



Delft University of Technology

Document Version

Final published version

Citation (APA)

Subramaniam Rajkumar, V., Silano, G., Gehrke, O., Vogel, S., Widl, E., Paludetto, G., Rikos, E., Stefanov, A., Palensky, P., & More Authors (2024). Laboratory Middleware for the Cyber-Physical Integration of Energy Research Infrastructures. In *12th Workshop on Modeling and Simulation of Cyber-Physical Energy Systems (2024 12th Workshop on Modeling and Simulation of Cyber-Physical Energy Systems, MSCPES 2024)*. IEEE. <https://doi.org/10.1109/MSCPES62135.2024.10542755>

Important note

To cite this publication, please use the final published version (if applicable). Please check the document version above.

Copyright

In case the licence states "Dutch Copyright Act (Article 25fa)", this publication was made available Green Open Access via the TU Delft Institutional Repository pursuant to Dutch Copyright Act (Article 25fa, the Taverne amendment). This provision does not affect copyright ownership. Unless copyright is transferred by contract or statute, it remains with the copyright holder.

Sharing and reuse

Other than for strictly personal use, it is not permitted to download, forward or distribute the text or part of it, without the consent of the author(s) and/or copyright holder(s), unless the work is under an open content license such as Creative Commons.

Takedown policy

Please contact us and provide details if you believe this document breaches copyrights. We will remove access to the work immediately and investigate your claim.

This work is downloaded from Delft University of Technology.

Green Open Access added to TU Delft Institutional Repository

'You share, we take care!' - Taverne project

<https://www.openaccess.nl/en/you-share-we-take-care>

Otherwise as indicated in the copyright section: the publisher is the copyright holder of this work and the author uses the Dutch legislation to make this work public.

Laboratory Middleware for the Cyber-Physical Integration of Energy Research Infrastructures

Vetrivel Rajkumar*, Giuseppe Silano^{¶††} Oliver Gehrke^{†1}, Steffen Vogel^{†1},
Edmund Widl^{§1}, Gabriele Paludetto^{¶1}, Evangelos Rikos^{||}, Tesfaye Amare Zerihun^{**},
Alexandru Ştefanov*, Peter Palensky*, and Thomas I. Strasser[§]

*Delft University of Technology, Delft, The Netherlands. Email: v.subramaniamrajakumar@tudelft.nl

[¶]Ricerca sul Sistema Energetico (RSE), Milan, Italy.

[†]Technical University of Denmark, Roskilde, Denmark.

[‡]RWTH Aachen University, Aachen, Germany.

[§]AIT Austrian Institute of Technology, Vienna, Austria.

^{††}Czech Technical University in Prague, Prague, Czech Republic.

^{||}Centre For Renewable Energy Sources and Saving (CRESS), Athens, Greece.

^{**}SINTEF Energy AS, Trondheim, Norway.

Abstract—The virtual integration of geographically distributed Research Infrastructures (RIs) for joint experiments in the domain of power and energy systems poses numerous challenges, particularly in terms of tool compatibility and user-friendliness. To address some of these challenges, this work presents the development and implementation of a laboratory-based middleware and data exchange service as part of the H2020 ERIGrid 2.0 project. The middleware comprises a suite of shared software tools and services designed to seamlessly integrate RIs including transport protocols as well as interface semantics. Specifically, this work details the development of a simplified and standardised interface known as the Universal Application Programming Interface (UAPI). It eliminates the need for users to grapple with the diverse intricacies of each individual RI, offering instead a tool-agnostic and standardised interface for conducting joint experiments. The work also presents and discusses the results of a real-world case study of a geographically distributed, sector-coupling experiment conducted between laboratories in Denmark, Greece, Italy, Netherlands, and Norway utilising the developed middleware.

Index Terms—API, middleware, lab-coupling, research infrastructure, power and energy systems.

I. INTRODUCTION AND RELATED WORK

The energy transition and its associated digitalisation have spurred the emergence of newer testing and experimentation methods, such as Geographically Distributed Real-Time Simulation (GDRTS) [1]–[3] and virtual laboratory integration [4], [5]. These techniques enable the expansion of individual laboratory capabilities by virtually interconnecting them, thereby facilitating resource sharing and domain-specific expertise. This approach offers several advantages, particularly in investigating large-scale scenarios that may not be feasible within a single Research Infrastructure (RI) [2], [6]. To this end, several

This work received funding under the European Community’s Horizon 2020 Program (H2020/2014-2020) in project “ERIGrid 2.0” (Grant Agreement No. 870620).

¹Equal contributions to the development of UAPI.

software tools, hereafter referred to as transport modules, have been developed for lab-coupling and virtual interconnections. Some examples include:

- Virtually Interconnected Laboratories for LARge systems Simulation/emulation (VILLAS) [2], [3], [6],
- Lablink [7],
- Joint Test Facility for Smart Energy Networks with Distributed Energy Resources (JaNDER) [5], [8],
- Hierarchical Engine for Large-scale Infrastructure Co-Simulation (HELICS) [9].

These tools cover a wide range of applications, from high-fidelity, fast data exchange to quasi-steady-state and interconnecting physical laboratory equipment-based applications. Table I provides a basic comparison of these tools. In this table, “high-data rate” refers to a rate in the order of kHz, while “connectivity” refers to the ease of setting up the tool concerning typical IT restrictions, such as opening ports and firewall rules. However, none of these tools offers a one-size-fits-all solution. Furthermore, they are typically not interoperable with each other, despite aiming to achieve common functionality such as data exchange for most applications. This lack of harmonisation motivates the work described in this paper, which is subsequently discussed in greater detail.

TABLE I: Comparison of existing lab-coupling solutions. Included (✓) and Not Included (✗)

Tool	High data-rate	Connectivity	Physical-equipment
VILLAS	✓	✓	✓
Lablink	✗	✓	✓
JaNDER	✗	✓	✗
HELICS	✗	✓	✗

Although various ongoing development projects, as described above, partially cover the intended scope of inter-

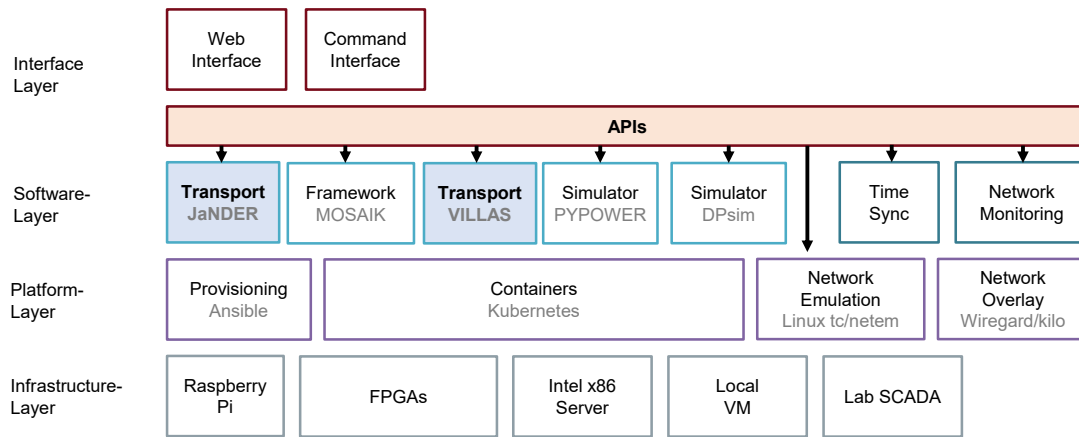

Fig. 1: Overview of the laboratory middleware architecture with a focus on the developed UAPI.

connecting RIs, performing multiple experiments using different lab-coupling tools remains challenging due to a lack of harmonisation in their core functionality. This problem can be addressed by developing a generic laboratory middleware software framework aimed at making the transport modules easier to use, interoperable, and preventing duplication of work. Hence, the key contributions of this work are as follows:

- 1) Development of a generic laboratory middleware software framework to harmonise the core functionality of existing transport solutions.
- 2) Highlight the application and advantages of the developed middleware through a geographically distributed experiment demonstration.

The remainder of this work is structured as follows. Section II discusses the architecture and functionality of the developed middleware solution along with the UAPI. The geographically distributed experimental test setup is described in Section III, while Section IV presents the results of the sector-coupling experiment. Finally, conclusions are drawn and future work is discussed in Section V.

II. DISTRIBUTED LAB MIDDLEWARE

A. Architecture and Functionality

The primary objective of the proposed middleware is to facilitate seamless data exchange between different RIs, such as physical laboratories as well as real-time and non-real-time simulators. Therefore, the design and development of the middleware focused on two core aspects:

- Development of approaches geared towards efficiently transferring data from one RI to another, achieved through interchangeable “transport modules” selected based on the specific requirements of each experiment/use case.
- Creation of a general software framework aimed at enhancing the usability of transport modules, allowing for easier modification of their functionality and preventing duplication of effort.

To achieve this, a general software architecture, as depicted in Figure 1, was designed. This architecture follows a service-based approach, wherein a multi-RI experiment is divided into multiple layers. At the lowest layers are the infrastructures themselves, such as physical equipment, virtual machines, and simulators, connected via a dedicated platform layer. The platform layer facilitates interactions with the software layer, enabling multiple applications like GDRTS.

In particular, this work focuses on the UAPI module, which serves as a transport-independent abstraction layer, enabling the use of multiple transports for multi-RI experiments. This eliminates the need to implement individual laboratory-to-transport interfaces and provides common core functionality, such as accessing a list of available signals, RIs status, and more.

B. Development and Implementation

The UAPI was designed with a focus on ease of use and widespread adoption. Therefore, it is developed as a Representational State Transfer (REST)-based Application Programming Interface (API), which is an architectural style defining a set of constraints for creating web services. A REST API exposes a set of endpoints (URLs) for performing operations over Hypertext Transfer Protocols (HTTPs) typically mapping to resources or objects in a system, such as a database. The basic implementation of the UAPI comprises of the following components:

- *Server*: An HTTP server implementing the UAPI accessed by clients.
- *Client*: An HTTP client implementing the UAPI making requests to a compatible server.
- *Transport*: External tool facilitating data exchange between RIs, such as VILLAS framework, JaNDER, or LabLink.
- *Node*: A software instance of the transport solution deployed in each RI, e.g., a virtual machine or dedicated computer.

- *RI Adapter*: RI-specific data-exchange software client between the RI Supervisory Control and Data Acquisition (SCADA)/laboratory and the UAPI server.

This data exchange process is visualised in Figure 2, where the RI adapter acts as the client between the UAPI server and the laboratory/SCADA of RI 1 for data exchange. It places standard HTTP requests (e.g., GET, POST, PUT, and DELETE). A similar setup exists in RI 2, enabling the seamless use of multiple transports for different multi-RI experiments. The core idea is to implement the RI adapter only once, usable across a wide range of multi RI experiments, as the UAPI handles upper abstractions and interacts with transport modules. An example JSON response of a VILLAS node UAPI client to a GET `info` request is shown in Listing 1.

The UAPI is also designed to conform to the OpenAPI specification¹, aimed at standardising HTTP(S) APIs. Utilising this specification promotes consistency, reduces the need for extensive documentation, and allows for the automatic generation of client libraries. The documentation for the developed Universal Application Programming Interface is publicly available at its GitHub repository².

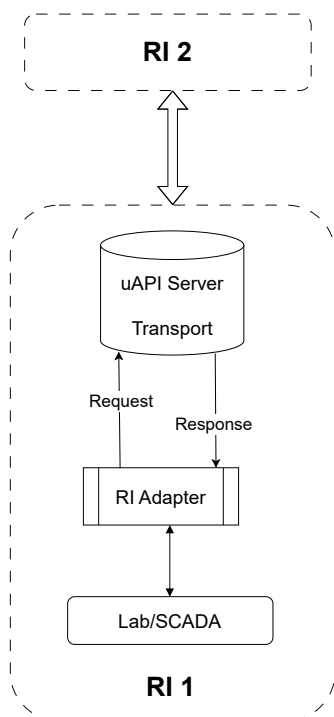

Fig. 2: Example implementation of the UAPI between two RIs.

III. TEST SETUP

To examine the application of the developed middleware and UAPI, a sector-coupling experimental demonstration inspired by [10] is conducted. The experiment aims to investigate

¹<https://spec.openapis.org/oas/v3.0.3>

²<https://erigrad2.github.io/JRA-3.1-api/universal-api.html>

```
{
  "id": "rwth",
  "transport":
  {
    "type": "villas-node",
    "version": "v0.12.0"
  }
}
```

Listing 1: JavaScript Object Notation (JSON) response of UAPI to GET/info request.

power-to-heat service provision in a local multi-energy district and its impact on the electric and thermal networks. Flexibility requested by a system operator is provided by a combination of electric and thermal storage systems, as well as flexible controllable loads such as heat pumps, thermal loads, and electric boilers. The distributed lab setup is illustrated in Figure 3, and each lab employs the developed UAPI for data exchange during the experiments. Given the “slower” dynamics of electro-thermal experiments in the order of seconds, the data-exchange rate ranges between 1 to 2 Hz.

A. Electrical System

A radial distribution grid, loosely based on the CIGRE LV-distribution benchmark system originally presented in [11], is simulated on the real-time grid simulator at TU Delft. It is a 0.4 kV, 50 Hz low-voltage system with five feeders. All loads, Distributed Energy Resources (DERs), and storage are modelled as controllable current sources. The control blocks of these sources accept a set of P and Q values as inputs, and then calculate the current magnitude and angle that corresponds to these P and Q values, concerning the voltage of the bus to which the current source is connected. The single-line diagram of the grid is depicted in Figure 4.

B. Thermal System

The thermal system consists of the following equipment:

- *Heat pump*: A heat pump with a nominal capacity electrical capacity of 18 kVA and 16 kW, located at CRES in Athens, Greece, is utilised. Its normal operating conditions are as follows:
 - Indoor temperature: 18 °C to 22 °C,
 - Maximum operating limits: 15 °C to 25 °C.
- *Heat network*: A dedicated heat network situated at the Technical University of Denmark is employed. It consists of a stack of nine electrical flow heaters, each with a capacity of 2.5 kW, totalling 22.5 kW, individually controlled by semiconductor relays. These heaters supply heat to a 200 L accumulator tank, enabling the device to function as a constant power source by regulating tank discharge through a remotely controllable feed pump. The system includes two lines, each approximately 400 m in length, totalling 1600 m for both forward and return circuits. Positioned in the middle of each line is a controllable heating system consisting of a water-to-air heat exchanger for a laboratory hall, while at the end of each line is a controllable heat dump load.

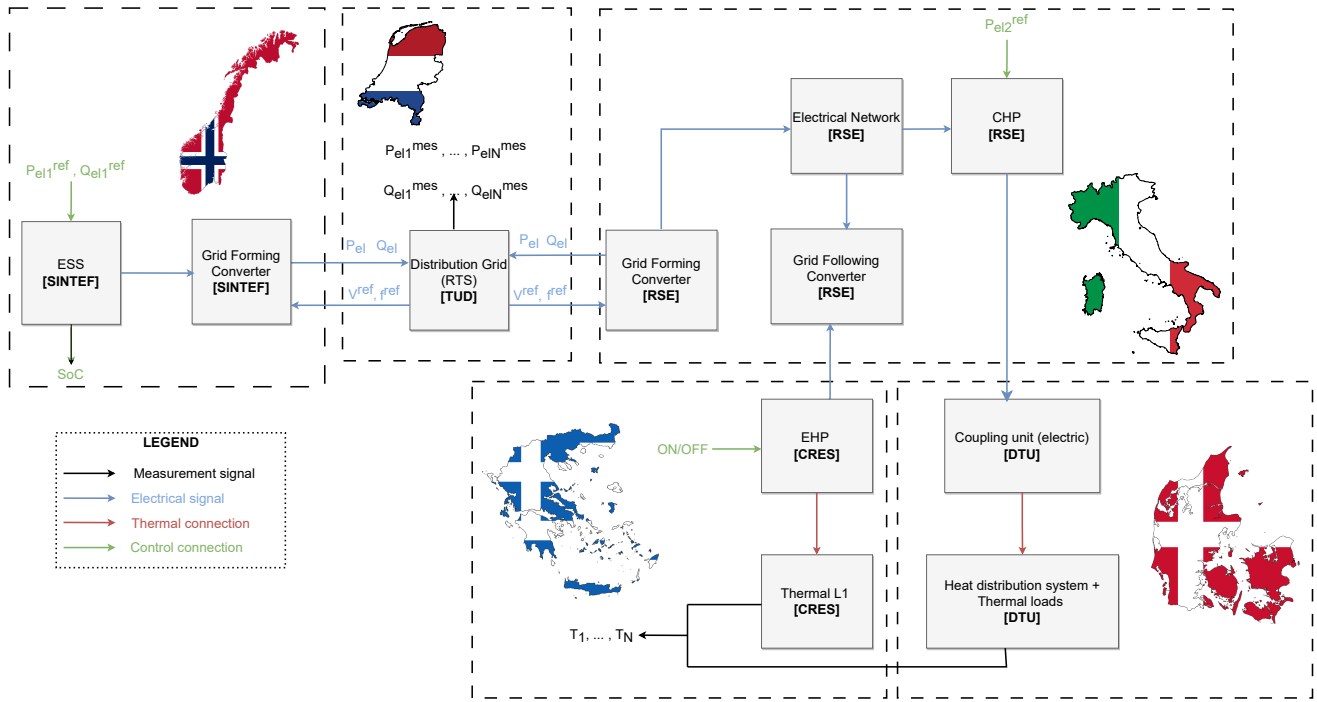

Fig. 3: Geographically distributed multi-RI lab setup to study sector coupling between electrical and thermal systems.

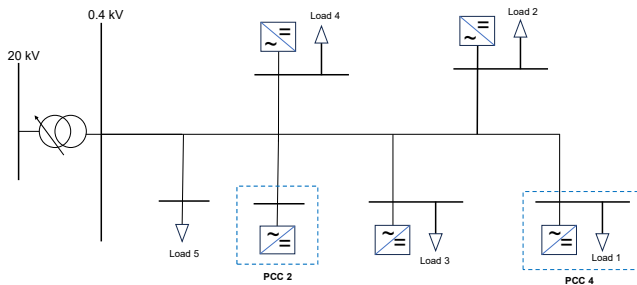

Fig. 4: Single line diagram of the distribution grid. The Points of Common Couplings (PCCs) indicated are virtually connected at RSE, Italy and SINTEF, Norway, respectively.

IV. EXPERIMENTAL RESULTS

A. Scenario: Excess DER Generation

In the experimental case study, an over-voltage condition caused by excessive photovoltaic production is considered. To address this voltage regulation issue and provide flexibility, both the virtually interfaced heat pump and Combined Heat and Power (CHP) are activated. The voltage rise of 5% occurs at approximately 40 s into the experiment, as depicted in Figure 5. To mitigate this voltage increase, proactive measures are taken by adjusting the active power outputs at PCC 2 and 4, as observed in the subplot of Figure 5. This increase in active power is crucial to counteract the voltage rise and prevent potential disruptions to the power grid.

The heat pump is already activated but steadily increases its power consumption, as shown in Figure 6a. Despite the inherent delay in achieving the heat pump's optimal operational

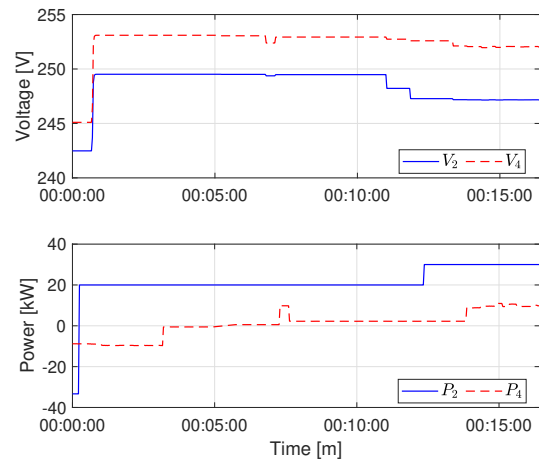
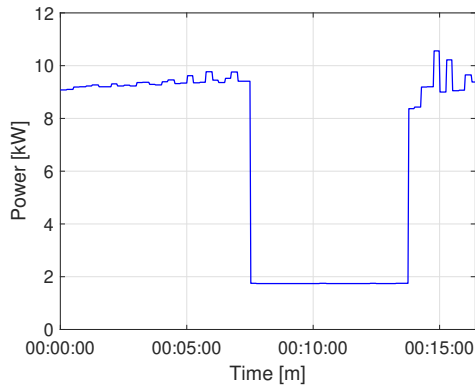

Fig. 5: Comparison of voltage and active power at at PCC 2 (SINTEF) and 4 (RSE).

temperature range, the subsequent increase in active power consumption plays a pivotal role in stabilising the voltage levels. However, around 7 min into the experiment, the power consumption of the heat pump drops to around 2 kW. This behaviour is attributable to the temperature going out of the nominal range and is visualised in Figure 6b, occurring around 09:44:00 Coordinated Universal Time (UTC).

This behaviour of the heat pump underscores the importance of multi-RI experiments for sector-coupling studies. As evidenced, real device behaviour can significantly differ from pure simulation/modelling and is highly dependent on

experimental conditions [10]. Equally, this control strategy highlights the intricate interplay between electrical and thermal dynamics within the system, illustrating the importance of coordinated strategies to ensure voltage stability.



(a) Thermal active power of the heat pump.

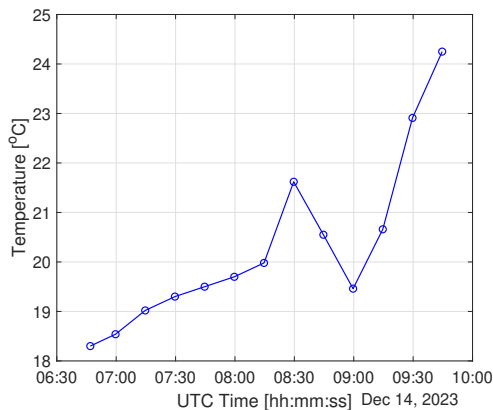

(b) Temperature recordings of the heat pump.

Fig. 6: Heat pump thermal active power and temperature.

V. CONCLUSIONS AND FUTURE WORK

This work presented the development of a generic middleware software platform, aimed at increasing the ease of usability and reproducibility of multi-RI experiments. Specifically, it introduced a lab-coupling tool agnostic UAPI paradigm designed to simplify and standardise joint multi-RI experiments. It provides a simplified interface for users to access and interact with other RIs eliminating the need for users to understand the complex and varied details of each RI. Furthermore, it has been designed to support a wide range of applications, including co-simulation and distributed laboratory experiments. The API can be easily integrated into existing simulation frameworks and is compatible with a variety of programming languages and operating systems. As a proof-of-concept, the UAPI and middleware were used in a geographically distributed, sector-coupling experiment to study flexibility in distribution grids, offered by electro-thermal resources such as heat pumps.

Known limitations of the UAPI include its slow performance due to its inherent “REST-ful” nature. It must be emphasised, however, that for most multi-RI experiments, especially those that are multi-domain and timescale in nature, the benefits of ease of usage and interoperability may outweigh the “slower” performance. Nevertheless, this limitation presents a trade-off that needs further investigation. Additionally, the configuration of the individual transport tools can also be partially automated through machine-readable `.config` files, which will be the focus of our future work.

CODE AVAILABILITY

The developed UAPI code can be found at <https://github.com/ERIGrid2/JRA-3.1-api> and its associated API documentation is available at <https://erigrd2.github.io/JRA-3.1-api/universal-api.html>

REFERENCES

- [1] S. K. Srivastava, R. Cox, E. Shoubaki, G. Ozkan, and B. Chowdhury, “Geographically Distributed Real Time Co-Simulation Testbed For Community Microgrids,” in *2023 8th IEEE Workshop on the Electronic Grid (eGRID)*, 2023, pp. 1–6.
- [2] A. Monti, M. Stevic, S. Vogel, R. W. De Doncker, E. Bompard, A. Estebarsari, F. Profumo, R. Hovsapien, M. Mohanpurkar, J. D. Flicker, V. Gevorgian, S. Suryanarayanan, A. K. Srivastava, and A. Benigni, “A Global Real-Time Superlab: Enabling High Penetration of Power Electronics in the Electric Grid,” *IEEE Power Electronics Magazine*, vol. 5, no. 3, pp. 35–44, 2018.
- [3] M. Syed, T. T. Hoang, A. C. Kontou, A. G. Paspatis, G. M. Burt, Q. T. Tran, E. Guillo-Sansano, S. Vogel, H. T. Nguyen, and N. D. Hatziaargyriou, “Applicability of Geographically Distributed Simulations,” *IEEE Transactions on Power Systems*, vol. 38, no. 4, pp. 3107–3122, 2023.
- [4] T. Strasser *et al.*, “An Integrated Research Infrastructure for Validating Cyber-Physical Energy Systems,” in *Industrial Applications of Holonic and Multi-Agent Systems*. Cham: Springer International Publishing, 2017, pp. 157–170.
- [5] L. Pellegrino, D. Pala, E. Bionda, V. S. Rajkumar, R. Bhandia, M. H. Syed, E. Guillo-Sansano, J. Jimeno, J. Merino, D. Lagos, M. Maniatopoulos, P. Kotsampopoulos, N. Akroud, O. Gehrke, K. Heussen, Q. T. Tran, and V. H. Nguyen, *Laboratory Coupling Approach*. Cham: Springer International Publishing, 2020, pp. 67–86.
- [6] S. Vogel, V. S. Rajkumar, H. T. Nguyen, M. Stevic, R. Bhandia, K. Heussen, P. Palensky, and A. Monti, “Improvements to the Co-simulation Interface for Geographically Distributed Real-time Simulation,” in *IECON 2019 - 45th Annual Conference of the IEEE Industrial Electronics Society*, vol. 1, 2019, pp. 6655–6662.
- [7] E. Widl, A. Sporr, R.-R. Schmidt, T. Natiesta, and N. Marx, “DigitalEnergyTestbed: An Open Testbed Prototype for Integrated Energy Systems,” in *2023 Open Source Modelling and Simulation of Energy Systems (OSMSES)*, 2023, pp. 1–7.
- [8] L. Pellegrino, R. Lazzari, M. Verga, and C. Sandroni, “Research Infrastructures integration to foster Smart Grid testing,” in *2020 AEIT International Annual Conference (AEIT)*, 2020, pp. 1–5.
- [9] B. Palmintier, D. Krishnamurthy, P. Top, S. Smith, J. Daily, and J. Fuller, “Design of the HELICS high-performance transmission-distribution-communication-market co-simulation framework,” in *2017 Workshop on Modeling and Simulation of Cyber-Physical Energy Systems (MSCPES)*, 2017, pp. 1–6.
- [10] E. Widl, C. Wild, K. Heussen, E. Rikos, and T.-T. Hoang, “Comparison of two approaches for modeling the thermal domain of multi-energy networks,” in *2022 Open Source Modelling and Simulation of Energy Systems (OSMSES)*, 2022, pp. 1–6.
- [11] M. Maniatopoulos, D. Lagos, P. Kotsampopoulos, and N. Hatziaargyriou, “Combined control and power hardware in-the-loop simulation for testing smart grid control algorithms,” *IET Generation, Transmission & Distribution*, vol. 11, no. 12, pp. 3009–3018, 2017.