

BANK OF MAAS

Danica Mijonic 4739019



complex projects

drawing set

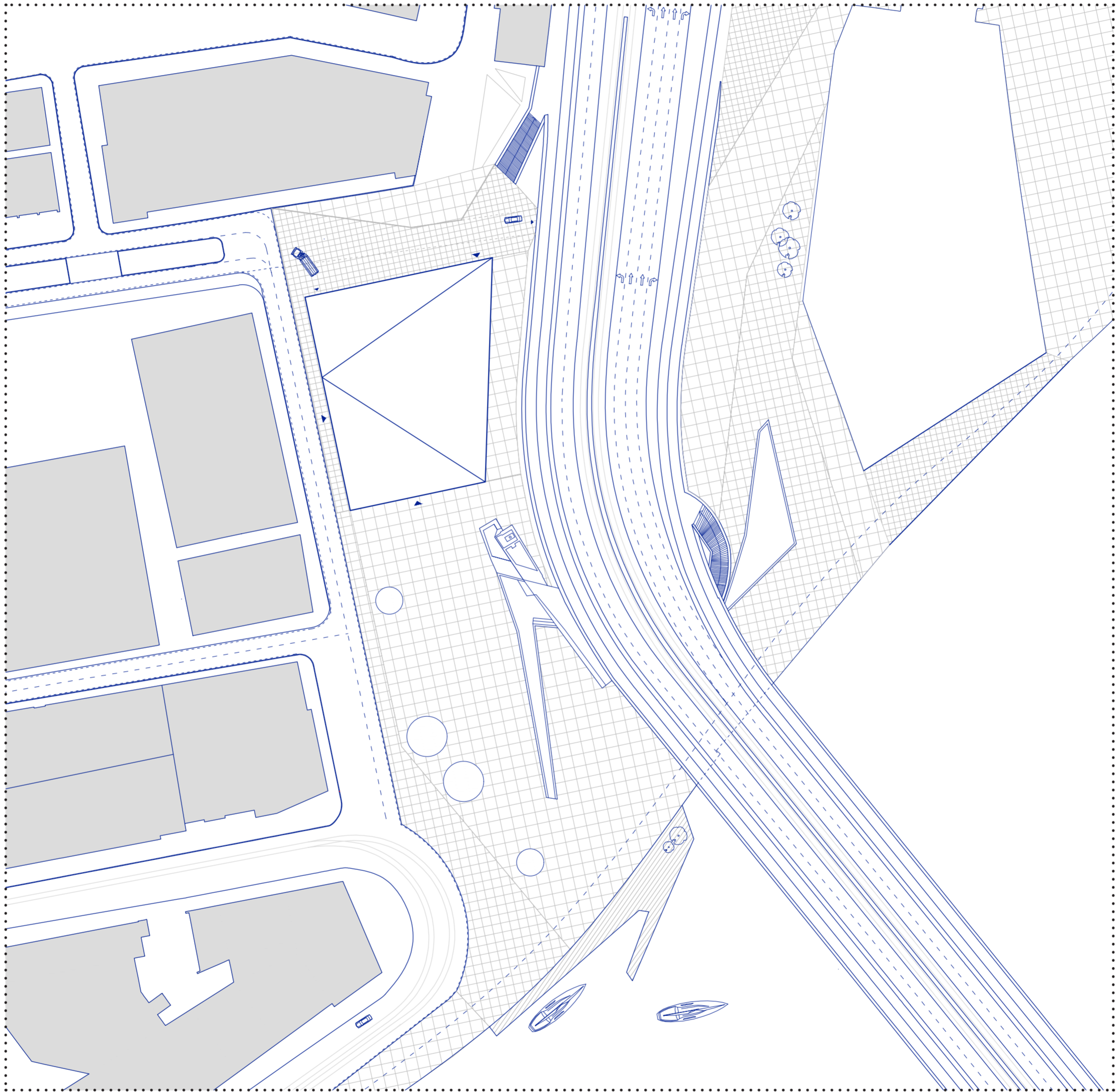

Urban implementation 1:500

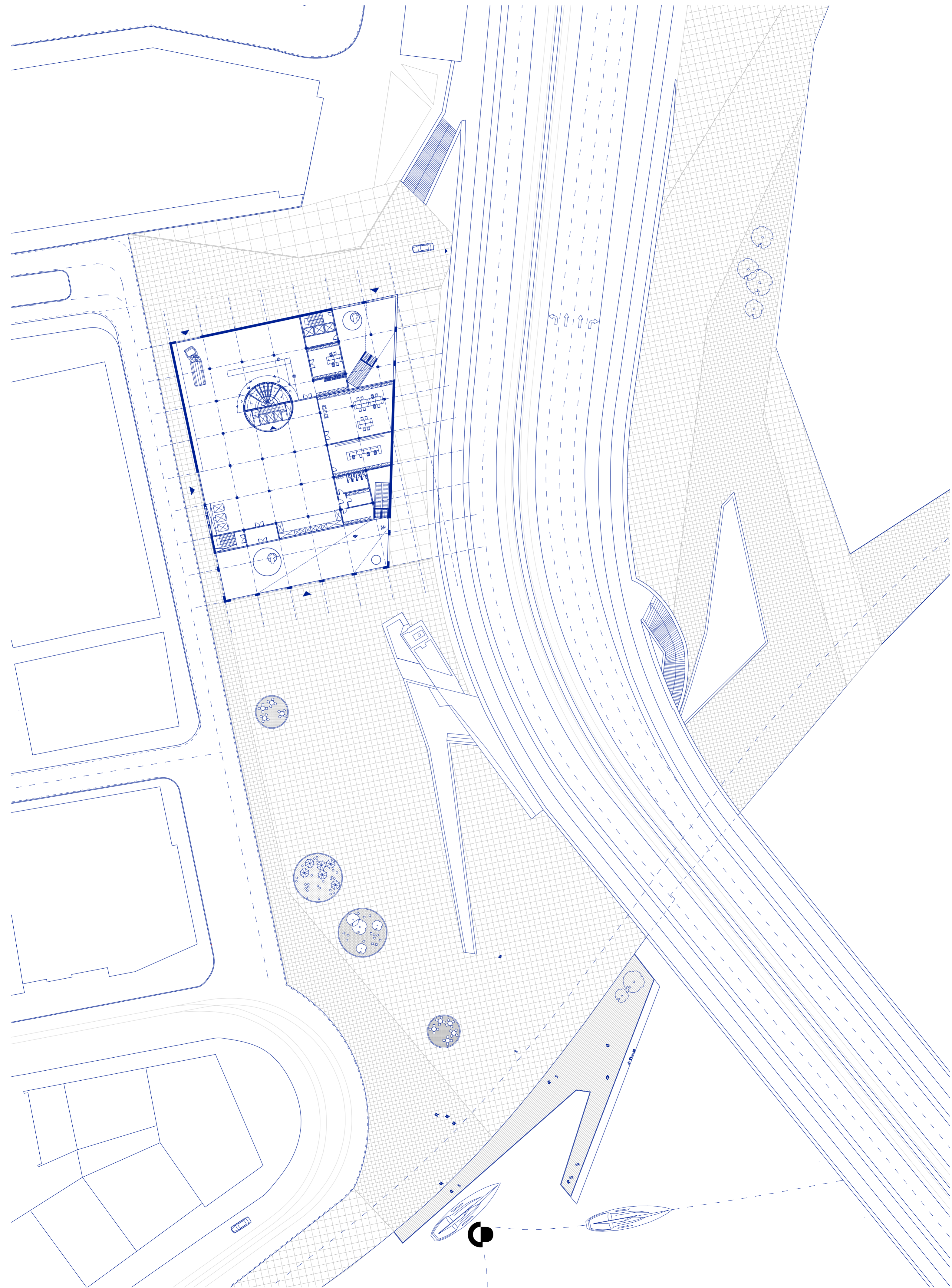

Floorplan 1:200
Level -1 / -2

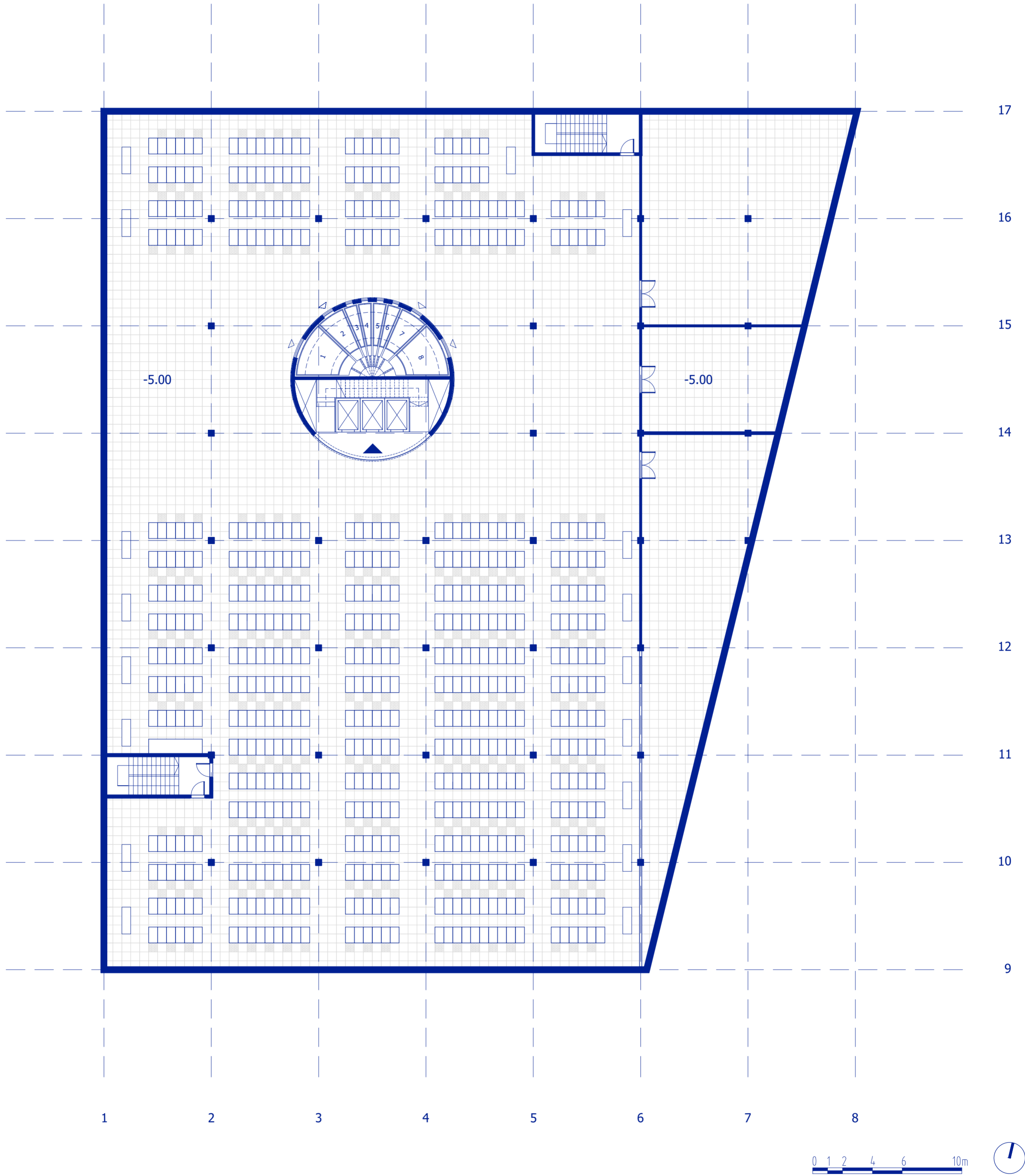

Floorplan 1:200
Level 0

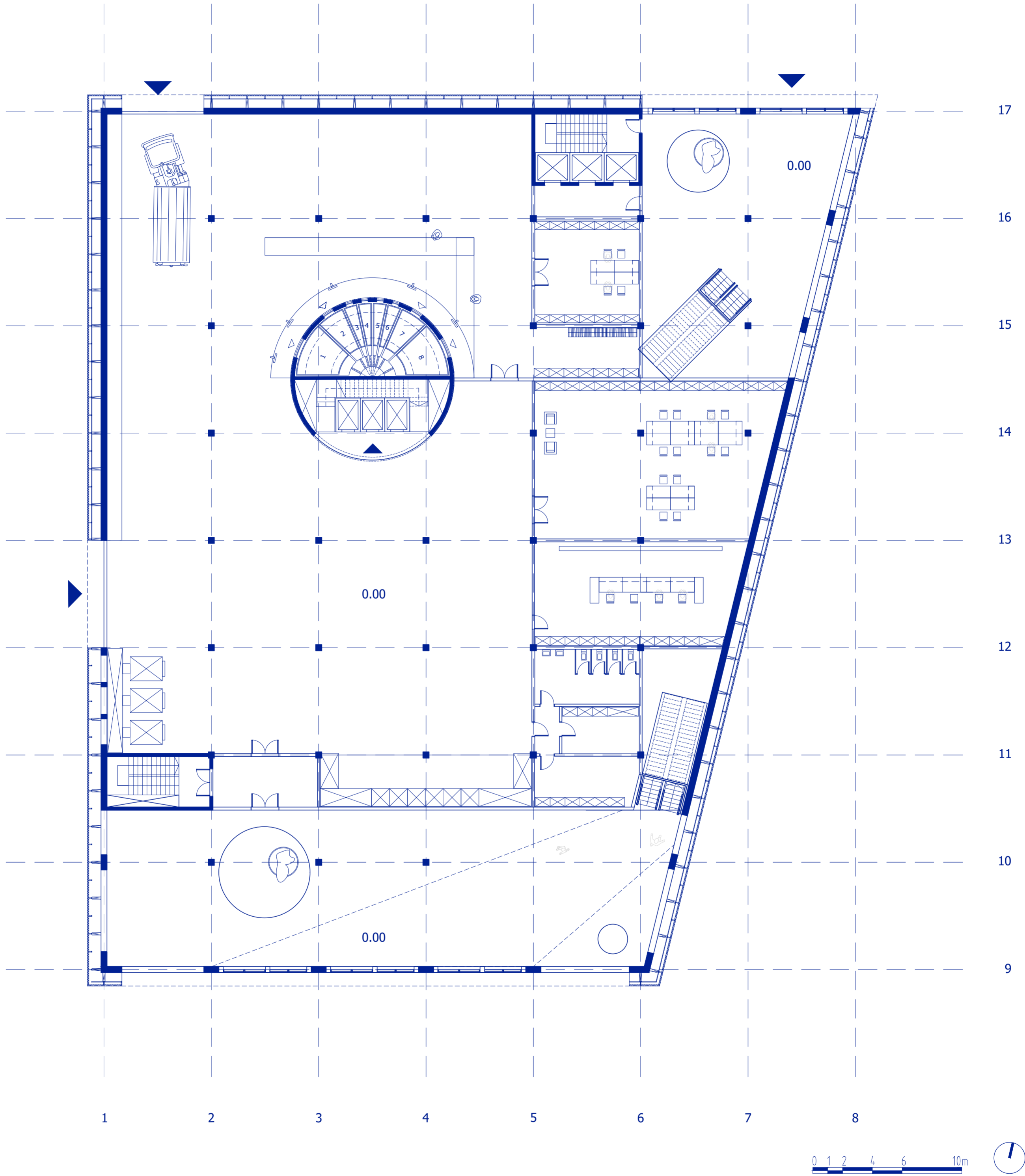

Floorplan 1:200
Level +1

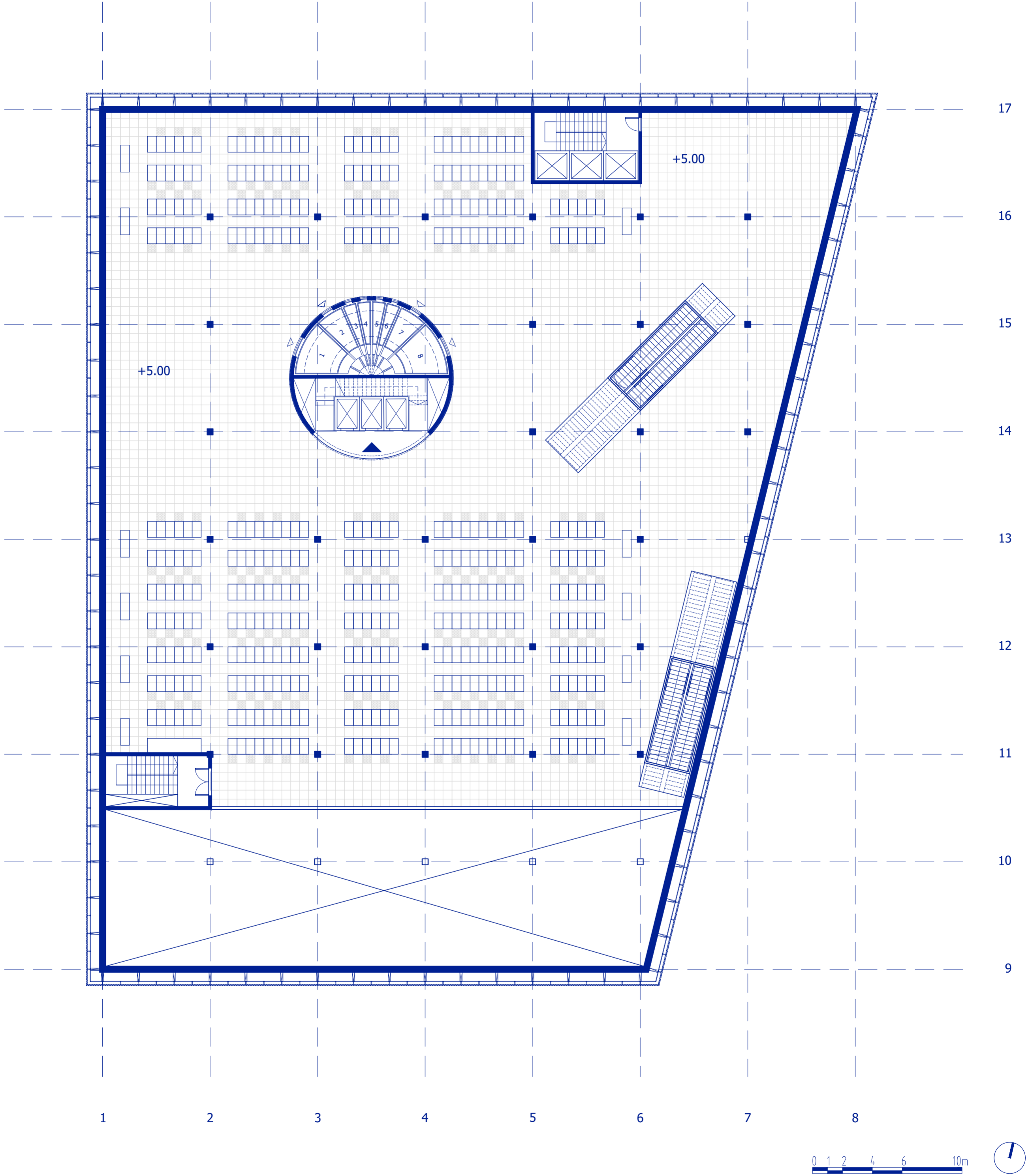

Floorplan 1:200
Level +2

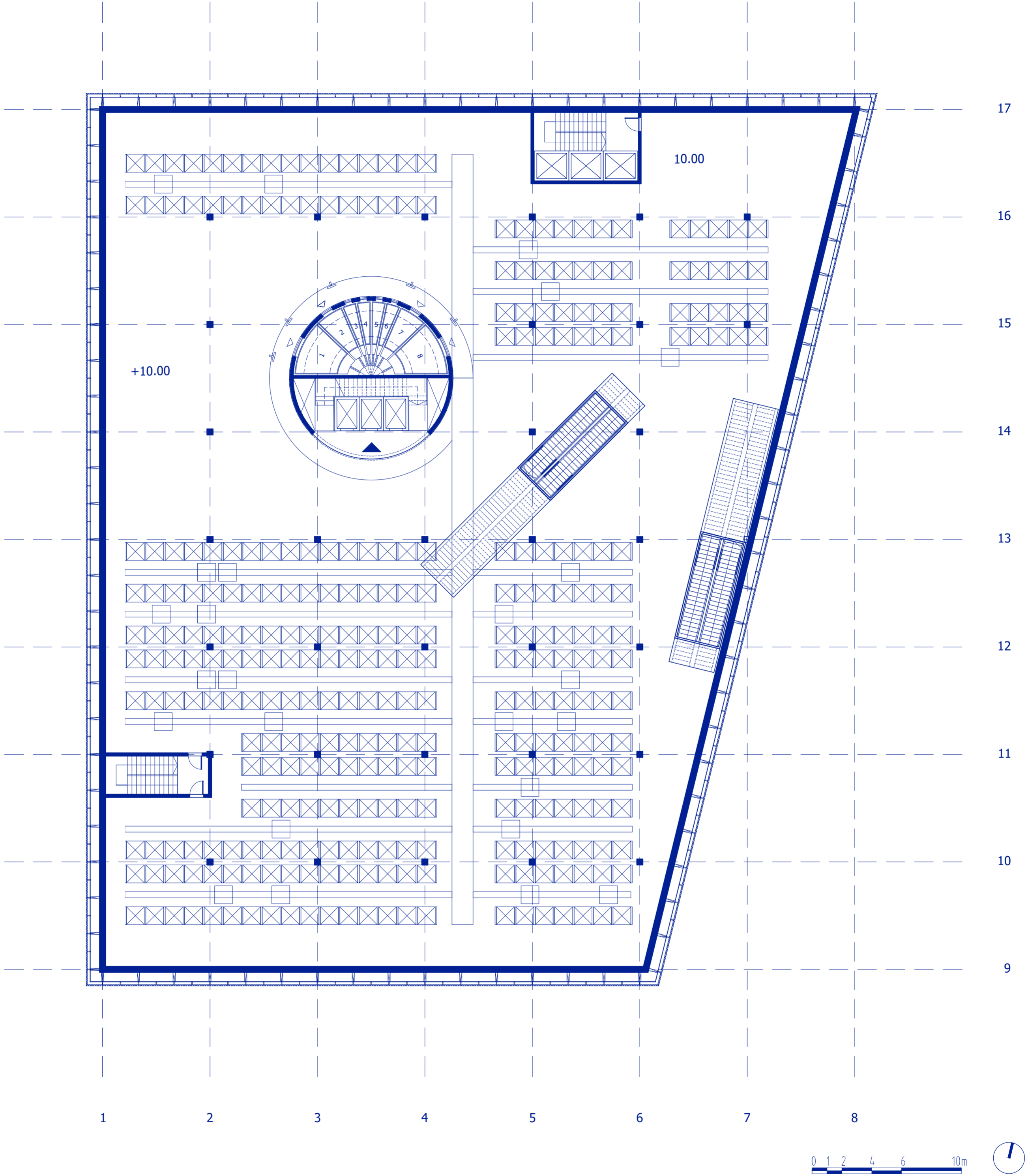

Floorplan 1:200
Level +3 / +4

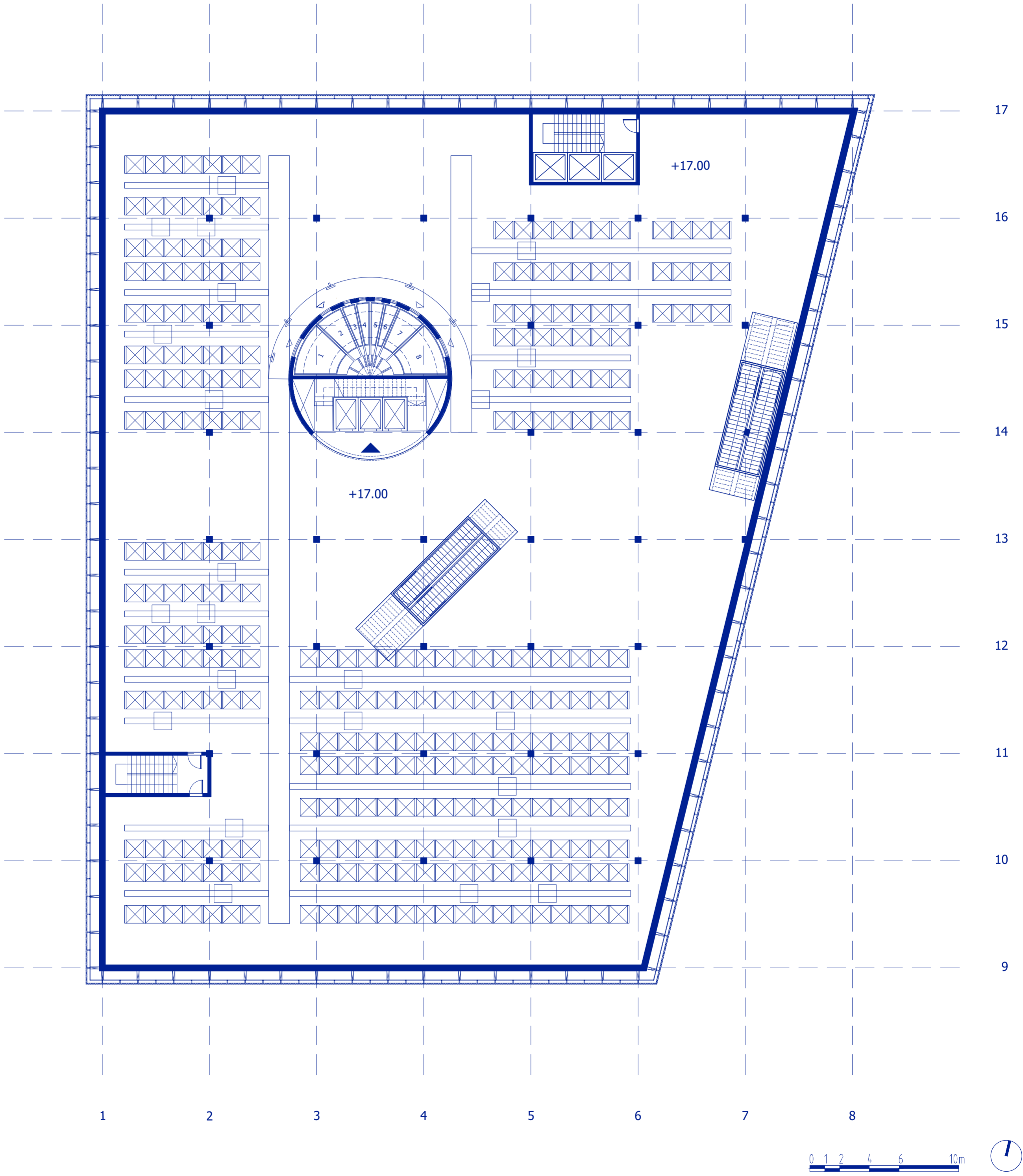

Floorplan 1:200
Level +5

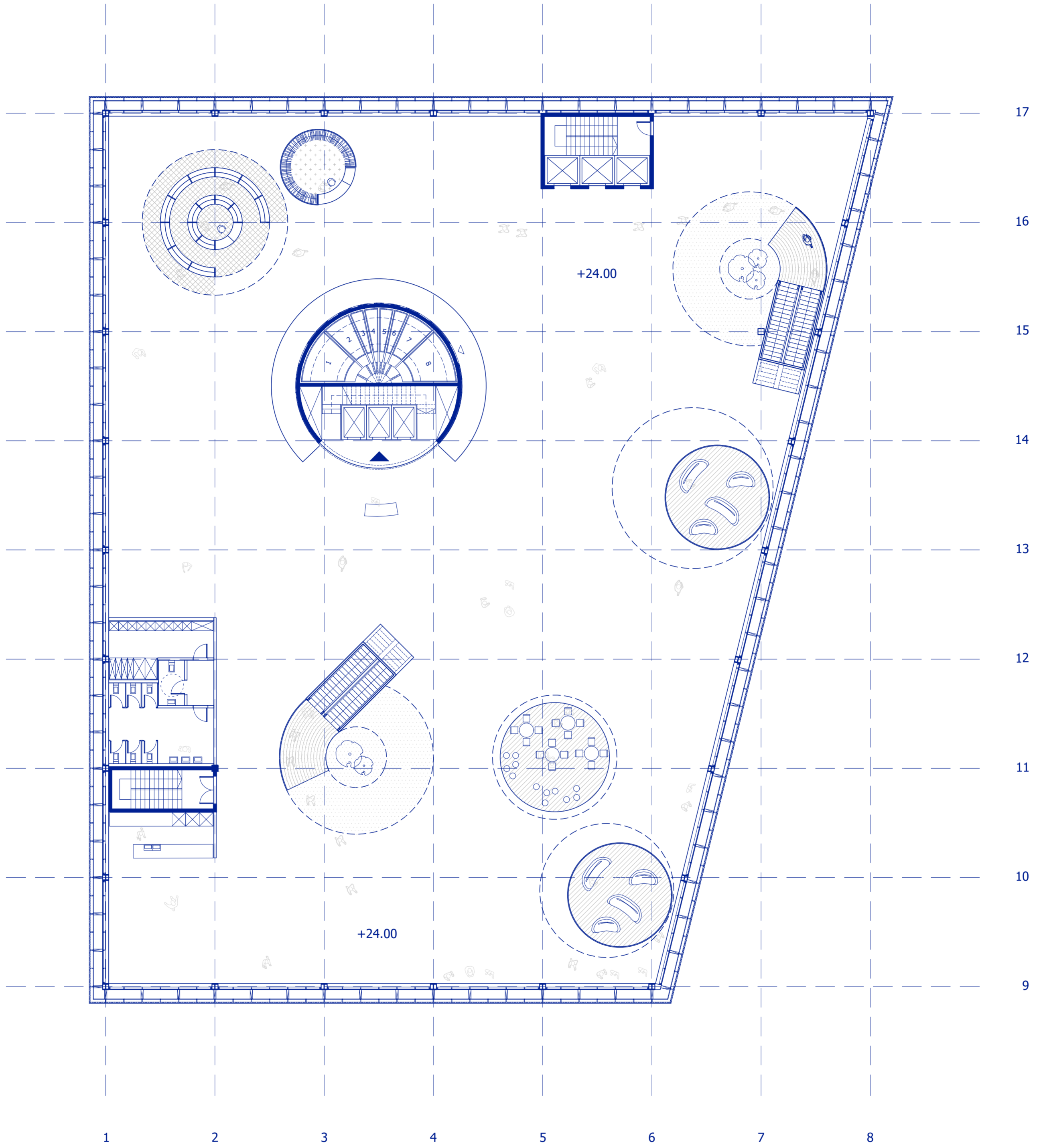

0 1 2 4 6 10m



Floorplan 1:200
Level +6

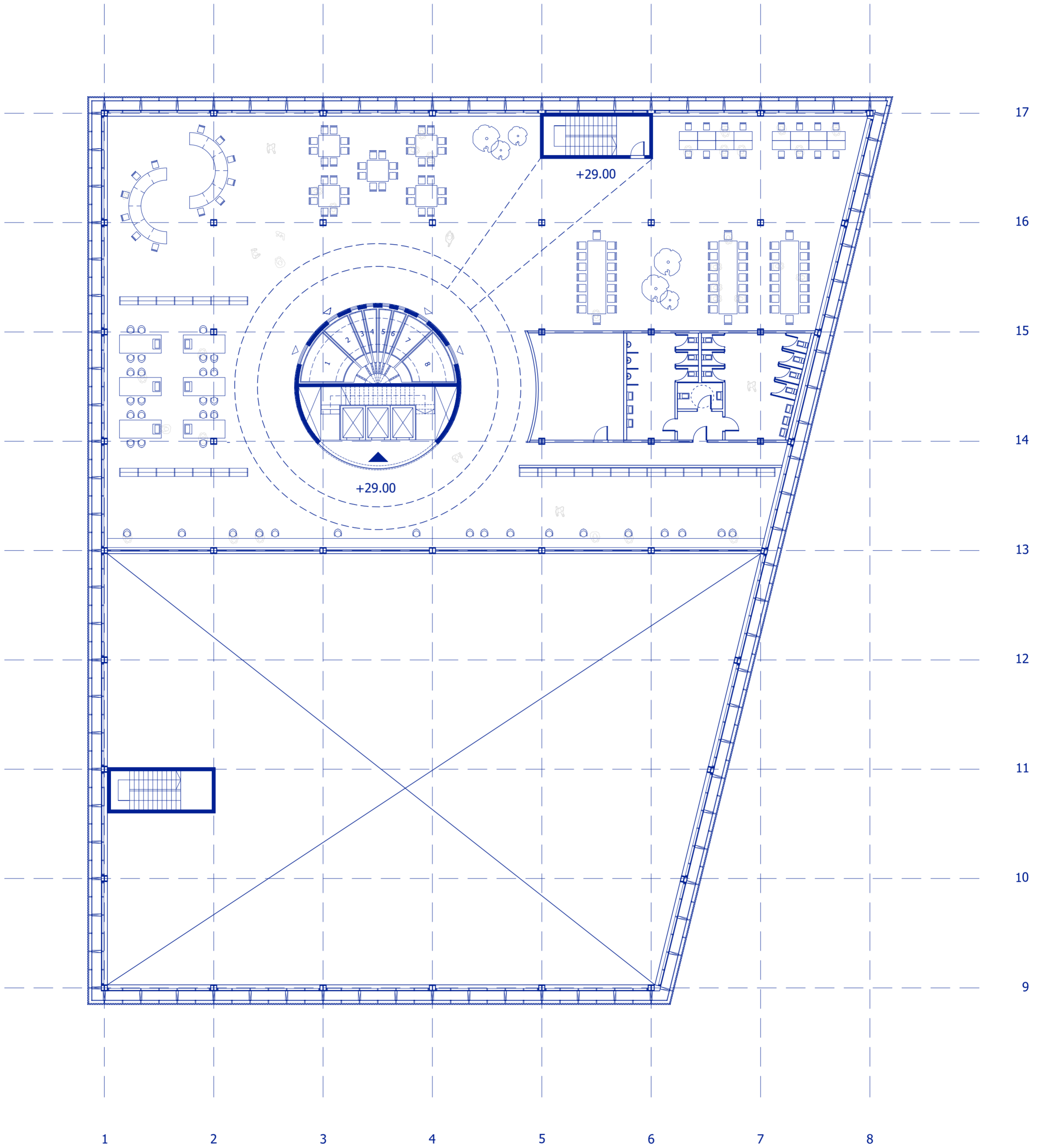

Floorplan 1:200
Level +7

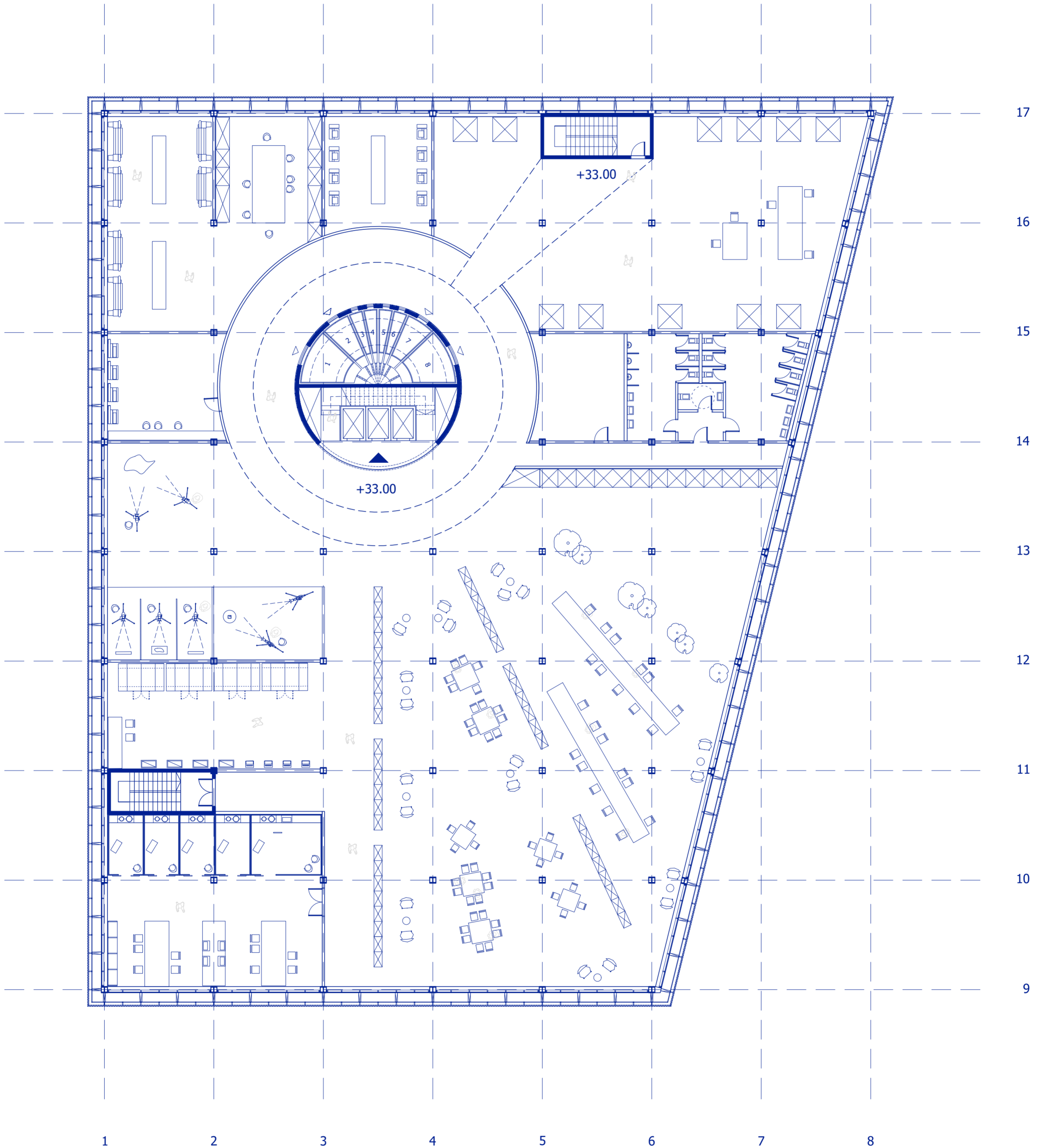

Floorplan 1:200
Level +8

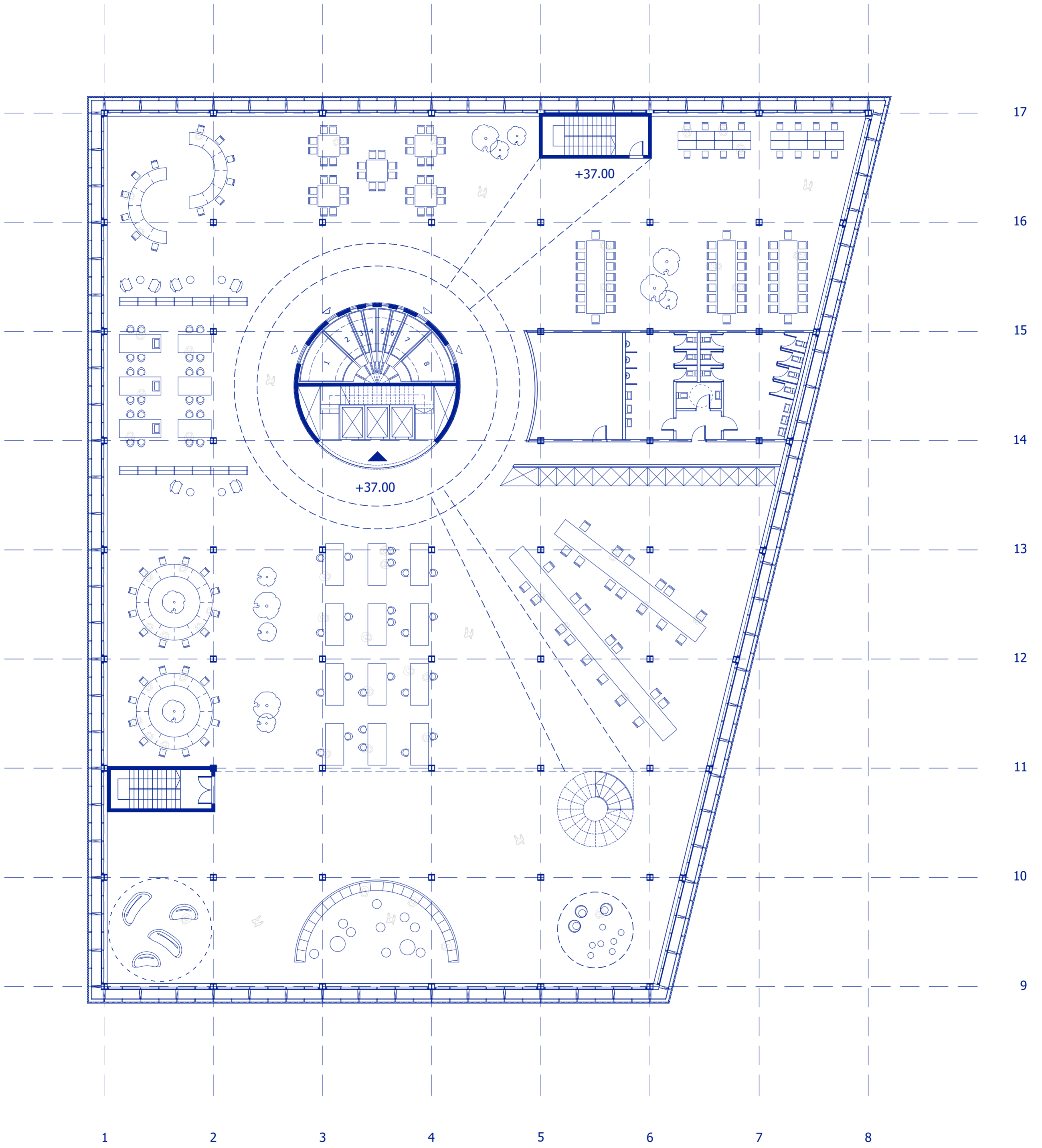

Floorplan 1:200
Level +9

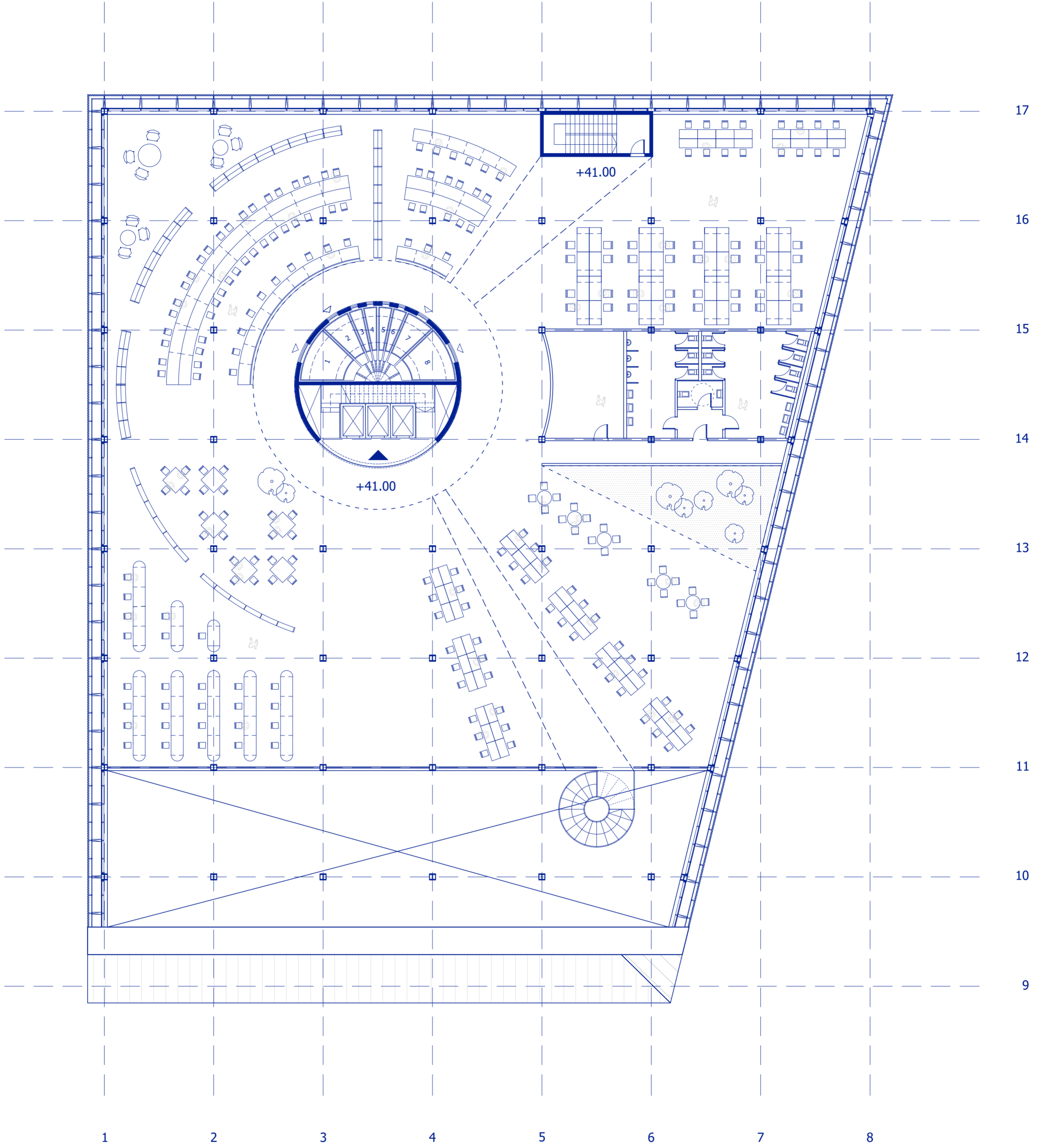

Floorplan 1:200
Level +10

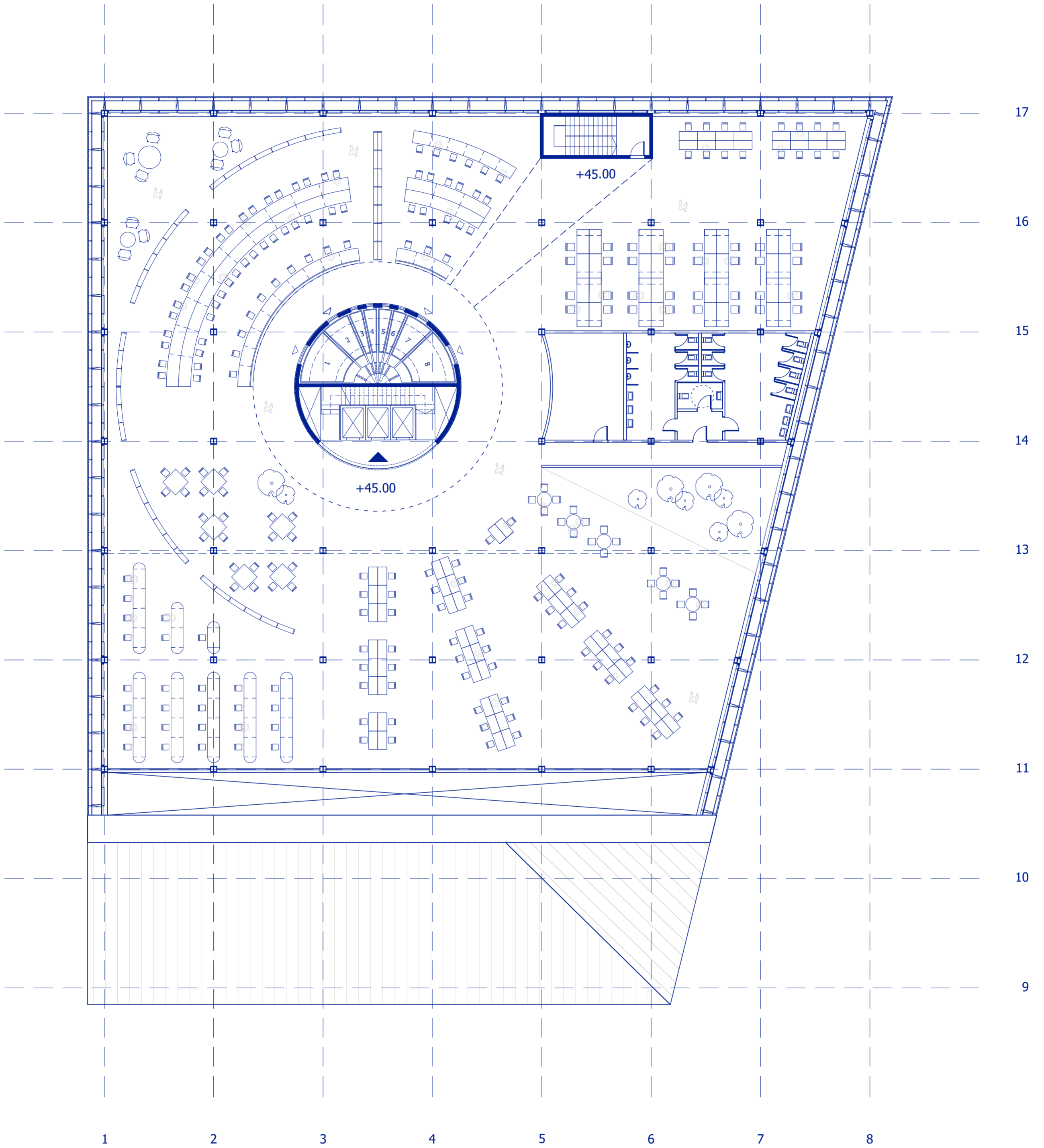

Floorplan 1:200
Level +11

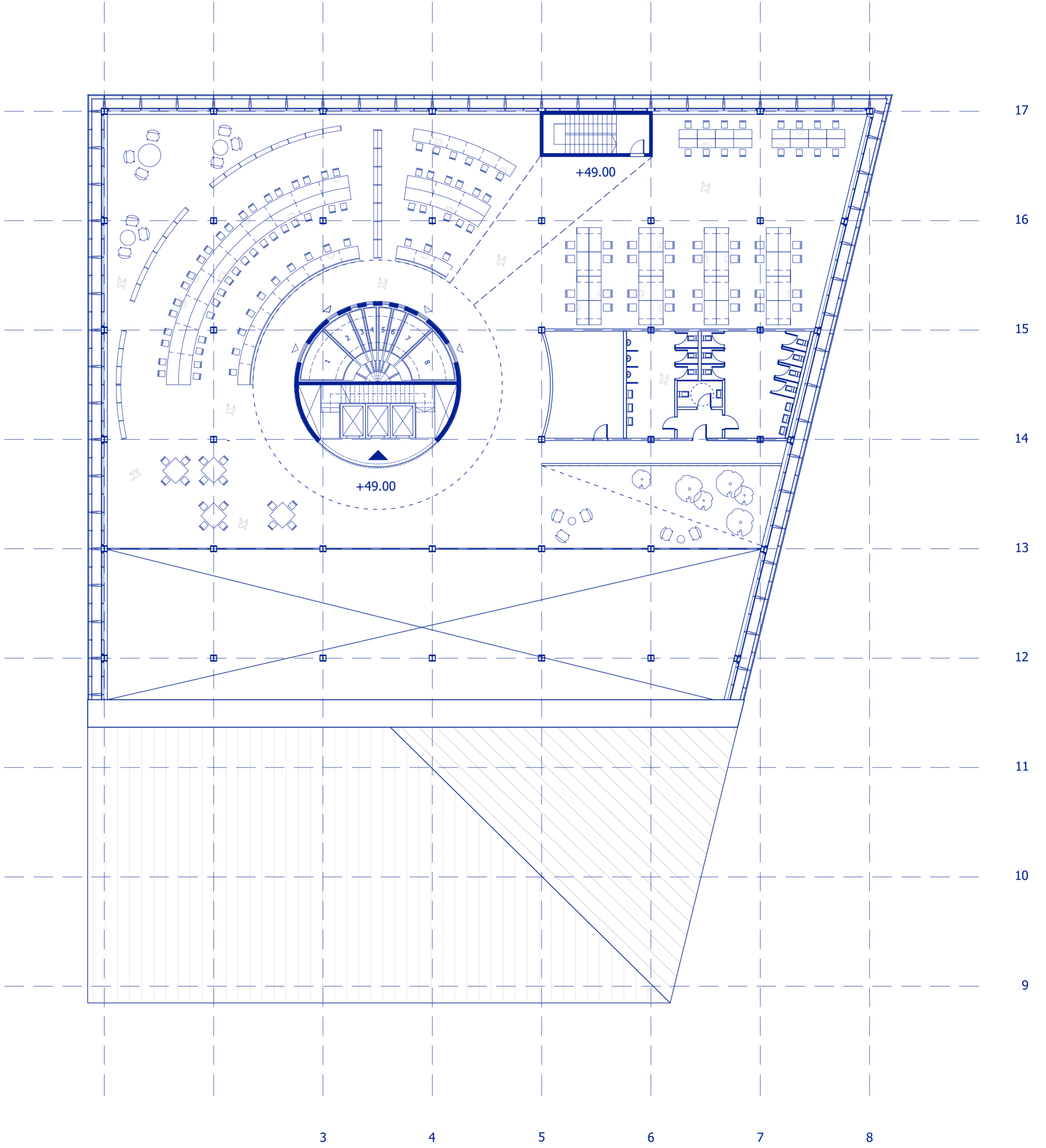

Floorplan 1:200
Level +12

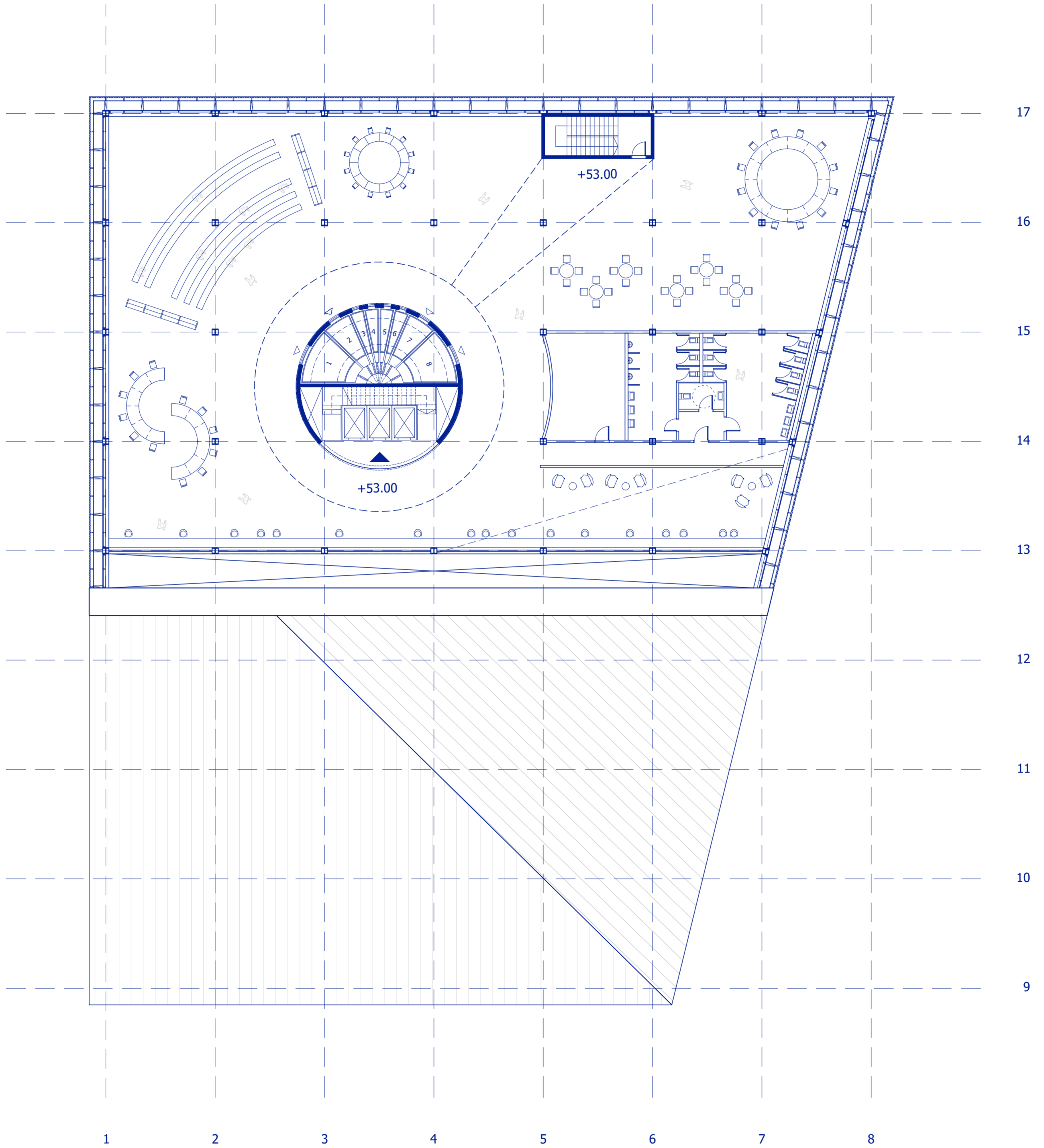

Floorplan 1:200
Level +13

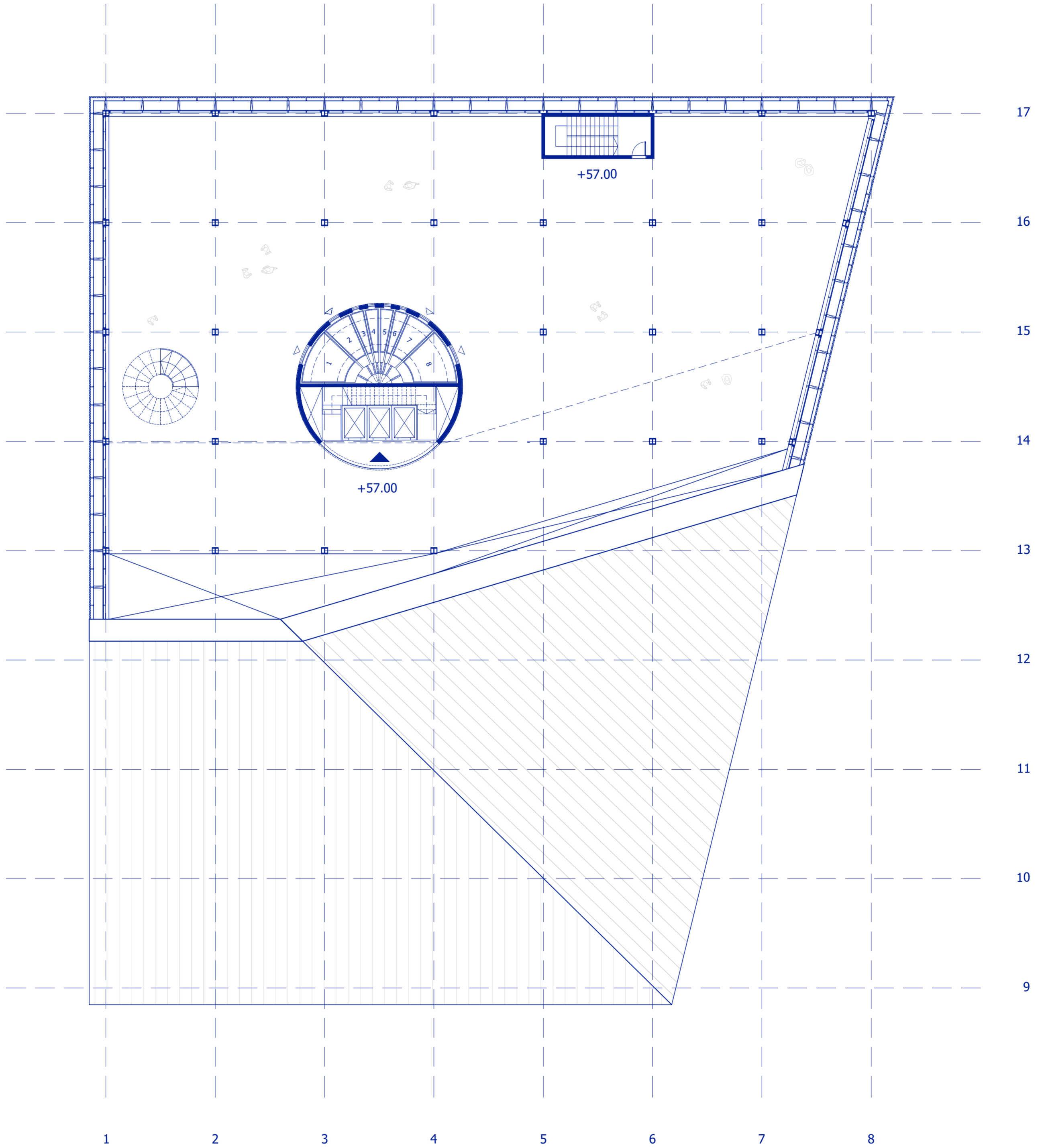

Floorplan 1:200
Level +14

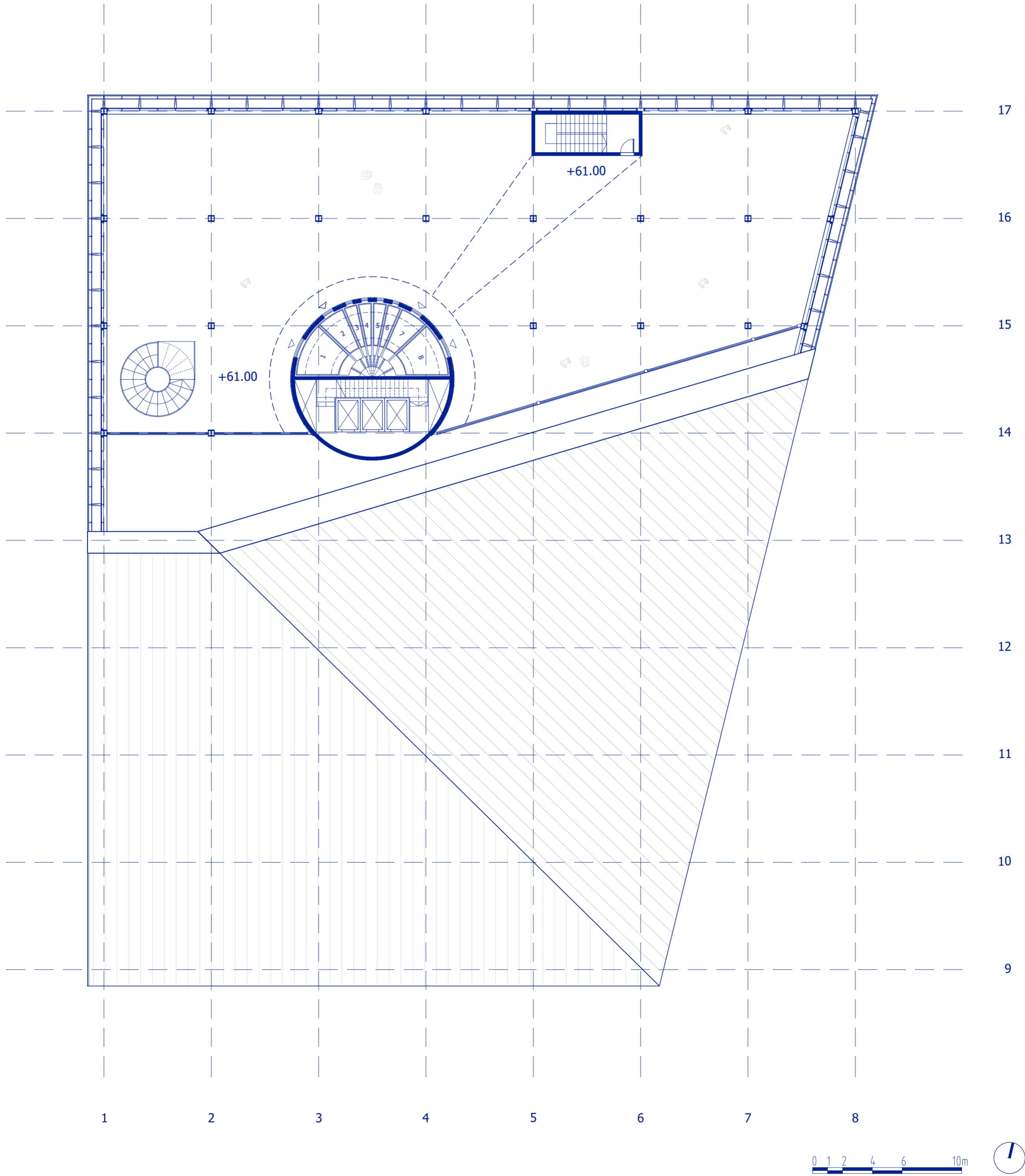

Floorplan 1:200
Roof view

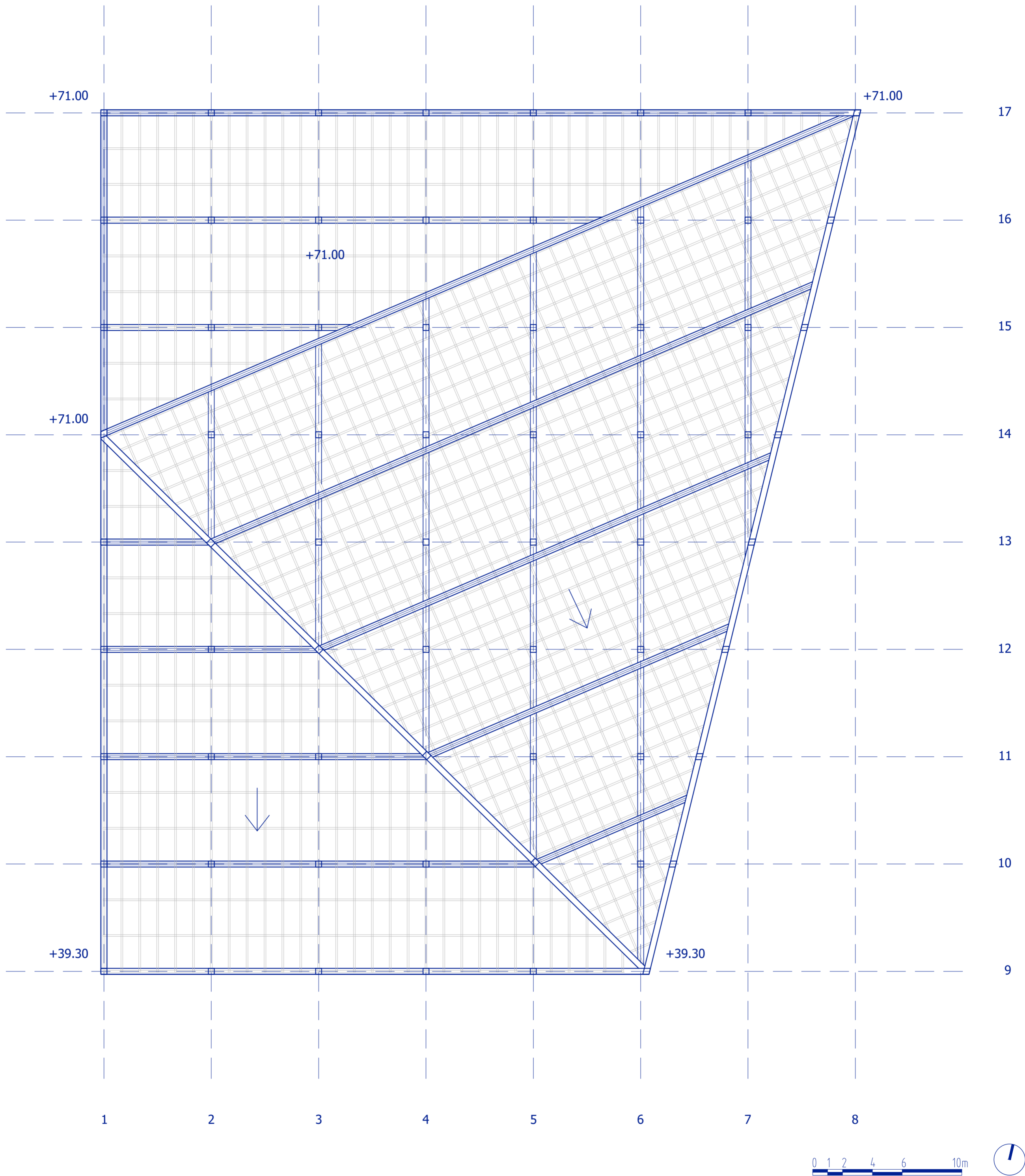

Section 1:200
1.0

+71.0

+65.0

+61.0

+57.0

+53.0

+49.0

+45.0

+41.0

+37.0

+33.0

+29.0

+24.0

+20.5

+17.0

+10.0

+5.0

0.0

-5.0

-10.0

1

2

3

4

5

6

7

8

9

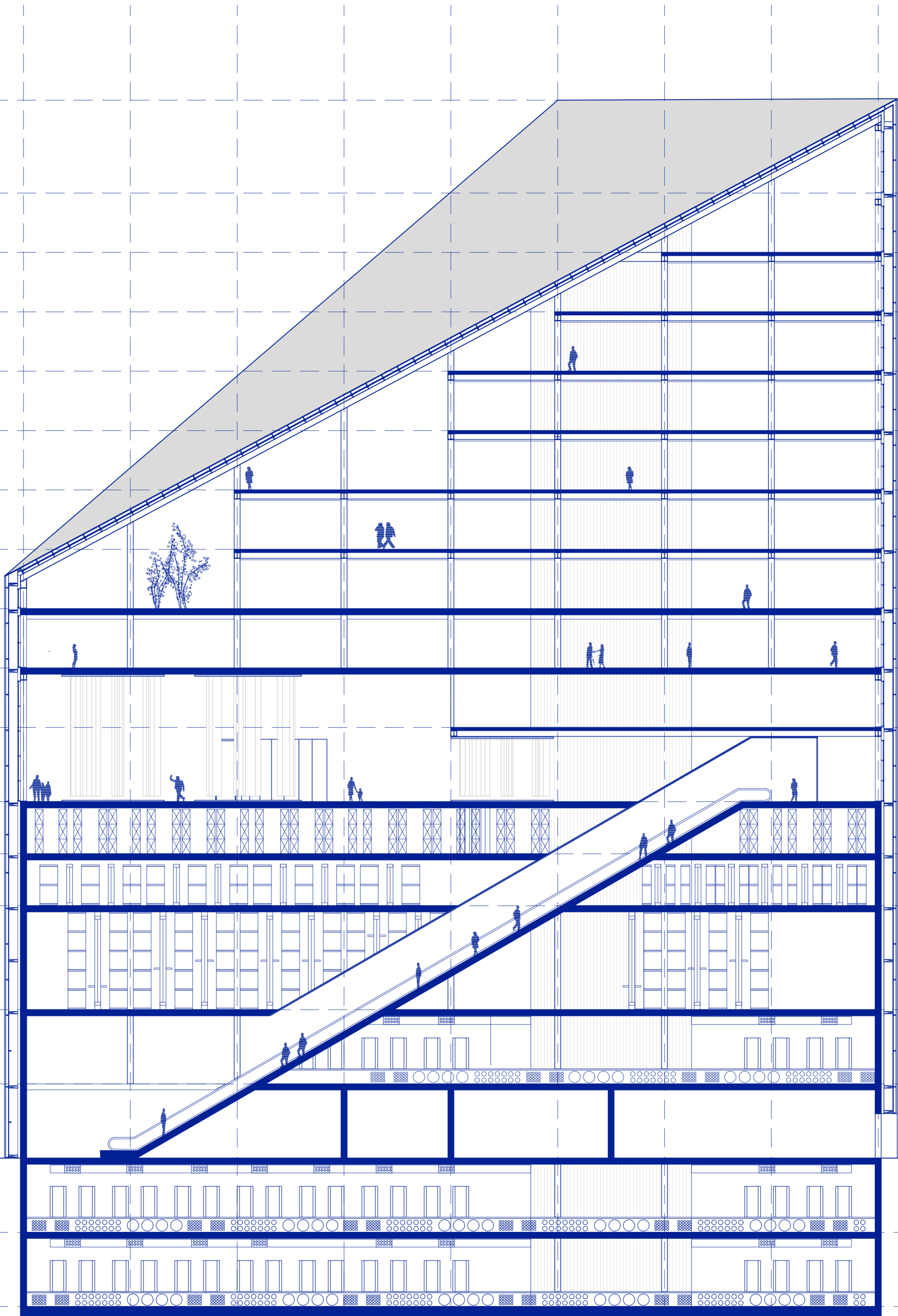

Section 1:200
2.0

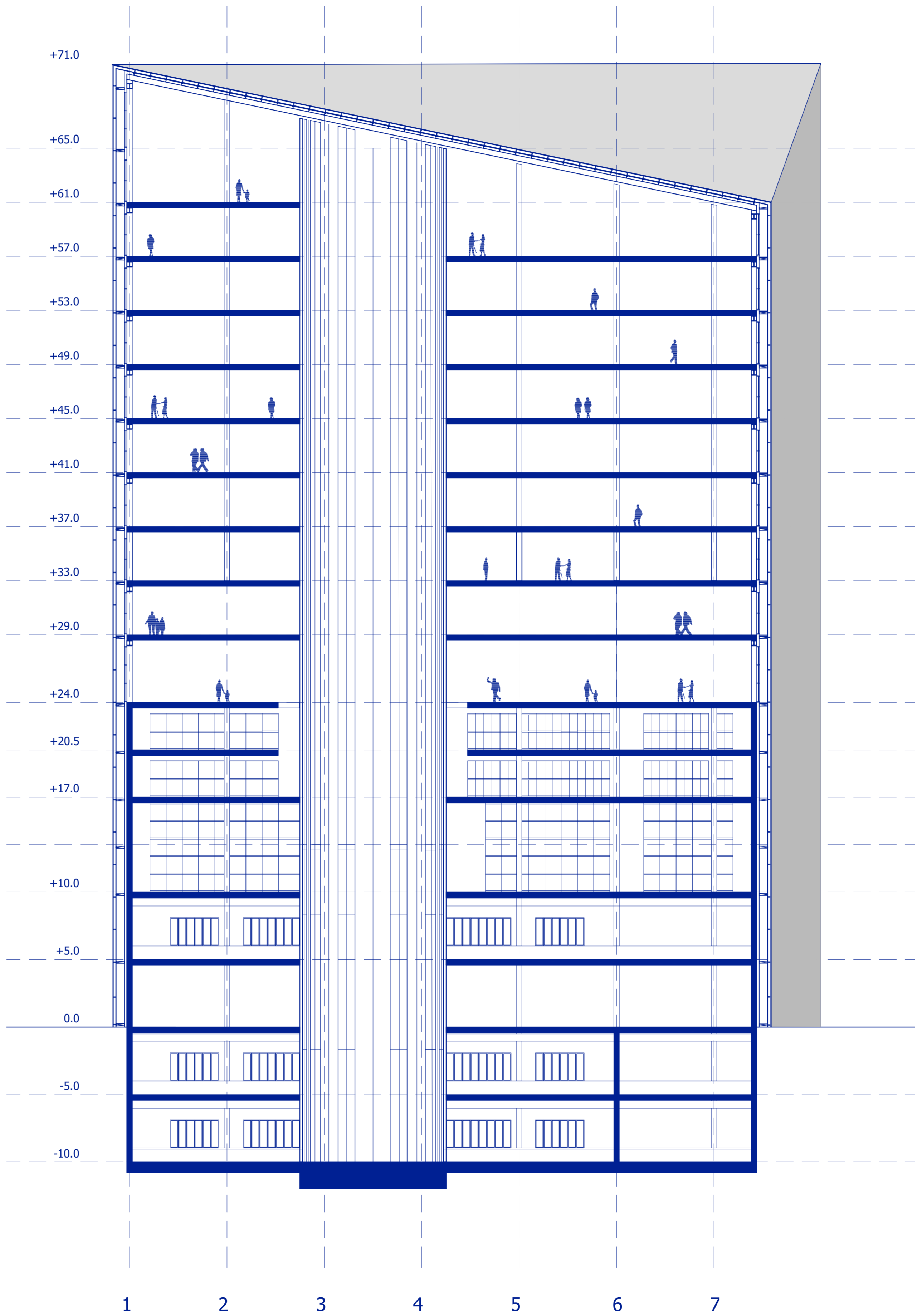

Interior fragment 1:50

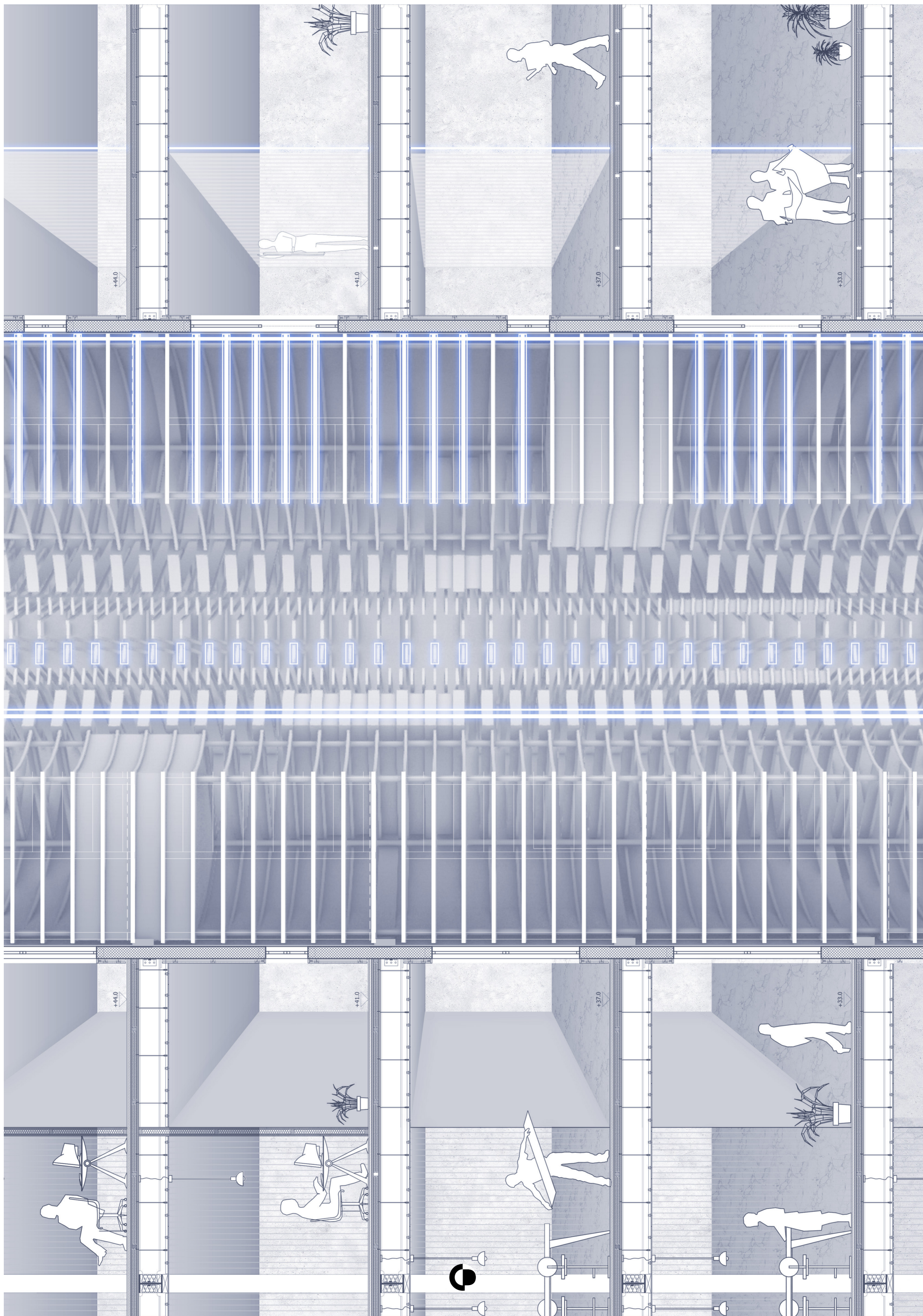

Circulation core 1:50

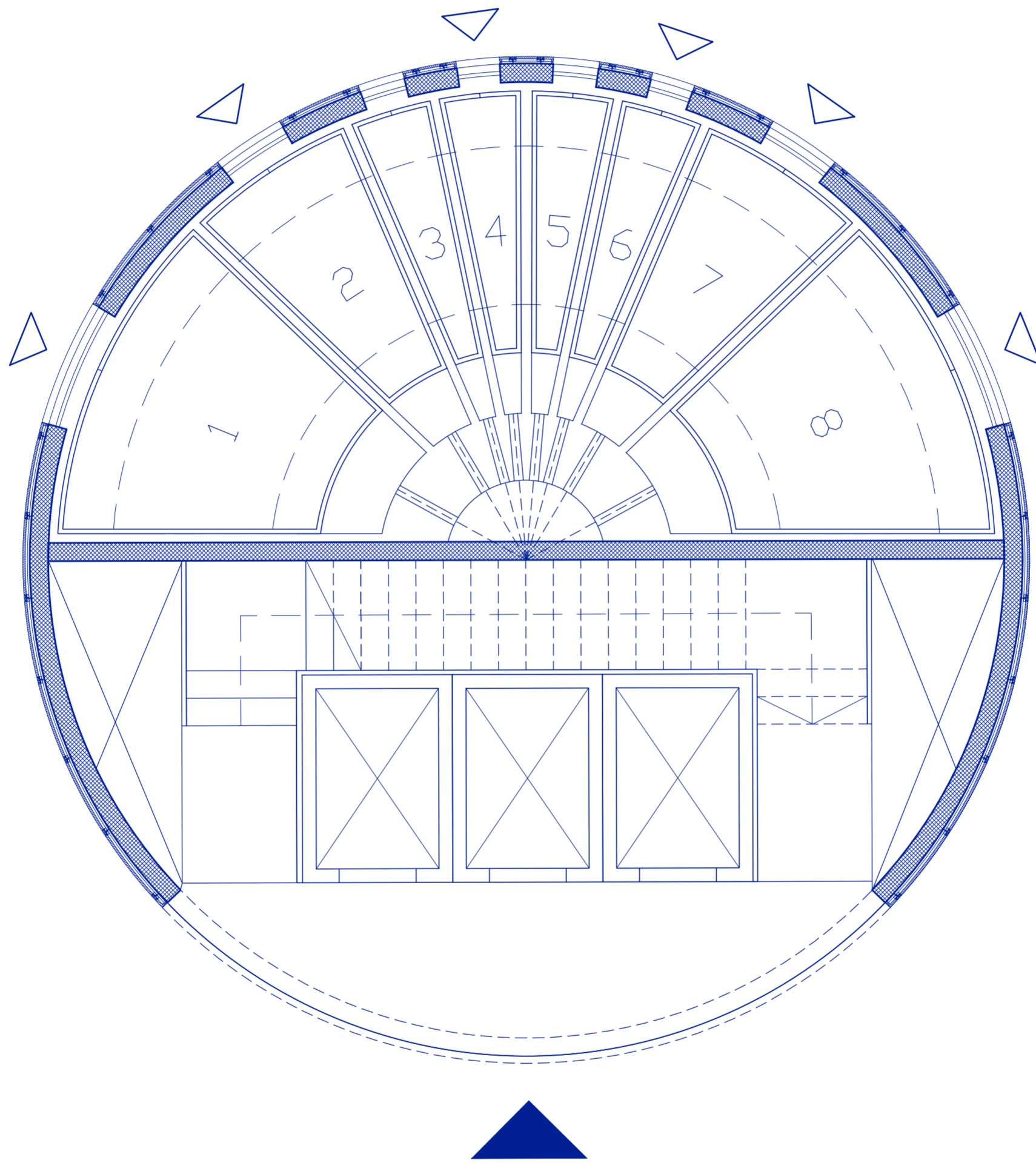

Envelope fragment 1:20 / 1:5

Interface

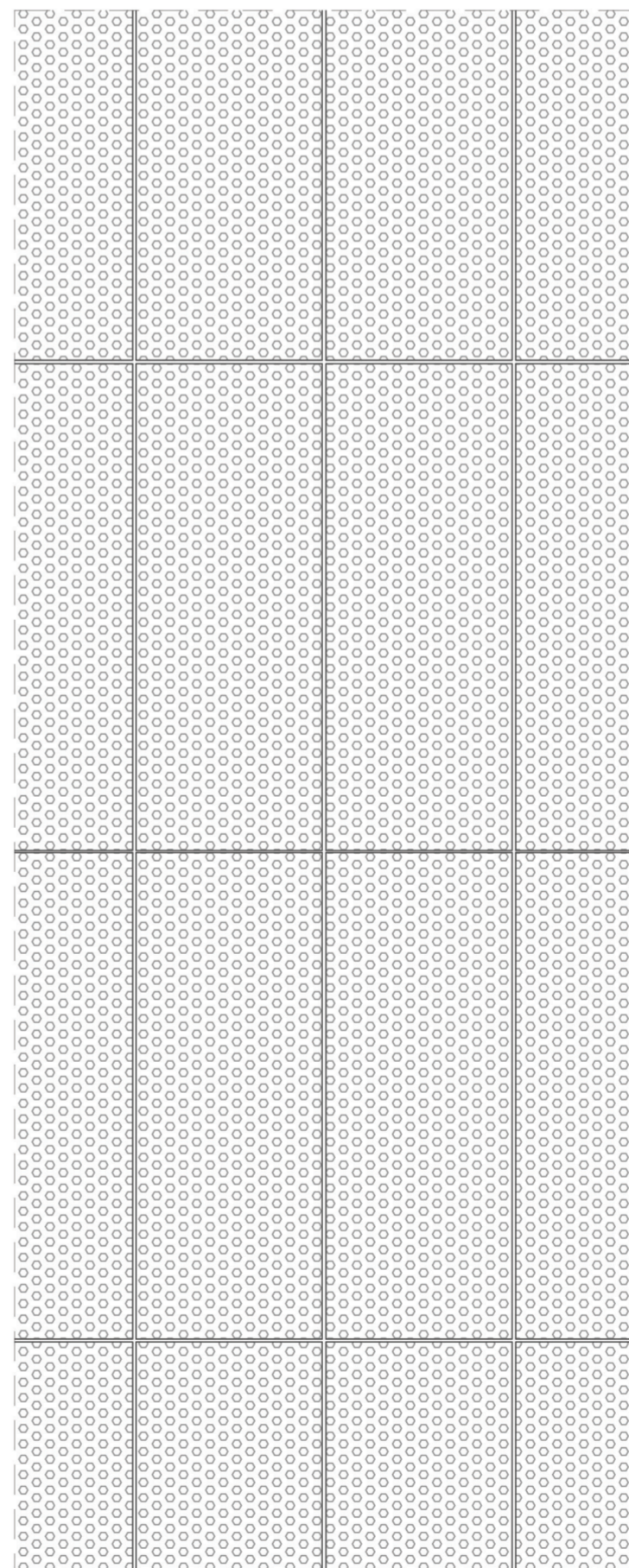
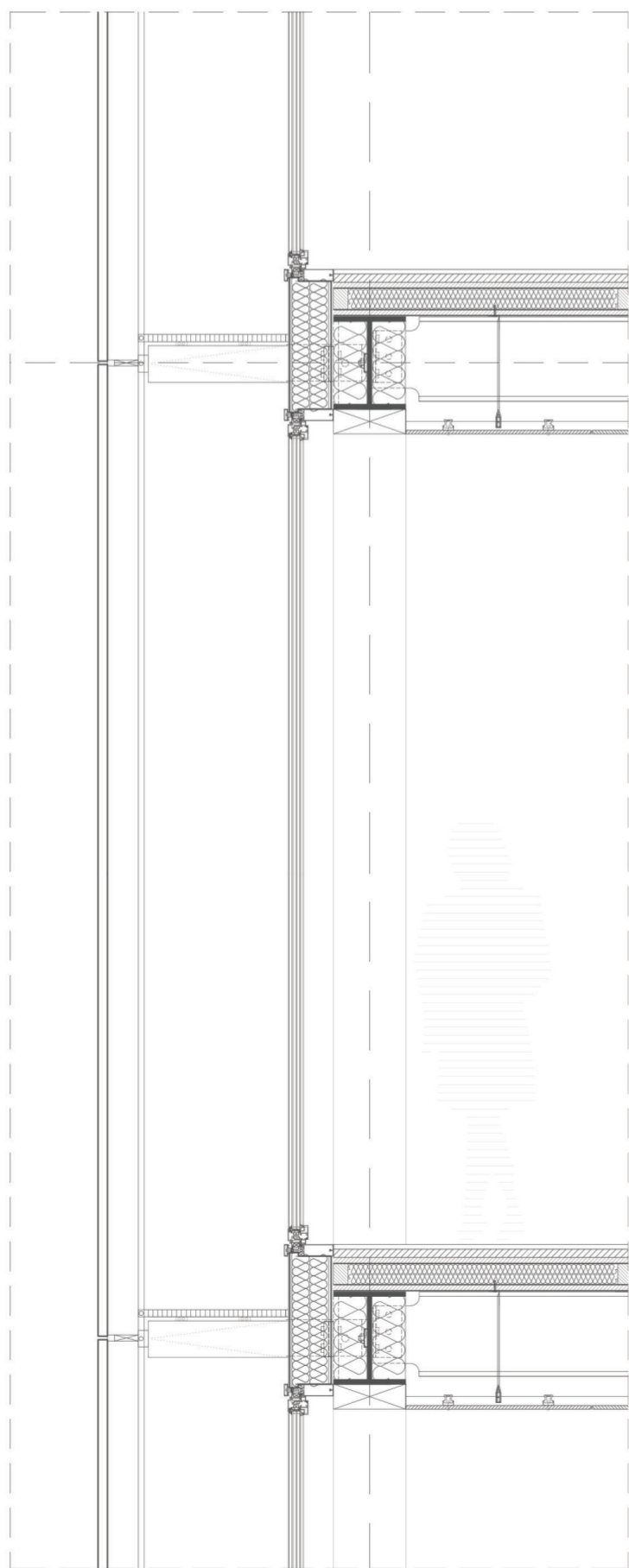
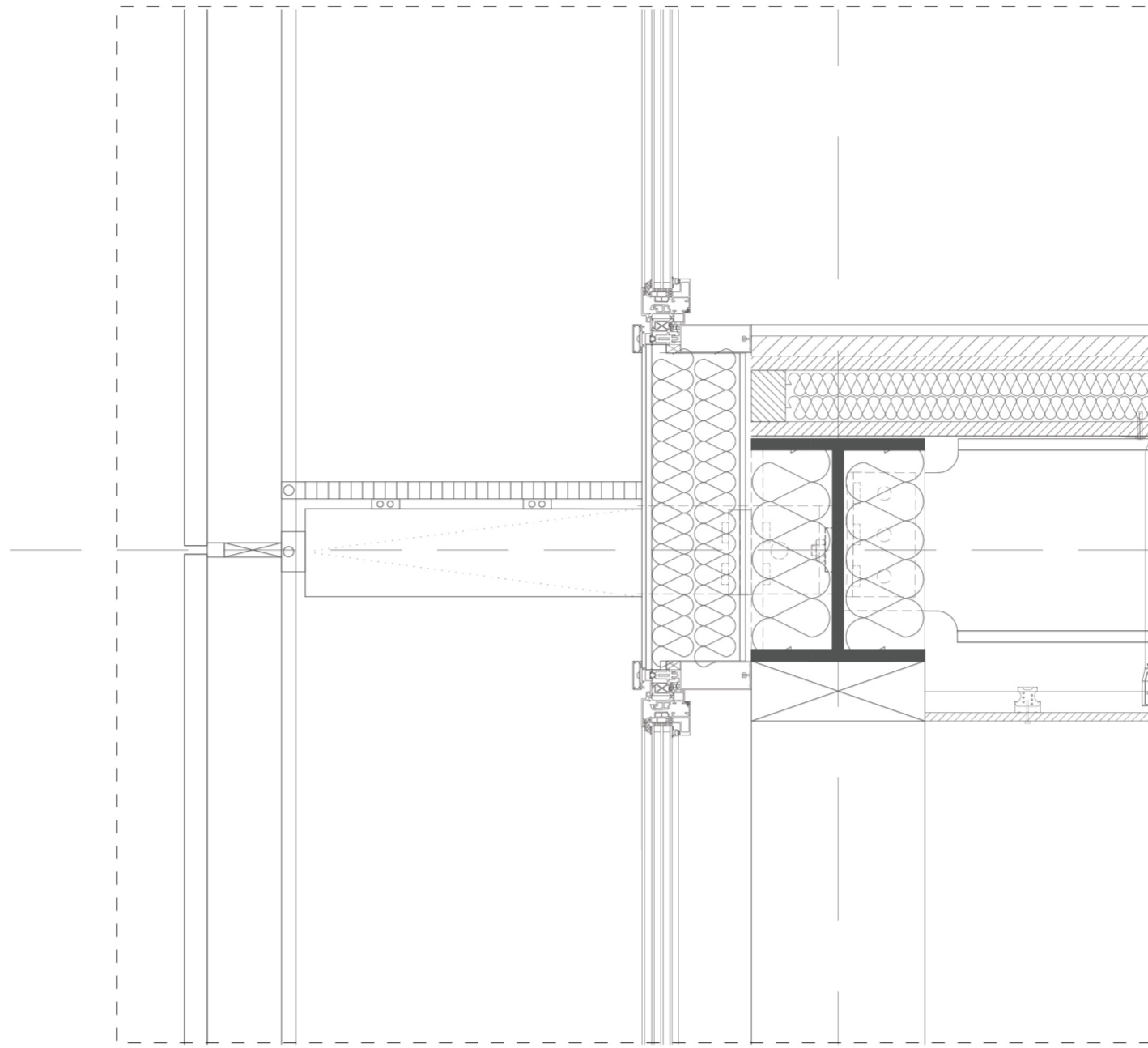

Envelope fragment 1:20 / 1:5

Storage

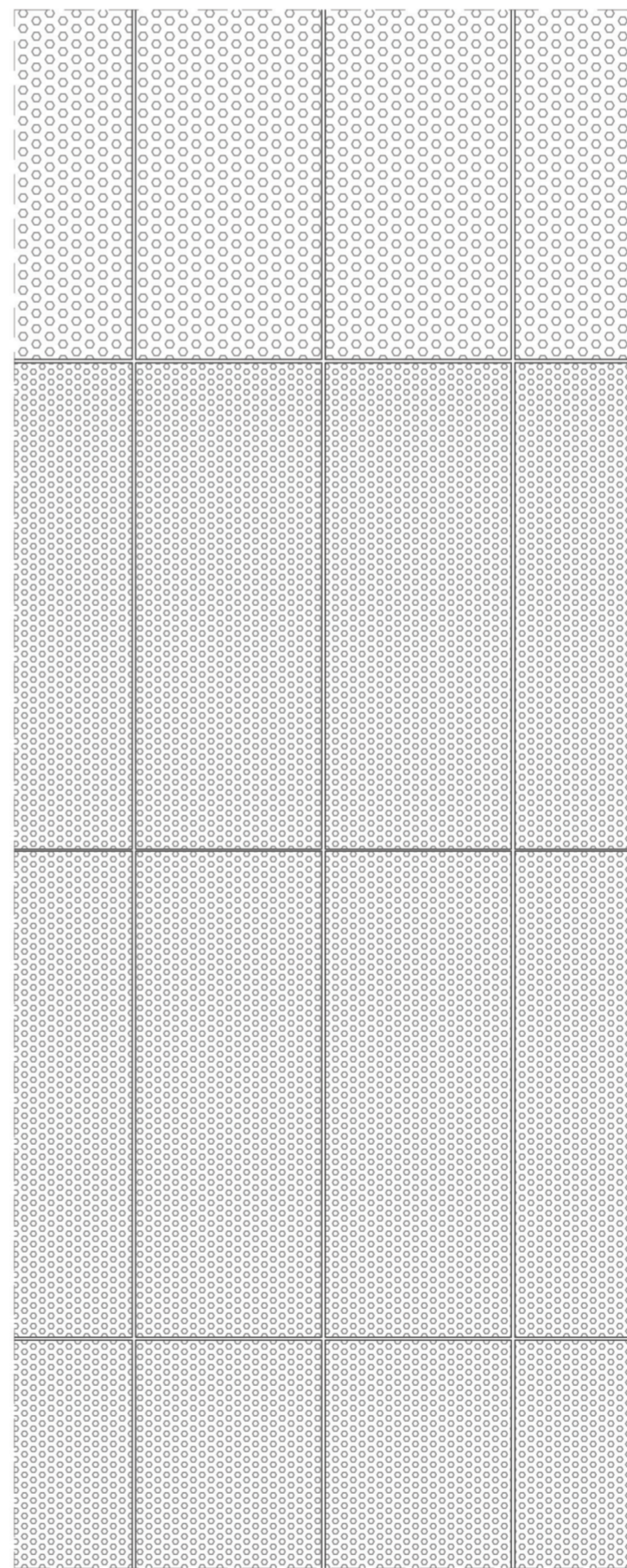
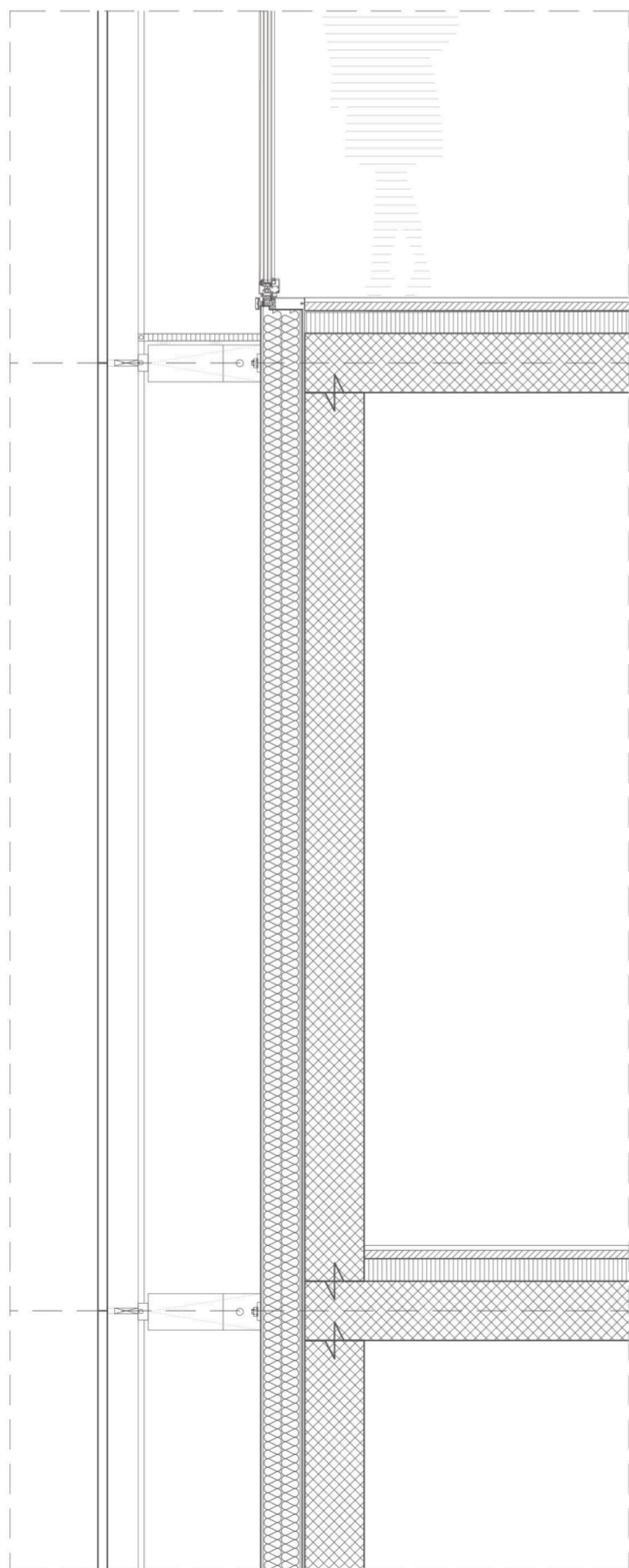
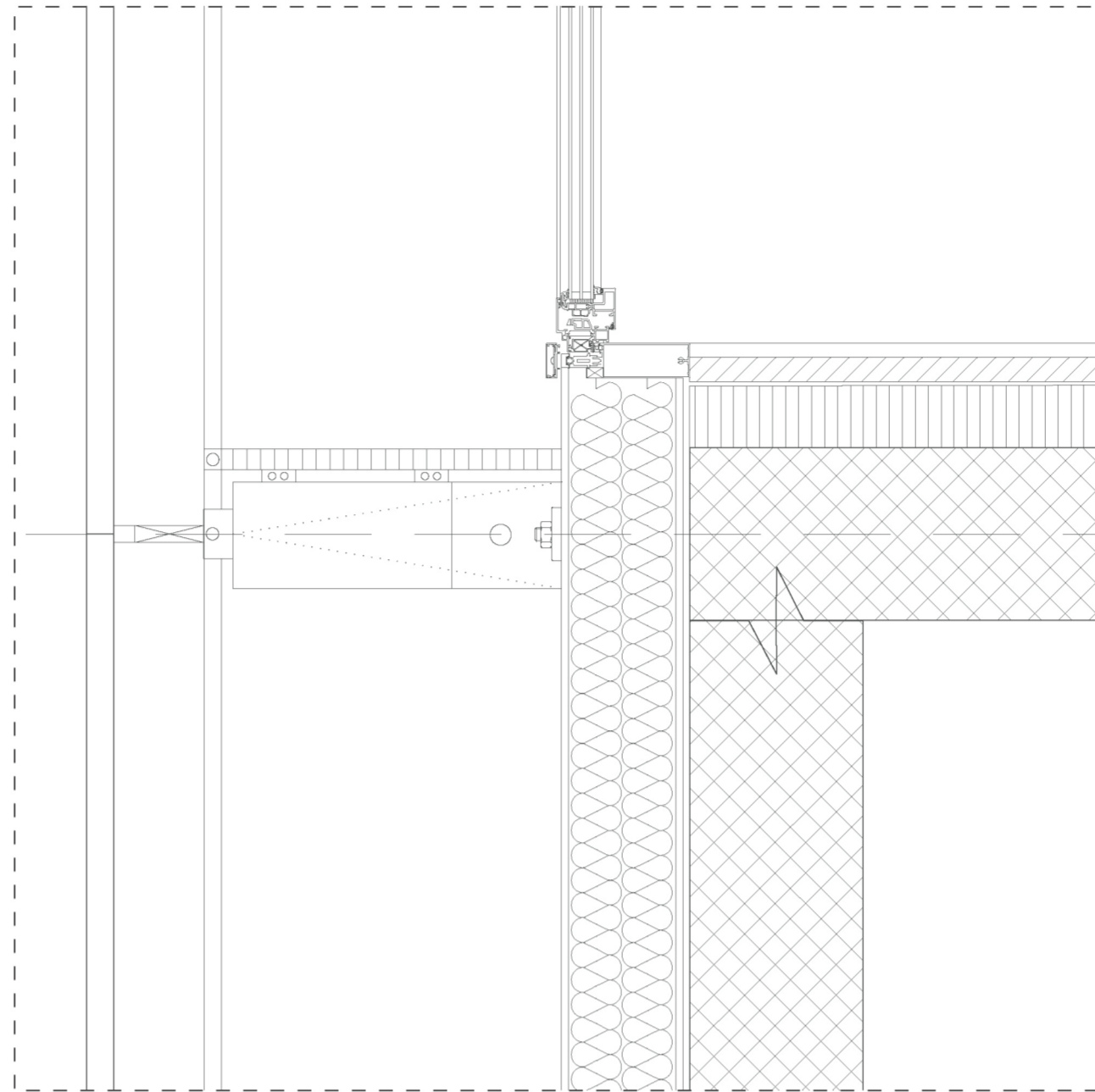

Roof detail 1:5

