

**Critical Proof Load**  
**for Proof Load Testing of Concrete Bridges**  
**based on Scripted FEM Analysis**

by

**Xin Chen**

Student number: 4587480  
Committee members: Dr. ir. Y. Yang TU Delft  
Dr. ir. M. A. N. Hendriks TU Delft

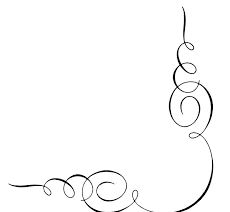

## Contents

1	Introduction .....	1
1.1	outline.....	2
2	Load model 1 .....	3
2.1	Development of the Static Load Models of EC1.2 .....	3
2.2	Details in Eurocode Load Model 1 .....	3
2.3	Load Factor in RBK .....	5
3	Methodology (Equivalent Critical Proof Load).....	6
4	Finite Element Model .....	7
4.1	Reference Case .....	7
4.2	Bridge Configuration in FEM .....	9
4.3	Thickness Distribution .....	10
4.4	Load Configuration .....	12
4.5	Tandem System .....	13
4.6	Equivalent Tandem Area.....	13
4.7	Post-process of Bending Moment .....	14
4.8	Verification of Finite Element Model .....	15
4.9	Mesh Dependency .....	16
5	Illustration of Results.....	17
5.1	Scope of Parameters .....	17
5.2	Combinations of parameters. ....	19
5.3	An Example Figure .....	20
5.4	Skewness Group.....	21
5.5	Width Group.....	22
5.6	Span Length and Thickness Group .....	23
5.7	Thickness Ratio Group.....	24
5.8	Extrapolation of the General Formulas .....	26
5.9	Sensitivity of $k_p$ and $k_q$ .....	27
6	Conclusion and Recommendation .....	28
	Bibliography .....	29
	Link of Codes.....	30

# 1 Introduction

In the Netherlands, many existing bridges are ageing and require detailed inspection. This is because of the high building activity in road and railway construction occurred during the post-World War II period, the fifties and sixties. Bridges built in this period are reaching their originally advised service life. Also, with the development of the society, both the number and the weight of the vehicles are increasing. Therefore, an increase of assessment on the capacity and remaining life time of the existing bridges can be expected in the coming 20 years.

Field testing can be used for example when the effect of deterioration on the structural capacity is unknown. Proof load testing is one of the field test method that can assess the capacity and the remaining service life of a given bridges.

The common and widely accepted proof load testing consists two stages, preparation stage and execution stage. One of the purposes in preparation stage is determining the critical proof load, which can be separated into two steps. One is the estimation of the value of the critical proof load that need to be applied during the test. A reasonable value should be able to sufficiently represent the appropriate safety level without causing any irreversible damages or the collapse of the structure. Another one is the position of the critical proof load. The proof load should be situated in the most severe position based on Eurocode.

The aim of this additional thesis is to determine the value and the position of critical proof load for different bridges by performing Linear Finite Element Analyses (LFEA). Parameters such as skewness<sup>1</sup>, span length, width, and thickness are within the scope of this analysis, and these parameters are changed automatically in different cases by using python script. Over 3000 LFEA have been performed for different bridge configurations. Formulas for calculating the critical proof load have been created and they are approved to be accurate enough comparing with the numerical results.

---

<sup>1</sup> Definition of skewness are given in 5.1

## 1.1 outline

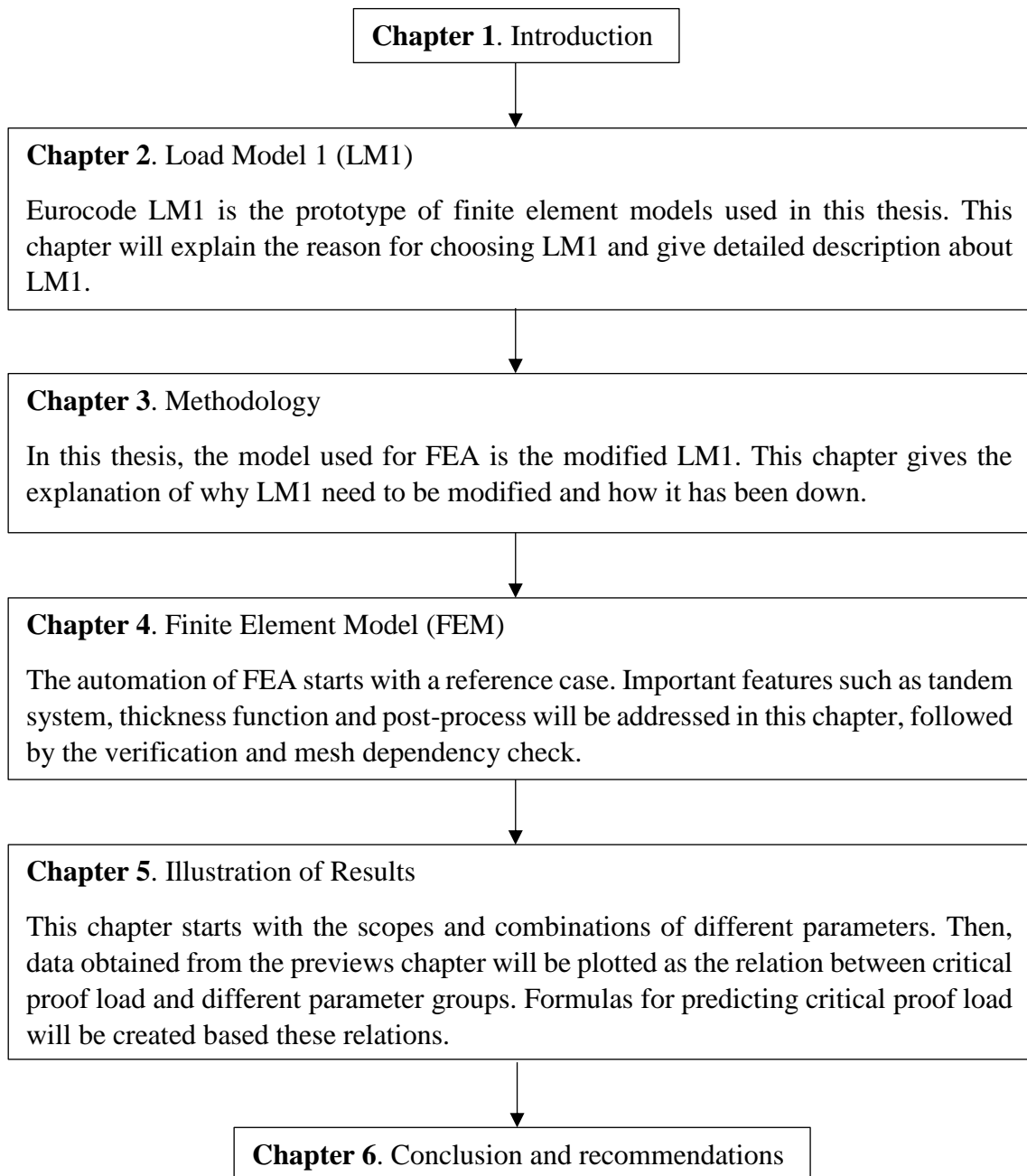

## 2 Load model 1

In this chapter, development of the static load models of Eurocode1991-2 [1] (EC1.2) will be illustrated. There are 4 different load models, namely load model 1 to load model 4. In this thesis, load model 1 (LM1) is applied. Reasons for using LM1 and the relation between LM1 and proof load testing will be discussed in the first section. Details about LM1 will be discussed in section 2.2. Load factors applied for LM1 are based on national guideline *Richtlijnen Beoordeling Kunstwerken (RBK)*, which will be introduced in section 2.3.

### 2.1 Development of the Static Load Models of EC1.2

The first phase regarded the statistical analysis of European traffic data. The available registrations of European traffics were mainly the result of two large measurement campaigns performed between 1977 and 1982 and between 1984 and 1988 respectively [2]. The distributions of the most significant traffic parameters, like traffic composition, inter-vehicle distances, inter-axles, weight, length and speed of each lorry are obtained by applying statistical analysis on these data. The characteristic values are determined based on 1000-year return period, which means the probability of extreme loads occurring in one-year period is 0.1%. When the design life is 50 years, the probability of exceedance is 5%.

There are four different vertical load models for road bridges in EC1.2, namely load model 1 to load model 4. Load model 1 (LM1) contains concentrated and uniformly distributed loads, which cover most of the effects of the traffic of lorries and cars. Load model 2 (LM2) is a single axle load applied on specific tyre contact area, which covers the dynamic effects of the normal traffic on short structural members. Load model 3 (LM3) is a set of assemblies of axle loads representing special vehicles (e.g. for industrial transport) which can travel on routes permitted for abnormal loads. Load model 4 (LM4) represents crows loading.

When performing proof load testing, LM1 should be applied. This is because LM1 represents the most severe traffic in practice. Road bridges are designed based on LM1. When one states that the capacity of bridge is not sufficient, it means the capacity cannot meet its requirement according to the live load model 1. Thus, LM1 is chosen as the load model for FEA in this report.

### 2.2 Details in Eurocode Load Model 1

To apply the LM1, the number of notional lanes need to be decided first. Notional lane is a fictitious lane that deemed to carry a line of cars. Based on Eurocode, the number and the width of notional lanes can be decided according to the carriageway width (the width between kerbs), as shown in Table 2-1.

Table 2-1. Number and width of notional lanes

Carriageway width $w$	Number of notional lanes	Width of a notional lane $w_l$	Width of the remaining area
$w < 5.4m$	$n_l = 1$	3m	$w - 3m$
$5.4m \leq w < 6m$	$n_l = 2$	$\frac{w}{2}$	0
$6m \leq w$	$n_l = Int(\frac{w}{3})$	3m	$w - 3 \times n_l$

LM1 is intended to cover flowing, congested or traffic jam situations with a high percentage of heavy lorries [3]. It consists of two partial systems as shown in Figure 2-1:

a) Double-axle concentrated loads (tandem system: TS), each axle having load  $\alpha_Q Q_k$ .  $\alpha_Q$  is the so-called adjustment factor. Therefore, the load per wheel should be taken into account is  $0.5\alpha_Q Q_k$ .

- Each TS should travel centrally along the axes of the notional lane.
- The contact surface should be taken as square with side of <sup>2</sup>0.4m .

b) Uniformly distributed loads (UDL system), having load  $\alpha_q q_k$  per square meter. UDL should be applied on the notional lanes and remaining area.

The characteristic values of  $Q_k$  and  $q_k$  should be taken from Table 2-2. Adjustment factors  $\alpha_Q$  and  $\alpha_q$  are adopted to 1.0 in this report.

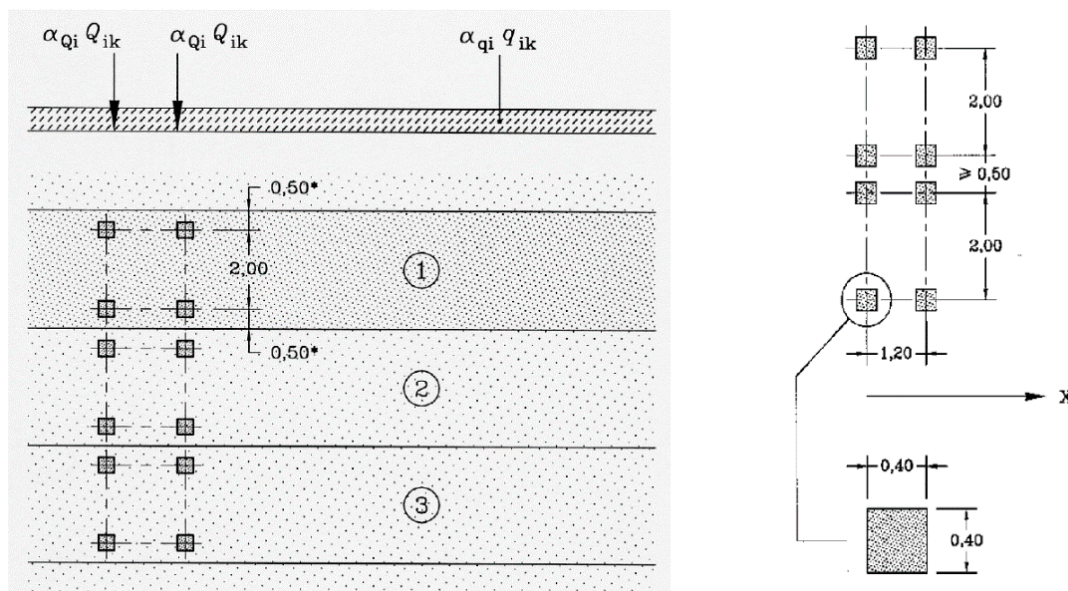

Figure 2-1. General (left) and local (right) configuration of LM1

<sup>2</sup> The length of 0.4m has been changed in finite element model. Detailed information sees 4.6

Table 2-2. Load model 1: characteristic values

location	Tandem system TS	UDL system
	Axle loads $Q_{ik}$ (kN)	$q_{ik}$ or $q_{rk}$ (kN / m <sup>2</sup> )
<b>Lane number 1</b>	300	9
<b>Lane number 2</b>	200	2.5
<b>Lane number 3</b>	100	2.5
<b>Other lanes</b>	0	2.5
<b>Remaining area (<math>q_{rk}</math>)</b>	0	2.5

### 2.3 Load Factor in RBK

For existing bridges in the Netherlands, a guideline for the assessment is available. This guideline is called the “Richtlijnen Beoordeling Kunstwerken (Guideline Assessment Bridges) [4],” abbreviated as RBK. Different safety levels for assessment are prescribed, which use different load factors, related to different reliability indices  $\beta$  and reference periods.

Load factors obtained from the Dutch guideline RBK are presented in Table 2-3. Different load factors are set for various safety level. In this report, only RBK Newly built level has been applied.

Table 2-3. load factors for various safety levels

	Dead weight	Permanent self-weight	Variable load
<b>EC ULS</b>	1.10	1.35	1.50
<b>RBK Newly built</b>	1.10	1.25	1.50
<b>RBK Renovation</b>	1.10	1.15	1.30
<b>RBK Usage</b>	1.10	1.15	1.25
<b>RBK Disapproval</b>	1.10	1.10	1.25
<b>EC SLS</b>	1.00	1.00	1.00

### 3 Methodology (Equivalent Critical Proof Load)

Eurocode LM1 consists of two partial load systems: double-axle concentrated load and uniformly distributed load. Whereas, the application of uniformly distributed load is not very practical. If we define that Critical Proof Load is the load that found by applying both concentrated load and distributed load. Then, we use Equivalent Critical Proof Load to present the load that found by applying only concentrated load, but this concentrated load is modified by a factor due to the absence of distributed load.

Here it is seen in Figure 3-1, the left pattern presents the load configuration as described in EC2. Both concentrated load and distributed load have been applied on the bridge. To search for the maximum bending moment  $M_{\max}$ , the location of tandem system (TS) are moved from the start of span 1 to the end of it with an increment of  $\Delta d$ . For each location,  $M_i$  can be found which represents the maximum bending moment of that location. With the moving of TS, a series of maximum bending moment  $M_i$  of each loading location will be found:

$$M_1, M_2, M_3 \cdots M_n \text{ (n is the total number of locations that moved.)}$$

Then, it can be defined that:

$$M_{\max} = \max\{M_1, M_2, M_3 \cdots M_n\}$$

$M_{\max}$  is the final maximum bending moment that represents the largest bending moment that can be possibly induced in this certain bridge configuration.

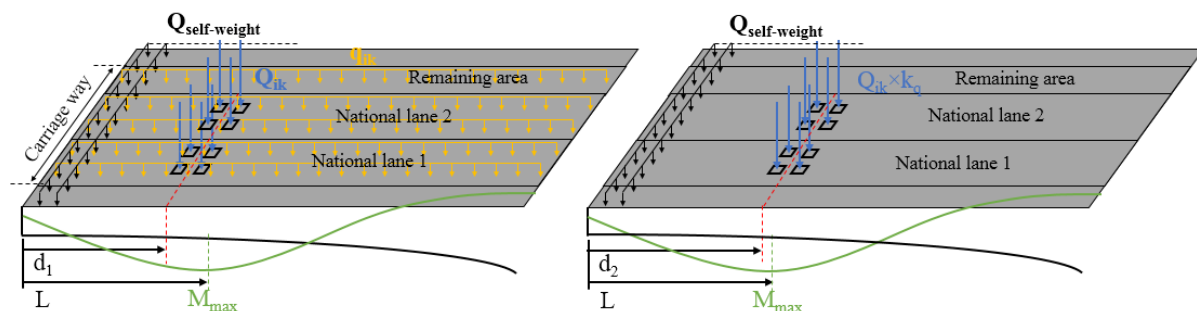

Figure 3-1. Equivalent critical proof load

However, since the distributed load is impractical for field test. An equivalent critical proof load need to be found to replaces the old two partial load systems. The equivalent critical proof load must lead to the same maximum bending moment (both value and position).

For instance, as shown in Figure 3-1, in the left picture,  $M_{\max}$  is found when TS at a distance of  $d_1$  from the start of span 1. In the right picture, it is found  $Q_{ik}$  modified by a factor and without distributed load lead to the same  $M_{\max}$  at the same distance L. The difference is that now  $Q_{ik}$  located at  $d_2$ . Now, the equivalent critical proof load can be defined:

$$Q_{eq,cri} = Q_{ik} \times k_q$$

Where,  $k_q$  is a factor to compensate the absence of  $q_{ik}$ .



The aim of FEA is to determine the value and the position of “critical proof load”, and this “critical proof load” actually means the equivalent critical proof load  $Q_{eq,cri}$  in this thesis.

## 4 Finite Element Model

In this chapter, details of how to adapt the physical model of De Beek bridge to finite element model will be addressed. A reference case will be introduced in the first section. Simplifications have been made when adapting the physical model, which will be discussed in the second section. The thickness distribution is not prismatic, it varies in both longitudinal and transverse direction. Realization of thickness distribution and load configuration will be dealt in the second 3 and section 4 respectively. For the tandem system, quadrilateral force has been applied and it is a new feature added in DIANA 10.2. The mechanism of this load model will be given in section 5. Illustration of equivalent tandem area is described in section 6. Details of post-possess of bending moment will be described in section 7 and followed by the verification and assessment of mesh dependency check.

### 4.1 Reference Case

De beek viaduct has been taken as a reference case for the finite element model in this report. De beek is a 4-span concrete reinforced viaduct located over the highway A67 in Netherlands, as shown in Figure 4-1. It was constructed in 1963 and is owned and managed by Rijkswaterstaat. It is reported that the capacity of de beek viaduct cannot meet its current safety requirement. In 2016, a proof load test has been performed on de beek viaduct to assess the load carry capacity. In this chapter, details of dimensions about this viaduct will be illustrated.



Figure 4-1. Location of viaduct De beek [5].

In Figure 4-2 a top view of the first two spans of the viaduct is presented. Here it is seen that the total width of the viaduct is 9940 mm and the width of the carriage way is 7440 mm.

Figure 4-3 gives an overview of the height distribution over the length of the viaduct. It can be seen that the thickness of slab 1 changes from 470 mm at the end beam to 870 mm at the intermediate beam. The thickness of slab 2 changes from 870 mm at the supports to 470 mm in the middle of the span. The end support beams, beam 1 and 5 have an additional thickness of 200 mm resulting in a total thickness of 670 mm. For the intermediate beams, the thickness increase with respect to the adjacent slab thickness is 250 mm which results in a cross-beam thickness for beams 2, 3 and 4 of 1120 mm.

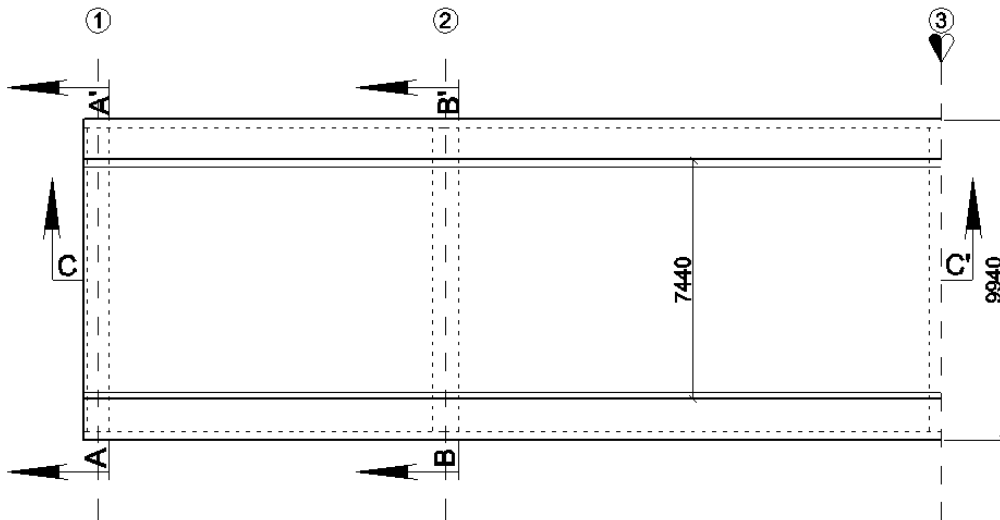

Figure 4-2. Top view of span 1 and span 2 [5]

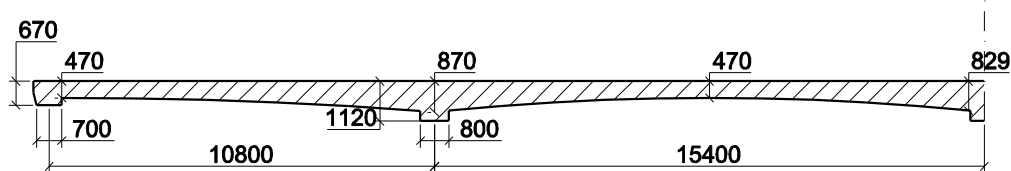

Figure 4-3. Height distribution over span 1 and span 2 [5].

The thickness of the viaduct also changes in the transverse direction. At the edges of the viaduct a kerb is present with a height of 200 mm. The height of the viaduct deck changes from 470 mm in the centre to 408 mm at the sides for the cross section near support 1 and from 870 mm at the centre to 808 mm at the side for the cross section near support 2. A layer of asphalt varying between 50 mm and 75 mm is present, as measured by BAS [5].

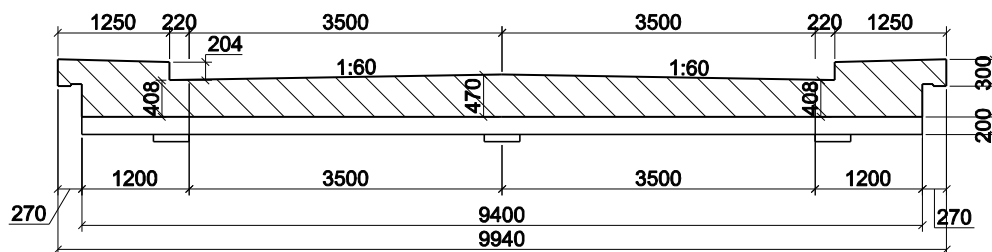

Figure 4-4. Cross section A-A' [5]

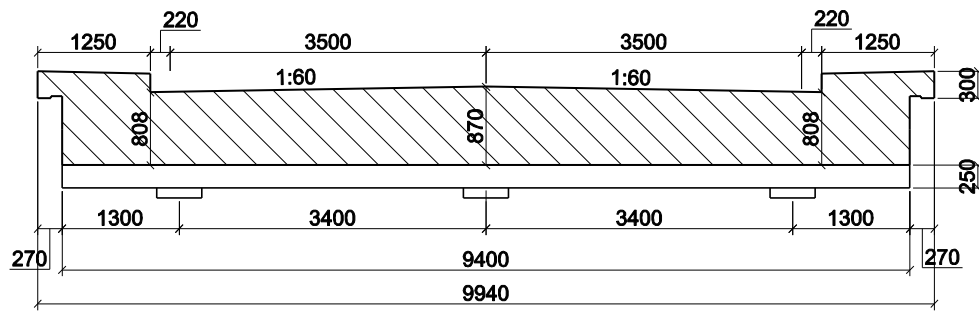

Figure 4-5. Cross section B-B' [5]

De beek is a 4-span bridge, but span 2 and span 3 are right above the highway A67. Considering the bridge might collapse during the proof load test, it was decided that those two spans cannot be considered as field test area [5]. Another reason is the second the third span are symmetric therefore it is easy to find out the critical position, no further analysis is needed. In the end, the operators decided to applied the proof load on the first span, as denoted in Figure 4-6. This also means in the FEA, only the first span will be considered as a possible field test area. The tandem load will be moved within the first span to find the critical loading position.

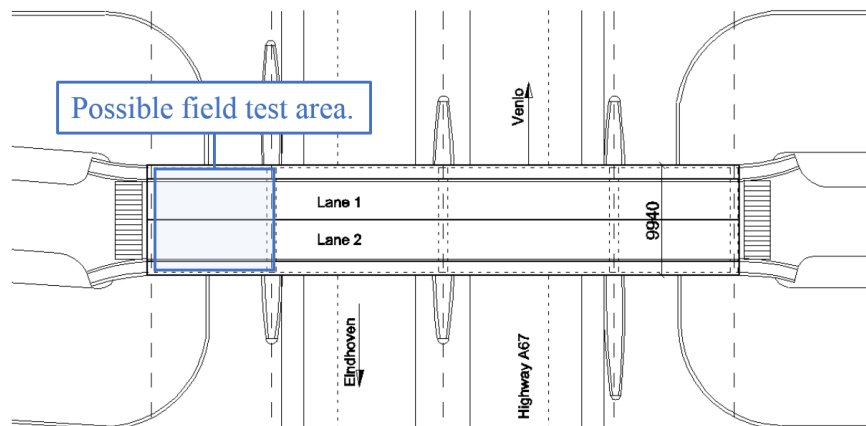

Figure 4-6. Planform of de beek bridge [5]

## 4.2 Bridge Configuration in FEM

### a) General Information

The De Beek bridge has been built in 2D model by using plate bending element Q12PL. It is a four-node quadrilateral isoparametric plate bending element according to the Mindlin – Reissner theory. The bridge deck located in x-y plane has a fictitious thickness in z direction.

### b) Simplification of Cross-section

Figure 4-7 shows two different configurations. The black outline represents the cross section of physical model, and the orange outline describes the shape of Finite Element Model (FEM). Here it is seen that, in the physical model, thickness changes along transverse direction with a slope of 1:60, whereas, in the FEM, it is decided that to keep it prismatic within traffic lane. The thickness of sidewalk is 200mm higher than the adjacent traffic lane. Also, an extra 200mm thickness of cross beam has been accounted at place where cross beam located.

Another simplification is about the bearing pad. Bearing pad transfers loads from deck to column and can be seen as the location where gives the reaction force to bridge deck. In this FEM, the bearing pad has been simplified into point support. The reason for this is that the target maximum bending moment is remote from point supports thus has a very limited influence on the target value.

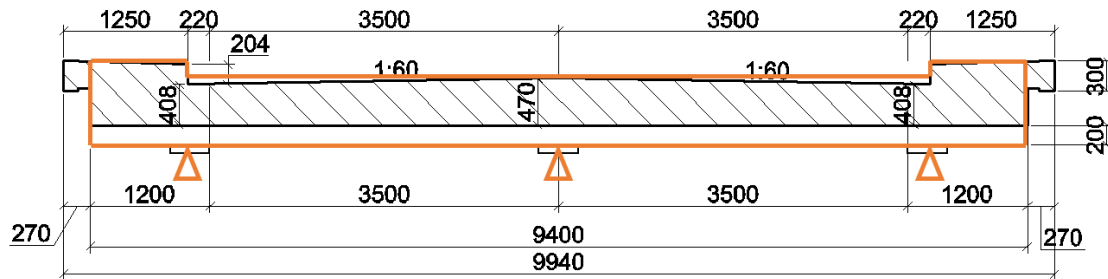

Figure 4-7. Simplification of cross-section A-A'

### c) Modelling of Bridge Deck

Figure 4-8 shows the top view of bridge with skewness of 90 ° and 60°. The total model consists of 58 plates, 40 for two spans and 16 for three cross beams. The reason to divide the whole bridge deck into different parts mainly are: a) to guarantee the displacement continuity. b) to make it easier to assign thickness property and distributed loads. c) to obtain a better mesh.

The width of carriageway of De Beek is 7.44m, as can be seen in Figure 4-8. Thus, based on EC2, Table 2-1, the number of notional lanes are 2 with a width of 3m for each lane. The remaining area has a width of 1.44m. Only half of bridge are modelled, due to the reason that the remote part of the structure has a limited influence on span 1.

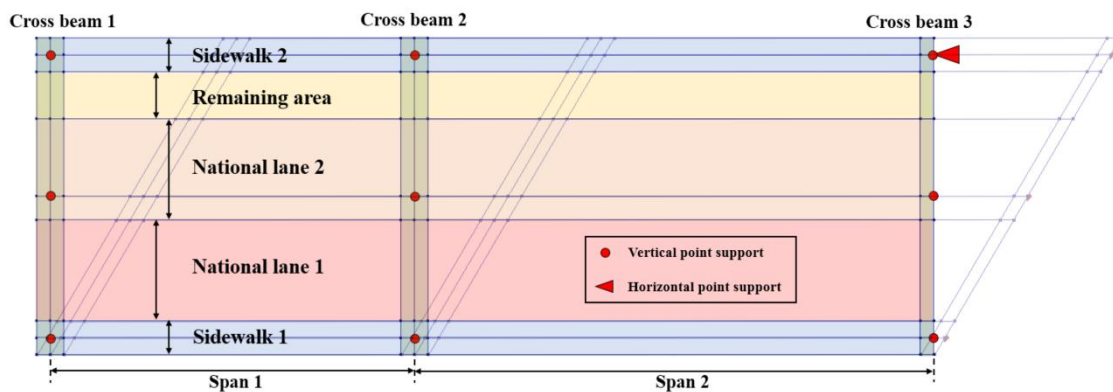

Figure 4-8. Top view of FEM with skewness of 90 ° and 60 °.

## 4.3 Thickness Distribution

### a) Thickness Distribution along Longitudinal Direction

The thickness distribution along longitudinal direction has been simplified into circular shape as shown in Figure 4-9.  $r_1$  represents the radius of the circle that describes the thickness distribution of span 1 and  $a_1$  is the vertical line that go through the centre of that circle. The same applies to  $a_2$  and  $r_2$ . If the origin of coordinates is set as described in the Figure 4-9, two more points can be easily obtained and then the formula of these two circles can be calculated as:

Span 1:  $y_1 = \sqrt{125200^2 - (x_1 - 800)^2} - 125670, x_1 \in [800, 10800]$

Span 2:  $y_2 = \sqrt{66813^2 - (x_2 - 18900)^2} - 67283, x_2 \in [11600, 26200]$

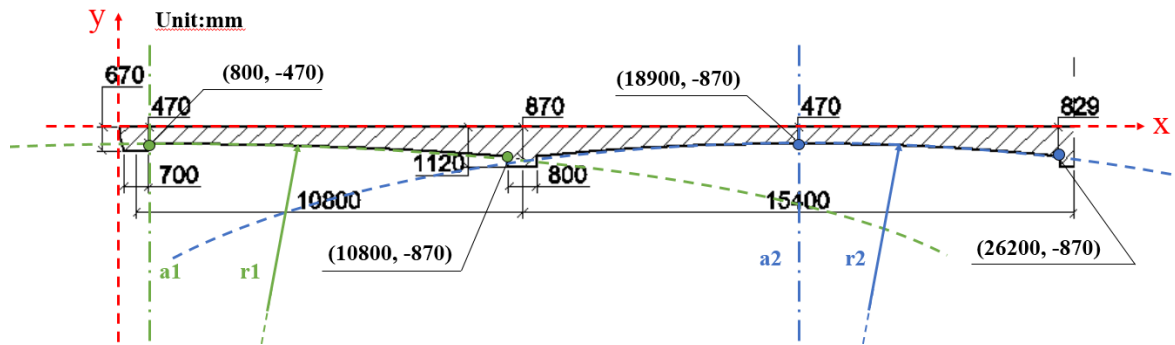

Figure 4-9. Thickness configuration in longitudinal direction

b) Thickness Distribution along Transverse Direction

When bridge has a skewness, the center of the circle will be indented along the transverse direction as shown below. Figure 4-10 is the top view of a bridge with a skewness of  $60^\circ$ . The center of circle for span1 and span2 located along line  $l_1$  and  $l_2$  respectively. Bridge has the same thickness along these two lines.

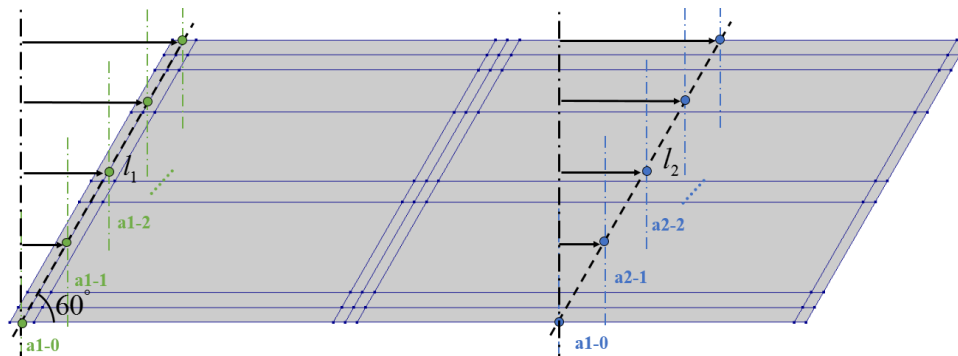

Figure 4-10. Locations of the center of the circle, top view

Thickness functions have been used to assign the thickness for the 2D deck. A “thickness filed” need to be defined by thickness function and the filed can be larger than the geometry shape of the deck. Then, assign the thickness field to the corresponding geometry shape. Figure 4-11 shows the thickness filed of the span 1 of De beek bridge and its corresponding geometry shape.

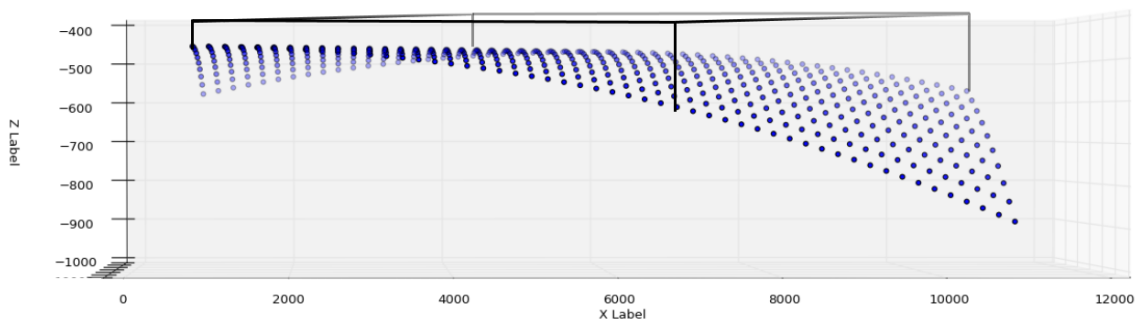

Figure 4-11. Thickness distribution of span1

#### 4.4 Load Configuration

The load configuration discussed in this section is derived from EC2, which will lead to critical proof load, instead of the equivalent critical proof load that discussed in chapter 3. In total, there are 4 load components: two kinds of proof loads from EC2, namely axle load  $Q_{ik}$  and uniformly distributed load  $q_{ik}$ , self-weight of the concrete, and dead weight (mainly due to asphalt).

Take references from Table 2-2, the characteristic value of  $Q_{ik}$  and  $q_{ik}$  for notional lane 1, 2 and remaining area are:

Notional lane 1:  $Q_{1k} = 300kN$ ,  $q_{1k} = 9(kN / m^2)$

Notional lane 2:  $Q_{2k} = 200kN$ ,  $q_{2k} = 2.5(kN / m^2)$

Remaining area:  $q_{rk} = 2.5(kN / m^2)$

For self-weight of concrete, take the density of concrete as  $2400kg / m^3$ , the averaging thickness is 0.7m (integration of thickness along longitudinal direction divided by the total length), thus the self-weight can be calculated:  $q_{self-weight} = 16kN / m^2$ .

The thickness of asphalt is assumed to be 75mm with density of  $2360kg / m^3$ , which lead to the followed dead load:  $q_{dead} = 1.8kN / m^2$ .

Load factors are taken from Dutch guideline as shown in Table 2-3. RBK Newly built level is applied. Table below concludes the value for all the load components. Figure 4-12 shows the load components listed in the above table.

Table 4-1. A conclusion of load components in Newly built level

RBK Newly built level	Characteristic value	Load factor	Design value
TS of lane 1 [kN]	300	1.5	450
UDL of lane 1 [kN / m <sup>2</sup> ]	9	1.5	13.5
TS of lane 2 [kN]	200	1.5	300
UDL of lane 2 [kN / m <sup>2</sup> ]	2.5	1.5	3.75
UDL of Remaining area [kN / m <sup>2</sup> ]	2.5	1.5	3.75
Self-weight [kN / m <sup>2</sup> ]	16	1.25	20
Dead weight [kN / m <sup>2</sup> ]	1.8	1.1	1.98

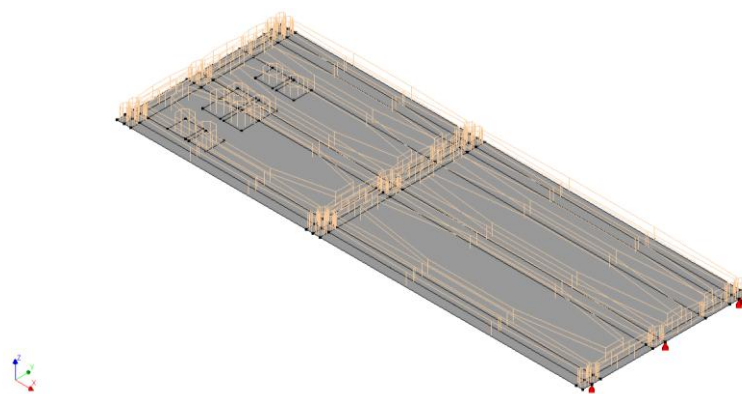

Figure 4-12. load components in FEM

## 4.5 Tandem System

The load of tandem system is simulated by using quadrilateral force in Diana10.2. A quadrilateral force load defines a force that is distributed over a quadrilateral surface on a larger surface of plate bending, flat shell, curved shell or solid elements. The quadrilateral area is rectangular and the edges will, in general, not match with the element edges. A quadrilateral force load can be useful when imprinting or a surface pressure load is not an option, e.g. because many different loading positions must be considered for wheel prints in a mobile load. Internally, the quadrilateral force load is converted to element surface and or element point loads. The sum of forces and moments will be exactly matching with the user defined force value and position of the quadrilateral force load. [6]

To apply quadrilateral force, two surfaces are needed at least, namely loaded surface and interest area. Loaded surface indicate the surface where the loads are distributed. Interest area is the possible area that the can be loaded by the quadrilateral force and it can be loaded only when there is superposition between the loaded surface and interest area along the loaded direction. For instance, in Figure 4-13, here it is seen that during P1 phase, there is no overlap between loaded surface and the interest area, then there will be no load applied on the interest area. During P2 phase, half of the loaded surface where indicated with shadow are overlapped with interest area. Thus, half of the load are applied on interest area. According to the same mechanism, all the load is applied on interest area in P3 phase.

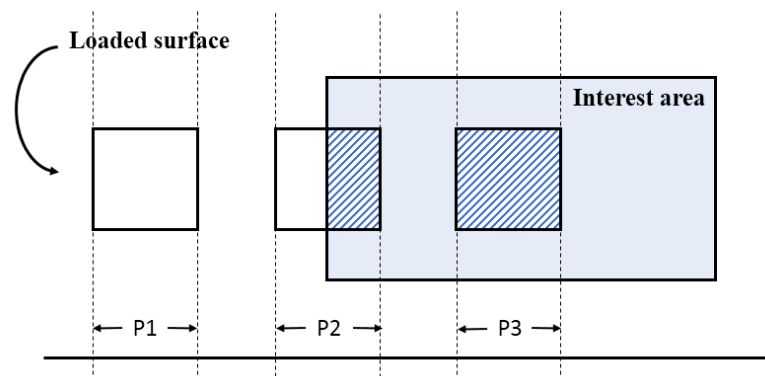

Figure 4-13. Mechanism of quadrilateral force

## 4.6 Equivalent Tandem Area

According to LM1, the loaded surface has an area of  $0.4m \times 0.4m$ , which represents the contact area between wheel and bridge surface. The compressive forces spread with an angle of  $45^\circ$ . In 2D model, an equivalent tandem area should be applied, which is the area the compressive force distributed on the middle layer of the bridge deck. Figure 4-14 shows the case when the thicknesses of asphalt and deck are 75mm and 470mm respectively.

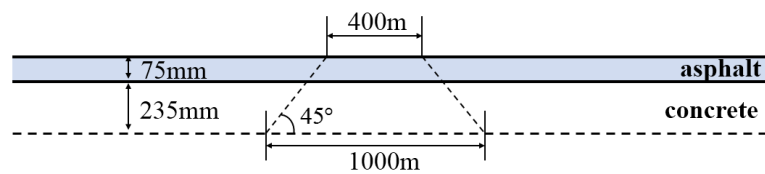

Figure 4-14. Equivalent tandem area

## 4.7 Post-process of Bending Moment

Probe curves are used to access the result. As presented in Figure 4-15, two probe curves are set along longitudinal and transverse direction with length of 1m of each curve. The center the circle is the location of the maximum bending moment  $M_{\max}$ . The following steps describe how  $M_{\max}$  is processed by using python script:

- 1) Search for the maximum bending moment within the scope of span1 and export its value  $M_5(M_{\max})$  and position  $px_5$  (or  $py_5$ ).
- 2) Create probe curve x (longitudinal direction) and probe curve y (transverse direction) with a length of 1m for each curve.  $M_5$  located at the intersection of curve x and y.
- 3) Extract the corresponding bending moment  $Mx_i$  and  $My_i$  of points  $px_i$  and  $py_i$ .
- 4) Extract the corresponding thickness  $dx_i, dy_i$  of points  $px_i$  and  $py_i$ .
- 5) Calculate  $\frac{Mx_i}{dx_i}$  and  $\frac{My_i}{dy_i}$
- 6) Take the average of all the points as modified bending moment:

$$M_{md,\max} = \frac{\sum_{i=1}^{11} \frac{Mx_i}{dx_i} + \frac{My_i}{dy_i}}{22}$$

The aim of the above procedure is to eliminate element size dependency and thickness dependency.

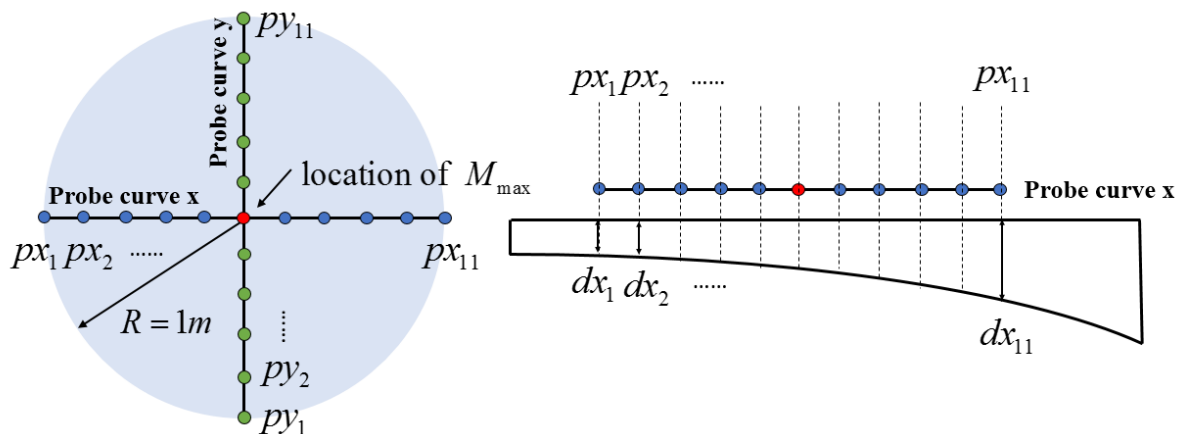

Figure 4-15. Probe curve to access moment



## 4.8 Verification of Finite Element Model

One of the case has been randomly chosen to perform equilibrium check. The thickness is uniformly distributed over the bridge. A straight-line  $x=5000$  [mm] cut the model into two parts. Both force and moment equilibrium are checked based on the left part (part A, the part shaded with blue in Figure 4-16).

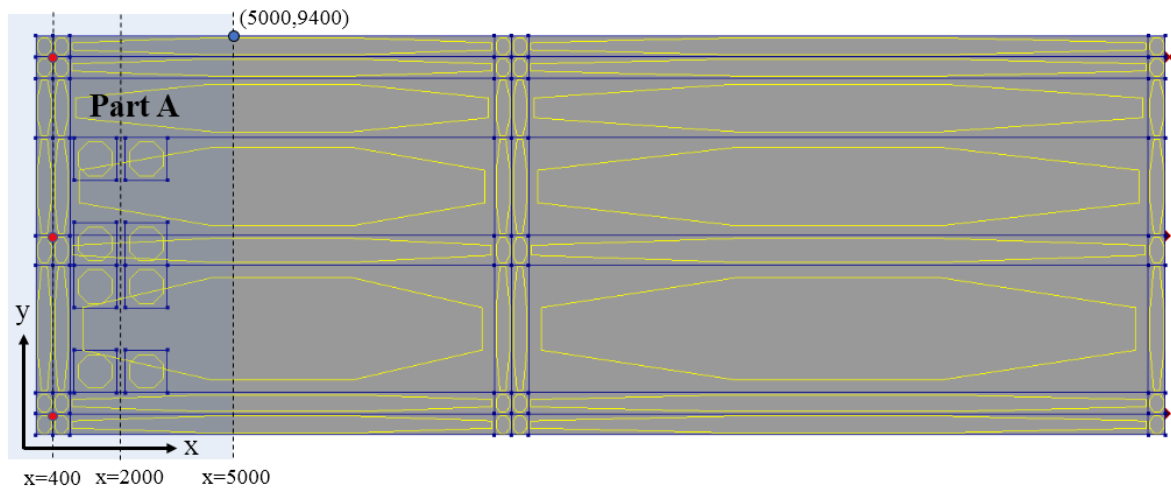

Figure 4-16. Case of equilibrium check

a) Force equilibrium within part A:

Total external force of part A:  $-2.85 \times 10^6 [N]$

Total reaction force of three left point support:  $2.20 \times 10^6 [N]$

Integration of  $Q_{xz}$  along  $x=5000$ :  $0.68 \times 10^6 [N]$

Total downward force is  $-2.85 \times 10^6 [N]$  and total upward force is  $2.88 \times 10^6 [N]$ , which means force is in equilibrium.

b) Moment equilibrium at  $x=5000$  [mm]:

Total moment induced by external force:  $-7.88 \times 10^9 [N \cdot m]$

Total moment induced by point support:  $1.01 \times 10^{10} [N \cdot m]$

Integration of  $m_{xx}$  along  $x=5000$ :  $-2.18 \times 10^9 [N \cdot m]$

Total clockwise moment is  $1.01 \times 10^{10} [N \cdot m]$  and total anticlockwise moment is  $-1.01 \times 10^{10} [N \cdot m]$ , which means moment is in equilibrium.

### 4.9 Mesh Dependency

A mesh dependency check is performed based on the reference model (De beek). Whereas, the skewness has been changed to 70 ° considering the complexity of thickness distribution when the angle of skewness is not 90 °.

Figure 4-17 presented the result. Abscissa is the loading position, representing the position of axle loads. Ordinate is the modified bending moment  $M_{md}$  discussed in the 4.7. The differences still can be seen when changing the element size from 200mm to 100mm. However, all the points are overlapped well when reducing the element size to 50mm.

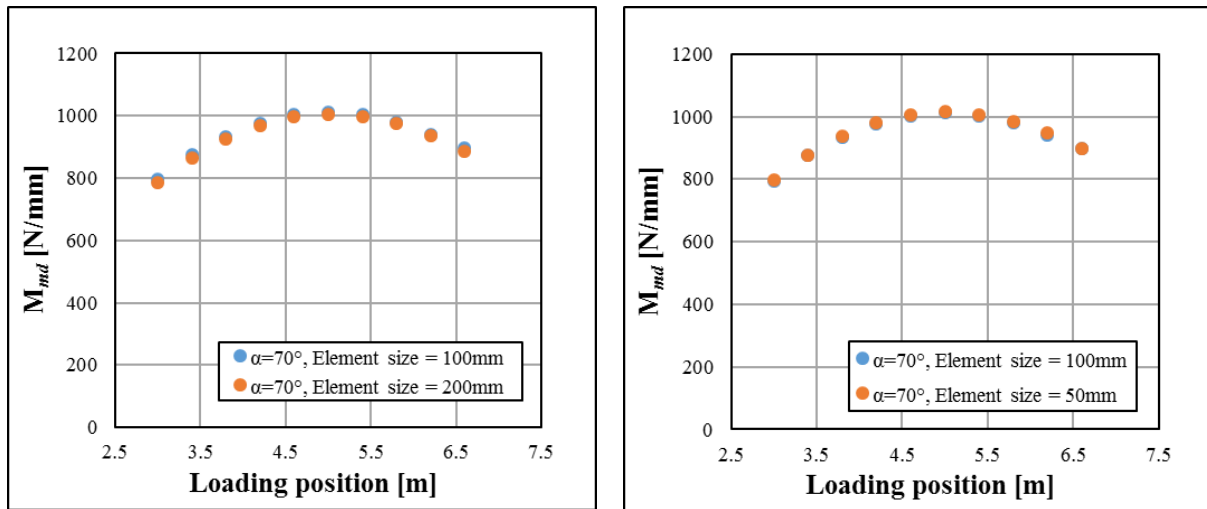

Figure 4-1. Bending moment for different loading position when element size equal to 50, 100 and 200mm.

Table 4-2 shows the specific values of Figure 5-4. Here it is seen that the averaging value between 100 and 200mm is 0.75%, and it is 0.36% between 100 and 50mm. Considering the loading position is very sensitive to  $M_{md}$ , it is decided to keep the results as accurate as possible. Thus, 100mm is used as element size in the modelling. Figure 4-17 shows the mesh of the case when  $\alpha=60^\circ$ .

Table 4-2. Relative errors for different element size

Relative error between element size =100 and 200mm [%]										Averaging
1.40	1.27	0.86	0.83	0.50	0.50	0.60	0.20	0.21	1.13	0.75%
Relative error between element size =100 and 50mm [%]										Averaging
0.25	0.00	0.32	0.41	0.30	0.40	0.40	0.51	0.74	0.22	0.36%

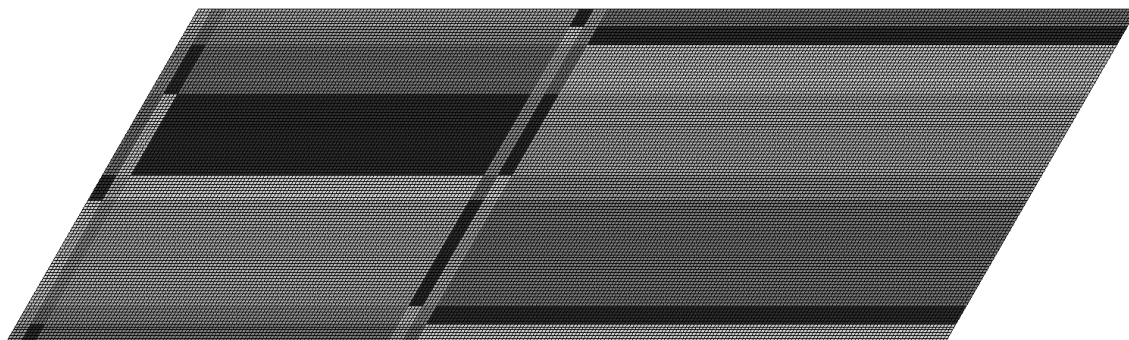

Figure 4-17 A mesh of  $\alpha=60^\circ$

## 5 Illustration of Results

In this chapter, the numerical results based on different parameters will be presented. The target parameters discussed in 5.1 have been divided into four groups based on their dependency. Namely, span length and thickness group, thickness ratio group, width group and skewness group. They are the independent variables of their respective groups. First, explanations and scopes of these parameters will be discussed. Then, the relation between critical proof load and each parameter will be plotted in the its corresponding section. Finally, formulas will be created based on the relation to predict the value and position of critical proof load.

### 5.1 Scope of Parameters

To determine the critical proof load for different bridges, bridges with different configurations need to be decided. A bridge configuration consists of several geometrical parameters, such as the total number of spans, span length, span width, thickness distribution and skewness, followed parameters are within the scope of analyses: length, width, thickness and skewness.

The term of skewness means the bridge spans at some angle other than a right angle, as shown in Figure 5-1. Skewness can be represented by this angle. This results in the deck not being perpendicular to its abutments and its plan view being a parallelogram. Table 5-1 gives the explanations of all the parameters used in this thesis.



Figure 5-1.skew bridges

Figure 5-2 shows the overview of bridge configurations that located in Netherlands, provided by Dutch Ministry of Infrastructure and Water Management. Four subfigures A, B, C and D, y-coordinate indicates the distribution of span width, span length, skewness, thickness respectively and x-coordinate represents the cumulative number of bridges. It is seen that, most of the bridges in Netherlands have a span width between 5m to 20m, and a span length between 6m to 20m. The angle of skewness usually located in  $40^\circ$  to  $90^\circ$ , and the thickness of bridge deck is between 0.3m to 1.3 m.

Table 5-1. Illustration of parameters

Parameters	Illustration	Explanation
Skewness		Skewness is presented by the angle of the parallelogram shaped deck.
Width		Total width of span.
Span length		The length of span. Different span can have different length. In this report, the length of span2 is 1.5 times longer than span1.
Averaging thickness		Integration of the thickness along longitudinal direction divided by the total thickness.
Thickness ratio		Ratio between the maximum thickness and minimum thickness of one span.

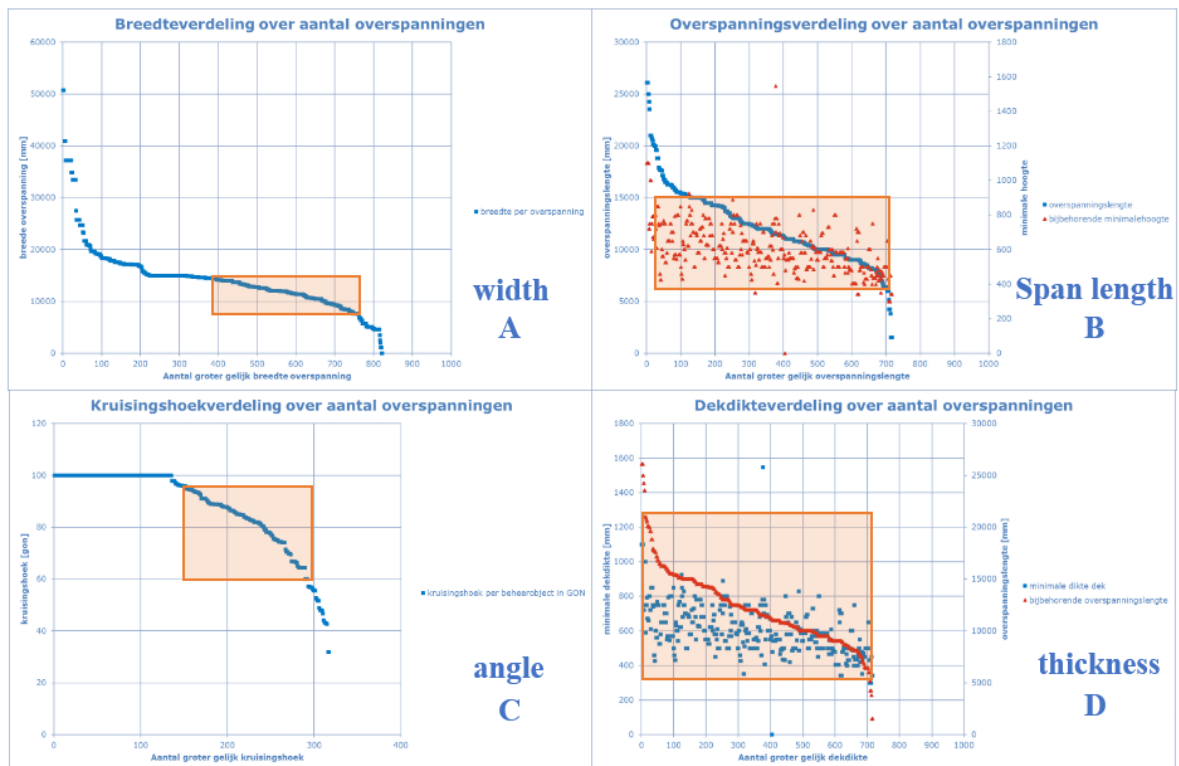

Figure 5-2. The scope of parameters

The scopes of parameters that are considered in this report have been indicated in Figure 5-2 with shaded boxes. Table 5-2 gives more specific values of the ranges for each parameter. In this report, the influence of parameters on critical proof load are limited within geometrical parameters. Other parameters such as material properties are out of the scope.

Table 5-2. Specific value of scopes

Parameters	ranges
Skewness	90 °-60 °
Span width	9m-13m
Span length	6m-15m
Averaging thickness	0.3m-1.3m
Thickness ratio	1.10-2.8

### 5.2 Combinations of parameters.

Five different parameters shown in Table 5-2 has been divided into four different groups based on their dependency, namely, span length and thickness group, thickness ratio group, width group and skewness group. Explanation of these parameters will be given at the beginning of chapter 5. Table 5-3 indicates the combinations of different parameters.

Table 5-3. Combinations of parameters

Parameter 1 \ Parameter 2	Skewness	Width	Length & thickness	Thickness ratio
Skewness		✓	✓	✓
Width	✓		✗	✗
Length & thickness	✓	✗		✗
Thickness ratio	✓	✗	✗	

Figure 5-3 shows the scope of different combinations. Skewness group is combined with width group, length and thickness group, and thickness ratio group respectively, and the latter three groups are not combined with each other.

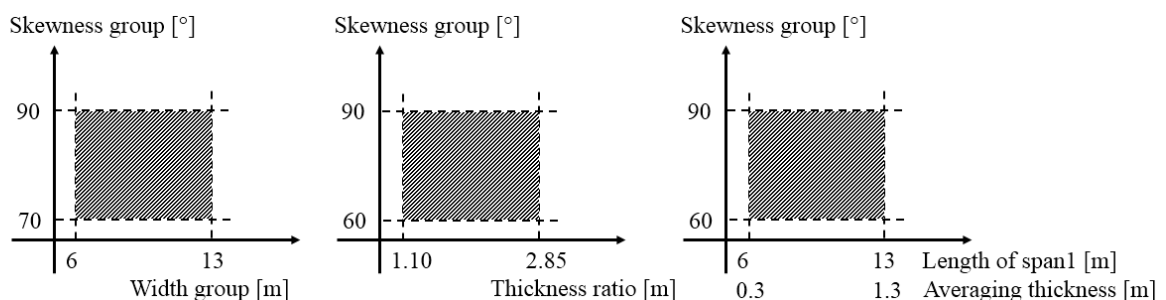

Figure 5-3. Visualization of combined parameters

### 5.3 An Example Figure

This section gives explanations of how the figures that used in the following sections are obtained. Generally speaking, there are two different types of graph. Namely, the [Critical Position Factor - variable] graph and [Equivalent Loading Factor - variable] graph. Variable depends on the group they belong to, which could be span length, width, skewness and thickness ratio.

Critical position factor  $k_p$  equal to critical loading position divided by the length of span1. Critical loading position is the corresponding position of axle loads of tandem system which can lead to the maximum modified bending moment  $M_{md,max}$ . Dividing by the length of span1 is to eliminate the effect of different span length.

Equivalent loading factor  $k_q$  is a factor to compensate the absence of distributed force as discussed in chapter 3.

Figure 5-4 shows an example of [critical position factor - length of span1] graph. For span1 length equal to 10.8m and with an angle of  $90^\circ$  (no skewness), python scripts run the analyses for different loading positions automatically and a blue curve shown in the small graph can be obtained. The corresponding critical position factor is 0.37, which means for this certain bridge configuration, the proof load should be placed at the location where is  $0.37 \times L_{span1}$  away from the start of the span. Then, python scripts run another bridge configuration with different span length but with the same skewness, a straight blue line in Figure 5-4 can be obtained.

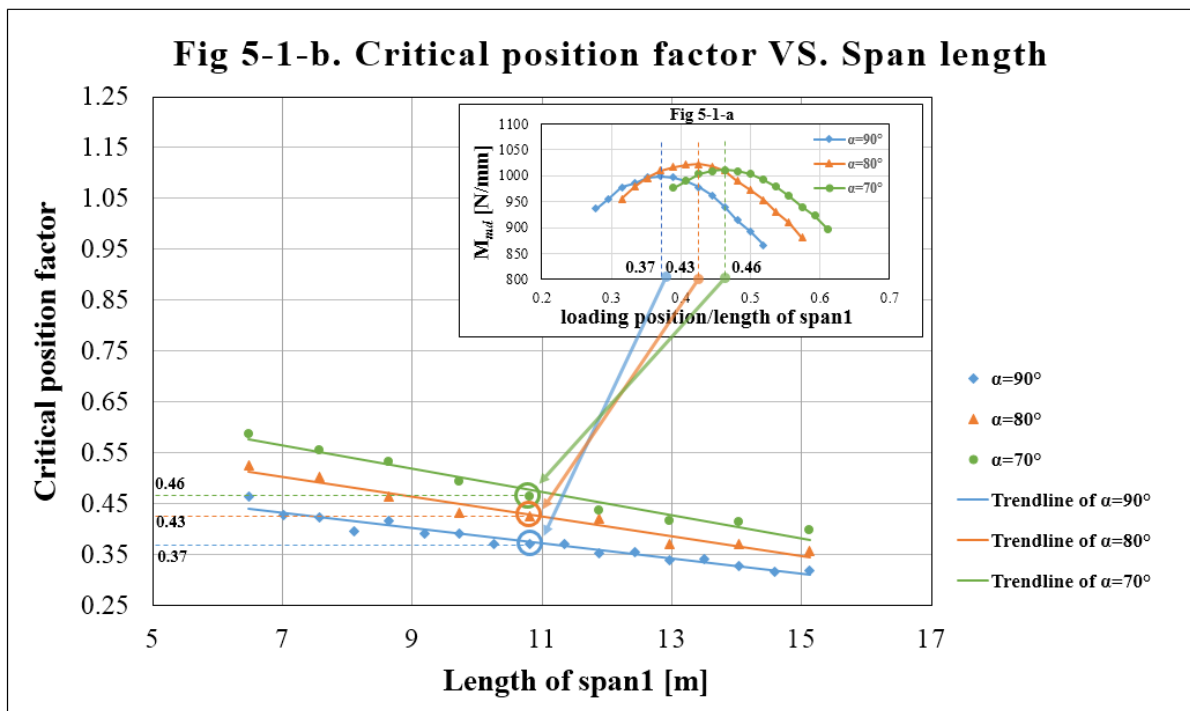

Figure 5-4. An example of graph

### 5.4 Skewness Group

Bridge configuration used in this group is based on De beek. The length of span1 and span2 are 10.8m and 15.4m respectively, with an averaging thickness of 0.7m. Width equals to 9.94m. The only difference is the angle of skewness as the variable changing from 50 ° to 90 °.

Figure 5-5 shows the relation between critical position factor  $k_p$  and the angle of skewness. Here it is seen that with the decrease of angle  $\alpha$  (or the increase of skewness),  $k_p$  increase from 0.36 to 0.56, which means the critical proof load moves away from the start of span1 to the middle part. Trendline shows a linear relation between  $k_p$  and  $\alpha$ . Figure 5-6 described the linear relation between equivalent loading factor and skewness.

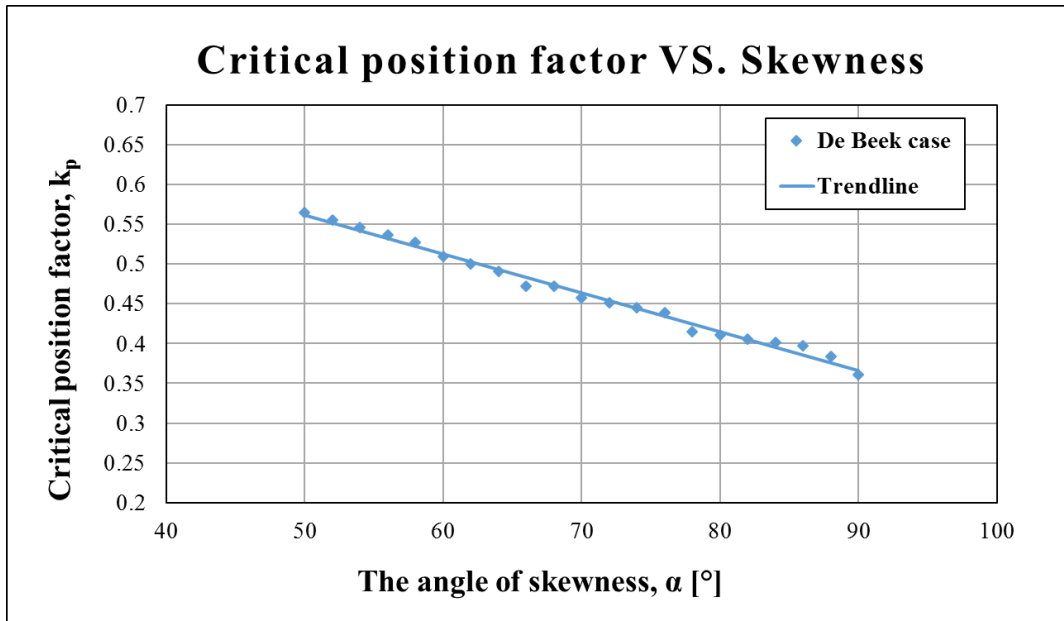

Figure 5-5. Critical position factor versus skewness

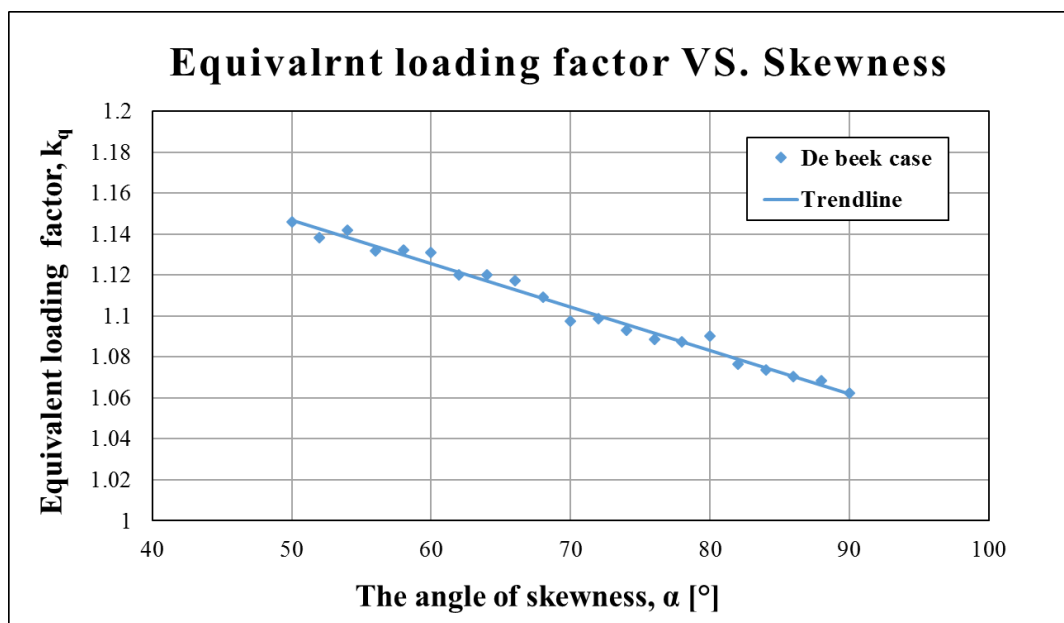

Figure 5-6. Equivalent loading factor versus skewness

### 5.5 Width Group

Still take De beek bridge as reference, now change the variable from skewness to width and keep other parameters remain unchanged. It can be seen from Figure 5-7 that  $k_p$  increases with a constant speed when the angle  $\alpha$  drops, the same trend also shown in previous figures. However,  $k_q$  remains the same with the change of span width, which means the critical loading position cannot be affected by span width.<sup>3</sup>

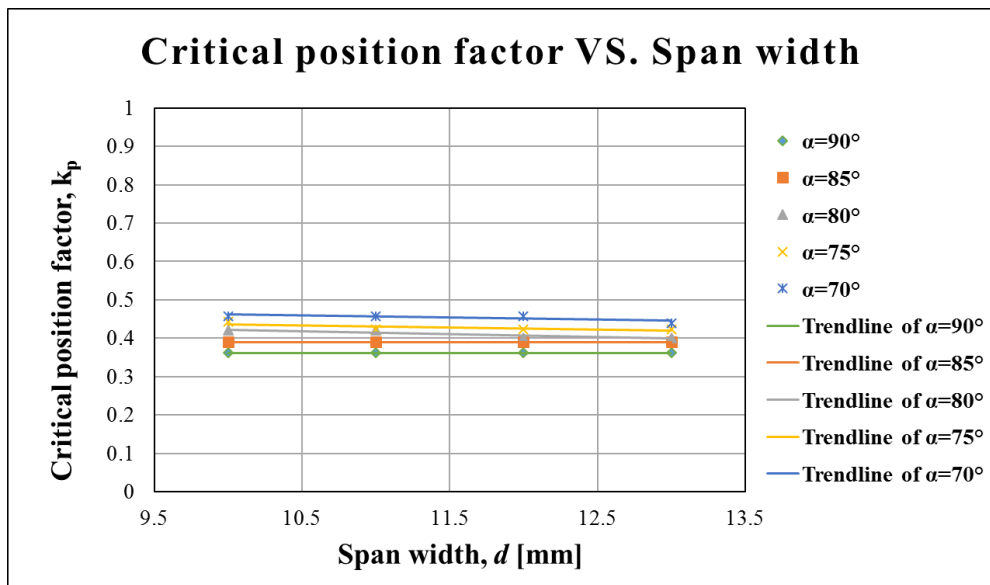

Figure 5-7. Critical position factor versus width

In Figure 5-8, even though a small slope can be observed, it still can be concluded that span width can hardly affect equivalent loading factor. Since within the scope shown in abscissa, the influence is so slight that can be ignored.

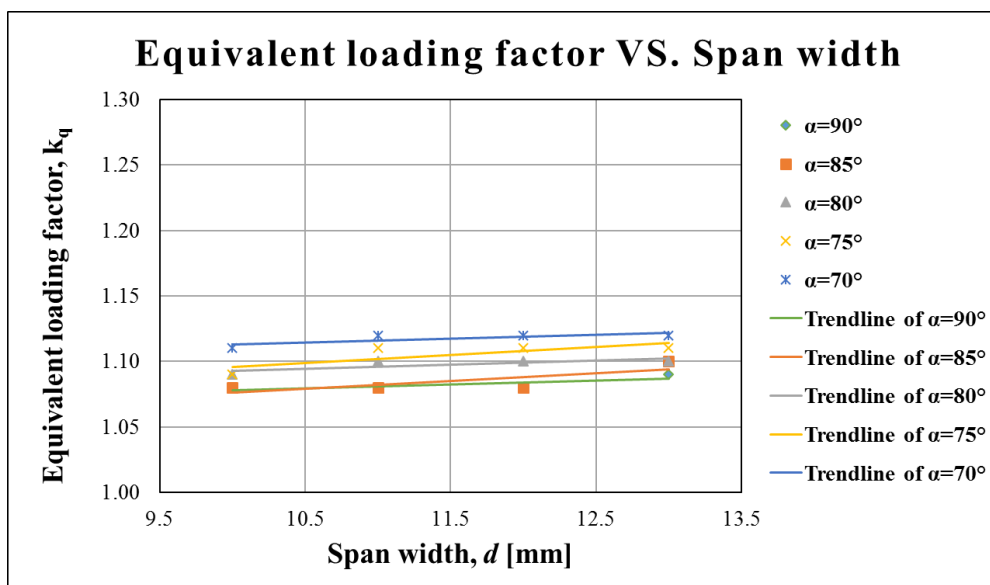

Figure 5-8. Equivalent loading factor versus width

<sup>3</sup> The increase of width may lead to increase of notional lanes, which is not included in this graph. Further data is needed to search the influence of extra notional lanes on critical proof load.



### 5.6 Span Length and Thickness Group

This group contains two parameters since they are not independent. When increase the length of span, the thickness need to be increased too, and they satisfy the following relation:

$$\left(\frac{l_i}{l_0}\right)^2 = \frac{t_i}{t_0}$$

In this group, the length of span1 changes from 6.48 to 15.12m and with a corresponding thickness changing from 0.169 to 0.921m. Figure 5-9 shows the relation between  $k_p$  and length  $l$ . Taking  $\alpha=90^\circ$  as an example,  $k_p$  decreases linearly with the increase of length  $l$ . However, the decreasing trend shown for all angle ranging from  $60^\circ$  to  $90^\circ$ , but slopes are different. It can be seen that, the intervals between different angle at  $l=6.58m$  is larger than intervals at  $l=15.12m$ . This means span length  $l$  not only can affect the critical loading position, but also can influence the relation between  $k_p$  and  $\alpha$ .

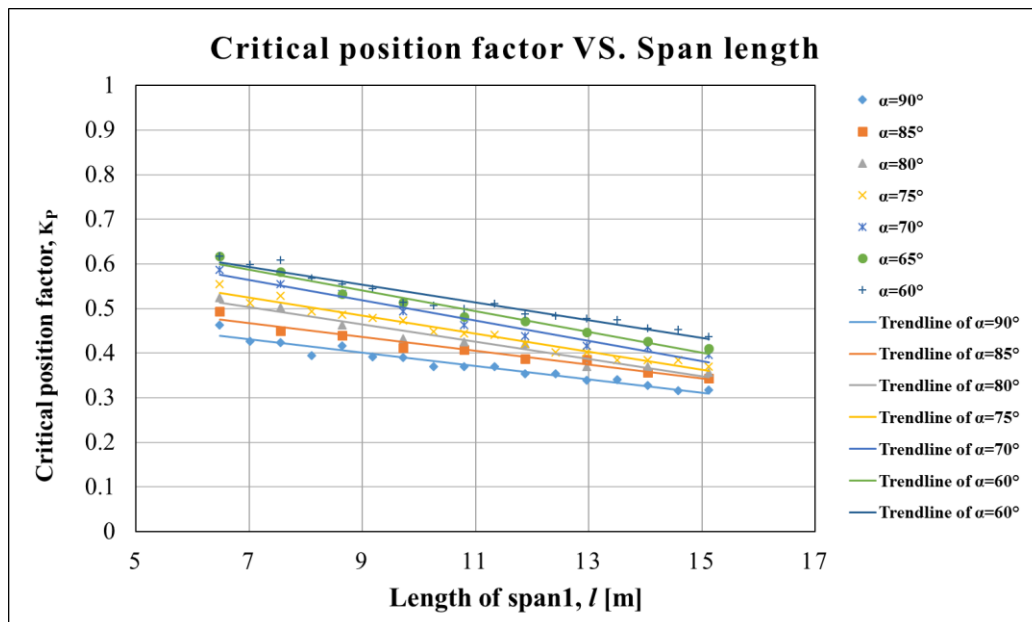

Figure 5-9. Critical position factor versus span length

Figure 5-10 presents the relation between equivalent loading factor  $k_q$  and length of span1. Here it is seen that  $k_q$  increases with the increase of span length, and the trendlines show the linear relation. Whereas, it can also be observed that the intervals of adjacent trendlines become larger with the decrease of angle. The interval between trendlines of  $\alpha=60^\circ$  and  $\alpha=65^\circ$  is the largest. Trendlines of  $90^\circ$  and  $85^\circ$  are almost overlapped.

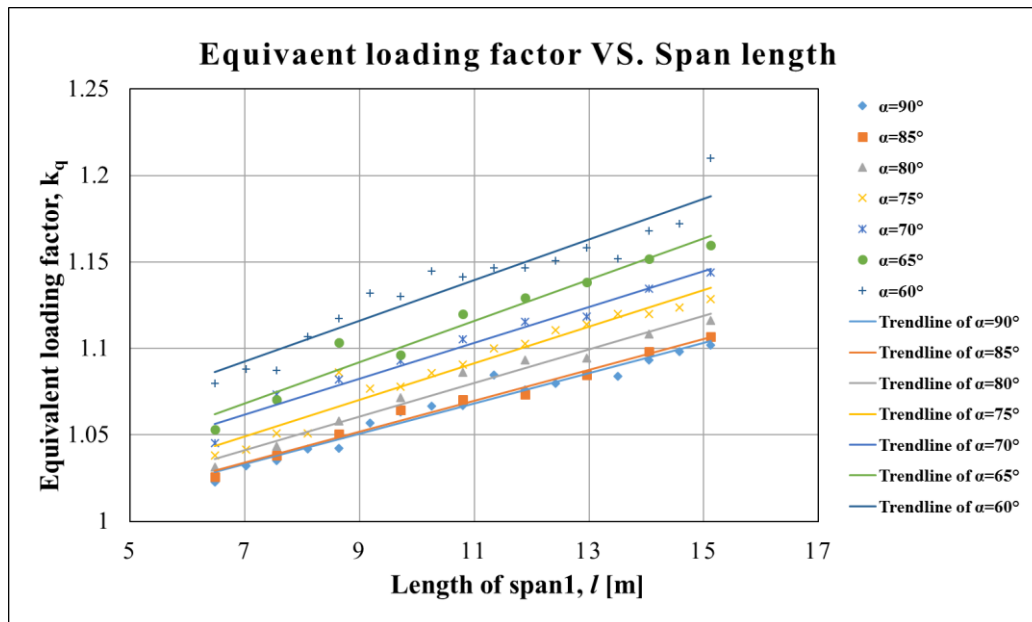

Figure 5-10. Equivaent loading factor versus span length

### 5.7 Thickness Ratio Group

Thickness ratio can be calculated as:

$$r = \frac{d_{\max}}{d_{\min}}$$

Where:

$d_{\max}$  is the thickness of the thickest part of span1, usually located at the ends of span.

$d_{\min}$  is the thickness of the thinnest part of span1, usually located at the middle of span.

The change of thickness ratio means the change of thickness distribution. Figure 5-11 presents the configurations of different thickness ratio. When  $r=1$ , the bridge deck is a slab, and with the increase of  $r$ , the change of thickness along longitudinal direction becomes faster. In this group, thickness ratio as variable changes from 1.10 to 2.85, and other parameters remains unchanged as the reference case. The change of thickness ratio is manipulated in a way that the thickness distribution changed but the averaging thickness stays the same. This means that the self-weight remains the same as well.

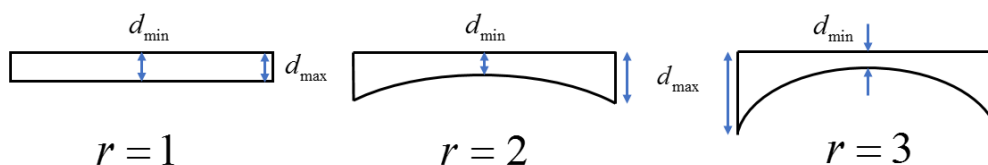

Figure 5-11. Configurations of different thickness ratios

Figure 5-12 shows the relation between critical position factor  $k_p$  and thickness ratio  $r$ . Here it is seen that the change of  $k_p$  based on  $r$  can be predicted by using a parabolic curve. When  $r$  is smaller than 1.85, there is a strong dependency between  $k_p$  and  $r$ . When  $r$  becomes relatively large, for instance between 2.35 and 2.85,  $k_p$  is not sensitive to  $r$  anymore. It also can be seen that, the intervals between different curves are the same, which means with the increase of  $\alpha$ , critical position factor decreases with a constant speed.

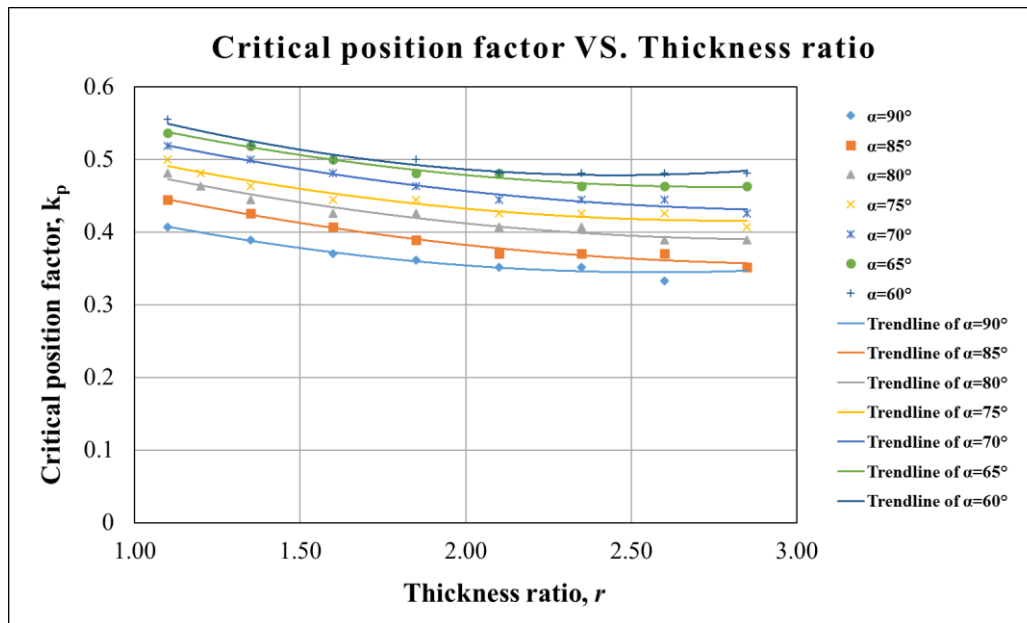

Figure 5-12. Critical position factor versus thickness ratio

The relation between equivalent loading factor  $k_q$  and thickness ratio  $r$  can be predicted by using straight lines as shown in Figure 5-13.  $k_q$  decreases with the increase of  $r$ . However, the slopes of those lines are different. Here it is shown that with the increase of angle  $\alpha$ , the slope becomes leveller. This means the sensitivity between  $k_q$  and  $r$  can be affected by skewness.

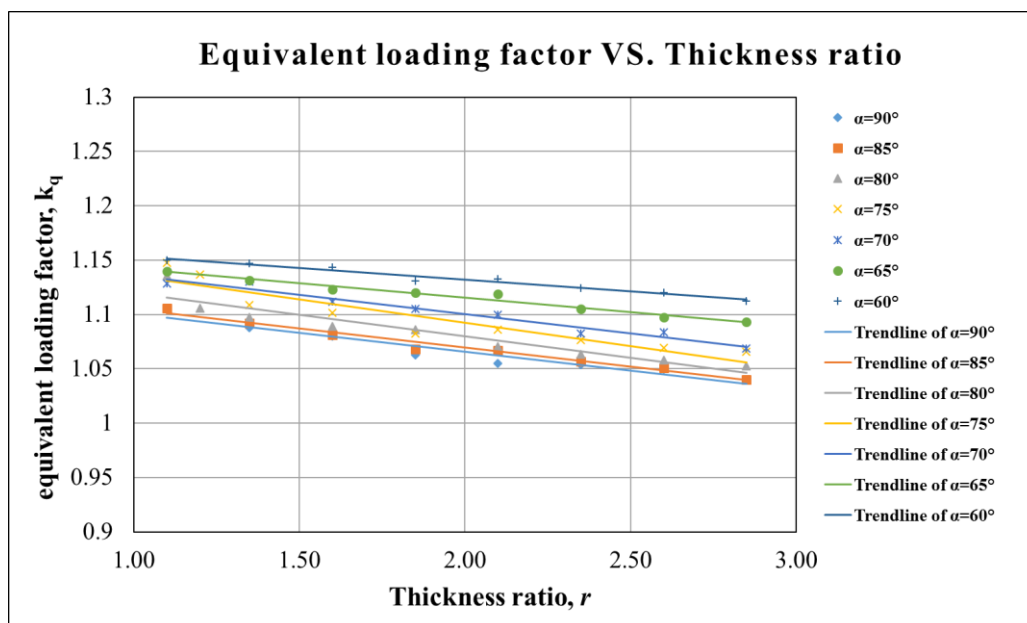

Figure 5-13. Equivalent loading factor versus thickness ratio

## 5.8 Extrapolation of the General Formulas

As shown in the previous sections,  $k_p$  and  $k_q$  can be affected by span  $l$ , thickness ratio  $r$ , and angle  $\alpha$ . Thus,  $k_p$  and  $k_q$  are functions of  $l$ ,  $r$  and  $\alpha$ .

- 1) For critical position factor  $k_p$ . Figure 5-9 shows when  $r$  remains unchanged,  $k_p$  can be written as:

$$k_p = x_1 l + x_2 l \alpha + x_3 \alpha + x_4$$

where,  $x_i$  is unknown and need to be determined.

It can be observed from Figure 5-12 that when  $l$  stays the same,  $k_p$  can be written as:

$$k_p = x_1 r^2 + x_2 r + x_3 \alpha + x_4$$

$k_p$  can be described by using the following function if  $l$  and  $r$  are assumed to be coupled:

$$k_p = x_1 l (x_2 r^2 + x_3 r) + x_4 l \alpha + x_5 \alpha + x_6$$

which can also be written as:

$$k_p = x_1 l r^2 + x_2 l r + x_3 l \alpha + x_4 \alpha + x_5$$

- 2) For equivalent loading factor  $k_q$ . It can be observed from Figure 5-10 that when  $r$  remains unchanged,  $k_q$  can be written as:

$$k_q = x_1 l + x_2 \alpha + x_3$$

When  $l$  remains unchanged,  $k_q$  can be written as:

$$k_q = x_1 r + x_2 r \alpha + x_3 \alpha + x_4$$

$k_q$  can be described by using the following function if  $l$  and  $r$  are assumed to be coupled:

$$k_q = x_1 l r + x_2 r \alpha + x_3 \alpha + x_4$$

$x_i$  are determined by applying linear least squares regression [7] with 166 points obtained from numerical results. Formulas of  $k_p$  and  $k_q$  can be written as:

$$k_p = 0.002 l r^2 - 0.0123 l r - 0.000038 l \alpha - 0.0043 \alpha + 0.9684$$

$$k_q = 0.0055 l r - 0.0012 r \alpha + 0.000043 \alpha + 1.1518$$

Where,

$l$  is the length of tested span. Unit: meter [m].

$r$  is the thickness ratio as shown in 5.7

$\alpha$  is the angle of skewness. Unit: degree [°]

A comparison has been made between the numerical results and the predicting results calculated by using the above formulas. For  $k_p$ , among all the 166 points, the maximum relative error is 8.8% and the mean relative error is 2.1%. For  $k_q$ , the maximum relative error is 3.1% and the mean relative error is 0.59%.

### 5.9 Sensitivity of $k_p$ and $k_q$

For critical position factor  $k_p$ , applying the critical proof load at the predicted position with an allowable error of  $\pm 0.5\text{m}$  will lead to a maximum error of 2% in the final results. A further increase of the allowable error will dramatically increase the error in final results. Thus, it is recommended that to apply the proof load within an allowable error of  $\pm 0.5\text{m}$ , as shown in Figure 5-14.

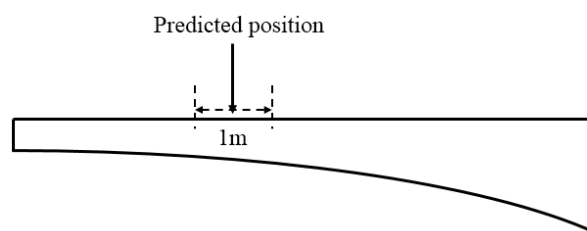

Figure 5-14. Recommended loading range

For equivalent loading factor  $k_q$ , the relation between error of  $k_q$  and error of modified bending moment can be seen as a linear relation within an error of 10%. For instance, if applied proof load is mistakenly increased 10%, the modified bending moment will increase around 10% as well.

## 6 Conclusion and Recommendation

Bridges with different geometrical configurations have been searched with linear finite element analysis. The aim is to find the position and value of critical proof load. Four different parameters, namely span length, width, skewness and thickness ratio, their influence on proof load are found. In total, 166 sets of data are obtained by performing more than thousands of finite element analyses. Formulas for calculating critical position factor  $k_p$  and equivalent loading factor  $k_q$  are obtained by these data and they are approved to be capable enough to predict the results.

Recommendations are discussed in the following paragraphs, most of the recommendations mentioned below can be achieved by directly modifying the python script.

According to LM1, EC1.2. The increase of width may lead to increase of notional lanes, which is not included in this thesis. Further analysis is needed to search the influence of extra notional lanes on critical proof load.

The equivalent critical proof load is found by applied two sets of tandem systems. However, in reality the second tandem system (related to notional lane 2) is not always possible. The equivalent critical proof load of one tandem system can be obtained by modifying the python script.

In this report, only RBK Newly built level has been applied.  $k_p$  and  $k_q$  of other levels can be obtained by simply change the design load in python script.

The thickness distribution has been simplified into circular curve. Whereas, this is not exactly the case for reality. The thickness distribution is more complicated in reality, it is considered necessary to describe the thickness in a more accurate way since the bending moment is very sensitive to thickness.

The parameters that analysed in this report is span length, width, skewness and thickness ratio, however, there more parameters can be included, such as the number of spans, the length ratio between different span etc. Also, for width and skewness, the scope is not fully covered all the bridges in Netherland. For example, there are around 7% of the bridges with an angle of skewness less than  $60^\circ$  which is not considered in this report. Thus, it is recommended to enlarge the scope for width and to gain a more comprehensive result.

To support the numerical results, it is recommended to perform experiments so that the numerical results can be compared with experimental results.

## Bibliography

- [1] Eurocode, NEN-EN 1991-2+C1/NB, in National Annex to NEN-EN 1991-2+C1: Eurocode 1: Actions on structures – Part 2: Traffic loads on bridges., 2011.
- [2] Hand book4, Design of bridges, Guide to basis of bridge design related to Eurocodes, 2005.
- [3] CEN, Eurocode 2. Design of Concrete Structures—Part 1–1: General Rules for Buildings, NEN-EN 1992-1-1:2005, Brussels, Belgium: Comité Européen de Normalisation, 2005, p. 37.
- [4] Rijkswaterstaat, Richtlijnen beoordeling kunstwerken, in Beoordeling van de constructieve veiligheid van een bestaand kunstwerk bij verbouw, gebruik en afkeur., 2013.
- [5] R. T. Koekkoek, E. O. Lantsoght, Y. Yang and D. A. Hordijk, “Assessment of Viaduct De Beek by Proof Loading,” Delft, 2017.
- [6] M. Jonna and P. K. Wijtze, User’s Manual - Material Library, 10.2, Ed., Delft, the Netherlands: DIANA FEA BV, 2017.
- [7] “Python code for ordinary least squares model,” [Online]. Available: [http://www.statsmodels.org/dev/generated/statsmodels.regression.linear\\_model.OLS.html](http://www.statsmodels.org/dev/generated/statsmodels.regression.linear_model.OLS.html).

## **Link of Codes**

Python script is available at:

<http://resolver.tudelft.nl/uuid:4ae6e2e1-39c2-455b-8435-7ef0bcea6ad3>