

**Performance evaluation of real time control in urban wastewater systems in practice
Review and perspective**

van Daal-Rombouts, Petra; Gruber, Günter; Langeveld, Jeroen; Muschalla, Dirk; Clemens, Francois

DOI

[10.1016/j.envsoft.2017.06.015](https://doi.org/10.1016/j.envsoft.2017.06.015)

Publication date

2017

Document Version

Accepted author manuscript

Published in

Environmental Modelling & Software

Citation (APA)

van Daal-Rombouts, P., Gruber, G., Langeveld, J., Muschalla, D., & Clemens, F. (2017). Performance evaluation of real time control in urban wastewater systems in practice: Review and perspective. *Environmental Modelling & Software*, 95, 90-101. <https://doi.org/10.1016/j.envsoft.2017.06.015>

Important note

To cite this publication, please use the final published version (if applicable).
Please check the document version above.

Copyright

Other than for strictly personal use, it is not permitted to download, forward or distribute the text or part of it, without the consent of the author(s) and/or copyright holder(s), unless the work is under an open content license such as Creative Commons.

Takedown policy

Please contact us and provide details if you believe this document breaches copyrights.
We will remove access to the work immediately and investigate your claim.

PERFORMANCE EVALUATION OF REAL TIME CONTROL IN URBAN WASTEWATER SYSTEMS IN PRACTICE: REVIEW AND PERSPECTIVE

Petra van Daal^{1,2,*}, Günter Gruber³, Jeroen Langeveld^{1,4}, Dirk Muschalla³, François Clemens^{1,5}

¹ Delft University of Technology, P.O. Box 5048, 2600 GA Delft, The Netherlands

² Witteveen+Bos, P.O. Box 233, 7400 AE Deventer, The Netherlands

³ Graz University of Technology, Stremayrgasse 10/I, 8010 Graz, Austria

⁴ Partners4UrbanWater, Javastraat 104A, 6524 MJ Nijmegen, The Netherlands

⁵ Deltares, P.O. Box 177, 2600 MH Delft, The Netherlands

*Corresponding author's contact details: p.m.m.vandaal-rombouts@tudelft.nl, +31 6 5090 9369

Highlights

- In literature no consensus on evaluation of RTC in urban wastewater systems exist
- Main deficiencies are lack of uncertainty analysis and too short evaluation periods
- A methodology is proposed for the performance evaluation of RTC in practice
- (Dis)advantages of a data or model driven evaluation are discussed
- The need for uncertainty analysis and a proper evaluation period is demonstrated

Abstract

Real time control (RTC) is generally viewed as a viable method for optimising the performance of urban wastewater systems. A literature review on the performance evaluation of RTC demonstrated a lack of consensus on how to do this. Two main deficiencies were identified: omitting uncertainty analysis and applying limited evaluation periods. A general methodology to evaluate the performance of RTC in practice, that takes into account these deficiencies, is proposed. The methodology is either data or model driven and the (dis)advantages of each are discussed. In a case study for a combined sewer system with limited discharge to a WWTP, it is demonstrated that the successful application of RTC and the possibility to determine a significant effect is very much dependent on the goal. It also clearly illustrates the need for taking uncertainties into account and that careful consideration in the chosen evaluation period is required.

Keywords

evaluation period, monitoring, modelling, RTC, uncertainty analysis, urban drainage systems

1. Introduction

In the past decades real time control (RTC) has been a research topic of interest in the field of urban wastewater systems. (Schilling, 1989) describes some of the first steps in RTC in this field, (Schütze et al., 2004) give a state of the art in the following years and a recent overview can be found in (García et al., 2015). At several locations RTC has been implemented and described in publications, see e.g. (Fradet et al., 2011; Fuchs and Beeneken, 2005; Seggelke et al., 2013). Such papers generally claim that the application of RTC improves the operation of the system; it leads for example to fewer combined sewer overflow (CSO) discharges. Overall, RTC is viewed as a viable method to reduce the impact on natural aquatic systems, to improve the operation of urban wastewater systems and to help adapt the systems to changing conditions.

Looking in more detail to the performance evaluation of RTC, most applied methods are deficient in two aspects: i) uncertainties are not accounted for, and ii) only a few events or short periods are applied. The first represents a lack of certainty on the significance of the outcome, whether the uncertainty arises from measurement uncertainty and model output uncertainty (originating from a combination of input, model structure or parameter uncertainty), see e.g. (Deletic et al., 2012). The second leads to an evaluation based on a limited range of conditions under which RTC in urban wastewater systems is operated. Knowing this, claims on the effectiveness of RTC in urban wastewater systems, without addressing the deficiencies outlined, can be viewed as just that.

This paper contributes to the discussion on the effectiveness of RTC in urban wastewater systems in practice and how to evaluate that. Questions on how to deal with ever changing conditions in real life situations and the need for and implications of including uncertainty analysis are addressed. It will focus on systems that at least encompass a combined sewer system. 'Regular' process control of wastewater treatment plants (WWTPs), such as aeration or return activated sludge control, is considered beyond the scope of this paper, as this topic is dealt with intensively in literature (Olsson, 2012; Olsson et al., 2014). On contrary, integrated control of urban wastewater systems is still considered to be at an early stage of development.

The paper is organised as follows: In the next section literature related to implemented RTC in urban wastewater systems is reviewed, resulting in the formulation of a more detailed problem statement. Section 3 proposes a methodology for the performance evaluation of RTC in practice. This is followed by a case study in section 4 to show the impact of the evaluation period and uncertainty analysis on the effectiveness of two RTC scenarios on a simple and easy to understand sewer network. Section 5

discusses the results from the case study and the methodology itself. Finally, conclusions are drawn and suggestions for further research are made.

2. Problem statement

RTC, hereby defined as changing the operation of an urban wastewater system based on real time measurements without changing its infrastructure, is claimed to be an effective and efficient manner of optimising a systems functioning with respect to a certain goal, see e.g. (Erbe et al., 2002; Fuchs and Beeneken, 2005; Nelen, 1992; Puig et al., 2009). Changes in the system objectives over time, e.g. from minimising the CSO volume towards minimising the overall impact on the receiving water body, are important drivers for RTC. Apart from this, imbalances in the system due to a faulty design, improper adaptation, uneven loading, or changes in design principles in an organically grown system, can cause unwanted effects that may also enhance the need for RTC.

Many developments in RTC in urban wastewater systems have taken place based on modelling exercises, for both hypothetical systems and 'real-world' case studies. For example (Schilling et al., 1996) describe an early application of RTC on a sewer system and wastewater treatment plant combined. (Einfalt et al., 2001) introduce the central basin approach, that to date in German speaking countries is viewed as the method to define the optimum controlled state of a system. (Erbe and Schütze, 2005) further integrate the modelling environment and take a quality approach. (Vanrolleghem et al., 2005) deal with the difficulties of preparing an integrated model for RTC application. An investigation into the effect of rainfall forecasting on the runoff and its potential for RTC are described by (Krämer et al., 2007). (Schütze et al., 2008) introduce the German M180 guideline document for the planning of RTC systems in urban drainage catchments. Equipment needed for the implementation of RTC is reviewed by (Campisano et al., 2013) and the effort needed is described by (Beeneken et al., 2013). (García et al., 2015) give an overview of and references for different implementation levels, optimisation strategies and software tools for RTC in urban wastewater systems. Recently, (Garbanini Marcantini et al., 2016) claim intermittent operation of RTC can help determine the impact of RTC more easily and (Löwe et al., 2016) looked into the influence of rainfall forecasting and its uncertainties on RTC strategies. For WWTPs, a benchmark for control strategies has been developed, allowing to test strategies in a general sense in a controlled model environment (Alex et al., 1999). This procedure is very promising for mutually comparing the effectiveness of control strategies at WWTPs, but not to quantify the added value of the control in urban wastewater systems in reality. This is due to for example the propagation of errors between

subsystems, the difference between model results and reality and the influence of operational issues.

Simultaneous to these developments, at several locations RTC has been implemented in practice, for which a non-exhaustive and concise overview will be presented. Unless stated otherwise the main objective of the applied RTC is reduction of CSO activity, possibly at specific sites. As early as 1994 a model predictive control strategy was prepared for implementation in Seattle (Gelormino and Ricker, 1994). (Fuchs and Beeneken, 2005) describe the process of implementing a rule-based control that includes rainfall forecasts in Vienna. In Quebec, a model predictive control RTC system based on rain forecasts is executed in a stepwise manner. The first phase is presented in detail in (Pleau et al., 2005), while (Fradet et al., 2011) describe the later phases and the project in a wider scope. The applied model and global control development for Berlin is described in detail in (Pawlowsky-Reusing, 2006). In Copenhagen RTC is implemented as described in (Grum et al., 2011). It includes risk assessment and flow forecasting. (Hoppe et al., 2011) describe the development of a pollution based RTC strategy for the separate sewer system of Wuppertal. In Wilhelmshaven the aim of the implemented RTC is twofold: CSO reduction and WWTP influent limitation in case of critical situations. (Seggelke et al., 2013) describe the effectiveness based on one year of operation. For Kessel-Lo, (Dirckx et al., 2014) provide details on construction and cost aspects regarding the implemented RTC. A recent application of RTC in the sewer system of Bordeaux is described in (Robitaille et al., 2016) , including an evaluation over a period of three years.

A table, summarising the system type, control type, objectives and evaluation characteristics (period and whether uncertainty analysis was performed) of the papers dealing with RTC performance evaluation referred to in the previous paragraphs, is presented in the supplementary material.

From the papers that deal with implemented RTC systems, the current practice for a performance evaluation of implemented RTC systems in the field of urban wastewater management was extracted. First of all, a performance evaluation is not always carried out (or reported). When it is executed, there is no consensus on the procedure. It is generally (with a few exceptions) based on either less than ten storm events or over a period of maximum a few months only. Comparisons are made between the systems functioning with and without RTC based on measurements or modelling results or a mixture of both. Only two publications were found that describe the effectiveness or functioning of existing RTC over periods longer than 1 year. Second, none of the publications cited report on uncertainties in parameters used for the performance evaluation, leaving the question on the significance of the effect open. Only (Hoppe and Gruening, 2007) and (Breinholt et al., 2008)

make a point for including uncertainty analysis in RTC evaluation, but their call has remained unheard so far. Even (Löwe et al., 2016), who in a modelling exercise do apply uncertainties in the rainfall estimation and use many events from a three year period, still refrain to include uncertainties in the final performance evaluation.

Current practice is thought to originate from the reality of working with actual systems, for customers in a commercial setting along with an unfounded trust in our ability to understand and describe reality in models (Harremoës, 2003). Urban wastewater systems are normally not operated for the purpose of research and therefore changes in set points, operation strategy and even infrastructural adaptations are continuously made. In other words, in practical situations one is never certain about the structure and geometry of the whole considered system, although this is desired from a scientific point of view. High quality measurements are hard to obtain in real working conditions, especially simultaneously and for extended periods of time. Generating a data set for a performance evaluation for a prolonged period is therefore an organisational feat. Uncertainty analysis is believed to be omitted because in actual systems uncertainties are often not known, it is deemed complicated and time consuming, and the results become more difficult to communicate. Customers add to this by expecting (fast) results and preferring their money well spent, at least on paper.

Omitting uncertainty analysis and too short evaluation periods are the two main deficiencies of current practice in performance evaluation of RTC in wastewater management. The first represents a lack of certainty in the significance of the result. An improvement of 10% could easily fall within the measurement or model output uncertainty, thus preventing a firm conclusion on the effectiveness and efficiency of the imposed RTC system. When comparing measurements with imposed RTC and model results without RTC or vice versa, different sources of uncertainty are involved making uncertainty analysis even more essential and cumbersome. The second leads to an evaluation based on a limited range of conditions in which urban wastewater systems are operated. E.g. applying only events in summer or winter might influence the RTCs impact on a WWTP functioning considerably. In addition, prolonged wet or dry weather periods could have a significant impact if they are not included in the data set.

To advance the field of RTC in urban wastewater management the two main deficits stated should be addressed in future work.

3. Methodology

Urban wastewater management is a wide research field and each system and each RTC application is unique. It is therefore impossible to supply one ready-made solution for the evaluation of the effectiveness of RTC. However, it is possible to define general steps that should be followed in every evaluation. These steps, with a distinction between data and model driven evaluations, are combined into a methodology which is described in the following sections. A flow chart for the methodology is supplied in figure 1.

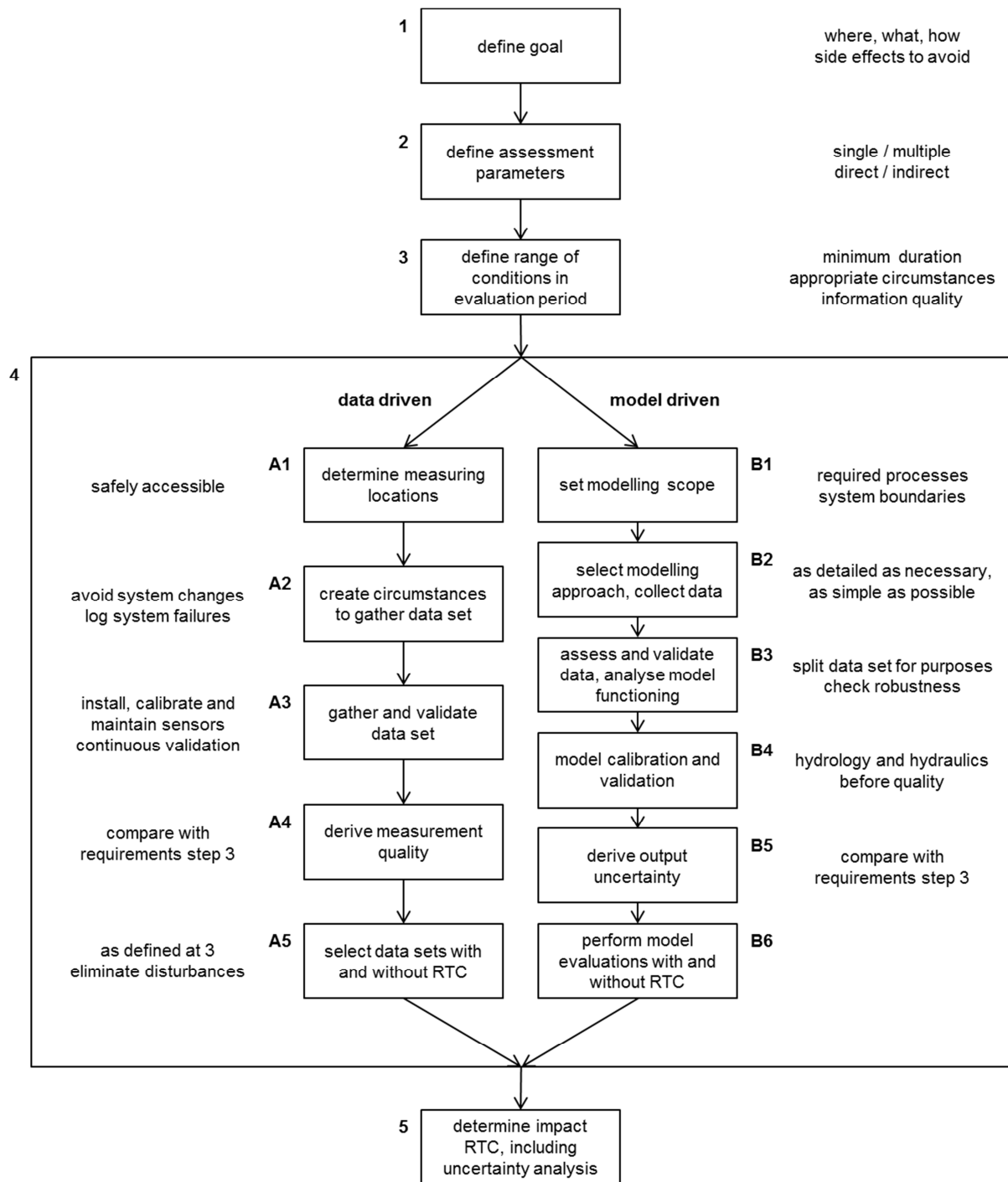

Fig 1. Flow chart for the proposed methodology for determining the impact of RTC in practice using a data or model driven approach.

It is considered beyond the scope of this paper to go into detail on all terminology used in RTC in urban wastewater systems. The reader is referred to review articles such as (Garcia et al., 2015; Schütze et al., 2004) for further definitions.

3.1. General

The first step in undertaking any RTC project is defining a clear goal (step 1 in figure 1). A clear goal describes the overall end one wants to achieve in as much detail as possible to facilitate objective assessment. In urban wastewater management this would specify where (e.g. WWTP influent), what (e.g. load), and how it should be optimised (e.g. minimise). It could also contain possible adverse effects that should be avoided (e.g. without increase of CSOs or causing more frequent flooding). Table 1 contains a list of possible goals classified to several RTC strategies.

Table 1. Overview of possible RTC strategies and examples of accompanying goals in urban wastewater management.

strategy	goal (examples)
emission based	hydraulic load reduction (at CSOs or WWTP influent)
	pollution load reduction (at CSOs, WWTP influent or effluent)
impact based	reduction of toxic discharges
	mitigation of oxygen depletion
	reduction of eutrophication
	reduce hydro morphological impacts
operational optimisation	reduce maintenance needs
	remove sewer sediments
	reduce energy needs

The second step is to determine an appropriate assessment parameter (step 2) to show whether the goal was reached or not. Several parameters might be interchangeable, multiple parameters could be used and also indirect parameters could help in the assessment. E.g. when aiming to reduce CSO discharges, one could try to determine lower CSO discharge capacities but maybe higher WWTP influent flows contain the same information and are more easily established. Table 2 contains examples of RTC goals and possible direct and indirect assessment parameters.

Table 2. Examples of RTC goals and possible assessment parameters.

strategy	goal	assessment (examples)	
		direct/indirect	parameter
emission based	pollution load reduction (at CSOs)	direct	- pollutant concentrations e.g. COD, TSS, NH4 - discharges - frequency and duration
		indirect	- surrogate pollutant concentrations e.g. electric conductivity, turbidity, temperature - visual pollution reports
impact based	prevention of toxic peaks	direct	- river pollutant concentrations e.g. NH4
		indirect	- CSO and/or effluent discharges - surrogate pollutant concentrations at CSOs and/or effluent e.g. electric conductivity, turbidity, temperature
operational optimisation	reduce maintenance needs	direct	- number of maintenance orders - man-hours spent on maintenance
		indirect	- number of pump switches - down time of installations

The third step is to determine the range of conditions needed to evaluate the performance of the applied RTC with respect to the goal (step 3). Matters of importance could be whether the interest lies in long or short term effects, anticipated variability in assessment parameters between events, if seasonal influences are expected, and if dry, wet or changing weather conditions are aimed for. From this the minimum duration and appropriate circumstances for the evaluation period can be determined. The evaluation period should naturally at least encompass the phenomenon that is assessed. As general rule of thumb the evaluation period should be quadratic to the return period of the phenomenon. This step also provides details on the required quality of the information on the assessment parameters such as the frequency and allowed uncertainty.

Further information needs and points of interest depend on the application of a data or model driven evaluation (step 4). They are described in the following sections. Both are aimed at acquiring time

series for the assessment parameters representative for the systems functioning with and without RTC and with known uncertainty intervals. These can then be applied to determine whether the RTC has a significant impact on the systems functioning (step 5) considering the defined goal (step 1). Since step 5 is very dependent on the assessment parameter(s) and evaluation period no further details are supplied. However, in section 4 an example is given where the evaluation is performed for the specified case.

3.2. Data driven evaluation

When carrying out a data driven performance evaluation, great care is needed in gathering and selecting the applied data set. The main points of attention will be addressed following the items numbered 'A' in step 4 in the flow chart in figure 1. First of all (item A1), appropriate measuring locations that provide the information needed within budget should be determined (Thompson et al., 2011). Also the locations should be safely accessible and be vandal-proof.

Then, the right circumstances should be created under which to gather the measurements (item A2). Changes to the system other than the implemented RTC should be avoided. If this is not possible, the changes (what, where, when, why, etc.) should be logged and communicated. This also holds for possible system failures (hardware, software, communication, etc.). Investing in a good working relation with operational personnel will pay off in this respect.

Next, the measurements themselves should be performed (item A3). Since a high quality data set is needed, much effort is required in this respect. Without going into too much detail, the sensors should be carefully installed, calibrated and maintained, and the measurement data should be regularly checked and validated to ensure a high yield. More information on performing high quality measurements can be found in e.g. (Gruber et al., 2004; Schilperoort, 2011), while e.g. (Métadier and Bertrand-Krajewski, 2011; Van Bijnen and Korving, 2008) deal with validation techniques.

Along with item A3, the achieved measurement frequency and uncertainty should be derived (item A4) and compared to the requirements defined at step 3. If it is insufficient, a return to item A3 is needed to improve the quality of the measurements.

Finally, data sets with and without RTC should be selected (item A5). Here, information from step 3 (conditions needed for evaluation), item A2 (logbooks on circumstances during measuring period) and item A3 (validated data set) converge. It goes without saying that enough validated data under

the right circumstances should be available to cover the conditions needed to perform the evaluation for both the situation with and without RTC.

Note that existing data could possibly be used, e.g. for the non-controlled situation, in which case the data itself should be scrutinised and metadata on the measurements and system known in detail.

While the previous description is meant for gathering a new data set, it could also serve as a guideline for working with existing measurements.

3.3. Model driven evaluation

The flowchart in figure 1 also shows the methodology for a model driven performance analysis for RTC in practice, step 4 items numbered 'B'. It is consistent with the modelling practice described in (Muschalla et al., 2009), to which the reader is referred for more details. In this case, the first step (item B1) is to set the scope of the models. System boundaries should be defined that determine which sub-systems have to be considered and which relevant processes have to be included.

As a second step the modelling approach and the models data demand have to be considered (item B2). The modelling approach should be able to meet the requirements from step 3, which means it should be able to model the processes during the appropriate circumstances and deliver the required information. To do so, measurements are required as model input and for model calibration and validation purposes. At this stage, data should be gathered for these purposes and its general adequacy for the tasks evaluated. If no suitable data set is available, the procedure described in the previous section could be adapted for obtaining the necessary measurements.

Next, the data should be validated and assessed (item B3) to see if they meet the conditions set in step 3. Different data sets should be defined that are going to be applied i) the model calibration and validation at item B4, ii) in the model output uncertainty evaluation (item B5), and iii) the simulations for the performance evaluation at item B6. Again further monitoring might be necessary. Also the models' functioning has to be analysed. Preliminary simulations should be checked with respect to the functioning of (possible) sub-models and interfaces, and the robustness of the model output due to uncertainty in the model inputs and parameters.

To ensure the model output is representative for the investigated system the model should be calibrated (identification of the model parameters) and validated (check the predictive capacity of the derived parameter set) (item B4). If applicable, first the hydrologic and hydraulic properties should be calibrated, followed by a calibration of any quality properties. Logically, the calibration

should include the relevant processes. If, for example, high frequency output will be analysed the calibration can't be performed on daily averaged values, or WWTP models should be calibrated for wet weather situations if the response to rain events is relevant.

Based on the prepared model, the uncertainty in the output assessment parameter(s) should be derived (item B5) and compared to the requirements from step 3. For this purpose, simulations with measured input should be performed and the output should be compared to corresponding measurements for the assessment parameter(s). If the output uncertainty is too large, the previous steps need to be retraced to improve the quality of the output.

The final model specific step (item B6) is to perform model simulations with the selected data with and without RTC applied.

Similar to the measurements, here existing models could possibly be used. In this case items B1 to B6 could be followed to check the fitness of the model for the purpose of RTC performance evaluation.

4. Case study

A performance analysis for two RTC scenarios is shown through a case study. The impact of the evaluation period and uncertainty analysis on the effectiveness of the RTC scenarios is investigated. The case study is based on a selection of the wastewater system of Eindhoven, the Netherlands, see (Schilperoort, 2011) for a detailed description. Three sewer catchments were selected and supplemented with a hypothetical transport sewer to a WWTP as boundary condition for explanatory purposes.

4.1. System characteristics

The investigated network consists of three catchments in the south of the Netherlands: Duizel (1), Eersel (2) and Riethoven (3), see figure 2. A fourth basin is added that represents a hypothetical transport sewer to a WWTP. The sewers consist of combined gravity systems with several mm in-sewer storage and limited emptying capacity through pumps (typically < 1 mm/h). Excess wastewater during heavy rainfall is discharged to the surface water through CSOs. Contrary to Duizel, the sewer systems of Eersel and Riethoven are equipped with storm water settling tanks (SSTs) that serve as additional storage prior to discharge to the surface water. An additional CSO without storage is available for the transport sewer. The network characteristics are given in table 3.

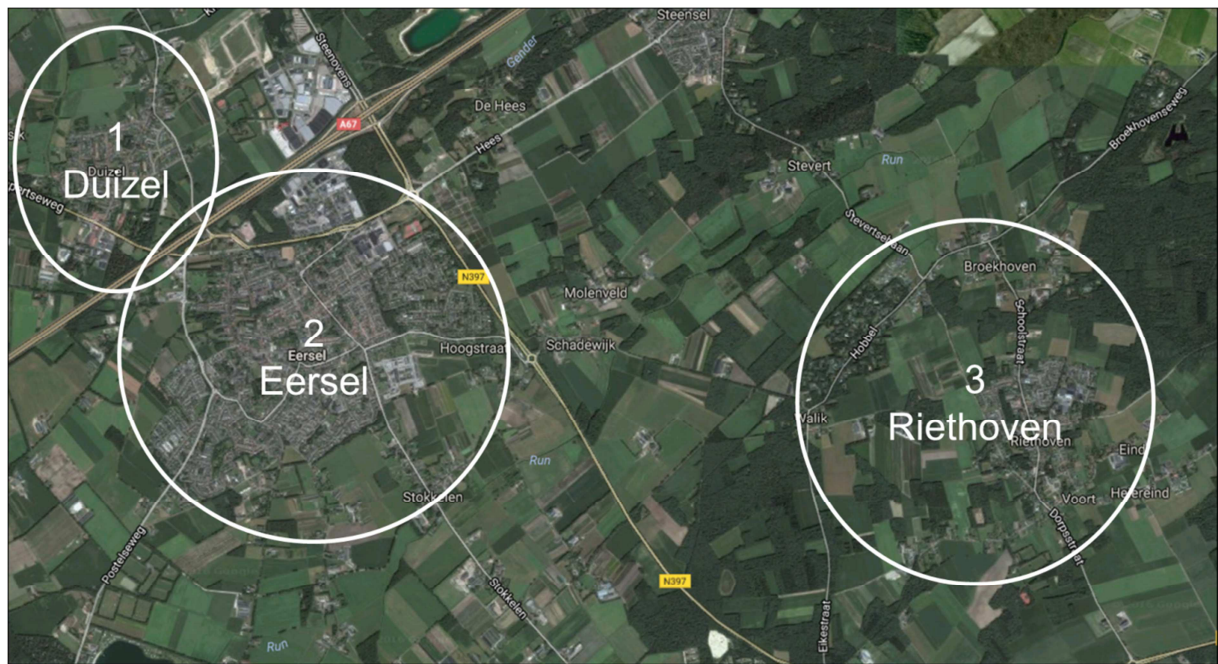

Fig 2. Geographical location of the catchments in the south of the Netherlands applied in the simplified sewer model (source: google maps).

Table 3. Characteristics of the sewer network with basins 1-3 representing actual catchments and basin 4 a hypothetical transport sewer.

basin	inhabitants	connected area	static storage		pump capacity
			network	tank	
	[-]	[ha]	[m ³] - [mm*]	[m ³] - [mm*]	[m ³ /h] - [mm*/h]
1	1,845	10.2	800 - 7.8	n.a.	93.6 - 0.92
2	9,526	88.4	5,747 - 6.5	230 - 0.3	1,101.6 - 1.25
3	2,318	19.0	861 - 4.5	586 - 3.1	140.4 - 0.74
4	n.a.	n.a.	1,176 - 1.0	n.a.	1,100.0 - 0.94

*Conversion from m³ to mm is based on the total connected area draining to the sewer system of the respective catchments. For basin 4 the summed connected area from basins 1 to 3 was applied.

4.2. Measurements

Radar rainfall measurements for the Netherlands with a 1 km² resolution are performed at a 5-minute interval by the Royal Netherlands Meteorological Institute. For each catchment, the radar measurements for the years 2011-2013 were applied. Table 4 summarises some rainfall characteristics for catchment 1, which is very similar to the characteristics for the other catchments.

Compared to the mean annual rainfall in the Netherlands, approximately 800 mm, especially 2013 was a relatively dry year. In 2013 also fewer events occurred that could have led to CSO activity.

Table 4. Rainfall characteristics for catchment 1, which is similar to other catchments. The event volume > 5 mm is chosen as a measure for events that are relevant for CSO discharges based on the in-sewer storage in table 3.

year	total annual rainfall [mm]	number of events [-]	number of events with total rainfall volume > 5 mm [-]
2011	748	226	45
2012	826	266	50
2013	699	216	41

At the pumping stations of catchments 1 to 3 water flows are registered at a 1-minute interval as part of daily operation.

4.3. Model

A simplified model for the sewer network, an overview of which is shown in figure 3, is built in Matlab[®] to simulate the water flows in the sewer network with a 1-minute interval. The model consists of one lumped basin per catchment and converts sewer inflows (dry weather flow (DWF), runoff, pump discharges from other basins), via the basin volume, into outflows (pump and CSO discharges). Basin 4 represents a transport sewer and only receives inflow from basins 2 and 3.

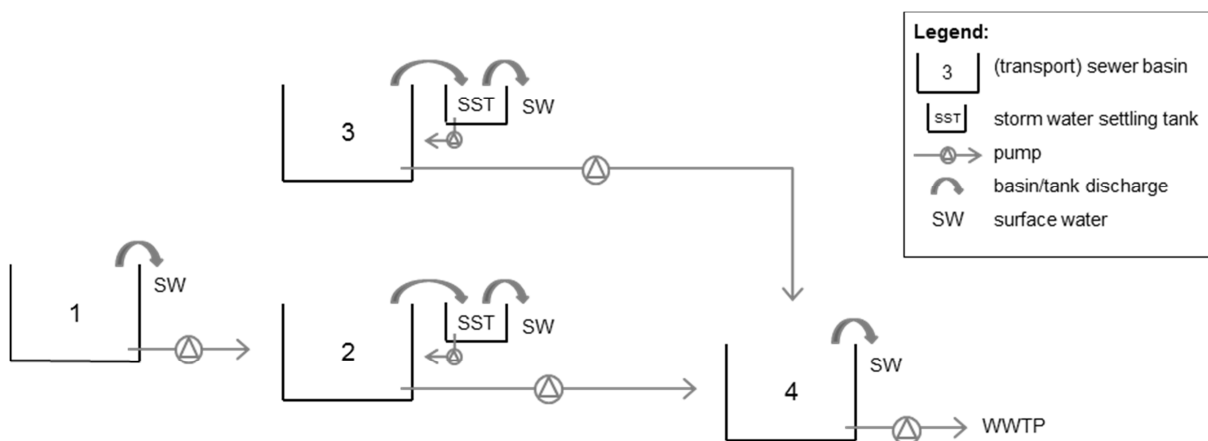

Fig 3. Overview of the simplified sewer model.

Regarding the inflows, diurnal DWF profiles with a water consumption per inhabitant have been generated from the flow measurements at the pumping stations following the procedure described in (Van Daal-Rombouts et al., 2016b). Runoff is calculated from the rainfall series following the Dutch guidelines through the NWRW-model that takes into account evaporation, initial losses, infiltration (Horton approach) and routing delays (linear reservoir). For more information see (Van Luijelaar and Rebergen, 1997).

The outflows are based on the filling degree (FD) of the basins, which is the current volume in the basin divided by the static storage volume of the represented sewer network. Pumps switch on at 2% FD with a linearly increasing capacity until the maximum is reached at 5% FD. For decreasing FDs the pumps remain at their current capacity until the systems are empty. CSOs immediately discharge all water volume above 100% FD. If multiple CSOs exist in the sewer network, they are lumped into one in the simplified model.

SSTs are modelled as separate basins located between a CSO and the surface water. Similar to the CSOs they immediately discharge all water volume in the SST above 100% FD. Filled SSTs are emptied into the corresponding sewer basin in 10 hours once the FD in the affected basin falls below 50%.

4.4. Uncertainty analysis

Uncertainties are included through a forward uncertainty analysis, executed through Monte Carlo simulations. 1000 replicates are simulated and ranked after which the median value (50%) and upper (95%) and lower (5%) boundaries are extracted. Uncertainties in the basin volumes (including dynamic storage) and maximum pump capacities are taken into account according to a normal distribution with 95% confidence intervals of 20 and 10% respectively. No correlation between the uncertainties of the parameters and catchments are assumed. The sampled uncertainties have, however, been kept the same between RTC scenarios to compare their results. The confidence intervals and number of parameters were chosen at the lower end of the representative scale so that the uncertainty in the model output remains as limited as possible.

No uncertainties in the runoff were taken into account, although it is noted that large uncertainties arise from the rainfall and subsequent conversion to runoff. For the sake of the example however, the interest lies in the effect of the RTC on the sewer system functioning (and in this case sewer model functioning) given a specific runoff. This situation reflects practical situations where the runoff is not exactly known, but does not change. Furthermore, the proposed RTC in no way affects the runoff and makes use of hydraulic input only, by-passing uncertainties in the hydrological models.

Both present further reason to exclude runoff uncertainties. This does not imply that whatever runoff can be applied. It should be representative for the actual rainfall and contain enough variation to account for the conditions in which the RTC should be functioning. In this example, it is deemed that the first condition is sufficiently covered by taking an established runoff model as described in the previous section. The second condition will be elaborated upon in the results and discussion sections.

Following the same reasoning, also no uncertainties are taken into account for the DWF. The representativeness is covered by applying calibrated DWF profiles. However, no variation during the year is present. As the DWF accounts for an equivalent of only several mm runoff per day and expected variations are $< 50\%$, this is not deemed to influence the results.

4.5. RTC scenarios

Two rule-based RTC scenarios have been implemented. Both scenarios are based on expert judgement, i.e. no optimisation of the rules was performed. Also no predictive control was applied.

CSO reduction (RTC CSO)

This RTC aims to reduce the CSO occurrence and discharged volumes. The following rules have been implemented:

1. *if the filling degree (FD) of any basin $> 80\%$ then pump at maximum capacity*
2. *if FD of an upstream basin $<$ FD of a downstream basin then limit maximum pump capacity to 85%*

Limit maximum WWTP inflow (RTC WWTP)

This RTC aims to limit the maximum discharge to the WWTP (pumped discharge of basin 4) without increasing CSO occurrence and discharged volumes. The following rules have been implemented:

1. *if the filling degree (FD) of basin 4 $< 80\%$ then limit the maximum pump capacity from 1,100 to 825 m³/h*
2. *if FD of any basin $> 80\%$ then pump at maximum capacity*
3. *if FD of an upstream basin $<$ FD of a downstream basin then limit maximum pump capacity to 75%*

4.6. Results

Before looking into the impact of the RTC scenarios on the systems functioning, first the representativeness of model results for the uncontrolled scenario (from here on referred to as 'reference scenario') was checked. For this purpose, the average number of CSO events per year (approximately 10), the total volume discharged through CSOs relative to the total inflow (approximately 3%) and the percentage of time the pump capacities surpassed 25% of the maximum capacity (<10%) were calculated for the median model result. All match with normal behaviour for sewer systems in flat areas that contain large in-sewer storage volumes and are emptied pumps discharging to a WWTP, see e.g. (Korving, 2004). Therefore, the model is found to represent the sewer systems functioning accurately enough for the purpose of this example.

4.6.1. RTC CSO

The impact of the RTC CSO scenario compared to the reference scenario, for the individual basins for the entire simulation period (2011-2013) and the separate years is displayed in figure 4. Hardly any difference to be found for the number of CSO events and total CSO volume. For both parameters, for every basin and for all displayed periods overlap between the confidence bands of the scenarios occurs. The median values do show change. For basins 1 to 3 the total CSO volume increases by 0 - 3.8% without changing the number of events. Because of this, less water is transported to basin 4 where all CSO events (and thus all CSO volume) are prevented in case of the RTC CSO scenario. Looking at the total network, the median number of CSO events decreases by 17% and the total CSO volume by 5%. Due to the large confidence bands this change is not significant.

The uncertainties in both number of CSO events and CSO volume are much larger for basin 4 in the reference situation than in the controlled situations. This is because in the controlled situations the outflow of basins 1 to 3 is limited regardless to the sampled uncertainty in the pump capacity, reducing the uncertainty in the inflow of basin 4. This cumulative effect leads to much smaller confidence bands in the investigated parameters in the controlled scenarios.

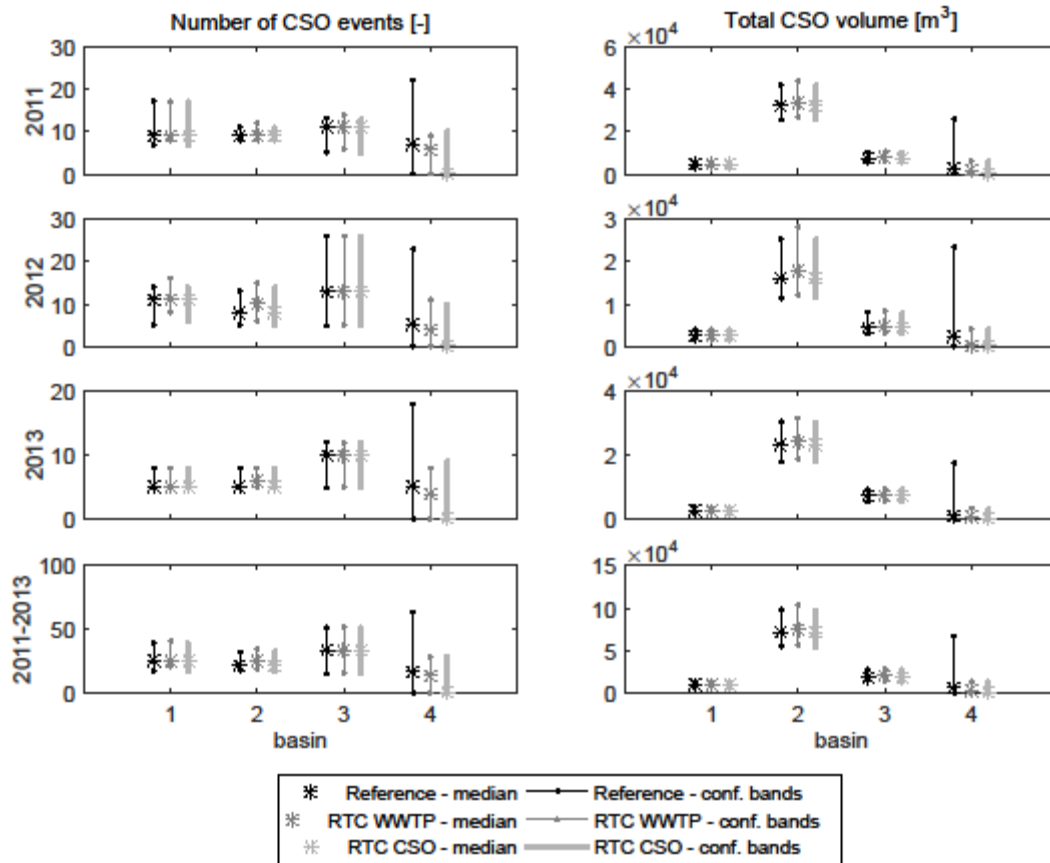

Fig 4. Number of CSO events (left) and total CSO volume (right) for each basin. From top to bottom first all years are displayed separately, followed by all years combined. In the graphs the results for the reference scenario and each of the two RTC scenarios are shown. Note the changing scales on the y-axis.

Figure 5 displays the same parameters, but now for the total system (sum of individual basins) and with more differentiation in the assessment periods. When comparing the efficiency of RTC within one period (e.g. 2011 or Q3 2013 with and without control), as one would do for a model driven evaluation, the same results are found as previously described: the median values change (-29 - 0% for the total number of events and -8 - 0% for the total CSO volume) but the confidence bands overlap for every period.

When comparing scenarios over different periods (e.g. 2011 for the reference situation with 2012 with RTC CSO, or Q2 2012 with Q3 2012), as one would do for a data driven evaluation, different results are found. Now the confidence bands sometimes do not overlap (e.g. Q2 and Q3 2011), indicating a significant influence from the applied RTC. The median values for comparison between adjacent quarterly periods, however, change between an improvement and a deterioration (-100 -

+1000% for the total number of events and -100 - >1000% for the total CSO volume). When comparing full adjacent years only, the median still changes sharply (-11 and -46% for the total number of events and -50 and 32% for the total CSO volume) and the confidence bands overlap again, so no definitive effect can be established anymore.

Finally, it is remarked that the influence of the annual rainfall and the number of events with a significant volume on the CSO activity is ambiguous. Both reflect the mean number of CSO events in a year (2012 highest, 2013 lowest), but for the total CSO volume this is opposite (2012 lowest, 2013 highest). This is to be expected as CSO activity is governed by more extreme rain events.

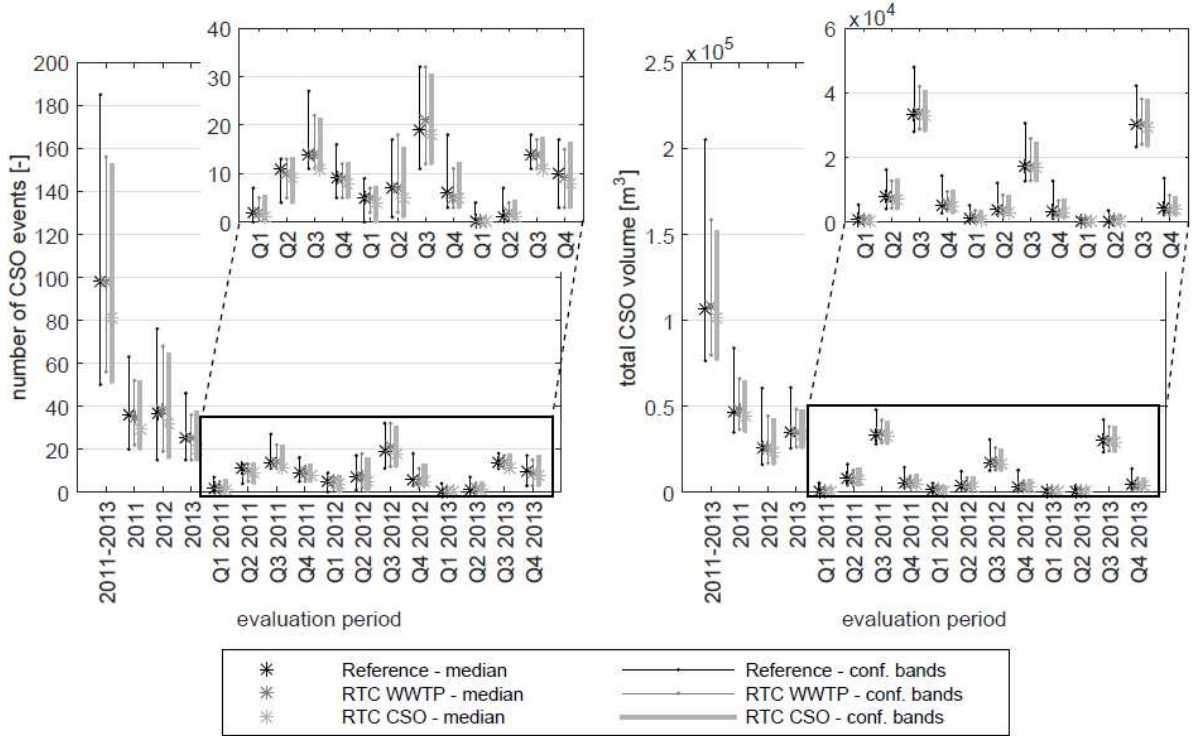

Fig 5. Number of CSO events (left) and total CSO volume (right) for all basins summed for simulations with the reference scenario and with each of the two RTC scenarios. On the horizontal axis different evaluation periods are given from all years together via separate years to separate quarters.

4.6.2. RTC WWTP

The impact of the RTC WWTP scenario on the pump capacity of the individual basins, for the entire simulation period (2011-2013) compared to the reference scenario, is displayed in figure 6. It contains the final 20% of the cumulative density functions (CDFs) of the pump capacity normalised to the maximum capacity, i.e. each pump capacity time series is ranked, normalised and the final 20% is

displayed. The control clearly changes parts of the CDFs, but the confidence bands overlap everywhere for basins 1 and 3. For basins 2 and 4, that receive inflow from upstream basins, significant changes are found. Looking at median values for the discharge to the WWTP (basin 4), the RTC WWTP scenario decreases the duration of pumping at > 0.9 times the norm capacity by 89% at the cost of an increase of 31% pumping at > 0.67 times the norm capacity. A decrease of the highest pump capacities is expected to be accompanied by an increase in lower capacities as the total discharge to the WWTP should stay approximately the same.

The RTC WWTP scenario was restricted to induce no negative side effects on the CSO operation. As can be found from figures 4 and 5 there is no indication of a significant negative effect on either the number of CSO events or the total CSO volume when compared to the reference scenario. The median number of CSO events for the entire period and total system stays the same, while the total CSO volume increases by an insignificant 1%.

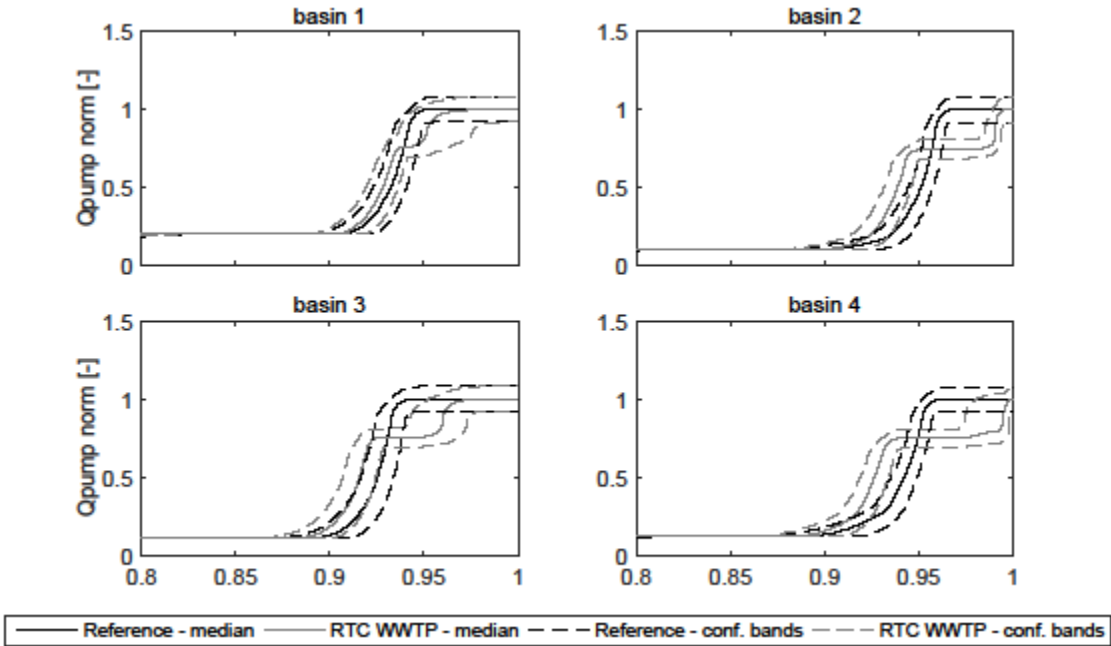

Fig 6. Pump capacity normalised to its maximum capacity for each basin for all years for simulations with the reference scenario and the RTC WWTP scenario. Normalised pump capacities of 1.1 are a result of the application of 10% uncertainty intervals in the Monte Carlo simulations.

In figure 7 the results for the discharge to the WWTP (basin 4) are displayed in more detail. It shows the percentage of time the normalised pump capacity is > 0.67 (left) and > 0.90 (right) with distinction in the evaluation period. Similar to the results for the RTC CSO scenario in figure 5, the results differ between evaluation periods. In this case, however, when comparing within one period

the impact of the RTC WWTP scenario with respect to the reference scenario is significant for all evaluation periods examined: the RTC WWTP scenario decreases the duration of pumping at > 0.9 times the norm capacity by 80 - 100%. When comparing between adjacent quarterly periods, RTC WWTP in all cases decreases the duration of the maximum pump capacity for the median value. The range of improvement widens to 67 - 100% and in some cases the change is not significant anymore (see e.g. Q2 and Q3 2011).

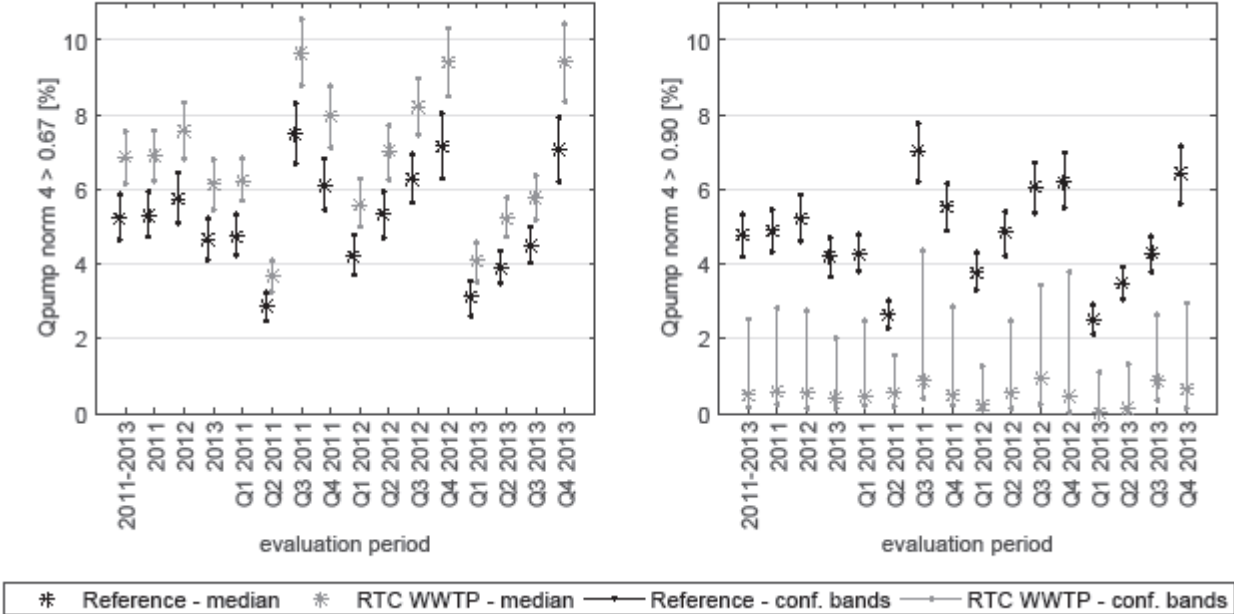

Fig 7. Percentage of time the pump capacity normalised to the maximum capacity of the WWTP (basin 4) is > 0.67 (left) and > 0.90 (right) for simulations with the reference scenario and the RTC WWTP scenario. On the horizontal axis different evaluation periods are given from all years together via separate years to separate quarters.

5. Discussion

5.1. Case study results

The case study presents a clear illustration of several aspects related to the evaluation of the effectiveness of RTC in practice:

1. The susceptibility for RTC and its effectiveness is very much dependent on the goal that is aimed for. In the case study a reduction in CSO activity (events or volume) could hardly be achieved even looking at the median values only. Contrary to the RTC CSO scenario, the RTC WWTP scenario showed great potential in reducing the WWTP influent with significant differences

between the reference and controlled situation. The RTC WWTP scenario focussed on reduction of influent flows (quantity). Reducing peak influent flows also reduces peak loads to the biological treatment of the WWTP, thereby also improving the treatment performance (quality) (Langeveld et al., 2002).

2. The evaluation period was shown to influence the outcome of an evaluation of the effectiveness of RTC to a very large extent, due to the variability in rainfall. Comparing between the same period (for a model driven evaluation) results differ between no effect and 30% reduction for the RTC CSO scenario. Comparing adjacent years (for a data driven evaluation) the results for the RTC CSO scenario differ up to 30% in case of the number of CSO events and up to 80% (spanning both reduction and increase) for total CSO volume. For the RTC WWTP scenario the influence of the evaluation period is smaller, but still the outcome differs up to 33% when comparing adjacent quarterly periods. This asks for a careful consideration of the chosen evaluation period when determining the effectiveness of RTC. Especially in case of CSO related parameters, which depend on less often occurring rain events, an evaluation period lasting at least the square of the return period should be applied.
3. For many evaluation periods in the example, the median values do respond to the imposed RTC scenarios and often in the desired way. Without uncertainty analysis it would have been credible to present these results as the effect of the imposed RTC. However, especially for the RTC CSO scenario, the uncertainty analysis reveals that the uncertainty bands are up to an order of magnitude larger than the effect itself. This shows the particular importance of including uncertainty analysis in any RTC effectiveness evaluation.

In the case study it was chosen to include the minimum number of parameters to describe the systems functioning as well as limited uncertainty intervals for these parameters. In this way the resulting model output uncertainty was as limited as possible. Still, the output uncertainty was largely dominant over the effect of one of the control scenarios. Including more sources of uncertainty, in the model input through for example the rainfall or connected area, or by applying a more elaborate model structure and thus more parameters, leads to even larger output uncertainties. This could result in the situation that no significant effect of any RTC scenario could be determined. To prevent this situation calibration and verification of the model is necessary, or a data driven evaluation should be adopted. In the next section this will be discussed further.

5.2. Methodology

For the final performance evaluation, it is not important if a data or model driven approach is taken. Both approaches have advantages and disadvantages, as listed in table 5, and for each situation a well-founded choice should be made and communicated.

Table 5. Advantages and disadvantages of a data or model driven performance evaluation.

assessment	(dis)advantages	examples
data driven	advantages	<ul style="list-style-type: none">- measurements contain information on the true functioning of the system that a model can never achieve- small uncertainty bands because errors are not propagated through models- operators usually have insight in measurements needed for an evaluation, which could enlarge the acceptance of the implemented RTC
	disadvantages	<ul style="list-style-type: none">- difficulty of obtaining high quality, simultaneous measurements at relevant locations- two evaluation periods are needed (with and without RTC) with representative and comparable conditions
model driven	advantages	<ul style="list-style-type: none">- assessment possible based on parameters that are difficult to measure due to practical constraints- possibly clear comparison is feasible between scenarios based on only one evaluation period (see next point)
	disadvantages	<ul style="list-style-type: none">- transferability of parameters sets between events was shown to be low by e.g. (Korving and Clemens, 2005). Applying RTC may require a new calibration and corresponding measurements for those parts of the model influenced by the control- large uncertainty bands because errors are propagated through models and additional errors associated with parameter identification- measurements are needed for the preparation of the models and to determine the uncertainties, which could possibly also be applied in the evaluation directly

Executing a performance analysis following the proposed methodology will take considerable effort. Gathering of measurements and preparation of models to the required standards, as mentioned in section 3.1 and 3.2, is challenging. Nevertheless, to quantify the effect of RTC, the use of sufficient quantity and quality measurements and models is necessary. And part of this work should already have been done when designing and implementing the RTC. From a scientific point of view, in an

evaluation quantifying the effect should be aimed at. Careful planning before implementation of the RTC and choosing the appropriate approach (data or model driven) will result in a minimal additional effort required. In a commercial setting, the willingness of a client to invest in a quantitative evaluation will be closely related to the gains the RTC is supposed to provide. If substantial investments in for example the treatment process depend on the performance of an implemented RTC strategy, the additional required effort will not be problematic. The practical applicability and consequences of the methodology will be investigated for an implemented RTC scheme in the wastewater system of Eindhoven (Van Daal-Rombouts et al., 2016a).

The case study highlighted the problem of determining a significant effect for RTC when small improvements are aimed for. One way to overcome this is the application of high accuracy measurements so that the uncertainty bands are strongly reduced. In a hypothetical experiment, the RTC CSO scenario for the case study can be shown to significantly cause a reduction in CSO volume for basin 4. This entails taking the median values from the simulated results and assuming these are measurements with corresponding uncertainty bands. The uncertainties were based on the paper by (Campisano et al., 2013) and were taken to be 1% for flow measurements in filled pipes (applied for the pump capacities) and 5% for flow measurements in partly filled pipes (applied for CSO discharges). As these percentages are deemed optimistic by the authors and a high yield for (simultaneous) measurements remains problematic, high accuracy and robust sensors are called for.

The RTC scenarios in the case study focus on reducing water quantity discharges. The methodology, however, is not restricted to quantity oriented performance evaluations. Also RTC aimed at objectives such as pollution or energy reduction could be evaluated using the same methodology.

Finally, the proposed methodology can also be applied for determining the expected effectiveness of a designed RTC strategy if historic measurements are available. The outcome could help to decide if the RTC should be implemented or redesigned. It would also provide valuable information for the actual performance evaluation such as an estimate on expected effect and the accuracy needed to significantly determine it, the locations for which information is needed, whether the available meta-information on the system is satisfactory and if the conditions needed for the evaluation are adequate.

6. Conclusions and recommendations

This paper dealt with the performance evaluation of RTC in practice in urban wastewater systems that at least encompass a combined sewer system. A review of literature on this topic demonstrated a lack of consensus on how to do this. In the procedures described two main deficiencies were identified: omitting uncertainty analysis and applying too limited evaluation periods. A general methodology was proposed to evaluate the performance of RTC that is either data or model driven and takes into account these deficiencies. What approach should be applied is case dependent. It is up to the engineer or researcher to choose the most appropriate approach and communicate the motivation for this choice.

A performance analysis for two RTC scenarios was shown through a case study for a combined sewer system with limited discharge to a WWTP. It was demonstrated that the susceptibility of a case for the successful application of RTC and the possibility to determine a significant effect is very much dependent on the goal. It also clearly illustrated the need for taking uncertainties into account and that careful consideration in the chosen evaluation period is required.

When RTC aims for small improvements, small uncertainty bands are needed to be able to determine a significant effect. To this end, sensors that are more robust and high accuracy than the ones now available are necessary. Also dedicated attention is required to ensure sensor output reaches its full potential.

Although some RTC systems should have been operational for over a decade, no publications were found that deal with the functioning and effectiveness of these systems after several years. It would be of great benefit for the field of urban wastewater management if these experiences would be shared.

The proposed methodology will be applied in the performance evaluation of an implemented RTC scheme in the wastewater system of Eindhoven (Van Daal-Rombouts et al., 2016a) to investigate the practical applicability and consequences of the methodology.

7. Acknowledgements

The research is performed within the Dutch 'Kennisprogramma Urban Drainage' (Knowledge Programme Urban Drainage). The involved parties are: ARCADIS, Deltares, Evides, Gemeente Almere, Gemeente Arnhem, Gemeente Breda, Gemeente 's-Gravenhage, Gemeentewerken Rotterdam, Gemeente Utrecht, GMB Rioleringstechniek, KWR Watercycle Research Institute, Royal

HaskoningDHV, Stichting RIONED, STOWA, Sweco, Tauw, vandervalk + degroot, Waterboard De Dommel, Waternet and Witteveen+Bos.

8. References

- Alex, J., Beteau, J.F., Copp, J.B., Hellinga, C., Jeppsson, U., Marsili-Libelli, S., Pons, M.N., Spanjers, H., Vanhooren, H., 1999. Benchmark for evaluating control strategies in wastewater treatment plants, in: Proceedings of European Control Conference ECC'99. Karlsruhe, Germany, pp. 1–6.
- Beeneken, T., Erbe, V., Messmer, A., Reder, C., Rohlfing, R., Scheer, M., Schütze, M., Schumacher, B., Weilandt, M., Weyand, M., 2013. Real time control (RTC) of urban drainage systems – A discussion of the additional efforts compared to conventionally operated systems. *Urban Water J.* 10, 293–299. doi:10.1080/1573062x.2013.790980
- Breinholt, A., Santacoloma, P., Mikkelsen, P.S., Madsen, H., Grum, M., 2008. Evaluation framework for control of integrated urban drainage systems, in: Proceedings of ICUD11. Edinburgh, pp. 1–12.
- Campisano, A., Cabot Ple, J., Muschalla, D., Pleau, M., Vanrolleghem, P.A., 2013. Potential and limitations of modern equipment for real time control of urban wastewater systems. *Urban Water J.* 1–12. doi:10.1080/1573062X.2013.763996
- Deletic, A., Dotto, C.B.S., McCarthy, D.T., Kleidorfer, M., Freni, G., Mannina, G., Uhl, M., Hendrichs, M., Fletcher, T.D., Rauch, W., Bertrand-Krajewski, J.-L., Tait, S.J., 2012. Assessing uncertainties in urban drainage models. *Phys. Chem. Earth* 42–44, 3–10. doi:10.1016/j.pce.2011.04.007
- Dirckx, G., Van Assel, J., Weemaes, M., 2014. Real Time Control from desk study to full implementation, in: Proceedings of ICUD13. Sarawak, Malaysia, pp. 1–8.
- Einfalt, T., Pape, E.-M., Hatzfeld, F., 2001. Güteorientiertes Nachweisverfahren für gesteuerte Mischwasserentlastungen - Quality-oriented test methods for controlled stormwater structures in combined sewers. *Korrespondenz Abwasser* 3, 1–7.
- Erbe, V., Risholt, L.P., Schilling, W., Londong, J., 2002. Integrated modelling for analysis and optimisation of wastewater systems - the Odenthal case. *Urban Water* 4, 63–71.
- Erbe, V., Schütze, M., 2005. An integrated modelling concept for immission-based management of sewer system, wastewater treatment plant and river. *Water Sci. Technol.* 52, 95–103.
- Fradet, O., Pleau, M., Marcoux, C., 2011. Reducing CSOs and giving the river back to the public: innovative combined sewer overflow control and riverbanks restoration of the St. Charles River in Quebec City. *Water Sci. Technol.* 63, 331–8.
- Fuchs, L., Beeneken, T., 2005. Development and implementation of a real-time control strategy for the sewer system of the city of Vienna. *Water Sci. Technol.* 52, 187–194.

- Garbanini Marcantini, L., Schegg, S., Mischler, B., Hesse, K., Gresch, M., Rieckermann, J., 2016. Ein hierarchischer Regelungsalgorithmus zur praxistauglichen Abflussregelung von Entwässerungsnetzen, in: *AquaUrbanica*. Tigi-Kaltbad, Switzerland, pp. 1–8.
- Garcia, L., Barreiro-Gomez, J., Escobar, E., Tellez, D., Quijano, N., Ocampo-Martinez, C., 2015. Modeling and real-time control of urban drainage systems: A review. *Adv. Water Resour.* 85, 120–132. doi:10.1016/j.advwatres.2015.08.007
- García, L., Barreiro-Gomez, J., Escobar, E., Téllez, D., Quijano, N., Ocampo-Martinez, C., 2015. Modeling and real-time control of urban drainage systems: A review. *Adv. Water Resour.* 85, 120–132. doi:10.1016/j.advwatres.2015.08.007
- Gelormino, M.S., Ricker, N.L., 1994. Model-predictive control of a combined sewer system. *Int. J. Control* 59, 793–816. doi:10.1080/00207179408923105
- Gruber, G., Winkler, S., Pressl, A., 2004. Quantification of pollution loads from CSOs into surface water bodies by means of online techniques. *Water Sci. Technol.* 50, 73–80.
- Grum, M., Thornberg, D., Christensen, M.L., Shididi, S.A., Thirsing, C., 2011. Full-scale real time control demonstration project in copenhagen’s largest urban drainage catchments, in: *Proceedings of ICUD12*. Porto Alegre, Brazil, pp. 1–7.
- Harremoës, P., 2003. Ethical aspects of scientific incertitude in environmental analysis and decision making. *J. Clean. Prod.* 11, 705–712. doi:10.1016/S0959-6526(02)00102-6
- Hoppe, H., Gruening, H., 2007. Significance of uncertainties in the input data used in the integrated design of wastewater systems, in: *Proceedings of Novatech*. pp. 1607–1614.
- Hoppe, H., Messmann, S., Giga, A., Gruening, H., 2011. A real-time control strategy for separation of highly polluted storm water based on UV–Vis online measurements – from theory to operation. *Water Sci. Technol.* 63, 2287–2293. doi:10.2166/wst.2011.164
- Korving, H., 2004. Probabilistic assessment of the performance of combined sewer systems. TU Delft.
- Korving, H., Clemens, F.H.L.R., 2005. Impact of dimension uncertainty and model calibration on sewer system assessment. *Water Sci. Technol.* 52, 35–42.
- Krämer, S., Fuchs, L., Verworn, H.-R., 2007. Aspects of Radar Rainfall Forecasts and their Effectiveness for Real Time Control - The Example of the Sewer System of the City of Vienna. *Water Pract. Technol.* 2, 42–49. doi:10.2166/wpt.2007.042
- Langeveld, J.G., Clemens, F.H.L.R., Van der Graaf, J.H.J.M., 2002. Increasing wastewater system performance - The importance of interactions between sewerage and wastewater treatment. *Water Sci. Technol.* 45, 45–52.
- Löwe, R., Vezzaro, L., Mikkelsen, P.S., Grum, M., Madsen, H., 2016. Probabilistic runoff volume forecasting in risk-based optimization for RTC of urban drainage systems. *Environ. Model. Softw.* 80, 143–158. doi:10.1016/j.envsoft.2016.02.027

- Métadier, M., Bertrand-Krajewski, J.-L., 2011. From mess to mass: a methodology for calculating storm event pollutant loads with their uncertainties, from continuous raw data time series. *Water Sci. Technol.* 63, 369–376. doi:10.2166/wst.2011.230
- Muschalla, D., Schütze, M., Schroeder, K., Bach, M., Blumensaat, F., Gruber, G., Klepizewski, K., Pabst, M., Pressl, A., Schindler, N., Solvi, A.M., Wiese, J., 2009. The HSG procedure for modelling integrated urban wastewater systems. *Water Sci. Technol.* 60, 2065–2075. doi:10.2166/wst.2009.576
- Nelen, F., 1992. Optimized control of urban drainage systems. TU Delft.
- Olsson, G., 2012. ICA and me - A subjective review. *Water Res.* 46, 1585–1624. doi:10.1016/j.watres.2011.12.054
- Olsson, G., Carlsson, B., Comas, J., Copp, J., Gernaey, K.V., Ingildsen, P., Jeppsson, U., Kim, C., Rieger, L., Rodríguez-Roda, I.R., Steyer, J.-P., Takács, I., Vanrolleghem, P.A., Vargas, A., Yuan, Z., Åmand, L., 2014. Instrumentation, control and automation in wastewater - From London 1973 to Narbonne 2013. *Water Sci. Technol.* 69, 1373–1385. doi:10.2166/wst.2014.057
- Pawlowsky-Reusing, E., 2006. Integrated Sewage Management - Final Report. KompetenzZentrum Wasser Berlin gGmbH.
- Pleau, M., Colas, H., Lavalée, P., Pelletier, G., Bonin, R., 2005. Global optimal real-time control of the Quebec urban drainage system. *Environ. Model. Softw.* 20, 401–413. doi:10.1016/j.envsoft.2004.02.009
- Puig, V., Cembrano, G., Romera, J., Quevedo, J., Aznar, B., Ramon, G., Cabot, J., 2009. Predictive optimal control of sewer networks using CORAL tool: Application to Riera Blanca catchment in Barcelona. *Water Sci. Technol.* 60, 869–878. doi:10.2166/wst.2009.424
- Robitaille, L., Komorowski, F., Fortier, V., Chadoutaud, E., Rousseau, J.-P., 2016. Gestion Dynamique des RUTP du bassin versant Louis Fargue à Bordeaux: en route vers une seconde phase de déploiement, in: *Proceedings of Novatech*. pp. 1–6.
- Schilling, W., 1989. Real-Time control of urban drainage systems - The state of the art. IAWPRC Task Group on Real-Time Control of Drainage Systems.
- Schilling, W., Andersson, B., Nyberg, U., Aspegren, H., Rauch, W., Harremoës, P., 1996. Real time control of wastewater systems. *J. Hydraul. Res.* 34, 785–797.
- Schilperoort, R.P.S., 2011. Monitoring as a tool for the assessment of wastewater quality dynamics. TU Delft.
- Schütze, M., Campisano, A., Colas, H., Schilling, W., Vanrolleghem, P.A., 2004. Real time control of urban wastewater systems - where do we stand today? *J. Hydrol.* 299, 335–348. doi:10.1016/j.jhydrol.2004.08.010
- Schütze, M., Erbe, V., Haas, U., Scheer, M., Weyand, M., 2008. Sewer system real-time control

- supported by the M180 guideline document. *Urban Water J.* 5, 67–76.
doi:10.1080/15730620701754376
- Seggelke, K., Löwe, R., Beeneken, T., Fuchs, L., 2013. Implementation of an integrated real-time control system of sewer system and waste water treatment plant in the city of Wilhelmshaven. *Urban Water J.* 10, 330–341.
- Thompson, K., Vamvakieridou-Lyroudia, L., Kapelan, Z., Savic, D., 2011. Optimal macro-location methods for sensor placement in urban water systems.
- Van Bijnen, M., Korving, H., 2008. Application and results of automatic validation of sewer monitoring data, in: *Proceedings of ICUD11*. Edinburgh, Scotland, pp. 1–10.
- Van Daal-Rombouts, P.M.M., De Jonge, J., Langeveld, J.G., Clemens, F.H.L.R., 2016a. Integrated real time control of influent pumping station and primary settling tank at WWTP Eindhoven, in: *Proceedings of SPN8*. Rotterdam, pp. 282–285.
- Van Daal-Rombouts, P.M.M., Sun, S., Langeveld, J.G., Bertrand-Krajewski, J.-L., Clemens, F.H.L.R., 2016b. Design and performance evaluation of a simplified dynamic model for combined sewer overflows in pumped sewer systems. *J. Hydrol.* 538, 609–624.
doi:10.1016/j.jhydrol.2016.04.056
- Van Luijtelaar, H., Rebergen, E.W., 1997. Guidelines for hydrodynamic calculations on urban drainage in the Netherlands: Backgrounds and examples. *Water Sci. Technol.* 36, 253–258.
- Vanrolleghem, P.A., Benedetti, L., Meirlaen, J., 2005. Modelling and real-time control of the integrated urban wastewater system. *Environ. Model. Softw.* 20, 427–442.