



P5 PRESENTATION
VROM DESIGN
SARA GISTELINCK

ASSIGNMENT

ANALYSIS

CONCEPT

PROPOSAL

ASSIGNMENT

Design for the first Rijkskantoor

Housing two different ministries

In an existing building,

The building of the former ministry of

Verkeer, Ruimtelijke Ordening & Milieu

Or:

VROM

ASSIGNMENT

The government strives for
OPENNESS and FLEXIBILITY
In their work spaces

To enable this flexibility
Work spaces should be generic

ANALYSIS - THE SITE

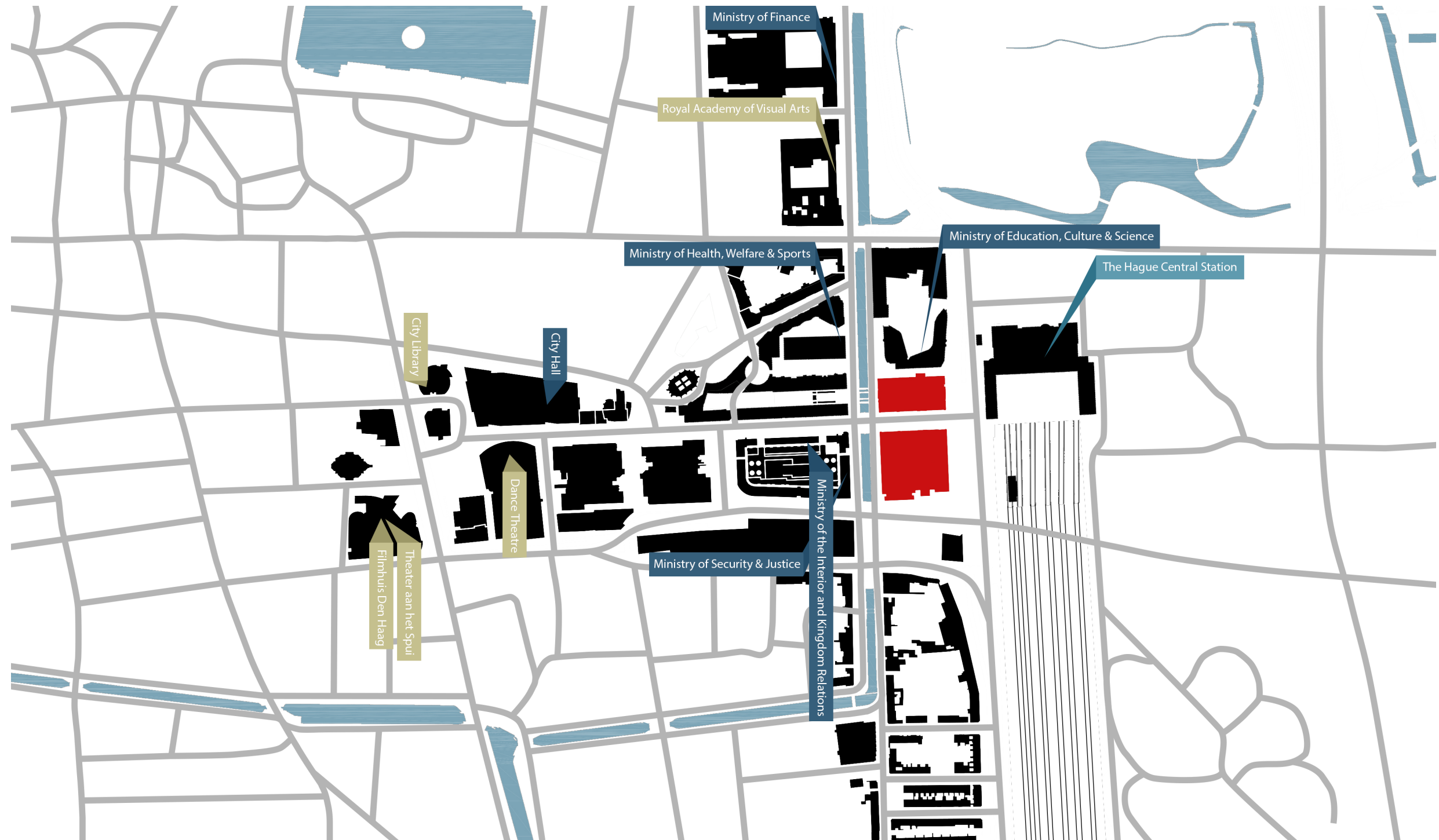

ANALYSIS - THE BUILDING

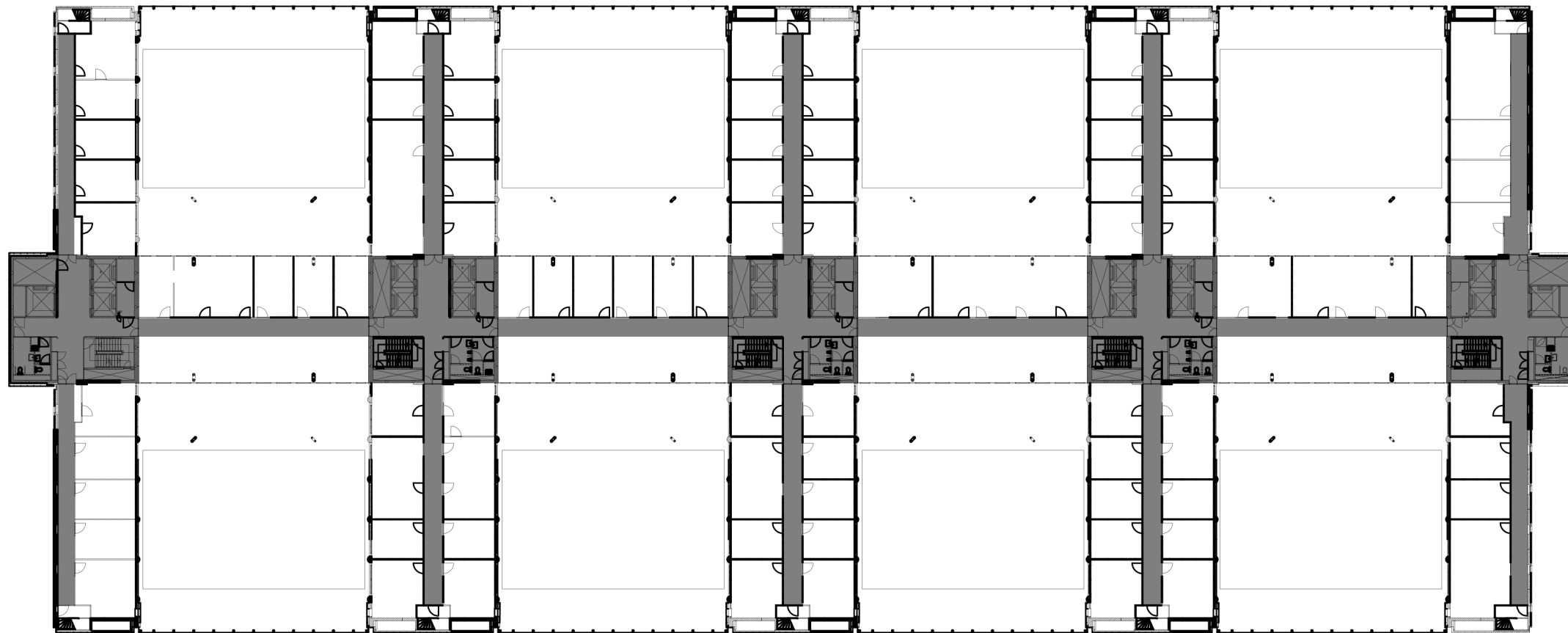

15e verdieping

ANALYSIS - THE BUILDING

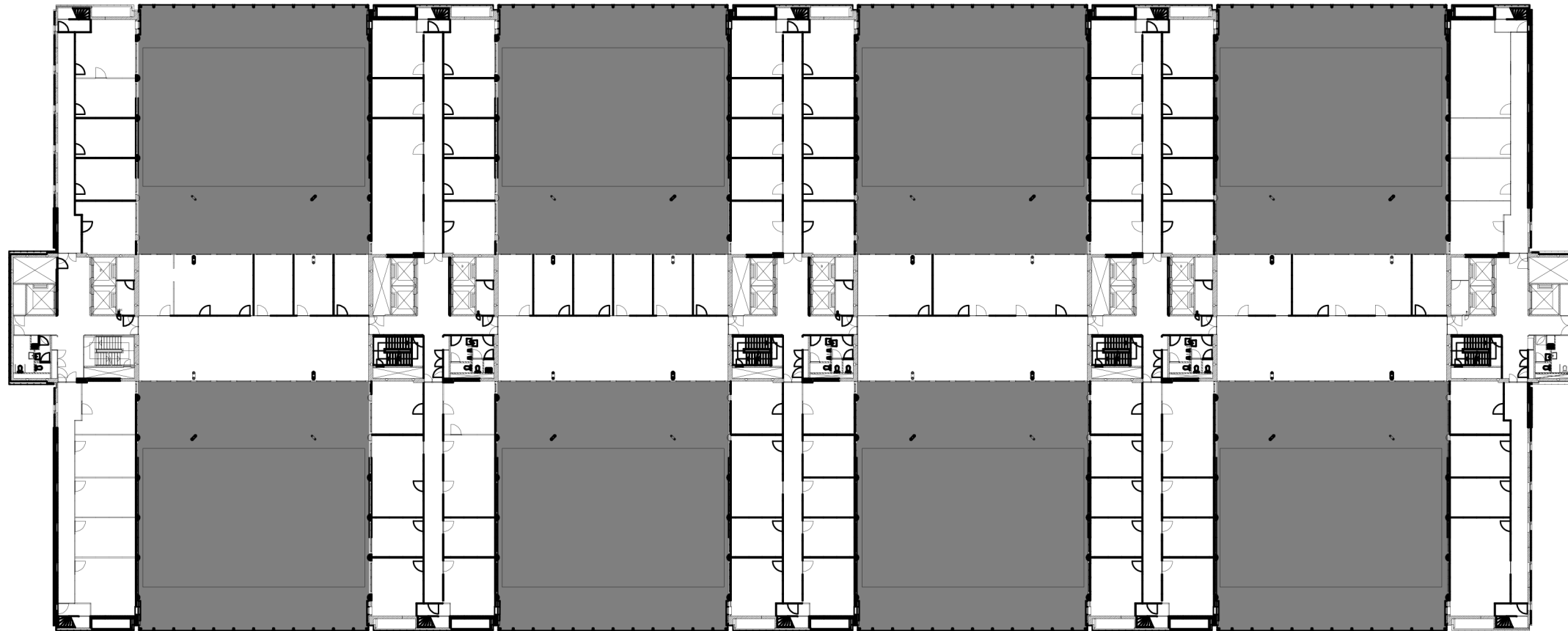

15e verdieping

ANALYSIS - THE USERS

Conclusions from the Research Seminar:

Civil servants support the flexible work space

But also propose zoning of the work spaces

To more easily find colleagues

TRANSFORMATION - original

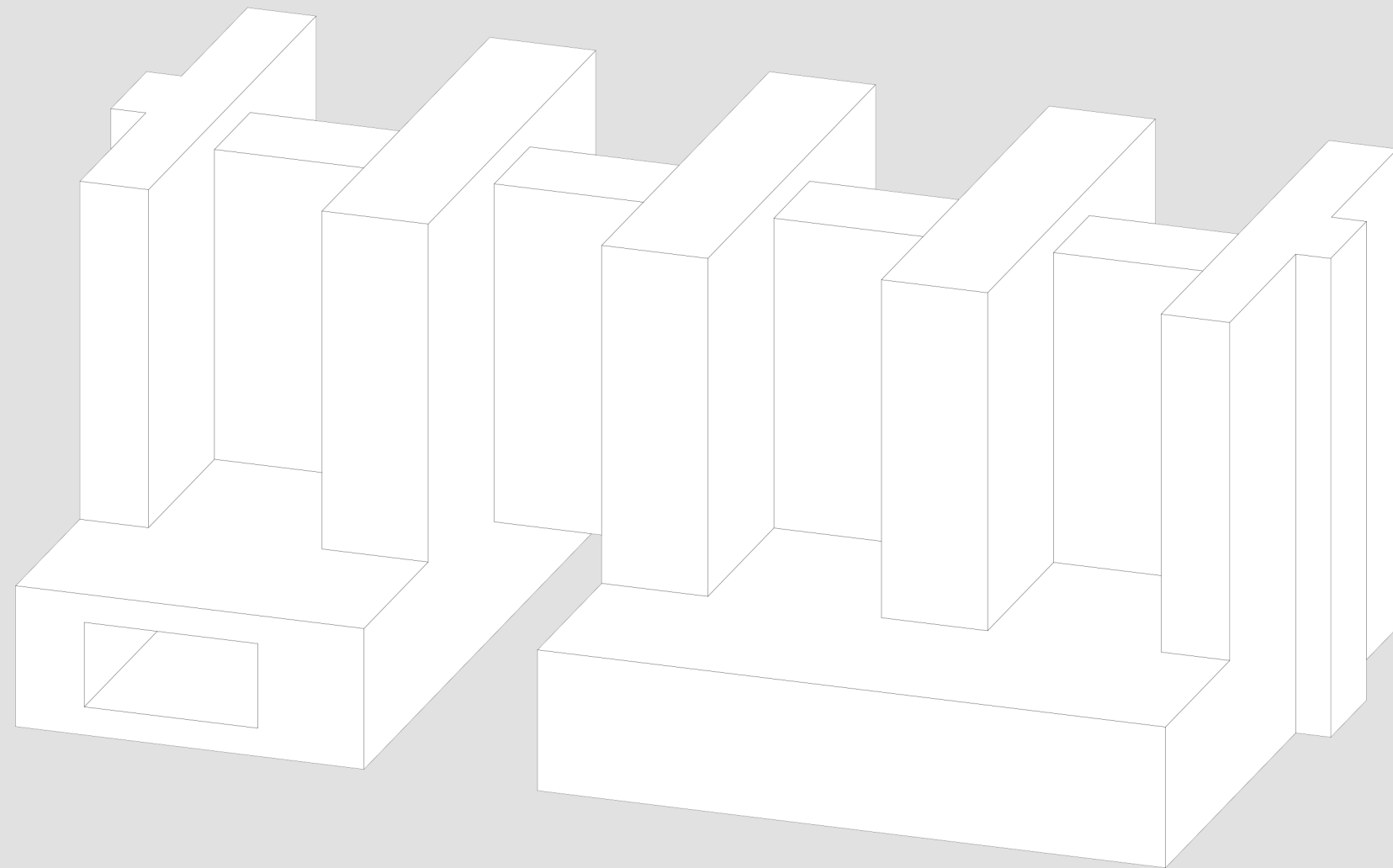

TRANSFORMATION - after demolition

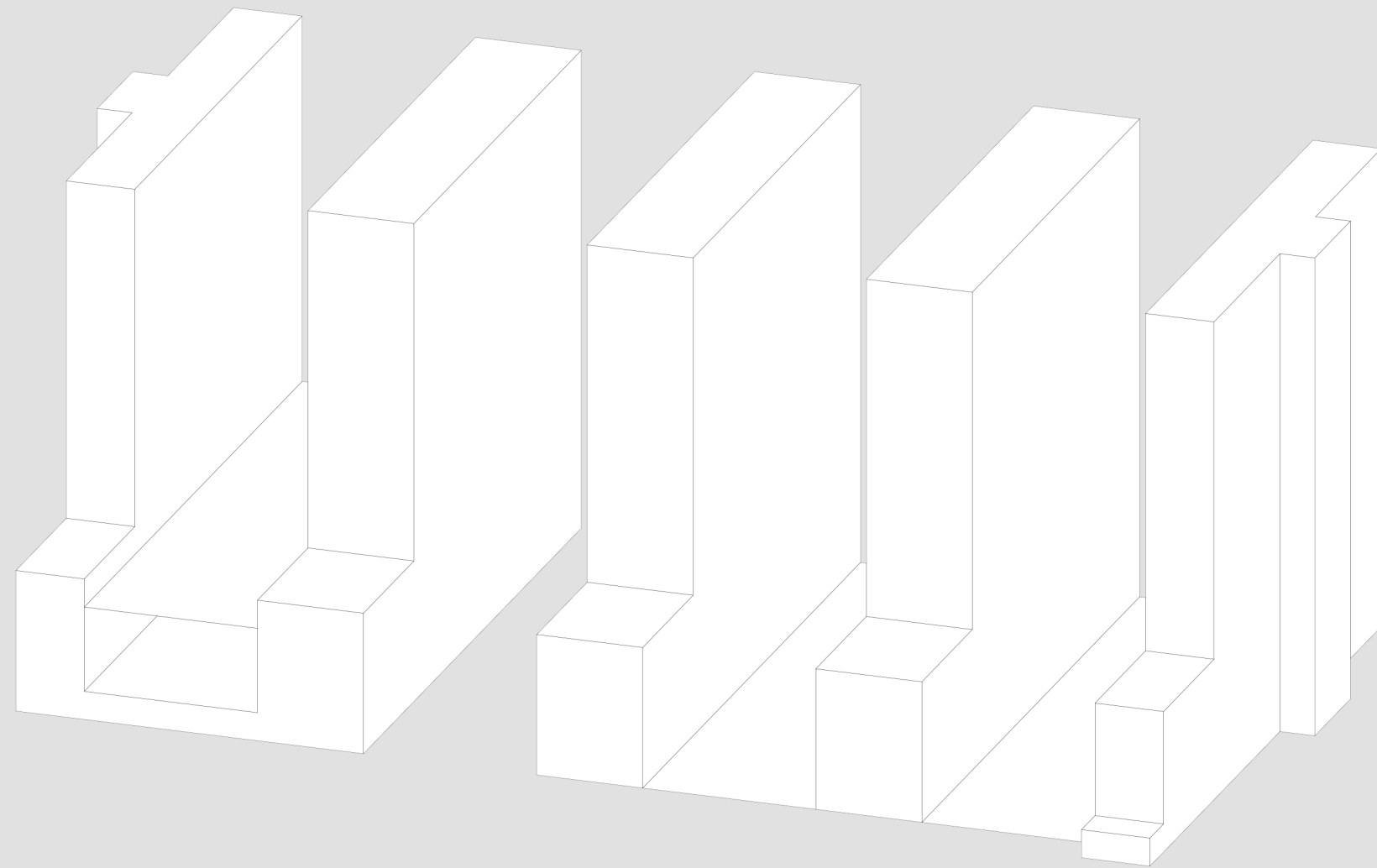

TRANSFORMATION - creating one block over tramline

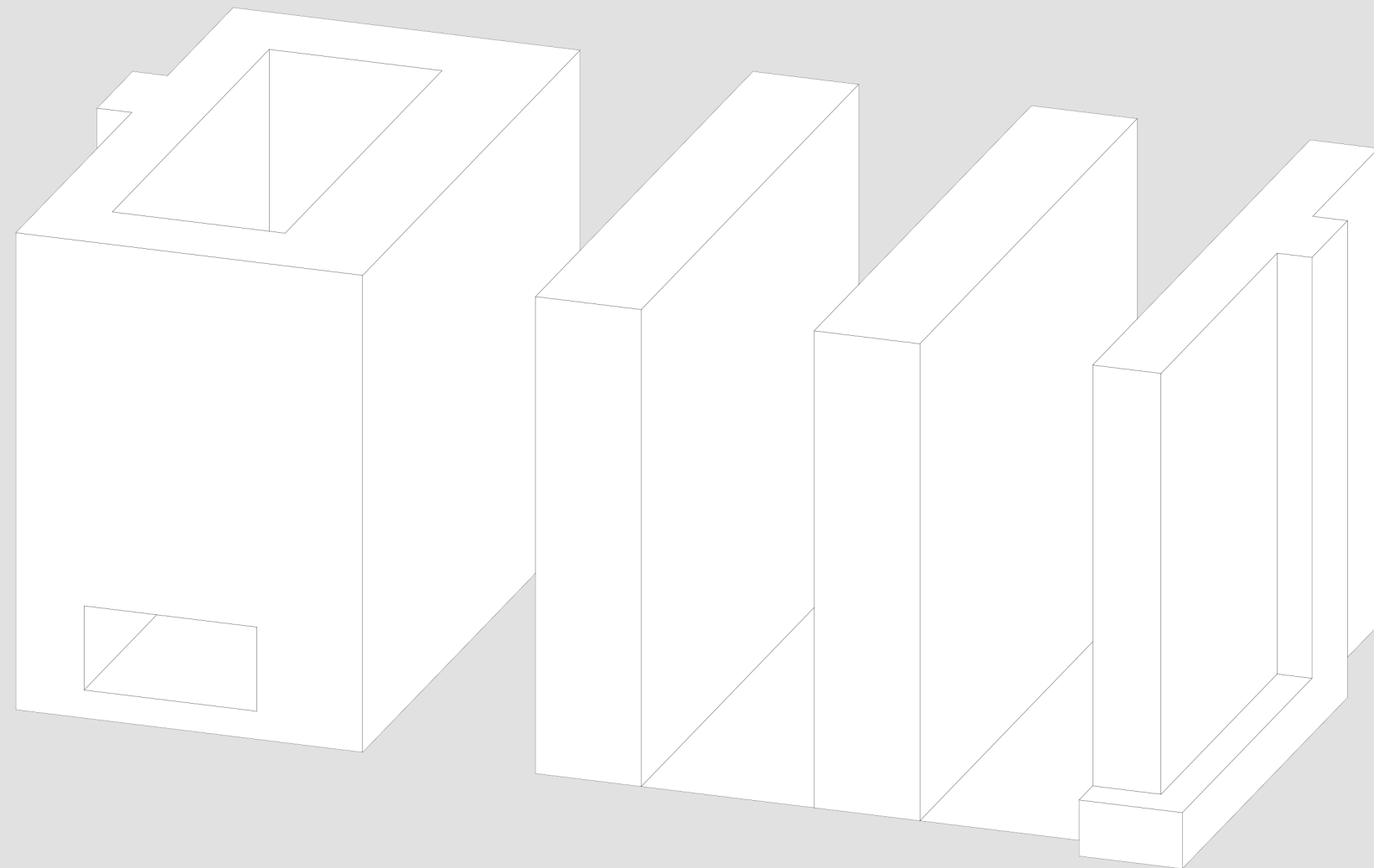

TRANSFORMATION - adding roof

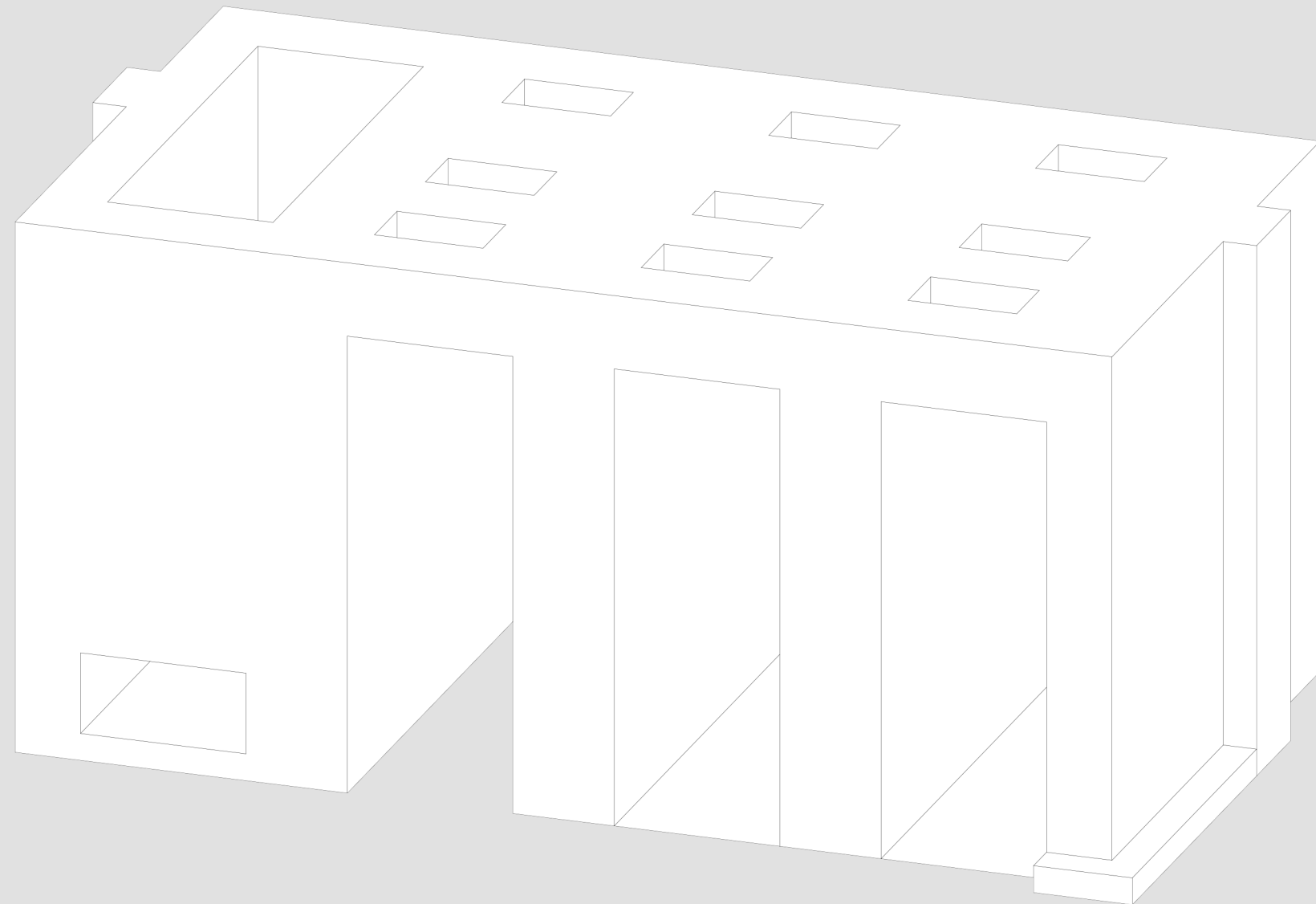

TRANSFORMATION - connecting by escalators

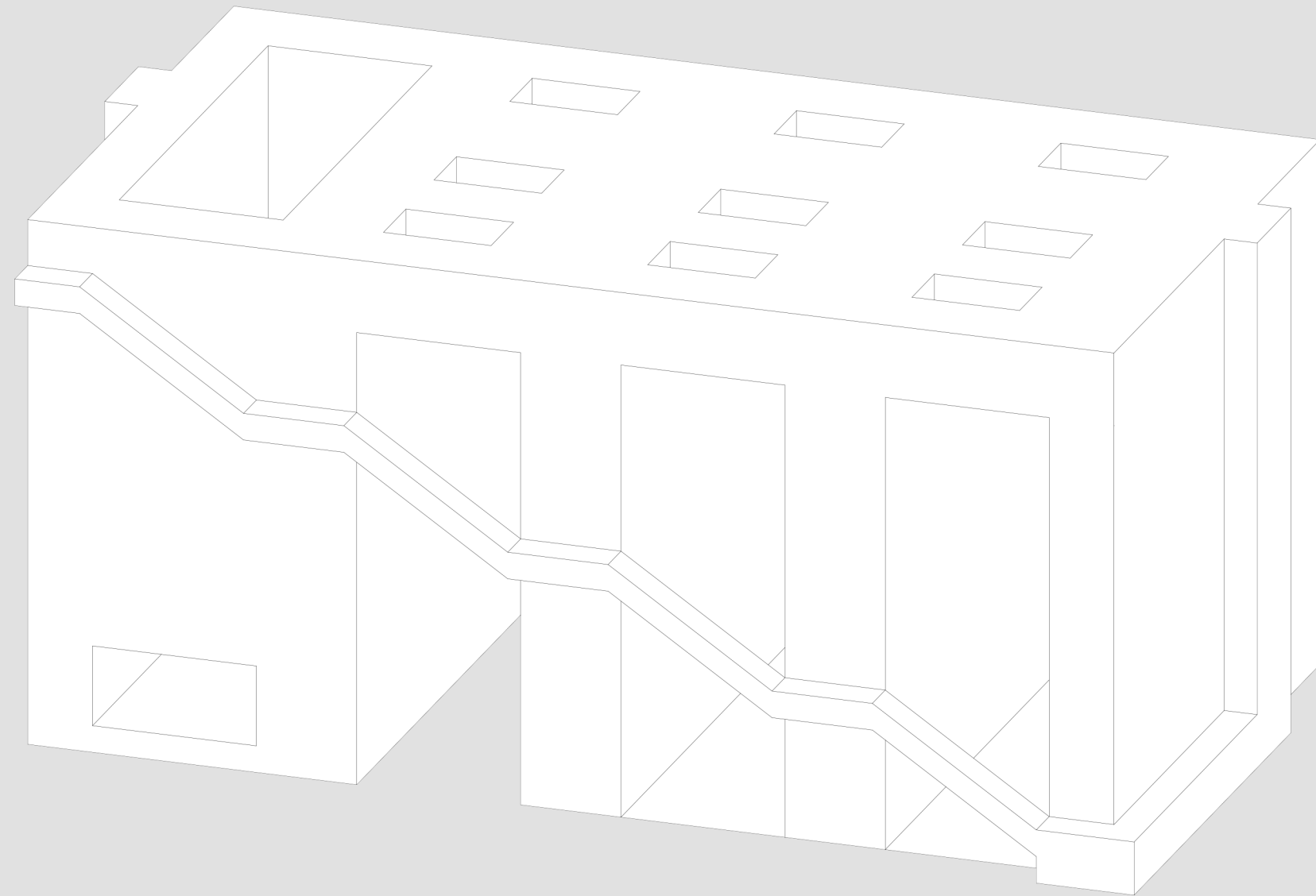

CONCEPT

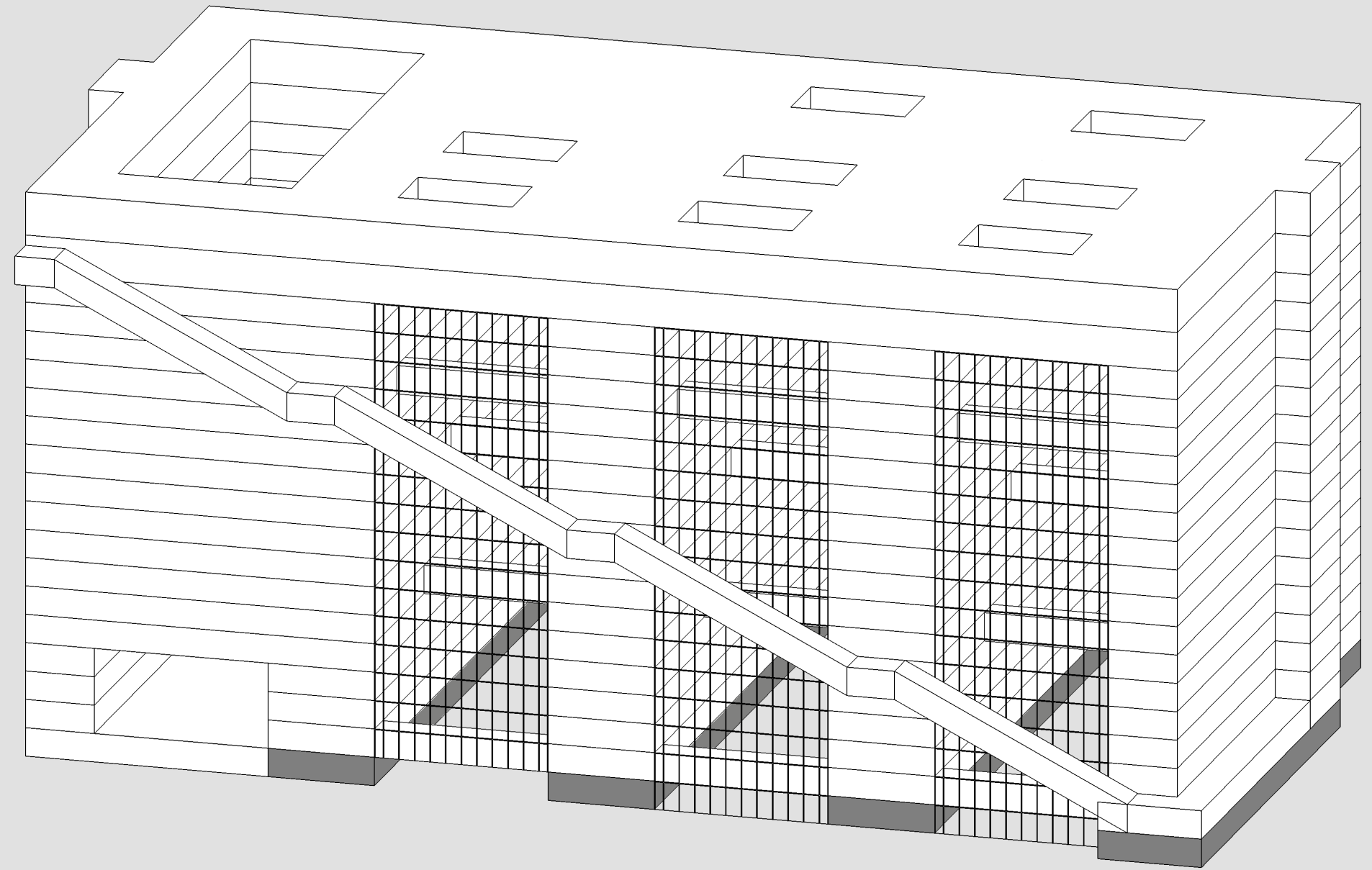

PUBLIC SERVICES

IND, LEGALISATION
INFORMATION

CONCEPT

OFFICES

4 'ZONES' OF OFFICES
EACH OF 4 FLOORS

PUBLIC SERVICES

IND, LEGALISATION
INFORMATION

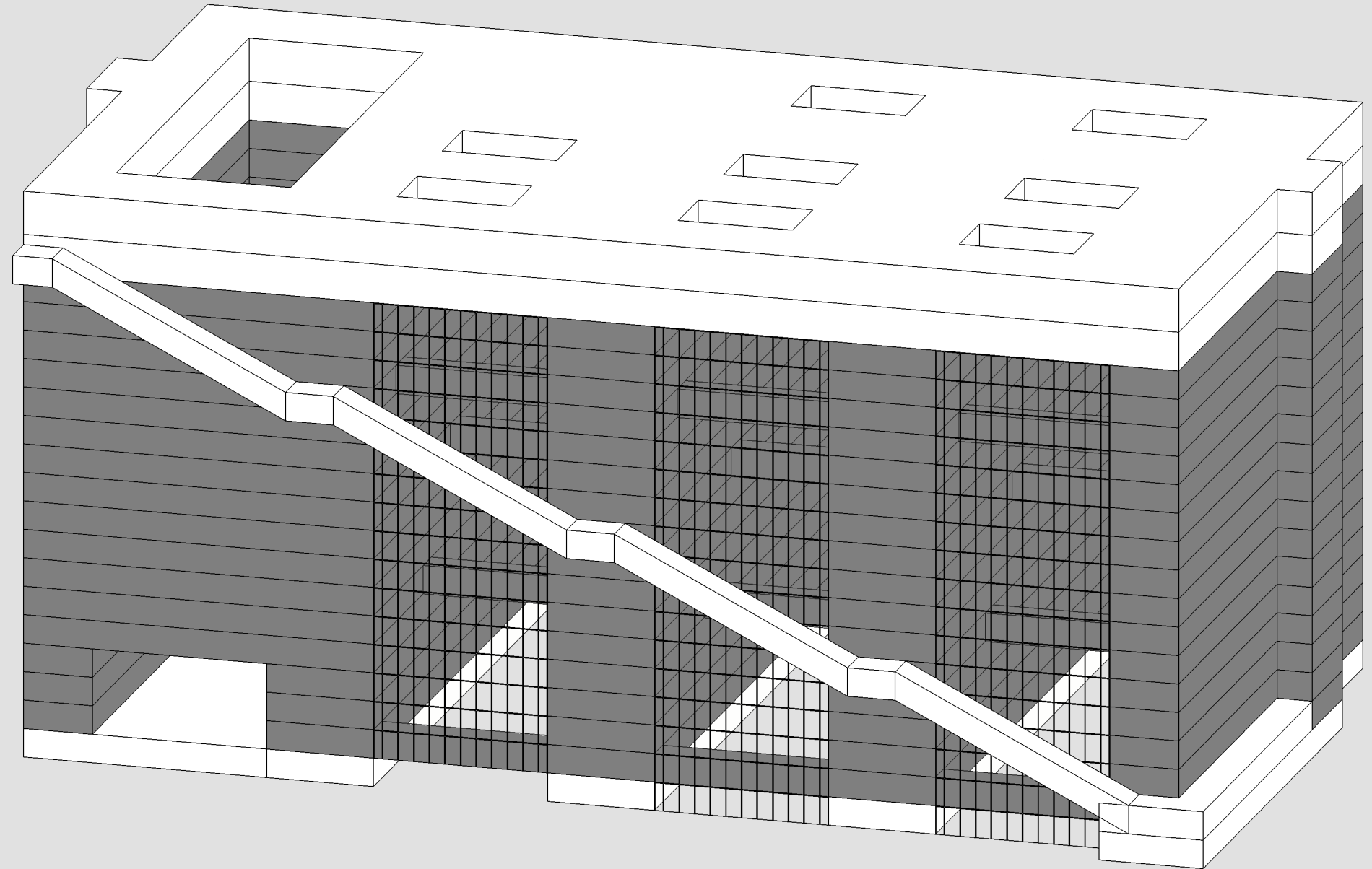

CONCEPT

PUBLIC FUNCTIONS

RESTAURANT
MEETING CENTER

OFFICES

4 'ZONES' OF OFFICES
EACH OF 4 FLOORS

PUBLIC SERVICES

IND, LEGALISATION
INFORMATION

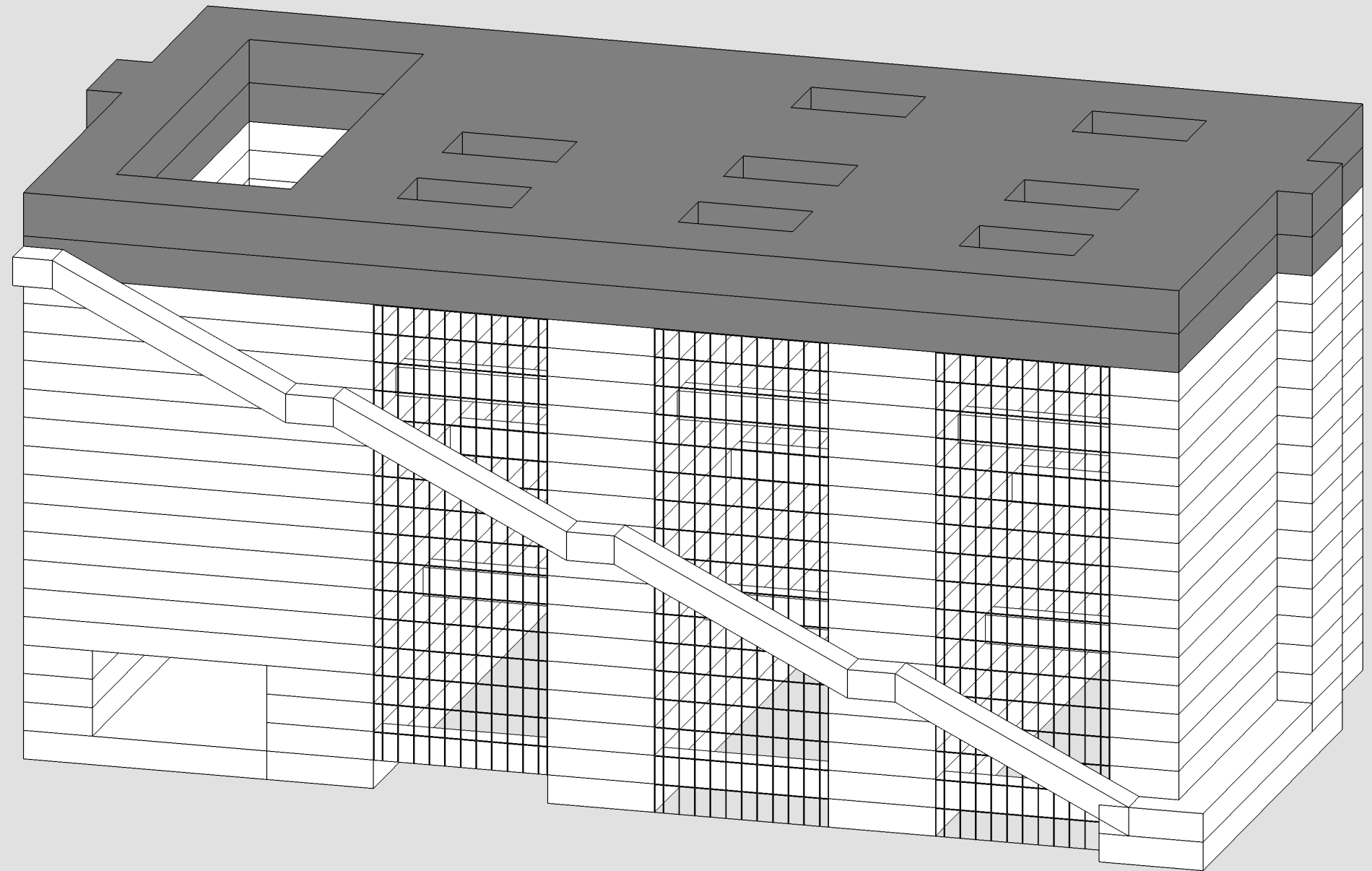

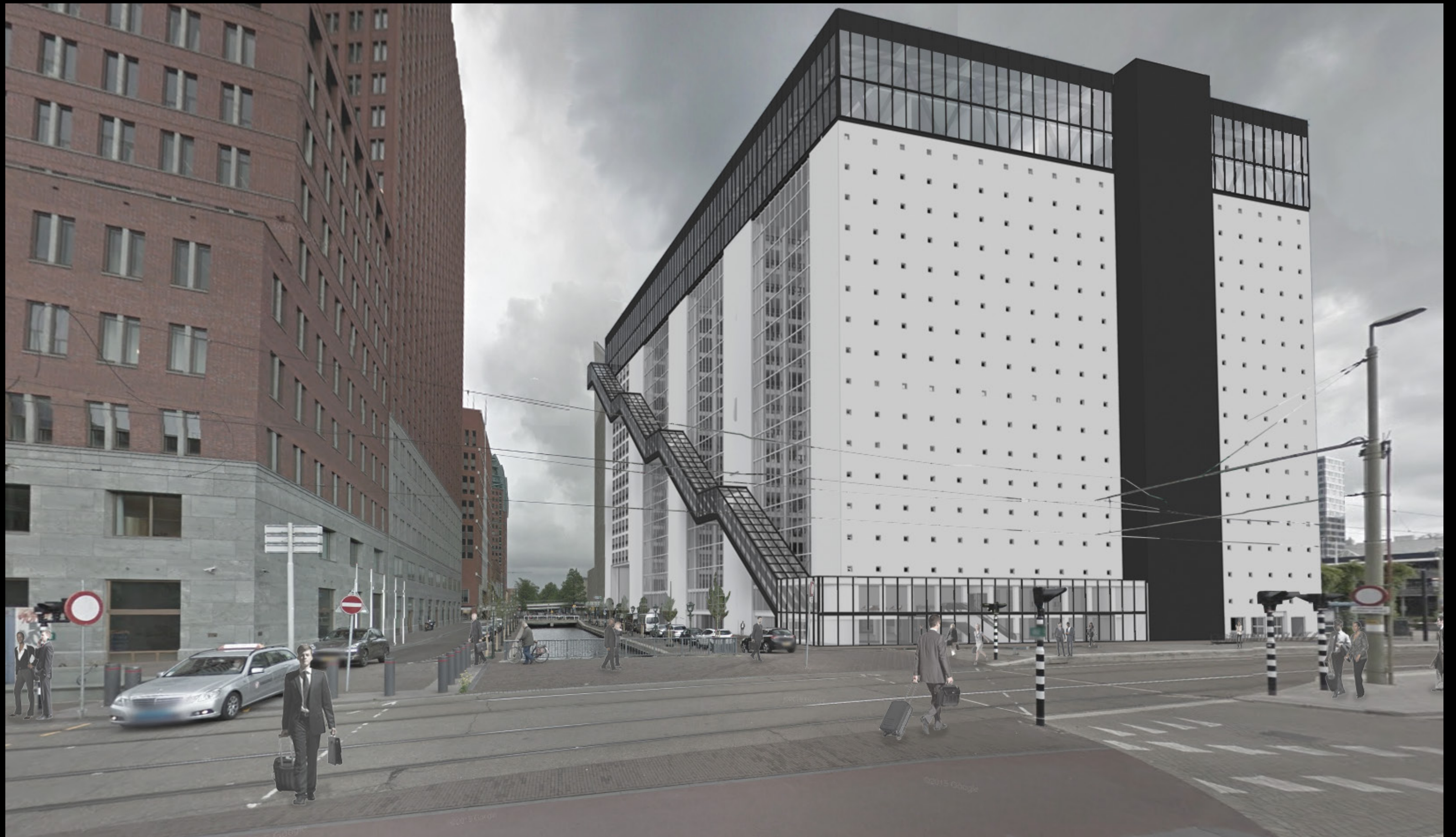

PUBLIC SERVICES

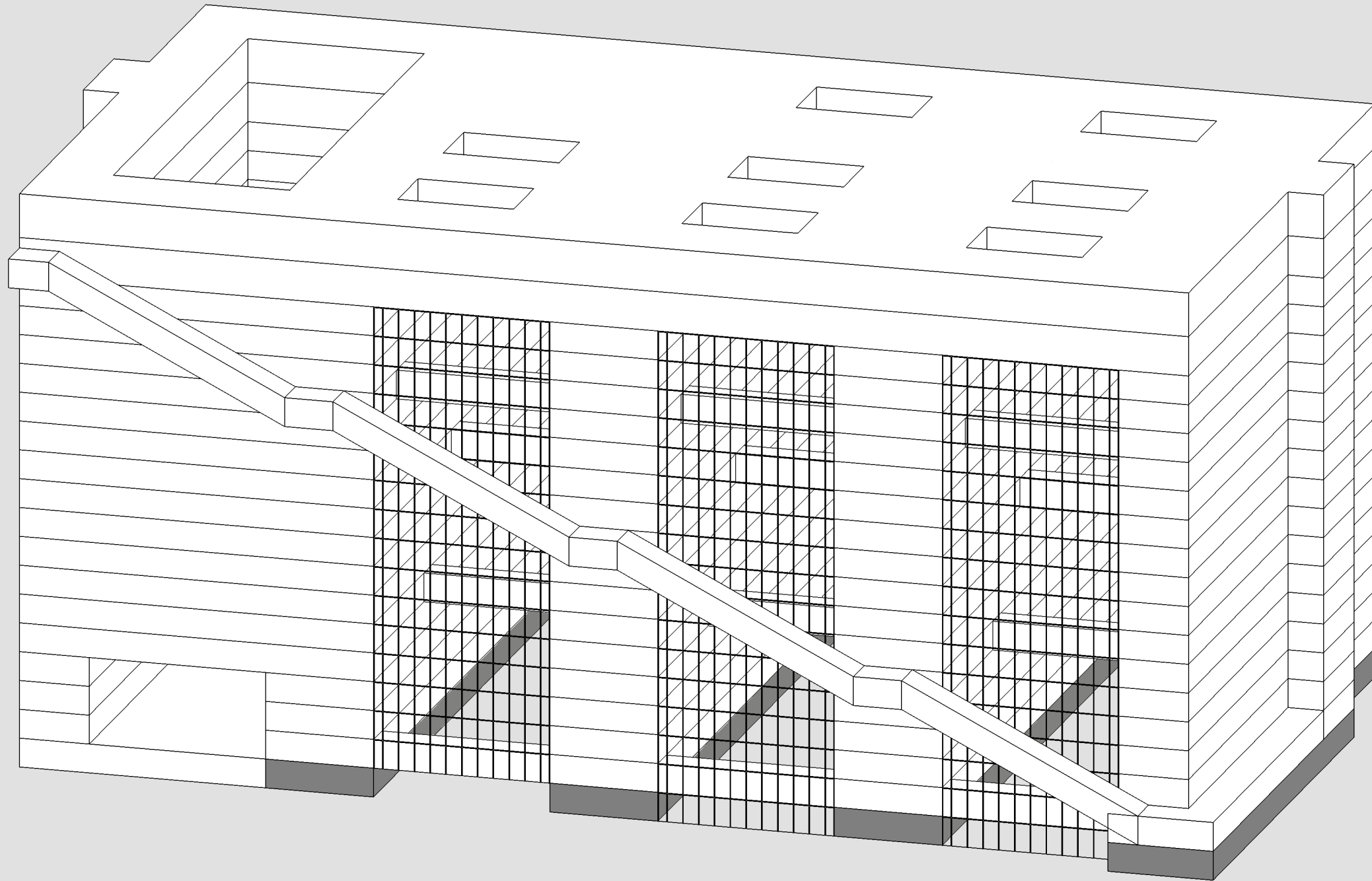

PUBLIC SERVICES

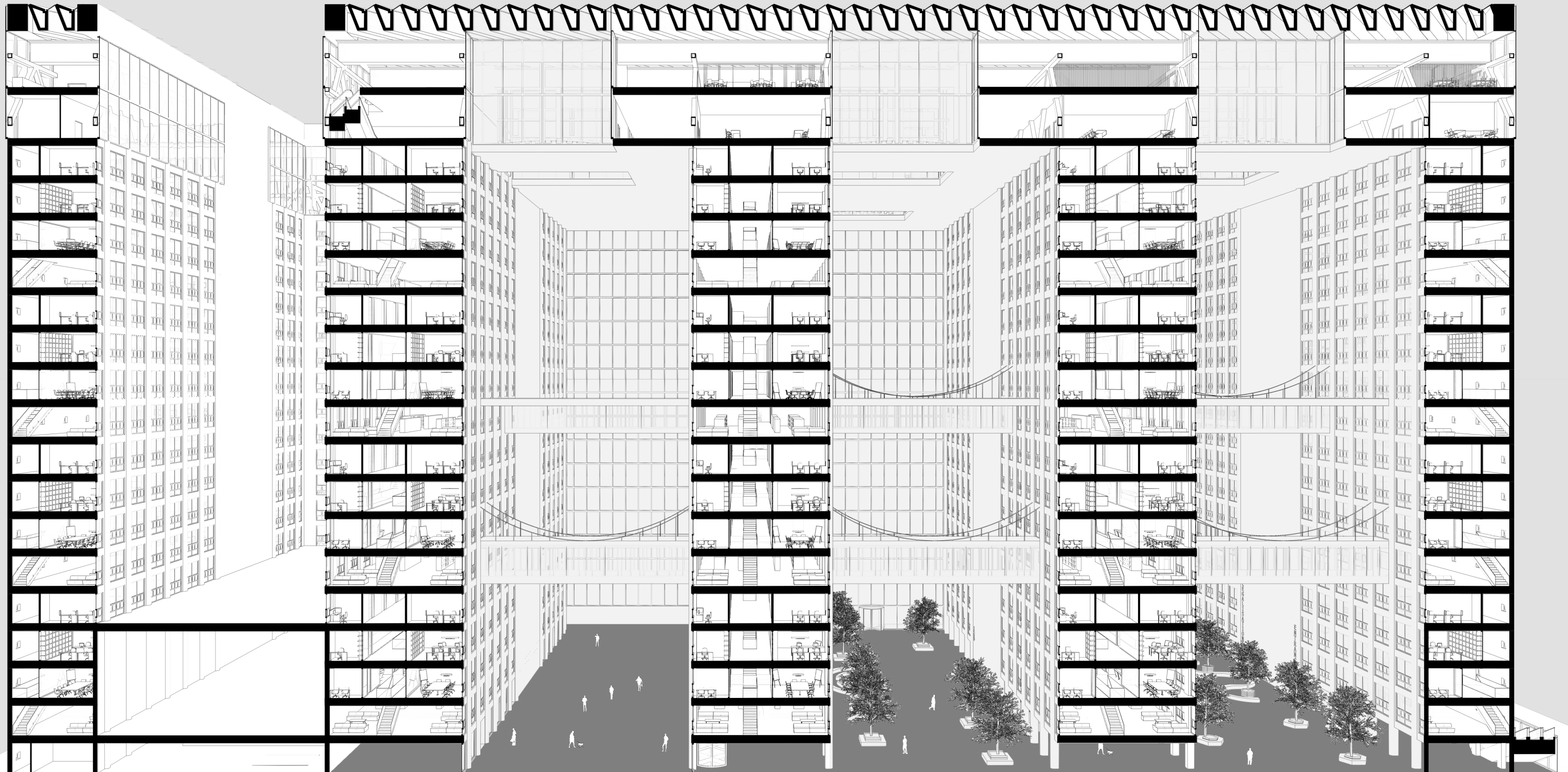

GROUND FLOOR - all entrances

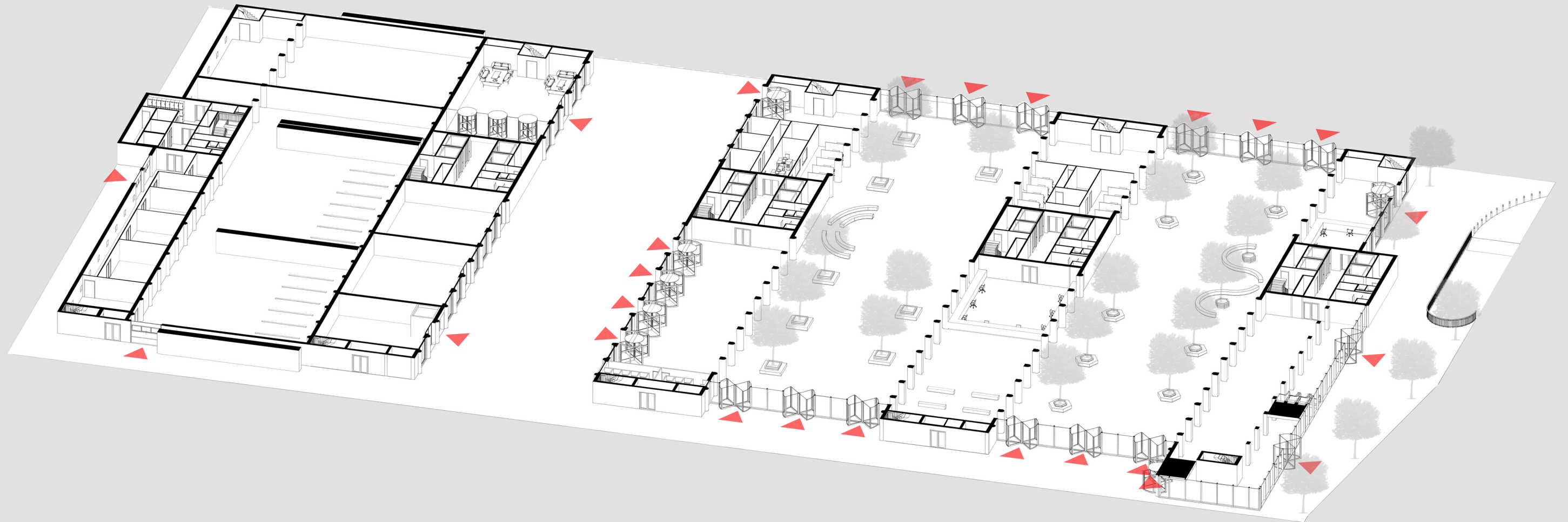

GROUND FLOOR - public entrances

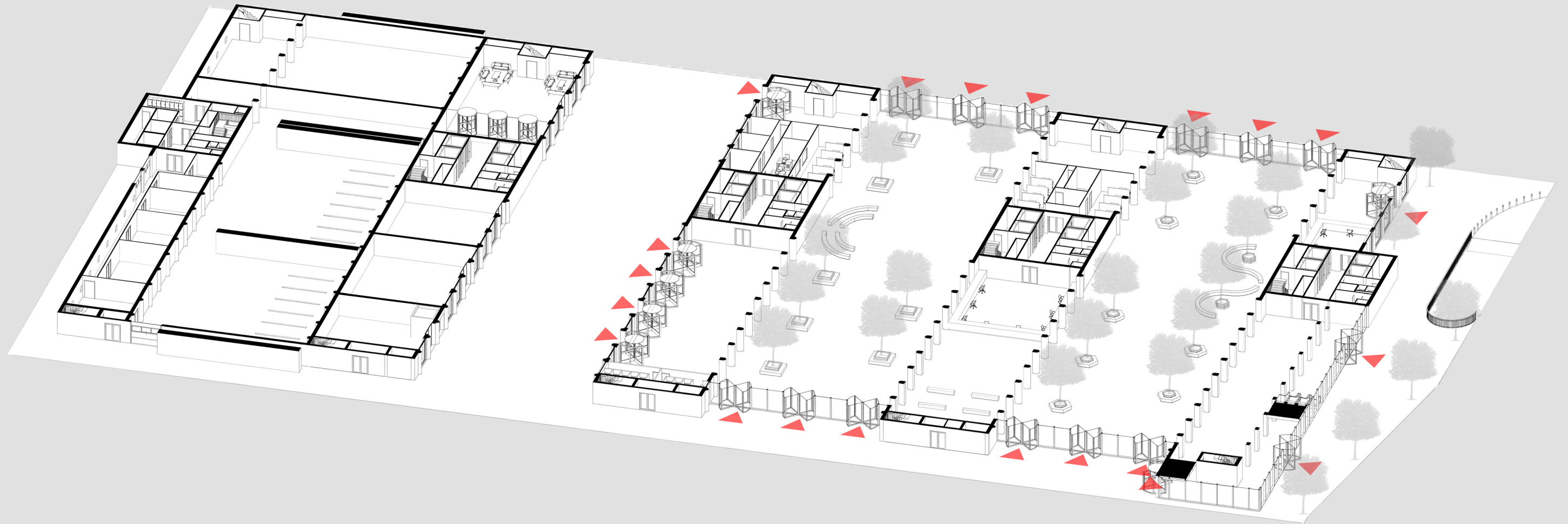

GROUND FLOOR - public elevator

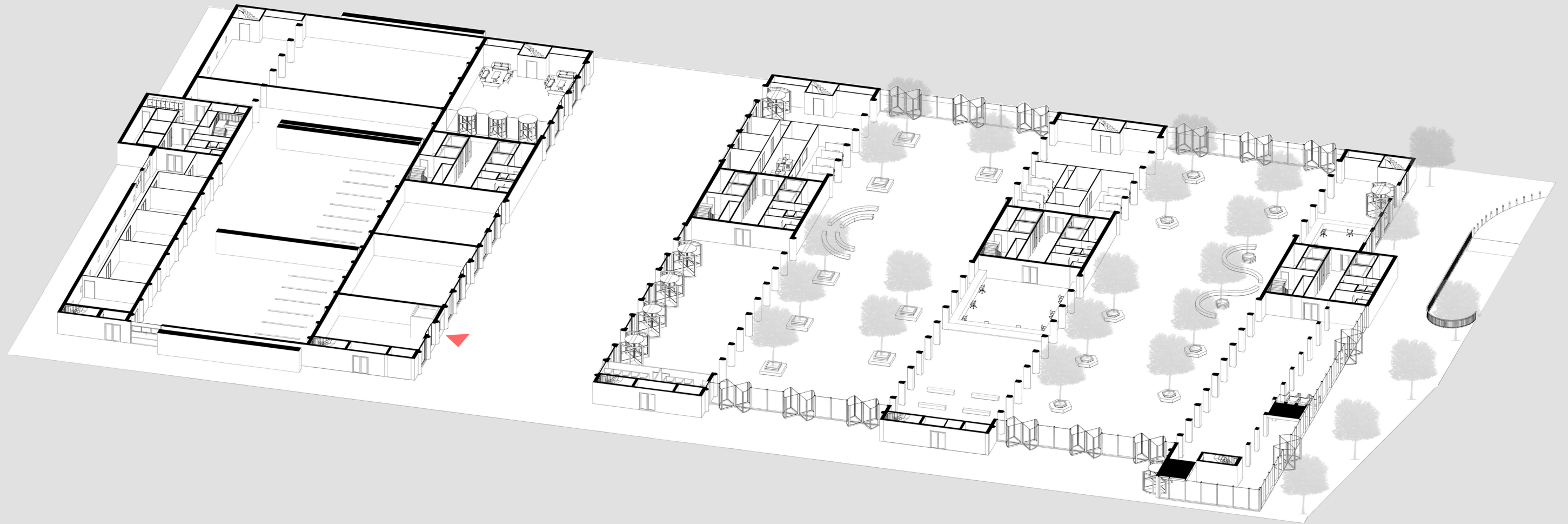

GROUND FLOOR - employee speed entrance

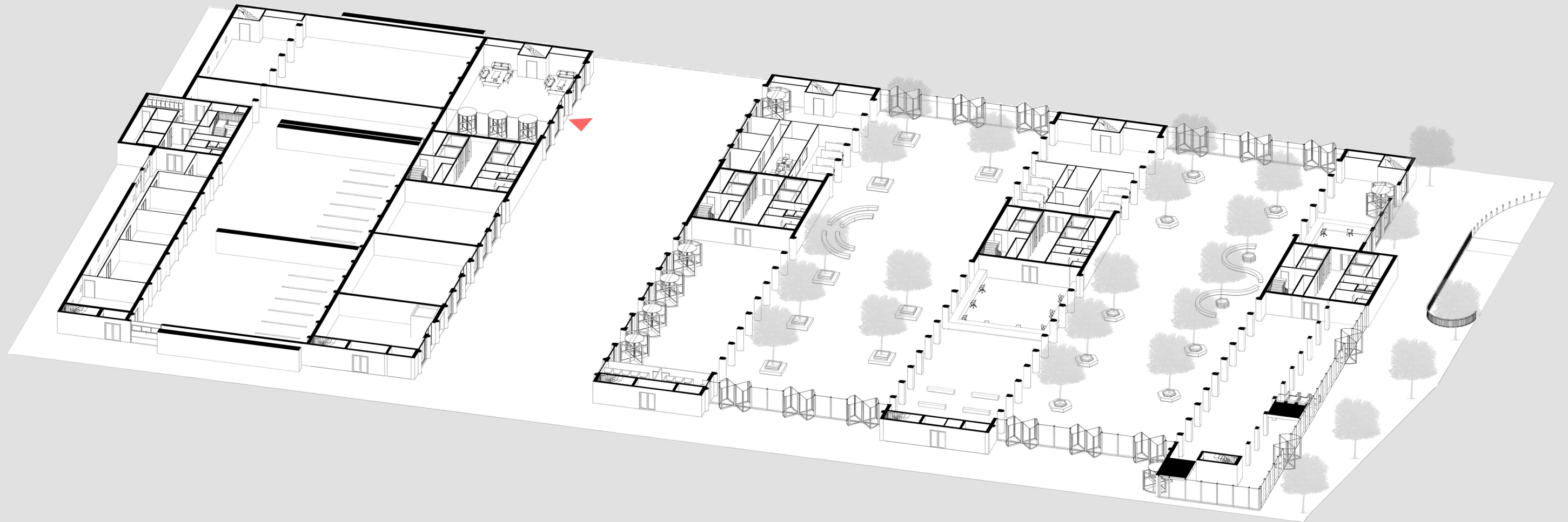

GROUND FLOOR - VIP parking garage entrance

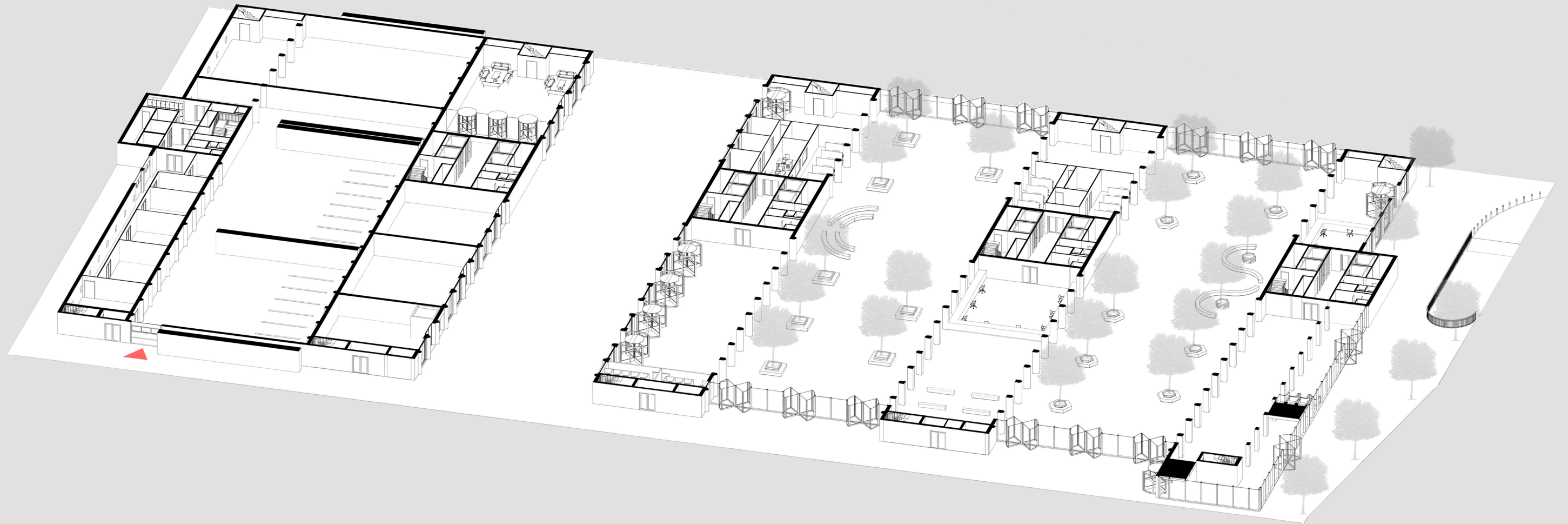

GROUND FLOOR - expedition entrance

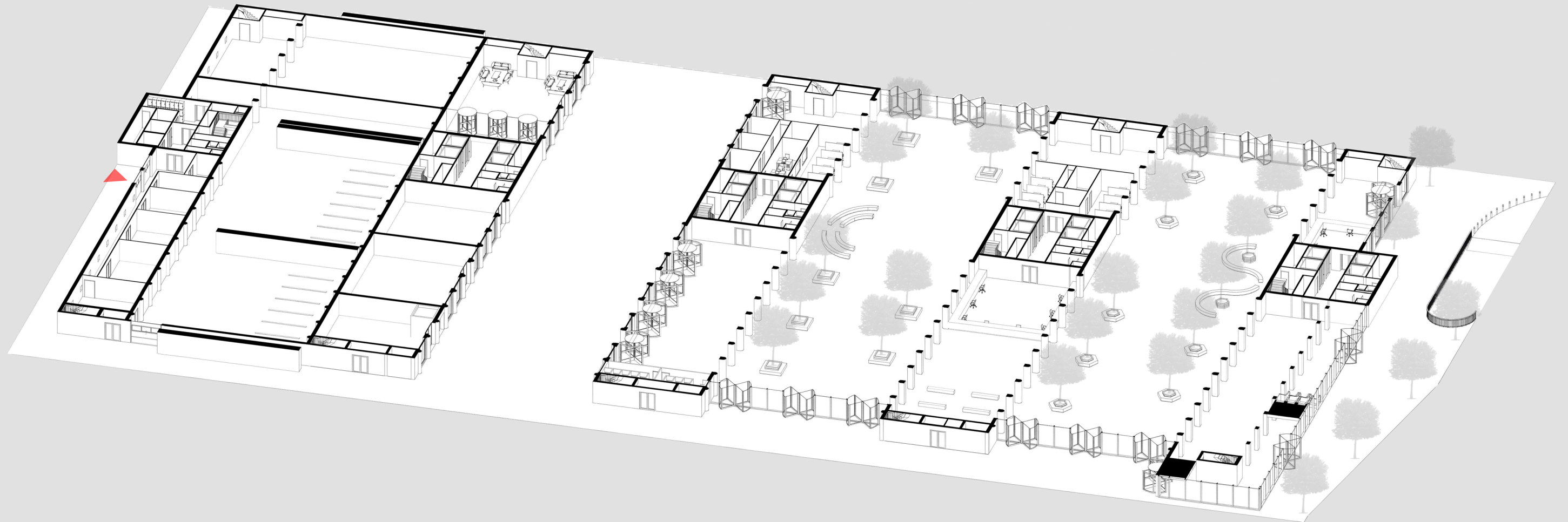

GROUND FLOOR - shops

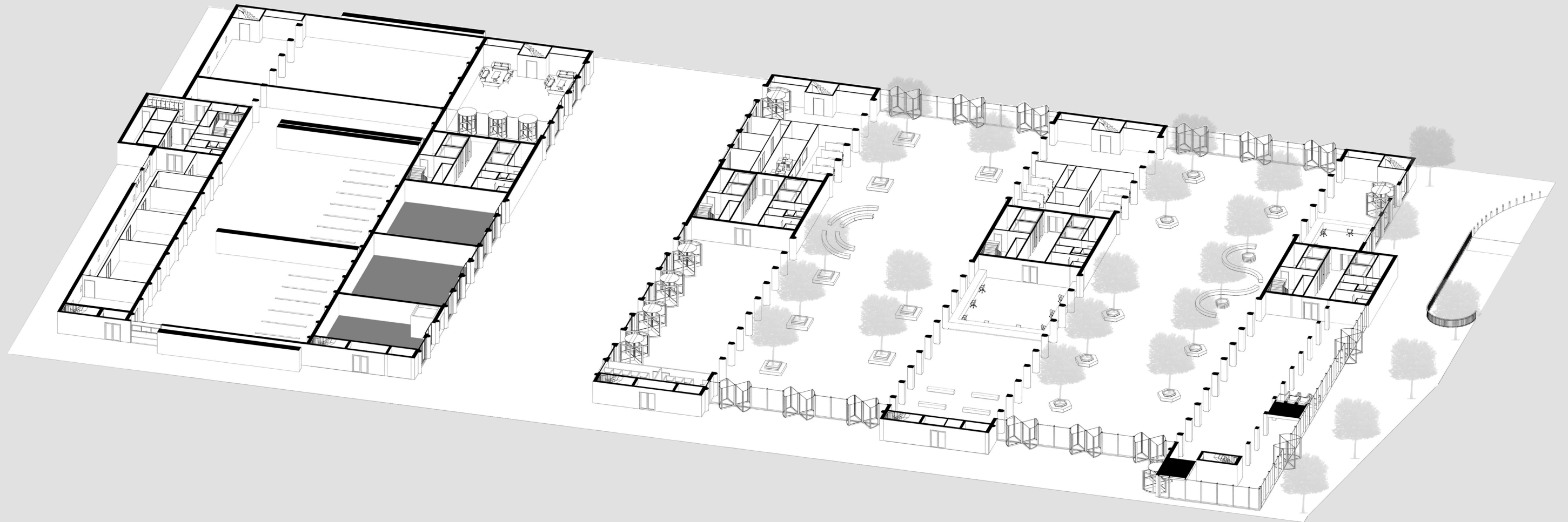

GROUND FLOOR - information desk

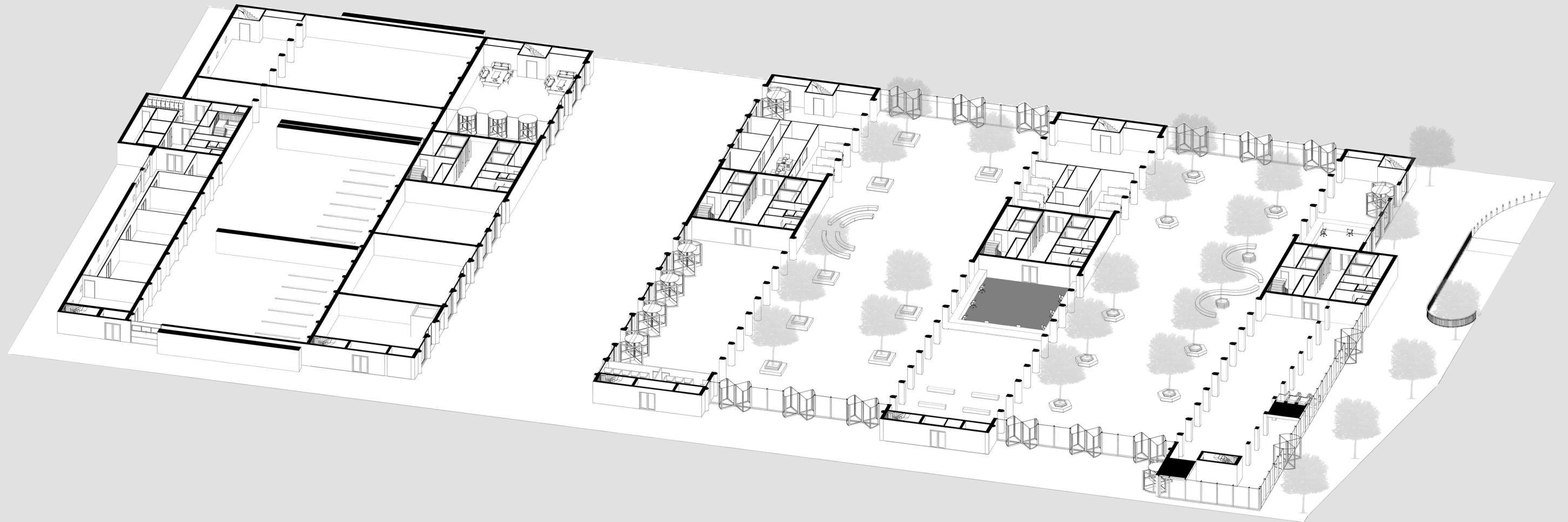

GROUND FLOOR - IND

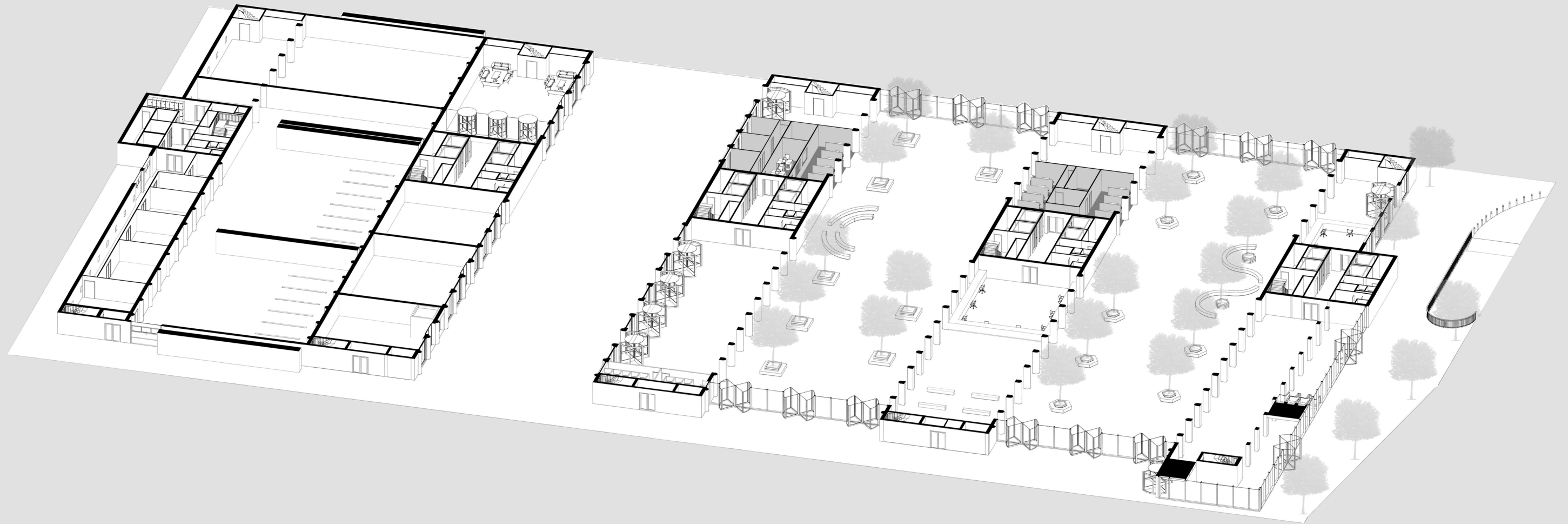

GROUND FLOOR - legalisation

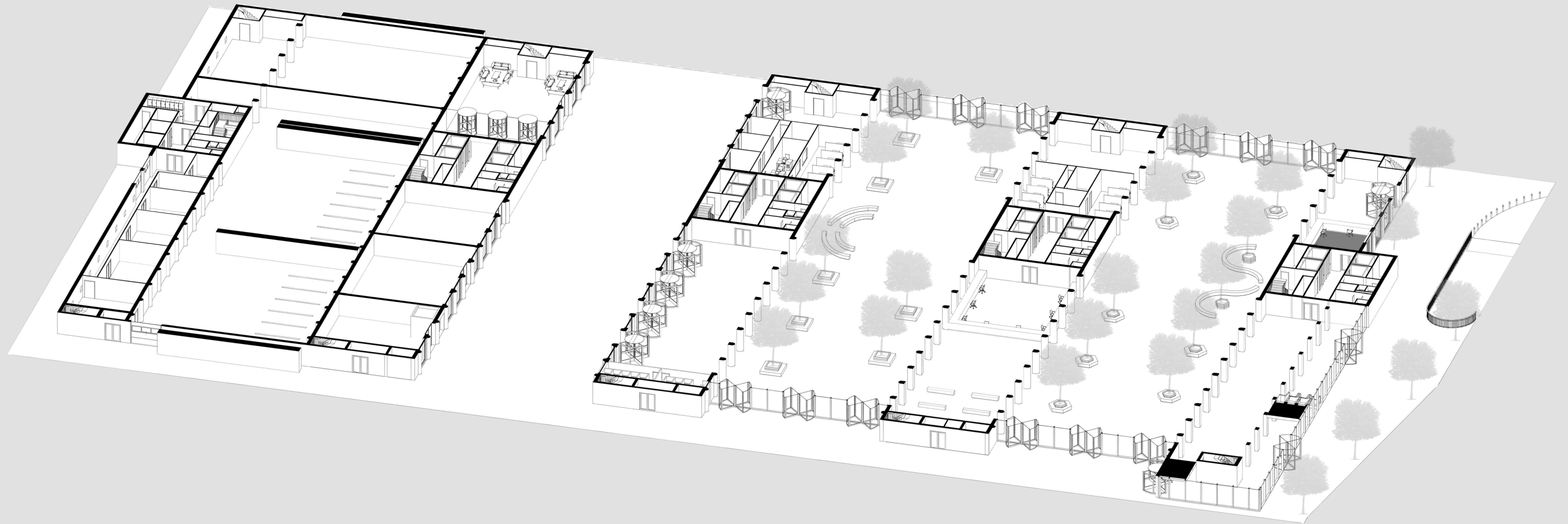



OFFICES

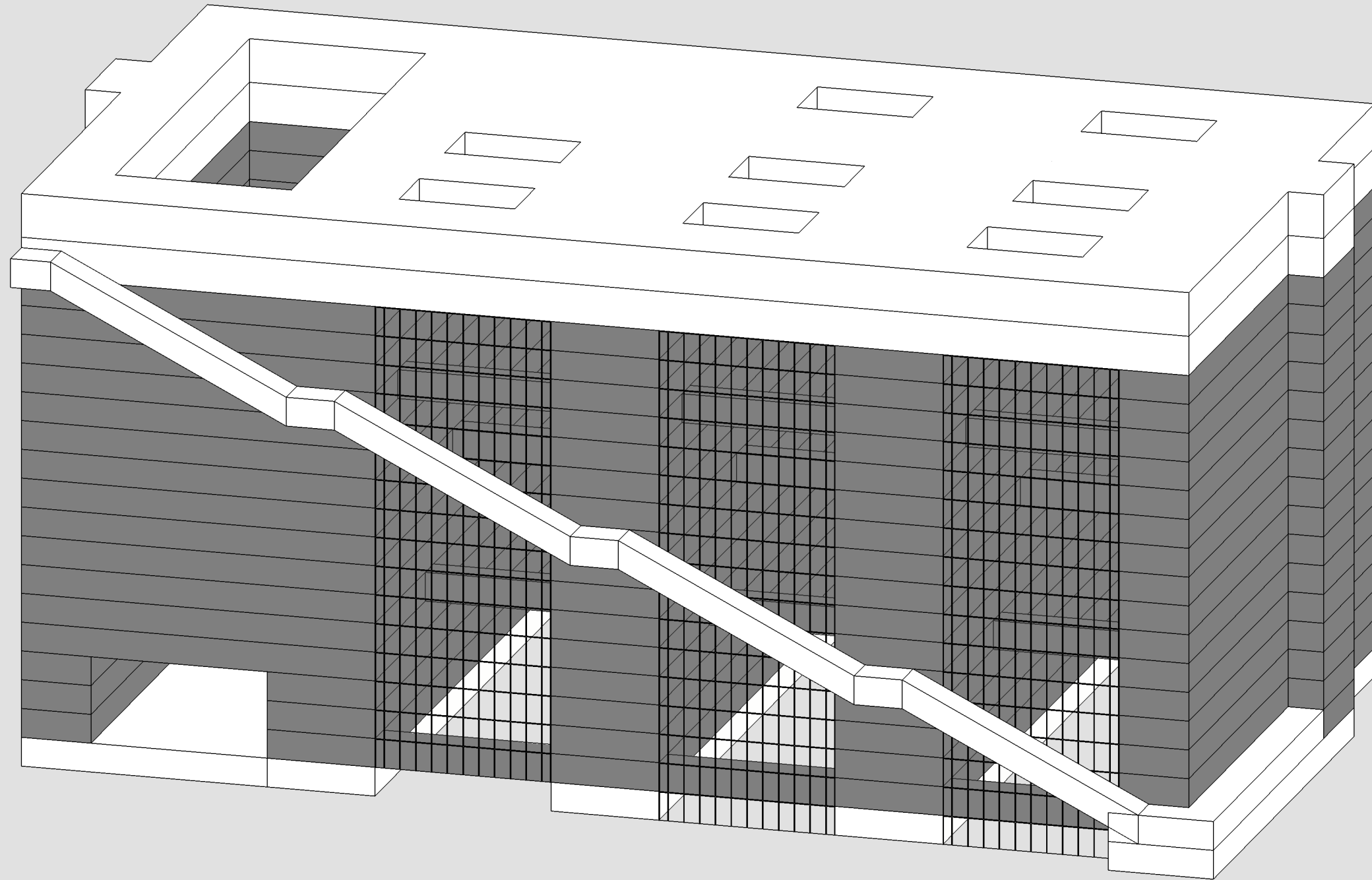

OFFICES - 1 zone

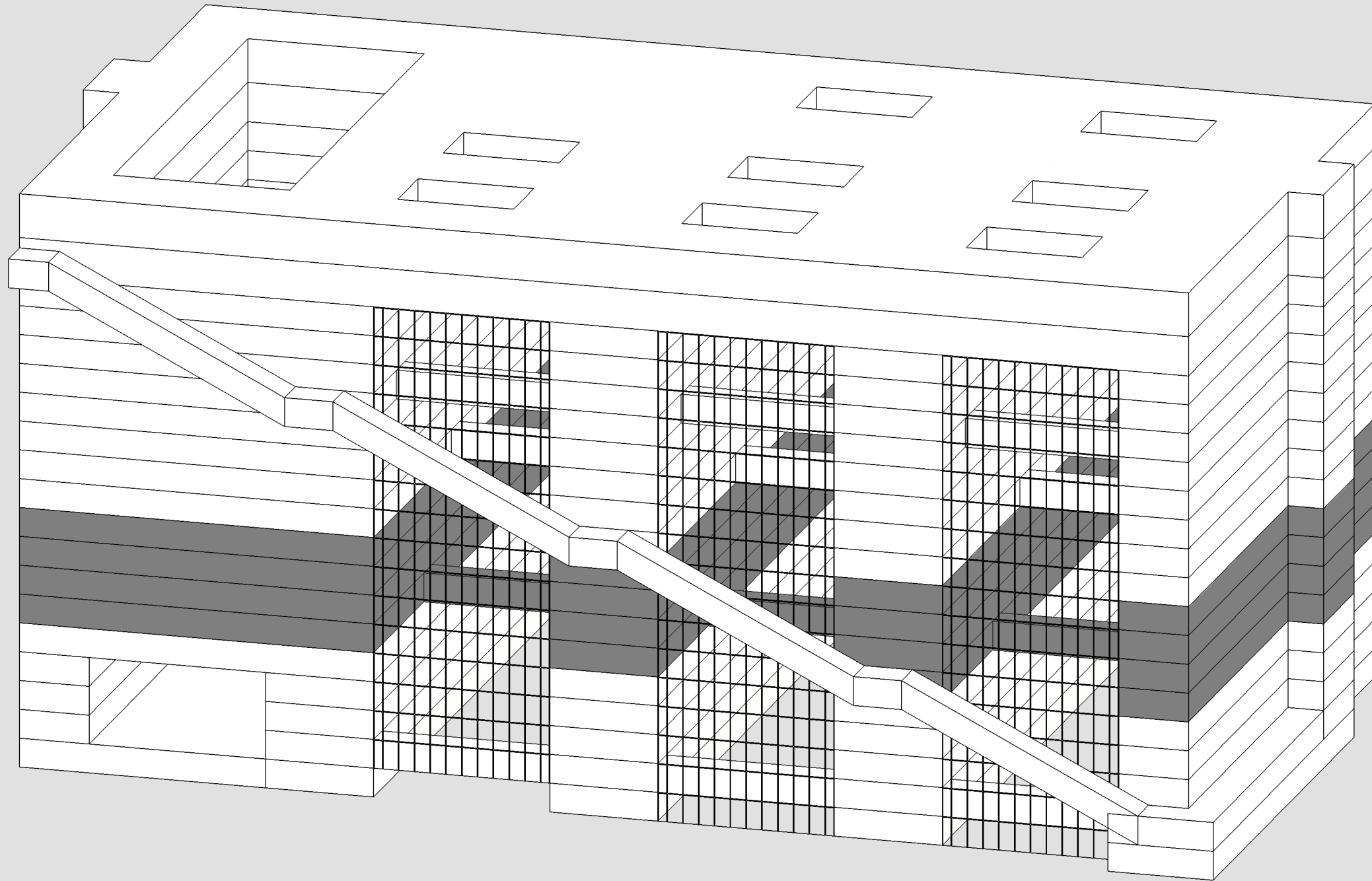

OFFICES - 1 zone

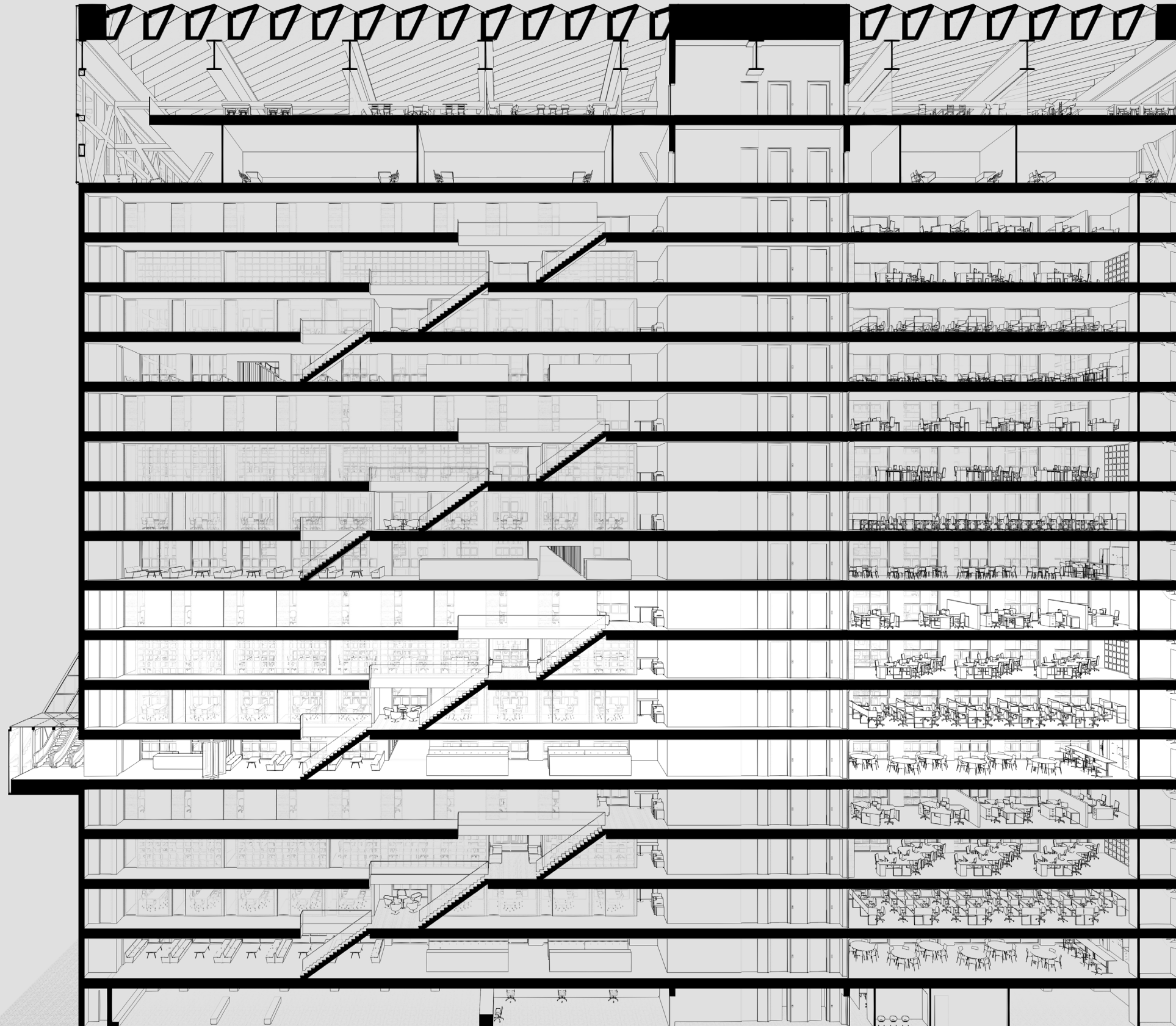

ZONE - 4th floor

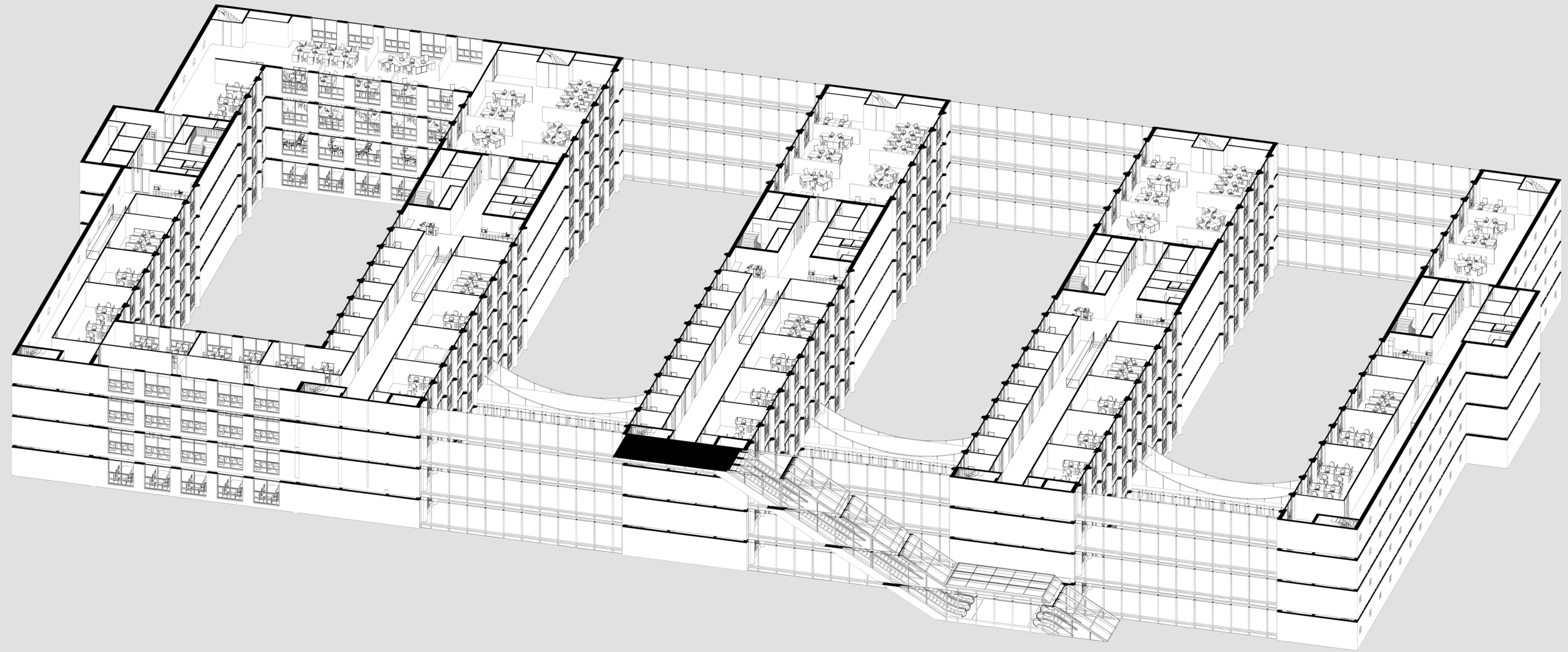

ZONE - 4th floor - concentration rooms

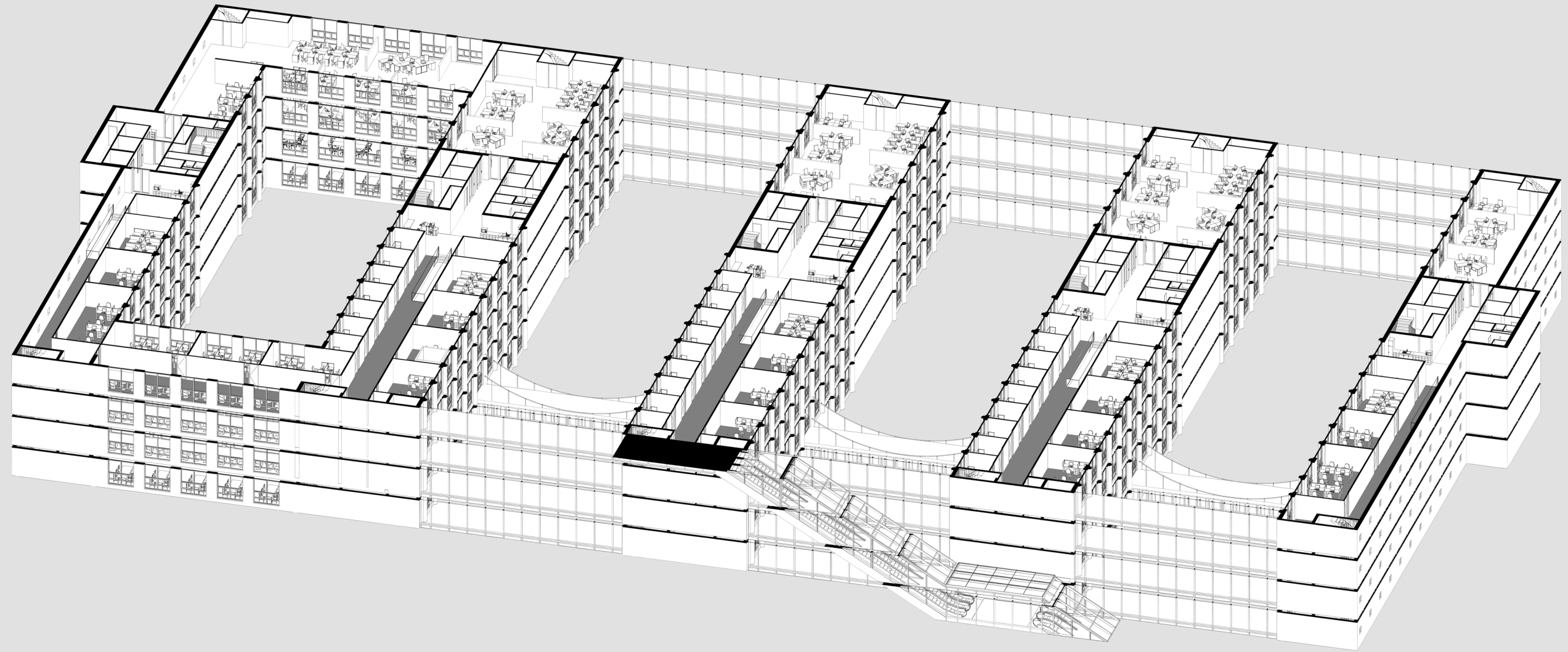

ZONE - 4th floor - half open work spaces

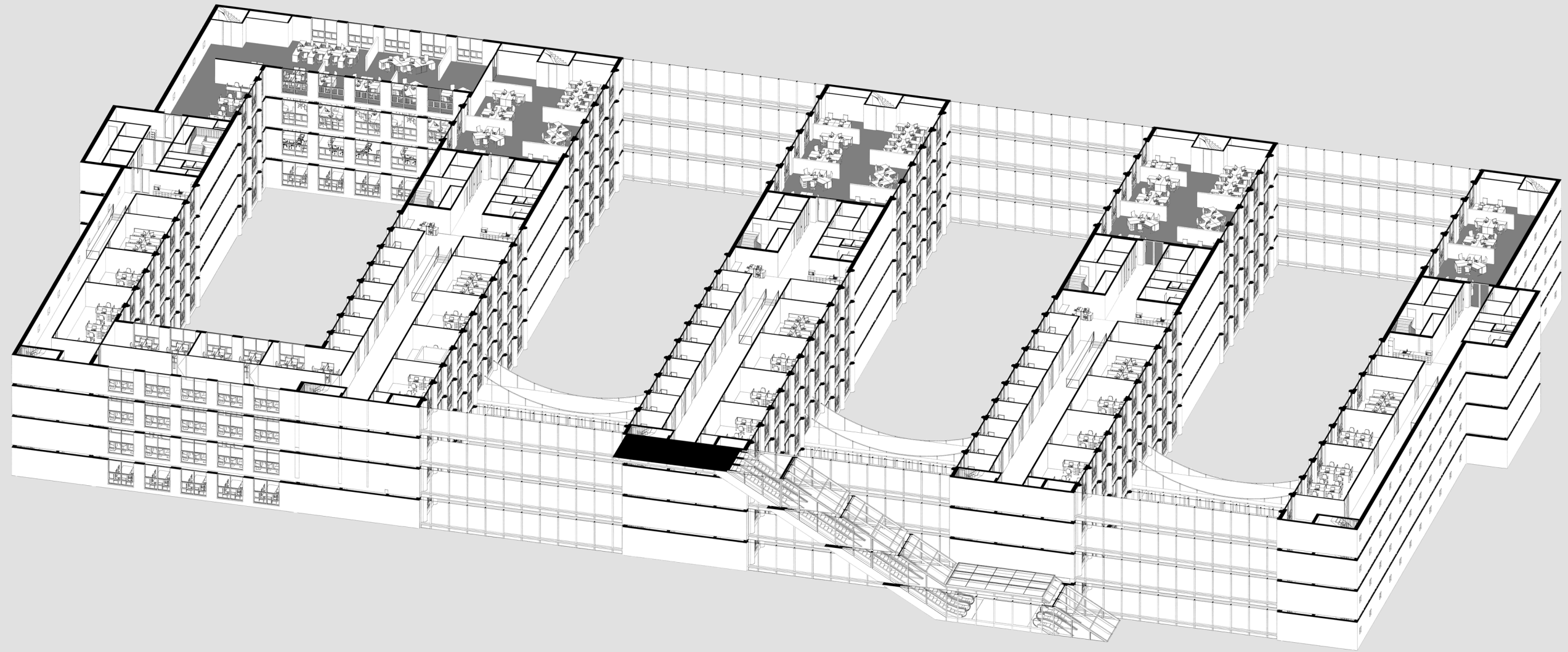

ZONE - 4th floor - informal meeting spaces

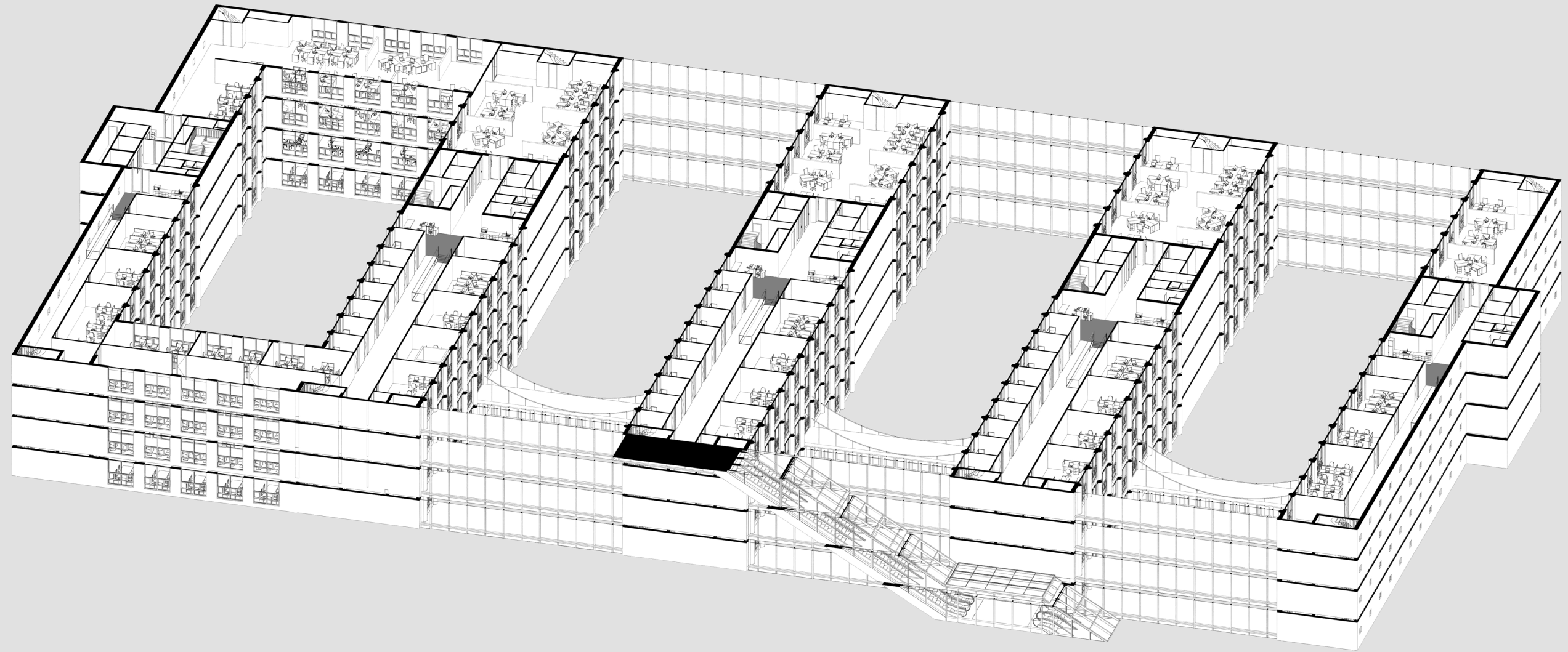

ZONE - 3rd floor - project rooms

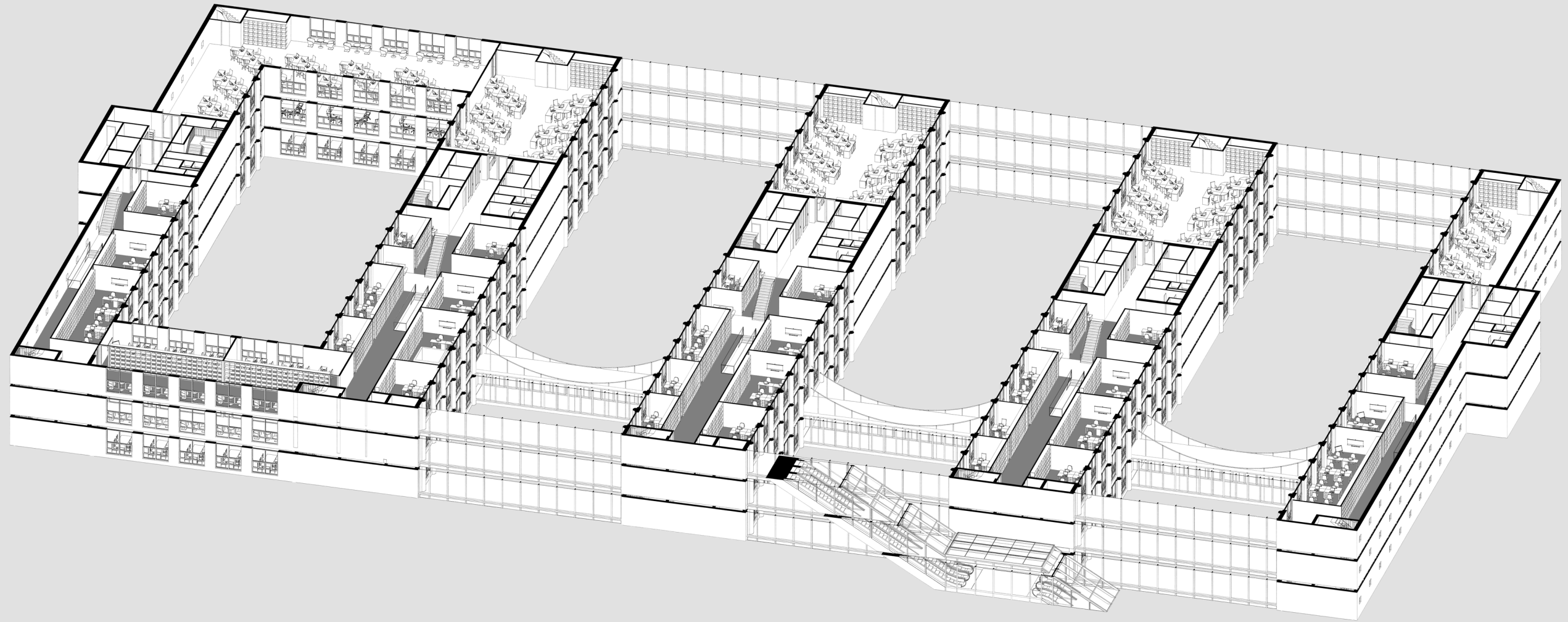

ZONE - 3rd floor - open work spaces

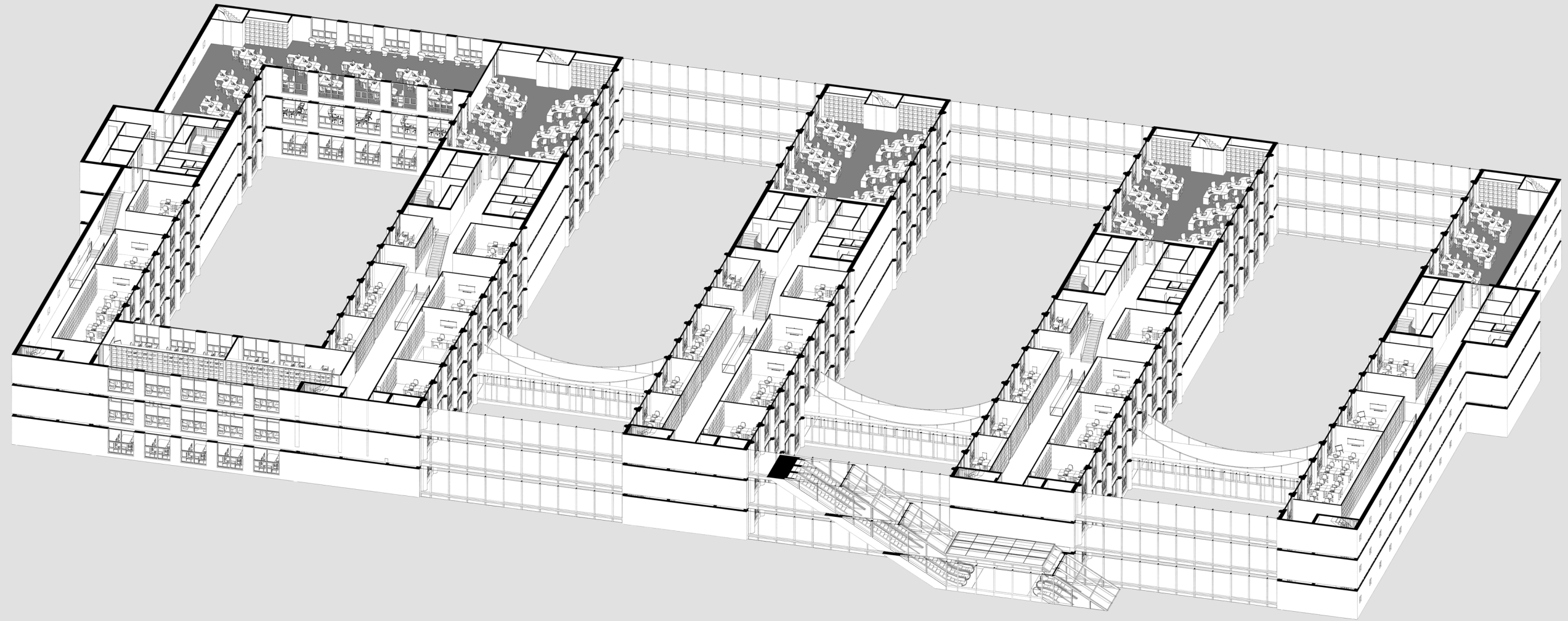

ZONE - 3rd floor - informal meeting spaces

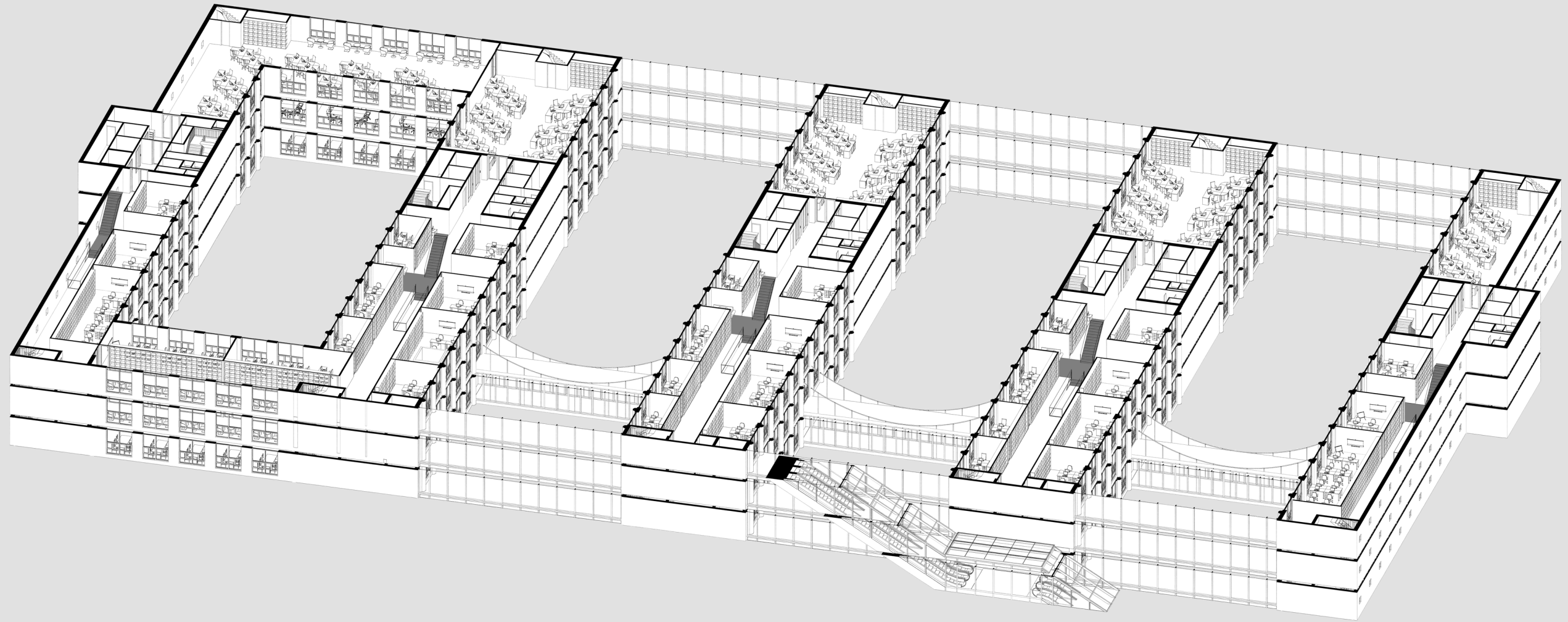

ZONE - 2nd floor - meeting rooms

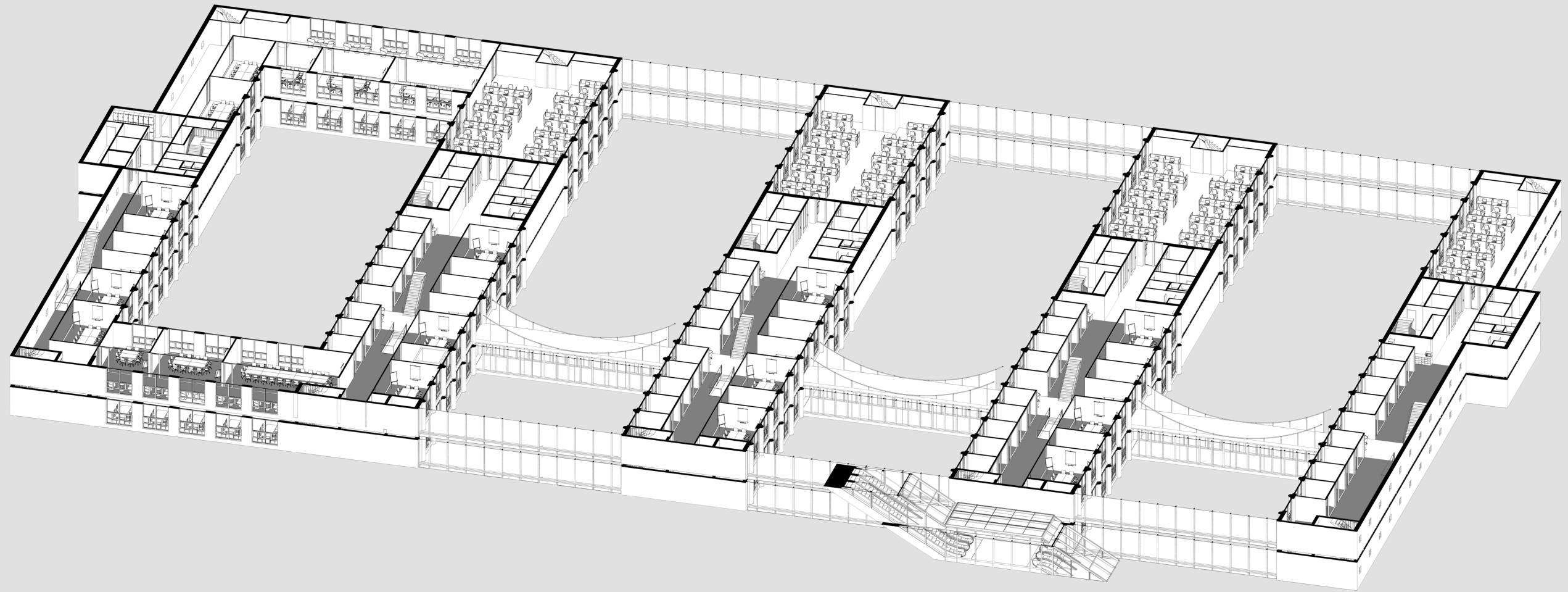

ZONE - 2nd floor - VIP meeting rooms

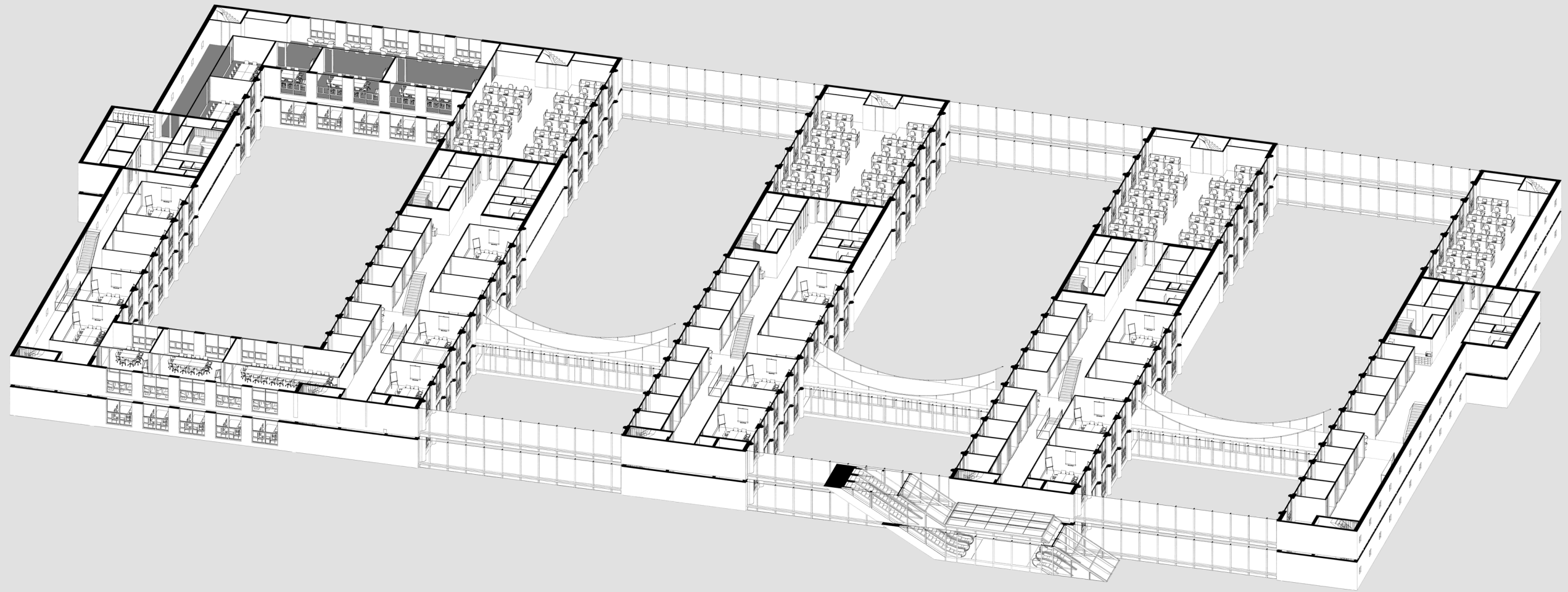

ZONE - 2nd floor - 'library' work spaces

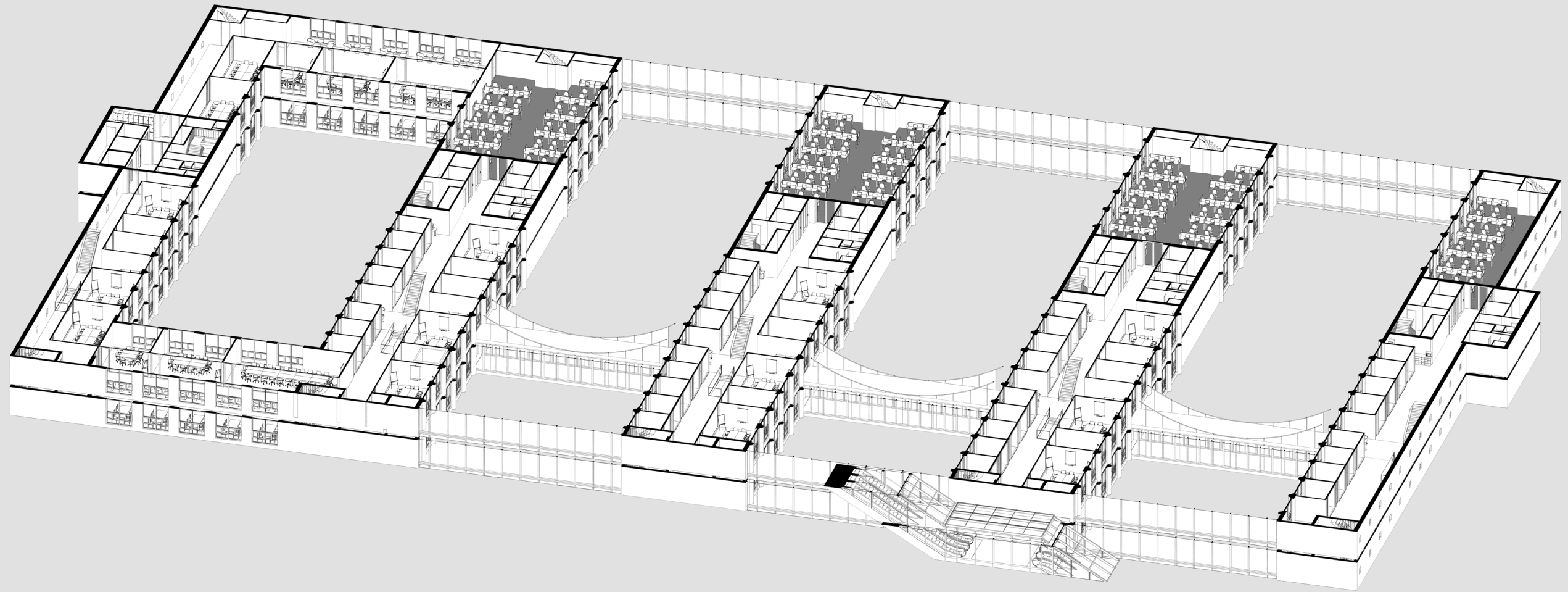

ZONE - 2nd floor - informal meeting spaces

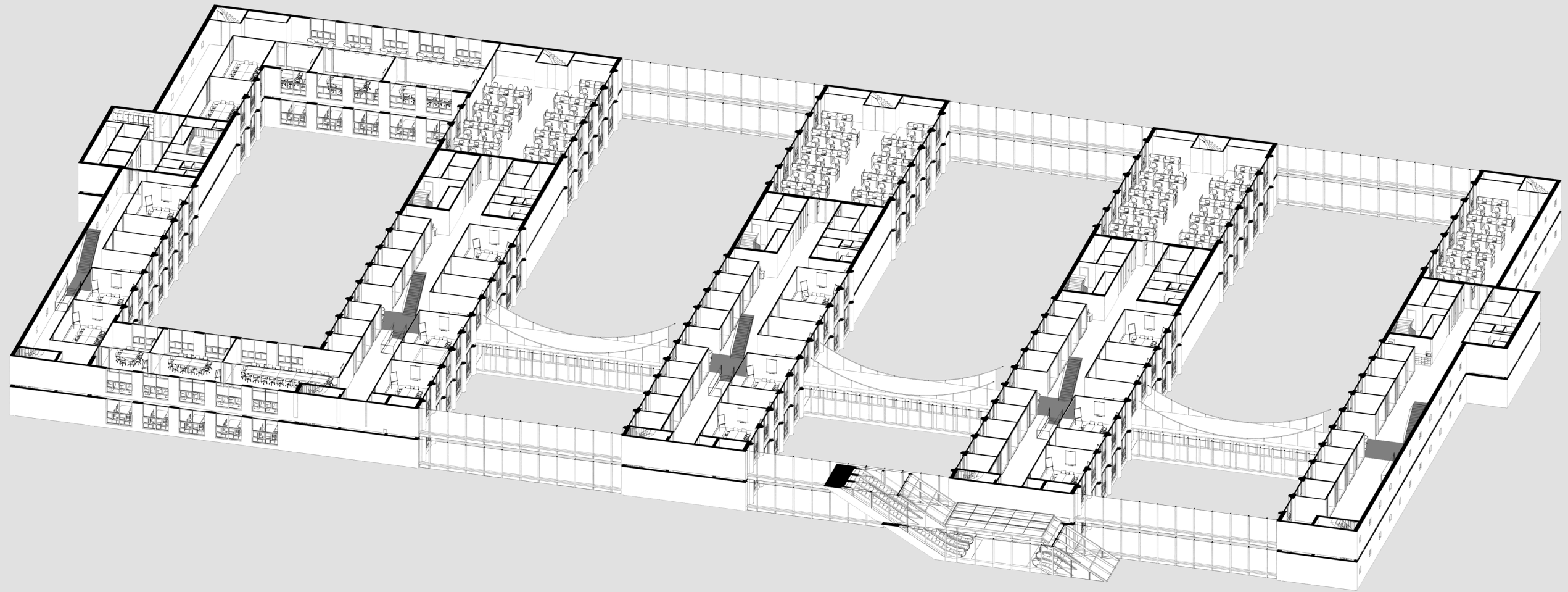

ZONE - 1st floor - security check point

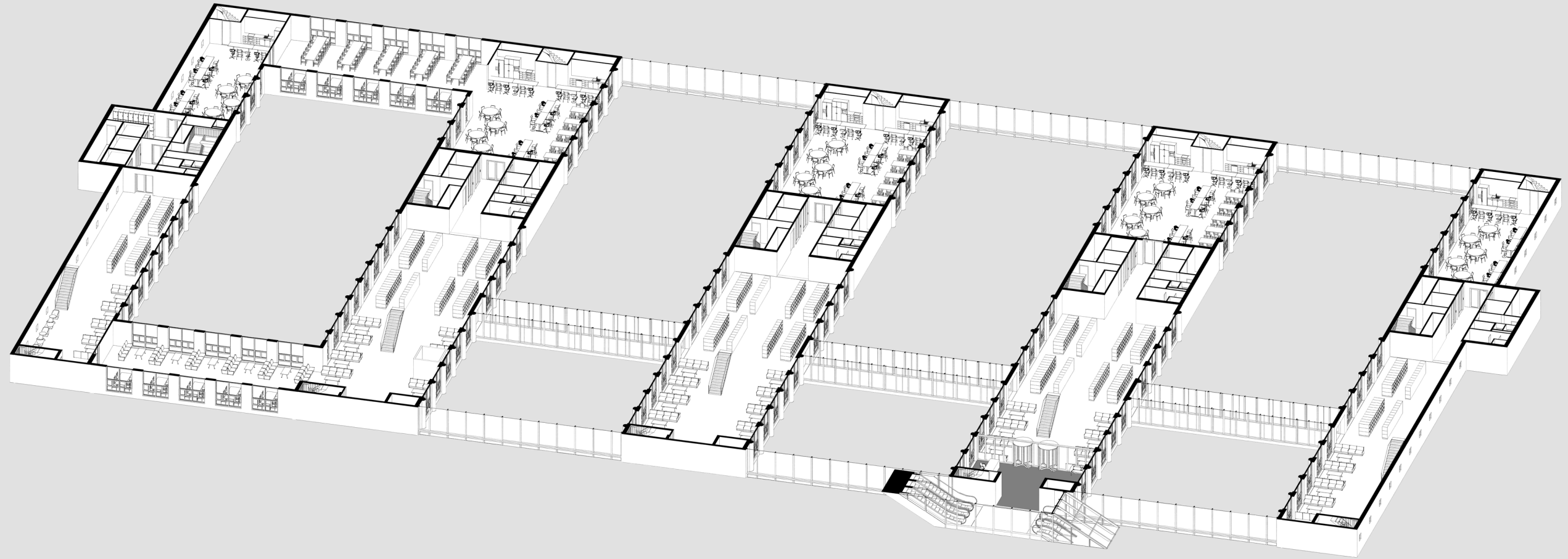

ZONE - 1st floor - welcome & waiting area

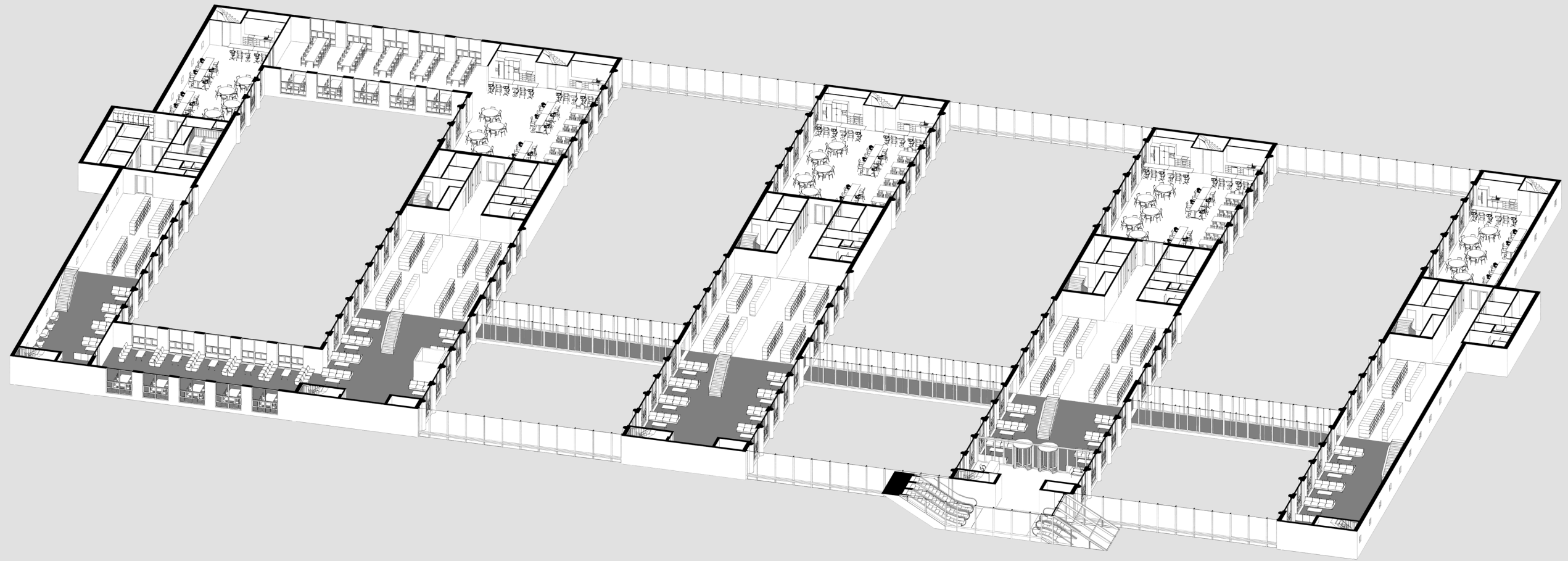

ZONE - 1st floor - locker area

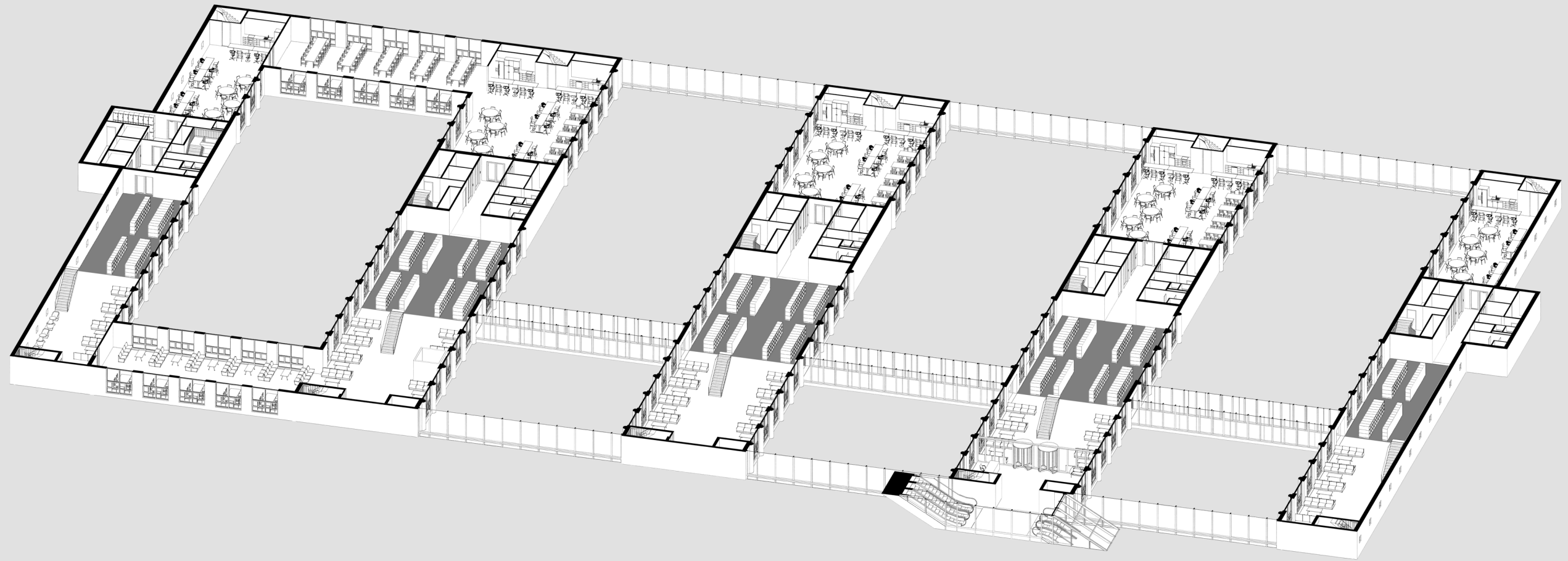

ZONE - 1st floor - office kitchens

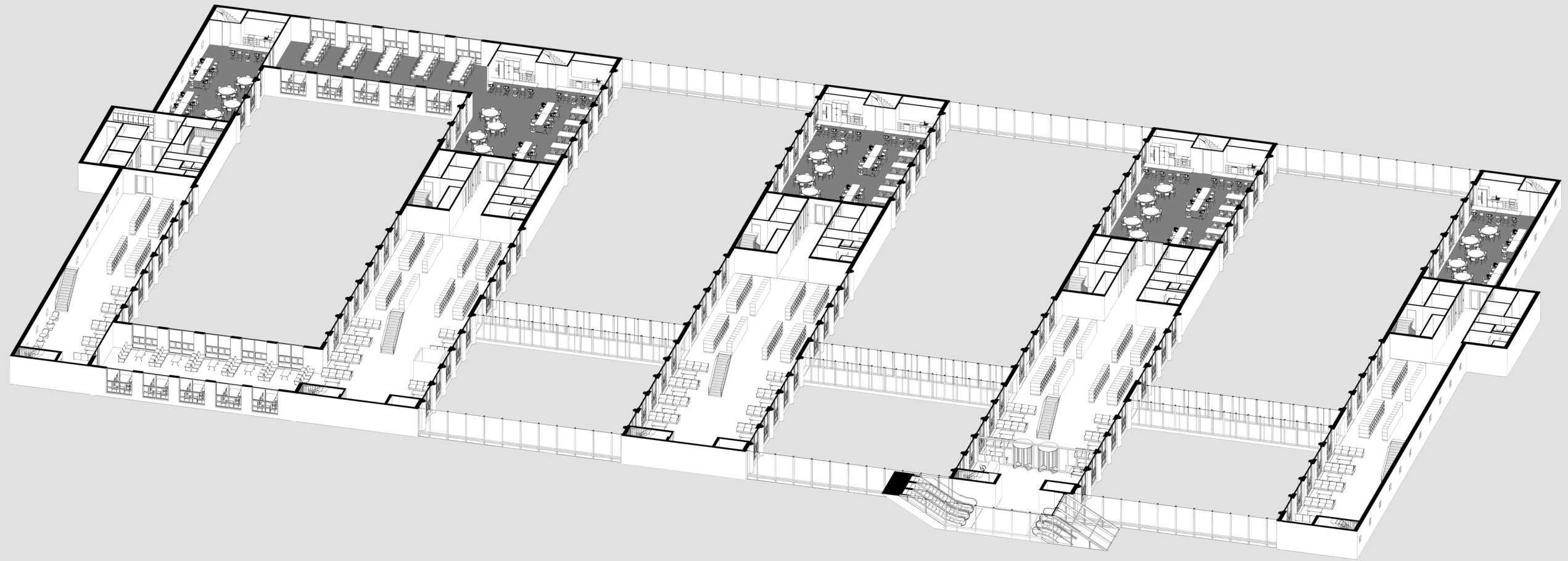





FOREIGN AFFAIRS









PUBLIC FUNCTIONS

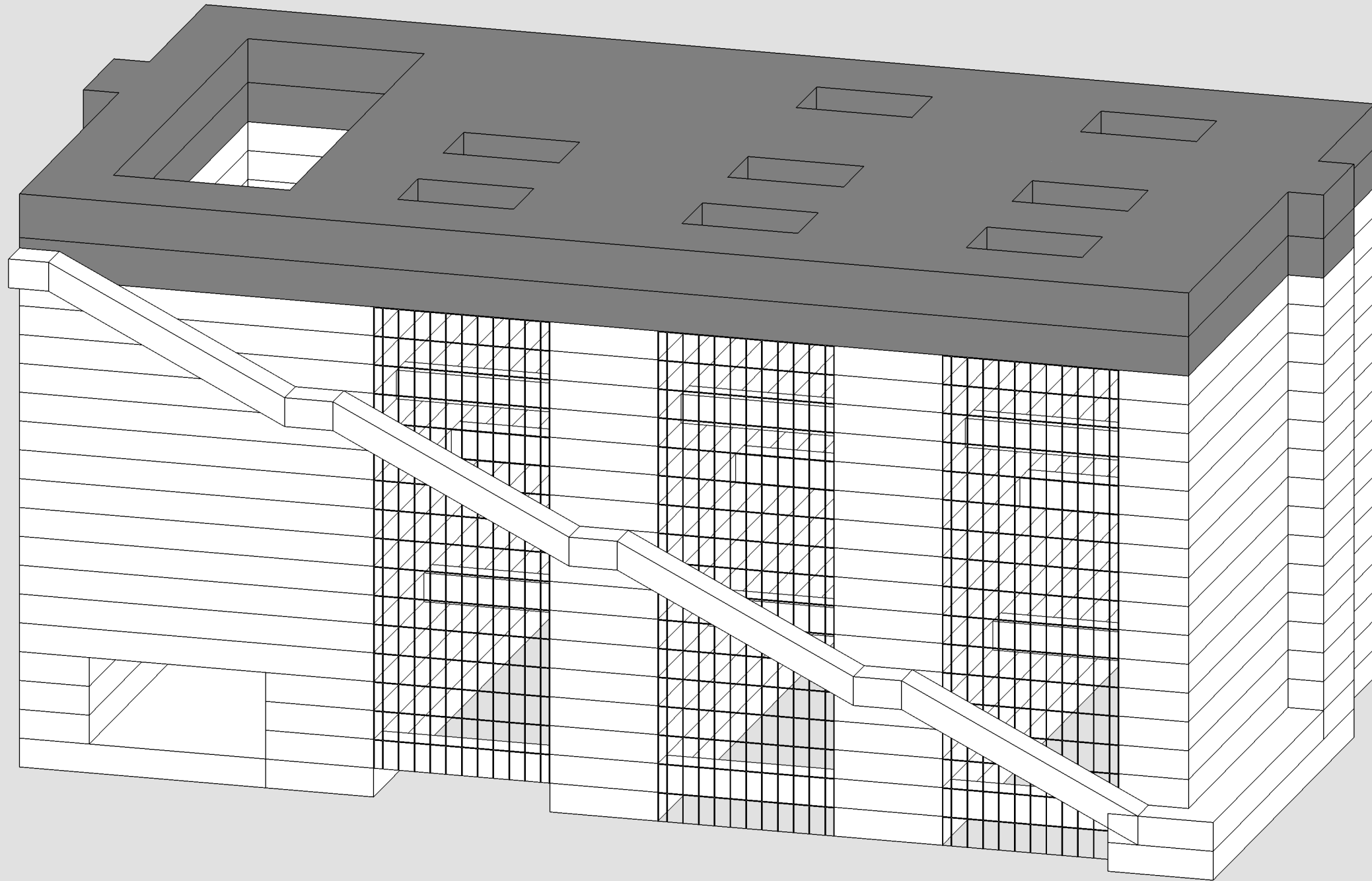

PUBLIC FUNCTIONS

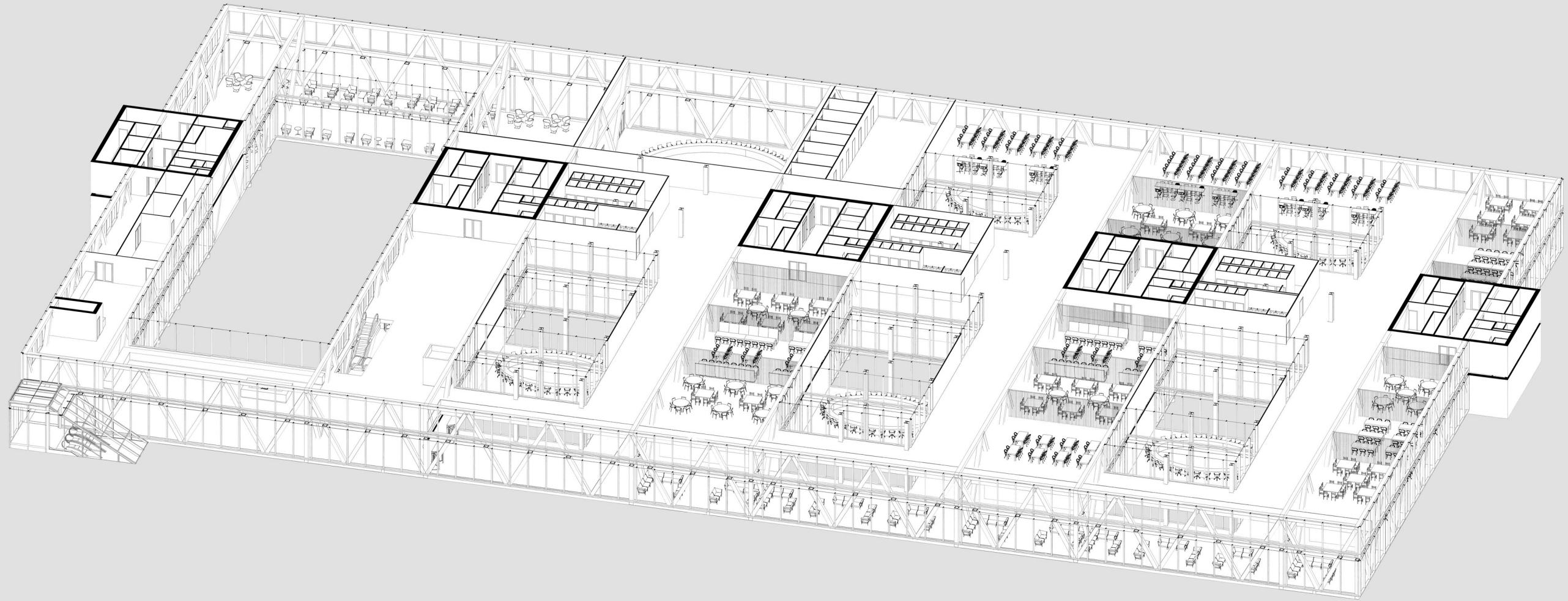

RESTAURANT - preparation kitchen

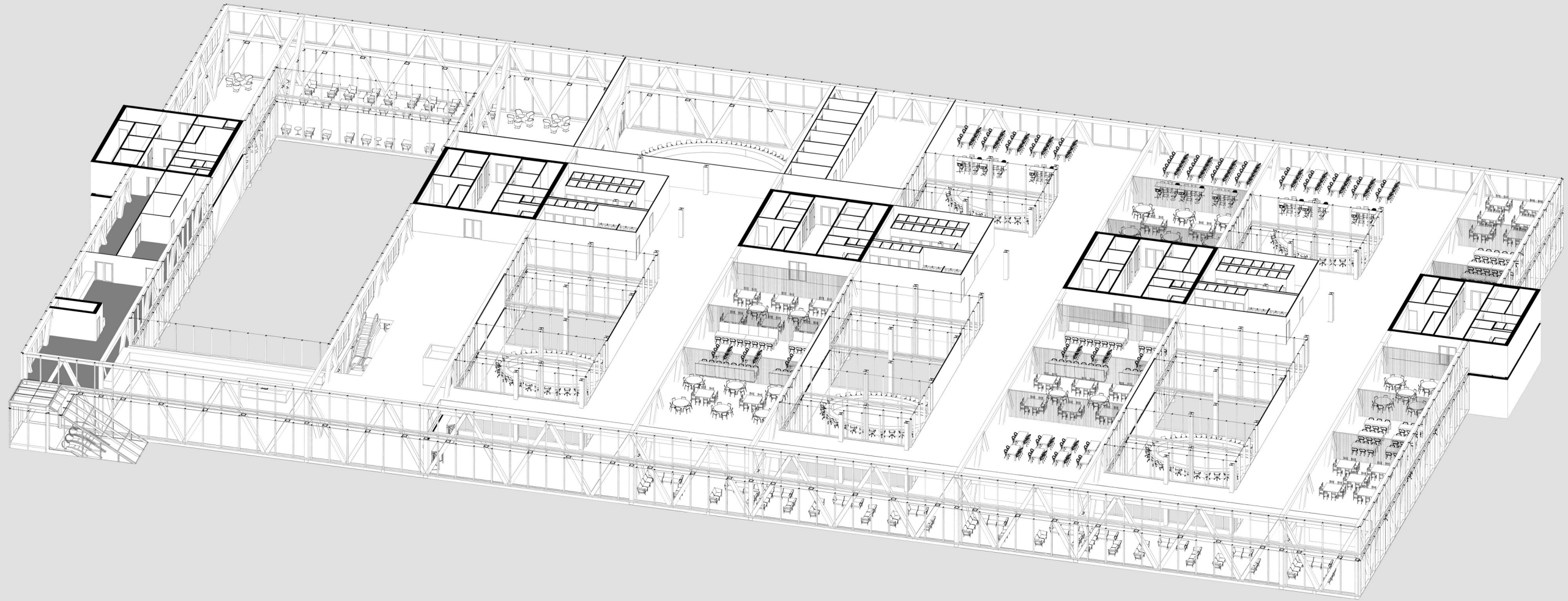

RESTAURANT - buffet

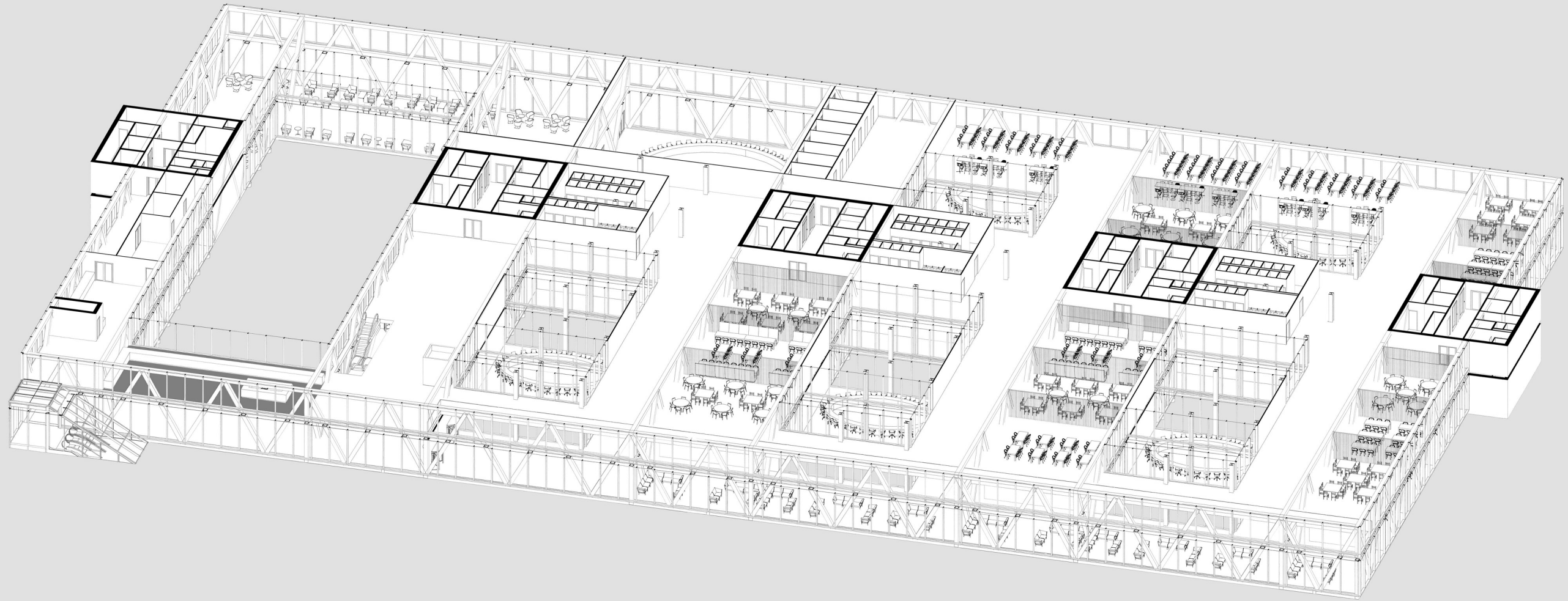

RESTAURANT - seating area

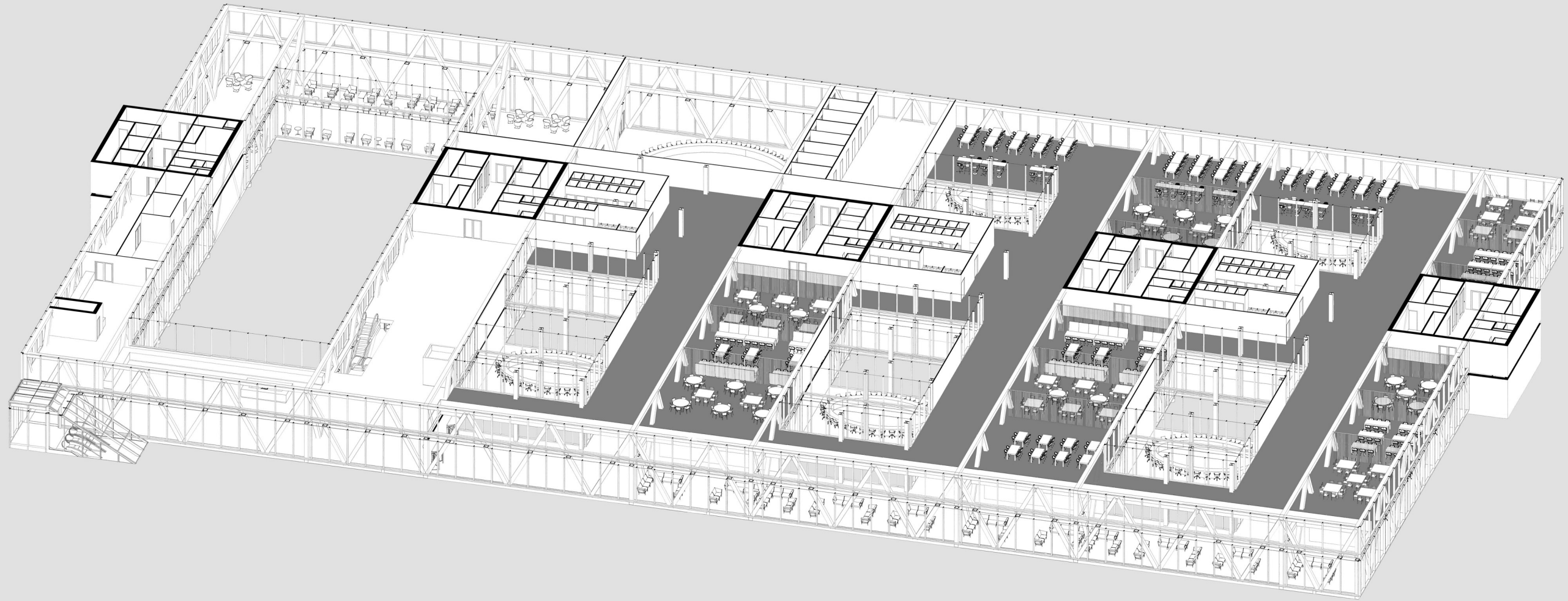

RESTAURANT - passages

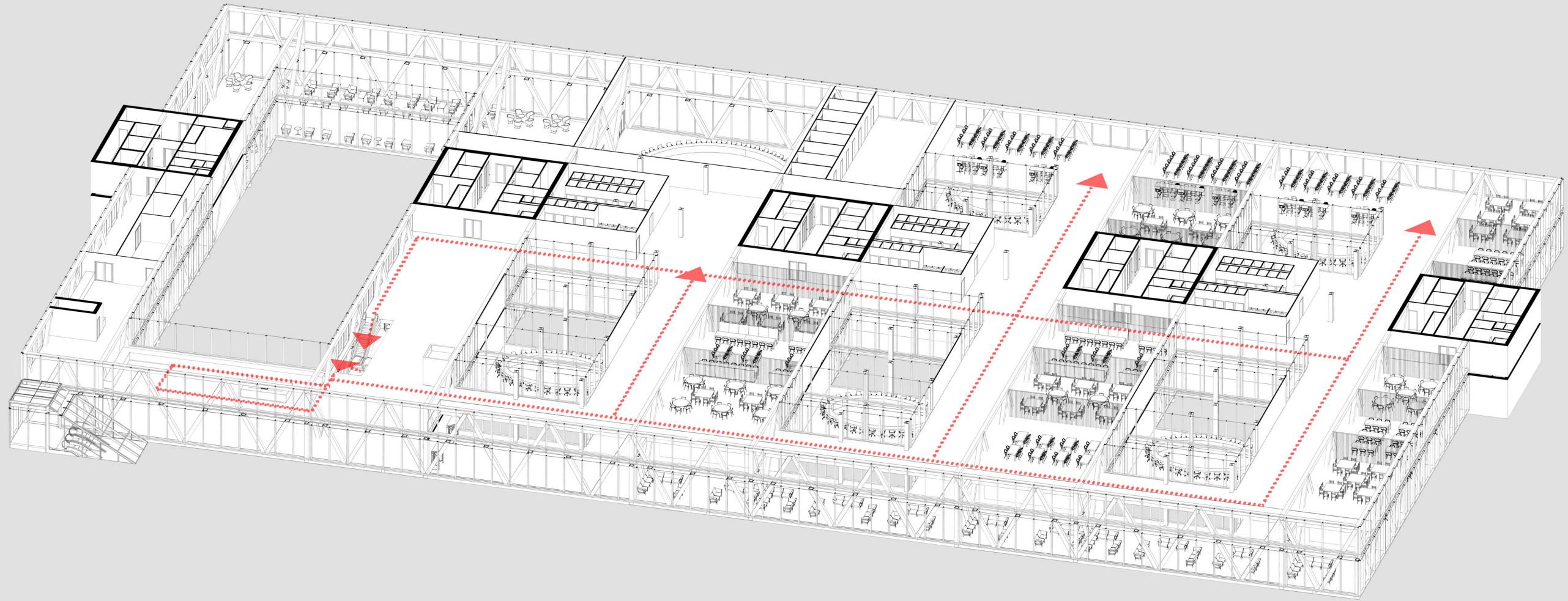

RESTAURANT - translators' spaces

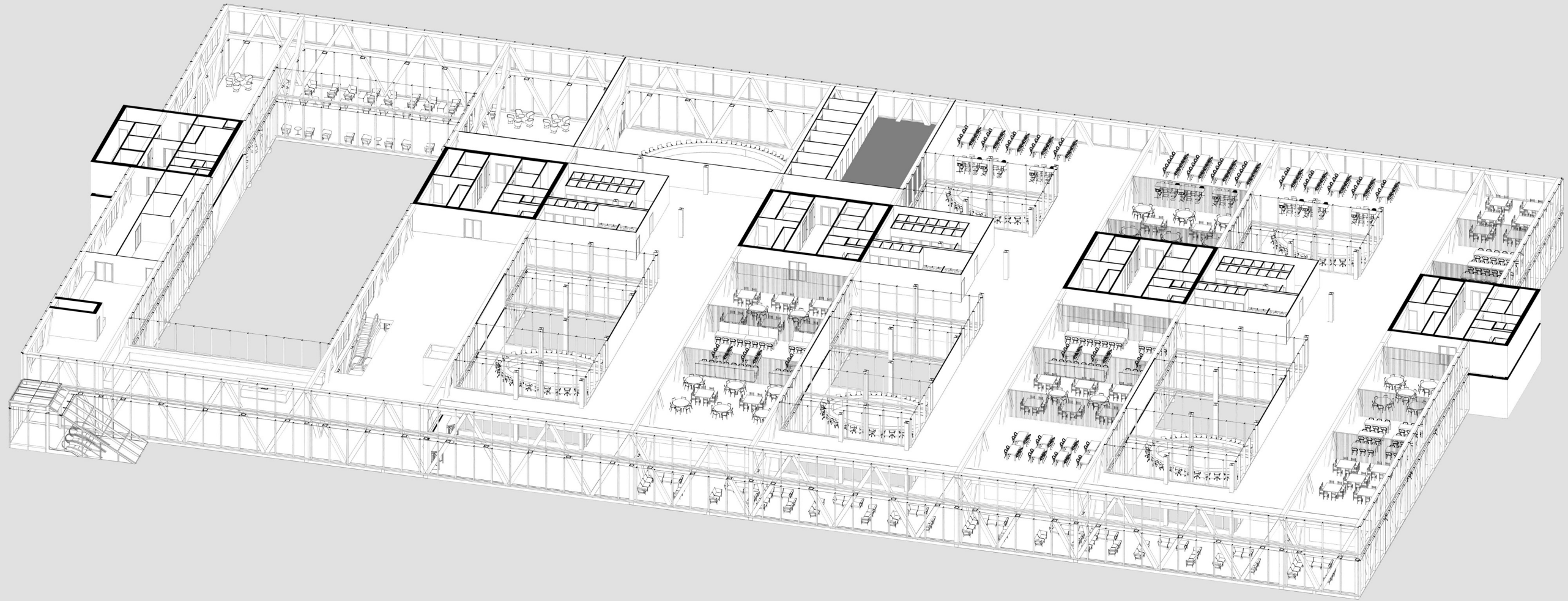

MEETING CENTER - Van Kleffenzaal

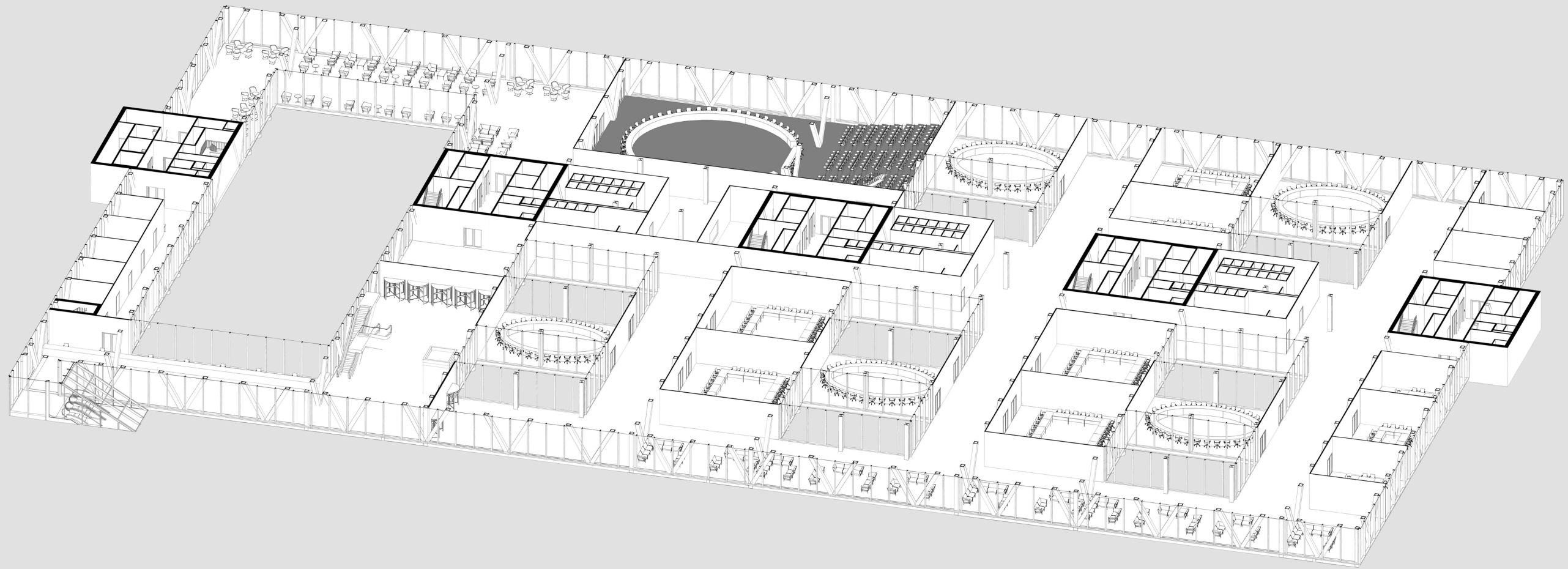

MEETING CENTER - VIP lobby

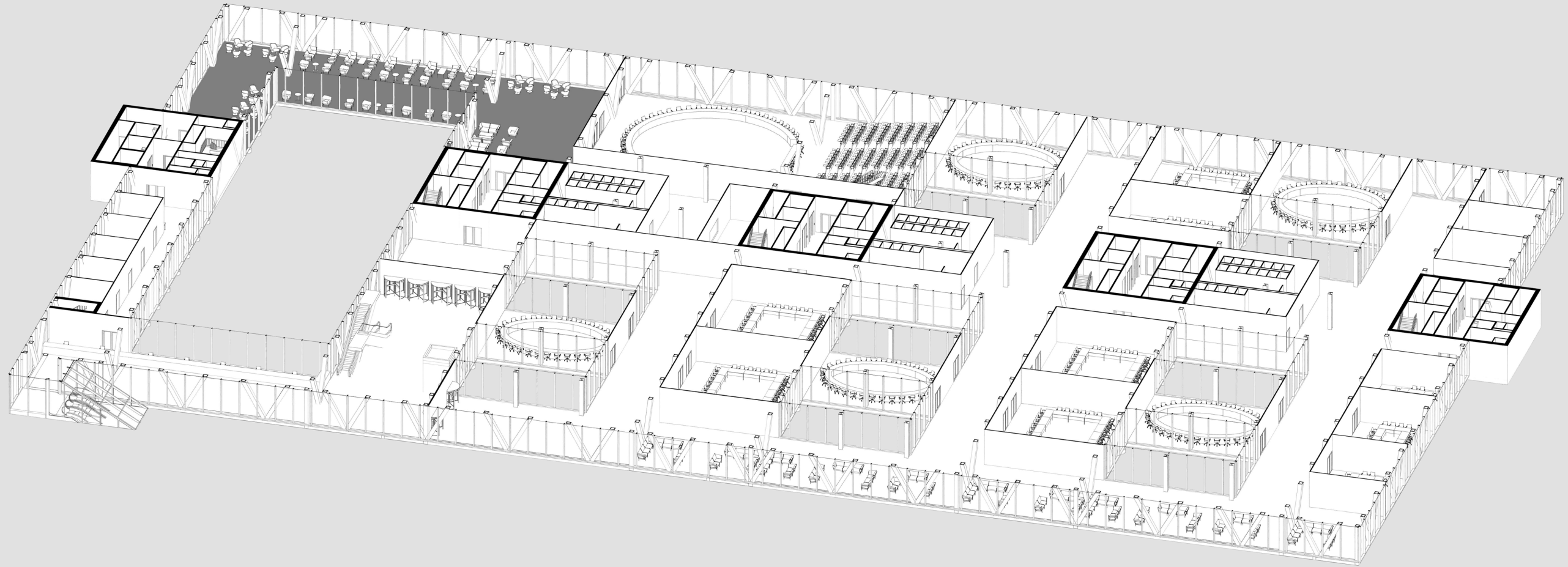

MEETING CENTER - VIP entrance

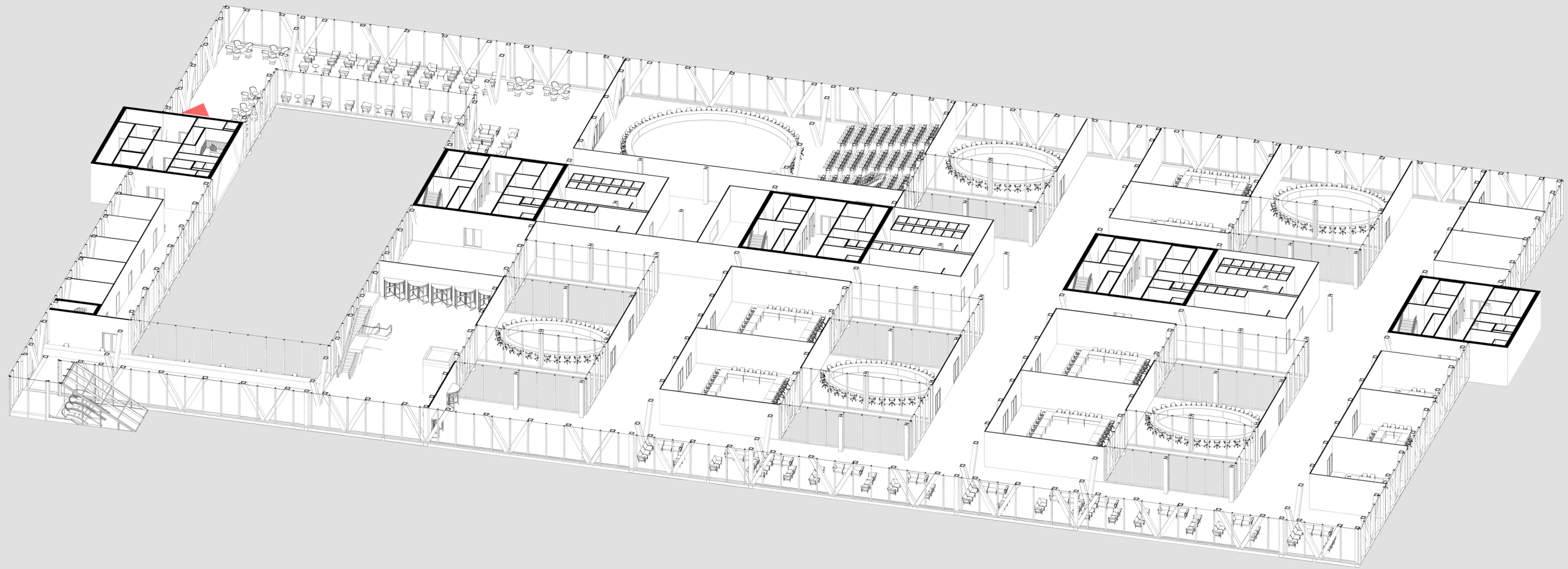

MEETING CENTER - public entrances

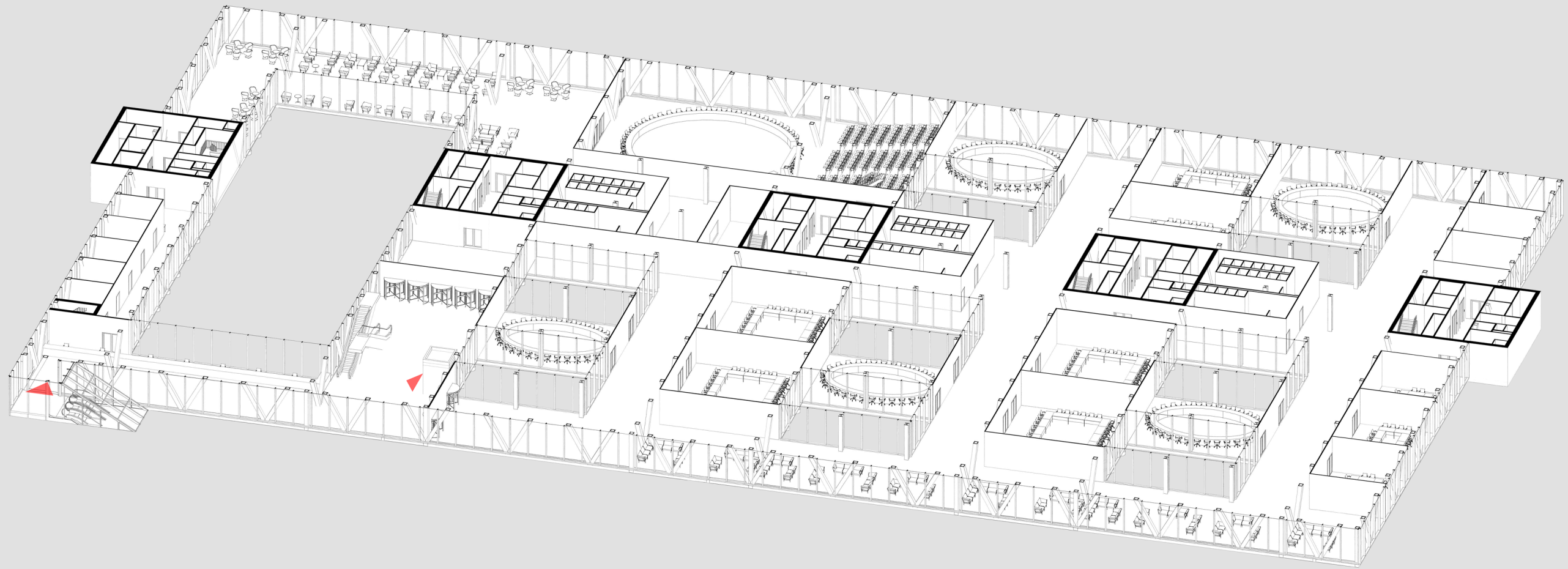

MEETING CENTER - lobby

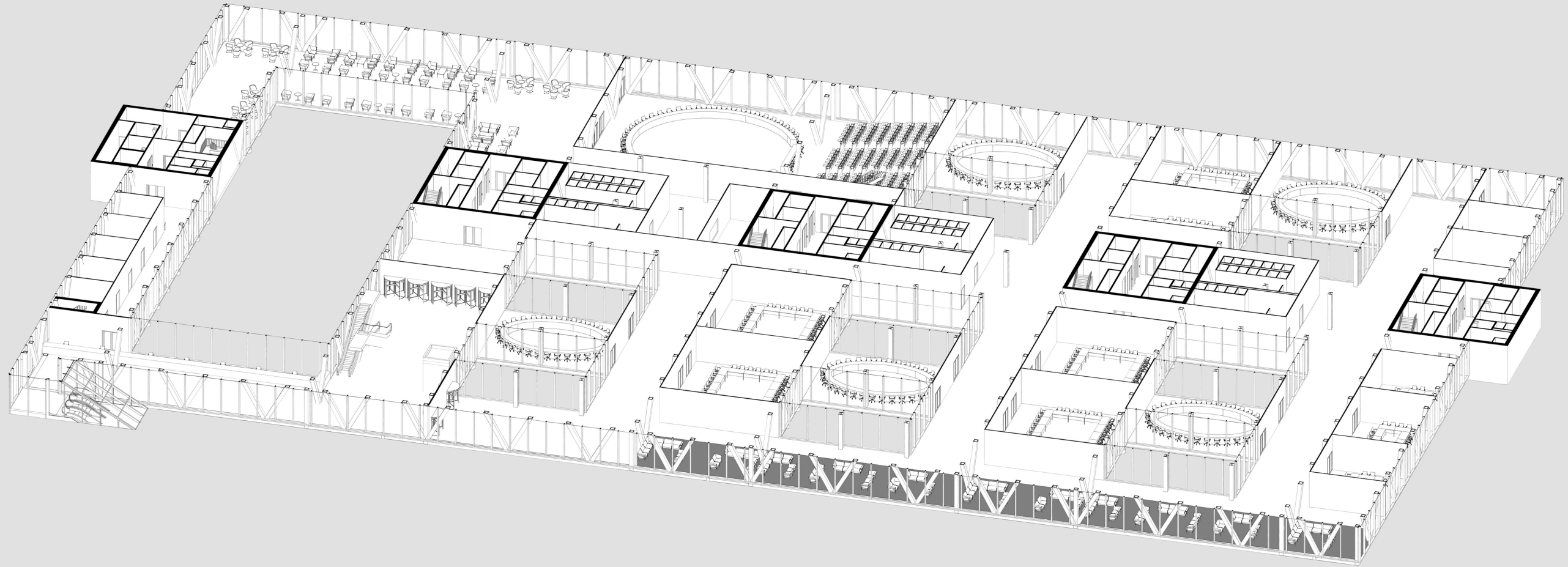

MEETING CENTER - meeting rooms

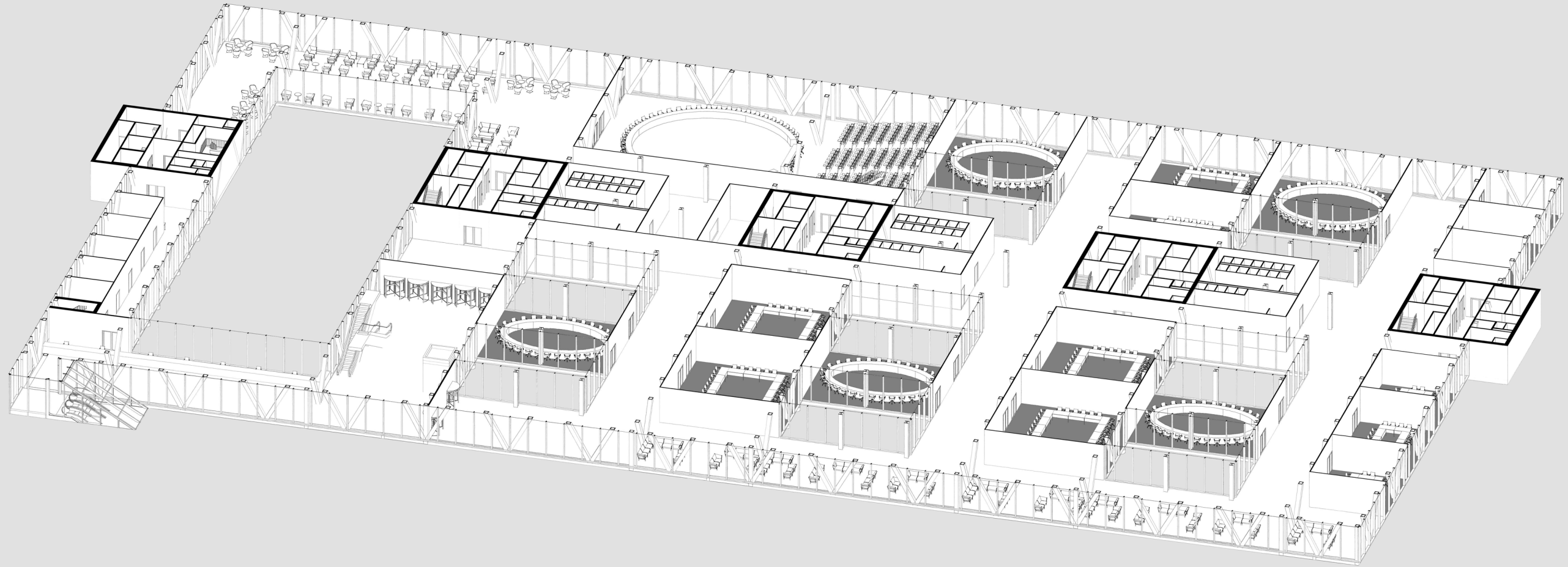











CLIMATE & STRUCTURE - roof beams

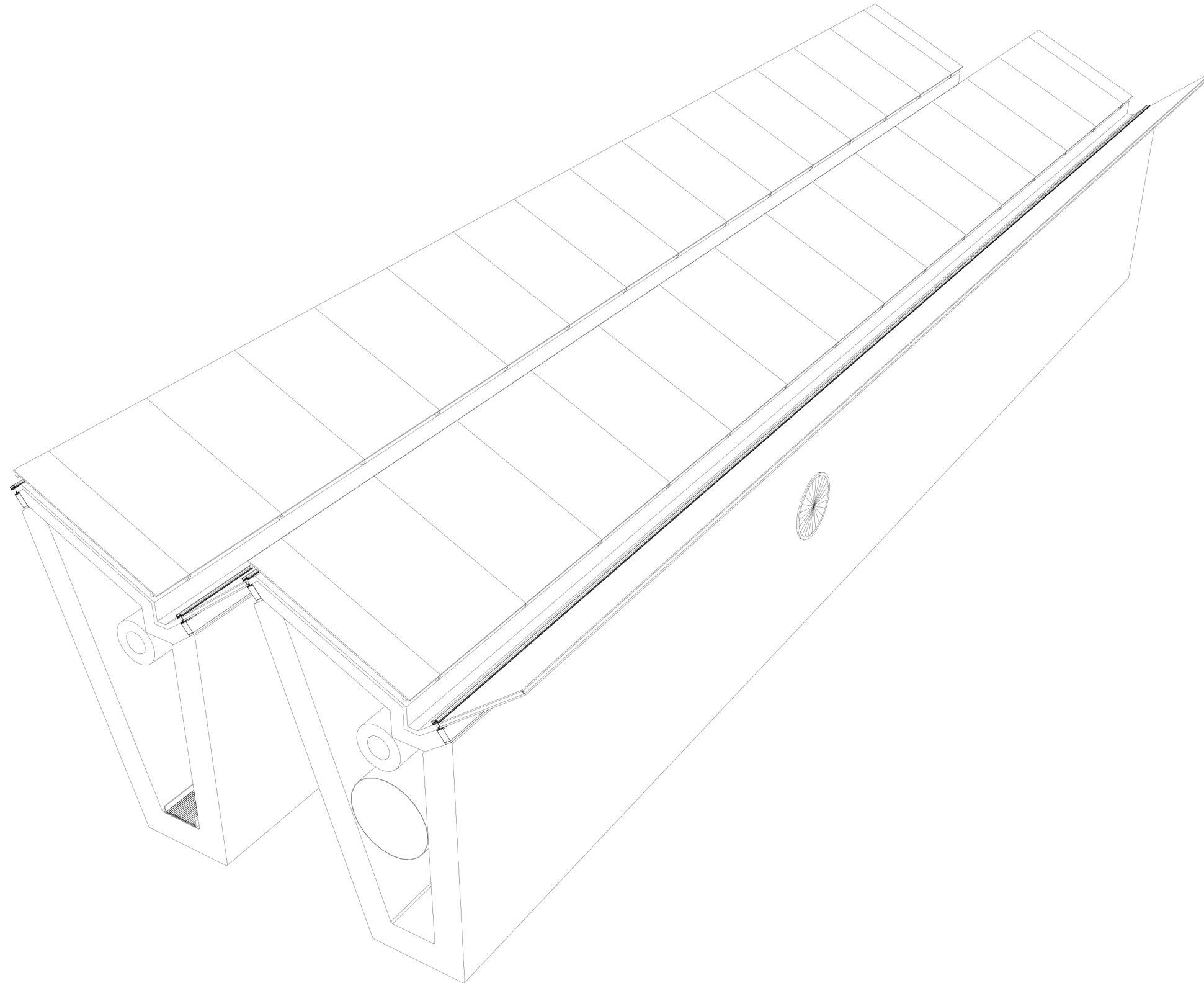

ROOF BEAM - solar panels

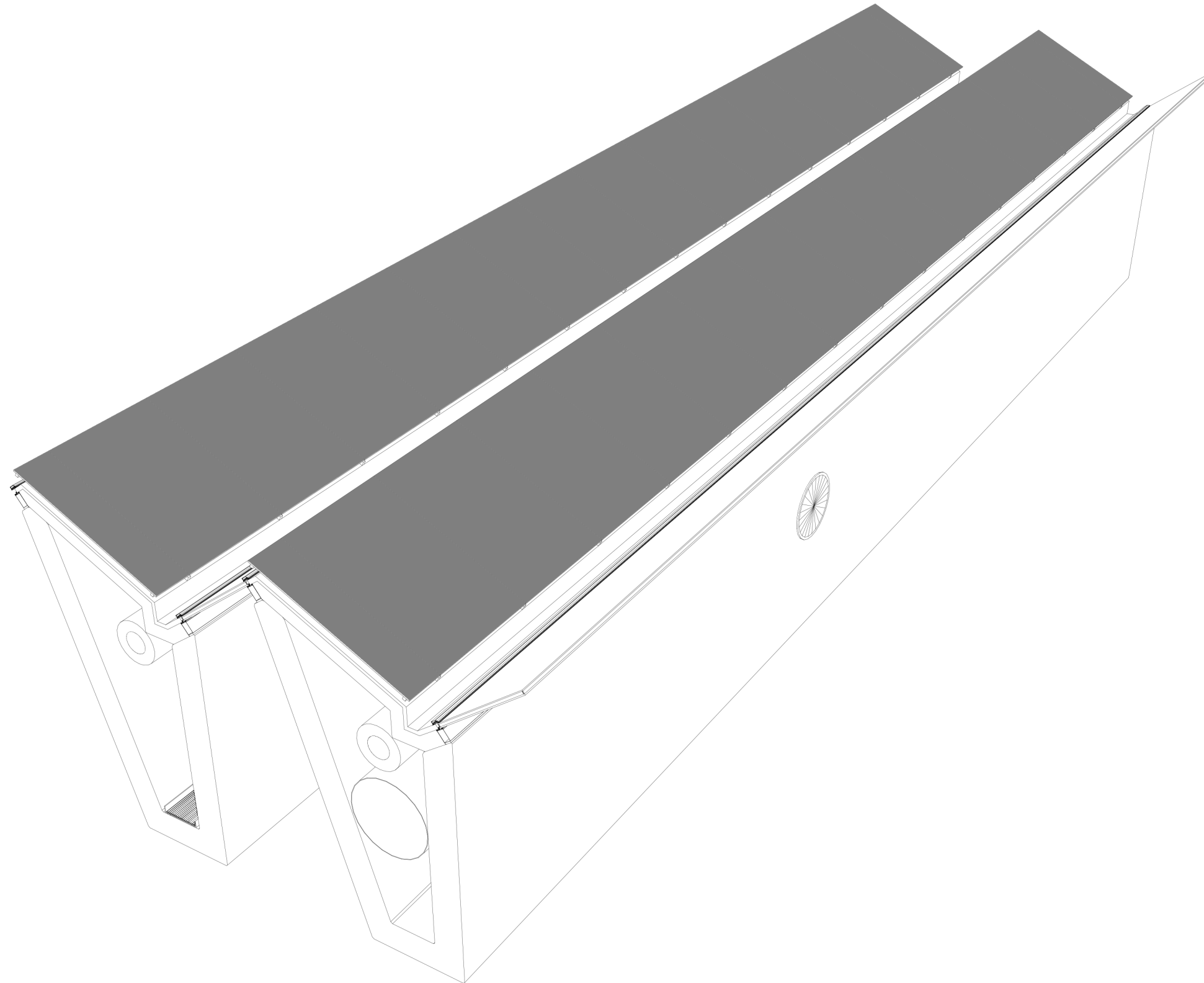

ROOF BEAM - solar panel mounting system

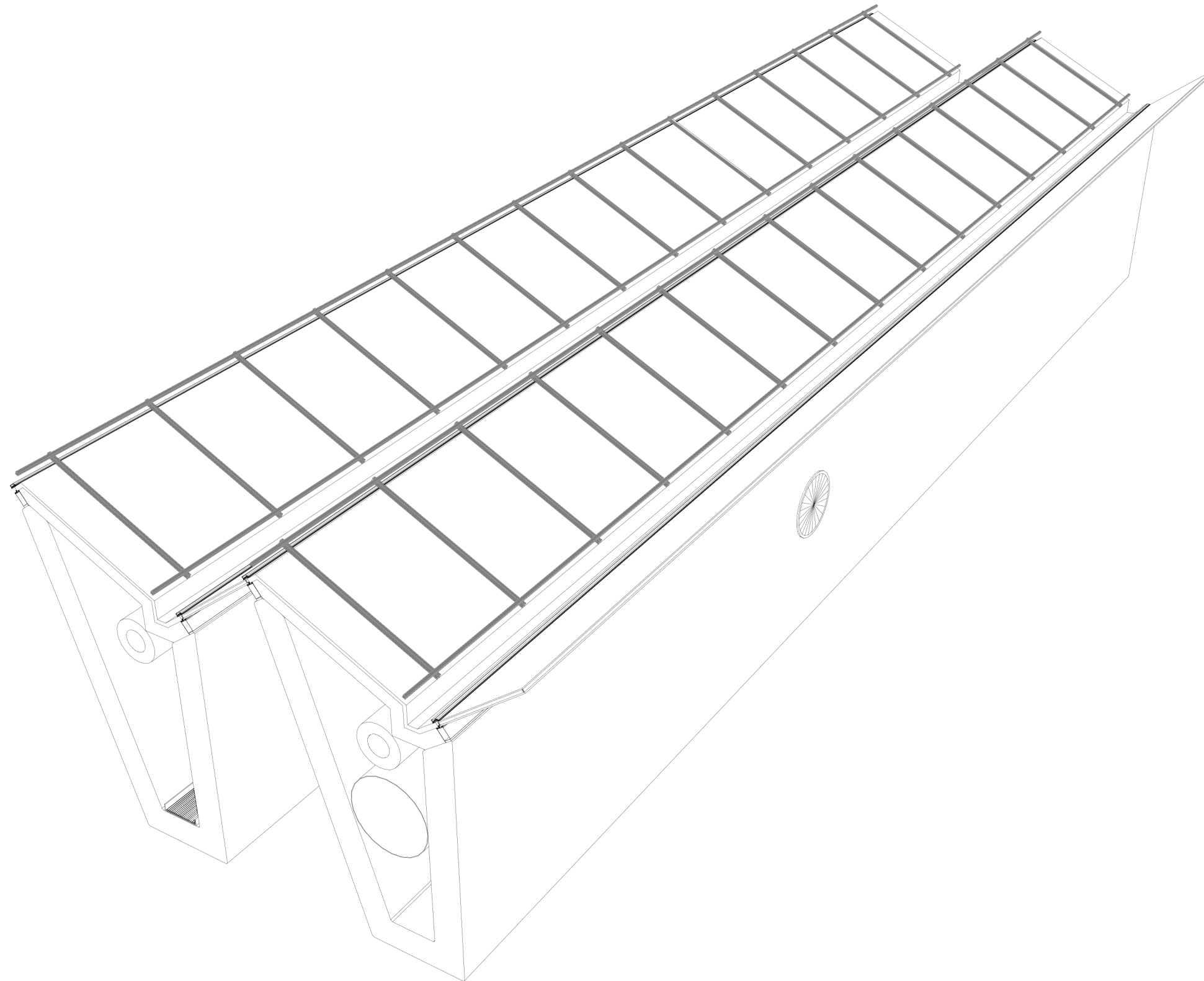

ROOF BEAM - waterproof layer

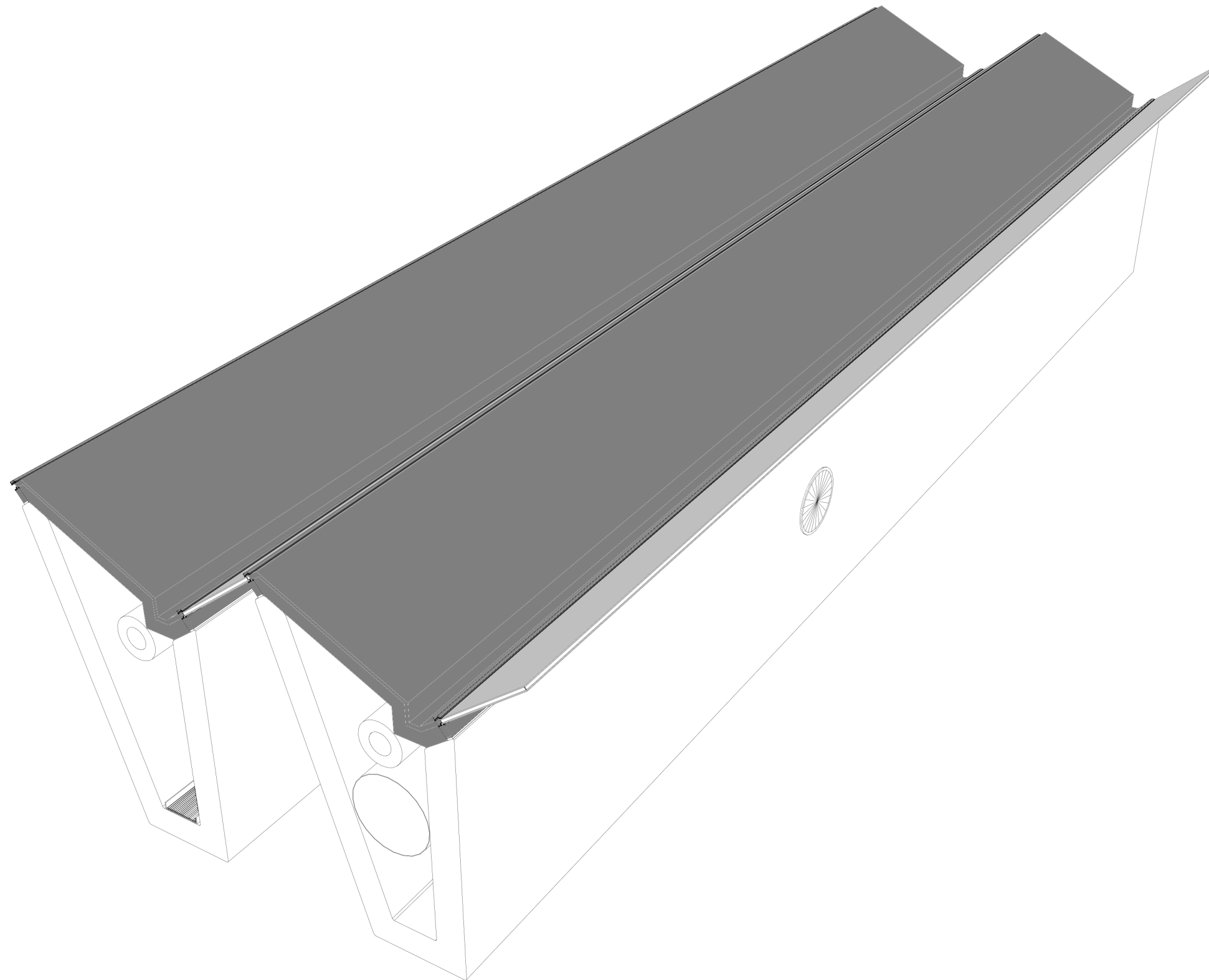

ROOF BEAM - sandwich panels

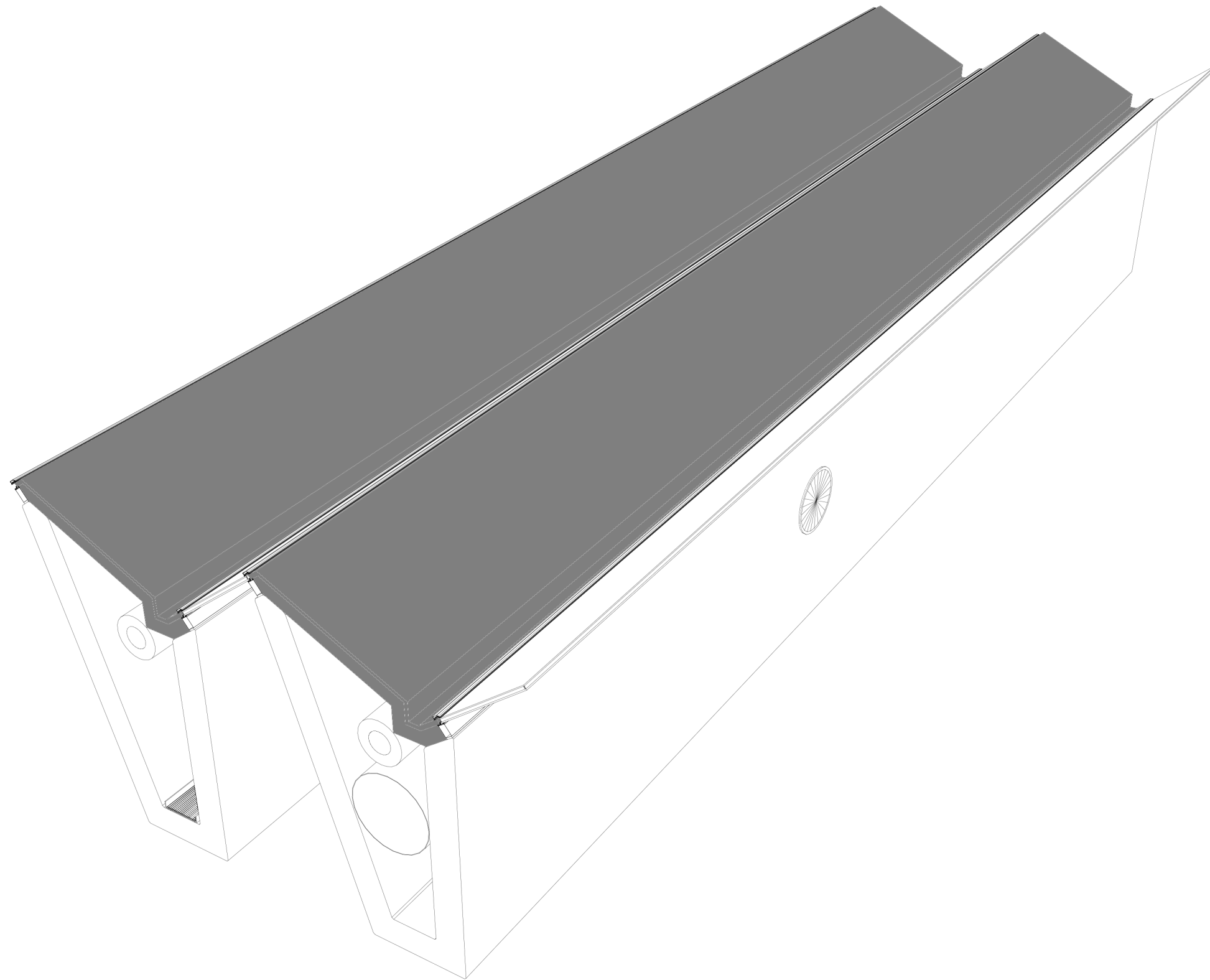

ROOF BEAM - curtain wall system

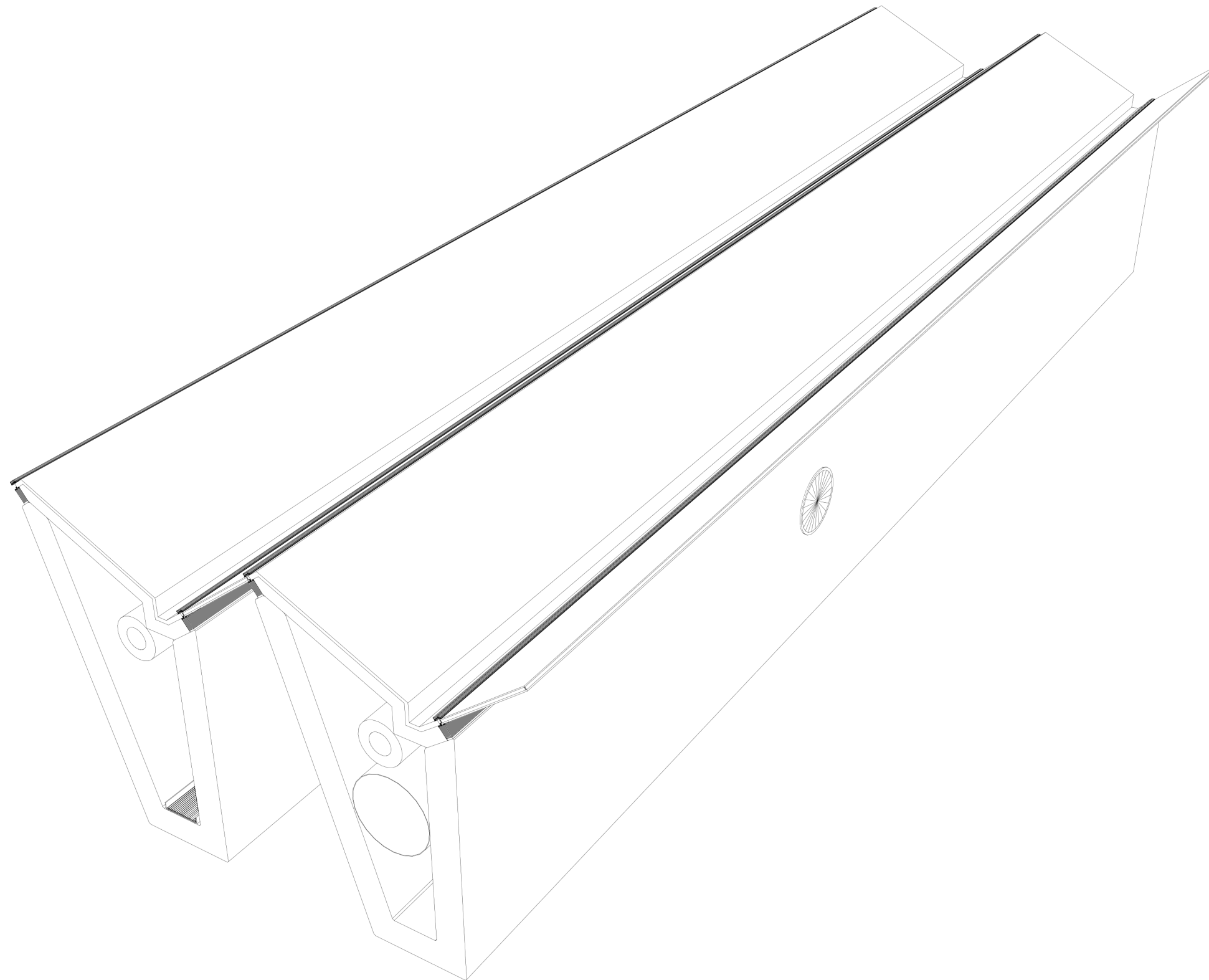

ROOF BEAM - roof lights

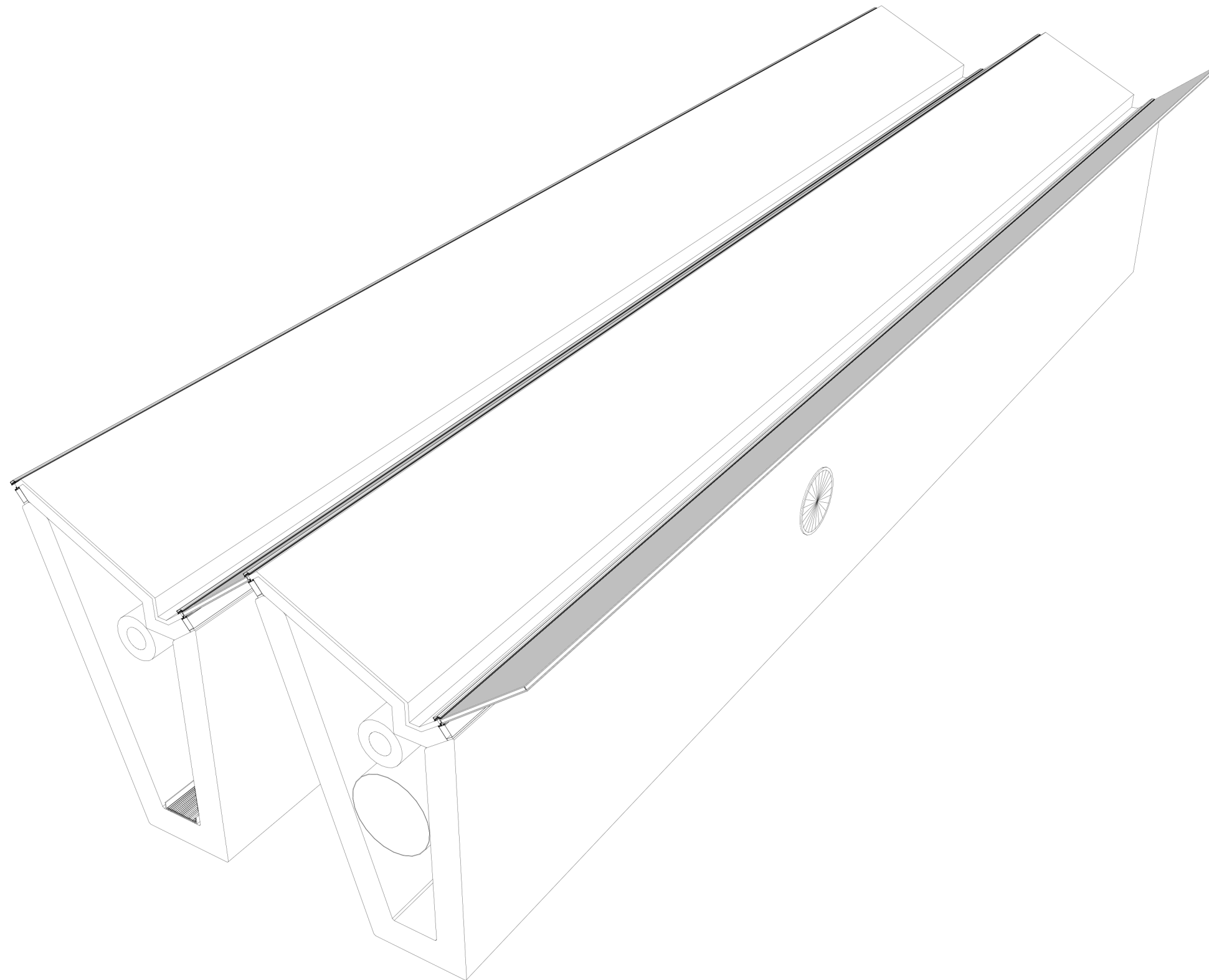

ROOF BEAM - rainwater drainage

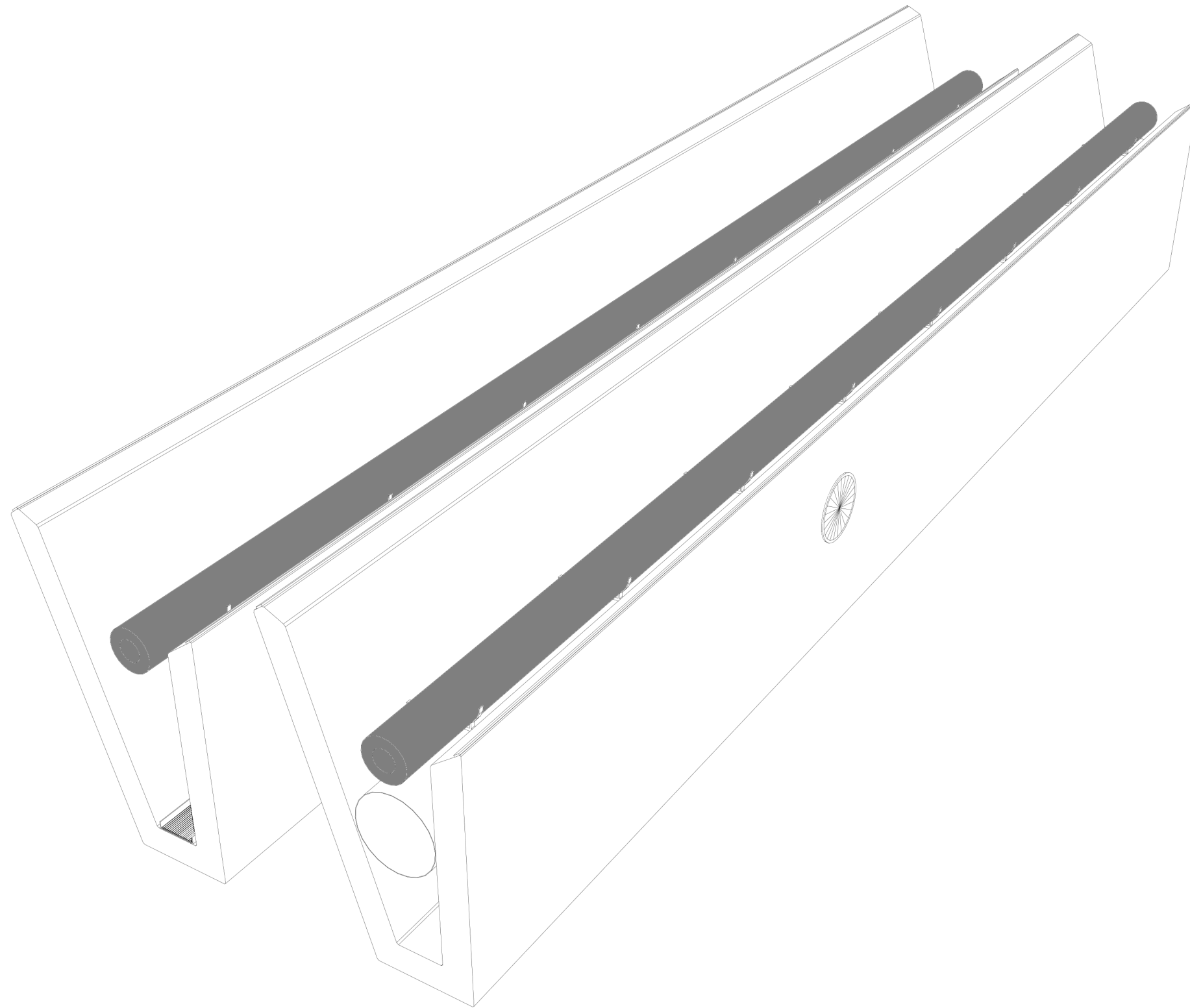

ROOF BEAM - pipe supports

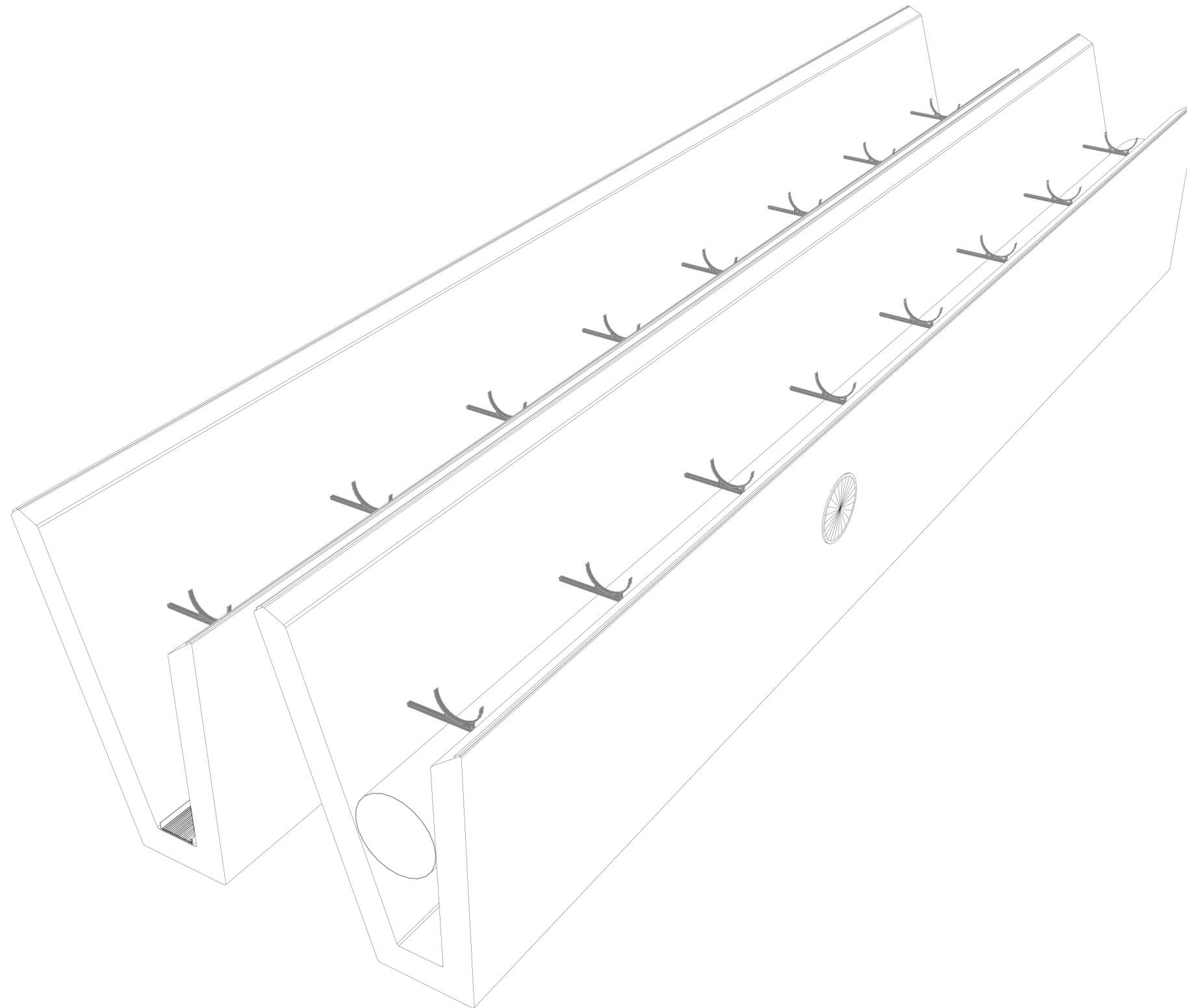

ROOF BEAM - ventilation

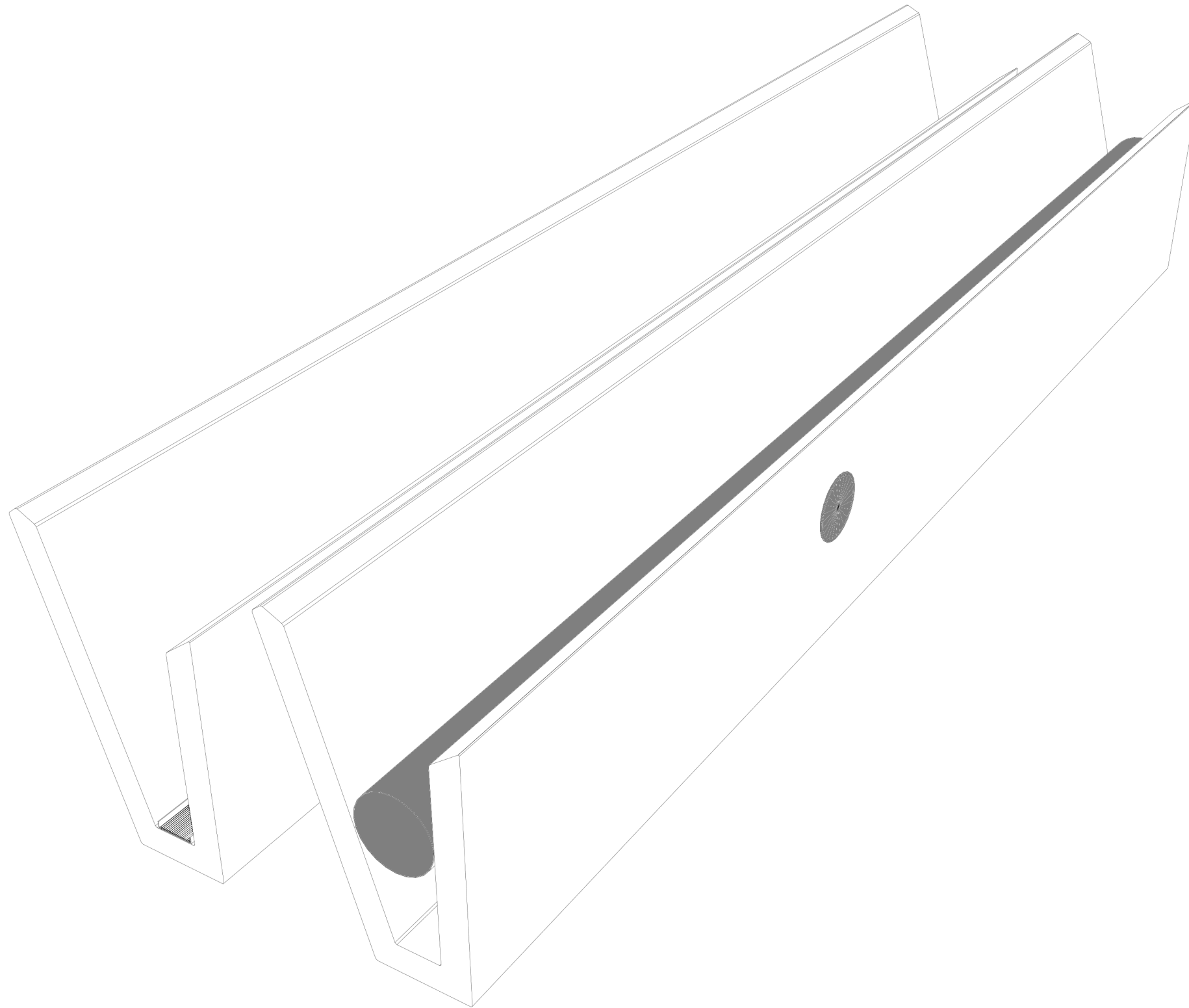

ROOF BEAM - cables

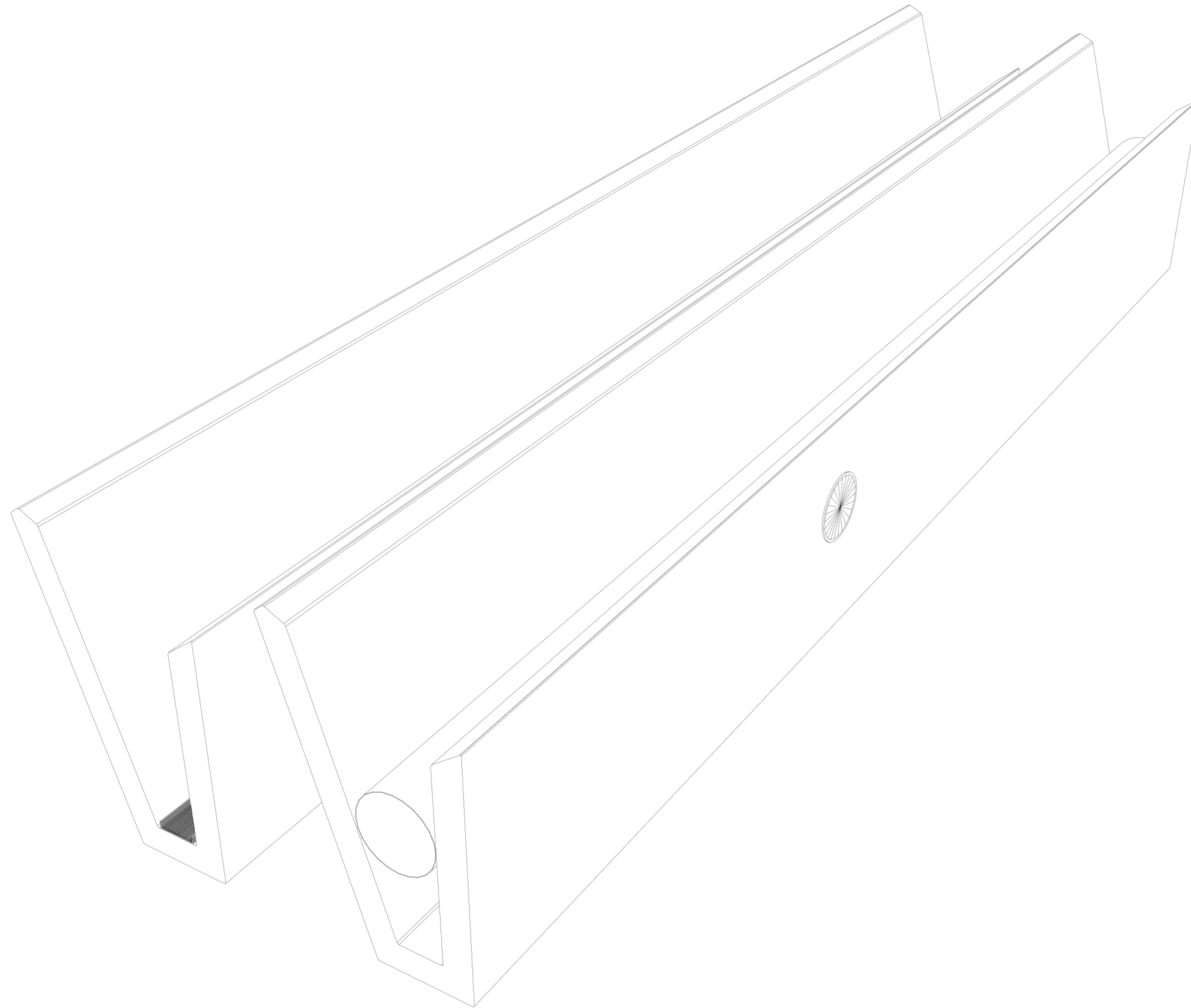

ROOF BEAM - prefab concrete beam

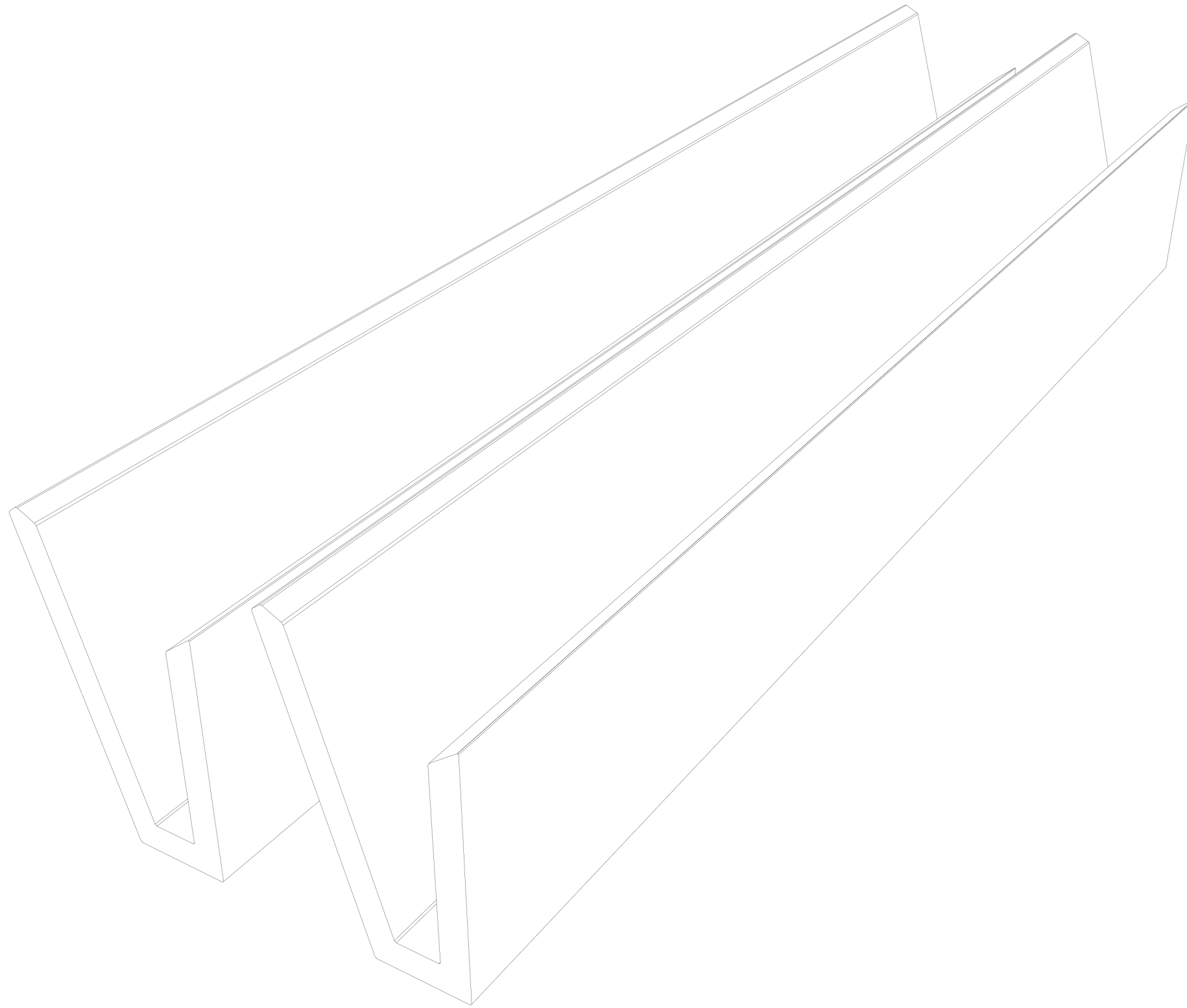

SOLAR ENERGY

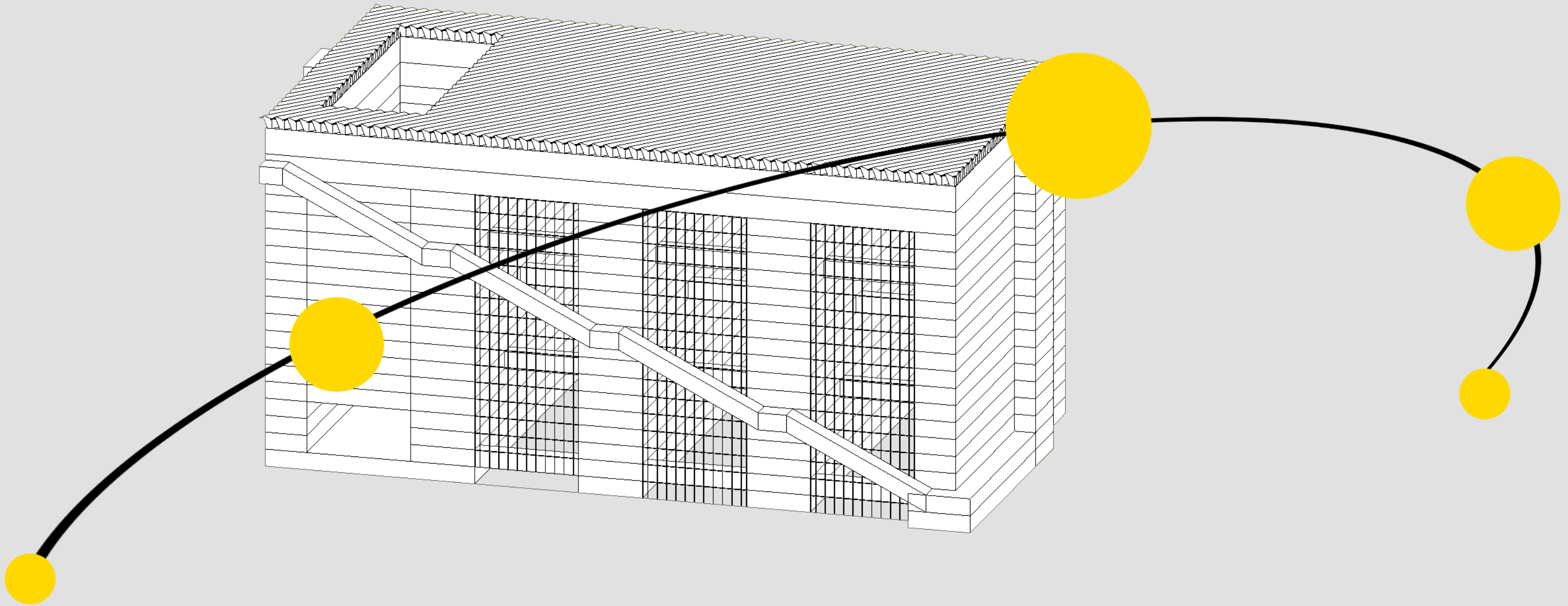



SOLAR ENERGY - regular dark solar panels

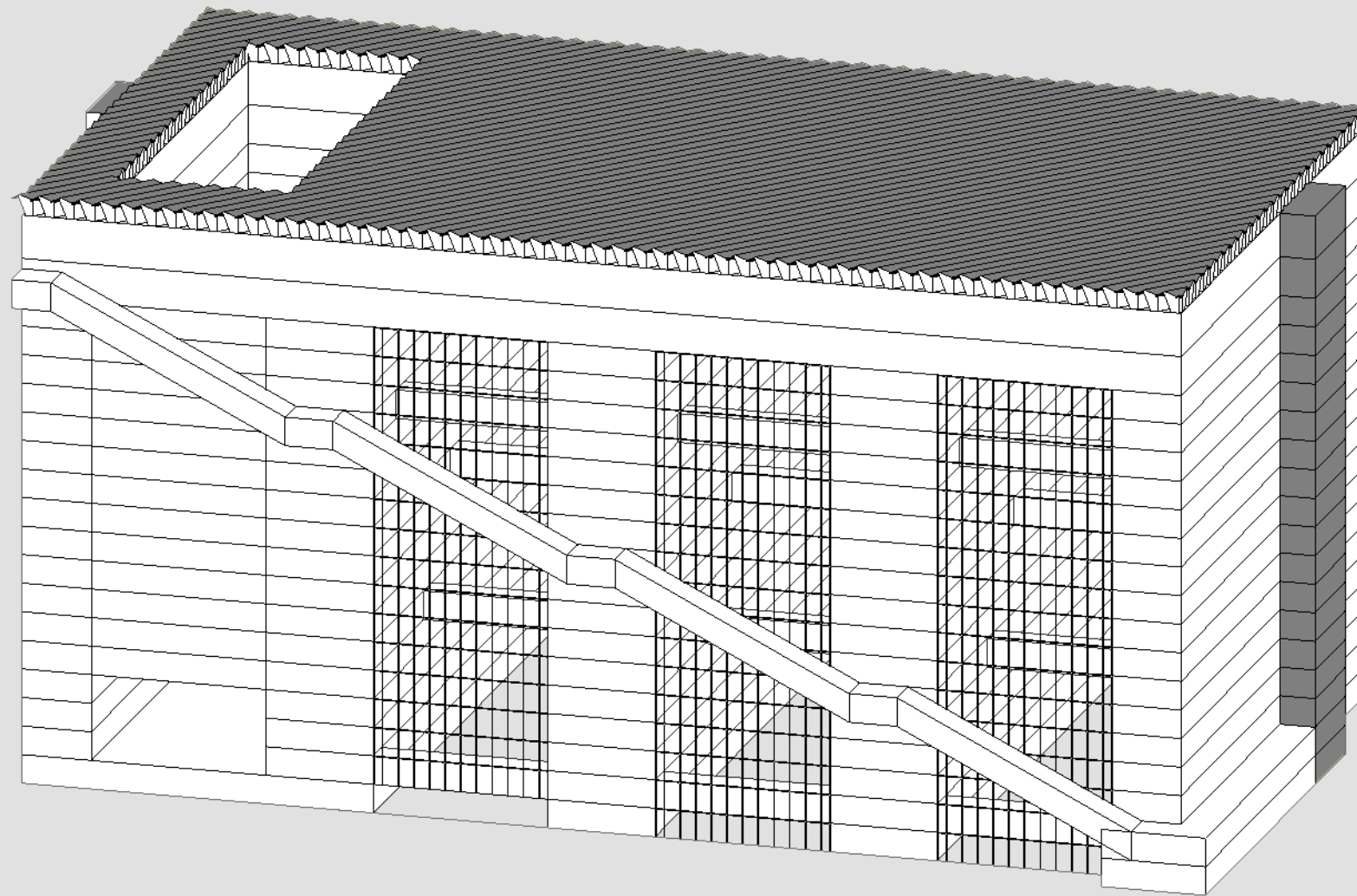

SOLAR ENERGY - CSEM white solar panels

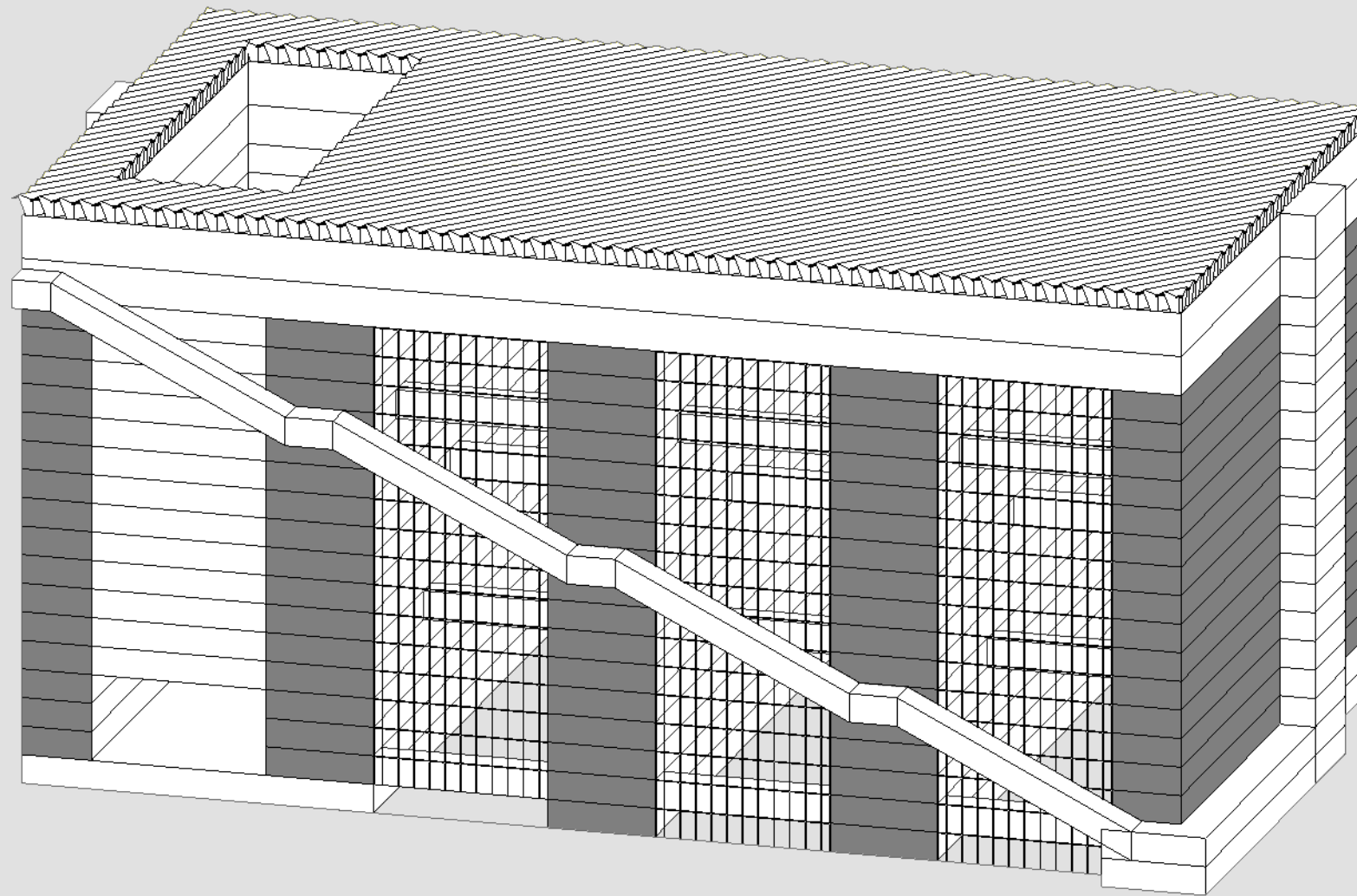

STRUCTURE - rigidity

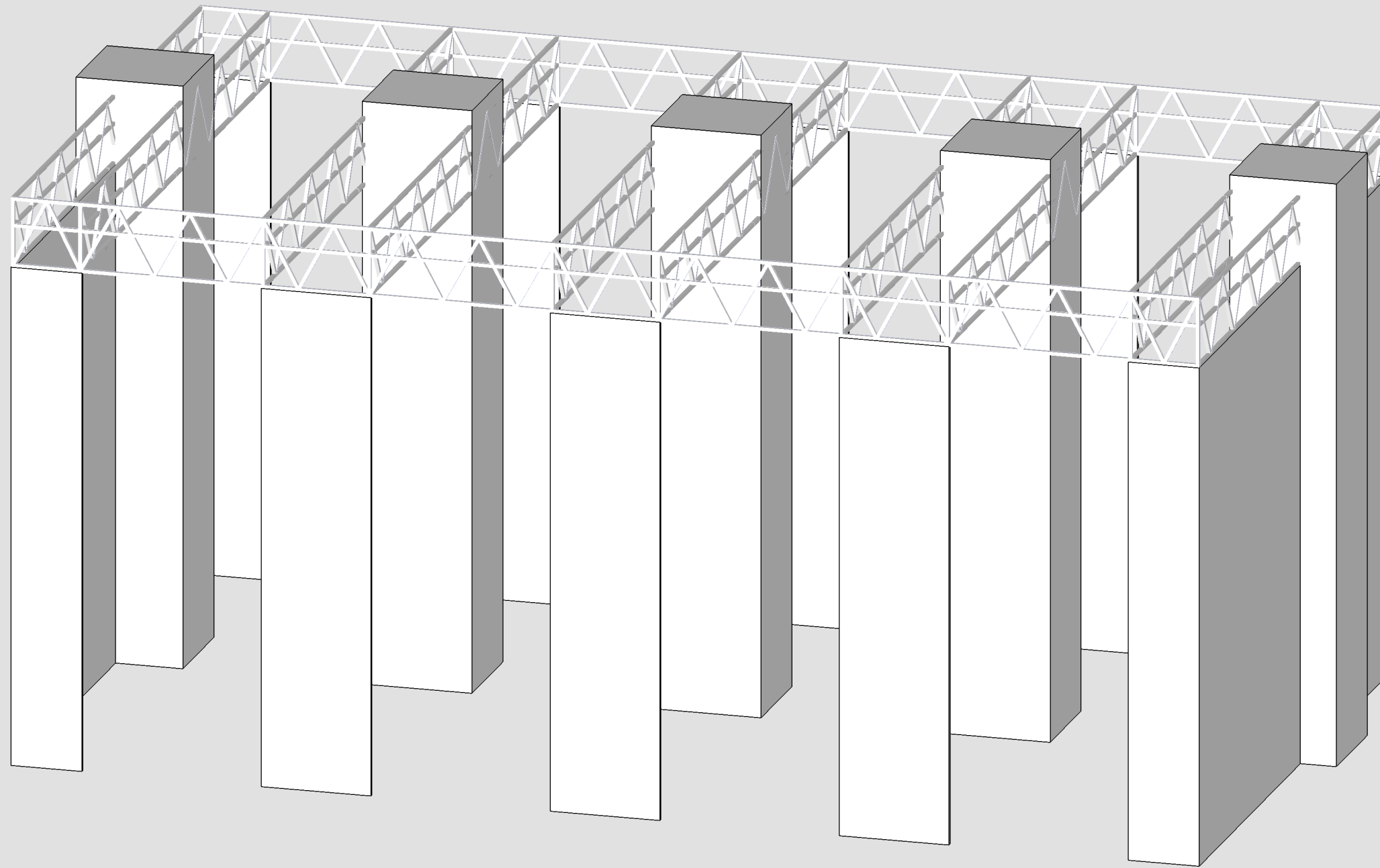

STRUCTURE - general structure

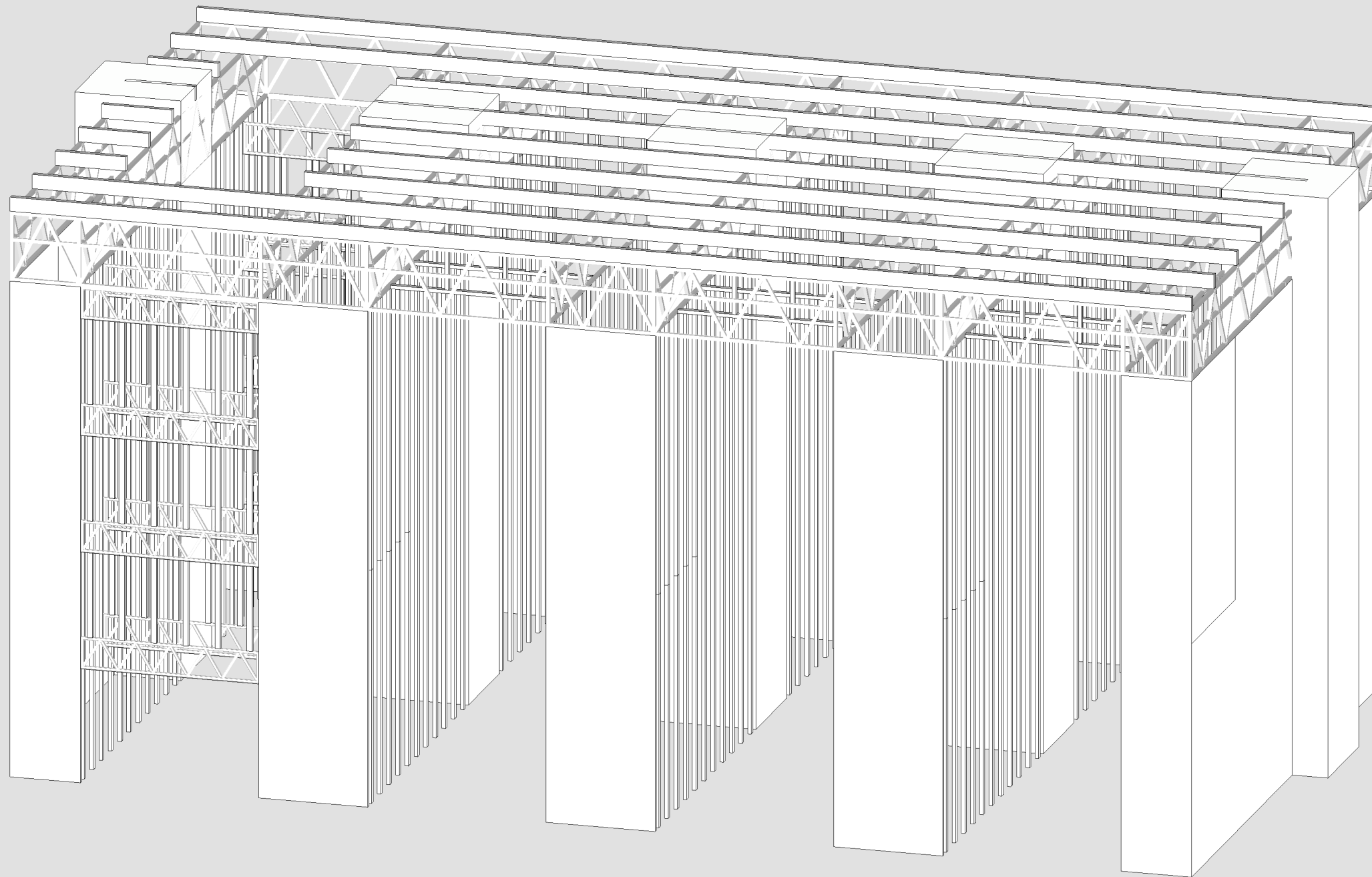

STRUCTURE - hanging load

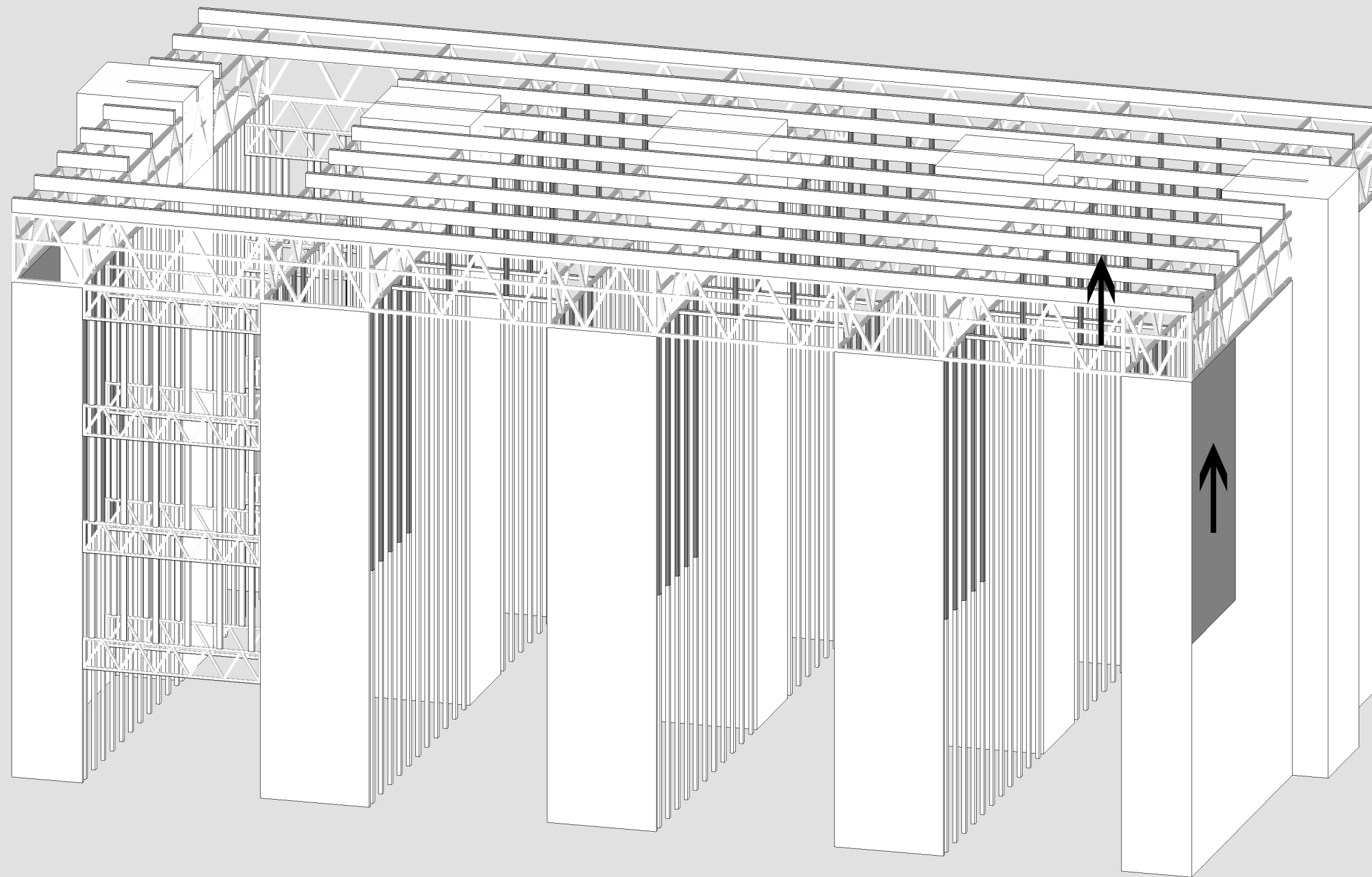

STRUCTURE - bridging structure transferring load

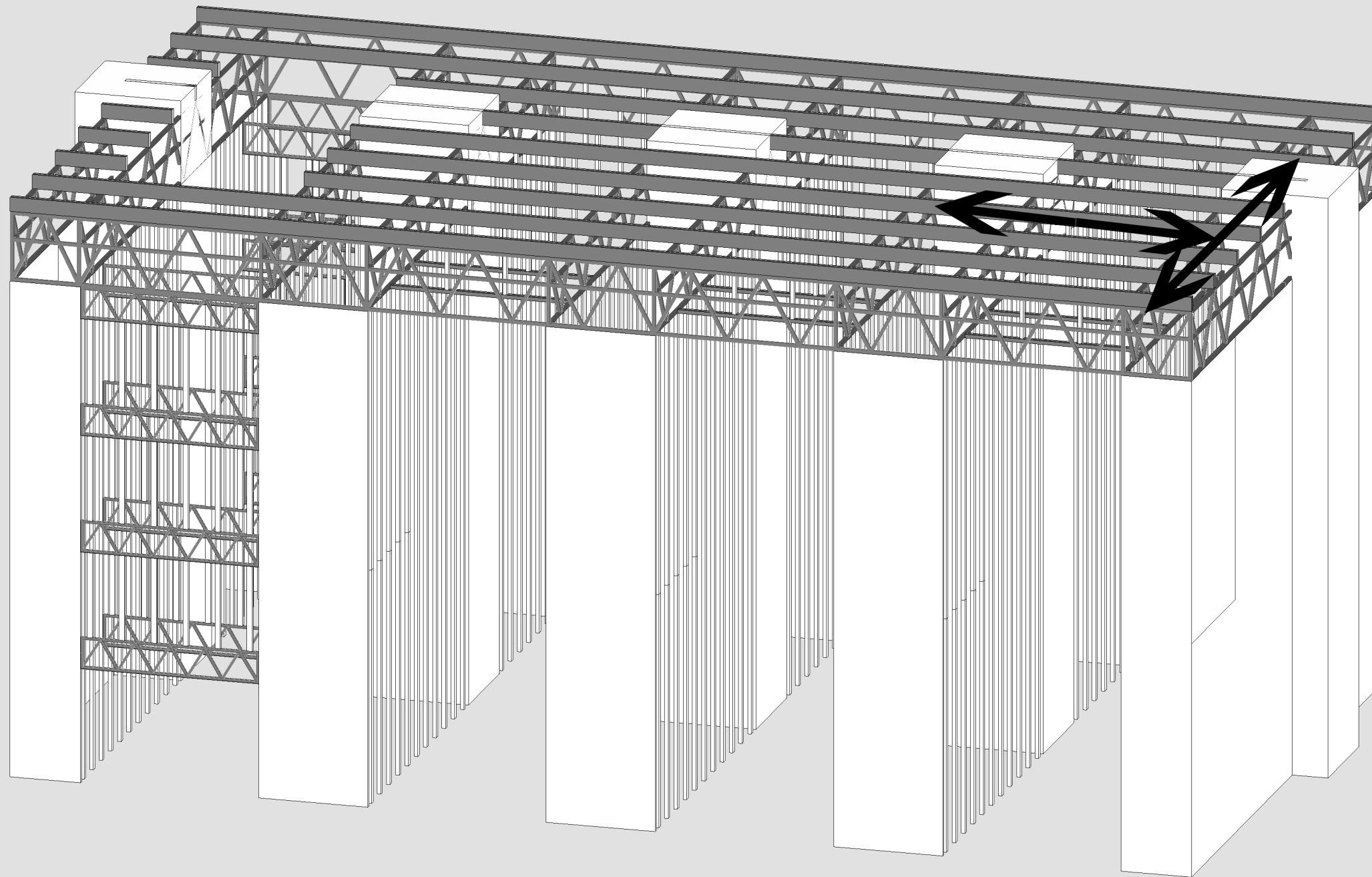

STRUCTURE - main structure

