

Energy transition in aviation: the role of cryogenic fuels

Gangoli Rao, A.; Yin, F.; Werij, H.G.C.

DOI

[10.3390/aerospace7120181](https://doi.org/10.3390/aerospace7120181)

Publication date

2020

Document Version

Final published version

Published in

Aerospace — Open Access Aeronautics and Astronautics Journal

Citation (APA)

Gangoli Rao, A., Yin, F., & Werij, H. G. C. (2020). Energy transition in aviation: the role of cryogenic fuels. *Aerospace — Open Access Aeronautics and Astronautics Journal*, 7(12), 1-24. Article 181. <https://doi.org/10.3390/aerospace7120181>

Important note

To cite this publication, please use the final published version (if applicable). Please check the document version above.

Copyright

Other than for strictly personal use, it is not permitted to download, forward or distribute the text or part of it, without the consent of the author(s) and/or copyright holder(s), unless the work is under an open content license such as Creative Commons.

Takedown policy

Please contact us and provide details if you believe this document breaches copyrights. We will remove access to the work immediately and investigate your claim.

Review

Energy Transition in Aviation: The Role of Cryogenic Fuels

Arvind Gangoli Rao *, Feijia Yin and Henri G.C. Werij

Faculty of Aerospace Engineering, Delft University of Technology, 2628 HS Delft, The Netherlands;
F.Yin@tudelft.nl (F.Y.); H.G.C.Werij@tudelft.nl (H.G.C.W.)

* Correspondence: A.Gangolirao@tudelft.nl; Tel.: +31-152-783-833

Received: 15 November 2020; Accepted: 14 December 2020; Published: 18 December 2020

Abstract: Aviation is the backbone of our modern society. In 2019, around 4.5 billion passengers travelled through the air. However, at the same time, aviation was also responsible for around 5% of anthropogenic causes of global warming. The impact of the COVID-19 pandemic on the aviation sector in the short term is clearly very high, but the long-term effects are still unknown. However, with the increase in global GDP, the number of travelers is expected to increase between three- to four-fold by the middle of this century. While other sectors of transportation are making steady progress in decarbonizing, aviation is falling behind. This paper explores some of the various options for energy carriers in aviation and particularly highlights the possibilities and challenges of using cryogenic fuels/energy carriers such as liquid hydrogen (LH₂) and liquefied natural gas (LNG).

Keywords: aviation; cryogenic fuels; energy transition; hybrid aircraft; liquid hydrogen; liquefied natural gas; sustainable aviation

1. Introduction

Aviation is the backbone of our modern society. In 2019, around 4.5 billion passengers travelled through the air. However, at the same time, aviation was also responsible for around 5% of anthropogenic causes of global warming [1,2]. Even though the number of people travelling by aircraft has reduced drastically in 2020 due to the outbreak of COVID-19, the aviation sector is expected to recover after the invention of a reliable vaccine [3,4]. From then on, air traffic in terms of passenger kilometers is expected to continue to grow at a rate of approximately between 4–5% per year for the next couple of decades [5], implying a doubling in the number of passenger-kilometers every 15–18 years.

Figure 1 shows the observed growth in passenger transport for different modalities over the past decades and the expected trend in the future. This indicates the ever-increasing number of passenger-kilometers by air travel (in yellow color-coding) [6]. It should be noted that these predictions are lower than the predictions of some of the commercial aircraft manufacturers, but are in line with the predictions of DLR carried out within the WeCare project [7].

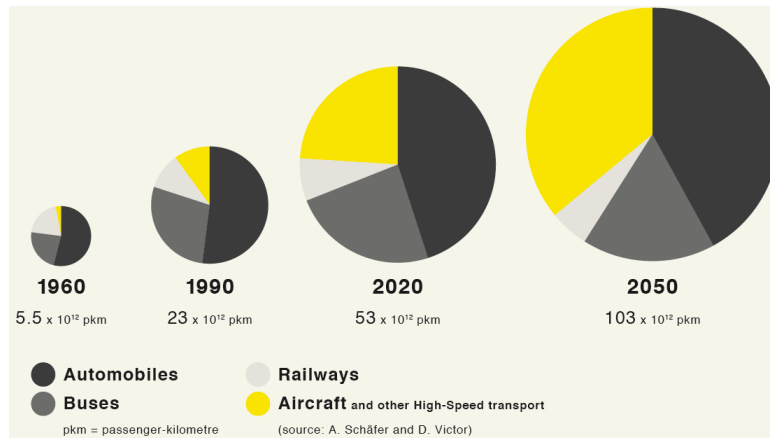

Figure 1. Historical values and future prediction of transport volumes in passenger-kilometers [6].

As a result, the environmental impact of aviation will continue to increase significantly unless we act now. Moreover, whereas modes of surface transportation systems can reduce CO₂ and emissions significantly by means of technological solutions, which are available or in reach (e.g., use of electric/hybrid vehicles), the aviation sector is facing severe technological challenges regarding the energy source, for instance, dictated by the stringent mass and volume constraints. This implies that the contribution to global warming originating from aviation will not only grow in absolute but also in relative terms.

Figure 2 shows the worldwide consumption of aviation fuel since 1990. Of course, this is proportional to the increasing amount of aviation-related CO₂ emission, which in 2019 amounted to around 2.5% of the total global anthropogenic CO₂ emission. In developed countries, the share of aviation in their total anthropogenic CO₂ footprint can vary substantially from the global average. For instance, Figure 3 depicts the percentage of aviation CO₂ in the Netherlands. It can be seen that aviation was responsible for almost 8% of CO₂ emission in the Netherlands (based on the amount of jet fuel used on all Dutch commercial airports) before the COVID-19 crisis [8,9].

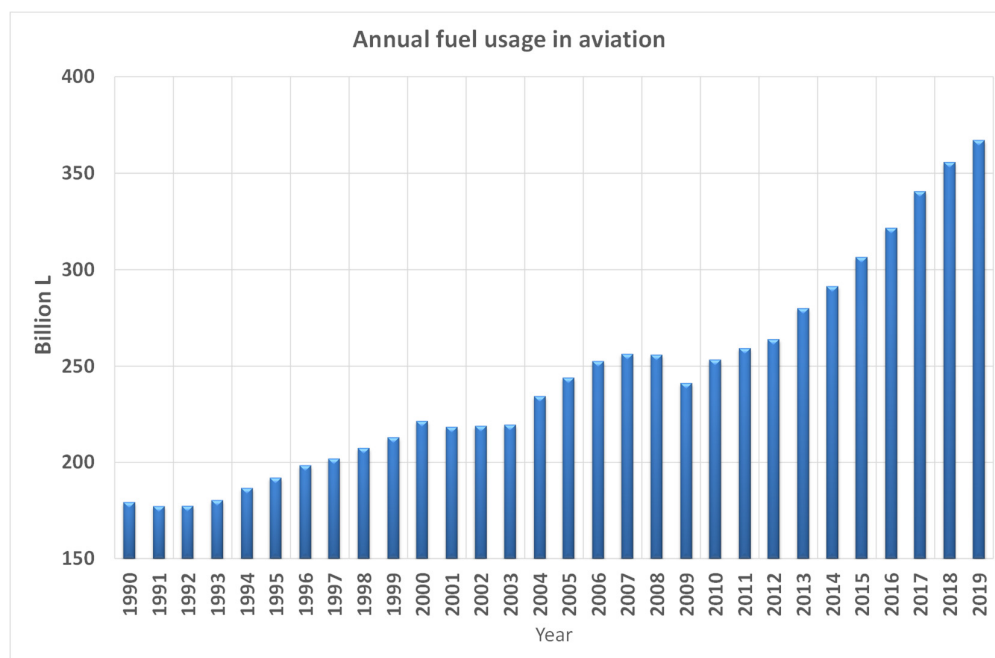

Figure 2. Annual fuel usage of Jet-A fuel (sources: Statistica, (IATA), DoE).

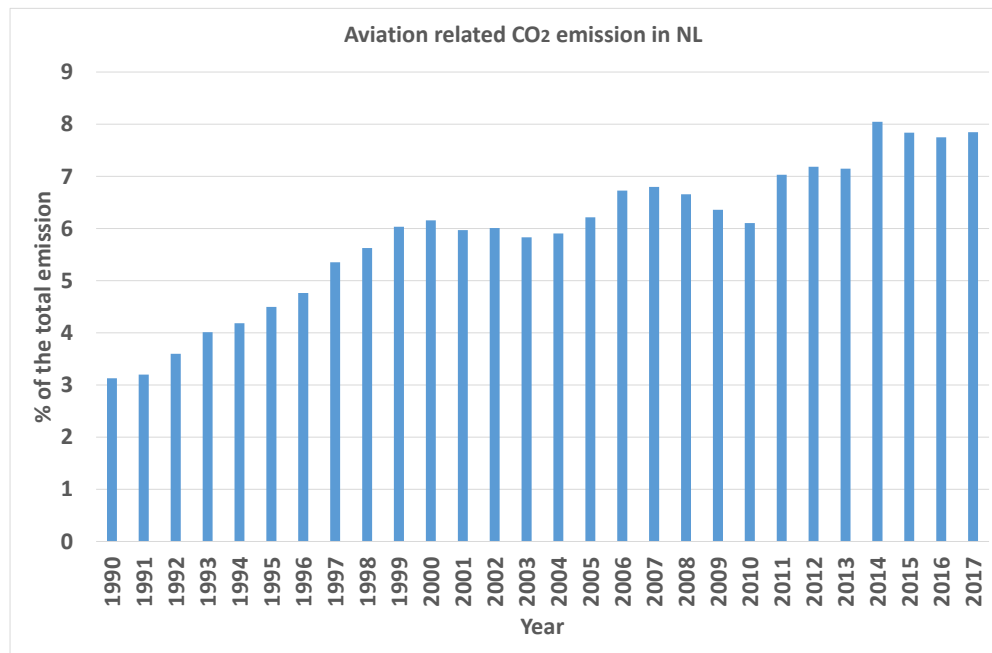

Figure 3. Annual CO₂ emission from aviation as a percentage of the total CO₂ emission from the Netherlands (source: CBS, RHK).

Even though the total kerosene consumption in aviation has increased, the aviation industry has done a remarkable job in improving its efficiency by using a combination of technological and operational measures. As depicted in Figure 4, the system-wide fuel consumption per revenue passenger-kilometer (RPK) has been reduced by more than 50% in the last 30 years. However, this is outpaced by the increase in RPK by around 440%. To shape the aviation industry's future, the Advisory Council for Aeronautical Research and innovation in Europe (ACARE) has set challenging goals to reduce aviation's environmental impact and to make aviation sustainable in the future. The ACARE flight path 2050 sets targets for the year 2050 of a 75% reduction of CO₂ emissions per passenger-kilometer and a 90% reduction in NO_x emissions. These targets are relative to the capabilities of typical new aircraft in 2000 [10]. Whereas the goals set by some of the other organizations (comprising Airports Council International (ACI), Civil Air Navigation Services Organization (CANSO), International Air Transport Association (IATA), International Coordinating Council of Aerospace Industries Associations (ICCAIA), and International Business Aviation Council IBAC) [11] state that from 2020 onwards, the net carbon emissions from aviation will be capped through carbon-neutral growth. The goal set by Air Transport Action Group (ATAG) is to reduce the net aviation carbon emissions in 2050 to half of what they were in 2005 [12]. In order to achieve the latter goal, the reduction of CO₂ emission per passenger-kilometer should decrease by more than 90%. In 2016 the International Civil Aviation Organization (ICAO) assembly decided that a global market-based measure should be put in place to offset CO₂ emissions from international aviation. The scheme has been named CORSIA (Carbon Offsetting and Reduction Scheme for International Aviation) and aims at limiting the CO₂ emissions from aviation to the levels of 2019 with the help of offsetting schemes. There are two phases of this scheme, the first one is voluntary until 2027 and the second phase is mandatory after 2027. There are several emission unit programs approved by the ICAO Council. The emissions can be offset by an airline by purchasing emission units equivalent to its offsetting requirements in other sectors such as wind energy, clean cook stoves, methane capture, afforestation and reforestation, carbon capture and storage (CCS), etc. It should be noted that CORSIA is applicable to only international flights, which account for around 60% of all flights (https://www.icao.int/environmental-protection/pages/a39_corsia_faq2.aspx).

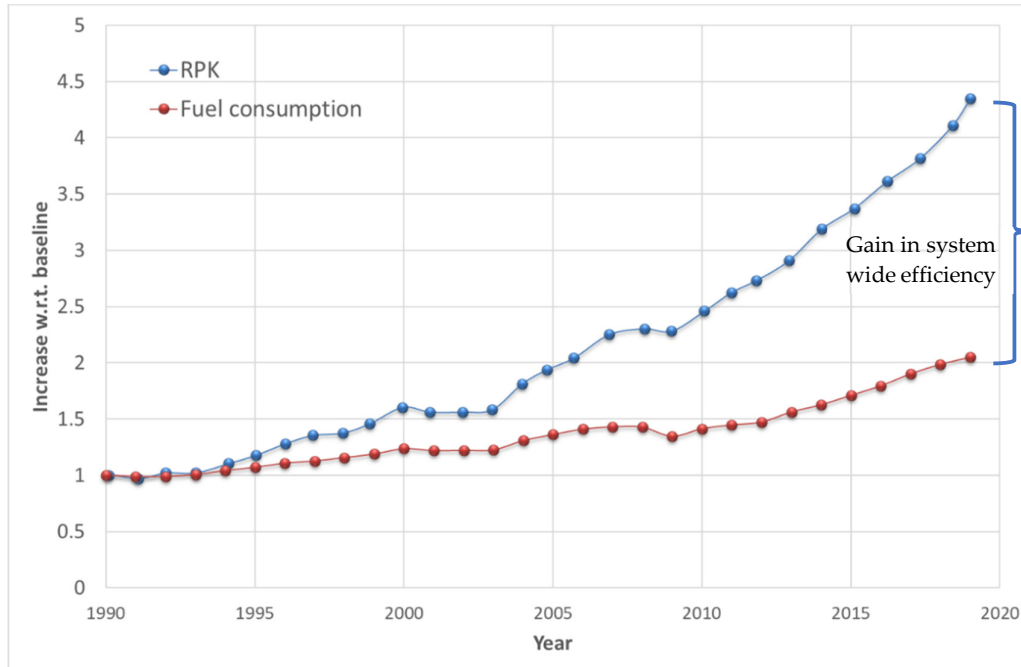

Figure 4. Increase in global revenue passengers-km (RPK) and fuel consumption for civil aviation (sources: Statista, International Civil Aviation Organization (ICAO), IATA).

Amongst the various possibilities for reducing aviation’s environmental footprint, the aviation industry is looking at alternative fuels as one of the cornerstones in making aviation sustainable. Fuel selection is affected by several factors, including fuel price, fuel reserve/availability, and emissions characteristics, as summarized in Figure 5. In 2019, aviation consumed around 1 billion liters of jet fuel every day (corresponding to 300 Mton/year). It is anticipated that this would increase by 3% every year despite the improvements in aircraft and engine efficiency. Decreasing oil reserves and increasing extraction costs, over time, will lead to an increase in the fuel cost. This increase in fuel cost has already increased the fuel share in airlines’ total operating costs to around 30% [13]. Furthermore, the urgency of tackling the climate issue forces us to look for alternative sustainable fuels long before the scarcity of fossil fuels becomes the driving factor. Sole dependence on kerosene also implies that there are significant fluctuations in the price of the fuel, discussed later in Figure 10.

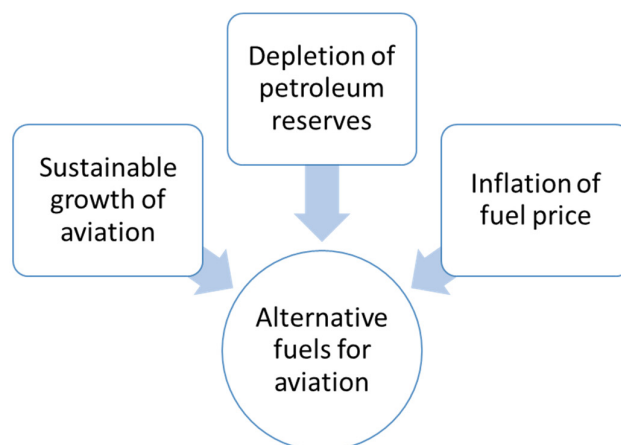

Figure 5. Motivation of alternative fuels for aviation.

2. Alternative Energy Carriers

Before we dwell on the details of different energy carriers for aviation, it is good to know the total energy required for various passenger transport modes. Figure 6 displays the energy carried on-board of some commonly used passenger vehicles. It shows that the energy carried on-board of a vehicle typically increases with the total amount of passenger-km. From a passenger-km point of view, an e-bicycle, small electric car, and a passenger bus are more efficient than other vehicles (as they are below the thin 45° line). An A320 on a long-range mission (e.g., 6000 km) reaches a million passenger-km, more than twice the distance between earth and moon if translated to one passenger. It is also clear from the figure that a small-medium range aircraft (e.g., 1000 km range) carries more than 100 GJ of energy, about three orders of magnitude more than a small electric car.

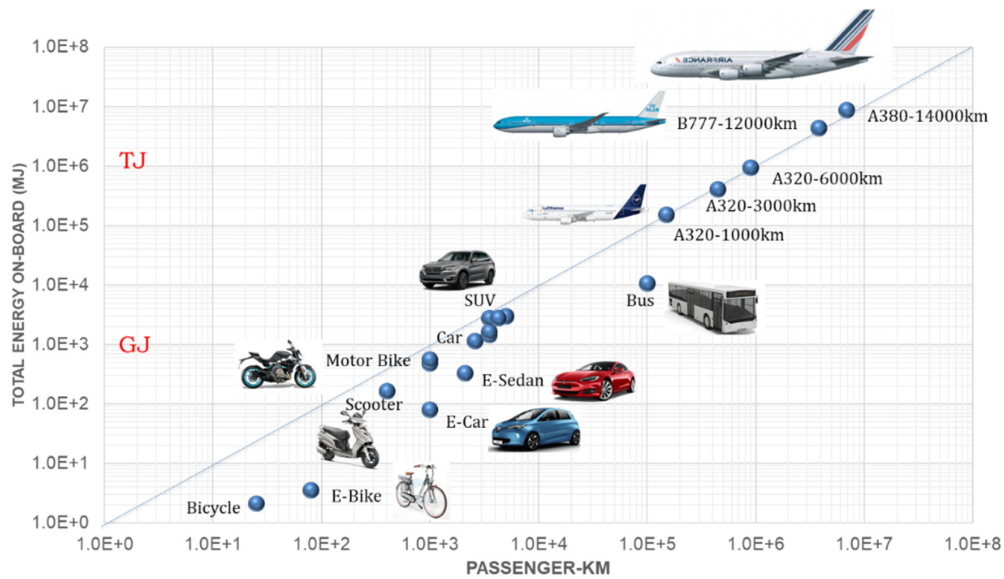

Figure 6. Typical values of the total energy carried on-board for different types of passenger vehicles.

Figure 6, therefore, provides us an insight that the total energy on-board increases linearly with the passenger-km. For aircraft, the range is largely dictated by the amount of fuel and therefore the energy density of fuels/energy carriers becomes vital as it significantly influences the vehicle’s total weight. The weight breakdown of a short-to-medium range single aisle aircraft is shown in Figure 7. If we increase the weight of the energy source/carrier, it will reduce the total number of passengers carried onboard significantly, thereby reducing the passenger-km (shifting the aircraft to the left of the dotted line on the graph), and hence significantly reducing its efficiency.

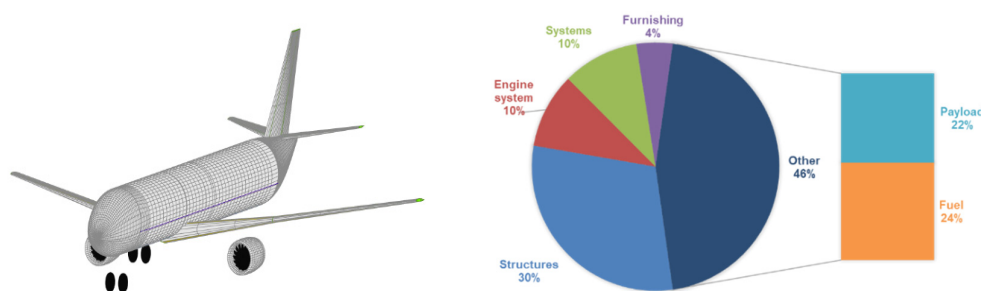

Figure 7. Typical weight breakdown of a short-to-medium range aircraft (data source [14]).

Figure 8 depicts some essential criteria to select fuel for aviation. Please note that these criteria are by no means exhaustive. They are used here to provide the reader with an overview and highlight some of the considerations that should be taken into account when discussing options for alternative energy carriers. The following subsections will elaborate on the most representative criteria.



Figure 8. Some of the important considerations during the selection of alternative fuel/energy carriers in aviation.

2.1. Specific and Volumetric Energy Density

As already highlighted, one of the main criteria is the energy density, as reducing weight and volume is of paramount importance for aviation. Both specific energy density (SED, amount of energy per unit mass of the fuel) and volumetric energy density (VED, amount of energy per unit volume) are important in this regard. Figure 9 shows several fuels/energy sources in terms of their SED and VED [15]. It is noticeable that Jet-A/kerosene has good SED and VED, and therefore is suitable for aviation. While biofuels and synthetic kerosene also have a similar energy density and therefore are ideal from an energy carrier point of view, their availability and costs are the main constraints, highlighted in subsequent subsections.

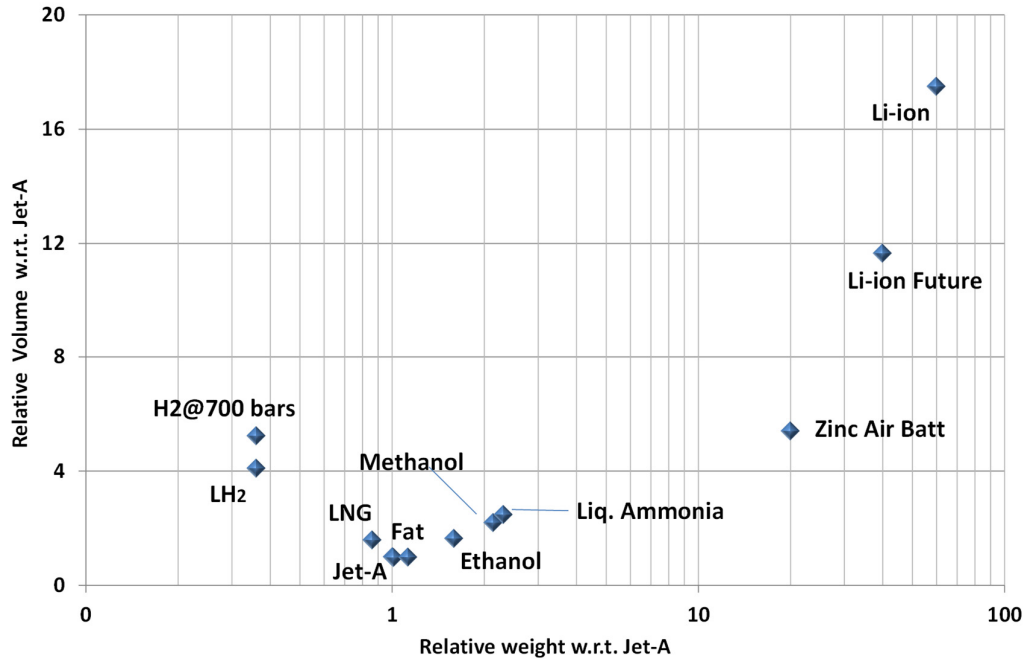

Figure 9. Comparison of various energy sources for aviation with respect to Jet-A [15]. LH₂—cryogenic hydrogen; LNG—liquefied natural gas.

Furthermore, cryogenic hydrogen (LH₂) has high SED but a poor VED, implying that we would require a large volume (about four times larger than for kerosene, not taking into account insulated tanks) to carry any reasonable amount of LH₂. In contrast, the LH₂ fuel weight would be only 1/3rd of kerosene for the same energy content. Figure 9 also shows that liquefied natural gas (LNG) lies halfway between kerosene and LH₂, in terms of VED, while its SED is slightly better than that of kerosene.

2.2. Cost of the Energy Source

Kerosene derived from the distillation of crude oil is a cheap fuel, as aviation fuel used on international flights are usually not taxed. This is primarily due to the ICAO Chicago convention article 24 (which bans taxing fuel and other fluids already onboard an international flight for its usage) and its subsequent revision in 1993 in which member countries are encouraged not to levy taxes on fuel for international flights [16]. This is one of the reasons why air travel, in general, is cheap. However, it should be noted that kerosene's price is subject to crude oil prices and therefore fluctuates significantly. Figure 10 shows the variation in kerosene's price over the last several decades; we can observe that the price is volatile and can vary significantly depending on the economic and geopolitical situation. Such variation is a significant risk for airlines, and therefore some airlines hedge on the price of kerosene in order to reduce the effect of the volatility in fuel price on their economics of operations.

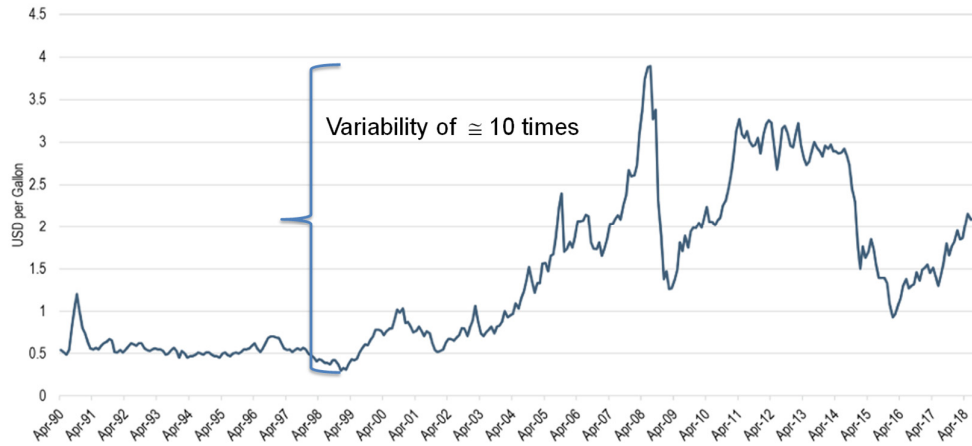

Figure 10. Variation in the price of kerosene over the last few decades (US Energy Information Administration, U.S. Gulf Coast Kerosene-Type Jet Fuel Spot Price FOB, USD per gallon).

Although biofuels and synthetic kerosene are similar to kerosene in their chemical and physical properties (except for their low aromatic contents), their cost is currently significantly higher. Figure 11 gives an overview of various fuels in terms of their costs and their greenhouse gas reduction potential [17]. As can be seen from the figure, most of the biofuels and synthetic fuels are significantly more expensive than kerosene, which reduces their likelihood of being used as an energy source in aviation unless enforced by governments through stringent regulations.

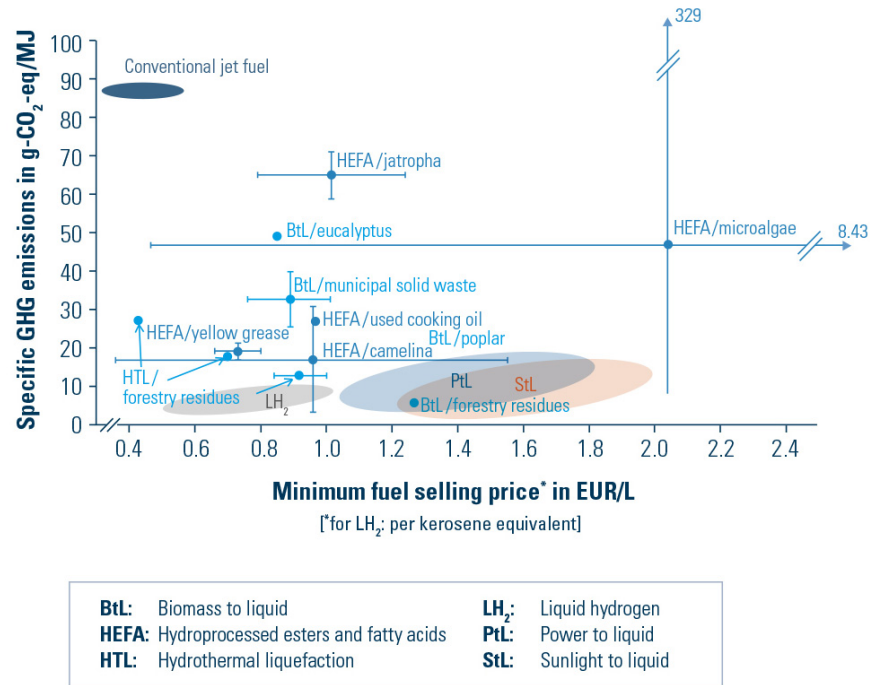

Figure 11. Comparison of cost estimates of various possible fuel/energy sources for aviation [17].

At present LH₂ production is expensive and not yet environmentally friendly; however, as we move towards a hydrogen-based economy by utilizing renewable energy sources, the price of LH₂ is expected to reduce substantially while meeting sustainability targets at the same time. The future energy scenario from Shell (Sky Energy Scenario [18]) lays out a roadmap for using H₂ in various

sectors to meet the Paris climate goals [19]. Hydrogen can be produced from renewable energy and serves as a long-term fuel for aviation [20].

LNG, on the other hand, is currently one of the cheapest fuels available. The gas reserves in the world are enormous thus implying that LNG prices would be stable. However, when we have to move away from fossil fuels and start producing methane either synthetically using renewable energy or using biomass, the price development in this scenario will be different.

2.3. Availability of Energy Source

As already mentioned, currently aviation consumes around a billion liters of jet fuel every day (about 300 Mton/year), which would increase by approximately 3% each year, despite the increase in aircraft efficiency. A clear alternative to fossil fuel is biofuel, which is produced from fatty acids and triglycerides obtained from plants or animal processing. Several biofuels have already been certified to be blended up to 50% along with kerosene [21]. The aviation sector has committed to developing bio-jet fuel through voluntary initiatives, and various stakeholders are actively involved. However, biofuels (as well as synthetic kerosene) projections so far have shown to be too optimistic, as their current usage remains very low. Currently, only a tiny fraction of the total fuel consumption comprises of biofuels [22]. There are several challenges in scaling up biofuel production, such as limited availability, ethical issues regarding the sourcing of feedstock, complicated logistics, certification costs, competition from other sectors, low price of kerosene, etc. Therefore, biofuel can be a part of the solution but not the solution itself.

Regarding LNG (mainly consisting of methane, CH_4), the world's gas reserves are enormous. LNG is a traded global fuel and has a well-established logistic and industrial network to support scaling of operations if required. Obviously, at present LNG is still a fossil energy source, which, when being used, contributes to global warming, even though the CO_2 emission is approximately 20% lower for the same energy content. During the last decade, a lot of progress has been made regarding the production of methane from green hydrogen (produced using sustainable electricity) and CO_2 (either captured from flue gasses or the air) [23]. In other words, for LNG/methane, a sustainable route can be a feasible option, where issues regarding the scalability of production plants and costs have to be considered.

Regarding H_2 , around 70 Mton H_2/yr is used today in pure form, mostly for oil refining and ammonia manufacture for fertilizers; a further 45 Mton H_2 is used in the industry without prior separation from other gases [24]. Thus, the amount of H_2 produced today in terms of the energy content is similar to the total amount of jet fuel used in civil aviation (mass energy density of H_2 is nearly three times higher than that of jet fuel). However, currently, most of this H_2 is grey H_2 and therefore still has a large CO_2 footprint.

There has been an enormous surge in the research related to H_2 . It is seen as a valuable contributor to a low carbon society and can support energy security in several ways. With the increase in the deployment of renewable energy sources like wind turbines and PV cells, the electricity grid faces many fluctuations. H_2 is seen as a buffer, as electricity can be converted to H_2 and back or further converted to other fuels, making end-users less dependent on specific energy resources and increasing the resilience of energy supplies. H_2 , produced from fossil fuels with CCUS (carbon capture and usage) or from biomass, can also increase the diversity of energy sources, especially in a low-carbon economy [24].

2.4. Infrastructure

The infrastructure for production, storage, and distribution of biofuels and LNG is well established and has reached good technical maturity. Although H_2 is used in several industrial processes, the infrastructure for storing and transporting LH_2 is not as mature as for LNG, partly because LH_2 has to be stored at very low temperatures, LH_2 at 20 K and LNG at 111 K.

The current infrastructure of airports is not suited for cryogenic fuels (both LH_2 and LNG), especially at big airports. Smaller airports typically supply fuel to the aircraft with tankers, and that

can be changed to accommodate LH₂/LNG tankers, but still requires substantial changes to the refueling protocols and requires investments.

All in all, using cryogenic fuels in aviation has several significant challenges, including the need for cryogenic storage where LH₂ by its nature requires a larger volume than kerosene, and boil-off losses come into play. Other aspects, such as safety, logistics, passenger perception, etc., as investigated in the Cryoplane Project [17], will be discussed in Section 4.

2.5. Sustainability

The combustion of conventional kerosene emits species like CO₂, NO_x, water vapour, and particulate matters. The interaction of these species with atmosphere cause air pollutants or global warming (directly or indirectly). The actual effects depend on where and when they are emitted. Figure 12 is a recent study by Lee et al. [1] showing aviation’s climate impact from different sources up to 2018. Contrails formed behind the engine exhaust play the biggest role followed by CO₂ emissions. The total non-CO₂ effects are more than 60% of the overall aviation’s climate impact. NO_x emissions in the upper troposphere and lower stratosphere cause formation of ozone and depletion of methane. The total effects of NO_x are warming. Water vapour itself is a greenhouse gas. Aerosols have direct or indirect effects. The direct effects of soot are warming and from sulphur are cooling. The number of soot particles can affect the microphysics of contrails and hence the contrails’ actual climate impact. Burning alternative fuels will affect the aviation’s emissions, and thereby its environmental impact.

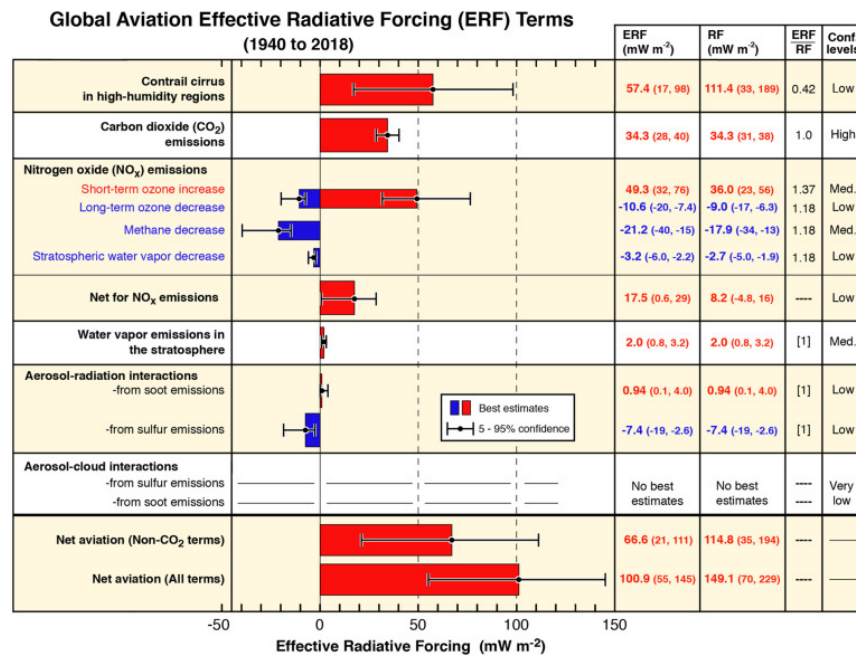

Figure 12. An overview of aviation’s climate impact from global aviation from 1940 to 2008 [1]. The bars and whiskers show the best estimates and the 5–95% confidence intervals. Red bars indicate warming terms and blue bars indicate cooling terms.

The assessment in Figure 12 is performed using both effective radiative forcing (ERF) (change in net downward radiative flux at the trapopause after allowing for stratospheric temperatures to readjust to radiative equilibrium, while holding surface and tropospheric temperatures and state variables fixed at the unperturbed values [25]) and radiative forcing (RF) (change in net downward radiative flux at the top of the atmosphere after allowing for atmospheric temperatures, water vapour, clouds and land albedo to adjust, but with global mean surface temperature or ocean and sea ice conditions unchanged [25]). The ERF allows the rapid adjustments of components of the atmosphere and surface, which are assumed to be constant in RF, therefore, the ERF is considered as

a better indicator of the final temperature change, especially associated to short-lived climate forcers, e.g., contrails. We can observe from Figure 12 that the ERF of contrail cirrus is nearly half of the RF. However, the contrail cirrus ERF is still the largest. The contrails cirrus ERF/RF ratio of 0.42 indicates that contrail cirrus is less effective in surface warming than other effects.

Biofuels have similar characteristics to kerosene and are therefore exchangeable with kerosene. The CO₂ emissions of biofuels depend on the source of the biomass, the type of biomass, the process adopted for converting the biomass, the resources used to grow the biomass, etc. The Renewable Energy Directive (RED) established by the European Commission (Directive (EU) 2018/2001 of 11 December 2018) is a good step in this direction as it lays down comprehensive methodology to calculate the greenhouse gas emissions from biofuels (with road diesel used as proxy). Directive 2009/28/EC introduced sustainability criteria including land usage with high biodiversity value and land with high-carbon stock. For aviation jet fuels, chapter 6 of the CORSIA agreement gives an overview of a set of criteria that have to be adhered to in claiming any biofuel as Corsia Eligible Fuels (ENVReport2019_pg228-231.pdf (icao.int) (https://www.icao.int/environmental-protection/Documents/EnvironmentalReports/2019/ENVReport2019_pg228-231.pdf)). Apart from the CO₂ reduction, biofuels, in general, contains substantially fewer aromatic contents than kerosene, which helps reduce the number of soot particles. Currently, certified biofuels can be used up to 50% with kerosene.

Regarding LNG, from a combustion technique point of view, using natural gas as a fuel is not a problem for the engine as natural gas is a clean fuel and can be burnt in a premixed or partially premixed mode. This substantially reduces the NO_x formation within the combustor when compared to kerosene. However, an additional heat exchanger has to be used for evaporating the LNG to natural gas. The CO₂ emission from LNG for the same energy content is around 25% lower than kerosene.

The main advantage of using LH₂ is that there is no CO₂ emission from the combustion of fuel. The engine will emit water vapor and some amount of NO_x as exhaust. The combustion properties of H₂ are quite different than other fuels as the laminar flame speed is almost an order of magnitude more than that of CH₄. Moreover, due to the high flammability limits, there is a huge risk of flashback in combustors designed to operate on H₂. The usage of H₂ also puts some severe limits on the metal pipes and fuel injectors due to H₂ embrittlement. These considerations have to be taken into account when designing turbofan engines using H₂.

The high water emission index of burning hydrogen/natural gas increases the chance of contrail formation, according to the well-known Schmidt Appleman Criterion [26]. However, earlier research suggests that hydrogen combustion produces no soot particles and methane combustion produces significantly lower soot than kerosene. The decrease in soot number density is expected to reduce initial ice crystal concentrations on average, the contrails' optical depth and contrails radiative forcing as soot particles form the nucleation sites which initiate ice crystal formation [27].

2.6. Fuel Selection

Table 1 summarizes the essential properties of several representative fuels. We can see that the energy density of LH₂ is only one-fourth of Jet A and the atmospheric boiling point is −253 °C. LNG has a slightly lower energy density than Jet A, and the boiling temperature at the atmosphere condition is −162 °C.

Table 1. Fuel properties.

	Vol. Energy Density (MJ/L)	Specific Energy Density (MJ/kg)	Boiling Point @ 1 Atm (°C)	Density @ 1 Atm (kg/m ³)
Jet A	35.3	43.02	176	802
LNG	24	53.6	−162	450
LH ₂	8.5	120	−253	70.8

Based on the criteria mentioned in Figure 8, Table 2 gives a simplistic comparison of different energy sources. It can be seen that apart from emissions/climate, kerosene is favorable in most other

aspects, and that is why it is widely used. One can note that LNG has several advantages compared to other fuels/energy sources (apart from kerosene).

Table 2. Simplistic comparison of different energy sources.

Parameter	Kerosene	Biofuel	Syn-Kerosene	Batteries	LNG *	LH ₂ **
Energy Density	+	+	+	--	+	++
Volume Density	++	++	++	--	+/-	-
Emissions	--	+	+	++	+	+
Cost	++	-	--	+	++	-
Availability	++	--	--	--	+	+/-
Infrastructure	++	-	--	+/-	+	-
Safety	+	+	+	--	+/-	--
Compatibility	++	++	++	-	+/-	-
Policy	-	+	+	+	+/-	+
Climate Impact	--	+	+	++	+	+
TRL	9	8	4	5	4	3

* refers to fossil-based LNG. ** refers to green LH₂.

This table can by no means be seen as a complete basis for a thorough trade-off between the different options. It is a start and will require a follow-on study which considers issues like overall energy requirement for worldwide production, scarcity of materials, modifications to the propulsion systems, logistics, life cycle analysis, etc.

3. Hydrogen as an Energy Carrier for Aviation

If aviation has to maintain its sustainable growth, the aviation sector must solve energy source problems in the first place. This section discusses the potential of hydrogen as an energy carrier for future aviation.

3.1. Features of Liquid Hydrogen for Aviation

The advantages and disadvantages of using LH₂ as an energy carrier in aircraft are summarized in this section:

As compared to the conventional kerosene, the benefits of using LH₂ are:

- The high energy density (almost three times of kerosene).
- Lower fuel weight than kerosene (see Figure 8).
- No CO₂ emission during the flight.
- No secondary emissions such as soot, CO, unburnt hydrocarbon (UHC), and volatile organic compounds.
- Large potential to reduce NO_x emission from combustion [26,27].
- Usage of the cryogenic heat sink can increase turbofan engine thermal efficiency substantially.
- Can also be used in conjunction with fuel cells and electrical motors.
- Wide combustion range and flammability limit [28].
- Less prone to combustion instabilities when compared to other fuels [29].
- It can be made by renewable energy sources.

Disadvantages of using LH₂ are:

- The poor volumetric energy density (70.8 kg/m³ for LH₂ vs. 750 kg/m³ for kerosene), approximately 4 times lower than kerosene for the same energy content.
- Increased storage space compared to conventional jet fuels.
- The fuel cannot be stored in the wings but only in the fuselage or in underwing pods.
- LH₂ storage requires cryogenic or pressurized tanks.

- LH₂ has an extremely low boiling temperature (20.3 K); therefore, it requires very effective insulation to keep the fuel cool.
- The fuel cost is higher than the conventional kerosene.
- The production capacity for “green” hydrogen is still inadequate.
- The airport logistics are quite difficult.
- The water emission increases substantially, water being a greenhouse gas at higher altitudes (>10 km).
- Hydrogen has a propensity to leak.
- Hydrogen has a tendency to flashback during the combustion process in a gas turbine.
- Safety of operations and usage in an airport environment is challenging.
- The energy efficiency for electrolysis and liquefaction is around 50%.

3.2. Hydrogen Storage

Gaseous hydrogen suffers from a vastly inferior volumetric energy density when compared to kerosene; 0.01 MJ/L for room temperature hydrogen versus 35 MJ/L for kerosene. Given the space constraints on-board current airliners, matching the current performance and range of kerosene engines is not easy. Liquid hydrogen boasts of a much higher volumetric density at 8.5 MJ/L. The National Aeronautics and Space Administration (NASA) relies on LH₂ for its rockets and claims it “is the signature fuel of the American Space Program”. Liquid hydrogen must be stored at $-253\text{ }^{\circ}\text{C}$ and handled with extreme care. The tanks must be heavily insulated to prevent the LH₂ from evaporating as it absorbs heat and expands rapidly; thus, venting is necessary to prevent the tank from exploding. Metals exposed to the extreme cold become brittle. Moreover, hydrogen can leak through minute pores in welded seams.

Figure 13 gives a schematic overview of some of the common options available for storing/carrying hydrogen. They are normally classified as physical-based or material-based. For aviation, due to the stringent mass and volume constraints, physically storing LH₂ in insulated tanks yields the highest volumetric and specific energy density. Other physical means such as storing H₂ at high pressure and cryo-compressed H₂ have a higher weight penalty, as shown in Figure 14 from Bauhaus Luftfahrt e.V. What can be seen from the figure is that the weight of hydrogen with respect to the weight of the tank improves when large quantities of H₂ are stored. For small amounts of H₂ (like in drones), it is better to store H₂ in compressed form rather than in liquid form, but for large quantities, it is better to store H₂ in the form of cryogenic LH₂. It also indicates that it is perhaps better to use larger tanks in the fuselage than smaller tanks. However, the tank design and placement will become an integral part of the aircraft design process as the cryogenic tank will change not only the weight and drag of the aircraft but also stability, passenger evacuation, operations, etc.

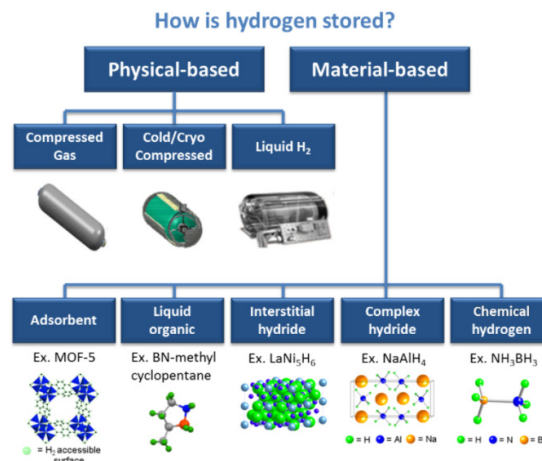

Figure 13. An overview of different hydrogen storage options (<https://www.energy.gov/eere/fuelcells/hydrogen-storage>).

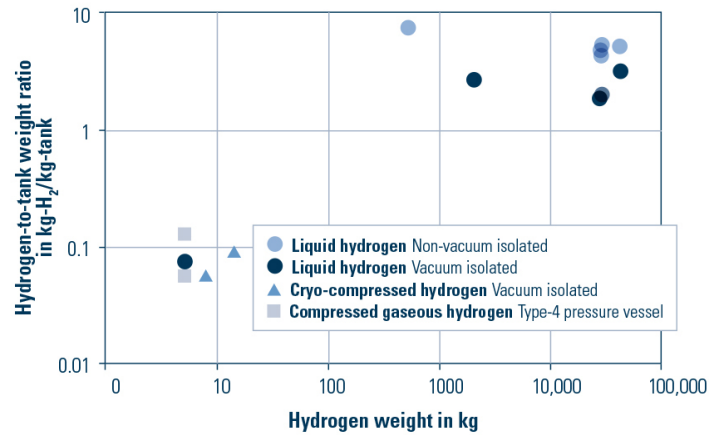

Figure 14. Comparison of various physical hydrogen storage options (source: Bauhaus Luftfahrt e.V. (<https://www.bauhaus-luftfahrt.net/en/topthema/hy-shair/>)).

Cryogenic LH₂ tanks are complex storage systems with several subsystems built into it. A schematic of a cryogenic tank from Linde® is shown in Figure 15. The following factors are taken into account while selecting the insulating material and type.

- The insulation system must minimize boil-off while keeping additional mass to a minimum.
- The insulation system must prevent atmospheric gasses from condensing and solidifying onto the tank.
- The insulation system must not fail due to the cyclic loading of LH₂.
- The insulation system must have low thermal conductivity and low density.

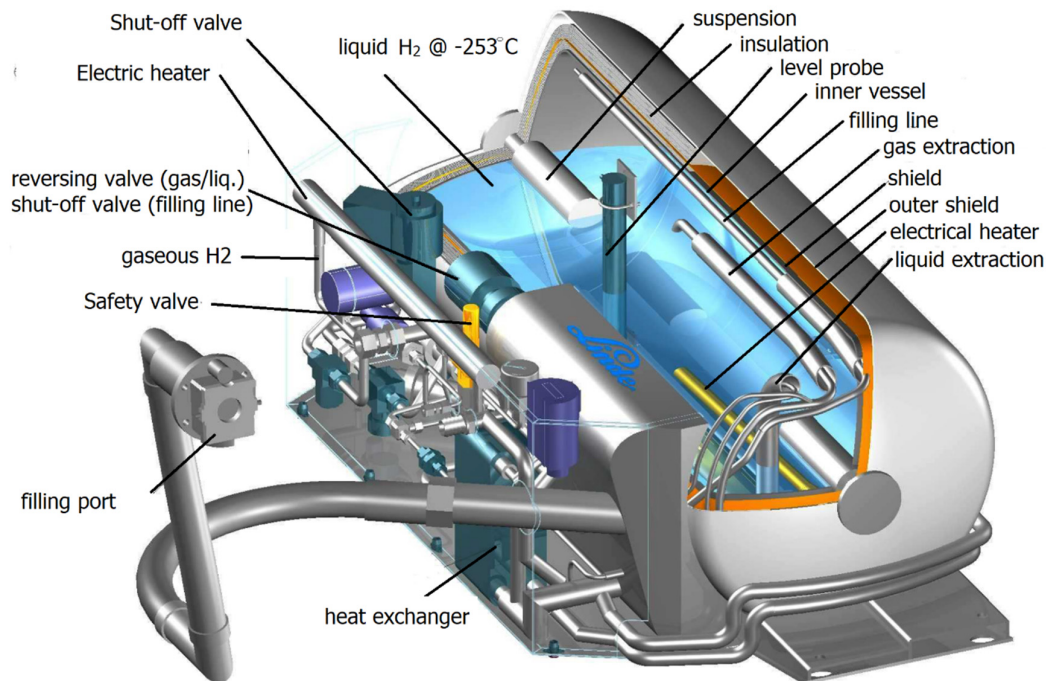
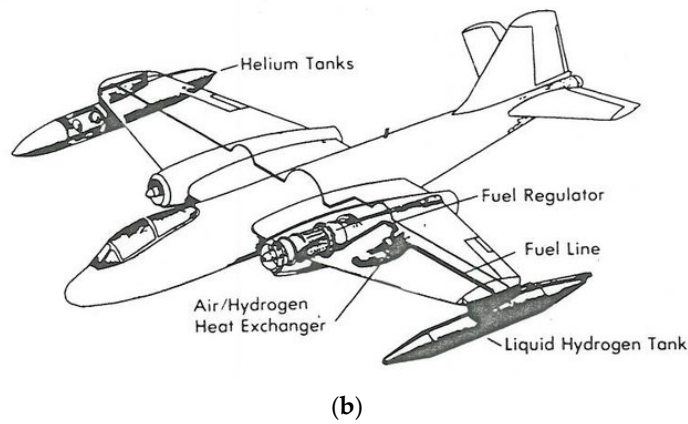
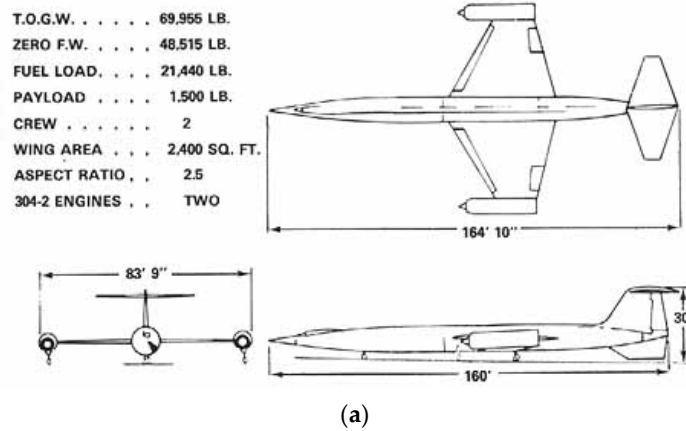

Figure 15. Schematic of a cryogenic hydrogen tank (source: Linde®).

Multilayer insulation (MLI) systems can achieve lower thermal conductivities compared to flexible polymer foam or Aerogel [30]. MLI systems consist of a spacer and a reflector stacked upon each other. The spacer is often made of thin fiberglass, polyester, silk, or plastic layer. On the other hand, the reflector is made of Mylar or aluminum foil with a thickness of 6–7 μm . Furthermore, MLI systems perform best in high vacuum (HV) conditions but can also operate in a soft vacuum with higher thermal conductivity [31].

3.3. History of Aircraft Designs with Hydrogen

Even though H_2 is not currently used in aviation, it is not a new fuel for aviation. There have been several attempts in the past to use hydrogen. One of the first attempts was by Sir Han Ohain to use hydrogen in his newly invented gas turbine back in 1937. During the Cold War, both the United States and the Soviet Union (USSR) tried to use hydrogen in aircrafts, with limited success. The United States built two aircrafts, one a reconnaissance aircraft called Suntan (shown in Figure 16a), and the other was in the NACA-Lewis LH_2 flight test program using a modified B-57B Canberra military aircraft (Figure 16b).





(c)

Figure 16. Examples of hydrogen-powered aircraft. (a) The Lockheed-Martin Suntan, taken from the symposium on hydrogen-fueled aircraft, NASA Langley Research Center, 15–16 May 1973 (b) B-57B aircraft with one engine capable of running on hydrogen, image is taken from NACA RM E57D23 (c) Tu-155 aircraft with one engine capable of running on hydrogen, image is taken from Tupolev history - http://www.tupolev.ru/en/about/#history_en.

The Russians had an ambitious program to modify TU154 aircraft to run on hydrogen (Figure 16c). The same aircraft was later used with LNG. Cryogenic fuels are stored in a fuel tank with a capacity of 17.5 m³ installed in a special compartment aft of the passenger cabin. On 5 April 1988, the aircraft performed its maiden flight using LH₂. Upon flight testing and development, TU-155 performed its first flight on LNG in January 1989. Subsequently, some international flight demonstrations were made. The test flights showed that H₂ propulsion was feasible and had various advantages, but not enough to overcome its disadvantages, most prominently the logistics problem of needing LH₂ to be available on all airports in addition to kerosene (Hydrogen Aircraft Technology, Brewer, 1991). These trade-offs did not take environmental impact into account. However, recent analysis shows the significant environmental benefits of using H₂ compared to kerosene and synthetic fuel generated with sustainably generated energy.

3.4. Proposed Aircraft Designs with Liquid Hydrogen

There has been a resurgence in the interest of designing aircraft using LH₂ and several designs utilizing LH₂ have been proposed. This section covers the prominent ones. The great challenge for LH₂ aircraft is to have a suitable configuration to store cylindrical spherical insulated and pressurized fuel tanks that occupy almost five times the volume compared to kerosene. Since the pressurized vessels do not fit in the wings, the fuselage seems a suitable option. However, the challenge of storing the fuel tanks in the fuselage is the enormous increase in the fuselage volume and the presence of the passengers next to hydrogen fuel tanks. While the former will lead to an increase in fuselage drag and a subsequent increase in aircraft fuel consumption, the latter poses some serious safety challenges.

Cryoplane: In the year 2004, the EC-sponsored CRYOPLANE project was completed. The project's main goal was to design aircraft using LH₂, covering various subjects from H₂ production methods to environmental compatibility. In total, six categories of aircraft were designed in the project ranging from a small regional aircraft, a business jet to a long-range passenger aircraft.

The baseline short–medium range (SMR) aircraft was designed to carry 185 passengers over 4000 nm (similar to the A321 but with more range) and a stretch version to carry 218 passengers over 3300 nm. The initial and final configuration is shown in Figure 17. For the initial design, the aerodynamic penalty due to the oversized inner wing turned out to be a 17.5% loss in L/D. The final configuration was an adaptation of the baseline kerosene aircraft with a low-set wing with a giant fuselage to accommodate the top and aft tank (Figure 17). This increased the trim drag. The horizontal tail was decreased in size compared to the kerosene baseline due to the longer fuselage, but the vertical tail needed more area due to the increase inside area caused by the overhead fuselage tanks. The

relatively higher maximum landing weight is required for a more sophisticated flap system. The operating empty weight (OEW) increased by around 30% compared to their kerosene baselines, and the maximum take-off weight (MTOW) decreased by about 3%.

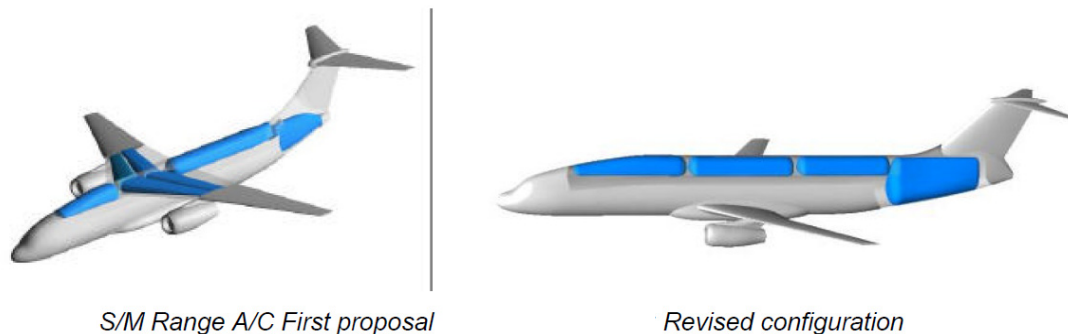

Figure 17. Schematic of the initial small–medium range (SMR) aircraft configuration and the revised aircraft configuration with cryogenic tanks.

In a recent EU project called EnableH2, the aircraft designed (shown in Figure 18) looks similar to the one designed in the Cryoplane project. However, the technical details of the aircraft have not been published yet to make a thorough comparison with the Cryoplane aircraft.



Figure 18. Artistic view of the aircraft designed in the EnableH2 project [32].

An interesting characteristic of aircraft designed with LH₂ is that their payload range diagram, in general, is different from an equivalent kerosene aircraft, as shown below (Figure 19, from the Cryoplane Project). The low fuel weight of LH₂ allows less payload to be traded for fuel, thereby making hydrogen aircraft extremely sensitive to payload variations.

The ratio of operating empty weight (OEW) to MTOW for all designs was found to be 0.68, i.e., independent of aircraft category or size. This is an interesting feature since, as for conventional aircraft, this ratio decreases with increasing range and thus fuel fraction. Apparently, for LH₂ aircraft, the increase in tank weight and the resulting OEW keeps pace with the lesser growth in MTOW due to the relatively light fuel [33]. Figure 20 shows the variation of the OEW and the MTOW for various aircraft categories with respect to the equivalent kerosene-fuelled aircraft. Overall, the OEW increases, whereas the MTOW reduces in most cases except for the regional propeller aircraft. The largest reduction of about 15% in the MTOW is observed for the long-range aircraft. Verstraete [34] also looked at the design of three types of aircraft fuelled with LH₂ and compared them with the kerosene version of the aircraft. He reported that the OEW/MTOW ratio for LH₂ aircraft is much higher than a corresponding kerosene fuelled aircraft, however for LH₂ aircraft the ratio did decrease slightly when increasing the aircraft design range, from around 0.75 for an SMR aircraft to 0.65 for a long-range aircraft.

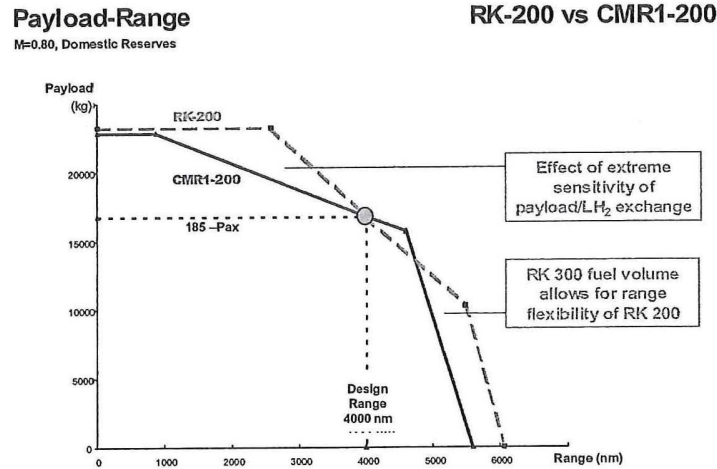

Figure 19. Comparison of the payload range diagram for a reference kerosene aircraft and a cryogenic medium-range aircraft designed in the Cryoplane project [35]. (RK: reference kerosene; CMR1-200: Cryogenic Medium Range aircraft).

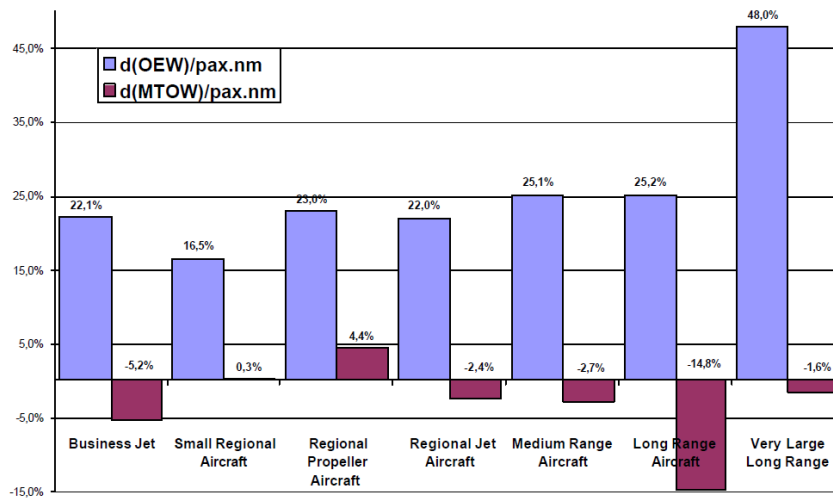

Figure 20. Changes in the operating empty weight and maximum take-off weight for an LH₂ powered aircraft as compared to equivalent kerosene-fueled aircraft. [36].

The increase in the LH₂ powered aircraft’s energy consumption compared to a conventional aircraft for different aircraft types is shown in Figure 21. It can be seen that, in general, LH₂ powered aircraft consume around 10–30% more energy per passenger-km depending on the specific designs and mission profile. Using LH₂ for business jets and very long-range aircraft is the most detrimental in energy increase. This is mainly due to the slender fuselage in business jets and the requirement to store a huge amount of LH₂ for a very long-range aircraft. Thus, the SMR aircraft is a good category to utilize LH₂.

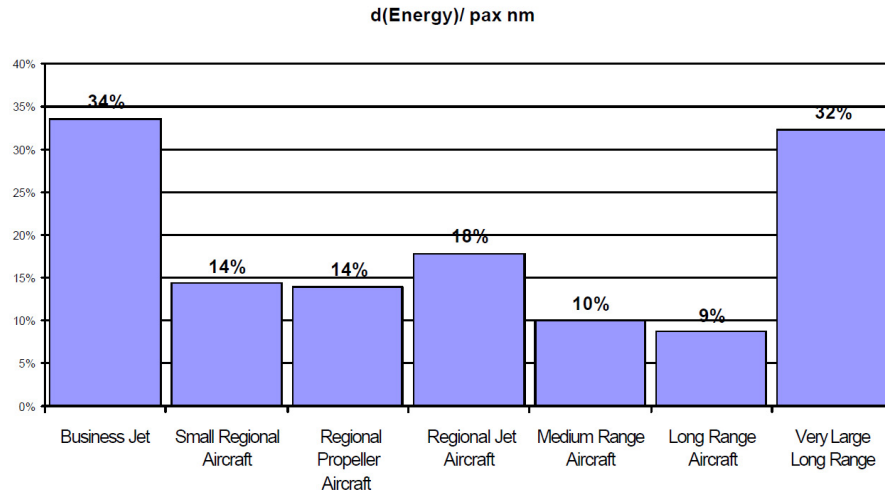

Figure 21. Change of energy consumption for H₂-fueled aircrafts as compared to equivalent kerosene-fueled aircrafts [36].

Airbus Zero-e: Recently, Airbus unveiled its concepts for the future with the ZEROe aircraft shown in Figure 22. All three aircrafts are based on LH₂ produced by renewable electricity as an energy carrier and use gas turbines as a power source. Even though the aircraft's technical details are not published, their performance can be expected to be similar to the ones discussed earlier within the Cryoplane project, except for the blended-wing body (BWB) aircraft, which has the advantage of having extra volume for storage of cryogenic tanks.



Figure 22. The three aircraft concepts from Airbus using LH₂ as an energy carrier to reduce the environmental footprint of aviation.

AHEAD multi-fuel concept: Aircraft designs based on an energy mix concept are promising ways to resolve cryogenic fuels' storage issues. The energy mix concept in this context refers to aircraft that use two types of fuels simultaneously. An example is the multi-fuel blended-wing body (MF-BWB) aircraft proposed in the AHEAD project [37] for a long-range mission of about 14,000 km. The MF-BWB uses a cryogenic fuel (LH₂ or LNG) and a liquid fuel (biofuel/kerosene) as energy sources. Figure 23 shows a schematic of the MF-BWB, where cryogenic fuel is stored in cylindrical insulated tanks within the fuselage (grey color-coded area). The biofuel is stored in the wings (blue color-coded area). The energy ratio between the two fuels is around 75%/25%.

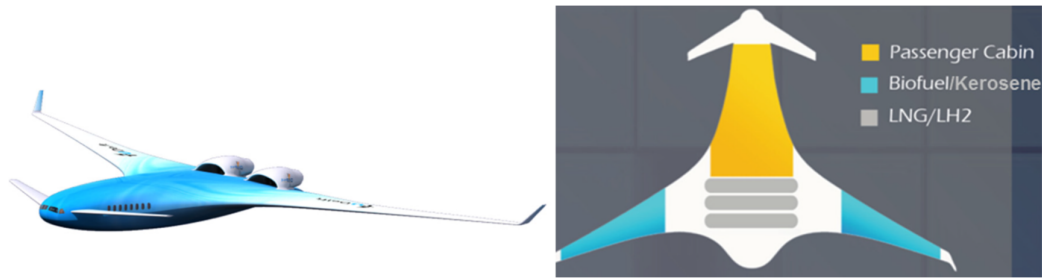

Figure 23. The multi-fuel blended-wing body investigated in the AHEAD project [37].

To power the MF-BWB, a multi-fuel hybrid engine (MFHE) which can simultaneously burn two different types of fuels has been studied in the AHEAD project. Figure 24 presents a schematic of the MFHE, and Figure 25 illustrates the design details of the dual combustion chambers. Details of the engine performance can be found in [37].

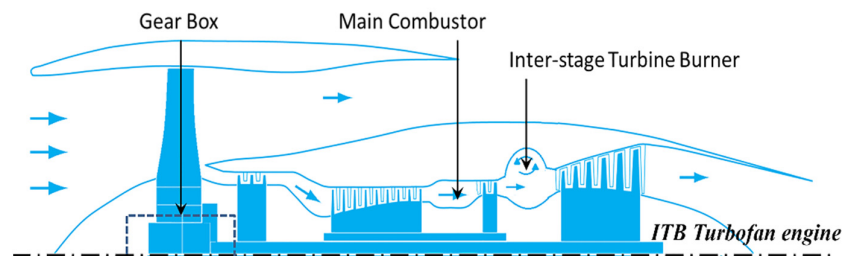

Figure 24. Schematic of the multi-fuel hybrid engine investigated in the AHEAD project. Adapted from Figure 3 of [37].

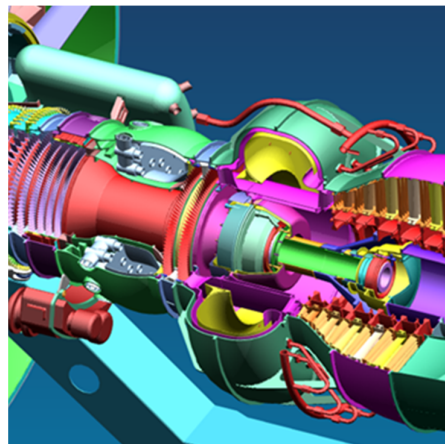

Figure 25. Cross-sectional view of the hybrid engine with two combustion chambers designed in the AHEAD project [38].

The main features of this engine are:

- **Multi-fuel capability:** The MFHE comprises dual combustion chambers. The first combustion chamber (located between the high-pressure compressor (HPC) and high-pressure turbine (HPT)) burns cryogenic fuel (e.g., LH₂ or LNG) in a vaporized state. In contrast, the second combustor is an inter-stage turbine burner (ITB) and uses kerosene/biofuels [15,37].
- **Low emissions:** The combination of cryogenic fuels and biofuels reduces CO₂ emission. The previous analysis shows that the LNG version of the MF-BWB aircraft can reduce CO₂ emission by around 50% as compared to the baseline B777-200ER for the design mission [38]. The CO₂

emission would be much higher for LH₂ version of the MF-BWB. The flammability limit for hydrogen/methane is wider than for kerosene. Therefore, combustion in the first combustion chamber can take place at lean conditions, hence reducing NO_x emissions. The vitiated combustion products from the first combustor enable flameless combustion technology in the second combustion chamber, reducing the NO_x emission further [39]. A combustor capable of working on H₂ was designed within the AHEAD project and was demonstrated at atmospheric conditions by the group of Professor Paschereit [40,41]. A combustor capable of sustaining flameless combustion was demonstrated by the group of Professor Y. Levy at atmospheric conditions [42].

- Bleed cooling: The cryogenic fuel first cools the turbine bleed cooling air through a cryogenic heat exchanger. The colder bleed air is then used to cool the high-pressure turbine blades. This process reduces the amount of air required for turbine cooling air substantially and increases engine performance. Meanwhile, LH₂/LNG vaporizes into the gas phase for the combustion process. [37].

Grewe et al. [43] also performed a climate assessment for the MF-BWB aircraft using either LH₂ (AHEAD-LH₂) or LNG (AHEAD-LNG) combined with biofuels. A FUT-B787 aircraft based on an assumed futuristic B787 available in the year 2050 was used as a baseline to enable a fair comparison. The B787-FUT burns kerosene but with improved fuel efficiency. The AHEAD-LH₂ uses 70% LH₂ and 30% kerosene and uses low NO_x combustion techniques; therefore, the NO_x effects (from O₃ formation, methane depletion) are less than the B787-FUT aircraft. As burning hydrogen produces more water vapor, the water vapor effects of AHEAD-LH₂ fleet are larger than the B787-FUT. The AHEAD-LH₂ contrail effects are slightly lower than the B787-FUT. The water vapor effects of AHEAD-LNG fleet are between the B787-FUT and AHEAD-LH₂ and the NO_x effects of AHEAD-LNG fleet are the lowest, but the CO₂ effects of AHEAD-LNG are slightly higher. An overview of the analysis in Figure 26 confirmed that MF-BWB using LH₂ could reduce the climate impact by about 30% per passenger-km compared to B787-FUT.

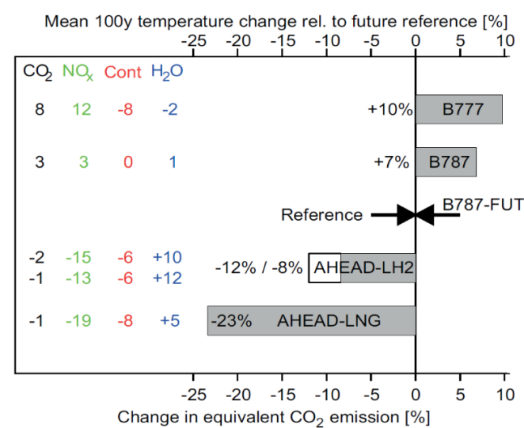

Figure 26. Change in average temperature response from 2051 to 2150 (ATR100) for fleets of different aircraft configurations relative to the reference configuration B787-FUT [43].

There are a few points that should be taken into consideration when extrapolating these results to single-aisle aircraft. Firstly, the AHEAD BWB aircraft was designed for cruising at a higher altitude than conventional tube and wing aircraft due to its lower wing loading, and therefore the effects of water vapor and contrails are amplified. Secondly, the aircraft uses 70% of its energy as LH₂ and 30% as kerosene; a tube and wing aircraft on LH₂ will therefore not have any soot emission, which acts as nucleation particles during ice crystal formation and therefore might have lower contrail formation. However, there is still a lot of investigation needed in this area.

4. Liquefied Natural Gas as an Energy Source for Aviation

Apart from LH₂, LNG is another potential fuel for future aviation. This section discusses the features of LNG and example designs in using LNG as fuel.

4.1. Features of LNG for Aviation

The advantages and disadvantages of using LNG are summarized based on the previous discussions on energy selection criteria and are listed below.

Compared to conventional kerosene, advantages of LNG are:

- LNG has a lower fuel weight and better combustion properties than conventional kerosene.
- Burning LNG reduces CO₂ emissions by about 25%. NO_x and particulate emissions are reduced substantially while eliminating sulphate emissions.
- LNG is a cryogenic fuel and is a good heat sink. It can be used beneficially for intercooling, bleed cooling, air-conditioning, etc., to enhance the thermodynamic efficiency of the engine. Using the LNG for cooling the bleed air used for turbine cooling was found to be most beneficial with SFC reductions in the order of 5% [44].
- The world gas reserves are substantial and therefore LNG is substantially cheaper.

Disadvantages of LNG are:

- LNG storage requires pressurized tanks and good insulation to keep the fuel cool, resulting in increased aircraft operating empty weight (OEW).
- LNG storage requires a larger space than conventional jet fuels.
- Airport facilities and logistics for tanking LNG are required.
- Methane slip during operations can lead to global warming as CH₄ has a higher greenhouse potential than CO₂, approximately 34 times compared to CO₂ over a 100-year period (Table 8.7 of [45]).

4.2. Proposed Aircraft Designs for LNG

The MF-BWB concept described in Section 3.3 also had an LNG version, which allows using LNG mixed with kerosene/biofuels for a long-range mission. Figure 26 shows that the MF-BWB LNG version (AHEAD-LNG) can reduce the climate impact by 40% compared to a contemporary B787-FUT aircraft and the biggest reduction is from the reduced NO_x and contrails effects.

Next to MF-BWB for long-range missions, a group of students at Delft University of Technology (TU Delft) designed a multi-fuel A320 class of aircraft for short- and medium-range missions (shown in Figure 27) [46]. Figure 28 shows the corresponding flight mission of multi-fuel A320. In this design, LNG is used in the landing take-off (LTO) cycle and the climb and descent phase to reduce the near-airport air pollution (soot, CO₂, NO_x, UHC, VOC, etc.). In the cruise phase, kerosene is used to limit the emission of water vapor. Water vapor is a greenhouse gas with stronger effects at a higher altitude due to longer residence time. Water vapor also forms contrails, as described earlier, which generally enhances global warming.

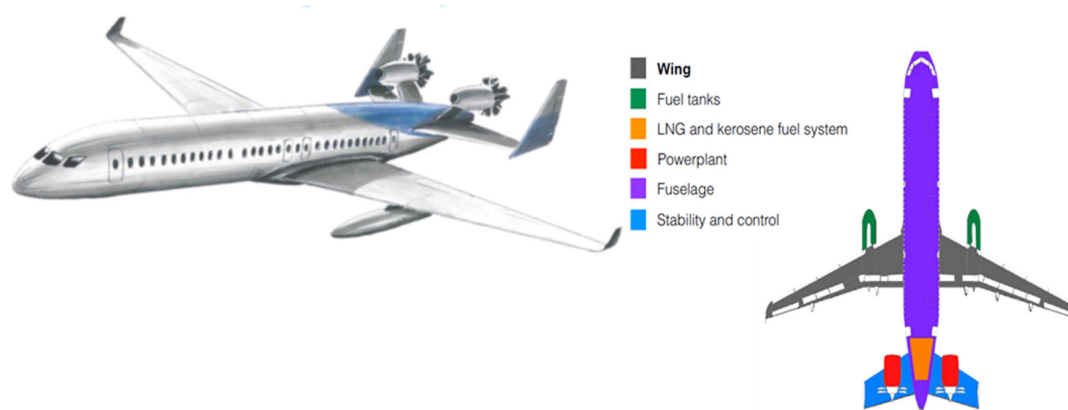

Figure 27. A multi-fuel A320 class of aircraft with podded LNG tanks and open rotors designed by students at Delft University of Technology (TU Delft).

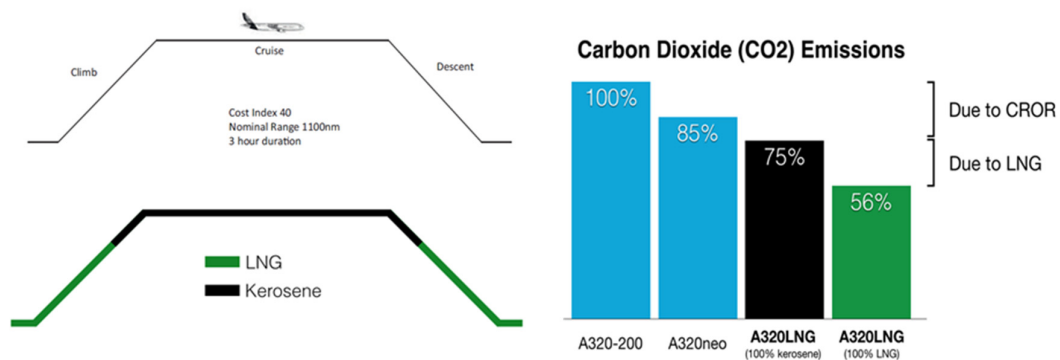

Figure 28. Mission and CO₂ emission reduction from the hybrid A320 class aircraft using LNG and kerosene on a typical mission [46].

Another advantage of using such a multi-fuel configuration is the flexibility to use the aircraft in places where LNG is not available. The results showed the multi-fuel A320 aircraft reduced emissions substantially when compared to a conventional A320 aircraft. The operating cost was 10% lower due to lower emissions and cheaper fuel [46].

5. Conclusions

A transition away from fossil fuels demands some radical changes, which certainly is the case in aviation, where severe weight and volume constraints play an important role. Liquid hydrogen, when produced using renewable energy, is widely considered to be a viable candidate to pave the way towards carbon-free aviation. Here we argue that also methane (the main constituent of natural gas), when made sustainably, could be a favorable candidate for aviation.

The challenges of LH₂ storage (at -253 °C) and the associated logistical issues are significant, which will increase the operating costs dramatically. The current aircraft design and architecture will have to be changed significantly to accommodate cryogenic fuels. Both LH₂ and LNG will require significant changes to the aircraft propulsion system. From previous studies, it seems that a short-to-medium range aircraft will be a suitable candidate for carrying cryogenic fuels. However, there is a lack of studies that have taken a detailed look at these designs.

Apart from the storage of cryogenic fuels, there are several important challenges, even beyond current cost issues, which have to be overcome before they can be widely used as a sustainable energy carrier for aircraft. The required ramp-up of sustainable production will require a massive worldwide investment, not only in facilities but also in R&D. The final trade-off between different alternatives

to fossil aviation fuel (indicative preliminary start of such a trade-off is shown in Table 2) will have to be performed taking into account the climate effects of non-CO₂ emissions and the limited availability of renewable energy since aviation is by far not the only sector demanding sustainable energy carriers. For this trade-off, it is also recommended to take a closer look into dual-fuel hybrid aircraft, combining the advantages of both fuels while reducing the associated drawbacks and risks.

Furthermore, we need more thorough research on the climate effect from non-CO₂ emissions, especially on contrail formation and persistence as LH₂ or LNG will increase the emission of water vapor during flight. As shown by several studies, the non-CO₂ effects can be more significant than those of CO₂. Therefore, looking into the future, carbon-neutral aviation is certainly possible, but climate-neutral aviation is very difficult to achieve.

Author Contributions: Conceptualization, A.G.R.; writing—original draft preparation, A.G.R., F.Y., and H.G.C.W.; writing—review and editing, A.G.R., F.Y., and H.G.C.W. All authors have read and agreed to the published version of the manuscript.

Funding: This research received no external funding.

Conflicts of Interest: The authors declare no conflict of interest.

Nomenclature

A/C	Aircraft
ACARE	Advisory Council for Aeronautical Research and innovation in Europe
ACI	Airports Council International
AHEAD	Advanced Hybrid Engine for Aircraft Development
ATAG	Air Transport Action Group
BWB	blended-wing body
CBS	Central Bureau of Statistics
CCS	carbon capture and storage
CANSO	Civil Air Navigation Services Organization
CCU	carbon capture and usage
CORSIA	Carbon Offsetting and Reduction Scheme for International Aviation
CROR	Contra Rotating Open Rotor
DoE	Department of Energy
EC	European Commission
ERF	effective radiative forcing (mW/m ²)
FOB	Freight on Board
HPC	High-pressure compressor
HPT	High-pressure turbine
IATA	International Air Transport Association
ICAO	International Civil Aviation Organization
ICCAIA	International Coordinating Council of Aerospace Industries Associations
ITB	inter-stage turbine burner
L/D	Lift to Drag Ratio [-]
LH ₂	liquefied hydrogen
LNG	liquefied natural gas
LTO	landing take-off
MFBWB	multi-fuel blended-wing body
MFHE	multi-fuel hybrid engine
MTOW	maximum take-off weight (kg)
NACA	National Advisory Committee for Aeronautics
NASA	National Aeronautics and Space Administration
OEW	operating empty weight (kg)
PV	Photo Voltaic
RHK	Royal Haskoning DHV
RF	radiative forcing (mW/m ²)
SED	specific energy density (MJ/kg)
SFC	Specific Fuel Consumption (kN/gm/s)
SMR	short–medium range

TRL	Technology Readiness Level
UHC	unburnt hydro-carbon
VED	volumetric energy density (MJ/L)
VOC	Volatile Organic Compounds

References

1. Lee, D.S.; Fahey, D.W.; Skowron, A.; Allen, M.R.; Burkhardt, U.; Chen, Q.; Doherty, S.J.; Freeman, S.; Forster, P.M.; Fuglestvedt, J.; et al. The contribution of global aviation to anthropogenic climate forcing for 2000 to 2018. *Atmos. Environ.* **2020**, *244*, 117834, doi:10.1016/j.atmosenv.2020.117834.
2. Lee, D.S.; Fahey, D.W.; Forster, P.M.; Newton, P.J.; Wit, R.C.N.; Lim, L.L.; Owen, B.; Sausen, R. Aviation and global climate change in the 21st century. *Atmos. Environ.* **2009**, *43*, 3520–3537.
3. Asquith, J. When Will Aviation Return To Pre-Coronavirus Levels? Available online: <https://www.forbes.com/sites/jamesasquith/2020/04/02/when-will-aviation-return-to-normal/?sh=2532f0485190#40a334d25190> (accessed on 12 September 2020).
4. Pearce, B. COVID-19 Outlook for Air Travel in the Next 5 Years. Available online: <https://www.iata.org/en/iata-repository/publications/economic-reports/covid-19-outlook-for-air-travel-in-the-next-5-years/> (accessed on 4 September 2020).
5. Airbus. *Global Market Forecast: Global Networks, Global Citizens 2018–2037*; Airbus: Toulouse, France, 2018.
6. Team, T.C. *CleanEra: A Collection of Research Projects for Sustainable Aviation*. IOS Press: Amsterdam, Netherlands, 2015; Available online: <https://repository.tudelft.nl/islandora/object/uuid:e3108e2d-0708-46e9-bdc1-17a5e44cf224?collection=research> (accessed on 30 December 2015).
7. Grewe, V.; Dahlmann, K.; Flink, J.; Frömming, C.; Ghosh, R.; Gierens, K.; Heller, R.; Hendricks, J.; Jöckel, P.; Kaufmann, S.; et al. Mitigating the Climate Impact from Aviation: Achievements and Results of the DLR WeCare Project. *Aerospace* **2017**, *4*, 34, doi:10.3390/aerospace4030034.
8. Uit Beijerse, G.; Hilbers, H. *Ontwikkeling Luchtvaart en CO₂-Emissies in Nederland Factsheet Voor de Omgevingsraad Schiphol*; PBL Planbureau voor de Leefomgeving: Den Haag, The Netherlands, 2018.
9. Berg, M.V.D.; Zuidema, J.; Oudman, F.; Driessen, C. *Emissiereductiepotentieel in de Nederlandse Luchtvaart*; Royal Haskoning DHV: Dutch, Netherlands, 2019.
10. ACARE. *Flightpath 2050 Europe's Vision for Aviation*; European Commission: Brussels, Belgium, 2011.
11. IATA. *Climate Change & CORSIA*; IATA: Montreal, QC, Canada, 2018.
12. ATAG. *Aviation Benefits Beyond Borders*; ATAG: Geneva, Switzerland, 2018.
13. Economics, I. *IATA Economic Briefing*; Montreal, QC, Canada, 2014.
14. Obert, E. *Aerodynamic Design of Transport Aircraft*; IOS Press: Amsterdam, Netherlands, 2009.
15. Rao, A.G.; Yin, F.; van Buijtenen, J.P. A hybrid engine concept for multi-fuel blended wing body. *Aircr. Eng. Aerosp. Technol.* **2014**, *86*, 483–493.
16. ICAO. *ICAO's Policies on Taxation in the Field of International Air Transport*; ICAO: Montreal, QC, Canada, 1994.
17. Penke, C.; Falter, C.; Batteiger, V. Pathways and environmental assessment for the introduction of renewable hydrogen into the aviation sector. In *Progress in Life Cycle Assessment 2019*; Springer International Publishing: Berlin/Heidelberg, Germany, 2020; doi:10.1007/978-3-030-50519-6.
18. Scenarios, S. SKY: Meeting the Goals of Paris Agreement. 2018. Available online: <https://www.ourenergypolicy.org/wp-content/uploads/2018/03/shell-scenarios-sky-1.pdf> (accessed on 14 November 2020).
19. United Nations. Paris Agreement. 2015. Available online: https://sustainabledevelopment.un.org/content/documents/17853paris_agreement.pdf (accessed on 14 November 2020).
20. Rondinelli, S.; Sabatini, R.; Gardi, A. Challenges and benefits offered by liquid hydrogen fuels in commercial aviation. In *Practical Responses to Climate Change Conference 2014*; ACT Engineers Australia: Barton, Australia, 2014; pp. 216–226.
21. Blakey, S.; Rye, L.; Wilson, C.W. Aviation gas turbine alternative fuels: A review. *Proc. Combust. Inst.* **2011**, *33*, 2863–2885, doi:10.1016/j.proci.2010.09.011.

22. Reals, K. Glacial Pace of Advancements in Biofuel Threatens Emissions Targets. *Aviat. Week Space Technol.* **2017**.
23. Kumar, S.; Kwon, H.-T.; Choi, K.-H.; Lim, W.; Cho, J.H.; Tak, K.; Moon, I. LNG: An eco-friendly cryogenic fuel for sustainable development. *Appl. Energy* **2011**, *88*, 4264–4273, doi:10.1016/j.apenergy.2011.06.035.
24. IEA. *The Future of Hydrogen*; IEA: Paris, France, 2019.
25. Myhre, G.; Shindell, D.; Bréon, F.-M.; Collins, W.; Fuglestedt, J.; Huang, J.; Koch, D.; Lamarque, J.-F.; Lee, D.; Mendoza, B.; et al. *Anthropogenic and Natural Radiative Forcing*; Cambridge University Press: Cambridge, UK; New York, NY, USA, 2013.
26. Appleman, H. The formation of exhaust condensation trails by jet aircraft. *Bull. Am. Meteorol. Soc.* **1953**, *34*, 14–20.
27. Burkhardt, U.; Bock, L.; Bier, A. Mitigating the contrail cirrus climate impact by reducing aircraft soot number emissions. *Npj Clim. Atmos. Sci.* **2018**, *1*, 37, doi:10.1038/s41612-018-0046-4.
28. Brand, J.; Sampath, S.; Shum, F.; Bayt, R.; Cohen, J. Potential Use of Hydrogen In Air Propulsion. In *AIAA International Air and Space Symposium and Exposition: The Next 100 Years*; AIAA: Reston, VA, USA, 2003; doi:10.2514/6.2003-2879.
29. Oztarlik, G.; Selle, L.; Poinot, T.; Schuller, T. Suppression of instabilities of swirled premixed flames with minimal secondary hydrogen injection. *Combust. Flame* **2020**, *214*, 266–276, doi:10.1016/j.combustflame.2019.12.032.
30. Mital, S.K.; Gyekenyesi, J.Z.; Arnold, S.M.; Sullivan, R.M.; Manderscheid, J.M.; Murthy, P.L. Review of current state of the art and key design issues with potential solutions for liquid hydrogen cryogenic storage tank structures for aircraft application. U.S. Patent NASA/TM—2006-214346, 1 October 2006.
31. Fesmire, J.E.; Johnson, W.L. Cylindrical cryogenic calorimeter testing of six types of multilayer insulation systems. *Cryogenics* **2018**, *89*, 58–75, doi:10.1016/j.cryogenics.2017.11.004.
32. Nalianda, D. Enabling Cryogenic Hydrogen-Based CO₂-free Air Transport (ENABLEH₂). In Proceedings of Aerospace Europe Conference, Bordeaux, France, 21 August–18 September 2020.
33. Kroo, I. VKI lecture series on Innovative Configurations and Advanced Concepts for Future Civil Aircraft. *Nonplanar Wing Concepts Increased Aircr. Effic.* **2005**, 6–10.
34. Verstraete, D. On the energy efficiency of hydrogen-fuelled transport aircraft. *Int. J. Hydrog. Energy* **2015**, *40*, 7388–7394, doi:10.1016/j.ijhydene.2015.04.055.
35. Oelkers, W.; Prenzel, E. Aircraft Configuration—Short/Medium Range Aircraft. *Task Final Rep.* **2001**.
36. Westenberger, A. *Liquid Hydrogen Fuelled Aircraft—System Analysis, CRYOPLANE*; European Commission: Brussels, Belgium, 2003.
37. Yin, F.; Gangoli Rao, A.; Bhat, A.; Chen, M. Performance assessment of a multi-fuel hybrid engine for future aircraft. *Aerosp. Sci. Technol.* **2018**, *77*, 217–227, doi:10.1016/j.ast.2018.03.005.
38. Yin, F. Modeling and Characteristics of a Novel Multi-fuel Hybrid Engine for Future Aircraft. Ph.D. Thesis, Delft University of Technology, Delft, The Netherlands, 2016.
39. Perpignan, A.A.V.; Gangoli Rao, A.; Roekaerts, D.J.E.M. Flameless combustion and its potential towards gas turbines. *Prog. Energy Combust. Sci.* **2018**, *69*, 28–62, doi:10.1016/j.pecs.2018.06.002.
40. Reichel, T.G.; Terhaar, S.; Paschereit, O. Increasing Flashback Resistance in Lean Premixed Swirl-Stabilized Hydrogen Combustion by Axial Air Injection. *J. Eng. Gas Turbines Power* **2015**, *137*, doi:10.1115/1.4029119.
41. Reichel, T.G.; Terhaar, S.; Paschereit, C.O. Flashback Resistance and Fuel–Air Mixing in Lean Premixed Hydrogen Combustion. *J. Propuls. Power* **2018**, *34*, 690–701, doi:10.2514/1.B36646.
42. Levy, Y.; Erenburg, V.; Sherbaum, V.; Gaissinski, I. Flameless oxidation combustor development for a sequential combustion hybrid turbofan engine. In Proceedings of ASME Turbo Expo 2016, Seoul, South Korea, 13–17 June 2016.
43. Grewe, V.; Bock, L.; Burkhardt, U.; Dahlmann, K.; Gierens, K.; Hüttenhofer, L.; Unterstrasser, S.; Gangoli Rao, A.; Bhat, A.; Yin, F.; et al. Assessing the climate impact of the AHEAD multi-fuel blended wing body. *Meteorol. Z.* **2017**, *26*, 711–725, doi:10.1127/metz/2016/0758.
44. Dijk, I.P.; Rao, G.A.; Buijtenen, J.P. Stator cooling & hydrogen based cycle improvements. In Proceedings of ISABE Conference, Montreal, QC, Canada, 7–11 September 2009.

45. IPCC. *Working Group I Contribution To The Ipcc Fifth Assessment Report Climate Change 2013: The Physical Science Basis*; IPCC: New York, NY, USA, 2013.
46. Cont, B.; Doole, M.M.; Driessen, C.L.V.; Hoekstra, M.; Jahn, P.B.; Kaur, K.; Klespe, L.; Ng, C.H.J.; Rezunenکو, E.M.; van Zon, N.C.M. *A320 Alternative Fuel Design the Next Generation Sustainable A320 Operating on Liquefied Natural Gas for the Year 2030*; TU Delft: Delft, The Netherlands, 2014.

Publisher's Note: MDPI stays neutral with regard to jurisdictional claims in published maps and institutional affiliations.



© 2020 by the authors. Licensee MDPI, Basel, Switzerland. This article is an open access article distributed under the terms and conditions of the Creative Commons Attribution (CC BY) license (<http://creativecommons.org/licenses/by/4.0/>).