



Architecture  
and the  
Built environment

#01  
2012

# International façades - CROFT

Climate Related Optimized Façade Technologies

Marcel Bilow



# International Façades - CROFT

**Climate Related Optimized Façade Technologies**

Marcel Bilow

*TU Delft, Faculty of Architecture, Architectural Engineering + Technology department*



# International Façades - CROFT

Climate Related Optimized Façade Technologies

Thesis

presented for the degree of doctor  
at TU Delft

under the authority of the Rector Magnificus, Prof.ir. K.C.A.M. Luyben,  
Chairman of the Board for Doctorates  
to be defended in public in the presence of a committee

on April 23th, 2012 at 15:00 o'clock  
by MARCEL BILOW

Diplomingenieur für Architektur Fachhochschule Lippe und Höxter / Detmold  
born at Bielefeld / Duitsland

This thesis is approved by the supervisor(s):  
Prof.dr.-Ing. U. Knaack  
Prof.dr.ir. A. C.J.M. Eekhout

**Composition of Doctoral Committee:**  
.....

Rector Magnificus,	Chairman
Prof.dr.-Ing. U. Knaack	Delft University of Technology, promotor
Prof.dr.ir. A. C.J.M. Eekhout	Delft University of Technology, promotor
Prof.dr.ir. A. van den Dobbelsteen	Delft University of Technology
Prof. T. Asselbergs	Delft University of Technology
Prof.dr.ir. A. van Timmeren	Delft University of Technology
Dipl.-Ing. T. Auer	Transsolar Energietechnik GmbH/Stuttgart
Prof.Ing. M. Haas	University of Pennsylvania, Philadelphia
Prof.ir. R. Nijssen	Delft University of Technology



[abe.tudelft.nl](http://abe.tudelft.nl)  
.....

**Ontwerp:** [Sirene Ontwerpers, Rotterdam](#)

ISBN/EAN: 978-94-6186-027-9

ISSN: 2212-3202

© 2012 [Marcel Bilow](#)







# Inhoudsopgave (beknopt)

Preface 9

---

1 Introduction 23

---

2 Climate zones 39

---

3 Principles of climate-adapted architecture 139

---

4 The Façade 169

---

5 Building services components 185

---

6 FET Façade Expert Tool 219

---

7 Climate Responsive Optimised Façade Technologies CROFT 299

---

8 Conclusion 327

---



# Preface

## Acknowledgments

**This thesis was written at the Technical University of Delft, Faculty of Architecture, at the chair Design of Construction.**

It would not have been possible without the help of others. Therefore I would like to express my gratitude and add a few personal notes.

First and foremost I would like to thank my doctoral advisors Ulrich Knaack and Mick Eekhout:

Ulrich Knaack not only supported my decision to undertake this work in the first place, but also became advisor, discussion partner and friend. We spent countless hours in the car going over different ideas and concepts. He provided me with invaluable constructive criticism. This work would not have been possible without all the many facets of his support. With him founding the Façade Research Group at the chair Design of Construction at TU Delft, I was able to broaden my studies on an international level, and quickly felt part of a team of like-minded.

Mick Eekhout helped me take my first steps into the world of science, particularly with his open and direct attitude. I will never forget the evening of our VCW, during which he impressively demonstrated that scientists need to conquer the unknown territories of our area of expertise – sword drawn – to bring light into the dark of the unknown. In addition, he helped me gain insight into the Dutch culture and history.

Both Ulrich Knaack and Mick Eekhout share the love of sailing. During the time I worked in this thesis I was fortunate to also become acquainted with this sport, and it provided me with numerous moments of inspiration.

I also owe particular thanks to Thomas Auer from Transsolar. As my favourite climate designer he got me addicted to the idea of intelligent climate concepts, and has demonstrated the principle of integral planning in practice. He and the entire Transsolar team offered content-related support and constructive criticism. Not least due to Thomas Auer was it possible to create the Façade Expert Tool.

I would also express my gratitude to the members of the exam commission Prof. Andy van den Dobbelaer, Prof. Arjan van Timmeren, Martin Haas, Prof. Thijs Asselbergs and Prof. Rob Nijssen.

I would also like to thank Tillmann Klein. In his function as Leader of the Façade Research Group he is not only available to all of the PhD students to help with any of the day-to-day problems they might have, but his ability to think outside the box for even the most complex detail or problem and find a solution has made him into a partner in practice and research as well as a personal friend who I do not want to miss. By the way, he is a passionate sailor, too...

**Thank you also to Cramer Silkworth for programming FET, Usch Engelmann for her help with translation and proof-reading and Mireille Snels for the dutch part of it.**

A great thanks also goes to all of my friends - Uli, Rouven and Michael in particular - who have mentally supported me during this time and have stood with me and supported decisions that were not always easy.

And, last but certainly not least, I am very grateful to my parents, especially for their trust in the path I took and the goals I set for myself. They have always supported me in any way possible, were always open to new ideas and provided criticism when necessary.

Marcel Bilow  
Delft, December 2011

'To my parents and my closest friends'



# Inhoudsopgave (uitgebreid)

<b>1</b>	<b>Introduction</b>	<b>23</b>
.....		
1.1	Background	23
.....		
1.1.1	Climate-adapted building methods, vernacular architecture	23
1.1.2	The façade as an interface between interior and exterior	24
1.1.3	Energy considerations; why we need to rethink	26
.....		
1.2	Research Framework	28
.....		
1.2.1	Problem definition	28
1.2.2	Objectives	29
1.2.3	Research Questions	30
.....		
1.3	Approach and Methodology	31
.....		
1.4	Structure of the dissertation	32
.....		
1.5	Schema of the dissertation	35
.....		
<b>2</b>	<b>Climate zones</b>	<b>39</b>
.....		
2.1	Climate zones basics	39
.....		
2.2	Climate zones basics	41
.....		
2.3	The basics of climate analysis	42
.....		
2.4	Climate analysis methods	43
.....		
2.4.1	Annual temperature profile	44
2.4.2	Annual air humidity profile	45
2.4.3	Psychrometric Charts	47
2.4.4	Monthly radiation distribution	48

2.4.5	Dew point profile	49
2.4.6	Wind rose	51
2.4.7	Wind force distribution	54
2.5	Climate zones / selection of boomtowns	55
2.6	Eight boomtowns	58
2.6.1	Berlin	58
2.6.2	Dubai	67
2.6.3	Las Vegas	75
2.6.4	London	83
2.6.5	Moscow	92
2.6.6	New York	101
2.6.7	Shanghai	111
2.6.8	Singapore	120
2.7	Summary of the climate analysis	128
2.8	Initial graphic analysis of the air conditioning required	132
<b>3</b>	<b>Principles of climate-adapted architecture</b>	<b>139</b>
3.1	Influence of the climate on architecture	139
3.2	Vernacular architecture / indigenous architecture / building without an architect	139
3.3	Building methods and principles in different climate zones	141
3.3.1	Snow climates / polar region	141
3.3.2	Boreal or snow-forest climate / moderate climate	142
3.3.3	Warm moderate rain climates / moderate zone	147
3.3.4	Tropical rain climates / Tropics	151
3.3.5	Dry climates / Subtropics	153
3.4	Wind catcher and solar chimneys	156
3.5	Matrix for climate-adapted architecture	163
3.6	Potential of transfer to modern building construction	165



<b>4</b>	<b>The Façade</b>	<b>169</b>
.....		
4.1	The evolution of the façade	169
.....		
4.2	The façade – buffer and regulator	174
.....		
4.3	Comfort	175
.....		
4.3.1	Thermal requirements	175
4.3.2	Visual requirements	178
4.3.3	Hygienic requirements	179
4.3.4	Acoustic requirements	180
4.3.5	Productivity	181
.....		
<b>5</b>	<b>Building services components</b>	<b>185</b>
.....		
5.1	Heating	186
.....		
5.1.1	Radiator (perimeter radiator)	187
5.1.2	Convactor (perimeter convactor)	188
5.1.3	Subsurface convactor (perimeter FloorFintube)	189
5.1.4	Underfloor heating (radiant floor)	189
5.1.5	Concrete core heating / overhead radiation heating (radiant ceiling)	190
5.1.6	Overhead induction heating (active beam)	191
5.1.7	Central air heating / air-conditioning system (overhead heating vent)	191
5.1.8	Decentralised air heating / air-conditioning system	192
.....		
5.2	Cooling	193
.....		
5.2.1	Concrete core cooling / overhead radiation cooling (radiant ceiling)	194
5.2.2	Overhead induction cooling (active chilled beam)	194
5.2.3	Passive chilled beam / baffles	195
5.2.4	Cooling panels / cooling ceilings / cooling sails	196
5.2.5	Central air-cooling	196
5.2.6	Decentralised air-cooling	196
5.2.7	Night flush ventilation	197
.....		
5.3	Ventilation	198
.....		
5.3.1	Natural ventilation	199
.....		
5.3.1.1	Gap ventilation	199
5.3.1.2	Window ventilation	200
5.3.1.3	Shaft ventilation	200

5.3.1.4	Double façades	201
5.3.1.5	Mechanical ventilation	202
5.3.1.6	Central ventilation systems	202
5.3.1.7	Decentralised mechanical ventilation	203
5.3.1.8	Window fan	204
5.3.1.9	Decentralised ventilation units	204
5.4	Humidification and dehumidification	207
5.4.1	Central air-conditioning	208
5.4.2	Decentralised air-conditioning	210
5.5	Sun protection	211
5.5.1	Internal sun and glare protection	212
5.5.2	Fixed sun protection	212
5.5.3	Operable sun protection	212
5.5.4	Specialised solutions	213
5.5.5	Summary sun protection	214
5.6	Light directing	214
6	FET Façade Expert Tool	219
6.1	Available façade or climate tools – background	220
6.1.1	Clear guideline	220
6.1.2	Climate Consultant 5.0	223
6.1.3	MIT Design Advisor	226
6.2	The idea behind FET	229
6.3	Development of FET	231
6.3.1	Temperature	231
6.3.2	Humidity	233
6.3.3	Wind	234
6.3.4	Recommendations for façades and building services functions	235
6.3.5	Ventilation and night time cooling	238
6.3.6	Waste heat recovery	240
6.3.7	Glazing ratio	241
6.3.8	Graphic editor	242

6.4	FET in use	245
6.4.1	FET recommendations for the eight boomtowns	245
6.4.1.1	Dubai	246
6.4.1.2	Berlin	248
6.4.1.3	Las Vegas	250
6.4.1.4	London	252
6.4.1.5	Moscow	254
6.4.1.6	New York	256
6.4.1.7	Shanghai	258
6.4.1.8	Singapore	260
6.4.2	Testing FET – comparison simulation	262
6.4.3	Building-related basic conditions for simulation	264
6.5	Test room comparison simulations	271
6.5.1	Dubai	272
6.5.2	Berlin	274
6.5.3	Las Vegas	276
6.5.4	London	278
6.5.5	Moscow	280
6.5.6	New York	282
6.5.7	Shanghai	284
6.5.8	Singapore	286
6.6	Comparison of the simulation results	288
6.7	Summary of simulation results	290
6.8	Conclusion FET	293
7	Climate Responsive Optimised Façade Technologies CROFT	299
7.1	Moscow – Façade air collector	301
7.2	Singapore – Condensate trap within façade panel	303
7.3	Berlin – Supply air heating in façade panel	305
7.4	Dubai – Rotating sun screen	308

7.5	Fully adaptive double façade by Solarlux	314
7.6	Summary	321
8	Conclusion	327
8.1	Discussion of the research questions	327
8.2	Vernacular architecture	331
8.3	Façade Expert Tool / FET	333
8.4	CROFT	335
8.5	Expected practical benefits	336
8.6	Research recommendations	337

Summary 339

Zusammenfassung 343

Samenvatting 347

List of figures 351

Bibliography 353

Curriculum Vitae 355

References 357



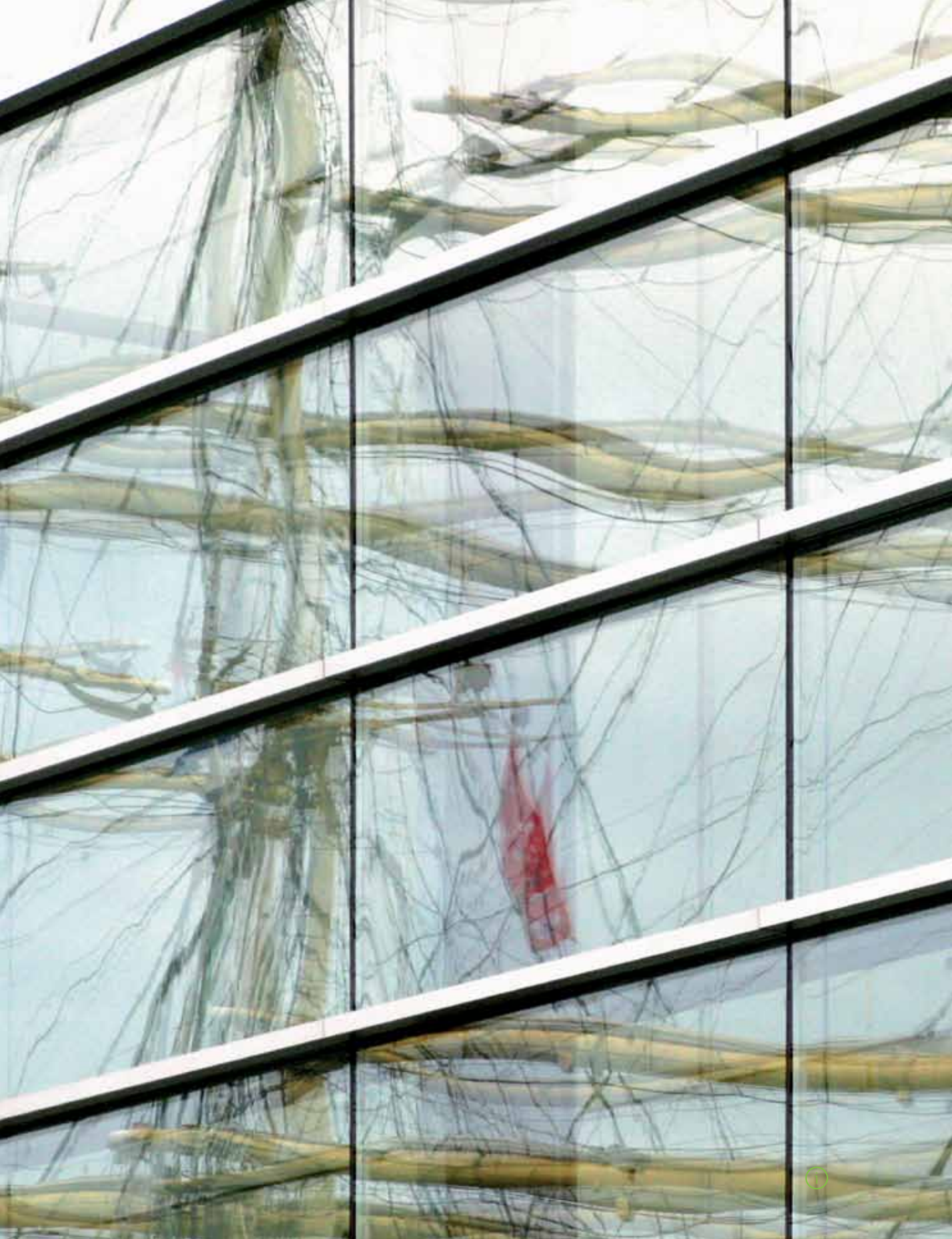

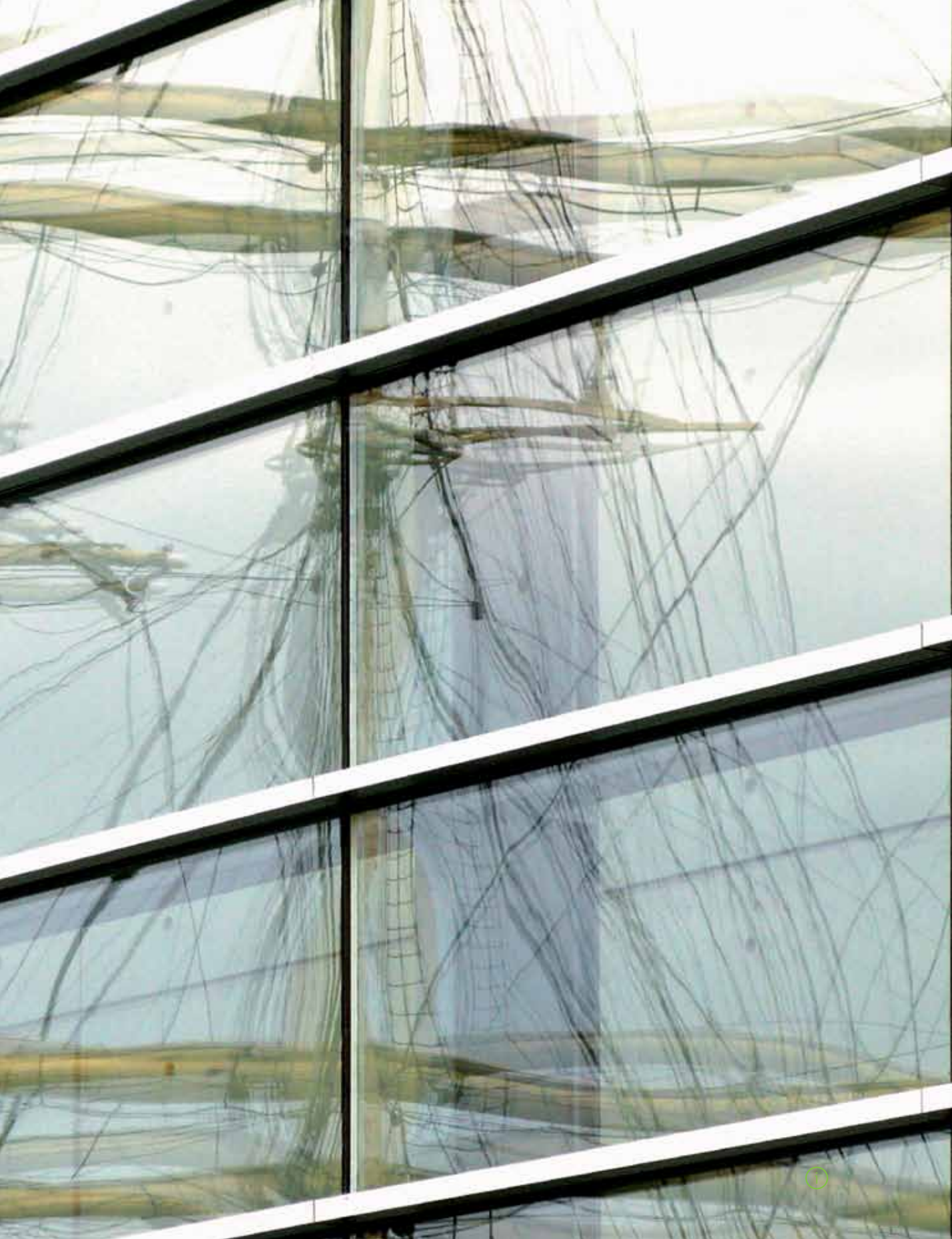





# 1 Introduction

---

## § 1.1 Background

---

This chapter describes the scope and background of the thesis. The broad scope of the thesis' topic requires limitations described herein. The motivation for the thesis is founded in the tension field of three different directions. Firstly, research of traditional building methods in different climate zones highlights the varying requirements of these individual climate zones. The façade - the main focus of this work - as the interface between the interior and the exterior, is the second major focus of this thesis. Since the building envelope is one of the major factors determining a building's energy consumption, the topic energy is the third motivational aspect for this thesis, whereby the focus lies on minimising consumption. Finally, the chapter is rounded off by listing the scientific questions and the structure of the entire thesis.

### § 1.1.1 Climate-adapted building methods, vernacular architecture

---

Climate-adapted building has a long tradition; strictly speaking it exists since humans struggle for survival by counteracting climatic conditions with clothing and shelter. This method of building is considered autochthonic building, which utilises the resources of the immediate environment. In addition to locally available building materials this includes the prevailing climate. Depending on the climatic conditions, types of housing evolved that were to withstand heat, cold, rain or wind, with the goal to provide safety and comfort. In Polar regions, the igloo has become the standard to protect from extreme cold and strong winds. Desert nomads use the tent as a mobile shelter for sufficient protection from the climatic conditions. In simple terms, every climate zone has its own skin, easily distinguishable by the clothing and shelters used. Mostly, these forms of living evolved from the locally available materials alone; without the help of architects and builders. Architecture has always been the privilege of a small, rich elite. And only those with the means to pay for architecture were able to defy energy efficient building methods and maintenance costs. Architecture is designed by specialists and expresses the power and status of the owner. In contrast, autochthonic building forms could be found in the less luxurious and often less comfortable houses for the masses (Behling et al., 1996).

In many rural regions, simple storage buildings based on constructional solutions are still used to protect precious goods such as corn or hay from climatic conditions throughout the year. Modern office buildings should also follow the principle of preserving “goods” as well as possible. Content users increase a company’s productivity; thus, conserving the value of these factors needs to be the foundation of modern building methods.

### § 1.1.2 The façade as an interface between interior and exterior

---

The building façade in general can be understood as a skin, similar to the skin of the human body. It is the building part that encloses the building, and must be able to efficiently protect from all external influences such as temperature, wind, rain, and sound. However, transparent areas in the façade also serve as the point of contact between the exterior and the interior. Furthermore, the façade must be able to transfer air and daylight into the inner space to ensure a high comfort level for the user. Thus, the façade serves the function of an interface between the interior and the exterior.

Since the Nineties, buildings with large glazed areas coin the image of cities in Central Europe. Quite a few of these highly glazed buildings have high-tech façades that respond to changing outer conditions such as varying temperatures, radiation, light and wind. Compared to North America and Asia, Europe clearly plays a pioneer role with regards to these developments.

The fact that the development of such an innovative material as glass began in Central Europe is certainly due to the climatically privileged situation of the European continent. There is no extreme cold, the summer heat periods do not last very long, and relative humidity is usually moderate.



**Figure 1.1**  
*The skyline of Frankfurt/Main with highly glazed office buildings*

The Central European climate does not necessarily require the installation of air-conditioning or mechanic ventilation. The result is that less space is needed for building services for ventilation and cooling such as suspended ceilings and centralised air conditioning units. Fresh air supply is achieved through the façade with the result that the depth of the building is limited if sufficient fresh air is to be introduced to the entire interior space. In addition, smaller depth dimensions result in an excellent daylight penetration; an important criterion in European building law (Auer and Bilow, 2007).

In Europe, very deep buildings are hard to conceive. Rooms without windows or connection to the outside as well as rooms with inoperable windows can cause anxiety or even claustrophobic conditions. On the other hand, a mandatory dependency of the façade bears certain risks or disadvantages. In winter, manual ventilation results in draft, and summertime requires efficient sun protection to prevent overheating.

Energy efficient building poses special demands on the quality and performance capabilities of the façade. Passive heat and sun protection as well as factors such as air tightness, thermal bridges and a ventilation strategy define the energy requirements as

well as the user quality of such buildings. In addition, location specific challenges such as high winds (e.g. high-rise buildings or those in coastal areas), sound and air pollution through traffic, amongst others can add to the problem.

Sophisticated façade concepts such as the double façade, for example, were developed during the Nineties to minimise or eliminate these issues. Double façades allowed for quasi exterior sun protection, even for high-rises, or natural ventilation at a highly frequented street. In order for such high-performance façades to function, we need to be aware of the complex physical relationships; therefore a certain degree of experience and careful planning are needed.

We must consider that the climatic conditions in North America or Asia typically differ significantly from those in Central Europe. Simply exporting façades to another climate entails numerous problems; most often it results in increased energy consumption. But exactly these climatic and cultural differences lead to other, often more interesting solutions.

### § 1.1.3 Energy considerations; why we need to rethink

---

The importance of discussing energy in architecture is undeniable since the building industry uses more than 50% of the resources used worldwide and holds accountable for more than 60% of all waste (Hegger et al., 2007). The consequences of these numbers are obvious: more than any other this sector drives the demand as well as the potential for change.

The invention of the steam engine revolutionised energy usage. Burning resources released a force that fundamentally changed mechanical processes. The knowledge gained from these developments is the basis for technologies that we take for granted today. The many possibilities of consumption and mobility also define the beginning of drastic environmental impact.

Following the economic miracle during the Fifties, technical devices became available to the masses. This resulted in rising energy consumption and the use of primary energy carriers, along with increased CO<sub>2</sub> emission; so that today there is 35% more carbon dioxide in the atmosphere than in 1880 (Stulz, 2007).

## Climate change

---

The media has made the general population aware of the climate change. The change in earth's temperature is considered a proven fact, just as the end of fossil energy carriers becomes more and more apparent to the public. Even today, energetic use of coal, gas and oil is problematic because Western Europe as well as other regions depend on international import.

The research concentrated by the Intergovernmental Panel on Climate Change (IPCC) is absolutely unique in terms of scope and intensity. This continuing research, refers to the opinion that human behaviour is responsible for the greenhouse effect and therefore global warming.

Without greenhouse gases ( like CO<sub>2</sub>, CH<sub>4</sub> NO<sub>x</sub> and others ) there would be no life on Earth. Mostly CO<sub>2</sub> is mentioned in order to describe all greenhouse gases, due to this fact, the text will also mention CO<sub>2</sub> as one of these, but not exclusively. The layer containing carbon dioxide reflects a large part of harmful radiation back into the universe and shields the earth. At the same time, it protects the earth from cooling. The heat generated through convection does not volatilise in the universe but remains between the earth's surface and the atmosphere. Since the industrialisation, this carbon dioxide containing layer has grown enormously, and will continue to grow if our energy consumption does not change drastically. The safeguard effect has incrementally developed into a problem.

Similar to the effect of a garment that is too warm, the air temperature rises, which in turn leads to heat build-up beneath the atmosphere. The effects of these temperature changes are extreme. Melting Polar caps cause the sea level to rise. This can endanger producing areas that ensure our livelihood and cause salinisation of the groundwater. Devastating scenarios are being shown with people suffering from war about water. (Bals and Harmeling, 2007) No one can determine the intensity of the effects of the climate change. And no one can accurately predict the ecologic, economic as well as social consequences. But it is safe to say that they will be extreme and can drastically change our lives.

As early as in the late Sixties, researchers have publicly announced that we need to act. Dennis Meadow's "The limits to Growth", a study commissioned by the Club of Rome, is one of the most important appeals to be aware of the finiteness of earth's resources and increasing environmental pollution. (Meadows et al., 1972) Even though not much appreciated by conservatives, studies such as this lay the groundwork for our ecologic conscience today. First drafts for an environmental code were prepared in the Seventies. Today, environmental awareness has reached mainstream society.

The Kyoto Protocol, initiated in 1992, adopted in 1997, and ratified in 2005, is one of the fundamental milestones in climate history. With its coming into effect in 2008, numerous nations committed to reduce their emissions by 5.2% by 2012, based on emission values ascertained in 1990. Concretely, the goal is to reduce the greenhouse gas carbon dioxide, which accounts for a majority of the pollutant emission.

Thus, a reduction of carbon dioxide must be the focus of architecture and the building industry; new or adapted façades could make a contribution.

---

## § 1.2 Research Framework

---

The following paragraphs explain the questions that lie at the basis of this work.

### § 1.2.1 Problem definition

---

If we look at the large building projects currently undertaken around the world, we can see a drive for prestige and best possible marketing strategies by using constructions and shapes that promote a particular image. In the Near East, for example in Dubai, but also in Moscow great financial efforts are taken to construct high-rises that compete for the title of the highest building as well as try to achieve the highest level of transparency possible. The International Style, intended to emanate cosmopolitanism and power, is becoming established throughout the world. Even though the user requirements posed on any office building are comparable around the world, in most cases the building itself does not reflect the region in which it is built. It might be an aspect of globalisation that our metropolises appear more and more alike; but from a climatic viewpoint, buildings that try to exploit and adapt to locally available climatic conditions cannot resemble each other as much. It appears that those able to afford architects designing such buildings can ignore the need to employ resource conserving building methods. Modern technology, air conditioning units in particular, allows for fully glazed buildings in the desert. But are such actions responsible? Considering the current climate discussion, global warming and the finiteness of fossil burning, we need to change our way of thinking. More often than not local energy sources that could be drawn from the specific climate and location for ecological operation remain unused.

During the past 20 years, Central Europe has seen the development of numerous innovative façade technologies; the moderate climate favours such façades and allows

for resource saving operation. From an ecological standpoint it is highly questionable to directly transfer these technologies to projects in more extreme climatic conditions.

This thoughts can be further articulated into a problem statement: The actual architectural planning process of sophisticated buildings envelope does not fully include the potential of the climate environment, the climate seems to be a problem, rather than seen as a chance to work with it.

What possibilities are there to create buildings with similar design requirements to that of the International Style with modern, structurally highly technological appearing glass façades in various climate zones? What are the requirements posed on façades in such regions and which new technologies have the potential for sustainable building operation? The following questions describe the fundamental topics that will be discussed in the scope of this research.

### § 1.2.2 Objectives

---

The following objectives derive from preceding problem definitions and form the motivation for his research.

- 1 Create an understanding of the interrelation between façade, building services (mechanical installations), comfort and climate zone
- 2 Compilation of the findings that will help the architect during the early design phase to determine a climate-friendly combination of façade and building services for office façades
- 3 Identification of potential for new concepts for the combination of façade and building services depending on a particular climate.

### § 1.2.3 Research Questions

---

#### Main research question

---

What are the best means to support a planner who is designing an office façade in combination with building services functions in order to realise solution that is both adapted to the local climate and offers energy-reduced operation?

The following sub questions derive from this main research question.

- How can the climate be described and analysed, and which climate zones should be selected to serve as exemplary locations?
- Which strategies and methods of constructions have been previously used in the different climate zones to exploit the local climate or effectively shelter from it?
- What are the developments that the building envelope and the façade have undergone, and what part did the indoor climate play in that process?
- Which components of building services and the façade are available to influence and control the indoor climate; which combinations of façade and building services lend themselves for a particular climate?
- In which manner can the combination of façade and building services for a particular climate zone be illustrated as an aid for the early planning stages?

As a conclusion of the findings developed from these questions, the question of the possible development potential for new façade concepts can be worked out:

- Can new façade concepts be developed from the requirements of the individual locations that in this particular shape and form are not yet available with existing technologies or products?

To answer these questions, there is a range of key questions dependant on a small area of research that could be answered using literature and case studies.

Definition of the terms: façade, climate, climate zone, climate related façade, comfort, energy efficiency



Which boom towns should be chosen for case studies to cover the different climate zones?

Which typical historic local methods could be transferred into new constructive solutions?

Which type of organising structure will determine the requirements of façade and climate?

How can we learn from historic solutions?

Which methods or simulation tools are applicable for comparison of the different façade systems?

How can the results be applied to the climate of other cities?

---

### § 1.3 Approach and Methodology

---

Thematically, this work lies between the engineering disciplines architecture and building physics / building services. Architecture is in reference to the architectural design with free choice of means of expression. However, all formative and constructive determinations are subject to building physical principles, which will impact the performance of the entire building design with the help of building services components. The façade as an interface between exterior and interior and as the building part with the largest surface area underlies numerous building physical requirements. In order to be able to consider the function and ecological operation of a building at an early planning stage, this thesis works out the requirements related to a particular climate zone and then develops them in form of design guidelines. The goal is to break down building physical and climate relevant requirements of the façade to easily understandable basic information that the architect can use as fundamental design principles during the early planning stages. If possible, such basic principles shall be transferred into the development of a software tool.

The aim is not to create a design standard. Whereas the architectural design shall remain in the hand of the architect the purpose is to identify an appropriate colour canon from the multitude of colours available which is practical for fulfilling defined planning goals. The aim is therefore the creation of an awareness of possibilities to

reduce the choices to a more appropriate set of solutions that will benefit from the buildings location and its surrounded climate.

This work only deals with office building façades. From a constructional point of view most of the internationally emerging office façades are curtain-type façades with no load-bearing properties. They offer a broad spectrum of façade design and similar construction methods globally. In addition, office buildings are regulated in terms of climatic requirements; another factor that facilitates international comparison. User times can be easily determined for this building type.

The façade has a major impact on the user comfort level of a building and therefore the performance capability of the people working; an economic productivity aspect of the entire operation. In a limited way this kind of comparison can also be employed to residential buildings. But significantly different user requirements and user times and partly different building methods make it difficult to directly transfer some requirements.

In addition to deriving façade planning requirements in different climate zones that result from a climate analysis of the selected locations; there are principles that, in a second parallel line of research are derived from an analysis of historic or traditional climate-adapted architecture. They are evaluated in terms of how they can be transferred to façade construction.

Thus, this work is based on three plots / focal points:

- 1 Generating requirement profiles / tools for façades and building services components related to the climate zone
- 2 Transfer of principles derived from the analysis of traditional climate-adapted architecture
- 3 Development of concepts that can be derived from the principles from point 2 under consideration of the requirement profiles from point 1.

The working program is separated into 8 work phases. The chronology is shown in the enclosed combined schedule and approach diagram.

---

## § 1.4 Structure of the dissertation

---

The structure of the work in general, the research questions and introductory background information explaining the research activity as a whole are included in the preceding text. The structure of the work with contextual links will now conclude this first chapter.

**Chapter 2 'Climate zones'** explains the basics of climate analysis and the different climate zones. What is climate in general, and which methods can be used to compare different climates. The individual climate zones are introduced and their particular characteristics are illustrated using parameters such as temperature profile, radiation intensity, atmospheric humidity profiles and wind conditions. This chapter also explains the selection of the eight cities/boomtowns that are included in the research, and illustrates and describes the specific particularities related to the climate zone under consideration of local characteristics.

**Chapter 3 'Principles of climate-adapted architecture'** concentrates on the principles of climate-adapted / vernacular architecture as well as the transfer of principles of this type of architecture to current constructions. Following the question of which aspects of historic examples can be translated into modern façade construction, the chapter also provides an overview of climate-adapted architecture classified by climatic zone. The principles used in particular historic or traditional examples are analysed in order to facilitate the transfer into façade construction. An overview of the principles of the individual climate zones rounds off the chapter.

A short introductory section in **chapter 4 'The Façade'** describes the development of the façade. This paragraph serves the purpose to take a closer look at the term façade and to narrow it down for this line of research. The main portion of the chapter examines in how far the façade can be utilised to regulate the comfort level inside a building. Comfort inside buildings is explained using different comfort aspects such as thermal, visual or acoustic comfort.

Since façades cannot regulate all parameters inside a space, building services components and their functions are described as well. **Chapter 5 'Building services components'** illustrates these functions of the façade and building services components in more detail which form the basic information for the development of a software tool.

**Chapter 6 'FET Façade Expert Tool'** brings together the topics discussed in the preceding chapters. They are worked out into the focal point of the research work. The chapter opens with an introduction and analysis of the currently available software tools that are aimed at fulfilling similar functionalities. The development of the Façade Expert Tool FET is described, followed by testing the tool for initial applications. In order to verify the performance capability of the tool related to the function of calculating the required portion of glazed area. A comparison simulation and a first summary round off this chapter.

Chapter 7 'Climate Responsive Optimised Façade Technologies CROFT' shows new concepts for climate-adapted façade solutions resulting from the derived principles of climate-adapted building and the previously developed findings and demands that show potential but are not yet available. These concepts are shown as sketches or described using realised projects.

The last chapter, chapter 8 'Conclusion' summarises the work and its most important findings. The chapter then discusses the research questions, critically examines the analysis of vernacular architecture, and lastly offers suggestions for further research topics. An estimation of the impact of this work and a summary of the research work in its entirety close this chapter.

## § 1.5 Schema of the dissertation

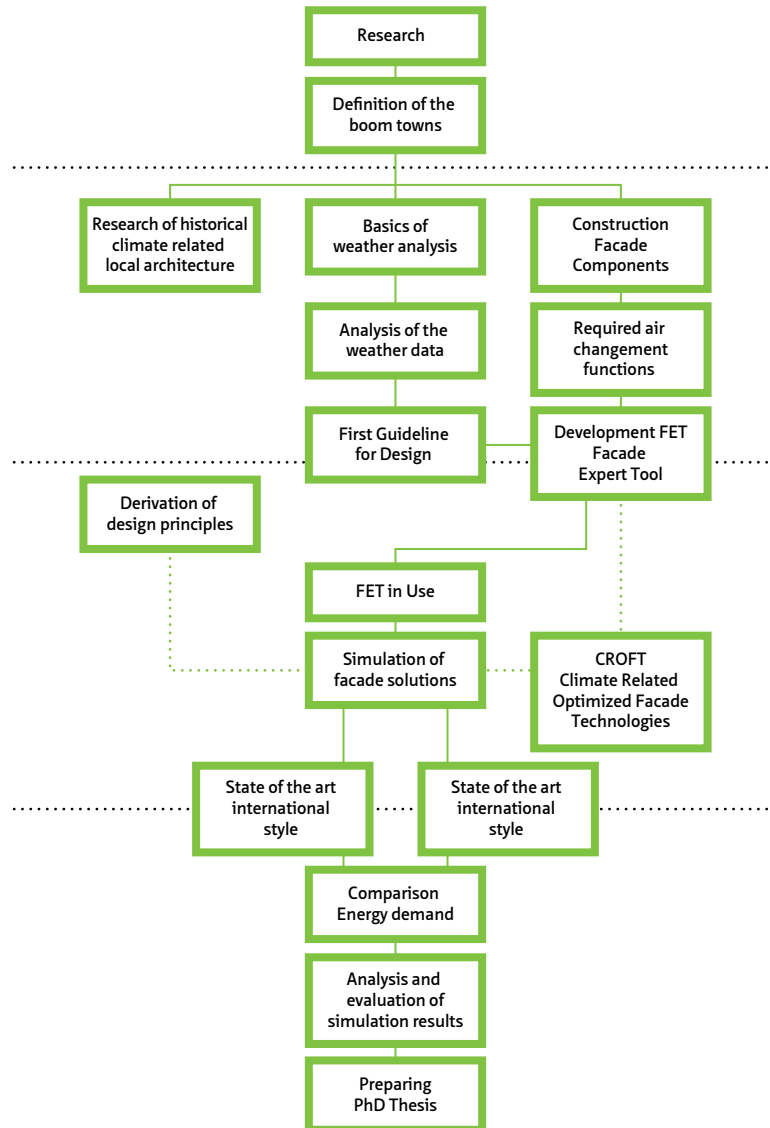
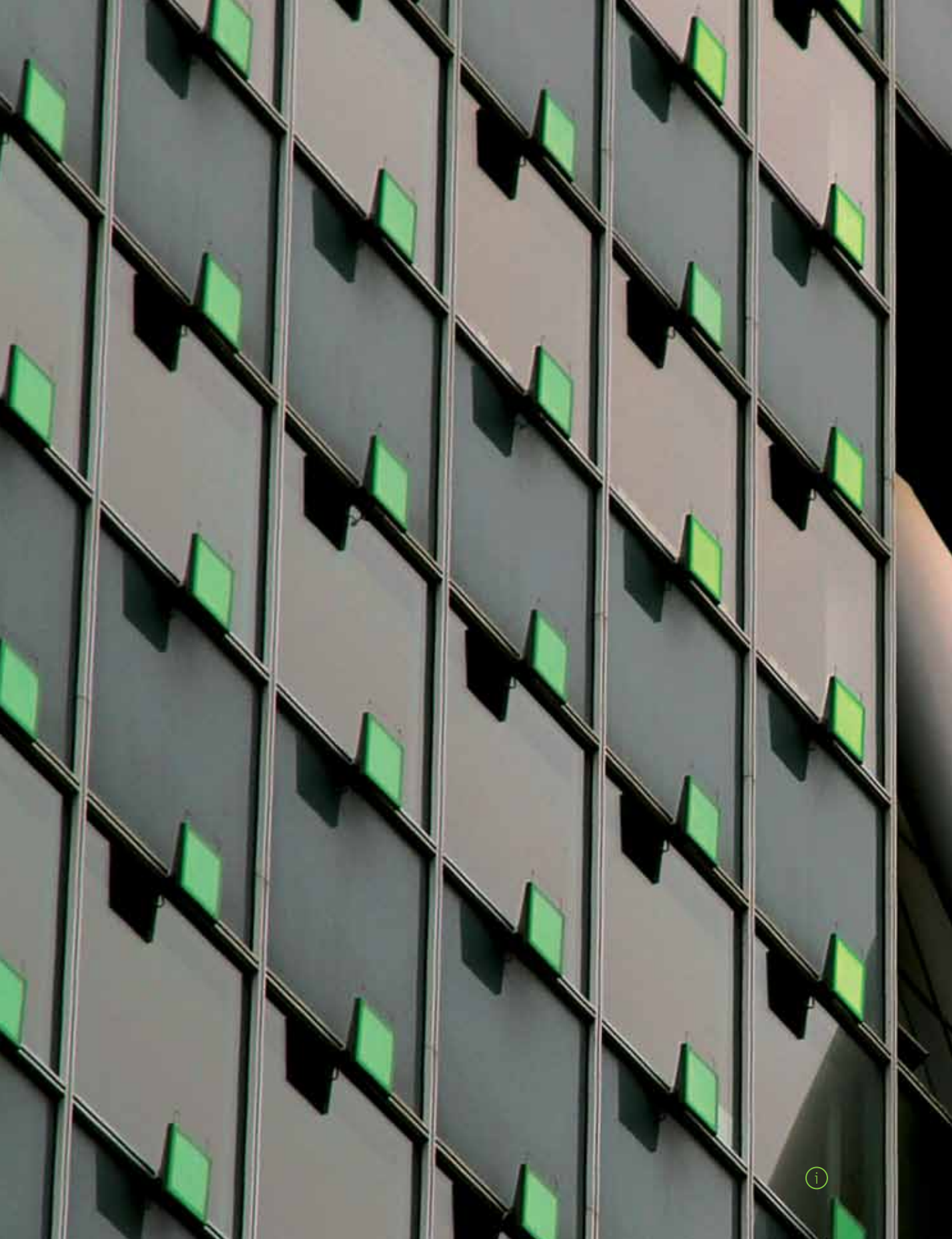

Table 1.1  
Schema of the dissertation









## 2 Climate zones

---

### § 2.1 Climate zones basics

---

Our earth can be divided into different climate zones. Hereby a climate zone describes zones with equal or similar climates. Climate zones can be categorised following two different points of view. On one hand, we can name mathematical or solar climate zones. This classification is based on the assumption that the earth as a homogenous mass is irradiated by sunrays, and that therefore different temperature zones run parallel to the equator. They form the tropic zone between the two tropics (Cancer and Capricorn) which in turn are formed by the two moderate zones between the two tropics and the polar circles. The two polar zones are situated beyond the polar circles and form a third climate zone.

Another possibility of categorising the Earth into climate zones is a true or physical classification, whereby a zone is identified by the same climate type resulting from spatial and seasonally different co-action of climate elements and climate factors. The individual climate zones are not necessarily contiguous regions due to disproportionate amounts of land and sea, the atmospheric circulation and other local influences. A division of the earth into physical climate zones can be done in different ways. A classification that does justice to all and every aspect and characteristic is not possible. Ernst Neef, for example, has generated a genetic climate classification. This means a classification based on the general atmospheric circulation. Hereby a location is allocated to a particular climate zone according to its position in a particular wind belt (Neef, 1956). The effective climate classification is based on the fact that there are interrelationships between climate elements and vegetation. Individual climates are separated from others using threshold values of the climate elements. Köppen generated a familiar classification. He developed his classification around 1900 and continued to improve it until 1936 (McKnight and Hess, 2000). The underlying principle of his classification is a division based on temperature, precipitation and the annual cycle of these two climate elements. From a climate-statistical point of view this translates into five main climate groups. They are identified by Latin letters, supplemented with additional letters for further subdivision:

- 1 Tropical rain climates / equatorial (A);
- 2 Dry climates / arid (B);
- 3 Warm moderate rain climates / warm temperate (C);
- 4 Boreal or snow forest climates / snow (D);
- 5 Snow climates / polar (E)

For Köppen, the climate zones are basically related to the main vegetation zones (Neef, 1956).

The description of the climate zones in [chapter 3 'Principles of climate-adapted architecture'](#) of this work is based on the Köppen climate classification because the relationship between vegetal factors and climate elements are helpful with regards to architectural aspects, and because this classification has attained international acceptance. In literature, the names of the climate zones often vary. This work will also include simplified names; maps showing the specific regions and zones will facilitate orientation.

To illustrate this procedure, the following shows a global map according to the Köppen classification, and an extremely simplified map, explaining the complexity of the differentiation.

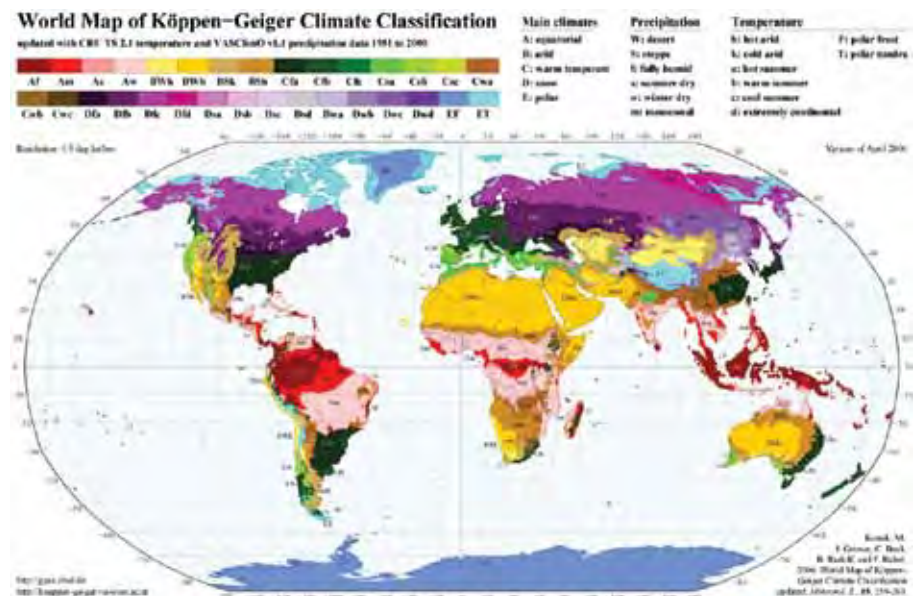

Figure 2.1  
 Climate zone classification according to Köppen

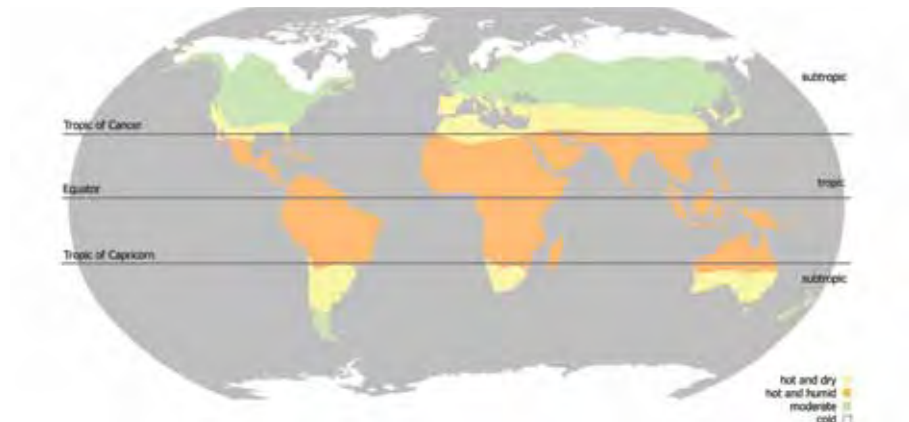

Figure 2.2  
Extremely simplified climate zone classification

## § 2.2 Climate zones basics

Climate, a term derived from the Ancient Greek word for inclination, describes the entirety of the weather conditions and temperatures, observed over a longer period of time in a particular region. It describes the interaction of atmospheric conditions and weather phenomena at the earth's surface in the characteristic progression of a particular location or region (climate zone).

Climate can be further subdivided into megathermal, mesothermal and microthermal climates.

The megathermal climate describes conditions observed over a wide area. A region can be determined by its position on the grid of longitudes and latitudes. Megathermal climates are seen as the basics of climate research and are the main focus of a climate analysis. Generally, the world climate is also a part of the megathermal climate but local occurrences such as the monsoon or the earth-spanning jet streams are also called megathermal climate elements. In terms of dimension, occurrences spanning up to 500 kilometres or 310 miles are considered megathermal climates.

Mesothermal climates describe local climates or area climates; thus the climate of a particular city can be called a mesothermal climate. In terms of dimension,

mesothermal climates are usually climates that span several hundred metres to a few hundred kilometres. However, the transition from mega- to mesothermal climate is fluent.

Microthermal climate describes the climate immediately around us. It deals with the local conditions on the smallest scale. Thus, the shading of buildings or vegetation as well as wind factors caused by the geographic situation, e.g. hillside or valley location, determine the microthermal climate. Microthermal climates can range from just a few metres up to several hundred metres. Contrary to the more permanent macrothermal climate, the microthermal climate is subject to constant changes and can also be altered by vegetal or building related activity (Schütze and Willkomm, 2000).

The smallest describable climate related to this thesis is the Indoor climate – however, it is only relevant from an architectural or building physical point of view. In terms of purely meteorological aspects there is no Indoor climate. The indoor climate is an artificially created climate that evolves from a building conception and the technical installations.

---

## § 2.3 The basics of climate analysis

---

The climate or weather data that climate analyses are based on are available as test reference years (TRY) or as IWEC weather data. Test reference years are data records of selected meteorological elements for every hour of a year collected at selected locations in Germany. Test reference years include the characteristic weather profile of one entire year. They are based on various real weather condition segments that are identical for all test reference years or for every region. The weather condition segments are selected such that the seasonal mean values of the individual weather elements (particularly air temperature and humidity) at the reference stations are as close as possible to the 30-year mean values. Smoothing and interpolation techniques are used to match the data from the different weather condition segments to one another. (M. Webs, 2004) These cyclic data records of an entire year were primarily developed for heating, cooling and climate technology. They provide the climatologically conditions to simulate heating and ambient air equipment and the thermal behaviour of buildings. Over the past 15 years they proved of value for related simulation calculations. In addition, TRY data can be used to simulate the functionality of other technical and non-technical systems that also rely on meteorological elements, for example solar energy.

Test reference years were established for many areas; 15 such areas have been defined in Germany. Within these regions and with the aid of weather stations, the data is recorded and later combined to establish a test reference year. In order to be able to

generate the most objective and representative climate analysis possible from this weather data, extremes such as the unusually dry summer 2003 in Western Europe are also included in the data records. Since particularly such extreme conditions can lead to ailments and discomfort they must be considered; however they should not be used as a standard. Therefore different data records are generated, including or excluding extreme conditions.

International weather data is available as IWEC weather data.

These data records are prepared for simulation calculations or climate analyses similar to the German test reference years. The name IWEC (International Weather for Energy Calculation) describes the purpose. The National Climatic Data Center in Asheville, North Carolina, USA collects and prepares data records from hourly weather recordings, some spanning a time period of 18 years currently available for 227 locations worldwide. The records include data on duration of solar radiation, temperature profile, air humidity, dew point temperatures as well as wind speeds and direction.

The weather data is created in two steps. The measured values over 18 years (1982 – 1999) are processed and combined, small gaps are interpolated and solar radiation is calculated based on the cloud coverage and earth-to-sun geometry. In a second step, twelve typical meteorological months are extracted from these long-term weather data values which are then combined into an IWEC weather data record. (ASHRAE, 2006) IWEC weather data describes typical meteorological climates; therefore the specifications of air-conditioning systems must be evaluated separately because extremes are not included in this data.

---

## § 2.4 Climate analysis methods

---

For the scope of this work, the focus of climate analysis lies on the mesothermal climate that describes the geographic situation and the microthermal climate which encompasses the topographic circumstances of a particular location as well as the urbanistic influences of the environment. Room climate is not taken into consideration, however; it must be seen as the direct result of the interaction between building design and micro or mesothermal climate.

The following gives a brief introduction of the methods of climate analysis. A detailed description of the individual climate zones and actual climate data is provided later. The climate analysis is based on IWEC weather data on a micro and mesothermal level described in the previous paragraph.

## § 2.4.1 Annual temperature profile

---

The weather data record is based on one measurement reading per hour. The temperature across one year can easily be graphed out in a diagram. In order to gain more detailed information about the temperature profile of one month, for example, it can be illustrated in a separate diagram that shows temperature fluctuation from day to night.

Taking Berlin, Germany as an example, the graph shows strong formations of high and low points with summertime peaks of more than 30°C (86°F) during June and July. The coldest periods can easily be identified as in mid February. The annual temperature profile is a suitable introduction into climate analysis because we are familiar with temperature gradients

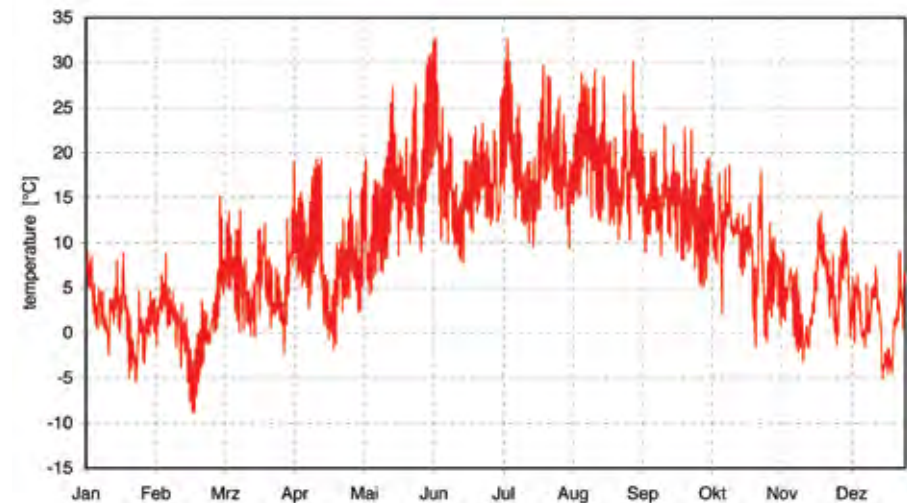

Figure 2.3  
Annual temperature profile for Berlin, Germany

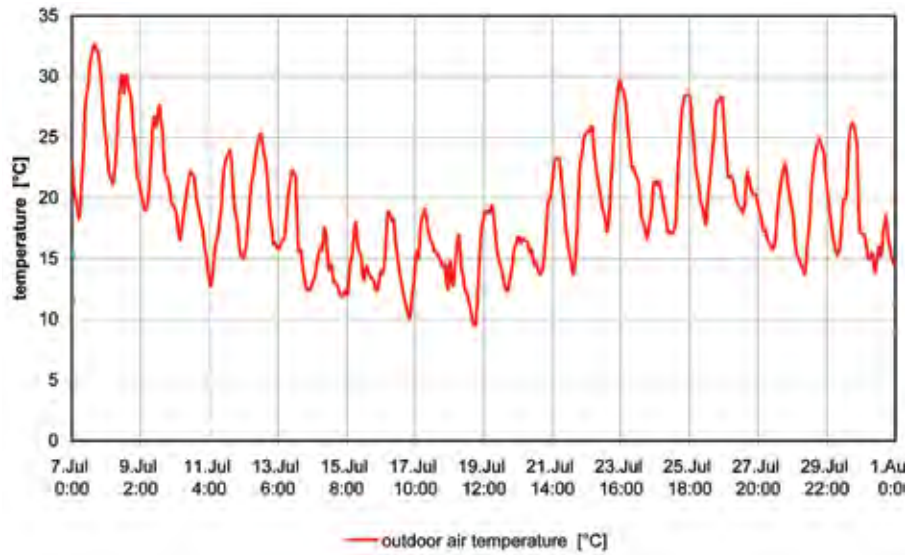

Figure 2.4  
 Temperature profile for Berlin during July; showing distinct day versus night time fluctuation

## § 2.4.2 Annual air humidity profile

The weather data record includes hourly measurement readings of the absolute air humidity in g water per kg dry air. These readings can be plotted on a diagram to show the annual air humidity fluctuation. When the level is at 12g water, for example, we consider the weather to be muggy. Indoor swimming pools are typically operated at 14g/kg to provide a sense of the absolute humidity. Because the measurement readings are done at an hourly rate, one-day or one-month periods can be examined in detail.

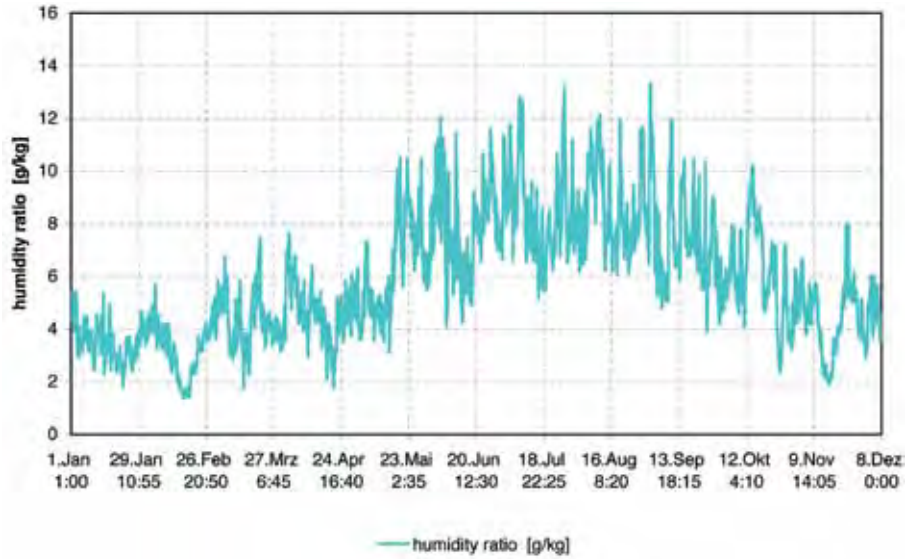

Figure 2.5  
Annual air humidity profile for Berlin, Germany

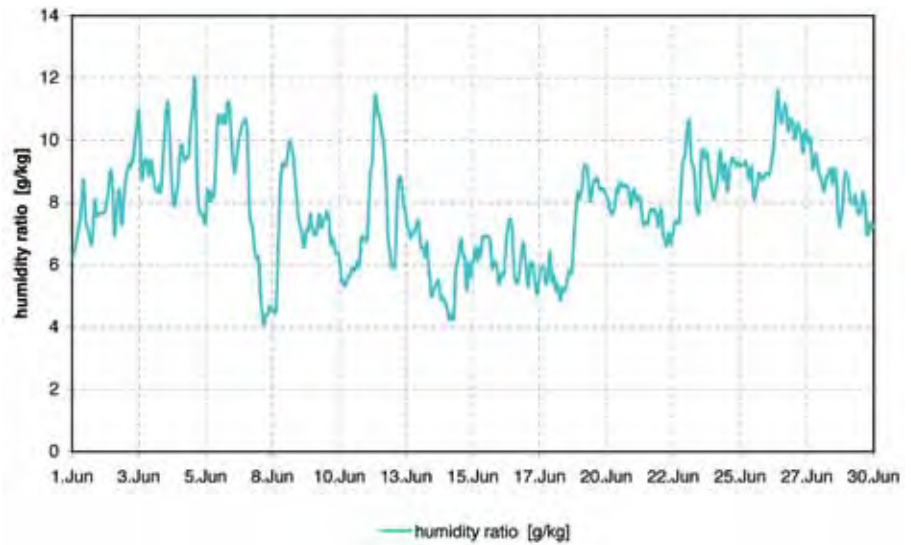

Figure 2.6  
Air humidity profile for Berlin in the month of June



### § 2.4.3 Psychrometric Charts

Graphs can be used to facilitate calculating fluctuations of the condition of the air. There are various versions of psychrometric charts. In Europe, the Mollier chart is the most well-known; whereas the Carrier chart prevails in the USA. In principle both models are set up the same way, but the axial direction is different. The Mollier chart depicts temperature on the vertical and water content on the horizontal axis whereas the opposite is true for the Carrier chart (Siemens, 2001).

The psychrometric chart is either a  $h,x$  or a  $t,x$  chart whereby  $t$  stands for temperature [ $^{\circ}\text{C}$ ],  $h$  for enthalpy [ $\text{kJ}/\text{kg}$ ] and  $x$  [ $\text{g}/\text{kg}$ ] for the absolute water content of the air. The «psychrometric chart for humid air» provides a graphic depiction of the condition of the air and possible fluctuations for easy calculation or readings.

For climate analysis, psychrometric charts can be used to illustrate the main climate elements such as temperature and air humidity. The IWEK climate data described in § 2.3 'The basics of climate analysis' includes hourly measurement readings. Plotting these values on a psychrometric chart creates point clouds that offer insight into the prevailing climate. A division into night and day (18-6h / 6-18h) further facilitates an analysis.

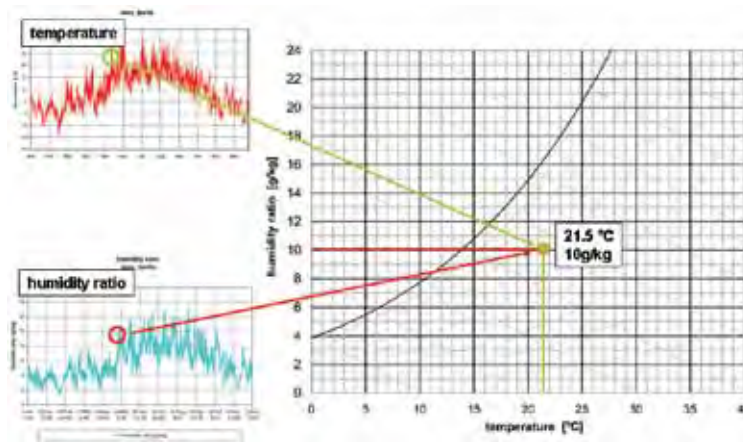

Figure 2.7  
Summary of the temperature and humidity measurements in a psychrometric chart

The examples of Singapore and Berlin exemplify the pronounced differences between the two climates. Each location has its specific point cloud formation and can easily be allocated to a particular climate. Singapore clearly shows a hot and humid climate that can be allocated to the tropics. Berlin, on the other hand shows a significantly broader temperature spread; we can see cold winters as well as warm summers and a significantly dryer climate than that of Singapore.

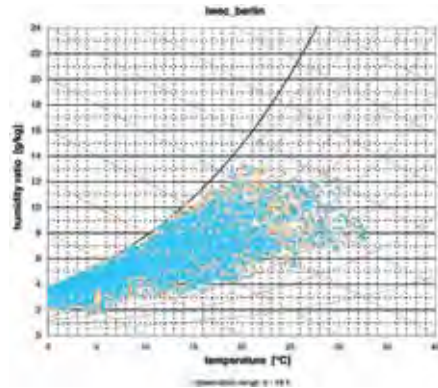

Figure 2.8:  
Point cloud, Singapore

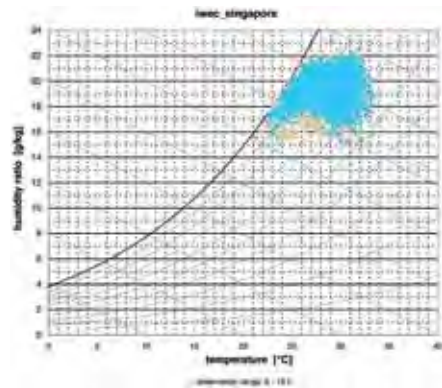

Figure 2.9:  
Point cloud, Berlin

## § 2.4.4 Monthly radiation distribution

Solar energy striking the earth occurs in the form of direct radiation as well as diffuse radiation. Global solar radiation measured in kWh/m<sup>2</sup>/a describes the amount of radiation received per square metre horizontal surface per year. Due to the orientation of the earth to the sun, global solar radiation is strongest near the equator and lessens toward the poles.

Sufficiently thick cloud coverage can reduce direct solar radiation to zero; in this case global solar radiation equals diffuse radiation.

The scattering of direct solar radiation on molecules in the air, aerosols and cloud droplets and crystals create diffuse radiation as do inclined surfaces that reflect global solar radiation (VDI, 1994).

IWEC weather data includes hourly measurement readings of solar radiation. The amount of radiation throughout a year can be plotted on a bar chart. To increase the information value, a curve of the annual temperature profile can be added to the global solar radiation bars. Temperature is recorded on the right side of the vertical axis. The Las Vegas example in Figure 2.10 clearly shows how, at the beginning of the year, global solar radiation is above the temperature curve. From summertime on with increasing hazy clouding and rising air pollution over the city, it remains below the temperature curve.

In addition, the chart provides information about the maximum amount of annual radiation. This example shows Las Vegas with 2078 kWh/m<sup>2</sup>/a; twice as high as Berlin with 986 kWh/m<sup>2</sup>/a.

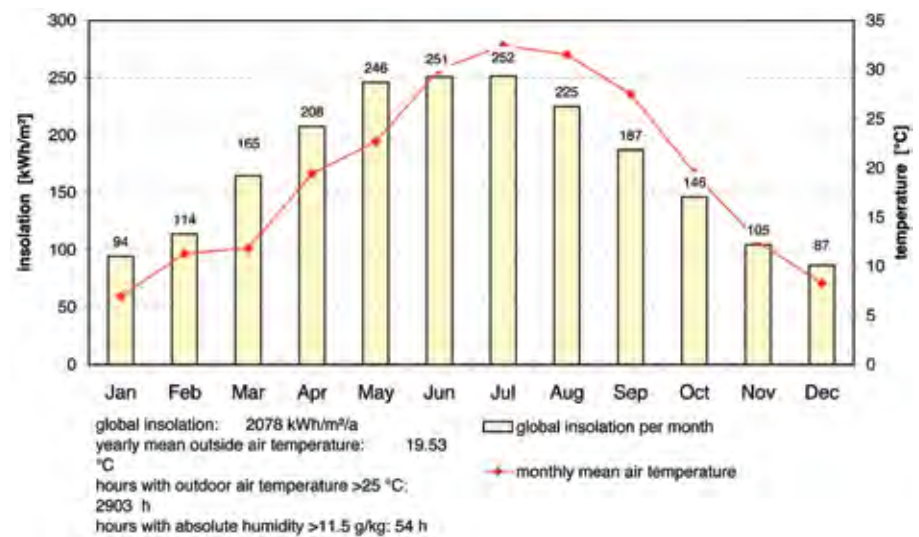

Figure 2.10  
Annual global solar radiation profile, Las Vegas

## § 2.4.5 Dew point profile

The dew point is an interesting factor for detailed analysis. Similar to an air temperature profile, annual dew point temperatures can be illustrated in a chart. If both temperature curves are plotted onto one chart, the interdependencies of both parameters can be identified. The greater the difference between temperature and dew

point, the dryer the air. A comparison of Las Vegas and Singapore clearly shows this difference. Las Vegas is a dry location, whereas Singapore has a tropical climate with a significantly lower discrepancy between the temperature curve and the dew point temperature.

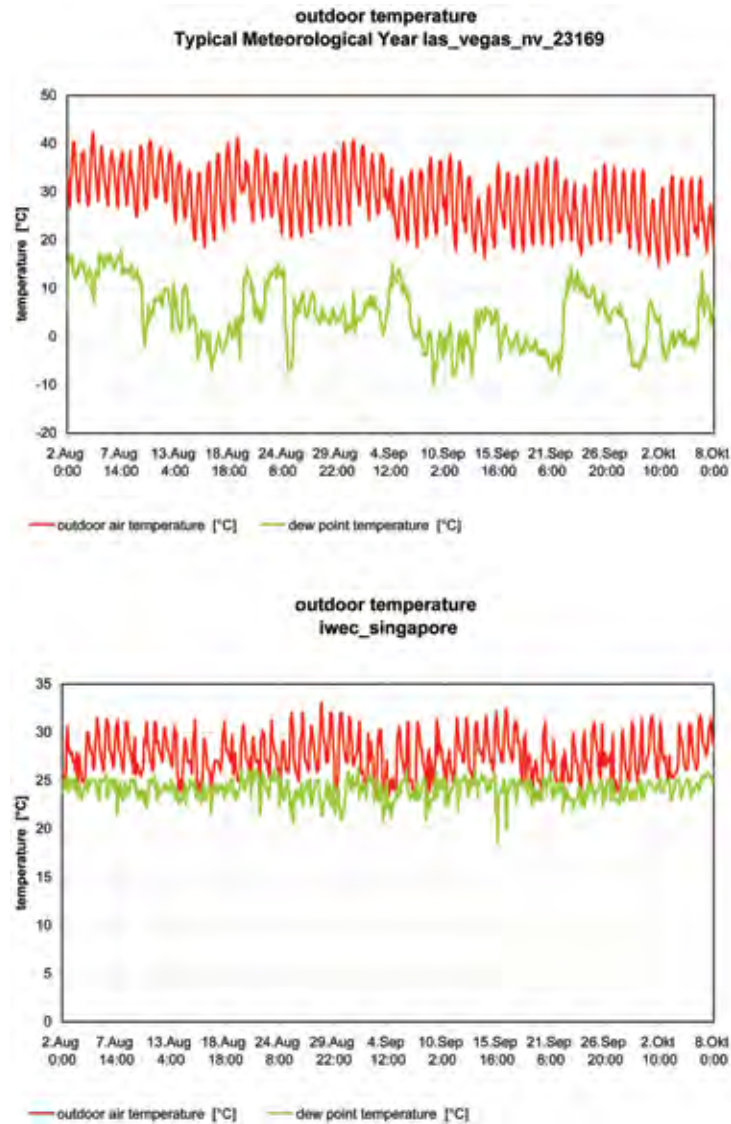

Figure 2.11

Comparison of the distance between air temperature and dew point as an indication of the air humidity of a location, exemplified by Las Vegas and Singapore

## § 2.4.6 Wind rose

A simplified explanation of wind, as a predominantly horizontal air movement, on one hand and air flow with horizontal as well as vertical movement on the other, is as follows: wind is the result of differences in air pressure between areas of unequal pressure which are created by irregular solar warming of the earth surface. Wind force is proportional to the air pressure gradient, but wind force as well as wind direction are also influenced by other forces. High winds, meaning wind in the free atmosphere, are also subject to the gradient force, the Coriolis force caused by the earth's rotation and by centrifugal force. They flow parallel to the isobars (areas of equal pressure) and are virtually turbulence-free. In contrast, ground wind is determined not only by the before mentioned forces but particularly by its friction with the earth surface. This results in winds flowing from areas of high pressure toward those of low pressure, whereby in the northern hemisphere it is deflected to the right and in the southern hemisphere to the left. Mountain ranges also impact the wind flow because the air is forced to flow over or around the obstruction (Neef, 1956).

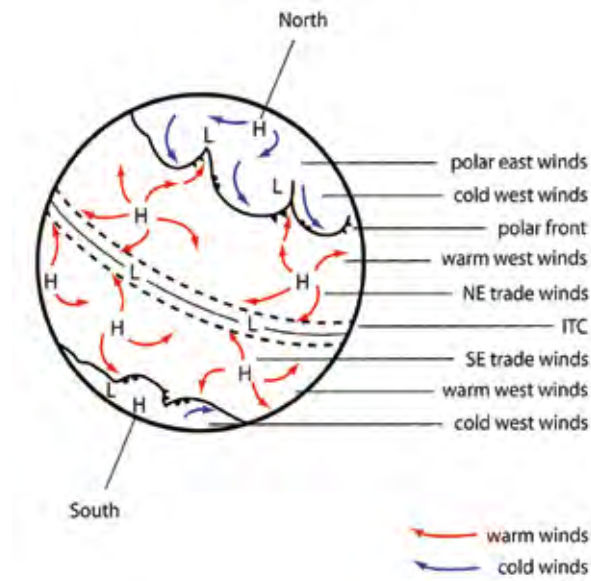

Figure 2.12  
Primary wind and pressure system (Dahl)

Ground wind is a relevant factor for the analysis in the scope of this work. Weather data records include hourly wind measurements that include the force and the direction of the wind. A wind rose is used to graphically depict these values. It shows the wind direction by use of cardinal directions and the force by different colouring. It has to be noted that the wind blows from the direction in which the graphic contours point. The example shows the main wind direction in London coming from the southwest.

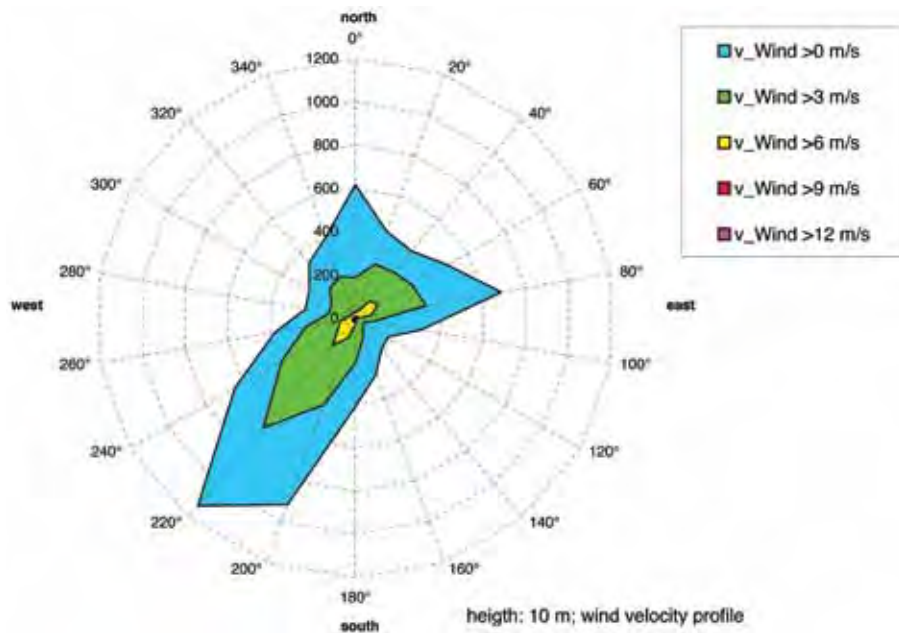

Figure 2.13  
London, wind rose with main wind direction from southwest

Areas highlighted in blue show wind speeds of 0-3 m/s: green areas wind speeds of 3-6 m/s.

A wind speed table makes these graphs easy to read. It depicts the wind force related to wind speed in Beaufort and km/h.

m/s	km/h	Beaufort	Bezeichnung	Beschreibung
0	0	0	calm	flat sea, smoke rises vertically
1	3,6	1	light air	Smoke drift indicates wind direction and wind vanes cease moving.
3	10,8	2	light breeze	Wind felt on exposed skin. Leaves rustle and wind vanes begin to move.
6	21,6	4	moderate breeze	Dust and loose paper raised. Small branches begin to move.
12	43,2	6	strong breeze	Large branches in motion. Whistling heard in overhead wires.

Figure 2.14  
Wind speeds compared, with description.

The frequency of the wind distribution is recorded in hours in concentric circles originating in the centre of the wind rose. In order to achieve good readability the hour scale is adapted. When examining the information it is important to note the type of hour scale used in order to exactly determine the results. In order to provide information about the wind distribution from day to night, one can set the observation period to, for example, 6.00 -18.00 for daytime or 18.00 – 6.00 for night time. Figures 2.15 and 2.16 show a comparison of rotating wind conditions, exemplified by Las Vegas. During the night the wind blows noticeable from west, southwest, whereas during the day it is more spread out and blows from the northeast as well as the southwest.

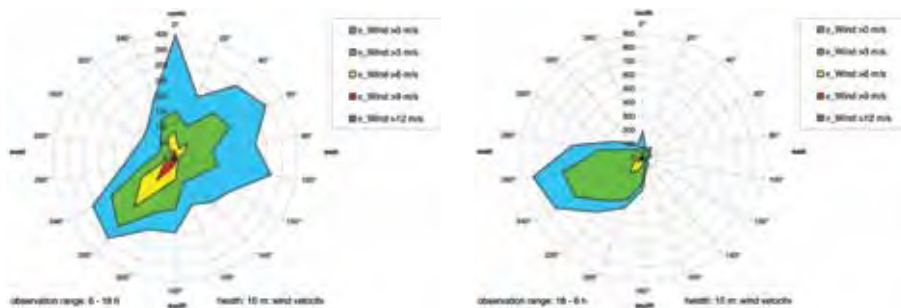

Figure 2.15, 2.16:  
During the change from day to night, the wind in Las Vegas shifts from the northeast to the southwest.

In order to determine exact wind temperatures, winds can be shown in a specific temperature range. This option can provide information about the direction of particularly hot or cool winds.

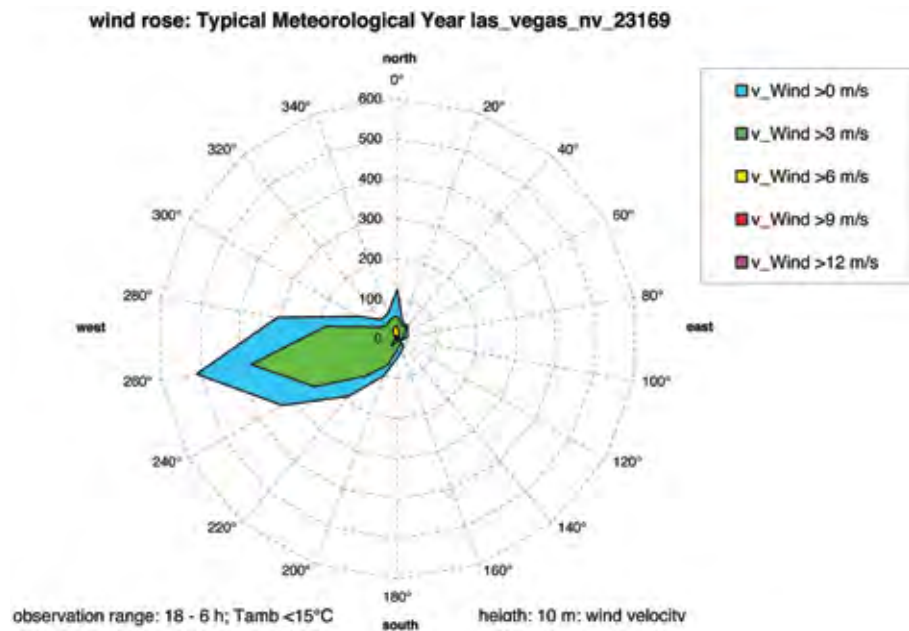

Figure 2.17  
Wind below 15°C in Las Vegas

### § 2.4.7 Wind force distribution

The days of a particular wind occurrence can also be summarised in a bar chart for statistical evaluation. Figure 2.18 shows such a bar chart of the wind distribution in Las Vegas. The hours of a year are plotted on the left vertical axis, and the absolute frequentness of the distribution in % on the right side. Wind speeds in m/s are plotted on the horizontal axis. It is clearly visible that 90% of all winds measure speeds of up to 4 m/s. Higher wind speeds of more than 6 m/s occur on significantly less days. The chart is a better means to highlight wind occurrence and its distribution related to the wind speed than the wind rose.



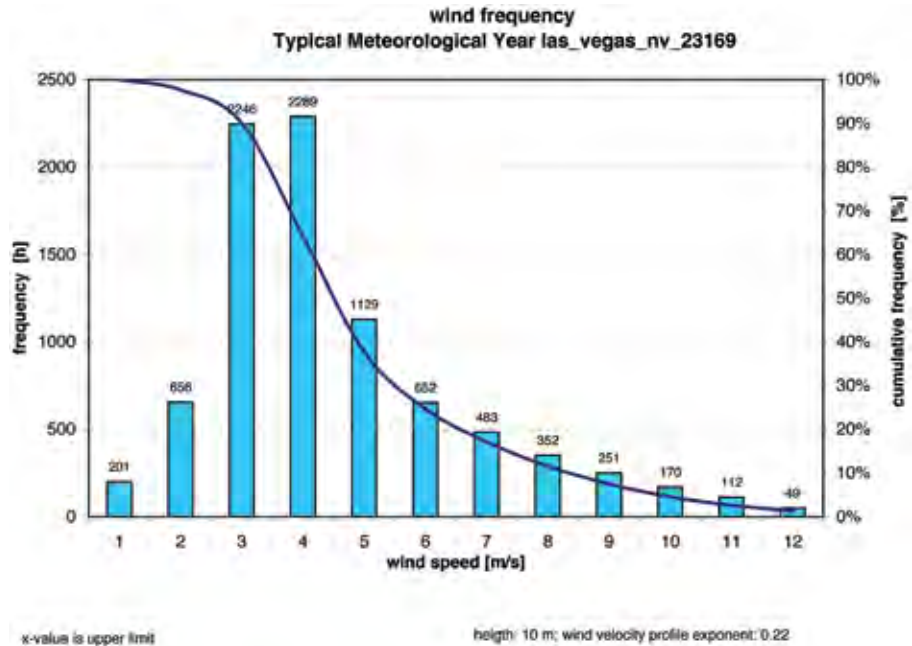

Figure 2.18  
Statistical analysis of wind speed distribution, example Las Vegas

The following section describes selected locations are described by use of the methods of climate analysis.

## § 2.5 Climate zones / selection of boomtowns

As mentioned in § 2.1 'Climate zones basics' this work is based on the Köppen climate zone classification. In order to find an approach to analysing climate zones and their requirements on buildings and the building envelope in particular, which is sufficiently universal to apply to most applications, eight boomtowns with extensive past and current building activity were selected. The selection was also based on the requirement to cover numerous different climate zones. Locations within the same climate zone but with very different microthermal climates highlight the importance of a precise analysis of the location.

The following eight cities were chosen for analysis and further research, these are representative cities for a climate zone:

- **Las Vegas**
- **Berlin**
- **Dubai**
- **Shanghai**
- **New York**
- **London**
- **Moscow**
- **Singapore**

The order of the cities listed is arbitrary; the sequence will change in upcoming chapters depending on the topic covered.

The selected locations span the entire globe and cover a broad range of climate zones. They are considered boomtowns because they exhibit extensive building activity and constant growth over the past 10-20 years. Due to the internationality of many business establishments in these cities, it seems safe to assume that the user behaviour in the office environment is comparable. Local influences and customs might vary, but user factors such as dress code or desired comfort level in the office are similar. It was a conscious decision to choose locations that are well known to everyone. This facilitates easier understanding and transferability to other planning locations.

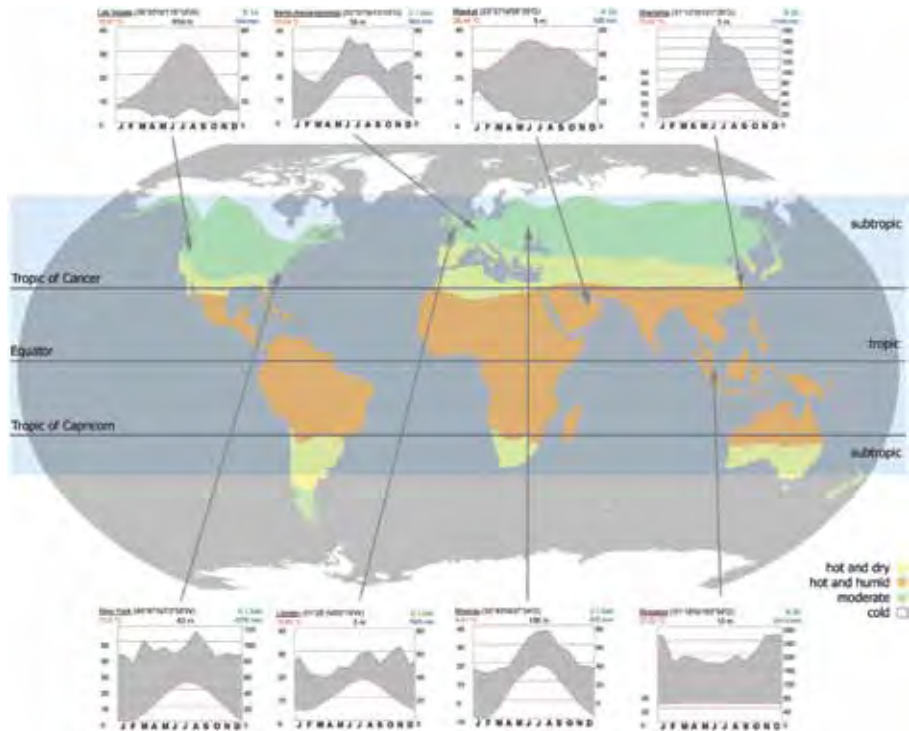

Figure 2.19  
The eight selected cities and their location on a global map

The selected boomtowns can be allocated to the five main climate zones according to the Köppen climate classification:

Locations	Classification
Las Vegas / Dubai	(B) Desert climate
Berlin/ Shanghai / New York / London	(C) Warm temperate climate
Moscow	(D) Snow climate (Snow-forest climate)
Singapore	(A) Tropical climate or equatorial climate

Table 2.1  
The selected boomtowns according to the Köppen climate classification

To achieve a more detailed description of the climate at the different locations, Köppen's system offers a finer subdivision that relates to the regional circumstances of the microthermal climate. A more precise classification of the eight locations is as follows:

Locations	Classifications
Las Vegas	(BWk) Cold desert climate
Berlin, London	(Cfb) Maritime temperate climate with warm summer
Dubai	(BWh) Hot desert climate
Shanghai, New York	(Cfa) Hot humid subtropical climate
Moscow	(D) Warm summer continental climate

Table 2.2  
A more precise Köppen climate classification of the eight locations

Even a further detailed Köppen climate classification shows that, for example, Berlin, London, New York and Shanghai lie in one climate zone. Therefore it is mandatory to examine each location and its prevailing microthermal climate more closely because regional topographic conditions often influence the climate. Thus, the results and rules drawn later in this thesis cannot be generally applied to one climate zone as a whole.

## § 2.6 Eight boomtowns

The following paragraphs introduce the eight selected locations and their respective microthermal climate according to the analysing methods described in § 2.4 'Climate analysis methods'. In addition to a mere description of the microthermal climate, characteristic features and particularities are also highlighted.

### § 2.6.1 Berlin

Germany lies in Central Europe. To the north it borders the North Sea, Denmark and the East Sea; to the east Poland and the Czech Republic; to the south Austria and Switzerland; and France, Belgium, Luxembourg and the Netherlands to the west. The official name is Federal Republic of Germany (BRD). The country covers an area of 357,027 square kilometres. Capital and largest city is Berlin (Microsoft, 1997).

Throughout Berlin there are traces of the city's eventful past. Since the fall of the Wall on 9 November 1989 the city is changing rapidly. As the capital, it houses the seat of the Bundestag (Lower house of German parliament) and the German Government. Urban accents established during the past 20 years are highly visible. Tower cranes can be seen throughout the city.

With its three opera houses, many theatres and renowned concert halls as well as the classicistic ensemble of the Museum Island - a World heritage Site -, Berlin has evolved into a cultural capital. This is also exemplified by the Jewish Museum which offers deep insights into the history of Jewish living environment.

The formerly separated city is subject to rapid structural change. The developmental potential lies in the centre of town. Berlin is not complete and offers a large number of open areas, thus is open for investment with room for creativity and entrepreneurship. In addition, the city has a well developed infrastructure. The telecommunication network is of the latest technology. The new central station (Hauptbahnhof – Lehrter Bahnhof) was built in the centre of town and all important train tracks that connect Berlin with other metropolises have been renewed. The capacity of the city's airports has been increased and a new major airport is in planning.

With Germany's Central and Eastern European neighbours having joined the European Union, Berlin has moved to the centre of joined Europe and is therefore considered a good starting point for investment in the Middle Eastern European area. (Berlin, 2005)



Figure 2.20

*Berlin Potsdamer Platz, a new development in the heart of the city*

Germany lies in the transition zone between the oceanic influenced climate of Western Europe and the continental climate of Eastern Europe. Due to their proximity to the North and East Seas, Germany's northern regions are influenced by a maritime climate. This contrasts with the south, where the temperature fluctuates more throughout the year.

The climatic circumstances are described in the following.

#### Annual temperature profile

---

The annual temperature profile of Berlin shows rising temperatures from spring to summer. After summer, temperatures during autumn drop until they reach the lowest values during winter. The average annual temperature lies at  $9.8^{\circ}\text{C}$ , a fact that points to a distinct winter period. The hottest months are the summer months from June to August with maximum temperatures of  $32.7^{\circ}\text{C}$ . During the winter months of December to March the temperature drops to minimum temperatures of  $-8.8^{\circ}\text{C}$ .

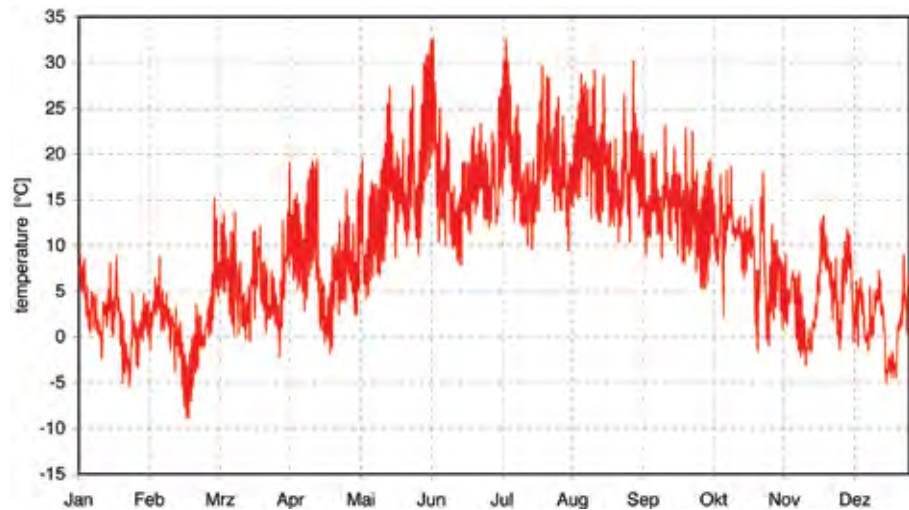

Figure 2.21  
Annual temperature profile for Berlin, Germany

The analysis of the temperatures during the hottest month of June clearly shows cooling during the night hours. The difference can be as large as 15K, as illustrated in the beginning of the month area of the chart. If masses can warm up over an extended period of time, the temperature difference decreases to 7-10K.

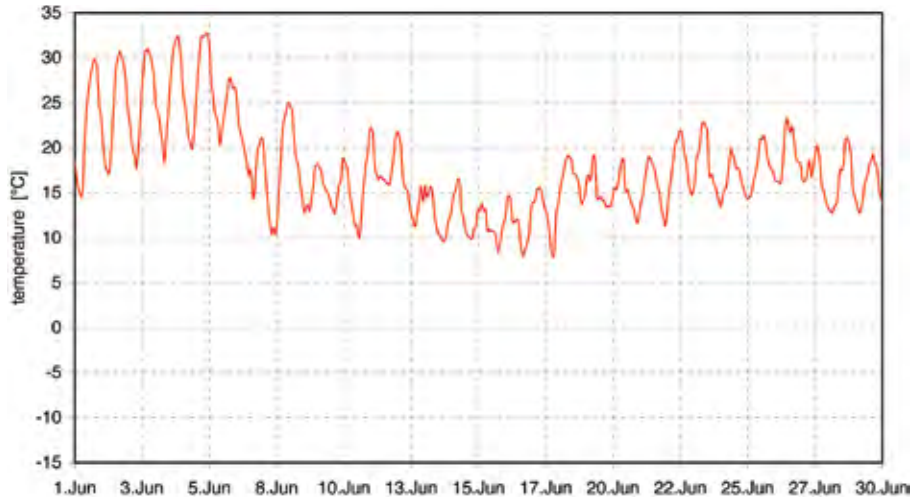

Figure 2.22  
Temperature fluctuations during the month of June

The statistical analyses describe the temperatures as follows:		
Number of hours	below 0°C	779 h
Number of hours	below 15 °C	6283 h
Number of hours	above 25 °C	268 h
	More than 25 °C	on 268 hours per year.
	More than 25 °C	on 32 days per year

Table 2.3  
The statistical analyses of the temperatures, Berlin

### Annual air humidity profile

The air humidity is subject to the temperature progression of seasonal changes. During the winter months the humidity drops to a minimum of 1.5g/kg and a maximum of 8g/kg. During summer, the values increase to 13 g/kg. Compared to night time, the differences is up to 8g.

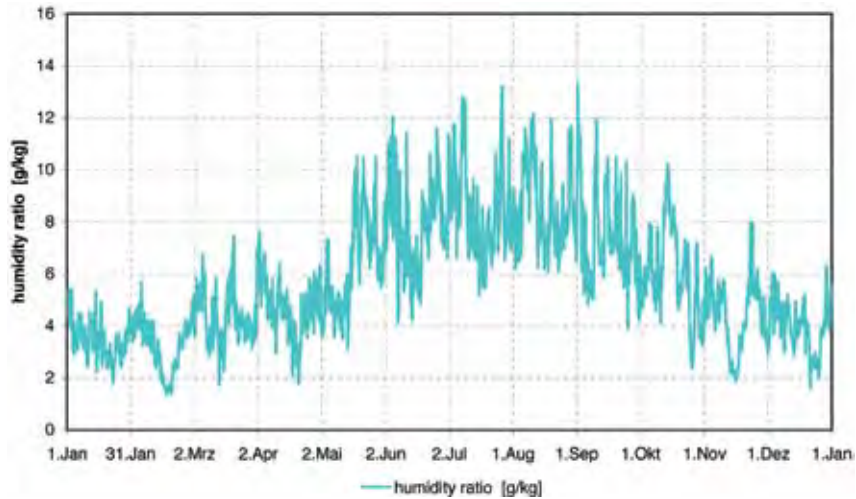

Figure 2.23  
Annual air humidity profile, Berlin

The detailed June curve shows prominent day / night fluctuations with a difference in values of up to 8g/kg. Considering the perception of the human body, this climate can be considered as dry; muggy days with values of more than 14g do not occur.

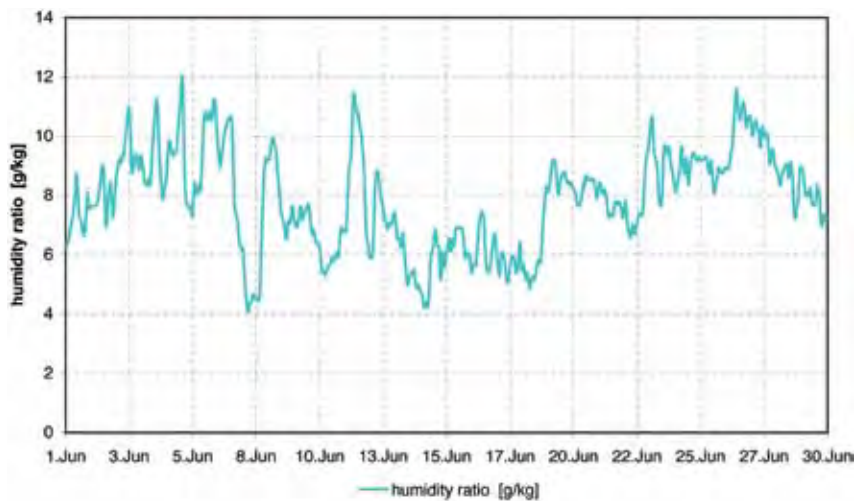

Figure 2.24  
Air humidity profile of the month of June

The statistical analysis of the air humidity shows a dry climate; the amount of hours with low values around 4g/kg greatly exceeds those with values of more than 10g/kg.



## Psychrometric chart

---

As can be seen in the temperature and humidity analysis, the psychrometric chart also shows a prominent spreading of the measurement values. The temperatures range from very cold (negative values are not shown) to a maximum of 32.7°C, typical for the continental climate.

Air humidity measurements range from 2-13g/kg. The formation of the point cloud describes a banana-shaped contour that touches the dew point line at cold temperatures and veers away from it at 15°C.

Graphically, the focal area of the point cloud is hard to read because temperatures below freezing are not depicted.

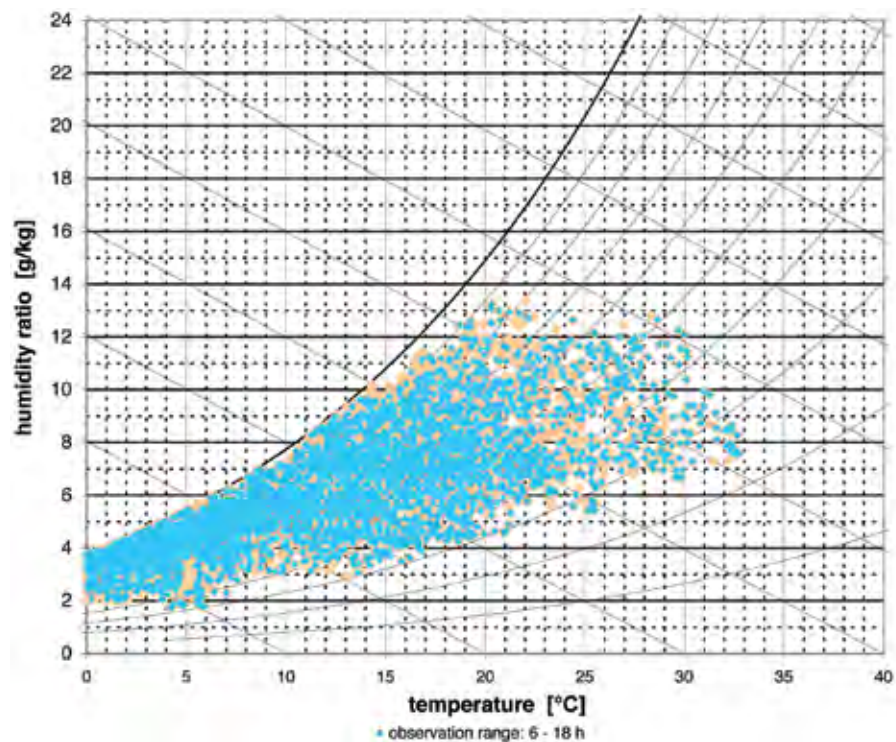

Figure 2.25  
Psychrometric chart, Berlin

## Monthly radiation distribution

---

The annual global solar radiation of Berlin lies at 986 kWh/m<sup>2</sup>; less than half of the solar radiation in Las Vegas. Analogue to the temperature curve, the highest values of up to 158 kWh/m<sup>2</sup> occur during the summer months, whereby May shows a significant increase in radiation volume with 150 kWh/m<sup>2</sup>. The winter months exhibit very little radiation; the month of December shows the smallest value with 13 kWh/m<sup>2</sup>. Overlaying the temperature curve shows that the sky becomes increasingly hazy over the course of summer. During this time the radiation values from August onward lie below the temperature curve.

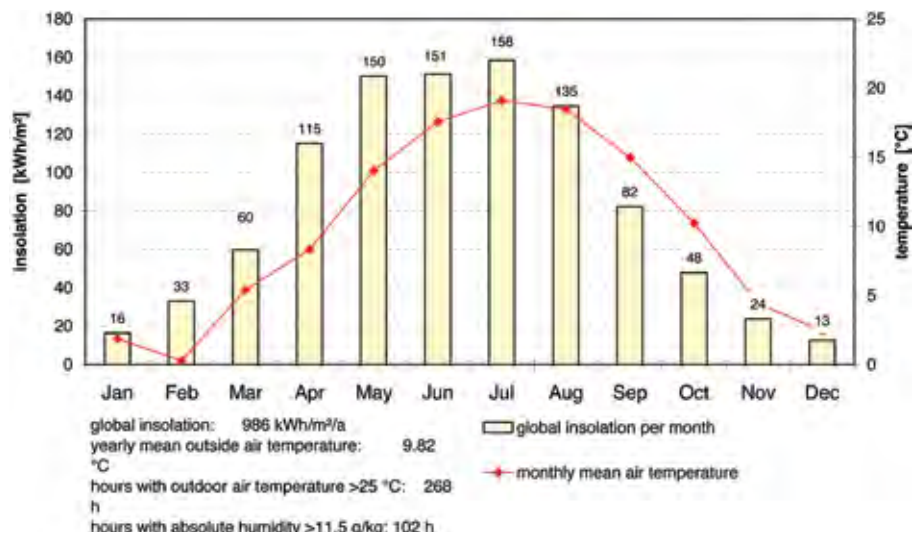

Figure 2.26  
Radiation distribution overlaid with a temperature curve, Berlin

## Wind distribution / Wind rose

---

The annual average wind speed is 4.18 m/s. The day time wind rose shows moderate winds of up to 6 m/s from the west and southwest with a frequency of occurrence of up to 450 hours per year. Stronger winds of up to 9 m/s can be seen for 200 hours from a westerly direction. For approximately 50 hours per year there are winds of more than 9 m/s from the west. And weaker winds blow for approximately 200 hours per year from a south easterly direction.

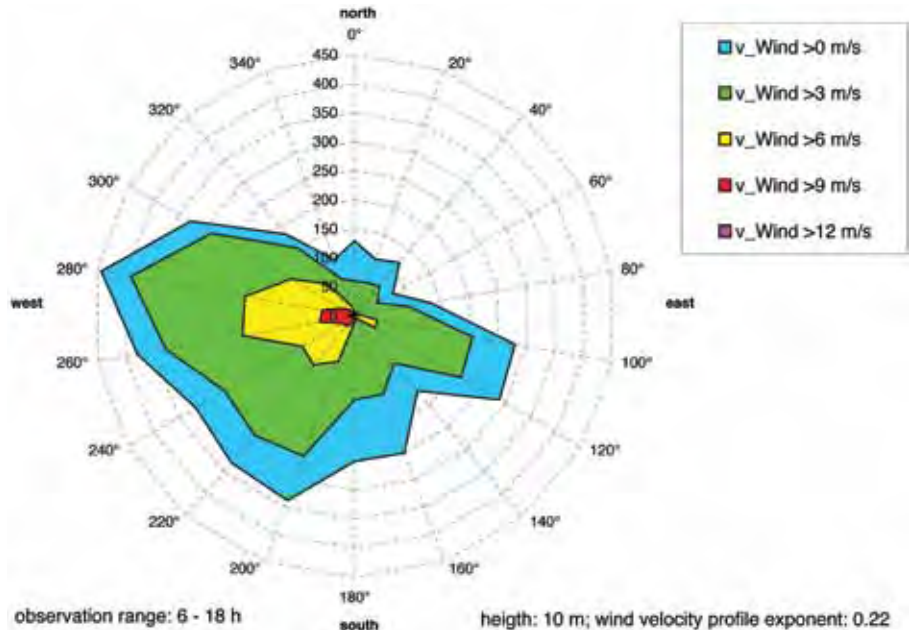

Figure 2.27  
Wind rose, Berlin, day time

The wind rose at night shows a similar picture, whereby the total winds from the southwest are more prominent than during the day. However, generally there is less wind during the night as the day.

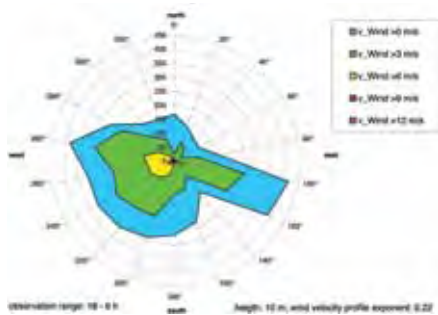

Figure 2.28  
Wind rose, Berlin, night time

Narrowing down the temperature range of the wind distribution shows that winds above 15°C exhibit a similar distribution as those across the entire temperature spectrum, whereas winds at temperatures above 25°C blow predominantly from the southwest. However, the frequency of such warm winds is very low, occurring during a maximum of 25 hours per year. The temperature curve also shows only a few days with such high temperatures.

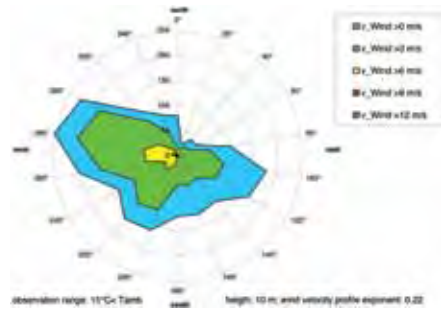

Figure 2.29:  
Wind rose with temperatures above 15°C, Berlin

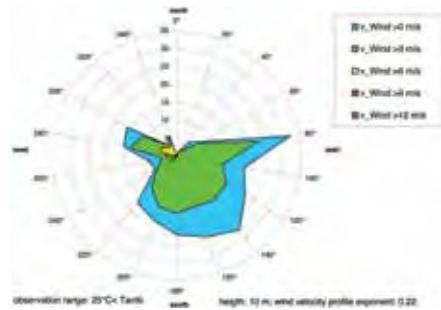

Figure 2.30:  
Wind rose with temperatures above 25 °C, Berlin

The statistical wind analysis shows an annual average value of around 4 m/s with a frequency of occurrence of 85 %. Also apparent is the low share of stronger winds that, starting with values around 5 m/s significantly decline in frequency.

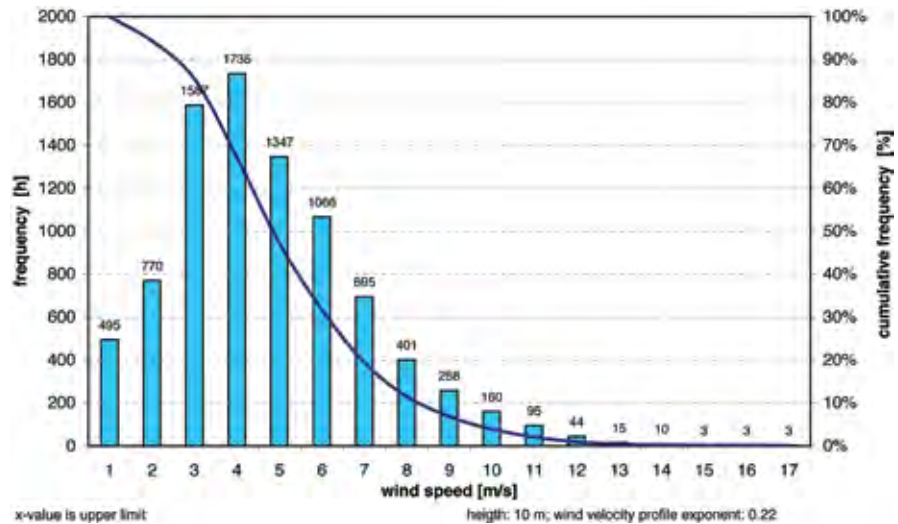

Figure 2.31  
Statistical wind analysis

## § 2.6.2 Dubai

---

The United Arab Emirates were founded on 2 December 1971. This ended the British protectorate and combined the individual emirates into a federation. The United Arab Emirates are situated in the southeast of the Arabian Peninsula. In the west and the south the country borders on Saudi Arabia; the Gulf of Oman and the Sultanate of Oman to the east; and Qatar and the Persian Gulf to the north.

The country covers an area of around 83,600 square kilometres. Its capital is Abu Dhabi. Members of the federation are Abu Dhabi, Ajman, Dubai, Fujairah, Ras al-Khaima, Sharjah and Umm al-Quwain. The country predominantly consists of dry sandy desert. The rocky Hajar Mountains extend in the east. (Microsoft, 1997)

Dubai city lies in the northeast of the United Arab Emirates, at a natural creek (Dubai Creek) connected to the Persian Gulf. The emir of Dubai, Sheikh Maktoum bin Raschid Al Maktoum, traditionally is the head of government of the United Arab Emirates. Head of State is the emir of Abu Dhabi.

The capital of the Emirate Dubai lies on the western side of the bay, the eastern part is known as Deira.

Dubai was the residence of the British representative for the earlier signatory states (1954 to 1971). The city, also known as the Venice of the Gulf Region, has the largest harbour and is the most important commercial centre of the United Arab Emirates. Approximately 99 percent of the 1.14 m inhabitants of the Emirate live here. (Microsoft, 1997)

Oil production in the region has more or less replaced traditional activities such as pearl diving, fishing and camel breeding. It helped the emirate which extends across about 4,000 square kilometres and consists of more than 90 percent desert area, close the gap to modern age.

But the Emirate's oil sources are limited; it is estimated that they will be exhausted between 2015 and 2030. Therefore Dubai has tried to gain independence from oil production for some time and is putting efforts into growing areas such as commerce, finances and tourism. Today only about 13% of the GDP come from the oil industry. Dubai's extreme growth rate over the past decades is largely due to a very liberal economic policy. (Brackmann, 2006)

In April 2001, the harbour was expanded to include a terminal for luxury liners in order to further tourism. In 2002 Dubai began to create artificial offshore islands (“The Palm” amongst others). The plan for the next few years is to establish extensive sandy beaches and many luxury facilities for tourists (Microsoft, 1997).

The following describes the climatic conditions. Because there is no IWEC data record for Dubai, the climate analysis is based on the data record for Abu Dhabi, the capital of the United Arab Emirates. Both Abu Dhabi and Dubai lie on the same coast and are separated by only 120km; thus the two locations are comparable.



Figure 2.32  
*The growing skyline of Dubai*

### Annual temperature profile

---

The annual temperature profile of Abu Dhabi shows a seasonal cycle. The maximum values, recorded during the summer months from May to August, lie at 46.6°C. Beginning in September, the winter months show lower temperatures, but they can reach highs of 25-30°C. Minimum temperature in Abu Dhabi lies at 8°C, and the average temperature is 27.1°C.

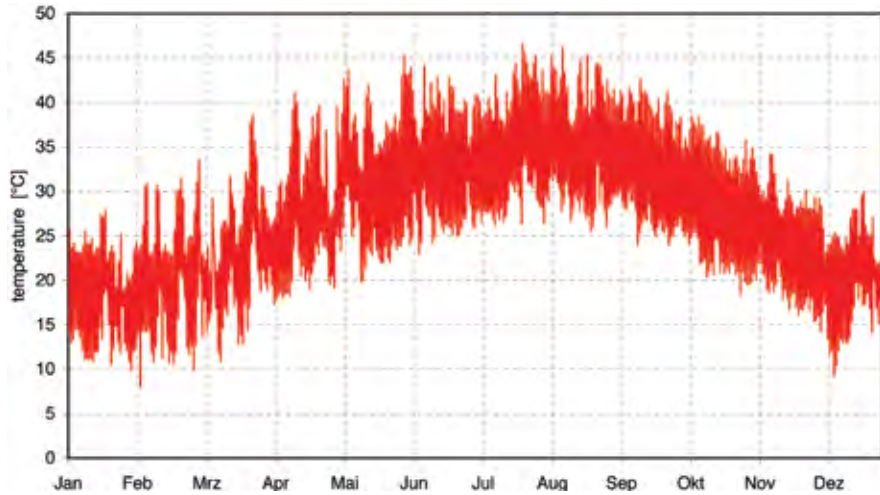

Figure 2.33  
Annual temperature profile, Abu Dhabi

The month of July, for example, clearly shows temperature fluctuation between night and day. The temperature difference can be as large as 20K; however, the average difference during the summer months lies at 15K.

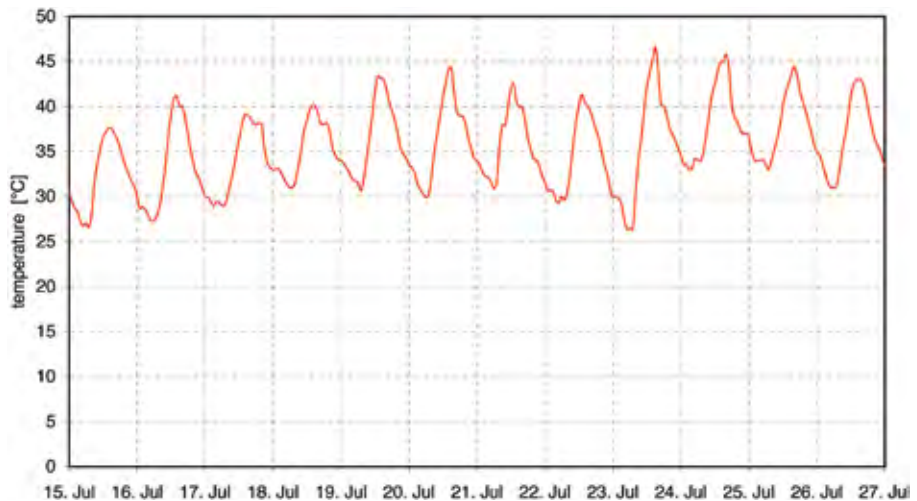

Figure 2.34  
Temperature fluctuation between day and night

Statistically, these high temperatures can be summarised as follows:		
Number of hours	below 0 °C	0 h
Number of hours	below 15 °C	61 h
Number of hours	above 25 °C	2997 h
	More than 25 °C	on 5219 hours per year
	More than 25 °C	on 300 days per year

Table 2.4  
Summary statistical high temperatures, Abu Dhabi

### Annual air humidity profile

Air humidity in Abu Dhabi varies analogue to the temperature profile with significantly higher values during the summer months. The maximum values reach 27g/kg. Due to the high temperatures, Abu Dhabi's climate is classified as a desert climate, but the values are significantly higher than those of Singapore which is classified as a tropical climate. During the winter months, air humidity values can fall to 8 g/kg.

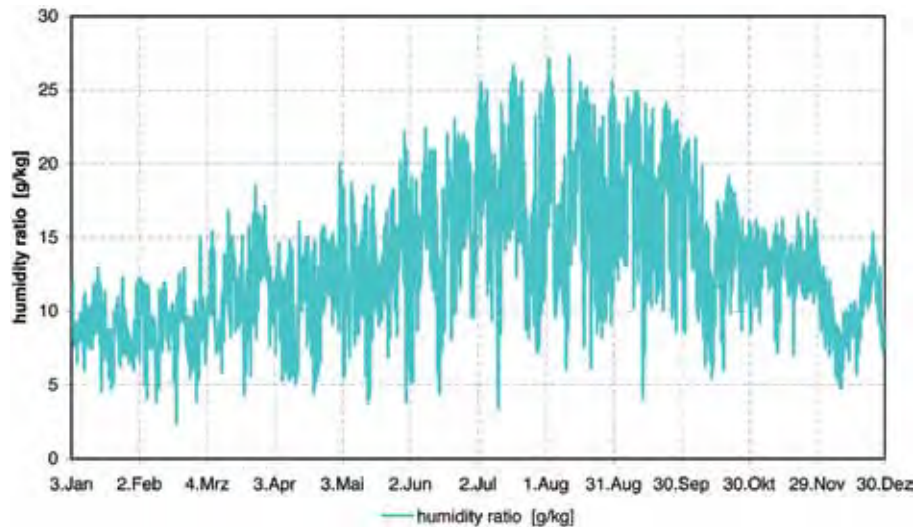

Figure 2.35  
Annual air humidity profile, Abu Dhabi



A detailed look at the month of July shows large humidity fluctuations analogue to the temperatures. The differences can be as large as 16g. However, it is more likely to observe differences of 10g between day and night. Even if the temperature profile of day and night shows a consistent progression, there are significant fluctuations in the humidity profile.

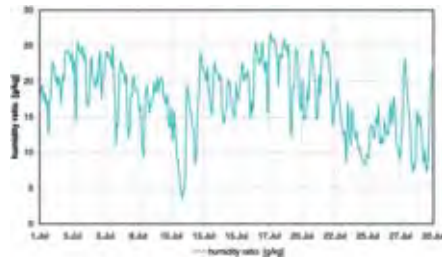

Figure 2.36  
Air humidity profile in July, Abu Dhabi

In this case, the statistic distribution of air humidity provides a more accurate estimation of the prevailing air humidity. If the curve profile shows maximum values of up to 27g/kg, this curve profile is relativised. The average air humidity lies at 11-12g/kg, and maximum values exceeding 20g occur on only a few days throughout the year. Here, the statistic analysis provides a clearer picture of the climate than the curve profile.

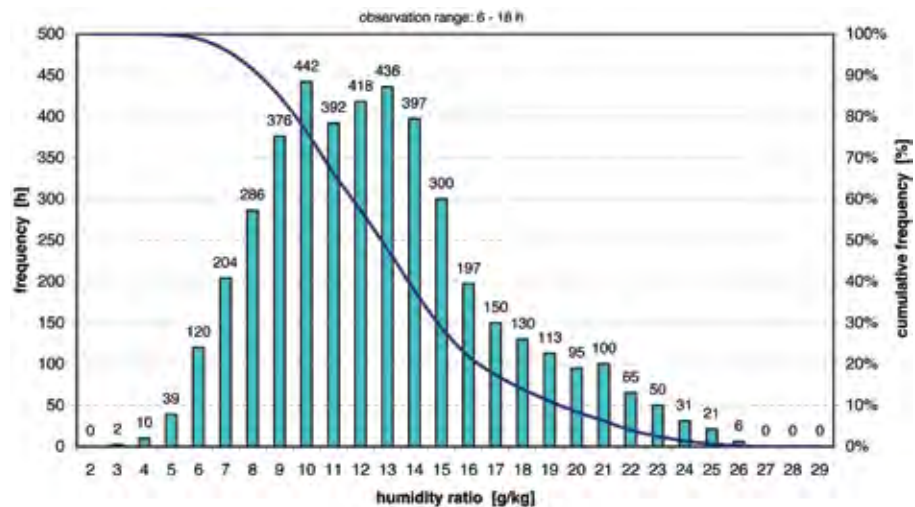

Figure 2.37  
Statistic distribution of air humidity

## Psychrometric charts

---

The psychrometric chart for Abu Dhabi shows a similarly large scattering of the temperature and humidity values. The chart shows temperatures in a distribution range of 10 – 40°C, whereby the temperatures seen on the temperature curve are even higher. The humidity values are plotted in a range of 4 - 24 g/kg. The point cloud is most concentrated at 27°C and 14g/kg, describing the core area as the average annual values. The large scattering of values lets us assume cold and dry as well as hot and humid periods. The preceding analyses defines these clearly as the winter and summer periods.

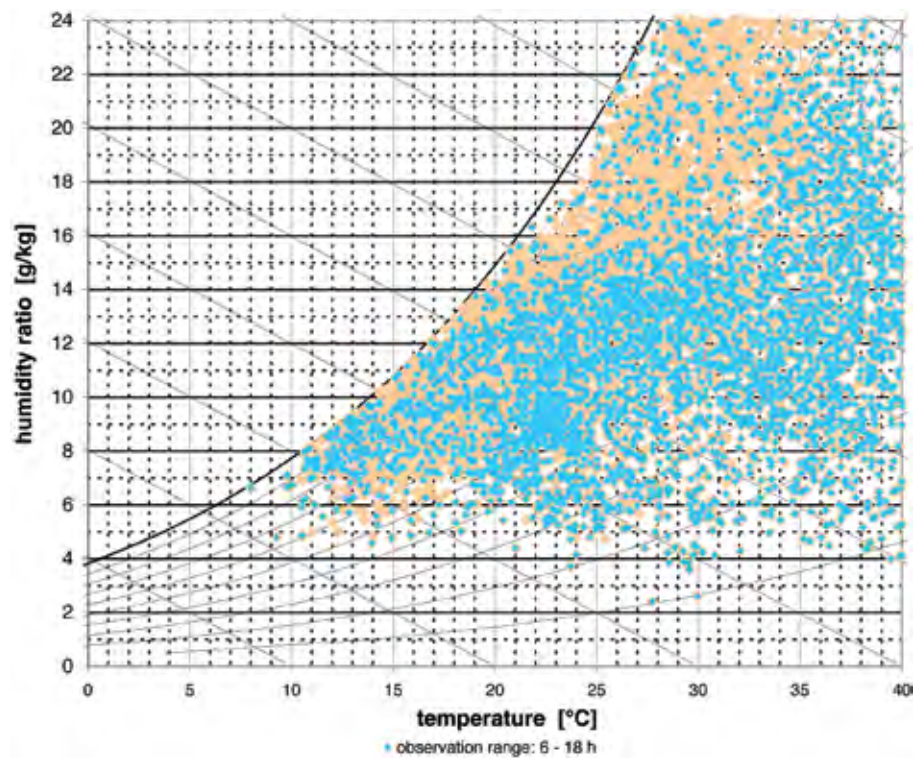

Figure 2.38  
Psychrometric chart, Abu Dhabi

## Monthly radiation distribution

---

The annual global solar radiation in Abu Dhabi is 2205 kWh/m<sup>2</sup> and thus lies above the already high value of Las Vegas. Analogue to the temperature curve the maximum values are recorded during the months from May to August. During these periods, radiation is measured at 230 kWh/m<sup>2</sup>. During the winter months it drops to 122 kWh/m<sup>2</sup> in December. A comparison with the temperature curve lets us assume hazy summer and autumn seasons because the radiation lies below the temperature. Several interviewees having travelled to the region for building activities have indicated that as early as in April the sky becomes more and more hazy and that the visibility during the summer months lies at only a few hundred metres. According to the interviewees blue skies are guaranteed only in winter.

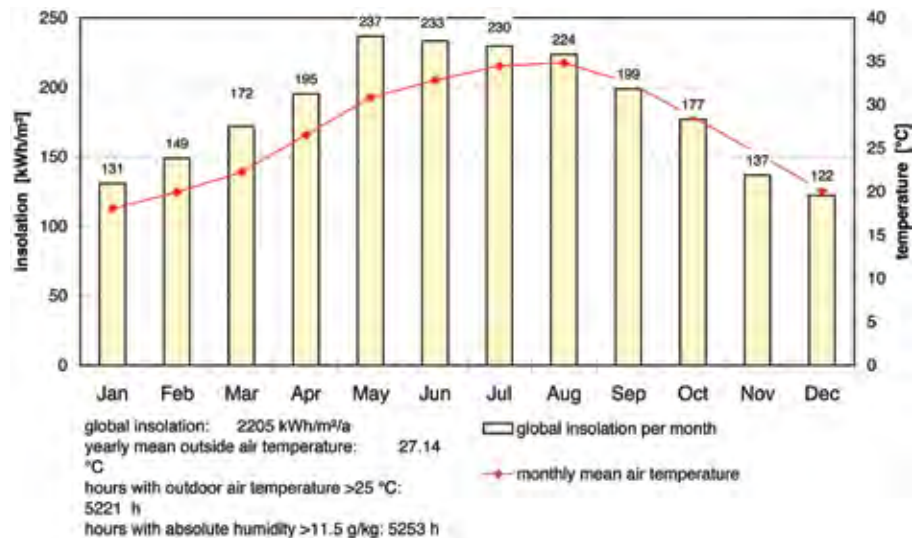

Figure 2.39  
Radiation distribution with temperature curve, Abu Dhabi

## Wind distribution / Wind rose

---

The annual average wind speed in Abu Dhabi is 3.64m/s. During the day, the wind rose shows two main wind directions. The most prominent direction with a frequency of occurrence of up to 700 hours are winds of up to 3 m/s

from the northwest. Winds of up to 9 m/s occur for significantly fewer hours, namely 200. The second main wind direction is coming from the south, from the mainland. With durations of approximately 300 hours they occur significantly less often.

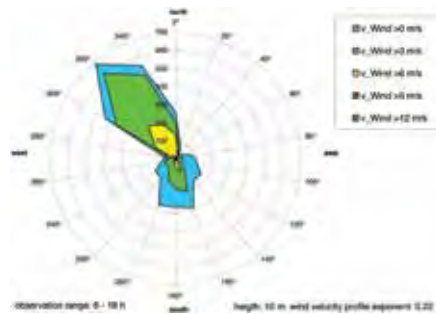

Figure 2.40:  
Wind rose, Abu Dhabi, day time

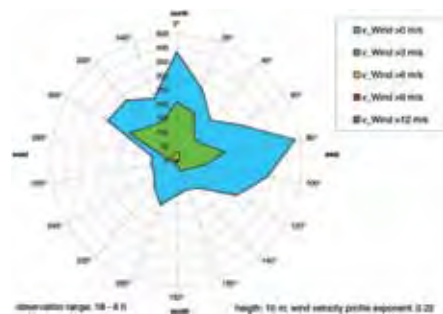

Figure 2.41:  
Wind rose, Abu Dhabi, night time

During the night, the wind shifts; it blows over the water from northeast to easterly directions. The frequency of occurrence at 400 hours is lower than that during day time. The wind force of a maximum of 6m/s is also lower than during the day.

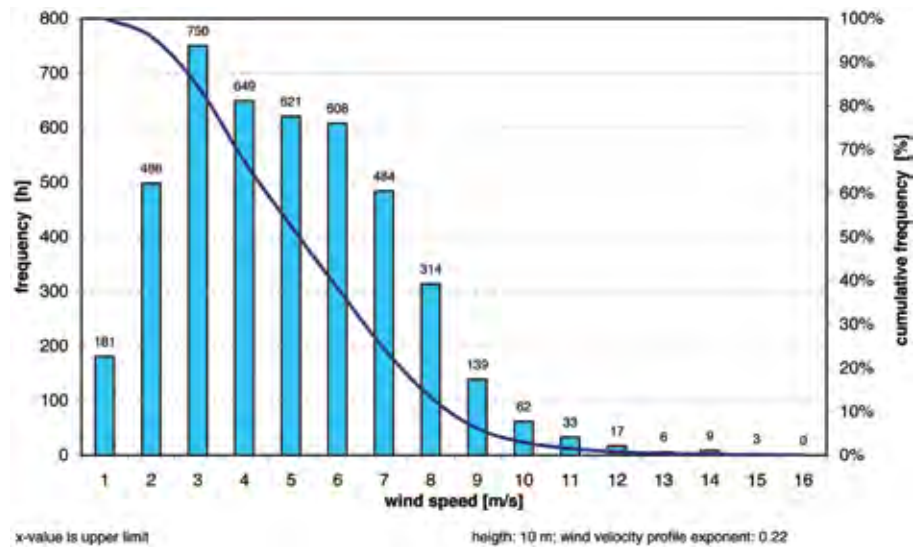

Figure 2.42  
Statistical wind analysis

When examining the wind distribution below 25°C it shows that cooler winds from the east occur at night time, a small amount blows from north turning to northwest. However, with 250 hours the frequency is significantly lower than that of the other winds. The temperature curve highlights this fact since temperatures below 25°C are rare.

A statistical wind analysis also shows that winds of up to 6 m/s are average; higher wind speeds do not often occur.

### § 2.6.3 Las Vegas

---

Las Vegas is a city in southern Nevada, USA. The well-known tourist and conference centre attracts 37 m tourists per year. It became famous by its numerous luxury high-rise hotels and glittering casinos, many located on the principle street, the Strip. As the largest city in Nevada, Las Vegas is also the commercial centre of the surrounding region. Las Vegas is the fastest growing metropolis of the United States, and an increasing number of people leaving the Pacific Coast of California move here. They account for approximately 60 percent of the new arrivals in Las Vegas and make a considerable contribution to the development of various economic activities in the city (Brackmann, 2006). These include the building industry and landscape architecture. One fourth of Las Vegas' business volume is still made with the casinos. But entrance cards to shows, souvenirs and luxury articles account for an increasing amount of revenue.



Figure 2.43  
*The Strip in Las Vegas*

Las Vegas is the seat of Clark County. It has 534,847 inhabitants; the entire urban agglomeration counts approximately 1.7 m people (Microsoft, 1997).

Las Vegas is situated on the eastern side of the Sierra Nevada mountain range that shelters the city from the humidity loaded winds of the Pacific Ocean. Practically the entire state of Nevada lies in a desert region and receives very little precipitation. The average annual precipitation level is only 85 ml with 300 days of sun (Microsoft, 1997).

Las Vegas is located at the southern tip of Nevada, in a broad flat basin surrounded by mountains. The city itself forms an enormous oasis in this desert valley. In order to enjoy green lawns and blooming shrubs and palm trees lining the streets, millions of cubic metres of water are transported to the city from near Lake Mead. Where ever there is no rocky ground, vast amounts of reinforced concrete are necessary to build the foundations of the buildings (Brackmann, 2006).

The following describes the climatic conditions analogue to the analysis methods introduced in § 2.4 'Climate analysis methods'.

#### Annual temperature profile

---

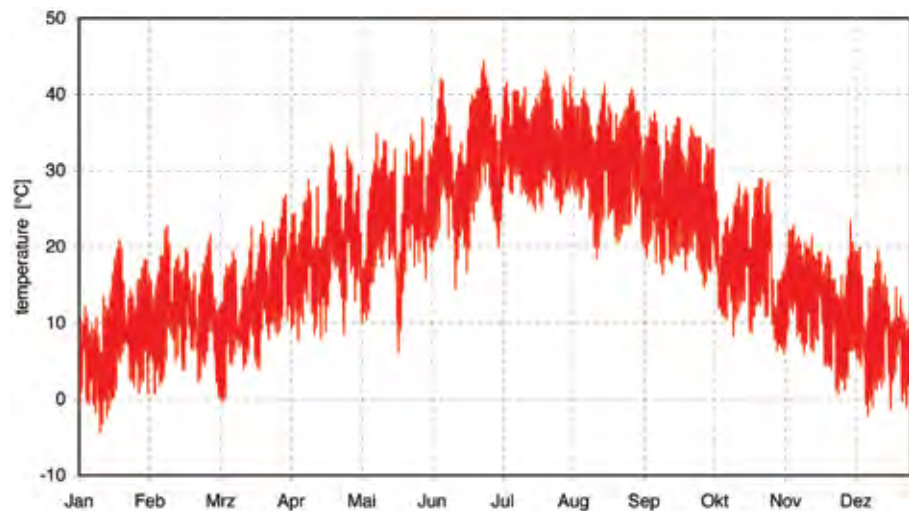

Figure 2.44  
Annual temperature profile, Las Vegas

The annual temperature profile of Las Vegas describes a cold desert climate. The curve shows a seasonal progression with the highest values during the summer months. The average annual temperature is 19.5°C. The hottest months are the summer months June to August with maximum temperatures reaching 44.4°C. During the transitional seasons spring and autumn maximum values lie at 35°C. The temperatures rise continuously from March to June. Autumn sees a more rapid temperature drop down to winter levels. Maximum temperatures during the winter months December to March are approximately 22°C.

The temperature curve shows large spreads throughout the day. At night, temperatures drop by approximately 18-20K. This is characteristic for desert climates with cold nights.

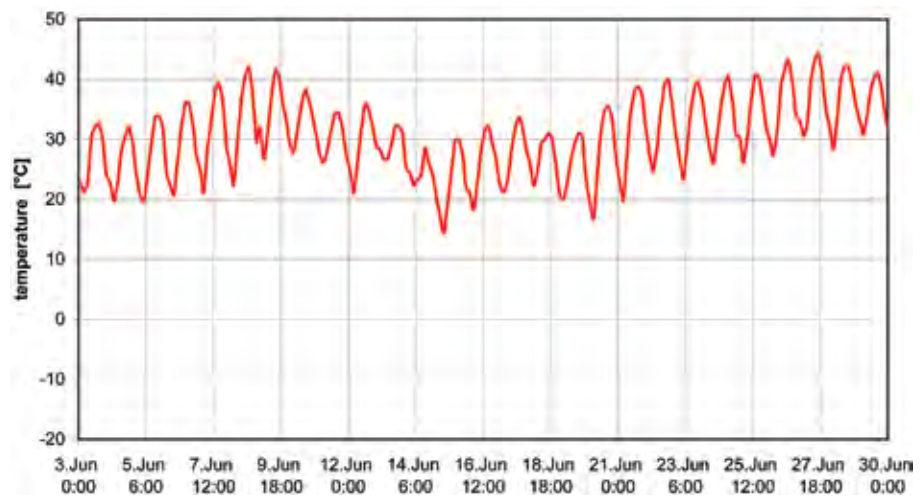

Figure 2.45  
Temperature spreads in the month of June

The statistical temperature analysis shows the following temperature spreads in hours:		
Number of hours	below 0 °C	68 h
Number of hours	below 15 °C	3300 h
Number of hours	above 25 °C	2902 h
	More than 25 °C	during 2902 hours per year
	More than 25 °C	on 181 days per year

Table 2.5  
Temperature spreads in hours, Las Vegas

During the winter months, minimum temperatures lie at  $-4.3^{\circ}\text{C}$ , occurring in the months of December and January. During summer, night time temperatures drop to  $20^{\circ}\text{C}$ .

### Annual air humidity profile

---

Air humidity levels in Las Vegas vary greatly throughout the year. Whereas during the winter months and the transitional periods between October and April maximum values are at 6-8 g/kg, the months of May to September show significantly higher values of up to 13g/kg. From 13.5g/kg onward the air is considered as muggy.

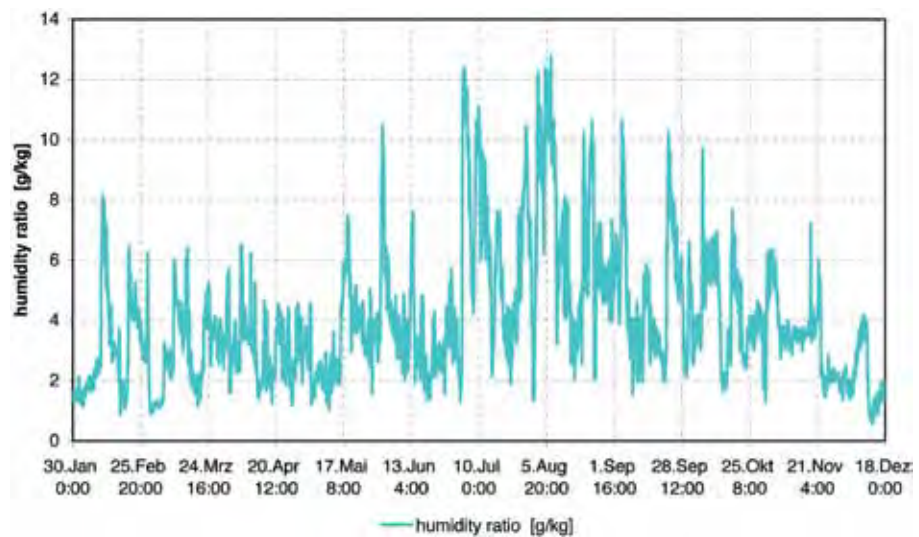

Figure 2.46  
Annual humidity profile, Las Vegas

It is also noticeable that, analogue to the temperature profile the difference between day and night is very large. Differences of up to 11g occur, for example, during the month of July, which entails a significant drop in humidity relative to the night time temperature.



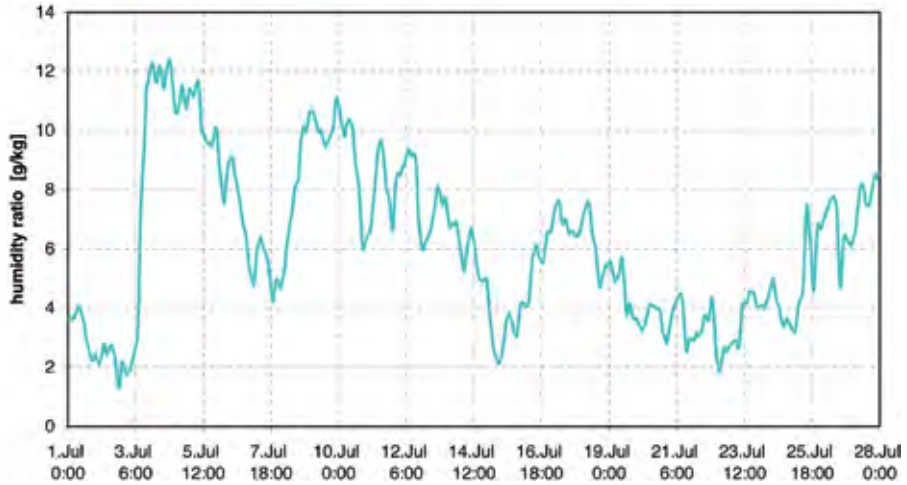

Figure 2.47  
Air humidity fluctuation in the month of June

The statistical distribution of air humidity can be plotted on a chart. This clearly shows that the air humidity level is at or above 10g/kg during only 188 hours per year.

The climate can be described as a dry desert climate. Fluctuations are due to the large differences between day and night time temperatures.

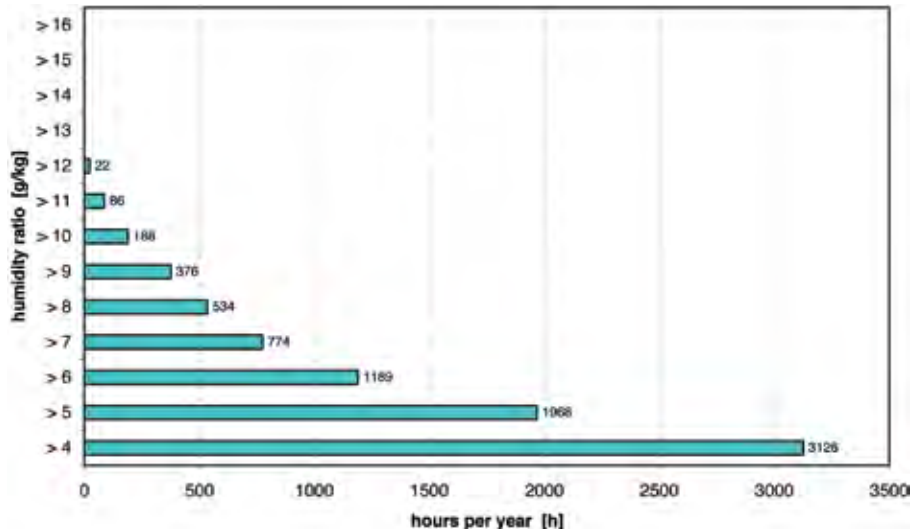

Figure 2.48  
Statistical air humidity distribution, Las Vegas

## Psychrometric chart

---

As explained in § 2.4.3 'Psychrometric Charts', temperature and air humidity can be combined in one chart. The graph highlights the results already derived from the temperature and air humidity analyses. Temperatures span a broad range, maximum air humidity lies at approximately 12 g/kg whereby a prominent concentration of the point cloud is visible in the range of 1-5 g/kg.

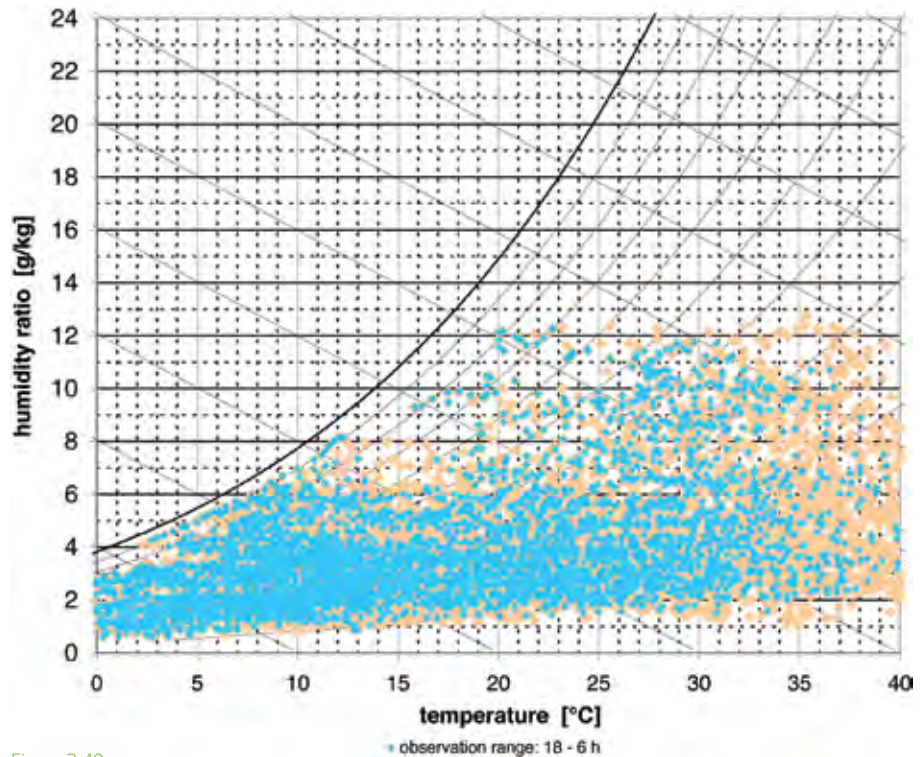

Figure 2.49  
Psychrometric chart, Las Vegas

## Monthly radiation distribution

---

The annual global solar radiation of Las Vegas is 2078 kWh/m<sup>2</sup>/a. The radiation distribution is also governed by a seasonal cycle and follows the temperature profile. Radiation is highest during the summer; in the months for May to August it is approximately 240 kWh/m<sup>2</sup>. From August on, the overlaid temperature curve veers away from the radiation distribution; a fact that points to polluted air above the city. During winter and spring the values remain above the temperature curve indicating clear skies.

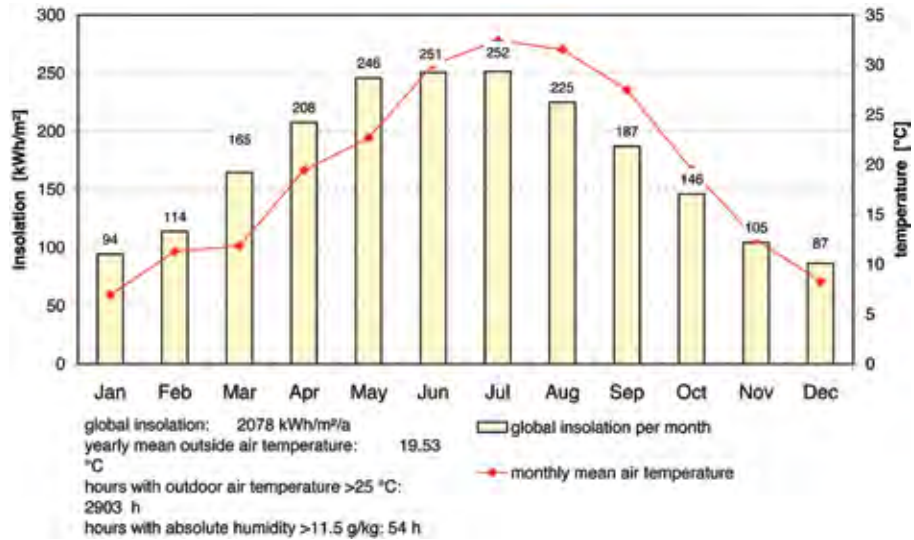

Figure 2.50  
Radiation distribution overlaid with the temperature curve, Las Vegas.

## Wind distribution / Wind rose

---

The average annual wind speed in Las Vegas is 4.06m/s. There is a noticeable difference in day time versus night time wind directions. During the day, winds can come from the north, turning through easterly all the way to south-westerly directions. Stronger winds of more than 9 m/s only occur from a south-westerly direction. However, on average wind speeds range up to 6 m/s. During the night, the main wind direction turns from westerly to south-westerly directions and shows a much smaller spread. The limitation of the temperature analysis to a minimum of 15°C shows that night winds are cooler than winds during the day.

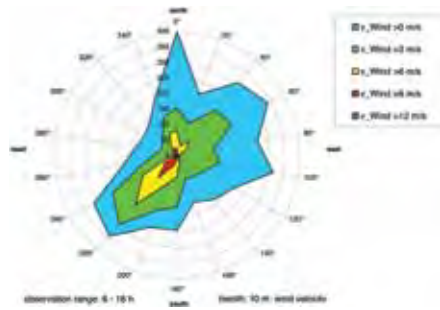

Figure 2.51:  
Wind rose, Las Vegas, day time

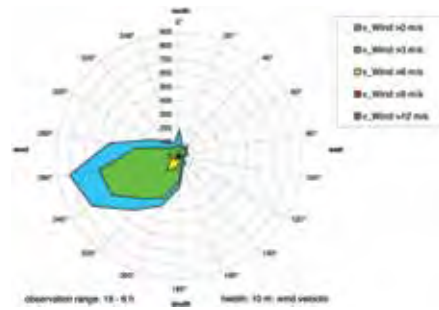

Figure 2.52:  
Wind rose, Las Vegas, night time

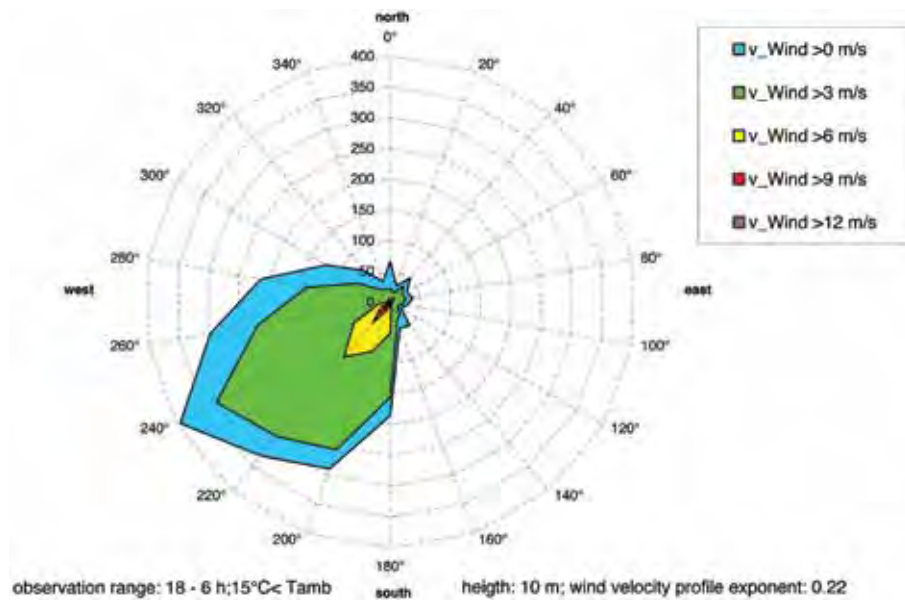

Figure 2.53  
Wind distribution above 15°C Night

Summarising the readings to collect the frequency of occurrence of wind speeds offers the opportunity of graphically illustrating wind speed distribution. The average wind speed is measured at 3-4m/s; indicated by the two largest bars on the chart.

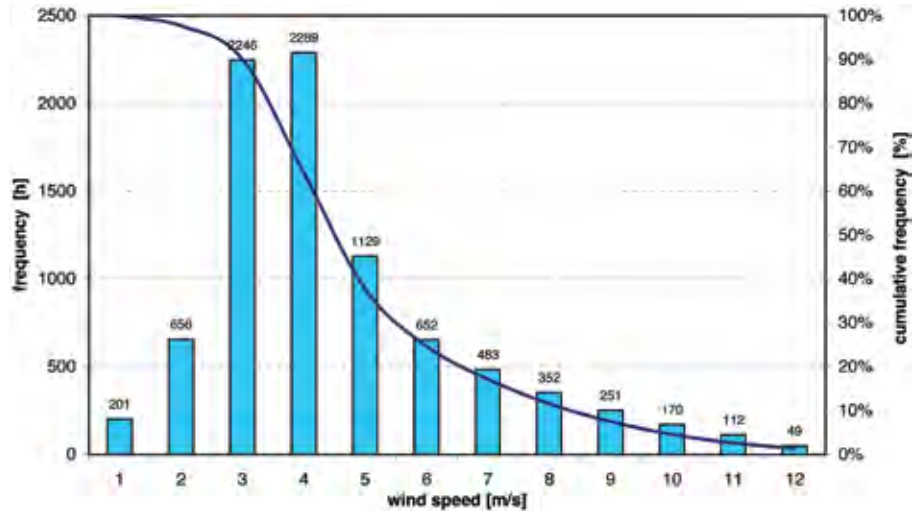

Figure 2.54  
Statistical analysis of wind speed distribution

## § 2.6.4 London

The United Kingdom of Great Britain and Northern Ireland is an island state and a constitutional monarchy in north western Europe. Great Britain is member of the European Union and the Commonwealth of Nations.

Great Britain encompasses England, Scotland, Wales and Northern Ireland (also known as Ulster) in the north eastern part of the island Ireland. The remaining part of this island belongs to the independent state Republic of Ireland.

There are numerous islands that also belong to the British national territory; Isle of Wight, Anglesey, Scilly Isles, Orkney, Shetland and the Hebrides to name a few.

To the south, the United Kingdom borders on the English Channel that separates it from the European mainland, to the east on the North Sea and to the west on the Irish Sea and Atlantic Ocean. The only land border is the border between Northern Ireland and the Republic of Ireland. Capital and largest city is London. (Microsoft, 1997)

London is situated in the southeast of England. It lies on the western side of the Thames Estuary.



Figure 2.55  
*London the city on the Themse*

London dates back to a Roman settlement. The Romans used the settlement as a harbour to ship agricultural products and minerals. Over time the settlement developed into the prosperous capital of a blooming industrial and agricultural country. The expansion of the British Empire during the 19th century drastically increased London's importance in the world. And even though the decline of the Empire after the Second World War reduced this fact to a certain degree, London remains to be a prospering cultural and financial centre.

The term City of London or City is only applied to a small territory (2.7 square kilometres) that corresponds to the Roman Londinium. Today, this area is part of the metropolis' business and finance district.

The City of London and 32 London Boroughs form the metropolitan area of greater London that spans an area of 1,580 square kilometres. The city which extends 40 kilometres along the Thames has numerous universities, colleges, theatres, museums and historic monuments. (Microsoft, 1997)

The climatic conditions are described in the following.

## Annual temperature profile

---

London's average annual temperature is 10.2°C. The temperature curve describes a seasonal cycle with a distinct cold period during winter and a noticeable increase in temperature during summer. Maximum temperatures during summer are at 31.3°C, minimum temperatures during winter at -5.8°C. Spring shows a continuous temperature increase, whereas in autumn the temperatures drop rather quickly.

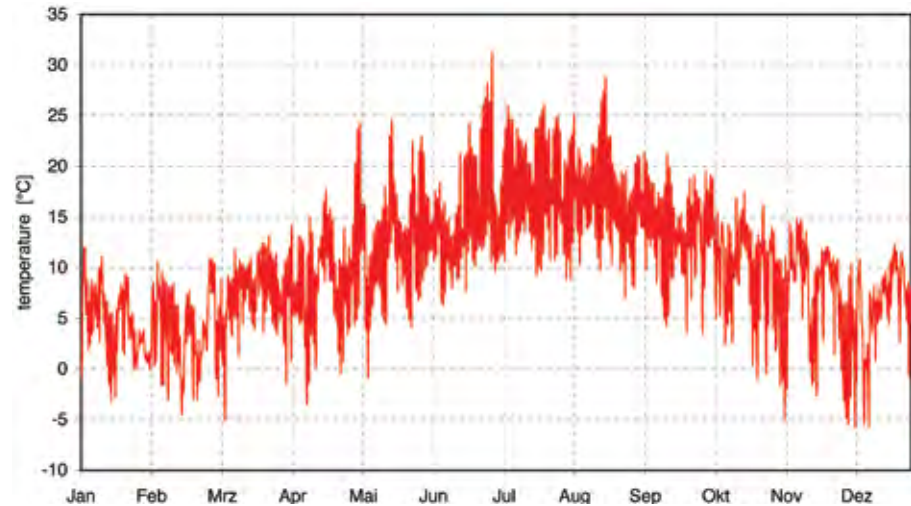

Figure 2.56  
Annual temperature profile, London

The month of July shows average temperature fluctuations of 10k, the maximum temperature differences of the day-night cycle can reach up to 15K.

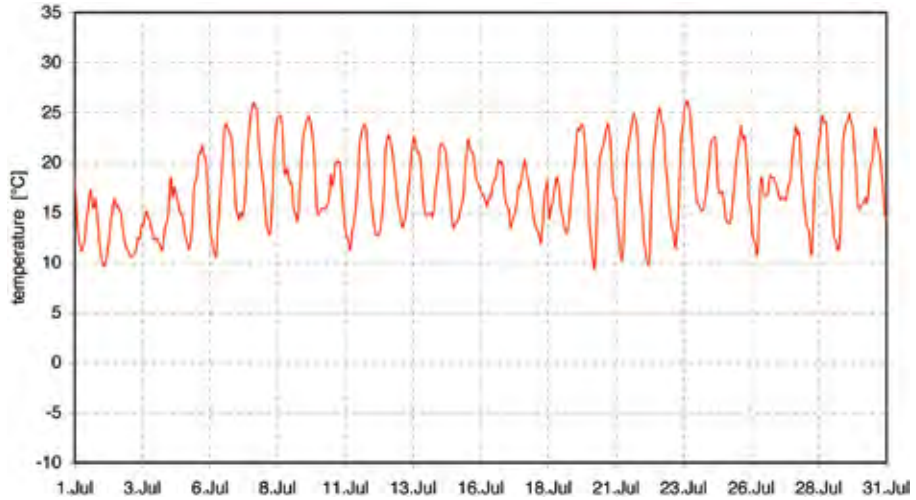

Figure 2.57  
Temperature profile for the month of July

The statistical temperature distribution can be described as follows:		
Number of hours	below 0 °C	374 h
Number of hours	below 15 °C	6910 h
Number of hours	above 25 °C	69 h
	More than 25 °C	on 69 hours per year
	More than 25 °C	on 11 days per year

Table 2.6  
The statistical temperature distribution, London

### Annual air humidity profile

.....

The annual air humidity profile describes a similar curve as that of the temperature. Maximum values range at 13g/kg, minimum values at approximately 1.5g/kg. During the summer months of June to August, air humidity reaches its highest values whereas the lowest humidity values occur during winter and spring.



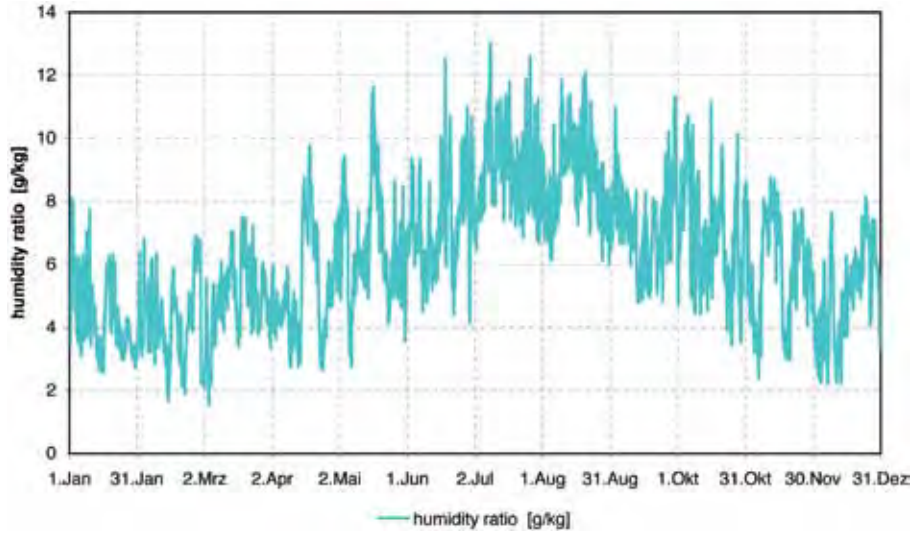

Figure 2.58  
Annual air humidity profile, London

The month of July shows differences between night and day of up to 5 g; however, differences of 2g are more common.

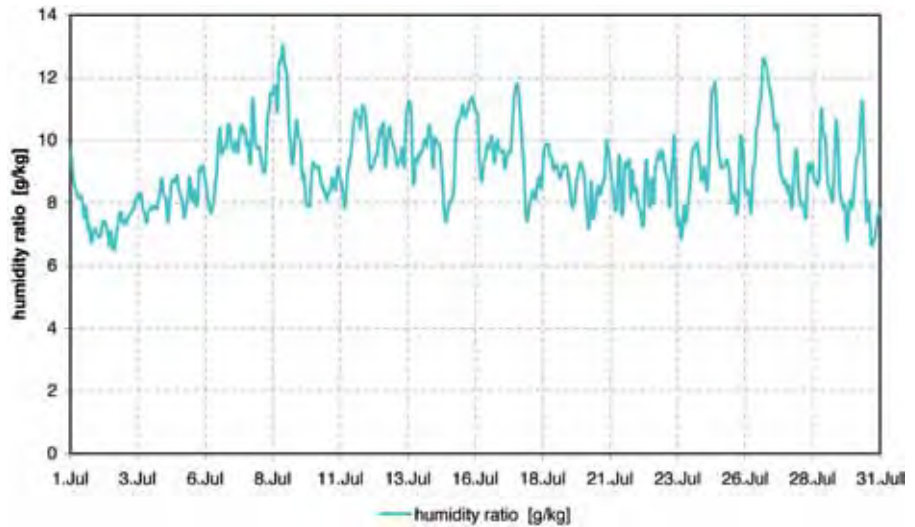

Figure 2.59  
Air humidity profile for the month of July, London

For half of the number of hours per year, the statistical distribution shows air humidity values of 6g/kg; indicating a very dry climate.

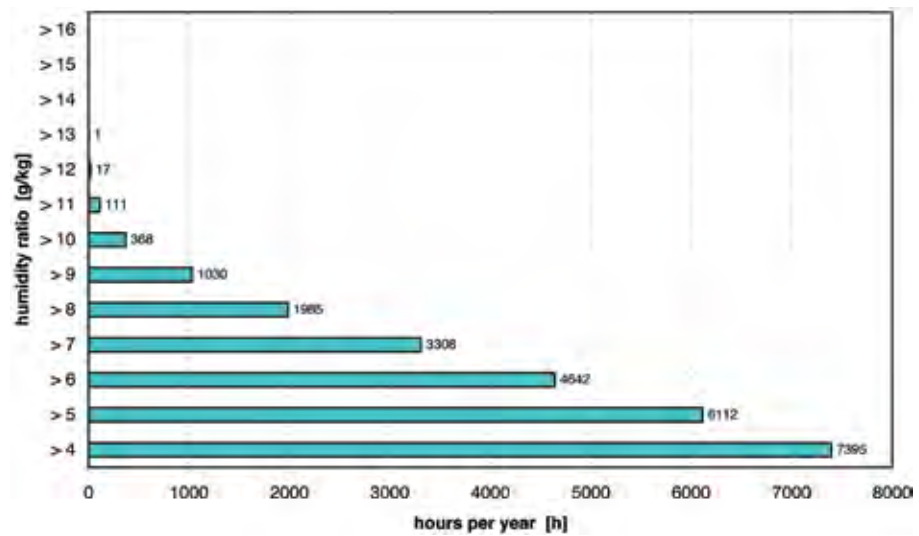

Figure 2.60  
Statistical distribution of hours per air humidity

### Psychrometric chart

.....

For the temperature range of 0- 18°C the psychrometric chart for London shows an approximation to the dew point line. As can be seen in the temperature analysis, the core area of the point cloud is at 10.2°C; however, geometrically this value is difficult to read using the point cloud. London's dry climate is indicated by the fact that the pairs of values are plotted on the lower part of the humidity scale.

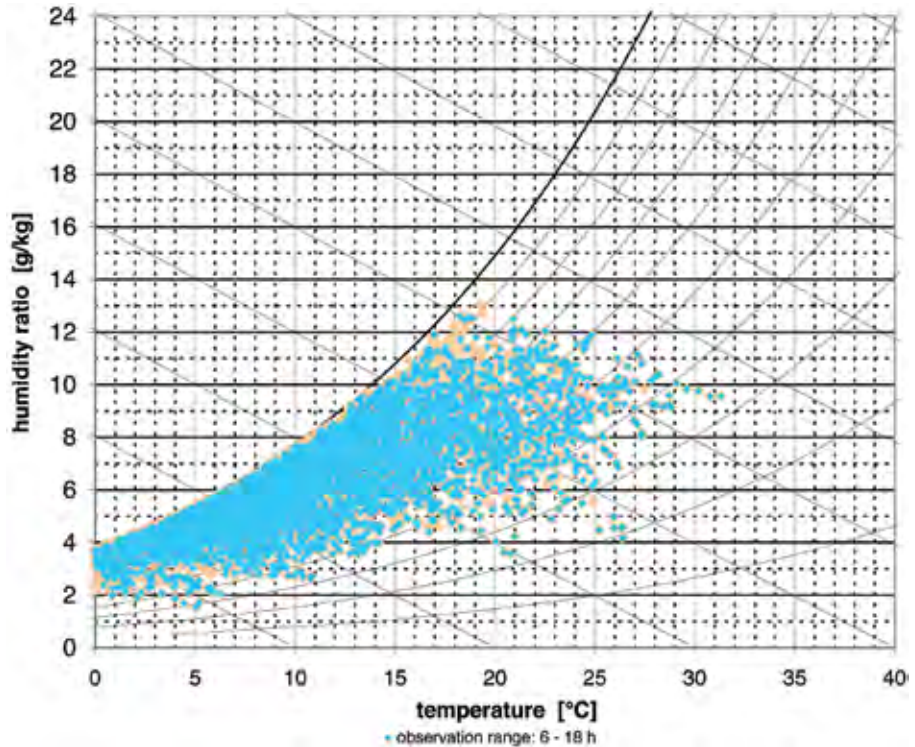

Figure 2.61  
Psychrometric chart, London

### Monthly radiation distribution

The annual global solar radiation in London is 1010 kWh/m<sup>3</sup>. The distribution of the radiation shows that the lowest amounts of radiation occur during the winter months; during December and January they are only 20 kWh/m<sup>3</sup>. Similar to the temperature curve, radiation rises from March with 66 kWh/m<sup>3</sup> to July with the largest amount of radiation at 156 kWh/m<sup>3</sup>. The phenomenon of increasing air pollution throughout the summer is also indicated by the radiation distribution: beginning in August, the temperature curve is above the amount of radiation.

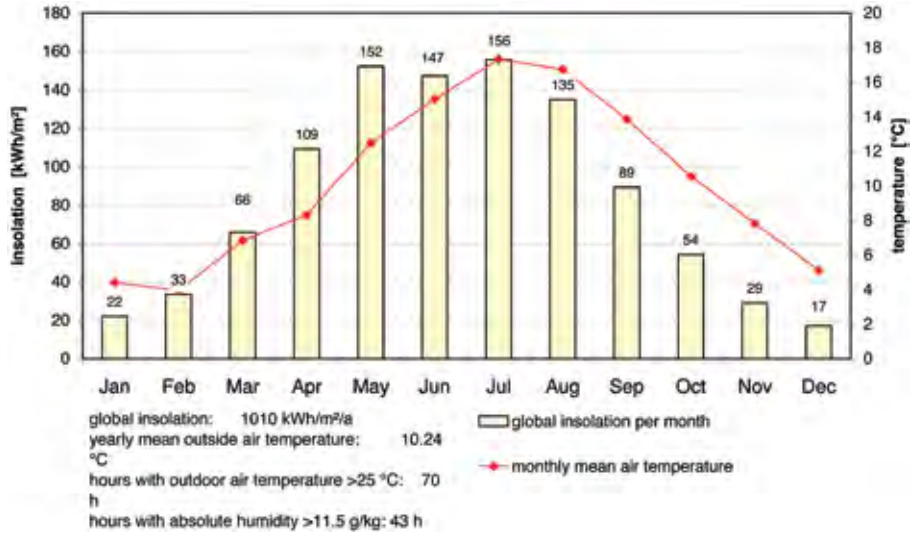

Figure 2.62  
Radiation distribution overlaid with the temperature curve, London

### Wind distribution / Wind rose

London's average annual wind speed is 3.24 m/s. For day time, the wind rose shows two prevailing wind directions. The most prominent direction is that from the south west with wind speeds of up to 3m/s. It occurs during up to 550 hours per year. Higher speeds of up to 6 or 9 m/s occur during 380 and 150 hours per year respectively. The second significant wind direction is from the north and north east with speeds of up to 3 m/s, however much less frequent with approximately 250 hours per year. The directional spread is somewhat larger than that of the above mentioned south westerly winds and measurements are much less prominent. Wind speeds of up to 6 m/s are only measured during 120 hours per year, whereby the chart shows a higher frequency of occurrence for the north-easterly direction than the northerly direction.

The wind rose for night time shows that, generally wind frequency is less during the night. This can be read from the wind speeds and their frequency of occurrence. Compared with day time occurrence, the frequency of winds with up to 6 m/s during 100 hours per year is much smaller. The two main wind directions prevailing at day time are clearly visible. The chart shows no directional shift during the night.

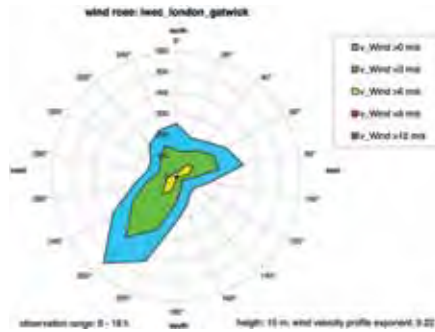

Figure 2.63:  
Wind rose, London, day time

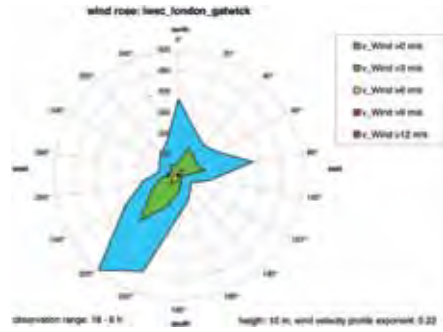

Figure 2.64:  
Wind rose, London, night time

Very few particularities can be seen when analysing the wind rose for a limited temperature range. Therefore we cannot further determine whether cold or warm winds blow from certain directions during day or night time. In general, the main wind directions remain the same, as the chart for winds below 10°C shows. Since these temperatures occur in autumn and winter, the low frequency of up to 180 hours per year is understandable.

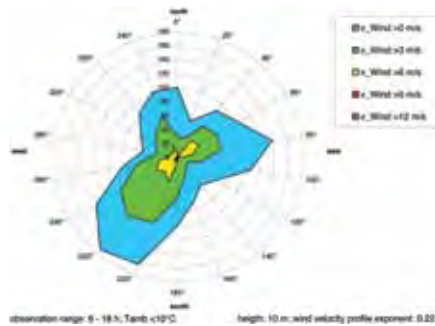

Figure 2.65  
Wind rose, London, day time below 10°C

The statistical analysis of the wind conditions in London clearly show average annual wind speeds of 3 m/s with a frequency of occurrence of 1766 hours. Significantly higher wind speeds of 6 or 9 m/s occur during far less hours per year, as can be seen in the profile of the chart.

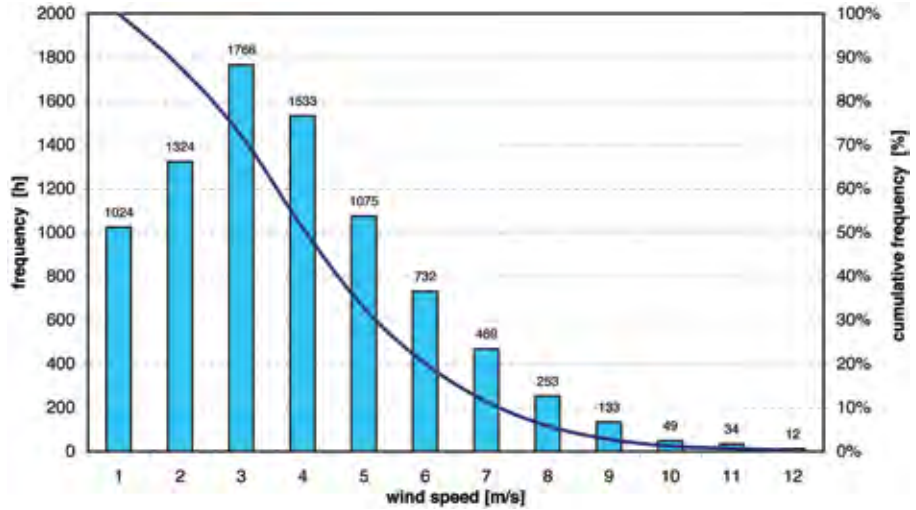

Figure 2.66  
Wind speed distribution, London

## § 2.6.5 Moscow

Russia, or Russian Federation, is a country in Eastern Europe and North Asia. With an area of 17,075,200 square kilometres, Russia is the largest country in the world and encompasses about one ninth of the earth's surface area. From the main ridges of the Caucasus to the south to the Arctic islands in the Arctic Ocean to the north, the country stretches across approximately 4,000 kilometres in north-south direction; and from the Gulf of Finland to the west to the Ratmanow Island in the Bering Sea to the east, it extends across almost 10,000 kilometres in east-west direction.

Russia borders on many countries and numerous oceans or estuaries and gulfs. To the north these are the arms of the Arctic Ocean. From west to east they include the Barents Sea, Kara Sea, Laptev Sea, East Siberian Sea and Chukchi Sea. To the east, Russia borders on the Pacific Ocean, the Bering Street which divides Russia and Alaska, as well as the Bering Sea, the Sea of Okhotsk and the Sea of Japan. To the south-east, Russia touches the north-easterly tip of North Korea. To the south it borders on China, Mongolia, Kazakhstan, Azerbaijan, Georgia and the Black Sea. To the south-west it borders on Ukraine and to the west Belarus, Lithuania, Latvia, Estonia and the Gulf of Finland, to the north-west Finland and Norway. The Russian exclave Kaliningrad borders on Lithuania, Poland, and the East Sea. (Microsoft, 1997)



Figure 2.67  
*Moscow City the new development in Moscow*

Moscow (Russian: Moskva) is the capital city of Russia and, until 1991, was the capital city of the former Union of Soviet Socialist Republics (USSR). The city on the banks of the Moskva River is Russia's political, economic and cultural centre, as well as the capital city of Russia's oblasts (subjects of the federation, an administrative division). Railways and numerous airlines from all areas of the country merge here. Navigable waterways such as the Moskva Canal, the Moskva and the Volga-Don Canal provide direct access to the harbour areas of the city for ships from the East Sea, the White, the Black, the Caspian Sea and the Sea of Azov.

Moscow extends across an area of approximately 880 square kilometres. Circular boulevards, predominantly built along former protective walls, structure the urban image. In the centre of the concentric circles and semicircles lie the Kremlin, seat of government of the Russian federation, and adjacent hereto the Red Square, the centre of the radial street system. (Microsoft, 1997)

The climatic conditions are described in the following.

## Annual temperature profile

---

Moscow's annual temperature curve shows rising temperatures in summer. The average annual temperature is  $5.5^{\circ}\text{C}$ . This low value can be explained by very low temperatures in winter. The temperatures drop to  $-25^{\circ}\text{C}$  during the months of November to February. Maximum values of  $30.7^{\circ}\text{C}$  are reached in the month of July. The temperature fluctuations occurring in winter are remarkable; temperatures can change from  $-25$  to  $5^{\circ}\text{C}$  within a few days.

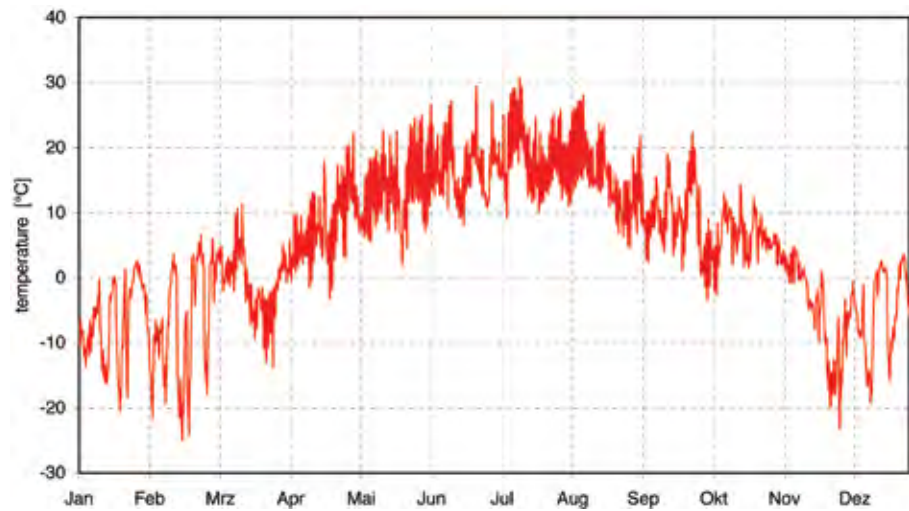

Figure 2.68  
Annual temperature profile, Moscow

A closer look at the month of July shows that temperatures fluctuate far less during summer. The average difference is 10 K between day and night time. The temperature for the month of July is almost constant.



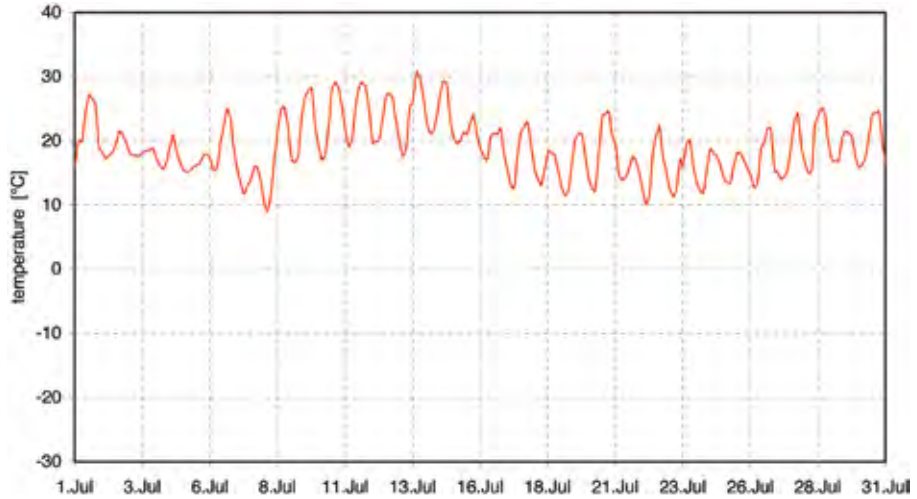

Figure 2.69  
Temperature profile for the month of July

However, the month of February as one of the coldest months shows temperature differences of up to 30K within a few days. Most noticeable hereby is that the temperature can reach above freezing even if they were at minimum values shortly before.

The statistical temperature distribution can be described as follows:		
Number of hours	below 0 °C	2561 h
Number of hours	below 15 °C	6796 h
Number of hours	above 25 °C	154 h
	More than 25 °C	on 154 hours per year
	More than 25 °C	on 19 days per year

Table 2.7  
The statistical temperature distribution, Moscow

## Annual air humidity profile

---

Moscow's annual air humidity profile describes a similar curve to the temperature curve. The driest months are from November to March which show minimum values of 0.5g/kg. In summer, the air humidity rises to maximum values of up to 14 degrees. Noticeable are fluctuations during the warm summer months.

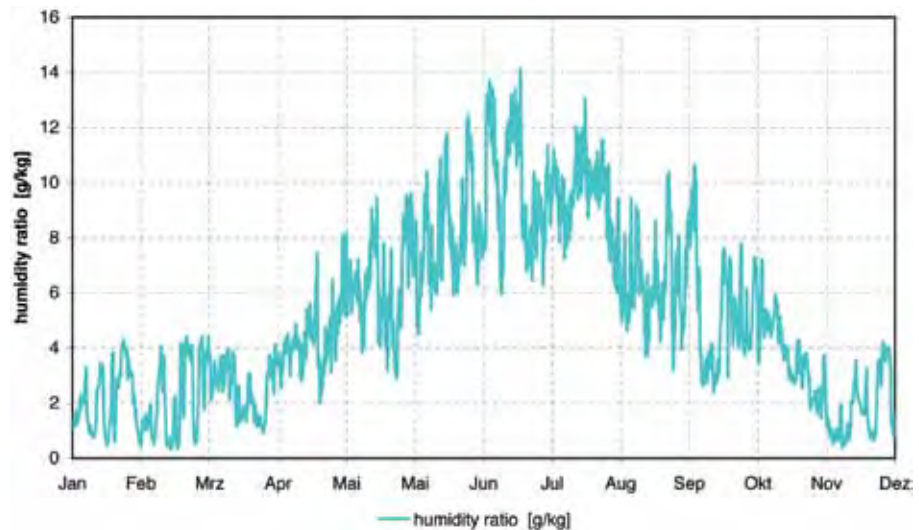

Figure 2.70  
Annual air humidity profile, Moscow

Over the year, the month of July shows the greatest fluctuations; there are fluctuations of up to 6 g throughout one day. On average, the air humidity in June however lies around 8 g/kg.

The statistical distribution of air humidity in Moscow shows a humidity of 4g/kg during 1340 hours per year as the most frequently occurring value. Humidity levels of more than 8g/kg occur during less than 30 % of the time.

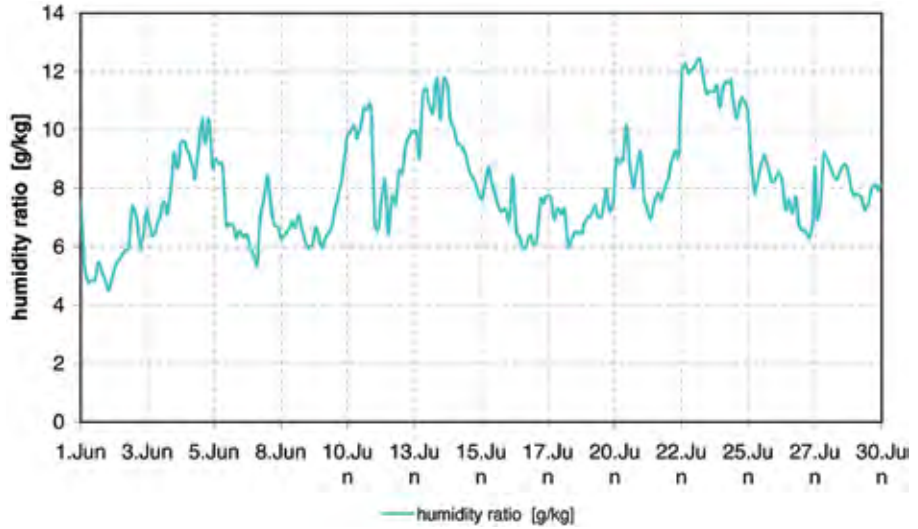

Figure 2.71  
Air humidity profile, Moscow, in the month of June

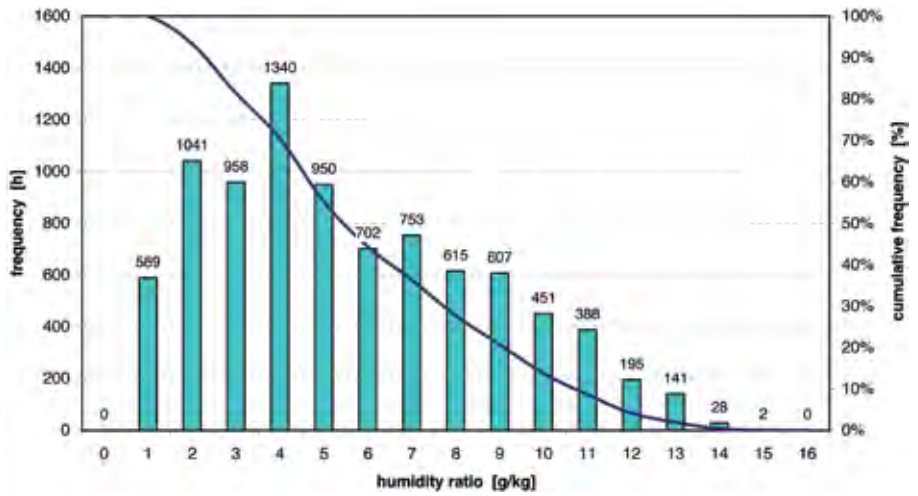

Figure 2.72  
Statistic distribution of air humidity

## Psychrometric chart

---

The psychrometric chart for Moscow shows a similar spread as that of Berlin. Because the temperatures below freezing are not included, the chart is somewhat imprecise since Moscow experiences very cold temperatures during the winter months. As seen in the temperature and humidity analysis, the core area of the point cloud lies at 4g/kg and 5.5 °C. It is remarkable that the lower limit of the air humidity occurs at approximately 40 % relative humidity.

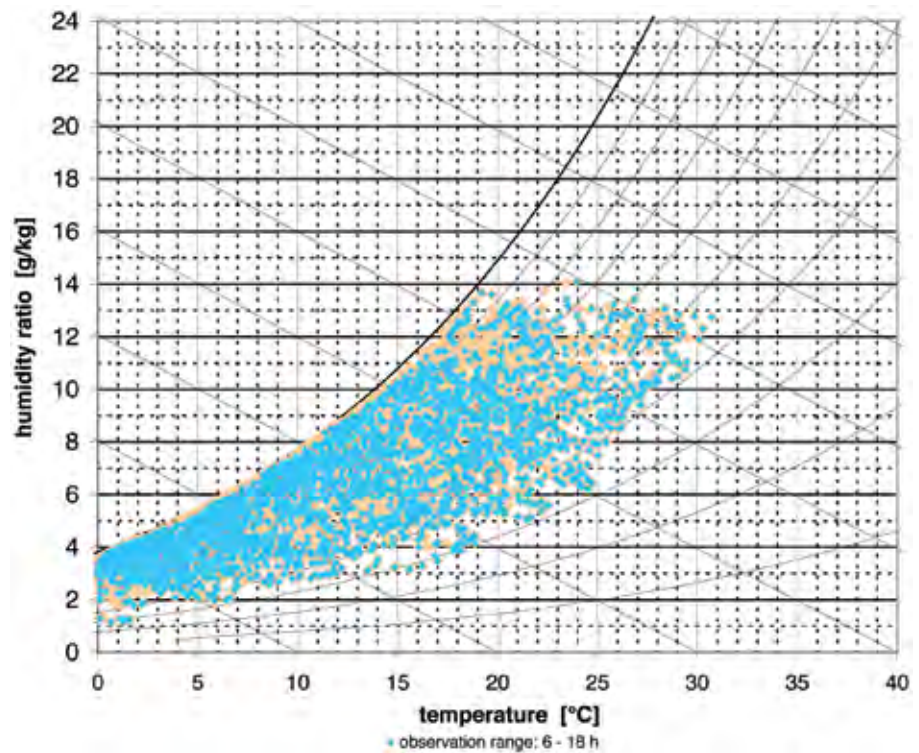

Figure 2.73  
Psychrometric chart, Moscow

## Monthly radiation distribution

---

The annual global solar radiation in Moscow is 973 kWh/m<sup>2</sup>. The lowest values are measured during the months of November to January reading 11-17 kWh/m<sup>2</sup>; maximum values during the summer time reach 163 kWh/m<sup>2</sup> during the month of June. Compared with the temperature levels, it should be noted that the sky becomes hazy from August onward and that radiation remains below the temperature – a phenomenon that occurs in the northern regions of Russia, particularly to the north of Moscow, especially in winter. The Russians have actually named this frequently occurring phenomenon “Pasmurno” which means dull, dreary weather. In December, Moscow’s sky is overcast on 23 days of the month. (Microsoft, 1997) The extremely low values of 11 kWh/m<sup>2</sup> during December prove this phenomenon.

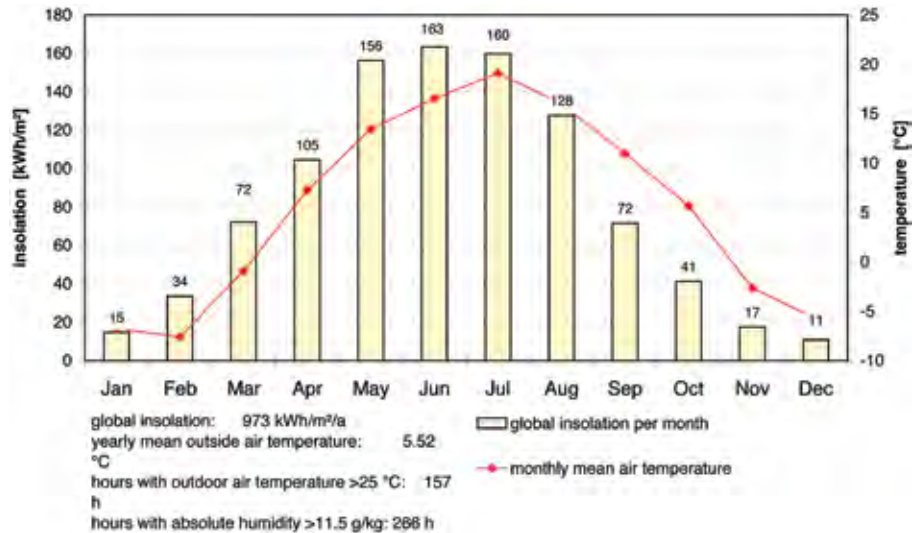

Figure 2.74  
Radiation distribution overlaid with the temperature curve, Moscow

## Wind distribution / Wind rose

---

The average annual wind speed value in Moscow is very low at 1.45 m/s. The day time wind rose shows three wind directions. The predominant direction with wind speeds of up to 3 m/s from the south west occurs during 160 hours per year. Other directions, though less frequently with approximately 140 hours are from north northwest, and

with approximately 100 hours from south southeast. It is remarkable that winds with speeds of up to 6 m/s occur only with a frequency of approximately 25 hours per year from north northwest.

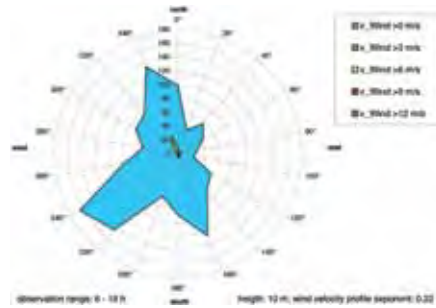

Figure 2.75:  
Wind rose, Moscow, day time

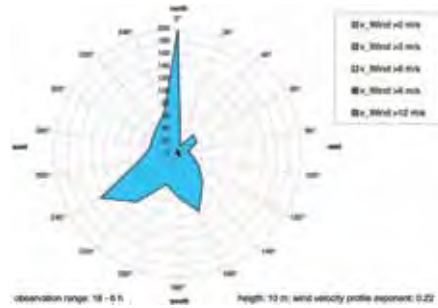

Figure 2.76:  
Wind rose, Moscow, night time

For night time, the wind rose always shows the same wind directions. The largest amount of wind comes from the north with frequencies of up to 200 hours per year and speeds of up to 3 m/s.

A detailed look at a selected temperature range – in this case of warm winds above 15 °C – does not show a large difference compared to the general wind rose. Frequencies of up to 50 hours per year highlight the few hours per year with temperatures above 15 °C.

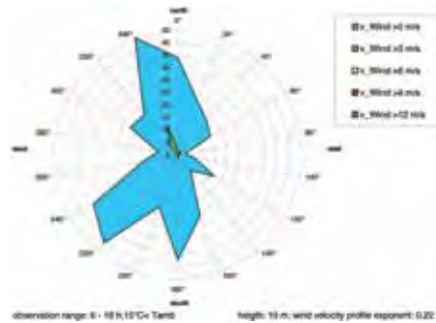

Figure 2.77  
Wind rose, Moscow, day time above 15°C

The statistical wind distribution also shows that Moscow does not experience significant wind activity. The prevailing winds blow at speeds of 1 and 2 m/s; speeds in excess of 5 m/s do not occur.

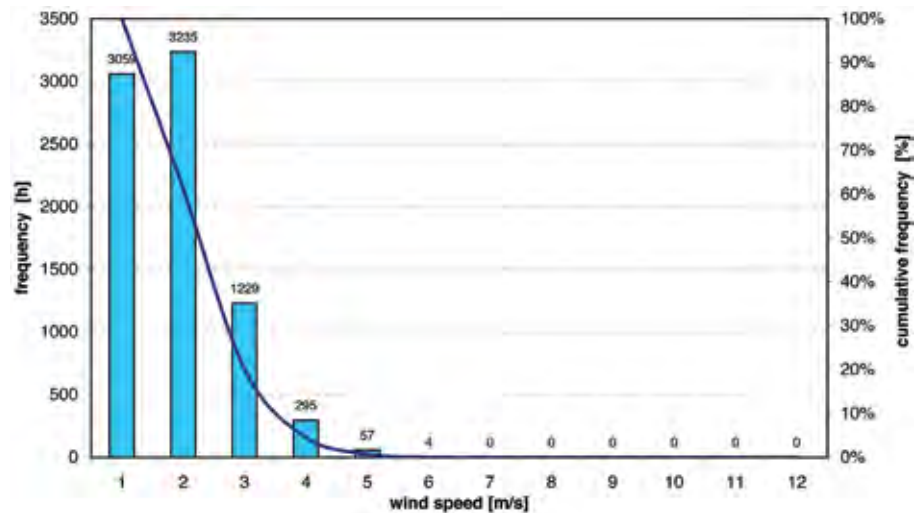

Figure 2.78  
Statistical wind distribution, Moscow

## § 2.6.6 New York

The United States of America are also known as the United States, the U.S., the USA or America. The USA is a presidential republic with a federal constitution in North America. It encompasses 50 states (including Alaska and Hawaii), and the District of Columbia with limited self-governance. Overseas territories of the United States are Puerto Rico, American Samoa, Guam, the United States Virgin Islands and the Northern Mariana Islands. The United States border on Canada to the north, the Atlantic Ocean to the east, the Gulf of Mexico and Mexico to the south, and the Pacific Ocean to the west. The northern border is partially formed by the Great Lakes and the Saint Lawrence River, the southern border partially by the Rio Grande. The total area of the United States is 9,826,630 square kilometres; hereof Alaska measures 1,717,854 square kilometres and Hawaii 28,311. Inland waters account for 507,788 square kilometres of the total area. The largest city is New York, capital city is Washington D.C. (Microsoft, 1997)



Figure 2.79  
*Manhattan New York*

New York is part of New York State and is distributed over an area of approximately 800 square kilometres. Population is approximately 8.1 m people. To distinguish the city from the state it is often referred to as New York City. Its nick name is Big Apple.

The Consolidated Metropolitan Area to which New York and the surrounding cities belong has approximately 18.09 m inhabitants. Administratively, Greater New York is divided into five boroughs: Queens, Brooklyn, Richmond (on Staten Island), The Bronx and Manhattan.

New York is situated on the East Coast of the USA in the New York Bay at the mouth of the Hudson River and the East River, directly adjacent to Jersey City. The city centre lies on Manhattan Island which is a narrow rocky island located between the Hudson and the East River. With a multitude of suburbs, urban developments spread from the river banks to other major cities and reach far into the country. The New York Metropolitan Area extends over more than 27,000 square kilometres.

Because of its location at the Atlantic Ocean and the Hudson River leading inland, the city has attracted immigrants from all over the world since 1825. Further development has made New York into the largest industrial city and a financial hub. (Microsoft, 1997)



At medium depths, the building ground in New York consists of granite (massive, coarse-grained intrusive igneous rock with high compressive strength). Therefore buildings of several hundred metres in height can be realised easily and cost effectively. (Brackmann, 2006)

The climatic conditions are described in the following. The weather data record is based on a TMY data record. The way a Typical Meteorological Year (TMY) data record is created can be compared to that for an IWEC data set. But because the average values are generated from up to 30 years of hourly readings, extreme readings do not influence the data as much as with IWEC data. (Energy, 2008) Since in the further course of the analysis the goal is to work out principles, this data set can be considered comparable to the IWEC data set for the scope of this thesis.

#### Annual temperature profile

---

The annual temperature profile for New York shows a curve with a clear incline during the summer months. The average annual temperature in New York is 12.1°C. The maximum outside temperature is 34.9°C and occurs in June. The lowest temperatures of -15.6°C occur during the month of January; the temperature during the winter months can lie significantly below freezing. The curve describes a constant incline from February to June; from July onward until winter the temperatures drop again.



Figure 2.80  
Annual temperature profile, New York

A detailed look at the month of July shows temperature fluctuations between day and night of up to 15K; however, fluctuations of around 10K are far more common.

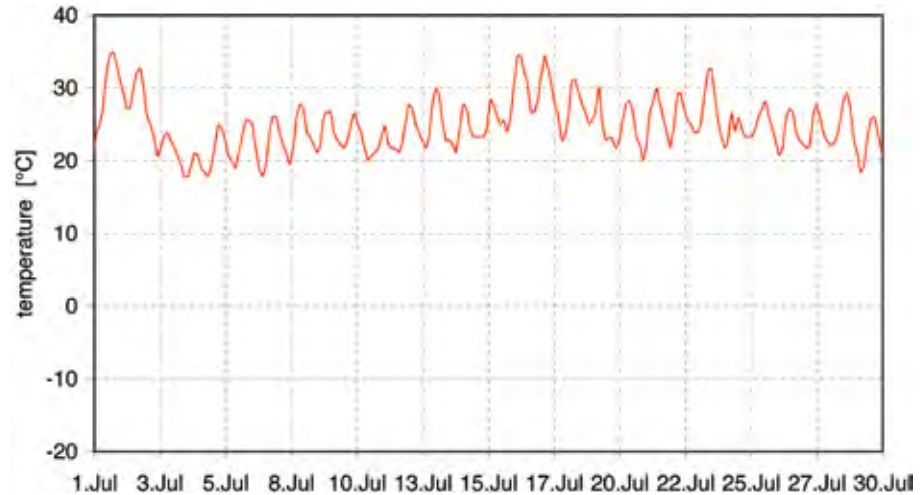

Figure 2.81  
Temperature profile for the month of July

The statistical temperature distribution can be described as follows:		
Number of hours	below 0 °C	1110 h
Number of hours	below 15 °C	4997 h
Number of hours	above 25 °C	816 h
	More than 25 °C	on 816 hours per year
	More than 25 °C	on 80 days per year

Table 2.8  
The statistical temperature distribution, New York

### Annual air humidity profile

.....

The annual air humidity profile of New York forms a similar curve to the previously described temperature profile. Notice though that the maximum values are offset by two months beginning in August. From the end of the month on air humidity experiences a strong decline through autumn and into winter. Maximum values are 19 g/kg during the month of August, minimum values 0.5 g/kg during January.

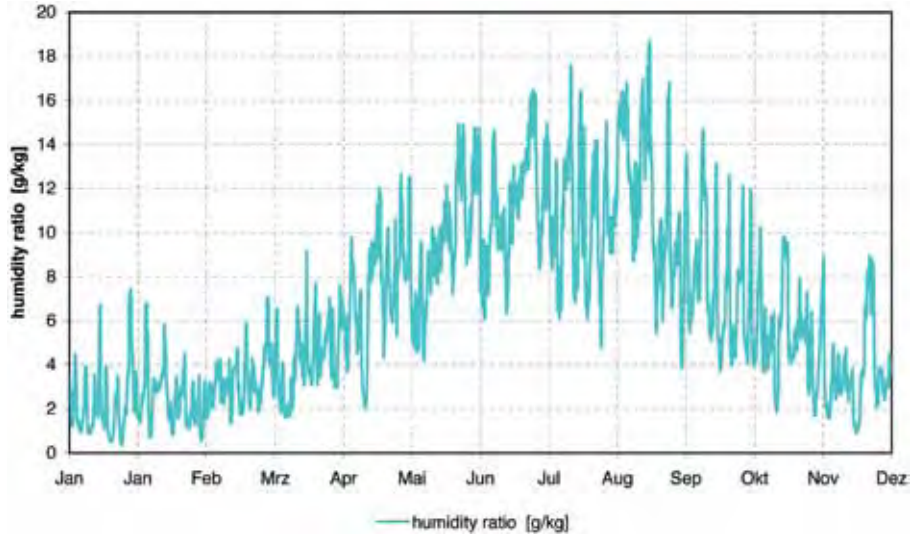

Figure 2.82  
Annual air humidity profile, New York

A detailed view shows that during the month of July, for example, large fluctuations occur between day time and night time. During this month, the differences vary from 1 g to 5 g.

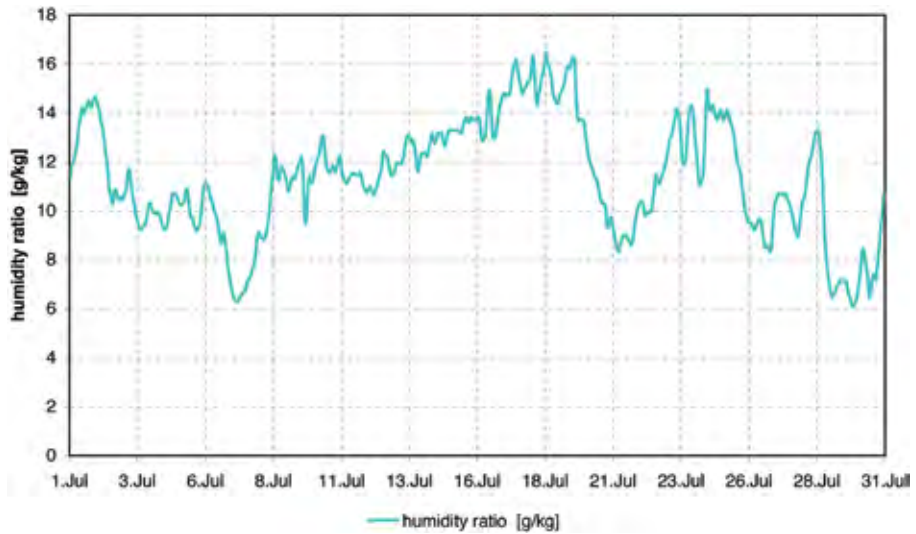

Figure 2.83  
Air humidity profile, New York, during the month of July

The statistical distribution of the measured air humidity shows a broad range of values. Those hours during summer that, with values in excess of 14g can be described as muggy, account for 425 hours of the year.

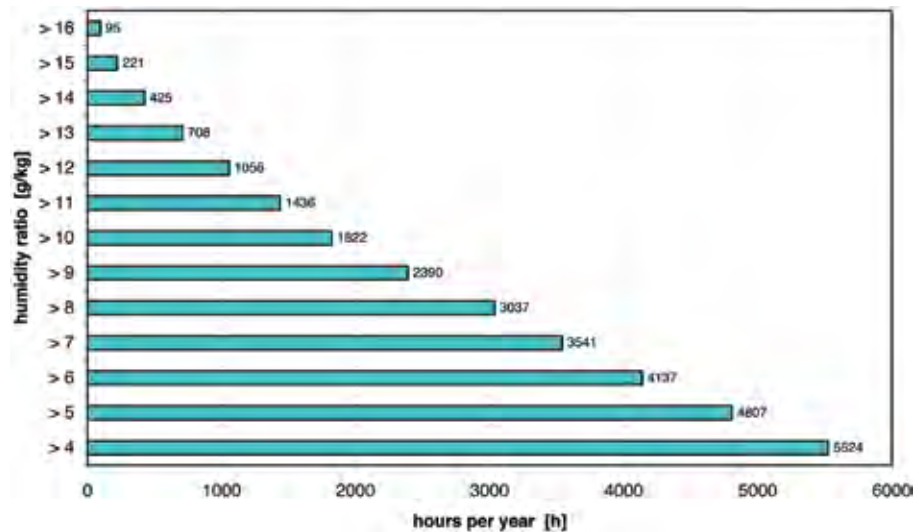

Figure 2.84  
Statistical distribution of air humidity in hours

### Psychrometric chart

The psychrometric chart shows an arc-shaped formation of the point cloud with a broad range of measurement values. As highlighted in the previous temperature and air humidity analysis, temperatures range from  $-15^{\circ}\text{C}$  to  $35^{\circ}\text{C}$ . Temperatures below freezing are not included in the chart. Air humidity is in the range of 0.5 – 19 g/kg maximum. But the point cloud clearly shows the most concentrated accumulation of measurement data in a temperature range of 10-15°C, and a humidity range of 1-10g/kg. The air humidity point cloud lies in the upper region with a maximum of 90% relative humidity, minimum values do not reach below 20% relative humidity at temperatures up to 15°C and 30% at temperatures above 15°C.

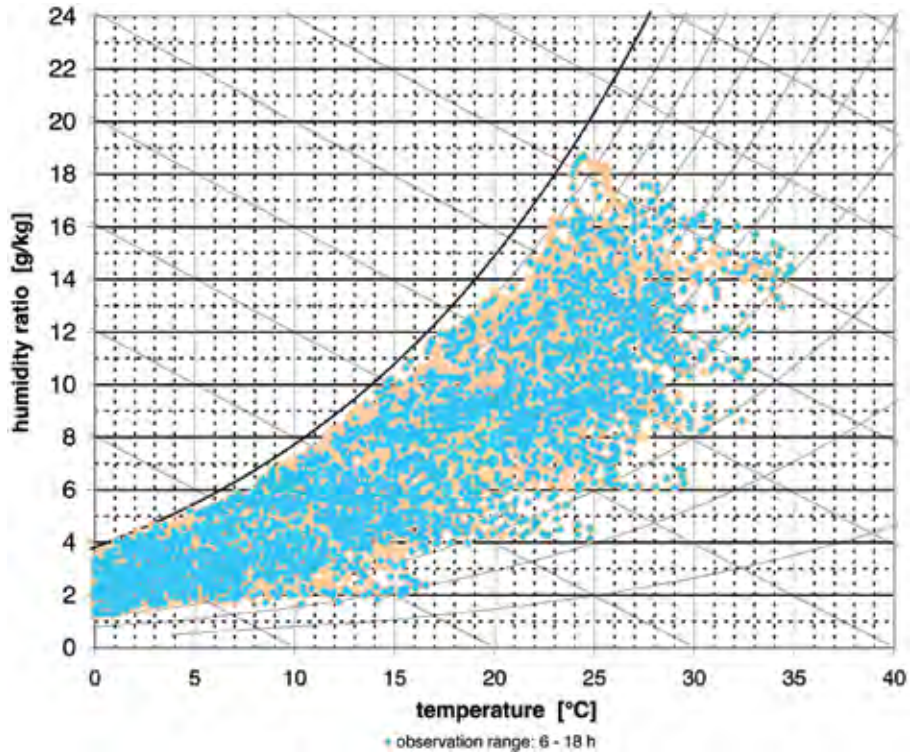

Figure 2.85  
Psychrometric chart, New York

### Monthly radiation distribution

The average annual global solar radiation in New York is 1462 kWh/m<sup>2</sup>. Similar to the temperature curve, the maximum values of the plotted radiation values occur during the months from May to August, and June and July show the highest radiation volume at 189 kWh/m<sup>2</sup> each. The lowest radiation values of up to 51 kWh/m<sup>2</sup> are measured during the months of November to January. There is a noticeable difference between the temperature curve and global solar radiation at the beginning of the year; until July global solar radiation lies above the temperature curve and then it drops slightly below it.

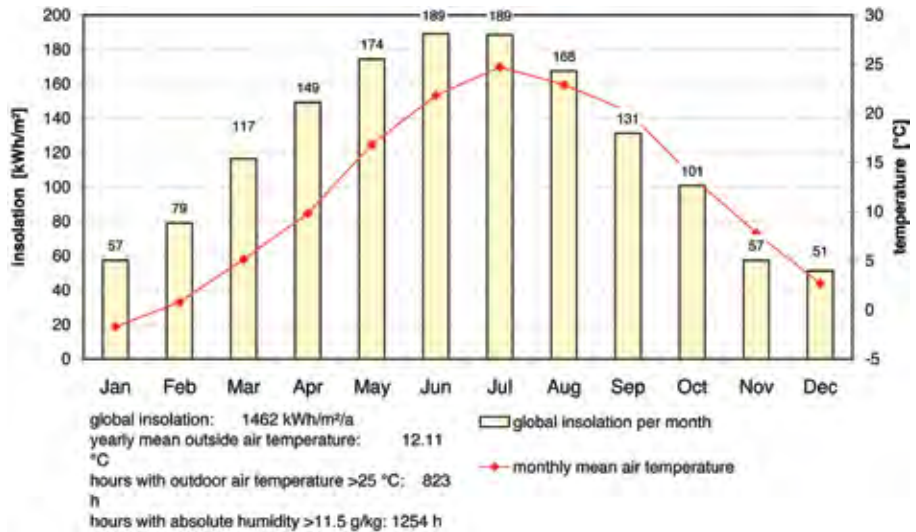

Figure 2.86  
Radiation distribution overlaid with the temperature curve, New York

### Wind distribution / Wind rose

The average annual wind speed in New York measures 5.19 m/s. The day time wind rose shows three main wind directions. Winds from the north west with speeds of up to 9m/s occur most frequently. Wind with wind speeds of up to 6m/s usually blow from the south or north east.

The night time wind rose shows less clearly definable wind directions. The directions of the day time winds are repeated also but they cover a larger spread which indicates constantly shifting wind directions. However, the strongest winds of up to 9m/s are north easterly winds at speeds of up to 9m/s during day time.

Looking at limited temperature areas shows that cold winds below 10°C during night time predominantly blow from north westerly directions. Warm winds during the day with temperatures above 15 °C on the other hand typically come from the south.

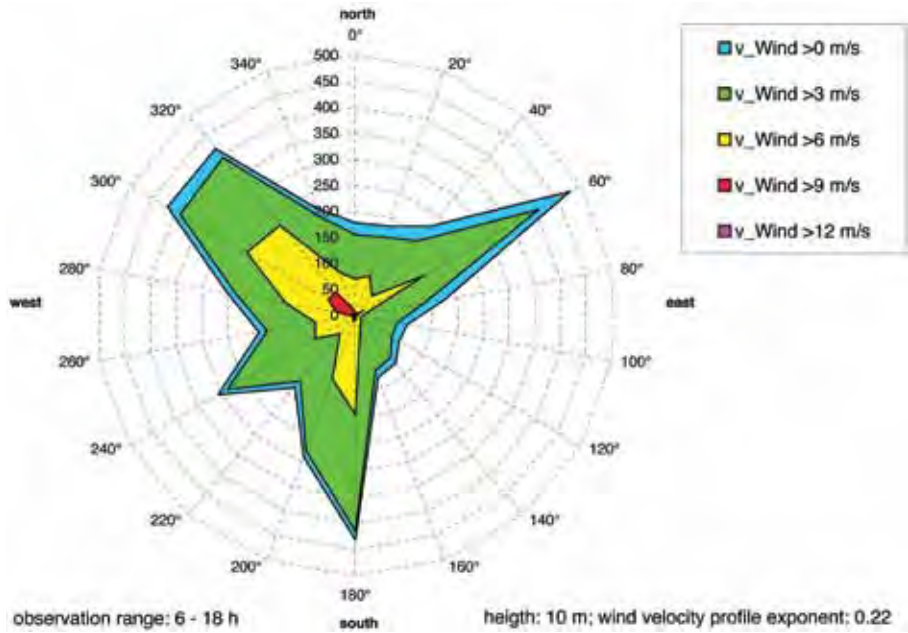

Figure 2.87  
Wind rose, New York, day time

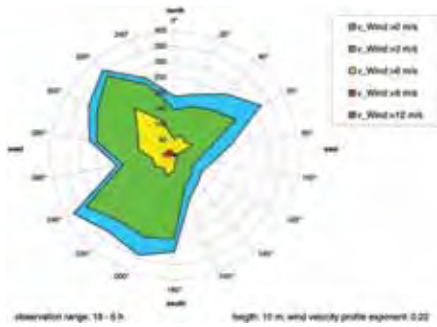

Figure 2.88:  
Wind rose, New York, night time

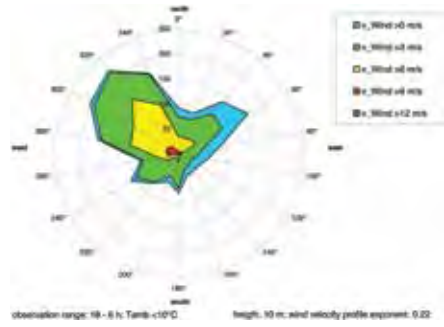

Figure 2.89:  
Wind rose, New York, night time below 10°C

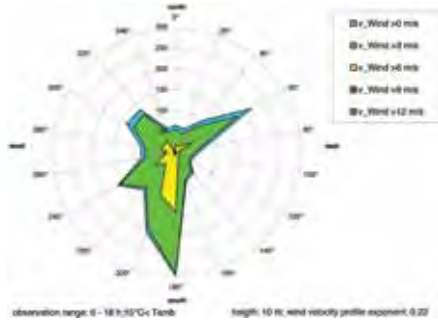

Figure 2.90  
Wind rose, New York, day time above 15°C

The statistical wind distribution clearly shows the frequency of wind speeds of 4-6 m/s during more than 4000 hours per year.

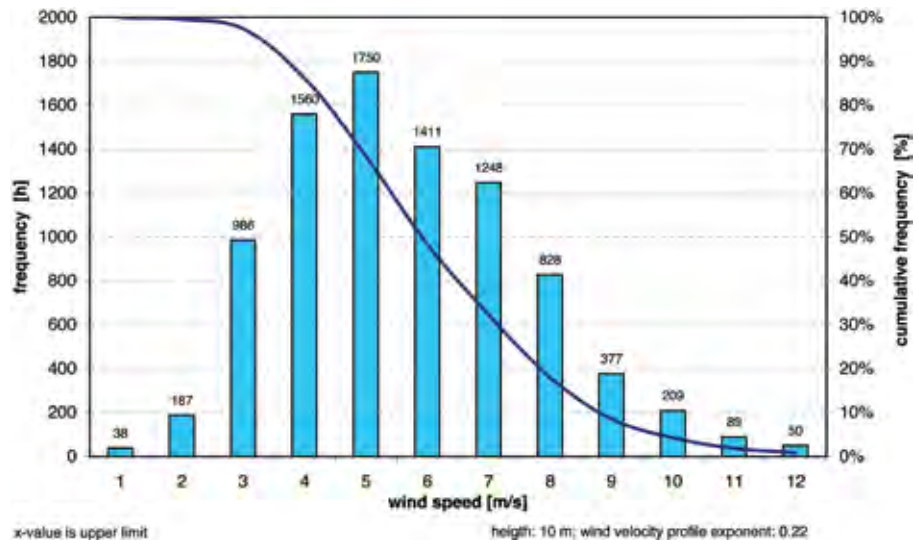

Figure 2.91  
Statistical wind distribution, New York



## § 2.6.7 Shanghai

---

The People's Republic of China is situated in East Asia. It borders on Mongolia and Russia to the north, Russia and North Korea to the north east, the Yellow Sea and the East China Sea to the east, the South China Sea, Vietnam, Laos, Myanmar, India, Bhutan and Nepal to the south, Pakistan, Afghanistan and Tajikistan to the west, and Kyrgyzstan and Kazakhstan to the north west. More than 3,400 islands belong to China. Hainan Island in the South China Sea is the largest Chinese island. Including Taiwan, which China considers to be a Chinese province, the country covers approximately 9.6 m square kilometres. China's capital city is Peking, the largest city is Shanghai. More than a fifth of the entire Earth's population lives within China's borders. China is one of the earliest civilisations on Earth. "Zhonghua", the Chinese name of the country, means "Middle Kingdom". It proves the Chinese belief that their country is the geographic centre of the Earth and the only true civilisation. (Microsoft, 1997)

Shanghai is a city in eastern China, lying in the mouth of the Yangtze River. Shanghai is one of the largest cities in the world, the largest city in China, and the country's most important trade and finance centre. The city is directly administered by the government and the entire urban agglomeration covers approximately 6.2 square kilometres. Including the city proper it encompasses several industrial zones, suburbs and agricultural districts. (Brackmann, 2006)



Figure 2.92  
*The skyline of Shanghai*

Shanghai has the largest harbour in the world. In 2004, the port handled 380 m tons. The city is an important transportation hub as well as a significant cultural and educational centre with numerous universities, colleges, research institutes, theatres and museums.

The city proper is the principle residence of approximately 9.26 m people; the entire area of administration of Shanghai counts approximately 18 m inhabitants. About 13.5 m of these are registered inhabitants with a permanent residence, whereas approximately 4.7 m people live in Shanghai with a temporary residence authorisation. Another approximately 3 m unregistered people live in the urban area illegally. (Microsoft, 1997)

The high occurrence of earthquakes makes building high-rises in Shanghai particularly challenging. Even though this analysis does not usually include amounts of precipitation, three periods of strong rainfall during the months of June to September need to be mentioned here.

The climatic conditions are described in the following.

#### **Annual temperature profile**

---

The annual temperature profile of Shanghai clearly shows the individual seasons of the year; the temperature curve rises continuously beginning in March until mid summer, and then continuously falls throughout the autumn months into winter. The average annual temperature is 16.3°C. Maximum outside temperature is 38.1°C, with the hottest month being July. The lowest temperatures are registered during the winter months December and January. With minimum temperatures of -3.5°C they can reach below freezing level.



Figure 2.93  
Annual temperature profile, Shanghai

During the hottest month, July, temperature fluctuations of up to 10K occur. The average temperature difference between day and night is approximately 8K. Temperatures, that during daytime can reach 38°C, fall to 28°C during the night, which is still very hot.

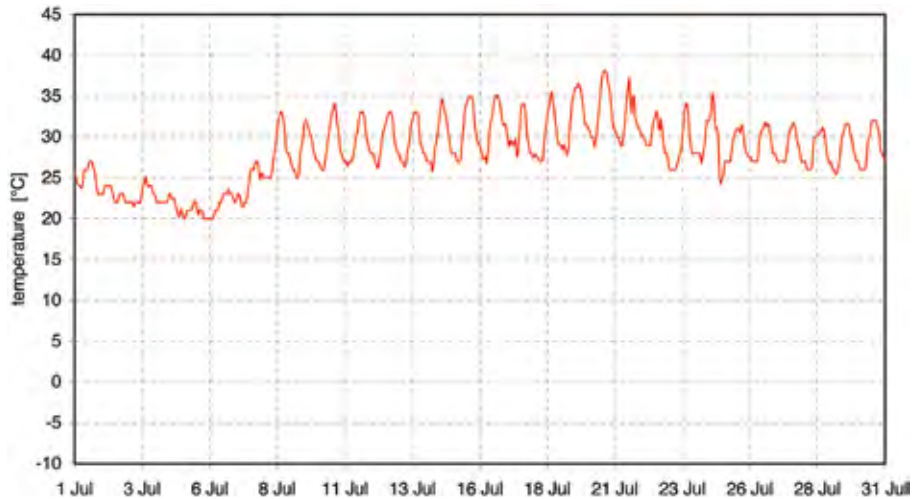

Figure 2.94  
Temperature profile for the month of July

The statistical temperature distribution can be described as follows:		
Number of hours	below 0 °C	172 h
Number of hours	below 15 °C	3863 h
Number of hours	above 25 °C	1781 h
	More than 25 °C	on 1781 hours per year
	More than 25 °C	on 109 days per year

Table 2.9  
The statistical temperature distribution, Shanghai

### Annual air humidity profile

The annual air humidity profile describes a similar curve as that of the temperature. Maximum values of up to 24g/kg can be measured during the summer months July, August and September. Minimum values during the winter months lie at 2g/kg. Compared to the temperature curve, air humidity notably rises higher than temperature during the month of April. The curve shows the periods with intense rain that begin in June.

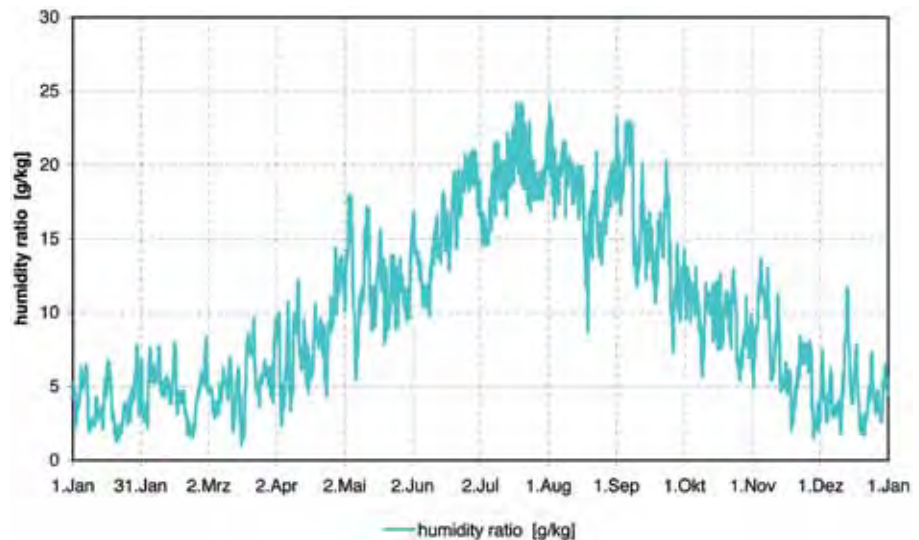

Figure 2.95  
Annual air humidity profile, Shanghai

The month of July is a good example to show the large differences between day time and night time. The curve shifts within a range of 14g to 24g. However, the fluctuations between day and night lie within a difference of 3 and 8g maximum.

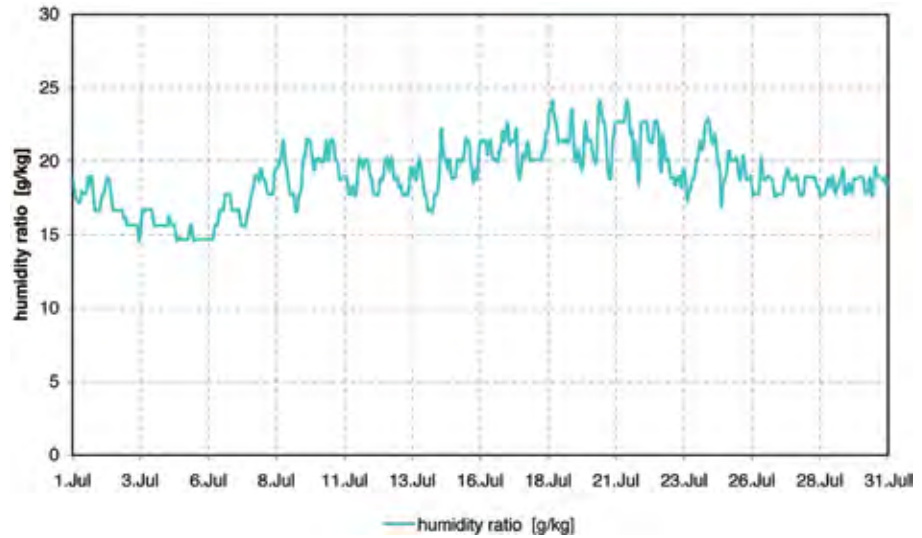

Figure 2.96  
Air humidity profile for the month of July, Shanghai

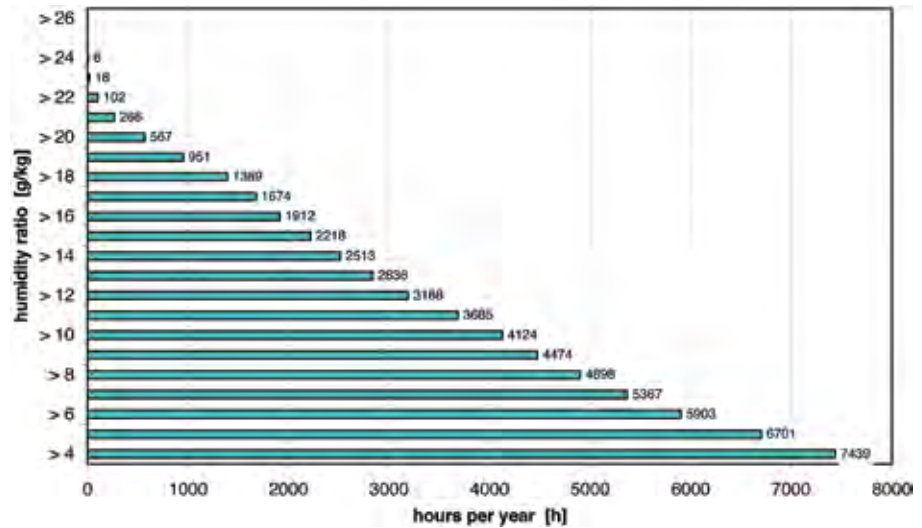

Figure 2.97  
Statistical distribution of hours per air humidity

The statistical distribution of the air humidity measurements clearly identifies a humid climate. During about half of the year, air humidity values of approximately 12g prevail. The number of hours with very humid conditions in excess of 18g/kg add up to 1300 hours per year.

### Psychrometric chart

---

The psychrometric chart describes a banana-shaped accumulation along the dew point curve of 100% relative humidity, which points at very high air humidity, the maximum values of 24g described earlier prove this. The wide spread of the temperature and humidity pairs of values across the entire chart are remarkable. Temperatures range from 0 – 38°C; the temperature analysis shows temperatures below freezing as well, which are not included in this chart. In the area of relative humidity the minimum lies at 50%; however the highest concentration of the point cloud lies around values of 70% and more. Due to the wide spread of the point cloud it is difficult to describe its core area geometrically, but in terms of temperature it is defined by the average annual temperature around 16.3°C.

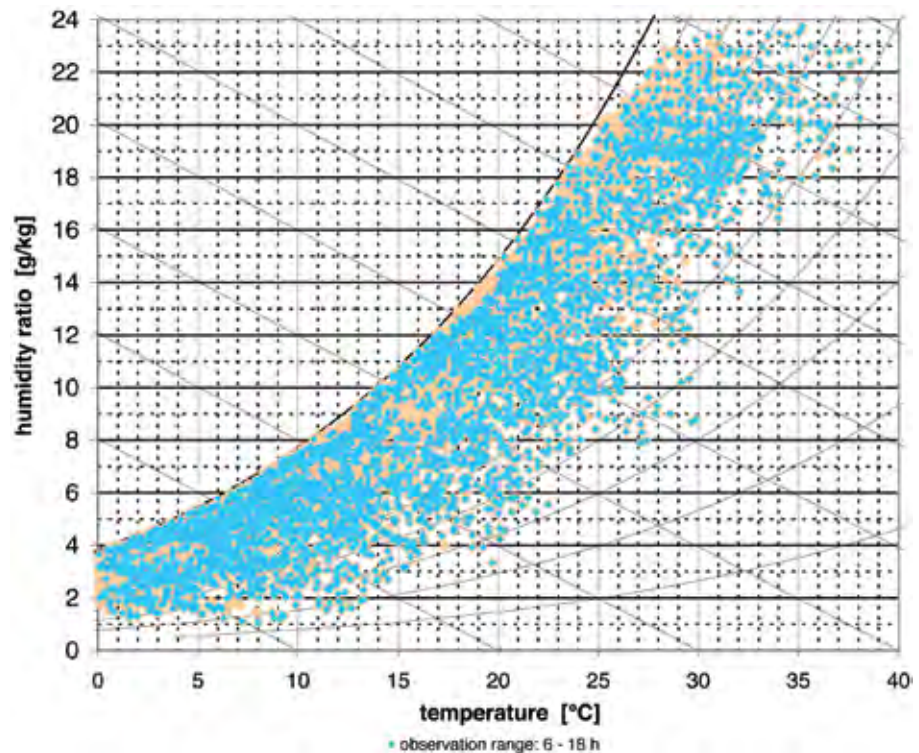

Figure 2.98  
Psychrometric chart, Shanghai

## Monthly radiation distribution

---

Global solar radiation in Shanghai is 1242 kWh/m<sup>2</sup> per year. The distribution follows a seasonal cycle analogue to the temperature values. The winter months with approximately 65 kWh/m<sup>2</sup> have a significantly lower radiation level than the summer months, during which values of up to 150 kWh/m<sup>2</sup> can be reached. Notable are strong fall-offs during the months of June and September. Seasonal cloudbursts that occur during these months explain the phenomena. A comparison with the temperature curve shows that radiation levels are above the temperature curve up until May. Only beginning in June, radiation falls compared to temperature, pointing to increased air pollution or hazy skies.

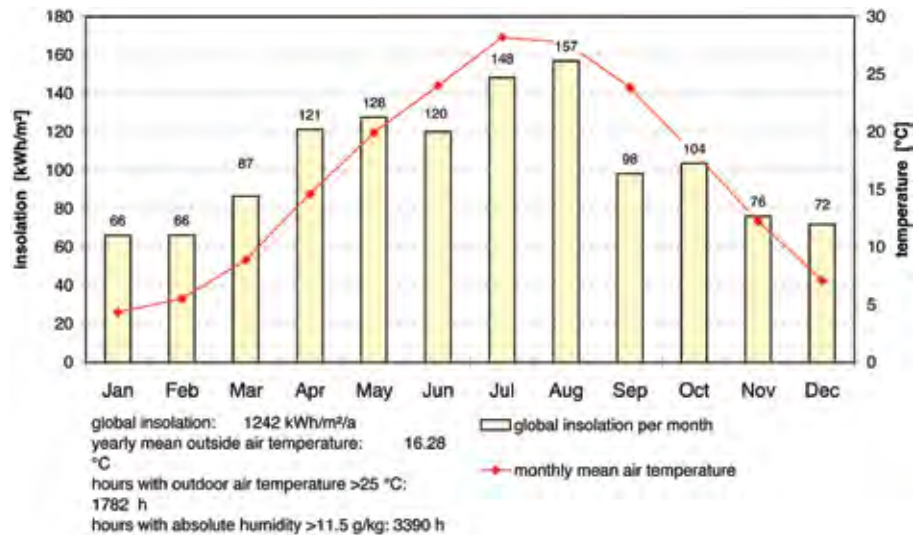

Figure 2.99

Radiation distribution overlaid with the temperature curve, Shanghai

## Wind distribution / Wind rose

---

Shanghai's average annual wind speed is 3.11 m/s. For day time, the wind rose shows two prevailing wind directions. Slightly more frequently the wind comes from the south west; maximum wind speeds lie at up to 9m/s during 100 hours, whereas lower wind speeds of up to 6m/s occur more frequently. The second main wind direction shown on the wind rose is north east; however its spread shows that this occurs less frequently and that wind speeds from this direction are limited to 6m/s.

Night time shows similar wind distribution, whereby north easterly winds occur more frequently than those from the south west.

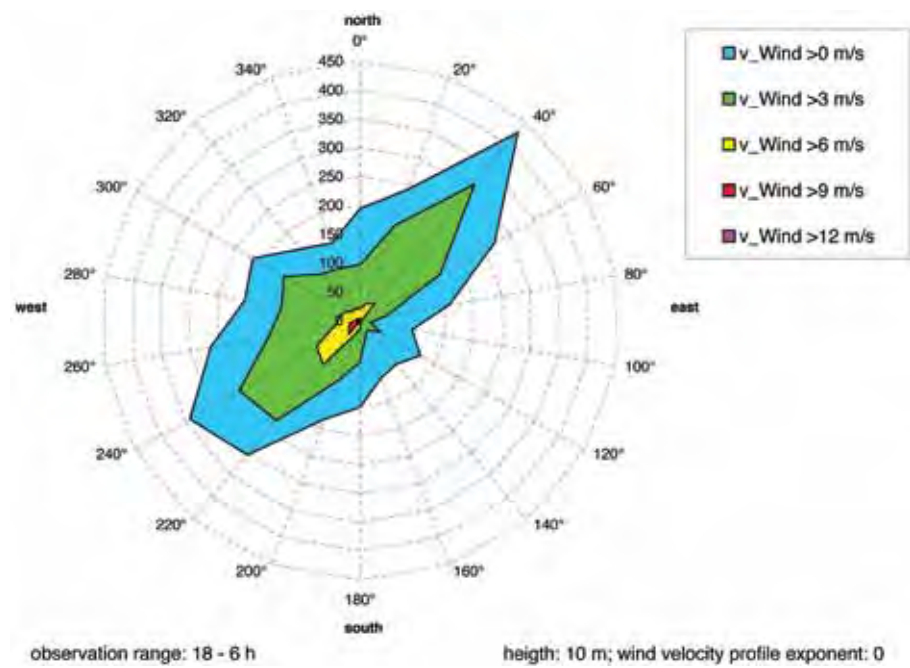

Figure 2.101  
Wind rose, Shanghai, night time

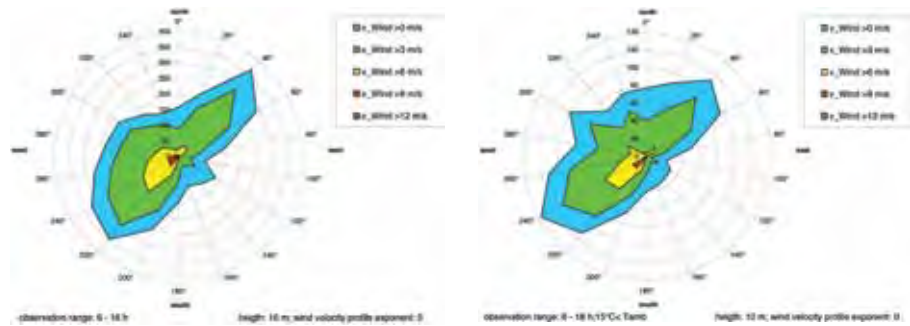

Figure 2.100:  
Wind rose, Shanghai, day time

Figure 2.102:  
Wind rose, Shanghai, day time above 15°C



A closer look at the wind rose highlights that warm winds at 15°C and above can also blow from the North West, but with speeds of up to 3m/s they occur only during 100 hours per year and only during 60 hours per year up to 6m/s.

The statistical spread of the wind frequency also shows the average annual value of 3m/s as the largest bar with 2090 hours per year. Higher wind speeds occur significantly less often and winds of more than 6m/s are only measured during 15% of the year.

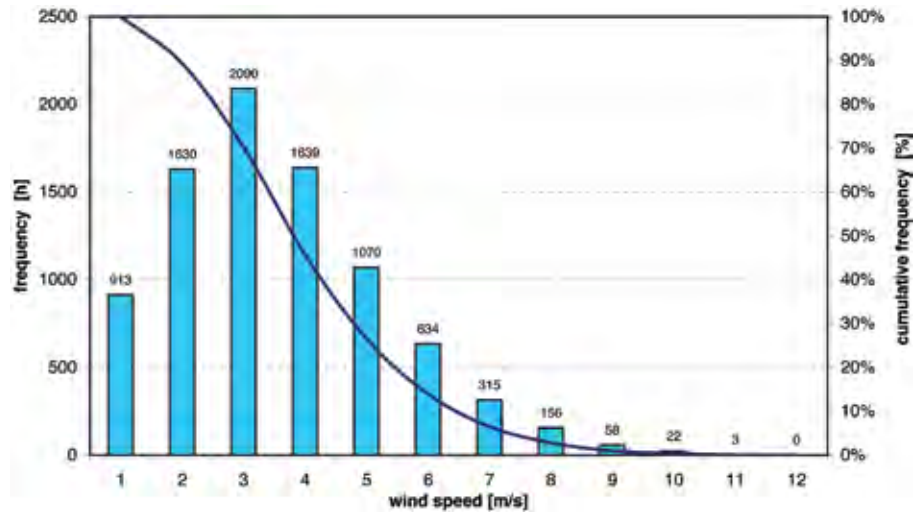

Figure 2.103  
Wind frequency statistics, Shanghai

## § 2.6.8 Singapore

---

The Republic of Singapore is an independent city-state in Southeast Asia. The national territory encompasses the main island and 62 smaller islands off the southern tip of the Malay Peninsula. It covers an area of approximately 700 square kilometres. The main island, Singapore Island, is separated from Malaysia through the narrow Straits of Johor. In the south, the Singapore Strait separates the country from Indonesia's Riau Islands. The Strait is an important shipping route between the Strait of Malacca leading into the Indian Ocean to the west and the South China Sea to the East. The city of Singapore lies on the south eastern tip of the island. It is one of the most important seaports and economic centres in Southeast Asia (Microsoft, 1997).

Singapore's extraordinary economic success during the past 30 years have made it into the most important financial metropolis in Southeast Asia. The harbour facility on the southern coast has allowed Singapore to rise to a major economic centre as early as during the 13th century. In 1819 Sir Stamford Raffles recognised that Singapore was perfectly suited to be a commercial harbour for the British East India Company. Five years later, Great Britain purchased the island. Its economic advancement was secured in 1869 with the opening of the Suez Canal as well as due to a globally increased demand for the natural resources available on the islands, such as natural rubber. These goods were shipped from Singapore (Microsoft, 1997).



Figure 2.104  
*The skyline of Singapore*

The city attracted many immigrants, predominantly coming from China and India. Singapore was occupied by Japanese troops during the Second World War, later reconquered by the British and given the status of a self-governed British colony.

After Singapore gained inner autonomy in 1959 and national independence in 1963, it became a member of the Federation of Malaysia until 1965, and then capital city of the independent Republic of Singapore.

Almost the entire population of the Republic of Singapore (5.1 m) lives in the capital city (Brackmann, 2006).

The climatic conditions are described in the following.

### Annual temperature profile

---

The annual temperature profile in Singapore shows the temperature to be almost constant throughout the year, typical for a tropical climate. Thus the climate is subject to day-night fluctuations rather than a seasonal rhythm. The minimum temperature is 21.4°C, whereas maximum outside temperatures reach 33.4°C. The average annual temperature is 27.5°C.

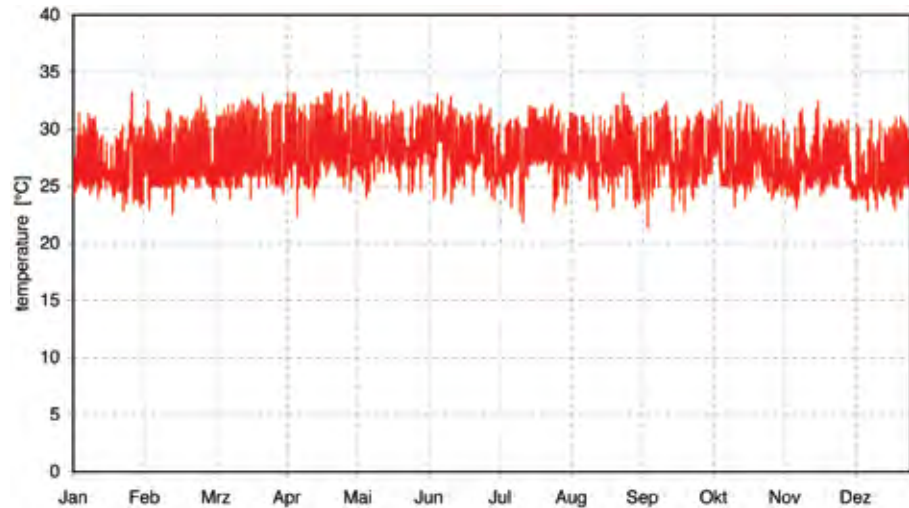

Figure 2.105  
Annual temperature profile, Singapore

A look at a period of a few days during the month of June shows a temperature curve that is subject to clearly marked differences between day and night. However, the difference is only approximately 7K. This means that there is little to no cooling during the night hours.

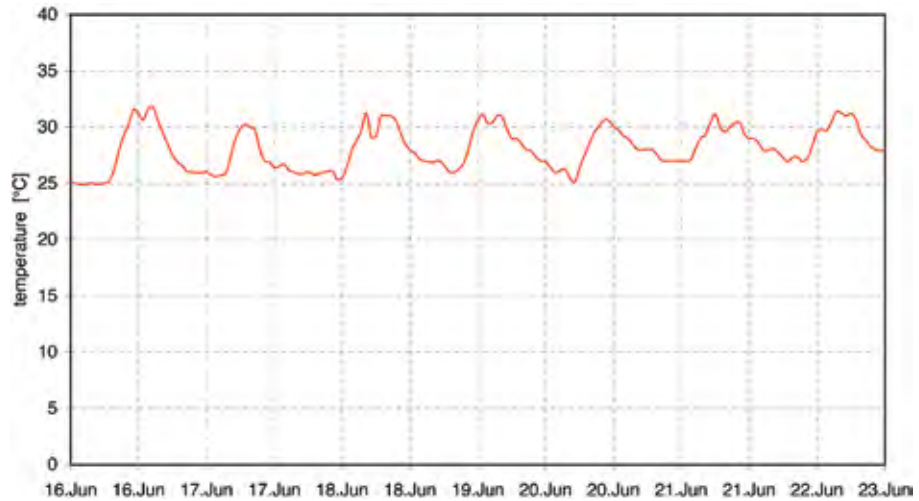

Figure 2.106  
Temperature profile during the month of June

The statistical temperature analysis shows that the temperature curve remains within a small range:		
Number of hours	below 0 °C	0 h
Number of hours	below 15 °C	0 h
Number of hours	above 25 °C	7626 h
	More than 25 °C	on 7626 hours per year
	More than 25 °C	on 365 days per year

Table 2.10  
The statistical temperature analysis, Singapore

## Annual air humidity profile

---

The air humidity profile follows the trend of the temperature profile in that there are day-night time fluctuations but almost no seasonal fluctuations. The average air humidity is measured at approximately 18g/kg.

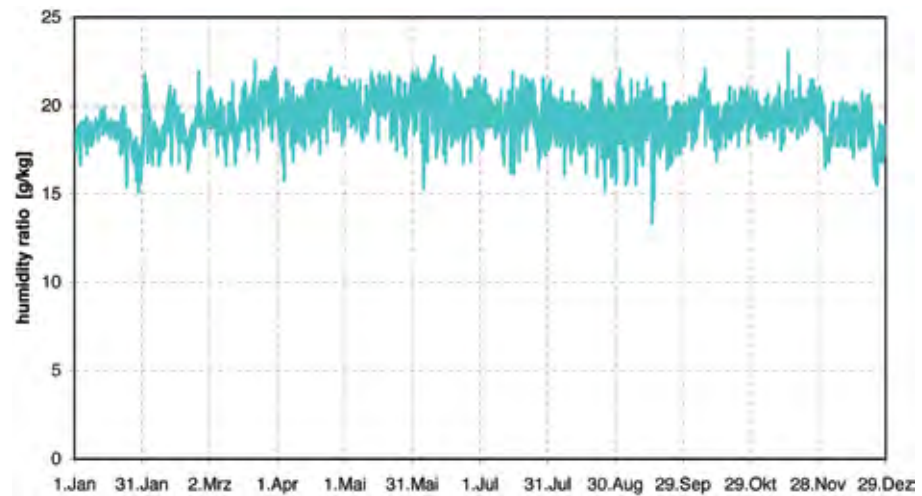

Figure 2.107  
Annual air humidity profile, Singapore

A detailed look at the month of June shows air humidity fluctuations between 17g/kg and 22g/kg. The climate is very muggy. The human organism senses muggy conditions with humidity levels of 14g/kg and above.

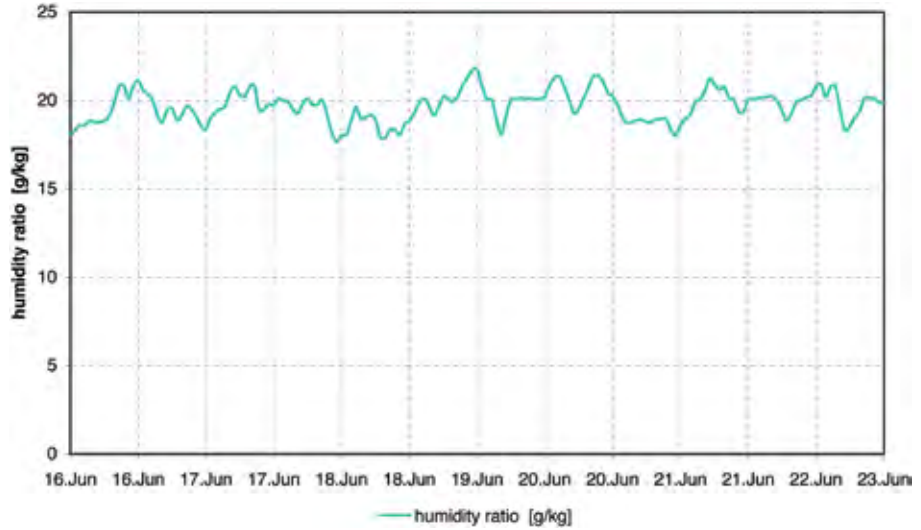

Figure 2.108  
Air humidity fluctuations during the month of June

The statistical analysis shows that air humidity levels of up to 18g/kg occur on 7570 hours per year; significantly higher values of up to 21g/kg only occur on 480 hours per year.

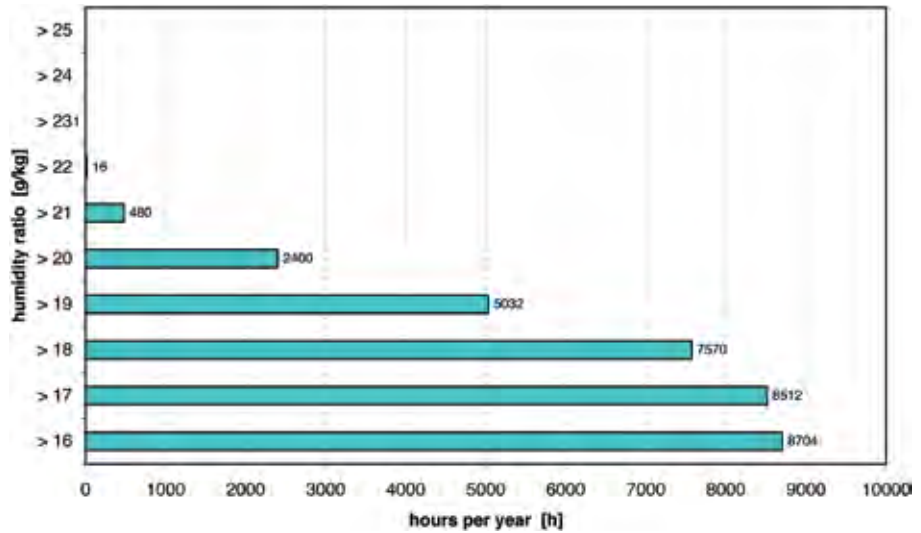

Figure 2.109  
Statistical air humidity distribution, Singapore

## Psychrometric chart

---

The point cloud in a psychrometric temperature and air humidity chart is a defined spot in the upper area of the chart. The extreme concentration of the pairs of values illustrate the earlier statements about the uniformity of the temperature and air humidity levels throughout the year. The chart also shows that relative humidity lies in a range of 50 - 100%. At the condensation water limit (100% air humidity), the point cloud is cut - meaning that on many hours per year the water dissolved in the air condenses onto surfaces with ambient air temperatures. The average annual temperature of 27.5°C can be clearly read from the horizontal temperature scale as the centre of the point cloud.

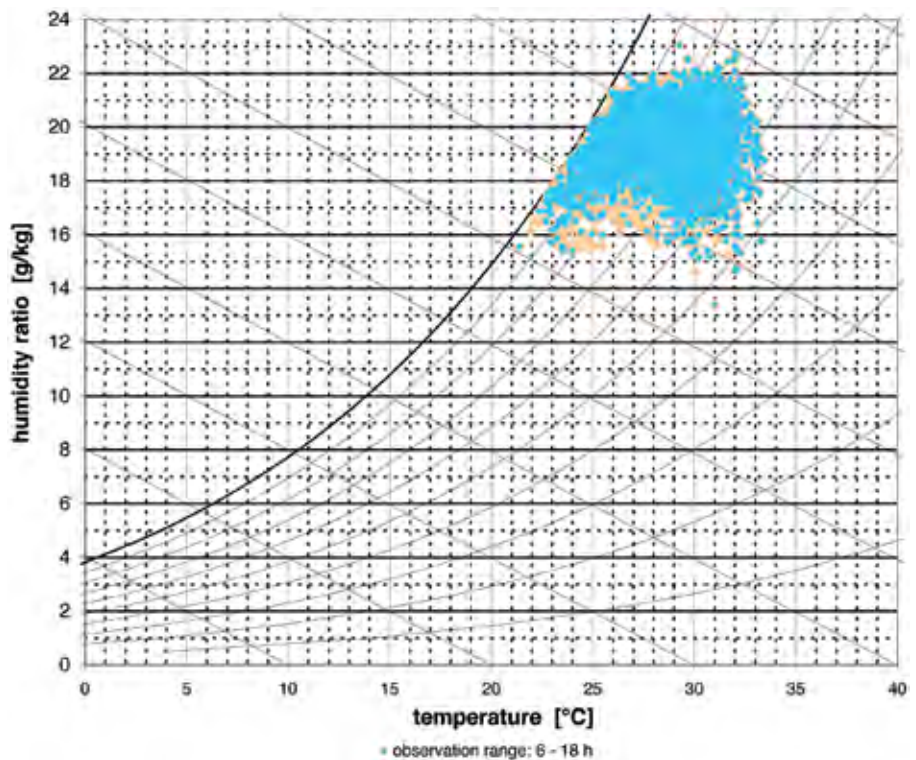

Figure 2.110  
Psychrometric chart, Singapore

## Monthly radiation distribution

---

The annual global solar radiation in Singapore is 1672 kWh/m<sup>2</sup>.

The radiation distributions shows a global solar radiation of 127 – 149kWh/m<sup>2</sup> during the particular months; the highest radiation values are measured during the months of March and April, and the lowest values during the months of November and December. A comparison with Las Vegas with its annual radiation of 2078 kWh/m<sup>2</sup> and maximum temperatures of 44°C shows the effects of high air humidity - in Singapore it prevents extreme heating.

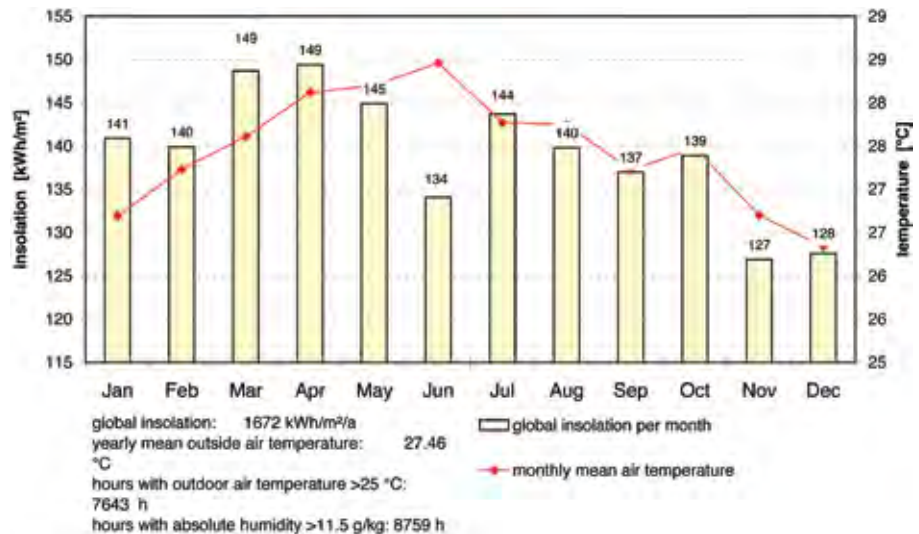

Figure 2.111

Radiation distribution with temperature curve, Singapore

## Wind distribution / Wind rose

---

The average annual wind speed in Singapore is 1.99 m/s. The wind rose shows these light winds in form of the blue-green areas that describe winds of up to 3m/s. During day time, the main wind direction is from the north on up to 500 hours per year. On up to 250 hours per year, there are southerly winds.



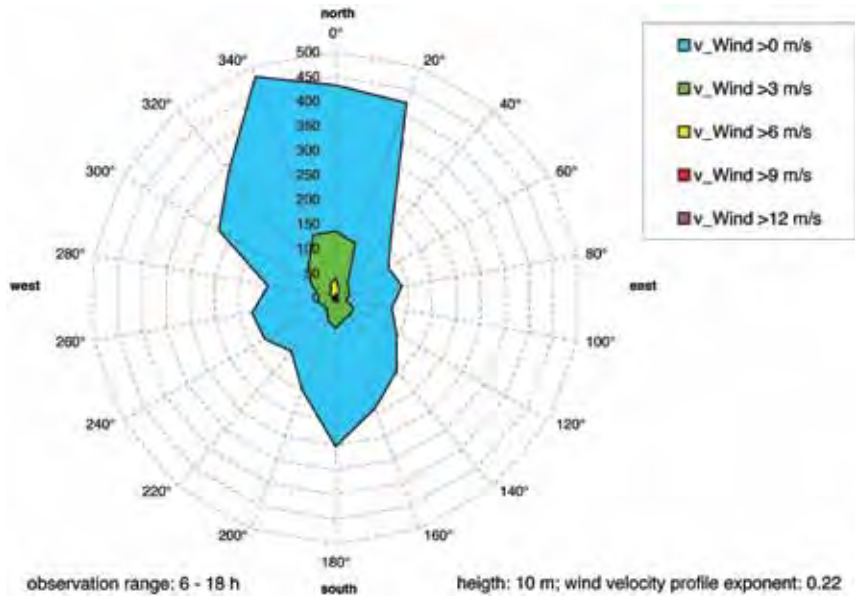

Figure 2.112  
Wind rose, Singapore, day time

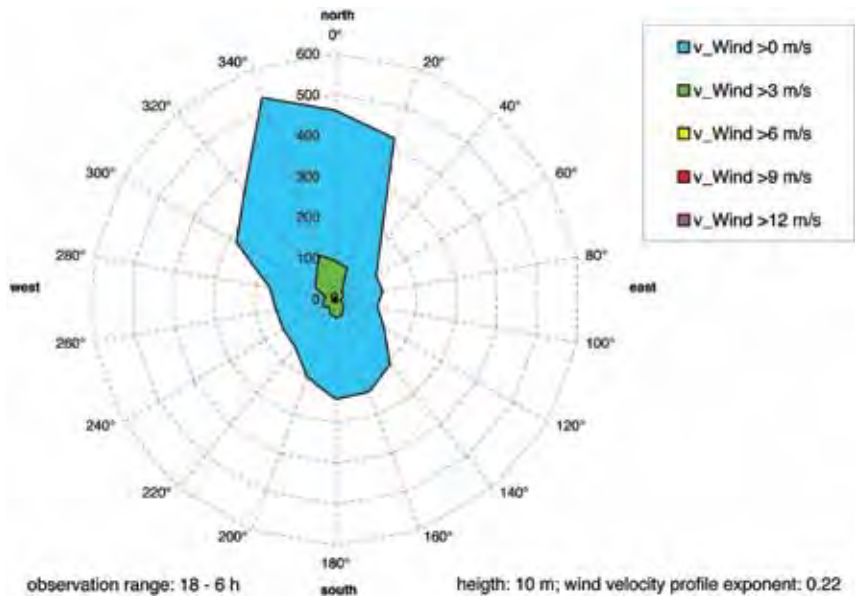

Figure 2.113  
Wind rose, Singapore, night time

The area on the wind rose showing the night hours (18-6h) shows a slight rotation of the wind toward the west; however, speed and frequency of occurrence remain almost constant.

Analysing the wind directions in dependence of the temperature does not make sense due to the relatively uniform temperature levels.

The statistical wind distribution highlights a low frequency of occurrence with almost 90% of the wind speeds ranging around 1m/s. Wind speeds in excess of 4m/s occur on only 632 hours per year, corresponding to 26 days per year.

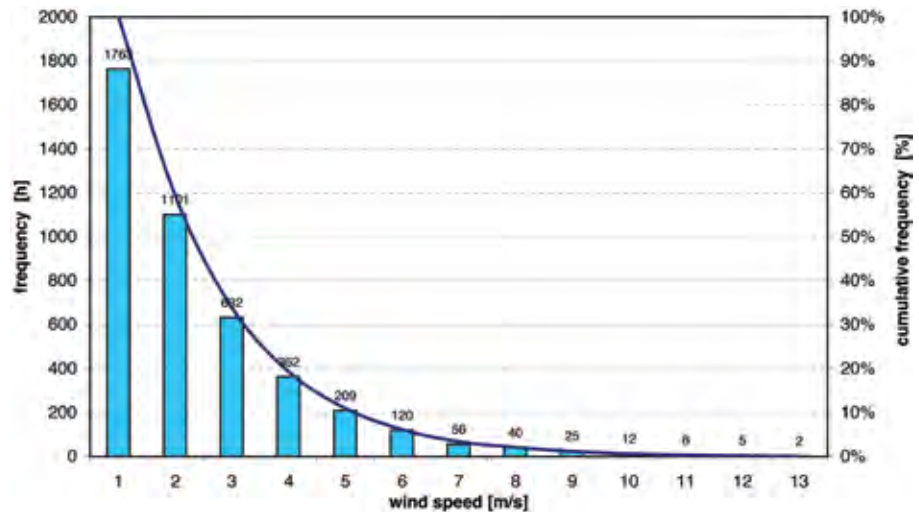

Figure 2.114  
Statistical analysis of wind speed distribution

## § 2.7 Summary of the climate analysis

The climate analysis of the eight boomtowns clearly shows the differences between the individual climate zones. When analysing individual measurement readings it also becomes obvious that regional circumstances such as the position of the city related to a body of water or certain landscapes have an influence on the microthermal climate. For this thesis these location will serve as a base for analysis; however, a climate zone by itself should not be considered the sole basis for the development of principles for

climate-adapted building and the design of a façade. Table 2.11 shows a comparison summary of the worked out measurements.

	Global Solar radiation kWh/m <sup>2</sup> /a	Tamb min °C	Tamb mean °C	Tamb max °C	Humidity ratio min g/kg	Humidity ratio mean g/kg	Humidity ratio max g/kg	Average air speed m/s
Las Vegas	2078	-4.3	19.5	44.4	6	3.9	13	4.06
Berlin	986	-8.8	9.8	32.7	1.5	5.7	13	4.18
Dubai Abu D	2205	8	27.1	46.6	8	13.2	27	3.64
Shanghai	1242	-3.5	16.3	38.1	2	6.6	24	3.11
New York	1462	-15.6	12.1	34.9	0.5	6.4	19	5.19
London	1010	-5.8	10.2	31.3	1.5	6.3	13	3.24
Moskow	973	-25	5.5	30.7	0.5	5.08	14	1.45
Singapore	1672	21.4	27.5	33.4	18	19.1	21	1.99

Table 2.11  
Summary of several characteristic measurement values of the eight boomtowns

As explained in § 2.5 'Climate zones / selection of boomtowns', Berlin, Shanghai, New York and London, for example, lie in the warm temperate climate zone, but a look at the table shows significant differences in the measurement values. A compilation and comparison of the values underlines the necessity to thoroughly examine and analyse a particular location.

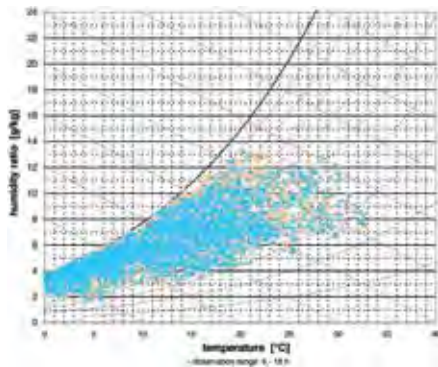

Figure 2.115:  
Psychrometric chart Berlin

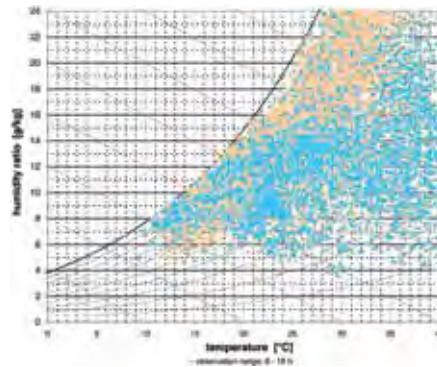

Figure 2.116:  
Psychrometric chart Abu Dhabi

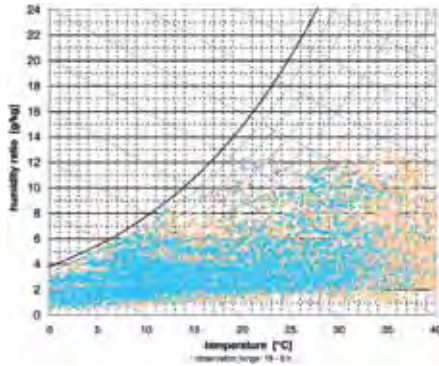

Figure 2.117:  
Psychrometric chart Las Vegas

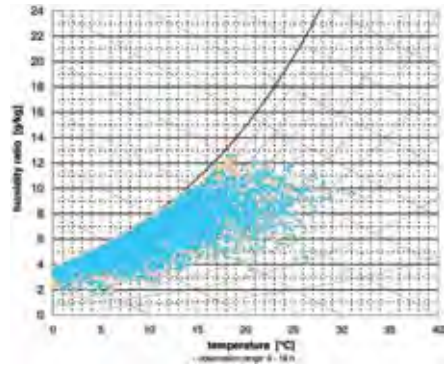

Figure 2.118:  
Psychrometric chart London

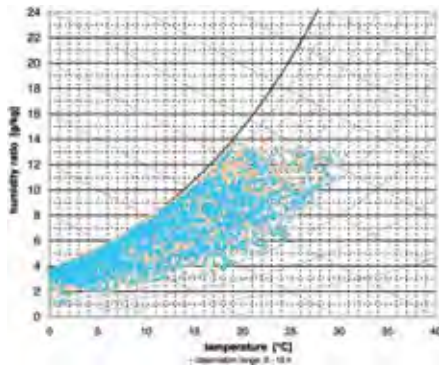

Figure 2.119:  
Psychrometric chart Moscow

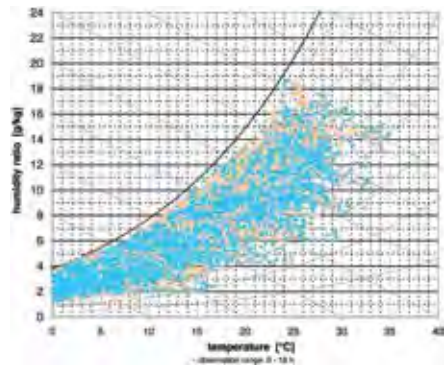

Figure 2.120:  
Psychrometric chart New York

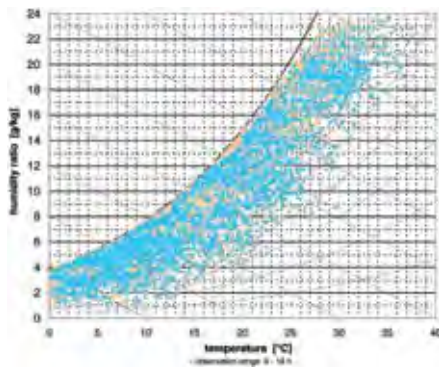

Figure 2.121:  
Psychrometric chart Shanghai

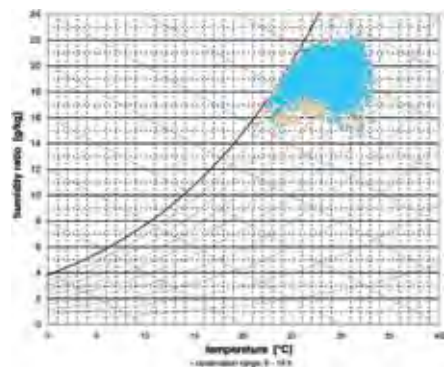

Figure 2.122:  
Psychrometric chart Singapore

However, to provide an easy introduction into the selection of principles to be developed it is sensible to facilitate the classification of specific locations using climate analysis. The psychrometric chart is a good means to identify the prevailing climate. The previous analysis of the eight boomtowns shows that a characteristic geometric shape of the point cloud of temperature and humidity can be used to classify the climate zone.

Charts 116-123 are Psychrometric charts of the analysed locations. As described earlier, Berlin, Shanghai, New York and London lie in one climate zone; the geometric shapes of the point clouds are similar – not surprising when looking at the individual measurement values.

Following this basic principle, the climate zones can be classified using the pairs of values temperature and humidity from the geometric shape of the point cloud up to the first order according to Köppen.

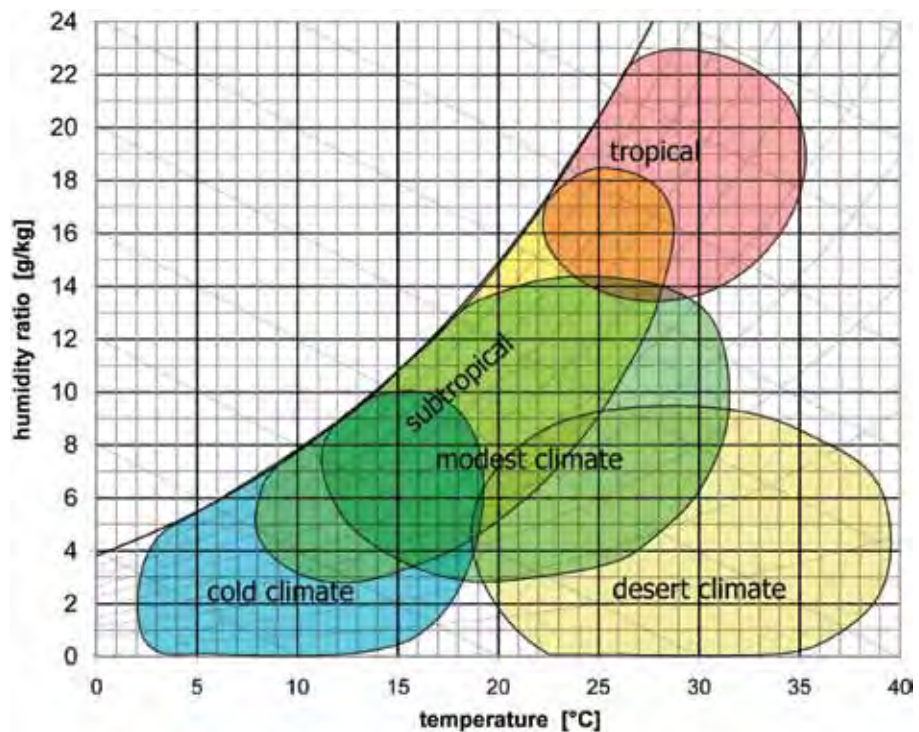

Figure 2.123  
Classification of climate zones in a psychrometric chart

The chart can be utilised as a simple overview. However, Moscow, for example, exhibits a similar point cloud shape as does Berlin, but a look at the temperature curve shows significantly lower temperatures not shown in this psychrometric chart. Therefore Moscow cannot be allocated to the exact same climate zone as Berlin.

The borders of the plotted areas in the chart are blurred, and some spreads of various locations span large areas. However, the concentration of a point cloud with the strongest density is the most meaningful factor since density indicates a high frequency of a particular measurement. Singapore with its clearly defined point cloud can be easily identified as a tropical climate zone.

The blurriness of the chart can be explained from a climatic point of view; the borders of the climate zones are also blurred and flow into each other in certain areas. Ultimately, for further analysis the deciding factor is not the determination of a specific climate zone, but the position of the point cloud as such because it shows the area of the prevailing climate and clearly illustrates the climatic conditions. In the following, chart X will be continued to be used for a simplified illustration of initial analyses.

## § 2.8 Initial graphic analysis of the air conditioning required

Psychrometric charts can be used as a first graphic tool to illustrate the air conditioning required at a particular location.

Individual comfort zones according to different international norms can be filled into a psychrometric chart as a simple field with the maximum allowable values.

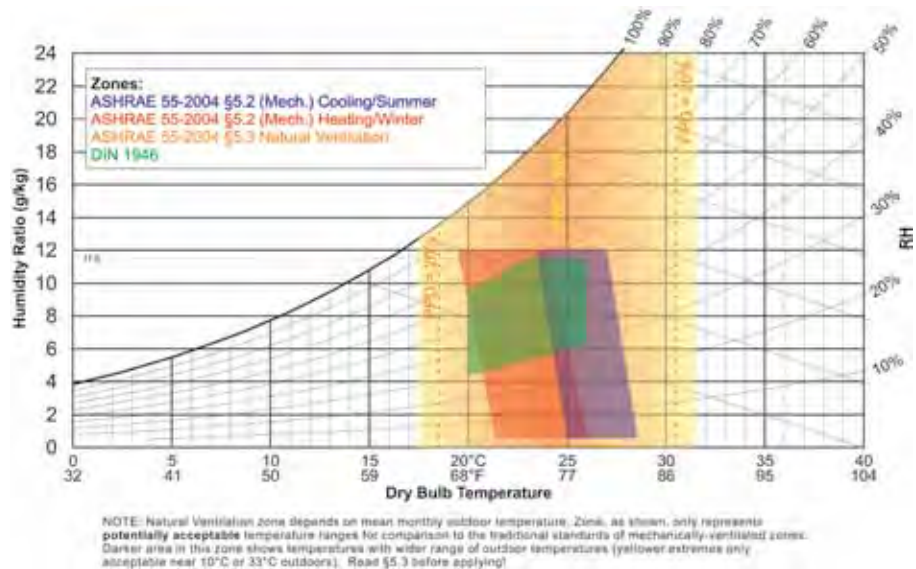

Figure 2.124  
 Psychrometric chart with different comfort zones / Transsolar

Comfort areas of different norms can be plotted onto a psychrometric chart. Chart 125 shows the comfort zones of the American ASHRAE 55-2004 norm for cooling in summer and heating in winter in case of mechanical ventilation. The extended area of natural ventilation of the ASHRAE code for natural ventilation is also included. It is clearly visible that the area of natural ventilation does not show any minimum or maximum humidity values because they cannot be regulated by free natural ventilation. The fourth comfort zone plotted on the chart is that according to the German DIN 1946 norm which regulates ventilation.

Depending on the individual requirements of a country and the use of mechanical as well as natural ventilation, different comfort zones and calculation models need to be selected to determine the comfort area and its limits. Since in this work the determination of user comfort is not the main focus the author uses the DIN 1946 norm for further explanations. The comfort zone of DIN 1946 graphically depicts a clearly defined area and can therefore be used to explain the use of psychrometric charts. The principle of graphical use of the chart remains the same for all comfort zones; thus they can be easily exchanged. However, the comparison chart of the different comfort zones also shows that the comfort area of DIN 1946 forms the smallest window. This means that more energy must be expended to reach its specification.

As explained in § 2.4.3 *Psychrometric Charts*, the chart is a tool with which we can read or determine possible changes in air conditioning. Building services functions such as heating, cooling or dehumidifying can be entered into the chart as simple arrows. If these arrows are overlaid onto the point cloud of a particular location, the building services functions for this location required to reach the comfort zone in the centre of the chart can be read. Following ASHRAE, a slightly larger zone can be drawn around the comfort zone, showing the possibility of natural ventilation. With natural ventilation the user senses different conditions of the air as less disturbing even if they fall outside the comfort zone.

The examples of Las Vegas and Singapore show the easy application of this graphic tool.

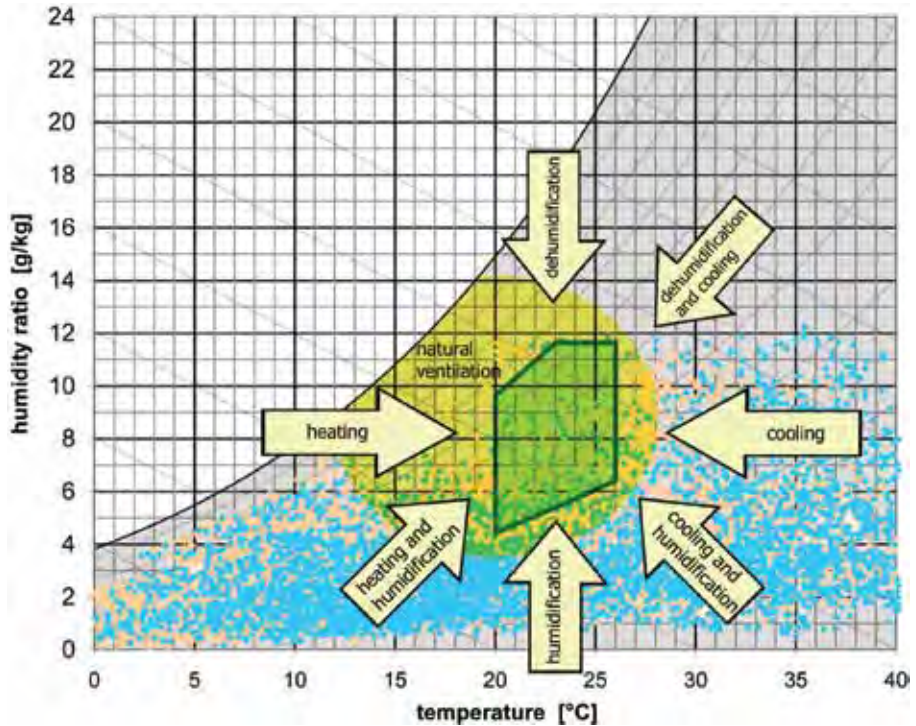

Figure 2.125  
 Psychrometric chart with overlapping of function and location, Las Vegas

The example Las Vegas shows the required functions heating, humidifying and cooling; the point cloud fills the lower part of the chart and depicts a large spread of the temperatures occurring throughout the year. However, common to all is a concentration of the pairs of value up to max. 8-10 g/m<sup>3</sup> water, which means that this particular location requires no dehumidification.

Natural ventilation can only take place on a few days of the year since only a small number of pairs of value fall into this range.

The Singapore example shows a very different picture in that the functions dehumidification and cooling necessary to reach the comfort zone at this location are clearly visible. Natural ventilation can be completely excluded because the point cloud falls noticeably outside of this area.



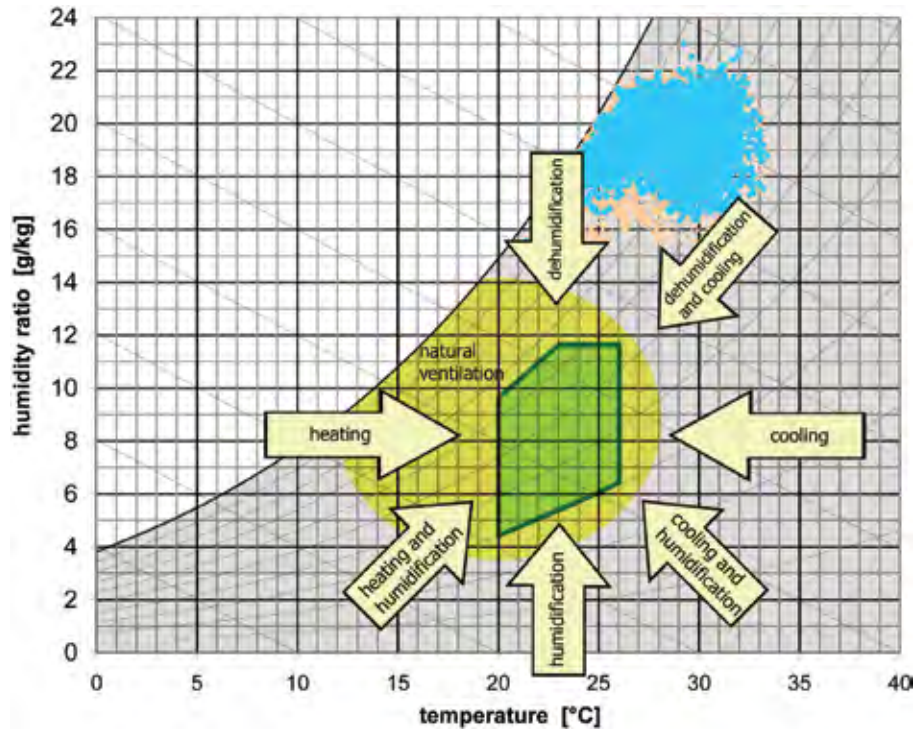

Figure 2.126  
Psychrometric chart with overlapping of function and location, Singapore

The charts show that with psychrometric charts and a simple overlay of the measurement values of a location we can obtain an initial estimation of the necessary air conditioning requirements. Its easy readability makes this chart particularly suited for an initial introduction into a project because the bounding parameters of building services functions can be determined at a very early stage.

A more detailed analysis of the climate data will follow in subsequent chapters of this thesis with the development of an expert tool.







# 3 Principles of climate-adapted architecture

Following the preceding climate analysis of eight selected locations, this chapter analyses the principles of climate-adapted building. Since there is insufficient information about the historic building methods of the selected boomtowns, this research and analysis is broadened to cover the climate zones in which they lie. The goal of this analysis is not to create a list of all existing building types and principles of climate-adapted architecture for an overview or compendium, as has previously been attempted by Oliver (Oliver, 1997a, Oliver, 1997b, Oliver, 1997c), Behling (Behling et al., 1996) or Vellinga (Vellinga et al., 2007), but to compile the data in order to select potential principles that can be used for the building envelope. The examples show traditional building methods, some of which more than a thousand years old. Some are rarely used today; others have been preserved into modern times. The core question of this chapter is the potential use of such traditional principles in modern building construction; and their application to façade design in particular.

---

## § 3.1 Influence of the climate on architecture

---

The prevailing local climate has always influenced building methods or architecture in general. It is therefore understandable that building typologies found around the world are very diverse. Humans created protection from the climate by building shelters that were adapted to the climatic conditions they were in. The home, often very simple in its construction, and storage areas for food and other live-sustaining goods - often of higher priority to the community - attest to this principle. The following section will give an outline of the building methods and principles that developed on the basis of climatic conditions - the climate zone.

---

## § 3.2 Vernacular architecture / indigenous architecture / building without an architect

---

Vernacular architecture means local or regional architecture. Because it is typically adapted to the climate, the term is often used synonymously for traditional climate-

adapted building methods. Typical for vernacular architecture is its origin from materials found in the surrounding area. Traditional buildings, shelters, magazines or storage facilities were built from regionally available building materials. A few particularly representative buildings form an exception; here logistical and financial efforts were undertaken to obtain materials not available locally.

It is a remarkable fact that vernacular architecture was created without the help of architects; it should rather be understood as an evolutionary building method that has developed over centuries to optimum levels using the available resources. In his book "Architecture without architects", Rudofsky described this anonymous architecture that has developed more as an evolutionary advancement than from the plans of an architect or engineer. (Rudofsky and Museum of Modern Art, 1965)

Vernacular architecture has existed as long as mankind. The earliest known caves and tents are based on the principle of using resources found in the area to protect from the weather. Over time, new forms of housing types have developed with the acquirement of "new technologies" such as fire, metal forming and, as a result, the manufacturing of tools. Still today there are types of housing that, over time, have been further adapted to the requirements of the user or the regional conditions. Most of the currently existing vernacular buildings are found in the so-called developing countries; that is in large areas of Africa, Asia and South America. Even today, traditional ways of life, social structures and cultural influences are of much higher importance in these countries than those in industrial countries. Whereas the metropolises around the globe today feature buildings strongly oriented on the demands of society, regional architecture can still be found outside of the large cities (Oliver et al., 2007).

Due to increasing pressure from the cities on rural areas, natural disasters or political upheaval, the second half of the 20th century saw the loss of many traditional buildings; and with them often the loss of knowledge about their construction. This phenomenon can be seen in China today with its ever increasing population and strong urban growth. The displacement of vernacular architecture occurs at a rate and speed comparable to the rapid economic growth. (Knapp, 2000)

With today's awareness that the loss of vernacular architecture is accompanied by a loss of important knowledge about traditional building methods, this topic now attracts great attention. Oliver's 1997 published "Encyclopedia of vernacular architecture of the world", a collection of more than 80 international contributions on 1200 pages, underlines this research activity (Oliver, 1997a, Oliver, 1997b, Oliver, 1997c). The preservation of vernacular buildings and ways of living is supported by the potential they provide for tourism; many almost or entirely lost buildings and settlements have been renovated or reconstructed with the help of international promotion and regional help funds; not least to increase the sources of income of the country in question (Oliver et al., 2007).

## § 3.3 Building methods and principles in different climate zones

The following details principles of climate-adapted building or vernacular architecture organised by their prevalence and affiliation with a climatic zone. As mentioned in the beginning, the focus hereby lies on principles that allow for effective application related to the building envelope or functional building services components. In some cases, entire buildings are explained, as, for example, the igloo with its purpose to provide shelter in polar regions.

### § 3.3.1 Snow climates / polar region

Hostile temperatures of far below freezing make human life in the polar zones extremely difficult. None of the boomtowns lie in this zone; however for the sake of completeness the zone and its solutions to deal with the climate are presented. The extreme temperatures limit building activities to a minimum, for example for research facilities. Therefore there will be no detailed discussion in this research.



Figure 3.1  
Expansion of the polar zone highlighted in white, and of the tundra regions in blue

Only the Inuit live in the arctic part of Central and North America and Greenland. Their housings are traditionally built from compacted snow in shape of igloos, thus utilising the best building material available. The compact form of these dome-shaped buildings with a diameter of approximately 5m protects from ice storms, and the massive snow blocks in combination with a small entrance, often separated by an entry zone, provide optimum insulation against the cold. In order to keep the warm air within the living space, the entrances are usually built at a slightly lower level. Typically, the interior of an igloo is partially clad with animal skins. The occupants' body heat and blubber-oil lamps generate temperatures of up to 5°C at outside temperatures of -40°C. (Behling et al., 1996)

We can derive a principle of strong insulation against outside temperatures as well as a wind-protected entrance area, plus the principle of maintaining air layers of different temperatures.



Figure 3.2  
*Igloo with Inuit (Lorne Smith)*

### § 3.3.2 Boreal or snow-forest climate / moderate climate

---

The type of vegetation prevailing in the northern areas of the boreal or snow-forest climate, which encompasses large parts of Russia and the northern parts of Canada, are tundra and taiga. Nomads are the typical inhabitants of these barren regions. As they roam the land with their productive livestock throughout the year their shelters are mobile, tent-like structures that differ slightly according to traditions and regions.



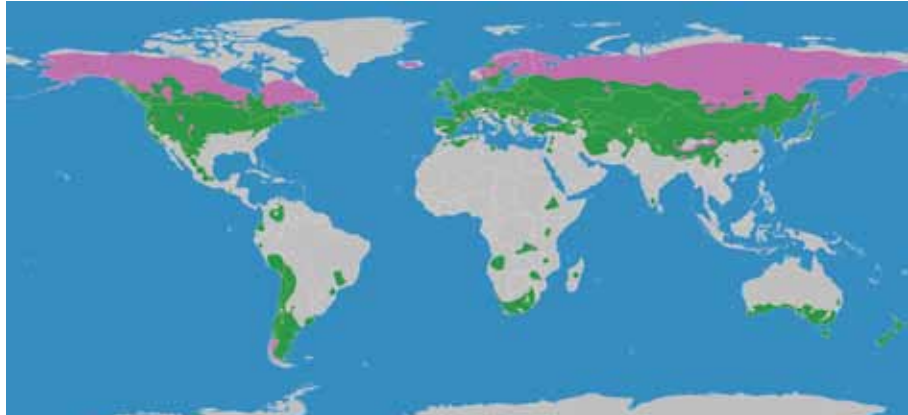

Figure 3.3  
 Expansion of the boreal or snow-forest climate moderate zone  
 pink: cold moderate borealis climate  
 green: warm moderate climate

In Thule, in the northernmost regions of Greenland, permanent dwellings are completely or partially dug into the ground. The entrance areas of these wooden houses are built at a lower level to keep the warm air inside. The façades and roof area protruding from the earth are covered with sod that begins to grow every summer. The buildings are ventilated through a roof-top opening which is caused by hollow whale vertebrae. (Behling et al., 1996)



Figure 3.4:  
 Earth covered houses in Island (Michael Scaduto)



Figure 3.5:  
 Typical yurt in Mongolia (Linda Hildebrand)

The transportable shelters used by nomads in the steppe during spring and autumn consist of spiles or whale rib bones covered with skins and furs.

In Mongolia and other regions of Russia or Afghanistan, the yurt has developed into the traditional housing type for nomads. This building type, approximately 5m in diameter, is formed by diagonal, open lattice wall sections made of willow branches and a crown which is formed with concentrically positioned poles. The diagonal arrangement of the wall sections allows for it to be easily pulled together for transportation. The skin is made of felt or reed mats. Their thickness can be adapted depending on the thermal requirement and season. The centre of the roof features a closable smoke outlet. (Behling et al., 1996)

The following principles can be derived:

- **Use of earth as thermal mass for insulation**
- **Exhaust air outlet at the highest point of the building**

In the southern parts of the boreal or snow-forest climate, also referred to as continental climate or, according to Köppen as a sub-climate; there are two different climate conditions. We differentiate between summer-warm and summer-cold winter-humid climates. Moscow can be classified as a summer-warm winter-humid climate. The houses in summer-cold regions such as northern Russia or Canada were mostly built with massive wood constructions since this building material was readily available. Besides availability, another advantage of the material wood is its low thermal conductivity, providing a relatively good insulation. If climatically necessary, the houses warm up quickly when heated, saving burning material which in most cases was again wood. (Behling et al., 1996)

The following principle can be derived:

- **Use of materials that offer high insulation values to allow for effective heating**



Figure 3.6:  
*Typical Russian timber house (Danja Vasiliev)*



Figure 3.7:  
*Dugout in Shanxi / Northern China*

The temperatures in the summer-warm regions of parts of China and the southern regions of Russia as well as the northern regions of North America fluctuate from  $-10^{\circ}\text{C}$  in winter to  $30^{\circ}\text{C}$  in summer in a seasonal cycle.

In the northern Chinese regions around the cities of Shanxi and Henan inhabitants utilise the calcareous earth as building ground. This loess ground can be trenched vertically; the farmers dig inner courtyards of up to 100 square metres directly out of the earth and then cave out living and storage areas. Living quarters are oriented toward the south, secondary functions such as pigsties and storage areas toward the north. Other functions such as cooking are often located in the east, and children sleep in caves oriented toward the west.

In the style of the traditional Chinese courtyard house, the dugout is also dug out in a square or rectangular shape even though round building forms are easier to create. At the edges, the earth hardens into a crust, a fact that supports the longevity of these houses. In the absence of building materials such as clay or bricks this type of housing is very cheap and thus often found with poor farming families. The good insulation properties of the earth allows the inside temperatures in winter to be up to 10K higher than the outside temperature; during summer they can be up to 10K lower. (Behling et al., 1996) Since the individual rooms have only one opening toward the courtyard, ventilation is very limited and condensation accumulates on the walls. (Oliver, 1997b)

Another variant of an earth house are dwellings built onto cliffs, on ridges or into caves. The geographic situation simplifies the building process because access is already given at ground level. However, the orientation of the rooms depends on the geographic direction of the particular location and can entail the disadvantage of a sunless orientation. (Oliver, 1997b)

The following principle can be derived:

- **Mass used as a temperature buffer**



Figure 3.8  
*Cave dwelling on a ridge*

In parts of Northern China temperatures can drop to  $-40\text{ }^{\circ}\text{C}$  during the winter months. Therefore heated beds or sleeping platforms referred to as Kang are used. During the day, hot exhaust air from the cooking stove is channelled through a cavity system made of large bricks, located at knee height next to the stove. During the winter months this space is used for every day activities. At night, the inhabitants sleep on the sleeping platforms which maintain the heat stored in the bricks. More affluent houses feature several of these Kangs, each with a small stove. The disadvantage of this system is low thermal performance for heating the entire room. (Oliver, 1997a)

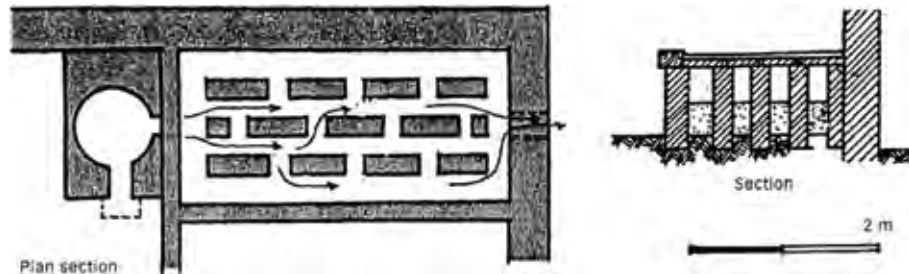

Figure 3.9  
Footprint and section of a typical Kang

Wall heating was known in the cold northern regions of China as early as in the age of the Han Dynasty, which lasted from 206 BCE to 220 CE. The principle is similar to the Kang; however, it is arranged vertically and found as a heating element in many houses. In order for the warm air to flow efficiently through the various chambers of the double-leaf brick walls, the insides walls of the wall heating, referred to as Huoqiang, are polished smooth with sand and dust paste. The large surface area radiating warmth allows the entire room to be heated. Dried waste was often used as fuel, resulting in a very cheap operation.

Principles:

- Utilise air flow to heat massive building parts; use mass as storage medium; increase surface area

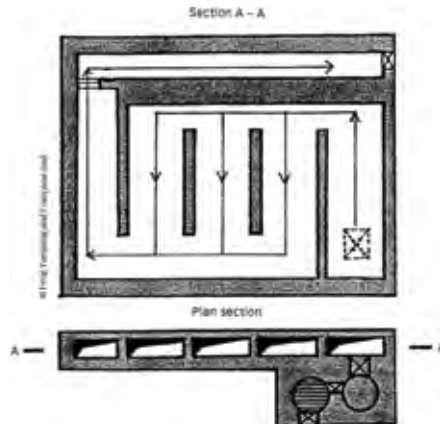
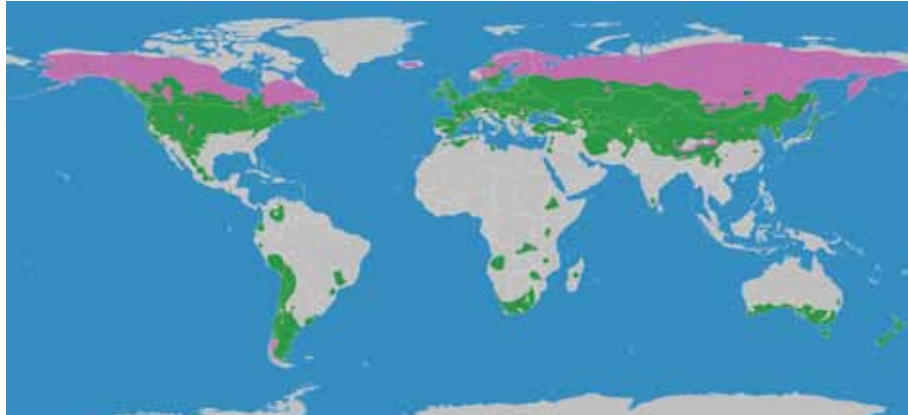

Figure 3.10  
Section and footprint of a Chinese wall heating element

### § 3.3.3 Warm moderate rain climates / moderate zone

The boomtown locations Berlin, Shanghai, New York and London lie in the warm moderate climate zone. The prevailing climatic conditions show large annual temperature differences of up to 20K. Air humidity of approximately 60-80% is at a mid to high range. On the northern hemisphere, the months from December to February are the coldest, and the months from June to July the hottest months of the year. The transition periods between the warm and the cold seasons typically extend with increasing distance from the equator. The bordering areas between the moderate climate zones and the Tropics have long, warm summers with relatively short rainy winters. In Europe, they are referred to as the Mediterranean winter rain zone. In contrast, the areas bordering on the cold climate zones (such as southern Scandinavia) are dominated by long cold winters and often as few as two or three warm summer months. Particularly extreme temperature differences between the individual seasons are characteristic for continental climates (e. g. the countries in the American Midwest or Central Asia). Proximity to coastal areas and the influence of the warm gulf stream in particular cause lesser temperature extremes (for example, in Western Europe, particularly in south west Ireland with its sup tropic vegetation). (Schütze and Willkomm, 2000)



**Figure 3.11**  
*Expansion of the borealis or snow-forest climate moderate zone*  
*pink: cold moderate borealis climate*  
*green: warm moderate climate*

The climatic conditions of the moderate zones provide good basic conditions for the human organism; but they do require protection from extreme temperatures during winter and mid summer. (Schütze and Willkomm, 2000)

In many areas of Spain, and particularly on the northern plateau, a central heating system was commonly used at the end of the 19th century. This under floor heating system called Gloria developed from the Roman hypocaust, independent of the cooking function. Gloria is typically installed on the ground floor, with the entire floor area being doubled. The ground floor usually serves as space for dining and living rooms. The elevated floor is about 15 cm high and is built with bricks that serve as spacers as well as floor covering.

Outside of the dining and living rooms, typically in the hallway or an adjacent courtyard, there is a small fireplace, covered with a perforated metal plate. The cover provides control over the fire and its intensity. The hot exhaust air flows through a tunnel and chamber system, and then, on the opposite wall, upward through a chimney. During winter, the warm air flow warms up the entire space. During summer, the system can also cool the space which makes it very efficient throughout the entire year. In addition to hay, straw and wood dried waste was also often used as fuel, furthering a sustainable use. (Oliver, 1997a)

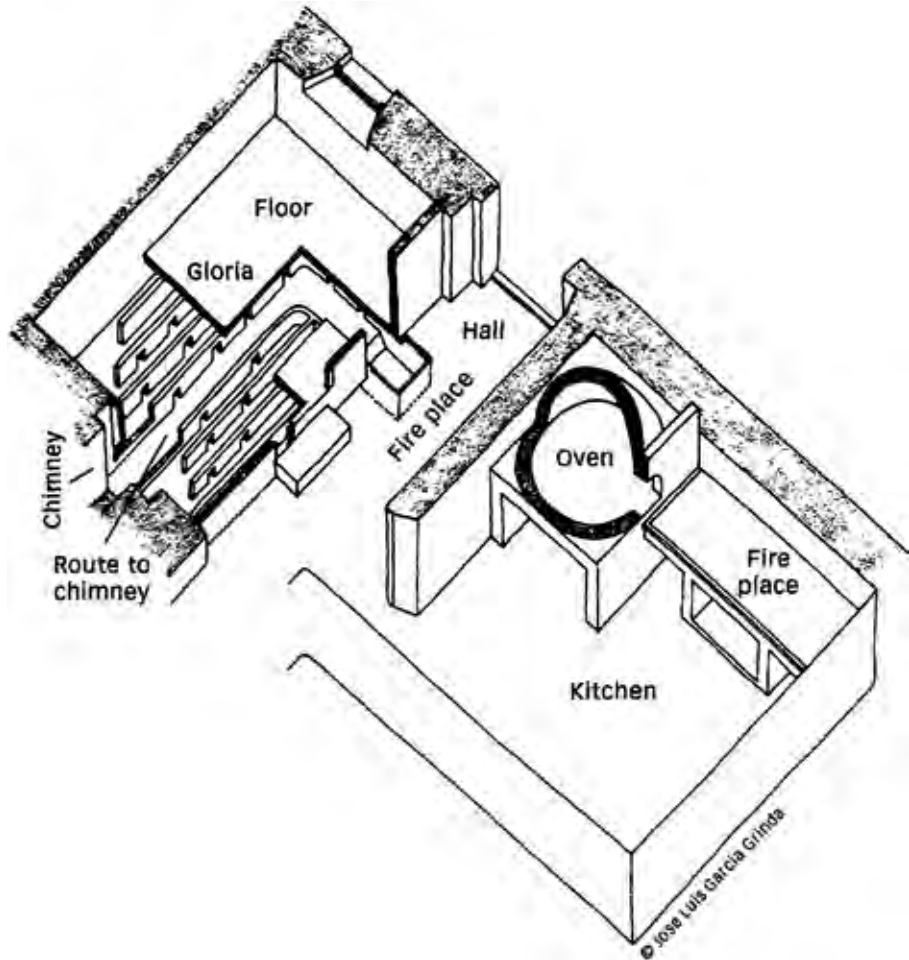

Figure 3.12  
 Isometric drawing of a Gloria to illustrate the mode of operation

In parts of Korea a similar principle was developed 2000 years ago; a hypocaust system that, even though derived from the Kang, in contrast hereto spreads across the entire living area. The hypocaust is widely spread throughout very cold northern Korea. The entire house, built with an elevated wood construction, includes an air-ducting layer with channels made of clay and stones. The floor plates are made with 5cm thick stone plates and the joins are carefully sealed against the smoke of the fire.

Two systems can be differentiated; one uses the warm air resulting from cooking activities; other systems comprise of a dedicated fireplace and are heated on demand.

Depending on the size of the system, chimneys are placed on the exterior walls of the buildings. A disadvantage of this system is the dry dusty air created by the heating process. The rooms need to be ventilated which means that they cool off periodically. (Oliver, 1997a)

Principle:

- **Use of artificially or naturally generated temperature flow to heat surface areas.**  
**Heating and cooling are possible.**



**Figure 3.13:**  
*Residential house with hypocaust heating; the chimney is clearly visible on the front side of the building*



**Figure 3.14:**  
*Narrow street canyons create shadowy micro-climate zones, example Florence.*

Stone and brickwork are the predominating building materials used throughout the moderate zone. The material mass provides protection against the winter cold as well as overheating in summer. In principle, this climate-adapted architecture is mirrored in urban development. Densely populated cities in Italy such as Siena or Florence feature narrow street canyons that provide cool shadow zones and therewith comfortable coolness during the hot summer months.

In order to achieve sufficient daylight inside the buildings, windows in such densely built streets have larger dimensions. They provide a balanced compromise between light incidence and heat loss in winter. Since they receive almost permanent solar radiation, the south-facing façades surrounding the Piazza del Campo, the largest central plaza in Siena, feature fewer windows. Wooden louvers provide additional protection from overheating in summer.

A settlement as well as the individual building should be located and oriented such that cooling through cold winds or a position in cold air pockets (ground depression, hollow, enclosed valleys) is avoided, but use of incident solar radiation during winter is possible to warm the buildings. In Central Europe this typically means shielding toward the north and northwest as well as opening toward southern directions. Shielding can



be accomplished by grouping buildings, wind barriers or concentrated urban layout with short and winding streets.

Other regions might require the highest wind exposure possible, for example if maximum mid-summer temperatures pose the greatest problem and efficient ventilation of the settlement is necessary. Each individual location requires a thorough analysis of the year-round climatic conditions in order to find a suitable compromise for opposing demands. (Schütze and Willkomm, 2000)



Figure 3.15:  
*Low share of window area at the Piazza del Campo in Siena.*



Figure 3.16:  
*Cities on the island Thira in Greece are built into the hillside; they benefit from the wind, and the use of small windows is clearly visible. (Thaleia Konstantinou)*

Principles:

- **Self-shadowing during summer through intelligent urban layout, Southerly orientation for energy generation during the transitional periods,**
- **Shielding toward the north to minimise cooling in winter.**

### § 3.3.4 Tropical rain climates / Tropics

---

The tropical climate predominantly extends around the equator and adjacent regions. They include, for example, the Amazon Region and large areas of South and Central America, Central Africa and Southeast Asia. Due to similar climatic conditions, the Monsoon climates in India and northern Australia can also be classified as tropical climate zones. (Schütze and Willkomm, 2000) Singapore as one of the selected cities lies in the tropics.



Figure 3.17  
*The expansion of the tropical zone*

The dominating climate characteristics of humid-warm climate zones are high relative air humidity of 60-100%, large amounts of precipitation and, as was seen in the climate analysis of Singapore, almost constant high average temperatures around 30°C with low day / night fluctuations. The share of diffuse radiation is very high due to the high humidity levels and cloud coverage. (Schütze and Willkomm, 2000) Climatic particularities are the high number of hurricanes, typhoons and hurricanes.

The most important functions when building in humid climates with high temperatures and frequent precipitation are highest possible ventilation and materials that dry quickly. The cooling mechanism of the human skin is based on evaporation. This mechanism is inhibited when ambient temperatures are close to the body temperature, and high relative humidity makes the natural human cooling function even more difficult.



Figure 3.18  
*Toraja houses in South Sulawesi*

The houses of the Batak people in North Sumatra feature large saddleback roofs with far projecting eaves. Similar, multi-storey buildings can be found in South Sulawesi. The up swinging eaves here provide a shadowed area in front of the house; both types of houses are built from wood and rushes. The living areas are elevated on beams and feature well ventilated floors. The side walls are protected by the roof overhangs and maximum ventilation is achieved by covering them with rushes. There are different temperature zones within the houses; the coolest areas are reserved for the Eldest of the extended families living in these houses. (Behling et al., 1996)

Using different zones within a building is a typical building feature in all tropical regions. The buildings often feature porches or covered outside areas which create shaded areas for the living quarters behind them.

The following principles can be derived for this climate zone:

- **Maximisation of natural ventilation**
- **Selection of quickly drying materials**
- **Buffer zones that create micro-climates within a building**
- **Light buildings, heavy mass is not helpful**

### § 3.3.5 Dry climates / Subtropics

---

Dry climates are those climate zones at the transition between the tropics and the moderate zones. They form a belt around the globe with deserts, warm steppes, winter rain regions and constantly humid hot summer climates. They are often referred to as Subtropics even though this term is deceiving since they also include the dry hot desert climates. A desert climate is a climate in dry and hot areas; obviously including deserts but also semi-deserts and steppe areas known as semi-arid regions. Figure 3.19 shows these regions, also known as dry climates.

From a geographic viewpoint they include regions in North and South Africa, parts of the North American West coast and southern parts of South America. Typical desert regions such as the Near East as well as parts of China and a great portion of Australia can also be allocated to this climate zone. The cities of Las Vegas and Dubai lie in this climate zone.

Characteristic features of these climate zones are very high solar radiation and very low relative air humidity of 10-50%. Also typical for these zones is a low amount of precipitation, often occurring as short strong rain falls.



Figure 3.19  
Subtropics, including deserts and dry climates as well as semi-arid steppes.

One benefit is that night-time temperatures drop considerably, sometimes to close to freezing, making regions in these climate zones some of the most extreme living environments. (Schütze and Willkomm, 2000)

Low relative humidity makes the dry hot climate more bearable; however, protection from direct solar radiation with day-time temperatures of up to 50°C is critical. The large difference in temperature between day and night-time often provides the basis for the given principles and building methods to survive in this extreme climate.

All building measures within this climate zone are aimed at protecting the living environment from the ambient heat. Principles for cooling can be differentiated into two methods which are the basis for almost all of the subsequent constructions. The temperature within buildings can be lowered by, firstly, the evaporation of water (adiabatic cooling) and, secondly, by exchanging warm with cold air.

Air exchange creates air movement; a comfortable sensation for the human body that aids in lowering the body temperature. Under normal circumstances the human body emits warmth with 30% as convection, 45% as radiation and 25% in form of evaporation. Air movement increases convection and evaporation. (Oliver, 1997a) The dry heat lets perspiration or water quickly dissolve in the air, i. e. evaporate, which makes the use of evaporative heat loss very effective.

### Air-permeable window covering

---

In hot dry climates, perforated or other air-permeable coverings are often set in window openings to maximise natural ventilation. Wooden window lattices known as Mashrabiya are used in Egypt and other regions in the Near East. They consist of carved or lathed wooden posts arranged to latticework which is set in the window opening. Oriels often feature these lattices, which explains the term “A place to drink”. Unglazed clay jars filled with water were placed in these niches or oriel niches so that water evaporates on the surface and cools the incoming air. The resulting evaporative heat loss made these spaces particularly comfortable.

The Mashrabiya fulfil the following functions that can be used as principles:

- **Controlled diffuse supply of daylight**
- **Protection from direct solar radiation**
- **Control of the air flow by using differently sized lattice apertures**
- **Protection of privacy, outside view possible through contrast, limited view inside** (Hindrichs et al., 2007)



**Figure 3.20:**  
*By providing shading, the Mashrabiya oriel offers sun protection and good ventilation.*



**Figure 3.21:**  
*Jali, the Indian counterpart of the Mashrabiya.*

In India, similar screens in the window opening are known as Jali. In addition to wood, they are often built from stone or brick. The term Jali, derived from Sanskrit, means lattice or netting.

In most cases, the Jali just as the Mashrabiya in combination with courtyards and ventilation towers serve to maximise natural ventilation. (Oliver, 1997a). Since Jali are often used on the ground floor, they provide the additional function of burglary protection; the aperture size is never larger than a fist. The lattice formation of the Jali and Mashrabiya reduces open geometries, and thus accelerates the flow of the incoming air, which in turn increases the cooling effect.

On many houses there are additional superstructures featuring Mashrabiya. These superstructures serve as a light source for deeper rooms as well as another source of natural ventilation. They are known as Sahrigi, and are primarily oriented toward the sun; the wind direction is of secondary importance.

**The principles derived from the functionality of the Mashrabiya and Jali are sun protection and ventilation element.**

---

### § 3.4 Wind catcher and solar chimneys

---

Wind catchers are placed on roofs of buildings to channel wind through ducts and shafts into the living space. They are called badgir, and can vary greatly. The simplest forms have an opening toward the main wind direction and guide the wind through a hole in the ceiling into the room below. The most thought out versions of badgirs are found in the Iranian city of Yazd; some are octagonal towers up to 30 m high that can channel wind from any direction and thus provide cool air into the adjacent courtyards.

In the Middle East, wind catchers have been known since 2000 B.C.E., as is documented by Egyptian burial sites. Solar chimneys are mainly used in the Middle East. Because of its opium trade, Yazd became a wealthy city around 1900. This is evident by the high number of badgirs which were a prominent sign of wealth. (Oliver et al., 2007)

In very hot, dry climates such as Baghdad in Iraq with temperatures of up to 50°C, the wind catchers or badgirs serve the sole purpose of exhausting high air humidity and odours that accumulated as a result of up to 20 family members gathering on the lower levels. In hot, dry climates with maximum temperatures of up to 40°C, large wind catchers supply fresh air to the living area on ground level. During the day, the air flow provides comfortable coolness by evaporating perspiration on the skin and by convection. At night-time, the significantly cooler air cools down the massive buildings for the following day. In the hot and humid regions of the Gulf region with temperatures above body temperature the only method of achieving a sufficient comfort level is evaporation of perspiration. This process requires maximum air movement which led to very large wind catchers open in all directions. (Oliver, 1997a)



Figure 3.22:  
*Badgirs in Yazd.*



Figure 3.23:  
*Wind catcher in the Province Sindh in Pakistan.*

The summer in the southern part of the Province Sindh in Pakistan is long and very hot. During the evening, however, there is a cool south westerly breeze from the ocean that can be felt up to 100 km inland. This cool breeze occurs during nine months out of the year and is used for cooling almost all of the buildings in Sindh. The constant wind direction makes it easy to perfectly align any wind catcher. The top is slanted to redirect the cool night air into the building interior. All wind catchers are located as high as possible so that the least amount of dust possible is introduced in the building. In addition the wind catchers are situated such that their functionality is not hindered by neighbouring buildings shielding the wind. (Oliver, 1997a)

The principle of a guided air flow that provides a cooling draught in the building is used in almost all buildings in dry hot climates. In southern India the term “lifeline” flowing through a house is used for an air-ducting hallway that provides maximum cross ventilation throughout the building. Figure 3.24 shows a typical footprint of a residential building in southern India. The air is funnelled through the covered entrance area and is then led through hallways to the courtyard. Here, the air is cooled by water fountains or earthen vessels filled with water. It then flows into the adjacent living spaces. During the day, the air flow causes a refreshing breeze, at night it cools down the massive walls. In addition, the courtyards feature shade-providing arcades that help making the hot day-time temperatures bearable.

**The principle to be derived is continuous airflow inside the building.**

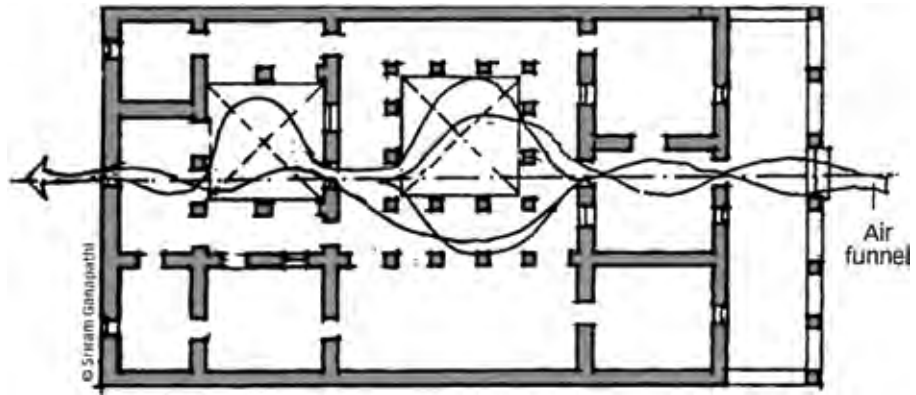

Figure 3.24  
 Typical footprint of a southern Indian residential building with a cross ventilation arrangement called "lifeline".

### Yards and courtyards

For large massive buildings in dry hot climates, a central courtyard can serve to cool the entire house. At night, sinking cool air is trapped in the yard, and adjacent building mass cools off. During the day they do not heat up very much due to shading provided by the buildings themselves. Since cooler air is heavier it not only cools of the building mass during the night but also penetrates adjacent rooms. The principle is based on the pressure gradient between cold and warm air; the cooler night air automatically displaces the warm air in the yard. During the day, the warm air above encloses the cool air in the courtyard.

Since the buildings shade themselves, the massive walls facing the courtyard are protected from overheating during the day; however the yards may not be dimensioned too large. This principle works particularly well in climates with large difference between day and night-time temperatures. In order for the principle to be maintained, the walls facing the courtyard and those forming the outer enclosure need to be well insulated or massive.

And large opening need to be avoided; a slight breeze through the building is sufficient to eliminate the stored coolness. The determining factors of this cooling effect are the volume of the yard and the adjacent rooms storing the cooled air. (Oliver, 1997a) In terms of urban layout, narrow streets and alleyways prevent strong air movement, as can be seen in the example of Morocco.





Figure 3.25:  
Courtyard houses in Morocco.

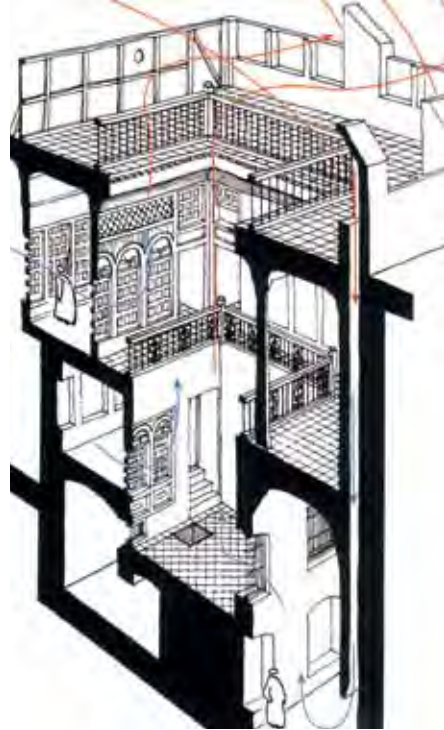

Figure 3.26:  
Convection ventilation in a courtyard.

**The principles that can be derived are using large building mass to store cold night air as well as exploiting cold air pockets and the fact that cold air sinks to the ground.**

Another principle of the courtyards is convection cooling. If building height and courtyard size are insufficient to shade the entire courtyard for the better part of the day, the effect of the ground of the courtyard warming up can be exploited. Together with the ground, the lower air layer also warms up. It begins to rise and generates an air flow out of the building, at the same time dispensing the coolness that dissipates from the massive walls into the ambient air. This creates a circulating breeze in the house that rises upward in the courtyard. With this principle at work, the courtyard cannot be used during day-time, but the heat it stored such that it provides comfortable temperatures long into the night. (Oliver, 1997a)

**The principle derived is use of solar generated thermal lift for natural ventilation.**

## Sun sails and shading

---

The simplest form of shading is often provided by large trees with projecting crowns. In the African savannah, many settlements are located in direct proximity of large, shade-providing trees. The trees often form the central gathering place or the school area. Many Greek island towns show that, in the absence of trees, wine palisades are often planted for the same purpose.

In dry hot Arabic regions, sun sails or straw mats hanging over winding alleys provide sun protection to counteract overheating caused by strong solar radiation. Since the alleys are narrow it is easy to build wooden constructions spanning from roof edge to roof edge. These are covered with coarse linen sheets, straw mats or palm fronds. The intention is to create air-permeable coverage to promote air circulation.

In India, projecting sun sails that are installed in front of the window openings are very common. In some cases a rope can be attached to the lower edge of the sun sail to manually introduce a slight breeze into the building. Similar constructions, however mostly rigidly mounted, can be found around the world as sun sails or awnings to provide shade for stores or cafés. (Oliver, 1997a)

**The principle derived is any kind of sun protection that provides shade.**



Figure 3.27:  
*Shading of a bazaar in Morocco with light reeds.*



Figure 3.28:  
*Salsabil with water basin in an Arabic palace.*

## Adiabatic cooling

---

Adiabatic cooling, also known as evaporation cooling is based on the same principle as that of the human skin cooling by perspiration. Warmth is drawn from the ambient air to evaporate the water, creating a cool sensation on the skin.

As was previously explained for the Mashrabiya, unglazed vessels filled with water were used to achieve a cooling effect. In addition to the cooling effect, humidifying dry air is another benefit of adiabatic cooling in dry hot regions. According to Oliver (Oliver, 1997a) 0.5g of water can cool a cubic metre dry air by 1K. In Egyptian or Arabic regions, small meshed window coverings made of palm rods are wetted to create a cooling effect. Further developed solutions include moistened hangings installed over air inlets in exterior walls to cool down the incoming air and filter out dust particles.

Some dry hot cities in the Middle East featured a central water supply system. The water was collected through channels and viaducts and fed to the highest point in town. Here, more complex solutions were developed to make use of adiabatic cooling. Buildings in Damascus in Syria, for example, or in Isfahan in Iran, featured specific walls or sloped ramps that were kept wet constantly. In order to increase the efficiency of these cooling walls, also known as Salsabil or “Spring in Paradise”, the stone surfaces were designed with ornaments and patters that created turbulences in the water and therefore increased the cooling effect.

Water fountains are used all over the globe to cool the immediate environment; and particularly in dry hot regions small water fountains are installed in the courtyards if water supply is available. In some case, simple water-filled basins were used to provide a small amount of cooling. Even if the cooling effect can add only little to the overall comfort level, the vitalising and refreshing effect of water has a positive psychological effect on the human mind. (Oliver, 1997a).

**The principle derived is adiabatic cooling.**

## Thermal mass

---

One common characteristic of all building types in this climate zone is the massive building method. Massive walls reduce warming by solar radiation (amplitude attenuation) because the incident energy must first warm the massive building material before it can slowly spread to the inside. Due to the storage capacity of the building material, often dried clay bricks (adobe), it takes until evening for the heat of the day penetrating the interior; when it actually provides comfortable temperatures during cool nights. Clay mosques in Mali, West Africa, are still built according to this traditional building method today; the interior is cooler than the area in front of the building.



Figure 3.29  
*Typical clay mosque in Mali*

In many desert regions heavy, massive buildings have been used for ice houses or ice storage. Minimal outside surface area – often in shape of a truncated cone – provided the means to store ice blocks collected from ice covered mountain ridges or imported from distant regions. In Yazd in Iran, for example, ice was stored for several years while outside temperatures reached 50°C. The ice is periodically rearranged to maintain homogenous temperatures, and large amounts of ice help maintaining low temperatures. The cool night air in those regions allows for the building mass to cool off during the night.

**The principle derived is to use massive building components as thermal energy storage to achieve amplitude attenuation of the temperature and a phase shift of the temperature toward the night.**



Figure 3.30  
*Ice house in Yazd next to a caravanserai*

## § 3.5 Matrix for climate-adapted architecture

The following principles can be derived from the compiled examples:

### **Polar zone**

- Strong insulation as well as a wind-protected entrance area
- Creating air layers with different temperatures

### **Borealis or snow-forest climate**

- Using earth / the ground as a thermal mass for insulation
- Exhaust air outlet at the highest point of the building
- Using materials that offer high insulation values to allow for effective heating
- Using mass as a temperature buffer
- Utilising air flow to heat massive building parts, mass as a storage medium, increase surface area

### **Warm moderate climate**

- Artificially or naturally generated temperature flows to temperate surface areas - both heating and cooling possible
- Self-shading through intelligent urban layout
- Southerly orientation for energy generation during the transitional periods
- Shielding toward the north to minimise cooling in winter

### **Tropical climate**

- Maximising natural ventilation
- Selecting material that dry quickly
- Buffer zones that create micro-climates within a building
- Light buildings, heavy mass is not helpful
- Shading in front of building apertures

### **Desert climate / Subtropics**

- Using sun protection and ventilation element
- Allowing continuous air flow within the building
- Using solar generated thermal lift for natural ventilation
- Sun protection that provides shading
- Adiabatic cooling
- Using thermal storage mass to allow amplitude attenuation and phase shift toward the night

The principles and solutions compiled here can be arranged in a matrix; the content relates to the research and analysis of traditional, climate-adapted architecture.

Principle / Climate zone	Polar Zone	Boreal Zone	Modest climate	Subtropical Zone	Desert Climate
<b>Sunscreen</b>	not necessary, use the most of the sun irradiation to receive most of the sun energy	variable, to gain sun energy if needed. Block when necessary	variable, to gain sun energy if needed. Block when necessary	shading required, often through open gutters or grids, overhanging roofs	shading required, often through open gutters or grids, overhanging roofs. Urban context helps to maximize shading
<b>Insulation</b>	maximize insulation, to prevent thermal heat loss. Buffer zones allow temperature zones within the building	insulation required, Use thermal mass of material, like earth. Multilayer walls with insulating layers to allow a fast heating.	insulation required, Multilayer walls with insulating layers to allow a fast heating. Used for winter and summer to prevent overheating	no insulation required, thermal mass is able to buffer. Buildings are light as possible	insulation required, Use thermal mass of material to lower the temperature peaks during the day.
<b>Natural ventilation</b>	minimize ventilation for hygienic comfort. Air intake via buffer zone to allow a natural preheating	Exhaust Air Outtakes on highest points in the building. Natural ventilation supports the distribution of heat.	Ventilation due to the season, Cross Wind ventilation, in winter low as possible	maximize natural ventilation, allowing materials to dry fast during the rain seasons	maximize natural ventilation, to gain maximum comfort by air velocity
<b>Heating</b>	necessary, often through basic fire places	necessary, often through basic fire places, use of aerial heating like wall or floor heating	required in cold season, distributed by central systems, or local fire places	not necessary	sometimes needed in the night, can be solved by thermal mass temperature storage
<b>Cooling</b>	not necessary	not necessary	not totally necessary, or solved by natural ventilation and thermal mass	required, but mostly by using a good natural ventilation, use of adiabatic cooling	required, but mostly by using a good natural ventilation, use of adiabatic cooling, or use of thermal mass storage
<b>Sun orientation</b>	Maximize orientation towards south, to gain sun energy	Maximize orientation towards south, to gain sun energy	Covering the north side, to gain maximum insulation, open to south to gain solar gains	blocking direct sun, minimize solar gains	blocking direct sun, minimize solar gains

Table 3.1  
Matrix of vernacular architecture principles

## § 3.6 Potential of transfer to modern building construction

Examining all of the principles, building methods and facilities that have developed over many hundreds or even thousands of years show that there are many parallels to today's "engineered" solutions. Adiabatic cooling is now part of compact cooling systems; the use of heat exchangers even eliminates additional humidification. Sun protection curtains, awnings or similar devices of various designs are used in modern building envelopes. Many of the solutions shown have been adapted to current material and production method technologies.

However, it must be pointed out that examples given should be understood as principles and solutions that made living in a particular climate possible. In part they provided an additional level of comfort, but this should rather be described as a small relief or slight improvement of the climatic conditions. Life and daily cycles in dry hot regions, for example, has been adapted to the extreme temperature conditions. Entire extended families move from one part of the building to another to benefit from the different temperature areas that form over the course of the day. At night-time, rooftops provide a comfortably cool place to sleep while at the same time offering warmth that was stored in the building material throughout the day.

With all the traditional building methods to exploit or to counteract the climate, we cannot really speak of comfort in the sense that we understand it today. Our society today, driven by industrialisation and globalisation, expects virtually equal comfort levels anywhere in the world.

As tourists only, we might adapt our clothing and attitude to the climatic conditions of our travel destination; considering extreme heat in Egypt, for example, as part of the adventure. Every year, the ice hotel in Jukkasjärvi is erected approximately 200 km north of the Arctic Circle for duration of 4 months. It is booked out months in advance. This is another example of the thirst for adventure to defy extreme weather conditions.

Today's business travellers or office employees expect almost equal work conditions around the world – not least because of the given dress codes. In addition, comfort parameters are regulated by law and homogenised to more international, meaning similar standards. The topic comfort will be further discussed in the following chapters, but it needs to be noted here that using traditional building methods alone does not mean that we can achieve our expected comfort levels. And this is irrelevant of the fact that massive clay buildings, for example, do not meet the structural requirements that modern office high-rises need to fulfil.

The results of this analysis and the basics of comfort and façade technologies described in the following chapters will be used in [chapter 7 'Climate Responsive Optimised Façade Technologies CROFT'](#) to develop new approaches for energy efficient operation of buildings with specific focus on the façade.

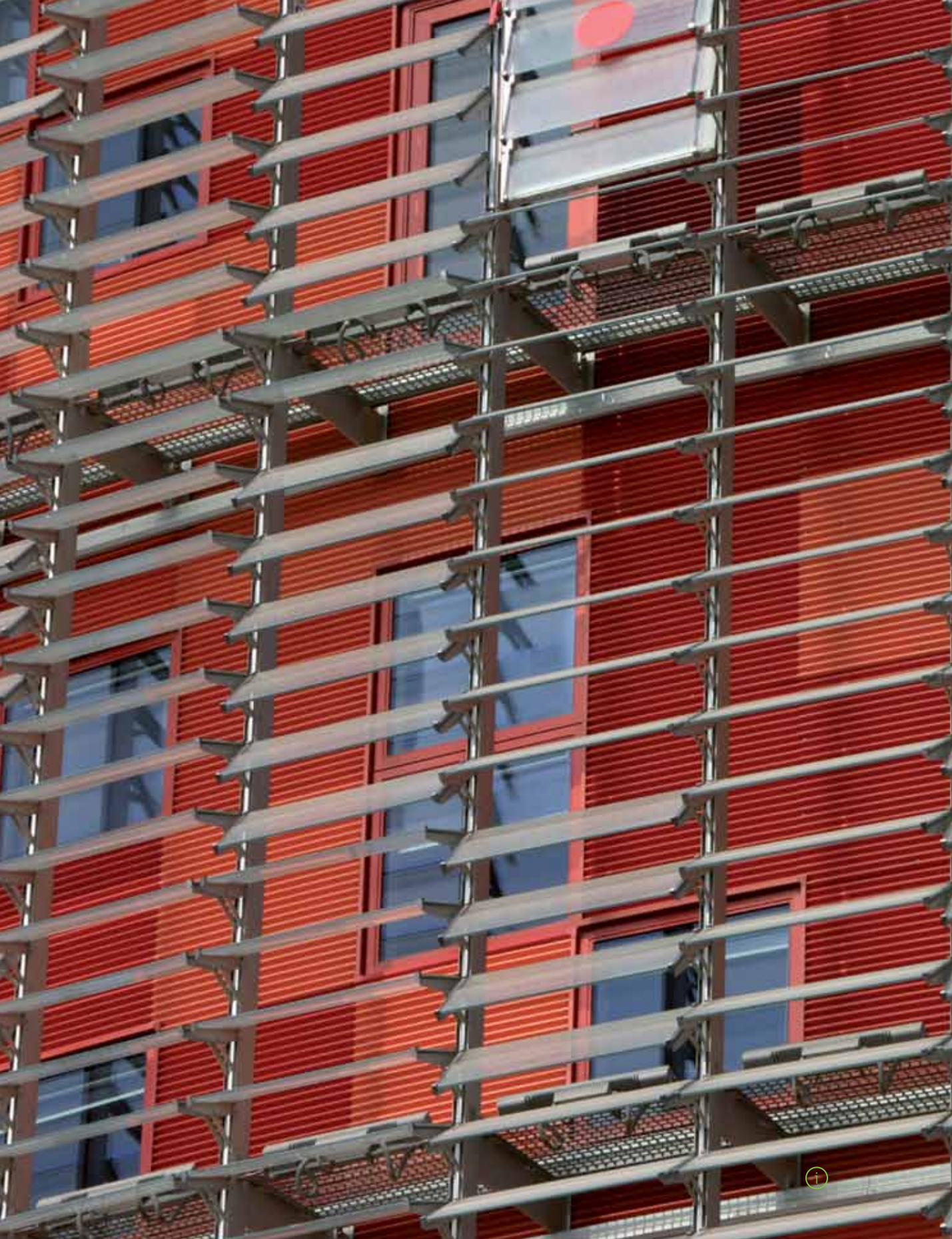







# 4 The Façade

## § 4.1 The evolution of the façade

The façade as a building component with a multitude of variants and functionalities as we know it today is a result of a long developmental process. The following will describe the evolutionary history, illustrated with several exemplary buildings. The chapter will be concluded with the requirements posed on the façade.

Shelters for human beings consist of an envelope enclosing a space to protect that space against exterior conditions and to provide the occupant with a feeling of security.

In principle, the evolutionary development of human shelter followed two directions. Firstly, massive constructions whereby the building envelope fulfills the functions load-bearing, leak tightness against rain, cold and sun, and enclosure. Secondly, skeletal constructions in form of tent-like structures whereby these functions began to be separated into load-bearing (skeletal structure), and leak tightness against rain, cold and sun, and enclosure (envelope). Both constructive variants underwent an evolutionary development toward increasingly effective solutions so that in a subsequent step the function of ventilation was integrated into the construction by adding apertures. These apertures offer the added bonus of providing the interior space with daylight.

Massive constructions evolved from completely enclosed structures to structures with simple openings for ventilation and, at a later stage, lighting.

At first this was achieved by using thinly cut marble panels, which were later replaced with glass. The use of glass offered transparency and therewith the opportunity to develop inside-outside interaction.

Another step was to subdivide the window to allow for lighting in the upper area, and for ventilation as well as rain tightness in the lower part, sometimes with the help of folding shutters. (Nijssen, 2008).



**Figure 4.1:**  
*Dutch window; in early stages outfitted with folding shutters in the lower section to offer ventilation but provide rain tightness at the same time; and lead glazed window panes for lighting in the upper section.*



**Figure 4.2:**  
*Church window Aachen Cathedral. (Tillmann Klein)*

In the course of the development of building styles, the inside-outside-relationship became a design feature: particularly in European churches, windows developed into glazed areas of impressive dimensions. The goal was to impress church goers. At the time, colour played almost no role in their lives which made the spirituality of the church all the more impressive. (Kohlmaier and Sartory, 1981)

The dissolution of the church wall must be seen as a constructive step: from the massive wall of the Romanic church to Gothic church windows where force of gravitation was the design-forming tool. The forces from the church vault are bundled and merged in the walls in risalits and pillars with the goal to achieve maximum window dimensions. This creates large apertures with pointed arches, typical for the Gothic style. The growing strength of bourgeoisie and commerce secularised this constructive and formative design vocabulary. (Knaack, 2003).

In the course of the industrialisation and the accompanying development of technologies and materials, these principles are first intuitively and then technical-analytically translated. The formative apogee can be seen in the greenhouses, passages and railway stations of the 18th and 19th centuries. (Kohlmaier and Sartory, 1981) (Knaack, 2003).



Figure 4.3  
*Royal Kew Garden, London, Richard Turner, 1844-1848*

Driven by the desire to find a different architectural language, classic modernism is dominated by the idea of transparency. The result are large glazed areas that manifest the skeletal construction method and therewith the separation of load-bearing structure and façade.

The above described process explains the separation of functions in the building envelope toward a differentiated structure. The load-bearing function, which requires compactness or at least closed structures, alternates with open structures for lighting and ventilation, which require open, operable or transparent designs. Subsequent evolutionary steps saw an improvement of the efficiency of individual functions; however, the individual functions were not merged.

Triggered by the oil crisis in 1973, the awareness of global energy consumption has played a major role in changing the approach to the building envelope over the past 40 years. The insulating properties of closed structures as well the possibility of energy generation through solar radiation in the area of open/transparent structures has led to further development in wall and façade systems. (Wikipedia, 8 Aug 2010)

As a first response to the oil crisis in the Western world, the glazing ratio of buildings was significantly reduced. And thermal separation in the window profiles was introduced to reduce thermal bridges. In a second, certainly aesthetically motivated step, a generation of buildings developed around the sun as the central theme, including the “house within a greenhouse” concepts, following the deliberate goal to collect and store solar energy. This entails the risk of overheating and required careful planning of ventilation, exhaust systems, and shading. (Knaack et al., 2007).



Figure 4.4:  
*Farnsworth House, Plano, Illinois, Mies van der Rohe; 1946-51.*



Figure 4.5:  
*Academy Mont Cenis, Jourda + Perraudin, Herne 1999*  
*"House within a greenhouse" concepts*

The development of the double façade can be seen as one step in the described evolution of the façade: in the wake of the “house in a greenhouse” solutions, the late Nineteen Nineties saw the development of double façades, consisting of an outer glass layer to collect solar energy and provide protection for the inner façade, which could thus follow a simpler design. In the beginning, planners used a large gap between the inner and outer leaf in order to achieve greatest possible control options and to be able to employ the effects of the “house in a greenhouse” concept. Subsequently, these gaps were reduced and air ducting was differentiated so that targeted supply and exhaust air-ducts allowed for controlled air quality and temperature. (Knaack et al., 2007).

In consequence of this development it seems obvious to integrate buildings services functions into the façade and thus add to the traditional functionality of the façade as described above. This includes actively influencing the room air and temperature by using heating and cooling devices that can be integrated into the façade in a decentralised manner. But it can also mean adding lighting to the façade's functionalities: in addition to targeted day light regulation, the façade can also be used to introduce artificial light. (Knaack et al., 2007)



**Figure 4.6:**  
*Stadttor Duesseldorf, Petzinka, Pink und Partner, 1998 Corridor façade: The outer pane (function: tightness and solar penetration) and the inner façade (function: wind tightness and room enclosure) are almost one metre apart.*

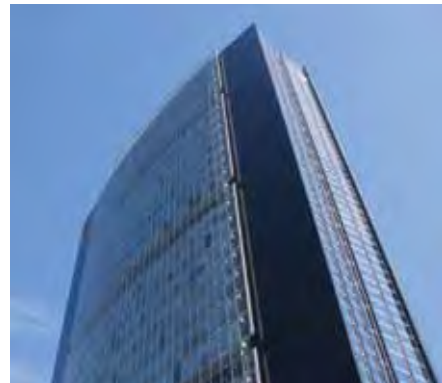

**Figure 4.7:**  
*ARAG Duesseldorf, Foster and Partner with RKW, 2000 Shaft-box façade: The gap is minimised and designed such that supply air streams in across individual storeys whereas exhaust air is heated in a shaft within the façade and thus rises upward.*

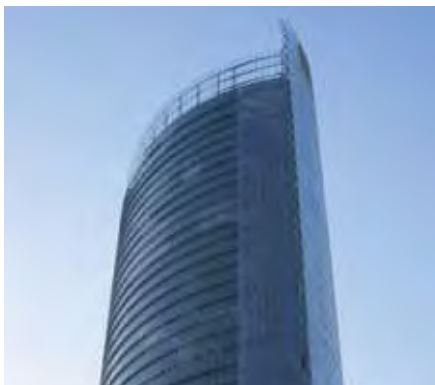

**Figure 4.8:**  
*Post Tower Bonn, Helmuth Jahn, 2003 Component façade with integration of decentralised heating and cooling devices in a double façade.*



**Figure 4.9:**  
*Capricon Duesseldorf, Gatermann und Schossig 2006 Component façade with modularised building services components as well as an integration of daylight directing and artificial light facilities.*

**Two significant observations should be noted here:**

Firstly, it is necessary to further specialise the components and planning processes due to increased differentiation of the façade functionalities. This is one reason why climate engineering as well as façade planning have become an essential part of the planning process and influence the performance of the façade.

Secondly, this development occurs mainly in the Western industrial countries and sees its biggest drive in the temperate climate zones of Europe. This is not only due to the possibilities a temperate climate offers but also due to the fact that these countries as the largest energy consumers are forced to consider the operational energy of buildings and therefore the building envelope.

As a consequence it can be noted that the described façade types with integrated building services components are understood as a tool of building services engineering in a broader sense and must therefore be employed accordingly. The goal should not be to use them as mere formative ornamental elements without integrating them into the functionality of the building.

---

## § 4.2 The façade – buffer and regulator

---

As mentioned above, the façade or building envelope plays a significant role in the energy consumption of a building. Since it functions as the interface between interior and exterior in addition to enclosing as well presenting the outer appearance of the entire building it provides great potential for innovative solutions and constructions.

Parts of this chapter have been published in the book “Principles of construction – Façades”; the content has been reworked for the purpose of this thesis.

Air and warmth can be drawn as well as dissipated through the façade. In order to ensure comfort for the current user, the façade must comply with many functional requirements. If the façade cannot provide certain functions, additional components must be installed in the façade layer or in its vicinity.

In the interior, all comfort requirements must be met, and on the outside, the façade must be able to withstand local influences and possibly exploit them in an energy efficient manner. Façade and technical components interact with each other. The better the passive thermal protection of the façade, the smaller are the required heating areas. And the more effective the sun protection, the smaller the necessary cooling systems. Depending on the climatic conditions and interior thermal loads,



active cooling measures can be entirely avoided in Central European regions, for example. The façade has a major impact on the energy balance as well as the comfort parameters of a building. It therefore acts as a buffer and regulator. The following introduces parameters which are influenced by the façade.

---

## § 4.3 Comfort

---

Different building types such as residential dwellings or office buildings pose similar comfort requirements. However, in office buildings the comfort parameters are regulated by law in terms of quality of the work place; whereas those for residential dwellings are often oriented on their attractiveness for the renter or buyer. The most important factors are thermal, hygienic, acoustic as well as visual comfort. All of the parameters to be considered during planning should be agreed upon in a discussion between all of the participating specialist consultants. An isolated consideration of individual aspects can lead to adverse effects on other requirements. Each user defines comfort subjectively. Therefore comfort cannot be measured for all users equally with objective measuring techniques. When determining factors that determine comfort such as air movement, temperature, light intensity or humidity, we can only strive to provide suggestions in form of guideline values. However, every user will sense these differently and will feel more or less comfortable. National laws pose minimum requirements on the conditions of a workplace or living environment; but typically these requirements only serve to ensure the main determining factors. Special requirements related to comfort should be determined during the planning process by the participating planners. The following gives a short explanation of individual aspects of comfort.

### § 4.3.1 Thermal requirements

---

According to ASHRAE, thermal comfort is defined as follows: “Thermal comfort is that condition of mind, which expresses satisfaction with the thermal environment.” (ASHRAE, 2004)

Inside a room, the human body not only exchanges thermal energy through the air by convection, i.e. transferring energy through the flow of tiny particles, but is also in contact with the enclosing surfaces through radiation. This means that thermal energy must be transported by convection as well as radiation to achieve thermal comfort.

Due to these thermal energy transport mechanisms temperature is given as 'felt' temperature or 'operative' temperature. This value, also known as room temperature, approximately corresponds to the mean value of room air temperature and mean radiation temperature of the room enclosing surfaces. This shows how important the enclosing surfaces of a space are for our sense of thermal comfort.

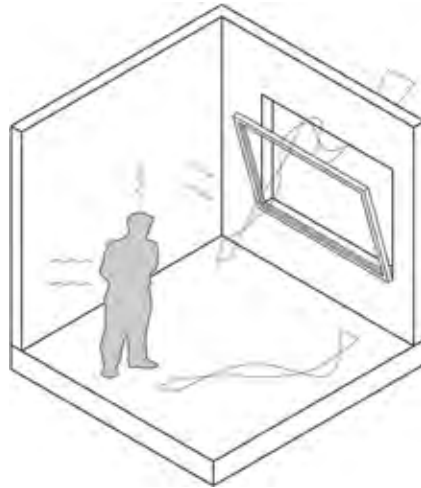

Figure 4.10:  
The human body exchanging thermal energy with the environment.

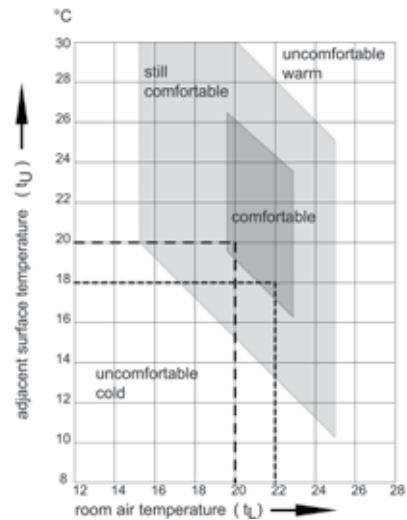

Figure 4.11:  
Diagram according to Recknagel. Illustrating the influence of air temperature, surface temperature and comfort.

Every human being experiences temperature differently; thus user opinion has to be understood as subjective information. Form of the day and various other circumstances such as clothing have an influence on thermal sensation. Feeling comfortable or uncomfortable, i.e. feeling well or unwell under the current thermal conditions describes thermal comfort as a subjective measurement. (Hellwig, 2005)

The requirements for work space environment are regulated by the individual countries. In Germany, for example, the workplace ordinance ASR 6 determines that room temperature in work areas should not exceed 26 °C. However, a notation adds that this maximum value does not apply to extreme summer temperatures. Until recently the general consensus was that with natural window ventilation it is not possible to guarantee temperatures below +26 °C, and that therefore the regulation was not of determining significance for naturally ventilated offices. (See Bundesanstalt für Arbeitsschutz und Unfallforschung, 1979). A debate about maximum temperatures in office spaces began with the 'Bielefelder Urteil' in 2003, which mandates interior

temperatures of 26 °C maximum at outside temperatures of up to 32 °C. If outside temperatures exceed 32 °C, room temperature must be at least 6 °C below the current outside temperature.

In 1982 Fanger generated a computational model to determine comfort levels (Fanger, 1982). The results are included in DIN EN ISO 7730 and offer the possibility to estimate achievable comfort levels. DIN EN ISO 7730 specifies thermal comfort in form of a predicted percentage of dissatisfied people, measured in PPD (Predicted percentage of dissatisfied). For light summer clothing, the minimum number of dissatisfied is reached at +25 °C. The percentage of dissatisfied rises to 50% when the felt temperature reaches approximately +30 °C. Heavy work clothes have the effect that slightly lower temperatures are sensed as comfortable. The chart shows that in this case minimum dissatisfaction occurs at felt temperatures of 23 to 24 °C. The ISO regulation suggests maintaining a pmv of +0.5, whereby a maximum temperature of 27.5 °C still lies within the ISO specifications assuming light clothing and office activities. If component cooling is applied, air temperatures of almost 29 °C are permissible because of the low temperatures that the enclosing component surfaces radiate.

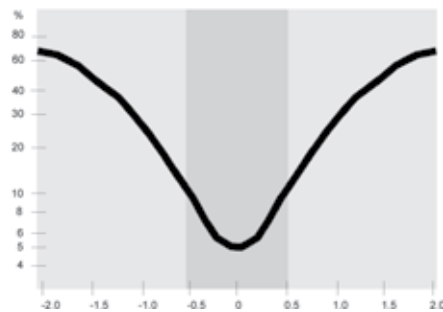

Figure 4.12  
Chart DIN EN ISO 7730

In addition to the above mentioned air and radiation temperatures reflected by the felt temperature, thermal comfort is also influenced by air humidity. The human body regulates its temperature by water-vapour emission (perspiration); particularly important in hot humid climates. According to DIN 1946-2, for example, the relative air humidity should lie between 30% and 65%. The climate examination in [chapter 2 'Climate zones'](#) shows that air humidity, especially in tropical zones exceeds the required values; a fact that requires consideration in the planning process.

In the past, the comfortable temperature range according to DIN EN ISO 7730 or local German regulations such as the work ordinance was determined independently from the outside temperature or dependent on the current outside temperature only. Newer research, published by de Daer and Brager in 1997 and 2002 (de Daer, 1997), (de Daer, 2002) describe an adaptive model of determining comfort that presupposes that the user adapts his/her requirements to the prevailing conditions in a building. He or she assumes that the indoor climate is kept at a constant level if the building is air-conditioned. In buildings with natural ventilation, the expectation is lower; temperature and humidity fluctuations are considered normal and have a less negative impact.

Research shows significant differences in the hitherto effectual thermal comfort parameters published in the ASHRAE Standards 55 in 1992. These standards were reworked in 2004 and now include the results of de Daer and Brager's research results. One of the most important results from this user input analysis from different countries is that in naturally ventilated buildings a sufficient comfort level is maintained at significantly higher inside temperatures than was predicted in the old computational models. The computational model using the adaptive method of setting inside and outside temperature in relation with each other was adopted in 2007 in the European norm DIN EN 15251 for the European region. (DIN EN 15251:2007) For the first time, this norm offers a computational model which can determine the comfort of not only air-conditioned but also naturally ventilated buildings.

### § 4.3.2 Visual requirements

---

The visual requirements posed on a room have the goal to make this room appear pleasant to the people occupying it. As with thermal comfort, the visual perception and also the taste of individual users can vary significantly. As a general rule, rooms should be designed such that the human eye can quickly comprehend its environment and that a clear spatial impression is given. Good orientation guides, sufficient lighting, and low contrast aid in perceiving a room and promote visual comfort.

The influence of colours in a room is another factor to be considered in this context. And another important but often underestimated aspect of visual comfort is natural lighting. If natural incident sunlight is at all available, it should be used. The human metabolism needs sunlight. But in order to avoid overheating and glare at the workspace, sun protection facilities are needed. Shading that produces high contrast is problematic. Compromises during planning are unavoidable.



Figure 4.13  
*High contrast influences visual comfort*

### § 4.3.3 Hygienic requirements

---

In 1998, a comparative study by the BMFT (German Federal Ministry of Research and Technology) about air-conditioned office spaces and naturally ventilated rooms determined that occupants feel unwell more often in air-conditioned spaces than in rooms with natural ventilation and lighting. Thus, working in air-conditioned rooms has an influence on the productivity of the employees as well as the company. The fatigue and lack of concentration that occur in this context are known as Sick Building Syndrome (SBS).

The quality of the room air plays an important role in perception of hygienic comfort. In addition to many other factors, it is determined by the quality of the supply air on one hand and user or room-related contamination on the other. Such contamination includes dust, gases, CO<sub>2</sub>, odours, viruses and bacteria. In order to ensure hygienic comfort a sufficient air exchange must take place.

Hygienic ventilation rates can be measured per person or per square metre. 40 – 60 m<sup>3</sup> / h / person is a reference point for office activities. (Daniels, 1999)

#### § 4.3.4 Acoustic requirements

---

Acoustic comfort in a room is influenced by the sounds transmitted from the outside, sounds inside the building, and self-created sounds or their reflection.

Traffic and construction site noise are the largest sound sources outside a building. Inside a building, noise pollution is caused by the users themselves by talking on a telephone, walking or playing music. We need to differentiate airborne noise, which propagates through the room from the source via the air, and structure-borne noise that propagates through the building components such as footfall sound from walking on hard floors. In addition, sound can originate in technical devices or conduits. It travels through the distribution network inside the building and reduces the acoustic comfort level.

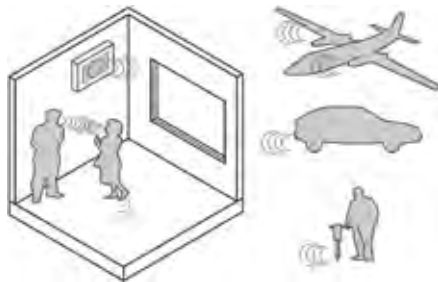

Figure 4.14  
*Sound development inside and outside a building*

The individual requirements posed on a building can add up to contradicting demands. For example, from an acoustic point of view it might make sense to suspend the entire ceiling. However, covering the rough concrete reduces its thermal storage capacity and thereby the natural cooling effect during summer that the concrete mass provides. If a suspended ceiling is mandatory because measures such as room dividers or sound absorbing furniture prove insufficient, different cooling methods must be considered. Thus, in planning all requirements must be considered at all stages to accommodate them to each other.

If the outside noise level requires the façade to provide sound proofing and at the same time windows are to be used to provide natural ventilation, the demands contradict each other because open windows would obviously introduce outside noise.

An alternative ventilation solution must be found or the façade must be modified to improve sound proofness even with natural ventilation.

## § 4.3.5 Productivity

---

High comfort levels in a building raise productivity. Over the past 10 years research about the relationship between comfort and productivity has been conducted in the USA. The research was driven by the green building movement which originated in Europe. An important economic factor in this context is that the cost for personnel is 10 times higher than that for building maintenance. Thus the potential to reduce these cost, or to increase personnel productivity, is very interesting and provides stimuli to consider increasing the comfort level of buildings.

Particularly in the USA, where office buildings usually have large footprints and office spaces therefore no contact to the exterior nor the option of natural ventilation through the façade, the argument of productivity increase is an economic inducement to design new buildings with higher comfort levels. The report "The Costs and Financial Benefits of Green Buildings" estimates a growth of up to 235 billion US Dollars if the productivity of all US American employees is raised by just 1%. (Greg Kats, 2003).

Such numbers are financial incentives to invest in more comfortable buildings. For a large number of individual businesses the fact alone that higher comfort levels translate into shorter absence periods from work and increased employee motivation which in turn translates into higher productivity is an incentive for change.

A survey of 1800 office employees from 126 US cities proved that their biggest demand were more comfortable office spaces. 95% of the interviewees called air temperature and 94% air quality the most important factor around their work place. And the most frequently mentioned reason for a company to change location were problems with the air-conditioning system. (www.BOMA.org, 1999)

Studies by William Fisk and Satish Kumar have shown that an office employee's productivity level would increase by 3-7% if he/she could self-regulate the temperature within a range of only +/- 3°C. (William Fisk, 2002)

In the USA, the LEED certification of new buildings accommodates demands for "healthier buildings". The certification is voluntary; however its label ensures lettability. In Western Europe, the aspect of productivity itself does not attract as much attention, partly because laws regulating the reduction of energy consumption and ecologic requirements inherently encompass these demands. Natural ventilation options, individually controllable temperature, sun and glare protection become more and more common.









# 5 Building services components

The functions ventilation, heating, cooling, sun protection and light directing have to be fulfilled in order to achieve the comfort levels in buildings described in [chapter 4 'The Façade'](#). An important factor when controlling the individual parameters is the reciprocal impact of the different components on each other. For example, sun protection and optimum natural lighting contravene each other. During planning, variants must be compared and compromises made to achieve comfortable operation.

The façade as a building component can control incident light and air by means of components such as operable windows or shutters, glazing and sun protection elements. By using the greenhouse effect, functions such as heating, for example, can also be accomplished indirectly by parts of the façade; however, the building envelope itself cannot provide sufficient overall comfort inside the building. Additional building services components are necessary to provide sufficient heating or cooling, depending on the exterior climate. The selection of available components is very large and their functionalities can be misleading. This chapter provides a detailed introduction into different functions and the related components. This forms the basis for the development of an expert tool used to analyse the climate and provide guideline information for façade and building services functions.

The components can be differentiated by their functionality and their installation location within the building. The following classifications can be made:

Function

- **Heating**
- **Cooling**
- **Ventilation**
- **Humidification**
- **Dehumidification**

Installation location

- **Decentralised in the vicinity of the façade**
- **Centralised as part of the building**

The first classification shows that the topic ventilation must be further subdivided into mechanical and natural components. The easiest method of natural ventilation is using operable windows. But because windows are not typically considered to be building services components, this thesis uses the term components in a more general fashion. Component here is an umbrella term for parts that are arranged within or in the vicinity

of the façade used to influence the indoor climate. The following describes such components in terms of their function to impact the room climate; a system sketch highlights the installation location. Due to the large number of available products, this overview shows the most commonly used components. Many components today combine the functions of heating and cooling. They can be equipped with additional ventilators to increase the inherent effectiveness; however, this complicates their classification. In as far as the listed components feature particularities in usage or functionality, such particularities are noted.

The psychrometric chart described in previous chapters is an easy to understand chart that depicts individual functions influencing the room climate. The state change of the air that a particular component causes can also be shown in the chart. Where ever possible, the functionality of a component is illustrated in a psychrometric chart followed by a detailed description.

---

## § 5.1 Heating

---

Ventilating a room causes repeated drops in room temperature. The energy needed to heat the cold fresh air is called ventilation heat requirement. The enclosing surfaces cause additional heat loss that also requires re-heating. The following shows several possibilities to heat a building with façade-related components.

In principle, heating should be understood as mere warming of the air. In a psychrometric it is displayed horizontally as dry heating. The air in its original state warms up and the relative air humidity drops. Absolute humidity remains the same; no water is added or extracted.

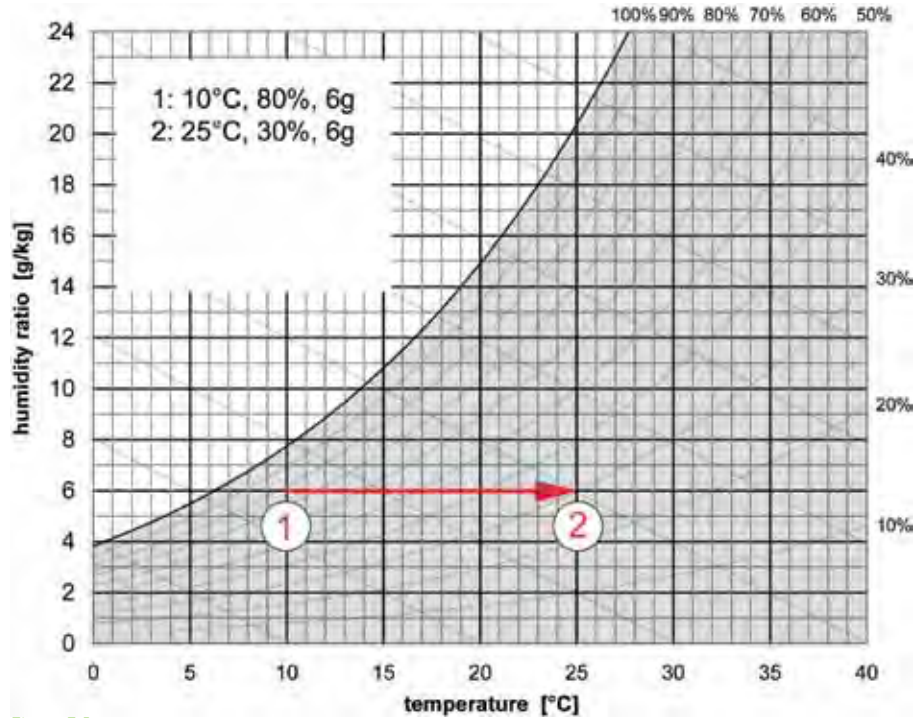

Figure 5.1  
The principle of heating

### § 5.1.1 Radiator (perimeter radiator)

The classic heating system that warms the room by radiation. Hot water flows into a cast-iron body (feed), the body warms up and radiates thermal energy into the room. The cooled water flows out of the heater (return) and is re-heated in a central heating system. Radiators are available in a large number of different sizes; due to their modular construction, a particular heating value can be achieved by coupling two or more elements. They are also available in horizontal or vertical format.

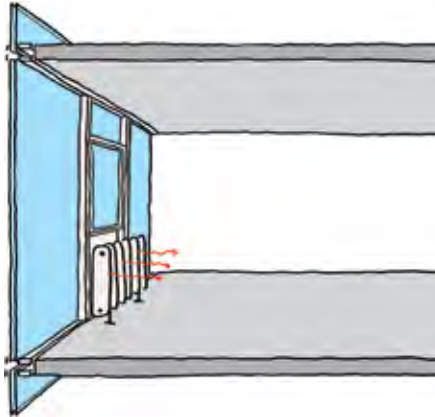

Figure 5.2:  
Radiator in context situation

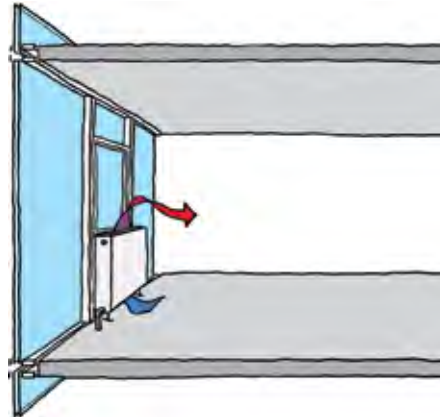

Figure 5.3:  
Convector in context situation

### § 5.1.2 Convector (perimeter convector)

Further development of the radiator with less radiation energy. Convectors are based on the principle of heat emission through convection; the most common type is the panel-type radiator which, from a constructive point of view differs slightly from the convector. In a panel-style radiator, a panel is filled with hot water. The heat is then dissipated through welded ribs that are attached on the rear side of the device. The air rising within the ribs causes the air to circulate and to suck in cold air at the lower point, heating it up and releasing it at the top. Panel-type radiators are mounted on the surface. Classic convectors are mostly installed flush-mounted and are concealed by a cover plate. Since the functionality of both heaters is the same, both have been mentioned in this one paragraph. These heaters radiate significantly less energy than radiators.

Depending on the requirement, the performance capacity can be enhanced by combining two or more heating panes which increases the heat-dissipating surface. These heating systems are available in horizontal or vertical format.

### § 5.1.3 Subsurface convector (perimeter FloorFintube)

---

Subsurface convectors are based on the same principle as regular convectors. They can be installed inside the floor construction in the vicinity of the façade. Air flows into the convector through a grate flush with the floor and is dissipated into the room. Since the installation height is very low, the heating element must be significantly longer in order to fulfil the required heating capacity. Subsurface convectors are typically installed alongside high, fully glazed façade areas to minimise cold air drop. In case of large rooms, the capacity is often insufficient and must be supported by additional measures. Regular cleaning must be performed due to the subsurface installation.

Particularity: Also available with additional cooling function and / or mechanical ventilation.

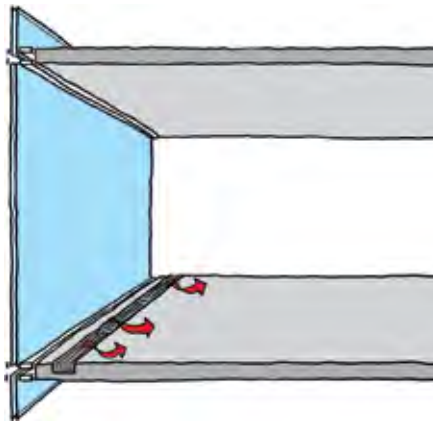

Figure 5.4:  
*Subsurface convector in context situation*

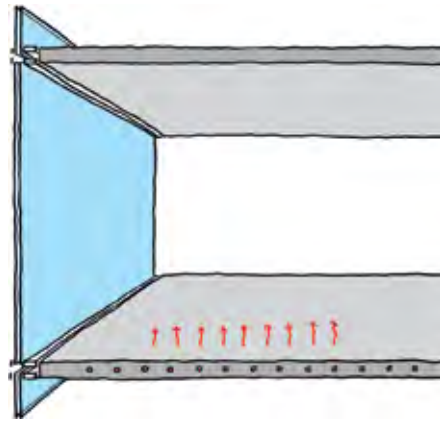

Figure 5.5:  
*Underfloor heating in context situation*

### § 5.1.4 Underfloor heating (radiant floor)

---

Underfloor heating systems use the entire available floor area to heat a room via radiation with a low-temperature heating system. Modular ducts are mounted in the floating screed or onto raised floors. The heating water flows through the ducts across the entire area. In order to minimise cold air drop along the façade, the first meters of the feed duct are installed along the façade to provide this area with high temperatures.

Alternatively, the heating duct is laid in closer loops along the façade to offer a higher energy yield. Underfloor heating systems are more commonly used in residential dwellings than in office buildings because in office buildings the use of a raised floor compromises access to the underfloor area for other installations at a later time. The selection of floor coverings is limited; thick carpets, for example, are not suited due to their insulating effect.

### § 5.1.5 Concrete core heating / overhead radiation heating (radiant ceiling)

Similar to the floor, the ceiling can be used for heating.

We differentiate between ducts that are integrated in the concrete ceiling (concrete core heating) and ceiling heating systems that are suspended from a load-bearing ceiling, flush-mounted or concealed under false ceilings. Ceiling heating systems and concrete core heating are typically used in office buildings because the ceiling surfaces usually remain undisturbed even if office use or furnishing changes. Also, radiant heat from above increases the comfort level of a work space because desk surfaces reflect the radiant heat; giving the occupant the impression of two heat sources. When planning concrete core heating, special consideration must be given to built-in lights or other components in the ceiling or concrete reinforcement.

Because they are installed in the concrete mass, concrete core heating systems are inherently slow systems that typically run in a seasonal cycle. In contrast, ceiling heaters with very low mass (e.g. installed in suspended plasterboard ceilings) are much faster systems that can be operated on demand. The systems can also be used for cooling.

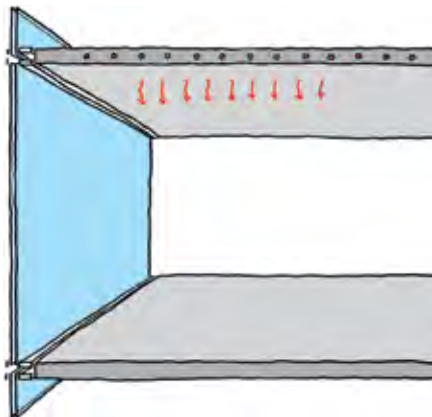

Figure 5.6:  
Concrete core heating

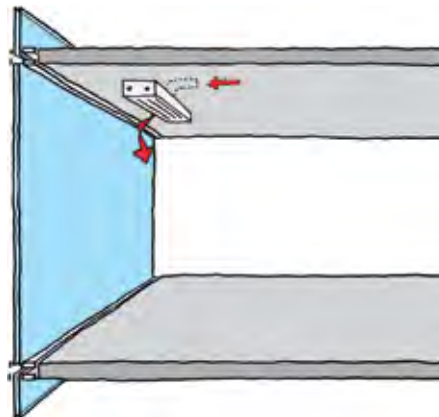

Figure 5.7:  
Overheat induction heating in context situation



### § 5.1.6 Overhead induction heating (active beam)

---

Overhead induction outlets are air outlets that can be mounted in the ceiling or a suspended ceiling. Supply air is heated in an integrated heat exchanger. The elements are connected to a central ventilation system which supplies them with fresh air. The heat exchanger is installed at the outlet area. It is fed with warm water from a central heating system and warms the supply air. The fact that the supply air is heated directly at the outlet opening allows for economic heating with high heating performance. Since water is a better medium to transport thermal energy, the supply air ducts can remain uninsulated. Only the water supply ducts with feed and return are insulated which allows for space-saving solutions, particularly in suspended ceilings. The systems can also be used for cooling.

### § 5.1.7 Central air heating / air-conditioning system (overhead heating vent)

---

A room can also be heated by a central ventilations system. Hereby the warm air needed for the entire building is heated in the central unit and is then led into the rooms via air ducts. Depending on the system, the exhaust air can be extracted via exhaust openings and fed back to the central unit. In this case, the exhaust air is cleaned, enriched with fresh air and fed back into the room. Typically, fresh air is further conditioned, for example by dehumidifying, humidifying or cooling. If the humidity level of the air is changed, we talk about air-conditioning systems. In most cases, air-conditioning systems are used. However, for the purpose of completeness, air heating must also be mentioned.

Particularity: Rarely used as air heating alone, mostly used as air-conditioning including the functions heating, cooling, humidifying and dehumidifying.

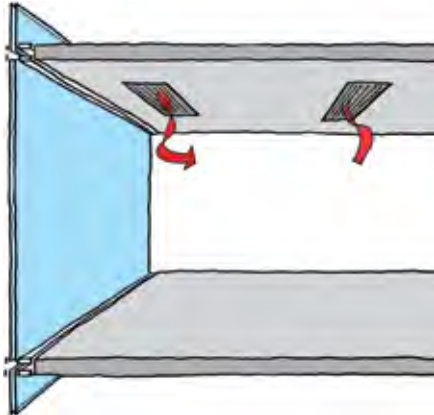

Figure 5.8:  
Central air heating in context situation

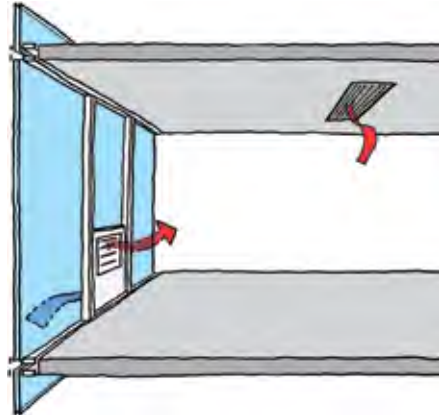

Figure 5.9:  
Decentralized air heating in façade element / in this case with an optional centralized exhaust air exit

### § 5.1.8 Decentralised air heating / air-conditioning system

Decentralised air heating as a mere heating system is rarely used. For the purpose of completeness it is included here; a more detailed description follows in a later section of this chapter under Ventilation. Façade-integrated decentralised ventilation components equipped with a heating battery can be used as air heating; however, they always combine the function heating with the function ventilation. One variant is a system that sucks in the air from outside, heats it, distributes it into the room and then extracts it in a continuous cycle. Another variant is a mere supply air system with a heating function; it can be used if a central exhaust air unit is available, as depicted in the system sketch.

## § 5.2 Cooling

Glazed panes and heat transport through opaque façade elements allow for thermal energy to enter the room from the outside. Inside a room, waste heat from electronic devices and lighting as well as the thermal load of the user can let the room temperature rise above a comfortable level. Various components and technologies to cool down the room air temperature are described in the following.

In principle, cooling should be understood as mere cooling of the air. In a psychrometric chart it is displayed horizontally as dry cooling. The air in its original state cools down and the relative air humidity rises. Absolute humidity remains the same; no water is added or extracted.

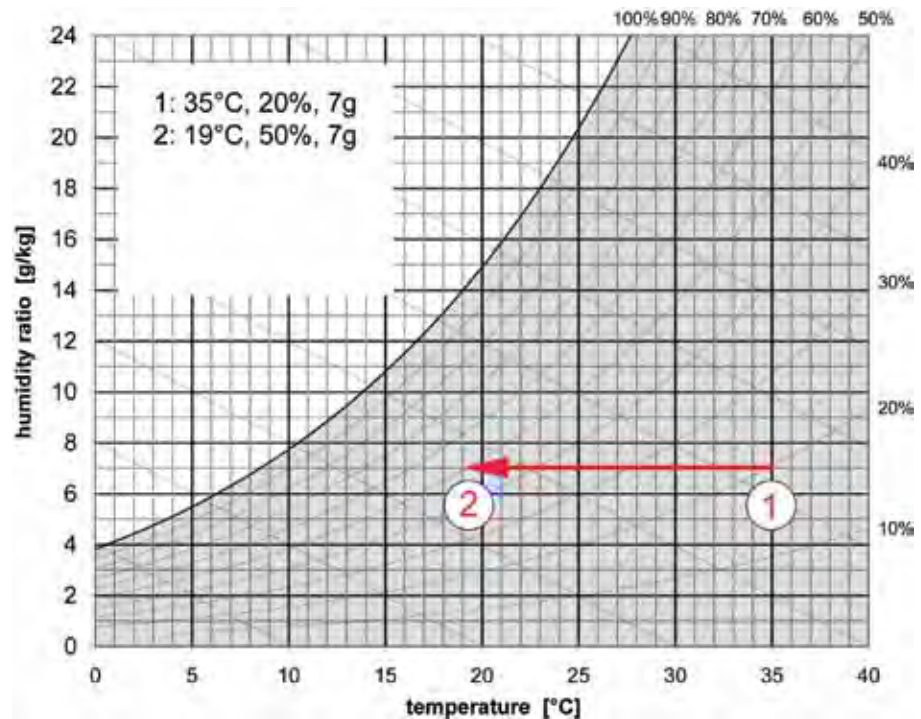

Figure 5.10  
The principle of cooling

### § 5.2.1 Concrete core cooling / overhead radiation cooling (radiant ceiling)

---

As described in the paragraph about ceiling heating, the ceiling area can also be used for cooling. Water pipes are installed in the concrete ceiling, which radiate the cooling capacity into the room. The cooling water can be drawn from bore holes, wells or other local regenerative sources. This allows for very effective cooling because usually the water is sufficiently cold to provide a cooling effect, and the only energy needed is that for a circulating pump.

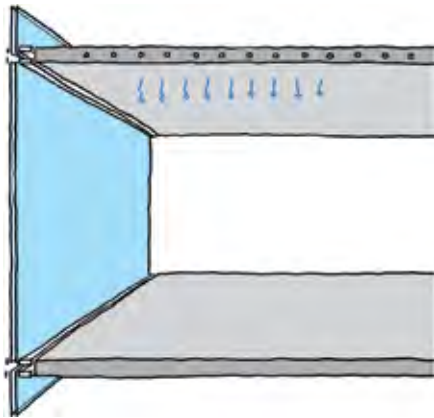

Figure 5.11:  
Concrete core cooling

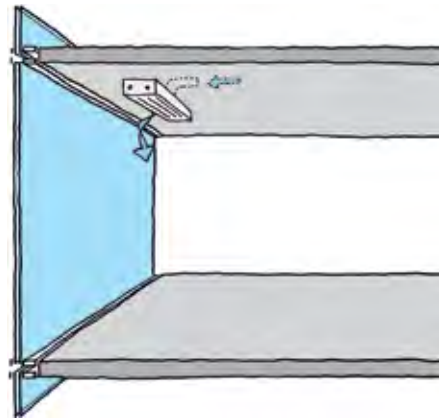

Figure 5.12:  
Overhead induction cooling in context situation

### § 5.2.2 Overhead induction cooling (active chilled beam)

---

Similar to the heating components described above, ceiling induction outlets can also be used for cooling. The elements are connected to a central ventilation system which supplies them with fresh air. The heat exchanger is installed in the outlet area. It is fed with warm water from a central cooling system and cools the supply air. The fact that the supply air is cooled directly at the outlet opening allows for economic cooling with high cooling performance. Since water is a better medium to transport thermal energy, the supply air ducts can remain uninsulated. Only the water supply ducts with feed and return are insulated which allows for space-saving solutions, particularly in suspended ceilings.

Installation position: Flush-mounted in the ceiling or installed above a suspended ceiling.  
Necessary connections: Cooling ducts to central cooling system, fresh air supply via central air supply system.  
Particularity: Can also be used for heating.

### § 5.2.3 Passive chilled beam / baffles

---

Also known as passive air-water systems. The setup of chilled beams is similar to that of ceiling induction outlets, but no air is introduced through the heat exchanger. Similar to a ceiling-mounted convector, cooling water is fed through a heat exchanger; warm air in the room rises until it hits the heat exchanger of the chilled beam, and, when cooled, drops down again. Chilled beams as local cooling units are typically mounted under the ceiling in a linear manner or integrated into the grid of a suspended ceiling. Their operation is virtually noiseless; however, due to force of gravity being the only active principle they are not as efficient as active chilled beams that encompass fresh air supply. (Troxy, 2009)

Installation position: Flush-mounted in the ceiling or installed above a suspended ceiling.  
Necessary connections: Cooling ducts to central cooling system.  
Particularity: Can also be used for heating.

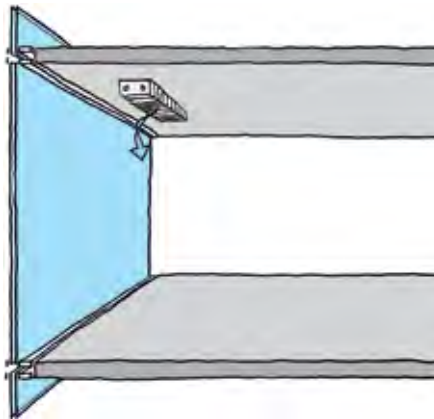

Figure 5.13:  
Passive chilled beam

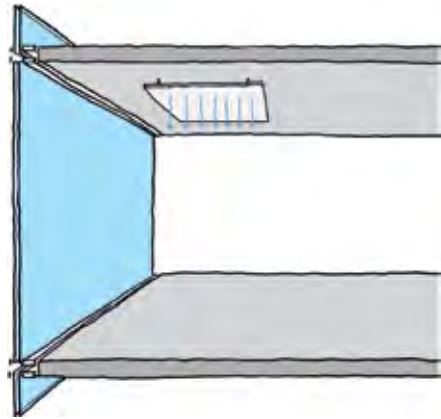

Figure 5.14:  
Cooling panel mounted on the ceiling

## § 5.2.4 Cooling panels / cooling ceilings / cooling sails

---

Cooling ceilings or cooling panels work in a similar fashion as cooling beams. One difference is that they are designed as planar systems. Water pipes with thermally conductive metal surfaces or ribs are combined to a planar cooling system, either locally in form of cooling sails or cooling panels or spread across the entire ceiling area integrated in a suspended ceiling. Energy transmission functions via radiation and the gravitation that causes cooled air to sink. Cooling panels or cooling sails can be designed in many shapes; they are commonly installed above work places, which compromises later rearrangement of the work area. Functional elements such as lighting and acoustic elements to improve soundproofing can be integrated.

Installation position: Flush-mounted in the ceiling or installed above a suspended ceiling.

Necessary connections: Cooling ducts to central cooling system.

Particularity: Numerous design options.

## § 5.2.5 Central air-cooling

---

Just as air-conditioning units can be used for heating, they can be used for cooling. A central air-conditioning system includes a cooler that cools the air which is introduced into the rooms via ducting networks. The condensate is discharged in the central unit.

Installation position: Air inlets and outlets flush-mounted in the ceiling or installed in a suspended ceiling, alternatively via floor outlets.

Necessary connections: Air ducts to mechanical equipment room.

Particularity: Rarely used as air cooling alone, mostly used as air-conditioning including the functions heating, cooling, humidifying and dehumidifying.

## § 5.2.6 Decentralised air-cooling

---

Decentralised air-condition systems integrated in or in the vicinity of the façade can be used for cooling. A later segment of this chapter provides detailed information about these components because they typically provide more functions than just cooling.

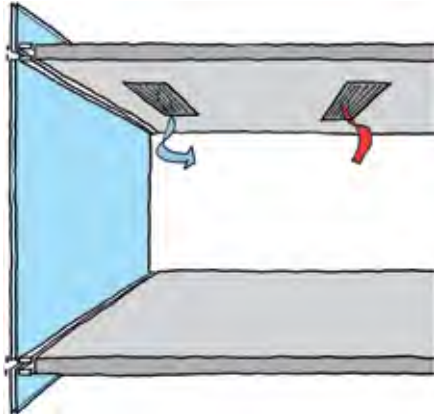

Figure 5.15:  
Central air heating in context situation

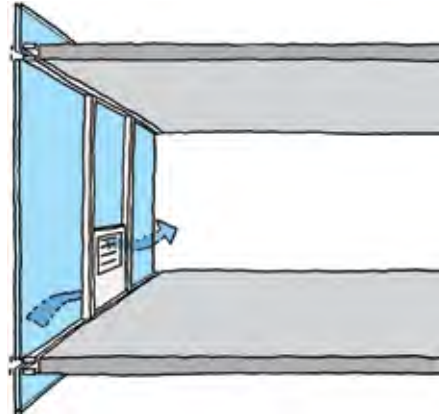

Figure 5.16:  
Decentralized air cooling in façade element

### § 5.2.7 Night flush ventilation

The natural storage capacity of massive building components can be exploited when using air as a cooling medium. With light frame construction the ceilings are the only building component that can be used for this purpose but they provide large areas to exploit. Concrete ceilings can store thermal energy during the day. During hot summer periods, some of the engine-driven windows are opened during the night, and the cooler outside air penetrates the room and flows along the raw concrete ceiling. Thermal energy stored during the day is thus extracted from the ceiling, and the cooled ceiling will not reheat as quickly; thus, the room remains cool for a longer period of time.

Night flush ventilation is no building services component, but rather a passive solution with motor-driven sash windows in combination with control units. Protective grating ensures weather independent functionality. And rain sensors can be used to automatically close the windows; which, however, would prevent a cooling function during rainfall. In addition, burglary protection is needed due to the automatic opening of the windows at night.

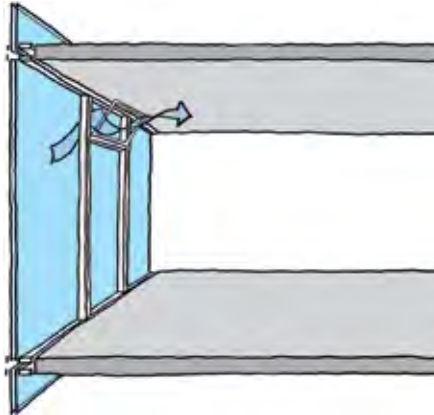

Figure 5.17:  
Night flush ventilation via the top window



Figure 5.18:  
Weather-protected night ventilation flap installed below concrete projections

Installation position: Within the façade, near the ceiling, mostly in form of transom windows.

Necessary connections: Power lines for motor.

Particularity: Connected to temperature control / primary building control unit necessary, often in combination with smoke outlet / supply air is used in case of fire.

## § 5.3 Ventilation

Ventilation is very important for our sense of comfort. The room climate that a user is surrounded by is influenced by the presence or absence of ventilation. Depending on the activity level, a human body can dissipate several litres of water per day into the room air in form of vapour. Exhaling raises the CO<sub>2</sub> content of the air and the temperature level. The CO<sub>2</sub> content should be reduced to a maximum of 0.1-0.15 %. (Knaack et al., 2007) Ventilation regulates the temperature as well as the humidity in a room; exhausted air is replaced and odours and harmful substances carried away. There are different methods of ventilation; particularly natural and mechanical ventilation.

The principle of ventilation cannot be shown in a psychrometric chart, because depending on the prevailing conditions, the inside and outside temperatures and humidity levels will be levelled out. If, for example, the window of a room is left open



for an extended period of time, the inside climate will eventually be the same as the outside climate.

There are different methods to ventilate a space:

- **Natural ventilation**
- **Gap ventilation**
- **Window ventilation**
- **Shaft ventilation**
  
- **Mechanical ventilation**
- **Central ventilation systems**
- **Decentralised ventilation systems**
- **Centralised and decentralised air-conditioning units** can also serve as ventilation

### § 5.3.1 Natural ventilation

---

Natural ventilation means ventilating a space through apertures in the exterior envelope of a building. Differences in pressure, wind direction and the orientation of a building will cause the outside air to be blown or sucked into the building naturally. With natural ventilation, the outside air is not filtered or otherwise conditioned. In addition to manually operable windows, natural ventilation can be achieved with motor-driven flaps or window sashes.

#### § 5.3.1.1 Gap ventilation

---

Gap ventilation means the exchange of air that occurs in rooms with closed windows, outside doors or roller shutter housings. The air is drawn through the gaps of these elements due to the pressure gradient caused by temperature differences and wind load. Due to the air tightness of modern windows they allow almost no gap ventilation; but in some cases they include small, operable flaps that allow for weather-independent gap ventilation.

### § 5.3.1.2 Window ventilation

---

The most common method of natural ventilation is window ventilation, whereby different fittings influence the ventilation effectiveness. The function of ventilation is also impacted by the prevailing wind load conditions at a façade. If ventilation elements are installed on one façade side only, the largest possible room depth that can be ventilated is approximately 2.5 times the room height. Cross ventilation is more efficient; the resulting draft can ventilate room with depths of up to 5 times the room height.

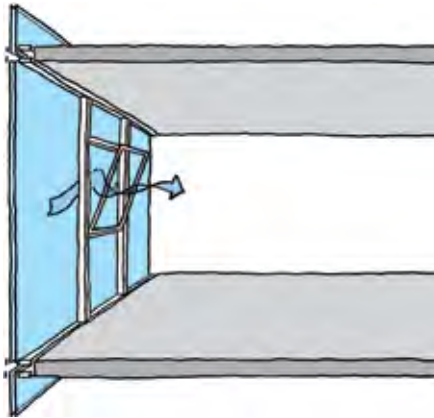

Figure 5.19  
*Natural ventilation via the window*

Today, windows can be outfitted with motors to automatically ventilate a room depending on current conditions, or to open windows which are difficult to access. Often, natural smoke and heat outlets are connected to the automatically controlled windows to automatically open in case of fire.

### § 5.3.1.3 Shaft ventilation

---

Shaft ventilation is the ventilation method of choice if larger volumes of air need to be moved. Fresh air flows in through the windows and is then led into a shaft, typically located in the centre of the building. Inside the shaft the air rises and exits through the roof. Shaft ventilation is often found in residential housing, and, in the past, was used

to ventilate large footprint buildings. Shaft ventilation is also very dependable during winter, because the wind-protected location inside the building prevents the exhaust air from cooling to quickly. Concepts with exhaust air shafts within the façade layer have been realised during the past ten years, often in combination with double façades. Examples here for are shaft-box façades where solar radiation heats the exhaust air and thus accelerates its upward movement. Another shaft ventilation variant is the solar chimney. With a glass chimney installed on the sun-facing façade area or on the roof top, the greenhouse effect causes a chimney effect that can be used to extract exhaust air from the building.

#### § 5.3.1.4 Double façades

---

In temperate climate zones the different types of double façades can offer natural ventilation throughout the entire year. Therefore, the double façade is listed as one method of natural ventilation in this context; it can be allocated to the principle of window ventilation. In this thesis, the principle of the double façade is defined as a buffer zone with the possibility to heat the supply air in the space between the façade layers. Depending on the particular type of construction, the double façade can support natural ventilation. Firstly, an exterior glass layer provides protection from strong winds, which, in case of single façades prohibit opening windows on higher levels of tall buildings. A secondary glass layer can effectively lower the wind load on the window sashes and allows for regulated fresh air supply through flaps in the outer layer. The space between the two façade layers can be used for wind-protected natural ventilation. Another advantage of the double façade is the option of exterior sun protection; in case of high wind loads it can be retracted to prevent damage. If the sun protection is installed in the space between the façade layers it can be used independent of the prevailing wind loads.

With second-skin façades that are not subdivided or shaft-box façades, the tall spaces in between the façade layers can further promote natural ventilation by exploiting the chimney effect. Corridor façades, where the space between the façade layers extends across the width of the building horizontally, can balance different wind loads. This allows for natural ventilation even in locations with high wind loads. To compensate for different wind loads, controllable air intake flaps must be installed in the façade that, depending on the current wind conditions provide optimum fresh air supply.

However, since they typically consist of large areas of glazing, double façades have the disadvantage that the space between the layers can easily overheat. Overheating, mostly on summer days, prevents or inhibits natural ventilation. On the other hand the

greenhouse effect can be used to preheat the fresh air supply, particularly during winter and the transitional seasons. In regions with extremely low winter temperatures, such as Moscow, for example, there is the added risk of condensate forming on the outer glass pane which can eventually freeze. (Heusler, 2007) Thus, the façade concept must be tested and simulated, and controllability with operable intake and outlet flaps must be carefully planned and adjusted.

Today, with the knowledge of more than 15 years of trial and implementation, the most suitable application for the various double façade concepts seem to be sun protection and to reduce the wind loads on the inner façade layer, particularly for high-rise buildings. Another application is to reduce the noise level at highly frequented streets or railway lines. Here, the second façade layer can act as noise protection by lowering the inside noise level.

#### § 5.3.1.5 Mechanical ventilation

---

Mechanical ventilation can provide a building with fresh air throughout the entire year. In addition, control mechanisms can regulate the amount of air introduced into the building. Ventilation systems can be designed as mere supply and exhaust air systems; in this case the air is usually filtered and led in or out of the room. The air can also be used to heat, cool or air-condition a room. Additional information can be found in the paragraphs Air heating and Air cooling. A benefit of mechanical ventilation is the energy of the exhaust air can be reused to heat the fresh supply air. This is called waste heat recovery.

Mechanical ventilation systems can be classified as centralised and decentralised units.

#### § 5.3.1.6 Central ventilation systems

---

Central ventilation systems are installed in mechanical equipment rooms or, in large buildings, can cover entire mechanical equipment storeys. A pipeline network connects the central ventilation system with fresh outside air and the rooms to be ventilated. Typically, the ducts run in channels in the floor or under the ceiling – often in suspended ceilings – leading to intake and outlet openings. Due to the great distance that conditioned air must travel inside a building, a central ventilation system is a complex system to plan and execute and requires particularly intensive maintenance.

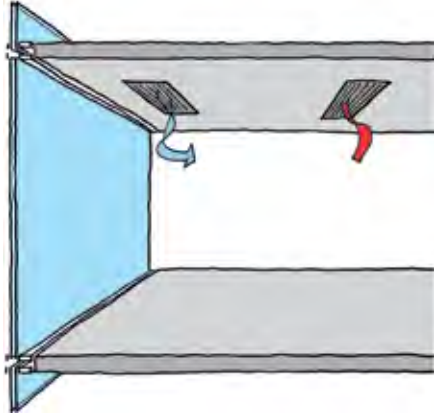

Figure 5.20:  
Central air heating supply via ceiling

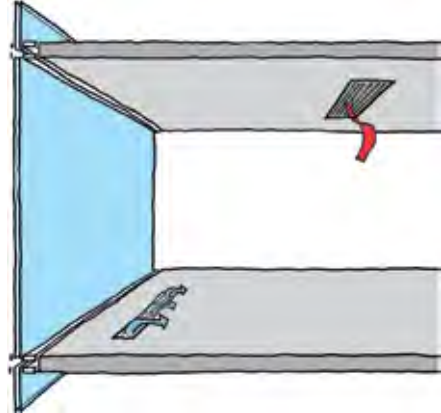

Figure 5.21:  
Central air heating supply via the floor

### § 5.3.1.7 Decentralised mechanical ventilation

To avoid the large space requirement for central ventilation systems, an increasing number of decentralised ventilation systems have been made available over the last few years. Evolving from simple fan and filter units that were installed in the parapet area of the window, decentralised ventilations systems have developed into compact micro air-conditioning systems that, in addition to simply ventilating, can also be used for heating, cooling and conditioning. These devices can be particularly beneficial for restoration projects that do not allow installing additional air ducts inside the building. The devices commonly in use are mostly based on the same working principle, and, with the use of different mounting cases can be placed at various locations in the parapet area, the wall, in a false floor or suspended ceiling in or close to the façade. The following gives an introduction into different systems and installation variants.

### § 5.3.1.8 Window fan

---

The simplest method to mechanically ventilate a room is using built-in fans. They are installed in the exterior wall or a window. This solution is sometimes used for server rooms or similar spaces that require additional ventilation. Since window fans are rarely considered as a basic concept in the early planning stages of a design, they are only mentioned here for the purpose of completeness, but will not be further discussed.



Figure 5.22:  
*Built-in fans in a server room*

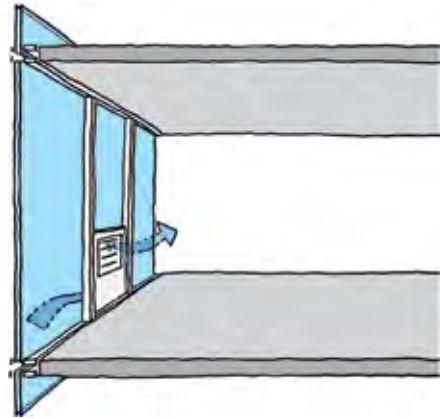

Figure 5.23:  
*Decentralized ventilation unit in façade element*

### § 5.3.1.9 Decentralised ventilation units

---

One variant of decentralised ventilation systems are devices built in the parapet area of window façades. Hereby, the components are mounted in front of the parapet of the façade; air intake and outlet openings are located directly beneath the window oriented outward. On the inside, fresh air can be introduced at parapet height or close to the floor. Alternatively to installing the system in the parapet area of the load-bearing wall, it can also be integrated into the façade.

The elements can also be installed in the façade close to the ceiling or in the hollow space of a double floor or suspended ceiling.

Over the past eight years, the trend has gone toward decentralised ventilation; mainly due to the small space requirement for these systems and the resulting possibility to save storey height as well as the individual control the user has over regulating the comfort level in his/her surroundings.

Since the development to integrate decentralised façade ventilation units is relatively new, the following introduces several projects that provide further insight into this technology.

The Posttower in Bonn, Germany (2002) by Murphy and Jahn Architekten can be considered the first project to integrate decentralised elements in a large scale building project. Following the climate concept of Transsolar Energietechnik, Stuttgart, Germany, decentralised ventilations devices are mounted in a false floor directly adjacent to the façade because at the time, the units were too large to be installed in the façade. In addition to the air ducts that guide fresh air from the space between the façade layers to the offices, the elements comprise an integrated heat exchanger to also heat or cool the air. Exhaust air from the offices is extracted through 8-storey high atria, which also serve to passively heat this volume of air.

The trend to use decentralised ventilation systems has driven architecture firms and façade system manufacturers to bring a large number of new façade concepts to market. The concepts E<sup>2</sup> by Schüco and TE Motion by Wicona are examples underlining this trend. The common theme of all of these new concepts is that element-based façade systems are outfitted with decentralised ventilation devices. This means that pre-mounted façade elements that already include most or all necessary building services for individual controllability of the comfort level, can be installed quickly and economically.

The need for building services in the building can be further reduced by integrating artificial lighting elements in the façade. The advantage of these concepts, known as component façades, is that when the user is present he or she can individually control his/her office space, leading to lower operational energy consumption. An additional benefit can be lower storey heights because there is no need to integrate a central ventilation system in a suspended ceiling. A study about decentralised exterior-mounted ventilation devices (B.Mahler, 2008) was not yet able to confirm this advantage because usually these systems were considered too late in the planning phase; integral planning from the start of the project on is necessary to reap this benefit.

However, the study did confirm that decentralised systems in combination with slow systems such as concrete core activation can offer a very efficient and comfortable operation. If decentralised ventilation is used in open-plan offices, the individual controllability that the system offers can not be exploited. A disadvantage of

decentralised systems is the additional expenditure of frequent filter exchange. According to the study this needs to occur two to three times more frequently than with central ventilation systems. But the high user comfort level and efficient use of energy and space should balance out this factor. Newer developments offer a combination of ventilation with waste heat recovery.



Figure 5.24  
*Decentralised ventilation components in a suspended floor; air and water supply lines are clearly visible*



## § 5.4 Humidification and dehumidification

Room air humidity plays an equally important role as the thermal aspects. The human body senses the climate as muggy at water vapour contents of approximately 14g. Since air absorbs water vapour depending on the temperature, we need to differentiate between absolute and relative humidity. A comfortable level of relative humidity lies between 30 and 65% (DIN, 1994-01); absolute humidity can be easily derived in a psychrometric chart.

At 25°C, for example, the chart shows relative humidity at 50% and absolute humidity at 10g/kg. If the temperature drops (the dot wanders to the left) relative humidity rises, whereas absolute humidity remains constant.

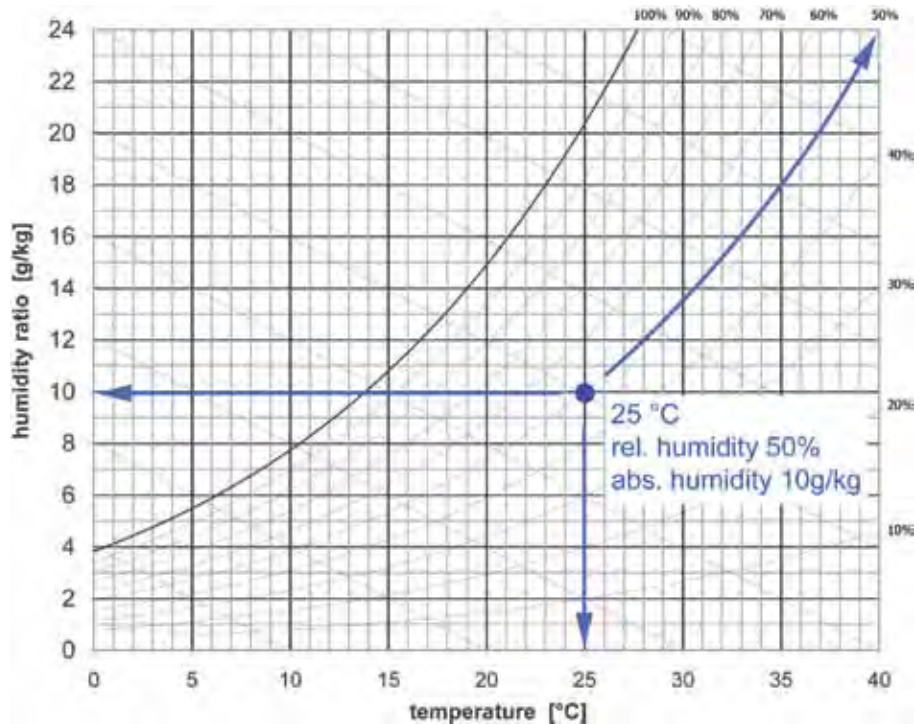

Figure 5.25  
Using psychrometric charts to calculate air condition

## § 5.4.1 Central air-conditioning

---

The most common method to change air humidity levels is air-conditioning.

Air-conditioning systems regulate temperature and air humidity within a predefined range throughout the entire year. In combination with heating and cooling registers, they can continuously influence the condition of the air. Fresh supply air is sucked in from the outside through a piping network. After conditioning, the air is blown through ducts into the rooms. Exhaust air is extracted through an additional piping network and is reconditioned in the air-conditioning unit.

With waste heat recovery, the thermal energy from the exhaust air can be reintroduced to the supply air; offering a more efficient operation with low energy consumption. Waste heat recovery can be achieved with cross heat exchangers (supply and exhaust air stream against each other in a duct system, reintroducing waste heat of the exhaust air to the supply air). It can also be achieved with enthalpy wheels. Enthalpy wheels are used to recover thermal energy that is stored in water vapour as latent thermal energy. The surface of an enthalpy wheel is hygroscopic promoting humidity transfer. Enthalpy wheels can be integrated as a part of an air-conditioning system, and are particularly suited for especially cold regions as well as tropic conditions.

Psychrometric charts can explain the principle of controlled dehumidification with central air-conditioning.

The air in a tropical climate (point 1, 34°C 60% relative humidity) is cooled to the dew point (point 2). The water vapour dissolved in the air condensates and falls along the dew point. Upon reaching the desired absolute humidity (point 3, 10g/kg) the temperature has dropped to 14°C. The air is now warmed up to 25°C (point 4) in order for it to reach the comfortable temperature range. During this process, relative humidity has dropped from 60 to 50%, and absolute humidity has dropped by 10g/kg. The described process shows that the heating registers of an air-conditioning system must also be used for dehumidification.

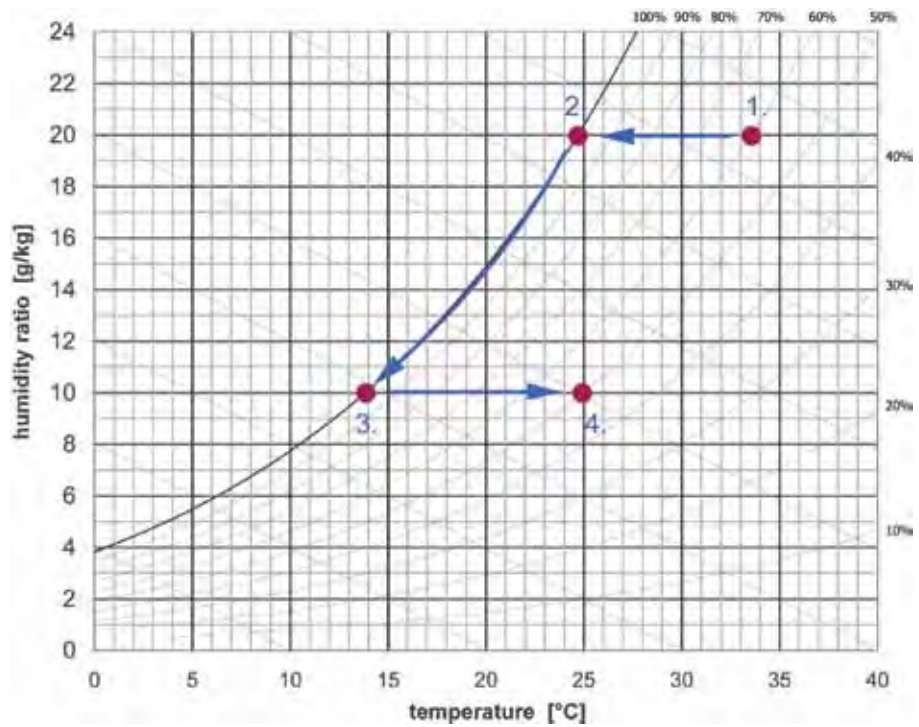

Figure 5.26  
Principle of uncontrolled dehumidification

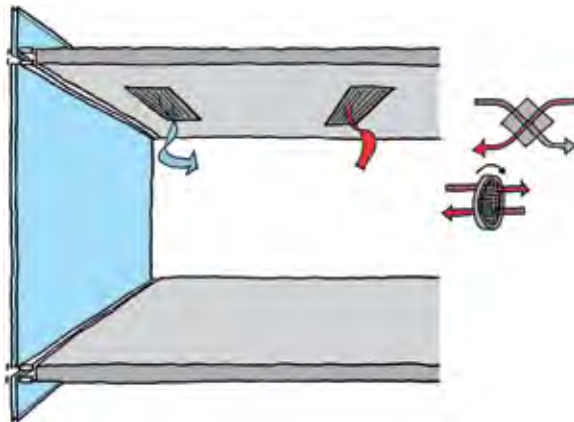

Figure 5.27  
Central air-conditioning with waste heat recovery and enthalpy wheel systematic

## § 5.4.2 Decentralised air-conditioning

Basically, decentralised air-conditioning basically does not exist yet because the compact design does not allow including all of the components needed for a complete air-conditioning system. Therefore decentralised units are typically used as ventilation devices. Dehumidification can only be accomplished uncontrolled whereby the room air is cooled down to almost dew point temperature which inherently dehumidifies the air. Condensate does not accrue, and it is not necessary to further heat the air. Thus, these devices are not suited for tropical regions, but do provide potential for further development in terms of more efficient dehumidification.

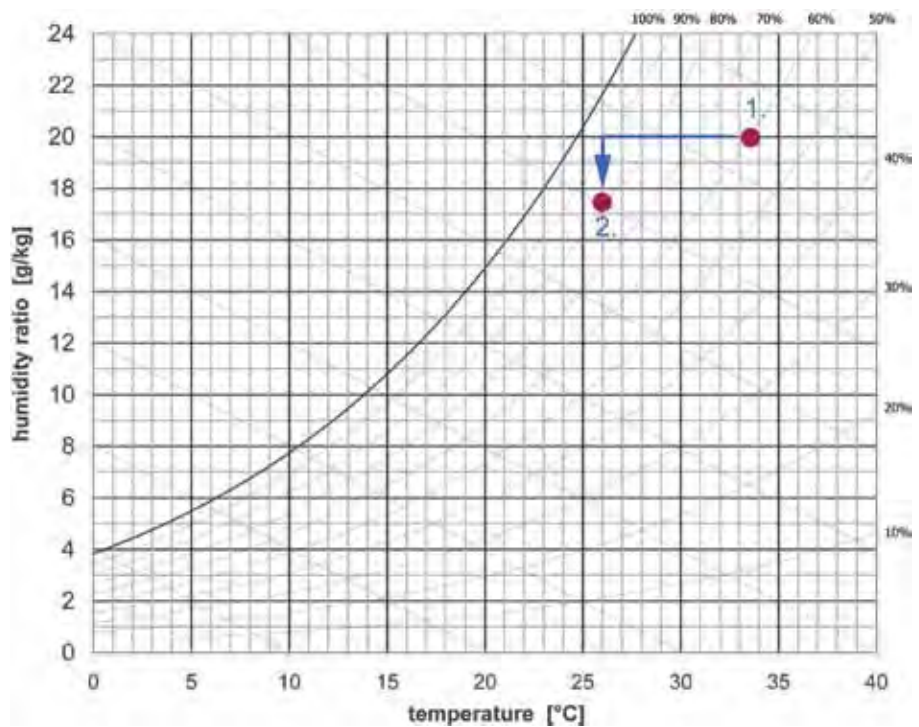

Figure 5.28  
Principle of controlled dehumidification

## § 5.5 Sun protection

An adaptive façade that supports energy saving can adequately respond to the changing requirements of the individual seasons. Considering solar heat input, the requirements posed on a façade during winter and summer are diametrically opposed. During winter, solar energy gain is desirable, requiring the highest possible total energy transmittance of the façade. In summer, on the other hand, overheating through solar incidence must be avoided which, in addition to other passive measures mainly means keeping the total energy transmittance of the façade at a minimum. A façade can only fulfil these requirements if its solar energy permeance can change; currently, this type of flexibility can be best achieved by using sun protection systems.

Sun protection is an essential aspect of façade design and façade performance. In most cases, it is the first layer that shields the glazed areas from solar radiation, or it reduces solar radiation to protect the inside space from overheating.

In the beginning of planning, the urban layout in the vicinity should be checked for possible shading from surrounding buildings. Some sides of the façade might not need sun protection if neighbouring structures provide shading. The following explains various sun protection systems in terms of their working principle and installation location.

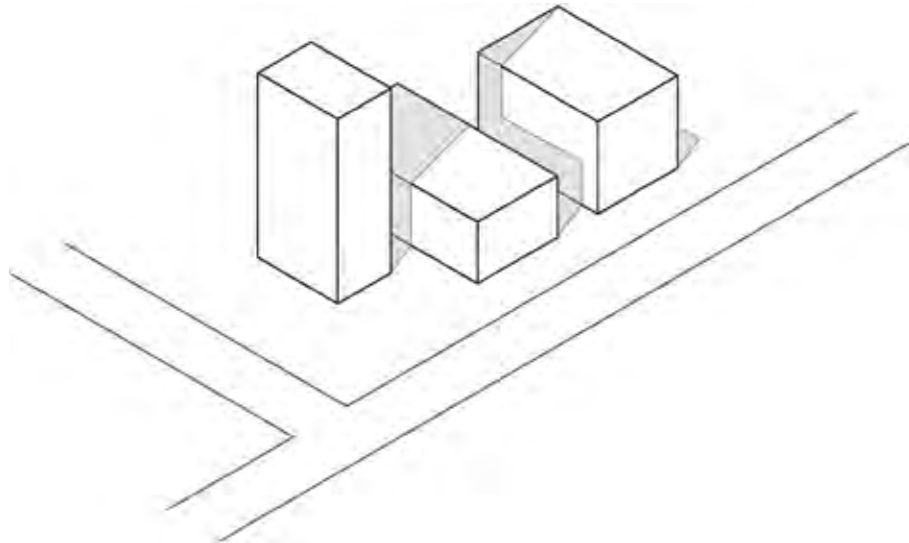

Figure 5.29  
*Shading by neighbouring buildings*

### § 5.5.1 Internal sun and glare protection

---

The effectiveness of an internal sun protection system is significantly lower than that of external systems. Once thermal energy has entered the room through the glass, internal sun protection can block only a portion of the heat radiation. Screens provide effective internal glare protection, particularly for data processing work places. The foil or textiles for these screens are available with varying light transmission values.

### § 5.5.2 Fixed sun protection

---

Fixed sun protection provides good shading possibilities. Far projecting, horizontal elements at ceiling level are known as brises soleil. Another solution is fixed or pivot-mounted louvers installed onto the façade; however, they are not as effective as adjustable elements. The method of cleaning the glass panes behind fixed sun protection should be considered at an early stage. Fixed sun protection can also be used as a maintenance balcony or secondary emergency route if they project out far enough from the glass pane. Plantation is another means of providing fixed shading. The optimum choice are deciduous plants, because these plants lose their leaves during the heating period in winter, which promotes solar heat input.

### § 5.5.3 Operable sun protection

---

Textile systems are one example of operable sun protection. They are lowered in front of the glass pane in form of roller blinds or awning-type devices that project from the façade on rails and thus provide unobstructed views. Another, widespread variant are gathered blinds that consist of louvers adjustable to the angle of the incident solar radiation. These blinds can comprise different section; the louvers in the upper area, for example, could be adjusted to a lower angle to let light penetrate deep into the room. Today, motorised control is standard. In the most advanced systems, light sensors are used to automatically adjust the louvers. Operable sun protection systems are susceptible to damage by strong wind and must therefore be retracted in windy weather conditions. This means that installing sun protection in the gap between the two façade layers is an efficient solution, particularly for high-rise buildings subjected to high wind loads.

Since several years ago, horizontally slidable sun protection systems are used for residential dwellings or other low buildings. These elements are suspended from

rails and can be adjusted manually or motor-driven. The frames are typically filled in with aluminium or wooden louvers or metal grids. The horizontal movement of these elements requires park positions to be included in the façade layout, where the sliding panes are parked when open.

#### § 5.5.4 Specialised solutions

---

The industry continuously develops new sun protection products. Some of these developments remain specialised solutions; others mature into standard products. One solution is to install sun protection in the space between the glass panes of insulating glass. However, this method has advantages and disadvantages. If, for example, metal mesh or wooden louvers are inserted into the insulating glass, installing the windows is quick and the sun protection elements will not need to be cleaned regularly. But if a glass pane breaks, not only the glass but also the sun protection must be renewed. Motorised gathered blinds installed in the space between the glass panes should be viewed critically. If a motor fails or one or more louvers get jammed, the entire window pane must be replaced.

A very simple form of sun protection is screen printing or enamelling patterns onto the glass because this process involves the glass alone. Graphic elements can be applied onto the pane in any pattern or grid, which will reduce incident solar radiation. Since the printing method offers numerous variations, this form of sun protection can be customised for a particular user.

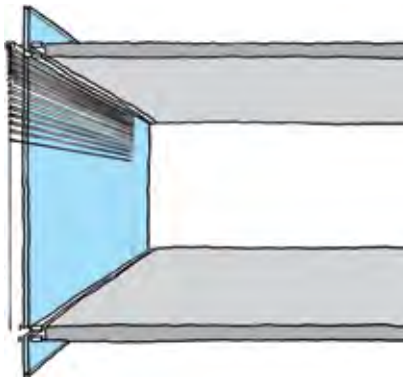

Figure 5.30:  
*Exterior sun protection schematic*

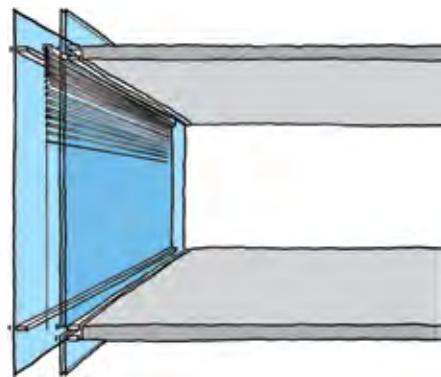

Figure 5.31:  
*Sun protection within the space between two façade layers*

### § 5.5.5 Summary sun protection

---

The analysis of sun protection for use in the expert tool in a later chapter will not consider detailed functional differences in working method or construction of various sun protection systems. It will be reduced to exterior sun protection in front of the façade or within the space between façade layers in case of a double façade. The individual parameters of the different systems will not flow into the expert tool development in its initial stages.

## § 5.6 Light directing

---

Natural lighting might not be sufficient for work places located far away from the windows of a room. In such cases systems can be used that direct daylight deep into the room. They can also be efficient to prevent glare when solar radiation falls directly onto the work place. Daylight directing systems can reduce the energy consumption for artificial light and improve the visual comfort level. Light-directing systems are still very expensive and interrupt a homogenous façade design because they do not yet provide unobstructed views.

Therefore sun protection systems such as gathered blinds are often combined with light directing features in the upper area. The upper louvers are set at a different angle than the lower ones, or are formed in a different shape. Light directing systems can be classified in different types of construction. There are horizontal elements that reflect and therewith direct the light, and systems integrated into a sun protection unit or the glass layer vertically. These elements do not reflect the light but rather redirect it at a different angle. There are many solutions for this principle: holographic foils, fine prism surfaces and reflecting louvers arranged in a particular geometry.

For light directing, the surface finish of the ceiling plays an important role because it, too, can direct light further into the room. The simplest solution is a white coat of paint or a cladding with light directing elements.

The façade itself is able to provide efficient support with natural daylight, but it has to be mentioned that the focus of this work is not too much related to the aspects of light.







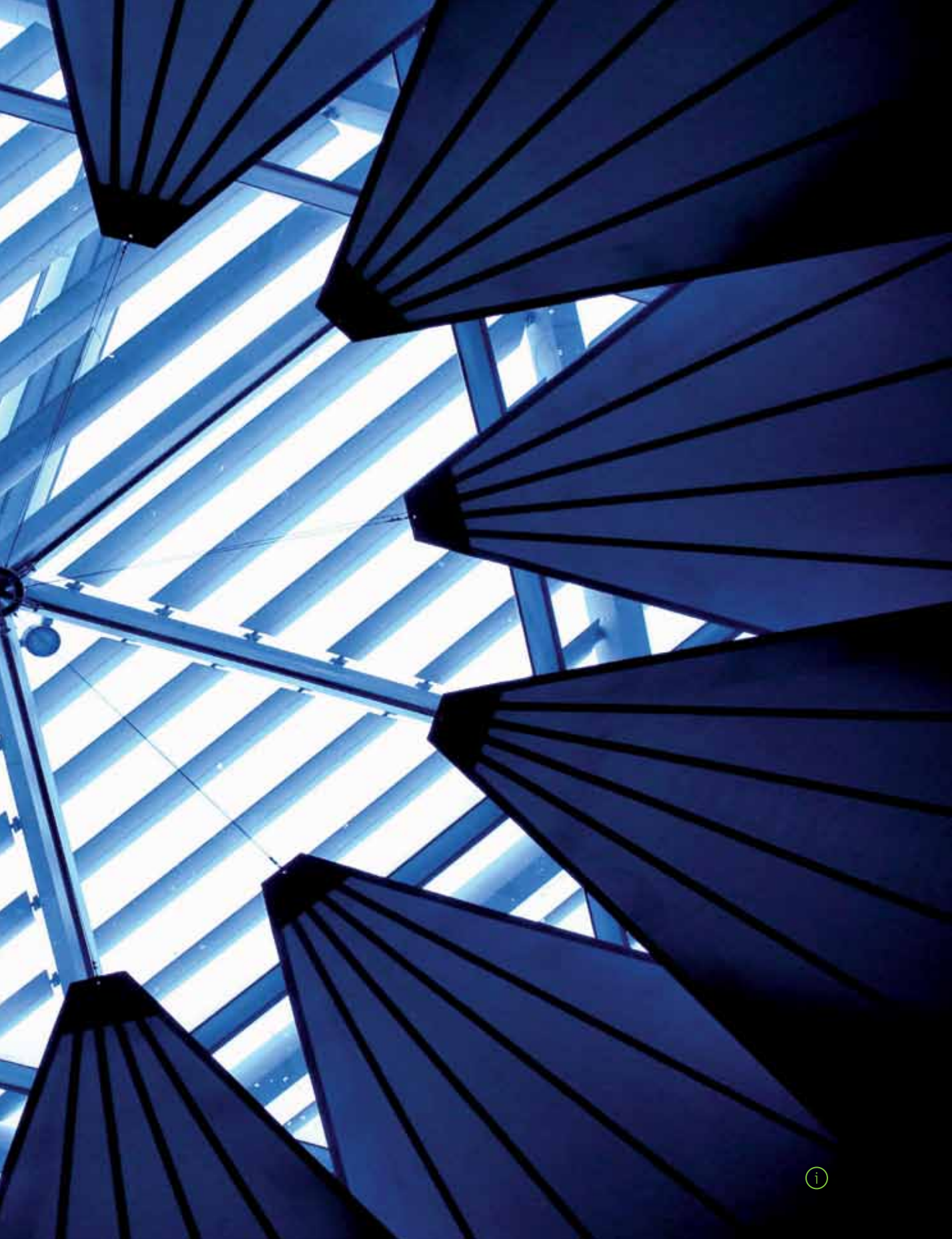



## 6 FET Façade Expert Tool

The idea to create a façade tool developed during the scope of this work. Every project begins with a list of requirements for the building envelope. Today we also consider the sustainability of the overall concept and low energy consumption of the building, besides classic requirements such as load transfer, air tightness, water tightness and insulation values, . The classic requirements are regulated by local building codes; the architect or investor can choose from a broad palette of available systems and determine the desired performance capability of the building envelope in dependence of the design and the budget. Façade systems offered by system manufacturers today are watertight and airtight; all of the connections with the shell of the building are principally known, and adaptations to the individual building project are worked out by the architect or specialist. The planner can resort to a multitude of planning aids and information about a particular façade system. Architecture consultants help in selecting the appropriate product and provide detailed information in accordance with the specific requirements in form of precise tender documents. Façades continue to be improved upon, insulation values are adapted to current requirements and building codes; today there is a solution or product for virtually any problem.

However, most of the aids available to the architect will not help during the early design stage. Typically, analysing the location is one of the first steps in the design process; if the location is known, the climate is too, but what if you need to plan for an unknown climate zone? Who knows the local climatic conditions and what requirements are posed on the design?

On a worldwide scale, new buildings resemble each other more and more. Looking at a building alone will not provide any information about its location. Even though the comfort requirements and expectations on office buildings are similar, we should expect the buildings to feature significant differences due to the very different climatic locations they are in.

The International Style with storey-high glazing is popular; it is characterised by an outwardly cosmopolitan attitude. Architecture has always been an art form that only a few were able or willing to afford. (Behling et al., 1996). It is therefore not surprising that today we erect glass houses in the desert, which are cooled down to a comfortable level using a massive amount of building services. These buildings are a sign of power; the power to defy the prevailing climate.

Even though some of the designs actually aim for this impression, there are quite a few that must allow the question of responsibility for subsequent generations. Should it not be the goal for buildings to use as little energy as possible, and draw this energy from local sources? In order to design such buildings we need to know the local climate. What does a building need, which building services need to be included, how can the façade participate in reducing operational energy?

A tool that, upon entering a certain location, renders the necessary requirements for the building envelope and building services could provide valuable information needed to make knowledgeable decisions during the early planning stages.

---

## § 6.1 Available façade or climate tools – background

---

The development of the Façade Expert Tool (FET) is based on the demand for early planning relevant information from the analysis of a particular location. The name Façade Expert Tool evolved during a later stage of this work, but is already used here. The core question at the beginning of the research aimed at identifying existing applications or tools that have a similar purpose or are used in a similar field of activity.

As early as in 1963 Victor Olgyay published a text titled: “Design with Climate” that called on architecture to focus on the surrounding climate. (Olgyay and Olgyay, 1963). One decade later, in 1973, Königsberger (Koenigsberger, 1974) published the “Manual of Tropical Housing” that showed principles of architecture climatically adapted to the tropics to serve as a basis for new architectural considerations. He clearly pointed out that we need to know the particularities of a certain climate to successfully build there.

### § 6.1.1 Clear guideline

---

Besides many other works related to this topic, the work of Prof. Arvind Krishan from New Dehli stands out, who introduced a design tool in his book “Climate Responsive Architecture” (Krishan et al., 2001). In 1981, an international group of researchers joined forces and founded “Passive and Low Energy Architecture International” (PLEA). They compiled principles to reduce energy consumption in building operation. The work is compiled in the book “Climate Responsive Architecture” and describes the results of the research.

Table 4.1 & 4.2, Vol.2	ART TEMP RADIATION R.H. AIR FLOW DAYLIGHT	STREET WIDTHS & ORIENTATION	Table 4.1 & 4.3, Vol.2	ART TEMP RADIATION R.H. AIR FLOW DAYLIGHT	STREET WIDTHS & ORIENTATION	Table 4.1 & 4.3, Vol.2	ART TEMP RADIATION R.H. AIR FLOW DAYLIGHT
Table 4.1 & 4.2, Vol.2	ART TEMP RADIATION R.H. AIR FLOW DAYLIGHT	STREET WIDTHS & ORIENTATION	Table 4.1 & 4.3, Vol.2	ART TEMP RADIATION R.H. AIR FLOW DAYLIGHT	STREET WIDTHS & ORIENTATION	Table 4.1 & 4.3, Vol.2	ART TEMP RADIATION R.H. AIR FLOW DAYLIGHT
Table 4.1 & 4.3, Vol.2	ART TEMP RADIATION R.H. AIR FLOW DAYLIGHT	OPEN SPACES & BIOT FORM	Table 4.1 & 4.3, Vol.2	ART TEMP RADIATION R.H. AIR FLOW DAYLIGHT	OPEN SPACES & BIOT FORM	Table 4.1 & 4.3, Vol.2	ART TEMP RADIATION R.H. AIR FLOW DAYLIGHT
Table 4.1 & 4.3, Vol.2	ART TEMP RADIATION R.H. AIR FLOW DAYLIGHT	GROUND CHARACTERISTICS	Table 4.1 & 4.3, Vol.2	ART TEMP RADIATION R.H. AIR FLOW DAYLIGHT	GROUND CHARACTERISTICS	Table 4.1 & 4.3, Vol.2	ART TEMP RADIATION R.H. AIR FLOW DAYLIGHT
Table 4.1 & 4.3, Vol.2	ART TEMP RADIATION R.H. AIR FLOW DAYLIGHT	PLANTFORM	Table 4.1 & 4.3, Vol.2	ART TEMP RADIATION R.H. AIR FLOW DAYLIGHT	PLANTFORM	Table 4.1 & 4.3, Vol.2	ART TEMP RADIATION R.H. AIR FLOW DAYLIGHT
Table 4.1 & 4.3, Vol.2	ART TEMP RADIATION R.H. AIR FLOW DAYLIGHT	PLAN ELEMENTS	Table 4.1 & 4.3, Vol.2	ART TEMP RADIATION R.H. AIR FLOW DAYLIGHT	PLAN ELEMENTS	Table 4.1 & 4.3, Vol.2	ART TEMP RADIATION R.H. AIR FLOW DAYLIGHT
Table 4.1 & 4.3, Vol.2	ART TEMP RADIATION R.H. AIR FLOW DAYLIGHT	ORIENTATION	Table 4.1 & 4.3, Vol.2	ART TEMP RADIATION R.H. AIR FLOW DAYLIGHT	ORIENTATION	Table 4.1 & 4.3, Vol.2	ART TEMP RADIATION R.H. AIR FLOW DAYLIGHT
Table 4.1 & 4.3, Vol.2	ART TEMP RADIATION R.H. AIR FLOW DAYLIGHT	SV RATIO	Table 4.1 & 4.3, Vol.2	ART TEMP RADIATION R.H. AIR FLOW DAYLIGHT	SV RATIO	Table 4.1 & 4.3, Vol.2	ART TEMP RADIATION R.H. AIR FLOW DAYLIGHT
Table 4.1 & 4.3, Vol.2	ART TEMP RADIATION R.H. AIR FLOW DAYLIGHT	ROOF FORM	Table 4.1 & 4.3, Vol.2	ART TEMP RADIATION R.H. AIR FLOW DAYLIGHT	ROOF FORM	Table 4.1 & 4.3, Vol.2	ART TEMP RADIATION R.H. AIR FLOW DAYLIGHT

Figure 6.1  
Reworked screenshot design matrix CLEAR.

A tool that is now available through a website is Comfortable Low Energy Architecture (CLEAR) (LEARN, 1987). It serves as a guideline offering recommendations for different topics such as context, building volume, material selection, window position and shading solutions for the three climatic conditions cold, temperate and hot.

In the table, each principle is complemented by a linked information page; in the book these topics are divided into chapters and show each level of the table.

The tool is based on an analysis of buildings worldwide and exploits the great resource of vernacular architecture; thus, the tool is most suitable for residential dwellings. It cannot be used for office buildings due to their highly varying construction methods and the different basic building types.

The simplistic classification of three climatic conditions does not provide sufficiently detailed information about the prevailing climate. It is not connected to weather data.

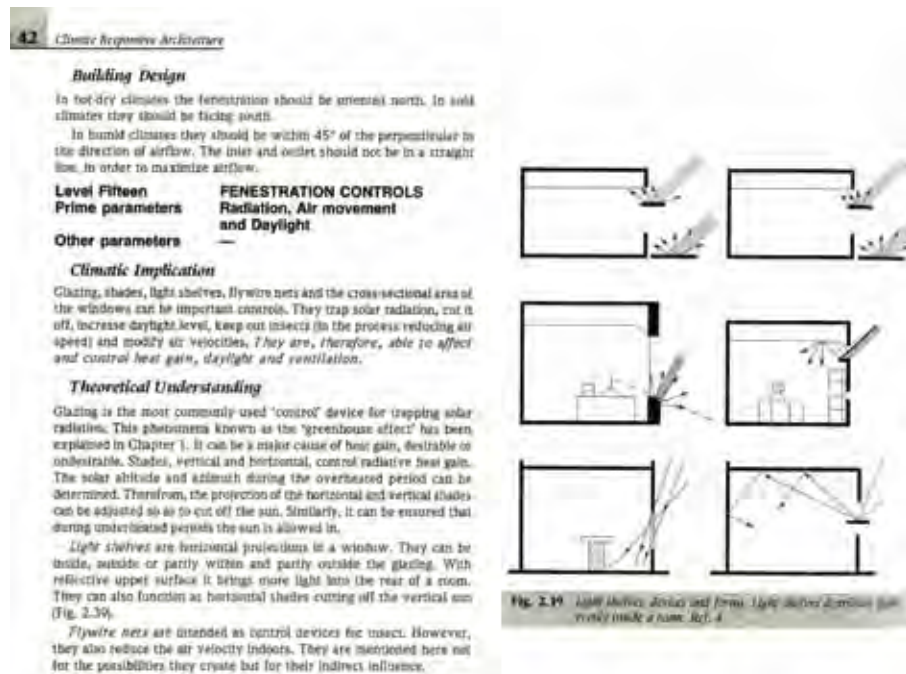

Figure 6.2  
 Example page from the book showing the principles of fenestrations controls



## § 6.1.2 Climate Consultant 5.0

Within the scope of the work at the UCLA Energy Design Tools Group (UCLA), Robin Liggett and Murray Milne have further developed this climate tool, which was originally created in 1996. The tool is available as a free download and allows for an analysis of hourly weather data records. The goal is a graphic depiction of the measurement values to provide a better understanding of the climate than mere numbers do.

An additional function of the tool is an embedded comfort calculation application that shows the dependencies between comfort and climate. The climate analysis is rounded off with a sentence stating design recommendations that are suited for a design in the particular location. These brief textual recommendations are illustrated with simple drawings of the used principles, similar to those in the CLEAR Guideline.

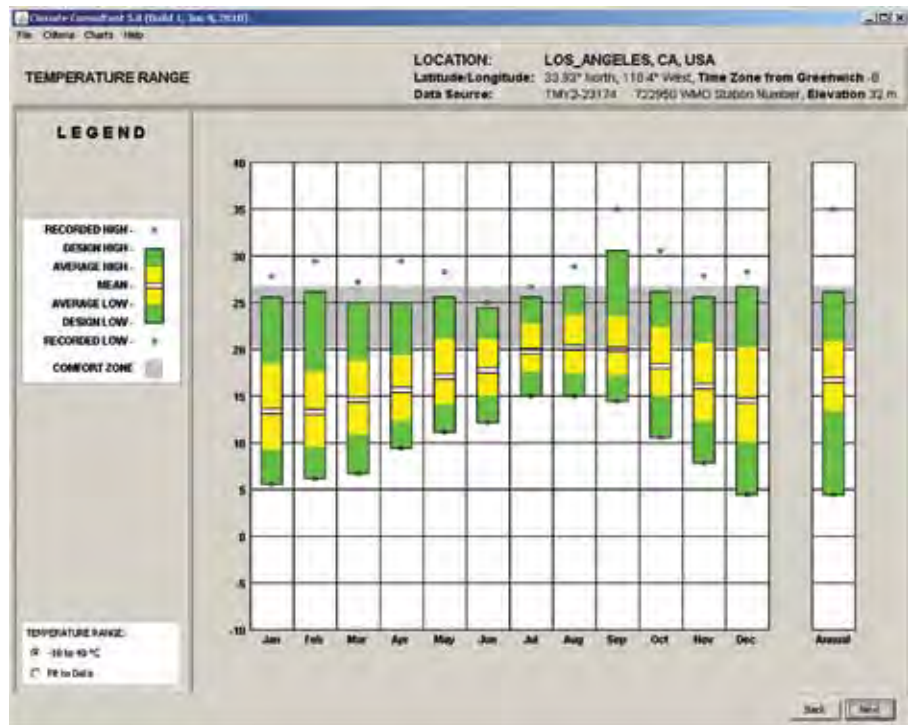

Figure 6.3  
Annual temperature range, Los Angeles, displayed in Climate Consultant 5.0

The illustration of the climate in a psychrometric chart is particularly interesting. In addition to humidity and temperature spreads, different comfort calculation models according to ASHREA can be laid over the chart. Thus, one can determine the time of the year during which a comfortable range is achieved in a particular climate. As a planning aid, various buttons are provided to analyse climatic data for specific designs strategies. Areas with mandatory dehumidification, for example, can thus be shown as percentage values and depicted graphically in a point cloud.

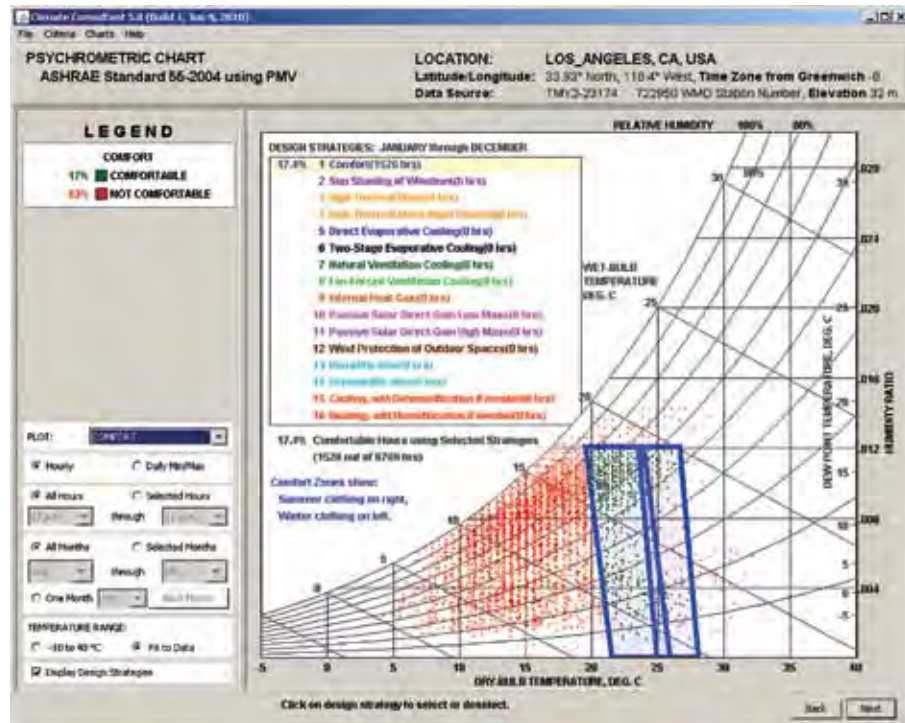

Figure 6.4  
Psychrometric chart depiction of Climate Consultant 5.0, example Los Angeles

Due to the computer-based interpretation of weather data records, the tool can be applied to many different applications. Weather data records from more than 2100 locations can be obtained from the US Energy Department (U.S. Department of Energy) website. The strength of this program definitely lies in the interpretation of weather data and comfort calculations. The Design Guideline is more general and does not refer to a particular project.

The recommendations are similar to those in the CLEAR Guideline, and mostly refer to residential dwellings and the requirements typical for this building type.

General information about type of glazing or material selection can be applied to office buildings, but they are not specifically designed for this purpose. The influence of the façade or building services is not taken into consideration. A positive aspect of the program is the continuous adaptation and actualisation to current norms and requirements.



Figure 6.5  
Design guidelines of Climate Consultant 5.0

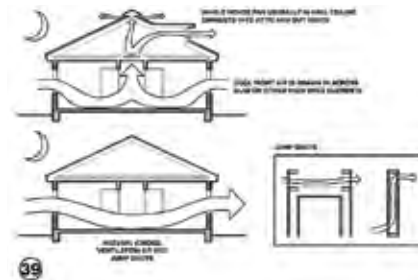

Figure 6.6  
Example of an illustration of the design guidelines

## § 6.1.3 MIT Design Advisor

**Setup: Describe the Building You Wish to Simulate**

Settings Saved

**Building Properties**

1. Location  Region: Europe City: Germany - Berlin

2. Occupancy and Equipment  Office Building  
Occupancy Schedule: 7:00 AM begins 5:00 PM ends  
Person-density: 0.10 people per m<sup>2</sup>  
Lighting: 400 - office work (EU) lux  
Treatment: 5.0 - office (light) view

3. Ventilation System  Natural Ventilation Cooling, Mechanical Heating  
Indoor Air Temperature: Min: 26 °C Max: 20 °C  
Max Relative Humidity: 60 %  
Ventilation Rate: Fresh Air Flow: 1.5 l/s/m<sup>2</sup> per person  
Air Change Rate: 1.5 times per hour

4. Thermal Mass   High Mass: exposed concrete slab floor  
 Low Mass: lightweight or obstructed floor  
 Zero Mass

5. Heating Strategy  Single Zone (1 facade)

6. Roof Description  Don't consider roof

**Typical Room Properties**

7. Room Dimensions  Width: 5 m Depth: 5 m Height: 3 m  
Window / Floor / Ceiling Overlap: 0.50

8. Window Description  Window Area: 50 % of exterior wall area  
Window blind setting: Venetian window setting

Window Type: single glazed, double glazed, triple glazed, single glazed, double glazed, triple glazed, insulate, outside vent.

Glass Type: Choose a glass coating

Overhang  Distance: 0 m

9. Wall Description  Wall Insulation: Choose an insulation, or enter an R-Value manually. Wall R-Value: 3.0 m<sup>2</sup>·K/W

save | add | delete  
Scenario Two Scenario Three Scenario Four

Figure 6.7  
Input mask of MIT Design Advisor

Design Advisor, a program published in 1996 by the Building Technology Laboratory at Massachusetts Institute of Technology (MIT) under Prof. Leon Glicksmann is the final

tool mentioned here fitting in a similar field of activity. Design Advisor is an on-line building simulation program, designed to provide architects and planners with a tool to quickly simulate energy consumption for heating, cooling and lighting without prior in-depth knowledge. A simple user interface is provided to test the performance capability of a building in the early concept phase. The tool offers the possibility to read climate data from a predefined database and, using input mask to describe the building in terms of type of use, usage times, ventilation system, thermal mass, room dimensions and the façade and glass type to be used.

After a short calculation period, the program generates a chart that shows the energy consumption based on indoor temperature, comfort and lifecycle cost. In addition, a results window can show the expected lighting situation in a simple 3-dimensional graphic over the period of one day and for a selected season.

Four different scenarios can be juxtaposed in order to easily compare changes and their impact, or to compare different concepts with each other. A so-called optimizer rounds off the program; a tool to play with variants derived from earlier selections made and to identify the optimum alternative for a particular design.

In contrast to the previously mentioned tools, Design Advisor requires the user to input a concept with specifications for room dimensions, ventilation strategies and the type of façade to be used. Thus, this tool should be used at a later stage in the planning process than the other tools. It is a simulation tool not specifically designed to analyse the climate. The need to input building parameters means that certain design decisions have already been made.



Figure 6.8:  
*Primary energy consumption in Design Advisor*



Figure 6.9:  
*Room temperature spread for the year*

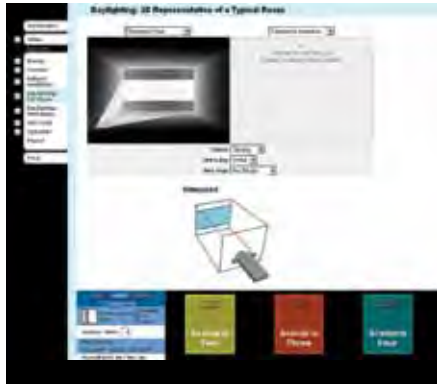

Figure 6.10  
Daylight simulation

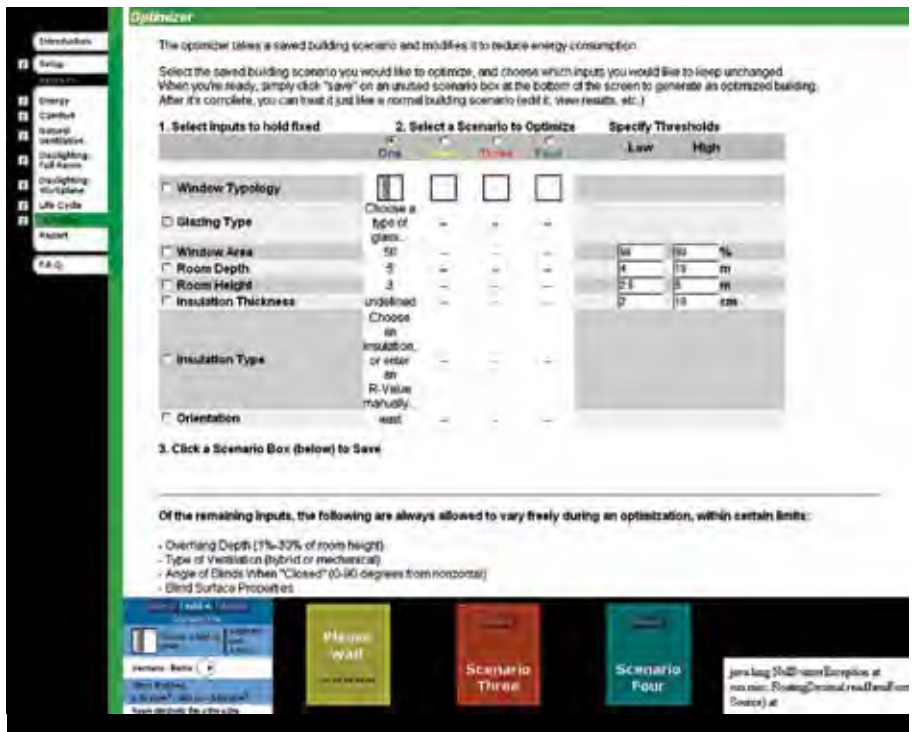

Figure 6.11  
Optimizer to compare selected concepts and identify the optimum configuration

The tool makes no recommendation; feedback can be drawn from the results alone. If the user wants to decide between two façade types, he/she is required to input these as variants, calculate and then compare the results. The knowledge gained is generated by using, testing and comparing different variants; the dependencies of the individual components are not clear and must be worked out by trial and error. The tool is the only one that calculates energy consumption based on the input of exact room and façade information, but it does require more knowledge about the building design than the other programs described.

Since there are no climate-related selection limitations, the tool cannot offer related design recommendations. Operation is easy, and a help function is provided. However, learning success is only achieved with continuous use of the tool and by comparing the variants.

---

## § 6.2 The idea behind FET

---

An analysis of the currently available tools or guidelines has shown that they follow two directions: on one hand to derive basic principles and on the other to estimate the performance of a design concept in the early planning stages by means of simulation. The CLEAR Guideline system provides the best recommendations for residential dwelling designs; the accompanying book features a comprehensive overview of the possibilities and principles, based on long term research in the field of vernacular architecture.

The reference to the climate classified only as cold, temperate and hot is very superficial, however; and climatic requirements for a particular location can therefore not be derived. Climate Consultant provides a detailed climate analysis based on weather data records; but the final recommendations are very general. The most complex tool is MIT's Design Advisor, which provides an overview of the performance capability of a design via on-line simulation programs. It is surprising that the climate is not written out in detail since the tool uses weather data records. A particular disadvantage is that no recommendations are given at all; no basic information necessary to make informed decisions about a particular location. The quality of a design must be iterated, making the process unsuited for the beginning stage of a design project. Particularly problematic is the choice of ventilation systems offered, which in Design Advisor can be selected as natural ventilation, mechanical ventilation or a combination of both. Here, a location-based recommendation would be most helpful.

As mentioned in the beginning the Façade Expert Tool (FET) shall offer basic information for the design of the building envelope and the necessary building services. The essential question hereby is which factors can be specified by the climate of a particular location to describe the requirements for the building envelope and building services. The FET should provide solutions for the following aspects of the early conceptual phase of a design:

- **Can natural ventilation be achieved?**
- **Is heating/ cooling necessary?**
- **Which façade type is most suitable: double or single leaf?**
- **What glazing ratio is necessary to obtain sufficient daylight?**
- **Requirements in terms of geographic direction?**
- **Is dehumidification or humidification necessary, and how much building services are needed?**

To answer these questions, we need to have thorough knowledge of the local climate. The analysis must be based on weather data records derived from hourly measurements over one year (8760 hours).

A weather data record consists of data collected by weather stations over time periods of up to ten years. These data are compiled into a test reference year in order to provide a representative image of the expected annual climate. Weather data records are available for a large number of locations worldwide. They provide the basis for thermodynamic building simulations. A weather data record includes the following measurement data amongst others:

- **Position incl. city, country, state, elevation, time zone, etc.**
- **Air temperature**
- **Dry-bulb temperature**
- **Relative humidity**
- **Ground temperature at different depths**
- **Wind speeds/frequency**
- **Wind direction**
- **Intensity of radiation**

The data is provided in machine-readable format. It can be read into a simulation software program or into MS Excel. The biggest effort is to provide the data in readable and analysable charts, a feature the weather data record alone can not provide.

The cooperation with Transsolar Energietechnik GmbH in Stuttgart/New York, who support the development of FET, allowed creating a MS Excel-based weather tool which serves as a suitable basis to further interpret weather data analyses. The weather data is processed into readable diagrams and charts. Known interfaces allow for further analysis of the climate data. The climate analyses for eight locations in [chapter 2](#) 'Climate zones' were generated with the weather tool by Transsolar. They provide first insight into the performance capability of the program.



## § 6.3 Development of FET

At the beginning of the FET development stands the analysis of a weather data record to provide easy to understand information about the prevailing conditions at a particular location. The focus hereby lies on subdividing the climate into areas that can be analysed for subsequent recommendations. The tool provides a description of the climate, and allows determining necessary measures such as heating, cooling, humidification and dehumidification via specified values.

### § 6.3.1 Temperature

Temperature can be subdivided into different ranges easily because we are familiar with temperature information and have developed a sense for different temperatures. The following temperature ranges lend themselves to classification because they are used in our habitual language use:

Very cold – Cold – Cool – Moderate – Hot – Very hot

The following temperature ranges have been selected as switch limits:

Temperature ranges	Switch limits
Very cold	-100°C > Temp < -10°C
Cold	-10°C > Temp < 10°C
Cool	10°C > Temp < 15°C
Moderate	15°C > Temp < 28°C
Hot	28°C > Temp < 35°C
Very hot	35°C > Temp < 100°C

Table 6.1  
Temperature ranges as switch limits

The upper limit was consciously set to +/- 100°C, so that the entire temperature range provided by the climate data can be analysed. In view of indoor comfort and the recommendations to be provided, the moderate range has been selected to cover temperatures between 15°C and 28°C. Hereby 28°C is the maximum upper limit; cooling is necessary at higher temperatures. In naturally ventilated spaces this temperature can be set as the upper limit; it might be possible to reduce the temperature by applying passive measures. The switch limits need to be verified at

a later stage of the process and might need to be adapted. Temperature analysis can determine requirements for heating and cooling for a desired comfort range.

The weather data records are analysed according to these temperature ranges and the 8760 hours of one year are subdivided accordingly. Generally, there is no day/night differentiation; however it can be used when necessary.

New York is used as an example to illustrate the temperature distribution over one year. The most frequently measured temperature occurs at 39.46% of the time and lies in the moderate range; thus the temperate can be classified as "moderate".

In order to better describe frequency in subsequent recommendations, another category is added. The differentiation was determined as follows. The threshold values are to be understood as the lower value; meaning that, for example, everything between 4 and 25% is described as "sometimes". In order to allow for the differentiation between no hours = never and a low number, one hour was set at 1/8760 as 0.0114%. This categorisation is also used for other weather conditions.

Conditions	Categorisation
0%	never
0.0114%	rarely
4%	sometimes
25%	often
50%	frequently
75%	almost always
100%	always

Table 6.2  
Categorisation weather conditions

The temperature analysis for New York can thus be described as in Table 6.3.

Climate Analysis for TMY2 New York City Ny					
Temperature	>= Temp	<	Time in Range	% of Year in Range	Climate
Very Cold	-100 °C	-10 °C	58 hours	0,66%	Rarely Very Cold
Cold	-10 °C	10 °C	3605 hours	41,15%	Often Cold
Cool	10 °C	15 °C	1384 hours	15,80%	Sometimes Cool
Moderate	15 °C	28 °C	3457 hours	39,46%	Often Moderate
Hot	28 °C	35 °C	257 hours	2,93%	Rarely Hot
Very Hot	35 °C	100 °C	0 hours	0,00%	Never Very Hot
Hours Check:			8.761	100,0%	

Table 6.3  
Temperature analysis, New York

## § 6.3.2 Humidity

The humidity level is an important aspect of the comfort level in a room; the façade, however, does not have any influence on this parameter. But the humidity content gives an indication of the possibility to employ natural ventilation. If humidity is too high, window ventilation is impossible; the limit is set at 12g/kg absolute humidity which reflects the upper limit of the comfort zone.

The climate is analysed according to the measurement values; ranges in excess of 12g/kg absolute humidity are considered “humid”. If the climate is considered too humid too often, suitable measures must be taken to dehumidify. In this case, humidity might have an influence on the façade, which, in extreme situations, should be designed as a non-operable façade – particularly if the humidity level never drops below the threshold value of 12g. In order not to entirely eliminate natural ventilation, the measurement values are also analysed by time of day. The measuring period is set at 7am to 7pm which corresponds to typical usage periods of office buildings. As can be seen in the weather data analysis in [chapter 2 ‘Climate zones’](#), humidity levels in tropical areas such as Singapore are very high, which will be reflected in different recommendations for conditioning a building and façade requirements. In order to identify a tropical climate, the enthalpy limit is set at 64 KJ/kg (the heat or energy balance of the air). The analysis of New York shows 1026 hours with absolute humidity in excess of 12g/kg; however, this occurs only during 504 daytime hours, and is thus described as “sometimes humid during the day”. New York’s climate can still be called “rarely tropical”.

Humidity	Limit			
Humid	12 g/kg	1026 hours	11,71%	Sometimes Humid
Humid During Day		504 hours	5,75%	Sometimes Humid During Day
Tropical Conditions	64/kg	261 hours	2,98%	Rarely Tropical Conditions

Table 6.4  
Humidity statistics, New York

### § 6.3.3 Wind

Wind speed is one factor that can be analysed from overall wind data. There is no direct requirement that can be derived for the façade. Façades must be wind tight and able to resist prevailing wind loads. Hereby, the building geometry plays an important role; depending on the façade system used it must be verified and determined in detail. One important factor relating to the façade is sun protection, however. It is a passive measure to protect the building from overheating. At wind speeds of more than 12m/s it is retracted for safety reasons. Louver-type sun protection is the standard system for exterior sun protection. On high buildings that are particularly subjected to high wind loads these systems often are inefficient because they must be frequently retracted to the safety position. One means of shielding sun protection systems is to install them in the space between two façade layers.

Wind				
High wind conditions	12,0 m/s	26 hours	0,30%	Rarely High wind conditions
High wind and high solar radiation	500 W/m <sup>2</sup>	1 hours	0,01%	Rarely High wind and high solar radiation

Table 6.5  
Wind speeds, New York

Thus, analysing wind speeds can determine whether or not a double façade is suited for a particular project. It has to be noted though, that this examination treats the double façade as a wind buffer and protection of the sun protection which could also be realised in the form of a single protective plate. In order to include the bulging height as an influential parameter into the decision making chain, this parameter must be retrieved. But it is important to note that the wind loads on the building must be examined in detail to determine reciprocal effects of adjacent buildings. A wind tunnel examination can provide more detailed information.

A recommendation whether or not a double façade is suitable as protection for the sun protection system must be based on the intensity of solar radiation. It is only recommendable if high wind speeds coincide with high solar radiation. If there is no need for sun protection nothing must be protected. As a first approach, radiation intensity has been set to 500W/m<sup>2</sup>. Sun protection systems are often lowered or extended at radiation intensities of only 200W/m<sup>2</sup>. However, this threshold value can easily be reached when there is diffuse radiation rather than direct incident radiation; in which case traditional sun protection is ineffective because diffuse radiation is omnidirectional. In order to ensure that a certain amount of direct radiation falls on the façade, the threshold value has been set to the relatively high value of 500W/m<sup>2</sup>. It can

manually be lowered at a later stage. The criterion whether a double façade is a suitable method to protect sun protection in between the façade layers is determined as follows:

**Double façade:**

**Recommended at strong winds and high solar radiation >4%**

The wind data of New York for building heights of 10m can be analysed as shown in [Table 6.5](#).

The wind load on the façade is different at different altitudes. The following table shows the results of a wind analysis with winds in excess of 12m/s for larger building heights. The second column shows the number of hours during which winds in excess of 12m/s coincide with radiation intensities of more than 500W/m<sup>2</sup>.

Building height	Wind	Result
50m	604 h more than 12m/s	68 h wind and radiation
100m	1328 h more than 12m/s	167 h wind and radiation
150m	2078 h more than 12m/s	285 h wind and radiation
200m	2470 h more than 12m/s	350 h wind and radiation
250m	3003 h more than 12m/s	421 h wind and radiation

*Table 6.6  
The results of a wind analysis with winds in excess of 12m/s for larger building heights.*

The table shows that the higher the building the more frequent are wind loads in excess of 12m/s. But these conditions seldom coincide with high radiation intensity on the façade. Even with 250m high buildings with wind speeds higher than the threshold value of 12m/s for 34% of the time, the duration of simultaneous high intensity radiation is only approximately 5%. Thus double façades or specific measures to protect sun protection systems do not make sense in this region.

### § 6.3.4 Recommendations for façades and building services functions

In the beginning, the goal for the tool was to generate a detailed list of requirements of the façade and building services after selecting the climate of the particular location. Further examination proved that innumerable parameters need to be entered and calculated in order to provide recommendations for aspects such as specific technical cooling components, for example. Since the required state changes heating, cooling,

humidification and dehumidification can be resolved with a number of different building services components, it does not seem sensible to recommend a specific component. The interaction of individual components cannot be shown in the first version of the program; problems with one component can be solved with another. This fact shifted the development of the tool in the direction of general recommendations and requirements. The tool now known as Façade Expert Tool describes exactly this difficulty. The selection of suitable building services components must remain in the hands of experts because, at least in the initial version of the tool, this information cannot be generated satisfactorily from the analysis of the weather data. Take a cooling ceiling as an example: if humidity at the location is very high, the dew point temperature can drop below the operational temperature of the cooling ceiling; with the result that the water content of the air condensates – water droplets would fall from the ceiling. Thus, depending on the dew point temperature and the operational temperature of the cooling ceiling, this component could be excluded or recommended for certain climates. On the other hand, changing the rate of air exchange of the ventilation system could counteract the condensation issue.

In general, recommendations and requirements should be given by function. Is heating required; is there a need for cooling; can natural ventilation be used – these are some of the questions that the tool should provide answers to in the first phase. The general method to generate recommendations is to analyse the climate in relation to the relevant parameters, and then to transfer these into a comprehensive description of the climate. Then recommendations are given on the basis of the climatic description and the parameters are arranged in order, where practical.

Climate Analysis for TMY2 New York City Ny						
Temperature						
	>=	Temp	<	Time in Range	% of Year in Range	Climate Description
Very Cold	-100 °C		-10 °C	58 hours	0.66%	Rarely Very Cold
Cold	-10 °C		10 °C	3605 hours	41.15%	Often Cold
Cool	10 °C		15 °C	1384 hours	15.80%	Sometimes Cool
Moderate	15 °C		28 °C	3457 hours	39.46%	Often Moderate
Hot	28 °C		35 °C	257 hours	2.93%	Rarely Hot
Very Hot	35 °C		100 °C	0 hours	0.00%	Rarely Very Hot
Natural Ventilation Potential						
Daytime natural ventilation	10 °C		25 °C	89 days	24%	
Daytime natural ventilation	10 °C		25 °C	1796 hours	32%	
Night flush ventilation	25 °C		20 °C	32 days	9%	
Humidity						
		Limit				
Humid		12 g/kg		1026 hours	11.71%	Sometimes Humid
Humid During Day		64 kJ/kg		504 hours	5.76%	Sometimes Humid During Day
Tropical Conditions				261 hours	2.98%	Rarely Tropical Conditions
Wind						
High wind conditions		12.0 m/s		26 hours	0.30%	Rarely High wind conditions
High wind and high solar radiation		500 Wh/m²		1 hours	0.01%	Rarely High wind and high solar radiation
Basic Temperature Statistics:						
Annual Mean		12.1				
Maximum		34.9				
Minimum		-15.2				
Source Hours		8761				

Table 6.7  
Climate analysis, New York

The functionality of the recommendations can be explained as follows: according to the frequency of occurrence, areas can be defined for which recommendations are given. The statements are weighted differently by using “recommended or necessary”. If a particular function is not necessary, this fact is not specifically expressed. In most cases, the logic has been adapted so that only one of the statements is made. In case of heating, the statement will be “necessary” because heating or a warm environment is considered to be a basic need. In the case that employing a particular technique sensibly exploits the potential of the climate, the statement will be “recommended”. As a general rule, cooling measures should not be considered standard measures; if temperatures go beyond the threshold value, cooling is recommended because it raises the comfort level but is not absolutely necessary.

The climate description for the example New York was analysed as follows according to the previously described climate classification. FET output is shown in [Figure 6.32](#).

The switch points or threshold values for heating, cooling, humidification and dehumidification have been specified as follows:

Systems	Switch points or threshold values
Heating:	Necessary if Cold > 1 hour
Cooling:	Recommended if Hot > 1 hour
Dehumidification:	Necessary if Humid or Tropic > 4%
Humidification:	Recommended if Very cold > 4%

**Table 6.8**  
The switch points or threshold values for heating, cooling, humidification and dehumidification.

System Recommendations	
Basic Systems	Systems Recommendations
Heating	Required
Humidification	
Cooling	Recommended
Dehumidification	Required
Mechanical Ventilation	Required
Heat recovery	Recommended
Indirect adiabatic cooling	
Daytime natural ventilation	Recommended
Night flush ventilation	Recommended
Façade Types	
Double façade	

**Table 6.9**  
System recommendations, example New York

The example of New York provides a clear view of how the working method of the climate analysis. For heating, the frequency of occurrence of cold temperature is shown with 3605 hours, the query thus falls into the category necessary of cold >1 hour. The climate analysis states the frequency of occurrence of hot temperature with 257 hours per year. Therefore, FET puts out a recommendation for cooling because the condition hot is fulfilled for more than 1 hour.

One technical cooling option in centralised systems is adiabatic cooling; hereby water is dispersed into the air, evaporates and thus cools the air via evaporative heat loss. A downstream heat exchanger cools the supply air. Since no water is added to the supply air, this method is also known as indirect adiabatic cooling. Due to the physical mode of functioning, this cooling method is subject to limitations; the potential of adiabatic cooling can not be exploited if the air is too humid or too cold. In order to decide for or against the use of adiabatic cooling the following criteria is queried:

**Adiabatic cooling:**  
**Recommended if Tropic < 4% and Hot >4%**

### § 6.3.5 Ventilation and night time cooling

---

Natural ventilation is always recommendable if outside temperatures are within an acceptable temperature range compared to inside temperatures. Outside temperatures that are too high or too low have a negative influence on the room climate or cause excessive energy consumption due to high ventilation heat loss. The limits for natural ventilation are set at between 10°C and 25°C. In order to be able to offer a recommendation in relationship to the operating times, a time frame must be entered in order to avoid influencing the recommendation by the cooling effect of colder night air. With natural ventilation we can assume that it is controlled by the user; thus an unused office will not be ventilated at night. The humidity level of the location also plays a role for natural ventilation; if absolute humidity exceeds 12g/kg, natural ventilation is not recommended.

Result output follows two different calculations; on one hand by the number of days entered at which the temperature level remains within the query range of 10-25°C – only these numbers are added up; and on the other by the number of hours – expectedly higher – which also include those days during which the temperature lies beyond the limits. The example New York shows 89 days and 1796 hours per year during which natural ventilation is possible.

The following query was chosen as the criteria to evaluate natural ventilation:



### Natural ventilation daytime:

**Recommended if Frequency nat. ventilation < 4%**

The query refers to the pairs of values that indicate the frequency in days to ensure the climate does not vary to an extent that only individual hours per day allow for natural ventilation because the user cannot be expected to use these periods efficiently.

Night time temperatures are particularly interesting for determining the possibility of night flush ventilation. At night, outside air can flow into the building through motorised flaps to cool down the building mass for the following day. Night flush ventilation, however, is only effective if the outside air cools down sufficiently during the night. Thus, a query is determined that adds up all night time hours during which temperatures drop below 20°C while daytime temperatures are in excess of 25°C. This method ensures that night time cooling is only recommended if the difference in temperature between day and night is sufficiently large and daytime temperatures have caused the building to heat up beyond the comfort level and cooling is really necessary. The example New York shows 32 days during which night cooling makes sense.

The criterion for the night flush ventilation query was determined as follows:

### Night flush ventilation:

**Recommended if Frequency night flush ventilation < 4%**

Natural Ventilation Potential				
Daytime natural ventilation	10 °C	25 °C	89 days	24%
Daytime natural ventilation	10 °C	25 °C	1796 hours	32%
Night flush ventilation	25 °C	20 °C	32 days	9%

Table 6.10

Potential natural ventilation and night flush ventilation, New York

Conversely, mechanically ventilation might be necessary if outside temperatures are significantly higher or lower than the temperature level in the room. In this case, natural ventilation is no longer feasible. Regions with high humidity levels require mechanical ventilation systems which must also be equipped to dehumidify the supply air. The criterion for the weather data query was determined as follows:

### Mechanical ventilation:

**Necessary if Very cold or Humid or Tropic <4%**

The query Tropic indirectly includes information about temperature ranges that are too high; and if the climate is too hot, cooling is recommended.

### § 6.3.6 Waste heat recovery

---

If outside temperatures are higher or lower than the desired room temperature, it makes sense to employ waste heat recovery. The exterior air and the exhaust air flow through a heat exchanger which causes an exchange of thermal energy. Cold fresh air is thus pre-warmed by the thermal energy of the exhaust air, for example. There are many technical solutions for this process: efficient heat exchangers can be installed in centralised ventilation or air-conditioning systems; and modern decentralised ventilation systems can also include heat exchangers to minimise the use of primary energy by exploiting the thermal energy of the exhaust air.

The application of waste heat recovery is only practical if there is a temperature difference between the inside and outside temperatures. In order to avoid condensation problems within the heat exchanger when the humidity level is too high, the query includes humidity as well as temperature level. Thus, waste heat recovery alone will never be recommended for tropical regions.

The following rule has been specified as the decision making criteria for the analysis:

#### **Waste heat recovery:**

**Recommended if Tropic < 4% and Hot >4% or Cold >4%**

In addition to using sensible energy, an enthalpy wheel helps to exploit the thermal energy that is stored in the air humidity as latent heat. The working method of an enthalpy wheel is described in § 5.4.1 'Central air-conditioning' as part of centralised air-condition systems. The use of an enthalpy wheel makes sense if there is a difference in inside and outside humidity as well as temperature. To recommend the application of this technology, the following criterion must be fulfilled:

#### **Enthalpy wheel:**

**Recommended if Very cold or Tropic > 4%**

A temperature range of Very cold inherently means low humidity because cold air can contain only a very small amounts of water.

### § 6.3.7 Glazing ratio

In order to determine the amount of glazing for a façade, a computational model by Transsolar Energietechnik was implemented in the logics of FET. It assumes a model space with horizontal panels as glass elements in front of a room. During simulation, glass panels are incrementally added from top to bottom to calculate the daylight factor inside a room (reference point is 3 meters into the room) in dependence of the light transmission. The FET tool allocates the point of intersection of the desired daylight factor with the glazing factor and returns a percentage value. The calculations are done for different light transmission rates. Thus, FET can calculate the necessary proportion of glazing in a façade according to the choice of class selected.

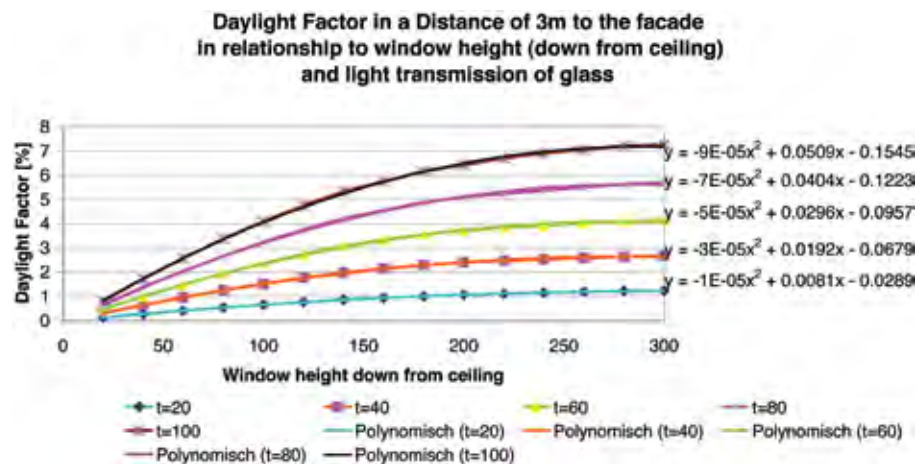

Figure 6.12  
Calculation model for glazing ratio

The daylight factor is based on a calculation model with diffuse skies. Since light intensity is determined from the weather data independent of the geographic direction, this computational model does not allow inputting requirements for a geographic direction. The method seems adequate for an initial approach; later developments, however, should include a reference to the geographic direction in order to allow a recommendation based on a detailed differentiation between the various possible façade orientations.

FET recommendations are calculated in 10% increments from the interpolation of the above shown curves. It has to be noted that the computational model is based on the assumption that areas of glazing should be arranged as high up as possible. The

higher the window element is located on the façade, the more light penetrates the entire room. In practice, window elements also need to be placed in the viewing area of the user and should extend to the ceiling to achieve efficient yield of daylight. Glazing below the parapet will not improve daylight autonomy; rather it might cause the room to overheat.

### § 6.3.8 Graphic editor

---

In addition to façade recommendations and climate description, façade planners and consultants benefit from a visual interpretation of the façade design. The underlying idea is a simple selection of the recommended options. These are then combined to create a model space that provides the architect with an easy to read summary of the climate and façade concept. The graphic editor of the Façade Expert Tool includes a selection matrix in MS Excel, via which the user can select façade and building services components. The recommendations according to the climate analysis are shown in the side area of the editor, helping the user to compile a model space.

The initial goal to graphically display the optimum combination of façade and building services directly after selecting a location was discarded for the above mentioned reasons – an expert is needed to select an intelligent combination; the mere combination of various items can never provide the best and most suitable solution.

Following a modular design principle, the components for the model space can be compiled from 8 different check boxes depending on the requirements and recommendation given. All parts of the image are coordinated depending on their location and, when put together, generate an image of the model space. In addition to selecting different components, the tool can also illustrate individual functions in different modes of operation. The façade and building services components available in the tool have been introduced in [chapter 5 'Building services components'](#).

Besides a mere representation of the components, the functions Heating, Cooling and Ventilation only are available. In the different states, named seasons, coloured arrows or the opening of a window illustrate the functionality. It was a conscious decision to render only abstract representations; if the recommendation is to reduce the glazing ratio, one window will be displayed automatically to provide some means of outside view. Starting at the bottom, grey bars appear in 10% increments to demonstrate a successively smaller glazing ratio. The façade layout must be determined at a later stage by the design members of the planning team.

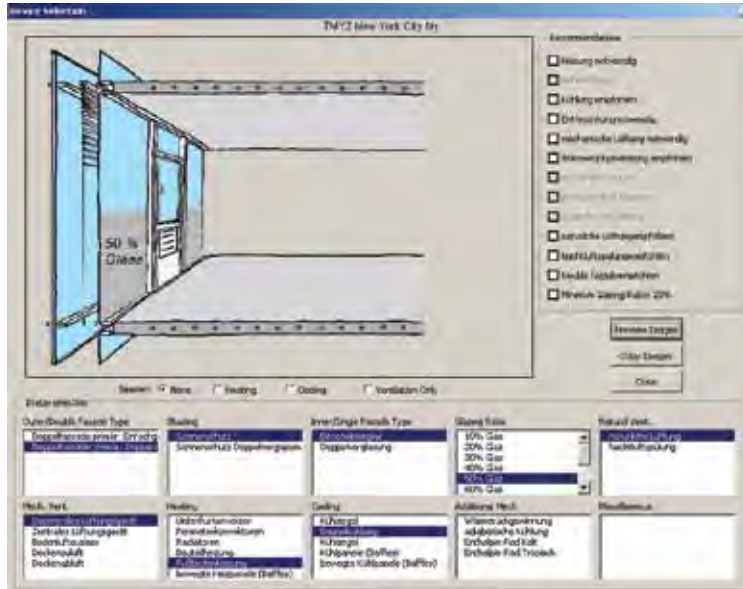

Figure 6.13:  
Graphic editor of the FET

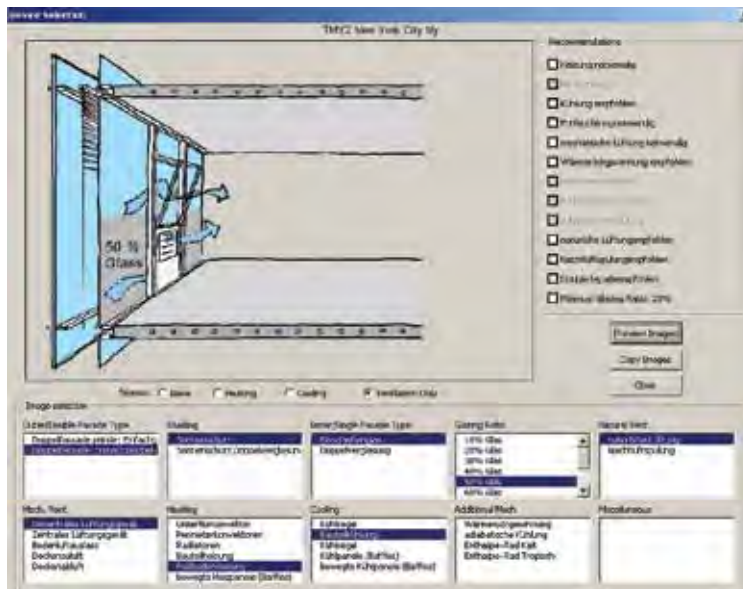

Figure 6.14  
Ventilation in the graphic editor

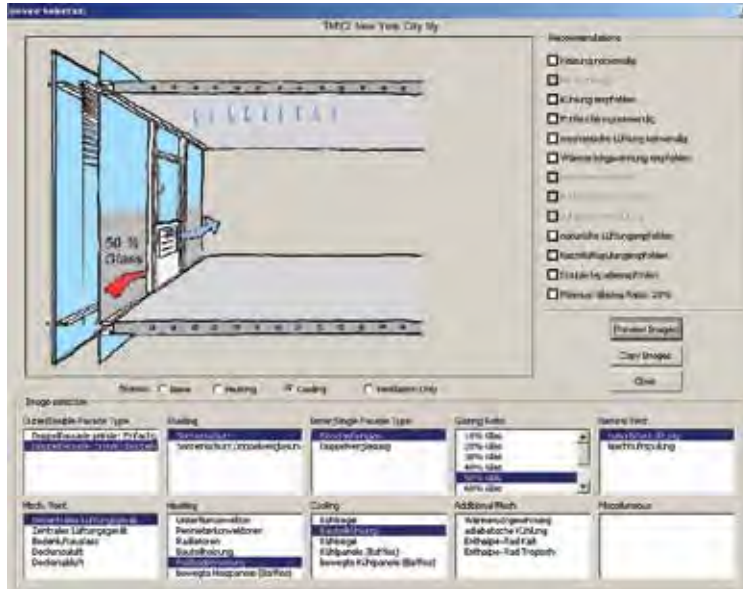

Figure 6.15  
Cooling in the graphic editor

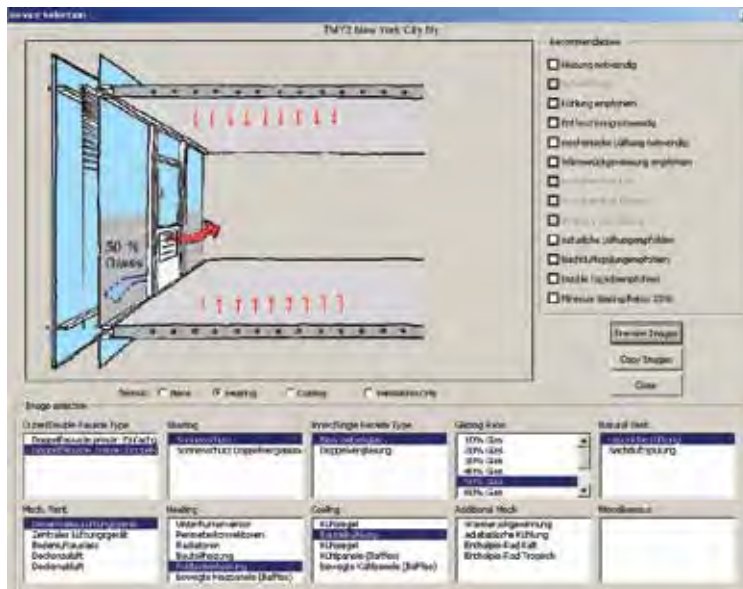

Figure 6.16  
Heating in the graphic editor

The resulting image can be exported into PowerPoint or any other program. The graphic representation of the reference or model space is a simple tool to show all of the previously determined components for subsequent planning.

---

## § 6.4 FET in use

---

After several testing series, all obvious bugs of the tool have been eliminated or fixed. The first version of the Façade Expert Tool with the previously described functions is operational and, in the following, is used to create the requirement profiles for the eight selected boomtowns. Recommendations are output as a direct result of the input provided by the user. The realisation of the model space created with the graphic editor provides an intelligent composition of façade and building services components. Different combinations are possible; subject to the experience and preferences of the architect and expert planner responsible for the project.

In order to test the performance capability of the tool and its influence on reducing the operational energy of a building, § 6.5 'Test room comparison simulations' includes comparison simulations of optimised façade concepts and the International Style. These simulations are simplified versions to allow an easy comparison of the locations and the influence of the climate on the energy consumption of the building concept.

The chapter is round of with a summary and critical analysis of the simulation results and the development of the Façade Expert Tools.

### § 6.4.1 FET recommendations for the eight boomtowns

---

This section describes a FET analysis of the eight boomtowns and shows possible combinations of façades and building services components edited with the graphic editor. The height for all buildings has been specified at 150 m to show potential wind loads; if applicable, the tool will output a recommendation for a double façade. The glazing type used in all variants is selective glass (33/66); in practice this should be further adapted at a later stage. The choice of a highly selective glass is based on most architects' desire for maximum transparency and colour neutrality. From a physical point of view it offers a very beneficial balance of transparency and overall energy transmissibility. In a first approach, the types of façades and building services components chosen are a direct result of the FET requirements and recommendations output. A FET climate analysis was conducted for each location. The decisions made in

terms of which components were chosen and possible alternatives are described and critically discussed. It must be noted that the individual component selection made here was done by the author; other solutions are possible. A different user could very well compile a different combination of components from the FET recommendations and requirements that would also fulfil the requirements.

§ 6.4.1.1 Dubai

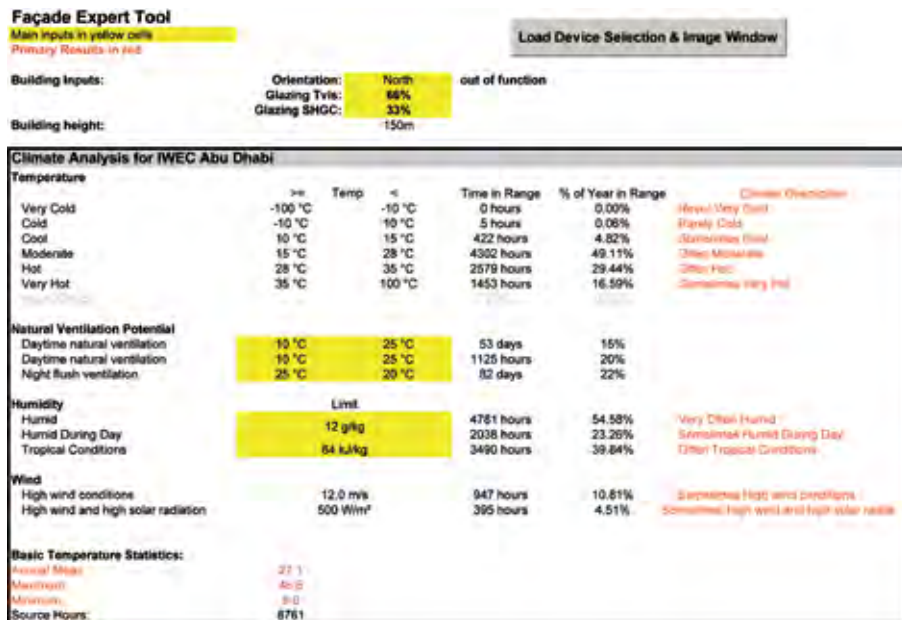

Figure 6.17  
 FET Climate analysis, Abu Dhabi

The climate analysis shows Abu Dhabi as a hot and often humid location. As mentioned earlier there is no Weather file for Dubai, so Abu Dhabi Is used instead. The recommendations and necessary requirements for this location are manifold. An enthalpy wheel is recommended due to high humidity levels, which inevitably leads to the use of central air-conditioning. In addition, concrete core heating and cooling has been selected to cover basic loads. The goal is to reduce the load posed on the central air-conditioning system. The airflow of the central air-conditioning system should be used for night cooling. Because the wind loads are calculated for a 150 high



building, a double façade should be used to protect the sun protection system in the space between the two façade layers. With a recommended glazing ratio of only 20%, box windows would be a good choice. The region around Abu Dhabi requires a rather enclosed façade due to the high occurrence of wind storms, which means that natural ventilation is difficult to realise.

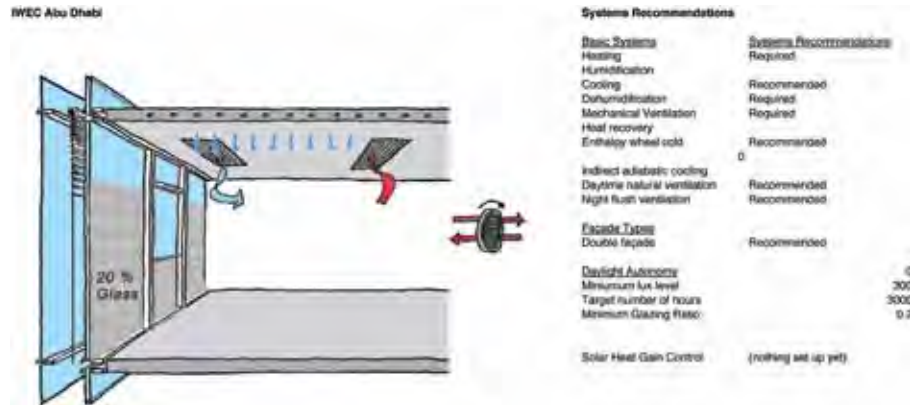

Figure 6.18  
System recommendations cooling, Abu Dhabi

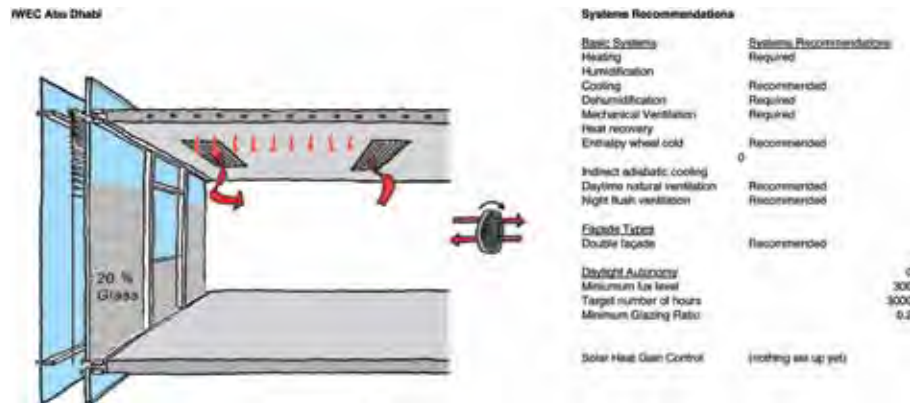

Figure 6.19  
System recommendations heating, Abu Dhabi

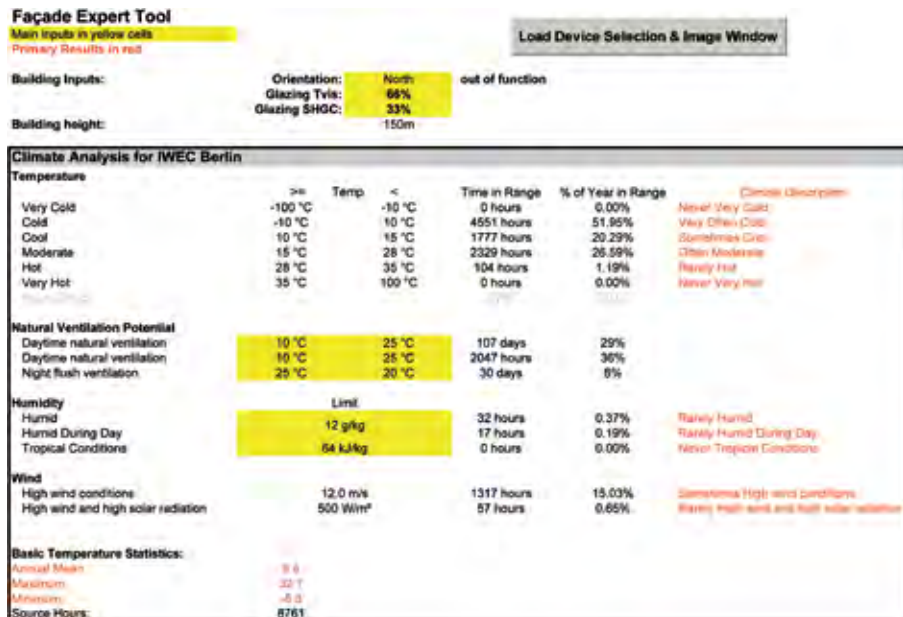
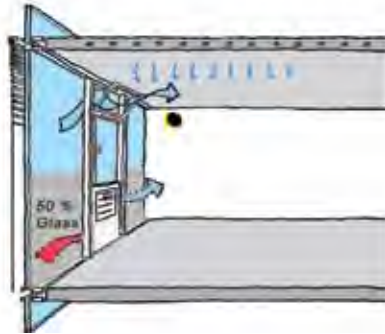

Figure 6.20  
 FET Climate analysis, Berlin

The climate analysis for Berlin shows a moderate dry climate. Heating and cooling are recommended or necessary. Natural ventilation and night flush cooling are also recommended. Decentralised ventilation devices have been used to comply with the recommendation for mechanical ventilation. They can provide quick cooling in combination with concrete core activation. Waste heat recovery is recommended; if used it should be considered when selecting a decentralised ventilation system. As an alternative to night air flaps, night cooling could be done using the decentralised units. The recommended glazing ratio is shown at 50%; double façades are not recommended due to the wind speeds prevailing in this region.

IWEC Berlin



**Systems Recommendations**

Basic Systems	Systems Recommendations
Heating	Required
Humidification	
Cooling	Recommended
Dehumidification	Recommended
Mechanical Ventilation	Recommended
Heat recovery	Recommended
Entropy wheel cold	0
Indirect adiabatic cooling	
Daytime natural ventilation	Recommended
Night flush ventilation	Recommended
<b>Facade Types</b>	
Double facade	
<b>Daylight Autonomy</b>	
Minimum lux level	0
Target number of hours	3000
Minimum Glazing Ratio	0.5
<b>Solar Heat Gain Control</b>	
	(nothing set up yet)

Figure 6.21  
System recommendations cooling, Berlin

IWEC Berlin

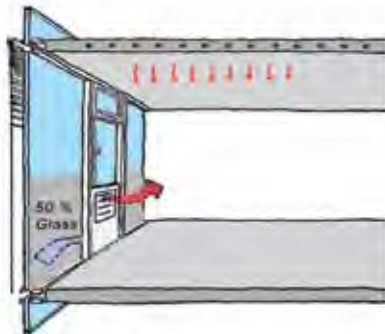

**Systems Recommendations**

Basic Systems	Systems Recommendations
Heating	Required
Humidification	
Cooling	Recommended
Dehumidification	
Mechanical Ventilation	Recommended
Heat recovery	Recommended
Entropy wheel cold	0
Indirect adiabatic cooling	
Daytime natural ventilation	Recommended
Night flush ventilation	Recommended
<b>Facade Types</b>	
Double facade	
<b>Daylight Autonomy</b>	
Minimum lux level	0
Target number of hours	3000
Minimum Glazing Ratio	0.5
<b>Solar Heat Gain Control</b>	
	(nothing set up yet)

Figure 6.22  
System recommendations heating, Berlin

§ 6.4.1.3 Las Vegas

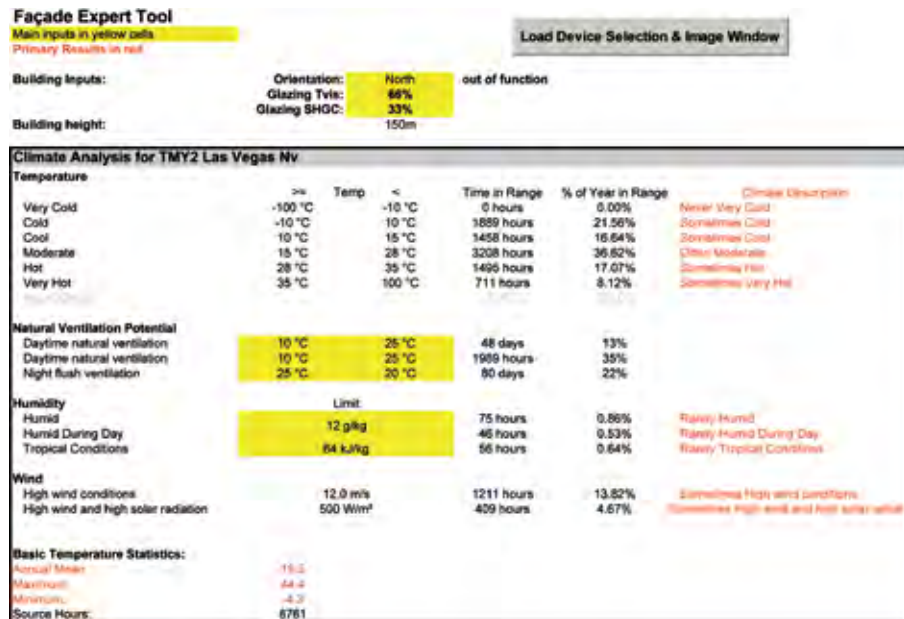
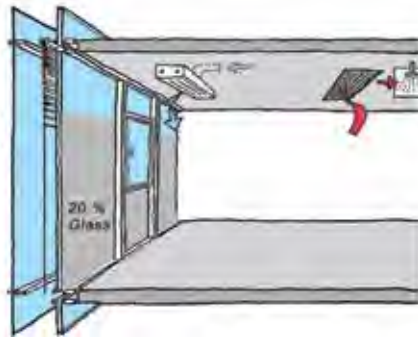

Figure 6.23  
 FET Climate analysis, Las Vegas

The climate analysis for Las Vegas shows a dry and hot climate with a high ratio of cold days per year. Since adiabatic cooling and waste heat recovery is recommended, an active beam with a central exhaust system was chosen for the model space. The active beam can be used for heating and cooling and, realized as a water-based system combined with central ventilation should offer efficient operation. The large potential of 35% natural ventilation was fulfilled with an operable window, which should be further analysed in subsequent planning. Using windows for natural ventilation in combination with a central ventilation system should be discussed in detail. The windows should only be opened when outside conditions permit; otherwise the user and the ventilation system might work counterproductively. A glazing ratio of only 20% and the recommendation for a double façade indicate that box window solutions or windproof, exterior sun protection in a window façade should be further examined.

TMY2 Las Vegas NV



**Systems Recommendations**

Basic Systems	Systems Recommendations
Heating	Required
Humidification	
Cooling	Recommended
Dehumidification	
Mechanical Ventilation	Recommended
Heat recovery	Recommended
Enthalpy wheel cold	
Indirect adiabatic cooling	Recommended
Daytime natural ventilation	Recommended
Night flush ventilation	Recommended
<b>Facade Types</b>	
Double facade	Recommended
<b>Daylight Autonomy</b>	
Minimum lux level	11
Target number of hours	3000
Minimum Glazing Ratio	0.2
<b>Solar Heat Gain Control</b>	(nothing set up yet)

Figure 6.24  
System recommendations cooling, Las Vegas

TMY2 Las Vegas NV

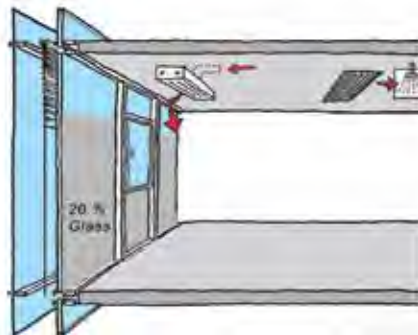

**Systems Recommendations**

Basic Systems	Systems Recommendations
Heating	Required
Humidification	
Cooling	Recommended
Dehumidification	
Mechanical Ventilation	Recommended
Heat recovery	Recommended
Enthalpy wheel cold	
Indirect adiabatic cooling	Recommended
Daytime natural ventilation	Recommended
Night flush ventilation	Recommended
<b>Facade Types</b>	
Double facade	Recommended
<b>Daylight Autonomy</b>	
Minimum lux level	11
Target number of hours	3000
Minimum Glazing Ratio	0.2
<b>Solar Heat Gain Control</b>	(nothing set up yet)

Figure 6.25  
System recommendations heating, Las Vegas

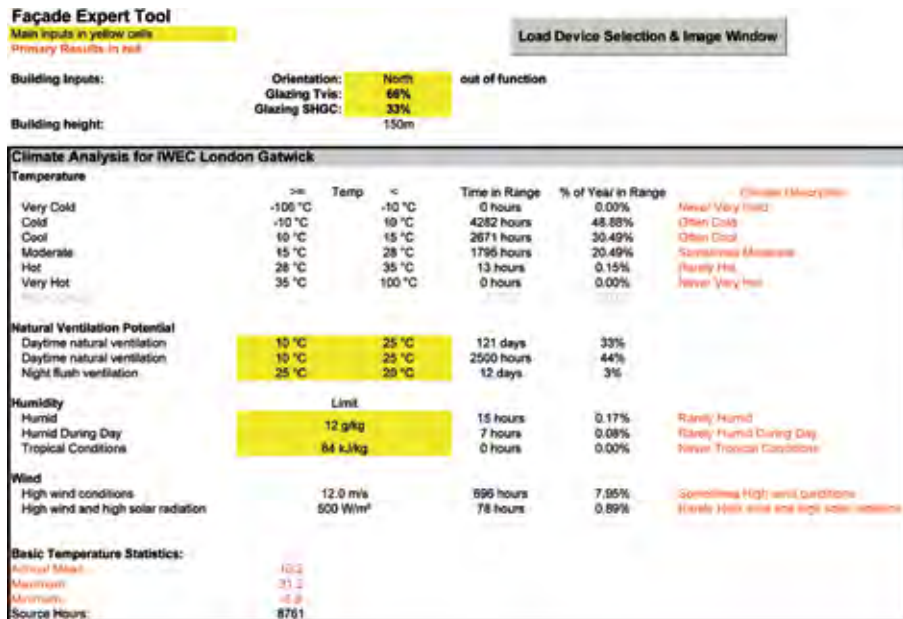
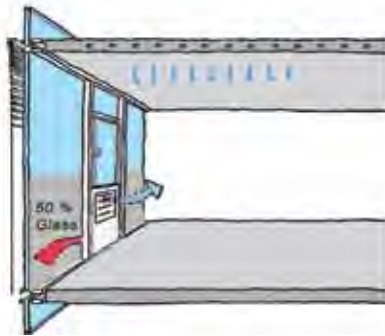

Figure 6.26  
 FET Climate analysis, London

The climate analysis shows a dry, cool climate with distinctively mild summers. Heating and cooling are recommended as well as the potential of natural and mechanical ventilation. The system used is a decentralised ventilation device with waste heat recovery which can provide quick heating and cooling in combination with concrete core activation. An operable window provides user-controlled natural ventilation; the glazing ratio lies at 50% with exterior sun protection.

BWEC London Gateck



**Systems Recommendations**

Basic Systems	Systems Recommendations
Heating	Required
Humidification	
Cooling	Recommended
Dehumidification	
Mechanical Ventilation	Recommended
Heat recovery	Recommended
Enthalpy wheel cold	0
Indirect adiabatic cooling	
Daytime natural ventilation	Recommended
Night flush ventilation	
<b>Facade Types</b>	
Double facade	
<b>Daylight Autonomy</b>	
Minimum lux level	0
Target number of hours	3000
Minimum Glazing Ratio	0.5
Solar Heat Gain Control	(nothing set up yet)

Figure 6.27  
System recommendations cooling, London

BWEC London Gateck

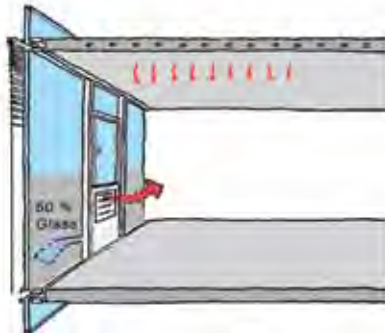

**Systems Recommendations**

Basic Systems	Systems Recommendations
Heating	Required
Humidification	
Cooling	Recommended
Dehumidification	
Mechanical Ventilation	Recommended
Heat recovery	Recommended
Enthalpy wheel cold	0
Indirect adiabatic cooling	
Daytime natural ventilation	Recommended
Night flush ventilation	
<b>Facade Types</b>	
Double facade	
<b>Daylight Autonomy</b>	
Minimum lux level	0
Target number of hours	3000
Minimum Glazing Ratio	0.5
Solar Heat Gain Control	(nothing set up yet)

Figure 6.28  
System recommendations heating, London

§ 6.4.1.5 Moscow

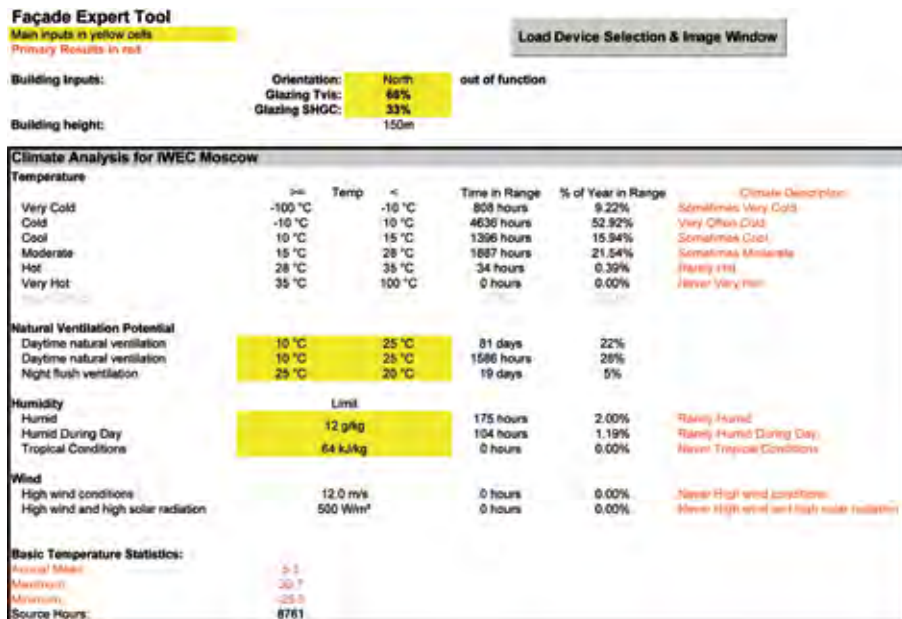
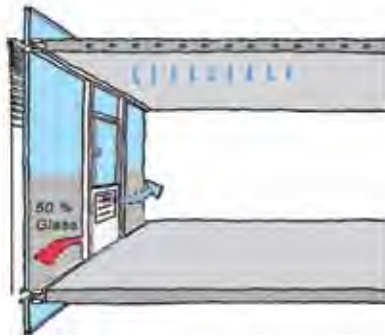

Figure 6.29 FET  
 Climate analysis, Moscow

The climate analysis for Moscow shows a cold dry climate. Since the FET recommends an enthalpy wheel as well as waste heat recovery, the system chosen is a central ventilation system with additional heating and cooling functions. During winter, concrete core heating provides slow supportive heating. During summer, night air ventilation through small window flaps can lower the temperature inside the building; in addition these flaps can be used for natural ventilation. The recommended glazing ratio is 50%.



BWEC London Gateck



**Systems Recommendations**

Basic Systems	Systems Recommendations
Heating	Required
Humidification	
Cooling	Recommended
Dehumidification	
Mechanical Ventilation	Recommended
Heat recovery	Recommended
Enthalpy wheel coil	0
Indirect adiabatic cooling	
Daytime natural ventilation	Recommended
Night flush ventilation	
<b>Facade Types</b>	
Double facade	
<b>Daylight Autonomy</b>	
Minimum lux level	0
Target number of hours	3000
Minimum Glazing Ratio	0.5
Solar Heat Gain Control	(nothing set up yet)

Figure 6.30  
System recommendations cooling, Moscow

BWEC London Gateck

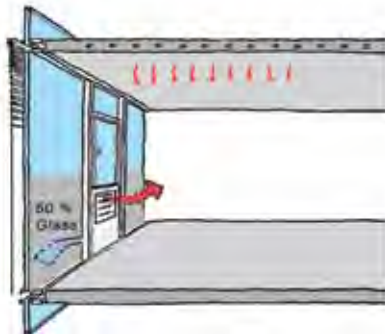

**Systems Recommendations**

Basic Systems	Systems Recommendations
Heating	Required
Humidification	
Cooling	Recommended
Dehumidification	
Mechanical Ventilation	Recommended
Heat recovery	Recommended
Enthalpy wheel coil	0
Indirect adiabatic cooling	
Daytime natural ventilation	Recommended
Night flush ventilation	
<b>Facade Types</b>	
Double facade	
<b>Daylight Autonomy</b>	
Minimum lux level	0
Target number of hours	3000
Minimum Glazing Ratio	0.5
Solar Heat Gain Control	(nothing set up yet)

Figure 6.31  
System recommendations heating, Moscow

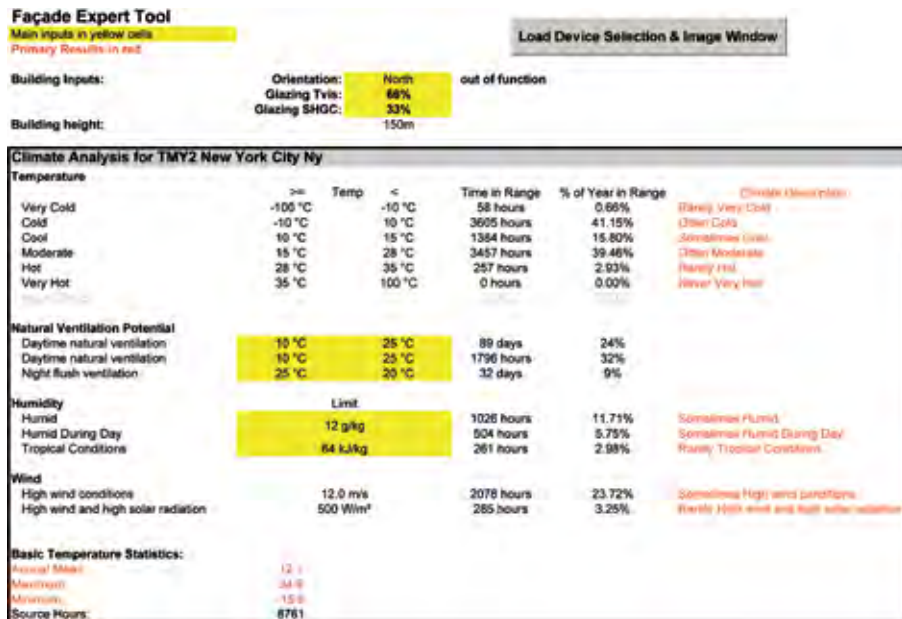
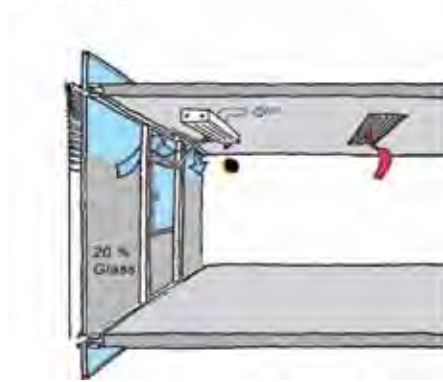

Figure 6.32  
 FET Climate analysis, New York

The FET determines the climate as a cold moderate climate with the tendency of high humidity. The recommendations are manifold; since dehumidification is necessary and waste heat recovery is recommended, a central air-conditioning system was chosen to dehumidify, and active beams for heating and cooling. The recommended glazing ratio is 20%. Operable windows are used for individual natural ventilation and for night cooling whenever outside conditions permit. But night cooling could also be accomplished with the central ventilation / air-conditioning system.

TMV2 New York City Ny



**Systems Recommendations**

Basic Systems	Systems Recommendations
Heating	Required
Humidification	
Cooling	Recommended
Dehumidification	Required
Mechanical Ventilation	Required
Heat recovery	Recommended
Enthalpy wheel cold	
Indirect adiabatic cooling	0
Daytime natural ventilation	Recommended
Night flush ventilation	Recommended
<b>Facade Types</b>	
Double facade	
<b>Daylight Autonomy</b>	
Minimum lux level	0
Target number of hours	3000
Minimum Glazing Ratio	0.2
<b>Solar Heat Gain Control</b>	(nothing set up yet)

Figure 6.33  
System recommendations cooling, New York

TMV2 New York City Ny

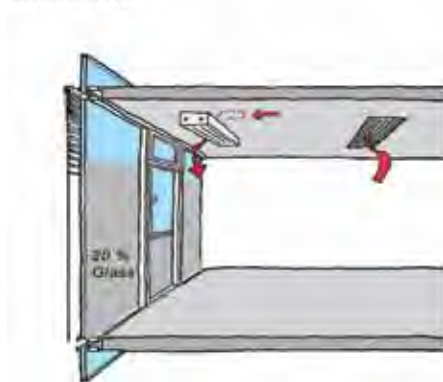

**Systems Recommendations**

Basic Systems	Systems Recommendations
Heating	Required
Humidification	
Cooling	Recommended
Dehumidification	Required
Mechanical Ventilation	Required
Heat recovery	Recommended
Enthalpy wheel cold	
Indirect adiabatic cooling	0
Daytime natural ventilation	Recommended
Night flush ventilation	Recommended
<b>Facade Types</b>	
Double facade	
<b>Daylight Autonomy</b>	
Minimum lux level	0
Target number of hours	3000
Minimum Glazing Ratio	0.2
<b>Solar Heat Gain Control</b>	(nothing set up yet)

Figure 6.34  
System recommendations heating, New York

§ 6.4.1.7 Shanghai

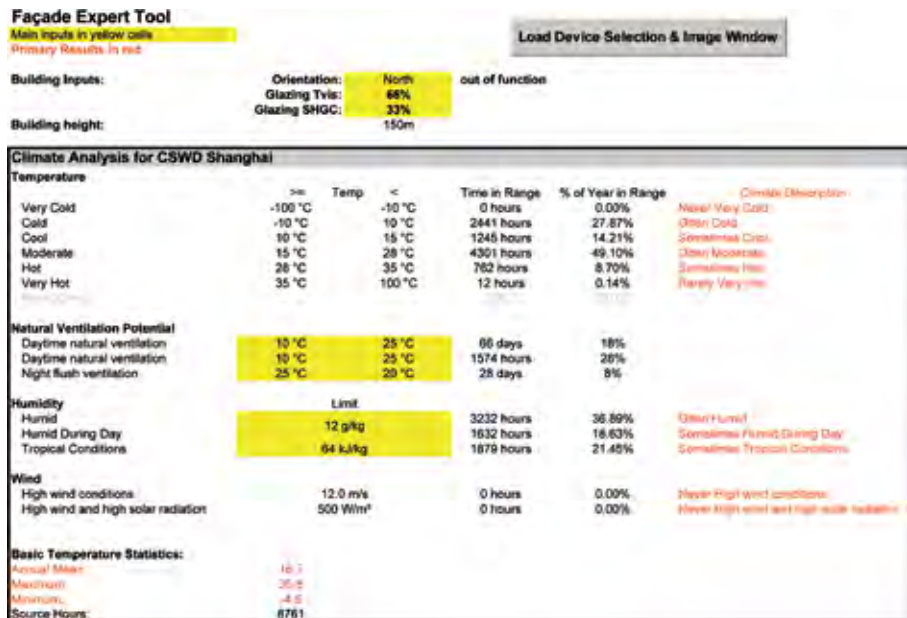
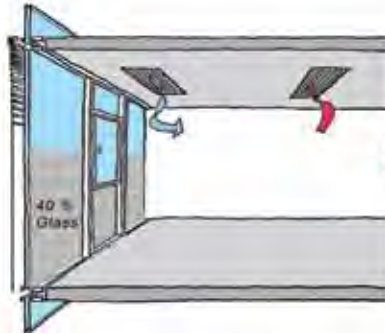

Figure 6.35  
 FET Climate analysis, Shanghai

The climate in Shanghai is an often humid warm climate. Because the recommendations call for an enthalpy wheel and waste heat recovery, a central air-conditioning system is recommended. Operable windows were selected to further raise the user comfort level and to provide the option of natural ventilation whenever outside conditions permit. The recommended glazing ratio is 40%.

CSWD Shanghai



**Systems Recommendations**

Basic Systems	Systems Recommendations
Heating	Required
Humidification	Recommended
Cooling	Required
Dehumidification	Required
Mechanical Ventilation	Required
Heat recovery	Recommended
Enthalpy wheel cold	Recommended
Indirect adiabatic cooling	0
Daytime natural ventilation	Recommended
Night flush ventilation	Recommended
<b>Facade Types</b>	
Double facade	
<b>Daylight Autonomy</b>	
Minimum lux level	C
Target number of hours	30%
Minimum Glazing Ratio	0.4
<b>Solar Heat Gain Control</b>	(nothing set up yet)

Figure 6.36  
System recommendations cooling, Shanghai

CSWD Shanghai

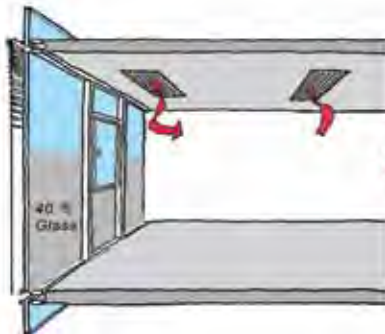

**Systems Recommendations**

Basic Systems	Systems Recommendations
Heating	Required
Humidification	Recommended
Cooling	Recommended
Dehumidification	Required
Mechanical Ventilation	Required
Heat recovery	Recommended
Enthalpy wheel cold	Recommended
Indirect adiabatic cooling	0
Daytime natural ventilation	Recommended
Night flush ventilation	Recommended
<b>Facade Types</b>	
Double facade	
<b>Daylight Autonomy</b>	
Minimum lux level	C
Target number of hours	30%
Minimum Glazing Ratio	0.4
<b>Solar Heat Gain Control</b>	(nothing set up yet)

Figure 6.37  
System recommendations heating, Shanghai

§ 6.4.1.8 Singapore

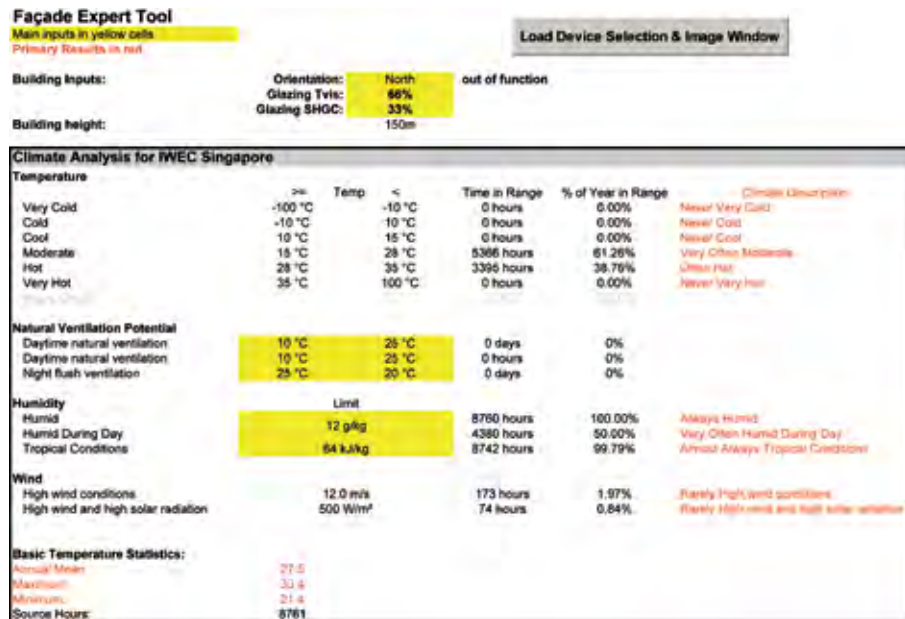
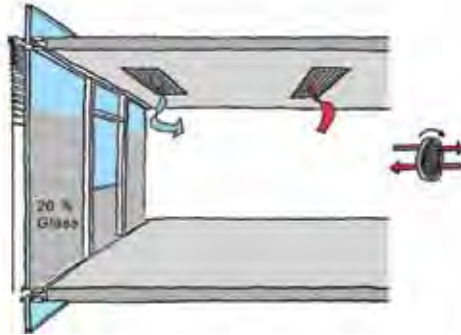

Figure 6.38  
 FET Climate analysis, Singapore

The climate in Singapore is described as tropical hot. Therefore, the recommendations and requirements are easy to interpret; a central air-conditioning system with enthalpy wheel is used. The recommended glazing ratio is 20%. Since the humidity levels continuously exceed the acceptable level, sash windows are not used. Exterior sun protection is used to reduce heat transfer.

IWEC Singapore



**Systems Recommendations**

Basic Systems	Systems Recommendations
Heating	
Humidification	
Cooling	Recommended
Dehumidification	Required
Mechanical Ventilation	Required
Heat recovery	
Enthalpy wheel cold	Recommended
Indirect adiabatic cooling	0
Daytime natural ventilation	
Night flush ventilation	
<b>Facade Types</b>	
Double facade	
<b>Daylight Autonomy</b>	0
Minimum lux level	300
Target number of hours	3000
Minimum Glazing Ratio	0.3
Solar Heat Gain Control	(nothing set up yet)

Figure 6.39  
System recommendations cooling, Singapore

IWEC Singapore

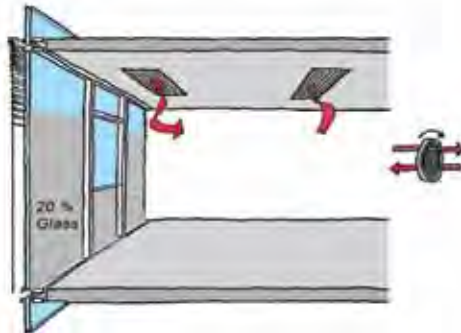

**Systems Recommendations**

Basic Systems	Systems Recommendations
Heating	
Humidification	
Cooling	Recommended
Dehumidification	Required
Mechanical Ventilation	Required
Heat recovery	
Enthalpy wheel cold	Recommended
Indirect adiabatic cooling	0
Daytime natural ventilation	
Night flush ventilation	
<b>Facade Types</b>	
Double facade	
<b>Daylight Autonomy</b>	0
Minimum lux level	300
Target number of hours	3000
Minimum Glazing Ratio	0.3
Solar Heat Gain Control	(nothing set up yet)

Figure 6.40  
System recommendations heating, Singapore

## § 6.4.2 Testing FET – comparison simulation

---

The functionality of the FE Tool is based on an analysis of weather data, providing recommendations and requirements of functions. As explained previously, the implementation and selection of building services components is subject to many different aspects. A suitable combination of these elements can optimise the operation of a building and reduce operating cost.

In order to evaluate the quality of the prognoses that the tool puts out, a comparable test series must be conducted. In the beginning, the comparison was to be based on the calculation of a model space with a façade developed with the FET that exemplified a typical built example at a particular location. However, since the information available about realised projects varies greatly, it did not seem feasible to generate a representative building for each location that represents the International Style and can be compared to the optimised model space.

In as far as footprints are available they vary in usable size; in most cases building services information is very rudimentary; exact information about the materials used, the performance data of the façade, and the finishing of the rooms are hard to retrieve. And lastly, there is no uniform geographic orientation of the buildings; they are oriented depending on the circumstances of the property or follow the requirements of a zoning plan – making it impossible to conduct a uniform comparison. In order to allow for scientific analysis and comparison, it is necessary to simplify the boundary conditions of the simulation and to specify numerous conditions. The focus of the examination must be narrowed down to analyse simulations. If too many parameters vary from each other, it is impossible to determine the influence of individual façade components or functions.

A look at the building projects published in specialised and the general press illustrates that fully glazed office buildings account for the largest number of office buildings worldwide. In addition to the published projects, reality makes this phenomenon even more obvious: since published buildings are often particularly thoroughly planned; the great mass of buildings has a significantly lower standard; for high-rises this typically means that no sun protection was installed.

The general style, typically summarised as International Style, with a single leaf curtain wall façade is used as the basis for a comparison simulation. A comparison simulation highlights the performance capability of this building type and can prove the theory that fully glazed buildings tend to consume large amounts of energy, irrespective of their location and the local climate.



One of the tool's functions is to indicate the minimum glazing ratio required. This value has a significant influence on the appearance of the façade and thereby the entire building. The function seems particularly suited to test the tool's potential and, by being reduced to only one parameter, allows easy comparison.

The base model of the comparison simulation is a cellular office with a fully glazed façade, reflecting the International Style. For comparison reasons, the façade is compared to an optimised variant created according to the glazing recommendations of the FET. The goal of the simulation is to compare the energy consumed to maintain a comfortable level in the test room. The consumption values for heating and cooling are annualised. The outside temperature is compared to the resulting room temperatures in incremental one-hour steps. If the inside conditions fall below or above the specified comfort level, corrections are automatically made and these consumption values are added up for the year.

The simulation only captures the façade's sensible influence on the heating and cooling loads because the façade has no impact on the humidity content of the inside space. In order to calculate the amount of energy needed for possibly necessary humidification/dehumidification, it will be included in the simulation. In tropical areas, dehumidification will most likely account for a significant share of the operating energy. For the simulation, the amount of energy needed for humidification/dehumidification is calculated once per location, and is then included in the charts of both variants. Thus, the results are the same for both variants.

The switch values were defined as 30% and 65% relative humidity. These specifications are based on the German regulation DIN 1946. ASHREA allows for a larger humidity tolerance; but since the façade has no influence on humidity levels, the results provide a helpful overview. If the measurement values fall outside the comfort range, they will be adapted automatically; the energy amounts are added up over the year. These values only represent the exact amount of energy needed to add or retract water from the air (condensation/evaporation). None of the thermodynamic processes required to add or retract water from the air are included.

The amount of energy needed for these processes greatly depends on the particular system technology used. In modern systems, however, this process energy is almost zero. It has to be noted that the amount of energy needed for heating, cooling, humidification/dehumidification determined by the simulation only accounts for part of the total energy required for operating the building. Other types of energy needed are those for lighting, infrastructure, lifts, for example, and other technical building installations. Since they stand in no relationship to the façade, they find no consideration in the simulation.

### § 6.4.3 Building-related basic conditions for simulation

---

For the purpose of evaluating the impact of the façade and its glazing ratio in individual climate zones/locations relating to geographic orientation, a test room was specified for thermal simulation.

In order to create a comparable simulation of the International Style buildings for all eight locations, boundary conditions were specified that allow for subsequent comparison with the optimised solutions.

A 3-axial office with storey-high glazing was chosen as a suitable test room. It was a deliberate choice to define a small space in order to illustrate the weak points in the performance. Overheating problems with high cooling loads in summer or high heating loads in winter are easier to detect in a small room than a large space, in which the large volume balances out some of the peak loads. For the simulation, the test room was not specified at a specific height within the building. However, hypothetically it is located in a high-rise building that is not shaded by any other construction on any side. The room is assumed to be positioned in the centre of the building with comparable adjacent offices. Corner locations were avoided to provide clear input in terms of the geographic orientation.



Figure 6.41  
*Testroom location in a highrise building*

In order to achieve a realistic comparison of the reference room and an optimised FET variant, the reference room needs to be adapted to the particular type of façade used. A fully glazed, non load-bearing curtain wall façade is the International Style standard; however, it is principally wrong to assume that one and the same building is designed exactly alike in all eight locations around the world.

The performance of the façade will be adapted for every climate and every location by choosing the appropriate construction and type of glass. Very high solar radiation in some of the selected locations mandates the use of tinted glass or highly reflective sun protection glass. Anti-sun glass with a high selectivity index of 40/20 was chosen for the glazing for all reference test rooms because it was not possible to determine a single typical type of glass for each of the locations. The degree of light transmissivity of 40% offers a good yield of daylight, and a low g-value of 20 % ensures low energy transmittance. Even though this type of glazing is not standard, it is readily available and can be used in all regions.

And although in many of the regions examined these specifications result in an increased façade performance compared to the currently built standard, they allow for easy comparison of the individual simulation results. The glazing for the optimised variant is based on the glazing ratio recommendations of the FET. In parts the glazing ratio is only 20 % and thus rather low, but it is based on a daylight yield of 300 lux minimum during 3000 hours of daylight autonomy per year. The types of glazing are listed in Table 6.11 the selection is based on the experience of the author. In order to achieve efficient sun protection, most of the optimised façade variants include exterior sun protection systems.

City	Reference	Optimized (300 lx /3000hr)
Singapore	100% glass / 40/20 / blinds / SF	40/20 glass / 30% glazing / SF internal blinds
Berlin	100% glass / 40/20 / blinds / SF	70/50 glass / 50% glazing / DF single outside double inside / shading in gap
Abu Dhabi	100% glass / 40/20 / blinds / SF	40/20 glass / 20% glazing / SF internal blinds
Las Vegas	100% glass / 40/20 / blinds / SF	66/33 glass / 20% glazing / DF single outside double inside / shading
London	100% glass / 40/20 / blinds / SF	70/50 glass / 40% glazing / DF single outside double inside / shading in gap
Moscow	100% glass / 40/20 / blinds / SF	70/50 glass / 40% glazing / DF single outside double inside / shading in gap
New York	100% glass / 40/20 / blinds / SF	70/50 glass / 20% glazing / DF single outside double inside / shading in gap
Shanghai	100% glass / 40/20 / blinds / SF	66/33 glass / 40% glazing / DF single outside double inside / shading in gap
DF = Double Façade		SD = Single Façade

Table 6.11  
Parameters of the testroom configurations

Exterior sun protection installed in great heights must be protected from wind loads. This is usually done by placing it behind an exterior protective panel. The table shows a double façade; but note that it is assumed to be sufficiently ventilated and, in the simulation, is not considered as an enclosed space in front of the primary façade. Thus, overheating of the space in-between the façade layers can be excluded. Depending on the type of protective panel used, it can be used to provide natural ventilation. Due to high humidity levels in tropic zones such as Singapore, natural window ventilation is not possible. Therefore the façade for these regions has been designed as a single-leaf façade with interior sun protection. In very cold regions such as Moscow, the façade has been designed as a double façade with exterior sun protection. With single glazing, the surface temperatures on the outside of the glass pane can cause condensation and icing. (Heusler, 2007)

The installation and finishing methods of different buildings also vary greatly, but for office buildings the focus lies on the necessity of an elevated floor to accommodate cables for telecommunications and power. Thus, an elevated false floor is specified for both variants. Since most of built projects include air-conditioning, the reference variant assumes suspended ceilings. The optimised version is simulated without a suspended ceiling; the raw concrete ceiling functions as a thermal mass providing a positive influence on the room climate.

The following shows the conditions specified for the reference variant and the optimised variant. The dimensions and constructional design reflect common constructions and first and foremost serve the purpose of comparison. Suspended ceilings, false floor constructions and other constructional details have been specified to determine thermally active surfaces that, during simulation, will have an influence on the conditions in the room. The dimensions conform to common grid sizes for office use with modern computer work places with flat panel monitors.

#### **Boundary conditions**

Width: 3 axes, each 1.35m = 4.05m, clear opening 3.92m

Depth: 5m

Clear height: 3.0m

#### **Construction / finishing Interior/Partition walls:**

25mm plasterboard, 80mm thermal insulation 0.040 W/mK, 25mm plasterboard, total thickness 130mm

#### **Floor/ceiling construction (top to bottom):**

5mm carpet

45mm dry screed for false floor

100mm air space within the false floor for installations

300mm concrete

100mm air space (reference building only)  
Suspended ceiling 12.5mm drywall (reference building only)

Façade as post-beam façade, aluminium,  $U_{cw} = 1.5 \text{ W}/(\text{m}^2\text{K})$   
Glazing:  $U_g = 1.0 \text{ W}/(\text{m}^2\text{K})$

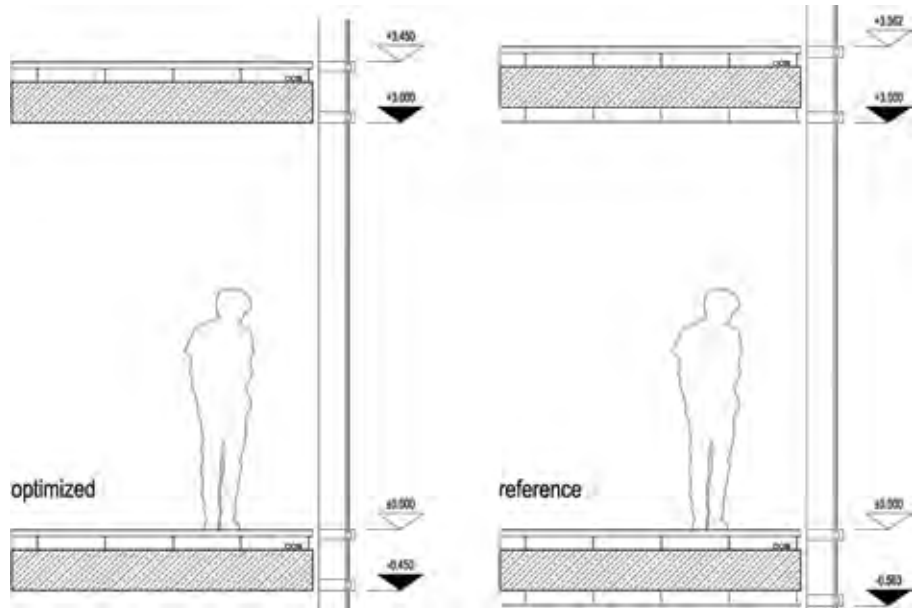

Figure 6.42  
Section of the test room configurations left without suspended ceiling, right with suspended ceiling

The façade glazing ratio for the reference room is specified at 100%; this does not reflect realistic conditions because framing parts and cladding of the ceilings, in particular, include opaque parts. However, for the sake of simplicity the text refers to 100% glass; which describes a fully glazed building from the point of view of the user. The user senses the reduced glazing ratio of the optimised variant as opaque façade elements.

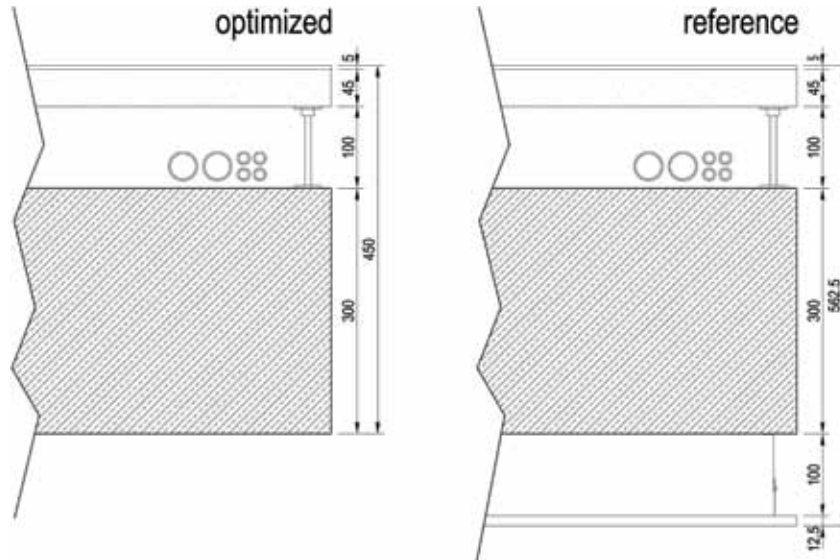

Figure 6.43  
Construction of the test room configurations floor left without suspended ceiling, right with suspended ceiling

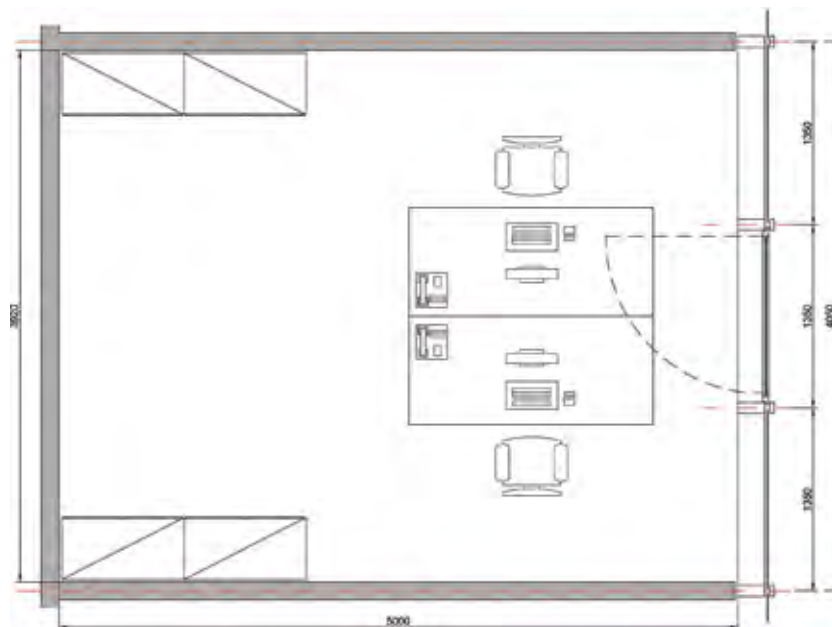

Figure 6.44  
Floor plan of the test room configurations

### Internal loads and operating parameters

In addition to the construction related conditions that have been described above, internal loads and operating parameters must be determined. The test room is assumed to be subjected to the following internal loads.

These loads reflect typical usage:	
Occupancy:	2 persons / working hours 8.00 am – 6.00 pm / 5 days per week
Lighting:	12W/m <sup>2</sup> for artificial lighting in conjunction with daylight autonomy of 300lux for 3000h per year
Hardware:	2 computers incl. monitor / 1/3 printer

Table 6.12  
Internal loads

The simulation assumes a building that is outfitted with a building services system that can heat, cool, ventilate and air-condition. The building services system might be activated to ensure a comfortable indoor climate; the amounts of energy required for the relevant operations are calculated and recorded as measurement results.

The parameters have been specified as follows:	
Infiltration:	0.15/h (gap tightness and opening of doors)
Air exchange rate:	2/h
Heating:	unlimited, room temperature 20°C unlimited, room temperature 24 °C reference
Cooling:	unlimited, room temperature 26 °C optimised
Humidity:	30 % - 65 % relative humidity

Table 6.13  
Operating parameters

The room temperatures related to cooling are different for the reference and optimised test rooms. With interior sun protection, as specified for the International Style reference room, 24°C is the maximum room temperature limit. Due to high radiation heat transmitted from the façade into the room, the space in the vicinity of the façade is no longer comfortable if this value is exceeded. Records show that the temperature is often set to an even lower setting. However, for the sake of comparison the value has been determined equally for all reference rooms. The optimised room with partially exterior sun protection and improved glazing can feature room temperatures of up to 26°C, which reflects the upper limit of the comfort range.

The simulation is based on eight different weather data records. As far as available they are drawn from IWECC data sets (see: § 2.4 'Climate analysis methods'). Typical Meteorological Year data has been used for the two North American locations (TMY2 – a third version is now available). The simulation for Shanghai is based on a CSWD data set, which was generated as a standardised Chinese weather data set for simulations. In principle, the data sets are comparable, and set the standard for thermodynamic simulations in their respective countries.

Weather data sets used	
Singapore:	IWECC_Singapore
Berlin:	IWECC_Berlin
Abu Dhabi:	IWECC_abu_dhabi
Las Vegas:	Typical_meteorological_year_las_vegas_23169
London:	IWECC_London_gatwick
Moscow:	IWECC_moscow
New York:	tmy2_ne_york_city_ny_94728
Shanghai:	CSWD_shanghai

Table 6.14  
Weather data sets used



## § 6.5 Test room comparison simulations

The simulation results are shown as bar diagrams; the amounts of energy for heating, cooling, humidification and dehumidification are shown as total amounts. To highlight the amount of energy influenced by the façade (heating and cooling) it is shown as a second sum behind the total amount on the respective bars in the diagram. The diagram description also notes façade-related energy for heating and cooling, indicated by brackets. The diagrams include a reduction of the heating and cooling loads as a percentage value. The amount of energy needed to condition the humidity level is not included in this percentage savings value because it is the same for both variants. The results are preceded by an annual overview of the location's temperature profile and room temperature. For the purpose of result comparison, the north and south facing façades and a summary of all four geographic directions are added as an average calculation. The results of the west and east facing façades can be found in the appendix. The following is a description of the results; an evaluation rounds off the chapter.

## § 6.5.1 Dubai

---

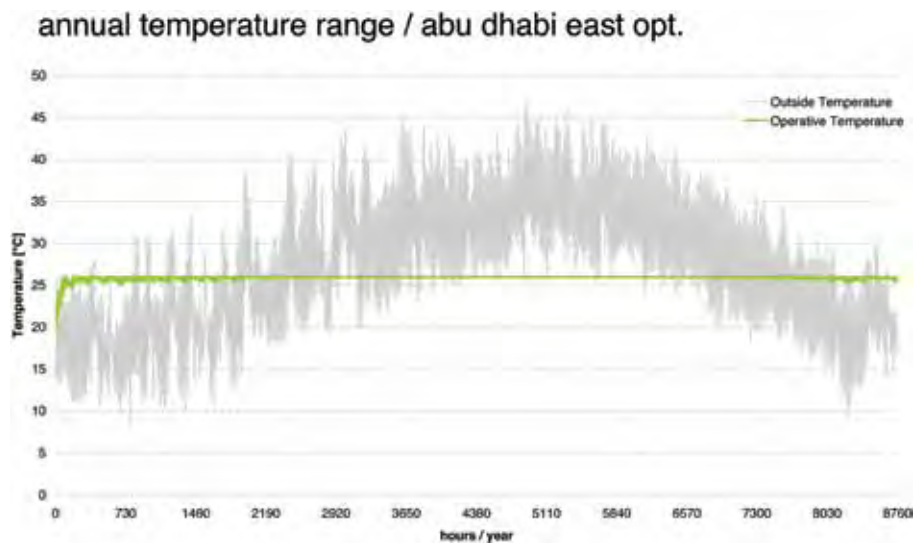

Figure 6.45  
Annual temperature profile in the optimised test room Eastern Abu Dhabi, showing interior and exterior temperatures

The annual temperature profile shows rising temperatures during summer; approximately 80% of the temperature lies above the selected maximum room temperature of 26°C. The green line showing the room temperature illustrates the cooling function maintaining the room temperature below 26°C. The according cooling loads are reflected in the amounts of energy consumed.

As could be seen in the annual profile, the amount of energy used for cooling accounts for most of the energy needed to condition the room. And, considering the outside temperatures, it is as obvious that no energy is consumed for heating. 343 (182) kWh/m<sup>2</sup>/a are needed to air-condition the reference room averaged over all four geographic directions; in contrast to 274 (113) kWh/m<sup>2</sup>/a for the optimised room. A comparison of both variants shows that on the northern façade the operating energy can be reduced by 22 % and by 47 % on the south-facing façade. Averaged out across the entire building, the cooling energy is reduced by 38 %. In the reference room, dehumidification takes up approximately one half of the total energy, whereas in the optimised variant it accounts for a much larger share, which is due to the high relative humidity in this location.

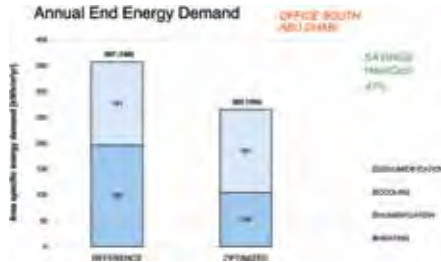

Figure 6.46: Annual end year energy demand, south-facing façade, Abu Dhabi

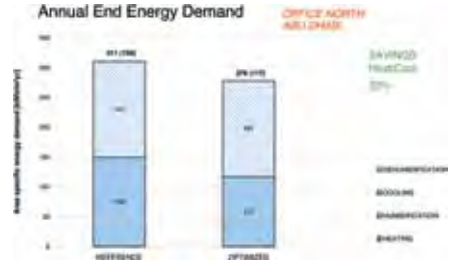

Figure 6.47: Annual end year energy demand, north-facing façade, Abu Dhabi

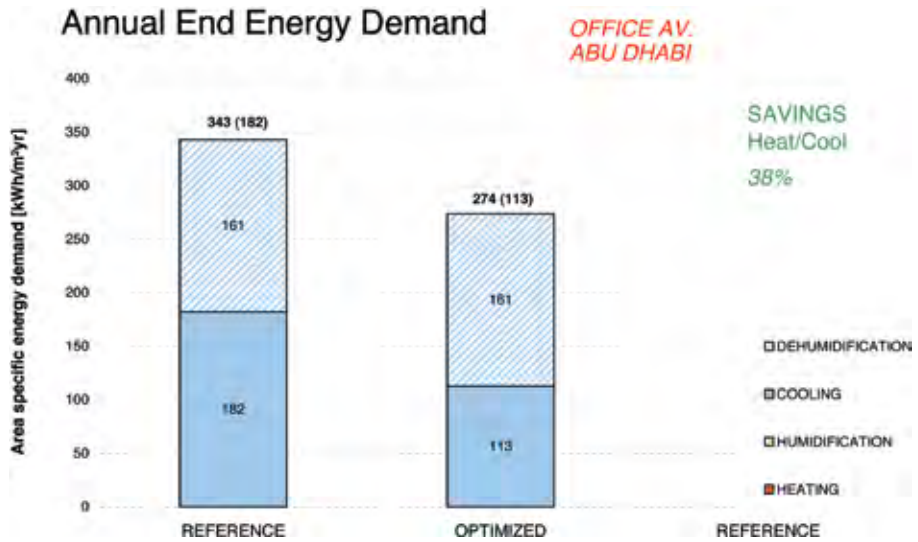

Figure 6.48: Average annual end year energy demand, Abu Dhabi

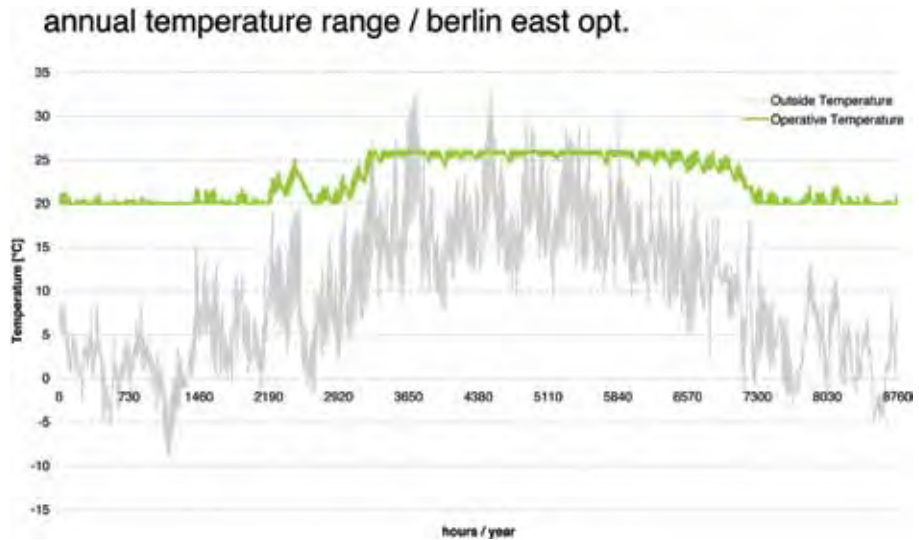

Figure 6.49 Annual temperature profile of the optimised test room including inside and outside temperatures, East Berlin

The annual temperature profile shows distinct heating and cooling periods. During the winter months, the room temperature drops to 20°C and is maintained at this level with a heating system. During the transitional months, the room temperature ranges between the minimum and maximum values of 20°C and 26°C. During summer, cooling controls the room temperature to a maximum of 26°C, whereby outside temperatures can reach peaks of 33°C. However, the frequency is much lower than in Abu Dhabi, for example.

The annual temperature profile shows distinct heating and cooling periods. 78 (63) kWh/m<sup>2</sup>/a are needed to air-condition the reference room averaged over all four geographic directions; in contrast to 46 (31) kWh/m<sup>2</sup>/a for the optimised room, which represents savings of 50% for heating and cooling. Reductions of 46 and 52% of façade-related operating energy are achieved for the north and south-facing façades. The energy needed for cooling across all façades can be reduced by 55%, and by 44% for heating. It is remarkable that for both variants the amount of energy needed for humidification is similar to that for heating and cooling. Humidifying the test rooms required 13 kWh/m<sup>2</sup>/a; but since almost no rooms in Berlin are humidified, this value is only theoretical.

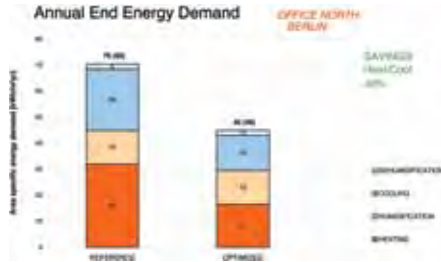

Figure 6.50: Annual end year energy demand, north-facing façade, Berlin

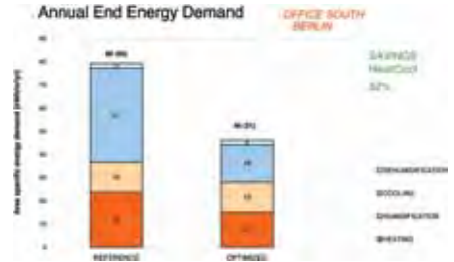

Figure 6.51: Annual end year energy demand, south-facing façade, Berlin

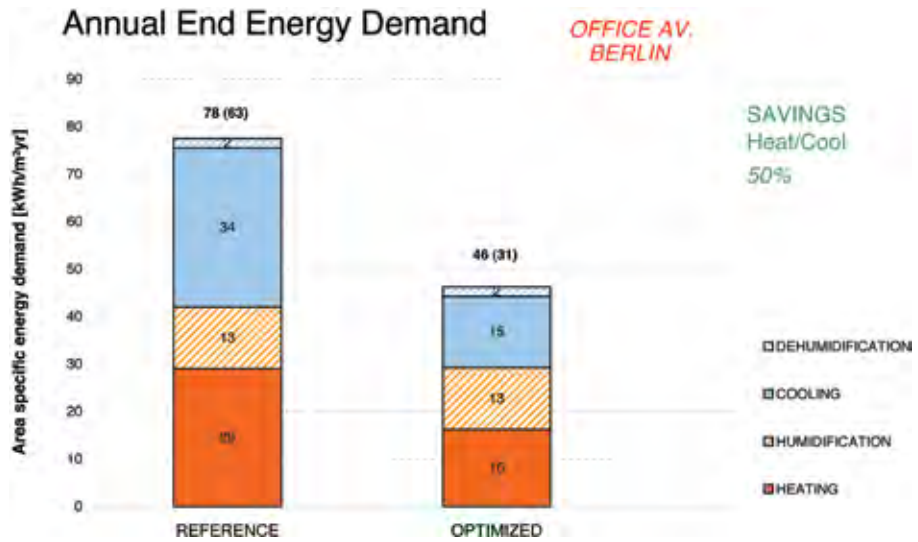

Figure 6.52: Average annual end year demand, Berlin

### § 6.5.3 Las Vegas

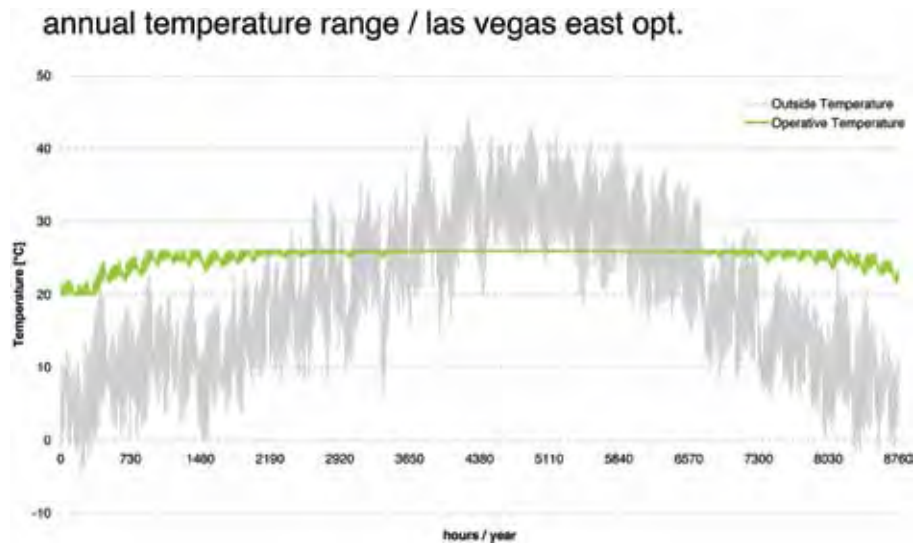

Figure 6.53  
Annual temperature profile in the optimised test room including interior and exterior temperatures, Eastern Las Vegas

The annual temperature profile shows that temperatures rarely drop below freezing during the winter months; however, summertime temperatures can reach 45°C. Cooling systems are needed throughout most of the year to maintain the indoor temperatures at a maximum of 26°C. Heating systems are only needed from December until February to keep the room temperature at a comfortable level.

Due to high cooling loads, the operating energy consumption in Las Vegas is high. The average value for all reference rooms is 175 (128) kWh/m<sup>2</sup>/a, that for the optimised rooms is 111 (64) kWh/m<sup>2</sup>/a, which reflects a reduction of 50% of the façade-related energy parameters.

Considering the individual geographic directions, there is a difference between the optimised room and the reference room of 34% on the north side and 55% on the south side. Due to the hot climate, the cooling load accounts for the largest share of the operating energy. One third is needed to humidify the reference room, explained by the dry Las Vegas climate. Particularly notable is that the optimised variant does not require any energy for heating.



Figure 6.54: Annual end year energy demand, north-facing façade, Las Vegas

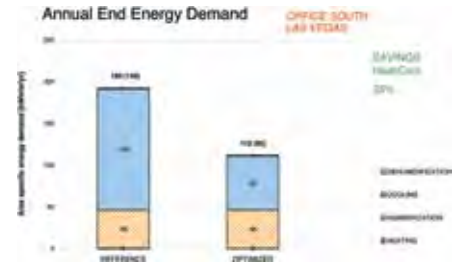

Figure 6.55: Annual end year energy demand, south-facing façade, Las Vegas

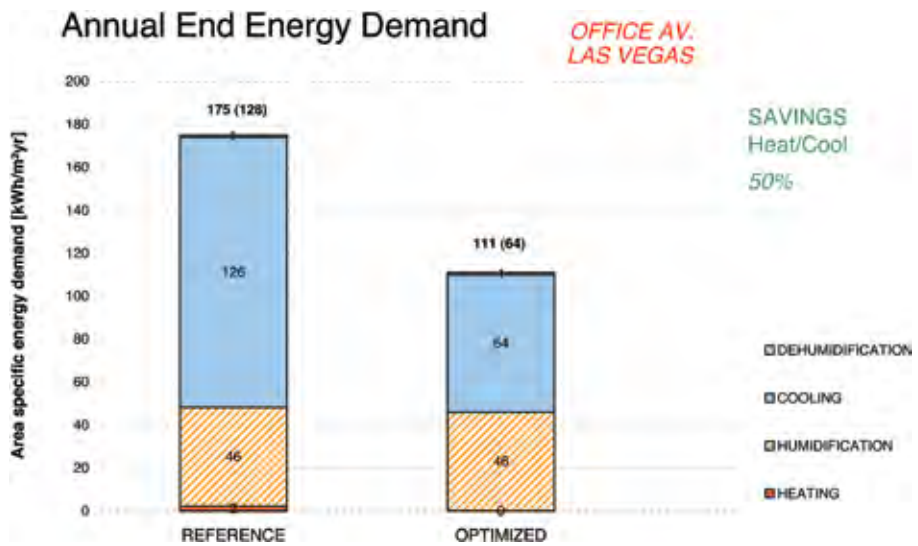

Figure 6.56: Average annual end year demand, Las Vegas

## § 6.5.4 London

---

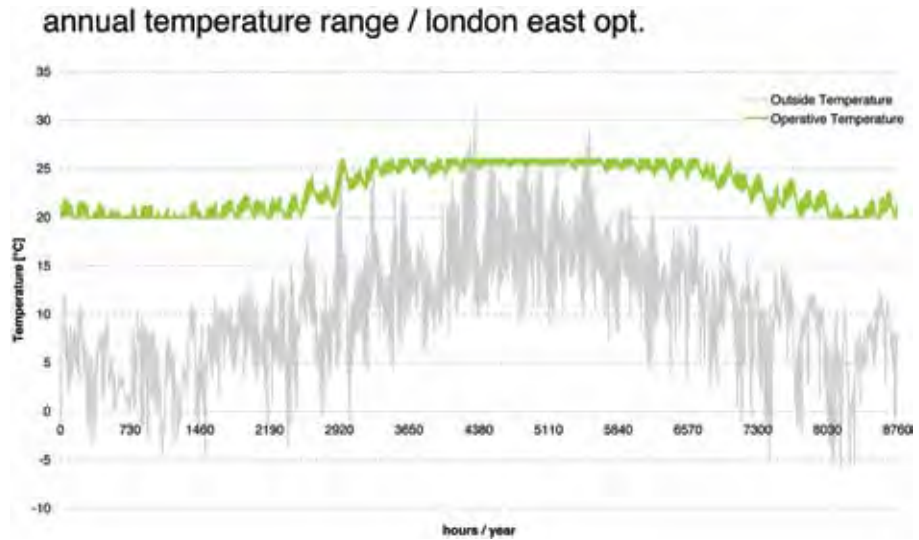

Figure 6.57

Annual temperature profile in the optimised test room including interior and exterior temperatures, Eastern London

The annual temperature profile shows a similar picture to that of Berlin; winter and summer periods are distinctly distinguishable. The temperature during the cold periods does not drop significantly below  $-5^{\circ}\text{C}$ . Summertime peak temperatures reach approximately  $32^{\circ}\text{C}$ . Cooling is required for approximately one half of the year, heating for the other to maintain comfortable indoor levels.

The operating energy consumption values for both the reference and the optimised variant show balanced values for the different functions. The overview shows the average total energy consumption for London at  $53$  ( $45$ )  $\text{kWh}/\text{m}^2/\text{a}$ . The optimised variant shows a reduction of  $64\%$  to  $25$  ( $17$ )  $\text{kWh}/\text{m}^2/\text{a}$ . A comparison illustrates that the cooling energy can be reduced to  $60\%$  and the heating energy to  $64\%$ . Referring to the individual geographic directions, it is notable that the savings for the northern façade ( $58\%$ ) and the southern façade ( $64\%$ ) lie very close together. Due to the local climate, humidification plays a more important role in this location than dehumidification. Natural ventilated buildings will not include air-conditioning related to de-/humidification. Thus, the simulation results should only be applied to heating and cooling loads.



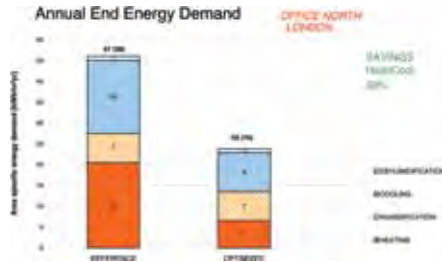

Figure 6.58: Annual end year energy demand, north-facing façade, London

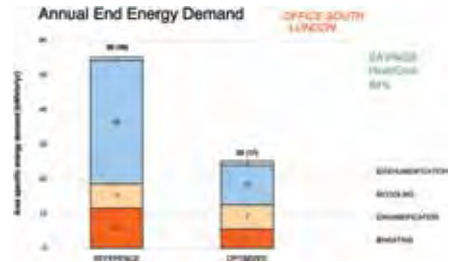

Figure 6.59: Annual end year energy demand, south-facing façade, London

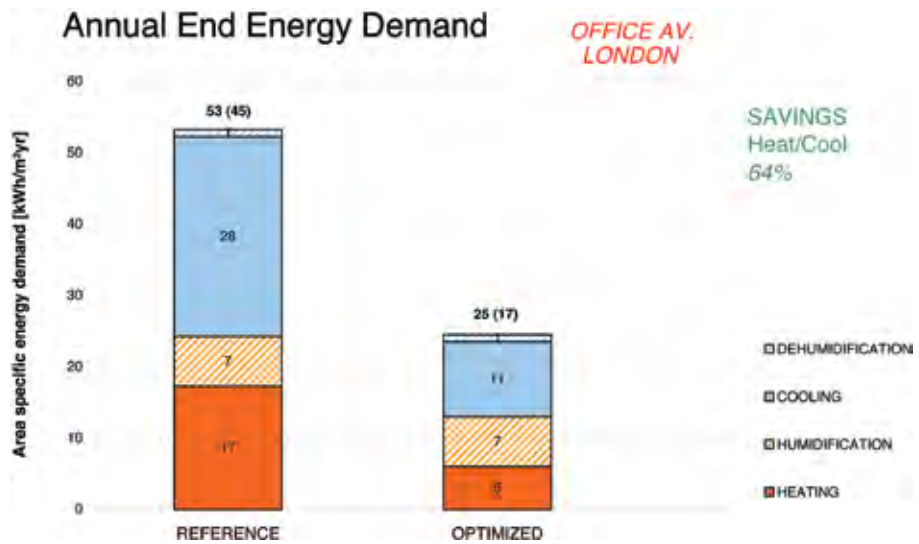

Figure 6.60: Average annual end year demand, London

## § 6.5.5 Moscow

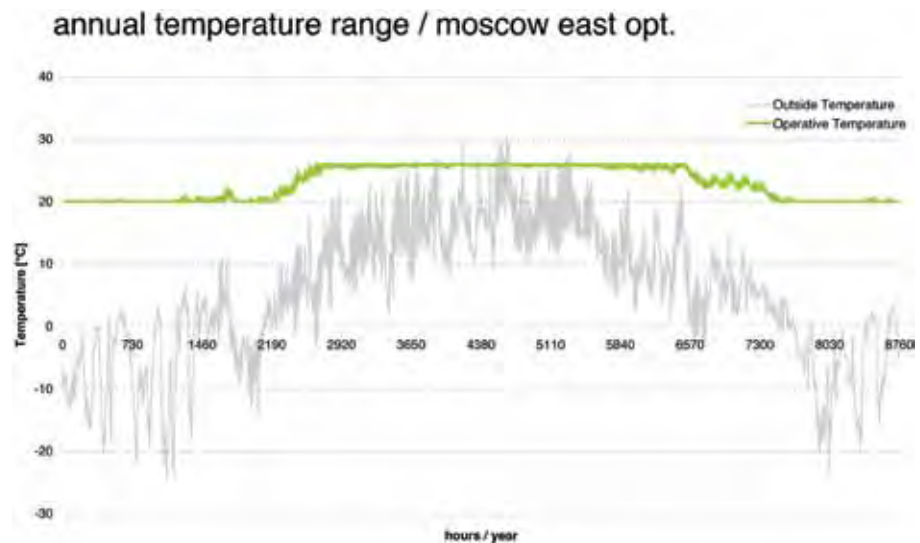

Figure 6.61

Annual temperature profile in the optimised test room including interior and exterior temperatures, Eastern Moscow

During the winter months, outside temperatures average around  $-10^{\circ}\text{C}$  with minimum values of as low as  $-25^{\circ}\text{C}$ . During summer, the temperature can reach  $30^{\circ}\text{C}$ . Room temperature often settles at the switch limit temperatures for heating and cooling; the temperature varies across this range only during fall.

The summarised average energy consumption values for the reference rooms are  $125$  ( $83$ )  $\text{kWh}/\text{m}^2/\text{a}$ , and  $90$  ( $48$ )  $\text{kWh}/\text{m}^2/\text{a}$  for the optimised variant, which corresponds to a reduction of 43 % of the façade-related parameters. For the reference variant, heating accounts for the largest share of energy consumption at  $54 \text{ kWh}/\text{m}^2/\text{a}$ . Humidification, on the other hand, accounts for the largest share in the optimised variant; the heating ratio was reduced by 62%. For both variants, the share of energy required for humidification is relatively high at approximately  $38 \text{ kWh}/\text{m}^2/\text{a}$ , due to the cold dry winters typical for Moscow.

Looking at the individual geographic directions, savings for the façade-relevant parameters heating and cooling can be observed at 42 % on the north side and at 35 % on the south side.

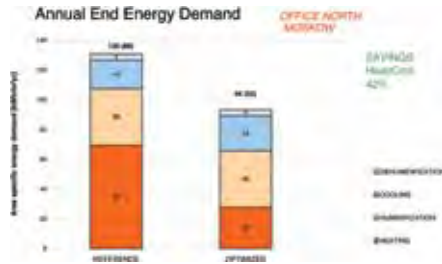

Figure 6.62: Annual end year energy demand, north-facing façade, Moscow

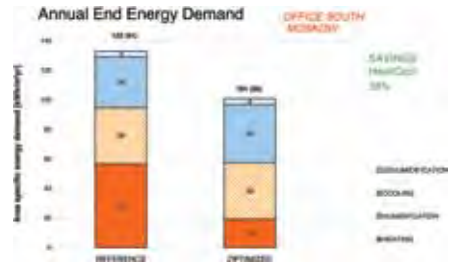

Figure 6.63: Annual end year energy demand, south-facing façade, Moscow

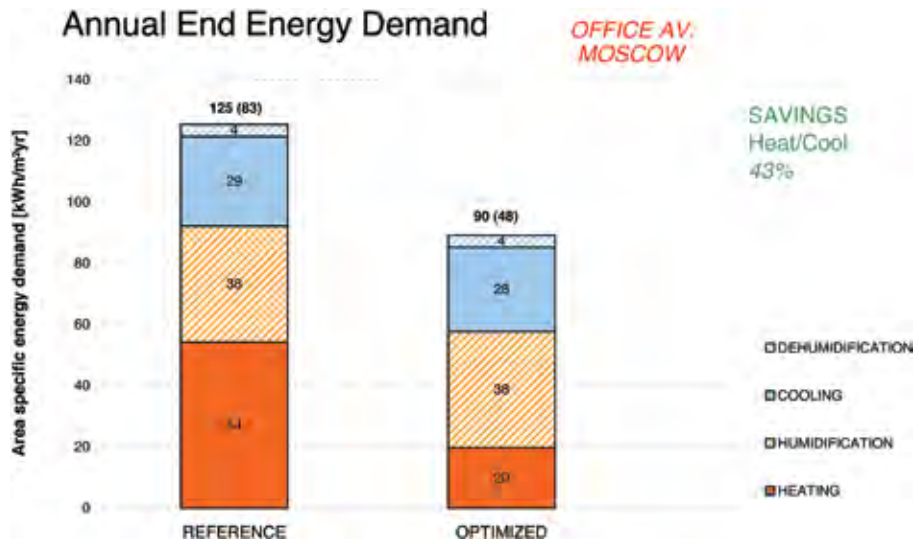

Figure 6.64: Average annual end year demand, Moscow

## § 6.5.6 New York

---

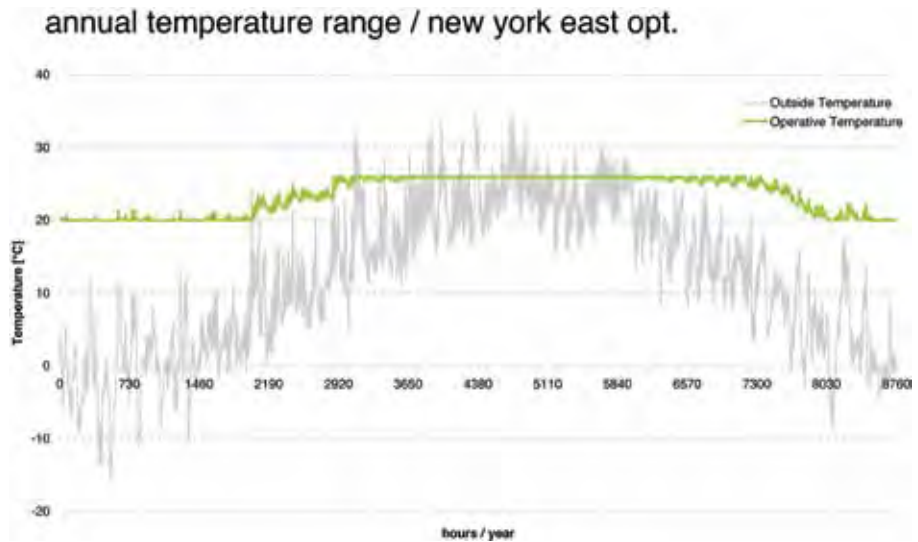

Figure 6.65

Annual temperature profile in the optimised test room including interior and exterior temperatures, Eastern New York

New York's annual temperature profile shows a prominent temperature spread with minimum temperatures in winter of as low as  $-15^{\circ}\text{C}$  and peak temperatures in summer of up to  $35^{\circ}\text{C}$ . During most of the heating and cooling periods, the room temperature lies at the predefined values of 20 and  $26^{\circ}\text{C}$ ; during the transitional months it shifts back and forth between the two values.

The average overall operating energy requirement across all geographic directions is  $134$  ( $81$ )  $\text{kWh}/\text{m}^2/\text{a}$  for the reference room. The requirement for the optimised room is reduced by 50 % and lies at  $93$  ( $40$ )  $\text{kWh}/\text{m}^2/\text{a}$ . Cooling accounts for the largest portion of the energy consumed in the reference room; in the optimised room this value was also reduced by 50 %. The energy requirement for heating is also significantly lower in the optimised variant; it shows a 50 % reduction. The reference room shows a significant larger portion of the heating energy needed for the north-facing façade than the south-facing one.

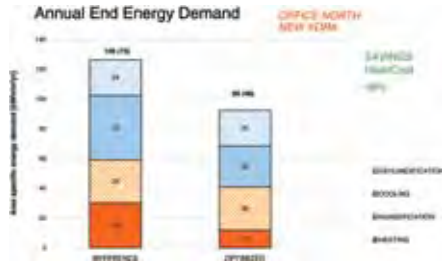

Figure 6.66: Annual end year energy demand, north-facing façade, New York

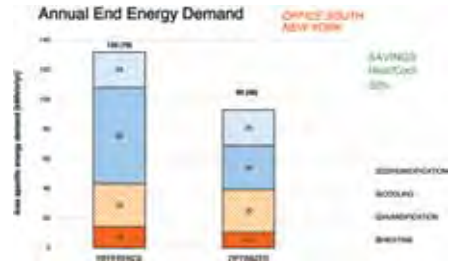

Figure 6.67: Annual end year energy demand, south-facing façade, New York

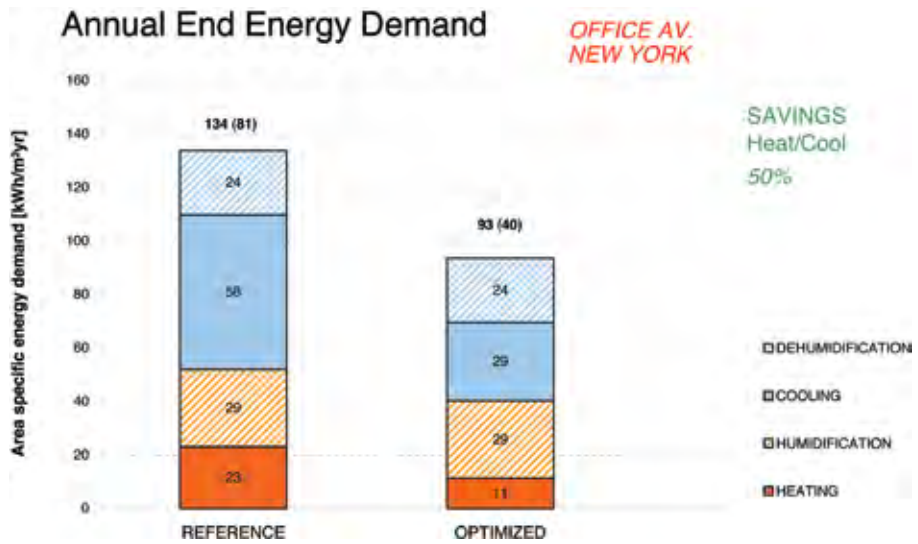

Figure 6.68: Average annual end year demand, New York

## § 6.5.7 Shanghai

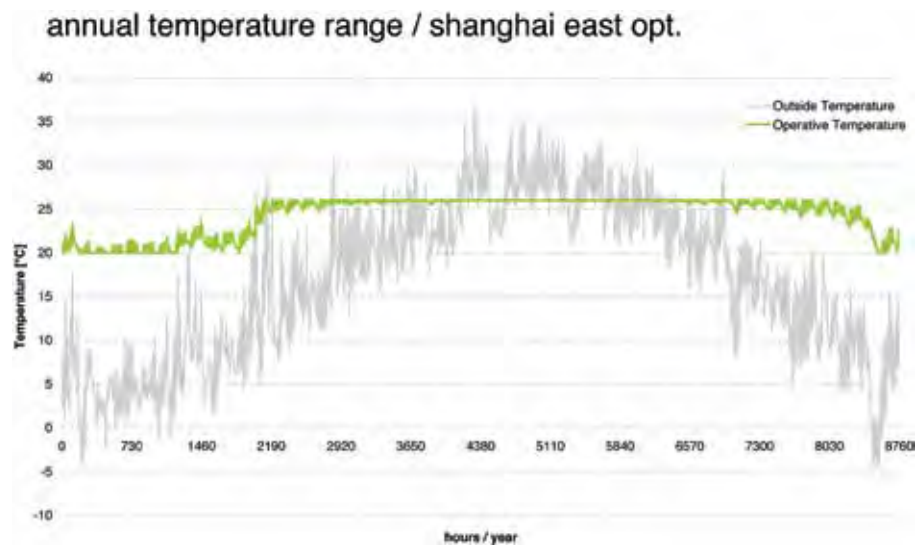

Figure 6.69

Annual temperature profile in the optimised test room including interior and exterior temperatures, Eastern Shanghai

The annual exterior temperature profile highlights a summer period with peak temperatures reaching 35°C; in winter temperatures drop to 0°C. The room temperature curve shows that the temperature often rises above 20°C, even during the heating period at the beginning of the year. Thus, warm temperatures heat up the room through the façade, and heating systems are activated less frequently. Cooling is needed to maintain the room temperature at a level below 26°C throughout more than half of the year, resulting in higher cooling loads.

The energy required for dehumidification accounts for the largest share of the overall energy consumption in both variants due to prevailing high humidity levels at this location. In terms of façade-related energy consumption, cooling energy accounts for the largest share of the overall energy needed for both variants; whereby the average consumption for the optimised variant can be reduced by 44%. The average total amount of energy is 204 (86) kWh/m<sup>2</sup>/a for the reference rooms and 165 (47) kWh/m<sup>2</sup>/a for the optimised variant, which corresponds to a reduction of 45% for heating and cooling. Detailed views of the results per individual geographic direction show similar results.

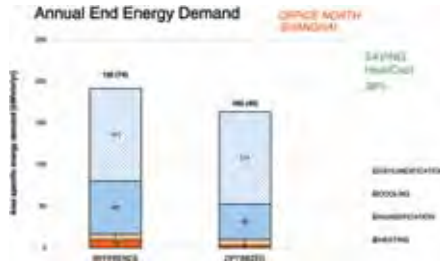

Figure 6.70: Annual end year energy demand, north-facing façade, Shanghai

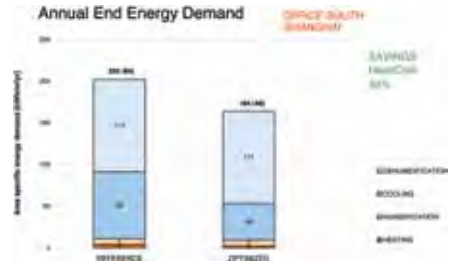

Figure 6.71: Annual end year energy demand, south-facing façade, Shanghai

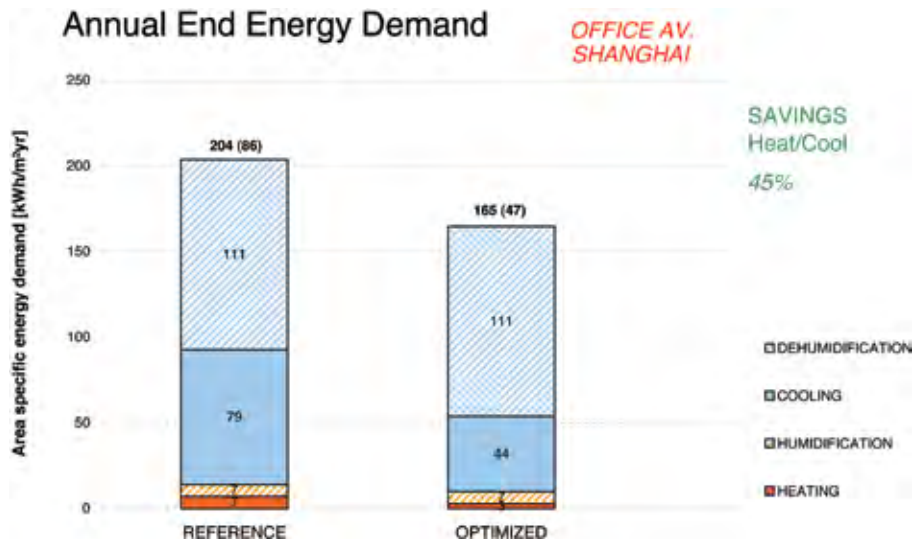

Figure 6.72: Average annual end year demand, Shanghai

## § 6.5.8 Singapore

---

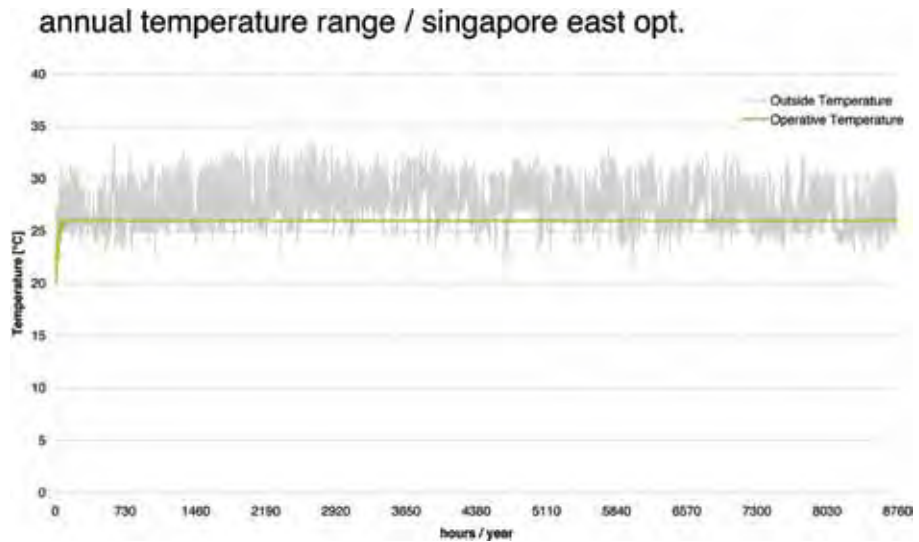

Figure 6.73  
Annual temperature profile in the optimised test room including interior and exterior temperatures, Eastern Singapore

Singapore's annual temperature profile underlines its tropical location. Throughout the year, the temperature remains between 23°C and 32°C, which means that the outside temperature almost always exceeds the desired indoor temperature level. Therefore, the room temperature profile highlights the fact that only cooling is needed to achieve the specified comfort level.

The analysis shows amounts for cooling and dehumidification only. Averaged out across all geographic directions the reference room requires 561 (165) kWh/m<sup>2</sup>/a and the optimised room 506 (110) kWh/m<sup>2</sup>/a, which relates to a reduction in required cooling energy of 33%. In contrast to Berlin, for example, where dehumidification is not commonly applied, Singapore definitely requires dehumidification. As a result, 2/3 of the total amount of energy is required for dehumidification; the largest energy consuming function. Different geographic directions do not show any differences.



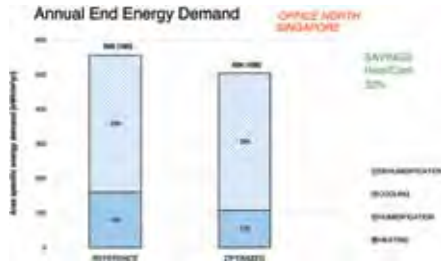

Figure 6.74: Annual end year energy demand, north-facing façade, Singapore

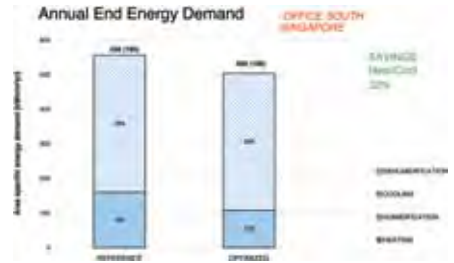

Figure 6.75: Annual end year energy demand, south-facing façade, Singapore

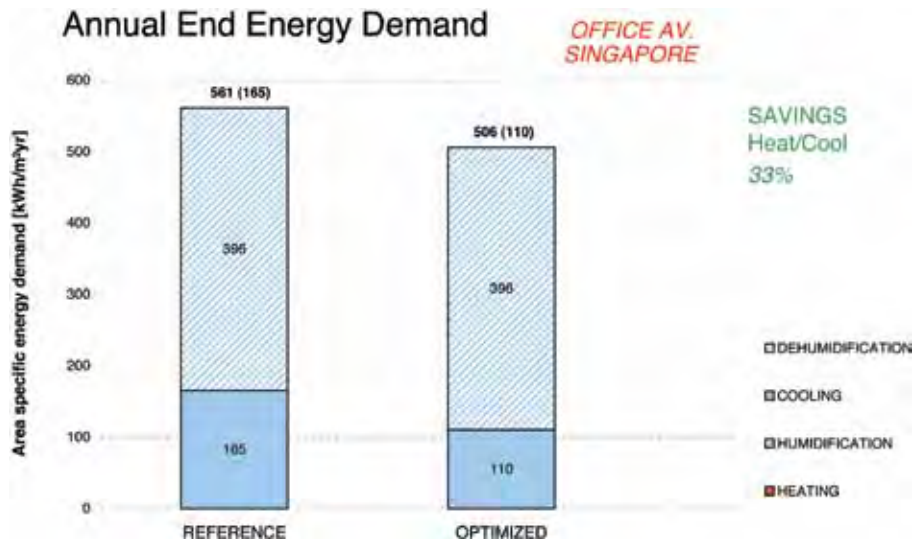

Figure 6.76: Average annual end year demand, Singapore

## § 6.6 Comparison of the simulation results

The results of the individual locations highlight the differences and requirements of the two variants compared. It is difficult to show a comparative overview of the different climate zones and their results because the measuring scales of some diagram axes have been adjusted. The following provides a comparison of all eight locations that offers a comprehensive overview. A compilation of all of the averaged results across all façade orientations in one chart illustrates the complexity and the requirement profile of the individual climate zones.

Average annual specific end energy demand kWh/m <sup>2</sup> /a																
	Abu Dhabi		Berlin		Las vegas		London		Moscow		New york		Shanghai		Singapore	
	REF	OPT	REF	OPT	REF	OPT	REF	OPT	REF	OPT	REF	OPT	REF	OPT	REF	OPT
Heating	0	0	29	16	2	0	17	6	54	20	23	11	7	3	0	0
Humidification	0	0	13	13	46	46	7	7	38	38	29	29	7	7	0	0
Cooling	182	113	34	15	126	64	28	11	29	28	58	29	79	44	165	110
Dehumidification	161	161	2	2	1	1	1	1	4	4	24	24	111	111	396	396
Total	343	274	78	46	175	111	53	25	125	90	134	93	204	165	561	506
Total heat/cool	182	113	63	31	128	64	45	17	83	48	81	40	86	47	165	110
Savings heat/cool		38%		51%		50%		62%		42%		51%		45%		33%

Table 6.15  
Annual average end year energy demand for all eight cities

The difference between the overall energy consumption of the individual locations is particularly interesting. Singapore, with an annual energy consumption per square metre of 561 kWh for the reference variant and 506 kWh for the optimised variant is the absolute leader in this field. Abu Dhabi comes in second with 343 kWh/m<sup>2</sup>/a for the reference room. London and Berlin feature the lowest consumption. Maintaining a comfortable level in International Style buildings (reference) in London requires 53 kWh/m<sup>2</sup>/a. And this value can be further reduced to 25 kWh/m<sup>2</sup>/a by reducing the glazing ratio. The two extremes clearly illustrate the difference in the climatic conditions and the resulting requirements for architecture. Energy consumption for the reference room in Singapore is 10.5 times higher than that in London. It has to be noted that energy for humidification / dehumidification does not typically need to be considered in London, whereas it is mandatory in Singapore. The distribution of the energy required for the functions heating, cooling, humidification / dehumidification is particularly noteworthy. In most locations, cooling accounts for the larger share of the necessary façade-relevant

amounts of energy. A few locations such as Abu Dhabi, Shanghai and Singapore show dehumidification as the largest consumer. Also noticeable is the fact that in locations of lower energy consumption such as Berlin, London and Moscow, heating accounts for a significant share of the total energy required.

Specifying the energy values for humidification and dehumidification obscures the influence of the façade on the energy consumption. A comparison of the required amounts of energy for heating and cooling only shows a different picture. Abu Dhabi now heads the list with 182 kWh/m<sup>2</sup>/a for the reference room, followed by Singapore and Las Vegas. A comparison of the cooling energy needed in all locations is very interesting; the chart shows that in some of the locations it is the only façade-related energy required. Only the reference room in Moscow shows a higher heating than cooling load.

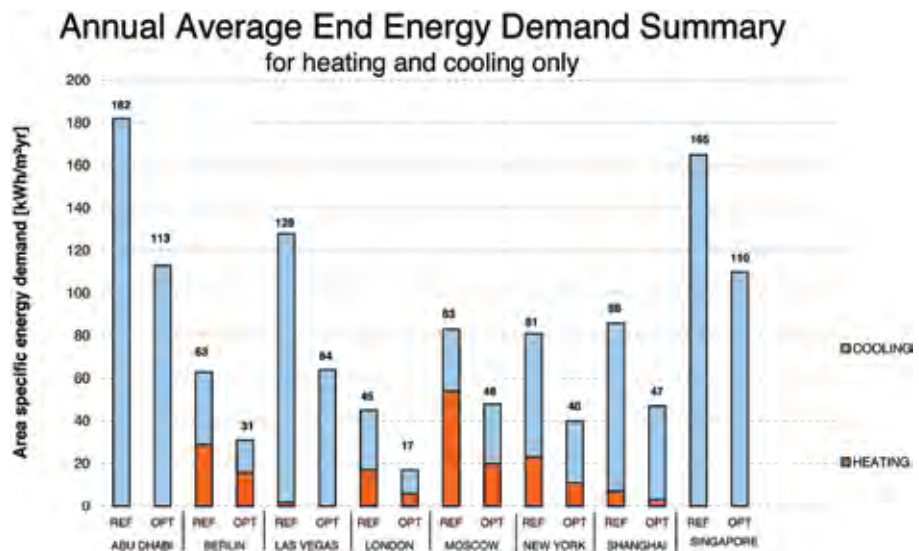

Figure 6.77  
Annual average end year energy demand for all eight cities, heating and cooling only

In order to provide an easy to read overview of the simulation results, the numbers are summarised in the following table.

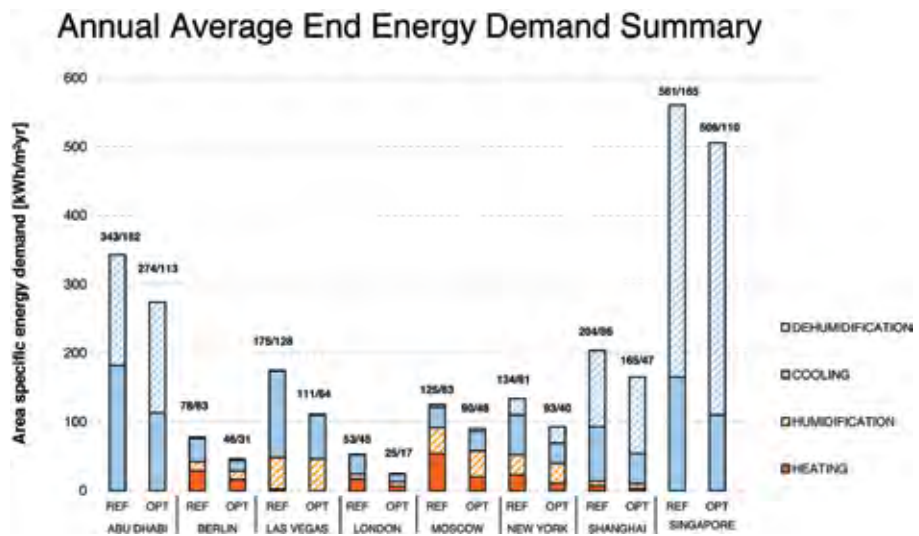

Figure 6.78  
Table showing the annual average end year energy demand for all eight cities

The table clearly shows the 33 % to 62 % savings potential in operating energy that can be gained compared to the reference rooms.

## § 6.7 Summary of simulation results

A detailed look at the individual simulation results indicates that there is a large potential for savings in total energy consumption. But what does that mean in practice?

The simulation is provocative because a building standard with fully glazed façade and interior sun protection is compared with a building with a significantly lower glazing ratio and partially exterior sun protection. Thus, it is not surprising that lower energy consumption rates can be achieved. But it has to be noted that the highly selective glass chosen for the reference room already is a concession to this building standard. Most of the currently realised projects do not feature glass of this quality level. The results for the reference room could thus be even higher. For the purpose of this

comparative simulation, the FE Tool has only been applied to the glazing ratio. The assumed building services are virtual, and have not been individually adapted to the particular locations. But this type of generalisation is needed to compare the locations. The maximum room temperature limit of 26 °C can also be subject of criticism because some locations might permit higher values, but again, one specific value across all locations is necessary to conduct a comparison.

Reducing the glazing ratio of the façade to the level necessary to achieve maximum usage of daylight autonomy of 300 lux over 3000 hours per year can lead to energy savings of up to 62 %. Optimisation was the same for all geographic directions. The comparison of the two variants in Las Vegas shows that no heating is necessary if the glazing ratio is reduced.

The boundary conditions for the optimised variant show exterior sun protection for most of the locations. A glass pane mounted in front of the exterior sun protection protects it from damage, particularly in the upper storeys of high-rise buildings, and minimises the need to retract it when high wind loads occur. Do the simulation results mandate double façades for each and every project? The answer is definitely NO. If the glazing ratio of a façade is 30 %, for example, it would make no sense to design it as a double façade because one of the primary purposes of double façades is to offer maximum transparency. Rather, the results indicate that exterior sun protection is essential for reducing the cooling loads. As described in the boundary conditions, this can be achieved with protective panels, which act like buffers against impacting winds and, at the same time, allow sufficient ventilation in the space between the two façade layers to avoid overheating. Particular sun protection systems can also be selected to resist higher wind loads, thus preventing the system to retract too early. Exterior sun protection must undergo further development, mainly related to higher wind load resistance, so that the cost for protective panels or similar constructions can be avoided or minimised.

High humidity levels play an important role in some of the locations. Even though the simulations determined these values, they can not be influenced by different façade designs. A completely closed façade can keep humidity outside, but it cannot otherwise be used to condition the indoor climate in terms of humidity. Currently, dehumidification can only be done via building services, which in most cases means the installation of an air-conditioning system. The amount of energy required for dehumidification in tropical regions far exceeds the cooling energy, as the example of Singapore highlights. This means that there is a definite need for alternative solutions that would reduce energy consumption.

It is particularly noteworthy that the amount of energy that can be saved by optimised cooling in Singapore is sufficient to heat and cool an optimised building in London,

New York, Shanghai or Berlin. Should the results of the simulations therefore be interpreted such that the future façade should return to be one of small window openings? The answer here is also NO. The results only point out that reducing the glazing ratio is an efficient and simple means of reducing operating energy. The simulations do not propose certain façade layouts or designs; if the design is to feature a storey-high façade it could be alternated with enclosed façade elements. It is also possible to use different window formats in one façade if they respond to the functions of the individual rooms behind them. 30 % glazing does not only mean 70 % less glass and therewith a loss in transparency and the so-called 'democratic' façade. Rather, 70 % less glass should be understood as 70 % more freedom in façade layout. A significantly larger, non-transparent area of the façade provides the opportunity to play with materials, formats, and colours. It is a chance to give the façade and thus the entire building a new appearance which in turn can improve the recognition value and the identity of the building. Areas of the façade now made available can be used not only for insulation – as this is always required – but for new functions such as collector surfaces or photovoltaic cells. Reducing the glazing ratio does not mandate a different type of construction; existing constructions such as elemented façade units can be designed with closed panels instead of transparent ones.

The boundary conditions specify a test room 5 m deep. The simulation results presented here illustrate the influence of the façade on the room climate; the deeper the room the less influence the façade has. It must be pointed out that this research is focussed on workplaces in the vicinity of the façade since it is only here that the façade can have an impact on the user climate. This also means that typical North American buildings with 50 m wide footprints do not lend themselves to influence the performance of the building via the façade. The façade can only have a beneficial impact on the indoor climate if its surface area is large enough compared to the building footprint. One determining factor for this consideration is the possibility to use natural lighting; which is impossible for rooms with a depth of 7 m and more. Access to the façade is mandatory to achieve high comfort levels in a building.

However, workplaces close to the façade pose basic requirements on the footprint design of a building. Ideal are maximum building widths of 20 m with a central hallway that acts as a multifunctional zone flanked by offices on either side.

A look at the comparative charts shows how mild the climate in Western Europe is. London and Berlin represent a climate in which a building can be operated with low energy consumption. Pronounced winter and summer periods require heating and cooling solutions, but the low humidity levels are almost negligible. The energy consumption needed to operate a building here is only a fraction of that in other climate zones. The results support the thesis that façades originally designed for Central European regions are not necessarily suited to be "exported" into other climate

zones. In moderate climates, large glass areas can help achieving solar gains during winter – thereby saving heating energy; in regions requiring no heating, however, these advantages turn into disadvantages.

In closing, the simulation results and analysis can be summarised as follows:

- **Significantly reduced glazing ratios down to the minimum required for sufficient daylight yield can help save up to 62 % operating energy to be used for heating and cooling.**
- **Efficient exterior sun protection is essential and must be optimised and further developed to provide higher wind resistance.**
- **Building depths must be reduced to create a maximum number of workplaces in the vicinity of the façade if high user comfort is the goal. This also means that the performance of the façade gains in importance because the ratio of surface to volume is increased.**
- **Particularly in hot humid regions, alternative solutions for dehumidification and cooling could offer great potential for energy savings.**

---

## § 6.8 Conclusion FET

---

The Façade Expert Tool in the described format is a fully functional tool that provides the architect with information to better understand the climate at a particular location during the initial planning stages. The fact that weather data from more than 4000 locations worldwide can be imported into the program makes it a very flexible tool and allows analysing any location in the world. Climate data for a neighbouring area can easily be found and used if the particular one needed is not available.

The description of the climatic conditions is consciously rendered in easy to understand verbal phrases, providing the architect with an overview of the prevailing climate. More detailed considerations can be based on the number of hours and percentages given for certain meteorological occurrences.

The recommendations and requirements of the tool appear plausible; however their usefulness must still be proven in practice. The façade and building services combinations generated by the FET as described in § 6.4 'FET in use' illustrate the working method of the tool, but also highlight the earlier stated fact that expert knowledge is needed to select the most appropriate and intelligent choice. For a few of the eight locations examined here, it is easy to compile a combination of components with help of the tool. The recommendations for London, Singapore or Shanghai, for example, provide clear guidelines for practical realisation.

If the tool recommends waste heat recovery in general as well as an enthalpy wheel, a central ventilation or complete air-conditioning system should be chosen. This is underlined by the recommendations for a tropic climate such as in Singapore because the humidity is at a constantly high level. In most cases the tool recommends concrete core activation for heating and cooling demands because it provides an efficient solution for low temperature ranges. However, the exemplary application of the tool also highlights weak points that should be improved upon in a subsequent version. Locations such as Abu Dhabi or Las Vegas, with recommendations for a multitude of components that sometimes seem to contradict each other, make the selection process difficult. If mechanical and natural ventilation are recommended, each individual recommendation must be evaluated. Contradictory recommendations can be caused by different climatic conditions during different seasons. It is possible that due to low winter temperatures mechanical ventilation is necessary, whereas window ventilation is possible during the summer months. Choosing a mechanical central ventilation system also means the possibility of combining heating and cooling by choosing an air-conditioning system. The examples presented show a preference for window ventilation over other ventilation methods. Built projects support this preference because the user can individually control the comfort level by opening or closing the window at his/her will.

As a general rule, there is no one single solution for combining components. All members of the planning team will input their respective experiences, knowledge or design preferences; particularly when there is interdisciplinary cooperation between planning members of different areas of expertise. And last but not least, there are fiscal criteria that will play a role in the selection of certain components over others. It is very useful to have a climate designer simulate different concepts to ensure the safety and functionality of the combination of individual components.

First implementations of the tool by Transsolar Energietechnik and the author used to consult architects resulted in positive feedback from all users. It is possible to include individual preferences or empirical values by adapting parameters in the base logic of the application. Particularly the graphic editor provided positive feedback because of the possibility to easily record the consultancy results in form of graphic representation, which the architect can later use to develop the building and façade design. The fact that statements correlate to functions only, not design elements, provides the architect with the freedom of formative conceptualisation.

The initial goal for the tool to recommend the optimum façade and most suitable building services elements for any given location at the push of a button could not be realised, as explained earlier. However, since the program is part of Transsolar's weather tool and is linked to the thermal simulations software TRNSYS, further calculations can be conducted that can extend the functionality and scope of



recommendations of the FET. In principle, a simulation could be run that is based on previously determined room geometries and façade and building services components to test the performance capability of the concept.

The criticism stated about the program MIT Design Advisors – the need to enter too many parameters at an early stage of the design process - would also apply to the FET if further development would include too many specifications to be determined. It is not the intention for this tool to replace the expert consultant. Rather, it is intended to support the communication within the planning team and the creative freedom of the designing architect. During the development phase the tool has often been described as follows: “Tell me where you want to build, and the tool will reduce the choices to a practical number of applicable components”. Such boundaries facilitate the design process and further creativity.

Therefore the goal set for the tool as a design assistant during the early planning phases has been reached. The statements and recommendations should be understood as soft specs rather than definite answers. Recommendations related to the glazing ratio clearly show the potential for energy savings, Illustrated by the comparative simulations. The demand to reduce glazing ratios is not new; but the tool and the simulations underline this requirement. It is important to understand the recommended boundaries and particularly the reduced glazing ratio as an opportunity for new façade design. They can promote architecture that not only responds to but also represents the particular location.

One major criticism of this first version of the tool is that specific geographic directions cannot be specified. The underlying calculation model assumes diffuse radiation, which is omni directional and therefore the same independent of a particular geographic direction. This issue is at the top of list of future developments. Another issue is the inability to differentiate between seasons or between heating and cooling periods. It might make sense to use mechanical ventilation in winter and window ventilation in summer for the same building.

Particularly the interaction of different components demands that an expert selects the most suitable components for a project. Presenting the results as recommendations underlines this fact; it is not purposeful to include each recommended component into the design because this could lead to excessive investment cost as well as excessively complex control systems. The goal must be to ensure comfortable operation with the lowest number of components and operating cost.







## 7 Climate Responsive Optimised Façade Technologies CROFT

As was described in [chapter 3 'Principles of climate-adapted architecture'](#) Climate responsive architecture, many solutions have been developed over the course of many centuries; firstly, to ensure survival, and secondly, to make the surrounding living space bearable. But the term comfort as we understand it today can not be appropriately used in this context. It is true that during the past century Willis Carrier's invention of the air-conditioning system in 1911 and the start of the Float Glass production by Pilkington in 1959 have revolutionised today's building methods. (Grimm, 2004) But examining the consequences from a modern ecological and economic point of view indicates that the use of both technologies in widely spread application is also subject to criticism.

In no case should the application of large glazed areas as such be criticised, since glass is one of only a few materials that offer transparency, insulation and energy savings. But it does also promote overheating if applied excessively or inappropriately. In this case, air-conditioning would need to be installed to maintain a comfortable indoor climate, which is obviously counterproductive.

Of course there are regions, as described in [chapter 2 'Climate zones'](#), where outside temperatures far exceed the expected indoor temperatures and cooling is required. But even here, from an ecological as well as economic point of view the use of air-conditioning should be limited to a sensible degree; the comparison simulations in [chapter 6 'FET Façade Expert Tool'](#) show that reducing the glazing ratio is a good start to reduce cooling loads.

The traditional architecture of Dubai and adjacent regions in the Near East features smaller window dimensions and ornamental coverings over the windows. This can not be attributed to the fact alone that large float glass panes were not yet available but rather to the fact that the amount of solar radiation penetrating into the room had to be minimised to avoid overheating.

In many areas, the principles of vernacular architectural can still be applied today or have been translated into adapted technologies over the course of time. Predecessors of under floor heating as we know it today can be found in the Spanish Gloria or the Chinese Kang as a heated lying area next to the fireplace. The Roman hypocaust can also be considered the ancestor of under floor heating. The principles of adiabatic cooling by creating microclimate zones within a building or courtyard – like the open water streams or fountains used in Arabic regions - can still be found in modern air-

conditioning and cooling towers. And open bodies of water near a building or in atria are still used to provide a cooling effect.

With the focus of this work lying on façades, almost all urban design principles of vernacular architecture can be applied to today's urban development. Orientation toward the sun, creating shaded arcades or planting trees and/or green spaces to lower temperatures, using wind circulation and buffer zones can all be applied today. Modern simulation programs allow for early evaluation and verification of the selected principles.

In order to design climate-adapted façades, however, the knowledge of the local climate should and must lead to solutions that differ from the International Style of fully glazed buildings. The primary goal is to reduce operating cost while maintaining or improving the comfort level and saving natural resources during operation. A secondary goal is more subjective – diverting from the common style can be used to increase a building's identity, since exploiting particular local sources of energy can result in different designs for every location and in every climate zone.

The development of the FET, specifically the components that can be selected in the graphic editor, is based on commercially available components. Thus, the possible combinations are reduced to these components. An analysis of the individual climates and comparison simulations show, however, that particularly the functions cooling and dehumidification require a large amount of operating energy. In most cases central air-conditioning systems can be employed.

The fact that lower glazing ratios can aid in reducing energy consumption inevitably leads to more enclosed façade surfaces. The following introduces several concepts that exploit these new closed surfaces and illustrate decentralised approaches. The individual concepts are assigned to a specific climatic location but might be used in others, too.

These concepts are not yet fully worked out. They are provided to promote discussion and innovative development. The concepts are summarised as CROFT (Climate Responsive Optimised Façade Technologies) and have been developed to offer architects a source of inspiration that can be adapted to individual design ideas and concepts. Not all of the ideas are new; often they are a combination of existing options or technologies, some will not be realisable in the immediate future; but they do draw attention to the potential each location offers and should be further examined in practice-oriented research. They should be understood as promising fields of research, particularly related to their functionality. To exemplify architectural design, the concepts are shown in a coherent façade; however, as mentioned previously, the focus lies on the technical principle rather than the creative design. The chapter is round off by a realised project that demonstrates the possibilities of a fully glazed façade in the Dutch climate.

## § 7.1 Moscow – Façade air collector

The long winter period in Moscow require special heat insulation. Therefore, the glazing ratio is smaller and glazed elements could alternate with non-transparent façade elements. Such elements could include efficient heat insulation, for example with mineral rock wool. This would raise the heat insulation value of the entire façade. Outside air could be preheated through integrated collector areas within the panels during the transitional periods when the air temperatures are still below the desired indoor temperatures. The underlying idea is to exploit solar radiation that strikes onto closed façade elements and heats the air inside the insulated panel. Because the warm air inside the panel rises, cold supply air is drawn in at the lower edge, heats up and streams into the room at the upper edge. Such fresh air preheating can reduce ventilation heat loss and also allows for natural ventilation. Air supply could be regulated via controllable flaps. On extremely cold winter days with minimum temperatures of  $-30^{\circ}\text{C}$ , there is the risk that the internal space of the panel freezes; meaning that panel ventilation is not possible during such periods. The horizontal orientation of the air intake flaps at the lower edge of the panel provides for rain protection.

Closed façade areas can be realised with various construction methods. One option is a punctuated façade with load-bearing wall panels or panel constructions within a suspended façade. In both cases, the air space created in the outer layer in front of the required insulation serves as an additional insulation layer. During summer, when outside temperatures exceed the desired interior temperature level, the flaps on the interior walls are kept closed to prevent overheating. Short-term full ventilation is still possible. During summer, this system could also be used to exhaust the indoor air; the air rising within the panel would draw the exhaust air out of the building. Cross ventilation of adjacent rooms and hallways is recommended. Natural ventilation should be promoted by adding operable sashes in some areas of the façade. Natural ventilation can be achieved at high wind speeds as well by using the flaps on the interior side of the walls where they serve as a buffer and reduce the air velocity. Horizontal light shelves optimise natural lighting; reflectors guide the sunlight below the ceiling from which it reflects farther into the room.

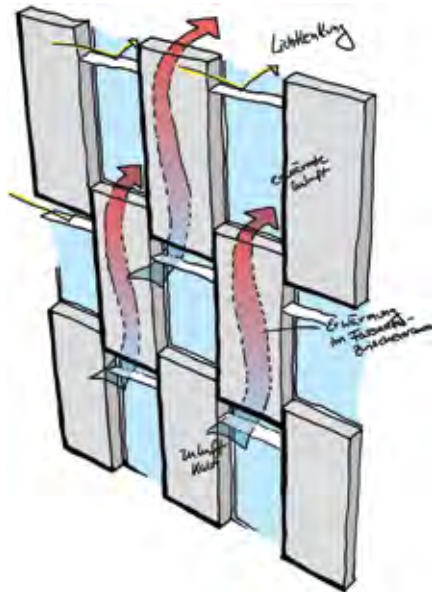

Figure 7.1:  
 Concept Moscow – Façade panels used to preheat the air coming into the room through natural ventilation

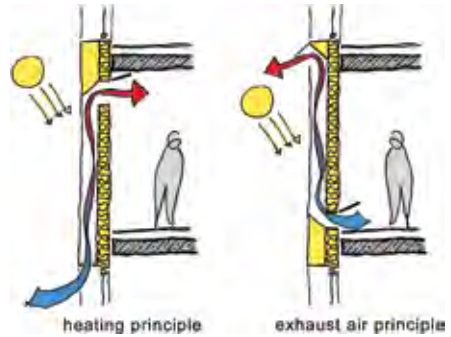

Figure 7.2:  
 Concept Façade panels

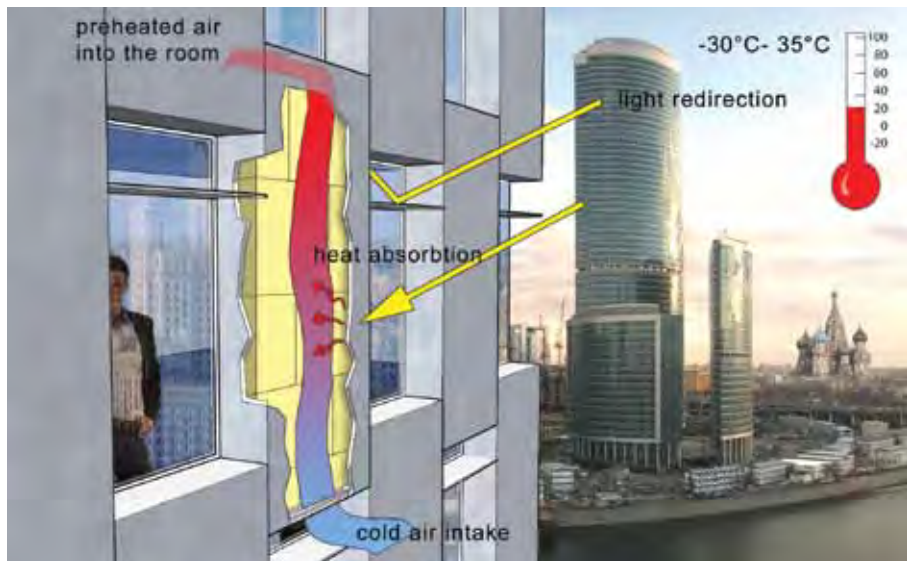

Figure 7.3  
 Concept visualisation collector panel, Moscow



## § 7.2 Singapore – Condensate trap within façade panel

In Singapore and the Tropics in general, natural window ventilation is virtually impossible to realise due to the prevailing high humidity levels. In addition, high outside temperatures require high cooling capacities, which are usually generated by air-conditioning. A concept of natural ventilation in combination with dehumidification of the incoming air offers great potential for this climate zone to minimise the building services components required and possibly provide alternative cooling solutions such as cooling sails or cooling ceilings.

The concept is based on the principle of a condensate trap; incoming air strikes cold piping or wiring, the water contained in the air condenses onto these surfaces and precipitates. The condensate can be collected and drained on the outside of the façade. The void in the façade element is ventilated through an intake opening at the lower edge, the air is dehumidified and cooled and then streams back into the room.

Due to strong rainfall during the monsoon season, the air inlets in the façade are recessed and horizontally oriented so that the air intake area is protected from direct rain. This geometric solution for natural ventilation can be applied to other climate zones as well. Due to the cold air downdraught inside the panel, a fan is necessary to move the air. Alternatively, the air can stream in from the upper part of the outside surface; it then drops to the bottom of the panel due to the cold air downdraught, and exits close to the floor. One disadvantage of this more efficient solution is the cold air pocket that forms in the room, which can cause discomfort around the feet and legs. If the air is introduced into the room at a higher level, it can spread throughout the room more evenly.

The cooling surface in the panel void could be created with the Fine Wire Heat Exchanger by the Dutch company HSW. It consists of small diameter piping interwoven with fine wires. A centralised or decentralised cooling unit must be used to pump the cooling medium through the pipes.

Since a fluid medium typically features higher heat insulation values than air, this system could aid in lowering the operating energy consumption compared to a central air-conditioning system. From a hygienic point of view, the system might be problematic. Further research must evaluate whether bacteria would develop on the surface of the piping network that could potentially contaminate the supply air and therefore require extensive maintenance.

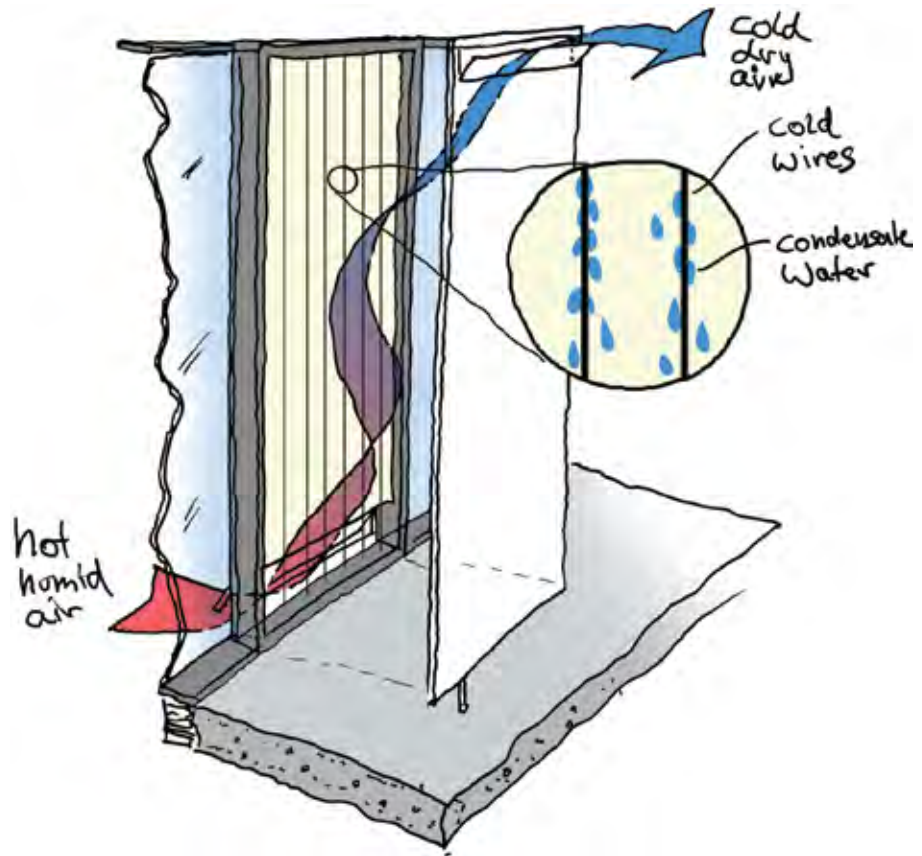

Figure 7.4  
Possibilities of dehumidification within a façade panel in tropical climates with cooling wires or piping

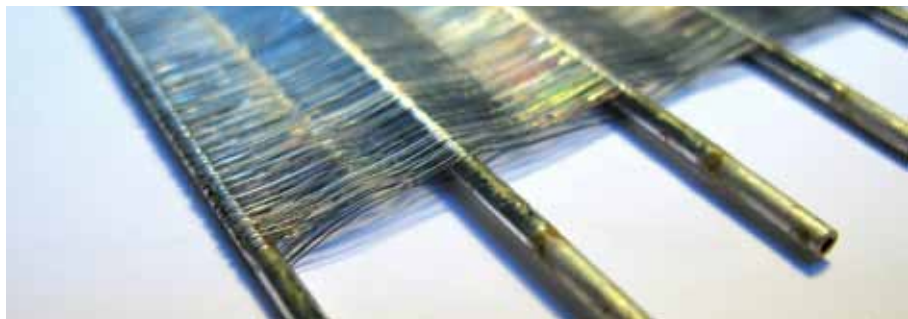

Figure 7.5  
Fine Wire Heat Exchanger as one option to cool the void in a façade panel

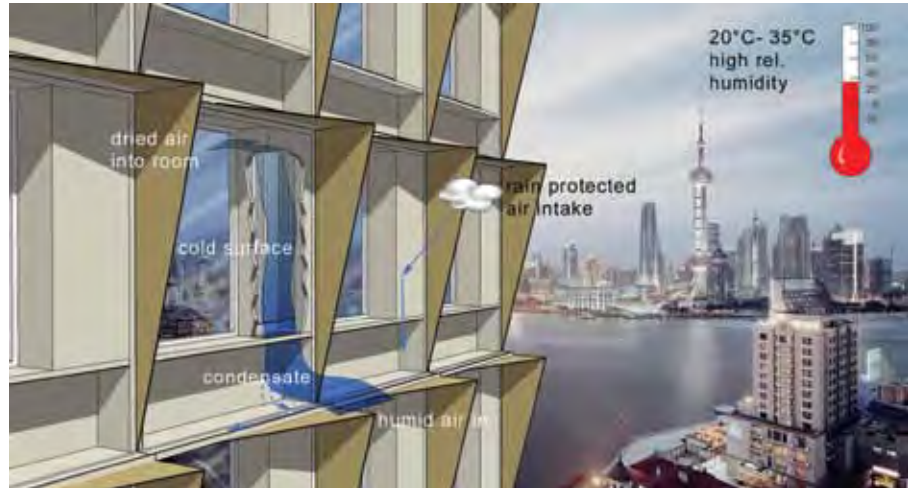

Figure 7.6  
Concept visualisation condensate trap, Singapore

The concept visualisation also shows exterior sun protection in the form of fixed shading elements; these elements must be optimised depending on the orientation of the façade geometry. The façade also comprises a channel system to easily disperse rain water and condensate.

### § 7.3 Berlin – Supply air heating in façade panel

In regions such as Berlin, the heating periods in spring, autumn and winter play an important role. With smaller glazing ratios, the outside air can be drawn through the façade panels, and then introduced into the room via heating panels mounted on the inside walls. Such heating panels could consist of fibre concrete panels with inlaid heating pipe matting or aluminium panels with clad heating loops, similar to those in cooling ceilings, for example. The heating elements not only generate a stream of warm air in the panel void but also create a comfortable area near the façade because the elements radiate heat into the room.

The author has examined the use of fibre concrete elements with integrated capillaries for radiation heating in earlier experimental research. The heat emission is too low to generate the total amount of energy needed because the surface areas available within the façade are too small. However, in combination with other low-temperature heating systems or concrete core activation, this type of heating can significantly improve the

comfort level in the vicinity of the façade. And using the heating elements to preheat the supply air can reduce ventilation heat loss. The system can also be used as a weather independent ventilation aperture for night cooling when the heating function is inactive.

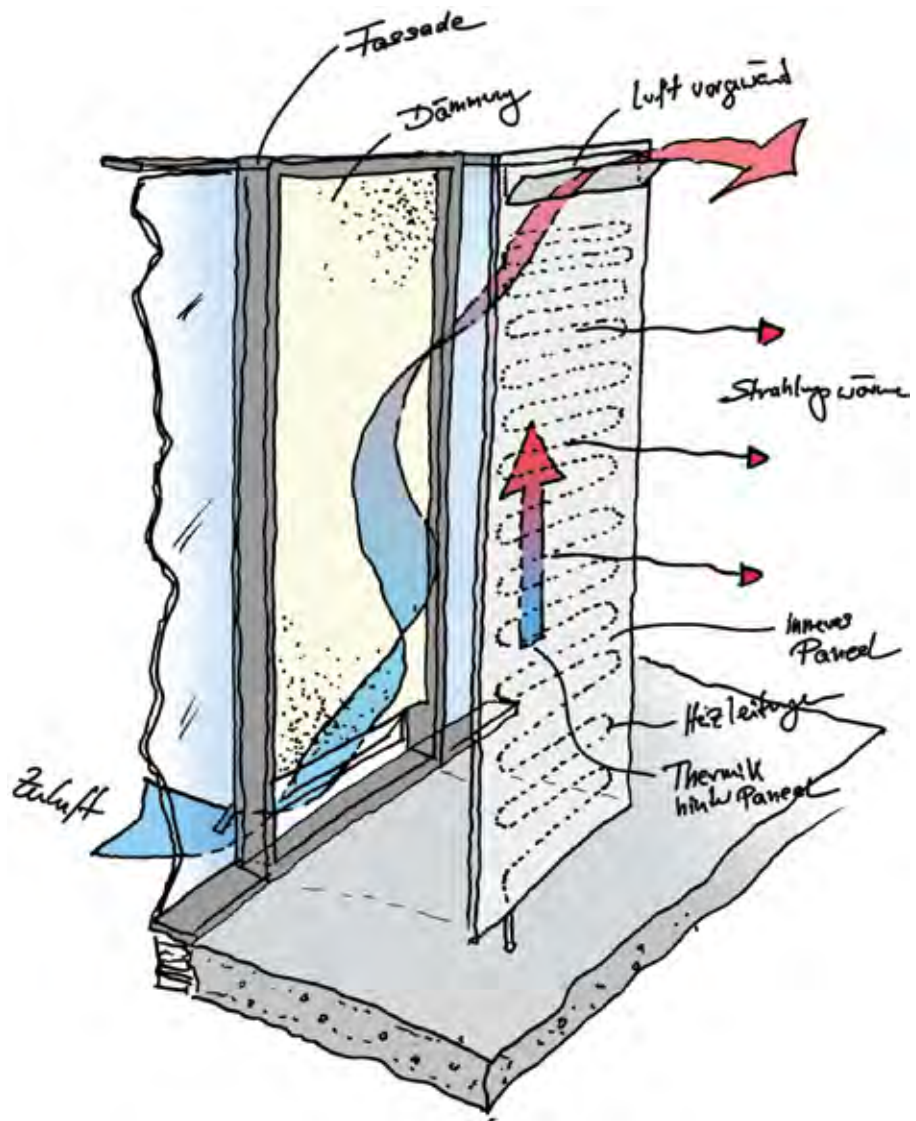

Figure 7.7  
Conceptual sketch



Figure 7.8  
Inserting capillary elements into fibre reinforced concrete

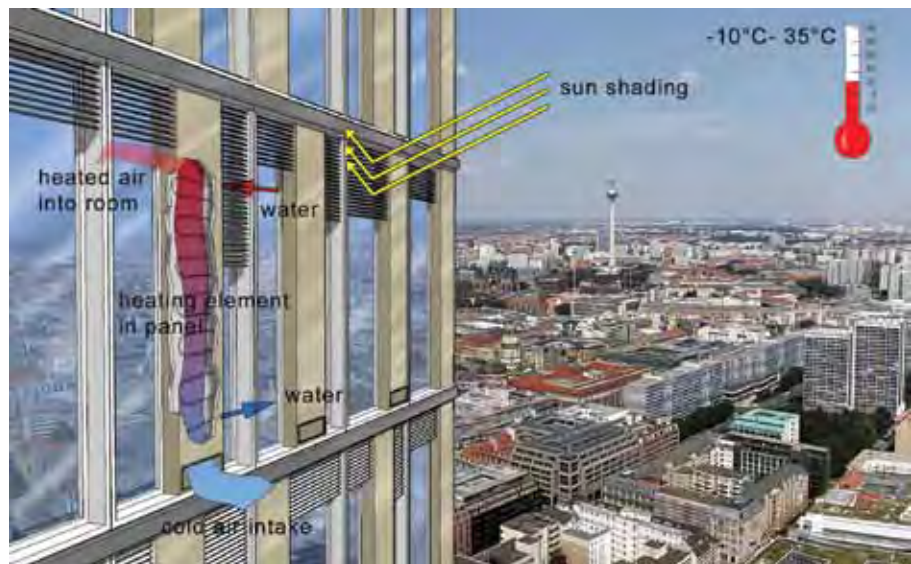

Figure 7.9  
Concept visualisation of a façade-integrated heating panel, Berlin

## § 7.4 Dubai – Rotating sun screen

Regions with high solar radiation such as Dubai require year-round sun protection. This means that the connection between the inside and the outside is often if not always obstructed. In addition, conventional louver-type sun protection is problematic in these regions because of the frequent sandstorms occurring here. They result in high maintenance, cleaning and repair cost. Therefore, exterior sun protection is rarely used here.

The underlying idea of the sun protection presented here is based on the phenomenon of optical delusion that rotating discs create. When looking at the rotating blades of a fan, the individual blades are invisible; the human eye senses only the contour of the blades and the view through the fan appears to be unobstructed. Thus, for the human eye, rotation creates transparency.

As part of her master thesis at TU Delft, Leonie van Ginkel developed this principle into a sun protection system following the concept and under the guidance of the author. Series of measurements have verified that the ratio of incident light corresponds to the exact share of transparency of the rotating disc. Meaning that a rotating disc with a transparency of 50 % transmits 50 % of light, but the human eye senses a much higher degree of transparency.

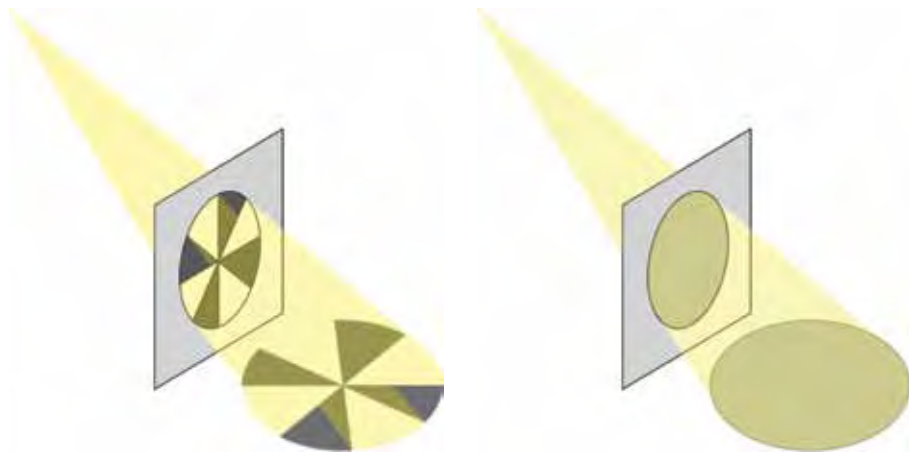

Figure 7.10:  
Schematic diagram of rotating sun protection ( L. van Ginkel )

The series of measurement have also shown that under rotation the pattern of the disc has a significant influence on the shape that the eye perceives, but not on the measured light yield.

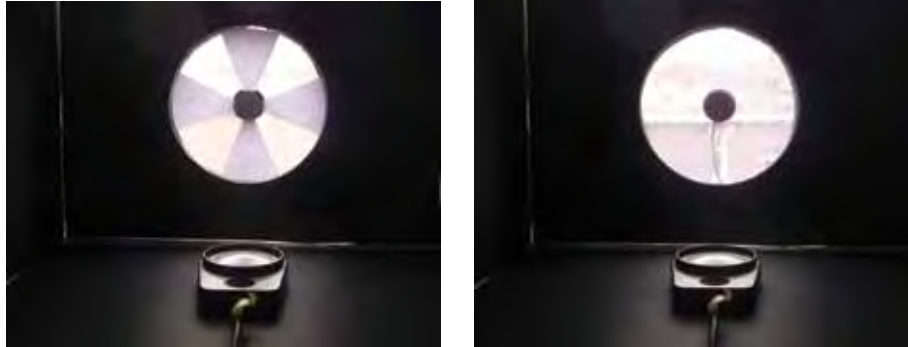

Figure 7.11, 7.12:  
Series of measurement with luxmeter; top: static, bottom: rotating ( L. van Ginkel )

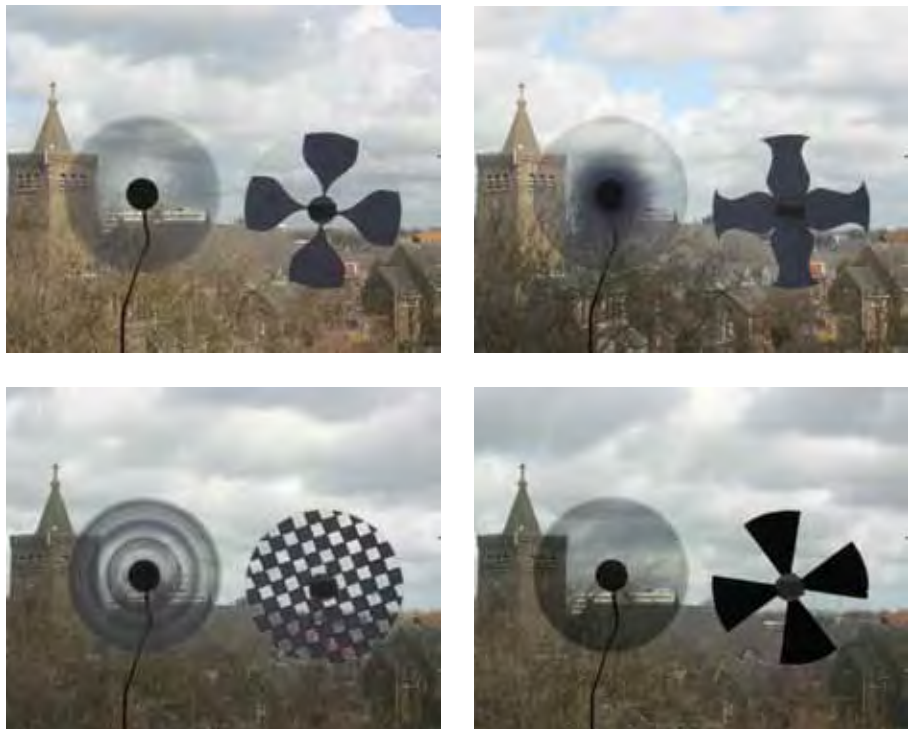

Figure 7.13, 7.14, 7.15, 7.16:  
Comparison of different pattern variants ( L. van Ginkel )

Tests with different colours have shown that the eye sees the motive behind the glass in higher contrast if the pattern is printed in black. White patterns are not as suited because they create a more milky image. Light is still transmitted through white print so that the possible shading of the non-transparent part is not fully exploited.



Figure 7.17, 7.18:  
*Comparison of white and black printing ( L. van Ginkel )*

The first evaluation model was a sun protection element with rotating discs installed between two glass panes to allow for wind and dust free operation. The rotating discs are driven by miniature motors. Black patterns are printed on the glass areas around the discs to achieve the maximum degree of shading possible. Ideally, the electric motors are driven by photovoltaic modules integrated in the glass panes. The elements are conceptualised as insulating glass units, and could be operated self-sufficiently with incident sunlight. As an alternative, low-voltage power supply could be led through the windows or façade elements so that the sun protection system functions without direct sunlight as well. Other solutions could include rechargeable batteries installed in the space between the glass panes that store solar electricity until needed. This way, the system could also be operated during short periods of cloudy skies.

As described above, the rotating principle does not compromise the functionality of the sun protection. The selected degree of transparency determined by the printed pattern on the disc is fully preserved during rotation; the human eye senses the panels as more transparent which results in a better outside view through the rotating discs.

The concept offers great design freedom. The circles can be arranged in different patterns and sizes. And the discs can be printed with numerous patterns.



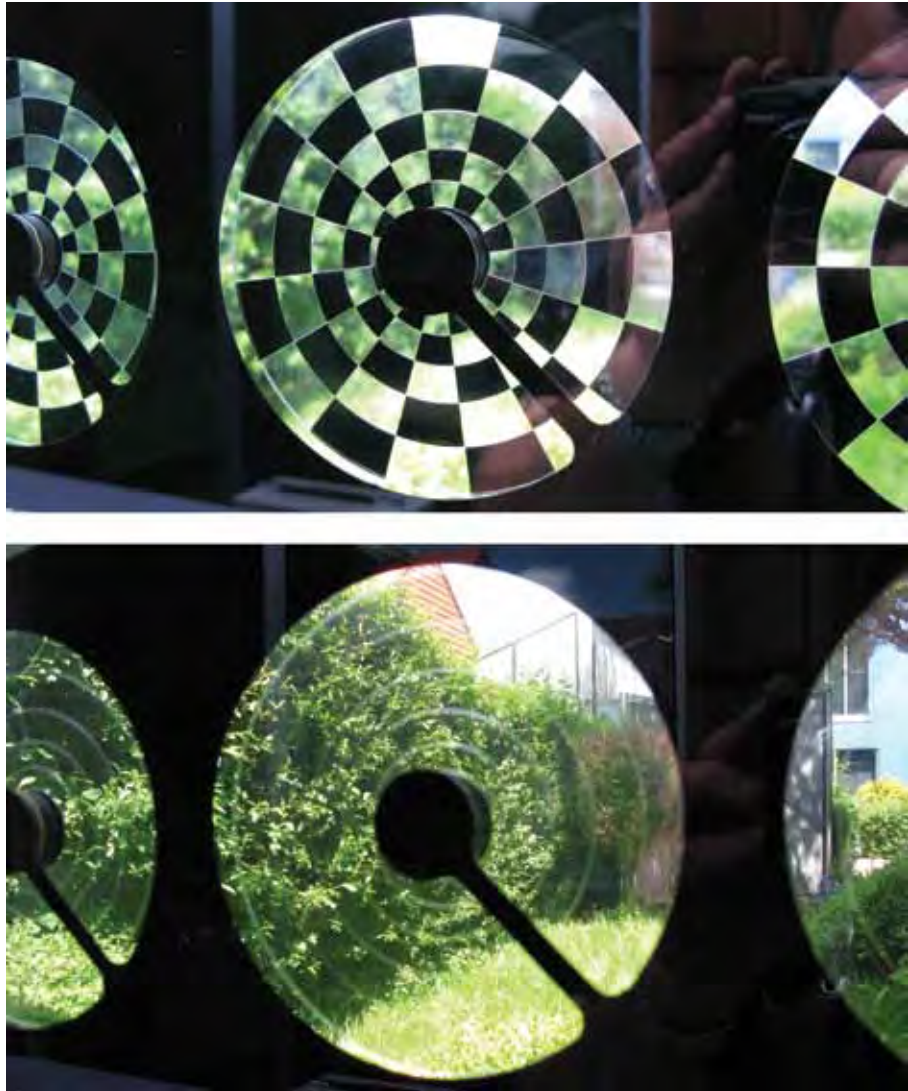

Figure 7.19, 7.20  
Functional principle of rotating sun screen; top: off, bottom: on



Figure 7.21:  
Discs arranged in an insulation glass unit – motors turned on



Figure 7.22:  
Mock-up installed in window element – motors turned off

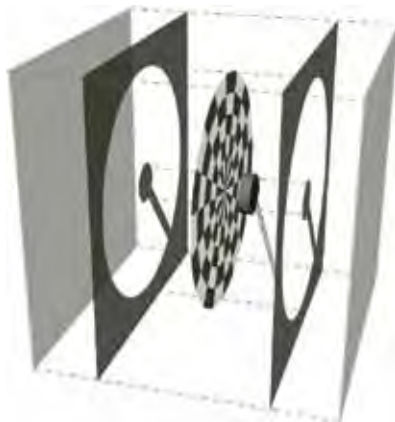

Figure 7.23:  
Construction Design principle ( L. van Ginkel )

In order to prevent a room from overheating - the transparency ratio is already significantly reduced due to the print on the glass encircling the discs – the rotating discs can also be installed within a triple glazing window. It would be most practical to install the motors in the most exterior space between two glass panes, so that the space closest to the interior could be designed as an insulating layer with protective gas. This concept has the added benefit that the outermost glass layer could be operable which would allow for maintenance and cleaning of motors and glass without disturbing the protective gas filling.

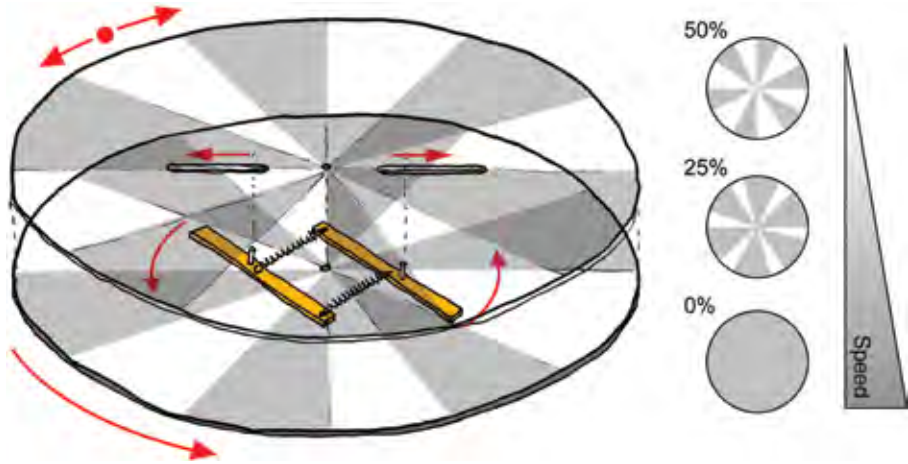

Figure 7.24  
Schematic sketch of an evolution per minute controlled centrifugal force mechanism

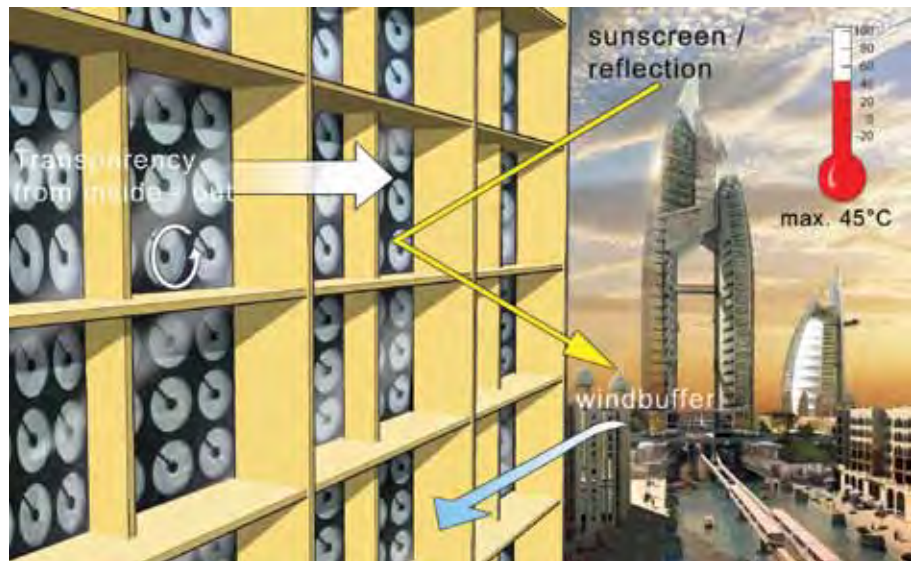

Figure 7.25  
Concept visualisation of the RSS in Dubai

Another version with improved functionality could be to include two discs - independently mounted on the motor shaft - which rotate in opposite direction. A central force controller is used to regulate the speed by revolutions per minute. If two discs with a printed coverage of 50 % each are laid one on top of the other, a combined coverage of between 50 and 100 % can be achieved; 100% of course meaning total darkening. Thus, the transparency can be adjusted from inside the room via a speed regulator.

The concept visualisation shows the system integrated in a Dubai façade. An exterior façade grid has been added as fixed sun protection in addition to the discs in the glass layers. It minimises incident solar radiation and serves as a wind buffer. However, using such shading methods requires the photovoltaic cells to be located in a different position, since the shading limits their performance significantly.

---

## § 7.5 Fully adaptive double façade by Solarlux

---

Façades for modern office buildings face the most challenging requirements. The façade should provide high thermal insulation to avoid unnecessary energy loss during winter. Current window designs with their very high U-values fulfil these demands. But high glazing ratios in office buildings often result in overheating during summer. The greenhouse effect – desirable during winter – is a problem in summer because the energy needed for cooling in summer often far exceeds that needed for heating in winter.

The solution is exterior sun protection, but in windy locations it needs to be protected by an additional glass layer in the form of a double façade to prevent it from retracting during high wind loads. A well thought out ventilation and climate concept ensures that the solar heat in the space between the façade layers of the double façade are utilised during winter. In summer, the largest possible degree of ventilation of the façade space is desired to dissipate unwanted heat. Such façade concepts require numerous technical components such as ventilation flaps, actuators and sensors to allow for optimum air movement in the space between the façade layers. Optimum indoor climate in the offices behind these façades is typically achieved by mechanical ventilation. The windows remain closed, the user is walled off from the outside world, and his/her influence on the room climate is minimal.

## The concept of a fully adaptive double façade (FAD)

---

In the course of a cooperation between the TU Delft / imagine envelope bv and Transsolar Energietechnik, a façade concept was developed for a new building for the Dutch sales office of Solarlux Aluminium Systeme GmbH, a German manufacturer of folding and sliding windows. The goal was to use company-owned products and to achieve the highest possible comfort level using natural resources. The fully adaptive façade responds to the requirements of a sustainable future-oriented office with an innovative concept that focuses on the user and his/her desires.

To reach this goal, the development is based on the basic idea underlying the double façade: box-type windows with interior and exterior sashes. Typically, the exterior sash is located outside the interior sash that actually encloses the room. It is usually closed during the cold seasons to achieve high insulation values. During summer, the exterior sash is fixed open; what remains is a simple window that provides a certain degree of insulation and prevents undesirable heat accumulation during summer. The window was opened at night, and the night air cooled down the building mass for the following day.



Figure 7.26

*Box-type window with interior and exterior sash as the basis for the façade concept*

For the new Solarlux building in the Netherlands, this principle was further worked out. A primary, insulated façade with wooden frame forms the room enclosure. A fully glazed horizontal sliding wall is placed one metre apart, creating an uninsulated glass layer. The double façade thus creates a corridor that envelops the building on three sides. When the sun is high in the sky, the walkable corridor itself functions as sun protection. In addition, adjustable sun protection is installed in the space between the two façade layers. Inside the room, a curtain provides individual glare protection for computer workplaces.

Both façade layers can be folded open completely so that the building envelop can be adjusted depending on current weather conditions and the desired indoor temperature. The lack of automatic control units requires the user to actively use the façade, resulting in a higher identification with the building.

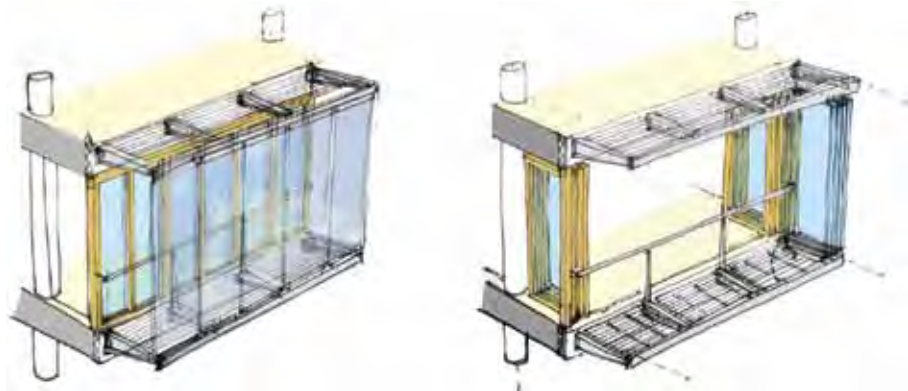

Figure 7.27  
Façade concept in closed and open position

**A few examples of the options available to the user:**

.....

If it is colder outside than inside, both façade layers remain closed, short bursts of full ventilation at regular intervals provide the necessary fresh air supply. The sun heats the space between the two façade layers, thereby protecting the building from further cooling.

If it is warmer outside than inside, the inner façade remains closed, the outer façade is partially or fully open. The space between the façade layers is fully ventilated, preventing overheating.

If the outside temperatures are close to the desired interior temperature, both façade layers can be moved at will. The possibilities reach from comfortable air circulation by placing the elements at gap to opening both layers completely. Opening the storey-high folding walls creates the sensation of working on a balcony.

The operable second façade layer allows regulating the indoor climate according to one's own wishes. If it is cold outside, the sun is shining, and the outer layer is closed, the space between the façade layers warms up quickly to comfortable temperatures. The inner façade can be opened to warm the indoor space. This creates a sense of

working in a conservatory. When closed, the exterior folding walls form a continuous corridor with the same air pressure on all sides of the building. Therefore any window can be opened without the risk of creating a draught.

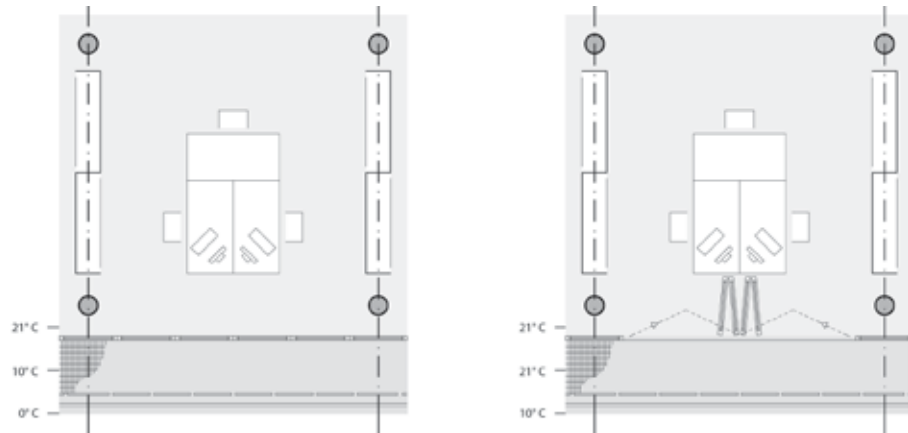

Figure 7.28

*Left: Winter night, both façade layers are closed. The sun protection is extended. The heat remains inside the building. Right: Cold winter day, individual sashes in the outer layer are open at either end of the façade corridor. The sun warms up the space in between the two façade layers. A moderate exchange of air occurs and the air pressure is balanced across all sides of the building. The user can open individual parts of the interior façade layer to adjust the fresh air supply he/she desires. The sun protection is lowered only in those areas where it is currently needed. The result is maximum gain of heat and an optimum individual comfort level.*

Being able to actively regulate one's surrounding climate has a positive influence on daily work patterns and productivity levels. Studies have shown that people are particularly unproductive if they are dissatisfied with the room climate, but are forced to tolerate it.



Figure 7.29  
Exterior view of the double façade (Solarlux Bissendorf)

The building is ventilated with manually operable windows alone; there is no mechanical ventilation system. The natural air flow is enhanced by passive building technical measures. Two atria are covered with mono pitch roofs, which are tilted toward the main wind direction. In Nijverdal, the location of the new subsidiary, the wind predominantly blows from westerly directions (75% of the time). The roof overhang of the mono pitch roofs creates an area of underpressure that draws air from the atria. If a window is opened, fresh air flows in from the façade. This principle is particularly useful during winter because the solar heat gain in the façade space can support the heating of the rooms.

The heating and cooling concept for the building is entirely based on regenerative sources of energy. Throughout the year, a geothermal facility 85 m deep in the ground delivers water with a temperature of 15°C through 24 boreholes. A heat pump raises the water temperature to the necessary level. In addition, the waste heat of the server room is fed into the heating system.



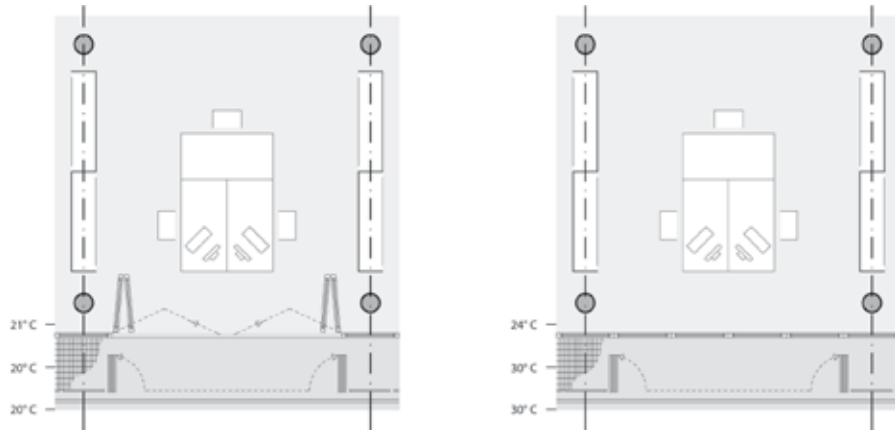

Figure 7.30

*Left: midsummer day, the exterior envelope is fully opened. The interior windows are opened for short burst of ventilation only. The building remains cool. Also a wintergarden feeling is possible right: hot summer day, the interior façade is closed for insulation, the outer layer is fully opened to prevent overheating of the façade space areas where it is currently needed. The result is maximum gain of heat and an optimum individual comfort level.*

The entire heating system is based on a low temperature system with a maximum water temperature of 30°C. The water flows through all ceilings and the underfloor heating in the exhibition hall. Thus, all surfaces in the building emit radiation heat into the rooms.

During summer, the cool water from the borehole heat exchangers is used to cool all massive parts of the building to the desired room temperature. In addition to this slow temperature control system, each office is equipped with a “heating” socket. In rooms with particularly high heating or cooling demands, radiators can be connected on demand via simple plug-in couplings. They can be individually controlled by the user and provide quick heating or cooling.

Since there is no ventilation system, there is no need for suspended ceilings; resulting in higher rooms, better daylight yield and therefore lower cost for artificial lighting.

The solution realised leads to lower cost for maintenance and operation compared to a ventilation system that must be cleaned at regular intervals. Water is a much better heat transmitter than air. Therefore small pumps replace large fans, keeping the necessary operating power and the noise level to a minimum. In addition to using geothermal energy for heating and cooling, a share of the electrical operating energy for the mains is gained through a building-integrated photovoltaic system on the atrium roofs.



Figure 7.31  
View into the double façade space (Solarlux Bissendorf)



Figure 7.32:  
The different possibilities to change the façade (Solarlux Bissendorf)

The façade concept and the building services have hitherto functioned satisfactorily during the first hot summer months; when the façade was properly set, room temperatures did not exceed 28°C at outside temperatures of 35°C. Long-term monitoring and user feedback shall aid in further optimising the performance of the climate and façade concept.

The façade concept shows efficient adaptability throughout all four seasons. The u-value and the g-value can be changed by the combination of the two glass layers and a sun protection system.

However, user behaviour is a problematic aspect; training and a thorough understanding of the functionality of the façade are required to achieve optimum comfort levels in the offices. If the user is passive and does not adjust the façade according to current weather conditions, the office space can easily overheat. The customised solution for Solarlux' own facility in Nijverdal promotes a critical examination of the company-owned building and products. For third-party customers and building projects, however, solutions with mechanical adjustment of the exterior glass layer are being developed.

---

## § 7.6 Summary

---

The examples presented in this chapter demonstrate a broad scope of solutions for different climate zones. It is important to note that particularly in tropical zones there is a definite need to reassess existing technology. Conventional climate technology can, of course, solve all problems, but we should find alternatives, particularly for these hot and humid climates. The potential here not only lies in more efficient energy usage, but can also lead to solutions that underline the identity of these regions and represent the climate in the building envelope. Merely copying Central European architecture with large glazing ratios often results in problems that can only be solved with high energy consumption and the application of a high number of building services components.

Particularly the fact that buildings all over the world look very similar should create a stimulus to apply technologies adapted to the particular location and thereby creating architecture that represents the location and climate. A reduced glazing ratio provides the opportunity to use the freed space for creative design and to integrate more functions into the façade. Solutions such as the rotating sun protection offer the architect possibilities to include ornamental designs in the façade that might reflect oriental patterns such as the Mashrabiya, for example; thus translating local roots into modern architecture.

The fully adaptive double façade is an example of adaptability to the seasonal cycles in temperate latitudes, also demonstrating the possibility for the user to interact with the façade, thus creating a relationship with the building and the indoor climate directly surrounding him/her. The building is particularly oriented toward the Dutch climate which is predestined for natural ventilation; here an extensive use of mechanical ventilation systems seems particularly questionable. It is important to raise the awareness that the user can be involved in the building concept; particularly in terms of sustainability of buildings and climate concepts .

Climate-adapted façade technologies can contribute to an understanding of the mode of operation and technological principles. They should be distinguished from fully automated solutions in as far as this is possible or desired. One remarkable aspect of all of the solutions represented in this chapter is the interaction between façade and building services requiring close cooperation between the different planners of the project team during the early stages of planning. The difficulty and challenge often lies in leaving behind the well-known path of one's own experiences and knowledge and being open to new approaches. Subsequent generations will be even more aware of the finiteness of natural resources because it will most likely play a more prominent role in the education.











# 8 Conclusion

This work aimed at offering more clarity about the questionable trend to build glass houses in the desert. The main research focus lay on the means and methods necessary to create optimised façades that offer high comfort levels and economic operation in different climate zones. Three different topics were examined to identify basic information for these issues.

The study of vernacular architecture was chosen to identify principles that can be applied to modern architecture and offer improved adaptation to a particular climate. The façade as the enclosing element and the interface between the inside and the outside is the second topic to be researched. The third part discusses energy consumption and how to reduce it, which leads into an examination of building services components because, in combination with the façade they account for the largest share of energy consumed.

The findings of the individual criteria examined for all of the 8 boomtowns are listed, followed by recommendations and an outlook of further development. Each chapter is concluded with self-critical notes; this last chapter provides an overall summary.

---

## § 8.1 Discussion of the research questions

---

This thesis focuses on the question as to which methods are needed to create a façade that offers comfort as well as economic operation in different climate zones. A comprehensive answer requires an examination of other questions complementing the topic.

The key question as well as basic information about the different climate zones account for a significant part of this research project. The selection of the eight boomtowns used here was based on identifying locations that are well-known and represent their respective climate zones. The term boomtown also implies a high level of building activity. In the beginning stages of the research, Dubai met this criterion; the current economic crisis and stagnation shows the rapid developments. Enhancing the selection to include Abu Dhabi, whose climate data was used in the scope of this research the region still seems to be well represented.

A comparison of the different locations in various climate zones highlights the extreme differences in prevailing conditions, whereas the requirements of the façade and the indoor climate are virtually the same. The comparative simulations have shown that buildings can be operated with very low energy consumption in Central European locations such as London or Berlin. The climate is well-balanced, and heating and cooling periods can be utilised throughout the year by employing natural resources. In tropical locations such as Singapore there is not one day per year during which the climate complies with the desired indoor climate. Since prevailing temperatures are significantly higher than the desired temperature, continuous cooling is mandatory. And high humidity levels require additional dehumidification. Cooling and dehumidification account for the largest share of the energy consumed; measurements indicate that the consumption is four times higher than that in Central European locations.

Another result of the research is that the façade cannot be examined alone but only in its complex interaction with building services. The façade itself cannot provide an active cooling function, but by choosing a suitable glazing ratio and sun protection system it can help to reduce the risk of overheating adjacent office areas. Also, air flaps integrated in the façade can serve to cool the building at night time. The influence of the façade is limited; depending on the climatic conditions building services components have to be added. To summarise; climate zones with prevailing temperature and humidity levels close to the specified indoor comfort levels offer the greatest potential to use the façade alone for optimum energetic operation at low energy consumption. The influence of the façade as a separate building component becomes increasingly less the more extreme the climate is; in such areas it is necessary to use building services components in combination with the façade to achieve comfortable indoor conditions.

The development of the Façade Expert Tool (FET) is one possible answer to the question of how to facilitate the design of climate-responsive façades. Specifying the requirements that the façade and buildings services must fulfil means reducing the choice of available components to a list of suitable elements; instead of limiting, this process actually increases the creative freedom because the evaluation and selection process is very targeted.

Reducing the glazing ratio and combining building services components that, depending on the project, can either save or recover energy can be summarised as the answer to the central research question. Knowing and understanding a particular climate and awareness to utilise rather than to fight local energies is the main statement of this thesis. It allows us to generate climate-responsive solutions that can also serve to represent the location.

The research questions formulated in § 1.2.3 'Research Questions' have provided the main structure of the thesis; therefore these questions are answered in detail within the different chapters. However, a more abstracted answer is given here to round off this work:

**What are the best means to support a planner who is designing an office façade in combination with building services functions in order to realise solution that is both adapted to the local climate and offers energy-reduced operation?**

The use of a software-based planning tool that accesses weather data helps to analyse and interpret the climate at a particular location. In terms of its affiliation and influence on particular technologies and methods of construction, this data is used to describe requirements and recommendations for the façade and building services. Since the use of the tool requires specific knowledge that cannot be presumed for every planner, the assistance of experts is necessary when entering border parameters. The goal of the recommendations given is to reduce the number of possible combinations to further creative discussion and thus goal-oriented design decisions.

**How can the climate be described and analysed, and which climate zones should be selected to serve as exemplary locations?**

The climate can be described by using IWEK weather data; which, based on statistical measurement values, should be used as artificial yet representative data records to calculate thermodynamic simulation. The analysis of the climate zones results in a reduction of those climate zones that are usable for human beings; the polar zones at the polar caps, for example, are not suited for permanent settlement. The following cities were selected as representative locations:

- Las Vegas (BWk) Cold desert climate
- Berlin, London (Cfb) Maritime temperate climate with warm summer
- Dubai (BWh) Hot desert climate
- Shanghai, New York (Cfa) Hot humid subtropical climate
- Moscow (D) Warm summer continental climate

**Which strategies and methods of constructions have been previously used in the different climate zones to exploit the local climate or effectively shelter from it?**

The approaches and solutions that can be derived from a study of vernacular architecture mostly consist of passive measures; they include using sun protection, insulating exterior walls, using thermal mass and maximising natural ventilation. One example of active systems is adiabatic cooling which enables cooling of the surrounding area by exploiting the cold due to evaporation around open water basins or fountains.

**What are the developments that the building envelope and the façade have undergone, and what part did the indoor climate play in that process?**

An ever increasing amount of glazed areas in the building envelope has not only led to increased transparency but has also increased the amount of energy needed to operate such buildings. While large glazed areas offer solar energy gains during winter, they also entail problems of overheating during summer. An increased awareness of the finiteness of fossil energy resources has shifted the attention toward improved insulation and the efficient use of natural ventilation. The development of the double façade and a sophistication of insulated glass is a result of this fact. With an increasing demand for an individually controllable indoor climate, the integration of building services components has transformed the façade into complex structures.

**Which components of building services and the façade are available to influence and control the indoor climate; which combinations of façade and building services lend themselves for a particular climate?**

We can summarise that the combination of façade and building services strongly depend on the climate. The milder the climate, the greater the range of possible combinations. Extreme climates such as the tropic climate with high temperatures and humidity levels leave little room when making decisions about suitable combinations. In this case, good insulation and efficient sun protection must help to reduce the temperature levels inside the building, while a central air-conditioning unit must ensure a supply of cool and dehumidified air.

**In which manner can the combination of façade and building services for a particular climate zone be illustrated as an aid for the early planning stages?**

With the Façade Expert Tool ( FET) developed as part of this project, requirements and recommendations for façade and building services can be shown as graphic, easy to understand results for the situations heating, cooling and ventilation. Foreshortened sectional views aid in adapting the design to accommodate the requirements and facilitate communication during the planning process. Additional information about the climatic conditions is provided in form of diagrams, based on the analysis of the climate data records.

**Can new façade concepts be developed from the requirements of the individual locations that in this particular shape and form are not yet available with existing technologies or products?**

The analysis has shown that in mild climates, for example, the use of natural ventilation offers high potential when combined with concrete core cooling and geothermal energy. Alternative dehumidification solutions might be suitable for tropic zones, such as a condensate trap – as is shown in the location Singapore. Sun protection is another area with a large potential for alternative solutions that can also be used to influence the exterior appearance of the building.

## § 8.2 Vernacular architecture

Studying vernacular architecture or “Building without an architect” as Rudowsky described it in 1965 (Rudofsky, 1965), at first glance seems like finding a treasure trove of knowledge and methods to exploit a region’s climate and therewith creating more efficient buildings or concepts that work with rather than against the climate. The study of such ancient knowledge also offers the potential to develop architecturally and culturally more integrated buildings that blend well into their surroundings and can result in an individualised appearance representing the location.

Chapter 3 ‘Principles of climate-adapted architecture’ describes these methods and construction principles categorised by origin and climate zone. Particularly noteworthy in this context are the works of Oliver, including his encyclopaedia of vernacular architecture which was compiled by several international researchers. (Oliver, 1997)

The concepts of adaptation to different climates worldwide can be broken down into simple principles. One example is using thermal mass, as it is used in massive mud brick buildings in hot regions to reduce daytime heat. The air cools considerably during the night, and the building mass can store the coolness into the day. Another aspect is a building’s orientation toward the main wind direction; wind catchers on the roof top are used to promote a natural breeze through the building, thus reducing the temperature to a bearable level.

These wind catchers, called Bagdirs in Iraq, can still be seen in old city centres. In the past they were also a sign of wealth and power. In southern India, buildings were arranged such that a breeze could stream through the hallway, called “lifeline”, and into adjacent rooms to lower daytime temperatures. The use of adiabatic cooling created by small artificial waterways or fountains in atria or meeting places to raise the comfort level is another good example of adapting to the climate conditions of a particular region.

Using massive materials or thick layers of insulation material such as grass or straw is a principle to protect from long cold winter periods in cold regions. A low window ratio further reduces heat loss and permits survival in extremely cold climates. The igloo of the Inuit enables survival in such hostile environments as the Arctic, because of its lowered entrance area and the different temperature layers created within the building.

In China and Spain, techniques to exploit exhaust heat from cooking have been developed a long time ago to maintain warmth during cold nights. The Spanish Gloria and the Chinese Kang are predecessors of modern underfloor or wall heating systems. The Roman Hypocaust is another floor heating system.

The sun is the motor behind many principles of vernacular architecture; other principles can be developed from the knowledge of the prevailing wind conditions and the daily or annual temperature profile of a particular location. The use of the term “comfort” in this context should not be confused with the modern usage of the word. All available options to make habitation more pleasant were exploited; while less affluent people had only natural local resources at their disposal, the rich could afford a little more comfort. But in general, the principles were means of survival rather than options to increase the comfort level in our sense of the word.

The study of traditional techniques, building methods and solutions is fascinating; however, it has to be noted that the initial desire to transfer completely new solutions to our modern building culture was naïve.

In principle, current engineering solutions for heating, cooling or air-conditioning are already based on ancient techniques such as adiabatic cooling or using thermal mass to buffer temperature peaks. Night flush cooling is a good example: it can be considered a successor of the “lifeline” or the Iraqi wind catcher. Current building codes and increasingly homogenous international user expectations no longer allow applying principles that are based on the prevailing climate conditions and minimal use of local resources alone. In the past, entire families and craftsman’s businesses have moved from one area of a building to another throughout the course of a day to exploit the most comfortable area at any given time. Today, employees and other users are usually tied to one work place, expecting a comfortable surrounding regulated by law.

Studying traditional building methods does, however, show the potential of interaction between building and climate. A well thought out climate concept follows the same basic principles used in ancient buildings. Particularly solutions such as natural ventilation, solar chimneys, atria as buffer zones and night flush cooling must be further examined since they offer possibilities to efficiently operate buildings throughout the better part of the year without the high energy consumption that is inherent to large-scale air-conditioning systems.

## § 8.3 Façade Expert Tool / FET

The main focus of this thesis was to develop a planning aid that helps selecting suitable façade and building services elements for the early planning stages. The idea soon evolved to create a computer-based tool that, upon entering the location, analyses the climate and then generates recommendations for these components. After initial discussions with Thomas Auer from Transsolar Energietechnik GmbH, who support the programming of the tool as a plug-in for their existing weather analysis tool, it soon became obvious that a link between the façade and building services requires too many details to be entered to generate recommendations for the most appropriate building concept.

Problems arising through the use of one technological component can be compensated by changing or modifying others. Thus, the tool evolved into a tool for experts, hence the name FET – Façade Expert Tool. A research of similar, already existing design tools has proven that querying too many parameters during the initial phase of planning does not promote design creativity and proves to be more of a limitation than an aid.

With FET, the climate can be analysed using test reference years. Test reference years are artificially generated weather data that render a representative image of the expected climate from hourly long-term weather recordings. They are the basis for thermodynamic building simulations. Since this data is available for more than 2000 locations, the tool is very flexible and can be used for international planning processes.

The description of the climate analysis is rendered in an easy to read format for non-experts and experts alike. Terms such as rarely cold or often warm correspond to our daily use of weather terminology; again making it easy to understand the analysis. On the basis of this analysis, the FET selects façades and building services components according to predefined strategies and switch values; then puts out recommendations or requirements. The differentiation between recommendation and requirement reflects the choices available. Heating, for example, is defined as a requirement, whereas cooling is defined as a recommendation because it is considered a measure to increase the comfort level. With few exceptions, the tool specifies the required functions rather than actual building services components. In most cases, individual components must be selected manually in a second step of the FET process after the climate analysis has been completed. For example, the tool first determines that heating is required; the user then selects from a number of possible heating components. The individual components that can be used to change indoor air conditions are listed and described in an earlier chapter.

The evaluation of the tool on the basis of eight international locations shows its performance capability and ease of use. Since the recommendations of the tool are not interlinked, it is difficult to select a suitable combination of building services components

for some locations; particularly if contradictory recommendations are given such as natural and mechanical ventilation. In some cases, the recommendation for an enthalpy wheel for waste heat recovery in tropical regions is a direct indication for mechanical ventilation or the use of air-conditioning.

A FET recommendation for double façades depending on building height, radiation intensity and wind speed, must be explained. In this context, the double façade is reduced to its function of protecting exterior sun protection devices. Using a double façade for other purposes, for example to reduce external noise emission, can be appropriate, but the tool does not render such recommendations. It has to be noted as well, that a recommendation of a double façade indirectly implies that the exterior sun protection is not windproof. Double façades are not needed if highly wind-resistant exterior sun protection is used.

The tool's recommendation for certain glazing ratios is its strongest function because it has the biggest impact on potential energy savings and the appearance of the façade. Comparison simulations of the glazing ratio calculated by the FET juxtaposed with that of fully glazed International Style façades show savings potentials of up to 50%. The comparison simulation also highlights that energy consumption for dehumidification and cooling in tropical zones account for the largest share of overall energy consumption.

Initial tests of the tool were successful, and the feedback from Transsolar Energietechnik users and the author were positive. With the graphic editor, the user can modularly compile a concept. Thus, the design discussion can be recorded for further planning; a feature that enjoyed particular approval.

One negative aspect of the tool is the lack of a geographic orientation of the building. Since the tool's calculations are based on radiation measurements independent of the geographic orientation, there is no detailed output concerning the orientation. But in terms of potential energy savings and architectural design it is particularly important to be able to determine which side of the façade should face in which geographic direction. Further development of the tool should also include a weighting function that rates the importance of the different recommendations given. This would simplify component selection. Differentiating between heating and cooling conditions can also aid in facilitating the most suitable component combination; as can a differentiation between day and night time operation. However, the overall goal of user-friendliness and easy to understand recommendations must be maintained when adding additional functionality.



## § 8.4 CROFT

The chapter Climate Responsive Optimised Façade Technologies (CROFT) shows a compilation of different concepts. In parts, these were developed from the requirements of individual locations such as the necessity to dehumidify in Singapore or a new sun protection concept. The built façade for Solarlux in Nijverdal introduces a building and façade concept that specifically exploits the climatic conditions of the region.

The concepts described show a broad spectrum of solutions for different climate zones; and the comparison simulations highlight the particularly high energy demand for dehumidification in tropical zones. Since these regions show large market potential due to enormous building activities, a concept to dehumidify supply air with a condensate trap has been provided. Many concepts use significantly reduced areas of transparency following the FET calculations for optimum glazing ratios. Reduced glazing ratios should be seen as added freedom of architectural design rather than a limitation. Not only the potential energy savings achieved by using less glass but also the increase of opaque areas that leave more room for architectural design offer great opportunities during planning and can result in architecture that bears reference to the specific location.

In addition to creating space for identity-creating characteristics, the newly obtained areas provide space for new building services functions. For example, in the form of a panel construction for a collector surface to gain energy or preheat the supply air.

The rotating sun protection system introduced in this chapter is a particularity; from a technical viewpoint it is based on the simple principle of creating transparency through rotation, but its design can be seen as a reference to the Arabic Mashrabeya or Jali – the highly ornamented wooden lattices installed in front of window openings. The concept provides the designer with a multitude of creative possibilities. It is intentionally kept simple and offered as an inspiration to adapt a project to the particular requirements.

The built project for Solarlux in the Netherlands with the development of a fully adaptive double façade has shown which planning efforts must be taken to create a naturally ventilated building. The maxim “Anyone can drive a motorboat as long as there is gas available; but he who wants to cross the ocean must learn to sail” has been referenced in the beginning of this work. This project demonstrates that a building – similar to a sailboat – can be operated efficiently with the use of locally available energy sources. Satisfied users prove that to give more personal responsibility to the user can be an appropriate strategy for new building designs.

## § 8.5 Expected practical benefits

The building envelope and necessary building services offer numerous options to operate a building in an energy efficient manner while maintaining high user comfort levels. Often, a particular concept is copied from one climate zone to another based on a wrong understanding of its functionality or the mere desire to imitate the design. The International Style with predominantly fully glazed office buildings resembling each other around the world is made possible with the use of high performance air-conditioning and building services components.

This research work intended to show that a closer examination of a particular location and its prevailing climate offers the potential to develop more efficient customised solutions. An analysis of traditional building methods shows many different methods of climate adaptation; the formative diversity of these methods reflecting a particular region or culture is particularly impressive. Reassessing these techniques will generate creative climate designs to create local architecture with unique identities.

The comparison simulations highlight the potential of reduced glazing ratios. With primary energy savings of up to 50% for building operation, non-transparent façade areas can be used to develop new façade layouts, material combinations and design methods. Innovative climate concepts or alternative building services can be integrated into the building envelope by exploiting these opaque areas – the décor of the future should be a function.

The Façade Expert Tool can evolve into a manageable tool for the designing architect, providing him or her with an intelligent selection of necessary components to use in early planning. With its goal to reduce primary energy consumption, this work contributes to a more sustainable future.

Further development and application of the rotating sun protection system is desirable because it offers added design possibilities in addition to its protective function.

## § 8.6 Research recommendations

This research work is focused on practical application when designing building envelopes; however, during the course of the research other topics evolved that should be examined further.

Even though the main point of discussion in this research are office building façades, the examples given in the analysis are predominantly residential dwellings because in vernacular architecture office buildings in our sense of the term did not yet exist. It is thus recommended to work out a similar approach for residential housing as well. Residential housing is typically characterised by a lower glazing ratio than that of office building, so the risk of overheating is smaller, but larger building masses offer great potential for alternative air-conditioning methods. Principles of vernacular architecture related to the footprint design could be adapted to residential housing as well.

Considering the expanse of the tropical climate zone highlights the market opportunities for alternative dehumidification solutions. Decentralised controlled dehumidification devices offer great research potential because they can increase the individual comfort level significantly. Another potential area of research are condensate traps as they are described in [chapter 7 'Climate Responsive Optimised Façade Technologies CROFT'](#) to dehumidify supply air. If regenerative energy could supply sufficient energy to operate the condensate trap, this concept could be developed into an efficient system.

The Façade Expert Tool opens up numerous other fields of research; geographic orientation should be the first issue to be examined, followed by a module specifically designed for residential buildings. Even though FET recommendations are not limited to office buildings, the selection of available components was oriented on this building type. Other functions could be to implement specific statements about the use of sun protection systems, user comfort and estimated energy consumption. However, as mentioned before, adding more and more functions to the tool carries the risk that the user needs to supply too many predetermined parameters during early planning stages which might limit creativity.



# Summary

Looking at Central European building projects illustrates an awareness of sustainability and the need to save energy. This trend is based on the finiteness of natural resources, and is thus wise to follow. Developments in this region including passive house technologies, and energy plus solutions that create more energy than they use have become realisable. But it is not increasing technological knowledge alone that supported these developments; the Central European climate makes it possible to invent technological solutions that allow for maximum comfort while maintaining low energy consumption.

Other regions have experienced a building boom over the past decades that has dramatically increased city sizes. A detailed examination of such building projects illustrates that most of them strive for the international standard with a high glazing ratio in the style of the Central European examples. But how can architecture be transferred to regions with entirely different climate conditions? The answer lies in the technological possibilities we have at our disposal today. The main research question of this thesis refers to utilising the local climate. Which methods are necessary to plan a building - and a façade as the interface between the inside and the outside, in particular - while working with, not against the climate? Sailing has been used as an analogy: only with the knowledge of winds and tides can we use them to efficiently move across bodies of water. Those who have not learned or understood this will have to use a motorboat and pay the price for petrol.

[chapter 2 'Climate zones'](#) describes the different climate zones and their particularities, analysed with the help of eight different boomtowns. The mild Central European climate becomes particularly apparent when compared to tropic locations such as Singapore. Here, very high average temperatures and humidity levels require that we rethink and find new solutions.

In [chapter 3 'Principles of climate-adapted architecture'](#) a journey back in time to traditional building methods and vernacular architecture lets us identify how building styles and building methods derived from an adaptation to the local climate. Have we lost some of this knowledge, and what can we learn to adapt modern architecture to the local climate? The study of traditional architecture is sobering; all or most of the solutions found in traditional architecture have, in principle, been implemented or further developed in modern technological solutions. The Roman hypocaust is the predecessor of modern underfloor heating and the fresh air stream, called "lifeline" in India, that cools down massive walls during the night can be compared to night

flush ventilation used in modern office buildings. All of the traditional methods and solutions have made survival possible under sometimes extreme climatic conditions. But the comfort level expected by the modern user and regulated by building codes could have never be achieved.

The façade is the focal point of this work because, as an enclosing building component, it connects or separates the interior and the exterior. After a short introduction about the evolutionary history of the façade, [chapter 4 'The Façade'](#) describes the reciprocity of the façade with reference to the indoor room climate. Since the possibilities of regulating the indoor climate and thereby the comfort level with the façade itself are limited, [chapter 5 'Building services components'](#) includes a description of the building services components necessary to control the room climate.

[Chapter 6 'FET Façade Expert Tool'](#) describes the process of combining the findings from the previous chapter for a tool to analyse the climate and the combination of façade and building services. The goal of the "Façade Expert Tool" (FET) software tool is to easily analyse the climate of a particular location and to then limit the possible combination of façade and building services components to a practical level. The initial aim to generate the perfect combination of components and therewith the ideal façade and building services after entering a particular location upon a click of the mouse was replaced by the idea of an expert tool that requires basic knowledge of the working principle of the individual components and their reciprocal action. The application of the FET and its recommendations as well as comparison simulations rounds off the chapter. The performance capability of the tool is illustrated by a reduction in energy consumption of up to 50% in the comparative thermal simulations.

In many cases, the approaches to solutions and examples introduced in [chapter 7 'Climate Responsive Optimised Façade Technologies CROFT'](#) under the name "Climate Responsive Optimised Façade Technologies" (CROFT) use reduced glazing ratios recommended by the FET to integrate new technical solutions into non-transparent areas of the façade. To name a few: a condensate trap that enables dehumidification of the outside air in tropical climates as well as a rotating sun protection system that creates the sensation of transparency for the human eye while providing efficient sun protection.

The final [chapter 8 'Conclusion'](#) takes a critical look at the research, highlights potential for further research and new markets, and summarises the overall results.

This thesis can be linked to the fields of architecture, building services and building physics. The focus of the research and the author's background in architecture is easy to perceive. But beyond purely formative architectural aspects, the building envelope as the interface between the inside and the outside requires knowledge of building

physical basics and the function and interaction with or as part of the building services system.

The thesis also aims at mediating between different planning disciplines and at supporting an interdisciplinary planning process. If it furthers international diversity in façade design that represents the respective location in addition to reduced energy consumption, the author's intentions have been met and another step toward a sustainable future has been accomplished.

Marcel Bilow





# Zusammenfassung

## Internationale Fassaden

### Klimazonen reaktive Fassadentechnologien

Betrachtet man mitteleuropäische Projekte wird das Bewusstsein für Nachhaltigkeit und die Erfordernis Energie zu sparen deutlich. Dieser Trend ist durch die endlichen Ressourcen fossiler Brennstoffe begründet und richtig. Die Entwicklungen in unseren Breitengraden mit Passivhaustechnologien, Energy Plus Lösungen mit Gebäuden die mehr Energie erzeugen als sie zum Betrieb benötigen sind mittlerweile realisierbar. Aber nicht nur das stetige Wachsen unseres ingenieurmäßige Wissens das über die letzten hundert Jahre diesen Fortschritt ermöglicht hat ist als Grund dieser Lösungen zu nennen, unser Klima erlaubt es zudem mit Hilfe technologischer Lösungen Gebäude zu erdenken, die mit regenerierbaren Energien ein Höchstmass an Komfort bei gleichzeitig geringem Energieverbrauch ermöglicht.

Blickt man über die Grenzen unserer Breitengrade hinaus, kann man einen Bauboom an internationalen Standorten feststellen in dem im Verlauf von Jahrzehnten die Städte um ein Vielfaches wachsen ließen. Schaut man sich diese Bauvorhaben im Detail an wird deutlich das ein internationaler Standart mit hohem Glasanteil angelehnt an mitteleuropäischen Beispielen das Maß des Strebens darstellt. Wie kann jedoch diese Art des Architekturexports unter völlig unterschiedlichen klimatischen Konditionen möglich sein?

Die Antwort ist in den technischen Möglichkeiten zu finden, mit denen wir heute in der Lage sind unsere Gebäude zu betreiben. Die Hauptfragestellung dieser Arbeit ist der Nutzung des lokalen Klimas gewidmet. Mit welchen Mitteln kann ein Gebäude und vor allem die Fassade als direkte Schnittstelle zwischen Außen dem Klima und Innen dem Komfort geplant werden, um mit und nicht gegen das Klima zu arbeiten. Als Analogie ist das Segeln genutzt worden: Erst wenn wir die Winde und Gezeiten erlernen, können wir uns diese zu Nutze machen um uns auf dem Wasser effizient fortzubewegen. Wer dies nicht erlernt und versteht muss auf das Motorboot zurückgreifen und die Benzinrechnung bezahlen.

Das Verständnis der unterschiedlichen Klimazonen mit Ihren Besonderheiten die anhand von acht unterschiedlichen Boomtowns analysiert worden ist, wird im [Kapitel 2 'Climate zones'](#) der Arbeit vorgestellt. Das milde Klimat unserer Breitengrade wird besonders im Vergleich mit tropischen Standorten wie Singapur deutlich, in denen nicht nur die Temperatur um ein Vielfaches höher liegt verglichen mit unserem Klima sondern auch die hohe Luftfeuchtigkeit ein Umdenken und somit neue Lösungsmöglichkeiten erfordert.

Im [Kapitel 3 'Principles of climate-adapted architecture'](#) hilft eine Reise in die Vergangenheit der traditionellen Bauweisen oder vernaculären Architektur die Anpassung der Baustile und Bauweisen aufzuspüren. Was ist zum heutigen Tage in Unwissenheit geraten, was können wir lernen unsere Architektur an das lokale Klima anzupassen? In Kürze zusammengefasst ist das Studium der traditionellen Architektur ernüchternd, alle oder die meisten Lösungen vergangener Zeiten sind bereits in ihrem Grundprinzip in heutigen technischen Lösungen enthalten oder weiterentwickelt. Die römischen Hypokausten sind die Vorgänger unserer heutigen Fußbodenheizung und die im Iran als „Lebenslinie“ bezeichnete Frischluftströmung im Haus die ein Auskühlen der massiven Wände über Nacht ermöglicht ist mit der Nachtlüftungspülung heutiger moderner Bürobauten gleichgesetzt.

Alle traditionellen Techniken und Lösungen haben ein Überleben in den zum Teil sehr extremen klimatischen Konditionen ermöglicht, heutigen Komfort wie man ihn in Bauvorschriften auferlegt bekommt und vom Nutzer erwartet wird, konnte nicht geschaffen werden.

Die Fassade bildet den Schwerpunkt dieser Arbeit stellt sie als umhüllendes Bauteil den direkten Kontakt von Innen und Außen her oder trennt diese voneinander. Einleitend mit einer kurzen Evolutionsgeschichte der Fassade wird in [Kapitel 4 'The Façade'](#) vor allem die Wechselwirkungen der Fassade bezogen auf den Innenraumkomfort vorgestellt. Da die Fassade nur in eingeschränkter Form das Innenraumklima und somit den Komfort regeln kann werden im [Kapitel 5 'Building services components'](#) neben den Funktionen der Fassade auch haustechnische Komponenten die zur Regulierung des Innenraumklimas eingesetzt werden müssen vorgestellt.

Das [Kapitel 6 'FET Façade Expert Tool'](#) beschreibt die Kombination des aus den vorherigen Kapitels gewonnen Erkenntnissen, die in einem Tool zur Analyse des Klimas und der Kombination von Fassade und Haustechnik genutzt werden können. Ziel ist bei dem als „Façade Expert Tool“ (FET) bezeichneten Softwaretool die einfache Analyse des Klimas eines Standortes und daraus die Kombination von Fassade und Haustechnik auf ein sinnvolles Maß einzuschränken. Dem anfänglichen Wunsch mit einem Klick nach Angabe des Standortes die perfekte Kombination von Komponenten und somit die ideale Fassade und Haustechnik zu erhalten ist der Idee eines Expertentools gewichen, bei dem Grundkenntnisse über die Wirkungsweise der einzelnen Komponenten und deren Wechselwirkung miteinander vorausgesetzt werden müssen. Die Anwendung des FET und deren Empfehlungen sowie Vergleichssimulationen runden das Kapitel ab. Die Leistungsfähigkeit des Tools wird mit der Senkung des Energieverbrauchs um bis zu 50% in den vergleichenden thermischen Simulationen verdeutlicht.

Die im **Kapitel 7 'Climate Responsive Optimised Façade Technologies CROFT'** unter dem Namen „Climate Responsive Optimized Façade Technologies“ (CROFT) vorgestellten Lösungsansätze sowie Beispiele nutzen vielfach die reduzierten Glasanteile die durch das Façade Expert Tool ausgegeben worden sind um neue technische Lösungsansätze in nicht transparenten Fassadenbereichen zu integrieren. Zu nennen sind die Kondensatfalle die ein Entfeuchten der Außenluft in tropischen Klima ermöglichen soll sowie der rotierende Sonnenschutz der durch Rotation für das menschliche Auge Transparenz erzeugt und gleichzeitig einen effizienten Sonnenschutz darstellt.

Im letzten **Kapitel 8 'Conclusion'** wird das Forschungsvorhaben kritisch betrachtet, Potentiale für Forschung und neue Märkte aufgezeigt und die Ergebnisse noch einmal zusammengefasst.

Zusammenfassend lässt sich diese Arbeit aus den Themenbereichen der Architektur Haustechnik und Bauphysik beschreiben. Der Schwerpunkt und ebenso die Herkunft des Autors aus der Architektur ist ablesbar. Die Gebäudehülle als Schnittstelle von Innen und Außen erfordert jedoch über rein gestalterische Aspekte der Architektur hinweg das Wissen über die bauphysikalischen Grundlagen und die Funktion und Interaktion mit oder als Teil der haustechnischen Gebäudeausrüstung.

Die Arbeit versucht zudem zwischen den verschiedenen Planungsdisziplinen zu vermitteln und den interdisziplinären Planungsprozess zu unterstützen. Wenn neben der Reduzierung des Energieverbrauchs auch eine internationale Diversität der Fassadengestaltung entsteht, die den Standort ablesbar macht, ist der Intention des Autors genügt und ein weiterer Schritt in eine nachhaltige Zukunft getan.

Marcel Bilow



# Samenvatting

Als we Centraal-Europese bouwprojecten bekijken, dan zien we dat de makers zich bewust zijn van duurzaamheid en van de noodzaak om energie te besparen. Deze trend komt voort uit het feit dat fossiele bronnen eindig zijn en is daarom te rechtvaardigen. Daardoor hebben in deze regio inmiddels ontwikkelingen plaatsgevonden als “Passive house technologies” en “Energy Plus solutions” met gebouwen die meer energie creëren dan ze nodig hebben in hun gebruik. Niet alleen de groei van onze technologische kennis in de afgelopen honderd jaar heeft deze ontwikkelingen bevorderd; het Centraal-Europese klimaat maakt het mogelijk technologische oplossingen voor gebouwen te bedenken die met regenererebare energie een maximaal comfort mogelijk maken bij een laag energieverbruik.

Andere regio's hebben de afgelopen tien jaar een bouw boom ondergaan die de steden enorm in omvang heeft doen toenemen. Gedetailleerd onderzoek naar dergelijke bouwprojecten laat zien dat men streeft naar een internationale standaard met een hoog aandeel van glas in de stijl van Centraal-Europese voorbeelden. Maar hoe kan deze architectuur geëxporteerd worden naar regio's met totaal andere klimaatcondities? Het antwoord ligt in de technologische mogelijkheden die we vandaag de dag tot onze beschikking hebben om een gebouw neer te zetten.

De belangrijkste onderzoeksvraag van dit proefschrift richt zich op het gebruikmaken van het lokale klimaat. Welke methoden zijn nodig om een gebouw te plannen – en in het bijzonder de façade als het verbindende element tussen binnencomfort en buitenklimaat – als we met het klimaat willen samenwerken in plaats van ertegenin? Zeilen wordt als analogie gebruikt: alleen met kennis van wind en getijden kunnen we deze efficiënt gebruiken om ons over het water te bewegen. Zij die dit niet geleerd hebben of niet begrijpen zullen een motorboot moeten gebruiken en benzine moeten betalen.

Hoofdstuk 2 ‘Climate zones’ beschrijft de verschillende klimaatzones en hun bijzonderheden, geanalyseerd aan de hand van acht verschillende boom towns. Het milde Centraal-Europese klimaat wordt vooral zichtbaar als het vergeleken wordt met tropische locaties als Singapore. De zeer hoge gemiddelde temperaturen en vochtigheidsgraad hier vereisten nieuwe oplossingen en andere benaderingen.

In hoofdstuk 3 ‘Principles of climate-adapted architecture’ identificeren we door een reis terug in de tijd naar traditionele bouwmethoden en vernacular architecture hoe bouwstijlen en –methoden zijn aangepast aan het lokale klimaat. Wat is er van deze kennis verloren gegaan, en wat kunnen we ervan leren als we onze moderne

architectuur aanpassen aan het lokale klimaat? Kort samengevat: de studie van traditionele architectuur is ontvullend; alle of de meeste oplossingen die we in de traditionele architectuur vinden, zijn in principe geïmplementeerd of verder ontwikkeld in moderne technologische oplossingen. De Romeinse hypocaustum is de voorloper van de moderne vloerverwarming en de koele luchtstroom in huis - die in Iran "lifeline" genoemd wordt -, die dikke muren 's nachts afkoelt, kan vergeleken worden met night flush ventilatie die in moderne kantoorgebouwen gebruikt wordt.

Al deze traditionele methoden en oplossingen hebben het mogelijk gemaakt zeer extreme klimaatcondities te doorstaan. Maar het comfortniveau dat de moderne gebruiker verwacht en dat bouwvoorschriften vereisen, zou nooit bereikt hebben kunnen worden.

De façade is het belangrijkste onderwerp van dit proefschrift omdat het als het omhullende gebouwonderdeel binnen- en buitenkant verbindt en scheidt. [Hoofdstuk 4 'The Façade'](#) beschrijft na een korte introductie over de evolutionaire geschiedenis van de façade, de wisselwerking tussen de gevel en het binnenklimaat. Gezien het feit dat de mogelijkheden beperkt zijn om het binnenklimaat en daarmee het comfortniveau met de façade zelf te reguleren, beschrijft [hoofdstuk 5 'Building services components'](#) naast de functies van de façade, de installaties die nodig zijn om het binnenklimaat te reguleren.

[Hoofdstuk 6 'FET Façade Expert Tool'](#) beschrijft hoe door de bevindingen uit het vorige hoofdstuk te combineren een tool ontwikkeld kan worden om het klimaat en de combinatie van façade en installaties te analyseren. Het doel van de Façade Expert Tool (FET) software tool is om op een eenvoudige manier het klimaat van een bepaalde locatie te analyseren om vervolgens de mogelijke combinaties van façade en installatiecomponenten te beperken tot het praktisch bruikbare. Het aanvankelijke doel om met een klik op de muis voor een bepaalde locatie de perfecte combinatie van componenten te maken en daarmee de ideale façade met installaties te verkrijgen, werd vervangen door het idee van een expert tool, die basale kennis vereist van het werkende principe achter de componenten en de manier waarop ze op elkaar inwerken. De toepassing van FET en de aanbevelingen daarbij, evenals vergelijkingssimulaties sluiten het hoofdstuk af. De doelmatigheid van de tool wordt geïllustreerd door een reductie van het energieverbruik tot 50% ten opzichte van vergelijkbare thermische simulaties.

In veel gevallen gebruiken de oplossingsbenaderingen en voorbeelden die in [hoofdstuk 7 'Climate Responsive Optimised Façade Technologies CROFT'](#) geïntroduceerd worden onder de naam "Climate Responsive Optimised Façade Technologies" (CROFT), een laag glasaandeel. Dit wordt door FET aanbevolen om nieuwe technische oplossingen te integreren in niet-transparante delen van de façade. Om er een paar te noemen: de condensval die het ontvochtigen van de buitenlucht mogelijk maakt in tropische gebieden evenals een draaiend zonweringssysteem dat voor het menselijk oog een

sensatie van transparantie creëert terwijl er toch efficiënte bescherming tegen de zon wordt geboden.

In het laatste hoofdstuk 8 'Conclusion' wordt het onderzoek kritisch onder de loep genomen, worden mogelijke verdere onderzoeksrichtingen en nieuwe markten aangestipt en worden de resultaten samengevat.

Dit proefschrift bestrijkt de thema's architectuur, installaties en bouwfysica. Het zwaartepunt van het onderzoek en de achtergrond van de auteur als architect zijn makkelijk te herkennen. Maar boven kennis van puur formele aspecten van architectuur vereist de gevel van een gebouw als de verbinding tussen de binnen- en de buitenkant kennis van de basics van bouwfysica en diens functie en interactie met of als onderdeel van de installaties van een gebouw.

Het proefschrift beoogt ook de verschillend planningsdisciplines te verbinden en het interdisciplinaire planningsproces te ondersteunen. Als het naast een reductie in energieverbruik ook internationale diversiteit in façadeontwerp bevordert dat een afspiegeling is van de betreffende locatie, dan heeft de auteur zijn doel bereikt en is een stap verder in de richting van een duurzame toekomst gezet.

Marcel Bilow





# List of figures

## List of Tables Image providers

I am especially grateful to these image providers. All other illustrations were created specifically for this thesis or were provided by the author or members of the Façade Research Group / TU Delft. Special thanks to Ulrich Knaack and Tillmann Klein. Especially the climate diagrams are created with support of Transsolar / Stuttgart. Every reasonable attempt has been made to identify owners of copyright or the source from which there are taken especially in case of websites - these will be named. If unintentional mistakes or omissions occurred; I sincerely apologise and ask for a short notice. Such mistakes will be corrected if this thesis will be officially publicised.

## Chapter 2

Figure 2.1: <http://koeppen-geiger.vu-wien.ac.at> / M. Kottek

Figure 2.11: Climate and Architecture, Torben Dahl

Figure 2.31: [www.flickr.com](http://www.flickr.com) / Barcroti Media

Figure 2.43: [www.flickr.com](http://www.flickr.com) / Balylolo

Figure 2.55: [www.flickr.com](http://www.flickr.com) / Andrey

Figure 2.104: [www.flickr.com](http://www.flickr.com) / theurbannexus

Figure 2.125: Transsolar GmbH, Cramer Silkworth

## Chapter 3

Figure 3.1: <http://koeppen-geiger.vu-wien.ac.at> / M. Kottek

Figure 3.3: <http://koeppen-geiger.vu-wien.ac.at> / M. Kottek

Figure 3.5: Linda Hildebrand

Figure 3.6: Danja Vasiliev

Figure 3.9: Oliver, Encyclopedia of vernacular architecture of the world

Figure 3.10: Oliver, Encyclopedia of vernacular architecture of the world

Figure 3.11: <http://koeppen-geiger.vu-wien.ac.at> / M. Kottek

Figure 3.12: Oliver, Encyclopedia of vernacular architecture of the world

Figure 3.13: Oliver, Encyclopedia of vernacular architecture of the world

Figure 3.14: Schütze (2000) Klimagerechtes Bauen in Europa

Figure 3.16: T. Konstan\_nou

Figure 3.17: <http://koeppen-geiger.vu-wien.ac.at> / M. Kottek

Figure 3.18: H. Rairez

Figure 3.19: <http://koeppen-geiger.vu-wien.ac.at> / M. Kottek

Figure 3.20: <http://trekearth.com>

Figure 3.21: [www.flickrriver.com/juicyrai](http://www.flickrriver.com/juicyrai)

Figure 3.22: [www.travel.webshots.com](http://www.travel.webshots.com)

Figure 3.23: Rudofsky (1965) Architecture without architects  
Figure 3.24: Oliver, Encyclopedia of vernacular architecture of the world  
Figure 3.25: Rudofsky (1965) Architecture without architects  
Figure 3.26: Solar Power, S.Behling  
Figure 3.27: Oliver, Encyclopedia of vernacular architecture of the world  
Figure 3.28: <http://ocw.mit.edu/index.htm>  
Figure 3.29: <http://www.alovelyworld.com>  
Figure 3.30: <http://www.pbase.com>

## Chapter 5

Figure 5.24: Ilja Sucker

## Chapter 6

Figure 6.1: <http://new-learn.info>  
Figure 6.2: <http://new-learn.info>  
Figure 6.3: Screenshot – Climate Consultant 5.0  
Figure 6.4: Screenshot – Climate Consultant 5.0  
Figure 6.5: Screenshot – Climate Consultant 5.0  
Figure 6.6: Screenshot – Climate Consultant 5.0  
Figure 6.7: <http://designadvisor.mit.edu/design>  
Figure 6.8: <http://designadvisor.mit.edu/design>  
Figure 6.9: <http://designadvisor.mit.edu/design>  
Figure 6.10: <http://designadvisor.mit.edu/design>  
Figure 6.11: <http://designadvisor.mit.edu/design>  
Figure 6.12: Transsolar

## Chapter 7

Figure 7.10: Leonie van Ginkel  
Figure 7.11: Leonie van Ginkel  
Figure 7.12: Leonie van Ginkel  
Figure 7.13: Leonie van Ginkel  
Figure 7.14: Leonie van Ginkel  
Figure 7.15: Leonie van Ginkel  
Figure 7.16: Leonie van Ginkel  
Figure 7.17: Leonie van Ginkel  
Figure 7.18: Leonie van Ginkel  
Figure 7.23: Leonie van Ginkel  
Figure 7.28: Illustration Solarlux Bissendorf concept imagine envelope  
Figure 7.29: SOLARLUX / SL Co2mfort  
Figure 7.30: Illustration Solarlux Bissendorf concept imagine envelope  
Figure 7.31: SOLARLUX / SL Co2mfort  
Figure 7.32: SOLARLUX / SL Co2mfort

# Bibliography

- U. Pottgiesser, U. Knaack, M. Bilow Hrsg.: „fassade2005 – Energie – Material – Konstruktion Tagungsband, Detmold, 10/2005
- U. Pottgiesser, U. Knaack, M. Bilow: „Technologietransfer in Richtung Architektur“ in DBZ 11/2005
- M. Bilow, J. Brackmann: „Ein Blob geht um die Welt“, in FH print 3/2006
- U. Knaack, M. Bilow: „Pneumatische en vacuümversterkte constructies – De mogelijkheden van lucht“ in Bouw IQ 7/2006
- U. Pottgiesser, U. Knaack, M. Bilow Hrsg.: „fassade2006 – Sanierung und Erneuerung“ Tagungsband, Detmold, 10/2006
- M. Bilow: „Haarfeine Kunststoffäden: 3D – Prototyping“, in FH print 1/2007
- U. Knaack, M. Bilow: „Vezelversterkt beton – Modulair en zelfdragend gevelement“ in Bouw IQ 2/2007
- T. Auer, M. Bilow: „Die Nutzung regenerativer Energien – Integrative Planung ist gefragt“ in DBZ 7/2007
- U. Knaack, M. Bilow: „Experimentelle Forschung in der Lehre“ FH News 4/2007
- U. Knaack, T. Klein, M. Bilow, T. Auer: „Prinzipien der Konstruktion – Fassaden“ Birkhäuser, Berlin 2007
- U. Knaack, T. Klein, M. Bilow, T. Auer: „Principles of Construction – façade“ Birkhäuser, Berlin 2007
- M. Bilow: Glaswelt, „Internationale Fassaden“ 07/2008
- M. Bilow: German Construction Industry: 01/2008 „International Façades
- M. Bilow: „Fassade International – Anforderungen an Fassaden in verschiedenen Klimazonen“, Fassadentechnik 03/2008
- M. Bilow: IndustrieBAU Architektur, Technik, Management, „Industriefassaden – Ungenutzte Potenziale“, Ausgabe 4/2009
- U. Knaack, T. Klein, M. Bilow, T. Auer: „Principles of het Construeren – gevels“, Sun Architecture, Amsterdam 2011
- U. Knaack, T. Klein, M. Bilow: „Imagine 01 - Façades“ 010 Publisher, Rotterdam 2008
- U. Knaack, T. Klein, M. Bilow: „Imagine 02 - Deflateables“ 010 Publisher, Rotterdam 2008
- U. Knaack, T. Klein, M. Bilow: „Imagine 04 - Rapids“, 010 Publisher, Rotterdam 2010
- M. Bilow: Article: „Pushing the envelope – workshop publication“, Copenhagen 2011
- U. Knaack, T. Klein, M. Bilow: „Imagine 03 – Performance Driven Envelope“, 010 Publisher, Rotterdam 2011
- M. Bilow: Expertpanel Flatgevels – Renovatie, Stedebouw & Architecture, Magazine No 10/2011
- U. Knaack, T. Klein, M. Bilow: „Imagine 05 – Energy“, 010 Publisher, Rotterdam 2011
- M. Bilow: Detail Research, „Positionen zur Zukunft des Bauens“, book article „Motivation, Hintergründe und Strategien zu Forschungsprojekten aus Herstellersicht“, Detail Verlag, München 2011



# Curriculum Vitae



## **Dipl. Ing. Marcel Bilow**

1976 Born in Bielefeld, Germany

1996 - 1999 Apprenticeship as a bricklayer

1999 Study in architecture at the Hochschule OWL / Detmold

2001 Co-founder of the architecture office raum204

2004 Diploma Architecture

2004 - 2008 Chair „Entwerfen und Konstruieren“  
Prof. Dr. U.Knaack / Hochschule OWL

since 2006 Member of the Façade Research Group / external phd researcher /  
TU Delft

Since 2008 Phd researcher / Chair „Design of Construction“ /  
Prof. Dr. U. Knaack / TU Delft

2008 Co-founder imagine envelope b.v.

### **Contact:**

[bilow@imagine-envelope.eu](mailto:bilow@imagine-envelope.eu)

[www.imagine-envelope.eu](http://www.imagine-envelope.eu)

[www.imagineblog.tumblr.com](http://www.imagineblog.tumblr.com)



# References

- ASHRAE (2004) ASHRAE Standard 55-2004: Thermal environmental Conditions for Human Occupancy, Atlanta, ASHRAE.
- ASHRAE (2006) International Weather for Energy Calculations, Atlanta, ASHRAE.
- AUER, T. & BILOW, M. (2007) Die Nutzung regenerativer Energien – Integrative Planung ist gefragt. DBZ, 7.
- B. MAHLER, R. H., C. SILBERGER, C. MATT (2008) DeAl Evaluierung dezentraler außenwandintegrierter Lüftungsgeräte. IN FORSCHUNGSZENTRUM, S. (Ed. Stuttgart.
- BALS, W. & HARMELING, M. (2007) Klimawandel und Ernährungssicherheit, Trends und zentrale Herausforderungen. <http://germanwatch.org/klima/klimern07.pdf>.
- BEHLING, S., BEHLING, S. & SCHINDLER, B. (1996) Sol power; the evolution of solar architecture, München, Prestel.
- BERLIN, C. O. (2005) [www.berlin.de](http://www.berlin.de). Berlin.
- BRACKMANN, J. (2006) Internationale Planungsstrukturen, Detmold, Diplom Thesis
- BUNDESANSTALT FÜR ARBEITSSCHUTZ UND UNFALLFORSCHUNG (1979) Arbeitsstätten; Arbeitsstättenverordnung - ArbStättV - und Arbeitsstätten-Richtlinien - ASR -; Stand November 1979, Bremerhaven, Wirtschaftsverlag NW.
- DANIELS, K. (1999) Technologie des Ökologischen Bauens; Grundlagen und Massnahmen, Beispiele und Ideen Klaus Daniels, Basel, Birkhäuser.
- DE DAER, B. (2002) Thermal comfort in naturally ventilated buildings: revisions to ASHRAE Standart 55.
- DE DAER, B., COOPER (1997) Developing an adaptive model of thermal comfort and preference - Final Report. ASHRAE.
- DIN (1994-01) DIN 1946-2 Raumlufttechnik; Gesundheitstechnische Anforderungen. IN DIN (Ed. ENERGY, U. S. D. O. (2008) Weather Data Sources.
- FANGER, P. O. (1982) Thermal comfort; analysis and applications in environmental engineering, Malabar Florida, Krieger Publishing Company.
- GREG KATS, L. A., ADAM BERMAN (2003) The Costs and Financial Benefits of Green Buildings. Lawrence Berkeley National Laboratory.
- HEGGER, M., FUCHS, M., STARK, T. & ZEUMER, M. (2007) Energie Atlas - Nachhaltige Architektur, Berlin, Birkhäuser.
- HELLWIG, R. T. (2005) Thermische Behaglichkeit - Unterschiede zwischen frei und mechanisch belüfteten Bürogebäuden aus Nutzersicht. München, TU München.
- HEUSLER, W. (2007) Außenhaut. facade 2007. Detmold.
- HILDEBRAND, L. (2008) Diploma thesis / Material und Energie - Ökobilanz in der Architektur, Detmold, Detmolder Schule.
- HINDRICH, S. D. U., DANIELS, K. & BERTHOLD, S. (2007) plusminus20\02DA/40\02DAlatitude sustainable building design in tropical and subtropical regions, Stuttgart, Menges.
- KNAACK, U. (2003) Konstruktiver Glasbau 1, S.I., S.n.
- KNAACK, U., KLEIN, T. & BILOW, M. (2007) Façades principles of construction, Basel, Birkhäuser.
- KNAPP, R. G. (2000) Chinas Old Dwellings, Honolulu, University of Hawaii Press.

- KOHLMAIER, G. & SARTORY, B. V. (1981) DAS GLASHAUS; ein Bautypus des 19. Jahrhunderts, München, Prestel.
- M. WEBS, T. D., J. CHRISTOFFER (2004) Testreferenzjahre von Deutschland für mittlere und extreme Witterungsverhältnisse TRY, DWD Deutscher Wetter Dienst - Klimastatusbericht 2004.
- MCKNIGHT, T. L. & HESS, D. (2000) Physical geography a landscape appreciation - virtual field trip edition by Tom L. McKnight and Darrel Hess, Upper Saddle River, Prentice-Hall.
- MEADOWS, D. H., MEADOWS, D. L. & RANDERS, J. (1972) The limits to growth; a report for the Club of Rome's project on the predicament of mankind, New York, New American Library.
- MICROSOFT (1997) Microsoft Encarta 98 Enzyklopädie, Unterschleißheim, Microsoft
- NEEF, E. (1956) Das Gesicht der Erde, Leipzig, Brockhaus.
- NIJSSE, R. (2008) The future envelope 2, conference. Delft, EOS.
- OLIVER, P. (1997a) Encyclopedia of vernacular architecture of the world. Vol. 1. Theories and principles ed. by Paul Oliver, Cambridge, Cambridge University Press.
- OLIVER, P. (1997b) Encyclopedia of vernacular architecture of the world. Vol. 2. Cultures and habitats ed. by Paul Oliver, Cambridge, Cambridge University Press.
- OLIVER, P. (1997c) Encyclopedia of vernacular architecture of the world. Vol. 3. Cultures and habitats ed. by Paul Oliver, Cambridge, Cambridge University Press.
- OLIVER, P., VELLINGA, M. & BRIDGE, A. (2007) Atlas of Vernacular Architecture of the Worlds, Abingdon, Routledge.
- RAUMLUFTTECHNIK, N. H. U. (2007) DIN EN 15251: Eingangparameter für das Raumklima zur Auslegung und Bewertung der Energieeffizienz von Gebäuden EN 15251:2007.
- RUDOLFSKY, B. & MUSEUM OF MODERN ART (1965) Architecture without architects; a short introduction to non-pedigreed architecture, New York, Museum of Modern Art.
- SCHÜTZE, T. & WILLKOMM, W. (2000) Klimagerechtes Bauen in Europa. IN ARCHITEKTUR, F. (Ed. Hamburg, Fachhochschule Hamburg.
- SIEMENS (2001) Das h,x-Diagramm Aufbau und Anwendung, Frankfurt am Main.
- STULZ, R. (2007) Die 2000 Watt Gesellschaft. Archplus, 10.
- TROX (2009) The art of handling air.
- VDI (1994) VDI-Richtlinie 3789 Blatt 2: Umweltmeteorologie - Wechselwirkungen zwischen Atmosphäre und Oberflächen Berlin Beuth-Verlag.
- VELLINGA, M., OLIVER, P. & BRIDGE, A. (2007) Atlas of Vernacular Architecture of the Worlds, Abingdon, Routledge.
- WIKIPEDIA (08.08.2010) <http://de.wikipedia.org/wiki/Ölkrise>.
- WILLIAM FISK, S. K. (2002) The Role of Emerging Energy Efficient Technology in Promoting Workplace Productivity and Health - Final Report.
- WWW.BOMA.ORG (1999) What Office Tenants Want.





