

Subsurface Equilibrium

Transformation towards synergy in construction of urban systems

Hooimeijer, Fransje; Rizzetto, Francesca; Acheilas, Ian; ter Heijden, Wouter; de Vette, Kees; von der Tann, Loretta; Durand Lopez, Leyden

Publication date

2020

Document Version

Final published version

Citation (APA)

Hooimeijer, F., Rizzetto, F., Acheilas, I., ter Heijden, W., de Vette, K., von der Tann, L., & Durand Lopez, L. (2020). *Subsurface Equilibrium: Transformation towards synergy in construction of urban systems*. Delft University of Technology.

Important note

To cite this publication, please use the final published version (if applicable).
Please check the document version above.

Copyright

Other than for strictly personal use, it is not permitted to download, forward or distribute the text or part of it, without the consent of the author(s) and/or copyright holder(s), unless the work is under an open content license such as Creative Commons.

Takedown policy

Please contact us and provide details if you believe this document breaches copyrights.
We will remove access to the work immediately and investigate your claim.

Subsurface Equilibrium 006

Transformation towards synergy in construction of urban systems

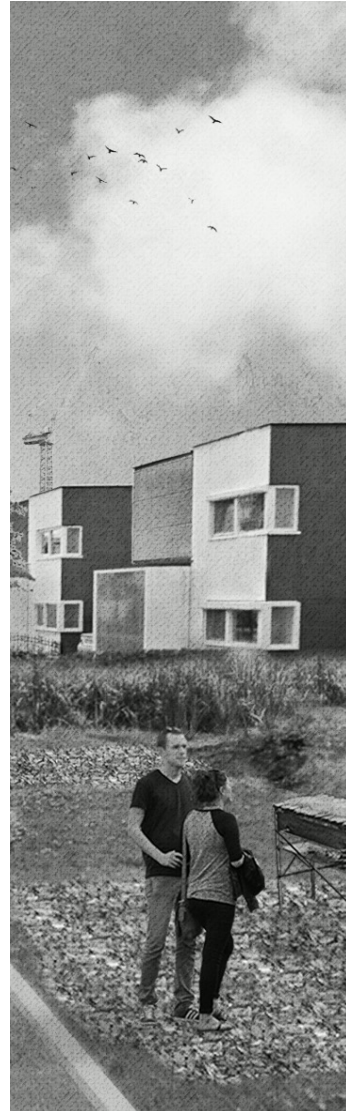

Colophon

Editors:

Fransje Hooimeijer
Francesca Rizzetto

Authors:

Fransje Hooimeijer
Francesca Rizzetto
Ian Acheilas
Wouter ter Heijden
Kees de Vette
Loretta von der Tann
Leyden Durand Lopéz

Graphic design:

Wouter ter Heijden
Leyden Durand Lopéz

Layout:

Sam van Hooff

Delft University of Technology (TUD)

Faculty of Architecture and the Built Environment
Department Urbanism
2628 BL Delft
Postbus 5
2600 AA Delft
The Netherlands

Delft Research Initiative Infrastructures & Mobility (**DIMI**)

Delft Infrastructures & Mobility Initiative
Postbus 5048
2600 GA Delft

Delft, May 2020

Index

Preface and reading guide

PART 1 - Design methodology SUBSURFACE EQUILIBRIUM	5
Introduction	5
Six step design approach	6
Design concepts	14
PART 2 - Design research and methodology SUBSURFACE EQUILIBRIUM	22
1 Introduction	23
1.1 Material informed design	24
1.2 Research design	25
2 Urban Metabolist Hunger	27
2.1 Modern Holistic Sustainable Design Approaches	27
2.2 Urban mining	29
2.3 Estimation and analysis of the urban material stock	30
2.3.1 Method and approach	30
2.3.2 Modelling methodology	31
2.3.2.1 Buildings material stock	33
2.3.2.2 Sand filling	37
2.3.2.3 Road construction	39
2.3.2.4 Cables and pipes	41
2.3.2.5 Biomass from green space	42
2.4 The materials opportunity	44
2.4.1 Recycled concrete	45
2.4.2 Recycled aggregates from construction and demolition activities	46
2.4.3 Metals	46
2.4.4 Asphalt	46
2.4.5 Excavated sand and soil	47
3 Synthesis and design	48
3.1 Resilient infrastructure	48
3.2 Redesign with material flow	50
3.3 Six step design approach & 15 design samples overview	51
4 Perspective from healthy soil	52
4.1 Methodologies	88
4.1.1 Gentle Remediation Options	88
4.1.2 Fertilization Maintenance Regime	88
4.1.3 Restoration original landscape: peat	93
4.1.4 Script 4. Maya system	98
4.2 Three different perspectives	101
4.2.1 50s Perspective new soil maintenance regime and approach	103
4.2.2 70s Fertile soil perspective	104
4.2.3 90s Clean soil perspective	106
5 Discussion	108
6 Conclusions	110
7 References	119
	120

Preface and reading guide

This report is the result of the research project **SUBSURFACE EQUILIBRIUM**, Transformation towards synergy in construction of urban systems, which was executed as part of the larger research project **FUTURE CITIES** initiated by the DIMI (Delta Infrastructure and Mobility Initiative) and BNA (Dutch Chamber of Architects). This research was a continuation of the research **RESILIENT INFRASTRUCTURE** which was part of the **HIGHWAY** and **CITY** project, also initiated by DIMI and BNA.

The first part of this report is presenting the design methodology **SUBSURFACE EQUILIBRIUM** which the result of both research projects. It beholds a six-step approach with sets of design concepts.

The background of this methodology can be found in the Resilient Infrastructure report and is presented in Part II of this report.

PART 1

Guidelines of results SUBSURFACE EQUILIBRIUM

Introduction

The city of the future is a circular city in which the condition of the soil is crucial to liveability and to the successful achievement of necessary transitions. Given the present condition of the soil in the Netherlands, a structured approach is needed to restore balance between subsurface and surface. By jointly approaching the challenges we face – such as ongoing urbanization, climate change, energy transition and the introduction of new mobility such as automated and electric vehicles – urban areas can be made more resilient. The subsurface of the city can play a central role in this, for instance by using space made available by a different use of infrastructure for the ecological and functional improvement of the city. The subsurface is the ‘engine room’ of the city. It consists of the natural system of soil, water and ecosystems, but also of man-made constructs such as foundations, cables and pipes and underground space. The subsurface is often plagued by subsidence, contamination, damage to infrastructure and a shortage of space for new urban systems. At the same time, the subsurface presents opportunities, as a fertile soil for green structures, for solutions for water storage, reduction of heat stress and accommodation for decentralized energy systems. In order to combine ecosystem services, climate and urban systems in a single design that accounts for the dynamics of the subsurface, it must be seen as an integral element of spatial planning and design.

A ‘healthy’ soil supports plant and animal life, biodiversity. A healthy soil accommodates the water system and works as a filter and improves air quality by capturing particulates, all of which makes it a crucial prerequisite for health in general. Producing ‘healthy soils’ requires decontamination in cases of contamination and regeneration in cases of degeneration.

Urban soils are often contaminated by erstwhile industries or by the introduction of contaminated soil. Degenerated soils may be the result of the addition of sand to the public space in order to counter subsidence, a common practice in the Netherlands, or of overexploitation through poor land management.

The future of the city demands soil that is and remains healthy. This perspective produces a fundamentally different design of urban patterns and also leads to a fundamentally different maintenance of urban public space, as well as a different way of dealing with subsidence. This will be less constructed and will anticipate the dynamics of the soil and the performance of the ecological systems of the original landscape more. In other words, ecosystem participation.

Six step design approach

This six-step design approach aims at integrating challenges of climate change, energy transition, new mobility while at the same time reduce and re-use of materials and using healthy soil as central perspective. This combination is done by integrating the material flow analysis in the design process which functions as an assessment (material flow design assessment) to evaluate and to improve the designs.

The design approach is developed by fundamental explorative design research taking three urban typology samples as basis: 1950s, 1970s and 1990s. Here the 1950s are presented as example, the other examples can be found in part II of this report.

Six step design approach

Step one

Analysis of the original situation of the case area.

General

Qualitative

- Typological
- Social-spatial issues
- Environmental issues
- Spatial context and quality

Quantitative

- Land-use (occupation, infrastructure, green)
- Surfaces (buildings, paved, open soil, water etc)
- Functions (housing, supermarket, school, office, industry)

Example Dike 1950s

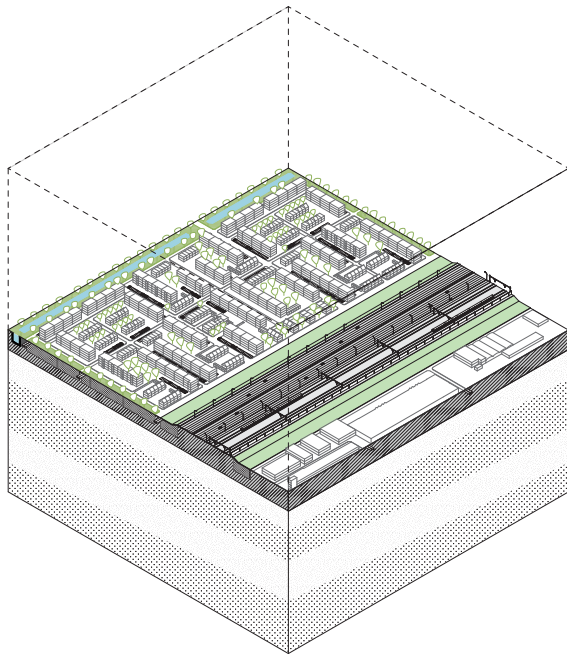

Urban Typology 1950s

Post War '50s urban sample is characterized by a strong and clear idea about what the 'public realm' was to enhance social coherence, expressed in oversized public space, mixed typology of housing in a repetitive stamp. Industrial production and very technocratic approach in which the buildings are prefab, building site preparation by hydraulic filling, subsurface drainage and well-structured infrastructure network. Variety in housing types too low, maintenance issues in housing and public space, water quantity and quality issues. Solution could be more ground bound housing, more defined public space, more water surface. Sample 1 km²:

67,5% Residential area

6% 30-meter buffer zone on both sides

16,5% Industrial area

10% Highway & railway

Residential area

- 30% Built up (of which 50% flats (184x32 units) 30% family housing is 506 units) and 17% Utilities (offices 8%, school 3% and supermarket 6%)
- 44% Green space
(of which 30% private)
- 22% Infra (of which 5% parking spaces)
- 4% Water

Industrial area

- 60% Built up
- 5% Green space
- 31% Infra
- 4% Water

Characteristics

- Hydraulically filled with sand (2m)
- Industrial constructed buildings

Main characteristics	Post war 50's
Concepts	<ul style="list-style-type: none"> ▪ 'Neighbourhood Concept' where the city is built up out of units, the smallest unit is the living unit that determines the allotment principle. ▪ Strong and clear idea about what the 'public realm' was to enhance social coherence. ▪ Vague borders between public and private, semi-public and semi-private domain. ▪ Spatial confrontation of open space and mass.
Car infrastructure	High accessibility, high connectivity and tuned hierarchy in street: ore street, neighbourhood street, living street, living path hierarchy.
Housing blocks	Urban stamp of two or three housing typologies of which most housing slab, revenue houses, collective heating, industrial buildings, rental and social housing.
Public space	Introduction of green structure that is on city and district scale, with more public than private green and more of the same sorts, little differentiation.
Subsurface	Hydraulic filling, drainage systems, artificial water system.
Energy infrastructure	Gas + Electric, Heat + Electric
Energy potential	Low energy labels of housing
Waste water potential	Combined system, large green surface for higher infiltration rate, space for natural cleaning of grey water.
Societal and spatial issues or potentials	Variety in housing types too low, maintenance issues in housing and public space, water quantity and quality issues.
Utilities	Usually a centre with services, or close to city centre.
Solutions	More ground bound housing, more defined public space, more water surface.

Table 1. Design statements Dike 1950's

Step two

Analysis of the stock of the materials in the area

General

The progressive concentration of humans in urban areas is proportional to an increasing use of materials in the built environment. Urban construction activities are predominantly responsible for the consumption of primary materials that derive from natural stocks and produce massive amounts of waste. It has become, therefore, critical for cities to minimise their waste flows and extract value from existing man-made stocks. Construction and Demolition (C&D) waste contain a complex and heterogeneous mix of materials that are often recycled as an end-of-pipe solution. Nevertheless, recovering value from C&D waste is not a trivial problem in today's resource intensive urban structures. It is necessary to adopt a cradle-to-cradle approach where output flows are used as secondary resources. In this work, we design a circular material flow model that facilitates urban mining by incorporating the principles of a bottom-up Material Flow Analysis (MFA). First, MFA is applied herein as a tool to: (1) identify the largest material flows in the urban samples, (2) detect in which flows direct reuse of secondary materials is possible, (3) calculate the waste flows derived from the demolition of buildings. Second, we seek opportunities for recovery of the largest material flows that leave the system to support urban planners design a more circular built environment with improved recycling of materials.

Example Dike 1950s

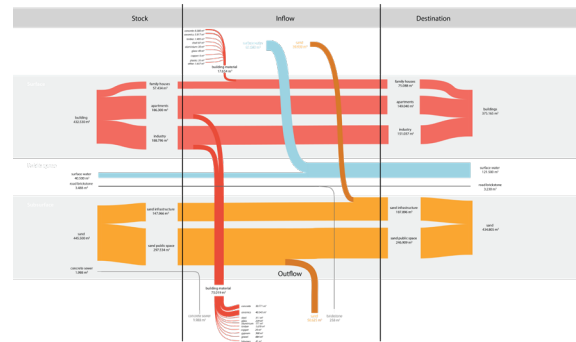

Material flow out

- Building material industrial buildings
- Soil from waterways
- Material sewer systems (concrete)
- Brick stone from private parking spaces

Material flow in

- Material for family housing
- Sand for road maintenance

8

Post-war	Surface [m ²]
Total surface	1.000.000
Built up surface	301.500
Unbuilt surface	698.500
Housing area	675.000
Family houses 1950s	66.825
Apartment blocks 1950s	101.250
Offices 1950s	16.200
Schools 1950s	6.075
Supermarket 1950s	12.150
Green public space	207.900
Private gardens	89.100
Infrastructure	141.075
Parking space	7.425
Water surface	27.000
Industrial area	165.000
Industries 1950s	99.000
Green space	8.250
Infrastructure	51.150
Water surface	6.600
Buffer zone	60.000
Highway	50.000
Railway	50.000

Table 2. Material inventory Dike 1950's

Step three

Redesign on the base of urbanization, mobility, energy and climate challenges

General

Programmatic demands (liveability)

- Building demand (densification)
- Mitigating (waste) water issues
- Energy transition
- Changing mobility effects
- Environmental impact
- Reducing heat impact
- Improve biodiversity

Example dike 1950s

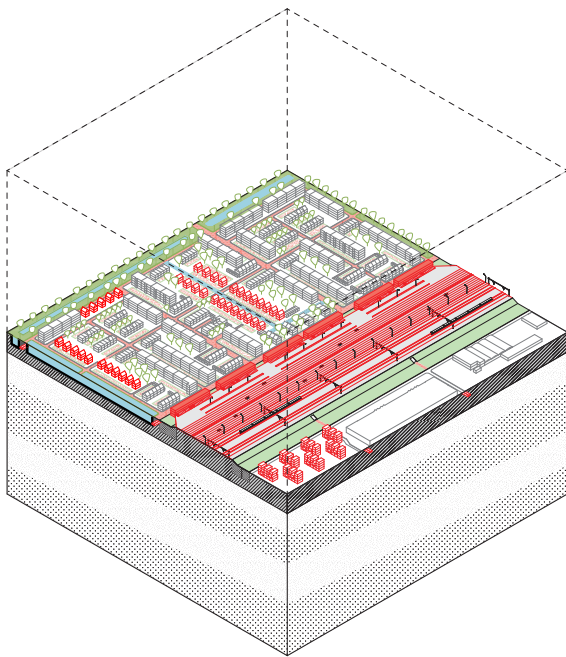

Ambitions

Healthy city: making inclusive by mixing social economical groups and diversification housing stock, programming public domain from mono to multifunctional.

New economy: mixing housing and industry (residential area ratio 80/20, industrial area 80/20), flexible usage, technical and social innovation, create new business models and entrepreneurship, create networks for business and public life.

Connectivity: new model split, highway and city connected, new parking scheme.

Climate adaptation: water storage, infiltration, reducing heat stress with green areas

Energy: generate energy in buffer and highway, take of gas.

Mobility: automated electrical cars as driver for new relation highway and city, redesign infrastructure.

Circularity: using material flows as a driver for a circular design by re-using or re-cycling the available materials.

Design

Potential to connect the highway to program in the buffer zone (N4 model) that is also used as inter-modality for people in the urban area and industrial space. The industrial area will remain 80% and 20% of the area will become residential. Cars are taken out of the area and charged in the buffer zone. The gardens and former parking placed are used for decentralized waste water treatment. In the residential area the water surface is increased to 8% and 20 % of the flat apartments are replaced by single housing. The increase of green and water is functional for storing water and heat stress reduction.

Step four

Analysis of the material stock

General

Again, the materials are studied but now of the new design to be able to see if choices could be made better (see step 2).

Recycled material flow

- Brick stone road from road can be used for new foundations and cladding
- Soil from singel and streets into moulds
- Outflow of building materials to moulds

Material flow in

- Building material inflow should be regulated by choosing modular or bio-based or recycled materials

Material flow cut

- Inflow of sand for building

Step five

Adaption of the design

General

In order to reduce or make the material flows as circular as possible design concept that anticipate on reuse of material are applied. See the next paragraph for the overview of the design samples.

New design interventions

Mould Landscape: the soil coming out of the excavation of the new singel and concrete and ceramics coming from demolished buildings is used for building moulds for new houses instead of adding sand to the whole area.

Re-use ARCH: materials are reused in in new housing.

Programming: Biomass plant

Example 1950s dike

Incoming circular-modular or biobased construction materials for new buildings

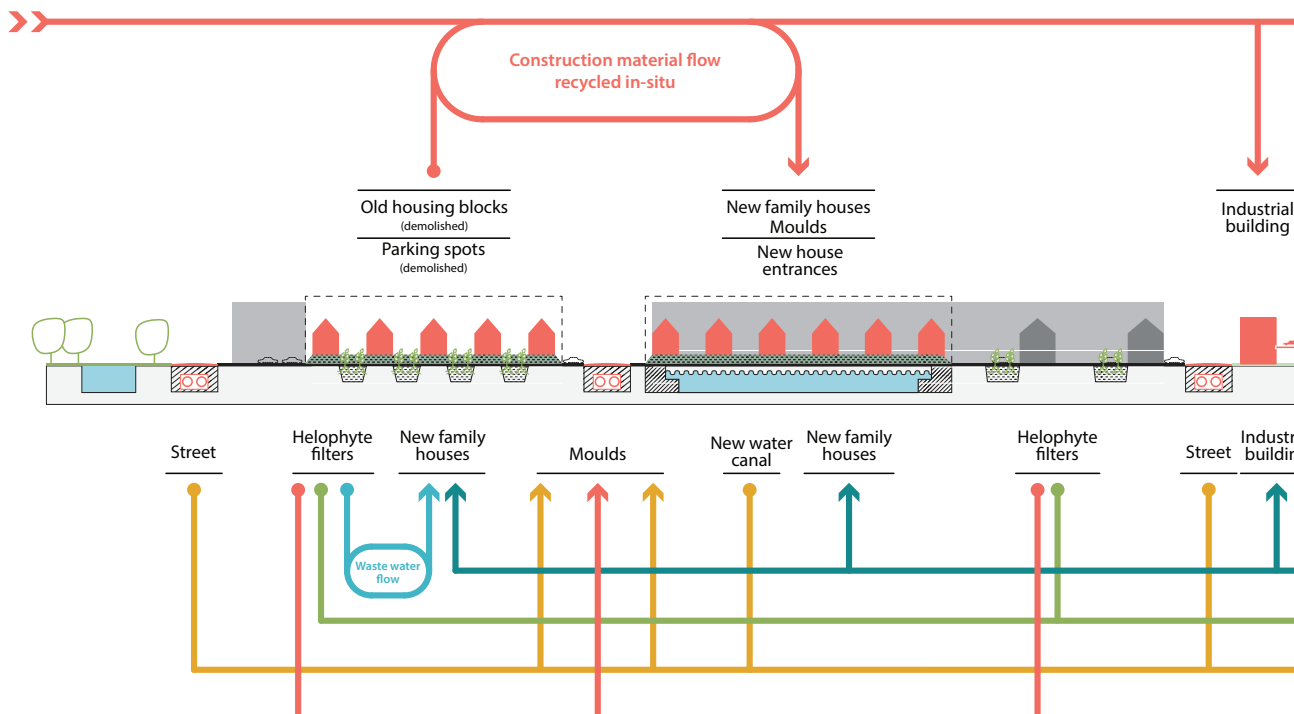

Example 1950s dike

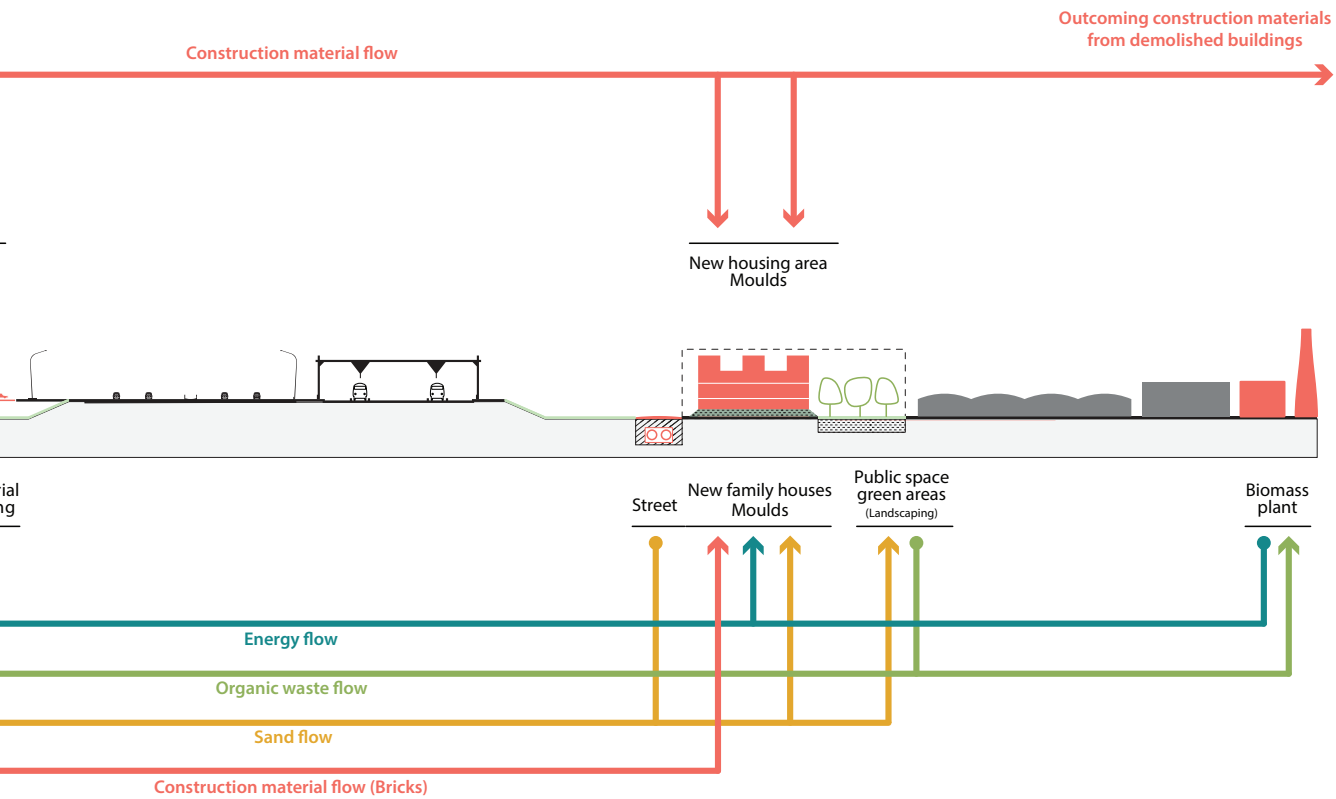
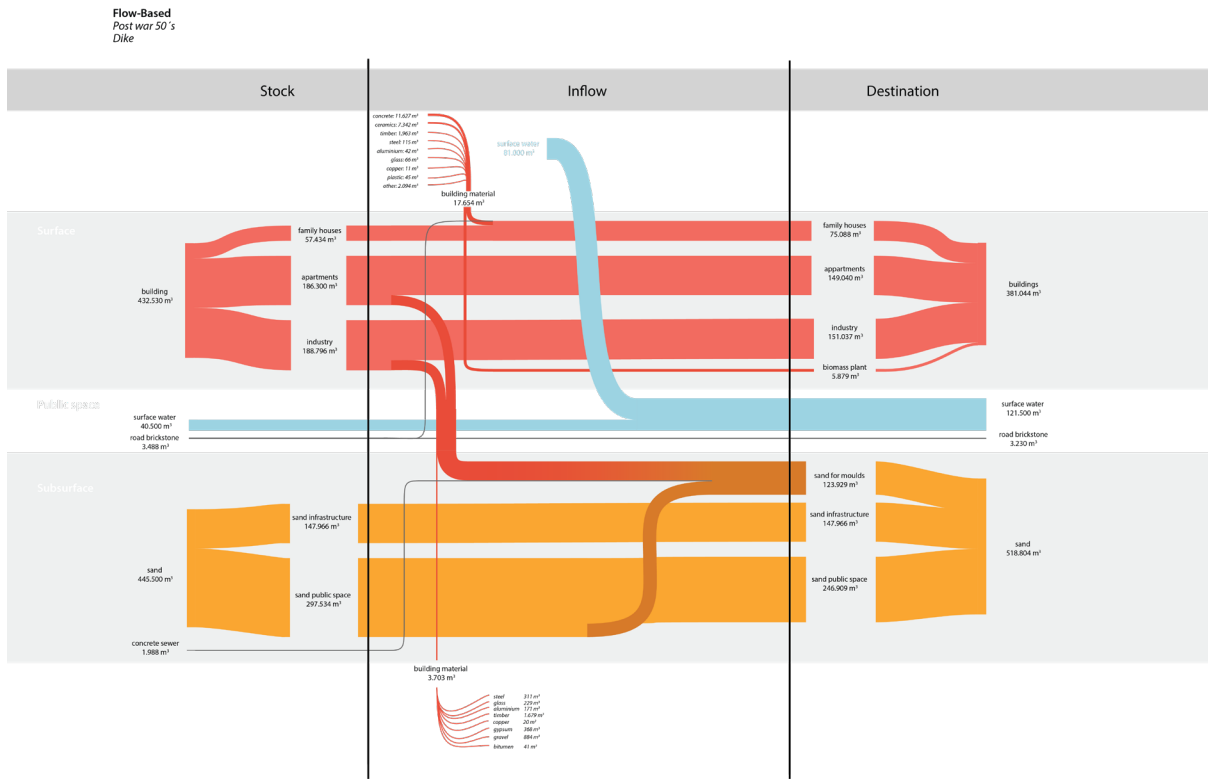

Step six

Redesign of public space

With the aim to restore the environmental health of the area the soil design concepts that improve degraded and polluted soils are used as the base of public space design which is executed in phases.

Example 1950s

Restored Landscape:

The subsidence is dealt with without adding sand to the area (as is usually done) and by stimulating the restoration of the endogenous ecological system.





Proposal by Wouter ter Heijden (urban design), Ivar Janmaat, Emmelie Janse and Jasmijn Kusters (TIL). They recycled Constant Nieuwenhuys's New Babylon concept as a strategy for urbanizing Alexanderknoop the Alexanderknoop in a renaturalized landscape (Hooimeijer, 2019)

Dutch post-war 1950s urban planning represents an ideal of the 'public realm' expressed in oversized public space and the implementation of mixed housing types. To deal with the soft and wet soil sand is added to the areas for stabilization and led to degraded soil conditions. We propose first to implement GRO to clean the soils and second to stop adding sand. The mitigation of subsidence is done by stimulating the restoration of the endogenous ecosystem and design the buildings on piles so that they can function with subsiding soils.

Subsidence Architecture: The growing height difference between buildings (stabilized on piles) and public space is solved in a new architectural typology.

Design concepts

The six-step design approach tested on the 15 samples makes use of various design concepts in different arrangements. The main groups of concepts that are presented here are:

- Mobility
- Infrastructure
- Water
- Soil
- Architecture
- Programming

Mobility design concept

These concepts are based in the technology of electrical and self-driving cars.

Cars in the area

The cars will still be parked near the houses and can be used at battery for the houses, they will be charged at the houses which mine sun or wind energy.

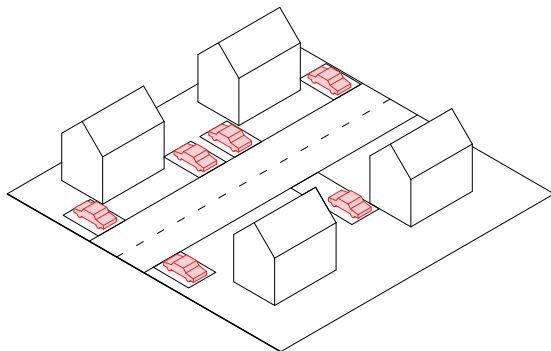

Cars out of the area

The cars will be taken out of the housing area and drive to collective carpark where they will be charged. The space of the parking place can be used for other functions like waste water treatment or growing crops.

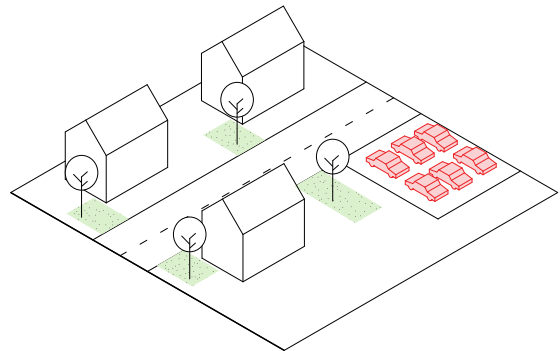

Infrastructure design concepts

These design concepts are aiming at the functional change to the hard infrastructure like highway and bridges.

N4 Model

Self-driving cars will be able to anticipate more on the flow of cars on the highway thus more exits and entrances become possible. The N4 model is referring the Belgium highway which has house addresses, individual exits. The model proposed more exits that then collectively have one entrance again. There multimodal transport systems can come together and commercial or industrial functions can be placed.

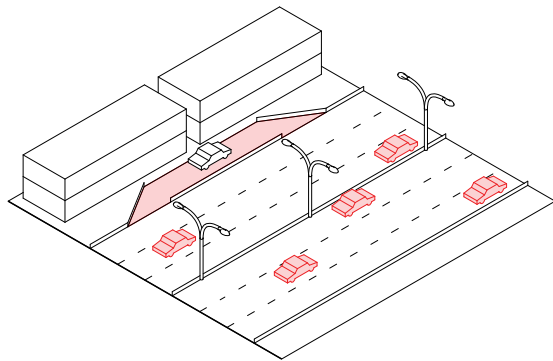

Circular and modular bridge

New bridges will be designed with material reuse and in modular systems that can then again be reused. RWS recently designed a circular bridge, it looks like a normal bridge but the end-of-life scenario is considered at the design phase¹.

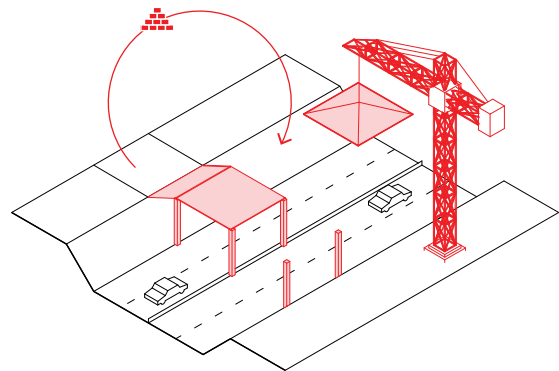

Ponte Rialto (Venice)

The materials coming out of the changes in buildings and public space (from within but also from outside the area) is used to construct an eco-commercial bridge.

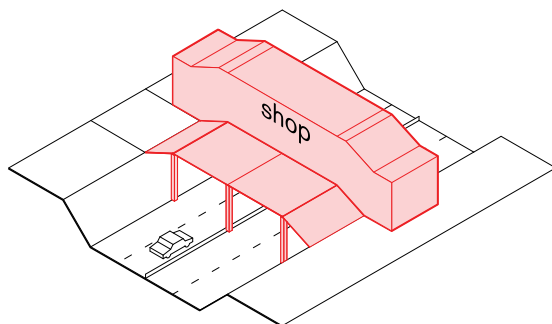

Eco Bridge

The materials coming out of the changes in buildings and public space (from within but also from outside the area) is used to construct an eco-bridge².

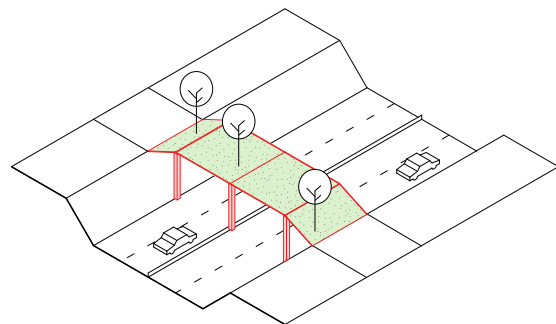

¹ <https://www.rijkswaterstaat.nl/nieuws/2018/10/bouw-circulair-viaduct-bij-kampen.aspx>

² <https://www.wur.nl/en/Dossiers/file/Wildlife-bridges.htm>

Energy design concepts

These concepts propose a system transition to the energy supply in the area.

Biomass plant

Organic waste (from households, sewer or public green structures) is collected in a biomass plant in which energy, heat and electricity is produced. There needs to be a specific balance between supply and demand. Example is biomass village Jünde in Germany.

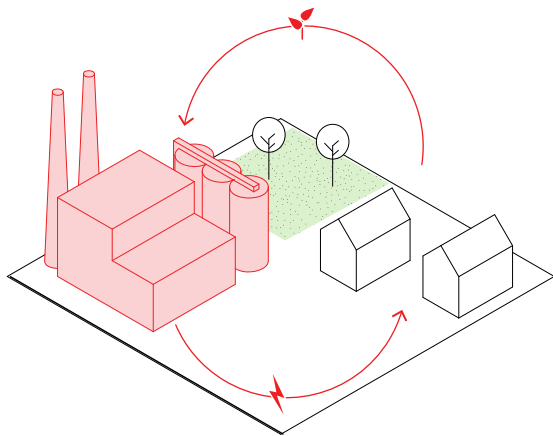

Producing electricity on the highway

Two methods of generating energy on the highway are under development. First is piezoelectric generation in which this material converts vibrations from passing vehicles into energy. The technology is based on a principle called the piezoelectric effect, in which certain materials have the ability to build up an electrical charge from having pressure and strain applied to them. The second is SolaRoad, or solar road, that was tested on a bicycle lane that connects Krommenie and Wormerveer on the outskirts of Amsterdam (opened in November 2014). The test track produces 70 kWh/m²/year and is more efficient than expected. It has indeed produced more than 3,000 kilowatt-hours of energy which is enough to power a single small household for one year.

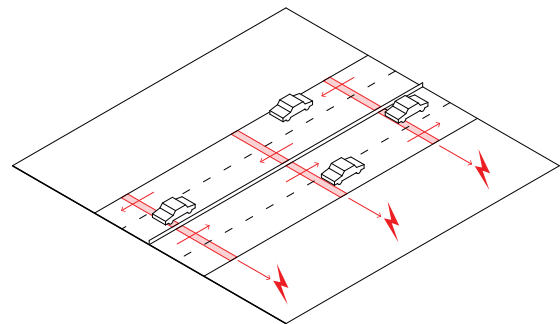

Option a: Electricity by piezoelectric effect

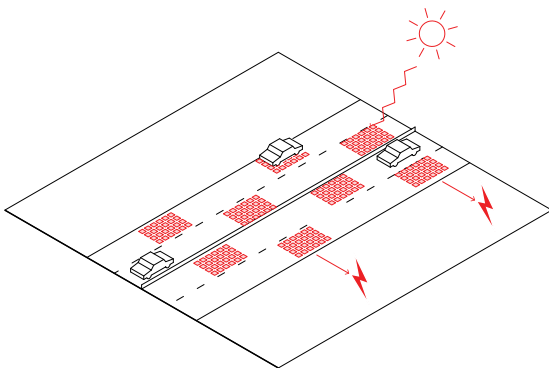

Option b: Electricity by solar panels

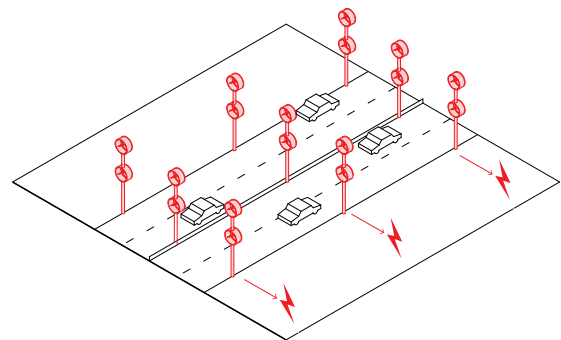

Option c: Electricity by windturbines

Water design concepts

These concepts include water treatment and other arrangements with water.

Den Bosch model

The Palace Quarter in Den Bosch has the largest solar water heater in the Netherlands: an elongated water basin stores the heat from the water in the soil in the summer and this heat is used in the winter for heating the apartments, offices and commercial spaces. Conversely, it also works: in the summer the offices are cooled with the stored winter cold. This system saves 25% in CO₂ emissions.

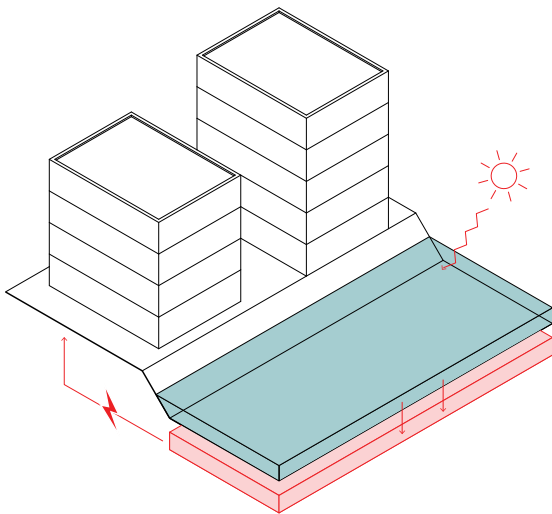

Decentralized waste water treatment

Waste water is collected in a large-scale sewer system that transports it to the waste water treatment plant. This also includes water that is coming from roofs and streets, which during severe rains storms can cause overflows from the sewer to the open water system. Besides the fact that this degrades the water quality, it is also quite costly to treat water that is not that polluted. Decentralized systems can treat water coming from road and roof, or grey water coming from the washing machines and showers, or black water from the toilet. These systems are natural reed beds, helophyte filters in combination with septic tanks.

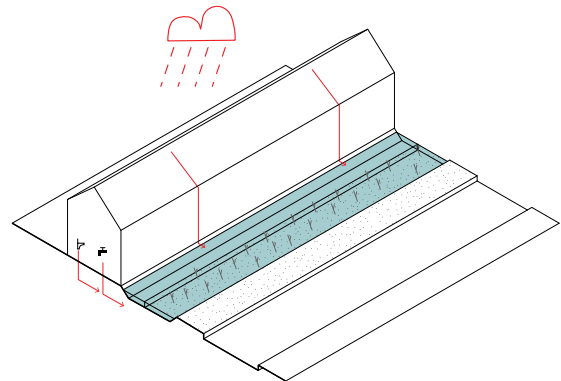

Soil design concepts

These design concepts are aiming for a better re-use of soils and material and also to restore polluted and degraded soils in the city.

Gentle remediation options

These are strategies to decontaminate contaminated soils in a natural way, using plants such as sunflowers or willows. The spatial effect and the functionality of growing plants contribute to the green quality of cities;

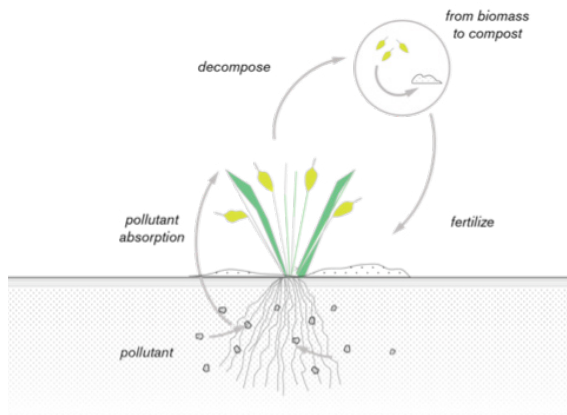

The healthy soil maintenance regime

This method is related to the concept of the 'woodland garden', in which a specific, circular ecosystem operates. This is based on the tree, which organizes its food chain (fallen leaves, along with other organic debris, decompose into the soil). On a greater scale, natural processes in a woodland garden take care of crop propagation, weed, pest and disease control, and pruning;

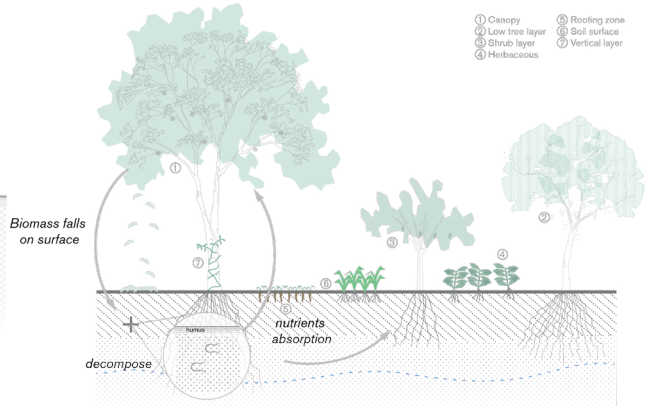

The Mayan concept

In Mayan culture, land management was highly integrated with occupancy patterns. In applying this method, habitation sites are surrounded by horticultural areas, and the use of the soil and water system is made circular at a higher level of scale as well.

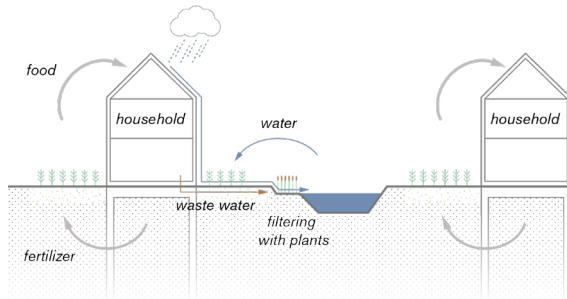

Deposit Landscape

The area is functionally landscaped for the temporary deposit of used material (soil, building material) and distribution. Here also industry and research into material re-use cycles are located.

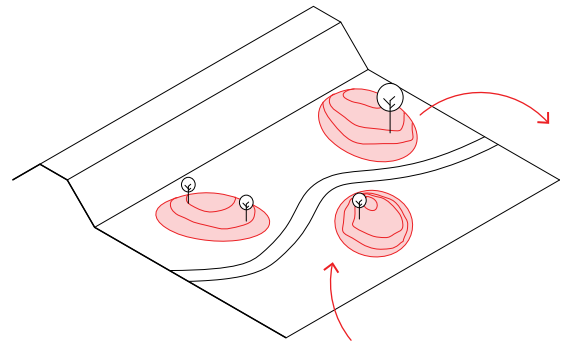

Mould Landscape

The soil coming out of the excavation of new waterways and concrete and ceramics coming from demolished buildings is used for building moulds for new houses instead of adding sand to the whole area.

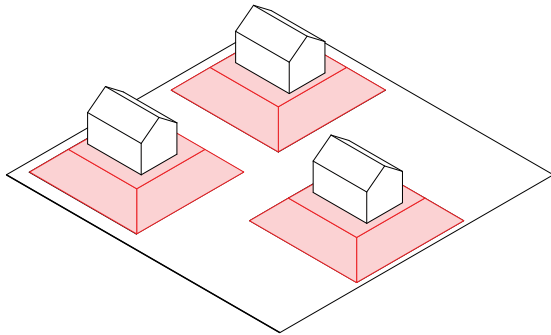

Restored Landscape

The subsidence is dealt with without adding sand to the area (as is usually done) and by stimulating the restoration of the endogenous ecological system. Restoring the original peat bog landscape. In many places the long-term water extraction has resulted in subsidence of the peat. In this method, we accept the subsidence and incorporate it as a design challenge in a maintenance regime that no longer relies on sand to raise soil levels. This will restore the landscape in the city to a more natural state and make the urban soil fertile again.

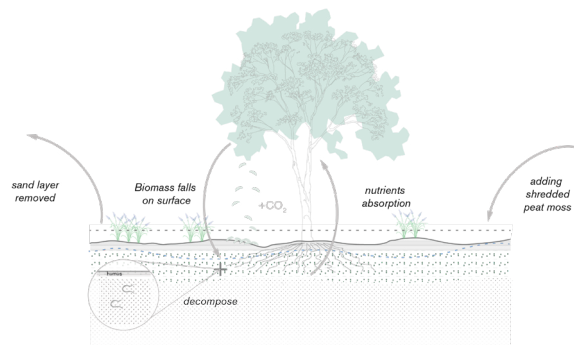

Architecture design concepts

These concepts relate to the impact choices on the larger scale have to the architecture in the area.

Subsidence Architecture

The growing height difference between buildings (stabilized on piles) and public space is solved in a new architectural typology.

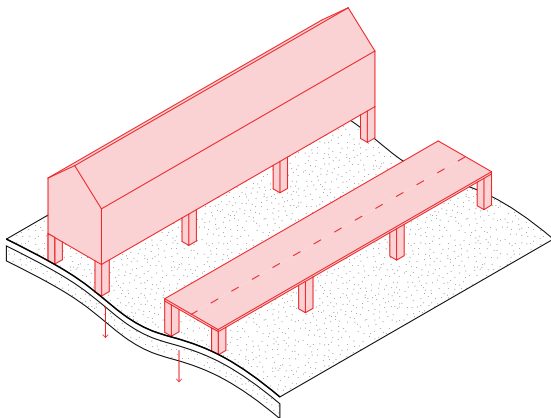

Re-use ARCH

Materials are reused in in new architecture typology.

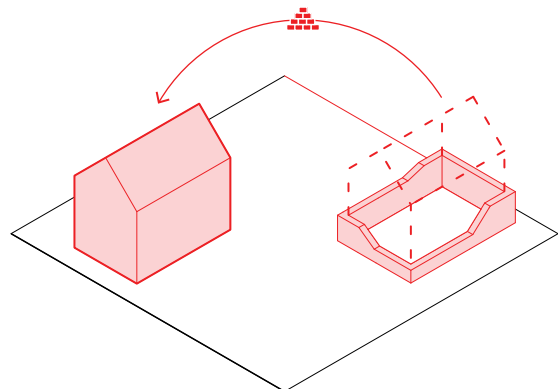

Programming design concepts

These concepts propose new programming perspectives for the area.

Flow facility

Newly introduced program that stimulates circularity like a biomass plant or recycling industry.

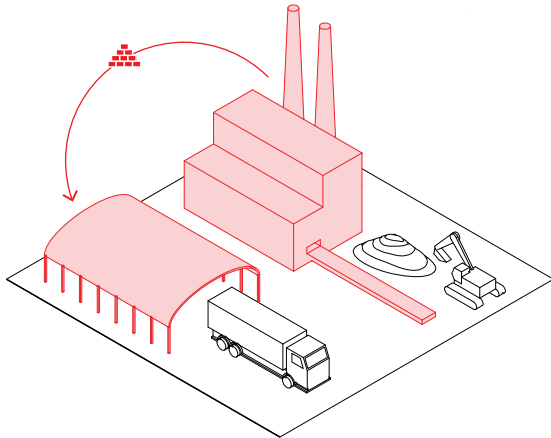

Switching program

New program is introduced that does not need intensive spatial alteration, like the change of the buffer zone to sports parks.

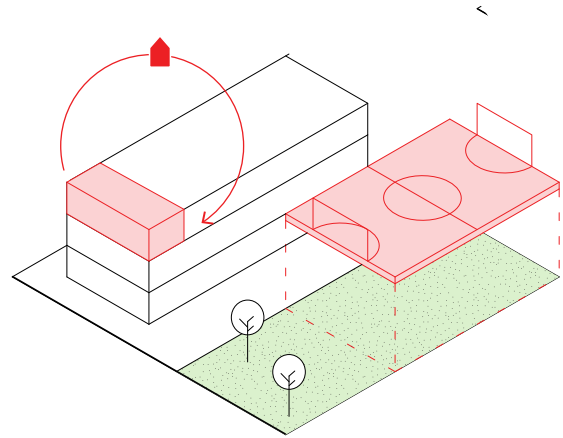

Refurbishment

New functions in old buildings, like the transformation of industrial buildings into housing.

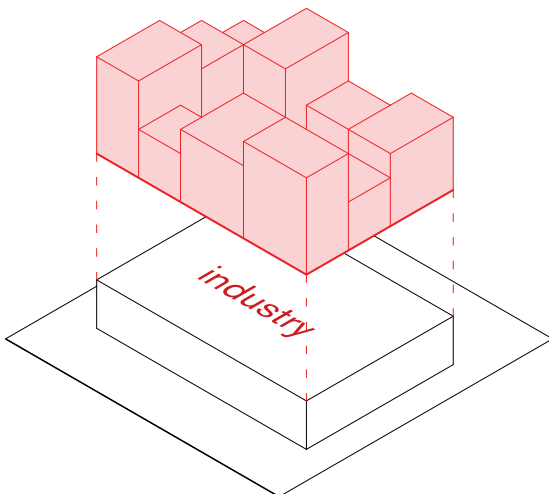

Building regulations

To stimulate modular and reusable materials in buildings for the future new projects need to meet these standards.

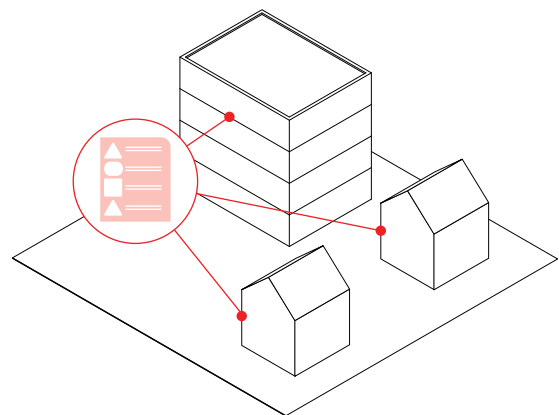

* A gradation in the degree of transformation is proposed from switching program <-> re-use arch <-> refurbishment. These differ in the degree of adjustments. The switching program has no material flows at all to hardly any material flows, the re-use arch only causes material flows from building material, but because the urban structure remains the same, there is no material flow in fill sand, asphalt or subsurface infrastructure. These steps correspond to the short cycles that, for example, the Ellen McArthur Foundation (but also other theories about circularity) present. This is partially integrated into the research part of this report)

Water regulations

To organize the water system bottom up the owners of houses will have to prove that they cannot store or reuse the rain water that fall on their lot, and need to apply for discharge to the sewer and pay. There will be regulation to the recovery of nutrients.

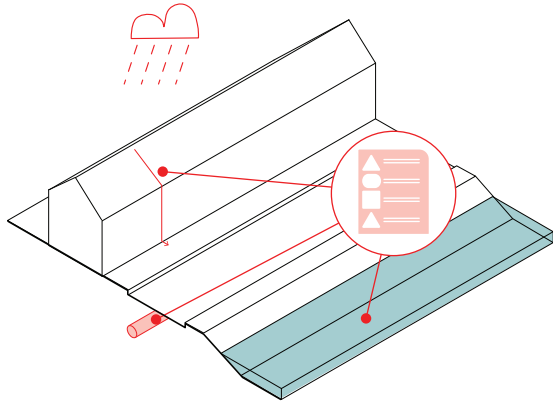

PART 2

Design Research and Methodology

SUBSURFACE EQUILIBRIUM

The results of the research are presented in this report but also available in two video's and has been presented in an exhibition. The fundamental explorative research that has been performed in the project Resilient Infrastructure resulted in an overview of the implementation on resilience topic into 15 combinations of urban typologies and highway prototypes. This project added the material informed design and design with methods that improve polluted and degraded soils as a part of the six-step design approach. In chapter two the methods of mapping materials and application of re-use in presented.

The synthesis and design of the six-step methods onto the 15 combinations is presented in chapter three. Chapter four explains the methods of improving polluted and degraded soil and the application in the design of public space of the three urban typologies. Finally, the discussion in which the results are reflected on and the conclusions on the potentials of designing with materials and aiming for healthy soils are presented.

Cities globally are dealing with trends of urbanization and new mobility, climate change and energy transition. More people move to cities and new forms of mobility like automated and electrical driving offer opportunities to make urban areas more resilient. This can be done by using infrastructure space for the ecological and functional improvement of the city that is needed for climate change adaptation, dealing with more water and more heat, and energy transition towards renewable energy.

'City of the Future' is a large study set up by the Delta Infrastructure Mobility and Infrastructure and Dutch Chamber of Architects in cooperation with the ministry and five municipalities.

The question central to the study is how transformation of inner cities can be designed and developed in an integrated manner to reach attractive and sustainable urban environment. The societal and local urgencies are urbanization, inclusiveness, new economy, climate adaptation and the transitions in energy, mobility, circularity and digitalization. This investigation is part of this project focussing on the potentials of the re-construction of three urban typologies and their potential futures taking into account to above mentioned issues.

In cities the subsurface is a hybrid space that is not only the home of the natural system made out of soil, water and ecosystems, but also supporting man-made constructions like foundations, cables and pipes or usable space. As the 'engine room' of the city it plays an important, if not crucial, role in the urban climate and global energy transition.

On one hand, the subsurface is associated with a variety of challenges such as subsidence, pollution, damage to infrastructure and shortages of space for new urban systems. On the other hand, the subsurface presents opportunities in terms of providing green structures, solutions for flooding, reduction in heat stress, and decentralized energy systems. Therefore, it is necessary to place subsurface issues in their appropriate perspective, to enable a more resilient design that brings together ecosystem services, climate and urban systems, and which takes full account of the dynamics of the subsoil. To achieve this, the subsurface must be an integral part of (above ground) spatial planning and design.

The quality and space for 'healthy soil' is of crucial importance in making cities healthy which is the focal point on thinking about Cities of the Future. This asks for regeneration of polluted and degraded soils and urban development that connects to soil and material cycles.

The anticipation on the global trends, inclusion of the subsurface and aim for healthy soils is explored in this project by performing fundamental research into specific urban typologies and test spatial strategies. These strategies are subjected to the equilibrium concept wherein the flow of materials and possibilities for urban mining is studied. The urban typologies are re-designed with the aim to reduce material flows and reduce materials in the public space as much as possible and achieve a healthy and high qualitative city design.

1.1 Material informed design

Subsurface Equilibrium is the idea to investigate how urban designs can be informed by flows of construction material connected to the subsurface. How would it change urban design if for defined urban samples the material flow would reduce and reused? What kinds of typologies, strategies and bottom-up initiatives would emerge?

Subsurface Equilibrium anticipates on the concepts of Zero Land Take and Compact City³ by focussing on re-use and recycling of the public and private urban construction of the subsurface in existing urban areas. The input from subsurface specialists is used to rethink the urban landscape as a result of synergies between subsurface elements and the (re) design of vital urban infrastructure. In current maintenance and renewal practice new materials are coming in - and waste is put out - of the constructed urban system. These flows are kept by habit and maintenance regimes that are not critically reflected onto. Also, the changing of urban systems is quite hard on investment and behaviour. In this project a method for decision and design is sought to make the material flows visible and to ask 'what if' the flows are mapped and reused to keep them inside a defined urban sample. This exploration is done in the Dutch setting, but the basic concept is transferrable and scalable to a range of settings.

The need for renewal in existing urban settings relates to the ambition to monitor and halt 'land take' – in the EU by 2015 (EC 2016). Zero land take requires to avoid or at least compensate for the loss of undeveloped land to human developments. As in our idea the amount of all materials in an "urban sample" shall be kept constant, applying this strategy to soil implies zero land take. It also relates to the idea of Compact City or 'city of short distances' is an urban planning and design concept, which promotes relatively high residential density with mixed land uses.

Especially important aspects of soil for the Netherlands and other deltaic areas is healthy soil and the dynamics of subsidence.

Human use of the earth has had either a polluting or degrading effect on the soils in cities. Interesting consequence is that soil scientist don't draw the soil in cities because of this unclear, mixed status, they only map soils outside of cities. The pollution can be coming from (historical) industries like the textile or gas factories, but also coming from cars like lead, rubber and oil. Degradation of soil happens to soils that are not managed properly and is overexploited or like is done in the Netherlands by the adding of sand to deal with unstable and wet soils. Healthy soil means that it supports plant and animal productivity, it maintains biodiversity, it has balanced water system of good quality, it supports air quality and with this it supports human health and habitation.

In delatideltaic areas and specifically the western part of The Netherlands natural and human induced subsidence occurs: the plates move down and due to pumping the peat landscape shrinks. This adds to the complications caused by climate change and transitional problems towards renewable energy. Subsidence puts pressure on maintenance budgets in urban areas because sand has to be added to public space continuous to keep it levelled with the entrances of homes and to stabilize the connection of the sewer to the dwellings. In addition, subsidence affects the water system: the groundwater level rises relatively and puts pressure on the natural and artificial water system.

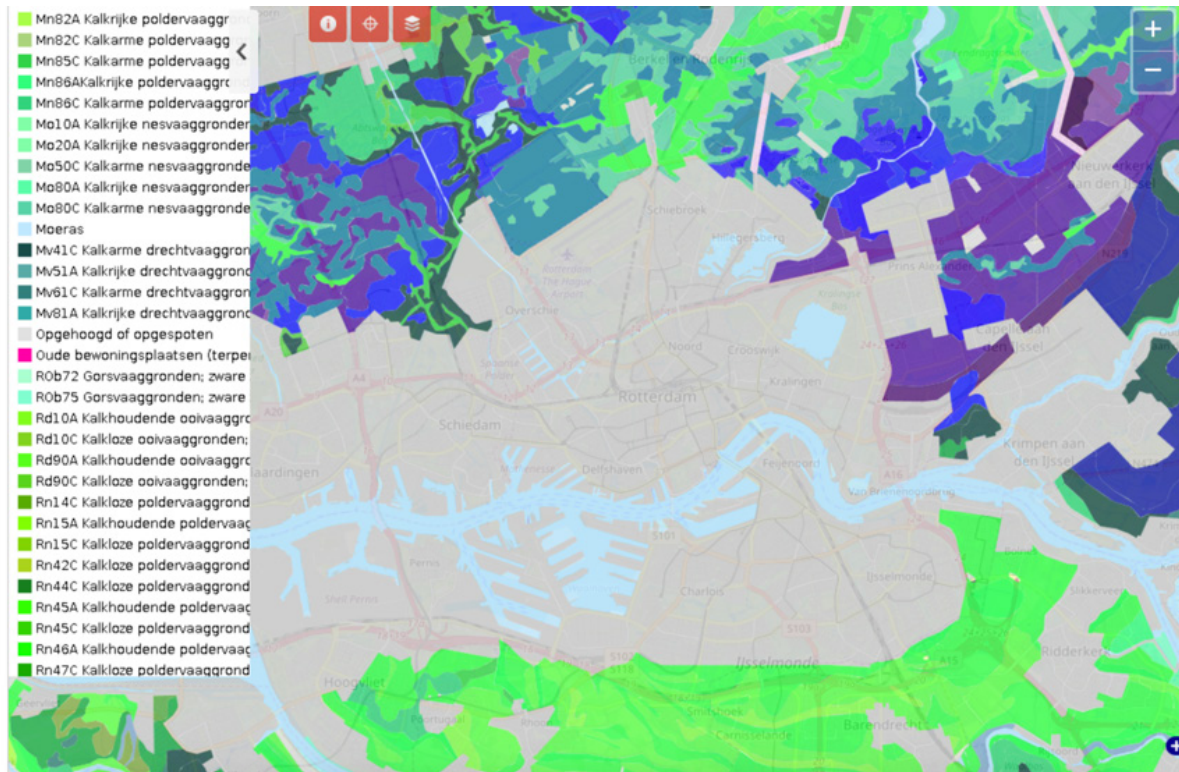

Figure 1.1 Soil map of Rotterdam⁴

In deltaic areas and specifically the western part of The Netherlands natural and human induced subsidence occurs: the plates move down and due to pumping the peat landscape shrinks. This adds to the complications caused by climate change and transitional problems towards renewable energy. Subsidence puts pressure on maintenance budgets in urban areas because sand has to be added to public space continuously to keep it levelled with the entrances of homes and to stabilize the connection of the sewer to the dwellings. In addition, subsidence affects

the water system: the groundwater level rises relatively and puts pressure on the natural and artificial water system.

In this project subsidence and healthy soil are made central by proposing to investigate the hypothesis of not adding sand to the area (as is usually done) and by stimulating a new constructed ecological system as the main strategy of urbanization. This approach beholds long term environmental processes and circular construction to try to foster interdisciplinary integration.

1.2 Research design

Main question tackled in the proposal is: which synergies can be found when the design of new urban systems is based on circular material flows? The answer to this question is the approach applied to see the city as a construction in which materials can flow from one to another component. Secondly, the need

to have a proper understanding in how circular material flow influences public and private roles connected to construction development. The aim for circularity in buildings, greenery, soil, water and infrastructure material flows is the driving force in the design proposal. The flow of materials come from demolished buildings, road

⁴ <http://geoplaza.vu.nl/data/dataset/bodemkaart-van-nederland/resource/d2dd4e10-b5d8-4191-877e-22f9a0cf4e6a>

re-constructions, waste from households and green structures, and the reuse of (remediated) soils; the flow of sand to public space is halted. To direct the flows differently and keep them in the area the following questions are posed:

- In the Netherlands streets, public space and gardens are raised due to subsidence, what if this flow can be stopped and solved differently?
- Roads are well maintained but due to new mobility the profile of the roads will change, what kind of material flow does this delivered? How can we design with this flow?
- We now have a centralized sewer and energy system, these systems may change to detached systems, how can we reuse the pipes and cables for future design?

In addition to the fact that bridges are needed between engineering and design, also maintenance regimes need to be integrated in urban renewal over a longer period of time. As proposed by the Long Now Foundation⁵ our time frame is currently so short that we miss out on long term opportunities. The Long Now

Foundation hopes to provide a counterpoint to today's accelerating culture and help make long-term thinking more common. When looking at time in a different way other options of maintenance become available like one example of the beams in the roof of the College of Oxford. When the building was built 500 years ago, a local oaks nursery was created, this small forest would become useful to replace the deteriorated beams 500 years later⁶.

The proposal here presented is built on the results of the Resilient Infrastructure project (Hooimeijer, F.L. & Rizzetto, F. (eds.), 2017) in which the effects of the trends in temperature, automation, demographics and resources were investigated and projected to the redesign of typical urban samples. The (so named future) scenarios are mapped according to material flows and re-designed by Material Informed Design. Three of these design-samples were chosen to deeper explore the circularity in the design of public space, specially taking healthy soil as most important aim for urban redevelopment. In these designs the public and private stakeholders' responsibilities are getting a central meaning in order to be able to explain 'purpose' as the new P in the triple bottom line, in which prosperity in not monetary but in it is a new value in the integrated system meaning.

⁵ <http://longnow.org>

⁶ <https://www.atlasobscura.com/places/oak-beams-new-college-oxford>

⁷ Hooimeijer FL, Rizzetto F (eds.) (2017) Resilient Infrastructure and Environment. Spatial operation perspective. Delft: University of Technology. See: [uuid:c32c3349-e76e-4139-a070-a102f2382522](https://doi.org/10.1007/978-94-007-5222-2)

This chapter is dedicated to the background of the data, information and methods that are at the base of including material flows as information for a fundamental new approach in urban design.

2.1. Modern Holistic Sustainable Design Approaches

Eco-efficiency strategies seek to reduce the unintended negative impacts of production and consumption processes, by maintaining or increasing the value of economic output. An extension of eco-efficiency strategies is the 'zero-emission' concept which aims at offering maximal economic value with zero adverse ecological impact. These approaches begin with the assumption of a one-way, linear flow of materials through systems, where raw materials are extracted from the earth, used and eventually discarded. In this system, eco-efficient techniques seek only to minimize the volume, velocity and toxicity of the material flow system, but are incapable of altering its linear progression. Some materials are recycled, but often as an end-of-pipe solution since these materials are not designed to be recycled. Instead of true recycling, this process is actually downcycling, a downgrade in material quality, which limits usability and maintains the linear, cradle-to-grave dynamic of the material flow system (Braungart, McDonough & Bollinger, 2007).

In contrast to these approaches of minimization and dematerialization, eco-effectiveness and cradle-to-cradle design concepts focus on the development of products and systems that improve the quality and productivity of materials through subsequent life cycles. In the cradle-to-cradle approach, the transformation of products and material flows forms a supportive relationship with ecological systems and future economic growth. The objective is to produce cyclical "metabolisms" that enable materials to maintain their status as resources over time (upcycling). This inherently creates a positive recoupling of the relationship between economy and ecology (Braungart, McDonough & Bollinger, 2007). Eco-effectiveness mimics the metabolisms in nature where everything is recycled and makes a distinction between biodegradable materials which are part of the biosphere, and materials which can be continuously upcycled (e.g. recycled to a level at least equal to the original quality) which are part of the technosphere (Wever & Vogtländer, 2014).

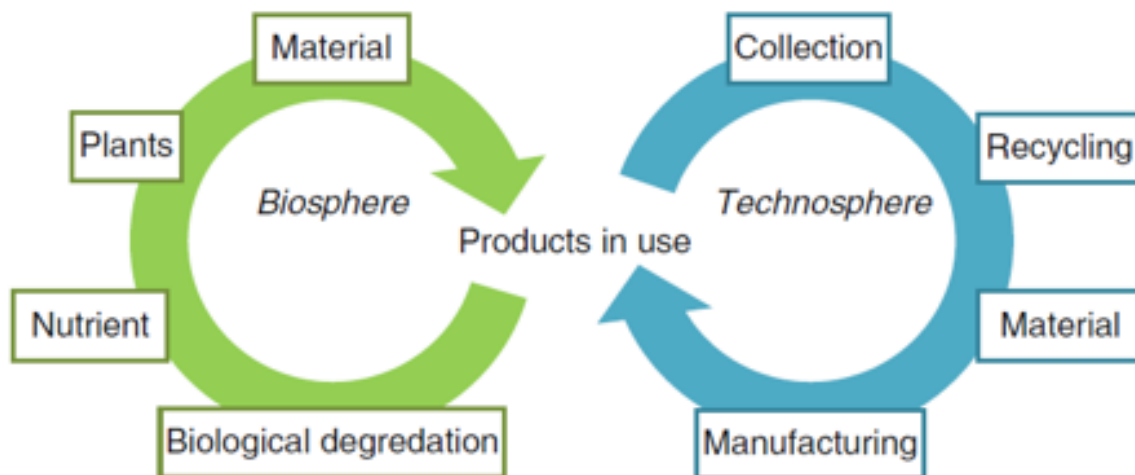

Figure 2.1 Material loops in the biosphere and in the technosphere according to cradle-to-cradle (Wever & Vogtländer, 2014)

2.2 Urban Mining

In recent times, the rising demand for raw materials and the increased scarcity of land for waste disposal have stimulated interest in Urban Mining. Furthermore, extraction and transportation of primary materials incurs high costs and sustains dependency ties with those who control the resources. Although recovering resources from the technosphere in urban areas is quite complicated, it has become necessary

for cities to reduce their waste flows and extract value from existing man-made stocks and flows. Such stocks and flows concern not only household waste and end-of-life products (such as vehicles or electrical equipment) but also the built environment, since the construction sector is both a major consumer of materials and a primary producer of waste (Koutamanis, van Reijn & van Bueren, 2018).

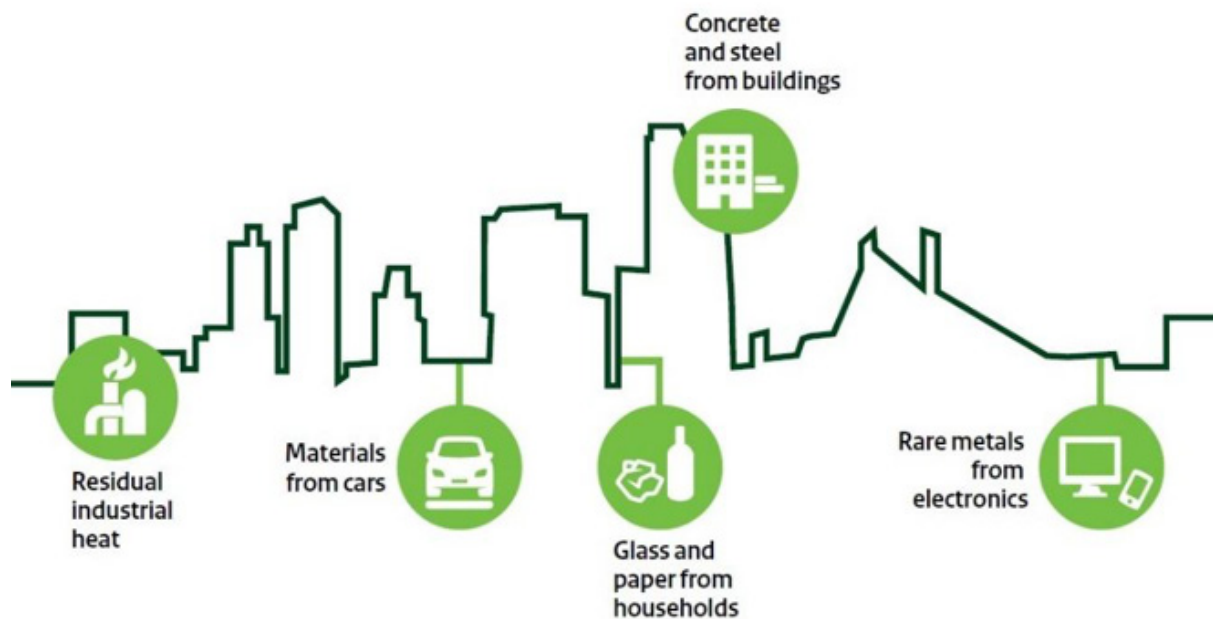

Figure 2.2 The urban mine (Government of the Netherlands, 2016)

With the ongoing rapid urbanization of societies, construction activities are increasing at an accelerating rate. In addition, the demolition of existing structures, that have completed their service life, occurs simultaneously with the construction activities. Demolition does not necessarily take place at the end of the service life of buildings, instead deconstruction activities might occur to create more space or reconstruct healthy structures. All these projects are producing waste in bulk, which is known as Construction and Demolition (C&D) waste (Gagan & Arora, 2015). Construction and demolition (C&D) waste contains a wide range of materials including concrete, metals, timber, glass but also hazardous elements (e.g. mercury

and asbestos). Consequently, when C&D waste is segregated, it can include high-value materials and resources for new construction.

Around the world, waste generated through construction and demolition activities, continues to follow a sharp rise coinciding with the economic growth of less developed countries (Mah, Fujiwara & Ho, 2016). Among the biggest producers of construction and demolition (C&D) waste, China generates about 100 million tonnes per year, while India and the United States produce about half of that amount. Many countries are enforcing different legislations in order to minimise their C&D waste and reduce the pressure on landfills. While some including New Zealand, Nigeria, South Africa, Croatia and

Canada have insufficient recycling and reuse strategies resulting into dumping a large share of their waste in landfills – between 70% and 90% of the total (C&D) waste flow – others such as Austria, the Czech Republic, and South Korea, are achieving high recovery rates (>80 %) (Akhtar & Sarmah, 2018).

In the Netherlands, the construction industry is estimated to account for 50% of the raw materials used, while 40% of the total waste generated involves construction and demolition waste. Even though more than 95% of C&D waste is recycled, only 3% of all building materials used to construct buildings originate from a recycled material (Government of the Netherlands, 2016). In most cases C&D waste is only crushed and reused as aggregates for roads. Such end-of-pipe solutions significantly downgrade the technical and economic value of construction materials, addressing only partially the demand for natural resources and waste

generation and management. This pattern is expected to further increase in the future, thus, it is necessary to shift towards a more circular economy where output flows could be reused as secondary resources.

In urban construction activities, a considerable amount of these output flows can be reused directly without further processing. Soil and sand are generated from site preparation and excavation works related with construction and demolition activities. Large volumes of fine materials are produced and unless the material can be reused on site it requires treatment or disposal. This includes soil and sand, as well as other particles smaller than 4.75 mm that come from mixed skip-bin waste (Australian Government, 2012). The opportunities of the direct reuse of excavated sand and soil, as well as other C&D waste recycling options are discussed more thoroughly in section 2.4.

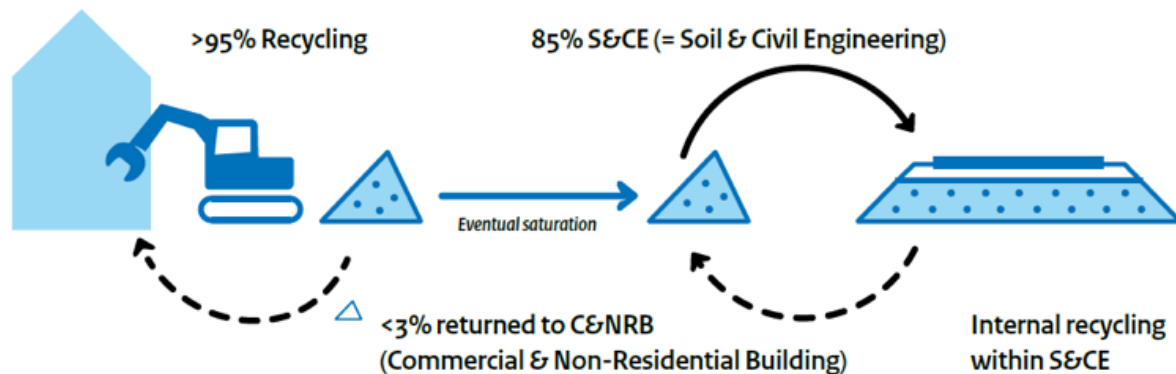

Figure 2.3 Recycling in the construction sector in the Netherlands (Government of the Netherlands, 2016)

2.3. Estimation and analysis of the urban material stock

2.3.1 Method and approach

To realistically implement circular economy strategies for the built environment, such as urban mining, it is important to have a better understanding of the type of materials that enter, exit and are being stocked within the samples (Stephan & Athanassiadis, 2018). A linear approach to chart and quantifies the construction material flows moving through the five sub-divided areas is shown in Figure 3. To get a grip on the flows in the built-up area the System Exploration Environment and Subsurface (Hooimeijer and Maring, 2018) is used in which the urban structure is understood in 6 domains: people, metabolism, buildings, public space, infrastructure and subsurface. Each domain

has its own specific specialists, concepts and language that need to be recognized. For this investigation the urban typology samples are separated into five zones where five layers intersect including buildings, infrastructure, public space and from the subsurface: sand filling and subsurface infrastructure. The inflows considered are the materials used for the construction of new buildings, roads, and underground infrastructure and the sand imported for filling purposes for building site preparation. The outflows of the system include, demolition (e.g. concrete, steel etc.) and excavation waste, i.e. cables and pipes as well as the sand excavated from the interventions on land use.

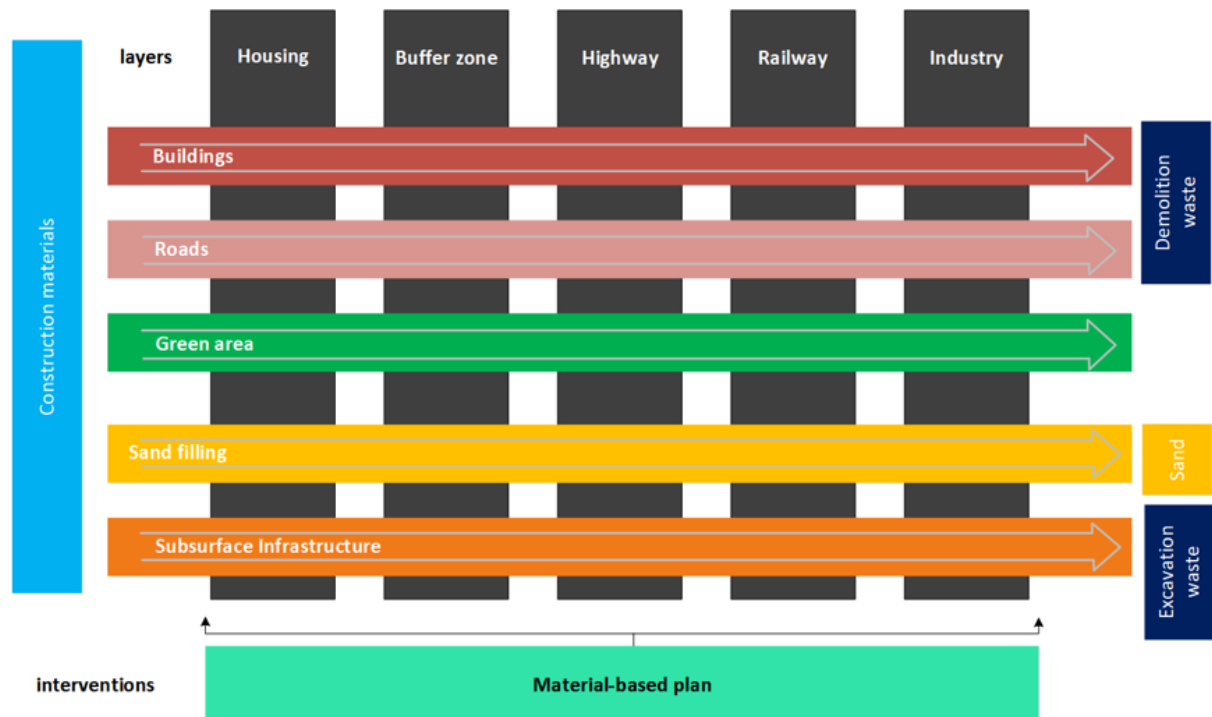

Figure 2.4 Linear approach to quantify material flow

One of the hurdles to implement circular strategies and urban mining at a local level is to provide qualitative information on material flows exiting the built environment to determine whether it is possible to reuse these materials as entering flows. Based on the Cradle to Cradle principles introduced in section 1.1, the previous linear approach is transformed into a circular material flow model that fosters urban mining (Figure 2.5). The underlining goal of the model is to quantify, spatialize, and estimate these flows to support

urban planners design a more circular built environment. The resulting material outflows determine the recovery options of waste management processes for improved recycling of materials. The analysis is based on the combined perspective of three principles: 1) Reduce material resource consumption, 2) Reuse building components (e.g. bricks, window frames, concrete elements etc.) and 3) Recycle materials (e.g. metals, asphalt etc.).

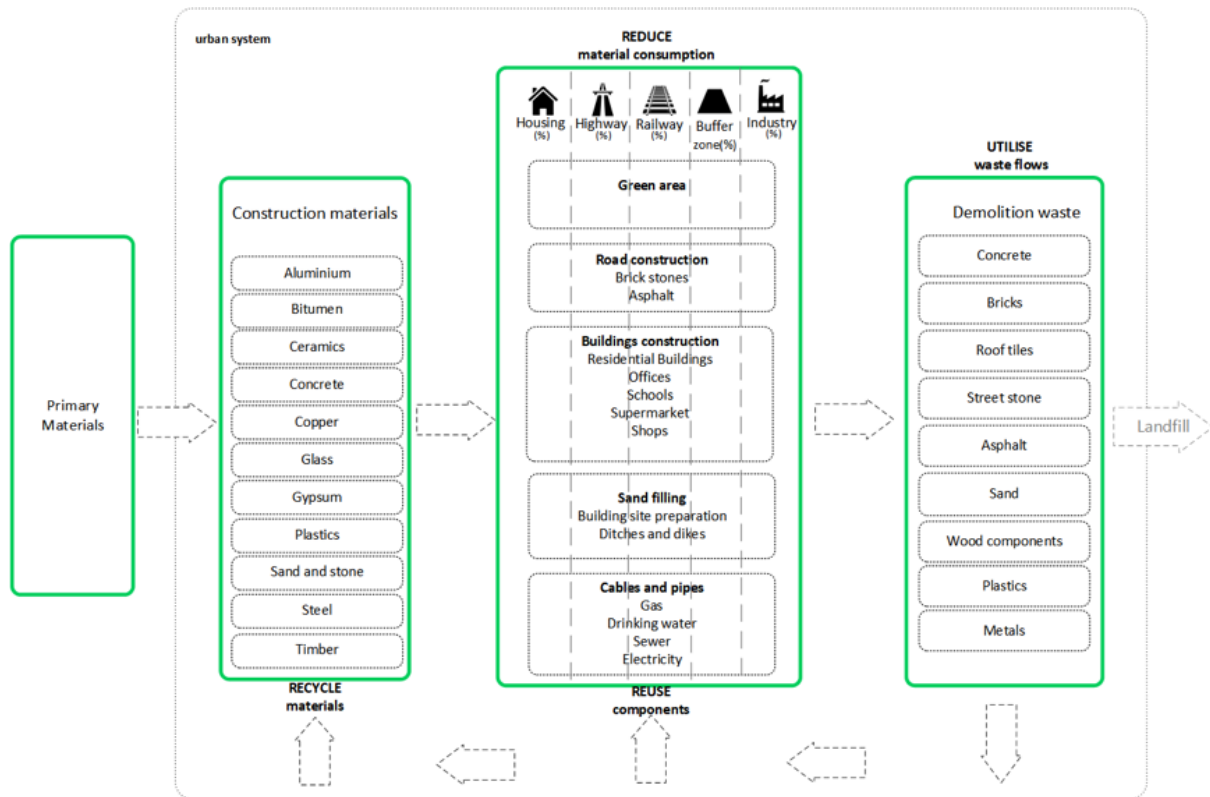

Figure 2.5. Material flow hierarchy and diagram

2.3.2 Modelling methodology

This model uses a similar methodology to the paper of Condeixa, Haddad & Boer (2018), who applied a Material Flow Analysis (MFA) approach in order to assess the construction and demolition waste (CDW) from the residential building stock in the city of Rio de Janeiro. Other studies (Schebek et al., 2018; Stephan & Athanassiadis, 2018; Gontia, Nægeli, Rosado, Kalmykova & Österbring, 2018) have also applied MFA approaches to calculate the stock and flows

of materials of buildings in cities. MFA in bottom-up approach promotes inventories of materials in small scales (e.g. a building) through the extrapolation of construction variables to the total constructed area. This model is bottom-up and stock-driven, which means that it is built up from individual materials into construction assemblies and then buildings (Schebek et al., 2018). MFA is applied herein as a tool to: (1) identify the largest material flows, (2) detect in which flows

direct reuse of secondary materials is possible, (3) calculate the waste flows derived from the demolition of buildings.

The urban construction system is viewed into the chosen urban samples that consist of zones: housing, highway, railway, buffer zone and industry and their flows as described above. Figure 5 shows the inputs, throughputs, and outputs of the urban construction system and how they affect the material stock balance of in-use materials. At a given year (t) the material

stock of all buildings (MS(t)) equals the material stock of the previous year (MS(t-1)) plus the construction materials (CM(t)) used for the construction of new building, minus the waste occurring from the demolition of buildings (DM(t)) (Condeixa, Haddad & Boer, 2018). The basic assumptions of the model are that there are no material replacement flows because of building renovation and no construction waste generated during the construction phase.

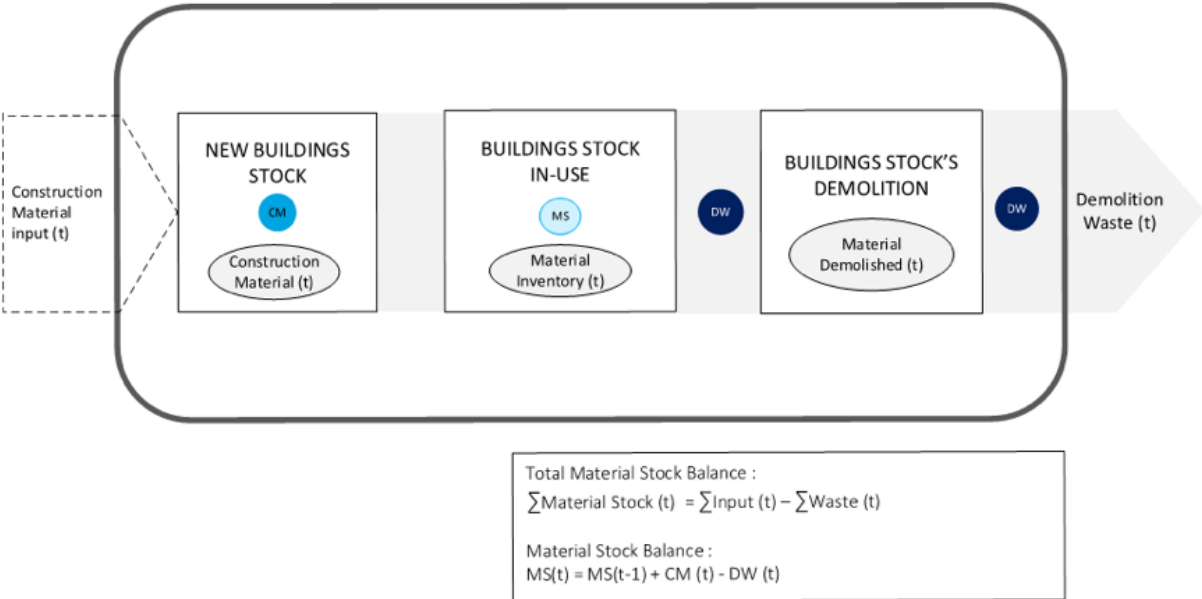

Figure 2.6 Balance of material in urban construction system

The model is able to answer the questions where? what? when? and how much? This provides information to identify major flows of materials, anticipate time periods of intense material replacements or flows and understand where these flows take place. The methodology of this modelling approach is laid down into four steps: First, the material quantities (material stock) for a single building per

building type is calculated, based on its geometry and assemblies. Second, the extrapolation of these quantities to the total area give us the building material stock (Section 2.3.2.1.). Next, we estimated the material quantities derived from the other layers (Section 2.3.2.2-1.3.2.5). Lastly, based on the interventions we identify the largest material flows and propose a new plan for improved circular strategies.

2.3.2.1. Buildings material stock

This study uses three different urban typologies that represent historical building construction periods in the Netherlands including the post-war 50s (16%), Woonerf 70s (36 %), and VINEX 90s (24%); total of 76% of Dutch housing stock . Each urban prototype has a specific spatial composition for that time and specific building types and construction methods, which means that the total material stock is different but typical for each urban typology. The model quantifies the material inventory of different housing typologies and different building types, i.e. offices, schools, shops, supermarket, and industries.

Woningen naar eigendom, woningtype en bouwjaar

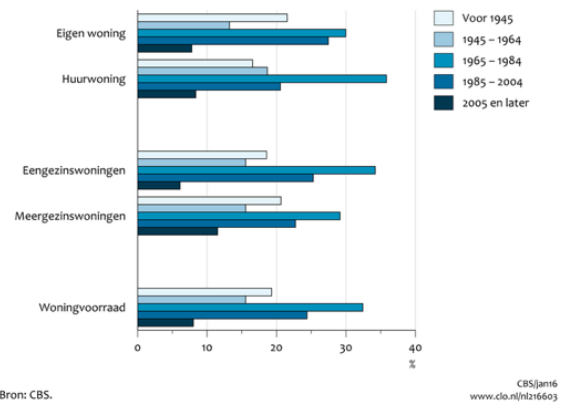

Bron: CBS.

CBS/jan16
www.cdo.nl/nl216603

Figure 2.7

Surface [m ²]	Current situation		
	Post-war	Woonerf	Vinex
Total surface	1.000.000	1.000.000	1.000.000
Built up surface	301.500	237.700	229.500
Unbuilt surface	698.500	762.300	770.500
Housing area	675.000	685.000	675.000
Family houses 1950s	66.825		
Family houses 1970s		141.000	
Family houses 1990s			54.945
Apartment blocks 1950s	101.250		
Apartment blocks 1990s			60.885
Offices 1950s	16.200		
Schools 1950s	6.075		
Schools 1970s		9.700	
Schools 1990s			5.940
Supermarket 1950s	12.150		
Shops 1990s			26.730
Green public space	207.900	167.825	124.875
Private gardens	89.100	167.825	124.875
Infrastructure	141.075	143.850	209.250
Parking space	7.425		
Water surface	27.000	54.800	67.500
Industrial area	165.000	145.000	135.000
Industries 1950s	99.000		
Industries 1970s		87.000	
Industries 1990s			81.000
Green space	8.250	7.250	6.750
Infrastructure	51.150	44.950	41.850
Water surface	6.600	5.800	5.400
Buffer zone	60.000	70.000	90.000
Highway	50.000	50.000	50.000
Railway	50.000	50.000	50.000

Table 3. Quantification of the three urban typology samples for the current situation

The housing typologies were defined based on the Tabula Webtool which contains datasets of the Dutch building stock (“TABULA WebTool”, 2018). Each building type was identified through the housing size (single family house or apartment block) and the building construction age. In the Tabula database each building type

is characterized by specific geometrical features (e.g. building footprint, number of floors etc.) and construction assemblies. A construction assembly is a group of construction materials or elements that serve a certain function, like outer walls, roof, internal walls and windows.





















Country	Region	Construction Year Class	Additional Classification	SFH Single Family House	TH Terraced House	MFH Multi Family House	AB Apartment Block
	national (nationaal)	... 1964	generic (generiek)	 NL.N.SFH.01.Gen	 NL.N.TH.01.Gen	 NL.N.MFH.01.Gen	 NL.N.AB.01.Gen
	national (nationaal)	1965 ... 1974	generic (generiek)	 NL.N.SFH.02.Gen	 NL.N.TH.02.Gen	 NL.N.MFH.02.Gen	 NL.N.AB.02.Gen
	national (nationaal)	1975 ... 1991	generic (generiek)	 NL.N.SFH.03.Gen	 NL.N.TH.03.Gen	 NL.N.MFH.03.Gen	 NL.N.AB.03.Gen
	national (nationaal)	1992 ... 2005	generic (generiek)	 NL.N.SFH.04.Gen	 NL.N.TH.04.Gen	 NL.N.MFH.04.Gen	 NL.N.AB.04.Gen

Figure 2.8 Tabula Webtool classification of housing typologies (“TABULA WebTool”, 2018)



		Existing state
Roof 1	surface area	501.9m ²
	type of construction / refurbishment measure	flat roof, not afterwards insulated, with cavity walls plat dak, bij spouwmuur en geen na-isolatie
	picture	
	U-value	1.54 W/(m ² K)
Wall 1	surface area	1189.7m ²
	type of construction / refurbishment measure	cavity walls, not afterwards insulated spouwmuur, geen na-isolatie
	picture	
	U-value	1.61 W/(m ² K)
Floor 1	surface area	462.0m ²
	type of construction / refurbishment measure	not afterwards insulated; with cavity walls geen na-isolatie, bij spouwmuur
	picture	
	U-value	1.14 W/(m ² K)
	surface area	81.2m ²
	type of construction	single glass

Figure 2.9 Tabula Webtool building data per construction assembly (“TABULA WebTool”, 2018)

After determining all the construction assemblies and their total surface for the different housing typologies the assemblies into material categories are analysed. This was done with the help of average building material construction values and material densities (kg/m³) (“Densities of Common Materials”, 2018). For example, an outer wall is made of clay bricks, air cavity and mortar. To estimate the brick/mortar ratio specialized webtools were consulted to give an average value. Then, considering the total surface of outer walls the final mass of clay bricks for a single house was estimated. Clay bricks were assigned to the ceramic’s material category together with the total mass of roof tiles. The same process was followed for all construction assemblies depending on their material categories (Table 4).

Material	Type	Volume (m ³)	Density (kg/m ³)	Material mass (kg)	Used in		
					Envelope	Structure	Finishes
Ceramics	Clay bricks (110 mm)	25,8	1644	42.448	x	x	
Ceramics	Clay roof Tiles	-	-	2.104			x
Concrete	Precast slab	9,9	2400	23.760		x	
Concrete	Mortar	-	-	24.924	x	x	
Concrete	Columns	2,4	2400	5.702		x	
Glass	Single panel window (4mm)	0,3	2580	775	x		x
Gypsum	Plasterboard (10 mm)	0,8	732	586	x		x
Steel	Reinforcement (floor)	-	-	713		x	
Timber	Hardwood (floor)	2,5	455	1.141			x
Timber	Wooden rafters (100 mm)	7,7	455	3.494	x	x	
Timber	Wooden staircase (40 mm)	0,1	455	46			x
Timber	Softwood (window frames)	0,8	455	342	x		x
Timber	Hardwood (doors)	1,2	455	546	x		x

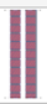
Table 4. 50s single-family houses construction elements assigned to material categories

This led to an aggregate table (table 3) of the total amounts of each material category for a specific housing typology. By dividing the total mass and total volume of each material category with the building footprint the material intensities (MI), i.e. kg per 1 m² of constructed area were obtained for each building type (Equations 1 and 2).

$$MMI_{x,y} \left[\frac{\text{kg}}{\text{m}^2} \right] = \frac{TMM_{x,y}}{BF_y}$$

Equation 1. Material Mass Intensity

$$MVI_{x,y} \left[\frac{\text{m}^3}{\text{m}^2} \right] = \frac{TMV_{x,y}}{BF_y}$$

Equation 2. Material Volume Intensity

Where, $MMI_{x,y}$ is the Material Mass Intensity for material x in housing type y, $TMM_{x,y}$ is the Total Material Mass of material x in housing type x in kg, $MVI_{x,y}$ is the Material Volume Intensity for material x in housing type y, $TMV_{x,y}$ is the Total Material Volume of material x in housing type x in m³, and BF_y is the Building Footprint of housing type y in m². For example, the $MMI_{x,y}$ for concrete in the 50s single-family housing type is 824 kg/m². The same process was followed for the calculation of the total volume of materials (Equation 4).

Then, by extrapolating to the entire constructed

area we calculated the total material stock of all houses (Equations 3 and 4).

$$TMM_{x,y} = MMI_{x,y} \cdot TCA_y$$

Equation 3. Total Material Mass

$$TMV_{x,y} = MVI_{x,y} \cdot TCA_y$$

Equation 4. Total Material Volume

Where, $TMM_{x,y}$ is the Total Material Mass for material x in housing type y in kg, $TMV_{x,y}$ is the Total Material Volume for material x in housing type y in m³, and TCA_y is the Total Constructed Area of housing type y in m².

Table 5 shows the aggregate results of the 4 steps followed in the previous Equations (1-4) for the 50s single-family houses. The same process was followed for all other housing typologies.

50s post-war single-family houses (y)

Material category (x)	$TMM_{x,y}$ Material mass for one house (kg)	$TMV_{x,y}$ Material Volume for one house (m ³)	$TMM_{x,y}$ Material Mass Intensity (kg/m ² built up area)	$TMV_{x,y}$ Material Volume Intensity (m ³ /m ² built up area)	$TMM_{x,y}$ Material mass for all houses (kg)	$TMV_{x,y}$ Material Volume for all houses (m ³)
Ceramics	44.552	27	675	0,409	45.109.305	27.338
Concrete	54.386	12,2	824	0,185	55.066.230	12.353
Glass	775	0,3	12	0,005	784.762	304
Gypsum	586	0,8	9	0,012	592.920	810
Steel	713	n/a	11	n/a	721.710	92
Timber	4.428	9,7	67	0,147	4.483.337	9.821

Table 5. 50s single-family houses material stock calculation

Regarding the other building types, i.e. offices, schools, supermarkets, shops, and industries, the material intensities were derived from the German building stock and expressed for the functional unit of 1 m³ constructed area (Schebek et al., 2018). Considering the volumetric constructed area for each building type, the material intensities and obtained final material amounts were extrapolated (Equation 5 and 6).

$$TMM_{x,y} = MMI'_{x,y} \cdot TCA'_y$$

Equation 3. Total Material Mass

$$TMV_{x,y} = \frac{TMM_{x,y}}{d_x}$$

Equation 4. Total Material Volume

Where, $MMI'_{x,y}$ is the volumetric Material Mass Intensity of material x in building type y in kg/m³, TCA'_y is the total volumetric constructed area of building type y in m³, and d_x is the density of material x in kg/m³. For example, the $MMI'_{x,y}$ of concrete for an office built in the 50s was 178,1 kg/m³ gross volume. Considering that the total building footprint of offices in the 50s post-war urban prototype was 16.200m² with an average height of 6.6m, the total concrete mass would be 19.042.452 kg

2.3.2.2. Sand filling

The preparation of building sites and roads is a necessity in the western part of the Netherlands where the soil consists of vast layers of soft clay and peat. In the regions where soft soils are found, land subsidence is a very serious problem, also related to the lowering of the groundwater table in polders (de Lange et al., 2016). The building-site preparation needs to be done to increase the carry capacity and deal with high ground water levels (Segeren and Hengeveld,

1985). This can be done with raising the site or street level with sand, in combination with lowering the ground water level. High quality preparation In Rotterdam subsidence is such that streets are raised every 45 years (see fig 2.10). Next to the site preparation buildings need to be built with bearing piles of 12 to 15 m deep to touch the stable layer of sand and buildings and public space need to be built 1.2 m above groundwater level.

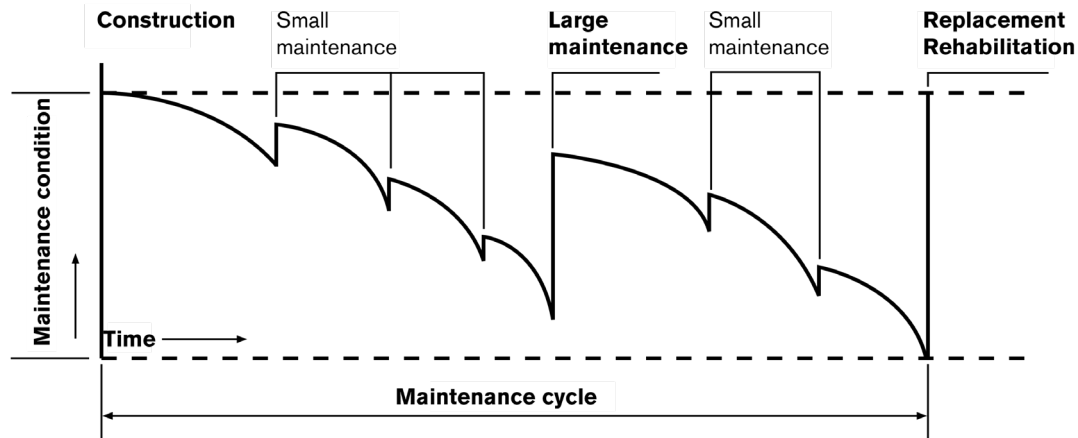

Fig. 2.10 Maintenance cycle of roads in Rotterdam (Municipality Rotterdam, 2017)

Depending on the area and construction age of the area different building-site preparation methods have been applied. In the nineteenth century the 'cunet' method was used under roads which is the excavation of the soft soil to a depth of 1 m and fill with sand.

The building-site preparation methods in the three urban typologies are hydraulic filling and partial filling. The most commonly used method of building site preparation in the 1950s is 'hydraulic filling' with sand. This layer of sand covers the landscape and fixes the soft and wet conditions. In this layer the green areas need to be constructed by the partial removal of sand replaced by black soil and waterways also need to be dug out. The method requires

high quantities of sand, same load bearing and drainage capacity as in the 'cunet' method, higher investment, and that the whole area is prepared at once. For small scale developments the method of hydraulic filling with sand, transported by trucks, with vertical drains is very useful (Hooimeijer, 2011).

In the 1970s and 1990s most commonly used method is partial filling. This method was applied to keep the original landscape structure in the planned nature area's and gardens, only under streets and housing the level is partly raised.

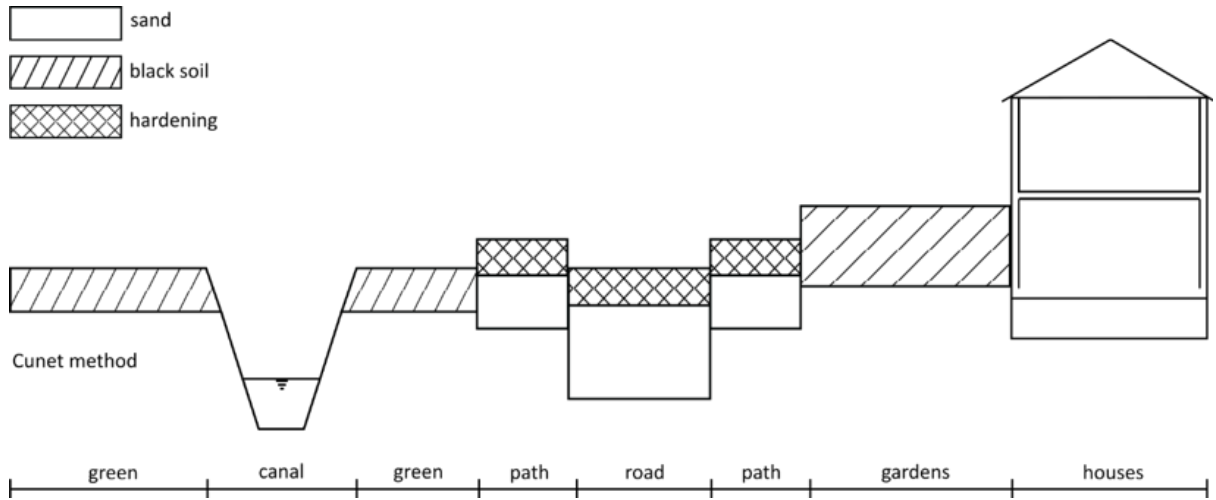

Figure 2.11. Cunet method (Segeren & Hengeveld, 1985)

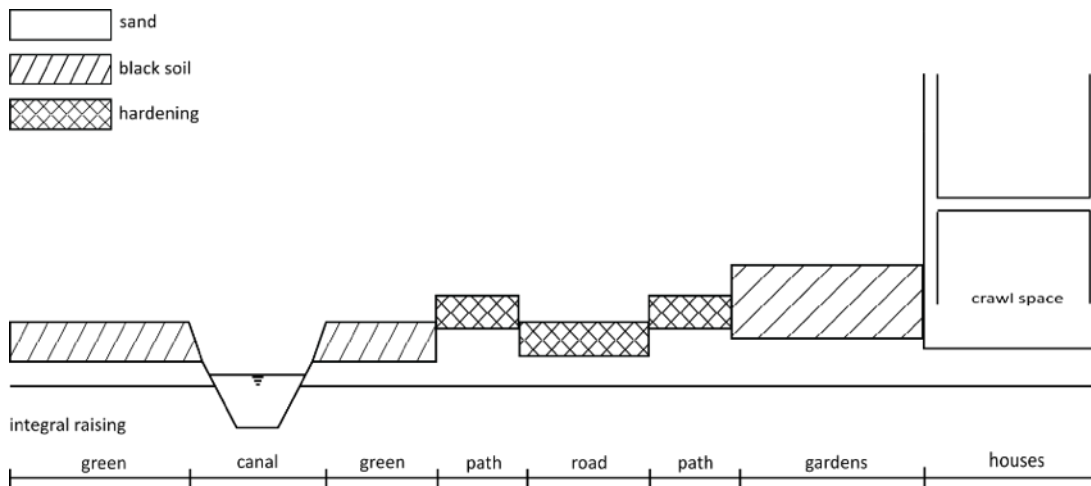

Figure 2.12. Integral raising (Segeren & Hengeveld, 1985)

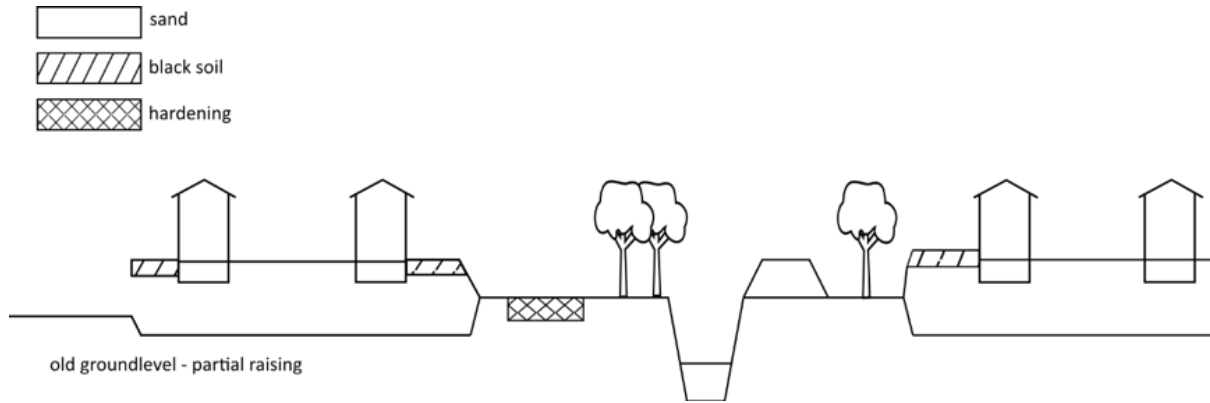

Figure 2.13 Partial filling (Segeren & Hengeveld, 1985)

The estimation of the total amount of sand used in building site preparation in each urban prototype is based on these sand filling techniques. In the 50s post-war urban sample hydraulic filling of a

2-meter layer of sand was taken as standard, the 70s and 90s samples both use partial filling in which the filled parts also have a 2-meter layer of sand (see Table 6).

Urban typology	Housing area		Industrial area	
	Building footprint [m ²]	Sand Volume [m ³]	Building footprint [m ²]	Sand Volume [m ³]
post-war 50s	202.500	405.000	99.000	198.000
Woonerf 70s	144.100	288.200	87.000	174.000
VINEX 90s	148.500	297.000	75.000	150.000

Table 6. Sand used in building site preparation

2.3.2.3. Road construction

The materials considered for the construction of infrastructure include the asphalt used in roads, highways and bike lanes, brick stone used in pavements and parking spaces, and crushed stone that forms the track bed upon which railroad ties are laid.

In order to calculate the total stock of these materials for the three urban typologies the average composition of a typical Dutch residential street which is comprised of 45% roads, 25% bike lanes, and 30% sidewalks was considered. Another consideration is that the thickness of the

asphalt pavement depends on the volume and weight of the traffic and on the load-supporting capability of the underlying soil (Wisconsin Asphalt Paving Association, 2016). In addition, the height of track ballast for railways should never be less than 150 mm thick (Bell, 2004). The rest geometrical parameters based on which the calculations were done are shown in the 50s urban typology in Table 7. The same process was followed for the estimation of the material stock of infrastructure for the other two urban typologies.

Post-war road construction materials						
Layer	Surface (m ²)	Material	Height (mm)	Total Volume (m ³)	Material Density (kg/m ³)	Total Material Mass (kg)
Housing area	148.500					
Road	63.484	Asphalt	120	7.618	1.020	7.770.411
Bike lane	35.269	Asphalt	100	3.527	1.020	3.597.413
Sidewalk	42.323	Brick stone	75	3.174	1.900	6.030.956
Parking	7.425	Brick stone	75	557	1.900	1.058.063
Industrial area	51.150					
Road	35.805	Asphalt	120	4.297	1.020	4.382.532
Sidewalk	15.345	Brick stone	75	1.151	1.900	2.186.663
Highway	50.000	Asphalt	150	7.500	1.020	7.650.000
Railway	50.000	Crushed stone	150	7.500	1.600	12.000.000

Table 7. Post-war road construction materials



Figure 2.14. Asphalt paving⁸



Figure 2.15. Brickstone replacement on pavements⁹



Figure 2.16. Track ballast on railways¹⁰

⁸ https://nl.wikipedia.org/wiki/Bestand:2004feb20_Aanleg_road_fietspad.jpg

⁹ https://farm2.staticflickr.com/1644/26170653185_42300845ca_b.jpg

¹⁰ <https://www.bemorail.com/portfolio-item/ballast/>

2.3.2.4. Cables and pipes

The calculation of the materials used in the underground infrastructure is based on an estimation of the average material intensity (kg per m² of surface road infrastructure) of concrete sewers, copper gas pipes, and PVC water supply pipes. The volume of each pipe used in 1 cubic meter of the subsurface is equal to the surface of the cylinder multiplied by the length of the pipe.

$$S = \pi \left(\left(\frac{D_o}{2} \right)^2 - \left(\frac{D_i}{2} \right)^2 \right)$$

$$V = S \cdot l$$

Where D_o and D_i the outside and inside diameter of the pipes, V the volume of the pipes, and L the length of the pipes. Table 8 shows the total amount of materials used for pipes in the 50s.

Equation 7. The calculation of the materials used in the underground infrastructure

Post-war cables and pipes						
Service	Material	Material Intensity (kg/m ² road)	Road surface (m ²)	Material Mass (kg)	Material Density (kg/m ³)	Material Volume (m ³)
Housing area						
Sewer pipe	Concrete	34,6	63.484	2.196.538	2.400	915,22
Natural gas	Copper	0,098	63.484	6.221	8.950	0,7
Water supply	PVC	0,091	63.484	5.777	1.400	4,13
Industrial area						
Cables and						
Sewer pipe	Concrete	34,6	35.805	1.238.853	2.400	516,19
Natural gas	Copper	0,098	35.805	3.509	8.950	0,39
Water supply	PVC	0,091	35.805	3.258	1.400	2,33

Table 8. Post-war material stock of cables and pipes



Figure 2.17. Concrete sewers¹¹

¹¹ <https://www.ad.nl/rivierenland/de-zuidwesthoek-gaat-een-jaar-lang-op-de-schop~a3df6588/>

2.3.2.5. Biomass from green space

In the green space, wood waste is generated during the felling of trees and sanitation in the care of plantations. Due to the sustainable management of the stock, the harvestable quantity is limited to the annual growth of trees and vegetation. Agrotechnical activities include the replacing of diseased and shrinking trees

and shrubs and pruning woody and shrubby vegetation. Wood waste is collected by organizations that are responsible for pruning branches in crowns as well as removing trees that could cause accidents or have lost their decorative value (Khudyakova, G., Danilova, D., & Khasanov, R., 2017).



Figure 2.18 Pruning activities

The energy potential calculation of wood waste should begin with an estimate of the total energy potential (MJ) of wood waste, which is determined by the equation:

$$E_{ww} = m \cdot Q_f \cdot 10^{-6}$$

Equation 8. The energy potential calculation of wood waste

Where, m (mass) is the wood waste in kg, and Q_f is the lower calorific value of wood waste on the working mass fuel KJ/kg. The lowest calorific value of the processing waste is 6000 KJ/kg (Khudyakova, G., Danilova, D., & Khasanov, R., 2017).

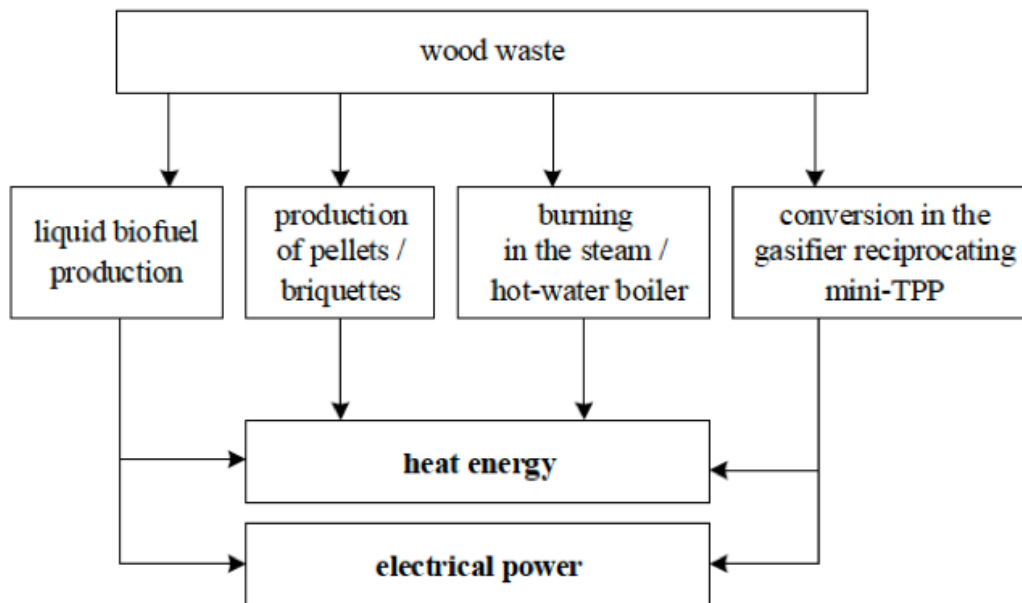

Figure 2.19 Wood waste recovery options (Khudyakova, G., Danilova, D., & Khasanov, R., 2017)

Based on the technology for heat energy production described above, the quantitative potential of the heat energy generated from waste considering the efficiency of the boiler is determined according to the following formula:

$$Q_b = E_{ww} \cdot \eta_b$$

Equation 9. The quantitative potential of the heat energy generated from waste.

Where, η_b is the efficiency of the plant for wood waste burning (boiler water). The amount of electrical energy produced from wood waste during their gasification with further combustion of synthesis gas in the internal combustion engine is defined as:

$$W_g = E_{ww} \cdot \eta_{gf} \cdot \eta_{ICE} \cdot \eta_{eg}$$

Equation 10. The amount of electrical energy produced from wood waste during their gasification.

Where, η_{gf} is the efficiency of gasifier; η_{ICE} is the efficiency of internal combustion engine, and η_{eg} is the efficiency of electric generator. Based on data found in the “Atlas Natuurlijk Kapitaal” (2018), the harvestable amount of top wood waste from sawn trees and the annual potential energy production is shown in Table 9 for the three samples.

Urban typology	post-war 50s	Woonerf 70s	VINEX 90s
Green space [m ²]	216.150	175.075	131.625
Wood waste [kg/year]	2.918	2.364	1.777
Energy potential E _{ww} [MJ/year]	17.508	14.181	10.662
Heat energy Q _b [MJ/year]	15.407	12.479	9.382
Electricity W _g [kWh/year]	1.198	971	730

Urban typology	post-war 50s	Woonerf 70s	VINEX 90s
Green space [m ²]	216.150	175.075	131.625
Wood waste [kg/year]	2.918	2.364	1.777
Energy potential E _{ww} [MJ/year]	17.508	14.181	10.662
Heat energy Q _b [MJ/year]	15.407	12.479	9.382
Electricity W _g [kWh/year]	1.198	971	730

Table 9. Energy potential of public space materials

2.4 The materials opportunity

The transition to a more circular economy in the buildings construction sector calls for a better understanding of the current material recovery rate. On one hand, the Netherlands is achieving high recovery rates by recycling more than 95% of the total volume of construction and demolition waste. On the other, less than 3% of new building materials originate from a recycled material. This low rate in new building materials occurs because most aggregates resulting from the recycling of building materials are used in civil engineering as foundation materials, primarily in the road construction section (Government of the Netherlands, 2016).

Construction and demolition waste contain a complex mix of materials including ceramics, concrete, wood, and metals among others. Given the high heterogeneity and composition of these waste flows, one can easily understand that segregation of C&D waste is a tough challenge for the builders, developers and owners (Akhtar & Sarmah, 2018). Nevertheless, there is a shortage of natural aggregates for construction of structures. Increasing this supply to a small extent becomes possible by introducing recycled aggregates or by reusing construction elements separated during construction and demolition activities (Gagan & Arora, 2015).

Recyclability decreases with material complexity. For example, special metal alloys, laminated or fibre-reinforced materials are more difficult to separate into pure materials. Some building materials such as window glass and insulation such as glass fibres and Rockwool can be recycled, but the costs of removal and transport may outweigh the benefits. Figure 2.20 shows the main flows of activities that are followed during demolition of structures for optimal material recovery. In the following sub-sections the opportunities for reuse and recycling of the main building construction material categories are reviewed.

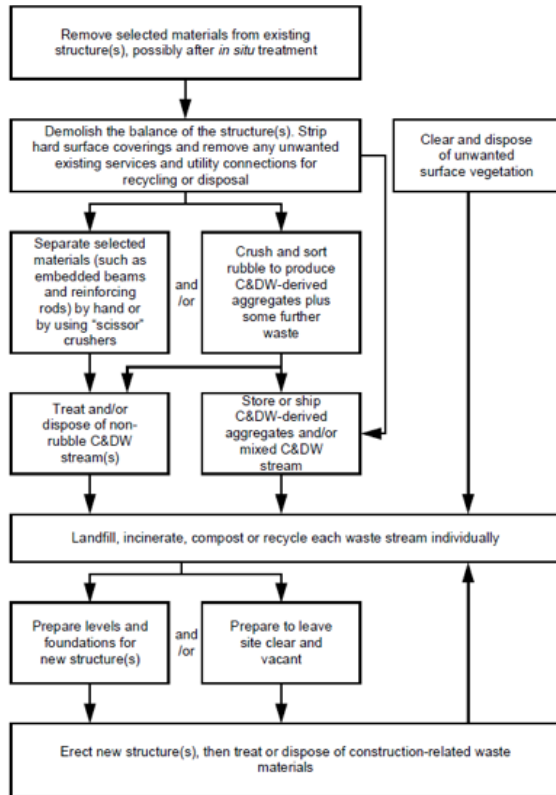

Figure 2.20 Main activities followed after demolition. Retrieved by European Commission, 1999.

2.4.1. Recycled concrete

Concrete is the largest waste flow resulting from construction and demolition activities. Rather than dumping massive amounts of concrete in a landfill, concrete recycling offers many benefits to the construction sector. Concrete recycling minimizes transportation routes, reduces dependency on natural resources and reduces costs related to purchases of natural aggregates. Furthermore, keeping concrete waste out of landfills saves a large amount of space, reduces emission rates related to manufacturing and transportation of new building materials and creates a local source of secondary material for the construction sector (Ganiron, 2019; Gagan & Arora, 2015).

Concrete recycling is usually done *in situ*. After sorting, crushing, screening and removing contaminants (e.g. reinforcement and plastics) from the demolished concrete, about 60% sand and 40% concrete aggregates are produced. The reuse of sand, however, depends on its qualities. Recycled concrete aggregate (RCA) can be used for the manufacturing of new concrete, yet compared to the natural aggregate, RCA has a rough surface, lower strength (10 – 15%) and higher water absorption (Ganiron, 2019). This alteration in density, porosity, and water absorption happens because of the remaining amounts of mortar and cement paste attached to stone particles in recycled aggregate. Even though these characteristics may cause complications while mixing RCA with cement and water, suitable mix designs have been developed for the manufacturing of new concrete (Junak & Sicakova, 2017). Compared to the use of other recycled aggregates resulting from construction and demolition activities (mainly mixed masonry) for the production of new concrete, recycled crushed concrete has a higher strength. This implies that for the same product mass, the crushed concrete alternative offers an additional 10–15 per cent of product volume.



Figure 2.21 Process of concrete recycling. Retrieved from (Ganiron, 2019).

2.4.2. Recycled aggregates from construction and demolition activities

A high percentage of C&D waste, and specifically the segment derived from masonry – that is, bricks and tiles mixed with concrete– is appropriate after crushing in situ to be reused as a substitute for primary aggregates in certain lower grade applications (such as hydraulic engineering and use as road sub-base). The road construction sector is the biggest consumer of aggregates derived from construction and demolition activities. Hence, these C&D waste-derived aggregates can entirely replace volumes of newly quarried aggregates, thereby preserving non-replenishable resources and minimising pressure on landfill space (European Commission, 1999). In addition, they may be used to facilitate drainage for perimeter drains, septic leach fields, and retaining walls. Other applications of coarse aggregates include backfill retaining walls, as temporary road surfaces (think of gravel roads), and to make the tire knock off areas for trucks leaving construction sites.

2.4.3. Metals

The vast majority (about 90 %) of the total mass of metals recovered from the urban construction and demolition sector derives from commercial structures. Of this material, approximately 95% is steel and the rest are non-ferrous metals. Non-ferrous metals mostly contain aluminium (1-2%), stainless steel and copper piping or wire (Australian Government, 2012). Ferrous metals like steel can be easily recovered from the waste stream using relatively inexpensive magnets. Steel is 100 % recyclable and can be recycled indefinitely without changing its qualities. A large quantity of all steel is recycled in situ and reused to develop infrastructures and buildings. The recycling of steel emits between 400 and 1020 kg CO₂-equivalents per tonne of recovered steel (Damgaard, Larsen & Christensen, 2009).

2.4.4. Asphalt

Asphalt material is produced during road construction activities and has the potential to reach 100% recyclability rates. Asphalt pavements on average are made of 4% bitumen and 96% aggregate. In general, the upper layer of asphalt, called the wearing course (with a thickness of 25 to 40 mm) is removed and laid again every 10 to 15 years. A milling machine removes the wearing course which is transported to an asphalt plant for sorting and batching to ensure that the physical properties of the mix have the correct proportions of bitumen to aggregate and aggregate size to air voids. Furthermore, recycled asphalt can be used as road base layers but the most common practice is to send it back into the wearing course of pavements (Australian Government, 2012).

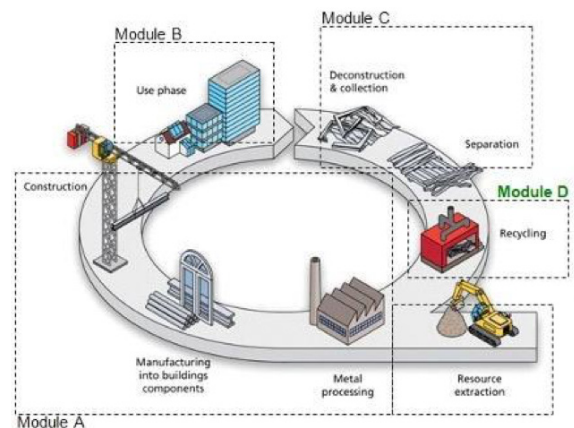

Figure 2.22 Metals recycling in urban construction. Source: “ArcelorMittal steel in construction - Constructalia” (2019).

2.4.5. Excavated sand and soil

Sand is a non-renewable and scarce natural resource, however, in urban construction the recycle rate is low. Recycling uncontaminated excavated construction sand and soil is beneficial because it reduces the costs and emissions of abandoning excess sand or bringing refill sand from a distant location. From an economic point of view, moving sand incurs high construction and demolition costs, that might reach a significant 16 % of the capital cost of infrastructure projects. Therefore, different practices and techniques have been explored to reuse sand on-site (Choi, Park, Jeong & Kim, 2017).

To promote the reuse of excavated soils from urban construction, standardization is an important step. One of the reasons is to ensure that the soils that will be reused in other geotechnical applications are uncontaminated. The classification of soils is based on the soil type, permeability, and water content. The various applications involve road base, dykes, backfill,

and elevated land construction among others. Soil improvement technologies producing higher class soils have also been developed by many institutions (Katsumi, 2015).

Ideally, the excavated sand can be reused by selling it or moving it to another construction site that needs it. Katsumi (2015) for instance, reports that a joint project has been conducted in Japan to reuse the soils excavated from a tunnel at a highway construction work as soil materials at a land reclamation site (see Figure 2.23). Nevertheless, this requires that the activities of the construction sites are well-coordinated and all involved parties are financially benefitted. For this reason, tracing technologies such as Earth observation systems have been created to facilitate the sharing of information on soil availability, needs, and tracking (Choi, Park, Jeong & Kim, 2017).

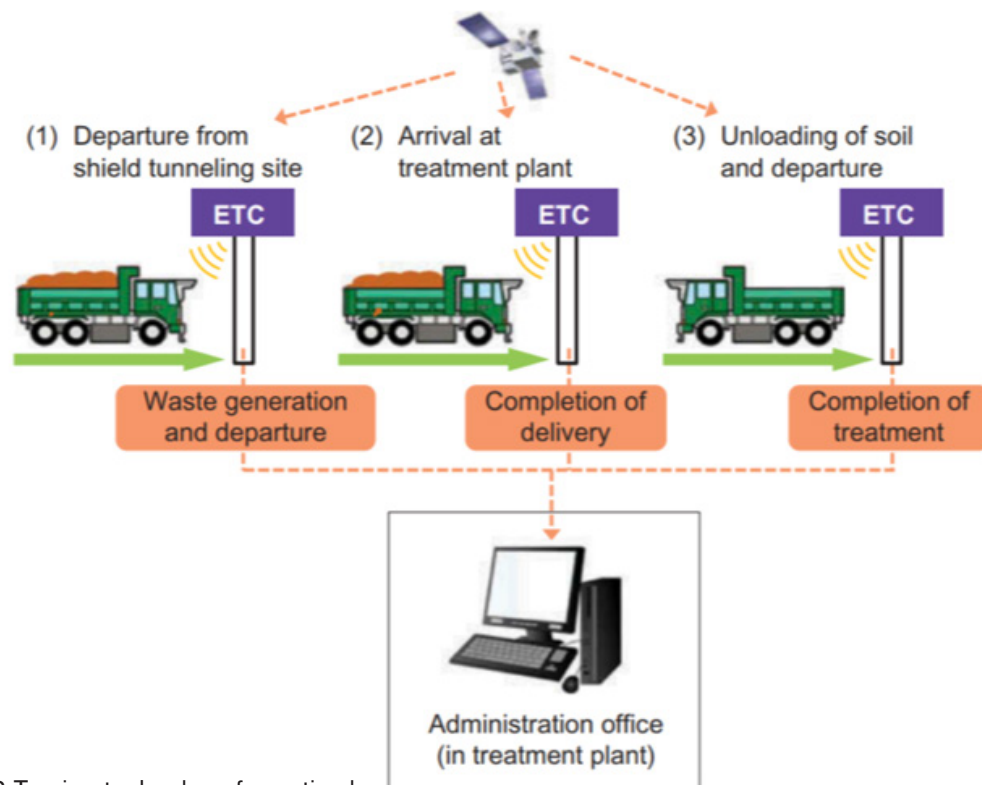

Figure 2.23 Tracing technology for optimal coordination of excavated sand and soil reuse. Retrieved from Katsumi (2015).

In this chapter the synthesis of the research and the testing of the design method is presented. Central is the six-step design approach that aims at integrating challenges of climate change, energy transition, new mobility (explained in §3.1) while at the same time reduce and re-use of materials and using healthy soil as central

3.1. Resilient Infrastructure

In the Resilient Infrastructure project sequence of steps were taken to clarify and specify the performance of fundamental urban typologies in considering new technologies and challenges. An operational perspective has been developed to explore new relations between new technologies and challenges in order to reach more insights into the topic of resilience. This operational perspective aims to identify potentials for increasing resilience in the relation between the urban field, that aligns the highway, and the highway itself. These potentials are used to anticipate future technological innovations and ecological improvements in future resilient cities. Resilience is the persistence of relationships within a system and the ability of these systems to absorb changes of state variables, driving variables, and parameters (Holling, 2001; De Bruijn, 2004).

New technologies like new forms of mobility offer opportunities to make urban areas along highways more resilient by using those specific areas for the ecological and functional improvement of the city. This requires spatial interventions that approach the highway, the buffer zone and the specific urban area along the highway as a whole rather than as separate zones that just happen to be juxtaposed. Anticipating new forms of mobility, how can we design the correlation between these spaces and how can these spaces foster resilient urban systems? To examine the correlation between highway and city, we zoomed in on combinations of highway prototypes and urban types that represent the majority of urban territories along highways in the Netherlands. The highway prototypes were chosen following the research by West 8 Landscape and Urbanism (Dijkstra, 2013) "Research to a healthy relation between city

perspective (explained in §3.2). This six-step design approach (§3.3) is applied to the 15 combinations of urban samples (§3.4). In this chapter the results of five steps per sample is presented. The last step of 'redesign of public space' is presented in chapter 4.

and highway" (2013). From the proposed 11 prototypes a selection of 5 was done on the basis of the future situation: are they affected by the changing conditions on the highway, and the real time situation: do they occur in relation to the three typologies? In this way five highway-prototypes, the most likely to meet the two latter conditions, were selected: Floor, Dike, Stilts, Ditch + Dike and Ditch.

These prototypes are related to urban typologies that are situated in the field around the infrastructure line. Contemporary cities are subjected to important changes: demographic, climatic and energetic pressure. To provide inspiration for an approach linking these changes to social and/or spatial tasks and resources in the new future conditions on the highway, 'virtual' samples of urban typologies are used to demonstrate an approach from an integral perspective.

The selection of samples is done on the basis of the Space Mate (Haupt and Berghauer Pont, 2010). The urban types are strongly related with the period in which they are built and thus also have a certain construction typology in itself and a certain relation to the highway. For this project three types are chosen from three different specific periods in time that also are characterized by specific social/spatial issues and another relation to the highway: the car-oriented post-war neighbourhood of the 1950s, the slow traffic-oriented Woonerf of the 1970s and the suburban VINEX neighbourhood of the 1990s. This results in 15 combinations of highway prototypes and urban types in which the highway zone can be activated to enhance urban resilience, quality and liveability on a larger scale.

STEP ONE

Analysis of the original situation of the case area.

Qualitative:

- Social-spatial issues
- Environmental issues
- Spatial context and policy

Quantitative

- Land-use (occupation, infrastructure, green) using soil waterways to landscape industrial area
- Surfaces (buildings, paved, open soil, water etc)
- Functions (housing, supermarket, school, office, industry)

The approach is to be executed in two phases: the polluted buffer zones will be cleaned in the first phase and the potential of the urban area will be activated in the second phase. This involves opportunities for wastewater treatment, energy production and newly built programme. How can the different combinations create spatial opportunities to enhance the resilience of a specific area? In this context, climate change, the energy transition and the quality of urbanization are the main key factors. The need to mitigate and adapt changes in the hydrological cycle, to reduce energy dependency and find more renewable energy sources is increasing, but at the same time there is less space available to achieve these goals.

The densification that is necessary to house the growing urban population involves problems in the fields of sustained urban quality and liveability, (waste)water, energy, redevelopment and provisions for new forms of mobility. For each urban type, current qualities and opportunities to create balanced relation between human and natural systems can be defined in relation to the present situation. In addition, we can address

actual problems and shortcomings.

The adaptation of each urban type requires an incremental process that develops from the current situation (phase zero) and progresses during an intermediate stage of ten years (phase 1) toward a final horizon when the highway, the buffer zone and the residential area involved form a single urban fabric (phase 2). The redevelopment of the polluted buffer zone can be addressed by using natural technologies in combination with wastewater treatment. These are the earliest adaptations that take place in phase 0 and can continue during the whole of phase 1. The development of new buildings becomes relevant in phase 1, when the introduction of plants nears its completion and energy production through various renewable sources yields sufficient results. During the second and last phase, new urban concepts emerge, for all combinations of highway prototypes and urban types, couple matters of resilience with spatial matters, that is: the design of street hierarchy, residential blocks and the structure of public space and local ecology to improve liveability.

STEP THREE

Redesign on the base of urbanization, mobility, energy and climate challenges

- Programmatic demands (livability)
- Building demand (densification)
- Mitigating (waste) water issues
- Energy transition
- Changing mobility effects
- Environmental impact
- Reducing heat impact
- Improve biodiversity

The scale at which resilience influences the new urban systems shows the overwhelming potential of the space around the highway once new technological innovations in the field of mobility and environment are combined. New correlations between human and natural systems transform the as yet orphaned fragments of land into pioneer zones that enhance the resilience.

3.2 Redesign with material flow

STEP TWO AND FOUR

The progressive concentration of humans in urban areas is proportional to an increasing use of materials in the built environment. Urban construction activities are predominantly responsible for the consumption of primary materials that derive from natural stocks and produce massive amounts of waste. It has become, therefore, critical for cities to minimise their waste flows and extract value from existing man-made stocks. Construction and Demolition (C&D) waste contain a complex and heterogeneous mix of materials that are often recycled as an end-of-pipe solution. Nevertheless, recovering value from C&D waste is not a trivial problem in today's resource intensive urban structures. It is necessary to adopt a cradle-to-cradle approach where output flows are used as secondary resources. In this work, we design a circular material flow model that facilitates urban mining by incorporating the principles of a bottom-up Material Flow Analysis (MFA). First, MFA is applied herein as a tool to: (1) identify the largest material flows in the urban samples, (2) detect in which flows direct reuse of secondary materials is possible, (3) calculate the waste flows derived from the demolition of buildings. Second, we seek opportunities for recovery of the largest material flows that leave the system to support urban planners design a more circular built environment with improved recycling of materials.

STEP FIVE

Adaption of the design

In order to reduce or make the material flows as circular as possible design concept that anticipate on reuse of material are applied. See the next paragraph for the overview of the design samples.

STEP SIX

Redesign of public space

With the aim to restore the environmental health of the area the soil design concepts that improve degraded and polluted soils are used as the base of public space design which is executed in phases.

3.3 Six step design approach

The research Infrastructure resilience offered two steps in the new six step design approach that ultimately aiming for balance between surface and subsurface. Introducing more insight about material flows and redirecting design decisions to circular or reduction of use of soil and improvement of the quality as is done in this research added four more steps to the design approach.

STEP ONE

Analysis of the original situation of the case area.

STEP TWO

Analysis of the stock of the materials in the area

STEP THREE

Redesign on the base of urbanization, mobility, energy and climate challenges

STEP FOUR

Analysis of the stock of the materials in the new design

STEP FIVE

Adaption of the design in order to make the material flows as circular as possible

STEP SIX

Redesign of public space

This six-step design approach is applied to the 15 combinations of urban samples. In the next chapter the results of five steps per sample is presented. The last step of 'redesign of public space' is presented in chapter 4.

Design samples

Design overview

Post war 50's car oriented

Post War '50s urban sample is characterized by a strong and clear idea about what the 'public realm' was to enhance social coherence, expressed in oversized public space, mixed typology of housing in a repetitive stamp. Industrial production and very technocratic approach in which the buildings are prefab, building site preparation by hydraulic filling, subsurface drainage and well-structured infrastructure network.

Variety in housing types too low, maintenance issues in housing and public space, water quantity and quality issues.

Solution could be more ground bound housing, more defined public space, more water surface.

Sample 1 km²:

- 67,5 % Residential area
- 6 % 30-meter buffer zone on both sides
- 16,5 % Industrial area
- 10 % Highway & railway

Residential area:

- 30 % Built up (of which 50% flats (184x32 units) – 30% family housing is 506 units) and 17 % is utilities (offices 8%, school 3% and supermarket 6%)
- 44 % Green space (of which 30% private)
- 22% Infra (of which 5% parking spaces)
- 4 % Water

Industrial area:

- 60% Built up
- 5 % Green space
- 31% Infra
- 4% Water

Characteristics:

- Hydraulically filled with sand (2 m)
- Industrial constructed buildings

Healthy city: making inclusive by mixing social economical groups and diversification housing stock, programming public domain from mono to multifunctional.

New economy: mixing housing and industry (residential area ratio 80/20, industrial area 80/20), flexible usage, technical and social innovation, create new business models and entrepreneurship, create networks for business and public life.

Connectivity: new model split, highway and city connected, new parking scheme.

Climate adaptation: water storage, infiltration, reducing heat stress with green areas

Energy: generate energy in buffer and highway, take of gas.

Mobility: automated electrical cars as driver for new relation highway and city, redesign infrastructure.

Circularity: using circular material flows as driver for design. Re-use, recycle, remediate.



Fig 3.1 Phase one is the original state. In phase two the first step is implementing GRO to clean soils and to stop adding sand to mitigate effects of subsidence. This is done differently in phase 3 by stimulating the restoration of the endogenous ecosystem and design the buildings on piles so that they can function with subsiding soils.

4.1.1 Floor

Potential to connect the highway to public program in the buffer zone (N4 model) that is also connected to the urban area. Replacement of 20 % flats by single family housing in the residential area. Cars are used as battery for the houses and

charged on the highway. The industrial area is used for recycling of water and materials. Increase water surface with 8 % is used to set the environment for the new single-family houses that replace (20%) of the flat buildings.

Existing situation

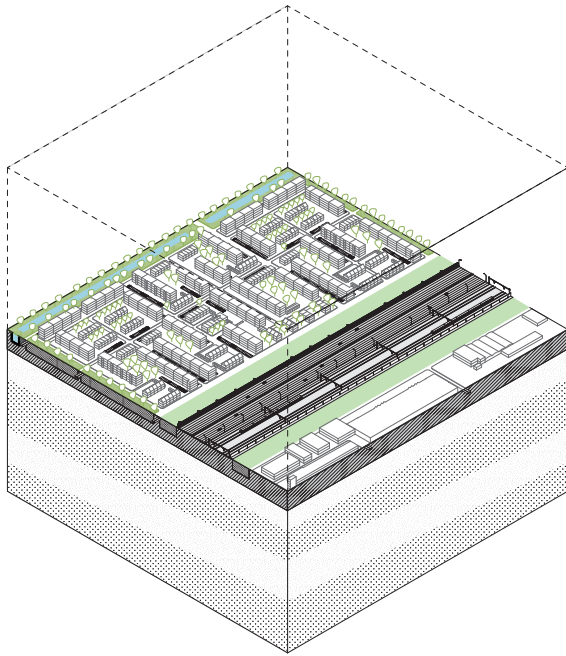

Design intervention (1)

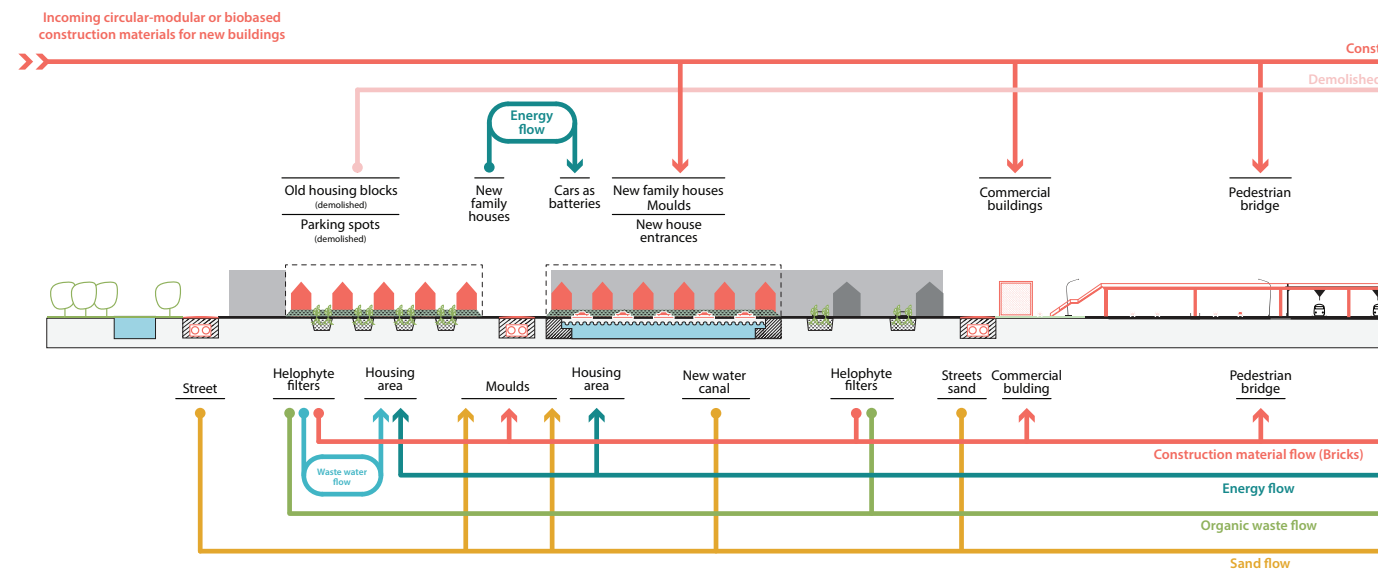
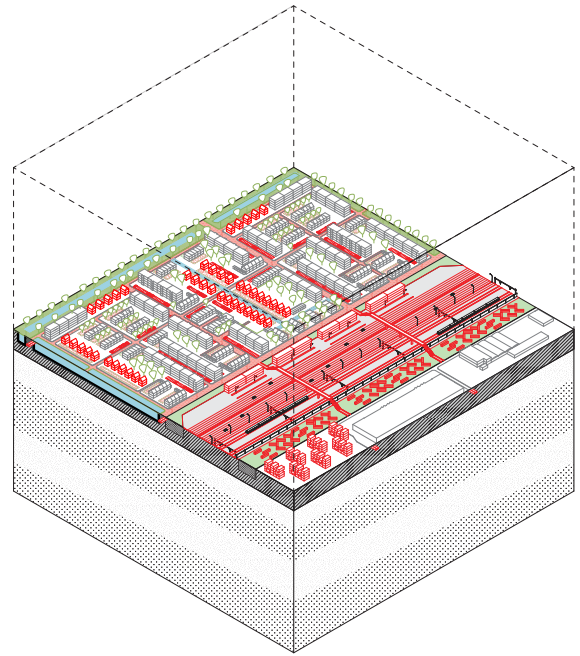

Flow from Existing situation to Design intervention (1)

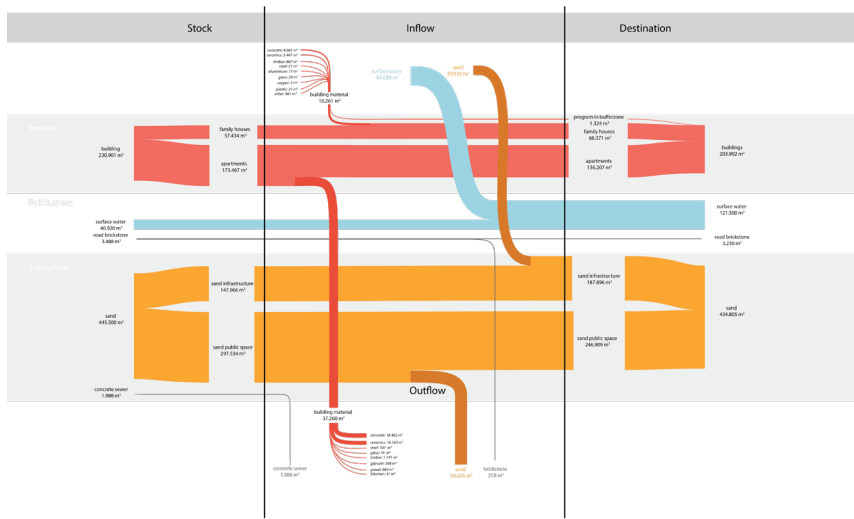

Material flow out:

- Building material industrial buildings
- Soil from waterways
- material sewer systems (concrete)
- Brick stone from private parking spaces

Material flow in:

- Material for family housing
- Sand for road maintenance

Flow from Existing situation to Design intervention (2)

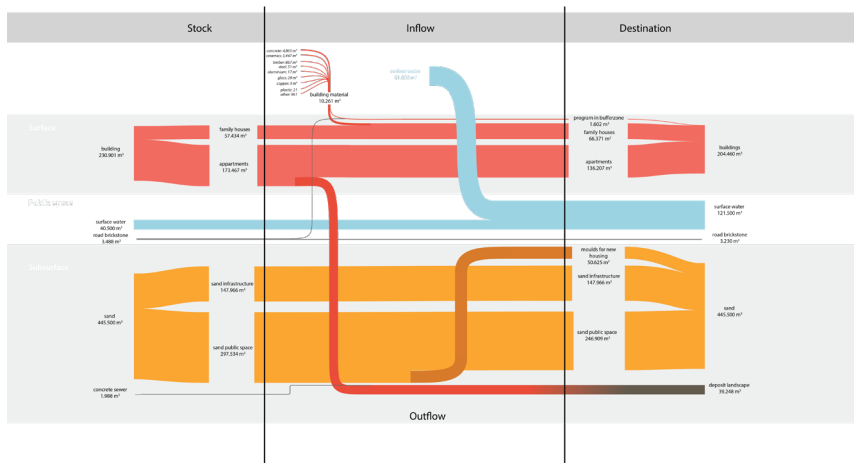

Recycled material flow:

- Building materials into Deposit Landscape
- Soil from singel and streets into moulds

Material flow in:

- Building material inflow should be regulated by choosing modular or bio-based or recycled materials

Material flow cut:

- Inflow of sand for building site preparation is avoided

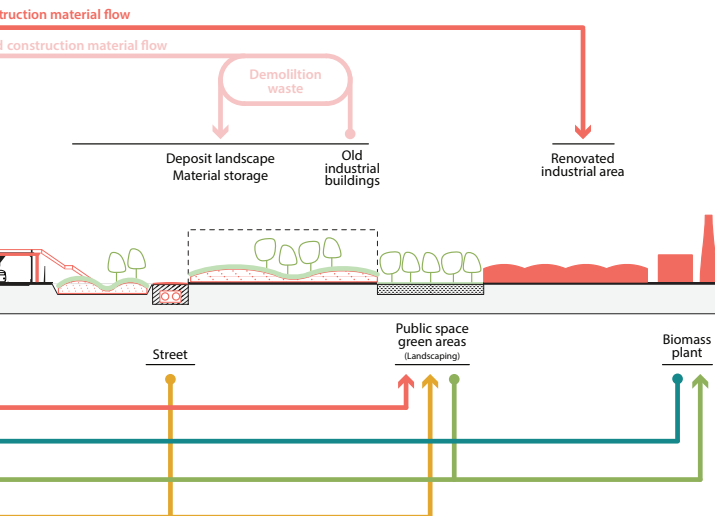

Design intervention (2) additional:

Deposit Landscape: the buffer zone and part of the industrial area is used for material storage and distribution. Here also industry and research into material re-use cycles are located.

Mould Landscape: the soil coming out of the excavation of the new singel is used for building moulds for new houses.

4.1.2 Dike

Potential to connect the highway to program in the buffer zone (N4 model) that is also used as inter-modality for people in the urban area and industrial space. The industrial area will remain 80% and 20% of the area will become residential. Cars are taken out of the area and

charged in the buffer zone. The gardens and former parking placed are used for decentralized waste water treatment. In the residential area the water surface is increased to 8% and 20 % of the flat apartments are replaced by single housing. The increase of green and water is functional for storing water and heat stress reduction.

Existing situation

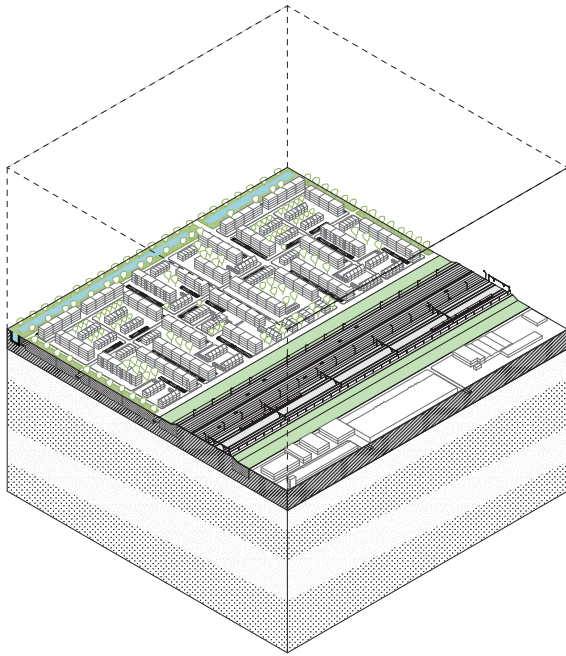

Design intervention (1)

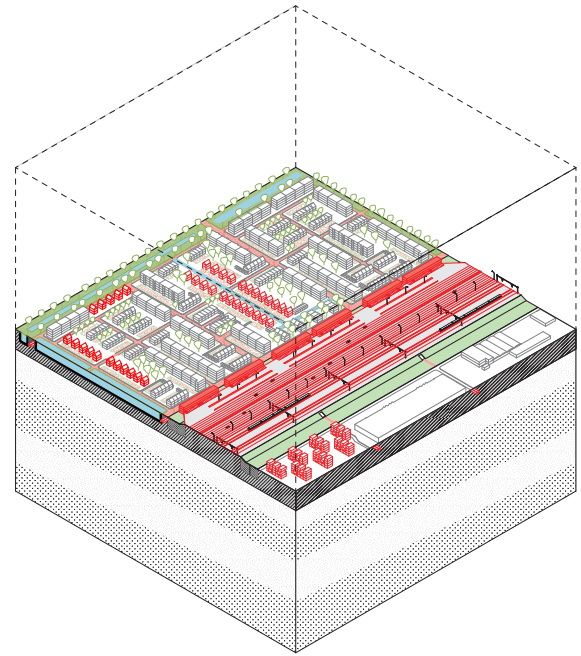

56

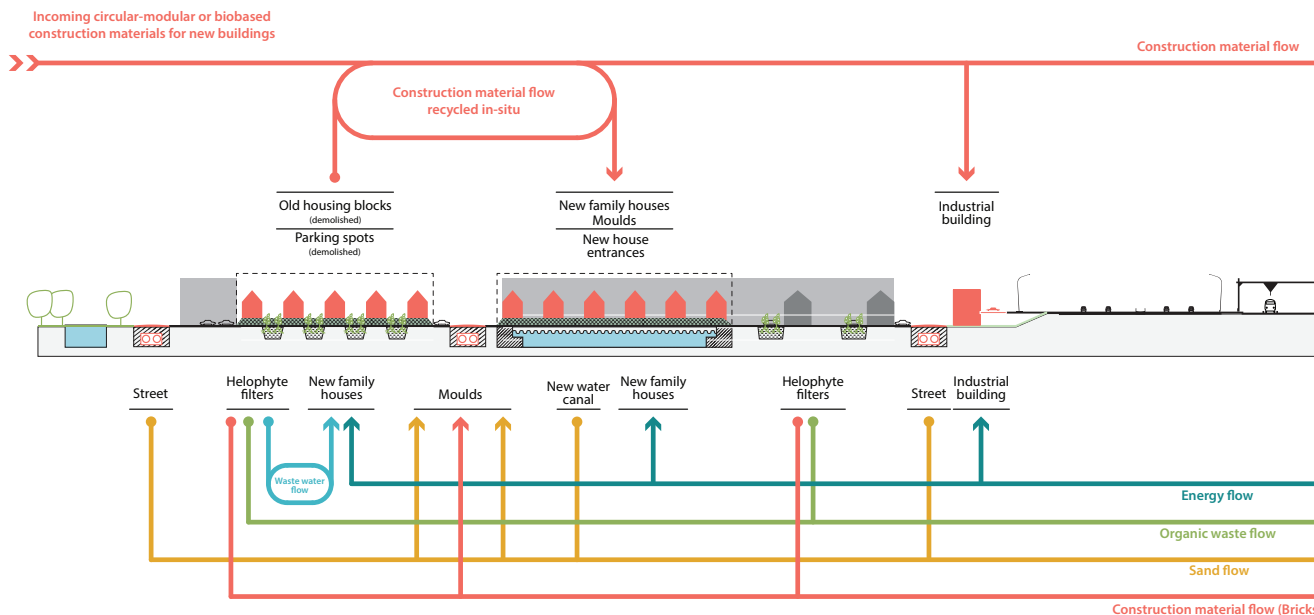

Flow from Existing situation to Design intervention (1)

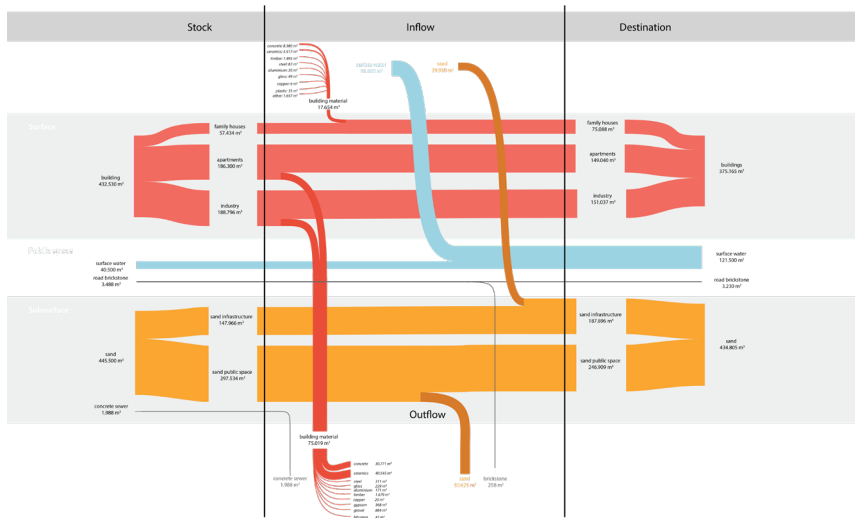

Material flow out:

- Building material industrial buildings
- Soil from waterways
- Material sewer systems (concrete)
- Brick stone from private parking spaces

Material flow in:

- Material for family housing
- Sand for road maintenance

Flow from Existing situation to Design intervention (2)

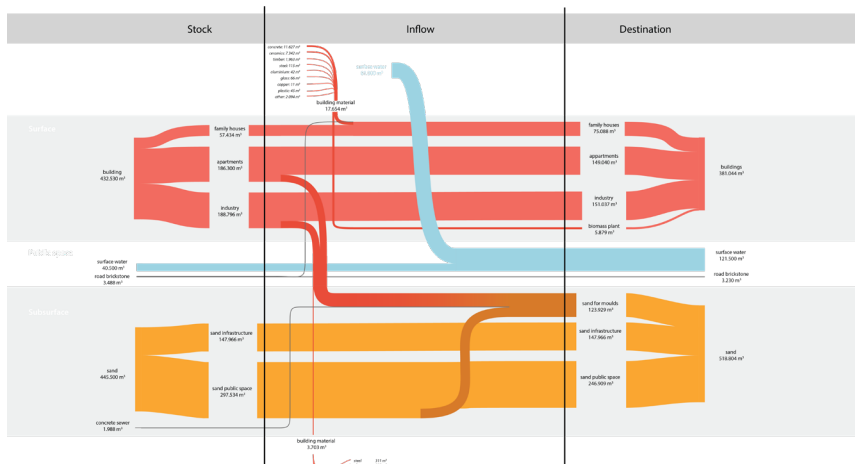

Recycled material flow:

- Brick stone road from road can be used for new foundations and cladding
- Soil from singel and streets into moulds
- Outflow of building materials to moulds

Material flow in:

- Building material inflow should be regulated by choosing modular or bio-based or recycled materials

Material flow cut:

- Inflow of sand for building site preparation is avoided

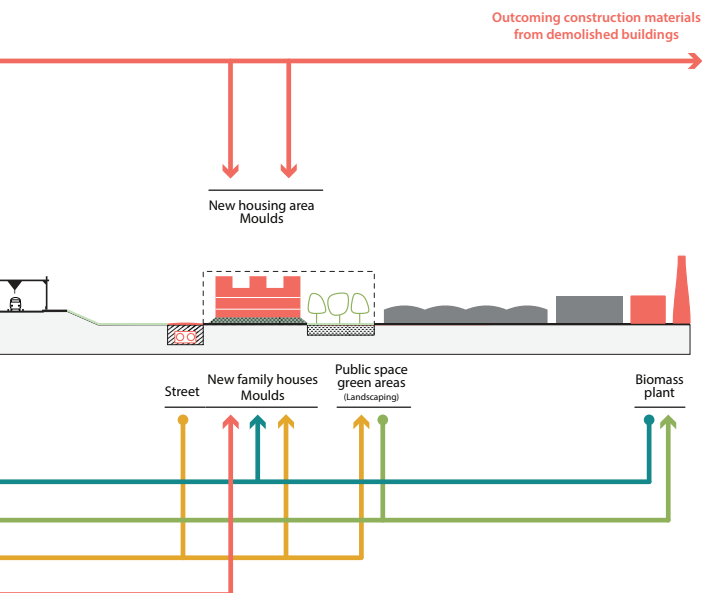

Design intervention (2) additional:

Mould Landscape: the soil coming out of the excavation of the new *singel* and concrete and ceramics coming from demolished buildings is used for building moulds for new houses instead of adding sand to the whole area.

Re-use ARCH: materials are reused in in new housing.

Programming (flow facility): Biomass plant

4.1.3 Stilts

Potential to intertwine residential and industrial zone by making more underpasses. The industrial function moves into the buffer zone and the industrial area will be transformed into residential. Cars will be charged under the highway so parking spaces can be changed to helophyte

filter for decentralized wastewater treatment. Along the new water structure (8% more) single family housing is replacing 8 % of the flats.

Existing situation

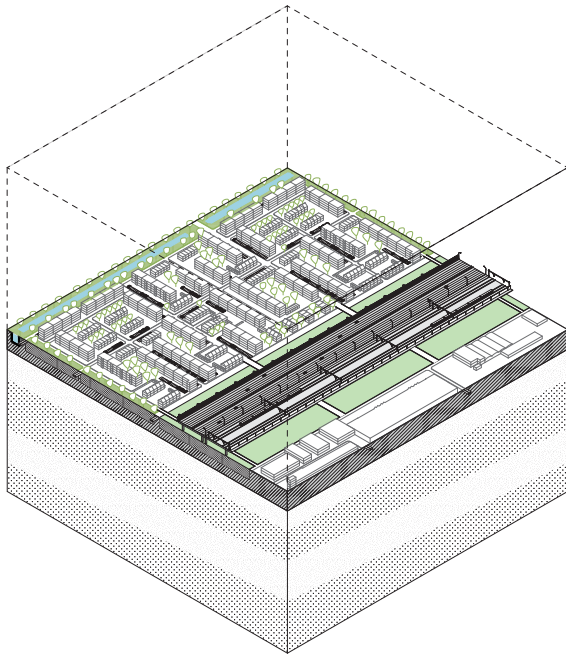

Design intervention (1)

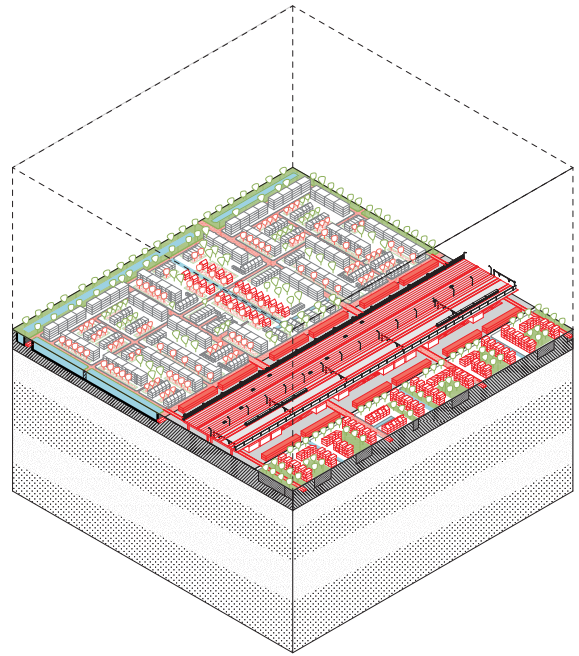

58

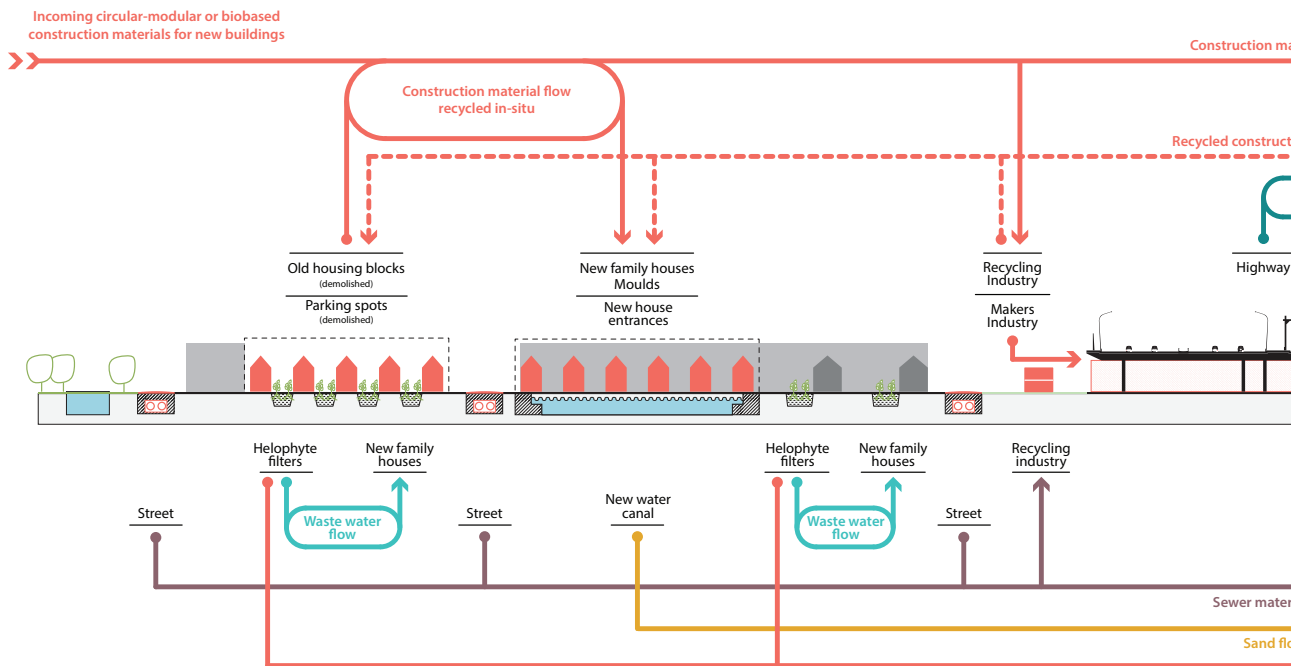

Flow from Existing situation to Design intervention (1)

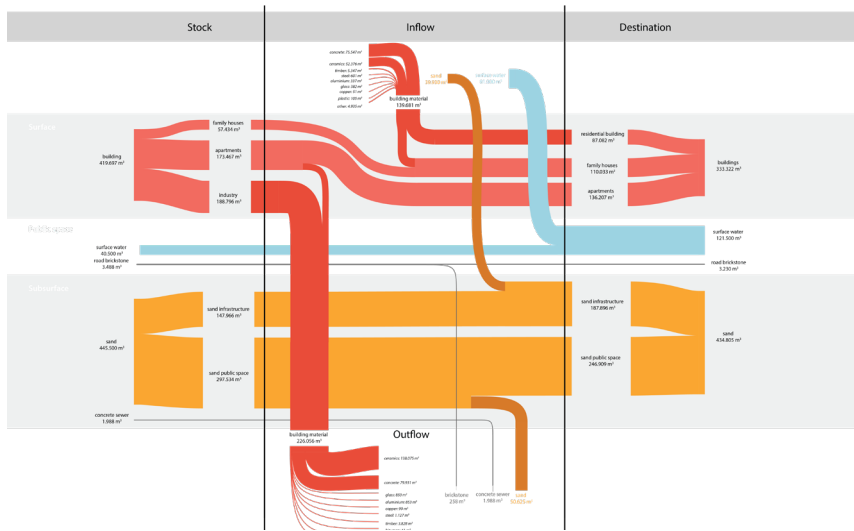

Material flow out:

- Building material industrial buildings
- Soil from waterways
- Material sewer systems (concrete)
- Brick stone from private parking spaces

Material flow in:

- Inflow of material for family housing
- Sand for road maintenance

Flow from Existing situation to Design intervention (2)

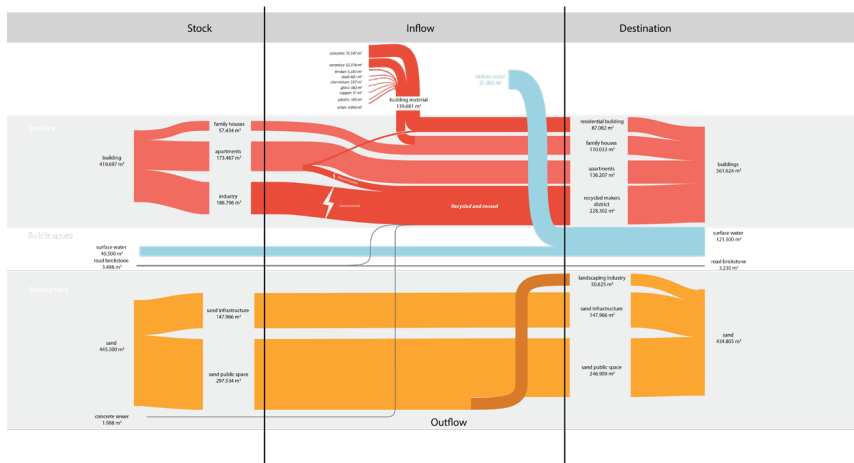

Recycled material flow:

- Reuse of demolished building and sewer material
- Soil from singel and streets into new landscape

Material flow in:

- Building material inflow should be regulated by choosing modular or bio-based or recycled materials

Material flow cut:

- Inflow of sand for building site preparation is avoided

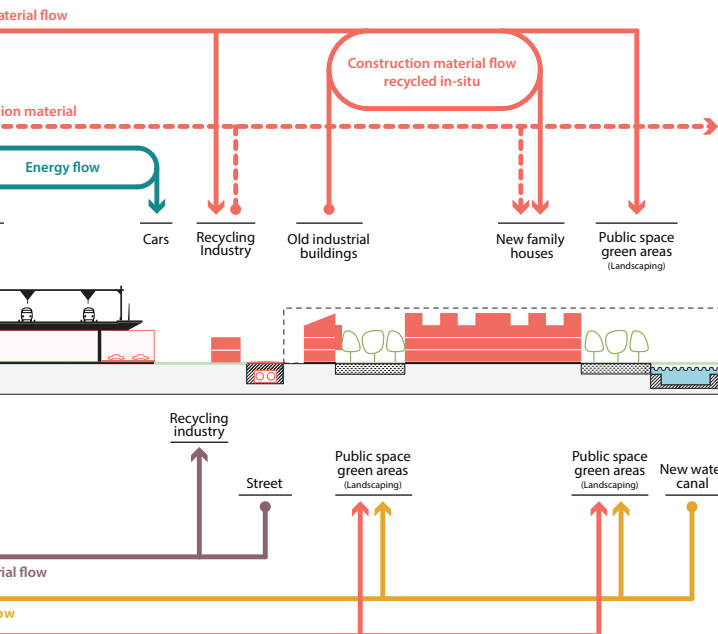

Design intervention (2) additional:

Programming (refurbished/flow facility): industrial area becomes residential and the buffer zone is programmed for the recycling industry. Under the highway a new makers district is planned.

Re-use ARCH: materials are reused in in new housing.

Deposit Landscape: the soil coming out of the new singel is used for landscaping in the former industrial area.

4.1.4 Ditch + Dike

Potential to connect the residential and industrial space with mixed use buildings over the highway. Cars are taken out of the area and charged in the buffer zone. Parking spaces are changed to helophyte filters that filter domestic water. In the residential area a new water structure

(increase with 8%) with single family houses is replacing 20% of the flat buildings. Gardens are used for decentralized waste water treatment. The industrial area is used for power generation. The residential area is more green offering water storage and heat stress reduction.

Existing situation

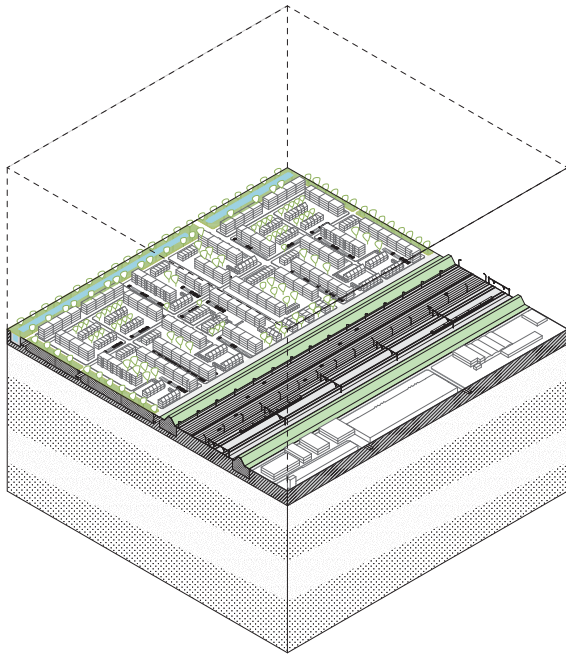

Design intervention (1)

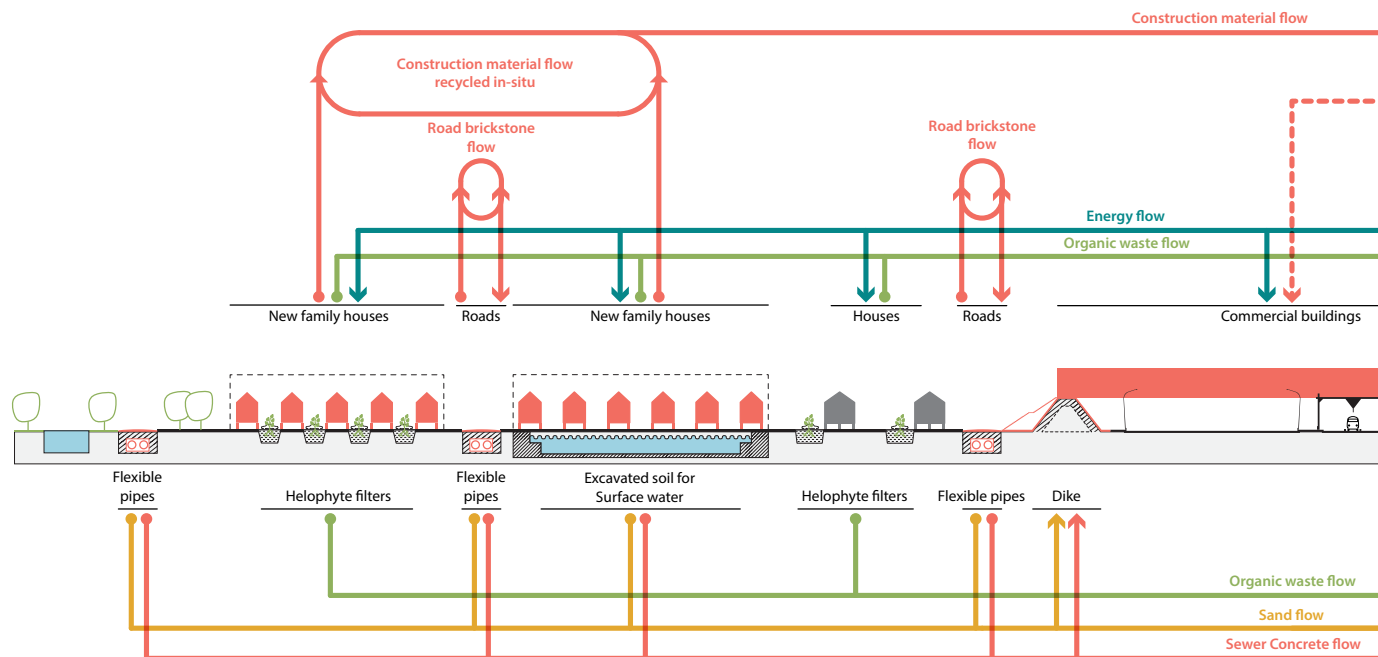
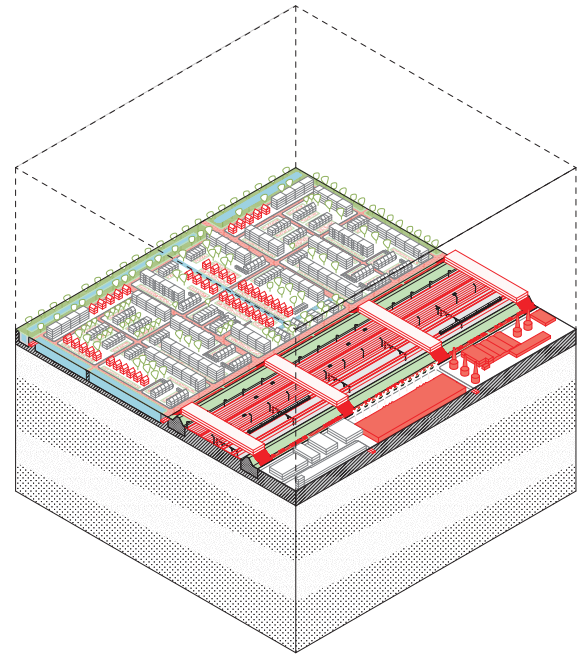

Flow from Existing situation to Design intervention (1)

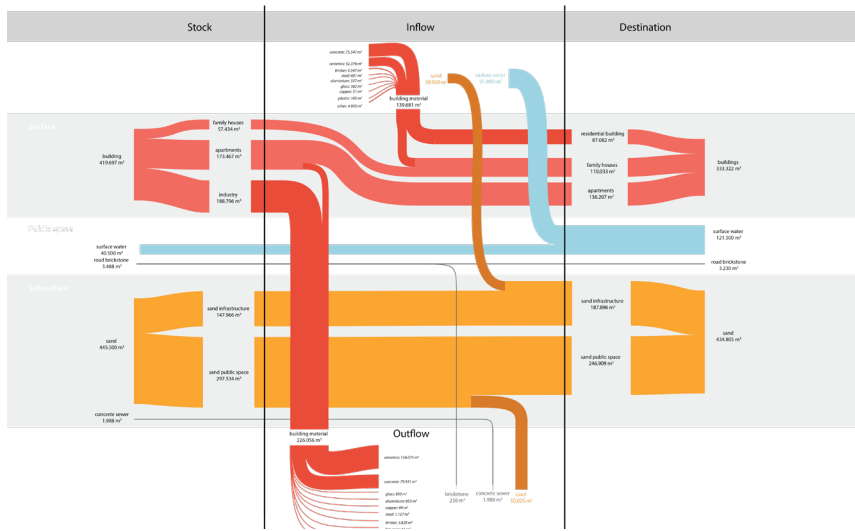

Material flow out:

- Building material industrial buildings
- Soil from waterways
- Material sewer systems (concrete)
- Brick stone from private parking spaces

Material flow in:

- Inflow of material for family housing
- Sand for road maintenance

Flow from Existing situation to Design intervention (2)

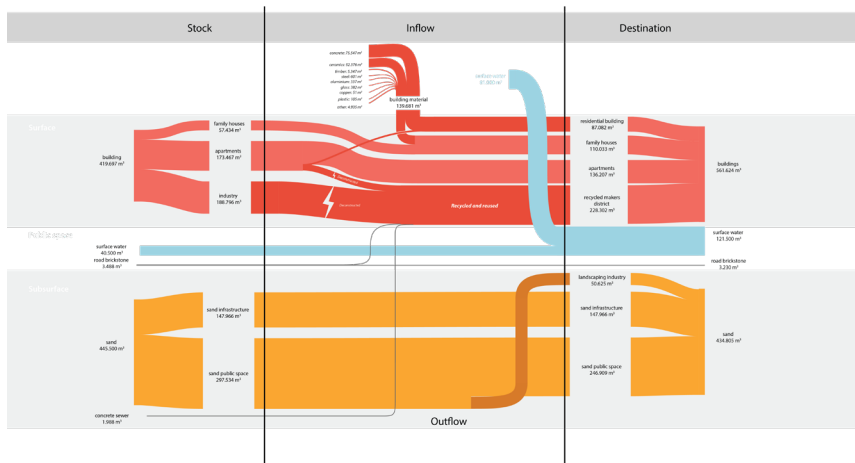

Recycled material flow:

- Reuse of demolished building and sewer material
- Soil from singel and streets into new landscape

Material flow in:

- Building material inflow should be regulated by choosing modular or bio-based or recycled materials

Material flow cut:

- Inflow of sand for building site preparation is avoided

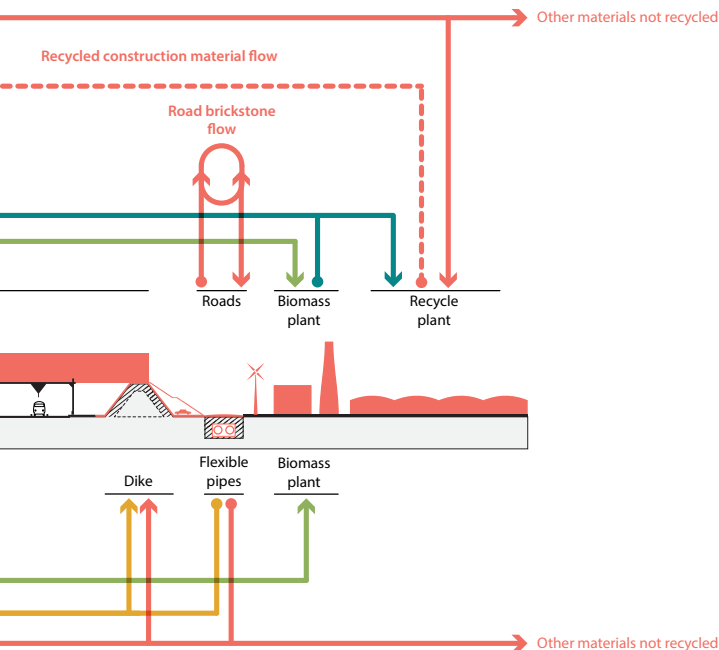

Design intervention (2) additional:

Restored Landscape:

The subsidence is dealt with without adding sand to the area (as is usually done) and by stimulating the restoration of the endogenous ecological system.

Subsidence Architecture: The growing height difference between buildings (stabilized on piles) and public space is solved in a new architectural typology.

Deposit Landscape:

The soil that comes out of digging the water way is used to heighten the dike.

4.1.5 Ditch

Potential to connect the highway to program the 20 % industrial space in the existing buffer zone (N4 model) that is also used as inter-modality for people in the urban area. Cars will be in the area

used as battery for the housing. The industrial area will become residential where just as in the residential area the water surface is increased to 8%.

Existing situation

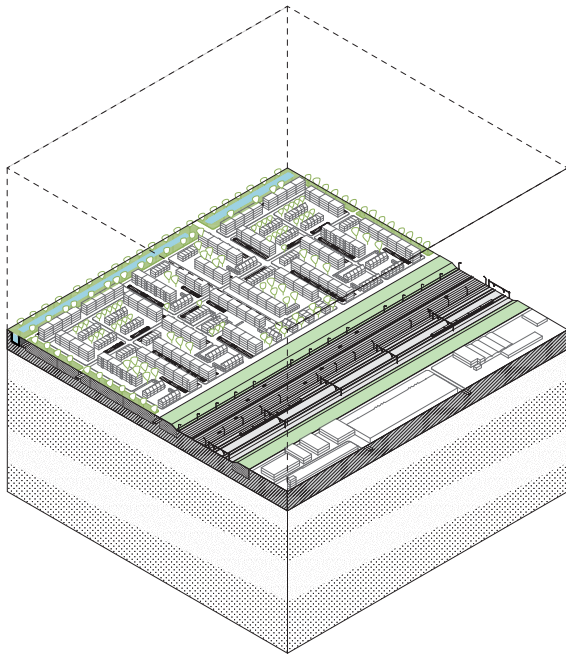

Design intervention (1)

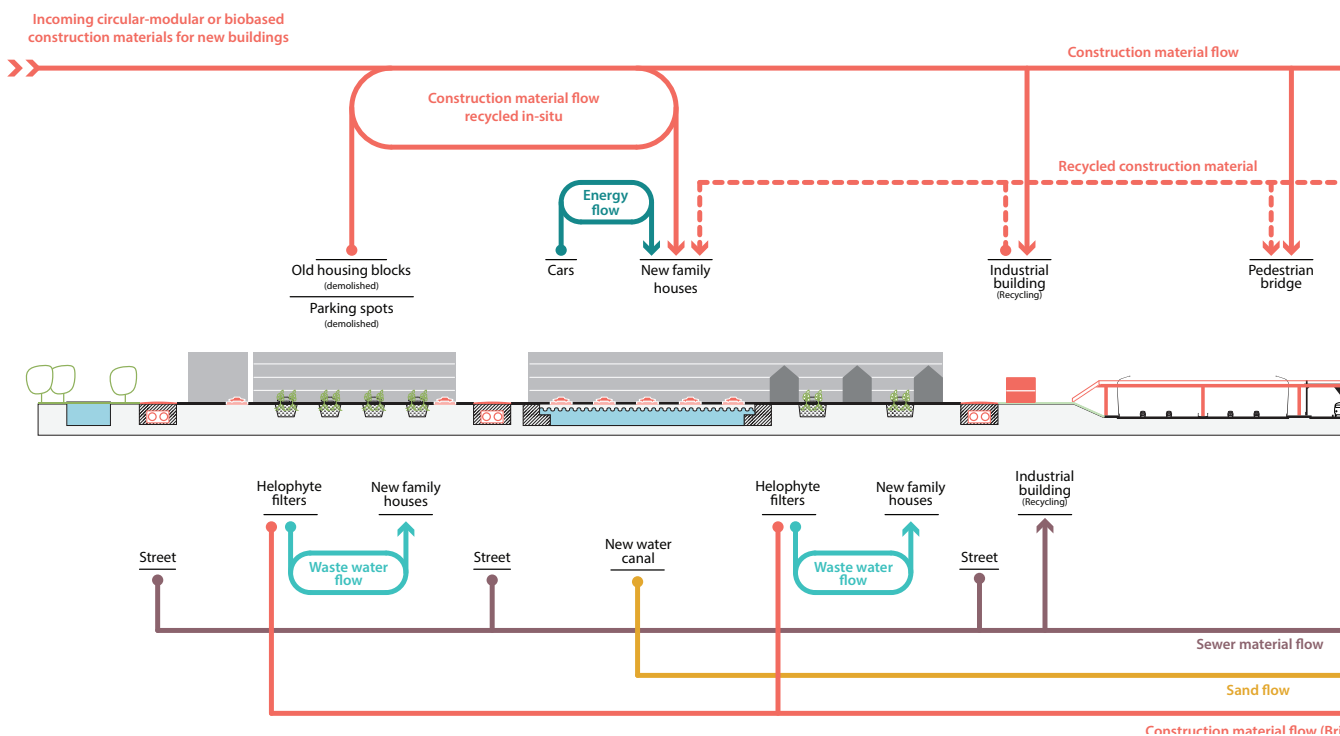
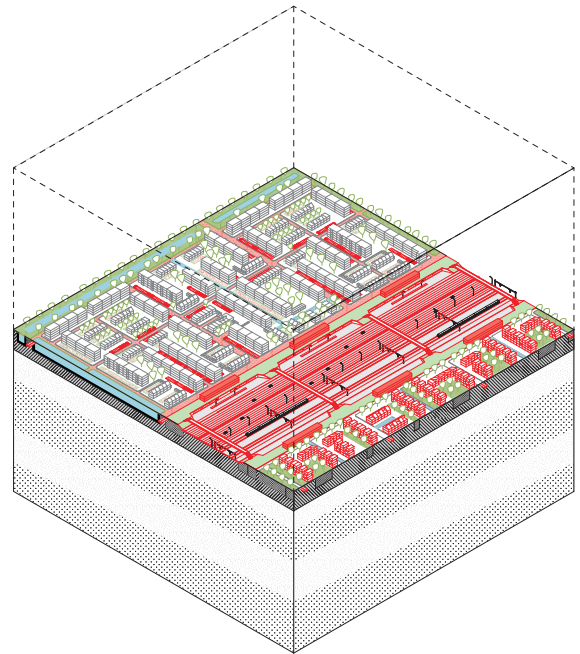

Flow from Existing situation to Design intervention (1)

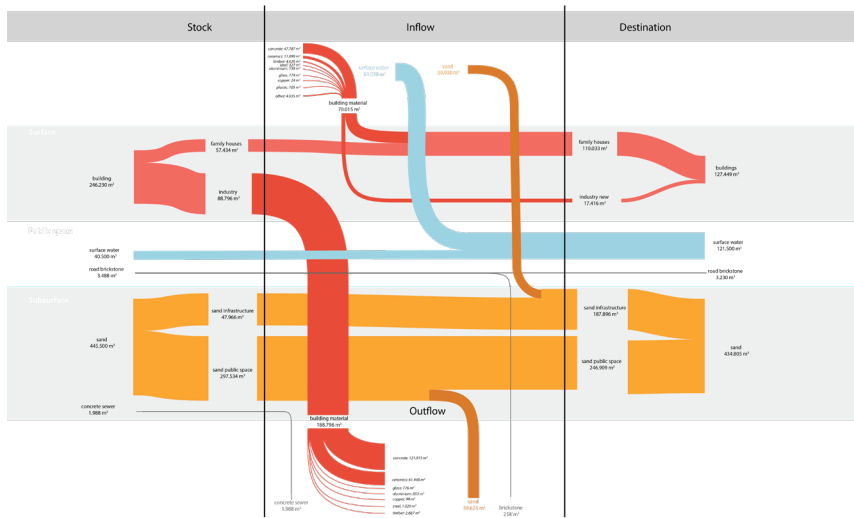

Material flow out:

- Building material industrial buildings
- Soil from waterways
- Material sewer systems (concrete)
- Brick stone private from parking spaces

Material flow in:

- Sand for road maintenance
- Inflow of material for family housing

Flow from Existing situation to Design intervention (2)

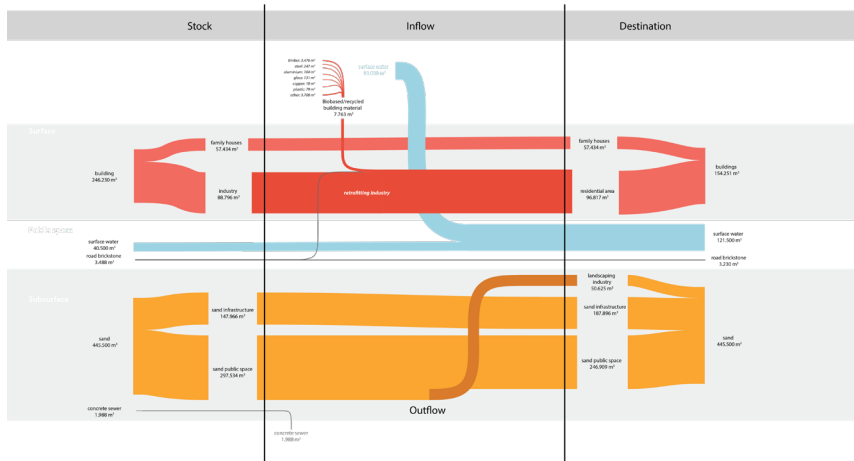

Recycled material flow:

- Reuse of demolished industrial building and sewer material for new housing
- Soil from singel and streets into new landscape in industrial area

Material flow in:

- Building material inflow should be regulated by choosing modular or bio-based or recycled materials (no concrete coming in)

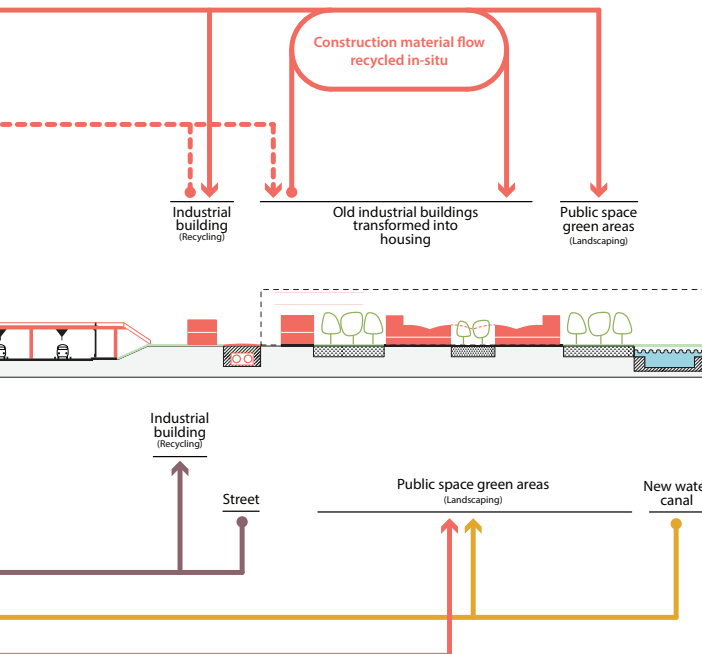

Design intervention (2) additional:

Deposit Landscape: the soil coming out of the new *singel* is used for landscaping in the former industrial area.

Re-use ARCH: materials are reused in new architecture typology.

Design overview

Woonerf 70's slow traffic oriented

Woonerf '70s have a strong focus on identity and human scale, gezelligheid, and a strong aversion to car mobility: focus on slow traffic. Ecology was very important resulting in partial filling and the re-introduction of water in urban setting as natural spatial element.

Green structures more differentiated, smaller scale and more natural (ecology).

The woonerven are out of date, housing is not well insulated and use a lot of energy, vulnerable for demographic changes, unclear public space and infrastructure, maintenance of public space is costly and low social cohesion, no clear identity. Future renovation of housing, redesign public space.

Sample 1 km²:

- 68,5% Residential
- 7% 50-meter buffer zone on one and 20-meter on the other sides
- 14,5% Industrial area
- 10% Highway & railway
-

Residential area:

- 22 % Built up (Ground bound family houses: 1065 Units, 135 m² building footprint each)
- 49 % Green space (of which 50% is garden)
- 21% Infra (of which 5% is parking space)
- 8 % Water

Industrial area:

- 60% Built up
- 5 % Green space
- 31% Infra
- 4% Water

Healthy city: making inclusive by mixing social economical groups and diversification housing stock, programming public domain from mono to multifunctional.

New economy: mixing housing and industry (residential area ratio 80/20, industrial area 80/20), flexible usage, technical and social innovation, create new business models and entrepreneurship, create networks for business and public life.

Connectivity: new model split, highway and city connected, new parking scheme.

Climate adaptation: water storage, infiltration, reducing heat stress with green areas

Energy: generate energy in buffer and highway, take of gas.

Mobility: automated electrical cars as driver for new relation highway and city, redesign infrastructure.

Circularity: using circular material flows as driver for design. Re-use, recycle, remediate.



Fig 3.2 The renovation of the houses will be combined with the reclaim of the 'living streets' as public green community spaces. The GRO method of soil cleaning is the first step and after that the 'forest garden' will be applied, which focusses on managing soil fertility to enhance food production.

4.2.1 Floor

The highway is connected to the buffer zone (N4 model) that is also used as inter-modality and commercial programme for people in the urban area. Cars are taken out of the area and charged by energy production at the highway through biomass factories. The parking spaces

are changed to helophyte filters for cleaning domestic water.

The residential area will be greener for water management and will not be mixed use. The industrial area will be aimed at energy-oriented businesses.

Existing situation

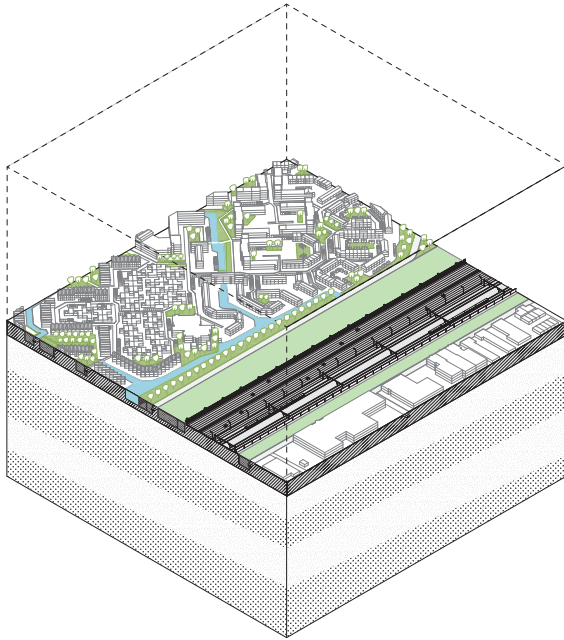

Design intervention (1)

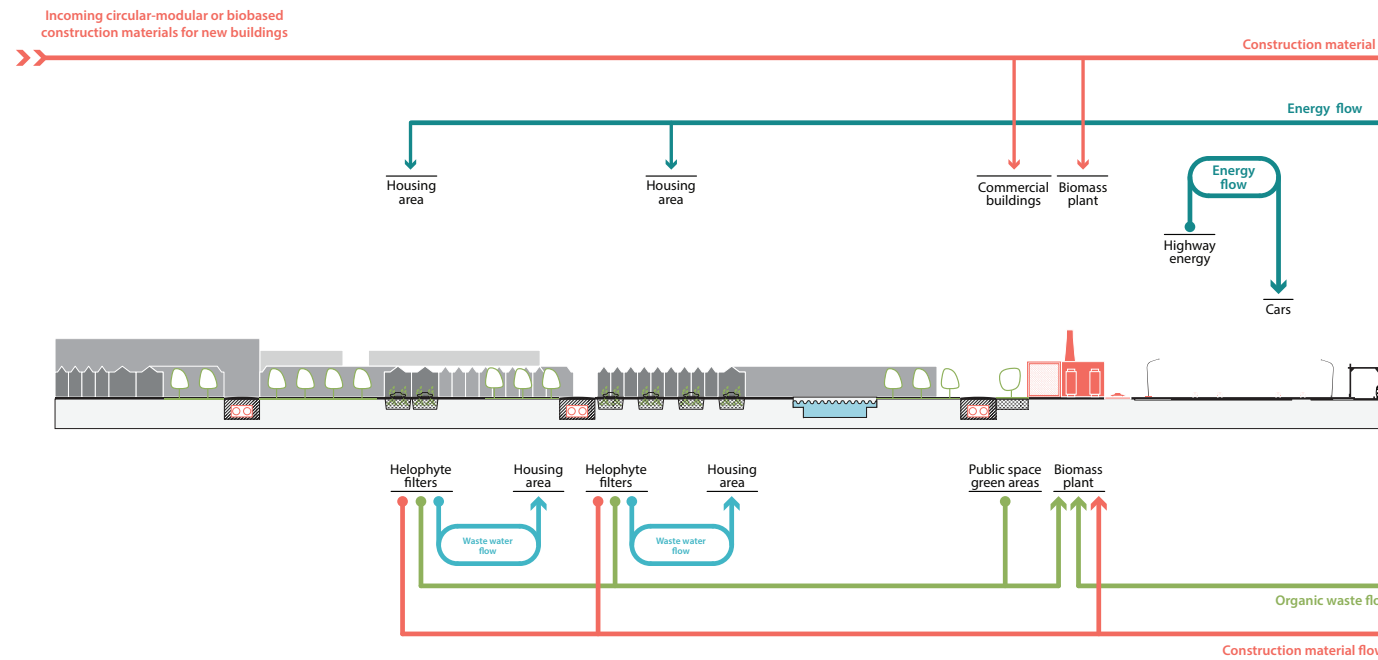
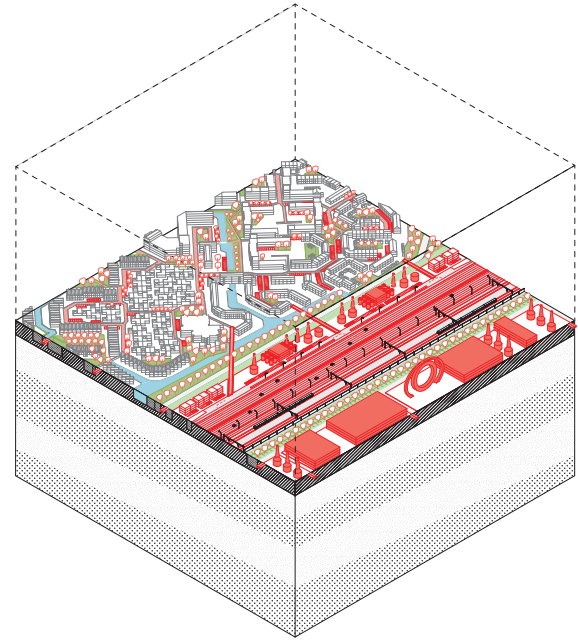

Flow from Existing situation to Design intervention (1)

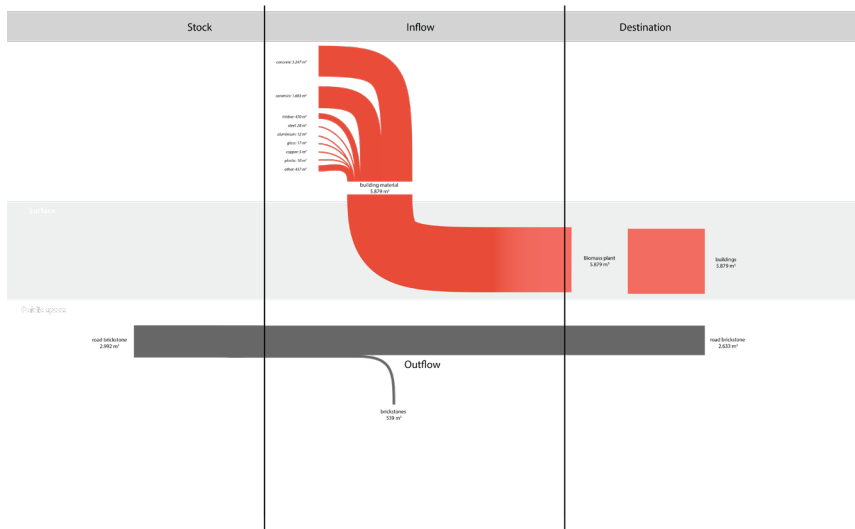

- Material flow out:*
- soil from excavation waterways
 - brick stone private parking spaces

- Material flow in:*
- new buildings

Flow from Existing situation to Design intervention (2)

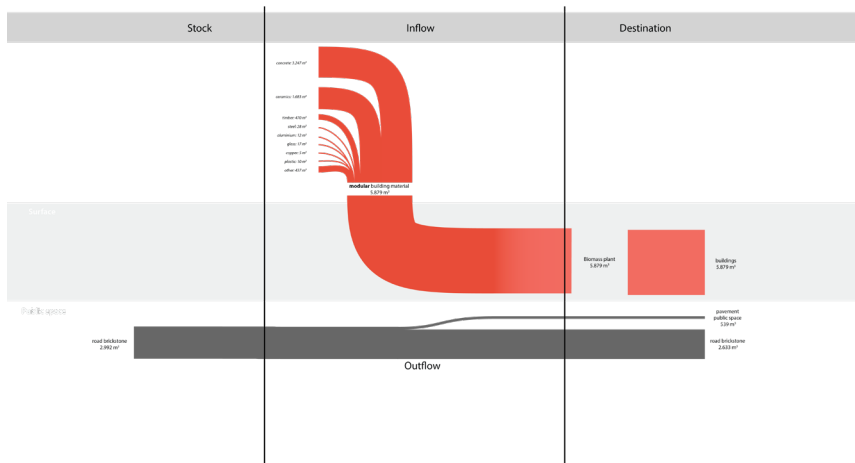

- Recycled material flow:*
- soil from waterways goes to buffer zone
 - brick stone private parking spaces go to buffer zone

- Material flow in:*
- building material inflow should be regulated by choosing modular or bio based or recycled material

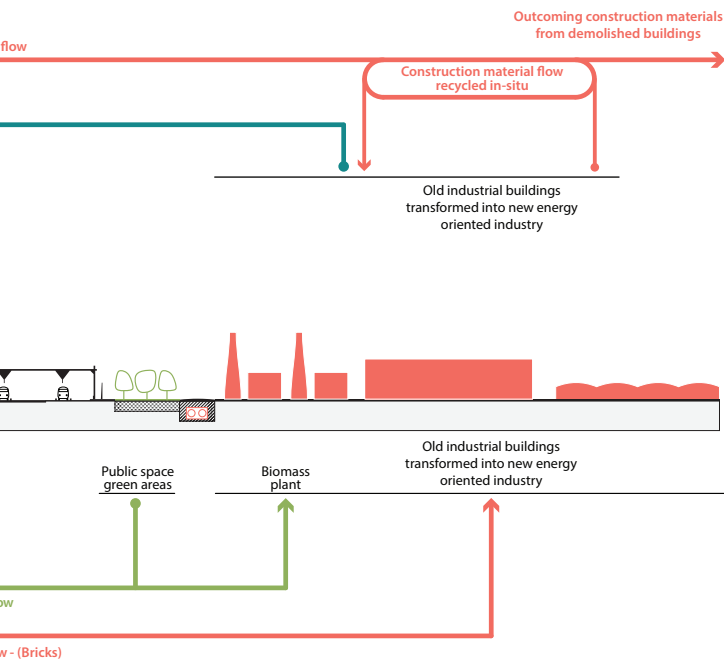

Design intervention (2) additional:

(Building input) new building regulations regulate modular and reusable materials, **Programming (flow facility)** new energy flows and biomass plant.

Deposit Landscape: the soil coming out of the new singel and the brick stones from the parking spaces is used for landscaping the buffer zone.

4.2.2 Dike

The buffer zone is on both sides programmed as horticulture. There will be small scale commercial functions in the buffers. Cars are parked at the highway and charged by energy produced by the highway, the parking spaces are changed

to helophyte filters. The residential area will be greener for water management. The industrial area will be aimed at food-oriented businesses. Housing will be introduced in towers.

Existing situation

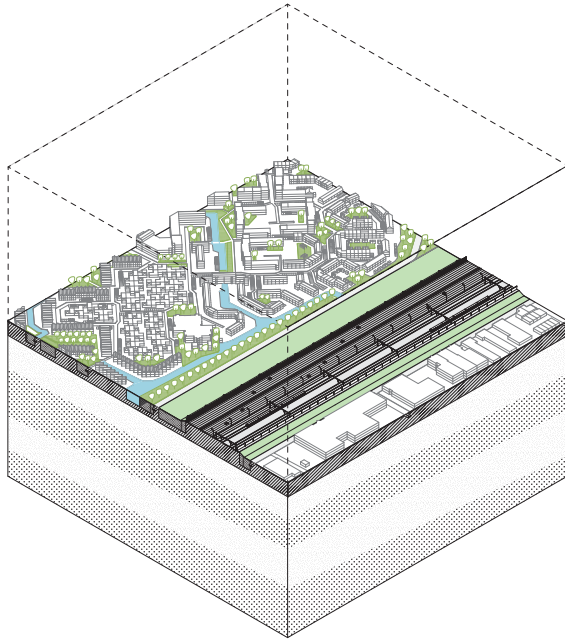

Design intervention (1)

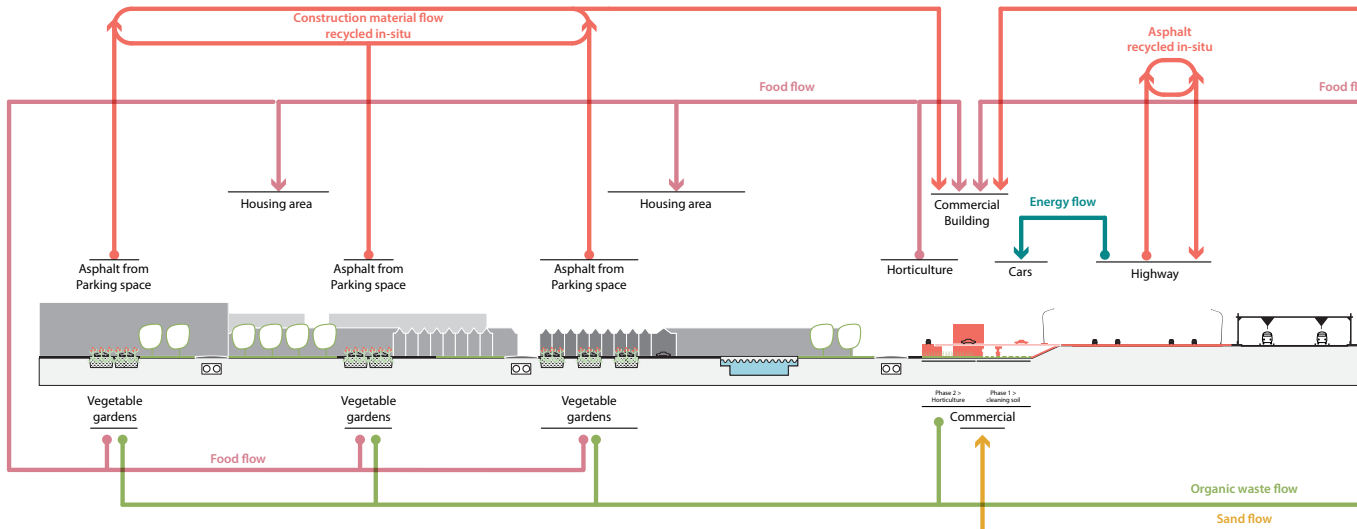
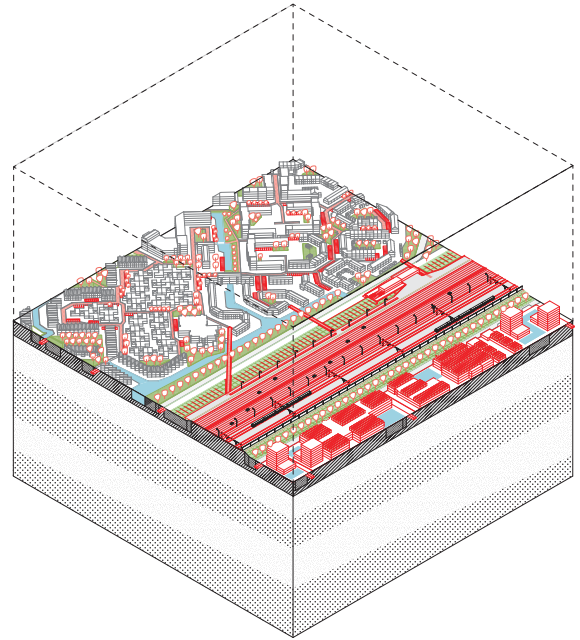

Flow from Existing situation to Design intervention (1)

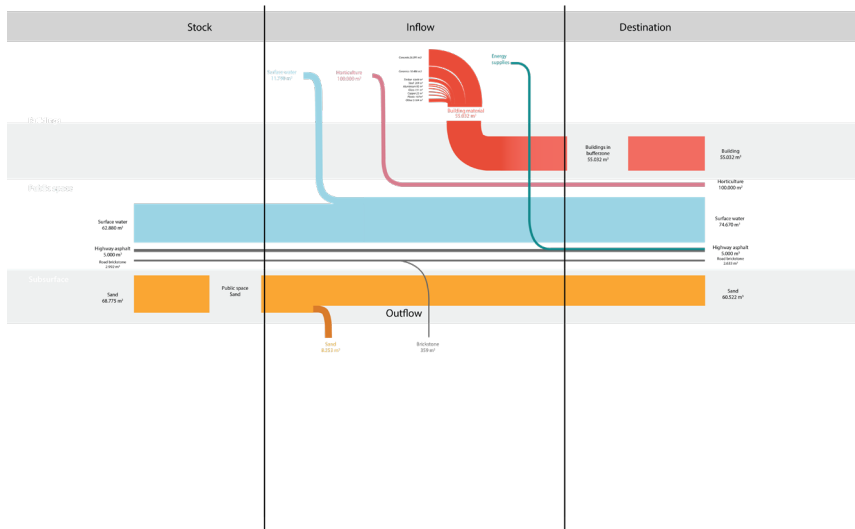

- Material flow out:*
- soil from excavation waterways
 - brick stone private parking spaces

- Material flow in:*
- new buildings

Flow from Existing situation to Design intervention (2)

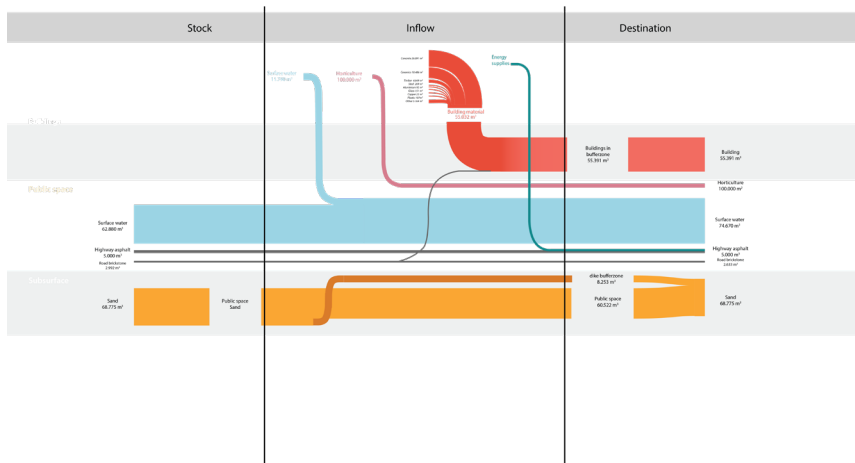

- Recycled material flow:*
- reuse of brick stone for façade cladding

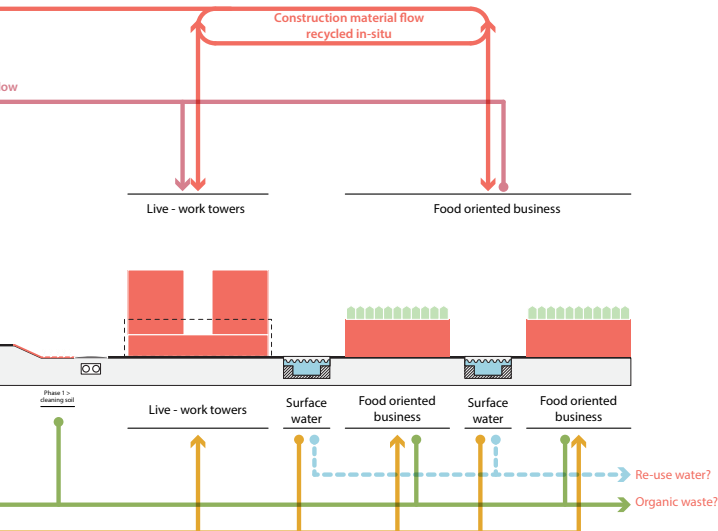

Design intervention (2) additional:

Healthy soil maintenance regime: in which makes use of circular ecosystem to improve the quality of the soil.

Deposit Landscape: the soil coming out of the new singel and the brick stones from the parking spaces is used for landscaping the zone of car charging.

4.2.3 Stilts

The buffer zone is programmed as leisure and sports on the residential side, and biomass and recycling at the side of the industrial zone. Cars will be charged under the highway by energy generated on the road, changing the parking

spaces to helophyte filters for domestic waste water. The industrial area will be transformed into commercial area added with units for work/living in the making industry. There open water will be realised for a better water management regime.

Existing situation

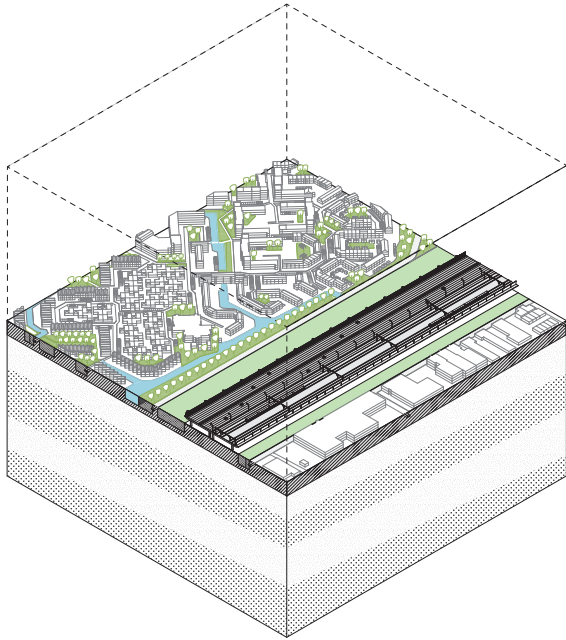

Design intervention (1)

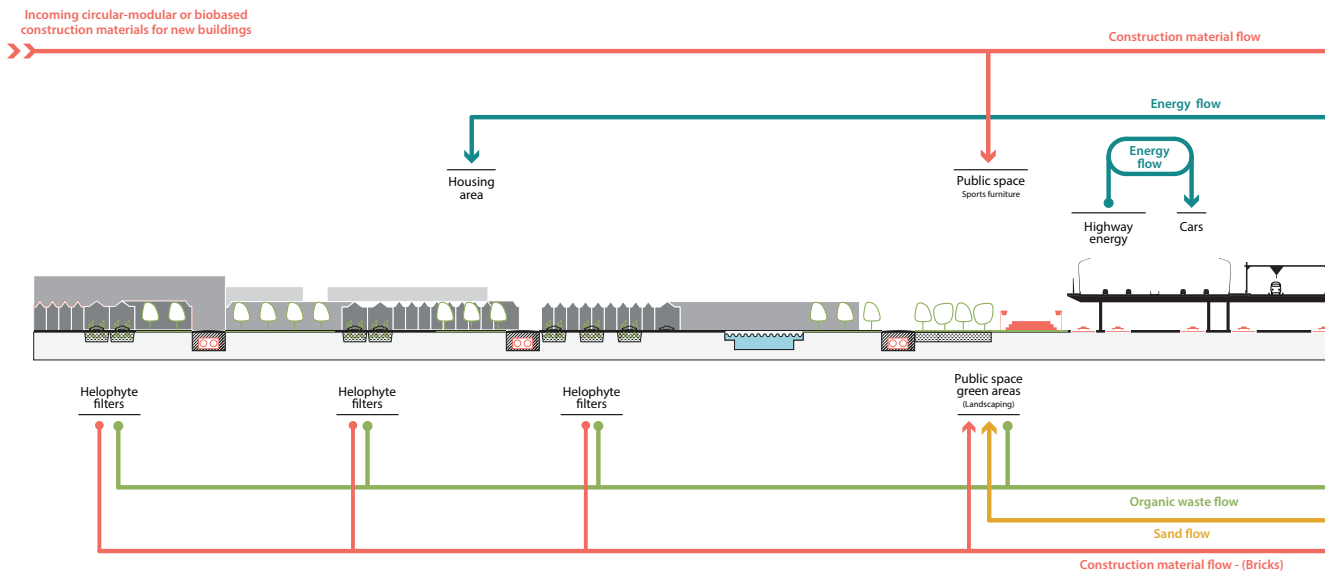
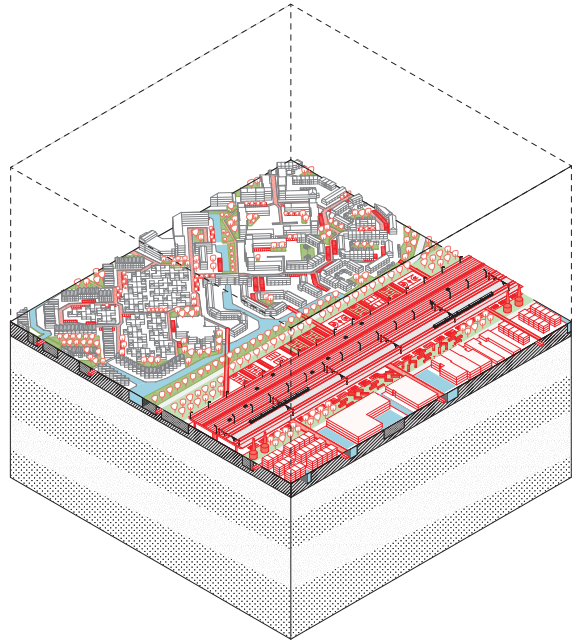

Flow from Existing situation to Design intervention (1)

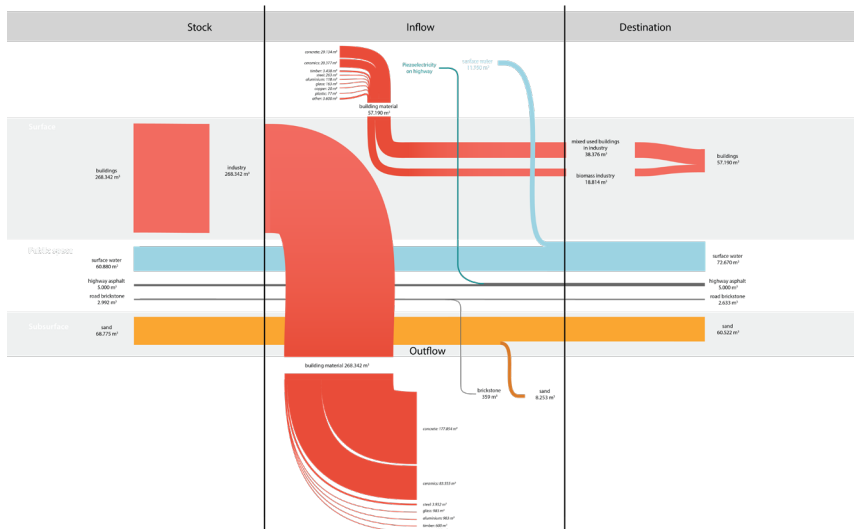

Material flow out:

- building material of industrial and row houses
- soil from waterways
- brick stone from private parking spaces

Material flow in:

- inflow mixed use buildings in industrial area and biomass plant

Flow from Existing situation to Design intervention (2)

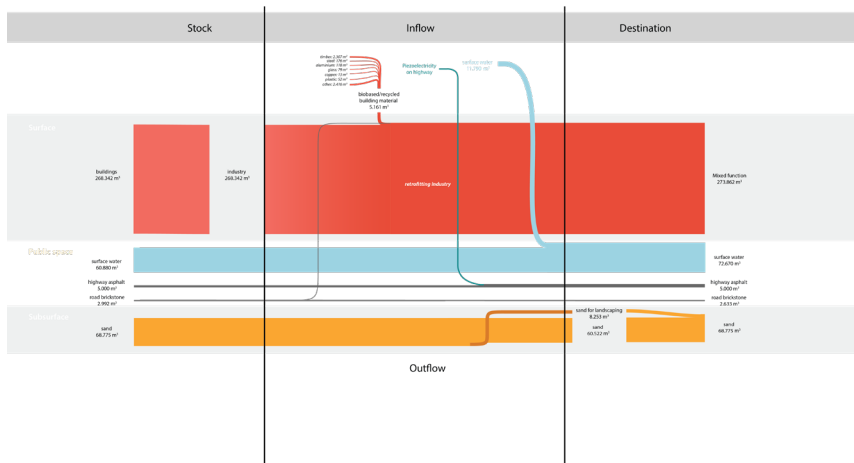

Recycled material flow:

- recycling sewer and building materials
- using soil waterways to landscape industrial area

Material flow in:

- building material inflow should be regulated by choosing modular or bio-based or recycled materials

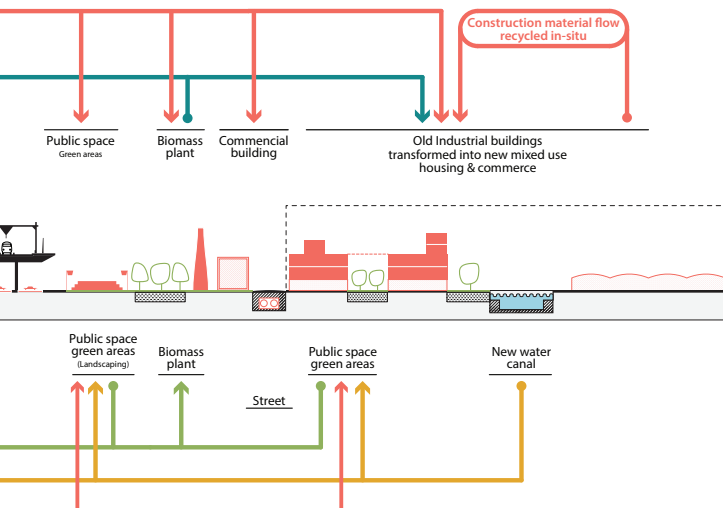

Design intervention (2) additional:

Deposit Landscape: the soil coming out of the new single and parking spaces is used for landscaping the buffer zone.

Re-use ARCH: industrial buildings are retrofitted and building materials are reused in new architecture typology.

Programming (program switch): the buffer zone at the side of the industrial site will be also sports so the both sides can be connected under the highway.

4.2.4 Ditch + Dike

Cars will be charged on the highway by energy produced by the windmill park on the highway and in the buffer zones. Cars are used as battery for the houses. The residential and industrial areas are connected by a building over the

highway in which the commercial functions are placed. The industrial area remains industrial and some buildings are re-used for commercial function.

Existing situation

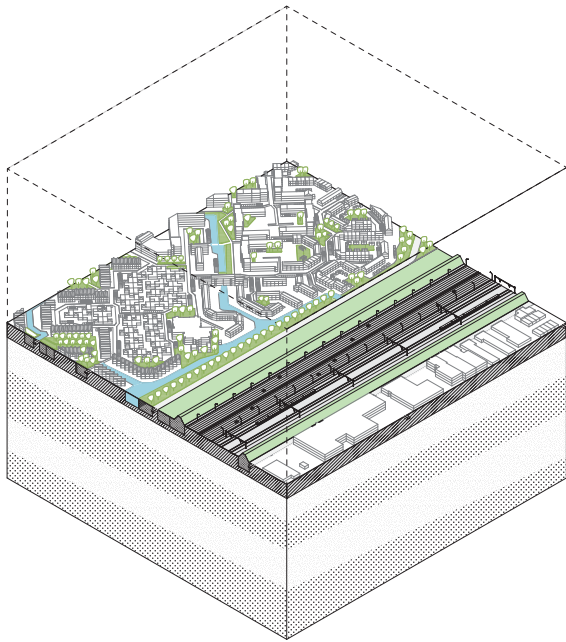

Design intervention (1)

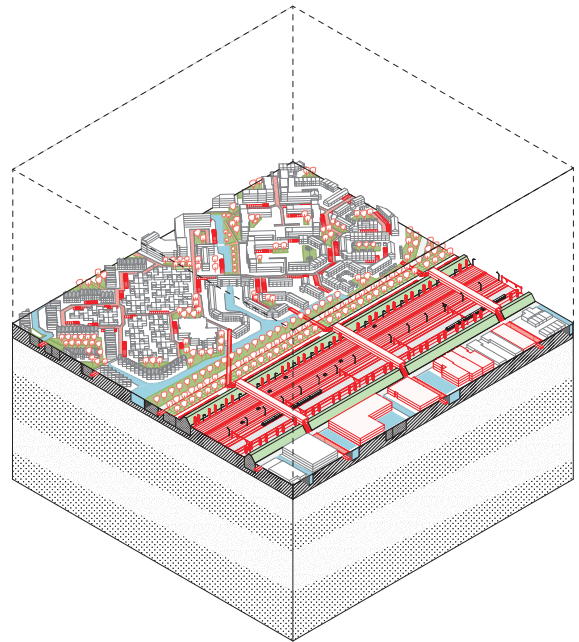

Incoming circular-modular or biobased construction materials for new buildings

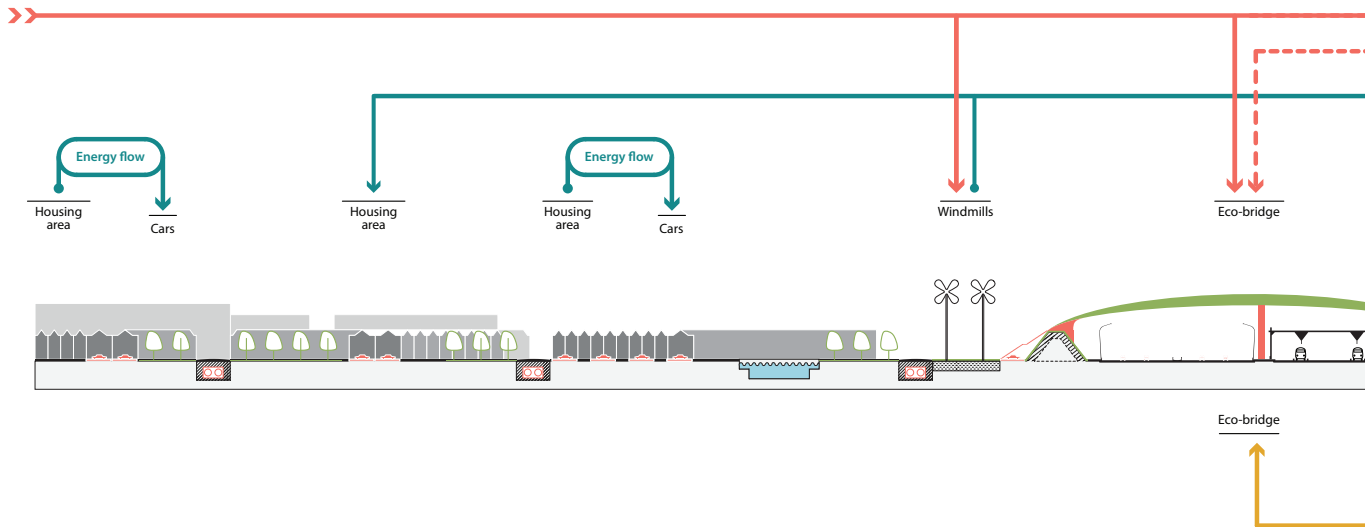

Flow from Existing situation to Design intervention (1)

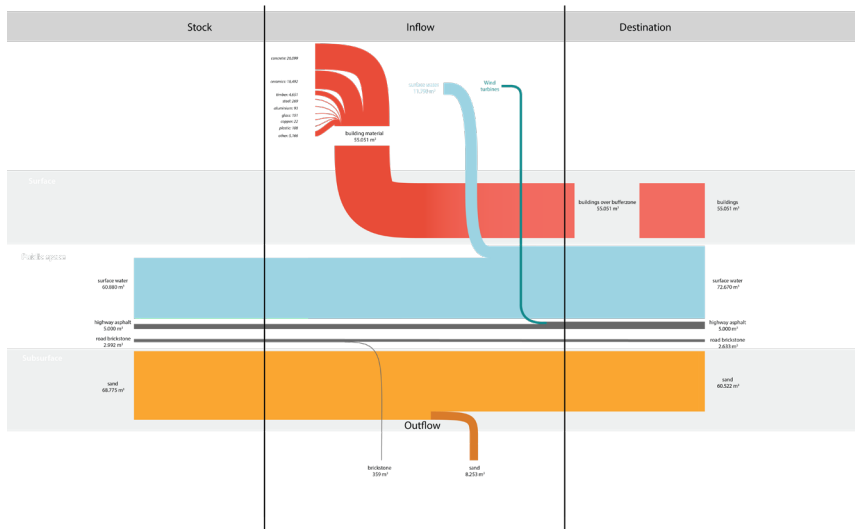

- Material flow out:**
- new buildings over the highway
 - soil from waterways

- Material flow in:**
- biomass material for energy supply

Flow from Existing situation to Design intervention (2)

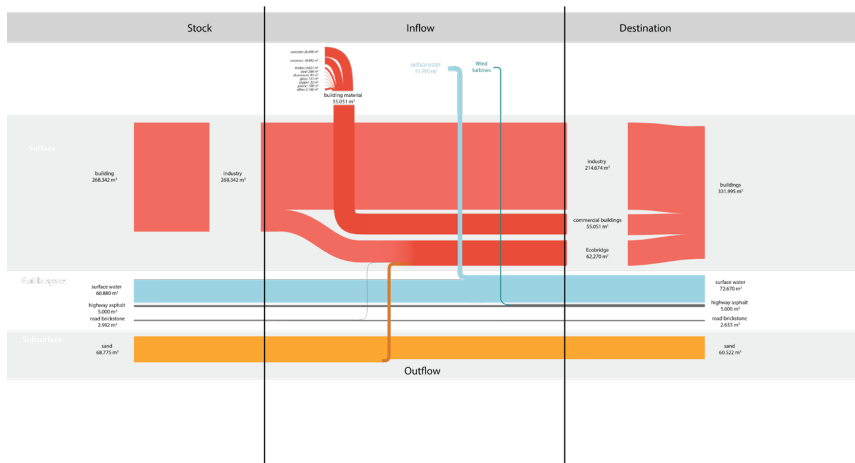

- Recycled material flow:**
- soil, building material goes to Eco bridge.

- Material flow in:**
- bio mass for energy supply
 - building material inflow should be regulated by choosing modular or bio based or recycled material

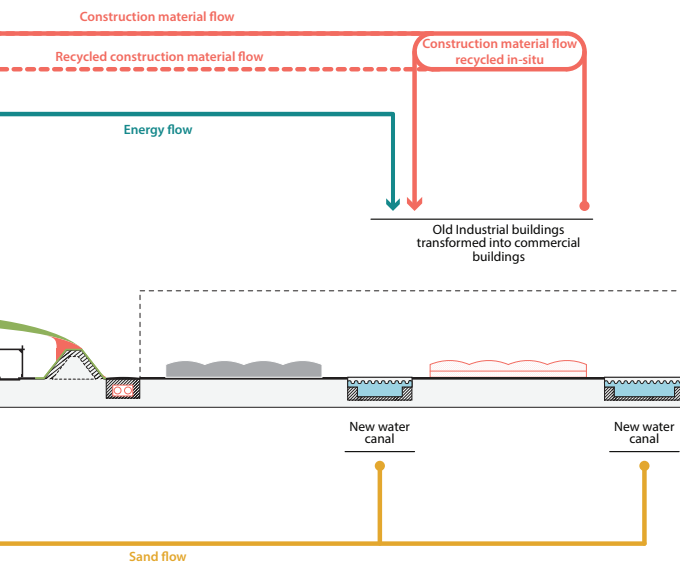

Design intervention (2) additional:

Eco Bridge: all materials coming out of the changes in buildings and public space (from within but also from outside the area) is used to construct an eco-bridge.

4.2.5 Ditch

The buffer zones are completely planted with trees, a biomass plant is built that is fed by the forest and the manure from the housing (separated sewer collection faeces). Cars are charged and parked along the highway, parking

spaces are changed to helophyte filters. In the residential area there can be commercial activities (20%) and in the industrial area 20% will be for residential and 8% of water surface will be built for water management regime.

Existing situation

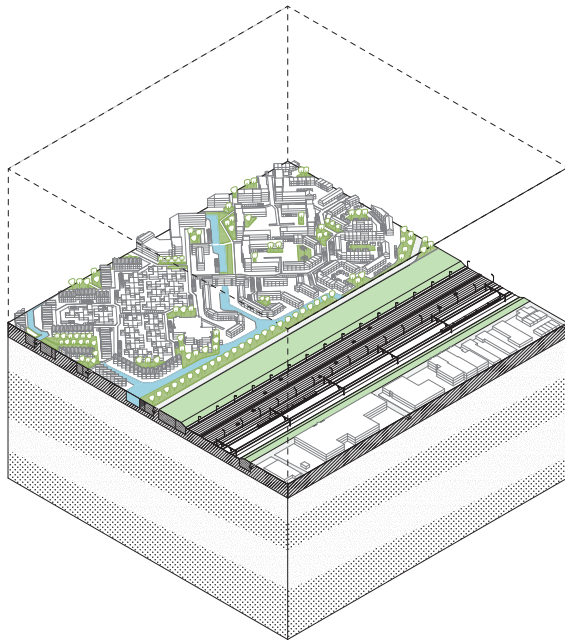

Design intervention (1)

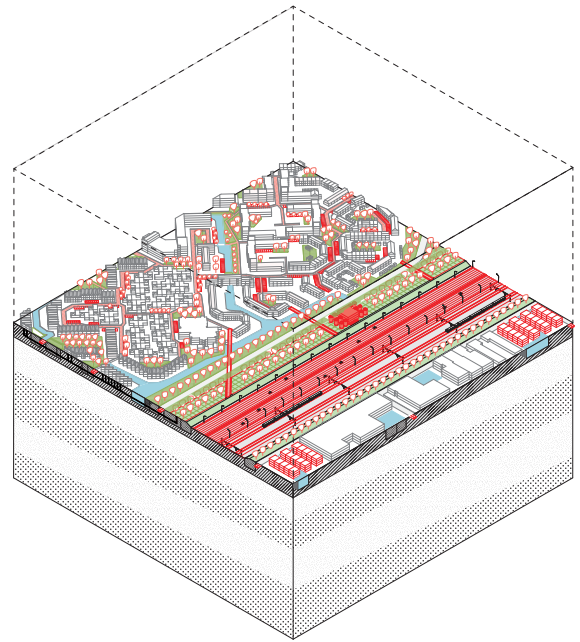

74

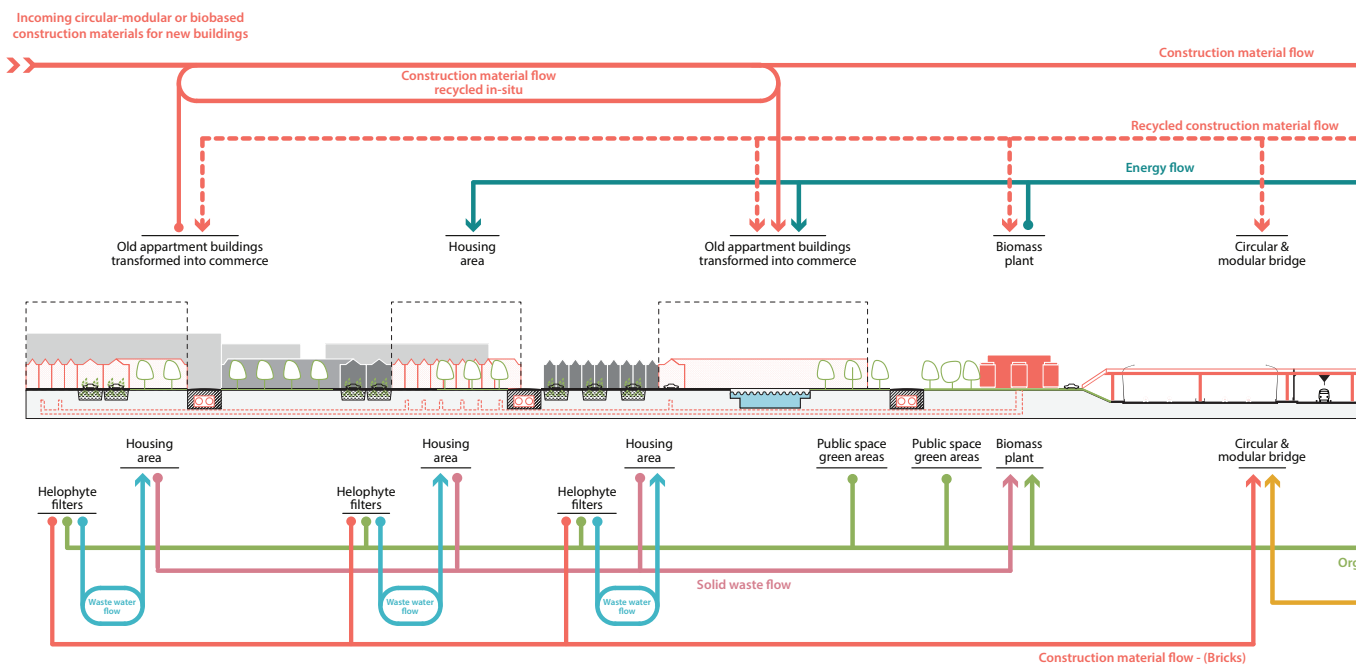

Flow from Existing situation to Design intervention (1)

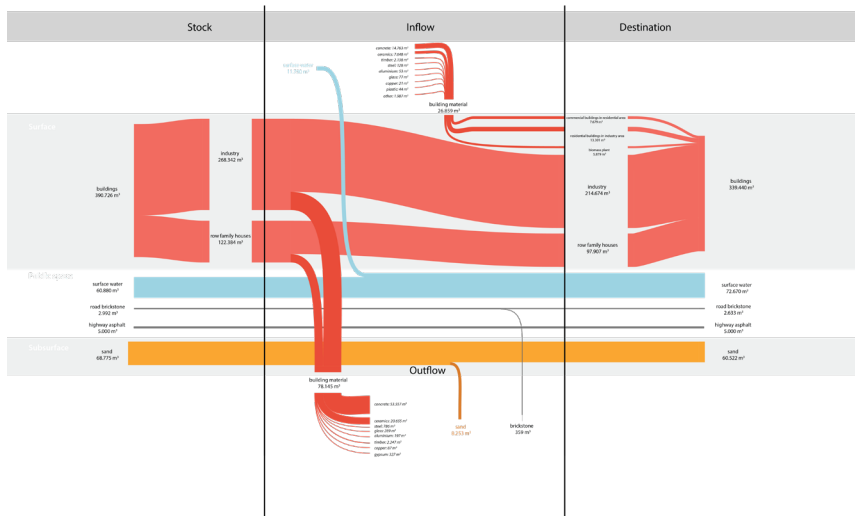

Material flow out:

- building material of industrial and row houses
- soil from waterways
- brick stone from private parking spaces

Material flow in:

- material for commercial buildings and housing in industrial area and housing and biomass plant

Flow from Existing situation to Design intervention (2)

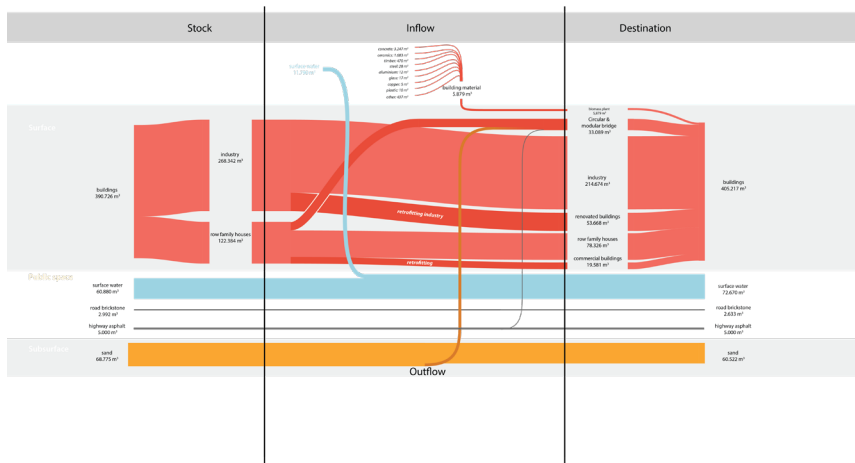

Recycled material flow:

- brick stone from private parking spaces and soil from waterways

Material flow in:

- inflow material that is circular and modular for bridge
- inflow biomass plant

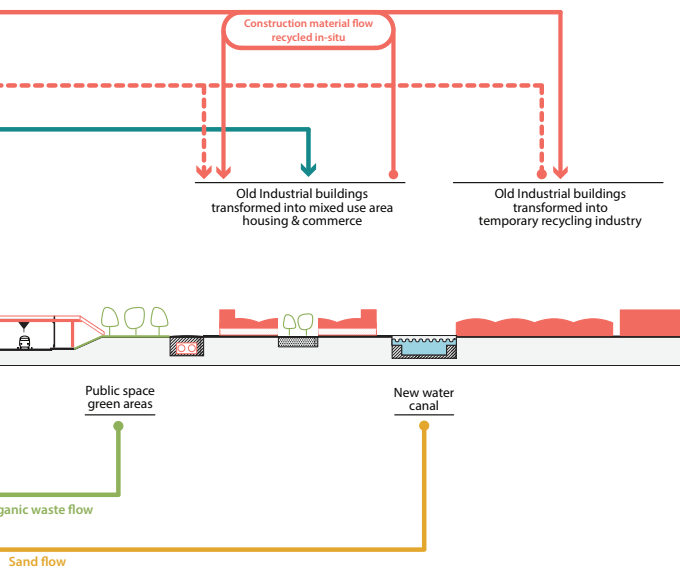

Design intervention (2) additional:

Deposit Landscape: the soil coming out of the new singel and parking spaces is used for landscaping the former industrial zone.

Re-use ARCH: industrial buildings are retrofitted and building materials are reused in in new architecture typology.

circular and modular bridge

Programming (flow facility+program switch) : old industry becomes recycling industry

Design overview

VINEX 90's, highway linked

VINEX '90s is a large scale national housing program with project development driven developments on the outskirts of cities. The clear street hierarchy define different concepts for the urban design with mixed housing typology. The partial filling leaves larger green structures for ecology and water, more private gardens. Housing has a high energy label or is passive housing. There is a separated sewer system, high infiltration rate, large open water structures, space for natural cleaning of grey water. Considered as future social-problematic area due to mono-functionality and a low number of services, far away from the centre. Addition of program, creating communities around resilient topics.

Sample 1 km²:

- 67,5 % Residential area
- 9 % 70-meter buffer zone on one and 20-meter on the other side
- 13,5 % Industrial area
- 10 % Highway & railway

Residential area:

- 22 % Built up (Ground bound family houses: 620 Units (190 m² building footprint each). Apartment blocks: 12 units x 32 apartments (2560 building footprint each)
- 37 % Public green space of which 50% is private garden
- 31% Infra (5% parking spaces)
- 10 % Water

Industrial area:

- 60% built up
- 5 % green space
- 31% infra
- 4% water

Characteristics:

- Hydraulically filled with sand (2 m)
- Industrial constructed buildings

Healthy city: making inclusive by mixing social economical groups and diversification housing stock, programming public domain from mono to multifunctional.

New economy: mixing housing and industry (residential area ratio 80/20, industrial area 80/20), flexible usage, technical and social innovation, create new business models and entrepreneurship, create networks for business and public life.

Connectivity: new model split, highway and city connected, new parking scheme.

Climate adaptation: water storage, infiltration, reducing heat stress with green areas

Energy: generate energy in buffer and highway, take of gas.

Mobility: automated electrical cars as driver for new relation highway and city, redesign infrastructure.

Circularity: using circular material flows as driver for design. Re-use, recycle, remediate.



Fig 3.3 The Maya-inspired approach beholds a decentralized services of waste and water to bring the end-user closer to the system. This is done in the large open areas for water and greenery and supplement the advantages of the present designs - including good energy efficiency of housing, a separated sewer system, high rainwater infiltration, and natural methods for cleaning open water - whilst turning fertile soil into a public asset that reorganises water flows and waste processing on a communal scale.

4.3.1 Floor

Buffer zone on the residential side is used for waste water treatment (grey and black). All wastewater in the residential and industrial area will be brought there. The other buffer side will be transformed into industrial area and the original

industrial area will become residential with 8% surface water. Highway is expanded with program that also is connected to the urban area. Cars are used as battery for the housing.

Existing situation

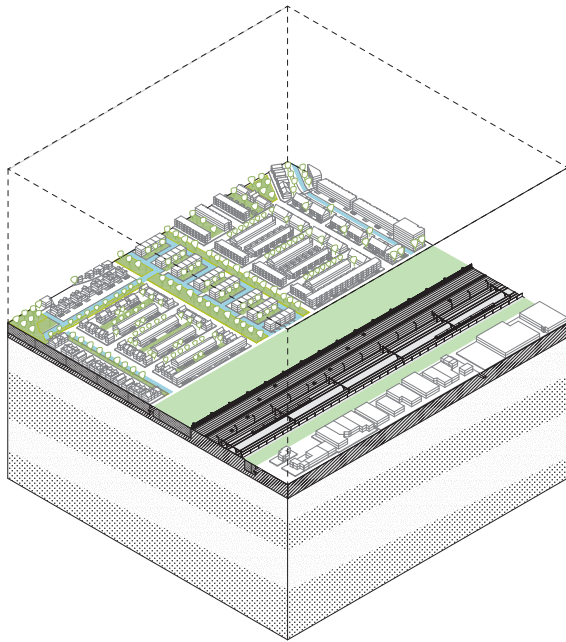

Design intervention (1)

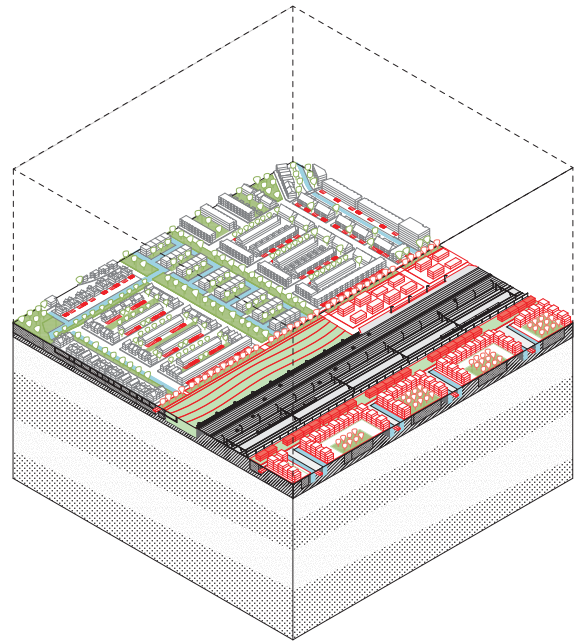

78

Incoming circular-modular or biobased construction materials for new buildings

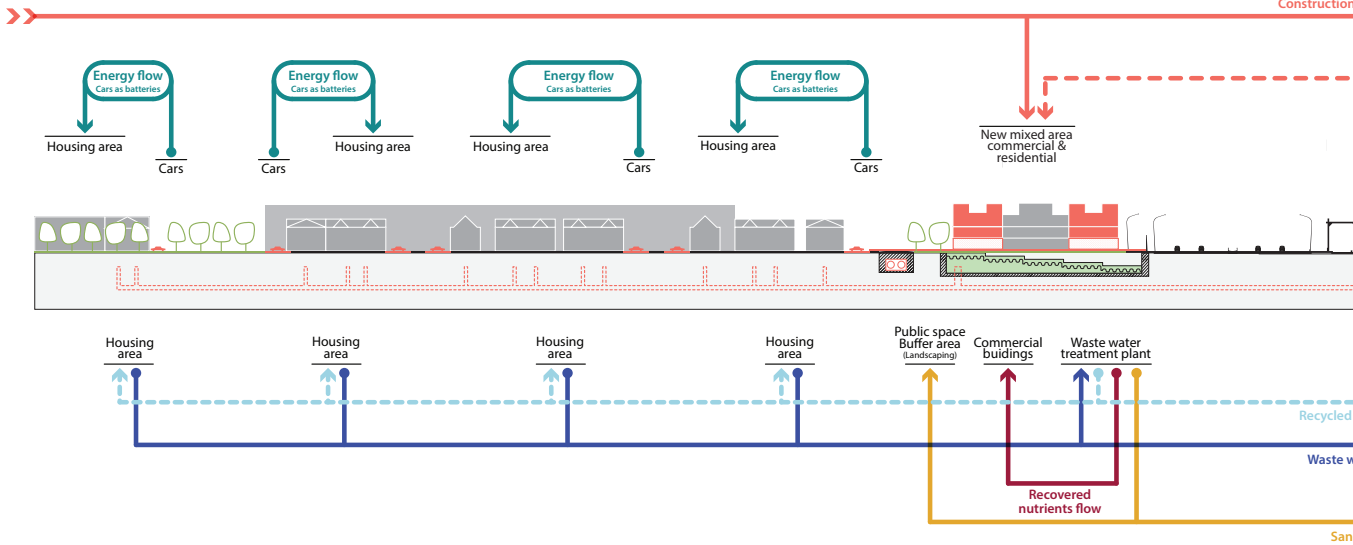

Flow from Existing situation to Design intervention (1)

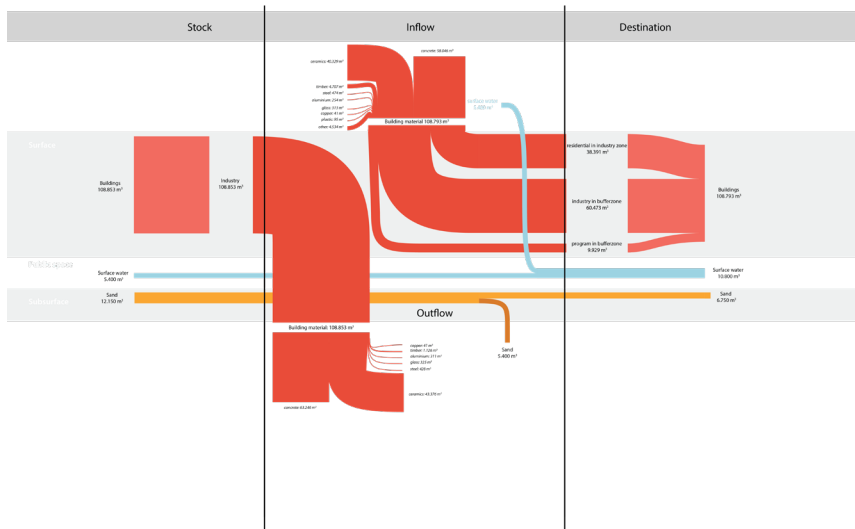

- Material flow out:*
- building materials of industrial area
 - soil from excavating water ways

- Material flow in:*
- residential buildings in industrial area and new program in buffer zone

Flow from Existing situation to Design intervention (2)

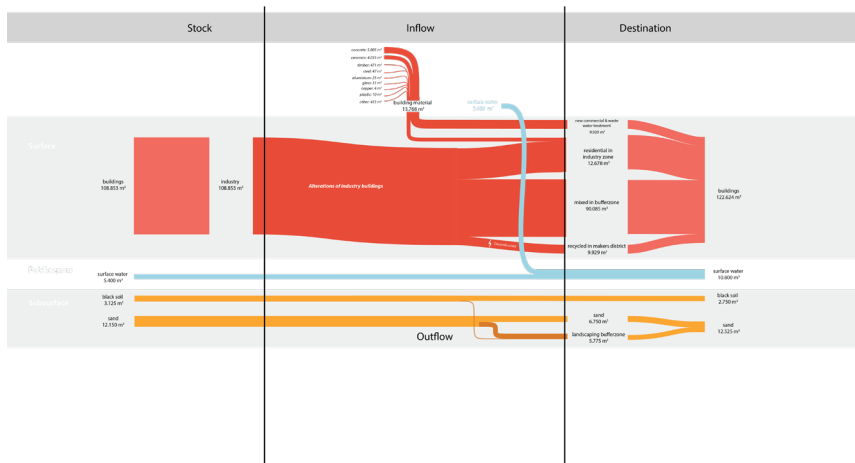

- Recycled material flow:*
- soil from waterways is landscaped in buffer zone

- Material flow in:*
- inflow for residential buildings in industrial area and new program in buffer zone
 - building material inflow should be regulated by choosing modular or bio based or recycled material

- Material flow out:*
- outflow of building material of industrial area

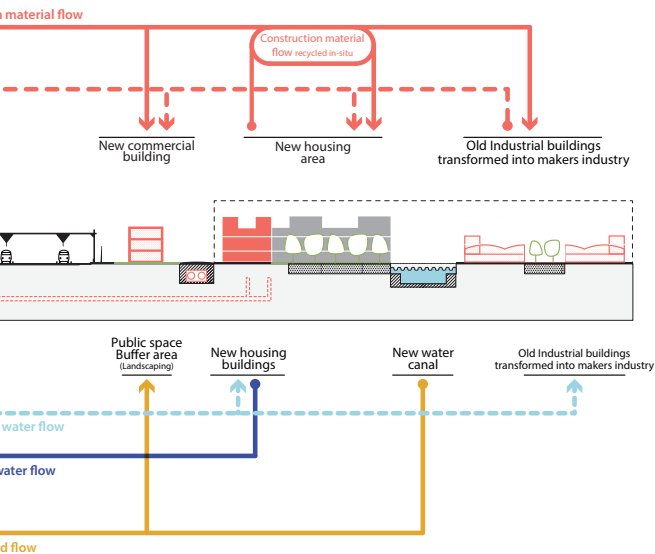

Design intervention (2) additional:

Programming (refurbishment/flow facility): the industrial will partly be new buildings (25%) and partly renovated (75%) and created as makers district . The buffer zone will be mixed use: commercial, residential and water treatment. There will be recovery of nutrients.

4.3.2 Dike

Buffer zone on the side of the residential area is used for biomass plant fed by black waste water. Highway is expanded with program that also is connected to the urban area. Cars are recharged in the buildings in the buffer zone, making room

for private black grey water treatment on the former parking spaces. Solid waste is treated on the side of the industrial area where 20% is turned into residential.

Existing situation

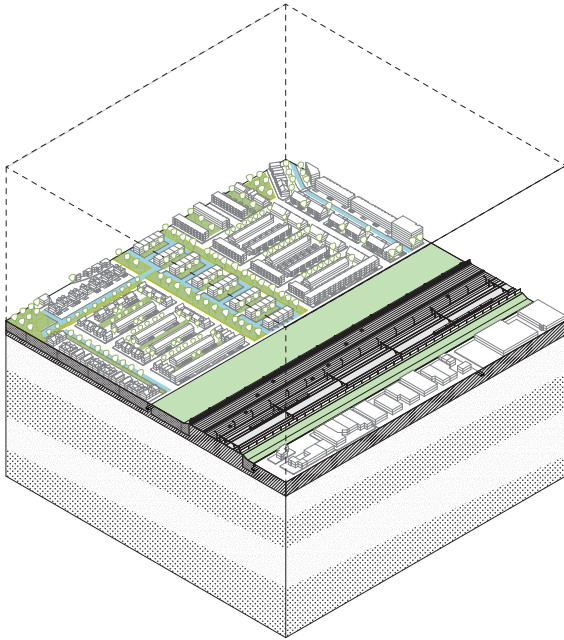

Design intervention (1)

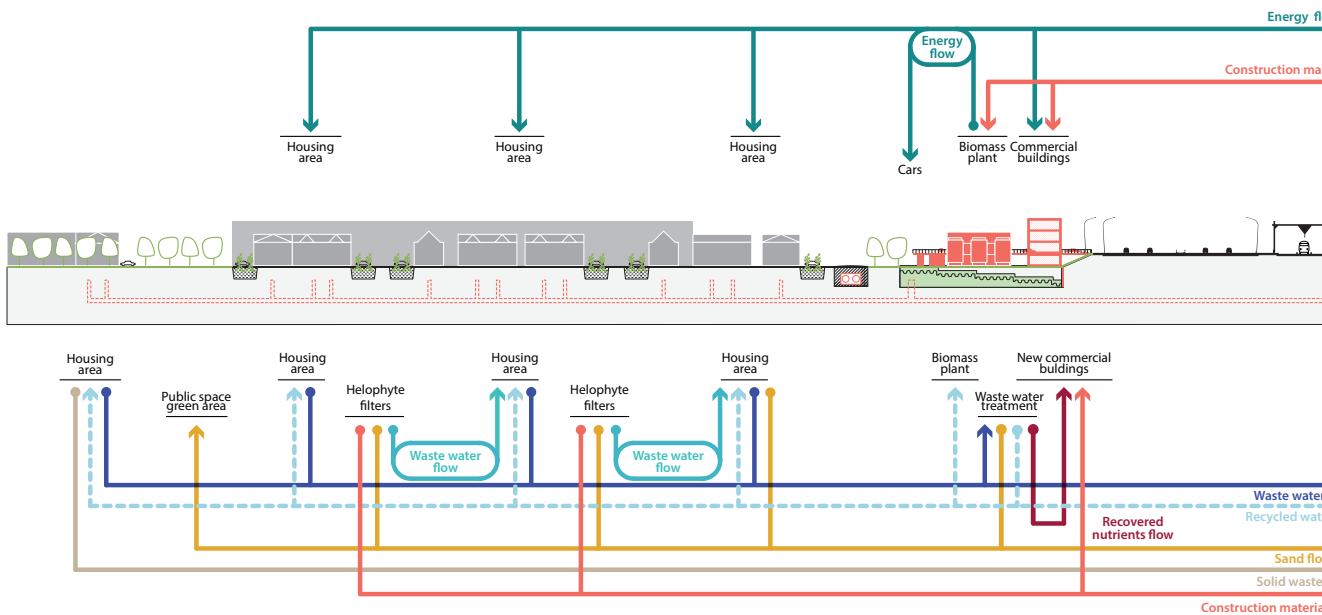
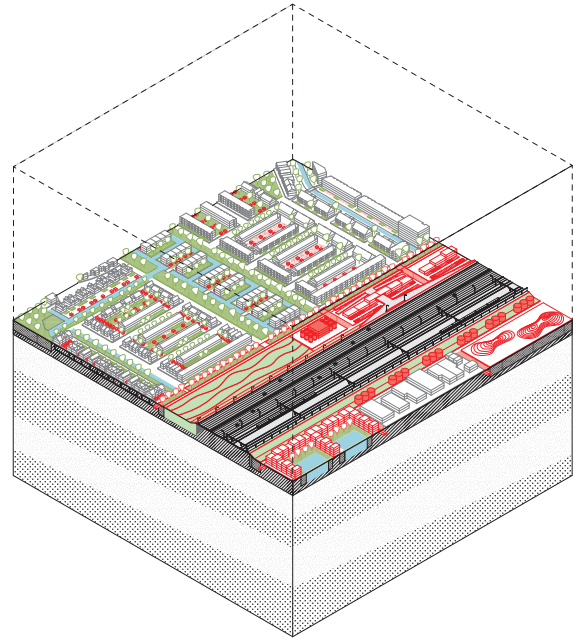

Flow from Existing situation to Design intervention (1)

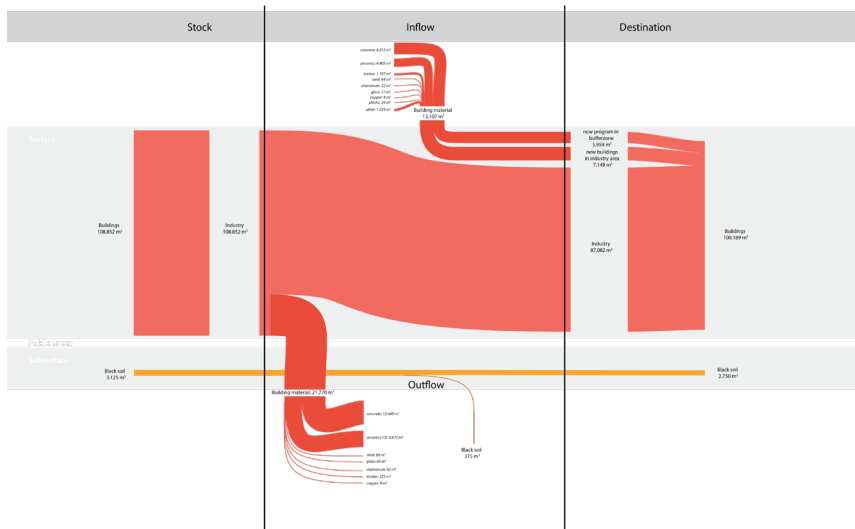

- Material flow out:*
- building material of industrial area
 - brick stone from private parking spaces
 - soil from excavating waterways

- Material flow in:*
- residential buildings in industrial area and new program in buffer zone

Flow from Existing situation to Design intervention (2)

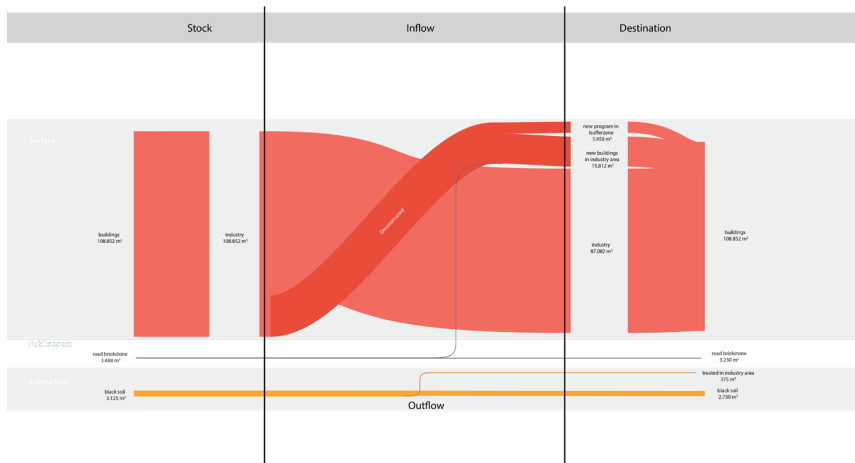

- Recycled material flow:*
- soil from waterways is landscaped in buffer zone

- Material flow in:*
- inflow for residential buildings in industrial area and new program in buffer zone
 - building material inflow should be regulated by choosing modular or bio based or recycled material

- Material flow out:*
- outflow of building material of industrial area

Design intervention (2) additional:

Programming (refurbishment/flow facility): The industrial area becomes mixed use, industry and housing, new housing and retrofitting of buildings. Solid waste treatment plant is built in which new soil is produced. The buffer zone becomes commercial and zone where a biomass plant will use solid waste and industry that recovers of nutrients.

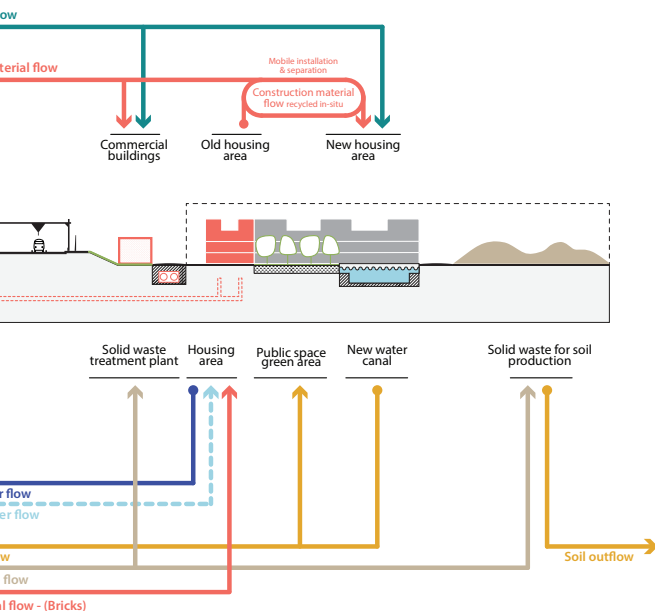

4.3.3 Stilts

The whole buffer zone is used for wastewater treatment and run off of the highway. Cars are charged by their houses by sun and wind energy. Next, other commercial and leisure uses are

related to the recovery of nutrients are under the highway area. Industrial area is transformed in a residential area.

Existing situation

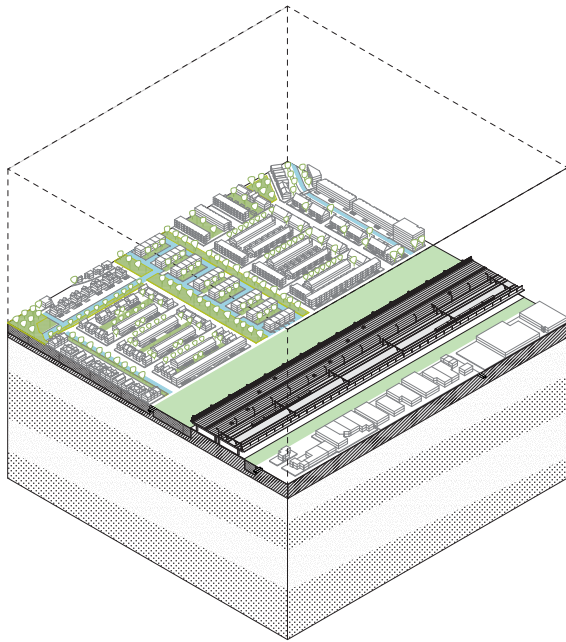

Design intervention (1)

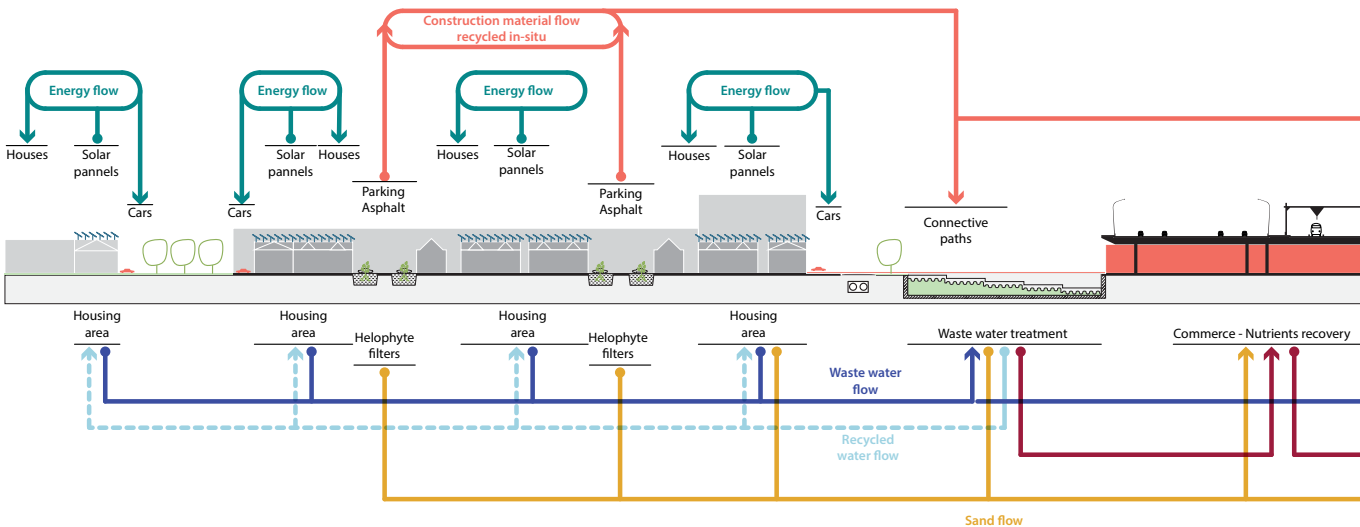
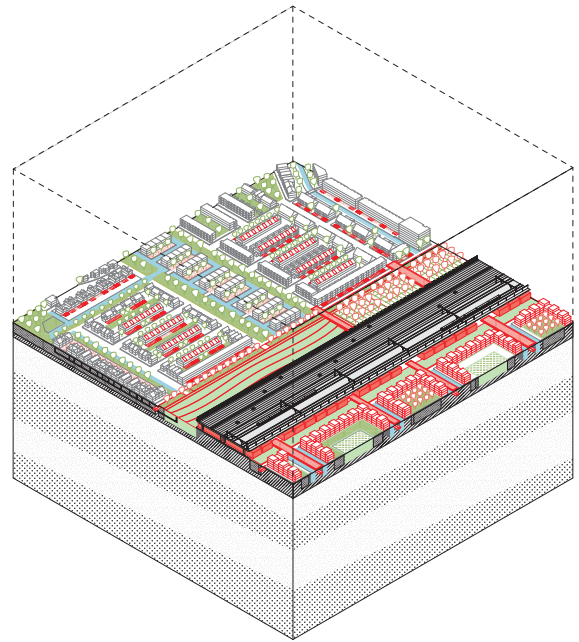

Flow from Existing situation to Design intervention (1)

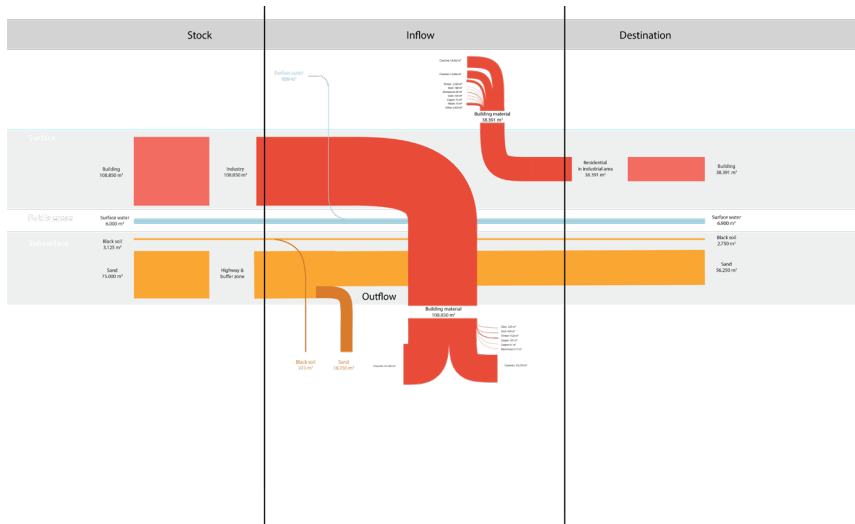

- Material flow out:*
- building material of industrial area
 - brick stone from private parking spaces
 - soil from excavating waterways

- Material flow in:*
- inflow for residential buildings in industrial area and new program in buffer zone

Flow from Existing situation to Design intervention (2)

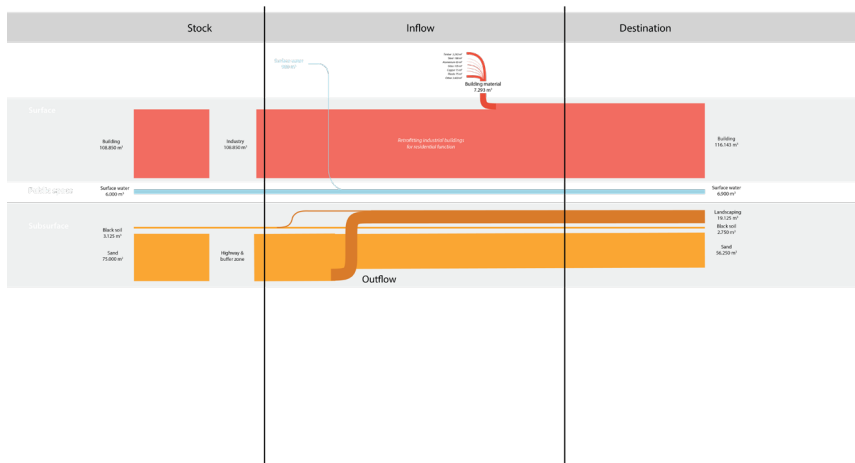

- Recycled material flow:*
- soil from waterways is landscaped in buffer zone

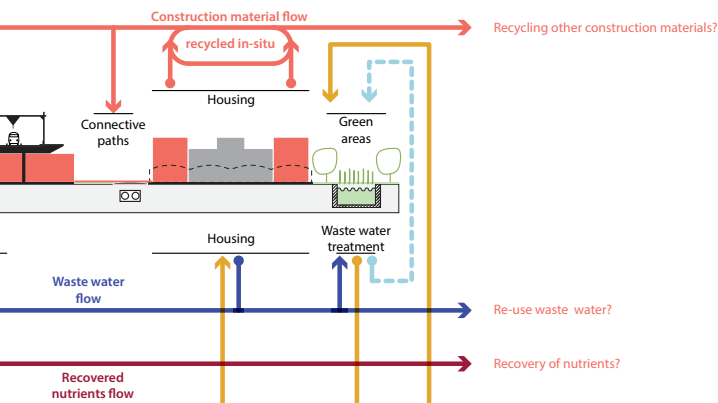

Design intervention (2) additional:

Deposit Landscape: the soil coming out of the new singel is used for landscaping the buffer zone where waste water will be treated.

4.3.4 Ditch + Dike

The buffer zones on both sides are completely planted with trees, a biomass plant is built that is fed by the forest and the manure from the residential and industry (separated sewer collection faeces). Commercial functions are

placed in buildings over the highway. Cars remain in the area as battery. Industrial area is transformed in mixed neighbourhood living/ working with new water surface of 8%.

Existing situation

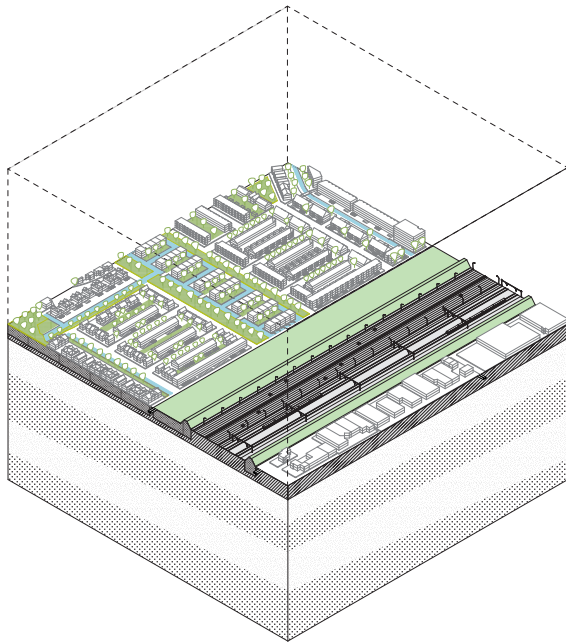

Design intervention (1)

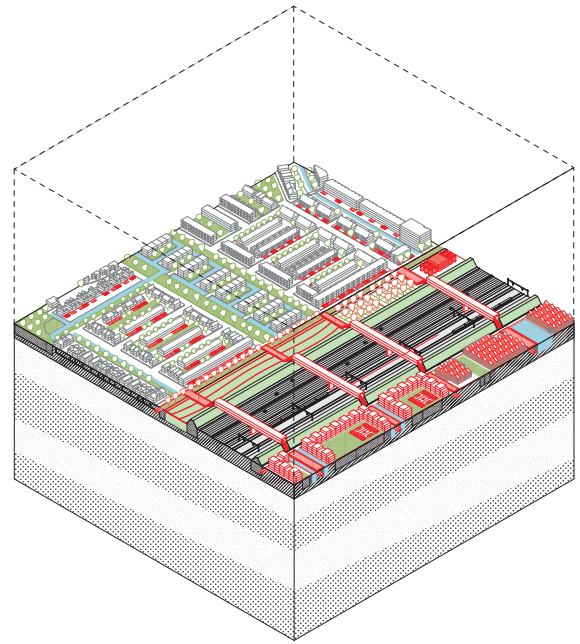

Incoming circular-modular or biobased construction materials for new buildings

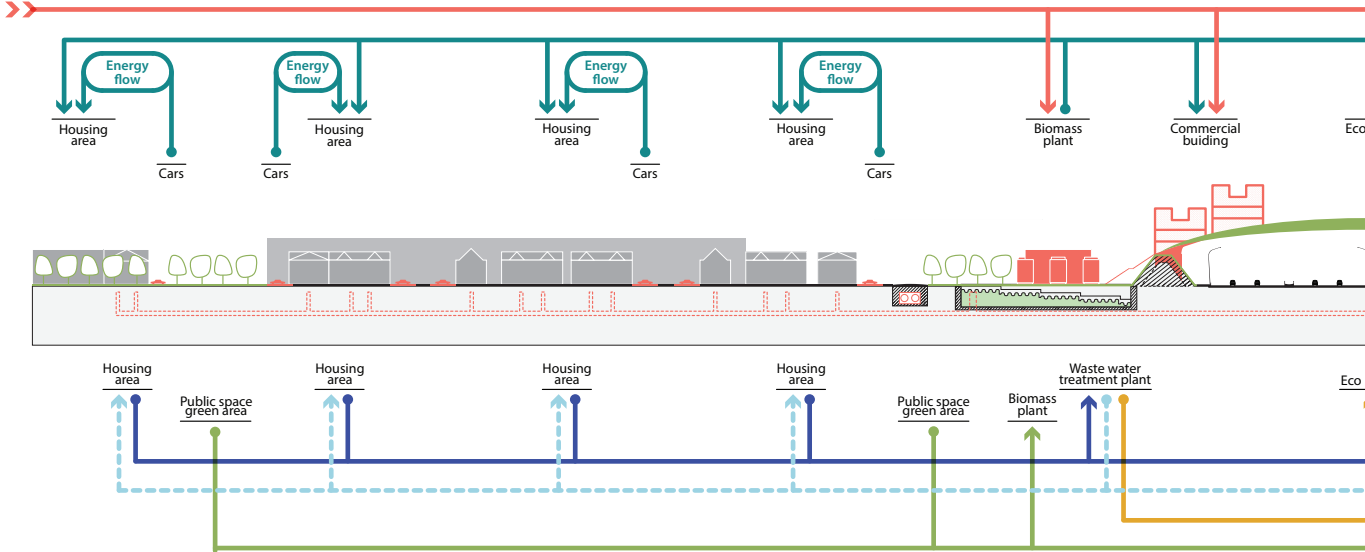

Flow from Existing situation to Design intervention (1)

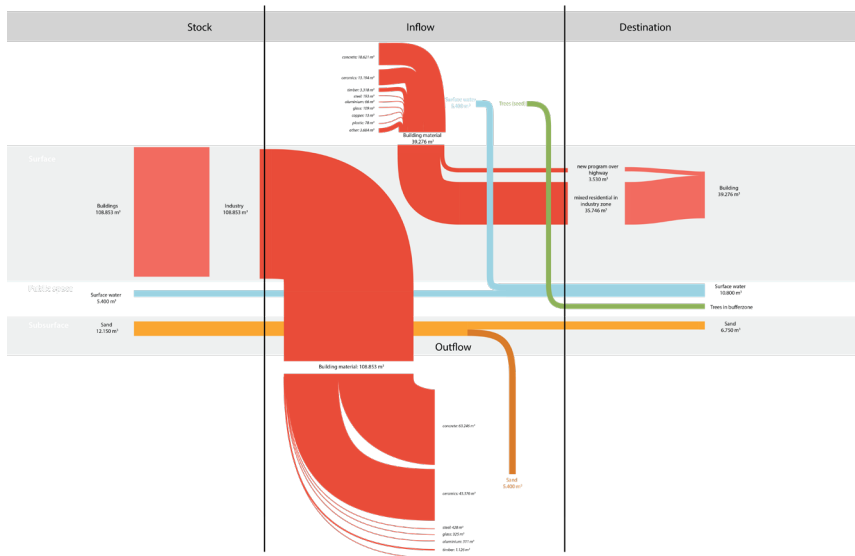

Material flow out:

- building material of industrial area
- brick stone from private parking spaces

Material flow in:

- material for residential buildings in industrial area and new program in buffer zone

Flow from Existing situation to Design intervention (2)

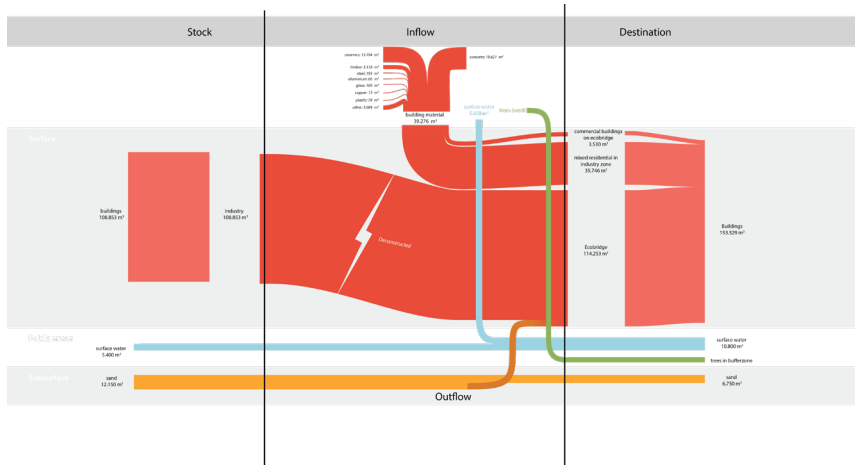

Recycled material flow:

- soil from waterways to eco- and commercial bridge
- material of building reconstruction for eco- and commercial bridge

Material flow out:

- building material inflow should be regulated by choosing modular or bio based or recycled material

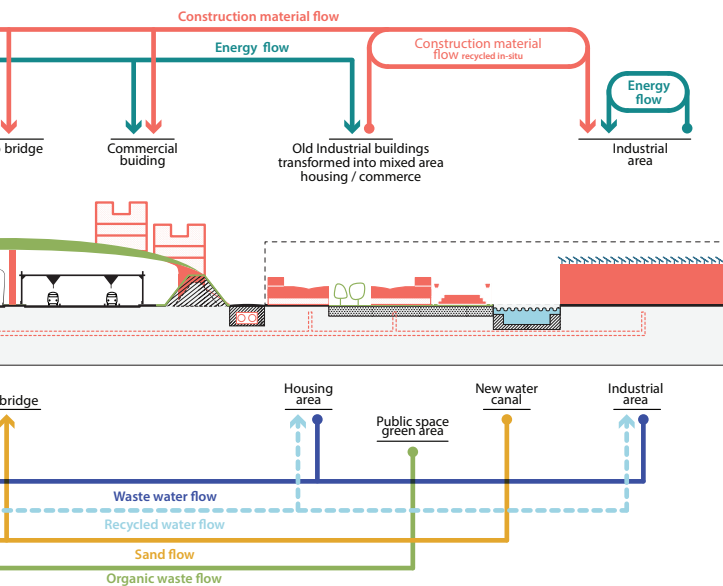

Design intervention (2) additional:

Ponte Vecchio: all materials coming out of the changes in buildings and public space (from within but also from outside the area) is used to construct an eco-commercial bridge.

Re-use ARCH: industrial buildings are retrofitted.

Programming (flow facility): there will be trees on both buffer zones, the industrial area will be used for the generation of energy of which a biomass plant

4.3.5 Ditch

The buffer zone is used for energy production in surface water (Den Bosch model). Soil is moved towards the highway; cars remain in the area as battery. The residential and industrial are

connected by a building over the highway for commercial use. Industrial area transformed into mixed use with 20% housing.

Existing situation

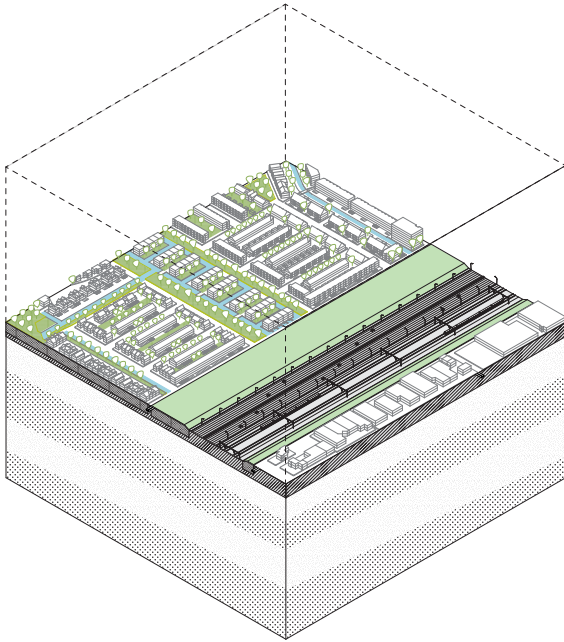

Design intervention (1)

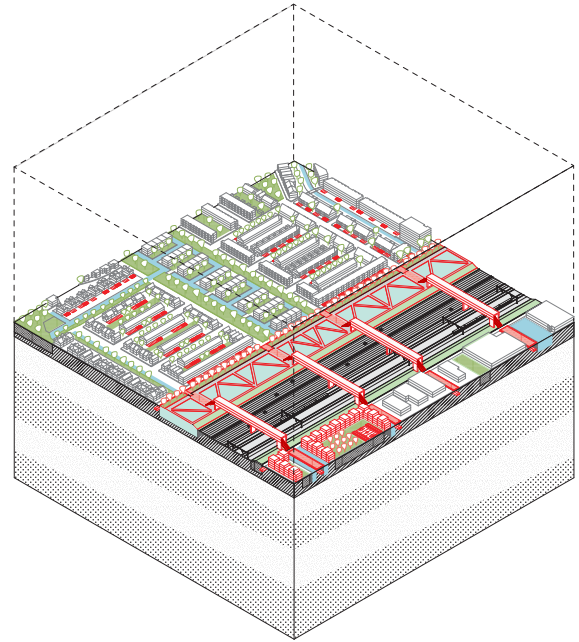

Incoming circular-modular or biobased construction materials for new buildings

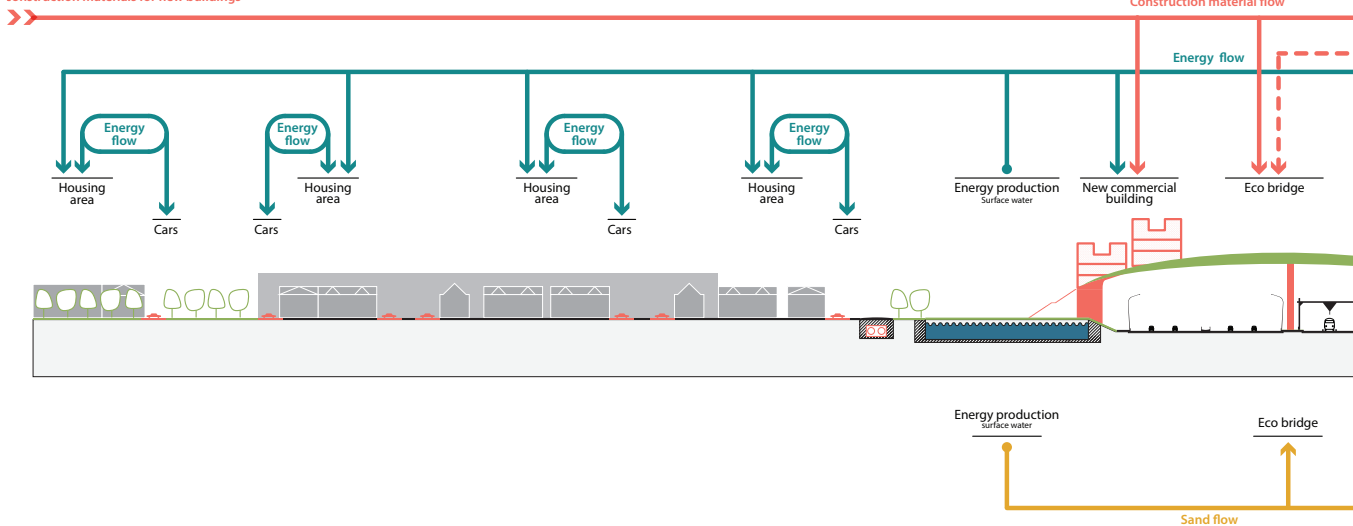

Flow from Existing situation to Design intervention (1)

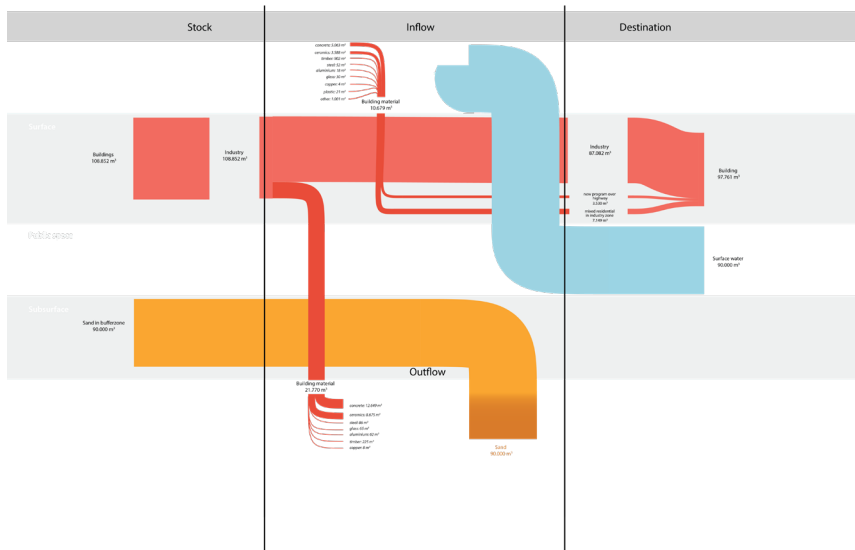

Material flow out:

- building material of industrial area

Material flow in:

- material for residential buildings in industrial area and new program over the highway

Flow from Existing situation to Design intervention (2)

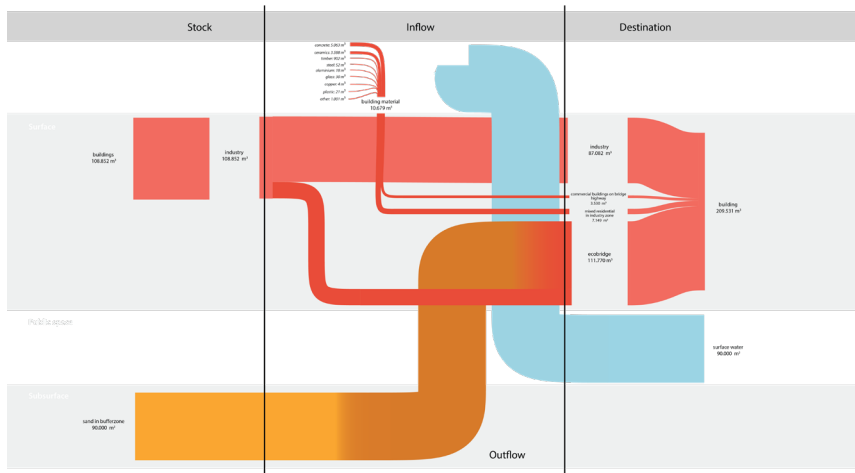

Recycled material flow:

- soil from waterways to eco- and commercial bridge and landscaping
- material of building reconstruction for eco- and commercial bridge

Material flow out:

- building material inflow should be regulated by choosing modular or bio based or recycled material

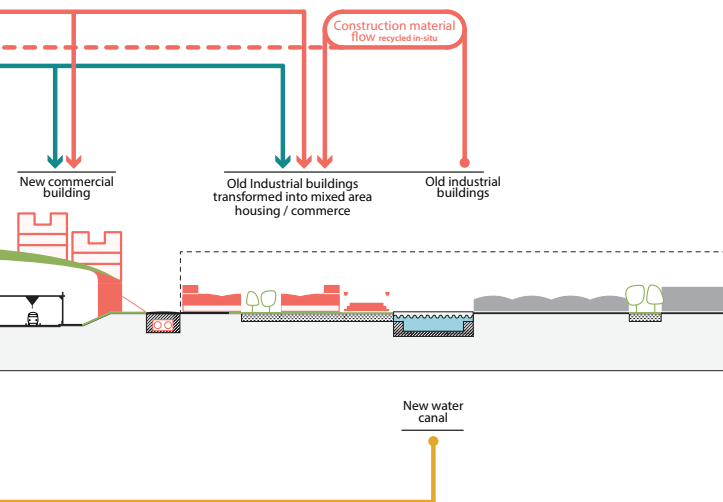

Design intervention (2) additional:

Ponte Vecchio: all materials coming out of the changes in buildings and public space (from within but also from outside the area) is used to construct an eco-commercial bridge.

4.1 Methodologies

Odum (1959) describes what are called more or less “perfect” cycles: biogeochemical cycles that involve equilibrium states. That is, there exists in nature a balance in the cycling of the element between various compartments, with the element or material moving into abiotic compartments about as fast as it moves into biotic compartments.

4.1.1 Gentle Remediation Options

Gentle Remediation Options (GROs) are strategies that involves using plant (phyto-), fungi (myco-), and/or bacteria-based methods to clean the soil from certain pollution. The spatial effect and functionality of this strategy adds to the green quality of cities. Due to the fact that this remediation method takes more time then old-fashioned methods of excavation, there is the possibility to line up in time the treatment with transformation trajectories in urban development.



Figure 4.1 Gentle Remediation Options

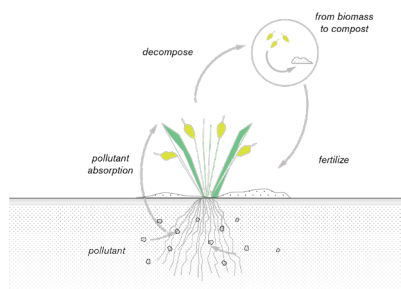

Figure 4.2 Gentle Remediation Options

Taking healthy soil first in urban design is tested through application of four concepts: gentle remediation (cleaning with plants), fertilization maintenance regime, bringing back the original (Dutch peat) landscape and using the Maya concept.

A short overview of plant functions

For a plant to grow, it needs several resources including energy (sunlight), nutrients and water. In the processing of these resources, contaminants can get taken up, transformed or broken down. Three transformations in plant growth are essential to consider.

A. Energy transfer

Leaves transform energy from the sun via photosynthesis to generate plant biomass. About 20-40% of total photosynthetic products produced by the plant are sugars that are transported down to the root zone and are leached out into the soil through the roots (Campbell and Greaves, 1990). The sugar oxygens and other root exudates released around the root zone (organic acids, amino acids and enzymes etc) both can help to transform contaminants and also attract many micro-organisms to live there (Lugtenberg and Dekkers, 1999). The presence of these root exudates causes the soil to be populated with 100 to 1000 times more living microorganisms around the root zones than in the soil alone (Reynolds et al., 1999). The microbes create a protective barrier around the root zone and play a large part in breaking down potentially harmful substances such as pathogens. This high microbe-populated area with a symbiotic relationship to the plant is called the rhizosphere (Lugtenberg and Kamilova, 2009). The rhizosphere creates a rich environment for contaminants to potentially be modified, by either the plant itself or the microbes.

B. Nutrient transfer

In exchange for the provision of sugars and phytochemicals from the plant, the microbes help the plant to obtain nutrients. There are 13 essential nutrients required by plants. Many of these are in forms not available to the plants, and microbes can unlock them into forms for uptake. This is similar to digestion in humans, where microbes process food and nutrients internally in our stomachs; however, in plants much of this occurs externally in the root zone. Rather than internal digestion, plants have something akin to external stomachs, processing many nutrients they need outside the plant (Rog, 2013). Once the nutrients are made available by the soil biology, enzymes, acids and other exudates released by the plant, transport pathways existing for the plant to take up the need nutrients. Pollutants in soils can sometimes have a similar chemical structure to the resources a plant requires, and can be inadvertently taken up by plants in the process (ITRC, 2009).

C. Water transfer

Plants act as pumps, extracting water from the soil, moving it through the stems and the leaves, using it in photosynthesis and transpiring extra water to the air through the leaves. It is estimated that only 10% of the water taken up by plants is used by plant by plant and the rest goes via evapotranspiration into the air. Plants move an incredible amount of water, in fact 75% of water vapor over land worldwide is a result of plants transpiration (Von Caemmerer and Baker, 2007). As plants may take up polluted water, create a hydraulic pull towards the plant. In phytotechnology, plants may take up polluted water, potentially degrading or extracting away pollutants during the process. This pull of water can also potentially slow the migration of contaminants in water below the surface.

Soil Pollution

Pollutant can be encountered in many different site and location; main sources can be found in soil ground water and air. Pollutants can be found in soil after spills or after long term accumulation of repeated small releases. For phytotechnology's to be considered for soil remediation, the pollution must be located at a depth that plants can reach. Most of herbaceous plant species have a maximum root depth of 60 cm, with tap-rooted tree species maximizing root depth at 300 cm. Soil pollution within 300 cm of the soil surface is about the maximum depth where phytotechnology should be considered. Soil contaminated within 100 cm is the most effective zone for phytotechnology (Kennen, Kirkwood 2015).

Contaminated type Organic vs Inorganic

Phytotechnology treatment techniques are contaminant specific. The first step in deciding if phytotechnology system may be applicable is to consider which of two categories the targeted pollutant falls into, either organic or inorganic.

Organic contaminants: Pollutant compounds that typically contain bonds of carbon, oxygen and nitrogen.

Inorganic contaminants: Elemental pollutants found on the periodic table that have been released into the environment

Excess Nutrients: N, P

Metal and metalloids: Cr, Mn, Fe, Co, Ni, Cu, Zn, Mo, Cd, Hg, B, F, Al, As, Se, Pb





Salts: Na, Mg, Ca, Cl,

Radionuclides: Sr, Ce, U

Sulphur: S

In this research the proposition is to apply the phytoremediation method to three main locations, the first is the built neighbourhood environment, the second the buffer zone next to the highway the third the industrial area.

Figure 2.3 List of Common Organic Pollutants Successfully Degraded or Volatilized at Field Scale with Phytotechnologies

Pollutant	Typical Sources
 Petroleum Hydrocarbons: Oil, Gasoline, Benzene, Toluene, PAHs, gas additive: MTBE: Methyl Tertiary Butyl Ether	Fuel spills, leaky underground or above-ground storage tanks
 Chlorinated Solvents: such as TCE: trichloroethylene (most common pollutant of groundwater), Perc	Industry and transportation, dry cleaners
 Pesticides: Atrazine, Diazinon, Metolachlor, Temik (to name a few)	Herbicides, insecticides and fungicides from agricultural and landscape applications
 Explosives: RDX	Military activities

List of Common Organic Pollutants not Easily Degraded or Volatilized at Field Scale with Phytotechnologies





Pollutant	Typical Sources
 Persistent Organic Pollutants: Including DDT, Chlordane, PCBs	Historic use as pesticides or in products such as insulation and caulking
 Explosives: TNT	Military activities

Figure 2.5 List of Common Inorganic Pollutants Successfully Extracted (and Harvested) or Volatilized with Phytotechnologies

Pollutant	Typical Source
 Plant Macronutrients: Nitrogen and Phosphorus	Wastewater, landfills, agriculture and landscape practices
 Metals: Arsenic, Nickel, Selenium (shorter time frame) Cadmium and Zinc (longer time frame)	Mining, industry, emissions, automobiles and agriculture

List of Common Inorganic Pollutants not easily Extracted or Volatilized with Phytotechnologies



Pollutant	Typical Source
 Metals: Boron (B), Cobalt (Co), Copper (Cu), Chromium (Cr), Iron (Fe), Manganese (Mn), Molybdenum (Mo), Lead (Pb), Fluorine (F) Lead (Pb), Mercury (Hg), Aluminum (Al)	Mining, industry, emissions, automobiles, agriculture, and lead paint
 Salt: Sodium chloride, Magnesium chloride	Road de-icing, gas fracking and oil drilling, fertilizers, herbicides
 Radioactive Isotopes: Cesium, Strontium, Uranium	Military and energy production activities

Figure 4.3 (maintenance) regime

1. Residential area

Scientific researches are not yet published on the recent contamination of soil inside the city, especially in the neighbourhood residential areas. We can hypothesize from other similar urbanized areas and the use of the soil in the residential areas, which pollutants are present in the area. Since we are talking about residential areas, we may speculate that many household chemicals, particularly those used in bulk quantities such as detergents and personal care products (PPCPs), also end up as sanitary sewage. Biosolids generated from municipal wastewater treatment can be a major sink for many PPCPs, and their land application can potentially introduce these contaminants into terrestrial and aquatic environments.

Lead-based paint is a major legacy source of lead (Pb) contamination in urban areas. Soils become contaminated when lead-based paint is pulverized into dust or small particles during renovations or demolition and then enters the environment (Mielke and Reagan, 1998).

Plastics are also a major source of pollution. They are widely used in food packaging, shopping bags, and household items such as toothbrushes and pens, facial cleansers, and many other common items. They are, in general, extremely persistent in the environment and they widely accumulate in oceans and landfills, but also in soils where producing factories are located. Polymers are usually considered to be biochemically inert and do not pose a threat to the environment. Unreacted residual monomers or small oligomers can, however, be found in the plastic material, since polymerization reactions are seldom complete (Araújo et al., 2002).

The most hazardous monomers, classified as either carcinogenic or both carcinogenic and mutagenic, are those belonging to families of polyurethanes, polyacrylonitriles, polyvinyl chloride, epoxy resins and styrene copolymers (Lithner, Larsson and Dave, 2011). In addition, several thousand different additives such as brominated flame retardants, phthalates and lead compounds are used in the production of plastic. All plastic, from the macro- to the nano- scale, are at risk of being leached and of adsorbing hazardous substances such as persistent organic

pollutants and polycyclic aromatic hydrocarbons (Stylianou et al., 2015). They also accumulate heavy metals in high proportions (Mato et al., 2001). The size and surface area are important factors influencing the leaching and adsorption behaviour: the smaller the particle, the larger the surface-volume ratio. The capacity to release or bind compounds is therefore also higher for smaller particles than for larger ones.

2. Buffer zone

Can be polluting in the activities linked to transportation in and around urban centers constitute one of the main sources of soil pollution, not only because of the emissions from internal combustion engines that reach soils at more than a 100 m distance by atmospheric deposition and petrol spills, but also from the activities and the changes that result from them as a whole (Mirsal, 2008). Splashes generated by traffic during rainfall events and runoff, which may be significant if the drainage system is not well maintained, may translocate particles rich in heavy metals from the corrosion of metal vehicle parts, tires and pavement abrasion (Zhang et al., 2015b) and other pollutants such as polycyclic aromatic hydrocarbons, rubber and plastic-derived compounds (Kumar and Kothiyal, 2016; Wawer et al., 2015). Soil pollution associated with roads and highways is especially important in urban and peri-urban soils, and can be a major threat when food production occurs in adjacent areas. Foliar deposition and root uptake and transfer to above-ground tissues of bioavailable heavy metals are the main processes observed in roadside soil (Zhang et al., 2015b). Grazing in roadside soils is also quite common, and the ingestion of contaminated soil and plants constitutes potential dietary transfer of pollutants affecting animal and human health (Cruz et al., 2014).

But also, general garbage pollution can be a problem, elements such as Cadmium, Chromium, Copper, Lead, Zinc, Nickel.

Particles coming from the pavement, its

maintenance or the traffic enter the soil carried by water and more pollutants transferred by air are dispersed in different distances, also polluting the soil.

Elements requiring special care in total soil pollution are:

- heavy metals (lead, zinc, cadmium, nickel) (Pb, Zn, Cu, Cd, Ni)
- sodium chloride (Na, Cl)
- hydrocarbons and dust

The main processes by which vehicles spread heavy metals (Pb, Zn, Cu, Cd, Ni) into the environment are combustion processes, the wear of cars (tires, brakes, engine), leaking of oil and corrosion. Certain components of automotive engines, chassis and piping contain manganese and copper, while chromium and nickel (also coming from combustion of lubricating oils) are used in chrome plating. Lead is released in combustion of leaded petrol, zinc is derived from tire dust, copper is derived from brake abrasion and corrosion of radiators, and the other heavy metals have mixed origins. Heavy metals are also released due to weathering of road surface asphalt and corrosion of crash barriers and road signs.

Sodium chloride, which is the most used ice melting material, has an impact on soil and on plants. In a distance up to three meters from the roads carriageway its concentrations are due to the flow of salt water from the pavement as well as to splashing; between three and eight meters are due mainly to splashing.

Hydrocarbons impact is of secondary importance, in the case of time impact associated with automobile's movement. Hydrocarbons' time pollution modifies soil's natural properties (increases the imperviousness with time) and blocks plant's respiration since it seats on the leaves. Dusts have a similar behaviour, as they also seat on the leaves blocking the air alternation.

3. Industrial area

The main anthropogenic sources of soil pollution are the chemicals used in or produced as by-products of industrial activities, domestic, livestock and municipal wastes (including wastewater), agrochemicals, and petroleum-derived products. These chemicals are released to the environment accidentally, for example from oil spills or leaching from landfills, or intentionally, as is the case with the use of fertilizers and pesticides, irrigation with untreated wastewater, or land application of sewage sludge. Soil pollution also results from atmospheric deposition from smelting, transportation, spray drift from pesticide applications and incomplete combustion of many substances

New concerns are being raised about emerging pollutants such as pharmaceuticals, endocrine disruptors, hormones and toxins, among others, and biological pollutants, such as micropollutants in soils, which include bacteria and viruses.

Industrial activities release pollutants to the atmosphere, water and soil. Gaseous pollutants and radionuclides are released to the atmosphere and can enter the soil directly through acid rain or atmospheric deposition; former industrial land can be polluted by incorrect chemical storage or direct discharge of waste into the soil; water and other fluids used for cooling in thermal power plants and many other industrial processes can be discharged back to rivers, lakes and oceans, causing thermal pollution and dragging heavy metals and chlorine that affect aquatic life and other water bodies. Heavy metals from anthropogenic activities are also frequent in industrial sites and can arise from dusts and spillages of raw materials, wastes, final product, fuel ash, and fires (Alloway, 2013).

According to the European Directive concerning integrated pollution prevention and control (IPPC) (EC, 1996), potentially polluting activities can be grouped into six main categories:

- 1) energy industries;
- 2) production and processing of metals;
- 3) mineral industry;
- 4) chemical industry and chemical installations;
- 5) waste management; and
- 6) other activities (which include paper and board production, manufacture of fibres or textiles, tanning of hides and skins, slaughterhouses, intensive poultry or pig rearing, installations using organic solvents, and the production of carbon or graphite) (García-Pérez et al., 2007).

4.1.2 Fertilization Maintenance Regime

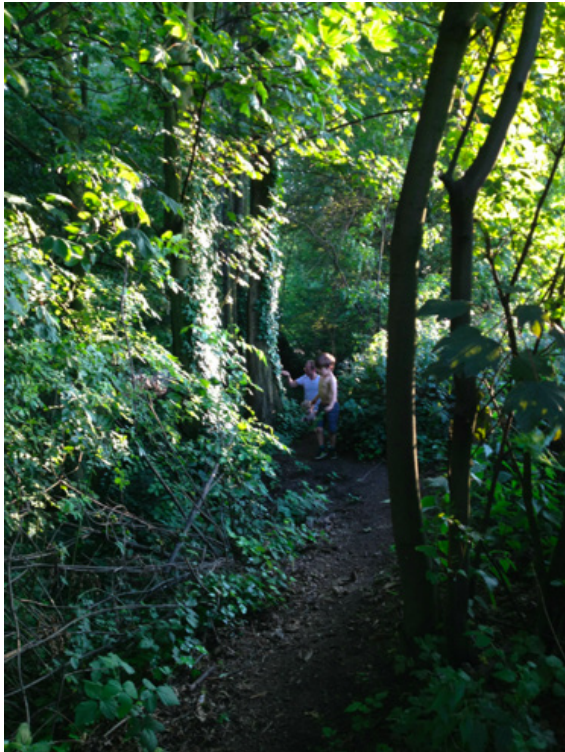

Figure 4.4 Forrest as public space (source: Hooimeijer)

The fertilization maintenance regime is about empowering the natural system in a functional role as base for the maintenance regime of public space. This perspective produces a fundamentally different design of urban patterns and also leads to a fundamentally different maintenance of urban public space, as well as a different way of dealing with subsidence. As result from a common practice in the Netherlands

Salinization, another major threat to global soils, affects many soils which are close to certain industrial activities, mainly those associated with chloralkaline, textiles, glass, rubber production, animal hide processing and leather tanning, metal processing, pharmaceuticals, oil and gas drilling, pigment manufacture, ceramic manufacture, and soap and detergent production (Saha et al., 2017).

to add sand to the public space in order counter subsidence, soils are degenerated. New maintenance regimes that are less constructed and anticipate the dynamics of the soil and the performance of the ecological systems of the original landscape more, should result in healthy urban soils.

First step is to programme public space with nature, the example is the concept of Food Forest where the tree community is feeding each other, plus people. Second is taking example in the self-maintenance regime of the natural system like a tree. The tree loses its leaves which together with other plant and animal rests decompose in the soil. There the fungus, bacteria, soil animals like worms feed themselves and reproduce minerals, these minerals are then again food for the tree.

The soil, that is also known as the pedosphere, integrates the biotic factors which is everything that lives and the abiotic factors which consists out of the lithosphere (soil) hydrosphere (water) and atmosphere (air). The integration of these spheres is achieved by linking cycles of carbon, nitrogen and water. The soil is weathering and rinsing the sediments and the biotic deposition. The plants and animals that provide decomposing organic material and other by-products, this is the biotic deposition, are mixed in the soil with rainwater, feeding benthos, organisms in water, and other micro-organisms.

In the new maintenance regime, the chemical processes of nitrification and ammonification play an important role. Nitrification is the biological oxidation from ammonium to nitrite followed by the oxidation of this nitrite to nitrate. This process

is an important step in the nitrogen cycle of ecosystems, because the dead organic material captures nitrogen that is then again available for the living plants. Ammonification is the process of decay or mineralization that releases ammonia which can be used as fertilizer, or nitrified again (Lal et al., 1998).

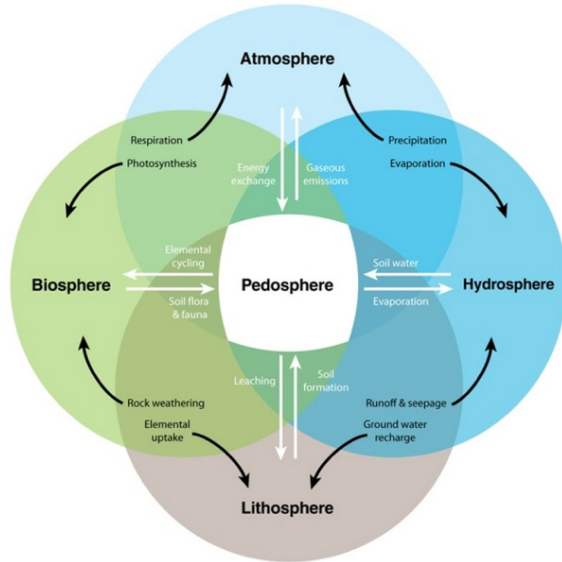

94 Figure 4.5 Interactive processes linking the pedosphere with the atmosphere, biosphere, hydrosphere, and lithosphere (Nature Education Adapted from Lal et al., 1998)¹².

The forest is an ecosystem model for how food chains work and cooperate. The tree loses its leaves which together with other plant and animal rests decompose in the soil. There the fungus, bacteria, soil animals like worms feed themselves and reproduce minerals, these minerals are then again food for the tree.

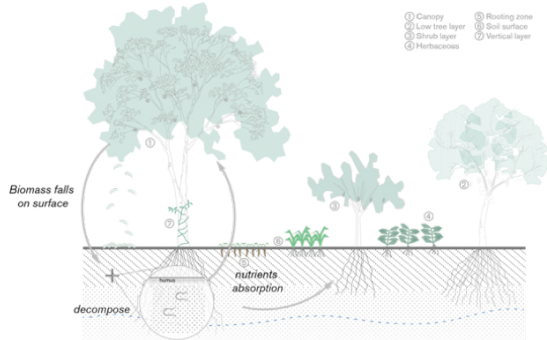

Figure 4.6 Food forest

Food Forest

This concept is representing the application of principles of nature to the program and design of public space in cities in the shape of a food production garden. It is a typical ecosystem in which the humans and animals interact, aimed at providing food. This production is completely based in the natural ecosystem which means that there is no use of fossil fuels involved, no pesticides, no artificial fertilizer and no over-exploitation of the soil conditions but eco land management.

The design of a food forest is done on the base of creating a living system in which parts work together and complement each other. The aim is on a productive variety of plants and trees that co-benefit from each other. Per landscape typology the indigenous types and plants and trees from comparable climate are brought together in the most productive mix.

Important notion is that by placing the right species in the right position the sowing, weed control, pest control and pruning can be left to the natural system.

The result is a half open forest with different plant heights, it is a long-term poly culture, which means that the species reproduce themselves. The plans consist out of 7 layers: large trees, small trees, bushes, herbs, covering, roots and climbers.

1. Canopy, large fruit and nut trees
2. Low tree layer, dwarf fruit trees
3. Shrub layer, currents and berries
4. Herbaceous, beets herbs
5. Rhizosphere, root vegetables
6. Soil surface, ground cover, strawberries
7. Vertical layer, climbers and vines

¹² <https://www.nature.com/scitable/knowledge/library/the-soil-biota-84078125>

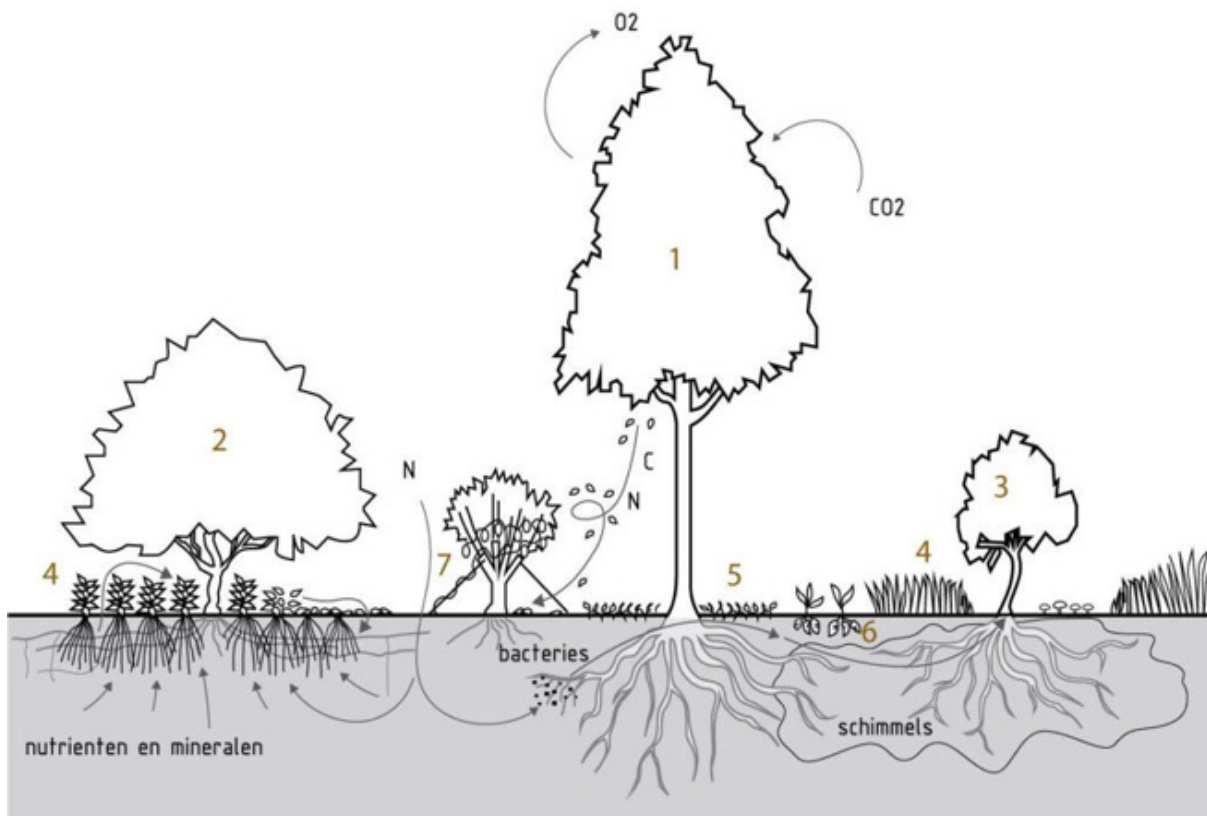

Fig 4.7 The seven layers of the food forest

The herbs under fruit trees will attract bees and insects for the fertilization. The herb scent also confuses fruit flies so they will not eat ripe fruit. When positioned on the south side the fruit tree will be in the shadow of the large tree it will be in the sun and protected from night frost. The assets of the food forest have more functions: fertilization, plague management, soil covering, shelter from sun, wind and cold.

The 8th layer is the foundation, the soil that plays an essential role in the cooperation between the plants, bushes and trees. Fertile soil is also living soil with bacteria, soil life and fungus that transform dead leaves and animals into food for plants. The organic substance that comes out of this keeps moisture in the soil. The roots of plants and animals like worms and moles also keep the soil permeable and loose, which is good for the complete soil life.

The different plants fulfil different functions and cooperate that is why plants with deep roots

are next to ones with superficial roots, this is multiple land use and use of resources. The plants with superficial roots live of the leaves that fall of the trees that are taking their food from a deeper layer in the soil. Also binding the essential fertilizer nitrogen is done by cooperation between bacteria.

Fungus play a special role in the food forest ecosystem because they form networks that can reach over kilometres. Through this network information, water and food is transported and makes it possible for trees to share food and warn each other when there is a disease or plague. The other way around trees and bushes provides the fungus with sugars. The fungus connects to the root systems and exchange nutrients, sometimes also with the help of bacteria. The distribution is aimed at the health of the whole system and not at survival of one part. This strategy is on the long term best for all the parts¹³.

¹³ <http://www.rfgn.nl/wat-is-een-voedselbos/> Rotterdam Forrest Garden Network

Food Forests' Living Web

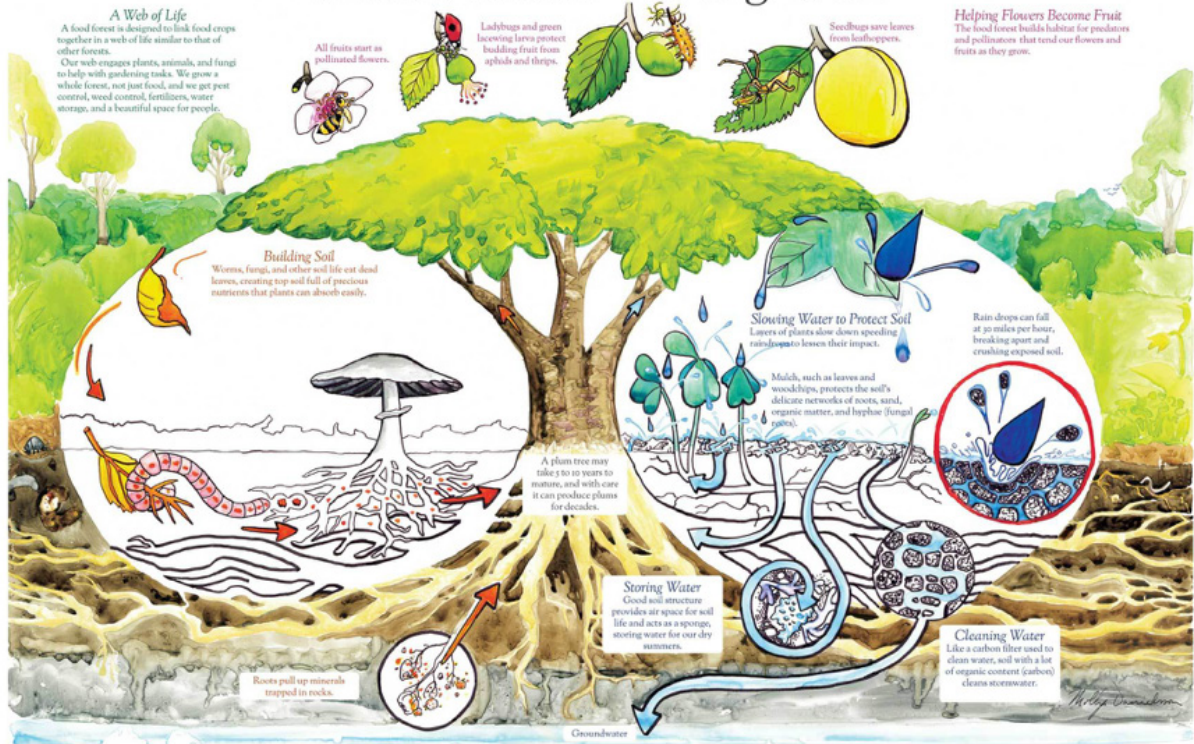

96

Fig 4.8 The visual representation of the living web of a food forest (Permaculture Action Network)¹⁴.

Besides food, the natural system also offers resources to build houses and infrastructure. Wood as a clear example is only one part of a tree. The research by CEI-Bois, CEPI, CEPF and EUSTAFOR explains the bio-economy potential of a tree (European State Forest Association (EUSTAFOR))¹⁵ see fig 4.10.

Another nice example is the story of the beams in the roof of the College of Oxford. When the building was built 500 years ago, a local oaks nursery was created, this small forest would become useful to replace the deteriorated beams 500 years later¹⁶.

For infrastructure there are also examples of how material from the location can be used, like bridges from trees or stones found in the river depicted in fig 4.9 and 4.11.

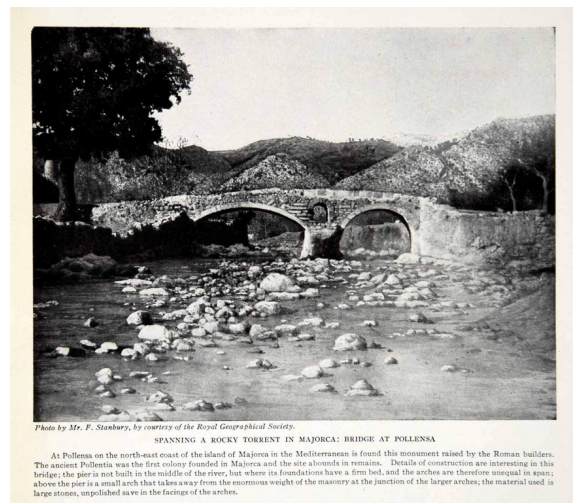

Fig 4.9 Roman bridge in Pollensa, Mallorca (Spain) (Royal Geographical Society)

¹⁴ <http://www.permacultureaction.org/food-forest-living-web/>

¹⁵ <https://eustafor.eu/what-a-tree-can-do/>

¹⁶ <https://www.atlasobscura.com/places/oak-beams-new-college-oxford>

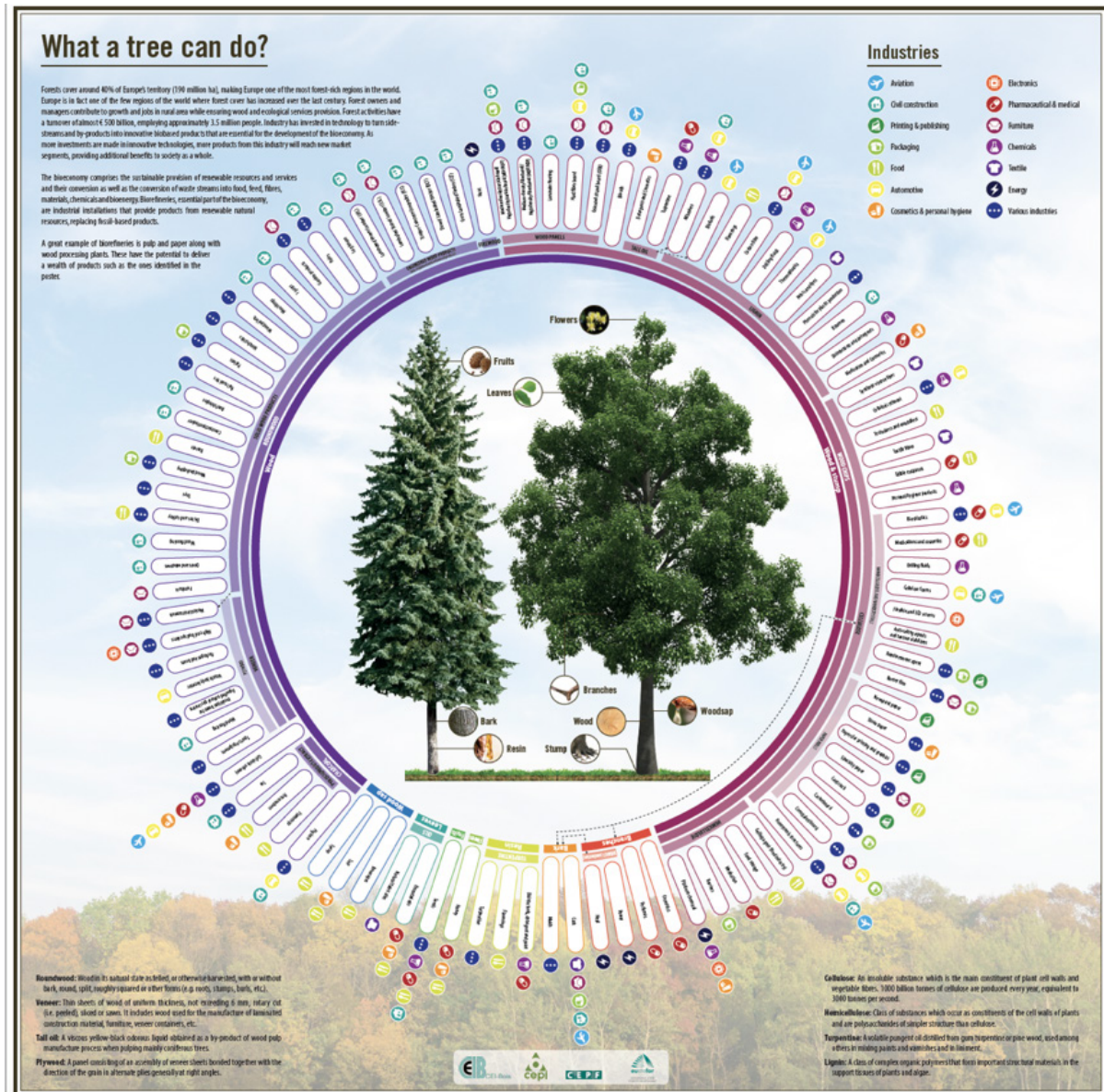

Fig 4.10 Poster by CEI-Bois, CEPI, CEPF and EUSTAFOR explains the bio-economy potential of a tree¹⁷



Fig 4.11 Hanging bridge of tree roots in East Khasi Hills (India) (Native Planet)

¹⁷ <https://eustafor.eu/what-a-tree-can-do/> (European State Forest Association, EUSTAFOR)

4.1.3 Restoration original landscape: peat



Fig 4.12 Peat landscape (Patrick Post, Trouw)

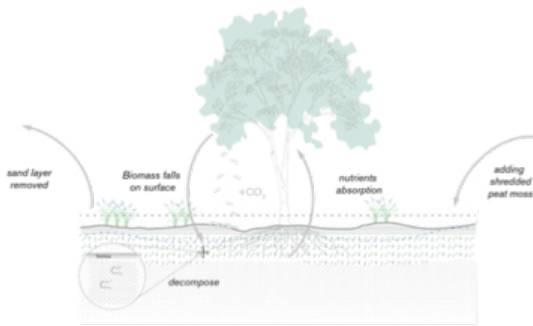

Fig 4.13 Peat decomposition system and reconstruction by adding shredded peat moss.

Peat is a brown deposit resembling soil that is formed in a slow process by the partial decomposition of vegetable matter in the wet acidic conditions of bogs and fens. The original peat landscapes the Netherlands have been quite dynamic since peat has been extracted and dried for use as fuel and in gardening. The mining of peat left a water landscape that later on was often pumped and became a dried lake for agriculture or occupation.

Currently the subsiding of the peat landscape in the Netherlands is stimulated by the pumping regime. This regime induced the subsidence process already for centuries, starting with the digging of ditches to drain, followed by pumping with windmills, steam engines to induction and electrical pumping. The subsiding of peat releases large CO₂ output, which can

be considered very unsustainable, and brought about the tradition to add sand to the city to stabilize soils and enlarge the free board (manage ground water levels). The mining of sand and cover the original landscape with it can also be considered unsustainable.

Changing this land management could be done by changing the water pumping regime and programme public space as such that it can accept the wet landscape. This will allow for the peat to grow back to replace the infertile sand in the city.



Figure 4.14 Position of peat in the Netherlands (Illustrated by Frank Wesselingh, Naturalis)¹⁸

¹⁸ <http://www.geologievannederland.nl/landschap/landschappen/veenlandschap>



Figure 4.15 Left side is the original situation of a drained peat soil. The right side is showing the growth of the peat after 4 years by adding small pieces of peat and keeping it moisture. (Rob Buitter, Omhoog met nieuw levend veen Trouw 19 oktober 2017)¹⁹.

The design of the public space as peat landscape should consider that peat landscape is quite sour and only specific plants can grow in this environment. Peat has a very low base value (low PH) which is good for Rhododendrons and the colouring of Hortensia's into blue.

Trees that grow well on peat are the black alder and willow. Other plants that characterise the peat landscape are:

- 1- *Acer palmatum* - Japanese maple
- 2- *Actaea rubra* - Chinaberry
- 3- *Azalea mollis* – *Rhododendron mollis*
- 4- *Corylopsis sinensis* - Common hazel
- 5- *Osmunda regalis* - Royal fern
- 6- *Pieris* - Fetterbushes
- 7- *Polygonatum multiflorum* - Solomon seal
- 8- *Rhododendron* - Rhododendron
- 9- *Salvia nemorosa* - Woodland sage
- 10- *Styrax japonicus* - Japanese snowbell

¹⁹ <https://www.trouw.nl/groen/omhoog-met-nieuw-levend-veen~a7c30a31/>

When restoring the peat landscape and accepting that public space will be wetter and subsiding, this demands another approach into the design of buildings and infrastructure. This

approach was tested in the project Intelligent Subsurface Quality (Hooimeijer et al., 2018) by proposing this in the design of public space and buildings that can adapt to subsidence and a wet landscape (see fig 4.16).

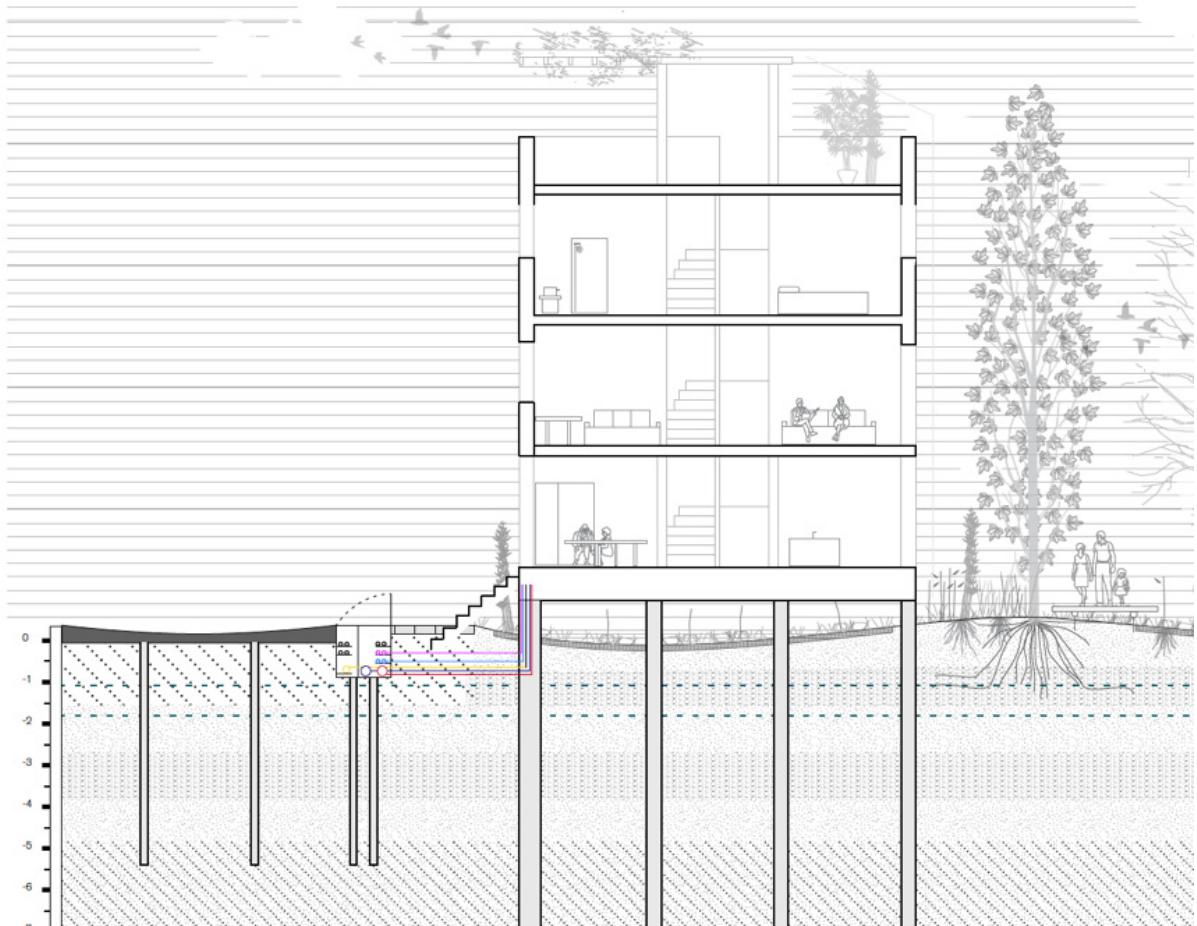

Fig 4.16 The public space is natural and will subside. The buildings are on piles and designed with the flexible entrance to the subsiding public space. Infrastructure and subsurface infrastructure are also founded on piles to prevent breakage and high maintenance costs by subsidence (drawing by Filippo Laflleur).

4.1.4 Script 4. Maya system

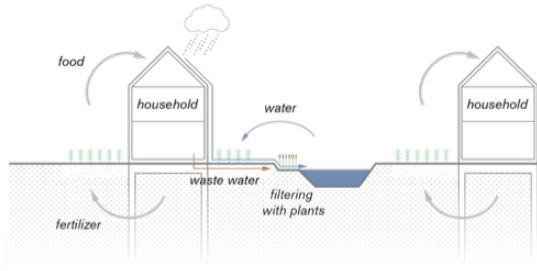

Figure 4.17 Schematic representation of the Maya system of circular soil and water systems

The Maya's have a long-term political and economic history that forms a series of cycles of growth, decline, and reorganization and numerous cities emerged during the Pre-classic (1000 BC – AD 250), Classic (AD 250–1000), and Postclassic periods (AD 1000–1500).

Taking out the Classic Period it is characterised by state societies with cities that - for that time - had large populations that used remarkable advanced technology and art, had long-distance contacts and trade and a heterogeneous environment.

Special interest for this research goes out to the complex resource management systems that were used in these cities. Their cities were not concentric but had a dispersed settlement layout with low population densities. The Maya's settlements worked with an integrated land management strategy concerning fertile soil and water. Each farmstead was surrounded by food-production gardens and the larger open spaces were devoted to short-fallow or permanent infield agriculture like orchards and forest patches. This organisation and closing of soil and water systems is an inspiration to taking new design strategies with the aim of fertile soil. (Barthel & Isendahl, 2013)

Principles:

- Production gardens around each farmstead (extended family house);
- Larger open spaces were devoted to short-fallow or permanent infield agriculture;
- Gardens and farming areas are shaded;
- Urban green space also included orchards and forest patches.

The integration of built space with green space, gardens, and agricultural fields was an energy-efficient strategy for food security in a society that lacked beasts of burden, wheel-based transport, and (in many Maya lowland regions) navigable rivers.

Historical ecological research indicates that agricultural production is not the antithesis of “the city” but to the contrary an urban function that contribute to the resilience of cities.

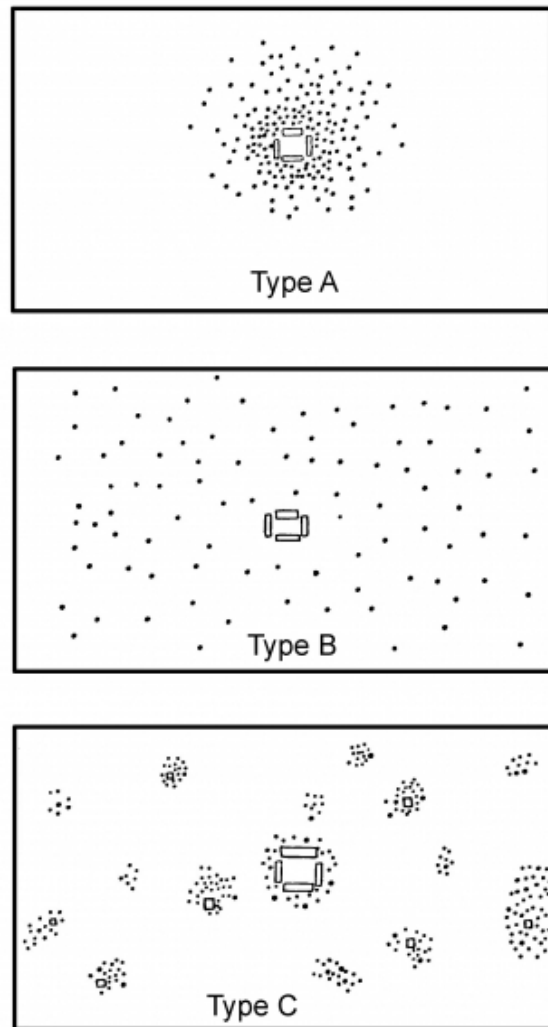

Fig 4.18 Willey's classification of Maya settlement patterns around monumental centres, type C consists of multiple clusters of houses and patio groups (Smith, 2011) modified after Willey (1956).

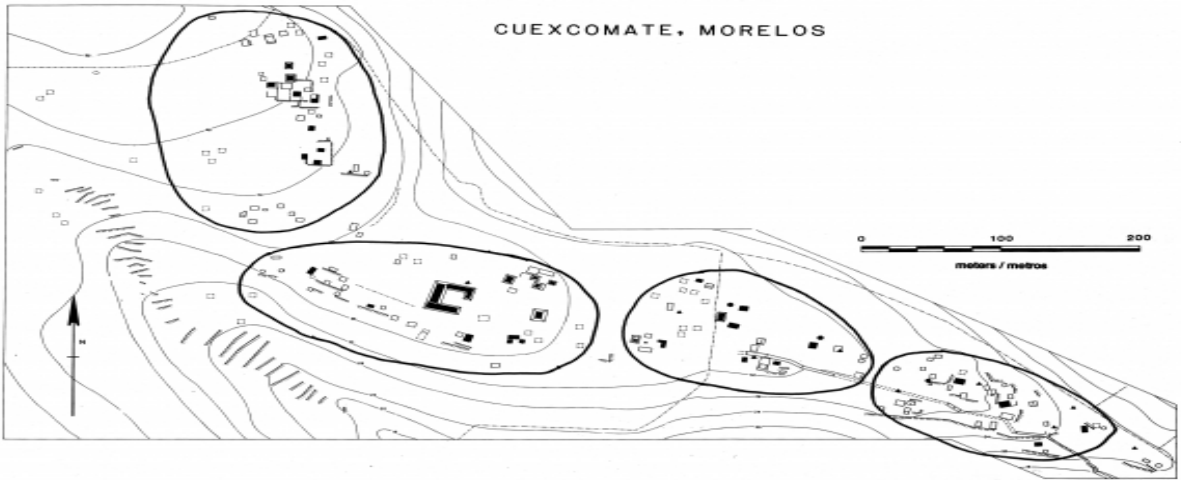

Fig 4.19 Settlement clusters of the Maya (Smith, 2011)

4.2 Three different perspectives

These 4 approaches (in figure 4.20) are applied to the 3 urban typology samples, 50s, 70s and 90s, to question how the application of these

methods in urban development - with putting the healthy soil first - affects the urban morphology and relation between public private and ultimately the design of public space.

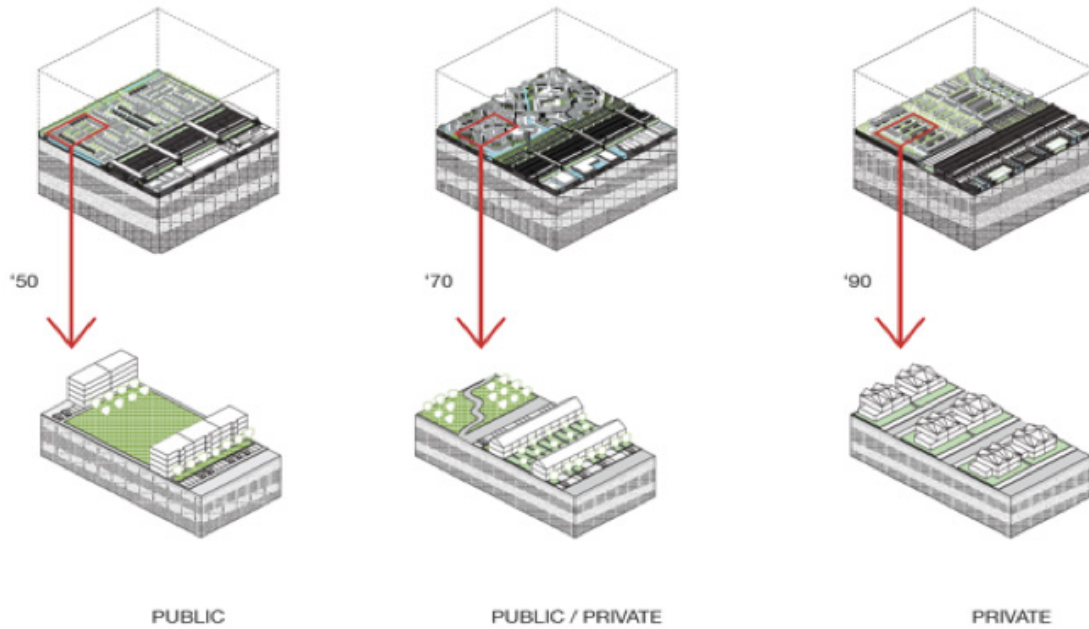

Fig 4.20 These 4 approaches are applied to the 3 urban typology samples

4.2.1 50s Perspective new soil maintenance regime and approach

Post War 1950s urban typology is characterized by a strong and clear idea about what the 'public realm' was to enhance social coherence, expressed in oversized public space, mixed typology of housing in a repetitive stamp. Industrial production and very technocratic approach in which the buildings are prefabricated, building site preparation by hydraulic filling, subsurface drainage and well-structured infrastructure network.

The healthy soil approach is taking the perspective of a new soil maintenance regime and deal with subsidence without adding sand to the area (as is usually done) and by stimulating the restoration of the endogenous ecological system.

It means that there will be height difference between buildings (stabilized on piles) and public space. The sewer system will not be stabilized and transformed to a flexible system that collects organic waste that goes to industrial area. Housing is designed with flexible entrance.

Conclusions applicability to the urban typology 50s:

- Over-sized public spaces gives an opportunity for large scale public interventions to remediate soil.
- Experiments as to how to involve the community are possible but challenging as probably identification with the affected space less than in the other two samples of 70s and 90s.
- Responsibility for action lies mainly with public bodies as they have to make the space available there is the pitfall of taking action without sufficient community involvement.

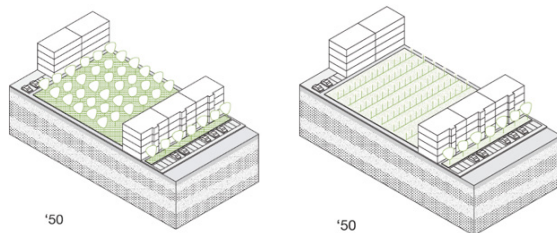

Fig 4.21 The 1950s sample minimised to block scale and tested on potentials for red-design of public space.



Fig 4.22 Phase one is the original state. In phase two the first step is implementing GRO to clean soils and to stop adding sand to mitigate effects of subsidence. This is done differently in phase 3 by stimulating the restoration of the endogenous ecosystem and design the buildings on piles so that they can function with subsiding soils.

4.2.2 70s Fertile soil perspective

Woonerf 1970s have a strong focus on identity and human scale, *gezelligheid*, and a strong aversion to car mobility: focus on slow traffic. Ecology was very important resulting in partial filling and the re-introduction of water in urban setting as natural spatial element. Green structures more differentiated, smaller scale and more natural (ecology). The woonerven are out of date, housing is not well insulated and use a lot of energy, vulnerable for demographic changes, unclear public space and infrastructure, maintenance of public space is costly and low social cohesion, no clear identity. Future renovation of housing, redesign public space.

The healthy soil approach is taking the perspective of fertile soil to enhance food production. The buffer zone first needs to be cleaned with gentle remediation, the organic waste coming out is used for the biomass plant. After that the space is used for the production of food. The material coming out of the parking space and new water structure is used to heighten the zone of car charging.

Conclusions applicability to the urban typology 70s:

- Large public spaces but differentiated makes community scale interventions less applicable then in the urban typology of the 50s, but still possible.
- There lies the opportunity to develop step by step with a mix of public and private investment of money and time. Speed of change can be adjusted to the community needs.
- The challenge is that potentially there is a strong identification with current form of public spaces and people might resistant the change.
- It is in between the other two samples, which has the risk of lack of clarity due to a range of possibilities and interventions.

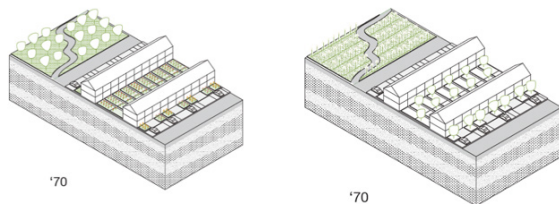

Fig 4.23 The 1970s sample minimised to block scale and tested on potentials for red-design of public space.



Fig 4.24 The renovation of the houses will be combined with the reclaim of the 'living streets' as public green community spaces. The GRO method of soil cleaning is the first step and after that the 'forest garden' will be applied, which focusses on managing soil fertility to enhance food production.

4.2.3 90s Clean soil perspective

VINEX '90s is a large-scale national housing program with project development driven developments on the outskirts of cities. The clear street hierarchy define different concepts for the urban design with mixed housing typology. The partial filling leaves larger green structures for ecology and water, more private gardens. Housing has a high energy label or is passive housing. There is a separated sewer system, high infiltration rate, large open water structures, space for natural cleaning of grey water. Considered as future social-problematic area due to mono-functionality and a low number of services, far away from the centre.

The healthy soil approach is clean soil perspective in which it is supporting the cleaning of human waste flows. Addition of program, creating communities around resilient topics. The soil is used to treat all the waste water in buffer zones and clean the polluted soil of the industrial area. The soil coming out of the construction of the waterway in the industrial area is used to morph the landscape.

Conclusions applicability to the urban typology 90s:

- Mainly private gardens, little public space so the responsibility to remediate soil is in private hands, influence via public incentives (tax relief for example) possible.
- Remediation needs to answer the question “what is in there for me?”
- Potential for neighbourhood organisation.
- Public bodies can only incentivise which means that the large scale success or change is very difficult to predict or to rely on.

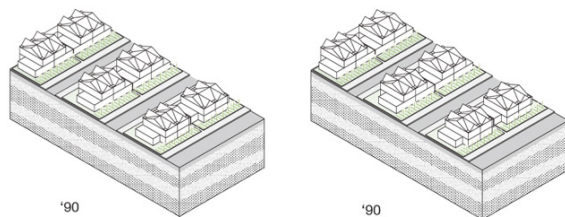

Fig 4.25 The 1990s sample minimised to block scale and tested on potentials for red-design of public space.



Fig 4.26 The Maya-inspired approach beholds a decentralized services of waste and water to bring the end-user closer to the system. This is done in the large open areas for water and greenery and supplement the advantages of the present designs - including good energy efficiency of housing, a separated sewer system, high rainwater infiltration, and natural methods for cleaning open water - whilst turning fertile soil into a public asset that reorganises water flows and waste processing on a communal scale.

The recognition of temporal dynamics of different type of spatial structures is at the base of the Layers Approach (Sijmons, and Verschuren, 1998) which for the larger planning dimensions promotes placing the priority on the lowest and slowest layer substratum. To make the policy-oriented Layers Approach operational on the urban scale the System Exploration Environment & Subsurface (SEES) uses more defined layers representing the working domains in the city, represented in the layers:

- People
- Metabolism
- Buildings
- Public space
- Infrastructure
- Subsurface

The SEES closes the disciplinary gap in an instrumental way, by bringing together information from different disciplines new crossovers become possible and can tackle problems using solutions from another domain. (Hooimeijer and Maring, 2018) Each layer represents a domain of a collective of disciplines that have a way of cooperating, exchanging information, concepts and specific contracts. In the project Resilient Infrastructure (Hooimeijer et al, 2017) the dynamics induced by new mobility in the layer of infrastructure were combined this with trends in the metabolism layer (energy and waste- and water) the buildings layer in renewal and new program, in public space considering ecology and subsurface with water and soil. The main conclusion about the developed approach named “spatial operation perspective” was that: *it opens up an overwhelming potential of the future relation between the urban field that aligns the highway and the highway itself. This potential is not only created by future technological innovations on product scale but also by including environmental and vital infrastructure (water, waste and energy) a huge ecological and programming improvement of the three urban typologies can increase their resilience. This spatial operation perspective offers new trade-offs between field and line,*

between the human and nature system and includes a system approach that can identify potentials and issues in the field of different nature. It promotes an interdisciplinary approach in which the fragmentation caused by the highway lines are made useful and add to urban quality (Hooimeijer et al., 2017).

Considering an opening dynamic and search for positive cascading effects in the other layers gives means of argumentation and design, however it could maybe very easy lead to other decisions if the dynamics in another layer is taken first?

In the sequel of Intelligent Infrastructure, this project SUBSURFACE EQUILIBRIUM a more detailed investigation was done into the redesign of the urban typology samples of the 50s, 70s and 90s and test their potentials to ultimate aim living with healthy earth. The new information of material flows and possibilities in urban mining was a more complex issue because the material flow is part of all layers of the SEES, but all constructions are ‘temporary’ stocks of material, only with a different dynamic and purpose of where and when it could be reused.

There is already a lot of research done only into material flows of buildings and solutions for circular constructions are quite clear: reduce, reuse, recycle. Integrating material flows into urban design can make good use of the RRR approach to organise flows but due to the complexity of the different layers in urban construction, the focus for this enterprise was put on material in public space which opened up more clear new perspectives and questions for urban and landscape design.

Second decision is to consider that there will only be a future city if there is a future earth represented by health soils. There are a lot of potentials like reducing the use of sand for subsidence maintenance, or the un-used (private) soil that can make a difference in climate adaptation, e.g. water treatment, food production. However, this requires clean and healthy soil first. For that first urban soils need to be cleaned and regenerated and second material should be used wise and re-used as much as possible. This aligns with the concept of Reversed Engineering

with Nature (Hooimeijer and Maring, 2017). How do you organize and design public space when healthy soil is first priority? Basically, the perspective in this project shifted from the layer of infrastructure to the layer of subsurface which is the under-arching domain for all other domains.

The relation between the layers and the material flows between them offers a principle structure on how flows could be exchanged between different domains sectors, the building sector is quite separated from the sector that works in the public space. In this report the material is presented for the spatial typology like road and railway and their subsurface materials, it could be set up according to the logic of the SEES. That can open up the concept of circularity and organise the fact that in aiming for sustainability and durability it is maybe not done by closing the cycles but circularity as an open cycle, which means one cycle can feed into the other.

Open system, Infinite loop

Drawing on literature, the framework developed in this research was based on the RRR principle (Reduce-Reuse-Recycle) for Construction & Demolition Waste (CDW) that has been discussed by Bouanini (2013); Beijia et al. (2018) and Thirimoorthy (2019) among others. In a nutshell, the RRR concept describes a dedicated waste management approach that aims at reducing primary resources in manufacturing, distribution and consumption of products with maximum reuse, recycling and recovery. The proposed framework builds upon the above theory and is adapted respectively to the composition of the urban typologies presented in our study. Our novel idea was to explore the flow of construction materials through the urban system and analyze the spatial context into different layers of material use. These layers involve the railway, the highway, the buffer zone and the land occupied by houses and industries, along with the intersecting layers of civil construction including buildings, below-ground infrastructure, roads and green space.

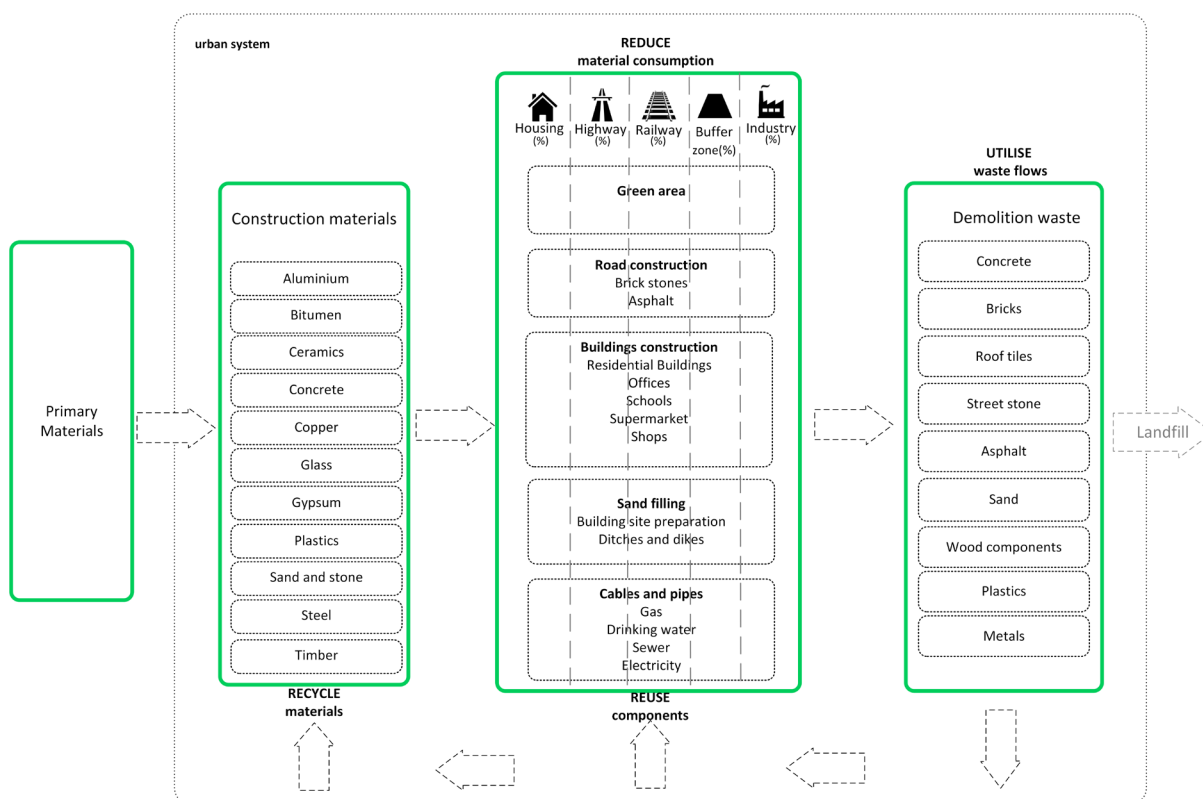

Figure 5.1 Material flow hierarchy and diagram

The purpose of the framework is to offer a comprehensive overview of the construction materials supply chain by using a 'system thinking' approach as described in the next paragraph. This approach is used to deal with complex adaptive systems that are constantly evolving, such as the urban construction land that provides space to above and underground infrastructure, offices and residents. Hence, to understand urban systems in a holistic manner there is a need for setting distinct boundaries and explore the interrelationships between materials that are used in different layers of space. Consequently, individual flows are identified for each material group at end-of-life and quantify them in order to re-design the urban landscape with upcycled construction materials. This was accomplished by performing a quantitative analysis, a static Material Flow Analysis, by means of a mathematical model that describes the Material Stock Balance. Subsequently, the count of the material flows that move through the urban system is done and on the base of that circular loops to reduce the input of primary materials are designed, thereby saving substantial costs for extraction and processing of raw materials. In addition, designing a future city with circular material loops increases the environmental value because the pressure on landfills from accumulation of bulk materials, such as concrete and steel, is considerably reduced and greenhouse gases emitted during transportation of CDW waste is minimized.

Important aspect with scaling up circularity to urban scale and more specific public space is that circularity is not considered as closed-loop recycling. This concept focusses on supply chains and developed in order to have the materials in manufactured goods recycled, usually for using in the same type of production. For closed-loop recycling, the manufacturing process is usually designed with recycling in mind. As an example, Aluminum can be based in the closed-loop recycling process since aluminum can be recycled to form new objects with little material degradation or waste creation. Closed-loop recycling focuses on bringing the products back to the company or industry of manufacture so that they can be reused or refurbished without a loss of material.

The so-called 'open-loop' recycling method is about connecting different loops in which the recycling of one material can done into another material, like the work by Ekvall (2000) in fig 5.2 and 5.3 shows.

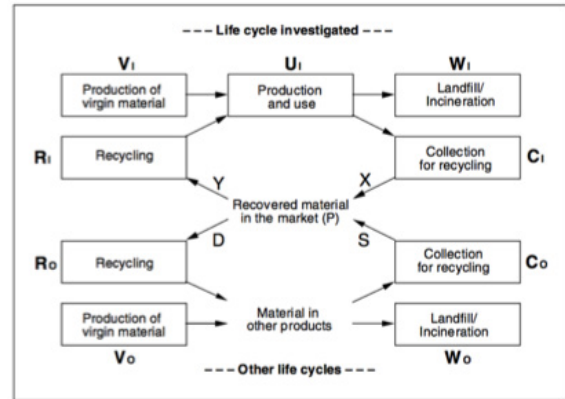

Fig 5.2 Conceptual model of open-loop recycling through a market for recovered material (Ekvall, 2000)

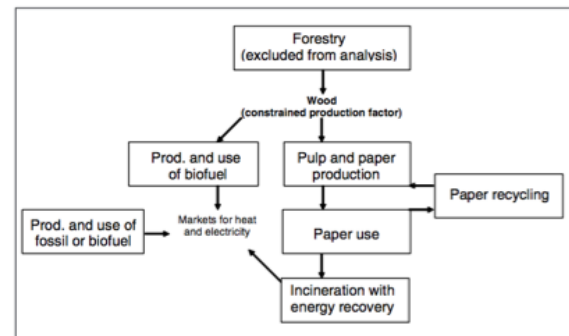

Fig 5.3 Illustrations of analysis of alternative use of wood by Baumann et al. (1993)

The concept of open-loop can be directly related to the work of C.S. Holling and system approach thinking. C.S. Holling is an ecologist who is working in the field of ecological economics that aims to address the interdependence and co-evolution of human economies and natural ecosystems over time and space. Holling is known for this work which is at the base of the field system approach (Holling, 2001), a method to study phenomena as whole with a mutual consistency and in interaction with the surroundings. It is also an appropriate approach towards urban environmental issues because it offers the possibility to consider changes on

complex systems. Holling has blended systems theory and ecology with simulation modelling and policy analysis to develop integrative theories of change that have practical utility. He has introduced important ideas in the application of ecology and evolution, including resilience, adaptive management, the adaptive loop and the linking of these loops over time and scale in the concept of Panarchy.

Holling arrives at the logic of a dynamic system that can be used to get insight on how to be adaptive.

The base of his view is the adaptive loop in fig 5.4 in which four phases are presented R is the exploitation of the system, K the conservation in which main stream and institutions are consolidated, these are opened up through a crisis and release of the system in the Ω phase after which the reorganisation in the α phase prepares again for exploitation (Holling, 2001)

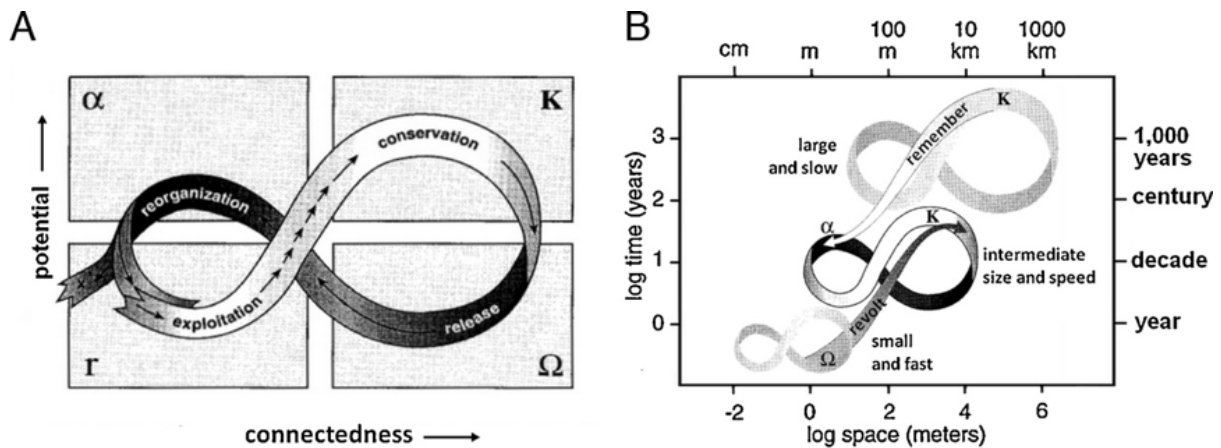

Fig 5.4 Holling's representations of an adaptive loop (A) and a panarchy (Holling, 2001)

Panarchy explains the evolving nature of complex adaptive systems and how they over time and scale affect each other. It links smaller and faster scales to the intermediate and larger systems in their revolt, and the remembrance of larger scale to their origin in the lower scale. It can be applied to systems of nature, human-nature systems and social ecological system, linking the adaptive cycles of growth, accumulation, restructuring and renewal (Holling, 2001).

In the field of Ecological Economics, the interdependence and co-evolution of human economies and natural ecosystems over time and space are addressed. The study of the ecological system delivers characteristics of the nature of the system, drivers of the system, that are comparable with the ones coming from investigating human history. There also a set of critical self-organized variables keep returning. However, the human system is different from the eco-system due to foresight, communication and technology (changing the rules of the ecosystem).

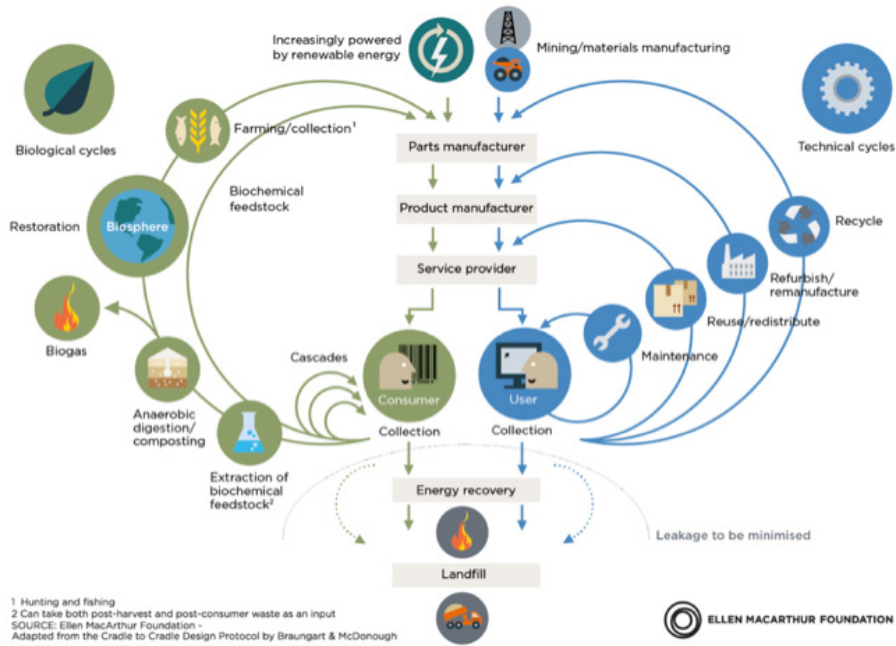

Fig 5.5 Circular economy systems diagram, The Ellen MacArthur Foundation (2012)

Applying Holling's logic of panarchy to the subject of this research is helpful to consider material flows as intertwining and connected to the larger scale. It also gives way to connect what in the model of circular economy is differentiated as two types of cycles, as in fig 5.5, the biological and the technical cycle. The biological cycles are non-toxic materials that can return to the biosphere and the technical cycles are the products, components and materials that are brought back to the market through repair and maintenance, reuse, refurbishment, remanufacture and ultimately recycling (McDonough and Braungart, 2002; The Ellen MacArthur Foundation, 2012). Especially for public space these two cycles should be intertwined and brought into synergy on the smaller scale. Take for example the soil bank, which is the place where abundant soil is brought and where it also taken from when soil is needed. However, the scale of the soil bank is so large and the connection between abundance and need is not made on project basis that there are no smart designs made in which abundance in one place can be solved in a closer by other place.

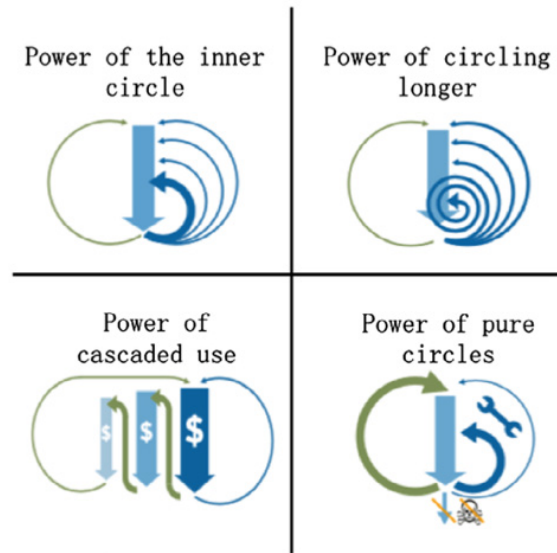

Fig 5.6 Four sources of value creation for circularity (MacArthur Foundation, 2015)

The propositions of the MacArthur Foundation (2015) for value creation should like Hollings Panarchy be linked through scales. Because in the complexity of urban systems, open-loop is not enough. For public space the 'linking open-loop system circularity' describes better the system necessary that is already introduced on the

building scale of reduce, reuse, recycle of use of recourses and output of waste going through the urban system. This is done by including waste (of public space) and material efficiency (like sand or paved surface in public space) hierarchy for cascading (Cordella, 2019).

OPEN RE-CYCLE SYSTEM - Closed Loop

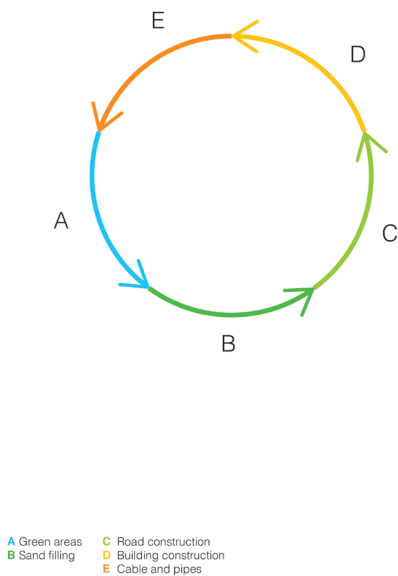

Fig 5.7 Conceptual diagram of closed-loop recycling inside the neighbourhood. Materials are decomposed and categorized in 5 macro groups: Green areas, Sand filling, Road construction, Building construction, Cable and pipes.

OPEN RE-CYCLE SYSTEM - Open Loop

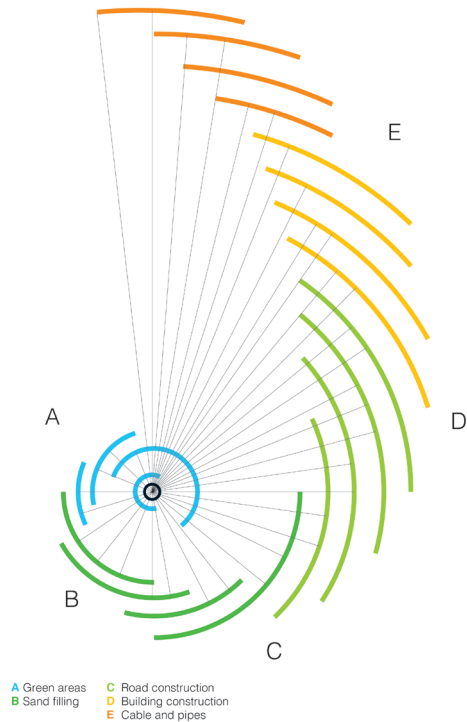

Fig 5.8 The 5 macro groups: Green areas, Sand filling, Road construction, Building construction, Cable and pipes. Each of the group are composed by sub materials, which need to classified with a passport.

OPEN RE-CYCLE SYSTEM - Starting activation

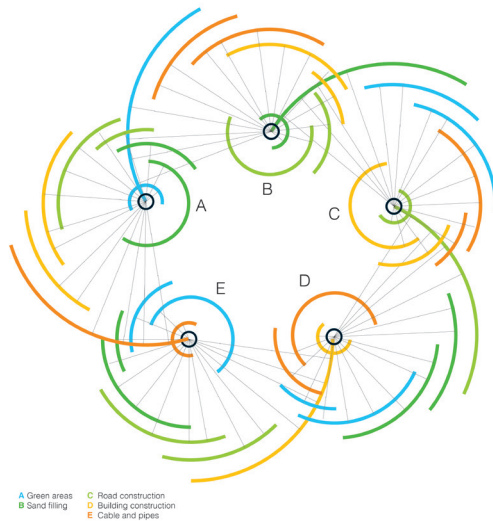

Fig 5.9 Each material can be stored in a deposit if not recycled immediately inside the transformed area and can be utilized in a different neighbourhood when needed.

OPEN RE-CYCLE SYSTEM - INFINITE Loop

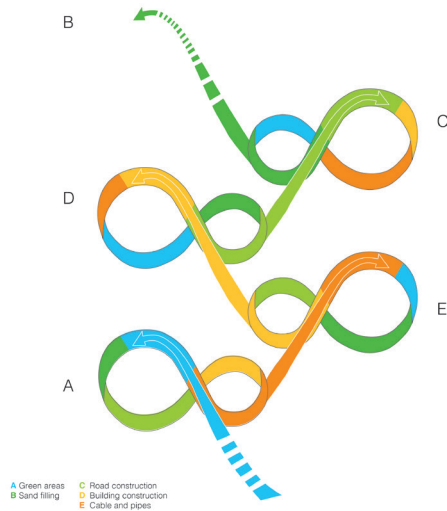

Fig 5.10 The process will start a chain of reutilizing all the materials from the deconstructed side. The infinite loop, is meant to be a chain of decomposed material market, reutilized inside the area but also, giving to another area to start a requalification process.

The 'linking open-loop system circularity' approach can only be successful when meeting three conditions: recordkeeping, performance guidelines and space for deposition. The first condition of recordkeeping is, by law, the bookkeeping of materials represented in a material passport on which potentials for future developments can be utilized. This is already put in action by 'Madaster' the cadastre for materials, the formal institutions for material passport for the building industry.²⁰

The second condition of performance guidelines is about the 'management of choice' that can be about reduce by change or balance out the values of choices differently. The concrete example of reduce by change Unilever's Sustainable Living Plan in which their business growth is decoupled from their environmental by

reducing the weight of their packaging by one third by 2020 and halving the waste associated with the disposal of products by 2020.²¹ Another example is the circular bridge designed by Rijkswaterstaat of which all materials can be reused, this can be applied to the architectural scale and will reduce material use in the future.²² The third condition of space for deposition is making space for sorting and storing materials as part of a new self-evident urban function, in the research called Deposcape. In the design approach having the possibility to reuse the same material in the same or similar area, create a vernacular attitude in thinking the project. The shape of the area will change but the material remains the same.

²⁰ <https://www.madaster.com/en/about-us>

²¹ <https://www.unilever.com/sustainable-living/reducing-environmental-impact/waste-and-packaging/>

²² <https://www.rijkswaterstaat.nl/zakelijk/innovatie-en-duurzame-leefomgeving/duurzame-leefomgeving/circulaire-economie/index.aspx>

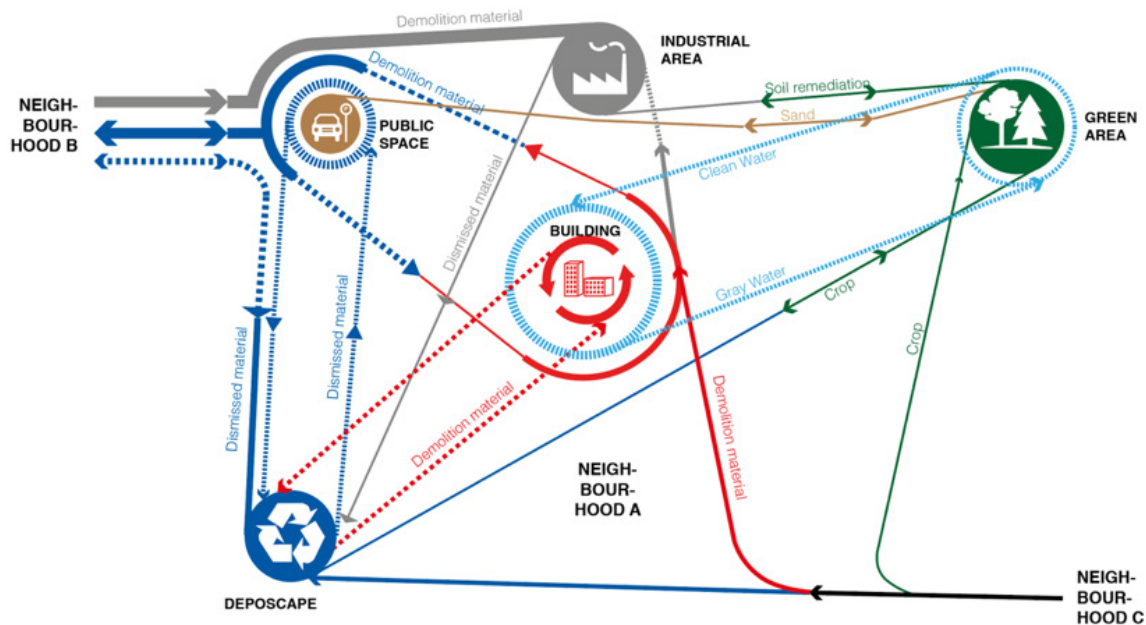

Fig 5.11 Open System - Infinite Loops, allows interchanges among under renovation areas.

Taking it a step further is the 'balancing out of values' which is an integrated performance that is expressed in monetary values over a long time period. PUMA, the sportswear company, is pioneer for this approach by voluntarily publishing an environmental profit and loss account. The World Business Council for Sustainable Development is working on the development of Redefining Value. It should create transparency in true value creation throughout the value chain. By calculating and publishing the environmental profit and loss account by companies will transform economies.

Building on the three enabling conditions of record keeping, performance guidelines and space for deposition, the design concepts delivered by this research can be applied. These concepts can be placed in the domains of SEES but with a fundamental link to the metabolism layer and through that stronger links to the other layers became clear. This innovated the SEES in the sense that it also gives system overview on material flows, in between and linking the layers. The concepts proposed for Mobility (Cars out of

the area and Cars in the area) Infrastructure (Eco Bridge, Ponte Rialto, Circular and modular bridge and N4 Model) and Energy (Producing electricity on the highway) affect the infrastructure layer of the SEES considering that implementing open loop thinking in the domain there is a large integration with the public space and building layers.

Energy (Biomass plant) and Water (Decentralized waste water treatment, Den Bosch model) Soil (Gentle remediation options, Healthy soil maintenance regime, The Mayan concept, Deposit Landscape, Mould Landscape, Restored Landscape) are working in the public space domain with a concrete links to the subsurface. The architecture design concepts (Subsidence Architecture, Re-use ARCH) are dependent on public space and more connection within the domain itself. The more planning concepts Programming (Flow facility, Switching program, Refurbishment, Building regulations, Water regulations) are the base for enforcing new concepts that are needed to be designed by architects and urban designers to really change ways of doing.

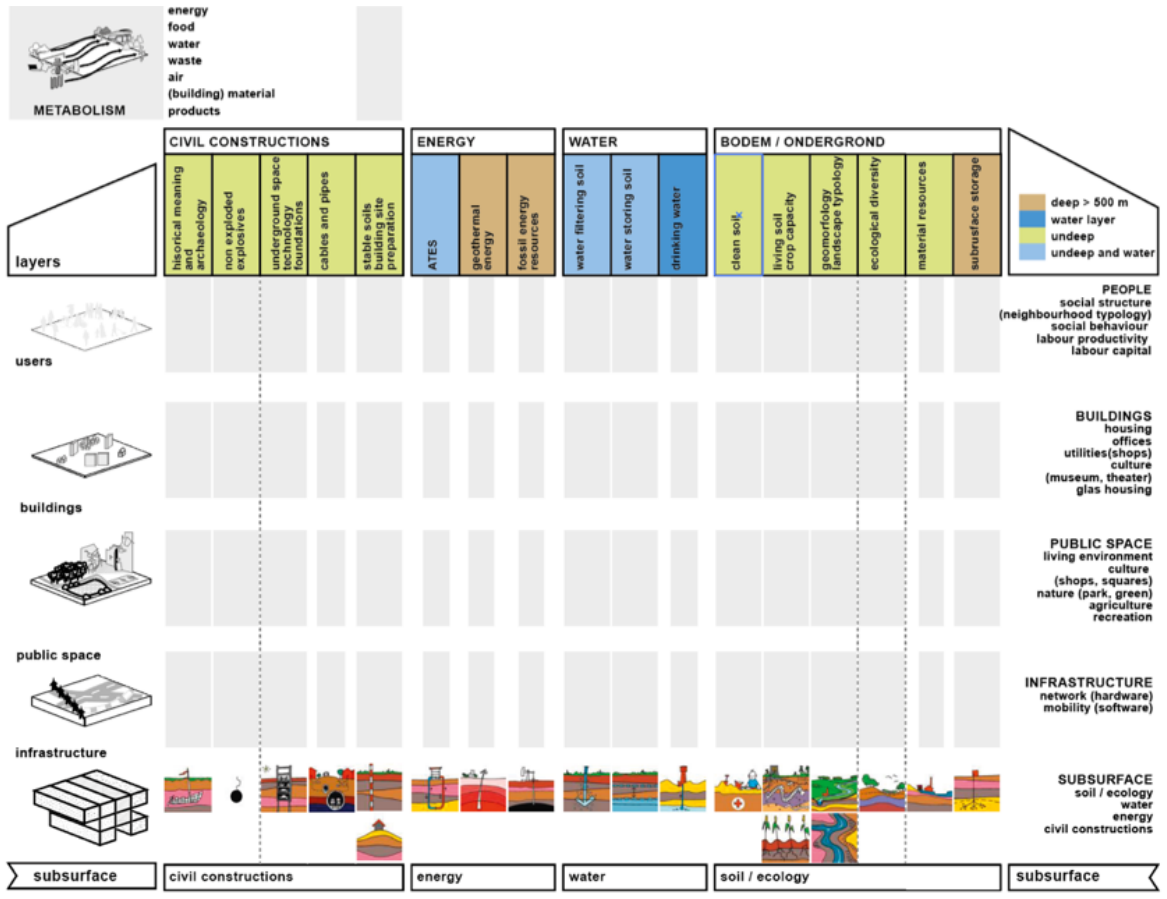

Fig 5.12 SEES version in which the metabolism flows are forming the main network, crossing borders of the domains.

Innovations are initiated under pressure or crisis, like wars and disasters. This project responds to the ecological crisis and the fact that material mining options are becoming finite and also adding to the ecological crisis. Like Holling (2001) shows, through crisis there is room for change and acting differently. This project aims at evoking thinking about the city as a natural landscape and taking back earth as stakeholder in the development process. The future should aim at creating healthy places for healthy humans on the base of a healthy earth.

The subsurface is key to this future since it is the real foundation of all development and activities, it is the ecosystem that services human health in clean air, food and housing anthropogenic urban systems like sewers and energy. Being careful with the earth as resource is promoted by introducing stewardship to the quality of urban soils by reducing the material flows in public space, and make them cater directly to quality of soil and space.

Urban design is an important discipline because it links the subsurface with human activities.

The 'linking open-loop system circularity' approach is about the development of a design personality, not specific design guidelines how to do it. Circularity is an attitude because it beholds too many elements that can be considered generic for each project: it can be about recycling or re-use, about cutting costs or time and output of CO₂ through reducing material inflow and transport of materials. There are many choices and priorities that can be made or set, most important is to have the right information on the table to be able to get a grip on the possibilities. That is what this project offered.

The investigation presented is built on the results of the Resilient Infrastructure project in which the effects of the trends in temperature, automation, demographics and resources were studied and projected to the redesign of the typical urban samples of the 1950s, 1970s and 1990s. These scenarios are mapped according to material flows and re-designed by Material Informed Design using the 'linking open-loop system circularity' approach. Three of these design-samples were chosen to deeper explore the circularity in the design of public space, specially taking

healthy soil as most important aim for urban redevelopment. In these designs the public and private stakeholders' responsibilities are getting a central meaning in order to be able to explain 'purpose' as the new P in the triple bottom line, in which prosperity is not monetary but in it is a new value in the integrated system meaning.

Main question tackled in the is: which synergies can be found when the design of new urban systems is based on circular material flows? The answer to this question is Material Informed Design and the use of the 'linking open-loop system circularity' approach. This is illustrated by the set of design concepts plus examples of how to synergize them in space. The results show that materials can also be considered for very different designs, and can be used to characterise and define space. The combinations are representative for all combinations of different way of dealing with the in- and outflow, energy production, waste treatment, water management. In these concepts also the new relation between public and private in urban development become clear. Urban systems are now only publicly owned and managed, when decentral and circular system are introduced and the necessity for new soil regimes the private domain needs to take an active role in the governance of these systems.

Considering 'healthy soil' as a decentralized urban system the regeneration of polluted and degraded soils and urban development can only be done including public and private stakeholders regarding spatial interventions and transformation with the focus on managing the flows.

In anticipation on the global trends, fundamental inclusion of the subsurface and healthy soils is crucial to make healthy cities. The opportunities for this inclusion are different per specific urban typologies and together define the spatial strategies. There needs to be two conditions in place in order to implement successful strategies: the keeping of material records and regulation of performance guidelines. In this sense it is very much a matter of organisation and scale to enable design, especially to make material flows an integrated part of urban development and dealing with other challenges in urban development. It is not about closing loops but connecting loops.

- Akhtar, A., and Sarmah, A. (2018). Construction and demolition waste generation and properties of recycled aggregate concrete: A global perspective. *Journal of Cleaner Production*, 186, 262–281. doi: 10.1016/j.jclepro.2018.03.085
- Alloway BJ (2013) Heavy metals in soils: trace metals and metalloids in soils and their bioavailability. Springer, Dordrecht.
- Artgineering (2007) N4 Toward a Living Infrastructure ! Brussel: A16.
- Atlas Natuurlijk Kapitaal (2018). Retrieved from <http://www.atlasnatuurlijkkapitaal.nl/>
- Australian Government. (2012). Construction and demolition waste guide, recycling and re-use across the supply chain. Edge Environment: Sydney.
- Barthel, S., & C. Isendahl (2013). Urban Gardens, Agriculture, and Water Management: Sources of Resilience for Long-Term Food Security in Cities. *Journal of Ecological Economics* 86, 224–234.-
- Bell, F.G. (2004). *Engineering Geology and Construction*. Spon Press: London.
- Berghauser Pont MY & Haupt PA (2010) *Spacematrix. Space, Density and Urban form*. Rotterdam: NAI Publishers.
- Braungart, M., McDonough, W., & Bollinger, A. (2007). Cradle-to-cradle design: creating healthy emissions – a strategy for eco-effective product and system design. *Journal of Cleaner Production*, 15(13-14), 1337-1348. doi: 10.1016/j.jclepro.2006.08.003
- Bruijn, K.M. de (2004) Resilience and flood risk management. *Water Policy*. Delft : Delft University Press.
- Campbell, R., Greaves, M. P. (1990). Anatomy and Community structure of the rhizosphere. In *The Rhizosphere.*, Wiley & Sons: West Sussex.
- Choi, H., Park, M., Jeong, D., & Kim, J. (2017). Soil Recycling Among Construction Sites by Optimizing Schedule and Costs for Earthmoving. *Journal of Asian Architecture And Building Engineering*, 16(2), 439-446. doi: 10.3130/jaabe.16.439
- Condeixa, K., Haddad, A., & Boer, D. (2018). Material flow analysis of the residential building. *Journal of Cleaner Production* 149: 1249-1269.
- Cordella, M., Alfieri, F., Sanfelix, J., Donatello, S., Kaps, R., Wolf, O. (2019). Improving material efficiency in the life cycle of products: a review of EU Ecolabel criteria. In: *The International Journal of Life Cycle Assessment*.
- Cruz, M. Dela, Müller, R., Svensmark, B., Pedersen, J.S., Christensen, J.H. (2014) Assessment of volatile organic compound removal by indoor plants — a novel experimental setup. *Environ Sci Pollut Res Int*. 2014;21(13):7838-46. doi: 10.1007/s11356-014-2695-0. Epub 2014 Mar 19.
- Damgaard, A., Larsen, A., & Christensen, T. (2009). Recycling of metals: accounting of greenhouse gases and global warming contributions. *Waste Management & Research*, 27(8), 773-780. doi: 10.1177/0734242x09346838
- De Araujo, B.S., Charlwood, B.V., and Pletsch, M. (2002). Tolerance and metabolism of phenol and chloroderivatives by hairy root cultures of *Daucus carota*.
- De Hoog, M., D. Sijmons, and S. Verschuren. (1998). Herontwerp van het Laagland. [Re-design of the LowLands.] In *Het Metropolitane Debat [The Metropolitan Debate]*, edited by J. Blom, 74–87. Bussum: THOTH.
- Densities of Common Materials. (2018). Retrieved from https://www.engineeringtoolbox.com/density-materials-d_1652.html
- Dijkstra, R. & Atelier Rijksbouwmeester (2013) *Naar een gezonde relatie tussenstad en snelweg*. Atelier Rijksbouwmeester: Den Haag.
- Economic Affairs. Retrieved from <http://www.government.nl/circular-economy>
- Ekvall T (2000). A Market-Based Approach to Allocation at Open-LoopRecycling. *Journal of Resources, Conservation and Recycling* 29, 91–109
- Ekvall, Tomas & Weidema (2004). System boundaries and input data in consequential life cycle inventory analysis. *The International Journal of Life Cycle Assessment*. 9. 161-171. 10.1007/BF02994190.

European Commission. (1999). Construction and demolition waste management practices, and their economic impacts. Symonds Group Ltd. Retrieved from http://ec.europa.eu/environment/waste/studies/cdw/cdw_chapter1-6.pdf

Gagan, & Arora, S. (2015). Recycled Aggregates: A Sustainable Solution of Construction and Demolished Waste. *IOSR Journal of Mechanical and Civil Engineering (IOSR-JMCE)*, (e-ISSN: 2278-1684), PP 58-63.

Ganiron, T. (2019). Recycling Concrete Debris from Construction and Demolition Waste. *International Journal of Advanced Science and Technology Vol.77 (2015)*, pp.7-24 <http://dx.doi.org/10.14257/ijast.2015.77.02>

Garcia-Perez, M., Chaala, A., Pakdela, H., Kretschmerb, D. Royad, C., (2007). Characterization of bio-oils in chemical families. *Biomass and Bioenergy*, Volume 31, Issue 4, April 2007, Pages 222-242

Gontia, P., Nägeli, C., Rosado, L., Kalmykova, Y., & Österbring, M. (2018). Material-intensity database of residential buildings: A case-study of Sweden in the international context. *Resources, Conservation and Recycling*, 130, 228-239. doi: 10.1016/j.resconrec.2017.11.022

Government of the Netherlands. (2016). A Circular Economy in the Netherlands by 2050. The Ministry of Infrastructure and the Environment and the Ministry of

Holling C. S. (2001) Understanding the Complexity of Economic, Ecological, and Social Systems. *Ecosystems (2001) 4*: 390–405

Hooimeijer F.L. (2019) The city of the future is rooted in healthy soil. In: M. Berken (ed) *City of the future*. Wageningen: Blauwdruk

Hooimeijer F.L. & L. Maring (2018) The significance of the subsurface in urban renewal. *Journal of Urbanism: International Research on Placemaking and Urban Sustainability*, 11:3, 303-328, DOI: 10.1080/17549175.2017.1422532

Hooimeijer F.L. and Lafleur (2018) Intelligent SUBsurface Quality 4: Drawing the subsurface: Integrated Infrastructure and environment design. Delft: University of Technology Delft <https://repository.tudelft.nl/islandora/object/uuid%3Adb82675d-5fb1-4d5a-914b-3977fb00b7cf?collection=research>

Hooimeijer FL, Rizzetto F. (2017) Resilient Infrastructure and Environment. Spatial operation perspective. Delft: University of Technology. See: [uuid:c32c3349-e76e-4139-a070-a102f2382522](https://doi.org/10.1016/j.resconrec.2017.11.022)

Hooimeijer, F. (2014). The tradition of making polder cities. JapSam Publishers: Heyingen.

Hooimeijer, F.L. (2017) Ontwerpen met bodemdaling in de stad. Web published: <https://www.gebiedsontwikkeling.nu/artikelen/ontwerpen-met-bodemdaling-de-stad/>

Huang, Beijia & Wang, Xiangyu & Kua, Harn & Geng, Yong & Bleischwitz, Raimund & Ren, Jingzheng. (2018). Construction and Demolition Waste Management in China through the 3R Principle. *Resources Conservation and Recycling*. 129. 10.1016/j.resconrec.2017.09.029.

ITRC (Interstate Technology & Regulatory Council). (2009). PHYTO-3 Phytotechnology Technical and Regulatory Guidance and Decision Trees Revised. Washington, DC: Interstate & Regulatory Council, Phytotechnology Team, <http://www.itrcweb.org>.

Junak, J., & Sicakova, A. (2017). Concrete Containing Recycled Concrete Aggregate with Modified Surface. *Procedia Engineering*, 180, 1284-1291. doi: 10.1016/j.proeng.2017.04.290

Katsumi, T. (2015). Soil excavation and reclamation in civil engineering: Environmental aspects. *Soil Science And Plant Nutrition*, 61(sup1), 22-29. doi: 10.1080/00380768.2015.1020506

Kennen, K. & N.Kirkwood, (2015), PHYTO Principles and resources for site remediation and landscape design. Routledge: New York.

Khudyakova, G., Danilova, D., & Khasanov, R. (2017). The use of urban wood waste as an energy resource. *IOP Conference Series: Earth and Environmental Science*, 72, 012026. doi: 10.1088/1755-1315/72/1/012026/

Koutamanis, A., van Reijn, B., & van Bueren, E. (2018). Urban mining and buildings: A review of possibilities and limitations. *Resources, Conservation and Recycling*, 138, 32-39. doi: 10.1016/j.resconrec.2018.06.024

Kumar, V. (2016). Phytoremediation as a Potentially Promising Technology: Prospects and Future,

Jaipur, Rajasthan, India

Lal, R. (1998) Pedospheric processes and the carbon cycle. In: Soil Processes and the Carbon Cycle. eds. R. Lal. Boca Raton, FL: CRC Press, 1- 8.

Lange, G. de, Lelieveld, C., van Zomeren, A., Rover, V., Visser, J., & de Vos, S. (2016). Climate resilience in construction assignments. Published by ECN Environment & Energy Engineering. Retrieved from: <http://www.adaptivecircularcities.com/wp-content/uploads/2016/04/Climate-Resilience-and-Circularity-in-construction-assignments.pdf>

Lithner, D., Larsson, Å., Dave, G. (2011). Environmental and health hazard ranking and assessment of plastic polymers based on chemical composition, *Science of The Total Environment* Volume 409, Issue 18, 15 August 2011.

Lugtenberg B., Dekkers, L.C. (1999). What makes *Pseudomonas* bacteria rhizosphere competent? *Environmental Microbiology* 1999 Feb;1(1):9-13.

Lugtenberg, B., Kamilova, F. (2009). Plant-Growth-Promoting Rhizobacteria. *Annual Review of Microbiology* 63.

Mah, C., Fujiwara, T., & Ho, C. (2016). Construction and demolition waste generation rates for high-rise buildings in Malaysia. *Waste Management & Research*, 34(12), 1224-1230. doi: 10.1177/0734242x16666944

Mato, Y., Isobe, T., Takada, H., Kanehiro, H., Ohtake, C., Kaminuma, T. (2000) Plastic Resin Pellets as a Transport Medium for Toxic Chemicals in the Marine Environment. *Environ. Sci. Technol.* 2001, 35, 2, 318-324

McDonough W. and Braungart M. (2002). *Cradle to Cradle: Remaking the Way We Make Things*. Vintage Uk

Michael E. Smith (2011) Classic Maya Settlement Clusters as Urban Neighborhoods: A Comparative Perspective on Low-Density Urbanism. *Journal de la Société des américanistes* p. 51-73

Mielke HW, Reagan PL (1998) Soil is an important pathway of human lead exposure. *Environ Health Perspectives*.

Mirsal, I. A. (2008) *Soil Pollution, Origin, Monitoring & Remediation*, Springer: Berlin Heidelberg.

Municipality Rotterdam (2017) *Wegen, asset management plan*. Rotterdam: Municipality

Odum, E. (1953) *Fundamental of Ecology*. Saunders, Philadelphia

Reynolds, C.M., Perry, L.B., Pidgeon, C.S., Koenen, B.A., Peltron, D.K. Foley, K.L. (1999).

Plant based treatment of organic-contaminated soil in cold climates. In Edmonton 99, *Processing of Assessment and Remediation of Contaminated Sites in Artic and Cold Climate workshop*, Edmonton, Alberta, Canada

Rog, C. (2013) Presentation to Harvard University GSD 6335, *Phyto Practicum Research Seminar*, 17 October.

Saha, P., Shinde, O., Sarkar, S. (2017) Phytoremediation of industrial mines wastewater using water hyacinth, *International Journal of Phytoremediation*.

Samiha, Bouanini. (2013). The Importance of the 3R Principle of Municipal Solid Waste Management for Achieving Sustainable Development. *Mediterranean Journal of Social Sciences*. 4. 129-135. 10.5901/mjss.2013.v4n3p129.

Schebek, L., Schnitzer, B., Blesinger, D., Köhn, A., Miekley, B., & Linke, H. (2018). Material stocks of the non-residential building sector: the case of the Rhine-Main area. *Journal of Cleaner Production* · January 2019 DOI: 10.1016/j.jclepro.2019.01.199

Segeren, W.A. and H. Hengeveld (1984). *Bouwrijp maken van terreinen*. Deventer: Kluwer

Stephan, A., & Athanassiadis, A. (2018). Towards a more circular construction sector: Estimating and spatialising current and future non-structural material replacement flows to maintain urban building stocks. *Resources, Conservation And Recycling*, 129, 248-262. doi: 10.1016/j.resconrec.2017.09.022

Stylianoua, M. Björnsdotter M.K., OlssonIngrid, P.E., Jogsten, E., Jassa, J. (2015). Distinct transcriptional response of *Caenorhabditis elegans* to different exposure routes of perfluorooctane sulfonic acid. *Environmental Research* 2019 Jan; 168:406-413. doi: 10.1016/j.envres.2018.10.019. Epub 2018

Oct 18.

- TABULA WebTool. (2018). Retrieved from <http://webtool.building-typology.eu/#bd>
- The Ellen MacArthur Foundation (2012) Towards the Circular Economy. The Ellen MacArthur Foundation: Cowes UK.
- Thirumoorthy, P. (2019). Application of 3R Principles in construction Project – A Review. *International Journal of Industrial and Systems Engineering*. 2. 1-3.
- Von Caemmerer, S. Baker, N. (2007). The biology of transpiration: from guard cells to globe. *Journal of Plant Physiology*.
- Wever, R., & Vogtländer, J. (2014). Design for the Value of Sustainability. *Handbook of Ethics, Values, And Technological Design*, 1-31. doi: 10.1007/978-94-007-6994-6_201
- Willey Gordon R. (1956). The structure of ancient Maya society: evidence from the Southern Lowlands. *American Anthropologist*, 58, pp. 777-782.
- Wisconsin Asphalt Paving Association. (2016). Asphalt pavement design guide. Wisconsin Asphalt Paving Association: Wisconsin. Retrieved from: https://www.wispave.org/wp-content/uploads/dlm_uploads/WAPA-Design-Guide-2020-Final.pdf
- Zhang, Z., Sugawara, K., Hatayama, M., Huang, Y., Inoue, C. (2014). Screening of plants using a foliar application and a native accumulation of As. *International Journal of Phytoremediation* 16.