



**Designing inclusivity:**

Eliminating social barriers, increasing collective identity  
Majd Shahoud - 5153301 - 27-06-2024

# Story line

Inclusivity

Horizontal brief

Research topic

Design location and strategy

Design proposal

Aspects for sustainability and structure

Facade fragment



# Inclusivity

Social engagement

Accessibility

Shared spaces

Hybridity

Inclusivity: Active inclusivity  
Social and public inclusivity  
Professional inclusivity  
Private/ intimate inclusivity

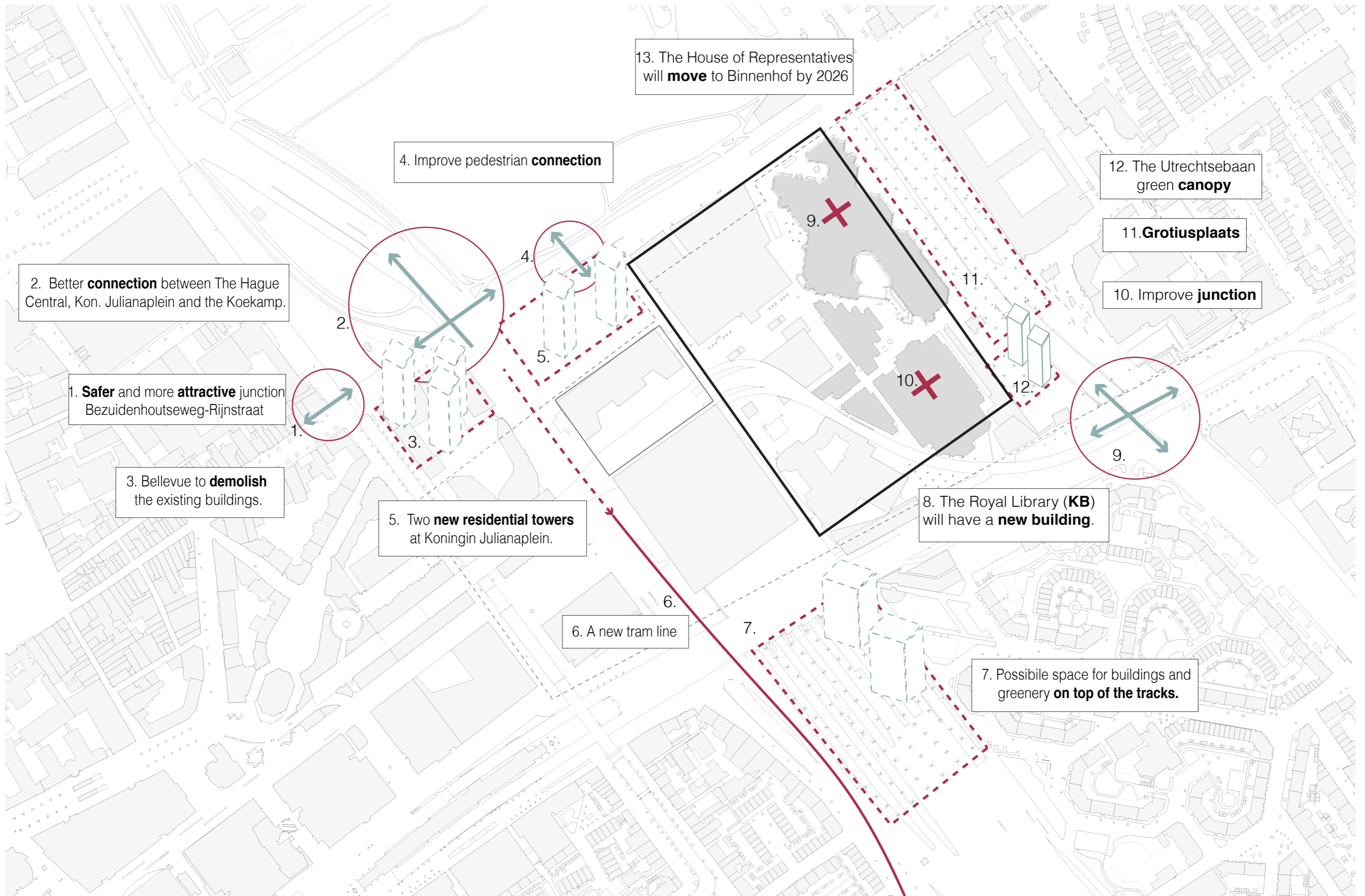

2. Better **connection** between The Hague Central, Kon. Julianaplein and the Koekamp.

1. **Safer** and more **attractive** junction  
Bezuidenhoutseweg-Rijnstraat

3. Bellevue to **demolish**  
the existing buildings.

4. Improve pedestrian **connection**

5. Two **new residential towers**  
at Koningin Julianaplein.

6. A new tram line

8. The Royal Library (**KB**)  
will have a **new building**.

7. Possible space for buildings and  
greenery **on top of the tracks**.

13. The House of Representatives  
will **move** to Binnenhof by 2026

12. The Utrechtsebaan  
green **canopy**

11. **Grotiusplaats**

10. Improve **junction**

Municipality plans for the Central Innovation District area





Demolished  
27655m<sup>2</sup>

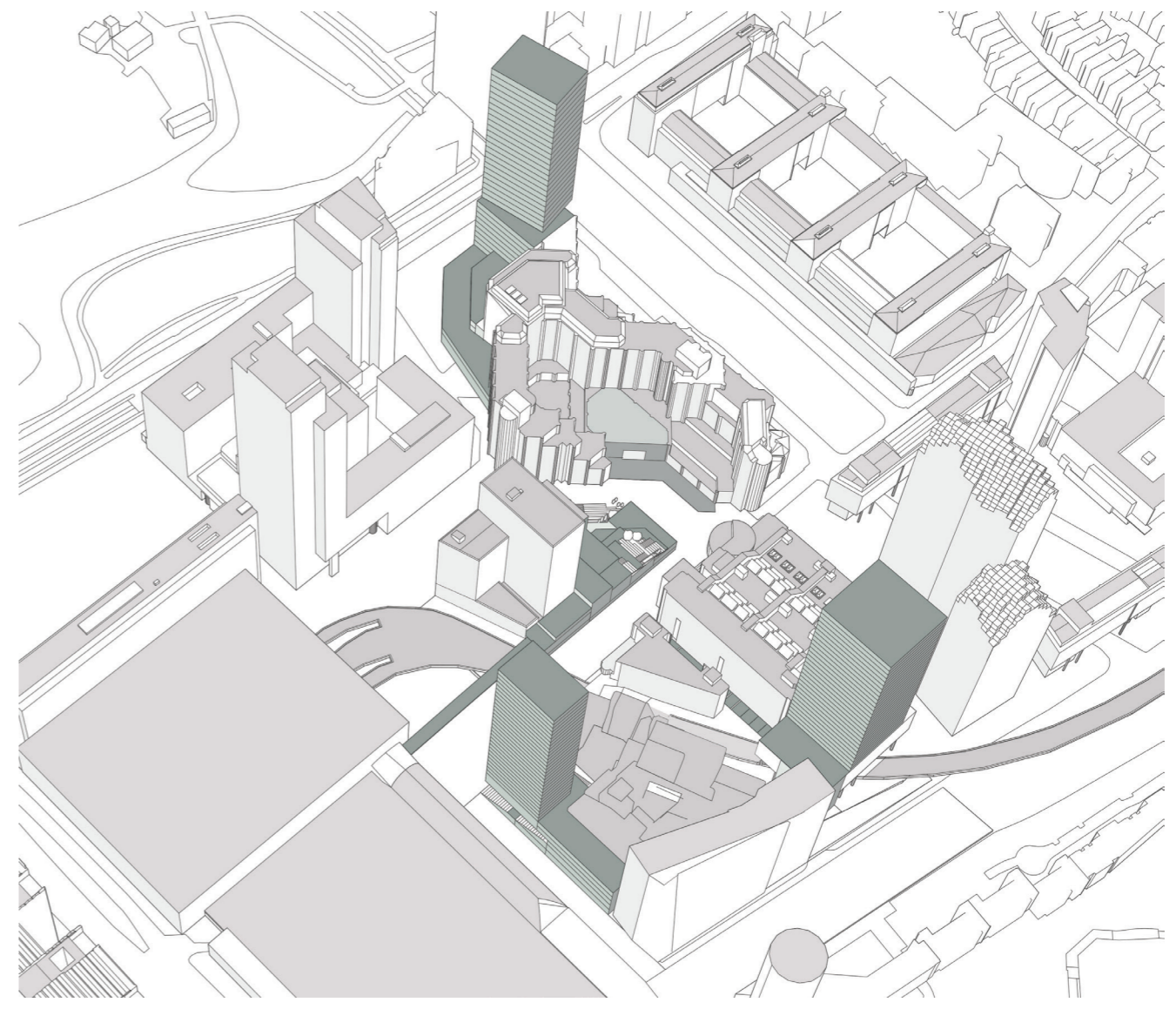

Added  
112400 m<sup>2</sup>

Added and demolished volumes

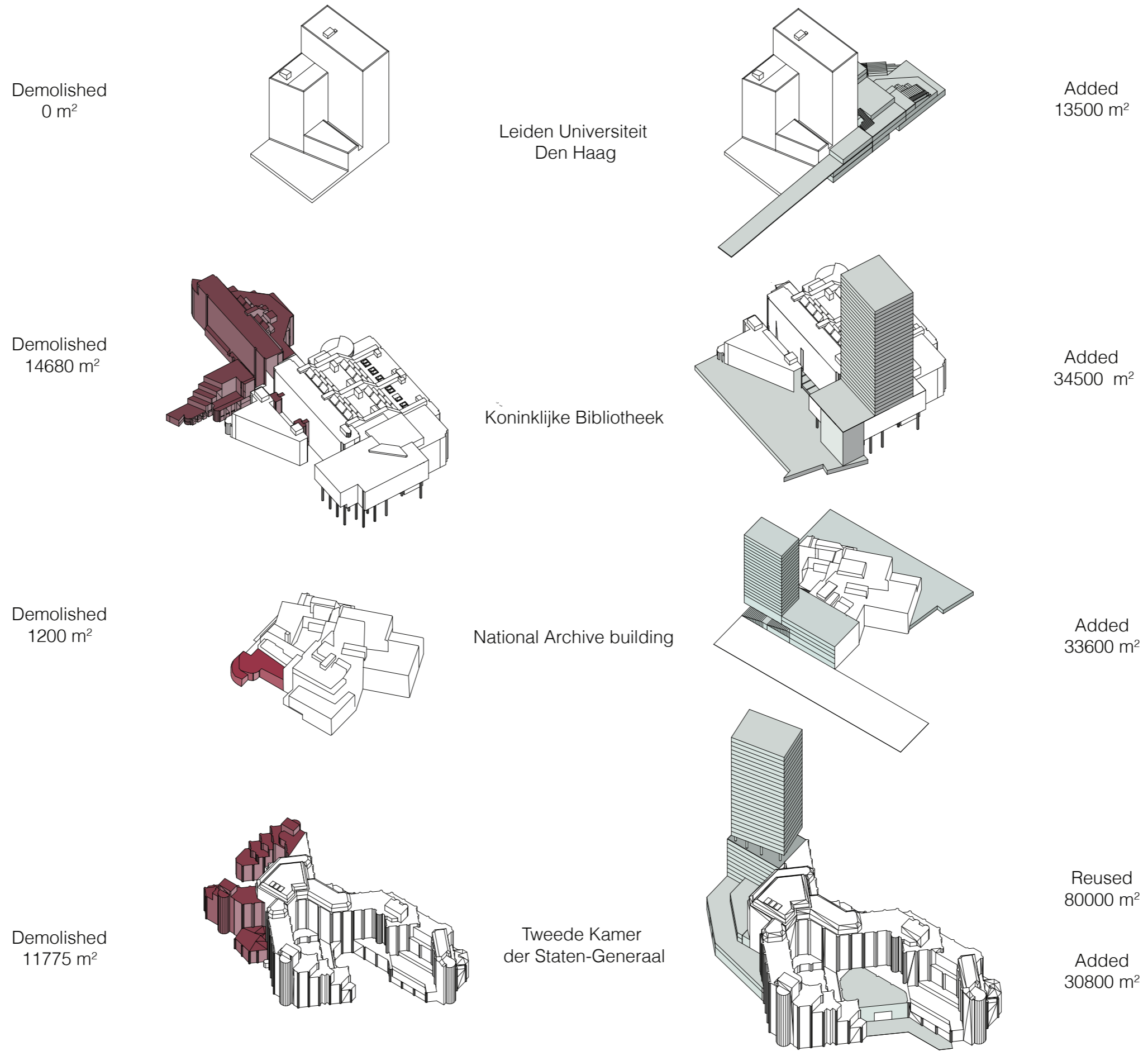

Strategy per building



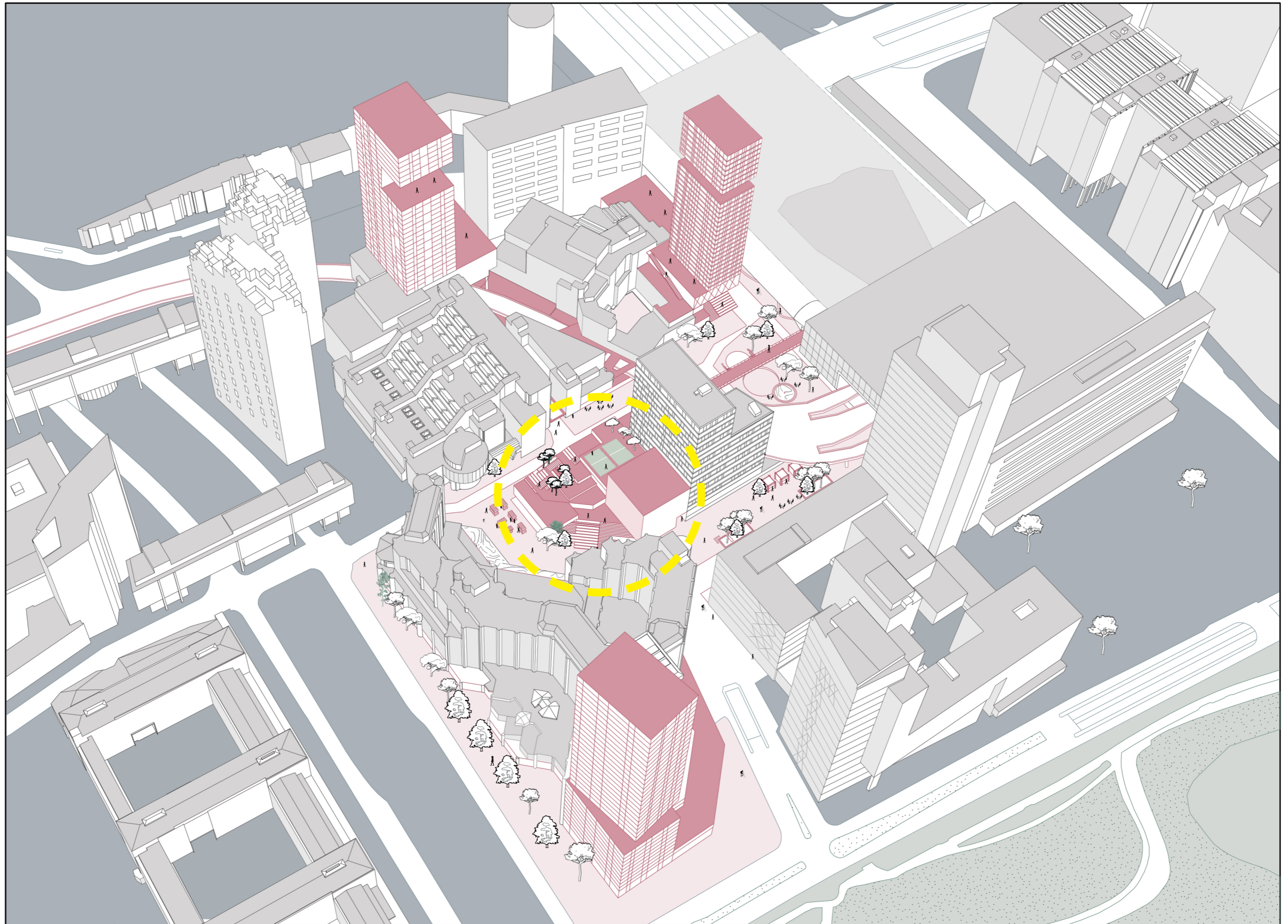

Proposal and point of interest

# Research topic



The site is mainly used for commuting and by employees

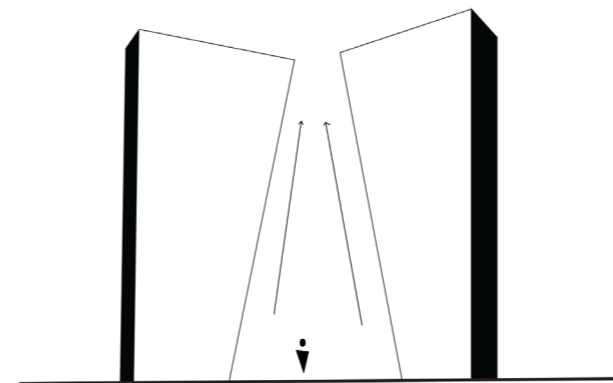

Lack of human scale in the area

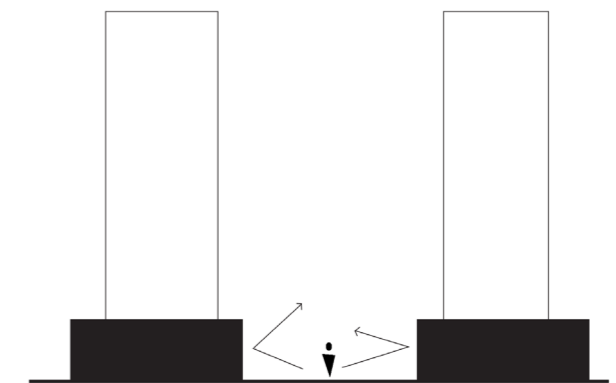

Inaccessible plinth

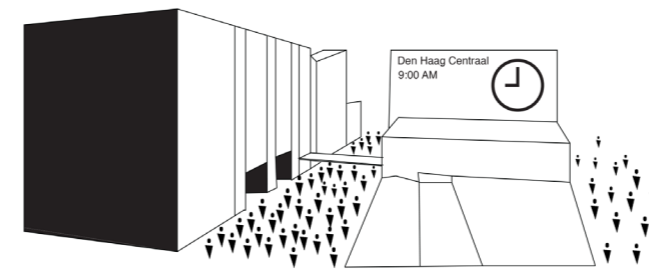

Day scenario

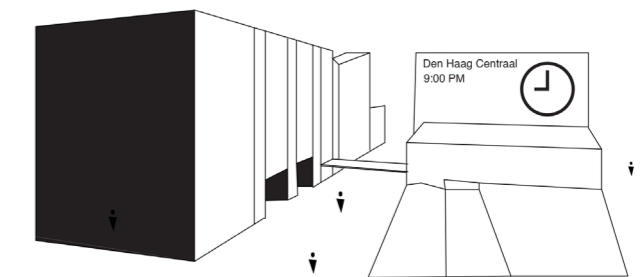

Night scenario and the vacancy on the site



# Goals and ambitions

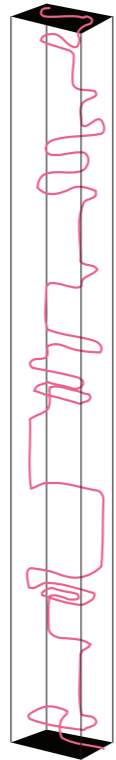

Wayfinding and navigation

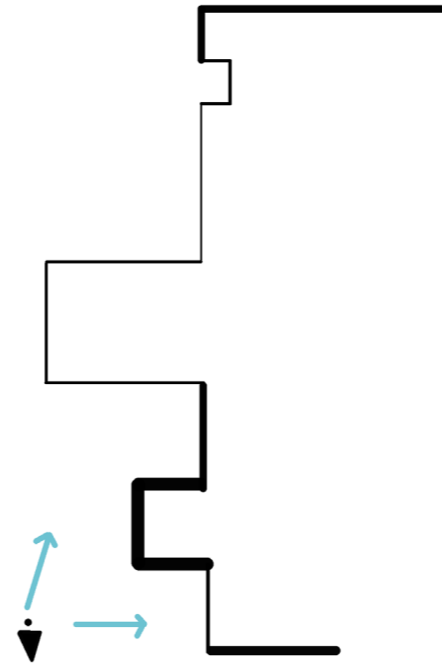

Accessibility, transparency

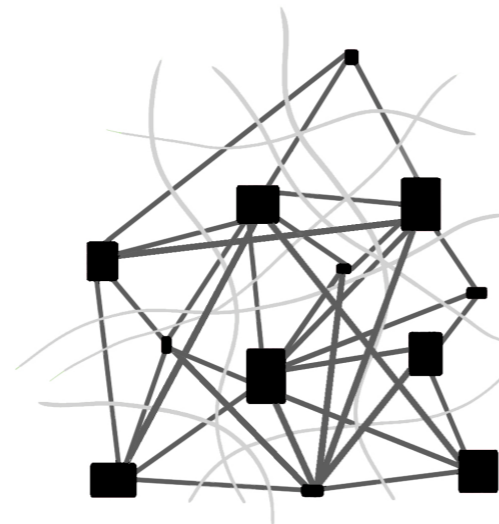

Social interactions

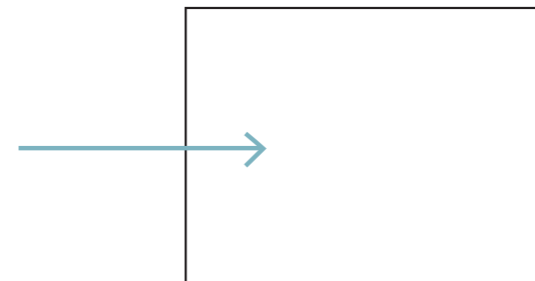

Destination and not only a Transition

# Survey about AvB Plein

Students like the following things about Anna van Buerenplein

A place to go through'.

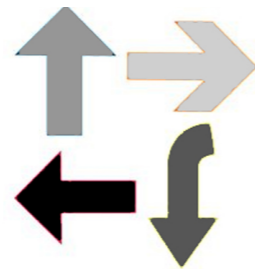

The site can be greener.



The following things will make the environment more attractive to students

- Create **more communal facilities**.



- **More co-working places**.

Students do not like the following things about Anna van Buerenplein

- In the **evening** the square is very **empty**,

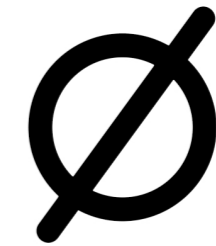

- The square and the surrounding area are extremely petrified. It therefore **heats up** quickly.



- Students indicate that there should also be **room for homeless people** to stay.

- **More color** in the buildings.

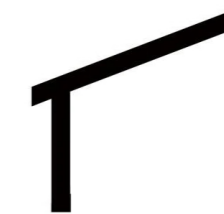

- **Sheltered places** against the wind/cold in winter or sun in summer



Site  
Den Haag





Site  
Den Haag Central Station area





# Location

**Site 1: Next to Leiden University**  
Design a tower and plinth and make connection with the existing tower

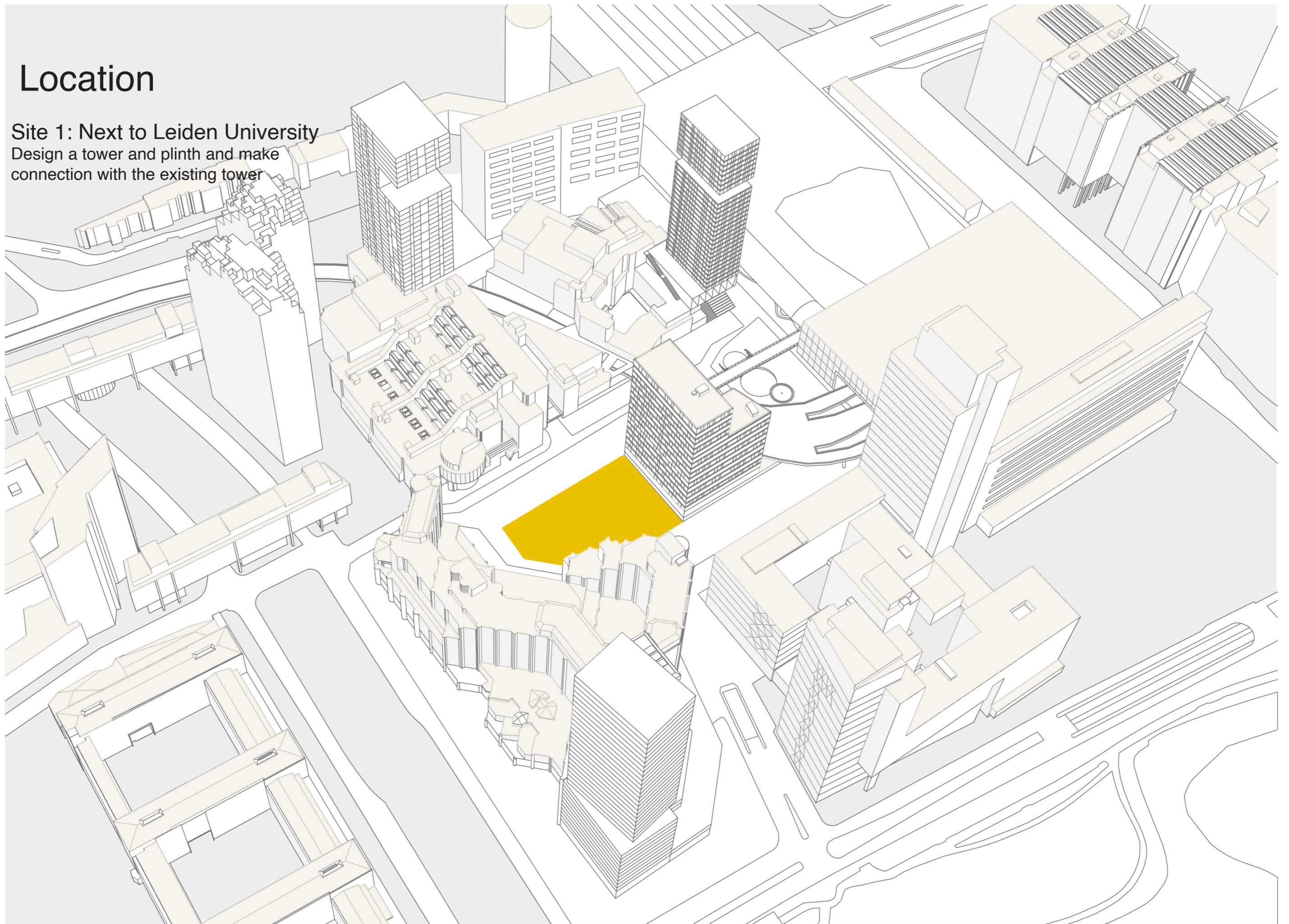



What should it become?

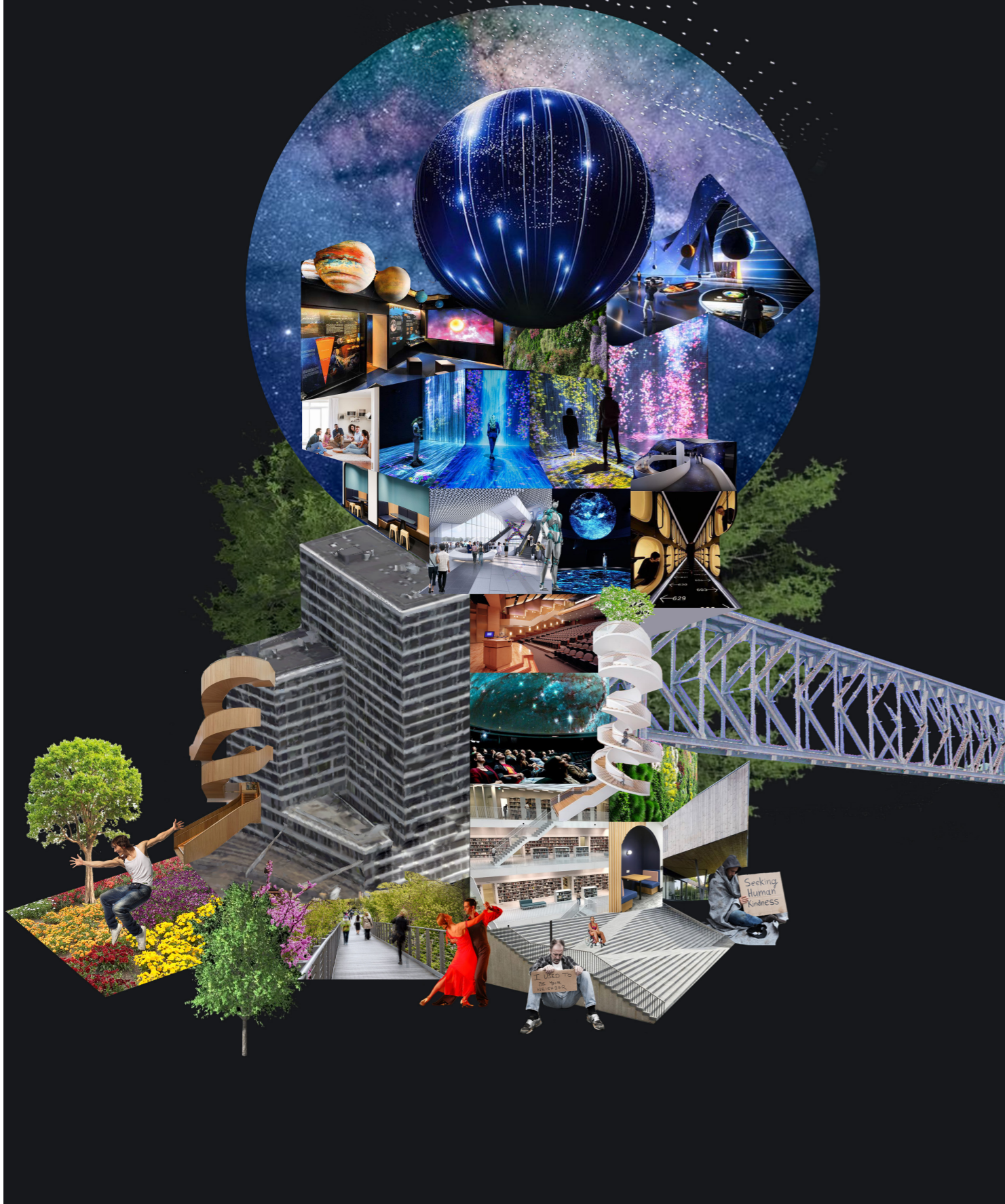



# Design steps

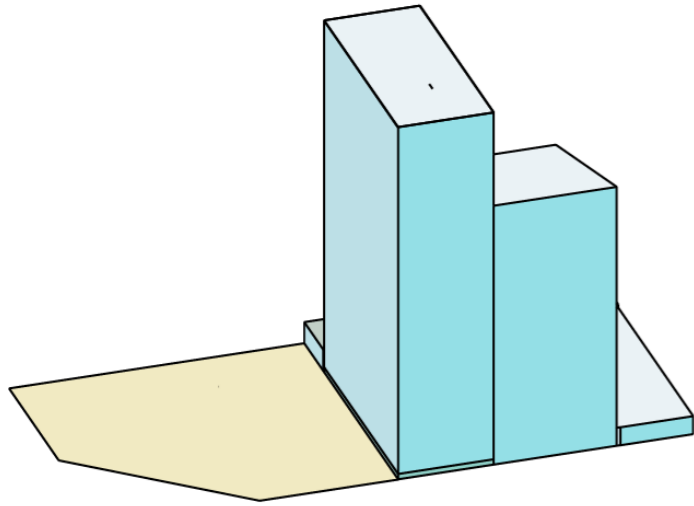

Site selection  
Following the boundaries of the site

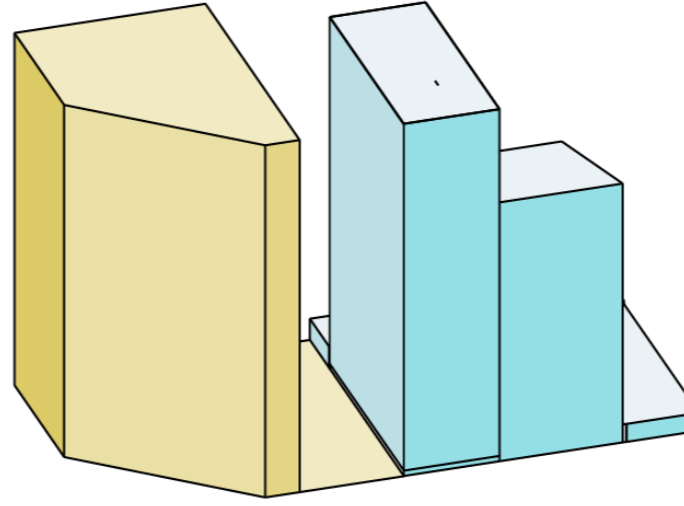

Addition of the tower  
And keeping space for daylight

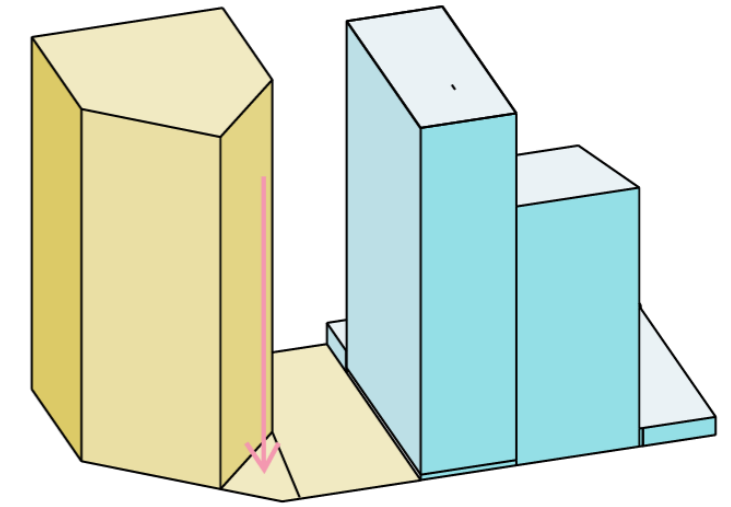

Subtraction from the tower  
To allow more daylight

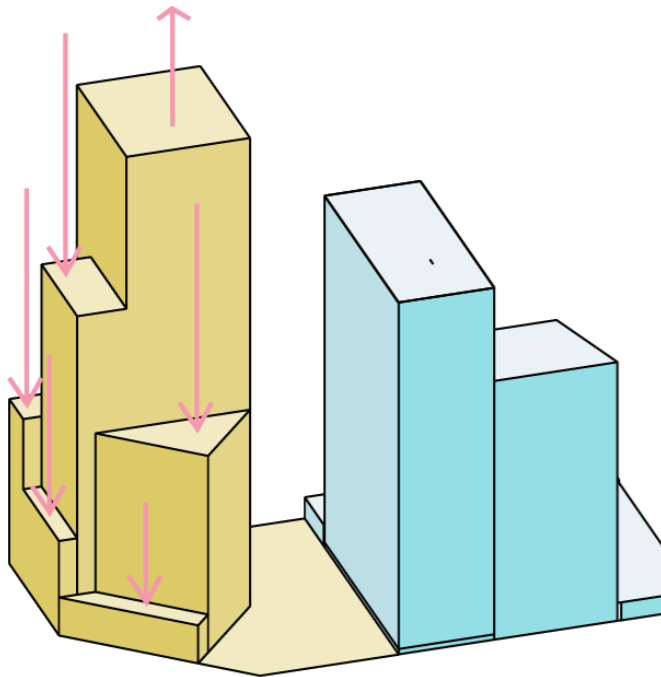

Raising or lowering parts of the tower  
To create terraces and improve proportions

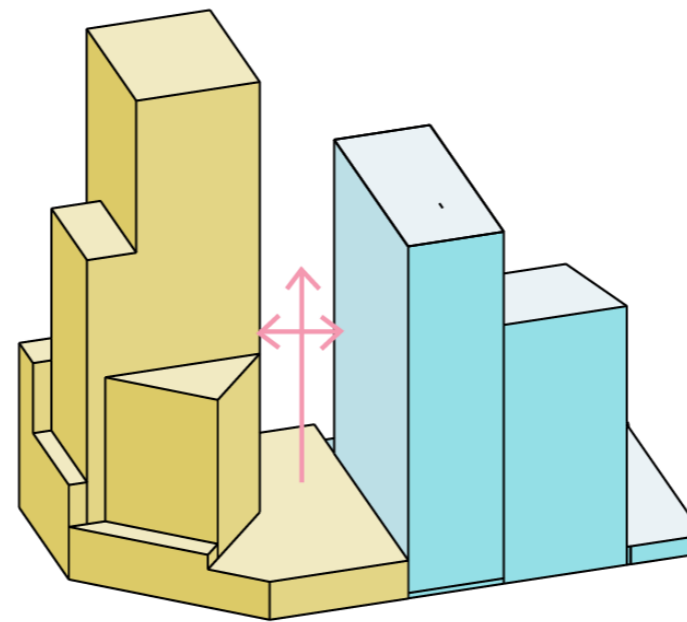

Extending the plinth and connecting the towers  
By adding a plateau

Conceptual section

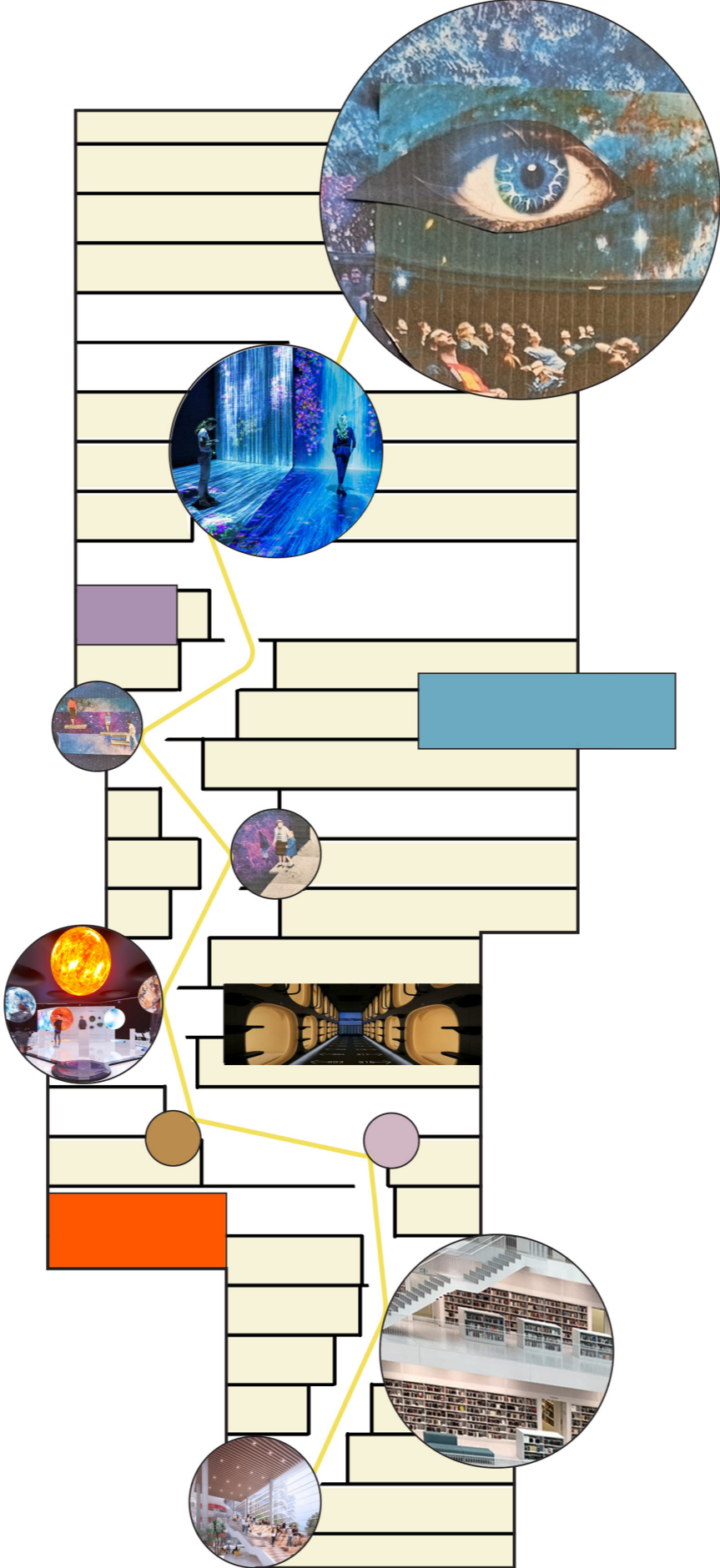



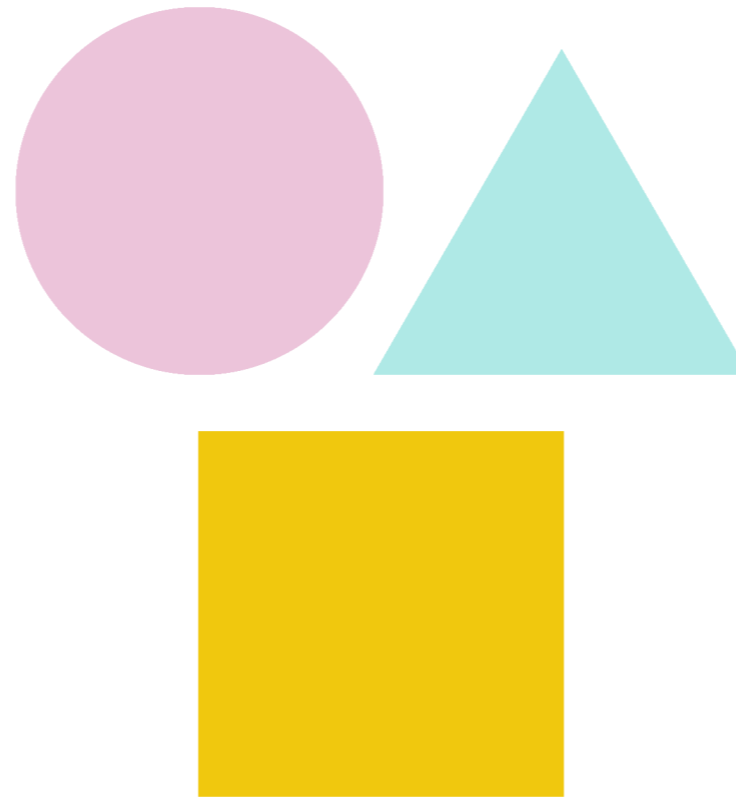

*Primary shapes*

Strategy

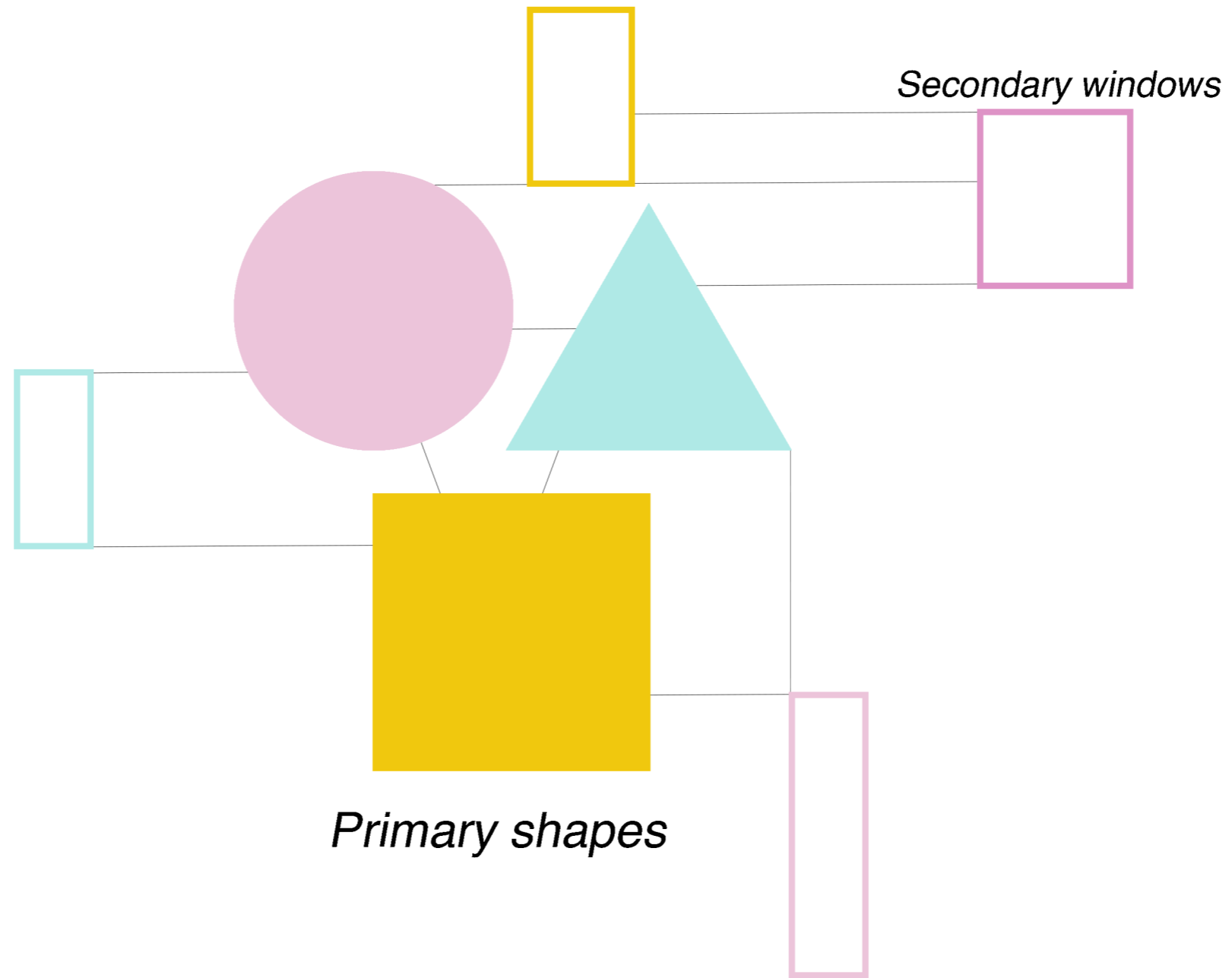

*Primary shapes*

*Secondary windows*

Strategy

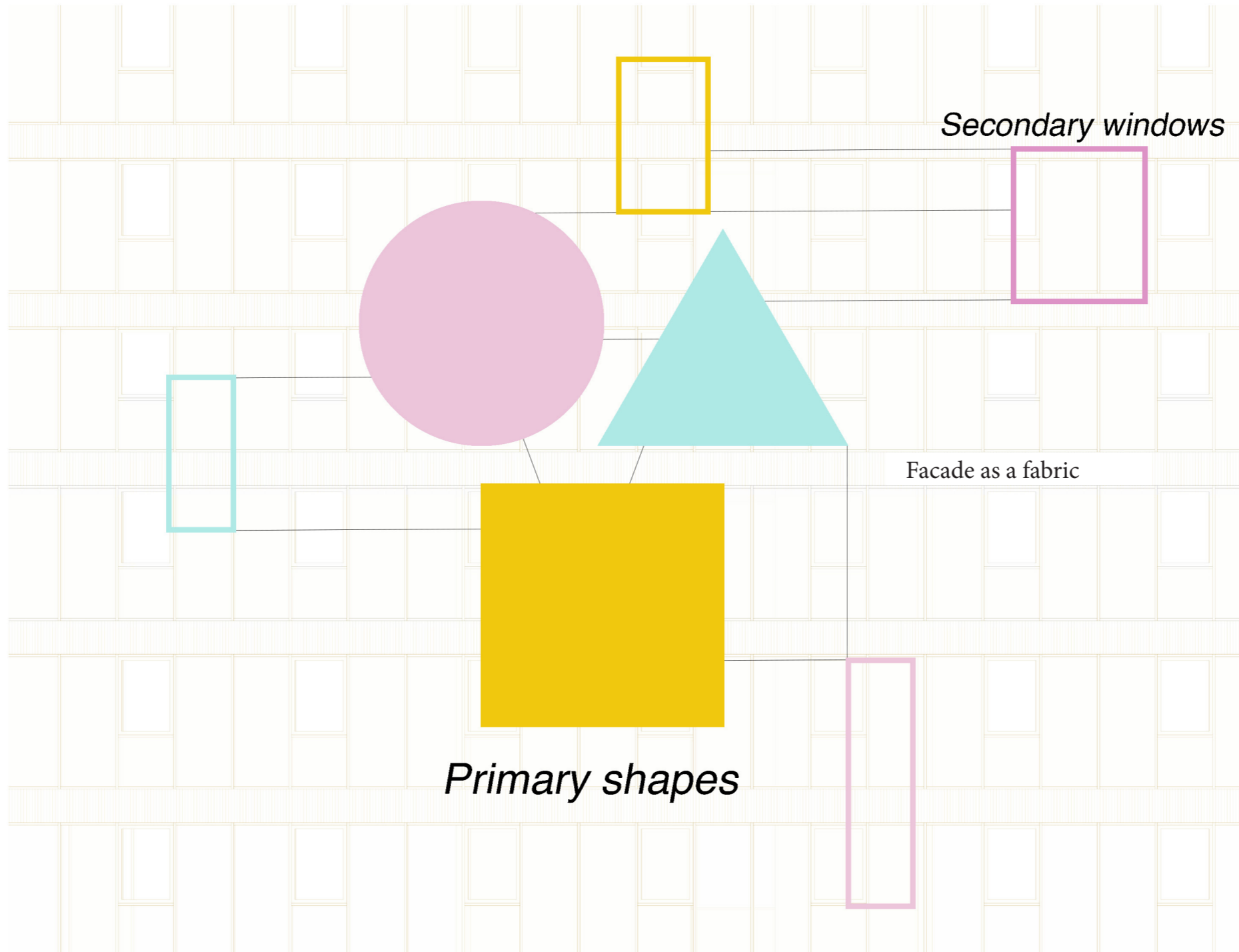

Strategy



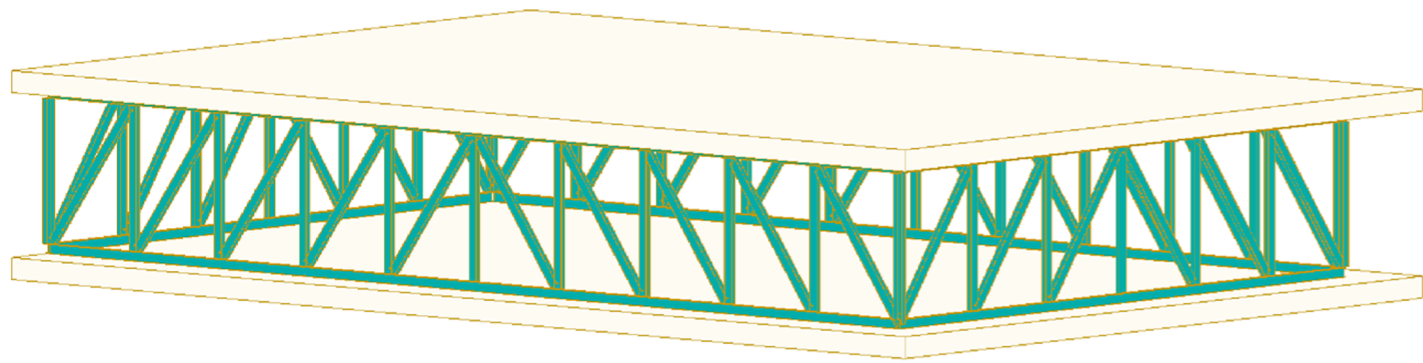

*Special Floor*

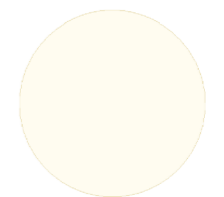
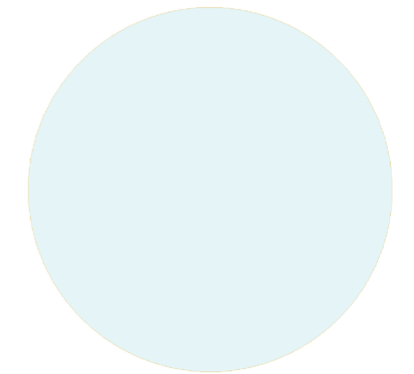
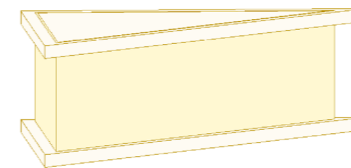
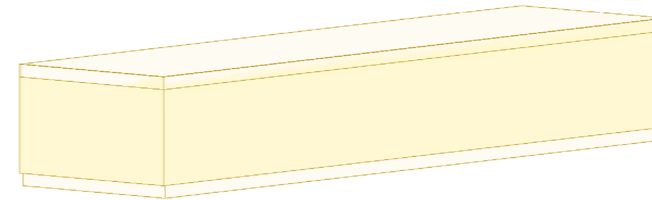
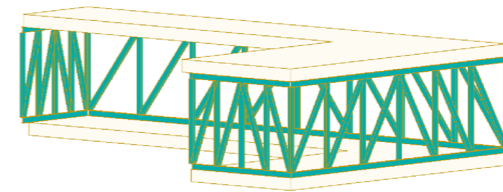

*Special Elements*

Strategy

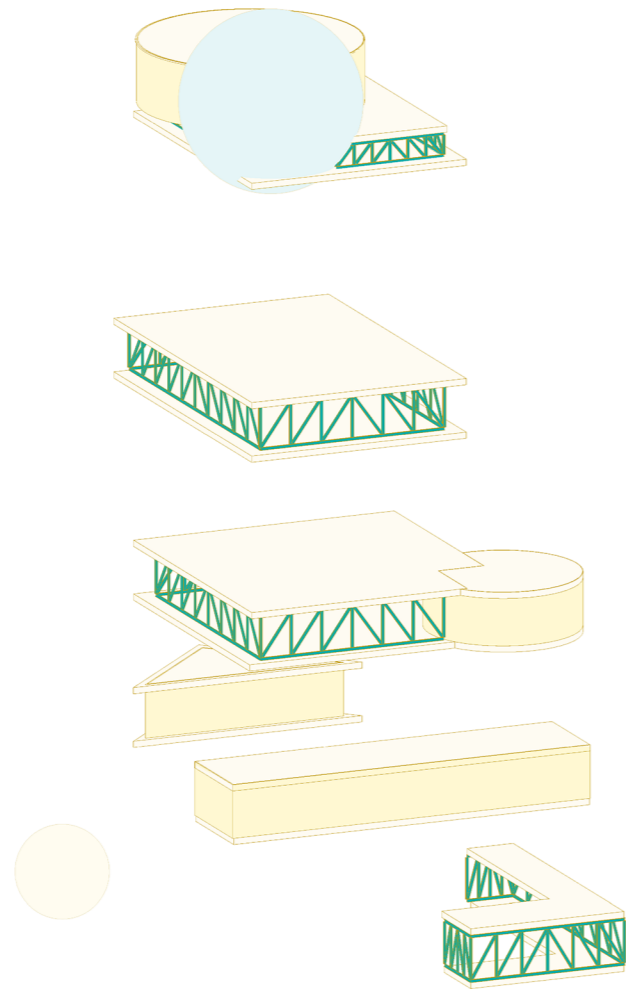

*Positioning the specials*

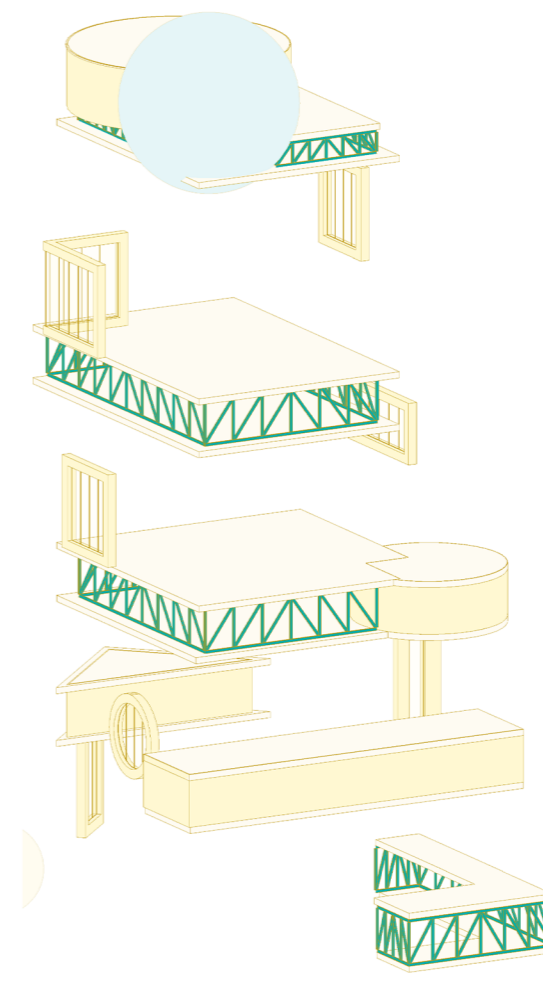

*Adding the Windows*

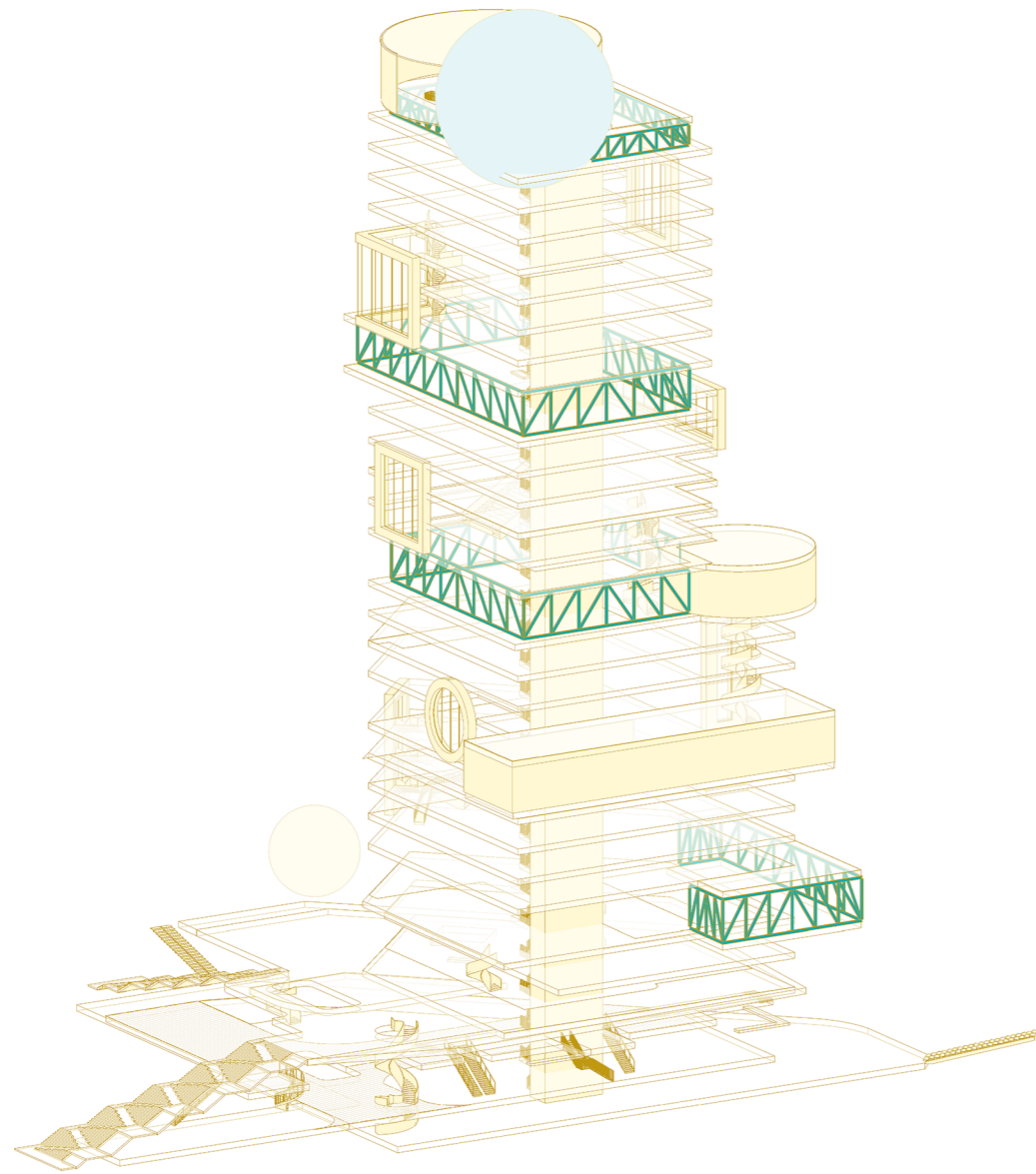

*Circulation and program*

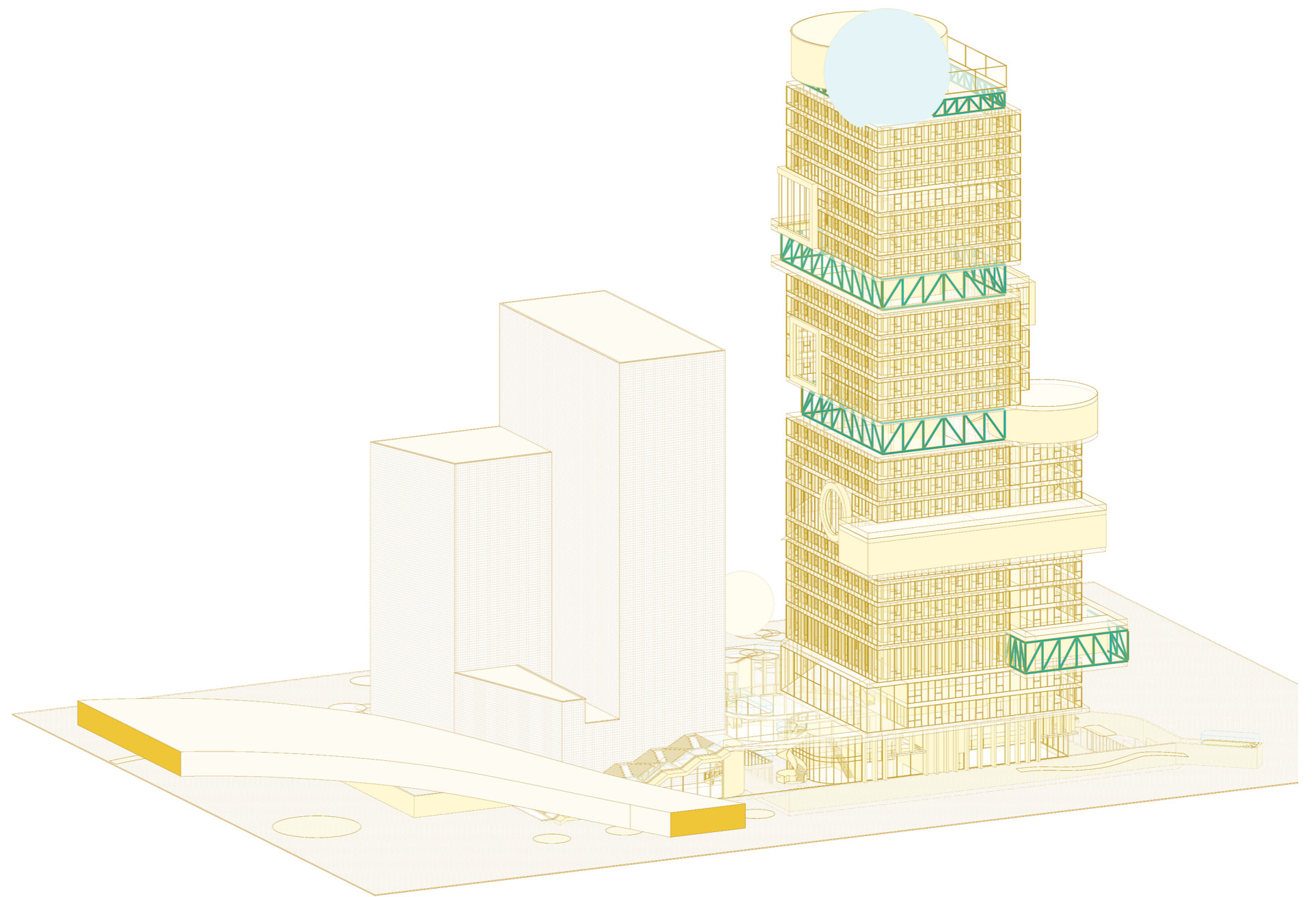

*The Facade*

Strategy



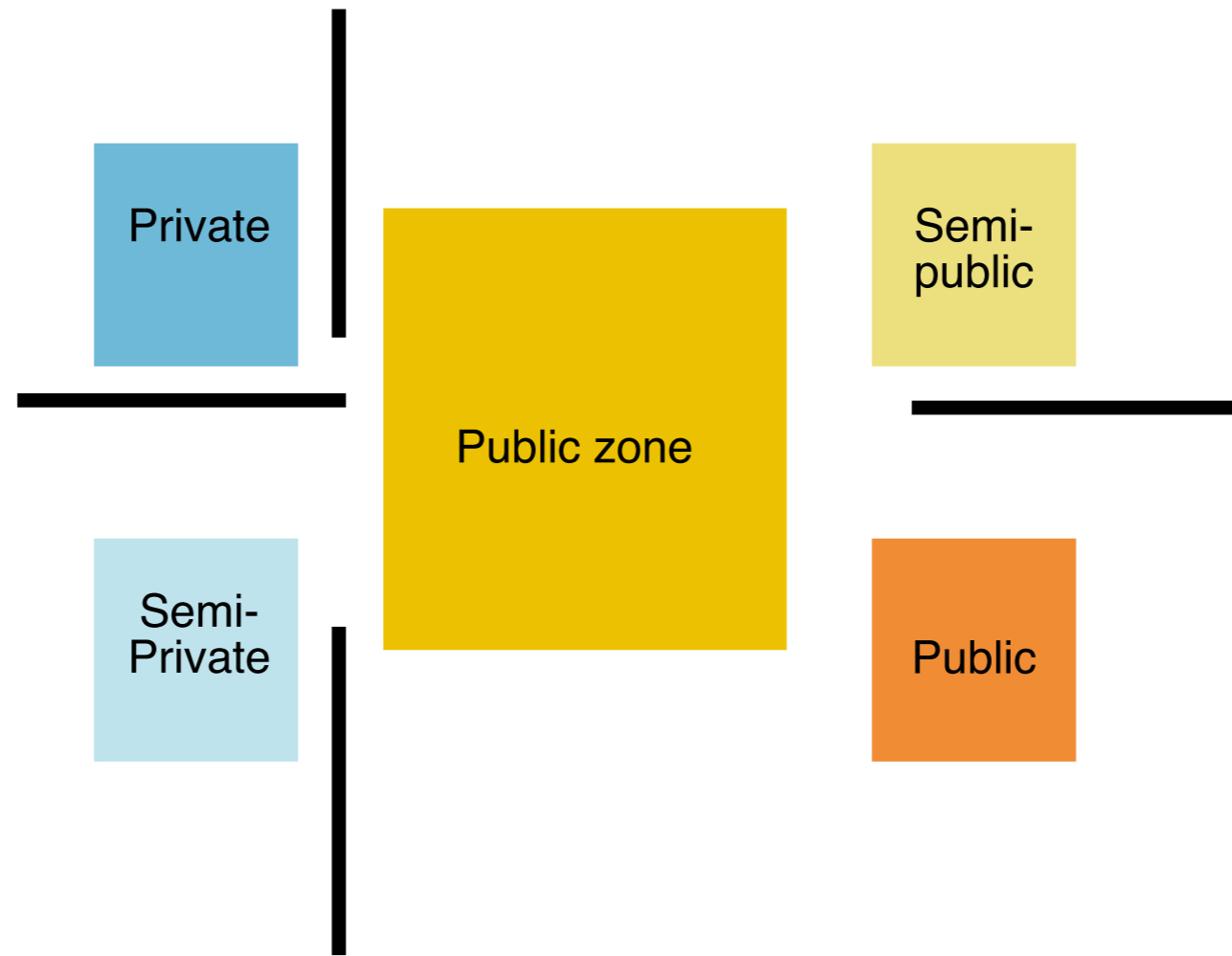

Program

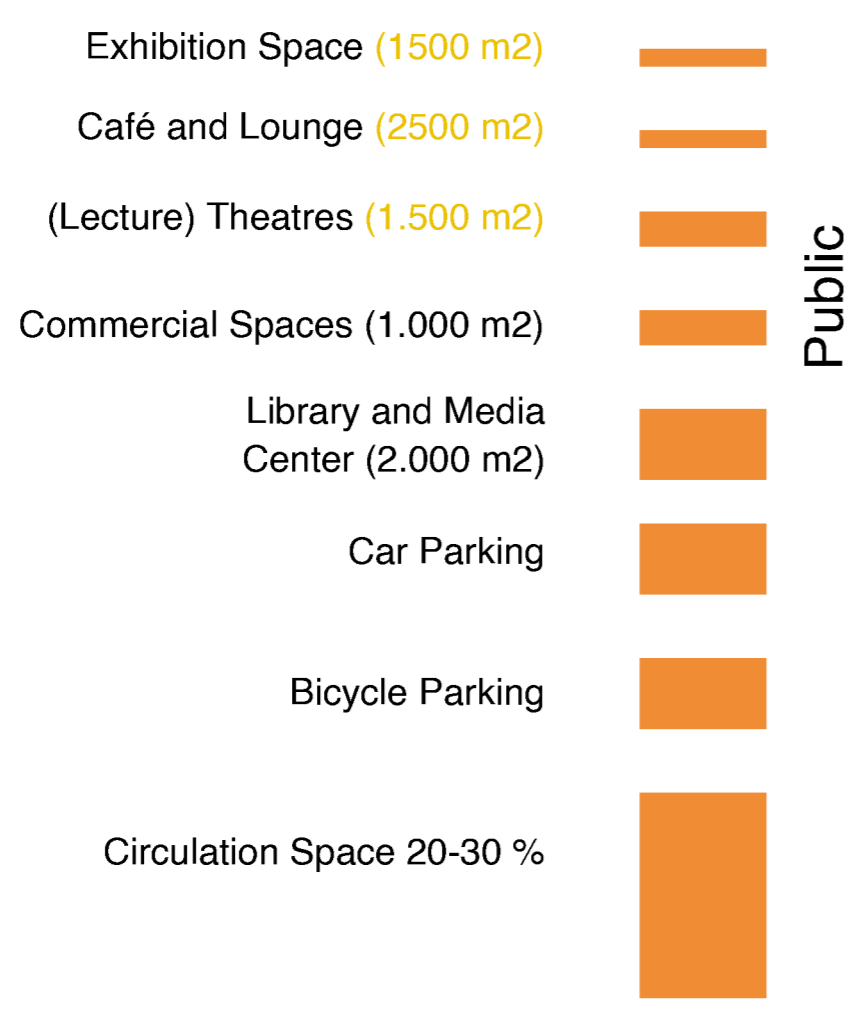

Public

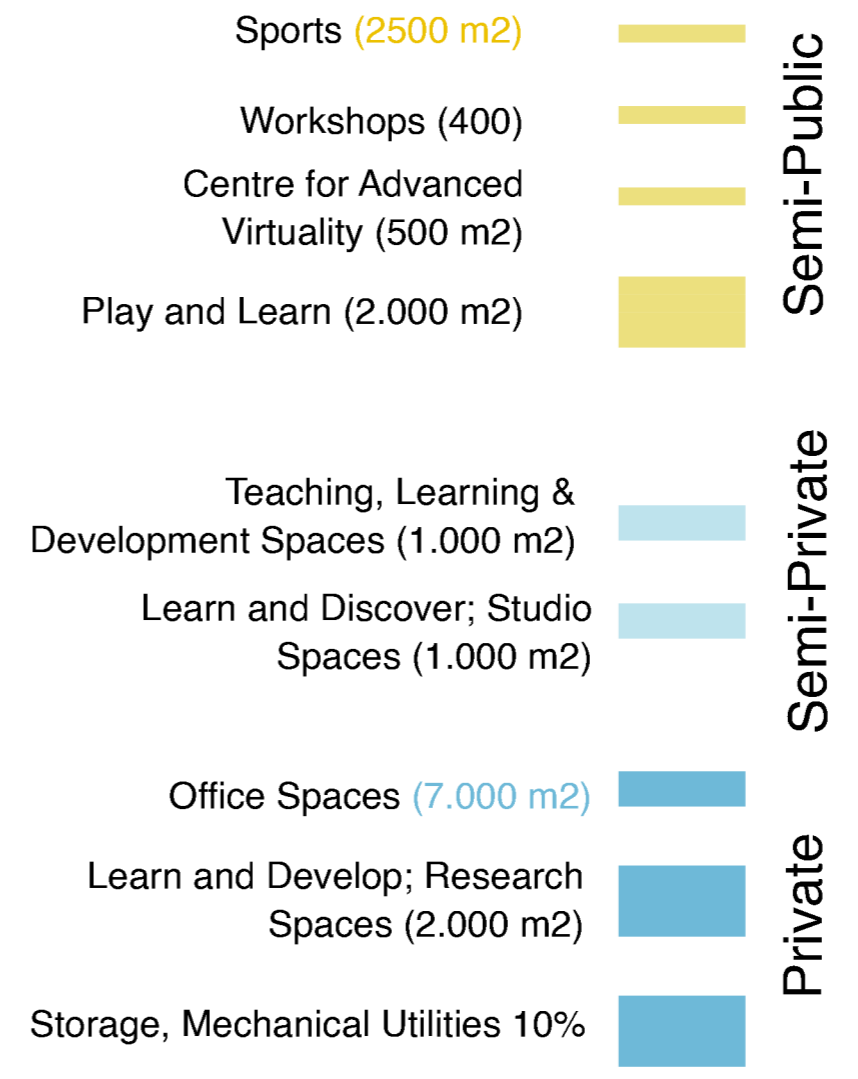

Semi-Public

Semi-Private

Private

Program

Impact &  
Impression

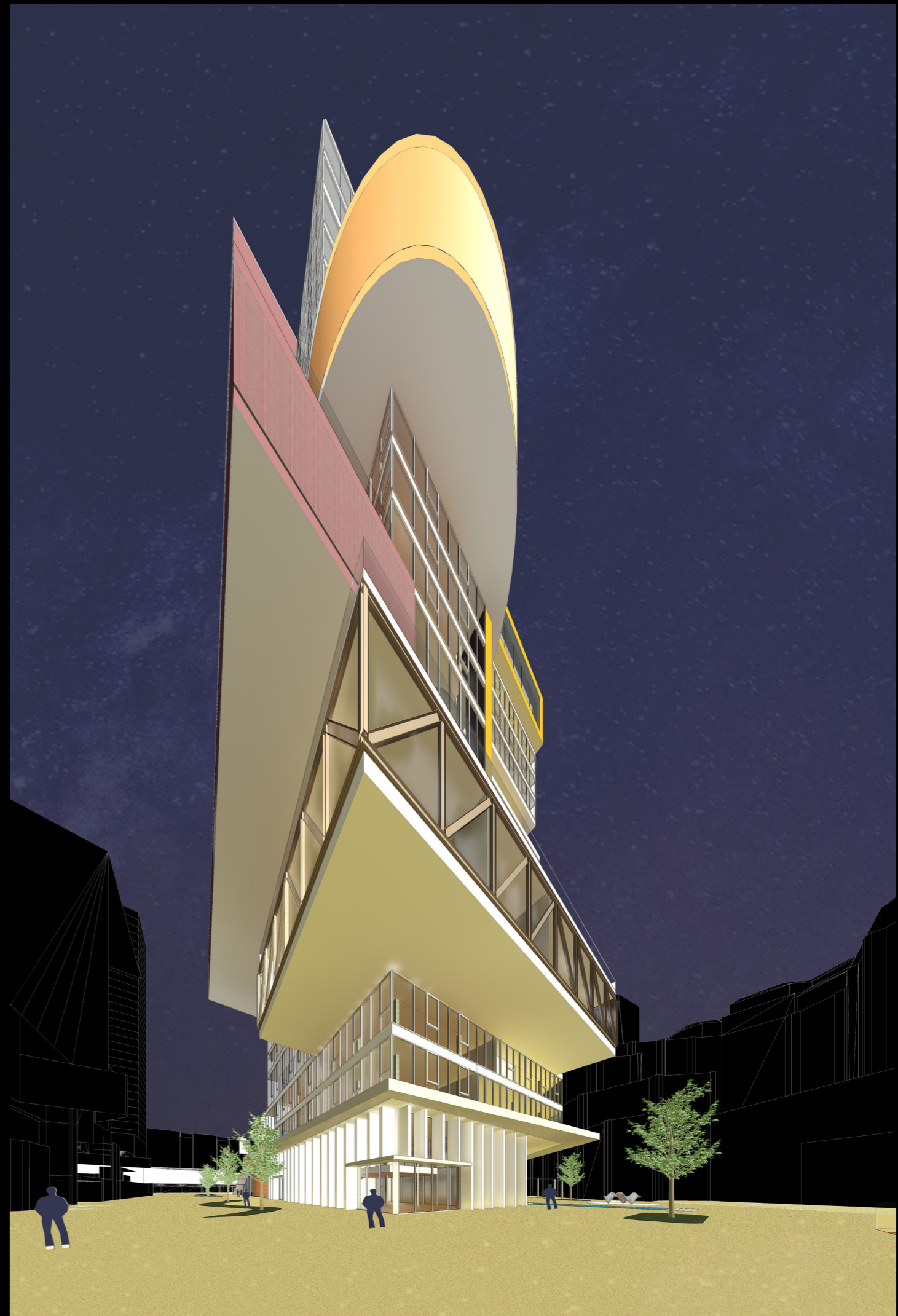



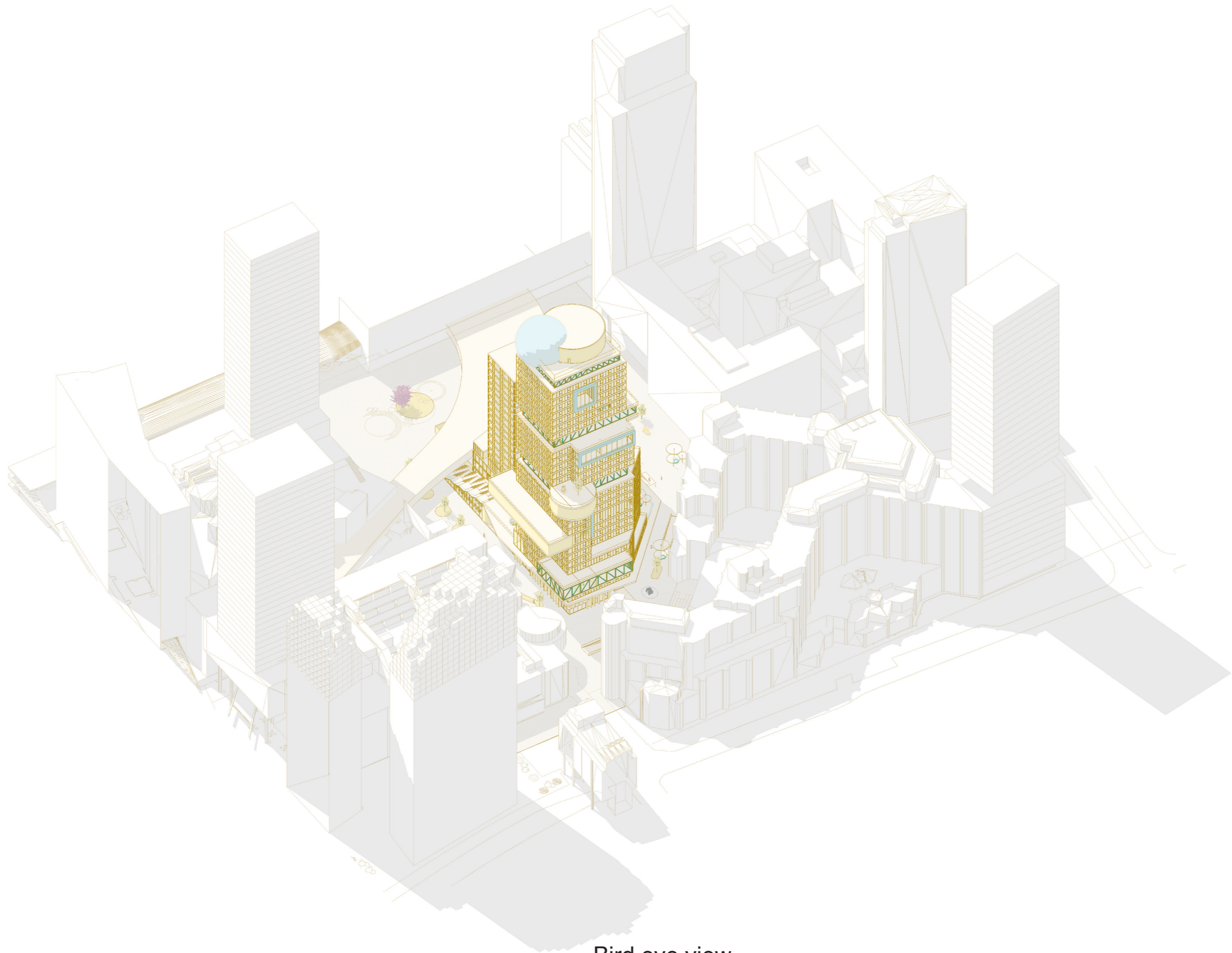

Bird eye view

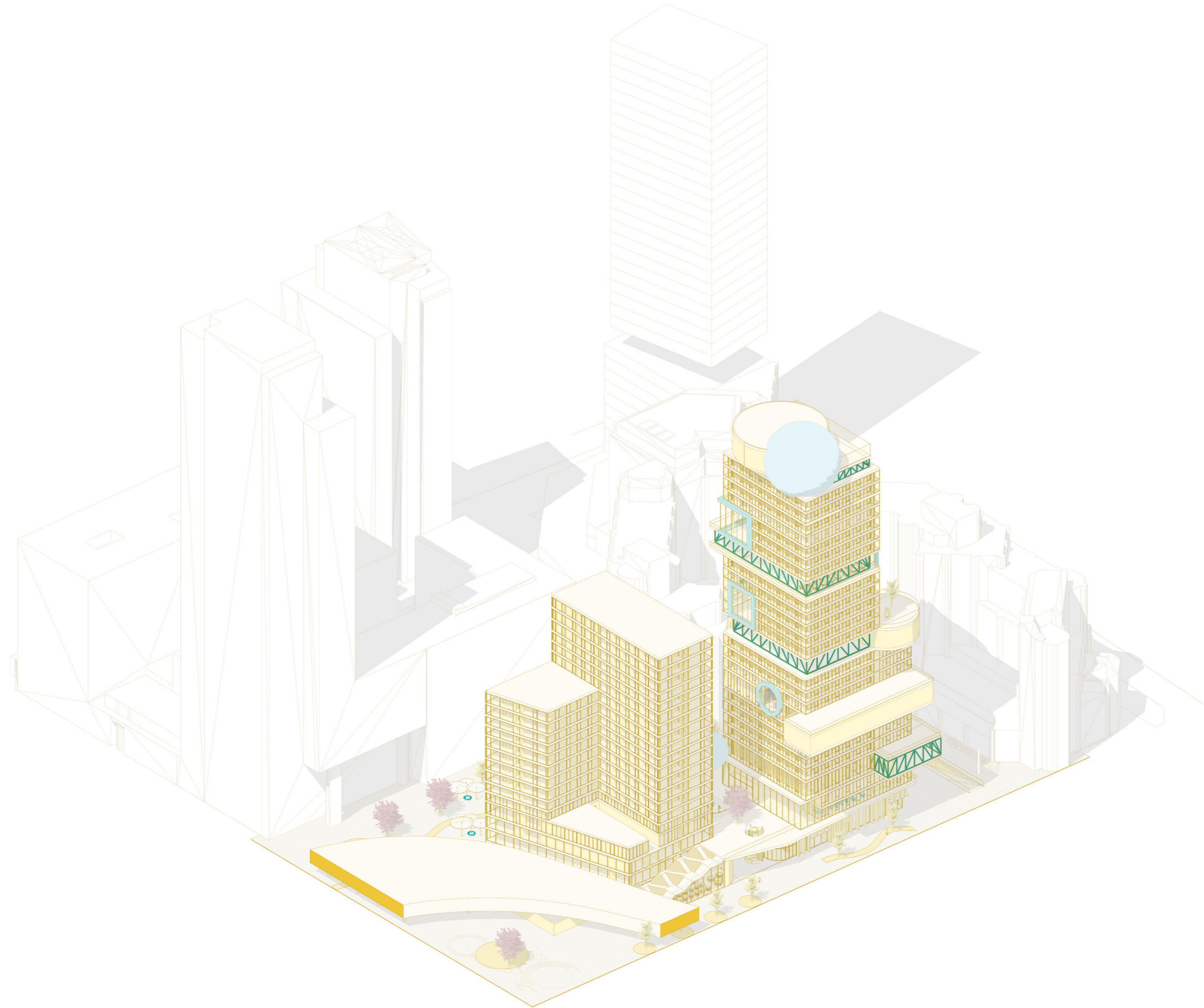

Axonometrie Building connection to station



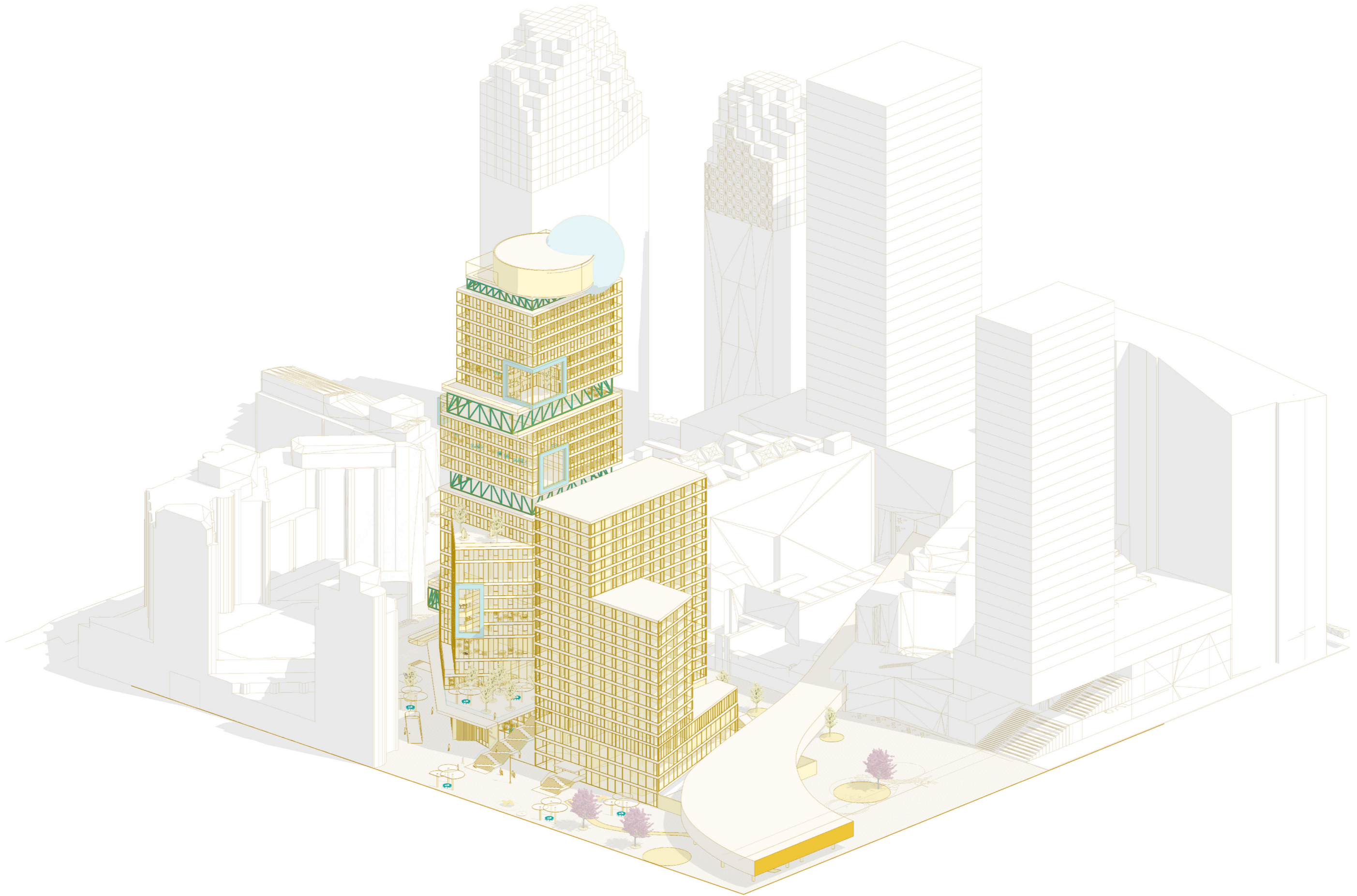

Axonometrie Building and AvB Square

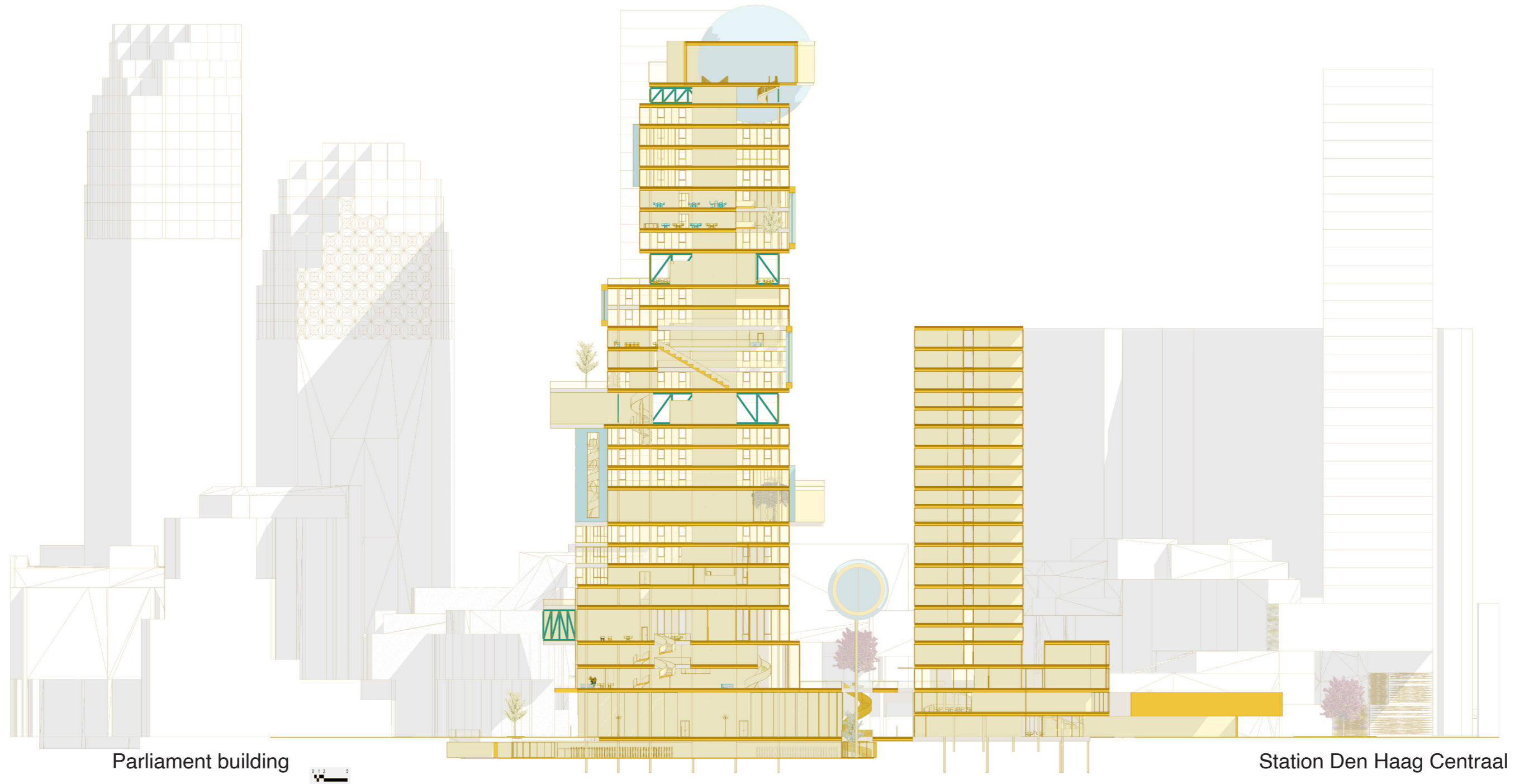

Parliament building

Station Den Haag Centraal

Urban section



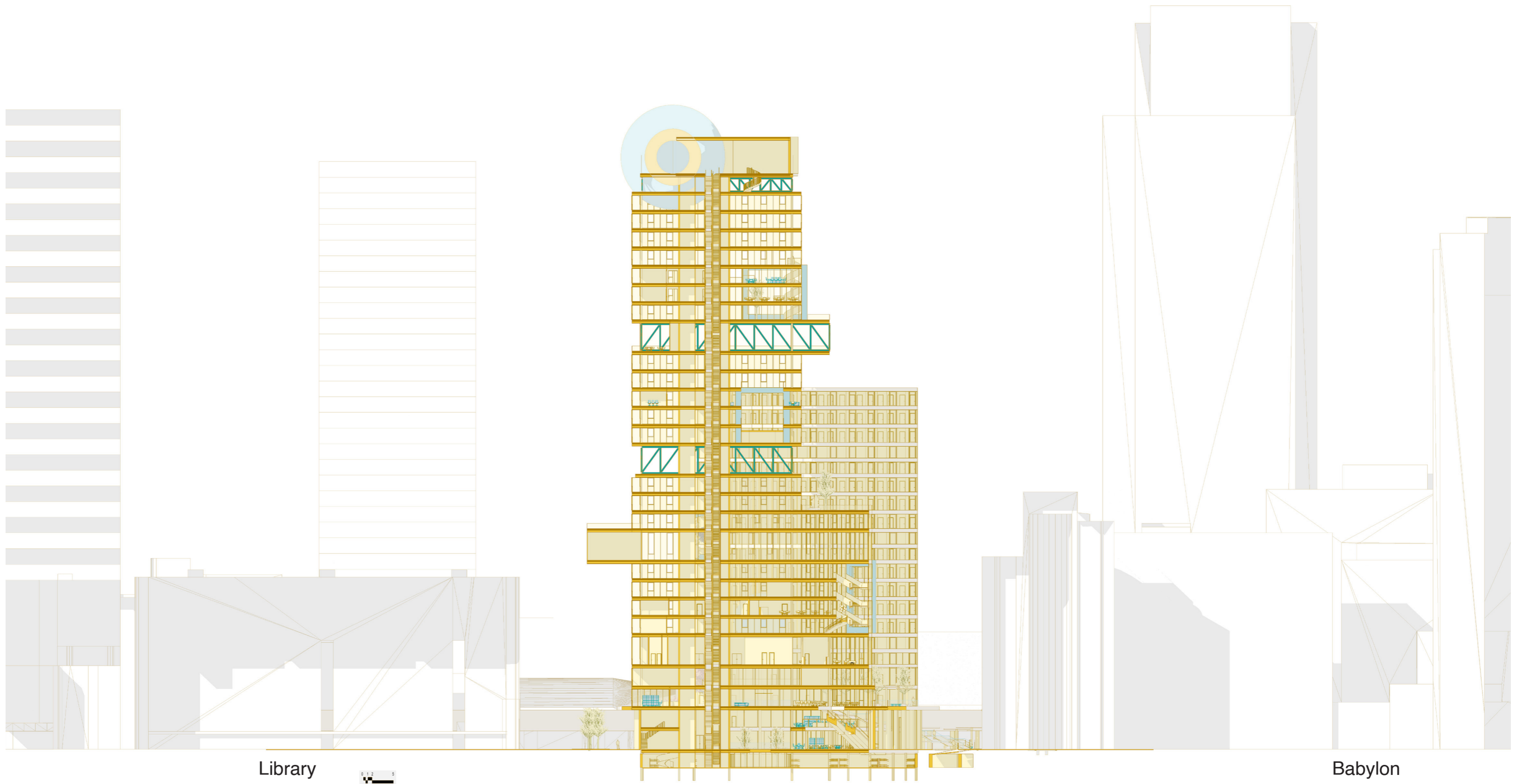

Library



Babylon

Urban section

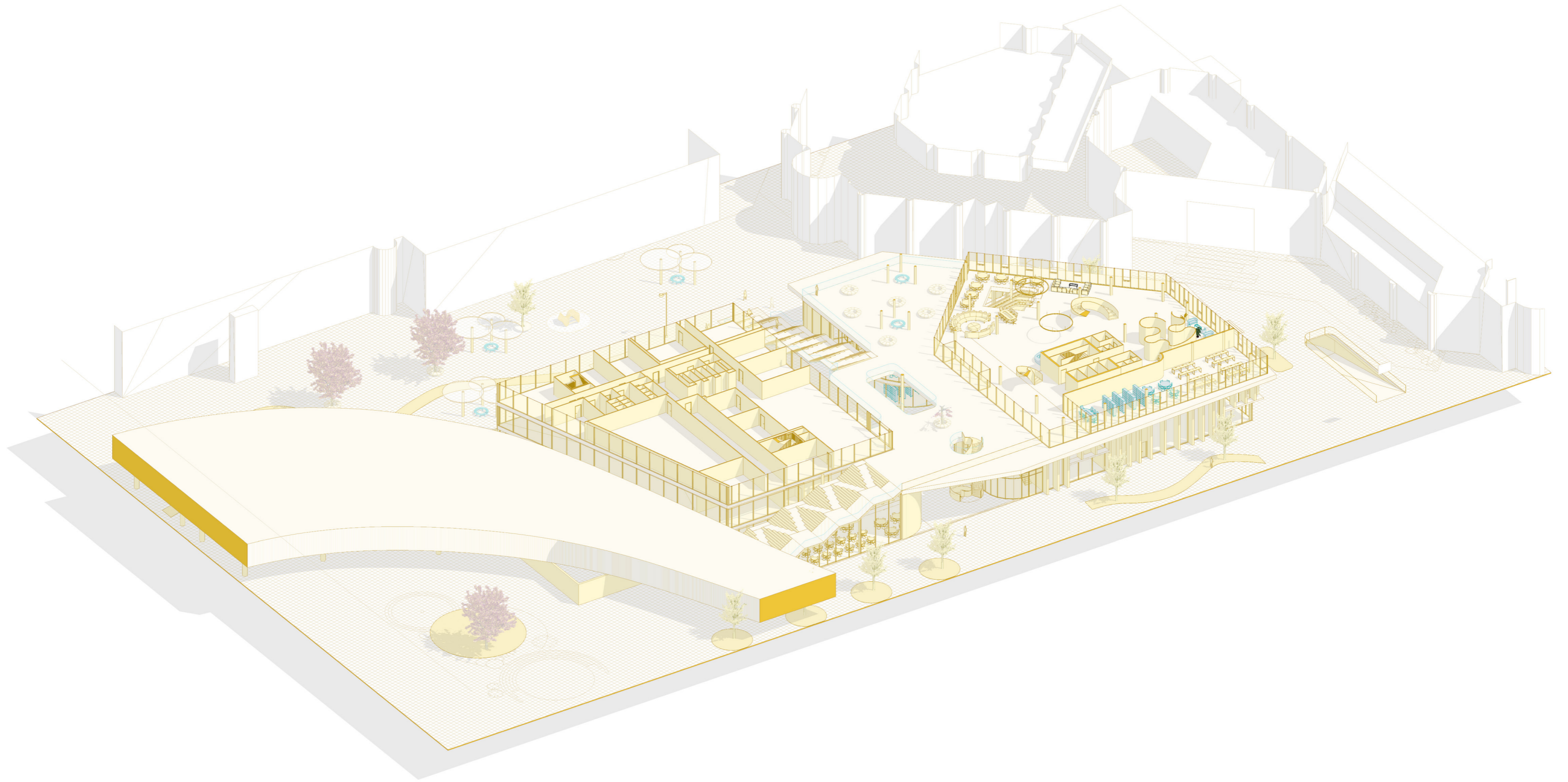



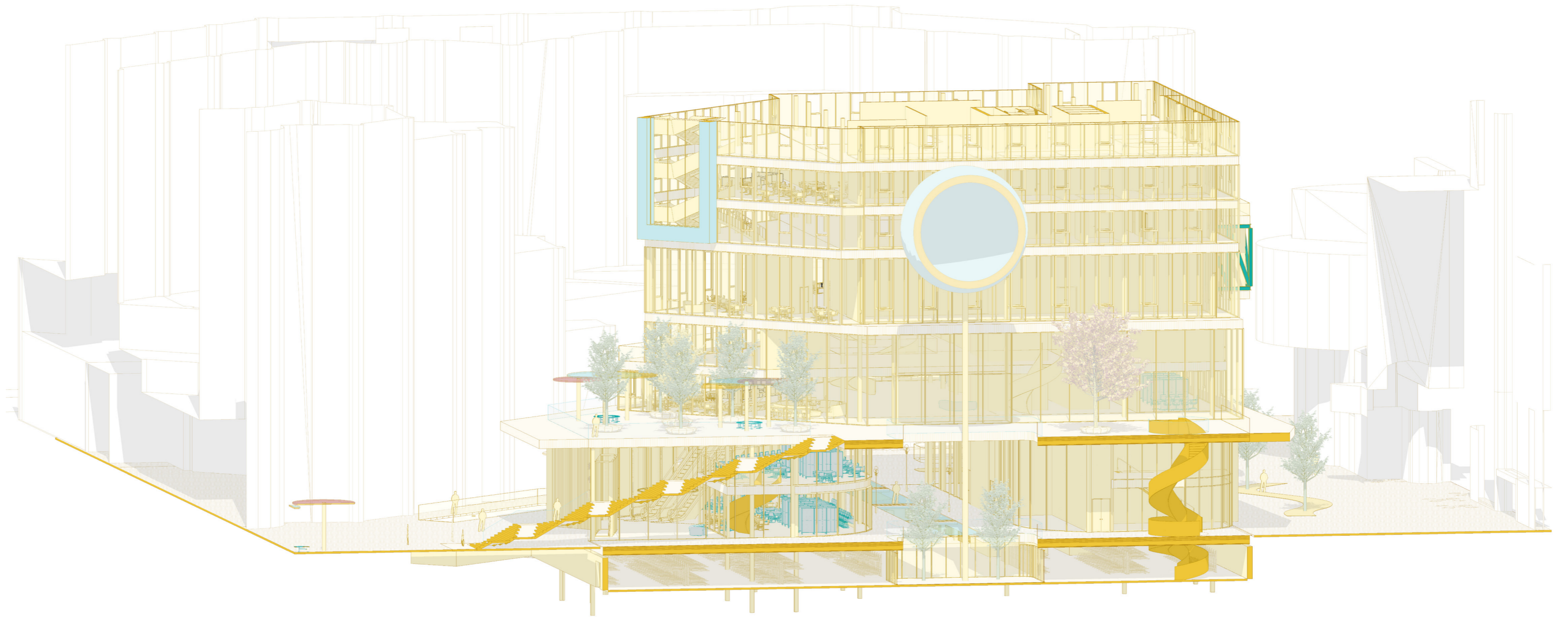

Extending the Plinth and creating Passages

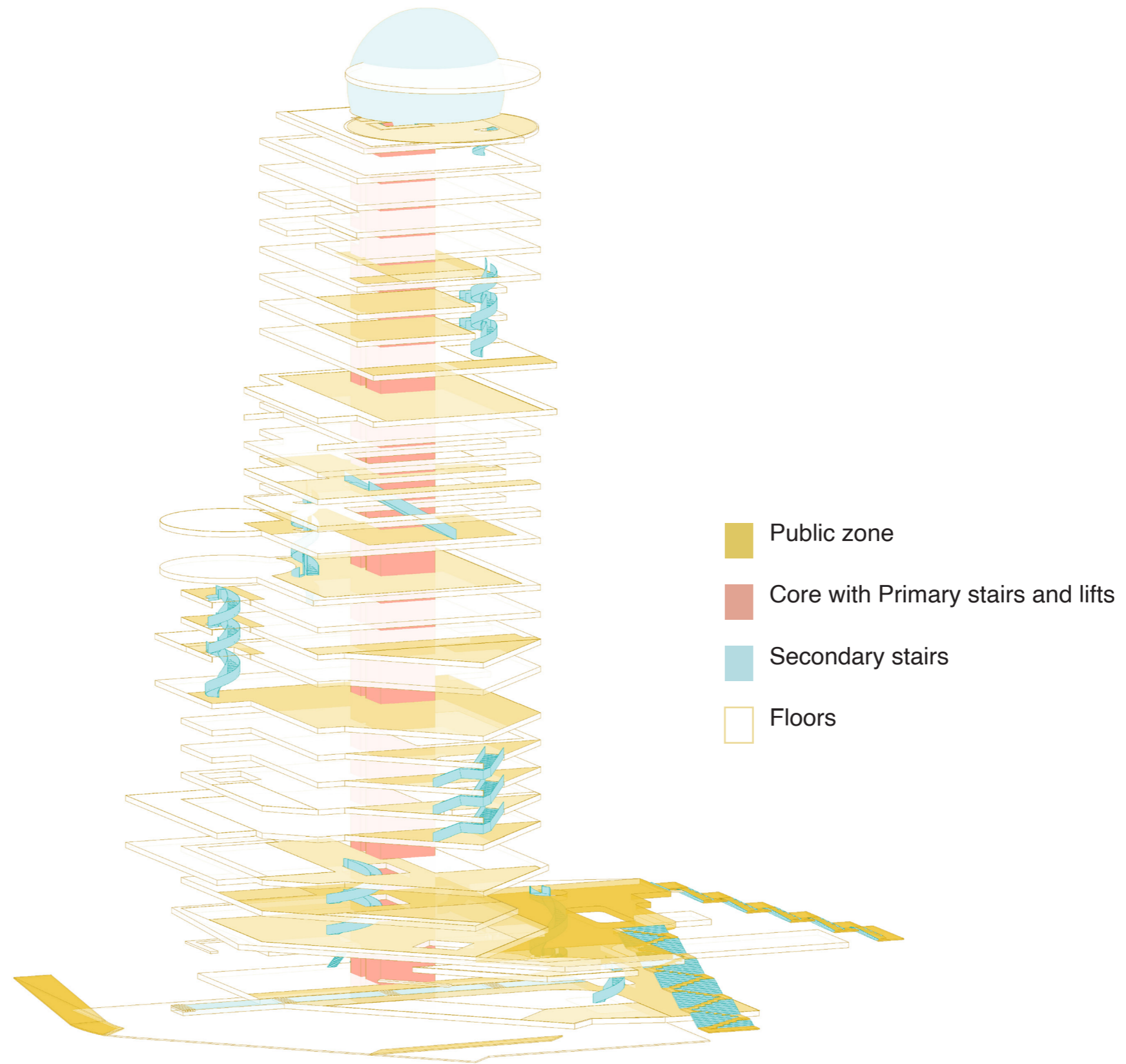

Circulation Diagram



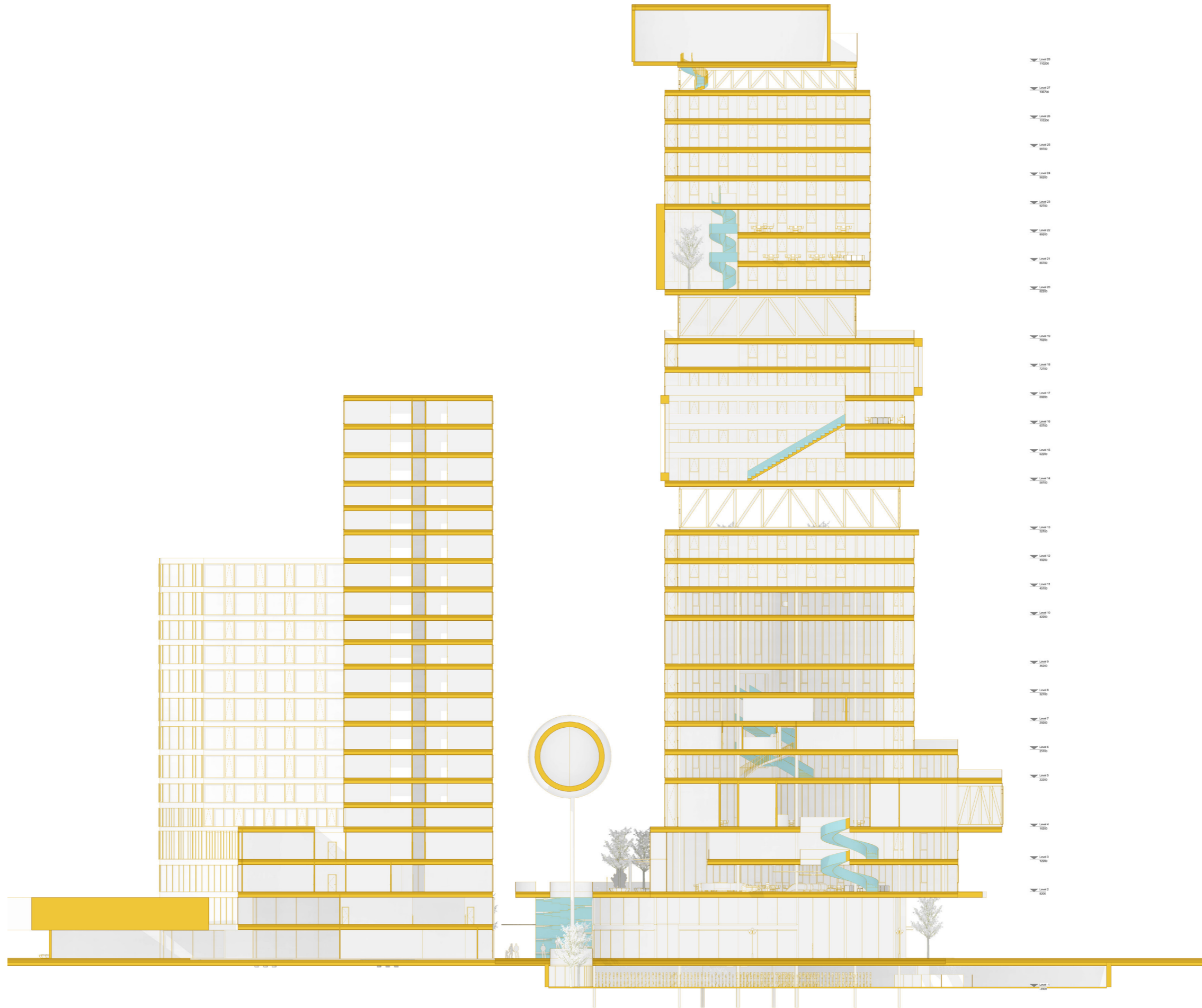

Section

# Exploded View

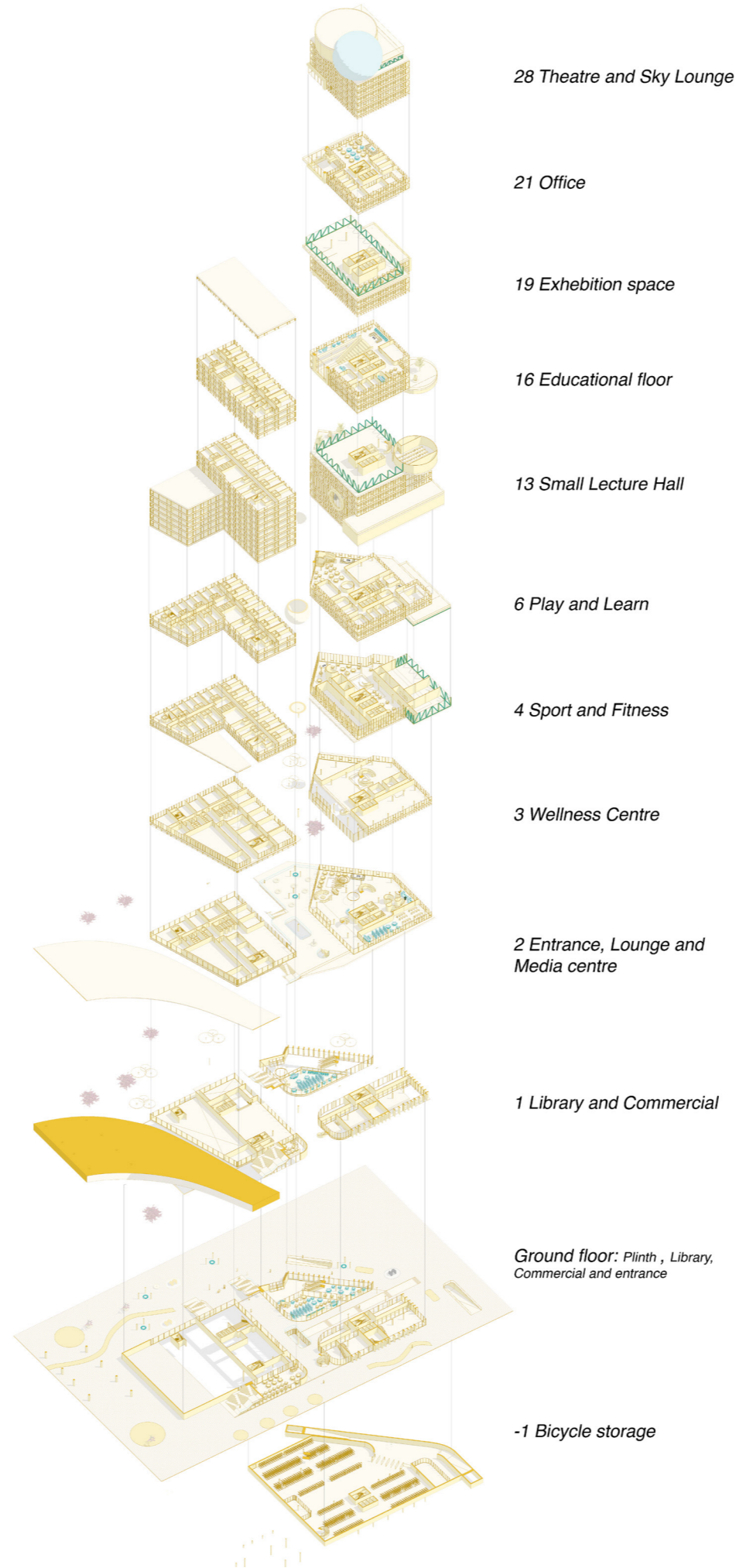



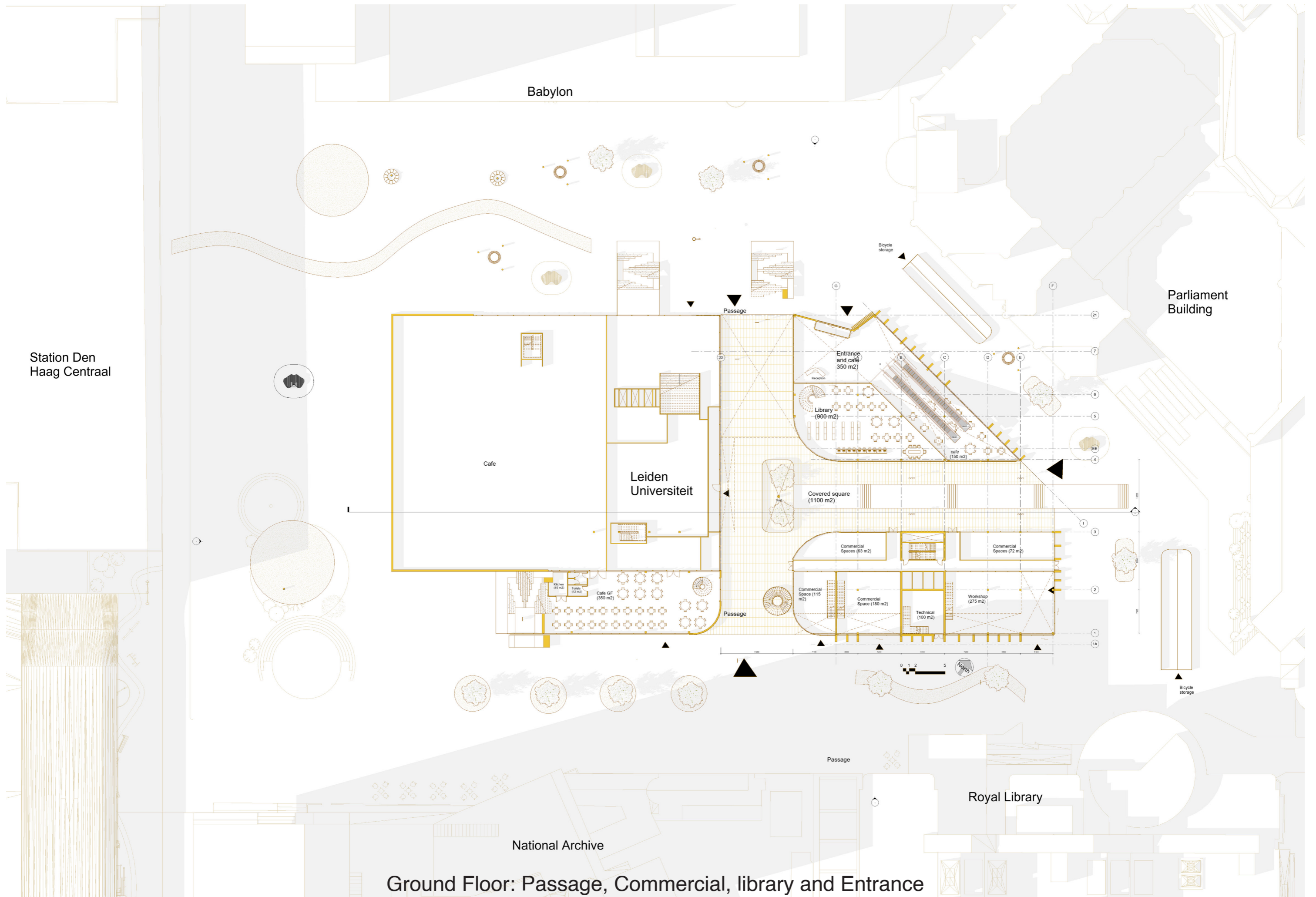

Babylon

Station Den Haag Centraal

Parliament Building

Cafe

Leiden Universiteit

Passage

Bicycle storage

Entrance and cafe (350 m2)

Library (900 m2)

cafe (150 m2)

Covered square (1100 m2)

Commercial Spaces (63 m2)

Commercial Spaces (72 m2)

Commercial Space (115 m2)

Commercial Space (180 m2)

Technical (100 m2)

Workshop (275 m2)

Passage

0 1 2 5 North

Bicycle storage

Passage

Royal Library

National Archive

Ground Floor: Passage, Commercial, library and Entrance





Passage and AvB square





THE  
FUN  
FACTORY

Third Entrance:  
AvB Plein





2nd Floor Plateau Entrance: Active inclusivity, Social and public inclusivity





Ground Floor Entrance and Library: Social and public inclusivity





Entrance and Library 2nd Floor: Social and public inclusivity



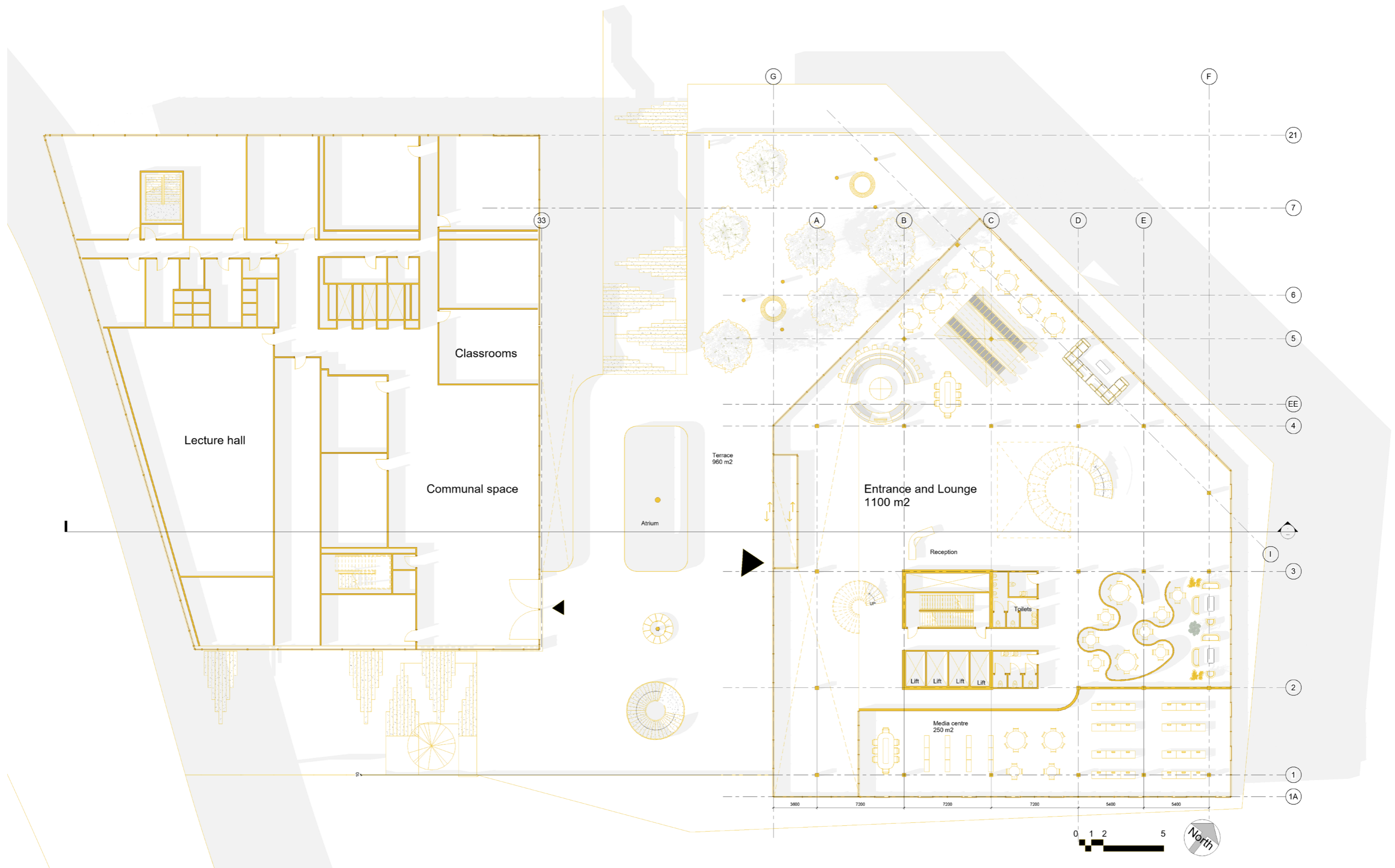

Second Floor: Plateau, entrance and Media centre



Providing a variety of public and communal space: Private/ intimate inclusivity





Fourth Floor: Sport



# Active inclusivity

Sport halls







Connection and communication with the surroundings



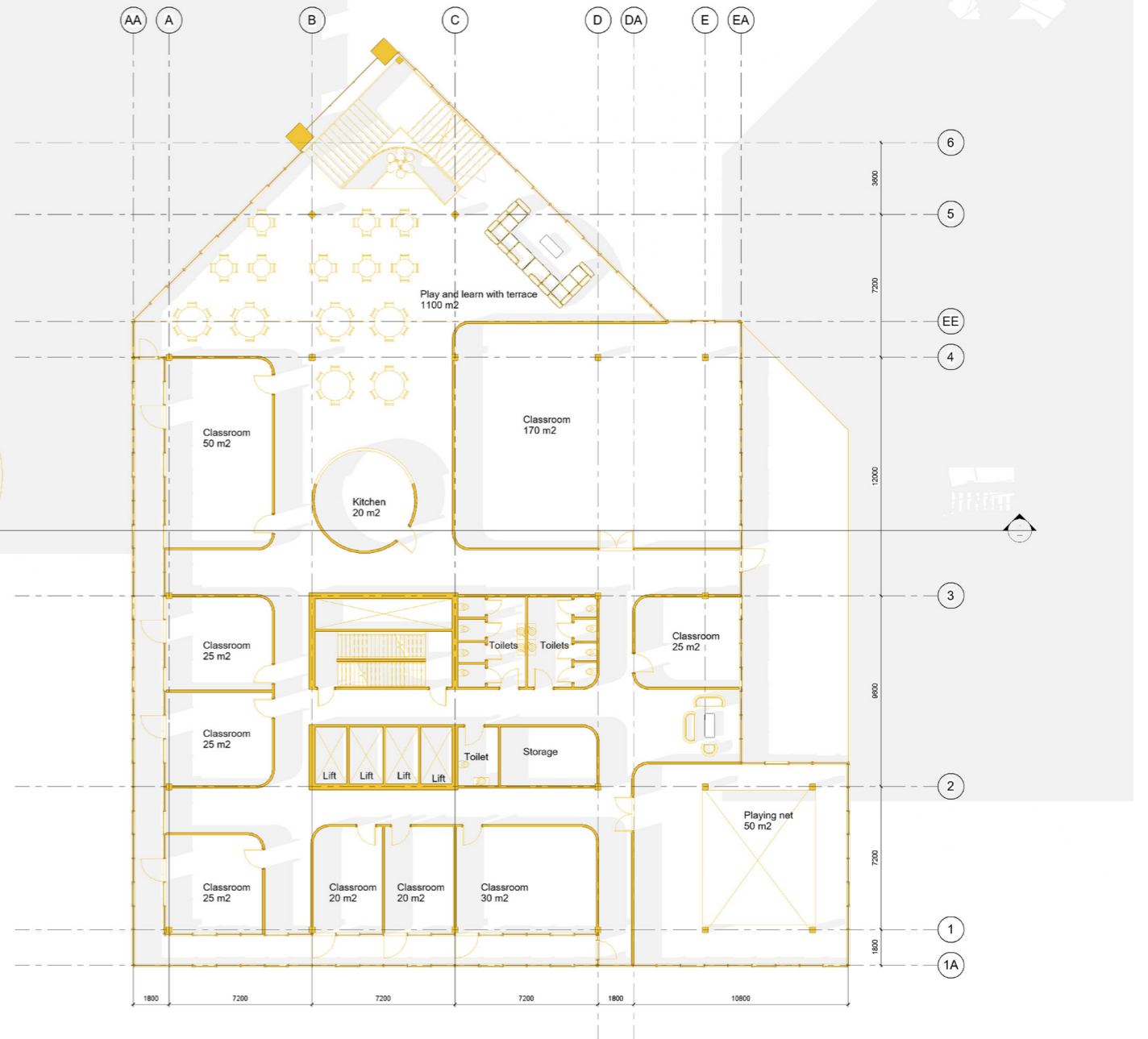
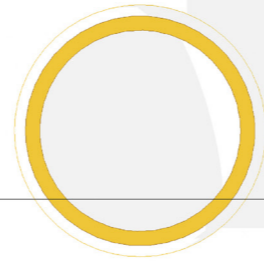

6th Floor: Educational



Social and public inclusivity









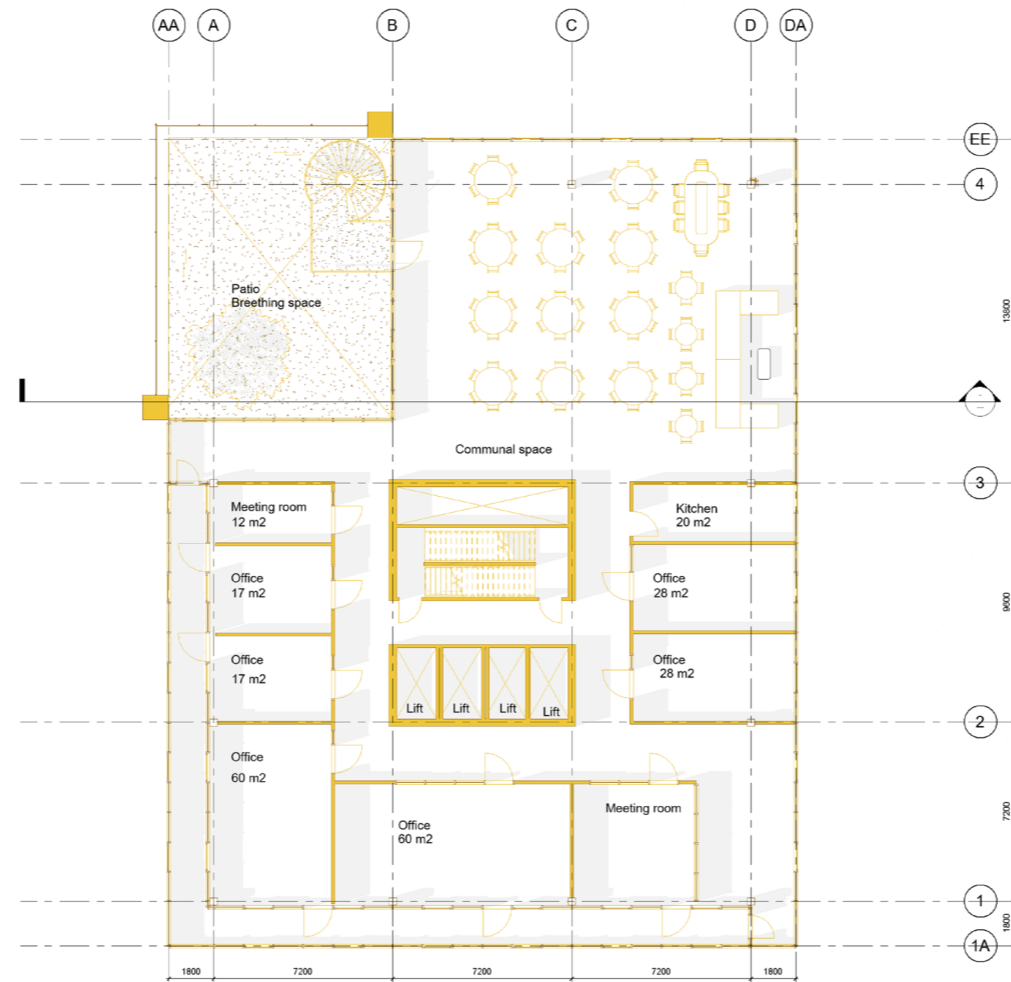

21th Floor: Office

Social and public inclusivity  
 Professional inclusivity  
 Breathing Space







Relation : Introvert vs. Extrovert





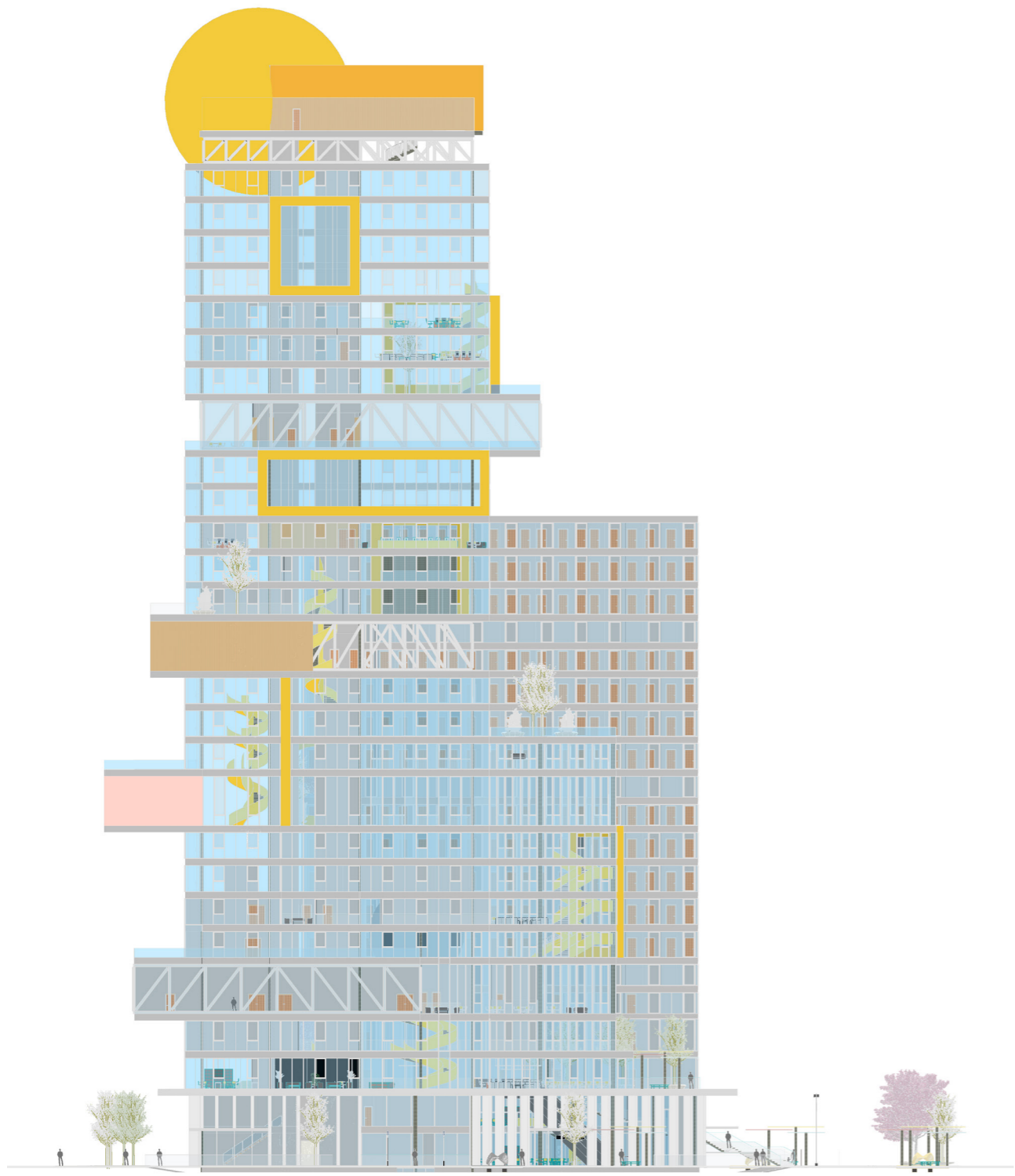

North Elevation



East Elevation



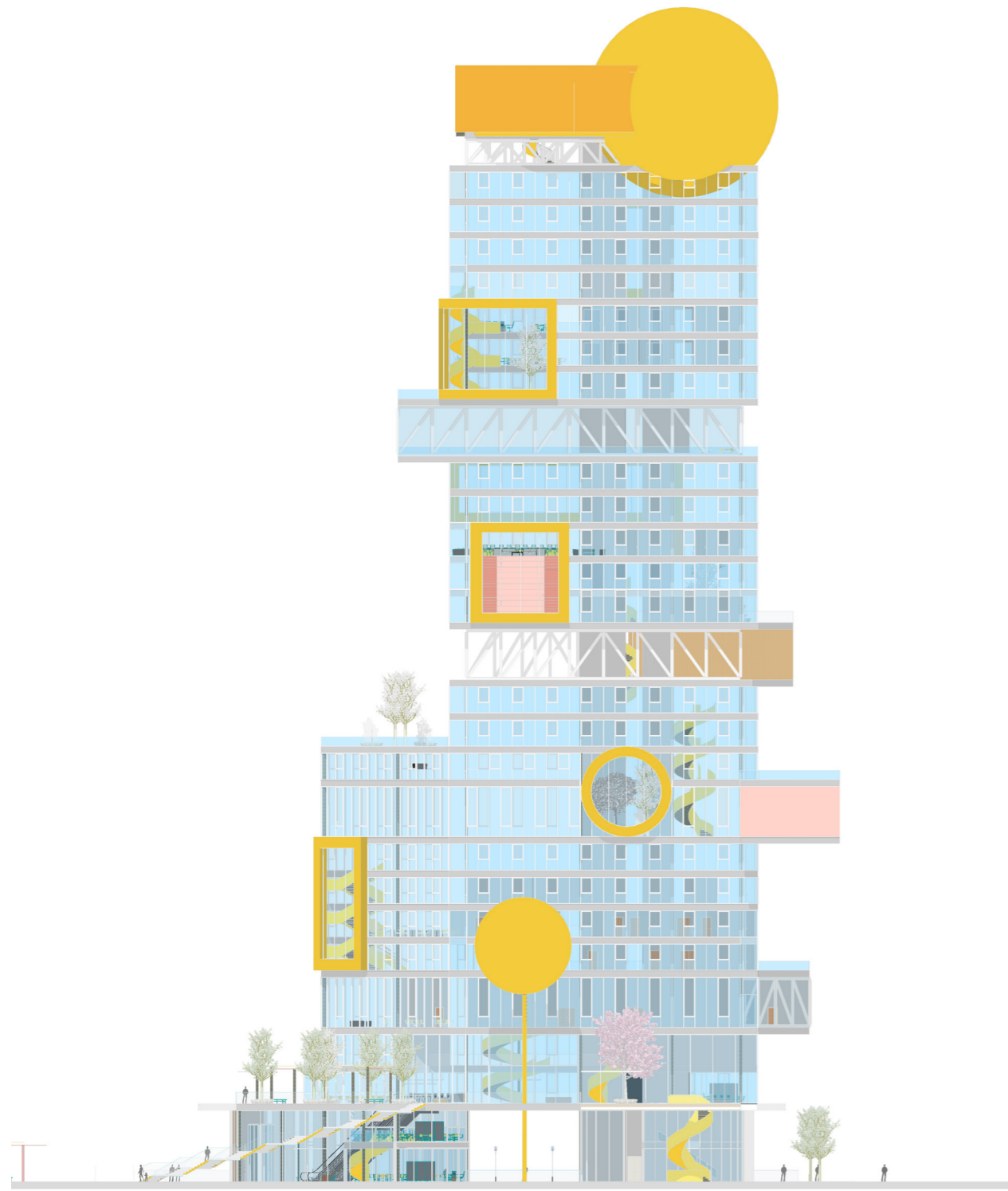

South Elevation



West Elevation





Impressions





# Climate Design

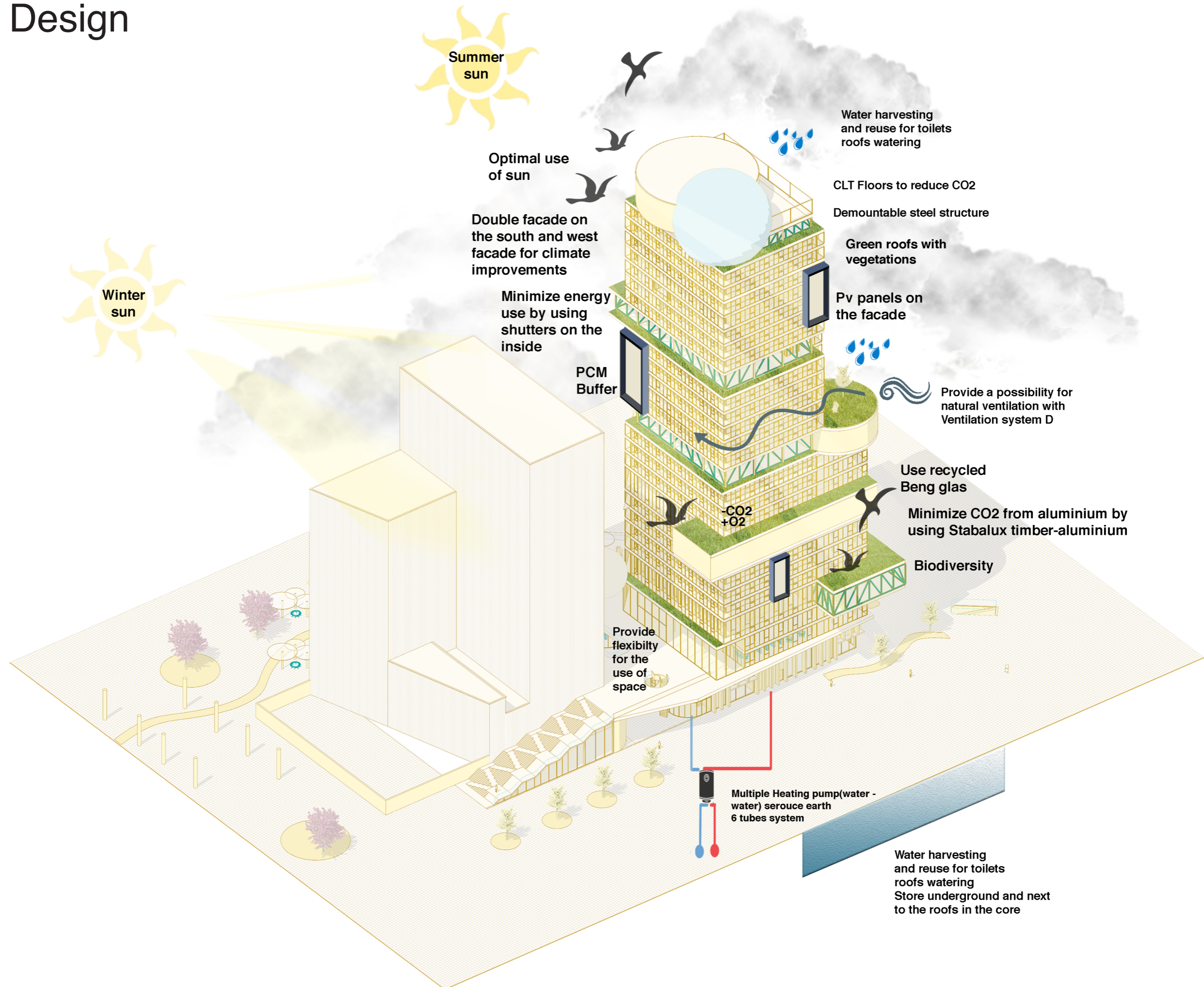



# ClimateDesign: Sun Study

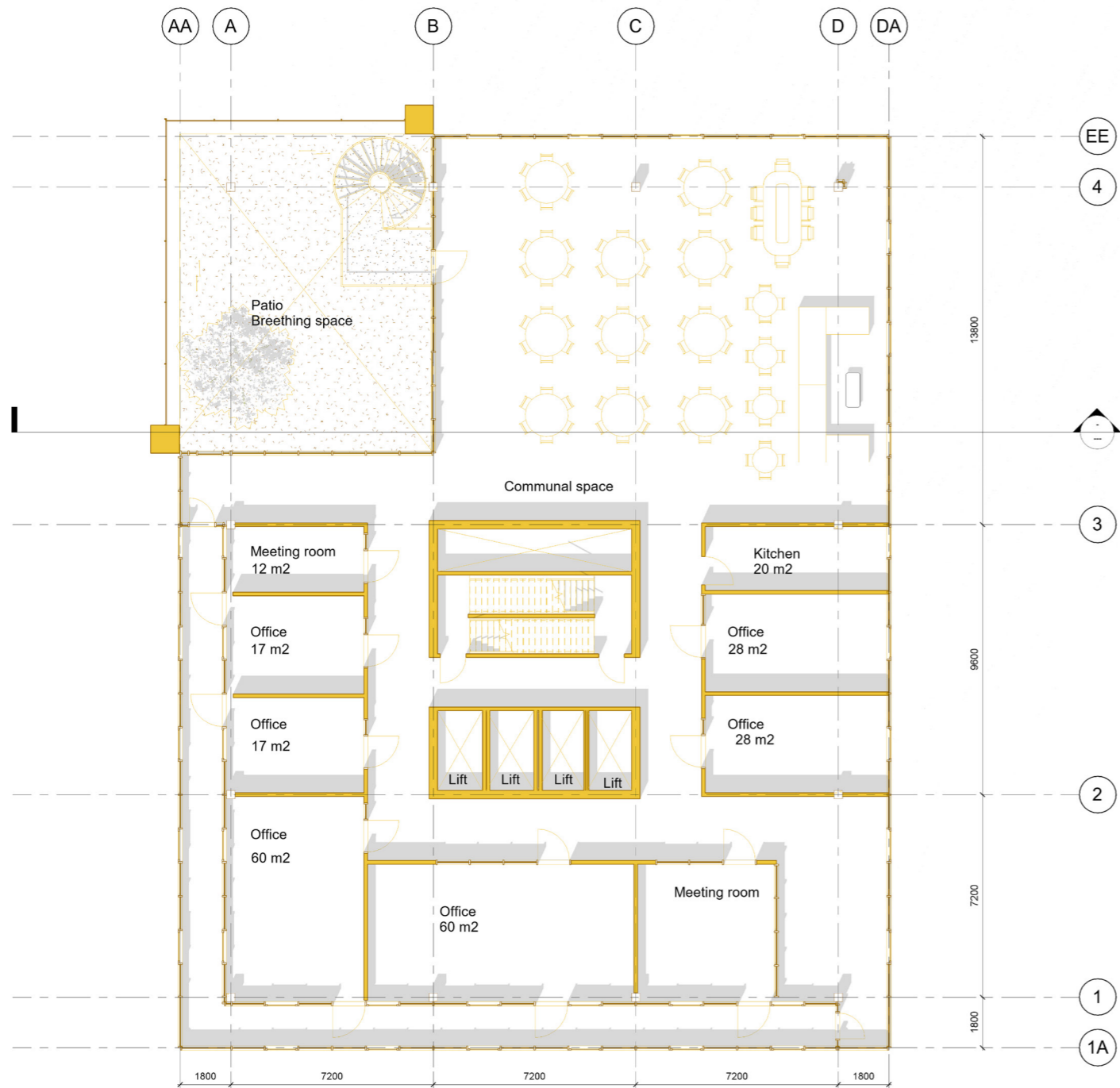

1 June 12:00

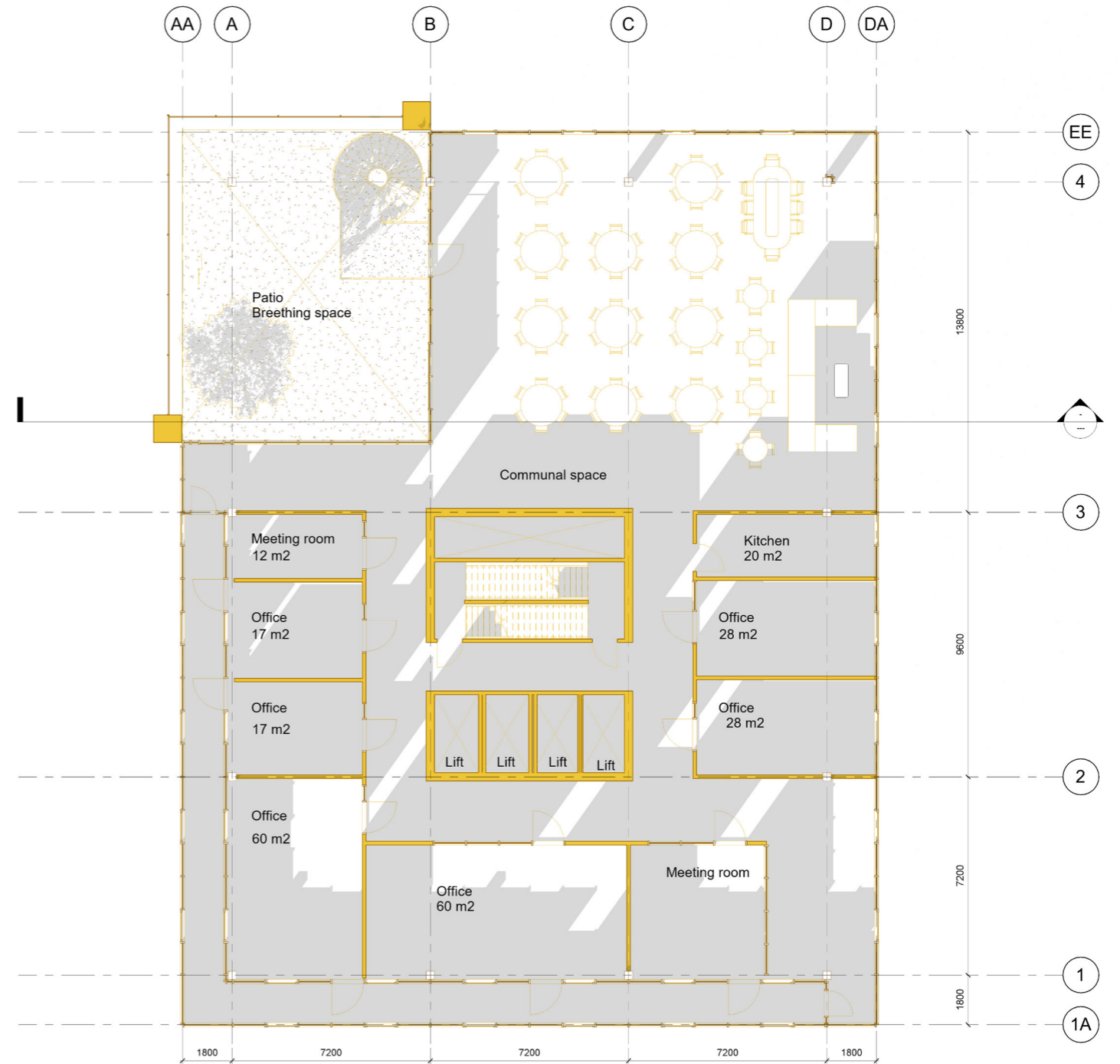

1 December 12:00



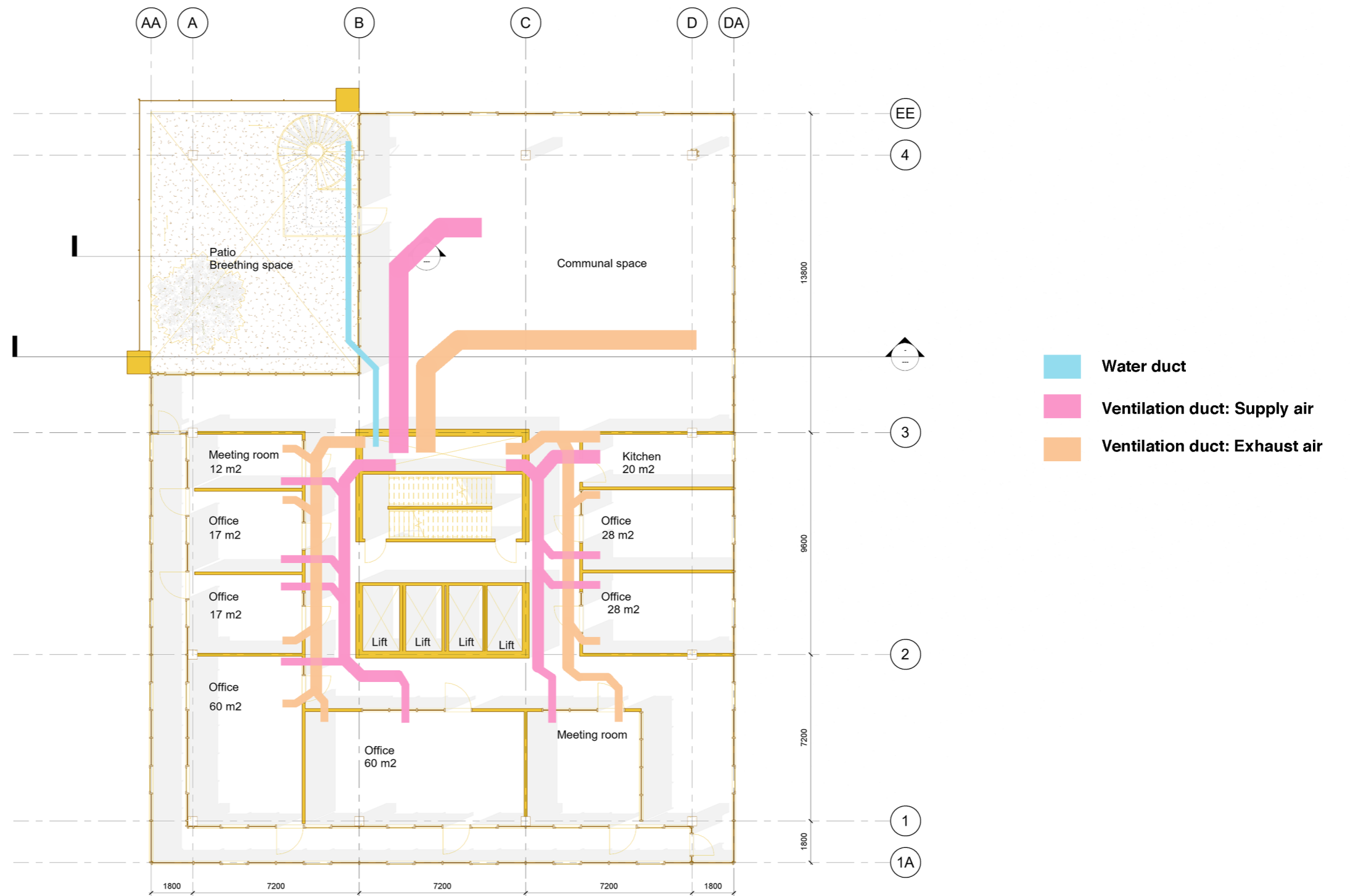

Main water and ventilation ducts



# Structure

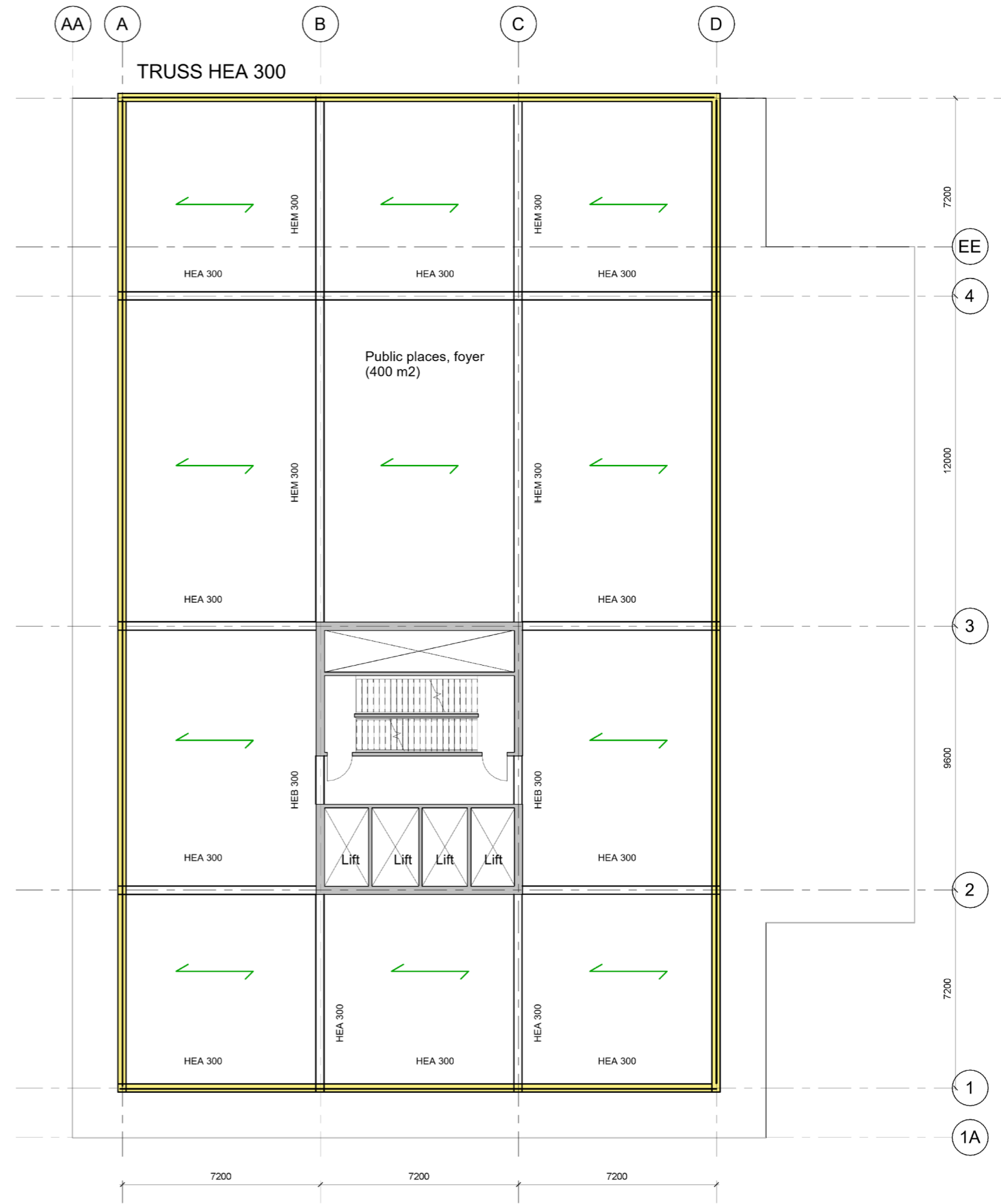
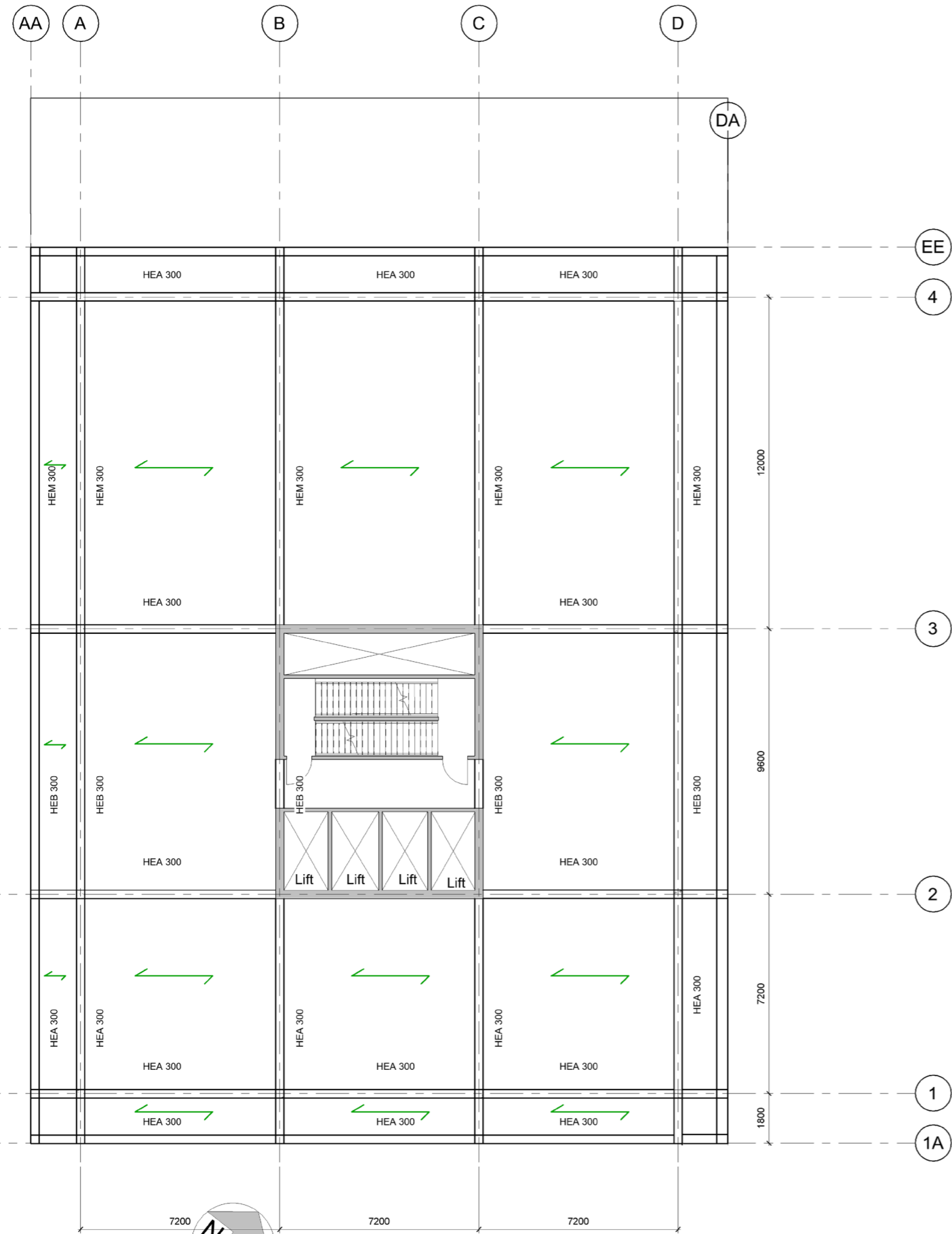



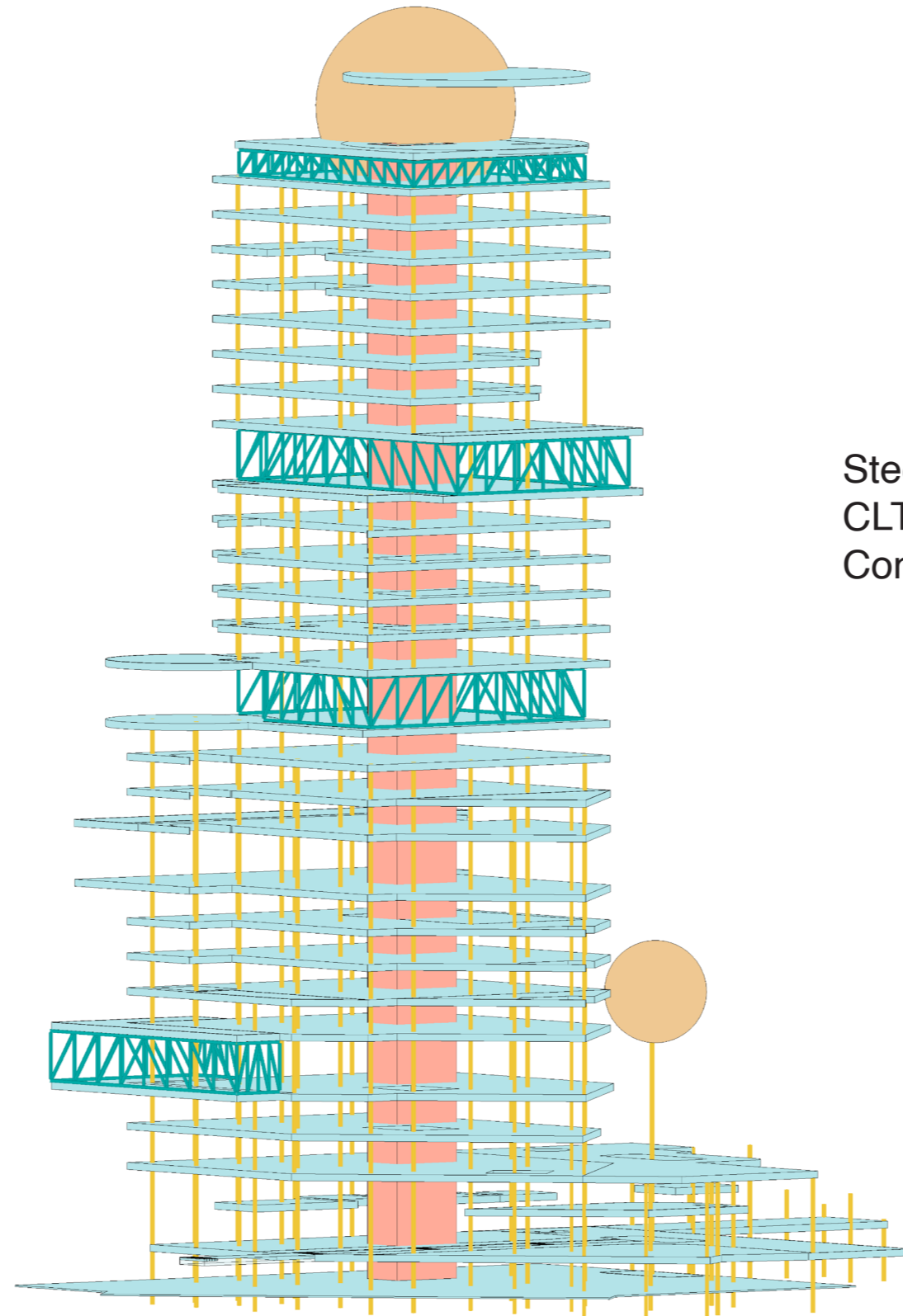

Steel HEA 300 columns, beams and trusses  
CLT floors  
Concrete core

Structural Diagram







# Details

Fermacell floor finish 30 mm  
CLT floor 300 mm  
Multiplex 22 mm  
Ventilation tubes  
Timber framing 2x22 mm  
Gypsum 2x12.5  
Total thickness 700 mm

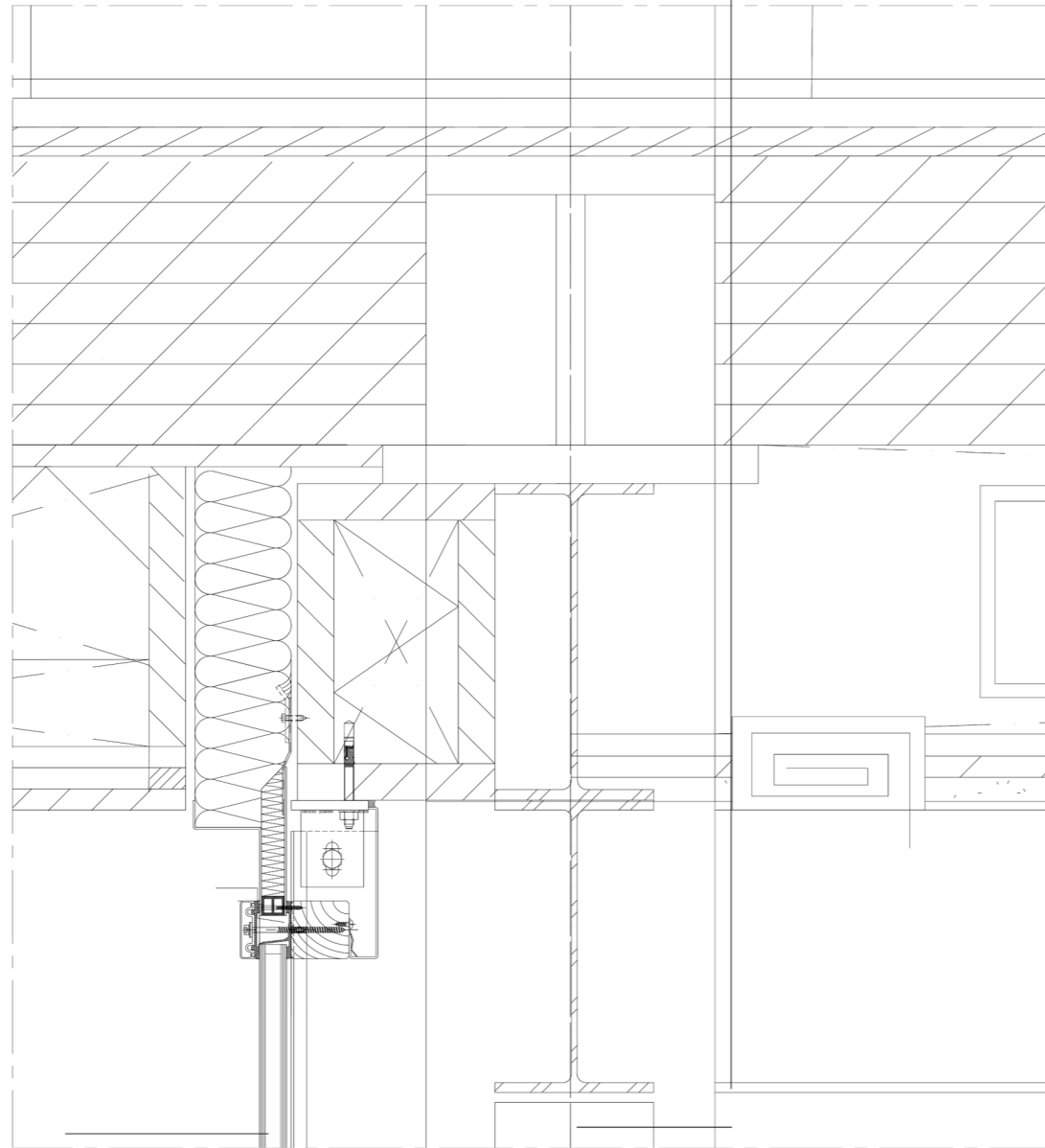

Stabalux curtain wall with timber and aluminium profil

HEM 300 steel beam and column

## Detail 1

Green roof:  
Vegetation  
Soil 180 mm  
Drainage 24 mm

Pressproof Inulation 20 mm  
Foil against roots  
Pressproof Insulation 50  
EPDM  
Multiplex 22 M  
Insulation 160 mm between timber beams 38 mm  
Timber framing 2x22 mm  
Facade sheet  
Total thickness 700 mm

Glass balustrade

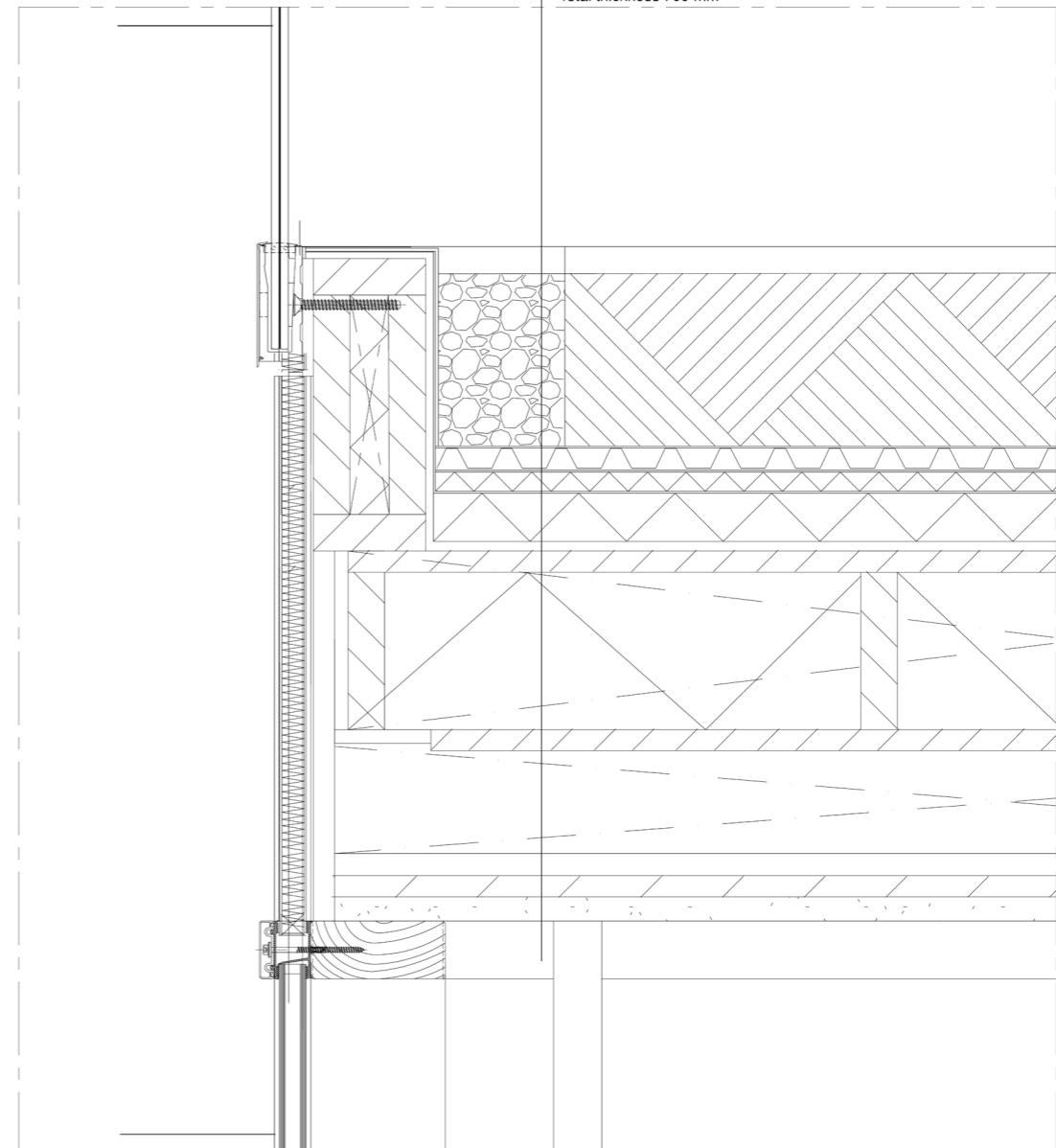

Stabalux curtain wall with timber and aluminium profil

## Detail 2



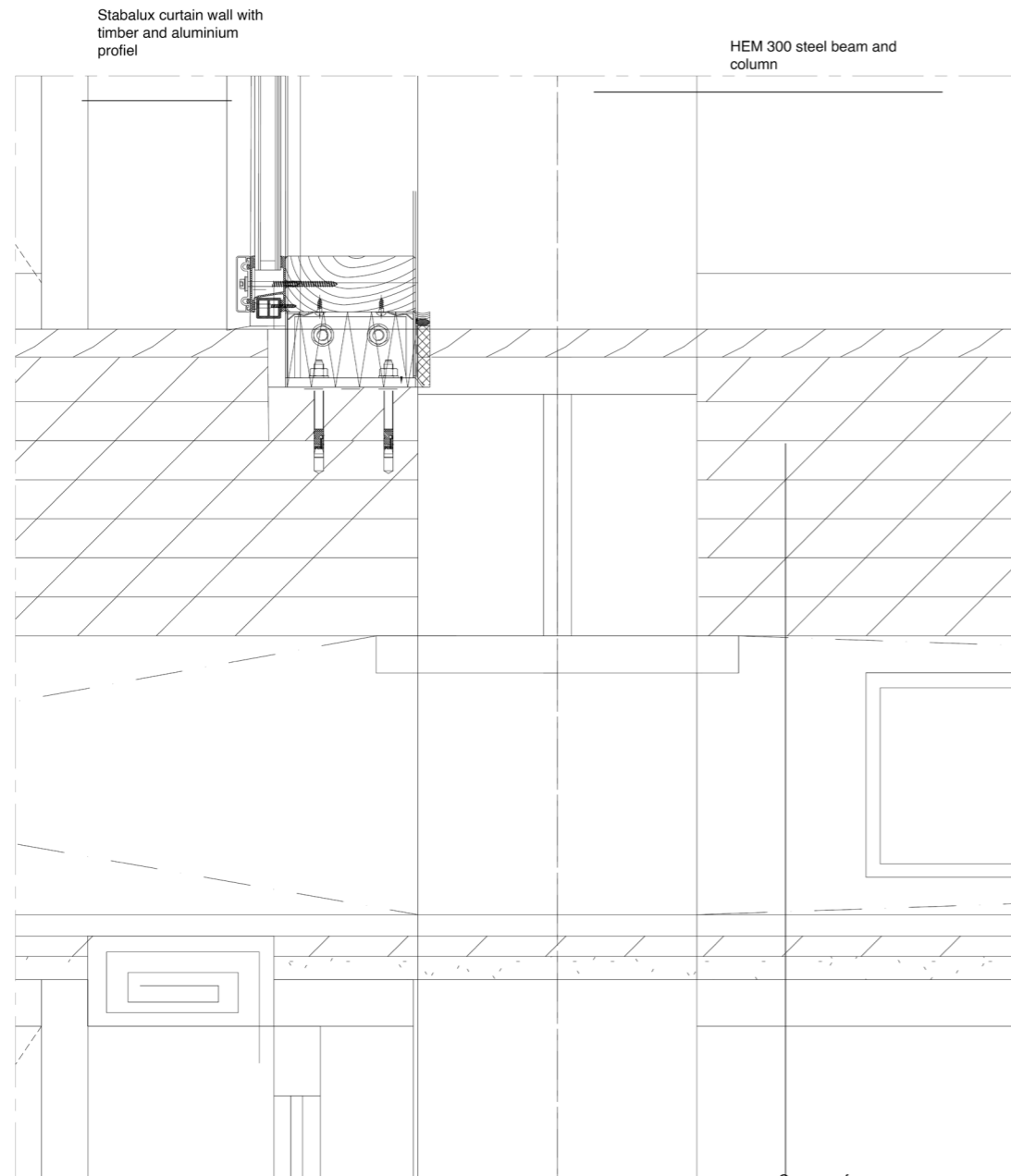

Stabalux curtain wall with  
timber and aluminium  
profil

HEM 300 steel beam and  
column

Green roof:  
Vegetation  
Soil 180 mm  
Drainage 24 mm

Pressproof Inulation 20 mm  
Foil against roots  
Pressproof Insulation 50  
EPDM  
Multiplex 22 M  
Insilation 160 mm between timber beams 38 mm  
Timber framing 2x22 mm  
Facade sheet

Total thickness 700 mm

Detail 3

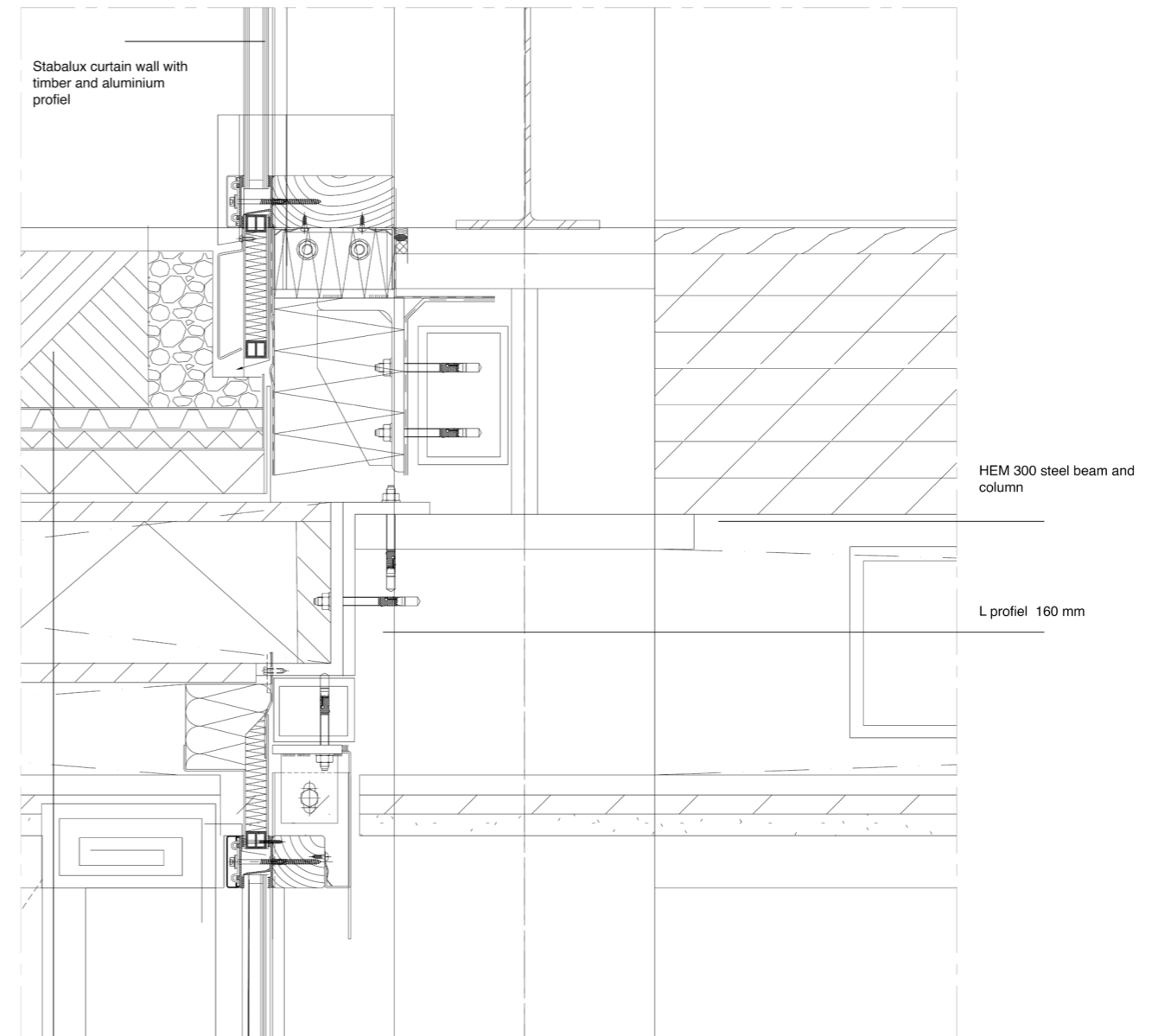

Stabalux curtain wall with  
timber and aluminium  
profil

HEM 300 steel beam and  
column

L profil 160 mm

Green roof:  
Vegetation  
Soil 180 mm  
Drainage 24 mm

Pressproof Inulation 20 mm  
Foil against roots  
Pressproof Insulation 50  
EPDM  
Multiplex 22 M  
Insilation 160 mm between timber beams 38 mm  
Timber framing 2x22 mm  
Facade sheet

Total thickness 700 mm

Detail 4



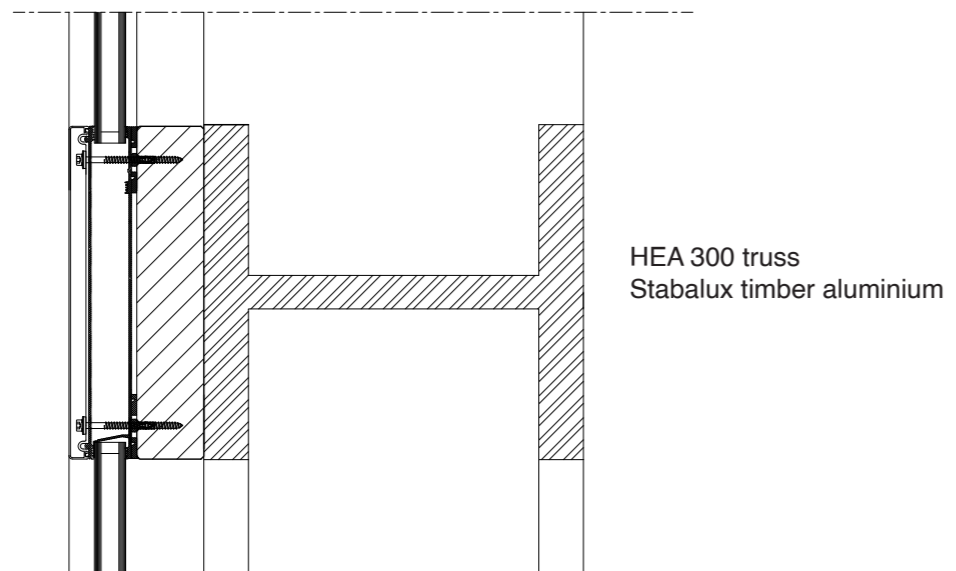

Horizontal detail: truss and facade

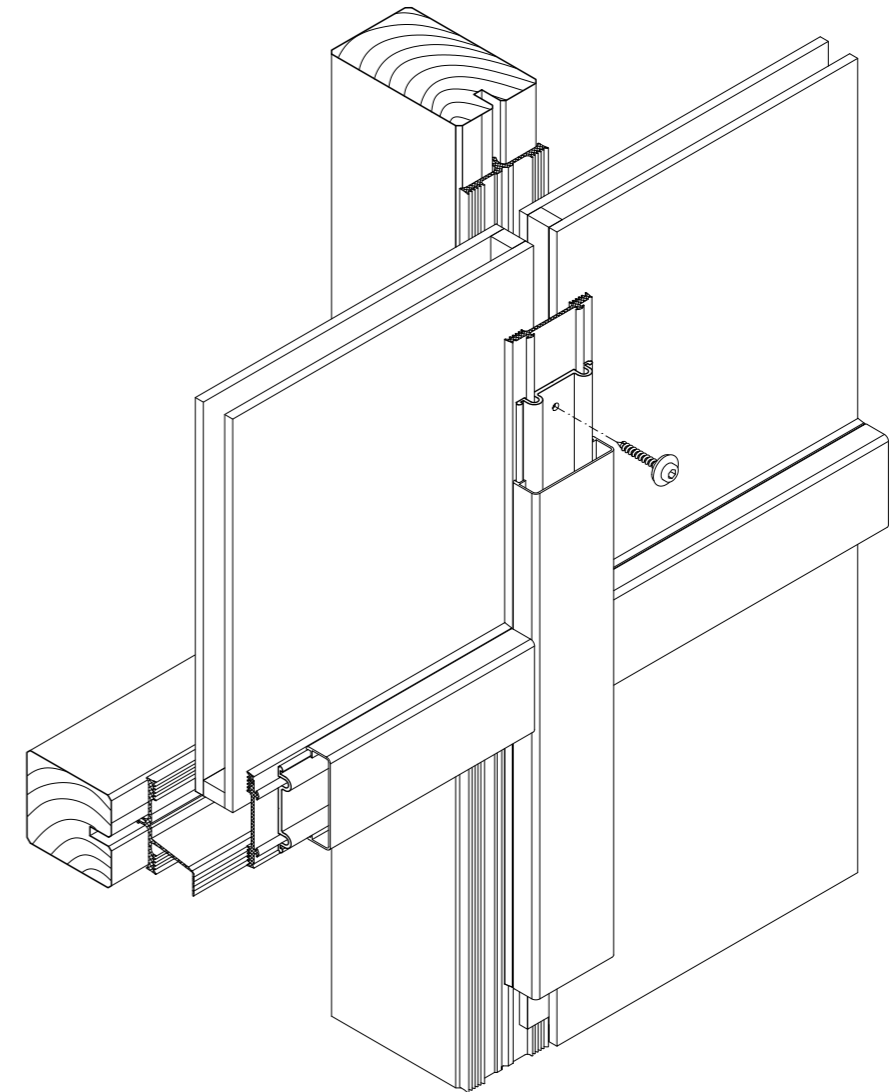

Stabalux timber aluminium





The Sphere



*THANK YOU!*

