

No.	Description	Format	Scale	Date	Change A	Change B	Change C
0.00	Drawing list	A3	-	05-16-23			
1.01	Situation	A2	1:500	05-16-23			
2.01	Ground floor plan	A2	1:200	05-16-23			
2.02	2nd floor plan	A2	1:200	05-16-23			
2.03	3rd floor plan	A2	1:200	05-16-23			
2.04	4th floor plan	A2	1:200	05-16-23			
2.05	5th floor plan	A2	1:200	05-16-23			
2.06	6th floor plan	A2	1:200	05-16-23			
2.07	7th floor plan	A2	1:200	05-16-23			
2.08	Roof	A2	1:200	05-16-23			
3.01	Section AA	A0	1:100	05-16-23			
3.02	Section BB	A0	1:100	05-16-23			
3.03	Section CC	A0	1:100	05-16-23			
3.04	Section DD	A0	1:100	05-16-23			
3.05	Section EE	A0	1:100	05-16-23			
4.01	Elevation south/south east	A2	1:200	05-16-23			
4.02	Elevation east/north east	A2	1:200	05-16-23			
4.03	Elevation north/north west	A	1:200	05-16-23			
4.04	Elevation west/south west	A2	1:200	05-16-23			
6.01	Facade fragment	A0	1:20	05-16-23			
7.01	Detail dwelling foundation	A3	1:5	05-16-23			
7.02	Detail storage foundation	A3	1:5	05-16-23			
7.03	Detail upper door connection	A3	1:5	05-16-23			
7.04	Detail storage roof	A3	1:5	05-16-23			
7.05	Detail under window frame connection	A3	1:5	05-16-23			
7.06	Detail upper window frame connection	A3	1:5	05-16-23			
7.07	Detail landing with balustrade	A3	1:5	05-16-23			
7.08	Detail under connection curtain wall door staircase	A3	1:5	05-16-23			
7.09	Detail curtain wall upper door and under panel staircase	A3	1:5	05-16-23			
7.10	Detail curtain wall	A3	1:5	05-16-23			
7.11	Detail window frame with connection with the wall	A3	1:5	05-16-23			
7.12	Detail window frame	A3	1:5	05-16-23			
7.13	Detail connection curtain wall staircase - dwelling	A3	1:5	05-16-23			
7.14	Detail curtain wall door and vegetation panel	A3	1:5	05-16-23			
7.15	Detail dwelling wall connection with the sound wall	A3	1:5	05-16-23			
7.16	Detail floor connection with the sound wall	A3	1:5	05-16-23			
7.17	Detail floor - ceiling - green roof	A3	1:5	05-16-23			
7.18	Detail green roof	A3	1:5	05-16-23			
10.20	Green dwelling floor plan	A2	1:50	05-16-23			
10.30	Green dwelling section	A2	1:50	05-16-23			
11.20	Red dwelling floor plan	A2	1:50	05-16-23			
11.30	Red dwelling floor plan	A2	1:50	05-16-23			
12.20	Yellow dwelling 1.0 floor plan	A2	1:50	05-16-23			
12.21	Yellow dwelling 2.0 floor plan	A2	1:50	05-16-23			
12.30	Yellow dwelling 1.0 section	A2	1:50	05-16-23			
12.31	Yellow dwelling 2.0 section	A2	1:50	05-16-23			

## 0.00 DRAWING LIST

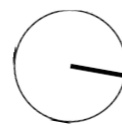

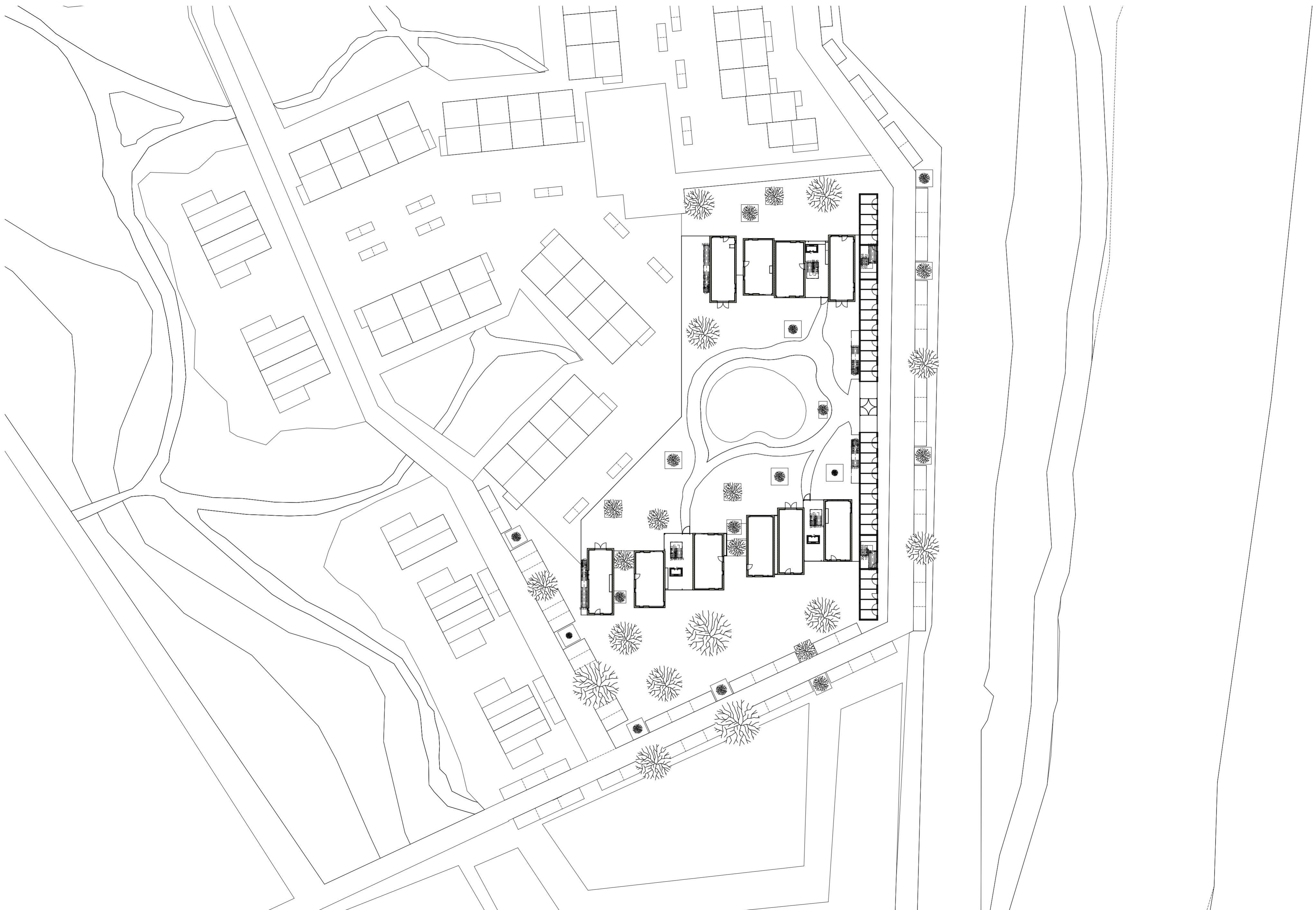

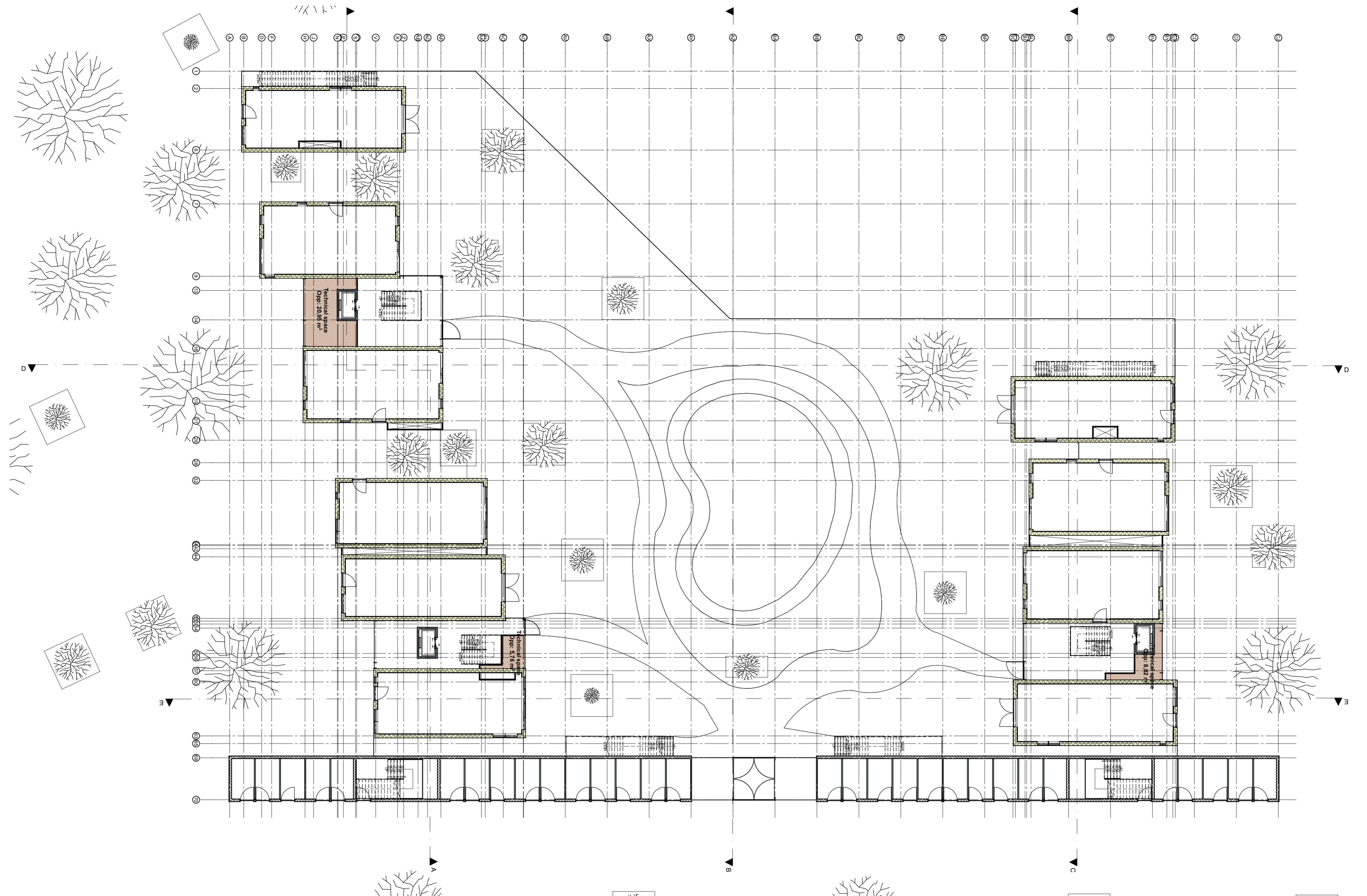

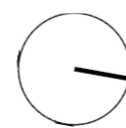

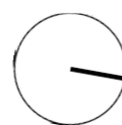



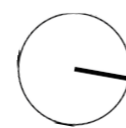

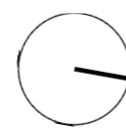

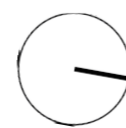



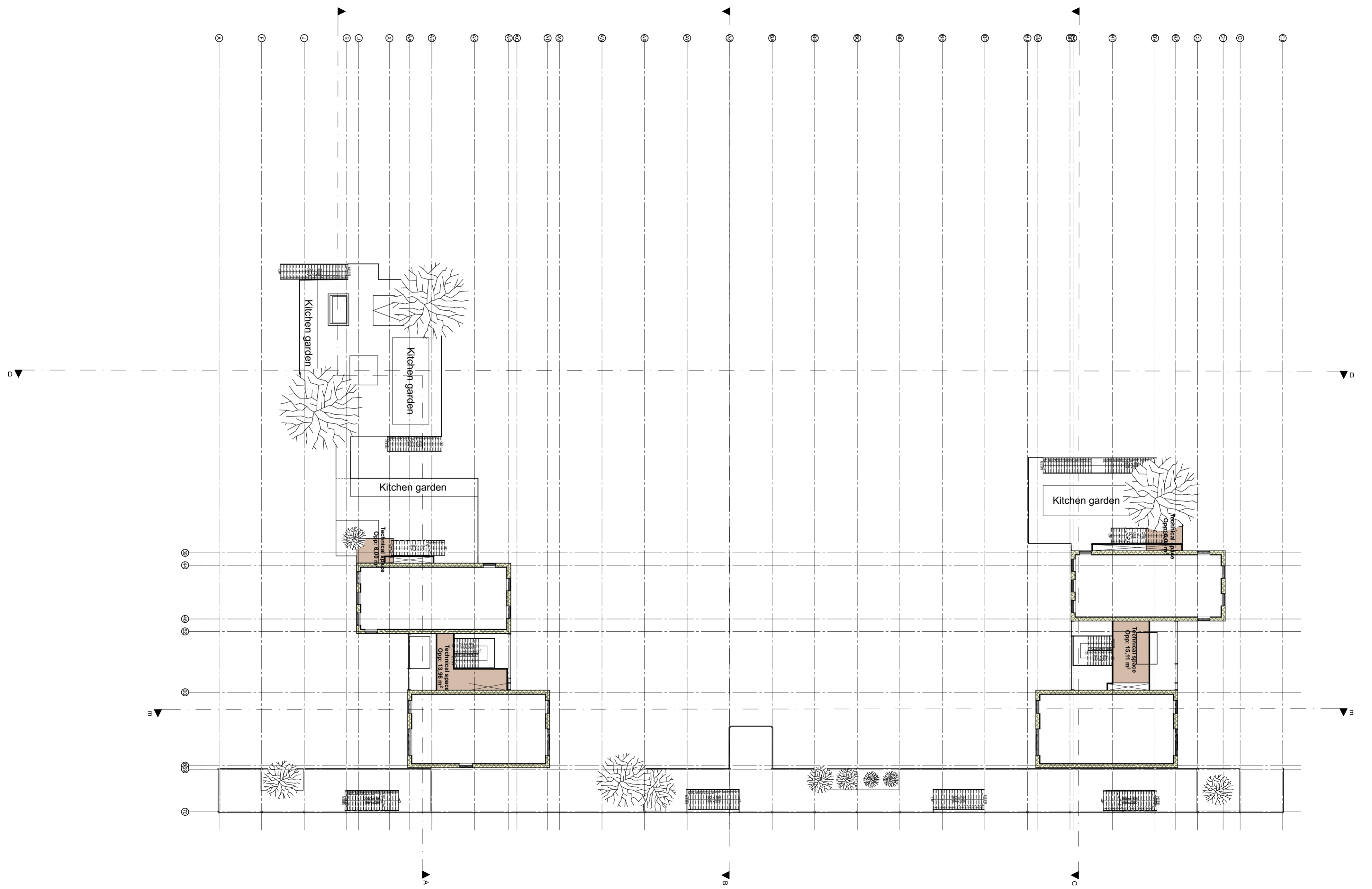

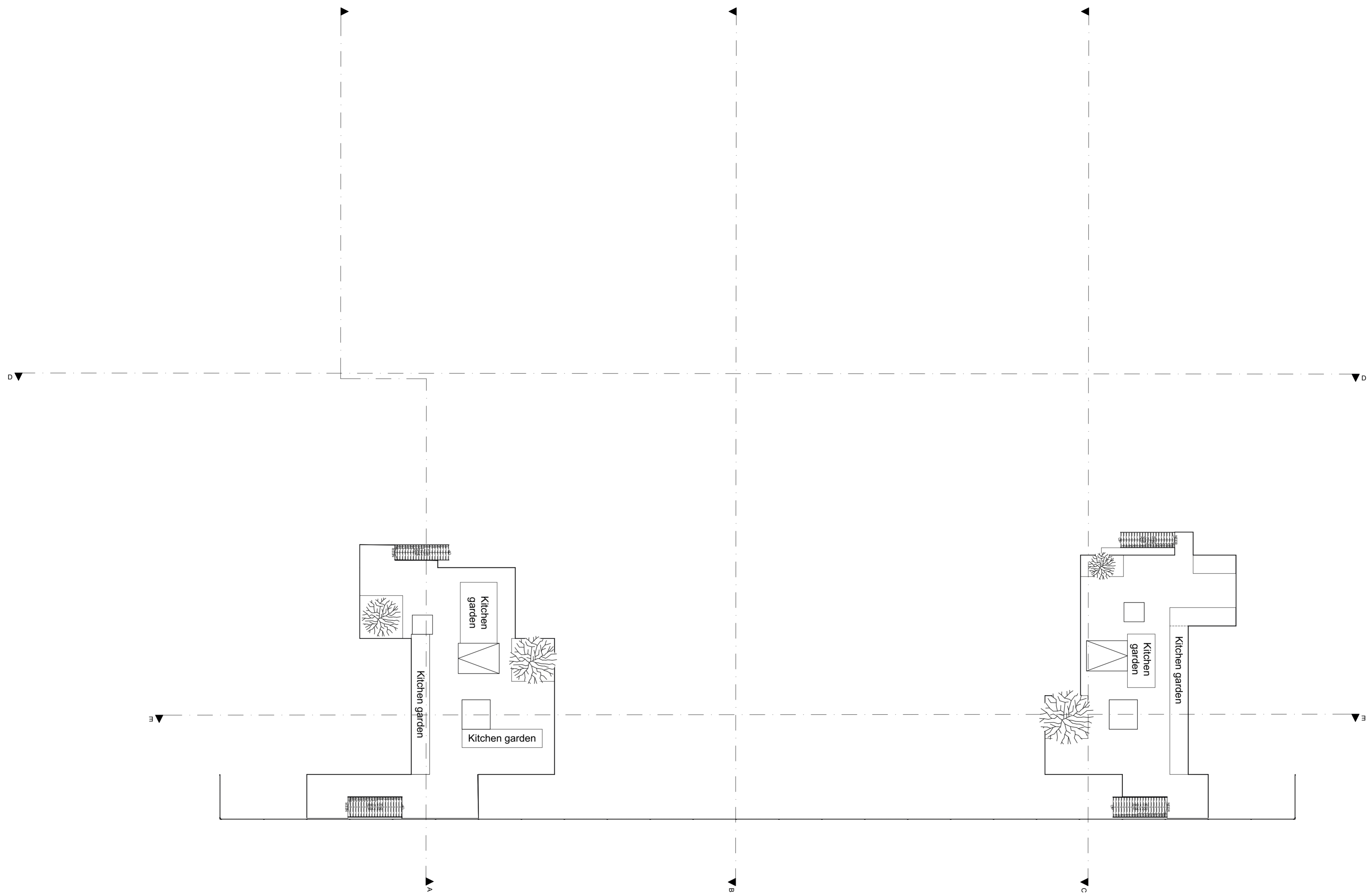



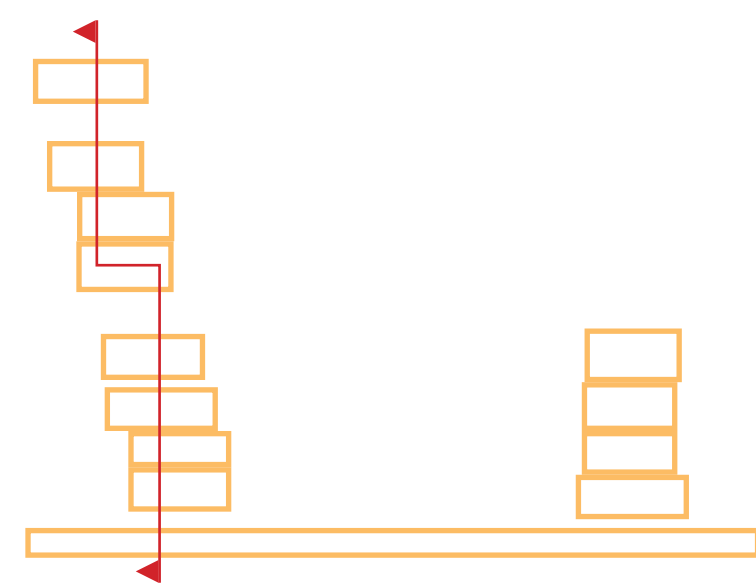



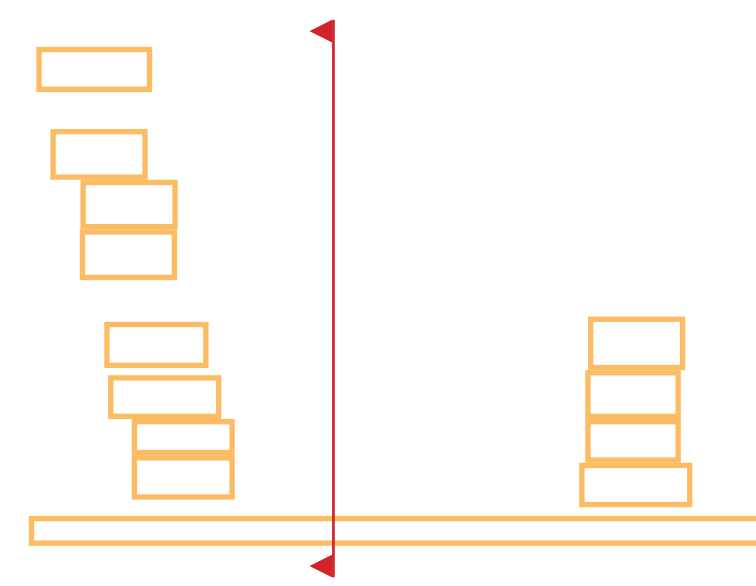



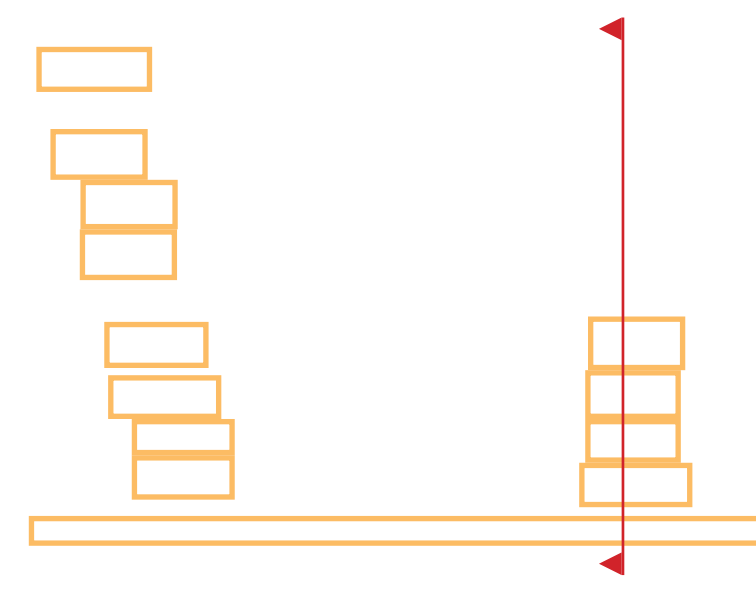







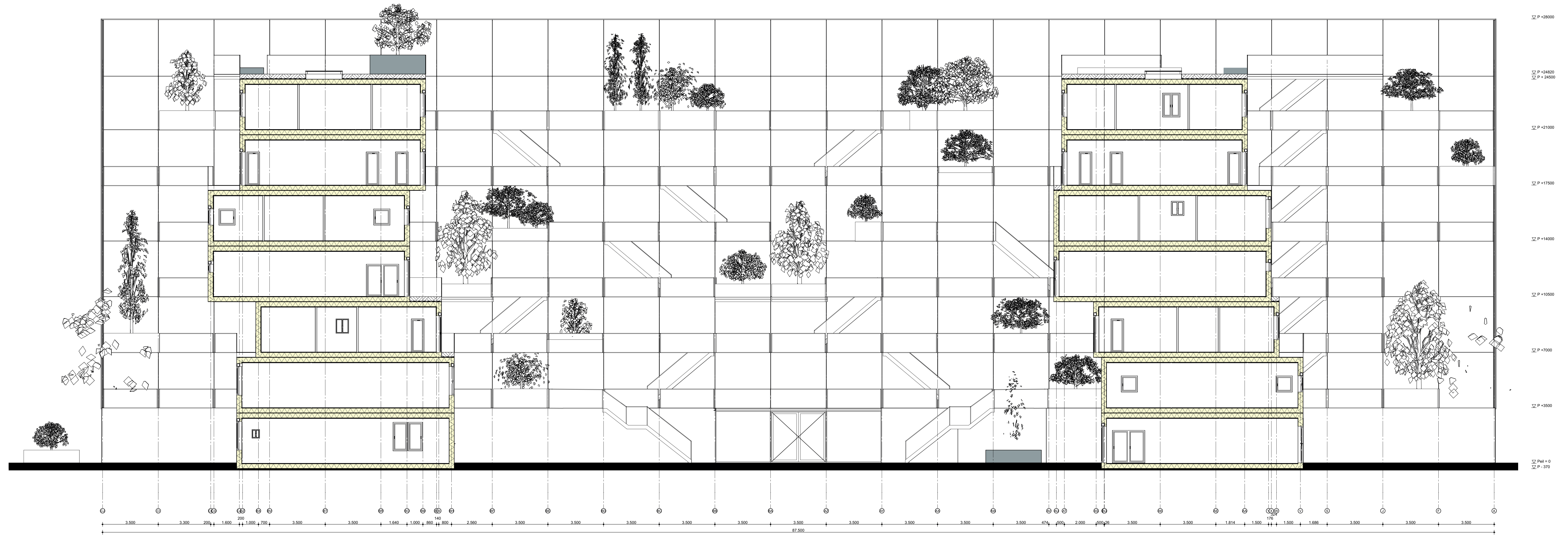
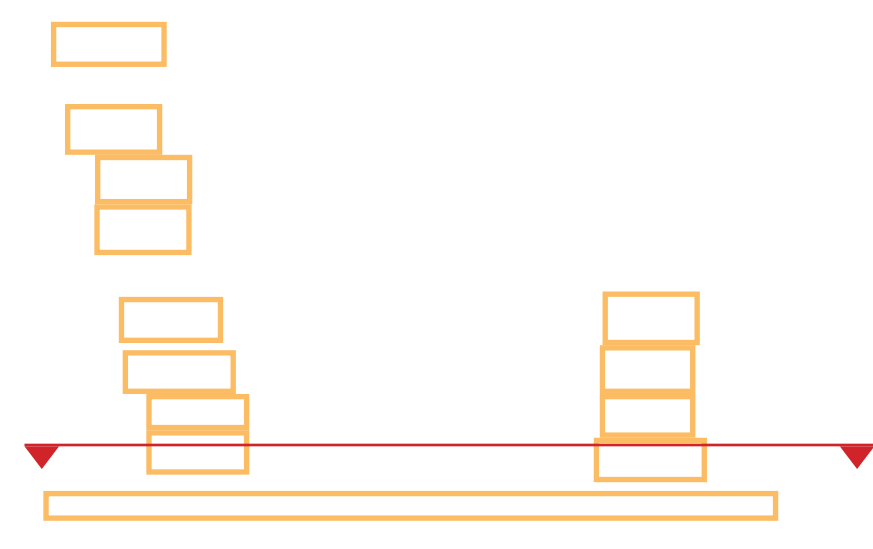





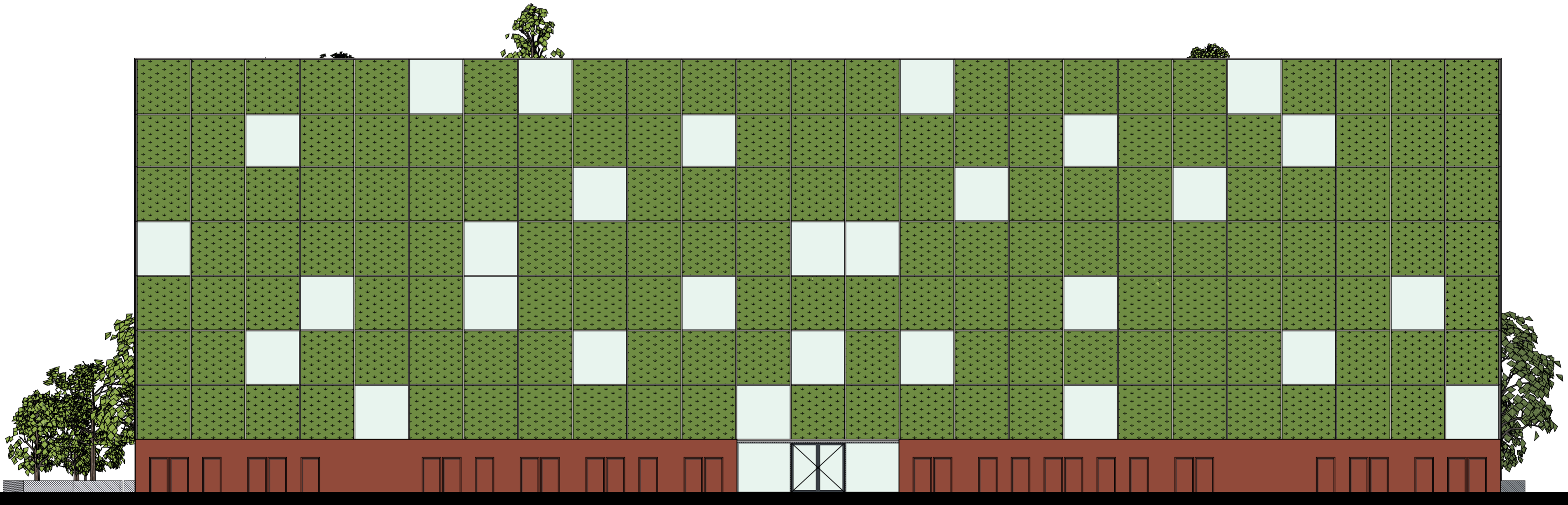







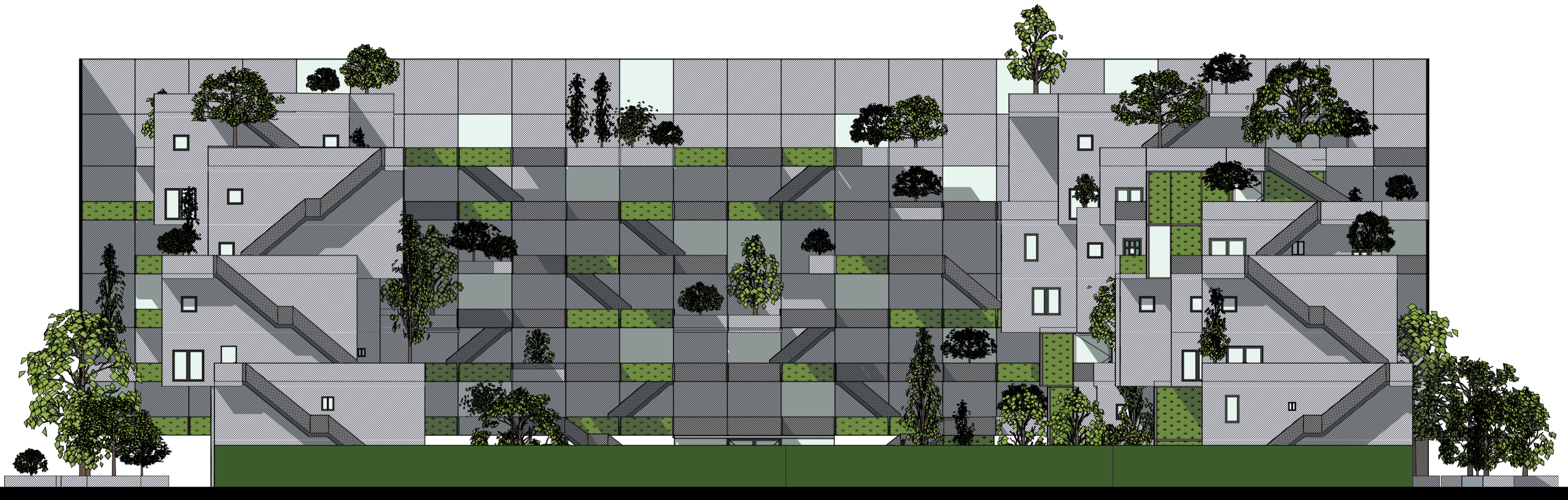



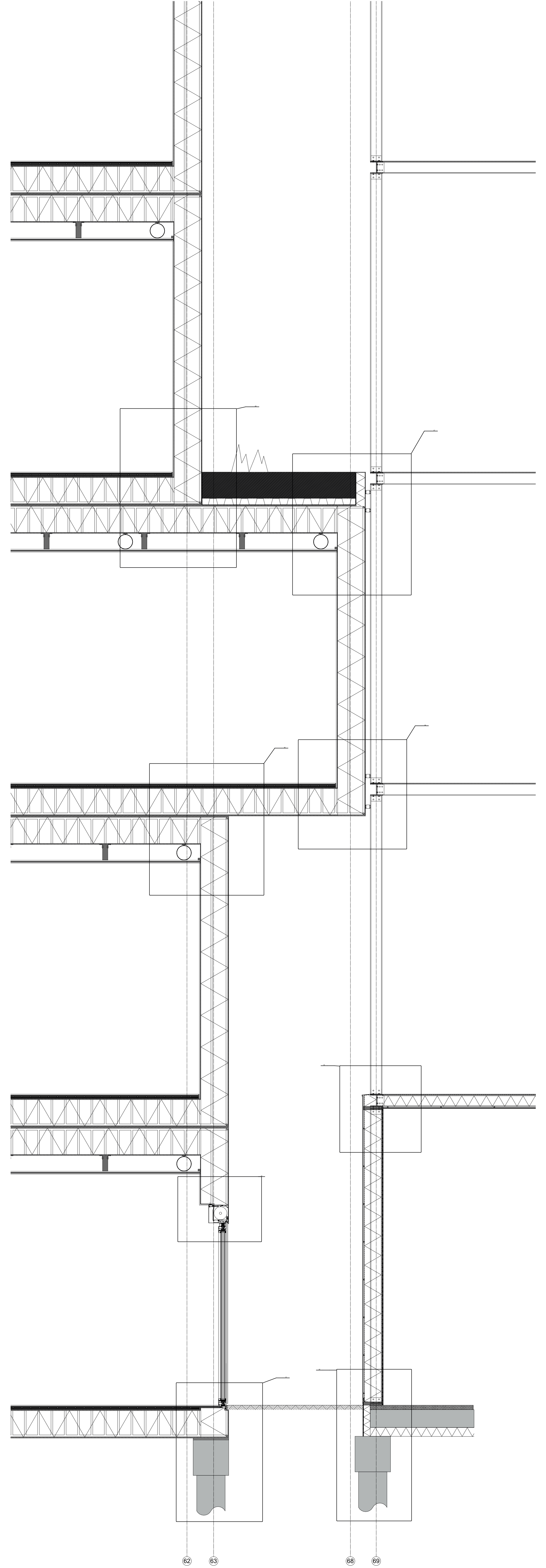
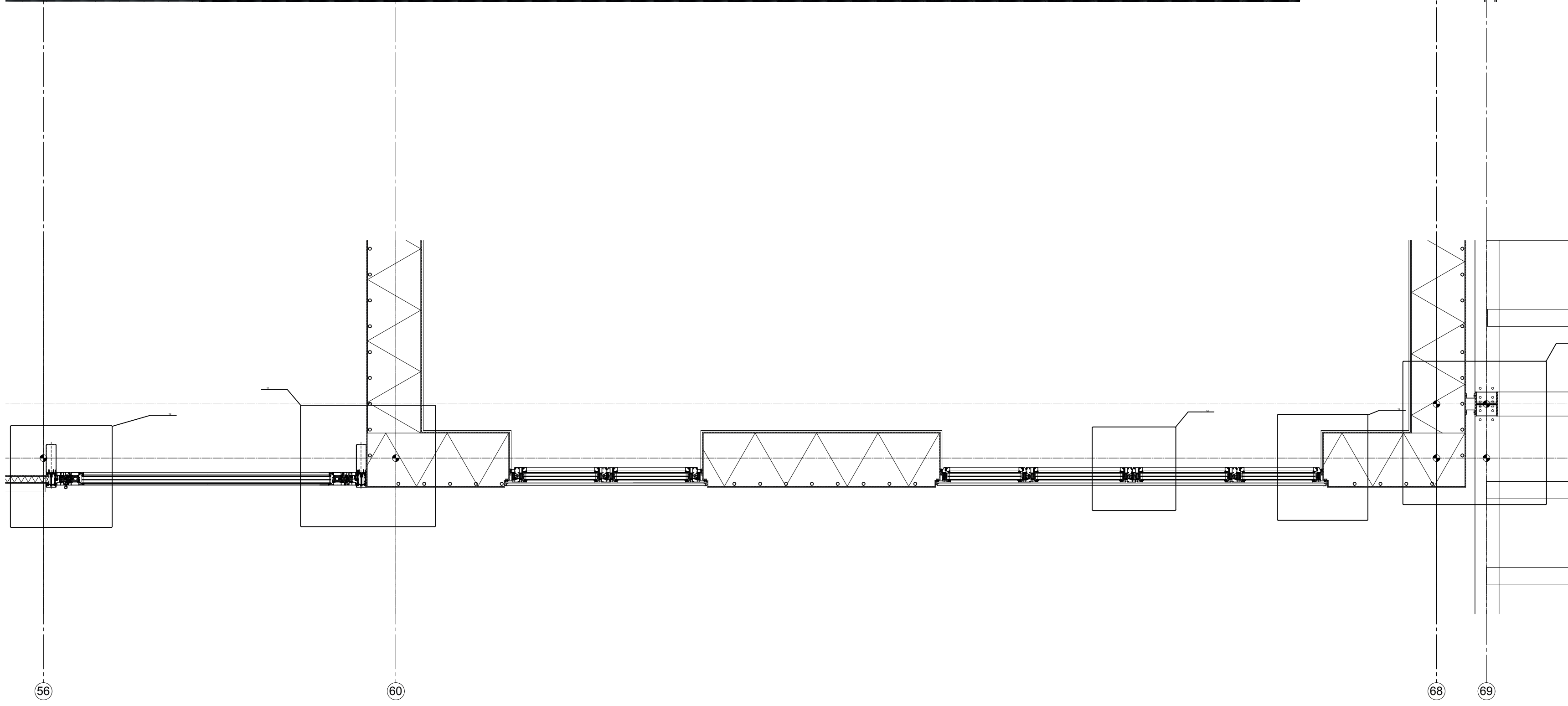



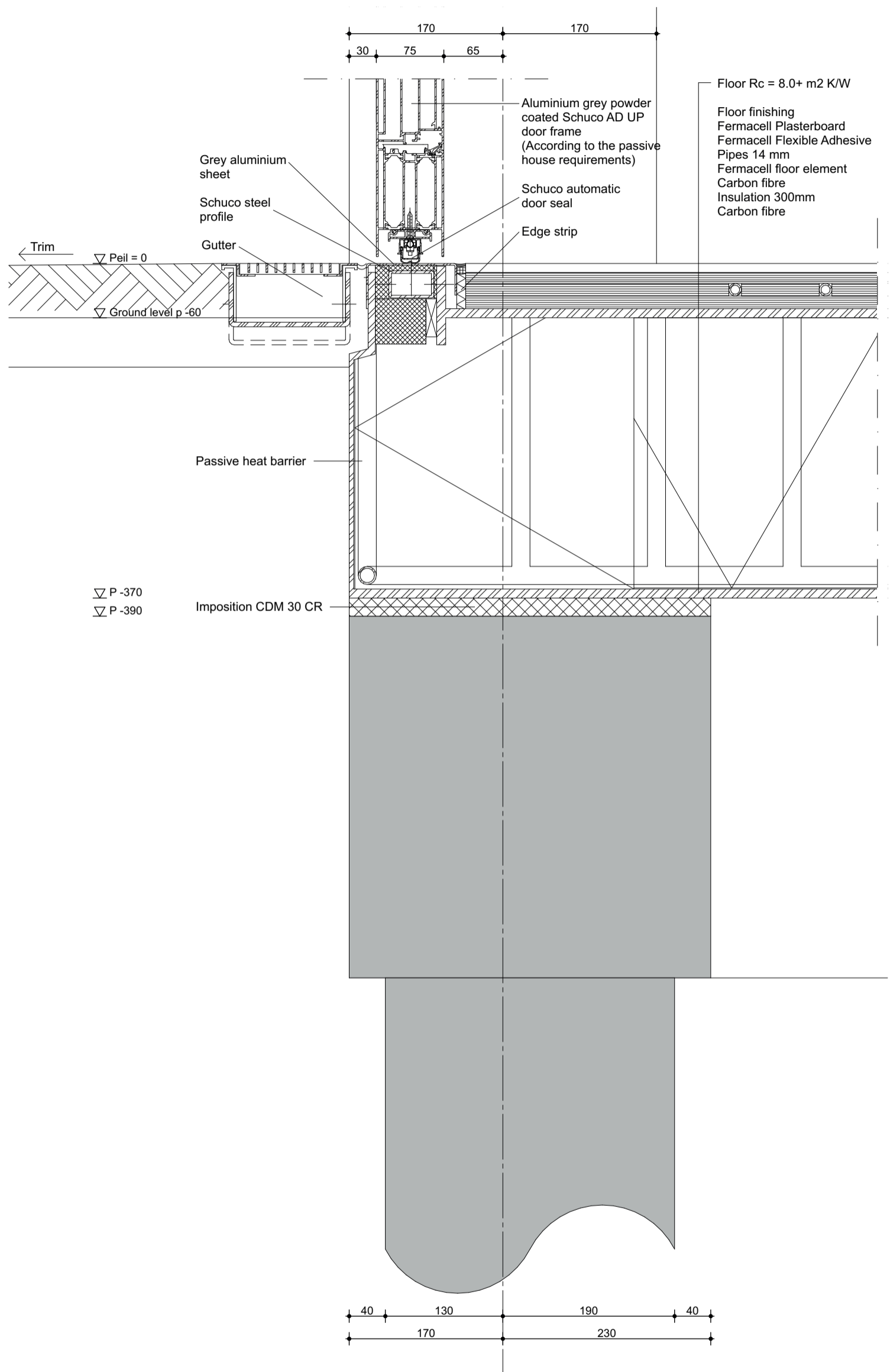
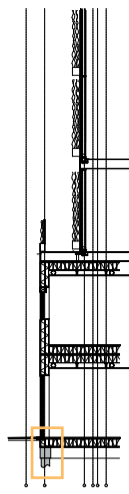

Dwelling foundation  
7.01 DETAIL

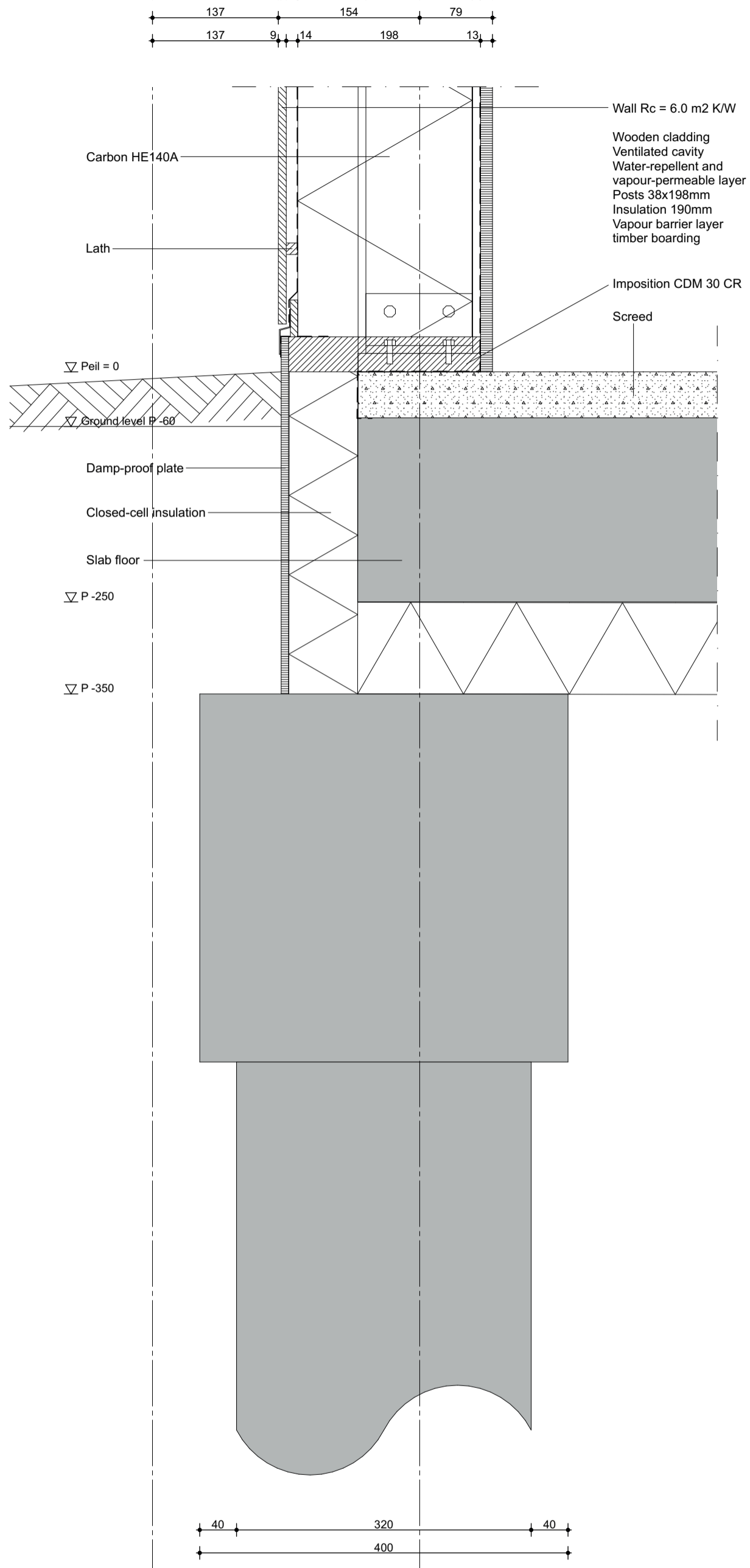

Storage foundation  
7.02 DETAIL



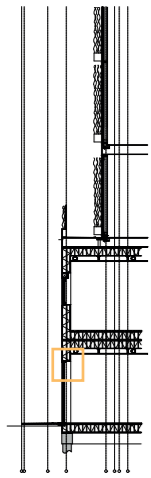

▽ P +2810

▽ P +2600

▽ P +2300

Wall Rc = 8.0+ m2 K/W

Breathable stucco  
Carbon fibre  
Insulation 310mm  
Passive heat barrier  
Carbon fibre

Compression tape

Plaster bead

Compression tape

Aluminium grey powder coated Schuco AD UP door frame  
(According to the passive house requirements)

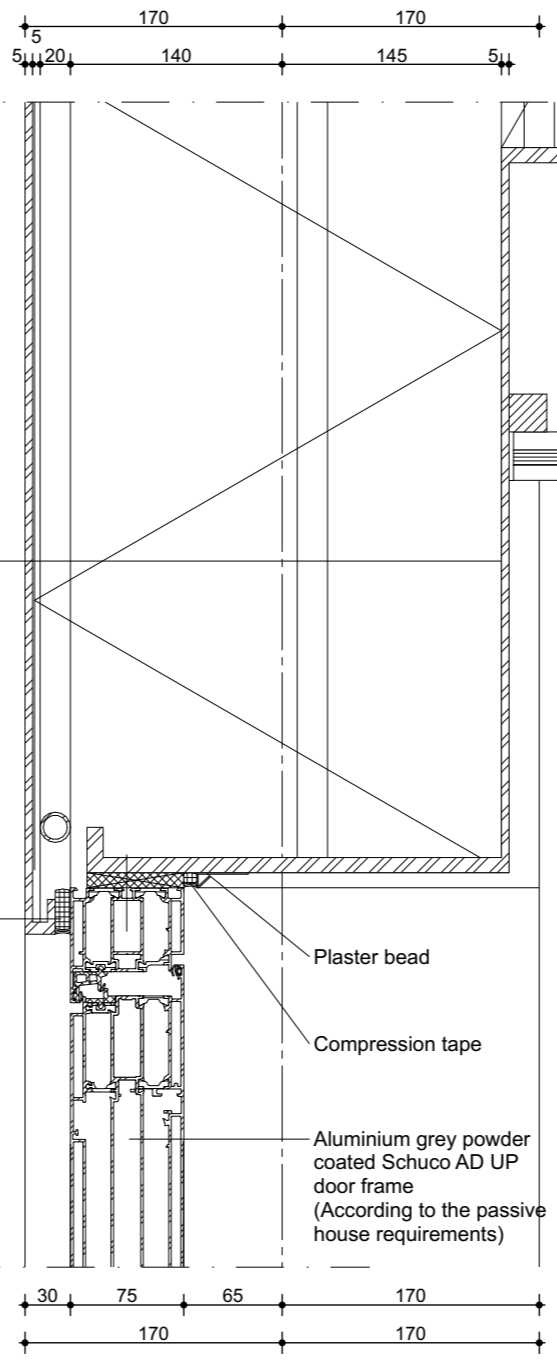

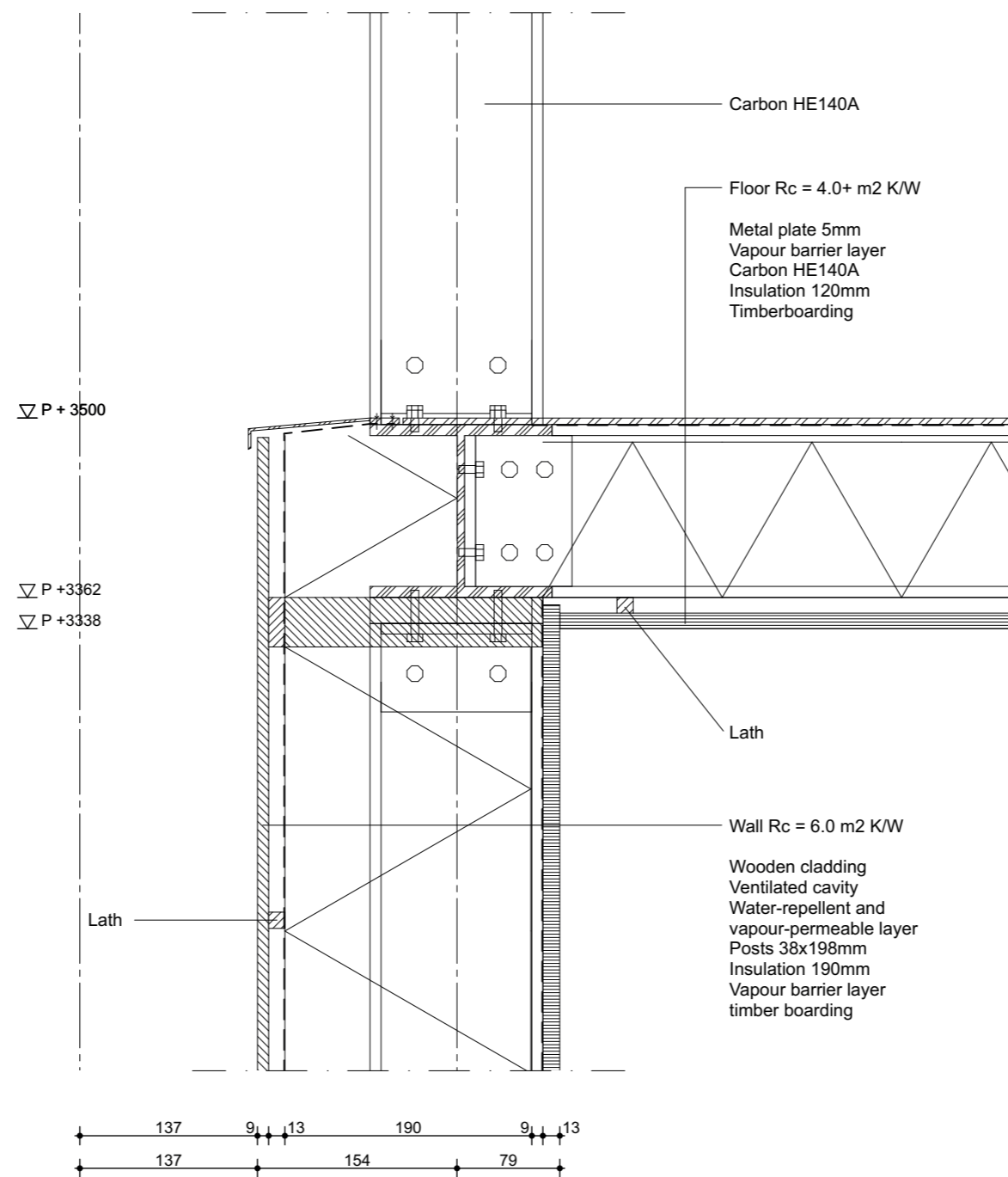

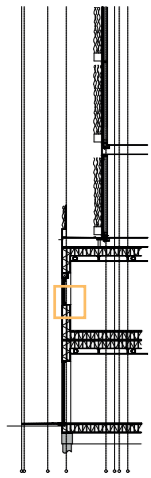

▽ P 34475  
 ▽ P +4435

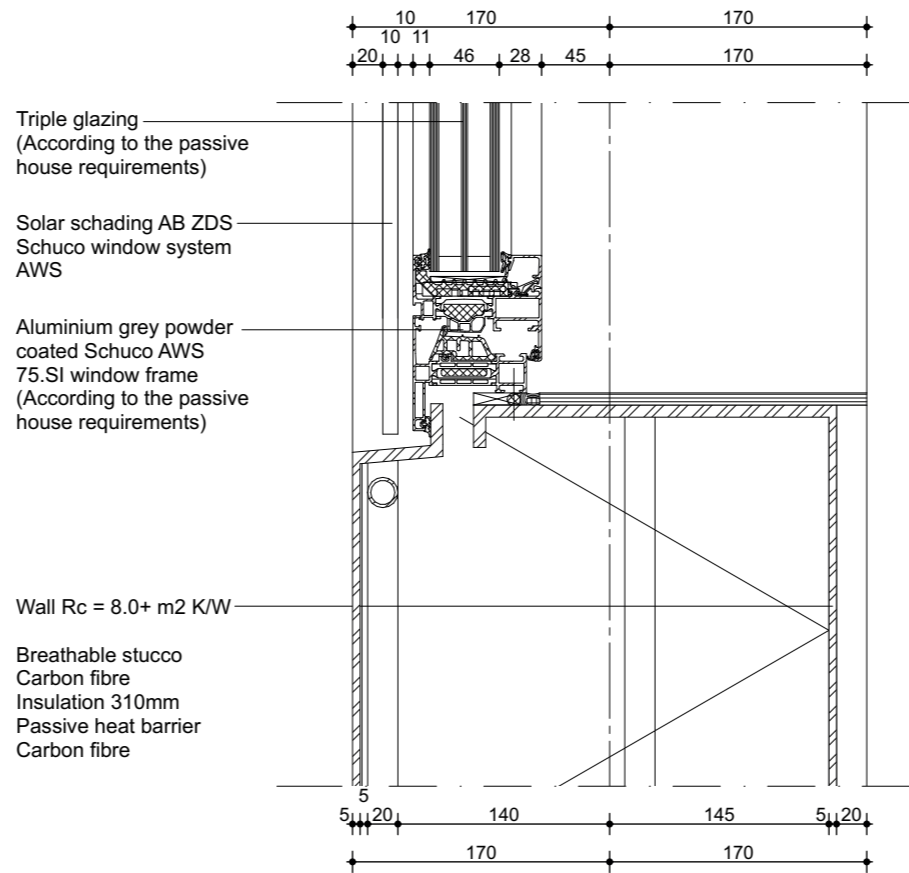



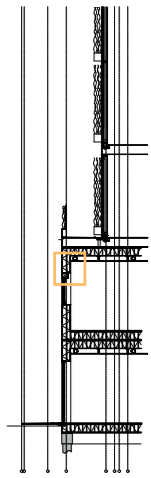

▽ P +5680

▽ P +5470

Wall Rc = 8.0+ m2 K/W

Breathable stucco  
Carbon fibre  
Insulation 310mm  
Passive heat barrier  
Carbon fibre

Solar shading AB ZDS  
Schuco window system  
AWS

Aluminium grey powder  
coated Schuco AWS  
75.SI window frame  
(According to the passive  
house requirements)

Triple glazing  
(According to the passive  
house requirements)

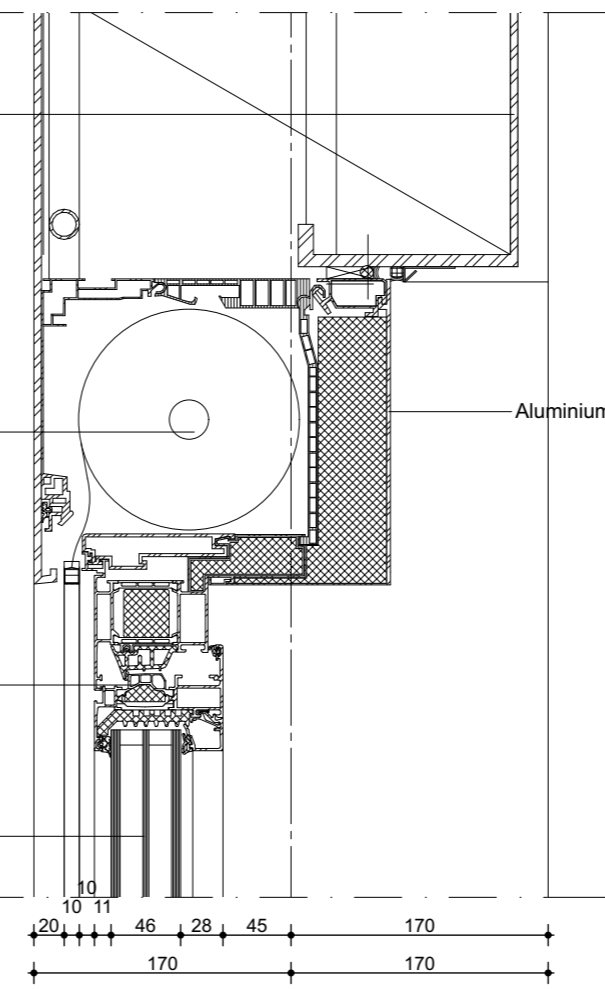

Aluminium cover

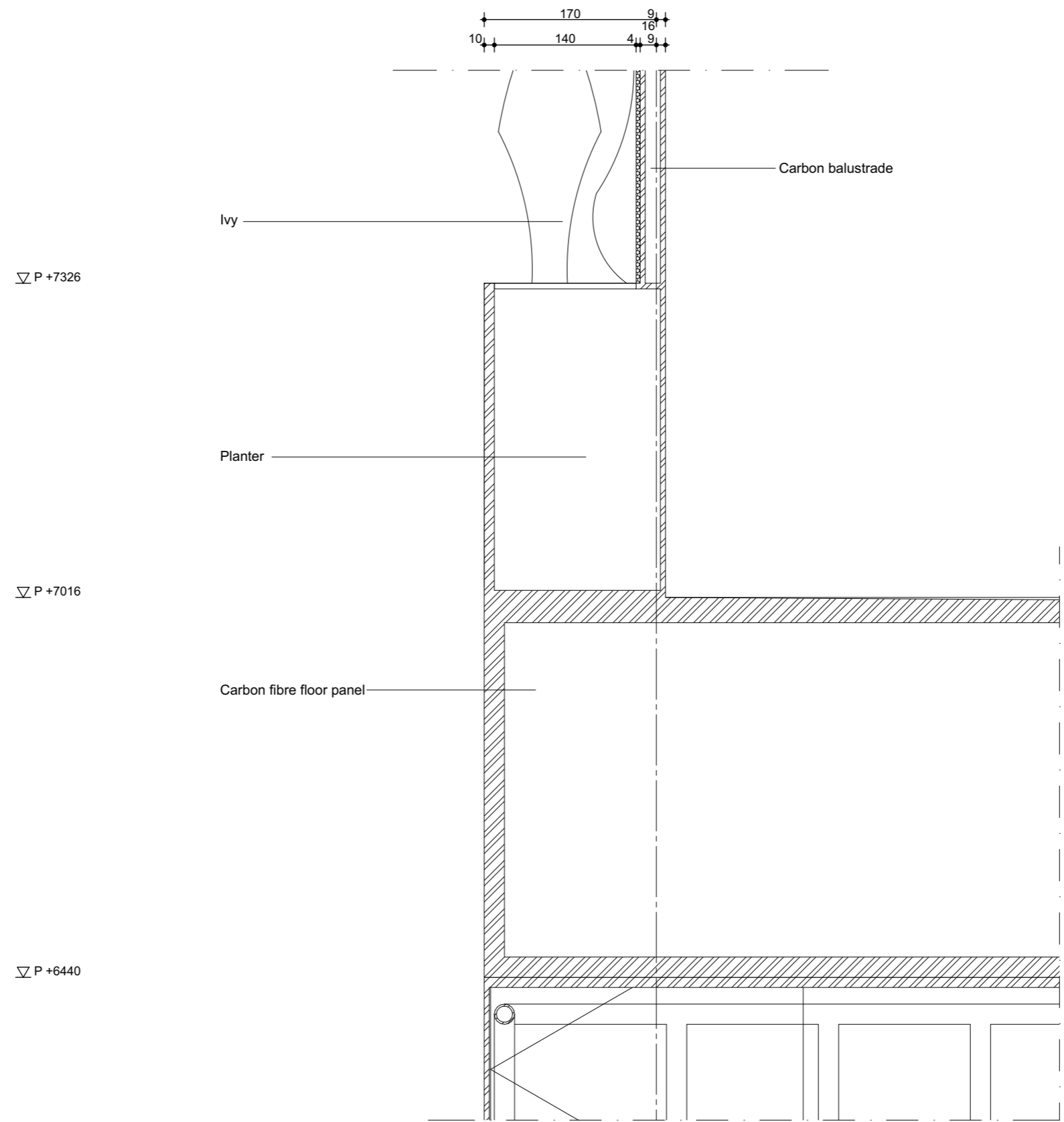
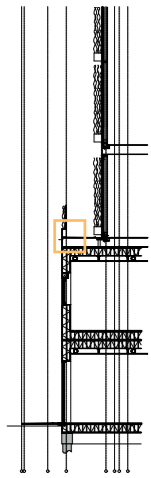

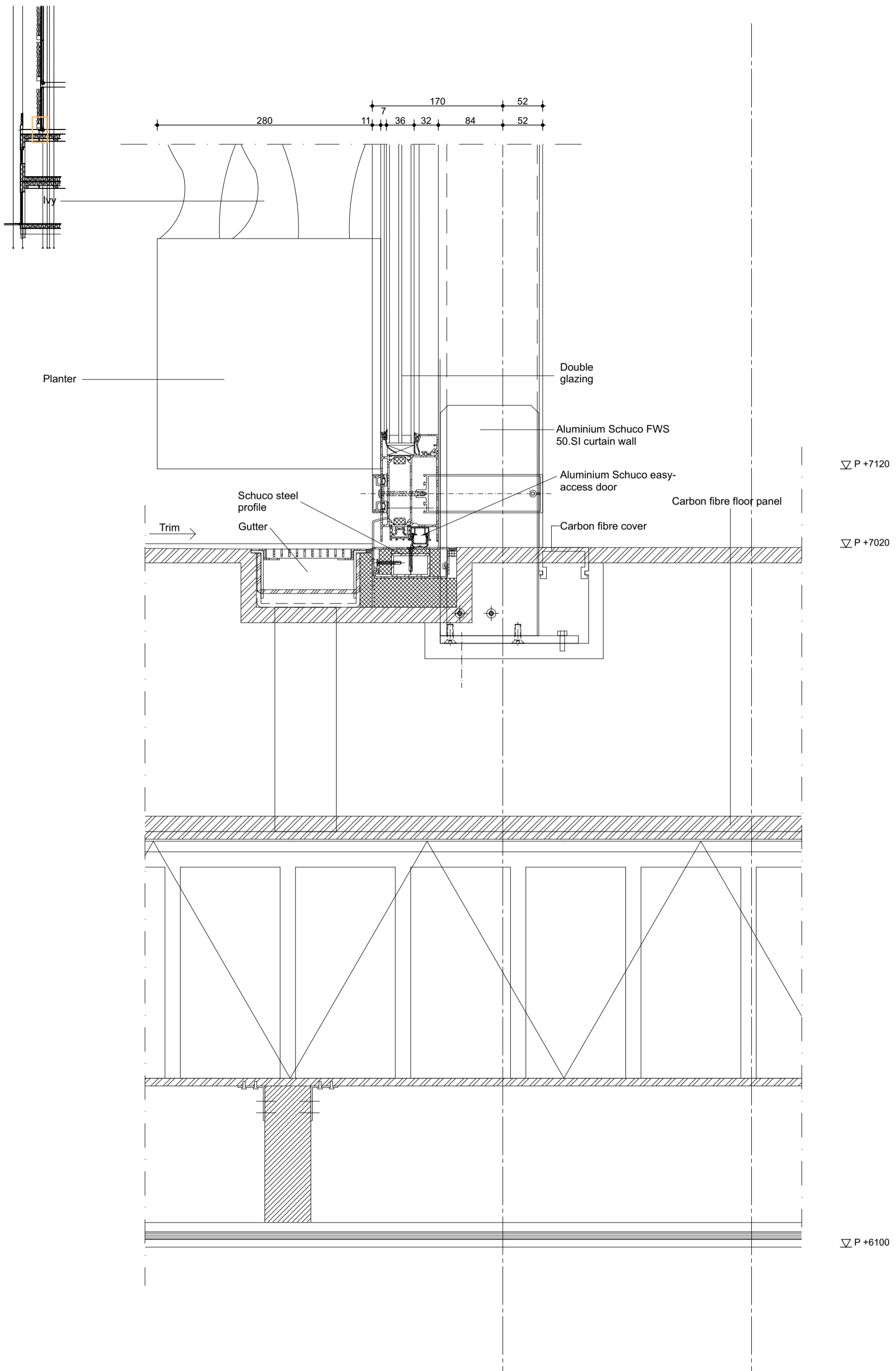

Under connection curtain wall door staircase  
7.08 DETAIL

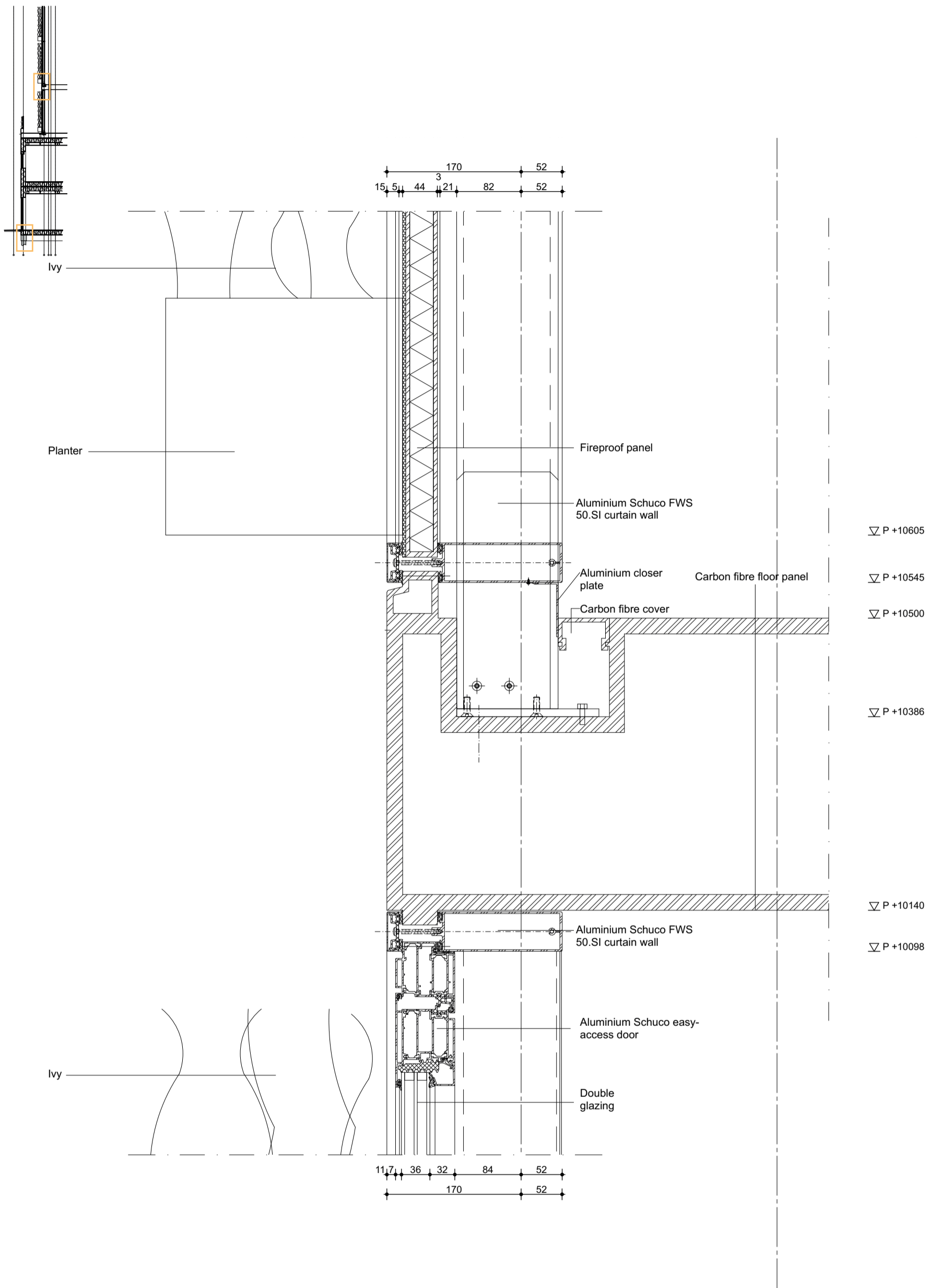

Curtain wall upper door and under panel staircase  
7.09 DETAIL



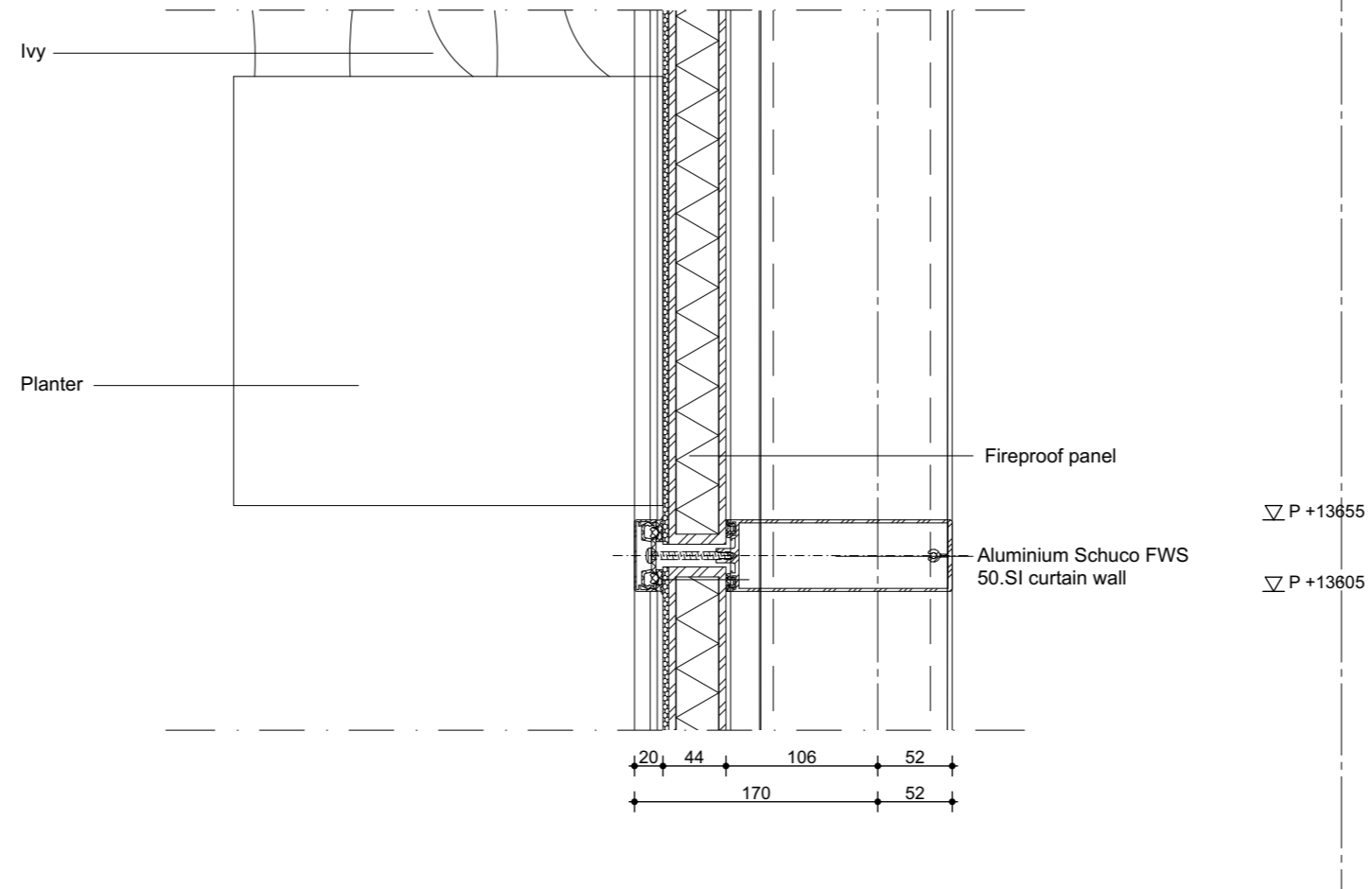
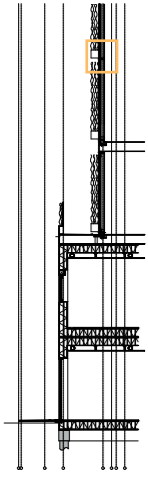

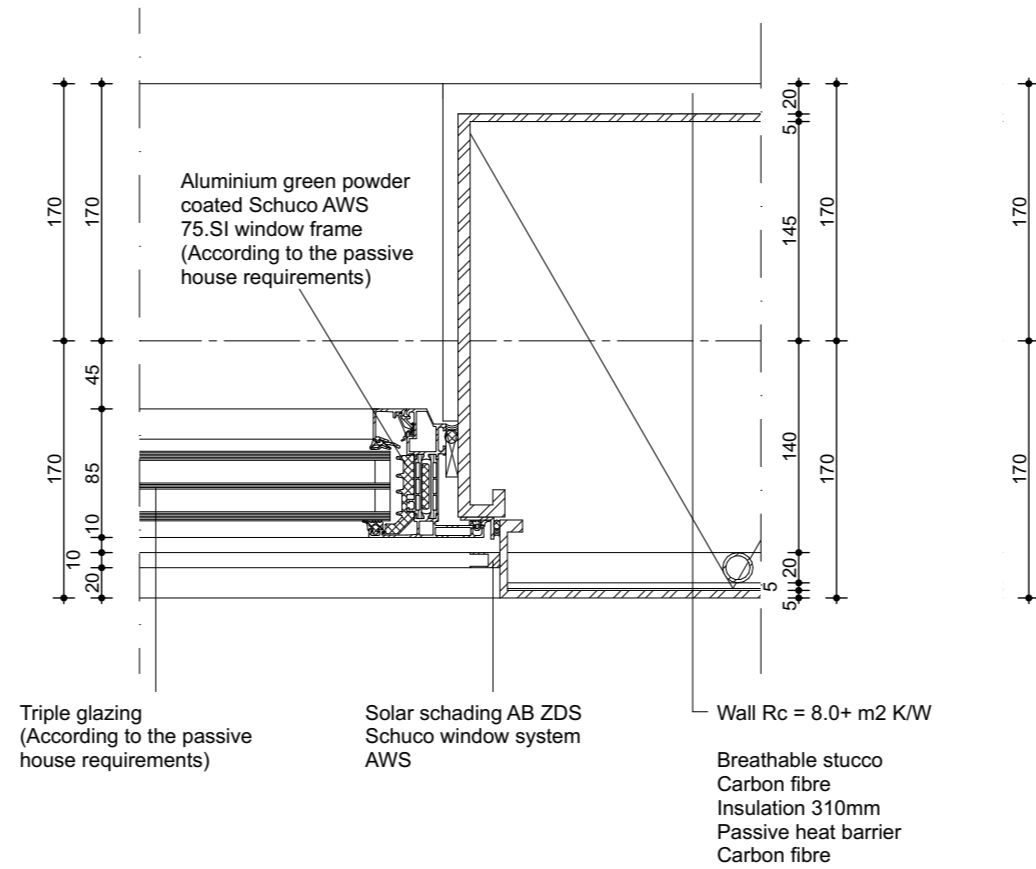
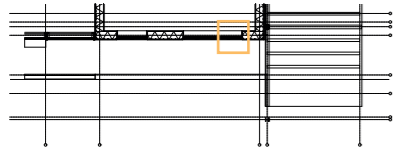

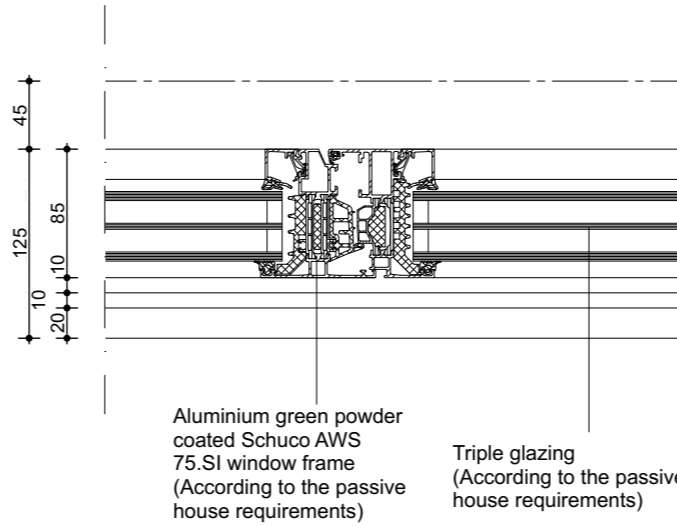
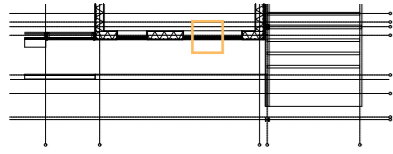



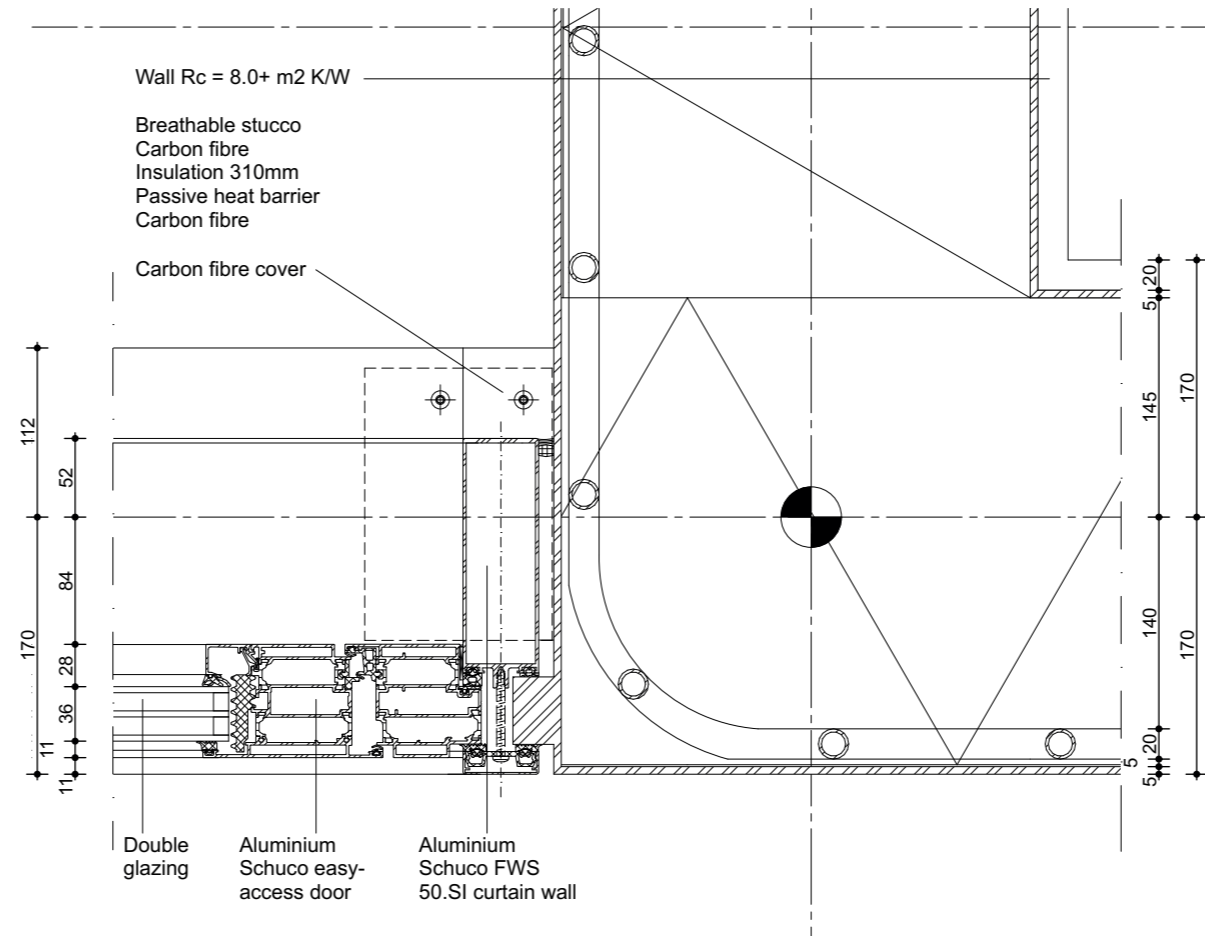
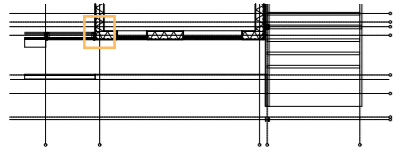

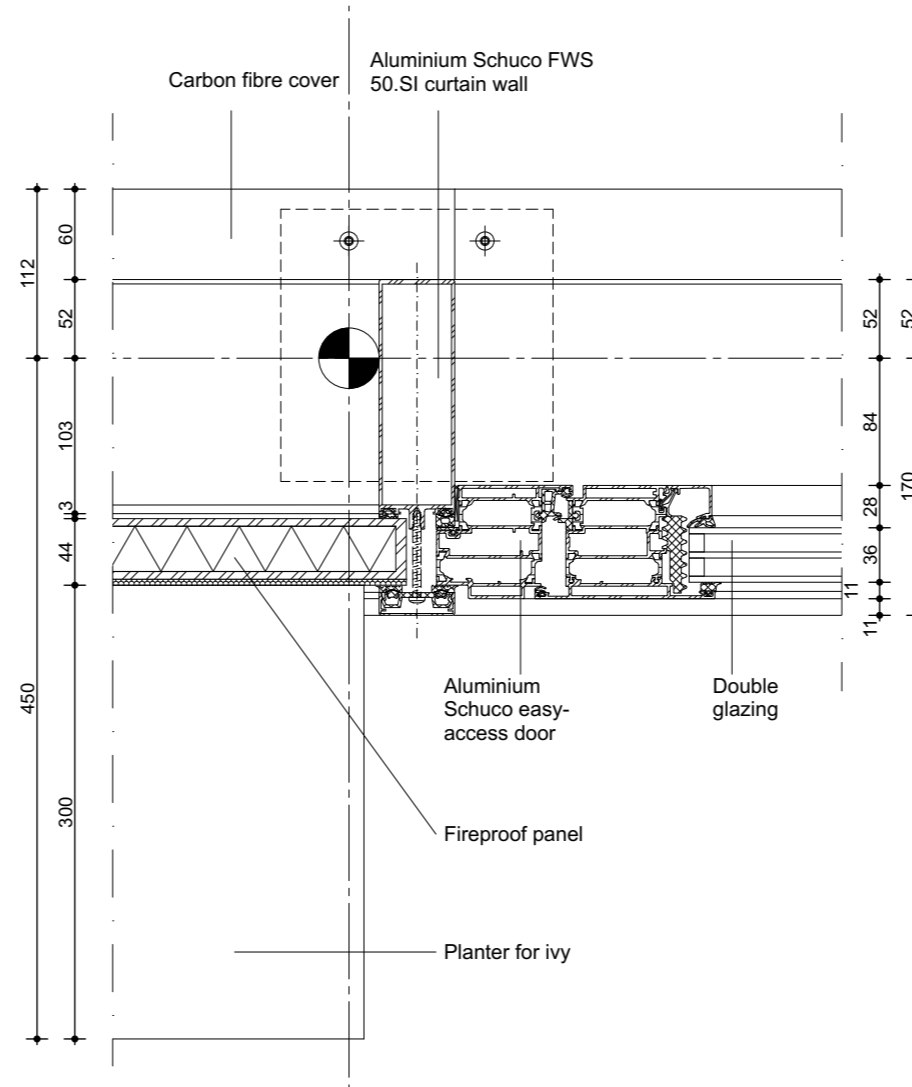
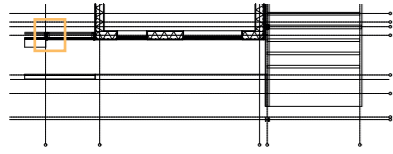

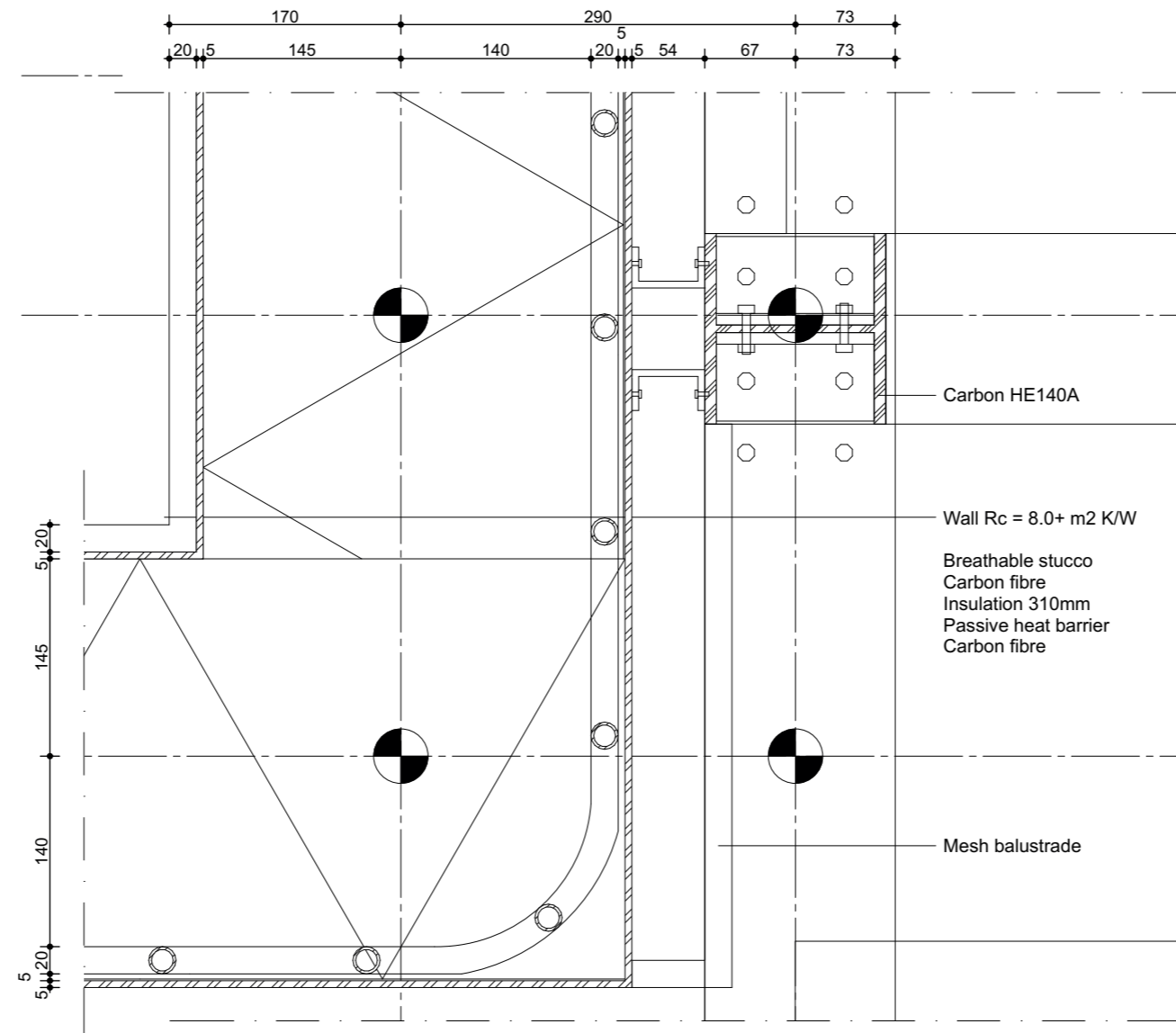



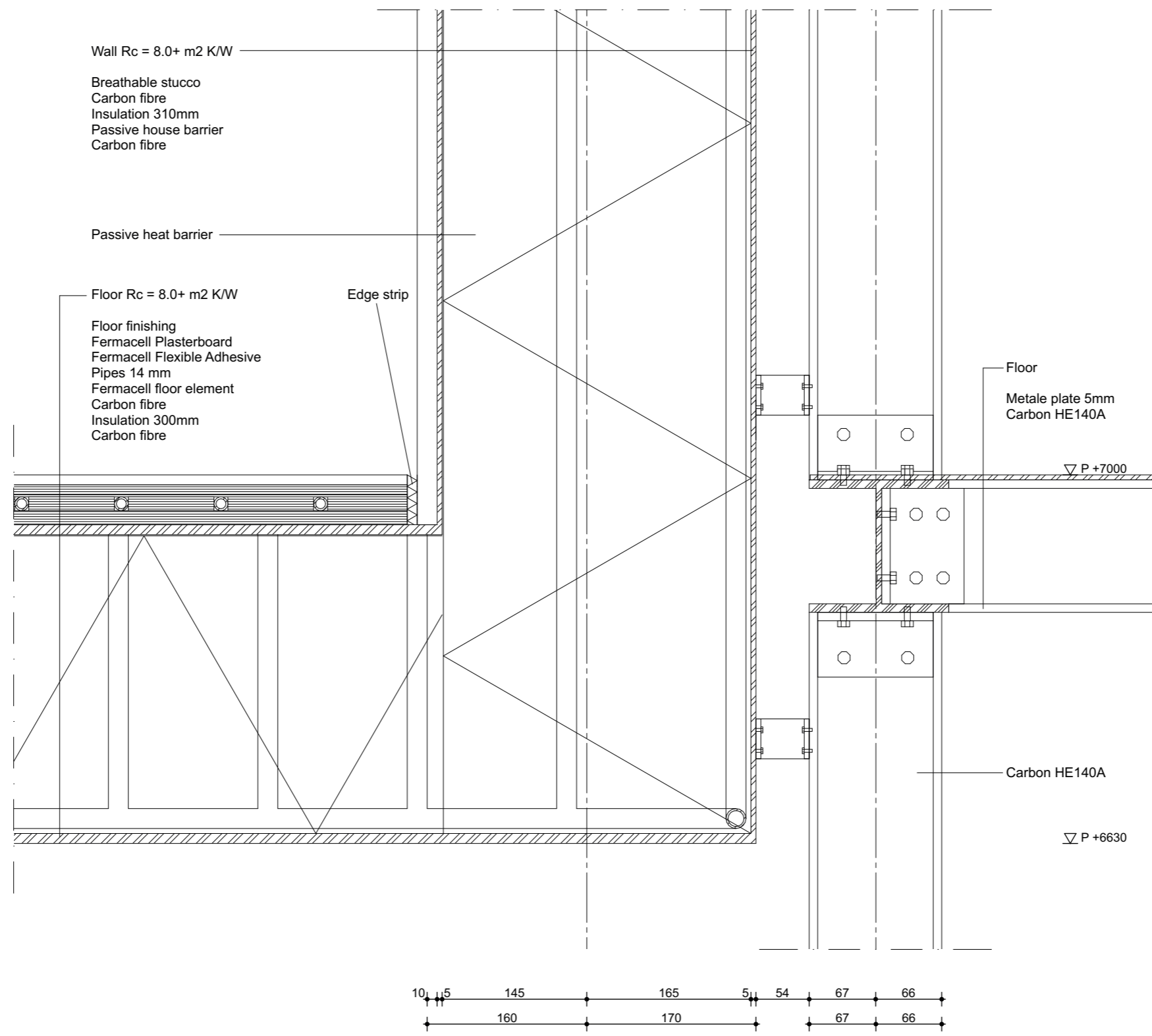

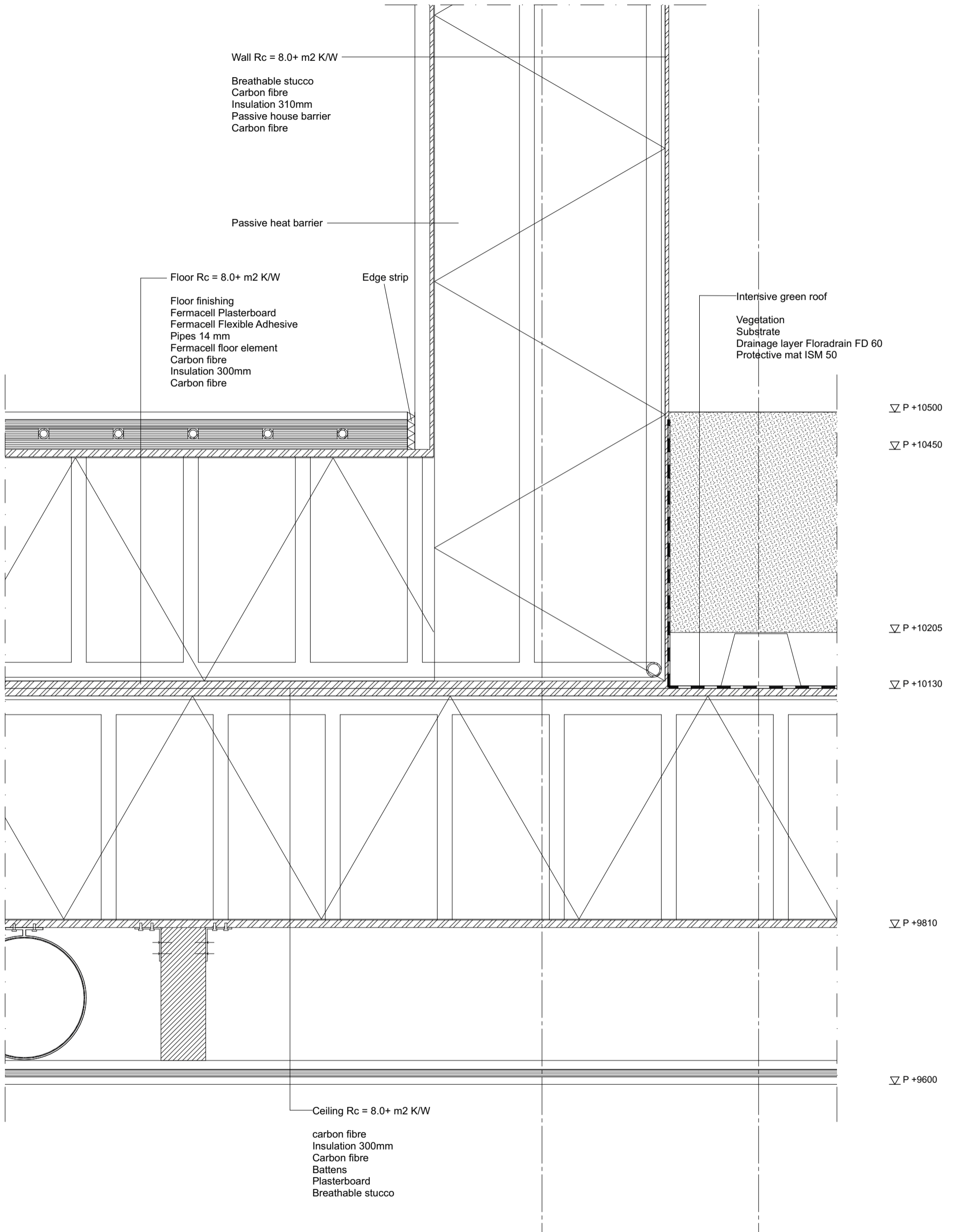
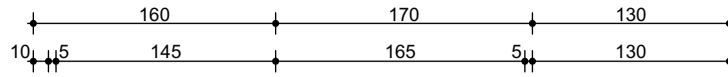

Floor - ceiling - green roof  
7.17 DETAIL



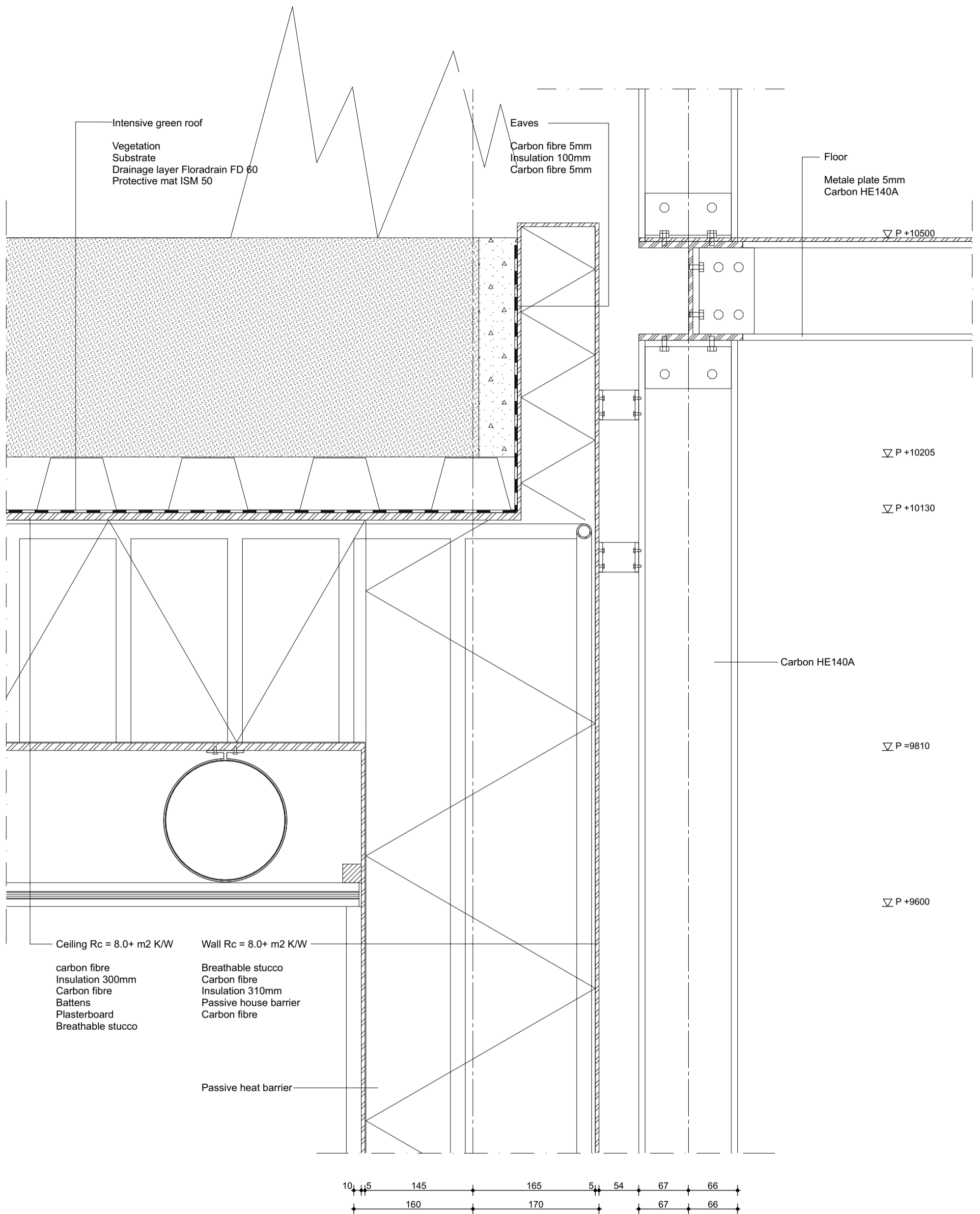

Green roof  
7.18 DETAIL

