



Development of a 3D printed patient specific Ankle Foot Orthosis

Master thesis
Ewoud Veltmeijer



Colofon

Master thesis

MSc. Integrated Product Design
Faculty of Industrial Design Engineering
Delft University of technology
The Netherlands
23 April 2019

Author

E. (Ewoud) Veltmeijer
e.veltmeijer@gmail.com
4207920

Supervising chair

Dr. ir. Doubrovski, E. L.
Mechatronic Design
Department of Design Engineering
Faculty of Industrial Design Engineering

Supervising mentor

Jellema, A. H., MSc.
Applied Ergonomics & Design
Department of Industrial Design
Faculty of Industrial Design Engineering

Supervising company mentor

Ten Cate, W. J. A., MSc.
Centrum Orthopedie Rotterdam
Haastrechtstraat 7, Rotterdam



Executive summary

Patients diagnosed with drop foot syndrome experience difficulties creating enough clearance during walking, resulting in stumbling over very small obstacles. An Ankle Foot Orthosis is an orthopaedic aid which limits the plantar flexion of the foot, providing a safe walking gait for the patient.

Currently, these AFOs are vacuum formed over a machined foam reproduction of the patients leg. The patient specific geometry requirements make it ideal for the one-off production freedom of 3D printing. This master thesis investigated the feasibility of 3D printing a patient specific Ankle Foot Orthosis and explored the possible improvements compared to the current vacuum formed AFOs.

The current vacuum formed AFOs provides suboptimal support and increases the energy cost of walking, this was taken into account when deciding the approach for this project. The approach was divided in the creation of an improved walking support and the investigation to other possible improvements of 3D printing.

A new spring system was developed which provided the minimal required support during walking: free dorsiflexion and a constant counter moment during plantar flexion for every ankle. Rigged

bending tests which simulated the ankle range of motion showed near perfect support results. However, the improved effect on the patient's gait could not yet be proven. This was due to an imperfect testing prototype, the required low tolerances of the spring system which could not be met and the fact that the springs were not strong enough.

Several design improvements have been proposed and can be found in the last chapter

A proper footplate can only be produced with SLS printing. SLS printing a full AFO will cost XXXX but a segmentation into two parts resulted in an average production cost of XXX per AFO. The calf plate could also be printed in FDM reducing the production cost but also the quality.

For COR, the best continuation of this project would be to use the gathered requirements and design improvements to develop a simple 'plantar flexion stop AFO'. If an orthosis with sufficient support is developed, gradual dynamic improvements can be implemented to allow for more freedom of movement.

Figure 1: The functional prototype

Figure 2: (right) the final SLS design with the improvements but it does not contain the spring system as seen in figure 1





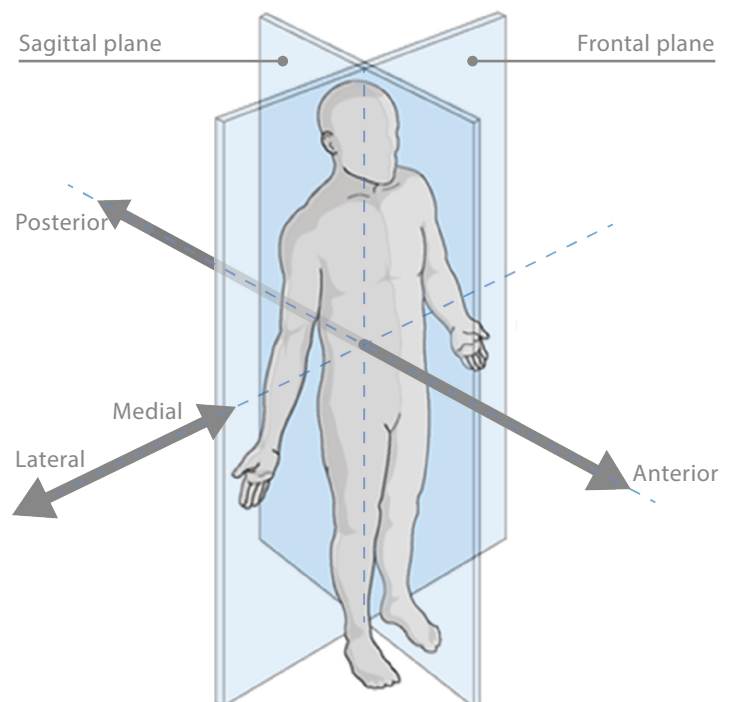
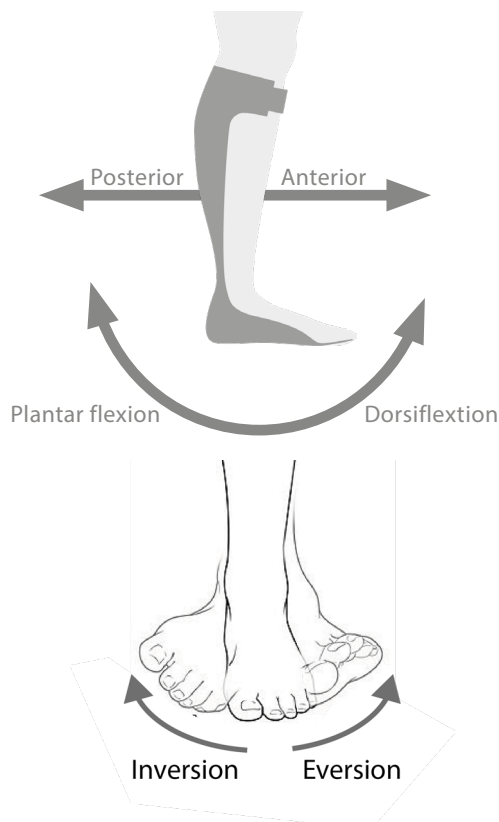

TABLE OF CONTENTS

4	Executive summary	60	5. Embodiment
9	Glossary	61	5.1 Approach
10	1. Introduction	61	5.2 2D functional prototype
11	1.1 Introduction	64	5.3 Mathematical approach
12	1.2 Approach	66	5.4 Geometrical parameter extraction
13	1.3 COR	70	5.5 3D functional prototype
14	2. Analysis	73	5.6 Improving the moment output
15	2.1 Scope with regard to the type of AFO	78	5.7 Material analysis
16	2.2 Production at COR	80	6. Evaluation
19	2.3 The PLS-AFO	81	6.1 Personal walking test
20	2.4 Who is involved?	82	6.2 Patient walking test
28	2.5 Production process integration	84	6.3 Conclusion
34	2.6 3D printed AFOs	85	7. SLS Optimization
35	2.7 Gait analysis	86	7.1 Design for discretion
45	2.8 Anatomical boundaries	88	7.2 Stiffness adjustments
46	2.9 Post production adaptability	89	7.3 Adaptability
47	2.10 Possible 3D print techniques	90	7.4 Sliding of the foot plate
47	2.11 Extra boundaries	91	7.5 Breathable solution
48	3. Design brief	94	8. Advise for COR
49	3.1 Design brief	95	8.1 Continuation of the project
50	4. Synthesis	98	9. References
51	4.1 Start of the ideation	99	9.1 Literature references
54	4.2 Ideation	101	9.2 Other references
54	4.3 Program of requirements	102	9.3 Image references
56	4.4 Conceptualization	104	11. Appendix
58	4.5 Concept selection		

Glossary

Orthosis	Brace, supports the function of a body part
FDM	Fused Deposition Moulding, 3D printing technique which positions a melted filament string
SLS	Solid Laser Synthering, 3D printing technique which melts and fuses powdered material with a laser
Hemiparetic	Weakness in one side of the body
Hemiplegic	Complete paralysis of one side of the body
Physiatrist	Doctor specialized in rehabilitation
Delivery	Handing over the product to the client, checking the fit and making small adjustments.
Foot plate	Bottom of the AFO which fits around the foot (term used in this report only)
Calf plate	Top part of the AFO which is located on the calf (term used in this report only)
Malleoli	The bony prominence on either side of the ankle



INTRODUCTION

1. INTRODUCTION

This chapter introduces the report and what approach i took to tackle the project.



1.1 Introduction

'Foot drop' or 'drop foot' syndrome (DFS) is the name for a phenomenon indicating a certain dropping of the foot during walking (Michalina et al., 2017). Due to a muscular weakness or paralysis in the lower leg the patient diagnosed with drop foot syndrome is not able to create enough clearance during their gait, resulting in stumbling over obstacle of only a few millimeters high. Next to that a loud slap is heard when every time the foot of the impaired leg hits the ground known as 'foot slap'. The reduced or absent dorsiflexion capabilities (upward rotation of the foot) is caused by, among others, nervous problems, brain and spinal cord disorders, diabetes and trauma (Foot drop, 2016). To prevent stumbling and foot slap, the patient could wear an Ankle Foot Orthosis (AFO). This orthopaedic brace limits the ankle movements and prevents the foot from downward rotation (plantar flexion). AFOs are frequently prescribed to patients with weakened or paralysed ankle dorsiflexor muscles (Gebroers, et al., 2002).

There are many types of mass produced AFOs which provide an appropriate solution to the general public, but there is also a patient group for which these conventional AFOs are not suitable. This project focusses on the latter and the production of a custom-made patient specific AFOs.

Currently, these custom-made AFOs are produced via 3D scanning, CNC milling and vacuum forming. **This product design has been around for decades** and is comparable to a US patent filed in 1981 (Mason et al., 1981).

Centrum Orthopedie Rotterdam (COR) is a company which produces custom-made prosthesis and orthoses. With the growth of 3D printing, the company is looking for ways to renew the traditional production processes, to reduce production costs and to meet more accurately the patients' health care demands. Changing the production method from vacuum forming to 3D printing might create new design opportunities which could improve the function of the AFO. It also generates a new possibilities to investigate the actual demands for an AFO to more accurately meet the patient health care demand and improve their wellbeing.

Accordingly, the goal of this thesis is:

'To develop a 3D printed patient specific Ankle Foot Orthosis and to investigate the feasibility of integrating it into the production process of COR'

1.2 Approach

Design based approach

The project was divided in three phases: the analysis, the synthesis and the embodiment phase to eventually end up with a working prototype and recommendations regarding 3D printing an AFO for COR. The process is visualized in Figure 1.

Analysis

The goal of the analysis phase was to gather all the needed information to design an AFO. The collaboration sessions with the orthopaedic technicians at COR were used to evaluate the collected knowledge (Orthopaedic technicians are certified to create orthoses and prosthetics for patients). Throughout the analysis, the scope of the project was defined to keep it within realistic boundaries. The gathered knowledge was used to define a problem statement and a design direction, which was the starting point for the next phase.

Synthesis

After the analysis phase ideas were generated to create design solutions. The most promising design solutions were more extensively developed in the conceptualization phase and eventually one final concept was chosen.

Embodiment

During the embodiment phase the final concept was improved through various steps and eventually evaluated with a user test with a patient diagnosed with DFS. After the evaluation, one more optimization was executed to create the final concept and all the gathered knowledge was transferred into an advise for the company.

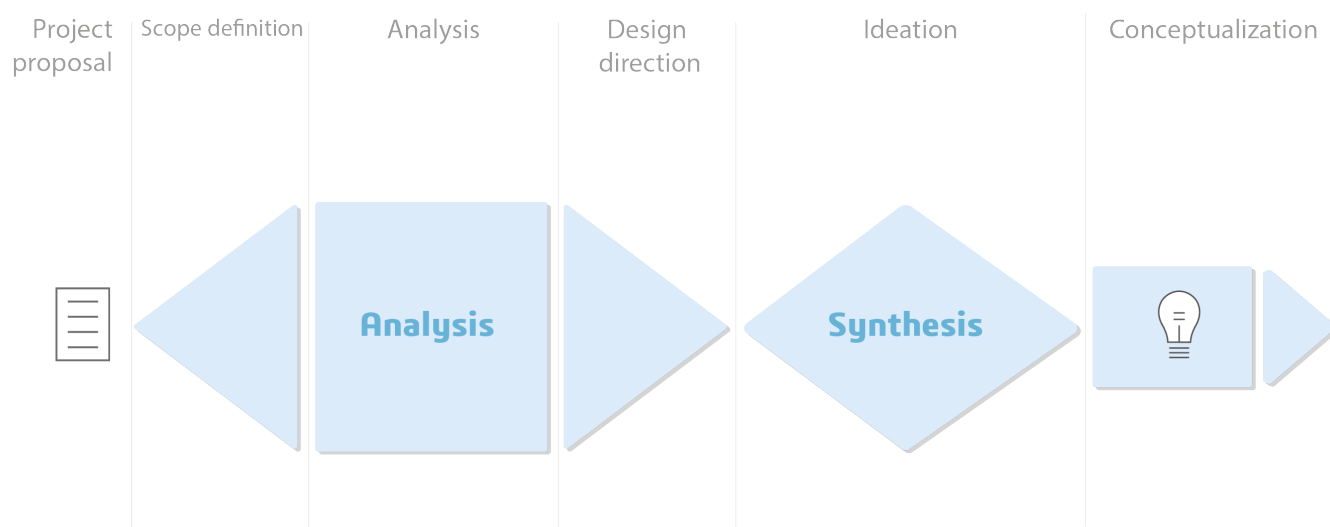

Figure 1: Process visualization.

1.3 COR

As explained in the introduction, this project was initiated by COR. They allowed me to work at their location in Rotterdam. The ability to work at their office lead to the close co-operation with the Orthopaedic Technicians (OTs, plural) of COR. An orthopaedic technician (OT) is educated and certified to develop and test orthopaedic aids. The OTs were a vast source of information and easily approachable. Via various feedback sessions they have shared their knowledge of the complex world of orthosis development.

Improvements

Evaluation

Optimization

Final concept

Advise

Embodiment

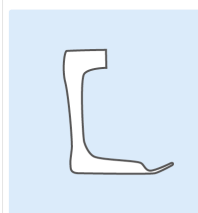

2. ANALYSIS

2. ANALYSIS

This chapter contains the gathered knowledge which is needed to design a new 3D printed AFO. Several different topics, for example the relevant stakeholders, the gait and the anatomical boundaries will be addressed. This chapter will finish with a problem statement and a design direction to solve it.

The image shows a person in a white striped shirt kneeling on a grey floor, measuring a person's foot. They are using a green device with a white ruler. The person being measured is wearing light blue shorts. In the bottom right corner, there is a form titled 'EVO' with various fields and a logo.

EVO	
Name	
Address	
City	
Country	
Phone	
Other	
Signature	
Date	

© EVO

2.1 Scope with regard to the type of AFO

There are many types of Ankle Foot Orthoses (AFOs, plural), the most common are shown below.

Solid or AFO

This type of AFO covers the malleoli (the two strongly defined knobs on the ankle joint) and blocks all ankle motion.



Posterior Leaf Spring AFO

The PLS-AFO is similar to the solid AFO but has a thinner posterior design which allows for more ankle dorsi- and plantar flexion.



Hinged or articulated AFO

This subgroup consists of all AFOs with a physical hinge which provide medial and lateral support to prevent sideways tilting of the ankle, next to that it also influences dorsi- and plantar flexion



Floor Reaction AFO

The floor reaction AFO has an anterior shell instead of a posterior one and has a high level of rigidity. Its sturdy design creates a moment in the knee joint forcing it into extension to relieve the quadriceps.



Night splint

This AFO is only for nocturnal use and is design to influence the length of the calf muscles, it can be both dynamic and static (Ambroise, n.d.).



Miscellaneous

There are many other small categories of AFO's, each with its own special characteristics. There are, among others, supra malleolar orthoses, carbon fibre AFO's and metal PLS-AFO's



Figure 2: (top left) Solid AFO (adapted from Kevin orthotics, n.d.).

Figure 3: (top right) PLS-AFO (adapted from Lakeland orthotics, n.d.).

Figure 4: (middle left) Floor Reaction AFO (adapted from Trulife, n.d.).

Figure 5: (middle right) Hinged AFO (adapted from Arizona afo, n.d.).

Figure 6: (bottom left) Night splint (adapted from Ambroise, n.d.).

Figure 7: (bottom right) Metal and leather AFO (adapted from Cascade, n.d.).

Confident

trial chapter

Conclusions

Form the specifications of the types of AFO and the production at COR the scope regarding the type of AFO can be narrowed down.

Solid AFO / PLS-AFO

Most of the patients of COR who need a custom-made AFO need a Solid AFO or a PLS-AFO, therefore this was selected as the main focus point of this project. Yet, because the Solid AFO is in fact a rigid version of the PLS-AFO it is important to solve the more complex dynamic situation of the PLS-AFO first.

Night splints

The night splints are removed from the scope because the purpose of night splints is to slowly adjust or maintain a certain muscle length (Ambroise, n.d.) whether the purpose of a day AFO is to influence the patient's gait.

Floor Reaction AFOs

The kinetic situation of a Floor Reaction AFO is completely different from a Solid AFO or a PLS-AFO and the patients have different diagnoses, therefore this category was also removed from the scope as well.

Hinged AFOs

The occurrence of this type of AFO at COR is notably low. According to the OTs at COR this is due to the fact that not every patients need the current voluminous hinged AFOs and a PLS-AFO is often sufficient. However, this is the case with the current types of Hinged AFOs and PLS-AFOs, a new 3D printed AFO might influence this.

No scientific proof has been found that a Hinged AFO performs better than a PLS-AFO. Only one specific Hinged AFO, the Chignon orthosis, showed better results for hemiparetic adults (Bleyenheuft et al., 2008) and hemiplegic adults (Bruguete et al., 2011). It is difficult to foresee if a hinged 3D printed AFO could improve the patient's gait, therefore the hinged AFO is removed from further analysis but a hinged solution for the project is still possible outcome.

Miscellaneous

This category contains the strange cases with individual solutions with large differences with the rest of the AFOs. Next to that, their occurrence is too low that it would financially not be wise to focus on for COR. Therefore, this group will not be addressed during this project.

SUMMARY

The scope of this project was limited to a custom-made PLS-AFO. Suggestions with regard to the Solid AFO will be added at the end of this report. The Floor Reaction AFO, the Hinged AFO, night splints and miscellaneous categories were removed from the scope of this project.

2.3 The PLS-AFO

A detailed description of the most important aspects of a PLS-AFO (hereinafter AFO) is shown in Figure 11.

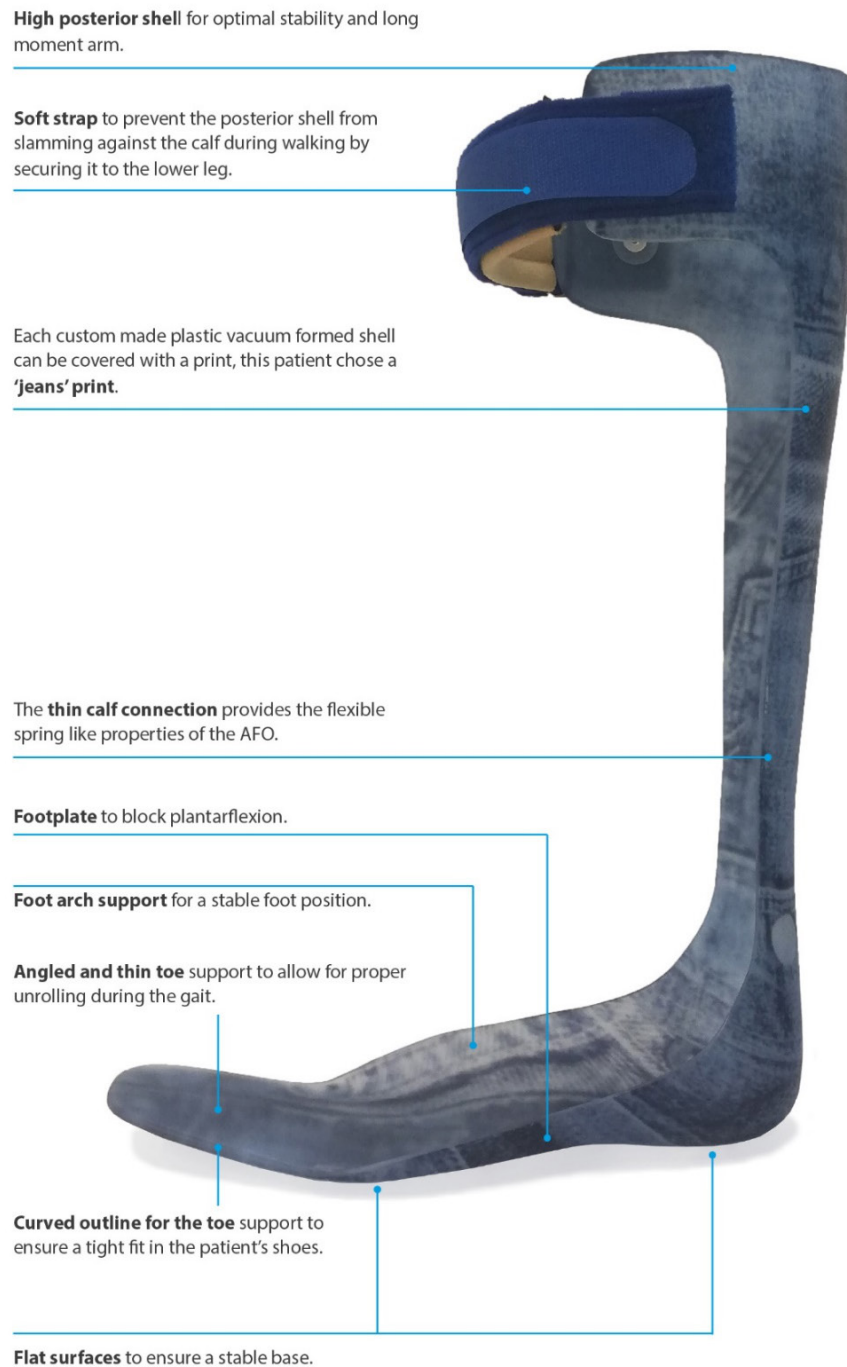

Figure 10: Detailed explanation of a PLS-AFO

General working principle

As explained before, an AFO is a solution to account for the absence of dorsiflexion abilities of the patient, but how does it work? Imagine a situation where the lower leg is suspended in the air (Figure 11, 1). In this situation the dorsiflexion muscles counteract the effect of the gravity on the foot and keep the foot horizontal (2). For patients diagnosed with DFS these dorsiflexion muscles do not work properly and the gravity will pull the foot towards plantarflexion (3). To compensate for the absence of these muscles a force is needed which counteracts the clockwise moment around the ankle (4), F_{foot} reaction. The AFO creates this force via its 'L' shaped design which transfers the reaction force created from pressing against the calf towards the ball of the foot, preventing the foot from dropping down (5). This can only be achieved if the AFO is worn inside a tightly fastened shoe, otherwise the AFO would simply fall down (6). If the shoe is too loose the same effect will happen but inside the shoe, reducing the effect of the AFO.

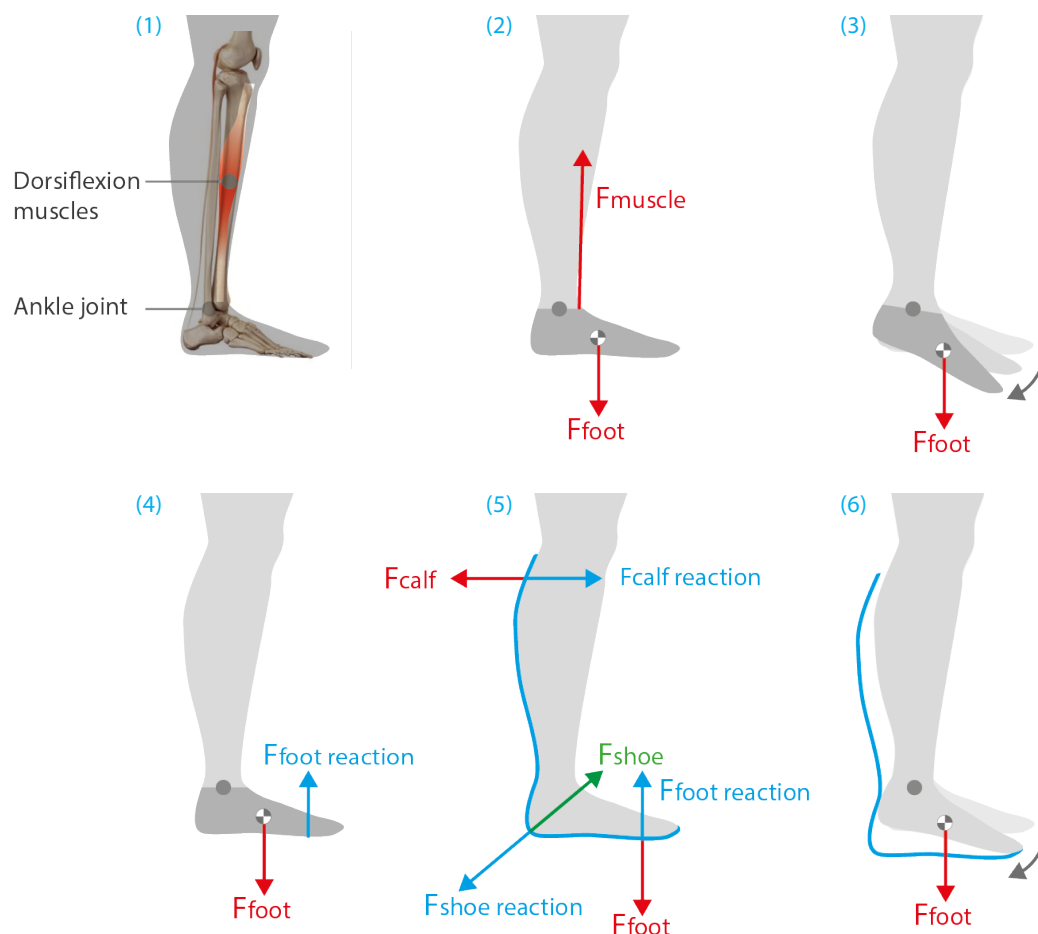

Figure 11: The working principle of an AFO

2.4 Who is involved?

When designing an AFO it is important to understand the demands of the stakeholders to make an optimal design. To map who the relevant stakeholders are, the establishment of an AFO was analysed from the initial health care demand until the relieve from health care (Figure 12 on page 23).

The following steps explain the diagram to the right:

- 1 The patient arrives at the physician with a health care demand. The physician refers him to a specialist. The physician cannot directly refer the patient to COR because the insurance requires a diagnosis of a specialist.
- 2 The specialist makes a diagnosis and creates a health care strategy to treat the patient. If the health care strategy involves the need for an orthosis the specialist refers the patient to an orthopaedic brace producer. Sometimes the patient arrives at the specialist via a physiotherapist or another medical trajectory.
- 3 At the intake the orthopaedic technician assess the patient and defines the required type of the orthosis and the trim lines. If this orthosis is a custom-made AFO, the patient's leg will be 3D scanned and measured.
- 4 A different orthopaedic technician analyses the scan and measurements to create a CNC file of the mould of the orthosis.
- 5 An external company will CNC machine the mould.
- 6 When the mould arrives at COR, the workshop produces the AFO corresponding to the trim lines and measurements determined at the intake meeting.
- 7 Two weeks after the intake meeting the orthosis is ready for delivery. The orthopaedic technician who assessed the patient before will now check the orthosis' fit and adjust any imperfections. If he is satisfied, he will hand over the orthosis to the patient.
- 8 A final check is performed by the specialist to see if the orthosis fits the health care strategy of the patient. If so, the patient will be referred to an other health care trajectory or relieved from healthcare. If not, the specialist will send the patient back to COR to get the orthosis adjusted.
- 9 If the patient experiences troubles with the orthosis, he will return to the specialist with complaints or immediately go to COR to get it fixed.

The diagram shows 6 stakeholders: The patient, the physician, the specialist, the physiotherapist, COR and the insurance carriers. The physician is regarded as not relevant since he only refers the patients to a specialist. The demands of the relevant stakeholders are explained in the next pages.

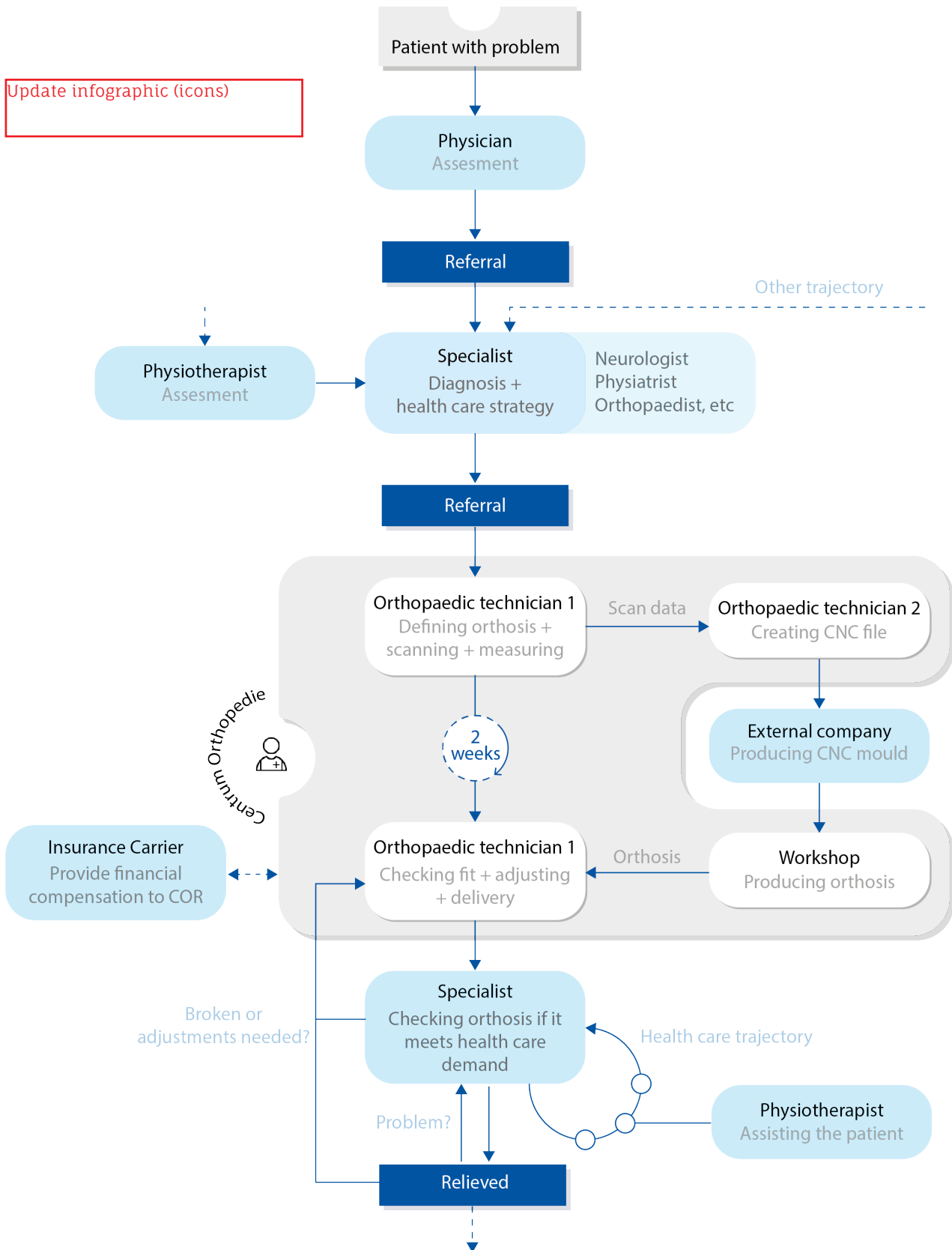

Figure 12: The process of the establishment of an AFO

Relevant stakeholders

The next pages go more in depth on the main stakeholders. This information regarding the stakeholders was gathered by interviewing 1 physiatrist, 2 physiotherapists, 4 Orthopaedic technicians of COR, 1 CEO of COR, 1 patient with an underdeveloped leg due to polio 74y/o and 1 with nerve trauma but fully recovered 29y/o.

PATIENT

Main goal

Go back to normal way of living

Subgoals

- Normal, comfortable and safe walking gait
- Not standing out

Other wishes

- Wear multiple kinds of shoes (sneakers, heels, formal shoes, etc.)
- Wear same shoe size as before (due to the thickness of the AFO the shoe size of the foot increases resulting always in one shoe with an improper fit.
- Breathable solution
- Lower energy cost of walking
- Less sticky on the skin
- Biking
- Improved stair locomotion

Age and Sex

The bar chart below (Figure 13) shows the age division for custom-made AFOs at COR (same chart as Figure 8 on page 16). The bar chart shows a clear peak is visible from 60 to 89 years old (66% of total). Next to that, more female wear a 'lower extremities mass-produced orthoses'. It is unknown if this is also applicable to mass produced AFOs. Finally, only a minor differences between man and women are seen with custom-made AFOs and are probably insignificant.

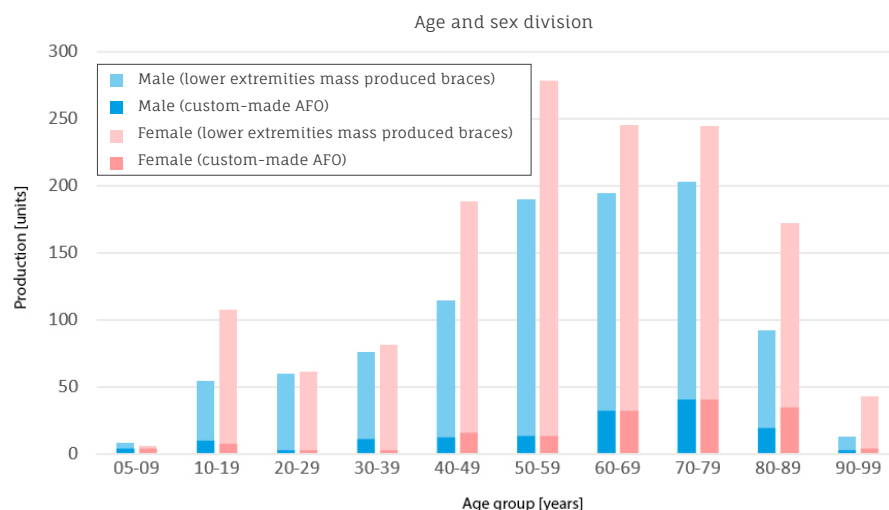

Figure 13: Age and sex division for custom-made AFOs

The reason behind the decision to use only 2 patient interviews is that the incidents leading to DFS can happen to anybody. Therefore, the patient group is diverse and the personal differences between patients can vary a lot. The two patient interviews were therefore used as indicative input but the perception and knowledge of the specialist, physiotherapists and orthopaedic technicians were used to create an impression of the patients' wishes. They have seen multiple patients and cases and can therefore more accurately explain the important wishes.

Diagnoses

The issues resulting in the diagnosis of DFS can be very different, among others: Neuro infarct, muscular or nervous disorders or brain and spinal cord disorders (MS, ALS, CVA) (Foot drop, 2016). In addition, the patients in need of a custom-made AFO often experience sensibility problems, diabetes, oedema, vascular problems, rheumatism, skin complexions or feet deformation (physiatrist, personal communication, September 18, 2018).

Energy cost of an AFO

A custom-made AFO is a semi-rigid solution which takes energy to bend. This increases the total energy cost of walking for the patients compared to normal healthy adults. Often elderly have a slower walking speed and shorter step length (physiotherapist, personal communication, september 28, 2018) because it takes more effort for them to walk. The effect of the increased energy-cost of walking with an AFO has a higher impact on the elderly patient group resulting in fewer and shorter walks. A more energy efficient solution will probably be of great influence for them.

Dimensions

Because the patient group is diverse, the dimensions are as well. From large young male adults to smaller elderly. From large legs, swollen due to lipoedema (abnormal build-up of fat cells in, among others, the legs (lipoedema, 2017)) to short and underdeveloped legs due to post-polio syndrome (patient, personal communication, October 15, 2018). Figure 14 shows the differences between an AFO of a large male patient and the AFO of an elder patient.



Figure 14: Different AFOs of a large male patient (left) and a smaller elder patient (right)

HEALTH CARE INSURANCE COMPANY



Main goal

Reduce health care cost

Subgoals

- Maintain compensation cluster system. All orthopaedic aids fall under special clusters for which a single financial payment is defined for the producer

Other wishes

- Not relevant

Info

The health care insurance company is the component which pays for the whole process. Their influence is limited, if the specialist claims that the patient needs an orthopaedic aid, the health care insurance company will obey.

Orthopaedic aids are just a fraction of their whole business and therefore they do not show a lot of interest in the production of an orthosis. As long as the current compensation cluster system stays the same, little action is expected from this stakeholder.

COR



Main goal

Sell orthopaedic aids

Subgoals

- Prepare for future developments

Other wishes

- Increase profit (by decreasing the production cost or increasing sales)
- Decrease expenses by creating durable products. (The insurance pays a fixed amount per AFO for product which lasts 2 years, if a product breaks within that time COR will pay the bill)

Info

The orthopaedic technicians at COR have to produce an adequate orthopaedic aids for their patients. While doing so they also have to keep the cost of the orthosis in mind because they only get a fixed compensation per type of AFO.

According to their CEO (personal communication, 2018) preparing for the future is the main motivation behind the investigation of 3D printed orthotics.

SPECIALIST

Main goal

Meet health care demand

Subgoals

- Create a normal and safe walking gait. (Prevent tripping or unstable walking to improve the patient's mobility.)
- 1. Prevent handicap.
2. Keep handicap within limits.
3. Help deal with handicap.
- Keep healthcare costs low.
- Decrease the energy cost of walking.

Other wishes

- Earlier delivery of the AFO to quickly start the health care strategy and limit the negative effects of compensation behaviour. (To compensate for their deficiencies patients learn themselves new abnormal gait pattern. This causes other muscles to show compensation behaviour and might eventually get injured).
- Durable healthcare solution. This means that it fulfils its purpose for a longer period of time.
- Increase comfort
- Easily adaptable when the patient's health care strategy demands an less intrusive AFO.

Info

Any medical specialist can prescribe an orthopaedic aid. Most of the time it is a neurologist, physiatrist or geriatrician.

The specialist is the key factor in the decision-making process, therefore it is of high importance that the specialists' requirements will be met. He is able to select to which orthopaedic aid producer he will send his patients. Therefore, if the specialist is convinced the new AFO better meets the patient's needs, it will be more likely he would refer more of them to COR, instead of COR his competitors.

PHYSIOTHERAPIST

Main goal

Increase mobility to meet health care demand

Subgoals

- Create a normal and safe walking gait. (Prevent tripping or unstable walking to improve the patient's mobility.)
- Decrease the energy cost of walking.

Other wishes

- Earlier delivery of the AFO
- Fit for multiple kinds of shoes
- Fit for same shoe size
- Stair locomotion (if possible)
- Easily adaptable when the patient's health care strategy demands an less intrusive AFO.
- More hygienic solution

Info

The physiotherapist is closely involved throughout the patient's rehabilitation process. Through exercises, massages and other treatments they try to improve the patient's mobility.

They are often well connected to the specialists and can influence them by stating their preferred orthotic device.

Officially only a specialist can make a diagnosis and prescribe an orthosis. Nevertheless, in revalidation centres the prescription is often also made by a physiotherapist because they are more involved in the rehabilitation process and are often well aware of the type of orthotic device the patient needs. The specialist than merely signs the referral to order it. Occasionally, the physiotherapists already have some mass produced AFOs to assess their impact on the patient's gait.

2.5 Production process integration

To investigate if COR is able to integrate a 3D printed AFO into their production, the current production pipelines need to be analysed and a future production pipeline needs to be constructed (Figure 15). This future production pipeline (the goal) is derived from three current production pipelines and an ideal situation. To deduce the necessary changes and requirements to integrate this pipeline in the production process of COR the production steps were analysed in detail, the results are shown in the next paragraphs.

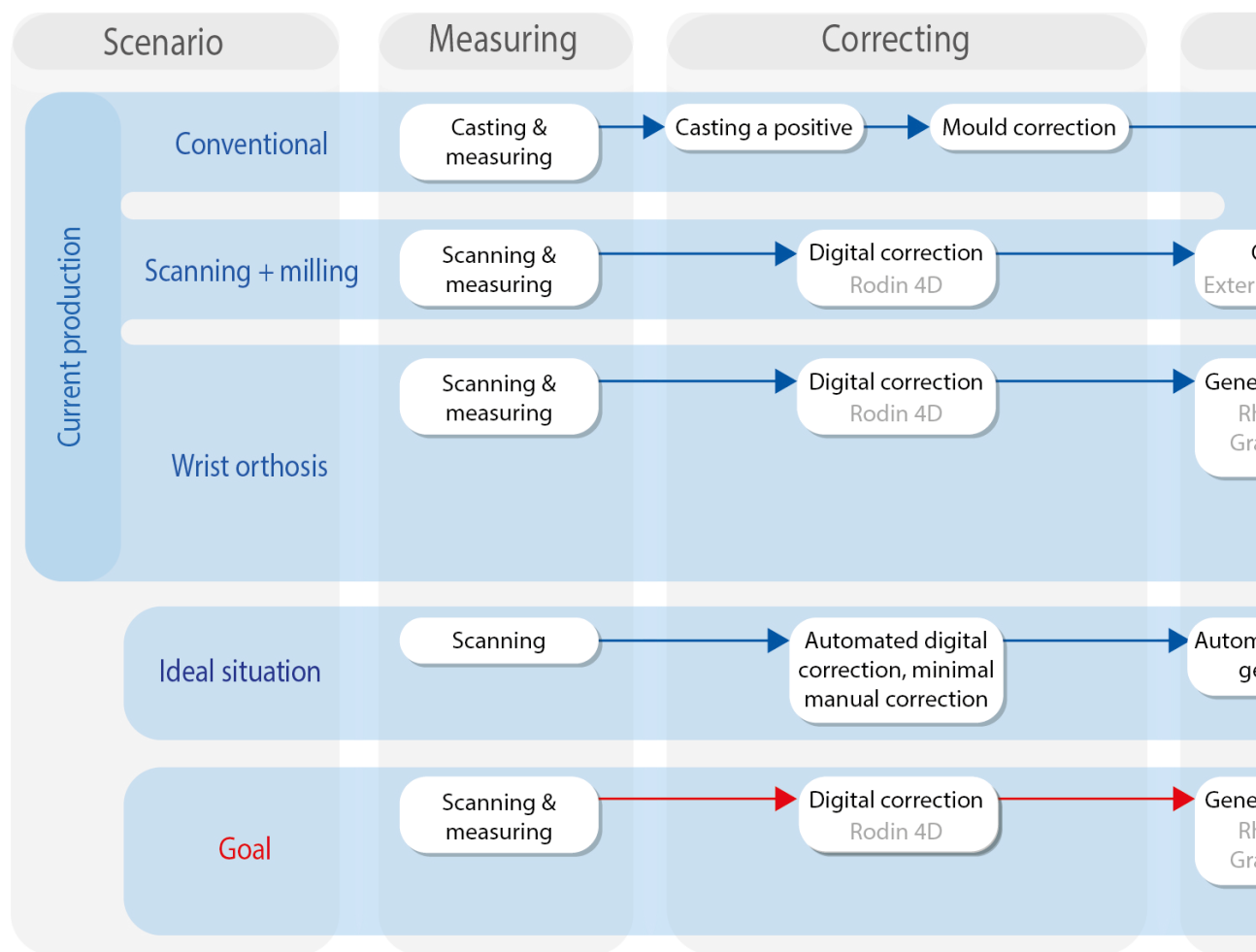

Figure 15: Production pipelines

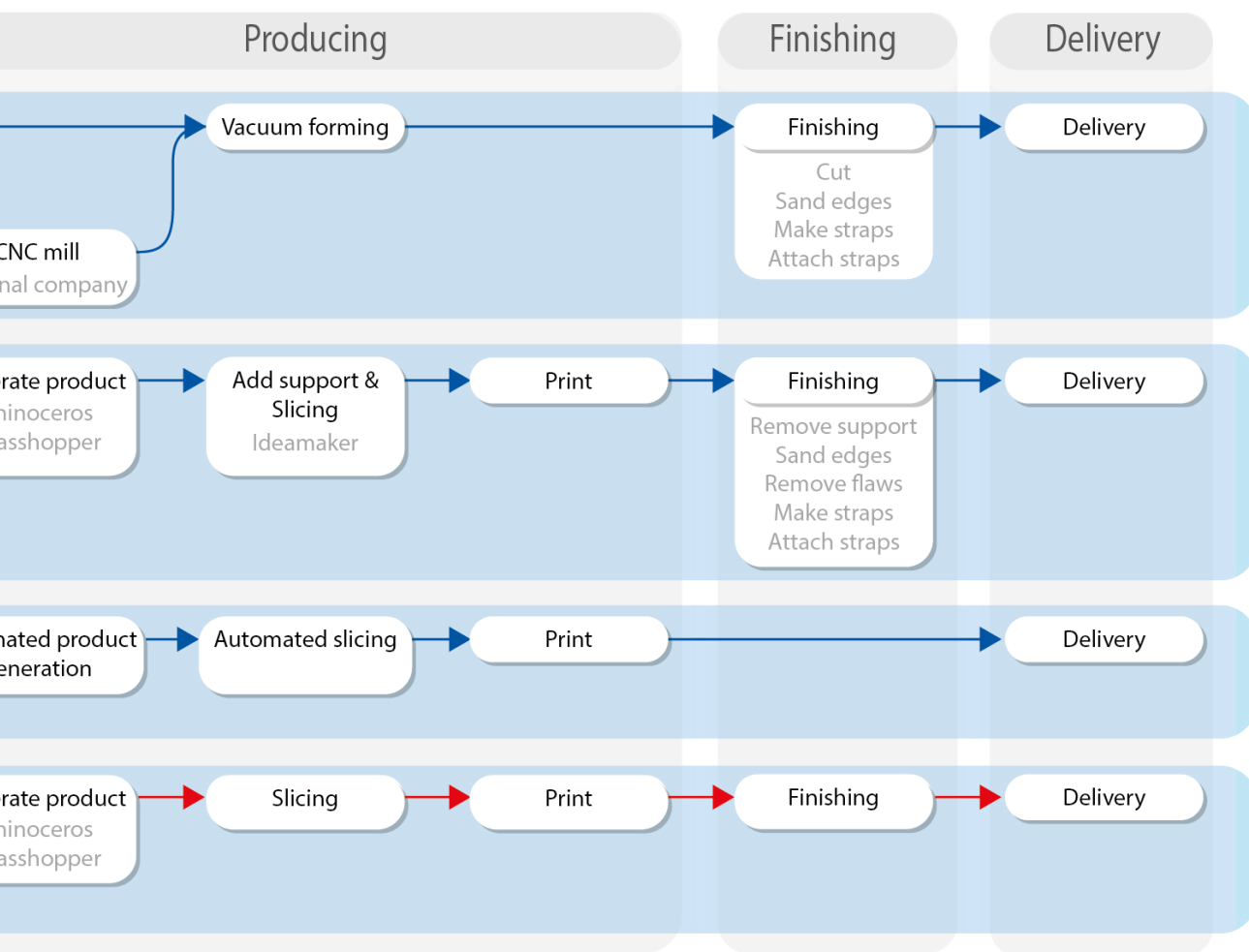



Figure 16: Scanning and measuring the foot

1. Measuring

The current measuring and scanning procedure does not show possible threats for the implementation of a 3D printing production method. The wrist orthosis production process uses the same scanning technique and shows that the generated meshes are fit for 3D modelling.

In addition to the scan, an order form is filled in with some extra measurements for the workshop to cut out the dimensions. The required parameters might be different for the new AFO. Therefore, a new measuring form and protocol with new parameters might have to be developed.

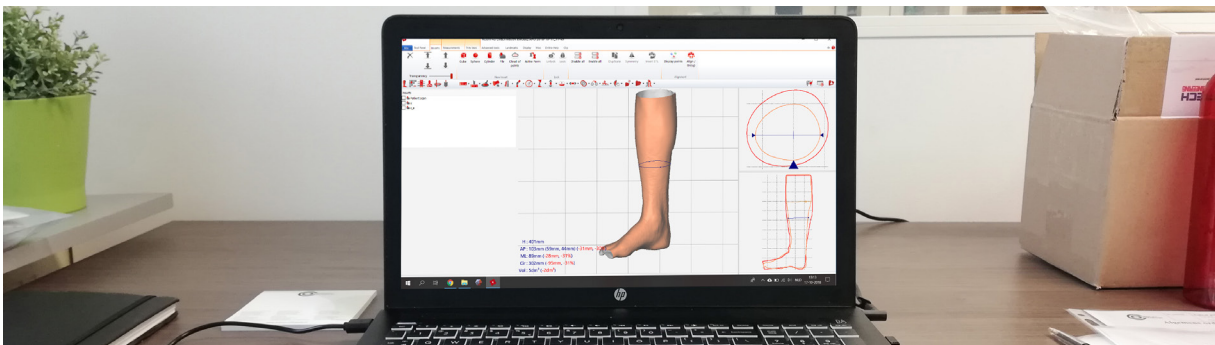

Figure 17: Correcting the scan.

2. Correcting

The raw scan is not fit for production because it only follows the patient's geometry at the moment it was scanned. In order to create a supporting brace this raw data has to be smoothened and deformed by an orthopaedic technician in order to create a supporting shell around which an AFO can be formed. (For example, adjusting joint angles or flattening the sole for a more stable surface). The mesh editing software used for the CNC mould design is NEO 2018 which gives the orthopaedic technicians lots of tools to digitally adjust the scanned leg.

The new production protocol should keep this software since it is a sufficient solution specifically designed for orthopaedic technicians and it is well understood among the relevant employees. Currently there is a step by step adjustment list created by COR to modify the mesh for vacuum forming, but because 3D printing might require a different mesh output a new adjustment list might have to be created. Furthermore, it is possible to standardize and include some of these adjustment steps in the generate product step using grasshopper software but this can only be defined when a preliminary design is developed.

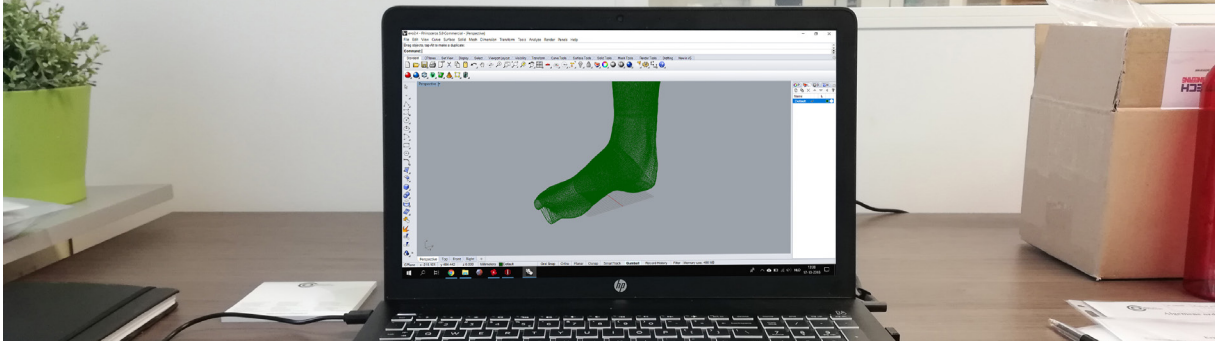

Figure 18: *Generating the product.*

3. Generate product

The corrected mesh is loaded into Rhinoceros and a product is automatically generated by grasshopper where measured parameters of the intake meeting are used to finalize the product. For the integration of this stage three things are needed: an AFO design in Rhinoceros, a grasshopper script which changes the mesh into a design and a protocol to customize

the grasshopper script to match the patient specific requirements (such as stiffness, location of trimlines or shoe size)

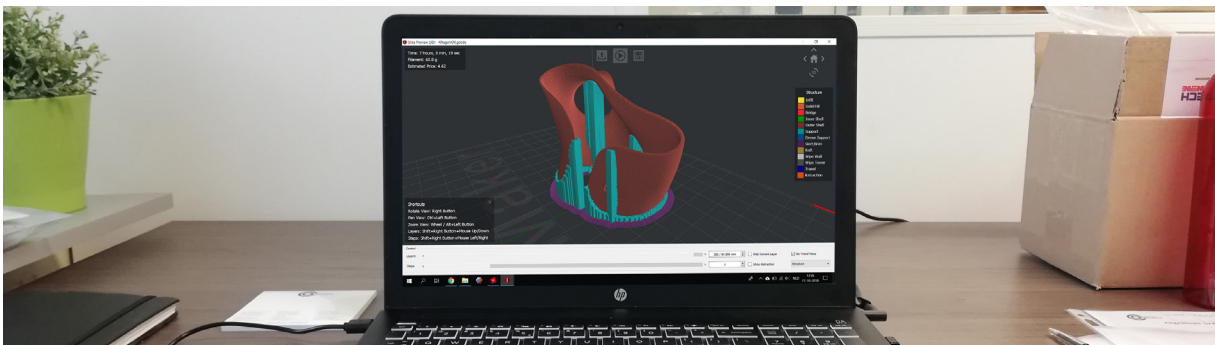

Figure 19: *Slicing the product.*

4. Slicing

When the product is generated it needs to be prepared for printing, this is called slicing. The needed actions and software to create a proper print set-up differ for every printer. For the current wrist orthoses the used program is ideaMaker which slices the product and exports the code for the printer. To ensure the code is exported a slicing protocol is needed (If the printing of the AFO will be outsourced, this step can be neglected).

The current slicing procedure for the 3D printed wrist orthoses includes a long manual support designing step because the automated support generation option of the program is insufficient. Including the support into the grasshopper script could be a time saving solution, but only if the choice is made for in-house printing. However, the development of this option might take more time than it could save.

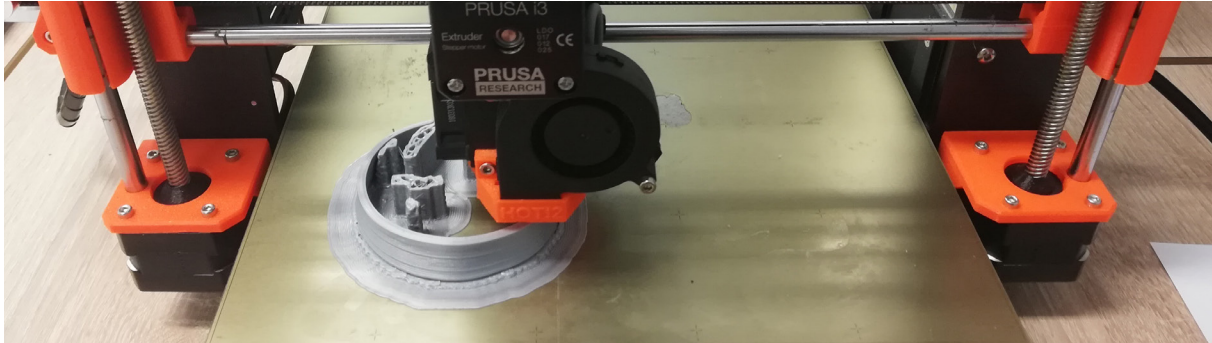

Figure 20: 3D printing.

5. Printing

The details and integration requirements of this step are dependent on the design, the 3D printer, the material and whether the new AFO will be printed in-house or by an external company. Therefore this step will not be described in detail.



Figure 21: The raw wrist orthosis straight out of the printer (left) and a finished wrist orthosis (right).

6. Finishing

The current finishing steps of the wrist orthosis include: discarding of the support, sanding, discarding of any flaws and producing and attaching the straps. For the new AFO, the details of this step are design depended, but to lower the production time the aim of the design should be to minimize the finishing steps.

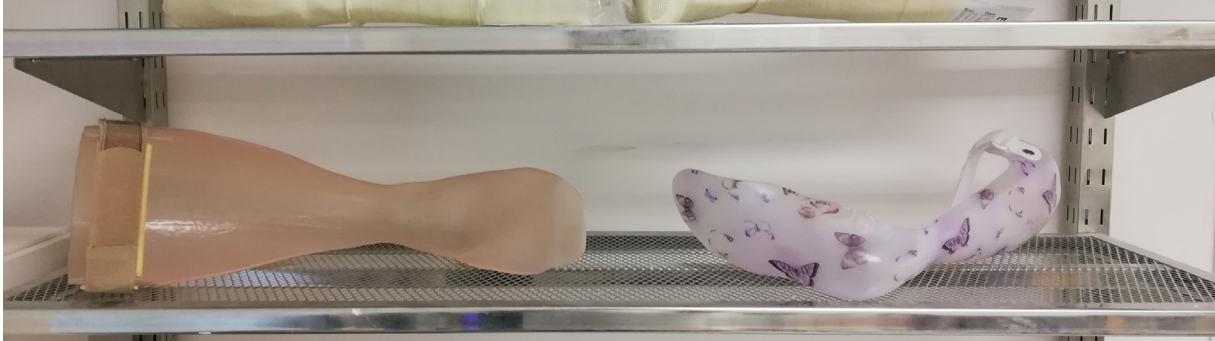

Figure 22: Figure 17: AFOs ready for delivery

7. Delivery

When the produced orthosis is finished it needs to be checked by an orthopaedic technician to ensure a correct patient fit or if adjustments are needed. Currently 50% of the produced custom-made AFOs need some adjustments on delivery according to some of the orthopaedic technicians at COR. These flaws in the final product can be caused by incorrect

mesh adjustments, difference in body dimensions compared to initial measurements (e.g. oedema) or an imperfect scan. Therefore, the new AFO should account for these possible flaws by allowing adjustments upon delivery (to some degree) or the design should eliminate the need for adjustments entirely.

Required changes

In order to ensure a proper integration of the 3D printed AFO in the production process of COR the following process requirements have to be met. Not everything will be addressed in this report, the main focus will be on the development of a new AFO.

Measuring: New measuring parameters, a new adjusted measuring protocol and a new adjusted measuring form.

Correcting: New adjustment list for NEO 2018.

Generate product: New AFO design in Rhinoceros / a grasshopper script to transfer the mesh into a design / customization protocol for the grasshopper script.

Slicing: For in-house printing a new slicing protocol should be established. If printing will be outsourced this step will become irrelevant.

Printing: Not yet defined, depending on the production method. If printing will be outsourced this step will become irrelevant.

Finishing: The aim of the new design should be to minimize finishing steps.

Delivery: An adaptable design.

2.6 3D printed AFOs

There have been multiple trials with 3D printed AFOs and all have their own benefits. Some AFOs utilize the great design freedom of 3D printing but can not be worn inside a shoe (1, 5). Crispin Orthotics recently created a range of light weight designs (2). This one offers a sufficient solutions for some patients but the connection of the spring to the footplate would create painful pressure points and blisters for other patients. The same counts for (7) where the large connection takes considerable space inside the shoe. Invent medical simply printed the design of a vacuum formed AFO.

There have also been developments for other lower limb orthoses such as a Knee-Ankle-Foot orthosis (4) which has a light structure to transfer all the forces. Also, several foot orthoses (6) have been developed which also tried to tackle the complexity of the anatomical requirements of the ankle leading to more flexible and thin designs.

These designs show that a lot of solutions are possible in the design of 3D printed AFO's but apparently everywhere concessions have to be made.



Figure 23: 3D printed AFOs: 1, (adapted from Andiamo, n.d.). 2, (adapted from Crispin Orthotics, 2019). 3, (adapted from Invent Medical, n.d.). 4, a knee-ankle-foot orthosis (adapted from Steiner, 2014). 5, (adapted from EOS², n.d.). 6, a foot orthosis (adapted from EOS¹, n.d.). 7, (adapted from O.L.T. Footcare, n.d.).

2.7 Gait analysis

The human walking gait is a complex phenomenon where the ankle, knee and hip joints work together as a smooth system to allow a person to move, but not for someone with DFS. Multiple studies have tried to create solutions for the complex dynamic ankle support a person with DFS requires. The results of these studies were large, bulky and complex mechanical concepts. In order to facilitate the needed support they used solutions such as: an electric motor (Figure 24-left), a pneumatic lock (Figure 24-middle) or a damper (Figure 24-right). Their large and heavy designs are unfortunately in contrast with the patients' wish of not standing out and their weight is also not beneficial for the energy cost of walking. The design freedom of 3D printing might be the key ingredient to combine the needed dynamic support with the stakeholders wishes.

In order to understand the support a patient with DFS needs a gait analysis was performed. In this chapter the human and DFS gait were analysed to define the ideal behaviour of the new AFO.

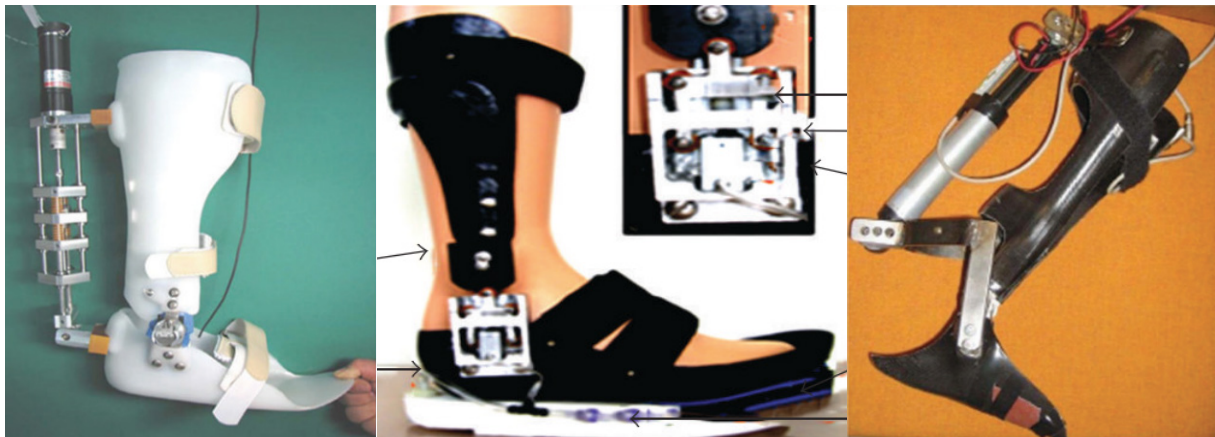
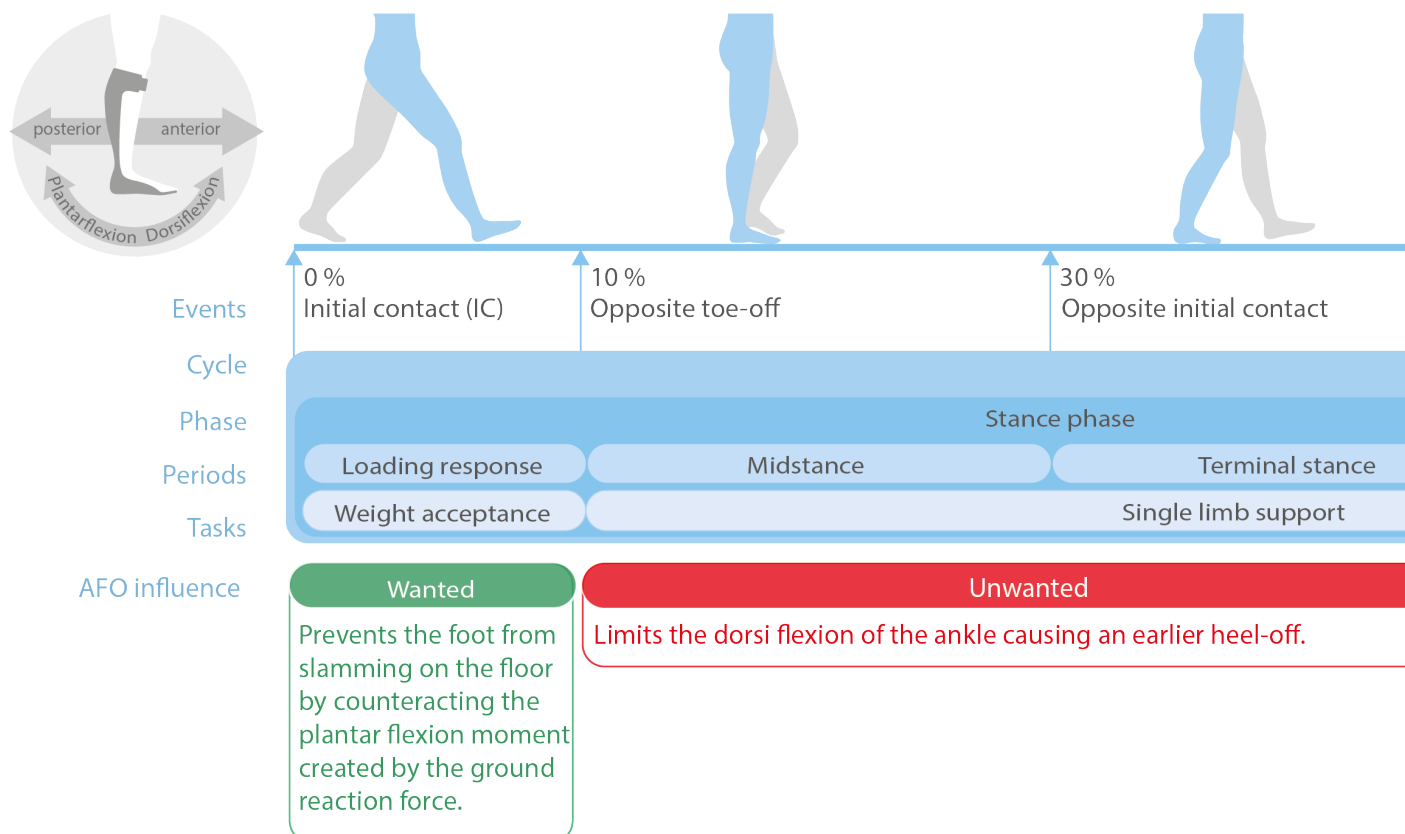

Figure 24: (left) Motor controlled Hinged AFO (adapted from Kim & Kim, 2007). (middle) Hinged AFO with a pneumatic lock (adapted from Chin et al, 2008). (right) Hinged AFO with a damper (adapted from Holmberg, 2014).

Background information

Before continuing this chapter, some relevant background information is needed. The normal gait can be divided in multiple subdivisions according to Neumann (2010). In cooperation with the Orthopaedic technicians of COR the influence of an AFO on these phases was captured in wanted and unwanted behaviour (Figure 25).



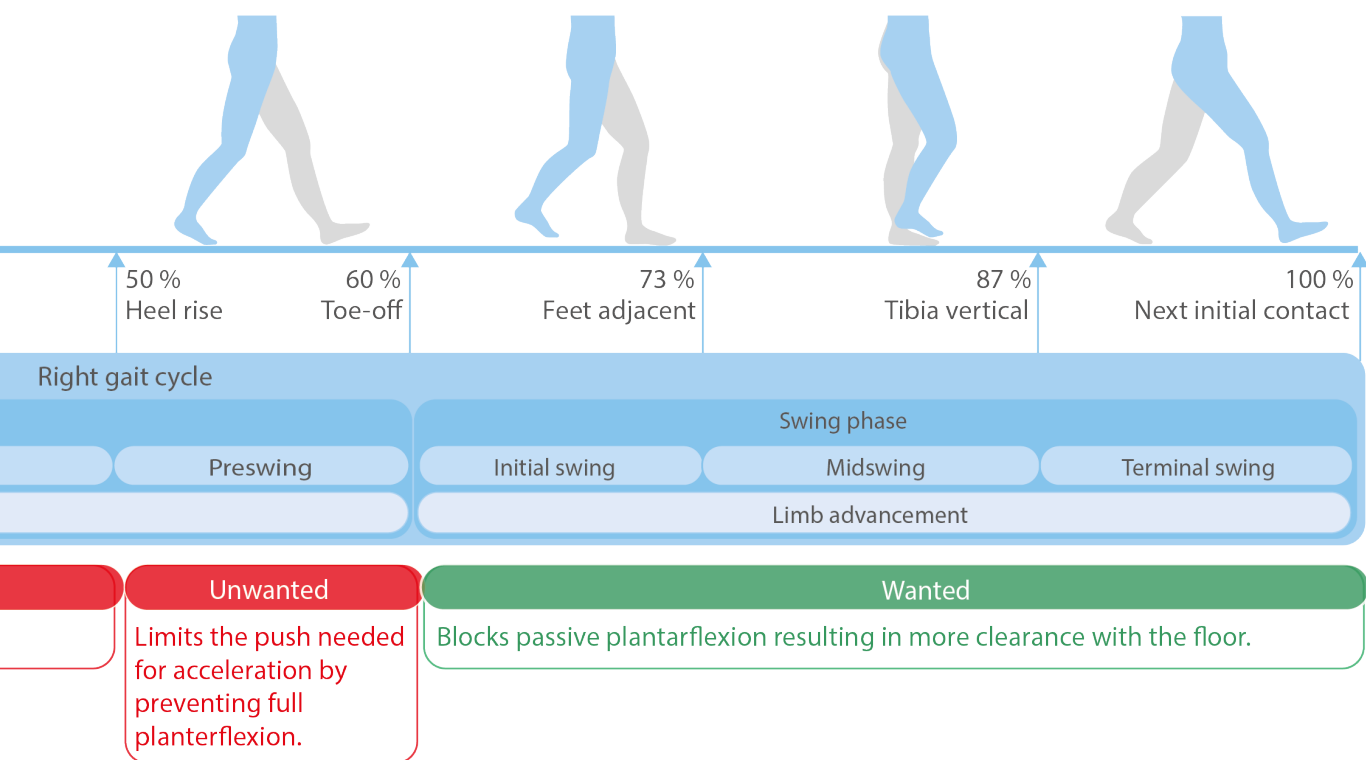

Figure 25: The subdivisions of the normal gait, adapted from Neumann (2010) and the wanted or unwanted behaviour of the AFO

Ankle angle

Figure 26-1&2 display the normal gait of a healthy adult and that of a person with DFS without the use of an AFO, both retrieved from the study of Wiszomirska et al. (2017). Multiple studies (Michalina et al., 2017)(Brocket, 2016) show similar curvatures for these gait graphs but with different angular values (+-5 deg.). The studies of Wiszomirska et al. and Michalina et al. are comparable with regard to participant specification and measurement techniques, therefore it can be concluded that the general curvature of the graphs can be justified, but the exact angle values cannot. A graphical explanation of this reasoning can be found in [appendix AAAAAA](#). The data of the study of Wiszomirska et al. was chosen because these graphs had the highest resolution and were therefore the most accurate to retrieve the data from.

The choice was made to solely work with the data of a person suffering only from DFS because this patient would have the most extreme dynamic scenario and to be able to exclude the influences of other possible illnesses.

Figure 26-3 shows the main differences between these graphs which the new AFO should solve. The patient with DFS shows a plantar flexed initial contact. It also shows a shorter swing phase compared to stance phase which is caused by an earlier initial contact due to the hanging foot. The third main difference is the plantar flexed swing phase leading again to a plantar flexed initial contact.

From these graphs, the literature research, the discussions with the OTs and seeing patients walk at COR I was able to generate the ideal walking gait for a patient with DFS with an orthosis (Figure 26-4). This graph was agreed upon by the orthopaedic technicians of COR. It is similar to a normal walking gait but it has dorsiflexed swing phase to create enough clearance.

The next step is to compare these graphs with the graph of a patient wearing an AFO. However, no usable scientific graphical data about the impact of an PLS-AFO on the gait of a patients with DFS was found. Lots of studies investigated the topic but were insufficient for this project due to a variety of reasons explained in paragraph PPP.

In order to visualize the difference between a patient wearing an existing AFO and the defined ideal scenario some graphical data was needed. [Because no scientific graphical data could be found I created a graph which should represent the behaviour of a patient diagnosed with DFS who wears an AFO](#) (Figure 26-5). I used the knowledge gained from the literature research, the discussions with the OTs, walking experience with an AFO custom-made for myself and seeing patients walk at COR to define the correct curvature.

The main differences are smaller minimal and maximum values for the existing AFO due to its high stiffness. Next to that it has shorter periods plantarflexed of the neutral position because the plantar flexion stiffness is much higher than the dorsiflexion stiffness of the existing AFO. The neutral position is when the AFO is not deflected, this is marked by the horizontal line in the swing phase. From these graphs it can be concluded that a lot of improvement can be made in the dynamic support of the ankle.

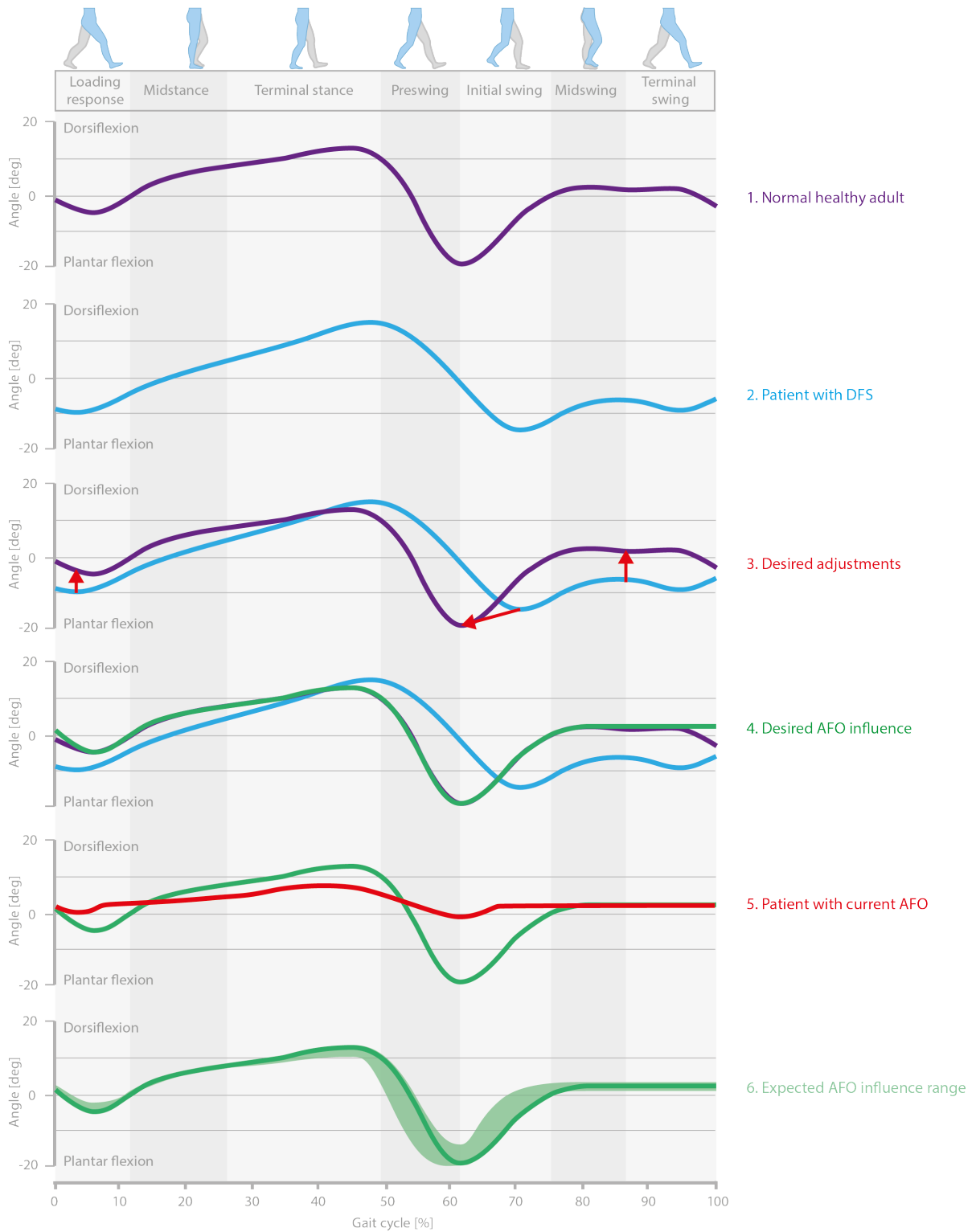

Figure 26: Gait graphs ankle angle

As explained in the paragraph before, not every patient will have the same gait graph as the extreme ideal situation expressed above. I expect that the results of the effect of the new orthosis on elderly and patients suffering from more complex illnesses will fall in the light green area. The reasons for the shape of this area can be found in the figure itself.

Not every patient diagnosed with DFS will show a pattern according to the ideal curvature. Elderly, for instance, have a slower walking speed and a shorter step length resulting in a shorter relative swing phase according to a consulted physiotherapist (physiotherapist, personal communication, September 28, 2018). These patients will also need a stiffer AFO and for them the ideal gait graph will have a different curvature. The expected results range of the optimal scenario are marked in Figure 26-6

Literature study with regard to DFS gait with AFO

Various studies only contained general measurements like velocity, cadence, step length or the patients perception (Rao et al., 2014; Kesikburun, 2017; Gök, 2003) instead of workable graphs.

Most studies included patients with diagnosis like multiple sclerosis or cerebrovascular accident (medical term for stroke), for example Bergman et al. (2010) and Mulroy et al. (2010). These illnesses could have a small impact on the gait but the severity of these illnesses cannot be checked. These patients could have a simple drop-foot but mostly the studies talk about a hemiplegic gait which is considerably worse and not comparable with a normal drop foot.

Next to that, various studies used other situations like bilateral AFOs (Rodda, 2015) or AFOs which are worn without shoes (Park et al., 2009) which makes them also too different from the scenario used in this study

Ankle moment

Figure 27-1 shows the moment around the ankle joint in the sagittal plane, also retrieved from the study of Wiszomirska et al. (2017). In the study this moment data is computed via inverse dynamics, they used the gathered angle data to calculate the moment in the joint. This means that this is not the actual contribution of the muscles but the visible result from the angular data. Comparable to the angular situation graphs, the values in these graphs have to be regarded as an indication and not fixed values.

Figure 27-2 displays the graph of an adult with DFS without an AFO and it clearly shows no negative moments, this means that no moment towards dorsiflexion is generated by the ankle.

The mathematical difference between these graphs is shown in Figure 27-3. However, this is not the actual support a person with DFS requires. According to the input of the orthopaedic technicians (Figure 25 on page 37) not all the support is needed. Figure 27-4&5 show the result if the unwanted support is removed.

The moment graph of Figure 27-5 will still not create the desired angular behaviour defined in the previous paragraph. In order to do so a few changes have to be made. First the graph has to be smoothed to allow a more fluent gate pattern. Secondly, a slight dorsal moment has to allow for the desired neutral angle during the swing phase resulting in the ideal support scenario in Figure 27-6. This graph was checked and agreed upon by the orthopaedic technicians of COR

To compare this ideal support scenario with the current AFO a moment graph of the current AFO was needed. The establishment of this graph was similar to the creation of the graph in Figure 26-5 and based on the knowledge gained from the literature research, the discussions with the OTs, walking experience with an AFO custom-made for myself, force measurements and seeing patients walk at COR.

Clear differences are shown in the timing of the application of the dorsal moments and the absence of the plantar moment during the stance phase. This mismatch in moment output of the current AFOs has to be compensated by a higher energy cost for the patient and will also result in a slower walking speed. A lot of improvement can be made here to facilitate a lower energy cost of walking for the patient.

Similar to Figure 27-6, not every patient diagnosed with DFS will show a comparable moment output pattern according to the desired AFO influence. The expected results for the desired moment scenario range are marked in Figure 27-7.

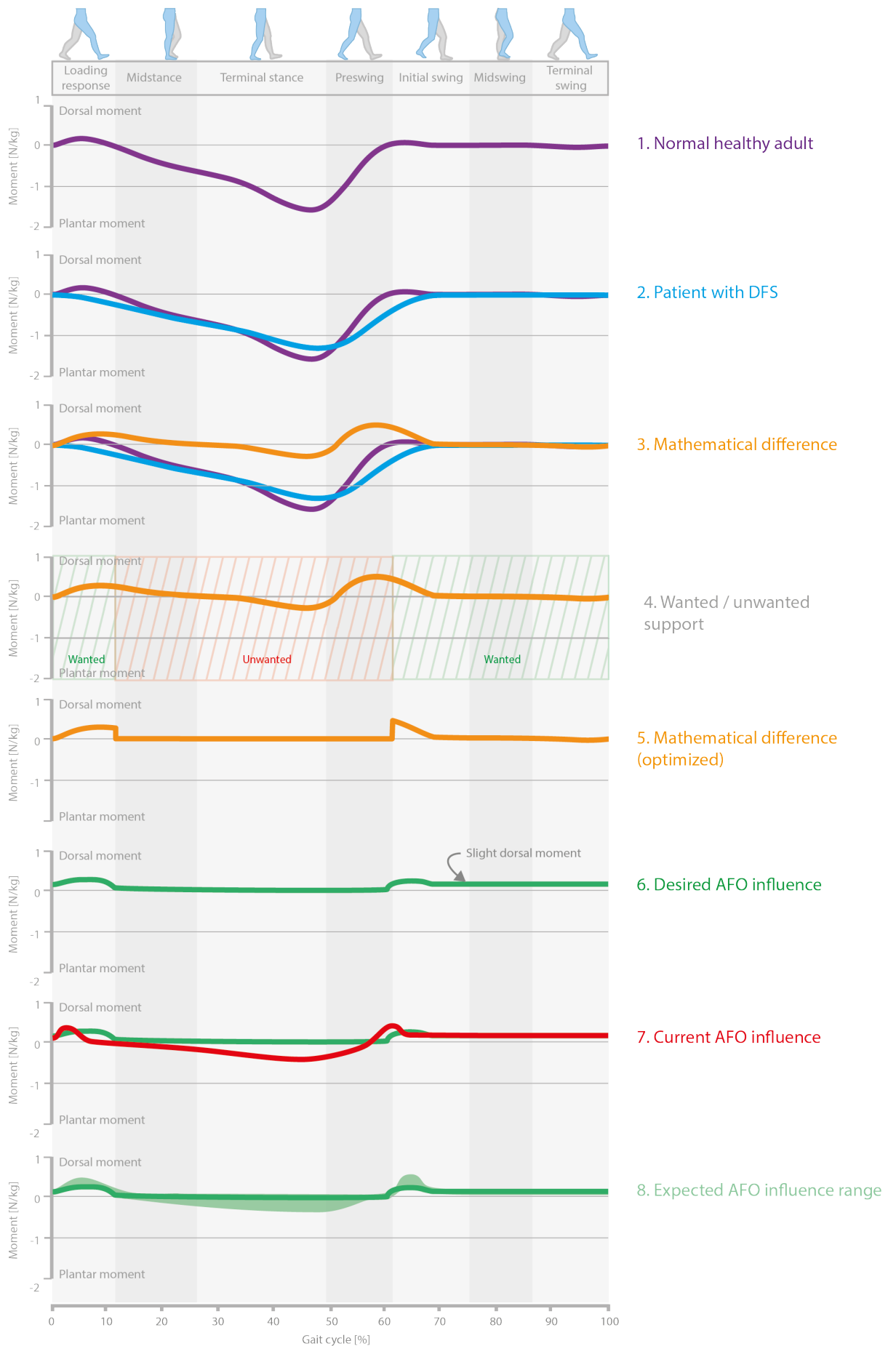

Figure 27: Gait graphs ankle moment

Complex movements

During his/her daily life activities the patient encounters more than just forward walking. What about that 180 degree turn when you forgot something in the living room? What about that backwards step to let someone pass in the hallway? Or what about that side shuffle in the kitchen to get to the stove? This report uses the term 'complex movements' for these kind of standing relocation movements which do not involve a change in elevation. The new 3D printed AFO should also account for these complex movement to allow for a normal active living standard of the patient.

Complex movements do not always involve a full plantar flexed ankle angle prior to the swing phase, but the AFO should still perform its function of lifting the foot in the swing phase. Therefore the AFO is required to be able to lift the foot towards a horizontal position at any given moment throughout the plantar flexed state of the preswing phase of the gait.

Movements which involve a change in height, for example descending the stairs or walking uphill are neglected because the ankle angle in the sagittal plane differs too much from the normal walking gait according to the data of Radtka et al. (2005). These movements would result in a too complex initial problem and are therefore set outside of the scope of this project.

2.8 Anatomical boundaries

The human anatomy puts certain restraints on an AFO. The following vital points were addressed by the orthopaedic technicians of COR (Figure 28). From these critical anatomical area, requirements were formed which have to be met by the new AFO, these can be viewed in [chapter CCCC](#).

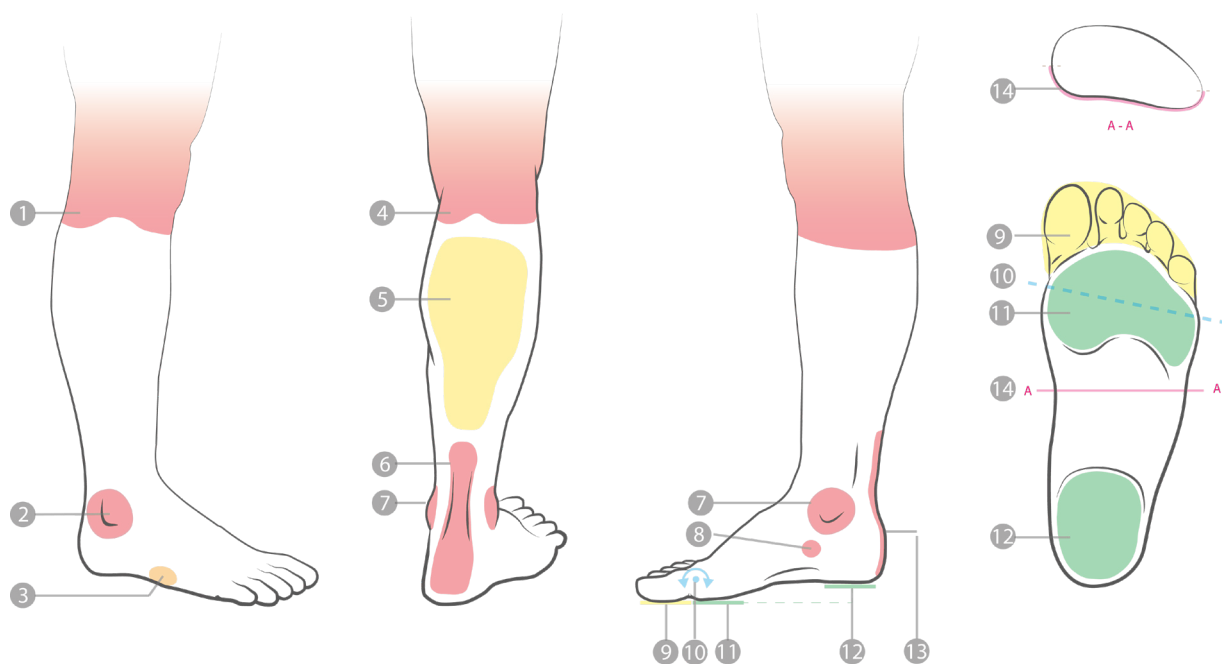

Figure 28: The anatomical requirements for an AFO

1. Fibula head (no contact)
2. Lateral malleolus (no contact)
3. 5th metatarsal (no pressure)
4. Hamstrings (no contact)
5. Calf pressure area (no sharp edges)
6. Achilles tendon (no contact)
7. Medial malleolus (no contact)
8. Navicular (no pressure)
9. Toe support (no sharp edges)
10. Allow for passive toe flexion during toe off
11. Ball of the foot (pressure area)
12. Heel (pressure area)
13. Calcaneus (no pressure)
14. Cross section: Sole of the foot (contact ends almost vertical)

2.9 Post production adaptability

As explained in chapter 2.5, 50% of the current custom-made AFOs have to be adjusted on delivery. There are various reasons for this post production adaptations:

- Incorrect adjustments to the mesh by the orthopaedic technician
- Difference in body dimensions compared to the initial measurements. (The volume of the lower extremities increases during the day according the orthopaedic technicians at COR)
- Flaws in the mesh result of the scan due to movement or improper scanning.

Next to that, according to the consulted physiatrist, 15% returns after the half yearly check-up at the physiatrist with physical improvements in need of adjustments to their AFO. There are 5 common adaptations for the current custom-made AFO, they are mentioned in Figure 29. These adaptations are transferred in product requirements for the new AFO, [see CCC](#)

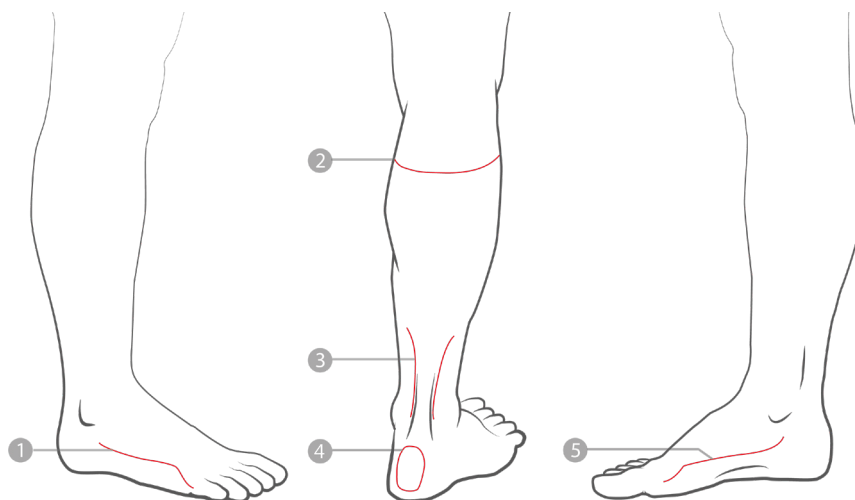

Figure 29: Most common adjustments of the current custom-made AFO.

1. The lateral trim line creates pressure areas on the foot. This line must be heated and deformed or sanded to relieve the pressure.
2. The upper trim line creates cuts of blood circulation or clamps the calf. To relieve pressure this edge is heated and deformed outward.
3. The AFO is too rigid. To allow more flexibility the posterior shaft is sanded on both sides to create a smaller surface.
4. The medial trim line creates pressure areas on the foot. This line must be heated and deformed or sanded to relieve pressure.
5. Posterior area of the heel creates pressure peaks during walking. If pressure peaks occur this area has to be heated and deformed outward

2.10 Possible 3D print techniques

This report will not go in depth on all available 3D printing methods, just on the 3 most suitable once for this project: Selective Laser Sintering (SLS), Multi-Jet Fusion (MJF) and Fused Deposition Modeling (FDM). They are the most suitable due to their accessibility, cost effectiveness and material

2.11 Extra boundaries

Unfortunately for the patient, the AFO does not work in combination with all types of shoes. The working principle of the AFO (Chapter 2.3) requires shoes which are fastened close to the malleoli. Slippers and loafers do not and are therefore removed from the scope.

Boots and high shoes cover the malleoli and considerably limit the design freedom around the ankle. To allow for a larger solution space these are also removed from the scope.

According to the orthopaedic technicians at COR every shoe has some sort of elevation from heel to the ball of the foot, in general this is around 10-15 mm. Shoes with a so called 'heel elevation' of more than that, for instance high heels, are also removed from the scope because they change the ankle angle throughout the gait.

3. DESIGN BRIEF

3. DESIGN BRIEF

This chapter describes which direction was chosen after the analysis to create an AFO



3.1 Design brief

In order to start up the ideation phase a design direction has to be formulated to guide the development into the right direction. Foremost, the AFO must perform its function, its reason of existence, which is providing support during walking by lifting the foot during the swing phase and preventing the foot from slapping on the ground at the loading response. Next to that, the opportunities of 3D printing should be incorporated to investigate their true potential. To integrate this in the new AFO the design direction is split in two.

Part 1: Improving the gait

Before the full potential of 3D printing can be utilized, a working AFO has to be created. This can be done by mimicking the working principles of a current AFO and using it as a building block to create value for 3D printed solutions. However, the analysis phase shows that the current AFOs have a big influence on the user's gait, more than ideally needed. This increases the energy cost of walking and as a consequence limits the patients mobility. Therefore, the opportunity to improve the patients gait by only providing what is actually needed will be included in the development of the AFO's function.

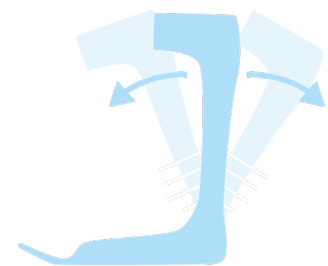

Problem definition:

How to transform the desired gait influence into a functional 3D printed AFO?

Part 2: Other improvements

Due to the design freedom of 3D printing it is expected that it could make a big positive impact in including the wishes of the stakeholders in the design. The current plastic shell of the custom-made AFOs does not allow for much design freedom while 3D printing allows for a diverse range of solution finding. Therefore, part 2 of the design direction will focus on meeting the stakeholders wishes via 3D printed solutions.



Problem definition:

Use the established AFO from part 1 as a basis to meet stakeholder wishes via 3D printed solutions.

4. SYNTHESIS

4. SYNTHESIS

This chapter explains how the design brief was tackled and displays the most promising ideas which are developed into concepts of which one was selected.

Ultimaker³

Write your details on the list
before starting your print

Cover UM3



Ultimaker
only!

4.1 Start of the ideation

The problem statement of part 1 was formulated as: 'How to transform the desired gait influence into a functional 3D printed AFO?'. This was tackled by looking more closely to the intended moment output of the new 3D printed AFO. This led to the conclusion that from the desired AFO influence graph (Figure 27) two main problems can be substituted:

1. How and when to (de-) activate the moment output of the AFO?
2. How to create the moment output of the AFO?

1. How and when to (de-) activate the moment output of the AFO?

Figure 31 on page 52 shows that the fixed moment is activated and deactivated at two specific moments during the gait, located at the vertical arrows. This (de-) activation of the system requires two triggers to create an impulse for the system. There are several possibilities to collect information for these triggers, but only two can be used for complex movements:

1. The ankle angle will always move to a plantarflexed state to push off.
2. The patients weight will always shift from one foot to the other.

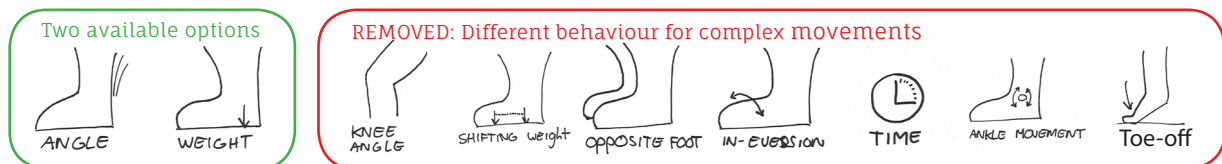

Figure 30: The options to collect timing data for (de-) activating the fixed moment.

Figure 31 shows the data which can be expected from these two trigger options. For the ankle angle the data of the desired AFO influence of a DFS patient with the new AFO is used to express the expected movements. For the weight intensity and distribution the barefoot ground pressure is used. This data was retrieved from an online video file because its purpose was indicative and not to be used as hard evidence.

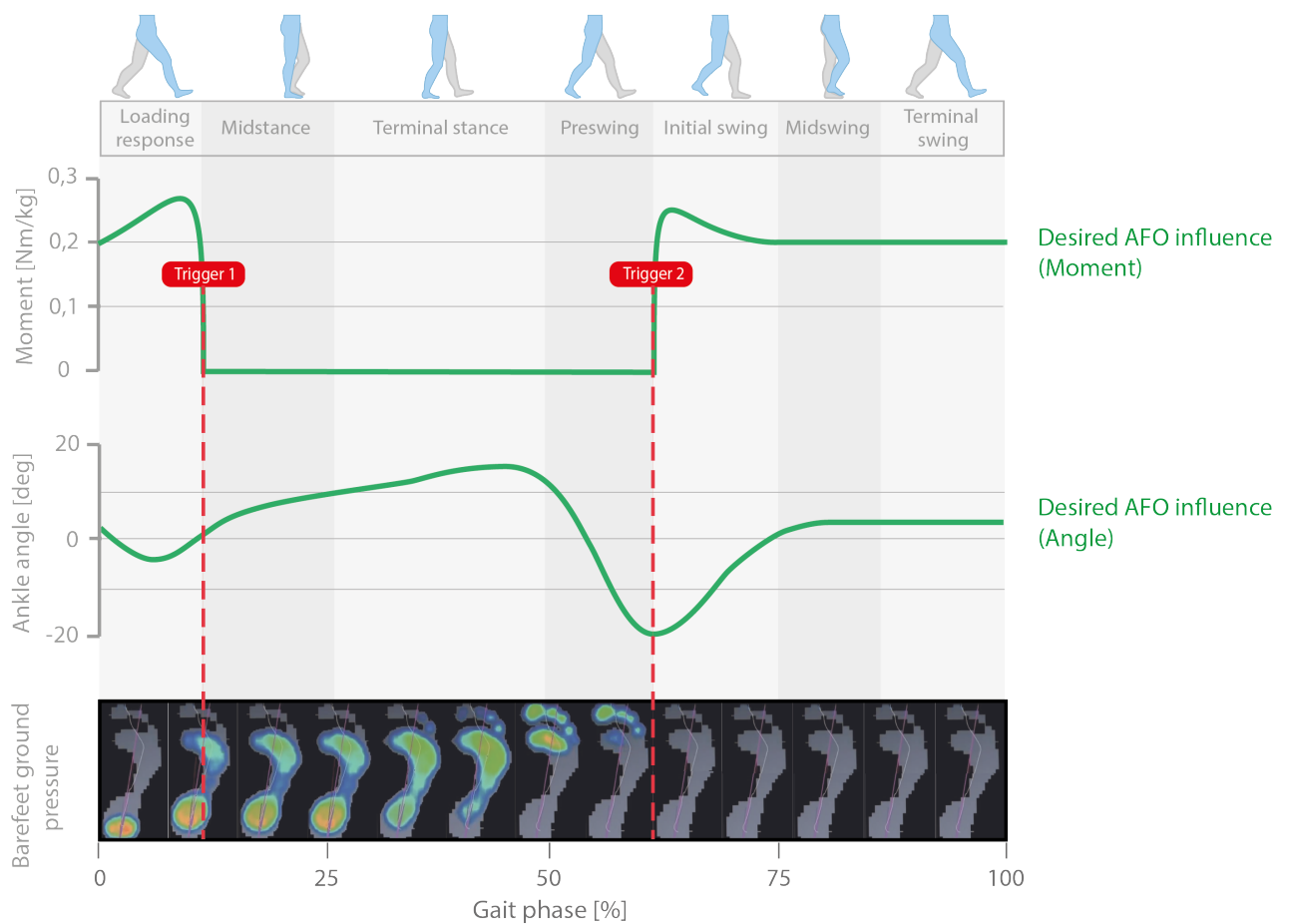

Figure 31: The data which can be expected for the ankle angle and barefoot ground pressure to collect trigger information. The data used for the ground pressure was for indicative use only and retrieved from a youtube video of www.sportsinjury.net. (2010).

2. How to create the moment output of the AFO?

The data of Figure 31 led to the conclusion that there are two possible directions to find solutions for. These directions are the 'pressure based solutions' and the 'angle based solutions', both are explained below and in Figure 32.

Pressure based solutions

Trigger:

Pressure in the footplate. By using foot pressure as a trigger, the moment output of the AFO can be timed to exactly match the desired output.

Pros:

- Perfect support behaviour during gait.

Cons:

- Requires complex solutions to transfer pressure into a trigger.
- Requires complex solutions to collect the energy to create the fixed moment.

Angle based solutions

Trigger:

Ankle angle. The complex movements require the AFO to work for all plantar flexed angles. This means that for every plantar flexed angle there should be enough energy stored to lift the foot to a neutral position. To minimize the energy cost during push off, it is important to aspire a fixed moment during plantar flexion, which is the minimal needed energy to prevent foot slap at the loading response.

Pros:

- Simpler and more feasible solution
- Still a good improvement

Cons:

- Less perfect support behaviour due to an increased energy cost of walking

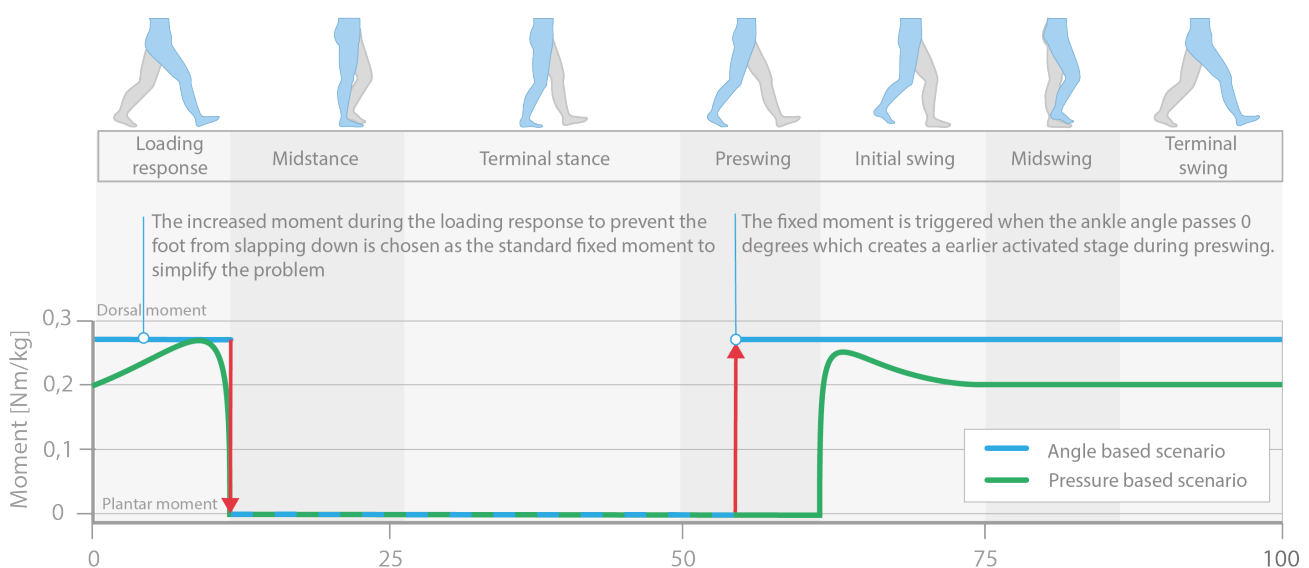

Figure 32: Gait graphs of pressure and angle based solutions

4.2 Ideation

For both the pressure and angle based scenarios, ideas have been generated. While doing so it became clear that both the trigger and the moment output problem could also be divided in multiple sub-problems which are listed below.

How and when to (de-) activate the moment output of the AFO?

- What could be used as sensory input for trigger 1?
- How to sense the input for trigger 1?
- What could be used as sensory input for trigger 2?
- How to sense the input for trigger 2?

How to create the moment output of the AFO?

- Where to collect the needed energy from?
- How to collect this energy?
- How to store this energy?
- How to exert the force?

In order to find the most promising solution combinations a morphological chart with the best ideas was created to provide an overview of the possible combinations. The full chart with the reasoning of the removed ideas is added in appendix D. From this morphological chart, the seven most promising idea combinations were selected and further developed into concepts. These seven are displayed to the right in Figure 33

4.3 Program of requirements

In order to create proper concepts of the seven most promising idea combinations and eventually select one final concept, more information was needed about the design wishes and requirements of the AFO. These wishes and requirements were listed in a program of requirements and were generated from the analysis, conversations with the orthopaedic technicians and my own findings. The program of requirements is added in appendix E.

















































Problems	Pressure based solutions		Angle based solutions			
	Pump & spring	Pump	Click-on-hinge	Shoehorn	Spring roll	Spring cord
What could be used as sensory input for trigger 1?	 WEIGHT	 WEIGHT	 ANGLE	 ANGLE	 ANGLE	 ANGLE
How to sense the input for trigger 1?	 WEIGHT PIEZOELECTRIC SENSOR (AIR) POCKET	 WEIGHT PIEZOELECTRIC SENSOR (AIR) POCKET	 ANGLE COMPLEX GEOMETRY	 ANGLE COMPLEX GEOMETRY	 ANGLE COMPLEX GEOMETRY	 ANGLE COMPLEX GEOMETRY
What could be used as sensory input for trigger 2?	 WEIGHT	 WEIGHT	 ANGLE	 ANGLE	 ANGLE	 ANGLE
How to sense the input for trigger 1?	 (AIR) POCKET	 (AIR) POCKET	 ANGLE COMPLEX GEOMETRY	 ANGLE COMPLEX GEOMETRY	 ANGLE COMPLEX GEOMETRY	 ANGLE COMPLEX GEOMETRY
Where to collect the needed energy from?	 PATIENT'S WEIGHT	 PATIENT'S WEIGHT	 ANGLE PUSH-OFF	 ANGLE PUSH-OFF	 ANGLE PUSH-OFF	 ANGLE PUSH-OFF
How to collect this energy?	 (AIR) POCKET	 (AIR) POCKET	 ANGLE PUSH-OFF	 ANGLE PUSH-OFF	 ANGLE PUSH-OFF	 ANGLE PUSH-OFF
How to store this energy?	 SPRING	 PRESSURE	 ANGLE PUSH-OFF	 ANGLE PUSH-OFF	 ANGLE PUSH-OFF	 ANGLE PUSH-OFF
How to exert the force?	 SPRING	 PNEUMATIC	 ANGLE PUSH-OFF	 ANGLE PUSH-OFF	 ANGLE PUSH-OFF	 ANGLE PUSH-OFF

Figure 33: The seven most promising options from the morphological chart

4.4 Conceptualization

The idea combinations from the morphological chart were further developed into the following concepts.

Pressure based solutions

During the gait there is a single leg support stage in which the patients weight compresses the bellows underneath the footplate of the AFO. The bellow underneath the foot pressurize the bellow in the back which, after activation, transfer it to a moment output. Next to that, the bellows underneath the foot can also be used as triggers for the activation of the spring.

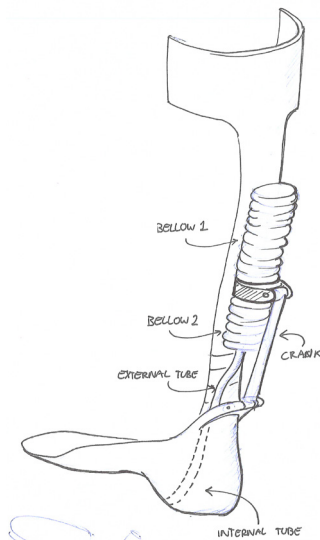

Pump

This concept uses the pressurized bellows to bring a spring in tension, storing the energy until the output is required. SLS printing

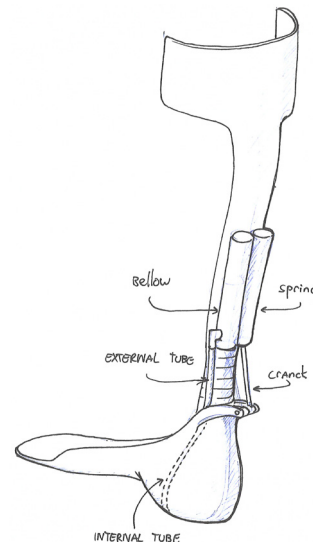

Pump & spring

This concept uses a double bellow in the back, the bottom bellow pushes the top bellow upward, charging it. When activated, the top bellow pushes a rod downward, transferring pressure into a moment output.

Angle based solutions

As explained before, the sub-ideal situation uses a fixed moment output throughout plantar flexion. This is done by playing with the point of application of a spring. This turns the bending force into a fixed moment output.

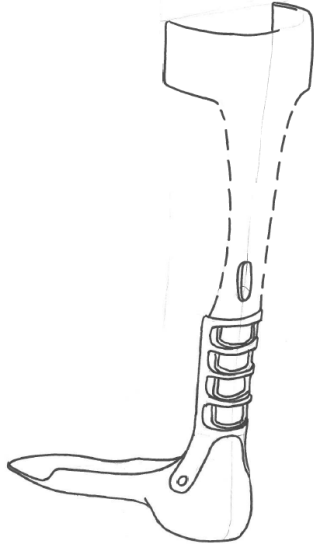

Click-on hinge

Around the ankle joint a spring system of multiple bending strips is located to create a rotational point. This system is a separate part and can be interchanged depending on the required moment output of the AFO

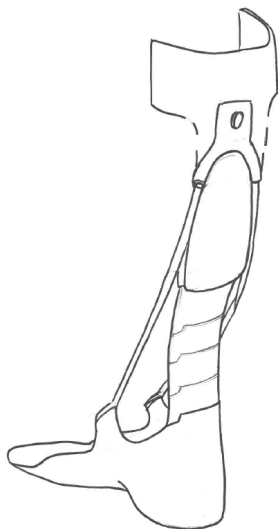

Springcord

The spring cord uses elastic bands to provide force. As the calf plate rotates backward the spring cord gets guided to provide a different point of application.

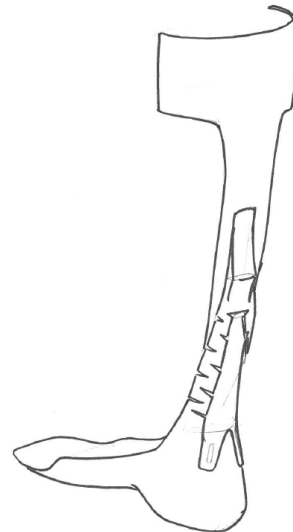

Shoehorn

Here the spring is located as a flat sheet at the back of the AFO. Due the shape of the spring the point of application of the force shifts up or down, depending on the rotation of the ankle.

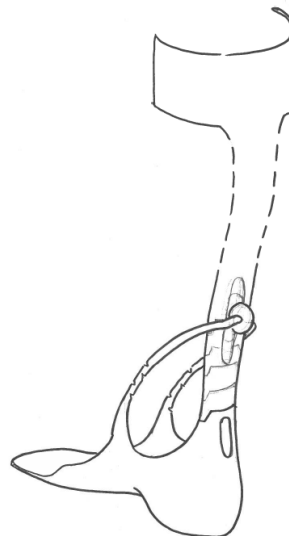

Springroll

Works similar to the shoehorn but uses rolling connection to transfer the spring force and it has the spring attached in front of the malleoli to create more vertical movement of the roller.

4.5 Concept selection

All concepts were discussed with the OTs and the consulted physiatrist through individual sessions. Afterwards the concepts were rated on their functionality and their influence on the stakeholders wishes. The concept 'Shoehorn' was selected because it had the best ratings and the low expected risks

	Lever & spring	Pump	Pump & spring
Impact on gait	++	++	++
Energy cost of walking	+	+	+
Prone to malfunction	--	?	?
Prone to damage (durable solution)	--	-	-
Resistant against malfunction due to . patient specific adjustments	+	++	++
Ease of adaptability	0	?	?
Earlier delivery of the AFO	-	-	-
Same shoe size as before	-	-	-
Safe walking gait	0	0	0
Not making the user stand out	?	--	--
Suitable for multiple kinds of shoes	+	+	+
	<ul style="list-style-type: none"> • The vertical displacement in the shoe will cause instability during the gait. • If there is damage to the sole, the system will not work. 	<ul style="list-style-type: none"> • The vertical displacement in the shoe will cause instability during the gait. • Large piston size makes the patient stand out. • Limited space in the sole for the system. • The weight of the AFO will increase the energy cost of walking, more than it should reduce. 	<ul style="list-style-type: none"> • The vertical displacement in the shoe will cause instability during the gait. • Large piston size makes the patient stand out. • Limited space in the sole for the system. • The weight of the AFO will increase the energy cost of walking, more than it should reduce.
	Stop development	Stop development	Stop development

Figure 34: Concept selection diagram

Click-on-hinge	Shoehorn	Spring roll	Spring cord	Current AFO
----------------	----------	-------------	-------------	-------------

Functionality				
+	+	+	+	0
+	+	+	+	-
-	0	--	0	+
--	-	--	0	+
++	++	--	--	0

Wishes				
+	++	0	+	-
-	-	-	-	-
-	-	-	-	-
0	0	0	0	0
0	+	-	+	0
+	+	-	-	+

Additional information			
<ul style="list-style-type: none"> • How to allow for different patient specific posterior geometries? • How to prevent the springs from slipping? 	<ul style="list-style-type: none"> • How to allow for different patient specific posterior geometries? 	<ul style="list-style-type: none"> • If the shoe is fastened the springs will be influenced. • Post production adaptations will influence the springs. 	<ul style="list-style-type: none"> • If the shoe is fastened the cord will be influenced. • Post production adaptations will influence the springs.

Conclusion			
Continue if no proof of principle can be created for the shoehorn	Continue if a more detailed proof of principle is provided	Stop development	Stop development

5. EMBODIMENT

5. EMBODIMENT

This chapter will explain the development from concept to 3D functional prototype.

5.1 Approach

The first embodiment step was done in 2D to prove the working principle of the system. When a working 2D model was established which showed the desired moment output, a mathematical and a geometrical approach were used to define the impact of every parameter in the system. With this knowledge, a 3D version of the functional prototype was adapted to meet the desired moment output requirements. At the end one more optimization step was performed to utilize the 3D printing to meet the patient's demands more accurately

5.2 2D functional prototype

To eventually develop a functional prototype first an improved proof of principle was needed to check whether the chosen concept displayed the proper outcome. This step was performed in 2D with a simplification of the lower leg. When the first prototype did not work as expected, several options had to be created to investigate what the correct design of the spring should look like.

Test setup

To be able to compare the performance of each spring a test setup had to be created (Figure 36). In this test setup a Newton meter was attached at the 'foot' at a fixed distance from the ankle joint to measure the moment output of the prototypes during plantarflexion rotational increments of 5 degrees.

2D prototypes

With the aid of the test setup every spring could be tested and improvements could be defined for the subsequent prototypes. The most important prototypes are explained below and their measured performance can be seen in Figure 41.



Figure 35: Test setup used to measure the 2D prototypes.

Figure 36: *Prototype no. 3*

No. 3

In this prototype, the decreasing moment arm was expected to compensate for the increasing force. However, due to the relation between deflection and force output of the spring, the intended effect was not strong enough to create a constant moment output. To make use of the deflection of the spring, the system had to be turned upside down, making the contact point of the spring with the calf move upward instead of downward. (Figure 36).

Figure 37: *Prototype no. 4*

No. 4

This prototype was used to turn the shifting of the contact point from downward to upward by adding a 180 degree turn at the top of the spring. This turn converted the rotation of the end of the spring from clockwise to counter clockwise leading to an upward movement of the contact point. However, the expected effect was not sufficient enough to be noted in the measurements. (Figure 37).

Figure 38: *Prototype no. 11*

No. 11

This prototype used differences in stiffness to allow for more deflection at the tip of the spring. Although this example was too flexible, it led to the conclusion that differences in stiffness could be beneficial to influence the behaviour of the contact point of the spring. (Figure 38).

Figure 39: *Prototype no.19*

No. 13

After concluding that all the previous models were not able to come close to a satisfactory constant moment output a different design was needed to allow for more change in moment arm per change in deflection. This prototype allowed for this change by switching from vertical displacement of the contact point to horizontal displacement. This was also the first prototype to show a clear change in moment output, see Figure 41. (Figure 41)



Figure 42: Prototype no.26

No. 26

Via FBD calculations I tried to mathematically create the right curvature for the back part of the spring to create a constant moment output. However, the first mathematical results created strange curvatures which resulted in the spring shooting forward instead of bending backward. This prototype demonstrated that not only the curvature of the spring could be important but also the angle at which it touched the contact point on the calf. (Figure 42)

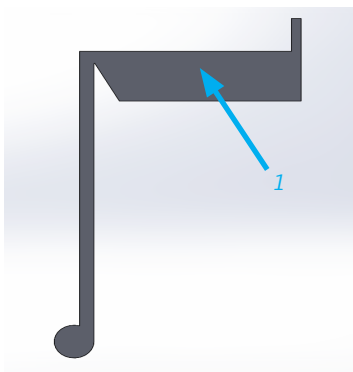

Figure 40: Prototype 34.

No. 34

This prototype marks the early stages of parameter extraction. It tried to capture the influence of the angle of the back of the spring without influencing the current working spring design. Excluding parameters and capturing their influence was quite challenging when working with measurement increments of 5 degrees, surface inconsistencies on the spring and plastic deformation of the springs after multiple test cycles. This expressed the need for a more detailed analysis to more accurately capture the influences of the relevant parameters: a mathematical approach. (Figure 40).

(1 The horizontal part of the spring will from now on be referred to as the 'wings' of the spring.)

Performance of the 2D prototypes

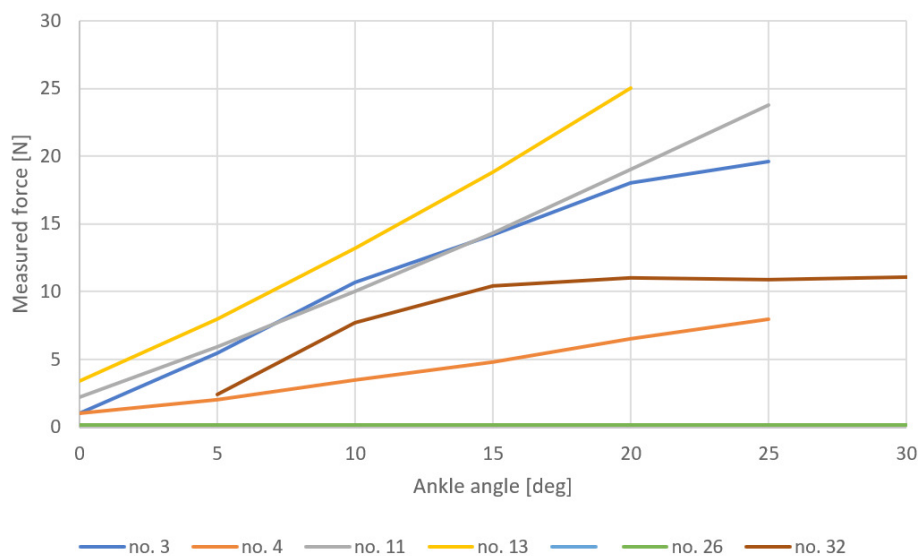

Figure 41: The performance of the 2D prototypes measured by the 2D.

5.3 Mathematical approach

The goal of the mathematical approach was to find the influence of the relevant parameters and create the optimal system which can be adjusted for every patient. The system was analysed with a free body diagram from which the equations which explain the system were derived.

Free body diagram

The functional system is shown as free body diagram in Figure 43-1. In this system, the foot with the spring attached (blue body) is considered fixed and the lower leg LOF is used as rotational input around the ankle O, marked by angle θ . L1 represents the foot and F_{Foot} is the force which the foot applies on the AFO. The lower leg LOF makes contact with the spring system at point F. The location of point F on LEF is variable since it slides due to the deflection of the spring LCD and the rotation of the lower leg LOF. The spring is the only flexible component in this system, all the other beams are rigid. The force of the lower leg on the system is F_{Leg} and is located at the contact point F. This force is always perpendicular LEF because the force is transferred via a ball bearing in F. δ is the deflection of the spring. θ_0 is the angle at which LAF touches the spring system for the first time. Because the system is working with moments around the ankle O, the angle AOB does not have to be 180°, this is just an abbreviation of the system for the FBD. Eventually it will be implemented in the AFO with a different angle, depended on θ_0 , see Figure 43-right.

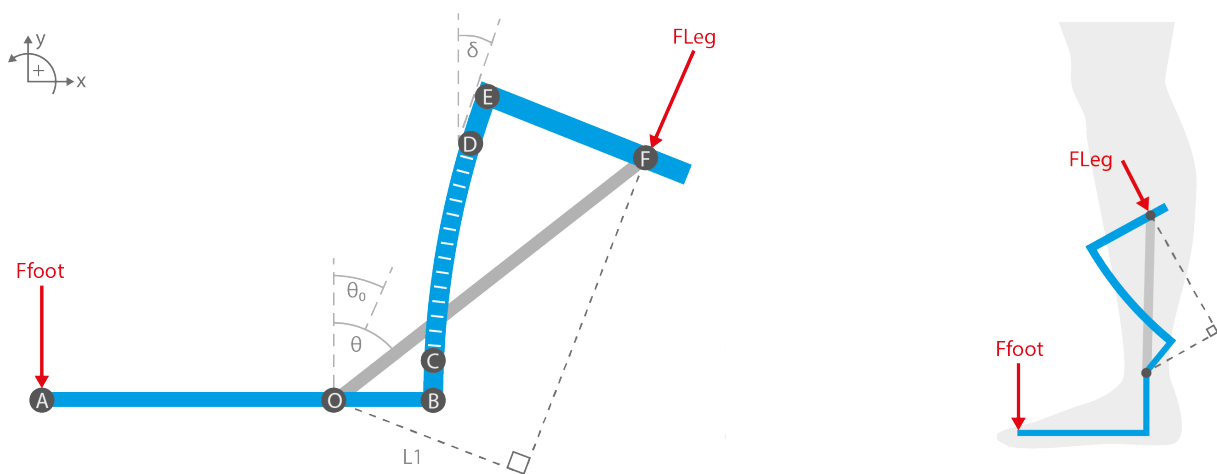

Figure 43: FBD of the functional system (left) and a possible implementation visualisation (right).

Equations

From this FBD the equations below could be created to mathematically explain the system. However, these equations are not perfect. There are two main issues, explained in the next paragraphs.

$$\mathbf{A} \quad \Sigma Ma := F_{\text{foot}} \cdot L_{ao} - F_{\text{leg}} \cdot \sin(\theta) \cdot L_{fo} = 0$$

$$\mathbf{B} \quad \delta l = \frac{L_{cd} \left(F_{\text{leg}} \sin(\delta) \left(L_{bc} + \frac{L_{cd} \sin(\delta)}{\delta} - L_{fo} \sin(\theta) \right) + F_{\text{leg}} \cos(\delta) \left(L_{bo} + \frac{L_{cd}}{\delta} - \frac{L_{cd} \cos(\delta)}{\delta} - L_{fo} \cos(\theta) \right) \right)}{E I_{\text{spring}}}$$

Large displacement

The formulas which are normally used for cantilever beams and link deflection to the applied moment at the tip are only applicable to beams subjected to small deflections (a few degrees) (below). However, this system involves large deflection of the spring (up to 40 degrees) and therefore the standard cantilever beam formulas do not apply. Unfortunately, the formula linking the spring force to the deflection had to be used in order to include the spring force in the equation.

$$\delta = \frac{M \cdot l^2}{2 \cdot E \cdot I} \quad \theta = \frac{M \cdot l}{E \cdot I}$$

The formulas for displacement (left) and deflection (right) of a cantilever beam subjected to small displacement. In these formulas 'Delta' indicates displacement instead of l in the formulas before. The same counts for 'theta' which is the deflection instead of the rotation of l .

Deflection of the spring

Because the formulas of small displacement could not be used, a different path was needed to include the deflection of the spring. To be able to do this, I made the assumption that the deflection of the spring in this system always follows a perfect arc. This assumption was founded on two points:

- Fleg is always perpendicular to the already perpendicular arm LEF resulting in a moment around D and no shear forces in D.
- A moment around D causes equal tension and compression within the spring resulting in comparable behaviour on both sides of the material, eventually leading to a perfect arc.

Non-linear optimization

The equations have 8 design variables if you exclude the design options of an angle DEF, a curvature in LEF or a length change in LDE. To obtain the perfect value for each parameter and create the optimal spring design, the system required non-linear optimization of which the end result would possibly not match the real world scenario. To take the system to the next level a different form of parameter extraction had to be used: geometrical parameter extraction.

5.4 Geometrical parameter extraction

The third approach used the geometrical relations within the system to define the effect of each parameter. In the CAD software Solidworks 2017 (Design Solutions, 2017) the functional system was converted into a 2D sketch with specific relations to represent the behaviour of the system. By changing the values of different parameters, the effect on the system could be visualized. An example for L_{bc} is shown below (Figure 44).

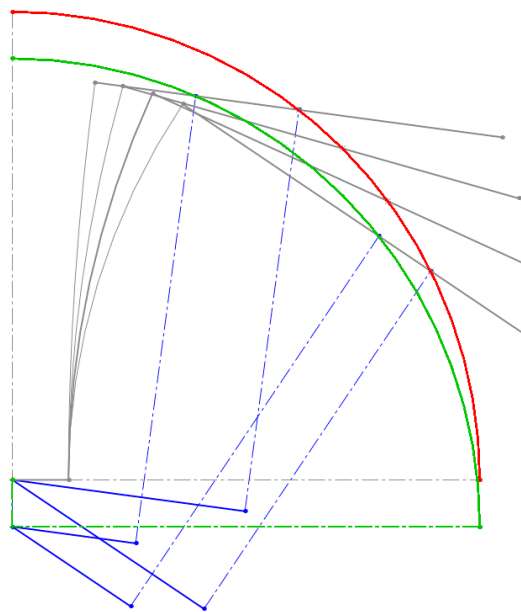

Figure 44: The sketch setup in Solidworks 2017 to analyse the effect of an increase of L_{bc} on the functional system. The red lines show the trajectory of point F, the green line shows the change in trajectory due to an increase of L_{bc} , the grey lines show the deformation of the spring system and the blue lines show the change in moment arm for both trajectories. By sliding and adjusting values relations could be determined between points.

Goals

The first goal of this analysis was to find the influence of the parameters on the moment output of the functional system and use this information to create the desired output. The second goal was to capture the effect of the variables on the design to be able to adjust the design without influencing the improved moment output. To retrieve the right information the goals were converted into analysable variables.

Goal 1: Adjust the system to get the correct moment output

The moment output of the functional system could be captured by two parameters, L3 and Fleg. The effect of the parameters on L3 can be visualized with geometric analysis but not Fleg. However, the effect of the parameter changes on Fleg could be estimated with the behaviour of the deflection of the spring and the behaviour of LEF. Together with L3 they could provide an insight in the effect of the parameters on the moment output. To capture this information the effect of the parameters have to be analysed on the following points:

- LEF at θ_0** The initial length of the moment arm when lower leg touches the spring system
- Δ LEF per $\Delta\theta$** The displacement of the contact point F per angular increment of the ankle joint
- L1 at θ_0** The moment arm of Fleg when the lower leg touches the spring system
- Δ L1 per $\Delta\theta$** The change in moment arm of Fleg per angular increment of the ankle joint
- δ per $\Delta\theta$** The deformation of the spring per angular increment of the ankle joint

Goal 2: Adjust the system without changing the moment output

Next to the information of the previous points there is one more important variable to capture the effect of the parameter changes on the system:

- θ_0** The first contact point of the lower leg with the spring. This indicates how much the system is rotated When implemented on the leg (Figure 43-right).

The results of this geometric analysis are displayed in Table 1 on the next page and will be used to optimize the system, this will be explained in the next chapter.

System parameters	Ffoot / Loa	E modulus	Moment of inertia of the spring
Type	Patient specific const.	Variable	Variable
Lef at θ_0	No change	No change	No change
ΔLef per $\Delta \theta$	No change	No change	No change
δ per $\Delta \theta$	No change	No change	No change
Ll at θ_0	No change	No change	No change
ΔLl per $\Delta \theta$	No change	No change	No change
θ_0	No change	No change	No change
Expected behaviour on Constant moment	Need for a higher moment output, this will have to be compensated	Higher overall moment output due to a stiffer spring	Higher overall moment output due to a stiffer spring
Other			

System parameters	Lcd (spring length)	Lde	Angle DEF
Type	Variable	Variable	Variable
Lef at θ_0	Shorter	Shorter	Shorter
ΔLef per $\Delta \theta$	Smaller	Smaller (minor effect)	smaller (major effect)
δ per $\Delta \theta$	Smaller	Larger (minor effect)	Larger (major effect)
L3 at θ_0	Smaller	Smaller	Larger
$\Delta L3$ per $\Delta \theta$	Minimal change	Minimal change	Larger
θ_0	Smaller	Smaller	Smaller
Expected behaviour on Constant moment	Unknown effect, multiple small differences compensating for each other	Higher moment output due to a shorter L3	Increasing the moment in the beginning but this effect might lower when θ increases

Table 1: The influence of each relevant parameter on the functional system

Overall size	Lof	Lob	Ibc
Variable	Variable	Variable	Variable
Larger	Larger	Larger	Smaller
Larger	Smaller	Smaller	Larger
No change	Larger	Larger	Smaller
Larger	Larger	Larger	Smaller
Larger	Minimal change	Smaller	larger
No change	Larger	Smaller	Smaller
No change in moment output if the spring is made stiffer	Increasing moment due to a larger deflection per θ	Increasing moment due to a smaller L3 and a larger deflection per θ	Unknown effect, multiple small differences compensating for each other
Lower contact point of the force on the calf. (This requires the backplate to be much stiffer to prevent pressure points on the Achilles tendon)			

Curvature at the back of the spring (downward)	Curvature at the back of the spring (upward)
Variable	Variable
Longer	Shorter
Larger + increasing	smaller
Smaller (major effect)	larger
Smaller	Larger
Larger	Larger
Larger	Smaller
Major difference in deflection per θ . This weakens the build-up of force	Unknown effect, multiple small differences compensating for each other

5.5 3D functional prototype

To investigate whether the 2D system would also work when applied to an AFO, a modular 3D functional prototype was constructed (Figure 45). The 2D spring no. 32 was used and put on both sides of the ankle to create an evenly distributed spring force. Both springs were angled slightly outward in the frontal plane (-7° and $+5^\circ$) to match the geometry of the calf.

Initial walking test

The first walking test, performed by me, showed quite promising results. The neutral moment during swing was around 90° and a full range of motion of the ankle could be reached. Unfortunately the foot slap at loading response was not prevented because the spring was not strong enough.



Figure 45: (left) The 3D first functional prototype. (middle) The neutral position during swing. (right) Performance measurement setup

Test setup

The moment output was measured by fixating the footplate and measuring the force needed for the rotation of the calf (Figure 45-right). The rotation was measured with a video camera and the motion capture software Kinovea (Version 0.8.27; Charmant, n.d.). The moment output was measured using a Newton meter connected at a fixed distance of the hinge. The newton meter was connected via a wire and an angle reference to the calf plate to make sure that the force measurements were taken consistently perpendicular to the calf plate.

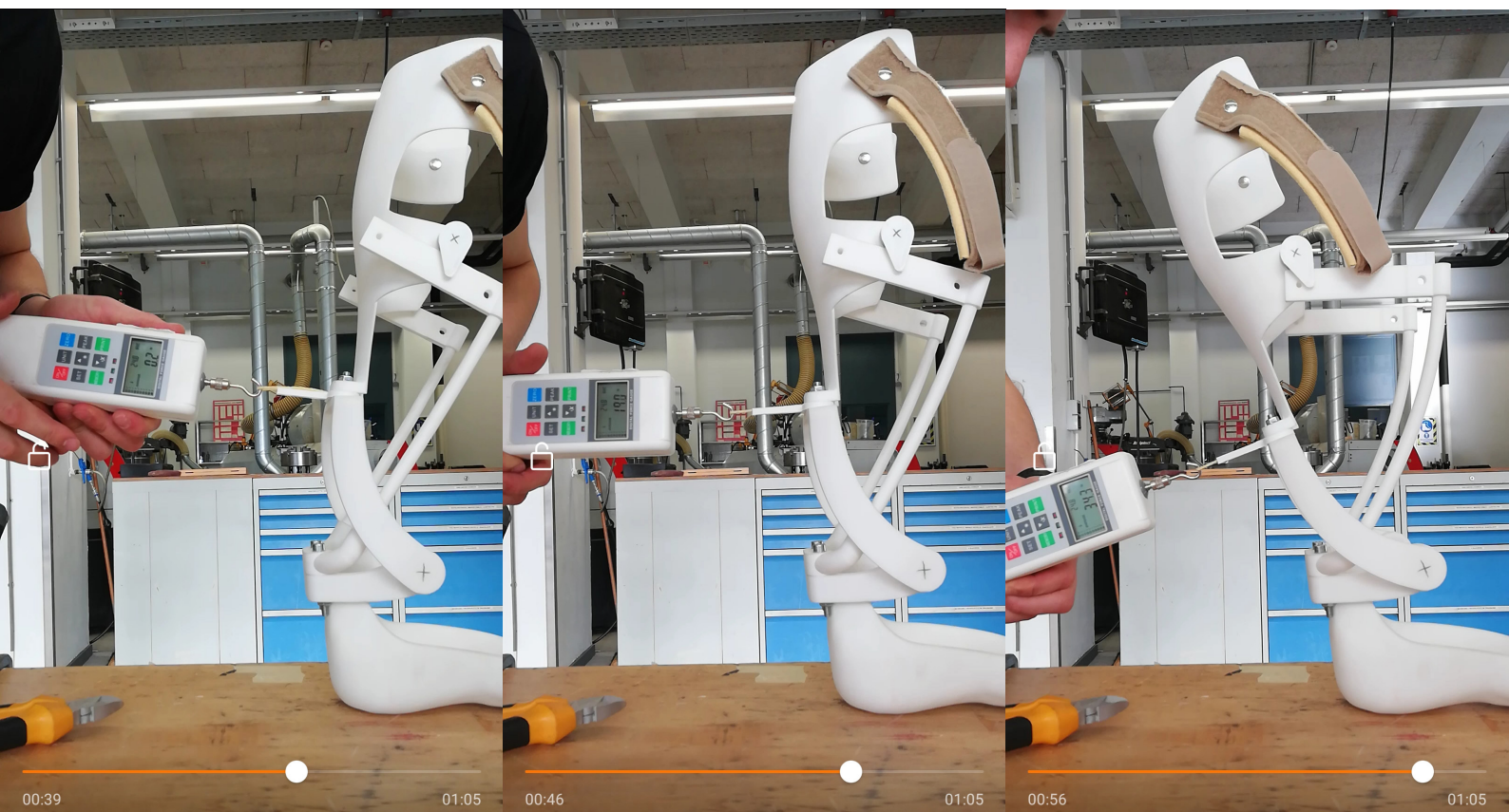

Results

The moment output of the 3D functional prototype was not as expected. Figure 46 shows the measurements of the 3D prototype and the expected results. The expected moment output is the graph of the 2D prototype (no. 32) but with the same normalized starting angle as the 3D prototype defined by the first constant moment measurement of 2D prototype no.32. The main difference is that the 3D prototype does not flatten out towards plantar flexion. The following paragraphs explain the adjustments made to get the correct moment output.

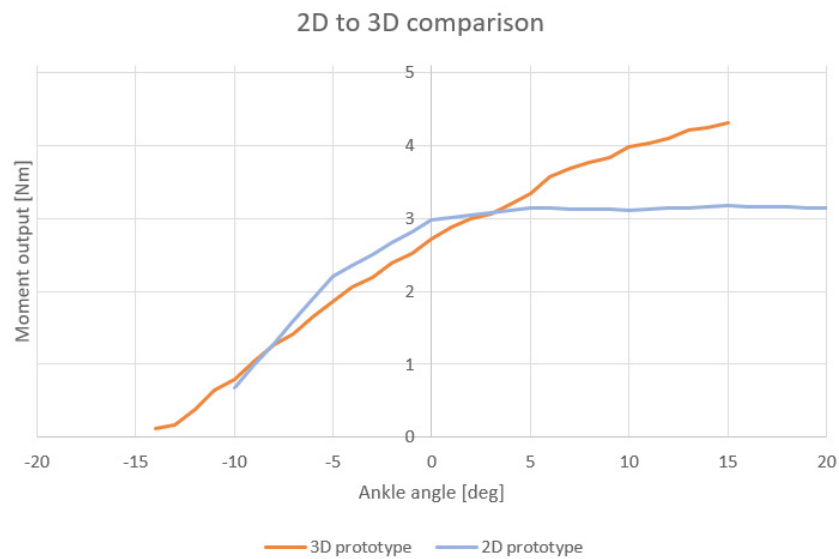

Figure 46: *Moment comparison of the 2D and 3D prototype.*

5.6 Improving the moment output

Figure 47 compares the measurements of the 3D prototype with the desired moment output from the analysis and is displayed as moment with regard to the angular position. The value of the horizontal part of the desired output graph is randomly chosen to display the curvature of the graph.

There are 4 main deficits in this graph:

- The possible influence of the deflection within the calf plate have to be removed
- The dorsiflexed moment should be 0 Nm
- The increasing plantarflexed moment should be a constant moment
- The graphs should be able to meet different horizontal moments outputs

The steps taken to improve this are addressed in the next paragraphs.

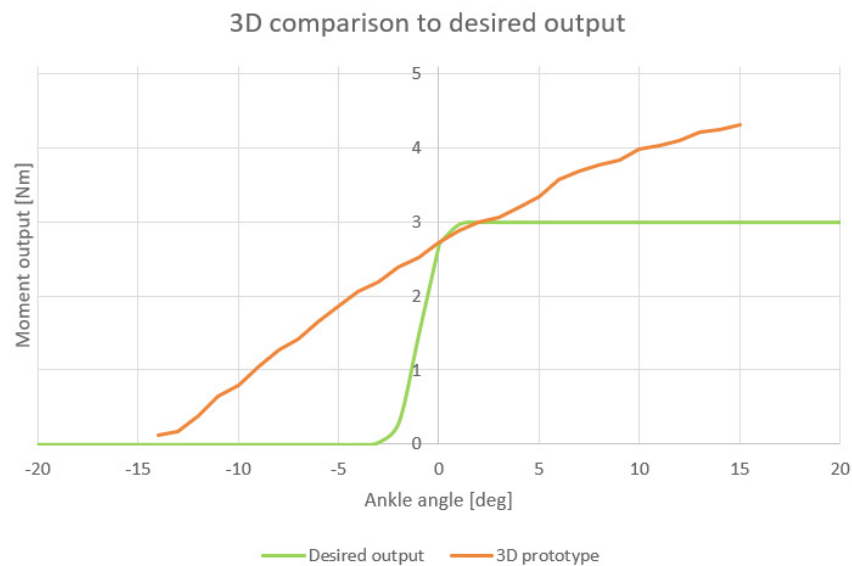

Figure 47: Comparison of the 3D prototype to the desired moment output

Step 1: Excluding unwanted deflection disturbances

As explained before, the calf plate was relatively flexible resulting in various deformations under pressure of the spring. To exclude the influences of these deformations on the spring a stiffer version of the calf plate was designed to conduct the future measurements (Figure 49). The impact of the tiffer calf plate calf plate is shown in Figure 48.

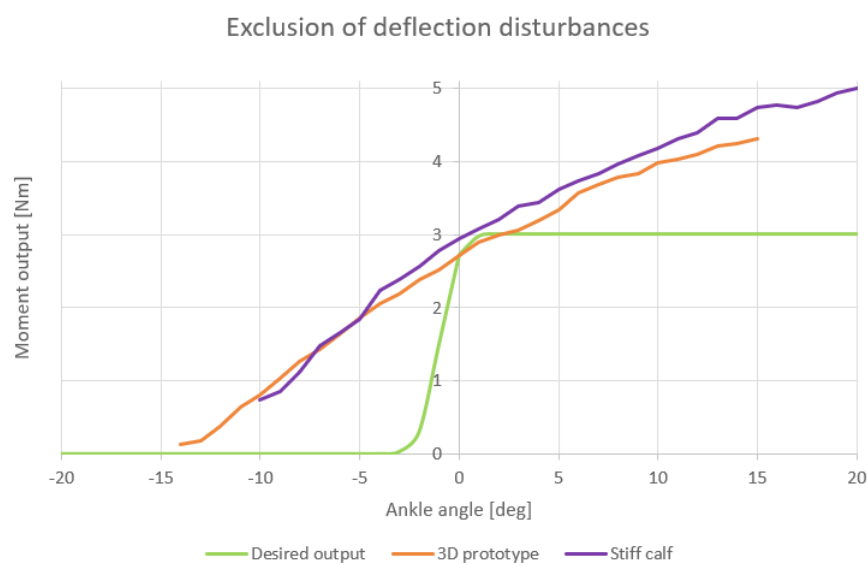

Figure 48: Effect of the exclusion of the deflection disturbances in the calf plate on the moment output.



Figure 49: The stiffer calf plate

Step 2: Flattening the output during plantar flexion

Figure 48 still shows an increase in the moment output. According to Table 1, this can best be influenced by adding a downward curvature to the wings of the spring. Three possible downward arcs (figure XXX) were tested to find the optimal curvature, their results are shown in Figure 50. As expected, when the curvature increases the graphs flatten. The graph of curvature 2 shows a large dip at the end, this was due to irregularities on the surface of this profile. The optimal curvature can be found somewhere between curvature 2 and 3.

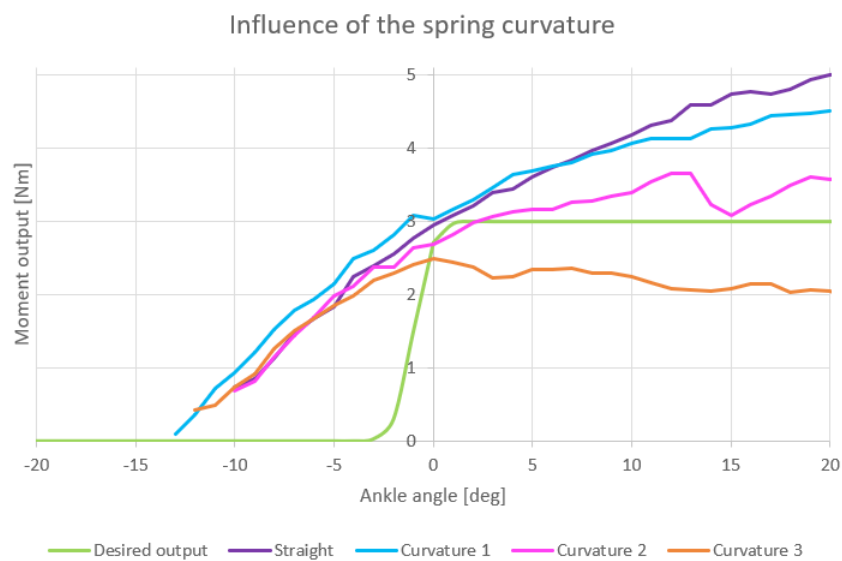

Figure 50: (boven) Effect of the spring curvature on the moment output



Figure 51: (onder) The different curvatures

Step 3: Minimizing the influence during dorsiflexion

The easiest way to make sure that the effect of the moment output has a fast incline is by already applying tension on the spring before the lower leg makes contact with it. This was done by tying a string at the end of the spring and pulling it towards the heel (Figure 53). The effect of the pre-applied tension is seen in Figure 52. The results still shows a light slope, this can be explained by two things. Firstly, the string contains some sort of elasticity which slows the transfer of forces between the string and the lower leg, this can be prevented by using a string with a lower elasticity. Secondly, the string is not attached perpendicular to the deflected tip of the spring leading to a slightly different deformation of the spring. This deformation is compensated when the forces are transferred from the string to the spring, leading to irregularities. This can probably be solved by adjusting the fixation points of the string.

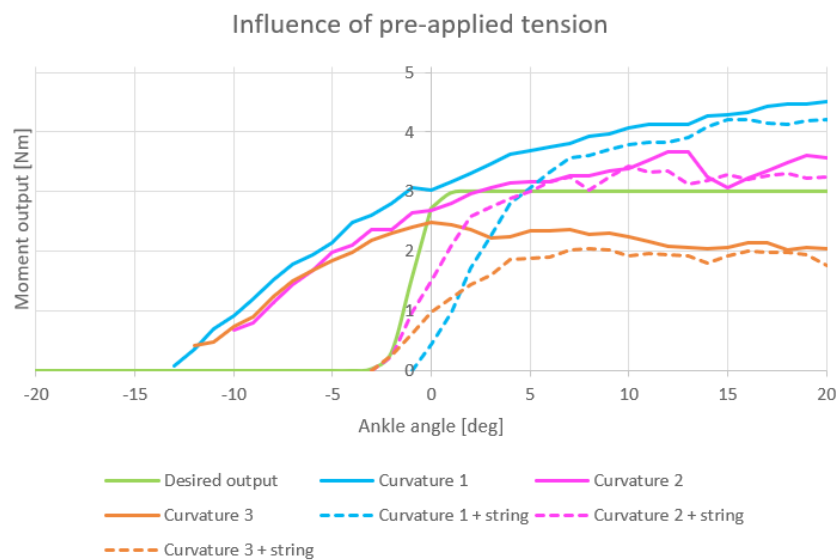

Figure 52: Effect of the pre-applied tension the the moment output of the 3D prototype

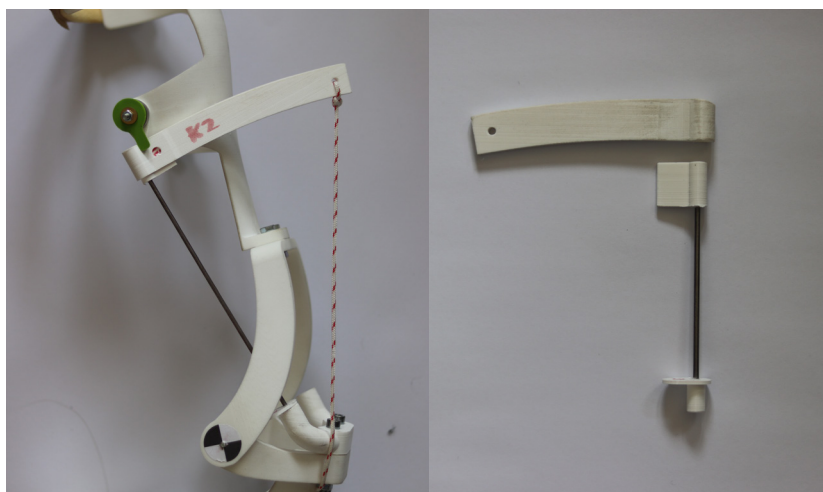

Figure 53: The rope addition (left) and the modular design for the different springs (right)

Step 4: Increasing the constant moment output

According to Table 1, the easiest way to influence the constant value of the moment output is by increasing the E-modulus and moment of inertia of the spring. This is done by trying various options of standardized spring steel profiles as springs (Figure 53). Figure 54 shows that for different spring stiffnesses multiple constant moment outputs can be reached and Figure 55 proves that there is a linear behaviour between the moment of inertia and the moment output.

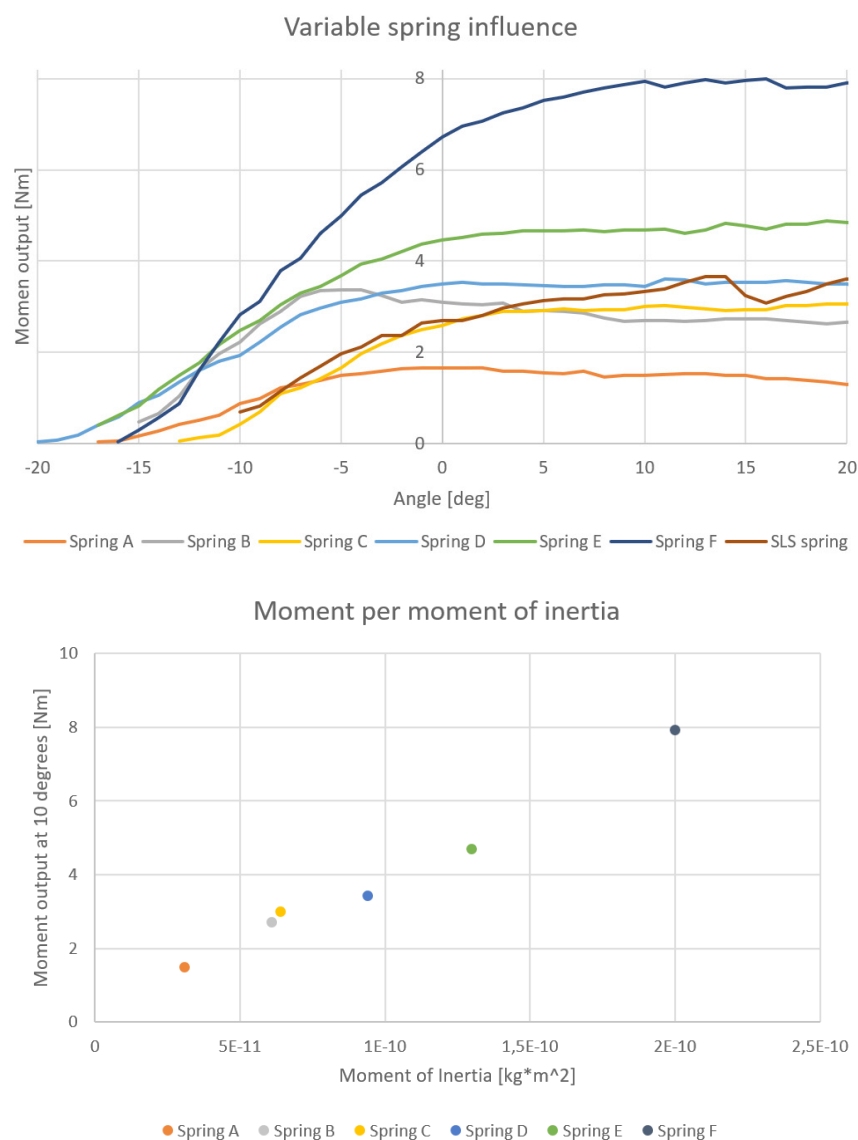

Figure 54: (top) Effect of different spring stiffnesses on the moment output of the 3D prototype.

Figure 55: (bottom) The linear relation between moment of inertia and moment output

5.7 Material analysis

To determine the right process and material it is best to look at the area of the AFO with the most demanding requirements, the foot plate. This has the most complex patient specific geometry with low tolerances which makes 3D printing a perfect fit.

FDM investigation

There are two main problems when producing the foot plate in FDM:

Finishing time

To print large overhanging segments extra supporting geometry is needed. They leave marks on the surface and often need to be sanded. Even with the most optimal print orientation for both footplate and calf the result still needs a lot of finishing time.

Delamination

Delamination is the separation of layers within the part caused by high stress. Delamination can create sharp edges which can cause severe damage, especially to patients with no sensitivity in their feet (one of the side effects of some illnesses causing DFS according to the consulted physiatrist and OTs).

Experiments with nylon and soluble supports caused extreme warping and indicated that a lot more research was needed to reach the required quality standards if FDM would be chosen.



Figure 56: (top) FDM result after support removal, (middle) delamination of the toe plate and (bottom) imperfect surface finish (bottom).

Day	1	2	3	4	5	6	7	8	9	10	11	12	13
FDM	Measuring	Correcting + product generation	FDM printing	Finishing									
SLS	Measuring	Correcting + product generation	SLS printing					Shipping	Finishing				
MJF	Measuring	Correcting + product generation	MJF Printing									Shipping	Finishing

Figure 57: Production time comparison.

SLS & MJF investigation

Both SLS and MJF insoles had great quality, but because of their thickness they were difficult to deform. The high heat needed to deform the thick double curved surface created burn marks (Figure 58). Slower heating with lower temperatures is not an option due to the limited time for delivery (30 min). A thinner surface with structural beams or engraved patterns might be a solution to allow for easier deformation.

Production time

FDM can be printed in one day but the external production of SLS will take 5 days (Materialise, 2019; Oceanz, 2019) but 9 days for MJF (Materialise, 2019). Figure 57 shows that MJF will lengthen the current total production time to 13 days instead of the current 9 days which is already too long according to the specialists and physiotherapists. If in the future faster production times can be reached with MJF more research can be done on this production method.

Colour

In general in the orthopaedic field no white orthoses are created since it will become dirty easily due to sweat. Coloured SLS prints will get white surfaces when sanded but the already dark coloured MJF will not get effected too much. Oceanz also offers the option to print with grey powder which is therefore the best option for all combinations

Conclusion

FDM is not suitable for the insole due to the quality, needed finishing steps, extra research to make it work and risk of delamination. Both MJF and SLS show good results for the foot plate although more research is needed to optimize the deformation process. The current production time for MJF is too long, but it might be interesting if faster production times can be reached.

Therefore the best option for the foot sole is grey SLS from Oceanz. For the calfplate SLS is the best option, but FDM is still a possibility if the cost of the final calfplate design is too high.



Figure 58: Deformed and sanded trim lines for SLS (top) and MJF (2nd from top). Deformed and sanded heel for SLS (3rd from top) and MJF (bottom).

6. EVALUATION

6. EVALUATION

This chapter explains how the functional model was evaluated via a personal and a patient walking test



6.1 Personal walking test

To experience the effects of the AFO several walking tests were performed by myself. It was quite difficult to mimic the walking gait of a patient with DFS because walking is an unconscious movement of the muscles which has been perfected through years of experience. Nevertheless, important insights were found:

Undisturbed dorsiflexion: The system allowed for free dorsiflexion leading to a comfortable motion with a lot of freedom.

Deformation of the calfplate: The calf plate used for the personal walking tests was not stiff enough and deformed due to the forces of the springs. This resulted in a different deformation of the springs and cutting off blood circulation. A stiffer solution would resolve this.

Sideways motion of the foot: Because the ankle joint consists of three joints which contribute to the motion of the foot (Brockett, 2016) there seemed to be a lot of internal deformations. For the normal custom-made AFO this is not a problem since it blocks most of the sideways movements, but the flexibility of the 3D prototype allowed for more freedom of movement in the frontal plane leading to misalignment of the bearings and the springs. The misalignment caused the springs to get stuck or have a different deformation than expected.

Plastic deformation: After multiple tries and the tests of the previous chapters the springs were plastically deformed leading to a different moment output.

6.2 Patient walking test

To get a better insight in the experience from the patient's point of view, a patient walking test was performed. For this test a young fit patient (17yo) was selected with DFS (right foot) and no other diagnoses. The patient was asked to walk multiple times on a treadmill at a comfortable pace of his own choice with their current AFO, without an AFO and with the prototype mounted with different spring settings. The walking gait was captured with a video camera and pressure measuring insoles. The video data was analysed with the motion capture software Kinovea (version 0.8.27; Charmant, n.d.). After every run a short interview was held to get an insight in the patient experience.

Prototype

The rope construction mentioned in chapter 6.6, step 4 was not yet added to this prototype and therefore the moment output was not as perfect as intended. The prototype can be seen in Figure 60.

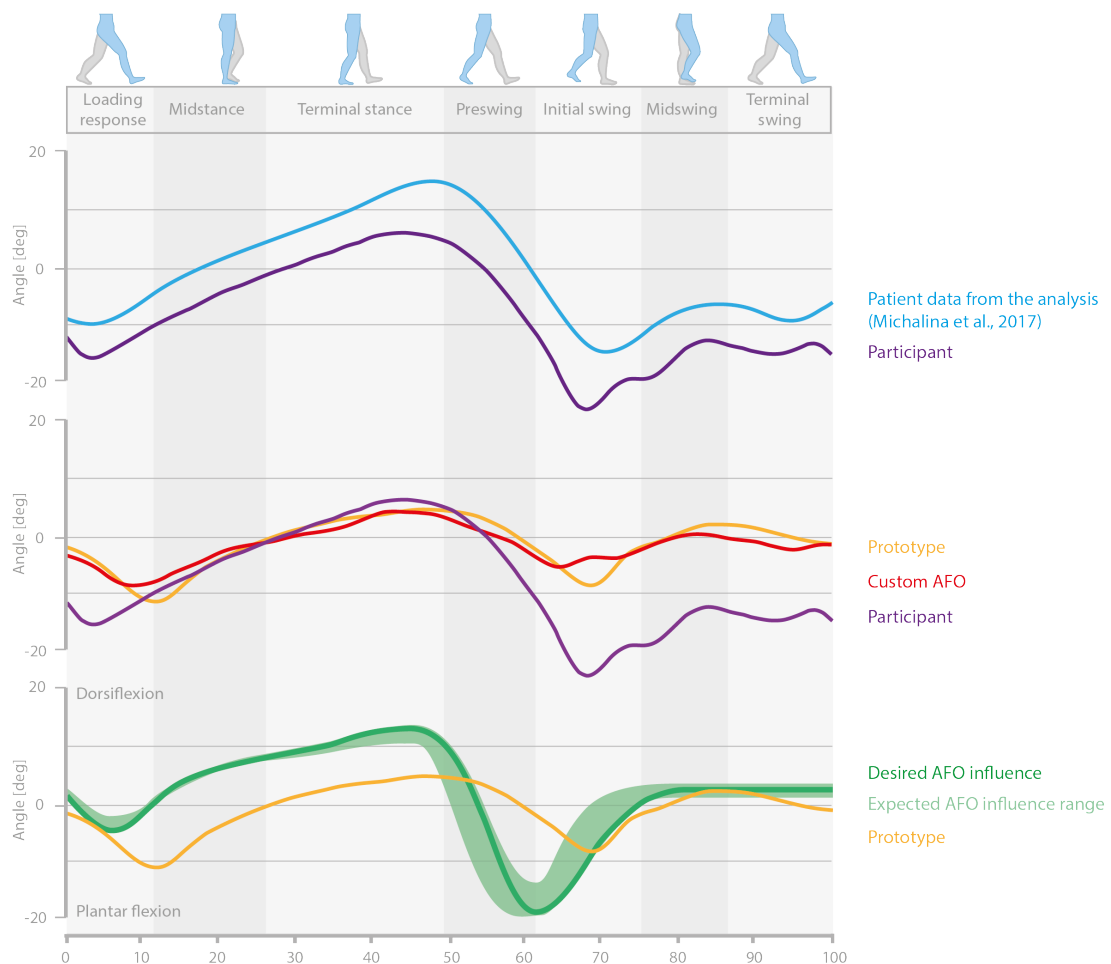

Figure 59: Gait graphs results of the patient walking test

Results

The resulting gait graphs (Figure 59) clearly show that the patient has DFS, this can be seen from the plantarflexed initial contact, the high plantar flexed push-off and the plantarflexed swing phase. The patient's custom orthosis also clearly limits the plantar flexion during loading response and the swing phase but it also slightly limits the dorsiflexion during the stance phase.

Comparing the prototype to the current AFO shows that the prototype allows for slightly more plantar flexion during loading response and push-off, as intended. However, this was due too the fact that the springs were not strong enough. According to the patient, the strongest spring configuration of the prototype did not fully prevent the foot from slapping on the ground during loading response. This can also be seen in the prototype graph as the slope is steeper than the slope of the current AFO.

The effect of the increased dorsiflexion freedom without restrictive moments during walking could not be shown because the patient already had low dorsiflexion freedom, approx. 5 deg. instead of the normal average around 15 degrees as seen in Figure 26. The intended increased freedom can seen in figure X, where the patient is crouching with both AFOs.

When comparing the results to the goals from the analysis (Figure 59-bottom) it shows that the prototype for this patient did not yet matches the optimal result. This was due to the imperfect prototype and the fact that this was one specific patient gait.



Figure 60: Patient prototype. the blue/grey block on the patient's shin is the transmitter of the pressure measuring insoles and does not belong to the prototype.



Figure 61: Crouching with the current AFO (left) and the prototype (right).

Ground pressure

Figure 62 displays the path of the centre of the pressure distribution during the walking tests. The bottom corners in the graphs, indicate the centre of pressure at the loading response phase. At the left foot this is lower than the right because the right foot touches the ground with the full foot instead of just the heel, leading to a more anterior location of the centre of pressure.

The insole was placed between the foot and the AFO. The difference between 'shoes only' and 'prototype without springs' shows that the addition of the 3D printed foot plate had an influence on the results on the pressure insoles and therefore no hard conclusion can be drawn from these measurements. Nevertheless, the results of 'prototype with springs' hints that the springs were indeed not strong enough.

Other relevant insights

Differences between foot plates: The prototype was modelled around the same corrected mesh as the patient's current orthoses but the patient foot was sliding inside the footplate of the 3D printed version. Showing that even though they were created around the same mesh, that there was a difference in geometry.

Flag size can be way smaller: The size of the 'wings' can be extremely reduced since the intended 20 degrees of plantarflexion will never be reached due to the stiffness of the springs.

6.3 Conclusion

The personal and patient walking tests were not able to proof that the intended impact of the design would improve the patient's gait compared to the current custom-made AFO. This was due to the limitations of the tested prototype and the fact that only one patient test was conducted. More patient walking tests with an improved functional prototype should result in a clearer outcome.

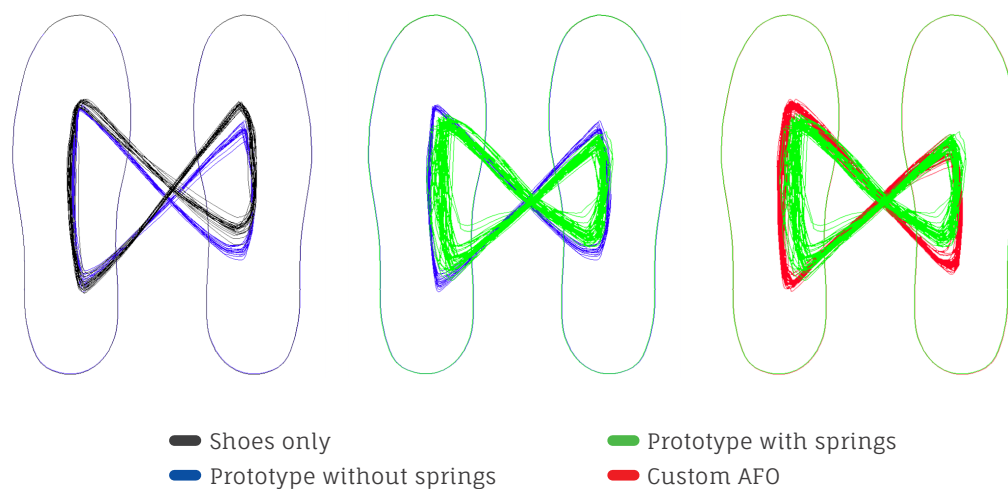

Figure 62: Cyclogram of the weight distribution between the feet during walking

7. SLS OPTIMIZATION

7. SLS OPTIMIZATION

This chapter explains the final improvements of the prototype, optimized for SLS production



7.1. Design for discretion

The functional prototype from the previous improvements is a large model with high anterior and posterior offsets. This is contrary to the patients' wish of not standing out, therefore there is need for a more discrete concept. The visibility and appearance of an AFO has a lot to do with how the person is dressed. To be able to create a discrete design a few assumptions have to be made about the patients' clothes:

- If the patient chooses to wear shorts or short skirts he / she is already willing to show the orthosis to the public and puts less value in the discretion of the design.
- The same applies for trousers with a tight fit (skinny jeans) because they require the orthosis to be worn on top of the pants.
- Dresses and long skirts have more spatial design freedom than trousers.

Therefore the scope for this iteration is limited to normal straight trousers. Trousers create three important areas of requirements with regard to discretion, visualized in Figure 63.

- A The calf is fully covered by the trousers. This puts no demand on visual representation of the orthosis but limits the spatial design freedom. Sharp edges, large offsets from the leg, high relief and moving geometry create undesired visual clues through the fabric of the pants. Because trousers have a tighter fit around the calf compared to around the ankle this effect is increased towards the top.
- B The area between the pants and the shoe is exposed and highly visible. In this area the visual representation is important and a discrete look should be applied. Next to that any sharp edges, large offsets, large geometry and moving parts attract attention and should therefore be avoided. Especially at both the lateral and medial sides since the malleoli have a substantial dimension.
- C The AFO requires to be worn inside a shoe as explained in [chapter CCCCCC](#) and this part will not be visible, therefore no demands are set with regard to discretion in this area.

When applying these design requirements on the functional prototype the following points will have to be adjusted:

- 1 The height and offset of the ball bearings have to be lowered (creating a smaller spring system).
- 2 Remove the contact points and create one smooth part.
- 3 The hinge system has to be converted to a less prominent system or redesigned into a different system at the back to remove the geometry on top of the malleoli. (Changing the hinge system into something else will not be addressed during this project because this will have a high impact on the trajectory of the contact point between the calf and the spring.)
- 4 The connection between the springs and the footplate have to become a combined subtle solution.
- 5 The flags on the side of the system have to be made less prominent.
- 6 The springs have to more accurately fall within the geometry under the pants.

These adjustments correspond to the following adjustments according to Table 1 without changing the moment output of course.

Shorter LEF to reduce the posterior and anterior offset of the spring

Smaller θ_0 to reduce the posterior offset of the spring

Smaller overall size to reduce the size of the mechanism

Two of these adjustments were already included in the patient prototype (below), the rest of the adjustment list for the final iteration on page XXX:

The height and offset of the ball bearings have to be lowered. To get an insight into the problems a possible size reduction would create, a 50% spring system size reduction was applied to the patient specific prototype (figure XX). This size reduction created a lot of stress in the connection between the spring steel springs and the 'flags' which eventually caused delamination in some of the connections of the stiffest springs. The offset between the tip of the spring steel spring and the upper surface of the flag was too big and created a lot of room for shear force. More research has to be done to investigate how to improve the connections between the springs and the flags.

The connection between the springs and the footplate have to become a combined subtle solution. The size reduction of the spring system also caused the bottom connection of the spring to become closer to the hinge, leading to a more coherent and more subtle design.

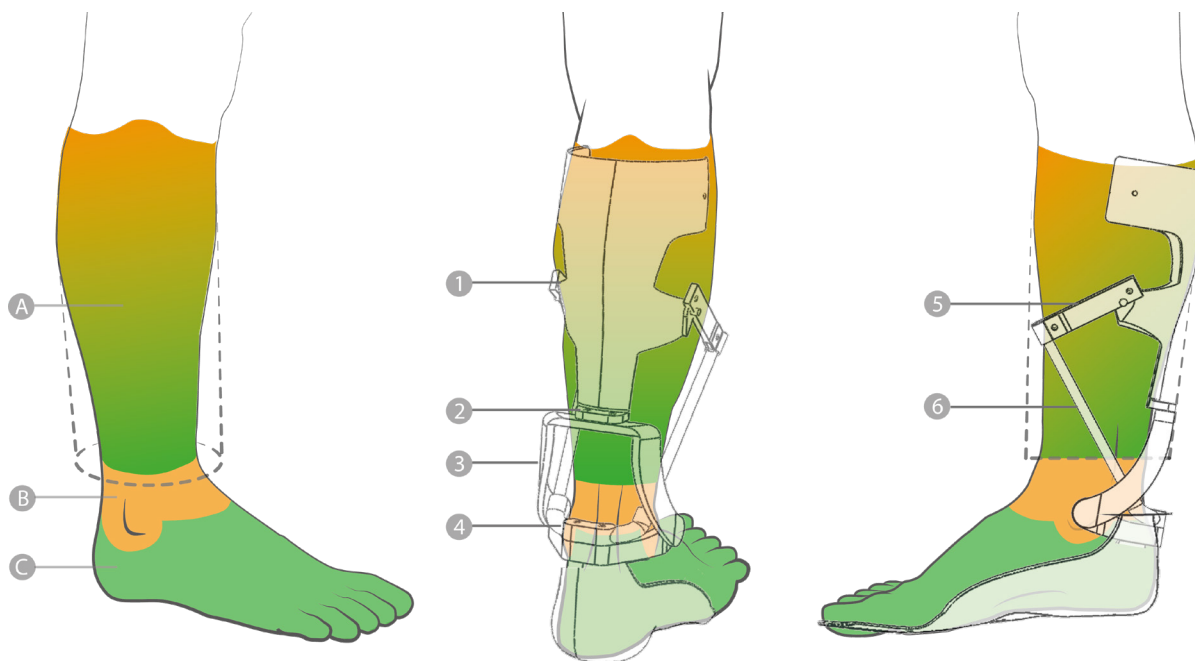

Figure 63: Influence of the clothes on the AFO prototype

7.2 Stiffness adjustments

As explained before in chapter 7.1, deformations and stiffness is a relevant topic when dealing with the forces of the springs. For the patient test this was sorted by increasing the thickness of the calf plate to 5mm (FDM, PLA). This added a considerable amount of weight to the AFO which counteracts the goal of lowering the energy-cost of walking.

SLS printing allows for complex structures with variable thicknesses and is therefore able to create a stiffer design with less material. Figure 64-left shows the relevant forces acting on the calf plate and Figure 64-right shows the desired and undesired deformations of the functional prototype which occurred during the personal walking tests. This problem was tackled by idea sketching of the best solutions per area of the calf plate ([Appendix AA](#)) and combining them to a coherent solution. No final element analyses were performed to check the made assumptions.

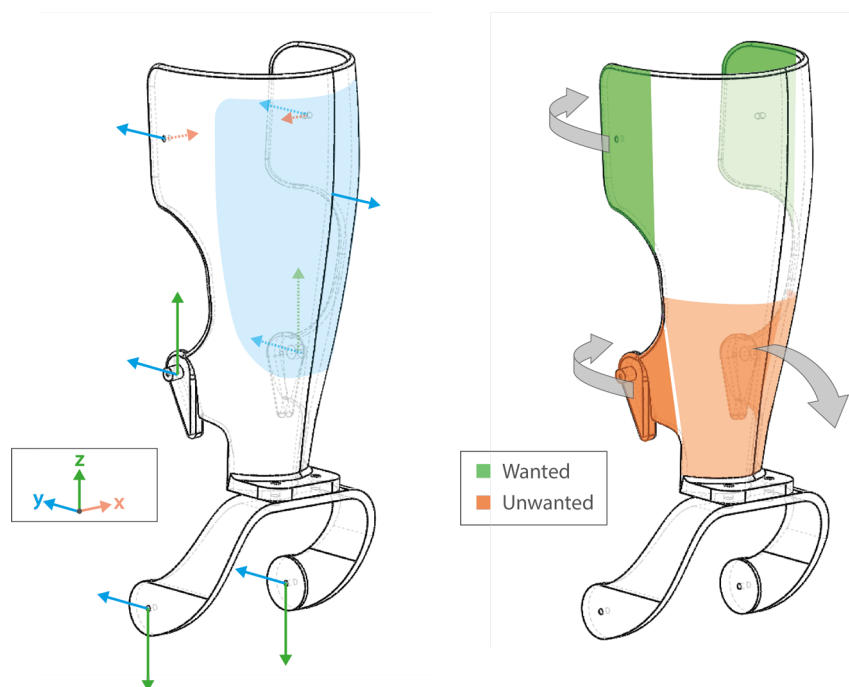

Figure 64: The relevant forces acting on the the calfplate (left) and the desired and undesired deformations of the prototype (right).

7.3 Adaptability

According to chapter 2.9 (post-production adaptability) in combination with chapter 6.8 (Material analysis) it shows that the current design does not allow for easy adjustments within the timeframe of the delivery meeting. This problem was tackled by idea sketching and a selection of the most plausible options and the reasoning behind the selection of the best idea is displayed in Figure 65. It is important to understand that every adaption is different and needs a different deformation.

The reduced thickness allows for easier heating and deforming. But, if adaptations outside of these thin areas need to be made it is possible to reduce the thickness with sanding first, before heating and deforming.

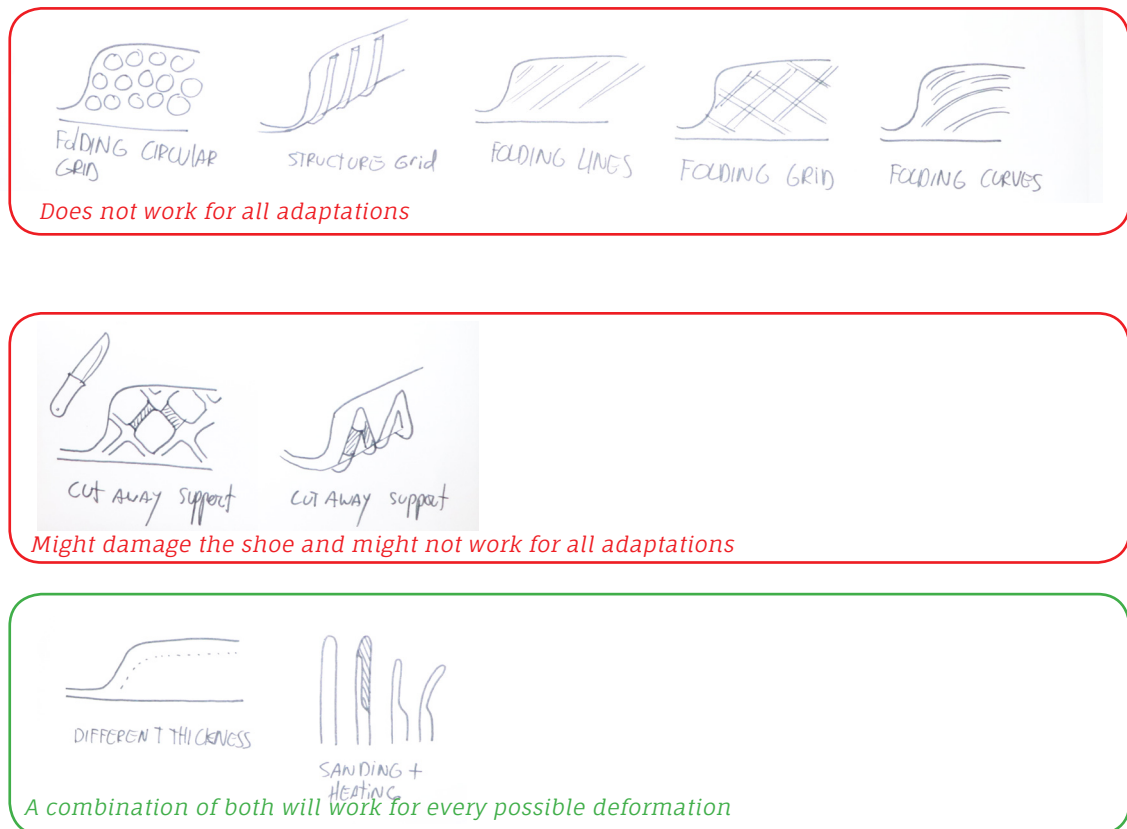

Figure 65: The ideas for the adaptations to the upper, medial and lateral trimlines (top) and the ideas for the adaptations for the heel (bottom).

7.4 Sliding of the footplate

One of the feedback of the patient during the walking test was that his foot was sliding in the footplate. There are three factors which could be the cause of this problem:

The tightness of the shoe around the foot: The stiff trimlines block the shoe from tightly fitting around the front foot. Their curvature was determined by me and based on the pictures of the patients previous orthosis, my own 3D printed version and other AFOs leading to a slightly longer ridge than normal on the medial side. The trimlines of the next prototype should be checked by an OT to make sure that the curvature is correct.

Influence of the different production methods on the size: The different steps between the vacuum forming and SLS printing processes of the same scan will lead to differences in the final geometry. The effects of these steps (figure X) is expected to lead to a smaller vacuum formed AFO compared to the 3D printed version.

If sliding is still the case after the adjustments to the trimlines the effects of the different production methods should be analysed more in detail. This should be done by roducing the same AFO with both production methods, cutting them at the exact same cross-sections and comparing the 2D scans of these surfaces. It is expected that the whole footplate needs a small surface offset which can be added to the product generation algorithm, but if the negative effects are only experienced at the front of the foot (an extra adjustment by the OTs during the correcting phase would be suffiencent).

The friction of the surface: The vacuum forming process leaves an embossed pattern on the inside of the AFO while SLS printing creates a smooth surface finish. If the previous two methods create pressure points on the skin it is possible to add a slight pattern on the inside of the foot plate.

7.5. Breathable solution

One of the wishes of the patients is a breathable solution compared to the current orthosis. Contrary to vacuum forming 3D printing makes it possible to add holes to the calf plate of the AFO without labour intensive drilling allowing air to come in contact with the skin. However, the adding extra holes in the calf plate of the orthosis will create another problem: 'window edema' (the swelling that occurs through holes in a surface when it is pressed on the skin).

Klundert (2017) faced the same problem in his master thesis about 3D printed casts and proposed adding a tight fitted low stretch fabric on the inside of the cast (Figure 66). The same principle can be applied to the 3D printed AFO, by adding a low stretch fabric on the calf plate. Printing a fabric substitute hole pattern would result in very thin wall thicknesses making it prone to break and cut the patients skin. To keep the AFO hygienic this fabric must be hydrophobic and have wicking properties (the act of drawing off liquid by capillary action) like sports clothing.

Currently the OTs are hesitant to stick fabrics or insoles on the inside of the AFO because the materials they use get dirty easily, are difficult to glue and even harder to glue back on if they come off due to the grease of the skin. SLS is able to solve that problem by integrating locking system which clamps the fabric in place instead of glueing it (Figure 67).



Figure 66: 3D printed cast of the thesis of Klundert (2017)

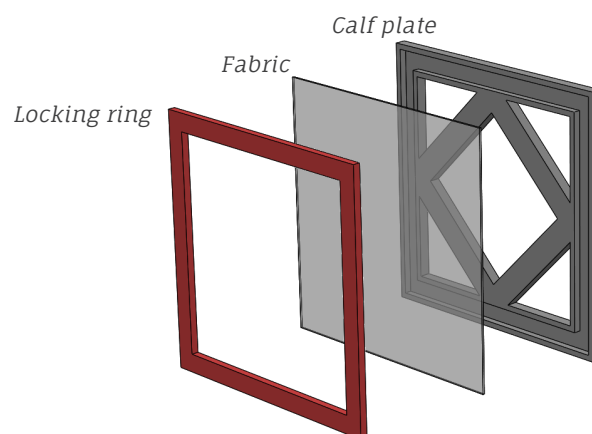

Figure 67: The click solution for SLS printing



Figure 68: *The final prototype with the SLS improvements.*



Figure 69: *The final prototype with the SLS improvements.*

8. ADVISE FOR COR

8. ADVISE FOR COR

8.1 Continuation of the project

The current design was created with the idea of improving the gait function compared to the current custom-made AFOs. However, this functional improvement still needs a lot of development before it can be taken into production.

For COR it will be more beneficial to first start by printing a so-called plantarflexion stop AFO and afterwards gradually adding dynamic support comparable to the current custom-made AFOs. Only after a sufficient dynamic AFO base is established, the attention could be focussed on improving the gait.

The design of a solid AFO can easily be adapted from the sufficient dynamic design by adding more geometry to create extra stiffness.

9. REFERENCES

9. REFERENCES

9.1 Literature references

Bregman, D. J. J., Groot, V. D. E., & Diggele, P. V. A. N. (2010). Polypropylene ankle foot orthoses to overcome drop-foot gait in central neurological patients : A mechanical and functional evaluation, 34(September), 293–304. <https://doi.org/10.3109/03093646.2010.495969>

Bregman, D. J. J., Harlaar, J., Meskers, C. G. M., & Groot, V. De. (2012). Gait & Posture Spring-like Ankle Foot Orthoses reduce the energy cost of walking by taking over ankle work. *Gait & Posture*, 35(1), 148–153. <https://doi.org/10.1016/j.gaitpost.2011.08.026>

Bleyenheuft, C., Caty, G., Lejeune, T., & Detrembleur, C. (2008). Assessment of the Chignon 1 dynamic ankle – foot orthosis using instrumented gait analysis in hemiparetic adults, 51, 154–160. <https://doi.org/10.1016/j.annrmp.2007.12.005>

Brockett, C. L. (2016). Biomechanics of the ankle. *Orthopaedics and Trauma*, 30(3), 232–238. <https://doi.org/10.1016/j.mporth.2016.04.015>

Burguete, E., Machat, H., Rousseaux, M., & Mazaux, J. M. (2011). Effect of early compensation of distal motor deficiency by the Chignon ankle-foot orthosis on gait in hemiplegic patients : a randomized pilot study. <https://doi.org/10.1177/0269215511410730>

Chin, R., Hsiao-wecksler, E. T., Loth, E., Kogler, G., Manwaring, S. D., Tyson, S. N., ... Gilmer, J. N. (2009). A pneumatic power harvesting ankle-foot orthosis to prevent foot-drop, 11, 1–11. <https://doi.org/10.1186/1743-0003-6-19>

Geboers, J. F., Drost, M. R., Spaans, F., Kuipers, H., Jf, A. G., Spaans, F., & Kuipers, H. (2002). Immediate and Long-Term Effects of Ankle-Foot Orthosis on Muscle Activity During Walking : A Randomized Study of Patients With Unilateral Foot Drop, 83(February), 240–245. <https://doi.org/10.1053/apmr.2002.27462>

Gök, H., Küçükdeveci, A., Altinkaynak, H., Yavuzer, G., & Ergin, S. (2003). Effects of ankle-foot orthoses on hemiparetic gait. *Clinical Rehabilitation*, 17(2), 137–139. <https://doi.org/10.1191/0269215503cr605oa>

Holmberg, U. (2014). Halmstad University Post-Print Ankle-Foot-Orthosis Control in Inclinations and Stairs, (July). <https://doi.org/10.1109/RAMECH.2008.4681479>

Kesikburun, S. (2017). Effect of ankle foot orthosis on gait parameters and functional ambulation in patients with stroke, *Turk J Phys Med Rehab* 2017;63(2):143–148. <https://doi.org/10.5606/tftrd.2017.129>

- Kim, J., & Kim, Y. (2007). Development of an Active Ankle-Foot Orthosis for Hemiplegic Patients, 110-113.
- Mavroidis, C., Ranky, R. G., Sivak, M. L., Patriitti, B. L., DiPisa, J., Caddle, A., ... Bonato, P. (2011). Patient specific ankle-foot orthoses using rapid prototyping. *Journal of NeuroEngineering and Rehabilitation*, 8(1), 1. <https://doi.org/10.1186/1743-0003-8-1>
- Michalina, B., Wiszomirska, I., Kaczmarczyk, K., & Wit, A. (2017). Clinical Biomechanics Mechanisms of compensation in the gait of patients with drop foot, 42, 14-19. <https://doi.org/10.1016/j.clinbiomech.2016.12.014>
- Mulroy, S. J., Eberly, V. J., Gronely, J. K., Weiss, W., & Newsam, C. J. (2010). Effect of AFO design on walking after stroke : Impact of ankle plantar flexion contracture, 34(September), 277-292. <https://doi.org/10.3109/03093646.2010.501512>
- Neumann, D. A. (2010). *Kinesiology of the musculoskeletal system : foundations for rehabilitation*. St. Louis, Mo. : Mosby/Elsevier. Retrieved from <https://clinicalgate.com/assessment-of-gait/>
- Park, J. H., Chun, M. H., Ahm, J. S., Yu, J. Y., Kang, S. H. (2009). Comparison of Gait Analysis Between Anterior and Posterior Ankle Foot Orthosis in Hemiplegic Patients. *American Journal of Physical Medicine & Rehabilitation* 88(8), 630-634. <https://doi.org/10.1097/PHM.0b013e3181a9f30d>
- Radtka, S. A., Oliveira, G. B., Lindstrom, K. E., & Borders, M. D. (2006). The kinematic and kinetic effects of solid , hinged , and no ankle - foot orthoses on stair locomotion in healthy adults, 24, 211-218. <https://doi.org/10.1016/j.gaitpost.2005.09.005>
- Rao, N., Wening, J., Hasso, D., Gnanapragasam, G., Perera, P., Srigriraju, P., & Aruin, A. S. (2014). The Effects of Two Different Ankle-Foot Orthoses on Gait of Patients with Acute Hemiparetic Cerebrovascular Accident, 2014.
- Rodda, J. (2015). The effect of bilateral solid AFO on gait, (December), 3-5. <https://doi.org/10.1016/j.gaitpost.2015.03.122>
- Wiszomirska, I., Michalina, B., Kaczmarczyk, K., & Wit, A. (2017). Effect of Drop Foot on Spatiotemporal , Kinematic , and Kinetic Parameters during Gait, 2017. <https://doi.org/10.1155/2017/3595461>

9.2 Other references

Ambroise (n.d.). Static Night Splint. Retrieved 16 October 2018 from <https://www.ambroise.nl/en/leg-orthoses/ankle-foot-orthoses/static-night-splint/>

Design Solutions. (2017). SOLIDWORKS 2017 [Computer software]. Retrieved from <https://software.tudelft.nl/>

Foot drop (2016). Retrieved from <https://www.nhs.uk/conditions/foot-drop/>

Mason et al. (1981). U.S. Patent No. 4,289,122. Retrieved from <https://patents.google.com/patent/US4289122A/en>

Charmant, J. (n.d.). Kinovea version 0.8.27. [Computer software]. Retrieved from <https://www.kinovea.org/download.html>

Klundert, J. van de. (2017). Design of a new fabrication method for lacing 3d printed wearables with fabric: Managing window oedema in open structured braces. Retrieved from <https://repository.tudelft.nl/islandora/object/uuid%3A3719834c-bdfd-4fa2-96a8-96a7617f2d69?collection=education>

Mason et al. (1981). U.S. Patent No. 4,289,122. Retrieved from <https://patents.google.com/patent/US4289122A/en>

Materialise (2019). Materialise Onsite [online automatic quotation webpage]. Retrieved from <https://onsite.materialise.com/en>

Oceanz (2019). youroceanz [online automatic quotation webpage]. Retrieved from <https://www.youroceanz.eu/main>

Physiatrist (2018). Personal communication.

Physiotherapists (2018). Personal communication.

CEO of COR (2018). Personal communication.

www.sportsinjury.net. (2010, March 6). The benefits of using a foot scanner in Podiatry [Video file]. Retrieved from <https://www.youtube.com/watch?v=JuFEO4JUodI>

The orthopaedic technicians of COR (2018-2019). Personal communication.

9.3 Image references

Ambroise (n.d.). Static Night Splint. Retrieved 16 October 2018 from <https://www.ambroise.nl/en/leg-orthoses/ankle-foot-orthoses/static-night-splint/>

Andiamo (n.d.). The highest quality orthoses [online image]. Retrieved from <https://andiamo.io/>

Arizona AFO (n.d.). Thermoplastic AFO – articulated [Online image]. Retrieved 16 October 2018 from <http://www.arizonaafo.com/default/index.cfm/products/thermoplastic-afos/articulated-afo/>

Cascade (n.d.). Becker Model 270 Metal and Leather AFO [Online image]. Retrieved 16 October 2018 from <https://www.cascade-usa.com/model-270-metal-and-leather-afo-13337.html>

Crispin Orthotics (2019). Additive lower limb orthosis – Dynamic. Retrieved from <https://www.crispinorthotics.com/brochures/co-additive-orthoses-brochure/>

EOS 1 (n.d.). Ankle/foot orthosis with a ring closure system (source: plus medica OT) [online image]. Retrieved from https://cdn.eos.info/e5fdd728fdbd44eb/4372b77f5ba4/CaseStudy_Plus_Medica_OT_Othese_Download.jpg

EOS 2 (n.d.). Details of the ankle/foot orthosis with a ring closure system (source: plus medica OT) [online image]. Retrieved from https://cdn.eos.info/35eb5118e62e96be/88945abc26d1/Plus_Medica_Download.jpg

Invent Medical (n.d.). piro [online image]. Retrieved from <https://www.inventmedical.com/products/>

Kevin orthotics (n.d.). Solid Ankle model T150 [Online image]. Retrieved 16 October 2018 from <https://kevinrxcom.worldsecuresystems.com/solid-ankle1.html>

Lakeland orthotics (n.d.). Maramed Drop Foot Splint Full Foot [Online image]. Retrieved 16 October 2018 from <https://lakelandorthotics.co.uk/product/maramed-drop-foot-splint-plsff/>

O.L.T. Footcare (n.d.). AFO [online image]. Retrieved from <https://www.oltfoot.com/afo/>

Trulife (n.d.). Trulife Matrix Max AFO carbon fiber [Online image]. Retrieved 16 October 2018 from <https://www.amazon.com/Trulife-Matrix-Max-carbon-fiber/dp/B007BHAK96>

Steiner, O (2014). יפוסה לדומה [online image]. Adapted from <http://orsteiner-splintkafo.blogspot.com/>

11. APPENDIX

11. APPENDIX

Table of contents

- A Survey AFO production at COR**
- B Program of requirements**
- C Morphological chart**
- D Sketches of the final improvements**
- E Project proposal**

A Survey AFO production at COR





Overzicht EVO productie

Om een overzicht te creëren over de maatwerk productie van EVO's wilde ik jullie vragen dit formulier in te vullen. Mochten er vragen zijn kunnen jullie me altijd aanschieten. Groetjes, Ewoud





Naam:

Functie:

Maatwerk EVO's:

				
	Standaard EVO	EVO met voorschaal	EVO met Scharnier	Overig
% Van totaal aantal maatwerk EVO's	<input type="text"/>	<input type="text"/>	<input type="text"/>	<input type="text"/>
	↓	↓	↓	↓
% Dagspalk	<input type="text"/>	<input type="text"/>	<input type="text"/>	<input type="text"/>
% Nachtspalk	<input type="text"/>	<input type="text"/>	<input type="text"/>	<input type="text"/>

Maatwerk KEVO's met Plastic onderbeen deel:

				
	Standaard KEVO	KEVO met voorschaal	KEVO met Scharnier	Overig
% Van totaal aantal maatwerk KEVO's	<input type="text"/>	<input type="text"/>	<input type="text"/>	<input type="text"/>
	↓	↓	↓	↓
% Dagspalk	<input type="text"/>	<input type="text"/>	<input type="text"/>	<input type="text"/>
% Nachtspalk	<input type="text"/>	<input type="text"/>	<input type="text"/>	<input type="text"/>

B Program of requirements

Spatial geometry



Requirements

1. -
2. No hard geometry may touch the medial and lateral malleoli to prevent skin damage or cutting off blood circulation [OTs].
3. Maximum of around 6 mm. Current AFOs have a thickness of around 4 mm. A slight increase is acceptable for the current development stage but too much would result in the increase in a large increase in shoe size and result in an improper fit of the shoe. Currently the OTs advise the patients to buy their shoes one size larger to create some room for the AFO and relieve any undesired pressure [personal conclusion].
4. No hard geometry in this area because there is too much spatial deformation of the patients leg during dorsiflexion and next to that the fitting of the shoe allows very limited space [OTs + personal conclusion].
5. No geometry because this would create friction, compression or pinching of the skin during movement [OTs].

Wishes

1. As thin as possible to ease the acceptance by the patients [OTs + personal conclusion].
2. No geometry would improve the acceptance of the AFO because any geometry here would be highly visible due to the width of the malleoli [OTs + personal conclusion].
3. As thin as possible to ease the acceptance by the patients, increase comfort and allow for same shoe size [OTs + personal conclusion].
4. No geometry to ease the acceptance by the patients
5. -

Customization parameters

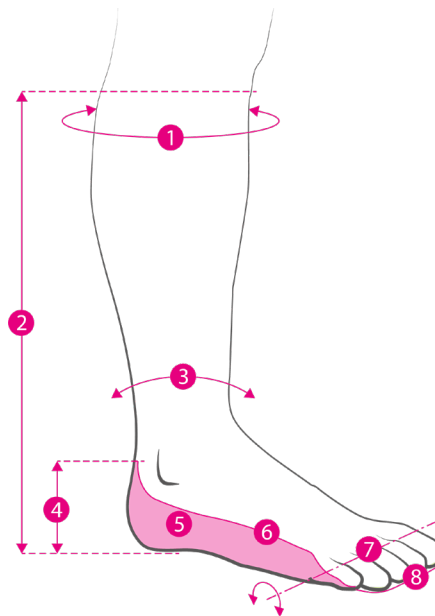

Requirements

1. The circumference at the top of the AFO [OTs].
2. The height of the AFO. The expected heights are between 392 mm (p5, age 60+, mixed, popliteal height sitting) and 533 mm (p95, age 20-30, mixed, popliteal height sitting) (Dined, 2004), measured from the bottom of the heel to the top of the AFO. Next to that the AFO may not pass the top border of border of 10 mm below the fibula head [OT + Dined].
3. The required moment. The required moment is highly dependent on the individual walking gait [OTs + personal conclusion].
4. The height of the sole. The height of the patients shoe differs per shoe size and type of shoes. The expected maximum value is 20 mm according to the OTs [OTs].
5. The sole geometry must follow the corrected scans geometry. This type of geometry is complex and highly patient specific and must be followed accurately [OTs].
6. The position of the medial and lateral edges [OTs].
7. Location of the toe plate connection. The connection between the toe and the foot plate must be flexible to allow for a proper roll off of the foot [OTs + personal conclusion].
8. Toe plate edge. The curvature around the toes differs between patients [OTs].
9. All customizable parameters, except from the sole geometry should be adaptable by the OT during the product generation phase, except the sole geometry (n. 5). The sole of the AFO will already be adjusted and defined in the correcting phase [personal conclusion].

Post production adaptability

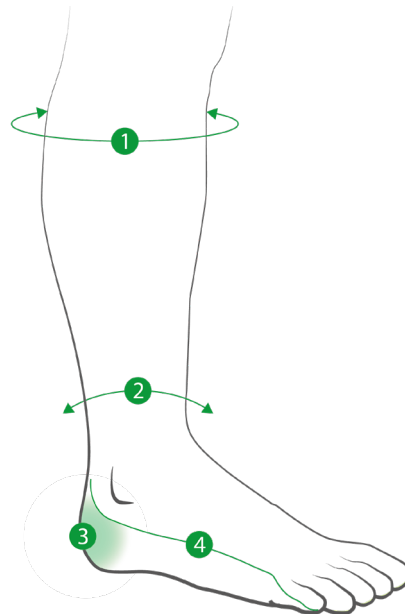

Requirements

1. The circumference at the top of the AFO must allow adjustments by the patient. The patients geometry might change over time as a result of, among others, daily activities or oedema [OTs].
2. The required moment must be adaptable. The required moment can be estimated and possibly measured prior to production. However, due to highly patient specific gait patterns and healthcare demands it is best to maintain the current adjustability after production [OTs + personal conclusion].
3. Outward deformability of the heel must be possible. In the scanning and correcting phases of the production the heel geometry might be adapted too much which leads to pressure points and a poor fit. The design must allow for post-production corrections because producing a newly corrected part is expected to take too much time [OTs + personal conclusion].
4. The position and curvature of the medial and lateral edges must be adaptable. These complex curvatures are defined as a result of the scanning and correcting process. Sometimes faults slip through these phases and create pressure points which cut off the blood circulation or form friction points [OTs].

Usage

Requirements

1. No sharp edges in contact with the skin
2. The AFO may not cause damage to the patients' clothing
3. The AFO may not cause pinching of the skin
4. The AFO may not cut off the patients' blood circulation
5. The AFO must have a patient operated fastening system
6. Soft anterior pressure area to avoid pressure peaks
7. The Anterior pressure area must have a height minimum of 50 mm.
8. The fastening system must ensure a tight and secure fit

Wishes

9. Easy to put on by the patient
10. The AFO should have a comfortable fit

Function

Requirements

1. Strong enough to transfer all forces
2. Stiff enough to not cause pressure points due to deformations
3. Slight flexibility in the sole to allow for deformations of the foot during walking
4. The AFO must be able to function without a full plantar flexion during the gait to allow for complex movements. Complex movements include 180 degree turn, a side shuffle in the kitchen to grab a pot or a backwards step to let someone pass.
5. Minimal vertical displacement of the foot in the shoe. If the displacement is too large, the shoe will not fit properly creating an unsafe walking gait.

Wishes

1. Easy to put on by the patient

Production









Requirements



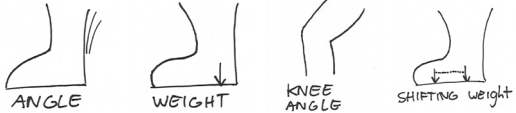

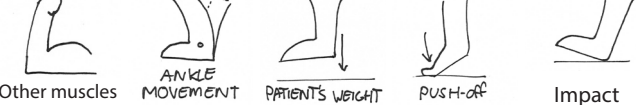

1. Must be deliverable in 2 weeks

Wishes

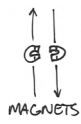

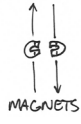

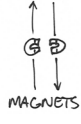
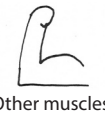

















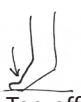



1. Fast and easy to assemble

C Morphological chart

Problems	Remaining ideas
What could be used as sensory input for trigger 1?	
How to sense the input for trigger 1?	
What could be used as sensory input for trigger 2?	
How to sense the input for trigger 1?	
Where to collect the needed energy from?	
How to collect this energy?	
How to store this energy?	
How to exert the force?	

			DEFORMING GEOMETRY
			DEFORMING GEOMETRY
			DEFORMING GEOMETRY
			Other muscles

Removed ideas

					
OPPOSITE FOOT	IN-EVERSION	TIME	ANKLE MOVEMENT	KNEE ANGLE	Toe-off
Do not work with complex movements					
					
WIRES					
Difficult to put on					
					
OPPOSITE FOOT	IN-EVERSION	TIME	ANKLE MOVEMENT	KNEE ANGLE	Toe-off
Do not work with complex movements					
					
WIRES					
Difficult to put on					
					
WEIGHT	CHARGING	SUN	WIND	SHIFTING weight	
Too heavy	No electric motor (sensor electronics neglected)			Do not work with complex movements	
					
WIRES					
Difficult to put on					
					
FLYWHEEL	TEMPERATURE	BATTERY	POTENTIAL ENERGY		
Too heavy	Hard to contain	No electric motor (sensor electronics neglected)		Too impractical due to large weight or needed elevation	
					
MOTOR	FLYWHEEL	WEIGHT			
Too heavy					

D Sketches of the SLS optimization

Calf plate redesign sketches

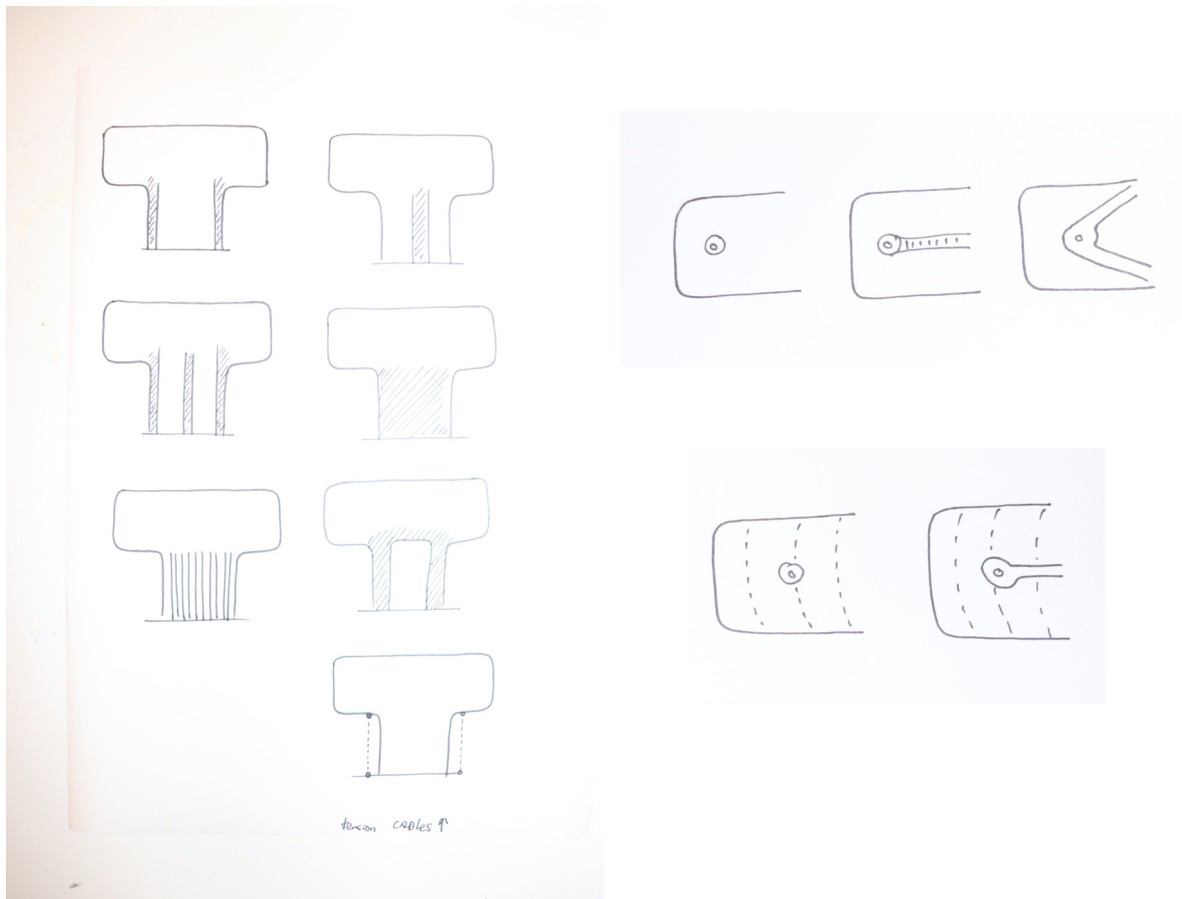

Connecting the hinge to the ball bearing

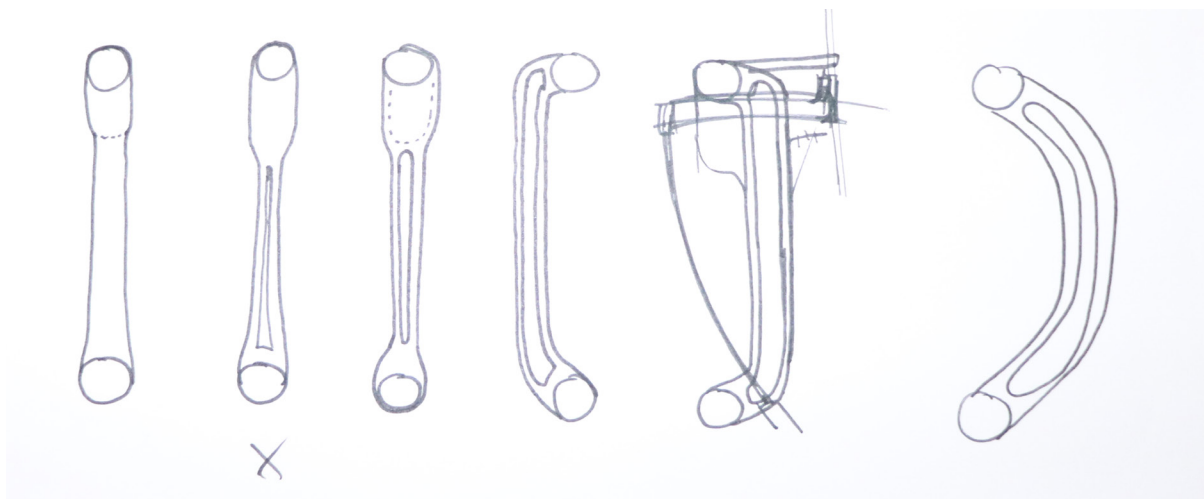

Connection the mesh fabric to the calf plate

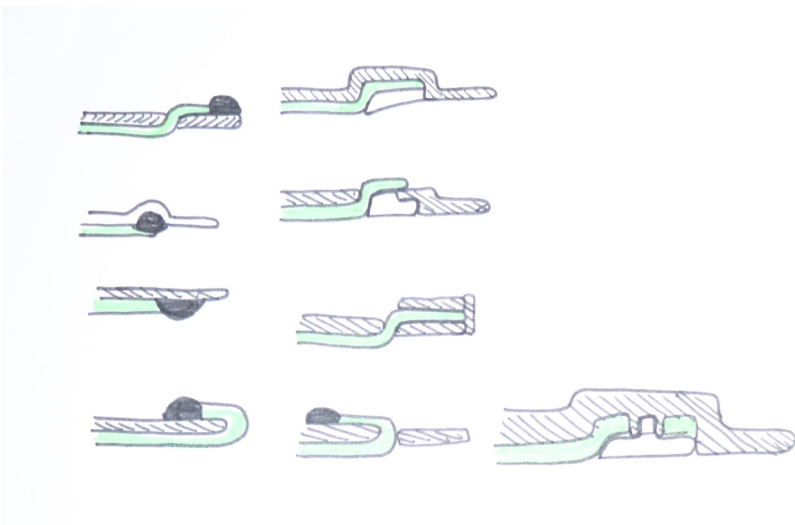

Possible hinge redesigns around the malleoli

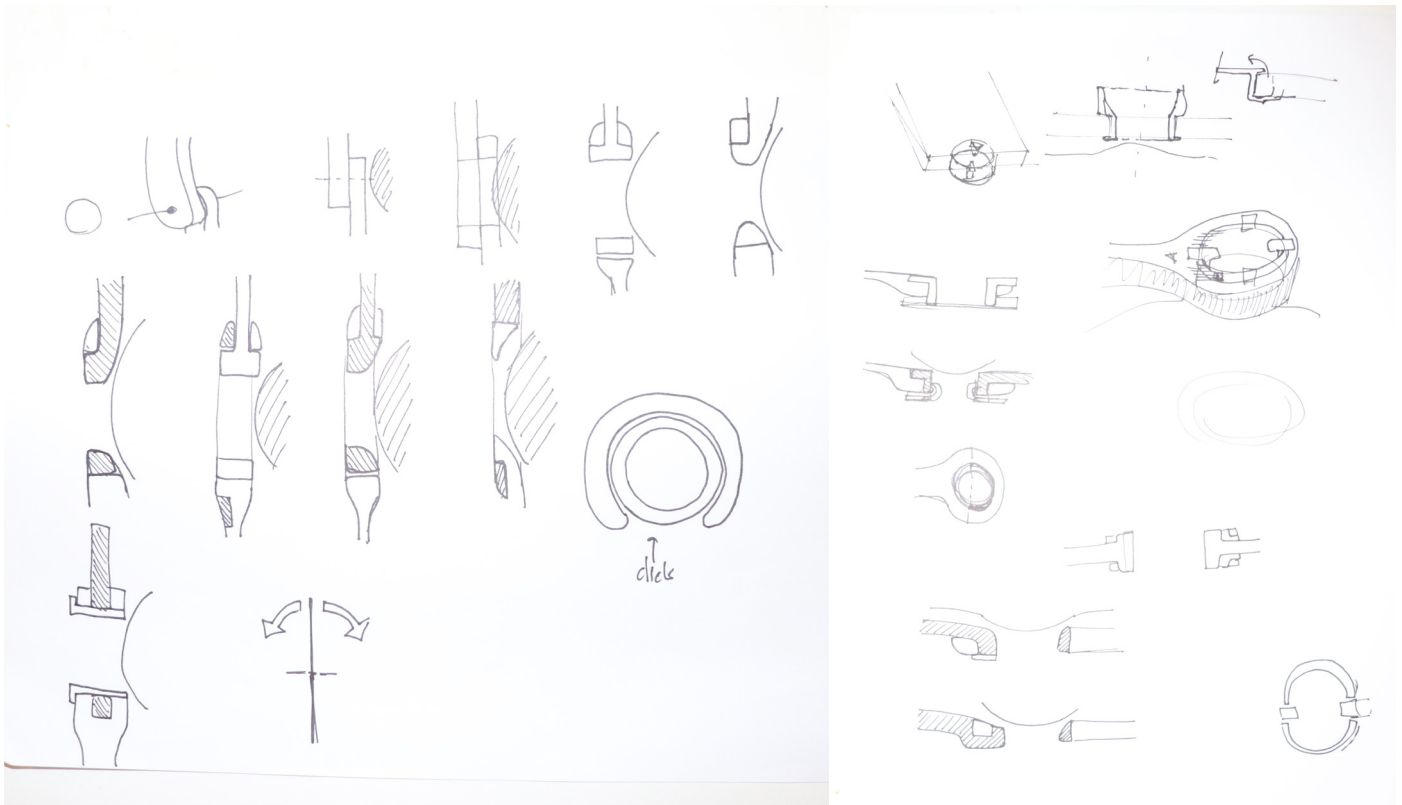

E Project proposal

