



EXPLORING  
THE  
VISUAL  
LANDSCAPE

RESEARCH IN URBANISM SERIES · VOLUME 2

**EXPLORING THE VISUAL  
LANDSCAPE**

ADVANCES IN PHYSIOGNOMIC  
LANDSCAPE RESEARCH IN  
THE NETHERLANDS

EDITED BY  
STEFFEN NIJHUIS  
RON VAN LAMMEREN  
FRANK VAN DER HOEVEN

# EXPLORING THE VISUAL LANDSCAPE

## **Research in Urbanism Series (RiUS)**

Volume 2

ISSN 1875-0192 (print)

ISSN 1879-8217 (online)

### **Series editors**

Frank van der Hoeven, PhD

Steffen Nijhuis

### **Scientific committee (peer reviewers)**

Marc Antrop, PhD

Professor Emeritus, Ghent University, Department  
of Geography

Michael Batty, PhD

Professor, University College London, Centre for  
Advanced Spatial Analysis

Christina von Haaren, PhD

Professor, Leibniz University Hanover, Department  
of Landscape Planning and Nature Conservation

James F. Palmer, PhD

Professor Emeritus, State University of New York,  
College of Environmental Science and Forestry,  
Department of Landscape Architecture

Mari Sundli Tveit, PhD

Associate Professor, Norwegian University of Life  
sciences, Department of Landscape Architecture  
and Spatial Planning

### **Aims & scope**

RiUS is a scientific series that deals with dynamics, planning, and design in contemporary urban areas. It provides an outlet for investigation, analysis, and exploration in the overlapping fields of urban design, urban planning, regional planning, metropolitan design, spatial planning, urban renewal, urban management, landscape architecture, environmental design, sustainability, urban technology, urban mobility, cultural heritage.

RiUS is aimed at designers, researchers, planners, consultants, decision-makers, and politicians. It pays special attention to design, research, techniques, methodology and theory.

RiUS laboratory facilitates a dialogue between the community and society at large through high quality publications focusing on transformation and sustainability.

# EXPLORING THE VISUAL LANDSCAPE

Advances in Physiognomic Landscape  
Research in the Netherlands

Edited by

Steffen Nijhuis

Ron van Lammeren

Frank van der Hoeven

In cooperation with



Delft University of Technology



WAGENINGEN UNIVERSITY  
WAGENINGENUR

IOS Press, 2011

**Editors**

Steffen Nijhuis  
Ron van Lammeren  
Frank van der Hoeven

**Copy-editing**

Sara King

**Art director**

Joost van Grinsven

**Layout**

Inkahootz, Amsterdam

**Photography**

Hollandse Hoogte: Mischa Keijser (p. 6), Goos van der Veen (p. 12), Peter Hiltz (p. 100), Joost Hoving (p. 226), Siebe Swart (p. 316)

**Published by IOS Press under the imprint****Delft University Press**

IOS Press BV  
Nieuwe Hemweg 6b  
1013 BG Amsterdam  
The Netherlands  
tel.: +31-20-688 3355  
fax: +31-20-687 0019  
email: [info@iospress.nl](mailto:info@iospress.nl)  
[www.iospress.nl](http://www.iospress.nl)

**Keywords**

Design research, landscape architecture, urban design, landscape planning, landscape policy, visual landscape, GIS, landscape perception

ISBN 978-1-60750-832-8 (print)

ISBN 978-1-60750-833-5 (online)

**Copyright**

© 2011 The authors, editors and IOS Press.  
All rights reserved. No part of this book may be reproduced, stored in a retrieval system, or transmitted, in any form or by any means, without prior permission from the publisher.

**Legal notice**

The publisher is not responsible for what use might be made of the following information.

Printed in the Netherlands

# CONTENTS

<b>Preface</b> .....	9	<b>8 Virtual historical landscapes</b> .....	185
		Arnoud de Boer, Leen Breure, Sandor Spruit, Hans Voorbij	
<b>Part 1</b>		<b>9 Mapping landscape openness with</b>	
<b>THEORY</b>		<b>isovists</b> .....	205
		Gerd Weitkamp	
<b>1 Exploring visual landscapes –</b>		<b>Part 3</b>	
<b>Introduction</b> .....	15	<b>LANDSCAPE POLICY</b>	
Steffen Nijhuis, Ron van Lammeren, Marc Antrop			
<b>2 Psychology of the visual landscape</b> .....	41	<b>10 Landscape policy and visual landscape</b>	
Maarten Jacobs		<b>assessment – The Province of Noord-</b>	
<b>3 The phenomenological experience</b>		<b>Holland as a case study</b> .....	229
<b>of the visual landscape</b> .....	57	Steffen Nijhuis, Miranda Reitsma	
Ana Moya Pellitero		<b>11 Preserving panoramic views along</b>	
<b>4 Geomatics in physiognomic landscape</b>		<b>motorways through policy</b> .....	261
<b>research – A Dutch view</b> .....	73	Maarten Piek, Niels Sorel, Manon van Middelkoop	
Ron van Lammeren		<b>12 Hi Rise, I can see you! Planning and</b>	
<b>Part 2</b>		<b>visibility assessment of high building</b>	
<b>LANDSCAPE RESEARCH AND DESIGN</b>		<b>development in Rotterdam</b> .....	277
		Frank van der Hoeven, Steffen Nijhuis	
<b>5 Visual research in landscape</b>		<b>13 Visions of Belle van Zuylen</b> .....	303
<b>architecture</b> .....	103	Han Lörzing	
Steffen Nijhuis		<b>Glossary</b> .....	319
<b>6 Mapping landscape attractiveness –</b>		<b>Literature guide to landscape perception</b>	
<b>A GIS-based landscape appreciation</b>		<b>research</b> .....	325
<b>model for the Dutch countryside</b> .....	147	<b>About the authors</b> .....	331
Janneke Roos-Klein Lankhorst, Sjerp de Vries, Arjen Buijs			
<b>7 The one- and two-dimensional isovists</b>			
<b>analyses in Space Syntax</b> .....	163		
Akkelies van Nes			



52° 6' 51" N, 4° 44' 15" E







# PREFACE

Visual landscape assessment is a key element in landscape planning, management and monitoring, and serves as an important basis for landscape policy. The identifying character of rural and urban environments is, to a large extent, built upon visual perception. Visual landscape attributes like spaciousness and related indicators, such as degree of openness, building density and the nature of spatial boundaries, are important elements in landscape perception and preference.

This book is about the combination of landscape research and planning, visual perception and Geographic Information Science. It showcases possible ways of getting a grip on themes like: landscape openness, cluttering of the rural landscape, high-rise buildings in relation to cityscape, historical landscapes and motorway panoramas. It offers clues for visual landscape assessment of spaces in cities, parks and rural areas. In that respect, it extends the long tradition in the Netherlands on physiognomic landscape research and shows the state of the art at this moment.

The book offers important clues for theory, methodology and application in research and development of landscapes all over the world, from a specifically Dutch academic context. It provides a wide range of insights into the psychological background of landscape perception, the technical considerations of geomatics and methodology in landscape architecture, urban planning and design. There are also some experiences worthwhile considering, which demonstrate how this research can be applied in the practice of landscape policy making.

An effort like this is only possible with the help and cooperation of many people. Firstly, we would like to acknowledge the esteemed members of the scientific committee: Marc Antrop, Michael Batty, Christina von Haaren, James Palmer and Mari Sundli Tveit for their critical, constructive comments on the manuscripts and the structure of the book.

Furthermore, we would like to acknowledge the Department of Urbanism, the Chair of Landscape Architecture and the Library of Delft University of Technology, and the Environmental Sciences Group of Wageningen University for their generous financial support. We would especially like to thank Amber Leeuwenburg, Anke Versteeg, Stephen Sheppard and Inge Bobbink for making this possible. We would also like to thank Mark Eligh of IOS Press for his patience and cooperation. And finally, Joost van Grinsven and Sara King for their efforts making it a well-designed and accessible book.

The editors



PART ONE  
**THEORY**



52° 20' 26" N, 5° 20' 59" E



1

# EXPLORING THE VISUAL LANDSCAPE

## INTRODUCTION

### 1.1 INTRODUCTION

The European Landscape Convention (ELC) defines landscape as “an area, as perceived by people, which character is the result of the action and interaction of natural and/or human factors” (Council of Europe, 2000). Thus, the ELC clearly emphasises the sensory relationship between the observer and the landscape. The major question here is how do we know and understand the landscape through perception?

Although ‘perceived by people’ refers to a holistic experience with all senses, very often it is reduced to the visual aspects. This has clearly to do with the ‘range’ of our senses. Already Granö (1929) <sup>1</sup> made the distinction between the ‘*Nahsicht*’ and ‘*Fernsicht*’. The *Nahsicht* or proximity is the environment we can experience with all our senses, the *Fernsicht* he called also landscape and is the part of our environment we mainly experience by vision. As Harris and Fairchild Ruggles (2007) put it: “For most human beings, the primary way of knowing the material world is through vision; the simple act of opening ones eyes and looking at an object, a scene, a horizon. The physiological processes engaged when the lid retracts from the eye are, when not impeded by pathologies, universal among humans. Because vision is an embodied experience, it is altered by the infinite range of the possibilities presented by corporeal performance. The body moves in space – quickly or slowly, the head still or moving side to side, up or down – the eyes view a scene, and a cognitive process begins in which particles of light are assembled by



the brain to create an ordered image". This quote exemplifies that the identifying character of rural and urban environments is, to a large extent, built upon visual perception, which is a key factor in behaviour and preference, and thus important for landscape protection, monitoring, planning and management and design.

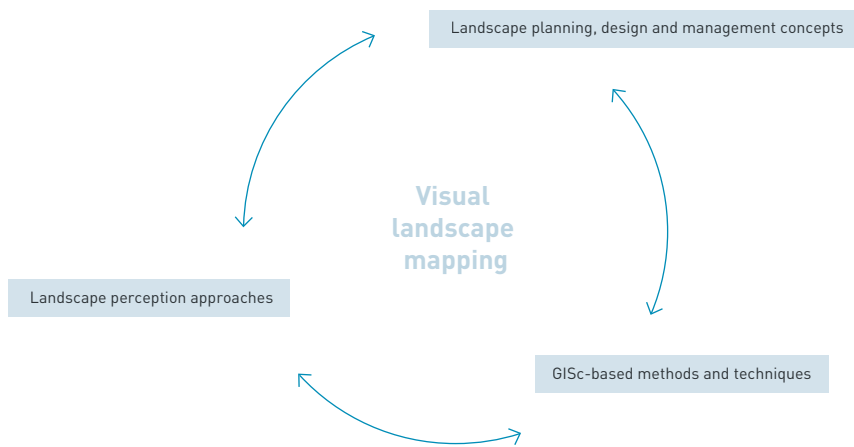
But how can we comprehend the 'face of the landscape' and its perception? And how can we make this applicable to landscape planning, design and management? Although these questions are not new<sup>2</sup>, we believe that the long tradition and current advances in the field of visual landscape research in the Netherlands offer interesting clues for further development in theory, methodology and application.

### 1.1.1 Visual landscape research

Visual landscape research is the central theme, and throughout the book you will find also terms like *landscape physiognomy* and *physiognomic landscape research*. In this book we consider rural, urban and infrastructural landscapes as *types of landscape*.

According to the Oxford dictionary (2011a) *landscape physiognomy* refers to the appearance of the landscape and is derived from the Greek *physiognōmonía* meaning 'judging of man's nature (by his features)' based on *gnōmōn* 'a judge, interpreter'. Initially, it refers to the human face as in the French '*visage*', and its meaning has extended to the appearance of features such as landscape (French '*paysage*'). In the late 1970s scholars like De Veer and Burrough (1978) adopted this term and introduced the comparable Dutch terms *landschapsfysiognomie* (physiognomic landscape), *visueel landschap* (visual landscape) and *landschapsbeeld* (landscape scenery) to refer to the visual landscape consisting of the visible properties of all the landscape phenomena and their structure (De Veer and Burrough, 1978). We use the initial term landscape physiognomy (or physiognomic landscape) and the more actual term visual landscape as synonyms.

*Physiognomic landscape research* refers to visual landscape research that is concerned with mapping the visual landscape. Physiognomic landscape mapping or visual landscape mapping (*landschapsbeeldkartering*) comprises of a wide range of theories, methods and techniques for analysis and visualisation, and which reflect different approaches to landscape as described for example by Sevenant (2010).



**Figure 1**  
 Visual landscape research is characterised by visual landscape mapping and determined by the integration of landscape planning, design and management, landscape perception and GISc-based methods and techniques

### 1.1.2 Landscape planning, perception and Geographic Information Science

Visual landscape research is an interdisciplinary approach important for landscape planning. It involves disciplines such as (landscape) architecture and urban planning and design, psychology and sociology, environmental ethics, and (humanistic) geography, all of which use data and tools offered by *Geographic Information Science* (GISc) such as computer mapping, spatial analysis, geomatics and (virtual) visualisation. The contributions in this book express this interdisciplinarity and reflect different perspectives on visual landscape research by their theoretical elaborations, research approaches and practical applications. However, the core of this book is the integration of (1) *landscape planning, design and management concepts*, (2) *landscape perception approaches*, and (3) *GISc-based methods and techniques* in order to map the visual landscape (see figure 1).

## 1.2 VISUAL RESEARCH IN LANDSCAPE PLANNING, DESIGN AND MANAGEMENT

In the Netherlands there is a long tradition of visual landscape research starting in the 1960s, which has had an important influence on Flemish work as well. Its origins are to be found on one hand in the widely acknowledged Dutch system of spatial planning, and on the other, in the academic interest in landscape perception influenced by parallel developments in the Unit-

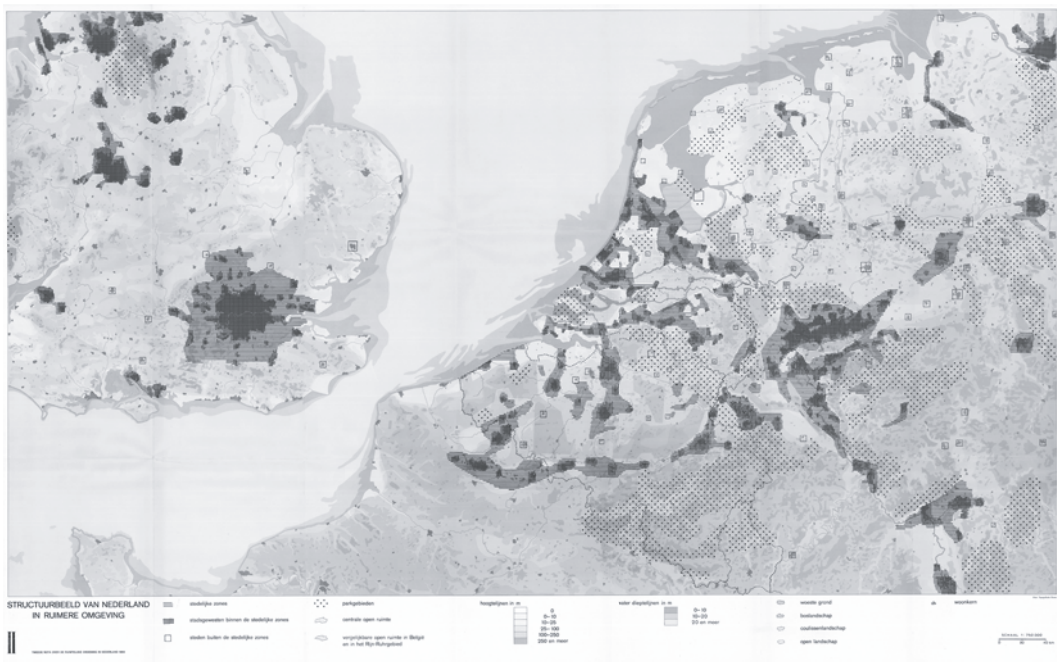
ed States. Nowadays, this rich tradition of visual landscape research continues to develop and find its way in landscape perception research, planning and design oriented landscape research and its implementation in landscape policy. The contributions in this book showcase the latest developments in the field.

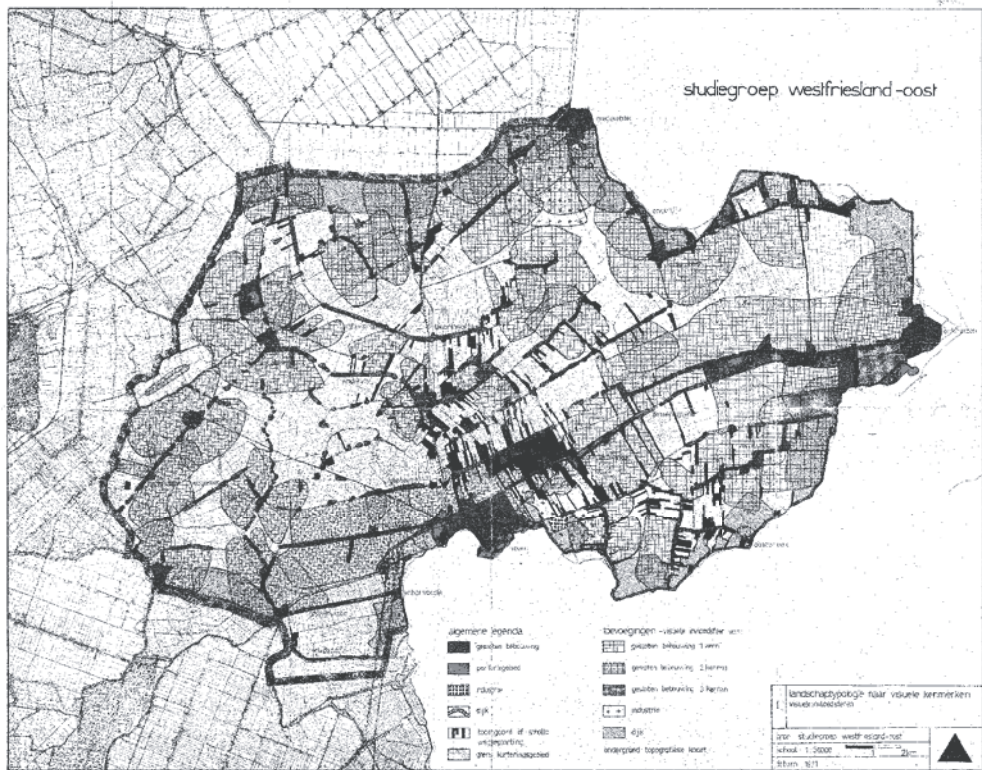
### 1.2.1 Visual research as policy-demand

The publication of a map called The landscape of the Netherlands and bordering regions (*Het landschap van Nederland met aangrenzende gebieden*) in the Second National Memorandum on Spatial Planning (*Tweede Nota over de ruimtelijke ordening van Nederland*) (RijksPlanologische Dienst, 1966)<sup>3</sup> represents an important step in visual research. This map presented the ‘open’ Dutch rural landscape as different ‘complexes of open spaces’ (figure 2) and addressed the visual landscape as an important issue for landscape planning and policy in the Netherlands for the first time. Inspired by this more detailed interest in the Dutch landscape, several scholars,

Figure 2

The landscape of the Netherlands and bordering regions showing complexes of open spaces (source: RijksPlanologische Dienst, 1966)

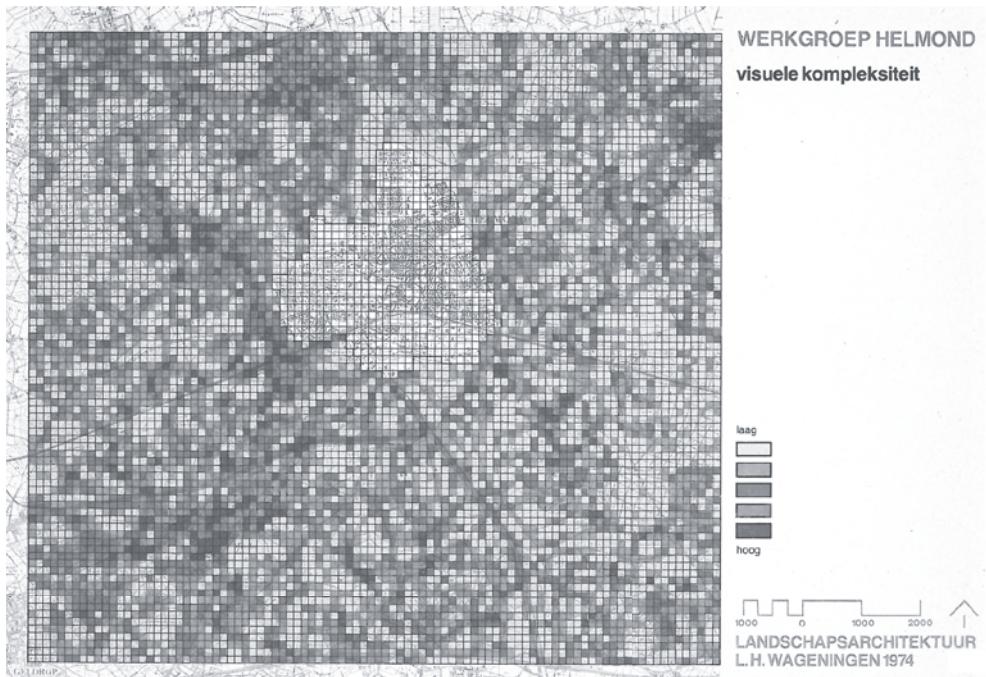




**Figure 3**  
**Landscape typology based on visual attributes (source: Van der Ham and Iding, 1971)**

from different Dutch universities and related research institutes, took the opportunity to develop visual landscape concepts for the purpose of landscape planning, design and management, exemplified by the work of Van der Ham et al. (1970, 1971), Nicolai (1971), Koster and De Veer (1972), Kerkstra et al. (1974), and De Veer (1977) (see figures 3 and 4). The first overview of developed methods for visual landscape mapping and its applications appeared in De Veer et al. (1977), followed by an academic article by De Veer and Burrough (1978). This article remained until now the only English-language overview of the Dutch visual landscape research (including the Flemish studies).

From the 1980s onwards we see applications of computational methods and techniques in visual landscape mapping appear, exemplified by the work of Burrough et al. (1982), Van den Berg et al. (1985), and Dijkstra (1985). From the late 1980s, early 1990s a vast amount of visual landscape studies appear, boosted by policy demands and stimulated by Dutch perception



**Figure 4**  
 Visual complexity [source: Kerkstra et al., 1974]

studies of e.g. De Boer (1979), Boerwinkel (1986), Coeterier (1987, 1994, 1996), Van den Berg (1999), influenced by the work of Berlyne (1971), Appleton (1975), Ulrich (1981) and Kaplan and Kaplan (1989). Simultaneously advances in GISc in landscape research appeared too, as by Buitenhuis et al. (1986), Piket et al. (1987), Alphen et al. (1994), Palmer (1996), Palmer and Roos-Klein Lankhorst (1998) and Dijkstra and Van Lith-Kranendonk (2000). Most of these studies cover the rural types of landscape.

### 1.2.2 Visual research as academic interest

Parallel to this there was a growing interest for visual research in Dutch universities and research institutes involving disciplines such as architecture in urban and landscape domains. These developments are characterised by visual perception research in the urban realm. The studies of Wentholt (1968), Steffen and Van der Voordt (1978) and Korthals Altes and Steffen (1988) are important examples with respect to urbanism and are highly influenced by the work of Lynch (1960) *cum suis* (see figure 5). The use of the *enthescoop* (camera with periscope

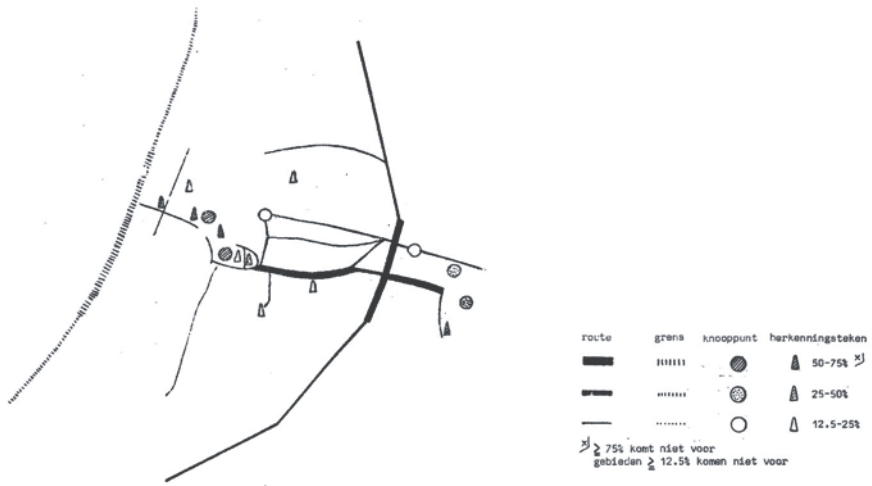


Figure 5  
Collective image of the city Antwerp [source: Steffen and Van der Voordt, 1978]

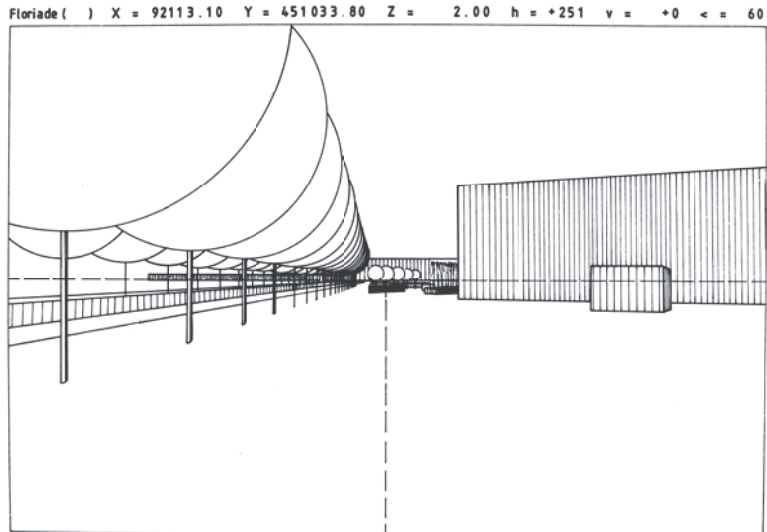


Figure 6  
Computational visualisation of the Floriade by M. den Ruijter, 1984 [source: personal archive Den Ruijter]

lens) for means of urban analysis by Bouwman (1979) was also influential. For architecture the work of Prak (1979), Steffen (1981) and Hoogstad (1990) are good examples, and with regard to landscape architecture the influential works of Bijhouwer (1954), Warnau (1979, 1990), Steenbergen (1985, 1990) and Reh (1995). However, it is striking to notice that computational methods and techniques hardly found their way in this type of research. Early exceptions are to be found in the pioneering work of Den Ruijter (1978, 1984) and Roos-Klein Lankhorst (1987, 1989) (see figure 6). The increasing amount of (inter)national publications, inclusion in academic research programmes and educational curricula of the last decade exemplify the ongoing academic interest in visual research.

### 1.3 RESEARCH ON VISUAL LANDSCAPE AND PERCEPTION

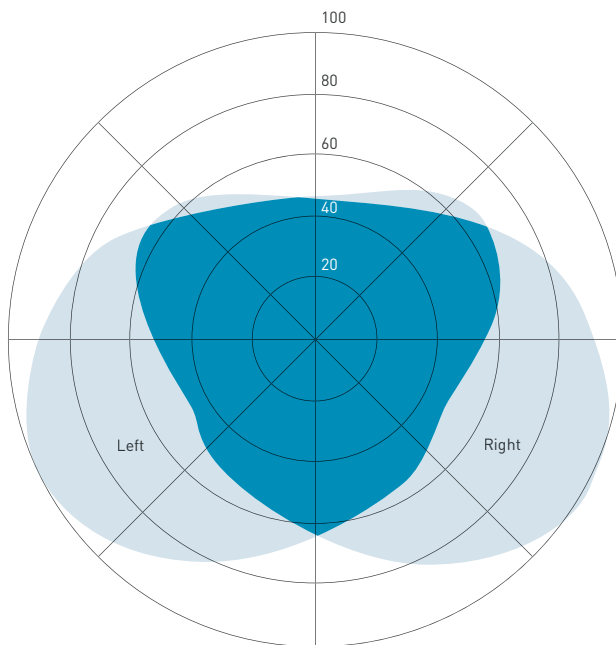
According to Bell (1996), perception refers to “the activity carried out by the brain by which we interpret what the senses receive. It is not merely a factual reporting, but tends to be referenced to associations and expectations already in the mind of the beholder” and is derived from the Latin *perceptio*, from the verb *percipere* ‘seize, understand’ (Oxford dictionary, 2011b). Although we use all our senses to analyse the surroundings, mainly vision stands out, because it covers 87% of the sensory perception. So, vision provides the most information, and it is the sense in which we ‘imagine’ and ‘think’ (Bell, 1999; Snowden et al., 2006). As all senses work together, they add different dimensions to visual perception and can reinforce or confirm the information. The term visual, derived from the Latin *visualis* and *visus* ‘sight’, from *videre* ‘to see’, is used as adjective relating to perception by seeing or sight: *visual perception* (Oxford dictionary, 2011c).

#### 1.3.1 Physiology of perception vs. psychology of perception

In (visual) perception studies there is a crucial difference between the *physiology of perception* (the ‘senses’) and the *psychology of perception* (the ‘brain’) (Jacobs, 2006; Bell, 1999). Physiology of visual perception refers to the processes of sensation and the mechanisms of sight, the structure of the eye, how it receives light, and its limitations. All aspects of physiological perception can be measured in an objective way (Sevenant, 2010; Jacobs, 2006; Bell, 1999). Although it is not the scope of this introductory chapter to elaborate on this, it is useful to mention the *field of vision*, which is an important aspect as it determines the visibility of the elements and their visual properties. Humans have an almost 120 degrees forward-facing horizontal, binocular field of vision, allowing depth perception (see figure 7). Also, the ability to perceive shape (pattern recognition), motion and colour varies across the field of vision. Pat-

tern recognition concentrates in the centre of the field of vision and covers about 20-60 degrees of the binocular view (Panero and Zelnik, 1979; Snowden et al., 2006) (for applications see chapter 5). There are also some physiological restrictions to the *range of vision*, which is the distance from the observer to an object, depth plan, or skyline. The range of vision depends on the position of the observer (altitude, proximity and angular size of the objects), viewing direction and atmospheric conditions (e.g. contrast threshold) (Duntley, 1948; Nicolai, 1971; Antrop, 2007). 1200-1400 metres is a critical distance, further away it is not possible to distinguish optical depth; individual (common) objects are hardly recognizable and merge with their background (Nicolai, 1971; Antrop, 2007). Also, for the recognition of characteristic elements of the landscape, the limiting distance of 500 metres is used (Van der Ham and Iding, 1971) and is a common step in the changing structural density (Antrop, 2007) (for applications see chapters 12 and 13).

The psychology of perception refers to two different processes: (1) the basically unconscious processing sensory information, and (2) the more or less conscious experience of analysing and interpreting this information (Jacobs, 2006). These two processes are complex and include pattern recognition (shape, size, spatial arrangement) and colour discrimination, and are the basis for the identification of objects and their relationships. It also comprises of assigning meaning, defining relations, classifying information and memorization. These processes integrate new



**Figure 7**  
The field of vision for a person looking straight ahead. The irregular boundaries of the left and right fields are caused by facial features such as the nose. The darker area shows the region of binocular overlap (source: Ware, 2004)



information with existing knowledge and experience, combining it with personal symbolic and cultural elements. This whole psychological process is individual and thus essentially subjective and determines the experience of the landscape (Jacobs, 2006; Bell, 1999; Coeterier, 1987). Finally, this will affect our behaviour and actions (Sevenant and Antrop, 2010) (see chapter 2 and 3 for elaborations on this topic).

### 1.3.2 Paradigms in landscape perception research

In the field of landscape perception research there is a vast amount of theories, methods and applications available. Valuable overviews are given by Daniel and Vining (1983), Zube et al. (1982) and Arthur et al. (1977) as well as the more recent overviews of Sevenant (2010), Scott and Benson (2002), Lothian (1999) and Dijkstra (1991). As found in these studies the existing approaches to landscape perception can be divided in four paradigms and two types of models:

#### (i) Expert models

- *Expert-approach*: evaluation of the visual landscape by experts and trained observers (e.g. landscape architects, geographers), characterised by heuristic methods and the use of systematic descriptive inventories, visual management systems, etc. Most of the early Dutch studies on the visual landscape can be labelled as expert-approaches (see section 1.2). For recent examples see section 1.4. However, the works of Boogert and Schalk (1995), Wasink (1999) and Hendriks and Stobbelaar (2003) are worthwhile mentioning here. International references include the classic works of Lynch (1960), Cullen (1961), Appleyard et al. (1964), Ashihara (1983), Sardon et al. (1986) and Higuchi (1988). Furthermore, the works of e.g. Bell (1996), Thiel (1997), Dee (2001) and The Landscape Institute (2003) are good examples of this type of approach;

#### (ii) Public preference models

- *Psychophysical-approach*: testing general public or selected populations' evaluations of landscape aesthetics/properties by, for example, environmental psychologists, landscape architects, characterised by the use of photo questionnaires. In these studies the behavioural approach is the dominant methodology. Exemplary Dutch studies are Van de Wardt and Staats (1988) and Staats and Van de Wardt (1990). International references include Appleton (1975) and Daniel (2001);
- *Psychological-approach*: search for human meaning associated with landscape or landscape properties by environmental psychologists, characterised by mapping landscape experience. As in the psychophysical-approach, the behavioural approach is dominant<sup>4</sup>. Korthals Altes and Steffen (1988) and Coeterier (1987) are Dutch examples. Important international references include Kaplan and Kaplan (1989), Bell et al. (2001) and Nasar (2008);

- *Phenomenological-approach*: research on subjective experience of the landscape (e.g. phenomenologists, psychologists, humanistic geographers), characterised by the interpretation of paintings, poetry, etc. These studies show a humanistic approach. The work of Lemaire (1970) is a good Dutch example. International examples include: Tuan (1974), Boyer (1994) and Olwig (2002).

Throughout the book these different approaches are present, although most chapters reflect typical expert-approaches. The literature guide after the last chapter gives further readings on the different approaches.

## 1.4 VISUAL LANDSCAPE RESEARCH AND GEOGRAPHIC INFORMATION SCIENCE

The term Geographic Information Science was introduced by Goodchild (1992) and is defined as: “an information science focussing on the collection, modelling, management, display, and interpretation of geographic data. It is an integrative field, combining concepts, theories, and techniques from a wide range of disciplines, allowing new insights and innovative synergies for an increased understanding of our world. By incorporating spatial location as an essential characteristic of what we seek to understand in the natural and built environment, Geographic Information Science (GISc) and Systems (GIS) provide the conceptual foundation and synergistic tools to [explore visual landscapes]” (Kemp, 2008). For the full breadth of GISc and the background to it see e.g. Goodchild (1992) and Wilson and Fotheringham (2008).

*Geographic Information Systems* (GIS) are computer systems for capturing, storing, querying, analysing, and displaying geodata. GIS developed from the integration of four different computer applications: *image processing* (raster-based), *computer aided design* (CAD) (vector-based), *mapping/cartography* and *database management* (Kraak and Ormeling, 2010). Introductory works to GIS include Longley and Batty (2003), Chang (2010) and Longley et al. (2011). Useful accounts on geo-visualisation are Dodge et al. (2008) and Kraak and Ormeling (2010).

The terms *geomatics* or *geomatic engineering* or *geospatial technology* all refer to techniques for the acquisition, storage and processing of spatially referenced information of any kind. It combines tools used in geodesy, photogrammetry, cartography, land surveying, geography, remote sensing, GIS and GPS. Thus geomatics refers to a scientific approach focussed on the fundamental aspects of geo-information and is elaborated in chapter 4 (Longley et al., 2011).

An essential aspect of geomatics for visual landscape research is the elaboration of *Digital Elevation Models* (DEM, the generic term), *Digital Terrain Models* (DTM) and *Digital Landscape*

*Models* (DLM) describing the earth's topographical surface. Basically two types of DEMs can be recognised:

- *DTM*: Digital Terrain Models only representing the bare ground surface;
- *DLM*: Digital Landscape Models also referred to as 'envelope models' representing the earth's surface including all objects on it ('obstacles' such as buildings, infrastructures and land uses).

DEMs can be acquired by different means such as interpolation from elevation points, digitising contour lines or direct measurements using stereo-photogrammetry or LiDAR (Light Detection And Ranging). They exist in different formats, as raster or vector (TIN: Triangular Irregular Network) data. A TIN dataset is also referred to as a primary or measured DEM, whereas a raster DEM is referred to as a secondary or computed DEM. All these factors define the accuracy, precision and uncertainty (fuzziness) of the DEM dataset, which are important conditions for the analyses and the quality of the results.

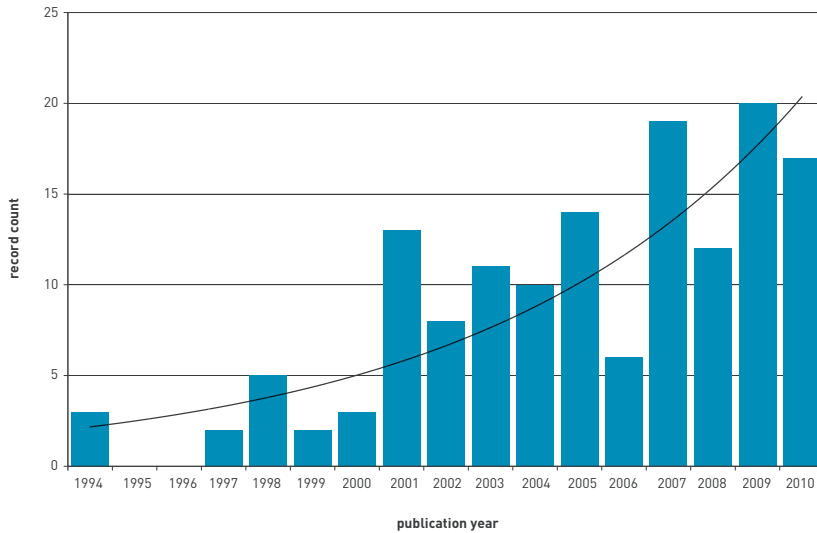
#### 1.4.1 Trends in GISc

During the last forty years visual landscape research has been constrained by computer technology and availability of digital data. The first decennia in using geo-information technology was characterised by problems to acquire useful digital data in appropriate formats and the development of system specific software standards. Today, the power of PCs allow complex GIS-applications, there is a multitude of geodata available from many providers and there is a lot of user's friendly 'of the shelf GIS-software' widely available, offering 'common' functions and tools for mapping the visual landscape. This will be exemplified by a brief bibliometric survey on the use of GISc in visual landscape research (see figure 8).

Influenced by national (NCG, 2010; VROM, 2008) and international initiatives supporting GISc and its applications in interdisciplinary approaches, GISc is likely to continue developing. The following trends can be recognised (Craglia et al., 2008):

- from *practice* to *theory*;
- from geo-information *application* to geo-information *infrastructure*;
- from spatial data *structuring* to meaningful spatial data *integration*;
- from *mapping* to *dynamic real-time spatial data collection and visualisation*;
- from *technological* to *socio-technical*;
- from a *few application areas* to *many disciplines in society*.

This list represents a rich research agenda and includes applications in space and place, description and classification and temporality. Alternative models of space and time (dynamics,



**Figure 8**  
 The diagram is based on a brief Web of Science literature research (1994-2010) using the key terms 'visual landscape' and 'GIS'. 145 references published in this period were found (source: Web of Science, 2011, 7<sup>th</sup> of July)

movement) will be explored and corresponding specific visualisation tools, and languages are being created (Fisher and Unwin, 2005). Especially with regards to visual landscape research the development of a *body-centred geography* in GISc offers interesting clues for addressing the perceptual space (Batty et al., 2005).

The trends mentioned before are also found in (academic) education, as can be seen in many recent BSc and MSc programmes, where learning goals aim to link academic knowledge and skills in information technology. For example, the List of relevant European teaching subjects in the studies of landscape architecture (EU-Teach, 2011) proposed by the European Council of Landscape Architecture Schools (ECLAS), the European Federation of Landscape Architecture (EFLA) and others, promote learning outcomes in information technology, including GIS and three-dimensional visualisation, besides basic learning outcomes of theory and methodology in landscape architecture and participation.

#### 1.4.2 Specific methods and techniques based on GIScience

De Veer and Burrough (1978) suggested that the core of visual landscape mapping is about distinguishing between *space* and *mass* (see figure 9). A *space* is defined as an area of the earth's

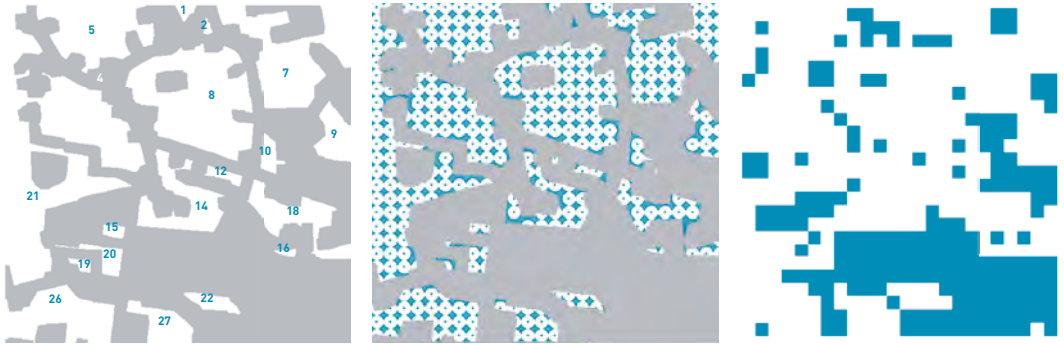
surface, bordered by linear or mass/volume elements higher than the eye level of a standing observer, within which all points are mutually visible. *Mass or volumes* are space-defining elements and can consist of vegetation (forest) or buildings or infrastructure (De Veer and Burrough, 1978). Later the concepts of screens and transparency were added (Buitenhuis et al., 1979; De Veer, 1981; Piessens, 1985).

Based on these definitions, De Veer and Burrough (1978) defined three approaches to map the visible landscape: the *compartment*, the *field of view* and the *grid cell* approach (see figure 10). These differ mainly by the way they define space and mass and how these can be determined using topographic maps or aerial photographs. The compartment approach considers the visible landscape as a set of concave compartments that can be characterised by size or shape, the type of border and their content. The field of view approach is based on measurements of fields of view and mapping sightlines from the observer's position in the landscape. The grid cell approach samples the landscape by a tessellation of (mostly square) grid cells, for which one or more variables are measured and used to classify the cell density and complexity or to assign a type to it (De Veer and Burrough, 1978; Palmer and Roos-Klein Lankhorst, 1998).

Methods for operationalising these approaches using geodata are given in studies like Burrough et al. (1982) and Buitenhuis et al. (1986). The last decennia, the number of processing methods and techniques to map the visual landscape increased, new algorithms were developed allowing the determination of new indicators for the visual landscape. Important are stereometric three-dimensional (3D) analyses that complement the planimetric two-dimen-

Figure 9  
Space and mass. Original map (l) and derived space (white) – mass (black) map





**Figure 10**  
 Three important approaches in landscape mapping: compartment (l); field of view (m); grid cell (r)

sional (2D) ones. Referring to the Dutch academic context, the following groups of methods and techniques can be recognised:

- *Grid cell analysis*: the landscape is subdivided into spatial features that are represented by raster cells or grid-shaped polygons. Each feature is described by one or more variables and can be integrated in each cell as integrated indicators, such as density or complexity. The origins and background of this 'raster analysis' go back to the work of Tomlinson et al. (1976) and Tomlin (1983, 1991). The Map Analysis Package (MAP) by Tomlin was the first raster based GIS and a milestone in the GIS development (see e.g. Blom et al., 1985; Van den Berg et al., 1985; Van Lammeren, 1985) (see figure 11). Regarding visual landscape assessment using this approach, recent examples are given by Dijkstra and Van Lith-Kranendonk (2000), Palmer and Roos-Klein Lankhorst (1998) and Roos-Klein Lankhorst et al. (2002). In the international context these studies are comparable with the ones of Bishop and Hulse (1994) and Dramstadt et al. (2006). Raster analysis is also used for landscape characterisation at different scale levels (see e.g. Van Eetvelde and Antrop, 2009). The research of Bishop et al. (2000) showcases an application in the vertical plane;
- *Landscape metrics*: were originally developed for spatial analysis of land use patches in landscape ecology. Landscapes are modelled into patches, corridors, matrix and mosaics. Landscape metrics are also used to describe the composition and spatial configuration of these elements (Turner and Gardner, 1991; Li and Wu, 2007). The software FRAGSTATS (McGarigal and Marks, 1995) had an important impact on the broad introduction of landscape metrics in landscape research. For Dutch applications in visual landscape studies see Antrop and Van Eetvelde (2000) and Van Lammeren and Kamps (2001). Palmer (2004) and Uuema et al. (2009) gave examples of visual landscape studies that use landscape metrics. Li and Wu (2004) point at the misuse of the landscape metrics because of conceptual flaws regarding spatial pattern concepts. Landscape metrics are two-dimensional and can be applied both on raster and vector data;

- *Viewsheds*: areas that can be seen from a given position. Viewshed-analysis is basically a three-dimensional visibility calculation based on raster data (surface analysis). Tandy (1967) introduced the term viewshed by analogy to the watershed. The computer program VIEWIT (Amidon and Elsner, 1968) was an important stimulant in viewshed-analysis, in particular as promulgated by the US Forest Service in the 1970s and used by many natural resource planners, landscape architects and engineers (Ervin and Steinitz, 2003). See De Floriani and Magillo (2003), Fisher (1991, 1992, 1993, 1995 and 1995) and Riggs and Dean (2007) for technical backgrounds. Interesting Dutch applications in visual landscape assessment are Sevenant and Antrop (2006), Kerkstra et al. (2007), Piek et al. (2007) and Nijhuis (2010) (see figure 12). International references are Wheatley (1995), Llobera (1996, 2003), Germino et al. (2001), Bishop (2003), Rød and Van der Meer (2009);
- *Isovists*: sight field polygons or limit-of-vision plottings are the vector-based counterpart of viewsheds and address only the horizontal plane. Tandy (1967) suggested the application of isovists to “convey the spatial composition from an observers point of view”. Later, Benedikt connected Gibson’s (1979) concept of the ambient optic array to isovists and isovist fields for means of architectonic research (Benedikt, 1979, 1981). Computational generation of isovists are found in Depthmap (Turner, 2001) and Iovist Analyst Extension (Rana, 2002). For technical backgrounds and interesting parameters see Batty (2001) and Turner et al. (2001). In the Netherlands this topic can be found in Van Bilsen and Stolk (2007), Nijhuis (2009) and Weitkamp (2010). Recently the so-called 3D-isovists became of interest e.g. Fisher-Gewirtzman et al. (2003, 2005), Morello and Ratti (2009) and Van Bilsen (2008). “A ‘3D-isovist’ defines the three-dimensional field of view, which can be seen from a vantage point with a circular rotation of 360 degrees and from the ground to the sky. In comparison to the definition of a 2D-isovist, which considers a plan parallel to the ground, this new definition refers to the real perceived volumes in a stereometric reference. Adding the vertical dimension helps to better simulate the physical environment observed from the vantage point” (Morello and Ratti, 2009);
- *Virtual 3D-landscapes*: current GIS are generally limited to the horizontal two dimensions but utilise three-dimensional visualisation and analysis. GIS support *3D-display of terrain models* (DEMs), *interactive navigation*, *3D-symbols/geometries* (including: custom 3D modelling, importing GIS data, importing 3D-data, 3D laser scanning), *surface analysis* (i.e. viewsheds and isovists) and *viewpoint and path creation* (i.e. fly-through animations) (Kemp, 2008; Raper, 1989, 2000). However, the embedding of 3D topology and, consequently, 3D analysis tools to become true 3D-GIS is still under development. See e.g. Batty (2008, 2000) and Abdul-Rahman et al. (2006) on this matter. Three-dimensional visualisation (GIS-based) offers a wide range of possibilities for means of visual landscape research. For an elaboration see Ervin (2001), Ervin and Hasbrouck (2001) and Bishop and Lange (2005). Degree of reality is an important topic that has to be addressed (Lange, 2001). Dutch examples of virtual 3D landscapes in visual landscape research include

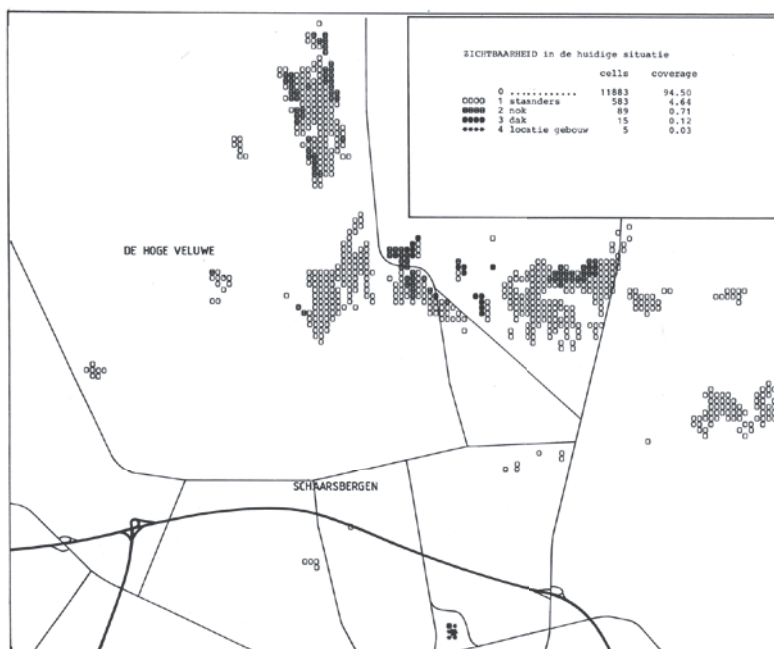


Figure 11  
 Visibility analysis using MAP2, an early GIS developed by Dutch scholars and based on Tomlin's MAP software (source: Van den Berg et al., 1985)

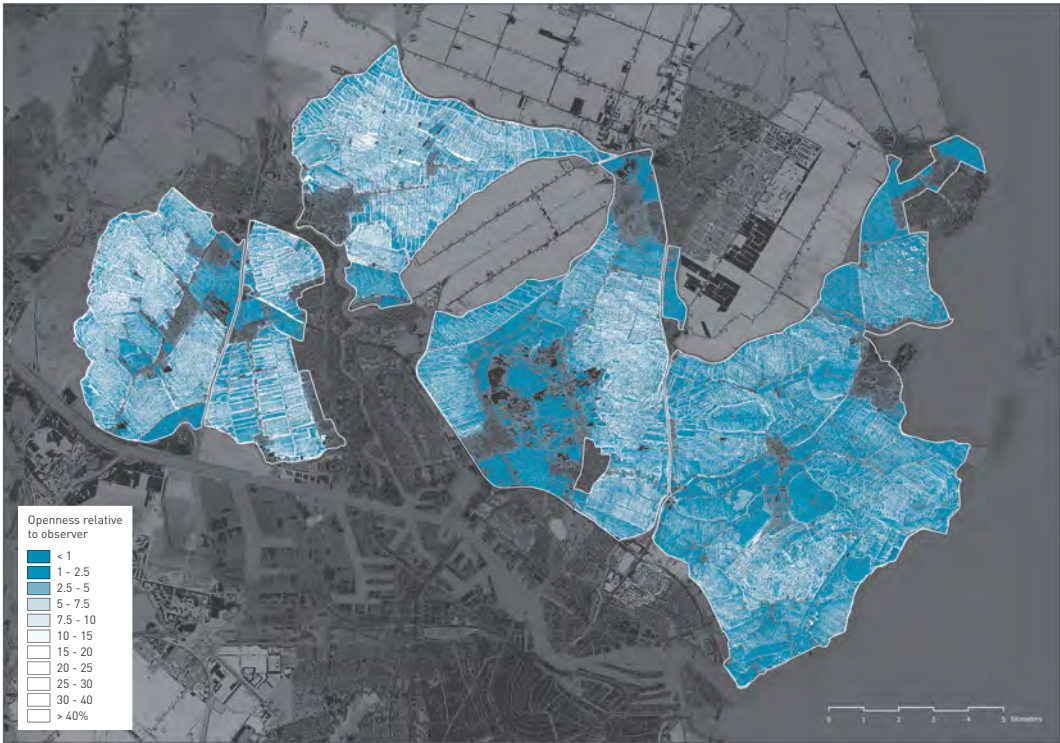
Alkhoven (1993) and Van Lammeren et al. (2003). International examples are Ribe et al. (2002), Hudson-Smith and Evans, (2003), Paar (2003), Rekitte and Paar (2006) and Hudson-Smith (2008).

Throughout the book the reader will find theoretical and practical applications of these methods and techniques, in particular in part two and three. More backgrounds on GIS in relation to visual landscape research can be found in chapter 4.

## 1.5 THREE PARTS, TWELVE CHAPTERS

This book is built up of twelve chapters, plus this introduction. The chapters are organised around three themes: (1) theory, (2) landscape research and design, and (3) landscape policy. This practical grouping in parts is derived from the content of the chapters and reflects the scope and direction of visual landscape research in the Dutch academic context. The chapters offer important clues for theory, methodology and application in research and development of landscapes all over the world, exemplified by their particular perspectives on the topic.





**Figure 12**  
 Analysis of landscape openness relative to the observer by means of viewsheds (by S. Nijhuis)

### 1.5.1 Part one: theory

This part comprises of theoretical elaborations on the psychology and phenomenology of the visual landscape and showcases recent developments in the field of environmental psychology. Furthermore it elaborates a perspective on GISc with regard to physiognomic landscape research from a typical geomatics point of view.

*Psychology of the visual landscape* (chapter 2) by Jacobs introduces the key concepts of psychological perception of the landscape. The chapter introduces biological, cultural and individual factors that determine the mental processes involved in landscape perception. It presents a comprehensive overview of disciplinary approaches to the study of psychological responses to the visual landscape and links it to GIS. *The phenomenological experience of the visual landscape* (chapter 3) by Moya Pellitero explores how phenomenological approaches can inform landscape planning, design and policy. This chapter elaborates how the qualitative and intangible nature of landscape can be incorporated into the analyses and monitoring typically performed

through GIS. It proposes a participative methodology to elaborate new ways of mapping the social phenomenological experience of landscape. *Geomatics in physiognomic landscape research* (chapter 4) by Van Lammeren introduces the key concepts of geomatics in relation to visual landscape research. It addresses the constituent elements of geomatics: *geodata*, *geodata processing* and *geodata visualisation*. Furthermore, the chapter reflects experiences in the Netherlands in the use of GISc in visual landscape research and embeds it in an international context.

### 1.5.2 Part two: landscape research and design

This part presents visual landscape research methods and techniques for landscape planning, design and management and comprises of examples in the urban and rural realm. It showcases recent examples of multi-disciplinary approaches in landscape architecture, environmental psychology, urban design, information science and landscape heritage management.

*Visual research in landscape architecture* (chapter 5) by Nijhuis explores visual landscape research for means of landscape architectonic design. It is about analysis of the visible form of a landscape architectonic composition as it is encountered by an individual within it, moving through it, making use of GIS-based isovists and viewsheds. It addresses the basic concepts of visual perception, the role of movement and showcases how GIS can reveal the particularities of the perceived landscape architectonic space by computational analysis and its representation. *Mapping landscape attractiveness* (chapter 6) by Roos-Klein Lankhorst et al. introduces a validated model that predicts the attractiveness of the landscape: the GIS-based Landscape Appreciation Model (GLAM). The authors elaborate on the theoretical background to GLAM, the attributes in the current version of the model, the final steps in calibrating the model, as well as its validation. The chapter concludes with a discussion on the usefulness of GLAM for spatial policy. *The one- and two-dimensional isovists analyses in Space Syntax* (chapter 7) by Van Nes elaborates on axial lines and isovists as constituent elements of the Space Syntax method for means of visibility analyses. It showcases how spatial properties derived from these analyses indicate degrees of street life, safety and economic attractiveness in urban areas. *Virtual historical landscapes* (chapter 8) by De Boer et al. is about realistic 3D virtual reconstructions of historical landscapes using GIS-technology. These virtual historical landscapes let users experience the historical landscape from different viewpoints by browsing and navigating through 3D virtual environments. These virtual environments provide a global, visual context for a detailed presentation of historical and archaeological research data for management of landscape heritage and edutainment projects. *Mapping landscape openness with isovists* (chapter 9) by Weitkamp describes a procedure to get a grip on landscape openness using GIS-based isovists. It is about the concept of landscape openness as an important aspect of the visual landscape, it describes a method to model landscape openness and a procedure to use this model for policy

making purposes. Furthermore, it discusses the evaluation of the results of the procedure with policy makers.

### 1.5.3 Part three: landscape policy

Landscape character assessment is a key element in landscape management, planning and monitoring and serves as an important basis for landscape policy. This part consists of applications of visual landscape research in the context of policymaking in the urban and rural realm. Important themes are landscape openness, the visual influence of high-rise buildings and panoramic views along motorways.

*Landscape policy and visual landscape assessment* (chapter 10) by Nijhuis and Reitsma elaborates a landscape planning and design-oriented approach to visual landscape indicators, involving GIS-based methods. It focuses on landscape character assessment addressing visual attributes such as spaciousness, degree of openness and visibility. The Province of Noord-Holland (the Netherlands) serves as a case study of how regional authorities can include visual landscape character assessment in landscape policy. *Preserving panoramic views along motorways through policy* (chapter 11) by Piek et al. introduces a practical approach towards motorway panoramas, it provides a definition and elaborates a GIS-based method to get a grip on views along motorways. The described approach fitted in well with policy discussions of the Dutch government about preventing spatial clutter across the landscape and preserving landscape openness. The research, to some degree, was used to formulate policy on motorway environments. *Hi Rise, I can see you!* (chapter 12) by Van der Hoeven and Nijhuis presents a framework for analysing high building development and the visual impact of high buildings on the surrounding landscape, with the city of Rotterdam as a Western European showcase. Architectural height, year of completion, location and functional use, as well as atmospheric circumstances and vertical size are constituent elements of the analysis comparing existing buildings with the urban policies that are in place. *Visions of Belle van Zuylen* (chapter 13) by Lörzing demonstrates that visual landscape assessment can have some tangible impact on a political decision-making process. As pointed out in the case of the proposed (and controversial) Belle van Zuylen skyscraper, a study into the tower's visual effects played an important role in the decision process of policy makers such as the Chief Government Architect, providing a solid basis for discussion on this issue of national importance.

## NOTES

- [1] Recently republished and translated in English: see Granö and Paasi (1997).
- [2] The quest of apprehension, representation and realisation of the perceived space started already in Ancient Greece and took a big step in development in Renaissance Italy by the invention, description and application of linear perspective.
- [3] For backgrounds to this see Maas and Reh (1968).
- [4] The differences between the psychophysical and psychological approaches are gradual and hard to distinguish.

## REFERENCES

- Abdul-Rahman, A., Zlatanova, S., and Cours, V. (2006) *Innovations in 3D geo-information systems*. Berlin, Springer.
- Alkhoven, P. (1993) *The changing image of the city: a study of the transformation of the townscape using computer-aided architectural design and visualization techniques: a case study: Heusden*. Utrecht, Utrecht University.
- Alphen, B.J. van, Dijkstra, H., and Roos Klein-Lankhorst, J. (1994) *De ontwikkeling van een methode voor monitoring van de 'Maat van de Ruimte'*. Wageningen, DLO-Staring Centrum (report 334)
- Amidon, E., and Elsner, G. (1968) *Delineating landscape view areas. A computer approach*. Pacific Southwest Forest and Range Experiment Station, Berkeley, CA, USDA Forest Service (report RN PSW-180)
- Antrop, M. (2007) *Perspectieven op het landschap. Achtergronden om landschappen te lezen en te begrijpen*. Gent, Academia Press.
- Antrop, M., and Van Eetvelde, V. (2000) Holistic aspects of sub-urban landscapes: visual image interpretation and landscape metrics. *Landscape and Urban Planning* 50; 43-58
- Appleton, J. (1975) *The experience of landscape*. London, Wiley.
- Appleyard, D., Lynch, K., and Myer, J. R. (1964) *The View from the Road*. Cambridge, Massachusetts. Massachusetts Institute of Technology.
- Arthur, L.M., Daniel, T.C. and Boster, R.S. (1977) Scenic assessment: An overview. *Landscape Planning* 1977(4): 109-129
- Ashihara, Y. (1983) *The Aesthetic Townscape*. Cambridge, Massachusetts, The MIT Press.
- Batty, M. (2001) Exploring isovist fields. Space and shape in architectural and urban morphology. *Environment and planning B: Planning and Design* 28; 123-150
- Batty, M. (2000) The new geography of the third dimension. *Environment and Planning B* 27; 483-484
- Batty, M. (2008) Virtual Reality in Geographic Information Systems. In: Wilson, J.P., and Fotheringham, A.S. (eds.) *The Handbook of Geographic Information Science*. Oxford, Blackwell Publishing, pp 317-334
- Batty, M., Galton, A., and Llobera, M. (2005) Not Just Space. An introduction. In: Fisher, P., and Unwin, D. (eds.) *Re-presenting GIS*. London etc., John Wiley & Sons, pp 127-133
- Bell, S. (1996) *Elements of Visual Design in the Landscape*. London, E&FN Spon.
- Bell, S. (1999) *Landscape. Pattern, Perception and Process*. London, E&FN Spon.
- Bell, P.A., Greene, T.C., Fisher, J.D., and Baum, A. (2001) *Environmental Psychology*. London, Lawrence Erlbaum Associates.
- Benedikt, M.L. (1979) To take hold of space: isovists and isovist fields. *Environment and Planning B* 6; 47-65
- Benedikt, M.L. & C.A. Burnham, (1981) Perceiving architectural space: from optic arrays to isovists. In: Warren, W.H., Shaw, R.E., and Hillsdale, N. J. (eds.) *Persistence and Change*. Connecticut, Lawrence Erlbaum, pp 103-114
- Berlyne, D. E. (1971) *Aesthetics and psychology*. New York, Appleton Century Crofts.
- Bijhouwer, J.T.P. (1954) *Waarnemen en ontwerpen in tuin en landschap*. Amsterdam, Uitgeverij Argus.
- Bishop, I.D. (2003) Assessment of visual qualities, impacts, and behaviours in the landscape by using measures of visibility. *Environment and Planning B: planning and design* 30; 677-688
- Bishop, I., and Hulse, D.W. (1994) Prediction of scenic beauty using mapped data and geographic information systems. *Landscape and Urban Planning* 30; 59-70
- Bishop, I., and Lange, E., eds. (2005) *Visualization in landscape and environmental planning. Technology and applications*. London/New York, Taylor & Francis.
- Bishop, I., Wherrett, J.R., and Miller, D. (2000) Using image depth variables as predictors of visual quality. *Environment and Planning B: Planning and Design* 27; 865-875
- Blom, R., Rip, F., Toes, H., and Voskens, M. (1985) *CALP 4, proefproject Haaglanden*, Rapport Tuin- en Landschaps-architectuur, Landbouwhogeschool Wageningen.
- Boerwinkel, H.J.W. (1986) *Cultuur, psychologie, omgevingsvormgeving en zelfoverstijging*. Wageningen, Landbouwhogeschool.
- Bouwman, M.J.A. (1979) *De waarde van het gebruik van de entheskoop in relatie tot andere presentatie-technieken voor de gebouwde omgeving*. Wageningen, Landbouwhogeschool Wageningen.
- Boyer, M.C. (1994) *The city of collective memory: its historical imagery and architectural entertainments*. Cambridge, Mass, MIT Press.
- Buitenhuis, A., Burrough, P.A., and Veer, A.A. de (1979) De doorzichtigheid van landschapselementen. *Groen* 7; 279-286

- Buithuis, A., Kerkhof, C.E.M. van de, Randen, Y. van, and De Veer, A.A. (1986) *Schaal van het landschap. Opbouw en gebruik van een geografisch informatie-systeem van schaalkenmerken van het landschap van Nederland, met landelijke kaarten 1:400.000*.
- Boogert, D.A., and Schalk, J. (1995) *Inrichting in vorm. De vormgeving van de maatregelen in landinrichting*. Utrecht, LBL (report 205)
- Burrough, P.A., Buithuis, A., and De Veer, A.A. (1982) *Het Informatiesysteem Landschapsbeeld, Reeks Landschapsstudies*. Wageningen, Pudoc.
- Chang, K.T. (2010) *Introduction to Geographic Information Systems*. New York, etc., McGraw-Hill.
- Council of Europe (2000) *The European Landscape Convention*. Florence, s.n.
- Coeterier, J.F. (1987) De waarneming en waardering van landschappen. Resultaten van omgevingspsychologisch onderzoek. Wageningen, Landbouwwuniversiteit Wageningen
- Coeterier, J.F. (1994) Cues for the perception of the size of spaces in landscapes. *Journal of Environmental Management* 42; 333-347
- Coeterier, J.F. (1996) Dominant attributes in the perception and evaluation of the Dutch landscape. *Landscape and Urban Planning* 34; 27-44
- Craglia, M, Goodchild, M.F., Annoni, A. et al. (2008) Next-Generation Digital Earth. A position paper from the Vespucci Initiative for the Advancement of Geographic Information Science. *International Journal of Spatial Data Infrastructures Research* 3; 146-167
- Cullen, G. (1961) *Townscape*. London, The Architectural Press.
- Daniel, T.C. (2001) Wither scenic beauty? Visual landscape quality assessment in the 21st century. *Landscape and urban planning* 54; 267-281
- Daniel, T.C., and Vining, J. (1983) Methodological issues in the assessment of landscape quality. In: Altman, I., and Wohlwill, J. (eds.), *Behavior and the Natural Environment: Advances in Theory and Research*. New York, Plenum Press, pp 5-45
- De Boer, H. (1979) *Landschapswaardering: rapport ten behoeve van het landschapsbeeldkarteringsonderzoek*. Wageningen, De Dorschkamp (report 209)
- De Florian, L. and Magillo, P. (2003) Algorithms for visibility computation on terrains: a survey. *Environment and Planning B: Planning and Design* 30; 709-728
- De Veer, A.A. (1981) De doorzichtigheid van landschapselementen. *Groen* 7; 279-287
- De Veer, A.A. (1977) De ruimtelijke classificatie van het Nederlandse landschap. *KNAG Geografisch Tijdschrift* (XI) 2; 98-109
- De Veer, A.A. (1978) Visuele verstedelijking. *KNAG Geografisch Tijdschrift* (XII) 3; 281-282
- De Veer, A.A., and Burrough, P.A. (1978) Physiognomic landscape mapping in the Netherlands. *Landscape Planning* 5; 45-62
- De Veer, A.A., Buithuis, A., and Van het Loo, H. (1977) *Vergelijking van Nederlandse methoden van landschapsbeeldkartering en hun toepassingsmogelijkheden*. Wageningen, Stiboka & Pudoc.
- Dee, C. (2001) *Form and fabric in landscape architecture*. London, Routledge.
- Den Ruijter, M. (1984) Perspektief in computergraphics. *Groen* 40(9); 338-341
- Den Ruijter, M. (1978) Perspectiefreeksen construeren met computerhulp en projecteren. *Bouw* 20; 55-58
- Dijkstra, H. et al. (1985) *Visuele en ecologische effecten van nieuwbouw in Burgers Zoo*. Wageningen, De Dorschkamp.
- Dijkstra, H. (1991) Het visuele landschap. Onderzoek naar de visuele kwaliteit van landschappen. *Landschap* 8 (3); 157-175
- Dijkstra, H., and Van Lith-Kranendonk, J. (2000) *Schaal-kenmerken van het landschap in Nederland. Monitoring Kwaliteit Groene Ruimte (MKGR)*. Wageningen, Alterra (report nr. 40)
- Dodge, M., McDerby, M., and Turner, M., eds. (2008) *Geographic Visualization. Concepts, Tools and Applications*. London, John Wiley & Sons.
- Dramstad, W.E., Tveit, M., Fjellstad, W.J., and Fry, G.L.A. (2006) Relationships between visual landscape preferences and map-based indicators of landscape structure. *Landscape and Urban Planning* 78; 465-474
- Duntley, S.Q. (1948) The Visibility of Distant Objects. *Journal of the Optical Society of America* 38(3); 237-249
- Ervin, S.M. (2001) Digital landscape modelling and visualization: a research agenda. *Landscape and Urban Planning* 54 (1-4); 49-62
- Ervin, S.M., and Hasbrouck, H.H. (2001) *Landscape Modelling: Digital Techniques for Landscape Visualization*. New York, McGraw-Hill.
- Ervin, S., and Steinitz, C., (2003) Landscape visibility computation: necessary, but not sufficient. *Environment and Planning B: Planning and Design* 30; 757-766
- EU-Teach (2011) *List of relevant European teaching contents in the studies of landscape architecture*. ECLAS, EFLA, etc., ERASMUS-Life Long Learning programme of the European Union / Education, Audiovisual and Culture Executive Agency.
- Fisher, P.F. (1991) First experiments in viewshed uncertainty: the accuracy of the viewshed area. *Photogrammetric Engineering and Remote Sensing* 57; 1321-1327
- Fisher, P.F. (1992) First Experiments in Viewshed Uncertainty: Simulating Fuzzy Viewsheds. *Photogrammetric Engineering and Remote Sensing* 58 (3); 345-352
- Fisher, P. F. (1993) Algorithm and implementation uncertainty in viewshed analysis. *International Journal of Geographical Information Science* 7 (4); 331-347
- Fischer, P.F. (1995) An Exploration of probable viewsheds in landscape planning. *Environment and Planning B: Planning and design* 22; 527-546

- Fisher, P.F. (1996) Extending the applicability of viewsheds in landscape planning. *Photogrammetric Engineering and Remote Sensing* 62 (11); 1297-1302
- Fisher-Gewirtzman, D., Dalit Shach, P., Wagner, I.A., and Burt, M. (2005) View-oriented three-dimensional visual analysis models for the urban environment. *Urban Design International* 10; 23-37
- Fisher-Gewirtzman, D., and Wagner, I. A. (2003) Spatial openness as a practical metric for evaluating build up environments. *Environment and Planning B: Planning and Design* 30(1); 37-49
- Fisher, P., and Unwin, D., eds. (2005) *Re-presenting GIS*. London etc., John Wiley & Sons.
- Germino, M.J., Reiners, W.A., Blasko, B.J., McLeod, D., and Bastian, C.T. (2001) Estimating visual properties of Rocky Mountain landscape using GIS. *Landscape and Urban Planning* 53; 71-84
- Gibson, J.J. (1979) *The Ecological Approach to Visual Perception*. London, Lawrence Erlbaum Associates.
- Goodchild, M.F. (1992) Geographical Information Science. *International Journal of Geographical Information Systems* 6; 31-45
- Granö, J.G. (1929) Reine Geographie. Eine methodologische Studie beleuchtet mit Beispielen aus Finnland und Estland. *Acta Geographica* 2 (2); 202
- Granö, O., and Paasi, A., eds. (1997) *Pure Geography*. Baltimore and London, The John Hopkins University Press.
- Harris, D., and Ruggles, D.F. (2007) *Sites Unseen. Landscape and Vision*. Pittsburgh, University of Pittsburgh Press.
- Hendriks, K., and Stobbelaar, D.J. (2003) *Landbouw in een leesbaar landschap. Hoe gangbare en biologische landbouwbedrijven bijdragen aan landschapskwaliteit*. Wageningen, Blauwdruk.
- Higuchi, T. (1975) *The Visual and Spatial Structure of Landscapes*. Cambridge, The MIT Press.
- Hoogstad, J. (1990) *Ruimte-tijd-beweging. Prolegomena voor de architectuur*. Den Haag, SDU Uitgevers.
- Hudson-Smith, A. (2008) The Visual City. In: Dodge, M., McDerby, M., and Turner, M. (eds.) *Geographic Visualization. Concepts, Tools and Applications*. London, John Wiley & Sons, pp 183-197
- Hudson-Smith, A., and Evans, S. (2003) Virtual cities: from CAD to 3D-GIS. In: Longley, P.A., and Batty, M. (eds.) *Advanced Spatial Analysis. The CASA book of GIS*. Redlands: Environmental Systems Research Institute, pp 41-60
- Jacobs, M. H. (2006) *The production of mindscapes*. Wageningen, Wageningen University.
- Kaplan, R., and Kaplan, S. (1989) *The Experience of Nature. A Psychological Perspective*. Cambridge, Cambridge University Press.
- Kemp, K., ed. (2008) *Encyclopedia of geo-information science*. London etc., Sage publications.
- Kerkstra, K., et al. (1974) De visuele aspecten. In: Werkgroep Helmond, *Landschapsonderzoek Helmond*. Afdeling Landschapsarchitectuur Landbouwhogeschool, Wageningen
- Kerkstra, K., Vrijlandt, P., De Jonge, H.C., and Houwen, J. (2007) *Landschapsvisie Zuid Limburg*. Wageningen, Wageningen University.
- Korthals Altes, H.J., and Steffen, C. (1988) *Beleving en routekeuze in de binnenstad van Delft*. Delft, Delft University Press.
- Koster, E.A., and De Veer, A.A. (1972) Een analyse van het landschap ten noorden van Amsterdam aan de hand van de topografische kaart. *Stedebouw en Volkshuisvesting* 53; 331-355
- Kraak, M.J., and Ormeling, F. (2010) *Cartography. Visualization of Spatial Data*. London, Prentice Hall.
- Lange, E., (2001) The limits of realism: perceptions of virtual landscapes. *Landscape and Urban Planning* 54; 163-182
- Lemaire, T. (1970) *Filosofie van het landschap*. Amsterdam, Ambo.
- Li, H., and Wu, J. (2004) Use and misuse of landscape metrics. *Landscape Ecology* 19; 389-399
- Li, H. and Wu, J. (2007) Landscape pattern analysis: key issues and challenges. In: Wu, J., and Hobbs, R.J. (eds.) *Key Topics in Landscape Ecology*. Cambridge University Press, Studies in Landscape Ecology. pp 39-61.
- Llobera, M. (1996) Exploring the topography of mind. GIS, landscape archeology and social theory. *Antiquity* 70; 612-622
- Llobera, M. (2003) Extending GIS-based visual analysis. The concepts of visualscapes. *International Journal for Geographical Information Science* 17 (1); 25-48
- Longley, P.A., and Batty, M., eds. (2003) *Advanced Spatial Analysis. The CASA book of GIS*. Redlands, Environmental Systems Research Institute.
- Longley, P., Goodchild, M.F., Maguire, D.J., and Rhind, D.W. (2011) *Geographic information systems & science*. London, John Wiley & Sons.
- Lothian, A. (1999) Landscape and the philosophy of aesthetics: is landscape quality inherent in the landscape or in the eye of the beholder? *Landscape and Urban Planning* 44; 177-198
- Lynch, K. (1960) *The Image of the City*. Cambridge, MIT Press.
- Maas, F.M. and Reh, W. (1968) The appearance and development of the landscape in the Netherlands up to approximately the year 2000. *Forum XXI*(1); 14-34
- McGarigal, K., and Marks, B.J. (1995) *FRAGSTATS: spatial pattern analysis program for quantifying landscape structure*. Pacific Northwest Research Station, Portland, OR, USDA Forest Service (Gen. Tech. Report PNW-GTR-351).
- Morello, E., and Ratti, C. (2009) A digital image of the city: 3D isovists in Lynch's urban analysis. *Environment and Planning B: Planning and Design* 36; 837-853
- Nasar, J.L. ed. (2008) *Environmental aesthetics. Theory, research and applications*. Cambridge, Cambridge University Press.
- NGC (Nederlandse Commissie Geodesie) (2010) *Nederland 2020 – Virtuele Delta: Agenda en aanpak kennis, innovatie en educatie – GIDEON Strategie 7*. Delft, Bureau van de Nederlandse commissie voor Geodesie.

- Nicolai, J. (1971) *De visuele invloed van woonplaatsen op open ruimten. Met enkele toepassingen op het midden van west-Nederland*. Delft, Delft University of Technology.
- Nijhuis, S. (2009) Mapping architectonic structures with GIS. In: Calabrese, L.M., et al. (eds.) *Architecture Annual 2007-2008*. Delft and Rotterdam, University of Technology / 010 publishers.
- Nijhuis, S. (2010) *Quickscan visuele effecten Landschapsplan Binnenduingsgebied Bergen*. Haarlem, Provincie Noord-Holland
- Olwig, K.R. (2002) *Landscape, nature and the body politic: from Britain's Renaissance to America's New World*. Madison, University of Wisconsin Press.
- Oxford dictionary (2011a) *Physiognomy*. Retrieved from: <http://oxforddictionaries.com/definition/physiognomy> [accessed 12 July 2011]
- Oxford dictionary (2011b) *Perception*. Retrieved from: <http://oxforddictionaries.com/definition/perception> [accessed 12 July 2011]
- Oxford dictionary (2011c) *Visual*. Retrieved from: <http://oxforddictionaries.com/definition/visual> [accessed 12 July 2011]
- Paar, P. (2003) Lenné3D-the making of a new landscape visualisation system. From requirements analysis and feasibility survey towards prototyping. In: Buhmann, E., and Ervin, S. (eds.) *Trends in landscape modelling*. Heidelberg, Wichmann. pp 78-84
- Palmer, J. (1996) *Modelling spaciousness in the Dutch Landscape*. Wageningen, DLO-Staring Centrum (report 119)
- Palmer, J. (2004) Using spatial metrics to predict scenic perception in a changing landscape. *Landscape and Urban Planning* 69 (2004) 201–218
- Palmer, J.F., and Roos-Klein Lankhorst, J. (1998) Evaluating visible spatial diversity in the landscape. *Landscape and Urban Planning* 43; 65-78
- Panero, J. and Zelnik, M. (1979) *Human Dimension & Interior Space*. New York, Whitney Library of Design.
- Piek, M., Middelkoop, M. van, Breedijk, M., Hornis, W., Sorel, N., and Verhoef, N. (2007) *Snelwegpanorama's in Nederland*. The Hague/Rotterdam, Ruimtelijk Planbureau/NAi Uitgevers.
- Piessens, C. (1985) Studie van de landschapstransparantie in het Land van Waas. *De Aardrijkskunde* 9 (2); 155-163
- Piket, J.C., Kalkhoven, J.T.R., De Veer, A.A., and Vos, W. (1987) *Landschap*. Edited by Stichting wetenschappelijke atlas van Nederland. Vol. 16, *Atlas van Nederland in 20 delen*. 's-Gravelhage, Staatsuitgeverij.
- Prak, N.L. (1979) *De visuele waarneming van de gebouwde omgeving*. Delft, Delft University Press.
- Rana, S. (2002) *Isovist Analyst Extension*. Version 1.1. Computer software program produced by the author at the Centre for Advanced Spatial Analysis, University College London.
- Raper, J. (1989) *Three-dimensional applications in Geographical Information Systems*. London, Taylor & Francis.
- Raper, J. (2000) *Multidimensional Geographic Information Science*. London, Taylor & Francis.
- Rekitté, J., and Paar, P. (2006) Digital Botany. *Journal of Landscape Architecture* (Autumn); 28-35
- Reh, W. (1995) *Arcadia en metropolis. Het landschapsexperiment van de verlichting*. Delft University of Technology.
- Ribe, R.G., Armstrong, E.T., and Gobster, P.H. (2002) Scenic vistas and the changing policy landscape. Visualizing and testing the role of visual resources in ecosystem management. *Landscape Journal* 21(1); 42-66
- RijksPlanologische Dienst (1966) *Tweede Nota over de ruimtelijke ordening van Nederland*. The Hague.
- Riggs, P. D., and Dean, D. J. (2007) An Investigation into the Causes of Errors and Inconsistencies in Predicted Views-heds. *Transactions in GIS* 11; 175–196
- Rød, J. K., and Van der Meer, D. (2009) Visibility and dominance analysis: assessing a high-rise building project in Trondheim. *Environment and Planning B: Planning and Design* 36(4); 698 – 710
- Roos-Klein Lankhorst, J. (1987) *Visualisation tool for (landscape) architects*. *Computer Aided-Design* 19 (4); 188-194
- Roos-Klein Lankhorst, J. (1989) *Visualisering van veranderingen in het landschap. Een computer-ondersteund ontwerpinstrument voor de (landschaps)architect*. Wageningen, Landbouwhogeschool Wageningen.
- Roos-Klein Lankhorst, J., Buijs, A.E., Van den Berg, A.E., Bloemmen, M., Vries, S. de, Schuiling, C., and Griffioen, A.J. (2002) *BelevingsGIS, versie februari 2002* (hoofdttekst). Wageningen, Alterra (werkdocument 2002/08).
- Scott, K. and Benson, F. (2002) Public and professional attitudes to landscape: scoping study. Newcastle, University of Newcastle.
- Sevenant, M. (2010) *Variation in landscape perception ad preference. Experiences from case studies in rural and urban landscapes observed by different groups of respondents*. Ghent University, Department of Geography.
- Sevenant, M., and Antrop, M. (2006) Settlement models, land use and visibility in rural landscapes: Two case studies in Greece. *Landscape and Urban Planning* 80; 362–374
- Sevenant, M., and Antrop, M. (2010) The use of latent classes to identify individual differences in the importance of landscape dimensions for aesthetic preference. *Land Use Policy* 27; 827-842
- Smardon, R.C., Palmer, J.F., and Felleman, J.P. (1986) *Foundations for visual project analysis*. New York etc., Wiley.
- Snowden, R., Thompson, P. and Troscianko, T. (2006) *Basic Vision. An introduction to visual perception*. Oxford, Oxford University Press.
- Staats, H., and Van de Wardt, J.W. (1990) Changing a small-scale landscape: Environmental psychology applied to the problems of the countryside. *Netherlands Journal of Housing and Environmental Research* 5; 65-86
- Steffen, C. (1981) *Psychologie van de waarneming*. Delft, Technische Hogeschool Delft.
- Steffen, C., and Van der Voordt, D. (1978) *Belevingsonderzoek*

- in Antwerpen. Delft, Technische Hogeschool Delft.
- Steenbergen, C.M., ed. (1985) *Architectuur en landschap. Rationele, formele en picturale encensering en het situatief ontwerp*. Delft, Delft University Press.
- Steenbergen, C.M. (1990), *De stap over de horizon. Een ontleding van het formele ontwerp in de landschapsarchitectuur*. Faculteit Bouwkunde, Delft University of Technology.
- Tandy, C.R. (1967), The Isovist Method of Landscape Survey, in: C.R. Murray (ed.) *Methods of Landscape Analysis*. London: Landscape Research Group, pp 9-10
- The Landscape Institute (2003) *Guidelines for Landscape and Visual Impact Assessment*. Second Edition. London and New York, Spon Press.
- Thiel, P. (1997) *People, Paths, and Purposes: Notations for a Participatory Enviroctecture*. Seattle and London, University of Washington Press.
- Tomlin, C.D. (1983) *Digital Cartographic modelling. Techniques in environmental planning*. Unpublished PhD thesis. Harvard University.
- Tomlin, C.D. (1991) Cartographic Modelling. In: Maguire D.J., Goodchild, M.F., and Rhind, D.W. (eds.) *Geographical Information systems: principles and applications*. London, Longman.
- Tomlinson, R.F. Calkins, H.W., and Marble, D.F. (1976) *Computer handling of geographical data*. Paris, UNESCO Natural Resources Research XIII.
- Tuan, Y.F. (1974) *Topophilia: a study of environmental perception, attitudes, and values*. New York, Columbia University Press.
- Turner, M.G., and Gardner, R.H. eds. (1991) *Quantitative methods in landscape ecology*. New York, Springer-Verlag.
- Turner, A. (2001) *Depthmap. A program to perform visibility graph analysis*. Proceedings Space Syntax symposium.
- Turner, A., Doxa, M., O'Sullivan D., and Penn, A. (2001) From Isovists to visibility graphs: a methodology for the analysis of architectural space. *Environment and Planning B: Planning and design* 28; 103-121
- Uuema, E., Antrop, M., Roosaare, J., Marja, R., and Mander, U. (2009) Landscape Metrics and indices: An overview of Their Use in Landscape Research. *Living Review in Landscape Research*.
- Ulrich, R.S. (1981) Natural versus urban scenes: some psychophysiological effect. *Environment and Behavior* 13; 523-556
- Van Bilsen, A. (2008) *Mathematical Explorations in Urban and Regional Design*. PhD thesis, Delft University of Technology.
- Van Bilsen, A., and Stolk, E. (2007) The potential of isovist-based visibility analysis. In: H. C. Bekering, J. Klatte, and D. Hauptmann (eds.) *The architectural annual 2005-2006*. Rotterdam, 010 Publishers, pp 68-73
- Van de Wardt, J.W., and Staats, H. (1988) *Veranderingen in een kleinschalig landschap*. Omgevingspsychologisch onderzoek. Leiden, Rijksuniversiteit
- Van den Berg, A.E. (1999) *Individual differences in the aesthetic evaluation of natural landscapes*. Thesis. Groningen, Rijksuniversiteit Groningen.
- Van den Berg, A., Van Lith, J., and Roos, J. (1985) Toepassing van het computerprogramma MAP2 in het landschapsbouwkundig onderzoek. *Landschap* 2(4); 278-293
- Van der Ham, R., G.F.A. Schut and J. Iding (1970) Een voorstel voor een nieuwe landschapstypologie naar visuele kenmerken. *Stedebouw en Volkshuisvesting* 11: 421-438
- Van der Ham, R. and J. Idding (1971) *De landschapstypologie naar visuele kenmerken. Methoden en gebruik*. Afdeling Landschapsarchitectuur Landbouwhogeschool, Wageningen.
- Van Eetvelde, V., and Antrop, M. (2009) A stepwise multi-scaled landscape typology and characterisation for trans-regional integration, applied on the federal state of Belgium. *Landscape and Urban Planning* 91(3); 160-170
- Van Lammeren, R.J.A. (1985) *MAP en de Wageningse Uiterwaarden*. Wageningen, Landbouwhogeschool Wageningen, Planologie (two volumes).
- Van Lammeren, R.J.A. (2003) *SALIX-2, Simulatie Agenten voor Landschapsarchitectonisch Design in Virtual Reality (X)*. Wageningen, Alterra.
- Van Lammeren, R.J.A., and Kamps, S. (2001) Quantitative landscape description. In: *Conference Proceedings of ECLAS, Velp*, pp 64-75
- VROM, Ministry of (2008) *GIDEON Basisvoorziening geoinformatie Nederland: Visie en implementatiestrategie (2008-2011)*. The Hague.
- Ware, C. (2004) *Information Visualization. Perception for design*. Burlington, Morgan Kaufmann Publishers.
- Warnau, H. (1979) *Rapport over de parken Sonsbeek, Zijpendaal en Gulden Bodem in Arnhem. Beschrijving, waardering, mogelijke veranderingen*. Wageningen, Vakgroep Landschapsarchitectuur, Landbouwhogeschool Wageningen
- Warnau, H. (1990) Ontwerpdoelstellingen in de landschapsarchitectuur. *Plan* 21(5/6); 12-21
- Wassink, W.T. (1999) *Beekdallandschappen. Een morfologisch onderzoek in de zandgebieden van Nederland*. Wageningen University
- Weitkamp, G. (2010) *Capturing the View. A GIS based procedure to assess perceived landscape openness*. Wageningen, Wageningen University.
- Wentholt, R. (1968) *De binnenstadbeleving in Rotterdam*.
- Wheatley, D. (1995) Cumulative viewshed analysis: a GIS-based method for investigating intervisibility, and its archaeological application. In: Lock, G., and Stancic, Z. (eds.) *Archaeology and Geographical Information Systems: A European Perspective*. London, Taylor and Francis, pp 171-185
- Wilson, J.P., and Fotheringham, A.S. (eds.) *The Handbook of Geographic Information Science*. Oxford, Blackwell Publishing.
- Zube, E.H., Sell, J.L., and Taylor, J.G. (1982) Landscape perception: research, application and theory. *Landscape Planning* 9 (1): 1-33



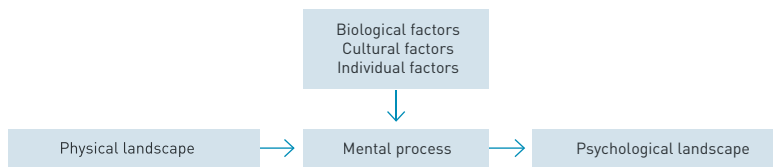
2

# PSYCHOLOGY OF THE VISUAL LANDSCAPE

## 2.1 INTRODUCTION

While environmental psychology is a leading discipline in the study of human responses to the visual landscape, various other disciplines contribute to our understanding of the psychological perception of landscape as well, such as human geography and sociology. Despite the disciplinary differences, all approaches share, explicitly or implicitly, three core assumptions (Jacobs, 2006: 47): (1) the way people perceive landscapes is influenced but not determined by physical landscape attributes, (2) a complex mental process of information reception and processing mediates between the physical landscape and the psychological landscape, and (3) various factors can exercise influence on this mental process, to be divided into biological, cultural and individual factors (Bourassa, 1990, 1991). Figure 1 illustrates these shared assumptions, and can be seen as a pre-disciplinary research model for studying the psychology of the visual landscape.

Disciplinary approaches differ with respect to the aspects of landscape perception under study (e.g. landscape preferences, meanings assigned to places), to the factors studied that influence landscape perception, and to the theories employed to explain how those factors influence landscape perception.



**Figure 1**  
**A default pre-disciplinary landscape perception research model**

This chapter presents contributions of various disciplinary approaches to the study of psychological responses to the visual landscape. Rather than giving a comprehensive overview, which would require a lengthy chapter (see Jacobs, 2006: chapter 4, for an elaborated overview), the aims are to present examples of approaches that stress biological, cultural and individual factors to explain the constitution of the psychological landscape (i.e. how landscape perception and experience come into being), to emphasise Dutch contributions within this framework, and to discuss the various bodies of knowledge in the face of GIS systems that support landscape policy, planning and design. To do so, the next three sections deal with examples of research into landscape perception devoted to biological, cultural and individual factors respectively. In the conclusion, the applicability of the various bodies of knowledge to developing GIS based support systems for landscape policy, planning and design will be discussed.

## 2.2 BIOLOGICAL FACTORS

The term ‘biological factors’ denotes innate dispositions that are evolutionarily determined and fixed in our genetic make-up. Adherents of the adaptive approach within environmental psychology contend that some landscape preferences are inborn as responses to physical landscape properties that have emerged in the course of biological evolution, because these responses enhanced survival (Saegert and Winkel, 1990). To appreciate this approach, a little understanding of the working of emotions is crucial. Generally, preferences are manifestations of emotions (LeDoux, 1996: 53; Jacobs, 2009): we tend to like objects or situations that invoke positive emotions (e.g. happiness), and tend to dislike objects and situations that invoke negative emotions (e.g. fear). Generic emotion research has demonstrated that many aspects of emotions are innate (Darwin, 1872; Ekman, 1992, 1999; LeDoux, 1996: 113). The innate aspects include some emotional bodily reactions, such as an increased heartbeat or the tendency to freeze in the case of fear. These responses were beneficial to the survival of organisms, for their adaptive value in dealing with fundamental life tasks (Damasio, 2001: 60; LeDoux, 1996: 40; Ekman, 1999). The tendency to freeze decreases the likelihood of being

spotted by a predator (predators typically react to movement), and the increased heartbeat prepares the body for a flight reaction (Jacobs, 2009). Research has also demonstrated that some stimuli automatically lead to emotional responses, without any previous learning being involved (Jacobs, 2006: 171). For example, rats that are being raised in isolation in a laboratory, never having seen a cat, show fear responses when exposed to a cat (LeDoux, 1996: 132). The advantage of automatically responding with an emotional reaction to some stimuli is that this response is quick: if an antelope would have to figure out the situation when it faces a lion, the antelope would be the lion's lunch (Jacobs, 2009). Thus, the emotional system has evolved as an adaptive system that serves survival, and includes automatic responses to some objects and situations.

The adaptive approach is concerned with these automatic, innate, quick, emotional responses (Ulrich, 1983). Since the environment is crucial for survival, it is very likely, within the framework of general evolution theory, that we have innate predispositions related to certain aspects of our environment. Genes that predispose us to particular emotional reactions to certain landscape attributes have survived in the course of evolution because those reactions have turned out to be adaptive responses to situations of life importance for human beings. Thus, innate landscape preferences are preferences for landscapes that were beneficial for our distant ancestors (but not necessarily for us, because over the last couple of thousand years, since the advent of agriculture 10.000 years ago, humans have created artificial environments at a pace that is much faster than our genetic make-up can adapt to).

The first theoretical accounts of biologically determined landscape preferences were based on the arousal theory, a general motivation theory developed by Berlyne to explain why people are inclined to stick to certain situations for a longer period of time than to other situations. Something (an artwork, a situation, a landscape) has a positive hedonic value if it is pleasant and rewarding to keep in touch with it (Berlyne, 1974: 8). For example, landscapes highly preferred by people have a high positive hedonic value. The stimuli that constitute an optimal hedonic value are a mixture of arousal-increasing and arousal-decreasing properties (arousal being the general level of excitement or activation). These stimuli make it cognitively difficult to understand the situation, but at the same time make it possible to resolve the problem. Thus, an optimal arousal potential trains our cognitive skills to resolve problems, and these are capacities we need to survive (Berlyne, 1971). While the complete arousal theory is a lot more complex (Berlyne, 1971, 1973, 1974), early environmental psychologists have used the rather simplified version as explained here. Wohlwill (1976) compared the results of then published environmental psychological research with Berlyne's theory, and found a relation between landscape preference and the degree of mystery. He also found a relation with the degree to which different landscape features fit to each other (Porteous, 1996: 119; Wohlwill, 1976).

Kaplan and Kaplan assert that landscape preferences are ‘ancient and far-reaching’ (Kaplan and Kaplan, 1989: 10), and have developed the preference matrix to explain for which landscapes we have innate preferences. The preference matrix globally resonates with Berlyne’s theory and describes the conditions that optimise the possibility to gain knowledge of the surrounding landscape. Gaining knowledge of a landscape depends on four factors: coherence, legibility, complexity and mystery (Kaplan and Kaplan, 1983, 1989: 53; Kaplan, 1987). According to Kaplan and Kaplan, we prefer those landscapes that score high values on all four factors. Coherence and legibility facilitate understanding a scene. Enough complexity makes a scene interesting, and mystery raises the expectation that there is more to learn about the scene. These four factors as such are not biological factors, but reflect perceptual factors that give the best opportunities to obtain the knowledge that is needed for survival. Thus, the biological factor in this theory is the assertion that liking those landscapes that foster obtaining knowledge trains the cognitive system, and thus contributes to survival. Kaplan and Kaplan (1989) report eleven empirical studies that have tested their theory: coherence and mystery appeared significant predictors of landscape preferences in most of these studies, while complexity and legibility were significant in only one study.

The theories of Berlyne and Kaplan and Kaplan share the assumption that we have evolutionarily developed preferences because they serve optimal cognitive functioning. This explanation, however, is very problematic in the face of recent progress in generic emotion research. Comparative phylogenetic research has demonstrated that the emotional system came into being at a much earlier stage in evolution than the cognitive system did (LeDoux, 2000). Therefore, the emotional system cannot be an adaptation to exercise cognitive capacities (Jacobs, 2006: 199). Explanations for innate landscape preferences must be much easier than the ones offered by Berlyne, and Kaplan and Kaplan. We have innate landscape preferences not because certain landscapes contribute to optimal cognitive functioning, but because certain landscapes have features that immediately serve survival. From this perspective, Appleton’s prospect-refuge theory is a better explanation for innate preferences.

According to Appleton (1984, 1996), the relationship of the human subject to the perceived environment is comparable to the relationship of an animal to its habitat. The innate human preference for landscape features is a spontaneous reaction to the landscape as a habitat (Appleton, 1975: 70). To put it simply: we prefer those landscapes that offered our primitive ancestors the best chances of survival (Appleton, 1975; Orians, 1986). We like to see without being seen: we prefer landscapes that allow us to hide, as well as to survey the environment. Our ancestors - hunters and gatherers - needed to be able to hide from large predators. They also needed to be able to survey the landscape, in order to gather vegetables and hunt for prey. Appleton’s prospect-refuge theory states that landscapes that provide both prospect and refuge opportunities are highly preferred, because they met the biological needs of our distant

ancestors. Thus, half open landscapes would be preferred over open landscapes or closed landscapes, an assertion that is corroborated by empirical findings. These empirical findings, however, do not necessarily determine whether Appleton's explanation rings true, as alternative explanations are still possible (e.g. half open landscapes often provide an optimal mix of coherence and mystery).

In addition to half-openness, an abundance of vegetation and an abundance of water are thought to be landscape properties for which we have an innate preference (e.g. Schroeder and Daniel, 1981; Ulrich, 1981, 1983, 1993; Yang and Brown, 1992). These innate preferences are easy to explain: we need water to survive, and the presence of vegetation often indicates the presence of food, water and a place to hide. Some scholars have suggested that we have an innate preference for nature (e.g. Herzog, 1989, 1992; Schroeder, 1991; Ulrich, 1993; Zube, 1991). However, it is highly unlikely that this hypothesis is true. Firstly, it contradicts the findings of historians who revealed that, during the Middle Ages, people disliked nature (Corbin, 1989; Lemaire, 1970). Secondly, because the hypothesis of an innate preference for nature contradicts basic premises of the evolutionary approach itself. The genetic make-up of humans does not change fast. We must theorise what the benefit has been for our distant ancestors – i.e. a hundred thousand years ago – to explain innate preferences. In those days, the whole environment was natural. Hence, there was no evolutionary benefit at all for our ancestors to have genes that predispose us to a preference for nature. Probably, those who argue that we have an innate preference for nature conflate nature with vegetation. While natural landscapes often contain more vegetation than human-made landscapes, it is the vegetation, not the naturalness, which triggers inborn mental dispositions to like those landscapes. To conclude, theoretically, it is very likely that we have innate preferences for half-open landscapes, and for landscapes with vegetation and water, as empirical studies indicate. While extensive cross-cultural research is absent, studies in various countries corroborate these assertions. Importantly, nobody argues that landscape preferences are solely based on innate dispositions: learning during the course of life affects those preferences as well.

## 2.3 CULTURAL FACTORS

While landscape perception and appreciation are in the end individual mental phenomena, culture exercises great influence on the individual mind, and hence, might explain certain experiential dispositions towards landscapes. Lehman et al. (2004) conclude in their review study on psychology and culture that “much recent research has demonstrated the strength of culture in influencing the perceptions, construals, thoughts, feelings, and behaviours of its members”. Culture consists of a set of collective views and habits (Jacobs, 2006: 143). Culture influences individual minds by means of public expressions: any material sign that can be

used to convey a message from one mind to another, which include written and spoken words, paintings, videos, body language, et cetera (Jacobs, 2006: 151). An individual, living in a culture, is exposed to a perpetual stream of public expressions that might influence his thoughts about the object the public expressions expound on. For example, all individuals in western culture get socialised into a certain view on nature by means of public expressions about the way nature works (e.g. texts on ecosystem theory), what nature looks like (e.g. paintings, TV documentaries), and what kind of experiences people have had in natural settings (e.g. poems, conversations) (Jacobs, 2006: 152).

Although many sociological and anthropological studies are somehow related to places (since social processes are often intimately related to places), sociological and anthropological studies and theories are seldom explicitly about place or landscape experiences (Gieryn, 2000). This is a logical consequence of the object of the studies conducted by sociologists: social processes and structures.

The bond between community and landscape is studied in anthropological work (Hirsch and O' Hanlon, 1996). For example, van Assche (2004) and Duineveld (2006) describe the various bonds between images of places and self-definitions of communities. These works focus on discourse, regarded as the production of meaning, that includes images of reality out-there as well as images of self (van Assche, 2004; Duineveld, 2006). In this approach, landscape experience is seen as dependent on discourse, for in discourse, ideas and meanings are conveyed between individuals.

Several historians have studied diachronic changes in the way people ascribe meaning to landscape and nature (e.g. Schama, 1995; Corbin, 1989; Pyne, 1998). According to de Groot (1999), for our distant ancestors – hunters and gatherers without a permanent residence – nature was taken for granted as the immediate, omnipresent religious universe. Trees and stones were thought to be animated. In that time, nature and culture were not separated. As agriculture entered human history, people built permanent settlements. Man projected intentions onto places; for example, a place has to be a field to grow corn. Nature and culture became divided. Nature appeared as a disorderly thread, producing plagues, weeds and vermin. Nature was an enemy of man (de Groot, 1999). For example, in the Middle Ages the ocean was regarded as the chaotic domain of the devil, abandoned by god, inhabited by sea monsters and ruled by chaos and death (Corbin, 1989). In the modern era, man started to master nature by using technical innovations (de Groot, 1999). The fear of primeval nature slowly faded. Writers, explorers, philosophers and painters constructed a romantic image of nature. The appreciation of nature, then, is a typical product of modern western culture.

Historians pay little attention to the diversity of ideas in a particular space of time. Moreover, historical research is often limited to the ideas of the upper class, such as writers, statesmen, painters, scientists and explorers. Little is known about the ideas of laymen. Since the 1990s, several Dutch philosophers and sociologists have been investigating images of nature amongst the public. Images of nature are complex formations of meanings, functioning as overall frames of mind, that structure the perception and valuation of nature (Buijs, 2000; 2009; Jacobs et al., 2002; Keulartz et al., 2000). This formation of meanings includes a cognitive dimension (what nature is), a normative dimension (how to act towards nature) and an expressive dimension (what the experiential values of nature are) (Keulartz et al., 2004). In different images of nature, a particular natural phenomenon can be given different meanings. For example, the ocean can be seen as primeval nature by people who have a particular image of nature. For people who have another image, the same ocean can be seen as space that provides leisure opportunities. Buijs (2009) has revealed five different images of nature amongst the Dutch public: the wilderness image, the autonomic image, the inclusive image, the aesthetic image and the functional image. People with a wild image of nature regard only nature that is untouched by man to be 'real' nature; they consider it not right to exploit nature for human purposes and regard rough nature without traces of human use the most beautiful. At the other end of the spectrum, people who have a functional image of nature consider nature that is highly influenced by man nature as well, consider it right to use nature for human purposes and consider nature ordered by man to be the most beautiful. The other images fall in between these extreme images. For example, people with an inclusive image consider everything to be nature as long as it grows spontaneously. In this image, man is allowed to intervene in nature, but not too much. Nature that expresses peaceful coexistence between man and nature is regarded as beautiful. The results of other empirical studies (Jacobs et al. 2002; Keulartz et al., 2004, van den Born et al., 2001) resonate with the findings of Buijs.

Based on more than 20 years of landscape perception research in many areas in the Netherlands, Coeterier (2000) argues that, within local cultures, inhabitants develop a special way of looking at the surrounding landscape. Often, a leading theme, which depends on the specific landscape, guides this way of looking. For example, in one region he found that the predominant theme for people was to divide the landscape into a front, consisting of paved roads where housing and human activities are concentrated, and a back, unpaved drives where nature and silence were to be found. This leading theme comprises the nature of the landscape as a whole and its function. Furthermore, Coeterier (1996, 2000) has found that other important attributes that determine landscape perception and evaluation by inhabitants are maintenance, naturalness, spaciousness, development in time, soil and water, and sensory qualities. These attributes are abstract perceptual qualities, and the way people fill them in depends on the leading theme. Thus, Coeterier developed a system of categories that determine a local culture's way of assessing landscape.



The individual mind is permeated with culture. Historical, sociological, and anthropological studies into landscape have demonstrated cultural influences on the way people perceive categories of places (e.g. natural places) and particular places (e.g. a specific region). Individuals are members of different cultural communities on different levels. As members of a global western culture they might be socialised into a general appreciation of nature, as historians have shown. As members of a national culture, they might be influenced by national discourse, e.g. the Dutch discourse of fighting against water, or the Polish discourse in which the forest is given a specific nationalistic connotation since the forest was the place where resistance to foreign powers started (Schama, 1995). As members of a local culture, people might gradually adopt a specific way of assessing the place they inhabit. Cultural influence, then, is a multi-layered set of influences.

## 2.4 INDIVIDUAL FACTORS

Next to biological factors, which point to cross-cultural commonalities in landscape perception, and cultural factors, that indicate meanings assigned to landscape that are shared within a cultural group and which may vary across groups and across time, the way a person perceives landscapes also depends on individual factors: mental dispositions that result from individual previous experiences or differences in personality traits. Think of a garden. According to the adaptive approach, someone's preference for the garden is predictable on the basis of general, non-individual factors, for example because it is a good mix of prospect and refuge opportunities (Appleton, 1975) or because it is complex, mysterious, legible and coherent (Kaplan and Kaplan, 1989). According to the images of nature approach, different people might appreciate the garden differently, dependent on their image. Apart from that, the garden can have special meanings for its owner and it can have a particular identity for people who visit it often. During the course of life, people give meaning to particular places and become attached to places (Tuan, 1980).

Previous experiences, and especially recurring patterns in previous experiences, leave traces in the human brain, which is highly plastic (open to change) in nature. Psychologically, these traces can be called mental concepts: enduring elementary mental structures, which are capable of playing discriminatory and inferential roles in an individual's life, in the sense of influencing various mental operations (Jacobs, 2006: 124). Neurologically, these mental concepts are constituted by specific neural circuits. The neural mechanisms for acquiring new mental concepts are unravelled by Kandel (2001): "our studies provide clear evidence that learning results from changes in the strength of the synaptic connections between precisely interconnected cells". He demonstrated that learning new concepts is established by the building of new specific circuits in the brain. These concepts play a crucial role in perception. Perception

is the experience of a meaningful image, based on sensory input. While sensations as such are chaotic, we organise the incoming raw information with help of mental concepts (Jacobs, 2006: 124). It is of importance that we have many mental concepts – probably millions. We have mental concepts for different categories e.g., for the tree it could be beauty, but also we then have more particular concepts, e.g. for that specific tree in your back yard it could be the place you were raised, and then mental concepts that relate to specific events, e.g. your tenth birthday. Mental concepts are mutually connected. Thus, somebody's mental concept for a specific place might become connected with mental concepts that represent personal memories of that place, mental concepts that denote general knowledge of that place, mental concepts that reflect value judgements, et cetera. Thus, people gradually develop networks of place meanings. Someone's sense of place is the specific network of mental concepts that is connected to his/her mental concept for a particular place – a network of mental concepts that specifies a place as a particular place for the subject, one that is distinct from other places. Subjects have a sense of place for a particular place as soon as specific mental concepts or specific combinations of mental concepts for the particular place have been created in their minds. By perceiving the particular place, or by thinking about it, the network of specific mental concepts, or parts of it, may be activated, thus contributing to a specific experience of place for the subject. Not all mental concepts that make up someone's sense of place are experienced during a particular experience of a particular place. Experiences and memories of a place may be different every time for an individual subject. And sometimes hardly any of the mental concepts that make up someone's sense of place may be part of his experience. It is not necessary at all to receive stimuli from the particular place for the mental concepts that constitute a sense of place to be activated. One may just think about the place while being elsewhere, or a sense of place may play a role in experience when seeing other places that resemble properties of a particular place, even if one is not consciously aware of this association.

In human geography, the study of the meanings that people assign to places is often labeled the concept of sense of place (Manzo, 2005; Patterson and Williams, 2005). Sense of place – understood as the total collection of meanings that people assign to a particular place (Jorgensen and Stedman, 2001) – is thus an overarching concept (Hay, 1998; Shamai, 1991) that includes all meanings an individual assigns to a place. The concept of place meaning is a broad concept that stresses any form in which a person is related to a place, for example, ways of using a place, aesthetic values, feelings of belonging, emotional attachment, memories of a place, or knowledge of a place. Importantly, place meanings are properties of subjects; the meanings are assigned to places, or features of places, by people (Manzo, 2005). Some scholars consider sense of place a holistic concept, and are therefore reluctant to distinguish between its components or dimensions (e.g. Relph, 1976; Tuan, 1980). Others have distinguished sense of place dimensions, such as cognitive, affective, and behavioral or conative meanings (Altman and Low, 1992). A compatible distinction between attachment to (emo-

tional bonds with the place), dependence on (perceived behavioral advantage of a place), and identification with (the role of the place in overall self-identity), is used to develop and test a psychometric scale for quantitative measurements of sense of place (Jorgensen and Stedman, 2001, 2006). These dimensions are based on an abstract theoretical distinction that goes back to Plato (Ajzen, 2001), who argued that man has three basic psychological faculties, viz. knowing (cognitive domain), feeling (affective domain), and willing (conative domain). In a similar vein, the two components of place dependence and place identity were measured in a psychometric approach to place attachment (Williams and Vaske, 2003). Jacobs and Buijs (2010) adopted a different approach to reveal various dimensions of sense of place. Instead of a theoretically determined categorisation, they formulated dimensions on the basis of an open, in-depth account of people's place meanings as elicited in two studies. Five categories of abstract place meanings emerged from the data-driven analysis: beauty (place meanings related to aesthetic judgments), functionality (place meanings that express ways of using the landscape), attachment (place meanings that convey belonging relations between subjects and the place), biodiversity (place meanings pertaining to species and nature), and risk (place meanings that articulate worries about current or expected problems). These categories of abstract place meanings, that considerably overlap with categories revealed by other studies (e.g. Tunstall et al., 2000; Davenport and Anderson, 2005), represent aspects of place that stand out to people.

Apart from individually developed place meanings that guide the way people perceive particular landscapes, individual variation in landscape perception can also result from differences in personality traits. While the effects of personality traits are not yet extensively studied, van den Berg and Winsum-Westra (2010) have demonstrated that a personal need for structure is positively correlated with the perceived beauty of manicured allotment gardens, and negatively with the perceived beauty of wild allotment gardens.

## 2.5 APPLICABILITY TO GIS SUPPORT SYSTEMS

The division into biological, cultural and individual factors is not only useful to appreciate various bodies of scientific knowledge about the psychology of the landscape, but is also a good basis to discuss GIS based instruments for landscape policy, planning and design. Note that, related to the subject of this chapter only GIS systems that somehow incorporate psychological values pertaining to the visual landscape will be discussed here. Theoretically, we can divide all planning support mindscape inclusive GIS systems into two types: closed systems, which have a set of fixed values that represent characteristics of mindscape, and open systems, in which values that represent mindscape properties can be moderated by the users of the system. The GIS-based landscape appreciation model (GLAM) that is presented

in chapter six of this book is an example of a closed system. In this model, fixed values (based on empirical studies), that express average landscape appreciation by the Dutch public, are assigned to landscape attributes that are represented in GIS databases. Closed models like GLAM can be useful for landscape policy and eventually for large scale landscape planning. When the values that represent appreciation are fixed, it is possible to produce estimates of landscape appreciation without actually measuring it in each and every different place. These estimates can be used to monitor landscape changes in landscape appreciation over time (based on comparing two GIS datasets that represent the physical landscape at different points in time). Thus, national policy makers can for example learn whether their efforts are successful in terms of landscape attractiveness. In large scale planning contexts (e.g. the Ecological Main Structure in the Netherlands), planners might estimate attractiveness based on GIS data that represent the future situation, and thus perform *ex ante* evaluation, using a closed mindscape inclusive GIS instrument like GLAM.

Of course, a closed mindscape inclusive GIS instrument faces constraints by necessity. Because the values are fixed, only values that reflect landscape preferences that are pretty similar in most people are suitable. Thus, only landscape preferences that are manifestations of either biological factors (more or less the same in all individuals) or high-level (e.g. on the scale of a nation) cultural factors (more or less the same amongst the inhabitants of a country) are useful. Landscape preferences that are based on lower level cultural factors (e.g. local communities), or individual factors cannot be catered for by closed systems, since these preferences would vary across small groups or individuals and thus not be feasible to be expressed as average values. As a consequence, closed systems are not useful for planning and designing intermediate or small-scale local spatial interventions, since differences across groups of people and individuals are often at stake.

In those situations, an open GIS system that can incorporate mindscape characteristics could support planning and design. In an open system, different stakeholders could express their unique special place meanings, bonds with landscape features, or landscape preferences, and assign those mental dispositions as values to specific physical landscape attributes represented in GIS databases. Since an open system is flexible with respect to assigning values to physical landscape attributes it can cater for different groups of people with different opinions and preferences. Such a system could be used in collaborative planning exercises, for example to get a mutual understanding of the consequences of various future scenarios for the mindscapes of different people who are affected, and thus looking for options that most people would be able to agree with.

## 2.6 CONCLUSION

The psychology of landscape – the way the landscape is perceived, experienced and appreciated by the subject – is studied by several scientific disciplines, even by disciplines that do not primarily focus on the individual mind, but on culturally shared meanings or images. The preceding sections presented a short overview, in which some Dutch contributions are emphasised. The Dutch contributions together do not form a separate approach that is distinctive from the international literature. Various Dutch contributions stress different aspects of landscape perception, without being mutually connected by a shared theoretical framework. This reflects the study of the psychology of landscape in general, that is fragmented and dispersed across disciplines. A generic body of theoretical and empirical insights that is generally accepted has not emerged. Rather, there is an abundance of theories, each carrying little explanatory weight, and cross-disciplinary debate is rare. This probably reflects the complex underpinnings of perceiving landscapes, in which numerous factors play a role. Nonetheless, some insights are shared by most scholars involved in landscape perception research. First, psychological responses to landscape are partly innate. Convergent results indicate we have innate preferences for half-open landscapes, and for landscapes with vegetation and water. There are, however, different specific explanations that stress why we are evolutionarily inclined to respond to landscapes in certain ways: the arousal theory, preference matrix, and prospect-refuge theory being examples. Empirical studies have not yet sorted out convincingly which of the specific evolutionary explanations is most adequate. Second, learning, both on the cultural or individual level, plays a role in psychological responses to landscape as well. Even those who address biological factors often emphasise that learning influences landscape perception. Which factors are most important, depends on context. In psychological responses toward landscape scenes not encountered before, biological factors probably play a predominant role. For familiar scenes, cultural and individual factors, which result in assigning meaning to landscapes, come to the fore.

## REFERENCES

- Ajzen, I. (2001) Nature and operation of attitudes. *Annual Review of Psychology* 52(1); 27-58
- Altman, I., and Low, S. (1992) *Place attachment*. New York, Plenum Press.
- Appleton, J. (1975) *The experience of landscape*. London, Wiley.
- Appleton, J. (1984) Prospects and refuges revisited. *Landscape Journal* 8; 91-103
- Appleton, J. (1996) *The experience of Landscape*. Chichester etc., Wiley.
- Assche, K. van (2004) *Signs in time*. Wageningen, Wageningen University.
- Berg, A. E. van den, and Winsum-Westra, M. (2010) Manicured, romantic or wild? The relation between need for structure and preference for garden styles. *Urban Forestry & Urban Greening*, in press.
- Berlyne, D. E. (1971) *Aesthetics and psychology*. New York, Appleton Century Crofts.
- Berlyne, D. E. (1973) The vicissitudes of aplopathematic and thelematopic pneumatology (or the hydrography of hedonism). In: Berlyne, D. E., and Madsen, K. B. (eds.) *Pleasure, reward, preference: their nature, determinants, and role in behavior*. New York/London, Academic Press.
- Berlyne, D. E. (1974) *Studies in the new experimental aesthetics: steps toward an objective psychology of aesthetic appreciation*. New York, Wiley and Sons.
- Born, R. J. G. van den, Lenders, R. H. J., Groot, W. T. de, and Huijsman, E. (2001) The new biophilia: an exploration of visions of nature in Western countries. *Environmental Conservation* 28(1); 65-75
- Bourassa, S. C. (1990) A paradigm for landscape aesthetics. *Environment and behavior* 22(6); 787-812
- Bourassa, S. C. (1991) *The aesthetics of landscape*. London/New York, Belhaven Press.
- Buijs, A. E. (2000) Natuurbeelden van de Nederlandse bevolking. *Landschap* 17(2); 97-112
- Buijs, A. E. (2009) Lay people's images of nature: Comprehensive frameworks of values, beliefs and value orientations. *Society & Natural Resources* 22(5); 417-432
- Coeterier, J. F. (2000) *Hoe beleven wij onze omgeving? Resultaten van 25 jaar omgevingspsychologisch onderzoek in stad en landschap*. Wageningen, Alterra
- Corbin, A. (1989) *Het verlangen naar de kust*. Nijmegen: Sun.
- Damasio, A. (2001/1999) *Ik voel dus ik ben (the feeling of what happens)*. Amsterdam, Uitgeverij Wereldbibliotheek.
- Darwin, C. (1965/1872) *The expression of emotions in man and animals*. Chicago, Chicago University Press.
- Davenport, M. A., and Anderson, D. H. (2005) Getting from sense of place to place-based management: An interpretive investigation of place meanings and perceptions of landscape change. *Society & Natural Resources* 18(7); 625 - 641
- Duineveld, M. (2006) Van oude dingen, de mensen, die voorbij gaan. Amsterdam, Eburon.
- Ekman, P. (1992) An argument for basic emotions. *Cognition and Emotion* 6; 169-200
- Ekman, P. (1999) Basic emotions. In: Dalglish, T., and Power, M. (eds.) *Handbook of cognition and emotion*. Sussex, John Wiley & Sons, pp 45-60
- Gieryn, T. F. (2000) A space for place in sociology. *Annual Review of Sociology* 26; 463-496
- Groot, W. T. de (1999) *Van vriend naar vijand naar verslagene en verder*. Nijmegen, Nijmegen University Press.
- Hay, R. (1998) Sense of place in developmental context. *Journal of Environmental Psychology* 18(1); 5-29
- Herzog, T. R. (1992) A cognitive analysis of preference for urban nature. *Journal of Environmental Psychology* 9; 27-43
- Herzog, T. R. (1992) A cognitive analysis of preference for urban spaces. *Journal of Environmental Psychology* 12; 237-248
- Hirsch, E., and O' Hanlon, M. (1996) *The anthropology of landscape*. Oxford, University Press.
- Jacobs, M. H. (2006) *The production of mindscapes*. Wageningen, Wageningen University.
- Jacobs, M. H. (2009) Why do we like or dislike animals? *Human Dimensions of Wildlife* 14(1); 1-11
- Jacobs, M. H., Berg, A. E. van den, Langers, F., Kralingen, R. B. A. S., and Vries, S. de (2002) *Waterbeelden. Een studie naar de beelden van waternatuur onder medewerkers van Rijkswaterstaat*. Wageningen, Alterra.
- Jacobs, M. H., and Buijs, A. E. (2010) Understanding stakeholders' toward water management interventions: the role of place meanings. *Water Resources Research*, in press.
- Jorgensen, B. S., and Stedman, R. C. (2001) Sense of place as an attitude: lakeshore owners' attitudes toward their properties. *Journal of Environmental Psychology* 21(3); 233-248
- Jorgensen, B. S., and Stedman, R. C. (2006) A comparative analysis of predictors of sense of place dimensions: Attachment to, dependence on, and identification with lakeshore properties. *Journal of Environmental Management* 79(3); 316-327
- Kandel, E. R. (2001) The Molecular Biology of Memory Storage: A Dialogue Between Genes and Synapses. *Science* 294(5544); 1030-1038
- Kaplan, R., and Kaplan, S. (1989) *The Experience of Nature. A Psychological Perspective*. Cambridge, Cambridge University Press.
- Kaplan, S. (1987) Aesthetics, affect, and cognition: environmental preferences from an evolutionary perspective. *Environment and Behavior* 19(1); 3-32
- Kaplan, S., and Kaplan, R. (1983) A model of person-environment compatibility. *Environment and Behavior* 15; 311-332
- Keulartz, J., Swart, S., and Windt, H. van de (2000) *Natuurbeelden en natuurbelied: Theoretische en empirische verkenningen*. Den Haag, NWO.
- Keulartz, J., Windt, H. van de, and Swart, S. (2004) Concepts of nature as communicative devices: the case of Dutch nature policy. *Environmental Values* 13; 81-99

- LeDoux, J. (1996) *The emotional brain: The mysterious underpinnings of emotional life*. New York, Touchstone.
- LeDoux, J. (2000) Emotion circuits in the brain. *Annual Review of Neuroscience* 23; 155-184
- Lehman, D. R., Chiu, C.Y., and Challer, M. (2004) Psychology and culture. *Annual Review of Psychology* 55; 689-714
- Lemaire, T. (1970) *Filosofie van het landschap*. Amsterdam, Boom.
- Manzo, L. C. (2005) For better or worse: Exploring multiple dimensions of place meaning. *Journal of Environmental Psychology* 25(1); 67-86
- Orians, G. (1986) An ecological and evolutionary approach to landscape aesthetics. In: Penning-Roswell, E. C., and Lowenthal, D. (eds.) *Landscape meanings and values*. London etc., Allen and Unwin.
- Patterson, M. E., and Williams, D. R. (2005) Maintaining research traditions on place: Diversity of thought and scientific progress. *Journal of Environmental Psychology* 25(4); 361-380
- Porteous, J. D. (1996) *Environmental aesthetics: ideas, politics and planning*. London, Routledge.
- Pyne, S. J. (1998) *How the canyon became grand. A short history*. New York etc., Penguin group.
- Relph, E. (1976) *Place and placelessness*. London, Pion.
- Saegert, S., and Winkel, G. (1990) Environmental psychology. *Annual Review of Psychology* 41; 441-477
- Schama, S. (1995) *Landschap en herinnering*. Amsterdam, Antwerpen, Uitgeverij Contact.
- Schroeder, H. W., and Daniel, T. C. (1981) Progress in predicting the perceived scenic beauty of forest landscapes. *Forest Science* 27; 71-80
- Schroeder, H. W. (1991) Preference and meaning of arboretum landscapes: Combining qualitative and quantitative data. *Journal of Environmental Psychology* 11; 2231-248
- Shamai, S. (1991) Sense of place: an empirical measurement. *Geoforum* 22(3); 347-358
- Tuan, Y.F. (1980) *Topophilia. A study of environmental perception, attitudes, and values*. Englewood Cliffs, New Jersey, Prentice-Hall Inc.
- Tunstall, S. M., Penning-Roswell, E. C., Tapsell, S. M., and Eden, S. E. (2000) River restoration: Public attitudes and expectations. *Water and Environment Journal* 14(5); 363-370
- Ulrich, R. S. (1981) Natural versus urban scenes: some psychophysiological effect. *Environment and Behavior* 13; 523-556
- Ulrich, R. S. (1983) Aesthetic and affective response to natural environment. In: Altman, I., and Wohlwill, J. F. (eds.) *Behavior and the natural environment*. New York, Plenum Press, pp 85-125
- Ulrich, R. S. (1993) Biophilia, biophobia, and natural landscapes. In: Kellert, S. R., and Wilson, E. (eds.) *The biophilia hypothesis*. Washington DC, Island Press, pp 73-137
- Williams, D. R., and Vaske, J. J. (2003) The measurement of place attachment: Validity and generalisability of a psychometric approach. *Forest Science* 49; 830-840
- Wohlwill, J. F. (1976) Environmental aesthetics: the environment as source of effect. In: Altman I., and Wohlwill, J. F. (eds.) *Human behaviour and environment*. New York, Plenum, pp 37-86
- Yang, B. E., and Brown, T. J. (1992) A cross-cultural comparison of preferences for landscape styles and landscape elements. *Environment and behavior* 24(4); 471-507
- Zube, E. H. (1991) Environmental psychology: Global issues, and local landscape research. *Journal of Environmental Psychology* 11; 321-224





3

# THE PHENOMENOLOGICAL EXPERIENCE OF THE VISUAL LANDSCAPE

## 3.1 INTRODUCTION

In our contemporary European context 'landscape' has become one pivotal topic to be considered by territorial planning at an institutional level. There is a huge concern for the preservation of the rich environmental landscape heritage, the careful integration of the landscape within territorial development processes and the understanding of the cultural and social relation at a perceptual level. In order to analyse and monitor landscape evolution and change, and at the same time to plan and manage territorial transformations, geographers, planners and landscape architects use GIS (Geographical Information Systems) as a powerful mapping tool. However, one of the main challenges they face is the mapping and monitoring of landscape taking into consideration its quantitative and tangible nature, together with its qualitative and intangible. Both natures of landscape are relevant in order to set planning decisions.

GIS is a tool that allows the mapping of the spatial qualities of landscape, identifying morphological and geometric properties, evaluating physical changes, allowing the comparison of their differences and analysing the properties of the vision of the physical space (optical axes, visibility fields, visual sequences). All of these values are quantitative and tangible. However the mapping of qualitative and intangible values in the environment creates the following problems: How to measure and map the cultural values of landscape and their changes?; How to detect the existence of *visual models* of reference?; How to know cultural landscape configu-

rations?; How to study the evolution of artistic and symbolic representations in a specific territory?; How to acknowledge the sensorial perception of different social groups?; How to understand the communicability of landscape?; What is the response of social groups to landscape threats or improvements?; How to capture and map the subjective emotional responses that involve the experience of landscape such as, tranquillity, fear, claustrophobia, stress, ennui, or the sense of beauty?

In order to take into consideration the collective and individual phenomenological experience of landscape, new methods to capture, map and represent qualitative data are needed. The main sources of information for the mapping of qualitative and intangible information are sociological inquiries and surveys. Experts are aware of the need to take into account mechanisms of social participation to elaborate landscape catalogues, to measure the evolution and the dynamics of the physical landscape and its perception, to achieve objectives of landscape quality, and to incorporate them into territorial planning. In the sphere of landscape planning and management, a participative methodology, unanimously recognised and tested, does not exist at the moment (Nogué, Puigbert, et al., 2010: 9). In relation to future research on a new social participative methodology, the following questions arise: How often periodical surveys to collect qualitative data are needed in order to map the evolution of the relation of society with its close environment?; Which is the minimum number of surveys that should be collected?; Who are the target groups to be addressed?; How many types of questionnaires are needed?; Which variety of platforms are required to inform these social groups?; Which type of locations and survey technologies are more adequate (workshops, door-to-door, websites, interviews to landscape agents, telephone surveys)?

This chapter aims to explore how the qualitative and intangible nature of landscape can be incorporated into the analyses and monitoring typically performed through GIS. In order to research a new participative methodology, and to elaborate new ways of mapping the social phenomenological experience of landscape, it is necessary to research the integration of computer mapping applications. These are specifically Geographic Information Systems, with digital platforms of collective participation and creation of knowledge, available through social networking sites on the Internet.

### **3.2 LANDSCAPE AND THE PHENOMENOLOGICAL RELATION WITH THE ENVIRONMENT**

Any environment, natural, rural or urban, cannot be only reduced to a physical object that is measured, analysed, monitored, or captured through mapping, human beings also relate to their environment through their beliefs, emotions and senses. This existential relation brings

together the objective and the subjective, the physical qualities of the space and its perceptual and sensorial experience, the tangible (quantitative) geographic values and the intangible (qualitative) emotional connotations. The Japanese philosopher Tetsurô Watsuji created a term, *fûdosei*, to define the intimate union between nature and culture and between the environment and human life (Watsuji, 1935). *Fûdosei* represents the life bond of being inside the environment and the climate, and the experience of it. The physical environment is being shaped by culture, however culture is also the result of the existential expression of a society being shaped by the environment. The cultural geographer and orientalist Augustin Berque translates the term *fûdosei*, created by Watsuji, in the term *médiance*, which he remarks, has a 'trajectory' nature, because it is developed in a specific historical time and in a particular geographical space. Berque asserts that the notion of landscape does not exist at all times, nor in all societies and cultures. The absence or the existence of landscape is based on the way of 'seeing' and perceiving the environment as landscape (Berque, 1995). There are societies that do not possess the notion of landscape, and therefore they perceive the environment as another type of reality. This is the case with the aborigines in the western desert of Australia, who do not possess the notion of landscape. They have related to their natural environment through myths projected into their geography. The *Tjukurpa* ("Dreaming Time") is a mytho-ritual structure with multiple expressions (songs, dances, ground and body paintings). The knowledge of their world emanates from *Tjukurpa*, which defines networks of social spaces of territorial and ritual knowledge, based on spatio-physical narratives ('ritual itineraries' or 'ancestral tracks') of the ancestors' journeys, actions and performances across their land (Poirier, 2005: 53). In particular cultural, social and historical conditions, societies have modelled their human relation with the environment, transforming it into landscape. Berque makes a distinction between societies that are only connected to the environment by the 'look' and other forms of non-aesthetic relation (*proto-landscape societies*), and with societies that appreciate the environment under qualitative ideals and cultural aesthetic modes of expression (*landscape societies*) (Berque, 1995). According to him, all landscape societies present the same five criteria: (1) treatises on landscape; (2) linguistic representations (or different ways to say 'landscape'); (3) written representations describing the aesthetic and sensorial values of the environment; (4) pictorial representations with the environment as a subject and (5) the existence of pleasure gardens, translating an aesthetic appreciation of the environment and nature (Berque, 1994). As such, a landscape epiphany appears in Western Europe in the sixteenth century, connected to the Humanism 'modern consciousness' of the world and in China, dating from the Han dynasty (206 B.C – 220 A.D.), both comprising their respective cultural zones of influence.

In our present time and in our European context, landscape planning and landscape urbanism also takes into consideration phenomenological values and the qualitative nature of landscape. The Council of Europe in the European Landscape Convention in Florence (2000), defines landscape as "an area, as perceived by people, whose character is the result of the action and



Figure 1

The rural landscape is a fragile cultural heritage. Its present physiognomy and the mental bonds to the land are in danger of disappearing, due to the abandonment of family farms, and the introduction of industrial agriculture. La Campiña, Madrid

interaction of natural and/or human factors” (European Landscape Convention, 2000: 3). The Convention aims to promote landscape protection, management and planning, and to organise European co-operation on landscape issues. Its scope applies to “the entire territory of the Parties and covers natural, rural, urban and peri-urban areas. It includes land, inland water and marine areas. It concerns landscapes that might be considered outstanding as well as everyday or degraded landscapes” (European Landscape Convention, 2000: 3). Each local government should include policies “to recognise landscapes as an essential component of people’s surroundings, an expression of the diversity of their shared cultural and natural heritage, and a foundation of their identity”, and “to integrate landscape into its regional and town planning policies and in its cultural, environmental, agricultural, social, and economic policies, as well as in other policies with possible direct or indirect impact on landscape” (European Landscape Convention, 2000: 4). In this way landscape planning as a “strong forward-looking action to enhance, restore and create landscapes”, aims to preserve the social links, the sense of belonging and the rich cultural mental bonds deposited into an environment shaped, after all, by culture. This may be any one type of environment; inside the city, in its periphery, in rural areas or natural spaces. We must emphasise that these environments are always perceived by people independently if they are historical or exceptional landscapes, or any everyday degraded space.

Surveys to understand the psychology of perception of the inhabitants of specific geographical areas are needed, in order to be able to apply, into planning policies, the requirements of the European Landscape Convention.

In this first decade of 2000, scholars, architects, urban planners and landscape architects agreed in the emergence of a new hybrid practice, involving urban planning and landscape. Landscape, incorporated inside planning, is not only understood as the interest in geographical studies -ecological and cultural, but also the study of landscape in its conceptual scope, as a tool to theorise, design, and organise large urban sites, territories, and systems (ecological, programmatic, infrastructural). James Corner in his article, *Terra Fluxus* (2006), defines *landscape urbanism* as a hybrid practice that takes into consideration “processes over time”, “anticipates strategic scenarios and operational logics through a wide range of scales”, “reconsiders representational and operative techniques”, by computer mapping applications (GIS), visual modelling, and malleable graphics, and “takes in account the phenomenal richness of physical life (social imaginary, collective memory, desires, the tactile and the poetic)”. In his definition of landscape urbanism, James Corner upholds the importance and relevance of the theme of the social imaginary in landscape in order to approach processes, staging of surfaces and operational methods in landscape urbanism. Therefore, the imaginary links organisational methods with phenomenological considerations. In his opinion, in any planning or urban design, it is necessary to consider the collective imagination, stimulated by the experience of the real world. He sees the space and the environment as a container of visual cultural memory and desires. For him, materiality, representation, and imagination are not separate worlds (Corner, 2006: 32).

### **3.3 SOCIAL IMAGINARY, COLLECTIVE IMAGINATION AND THE VISUAL CULTURAL MEMORY**

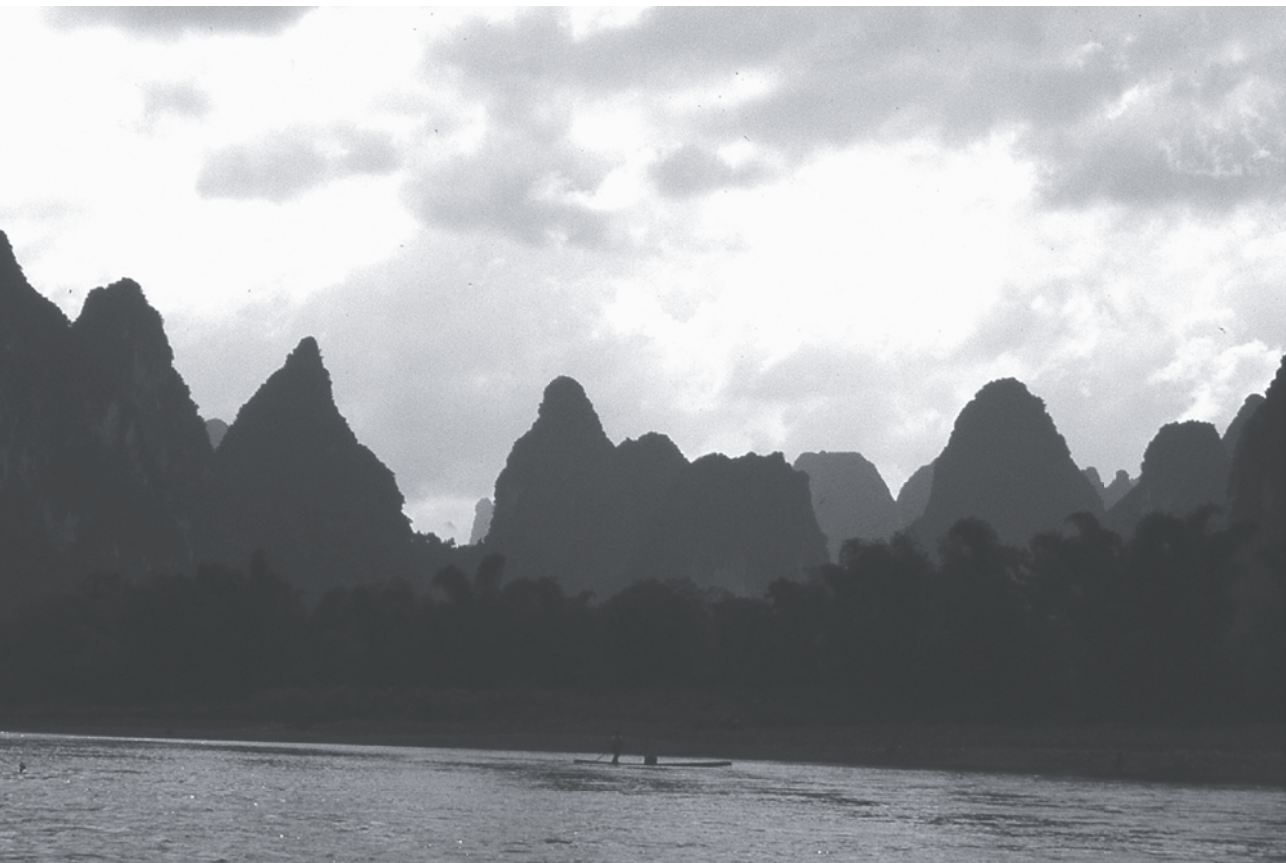
In order to be able to map the intangible values of the landscape, it is necessary to know and understand the psychology of perception of the society that relates with it. It is essential to discover which type of collective imagination shapes the aesthetic criteria that elevates a specific environment into the category of a significant landscape. When a person stops in his/her daily routine to look at a set, this fact already indicates that this person is conscious of the existence of this environment and recognises it. This ‘look’ can be impregnated by visual models coming from sources such as painting, literature, cinema, television, publicity, the Internet, or video games, among others. In this moment, this the ‘look’ becomes a ‘cultural look’ that transforms a space into a significant place. This cultural look has the power to transform the environment (urban, rural, natural, peri-urban, or any daily and ordinary space) into landscape. In the moment that an individual, a group or a cultural society qualifies a space as a *landscape*, and gives

this space the name of 'landscape' (or other linguistic forms that define the term landscape), means that this environment is charged with a mental signification.

Henri Bergson, in his work *Matter and Memory* (1896), asserts that perception is always “penetrated with memory”. He analyses that in the perception of any immediate reality, details of past experiences mix up with the present. Many times, memories displace the real perceptions. The real experiences work as ‘signs’ that help to remember old images (Bergson, 1986: 81). In Bergson’s opinion, memory gives to perception an individual conscience, that is to say, it gives subjectivity to the knowledge of reality. Any perception, independently of how short it is, links a process of remembrances; “Every perception is already memory” (Bergson, 1986: 84). The territory is covered by a layer of memories, individual and collective, gathering together the multiplicity of moments perceived and experienced in the past. The memory of human beings is only awakened in those spaces in the territory, the countryside, the natural or the urban environment, that remind them of a known historical past, while the perception of new environments, much more contemporary, can not become a new focus of attention without a conscious

Figure 2

When one looks at the mountains in Guilin, Guangxi region, China, we relate them to the imaginary of Chinese landscape paintings. These mountains, inserted in misty and watery environments, are Shan Shui (mountains and water), terminology that in Chinese language expresses the concept of landscape



and thoughtful experience. In our Information Age, society has an experience of the visible that is overwhelming, with the overload of too many images bombarding the senses inside visual mass media and Information and Communication Technologies (ICTs). This overload of visual information inhibits the recall and recollection of visual models stored in the mind. The overload of visual stimuli disorients. Too much and visual input, and too varying, becomes banal and trivial, rendering ceaseless information boring. For that reason, in our present time, the environment itself becomes the source of a true phenomenological experience, built on physical and sensorial impressions that construct a new awareness without the need of a visual cultural memory.

### 3.4 THE ENVIRONMENT AS A SOURCE FOR SENSORIAL IMPRESSIONS

Society appreciates the Arcadian countryside because it follows a pictorial archetype of landscape beauty. However, ordinary places, the daily indistinct environment of the suburban areas, have nothing to say to the majority. There are hardly visual models gathered in the visual cultural memory that can work as a reference for judgment to elevate them to the category of landscapes. According to the definition of *transparency* by Henry Lefebvre, in *The Production of Space* (1974), a *transparent space* is perceived as innocent, freed from cultural memory, visual stereotypes and cultivated 'look'. It is, at the same time, a space of mental relations, of thoughts, of perfect readability, where reality that was hidden becomes visible thanks to the intervention of a mental illumination (Lefebvre, 1974: 27-28). "Everyday or degraded spaces" are *transparent spaces*. These spaces have the potentiality to activate in the subject new mental associations, articulating thoughts. These spaces do not need to be readable through images in order to provoke desires, because a space in its own *transparency* can unleash desires by itself.

There are two perceptual approaches to reality, one by *seeing it*, the other one by *sensing it*. The first approach corresponds to a subject that, in order to understand and discover "everyday or degraded spaces", chooses to stop and look at them. Therefore, the act of seeing is moved by a conscious individual choice. The sensing of a space, however, can be motivated by a deep feeling of reverie and body awareness; an unexpected enchantment stimulated by the power of the scene. Maurice Merleau-Ponty states how both, the act of *seeing* and act of *feeling* are sustained by the same 'pure thought'. This pure thought can be described as that which can be proved to be integrated by the rigorous correlation between the individual exploration of the world and the sensorial responses that reality can produce (Merleau-Ponty, 1964: 48-49). However, there is an essential difference between seeing and sensing. Seeing depends on the individual power of thinking. The visual perception is a perception of thought, while the approach to reality by means of the body is linked to the unconscious and the dream, and does not have clear consist-





Figure 3

A degraded space in suburbia, such as this wasteland space, in an industrial setting at Tianjing, China, cannot be elevated to the category of landscape. Only the sensing of the space by a body awareness, can awake a sense of enchantment

ency inside reason. To be enchanted by the unexpected, it is necessary to participate in an existential experience, where the perception of the world is replaced by body awareness.

### 3.5 MAPPING THE QUALITATIVE EXPERIENCE OF LANDSCAPE

Landscape representations contain a *space of perception*, and do not reproduce only appearances and information, but also a world of experiences that enlarges the knowledge of reality (Moya Pellitero, 2007: 117). The *space of perception of landscape representations using new Information and Communication Technologies (ICTs)*, including Geospatial technologies has the particularity to be *dynamic*. GIS merges cartography with database technology, combining spatial data (geo-referential information) with non-spatial data. GIS has the capability to analyze spatial relationships within the digital stored spatial data, allowing complex modelling, and at the same time, it can interact with data and information created by users. In this way it is possible to examine processes and changes of qualitative order. For example, an extensive metropolitan area, such as Istanbul, with over twelve million inhabitants, is a hybrid and com-

plex territory, where the urban, the rural and the natural environment cohabit. However, the city itself is also a collective mode of reflection on the space. This mega-city generates a stratification of complex layers of reality and information in constant change, adapted to a specific physical context and cultural perception. In order to be able to comprehend and represent the quantitative and qualitative nature of its landscapes, and how these are perceived and appreciated, first it is necessary to find out which technologies of vision and data collection are needed to adapt to its complex physical and cultural nature.

The Dutch Environment Assessment Agency (PBL) monitors the perception and appreciation of landscape quality, with the aim to assess strategic policies in the field of environment, nature and spatial planning. Hans Farjon, Nickie van der Wulp and Leon Crommentuijn, in their article *Monitoring program of perception and appreciation of landscapes in the Netherlands* (2009), evaluate the results of the first enquiry in 2007. The main objective of the national policies on landscape is to improve by 25% the appreciation of the Dutch landscape between 2007 and 2020. Therefore, every three years the agency is carrying out a poll based on the SPEL (Scales for Perception and Evaluation of Landscapes), developed by Coeterier (2000), after twenty years of interviewing people in order to understand their landscape perception. In this poll, 4,800 persons were interviewed to evaluate 300 areas. Together with the poll they also used a GLAM - a GIS based Landscape Appreciation Model. They worked on a prediction of an average

**Figure 4**  
Metropolitan area Istanbul, Turkey



appreciation of an area based on its physical characteristics (naturalness, historical identity, absence of urbanisation, absence of horizon, obstruction and age). They observed how GIS gives limited information about perception and GLAM cannot adequately replace questionnaires. The geographic data selected in order to map the concept of attractiveness of landscape was vague, because the subjects that were polled had a wide range of different perceptions about what they considered as naturalness of landscape. They concluded that GIS had a limited value when predicting the levels of appreciation of landscape; therefore they agreed that questionnaires were a basic instrument to obtain information on how society appreciates and perceives landscapes.

If social questionnaires are still the basic instrument to obtain qualitative information about the landscape, then, there are still many critical gaps, which mean that this methodology is still not reliable. Firstly, the following aspects are not clear; the regularity of repetition of interviews and surveys, the critical number of surveys necessary to acquire enough information, the number of people and target groups addressed, or the variety of platforms required to inform these social groups, including the type of locations adequate for such surveys. All these problems could be solved once integrating the gathering of qualitative data through social digital networks and digital devices, and applying these data information into specific data visualisation interfaces working with GIS.

### 3.6 GIS AND DIGITAL INTERFACES

Visual artists, graphic designers, companies that deal with the management of digital information and data, need to map and give shape to the unlimited and variable contents of the Internet. Data information is alive and participative, built on connectivity, flows, inputs, exchange, and relations. The creation of interfaces helps to map this *complexity*. The visual experience of a complex information system requires, first, a clear structure and the ordering of data, establishing a grid of links and relations. It also requires flexibility to allow new information to enter the system and expand, in an open structure, where each user shares knowledge and participates. The aesthetic aspects of the interface help the visualisation of these data. The creation of exchange platforms requires the easy understanding of these digital spaces. Complexity sciences allow for the creation of an interactive and self-organised information space (topological algorithms, physical models, geometric representations, and geo-referenced information). Data visualisation companies are studios that create interactive mapping designs and data interface projects. The website VisualComplexity launched in 2005 by the interaction designer, information architect and design researcher Manuel Lima, gives a unified resource of the work that is being developed at the moment in the visualisation of complex networks. Many researchers (Ben Fry, Valdis Krebs, Santiago Ortiz, W. Bradford Paley, Martin Wattenberg, Stephen G. Eick, among others) are dedicated to data visualisation and the creation of spaces for the collective creation

of knowledge. With interactive methods, visual designs and images are linked to contents that can be ordered regarding the interests and the choice criteria of the Internet surfers, and simultaneously, the information and the contents relate and interact with each other. In this relation between people and information, the physical body, the corporeal movement and the touch, can also interact and relate with the data in the digital world. New multi-touch technologies allow more than one person to interrelate and communicate, fostering the phenomenological relation with the physical world through the digital space. These interfaces make the use of the data accessible and attractive, in order to facilitate interaction with the contents. Qualitative spatial data is built on the infinite number of contributions of users in the Internet, which interact with the physical space through social digital networks and digital devices. In the present Information Age, digital technologies are able to create an autonomous context, where the gathering of information about any environment can be done through the input of the same users, and at the same time can be distributed, stored and mapped. Both digital interfaces and GIS could work together in order to map both the quantitative and the qualitative nature of landscape. This dynamic space of information, constantly readapting to the new inputs of users, can create a reliable map of qualitative and intangible values of the landscape in any geographical context.

### **3.7 INFORMATION AGE AND THE DYNAMIC SPACE OF PERCEPTION**

In our information age, many individuals have digital technologies that accompany their lives wherever they go. In this mobile and wireless world, information is associated to places. Places acquire the load of the data, the territory (urban, rural and natural) digitalises, charged with referenced geographic information. Data and information gathers in places and is associated to any environment. The microprocessors inserted in the objects, and the space with wireless connection to the Internet, link and interconnect, simultaneously, places and persons to the physic and cybernetic environment. These digital technologies connect among themselves, with other devices and with the environment. The physical objects, the places and the people are already connected with the shared information in the Internet. In the near future, microprocessors will make permeable clothes, objects, buildings, neighbourhoods and the whole territory.

At present, the new mobile generation 3G, allows an 'augmented reality' through the use of GPS, a compass, and a specific platform. This platform allows the use of the mobile to interact with the environment. The subject points the mobile in order to frame a scene in front of his/her eyes. Over the real image, a series of visual layers of information opens in the screen, which can be chosen and selected, depending on the personal interest. More information about a location can be acquired such as height, addresses, monuments, transportation, restaurants, etc. Currently, it is only possible to display icons and texts, but new advances will allow the adding

of a layer of videos and 3D simulations. The relation and interaction with the real environment can also become a playful game where reality mixes with videogames, or with a 3D virtual world. 3G mobiles allow any person to build unique and personal information of the scene in front of his/her eyes. This 'look' can be immortalised in a digital image or a video that is sent to friends or is posted on the Internet. An intimate experience can be communicated to a group or the worldwide community. The interaction and the response can also be immediate, with comments from friends in *Facebook*, *Twitter* and other digital social networks. *YouTube* and *Flickr* allow any person to exchange lived moments in digital video and photography, and share them and discuss them in social networks. It also allows one to select what to see, how and when. *Google Earth* allows the virtual 'touring' in any geographical context, with the possibility to record virtual geographical trips and go back to them whenever, sharing them with other people. *Street View* transports the subject to cities in virtual street walks. Any person can return virtually to a geographical place and share it with a digital community.

This information world of data is shared, discussed, compared, made by consensus, created in participation and dialogue. It is a world in which more and more people take part. The physical space cannot be totally understood without knowing what is happening in the digital world. Both are interconnected. An action, and ephemeral event in the urban and natural environment, that could go unnoticed and be nonexistent for the majority, acquires a relevant importance for a social network in a digital community. The physical environment, then, becomes part of a communicative discourse, shared by a specific collective. In order to analyse and monitor landscape evolution and change, to set landscape management and planning policies, a new participative methodology should take into account these already established social networks inside digital communities. This shared information could be used in the mapping of the social phenomenological experience of landscape, integrating computer-mapping applications with specific interfaces of Internet data collection.

### 3.8 CONCLUSION

Going back to the main question: how to map and monitor the two natures of the landscape at the same time, the quantitative and the qualitative, the tangible and the intangible, we should argue that the mapping should include phenomenological information that is constantly expanding and actualising in the Internet. This information is outside the subject, and inside a digital environment that can be always consulted, as an external memory. In our present time any space contains mental relations, and articulating thoughts.

If we consider a new social participative methodology, we should see the potentials of a digital society that did not lose the physical and phenomenological contact with the environment,



Figure 5

The new Tripwolf iPhone App with augmented reality. Frame from You Tube advertising (source: Tripwolf GmbH, 2010)

on the contrary, this sensorial and corporeal contact has been intensified. The Information Age does not create isolated individuals in front of a computer, but collectives and groups eager for communication in infinite social networks. Landscape is not only appreciated by the 'look' but also by the rest of the body senses. Landscape becomes a somatic space where individuals are not outside, taking distance, and 'looking at' the view, but inside of it, creating it by the same corporeal action and body awareness. The collective game, based on the cooperation and the self-organisation is not only happening in the Internet, but also in the physical space and the landscape. The collective game, unexpected, breaks with the daily banal life. With the play, time stops for a while. This pause in the daily life, with the objective to have fun, can transform reality into a musical, establish new and temporary behaviour rules, provoke transgression, always during a short period of time, to return later to the normal life. For example *Flash mobs* is an action in which a group of people agrees to meet in a specific geographical location, to act and perform, and later disperse. These events are organised through the Internet and they do not have any purpose, only the game, the entertainment and the collective participation for its own sake. Any space in the territory can be transformed into a choreographic space. The body intervenes adding a new layer of signification. In the mapping of the qualitative and intangible values of the landscape, a new social participative methodology should take into consideration,



Figure 6

Tócame, soy tuyo [Touch me, I'm yours] by the artist Luke Jerram. From March 2010 twenty pianos were left in public spaces in Barcelona, for anonymous people to play them during the International Music Competition Maria Canals. The location of the pianos in the city and images of anonymous people playing them could be found in the Internet

together with the way society perceives and appreciates the landscape 'by the look', also the degrees of social interaction with it, and the layers of exchange of information and communication that the landscape contains.

## REFERENCES

- Baudrillard, J. (1995) *The perfect Crime*. London, Verso.
- Bergson, H. (1896) *Materia y Memoria*. In: Deleuze, G. (1995/1957) *Memoria y Vida, Textos Escogidos por Gilles Deleuze*. Barcelona, Altaya. In English: idem. (1996/1896) *Matter and Memory*. New York, Dover Publications.
- Bergson, H. (1907) *La Evolución Creadora*. In: Deleuze, G. (1995/1957) *Memoria y Vida, Textos Escogidos por Gilles Deleuze*. Barcelona, Altaya. In English: idem. (2007/1907) *Creative Evolution*. New York, Palgrave Macmillan.
- Berque, A. (1994) *Cinq Propositions pour une Theorie du Paysage*. Paris, Champ Vallon.
- Berque, A. (1995) *Les Raisons du Paysage, de la Chine Antique aus Environnements de Synthèse*. Paris, Hazan.
- Corner, J. (2006) *Terra Fluxus*. In: Waldheim, Ch. (ed.), *The Landscape Urbanism Reader*. New York, Princeton Architectural Press.
- Council of Europe (2000) *European Landscape Convention*, European Treaty Series, 176 (10)
- Farjon, H., Van der Wulp, N., and Crommentuyn, L. (2009) Monitoring program of perception and appreciation of landscapes in the Netherlands. In: *Indicadors de paisatge. Reptes i perspectives* [Landscape indicators. Challenges and perspectives]. Olot, Observatori del Paisatge de Catalunya.
- Lefebvre, H. (2005/1974) *The Production of Space*. Oxford, Blackwell Publishers.

- Merleau-Ponty, M. (1964) *Lo Visible y lo Invisible*. Barcelona, Seix Barral, (1970). In English: idem. (1968/1964) *The Visible and the Invisible*. Evanston, Northwestern University Press.
- Moya Pellitero, A.M. (2007) *The Image of the Urban Landscape. The Re-discovery of the City through different Spaces of Perception*. Eindhoven, Bouwstenen Publicatieburo.
- Nogué, J., Puigbert, L. et al. (2010) *Paisatge i Participació Ciutadana, L'Experiència dels Ctalàges de Paisatge de Catalunya* [Landscape and Social Participation, The Experience of the Catalanian Landscape Catalogues]. Olot, Observatori del Paisatge de Catalunya: 9.
- Pourier, S (2005) *A world of Relationships, Itineraries, Dreams, and Events in the Australian Western Desert*. Toronto, University of Toronto Press.
- Watsuji, T. (2006/1935) *Antropología del Paisaje: Climas, Culturas y Religiones*. Salamanca, Sígueme. In English: idem. (1971) *Climate and Culture: A Philosophical Study*. Tokyo, Hokuseido.



4

# GEOMATICS IN PHYSIOGNOMIC LANDSCAPE RESEARCH

## A DUTCH VIEW

### 4.1 INTRODUCTION

Starting a chapter by this title implies a lot of explanation to the reader. Terms like ‘geomatics’ and ‘physiognomic landscape research’ promise a wide interest in a diversity of scientific domains, especially when the geomatics component is the main focus.

In the pioneer stage of conducting physiognomic landscape studies by use of automated procedures most scientists discerned the limitation of computer capacities and the availability and accuracy of data. However, they affirm positively the role of computations; geo-information was already mentioned. This chapter surveys the expected role by the key-word geomatics. The geomatics definition evolved for the last decennium into “Geomatics is a field of activity which, using a systematic approach, integrates all the means used to acquire and manage spatial data required as part of scientific, administrative, legal and technical operations involved in the process of production and management of spatial information. These activities include, but are not limited to, cartography, control surveying, digital mapping, geodesy, geographic information systems, hydrography, land information management, land surveying, mining surveying, photogrammetry and remote sensing [url 1]” (Roswell and Tom, 2009).

However, the scope of this chapter is narrowed. For that reason the definition of physiognomic research as given in the introduction chapter is a starting point and will be used as a reference.

The geomatics definition from the Dutch perspective is given. Followed by a stepwise description of the geomatic items: *geodata*, *geodata processing* and *geodata visualisation*. Afterwards, geomatics and physiognomic landscape research will be linked again twice, firstly, from the geomatics perspective, and secondly, from the physiognomic landscape perspective. The final section concludes the relation between both domains and sets an outlook. However, the chapter is greatly based on the experiences in the Netherlands, but references will be made to an international setting.

## 4.2 GEOMATICS – AN EXPANDING DOMAIN

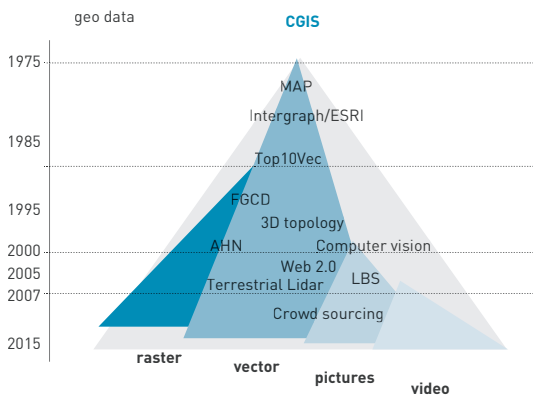
The current ISO definition of geomatics shows that the original focus on spatial information/geodata “a technology and service sector focusing on the acquisition, storage, analysis and management of geographically referenced information for improved decision-making” (Canadian Council of Land Surveyors, 2000) has been changed in favour of management and decision-making by integration and systematic approach items. Besides, ISO uses geomatics and geographic information science as synonyms.

A Dutch textbook on Geographic Information Systems and Spatial research (Hendriks and Ottens, 1997) presents Geomatics as the domain that integrates modelling on the levels of conceptual and logical representation of the spatial reality by developing geo-information methodologies and theory. The analysis of conceptual and logical models, as well as their relations of interest of different application domains, fuels these developments (Molenaar, 1997).

As we may understand from the more recent definitions, and notice from the reported inventions and developments (Fisher, 2006), the domain has dramatically changed and is still changing since the early days of Canadian GIS, CGIS [url 2], as did, and does, this sector in the Netherlands (Bregt and Van Lammeren, 2000). All these changes have an impact on the Dutch physiognomic landscape studies.

### 4.2.1 Data sources

In the relation with physiognomic landscape research the acquisition of geodata is still of primary importance, because the nature of the input datasets the scope of the analysis outcome. For that reason, first an overview of present data of interest is shown. Second to that, the ways to visualise the input and derived data needs a thorough look, after all we are dealing with the visible landscape. Finally, the (automated) functions to analyze these geodata needs will be exploited.



**Figure 1**  
**Geomatics events of importance for geodata availability**

A geomatics-time line (figure 1), which shows awareness of reported evolutions and is partly influenced by the GIS timeline [url 3], gives an overview of the change in available geodata.

Looking at the acquisition of geodata it is obvious that from the study of De Veer and Burrough (1978) and in line with the CGIS setup, the first geodatasets were manually made by a procedure that was very similar to the raster approach as used for physiognomic landscape research. This rasterising way of getting geodata was based on the definition of a variable (for example ‘space-mass difference’), the spatial extent and a spatial resolution (the raster-cell size). Via a physical overlay of a pellucid paper, with a drawn raster on it, over a hard copy map (“*don’t forget the fiducial marks!*”), per raster cell a value related to the variable was written down.

#### 4.2.2 Data availability

The introduction of vector-based geodata started as early as the raster approach originated by the work of Sutherland (2003). However, in contrary to CGIS it took a while before it strongly pushed, in a more practical sense, data developments in Computer Aided Design, and as originally developed. However, in the Netherlands, the role of vector geodata was serious from 1987 onwards, when the first versions of GeoPakket in relation to SiCAD (in 1987) and ArcInfo (in 1983) were introduced in the offices of the Dutch Administrations. Since that moment the map series of the Dutch Topographical Service of the Land Registry (*Topografische Dienst Kadaster*) began to become available as geodata (Top10Vec). Also, the early satellite images gave a boost to geodata in the early 80’s, by Landsat-TM images [url 4].

Since the well-known Geodata Act of the Clinton government (FGDC, 1994 [url 5]) the interest in authorised geodata became globally a serious item. In the Dutch Ministries in cooperation with their departments, like Dutch Topographical Service of the Land Registry and Census offices, started rapidly to develop standardised geodatasets of national concern, that gradually replaced the hard copy maps. The last hard copy topographic map series of the Netherlands, scale 1:50,000, dated from 1984 [url 6]. Besides the description of position based data was no longer a primarily a real map case, but instead geodata many organisational aspects change gradually. For example, the latest, 2008, Dutch Act on landscape planning demands the use of geodatasets in the procedure of creating and deciding upon municipality zoning plans (by January 2010, [url 7]).

Driven by the EU Inspire initiative (2009, Annexes) more of these enactments will follow. The guiding role of the Inspire Annexes is interesting in the case of physiognomic studies. What type of geodata has been described, and, may support such studies?

As soon as the airborne Lidar technology was available, the Dutch Ministry of Public Works (*Ministerie van Verkeer en Waterstaat*) started a campaign with this technology, to map, during the period 1997-2003, the elevation of the Dutch land area. This ‘actual state of the Dutch land elevation’ (*Actueel Hoogtebestand Nederland (AHN-1)*), was the first high-resolution digital elevation dataset [url 8]. The national authorities of Europe are encouraged by the European Inspire directive [url 9], which defined 34 spatial themes to develop geodatasets for. A closer look at the appendixes that describe these themes shows that the majority of the themes are about orthogonal two-dimensional geo-referenced (2D) geodata. However, many new developments with respect to CAD and 3D visualisation have been initiated to capture and deliver three-dimensional geo-referenced (3D) geodata. Experiments in these directions are on-going and are most promising (Xu et al, 2010; Döner et al 2010). Yet,

Figure 2  
Point cloud that represents a forest stand (by Van Leeuwen, 2010)



the debate on feasible data structures and flawless topology rules is still on. Especially in relation to the (combination of) airborne and terrestrial Lidar (Tang et al, 2008; van Leeuwen, 2010), 3D referenced data will offer more geometric details of real world phenomena, which may suit physiognomic landscape studies. Currently, the translation from point clouds, the measured points of reflection, into 3D objects for landscape visualisation remains challenging (figure 2).

#### 4.2.3 Occasional geographic data

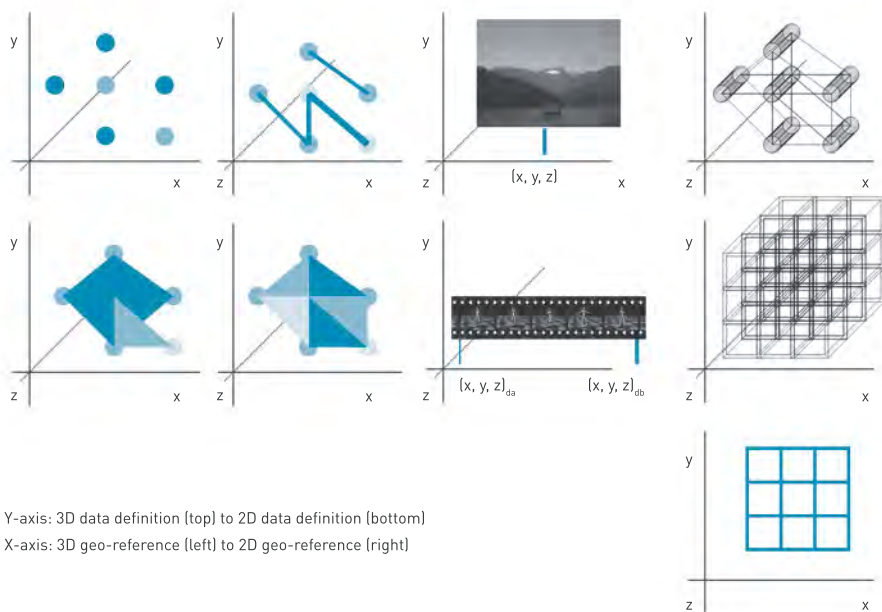
The Internet, on the other hand, has gradually become the main source of data. Wherrett (2000) presented the Internet as a medium to send out questionnaires in relation to landscape perception studies. Particularly the concept of participation and interaction by the Internet, as promoted by the concept Web 2.0 [10], has brought forward many Internet communities who store and share data. Mobile phones and digital cameras make it possible to geotag all data types ranging from mobile messages to photographs and videos, and once done, these data objects can be easily tracked by location based services (lbs) (Raper, 2007).

Successively applications like Flickr [url 11], Panoramio [url 12], Locr [url 13], Google Earth [url 14] and Bing [url 15] offer the many dedicated volunteers to geotag their photographs and put these on the Internet. The huge amounts of photographs do offer a great 'crowd source' of data that may be of use for physiognomic landscape studies (Jones et al., 2008). Of interest with these photographs is the variety of perspective projections. Sometimes orthogonally projected photographs are available.

One data type that is not mentioned in the time line is the set of 3D rasters, based on volume image elements, and mostly called voxels. Though it started as a promising development in a GIS setting (Marschallinger, 1996), the interest seems to have faded out. However, in some geological and geomorphologic studies the data type as such is still in use (Clevis et al., 2006), as in some remote sensing studies. Computer gaming and medical studies, like CT-scan analysis, still favour these data types [url16].

#### 4.2.4 Trend watch

With respect to the previous sketch of the geomatics development it is obvious that the variety of available and accessible digital geodata has increased dramatically. This variety does offer many options to be used in physiognomic landscape studies (figure 3). Yet, drawbacks still exist. Geodata can be 2D or 3D referenced and the reference systems can vary. The VGI datasets may be biased. An Internet search for photographs of the *Eiffel tower* (keywords in English, German and Dutch) on July 26th 2010 showed 1,550,000, 256,000 and 24,400 photographs respective-



Y-axis: 3D data definition (top) to 2D data definition (bottom)  
 X-axis: 3D geo-reference (left) to 2D geo-reference (right)

**Figure 3**  
**Available data types for physiognomic landscape studies**

ly. For the *Hoge Veluwe*, a Dutch National Park, the total of available photographs was 65,300. In any case not all datasets are accessible due to commercial or privacy reasons.

The role of all previously mentioned data types is to describe current, recent past and present states of the visible landscape and as such it could be useful.

It seems that rarely geodata is produced for the function of physiognomic landscape research. Consequently available data is not always optimal, and needs to be transformed or interpreted before it can be used in this kind of research.

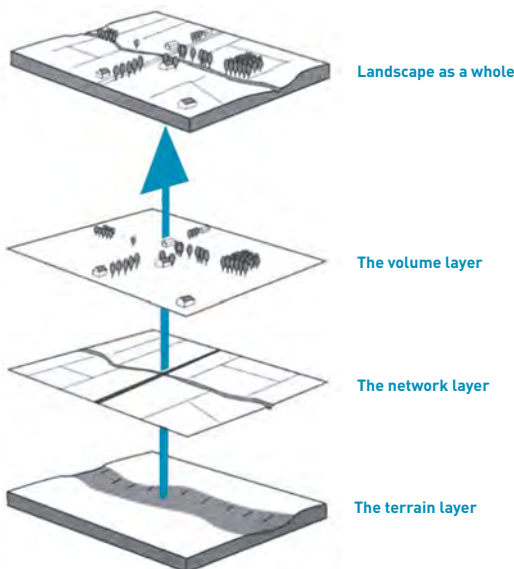
### 4.3 TWO OR THREE DIMENSIONAL GEODATA

The subject of physiognomic studies has been defined before as ‘the visible landscape’. Visibility in this case meant from the human’s eye perspective. As Mark (1999) explained, geodata is merely a representation of the things that exist and represent, in our case, the ‘visible landscape’. Comparable with his approach in this text (Mark, 1999), the words ‘phenomena’ and ‘entities’ point at the things that exist. The words ‘objects’, ‘features’ and associated words like ‘attributes’ and ‘values’ refer to the representations of phenomena and entities in the formal system of the digital world.

### 4.3.1 Digital landscape model attributes

The representation of the visible landscape phenomena and entities includes minimally a topographic surface. The surface represents the continuous phenomena elevation. This surface however may include more delineated features like pits, tops, ridges, edges, faults and stream patterns. This representation is known as a *digital elevation model (DEM)*. However such a DEM is not a representation of the visible landscape. Man-made entities like buildings, roads, canals, plantings, as well as natural vegetation, have to be clearly represented as well. Gathering and adding these definable delineated objects to the DEM will generate finally a *landscape object model (LOM)* or *digital landscape model (DLM)*. Such models may be understood as the representation of the visible landscape (figure 4). Wassink (1999) labelled the visible landscape by the nowadays old fashioned annotation 'landscape as a whole'. This label originated from a more static and fixed physiognomic landscape approach.

The different types of geodata, as presented in the second paragraph, could support the representation of the visible landscape in many ways. The 2D or 3D referenced geodata (raster and vector) could offer, for example after an interpolation process, a DEM coverage of a certain geographical extent [url17]. For example in a 2D geo-referenced setting the terrain layer (of figure 4) can be represented via surface, vector or raster definition. Besides the terrain layer, the volume layer (of figure 4) can also be generated in this way. In a 3D geo-referenced setting the terrain layer as well as the volume layer can be constructed by a 3D geometry and topology of morphologic objects. By adding 2D and 3D referenced objects, like representations of build-



**Figure 4**  
**A visible landscape representation**  
(source: Wassink, 1999)  
On bottom the DEM (terrain layer).  
Successive layers like network (line and area  
objects) and volume layer (3D objects) put  
forward a DLM (on top)



ings, trees and other artifacts, a DLM will be created out of the DEM. For example a 2D georeferenced elevation dataset, like the Dutch AHN, can be supported by a selection of vertically extruded 2D objects to generate a DLM out of a DEM as presented in figure 6.

If a 'complete' DEM or DLM coverage doesn't exist then many other software functions are available to create these models by a number of processing steps.

In many visible landscape studies in which a DLM is used, the spatial resolution or precision of the model that suits the study is problematic. Many studies refer to this item as a scale issue. However, this item deals, in fact, with the geometric precision and accuracy of the point, line, area and volume features defined in a vector structure, and the granularity of the raster cells and voxels. As well as the geodata representations of the terrain layer, the network layer and volume layer are also problematic, as the relations between these layers is still under exposed. Currently, it looks like the only solution to tackle this issue seems to be additional data sampling and adding ancillary geodata.

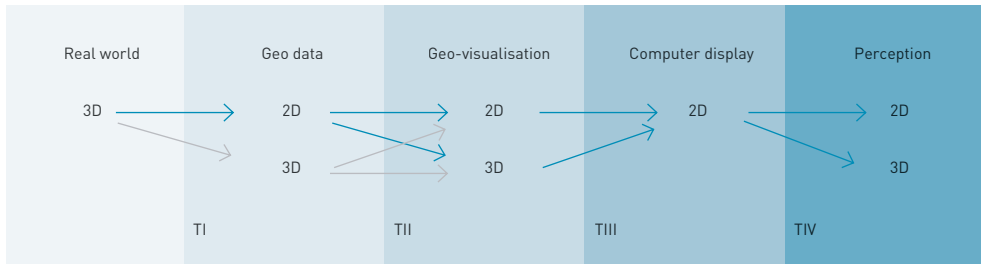
Photographs have a number of attributes that are implicitly related to the image. These graphic attributes like colour hue, colour saturation (grey value) and colour brightness are related to the smallest feature of a photograph, the image element (pixel). The combination of such pixels offers patterns and structures. These patterns and structures are cognitively understood by humans. In the domain of computer vision researchers try to mimic algorithmically these facilities of the human brain (Szeliski, 2010). Videos also have the same basic implicit variables per frame (Zhou, 2010), as a video consists out of series of related stills (scene) and series of scenes (video narrative).

Geodata however consists mostly of geometrically well-defined features like points, lines, polygons, volume objects (vectors) and raster cells or voxels. One or many thematic variables can be linked to these features to explain the meaning of the features in terms of characters and numbers. The values, the range of numbers and characters, of the attribute domains are constrained by a measurement scales (Gibson et al., 2000; Open GeoSpatial Consortium inc. [url 18]). In landscape physiognomic studies these graphic and thematic variables fulfil an important role.

#### 4.3.2 Digital landscape model visualisation

The previously introduced DLM has many digital expressions. The visualisation of such DLM expressions is the most important interface to discuss landscape physiognomy in most studies.

Geovisualisation has to be understood as defined by Dykes et al. (2005): "Geovisualisation can be described as a loosely bounded domain that addresses the visual exploration, analysis,



**Figure 5**

**Transformations in the Geovisualisation process (source: Van Lammeren, Houtkamp, et al., 2010)**

T1 geodata acquisition; TII geovisualisation definition; TIII display rendering; TIV perception triggers in 2D and 3D (parallax and/or depth cues). Light grey arrows refer to 3D referenced geodata types

synthesis and presentation of geospatial data by integrating approaches from cartography with those from other information representation and analysis disciplines, including scientific visualisation, image analysis, information visualisation, exploratory data analysis and GI Science.”

Figure 5 shows how real world phenomena, the visible landscape as perceived in reality, is represented and influenced by four different transformations before we can perceive the visualisation of it (Lammeren, Houtkamp, et al, 2010). The figure expresses the importance of transformations. The first transformation has been discussed in the previous paragraph. The second transformation (TII) shows the preparation of the data for visualisation. Different combinations of 2D and 3D defined objects and layers may need to be generated to finally result in a visualisation. All types of figure 5 can be combined, for example, Google Earth examples may illustrate such visualisations by the historical landscape paintings of Florence [url 19] and the 3D buildings layer of Amsterdam [url 20]. The latter (figure 6) shows different 3D house geometries (3D) plus mapped textures (images used to show the ‘realistic’ facades of the buildings). The former shows geotagged images of historic paintings of Florence and located into the original view direction. Photo’s and paintings like in the example of Florence, put forward the subject of atmospheric conditions that’s not yet covered by geodata and only gradually by geovisualisation (Daniel and Meitner, 2001).

We may conclude that the issue of missing and imprecise geodata, in the case of physiognomic landscape studies, can be partly dealt with by including other data types, especially geotagged photographs and videos in the visualisation of such data. The automated processing of such combined datasets is much harder however.

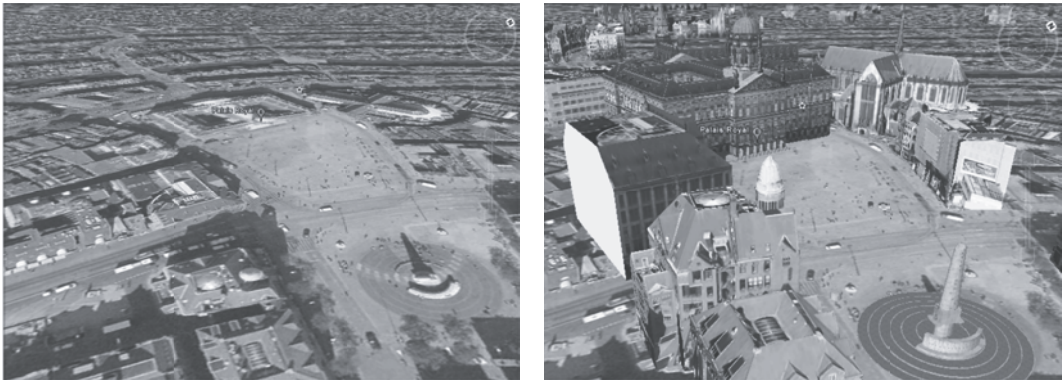


Figure 6  
Amsterdam Royal Palace without (left) and with (right) 3D models

## 4.4 GEODATA PROCESSING

All geodata types and the options to visualise these have previously been discussed with the meaning to show the variety of options to represent the visible landscape. The sheer variety relates to the fact that that a dataset, which will be used to analyse physiognomic landscape items, must be prepared by pre-processing before the more analytical processing can be performed.

### 4.4.1 Pre-processing

Pre-processing includes the transformation of geo-references (map projection, 3D into 2D, 2D into 3D), of geodata (like from vector into raster, raster into vector, geotagged images into vector) and of feature classes (for example points into lines, points into areas, points into volumes). It could also include (re-) classification of attributes and attribute domains to better fit to the physiognomic landscape analysis (like ratio measurement class variable classified as an interval measurement class variable).

A very special class of transformation is related to the data of volunteers, also known as voluntary geographic information. These geotagged photographs and videos can be used, thanks to the results in pattern recognition by computer vision research to stitch or construct photogrammetrically multi-faceted scenes like those offered by Microsoft Photosynth [url 21] and even 3D-models and -scenes [url 22] (Snavely, 2006; Pollefeys, 2002). These very promising developments must lead to an integration of horizontal and vertical definitions of reference.

#### 4.4.2 Re-classification and interpretation

After finishing the geodata pre-processing, the processing in line with the physiognomic landscape analysis may be started. Depending on the pre-processed data types available these processing steps may be as different as the physiognomic landscape interests.

The simplest analysis seen from a computational point of view may be the re-classification of 2D- or 3D-geodata layer, geotagged image or video. Re-classification could support for example user interpretation and appreciation by ranking or ordering, user understanding of classes of interest for policy making and user labelling of features (e.g. Wascher, 2005). Such classification may also follow after other types of processing. In more detail the re-classification can comprehend feature classes or thematic class values (Chrisman, 2003).

#### 4.4.3 Simple geometric analysis

As mentioned before, most analysis in the domain of physiognomic landscape research is basically starting with a digital landscape model. Besides classifications, a number of new attributes may be described and calculated describing visual properties of the landscape model (e.g. Ode et al., 2010). Geometric attributes of interest that may be used are: location, direction, distance, altitude, size (length, area, volume), shape and topological relation. All these attributes can be calculated for a single object, multiple objects and interrelated objects. Besides attributes like spatial density, distribution and variability can be derived as a next step. Most algorithms available by geodata processing software will support this type of geometric and topologic analysis functions.

#### 4.4.4 Visibility oriented analysis

An interesting dispute is always what type of object initiates the data processing. It always means that a second geodataset is involved by which point, line, area and volume objects have been described that will be used as the starting objects for the physiognomic landscape analysis. For example the algorithmic principles of visibility studies, is typified as visibility querying on a digital landscape model (Batty, 2001; De Floriani and Magillo, 2003). Before the real querying the continuous visibility mapping by TIN (vector) and discrete visibility mapping by raster is started from point objects that represent vantage points.

In a raster format the range of local, focal, zonal and global functions, as originally defined by Tomlin (1990), work in this way. For the voxel format there are comparable classes to be found (Marschallinger, 1996; Clevis et al., 2006).

#### 4.4.5 De Veer and Burrough revisited

Current geodata types are, in other words, able to be processed in many ways. If we take into consideration the examples of de Veer and Burrough (1978), then we may conclude that finding ‘concave objects’ is a matter of pre-processing (especially classification) 2D geodata, querying the area objects that represent spaces and ordering afterwards on size and shape of the selected objects.

The ‘breadth of view’ approach is able to do this via the isovist field’s concepts of Benedikt (1979), which have been implemented. After pre-processing and defining the points that represent vantage points, a number of attributes may be calculated like lines of sight, fields of sight and derivatives like the shape of the field of sight. Also the viewshed techniques could be categorised as such an approach.

The third approach, ‘raster’ as they called it, is in fact a combination of classifications of attributes belonging to the objects and a transformation from vector based objects into a raster geometry. The resolution of the raster cell size will be a most critical factor in a correct ascribing the intended values to each individual raster cell. Many studies still use this approach.

#### 4.4.6 What validity?

In this paragraph the main classes of geodata processing have been introduced in short. Each class delivers data output by which characteristics of the landscape physiognomy are descriptively explored, quantitatively explained or qualitatively predicted. In the academic research tradition the main question concerns the validity of these results.

From the position of this section in this chapter it could falsely be understood that the validity of the results is just a matter of selecting appropriate processing tools, like cross-validation of the used and resulted data. Or, on the other hand, the processing tools themselves could be also subject to validation, as has been illustrated by the study of Riggs and Dean (2007) about viewshed processing.

However, as put forward in the previous paragraphs, the variety of geodata that helps to represent the study of landscape physiognomy, are suspects themselves. Some geodata is generated by given definitions and procedures within the context or praxis of a certain application domain. A formal definition of visual landscape entities and phenomena seems an irrefutable issue. Fisher (1999) already explained that the nature of uncertainty is based on the well or poor defined classes of objects and their spatial delineations. In well-defined situations uncertainty is caused by errors and is probabilistic. In poorly defined situations uncertainty could be a matter of vagueness (weak definition) or ambiguity (confusing definition).

Indeed occasionally geodata has been generated without any given definition or procedure. Most geotagged photographs and tweets bear this origin. But does it mean that it is vague or ambiguous data? The enormous amounts of such geodata, accessible and available by social networks, do unveil vagueness and ambiguity. Perhaps expert validation of physiognomic landscape findings will be followed up by validation via social networks and E-communities. The works of Sheppard (e.g. Sheppard and Cizek, 2009), promoting the ethics of visualisation, also give clues for such more contextbased validation. The conclusion of Ode et al. (2010) that “*The results show that the different data sources were more or less adequate to use in different contexts and for different purposes*”, fuels this perspective.

## 4.5 GEOMATICS MEETS PHYSIOGNOMIC LANDSCAPE RESEARCH

From a geomatics perspective the link with physiognomic landscape studies may be based on the extent of the geodata types and related variables to be used as input, to be processed into a certain output variable, and to be visualised. The data types, as introduced in the second section, may be a starting point. The way this data could be combined, processed and finally visualised offer a combinatory set of options that may be of relevance for physiognomic studies (figure 7). It will show clearly that the methodological soundness is a tough case.

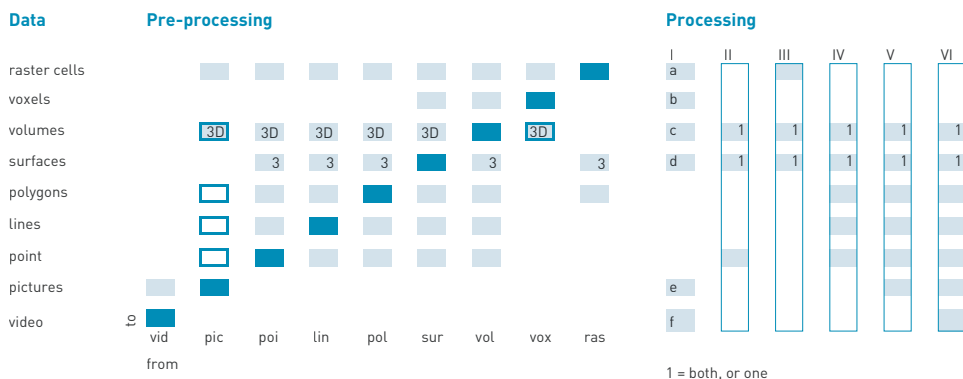
### 4.5.1 Geodata ensembles

Figure 7 consists of three blocks. The first block, entitled data, shows all data types as introduced in section three of this chapter. The second block, pre-processing, summarises all

**Figure 7**

**Geodata ensembles**

dark blue = original data; light blue = created data; box = based on photogrammetric functions



transformations available to realise a specific type of digital landscape model as introduced in section four. The third block, processing, ranges groups of data ensembles that may support physiognomic landscape studies. The ensembles are based on original data types (block one) or originated from the pre-processing results (block two) and take into consideration the processing options as introduced in the fifth section.

#### 4.5.2 Ensemble-related pre-processing

The focus of the second block is on transformation options. The x-axis shows the *from data* and the y-axis the *to data*. The first column of the block presents the transformation of a video into an image via a frame or still. Images can be used in many forms of transformation. As such the pixels of an image may be converted into a grid. However in case of an image made via a perspective projection the geo-referencing may be a difficult topic to handle. Yet, the many pattern recognition functions, resulting from computer vision research, could support the transformation from specific objects of an image into specific points, lines and polygons. Such derived data may be used for a photogrammetric construction of a 3D-model, which in the figure is labelled as volume data (indicated by 3D).

Transformations of points into lines, polygons and surfaces that finally represent elevation, by the terrain and/or volume layer (figure 4), as well as lines into points, polygons and surfaces and polygons into points, lines and surfaces, are very common functions in a 2D-reference system. The transformations of these vector-based data types into raster datasets are also common. The transformation of points into volumes is possible in case of 3D referenced point sets. Examples of such data are given by terrestrial Lidar data, that show transformation is also possible in cases of datasets with line and polygons objects defined by a 3D reference. Surfaces, sometimes described as 2.5D-referenced because once visualised they give a three-dimensional impression even though the geo-reference is still 2D, offer transformation options into both directions. Creating points, lines and polygons in a 2D or 3D reference are possibilities. Besides, surfaces could be transformed into a 3D (volumes), voxel and raster model. In fact, the volume data type (3D) offers the same classes of transformations. However these transformation functions have to include the conversion of 3D topology. Depending on the algorithm there is not a single result. However that's often the case in many of these transformations.

The seventh column presents the transformation of voxels. The creation of a volume model needs an intermediate step in which 3D referenced points and lines of significance have to be found in favour of the construction of polygons and volumes. The last column presents the transformation of raster data into polygons and surfaces.

### 4.5.3 Processing of single data ensembles

The third block of figure 7 gives an idea of the data ensembles that may be the object of processing options related to physiognomic landscape studies. The first column (figure 7: I) of the third block points at the processing of a single data type. Examples of physiognomic landscape applications that can be found by studies with raster cells (figure 7a) are very familiar with the raster approach of de Veer and Burrough (1976). A raster cell is, in most of these studies, the location identifier for a number of variables of interest for a specific analysis. These variables may originate from thematic themes and geometric items. For example McGarigal et al. (2002) introduced landscape metrics; a number of variables originally thought useful for landscape ecology studies. However, the concept of the matrix-patch-corridor model can be understood metaphorically and used in physiognomic landscape studies (Kamps and Van Lammeren, 2001; Palmer and Hoffman, 2004).

Voxel analysis (figure 7b) is not often found in physiognomic landscape studies. However, if geomorphology Clevis et al., 2006) or layered Isovist fields are included, the so-called Minkowski model (Benedikt, 1979), then voxel analysis has a lot to offer. The role of volume models (figure 7c) is at the moment mainly related to studies of perception and assessment. The lack of well-defined data structure and 3D topology blocked the availability of suitable analysis methods, like 3D Boolean operators, that offer immediately quantitative numbers of the calculated results. Surface analysis (figure 7d) is available in many ways, especially for the discovery of height derivatives like contours, slope types, slope aspect, edges and drainage patterns. At the moment the tools to process images (figure 7e) and videos (figure 7f) are mostly related to perception and appraisal by assessing single, pairs and series of images. Such studies are still in line with the studies like Schroeder (1988). Besides usability, analysis, like navigation and orientation, in relation to the visualisation of the above data types are of interest for physiognomy studies.

### 4.5.4 Processing steps of multiple data ensembles

The other columns of the third block (figure 7: II up to VI) show the ensembles that make use of integrated datasets. In all cases the DLM may be based on a surface (2.5D) or volume (3D) data types or a combination of both. The most common combination by now is the one where volume objects are placed on a surface. Depending on the physiognomic landscape analysis, in this example visibility, the data model could be extended by:

- Points, in the case of view point based visibility studies;
- Lines in the case of route based visibility studies;
- Polygons in the case of neighbourhood or specific landscape unit based visibility studies;
- Rasters in the case of all previously mentioned types of studies.



In fact all 'visualscapes' analysis tools as introduced by Llobera (2003), including isovist and viewshed, are look-a-likes. All of them derive values related to visibility variables from the above mentioned data ensembles. A serious 3D approach is suggested by the ViewSphere approach as discussed by Yang et al. (2007).

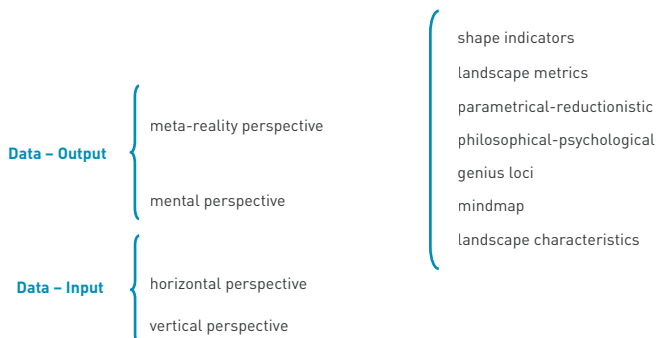
Recently, new combinations of data show the surplus of options of how geomatics meets physiognomic landscape studies. What seems promising is the integration of surface (2.5D) or volume (3D) data with:

- Images in case of (semi-) photo realistic renderings via texture mapping or having location based billboards or panoramic views in the digital landscape model for example like Streetview [url 23] to capture specific visibility items;
- Videos in case of dynamic renderings of objects or location based video streams also to capture visibility items.

## 4.6 PHYSIOGNOMIC LANDSCAPE RESEARCH MEETS GEOMATICS

Another approach to show how both domains meet may be given by the four landscape perspectives of Antrop (2007). A landscape perspective is defined as the way that human are confronted with the landscape. The four perspectives are the vertical, the horizontal, the mental and that of the meta-reality. The first two perspectives are mainly related with the primary cognition and definition as a human may sense. The latter two are more related to derivation and inference from the first two perspectives. For that reason the first two are primarily linked to data as input for processing and the latter two as output data of processing (figure 8). All derived variables are group-listed in the column furthest right in figure 8.

Figure 8  
Physiognomic landscape perspectives (based on Antrop, 2007)



**Table 1**

**Tentative summary of differences in human-landscape interaction paradigms.**

	<b>context</b>	<b>liability</b>	<b>sensitivity</b>	<b>validity</b>	<b>usability</b>
<b>expert - ecological</b>	research preference	medium	medium	medium-low	low-medium
<b>expert - formal esthetic</b>	artist view	low	medium-high	low	high
<b>psychophysical</b>	mutually well defined	high	low	medium-good	medium
<b>cognitive - psychological</b>	differ : cognitive, perceptive, affective	high-medium	high-medium	medium-low	medium-high
<b>experiential-phenomenological</b>	inside/outsideness	low-medium	high	pm - personal	local

The meta-reality and mental perspectives are recognisable in the studies of Zube et al. (1982) and Daniel and Vining (1983). 30 years later such an extensive literature review, as they did, could be of serious interest to find out how human-landscape interaction studies have been developed since and how these paradigms have evolved. Dutch studies of the past decennia have checked, and it may be considered, that the paradigms (table 1) are detectable and, in each of these applied geomatics, are traceable.

#### **4.6.1 Expert approach**

The expert-ecological approach may be recognised in the dissertation of Wassink (1999). The dissertation presents a methodological attempt on a qualitative landscape classification to define landscape form transformations of the Dutch landscape. A landscape morphological model has been developed, based on a layered concept (figure 5) of terrain forms (digital elevation), network pattern and vertical landscape features like buildings, trees and shrubs. The methodological framework was applied for the brook valley landscapes of the Pleistocene areas of the Netherlands. The study shows that this multilayered model may visually support the insight in specific relations between geomorphology, networks and vertical features in relation to landscape forms. The geodata in case of networks and vertical features were derived from the Dutch topographical data. Kamps (2001) repeated the analysis of Wassink's study by using raster data and landscape metrics (McGarigal et al., 2002). Steenbergen et al. (2009) made the same type of study for the Dutch polder landscapes.

The works of Wassink (1999) and Steenbergen et al. (2009) bridges the expert-ecological approach with the formal-esthetical approach. The latter is much more detectable in Steenbergen et al. (2003, 2008), with the use of architectural variables like vista, rhythm, symmetry and order in a variety of landscapes (like Italian Renaissance villa landscape and Dutch Polder landscape). Kerkstra et al. (2007) analysed vista's to find a leading architectural design principal for designs of the undulating Zuid Limburg area in the south of the Netherlands.

#### 4.6.2 Psychological and psychophysical approaches

In the psycho-physical approach the Dutch research groups show still many interests. These studies still start with defining space and physiognomic character by the type and amount of landscape features (Werkgroep Helmond, 1974; Blaas, 2004; Roos Klein-Lankhorst et al., 2002, 2004, 2005; Van Lammeren et al, 2010; Weitkamp, 2004, 2007, 2010). These types of studies are still grounded in an expert tradition but do validate the results by expert and respondent tests. These types of studies also bridge the expert-ecological approach and the psycho-physical perception approach. Most of these studies are based on stated references and not on revealed ones (Sevenant, 2010).

The psychological approach does have some Dutch examples. These are still in line with the previous studies of Coeterier (1996). Especially photo and video montages have been used as input data. The link with geodata is not always the case (Tress and Tress, 2003).

#### 4.6.3 Phenomenological approach

The more recent studies, in relation to Web 2.0 developments and as promoted by Coeterier (2002), which are in line with the humanistic or phenomenological, have been performed. These are especially studies (Lammeren et al., 2009) in which an attempt at classification of landscape photographs, which were taken by tourists, has been made, in relation to tourist landscape interest and their in-situ behaviour. In that study volunteer data (geodata as well as geotagged photos) has been used.

The Web 2.0, including the trends of geotagged photographs and augmented reality, heavily supports the challenging future of this research approach.

### 4.7 TENDENCIES AND PERSPECTIVES

In the previous sections the connection between the expanding domain of geomatics and the variety of physiognomic landscape studies have been outlined. Tendencies and perspectives are derived from the Dutch studies. One item is very sure and in line with previous writings of Ervin and Steinitz (2003). The nature of ongoing physiognomic landscape studies is not only dominated by strict ecological, formal-esthetical, psycho-physical, psychological and phenomenological approaches. The studies that show a cross-reference approach are increasing and seem very promising, thanks to geomatics.

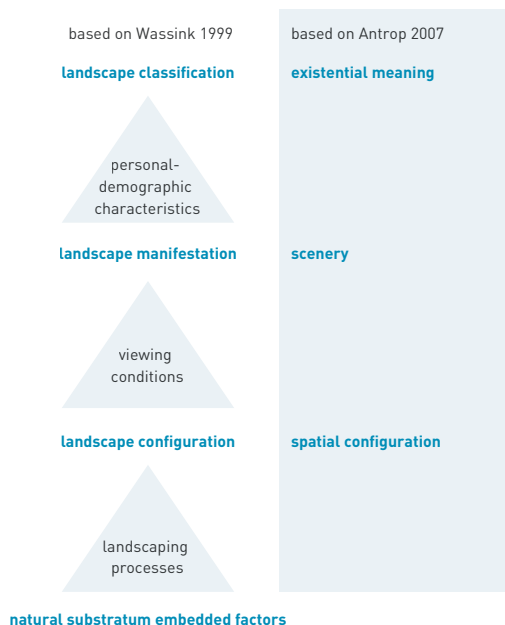
#### 4.7.1 Increase of geodata

The increase of geodata as result of institutional, societal and technology developments, show a variety of physiognomic landscape representations and, by creating data ensembles, there are many options to have geodatasets that fulfil the definition of landscape entities and the intended processing results. The most striking trends discovered are the increased precision of data, three-dimensional geometry of objects, data type integration (supported by computer vision), 3D references (horizontal plus vertical references), 3D geo-scenes (due to 3D reference) instead of 2D geodatasets, time series (initiated by digital photography and ground based Lidar) and even real-time geodata based on GPS tagged photos and video enabled smart phones. These trends will bring forward the need for geodata standards for physiognomic landscape studies including a related ontology.

#### 4.7.2 Outcome of data processing

Geo-computational innovations improved options to calculate many thematic, geometric and topology-based variables, and, even time-series based variables have dramatically increased. Besides listing the variables they could be linked to the type of physiognomic landscape studies (figure 9).

Figure 9  
Physiognomic landscape research and landscape studies



In relation to the availability of data ensembles the following types of variables are used:

- Basic vector and raster analysis tools based, including density and distribution variables (description substratum and embedded factors; configuration, classification);
- Landscape metrics (configuration, classification);
- DEM derived, like slope, aspect, curvature (description substratum and embedded factors; configuration);
- 3D Boolean operators that support geometric and topologic variables (configuration; manifestation; (re)classification);
- Viewsphere, Viewshed and Isovist derived variables (manifestation; configuration, classification);
- Interface perception variables based on eye tracking, time responses, interface tracking (manifestation; classification).

#### **4.7.3 Impact of visualisation**

Important research stimuli came from the many ways to visualise geodata and the variety and simplicity of interfaces. Based on the type of physiognomic landscape studies (figure 9) that each have their peculiar sets of variables, it is obvious that a high variety of visualisations are in use. These visualisations are primary based on the traditions of cartography.

In the perception-oriented studies' landscape manifestation, geomatics have been used to create (dynamic) landscape visualisations. Based on these visualisations derived variables related to usability and affective appraisal have been the subject of studies.

The nature of the interface for both, derived variables visualisation and landscape visualisation, have become the subject of studies too.

#### **4.7.4 Improving methodologies**

The increase in data and new variables, the latter as result of processing options, has influenced methodology. Most striking are the options to compare variables in relation to measured, perceived and simulated data. Even (cor)relations between variables can be generated like viewing graphs and visibility paths. In all of them, landscape configuration, manifestation and classification studies, an increase of variables can be discovered. There is an increased interest in the nature of a data due to the role of volunteers to collect, to review and to respond on landscape data. Specifically, the demographics of users underpin the findings of studies via demographic group based variables.

As noticed by Ervin and Steinitz (2003), even the so-called “viewer predisposition, or purpose” and the impact of other senses-related variables to measure landscape characteristics and perception, like noise, smell and crowdedness, become part of studies.

However one of the most important gains of geomatics is the automated reporting function. This function captures datasets and processing steps by flow diagrams and meta-datasets, which supports the discussion of results and makes an easy adaptation of the methodology possible.

#### **4.7.5 Meeting previous demands**

Let’s finish with the study of De Veer and Burrough (1978), who asked policy makers and consultants to score applications of physiognomic landscape studies. Those days five categories scored high: vulnerability designation (e.g. visibility of a new building, road or power line); suitability designation (e.g. for different recreation activities); public landscape preferences (e.g. as determined by a questionnaire using colour photographs of selected landscapes); landscape evaluation (using parameters such as diversity, rareness, or replacement possibilities) for conservation planning and landscape design (the creation of new, or modification of old landscapes).

The main conclusion from the questionnaire was that users’ demands for physiognomic landscape mapping vary enormously, both in terms of mapping scale and map content (De Veer and Burrough, 1978). With the contribution of geomatics we may notice that the variation of physiognomic landscape studies does increase. Applied geomatics in physiognomic landscape research will dramatically increase by the availability of mobile Internet services that will support citizens to become more aware of their surrounding environment and to participate in spatial planning procedures.

As mentioned by peers from many application domains (Tucci, 2010), the contribution of geomatics does not only consist of the application of the latest information technology based data and data processes, but it helps to create new methodological pathways, especially related to data acquisition and processing. Alongside that, geomatics proffer new and innovative ways of describing reality, which offers a wider spatial range related to more precision and accuracy of physiognomic features. Examples are: the enormous quantities of data relating to a single geographic location and generated at different times (past, present and future), the possible addition of extra variables to each of the representations during the research, the powerful extent to which topology rules spatial analysis, the variety of visualisation options, the fact that data can be created via volunteer sessions and Internet services and the acquired data, information and knowledge can be widely disseminated on-line via external databases in the ‘cloud’ and Internet sites.

All together geomatics doesn't only provide important contributions to physiognomic landscape studies, but it also create more awareness, different appreciation and more sustainable utilisation of landscapes. At least that's what may be proved in the near future.

The Dutch-Flemish physiognomic landscape research community tends to follow, and sometimes initiate, most of the here fore mentioned global geomatic developments. However this community is not afraid of using data ensembles and variables in line with cross-reference approaches to evolve and challenge physiognomic landscape studies.

## REFERENCES

- Antrop, M. (2007) *Perspectieven op het landschap: achtergronden om landschappen te lezen en te begrijpen*. Gent, Academia Press.
- Batty, M. (2001) Exploring isovist fields: space and shape in architectural and urban morphology. *Environment and Planning B: Planning and Design* 28; 123–150
- Benedikt, M.L. (1979) To take hold of space: isovists and isovists fields. *Environment and Planning B: Planning and Design* 6; 47-65
- Blaas, M. (2004) *Landscape Research Helmond: Geo-processed*. Wageningen University (MSc thesis Geo-Information Science GRS 2004-1)
- Bregt, A., and Lammeren, R. van (2000) 30 jaar GIS in Wageningen. *Kartografisch Tijdschrift* 26 (3); 15-21
- Burrough, P.A., and Veer, A.A. de (1982) Een informatiesysteem landschapsbeeld. Automatische produktie van landschapskaarten ten behoeve van de ruimtelijke planning. *Planning* 17; 2-15
- Burrough, P.A., and Veer, A.A. de (1984) Automated production of landscape maps for physical planning in the Netherlands. *Landscape Planning* II; 205-226
- Clevis, Q., Tucker, G.E., Lancaster, S. T., et al. (2006) A simple algorithm for the mapping of TIN data onto a static grid: Applied to the stratigraphic simulation of river meander deposits. *Computers & Geosciences* 32; 749–766
- Coeterier, J.F. (1996) Dominant attributes in the perception and evaluation of the Dutch landscape. *Landscape and urban planning* 34; 27-44
- Coeterier, J.F. (2002) Lay people evaluation of historic sites. *Landscape and Urban Planning* 59; 111–123
- Canadian Council of Land Surveyors, Canadian Institute of Geomatics, Geomatics Industry Association of Canada (2000) *Geomatics*. (Human Resources Study)
- Chrisman, N. (2003) *Exploring geographic information systems. 2nd edition*. New York, etc., John Wiley & Sons.
- Daniel, T.C., and Vining, J. (1983) Methodological issues in the assessment of landscape quality. In: Altman, I., and Wohlwill, J. (eds.) *Behavior and the Natural Environment: Advances in Theory and Research*. New York, Plenum Press, pp 5-45
- Daniel, T.C., and Meitner, M. (2001) Representational validity of landscape visualisations: the effects of graphical realism on perceived scenic beauty of forest vistas. *Journal of Environmental Psychology* (2001) 21; 61-72
- Floriani, L.D., and Magillo, P. (2003) Algorithms for visibility computation on terrains: a survey. *Environment and Planning B: Planning and Design* 30; 709–728
- De Veer, A.A., and Burrough, P.A. (1978) Physiognomic landscape mapping in the Netherlands. *Landscape Planning* 5; 45-62
- Döner, F., Thompson, R., Stoter, J., et al. (2010) 4D cadastres: First analysis of legal, organizational, and technical impact. With a case study on utility networks. *Land Use Policy* 27; 1068–1081
- Dykes, J., MacEachren, A., and Kraak, M.J. (2005) Exploring Geovisualization. In: Dykes, J., MacEachren, A., Kraak, M.J. (eds.) *Exploring Geovisualization*. Amsterdam, etc., Elsevier, pp 3-19
- Elsner, G.H. (1971) *Computing Visible Areas from Proposed Recreational Developments. A Case Study*. Pacific Southwest Forest and Range Experimental Station, California.
- Ervin, S., and Steinitz, C. (2003) Landscape visibility computation: necessary, but not sufficient. *Environment and Planning B: Planning and Design* 30; 757 -766
- Fisher, P.F. (1999) Models of uncertainty in spatial data. In: Longley, P., Goodchild, M. et al. (eds.), *Geographical Information Systems, Second Edition*. New York etc., John Wiley & Sons. pp 191-205
- Fisher, P.F., ed. (2006) *Classics from IJGIS: Twenty years of the International Journal of Geographical Information Science and Systems*. S.I.: CRC press
- Gibson, J.J. (1966) *The senses considered as perceptual systems*. Boston, Houghton-Mifflin.
- Gibson, C.C, Ostrom, E. and Ahn, T.K. (2000) The concept of scale and the human dimensions of global change: a survey. *Ecological Economics* 32; 217–239
- Hebblethwaite, R.L. (1973) Landscape assessment and clas-

- sification techniques. In: Lovejoy, D. (ed.) *Land Use and Landscape Planning*. Aylesbury, Leonard Hill, pp 19-50
- Hendriks, P., and Ottens H. (1997) *Geografische Informatie Systemen in ruimtelijk onderzoek*. Assen, Van Gorcum.
- Jones, C.B., Purves, R. S., et al. (2008) Modelling vague places with knowledge from the Web. *International Journal of Geographical Information Science* 22 (10); 1045–1065
- Kamps, S. and Lammeren, R. van (2001) Quantitative landscape description. In: *Conference Proceedings of ECLAS 2001*, pp 64-75
- Kent, M. (1985) Visibility analysis of mining and waste tipping sites. A review. *Landscape and Urban Planning* 13; 101-110
- Lobera, M. (2003) Extending GIS-based visual analysis: the concept of visualsapes. *International Journal for Geographical information science* 17 (1); 25-48
- Kerkstra, K., Vrijlandt, P., et al. (2007) *Landschapsvisie Zuid Limburg*. Provincie Limburg/Wageningen University
- Mark, D. (1999) Spatial representation: a cognitive view. In: Longley, P., Goodchild, M. et al. (eds.) *Geographical Information Systems, Second Edition*. New York etc., John Wiley & Sons, pp 81-89
- Marschallinger, R. (1996) A voxel visualization and analysis system based on Autocad. *Computers & Geosciences* 22 (4), 379-386
- McGarigal, K., Cushman, S.A., et al. (2002). *FRAGSTATS: Spatial Pattern Analysis Program for Categorical Maps*. Amherst, University of Massachusetts (<http://www.umass.edu/landeco/research/fragstats/fragstats.html>)
- Molenaar, M. (1997) Conceptuele ruimtelijke gegevensmodellen. In: Hendriks, P., and Ottens, H. (eds.) *Geografische Informatie Systemen in ruimtelijk onderzoek*. Assen, Van Gorcum, pp 21-44
- Ode, Å., Tveit, M.S., and Fry, G. (2010) Advantages of using different data sources in assessment of landscape change and its effect on visual scale. *Ecological Indicators* 10; 24–31
- Palmer, J.F., and Hoffman, R.E. (2001) Rating reliability and representation validity in scenic landscape assessments. *Landscape Urban Planning* 54; 149–161
- Pollefeys, M., Gool, L. van, Vergauwen, M., et al. (2002) Video-to-3D. *International archives of photogrammetry remote sensing and spatial information sciences* 34 (5); 579-584
- Raper, J., Gartner, G., et al. (2007) Applications of location-based services: A selected review. *Journal of Location Based Services* 1; 89–111
- Riggs, P.D., and Dean D.J. (2007) An Investigation into the Causes of Errors and Inconsistencies in Predicted Viewsheds. *Transactions in GIS* 11(2); 175–196
- Roos-Klein Lankhorst, J., Buijs, A.E., Berg, A.E. van den, et al. (2002) *Belevings GIS versie februari 2002*. Wageningen, Alterra (werkdocument 2002/08; planbureau-werk in uitvoering)
- Roos-Klein Lankhorst, J, Vries, S. de, Lith-Kranendonk, J. van, et al. (2004) Modellen voor de graadmeters landschap, beleving en recreatie; Kennismodel Effecten Landschap Kwaliteit KELK, Monitoring Schaal, BelevingsGIS. Wageningen, Natuurplanbureau vestiging Wageningen (planbureau-rapport 20)
- Roos-Klein Lankhorst, J., Vries, S. de, Buijs, A., Berg, A.E. van den, et al. (2005) *Belevings GIS versie 2: waardering van het Nederlandse landschap door de bevolking op kaart*. Wageningen, Alterra (alterra-rapport 1138)
- Roswell, C. and Tom, H. (2009) *Standards guide, ISO/TC 211 geographic information/geomatics* (2009-06-01)
- Rijksplanologische Dienst (1966) *Tweede nota over de ruimtelijke ordening in Nederland*. The Hague.
- Schroeder, H.W. (1988) Visual impact of hillside development: comparison of measurements derived from aerial and ground-level photographs. *Landscape and Urban Planning* 15; 119–126
- Sheppard, S. R. J., and Cizek, J. (2009) The ethics of Google Earth: Crossing thresholds from spatial data to landscape visualisation. *Journal of Environmental Management* 90(6); 2102–2117
- Sevenant, M. (2010) *Variation in landscape perception and preference. Experiences from cases studies in rural and urban landscapes observed by different groups of respondents*. Ghent University, Department of Geography (PhD-dissertation)
- Snavely, N., Seitz, S.M., and Szeliski, R. (2006) Photo Tourism. Exploring Photo Collections in 3D. *ACM Transactions on Graphics* 25(3); 835-846
- Szeliski, R. (2010) *Computer Vision: Algorithms and Applications*. University of Washington (draft may 2010).
- Steenbergen, C.M., and Reh, W. (2003) *Architecture and Landscape: The Design Experiment of the Great European Gardens and Landscapes*. Basel etc., Birkhäuser.
- Steenbergen, C.M., Meeks, S., and Nijhuis, S. (2008) *Composing landscapes: analysis, typology and experiments for design*. Basel etc., Birkhäuser.
- Steenbergen, C.M., Reh, W., Nijhuis, S., and Pouderoijen, M. (2009) *The polder atlas of the Netherlands*. Bussum, Thoth.
- Sutherland, I.E. (2003) *Sketchpad: A man-machine graphical communication system. Based on the original dissertation (1963)*. University of Cambridge, Computer Laboratory (Technical report nr. 574).
- Tandy, C.R. (1967) The Isovist Method of Landscape Survey, in: C.R. Murray (ed.) *Methods of Landscape Analysis*. London: Landscape Research Group, pp 9-10
- Tang, T., Wenji, Z., et al. (2008) Terrestrial laser scan survey and 3D TIN model construction of urban buildings in a geospatial database. *Geocarto International* 23 (4); 259 - 272
- Tomlin, D. (1990) *Geographic information systems and cartographic modeling*. Prentice-Hall



- Tomlinson, R.F. Calkins, H.W. and Marble, D.F. (1976) *Computer handling of geographical data*. UNESCO Natural Resources Research XIII, Paris
- Tress, B., and Tress, G. (2003) Scenario visualization for participatory landscape planning. A study from Denmark. *Landscape and Urban Planning* 64; 161–178
- Tucci, G., Algostino, F., Bucalossi, L., et al. (2010) Cultural heritage and sustainable valorization in the governorate of Tratous with reference to the Euromed IV project: the contribution of geomatics. In: Ioannides, M., Fellner, D. et al. (eds.) *Digital Heritage. Proceedings 3rd international conference, EuroMed 2010*. New York, etc., Springer, pp 399-408
- Van den Berg, A. (2009) *Handboek Natuurbeleving en gezondheid*. Wageningen University (Course syllabus, October 2009)
- Van Eetvelde, V. and Antrop, M. (2009) A stepwise multi-scaled landscape typology and characterisation for trans-regional integration, applied on the federal state of Belgium. *Landscape and Urban Planning* 91: 160–170
- Van der Ham, R.J.M., and Iding, J.A. (1971) *De landschapstypologie naar visuele kenmerken. Methodiek en gebruik*. Wageningen, Afdeling Landschapsarchitectuur, Landbouwniversiteit Wageningen
- Van der Ham, R.J.M., Schut, G.F.E., and Iding, J.A. (1970) Een voorstel voor een nieuwe landschapstypologie naar visuele kenmerken. *Stedebouw en Volkshuisvesting* 11; 421-438
- Van Lammeren, R., Goossen, M., and Roncken, P. (2009) Sensing Landscape History with an Interactive Location Based Service. *Sensors* (9); 7217-7233
- Van Lammeren, R., J. Houtkamp, J. et al. (2010) Affective appraisal of 3D land use visualization. In: *Computers, Environment and Urban Systems* 34; 465-475
- Van Leeuwen, M., and Nieuwenhuis, M. (2010) Retrieval of forest structural parameters using LiDAR remote sensing. *European Journal of Forest Resource*
- Wascher, D. (2005) *European Landscape Character Areas. Typologies, Cartography and Indicators for the Assessment of Sustainable Landscapes* (Alterra Report No. 1254)
- Wassink, W.Th. (1999) *Beekdallandschappen. Een morfologisch onderzoek in de zandgebieden van Nederland*. Wageningen University (PhD-dissertation)
- Weir, M.J.C. (1976) Landscape evaluation in Great Britain. A short review. *Mededelingen Werkgemeenschap Landschapsecologisch Onderzoek* 3; 15–20
- Weitkamp, G. (2004) *Landschappelijke beleving geparametriseerd. Een methode voor het bepalen van vijf belevingsaspecten aan de hand van de top10vector*. Wageningen University (MSc thesis Geo-Information Science GRS 2004-28)
- Weitkamp, G., Bregt, A., Lammeren, R. van, and Berg, A. van den (2007) Three sampling methods for visibility measures of landscape perception. In: Winter, S., Duckham, M. et al. (eds.) *COSIT 2007*. New York, etc., Springer-Verlag, pp 268-284
- Weitkamp, G. (2010) *Capturing the View: A GIS based procedure to assess perceived landscape openness*. Wageningen University (PhD-dissertation)
- Wergroep Helmond (1974) *Landschapsonderzoek Helmond*. Wageningen, Afdeling Landschapsarchitectuur Hogeschool Wageningen.
- Wherret, J.R. (2000) Creating Landscape Preference Models Using Internet Survey Techniques. *Landscape Research* 25 (1); 79-96
- Xu, W., Zhu, Q., et al. (2010) Design and Implementation of 3D Model Database for General-Purpose 3D GIS. *Geospatial Information Science* 13 (3); 210-215
- Yang, P.P., Putra, S.Y., and Li, W. (2007) Viewsphere: a GIS-based 3D visibility analysis for urban design evaluation. *Environment and Planning B: Planning and Design*
- Zhou, G. (2010) Geo-Referencing of Video Flow From Small Low-Cost Civilian UAV IEEE. *Transactions on automation science and engineering* 7 (1); 156-166
- Zube, E.H., Sell, J.L., and Taylor J.G. (1982) Landscape perception: research, application and theory. *Landscape planning* 9; 1-33

## URL (checked July 2010)

- [1] [http://neo.aseanflag.com/?option=com\\_content&view=article&id=65&Itemid=55](http://neo.aseanflag.com/?option=com_content&view=article&id=65&Itemid=55)
- [2] <http://www.igs.net/~schut/cli.html>
- [3] <http://www.casa.ucl.ac.uk/gistimeline/> (time line only available until 1/1/2000 )
- [4] <http://landsat.gsfc.nasa.gov/about/history.html>
- [5] [http://www.fgdc.gov/policyandplanning/executive\\_order](http://www.fgdc.gov/policyandplanning/executive_order)
- [6] <http://www.tudelft.nl/live/pagina.jsp?id=d11f4b18-63dc-46cc-a71e-14741f67928f&lang=nl>
- [7] <http://www.vrom.nl/pagina.html?id=46094>
- [8] <http://www.ahn.nl/>
- [9] <http://inspire.jrc.ec.europa.eu/>
- [10] <http://oreilly.com/web2/archive/what-is-web-20.html>
- [11] <http://www.flickr.com/map/>
- [12] <http://www.panoramio.com/>
- [13] <http://www.locr.com/>
- [14] <http://earth.google.com/>
- [15] <http://www.bing.com/>
- [16] <http://en.wikipedia.org/wiki/Voxel>
- [17] <http://www2.jpl.nasa.gov/srtm/>
- [18] <http://www.opengeospatial.org/>
- [19] <http://bbs.keyhole.com/ubb/ubbthreads.php?ubb=showflat&Number=1323176>
- [20] see Google Earth – active layer 3D buildings
- [21] <http://www.photosynth.net/>
- [22] <http://phototour.cs.washington.edu/>
- [23] [http://www.google.com/intl/en\\_us/help/maps/streetview/](http://www.google.com/intl/en_us/help/maps/streetview/)



PART TWO  
**LANDSCAPE RESEARCH AND DESIGN**



51° 57' 48" N, 4° 26' 6" E



5

# VISUAL RESEARCH IN LANDSCAPE ARCHITECTURE

“VISIBLE THINGS OFTEN APPEAR VERY DIFFERENT FROM WHAT THEY REALLY ARE.”

*Johann Heinrich Lambert (1752)*

## 5.1 INTRODUCTION

The core of landscape architecture as a design discipline is the construction and articulation of three-dimensional outdoor space. It considers the *representation, realisation* and *apprehension* of the three-dimensional composition as constituent components of spatial design. This architectural way of space-making is a living and constantly changing power, influenced by the philosophical, religious and scientific attitudes in the societal context (Bacon, 1967).

Representation is essential in the understanding and construction of space <sup>1</sup>, not only for visual thinking and visual communication in the design process, but also as it addresses the dialogue between the *conceptual* and *perceptual* order of space. It expresses the fundamental difference between the physical, metric reality (Euclidian space) and its visual appearance (perceived space). A representation can portray an already existing spatial reality, but can also be a projection of an imaginary three-dimensional concept. As Bacon (1967) suggested: “these two phases interact with each other, the concept influencing the structure and the structure influencing the concept in a never-ending interplay... The designer conceives a three-dimensional form which is later [constructed]. From observation of [the actual constructed space] the designer gains new understanding...” In other words: the designer acquires a new understanding by examining the physiognomy or visible form of the composition, which is linked with movement of the observer through the space, and then can implement it in another context. Thus we can



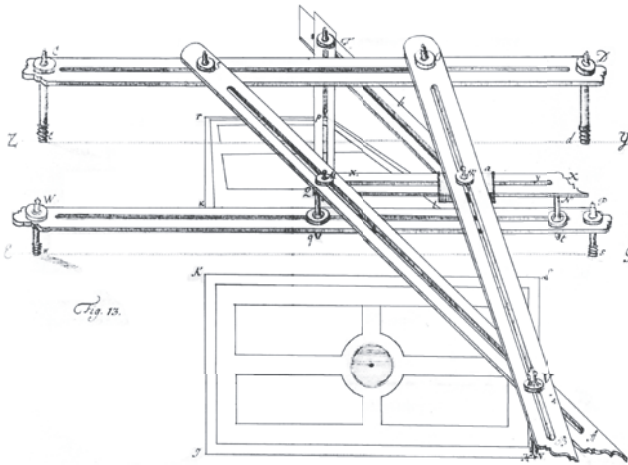


Figure 1  
18<sup>th</sup> century perspective pantograph (distorting pantograph), a device that could apparently transfer an orthographic plan of garden into a perspective representation. From *Anlage zur Perspektive* (1752) by Johann Heinrich Lambert (source: Pérez-Gómez and Pelletier, 1997)

consider the visible form and its representation as the interface between the conceptual and perceptual space, and as a container of object-related and typological design knowledge.

Since the early beginnings of design disciplines practitioners and researchers have been involved in discovery and development of instruments to map (represent and apprehend) architectonic space (see figure 1). This quest still continues, now influenced by computational and technical advances in, for instance, Geographic Information Science (GISc).

### 5.1.1 Landscape architecture, space making and GISc

In landscape architecture the dialogue between the conceptual and perceptual space is often subject of intuitive and experimental design, taking into account physiological, psychological, and anthropometric aspects. However, when we consider landscape architecture as a scientific discipline as well as a profession, knowledge-based design becomes an important issue, as put forward by Steenbergen et al. (2002, 2008), De Jong and Van der Voordt (2002) and Klaasen (2004). In knowledge-based design a methodical approach is required where understanding of space by means of analysis is the prerequisite for the formulation of new designs (Steenbergen et al., 2008; Nijhuis, 2010).

Early essays on landscape architectonic design, like Repton (1803), Andre (1879) and Hubbard and Kimbal (1935), offer valuable design knowledge by presenting principles of three-dimensional space construction based on practical experience and experimentation. GISc offers

designers new possibilities for mapping landscape architectonic compositions to deepen and broaden the body of knowledge about the understanding of the relation between the conceptual and perceptual space. Although this relationship is complex in nature (e.g. it's involvement of subjective aspects of perception) it is worthwhile to consider the concepts and tools of GISc for analysing the 'horizontal perspective' (as an observer exploring the visual space), which have a great potential for this kind of design research.

### 5.1.2 Aims and structure

This chapter aims to explore some basic concepts of the horizontal perspective linked to landscape architectonic design research by means of Geographic Information Systems (GIS). It is about the analysis of the visible form and its architectonic composition as would be experienced by an observer moving through a virtual space, by making use of GIS-based isovists and viewsheds. On one hand it introduces the basic concepts of visual perception and the role of movement. On the other, it explores how some of these concepts can be revealed by using GIS, presenting particularities of the perceived landscape architectonic space.

The chapter is structured as follows: Firstly, landscape architecture is positioned as a design discipline focussed on the study of three-dimensional compositions, following that a framework for design research is introduced in section 5.2. Secondly, the concept of visible form is elaborated involving the basic concepts of visual perception and movement in section 5.3. Thirdly, the potential of GIS in visibility analysis for grasping the visual form and it's architectonic composition is exemplified by two examples: *Piazza San Marco* (Venice, Italy), as a designed space of buildings, and Stourhead landscape garden (Wiltshire, UK), as a designed space of vegetation and relief in section 5.4. Isovist and viewshed functions in particular are explored. The chapter ends with concluding remarks and discussion.

## 5.2 LANDSCAPE ARCHITECTURE: DESIGNING OUTDOOR SPACE

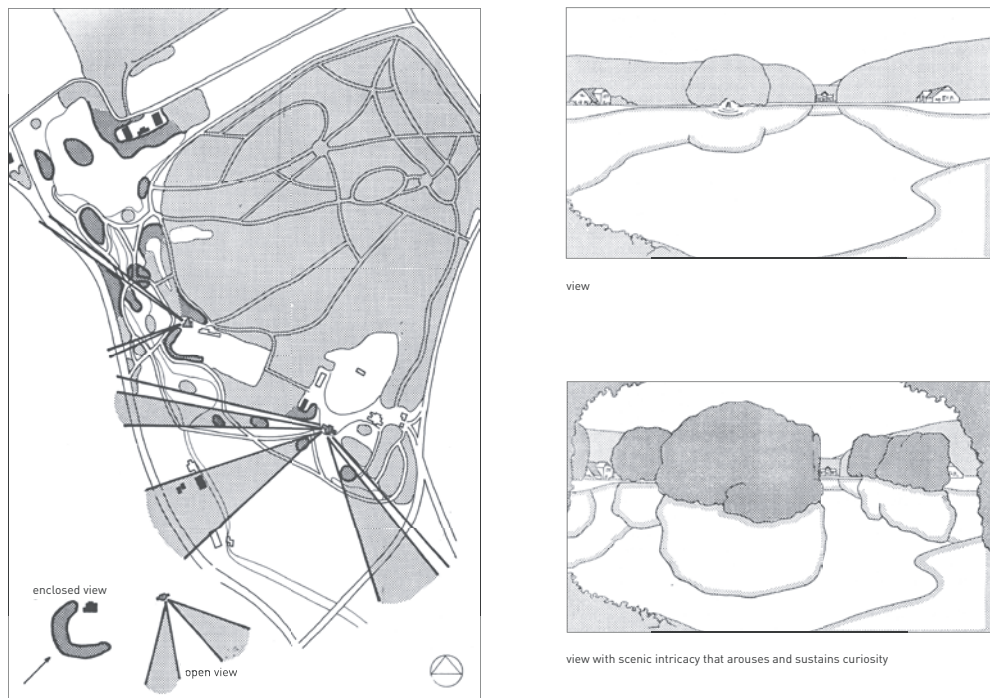
According to the Encyclopedic Dictionary of Landscape and Urban planning (Evert et al., 2010) landscape architecture is “a profession and academic discipline that employs principles of art and the physical and social sciences to the processes of environmental planning, design and conservation, which serve to ensure the long-lasting improvement, sustainability and harmony of natural and cultural systems or landscape parts thereof, as well as the design of outdoor spaces with consideration of their aesthetic, functional and ecological aspects.” However, the practice of landscape architecture <sup>2</sup>, the arrangement of landscape as manifestation of spaces

and objects, is as old as human existence (Pregill and Volkman, 1999; Rogers, 2001; Newton, 1971). Within the broad field of landscape architecture there are three areas of activity according to the scales of time and space in which they operate: *landscape planning*, *landscape design* and *landscape management*. See Stiles (1994a, 1994b) and Thompson (1999) for an elaboration on this topic. This chapter focuses upon landscape design, in particular the design of sites.

### 5.2.1 Research, design and three-dimensional space

Landscape architecture consists of a basic attitude that involves four principles of study and practice. These are: *anamnesis (palimpsest)*, *process*, *three-dimensional space* and *scale-continuum (relational context)* (Nijhuis, 2006; Prominski, 2004; Marot, 1995). This chapter is about three-dimensional space as a crucial aspect in landscape design and comprises of the representation, realisation and apprehension of outdoor space. In the Dutch landscape architecture tradition, especially design research, we find clues to grasp three-dimensional space in landscape

**Figure 2**  
**Visual analysis of the parks of Sonsbeek, Zijpendaal en Gulden Bodem in Arnhem (the Netherlands) representing views and their compositions (source: Warnau, 1979)**



		OBJECT	
		determined	variable
CONTEXT	determined	plan analysis	design experiment
	variable	comparative research	experimental design
		<i>design research</i>	<i>research by design</i>

**Table 1**  
**Design research and research by design: a variable relationship between object and context (source: Steenbergen et al., 2008)**

design, exemplified by the seminal works such as: *Architecture and Landscape* (Steenbergen and Reh, 2003), *Designing Parks* (Baljon, 1992), *Rapport over de parken Sonsbeek, Zijpendaal en Gulden Bodem in Arnhem* (Report about the parks Sonsbeek, Zijpendaal and Gulden Bodem in Arnhem) (Warnau, 1979) and *Waarnemen en ontwerpen in tuin en landschap* (Perception and design of garden and landscape) (Bijhouwer, 1954) (see figure 2). In these studies landscape design is considered as a three-dimensional composition of natural, cultural, urban and architectural elements related to aesthetic, ecologic, social and economic parameters.

Landscape design in relation to spatial compositions involves two important research domains: *design research* (analysis of existing designs or precedents) and *research by design* (formulation of new designs) (De Jong and Van der Voordt, 2002). These respective research domains and their variables are positioned in table 1. The two components cannot be seen apart from each other: design research is an indispensable step in research by design. From this point of view we can consider this approach as a form of heuristics (way to find), a scientific approach that leads to new discoveries and inventions by taking a methodical approach (Steenbergen et al., 2002).

Especially in the work of Steenbergen *cum suis* (2009, 2008, 2003) we find a well-established framework for (typo)morphological research related to landscape as an architectonic composition (see figure 3). Here the composition is understood as the vehicle that establishes the relationship between content and form. Content is everything that comprises the landscape architectonic object, its material, topography, technical structure, and cultural substance. The form involves the way in which the parts are assembled in a composition and is considered as the interface between intention and perception (Steenbergen et al., 2008).



Figure 3  
 Landscape as a composition. There are endless possibilities to arrange the landscape in a harmonious, good composition. The procedure, however, influences the quality of the result as illustrated by this 19<sup>th</sup> century game: 'Myriorama' or 'Endless Landscape' (Leipzig, 1830). When all 24 cards are laid side by side there are millions of combinations possible

### 5.2.2 Design research and visible form

Design research related to three-dimensional landscape compositions is about analysis of existing designs or precedents in order to acquire typological knowledge and designerly insights that can be used in the creation of a new design. Examining the architectonic composition is crucial here, because it is the container of design knowledge. This knowledge derived from the composition can extend beyond the intention of the designer; the plan analyst can reveal more insights than the designer consciously put in the design. It is possible to explore and to identify more than the designer's immediate goals. The researcher's interpretation can therefore be of equal value for the meaning of the design as the for designer's intention (Baljon, 1992; Mooij, 1981).

An architectonic composition can be comprehended by addressing the most general concepts that lay out the relation between the various aspects of the architectonic form and its perception in a systematic way (Steenbergen and Reh, 2003). Frankl (1968) defined four important layers of interest:

- *Basic form*: the way in which the topography of the natural landscape or the man-made landscape is reduced, rationalised and activated in the ground plan of the design;
- *Corporeal form*: three-dimensional (space defining) forms made by spatial patterns composed of open spaces, surfaces, screens and volumes in the landscape (Euclidian space);
- *Visible form*: appearance of the landscape (perceived space). It is about the perceptual space addressing the sensorial experience that emerge only by movement and is affected by atmospheric conditions;
- *Purposive intention*: relationship of the landscape architectonic object to the social institutions for which they are conceived. The (functional) zoning and organisation of the programme in relation to the configuration movement is usually an important expression of this.

These layers of interest for the description and analysis of architectonic compositions are partly adopted and elaborated for landscape architecture by Steenbergen et al. (2003, 2008), with emphasis on the rational analysis of a landscape architectonic composition (i.e. basic form, spatial form, metaphorical form and programmatic form) and the development of an effective way of representing them (see for examples e.g. Steenbergen et al., 2003, 2008, 2009). With regards to three-dimensional space the emphasis of this framework is on the conceptual space; the metric reality of a three-dimensional composition presented by its spatial form. However, Frankl (1968) emphasises that the design also consists of a perceptual space, it's visual reality, addressing the sensorial experience that emerges only by movement and is affected by atmospheric conditions. As opposed to *corporeal form* he suggested *visible form* as an important aspect of a design's three-dimensional composition. This visible form derives from the act of perceiving (especially seeing), which is linked with the sequential unfolding of information as our bodies pass through space (Frankl, 1968; Psarra, 2009).

### 5.3 VISIBLE FORM IN LANDSCAPE ARCHITECTURE

Visible form in landscape architecture is about the visual manifestation of three-dimensional forms and their relationship in outdoor space, expressed by its structural organisation (e.g. balance, tension, rhythm, proportion, scale) and ordering principles (e.g. axis, symmetry, hierarchy, datum, transformation) (Bell, 1993; Hubbard and Kimball, 1935). It refers to the appearance of objects; it is about the 'face' of the spatial composition. However, the meaning attached to it is referred to as semantic information, and is dependent on the receiver (Haken

and Portugali, 2003; Blake and Sekuler, 2006). Thus there is a subjective part containing symbolic, cultural and personal elements which finally determine the experience of landscape architectonic space (see e.g. Kaplan and Kaplan, 1989).

How can we understand visible form in order to extract design knowledge? According to Salingaros (2005) “we define our living space by connecting to solid boundaries, visually and acoustically as well as through physical contact. Strictly speaking, outdoor space doesn’t need [e.g.] buildings at all; only surrounding surfaces, nodes for sitting and standing, and paths”. In short, we define our environment as a collection of surfaces, screens and objects in space. So landscape architectonic composition consists of a given spatial relationship between these considering the diurnal and seasonal variations in natural light. The visible attributes of the space-establishing elements are position, size, direction, number, shape, colour and texture which every visible form possesses under any condition of illumination (Thiel, 1961; Gibson, 1986; Bell, 1993; Simonds, 1997).

The observer’s relationship to these visual descriptors is of a higher geometrical order and they locate their position by using a rough polar or vector orientation in terms of distance and direction (Gibson, 1986). This optical structure is called an *ambient optic array* and was introduced by Gibson (1961). He explained the optic array as a set of nested solid angles corresponding to surface elements in the environment. The architectonic space exchanges information via these fields with our senses; it is a visual information field (Gibson, 1986; Salingaros, 2005).

### 5.3.1 Perceiving visible form

Although physical space is three-dimensional, these dimensions are not equal to human perception of space. The cognitive organism acts on visual information that is imaged on the retina. In other words: the perceptual space is flattened in terms of information content (Blake and Sekuler, 2006; Snowden et al., 2006; Ware, 2008). Thus visual space has dimensions that are very different from the geographic or measured space and each dimension has different affordances. This perceptual space consists of an *up-down* and *left-right (sideways) dimension* (the *retinal image* or *picture plane*) and a *distance dimension (depth)* (Blake and Sekuler, 2006; Ware, 2008). These different characteristics are of greatest importance for landscape design because they not only determine if and how the visual form is perceived, but also can be consciously applied to achieve a certain spatial quality and establish space relationships.

The information from the up-down and sideways dimension is basically a matter of visual pattern processing and colour discrimination and is the basis for recognition of objects and their relationships. Pattern recognition is primarily about *contours (shape)*, *regions*, *spatial grouping*

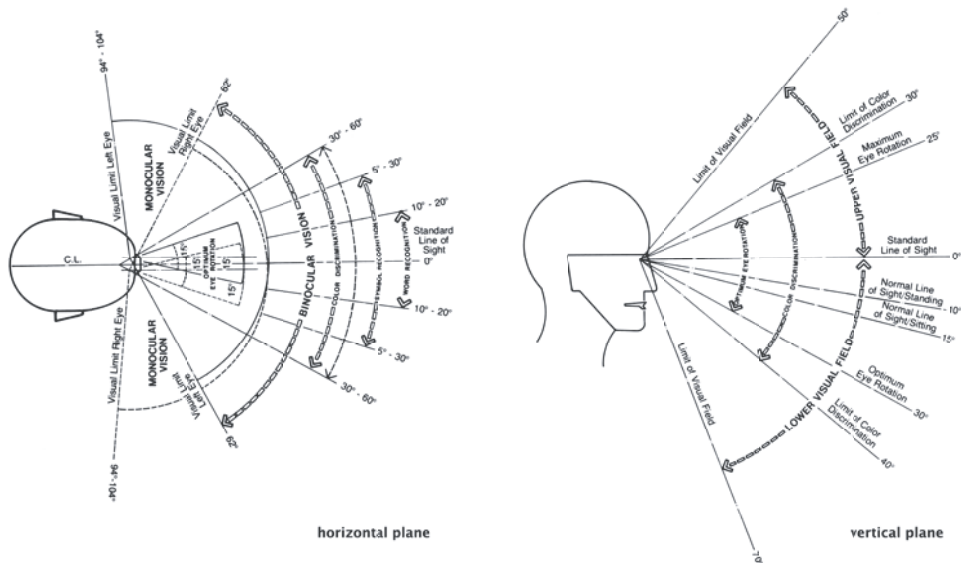


Figure 4  
Field of vision in the horizontal and vertical plane [source: Panero and Zelnik, 1979]

(based on: nearness, continuity, similarity, enclosure, shape and common direction) and visual distinctness. Visual distinctness describes the degree of feature-level contrast between the object and its surroundings (e.g. figure-background) (Blake and Sekuler, 2006; Ware, 2008; Bell, 1999, 1993). *Field of vision* (syn.: field of view) is crucial in this respect because it determines the visibility and perception of the visible form in the picture plane. Humans have an almost 120 degrees forward-facing horizontal, binocular field of vision. Within this field sharp images are transmitted to the brain, depth perception and colour discrimination is possible. However, the ability to perceive shape (pattern recognition), motion and colour vary across the field of view (see figure 4). Pattern recognition concentrates in the centre of the field of vision and covers about 20-60 degrees binocular view (Panero and Zelnik, 1979; Snowden et al. 2006). However, the highest degree of acuity we find in the range of about 20-30 degrees binocular view. This is due to the much higher concentration of cone cells (type of photoreceptors) in the fovea, the central region of the retina, which corresponds with a visual angle of 12-15 degrees per eye (= ca. 20-30 degrees binocular view), from there the acuity of the eye rapidly falls off (Snowden et al., 2006; Ware, 2004). This physiological fact determines the size and measurement of perceivable views and objects in landscape architectonic compositions, as we will discuss later.

The information from the distance dimension is about perception of depth. Depth cues consist of spatial information that is used to evaluate distances from the observer's point of view and can only be obtained by movement of the eye, head and body. In other words *we can only expe-*



*rience space by movement* (Blake and Sekuler, 2006; Ware, 2008; Bell, 1999). Depth cues can be divided in physiologic, kinetic and pictorial cues. Pictorial depth cues can be reproduced in a painting or a photograph, or consciously applied in landscape architectonic design. The most powerful depth cue is *occlusion* (objects that visually block other objects appear closer). Other depth cues are related to the geometry of perspective: *linear perspective*, *size gradients* and *texture gradients*. Furthermore, *cast shadows*, *height on picture plane*, *shading*, *depth of focus*, *size relative to known objects*, and *atmospheric contrast reduction* are important depth cues (Blake and Sekuler, 2006; Snowden et al., 2006; Ware, 2008). Each of the depth cues support different kinds of visual queries and can be applied (individually) in a landscape architectonic composition to create optical illusions or pictorial effects. Non-pictorial depth cues are related to the physiology of the visual system: *stereoscopic depth (stereopsis)*, *accommodation* and *convergence*, and kinetics: *structure from motion (motion parallax)* (Blake and Sekuler, 2006; Snowden et al., 2006; Ware, 2008).

### 5.3.2 Movement and landscape architectonic composition

We can only experience landscape architectonic space by movement. As opposed to a painting, we move through a landscape or a building and its visible form alters or changes constantly, as does its internal relationships. The interpretation of every single image as three-dimensional that we receive from different viewpoints are (usually) not ends in themselves but part of a series of three-dimensional images which draw together the architectonic image (mental image) of the composition (Frankl, 1968)<sup>3</sup>. This kinetic experience of the observer who arrives at a 'single' image as the product of many partial images is summarised by Hoogstad (1990) as:  $Space = Time (+ memory) \times Movement$ . In other words, visible form is about the construction of time-space relationships among the space establishing elements and their attributes (Hoogstad, 1990). Successive acts of perception and recognition influences one's sense of time. Observers in motion perceive change successively and adjust their knowledge. For instance, individuals tell the length of their walks by the rhythmic spacing of recurring elements. The more spatial variation, the shorter the walk appears; but recalling from memory, the walk appears longer (Bosselman, 1998).

Landscape architectonic compositions stimulate, or at least permit, certain kinds of movement with different modalities, and manage speed and direction. So movement takes place partly in response to or in accordance with the designer's intentions (Conan, 2003; Hunt, 2004). Yet together with spaces, paths are considered to be paramount structural components of (designed) landscapes because they play a crucial role in mediating or facilitating the experience and use of these compositions (Dee, 2001; Bell, 1993). In this respect paths and routes play a crucial role as structural organisers of the architectonic image (Appleyard, 1970; Lynch, 1960).

Related to movement through space we can distinguish three modes of vision:

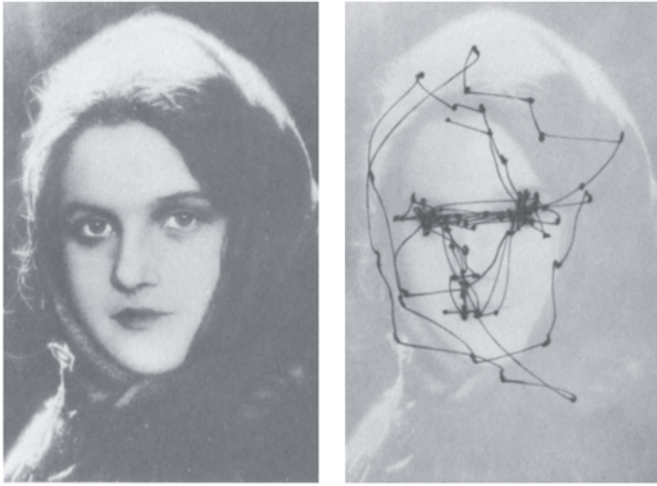
- *Stationary vision*: standing still or sitting; frontal perception of a fixed scene;
- *Slow-motion vision*: walking, cycling and horse riding; slow sequential frontal and/or lateral perception of scenes;
- *Fast-motion vision*: car driving, motorcycling and train; fast sequential frontal and/or lateral perception of scenes.

The characteristics of these modes of vision have wide ranging implications for the visible form. For instance, the speed of movement determines the visual angle and the focus towards the landscape (e.g. with increasing speed the visual angle narrows down). This chapter focuses on stationary vision and slow-motion vision because it closely relates to the primordial act of walking as an aesthetic and social practice (Careri, 2002; König, 1996; Solnit, 2001) <sup>4</sup>. The relevance of this for landscape architecture is put forward by Conan (2003), Hunt (2004) and De Jong (2007). The latter summarises it as follows: “the walk [(as an action, but also a route)] represents an important unifying and structural principle in the design of garden and landscape architecture and the discovery of landscape from past to present. It must be considered the hinge that steered more than anything else the changing options for use, experience, and design and contributed fundamentally to both personal and cultural developments” (De Jong, 2007).

### 5.3.3 Visually controlled movement

With regard to visible form it is important to link visually controlled movement to space perception. Perception of space is essentially about perception of action potential within the local environment. This concept is referred to as *affordances* (Gibson, 1986). Gibson (1986) conceived affordances as physical properties of the environment, which are about linking perception and action. So, paths afford walking, a bench affords sitting, et cetera. Affordances in visual space are readily perceived possibilities for action, especially movement. With regard to the visual form we can speak of *visually controlled movement*. An open environment affords movement in any direction, and an environment with surfaces, screens and objects only at openings (Gibson, 1986). Research in *wayfinding* <sup>5</sup> indicates that route choice behaviour is for 60% depended on spatial aspects such as space perception, spatio-visual attractiveness, arousal and orientation (Korthals Altes and Steffen, 1988). So the visible form is crucial because it affords movement by its openings, offers a sense of direction by its spatial orientation and offers arousal/attraction by its visual composition.

Visual *anchor points* are another important factor in the spatial composition and function as orientation points or ‘attractors’, and induce and direct movement (Golledge and Spector,



**Figure 5**  
 Record of eye movement during free examination of a photographed face. The eye fixates mainly on the eyes and mouth as anchor points in the 'landscape of the face' because they provide important information on the internal state of mind of the person on the picture and are the basis for action (source: Yarbus, 1967)

1978; Golledge, 1999; Hillier et al., 1993). Anchor points are key primitive elements or strategic foci (significant features or landmarks) in space and attract our attention more than other areas of the landscapes' face. Yarbus (1967) pointed out that they provide more information than others and carry useful or necessary information for recognition and understanding of spatial relationships and function as 'spatial magnets' or destinations (see figure 5). In this respect we can distinguish three different means for movement: travel to familiar destinations, exploratory travel and travel to novel destinations (Allen, 1999). In these types of movement *following a marked trail* and *landmark-based piloting* are important modes of wayfinding, which have their applications in landscape design, as we shall see later. Landmark-based piloting refers to the act in which the observer relies on sequentially organised knowledge: a landmark is associated with direction and distance information that leads to another (Allen, 1999). It can be considered as a landscape architecture tool for initiating movement.

#### 5.3.4 The shape of a walk: organising visual logic

As we have seen the visible form of a landscape architectonic composition derives from the act of visual perception, which is linked with the sequential unfolding of visual information by movement through space. Paths do not only provide passage but also direct movement through the three-dimensional composition. In addition, paths offer a means to organise the visual

logic of a site by directing the visitor's gaze at (distant) views or focal points (e.g. buildings, objects) and their sequence (serial vision) as a spatial narrative (O'Malley et al., 2010; Psarra, 2009; Potteiger, 1998). Focal points serve often as 'destinations' and induce movement (i.e. landmark-based piloting).

Hunt (2003, 2004) proposed a taxonomy of 'walkscapes' in designed landscapes, which exemplify the intended relation between movement and visible form:

- *Procession*: ritual movement that follows both a preordained path and purpose and is determined by implicit or explicit guidelines constituting the performance of that ritual laid down in formal records such as social or religious conventions or written text (examples: Sacro Monti, Varallo (Italy), and Versailles, Paris (France));
- *Stroll*: movement with an ultimate purpose within the site and a sense of destination. Strolling also implies a defined route between whatever incidents punctuate and give rhythm to the movement (examples: Stowe landscape gardens, Buckinghamshire (England), and California Scenario, Costa Mesa, California (USA));
- *Ramble*: movement without an external prompt, they are promoted largely by the will or curiosity of an individual. Rambles are for the pleasure of movement itself (examples: Central Park, New York (USA), and Vondelpark, Amsterdam (the Netherlands)).

As such the landscape architectonic composition is visible by stationary vision and slow-motion vision, and is choreographed by the configuration of paths. In this way we can consider a landscape architectonic design as a three-dimensional composition of scenes, views and tableaux with references, symbols and stories (Vroom, 2006; Olwig, 2002). This presumes that 'pictorialisation'<sup>6</sup> or *scenography* (stage setting) and its sequence are significant aspects of the visual organisation and perception of landscape architectonic compositions (Grandell, 1993). Furthermore, the individual surfaces, screens and objects within the composition can have a certain spatiality or visual effect such as *spatial radiance* which bestow a certain visual direction and amplitude (Arnheim, 1977; Von Meiss, 2004).

### 5.3.5 The scene as a image

The formal relationship of three-dimensional objects in space is visible as a *scene* (*tafereel*) on the retina (Hoogstad, 1990). A scene refers to an extensive piece of the (urban) landscape that can be seen from a single (or multiple) point of view as in a painting or as a stage of a theatre<sup>7</sup> with a foreground, middle ground and background (O'Malley et al., 2010; Repton, 1803). More particularly, it is about *views*, *feature views* or *focal views* (*vistas*), which are (composed) landscape unities within the horizontal, binocular field of vision of about 20-30 degrees (Hubbard and Kimball, 1935). This corresponds with the centre of our field of vision, as discussed before,

and it appears that this anthropometric fact is a decisive factor in spatial design. Research of Pechère (2002) pointed out that 22 degrees is a common used angle to determine appropriate views in landscape design, and Schubert (1965) discovered the sequence of 20, 30, 33 and 42 degrees in urban design with the emphasis on 20 and 30 degrees for important ensembles<sup>8</sup>. View-making involves demarcating, organising and framing of scenes with architectonic objects (e.g. by using buildings, porches and porticos), planting and barriers such as walls, fences and hedges. These barriers are used to direct the gaze by openings in them or screen less ‘picturesque’ elements.

Through the centuries the principles of view-making in relation to movement is a constant factor, while the context of landscape architectonic composition itself varied (Grandell, 1993). Steenbergen and Reh (2003) distinguished three important contexts: *rational*, *formal* and *pictorial*. For example: whereas the French formal garden was based on a single axial view from the house, the English picturesque garden was a series of multiple oblique views that were meant to be experienced while one walked through it. Through the ages “the [landscape architectonic] composition was becoming more cinematic than pictorial; it was designed to be experienced in motion as a series of compositions dissolving into each other rather than as a picture...” (Solnit, 2001). The sequential experience of ‘moving pictures’ also became the basis for film and cinema as beautifully illustrated by the rolled-up panoramic landscapes on translucent paper by Carmontelle, an eighteenth-century French painter and landscape designer (De Brancion, 2008).

Independent of the different contexts, views were carefully planned combining formal, transitional and progressive elements. Views were also often subject to optical illusions making use of depth perception (especially pictorial depth cues) and size constancy. By manipulating the spatial dimensions and layout landscape architects created the illusion of distance (impression of greater depth) as, for instance, brilliantly elaborated at Vaux-le-Vicomte, Melun (France) (Steenbergen and Reh, 2003; Hazlehurst, 1980). Views were not only valued as aesthetically pleasing, but were also equated with ownership and control of one’s domain (O’Malley et al., 2010).

## 5.4 MAPPING VISIBLE FORM WITH GEOGRAPHIC INFORMATION SYSTEMS (GIS)

As discussed before the visible form is the interface between the intention and the perception of the landscape architectonic design. Therefore it is important to acquire object-related and typological design knowledge on the perceptual order of landscape architectonic compositions. This addresses the question of how a design interfaces the conceptual order (physical space)

with the perceptual order (visual space). GISc in relation to the perceptual order considers architectonic compositions as visibility fields and explores those parameters that are observable by a viewer located within space (the horizontal perspective), and those configuration properties that can be discovered by visual experience evoked by optical axes, visibility fields and sequences of visual information (Psarra, 2009; Tzortzi, 2004). It incorporates the related concepts of visual perception with regards to the organisation of visual logic, space-making, composing views and the control of movement.

Tandy suggested already in 1967 the application of isovists or viewsheds (“limit-of-vision plottings” and “visual watersheds” as he called them) in order to “convey the spatial composition from an observers point of view” and “to enable visual analysis of the landscape” (Tandy, 1967). Later, Benedikt connected Gibson’s concept of the ambient optic array to isovists and isovist fields for means of architectonic research (Benedikt, 1979, 1981). For landscape planning, the concept of viewsheds is elaborated by Higuchi and Lynch for means of visual impact analysis (Higuchi, 1975; Lynch, 1976).

Due to advances in computer science the concepts of visibility-analysis are nowadays a widespread phenomena with a broad palette of applications (for examples see other contributions in this book). More particularly, advances in GISc offer researchers in (urban) landscape design interesting clues to engage in the field of visual research. GIS-based concepts of *isovists* (sight field polygons) (see e.g. Rana, 2002; Batty, 2001) and *viewsheds* (see e.g. Llobera, 2003; Fisher 1995) can especially help to comprehend the relation between the conceptual and perceptual space and offer different modes of representation. The typical difference between the two concepts is that the raster-based viewsheds represent parts of space that are visible, taking into account vertical viewing angle and elevation, while vector-based isovists consider visible space in the horizontal plane. The result is a closed polygon that can be characterised with different numerical parameters (Batty, 2001; Turner et al., 2001).

Although both concepts have great potential for landscape architectonic research we only see them sparsely applied in the field of landscape design. However, for means of visual impact analysis and landscape character assessment we see several applications of the GIS-based viewshed in landscape planning (see e.g. chapters 10, 11, 12, 13), and only recently the use of GIS-based isovists (Weitkamp, 2010; see chapter 9).

#### 5.4.1 Research approach towards examples

The aim of this section is to describe, map and analyse the visible form made by spatial patterns composed of open spaces, surfaces, screens and volumes as it could be experienced by

an observer moving through a virtual space, making use of GIS-based isovists and viewsheds. It addresses the physiognomy of space with visibility as a key element. The potential of 'being able to see' is mapped out and addresses plausible and/or probable visible space (Fisher, 1995, 1996; Weitkamp, 2010).

This section explores the use of viewsheds and isovists in landscape design research in order to reveal some important visual concepts by using two examples which are well-documented architectonic objects and offer widely acknowledged designed spatial qualities which have the potential to be tested and verified by means of GIS. It offers an actual (non- or a-historical) and formal reading of the sites. The analysis of visual form reveals the perceived spatial potential as a basis for performance and reception. The *Piazza San Marco* (Venice, Italy), famous for its space relationships and articulation of space, is used as an example for the analysis of a designed space of buildings. Stourhead landscape garden (Wiltshire, UK), famous for its pictorial circuit with composed views in a sequence, is used as an example for the analysis of a designed space mainly of vegetation and relief. The first example focuses on the application of isovists analysing the entrance of the square and the spatio-visual impact of the bell-tower using sequences of viewpoints and a field of viewpoints. The latter is about application of viewsheds for means of analysing composed views and their sequence by using multiple single viewpoints and their sequential/specific organisation.

The examples are based on highly accurate digital and digitised data obtained from field surveys provided respectively by the University of Venice (*Piazza San Marco*) and The National Trust (Stourhead) complemented or corrected by other sources (archival material, historical maps, map reconstructions, etc.) and field observations. For testing the results of the measurements we used text interpretation (expert-judgement), digital three-dimensional models, (aerial) photographs and measurements in the field.

#### **5.4.2 Space relationships and articulation of space: Piazza San Marco, Venice (Italy)**

The *Piazza San Marco* is one of the quintessential parts of Venice and is highly appreciated by inhabitants as well as thousands of tourists. The square is a symbol that represents the city of Venice, its history, politics, religion and social and ethical values. The vicissitudes of the piazza's transformation are slow and far-reaching and have occurred over a long period of time (see e.g. Samonà et al., 1970; Morresi, 1999; Schulz, 1991). The piazza is divided into two parts that form an L-shape: the actual piazza and the *piazzetta* (little square). The L-shape is one of the most challenging designs for a square, and the least liable to succeed. This shape has a distinct disadvantage as each branch, the piazza and the piazzetta, has a hidden counterpart (see figures 6 and 7). Nevertheless, the architectonic composition is very successful and is



Figure 6  
Piazza San Marco

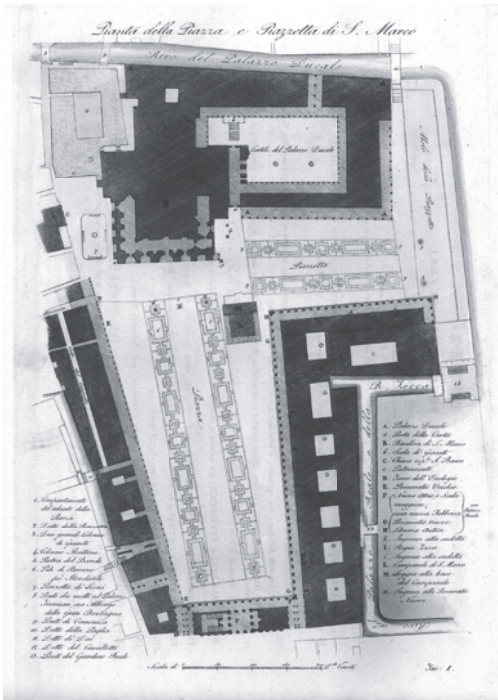


Figure 7  
Plan of the Piazza San Marco. Dionisio Moretti, 1828  
(source: Supernova Edizioni)

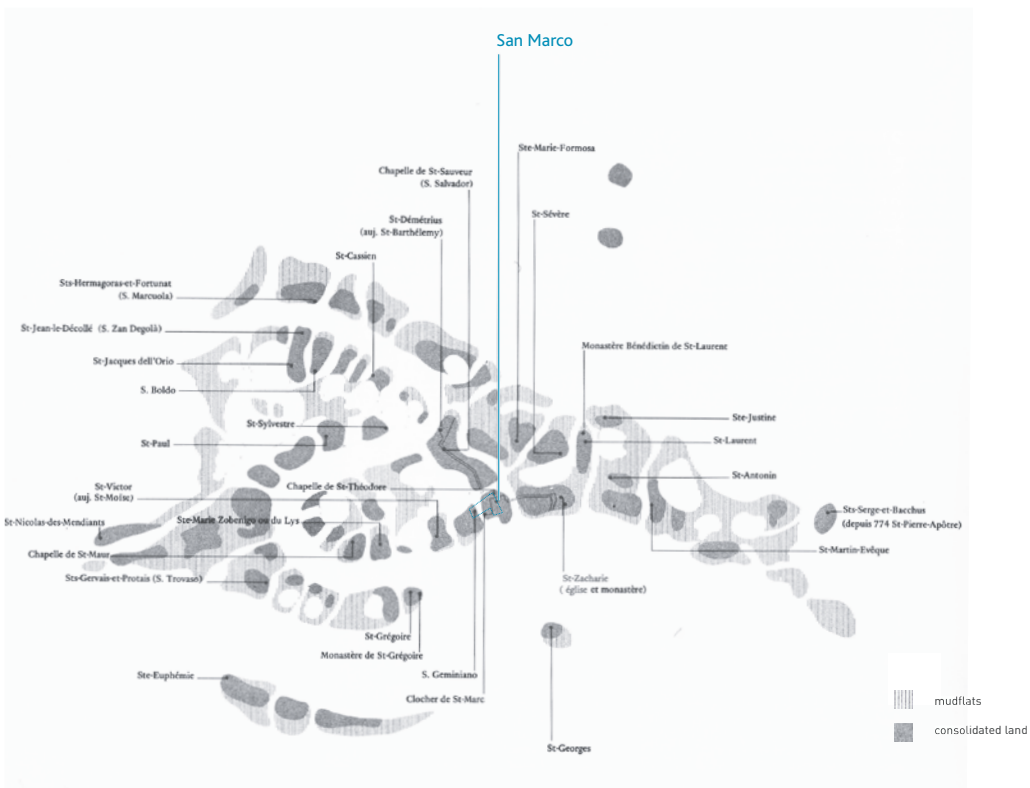


acknowledged for its spatial qualities such as the articulation of space and space relationships (see e.g. Janson and Bürklin, 2002; Newton, 1971; Samonà, 1970). In this example we focus on space relationships and the articulation of space.

### Origins of the square

A group of marsh islands or mudflats (called: *Barena*) in the Venetian Lagoon, formed some 6000 years ago, was a precondition for settlement starting in the 5<sup>th</sup> century. Venice began to emerge as an early archipelago in the 9<sup>th</sup> century (Ammerman, 2003; Crouzet-Pavan, 2002; Bellavitis and Romanelli, 1985). However, the occupation of the islands at San Marco dates from the 7<sup>th</sup> and 8<sup>th</sup> century (Ammerman et al., 1995). The actual *Piazza San Marco* had its beginning in 811, when the ducal seat was moved from Malamocco (Lido) to Venice. With the construction of the ducal palace and then the Basilica of San Marco, the doge's private chapel, the area at the head of the Grand Canal became the hub of political and ceremonial life in the city, and the Venetian Republic (Schulz, 1991; Fenlon, 2009, 2007).

**Figure 8**  
**The location of the Piazza on a map of the 8th and 9th century**  
**Venetian settlements (source: Trincanato and Franzoi, 1971)**



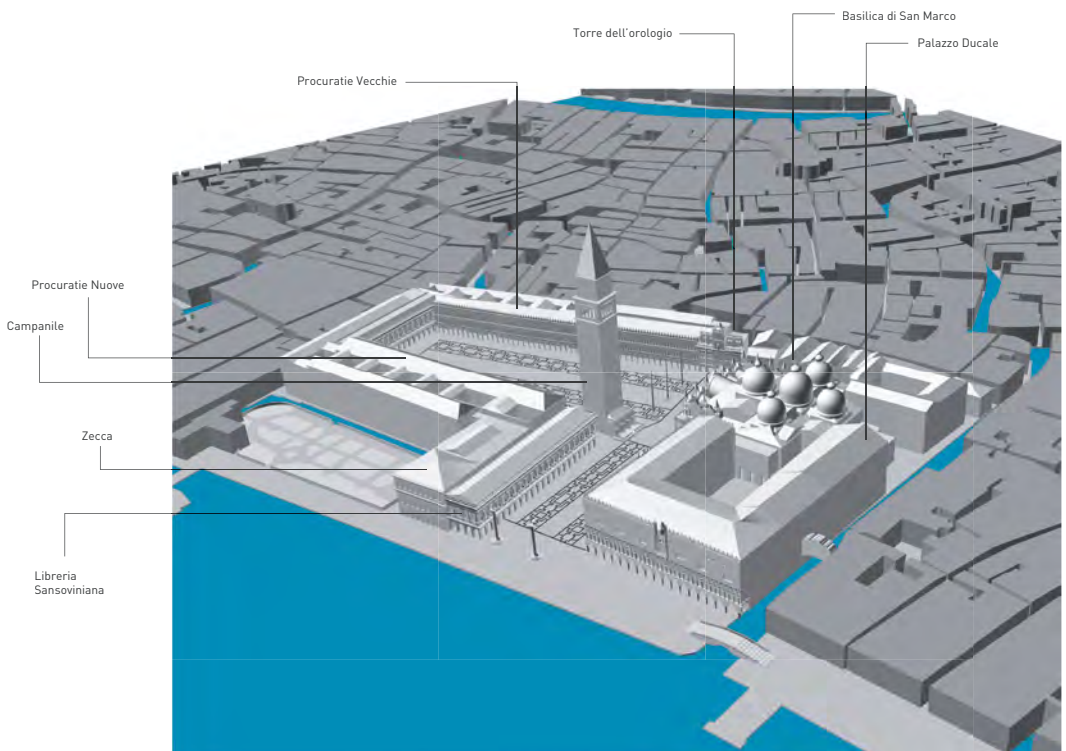
The site consisted originally of two islands, which by land reclamation and architectonic endeavours transformed radically from the 1160s (or 1170s) onwards (Schulz, 1991) (see figure 8). The shape of the square we know now dates from the mid 15<sup>th</sup> century as a result of an ambitious *renovatio urbis* led by the state architect Pietro Bon († 1529), later succeeded by Jacopo Sansovino (1486-1570). It remained the centre of the city-state until the fall of the Venetian Republic to Napoleon in 1797. He called the *Piazza San Marco* “the finest drawing-room in Europe” because of its architectonic qualities (Fenlon, 2009; Goy, 1997).

### Architectonic system of the square

In terms of geometry the piazza is the predominant part of the ensemble, with the *Basilica di San Marco* as the terminal focus of attention. The piazza is a trapezoidal form of 175 metres long and 81 metres wide at the campanile (bell tower), and 56 metres wide in front of the *Palazzo Reale*. The view towards the façade of the basilica is framed by the space defining façades of the *Procuratie Vecchie* and *Procuratie Nuove*, and the foot of the campanile. The whole

Figure 9

Three-dimensional model of the square (by S. Nijhuis and J. Wiers)



façade of the basilica is seen at glance because the determined view covers a visual angle of 20 - 33 degrees (Schubert, 1965), which corresponds with centre of the binocular field of vision. This view is also subject to optical illusions making use of pictorial depth cues, like the diverging lines of the surrounding facades 'slowing down' the optical perspective and shrinking the optical size of the basilica. In the reverse direction the length of the square is exaggerated by the converging lines, 'speeding up' the optical perspective.

The southern branch of the L-shape, the piazzetta, is 96 metres long and its width varies from a minimum of 40 metres (south-end) to a maximum of 48 metres. The piazzetta is formed by the *Palazzo Ducale di Venezia* and the *Libreria Sansoviniana*, which converge slightly at the south-end. Here two freestanding columns frame the sunlit view across the water to *San Giorgio Maggiore* (by Andrea Palladio; 1508-1580), the island church seemingly 'floating on the lagoon'. Also here the organisation and demarcation of the view is based on the field of vision of 20-30 degrees (Schubert, 1965). By pushing the *Libreria* (and *Zecca* (mint)) southward to the lagoon, the building mass gives direction and orientation to space and movement from the *Molo* (water-side) 'pointing' towards the piazzetta and piazza. In the piazzetta, the entrance of the campanile visually points towards the main-entrance of the palazzo.

The campanile acts as pivotal point or hinge on which the two spaces turn; the relatively greater height of the tower, compared to the *Libreria* and *Procuratie Nuove*, undoubtedly enhances its space-turning role (Janson and Bürklin, 2002; Newton, 1971; Von Meiss, 1991). The tower as occluding element gives the piazza and the piazzetta relative autonomy, yet at the same time they announce each other's presence (see figure 10). The position of the bell-tower provides for a constantly change in scenery (shifting of scenery or changing visibility at eye-level), as we will elaborate later. The space turning role of the tower is supplemented by an implicit boundary (by three bronze pedestals), denoting the small space immediately in front of the basilica. This space is shared by the piazza and the piazzetta and interlocks the two squares as a spatial unity. The continuous colonnade optically connects the squares "like broad ribbons of space with a feeling of continuity around the bend" (Newton, 1971).

As it is a square, the experience of visible form is not directed by paths or routes, but by the entrances to the square and the visual effect of the architecture and space relationships. In this respect the landscape architectonic composition affords movement by its openings, offers a sense of direction by its spatial orientation and offers arousal/attraction by its visual composition.

#### **Mapping the perceptual order: entrance and hinge-effect**

As previously discussed, space relationships and visual effect are decisive in the architectonic system of the square. More over, the entrances to the square and the hinge-effect of the campanile are crucial aspects of the visible form. In order to map the visible form of the piazza by

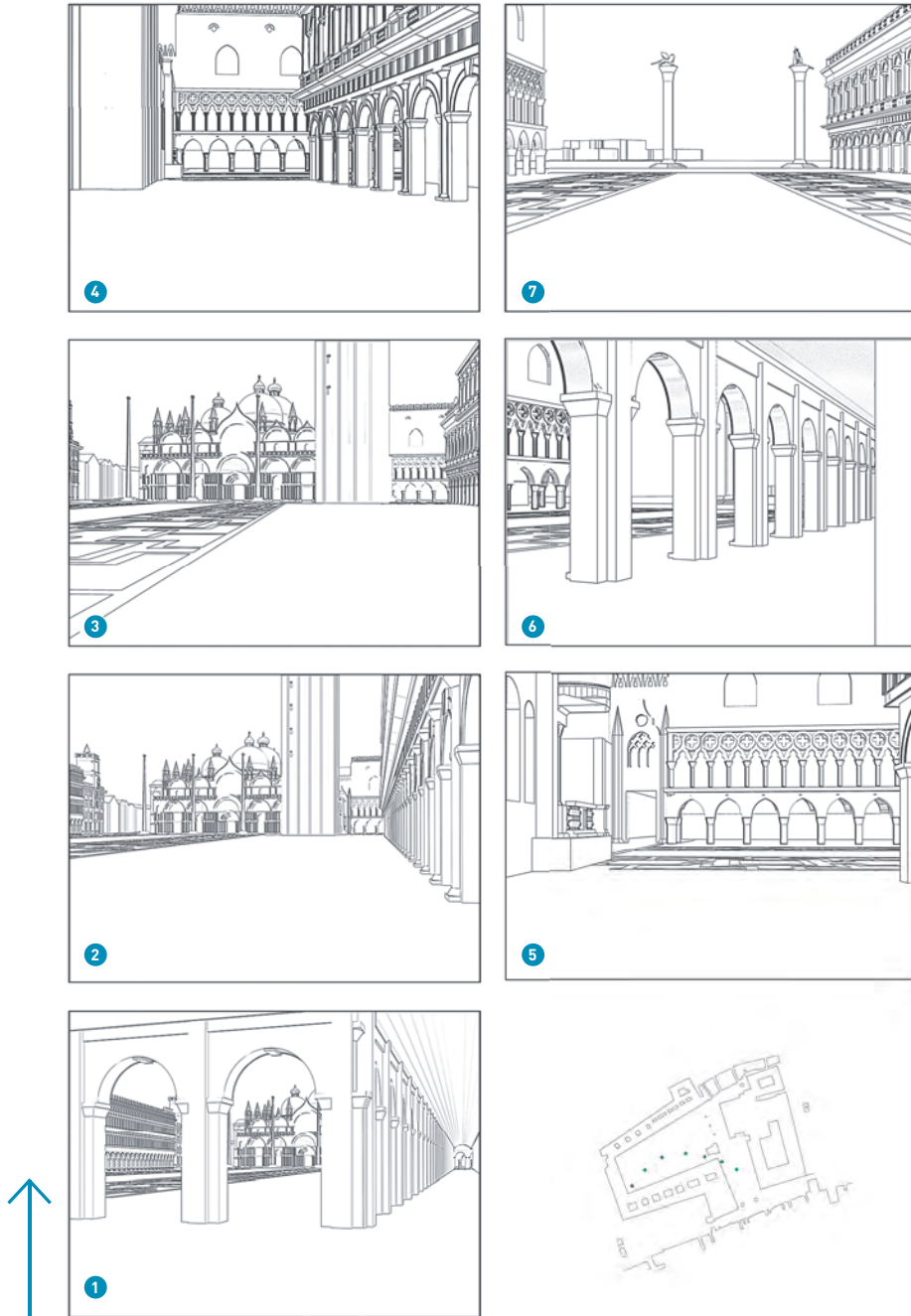


Figure 10

Serial vision from the west-end of the piazza to the south-end of the piazzetta showing the crucial role of the campanile in the changing visibility (degree of shifting scenery) of the spatial transition from the piazza to the piazzetta

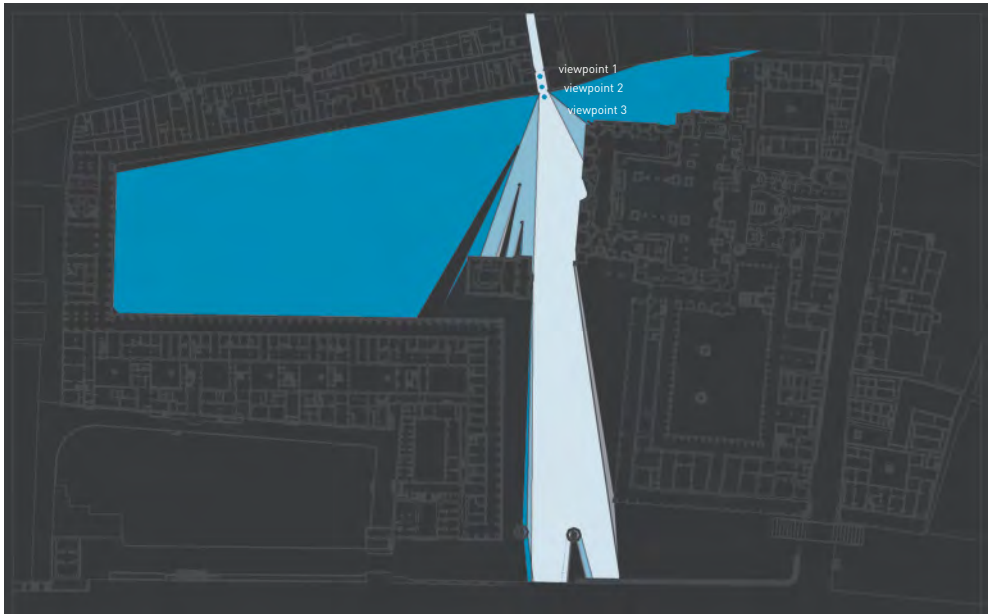


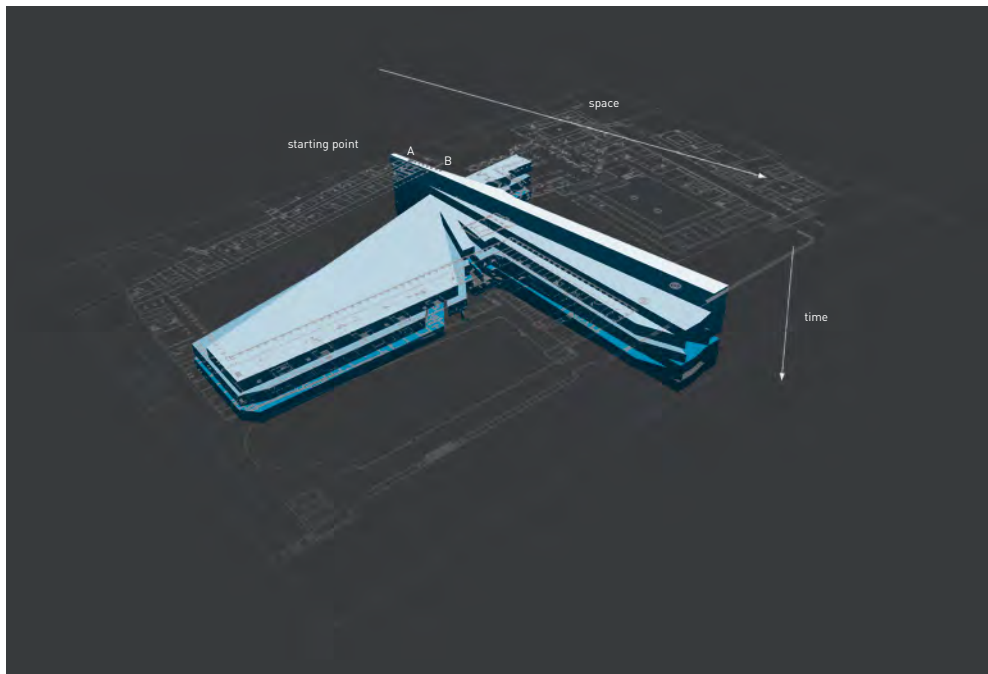
Figure 11  
Sequence of views entering the square at the Torre dell'orologio

means of GIS-based isovists we have built an accurate vector based GIS-model, based on field surveys by the University of Venice (1:100; 1:500) and research by Samonà et al. (1970) and Morresi (1999).

In order to represent and apprehend the visible form of an entrance we analysed the approach to the square from the *Torre dell'orologio* (Clock Tower). This clock tower is one of the most important links between the piazza and the rest of the city. We used GIS-based isovists (at eye-level) in a sequence of viewpoints to map the perceptual order of the entrance. The sequence of isovists shows the framed views into the piazza, across the façade of the Basilica, straight out through the piazzetta, until *San Giorgio Maggiore*. On the opposite side, it provides visual reference, taking the eye past the piazza and on in the direction of Rialto. However, towards the square the optical axis points towards the piazzetta, to gradually open out over the whole piazza. This slow sequence of frontal views can also be represented as a *Minkowski-model* (Benedikt, 1979) showing the relation between visible form and time (movement). The model is a sequential stacking of individual isovists and shows the gradual change of visible space by moving forward entering the square (see figures 11 and 12).

Figure 12

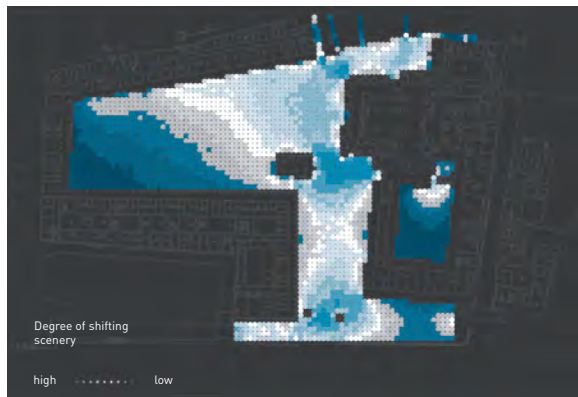
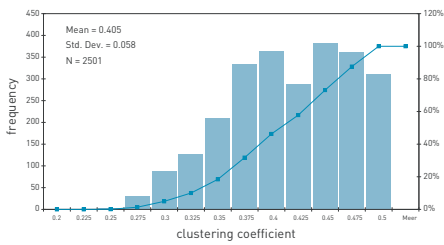
Minkowski-model from Piazza San Marco approached via the Torre dell'orologio. The top layer of the model represents the first isovist at point A; the bottom layer represents the isovist at point B



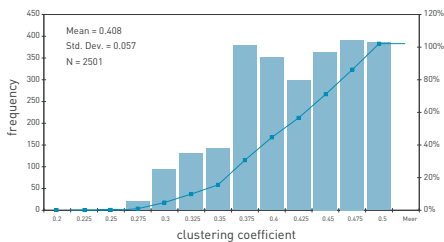
The shape and size of the isovists is liable to change with position and therefore generate specific characteristics. Because of the geometrical nature of these sight field polygons, we can compare the architectonic composition of spaces with measurements and can characterise them mathematically. Numerical measurements can quantify salient size and shape features such as perimeter, area, diameter, radius, circularity, etc. (see e.g. Batty, 2001; Rana, 2002). We can turn these measurements into a set of scalar or isovist fields. These isovist fields provide an overview of the visual properties of the architectonic space analysed. They show syntactical relations between isovists and can generate parameters such as a clustering coefficient, complexity or drift (Turner et al., 2001). But what do these parameters mean in terms of visible form? A short exploration of the clustering coefficient parameter as an example may help to illustrate this.

**Figure 13**

**Degree of shifting scenery with and without the campanile. The bell-tower articulates the visual transition between the two spaces by occlusion offering a wide variation in (inter)visibility and influences both spaces (gradual transition). In the situation without the bell-tower the variation concentrates at the corner (sudden transition)**



**a: Degree of shifting scenery with campanile**



**b: Degree of shifting scenery without campanile**

As we have seen, the campanile plays a crucial role in the composition of the *Piazza San Marco* as a hinge in the architectonic system that connects the two branches of the square. The campanile articulates the connection between piazza and piazzetta as an intermediate member, blocking a direct transition between the two areas of the piazza. As regards the movement of passers-by, this translates into a pause and a change in direction or division of space. This initiates an interesting shift of scenery (changing visibility), which offers spatio-visual attractiveness, arousal and clues for orientation. The shift of scenery can be mapped by using the clustering coefficient parameter in an isovist field at eye level. The clustering coefficient gives a measurement of the proportion of intervisible space within the visibility neighbourhood of a point. It indicates how much of an observer's visual field will be retained or lost as the individual moves away from that point (Turner et al., 2001). In order to show the impact of the campanile, a comparison of the piazza with and without the bell-tower can be seen. The results show that the campanile has a great impact on the variation in visibility, and influences large parts of both squares (see figures 13a, b).

#### 5.4.3 Composed views and their sequence: Stourhead landscape garden, Wiltshire (UK)

##### Introduction

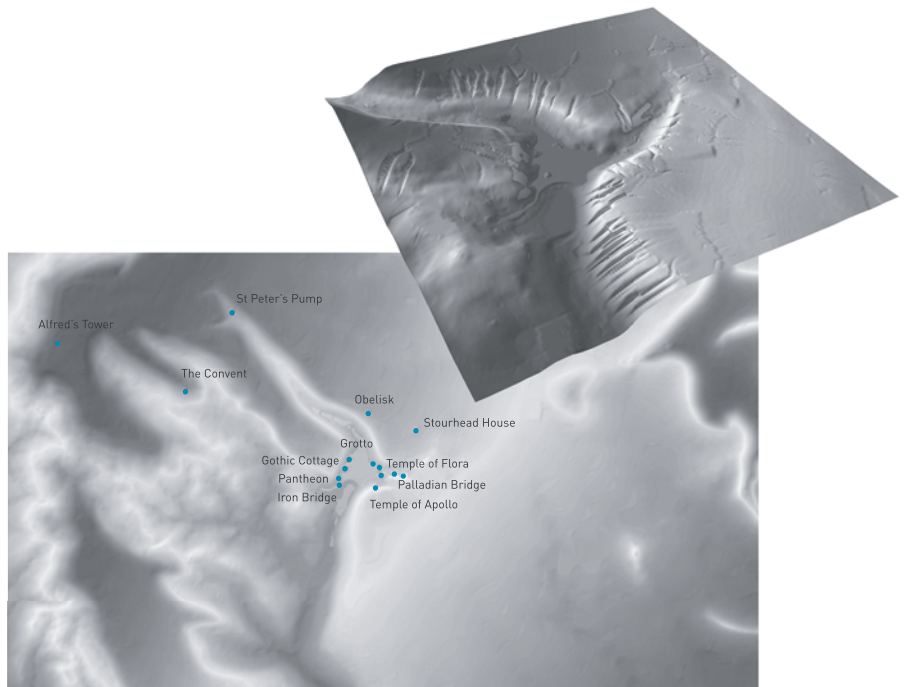
The finest example of a landscape architectonic composition that provides individuals with composed views or 'pictures' is the pictorial circuit of Stourhead landscape garden, especially the valley garden (Moore et al., 2000; Grandell, 1993; Watkin, 1982) (see figure 14 and 15). Here the circular walk is staged as a sequence of views with sightlines directed across a lake, terminating on small buildings placed in a larger valley landscape. Stourhead is thoroughly allegorical in nature: the monuments that terminate sightlines tell the story of Aeneas's founding of Rome. The landscape garden was designed and developed by the owners themselves, unassisted by landscape architects. In this example we analyse the framed views and their sequence.

##### Origins of the landscape garden

Stourhead landscape garden is located at the western edge of the Salisbury Plain (Wessex chalk lands). The plain is bordered by (deep) valleys or combes, where erosion has removed the weakened chalk and exposed the underlying upfolding older rocks as greensands (silty sand and sandstone) and gault clay (heavy non-calcareous clay) (Geddes, 2000). The Stourhead landscape is situated on a greensand ledge below the chalk downs. There are several prominent hills and ridges such as the afforested Greensand Hills of Stourhead and outliers of the chalk downs, sitting atop these greensands (e.g. Beech Knoll). In the lower parts of the ledge, in Six Wells Bottom near the junction with the underlying gault clay, the water table hits the ground surface and several springs emerge that feed the Dorset Stour (Geddes, 2000).

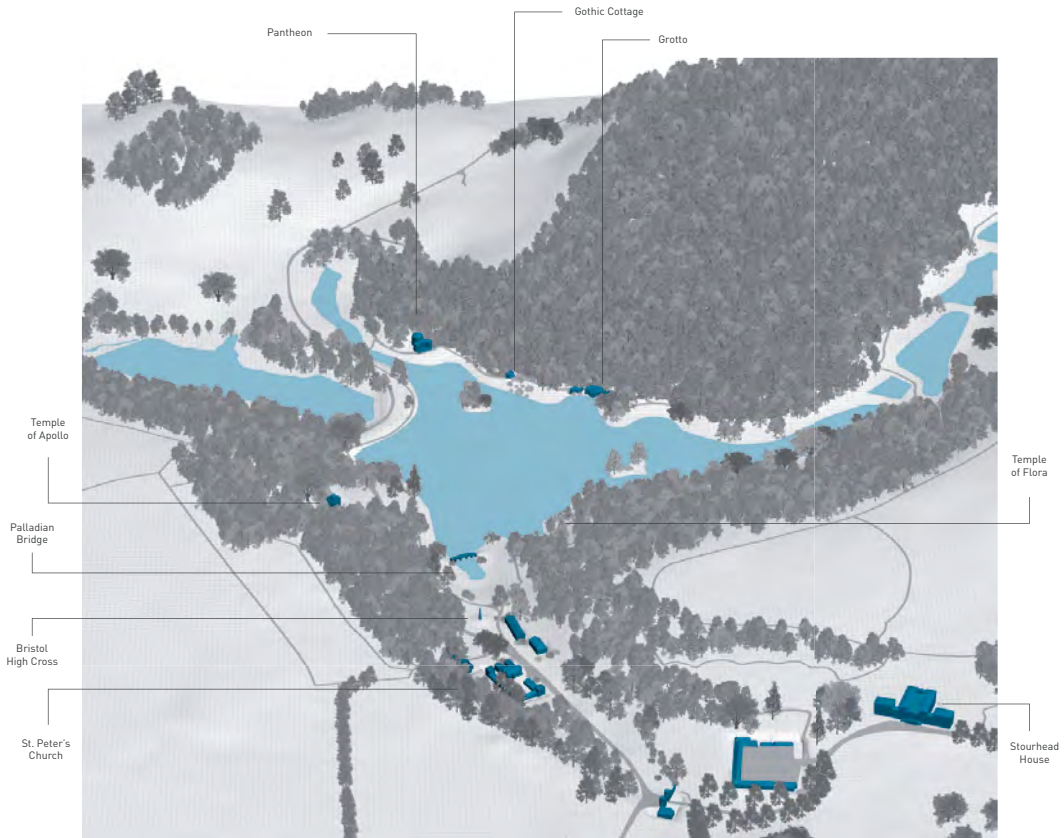






**Figure 16**  
**Stourhead in its**  
**geological context**

After a long history starting around 1350 the grounds came into the possession of the banker Henry Hoare (1677-1724), member of a burgeoning financial elite. In 1718 he built a house in Palladian style named Stourhead (Woodbridge, 1970, 1996). After his death, Henry Hoare II (1705-85) set about designing the Stourhead landscape garden, assisted by Henry Flitcroft (1697-1769). About three hundred metres west from the house, at a place called *Paradise*, the grounds fall steeply to where two valleys converge they created a ‘valley garden’ around a lake in the period from 1743-1770. This lake was made by building a dam across the southwest corner of the valley to contain the headwaters of the Stour, and is held in by the gault clay (Woodbridge, 1970, 1996; Geddes, 2000). Around the lake he built an Arcadian landscape with framed views containing temples and other features in the manner of paintings by Claude Lorrain and Salvator Rosa. As each building or feature was made, it became a goal; a stage in a circuit walk, beginning at the house and ending at the village inn (Woodbridge, 1976). In 1785 Richard Colt Hoare (1758-1838) inherited the estate. He broadened the palette of plant material as an increasing number of exotic species became naturalised in England. He removed some features and changed the path structure considerably (Woodbridge, 1970, 1976, 1996). Stourhead has changed very little since then and in 1946 all but 890 hectares of the estate were bequeathed to the National Trust.



**Figure 17**  
 Three-dimensional model of the valley garden (by S. Nijhuis and J. Wiers)

### Architectonic system of the landscape garden

The valley garden has a double visual structure, with axial views and circuitous, serial views with a lake as the reflecting pool mirroring the scenes. The first is about stationary vision and framed views across the lake, providing scenes with Classical and Gothic emblems dramatically juxtaposed. In fact, these strategic foci are goals, as a stage in a circuit walk and thus initiate movement. The counter-clockwise defined route directs the observer through slow-motion vision and tactile experience (going up and down) through a series of shifting views, offering sequential and gradual discovery of the various features involved. This stroll was allegorical in nature and designed as a series of compositions dissolving into each other, and is called a *pictorial circuit* (Paulson, 1975). The cinematic experience is a reflection of the visual story being told; and the storyline becomes a physical construction, starting originally at Stourhead house and ending in Stourhead's Inn (Woodbridge, 1976).

Henry Hoare probably used the text of Virgil's *Aeneid* as an important iconographic theme of Stourhead (Woodbridge, 1970, 1996). The pictorial circuit can be interpreted as a series of stations evoking Aeneas's journey from Troy to his founding of Rome, an odyssey that for Henry Hoare II might have symbolised his establishment of a family seat at Stourhead (Woodbridge, 1970, 1996). Juxtaposed on these Virgilean scenes, we find medieval, Gothic buildings and monuments, referring to England's past, like Alfred's Tower (Turner, 1979; Kelsall, 1983). This tower marks the site where the legendary king Alfred battled the Danes in 878. He is considered to be a founding father of the British Empire. In this respect the iconographic program evokes the dialogue between Aeneas, representing the founding of the Roman Empire (culminating in the Pantheon), and king Alfred, representing the founding of the British Empire (culminating in King Alfred's Tower). However, there is a lively discussion on the allegorical meaning of iconographic program among historians (see e.g. Paulson, 1975; Turner, 1979; Schulz, 1981; Kelsall, 1983). Whether or not a specific iconographic program was in his mind Hoare surely created a dream world inhabited by the gods, goddesses, and heroes of classical antiquity and England's history. As MacDougall suggested "it is likely that it was a device for creating a memory system<sup>9</sup> rather than a story with a deeper meaning, it was not the place to contemplate the deep philosophical or religious questions" (MacDougall, 1985). However, the attitude is clear: the landscape garden was a place for relaxation and pleasure and asked "to be explored, its surprises and unsuspected corners to be discovered on foot" (Hunt, 1989).

Hunt (2004) elaborates: "Stourhead comes to exist, it seems, in contested claims for meanings that can be shown to have been embedded in the original design by Henry Hoare on the basis of some tendentious reading of the cultural context... [However,] the richness of [the site] lies in [its] ability to provoke and promote a wider sea of emotions, ideas, stories than was ever anticipated by Henry Hoare [and its successors]". Yet, hardly any analysis offers an actual (non- or a-historical) and formal reading of the site. The following analysis of visual form reveals aspects of the tactile and sensorial potential as a basis for the performance and perception of the garden.

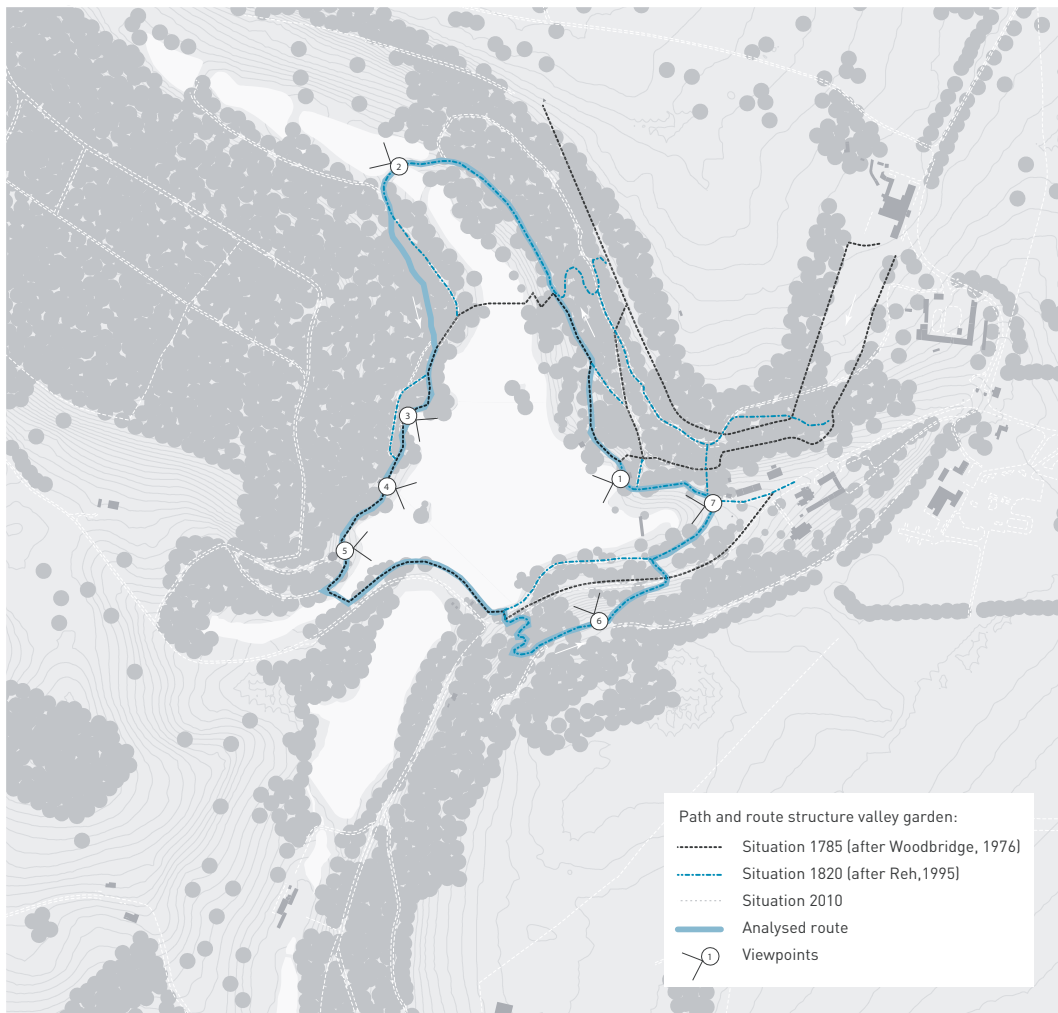
#### **Mapping the perceptual order: framing the view and cinematic route**

As previously discussed, framed views and their sequence (related to a particular route) are decisive in the architectonic system of the valley garden. The focus is on the analysis of the axial views and its formal content from designated viewpoints by means of GIS-based viewsheds. Viewsheds are very suitable because it is a topographic/vegetation space and includes differences in terrain heights with wide implications for visibility. In order to map the actual visible form of the valley garden by means of viewsheds we build an accurate raster based GIS-model, based on recent digital maps (1:2,000; 1:10,000; 1:25,000) provided by The National Trust and the British Ordnance Survey (2010). For the location and nature of the planting we used recent aerial photographs (orthographic), inventories of Woodbridge (1976, 1970, 1996) and a field

visit (2009). Finally, the reconstruction of the route and path-structure is based on research by Woodbridge (1976) and Reh (1995).

To determine the visual logic it is important to consider the original path structure, its changes and the related route, in order to determine the major viewpoints. At Stourhead there are actually three circular walks: the walk around Great Oar Pasture, the walk around the lake (valley garden) and the outer circuit to Alfred's Tower (Reh, 1995). The pictorial circuit around the lake in the valley garden and its related viewpoints is the object of study. In particular we focus

**Figure 18**  
Path structure and related viewpoints in the valley-garden



on the major views related to the 'unchanged' path structure that facilitate the counter-clockwise stroll starting at the Temple of Flora and ending at Bristol High Cross (see figure 18).

The path structure directs the movement through the three-dimensional composition. By following the counter-clockwise circuitous route the visual form becomes cinematic, because of the sequence of staged views. The axial views are framed by extensive use of trees and laurel for under-planting. Henry Hoare II also added planting contrasting masses of light- and dark-toned trees as inspired by Pope and Kent. This palette is later extended by Richard Colt Hoare, with more exotic species (i.e. Rhododendrons), which now dominate the views (Woodbridge, 1976). As a result several composed picture-like views with a foreground, middle ground and background can be seen, reflected by the lake. Occlusion is the most powerful depth-cue involved, exaggerating the perceived distance. But also depth cues like size relative to known objects and height on the picture plane are design principles that play an important role. For example, the Pantheon is a miniaturised version of the Roman original and is located on a terrain elevation, taking the eye for a run.

Focal points within the scene are juxtaposed Classic and Gothic emblems, which function as destinations and thus initiate movement. The slow-motion vision through following the path, offers sequential frontal and/or lateral perception of scenes and gradual discovery of the various features involved. This gradual change offers a sense of scenic intricacy that arouses and sustains curiosity. Upon arrival, the focal points (i.e. the temple) are used for enjoyment and repose for those walking through the valley garden and become viewpoints for other scenes as stages in the circuit walk. By using viewsheds we can analyse the visible area from the viewpoints, measure the (angular) extent of the view and see which objects can be seen within the view (see figures 19, 20 and 21).

The viewshed-analysis points out that the optimum angular extend of the composed views corresponds with the centre of the field of vision in the range of 20-30 degrees binocular view (see table 2). As we have seen within this zone the highest degree of optical acuity is achieved. The analysis suggests that this is the decisive factor for framing the view and (visual) grouping of the focal points in the scene. It is designed 'by eye' as a three-dimensional painting or theatre, rather than using rulers and a compass. This perceptual order is also expressed in the metric length of the lines of sight between the focal points across the lake establishing the axial relationships. The average distance is about 431 metres making sure that that the artefacts and their characteristics can be recognised (see table 2). The maximum distance for recognition of characteristic elements in a landscape is about 500 metres (Van der Ham and Iding, 1971).

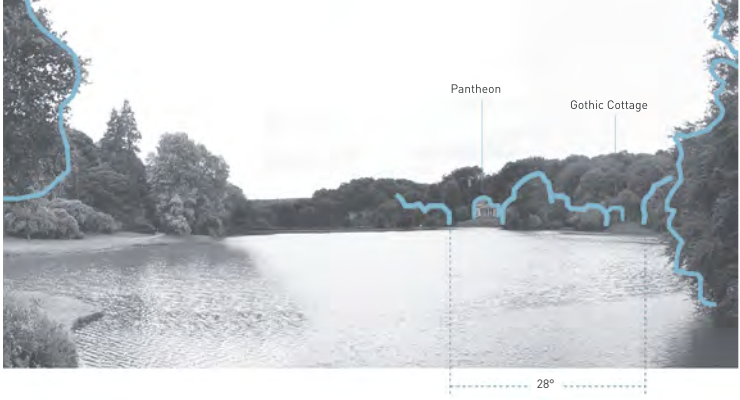
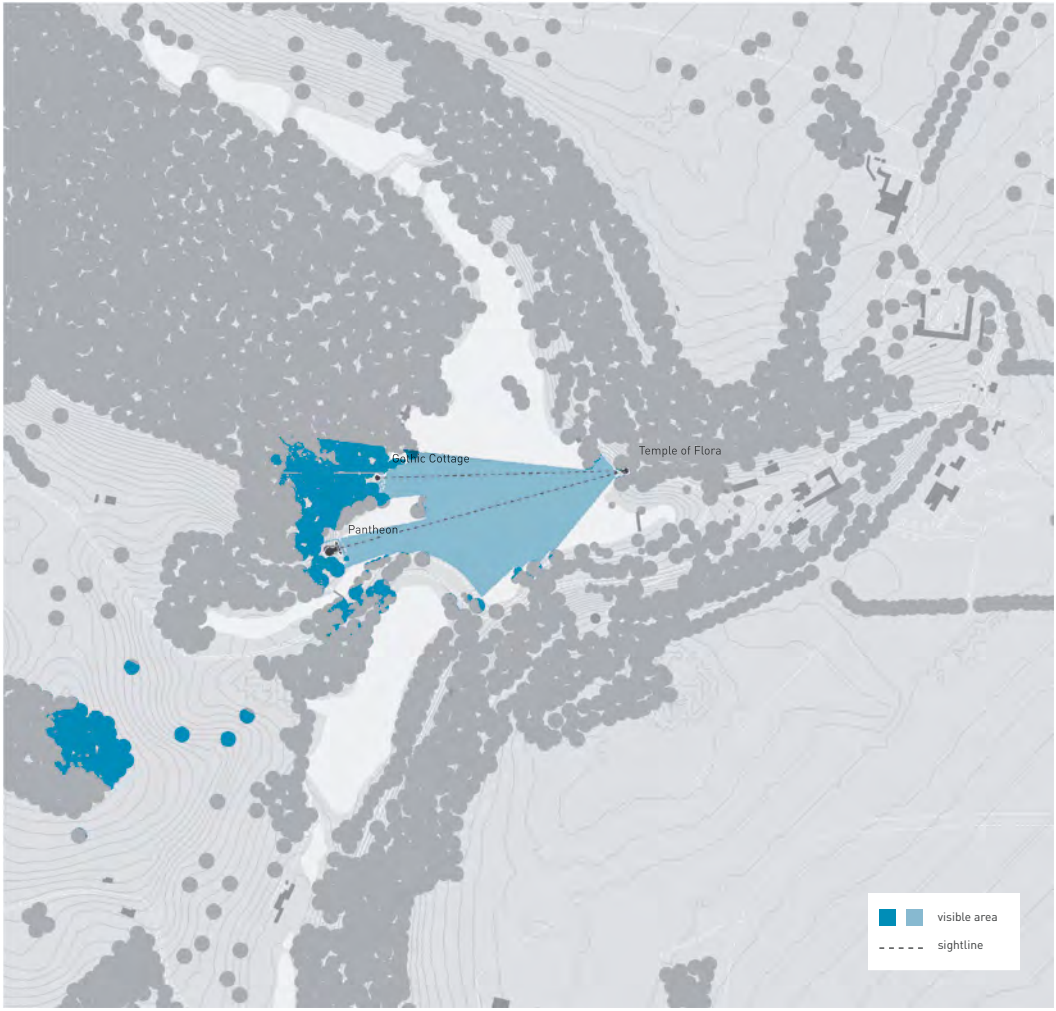
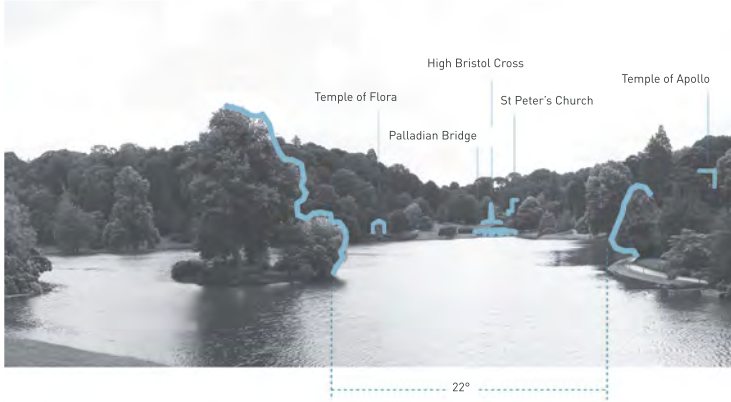
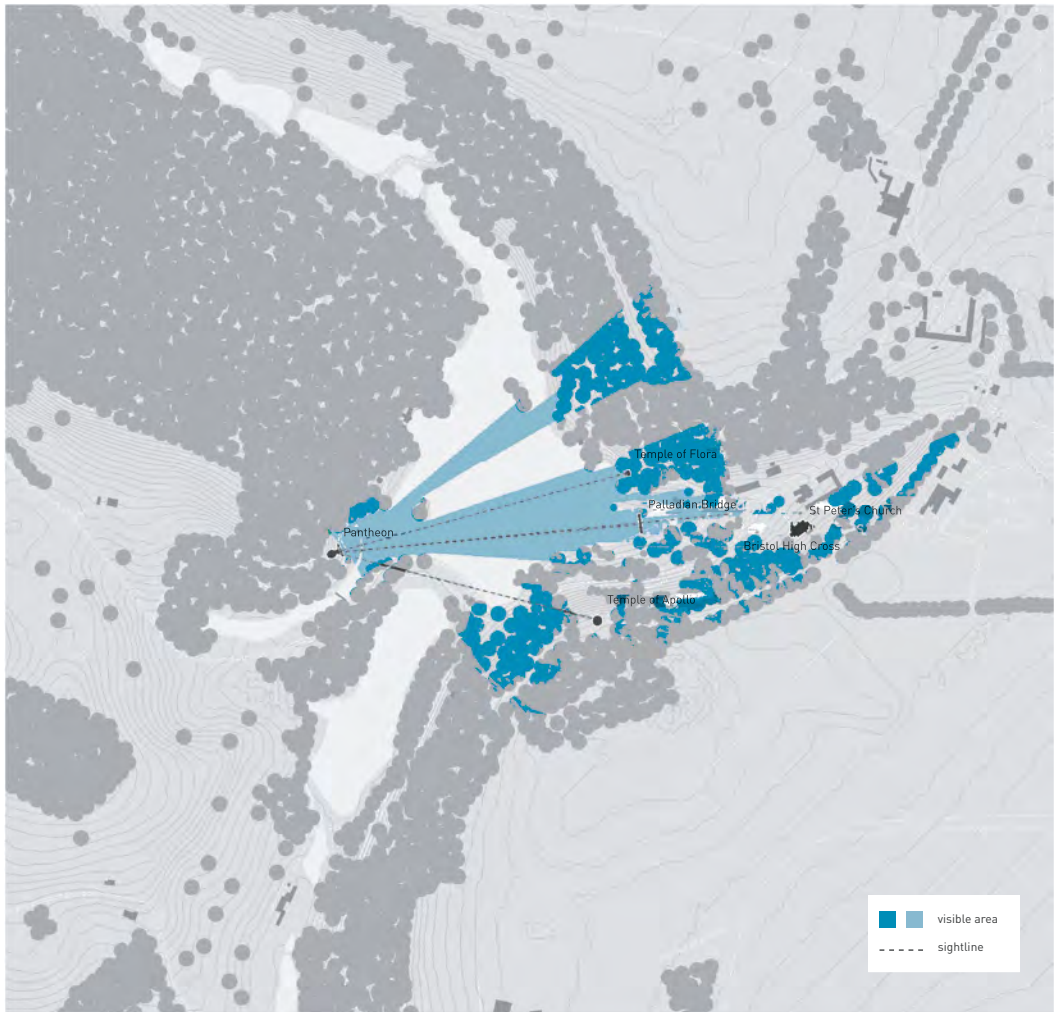


Figure 19  
Viewshed analysis from viewpoint 1  
(Temple of Flora) and corresponding  
view

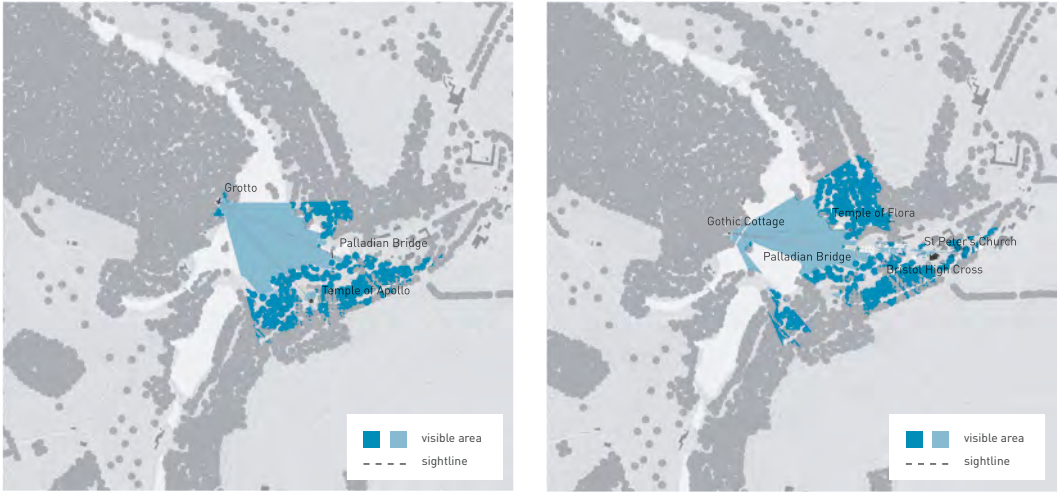




**Figure 20**  
Viewshed analysis from viewpoint 5  
(Pantheon) and corresponding view







**Figure 21**  
Viewshed analysis from viewpoint 3; Grotto (l), and viewpoint 4; Cottage (r)

**Table 2**  
Comparison of the views; extent of the view in angular degrees and metric length of lines of sight. The optimum angular extent is determined by the occluding objects in the middle ground, framing the view that contains the focal points

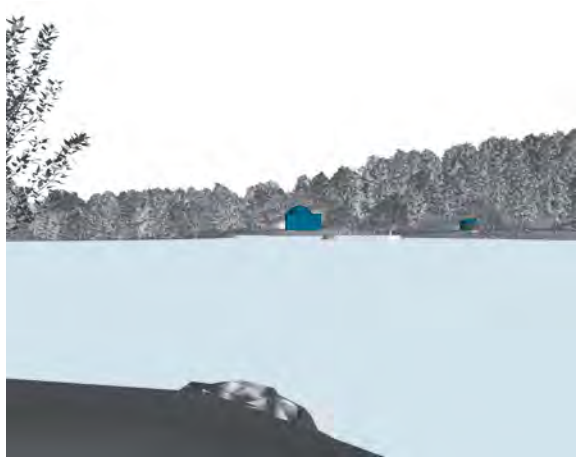
	Viewpoint 1	Viewpoint 2	Viewpoint 3	Viewpoint 4	Viewpoint 5	Viewpoint 6	Viewpoint 7	Mean	Std.dev.
	Temple of Flora	St. Peters Pump	Grotto	Cottage	Pantheon	Temple of Apollo	Bristol High Cross		
maximum angular extend of the view (degrees)	53	-	67	43	62	86	36	57,83	17,97
optimum angular extend of the view (degrees)	28	-	31	28	22	32	24	27,50	3,89
angular extend between foci	14	-	23	12	13 (30*)	60	12	22,33	18,92
maximum distance view-point - focal point (metres)	368	1440**	318	497	494	3120**	478	431,00	82,57
minimum distance viewpoint - focal point (metres)	306	-	343	305	324	320	90	281,33	94,76

measurements based on calculated viewsheds, decimal figures converted to an integer  
\* incl. Temple of Apollo  
\*\* outside the valley garden

With regard to the allegorical nature of the pictorial sequence organised by the circuitous route we can simply start by counting and characterising the elements within the views. Below is an overview of the findings:

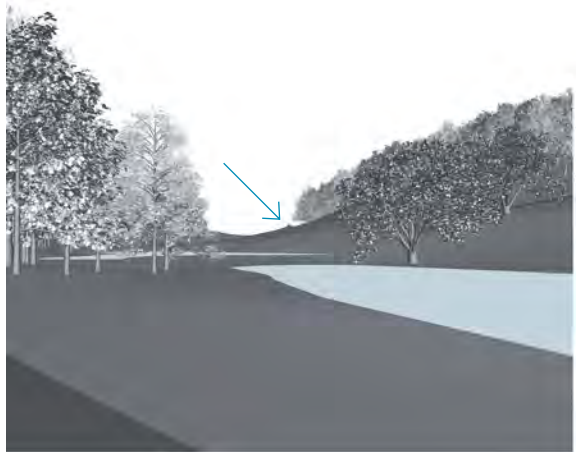
**Viewpoint 1 (Temple of Flora)**

*Focal points within the view:* The Gothic Cottage and The Pantheon (1753-54 by Henry Flitcroft: originally called the Temple of Hercules), a miniaturised version of the Roman temple



**Viewpoint 2 (Saint Peter's Pump)**

*Focal points within the view:* Saint Peter's Pump (erected 1768) in Six Wells Bottom, marking the origin of the Stour



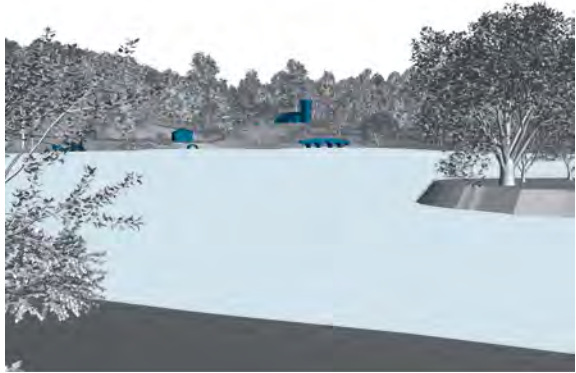
**Viewpoint 3 (Grotto)**

*Focal points within the view:* The Palladian Bridge and The Temple of Apollo (1765 by Henry Flitcroft)



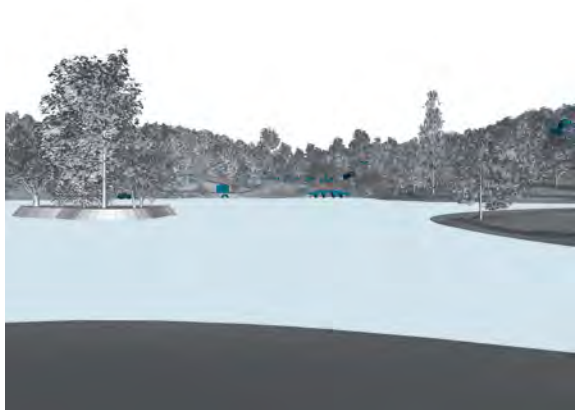
**Viewpoint 4 (Gothic Cottage)**

*Focal points within the view:* The Temple of Flora (1744-46 by Henry Flitcroft; originally called Temple of Ceres), The Palladian Bridge, The Bristol High Cross (derived from High Street of Bristol and erected near the entrance in 1765) and Saint Peter's Church



**Viewpoint 5 (Pantheon)**

*Focal points within the view:* The Temple of Flora, The Palladian Bridge, The Bristol High Cross, Saint Peter's Church and The Temple of Apollo



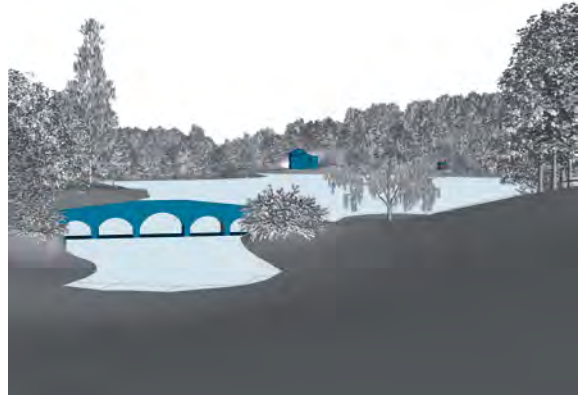
**Viewpoint 6 (Temple of Apollo)**

*Focal points within the view:* The Obelisk (1839-40), Alfred's Tower (1762 by Henry Flitcroft), The Rockwood Boathouse (near Temple of Apollo), The Grotto and The Pantheon. Measurements point out that Alfred's tower was visible only with young, low trees on the Greensand Hills. As the trees matured and grew taller the tower became hidden from view.



#### **Viewpoint 7 (Bristol High Cross)**

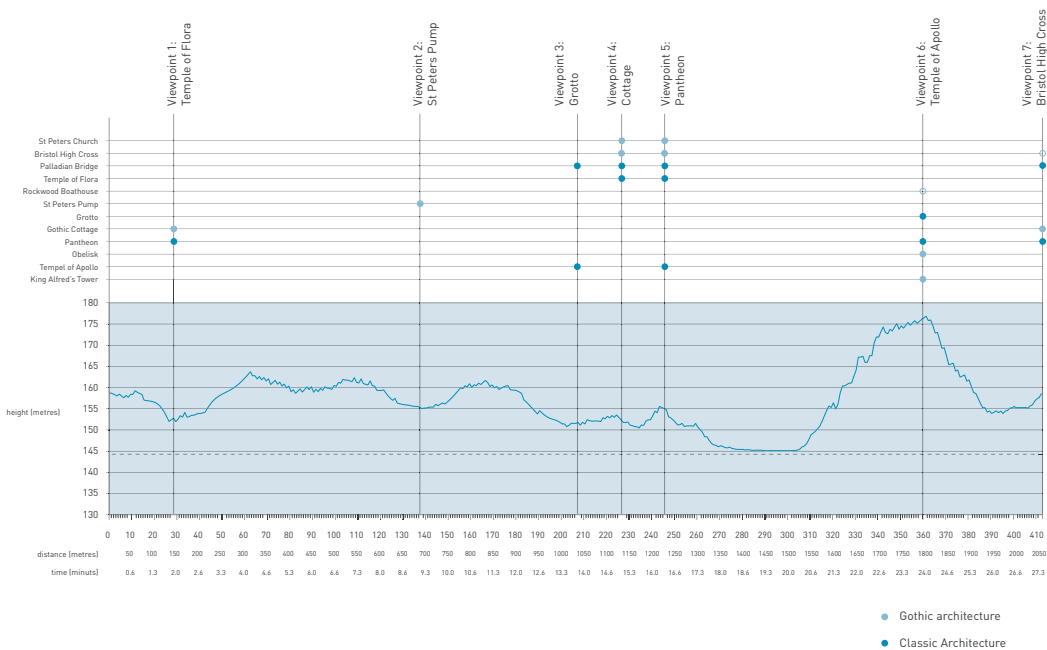
*Focal points within the view:* The Palladian Bridge, The Cottage and The Pantheon



The analysis show that almost every view contains juxtaposed Classical and Gothic architecture suggesting an allegorical dialogue between historical events, especially due to the fact that there is a balanced amount of artefacts within the view counting an even number of emblems. In other words, every Classical element is counterbalanced by a Gothic iconographic object. It also interesting to consider the relation of the viewpoints and the course of the path. In a horizontal direction there is a certain timing, with varying intervals, between the major views. In vertical direction the relation is in going upward and downward e.g. descending to the Grotto, ascending to the Pantheon and the steep climb to the Temple of Apollo (see figure 22). Whether this tactile experience and the related staging of views reflects a story with a deeper meaning, or is a kind of memory system facilitating pleasure and relaxation, it is a rich site which promotes and provokes a wide range of emotions, ideas and stories.

#### **5.4.4 Conclusions**

Mapping the visible form by means of GIS revealed particularities of the perceived architectonic space and included visual concepts as described in section 5.3. The example of *Piazza San Marco* showcases that it enables measurement of space relationships with isovists and isovist fields, such as the sequential unfolding of visual space at the entrance of the square and the hinge-effect of the bell-tower introducing a high degree of shifting scenery. At Stourhead landscape garden the analysis of the angular extent, the visual coverage of (composed) framed views and counting focal points by means of viewshed analysis, especially their angular extent in relation to the physiology of vision and the balanced amount of emblematic focal points within these views, gives an interesting result. It enabled the measurement of their sequential



**Figure 22**  
**The stroll at Stourhead explored. The sequence of the views in relation to distance, time and height of the path**

relationship in time based on slow-motion vision by walking, taking into account tactile properties such as differences in heights along the course of the path.

## 5.5 DISCUSSION

By the conversation with actual (and conceived) sites and the representations of their visible form researchers in landscape architecture acquire deeper understanding as a basis for knowledge-based design. By mapping the physiognomy of the composition, as it is encountered by an individual within it, moving through it, it is possible to acquire object related and typological design knowledge on visual aspects. GIS turned out to be a useful vehicle for systematic and transparent mapping of the visible form. The examples showcase that GIS-based isovists and viewsheds have the potential of measuring visual phenomena which are often subject of intuitive and experimental design, taking into account physiological, psychological, and anthropometric aspects of space. It offers the possibility to combine general scientific knowledge of visual perception and wayfinding with the examination of site-specific design applications.

In comparison to important landscape design research studies on visible form in the Dutch academic context, such as the seminal works of Steenbergen and Reh (2003), Baljon (1992), Warnau (1979) and Bijhouwer (1954), it seems that GIS deepens and broadens the body of knowledge in landscape architecture in two ways by:

- (1) *Following the discipline and developing specific aspects of it*: by using GIS we can map the ‘same types of design-knowledge’ but in a more precise, systematic/transparent, and quantified manner. It makes for precise delineation and alternative ways of representation of the visible landscape. By using GIS it is possible to reproduce and transfer methodology; it is a transparent and systematic approach for advanced spatial analysis. It also comprises of measurement (quantities), testing and verification of expert knowledge, or known visual phenomena in landscape architecture.
- (2) *Expanding the field by setting in motion fundamental new developments*: by using GIS we can map ‘new types of design-knowledge’ by advanced spatial analysis and the possibility of linking up/integrating other information layers, fields of science and data sources. GIS offers the possibility of integrating and exploring other fields of science (e.g. visual perception, wayfinding studies) and dealing with complexity (more variables). Also the availability of other types of data such as Web 2.0, terrestrial LiDAR, LBS, and Crowd Sourcing is important in this respect. This offers the possibility to enrich formal reading by revealing tactile and sensorial potentialities of a design, which was hardly possible before, and also expands the analysis with data derived from psychological and phenomenological approaches addressing matters of reception of a design.

Although there is lot left to be explored in examples, this research exemplified that it can offer clues for deeper understanding of particular spatial phenomena that constitute visible form. This is important for acquisition of design knowledge, but is also crucial in management and restoration of sites like Stourhead <sup>10</sup>.

## ACKNOWLEDGEMENTS

I like to thank professor Marc Antrop, Ron van Lammeren and Mari Sundli Tveit for their valuable comments and enthusiastic support. I also like to thank professor Clemens Steenbergen for his remarks on an early version of the manuscript and professor Erik de Jong for the inspiring conversations we had on the topic. Furthermore I like to thank The National Trust for their generous support providing digital maps and other information of Stourhead landscape garden. The digitised plan of the *Piazza San Marco* is used by courtesy of the University IUAV of Venice.

I am grateful to my father Jan Nijhuis for his enthusiasm and encouragement in my research. He unfortunately passed away while I was writing this chapter.

## NOTES

- [1] For an elaboration on scientific perspective and the influence it exerted on architecture see Pérez-Gómez and Pelletier (1997).
- [2] The term landscape architecture (*architecte-paysagiste*) was coined by Jean-Marie Morel in 1803 and marked the eclipse of the 'new' discipline (Disponzio, 2002). Landscape architecture as an English term appeared for the first time in a book title: On the Landscape Architecture of the Great Painters of Italy (Scott, 1828), and was subsequently used by Frederic Law Olmstead and Calvert Vaux at the design competition for the Central Park in New York in 1858. The profession became official, when in 1863 the title Landscape Architect was first used by the state-appointed Board of Central Park Commissioners in New York City (Steiner, 2001; Evert, 2010; Turner, 1990).
- [3] This corresponds with space-conceptions as described by Montello (1993), Mark (1993) and Tversky et al. (1999).
- [4] You can even consider it a science: *strolology* or *promenadology* as proposed by Burckhardt (2008). It engages in the study of sequences with which the observer is confronted by within the spatial environment.
- [5] Wayfinding refers to the cognitive and behavioural abilities of humans to find a way from an origin to a destination, see Golledge (1999).
- [6] This is not exclusively restricted to The Picturesque as a movement. In this tradition Picturesque is an aesthetic category derived from the idea of designing (urban) landscapes to look like pictures and was advocated by landscape architects like William Kent and urban designers like Camillo Sitte and Gordon Cullen.
- [7] The invention/description of the linear perspective by Filippo Brunelleschi as written down by Leon Battista Alberti played a crucial role in the architectonic compositions such as Pienza (see e.g. Pieper, 2000, 2009). The notion of pictorial staging or scenography was introduced by Hans Vredeman de Vries in his book *Sevenographia, sive perspectiveae* (1560), showing décor-like architectonic settings, using the rules of linear perspective to fit objects logically into surrounding space (Vroom, 2006; Mehrtens, 1990).
- [8] See also Van der Ven (1980) and Doxiades (1972).
- [9] Memory could be developed by establishing a mental image of a place inhabited by or 'decorated' with views. See MacDougall (1985) on this matter.
- [10] The author intends to elaborate the research on Stourhead and show applications for management and conservation.

## REFERENCES

- Allen, G.L. (1999) Spatial Abilities, Cognitive Maps and Wayfinding. In: Golledge, R.G. (ed.) *Wayfinding Behaviour. Cognitive mapping and other spatial processes*. Baltimore and London, The Johns Hopkins University Press, pp 46-80
- Ammerman, A.J. (2003) Venice before the Grand Canal. *Memoirs of the American Academy in Rome* 48; 141-158
- Ammerman, A.J. et al. (1995) More on the origins of Venice. *Antiquity* 69; 501-510
- Andre, E. (1879) *L'art des Jardins. Traite general de la composition des parcs et jardins*. Paris, G. Masson.
- Antrop, M. (2007) *Perspectieven op het landschap. Achtergronden om landschappen te lezen en te begrijpen*. Gent, Academia Press.
- Appleyard, D. (1970) Styles and Methods of Structuring a City. *Environment & Behavior* 2(1); 100-116
- Arnheim, R. (1977) *The dynamics of architectonic form*. Berkeley, University of California Press.
- Bacon, E.N. (1967) *Design of Cities*. New York, Penguin Books.
- Baljon, L. (1992) *Designing Parks*. Amsterdam, A&NP.
- Batty, M. (2001) Exploring Isovist Fields. Space and Shape in Architectonic and Urban Morphology. *Environment and planning B: Planning and Design* 28; 123-150
- Bell, S. (1993) *Elements of Visual Design in the Landscape*. London, E&FN Spon.
- Bell, S. (1999) *Landscape. Pattern, Perception and Process*. London, E&FN Spon.
- Bellavitis, G., and Romanelli, G. (1985) *Le città nella storia d' Italia. Venezia*. Roma-Bari, Editori Laterza.
- Benedikt, M.L. (1979) To take Hold of Space: Isovists and Isovist Fields. *Environment and Planning B* 6; 47-65
- Benedikt, M.L. and Burnham, C.A. (1981) Perceiving Architectural Space: From Optic Arrays to Isovists. In: Warren, W.H., Shaw, R.E. and Hillsdale, N. J. (eds.) *Persistence and Change*. Connecticut, Lawrence Erlbaum, pp 103-114
- Bijhouwer, J.T.P. (1954) *Waarnemen en ontwerpen in tuin en landschap*. Amsterdam, Uitgeverij Argus.
- Blake, R., and Sekuler, R. (2006) *Perception*. New York, McGraw-Hill.
- Bosselman, P. (1998) *Representation of Places. Reality and Realism in City Design*. Berkeley, Los Angeles & London, University of California Press.
- Burckhardt, L. (2008) *Warum ist Landschaft schon? Die Spaziergangswissenschaft*. Berlin, Martin Schmitz Verlag
- Careri, F. (2002) *Walkscapes. Walking as an Aesthetic Practice*. Barcelona, Editorial Gustavo Gili.

- Crouzet-Pavan, E. (2002) *Venice Triumphant. The Horizon of a Myth*. Baltimore & London, Johns Hopkins University Press.
- Conan, M. ed. (2003) *Landscape Design and the Experience of Motion*. Washington, Dumbarton Oaks Trustees for Harvard University (Dumbarton Oaks Colloquium on the History of Landscape Architecture Vol. XXIV)
- De Brancion, L.C. (2008) *Carmontelle's Landscape Transparencies: Cinema of the Enlightenment*. Los Angeles, Getty Publications.
- De Jong, E.A. (2007) Taking Fresh Air: Walking in Holland, 1600-1750. In: Conan, M. (ed.) *Performance and Appropriation. Profane Rituals in Gardens and Landscapes*. Washington D.C., Dumbarton Oaks Research Library and Collection, (Dumbarton Oaks Colloquium on the History of Landscape Architecture Vol. XXVII), pp 18-40
- De Jong, T., and Van der Voordt, T. (2002) Criteria for scientific study and design. In: de Jong, T. and van der Voordt, T. (eds.) *Ways to Study and Research*. Delft University Press, pp 19-30
- Dee, C. (2001) *Form and fabric in landscape architecture*. London, Routledge.
- Disponzio, J. (2002) Jean-Marie Morel and the Invention of Landscape Architecture. In: Hunt, J.D., Conan, M., and Goldstein, C. (eds.) *Tradition and Innovation in French Garden Art. Chapters of a New History*. Philadelphia, University of Pennsylvania Press, pp 135-159
- Doxiadis, C.A. (1972) *Architectural Space in Ancient Greece*. Cambridge, Massachusetts, The MIT Press.
- Evert, K.J., Ballard, E.B., Oquinena, I., Schmerber, J.M. and Stipe, R.E., eds. (2010) *Encyclopedic Dictionary of Landscape and Urban Planning. Multilingual Reference Book in English, Spanish, French, and German (2 vols.)*. Berlin, Heidelberg, New York, Springer Verlag.
- Fenlon, I. (2007) *The Ceremonial City. History, Memory and Myth in Renaissance Venice*. New Haven & London, Yale University Press.
- Fenlon, I. (2009) *The Piazza San Marco*. Cambridge, Massachusetts, Harvard University Press.
- Fischer, P.F. (1995) An Exploration of Probable Viewsheds in Landscape Planning. *Environment and Planning B: Planning and design* 22; 527-546
- Fisher, P. F. (1996) Extending the Applicability of Viewsheds in Landscape Planning. *Programmetric Engineering and Remote Sensing* 62(11): 1297-1302
- Frankl, P. (1968) *Principles of architectural history. The four phases of architectural style (1420-1900)*. The MIT press, Cambridge, Massachusetts and London.
- Gibson, J.J. (1986) *The Ecological Approach to Visual Perception*. London, Lawrence Erlbaum Associates (Original edition 1979).
- Geddes, I. (2000) *Hidden Depths. Wiltshire's Geology & Landscapes*. Bradford on Avon, Ex Libris Press.
- Golledge, R.G. and Spector, A.N. (1978) Comprehending the Urban Environment: Theory and Practice. *Geographical Analysis* 10(4); 403-426
- Golledge, R.G. (1999) Human Cognitive Maps and Wayfinding. In: Golledge, R.G. (ed.) *Wayfinding Behaviour. Cognitive mapping and other spatial processes*. Baltimore & London, The Johns Hopkins University Press, pp 1-45
- Goy, R. (1997) *Venice. The City and its Architecture*. New York, Phaidon Press.
- Grandell, G. (1993) *Nature Pictorialized*. Baltimore & London, The Johns Hopkins University Press.
- Haken, H. and Portugali, J. (2003) The face of the city is its information. *Journal of Environmental Psychology* 23; 385-408
- Hazlehurst, F.H. (1980) *Gardens of Illusion. The Genius of André Le Nostre*. Nashville, Vanderbilt University Press.
- Higuchi, T. (1975) *The Visual and Spatial Structure of Landscapes*. Cambridge, The MIT Press.
- Hillier, B., Penn, A., Hanson, J., Grajewski, T. and Xu, J. (1993) Natural Movement: or, Configuration and Attraction in Urban Pedestrian Movement. *Environment and Planning B: Planning and Design* 20; 29-66
- Hubbard, H.V., and Kimball, T. (1935) *An Introduction to the Study of Landscape Design*. New York, The Macmillan Company (revised edition).
- Hunt, J.D. (1989) *The Figure in the Landscape: Poetry, Painting, and Gardening during the Eighteenth Century*. Baltimore & London, The Johns Hopkins University Press.
- Hunt, J.D. (2003) "Lordship of the Feet": Toward a Poetics of Movement in the Garden. In: Conan, M. (ed.) *Landscape Design and the Experience of Motion*. Washington, Dumbarton Oaks Trustees for Harvard University, pp 187-213
- Hunt, J.D. (2004) *The Afterlife of Gardens*. London, Reaktion Books.
- Hoogstad, J. (1990) *Ruimte-tijd-beweging. Prolegomena voor de architectuur*. Den Haag, SDU Uitgevers.
- Janson, A., and Bürklin, T. (2002) *Scenes. Interaction with Architectural Space: the Campi of Venice*. Basel, etc., Birkhäuser.
- Kaplan, R., and Kaplan, S. (1989) *The Experience of Nature. A Psychological Perspective*. Cambridge, Cambridge University Press.
- Kelsall, M. (1983) The Iconography of Stourhead. *Journal of the Warburg and Courtauld Institutes* 46; 133-147
- Klaasen, I.T. (2004) *Knowledge-based design. Developing urban and regional design into a science*. Amsterdam, DUP
- König, G.M. (1996) *Eine Kulturgeschichte des Spazierganges. Spuren einer bürgerlichen Praktik, 1780-1850*. Wien, Böhlau Verlag.
- Korthals Altes, H.J. and Steffen, C. (1988) *Beleving en routekeuze in de binnenstad van Delft*. Delft, Delft University Press.
- Llobera, M. (2003) Extending GIS-based visual analysis: the concept of visualsapes. *International Journal for Geographical Information Science* 17(1); 25-48
- Lynch, K. (1960) *The Image of the City*. Cambridge, MIT Press.
- Lynch, K. (1976) *Managing the Sense of a Region*. Cambridge, MIT Press.



- Mark, D.M. (1993) Human Spatial Cognition. In: Medyckyj-Scott, D., and Hearnshaw, H.M. (eds.), *Human Factors in Geographical Information Systems*. London and Florida, Belhaven Press, pp 51-60
- MacDougall, E.B. (1985) Imitation and Invention: Language and decoration in Roman Renaissance Gardens. *Journal of Garden History* 5(2); 119-134
- Mehrtens, U.M. (1990) Johan Vredeman de Vries and the Hortorum Formae. In: Mosser, M, and Teyssot, G. (eds.) *The History of Garden Design. The Western Tradition from the Renaissance to the Present Day*. London, Thames & Hudson, pp 103-105
- Montello, D.R. (1993) Scale and Multiple Psychologies of Space. In: Frank, A.U. and Campari, I. (Eds.) *Spatial Information theory: A theoretical basis for GIS*. Berlin, Springer-Verlag (Lecture Notes in Computer Science 716), pp 312-321
- Marot, D. (1995) Landscape as Alternative. In: van der Marliere, K. (ed.) *Het Landschap/The Landscape*. Antwerpen, De Singel, pp 9-36
- Mooij, J. (1981) *Idee en verbeelding. Filosofische aspecten van de literatuurbeschouwing*. Assen.
- Moore, C.W., Mitchell, W.J., and Turnbull jr., W. (2000) *The Poetics of Gardens*. Cambridge, Massachusetts, The MIT Press.
- Morresi, M. (1999) *Piazza San Marco. Istituzioni, Poteri e Architettura a Venezia nel primo Cinquecento*. Milano, Electa.
- Motloch, J.L. (2001) *Introduction to Landscape Design*. Second edition. New York, etc., John Wiley & Sons.
- Newton, N.T. (1971) *Design on the Land. The Development of Landscape Architecture*. Cambridge, Massachusetts, Harvard University Press.
- Nijhuis, S. (2006) Westvaart als landschapsarchitectonische ontwerpogave. Vier ontwerpen nader beschouwd. In: *Westvaart in de polder*. Leiden, RAP Architectuurcentrum, pp 35-37
- Nijhuis, S. (2010) *Landscape Architecture: Theory, methods and techniques*. Delft University of Technology (internal report)
- Olwig, K. (2002) *Landscape, nature and the body-politic. From Britain's Renaissance to America's new world*. Wisconsin, The University of Wisconsin Press.
- O'Malley, T., Kryder-Reid, E., and Helmreich, A.L. (2010) *Keywords in American Landscape Design*. Washington / New Haven and London, Centre for Advanced Study in the Visual Arts, National Gallery of Art / Yale University Press.
- Panero, J. and Zelnik, M. (1979) *Human Dimension & Interior Space*. New York, Whitney Library of Design.
- Paulson, R. (1979) *Emblem and Expression. Meaning in English Art of the Eighteenth Century*. Cambridge, Mass.
- Pérez-Gómez, A., and Pelletier, L. (1997) *Architectural Representation and the Perspective Hinge*. Cambridge, Massachusetts & London, The MIT Press.
- Pechère, R. (2002) *Grammaire des Jardins. Secrets de métier*. Bruxelles, Éditions Racine.
- Pregill, P., and Volkman, N. (1999) *Landscapes in History. Design and Planning in the Eastern and Western Traditions* (Second Edition). New York, etc., John Wiley & Sons Inc.
- Prominski, M. (2004) *Landschaft Entwerfen*. Sl, Reimer Verlag
- Psarra, S. (2009) *Architecture and narrative. The formation of space and cultural space*. Abingdon and New York, Routledge.
- Rana, S. (2002) *Isovist Analyst Extension*. Version 1.1. Computer software program produced by the author at the Centre for Advanced Spatial Analysis, University College London.
- Reh, W. (1995) *Arcadia en metropolis. Het landschapsexperiment van de verlichting*. Delft University of Technology.
- Repton (1803) *The Theory and Practice of Landscape Gardening*. Reprinted in: Repton, H. (1907), *The Art of Landscape Gardening. Including his Sketches and Hints on Landscape Gardening and Theory and Practice of Landscape Gardening*. Edited by J. Nolen. Cambridge, Massachusetts, The Riverside Press (Houghton Mifflin Company).
- Rogers, E.B. (2001) *Landscape Design. A Cultural and Architectural History*. New York, Harry N. Abrams.
- Potteiger, M. (1998) *Landscape Narratives. Design Practices for Telling Stories*. New York, etc., Wiley & Sons Inc.
- Salingaros, N.A. (2005) *Principles of Urban Structure*. Amsterdam, Techne Press.
- Samonà, G. (1970) Caratteri morfologici del sistema architettonico di Piazza San Marco. In: Samonà, G. et al. *Piazza San Marco. L'architettura la storia le funzioni*. Padova, Marsilio Editori, pp. 9-42.
- Samonà, G. et al. (1970) *Piazza San Marco. L'architettura la storia le funzioni*. Padova, Marsilio Editori.
- Schubert, O. (1965) *Optik in Architektur und Städtebau*. Verlag Gebr. Mann, Berlin.
- Schulz, M.F. (1981) The Circuit Walk of the Eighteenth-Century Landscape Garden and the Pilgrim's Circuitous Progress. *Eighteenth-Century Studies* 15(1); 1-25
- Schulz, J. (1991) Urbanism in Medieval Venice. In: Molho, A. Raaflaub, K. and Emlen, J. (eds.) *City-States in Classical Antiquity and Medieval Italy. Athens, Rome, Florence and Venice*. Stuttgart, Franz Steiner Verlag, pp 419-445
- Simonds, J.O. (1997) *Landscape Architecture*. New York etc., McGraw-Hill
- Snowden, R., Thompson, P. and Troscianko, T. (2006) *Basic Vision. An introduction to visual perception*. Oxford, Oxford University Press.
- Solnit, R. (2001) *Wanderlust. A History of Walking*. Verso, London & New York.
- Steenbergen, C.M., Meeks, S., and Nijhuis, S. (2008) *Composing Landscapes. Analysis, Typology and Experiments for Design*. Birkhäuser, Basel, Boston, Berlin.
- Steenbergen, C.M., Muhl, H., and Reh, W. (2002) Introduction; Design Research, Research by Design. In: Steenbergen, C.M., Muhl, H., Reh, W. et al. (eds.) *Architectural design and composition*. Bussum, Thoth publishers, pp 12-25

- Steenbergen, C.M., and Reh, W. (2003) Architecture and landscape. The Design Experiment of the Great European Gardens and Landscapes. Revised and expanded edition. Basel, Boston, Berlin, Birkhäuser.
- Steenbergen, C.M., Reh, W., Nijhuis, S., and Pouderoijen, M.T. (2009) *The Polder Atlas of the Netherlands*. Pantheon of the Low Lands. Bussum, THOTH publishers.
- Steiner, F.R. (2001) Landscape Architecture. In: Smelser, N.J. and P.B. Baltes (eds.) *International Encyclopaedia of the Social and Behavioural Sciences*, pp 8270-8275
- Stiles, R. (1994a) In Search of a Definition. *Landscape Design* 234; 44-48
- Stiles, R. (1994b) Landscape theory: a missing link between landscape planning and landscape design? *Landscape and urban planning* 30; 139-149
- Tandy, C.R. (1967) The Isovist Method of Landscape Survey, In: Murray, C.R. (ed.) *Methods of Landscape Analysis*. London, Landscape Research Group, pp 9-10
- Thiel, P. (1961) A sequence-experience notation. *Town Planning Review* 32 (1); 33-52
- Trincanato, E., and Franzoi, U. (1971) *Venise au fil du temps. Atlas historique d'urbanisme et d'architecture*. Paris, Editions Joel Cuenot.
- Turner, J. (1979) The Structure of Henry Hoare's Stourhead. *Art Bulletin* 61(1); 68-77
- Turner, T. (1990) Was "Landscape Architecture" a Good Idea? *Landscape Design* 191; 28-29
- Turner, A., Doxa, M., O'Sullivan, D. and Penn, A. (2001) From isovists to visibility graphs: a methodology for the analysis of architectural space. *Environment and Planning B: Planning and design* 28; 103-121
- Thompson, I.H. (1999) *Ecology, Community and Delight. Sources of Values in Landscape Architecture*. New York, Routledge.
- Thompson, I.H. (2002) Ecology, community and delight: a trivalent approach to landscape education. *Landscape and urban planning* 60; 81-93
- Tversky, B., Morrison, J.B., Franklin, N., and Bryant, D.J. (1999) Three spaces of Spatial Cognition. *Professional Geographer* 51(4); 516-524
- Tzortzi, K. (2004) Building and exhibition layout. Sainsbury Wing compared with Castelvecchio. *Architectural Research Quarterly* 8(2); 128-140
- Van der Ham, R.J.M., and Iding, J.A. (1971) *De landschapstypologie naar visuele kenmerken. Methodiek en gebruik*. Wageningen, Department of Landscape Architecture, Wageningen University.
- Van der Ven, C. (1980) Van beeld tot maat I/II. *Intermediar* 16(17,18), 13-21/43-52
- Von Meiss, P. (1991) *Elements of Architecture*. London, E & FN Spon.
- Vroom, M. (2006) *Lexicon of garden and landscape architecture*. Basel, Boston, Berlin, Birkhäuser
- Ware, C. (2004) *Information Visualization. Perception for design*. Burlington, Morgan Kaufmann Publishers.
- Ware, C. (2008) *Visual Thinking for Design*. Burlington, Morgan Kaufmann Publishers.
- Warnau, H. (1979) *Rapport over de parken Sonsbeek, Zijpendaal en Gulden Bodem in Arnhem. Beschrijving, waardering, mogelijke veranderingen*. Wageningen, Vakgroep Landschapsarchitectuur, Landbouwhogeschool Wageningen
- Watkin, D. (1982) *The English Vision. The Picturesque in Architecture, Landscape & Garden Design*. London, John Murray Publishers.
- Weitkamp, G. (2010) *Capturing the View. A GIS Based Procedure to Assess Perceived Landscape Openness*. Wageningen, Wageningen University.
- Woodbridge, K. (1970) *Landscape and Antiquity. Aspects of English Culture at Stourhead 1718-1838*. Oxford.
- Woodbridge, K. (1976) The Planting of Ornamental Shrubs at Stourhead. A History, 1746-1946. *Garden History* 4(1); 88-109
- Woodbridge, K. (1996) *The Stourhead Landscape*. The National Trust (Reprint edition 2002)
- Yarbus, A.L. (1967) *Eye Movement and Vision*. New York, Plenum Press.

6

# MAPPING LANDSCAPE ATTRACTIVENESS

## A GIS-BASED LANDSCAPE APPRECIATION MODEL FOR THE DUTCH COUNTRYSIDE

### 6.1 INTRODUCTION

Offering people scenic beauty is one of the most frequently mentioned landscape services. In the Netherlands it also has become an explicit policy goal: “we want a beautiful country to live and work in” (LNV, 2000: 3). However, instruments to help policy makers and spatial planners to implement this relatively new goal are largely lacking. Where do people like the landscape in their living environment and where do they not? And which physical characteristics influence this appreciation and to what extent? To provide such information in a cost-efficient way, a model was developed to map, monitor, and simulate precisely this: the GIS-based Landscape Appreciation Model (GLAM). The model predicts the attractiveness of the landscape based solely on nationally available GIS-data on its physical aspects for each 250 x 250 metre cell. In this article, we describe the theoretical background to GLAM, the attributes in the current version of the model, the final steps in calibrating the model, as well as its validation. We conclude with a discussion on the usefulness of GLAM for spatial policy.

### 6.2 THEORETICAL BACKGROUND

Ever since the 1970s, the attractiveness of landscapes has been an issue in landscape and environmental management. It was one of the driving forces behind the emergence of environmen-

tal psychology as a discipline. In the mean time a vast amount of research has been conducted in explaining or describing environmental preferences of both experts and lay people (for an overview, see Aoki, 1999). Different theories have emerged, ranging from strongly evolutionary to more cultural explanations of environmental preferences. A dominant paradigm since the 1980's has been the cognitive view of landscape perception. It focuses on subjective, psychological categories. Most notably is the theory of Kaplan and Kaplan (1989), with its emphasis on mystery, complexity, legibility and prospect. Many studies have focused on the link between these psychological categories and landscape attributes, but this has proven to be rather difficult (Strumse, 1994).

Another paradigm, the psychophysical one, has been present in environmental psychology from the start. Within this paradigm, preferences for and attractiveness of a specific landscape are supposed to be based in its physical attributes. Although it does not deny the importance of exploring the psychological mechanism behind these relationships, its focus is very much on the physical landscape. It is therefore particularly suited for modelling landscape preferences using geographic data of the physical landscape (see for other examples e.g. Bishop and Hulse, 1994; Real et al., 2000). From the psychophysical as well as from the cognitive paradigm, a large array of attributes has been evaluated since the 1980's (Ulrich, 1983; Zube, 1987; Kaplan and Kaplan, 1989; Purcell and Lamb, 1998; Strumse, 1994; Aoki, 1999). It is from this body of knowledge that we derived attributes for the GLAM model to predict landscape preferences in the Netherlands.

The initial GLAM model consisted of three positive indicators: *Naturalness*, *Relief*, *Historical Distinctiveness*, and three negative indicators: *Skyline Disturbance*, *Urbanity* and *Noise Level*. The choice of these indicators was the result of the mentioned literature and previous research results of a prototype version of GLAM (Vries and Gerritsen, 2003). One of the changes resulting from this previous research is that 'Variety', an attribute that is prominently present in the literature (see e.g. Hunziker and Kienast, 1999), was dropped because of its high correlation with *Naturalness* in the Dutch situation. The non-visual attribute *Noise Level* was included in the attribute set of our model because studies in the Netherlands (Goossen et al., 2001) proved noisiness, especially from traffic, to be a very important factor for the appreciation of the landscape. Moreover, noise level may also be considered as a proxy for visual fragmentation and disturbance of an area by (rail)roads.

### 6.3 OPERATIONALISING THE GLAM

The GLAM model has been built in a dedicated modelling environment, named *Osiris* (Verweij, 2004) that supports the building and running of qualitative spatial models. *Osiris* enables the

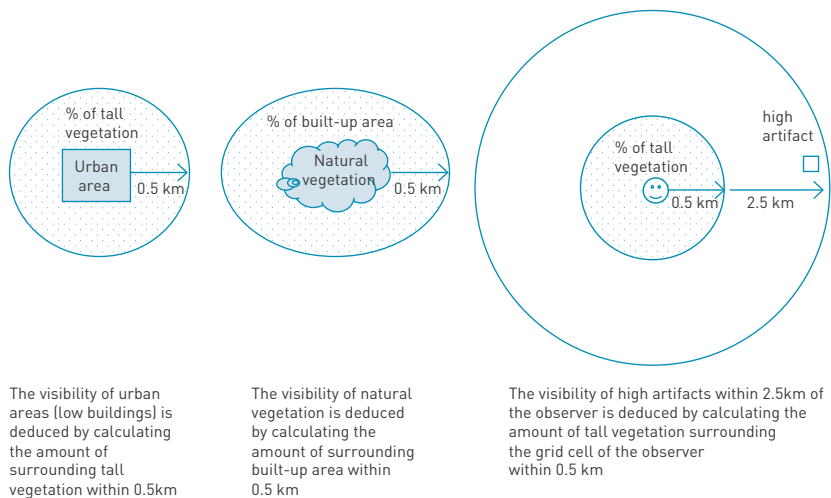
user to store qualitative expert knowledge in tables with which new grid maps are generated from two or three existing grid maps. It also enables the user to store and run map algebra scripts. It uses ArcView version 3.3 for the viewing of grid data and executing the grid algebra scripts.

### 6.3.1 Input data and computations

The most important dataset we use, is the digital topographic map 1:10,000 of the Netherlands, containing polygons representing e.g. forests, housing blocks, high-rise buildings (higher than 35 metre or 10 storeys), glass houses and water bodies, point elements such as power pylons and wind turbines, and lines of trees and ditches. Nevertheless, on pragmatic grounds we use grid maps with a resolution of 250 x 250 metre. Grid map computations are faster than vector-based computations, and indicator maps in grid format are easier to combine into one 'landscape attractiveness' map (without causing sliver polygons or inconsistencies in results due to differences in polygon boundaries). The grid cell size of 250 x 250 metre is generally viewed as a convenient size for national studies in the Netherlands.

Since in open landscapes larger areas are visible than the grid cell itself, we used neighbourhood operations to take a wider environment into account and to deduce the visibility of characteristics. Although specific algorithms exist to compute visibility in an accurate way, these tend to be very time consuming. We decided to use focal mean operations to compute to what extent urban areas were surrounded by vertical vegetation, and areas of natural vegetation were surrounded by buildings (see figure 1). For the high-rise artefacts of Skyline Disturbance we computed the openness of the surroundings of the observer, and not of the surroundings of the artefacts themselves. Such artefacts are usually higher than the surrounding trees and buildings, and are thus visible from a large distance if the observer has a clear view.

In open landscapes with clear weather, visibility of buildings and glass houses can be as far as 5 kilometres and for high artefacts like wind turbines even more than 10 kilometres. However, validation results (comparing maps with different neighbourhood distances with preference ratings by respondents) and field surveys suggested both that a distance of 2 to 3 kilometres is appropriate for Skyline Disturbance for high artefacts, and 0.5 kilometres for urban areas. For the indicator Historical Distinctiveness we used neighbourhood operations to merge grid cells containing monuments and nearby grid cells into larger areas that we considered to be of a more historical nature than areas further away from historical monuments. This neighbourhood operation was not only based on visibility considerations, but also on the assumption that the area surrounding a historical feature is more likely to have historical qualities itself.



**Figure 1**  
Neighbourhood operations used for the indicators Naturalness, Urbanity and Skyline Disturbance

### 6.3.2 Preference levels per GIS-indicator

Given the broad definition of most physical characteristics, encompassing different elements, defining indicator levels was not simply a matter of counting the incidence of relevant elements. It had to be decided which (combinations of) elements were preferred or disliked to a similar degree and thus could be combined in one level. So, a given level of an indicator does not indicate mere presence, but an evaluation of this presence in terms of its expected contribution to landscape attractiveness. Originally these operational decisions were made based on a literature review, insights gained from previous studies (Coeterier, 1996; Goossen and Langers, 2000; de Boer et al., 1999) and interviews conducted during the project. However, GLAM also has a strong empirical basis. It was developed in interaction with the results of a national survey in landscape appreciation among almost 3000 Dutch residents (de Vries and van Kralingen, 2002), which will be described in more detail later on.

Each of the six indicators has five levels, ranging from 0 (no or very small presence of appropriate physical characteristics) to 4 (strong visible presence of appropriate physical characteristics). For the positive indicators 0 means 'least preferred', and 4 'most preferred', for the negative indicators, 4 means 'least preferred'. The five levels per indicator should be interpreted as a semi-interval scale. The computation method per indicator is briefly described below, beginning with for the three positive ones. In table 1 a description of the levels per indicator is given.

The score for Naturalness depends on the amount and type of vegetation, the presence of natural water and the amount of built-up area within 500 metres. The amount of natural vegetation forms the basis. However, if there is less than 5% nature (e.g. heath, dunes, swamp, forest) but over 50% of grassland, the grid cell scores a point extra; grid cells with less than 50% natural vegetation also score an extra point if they contain a shoreline of natural waters (rivers, brooks, pools, lakes, sea). Big water bodies themselves are left out of the maps: the model is restricted to landscapes on land. On the other hand, if there is a lot of built-up area and few trees within 500 metres, the grid cell loses 1 point. The resulting score remains within the 0 - 4 range.

The score for Relief depends on the presence of the most valued type of relief in the grid cell: the more variety in altitude, the higher the score. For this indicator we used the Dutch geomorphology map, indicating different landforms, which we classified from flat areas to large hills.

For Historical Distinctiveness, the score depends on the presence or vicinity of nationally protected historical (clusters of) buildings or sites.

The score for Urbanity depends on the amount of built-up area within the cell, within 500 metres from that cell, and the area of trees within 500 metres (because of visibility). Glass house areas score less (because they are semi-transparent and generally lower than solid buildings) and (clusters of) office buildings more (these are considered to score the most negative). The calculation is quite complex. A grid cell scores e.g. 0 for urbanity if it contains less than 1% built-up area or less than 10% glass houses. But a grid cell also scores 0 if it contains 1-5% buildings, on the condition that the average built-up area within 500 metres is less than 1%. A grid cell also scores 0 if it contains 5-10% buildings but these are less visible because the average area of trees within 500 metres is more than 50%. At the other extreme, a grid cell scores 4 for urbanity if it contains more than 20% buildings and has less than 10% of trees within 500 metres. A grid cell also scores 4 if it contains only 1-5% buildings but the average built-up area within 500 metres is larger than 10% (these are densely built-up areas) and visibility is not reduced by trees. However, the city centres themselves are left out of the map: the model is restricted to the appreciation of the countryside.

For Skyline Disturbance the score of the focal cell depends on the type of visible man-made artefacts within a 1 kilometre to 2.5 kilometre radius; from the most to the least disturbing these are: high-rise, power pylons, wind turbines. Their visibility depends on the amount of nearby vertical vegetation from the focal cell (observer's position). We realise that these artefacts are not always negative: they can form important landmarks that make the landscape readable and help to orientate oneself, which most often receives a positive appreciation. We also realise that high buildings, for example, may be appreciated because of architectural quality. But no



**Table 1**  
**Map legends for the six GIS indicators**

<b>Indicator</b>	<b>Legend of indicator map</b>
<b>Naturalness</b>	0 < 0.1% nature and < 50% grassland and no natural water
	1 0.1-5% nature, or nature < 0.1% and > 50% grassland or natural water
	2 5-10% nature and < 50% grassland, or 0.1-5% nature and > 50% grassland or water
	3 10-50% nature or 5-10% nature and water
	4 > 50% nature (e.g. heath, dunes, swamps, forests) or 10-50% nature and natural water
	If there is a lot of built-up area visible within 500m, grid cells scoring >1 loose 1 point.
<b>Relief</b>	0 flat areas, man-made relief
	1 nearly flat, old man-made mounds (for housing)
	2 sloping
	3 hilly (or dunes)
	4 larger hills
<b>Historical Distinctiveness</b>	0 > 1 km from grid cells with nationally protected historical (clusters of) buildings or sites
	1 < 1 km from grid cells with nationally protected historical (clusters of) buildings or sites
	2 next to grid cells with single historical buildings / sites or within 500 m of a cluster
	3 next to grid cells with clusters of historical buildings
	4 grid cell containing nationally protected historical (clusters of) buildings or sites
<b>Urbanity (negative)</b>	0 1-5% in grid cell and average <1% in surrounding 500m or <1% built-up area visible in grid cell and average 1-5% in surrounding 500m
	1 1-5% visible built-up area in grid cell and average 1-5% in surrounding 500 m or <1% visible in grid cell and average >5% in surrounding 500m.
	2 5-10% built-up area visible in grid cell and <5% in surrounding 500m, or 1-5% visible in grid cell and average >5% in surrounding 500m
	3 10-20% built-up area visible within grid cell and average <5% in surrounding 500m, or 5-10% visible in grid cell and average >5% in surrounding 500m
	4 >20% built-up area visible within grid cell and average <5% in surrounding 500m or 10-20% visible within cell and average >5% in surrounding 500m
	Visible means here: less than 10% trees in the surrounding 500m of the buildings
<b>Skyline Disturbance (negative)</b>	0 no disturbing high-rise artefacts visible within 2.5 km
	1 wind turbines visible within 2.5km or other artefacts not very visible
	2 visible power pylons/high buildings > 1km < 2.5km, or < 1km but not very visible
	3 visible power pylons < 1km or high buildings < 1km but not very visible
	4 visible high buildings < 1km (higher than 35m or 10 storeys)
	Visible means here: less than 10% trees within 500m of the observer
<b>Noise Level (negative)</b>	0 quiet < 35 dB
	1 not noisy: 35-45 dB
	2 rather noisy: 45-55 dB
	3 noisy: 55-65
	4 very noisy: > 65 dB

distinction has been made in this respect; due to lack of data and the fact that these preferences may well differ between individuals.

Finally, for Noise Level the score depends on the amount of noise according to a model computing decibels depending on traffic intensity and type of industry (Jabben et al., 2000).

The maps of the 6 indicators, including the topographic map we used as input, were checked in the field, using a field computer with GPS. While driving through the countryside we could see our movements on the maps, making it quite easy to compare the maps with the real landscape. Although we found some inconsistencies in the data (sometimes existing tree lines did not appear on the maps) we found the indicator maps quite accurate. The accuracy of the Skyline Disturbance map varied strongly with weather conditions: the visibility of the high artefacts change dramatically depending on the amount of moisture in the air.

Interrelationships between the six GIS-indicators were calculated at the grid-cell level for the whole of the Dutch countryside ( $n = 545,652$ ). All correlations (Pearson's) are below 0.30, except the one between Naturalness and Relief:  $r = 0.34$ . This was considered acceptable. The predicted landscape attractiveness was calculated as a linear combination of these indicators, using regression weights. This will be explained later in more detail. More detailed information on GLAM can be found in Roos-Klein Lankhorst and colleagues (2005).

## 6.4 CALIBRATION OF GLAM

The model generates predictions for each and every 250 x 250 metre grid-cell of countryside in the Netherlands (excluding built-up areas and large water surfaces). However, the primary aim of the model is not to predict the attractiveness of the landscape at this detailed level, but rather the attractiveness at the broader level of the landscape surrounding one's place of residence. This was also the question asked in the survey that was used to calibrate the model: "how attractive do you find the landscape surrounding your place of residence?" In the study, the Netherlands was divided into 15 regions that were thought to be reasonably homogeneous with regard to dominant landscape type. Within each of these regions the sample was stratified by level of urbanity: non-urban versus at least somewhat urban. Within each stratum the chance to be included in the sample was proportional to the size of the postcode area. Due to the sampling design, the sample cannot be expected to be representative for the Dutch population: the design was focused more on sampling (ratings of) landscapes than on sampling people.

The aim was to have about 100 filled-in postal questionnaires for each of the strata, with a grand total of 3000 respondents. This goal was reached ( $n = 3006$ ), with response rates being

lower in the more urban strata (21%) than in the non-urban strata (28%). There were no significant differences in response rates between landscape regions. In the final sample males are overrepresented (61%), people below 30 years of age are underrepresented (7%). Typically the questionnaire was answered by a head of the household (90%). Of the respondents 48% characterises him-/herself as being full-time employed, 10% as part-time employed, 23% as being on retirement, and 14% as full-time homemaker. Since no special measures were taken, ethnic minorities are likely to be underrepresented. For more information on this sample, see de Vries and van Kralingen (2002).

No specific delineation of the landscape was given: it was left to the respondents what they considered the relevant area to be rated. The model's predictions can be scaled up by averaging the predicted values for a given area. At first instance 'the landscape surrounding one's place of residence' seems like a rather difficult spatial unit to delineate. However, research on the prototype version of GLAM has shown that in practice this constitutes less of a problem (de Vries and van Kralingen, 2002). Averages were calculated for circles around the midpoint of one's postcode, with different radii. The correlation between averaged predictions and the (average) rating by inhabitants proved to be remarkably consistent for radii between 2.5 and 7.5 kilometres. Therefore we have chosen to use the average of the model values for the countryside cells within 5 kilometres as predictor for the rating by inhabitants.

Relations between predictions and actual ratings become stronger to the degree the actual ratings are averaged over more respondents judging the same environment: individual differences are averaged out to a larger extent. Unfortunately many postcode areas had very few respondents. We decided to use only those postcodes that had at least three respondents to calibrate the GLAM model ( $n = 277$ ). The correlations between averaged GIS indicator values for 5 kilometre radius circles of the selected postcodes are given in table 2.

Correlations are especially high for Noise and Urbanity and for Relief and Historical Distinctiveness. But even in those cases, less than 50% of the variance in one indicator is 'explained' by the other indicator, implying there is quite a lot of unique variation left. A rule of thumb is that correlations above 0.80 constitute a serious multi-collinearity problem (Gujarati, 1995), which is not the case here. We started the calibration of the GLAM model with a calculation of the relations between GIS-indicators and the averaged attractiveness ratings. All six GIS-indicators show significant correlations ( $p < 0.001$ ) with the averaged overall attractiveness rating of the landscape and all in the expected direction (table 3). The correlations are strongest for Naturalness and Skyline Disturbance. The multivariate regression analysis shows four of the six indicators have a significant unique predictive contribution: Relief and Noise Level do not. Together the remaining four indicators 'explain' 36% of the variance in averaged attractiveness scores (adjusted  $R^2$ ). The standardised regression weights are similar for Urbanity, Naturalness and Historical

**Table 2**

**Pearson's correlations between averaged GIS indicator values for 5 kilometre radius circles (n = 277)**

	Historical Distinctive-ness	Relief	Urbanity	Skyline Disturbance	Noise
Naturalness	0.13 *	0.53 **	-0.11	-0.41 **	-0.12 *
Historical Distinctiveness		0.60 **	0.38 **	0.06	0.19 **
Relief			0.08	-0.31 **	-0.10
Urbanity				0.48 **	0.68 **
Skyline Disturbance					0.47 **

\* : significant at 0.05-level

\*\* : significant at 0.01-level

Distinctiveness, but lower for Skyline Disturbance. This is a different pattern than observed for the bivariate correlations with attractiveness, in which Skyline Disturbance has one of the highest correlations. This is likely to be due to the interrelations of Skyline Disturbance with Naturalness (negative) and Urbanity (positive; table 2). Historical Distinctiveness shows a reversed pattern: its standardised regression weight is higher than its bivariate correlation. Tracing the stepwise build-up of the regression equation shows that it is only after Urbanity has delivered its negative contribution, that Historical Distinctiveness can make its positive contribution. These indicators have a positive interrelation: historical monuments and features are more likely to be found in or near urban areas. But whereas urbanity in general has a negative effect on the surrounding countryside, historical monuments and historical features do indeed have a positive effect on the environment.

**Table 3**

**Relations between GIS indicator values for 5 kilometre radius circles and averaged attractiveness rating of surrounding countryside (n = 277)**

	Bivariate (Pearson's) correlation	Standardized regression weight (Beta)	Raw regression weight (B)
Naturalness	0.45 **	0.31	0.44
Historical Distinctiveness	0.20 **	0.30	0.57
Relief	0.34 **	ns	ns
Urbanity	-0.32 **	-0.32	-0.81
Skyline Disturbance	-0.42 **	-0.16	-0.21
Noise Level	-0.32 **	ns	ns
Constant			7.36

\*\* : significant at 0.01-level

Note: regression weights (all  $p < 0.01$ ) are from multiple regression analysis

Predicted attractiveness

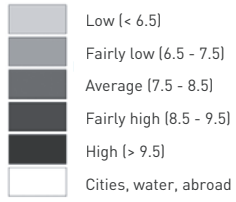


Figure 2  
Predicted attractiveness, based on calibrated version of GLAM

Figure 2 shows the attractiveness of the landscape, as predicted by the calibrated version of GLAM, applying the raw regression weights in table 3 (B's). Note that the map gives results at the grid cell level, while the calibration and validation took place at the level of averages within 5-kilometre circles.

## 6.5 VALIDATION OF GLAM

Whereas the calibration shows the fit of the model, these results could not be used to validate the model, because the weights are optimised for the dataset. To validate the model, independently acquired data from another study on landscape appreciation were used (SNM, 2005). Although this study was not set up to validate GLAM, the questionnaire was quite similar to the one that was used to calibrate the model. Most of the questions were identical in formulation and answering scale. The study differed on some other aspects. To start with, 52 areas were selected that landscape experts considered being of high quality. That is: the area was considered a good example of a certain type of landscape, or otherwise attractive. The size of the areas ranged between 500 and 9000 hectares. One or sometimes two (4-digit) postcodes were selected in the vicinity of each of these areas. Within the postcodes attached to each of the 52 areas 670 unaddressed questionnaires were randomly delivered by mail to residents. The overall response was about 15%, with a range of 42 to 142 respondents per area. Respondents were asked to rate the area that was delineated on the provided map on several aspects, among others on its overall attractiveness.

To validate the model, average ratings were calculated for each of the 52 areas. Averages for overall attractiveness ranged from 7.5 to 9.2 on a 10-point scale. The overall average for the 52 areas was 8.4. This is considerably higher than that observed in the study that was used to calibrate the model ( $M = 7.9$ ), signifying that the intended selection of high-quality areas was successful to at least some degree. Also the average predicted values for the attractiveness of all the countryside grid-cells were calculated, for each area separately. Predicted values were based on the regression equation from the calibration phase. The last step was the calculation of the correlation between the predicted attractiveness ratings and the actual average ratings. The correlation coefficient was  $r = 0.69$ , with an 'explained' variance of 47%. Note that the level of explained variance now is higher than in the calibration phase (36%), despite the fact that independent data were used.

## 6.6 CONCLUSIONS AND DISCUSSION

At the end of the calibration phase it appeared that only four of the six initially proposed indicators make a significant unique predictive contributions: Naturalness, Urbanity, Historical Distinctiveness and Skyline Disturbance.

A remarkable finding is that the explanatory power of the model (in a statistical sense) was higher in the validation phase than in the calibration phase. This outcome is even more surprising given the fact that in the validation study a restriction of the range may have occurred, due to the selection of high quality and/or attractive areas by experts. The result is likely to be due to the differences in the set-up of the empirical studies used in the two phases. Whereas in the calibrations study respondents were asked to rate the countryside surrounding their place of residence, in the validation study the area to be rated was delineated on a map. Consequently, ambiguity regarding the area being rated, and therefore individual differences in this respect, may have been smaller than in the calibration study. Furthermore, in the validation study the average rating per area was based on a much higher number of respondents than in the calibration study: at least 42 versus at least 3 (and usually not more). So, individual differences were averaged out to a larger degree in the validation study.

As for the desirability of averaging out individual differences, we make a distinction between differences in appreciation that are not related to the physical characteristics of the landscape, and those that are. The former (e.g. personal experiences with the landscape) are unlikely to be very informative with regard to landscape monitoring and spatial design. So, from an applied perspective it may not be that important to try and incorporate such differences into the model. That is not to say that such differences are also negligible in the social process evolving around spatial planning, but this is clearly beyond the scope of our model. Individual differences that are related to a different appreciation of the physical characteristics (see e.g. Dramstad and others, 2006) might be relevant, depending on their size. And although we do not deny the existence of individual differences in landscape preferences related to the landscape's physical appearance (see e.g. Van den Berg, 1999), we think in general they are small compared to the differences in appreciation caused by the physical differences between the Dutch landscapes themselves. In other words: we would like to argue that there is a substantial amount of agreement in landscape preferences between individuals (see also Herzog et al., 2000; Palmer and Hoffman, 2001), and it is precisely this agreement that allows for the predictive validity of the GLAM model.

At the same time we acknowledge that GLAM is not only crude in its spatial level, but also in the landscape (features) between which it distinguishes e.g. it mainly distinguishes between natural and agricultural areas, and between areas with significant (recent) human interference

(in the form of visible artefacts) and those without. This can be seen within the Naturalness indicator, where no distinction is made between different types of nature area, such as forests, dunes, heath and wetlands. At the same time it is known from other studies that even different types of forest are appreciated differently. For example, in general people seem to prefer old mixed forests to young coniferous production forests (Ribe, 1989). To a large extent the crudeness of the model in this respect is due to a lack of sufficiently detailed data on the landscape. It is reasonable to argue that, with further refinement on the side of the physical appearance of the landscape, also refinement on the side of individual differences in preferences becomes more relevant. People are more likely to agree on the crude distinctions between landscapes than on the finer ones. For example, in the Netherlands young people seem to prefer more rugged nature areas than elderly people, which tend to prefer more easily accessible, park-like landscapes (Reneman et al., 1999). Also the work by Tveit and others (2006) on landscape character may prove to be useful, pointing out aspects that are not explicitly included in GLAM yet, such as stewardship and visual scale.

A related aspect is that, besides differences in aesthetic preferences, functional aspects (fitness for use/suitability) may also play a part in rating the attractiveness of the landscape (see e.g. Ribe, 1989; Buijs et al., 2006). In other words, the attractiveness may depend on whatever function the individual has in mind when considering the landscape. GLAM primarily focuses on the pleasure of experiencing the landscape when travelling through or spending time in the area. In as far as functions are involved, this coincides with the landscape as a leisure setting, especially for resource-based recreation. This is probably the dominant function the countryside has for most Dutch inhabitants. The other way around, the scenic beauty of a landscape may determine its suitability for certain types of development, e.g. touristic development, and so inform planning (Brown, 2006).

Although we have the desire to elaborate GLAM, the validation provided quite strong support for the model. Does this mean that the model is also suited for use in practical application? We think it is, although only at a regional level. For example, the model does not take the local composition or the design quality of the area into account. So, the model's predictive capabilities should only be applied at a higher spatial level. But even at the lower spatial level it is likely to be quite useful for monitoring purposes: it can give early signs that the landscape may be changing in a way that makes it less attractive. This might also be one way to evaluate the effectiveness of landscape policies.

Moreover, the model offers a very cost-efficient way to get a valid impression of how people (or, more specifically, inhabitants) on average appreciate the countryside surrounding their place of residence. Two other methods to get such an impression would be a survey among the inhabitants living in or near the area, or to solicit an expert judgement. The survey method would



generate valid results, but is costly to perform for the whole of the Netherlands. The expert method, on the other hand, is less costly, but is also less likely to generate valid results. What experts consider high-quality, valuable and therefore attractive landscapes does not always coincide with the views of ordinary inhabitants (Herzog et al., 2000; Daniel, 2001). Replacing expert judgements by predictive models such as GLAM may contribute to what in the policy arena is called 'democratising landscape' (see e.g. Fairclough, 2002). This may also be considered a reminder that GLAM represents the opinions of Dutch people only.

## REFERENCES

- Aoki, Y. (1999) Review article: trends in the study of the psychological evaluation of landscape. *Landscape Research* 24: 85-94
- Bishop, I.D., and Hulse, D.W. (1994) Prediction of scenic beauty using mapped data and geographic information systems. *Landscape and Urban Planning* 30; 59-70
- Brown, G. (2006) Mapping landscape values and development preferences: a method for tourism and residential development planning. *International Journal of Tourism Research* 8; 101-113
- Buijs, A., Pedroli, B., and Luginbühl, Y. (2006) From hiking through farmland to farming in a leisure landscape. Changing social perceptions of the European landscape. *Landscape Ecology* 21; 375-389
- Coetier, J.F. (1996) Dominant attributes in the perception and evaluation of the Dutch landscape. *Landscape and Urban Planning* 34; 27-44
- Daniel, T.C. (2001) Whither scenic beauty? Visual landscape quality assessment in the 21<sup>st</sup> century. *Landscape and Urban Planning* 54; 267-281
- De Boer, T., Buijs, A.E., and Berg, A.E. van den (1999) *Groene gebieden rondom Zoetermeer*. Wageningen, Staring Centre.
- De Vries, S., and Gerritsen, E. (2003) *Van fysieke kenmerken naar landschappelijke schoonheid; de voorspellende waarde van fysieke kenmerken, zoals vastgelegd in ruimtelijke bestanden, voor de schoonheidsbeleving van Nederlandse landschappen*. Wageningen, Alterra (rapport 718)
- De Vries, S., and van Kralingen, R.B.A.S. (2002) *De beleving van het Nederlandse landschap door haar bewoners; de geschiktheid van het SPEL-instrument voor monitoringsdoelinden*. Wageningen, Alterra (rapport 609)
- Dramstad, W.E., Tveit, M.S., Fjellstad, W.J., and Fry, G.L.A. (2006) Relationships between visual landscape preferences and map-based indicators of landscape structure. *Landscape and Urban Planning* 78 ; 465-474
- Fairclough, G. (2002) A forward-looking convention: European landscapes for the 21st century. *Naturopa* 98; 5-6.
- Goossen, C.M., and Langers, F. (2000) Assessing quality of rural areas in the Netherlands: finding the most important indicators for recreation. *Landscape and Urban Planning* 46; 241-251.
- Goossen, C.M., Langers, F., and de Vries, S. (2001) *Gelderse stilte? Onderzoek naar de stiltebeleving van recreanten*. Wageningen, Alterra (rapport nr. 398)
- Gujarati, D.N. (1995) *Basic Econometrics* 3<sup>rd</sup> edition. New York, McGraw-Hill.
- Herzog, T.R., Herbert, E.J., Kaplan, R., and Crooks, C.L. (2000) Cultural and developmental comparisons of landscape perceptions and preferences. *Environment and Behavior* 32 (3); 323-346
- Hunziker, M., and Kienast, F. (1999) Potential impacts of changing agricultural activities on scenic beauty – a prototypical technique for automated rapid assessment. *Landscape Ecology* 14; 161-176
- Jabben, J., Dassen, A., and Hoffmans, W. (2000) *Informatie-structuur Landelijk Beeld Verstorning*. Bilthoven, RIVM (rapport 725501.202)
- Kaplan, S. and Kaplan, R. (1989) *The experience of nature: a psychological perspective*. New York, Cambridge University Press.
- LNv, Ministry of (2000) 'Nature for people, people for nature', policy document on nature, forest and landscape in the 21st century. The Hague, Ministry of Agriculture, Nature Management and Fisheries.
- Palmer, J.F., and Hoffman, R.E. (2001) Rating reliability and representation validity in scenic landscape assessments. *Landscape and Urban Planning* 54; 149-161
- Purcell, A.T., and Lamb R. (1998) Preference and naturalness: an ecological approach. *Landscape and Urban Planning* 42; 57-66
- Real E., Arce, C., and Sabucedo, J.M. (2000) Classification of landscapes using quantitative and categorical data, and prediction of their scenic beauty in north-western Spain. *Journal of Environmental Psychology* 20 (4); 355-373
- Reneman, D., Visser, M., Edelman, E., and Mors, B. (1999) *Mensenwensen; de wensen van Nederlanders ten aanzien van natuur en groen in de leefomgeving*. Wageningen/Hilversum, Staring Centre/Intomart (reeks Operatie Boomhut nr. 6)

- Roos-Klein Lankhorst, J., Vries, S. de, Buijs, A.E., Bloemmen, M.H.I. van den, and Schuiling, C (2005) *BelevingsGIS versie 2; waardering van het Nederlandse landschap door de bevolking op kaart*. Wageningen, Alterra (rapport 1138)
- Roos-Klein Lankhorst, J, de Vries, S., van Lith-Kranendonk, J., Dijkstra, H., and J.M.J. Farjon, 2004. *Modellen voor de graadmeters landschap, beleving en recreatie. Kennismodel Effecten Landschap Kwaliteit KELK, Monitoring Schaal en BelevingsGIS*. Wageningen, Natuurplanbureau vestiging Wageningen (Planbureau rapporten nr. 20) [http://www.wotnatuurenmilieu.wur.nl/NR/rdonlyres/BE00DD2C-51E0-4FB4-85CE-5B63673F07CB/20622/Planbureau rapporten\\_20\\_laag.pdf](http://www.wotnatuurenmilieu.wur.nl/NR/rdonlyres/BE00DD2C-51E0-4FB4-85CE-5B63673F07CB/20622/Planbureau rapporten_20_laag.pdf)
- Ribe, R. (1989) The Aesthetics of Forestry: what has empirical preference research taught us? *Environmental Management* 13 (1); 55-74
- SNM (2005) *Nederland kan zo mooi zijn; onderzoek naar de beleving van 52 gebieden door omwonenden; deel 1: landelijke conclusies en resultaten*. Utrecht, Stichting Natuur and Milieu.
- Strumse, E. (1994) Environmental attributes and the prediction of visual preferences for agrarian landscapes in western Norway. *Journal of Environmental Psychology* 14; 293-303
- Tveit, M.S., Ode, A., and Fry, G. (2006) Key concepts in a framework for analysing visual landscape character. *Landscape Research* 31 (3); 229-255
- Ulrich, R.S. (1983) Aesthetic and affective response to natural environment. In: Altman, I., and Wohlwill, J.F. (eds) *Human behavior and environment: advances in theory and research* 6. New York, Plenum Press, pp 85-126.
- Van den Berg, A.E. (1999) *Individual differences in the aesthetic evaluation of natural landscapes*. Thesis. Groningen, Rijksuniversiteit Groningen.
- Verweij, P.J.F.M. (2004) *Osiris manual*. WISL, Wageningen.
- Zube, E.H. (1987) Perceived land use patterns and landscape values. *Landscape Ecology* 1; 37-45

7

# THE ONE- AND TWO- DIMENSIONAL ISOVISTS ANALYSES IN SPACE SYNTAX

## 7.1 INTRODUCTION

This contribution aims to show the spatial properties for indicating degrees of street life, safety and economical attractiveness in urban areas through analysing the one- and two-dimensional visibility analyses of the space syntax method. The space syntax method is able to calculate the spatial configuration of built environments and compare it with numerical socio-economic data. The most known method is to calculate how spatially integrated a street is in relation to all others in terms of direction change and degree of angular deviation. It is able to identify the streets' spatial features for vital shopping areas, crime distribution, various social classes' spatial preferences when choosing a dwelling area, and the spatial features of the location of various institutional buildings. The space syntax method's elements are based on visual sight lines. Examples from Delft and Alkmaar will be used for showing the correlations between the spatial analyses and socio-economic data.

## 7.2 THEORETICAL FRAMEWORK, METHODS AND TECHNIQUES

In the past three decades the space syntax method, developed by Bill Hillier and his colleagues at the University College London, have been applied to urban studies. This method

consists of calculating configurative spatial relationships of built environments' public spaces.

In urban analyses, according to Hillier, space syntax is three things. Firstly, it is a family of techniques for *analysing* cities as the networks of space formed by the placing, grouping and orientation of buildings. Secondly, it is a set of techniques for *observing* how these networks of space relate to functional patterns such as movement, land use, area differentiation, migration patterns and even social wellbeing and malaise. Thirdly, based on the empirical results from the two first things, space syntax has made it possible to make a set of *theories* about how urban space networks relate in general to the social, economic and cognitive factors which shape them and are affected by them. The techniques have been applied to a large number of cities in different parts of the world. In this way a substantial database now exists of cities, which have been studied at some level using space syntax (Hillier et al., 2007).

What space syntax measures is the two primary all-to-all (all street segments to all others) relations. On the one hand it measures the *to-movement*, or accessibility, potential, of each street segment with respect to all others. With other words, it measures the location potentials for various urban centres. On the other hand space syntax measures the *through-movement* potential of each street segment with respect to all pairs of others. To say it differently, it measures the spatial potentials for streets with the highest potential flow of movement. Each of these two types of relational pattern can be weighted by three different definitions of distance. The *metric* distance measures the city's street and road network as a system of shortest paths, while the *topological* distance calculate the city's street and road network as a system of fewest turns paths. Finally, the *geometrical* distance gives a picture of the city's street and road network as a system of least angle change paths. Each type of relation can be calculated at different radii from each street segment, defining radius again either in terms of shortest, fewest turns or least angle paths (Hillier and Iida, 2005: 557-558).

Hillier distinguishes between intrinsic and extrinsic properties of space. Extrinsic ones determine the way in which spatial units relate to one another. According to Hillier, spatial configuration has its own rules (Hillier, 1996: chapter 8). If one intends to understand settlements in terms of these laws they are regarded as sets of *spaces*. In this perspective primarily topological issues become relevant. Volumes, textures and size are not taken into consideration. When regarded in purely extrinsic terms, spaces are shape-free. It is just their inter-relational aspect or structure that counts here. Each space has one or more functions either for occupation or movement. Extrinsic properties of space concern built form and function (Marcus, 2000: 40).

While extrinsic properties of space concern invisible, structural relationships, intrinsic properties concern visible ones. They rely on things we can see, such as the shape, the size, the

volumes, and the objects placed in space, and the texture of physical objects or built masses (Hillier, 1999e: 1). They consist mostly in geometrical properties. Describing and illustrating the intrinsic properties of a built environment does not abstract from meaning and intentions external to it. First and foremost, a physical object's purpose is important at the time it was made. In later contexts it is mostly left out of consideration. In this respect, intrinsic properties of space account for the inter-relationship between built form and social meaning (Marcus, 2000: 40). In research traditions belonging to urban morphology and place phenomenology, the concepts of space relate to intrinsic properties of space. Namely, they consist of descriptions of building typologies, property patterns, building morphology, forms of squares, and the shapes of built volumes, windows, and doors.

As intrinsic properties of space are perceptible and describable rather easily, there exist several writings about them. A narrow street, an intimate square, a large massive building, and a star shaped junction – they can all illustrate how to describe these properties of space in a built environment. On the other hand, however, it is rather difficult to describe extrinsic properties of space. Concepts like 'here' and 'there' or 'inside' and 'outside' are used to refer to seemingly simple spatial relationships. But as soon as one tries to describe whole buildings or towns, our language seems unable to spell out complex spatial relationships. Therefore abstract models or maps are often used to present such complex systems of space.

Describing extrinsic properties of space requires considering the city as a set of spaces. In terms of how we name things, urban space is recognised to be mostly linear. Apart from squares, one disposes of several names for the routes between them. Examples are alleys, streets, roads, avenues, boulevards, highways, paths, pavements, subways, bridges, stairs, etc. All these kinds of urban spaces shape a grid or network – a potential pattern of movement. The urban grid is defined to be “the pattern of public space linking the buildings of a settlement, regardless of its degree of geometric regularity” (Hillier, 2001: 02.1). If one looks at city maps most tourist offices distribute to visitors, the street grid is the most detailed represented part. Important buildings and squares may be indicated, but not in such a detailed scale as a whole street grid. Therefore, the urban street grid can be represented as a set of axial sightlines.

For more than 20 years ago, most calculations of the spatial relationship between these axes were done manually. Later on, several software programs, such as Axman, Uba Pesh, Orange box, Axwoman, Mindwalk, Webmap at home, and Meanda have improved the possibilities to analyse the complex spatial relationships of the public spaces of whole cities. The Depthmap software is able to describe and visualise a built environment's spatial inequalities, make point depth analyses, isovists analyses, all-lines analyses, and to simulate and trace movement routes of computer-generated agents. The way these agents move is based on research in a present urban context (Turner, 2007).

### 7.3 SPACE SYNTAX' ELEMENTS

The Space Syntax method operates with the following three basic elements: convex space, isovist field and axial line. A *convex space* is defined as a space such that “all points within that space can be joined to all others without passing outside the boundary of the space” (Hillier 1988: 68). The panoptical view is essential in the definition of what a convex space is. It is mostly used for occupation of various functions and place-bound human activities such as standing and sitting. Convex maps are used for analysing buildings and the public spaces between a group of buildings in neighbourhoods or smaller villages. In the urban analyses, the point depth and the all-lines analyses have replaced the convex space analysis. An explanation might be the time consuming work to make the convex map. Moreover, no software improvement has been done since the 1990's for the convex space analysis.

An *isovist field* represents the panoptical view a person has from a given point in an urban space. It is used for orientation or way finding in the urban fabric. First it was done manually. Now one-point as well as all-points isovist analyses can be carried out with the Depthmap software.

An *axial line* represents the longest sight line one has in an urban space or street. It represents the way human beings moves in lines through the urban street and road network. During the last two decades the axial line has been the basic spatial element in the methodology and theoretical development of space syntax in urban studies.

The main thought behind these three basic spatial elements is that human beings move in lines, interacts in convex spaces and sees changeable panoptical views when moving around in the built environment.

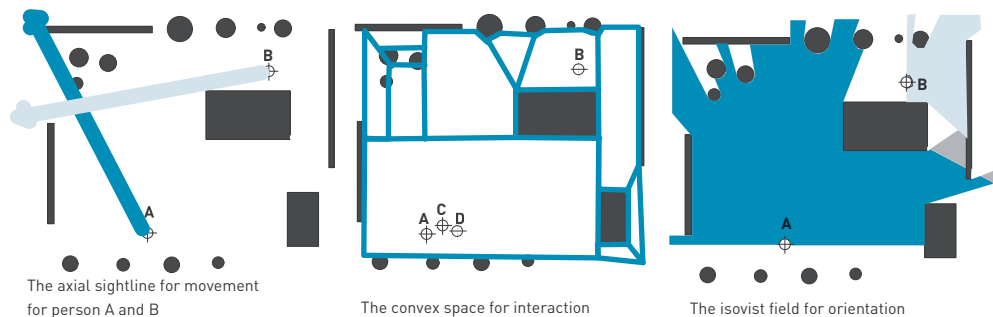


Figure 1  
Example of axial lines, convex space and isovist field

## 7.4 THE ONE-DIMENSIONAL VISIBILITY ANALYSES

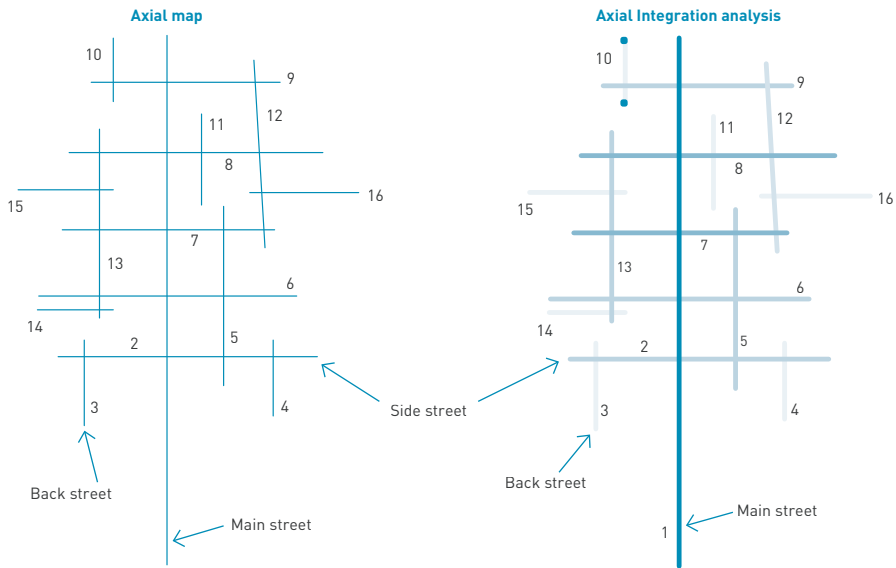
The basis for the space syntax method in urban studies is the *axial map*. The street and road network in built environments is represented with the longest and fewest sight lines. Therefore, direction changes in terms of visibility are presented. The notion of *syntactic step* on an axial map is meant to represent a change of direction from one axial line to another. The number of syntactic steps from each axial line to all other axial lines measures a settlement's *topological depth*.

A *global integration analysis* implies the calculation of how spatially integrated a street axis is in terms of the total number of direction changes to all others in a town or city. The fewer direction changes to all other streets, the higher spatial integration values. Conversely, streets with many direction changes to all others tend to have low global integration values. Hence, they are spatially *segregated*.

This simple one-dimensional analysis makes it possible through the Depthmap software to analyse whole cities and large metropolitan areas. As research has shown, streets with the fewest direction changes to all other streets in a built environment tend to be the most vital shopping streets with the highest flow of human movement (Hillier et al., 1993, 1998). Conversely, streets with a very high number of direction changes tend to be affected by crime and anti-social behaviour or they tend to be gated communities (Hillier, 1996; López and Van Nes, 2007; Hillier and Shu, 2000; Hillier and Sahbaz, 2005).

Figure 2 shows a simple settlement consisting of a main street with some side streets and some smaller back streets. On the right side the town's street network is represented as a set of fewest axial sight lines. Each axis is represented as a public urban space, connected to other public urban spaces. One can thus calculate how each axis is inter-related to all other axes in this system. In other words, one calculates the *topological depth* of each axis in relation to all other axes. Each time one has to change direction one has taken a syntactic step. This basic calculation is also used in the convex space analyses as well as in the all-lines and all-points isovist analyses. Figure 2 shows how the degree of spatial integration of the back street (axis number 3) is calculated. Every time one changes direction from the street, one multiplies the number of direction change from the street number 3 with the number of streets that can be reached. The total depth from street number 3 to all other streets is 50. When comparing the total depth from back street 3 with the main street, the total depth is 28 (below in figure 2). On the left in figure 2, the formula for calculating spatial integration is shown. The formula is useful when comparing changes in integration when cities grow, or changes due to new road or street links.





**Calculating axial integration:**

Mean depth for each axle (MD):  
 $MD = \text{sum depth}/k - 1$   
 $k = \text{number of axes in a system}$   
 $\text{sum depth} = \text{the topological depth from each axle to all others}$   
 $D_k = \text{diamond value}$

**Calculating the back street axle:**

$(MD) = \text{sum depth}/k - 1 = 50/16 - 1 = 3.3$

Real asymmetry (RA) =  $2(MD - 1)/k - 2 = 2(3.3 - 1)/16 - 2 = 0.3333333333$

Real relative asymmetry (RRA) =  $RA/D_k = 0.3333333333/0.086 = 3.87596899224806$

Integration value of the back street:  
 $1/RRA = 1/3.87596899224806 = 0.258$

$5 \times 3 = 15$

$4 \times 4 = 16$

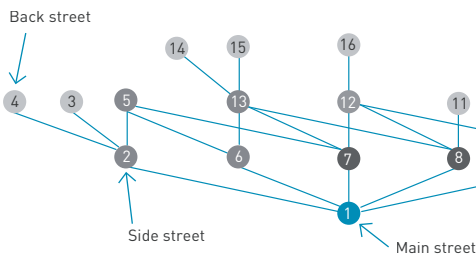
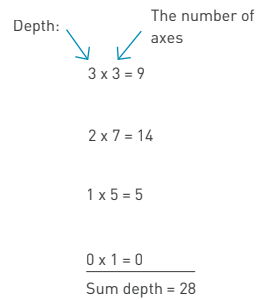
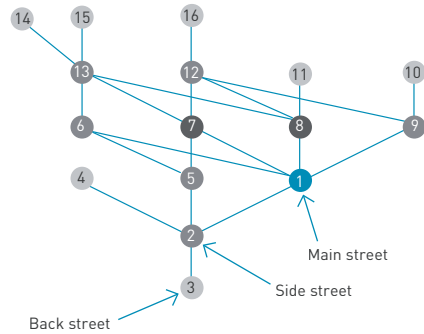
$3 \times 4 = 12$

$2 \times 3 = 6$

$1 \times 1 = 1$

$0 \times 1 = 0$

Sum Depth: 50



**Figure 2**  
 How spatial integration is calculated in a simple settlement



**Figure 3**  
Global integration analyses of Delft

Figure 3 shows a *global integration* analysis of Delft. As can be seen in the figure, the modern shopping centre in *De Hoeven* area has the most integrated streets (coloured in black). It is the most accessible area in Delft in terms of the fewest direction changes from every street to all others. The second best integrated area is the newly established *Zuidpoort* shopping area at the edge of Delft centre. The most segregated streets (coloured in light grey) are in the *Tanthof* area and some of the post war housing areas.

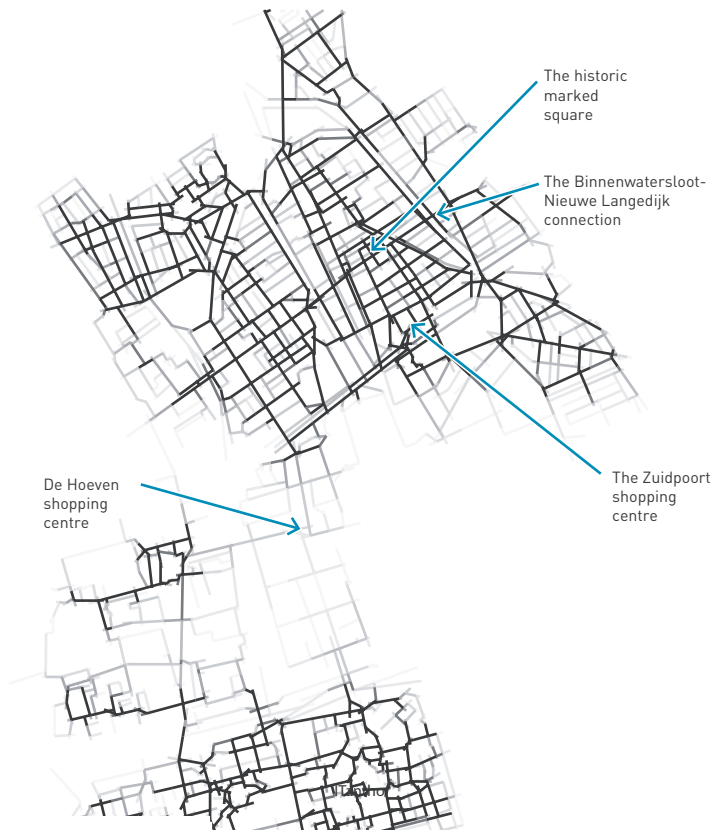
The *local integration* analysis highlights the various local urban centres. It is done as follows: one calculates how integrated an axis is when changing the direction three times from it. The Depthmap software calculates this for every axis in the whole built environment. Figure 4 shows a local integration analysis of Delft. The various local shopping streets in Delft historic centre are highlighted in black. The highest locally integrated shopping street is the *Binnenwatersloot – Nieuwe Langedijk* connection.



**Figure 4**  
Local integration analyses of Delft

During the last 10 years the angular relationship between the axial sight lines have been taken into account. This made it possible to highlight the main routes going through and between urban areas in cities through a pure calculation of spatial interrelationships. A city consists of a very small number of long streets that end up at another long street with an angle close to 180 degrees, and a very high number of short streets, ending up with an angle close to 90 degrees to another street.

This visibility property of a city's street and road network makes it possible for people to guide themselves from the edges towards the city centre with a few direction changes and small angular deviations. In particular in large complex cities, the angular analyses can show how the city's edges can reach the centre through the network of the main routes. The long lines have thus long visibility properties, and at the junctions one can see how the long lines continues with a small angular deviation to another long line.

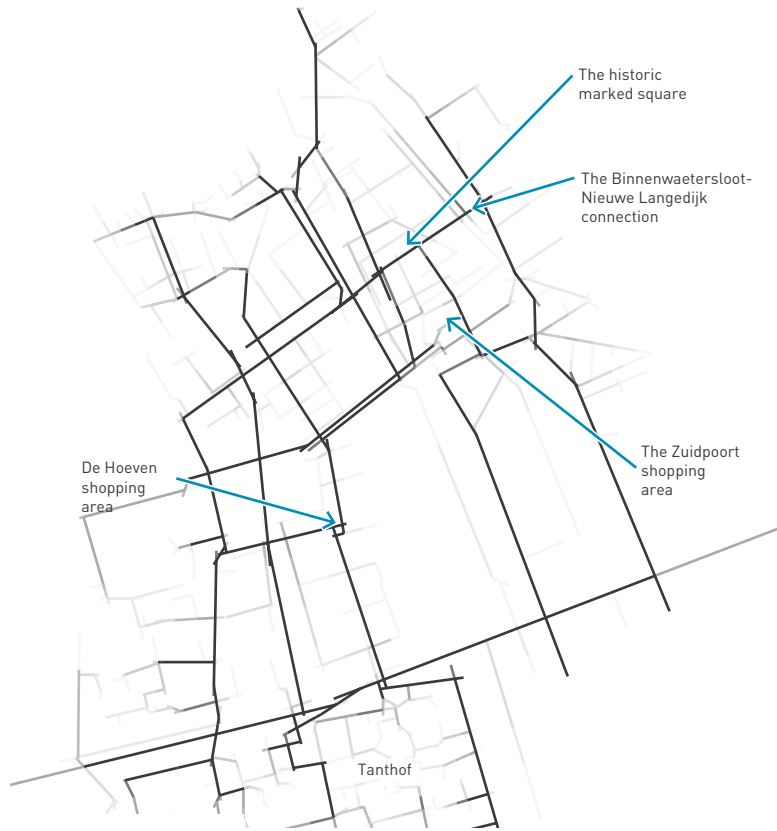


**Figure 5**  
Local angular analyses of Delft with low metrical radius

The axial line is still the basis for the angular analyses. When processing the angular analyses in Depthmap, the software breaks up the axial lines at every junction. At every junction an angular weighting is made. The fewer direction changes in terms of angular deviation, the higher values of the street segments.

One of the critics of the space syntax method was the lack of *metrical* properties in the analyses (Ratti, 2004). Now it is incorporated into the calculations. As the results show, the geometrical and topological distances correspond with the pedestrian and vehicle flow rates and the location pattern of shops more than the metrical *distances*. However, when applying metrical *radiuses* in the angular and axial analyses, some striking results can be seen.

Figure 5 shows an angular integration of Delft with a low metrical radius. The various local vital shopping streets are highlighted. When increasing the metrical radius to a high value, the



**Figure 6**  
Local angular analyses of Delft with high metrical radius

main routes linking the various urban areas together are highlighted. Figure 6 shows a local angular analysis with a high metrical radius. Here the *Binnenwatersloot – Nieuwe Langedijk* axis has the highest values, and the main streets for car traffic are highlighted.

When comparing the results from figure 5 and 6, the following can be stated. In traditional urban areas the main routes and the local shopping areas are located adjacent or in the same street, where the street network has high values in both a high and low metrical radius. Seemingly, a condition for a vital shopping area is to have a dense inter-connected street network within a short metrical distance in order to catch the local customers. Moreover, it needs also to be located on or adjacent to the integrated segments of the main routes in order to catch the through travellers.

In post war urban areas, the most integrated areas with low metrical radiuses are not located in the same place as those within the high metrical radiuses. The effect is that inside the housing area there is only one local super market with the necessary food facilities located along street, with high integration values with a low metrical radius. Sometimes there are no shopping facilities at all in these areas. Car-based shopping centres tend to locate along streets with high integration values with a high metrical radius.

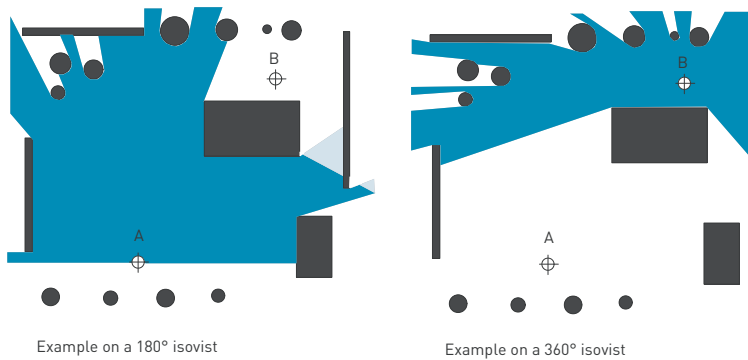
In Delft the post war urban areas have almost no shops inside their areas. The shopping centre *De Hoeven* serves most of the surrounding post war neighbourhoods. In Delft centre, the newly established *Zuidpoort* shopping centre is located adjacent to the fine-grained network of local shopping streets, while it is located along a highly integrated road with a large metrical radius.

While the traditional global and local integration analyses measures the *to-movement* potential, the angular analyses with metrical radiuses measures the *through movement* potential. Together these spatial measurements of the street and road network can show the degree of spatial inequalities on various scale levels. The results from research are useful in order to predict to some extent the socio-economic effect of proposed design interventions for future built environments, as well as understanding socio-economic activities based on the information of the physical form in excavated town or past built environments (van Nes, 2009).

The visibility component is essential for a human being's orientation in complex built environments. In a recent finished MSc thesis about the effects of the tsunami in Banda Aceh, a correlation was found between the spatial configuration from the axial analyses and the mortality rates. The more spatially broken up the street grid the lower integration values on the axes, the higher the mortality rates in the neighbourhood. The data about mortality rates was gathered from the local Red Cross based on neighbourhood levels. It was established from the interviews that people fled in the opposite direction of the tsunami. As claimed in the perception psychology literature, people cannot think rationally in the case of panic. The visual orientation plays a role in orientation when people are fleeing. Therefore, highly integrated neighbourhoods on various scale levels are indicators for way finding (Fakhrurrazi, 2010).

## 7.5 THE TWO-DIMENSIONAL VISIBILITY ANALYSES

On a neighbourhood level several tools exist for taking two-dimensional spatial aspects into account. The *isovists analyses* are useful for analysing the degree of visibility of the location of important urban artefacts (like towers), or the panoptical view of urban spaces when arriving in a place at the railway station, and how new urban interventions will increase or decrease existing isovists' views. Moreover, isovists analyses are useful in studies on how trees and vegetation can



**Figure 7**  
**Example on a 180- and 360-degree isovist**

block the degree of inter-visibility in parks. It can identify places attractive for junkies to operate, or places where there might be a risk of getting raped.

According to Benedikt, an isovist is: “the set of all points visible from a given vantage point in space and with respect to an environment” (Benedikt, 1979: 47). It visualises the panoptical view from the viewer from a particular standing point in a built environment. The panoptical view’s borders are defined by walls and free standing objects such as trees, bushes and statues located inside a built environment’s spaces. When moving around in built environments, the shape and size of the isovist change. It is thus possible to visualise the sequences of scenes or panoptical view arrows from particular points along the movement routes.

The applicability of isovists fields is manifold. As figure 7 shows, one can choose for a 180- or a 360-degree isovist field. The first one is what one sees when one for example enters a park, while the latter one shows what one can see when turning around right on the spot where one is standing.

Consider person A entering a place, as shown in figure 7. He or she is a visitor to this park and wants to have an overview over the area. Behind a building person B is standing. B is a junkie and needs a place where nobody can see him or her when operating. Person A and B can not see each other. Since person A is walking into the park, an isovist field of 180 degree is made. It visualises A’s direct view. Person B has to know that few people can see him or her. Therefore an isovist field of 360 degree is made from B’s position. The isovist field for person A is larger than person B, because person A is standing at a place in the park with a large overview. Person B is hidden behind a building, a fence and some trees which affects his or her isovist field. Drawing the isovist from a given point is a way of visualising the spatial possibilities on how children,

junkies and criminals can hide away from the social control of adults. Likewise, it visualises the spatial possibilities from where one can get a maximum view of an urban square.

The *point depth analyses* show the degree of visibility from every point of the public spaces of a neighbourhood. This method is useful to test out where the most visible and less visible areas are in urban squares and post-war housing areas with free standing buildings and the degree of visibility in urban parks. In particular it can describe the spatial properties in terms of inter-visibility in the unsafe spaces of parks and squares. The method is useful for testing out how the placement of trees and bushes can affect a park or a square's degree of inter-visibility.

As shown in the previous section, the isovist is a polygon, which contains the perceived visible area from a particular location. By using graph analyses, the software Depthmap is able to calculate the degree of integration of each point or isovist's root in relationship with the others in a built environment. All public spaces in a built environment are rasterised by a grid. One can choose how fine-grained the grid can be. The more fine-grained the grid is, the more time consuming the analyses is, however, the more exact the results will be.

Each point for the visibility analyses is taken from the centre of each cell's square. How integrated each point is in relationship to other points is calculated. The various integration calculations presented in earlier chapters can be used. Every time one moves from one cell in the grid to another, one takes a topological step. What the point depth analysis does, is to calculate how each cell relates to all other cells in the grid. Obstacles, like walls, fences, trees etc, contribute to increase the topological depth between various cells (Turner, 2007).

Figure 8 shows a point depth analysis of the same park used in the previous example. As can be seen from the figure, the large open space in the park is the most integrated one (coloured in black), while spaces behind buildings and trees are the most segregated ones (coloured in light grey).

When applying the point depth analyses with isovist properties on the public spaces in delft centre, the canals and the roads outside the centre are the most visible public spaces in Delft. Most of Delft's significant buildings, richly articulated in their architectural expressions, are located along these highly inter-visible spaces.

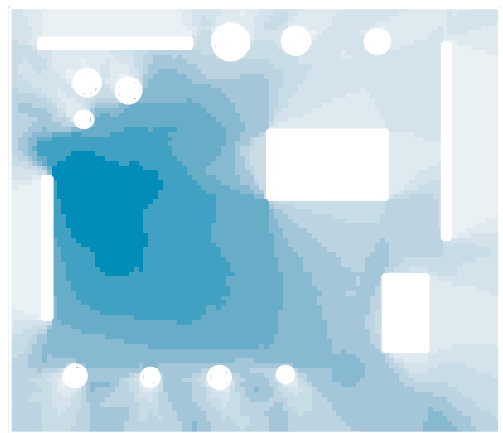


Figure 8  
Point depth analyses of the park



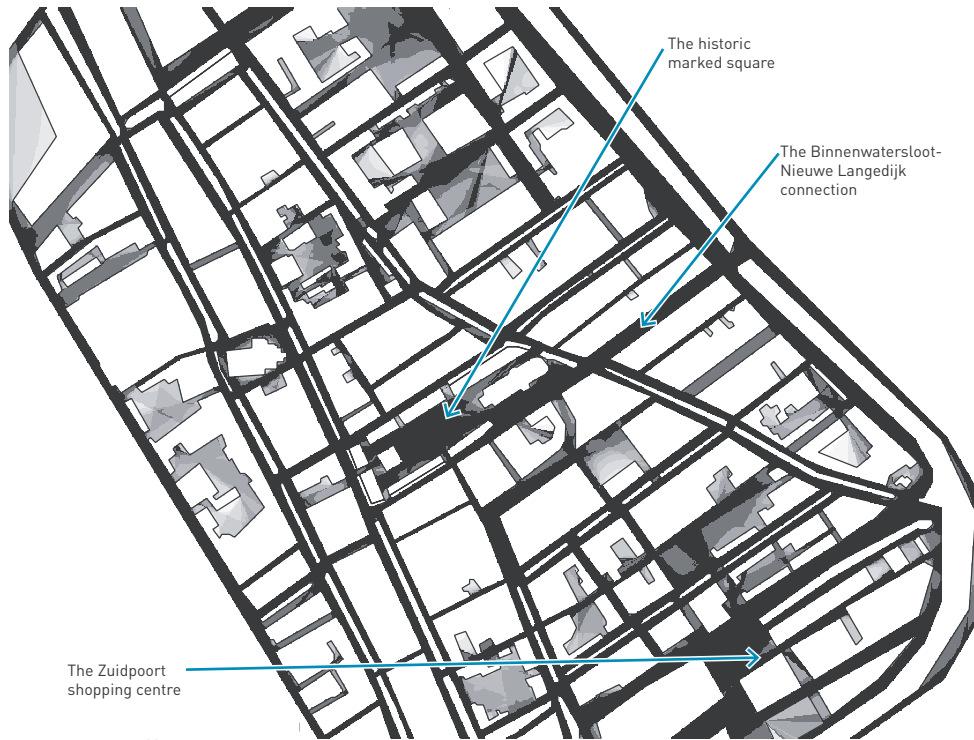
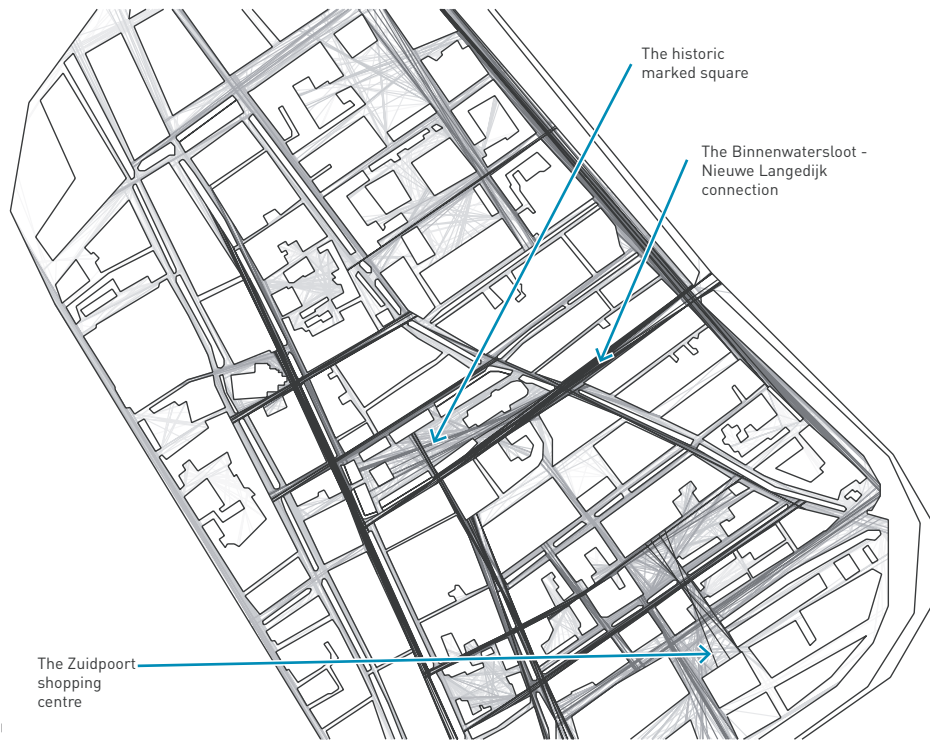


Figure 9  
Point depth analyses with isovist properties of Delft centre

While the point depth analyses shows how integrated each point is in a public space, the *all lines analyses* shows how integrated each sight line is in relationship to all other sight lines. The software Depthmap is able to make an all-line map of all the public spaces in a settlement. When preparing the basis map before processing, all obstacles and urban blocks are represented as polygons. All the publicly accessible spaces are represented as one space (Penn et al., 1997).

As research has shown, the degree of visibility of urban spaces affect the way users behave in these spaces. The higher the inter-visibility, the more it generates a mix of people of different social classes, genders, races and ages in public spaces. When comparing the results from the registration of human behaviour with the all lines analyses, the results comply with the dispersal of the integration values. The more spatially integrated the street is, the more people on streets and the more mix of women and men, age groups and ethnicity can be seen in these highly integrated areas. Conversely, the more spatially segregated the streets are, the fewer people on streets and the more the streets are dominated by unemployed immigrant men or groups of youngsters (Rueb and Van Nes, 2009).



**Figure 10**  
**All lines analyses of Delft centre**

Figure 10 shows an all lines analyses of Delft centre. In comparison with the point depth analyses, the most integrated lines are on the *Binnenwatersloot – Nieuwe Langedijk* axis, *Brabantse Turfmarkt*, and *Wijnhaven*. These streets are the most frequented streets and most individual shops are located along these streets. Modern urban housing areas are located along the most segregated spaces. While the point depth analysis shows visibility properties, all lines analysis shows accessibility properties. The first one influences the architecture of adjacent buildings, while the latter one affects the location of shops.

The recent developed *agent based modelling* in the Depthmap software is based on how people in fact orientate themselves through urban areas. Through empirical testing of how people orientate themselves through virtual environments with strange angles, correlations between the results from the all lines analyses and point depth analyses are found. The least angular deviation from one's direction plays a role in how people orientate themselves through built environments (Conroy, 2001). Therefore, this research's result can be useful in estimating how urban spaces will be frequented in the future as well as how they were frequented in the past.



**Figure 11**  
Agent based modelling of Delft centre

Figure 11 shows the traces of 5000 people moving inside Delft centre's public spaces from the agent based modelling in Depthmap. When comparing the results with the various spatial analyses, the highest locally integrated main streets comply with the results from the agent based modelling.

The recently developed *micro scale urban analyses* tools are about the relationship of buildings or private spaces and their inter-relationship with street segments. More precisely it is about demonstrating how dwelling openings relate to the street network, the way building entrances constitute streets, the degree of topological depth from private space to public space, and inter-visibility of doors and windows between buildings.

Since no software development is current available for analysing micro scale spatial relationships, Microsoft excel and Statistical Package for the Social Sciences (SPSS) software are useful. In a study on space and crime in Gouda and Alkmaar, 1,168 street segments were registered



**Figure 12**  
**Degree of inter-visibility between buildings and streets in Alkmaar compared with the dispersal of burglaries**

manually for the micro scale analyses part. All data were put into SPSS for comparison in order to run multi variable statistical comparisons between the various spatial parameters. As the results from the spatial analyses in Gouda and Alkmaar show, both micro and macro spatial variables are highly inter-dependent (López and Van Nes, 2007). The more segregated a street segment is, the lower the inter-visibility between doors, windows and streets is. In other words, the higher the spatial segregation of a street, the more the entrances are turned away from the street. Streets with low inter-visibility from windows and doors to streets tend to have high burglary rates (van Nes and Lopes, 2007).

Figure 12 shows the degree of inter-visibility between buildings and streets in Gouda's local area. The black coloured lines illustrate 100% visibility, the dark grey lines illustrate 80% visibility, the grey lines illustrate 60% visibility etc. The very light grey lines show 0% inter-visibility. Most intruded homes are entered from the streets or back paths with 0-20% inter-visibility.

The two-dimensional spatial measurements depend on the results from the one-dimensional analyses. Together they offer at least knowledge about the spatial conditions for different issues, such as vital street life, urban safety, vital shopping areas, social interactions and their interdependence. All seems to depend on various degrees of adjacency, permeability and inter-visibility taken into account on different scale levels. In particular results from research contributes to understandings on the socio-economic effects of one's design proposals when applying these tools in urban design.

## 7.6 THE THREE-DIMENSIONAL VISIBILITY ANALYSES

So far, two-dimensional isovist analyses have been applied in urban research and even in strategic planning and design. At present, software capable of analysing three-dimensional isovists have been developed by Van Bilsen and Stolk (2007). In the development of three dimensional measures, the first steps have been taken: spatial openness by Fisher-Gewirtzmann and Wagner (2003), sky opening by Teller (2003), real world measurements of the latter by Sarradin (2004) and more recently various measures in digital landscape models (DLMs) by Morello and Ratti (2009). However none of these can be considered a general three-dimensional approach. For example, DLMS cannot adequately represent cities when it comes to observer experience of inside spaces (roofed) and outside spaces (arches, bridges, etc.). Technology used for entertainment games is improving at an exponential rate. This technology is used to obtain large amounts of visibility information on acceptable timescales: full three-dimensional analyses have become feasible (van Bilsen, 2009, 2008).

The added value of three-dimensional analysis, compared to two-dimensional analysis, is summarised in the following (non exhaustive) list of points (van Bilsen, 2009):

- The vertical dimension (e.g. building height) is ignored in two-dimensional analyses;
- Walkable surfaces of cities differ in height, such as on hills and bridges;
- Incomplete landmark analysis in two-dimensional analyses, if any;
- Facade analysis, the inter-visibility between facades with regard to privacy, is possible in three-dimensional analyses;
- The possibility to relate to concepts relevant to urban design and planning like building density and incidence of sunlight, which are based on three dimensional measures;
- Comparison of perspectives with regard to safety (e.g. adult and child);

- A typology of space based on the full three-dimensional environment;
- A connection to cognitive pattern recognition, which occurs in three-dimensional analyses;
- Discrimination of lighting and cover conditions during night and day, bad and good weather, for navigation and safety.

However, due to a lack of research funding, it has never been applied systematically on various types of urban areas and correlated with socio-economic data. Seemingly, a three-dimensional isovist analyses can shed some light on to what extent building heights and building topography affect human perception and the social life between buildings.

## 7.7 CONCLUSIONS

The space syntax method can be applied on a wide scale level in research on built environments – from the organisation of furniture in a room up to the metropolis, making possible, in the first instance comparison of built environments with one another from a spatial point of view. Similarly, the method is a useful tool for comparison of the spatial changes in a before and after situation of structural urban changes in an area. However, while the method is a tool for explaining the physical spatial set up of buildings and cities, the interpretation of the results from the spatial analyses must be done in correlation with understanding of the societal processes and human behaviour.

Space syntax develops constantly. Its contribution to theories on built environments and methodology develop at the intersection of natural, social and technical sciences. So far, research projects range from anthropology or cognitive sciences to applied mathematics and informatics and touch upon philosophical issues. The evolution of space syntax asks for communication not just between various cultural contexts, but also likewise between different scientific domains.

As regards the development of scientific theories on the built environment, several credits have to be given to Space Syntax theory for applying it to research on the space and society relationship in built environments:

Firstly, the method has a high degree of testability. For it can be used in order to investigate various kinds of settlements belonging to different cultures. The choice of spaces as basic elements for explaining and comparing settlements allows for a rigorous comparison of settlements, independent of their cultural context (Hillier, 2001: 02.4). The space syntax method's context independence makes it applicable on all types of built environments, independent of types of societies, political structures and cultures. Therefore it is recognised to be a sustainable solid analyses and research method on built environments on various scale levels of a wide range of different cultures.

Secondly, the explanatory power of Space Syntax theory lies in the possibility to derive various effects from urban spatial changes. Configurative changes in the street grid are for example a sufficient condition for a change in according integration values. Likewise, a change in the integration values is a sufficient condition for a number of socio-economic changes. These functions are recognised to decide upon the locations of shops and the flow of pedestrian and vehicle movement. The theory thus allows for a high degree of predictability for future economically driven functional changes.

Thirdly, the theory's degree of falsifiability is of great interests. Taken in isolation the usage of laws of spatial combinatorics as meta-structures for the built environment is an application of an axiomatic method. In this respect Space Syntax theory is nothing but an *application* of mathematics to the built environment. In this way, this empirical theory is stated clearly, developed through 30 years of trial and error, conjectures and refutations. General statements gained through the application of the space syntax method on one type of built environment can be found in other types of built environments.

Fourthly, the method's whole key lies in a concise definition of space. It has contributed to operational and uniform research methods, which again has contributed to solid theories and generalisations on the relationship of society and space in urban studies.

## REFERENCES

- Benedikt, M. L. (1979) To take hold of space: isovists and isovist fields. *Environment and Planning B: Planning and Design* 6; 47–65
- Bilsen, A. van (2008) *Mathematical Explorations in Urban and Regional Design*. PhD thesis, Delft University of Technology.
- Bilsen, A. van (2009) How can serious games benefit from 3d visibility analysis. In: ISAGA (eds.) *Proceedings of ISAGA 2009*, Singapore.
- Bilsen, A. van, and Stolk, E. (2007) The potential of isovist-based visibility analysis. In: H. C. Bekering, J. Klatter, and D. Hauptmann (eds.) *The architectural annual 2005-2006*. Rotterdam, 010 Publishers, pp 68–73
- Conroy Dalton, R. (2001) The secret is to follow your nose. In: Peponis, J., Wineman, J., and Bafna, S. (eds.) *Proceedings Space Syntax*. 3rd International Symposium, Atlanta.
- Fakhrurrazi, R. (2010) *Reshaping Banda Aceh. Planning a better city in coping with future hazards of tsunami*. Delft, Faculty of Architecture, Delft University of Technology (MSc thesis)
- Fisher-Gewirtzmann, D., and Wagner, I. A. (2003) Spatial openness as a practical metric for evaluating built-up environments. *Environment and Planning B: Planning and Design* 30; 37–49
- Hillier, B. (1988) Against enclosure. In: Teymus, N., Markus, T., and Woaley, T. (eds.) *Rehumanising housing*. London, Butterworths, pp 63-85
- Hillier, B. (1996) *Space is the Machine*. Cambridge, Cambridge University Press.
- Hillier, B. (1999) *Space as paradigm for describing emergent structure in strongly relational systems*. Bartlett School of Architecture (unpublished paper).
- Hillier, B. (2001), The theory of the city as object or how spatial laws mediate the social construction of urban space. In: Peponis, J., Wineman, J., and Bafna, S. (eds.) *Proceedings Space Syntax*. 3rd International Symposium, Atlanta.
- Hillier, B., and Hanson, J. (1984) *The Social Logic of Space*. Cambridge, Cambridge University Press.
- Hillier, B., and Iida, S. (2005) Network effects and psychological effects: a theory of urban movement. In: Nes, A. van (ed.) *Proceedings Space Syntax*. 5th International Symposium, Delft.
- Hillier, B., and Sahbaz, O. (2005) High-resolution analysis of crime patterns in urban street networks: an initial statistical sketch from an ongoing study of a London borough. In: Nes, A. van (ed.) *Proceedings Space Syntax*. 5th International Symposium, Delft.
- Hillier, B., and Shu, C. F. (2000) Crime and urban layout: the need for evidence. In: Ballintyne, S., Pease, K., and McLaren, V. (eds.) *Secure Foundations. Key issues in crime prevention, crime reduction and community safety*. London, Institute for Public Policy Research.
- Hillier, B., Penn, A., Hanson, J., et al. (1993) Natural movement: or, configuration and attraction in urban pedestrian movement. *Environment and Planning B: Planning and Design* 20; 29–66
- Hillier, B., Penn, A., Banister, D., and Xu, J. (1998) Configurational modelling of urban movement network. *Environment and Planning B: Planning and Design* 25; 59–84
- Hillier, B., Turner, A., Yang, T., and Park, H. T. (2007) Metric and topo-geometric properties of urban street networks. In: Kubat, A. S. (ed.) *Proceedings Space Syntax*. 6th International Space Syntax Symposium, Istanbul.
- López, M., and Van Nes, A. (2007) Space and crime in Dutch built environments. Macro and micro scale spatial conditions for residential burglaries and thefts from cars. In: Kubat, A. S. (ed.) *Proceedings Space Syntax*. 6th International Space Syntax Symposium, Istanbul.
- Marcus, L. (2000) *Architectural Knowledge and Urban form. The Functional Performance of Architectural Urbanity*. Stockholm, Kungl. Tekniska Högskolan (PhD thesis)
- Morello, E., and Ratti, C. (2009) A digital image of the city: 3D isovists in Lynch's urban analysis. *Environment and Planning B: Planning and Design* 36; 837–853
- van Nes, A., and López, M. (2007) Micro scale spatial relationships in urban studies. The relationship between private and public space and its impact on street life. In: Kubat, A. S. (ed.) *Proceedings Space Syntax*. 6th International Symposium, Istanbul.
- Penn, A., Conroy, R., Dalton, N., Dekker, L., Mottram, C., and Turner, A. (1997) Intelligent architecture new tools for the three dimensional analysis of space and built form. In: Hillier, B. (ed.) *Proceedings Space Syntax*. 1st International Symposium, London.
- Ratti, C. (2004) Space Syntax: Some Inconsistencies. *Environment and Planning B: Planning and Design* 31; 487-499
- Rueb, L., and Van Nes, A. (2009) Spatial behaviour in Dutch dwelling areas. How housing layouts affects its users' behaviour. In: Koch, D., Markus, L., and Steen, J. (eds.) *Proceedings 7th International Space Syntax Symposium*, Stockholm.
- Sarradin, F. (2004) *Analyse morphologique des espaces ouverts urbains le long de parcours*. École Doctorale, Mécanique, Thermique en Génie Civil. Nantes, Université de Nantes. Doctorat: 224
- Teller, J. (2003) A spherical metric for the field-orientated analysis of complex urban open spaces. *Environment and Planning B: Planning and Design* 30; 339–356
- Turner, A. (2007) UCL Depthmap 7: From isovist analysis to generic spatial network analysis. In: Turner, A. (ed.) *New Developments in Space Syntax Software*, Istanbul.



8

# VIRTUAL HISTORICAL LANDSCAPES

## 8.1 INTRODUCTION

Landscapes are changing continuously due to human interaction with the natural environment. Historical maps, landscape paintings and drawings enable us to get a visual impression of how a particular landscape looked like in the past. However, our present digital culture would welcome more interactive and richer representations than the flat historical documents on which that we have had to rely so far. Using geographical information systems (GIS) and computer graphics technology, we are able to create 3D virtual reconstructions of historical landscapes, also referred to as *virtual historical landscapes*. These virtual historical landscapes let users experience the historical landscape from different viewpoints by browsing and navigating through 3D virtual environments. Such products would be interesting for edutainment projects in cultural heritage and for historical games; they could provide a global, visual context for a more detailed presentation of historical and archaeological research data. They would allow us, so to speak, “to step through a landscape painting” into the world of the past, as Alice in Wonderland did through the looking glass.

The historical sources and traces left in the landscape itself do not provide enough ready to use data for input into 3D modelling software. The type of 3D model discussed in this chapter differs fundamentally from more accurate and small-scale 3D models as produced by archaeologists and other geo-historical disciplines. The objective of our project is to design computer-

based methods for the creation of a realistic virtual historical landscape. This landscape will contain the characteristic features of the landscape in question, as we perceive them in the mainly visual historical sources left, like old maps, paintings and drawings. This implies, that the 3D model may not be accurate and complete in detail, but that the overall landscape structure and furnishing are based on sound arguments and have been constructed in a semi-automatic way. The construction process should be made affordable for the purposes mentioned above. It is expected that such virtual historical landscapes are an effective context to present landscape history and cultural heritage to the wider public. In addition, they may also support the presentation of historical and archaeological research. For that reason, both expert and lay users from the fields of historical geography, landscape archaeology, museums, education and so forth should experience virtual historical landscapes as realistic and plausible. However, up to now there is little knowledge of what users perceive as realistic. Therefore, we need to find decisive variables that influence the user experience in order to define appropriate visualisation requirements for virtual historical landscapes. However, before this kind of usability testing can be conducted, the methodological problem of creating a virtual historical landscape model in a semi-automatic way has to be solved, which will be discussed in this paper.

The 3D virtual reconstruction of the 17th century rural estate of Palace Honselaarsdijck and its surrounding landscape (near Naaldwijk, the Netherlands) served as a case study. The Palace Honselaarsdijck has completely disappeared and only few traces are left in the current landscape. Using modern technologies of 2D/3D GIS, CAD and computer graphics, information from remaining historical documents are processed and combined with contemporary geographical data to construct a reliable digital representation of the rural estate and its surrounding landscape.

This chapter is organised as follows. First, we provide an overview of related work to virtual landscape and city reconstruction in section 2. Next, we describe methods and techniques that we used to process a collection of historical documents to derive required input data for our 3D modelling software in section 3. Section 4 describes the case study of Honselaarsdijck and deals with the historical and geographical data used to model the terrain and 3D objects of the virtual historical landscape and then render the virtual historical landscape in 3D visualisation software to make it available through a user interface. Finally, we conclude with an outlook in section 5.

## **8.2 HISTORICAL VIRTUAL LANDSCAPES: “HOW GOOD IS GOOD ENOUGH?”**

Virtual landscapes represent a distinct genre in computer graphics (Ervin and Hasbrouck, 2001). The first attempts to create virtual representations of past, present and future land-

scapes go back to the early 80s of last century (Bishop and Lange, 2005). In the 90s, the technology of 3D GIS, CAD and computer graphics matured, and real-world and photo-realistic virtual models of cities and landscapes were developed. Applications of virtual landscapes range from visualisation and communication of spatial planning projects (Appleton and Lovett, 2005; Paar, 2006) to initiatives aimed at the study or experience of a historical city or landscape, e.g. *Walking with Vermeer* (De Boo, 2001) or the reconstruction of city Leusden (Alkhoven, 1993). Today, it is impossible to imagine the presentation of historical or archaeological research without 3D GIS and computer animation technology.

### 8.2.1 Virtual landscapes in the urban and rural

Virtual historical landscapes enable new approaches for exhibiting historical findings in museums and classrooms, and on the Internet. A well-known example is the *Rome Reborn* project of the University of Virginia. The project goal is to build 3D digital models showing the urban development of ancient Rome from the first settlement in the late Bronze Age (ca. 1000 B.C.) to the depopulation of the city in the early Middle Ages (ca. 550 A.D.). A Google Earth layer containing a 3D model of Rome in 320 A.D. shows more than 7,000 buildings. See figure 1.

Predominantly, these virtual reconstructions concern very highly detailed photo-realistic reconstructions of archaeological site excavations or heritage preservations using 3D capturing devices. However, Drettakis et al. (2007) observe that representations of historical situations that are too realistic are experienced by users as unbelievable or unconvincing, because (photo) realistic images pretend to be the actual truth even though the actual historical situations are uncertain or unknown. Moreover, photo-realistic and highly detailed modelling is a very laborious and skilful work, made more difficult by lack of sufficient historical data. Because of the resulting uncertainties about the precise situation in the past, the designer needs to be content with a good approximation of the historical situation. The virtual historical landscape resulting from this approximation may not lend itself to a true photorealistic representation. However, it enables more efficient realisation of virtual reconstructions of cities and landscapes, if the objective of presenting actual historical truth is somewhat loosened.

For the Rome Reborn project, a combination of detailed reconstructions of primary buildings from archaeological excavations and research, together with the procedural modelling of secondary buildings is applied (Dylla et al., 2010). Using sophisticated computer algorithms, procedural modelling creates complex city structures in an automatic way through matching objects (such as roofs, windows, and walls) from a dedicated object library along fixed (road) networks (Laycock and Drinkwater, 2008).

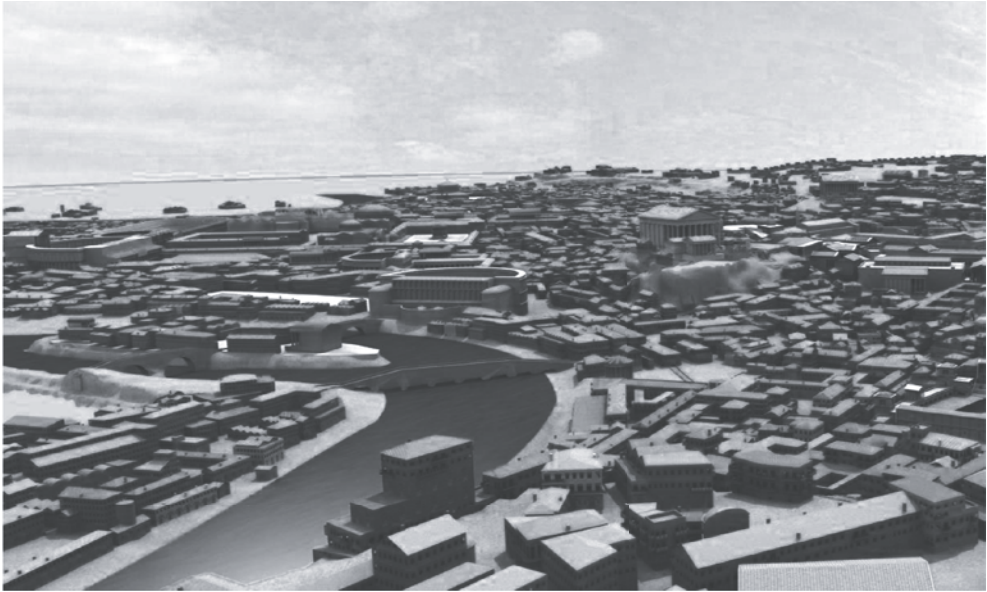


Figure 1

A download of the cityscape model of ancient Rome is available in Google Earth. This figure shows a highly detailed (offline) render of the Rome Reborn project (source: University of Virginia, 2010)

However, Ervin (2001) observes that rural landscapes are larger, continuous, more varied, and not easily bound in comparison to urban areas. In addition, there is limited availability of historical maps and other documents related to historical landscapes due to historical administrative or commercial reasons. In general, the creation of realistic vast virtual historical landscapes is experienced to be more difficult than virtual reconstructions of historical cities and villages. However, despite this larger complexity and uniqueness of landscapes, extended virtual historical landscapes may be created at reasonable efforts under certain circumstances. 3D GIS already offer the possibility to integrate, process and visualise large datasets of geographical areas in three dimensions. It enables the combination of datasets with different scales and accuracies as layered content, which is also relevant for creating vast virtual historical landscapes. For example, it could be the case that a detailed 3D building model is embedded within a low-detailed virtual environment resulting in some sort of multi-resolution / -scale visualisation of a historical landscape. This demands guidelines to visualise different accuracies and uncertainty levels, which is a well-studied topic in 2D/3D GIS research. Therefore, it is interesting to evaluate the potentials of 3D GIS methods and techniques to efficiently prepare input data for our 3D modelling software from historical documents. The integration of CAD and GIS software holds potentials to decorate a virtual historical landscape with virtual historical objects, which comprise its essential characteristics.

### 8.2.2 Levels of realism: 'real' vs. 'realistic'

The objective is to create virtual historical landscapes that are perceived as realistic by their viewers. Facing uncertainty and feasibility issues, one needs to consider whether the aim is to create a 'real' or a 'realistic' virtual reconstruction of historical landscapes (Ervin, 2001). Real(-world) landscapes are highly complex structures often covering very large areas. For visualisation, even in the case of a modern landscape, this is an extremely challenging task (Bishop and Lange, 2005). Ervin (2001) endorses the conflicts between resolutions, level-of-detail and object-field approaches in virtual landscape modelling with respect to a realistic experience. This modelling demands dedicated knowledge on what the image quality for perceived realism should be, or in other words "How good is good enough?" (after Perkins, 1992). The high image quality of photorealistic representations does not necessarily go together with realistic experiences (De Boer et al., 2009).

More abstract and simplified rendering of representations is also referred to as *non-photorealism*. Non-photorealism (NPR), considered as the counterpart of photorealism, uses artistic styles and rendering such as with digital paintings, drawings, and cartoons. Although the image is not photo-realistic, the experience can be realistic if the image holds identifying and recognisable characteristics for the viewer. For example, Disney's cartoon characters are not real-world characters; however, by following the principles of animation (Lasseter, 1987) the characters walk, move and talk as real-world people making us recognise and believe it. The 17th century Dutch painter Van Goyen, who adjusted the orientation of buildings to make them face forward so that viewers were able to recognise a certain city or landscape (Buijssen, 1993), already applied this 'recognition' principle.

Previous research described the potentials of NPR above photorealistic Virtual Environments (VEs) for applications in virtual heritage (Roussou and Drettakis, 2003) and landscape planning (Paar, 2005). The results of other studies also encourage exploring the potentials of non-photorealism to visualise historical landscapes, notably when applied to simplified and efficient modelling and visualising uncertainties. For example, Zuk et al. (2005) describe the use of non-photorealistic visual cues to communicate the existence of historical structures in the landscape. Bishop (1994) observes users' creative thinking (and increasing user engagement) when mixing abstract and realistic data, which stimulates both right brain-mode and left-brain mode in the thought process. Viewing these results, NPR promises to be a viable approach to create realistic virtual historical landscapes.

### 8.2.3 Dealing with uncertainty

If a landscape changed significantly and only a few original landscape elements are left traceable, historical documents are our only starting point for creating these virtual historical land-



**Figure 2**  
Jan van Goyen's "View on Leiden from the Northeast", dated 1650, in which the painting's composition deviates from the actual topography (source: Buijssen, 1993)

scapes. Even if there are a lot of historical documents available, the derivable information will often be limited, lacunose and inconsistent. For example, with regard to historical maps Blakemore and Harley (1980) identified three types of inaccuracies, i.e. in space (*geometric*), time (*chronometric*) and theme (*topographic*). These data imperfections leave us with uncertainty about the historical situation. Because computerisation tools fail to identify landscape features (and their accuracy) from these historical documents in an automatic way, we are not able to derive input data for our 3D modelling software easily and efficiently. A detailed, reliable reconstruction would require, of course, a profound landscape study to complement the surviving cartographic material. Altogether, this is such a laborious task that it would make highly detailed virtual historical landscape construction, for the purposes mentioned, almost unfeasible.

The question is how to deal with the types of uncertainty when selecting historical documents for the 3D terrain and object modelling of virtual historical landscapes? Consider a historical document as an observation in time. If only one document is available or selected, information can be derived from that particular source only and added to the 3D model. The deduced information is very 'precise' as no other documents reveal inconsistencies. However, the reliability is

very low as no other documents are available to corroborate the information from that single source. In modelling virtual historical landscapes from historical documents, there is always this problem of availability and selection of documents. On the one hand, a sufficient amount of historical documents would lead to an acceptable level of reliability; on the other hand, a large availability of historical documents may lead to inconsistent information and increased uncertainty about the historical situation. In that case, it is required to average, interpolate or approximate, to transform the information into appropriate input data for the 3D modelling phase. For example, for geometric information one needs to find the landscape features that still exist and derive the information by holding the unchanged and adjusting the changed. Although the landscape seems to be significantly changed, there are always some traces (e.g. church tower, canals, bridges) left serving as starting point for the 3D modelling.

These uncertainty issues demand visualisation guidelines. Zuk et al. (2005) describe the use of visual cues for visualising temporal uncertainties of historical buildings and objects, and De Boer and Voorbij (2010) elaborate on that by mapping visual cues as transparencies, saturation and fuzziness on the three types of inaccuracies.

## 8.3 MODELLING VIRTUAL HISTORICAL LANDSCAPES

Building and modelling virtual historical landscapes require an interdisciplinary approach, as it combines knowledge and methods from the science fields of historical geography, landscape archaeology, landscape painting, geographical information systems and computer vision technology. Specifically from a technical point-of-view, it requires efficient application and integration of methods and techniques from GIS, CAD and computer graphics.

### 8.3.1 An interdisciplinary approach

The aim is to build virtual historical landscapes by processing a selection of data from historical sources using sophisticated computer technology. More specifically, this process is evaluated for the feasibility of applying GIS and image processing software on historical maps and drawings, to derive appropriate input data for 3D modelling and visualisation software, i.e. CAD and computer graphics technology respectively. It is expected that a reliable and convincing virtual historical landscape can be obtained if, and only if, we consider an interdisciplinary and multi-faceted approach that integrates the fundamentals in terms of knowledge, methods and techniques from *engineering* and the *humanities*.

The fundamentals of the humanities related to our research include methods and techniques from particularly research fields of (landscape) archaeology, history of architecture and ge-



ography, landscape painting and cartographic heritage. Archaeology recovers and analyses relics from the past, environmental data using archaeological site excavations and – increasingly – virtual reconstructions of historical buildings and cities. Although we deviate from the traditional approach of minute archaeological site reconstruction, these related projects foster our 3D reconstruction methodology regarding an acceptable measure of accuracy (in terms of precision and reliability), and the application of multiple levels-of-detail in our virtual historical landscapes. Particularly, merging highly detailed archaeological virtual reconstruction with low-detailed virtual landscape environments enables the placing of (virtual) historical objects in their original landscape context.

This requires the acquisition of basic and specific information about the landscape context. Our basic principle is that we base our landscape reconstruction on historical maps and documents *without* doing extensive research on historical and archaeological reality. Therefore, we need to rely on research and deduced knowledge from history of architecture and geography. For example, we capture information about houses and buildings from architectural historical research (Blijdenstijn and Stenvert, 2000; Huijts, 1984; Meischke, 1993) and information about the landscape and its vegetation from research dedicated to historical geography and cultural-historical botany (Renes, 2010; Maes, 2006).

Furthermore, we extract information about the landscape decoration from landscape paintings and drawings. From the 17<sup>th</sup> century on, there is an increasing availability of topographical images of cities and landscapes. Bakker (2004) states that the objectives of cartographers and landscape painters are similar: capture the landscape as good as possible. However, many of these paintings and maps were custom-made, produced for a specific purpose. This implies that these documents include a measure of subjectivity. Cartographers created their maps according to purposive abstractions of the real world, leading to inaccuracies (Blakemore and Harley, 1993). Similarly, landscape painters diverted their composition from the actual topography, as long as the location remained identifiable to the audience (Buijsen, 1993). Therefore, a quality assessment on the use of landscape paintings to identify the essential characteristics of a historical landscape is required. Our future work elaborates on that in order to evaluate whether or not these historical documents are appropriate input data for creating virtual historical landscapes. Thus, historical maps and landscape paintings are processed and analyzed to seek mutual relationships regarding identifiable landscape elements, as will be shown in section 4.

Cartographic heritage concerns specifically all the valuables that are or may be inherited from historical cartography and maps. In cartographic heritage research, digital technologies are increasingly adopted to transform old maps, globes and cartographic documents into digital format, for example, and evaluate the map accuracy and spatial reference systems (Jenny, 2010). Similar to cartographic studies on the map content, GIS software is used to survey the available

landscape features in historical maps and compare these features with a collection of spatially related landscape paintings.

### 8.3.2 Integrating GIS, CAD, and computer graphics

The challenge is to transform the interdisciplinary knowledge and methods of the previous section into a technical realisation of a virtual historical landscape. For the case study on reconstructing Palace Honselaarsdijck and its landscape environment, a combination of GIS, CAD and computer graphics technology is applied. More specifically, GIS software is used to generate a digital historical terrain model, CAD software to build up a historical object library and computer graphics software for the final rendering of the virtual historical landscape. The advantage of GIS is its capability to process and visualise different layers of geographical data. This enables the combination of (georeferenced) historical maps with a current elevation map in order to derive a digital representation of the historical terrain. The derived historical elevation map serves as a height raster for the computer graphics software to construct the three-dimensional terrain.

Using CAD software, the distinct historical buildings and objects are modelled with the use of paintings and drawings, so as to convert the essential characteristics of historical buildings and landscape features to their virtual counterpart. Both 3D GIS and computer graphics software allow placing these virtual historical objects into the virtual environment on specific point locations. Generally, they differ in that 3D GIS software supports the visualisation of large geographic areas in a real-time rendering, though at the expense of a lower image quality, whereas computer graphics' virtual environments are limited and bounded, but, using sophisticated rendering techniques, photorealistic representations are achieved. However, the tendency is that next-generation 3D GIS software packages offer more potentials to create more realistic 3D geo-visualisation, merging the principles of GIS, CAD and computer graphics technology.

## 8.4 PALACE HONSELAARSDIJCK AS A CASE STUDY

As a case study, a 3D virtual reconstruction of the 17th century rural estate of Palace Honselaarsdijck and its surrounding landscape (near Naaldwijk, the Netherlands) is created. Palace Honselaarsdijck was a fortified building acquired by the Dutch governor (aka *stadtholder*) Frederick Henry in the early 17th century. He re-built and extended the country estate numerous times between 1621 and 1647 (see figure 3 top). At the end of the French Revolution, this estate was nothing more than a ruin. In 1815, King William I decided to demolish it. Today, the business estate De Honsel stands on the former location of Palace Honselaarsdijck (see figure 3 bottom). The only remainder is the small outbuilding De Nederhof. This case study perfectly

demonstrates how much data from historical sources needs to be gathered, evaluated and processed, before being used as input for a virtual reconstruction. This requires data gathering and processing from historical sources as input for modelling the historical landscape terrain and landscape features using methods and techniques from 2D/3D GIS, CAD and computer graphics (De Boer, 2010).

#### 8.4.1 Collecting and processing historical documents

The case study started with gathering digital copies of historical maps and drawings at national and local record offices. Digital copies of historical documents are increasingly available at (on-line) archive repositories due to increasing heritage digitisation projects. For example, some colour-prints of the Palace Honselaarsdijck estate were valuable for their rich topographic information, building plans and garden designs, and for detailed information about the building geometry and garden dimensions, along with an outline map of the landscape region around the rural estate, i.e. the Cruquius' map of Delfland (1712). The Cruquius' map of Delfland is an outline map covering the area of the district water control board Delfland, and several accompanying map sheets on a 1:10,000 scale. It was made by the Dutch land-surveyor and cartographer Nicolaus Samuel Cruquius (1678-1754) and despite the obsolete measurements techniques to capture the landscape geometry, the map is considered as highly accurate for that time (Postma, 1977). After importing the 1:10,000 scale map sheets into the GIS software (ESRI ArcGIS 9.3), a modern 1:10,000 scale vector map of the Netherlands (TOP10NL) is used for georeferencing the historical map sheets. Georeferencing enables the combination of historical maps with contemporary maps using one spatial reference system. Therefore, one needs to select connecting points of landscape features that are visible in both maps. Because parts of the parcellation in the Cruquius' map are still present on the modern vector map, it is possible to select approx. 50 points per map sheet to reference spatially the historical maps to the modern map.

Next, an affine transformation (aka *2<sup>nd</sup> order polynomial transformation*) on each map sheet is applied using the connecting points (aka *control points*) to adjust the map sheets to the Dutch spatial reference system (*Rijksdriehoekstelsel*) by rotating, scaling and translating it. This affine transformation corrects for the possible non-orthogonal axis due to the digitisation process, however without significantly changing the mutual position and angles between map elements. After merging (aka *mosaicking*) the map sheets, a rubber-sheeting transformation is used to georeference the small-scale outline map of Delfland to the map sheets. Although a rubber-sheeting transformation significantly distorts the outline map if the control points are not homogeneous distributed, it enables the seamless joining of the outline map with the map sheets. Next, the building plans and garden designs are georeferenced using the Cruquius' map and the large-scale base map of the Netherlands (GBKN). It starts with documents including the only remaining building De Nederhof (right of the main building) and depending on the al-



**Figure 3**  
Palace Honselaarsdijck around 1683 (top) and the business estate De Honsel in 2009 (bottom) (sources: Erfgoedhuis ZH, 2011 (top image) and Beekhuizen, 2008 (bottom image))

ready georeferenced map elements, it continues with the other plans and designs subsequently. From digital colour-prints of historical drawings and paintings, some relevant topographic information about the outward building and garden appearance of the Palace Honselaarsdijck estate is extracted. The colour and shape of the walls, roofs, windows, ornaments, fountains, flowerbeds and tree colonnades are identified. Next, we tried to find some evidence, as good as possible, for this deduced outward appearance from dedicated (historical) research on Palace Honselaarsdijck. For example, Morren (1909) confirms the redbrick walls and the grey-coloured Maas-slate roofs, which we also find on the colour print of figure 3, and Beekhuizen (2008) confirms that the colonnades of the leaf-holding beech trees exist. After the final preparation of the historical and geographic data, we continued with the digital terrain and building modelling.

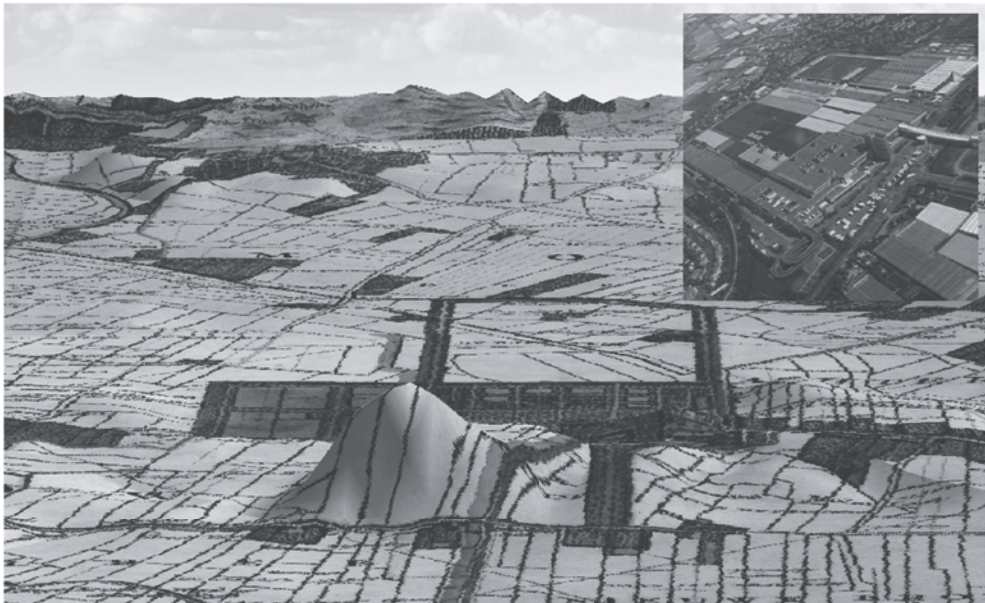
#### 8.4.2 Terrain and 3D object modelling (constructing the virtual historical landscape)

After the data preparation, the second objective is to extrude the particularly two-dimensional historical and geographic data to a third dimension. A spatial reference is added to the historical maps and an immediate next step is to combine the old Cruquius' map of Delfland with the modern Dutch height map, i.e. *Actueel Hoogtebestand Nederland* (AHN). This height map (or elevation raster) fully covers the area of the Netherlands having a ground resolution of 5 metres and each pixel value corresponds to the height above average sea-level (datum: NAP) on a centimetre-level. However, because the landscape has changed significantly since the 17th century, present landscape features distort the 3D visualisation. See figure 4.

Therefore, an approximated elevation map consistent with the historical situation is generated. In both the Cruquius' map and the modern vector map, similar existing meadows and pastures can be identified and it is assumed that ground levels have not changed considerably since the 17<sup>th</sup> century. Selecting the underlying height values from the modern elevation map using a spatial extraction, next, missing height values are inserted for a complete coverage of the Cruquius' map using a spatial interpolation delineated by existing polders and dykes.

Figure 4

Palace Honselaarsdijck and its surrounding landscape visualised in ESRI ArcScene©. The historical map of Cruquius (1712) is combined with a current elevation map; however, the view is distorted (bulge in front) by the flower auction hall (top right inset)



Using a combination of image processing and GIS spatial analysis, the large-scale landscape features are added to the generic historical elevation map, such as ditches, channels, villages and country estates. For example, the ditches and channels are modelled by cleaning the Cruquius' map for text and other cartographic symbols using Adobe Photoshop©, then the cleaned map is added to the generic elevation map using a simple raster calculation. Similar to the manual mapping of the parcellation and waterways, the text-cleaning process is a laborious task. However, as the experience has been that it is relatively easy to do, and it maintains the size and shape of the topographic features very well.

Green-coloured regions on the Cruquius' map depict farmhouses, country estates and villages, which we identify as 'areas-of-interest'. We add these areas to the historical elevation map by selecting pixel values using the magic selection tool in Adobe Photoshop©. Next, the derived raster is imported into ESRI ArcMap©, the pixels are converted to point features and the point features are related to one specific area-of-interest using a constraint Delaunay triangulation. After converting the Delaunay triangles to polygons, adjacent polygons are merged into single connected areas, and – in some cases – the derived polygons are generalised or smoothed. The result is an approximated delineation of the areas-of-interest, which is used in the virtual landscape decoration phase to fill with three-dimensional trees for example. See figure 5.

Figure 5

After converting the pixel colour values of the original Cruquius map into polygon features using a Delaunay triangulation to delineate the areas of interest, the virtual historical landscape is decorated with low-poly 3D tree objects; visualised in ESRI ArcScene©

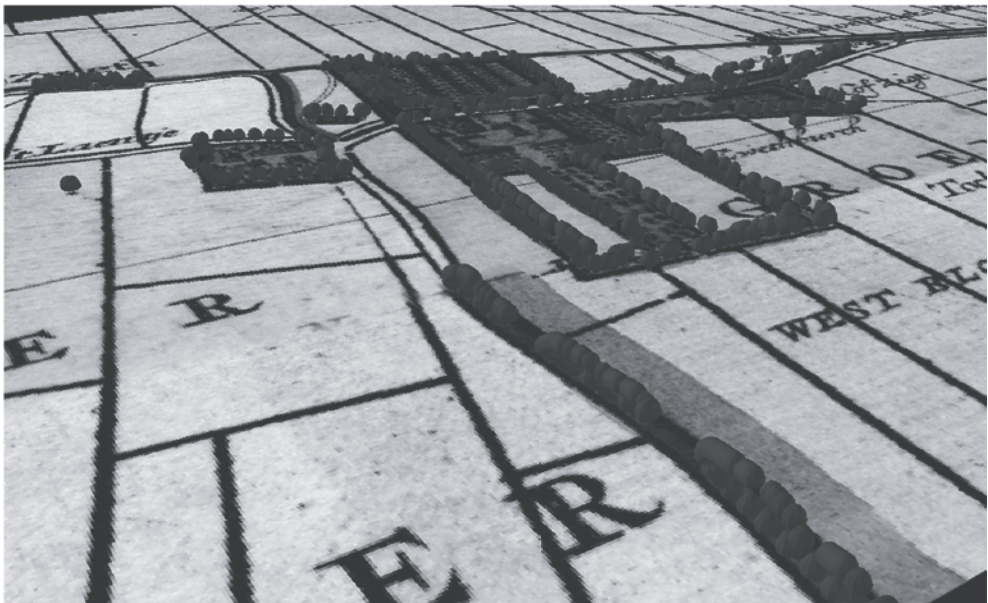




Figure 6

The user interface is based upon a collection of 17<sup>th</sup> century pictures (top left). If a user clicks on one of the small pictures, the virtual reconstruction is loaded in the middle frame (top right). Next, the user starts to fly over the virtual reconstruction (bottom left) to the corresponding location where he/she receives some additional information (bottom right)





For modelling the historical buildings and structures, we use old drawings and information from architectural-historical research to select the specific characteristics and identifying features to be added to the virtual counterpart of these objects. Google Sketchup© is used to construct the 3D geometry of the virtual historical objects. In the landscape decoration phase, the historical object library is (semi)automatically used to add 3D virtual objects to point feature locations from a 2D point feature layer in the virtual historical landscape.

#### 8.4.3 Rendering and interface

A virtual landscape comprises of five elements: water, atmosphere, vegetation, terrain and structures (Ervin and Hasbrouck, 2001). The previous section described how the terrain and 3D objects of the historical landscape have been modelled. Next, we need to complete the virtual historical landscape of Honselaarsdijck with the other three landscape elements. Numerous landscape visualisation software packages are available, e.g. Visual Nature©, Terragen© and Vue Infinite©. The latter is chosen for the case study because – despite its relatively low price – it offers high image quality rendering and large libraries for landscaping textures, atmospheres, plants and other 3D objects. Vue Infinite allows the use of a raster as height map for modelling the terrain and to import 3D objects to decorate the landscape. Finally, the virtual landscape is completed with atmosphere, water and vegetation (eco-systems).

The resulting virtual historical landscape of Honselaarsdijck was presented at the Royal Gardening exhibition of the Teylers Museum (Haarlem) in spring 2010. To make the virtual historical landscape available to the wider public, the digital landscape model is rendered and animated to derive animations and still images. Inspired by the 17<sup>th</sup> century pictures (see figure 6), a user interface is developed to show people the relationship between the rural estate and the distinct snapshots on the sides. Therefore, the choice was made to let users fly to the distinct snapshots in the main view and provide them some dedicated information about the place.

The entire user interface is implemented in Flash because of its ability to handle video. It shows a slideshow of cross fading historical images, surrounded by small clickable thumbnails. A mouse click starts one of the 16 short animations that form the heart of the presentation. In each animation, the camera wanders through the model to arrive at the very location depicted in the historical image, providing each image with some basic spatial context. The user is invited to compare the digital 3D-reconstruction with the original picture. A descriptive text containing basic facts and historical context information completes the user interface. The animations are created from a series of still images, created at regular intervals along a predefined path through the digital landscape model. The series of stills are combined into a movie, and subsequently converted to a Flash-supported video format. All the relevant files are merged

into a single Flash file from which both online and offline versions of the presentation are generated, circumventing the subtle differences between browsers. The demo is available for download at <http://honselaarsdijck.geomultimedia.nl/>.

## 8.5 DISCUSSION AND FUTURE OUTLOOK

The previous sections described the methods and techniques used to derive a 3D virtual reconstruction of Palace Honselaarsdijck and its surrounding landscape. One of the biggest difficulties experienced so far is to achieve a fully decorated landscape, as this requires the extraction of a sufficient amount of reliable information from historical documents to model the terrain and virtual objects. Information is needed about which terrain and landscape features have been present in the historical landscape, where they were located and in which frequency or density they appeared, in order to obtain a convincing and reliable virtual historical landscape. Whoever starts building virtual historical landscapes aims to create an as realistic as possible digital representation of a historical landscape. However, information about the actual historical situation is limited and information about what viewers actually experience as realistic is lacking. This requires further research to both affective and effective visual cues, i.e. user experience and uncertainty visualisation respectively.

During the case study, small experiments were performed to evaluate what viewers found more important in virtual historical landscapes: the actual objects (*content*) or the quality of image/rendering (*layout*). Various images of virtual historical landscapes with different content and rendering were shown to users, who next were asked to assess the images. As most comments concerned remarks on the size, shape or lack of landscape features, it is concluded that the user experience is more influenced by the actual content of the virtual historical landscape than by the image quality and rendering. More experiments about this hypothesis are needed for further conclusions to develop some guidelines for creating realistic virtual historical landscapes. For example, the visual cues that influence user experience can be tested by evaluating the ‘measure of realism’ of renders containing highly detailed objects in low-detailed environments (and vice versa), or renders from which certain landscape features will be erased in a specific sequence.

If there is insufficient information about the actual historical situation, a high-detailed photorealistic representation cannot be achieved. This creates a demand for guidelines on how to visualise uncertainties using non-photorealism. Future research is recommended on which visual cues are to be applied for an effective communication of uncertainties in virtual historical landscapes, to prevent misinterpretation or misleading experiences for its viewers.

It is expected that the number of virtual historical landscapes will strongly increase, as the technology of 3D GIS, CAD and computer graphics becomes more and more available for historical and archaeological research. These virtual historical landscapes hold strong potentials for presenting cultural heritage and landscape information to the wider public. Using interactive virtual historical landscapes, it enables the access of landscape-oriented archive records through a 3D visualisation interface. Therefore, it is recommended to explore methods and techniques to integrate, share, and access virtual historical landscapes and archive records, in order to make history interactively available.

## REFERENCES

- Alkhoven, P. (1993) *The changing image of the city: a study of the transformation of the townscape using computer-aided architectural design and visualization techniques: a case study: Heusden*. Utrecht, Utrecht University.
- Appleton, K., and Lovett, A. (2005) GIS-based visualisation of development proposals - reactions from planning and related professionals. *Computers, Environment and Urban Systems* 29; 321- 339
- Bakker, B. (2004) *Landschap en wereldbeeld: van Van Eyck tot Rembrandt*. Bussum, Thoth.
- Beekhuizen, M. (2008) *Met andere ogen*. Tour for the former real estate Honselaarsdijk.
- Bishop, I. D., and Lange, E. (2005) Communication, Perception and Visualization. In: Bishop, I.D., and Lange, E. (eds.) *Visualization in Landscape and Environmental Planning: Technology and Applications*. London, Taylor & Francis, pp 2-19
- Bishop, I. D. (1994) The Role of Visual Realism in Communicating and Understanding Spatial Change and Process. In: Unwin, D.J., and Hearnshaw, H.M. (eds.) *Visualization in Geographic Information Systems*. London, John Wiley, pp 60-64
- Blakemore M. and Harley J.B. (1980) The Search for Accuracy. Concepts in the History of Cartography. *Cartographica Monograph* 26; 55
- Blijdenstijn, R., and Stenvert, R. (2000) *Bouwstijlen in Nederland (1040-1940)*. Nijmegen, SUN.
- Buijsen, E. (1993) *Between Fantasy and Reality: 17th Century Dutch Landscape Painting*. Baarn, De Prom.
- De Boer, A., and Voorbij, J.B. (2010) Visualisatie van temporele aspecten in 3D virtuele historische landschappen. In: Bakker, N., Breure, L., and Quak, W. (eds.) *Geoinformatie kent geen tijd?* Delft, NGC, pp 29-34
- De Boer, A. (2010) Processing old maps and drawings to create virtual historic landscapes. *e-Perimtron* 5 (2); 49-57
- De Boer, A., Voorbij, J.B., and Breure, L. (2009) Towards a 3D Visualization Interface for Cultural Landscapes and Heritage Information. In: *Online Proceedings of the 37th International Conference on Computer Applications and Quantitative Methods in Archaeology (CAA)*.
- De Boo, M. (2001) *Een nieuw zicht op Delft: Delftse geodeten en industrieel ontwerpers tonen 3D-perspectief ontleend aan 17e eeuwse prenten*. Delft, Delft Integraal.
- Drettakis, G., Roussou, M., Reche, A., and Tsingos N. (2007) Design and Evaluation of a Real-World Virtual Environment for Architecture and Urban Planning. *Presence* 16; 318-332
- Dylla, K., Frischer, B., Mueller, P., Ulmer, A., and Haegler, S. (2010) Rome Reborn 2.0: A Case Study of Virtual City Reconstruction Using Procedural Modeling Techniques. In: *CAA 2009. Making History Interactive*. Oxford, Archaeopress, pp 62-66
- Erfgoedhuis ZH (2011) <http://www.geschiedenisvanzuidholland.nl/> [accessed: 22 February 2011]
- Ervin, S.M., and Hasbrouck, H.H. (2001) *Landscape Modeling: Digital Techniques for Landscape Visualization*. New York, McGraw-Hill.
- Ervin, S.M. (2001) Digital landscape modeling and visualization: a research agenda. *Landscape and Urban Planning* 54 (1-4); 49-62
- Huijts, C.S.T.J. (1984) *De ontwikkeling van de Middelflandse boerderij; een onderzoek in het kader van de reconstructie van Midden-Delfland*. Vlaardingen, Midden-Delfland Vereniging.
- Jenny, B. (2010) New features in MapAnalyst. *e-Perimtron* 5 (3); 176-180
- Lasseeter, J. (1987) Principles of Traditional Animation Applied to 3D Computer Animation. *Computer Graphics* 21(4); 35-44
- Laycock, R.G., and Drinkwater, D. (2008) Exploring Cultural Heritage Sites through Space and Time. *Journal on Computing and Cultural Heritage* 1; 1-23
- Maes, B. (2006) *Inheemse bomen en struiken in Nederland en Vlaanderen: Herkenning, verspreiding, geschiedenis en gebruik*. Amsterdam, Boom.
- Meischke, R. (1993) *Huizen in Nederland : architectuurhistorische verkenningen aan de hand van het bezit van de Vereniging Hendrick de Keyser*. Zwolle, Waanders.

- Morren, Th. (1909) *Het Huis Honselaarsdijk*. Leiden, vereniging "Die Haghe".
- Paar, P. (2006) Landscape Visualizations: Applications and Requirements of 3D Visualization Software for Environmental Planning. *Computers, Environment and Urban Systems* 30; 815-839
- Perkins, N. (1992). Three questions on the use of photo-realistic simulations as real world surrogates. *Landscape and Urban Planning* 21; 265–267
- Postma, C. (1977) *Kruikius. Kaart van Delfland, 1712*. Alphen aan den Rijn, Canaletto.
- Renes, H. (2010) *Op zoek naar de geschiedenis van het landschap : handleiding voor onderzoek naar onze historische omgeving*. Hilversum, Verloren.
- Roussou, M., and Drettakis, G. (2003) Photorealism and Non-photorealism in Virtual Heritage Representation. In: Arnold, D.B., Chalmers, A., and Niccolucci F. (eds.) *Proceedings of the International Symposium on Virtual Reality, Archaeology, and Intelligent Cultural Heritage (VAST'03)*. Switzerland, Eurographics Association, pp 51-60
- University of Virginia (2010) *Rome Reborn*. <http://www.romereborn.virginia.edu/> [accessed: 1 November 2010]
- Zuk, T., Carpendale, S., and Glanzman, W.D. (2005) Visualizing Temporal Uncertainty in 3D Virtual Reconstructions. In: Mudge, M., Ryan, N., and Scopigno, R. (eds.) *Proceedings of the 6th International Symposium on Virtual Reality, Archaeology and Cultural Heritage (VAST'05)*. Italy, Eurographics Association, pp 99-106

9

# MAPPING LANDSCAPE OPENNESS WITH ISOVISTS

## 9.1 INTRODUCTION

Today's fast changing society and environment resulted in the creation of new cultural and natural landscapes and in the deterioration of traditional landscapes (Antrop, 2005). New developments such as urban and infrastructure projects and the industrialisation and expansion of large-scale agriculture are resulting in new landscapes which are superimposed on traditional landscapes. The main difference between new landscapes and traditional landscapes is expressed by dynamics in speed and scale, as well as the changing perceptions, values and behaviour of their users (Antrop, 2005). As a result, the visual appearance and peoples perceived quality of landscapes are changing (Nohl, 2001; Antrop, 2004). As a consequence the extent to which people identify with the landscape may decrease and therefore people's well-being is at stake. This is not limited to landscapes with outstanding beauty, but in particular applies to everyday landscapes where people live and work (Council of Europe, 2000). Without interference of policy makers or planners, the visual quality of everyday landscapes will decrease because landscape changes are mainly economy-driven (Bell, 1999). The need to protect and enhance landscape quality is now widely recognised and has been put on European and national political agendas (Council of Europe, 2000; Wascher, 2000; Piorr, 2003; Antrop, 2004; Dramstad, Tveit et al., 2006). There is an increasing demand for decision support systems that offer information on the visual quality of landscapes in order to monitor and evaluate the impacts of ongoing developments (Tress, Tress et al., 2001; Scott, 2003).

Although a significant amount of scientific research has been done on visual landscape issues, policy makers are still calling for information that is more useful and relevant to policy-making processes and that can make these processes more effective (McNie, 2007). As McNie (2007) has indicated, there is often a mismatch between the information that is produced by scientists and the information that is required by policy makers. In particular, policy makers may need information that is not available or not useful, or they may not be aware of existing information that is of use to them.

So what do policy makers require from decision support models for monitoring and evaluating visual landscape quality? Two recent developments are of particular interest. The first is that policy makers have come to realise the need to include the perception of people in the decision-making process. This aspect of visual landscape assessment is included in the definition of landscape in the European Landscape Convention: "Landscape means an area, as perceived by people, whose character is the result of the action and interaction of natural and/or human factors" (Council of Europe, 2000). This definition implies that people's perception of the landscape should be included in policy making. The second is the increasing dependency of environmental policy making on a third wave of Geographic Information Systems (GIS) (Roche and Caron, 2009), which can combine and analyse many datasets in a transparent way. These developments have created a demand for a new generation of decision support tools that are both realistic and technologically advanced.

In recent decades, significant advances in computers and increasing access to high-resolution geodata have led to an increasing deployment of GIS in assessing visual landscape variables, using reproducible methods, over wide areas. Some of the first examples of mapping visual qualities using GIS are presented by Steinitz (1990) and Bishop and Hulse (1994). Mapping the environment based on people's perception poses interesting challenges for geographical information science because it requires expertise in both GIS analyzing techniques and the psychology of how people experience landscapes (Brabyn, 2008). The ability of GIS to represent individual views of landscape introduces the opportunity to explore subjective and personal views within a spatial environment, potentially coupling the quantitative processing capabilities of GIS with a wide range of social and psychological methods (Aspinall, 2005). Geographic information systems (GIS) provide a way of representing large amounts of data on landscape in a comprehensible format. As such, GIS enables the assessment and analysis of landscape quality in a scientifically sound, and practically useful manner (O'Shea, 2006). In particular, GIS provides the possibility of making the decision-making process more transparent, standardised, and replicable (O'Looney, 2000). In order to be useful for decision makers, GIS tools need to be flexible, easy to use, and adaptable (Geertman, 2002). Because of the tremendous growth in accessible and affordable geo-data, the role of GIS has increased within the decision-making process.

The present research is aimed at developing a procedure to describe the visual landscape, which takes advantage of improvements in measurement techniques, developments in GIS and availability of high-resolution topographic data. The procedure is developed for policy making and spatial planning purposes, and provides information about one specific aspect of the visual landscape, *landscape openness*. In the remainder of the chapter, first the concept of landscape openness is explained, then a method to model landscape openness is proposed. Subsequently, a procedure to use this model for policy making purposes is demonstrated. Finally the results of an evaluation of the procedure with policy makers are discussed.

## 9.2 LANDSCAPE OPENNESS

Openness is an aspect of the visual landscape that is strongly emphasised in theories relating to perceived visual quality and landscape preference (Herzog, 1987; Coeterier, 1996; Tveit, Ode et al., 2006). The quality of openness depends on biological, as well as cultural and personal factors. Theories emphasising the biological aspect are evolutionary theories such as the prospect-refuge theory (Appleton, 1975), in which prospect is the degree to which the environment provides an overview, which is directly related to landscape openness. According to this theory, people display a preference for certain configurations that combine enclosure and openness. Due to their evolution in the savannah, humans tend to prefer environments that offer various options for cover while at the same time allowing an overview of large spaces. Thus, a balance between open and enclosed landscapes appears to be preferred to either confined or exposed spaces (Strumse, 1994; Buijs, Jacobs et al., 1999; Hagerhall, 2001). Another evolutionary-based theory is the preference model developed by Kaplan et al. (1989). The model assumes people will be attracted to the landscape if human abilities to process information are stimulated. The model consists of four components: coherence, complexity, legibility, and mystery. Openness is a key aspect of the components (Herzog and Kropscott, 2004) and was found to be a predictor of landscape preferences. Kaplan et al. (1989) compared four domains of predictors of landscape preferences. They found that openness, which was rated by respondents based on photographs, was one of the most powerful predictors. Notably, in the study by Kaplan et al. (1989) openness was found to be negatively related to landscape preference, whereas other studies have revealed positive relations between openness and landscape preference (e.g. Rogge, Nevens et al., 2007). The quality of openness not only depends on biological factors, but also on other factors such as shared cultural values and personal learning experiences, which guide and filter people's perceptions (Gifford, 1987; Bourassa, 1990).

The preferred degree of openness may differ across various dimensions. For example, from a general user perspective, half-open landscapes tend to be most preferred because these provide opportunities for understanding as well as exploration (Appleton, 1975). From a cultural



perspective, however, extreme degrees of openness or enclosure can be highly valued because these are markers of cultural values such as uniqueness and historical importance. Policy makers often take cultural values as a starting point for planning and decision making. They take a point of reference in the past to determine the current cultural value of landscapes. In The Netherlands for instance, 1900 has often been taken as reference year because it pre-dates the large-scale landscape developments of the twentieth century, such as urban sprawl, heath land reclamation, and land consolidation (Koomen, Maas et al., 2007). Based on such a reference year, a high degree of openness is preferred for one landscape type and a low degree of openness for another. An example of varying preference is the landscape of the Netherlands, where one of the core qualities is a certain degree of openness.

### 9.3 MODELLING LANDSCAPE OPENNESS

By making use of advances in GIS and high-resolution geodata, physical objects can be modelled in detail. Models of openness have been developed based on physical objects, but here a perception-based approach is presented. The meaning of ‘perception-based’ in this chapter is that in contrast to a model constructed with objects alone, a subject or perceiver is added, on which the output of the model for openness is based. More precisely, the model is based on visual perception. To model landscape openness, the visual landscape – in particular the visual space – is simulated with the visible space. One way to model openness, which links perceptual factors with spatial information, is provided by the concept of the *isovist*, which has had a long history in architecture and geography, as well as mathematics. Tandy (1967) is generally acknowledged to be the originator of the term *isovist*. An *isovist* is the space visible from a given viewpoint with respect to an environment. Benedikt (1979) has further developed the concept of *isovists* and introduced a set of analytical measurements of *isovist* properties. The appeal of the concept of an *isovist* is that it provides an intuitively attractive way of thinking about a spatial environment, because it describes the space ‘from inside’, from the point of view of individuals, as they perceive, interact with, and move through the space (Turner, Doxa et al., 2001). A similar concept has been developed in the field of landscape architecture and planning, using the term *viewshed*. Although there are various methods to calculate both the *isovist* and *viewshed*, a typical difference between the two concepts is that the *isovist* represents the space that can be ‘overviewed’, while the *viewshed* represents (parts of) objects that are visible. Other differences, such as taking into account the vertical viewing angle and terrain height, which are typically only included in the *viewshed*, are no limitations for *isovists* per se. The possibilities of *isovists* and *viewsheds* have been investigated by many scientific studies for various purposes (Fisher, 1991, 1996; Batty, 2001; Llobera, 2003; Franz and Wiener, 2005; Stamps, 2005).

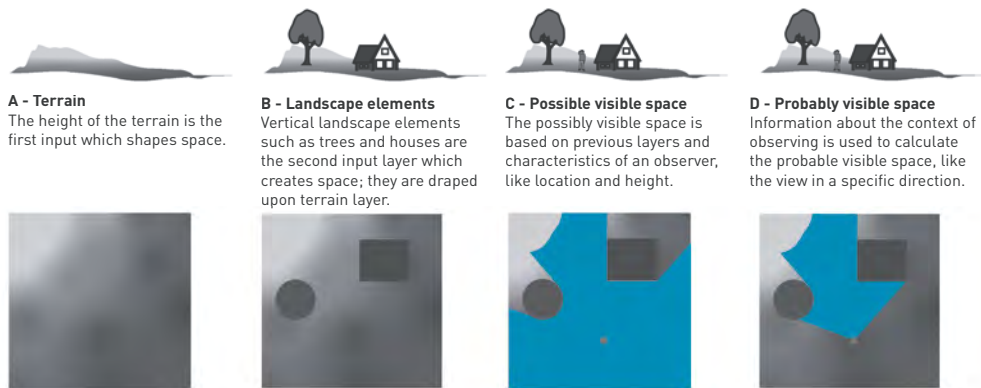


Figure 1

Aspects of landscape and space: terrain (A); landscape elements (B); possibly visible space (C); probably visible space (D)

In this research ArcGIS and Isovist Analyst are used to measure the visible space by calculating isovists (Rana, 2002). The software calculates isovist polygons from two input datasets: a point layer, which represents locations of observer points, and an obstacles layer, which represents the physical environment (figure 1A and B). Visual limitations are simulated by parameter values, which limit the size of the isovists. Figure 1C shows the possible visible space from one viewpoint, based on the terrain height, the landscape elements and the observer height. Besides the location and the eye level of the observer, other characteristics like the angle of view also determine the visible space. This probable visible space (figure 1D) is related to the context and viewing characteristics of people during various activities. The limitations on the field of view may be different for each activity. The isovist polygons for each observer point are constructed by first calculating a number of radials, which are straight lines from the observer point to the first obstacle and therefore represents lines of sight. The radials are calculated every  $n$  degrees. A disadvantage of this calculation method is that only the horizontal viewing angle is taken into account, and therefore does not detect a difference between for example a house of 7 metres high and a tower of 50 metres, while this difference is expected to affect the degree of openness. A solution for this limitation would be the calculation of three dimensional isovists, such as proposed by Culagovski (2007).

### 9.3.1 Validation

The isovist and related concepts are applied in many situations, for example for landscape planning and policy making (Weitkamp, Bregt et al., 2007). In general, there is a lack of actual validations of such numerical and spatially explicit information to assess openness. Although the use of the isovist to estimate perceived openness is an intuitively attractive representation, the many assumptions and simplifications when modelling the perceived landscape openness require a validation.

Three isovist variables were selected to compare with perceived openness, based on the literature (Van der Ham and Iding, 1971; De Veer and Burrough, 1978; Stamps, 2005; Tveit, 2009) and based on the ease of detecting their equivalents in the field. The first is the minimum line of sight. The second is the maximum line of sight which emphasises the importance of distance for the perception of openness. The third is the average line of sight, which is strongly related to the size of the field of view. In short, these three isovist variables and their perceived equivalents in the real world can be summed up as: minimum radial and shortest line of sight; maximum radial and longest line of sight; and average radial and average line of sight.

A field experiment was carried out to test the correspondence between the three isovist variables and perceived openness in the field. Thirty-two Dutch students were asked to rate the openness of the landscape for thirteen field locations, which cover the full range of openness in the Netherlands. A questionnaire was created in which the participants were asked to rate the openness of the landscape on a scale from 1 (low) to 10 (high). They were also asked to estimate the average line of sight, maximum line of sight, and minimum line of sight (in metres).

One way to examine how the isovist variables are related to perceived landscape openness is to calculate how much of the variation of openness can be explained by a combination of the variables. With openness as the dependent variable and the average radial, maximum radial, and minimum radial as predictors, multiple regression analysis was performed. This resulted in two models. The first, with the average radial as the predictor, with an  $R^2$  of 0.84. The second with the average radial and the maximum radial as predictors, with an  $R^2$  of 0.91. In general, the minimum radial did not contribute much to the model (the average radial was dominant), but for individual locations, the perception of openness could change with a landscape element close to the observer while retaining similar values for maximum radial and average radial.

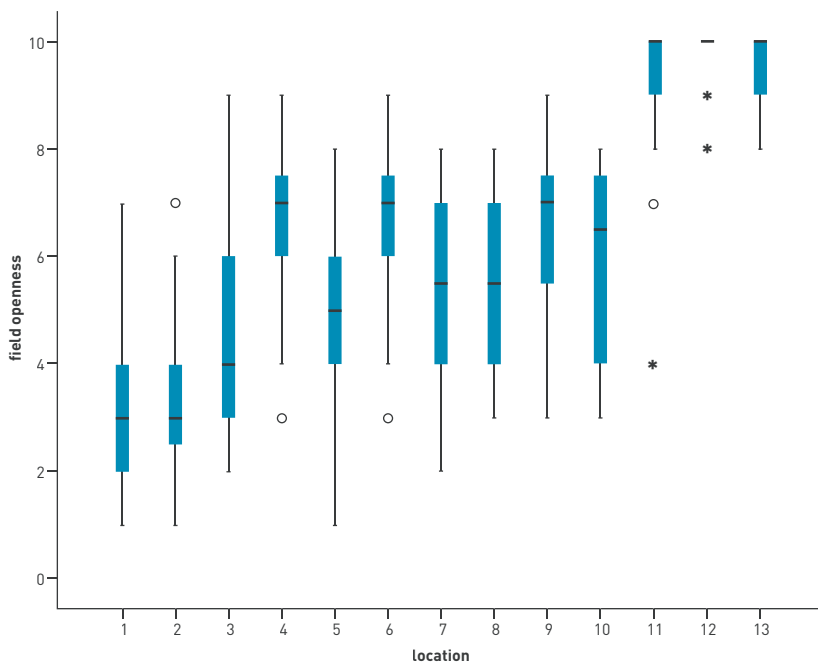
The relationship between perceived space and measured space is most often described by a power function (Wagner, 1985, 2006). The maximum radial and the average radial showed very high correlations with perceived openness, whereas the correlation of the minimum radial was lower. When values of the isovist variables reached above a certain value, further increase did not affect the openness rating. For example, if the maximum radial was higher than 3500 metres or the average radial was higher than 1000 metres, the perceived openness remained fairly constant (on a scale from 1 to 10, between 9.2 and 9.8). Again, the minimum radial did not contribute much to the model, but for individual locations, the perception of openness could change with a landscape element close to the observer but with similar values for maximum radial and average radial.

The most important difference between measured and perceived distances is that the measured distance only yields one result, whereas perception of distance varies within a group of people.

Because openness ratings are actually made by individuals, the reliability of individual ratings is an important aspect of the data analysis (Palmer and Hoffman, 2001). To obtain more information about the variation within the group of participants, the Intraclass Correlation coefficient is calculated. This measured the extent to which participants agreed when rating the openness of the 13 locations. The average of the scores of the 32 participants were highly reliable (the Average Measure Intraclass Correlation value was 0.99), suggesting that despite the participants' individual differences, the scoring process was successful in identifying different levels of openness. The Single Measure Intraclass Correlation is the reliability one would get if using just one participant. In this case, this value was 0.76. Landscape openness is a descriptive characteristic that can be rated in a fairly objective way and therefore there is high consistency between those rating.

The range of openness ratings of the 32 participants is illustrated with a box plot in figure 2. The locations with average openness values (between 4 and 7) tended to show more variation than very high or very low rated openness. The three locations with the highest average openness ratings (11, 12, and 13) showed the lowest variation. Location 12 had a very uniform

**Figure 2**  
**Box plots of rating of field openness by 32 participants for 13 locations. An increasing location number (x-axis) corresponds with and increasing isovist value**



rating except for two outliers. The locations were predicted to have an increasing value of openness based on the isovist calculations. However, locations 4 and 6 had higher values than location 5, and locations 7 to 10.

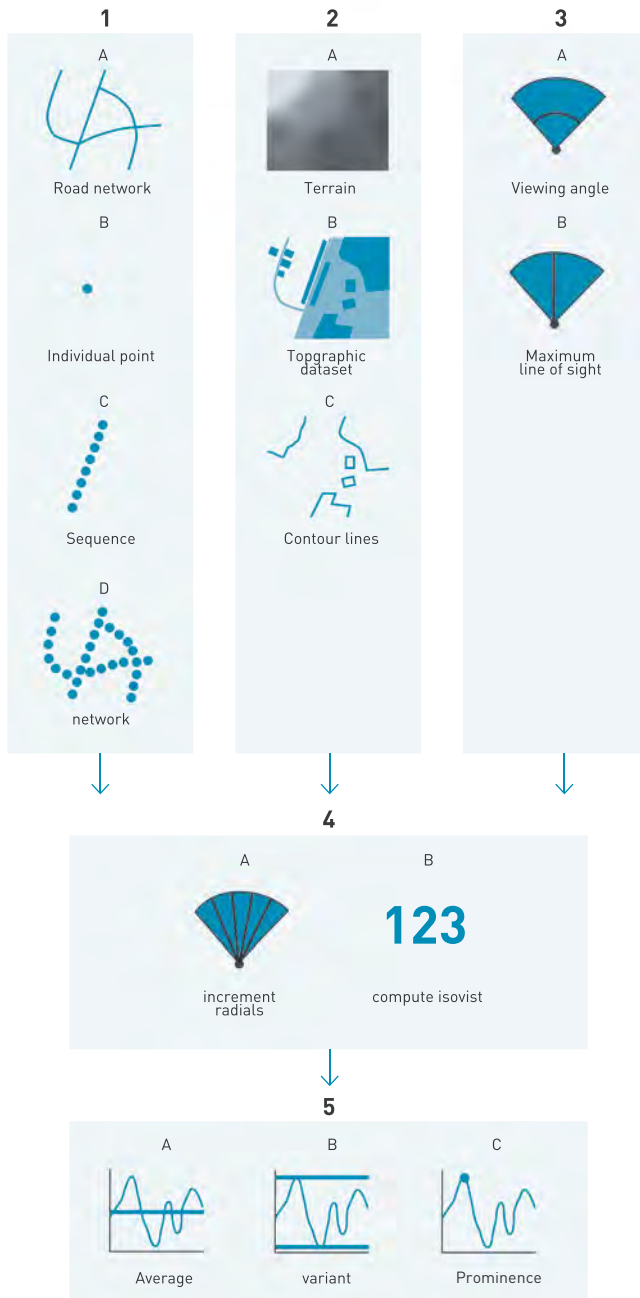
In summary, most of the variation in perceived field openness is explained by the average radial and the maximum radial of the isovist. There are however individual rating differences, but in particular, on group level, there are high correlations between isovist values and perceived openness ratings. When taking into account that differences between landscapes were relatively small (all Dutch landscapes), for European landscapes it will be easier to detect differences, and therefore even better correlations are expected. In short, the isovist appears to be a good indicator of perceived landscape openness.

## 9.4 PROCEDURE

With the use of isovist measurements, a step-by-step procedure was developed for policy makers to simulate landscape openness based on perception and expert knowledge. The design of the procedure is based on a literature study about landscape perception, and conversations with landscape researchers, policy makers and planners.

### 9.4.1 Create the observer layer

The first step is to create an observer layer. The observer layer represents the locations from which people may perceive the landscape. Since the majority of people perceive the landscape from a road, a road network should be selected. In order to decide where on the road the viewpoints are located, a mode of perception has to be defined. This can be either a static or dynamic mode of perception (Weitkamp, Bregt et al., 2007). The mode of perception reflects what people can see related to a certain activity. Accordingly it includes information about the observer as a subject, rather than as a physical object. Three main sampling strategies are distinguished to locate the viewpoints: individual point sampling, sequence points sampling and network point sampling. The first sampling strategy reflects perception of openness from individual locations, for example from a lookout (figure 3, step 1B). This is a static mode of perception. These individual points can be predefined by policy makers and planners or randomly selected on the road network. The second sampling method reflects perception from a sequence of locations (figure 3, step 1C). This is a dynamic mode of perception in which people perceive transitions and variations in landscape openness. The chosen distance between the points may depend on the expected perceived intensity of changes of openness: the more complex the spatial configuration, the shorter the distance between points should be. The distance may also



**Figure 3**

**Step-by-step procedure for measuring visibility**

The numbers and letters are explained in the main text. A black letter means that the sub-step is required; a grey letter means that the sub-step is optional. A connected box means that the previous step is necessary to execute it; a non-connected box does not need a previous step to be executed.

depend on people's activity in the landscape. For a walking tourist the distance should be shorter than for a person driving to work by car. The third sampling method reflects perception from a network of roads (figure 3, step 1D). These points may be either a collection of individual points (first sampling method) or a collection of sequences of points (second sampling method). The total collection of points does not reflect the locations visited during one activity, but is a summary of multiple activities. This is in contrast to point sampling and sequence sampling, where there is a direct relationship between perception and locations of points. This sampling method may reflect a static perception of openness, using predefined or random sampling, or a dynamic perception of openness, using regular or irregular sequencing points.

#### 9.4.2 Define the physical space

The second step in calculating the visible space is to define the physical space by merging a terrain dataset (figure 3, step 2A) with a topographic dataset (figure 3, step 2B). For each observer point defined in step 1, a contour line layer was created (figure 3, step 1C). This contour line layer is the obstacle layer input for calculating the isovists (figure 3, step 4). The height value of the contour lines is the sum of the value of the height model at the location of the observer point and the eye level value.

#### 9.4.3 Identify visual limitations

A person's field of view depends on their mode of perception and activity. For example, the field of view of car drivers is much smaller than the field of view of pedestrians. This limited field of view has been termed the 'useful visual field' and has been shown to be smaller than the peripheral visual field (Ball, Owsley et al., 1993; Caduff and Timpf, 2008). Visual limitations, like viewing angle and maximum line of sight, are inherent to human vision and have an effect on perceived landscape openness (Coeterier, 1994). For example, the maximum angle of view in the horizontal plane is about 210 degrees, with 120 degrees binocular overlap without movement of the head or eyes (Atchison and Smith, 2001). The useful visual field can have smaller values for the viewing angle, depending on the mode of perception. Another example is the maximum visual line of sight. Many studies relate threshold distances of the line of sight to the foreground, middle ground and background, but with varying Euclidean distances (Van der Ham and Iding, 1971; US Forest Service, 1974; Smardon, Palmer et al., 1986; Bishop and Hulse, 1994; Baldwin, Fisher et al., 1996). The viewing angle and the maximum line of sight vary with activity, motion speed, and perhaps complexity of the landscape. These parameters are added to the model to increase the accuracy of the visibility measurements for describing landscape openness (figure 3, step 3).

#### 9.4.4 Compute the Visible Space

The visible space is calculated with isovists, using ArcGIS and Isovist Analyst (Rana, 2002). The software calculates isovist polygons from two input datasets: a point layer which represents locations of observer points (figure 3, step 1) and an obstacles layer which represents the vertical landscape elements (figure 3, step 2). Visual limitations are simulated by parameter values that limit the size of the isovists (figure 3, step 3).

The isovist polygons for each observer point are constructed by first calculating a number of radials, which are straight lines from the observer point to the first obstacle and therefore represent lines of sight. The radials are calculated every  $n$  degrees. The most appropriate increment value for the radials (figure 3, step 4A) depends on the desired precision of the calculation and is also strongly correlated to computation time.

#### 9.4.5 Select and Calculate Variables

The last step of the procedure is to derive variables from the isovist (figure 3, step 5). This is an important step. It adapts the output data better to the phenomenon of landscape openness and turns the output data into a format suitable for landscape policy making and planning.

The variables can be derived from three unit types. The smallest unit is a point; the variables are derived from one isovist. The next unit is a line; the variables are derived from sequencing isovists. The last unit is a network; the variables are derived from multiple isovists. Three types of (statistical) analysis are proposed to derive the variables from the output data: average, variation and prominence. The average analysis produces one general description of landscape openness for a unit. The variation analysis produces a description that reflects the variation in openness within a unit. The prominence analysis selects a specific line of sight, isovist or sequence of isovists within a unit, which represents the character of landscape openness for that unit.

## 9.5 EVALUATION

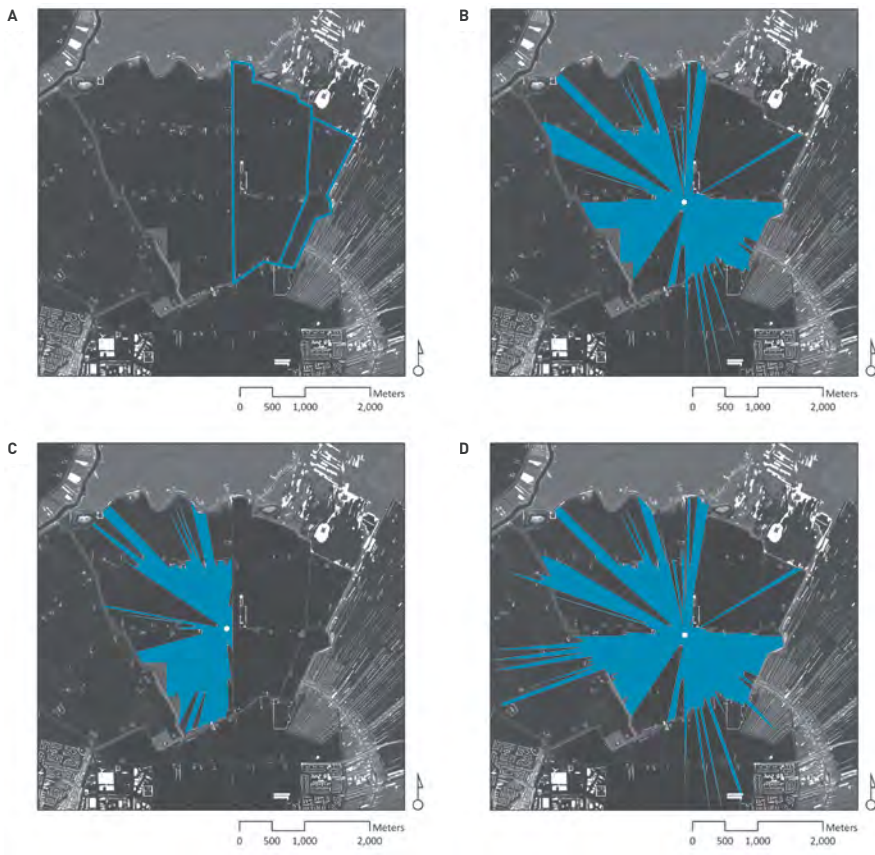
The procedure is designed to assess landscape openness in a way that meets the requirements for a good description of landscape openness as well as a generic procedure for landscape policy making and planning. A workshop was organised in which scientists and Dutch policy makers were brought together to evaluate the usefulness of the procedure. Six actual landscape openness cases, which were provided by the policy makers themselves, were used to present and illustrate the procedure. Three of the cases are shown in figure 4: *Ronde Venen* in the prov-



ince of Utrecht, figure 5: near Winschoten, Groningen, and figure 6: *Friese Meren*, Friesland. There are well-established criteria available for evaluating the usefulness of decision support models at the interface between science and policy making. Four criteria are selected: relevance to policy (Cash, Clark et al., 2003; Cash and Buizer, 2005; Jacobs, Garfin et al., 2005; Keller, 2009), scientific credibility (OECD, 1999; Cash and Buizer, 2005; Jacobs, Garfin et al., 2005; Doody, Kearney et al., 2009), usability for policy makers (OECD, 1999; Park, Stabler et

Figure 4

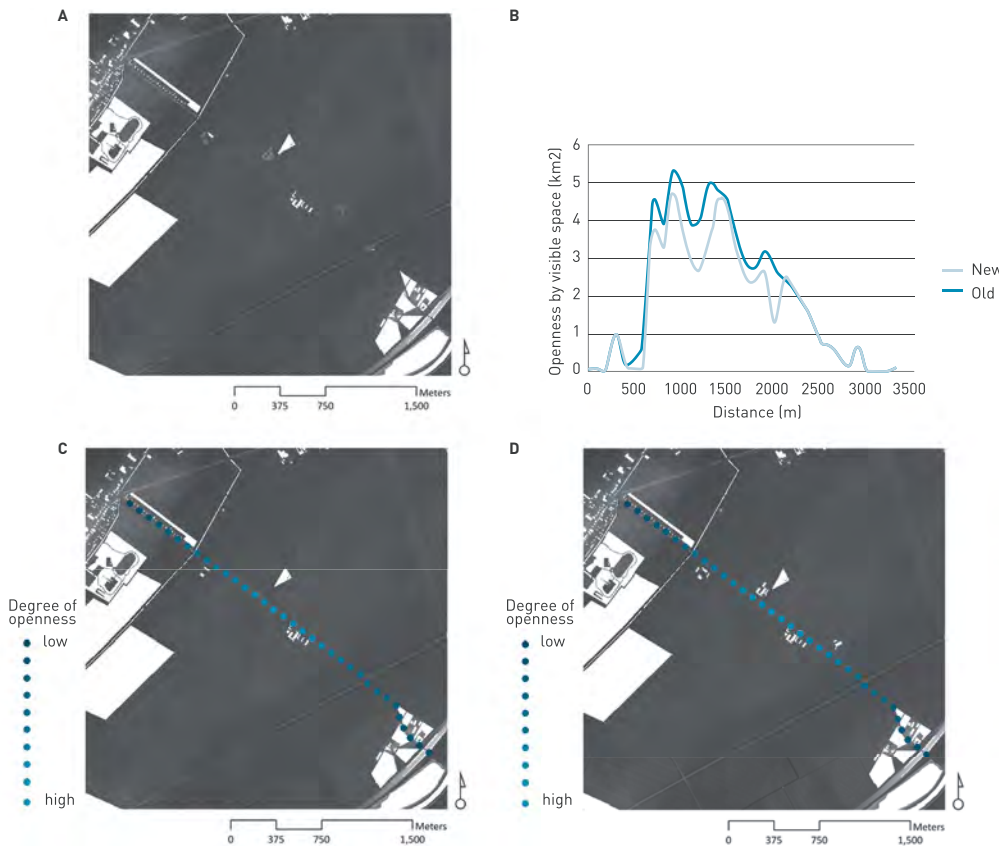
The case study area of Ronde Venen, Utrecht, is characterised by its polders, which have a high degree of openness. The development of natural habitats will require the construction of dikes to regulate the water table. Various scenarios for the location of dikes have been developed, one of which is shown in figure 4A. The background shows the height model of the landscape, the whiter areas representing higher height values and the darker areas representing lower height values. The policy question is how the dikes affect the openness of the landscape. The visible space from one viewpoint on the road, in the centre of the polder, is shown for the current situation in figure 4B. The viewing angle is 360 degrees and the maximum line of sight is 3000 metres at an eye level of 1.6 metres. In the possible new situation the same viewpoint is located on the planned dike and the visible space is therefore larger than in the current situation (figure 4D). However, the visible space decreases dramatically when located on a road next to the dike (figure 4C). This example illustrates that the exact location of the viewpoint is important when drawing conclusions about the effect on openness



al., 2004; Singh, Murty et al., 2009), and feasibility for implementation (OECD, 1999; Doody, Kearney et al., 2009). The policy makers who participated the workshop were asked to comment on these four criteria for the procedure.

Figure 5

The case study area of Winschoten, Groningen, is characterised by a contrast between large-scale open landscapes and enclosed landscapes. The open character is under threat, one of the reasons for this being the relocation of farm buildings from small settlements to the open agricultural areas. Figure 5.4A shows an example of recently built farmhouses. The provincial policy makers want to know the effect these buildings have on landscape openness. The calculation of the visible space is based on views from the road along which the buildings are located. To simulate the perception of openness during movement, viewpoints were fixed at 100 metre intervals along the road in the old situation (4C) and the new situation (4D), with the viewing angle set at 120 degrees in a southeasterly direction. The difference in visible space between the old and the current situation is shown in figure 5B. The difference is not big, partly because there were already some buildings and a patch of forest located along the road. The differences in openness at other locations on the road are even smaller because the road starts and ends in an enclosed area. The contrast between the enclosed areas and the open area along the road decreased slightly, but would still be perceived



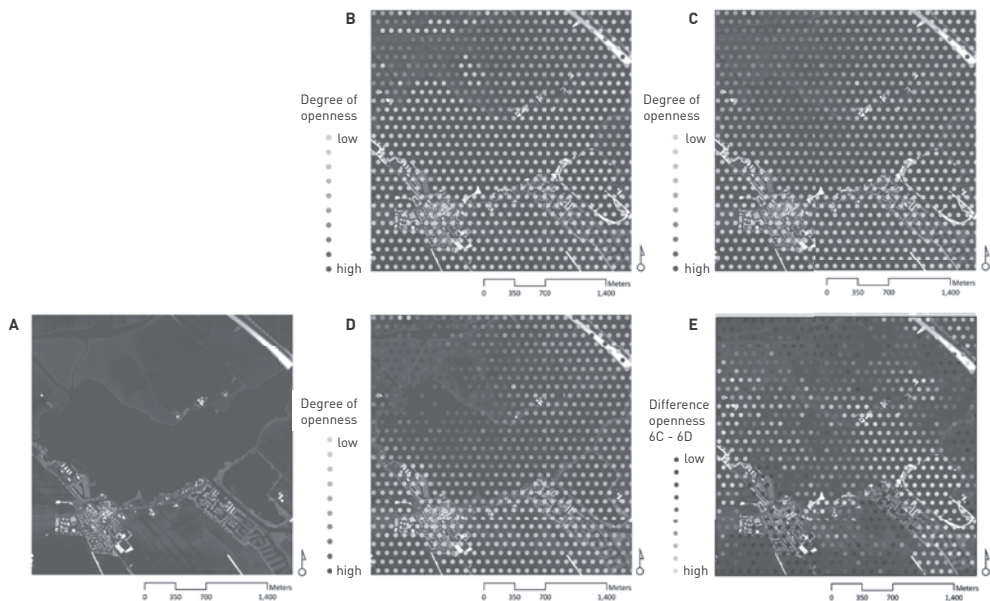


Figure 6

The case study area of the Friese Meren in the province of Friesland is characterised by its open landscapes. However, the spontaneous growth of vegetation around the lakes is reducing the openness of the landscape. The effect of the vegetation growth has to be assessed. The exact locations of the vegetation growth were not known, and the Top10vector may not show all this vegetation. We selected the vegetation within 50 metres of the shores of the lakes and designated it as spontaneous vegetation (figure 6A). We calculated the visible space for every location in the area based on a 100-metre grid. The viewing angle was set to 360 degrees and the eye level was set to 1.6 metres on the land and 1 metre on the water (figure 6B). A change in eye level can have a large effect on the openness. For example, the values for openness change dramatically when the eye level on the water is raised to 2 metres (figure 6C). The effect of the vegetation on openness can be seen by comparing figure 6C with 6D, in which the vegetation has been removed. The difference between the openness with vegetation (6C) and without vegetation (6D) is shown in figure 6E

### 9.5.1 Relevance

All the participants, including three who mentioned that they already used other methods, felt the need to assess openness. Openness is defined as one of the core qualities of Dutch national landscapes, and many other European countries also consider it relevant to measure openness. It was found relevant that people's perceptions are explicitly taken into account, and that landscape functions or activities could be linked to perception. The procedure makes it possible to identify perceived openness for activities such as driving a car and enjoying the view from a viewpoint, which is useful for policy making. The functions of modes of perception and visual limitations were generally appreciated by the participants because they make the procedure flexible enough to be applied to local situations. They also agreed that guidelines based on scientific research were indispensable for its proper use.

Furthermore the procedure was thought to be relevant because it can be used to develop valuation standards for openness. Although the procedure does not provide predefined standards for determining whether there is ‘enough’ or ‘too little’ openness, the participants agreed that the procedure would be helpful in developing these. There was a discussion on whether valuations should be included as a standard element in a procedure. This could increase the relevance of such a procedure, but may also decrease its credibility.

The procedure supports the communication of information about openness to stakeholders, such as other governmental organisations at different levels. The procedure was also considered to be useful for participatory planning because it is easy to generate visual impressions of openness and the effects of certain landscape changes on openness.

### 9.5.2 Credibility

The procedure was considered to be credible because it was clear and transparent. Participants considered the procedure much more credible than multi-criteria analysis, for example, which was compared with a ‘black box’. The isovist technique that is used to calculate the visible space was considered to be an intuitively good representation of landscape openness. The input data, the AHN and Top10vector, were the best data currently available, but are not yet detailed enough to accurately represent some elements. Although some improvement is possible, the participants agreed that the procedure could never entirely replace other methods of collecting information, such as field visits, no matter how accurate and precise the input data. However, because policy makers are likely to differ in their landscape preferences and interpretations from the general public (e.g. Vouligny, Domon et al., 2009), the use of more representative tools, that can make policy makers aware of their biases, was considered to be very important. Some participants indicated that the credibility of the procedure could be improved by including parameters related to people’s cultural background or living environments. These parameters would primarily affect their preference for a certain degree of openness. Among the participants of the workshop there was general agreement on the complexity of developing a procedure for assessing preferred openness.

### 9.5.3 Usability

The procedure is a usable instrument because of its transparency, which makes it possible to interpret the outcomes in an unambiguous way. The measured visible space is a usable basis for communicating landscape openness with other stakeholders because it is based on a simple and clear concept. The flexibility of the procedure, which allows for the selection of various modes of perception and other parameters for the visual limitations related to various activities, also contributed much to its usability. However, a guideline on how to make use of these options was considered to be necessary for proper use.

#### 9.5.4 Feasibility

The procedure employs widely used software and data and fairly simple techniques within GIS to make the measurements; this was appreciated by the participants. However, the whole process was not yet automated and ready to be implemented in ArcGIS, the GIS software in use at the organisations where the participants were employed. The participants indicated that there is sufficient knowledge of GIS in their organisations to use the procedure if it could be implemented in ArcGIS. As their organisations do not have the necessary knowledge about landscape perception, and therefore about parameter values such as the viewing angle and the maximum line of sight, a guideline for the proper use of all the options related to different types of perception is required.

The data that was used for the procedure, the AHN and Top10vector databases, was available to the participants. If such a procedure were to be used at the European level, data availability would be a major issue, because at this level such high-resolution topographic datasets and elevation models are not available.

Having enough time and money is also a precondition for the feasibility of the procedure. The participants indicated that this would not be a problem, given that information about openness can be generated relatively quickly and at low cost. This is especially true in comparison with other procedures for including perception in policy making, such as surveys.

## 9.6 CONCLUDING REMARKS

A systematic GIS-based procedure for measuring landscape openness was developed which is explicitly modelled from the perspective of humans. The model provides exact estimates of possible visible space based on biological features of human vision, and physical features of the environment. In addition it estimates probable visible space by specifying modes of perception with corresponding visual limitations. From the perspective of human perception, an important limitation of the procedure is that it is restricted to calculating visible space, and does not include space as it is seen by people. What is seen not only depends on human vision and modes of perception, but also on other dimensions such as cultural values and personal learning experiences. The procedure was found useful by policy makers, in particular its transparency and flexibility were appreciated.

Openness manifests itself differently in different cultural landscapes, and the development of prototypical openness values for each landscape type could be used as a guide for plans and policies. At the European level landscapes are typically classified by experts using a top-down

approach. A need has been expressed to link these European top-down approaches with more perception-based bottom-up approaches. Present research provides a first step in establishing this link by developing a perception-based approach that produces measurable data. This study provides the basis for research and identifies a number of areas where further research is required. The representation of openness may be improved by 3d isovists. However, validation is needed for indicating the benefits of 3d isovists. The three modes of perception also need validation to test how well the sampling strategies reflect how people perceive openness. Another area that needs further research is the implementation in planning and policy making. Guidelines need to be developed for the use of variable values. Finally, the development of prototypical descriptions of characteristic degrees of perceived openness for cultural landscape types, combined with bio-physical landscape types such as those of LANMAP (Mucher, Klijn et al., 2010), is another direction for further research.

## ACKNOWLEDGEMENTS

This chapter is written based on my PhD research and I am grateful to Arnold Bregt, Ron van Lammeren and Agnes van den Berg for their supervision during my PhD research.

## REFERENCES

- Antrop, M. (2004) Landscape change and the urbanization process in Europe. *Landscape and Urban Planning* 67(1-4); 9-26
- Antrop, M. (2005) Why landscapes of the past are important for the future. *Landscape and Urban Planning* 70(1-2); 21-34
- Appleton, J. (1975) *The Experience of Landscape*. London, John Wiley.
- Aspinall, R. J. (2005) GIS and landscape conservation. In: Longley, P. A. et al. (eds.) *Geographical information systems: principles, techniques, applications and management*. New York, Wiley, pp 358
- Atchison, D. A., and Smith, G. (2001) *Optics of the Human Eye*. Oxford, Elsevier Health Sciences.
- Baldwin, J., Fisher, P. et al. (1996) *Modelling Environmental Cognition of the View With GIS*. Third International Conference/Workshop on Integrating GIS and Environmental Modeling, Santa Fe, New Mexico.
- Ball, K., Owsley, C. et al. (1993) Visual attention problems as a predictor of vehicle crashes in older drivers. *Investigative Ophthalmology and Visual Science* 34(11); 3110-3123
- Batty, M. (2001) Exploring isovist fields: space and shape in architectural and urban morphology. *Environment and Planning B: Planning and Design* 28; 123-150
- Bell, S. (1999) *Landscape: Pattern, Perception and Process*. London, E & FN Spon.
- Benedikt, M. L. (1979) To take hold of space: isovists and isovists fields. *Environment and Planning B: Planning and Design* 6; 47-65
- Bishop, I. D., and Hulse, D. W. (1994) Prediction of scenic beauty using mapped data and geographic information systems. *Landscape and Urban Planning* 30; 59-70
- Bourassa, S. (1990) A paradigm for landscape aesthetics. *Environment and Behavior* 22(6); 787-812
- Brabyn, L. (2008) Using GIS to describe the landscape experience of hiking tracks. *New Zealand Geographical Society 24th Conference*. Victoria University of Wellington.
- Buijs, A. E., Jacobs, M. H., et al. (1999) *Graadmeters beleving: theoretische uitwerking en validatie van het begrip 'afwisseling'*. Wageningen, Staring Centrum.
- Caduff, D., and Timpf, S. (2008) On the assessment of landmark salience for human navigation. *Cognitive Processing* 9(4); 249-267
- Cash, D. W., and Buizer, J. (2005) Knowledge-Action Systems for Seasonal to Interannual Climate Forecasting. Washington D. C.
- Cash, D. W., Clark, W. C. et al. (2003) Knowledge systems for sustainable development. *Proceedings of the National Academy of Sciences of the United States of America* 100(14); 8086-8091

- Coeterier, J. F. (1994) Cues for the perception of the size of space in landscape. *Journal of Environmental Management* 42; 333-347
- Coeterier, J. F. (1996) Dominant attributes in the perception and evaluation of the Dutch landscape. *Landscape and Urban Planning* 34(1); 27-44
- Council of Europe (2000) *European Landscape Convention*. Florence.
- Culagovski, R. (2007) *Three dimensional isovist analysis method*. SIGRADI, Mexico.
- De Veer, A. A., and Burrough, P. A. (1978) Physiognomic landscape mapping in The Netherlands. *Landscape Planning* 5; 45-62
- Doody, D. G., Kearney, P. et al. (2009) Evaluation of the Q-method as a method of public participation in the selection of sustainable development indicators. *Ecological Indicators* 9(6); 1129-1137
- Dramstad, W. E., Tveit, M. S., et al. (2006) Relationships between visual landscape preferences and map-based indicators of landscape structure. *Landscape and Urban Planning* 78(4); 465-474
- Fisher, P. F. (1991) First experiments in viewshed uncertainty: the accuracy of the viewshed area. *Photogrammetric Engineering & Remote Sensing* 57(10); 1321-1327
- Fisher, P. F. (1996) Extending the applicability of viewsheds in landscape planning. *Programmetric Engineering and Remote Sensing* 62(11); 1297-1302
- Franz, G., and Wiener, J. M. (2005) *Exploring isovist-based correlates of spatial behavior and experience*. The 5th Space Syntax Symposium, Delft, The Netherlands.
- Geertman, S. (2002) Participatory planning and GIS: A PSS to bridge the gap. *Environment and Planning B: Planning and Design* 29(1); 21-35
- Gifford, R. (1987) *Environmental psychology: principles and practice*. Boston, Allyn and Bacon.
- Hagerhall, C. M. (2001) Consensus in landscape preference judgements. *Journal of Environmental Psychology* 21(1); 83-92
- Herzog, T. R. (1987) A cognitive analysis of preference for natural environments: mountains, canyons, and deserts. *Landscape Journal* 6(2); 140
- Herzog, T. R., and Kropscott, L. S. (2004) Legibility, mystery, and visual access as predictors of preference and perceived danger in forest settings without pathways. *Environment and Behavior* 36(5); 659
- Jacobs, K., Garfin, G. et al. (2005) More than Just Talk: Connecting Science and Decision Making. *Environment* 47(9); 17
- Kaplan, R., Kaplan, S. et al. (1989) Environmental preference: a comparison of four domains of predictors. *Environment and Behavior* 21(5); 509-530
- Keller, A. C. (2009) Credibility and Relevance in Environmental Policy: Measuring Strategies and Performance among Science Assessment Organizations. *Journal of Public Administration Research and Theory Advance Access*.
- Koomen, A. J. M., Maas, G. J. et al. (2007) *Veranderingen in lijnvormige cultuurhistorische landschapselementen: resultaten van een steekproef over de periode 1900-2003*. Wageningen, Wettelijke Onderzoekstaken Natuur & Milieu.
- Llobera, M. (2003) Extending GIS-based visual analysis: the concept of visualscapes. *International Journal of Geographical Information Science* 17(1); 25-48
- McNie, E. C. (2007) Reconciling the supply of scientific information with user demands: an analysis of the problem and review of the literature. *Environmental Science and Policy* 10(1); 17-38
- Mucher, C. A., Klijn, J. A., et al. (2010) A new European Landscape Classification (LANMAP): A transparent, flexible and user-oriented methodology to distinguish landscapes. *Ecological Indicators* 10(1); 87-103
- Nohl, W. (2001) Sustainable landscape use and aesthetic perception - preliminary reflections on future landscape aesthetics. *Landscape and Urban Planning* 54; 223-237
- O'Looney, J. (2000) *Beyond maps: GIS and decision making in local government*. Redlands, ESRI Press.
- O'Shea, C. (2006) Use of Geographic Information Systems (GIS) in Policy Making for Strategic Planning and Sustainable Development in Scotland.
- OECD (1999) *Environmental Indicators for Agriculture: Concepts and Framework*. Paris, France, Organisation for Economic Co-operation and Development.
- Palmer, J. F., and Hoffman, R. E. (2001) Rating reliability and representation validity in scenic landscape assessments. *Landscape and Urban Planning* 54(1-4); 149-161
- Park, J. R., Stabler, M. J. et al. (2004) The use of a multiple criteria decision analysis to evaluate the effectiveness of landscape and habitat enhancement mechanisms: an example from the South Downs. *Journal of Environmental Planning and Management* 47(5); 773 - 793
- Piorr, H.P. (2003) Environmental policy, agri-environmental indicators and landscape indicators. *Agriculture, Ecosystems & Environment* 98(1-3); 17-33
- Rana, S. (2002). *Isovist Analyst Extension*. London, Centre for Advanced Spatial Analysis, University College London.
- Roche, S., and Caron, C. (2009) *The organisational facets of GIS*. London, ISTE.
- Rogge, E., Nevens, F. et al. (2007) Perception of rural landscapes in Flanders: Looking beyond aesthetics. *Landscape and Urban Planning* 82(4); 159-174
- Scott, A. (2003) Assessing public perception of landscape: from practice to policy. *Journal of Environmental Policy and Planning* 5(2); 123
- Singh, R. K., Murty, H. R. et al. (2009) An overview of sustainability assessment methodologies. *Ecological Indicators* 9(2); 189-212
- Smardon, R. C., Palmer, J. F. et al. (1986) *Foundations for Visual Project Analysis*. New York, John Wiley & Sons.
- Stamps, A. E. (2005) Isovists, enclosure, and permeability theory. *Environment and Planning B: Planning and Design* 32(5); 735 - 762

- Steinitz, C. (1990) Toward a sustainable landscape with high visual preference and high ecological integrity: the Loop Road in Acadia National Park, USA. *Landscape & Urban Planning* 19(3); 213-250
- Strumse, E. (1994) Perceptual dimensions in the visual preferences for agrarian landscapes in western Norway. *Journal of Environmental Psychology* 14(4); 281-292
- Tandy, C. R. (1967) The isovist method of landscape survey. In: Murray, C.R. (ed.) *Methods of Landscape Analysis*. London, Landscape Research Group, pp 9-10
- Tress, B., Tress, G. et al. (2001) Bridging human and natural sciences in landscape research. *Landscape and Urban Planning* 57(3-4); 137-141
- Turner, A., Doxa, M. et al. (2001) From Isovists to visibility graphs: a methodology for the analysis of architectural space. *Environment and Planning B: Planning and Design* 28; 103-121
- Tveit, M., Ode, et al. (2006) Key concepts in a framework for analysing visual landscape character. *Landscape Research* 31; 229-255
- Tveit, M. S. (2009) Indicators of visual scale as predictors of landscape preference; a comparison between groups. *Journal of Environmental Management* 90(9); 2882-2888
- US Forest Service (1974) *The visual management system. National Forest Landscape Management*. Washington, DC US Department of Agriculture.
- Van der Ham, R. J. I. M., and Iding, J. A. M. E. (1971) *Landscape Typology System based on Visual Elements: Methodology and Application*. Wageningen.
- Voulligny, É., Domon, G. et al. (2009) An assessment of ordinary landscapes by an expert and by its residents: Landscape values in areas of intensive agricultural use. *Land Use Policy* 26(4); 890-900
- Wagner, M. (1985) The metric of visual space. *Perception & psychophysics* 38(6); 483-495
- Wagner, M. (2006) *The geometries of visual space*. London, Lawrence Erlbaum Associates.
- Wascher, D. M. (2000) The face of Europe. Policy perspectives for European landscapes: Policy perspectives for European landscapes. *ECNC Technical Report Series*. Tilburg, European Centre for Nature Conservation.
- Weitkamp, G., Bregt, A. et al. (2007) *Three Sampling Methods for Visibility Measures of Landscape Perception*. COSIT 2007, Melbourne, Australia, Springer-Verlag.





PART THREE  
**LANDSCAPE POLICY**



52° 2' 34" N, 4° 25' 4" E



10

# LANDSCAPE POLICY AND VISUAL LANDSCAPE ASSESSMENT

## THE PROVINCE OF NOORD-HOLLAND AS A CASE STUDY

### 10.1 INTRODUCTION

“One of the biggest challenges of the 21st century will be to maintain or strengthen landscapes as expressions of regional identity and sustainability while accommodating regional economic developments.” This observation by the Council of Europe is echoed by initiatives such as the European Landscape Convention (Council of Europe, 2000). This convention strives for the protection, management and planning of all landscapes and for raising awareness of the value of a living landscape<sup>1</sup>. From this perspective the individual undoubtedly has a part to play in the preservation of landscape quality, but laying down the general framework for protecting landscape quality is the responsibility of the public authorities. The convention is therefore trying to establish the general legal principles to guide regional and national policies on landscape and international cooperation in this field. Concepts related to landscape quality such as coherence, diversity and cultural identity can be effectuated by means of new policy instruments and state-of-the-art landscape assessment and monitoring. Targeted economic incentives and modern spatial planning techniques have put these landscape issues within reach, so that they can be incorporated in local, regional, national and international policies (Wascher, 2000).

#### 10.1.1 Visual character assessment and the Province of Noord-Holland

Landscape character assessment is a key element in landscape management, planning and monitoring and serves as an important basis for landscape policy. Landscape characterisation

can be broken down into four main categories of landscape value types: (1) *biophysical* (form and functioning of the landscape), (2) *socio-economic-technical* (human influence on the landscape form), (3) *human-aesthetic* (human experience of the landscape), (4) *political* (opinions and rights of stakeholders) (Groom, 2005; Wascher, 2000). It has been argued that identifying character is, to a large extent, built upon human perception and therefore landscape character assessment can be questioned with regards to its scientific rigour and hence its role as an analytical tool for landscape planning (Wascher, 2005). So, capturing aspects of visual landscape character is crucial in this respect.

This chapter aims to describe a landscape planning and design-oriented approach to visual landscape indicators, involving state-of-the-art GISc-based methods. It focuses on landscape character assessment addressing visual attributes such as spaciousness, degree of openness, landscape enclosure and visibility. The Province of Noord-Holland (the Netherlands) serves as a case study of how regional authorities can include visual landscape character (assessment) in landscape policy. The combination of expert knowledge and GISc-based research methods and techniques resulted in a physiognomic landscape framework for landscape policy, planning and design. This framework was recently adopted by the provincial authority and has been translated into the Structural Concept of Noord-Holland 2040 (*Structuurvisie Noord-Holland 2040*) (Province of Noord-Holland, 2010a) and the Policy Framework for Landscape and Cultural History (*Leidraad Landschap en Cultuurhistorie*) (Province of Noord-Holland, 2010b).

### 10.1.2 Structure of the chapter

This chapter provides some background on the current landscape policy in the Province of Noord-Holland and its context (section 2), introduces the recently implemented physiognomic landscape framework and describes the methodology and approach (section 3). Subsequently the methods and techniques to determine the *form of the landscape* (physical space) are elaborated (sections 4, 5, 6), followed by a description of the methods and techniques used to describe and monitor the *appearance of the landscape* (visible space) (sections 7, 8). Finally, the chapter ends with discussion and conclusions.

## 10.2 LANDSCAPE POLICY IN THE PROVINCE OF NOORD-HOLLAND

The polder landscapes of Noord-Holland, as part of the Dutch lowlands, are typical Western-European landscapes that consist of flat, open lowland areas with an artificial water level, most often partly or fully surrounded by dikes. Polders are considered to be one of the most man-made landscapes and are characterised by a very high percentage of pasture and arable

land (Steenbergen et al., 2009; Meeus, 1995). The agricultural sector, formerly the icon of this landscape, is now often seen as a threat precisely because agriculture is becoming increasingly industrialised and is increasing in scale. Many see this as a degradation of the landscape. Urbanisation (incl. industrialisation), large infrastructures, large-scale wind energy projects, etc. are however increasingly changing the open character of the landscape. The attendant fragmentation and cluttering of the landscape has been the subject of public debate for a number of years and is specifically aimed at encroachments on openness (Hoogbergen, 2008; Boersma and Kuiper, 2006). The concept of spatial quality plays an important role in this debate.

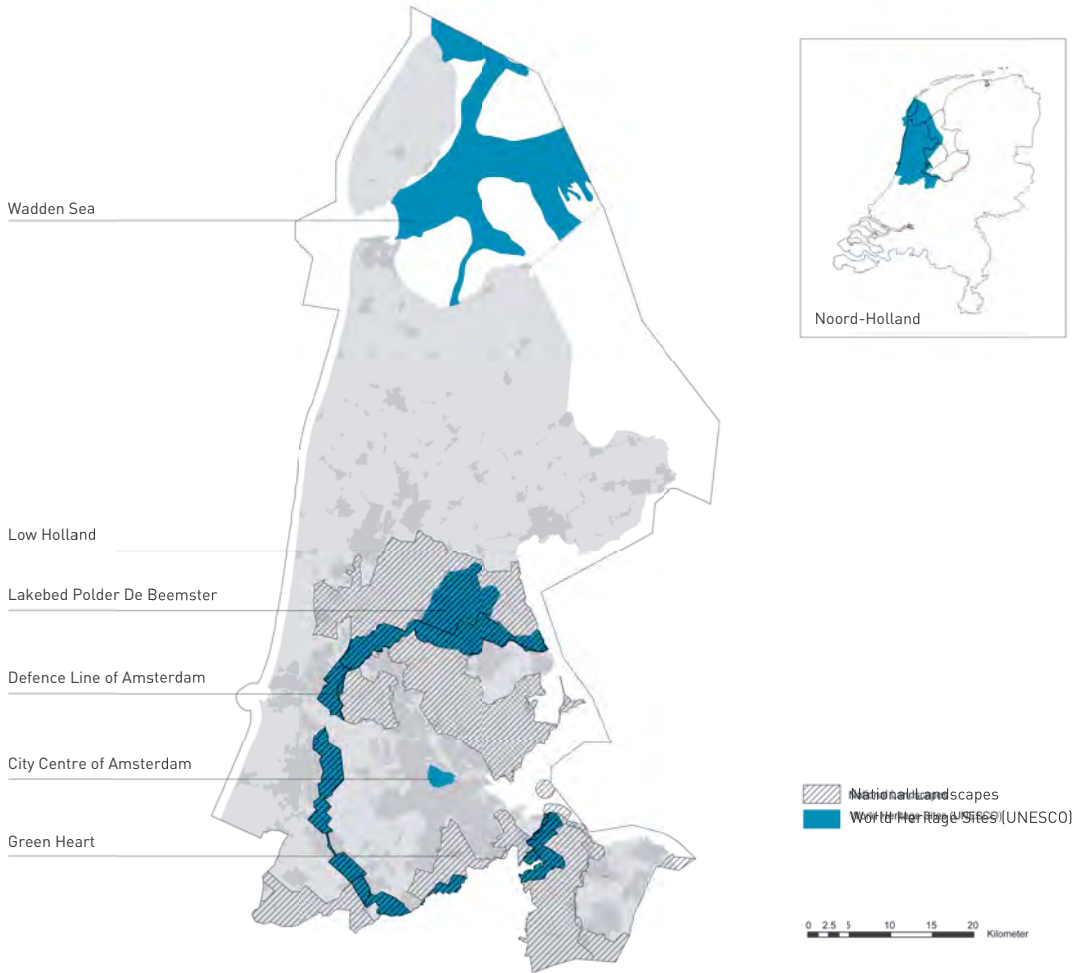
### 10.2.1 National Landscape policy

In terms of spatial quality in Europe, the Netherlands has a widespread and well-regulated set of building appearance standards and codes for listed buildings, although this is primarily aimed at architectural quality and is linked to the building permit procedure (Nelissen and Ten Cate, 2009). This happens at the end of planning development, however, when urbanisation itself is no longer part of the discussion on quality. In response to this the Dutch Government presented the Landscape Agenda recently (LNV and VROM, 2009). The Landscape Agenda pushes forward the policy and administrative relationships as set out in the National Memorandum on Spatial Planning (*Nota Ruimte*) (VROM, 2004) and Agenda for a Vital Countryside (*Agenda vitaal platteland*) (LNV, 2004). It also highlights the importance of integral spatial planning in order to combat landscape cluttering and the decline of heritage landscapes. Alongside this, the new Town and Country Planning Act (*WRO*) came into force in the Netherlands on 1 July 2008. Under the new Act, the Government and provinces are responsible for protecting the core qualities and reinforcing the spatial quality for landscapes indicated as National Landscapes, and also includes World Heritage Sites, National Motorway Panoramas and National Buffer Zones <sup>2</sup>.

The Province of Noord-Holland includes several National Landscapes that cover a large portion of the provincial landscape: Low Holland (*Laag Holland*), the Defence Line of Amsterdam (*Stelling van Amsterdam*) and the Green Heart (*Groene hart*). Parts of these landscapes and other designated areas have the exceptional status of World Heritage Site: the Wadden Sea, the Defence Line of Amsterdam and the Beemster polder. There are very strict requirements in these areas for preserving the current appearance of the landscape. The policy is conservation-oriented and aimed at preserving a number of characteristics of the current landscape appearance.

The governmental policy documents underline the responsibility of the province and municipalities to explore how core qualities of landscapes can inspire and give direction to spatial developments in the landscape. The tools to enforce the policy are however still under development.





**Figure 1**  
The province of Noord-Holland with the National Landscapes and the World Heritage Sites

### 10.2.2 Spatial quality as an objective

The Province of Noord-Holland recently adopted the Structural Concept of Noord-Holland 2040 and the associated Policy Framework for Landscape and Cultural History in order to enforce the governmental policy on spatial development. The documents identify spatial quality as a main policy objective. This means that the provincial authority is obliged to ensure and extend spatial quality. But what is spatial quality exactly? A general view (in the Netherlands) is that spatial quality is composed of three Vitruvian values: functionality (*utilitas*), beauty (*ve-*

*nustas*) and durability (*firmitas*). These can be augmented by other aspects of spatial quality: economic efficiency, social justice, ecological sustainability and cultural identity (Hooijmeijer et al., 2000). The Province of Noord-Holland uses the following definition: quality = identity = landscape + cultural history (De Vreeze, 2007). Although usually landscape itself is regarded as an expression of culture, this definition demonstrates that landscape and its history are essential from the province's perspective for defining the qualities (characteristics) of specific areas and serve as the backbone for their further development.

The policy of the Province of Noord-Holland is aimed at preserving the identity of the landscape by focusing on the current cultural and historical values of the landscape. The province intends to achieve this by encouraging densification in urban areas and by discouraging expansion into rural areas. In the case of new developments in the countryside, the initiators (e.g. project developers, municipalities etc.) will first be required to demonstrate the value and necessity of the proposed expansion and include a Visual Quality Plan (*Beeldkwaliteitplan*). If this is convincingly demonstrated, then the plans will be submitted to an independent advisory committee for spatial quality, the Advisory Committee for Spatial Planning (*Adviescommissie Ruimtelijke Ordening (ARO)*), which then reports its findings to the Provincial Executive. The ARO uses the Policy Framework for Landscape and Cultural History as its assessment framework.

### 10.2.3 Landscape classification as a basis

Landscape classification is the linchpin of provincial landscape policy and central to the assessment framework for spatial quality. According to Zonneveld (1995) landscape classification is a systematic typology that describes landscapes according to their form (morphology). Form and typology help in describing changes in time (chronology). Classification is abstraction. This implies that from the concrete tangible reality only a few of the many attributes are selected and are used to describe abstract units that are supposed to represent reality. The landscape attributes selected as diagnostic characteristics are chosen because of their ability to be recognised and measured (Zonneveld, 1995). So depending on the type of classification and its aim, each defined landscape unit (type) can be taken to mean a set of attributes that together explain the character of it.

In geography and related disciplines there is a strong orientation towards space and spatial form with regard to landscapes. From this perspective classification is basically an analysis of the landscape's composition (landscape attributes and their spatial pattern) in which the form of the landscape can be seen as the intermediary between the perception and the spatial organisation of the landscape attributes (Wassink, 1999).

In a landscape classification, a given landscape can be described in terms of (Berendsen, 2000):

- 1) a specific appearance (physiognomy): the visual landscape;

- 2) a specific structure and development: the spatial sequence and genetic succession (physical geography, historical geography, soil science, etc.);
- 3) an internal coherence between the landscape factors (biology, physical geography, landscape ecology, etc.).

The landscape classification used in the policy framework characterises landscapes with an emphasis on structure and evolution. It is therefore a historical-geographical and physical-geographical oriented description of the landscape that implicitly includes visual indicators. In this regard there was a need to develop a method to address aspects of the visual landscape and to make it a more explicit element of the landscape classification involved.

#### 10.2.4 Landscape openness and spatial developments

Openness is a diagnostic characteristic for the landscape of Noord-Holland, but not uniformly throughout the province. The Province of Noord-Holland considers openness also to be an important indicator of spatial quality. At the same time, this very openness makes landscapes vulnerable to the impact of new developments. Preserving the same landscapes means finding new, vigorous economic pillars, such as a modernised agricultural sector or 'red for green' projects (i.e. where building in open space is allowed in exchange for an investment in the landscape) such as the *Bloemendaler polder* or the *Wieringerrandmeer* lake. In the latter case, new landscapes are being created. The growth of urban peripheries and high-rise buildings in cities influence people's perception of openness. In addition, Noord-Holland has ambitions for large-scale wind energy projects. These enormous wind turbines are visible from afar.

If we want to assess the effect of these goals, some of which may be contradictory, on the openness of the landscape, then we need a more inter subjective, verifiable and reliable framework to study the effect. The output should be descriptive rather than normative, and as a consequence it is about landscape's visual *character* rather than visual *quality* (Ode et al., 2008). The insights gleaned will constitute an important contribution to the public debate on the desirability of developments in the open countryside.

The present chapter is a report on the quest for finding a physiognomic landscape approach in order to describe, protect and develop the visual landscape and serve as an instrument for landscape policy, planning and design <sup>3</sup>.

## 10.3 TOWARDS A PHYSIOGNOMIC LANDSCAPE APPROACH

Visual attributes of the landscape such as spaciousness and related indicators such as degree of openness, building density and the nature of spatial boundaries are important elements in the perception and preference of a given landscape (Nasar, 1998; Kaplan and Kaplan, 1989; Appleton, 1975). According to Coeterier (2000), visual aspects are themselves qualities of the landscape, including:

- *Unity*: the landscape as a whole, its individuality and clarity of character and boundaries;
- *Spaciousness*: the spatial pattern or spatial organisation, the spatial layout;
- *Appearance*: the comprehensive set of sensory impressions, especially 'seeing'.

Visual perception is therefore the basis for the experience and appreciation of landscapes (preference). So visual perception is an important theme in defining and assessing spatial characteristics. Although this is widely accepted, in practice we see that this theme is often only implicitly touched upon in policy documents. The assumption is that the visual landscape in itself is seen as an aspect that is difficult to deal with in a systematic and transparent way (i.e. it is not measurable), and that it is perceived differently by different people. It therefore can hardly be made explicit, if at all.

### 10.3.1 Methodology and approach

The present study is an attempt to make aspects of the visual landscape explicit as a major theme in the Province of Noord-Holland's set of policy instruments for spatial quality, and to develop the theme further. To do so, a practical expert approach was introduced (Zube et al., 1982; Dijkstra, 1991) in which the characteristics of the visual spaces (spatio-visual characteristics) of the Noord-Holland landscape were qualified and quantified using a number of GIS-based methods and techniques for physiognomic landscape mapping (De Veer et al., 1977; De Veer and Burrough, 1978; Palmer and Roos-Klein Lankhorst, 1998). The methods and techniques that were chosen are scale-dependent and complementary. None of them are new and they are already used in many areas. By cross-linking them, however, a dedicated approach to landscape policy is achieved that is practical applicable.

The approach is characterised by a description of the visual attributes and their pattern. Essentially the aim is to describe, analyse and map (physical) forms made by spatial patterns composed of open spaces, surfaces, screens and volumes in the landscape (Thiel, 1961). It addresses the morphology of space with landscape visibility and appearance as key elements. The potential of 'being able to see' is mapped out; this has to do with the plausible and/or probable visible space (Fisher, 1995, 1996; Weitkamp, 2010). The product is a morphologic description of elements and their position in their surroundings (the objective-intrinsic landscape attrib-

utes), removed to the greatest degree possible from symbolic, cultural and personal elements (the subjective-attributed landscape attributes).

This suggests two types of aesthetic variables that can describe a landscape: variables concerning the *form (shape)* of the landscape or variables concerning the *content* of the landscape. These are not black and white categories but rather a continuum. The study of the form of the landscape is often referred to as *formal aesthetics* or the *objectivist approach*, while the study of human response to the content is referred to as *symbolic aesthetics* or the *subjectivist approach* (Lang, 1988; Nasar, 1994; Lothian, 1999). Attributes of formal aesthetics are: shape, proportion, rhythm, scale, complexity, colour, order, hierarchy, spatial relationships, etc. and are considered to be intrinsic qualities of the landscape. Attributes of symbolic aesthetics refer to ascribing meaning and value (Nasar, 1994; Bell, 1999). In this case the quality of the landscape is determined by the viewer (it is 'in the eye of the beholder').

The expert approach used here focuses primarily on the form of the landscape and can therefore be seen as a formal aesthetic approach <sup>4</sup>. The psychological, psychophysical and phenomenological approaches are complementary to this, but have been excluded to promote workability in this study (Ervin and Steinitz, 2003).

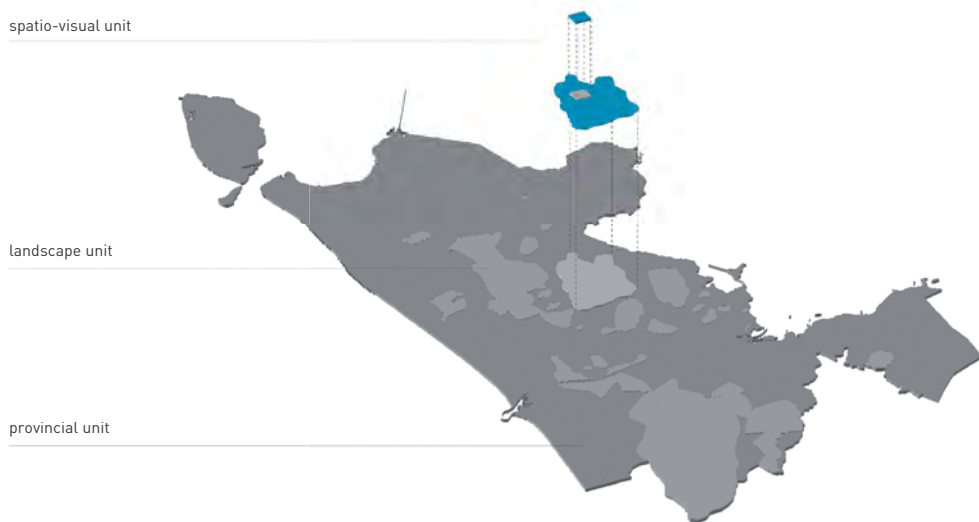
### 10.3.2 Scale-dependent description

Physiognomic landscape mapping is scale dependent (Vroom, 1986; Litton et al., 1974; Granö, 1929). It is important for the definition of the scope, grain-size and level of abstraction of the analysis. This aspect of scale refers to the *size of the object* under investigation. Scale is also important to the psychology of space (space conceptions). It has an important influence on how humans treat spatial information, and as a consequence several scale classes of space exist relative to the human body: e.g. small-scale, middle-scale and large-scale spaces. (Montello, 1993; Mark, 1993). So depending on their scale, certain systems of elements and spatial relations – relative size, shape and diversity – are explained and classified (Tversky, 2007). This aspect refers to the *scale of analysis*.

A unit as described in this study, contains three interrelated levels of space and involves three levels of perception: *the provincial unit*, *the landscape unit* and *the spatio-visual unit*, each with its own scope. The spatio-visual unit is apprehended from a single perspective (e.g. viewable area). The landscape unit is apprehended by locomotion, but spatial relationships can still be apprehended (e.g. line-of-sight). Spatial relationships within the provincial unit cannot be directly observed but must be constructed over time from movement through the region. These units share a hierarchical relationship with one another, and each has its own associated method of physiognomic landscape mapping. The connection between landscape, mapping method and the scale is summarised in the chart below. See figure 2.

In order to address the morphology of the visual landscape a distinction is made between the description of the *form of the landscape* (physical space) and the description of the *appearance of the landscape* (visible space). This is necessary because the physical space is not the same as the visible space. In other words, the landscape is different on the map from what it is in real life (Psarra, 2009; Rowe, 1976). The appearance is the way the landscape appears to the observer. In addition to form, other conditions related to visual observation also play a role in this regard, such as: position of the observer (altitude, proximity and angular size of the objects), viewing direction and atmospheric conditions (e.g. contrast threshold) (Duntley, 1948; Nicolai, 1971; Antrop, 2007). These aspects determine which forms can ultimately be observed. In addition, there are GISc-based principles available that are very suitable for analysing these two types of space: the physical space (form) and visible space (appearance).

**Figure 2**  
The connection between landscape, mapping method and the scale



**I Form (shape) of the landscape (physical space: grid based methods):**

- 1 degree of openness (provincial unit)
- 2 proportion and size of open space (landscape unit)
- 3 classification of spatial form (spatio-visual unit)

**II Appearance of the landscape (visible space: viewshed based methods):**

- 4 visible space (spatio-visual unit)
- 5 visual urbanisation and cluttering (all units)

The physiognomic landscape approach as described is elucidated further based on the following five themes:

- Degree of openness;
- Proportion and size of open space;
- Classification of spatial form;
- Visible space;
- Visual urbanisation and cluttering.

## 10.4 DEGREE OF OPENNESS

The visual landscape consists of many visible expressions that together constitute the image of the landscape (*landschapsbeeld*). This turns the job of bringing order to them into a seemingly impossible task. Nevertheless, there are certain visual concepts that make it possible to systematically name and sort the landscape images using indicators. In Ode et al. (2008) nine visual concepts were identified which together characterise the visual landscape. These were: complexity, coherence, disturbance, stewardship, imageability, visual scale, naturalness, historicity, and ephemera (Tveit et al., 2006). Because of the aims of this study and the available GISc-based analysis techniques, indicators of visual scale were used. Indicators of visual scale describe landscape rooms (perceptual units) in relation to their size, shape and diversity, and the degree of openness in the landscape (Ode et al., 2008; Picket et al., 1987).

The degree of openness is directly related to landscape preferences and is therefore an important indicator (Hanyu, 2000; Nasar et al., 1983). Explanations for that can be found in Appleton's prospect-refuge theory (Appleton, 1975) where prospect (openness) is used to describe the degree to which the environment provides an overview. This is related to the habitat theory which links aesthetic pleasure to fulfilment of biological need (Ode et al., 2008). Mystery, as put forward by Kaplan and Kaplan (1989), "describes the degree to which a viewer is drawn into a landscape by the intrigue of what lies ahead, which in turn is related to the ability of the viewer to see the landscape and hence a function of openness" (Tveit et al., 2006). However, landscape openness has a very low correlation with *scenic beauty*. So protection of open space through monitoring and management are largely unrelated to scenic beauty *per se* (Palmer, 1996).

The degree of openness can be understood as a derivative of patterns of screens and volumes in the landscape. In this regard, openness is an integrated concept. Each landscape room has its own characteristic open/closed ratio. This makes it possible to characterise landscapes according to their degree of openness (Buitenhuis et al., 1986; Dijkstra and Lith-Kranendonk, 2000). From the perspective of landscape physiognomy, open space is present where elements such as trees, houses, dikes etc. (visual limits) that rise above the observer's eye level are absent

throughout a specific surface area. In other words, openness is present where the landscape is 'empty' or 'open' (De Veer, 1977). One method for measuring openness is the grid landscape survey<sup>5</sup>. This method has been applied to the landscape of Noord-Holland on the scale of the province (provincial unit).

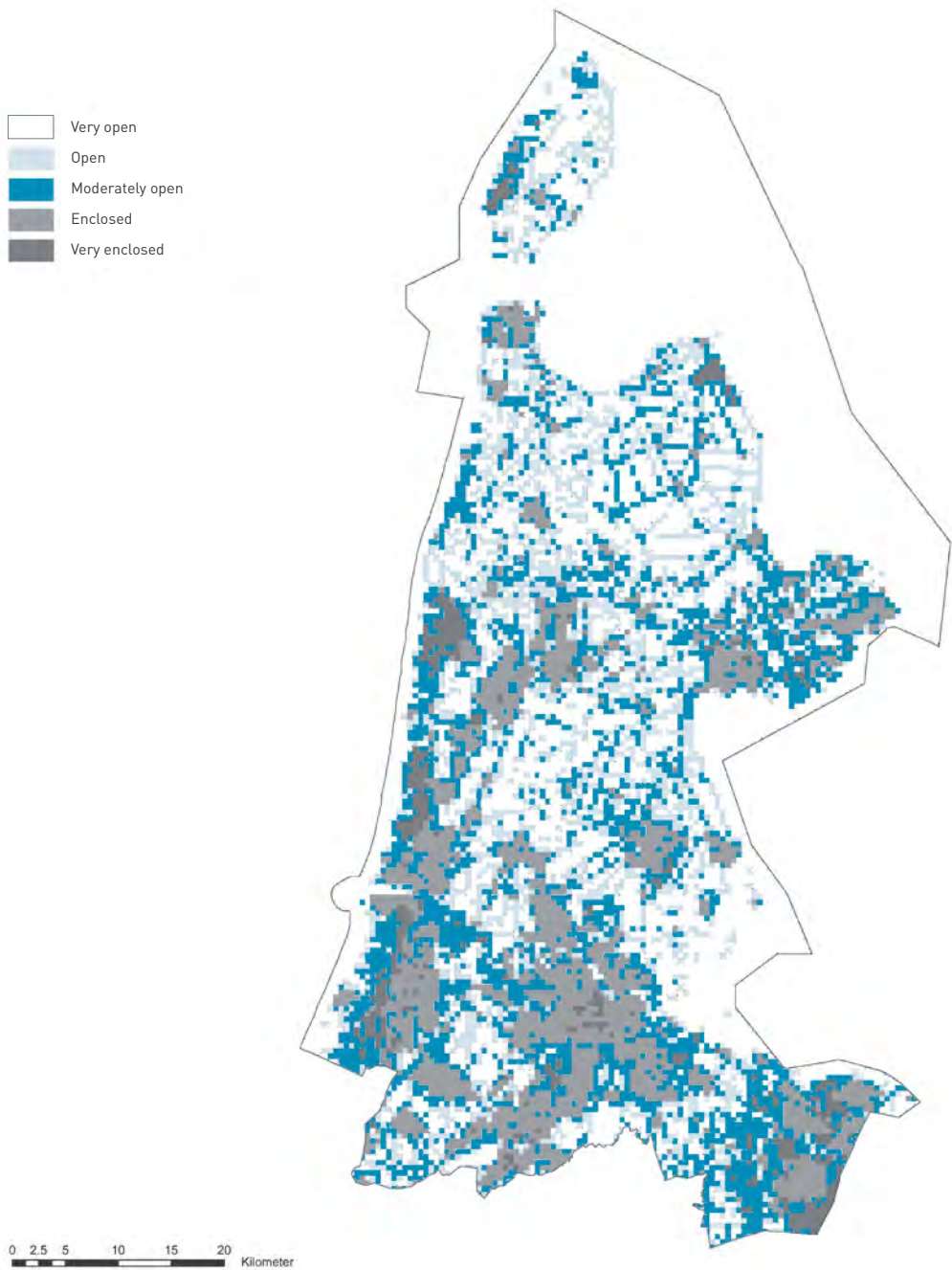
#### **10.4.1 Grid landscape survey: measuring openness**

The goal of the analysis is to visualise and quantify physiognomic landscape space, mapping the degree of openness using a grid landscape survey (Buitenhuis et al., 1986; Palmer and Roos-Klein Lankhorst, 1998; Dijkstra and Lith-Kranendonk, 2000). In doing so, GIS was used to quantify and visualise the open/closed ratio by using a horizontal grid of 500 x 500 metres squares over the landscape. This is based on the notion that characteristic elements of a landscape can be recognised within a distance of 500 metres (Van der Ham and Iding, 1971; Van der Ham et al., 1970). A recently prepared digital topographic map at a scale of 1:10,000 (TO-P10NL, 2009) was employed to achieve accurate results. For the calculations, all items selected for the legend were those that were higher than eye-level (including ascending elements, buildings, trees and/or shrubbery) based on the definitions of the Topographical Service of the Land Registry (*Topografische Dienst Kadaster*). This selection was corrected where necessary based on recent aerial photography and field visits. GIS was then used to automatically calculate the contents of each grid cell to determine how many, and which, ascending elements are present. The results were classified by degree of openness using a classification method developed and tested by Palmer (1996) and Dijkstra and Lith-Kranendonk (2000). The resulting maps show the degree of openness and the character of the space defining elements. See figures 3 and 4.

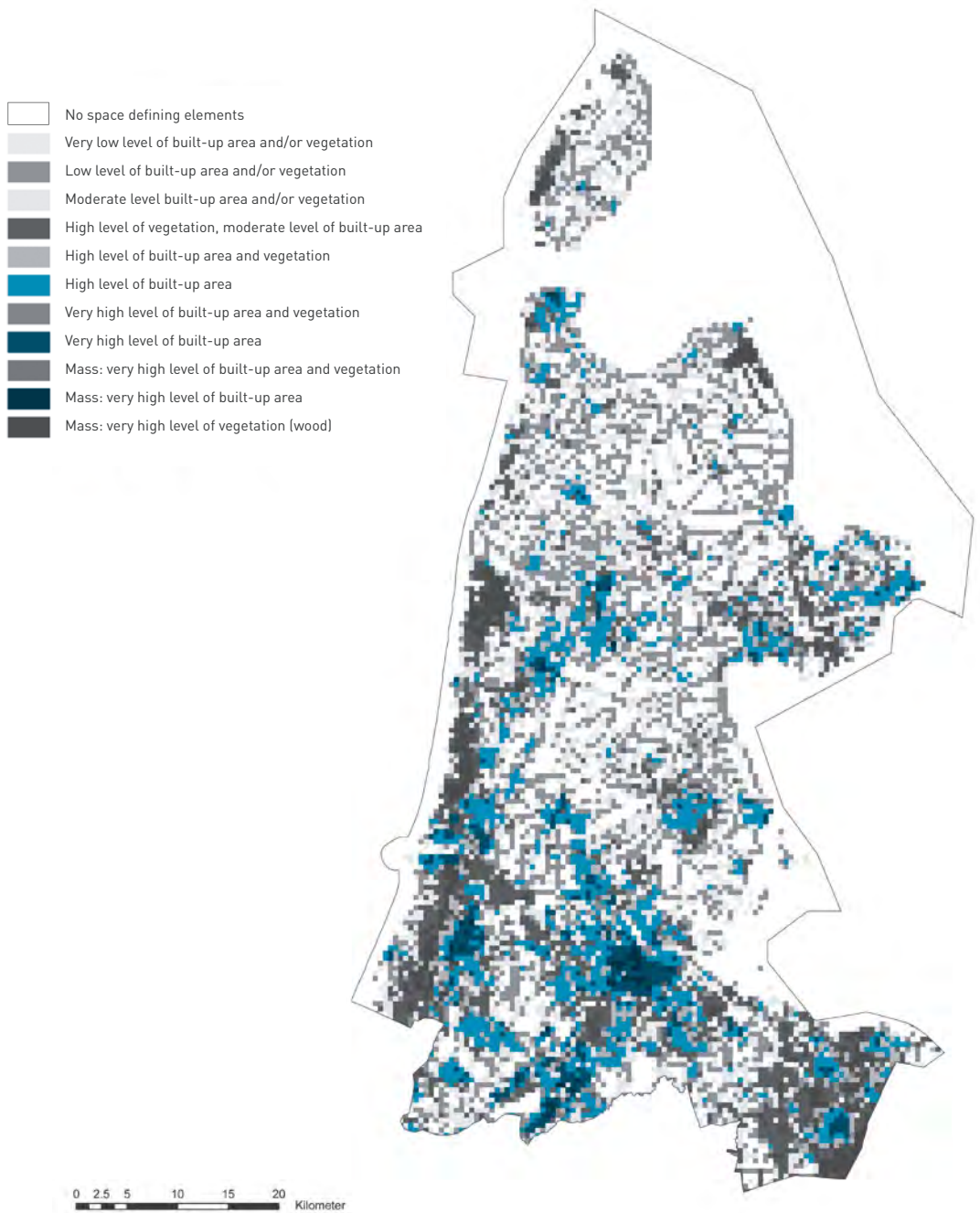
#### **10.4.2 Extremes in size of open spaces in the landscape**

The landscape of the Province of Noord-Holland is characterised by degree of openness (size and proportion of open space). See figures 3 and 4. From large, open areas in the Wieringermeer and Schermer areas to small-size closed areas with lots of green, space defining elements, including Het Gooi and areas with an urban character. The landscape policy of the Province of Noord-Holland is aimed at preserving the characteristics of the landscape. The degree of openness and the associated extremes are important policy issues in this respect. Research into the degree of openness shows that the diversity in size is decreasing. There is currently a general trend towards the creation of mid-size spaces (Piket et al., 1987; Dijkstra and Lith-Kranendonk, 2000). The province's large-size, characteristic open spaces are under threat from encroaching densification. This has a levelling effect on the characteristic differences in open spaces that contribute to the identity of the various landscape units. It follows that areas with a very open character need special protection from advancing visual densification. Based on this under-





**Figure 3**  
Degree of openness



**Figure 4**  
**Character of the space defining elements**

standing, provincial planning policy offers protection from this densification in the largest and most substantial of the open spaces in the province. These particular open spaces were designated as a result of a political process based on this analysis. See figure 5.

## 10.5 PROPORTION AND SIZE OF OPEN SPACE

As mentioned before, landscape classification is an important element in the present spatial quality assessment framework of the province. In addition, there is a wide variety of landscape units in the province, each with its own characteristics in degree of openness. The size and proportion of open spaces within the landscape units is an important variable in describing landscape identity (Farjon et al., 1999; Dijkstra et al., 1997). Based on this notion, it makes sense to analyse and describe the characteristic open/closed ratio for each landscape unit. This direct link with the existing landscape classification makes a qualitative interpretation of the concept of openness possible on the level of the landscape unit. The form of the landscape is thus not only described in terms of spatial structure or development, but also in terms of characteristic degree of openness. Different landscape classifications can be used, but the types described in the Policy Framework for Landscape and Cultural History have been chosen in order to link directly to provincial policy. See figure 6.

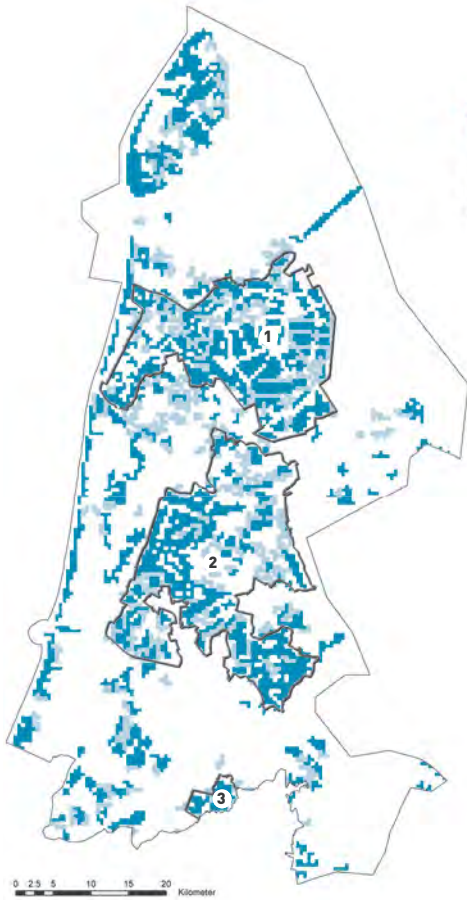
### 10.5.1 Quantification of openness by landscape units

The goal is to visualise and quantify the degree of openness at the level of the landscape unit. The grid analysis of the entire province as described above served as the basis for this work. Using GISc-based overlay techniques, the results of the individual landscapes were assigned and aggregated. The resulting degree of openness and change could then be determined for each type of landscape (Dijkstra et al., 1997). As a derivative of the openness analysis that covers the entire province, this method allows the characteristic openness for each landscape to be identified. It provides a valuable tool for describing landscape units more precisely and for future monitoring purposes. By determining the increase or decrease in differences in openness, it is possible to see whether landscapes are becoming more homogeneous or heterogeneous. The result of this analysis is a diagram that shows the openness classes for each landscape unit. See figure 7.

### 10.5.2 Landscapes with the largest degree of openness

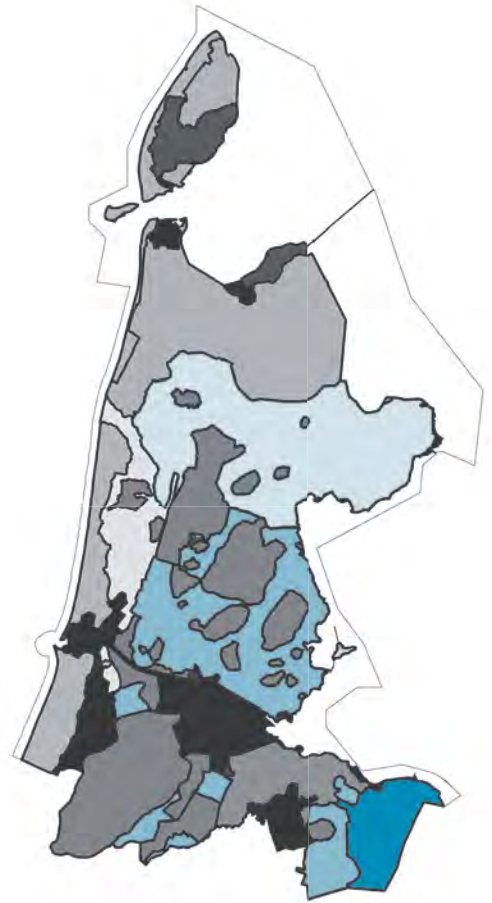
In the quantitative description it is striking that reclaimed land (*aandijkingenlandschap*) can be classified as a landscape unit with the largest degree of openness and that ice-pushed ridges (*stuwwallenlandschap*) are the landscapes with the lowest degree of openness. Also other

**Figure 5**  
**Policy protected open areas**



Very open  
 Open

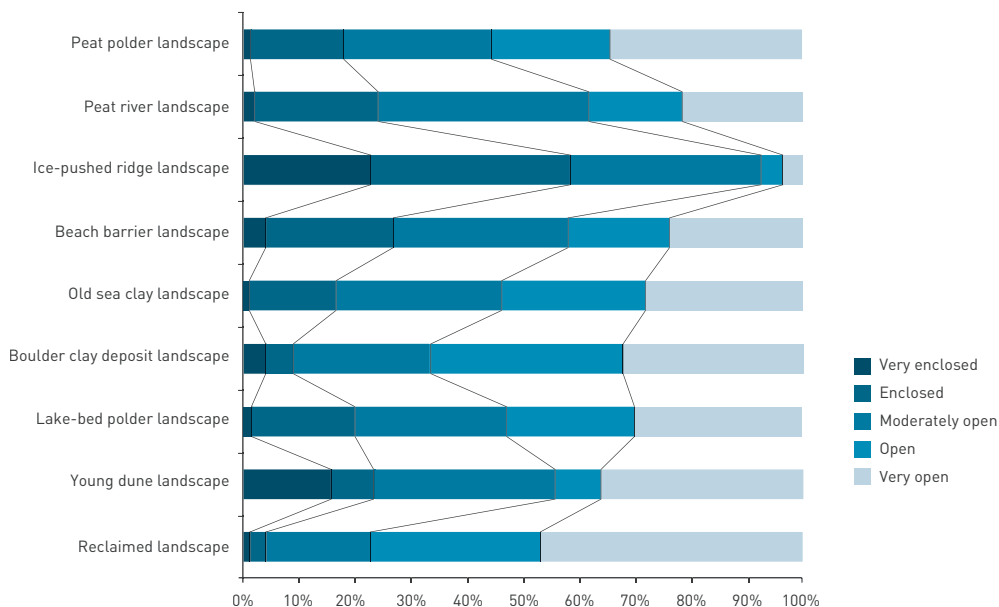
1. Wieringermeer-district
2. Low Holland
3. Green Heart



Reclaimed landscape  
 Lake-bed polder landscape  
 Young dune landscape  
 Boulder clay deposit landscape  
 Old sea clay landscape  
 Beach barrier landscape  
 Ice-pushed ridge landscape  
 Peat polder landscape  
 Peat river landscape

0 2.5 5 10 15 20 Kilometer

**Figure 6**  
**Landscape classification of Noord-Holland (source: Province of Noord-Holland)**



**Figure 7**  
Differences and stratification of openness within the landscape units

landscape units have a high degree of openness, such as peat polder landscapes (*veenpolderlandschap*), lake-bed polder landscapes (*droogmakerijenlandschap*), boulder clay deposit landscapes (*keileemlandschap*) and young dune landscapes (*jonge duinlandschap*). So, there are relatively many open landscapes, but they vary widely in terms of composition and appearance. Although it is generally possible to characterise landscape units in terms of openness, the difference in form and appearance of the space within the chosen landscape unit makes it difficult to use openness alone in a qualitative sense. This may be problematic, especially at a lower level of scale because this description covers aspects of space having to do with patterns, whereas structural aspects of the area are the ultimate determiners. A lower level of scale, the level of the spatio-visual unit, provides better opportunities for analysing and describing structural, three-dimensional aspects of the landscape (Wassink, 1999; Vroom, 1986). Taking these limits into consideration, policy that is geared toward ensuring the characteristic openness for open landscape units should be based on qualitative requirements with regard to densification (buildings and afforestation). Further study into the relationship between the degree of openness and the form and appearance of the space will be essential: classification of the spatial form is an important theme.

## 10.6 CLASSIFICATION OF SPATIAL FORM

As mentioned previously, openness may be considered to be a derivative of landscape elements, which function as surfaces, screens and volumes. In this regard it is important to ascertain whether these landscape elements also act as space-defining elements (spatial boundaries). Spatial boundaries include all linear and two-dimensional landscape elements that reach above eye level. These may be hedgerows or woods, wooded banks, ribbon developments, villages, towns, cities and dikes. The natural terrain also plays a role in giving form to space: areas that are relatively higher than the surroundings afford views. The location, orientation and density of the elements that function as spatial boundaries determine the openness of the landscape. This is why openness must also be described in terms of the composition of the spatial elements as well. The key to doing so is to classify the spatio-visual units according to the spatial form in each individual landscape (Wassink, 1999; Curdes, 1993; Thiel, 1961). The spatial form is then described based on the spaces (size and form) as they are determined by the spatial boundaries.

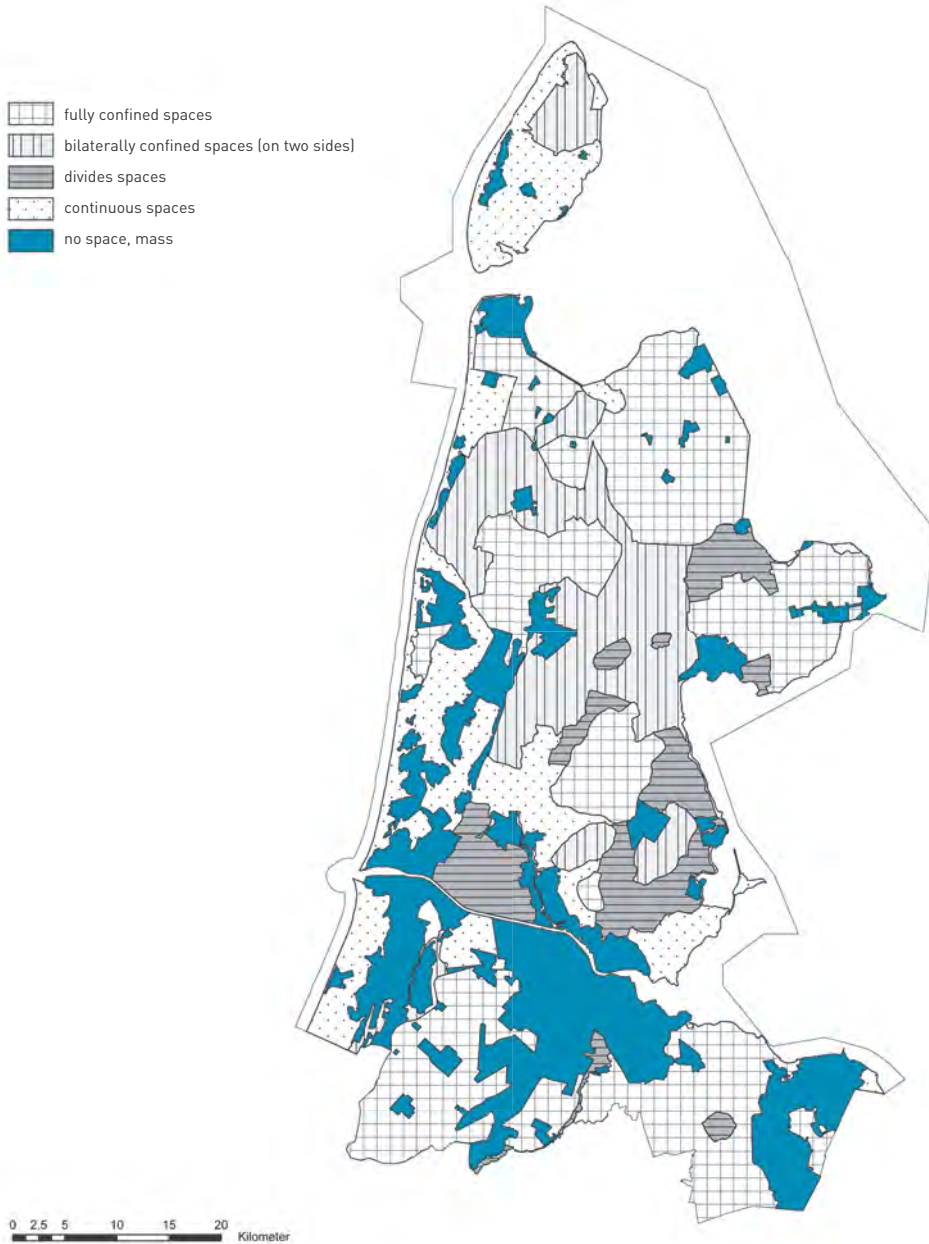
### 10.6.1 Determining the form of space

There is no reliable and workable GISc-based method for analysing categories of spatial form. Clues can be found in e.g. Patch-analyst (McGarigal and Marks, 1994), but this needs further research. Expert judgment has therefore been used. This is based on cartographic research, interpretation of aerial photography, field visits and Street View imagery (Google Earth, 2009). Space can thus be designated at the level of the spatio-visual unit. The primary resource was the digital topographic map at a scale of 1:10,000 (TOP10NL, 2009), which also served as the basis for a map of the entire province showing spatial categories. See figure 8.

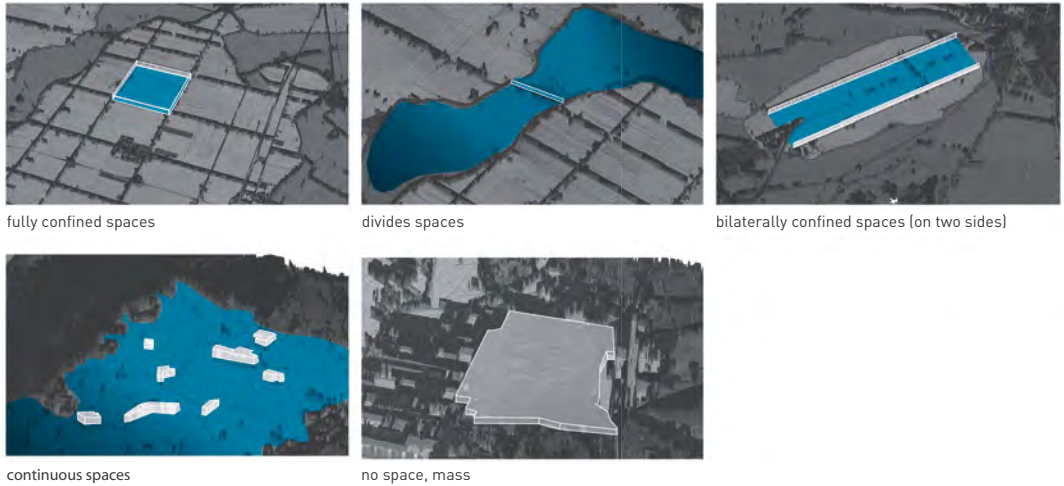
It is possible to classify spatial form according to a number of different classifications. The classification and description of Wassink (1999) is used here by analogy. This is based on the work of Thiel (1961), McCluskey (1979) and Curdes (1993). Wassink arrives at five spatial types, see figure 9:

- Fully confined spaces;
- Bilaterally confined spaces (on two sides);
- Divided spaces;
- Continuous spaces;
- No space, mass.

*Fully confined spaces* have boundaries on all sides. This means that they are turned inward; they encourage restfulness. The essence of fully confined spaces is that there is an ‘inside’ and an ‘outside’, and that the boundary between inside and outside is unambiguous. Fully confined



**Figure 8**  
 The form (shape) of space in the landscape of Noord-Holland



**Figure 9**  
**The classification of spatial form**

spaces are also called *Static Spaces* or *Space-contained* (Thiel, 1961; McClusky, 1979). An example of this is the reclaimed land in the Beemster polder.

*Bilaterally confined spaces* are characterised by being elongated. The beginning and end of the space can often not be seen from a single position. These spaces encourage movement and therefore an outward orientation. The boundary between inside and outside is fixed in its width but not in its length. Bilaterally confined spaces are also known as *Dynamic Spaces* (Thiel, 1961). An example of this is the reclaimed land in the Wijde Wormer polder.

*Divided spaces* are characterised by the space being divided into two sections. There is no inside or outside: space exists on either side of the spatial elements. This space is bordered on just one side. *Divided spaces* are also known as *einseitig gefaßte Räume* (Curdes, 1993). An example is the landscape around the Schermerhorn peat polder.

The hallmark of *continuous space* is that spatial elements do not confine the space. Any landscape elements present exist as separate elements in a continuous space. Continuous space is also known as *Vagues* or *diffuser Raum* (Thiel, 1961; Curdes, 1993). Polarised spaces known as *Space attracted* can develop around the individual volumes. An example of this is the area west of Alkmaar in the polder landscape / barrier dune and plains landscape.

Finally, certain situations may be distinguished where there is *no space, but mass*. An example of this is a landscape that is covered with forest. This is of course also dependent on the organi-



sational level at which the landscape is considered. Looking at the forest in detail may reveal paths and open spaces. Examples can be found in the woodlands of *Het Gooi*; the lateral moraine landscape.

### 10.6.2 Spatial form as structural carrier

This detailed classification of spaces within a landscape unit is a useful way of identifying openness more precisely and arriving at a qualitative description of openness. In this respect spatial form is a vehicle to describe, analyse and map the landscape formed by the composition of surfaces, screens and volumes and the resulting spaces. We consider the spatial form as the structural carrier of openness: the spatio-visual structure. The character of an open space could then be described in terms of the shape, size and extent of the visual space. This would make it possible to explain and describe the relationship between the degree of openness and the form of the space. These spatial units could then be used as a basis for continued spatial development. The spatio-visual structure of the landscape can thus be safeguarded (or expressly ignored) when designing new housing tracts, ecological developments etc. In the province of Noord-Holland the way landscape space is managed has certainly become an important guiding principle when it comes to discussing and assessing plans for spatial development.

## 10.7 VISUAL SPACE

Visual space is the way the landscape appears to the observer. As previously discussed, visual space is something quite different from physical space. Not only the three-dimensional aspects of space play a role in visual space; other conditions related to visual observation are also involved, such as: the position of the observer (altitude, proximity and angular size of the objects), the viewing direction and the atmospheric conditions (e.g. contrast threshold) (Duntley, 1947; Nicolai, 1971; Antrop, 2007). These aspects determine which shapes are actually observed. The observer's position is an important factor in methods for analysing the appearance of the landscape. Space appears to the observer in various ways. Dijkstra (1991) distinguishes three ways of analysing the appearance of space to the observer:

- Analysis from observation points;
- Analysis from routes;
- Analysis from areas.

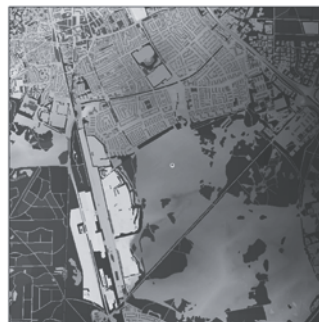
Viewsheds are a valuable method for analysing the appearance of a space in its current or in a future appearance. Viewsheds make it possible to portray a landscape objectively from the perspective of the viewer (Tandy, 1967; Lynch, 1976; Smardon, et al., 1986).

### 10.7.1 Viewsheds: measuring visibility

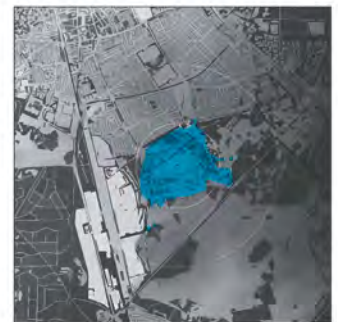
The goal is to analyse and portray the appearance and visibility of physiognomic landscape space. A GISc-based viewshed method may be used for this purpose, in which the observer's field of vision can be analysed from many different angles (Llobera, 1996 and 2003; Fischer, 1995 and 1996). The visual landscape can be analysed from observation points covering the entire 360 degrees of the viewing circle or any part thereof. The visible portion of the viewing circle is therefore calculated. The part that is immediately visible to an observer is called the breadth of view, or viewshed. See figure 10. Viewing angle, viewing distance and eye level (viewing height) may all be set as variables in the analysis. The following assumptions were used: a viewing height of 1.60 metres above ground level and a viewing angle of 360 degrees (the entire viewing circle). The stereographic viewing limit is 1,200 metres; this means that an observer can perceive depth up to 1,200 metres. Beyond this distance everything merges together (Van der Ham and Iding, 1971; Nicolai, 1971; Antrop, 2007). The maximum visual range depends on atmospheric circumstances and is referred to as the meteorological optical range<sup>6</sup>. To put it more precisely, the visual range of objects in the landscape depends on: the apparent contrast between the object and its background, the angular size of the object, its shape and vertical area, the contrast threshold at the level of luminance (type of day), the conditions and techniques of observing and, the eyelevel and related curvature of the earth (Dunt-



1. Acquisition of accurate topographic data includes heights and terrain heights (DEM)



2. Construction of a Digital Landscape Model by combining 3D topographic data and DEM



3. GIS-based Viewshed analysis [360° at eye level]

Figure 10

Principle of the viewshed analysis

ley, 1948; Middleton, 1952). It is possible to carry out the analysis from individual positions (viewsheds), from routes (incremental viewsheds) and/or areas (cumulative viewsheds). See boxes 1, 2 and 3 for examples of application.

To achieve reliable results, an accurate digital barrier model was constructed consisting of a digital elevation model (DEM) combined with topographic data. This is based on a high-resolution elevation model, the *Actueel Hoogtebestand Nederland* (AHN-1, 1997-2003), which is precise to about 15 centimetres per square metre. The DEM's density, distribution and planimetric accuracy is such that topographic objects with a size of two by two metres can be identified clearly and with a maximum deviation of 50 centimetres (AHN, 2010). The model has been supplemented with recent topographic data: the digital topographic map at a scale of 1:10,000 (TOP10NL, 2009). All legend items were selected that were higher than eye-level (including ascending elements, buildings and trees and/or shrubbery) based on the definitions of the Topographical Service of the Land Registry. The resulting digital landscape model (DLM) or barrier model was corrected using recent aerial photographs, field visits and Street View imagery (Google Earth, 2009). The viewshed analysis results were tested for reliability through field visits and photos.

### 10.7.2 Visual effects on the landscape image (landschapsbeeld)

The viewshed method can be used to simulate the physiognomic space visible to the observer. The observer's position plays a crucial role and field of vision or visibility can be analysed from specific points, routes and areas. This makes it possible to analyse and describe the way in which the landscape appears to the observer on the scale of the spatio-visual unit. Also, future interventions can be assessed based on their visual impact as part of a visual impact assessment. The policy of the province of Noord-Holland now requires that explicit attention must be paid to the visual impact of the intervention in addition to the requisite Visual Quality Plan (Province of Noord-Holland, 2010a). An example of such a Visual Impact Report with regard to the physiognomic landscape approach is the Quickscan on the visual impact of the landscape plan Bergen (*Quickscan visuele effecten landschapsplan binnenduigebied Bergen*) (Nijhuis, 2010a), see also box 1.

## 10.8 VISUAL URBANISATION AND CLUTTERING

The term 'visual urbanisation' is used when the city, and related objects like wind turbines and communication towers are visible from non-urban areas. Strictly speaking, visual urbanisation is the process that creates this visibility, but the term is often used to signify the result of this process (De Veer, 1978). Cluttering is a concept that is closely related to visual urbanisation.

## Box 1 Quikscan on the visual impact of the landscape plan Bergen

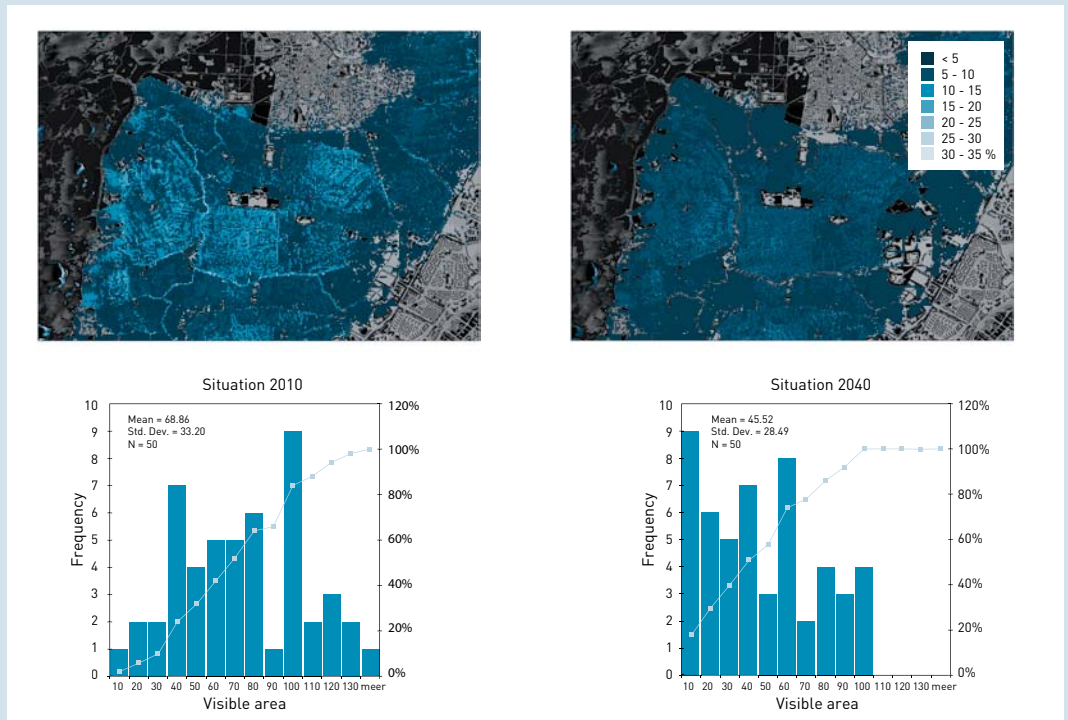
Spatial interventions in the landscape usually have a significant influence on the landscape image (*landschapsbeeld*). By portraying these effects systematically and transparently, it is possible to make informed choices that promote spatial quality. A visual impact assessment is a tool that can be used to reliably map the visual impact of planned spatial interventions. This has also been done for the landscape interventions proposed in the Visual Quality Plan for Bergen and the associated development plan as an application of the policy described in the Structural Concept of Noord-Holland 2040 and the Policy Framework for Landscape and Cultural History. The Quikscan on the visual impact of the landscape plan Bergen (*Quikscan visuele effecten landschapsplan*

*binnenduigebied Bergen*) (Nijhuis, 2010a) follows the methodology as described in this chapter and addresses the following themes: scale extremes in the landscape, the characteristic open/closed ratio, the space and the visibility/perception of the space. Cumulative and individual viewsheds were applied in order to measure the visual impact of the proposed development respectively, shown in the map and chart. See figure 11.

### Summary of the results

The visual impact assessment shows a densification of 3.5% (total of approx. 54 ha). The majority of the densification (approx. 49 ha) is due to foliage: bushes and trees. In this sense there is hardly any petrification because most new construction is covered

or shielded by greenery and the number of red elements is relatively small (approx. 5 ha). The character of the open area also changes: agrarian pasture largely makes way for natural grassland, which has a significant influence on the perception of the landscape. The new arrangement of the landscape means that the characteristic continuous space is transformed into a number of fully confined spaces. Correspondingly, the proposed density serves to decrease the relative openness by 108 ha (approx. 4%), which means that the spatio-visual characteristics of the area are significantly impacted as shown on the map and diagram. The characterisation of the open space changes from a 'varied open space with distant vistas' into a 'uniform open space without views'.



**Figure 11**  
Visual impact analysis using cumulative viewsheds (maps) and individual viewsheds (charts)

It has to do with the deterioration of the landscape (Hoogbergen, 2008; Boersma and Kuiper, 2006). Cluttering occurs when elements in the landscape such as housing (high-rise and low-rise), greenhouses, industrial estates, wind turbines, etc. are perceived to be disturbing (Van der Wulp, 2009; Boersma and Kuiper, 2006; Roos-Klein Lankhorst, et al. 2002). Nevertheless it must also be stated that buildings, urban boundaries, high-rises and elements such as wind turbines can contribute positively to the identity of the landscape and its orientation in space and time (as long as they are thoughtfully designed and positioned). Visual urbanisation of the landscape can therefore be perceived positively and negatively. The cluttering of urban boundaries (Burrough et al, 1982; Nicolai, 1971), the allocation of high-rise buildings (Rød and Van der Meer, 2009) and the positioning of wind turbines (State Advisor for Landscape, 2007) are therefore important issues that require extra diligence. Mapping the visual impact using sound simulation techniques is a notable principle in this regard (see e.g. Sardon, et al., 1986; The Landscape Institute, 2003).

### 10.8.1 Appearance of visual urbanisation

Areas exhibiting visual urbanisation generally have an open character and are located near cities or in metropolitan areas. These are often agricultural areas, open water or other natural expanses. The amount of visual urbanisation in the province of Noord-Holland is increasing. Reasons for this include increasing physical urbanisation (intrusion, i.e. lengthening of urban boundaries), and especially, changes to the structure of the city and its boundaries. Growing numbers of wind turbines are also being installed. The visual urbanisation of the landscape is generally regarded as undesirable, although there are significant differences of opinion on this topic, depending on the nature and extent of the elements involved and contextual considerations of the landscape (Van der Wulp, 2009; Thayer, 1994). Results from environment-reliant research emphasise the resistance to 'seeing the city in the landscape' (Roos-Klein Lankhorst et al. 2002; Coeterier, 2000). Other studies show that high-rise buildings and urban boundaries can play a role in defining the identity of areas (e.g. urban parks), or that they can function as landmarks. Think of the acclaimed ribbon villages that are such an integrated element in the polders, or of historic townscapes. They can make a positive contribution to the landscape in terms of identity and its orientation in space and time as long as they are thoughtfully designed and positioned. When visual urbanisation has a negative effect on the appreciation of the landscape, various forms of shielding can be considered (such as greenery), but again this must be diligently designed.

There are several methods available for analysing visual urbanisation or the city's sphere of visual influence (see e.g. The Landscape Institute, 2003; Burrough et al., 1982; Nicolai, 1971). See also chapter twelve for an example. Criteria applied include type, height, (vertical) size and location of buildings, the degree of openness of the surrounding landscape, the terrain and

## Box 2 High-rise buildings in the province of Noord-Holland

High-rise buildings have a significant visual impact in the province of Noord-Holland due to the open character of the landscape (Nijhuis, 2009, 2010b). The taller and larger the buildings, the greater the impact. This does not mean that high-rise developments are undesirable or impossible. High-rise buildings can function as markers for certain areas, thus serving as landmarks similar to prominent church towers, smokestacks etc. High-rise buildings can play an important role in the landscape as a point of orientation in time and space. They can also bolster the identity of a

landscape. They especially reinforce the character of urban parks when located at their edges; these parks function as regional landscape parks with an emphasis on recreational use. Examples of areas where this is the case include Amstelscheeg in the Arena area, Omval, the Zuidas business district, parts of Waterland, the southern part of Laag Holland, etc. Coastal high-rise development can also serve as a landmark, as is the case in Zandvoort. See figure 12. High-rise buildings can therefore make a positive contribution to the character of the landscape as long as

sufficient consideration has been given to the location and design of the development. High-rise buildings do not always positively impact their surroundings, after all. High-rise buildings are likely to have a negative effect on the appreciation of landscapes in areas lacking a metropolitan character, such as in the northern part of Noord-Holland and in the Schermer, Beemster and Zeevang areas. The study on *Hoogbouw in Noord-Holland* (high-rise in Noord-Holland) was used for locations and height (Zandbelt&Vandenberg, 2008). See also chapter twelve.

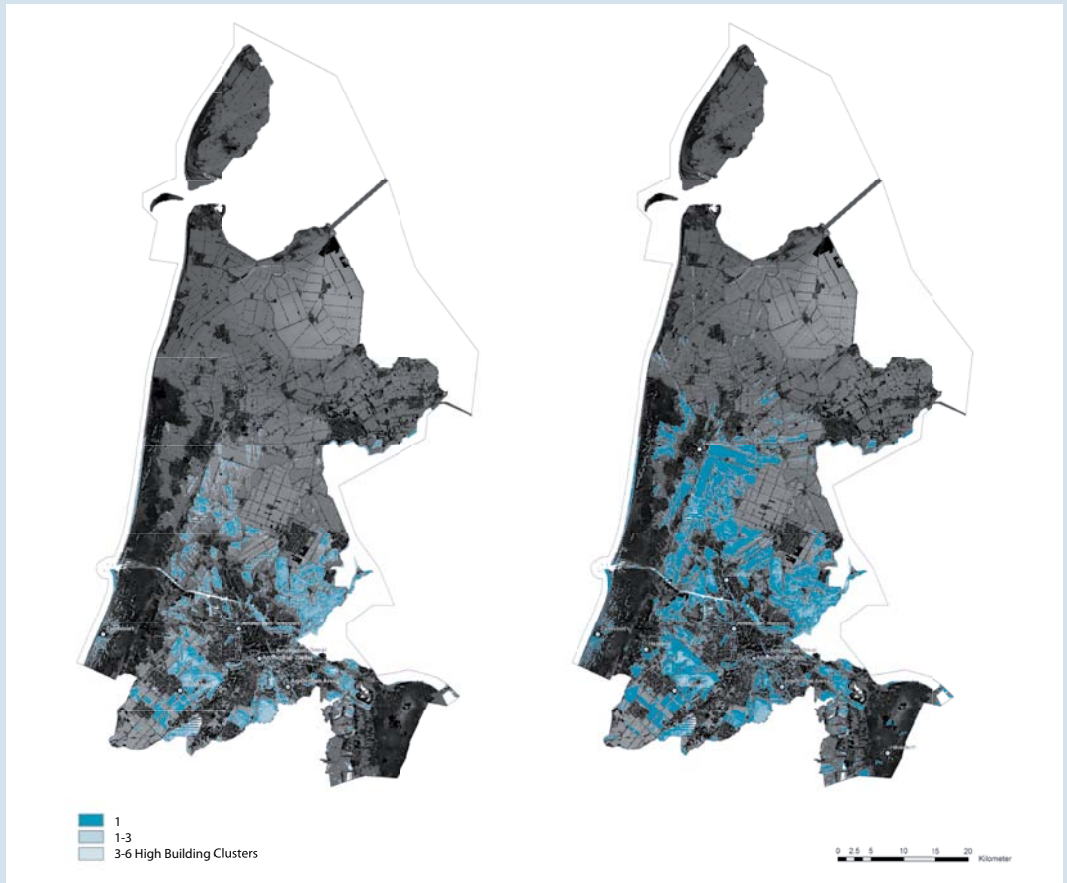


Figure 12  
Visibility of high-rise in Noord-Holland (now and in the future)

### Box 3 Visibility of wind turbines

The number of wind turbines in the Netherlands is increasing rapidly and the turbines themselves keep getting larger. There is a great deal of enthusiasm for this method of generating power, but criticism is also on the rise. One sees windmills looming in the landscape seemingly willy-nilly. It requires us to pause and ask ourselves what this means for our landscape. The cluttering and degradation of openness are important themes. The latest wind turbines have totally different dimensions than we are accustomed to. They are much taller and they generate more power. This not only presents

opportunities but also threats. This jump in scale requires us to reflect on the consequences that these new wind turbines will have on the visual landscape, the spatial framework and the wind turbines that are currently in use (a large part of which are due to be replaced in the years to come). It is therefore crucial to develop policies for wind turbines that take the landscape into account. Design research and research-by-design will be invaluable for determining the best locations for wind turbines and for establishing zones that are apparently turbine-free. As the example illustrates, research methodology

into visual effects can play a vital role. The image shows the current situation. The visibility of the 68 wind turbines in the extract has been mapped according to mast height and power generating capacity. This results in turbine visibility of 98,564 ha (47.3% of the extract, excluding large bodies of water). Design exercises show that this figure can be greatly reduced by careful placement of new wind turbines in conjunction with the replacement or removal of the current generation of wind turbines (Uum et al., 2010). See Figure 13.

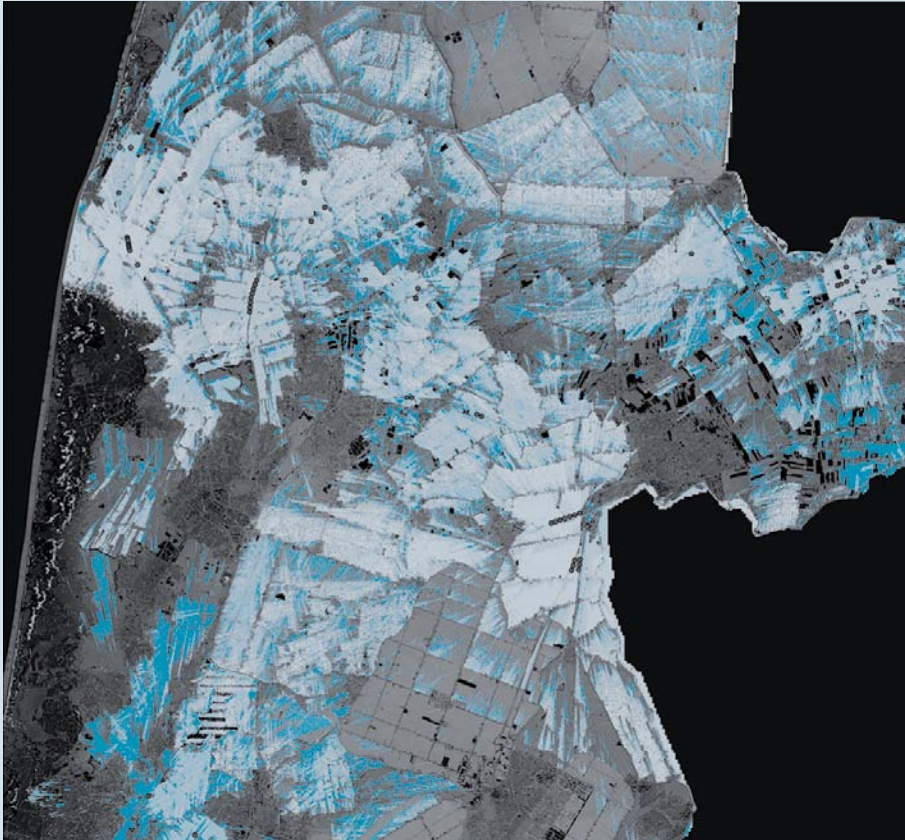


Figure 13  
Visibility of wind turbines

the maximum distance (threshold) where the buildings can still be clearly perceived. As part of this study, a GISc-based viewshed analysis was applied to two examples (Nijhuis, 2009, 2010b; Uum et al., 2010); see also Box 2 and 3.

### **10.8.2 Visual urbanisation as a design brief**

Urban boundaries and high-rises can contribute to the identity of the landscape and to its orientation in space and time (as long as they are thoughtfully designed and located). The cluttering of urban boundaries is an important issue that needs special attention. High-rise development is a hot topic and the subject of on-going research. In this regard it is important that any proposals for high-rise buildings are analysed using scientifically sound simulations to determine their visual impact. The examples demonstrate that the viewshed method can be a useful analytical tool, making it especially valuable when it comes to preserving highly sensitive open landscapes from visual urbanisation and cluttering. At the same time, and especially in urban areas, high-rise buildings can bolster the character of a given area and its orientation in space and time. When these kinds of interventions are mapped out, real-world options can be discussed and visual urbanisation becomes a true design brief.

## **10.9 IN CONCLUSION**

The Province of Noord-Holland can serve as an interesting case study of how regional authorities deal with matters of spatial quality in landscape policy. Besides the use of other landscape value types (e.g. biophysical, socio-economic-technical, and political) in landscape characterisation and monitoring, the implementation of the physiognomic landscape framework described here offered the Province of Noord-Holland a hands-on approach to elaborate aspects of spatial quality, such as openness. It illustrates that the application of GISc-based methods and techniques in combination with expert knowledge offers governmental authorities new policy instruments and practical landscape assessment and monitoring tools.

As we have seen, the Province of Noord-Holland attaches great importance to spatial quality. The parameters for the Policy Framework for Landscape and Cultural History are formed by the current landscape when it comes to new developments, preservation and modernisation. The province is using this principle to create a new set of tools to ensure landscape quality. Research into the visual effects (e.g. openness) of the changing use of the landscape can have a major impact on the way judgments are formed on this topic, both by government authorities and by members of the public who are involved in the process in one way or another. The use of GISc-based methods and techniques provides added value because, on the one hand, it promotes an transparent and systematic approach to problems, facilitates analysis of large amounts of data



and paves the way for a smooth exchange of knowledge (resource for design, planning and policy). On the other hand, it makes it possible to visualise research results in a variety of ways (presentation tool). This latter factor is exceptionally valuable as a tool in the public debate on spatial quality especially because of its descriptive, rather than normative, nature.

The scale-dependent description of the visual landscape proved to be useful because it organises the scientific knowledge available in relation to the GISc-based methods and techniques. Although the physiognomic landscape framework as applied is composed of methods and techniques rooted in a wide variety of (international) scientific research, there are of course some considerations for the further development of the methodology. Due to its applicability, the methodology as presented is primarily a formal, aesthetic approach and it could be easily complemented by psychological, psychophysical and phenomenological approaches. Most of the research used to compose the methodology, however, is founded in empirical research (e.g. the openness map legend). The accuracy of the datasets used can be tested more accurately by making use of questionnaires completed by laypeople, rather than depending solely on the assessment of experts.

The provincial policy (and especially the assessment of new plans in rural areas) is unprecedented in the area of the administrative preservation of spatial quality and the encouragement of the same. The province is a true pioneer in the way it has envisaged its self-imposed responsibility for spatial quality. Until today, assessments like these were reserved for municipalities when they were assessing building permit applications under the auspices of the Housing Act. In the current period of deregulation, this provincial assessment can be considered to be a counter-movement. Time will tell if these kinds of assessments will truly lead to widespread support for spatial quality, which is why this is so very important from a nationwide perspective but also in a European context. By adequately visualising landscape interventions, the debate is opened up to a wide audience, which is a prerequisite for societal involvement.

## ACKNOWLEDGEMENTS

I like to acknowledge Reinoud Bakker and Corine Meijer of the Province of Noord-Holland, and Miranda Reitsma, Provincial Advisor for Spatial Quality Noord-Holland for making this research possible. Miranda Reitsma made also an important contribution to the description of the spatial policy of the Province of Noord-Holland in this chapter.

## NOTES

- [1] The text of the European Landscape Convention was adopted by the Committee of Ministers in July 2000 and came into force 1 March 2004. For an overview of European landscape policies see Wascher, 2000 and Antrop, 2007.
- [2] This is also the purpose of the Cooperation Agenda for an Attractive Netherlands (*Samenwerkingsagenda Mooi Nederland*) (VROM, et al., 2007) and the Structural Concept for the Motorway Environment 'A good view of the Netherlands' (*Structuurvisie voor de Snelwegomgeving 'Zicht op mooi Nederland'*) (VROM, 2008) which are integral parts of the Governmental policy on landscape.
- [3] The chapter is partly based on: Nijhuis, 2008, 2009; Province of Noord-Holland, 2010a, 2010b.
- [4] Although this is an expert-approach intrinsic variables that were used for a landscape perception validation are used.
- [5] An overview of methods and techniques is provided in the introductory chapter of this book.
- [6] Research from the Royal Netherlands Meteorological Institute (KMNI) shows that the meteorological optical range varies from nearly zero up to several tens of kilometres. However, the ranges of 12 kilometres (50%), 20 kilometres (25%) and 28 kilometres (10%) are typical for Dutch circumstances. See also chapter twelve on this matter.

## REFERENCES

- Antrop, M. (2007) *Perspectieven op het landschap. Achtergronden om landschappen te lezen en te begrijpen*. Gent, Academia Press.
- Appleton, J. (1975) *The Experience of Landscapes*. Chichester, Wiley.
- Bell, S. (1993) *Elements of Visual Design in the Landscape*. London, E&FN Spon.
- Berendsen, H.J.A. (2000) *Landschappelijk Nederland*. Vol. IV, *Fysische geografie van Nederland*. Assen, Van Gorcum.
- Boersma W.T., and Kuiper R. (2006) *Verrommeling in beeld. Kaartbeelden van storende elementen in het Nederlandse landschap*. Den Haag, Milieu- en Natuurplanbureau (rapport 500074003/2006)
- Buitenhuis, A., Kerkhof, C.E.M. van de, Randen, Y. van, and Veer, A.A. de (1986) *Schaal van het landschap. Opbouw en gebruik van een geografisch informatie-systeem van schaalkenmerken van het landschap van Nederland, met landelijke kaarten 1:400.000*. Wageningen, Stichting voor Bodemkartering (report 1837)
- Burrough, P.A., Buitenhuis, A., and Veer, A.A. de (1982) *Het Informatiesysteem Landschapsbeeld*. Wageningen, Pudoc (Reeks Landschapsstudies)
- Coeterier, J.F. (2000) *Hoe beleven wij onze omgeving? Resultaten van 25 jaar omgevingspsychologisch onderzoek in stad en landschap*. Wijchen, Peter Tychon.
- Council of Europe (2000) *European Landscape Convention*. Florence, s.n.
- Curdes, G. (1993) *Stadtstruktur und Stadtgestaltung*. Stuttgart, etc., Verlag W. Kohlhammer.
- De Veer, A.A. (1977) De ruimtelijke classificatie van het Nederlandse landschap. *KNAG Geografisch Tijdschrift* (XI) 2; 98-109
- De Veer, A.A. (1978) Visuele verstedelijking. *KNAG Geografisch Tijdschrift* (XII) 3; 281-282
- De Veer, A.A., and Burrough, P.A. (1978) Physiognomic landscape mapping in the Netherlands. *Landscape Planning* 5; 45-62
- De Veer, A.A., Buitenhuis, A., and Loo, H. van het (1977) *Vergelijking van Nederlandse methoden van landschapsbeeldkartering en hun toepassingsmogelijkheden*. Wageningen, Stiboka and Pudoc.
- De Vreeze, N. ed. (2007) *LandschapNH. Over de regie van functieveranderingen en bouwactiviteiten in het landelijk gebied van Noord-Holland*. Alkmaar, WZNH adviescommissies voor ruimtelijke kwaliteit.
- Dijkstra, H. (1991) Het visuele landschap. Onderzoek naar de visuele kwaliteit van landschappen. *Landschap* 8 (3); 157-175
- Dijkstra, H., and Lith-Kranendonk, J. van (2000) *Schaal-kenmerken van het landschap in Nederland. Monitoring Kwaliteit Groene Ruimte (MKGR)*. Wageningen, Alterra (rapport nr. 40)
- Dijkstra, H., Coeterier, J.F., Haar, M.A. van der, et al. (1997) *Veranderend cultuurlandschap. Signalering van landschapsveranderingen van 1900 tot 1990 voor de Natuurverkenning 1997*. Wageningen, DLO-Staring Centrum (Rapport 544)
- Duntley, S.Q. (1948) The Visibility of Distant Objects. *Journal of the Optical Society of America* 38(3); 237-249
- Ervin, S., and Steinitz, C. (2003) Landscape visibility computation: necessary, but not sufficient. *Environment and Planning B: Planning and Design* 30; 757-766
- Farjon, H., Dijkstra, H., Dirx, J., et al. (1999) *Monitoring Kwaliteit Groene Ruimte (MKGR). Ontwerp voor indicator identiteit*. Wageningen, Alterra.
- Fischer, P.F. (1995) An Exploration of probable viewsheds in landscape planning. *Environment and Planning B: Planning and design* 22; 527-546

- Fisher, P. F. (1996) Extending the applicability of viewsheds in landscape planning. *Programmetric Engineering and Remote Sensing* 62(11): 1297-1302
- Granö, J.G. (1997) *Pure Geography*. Baltimore and London, The Johns Hopkins University Press. Original edition, 1929.
- Groom, G. (2005) Methodological review of existing classifications, In: Wascher, D.M. (ed.), *European Landscape Character Areas – Typologies, Cartography and Indicators for the Assessment of Sustainable Landscapes*. Report European Landscape Character Assessment Initiative (ELCAI), pp 32-45
- Hanyu, K. (2000) Visual properties and affective appraisals in residential areas in daylight. *Journal of Environmental Psychology* 20; 273 – 284
- Hoogbergen, M. (2008) De maatschappelijke onvrede over de verrommeling van het Nederlandse landschap. In: Zonderop Y., and van Weezel, T.G. (eds.), *29 Plannen voor een mooier Nederland. De ruimtelijke agenda*. Amsterdam, Meulenhof, pp 47-52
- Hooimeijer, P., Kroon, H., and Luttkik, J. (2001) *Kwaliteit in meervoud. Conceptualisering en operationalisering van ruimtelijke kwaliteit voor meervoudig ruimtegebruik*. Gouda, Habiforum.
- Kaplan, R., and Kaplan, S. (1989) *The experience of nature: a psychological perspective*. Cambridge, Cambridge University Press.
- Lang, J. (1988) Symbolic aesthetics in architecture: toward a research agenda. In: Nasar, J.L. (ed.) *Environmental Aesthetics. Theory, Research, & Applications*. New York, Cambridge University Press, pp 11-26
- LNV, Ministry of (2004) *Agenda vitaal platteland*. The Hague.
- LNV, Ministry of, and VROM, Ministry of (2009) *Landscape agenda. Doing business with respect for the landscape*. The Hague (in English)
- Litton, R.B., Tetlow, R.J., Sorensen, J., and Beatty, R.A. (1974) *Water and Landscape. An aesthetic overview of the role of water in the landscape*. New York, Water Information Center.
- Llobera, M. (1996) Exploring the topography of mind. GIS, landscape archaeology and social theory. *Antiquity* 70; 612-622
- Llobera, M. (2003) Extending GIS-based visual analysis: the concept of visualsapes. *International Journal for Geographical information science* 17(1); 25-48
- Lothian, A. (1999) Landscape and the philosophy of aesthetics: is landscape quality inherent in the landscape or in the eye of the beholder? *Landscape and Urban Planning* 44; 177-198
- Lynch, K. (1976) *Managing the Sense of a Region*. Cambridge, MIT Press.
- Mark, D.M. (1993) Human Spatial Cognition. In: Medycky-Scott, D., and Hearnshaw, H.M. (eds.) *Human Factors in Geographical Information Systems*. London and Florida, Belhaven Press, pp 51-60
- McClusky, J. (1979) *Road Form and Townscape*. London, The Architectural Press.
- McGarigal, K., and Marks, B.J. (1994) *Fragstats. Spatial Pattern Analysis Program for Quantifying Landscape Structure*. Corvallis, Oregon State University.
- Meeus, J.H.A. (1995) Pan-European landscapes. *Landscape and Urban Planning* 31; 57-79
- Middleton, W.E. (1958) *Vision through the atmosphere*. Toronto, University of Toronto Press.
- Montello, D.R. (1993) Scale and Multiple Psychologies of Space. In: A.U. Frank and I. Campari (eds.) *Spatial Information theory: A theoretical basis for GIS*. Berlin, Springer-Verlag (Lecture Notes in Computer Science 716), pp 312-321
- Nasar, J.L., Julian, D., Buchman, S., et al. (1983) The emotional quality of scenes and observation points: a look at prospect and refuge. *Landscape Planning* 10; 355-361
- Nasar, J. (1994) Exteriors Urban Design Aesthetics. The Evaluative Qualities of Building Exteriors. *Environment and Behaviour* 26(3); 377-401
- Nasar, J. (1998) *The Evaluative Image of the City*. London, etc., Sage Publications.
- Nelissen, N., and Cate, F. ten (2009) *Mooi Europa. Ruimtelijke kwaliteitszorg in Europa*. Amsterdam, Uitgeverij SUN / Federatie Welstand.
- Nicolai, J. (1971) *De visuele invloed van woonplaatsen op open ruimten. Met enkele toepassingen op het midden van west-Nederland*. Delft, Technische Universiteit Delft.
- Nijhuis, S. (2009) Het visuele landschap. In: *Werkboek bouwstenen structuurvisie Noord-Holland 2040. Analyses en Verkenningen 3/3*. Haarlem, Province of Noord-Holland.
- Nijhuis, S. (2010b) Openheid. In: *Leidraad Landschap en Cultuurhistorie. Beleidsregels voor ontwikkelingen met ruimtelijke kwaliteit*. Haarlem, Province of Noord-Holland.
- Nijhuis, S. (2010a) *Quickscan visuele effecten Landschapsplan Binnenduigebied Bergen*. Haarlem, Province of Noord-Holland.
- Ode, Å., Tveit, M.S., and Fry, G. (2008) Capturing Landscape Visual Character Using Indicators: Touching Base with Landscape Aesthetic Theory. *Landscape Research* 33(1); 89 -117
- Palmer, J.F. (1996) *Modeling spaciousness in the Dutch Landscape*. Wageningen, DLO-Staring Centrum (report 119)
- Palmer, J.F., and Roos-Klein Lankhorst, J. (1998) Evaluating visible spatial diversity in the landscape. *Landscape and Urban Planning* 43; 65-78
- Piket, J.C., Kalkhoven, J.T.R., Veer, A.A. de, and Vos, W. (1987) *Landschap*. Edited by Stichting wetenschappelijke atlas van Nederland. Vol. 16, *Atlas van Nederland in 20 delen*. 's-Gravehage, Staatsuitgeverij.
- Province of Noord-Holland (2010a) *Structuurvisie Noord-Holland 2040*. Haarlem.
- Province of Noord-Holland (2010b) *Leidraad Landschap en Cultuurhistorie*. Haarlem.

- Psarra, S. (2009) *Architecture and narrative. The formation of space and cultural space*. Abingdon and New York, Routledge.
- Rød, J.K., and Meer, D. van der (2009) Visibility and dominance analysis: assessing a high-rise building project in Trondheim. *Environment and Planning B: Planning and Design* 36; 698-710
- Roos-Klein Lankhorst, J., Buijs, A.E., Berg, A.E. van den, et al. (2002) *BelevingsGIS versie februari 2002*. Wageningen, Alterra (werkdokument 2002/08; planbureau-werk in uitvoering)
- Rowe, C. (1987) *The Mathematics of the Ideal Villa and Other Essays*. Cambridge, Massachusetts, The MIT Press. Original edition, 1976.
- Smardon, R.C., Palmer, J.F., and Felleman, J.P., eds. (1986) *Foundations for Visual Project Analysis*. New York, etc., John Wiley & Sons.
- State Advisor for Landscape (2007) *Windturbines in het Nederlandse landschap. Advies, achtergronden, Visies*. Den Haag, Atelier Rijksbouwmeester.
- Steenbergen, C.M., Reh, W., Nijhuis, S., and Pouderoijen, M.T. (2009) *The Polder Atlas of the Netherlands. Pantheon of the Low Lands*. Bussum, THOTH publishers.
- Tandy, C.R. (1967) The Isovist Method of Landscape Survey, In: Murray, C.R. (ed.) *Methods of Landscape Analysis*. London, Landscape Research Group, pp 9-10
- Thayer, R. (1994) Three Dimensions of Meaning. In: Swaffield, S. (ed.), *Theory in Landscape Architecture. A Reader*. Philadelphia, University of Pennsylvania Press, pp 104-108
- Thiel, P. (1961) A sequence-experience notation. *Town Planning Review* 32 (1); 33-52
- The Landscape Institute (2003) *Guidelines for Landscape and Visual Impact Assessment*. Second Edition. London and New York, Spon Press.
- Tversky, B. (2001) Structures of Mental Spaces. In: *Proceedings 3rd International Space Syntax Symposium Atlanta*, pp 12.1-12.5
- Tveit, M., Ode, Å., and Fry, G. (2006) Key concepts in a framework for analysing visual landscape character. *Landscape Research* 31 (3) 229-255
- Uum, van E., Gerwen, R. van, Nijhuis, S., and Rijn, R. van (2010) *Turbulente combinaties. Verkenning naar ruimte voor windenergie op land door windturbines te combineren met andere functies*. Den Haag and Amsterdam, Ministry of VROM/Het Noordzuiden (internal document)
- Van der Ham, R.J.M., and Iding, J.A. (1971) *De landschapstypologie naar visuele kenmerken. Methodiek en gebruik*. Wageningen, Afdeling Landschapsarchitectuur, Landbouww Universiteit Wageningen.
- Van der Ham, R.J.M., Schut, G.F.E., and Iding, J.A. (1970) Een voorstel voor een nieuwe landschapstypologie naar visuele kenmerken. *Stedebouw en Volkshuisvesting* 11; 421-438
- Van der Wulp (2009) *Verrommeling van het landschap*. *Landschap* 26(3); 132-144
- VROM, Ministry of (2004) *Nota Ruimte*. The Hague.
- VROM, Ministry of (2008) *Structuurvisie voor de Snelwegomgeving. Zicht op mooi Nederland*. The Hague.
- VROM, Ministry of, LNV, Ministry of, and EZ, Ministry of (2007) *Samenwerkingsagenda Mooi Nederland*. The Hague.
- Vroom, M.J. (1986) The perception of dimensions of space and levels of infrastructure and its application in landscape planning. *Landscape Planning* 12; 337-352
- Wascher, D.M., ed. (2000) *The Face of Europe. Policy perspectives for European Landscapes*. Tilburg: European Centre for Nature Conservation (ECNC Technical report series)
- Wascher, D.M., ed. (2005) *European Landscape Character Areas – Typologies, Cartography and Indicators for the Assessment of Sustainable Landscapes*. Report European Landscape Character Assessment Initiative (ELCAI)
- Wassink, W.Th. (1999) *Beekdallandschappen. Een morfologisch onderzoek in de zandgebieden van Nederland*. Wageningen, Landbouww Universiteit.
- Weitekamp, G. (2010) *Capturing the View. A GIS based procedure to assess perceived landscape openness*. Wageningen, Wageningen University.
- Zandbelt&Vandenberg (2008) *Hoogbouw in Noord-Holland. Collegebrede verkenning als input voor de structuurvisie*. Haarlem, Provincie Noord-Holland.
- Zube, E.H., Sell, J.L., and Taylor, J.G. (1982) Landscape perception: research, application and theory. *Landscape Planning* 9: 1-33

11

# PRESERVING PANORAMIC VIEWS ALONG MOTORWAYS THROUGH POLICY

## 11.1 INTRODUCTION

Motorway design is not merely a matter of pure functionalism. Naturally, its main purpose is to accommodate efficient transportation to and from a large number of places. However, aesthetic aspects and landscaping are historically also connected to infrastructure design.

Especially in the early days of motorway construction, much attention was paid to how it could fit in with the existing landscape. From time immemorial, people have enjoyed travelling, not in the least because of panoramic views from the road. It can hardly be a coincidence that the relationship between road design and landscaping goes back such a long time (for some international references, see: Appleyard, Lynch, and Myer, 1964; CPRE, 1971; Enis et al., 1973; FHWA, 1990; Jellicoe, 1958; and for the Netherlands, see Anoniem, 1971; Het Nederlandse Wegencongres, 1964; Landinrichtingsdienst, 1991; Overdijkink, 1941).

US and German motorways are often referred to as examples of design combined with landscaping, and can be traced back to the visual language of English landscape gardening of the 18th century (Jellicoe, 1958). These types of motorway networks often offer the combined experience of a fast route to certain destinations and beautiful scenery along the way. In the United States, examples are the motorways in the North American landscape that run to and from National Parks. Jellicoe (1958) even classified the design of these motorways as one of the

three great North American contributions to modern landscapes (the other two being National Parks and the comprehensive landscape). Today, US motorways are still considered as gateways to the North American landscape experience. The US National Scenic Byways Program expresses this promotional role most vividly <sup>1</sup>.

In Germany, much planning effort has gone into providing travellers with a good sense of the landscape that surrounds them (Jellicoe, 1958). Instead of providing the shortest connection between two points, German motorways were designed to form the most elegant connection possible. The country's main economic centres were connected directly to nearby cities, while motorways connecting to other main centres passed through open landscapes (Rekitté, 2003).

In the Netherlands, attention was also paid to integrating motorways into the landscape. In 1915, the then Minister of Water Management, Cornelis Lely, appointed the Department for Dutch Nature Reserve Management (*Staatsbosbeheer*) as an advisory body for motorway design. Its main tasks were to ensure unity in design, and to integrate aesthetic values into the design process. At this time, Dutch architect A.H. Wegerif also pointed out the aesthetic and idealistic values of motorways. Wegerif wanted an advisory committee to be set up, consisting of aestheticians, comparable to today's Commission for Architecture and the Built Environment, which advises on building aesthetics. In 1933, such an advisory committee, named Roads in the Landscape (*De Weg in het Landschap* (WIL)) was set up by a private organisation called *De Bond Heemschut*, to preserve Dutch cultural heritage. Its task was to promote good landscape design around the Dutch road network, and to improve the already spoiled road landscapes (Meurs, 2003).

Influenced by the Department of Roads of *Staatsbosbeheer* and the *WIL* committee, the archetypical Dutch motorway was created: a straight line that runs through man-made landscapes, lined with regional vegetation, spatially grafted onto the environment by means of landscape design (Meurs 2003: 423).

The advice of *Staatsbosbeheer* to the Dutch Directorate-General for Public Works and Water Management was not free of obligations. In the years that followed, it became more and more difficult to maintain a certain measure of unity in the design of the Dutch motorways. Due to reorganisations at *Staatsbosbeheer*, the centrally organised Department of Roads was dismantled and its tasks redistributed to regionally organised offices of the Directorate-General for Public Works and Water Management. To bring motorway design back on track, the then Minister of Transport, Public Works and Water Management, Tineke Netelenbos, set up a special professorship in the 'The aesthetics of mobility' and awarded this chair to architect Francine Houben. Francine Houben tried to rigorously change the functional approach to motorways that had been causing a rapid decay of the attractive Dutch motorway views (Nijenhuis and Van Winden, 2007). She coined the concept of *aesthetics of mobility*, advocating the notion that

the infrastructure system had, in fact, become the largest public space within the Netherlands, and that this deserved the same effort in planning and design as was being awarded to city squares, parks and the famous Dutch polder landscape (Houben, 2003). From the 1990s, large-scale urbanisation of motorway zones set in, with employment and business-related land use in those areas doubling or even tripling, compared to national averages (Hamers and Nabielek, 2006). In addition, new housing development sprang up close to motorways, often protected from a motorway's negative aura by noise barriers.

Motorways were initially built *outside* cities, and intended to connect them. Nowadays they are an integrated part of the urban landscape. In the Dutch context of high-density land use with a scarcity of open spaces, the challenge of motorway design is shifting from attempts to fit the infrastructure into the landscape towards moulding spatial developments to fit the motorway. This is presenting policymakers with a challenge, as new motorways are rarely being constructed, while urbanisation is an ongoing process. As early as 1928, Professor J.H. Valckenier (Delft University of Technology) wrote about infrastructure's magnetic effect on urbanisation; the fact that traffic attracts buildings seems to be a law of nature (Meurs, 2003). The question is how to preserve the once so carefully designed and highly valued panoramic views from the motorway.

The second section of this chapter sketches the background of this Dutch policy dilemma. Urbanisations along motorways have led to a cluttered landscape. Policymakers, therefore, are attempting to get a grip on urban developments along motorways, to protect the open landscape. The chapter's third section gives a definition of panorama, to provide policymakers with a basis to handle the concept of a motorway panorama. In the subsequent section this definition is elaborated, and a practical method is presented for identifying motorway panoramas, using GIS techniques. The fifth section discusses the results of the identification of motorways panoramas in the Netherlands. The sixth section describes how motorway panoramas are incorporated in Dutch spatial planning. This is followed by concluding remarks.

Despite the fact that this chapter focuses on the Netherlands, the presented method can also be applied in an international context. And although the Dutch policy agenda of wanting to prevent spatial clutter across the landscape carries a strong national connotation, the preservation of open landscapes deserves wider attention.

## **11.2 CLUTTERED LANDSCAPES ALONG MOTORWAYS: A POLICY PROBLEM**

The exact moment is difficult to pinpoint, but sometime around 2006 a societal debate was started, in which, next to a general dissatisfaction with Dutch spatial design, the clutter along



motorways was also identified as one of the more urgent problems (see e.g., Toorn, 2007). The Dutch newspaper *De Volkskrant*, for example, initiated an Internet discussion on the Dutch spatial agenda<sup>2</sup>. In an interview, Chief Government Architect Mels Crowwel (Hulsman, 2007) explicitly named cluttering of the landscape along motorways as one of the problems. The monotonous succession of business parks along these motorways had caused Dutch cities to slowly grow into one (corridor formation). Although there are undeniable advantages to building alongside the infrastructure, it seemed as though the balance between economic dynamics and human experience had been lost. The magnetic pull of infrastructure had created a ribbon of urbanisation, causing the contrast between ‘city’ and ‘countryside’ to disappear. The time had come for a government vision on urbanisation along motorways and preservation of scenic panoramas. The past defensive tradition of wishing to keep cities compact seems to have had a contrary effect. Development along motorways had continued without being based on clear choices. The planning device that reads “decide where development is to take place and where it is not – and do a proper job” (Hamers and Nabielek, 2006) would benefit many rural-urban (‘rurban’) areas that are struggling with expanding commercial areas and new housing estates. In line with this device, a planning strategy was developed to protect Dutch motorway panoramas (Hamers and Nabielek, 2006; Houben et al., 2002; VROM, 2006; Zelm van Eldik and Heerema, 2003). In taking on the integral task related to motorway environment, the Minister for the Environment decided in 2006 to develop a structural concept for the motorway environment. This structural concept explicated the generic policy on panoramas and motorway zones in the National Spatial Planning Act (Dutch Lower House (*Tweede Kamer*) 2006/2007, 29 435, no. 187). With the arrival of a new Environment Minister, the plans for motorway panoramas were incorporated in the policy programme Cooperation Agenda for an Attractive Netherlands (*Samenwerkingsagenda Mooi Nederland*) (VROM, et al., 2007). Apart from the development of this structural concept, its support base, the project on Route Design of Motorways (*Routeontwerp van Snelwegen*) was also extended<sup>3</sup>. This project worked on construction proposals for a number of Dutch motorways, on the one hand, and on a coherent (design) approach for the motorway environment, on the other. Although different organisations have adopted the panorama concept, there is no common understanding of what a motorway panorama is exactly, nor of how it could be protected or even developed. In order to define a commonly accepted, objective, verifiable and reproducible definition of the motorway panorama concept, an integrated project on research and design had to be set up (Piek et al., 2007). An important part of the project consisted of the development of a methodology for helping the Dutch Ministry of Housing, Spatial Planning and the Environment (VROM) to create a vision on motorway environment structure. In order to do so, regular meetings were held during the run of this project, between the Ministry of VROM, Route Design of Motorways, and the PBL Netherlands Environmental Assessment Agency.

### 11.3 DEFINITION

Policymakers were in need of a definition of ‘motorway panorama’ for practical applications. A panorama should be recognisable, valued and identifiable on a map. Over the years, several research efforts have been made to explore motorway views. The majority of these studies have assessed the scenery preferences of motorway users, local residents and experts on motorway scenery (Evans and Wood, 1980; Wolf, 2003; Hartig et al., 2003; Parsons et al., 1998; Eby and Molnar, 2002; Ulrich, 1974). Although the results from these studies indicate that, generally speaking, vehicle occupants probably enjoy motorway panoramas, the panoramas themselves have never been the focus of these studies, nor do these studies define panorama dimensions (length, depth, time).

A totally different approach was taken by the aforementioned Francine Houben. She developed a method for analysing the daily visual experience of motorists, by using four cameras to record the views as seen from an individual car, travelling along motorways leading into the main cities of the Randstad. This covered a distance of 153 kilometres, from Delft, to The Hague, Leiden, Amsterdam, Utrecht, Gouda, and Rotterdam, and ending back in Delft (Houben et al., 2002; Houben, 2003). Such data collection and processing is very time consuming. Therefore, it is unsuitable for identifying motorway panoramas along *all* the Dutch motorways.

An operational definition of a (motorway) *panorama* starts with the neologism ‘panorama’ (taken from the Greek, meaning ‘all seeing’). Panorama refers both to the realistic and the impressive, spectacular effect of immersion – in other words, to the visual experience offered by various media. The main reason why the word ‘panorama’ is used for describing different phenomena is that the term, in fact, denotes a form of abstraction. According to Verhoeff: “...*the term panorama is primarily used to refer to specific characteristics related to vision: the experience of limitless visual perception, wherein the spectator has a wide choice of directions to look in*” (Verhoeff, 2007: 9). The car window acts as a screen, giving the viewer a ‘cinematic experience’ (Neutelings, 1988). In order to apply the panorama concept to motorways, two conditions must be met. Firstly, there should be an unblocked view of certain dimensions. Secondly, the view should contain something worth looking at.

Motorway users will not be able to experience wide panoramic views if geological structures, buildings, trees or other physical barriers are located too close to the road. In order for travellers to experience a motorway panorama, the unrestricted view should have certain dimensions.

In their research on workable methods for analysing, classifying and evaluating landscapes, Van der Ham, Iding and Van der Veer determined different perception criteria for distinguish-

ing landscape elements (e.g. Van der Ham and Iding, 1971; Van der Ham, 1972; De Veer, Buitenhuis and Van het Loo, 1977). A measure used by these researchers for determining the necessary depth of field was derived from research by Jacobs and Way (1968). This research showed that the average maximum distance for determining a certain landscape type was 1000 metres. To be able to determine specific landscape components, 500 metres was the average maximum distance.

These criteria apply to a static view of the landscape; their value is limited to the dynamic view of a motorway traveller. Not only the depth of field should be taken into account, but also the distance along which the view exists. Based on fieldwork with the use of photographs, taken at 1.30 metres above the road surface (the average eye level of motorway travellers), we were able to confirm the findings by Jacobs and Way, which state that the minimum visual depth is 500 metres perpendicular to the road. For the Netherlands, with its mostly flat land surfaces, this covers approximately 80% of the projected landscape. The stretches of motorway along which a visual depth of at least 500 metres is unobstructed, is limited – also due to vehicle speed. Assuming safe driving speeds and based on field experience, the minimum ‘visibility time’ for motorway surroundings was set at five seconds. Given a maximum driving speed of 120 kilometres per hour, this would equal approximately 175 metres.

Not every motorway view qualifies as a panorama; in addition to the minimum dimensions of a view, the scenery should also be impressive. This implies that motorway panoramas can only be identified at local or regional levels. Since the landscape determines the panorama, it should be staged at full scale. In addition to features that are ‘indigenous’ to certain landscape types, panoramas may also contain aspects that are foreign to it. Examples include wind turbines, works of art, structural works and other eye-catching landmarks. Minimum view dimensions vary per landscape type and depend on features unique to that area. Large-scale landscapes, such as the Dutch polders, require larger ‘stages’ than smaller scale agricultural landscapes that are richly decorated with hedges and clumps of trees. Similarly, when the scenery contains a changeover from one type of landscape to another, the dimensions should be large enough to convey this occurrence to the motorway traveller. To offer road users a panoramic view, it is important that both indigenous and foreign landscape features are not only of the right size and composition, but also in the right sequence, relative to a vehicle’s viewing distance and travelling speed, and to each other.

In view of all of the above, we defined a motorway panorama as an unobstructed view of a discernable landscape of at least 175 metres wide by 500 metres deep, which includes all the features unique to that area. Or, put as a conditional proposition: if landscape types and their unique features could be identified within a delimited view, this view is panoramic. In a subsequent step we developed a reproducible method for determining motorway panoramas, based on this definition.

## 11.4 METHOD

The most difficult part of applying this definition is that it requires a further delimiting of the exact dimensions of a view. Apart from academic research, useful insights about how to delimit a view also can be gained from handbooks and instruction manuals for motorway design. A report that is often cited from the literature on roads and landscaping is *Visual Impact Assessment for Highway Projects*, published by the Federal Highway Administration (1990) of the U.S. Department of Transportation. It details the viewshed or 'visible area' that is affected by the construction of a motorway. According to that report, the viewshed is defined as the surface area visible from a given viewpoint and/or all the surface area from which the view could be seen. The composite viewshed from a motorway can be mapped by identifying the unobstructed view from successive motorway viewpoints using height information on landform, land cover and man-made development relative to the height of motorway viewpoints.

Our method has been elaborated on the viewshed analysis as it is specified in the Federal Highway Administration (FHWA) guide. Although the 1990 FHWA guide mainly proposes to use the (composite) viewshed analysis to identify the area that is affected by motorway construction, it could also be used to map motorway travellers' views and panoramas. Early viewshed analyses were carried out using paper and pencils. Our research, however, turned to GIS-based (Geographical Information System) viewshed mapping to analyse motorway views and the visible time of areas within these views. Our approach is more similar to that of the cumulative viewshed (Wheatley, 1995). This is like a so-called 'visuallandscape' (Llobera, 2003) that results when the viewsheds from multiple cells in a digital elevation model (DEM) are calculated and added together (the ultimate cumulative viewshed, where viewsheds from each cell within the DEM are added together, is known as the inherent or total viewshed (Llobera et al., 2004; Lee and Stucky, 1998)). In the case of motorway views, viewsheds are calculated at regular intervals along a motorway and subsequently added together to obtain a cumulative viewshed.

The delimited view is an important aspect of motorway panoramas. This view is delimited not only in space but also in time, as motorway travellers pass the view at a particular speed. From the results of cumulated viewsheds calculated at regular intervals along a motorway, we were able to calculate what we call the *visibilitime* of a view (the view as delimited by space and time). To calculate this *visibilitime*, three parameters need to be taken into account. The first parameter is the *physical barriers in the environment*, the second is the *traveller's viewing constraints*, and the third is the speed at which the view is passed, the *time-related viewing constraints*.

Physical barriers in the environment are a combination of buildings, vegetation, noise protection barriers and other objects. Together, these make up a 3D landscape of the Dutch motorway

zone. To create a digital landscape model (DLM) representing this 3D landscape, several data sources have to be combined. Ground level data is obtained from the *Actueel Hoogtebestand Nederland* (AHN) a digital elevation model of the Netherlands<sup>4</sup>. Data on the buildings and vegetation, which might block the view from the motorway, were taken from topographical maps 1:10,000, available from the Dutch Topographical Service of the Land Registry (Topografische Dienst Kadaster, 2005). Information on noise-protection barriers was obtained from the AVV, the Dutch advisory service for traffic and transport. Each type of barrier was assigned a certain height above ground level according to the AHN.

In addition, there are human limitations to the motorway traveller's view. We assumed that motorists would only look straight ahead and to the right when driving, and that the first 20° of their field of vision would be obstructed by other traffic. The natural field of clear vision of a fixed eye is 60° (Haak and Leever-van der Burgh, 1980), and as people can turn their heads by no more than 90° in either direction, we assumed a viewing angle of 20° to 120° ( $90 + 60/2$ ) in relation to the direction of travel. The viewing height from the car was set at 1.30 m, and the line of sight was limited to 7 kilometres (to save on calculation time). In our calculations, atmospheric attenuations have not been taken into account. The distance between two viewing points was set at 5 metres.

Furthermore, a motorist's impression of a view is limited by vehicle speed. In the cumulative viewshed, each visible grid cell was ascribed a value, equal to the number of viewing points from which the grid cell would be visible. Because even distances were used, we were able to draw conclusions on the length of time that each grid cell would be visible, in relation to vehicle speed. By coupling time to grid-cell visibility, the 'visibility time' of a view could be determined. In the GIS system, we calculated the spatially constrained view for every 5 metres along a motorway, in the direction of travel. As motorists experience views while driving at certain speeds, this distance of 5 metres could also be expressed in time. The minimum value that can be scored is 1, being given to each grid cell as it is visible from a single point along a particular motorway. At 120 kilometres per hour a motorist covers a distance of approximately 35 metres per second (equal to seven analysed viewshed points). A grid cell with a score of 1, therefore, is within a motorist's view for one-seventh of a second, but cannot consciously be observed within this time frame. When we verified this method in actual practice we found that an area would need to be in view for at least five seconds in order for the view to be registered. The visible area was calculated and checked from the position of the motorway, as well as from the position of the landscape. In this way, we dissected the first part of the relationship in an objective, controlled and reproducible manner: the delimited part of open space. This allowed us to depict where views, and thus potential panoramas, were located along the entire motorway network. See Figure 1, for an example of a visibility map.



Figure 1  
 Visibilitime of the motorway view between Bodegraven and Woerden

And then there is the matter of subject; *what* is seen. In order for a view to be regarded a panorama, it must offer something worth looking at. The landscape determines the nature of a view. It consists of generic components and features that are unique to a certain location. Generic components are associated with the type of landscape. For instance, peat reclamations are distinctive because of their long, narrow plots of land, the canals and waterways built for drainage, and the rows of trees lining some of the roads. If these components are still in place and visible from the motorway we speak of a recognisable landscape. In our definition, the importance awarded to landscape recognition flows from the National Memorandum on Spatial Planning (*Nota Ruimte*) (VROM, 2004) and the Agenda for a Vital Countryside (*Agenda vitale platteland*) (LNV, 2004). Both these policy documents consider the cultural landscape an important starting point for the (re)design of the Dutch landscape (LNV and VROM, 2006).

The valuing of what is seen is more arbitrary than the results from GIS analyses that determine which part of the landscape is seen and for how long. People consider a landscape worth

looking at for several reasons. Therefore, to indicate what makes a view interesting, we distinguished five categories. The combination of GIS analysis and whether or not a landscape fits into one of the five categories would determine if a certain view could be labelled as a panorama.

The first category describes a landscape's uniqueness. An example of this type of landscape is the view from the *Afsluitdijk*, (a dam carrying the A7 motorway), which separates the IJsselmeer from the Wadden Sea.

The second category describes landscape views that are spectacular because of great variation. For example, the hills of Limburg and the view from the A348 motorway along the meandering river IJssel.

The third category describes landscapes with views that are regarded as highly valuable because they show the transition from one type of landscape into another. An example of this is the view along the A12 motorway, coming from Germany, just past the town of Zevenaar. On the right-hand side of the road, the view stretches across river bends and riverbanks towards a lateral moraine landscape.

The fourth category describes landscape views that can be labelled as 'special' because of their context. For example, in strongly urbanised areas, views containing the last remaining open spaces can be awarded a special value.

The fifth and last category describes landscapes that contain specific elements, but are not rare. In this type of landscape location-specific features can turn views into panoramas. These elements could be indigenous to a certain landscape – such as the row of four (historic) windmills (*de molenviergang*) that were used to drain the Tweemanspolder, south of Zevenhuizen. Features could also be less historic, such as the large inflatable cows scattered hither and thither across the landscape; a creation by landscape architect Adriaan Geuze.

Figure 2 shows the discernable landscape in the motorway view between Bodegraven and Woerden. The view could be categorised as a panorama in the fifth category because of the visible characteristics of peat reclamation (with its ditches). Furthermore, the view also belongs to the fourth category, as its context is special because of the open connection between the northern and southern parts of the Green Heart.



Figure 2  
The discernible landscape in the motorway view between Bodegraven and Woerden

## 11.5 RESULTS AND DISCUSSIONS

We started our study by determining the number of views of at least 175 metres long that could be found along the Dutch motorways. In total, we found 1,753 views of varying dimensions. To determine which of these views could be considered panoramic, we would have had to scale down to each individual view level in order to recognise its particular landscape components. However, because of the large number of views this was unfeasible. Instead, we determined which of the views had quality potential, based on the map ‘Cultural and natural key landscape qualities’ (Snellen et al., 2006). This map provides an indication of whether a certain view is likely to contain a recognisable landscape and its components. According to this map, the Netherlands holds 231 of such views, together totalling nearly 440 kilometres in length, which have either highly visible, cultural and natural key landscape qualities, or potentially recognisable landscape components. These views, therefore, are the ones most likely to meet the panorama criteria. Most of these cultural and natural key landscape qualities can be found in views along motorways that run through the Green Heart, South Limburg, Flevoland and Friesland, and along the A7 and A9 motorways in the province of North Holland.



Apart from matching views and landscape qualities, we also looked at planned building developments within the resulting viewsheds. After all, important in the discussion on landscape cluttering were the corridor formations along motorways, which cause open views to disappear. Of the 1,753 views counted in the Netherlands in 2003, 880 appeared to be threatened by planned building developments. Of these 880, perhaps a third of the development plans could possibly be adjusted as these had not been legally finalised yet, and the panorama notion could still be taken into consideration. This became clear after we compared the development plans – both housing and commercial – in the New Map of the Netherlands (*Nieuwe Kaart van Nederland*, version of November 2006), to the map of national views (Piek et al., 2006: 28).

To determine the degree to which potential views would fit in with government policy, we looked at view locations bearing in mind the existing, so-called national policy categories. Dutch Government spatial policy has been established in the National Memorandum on Spatial Planning (VROM, LNV, VenW and EZ, 2006; final, approved version). In this Document a number of area categories have been distinguished for nature areas and landscapes of national interest. The number of threatened high quality views that lie within this ‘green’ spatial network, equals that outside of this network. Therefore, the national policy that is aimed to protect landscapes, does not seem to cover threatened views. However, if it is the government’s aim to also protect motorway panoramas, the above analysis could lead to a focus on the protection of views with high cultural and natural key qualities outside of this green spatial network.

## 11.6 MOTORWAY PANORAMAS ADOPTED IN POLICY

The method for identifying (potential) motorway panoramas was used for creating the Structural Concept for the Motorway Environment ‘A good view of the Netherlands’ (*Structuurvisie voor de Snelwegomgeving ‘Zicht op mooi Nederland’*) (VROM, 2008). This structural concept has a basic, generic function, relating to all motorways; it has to make local and provincial administrators aware of the importance of motorway panoramas. In the first instance, this vision is aimed at the prevention of landscape cluttering along motorways. In addition, ideas from the route design programme are being applied to large-scale motorway maintenance.

Secondly, the structural concept has appointed nine National Motorway Panoramas. The Ministry of VROM indicated that these nine panoramas had to be located within the different National Landscapes named in the National Memorandum on Spatial Planning. In addition to this criterion, community consultation also played an important role in the final selection of the nine national motorway panoramas. In this consultation, citizens were asked to indicate (on-

line) the locations of what they considered were the most appreciated views from motorways (Bureau KLB, 2007). In support of the spatial demarcation and descriptions of the qualities of the National Motorway Panoramas, and at the request of the Ministry of VROM, the PBL Netherlands Environmental Assessment Agency carried out a detailed viewshed analysis to determine the visibilitime for twelve of these panoramas, as selected by citizens.

It is not the intention to disallow all spatial development within the national panoramas, but rather that, just as for the other national landscapes, a ‘yes, provided that’ regime is followed. ‘Provided that’ refers to the requirement that key landscape qualities are to be maintained or fortified. Provincial administrations are to apply and implement these stipulations. Beside the qualities indicated by government for all the national landscapes, motorway panoramas need to meet some additional quality criteria. One obvious example of such an additional quality would be an open view of the landscape from motorways.

As the nine appointed motorway panoramas are part of national policy, the Inspectorate of the Ministry of VROM monitors whether spatial developments would go against the ideas of the structural concept. In April 2009, the Inspectorate published an overview of plans for developments within the areas of the nine national panoramas (VROM Inspectorate, 2009). The maps on visibilitime are the basis for an analysis of whether there are development plans that possibly could damage motorway panoramas. At this time, apart from one exception, none of the plans appear to be damaging, and some spatial initiatives even have been qualified as having a positive effect on their particular landscapes. In addition, a number of small activities still have to be assessed. Municipalities also consider these landscapes to be valuable and are in favour of protecting and reinforcing landscape qualities. Nevertheless, plans are being made for housing developments, business parks and infrastructural works that could have a negative effect on these national panoramas. Central government may need to formulate actions, in cooperation with provinces and municipalities, on how to manage these situations. Finally, the Inspectorate of VROM has pointed out that developments that take place just outside of the panorama areas as indicated in the policy map, could also have their influence on these panoramas.

## 11.7 CONCLUDING REMARKS

In our study we have defined motorway panoramas, and developed an objective and reproducible method for operationalising them. This fitted in well with policy discussions, and the research, to some degree, was used to formulate policy on motorway environments.

In the actual practice of spatial developments, however, it has proven difficult to manage the landscape quality of ‘openness’. Especially close to motorways, where spatial pressures of

urbanisation are great. The approach to motorway panoramas is based on the view from the road; it must be noted that this approach is only one of many. There are other interests, such as in commerce, housing, or ecology that affect motorways and their surrounding areas.

## NOTES

- [1] See: <http://www.byways.org/learn/>
- [2] See: <http://www.ruimtelijkeagenda.nl/>
- [3] The project Route Design of Motorways was one of the 'major projects' in the Architectural Document 'Ontwerpen aan Nederland' (Designing the Netherlands) (Ministries of OCenW, VROM, VenW and LNV, 2000), and initially focused only on the A12 motorway. See: <http://www.routeontwerp.nl/>
- [4] See: <http://www.ahn.nl/english.php>

## REFERENCES

- Anoniem (1971) *Weg en landschap, Preadviezen congresdag 1971*. Vereniging Het Nederlandse Wegencongres, The Hague.
- Appleyard, D., Lynch, K., and Myer, J. R. (1964) *The View from the Road*. Cambridge, Massachusetts. Massachusetts Institute of Technology.
- Bélangier, P., and Lago, D. (2003) Highway Surface A Brief History of the United States Interstate and Defense Highway System In: Houben, F., and Calabrese, L.M. (ed.) *Mobility: A Room with a View*. Rotterdam, NAI Publishers, pp 397-410
- Bohemen, H. D. van (2004) *Ecological Engineering and Civil Engineering Works. A Practical Set of Ecological Engineering Principles for Road Infrastructure and Coastal Management*. Delft, PhD Thesis Delft University of Technology.
- CPRE (1971) *Roads and the landscape*. London, Council for the Protection of Rural England.
- Bureau KLB (2007) *Snelwegpanorama's een burgerconsultatie*. The Hague.
- Eby, D. W., and Molnar, L. J. (2002) Importance of scenic byways in route choice: a survey of driving tourists in the United States. *Transportation Research Part A* 36; 95-106
- Enis, R., Kenyon, V., Gilboa, E., and Shalit, A. (1973) *The road and the landscape*. Haifa, Technion Research and Development Foundation Ltd.
- Evans, G. W., and Wood, K. W. (1980) Assessment of environmental aesthetics in scenic highway corridors. *Environment and Behavior* 12; 255-273
- FHWA (1990) *Visual impact assessment for highway projects*. Washington, Federal Highway Administration, Publication No. FHWA-HI-88-054 (first printing 1979 by ASLA, the American Society of Landscape Architects)
- Friedberg, A. (1993) *Window Shopping: Cinema and the Post-modern*. Berkeley, California. University of California Press.
- Haak, A.J.H., and Leever-Van der Burgh, D. (1980) *De menselijke maat: een studie over de relatie tussen gebruiksmaten en menselijke afmetingen, bewegingen en handelingen*. Delft, Delftse Universitaire Pers.
- Hamers, D., and Nabielek, K. (2006) *Bloeiende Bermen. Verstedelijk langs de snelweg*. The Hague/Rotterdam, Ruimtelijk Planbureau/NAi Uitgevers.
- Hamers, D., and Nabielek, K. (2006) Along the fast lane. Urbanisation of the motorway in the Netherlands. In Wang, C. Sheng, Q., and Sezer, C. (ed.) *International Forum on Urbanism 2006 in Beijing: Modernization and regionalism: Re-inventing urban identity*. Delft, International Forum on Urbanism, pp 274-281
- Ham, R.J.I.M. van der, and Iding, J.A. (1971) *De landschapstypologie naar visuele kenmerken, methodiek en gebruik*. Wageningen, Landbouwwuniversiteit Wageningen.
- Ham, R.J.I.M. van der (1972) *Voorlopig verslag van een onderzoek naar de beleving van het landschap met behulp van groepswaarnemingen*. Wageningen, Landbouwwuniversiteit Wageningen.
- Hartig, T., Evans, G. W., Jamner, L. D., Davis, D. S., and Gärling, T. (2003) Tracking restoration in natural and urban field settings. *Journal of Environmental Psychology* (23); 109-123
- Huhtamo, E. (2004) Peristrepic Pleasures: The Origins of the Moving Panorama. In: Fullerton, J. and Olsson, J. (ed.) *Allegories of Communication: Intermedial Concerns From Cinema to the Digital*. Rome, John Libbey Publishing, pp 215-248
- Hulsman, B. (2007) *Afslagje hier, baantje daar. Gesprek met rijksbouwmeester Mels Crouwel over de 'verrommeling' van Nederland*. In: *NRC Handelsblad* 3 februari 2007
- MNP (2006) *Verrommeling in beeld. Kaartbeelden van storende elementen in het Nederlandse landschap*. Bilthoven, Milieu- en Natuurplanbureau.

- Het Nederlandse Wegencongres (1964) *Weg en recreatie*. The Hague.
- Houben, F. (2003) A Room with a View. In: Houben F., and Calabrese, L.M. (ed.) *Mobility: A Room with a View*. Rotterdam, NAI Publishers, pp 23-71
- Houben, F., Weightman, M., Jongejan, B., Hoete, A., Verlaan, J., Koeleman, M., and Maagdenberg, T. (2002) *Holland Avenue 2002/2030. Research Road Atlas*. The Hague, Ministerie van Verkeer en Waterstaat.
- Jacobs, P., and Way, D. (1968) *Visual values of landscape development*. Cambridge, Massachusetts, Harvard University.
- Jellicoe, G. A. (1958) *Motorways - their landscaping, design and appearance*. London, Town Planning Institute (Fourth Rees Jeffreys triennial lecture)
- Landinrichtingsdienst (1991) *Landschap van wegen en kanalen*. The Hague.
- LNV (2004) *Agenda vitaal platteland*. The Hague.
- Meurs, P. (2003) Parkways and Polderways. In: Houben F., and Calabrese, L.M. (ed.) *Mobility: A Room with a View*. Rotterdam, NAI Publishers.
- Neutelings, W. J. (1988) De ringcultuur. Een studie naar het Ringmechanisme. *Vlees en Beton* (10). Mechelen, Laat-XXe-eeuws genootschap voor architectuur en stedenbouw.
- Nijenhuis, W., and Winden, W. van (2007) De diabolische snelweg, over de traditie van de mooie wegen in het Nederlandse landschap en het verlangen naar de schitterende snelweg in de grote stad. Rotterdam, Uitgeverij 010.
- OC&W, Ministry of, and VROM. Ministry of (2000) *Ontwerpen aan Nederland, architectuurbeleid 2001-2004*. The Hague.
- Oettermann, S. (1997) *The Panorama: History of a Mass Medium*. Cambridge, MIT Press/Zone Books.
- Overdijkink, G. A. (1941) *Langs onze wegen*. Heemschutserie [no. 11]. Amsterdam, uitgeverij Allert de Lange.
- Parsons, R., Tassinary, L. G., Ulrich, R. S., and Grossman-Alexander, M. (1998) The view from the road: Implications for stress recovery and immunization. *Journal of Environmental Psychology* 18; 113-140
- Piek, M., Middelkoop, M. van, Breedijk, M., Hornis, W., Sorel, N., and Verhoef, N. (2007) *Snelwegpanorama's in Nederland*. The Hague/Rotterdam, Ruimtelijk Planbureau/NAI Uitgevers.
- Rekette, J. (2003) 'Straight-Curve-Straight' or 'The Undulated Line' - the Dilemma of Rationality and Aesthetic Dogma. The Origins and Aesthetic Principles of Motorway Construction in Germany up Until 1945. In: Houben F., and Calabrese, L.M. (ed.) *Mobility: A Room with a View*. Rotterdam, NAI Publishers, pp 385-396
- Sullivan, W. C. and Taylor Lovell, S. (2006) Improving the visual quality of commercial development at the rural-urban fringe. *Landscape and Urban Planning* 77; 152-166
- Toorn, M. van (2007) *Project Nederland*. Amsterdam, Augustus.
- Ulrich, R. S. (1974) *Scenery and the Shopping Trip: The roadside environment as a factor in route choice*. Michigan, University of Michigan (Geographical Paper No. 12).
- Veer, A.A. de, Buitenhuis, A., and Loo, H. van het (1977) *Vergelijking van Nederlandse Methoden van landschap-kartering en hun toepassingsmogelijkheden*. Wageningen, Stichting voor bodemkartering.
- Verhoeff, N. (2007) *Panorama behind glass: framing the spatial and visual design of highways*. Webpaper: [http://www.rpb.nl/upload/documenten/Panorama\\_Behind\\_Glass.pdf](http://www.rpb.nl/upload/documenten/Panorama_Behind_Glass.pdf)
- VROM, Ministry of (2004) *Nota Ruimte*. The Hague.
- VROM, Ministry of (2008) *Zicht op mooi Nederland. Structuurvisie voor de snelwegomgeving*. The Hague.
- VROM-inspectie (2009) *Negen nationale snelwegpanorama's. Ruimtelijke ontwikkelingen in beeld*. Arnhem
- VROM, Ministry of, LNV, Ministry of, V&W, Ministry of, and EZ, Ministry of (2006) *Ruimte voor ontwikkeling. Deel 4: tekst na parlementaire instemming*. The Hague.
- VROM, Ministry of, LNV, Ministry of, and EZ, Ministry of (2007) *Samenwerkingsagenda Mooi Nederland*. The Hague.
- Wolf, K. L. (2003) Freeway roadside management: the urban forest beyond the white line. *Journal of Arboriculture* 29 (3); 127-136
- Zelm van Eldik, D. van, and Heerema, P. (2003) *Kompas voor het Routeontwerp*. Delft, Ministerie van Verkeer en Waterstaat, Dienst Weg- en Waterbouwkunde.

12

# HI RISE! I CAN SEE YOU

## PLANNING AND VISIBILITY ASSESSMENT OF HIGH BUILDING DEVELOPMENT IN ROTTERDAM

### 12.1 INTRODUCTION

Western European cities like London, Paris, Rotterdam and Frankfurt am Main have seen impressive high building developments over the past two decades. This has led them to develop policies for regulating the planning and construction of tall buildings, high-rise buildings and skyscrapers within their territory. So far, these high building developments and policies have received little attention from the academic community. This chapter elaborates a framework for analysing high building development and the visual impact of high buildings on the surrounding landscape with the city of Rotterdam as a Western European showcase. It presents a systematic approach for analysing high building development in terms of architectural height, year of completion, location and functional use, for use in the comparison of existing buildings with the urban policies that are in place. Comprehensive GISc-based viewsheds were used to analyse the visibility of the high buildings, factoring in both meteorological circumstances and the vertical area of the buildings. The showcase city of Rotterdam demonstrates that a considerable distance exists between the vision and reality. The city struggles to deliver a consistent and integrated policy for high-building urban areas, while the high building developments themselves seem to be ruled by a remarkable internal logic that is not fully recognised in policymaking.

The impact of tall buildings, high-rises and skyscrapers on neighbourhoods, urban districts and cities is widely acknowledged by architects, urban planners, politicians and developers all

over the world. The planning and construction of high buildings is not without controversy. Tall buildings, high-rises and skyscrapers have the ability, like no other building typology, to polarise the public debate on architecture and the built environment, to evoke a sense of urban identity or alienation, to represent the economic growth or decline of a city, and even to become the symbolic target in armed conflicts or acts of terrorism.

Concerns about the appropriateness of high buildings in the (urban) environment, the (iconic) quality of their architecture, and their impact on local real estate markets is increasingly reflected in municipal and metropolitan policymaking. Prominent cities with a longstanding tradition of urban management, building regulations and zoning plans seem to feel the need for additional instruments to control the development of what is described by McNeill as “an extremely complex spatial phenomenon” (McNeill, 2005). There is a tendency in the scientific literature, however, “... to neglect the substantial impact of skyscrapers on urban life. Yet the significance of these buildings — in terms of height, levels of human occupancy, aesthetic impact and popular representation and use — is in need of careful geographical interpretation” (McNeill, 2005).

There are many terms that are used to address high buildings: tall buildings, high-rise buildings and skyscrapers. Each of those terms has a specific means or connotation, depending on the context or the framework in which it is used. To avoid unnecessary confusion this chapter uses consistently the term high buildings.

The chapter starts with placing the developments in Rotterdam in its international context: Western Europe. It then describes the development of high buildings in Rotterdam and the city’s successive high building policies. It describes in detail the analysis of the visual impact of Rotterdam’s buildings on the surrounding territory by means of GISc (Geographic Information Science), before drawing conclusions on the same.

## 12.2 HIGH BUILDING DEVELOPMENT IN WESTERN EUROPE

Within this context, this chapter presents an original approach for analysing clusters of high buildings. Rotterdam serves as a showcase. The city represents a prominent European high building city that has a mature (already revised) high building policy in place. Rotterdam is part of the Emporis Top 20 of European high building cities (Emporis, 2009), as one of only four Western European cities that made it onto this list: London, Paris, Rotterdam and Frankfurt am Main. The leading position of the city of Rotterdam is furthermore underscored by DEGW’s report on London’s Skyline, Views and High Buildings (DEGW, 2002) commissioned by the Greater London Authority. The London policy document uses the same four European

cities to compare established European practices of high buildings policymaking: London, Paris, Frankfurt and Rotterdam.

There are many other cities worldwide with a substantial number of high buildings. Those in Europe, however, make up a special case. The development of tall buildings, high-rise buildings and skyscrapers in Europe is embedded in an environment very different to that of America, Australia, Asia or the Arabian Peninsula. The European cities and their surrounding cultural landscapes have evolved gradually over centuries, if not millennia. Their built heritage, when not ravaged by war, is substantial. The relatively slow pace of development, due to a moderate economic growth rate, provide the time that is necessary for careful consideration. The well-developed practice of local democracy allows for the involvement of many political parties, stakeholders and pressure groups in the decision-making process. Among them are organisations and individuals that place strong emphasis on the importance of preserving the value and quality of the built heritage that was put in place by previous generations.

High buildings have been controversial in the Netherlands for years, if not decades. In the 1960s and 1970s, large modernist residential estates were planned and built in the outskirts of many Dutch cities and towns. These buildings had a negative impact on the public opinion. It was only after the emergence of a new type of high building development in the inner cities and suburban centres in the early 1990s that this image started to change for the better, not just in Holland but also throughout much of Europe (Sudjic, 2005). Even now, high buildings evoke emotions and provoke controversies (Taillandier, Namias and Pousse, 2009). Some citizens and politicians seem to reject tall buildings altogether, regardless of the quality of their design, their position in the city or their contribution to the skyline. On the other hand, various enthusiasts and interest groups seem to embrace each new development without much criticism, as long the proposed building is higher than existing high buildings.

These controversies may very well explain why a substantial number of towns and cities have felt the need to regulate the planning and construction of this specific building type. Because all building activities are regulated in the Netherlands, policy makers and civil servants need a solid framework that helps them to approve or disapprove a specific high building proposal. The policy document that emerged in the Dutch context is called *Hoogbouwbeleid* (High Building Policy) or *Hoogbouwvisie* (High Building Vision). The high buildings policies bear resemblance to a number of policy documents recently produced in the United Kingdom and Germany: the Guidance on Tall Buildings by English Heritage and the UK Commission for Architecture and the Built Environment (CABE and English Heritage, 2007), London's Interim Strategic Planning Guidance on Tall Buildings, Strategic Views and the Skyline in London (Mayor of London, 2001), Birmingham's Planning Policy Framework for Tall Buildings (Birmingham City Council, 2003), the *Hochhausentwicklungsplan* Frankfurt am Main (*Stadtplanungsamt* Frankfurt am



Main, 2008) and the *Hochhausentwicklung in Düsseldorf Rahmenplan (Landeshauptstadt Düsseldorf, Stadtplanungsamt, 2004)*. In this chapter these policy documents are addressed as ‘high buildings policies’.

Height regulation is a key component of such policies. Height may be measured in many different ways: architectural height, floor-to-ceiling height, floor-to-floor height, highest occupied floor height, main roof height, observation deck height, observation floor height, roof height and tip height (Emporis, 2009).

Because the architectural height is internationally considered to be the official height for primary ranking purposes (Emporis, 2009) this article considers only the architectural height. The architectural height is defined as “the vertical elevation from the sidewalk level outside of its lowest exposed floorplate, to its highest architectural or integral structural element. These include fixed sculptures, decorative and architectural spires, ornamental fences, parapets, balustrades, decorative beacons, masonry chimneys, and all other architecturally integral elements along with their pedestals” (Emporis, 2009).

### 12.3 HIGH BUILDING DEVELOPMENT IN ROTTERDAM

Over the years, Rotterdam has carefully cultivated an image as a ‘city of architecture’. Historic architecture is not Rotterdam’s strong point. Few buildings were left standing after the bombing and fire of May 1940, and most of those were modern buildings from the 1920s and 1930s. The city had to rebuild its centre from scratch. It seized this opportunity to experiment with architecture and urbanism, which is why the Rotterdam city centre now contains numerous monuments and icons from the modern and modernist period, sometimes referred to as ‘reconstruction architecture’.

Discussions about the appropriateness of high buildings did surface from time to time, but never reached a climax, as they did in cities with historic centres. High buildings are now generally accepted and most are concentrated in the city centre. While Rotterdam as a whole uses modern and modernist architecture to promote itself, high buildings are an essential ingredient in the profile of the city centre: the skyline, including the famous Erasmus bridge, has become a true icon of the city (Ulzen, 2007).

Rotterdam’s semi-official history portrays a hundred-year prelude from the late nineteenth century, with the completion of the *Witte Huis* (1898; 42 metres) to the so-called ‘first wave’ of high buildings in the mid-1980s. It suggests that at the beginning of the 21st century, the city was on the verge of this ‘second wave’ of high buildings, which would feature super high



**Figure 1**  
**Weenatoren, Rotterdam city centre (106 metres; 1990)**

buildings. Some remarkable difficulties arise with this. To begin with, if one considers the early years of Rotterdam's 'century of high-rise' as a prelude to the current high building developments. Neither the height nor the location of the high buildings dating from this early period relate to the municipal policy on high-rises. Although the first 'high' buildings were relatively tall for their time, they fall far short of qualifying as 'high' by current standards.

The HBU building (1939; 40 metres) is now dwarfed by numerous neighbouring buildings that are almost twice its height. Even the GEB tower (1931; 61 metres) is too small to qualify under the current policy on high buildings, which applies only to buildings of 70 metres or more. Similar difficulties appear when the locations of these buildings are considered. In the four decades, between the construction of the GEB tower and the completion of *Hoboken* (1969; 114 metres), almost all high buildings were built to the west of the city centre or in the western part of the centre, among them the characteristic *Lijnbaanflats* (1956; 44 metres). It was only in the 1970s that the current high-rise area in the middle of the centre began to emerge.



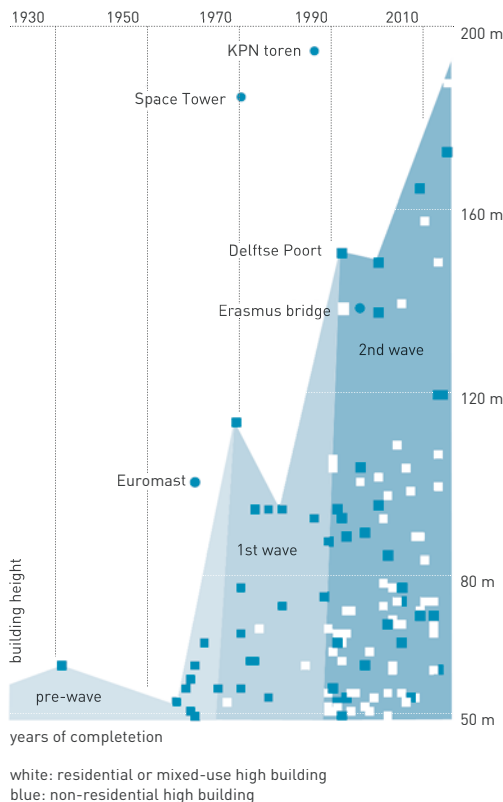
**Figure 2**  
The HBU building, nowadays dwarfed by the neighbouring high buildings from the 1990's

To get a better understanding of how the development of high buildings has evolved over the years it is necessary to look at some data. Data on high buildings can be presented as a simple list or as a scatter plot. This chapter uses the scatter plots because it is a simple but efficient way to display the relation between two types of quantitative data tagged to a number of specific objects. A simple graph of height (y axis) versus time (x axis) can be plotted using data on the architectural height and the year of completion of the high buildings. By including buildings under construction and proposed buildings, a timeline for high building development in a given city emerges. This method to visualise high building development through time and height was used for the first time in a lecture series organised by the sLIM Foundation, initiated and funded by the Dutch Counsel on Tall Buildings.

The beauty of Rotterdam's scatter plot lies in the clear patterns that emerge. In her book 'Form Follows Finance', Carol Willis explains that the end of a high building wave is typically marked by the construction of the highest building so far (Willis, 1995). If that insight is also applicable to Rotterdam, then the year in which the tallest building so far was completed could be used

as the breaking points between ‘high building waves’. Four such buildings stand out in Rotterdam: the GEB tower (1931; 61 metres), the Faculty of Medicine of the Erasmus University, also known as ‘Hoboken’ (1969; 112 metres), the *Delftse Poort* (1991; 93 and 151 metres) and the *Maastoren* (2009; 165 metres). If the high building history of Rotterdam is indeed characterised by waves, then, these buildings are indicative of four such waves, as represented in the scatter plot. The end of a wave is determined by the latest and highest building in a development cycle. The beginning of the next wave is determined by referring to the last high building built immediately prior to an economic downturn, such as the ones in 1981, 2001 and 2008, when the Netherlands experienced negative economic growth.

The current municipal policy states that a high building is at least 70 metres high. This makes 1969/1970 a true watershed. First *Hoboken*, the building of the Faculty of Medicine, was completed (1969; 114 metres), followed a year later by the Faculty of Economics (1970; 78 metres). In the same, year the *Euromast* (a panorama tower) was extended with the addition of the Space Tower (1970; 185 metres). High buildings then sprung up in various locations throughout the city, ranging in height from 50-100 metres. The barrier of 70 metres was broken. Al-



**Figure 3**  
Scatter plot of the architectural height and the year of completion of Rotterdam’s high buildings, including optimised height categories and the so-called waves of high buildings

though there seemed to be no reason to turn back, the construction of high buildings came to an abrupt end in the late 1970s, when the city council imposed a moratorium on the construction of office buildings.

‘Rotterdam’ is not eager to acknowledge the fact that its first generation of ‘true’ high buildings appeared in the 1970s. When it speaks of a ‘first wave of high buildings’ they usually mean a later period, starting in the mid 1980s. Looking back at this ‘first generation’, it is easy to see why; there is little of which a ‘city of architecture’ can be proud. This first decade of ‘true’ high buildings did not produce many beautiful ones. Their architectural quality is mediocre at best, exemplified by the PTT Telecom building (1970; 51 metres and demolished in 2007), Europoint I, II and III (1973/76/79; 95 metres) or the Hofpoort (1976; 95 metres). Even their contribution to urban life is doubtful, since they are mono-functional building schemes without any public functions at street level. Regardless of the quality produced during this period, it was in fact the first period to produce a substantial number of buildings over 70 metres high. Furthermore, for the first time, a significant proportion of these high buildings appeared within the current high building zones.

All things come to an end, even a moratorium on new office blocks. After years of rapid economic growth, the economy slowed down in the early 1980s and went into recession. The port, which had been the pillar of the Rotterdam economy for the last century, was increasingly shedding jobs. It was no longer possible to overlook the high employment potential of the city centre. Politicians changed their views on barring office developments and the construction of office buildings picked up with the completion of the World Trade Center (1986; 93 metres), the *Maas* (1988; 76 metres) and the *Willemswerf* (1988; 88 metres). Since 1990, construction of high buildings in the central area has been in full swing: *Weenatoren* (1990; 106 metres), *Weenacenter* (1990; 104 metres), *Delftse Poort* (1991; 93 and 151 metres) and the Robeco Tower (1991; 95 metres). The number of high buildings built since the end of the ‘freeze’ was higher than normal, mainly due to postponed demand. This fact alone does not justify talk of a new era or ‘the first wave’. It was already pointed out in this section that the significance of the 1970s as an earlier wave is generally overlooked. Perhaps more importantly, there is little or no evidence of a significant change that took place during the mid 1980s.

When office building picked up in the mid 1980s, the city did not impose additional regulations on high building development. Neither did a shift in the location of new high buildings occur. Considering the architecture, evidence, albeit anecdotal, can be found to support the idea that this period is actually characterised by continuity instead of discontinuity. The last office building before the moratorium, the *Coolse Poort* (1979, 74 metres) was the work of Rob van Erk, who also designed the first building after the moratorium was lifted, the World Trade Center (1986, 93 metres). Both buildings have the mirrored glass facades that are so typical of the

late 1970s and the 1980s, and they stand just a few hundred metres apart. This is not what one would expect from a radical break.

Because the first high building wave is now estimated to have begun around 1970, the wave beginning in the late 1980s, early 1990s must be the second one. This second wave is not just defined by architectural height only. There are strong indications that a new trend emerged. The periods before and after 1989-1992 display many qualitative differences relating to urban planning policies, architectural design, internationalisation and the actual use of high buildings.

In 1993, the Rotterdam Municipal Council launched its first high buildings policy (*Hoogbouwbeleid*) in a structured attempt to steer the development of high buildings in the city (Dienst Stedenbouw + Volkshuisvesting, 2000). The architectural quality of high buildings from the era between 1969 and 1991 is mediocre at best, and for almost two decades, it was dominated by the use of mirrored glass facades. The *Delftse Poort* (1992; 93 and 151 metres) was the last design with such facades. The quality of architecture then improved and designs became more diverse.

In a parallel development, foreign architects became involved in the design of such buildings. In the preceding 100 years, no foreign architect had designed a high building in Rotterdam, with the exception of SOM with their three identical Europoint buildings (1975/1978; 95 metres). Since the mid-1990s, foreign architects have played a major role in high building design in Rotterdam. The buildings designed by foreign architects include Helmut Jahn's Fortis Bank (1996; 104 metres), Renzo Piano's Toren op Zuid (2000; 96 metres), WZMH's Millennium Tower (2000, 149 metres) and Norman Foster's World Port Centre (2001; 138 metres), Hans Kolhoff's *De Compagnie* (2005; 55 metres), Alvaro Siza's New Orleans (2010; 158 metres) and the list is growing.

Finally, there has been a marked difference in the use of high buildings. Before 1990, most high buildings were office or university buildings. The first partial shift to residential use took place with the construction of the *Weenatoren* (1990; 106 metres) and the *Weenacenter* (1990; 103 metres). The market was a little slow to adapt to this change, but the *Schielandtoren* (1996; 101 metres) and the *Hoge Heren* (2000; 102 metres) made the breakthrough. Many new high buildings and proposals are now for residential uses (Klerks, 2005).

## 12.4 ANALYSIS OF ROTTERDAM'S SUCCESSIVE HIGH BUILDINGS POLICIES

With these issues in mind, Rotterdam produced its first high buildings policy in 1993 as an integral part of the strategic plan for the city centre. Formulating such a policy document is a clear

characteristic of the second wave, and so it deserves a closer look. The 1993 policy covers both urban design and urban planning. The *Hoogbouwvisie* (High Building Vision) allowed high buildings only along the 'urban axis' formed by *Coolsingel*, *Schiedamsedijk* and the Erasmus bridge, along the *Weena* and along the river *Nieuwe Maas* (*Wilhelminapier*, *Kop van Zuid*). John Worthington (DEGW) advised the city to treat its reconstruction architecture along the boulevards with care. He proposed a setback principle and the city acted accordingly (Maandag, 2001).

Concentrating all the new high buildings along this one axis seriously limited the number of locations the city could provide. Within a decade, Rotterdam ran out of suitable plots. In a further development, the city faced proposals for buildings much higher than had been previously

**Figure 4**  
Map of the 'official' Rotterdam high building zones



allowed. The policy provided no answers on how to deal with the shortages of building plots and the proposals for super high buildings; it was time for an update.

Almost ten years later, it was again John Worthington who gave the city advice on how to act. Worthington's firm DEGW (named after the partners Duffy, Eley, Giffone, and Worthington) proposed keeping the architectural heights along the river *Nieuwe Maas* relatively low and developing two concentrations of super high buildings at the beginning and the end of the urban axis. The river would then form a 'valley'. One focal point already existed: the Rotterdam Central public transport hub. The other had to be developed at 'Parkstad'. The 'valley' concept did not make it into the new policy and as a consequence, the *Wilhelminapier* remained a prime location for high and very high buildings. In the end, the policy document contained both quantitative and qualitative criteria; the high building zones in the centre were somewhat expanded and the city defined three different types of high building zones, each with its own height regulations:

- High building zones without height restrictions (*Weena* and *Coolsingel*);
- High building zones for buildings between 70 and 150 metres high;
- Transition zones adjacent to the other two high building zones.

According to the municipality these zones shouldn't be read as locations, but as areas in which locations can be found. The precise sites for high buildings remain to be determined within the framework of the municipal zoning plan. Among the qualitative criteria used in that process are public space, wind hindrance, living environment, accessibility, parking, flexibility, mixed-use, sustainability, construction and place (Dienst Stedenbouw + Volkshuisvesting, 2000).

Around the turn of the century, proposals emerged that surpassed the height of everything that was built before. The most controversial development concerned a super high residential building, the *Parkhaventoren* (392 metres; never built), next to the *Euromast* panorama tower (van der Hoeven, 2002). The proposal was an important impetus to update the city's high buildings policy. The original policy did not provide answers regarding how to judge proposals of this scale. Just after its revision was published in 2001, the economy stagnated. The demand for office space declined. The wave of super high buildings cooled off. The *Parkhaventoren* was never built and developments at *Parkstad* did not take off. In the end, the city approved the construction of just one 'super high building': the *Coolsingeltoren* (187 metres, never built), but even in this case, the developers were not able to find enough occupants to start construction. A new proposal for the site that was 156 metres high was stalled as a result of the 2008 credit crisis (Algemeen Dagblad, 2008). So far, the *Maastoren* (2009; 165 metres), which is located at the *Kop van Zuid*, is the only building that surpasses the *Delftse Poort* (1991, 151 metres). It may very well remain the highest building for some time to come.



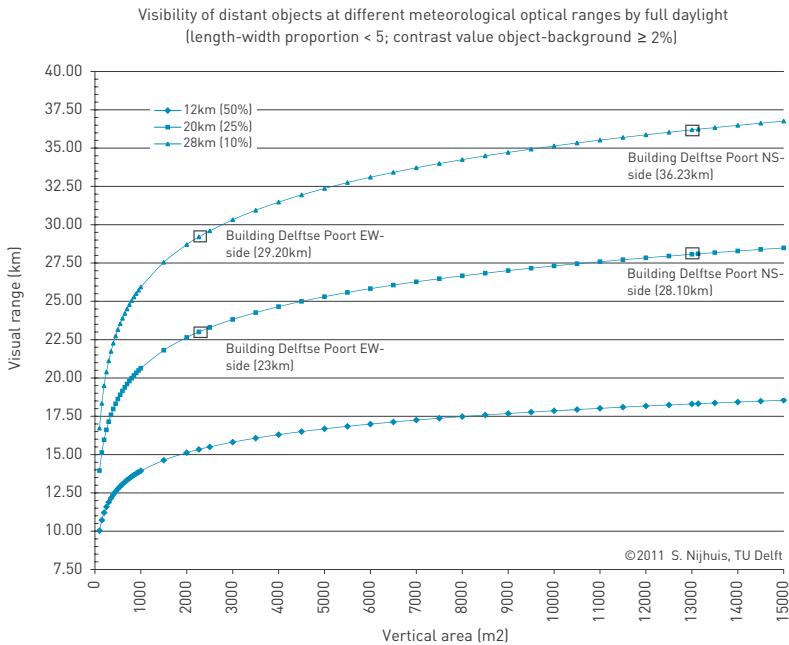
Currently, there are no higher buildings or under construction. The *Maastoren* may close off just another wave in the Rotterdam tradition and possibly introduce a third wave. No matter how, the development of the Rotterdam skyline is at least in its second wave. Its first wave did not start in 1986 like the city claims, but already in 1969/1970. The second wave started in 1989/1992, still three to six years off from the city's 'official' first wave.

Using different waves and height categories may lead also to different conclusions on the extent of the envelopes of the clusters of high buildings, but first the visual impact of the high building cluster must be reviewed.

## 12.5 GIS-C-BASED VISIBILITY ANALYSIS

The visual impact of a singular high building was successfully reviewed (Lörzing et al., 2007) in the case of the proposed 'Belle van Zuylen' tower (262 metres, never built) near the Dutch city of Utrecht. See also chapter thirteen: Visions of Belle van Zuylen, for some background. The challenge faced in the case of Rotterdam is more complex. In question is the collective visual impact of 130 buildings between 50 and 165 metres high. In order to analyse and represent the visibility of the high buildings in Rotterdam, a comprehensive GISc-based viewshed method was applied (Rød and Van der Meer, 2009; Nijhuis, 2009; Germino et al., 2001; Nicolai, 1971). The accuracy of this analysis depends on the digital landscape model (DLM), the basis of computational visibility analysis (Fisher, 1991 and 1993; Riggs and Dean, 2007). According to Riggs and Dean (2007), the average level of accuracy which can be achieved is up to 85%. These findings suggest that it is better to express the analysis results in terms of probability (Fisher, 1995 and 1996).

However, to achieve the highest degree of reliability, an accurate barrier model or digital landscape model was constructed consisting of a digital elevation model (DEM) in combination with topographic data. The basis is a high-resolution elevation model, the *Actueel Hoogtebestand Nederland* (AHN-1, 1997-2003), which is precise to about 15 centimetres per square metre. The DEM's density, distribution and planimetric accuracy is such that topographic objects with a size of two by two metres can be identified clearly and with a maximum deviation of 50 centimetres (AHN, 2010). The model has been supplemented with recent topographic data: the digital topographic map at a scale of 1:10,000 (TOP10NL, 2009). All legend items were selected that are higher than eye-level (including ascending elements, buildings and trees and/or shrubbery) based on the definitions of the Topographical Service of the Land Registry (*Topografische Dienst Kadaster*). The location, architectural height and year of completion of the high-rise buildings were derived from the Emporis database (Emporis, 2010) and added to the digital topographic map. The resulting digital landscape model was corrected using recent aerial photographs, field surveys and Street View imagery (Google Earth, 2010).



**Figure 5**  
**Visual range of high buildings as a function of the relationship between vertical area, shape and contrast value under different meteorological conditions by full daylight (source: Nijhuis, 2012)**

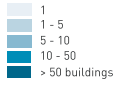
A number of parameters influence the result of the GISc-based viewshed analysis. Especially when it comes to high buildings the vertical size (area of the façade) and weather conditions play a crucial role in prediction of probable visibility (Nicolai, 1971). To put it more precisely, the visual range of objects in the landscape depends on: the apparent contrast between the object and its background, the angular size of the object, its shape and vertical area, the contrast threshold at the level of luminance (type of day), the conditions and technique of observing and; the eyelevel and related curvature of the earth (Duntley, 1948; Middleton, 1952). An important factor for determining the maximum visual range of distant objects is the meteorological optical range at different weather conditions. Observations from the Royal Netherlands Meteorological Institute (*KNMI*) show that the meteorological optical range by full daylight varies from nearly zero up to several tens of kilometres (KNMI, 2010). However, the average ranges of 12 kilometre (50% of the time), 20 kilometre (25%) and 28 kilometre (10%) are typical for Dutch circumstances (Nijhuis, 2012; Nicolai, 1971). For the analysis the maximum visual range of the high-rise buildings was calculated under different meteorological conditions by full daylight and involved vertical area (length-width proportion < 5), vertical shape (rectangular) and contrast value (object-background  $\geq 2\%$ ). See figure 5. The vertical area was calculated by using fifty percent of the perimeter of the footprint multiplied by the architectural height.

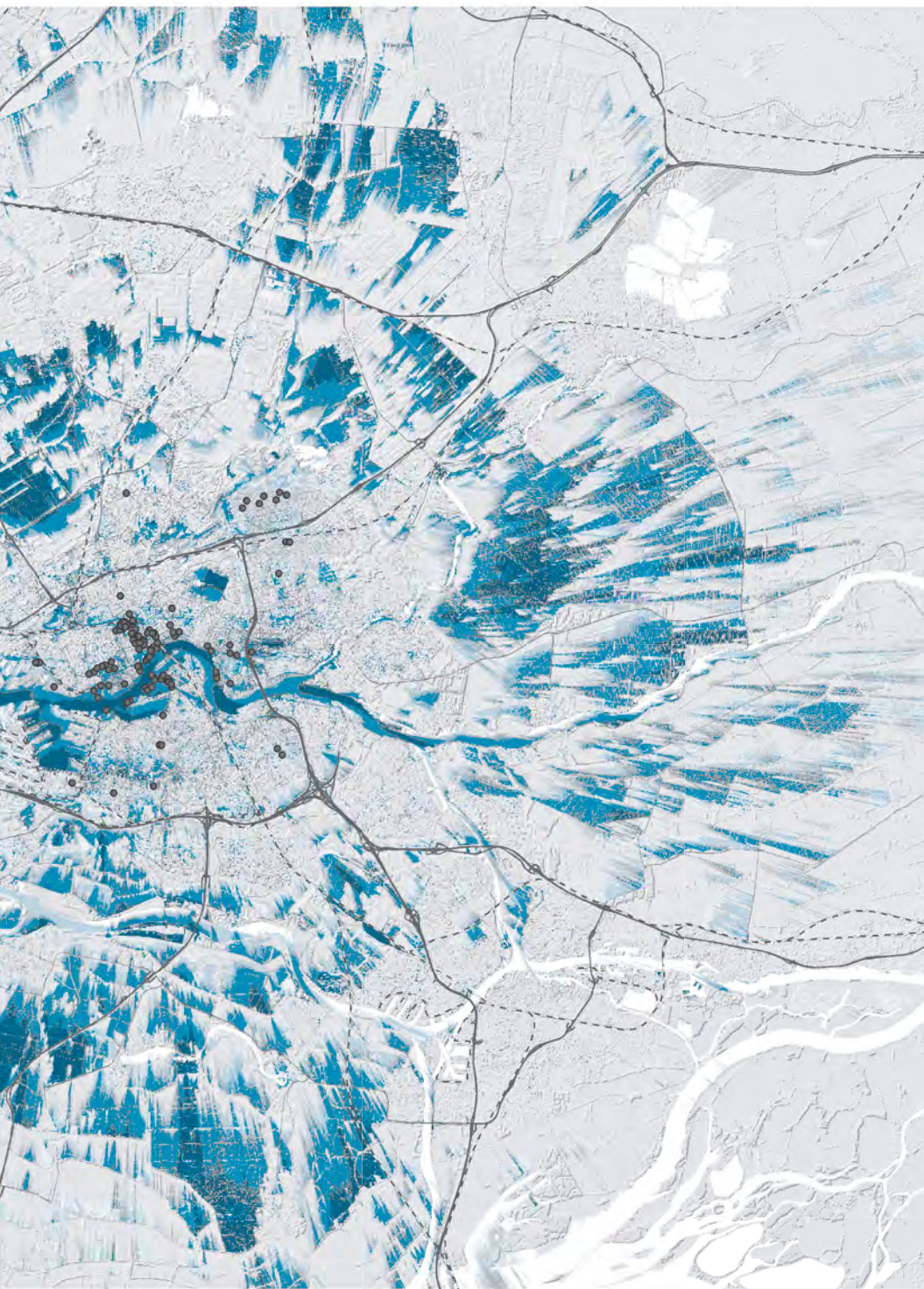
**Figure 6**

**Visibility of high buildings in Rotterdam. Visual coverage (where) and the cluster effect (how many)**

**Visibility buildings > 50 meters**

Full daylight: meteorological optical range 20km (25% of the time)  
in relation to vertical size and area of the building





The cumulative viewsheds from the analysis show the probable visibility at a meteorological optical range of 20 kilometres and takes into account the curvature of the earth. The analysis results were tested for reliability through field visits and photos.

The GISc-based visibility analysis results show two important aspects of visual information with regards to high buildings: *visual coverage* and *cumulative visibility* (Nijhuis, 2009). The output is meant to be descriptive rather than normative. Visual coverage is about *where* you can see high buildings from in the open landscape (tinted: see e.g. figure 6) and the cumulative visibility is about *how many* high buildings you can see. Or, to put it like this: it represents the intensity, or amount of high buildings in the skyline of the city (gradual tint; from light to dark means increasing amount of buildings: see figure 6).

The visibility analysis of Rotterdam's high buildings shows that their combined visual coverage reaches various places out of town at distances of 5 up to and as far as 20 kilometres away. Within the city large bodies of open water (river, harbours, lakes) offer similar opportunities to see many high buildings simultaneously. In most of the town however the skyline cannot be seen.

This observation questions the relevance of using a winding boulevard (in combination with a setback principle) as an organising design concept for the urban setting of high buildings in Rotterdam. The collective visual impact of a high building cluster cannot be seen in the city itself. Outside the city, at a distance of 5 to 20 kilometres, the relative position between the individual buildings can't be assessed by the human eye. Whether the high buildings are neatly lined-up or randomly positioned is impossible to tell, unless they are all the same size and shape (which they are obviously not). As a result a skyline appears mostly as a two-dimensional phenomenon.

## 12.6 VISIBILITY OF ROTTERDAM'S HIGH BUILDING CLUSTER

To develop a better understanding of the visual appearance of the city's skyline it is helpful if the geographical coverage of the corresponding cluster is known. To determine this a simple outline can be drawn that links the outer buildings that are supposedly part of the cluster. If a new building is erected within the outline it will not change the width of the city's skyline, regardless the angle from which it is viewed. Any building erected outside the outline does extend the skyline, as seen from a specific angle. Three distinctive height categories were identified in Rotterdam: below 80 metres, between 80 and 120 metres, and above 120 metres. This means that three of such outlines can be drawn. In the case of most buildings it is clear whether they belong to such a cluster or not due to their proximity to the others buildings. The current Rotterdam high building policy assumes that high buildings in the Central District, the Centre, the

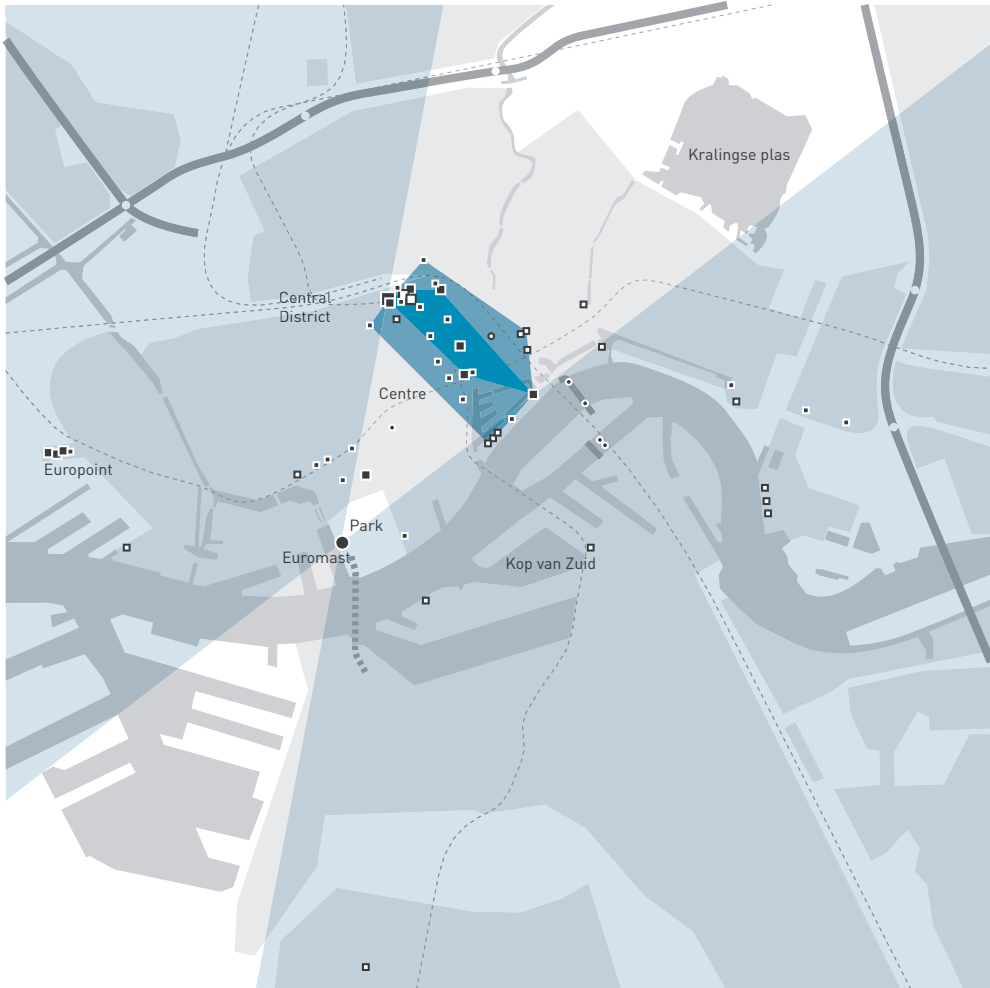


Figure 7  
The skyline of Rotterdam seen from the Kralingse Plas

*Nieuwe Werk* and the *Kop van Zuid* are part of one continuous area. The question is if the high buildings west of this area belong to the area that makes up the visual skyline or not: *Park* and *Europoint*. From some angles these buildings west of the centre are visually part of the cluster and from other angles they are not. A simple technique can be applied to visualise this. The areas from which a building appears to be part of the cluster (or not) is determined by drawing two lines that connect the building in question with the two buildings that mark the borders of the cluster. If the angle between the two lines is larger than 90 degrees, then the area in which the building appears as part of the cluster dominates over the area in which it is visually separated from the cluster. The area from which the building doesn't appear to be a visual part of the cluster can be tinted for clarity reasons.

It appears that the buildings in the park area should be considered to be part of the cluster: *Hoboken* (1969; 112 metres) and the *Euromast* (1970; 185 metres). The *Europoint* I, II and III buildings (1973/1976/1979; 95 metres) are clearly not part of it. Interestingly, if we disregard the buildings at the *Kop van Zuid* and the *Nieuwe Werk* (all completed in the 1990's), then both *Hoboken* and the *Euromast* would not be part of the high building cluster. Expanding the cluster in the southward direction did integrate buildings west of the cluster as well. Adjacent to the cluster of buildings over 80 metres, additional buildings with a height between 50 and 80 metres can be found. All these buildings were reviewed one by one to assess whether they are part of the cluster or not. A third outline is the result of this action. All three outlines are displayed in the overall map.

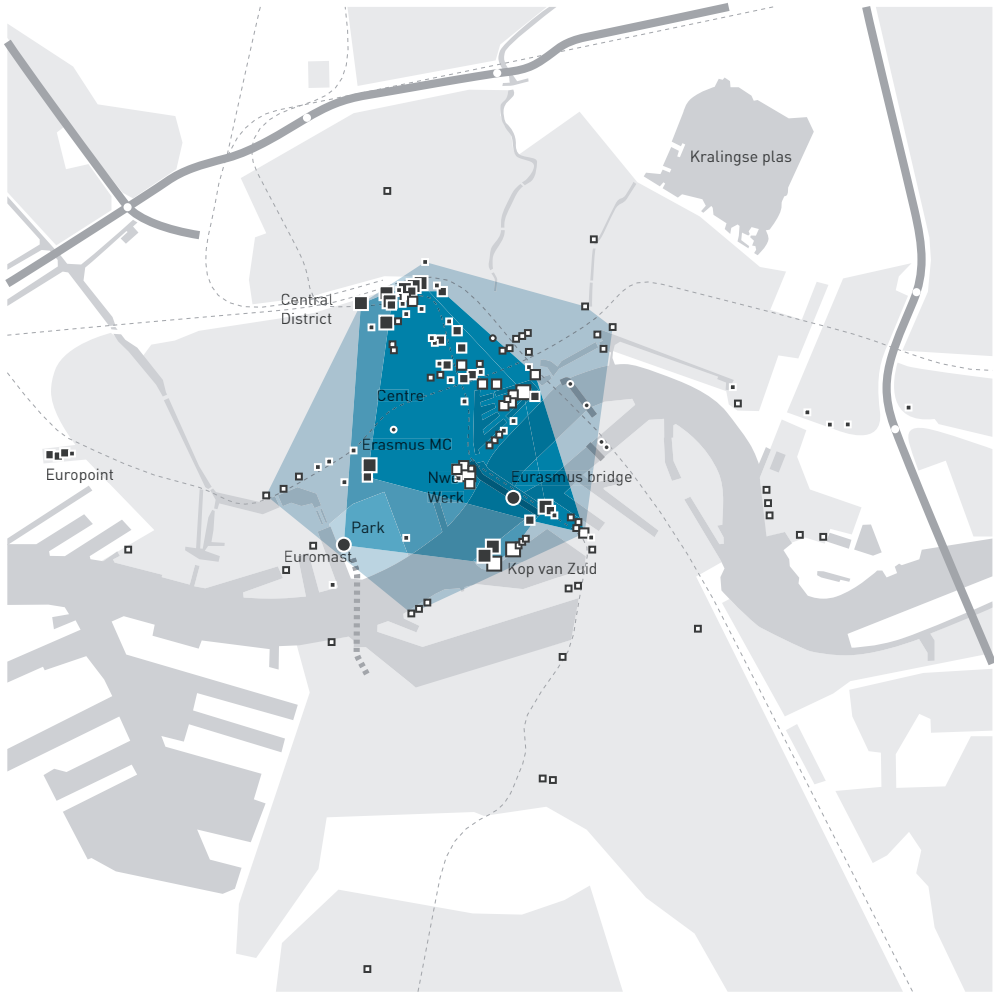
The official municipal zoning map for high buildings and the area that actually governs the visual appearance of the Rotterdam skyline differ markedly. It seems that considerations on the visual appearance of the skyline didn't make it into the Rotterdam policymaking. This is unfortunate as it would be interesting to see a clear and substantiated stance whether to extend or to densify the skyline, to learn about which viewpoints/directions would be dominant in such a decision and



**Figure 8**  
**Areas from which the Euromast is visually part of the Rotterdam skyline and the areas from which it is not (tinted), based on the high buildings built before 1992**

which would not. It would be equally interesting to learn why areas are excluded from the high building zoning that would actually not have an impact on the extent of the skyline.

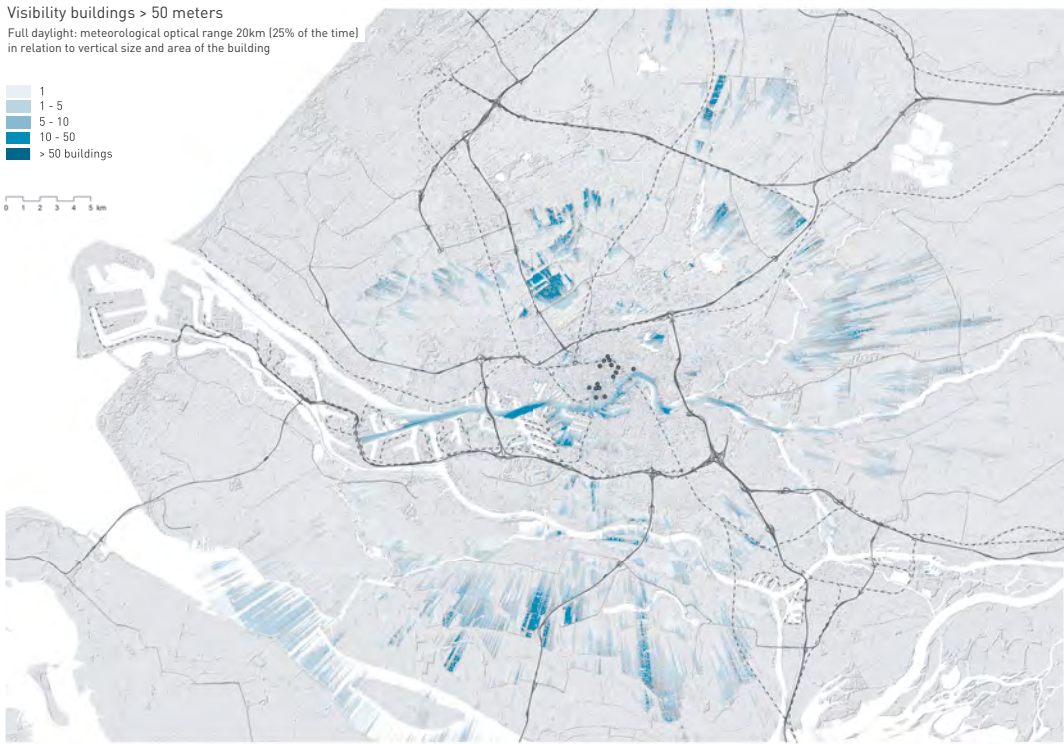
After identifying the Rotterdam high building cluster, its visual range can be established. Because that cluster is 'layered' the role of the three height categories can be assessed in that process. The cluster's evolution through time can be visualised as well. This can be done by reviewing the development of the outline of the cluster's envelope(s) and by reviewing the evolving visual impact of the cluster on the city and its surroundings. Both directions are explored here.



**Figure 9**  
**The 2015 multi-layered Rotterdam high building cluster**

Outlining the high building cluster allows us to look back in time at its development. A first, though minimal, envelope of buildings over 80 metres can be drawn in 1989 after the third building in that height category is build in the city's centre, the *Willemswerf* (1988; 88 metres). A true envelope emerges however only in 1992 after the completion of most of the buildings in the Central District, as shown in figure 8. This confirms the analysis by means of the scatter plot that suggests a break over the years 1989/1992. By this time the cluster just contains one building over 120 metres, the *Delftse Poort* (1992; 151 metres). An outline for buildings in this height category is lacking for this reason.

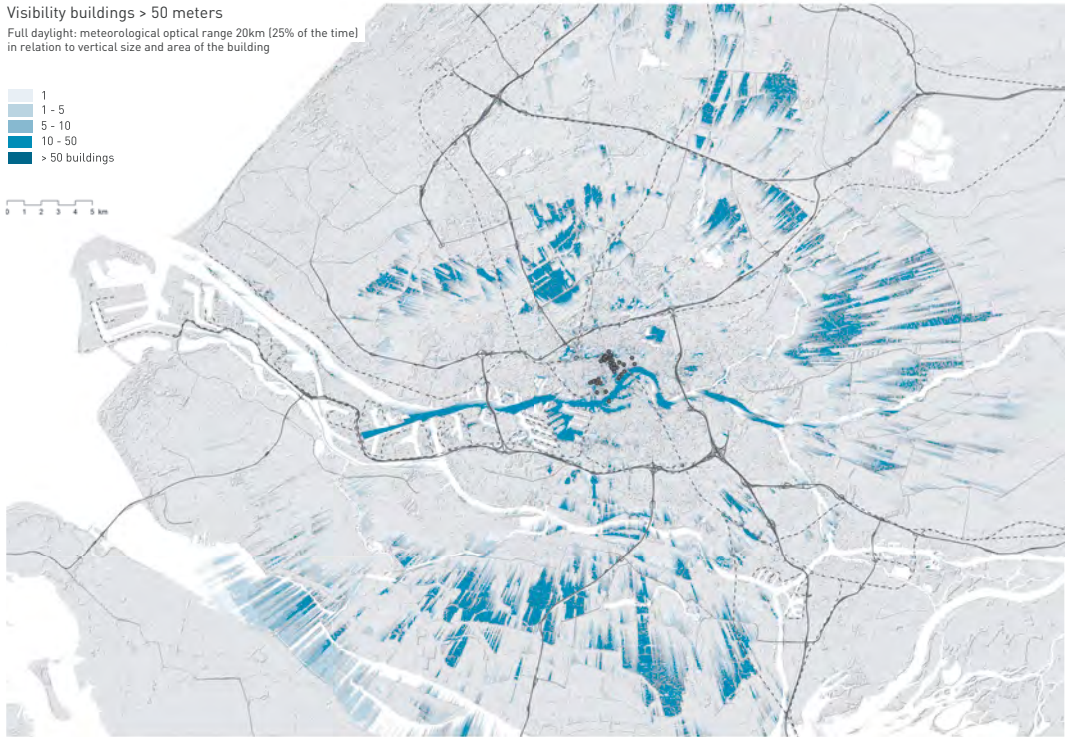




**Figure 10**  
The Rotterdam cluster: visibility of the high buildings built in 1970 or earlier

A first (minimal) cluster of buildings with a height over 120 metres emerges with the construction of the World Port Centre (2001; 138 metres) that closes the triangle with the *Delftse Poort* (1992; 151 metres) with the Millennium Tower (2000, 149 metres). A true cluster emerges ten years later with the Red Apple (2009: 128 metres), the *Maastoren* (2009; 165 metres) and New Orleans (2010; 158 metres) and is reinforced by the buildings that are completed in the next few years, as shown in figure 9. The new Erasmus MC (2012; 120 metres) and the Euromast (1970; 185 metres) are part of that cluster. The accompanying maps show the visual coverage and cluster effect of the buildings that would nowadays be considered to be part of the cluster, at vital moments in the development of the Rotterdam skyline: 1970, 1992 and 2015. See figures 10, 11 and 12.

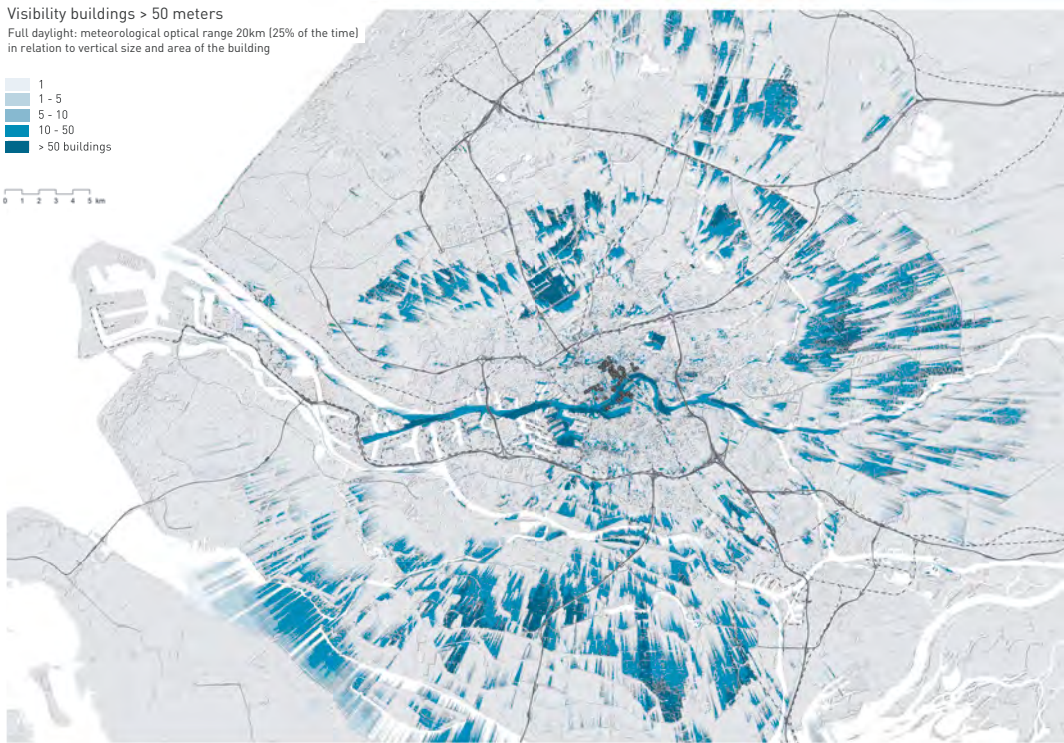
The analysis-results show that the visual coverage of high buildings outside the city was more or less established in 1970. The cumulative visibility (amount of visible high buildings) shows that the amount of singular buildings was high (visible coverage by one building). This implies that the 1970 skyline of the Rotterdam cluster was dominated by individual and small groups



**Figure 11**  
The Rotterdam cluster: visibility of the high buildings built in 1992 or earlier

of singular tall buildings. As stated before single landmarks are likely to be weak references by themselves. Their recognition requires sustained attention. However, in reality this usually does not happen. Of course sustained attention is also highly influenced by the angular size of the building involved; the further away the building is, the smaller its appearance and the smaller it gets, the more it tends to merge into the horizon. There is a slight increase of visual coverage over the years, especially north-west and south-west of the Rotterdam agglomeration up to 1992 and onwards.

However, the dominance of the cityscape dramatically increased over the years and is expressed by the increasing magnitude of cumulative visibility of high buildings. Especially in the last decades the cluster effect of high buildings in the skyline became the dominant development, in comparison with the development of increasing visual coverage. Starting north and south of Rotterdam in 1970 the visual accumulation of high buildings in the open landscape will develop into a city-embracing pattern in 2015. In summary, in 1970 most of the surrounding territory was visually covered by the city, but from 1970 onwards the skyline of Rotterdam



**Figure 12**  
The Rotterdam cluster: visibility of the high buildings built in 2015 or earlier

became more important as a cityscape in the surrounding territory. These findings underscore that the fact that first wave of high buildings started in 1970, not just in 1986.

Another aspect to be analysed is the contribution of the different height categories ( $< 80\text{m}$ ,  $\geq 80 / < 120\text{m}$  and  $\geq 120\text{m}$ ) to the visual coverage of the region. It is interesting that about approximately 80% of the visual coverage is established by the category 50-80 metres. Then the category  $\geq 120$  metres has more impact (about 3 %) on the visual coverage than the category 80-120 metres (17 %). With respect to the spatial cues: nearness, similarity and singularity, the height categories play a different role in the skyline of the city. Based on the visual coverage, the amount and distribution of buildings, we can conclude that the relative big amount of buildings within the category of 50-80 metres tends to merge together (nearness and similarity) and that the singular effect is formed by the higher buildings. However, evidence from future results has to underpin this conclusion.

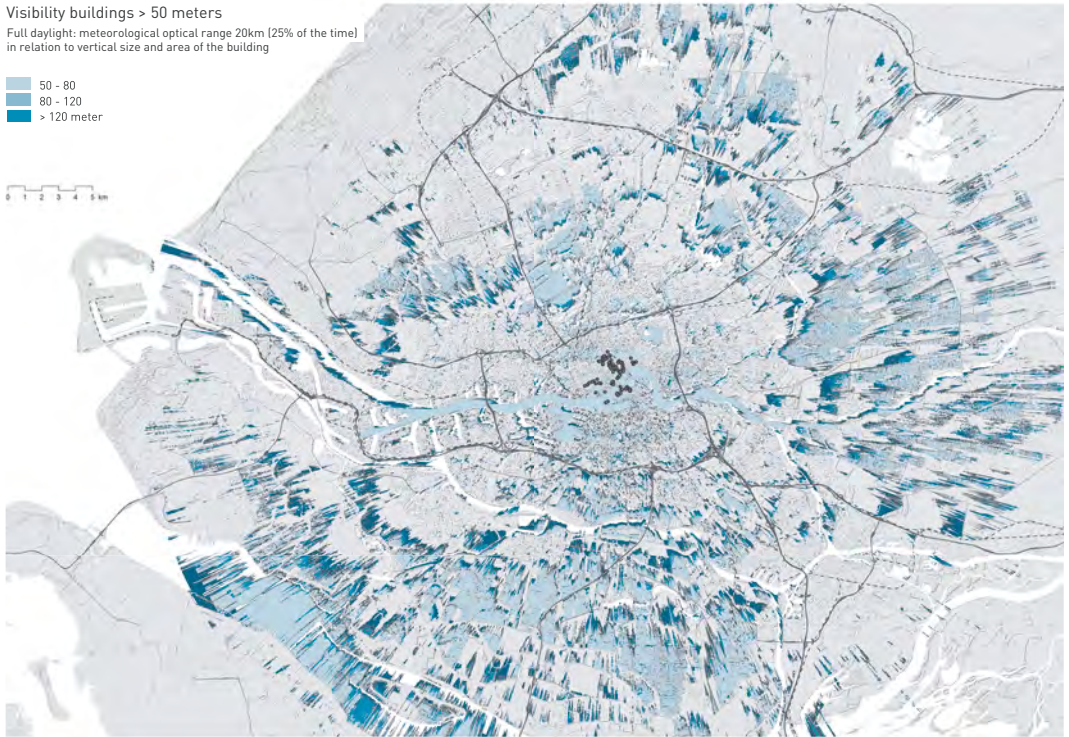


Figure 13  
 The Rotterdam cluster: visibility coverage of the three different height categories

## 12.7 CONCLUSIONS

The development of high buildings in Rotterdam is effectively analysed by considering the historical development in relation to the patterns that emerge from architectural height, year of completion, location in the city, and the functional use of the 130 buildings that measure 50 metres high or more. The height categories that were derived from this analysis are used to determine the visual impact that high buildings have on the city and its surrounding territory, and to determine the extend of the high building cluster that seem to drive the development of the city's skyline. The findings contradict the concepts of height categories and zoning used in the successive Rotterdam policy frameworks that were in place in the last two decades. Systematic research delivers new and robust height categories (less than 80 metres, 80-120 metres and above 120 metres) and a diamond shaped cluster that spans the core of the city's high building development already since early seventies. Both findings can be used as a solid scientific underpinning of a city's guidance on high building development.

## REFERENCES

- Algemeen Dagblad (7th November 2008) *Coolsingeltoren eerste 'slachtoffer' crisis*. Retrieved from: <http://www.ad.nl/ad/nl/1038/Rotterdam/article/detail/396387/2008/11/07/Coolsingeltoren-eerste-slachtoffer-crisis.dhtml> [accessed 1 September 2009]
- Beauregard, R.A. (2006) The radical break in late twentieth-century urbanization. *Area* 38(2); 218-220
- Bell, S. (1993) *Elements of Visual Design in the Landscape*. London, E & FN Spon.
- Birmingham City Council (2003) *High places, a planning framework for tall buildings*. Birmingham: Development Planning Division, Strategic Directorate of Development, Birmingham City Council.
- Brownste C., and Ruchelma L. (1974) Public needs and private decisions in high-rise building development - policy making model. *Urban Affairs Review* 10(2); 139-157
- CABE and English Heritage (2007) *Guidance on tall buildings*. London. Retrieved from: [http://www.english-heritage.org.uk/upload/pdf/CABE\\_and\\_English\\_Heritage\\_Guidance\\_on\\_tall\\_buildings.pdf?1252156283](http://www.english-heritage.org.uk/upload/pdf/CABE_and_English_Heritage_Guidance_on_tall_buildings.pdf?1252156283) [accessed 1 September 2009]
- CBS StatLine (2009). Retrieved from: <http://statline.cbs.nl> [accessed 1 September 2009]
- Charney, I. (2007) The politics of design: architecture, tall buildings and the skyline of central London. *Area* 39(2); 195-205
- Coeterier, J.F. (2000) *Hoe beleven wij onze omgeving? Resultaten van 25 jaar omgevingspsychologisch onderzoek in stad en landschap*. Wijchen, Peter Tychon.
- DEGW (2002) *London's Skyline, Views and High Buildings, SDS Technical Report Nineteen*. London, DEGW.
- Dienst Stedenbouw + Volkshuisvesting (2000) *Hoogbouw-beleid 2000-2010*. Rotterdam.
- DTZ Zadelhoff (2009) *Nederland compleet, Factsheets kantoren- en bedrijfsruimtemarkt medio 2009*. Amsterdam. Retrieved from: [http://www.dtz.nl/fbi/include/evi\\_imagebank/img.asp?id=1923&number=1&object\\_type=0&src=image](http://www.dtz.nl/fbi/include/evi_imagebank/img.asp?id=1923&number=1&object_type=0&src=image) [accessed 1 September 2009]
- Duntley, S.Q. (1948) The Visibility of Distant Objects. *Journal of the Optical Society of America* 38(3); 237-249
- Emporis (2009) *Commercial Real Estate Information and Construction Data*. Retrieved from: <http://www.eporis.com> [accessed 1 September 2009]
- Emporis (2010) *Commercial Real Estate Information and Construction Data*. Retrieved from: <http://www.eporis.com> [accessed 1 December 2010]
- Fagence, M. (1983) The planning control of the high-rise built-form - Some conceptual considerations and policy-forming parameters. *Journal of Environmental Management* 16(2); 79-89
- Fisher, P.F. (1991) First experiments in viewshed uncertainty: the accuracy of the viewshed area. *Photogrammetric Engineering and Remote Sensing* 57; 1321-1327
- Fisher, P. F. (1993) Algorithm and implementation uncertainty in viewshed analysis. *International Journal of Geographical Information Science* 7 (4); 331-347
- Fischer, P.F. (1995) An Exploration of probable viewsheds in landscape planning. *Environment and Planning B: Planning and design* 22; 527-546
- Fisher, P.F. (1996) Extending the applicability of viewsheds in landscape planning. *Photogrammetric Engineering and Remote Sensing* 62 (11); 1297-1302
- Frenkel, A. (2006) Spatial Distribution of High-rise Buildings within Urban Areas: The Case of the Tel-Aviv Metropolitan Region, *Urban Studies*, 44/10, pp. 1973-1996
- Germino, M.J., Reiners, W.A., Blasko, B.J., McLeod, D., and Bastian, C.T. (2001) Estimating visual properties of Rocky Mountain landscape using GIS. *Landscape and Urban Planning* 53; 71-84
- Hoeven, van der F.D. (2002) Omgaan met grootse plannen. *Nova Terra* 2; 2-7
- Hoeven, van der F.D. (2004) Te hoog gegrepen. *Rooilijn* 10; 497-503
- Kaplan, R., and Kaplan, S. (1989) *The experience of nature: a psychological perspective*. Cambridge, Cambridge University Press.
- Klerks, J. (2005) *New Metropolitan Living and the Skyscraper in a European City*, Council on Tall Buildings and Urban Habitat (CBTUH) Technical Papers. Retrieved from: <http://www.ctbuh.org/Portals/0/Repository/WC007-047.6662a190-ad74-4823-b8d7-fd84c1f3b388.pdf> [accessed 1 September 2009]
- KNMI (2010) *Daggegevens van het weer in Nederland 1951 t/m 2010. Metingen weerstation Schiphol: meteorologisch zicht*. De Bilt.
- Landeshauptstadt Düsseldorf, Stadtplanungsamt (2004) *Hochhausentwicklung in Düsseldorf Rahmenplan*, Beiträge zur Stadtplanung und Stadtentwicklung in Düsseldorf. Düsseldorf: Landeshauptstadt Düsseldorf, Der Oberbürgermeister, Stadtplanungsamt.
- Lörzing, H., Harbers, A., and Breedijk, M. (2007) *De zichtbaarheid van de Belle van Zuylen-toren*. Den Haag, Ruimtelijk Planbureau.
- Maandag, B. (2001) *Rotterdam Hoogbouwstad (Rotterdam High-Rise City)*. Rotterdam, Dienst Stedenbouw + Volkshuisvesting, Ontwikkelingsbedrijf Rotterdam.
- Mayor of London (2001) *Interim strategic planning guidance on tall buildings, strategic views and the skyline in London*. London, Greater London Authority.
- McNeill, D. (2005) Skyscraper geography. *Progress in Human Geography* 29(1); 41-55

- Middleton, W.E. (1958) *Vision through the atmosphere*. Toronto; University of Toronto Press.
- Nicolai, J. (1971) *De visuele invloed van woonplaatsen op open ruimten. Met enkele toepassingen op het midden van west-Nederland*. Delft, Technische Universiteit Delft.
- Nijhuis, S. (2009) Het visuele landschap, in: *Werkboek bouwstenen structuurvisie Noord-Holland 2040. Analyses en Verkenningen 3/3*. Haarlem, Province of Noord-Holland.
- Nijhuis, S. (2012) *Landscape Architecture and GIS. Geographic Information Science in landscape architectonic research and design*. Delft University of Technology (in preparation).
- Ode, Å., Tveit, M.S., and Fry, G. (2008) Capturing Landscape Visual Character Using Indicators: Touching Base with Landscape Aesthetic Theory. *Landscape Research* 33(1); 89-117
- Peters, M. (2004) Amsterdams Hoogbouwbeleid. *PlanAmsterdam* 1; 17-21
- Pol, P.M.J. (2002) A Renaissance of Stations, Railways and Cities. Economic Effects, Development Strategies and Organisational Issues of European High-Speed-Train Stations, TRAIL Thesis Series, Delft, Delft University Press.
- Riggs, P. D., and Dean, D. J. (2007) An Investigation into the Causes of Errors and Inconsistencies in Predicted Viewsheds. *Transactions in GIS* 11; 175-196
- Rød, J. K., and Van der Meer, D. (2009) Visibility and dominance analysis: assessing a high-rise building project in Trondheim. *Environment and Planning B: Planning and Design* 36(4); 698 - 710
- Rutten, J. (2007) *Stationslocaties, Kathedralen van de nieuwe tijd*. The Hague, Ministerie van VROM.
- Short, M. (2007) Assessing the impact of proposals for tall buildings on the built heritage: England's regional cities in the 21st century. *Progress in Planning* 68; 97-119
- Skyscrapercity (2009) *Skyscrapercity XL*. Retrieved from: <http://xl.skyscrapercity.com> [accessed 1 September 2009]
- Stadtplanungsamt Frankfurt am Main (2008) *Hochhausentwicklungsplan Frankfurt am Main - Fortschreibung 2008*. Retrieved from: [http://www.stadtplanungsamt-frankfurt.de/hochhausentwicklungsplan\\_frankfurt\\_am\\_main\\_\\_fortschreibung\\_2008\\_5801.html?psid=8a671b2e368cd6267998d0e9945db761](http://www.stadtplanungsamt-frankfurt.de/hochhausentwicklungsplan_frankfurt_am_main__fortschreibung_2008_5801.html?psid=8a671b2e368cd6267998d0e9945db761) [accessed 1 September 2009]
- Sudjic, D. (2005) *The edifice complex: how the rich and powerful shape the world*. New York, Penguin.
- Taillandier, I., Namias, O., and Pousse, J.F. (2009) *The Invention of the European Tower*. Paris, Editions A. & J. Picard / Editions du Pavillon de l'Arsenal.
- Tavernor, R. (2007) Visual and cultural sustainability: The impact of tall buildings on London. *Landscape and Urban Planning* 83; 2-12
- Tveit, M., Ode, Å., and Fry, G. (2006) Key concepts in a framework for analysing visual landscape character. *Landscape Research* 31(3); 229-255
- UNESCO (2009) *Tentative Lists: Historic Centre of Amsterdam*. Retrieved from: <http://whc.unesco.org/en/tentativelists/469> [accessed 1 September 2009]
- Ulzen, P. van (2007) *Imagine a Metropolis, Rotterdam's Creative Class, 1970-2000*. Rotterdam, 010 Publishers.
- Willis, C. (1995) *Form Follows Finance, Skyscrapers and Skylines in New York and Chicago*. New York, Princeton Architectural Press.

13

# VISIONS OF BELLE VAN ZUYLEN

## 13.1 INTRODUCTION

This is a story about an early feminist eighteenth-century intellectual, a proposal for a mighty skyscraper on the edge of a mid-size Dutch city, a chief government architect who was trying to find arguments to save the unspoilt views of the Green Heart of Holland and a group of researchers in the Netherlands Institute for Spatial Research. Historical references, unashamedly conspicuous architecture, present-day ideas on landscape conservation and planning policy are the main ingredients of the story. Why was the view of Utrecht in 2007 more widely discussed than Vermeer's View of Delft from 1660, and why were so many officials and politicians interested in the results of a highly technical GIS-based study by an institute many of them until then had hardly heard of?

As this chapter will make clear, even a largely academic study can have some tangible impact on a political decision-making process. In this particular case of the proposed (and controversial) Belle van Zuylen skyscraper, several seemingly unrelated facts and opinions came together. A succession of events worked in favour of the study that is the subject of this chapter: first, a proposal for an outsized building by the developer, then the rapid acceptance by a city eager to give its image a boost, followed by critical comments by the Chief Government Architect, who was backed up by his freshly installed cabinet minister. Suddenly, the skyscraper plan became something of a national issue, especially because the Green Heart of Holland, one of



the most precious icons of the Dutch planning system, had come into play. In this situation, a study into the tower's visual effects was more than welcome for the policy makers involved in the decision process.

## 13.2 THE LADY, THE TOWER AND THE ARCHITECT

Belle van Zuylen (1740-1805), née Isabella van Tuyll van Serooskerken (see figure 1), was born on a country estate near the city of Utrecht, in a family of landed gentry. She studied mathematics and several languages, travelled extensively throughout Europe, kept up correspondences with many scientists and writers in different countries, among them great French minds like Rousseau and Voltaire, and wrote a number of books and plays. By all means, she can be considered a typical 'woman of letters', especially in her days when generally recognised female intellectuals were a rare species <sup>1</sup>. Her unconventional ways became apparent when, after a broken-up marriage and a succession of male lovers, she indulged in a relationship with her French soul mate Madame de Staël. As a remarkable and unique person, Belle van Zuylen became a cult figure in and around Utrecht. In 1993, her life was the subject of a Dutch costume drama movie <sup>2</sup>.

Our nineteenth-century heroine Belle entered the twenty-first with a bang. In 2005, the city council of Utrecht approved a proposal for new high-rise buildings. The positive spirit of this decision was remarkable, because until then the city of Utrecht opposed any building taller than the historical bell tower of the *Dom* (the erstwhile cathedral tower), with its 110 metres a landmark in its own right that dominates not just the medieval downtown area but also most of the modern city itself. The proposal suggested the development of a strategic site on the A2

motorway and an important railway line, half-way between the old city and a large new suburban extension to the west, known as Leidsche Rijn. Central in this development, a tower of "unlimited height" could be erected to become the new landmark for the city of Utrecht. During further planning and design in 2007/8, the name 'Belle van Zuylen Tower' was adopted for the project, thereby honouring one of Utrecht's greatest names in the history of the city. In 2008,



Figure 1  
Portrait of Belle van Zuylen (1740-1805)

a draft design was presented by developer Burginvest and architect Pi de Bruijn <sup>3</sup>. By that time, Belle's tower had shot up to a staggering height of 262 metres (860 feet), almost 2.5 times the height of the Dom bell tower (perhaps as relief to concerned citizens, it should be said that the distance between both towers would have been at least 4.5 kilometres).

The idea of building a tower of such a commanding height was met with a lot of scepticism and outright criticism. Apart from practical questions about the construction and marketability of the tower, many were worried by the potential impact of such a landmark on the surrounding landscape. Although situated in the middle of an urban area, Belle's silhouette would reach much farther into rural areas, especially into the Green Heart of Holland (*Groene Hart*). Designated more than 50 years ago, the Green Heart is probably the internationally best-known icon of Dutch spatial planning <sup>4</sup>. It covers an area of roughly 80 by 60 kilometres across, situated between the four largest cities in the country: clockwise from the north Amsterdam, Utrecht, Rotterdam and The Hague. From a landscape point of view, the Green Heart is made up of wet meadowland, parcelled out into long and narrow strips of land and interspersed by lakes and rationally designed reclamation landscapes. Most of the Green Heart is wide-open, allowing long-distance views in all directions. High-rise urban areas like Central Rotterdam and the Amsterdam Arena stadium district are clearly visible from distances in the range of 10-15 kilometres. In 2004, the Green Heart was designated as a National Landscape in the National Memorandum on Spatial Planning, giving a certain level of governmental protection to the area (VROM, 2004).

This is where a rather unique official comes in. Since the early nineteenth century, the Dutch government employs a remarkable advisor known as the Chief Government Architect (*Rijksbouwmeester*). The 'national architect' heads an independent office that makes designs for important buildings but which also expresses opinions on matters of town and country planning. In the spring of 2007, the cabinet minister of Housing, Planning and the Environment (Ministry of VROM) asked the Chief Government Architect on his opinion on the positive and negative effects of tall structures in general, and the acceptability of the proposed Belle van Zuylen tower in particular. As the design of the tower went ahead at considerable speed, and the City of Utrecht seemed sympathetic toward the whole idea, the minister wanted advise in the shortest possible term.

In September 2007, Chief Government Architect, Mels Crouwel, advised strongly against the Belle van Zuylen tower, mainly on visibility grounds <sup>5</sup>. On the same day, the cabinet minister for housing and planning, Ms Jacqueline Cramer, according to her spokesman, agreed in principle with Mr. Crouwel. The minister made it clear that she endorsed the national architect's viewpoint that a tower of this height might be all right in other locations but certainly not here on the edge of the Green Heart. Mr. Crouwel's opinion was to a certain extent based on a study

by three researchers in the Netherlands Institute for Spatial Research (from 2008 part of the Netherlands Environmental Assessment Agency). Shortly before the architect and his minister expressed their opinion, the Hague-based Institute issued a study by the name of The Visibility of the Belle van Zuylen Tower (*De Zichtbaarheid van de Belle van Zuylen-toren*) (Lörzing, et al. 2007), which presented a method to measure the visual impact of such a disproportionate object on the horizon.

### 13.3 METHODS FOR MEASURING THE IMPACT OF A HIGH-RISE

In the spring of 2007, with crucial decisions about the go-ahead for the tower to be made within a year, none of the parties involved in the Belle van Zuylen project so far had developed a convincing method to depict the visual impact of the tower. Of course, architects and developers generously provided artist's impressions (see figure 2), but these gave only limited and selective perspectives of the tower's surroundings, focusing on the view from nearby highways.

Figure 2  
Artist's impression of the Belle van Zuylen tower (source: Architecten Cie Amsterdam)



In discussions with the national architect's office, as researchers for the government (the Institute for Spatial Research was independent but funded by the Ministry of Planning) we decided that it was high time to start a quick and object-specific study into the visual effects of Belle van Zuylen's tower.

Without any doubt, the ultimate method to experience the visual effects of a planned building is erecting a life-size model on scale 1 to 1. This has actually been done in a few cases, like the proposed reconstruction of the Berlin *Stadtschloss* (the Kaiser's City Palace that was razed to the ground by the GDR regime) and the *Valkhof*, a Medieval defence tower in the Dutch city of Nijmegen, which was to be rebuilt after an absence of several centuries. In Switzerland, the real-size outlines of new buildings have to be simulated with the use of pylons or building cranes. In the case of Belle van Zuylen Tower, however, this approach would be virtually impossible; building a 262 metre high-rise construction would require almost the same technological prowess as building the real tower, at an almost comparable price. Other methods, like hanging air balloons or zeppelins in place right above the proposed building site, may be less expensive but seem equally unrealistic.

We decided to use the available experience with GIS within the Institute. To make GIS applicable for the kind of study we had in mind, we needed to make a few technical choices. The most important one was the introduction of the *Viewshed* method as a tool to construct realistic sightlines between the Belle tower and its surroundings, thereby defining the tower's range of visibility. For a complete picture, we needed answers to the following questions:

- At which (maximum) distance will the Belle van Zuylen tower theoretically be visible, taking the curvature of the earth into account?
- In which locations and to which extent will the visibility be restricted by objects that stand in the way between the observer and the tower?
- To which extent will the visibility of the tower be influenced (or better: reduced) by the weather conditions?
- And finally, which role will the shape of the tower (esp. its height-width ratio) play in its impact on the horizon?

To put the effects of the Belle van Zuylen tower in perspective, we also decided to make comparative studies for a number of well-known existing high-rises, towers and pylons in or in the direct vicinity of the Green Heart of Holland.

First, we calculated the theoretical maximum visibility of the Belle van Zuylen tower. This maximum range is a hypothetical circle on the earth's surface. Under ideal circumstances, the tower can be seen on and everywhere within the circle, taking the earth's curvature into account. Outside the circle, the tower will never be visible, at least not from a viewpoint on ground level.

For the 262-metre Belle tower, maximum visibility turned out to be no less than 62 kilometres (38.5 miles). This would mean that, in theory anyway, Belle could be seen from all of the Green Heart and all the big cities in the Western part of the country; its visibility range would extend well into the North Sea and miss the German border by a few kilometres.

These effects may seem rather alarming, but in the real world the citizens of The Hague, the crew on a North Sea coaster and the German border police won't need to worry. Belle's impact on their environment will be non-existent. For a more realistic picture, we must take into account the effects of physical barriers within the theoretical visibility circle. Viewshed analysis is capable of including in its calculations data about hills, built-up areas, woodlands and other types of objects that can potentially obstruct the view of an observer. To create a digital landscape model (DLM), a three-dimensional landscape for use by Viewshed, we used the ground level heights from the *Actueel Hoogtebestand Nederland* (a modern digital elevation model of the Netherlands), and combined them with data from the digital topographic maps of the Dutch Topographical Service of the Land Registry (*Topografische Dienst Kadaster*) (esp. built-up areas, linear vegetation and woodlands) and more specific data on road noise barriers etc.

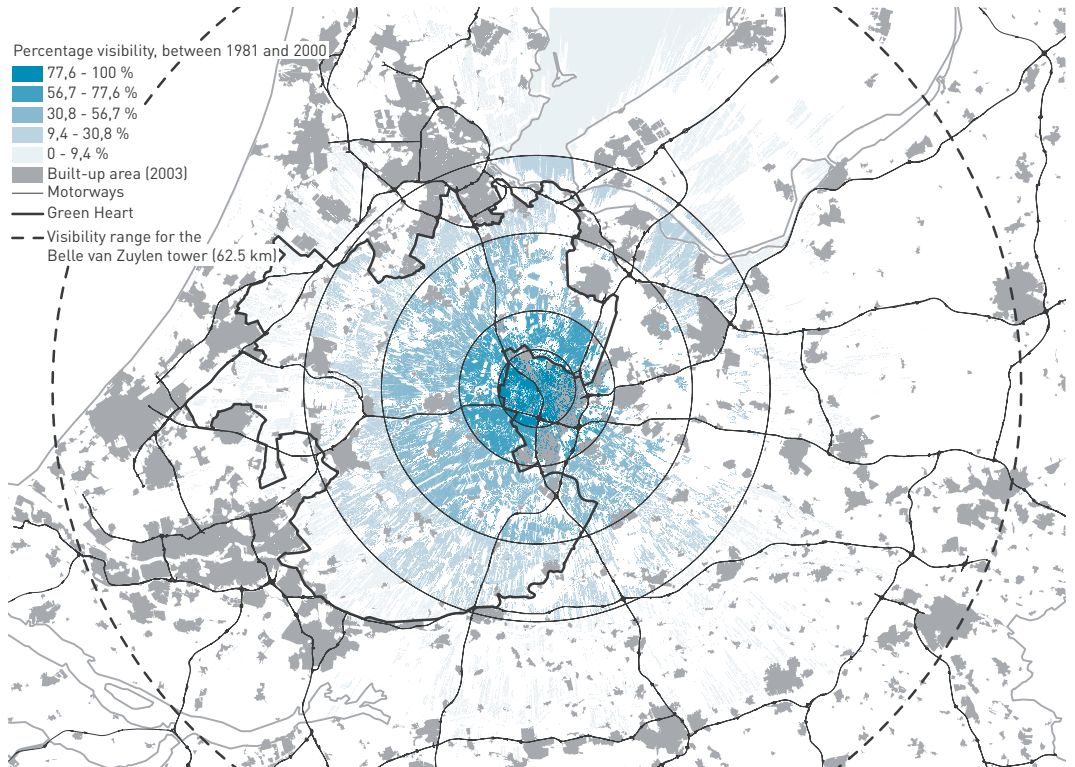
Making this data usable for viewshed analysis, we made a few assumptions, like uniform heights for low-rise and high-rise built-up areas (7 and 30 metres, respectively) and for tree lines, woods and forests (15 metres). The effects of visibility barriers on perception are substantial and complicated. Let's suppose, for instance, that an observer stands at a distance of 30 kilometres from a 262 metre tall tower, and in between is a 6 metre high building. As the observer moves toward the tower, he will pass a 950metre-long zone in which the tower disappears from sight. In case the obstacle would be 18 metres high, the zone of invisibility would be over 3 kilometres long. These examples are far from hypothetical; the supposedly 'open areas' of western Netherlands (like the Green Heart) are full of similar sight barriers, so that the overall perception of a tower like Belle van Zuylen will be vastly reduced. Feeding all this data and interpretations into viewshed analysis, we were able to give a fairly accurate approximation of Belle's impact on the countryside around the city of Utrecht.

So far, the visual impact of the Belle van Zuylen high-rise was calculated for ideal weather conditions. As any visitor to the Netherlands will testify, these conditions are extremely rare in reality. Fog, rain, haze and darkness often diminish the sight of tall and voluminous objects on the horizon, sometimes even at short distances. To put things into perspective, we collected data about the weather in this part of the Netherlands; the Royal Netherlands Meteorological Institute (KMNI) was happy to oblige. They were able to provide detailed data for a twenty-year period. Based on the weather bureau's material, we could calculate the average chance for the Belle tower to be visible from various distances under the prevailing weather conditions.

### 13.4 THE VISIBILITY OF BELLE FROM THE COUNTRYSIDE

The first conclusion that can be drawn from the results was that there would be very few places from where the Belle van Zuylen tower could be seen without any obstruction from the theoretical maximum distance of 62 kilometres, see figure 3. In fact, such a place existed only in a sector of the former *Zuyderzee*, a vast open lake in the heart of the country. To a yacht skipper, plying the waters of Lake Marken, it could be a spectacular sight, but he would be one of the very few lucky ones to ever see Belle from such a distance. More likely, people in large parts of the Green Heart would be able so see the tower from distances up to 25 kilometres. But their view would be fragmented and interrupted by numerous sight barriers. Only in the largest open areas (and the Green Heart is famous for its flat and open meadowland between the towns, woodlands and linear settlements), unobstructed views could be admired (or cursed, according to the preferences of the beholder).

**Figure 3**  
Visibility of the Belle van Zuylen tower based on earth's curvature and topography; the circles indicate sight limitations by the weather at 5, 10, 20 and 30 kilometres



From the major cities around the Green Heart, and even in large parts of the city of Utrecht itself, the tower would be virtually invisible. The same would go for the hilly and densely wooded areas to the northeast and east of Utrecht, known to the Dutch as *Utrechtse Heuvelrug* (Utrecht Hill Range). From here, Belle would be visible only in extremely exceptional cases, like the runway of a former air force base which, by a rather eerie coincidence, points directly at the high-rise tower as if making it a prime target for pilots training. For those in search of the best views of Belle at the horizon, the meadows to the southwest of Utrecht (*Lopikerwaard*) and the lakes to the north of the city would be the best choice.

All in all, the visibility of the Belle van Zuylen tower from the open landscapes around Utrecht would be substantial, but less comprehensive than the theoretical maximum of 62 kilometres seemed to suggest. Actually, the most impressive views of Belle could be expected from some of the major motorways that run toward Utrecht. As the city of Utrecht more or less is the geographical heart of the Netherlands, motorways from seven directions come together on the Utrecht Ring. No less than five of these roads would offer compelling views of the tower from distances up to 25-30 kilometres. Motorists travelling down the A2 motorway from Amsterdam would certainly be impressed the moment they caught the first sight of Belle, which would actually be immediately at Amsterdam's outskirts.

The influence of the weather, as it could be derived from the weather bureau's data, turned out to play a substantial role in the tower's visibility. When superposed on the aforementioned results, the actual visibility over time (expressed in percentages of total visibility) proved to be greatly diminished. The results are shown in figure 3, where changing colours in four circles around the Belle van Zuylen tower suggest changes in visibility percentage.

- The first circle, at 5 kilometres, has a visibility chance of 77.6%.
- On the second, at 10 kilometres, the visibility chance is 56.7%.
- For circle three, at 20 kilometres, the visibility chance is 30.8%.
- Finally, the visibility chance on the outer circle (at 30 kilometres) is a mere 9.4%.

These results make clear that at distances of over 20 kilometres, the actual chance to see a tall construction the size of Belle's tower is at most only 30% of the time. These findings should be combined with the Viewshed data, which show that at distances of 20 kilometres and more (which coincides with the third circle in figure 3), even the ideal visibility based on the topography of the area is fairly limited. To put it in simple terms: at distances of more than 20 kilometres the Belle high-rise will be visible from a limited number of places, and the visibility from these places will be greatly limited by the weather. On the other hand, within a circle of 10 kilometres (the second circle in figure 3) Belle's theoretical visibility from the open countryside will be near total, while the chance to see the tower under various weather conditions will vary from 55% to 100 %.

To put the effects of the Belle van Zuylen tower in perspective, we decided to make comparative studies for a number of well-known existing high-rises, towers and pylons in or in the direct vicinity of the Green Heart of Holland. These objects were deliberately picked with maximum diversity in mind, featuring:

- A Rotterdam office tower (then, with its 151 metres, the tallest building in the country);
- Good old *Dom* (cathedral) bell tower, Utrecht's proud landmark from the Middle Ages (112 metres);
- A radio relay mast in the middle of the Green Heart (125 metres);
- A characteristic water tower in the Green Heart (because of its shape colloquially referred to as 'the Pencil', 58 metres);
- The tallest construction by far in the Netherlands, Gerbrandy Communications Tower on the edge of the Green Heart close to a Utrecht suburb (375 metres).

The distance of maximum visibility for these tall objects is shown in figure 4. As can be seen, Belle's visibility range of 62.3 kilometres is second to that of the Gerbrandy tower (at 73.3 kilometres).

All these tall constructions and buildings turned out to have at least one thing in common with Belle van Zuylen's tower: their theoretical maximum visibility is greatly reduced by a wide range of sight barriers that pop up all over the countryside. The maximum visual range of the

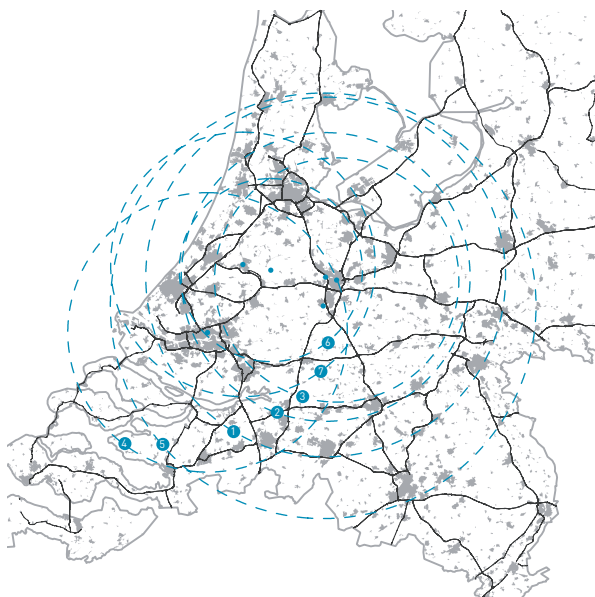


Figure 4  
Maximum visibility range for the Belle van Zuylen tower and 7 reference objects

- 1 Belle van Zuylen 262 m (62,3 km)
- 2 Belle van Zuylen 162 m (50,0 km)
- 3 Domtoren 112 m
- 4 Delftse Poort 151 m
- 6 Gerbrandytoren 375 m
- 5 Watertoren Meije 58 m
- 7 Straalverbindingstoren Alphen a/d Rijn 135 m



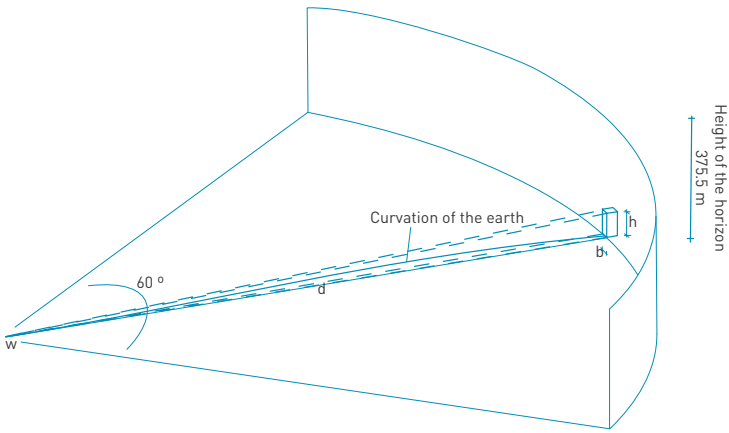
tallest object, the Gerbrandy tower, was calculated at 73 kilometres, but in reality this giant construction (dressed up as an illuminated Christmas tree every December) is seen mostly from the eastern and southern parts of the Green Heart at distances up to 30 kilometres, the most spectacular view being from a nearby motorway bridge across the Lek river south of Utrecht. Rather to our surprise, the largest area of unobstructed visibility can be found for the Rotterdam office tower; but here, these views are not from the Green Heart (where the tower certainly has some impact, but over no more than some 15 kilometres) but from the vast open arable fields to the south of Rotterdam, where the sight lines of over 25 kilometres are no exception. As a self-chosen experiment, we also introduced a more modest Belle van Zuylen tower of 162 metres (exactly 100 metres lower than the original). Much to our surprise, trimming back Belle's tower to just over 60% of its intended height wouldn't make a proportionate difference: 'Belle's little sister' would still be visible from a substantial part of the Green Heart. At 50 kilometres, its maximum visibility (see figure 4) turned out to be only gradually smaller than Belle's 62.3 kilometres.

So far, the distance between the observer and the object on the horizon was our only criterion. From the beginning, however, we felt that there had to be another important factor related with the actual presence of the object. With the visibility measurements of Belle and other towers available, we had a great example at our disposal. Just imagine the effects on the horizon, caused by a solid building like the Belle van Zuylen tower on the one hand, and an ultra-thin construction like the (much taller) Gerbrandy tower on the other. Even without any further study it will be clear that the Gerbrandy tower will practically disappear from sight against the sky on an average day, while the Belle tower will be a landmark in its own right, especially after dark when lit windows will make it a shining beacon on the horizon.

To provide ourselves with a more elaborate theory on the horizon effects of different structures, we developed a method based on the term 'horizon impact percentage' (see figure 5). We calculated this percentage by:

- defining the 'facade surface' of the object;
- introducing a measure for the 'viewer's horizon', expressed in the commonly accepted 60 degrees vision angle and a 'horizon height' for which we took the height of the tallest object in our comparative study: the Gerbrandy tower's 375 metres.

The results of these calculations are striking<sup>6</sup>. Mainly because of its considerable silhouette, the Belle van Zuylen tower will have a much higher horizon impact percentage than any of the other towers that were part of the study. At a uniform percentage of 0.1% for all towers, 'Belle' will be seen at a distance of 30 kilometres, while the much taller Gerbrandy tower would only be visible from 6 kilometres (see figure 6 for the circles of 0.1% horizon impact). The only other tower with a serious presence on the horizon is the Rotterdam office tower, which is easy to



**Figure 5**  
**Model of the horizon impact percentage measurement method**



**Figure 6**  
**Comparison of the visibility of the Belle van Zuylen tower and reference objects at a horizon impact of 0.1%**

understand given its rather plump, broad design. Compared to the other towers, ‘Belle’ will certainly make a great impression against the skies over Holland.

## 13.5 BELLE'S SUDDEN DEMISE

According to informal comments by the Chief Government Architect's office, our Institute's visibility study greatly helped the to form the Architect's opinion about the acceptability of Belle's tower. But even if the minister herself had expressed her doubts about such a huge tower at the edges of the Green Heart, civil servants in The Hague had to admit that the ministry didn't have the power to stop the Belle project altogether. In the City of Utrecht, prospects still looked rosy for the development of what was marketed as the city's future landmark. Before the minister's statement, in June 2007, the city's executives decided that they endorsed the results of a feasibility study, expressing the expectation that the tower would become a major tourist and business attraction for Utrecht. It seemed only a matter of time for the city to give its formal go-ahead.

But things began to change, albeit slowly. On October 10th of 2007, the City of Utrecht held a referendum as part of the appointment procedure of a new mayor (in the Dutch system, mayors are not elected but appointed by the government; in a few recent cases, however, the electorate has been consulted before the final decision). The winning candidate, social democrat MP Aleid Wolfsen, presented himself as an outspoken critic of the tower project. The fact that Mr. Wolfsen won the referendum and was subsequently appointed mayor of Utrecht didn't change the situation overnight. The city still seemed supportive of the project, but waited for the outcome of the developer's search for investors. However, in the city council, most parties (and most councillors) were in favour of the Belle van Zuylen, although some parties held a 'yes, but' or 'yes, provided that' view.

In 2008, a citizens' initiative to organise a consultative referendum on the tower project gathered a few hundred signatures, but a large majority in the city council rejected the idea. The only result of the referendum initiative was that an ever-larger number of citizens began to discuss the project. In these discussions, the outcome of our Institute's study into the long-distance visibility of Belle van Zuylen tower began to play a tangible role; supporters and opponents found a basis for their arguments in our study<sup>7</sup>. A smooth and rapid approval of the plans by the city council began to look increasingly unlikely. Within two years, the worldwide credit crunch did what ministerial doubts, council debates and citizens' protests could not achieve: on the 22nd of January, 2010, the City of Utrecht and Burginvest development stated in a joint declaration that preparatory work on the Belle van Zuylen tower project was to be discontinued due to economical difficulties. The dream of developers and city fathers, to erect the tallest tower in the country, already a nightmare to some, had suddenly ended as a pipe dream. Two hundred and five years after Belle van Zuylen's demise, her namesake tower had met its own death.

## 13.6 CONCLUSIONS

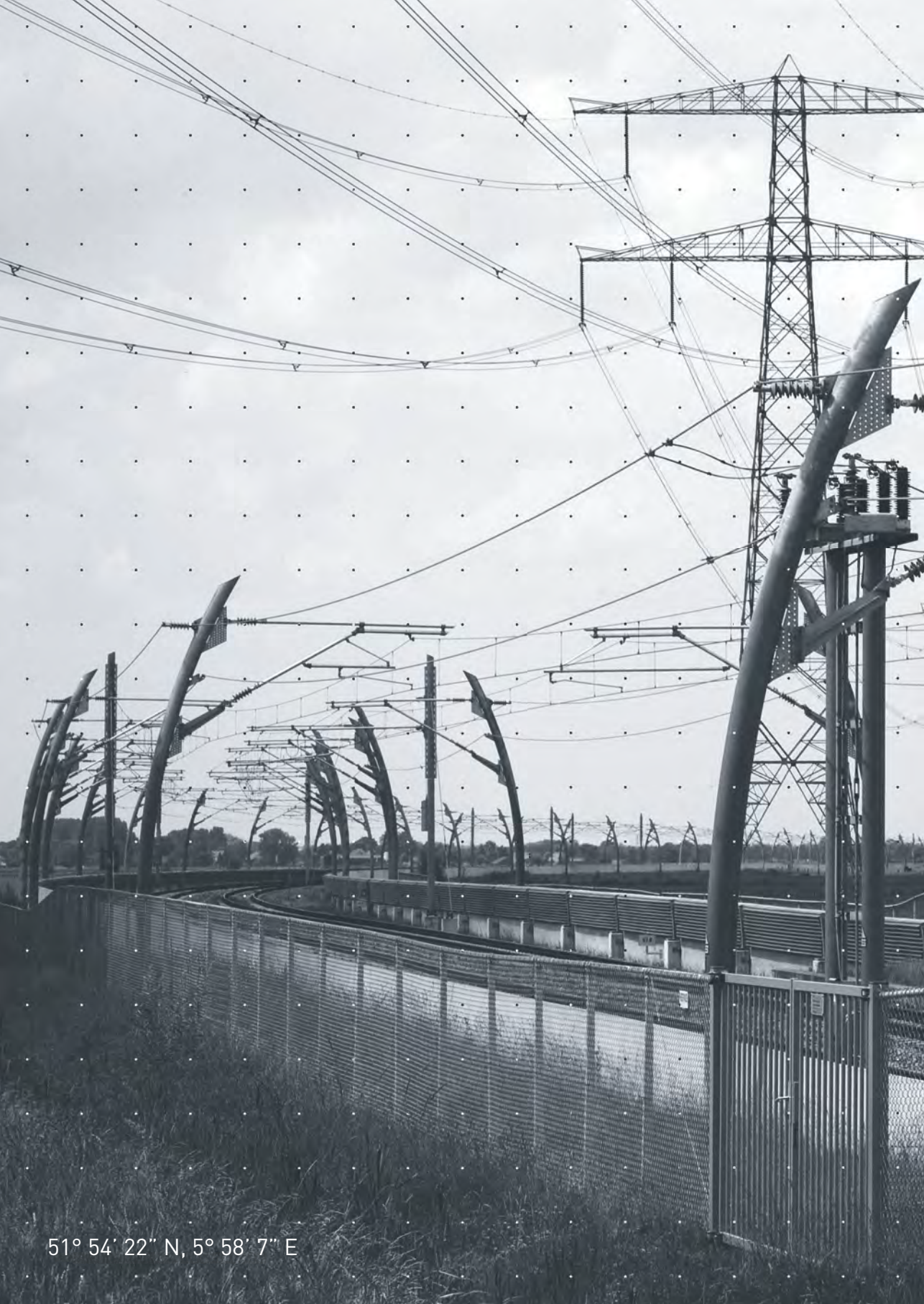
At first sight, the story of the rise and fall of a bold development scheme like the Belle van Zuylen skyscraper proposal seems interesting for the people of Utrecht and Dutch planning policy makers only. But obviously, there is more. As an example of GIS application, Belle's adventures show the level of precision with which the visual impact on the horizon of high and/or voluminous objects can be forecasted. Moreover, there is the political aspect. The Belle van Zuylen visibility study would never even have been considered if there had not been an ever-broader discussion in the city of Utrecht and in Dutch government circles. The study may not have been decisive in itself, but it was clearly helpful to many policy makers because it provided objective and accessible information to support their case (this does not only relate to opponents, as some might be inclined to think; this author heard advocates of the Belle project happily conclude that 'their' tower would be visible from the outskirts of Amsterdam as a shining landmark for Utrecht).

## NOTES

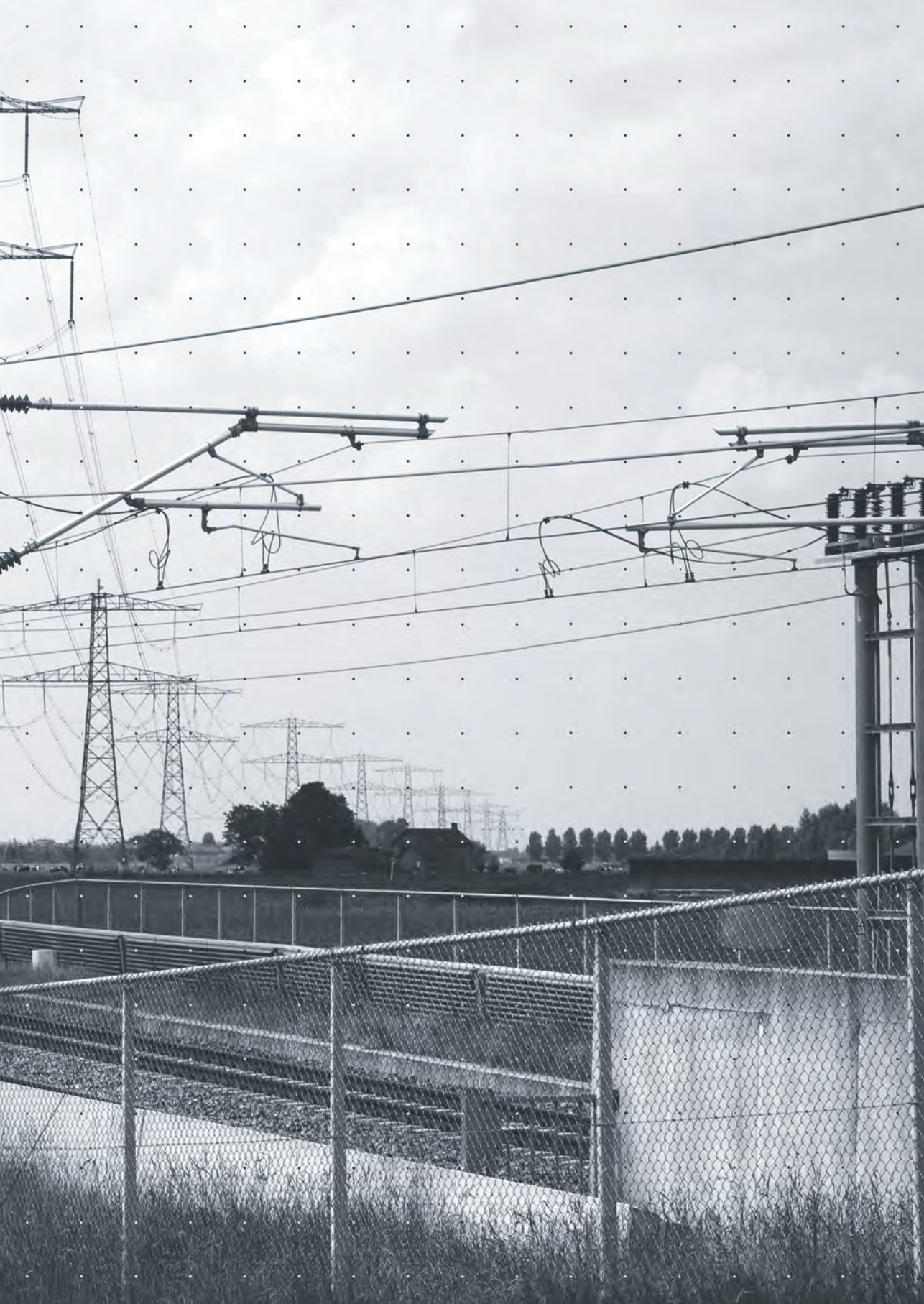
- [1] Books and articles on the life and works of Belle van Zuylen are mostly in either French or Dutch. For the English-language reader, the following two sources may be of interest: Courtney (1993) and Van Dijk et al. (2006)
- [2] Belle van Zuylen - Madame de Charrière, a film by Digna Sinke, 1993 (in Dutch). In 1996, the film was reworked into a three-episode TV series
- [3] For information on the project from the developer's and architect's point of view, visit <http://www.bellevanzuylen.info/english/index.php>
- [4] The term 'Groene Hart' appears in Dutch planning documents since the first National Memorandum on Spatial Planning (Nota Westen des Lands (1958)). The term is supposed to have been coined by Albert Plesman, a Dutch aviator who founded KLM Royal Dutch Airlines
- [5] See the ministry's press release on September 24th, 2007: *Rijksbouwmeester brengt advies Belle van Zuylentoren uit aan minister Cramer*
- [6] The calculation proceeds as follows:
  - If 'd' is the viewer's distance to the object, our horizon height is 375 metres, and we realise that 60 degrees is 1/6 of an all-around vision (the 'panorama'), then the viewer's horizon will be  $H=2d\pi.375/6$ .
  - Next, we have to establish the surface of the object's silhouette by multiplying its height ('h') and width ('w').
  - Finally, the object's surface is set against the viewer's horizon 'H' to calculate the percentage ('P') of the horizon that is taken up by the object:  $P=100.hw/H$ .For more information, see Lörzing, et al. 2007
- [7] Off the record comments by representatives of the Chief Government Architect's office, the Ministry of VROM, the City of Utrecht and the tower's designers

## REFERENCES

- Courtney, C.P. (1993) *Isabelle de Charrière (Belle de Zuylen)*. A biography. Oxford: Voltaire Foundation.
- Lörzing, H., Harbers, A., and Breedijk, M. (2007) *De Zichtbaarheid van de Belle van Zuylen-toren*. Den Haag/Rotterdam, Ruimtelijk Planbureau/NAi Publishers.
- Van Dijk, S., Valérie, C., Moser, M., and Strien, M. van (2006) *Belle de Zuylen/Isabelle de Charrière: Education, Creation, Reception*. Amsterdam, Rodopi.
- VROM, Ministry of (2004) *Nota Ruimte*. Den Haag.



51° 54' 22" N, 5° 58' 7" E





# GLOSSARY

This is a brief selection of the most important terms used in this book.

**Affordance** Physical properties of the environment, which are about linking perception and action. So paths afford walking, a bench affords sitting, et cetera. Affordances in visual space are readily perceived possibilities for action, especially movement

**Agent based modelling** A class of computational models for simulating the actions and interactions of autonomous agents (both individual and collective entities such as organizations or groups) with a view to assessing their effects on the system as a whole

**All lines analyses** Analysis delineating how integrated each sight line is in relationship to all other sight lines [*t.: space syntax*]

**Angular analyses** Analysis delineating how spatial integrated each street axis is in terms of the angular deviation to all others in a built environment [*t.: space syntax*]

**Appearance of the landscape** The way the landscape appears to the observer from a horizontal perspective. Perceived space: the landscape we see by movement within (synonyms: visible form, landscape physiognomy, physiognomic landscape)

**Axial line** Represents the longest sight line one has in an urban space or street [*t.: space syntax*]

**Axial map** The street and road net in built environments represented with the longest

and fewest sight lines [*t.: space syntax*]

**Biological factors** Factors that influence landscape perception, which are based on evolutionary developed innate dispositions

**Computer Aided Design (CAD)** Refers to the use of computer technology for the process of design, e.g. three-dimensional architectural buildings

**Conceptual (order of) space** Refers to the physical, three-dimensional Euclidian space (metric reality), usually expressed in Cartesian coordinates (x, y, z). Existing or conceived mathematical space

**Convex space** A space such that all points within that space can be joined to all others without passing outside the boundary of the space

**Cultural factors** Factors that influence landscape perception, which are based on socialisation into a culture

**Culture** A set of collective views or habits

**Delaunay triangulation** An algorithm for connecting points to form triangles such that all points are connected to their nearest neighbours and triangles are as compact as possible

**Digital Elevation Model (DEM)** Generic term for a digital model representing the earth's surface. Here, used as Digital Terrain Models (DTM), represents only the bare ground surface



**Digital Landscape Model (DLM)** Digital model representing the earth's surface including all objects on it (incl. man-made entities like buildings, roads, dikes, planting)

**Form of the landscape** The landscape as an arrangement of spaces, surfaces and objects known in Euclidian proportions. Physical space: the landscape we know by measurement (synonym: corporeal form)

**Geodata** Data that describes both the locations and characteristics of spatial phenomena on the Earth's surface

**Geodata ensemble** Geodata that consists of different geodata primitives like points, rasters, lines, planes (including pictures and videos) and volumes

**Geodata processing** Data centered exploration by using digital functions

**Geodata visualisation** Applying graphic communication rules by assigning graphic variables and their attributes to geodata, based on concepts from cartography, landscape visualization, image analysis and scientific visualization

**Geomatics** A field of activity which, using a systematic approach, integrates all the means used to acquire and manage spatial data required as part of scientific, administrative, legal and technical operations involved in the process of production and management of spatial information. These activities include, but are not limited to, cartography, control surveying, digital mapping, geodesy, geographic information systems, hydrography, land information management, land surveying, mining surveying, photogrammetry and remote sensing (chapter 4) – see Geo information science

**Geometrical distance** Measures the city's street and road net as a system of least angle change paths [*t.: space syntax*]

**Geographic information System (GIS)** Computer system for capturing, storing, querying, analysing, and displaying geodata

**Geographic information Science (GISc or GIScience)** An information science focusing on the collection, modelling, management, display, and interpretation of geographic data. It is an integrative field, combining concepts, theories, and techniques from a wide range of disciplines, allowing new insights and innovative synergies for increased understanding of our world. By incorporating spatial location as an essential characteristic of what we seek to understand in the natural and built environment, geographic information science (GISc) and systems (GIS) provide the conceptual foundation and synergetic tools to explore visual landscapes (chapter 1) – see Geomatics

**Georeference** Linking geodata to real world locations or define existence in geographical, or physical space

**Global integration analysis** Analysis delineating how spatial integrated each street axis is in terms of the total number of direction changes to all others in a built environment [*t.: space syntax*]

**High buildings** Mass term for all types of high buildings: tall buildings, high-rise buildings and skyscrapers.

**Individual factors** Factors that influence landscape perception, which are based on individual previous experiences [*t.: psychology*]

**Isovist** Limit-of-vision plotting or sightfield polygon representing the (eye level) panoptical view (or part thereof) from an observer, at

- a certain viewpoint. Mostly used to refer to a vector-based computational visibility analysis in the horizontal plane
- Isovist field** Field of isovists derived from multiple viewpoints
- Landscape** An area, as perceived by people, whose character is the result of the action and interaction of natural and/or human factors, and includes rural and urban areas
- Landscape analysis** A systematic process of describing landscape attributes, their spatial pattern and their importance to people
- Landscape preferences** Mental dispositions to favour particular landscapes over other landscapes
- Local integration analysis** Analysis delineating how spatially integrated each street axis is in terms of a given number of direction changes to all others in a built environment. For European and Asian cities, 3 direction changes are used, while it is 5 in Arab and Persian cities and 2 in American cities [*t.: space syntax*]
- Mapping** Mapping is an activity of constructing, exploring and communicating (spatial) knowledge. It refers to the process of graphical representation (or visualization) and gaining understanding of things, conditions, processes, or events by visual thinking and visual communication
- Map** Graphical or visual representation that facilitate a special understanding of things, conditions, processes, or events in the human world
- Mental concepts** Elementary units of thought, capable of playing an inferential role in a person's mental life
- Metric distance** Measures the city's street and road net as a system of shortest paths [*t.: space syntax*]
- Metrical radius** Radius with metrical units [*t.: space syntax*]
- Micro scale urban analyses** Analysis delineating the inter-visibility and accessibility relation between buildings and streets [*t.: space syntax*]
- Minkowski-model** Sequential stacking of individual isovists representing the gradual change of visible space by moving in a certain direction
- Motorway panorama** The delimited view – of at least 175 metres wide by 500 metres deep – on a discernable landscape, including any landscape features unique to that area
- Non Photorealism (NPR)** Refers to the use of a type of rendering in which a wide variety of expressive styles (e.g. painterly or cartoon-like) are applied to show uncertainty
- Perception** The activity carried out by the brain by which we interpret what the senses receive. It is not merely a factual reporting but tends to be referenced to associations and expectations already in the mind of the beholder
- Perceptual (order of) space** Refers to the visual appearance or physiognomy of three-dimensional space to an observer (perceived reality). The organisation of movement and visibility of the objects involved are important factors
- Photorealism** Type of rendering of a digital image that is indistinguishable from reality (or a photograph)
- Physiology of perception** Refers to the processes of sensation and the mechanisms of sight, the structure of the eye, how it receives light, and its limitations thereby. It brings information from the outside world to the brain. All aspects of physiological perception can be measured in an objective way

**Point depth analyses** Analysis delineating the degree of visibility from every point in the public spaces of a neighbourhood [*t.: space syntax*]

**Psychological landscape** The landscape as it appears in the mind of a person that exists subjectively in the sense of being dependent on the mental dispositions of the observer

**Psychology of perception** Refers to two different processes: (1) the basically unconscious process of analysing and interpreting sensory information (information processing), and (2) the conscious experience of analysed and interpreted information coming in through our senses

**Physical landscape** The landscape as a material phenomenon that exists objectively in the sense of being independent of the mental dispositions (e.g. feelings, thoughts) of potential observers

**Physiognomic landscape** Visual landscape (for an elaboration see chapter 1)

**Physiognomic landscape research** Refers to the field of visual landscape research and is concerned with mapping the visual landscape (see visual landscape research)

**Raster data** Geodata that uses geo-referenced 2D-arrays (of grids, cells or points) to represent spatial phenomena

**Rendering** Generating a digital image from a three-dimensional model by means of computer programs

**Scene** The formal relationship of three-dimensional objects in space is visible as a scene on the retina. It refers to an extensive piece of the landscape that can be seen from a single point of view as in a painting or as a stage of a theatre with a foreground, middle ground and background (related to view)

**Sightline** The direct line of vision between the eye of an observer and the object seen. The *central line of sight* is the line of vision that bisects the view

**Spatial features** Spatial representation of real world phenomena

**Syntactic step** Represents a change of direction from one axial line to another [*t.: space syntax*]

**Skyline disturbance** Visible objects against the sky on the horizon that are valued as disturbing

**Topological depth** The number of syntactic steps from each axial line to all other axial lines measures a settlement's topological depth [*t.: space syntax*]

**Topological distance** Calculates the city's street and road net as a system of the fewest turn paths [*t.: space syntax*]

**Topological radius** Radius with direction change units [*t.: space syntax*]

**Transparent space** It is a space that does not contain any visual model of reference, in order to judge it and value it. It is a space freed from the visual cultural memory. To elevate these spaces to the category of landscape, new mental associations are necessary. These spaces should be readable not through images but through the corporeal senses and the self will and the awareness of the observer to explore them [*t.: phenomenology*]

**3D Computer Graphics** Refers to graphics that use a three-dimensional representation of geometric data (aka 3D model)

**Vector data** Geodata that uses points and their x-, y-coordinates (2D) to construct spatial features of points, lines and planes

**View** Refers to (composed) landscape unities within the horizontal, binocular field of

vision of about 20-30 degrees (but up to 60 degrees). Views take a wide variety of forms and include: *Feature views* are dominated by one or a few eye-catching elements. *Focal views*, *vista's* or *axis* are framed sightlines. *Panoramic views* or *prospects* are unbroken views of the whole surrounding area covering the whole field of vision (up to 120 degrees)

**Viewshed** A geodata representation of areas of land surface that are visible from one or more viewpoints. Viewshed-analysis is basically a three-dimensional visibility calculation based on raster data

**Virtual historical landscape** A three-dimensional virtual reconstruction of a historical landscape

**Visual cultural memory** A cultural society has in common a shared historical past, a common cultural heritage with rich visual representations in art, and mental imagery in literature, traditions, legends, etc. All these memories build a common cultural consciousness that influence at the same time a common perceptual understanding. The territory, then, is covered by a layer of collective memories [*t.: phenomenology*]

**Visible form** The visual manifestation (appearance) of three-dimensional forms and their relationship in outdoor space, expressed by the structural organisation (e.g. balance, tension, rhythm, proportion, scale) and ordering principles (e.g. axis, symmetry, hierarchy, datum, transformation)

**Visual impact** Visual effect or influence

**Visual landscape** The appearance of the landscape as perceived by an observer. Synonym: landscape physiognomy or physiognomic landscape (see chapter 1).

**Visual landscape assessment** A process that aims at analysing visual landscape character

**Visual landscape character** The visual expression of the spatial elements, structure and pattern in the landscape

**Visual landscape research** Refers to the field of visual landscape research and is concerned with mapping the visual landscape. Physiognomic landscape mapping or visual landscape mapping (*landschapsbeeldkartering*) comprises of a wide range of theories, methods and techniques for analysis and visualisation, which reflect different approaches (see chapter 1)

**Visual models of reference** (also: visual references) Representations and mental images coming from sources such as painting, literature, cinema, television, publicity, and the Internet, that are stored in the memory of the observer. These representations become visual references of judgement to elevate a space that is observed into a significant place [*t.: phenomenology*]

**Visual quality** Visual excellence of form and shape

**Visibility** The geographic extent of a resource and legibility of its features that can be seen by an observer(s) determined by its position

**Visual perception** Refers to vision as function of perception (see perception and chapter 1)

**Visual urbanisation** Refers to the process of increasing visibility of urban features in the rural realm

**Visibilitime** View as delimited by space and time and by physical barriers in the environment, i.e. a motorist's viewing constraints and the time it takes a motorist to pass a view



# LITERATURE GUIDE TO LANDSCAPE PERCEPTION RESEARCH

This is an annotated bibliography of a brief selection of important and inspiring landscape perception studies addressing expert, psychological, psychophysical and phenomenological approaches. See chapter one for an elaboration on the topic.

## Expert approaches (by S. Nijhuis)

**Appleyard, D., Lynch, K., and Myer, J.R. (1964) *The View from the Road*. Cambridge, Massachusetts, The MIT Press.**

The book provides an interesting and straightforward investigation on how to describe and classify aspects of the city from the particular viewpoint of the car traveller. Aspects of mobility are considered as important in the preliminary conception of urban narrative as a succession of views. The work is a beautiful narrative engaging in the subject of city form as encountered by the people who live there.

**Bacon, E.N. (1976) *Design of Cities*. New York, Penguin Books.**

The work looks at the many aspects that influence city design, including spatial form, interactions between humans, nature and the built environment, perception of favourable environments, colour, and perspective. It considers the city as a three-dimensional composition and the apprehension, representation and realisation of space as constituent components of spatial design.

**Bell, S. (1993/2004) *Elements of Visual Design in the Landscape*. London, etc. E&FN SPON.**

The book presents a vocabulary of visual design, structured in a logical and easy to follow sequence. It shows how the landscape is composed using visual principles determined by basic elements, variables and organisation. It is their combination that describes the patterns to be found in the existing landscape or produces new visual patterns or designs.

**Girot, C., and Wolf, S., eds. (2010) *Blicklandschaften. Landschaft in Bewegung*. Zurich, gta Verlag.**

Through theoretical texts and reflections on practical work with video, the current mindset towards the perception of contemporary landscapes of the periphery is assessed.

**Higuchi, T. (1975) *The Visual and Spatial Structure of Landscapes*. Cambridge, The MIT Press.**

The work introduces the concept of visual analysis to landscape research for investigating the extent to which urban settings are legible and imaginable to their inhabitants. It identifies features such as

landmarks, boundaries, paths, and nodes that enable moving through a landscape by constructing a mental map, beginning with major structural elements and filling it in with successively finer detail.

**Psarra, S. (2009) *Architecture and narrative. The formation of space and cultural space.* Abingdon and New York, Routledge.**

The book explores the interaction between the conceptual aspects of architecture and the perceptual dimensions of the user's experience. It is about how design combines theoretical and analytical knowledge, how it formulates conceptual content and engages the imagination through the organisation of visual form and space, and how architecture and the city carry cultural narratives.

**Schubert, O. (1965) *Optik in Architektur und Städtebau.* Verlag Gebr. Mann, Berlin.**

The study addresses the perceptual order of architectural space using a system of visual angles. It takes the optical system as the starting point and uses it as a methodological tool in order to highlight the relationship between vision and architecture. It points towards a certain conceptualisation of vision as an analytical and aesthetic tool used in architectural and urban design.

**Smardon, R.C., Palmer, J.E., and Felleman, J.P., eds. (1986) *Foundations for Visual Project Analysis.* New York, etc., John Wiley & Sons.**

The various contributions in this book present different disciplinary perspectives, conceptual approaches and methodologies to visual landscape assessment. It addresses fundamental principles, methods and techniques for analysing the visual attributes of the landscape as it presently exists and then as it would exist with the changes being proposed by a particular project.

**Steenbergen, C.M., and Reh, W. (2003) *Architecture and landscape. The Design Experiment of the Great European Gardens and Landscapes.* Basel, Boston, Berlin, Birkhäuser.**

This research introduces a framework for the rational analysis of landscape architectonic compositions and showcases an effective way of representing them. It elaborates systematically, various aspects of the architectonic form and its perception in order to derive design knowledge for landscape architecture by the examination of rational, formal and pictorial examples.

**Thiel, P. (1961) A sequence-experience notation. *Town Planning Review* 32 (1); 33-52**

The paper presents a descriptive and prescriptive notation to communicate perceived (sequential) space and allows for the design of it. It emphasises the notion that environmental experience differs from that which is represented by traditional architectural drawing and, by extension, other forms of mapping.

## **Psychological and psychophysical approaches (by M. Jacobs)**

**Altman, I., and Low, S., eds. (1992) *Place attachment.* New York, Plenum Press.**

The various contributions to this book present different disciplinary perspectives, conceptual approaches and methodologies to the study of place attachment and the significance of various environments in an individual's life.

**Appleton, J. (1996/1975) *The experience of landscape*. Chichester, Wiley.**

This book presents an evolutionary approach to the study of landscape perception, stresses the prospect-refuge theory and the habitat theory and addresses empirical observations to discuss these theories.

**Berg, A.E. van den (1999) *Individual differences in the aesthetic evaluation of natural landscapes*.**

**Groningen, University of Groningen.**

This PhD thesis identifies landscape characteristics, personal characteristics, and contextual characteristics that explain individual differences in landscape preferences, and explains the psychological mechanisms that constitute those differences.

**Daniel, T.C. (2001) *Wither scenic beauty? Visual landscape quality assessment in the 21st century*.**

***Landscape and urban planning* 54; 267-281**

This paper offers a discussion on various approaches to assessing the quality of the visual landscape, with a focus on providing knowledge for environmental management decision-making processes.

**Jacobs, M.H. (2006) *The production of mindscapes: a comprehensive theory of landscape experience*.**

**Wageningen, Wageningen University.**

This PhD thesis gives an overview of various theories of landscape experience across different scientific disciplines. It constructs a comprehensive theory that explains how landscape experiences come into being, and that integrates various disciplinary contributions.

**Kaplan, R., and Kaplan, S. (1989) *The experience of nature: a psychological perspective*. Cambridge, Cambridge University Press.**

This book stresses human relationships with nature: how people perceive nature, what types of natural environments they prefer, what psychological benefits they seem to derive from wilderness experiences, and why backyard gardens are especially important to some people.

**Nasar, J.L., ed. (1988/2008) *Environmental aesthetics: Theory, research & applications*. Cambridge, Cambridge University Press.**

This book offers a collection of chapters by various experts with different disciplinary backgrounds on aesthetic responses to visual attributes of built environments. The consequences of theory and empirical findings for design and planning are discussed as well.

**Steg, L., Berg, A.E. van den, and Groot, J.I.M. de, eds. (2011) *Environmental psychology: an Introduction*. In press.**

This book provides an overview of the positive and negative effects of the environment on human well-being and behaviour, factors influencing environmental behaviour, and ways to encourage pro-environmental action and to promote human well-being.

**Sundstrom, E., Bell, P.A., and Asmus, C. (1996) *Environmental psychology 1989-1994. Annual review of psychology* 47; 485-512**

A general review of interactions between people and the physical environment from a psychological point of view. This is still the most recent review article about environmental psychology.



## Phenomenological approaches (by Ana M. Moya Pellitero)

**Bachelard, G. (1994/1957) *The poetics of space*. Boston, Beacon Press.**

This book offers a personal and intimate approach to the phenomenology of image, and elaborates a philosophy of poetry and the metaphysics of imagination. It addresses the problems brought up by the poetic imagination, and inquires inside the direct ontology of the poetic image and its communicability.

**Boyer, M.C. (1994) *The city of collective memory: its historical imagery and architectural entertainments*. Cambridge, Mass., MIT Press.**

Study on the visual genres and the parameters of representation that have affected, from the late nineteenth to present day, the social conscious existence of the city. It addresses the idea that artistic forms and representational logics control perception and influence the representational form of the city.

**Cosgrove, D.E. (2008) *Geography and vision: seeing, imagining and representing the world*. New York, I.B. Tauris.**

This book reflects on the complex relations between seeing, imagining and representing the world geographically within the Western tradition. It emphasises the power of geographical imagination, the visual knowledge, and explores how it shapes the cultures and the landscape we inhabit.

**Crary, J. (1990) *Techniques of the observer. On vision and modernity in the nineteenth century*. Cambridge, The MIT Press.**

This is an exploration of the relation between vision and the formation of the modern human subject. The advent of photography was one technological development that altered human consciousness. The camera obscura and the stereoscope have not been just instruments of visibility, but they have changed visual perception.

**Lemaire, T. (2006/1970) *Filosofie van het landschap [Philosophy of the landscape]*. Amsterdam, Ambo.**

The history of the landscape is first of all the story of the conquest of nature, a struggle that has left its traces in the landscape. This can be seen as a layered landscape. This layered landscape is not limited to concrete physical elements. The mental landscape is also layered, where different perspectives on the world can be simultaneously recognised.

**Merleau-Ponty, M. (1962/1945) *Phenomenology of perception*. London, Routledge.**

Merleau-Ponty applies the methods of Husserl's phenomenology to the relation of mind and body. He rejects dualism and diagnoses a pervasive ambiguity in the character of human life, attributing all consciousness to pre-reflective sensual awareness of the corporeal. He tries to overcome the traditional dichotomy between objective and subjective elements of human experience.

**Moya Pellitero, A.M. (2007) *The image of the urban landscape: the re-discovery of the city through different spaces of perception*. Eindhoven University of Technology.**

This book leads the reader on a journey into the image and the analysis of its construction, in order to reflect on the phenomenological parameters of the urban landscape perceived and represented. A theoretical discourse is developed in the field of the theory of landscape, urban culture, the psychol-

ogy of perception and visual media, which is interwoven with the work of painters, photographers and filmmakers in the European and Chinese urban context.

**Schama, S. (1995) *Landscape and memory*. New York, A.A. Knopf.**

A rich, vast, erudite and labyrinthine historical study on the role of nature and the landscape in Western civilization, from ancient times to the present, looking into art, myth, literature and history. It argues that Western culture has been shaped by nature as much as culture has shaped nature, discussing the impact of nature in forging Western imagination, cultural perception of landscape and its national discourse.

**Tuan, Y.F. (1990/1974) *Topophilia : a study of environmental perception, attitudes, and values*. New York, Columbia University Press.**

This book researches the links between environment and world view. Topophilia is the affective bond between people and place. The study examines the search for environment in the city, suburb, countryside, and wilderness from a dialectical perspective, distinguishes different types of environmental experience, and describes their character.



# ABOUT THE AUTHORS

## **Marc Antrop, PhD**

Emeritus professor of Geography at the University of Ghent (Belgium). His research focuses on landscapes as holistic phenomena in a transdisciplinary vision, integrating landscape typology and evaluation, landscape ecology, historical geography, landscape perception, landscape architecture and landscape planning. He conceived the landscape atlas of Flanders and Belgium. He is vice-president of the Royal Committee for Protection of Monuments and Landscapes in Flanders and member of the Belgian Scientific Committee of ICOMOS-IFLA. Since 2009 he is honorary president of Landscape Europe.

## **Arnoud de Boer, PhD-can.**

PhD-researcher in Information Science at the Faculty of Science at the Utrecht University (the Netherlands). He is specialized in geographic information engineering with focus on geographic multimedia and three-dimensional GIS modelling. His current research is about the application of computer technology (GIS, CAD, computer graphics) on historical maps and sources to create realistic 3D virtual reconstructions of cultural-historical landscapes.

## **Leen Breure, PhD**

Associate professor of Information Science at the Faculty of Science at the Utrecht University (the Netherlands). He has his background in his-

tory and humanities computing. His current research is on the architecture and design of multimedia web applications (also known as rich internet applications), in particular in the field of cultural heritage and cultural landscapes, and enhanced publications for scholarly research.

## **Arjen Buijs, PhD**

Senior researcher at Alterra and assistant professor at the Forest and Nature Policy group of Wageningen University (the Netherlands). His works concentrate on all the aspects of the human-nature interaction, including landscape preferences, social representations of nature, connectedness to nature, public participation and the framing of social conflicts on nature management.

## **Frank van der Hoeven, PhD**

Associate professor of Urban Design at the Faculty of Architecture at the TU Delft (the Netherlands). He conducted his PhD research in the field of underground space technology and multifunctional and intensive land-use. The core of his work deals with urban design issues related to mixed-use development: transit-oriented development, urban greenhouse horticulture, the use of underground space, high-rise urban areas, and recently climate change. Currently he combines his associate professorship Urban Design with the position of Research Director of the Faculty of Architecture.

**Maarten Jacobs, PhD**

Assistant professor of Socio-spatial Analysis at Wageningen University (the Netherlands). In his PhD-research he constructed a comprehensive theory of landscape experiences that combines various disciplinary contributions into a general theoretical framework. His current research interests include human dimensions of wildlife, perception and evaluation of landscape, place, nature and water, and methods for the social sciences. He is a regular visiting scholar at the Human Dimensions of Natural Resources department of Colorado State University.

**Ron van Lammeren, PhD**

Associate professor of Geo-Information at the Centre for Geo-Information, Wageningen University (the Netherlands). His dissertation entitled Computer use in regional spatial planning (in Dutch) is an early investigation on GIS-support of Dutch regional spatial planning activities. Currently his research focuses on 3D visualisation of land use and landscape changes, quantitative landscape characteristics, participatory planning GIS and location based decision interfaces. He is also programme director of the MSc-programme Geographical Sciences – Geo-Information Management and Applications (GIMA), a joint activity of four renowned universities: Utrecht University, Delft University of Technology, ITC Enschede and Wageningen University.

**Han Lörzing**

Landscape architect (MLA), senior lecturer at the Eindhoven University of Technology, senior researcher at the Netherlands Environmental Assessment Agency and Provincial Advisor on

Spatial Quality Utrecht. He works as a project manager for regional development plans, advisor to local and provincial executives, and as researcher in urban planning. He was co-founder of Nieuwe Gracht, a consultancy office for urban and rural design. For the Netherlands Environmental Assessment Agency, he did research into visual and structural aspects of present-day urbanism, disadvantaged neighbourhoods, new towns and urban fringes in the Netherlands.

**Manon van Middelkoop, PhD**

Researcher at the Netherlands Environmental Assessment Agency. Her master- and PhD-research were in the field of green areas, leisure and tourism. Subsequently, she worked as a researcher/consultant in that area for 5 years. At the Netherlands Environmental Assessment Agency she has worked on several projects, including one on 'motorway panoramas' and one on 'Enclosed residential domains in the Netherlands'. Currently, her research interests are in the fields of housing and demography.

**Ana Moya Pellitero, PhD**

Assistant professor of Architecture at the Architecture Master program, ISMAT, Grupo Lusófona, Portugal. She received her PhD at the Department of Architectural History and Theory, Eindhoven University of Technology (the Netherlands). Her dissertation entitled The Image of the Urban Landscape was developed as a transdisciplinary and intercultural study in the field of landscape perception of the urban environment. She is also principal of StudioMEB, office of architecture, planning and landscape. In this position she is involved in the program GreenEngines, a pedagogic tool on sustainable

landscape planning, in landscape theory, urban and visual culture.

**Akkelies van Nes, PhD**

Assistant professor of Urban Design at the Faculty of Architecture, Delft University of Technology (the Netherlands). She received her PhD at the Department of Land Use and Landscape Architecture at the Agricultural University of Norway entitled: Road building and urban change. The effect of ring roads on the dispersal of shop and retail in Western European towns and cities. The core of her research activities is developing and applying various spatial analyses tools on urban centralities on various scale levels, space and crime in neighbourhoods, archaeology, strategic planning in cities, and railway stations.

**Steffen Nijhuis, PhD-can.**

Assistant professor of Landscape Architecture at the Faculty of Architecture, Delft University of Technology (the Netherlands). Initiator of this book. His PhD-research, entitled Landscape Architecture and GIS, focuses on the application of Geographic Information Science in landscape architectonic research and design. The core of his work deals with theories, methods and techniques in the field of landscape architecture and urban design: design research, research by design, visual landscape assessment and visual knowledge representation. He is leader of the research programme Architecture and Landscape, series editor of RiUS and advisor to governmental and regional authorities in the Netherlands.

**Maarten Piek**

Researcher and urban planner at the Ministry

of Infrastructure and the Environment, the Netherlands. Holding a master in architecture, he trained himself in combining qualitative and quantitative research methods. Doing so he initiates new research and knowledge areas. This expertise is being used in a wide range of spatial studies. The 'visibilitime' method described in this book is an illustrative result of this expertise. He is also partner of POTH-PIEK Architects R&D, an office for research a design.

**Miranda Reitsma**

Provincial Advisor on Spatial Quality Noord-Holland (the Netherlands) and principal of Reitsma Stedebouw, an office for urban planning and design. As Provincial Advisor she has recently presented her research in a seminar she organized on change in rural landscapes, due to agricultural innovations, water management and new 'energy landscapes', in areas with a declining population. As former Head of Urban Planning at the Amsterdam Academy of Architecture she still teaches at the University of Amsterdam and at the Academy. She is a member of several advisory boards on spatial quality.

**Janneke Roos-Klein Lankhorst, PhD**

Senior researcher at the Landscape Centre of Alterra, part of Wageningen University and Research Centre (the Netherlands). She conducted her PhD research in the field of digital visualisation of landscapes. She is specialised in the development and application of integrated knowledge-based systems for monitoring and impact assessment of policy changes on regional, national and European levels. These systems make use of simplified models and rules, based on available expertise in The Netherlands and in Europe, concerning agriculture and other land

use, water management, environmental quality, ecology, landscape appreciation and economy.

#### **Niels Sorel**

Researcher at the Netherlands Environmental Assessment Agency. Holding a master in spatial planning, he is involved in a wide range of research projects. Varying from (GIS based) projects on motorway panoramas to land use changes in the rural area and a study on the future development of the rural urban fringe. Current projects are in the field of the institutional aspects of planning such as: an evaluation of the new Dutch spatial planning act, governance of offshore wind energy and the process of area development in relation to environmental laws.

#### **Sandor Spruit**

Scientific programmer at Utrecht University (the Netherlands). He studied electrical engineering and computer science, and has over ten years of experience in cooperating with researchers, designing and developing software tools for research applications. He has worked on different types of applications (web-based, desktop and mobile) in several domains, using a variety of development tools, programming languages and operating systems. He contributes to bachelor and master courses occasionally, and assists colleagues evaluate software that may be useful for their work.

#### **Hans Voorbij, PhD**

Lecturer of Information Science at the Faculty of Science at Utrecht University (the Netherlands). He has a background in medieval Dutch and Latin philology and literature. He is currently active in the fields of XML-standards and the design of multimedia web applications

and their use in digital cultural heritage, with a focus on cultural landscapes.

#### **Sjerp de Vries, PhD**

Senior researcher at the Landscape Centre of Alterra, part of Wageningen University and Research Centre (the Netherlands). His PhD research, entitled Egoism, Altruism, and Social Justice, dealt with cooperative behaviour in social dilemma situations. At present his work focuses on the interaction between people and their natural environment, more specifically on landscape appreciation, outdoor recreational behaviour, and the relationship between contact with nature and human health and well-being. In his work he combines GIS-analyses and social science research methods.

#### **Gerd Weitkamp, PhD**

Assistant professor of Cultural Geography at the Faculty of Spatial Sciences, University of Groningen (the Netherlands). He conducted his PhD research at the Centre for Geo-Information, Wageningen University on the development of a GIS based procedure to assess landscape openness. His research interests include landscape planning, landscape perception, and public participation GIS. Currently he is coordinator of the Honours education programme.

# EXPLORING THE VISUAL LANDSCAPE

*Exploring the Visual Landscape* is about the combination of landscape research and planning, visual perception and Geographic Information Science. It showcases possible ways of getting a grip on themes like: landscape openness, cluttering of the rural landscape, high-rise buildings in relation to cityscape, historic landscapes and motorway panoramas. It offers clues for visual landscape assessment of spaces in cities, parks and rural areas. In that respect, it extends the long tradition in the Netherlands on physiognomic landscape research and shows the state of the art at this moment.

*Exploring the Visual Landscape* offers important clues for theory, methodology and application in research and development of landscapes all over the world, from a specifically Dutch academic context. It provides a wide range of insights into the psychological background of landscape perception, the technical considerations of geomatics and methodology in landscape architecture, urban planning and design. Furthermore, there are some experiences worthwhile considering, which demonstrate how this research can be applied in the practice of landscape policy making.

Research in Urbanism Series is a scientific series that deals with dynamics, planning and design in contemporary urban landscapes. The series facilitates a dialogue between the scientific community and society at large through high quality publications focussing on transformations and sustainability in urban landscapes.

