

FLOORPLANS

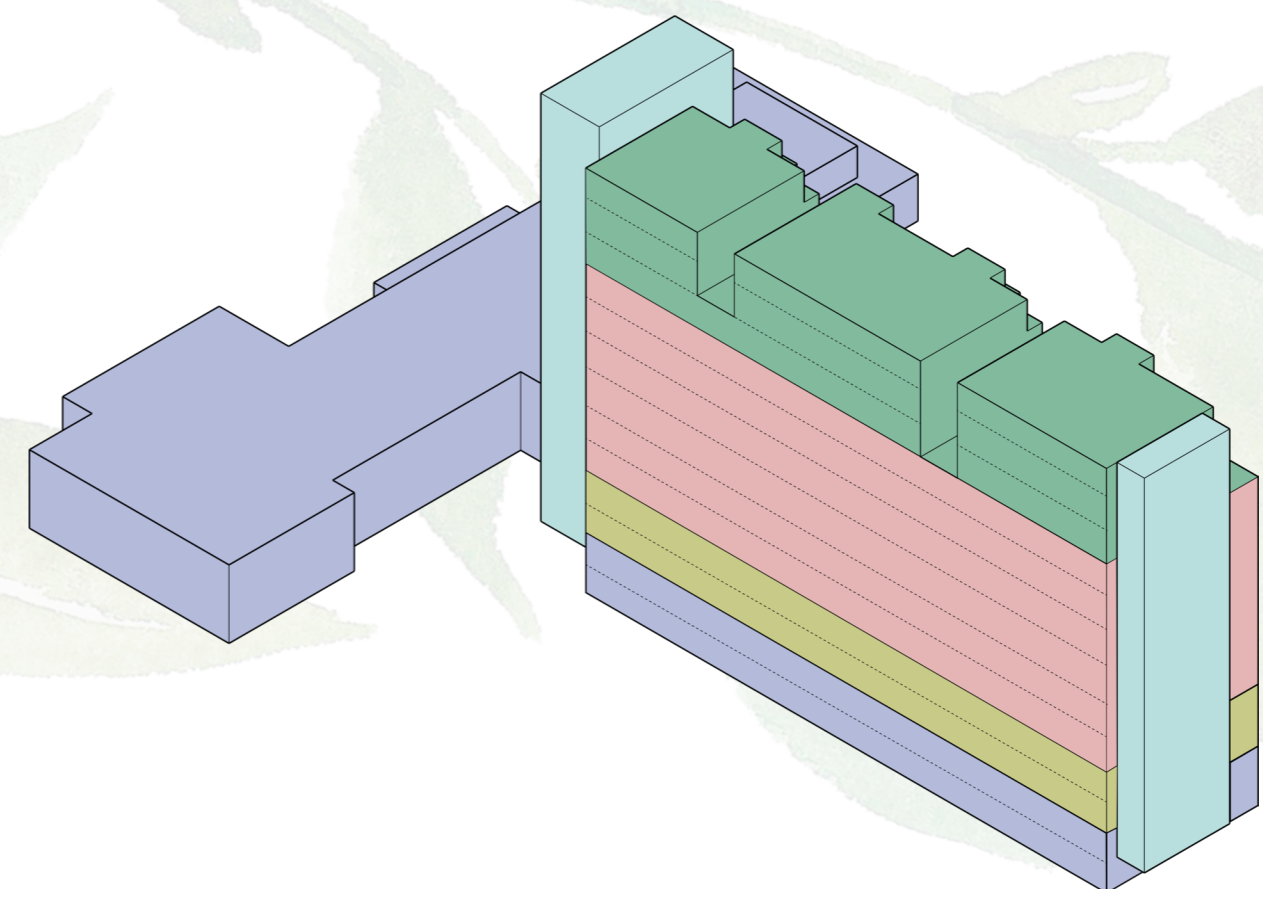

- Rooftop Apartments
- Housing
- Studios
- Public area
- Stairwell

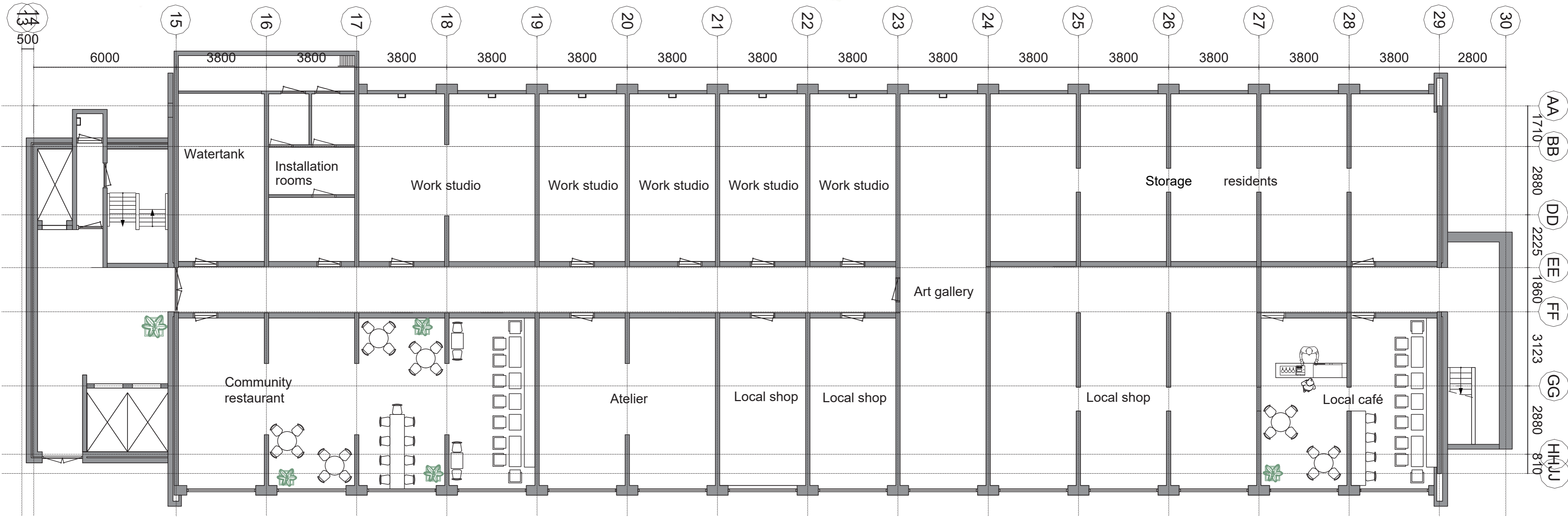

Basement

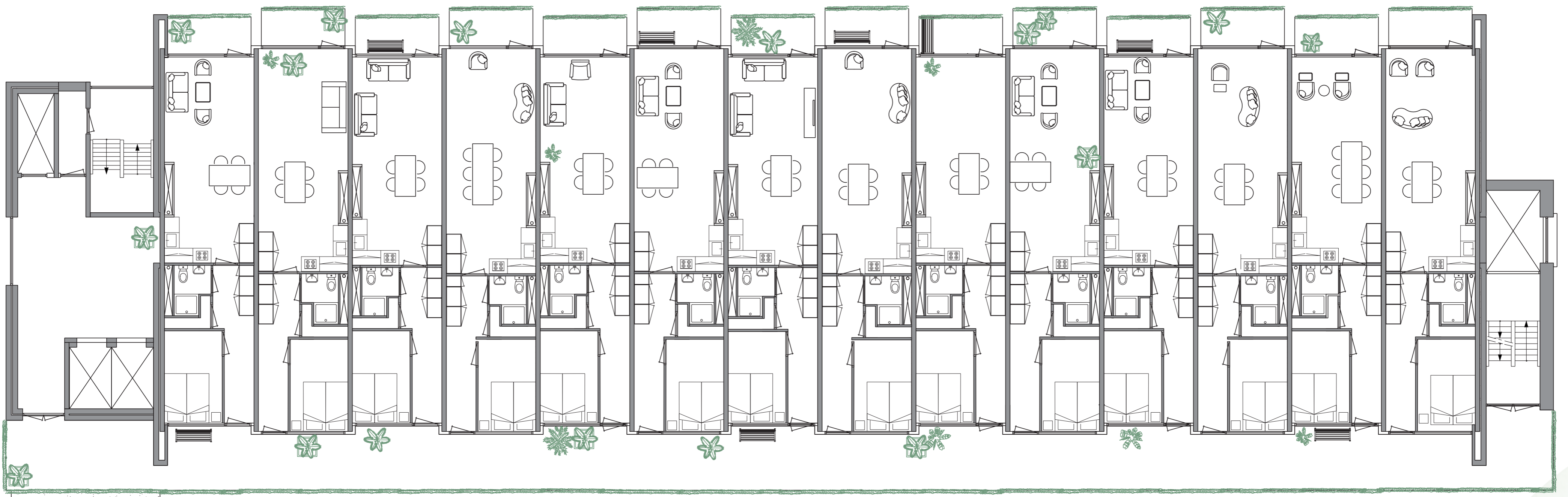

First floor, studios

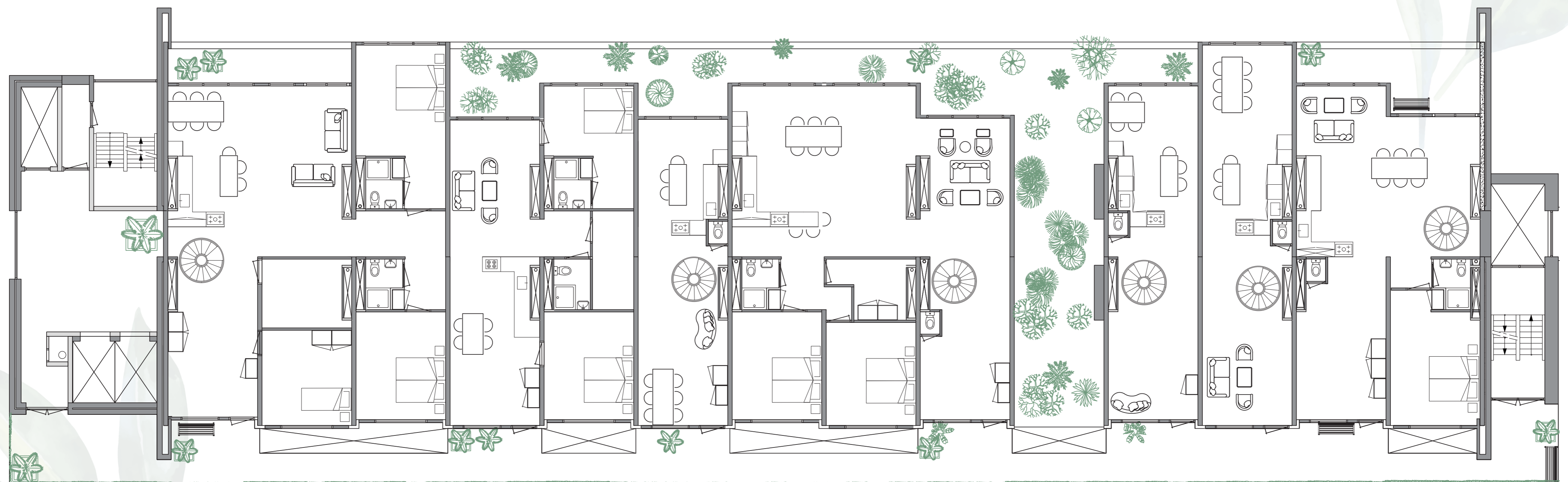

9th floor, rooftop apartments



SECTION & DETAILS



1:100

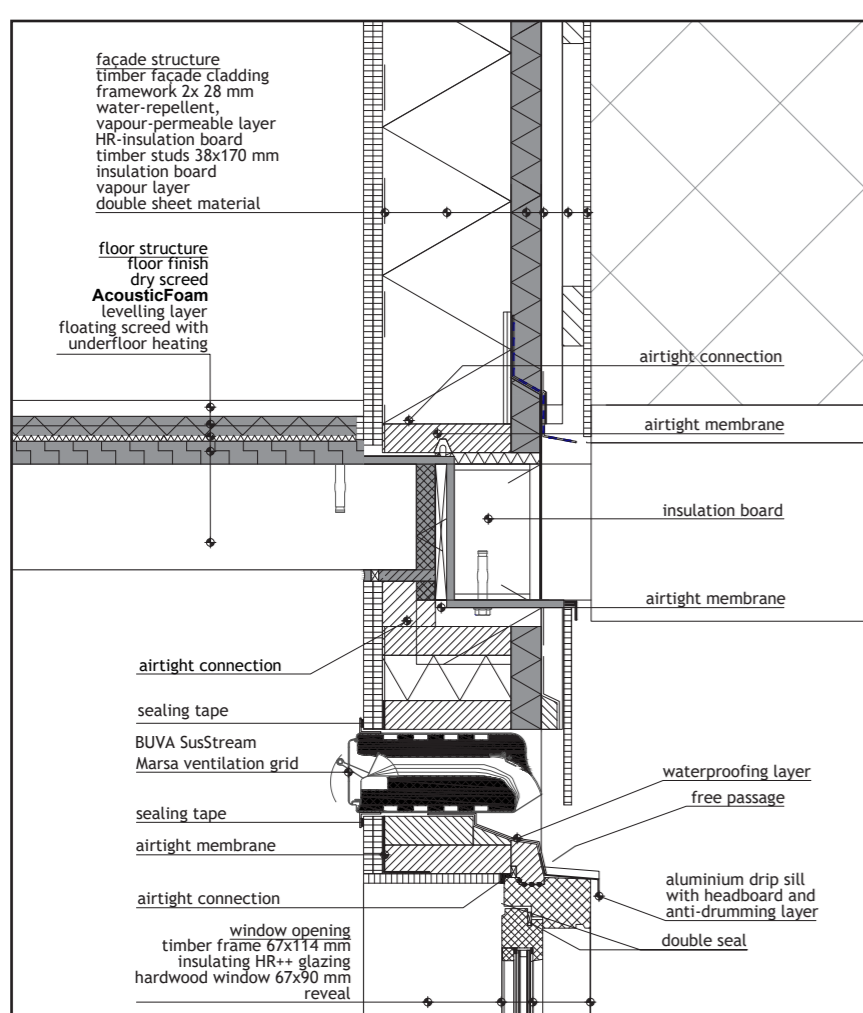

Detail 1

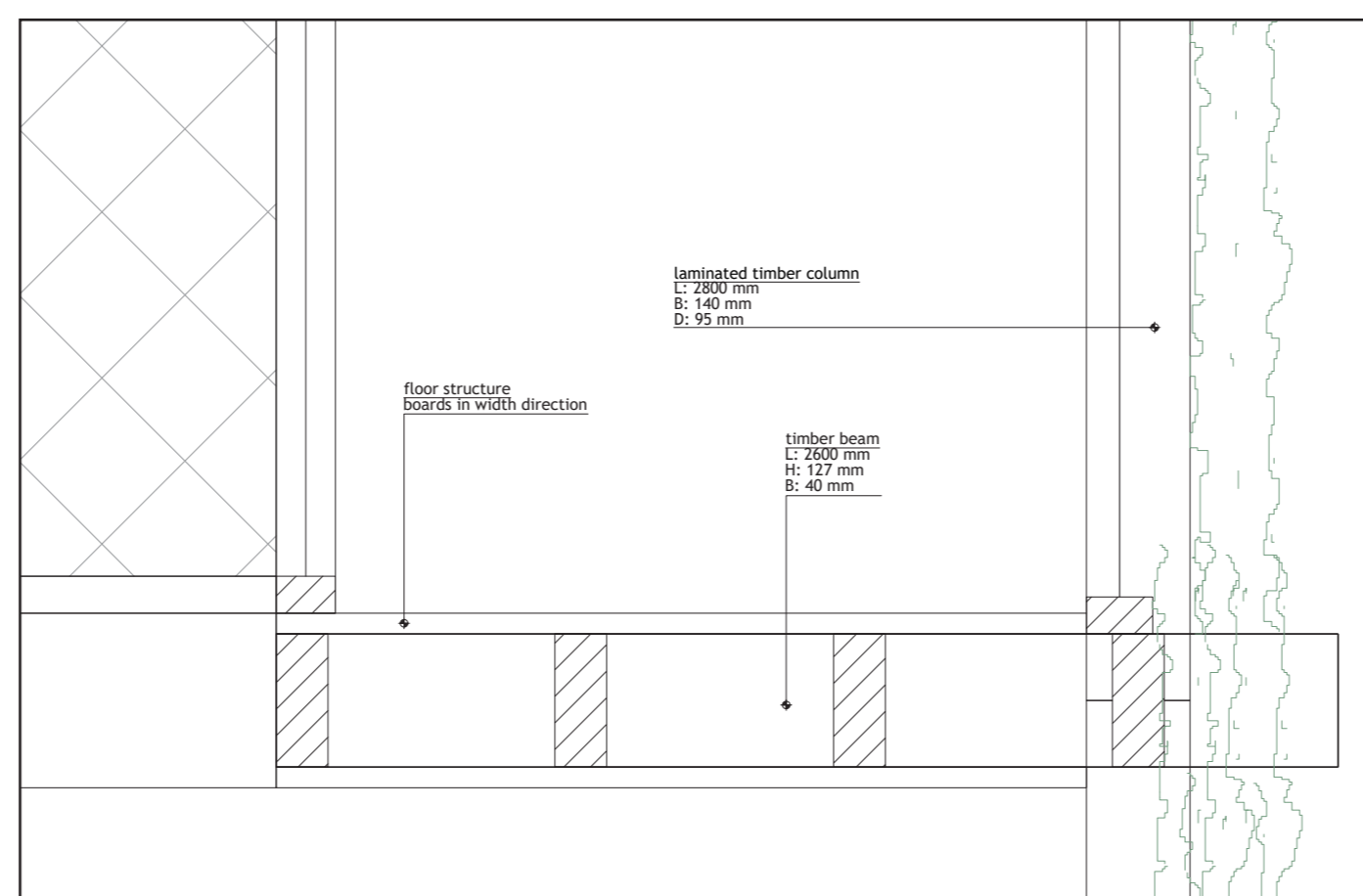

Detail 2

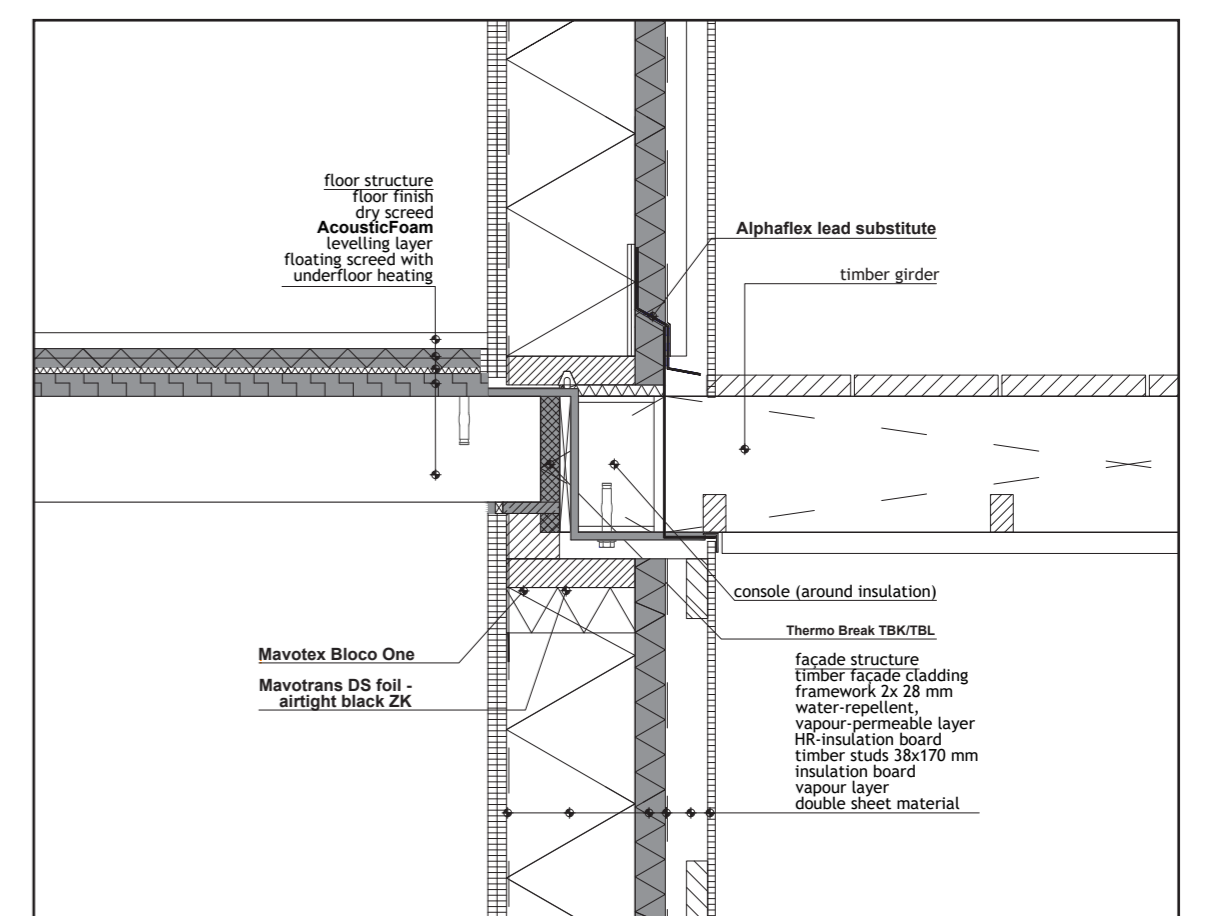

Detail 3

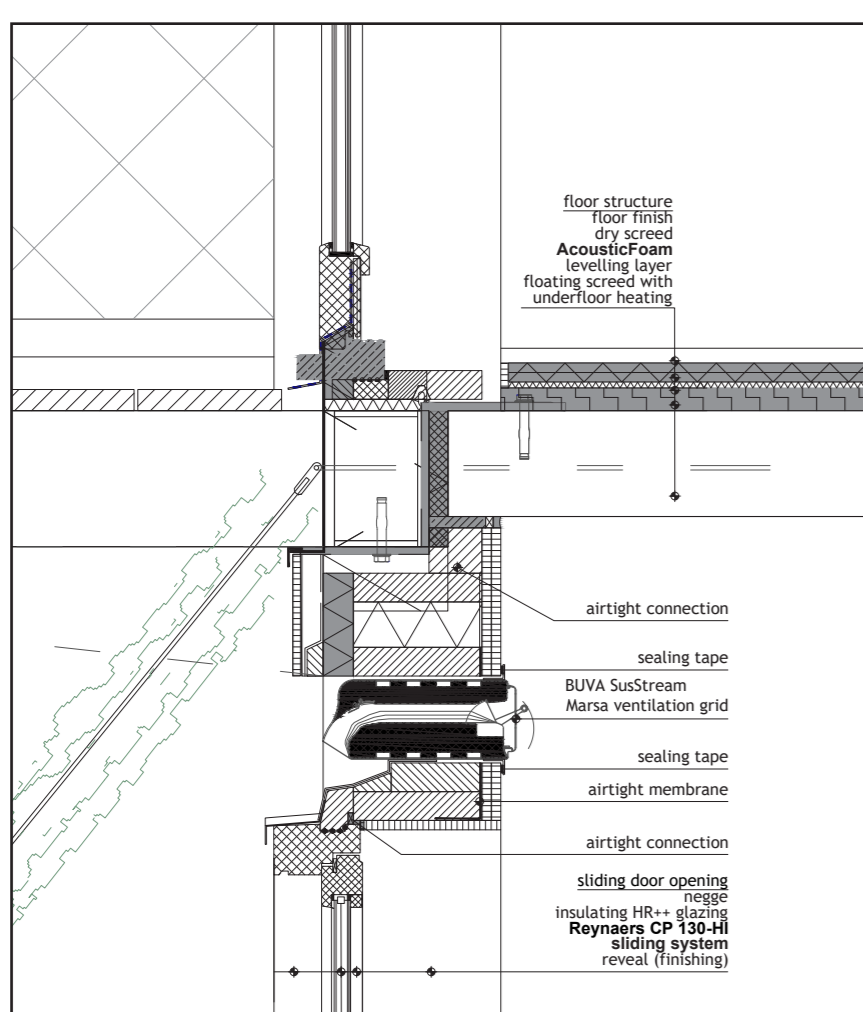

Detail 4

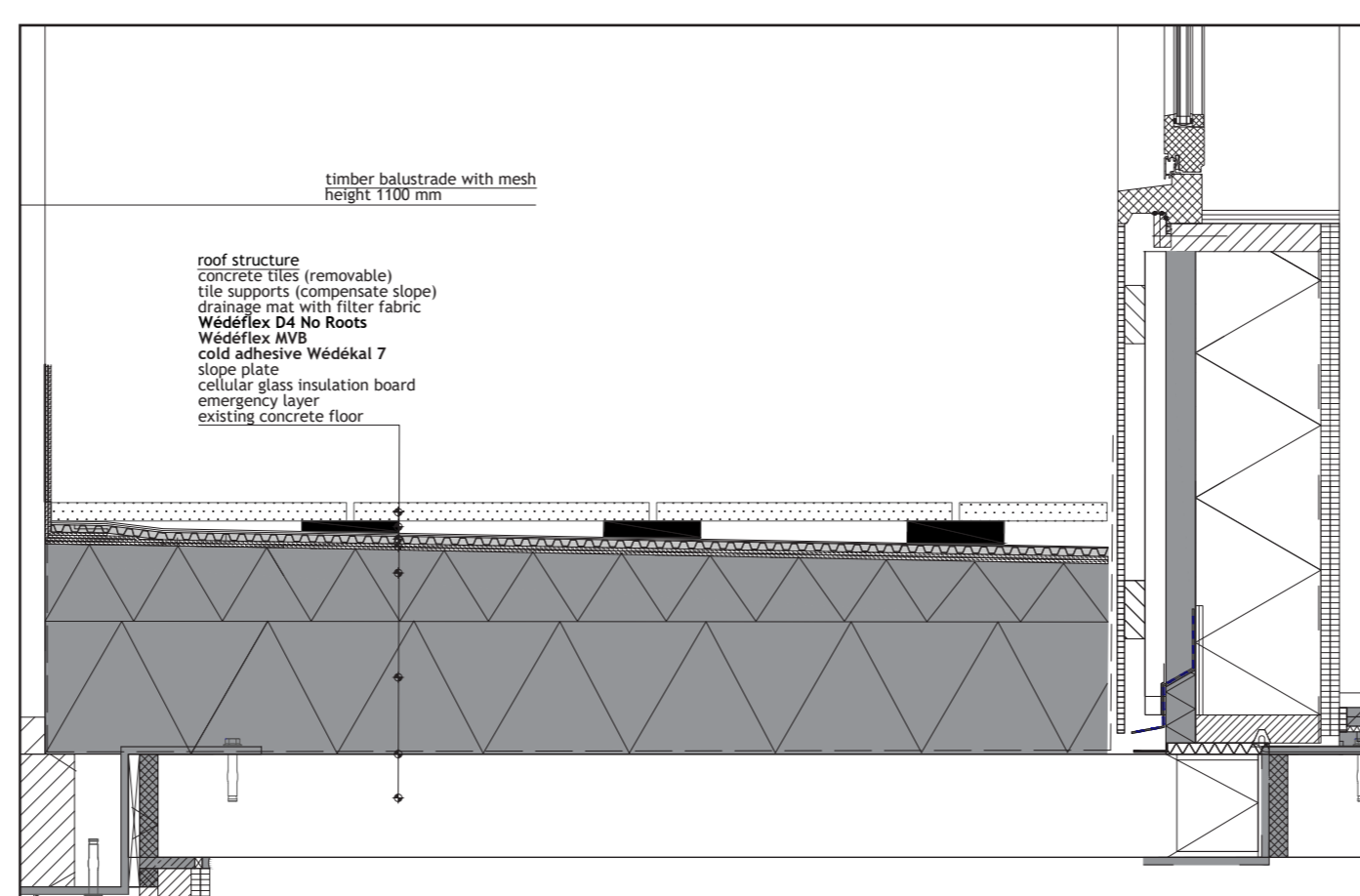

Detail 5

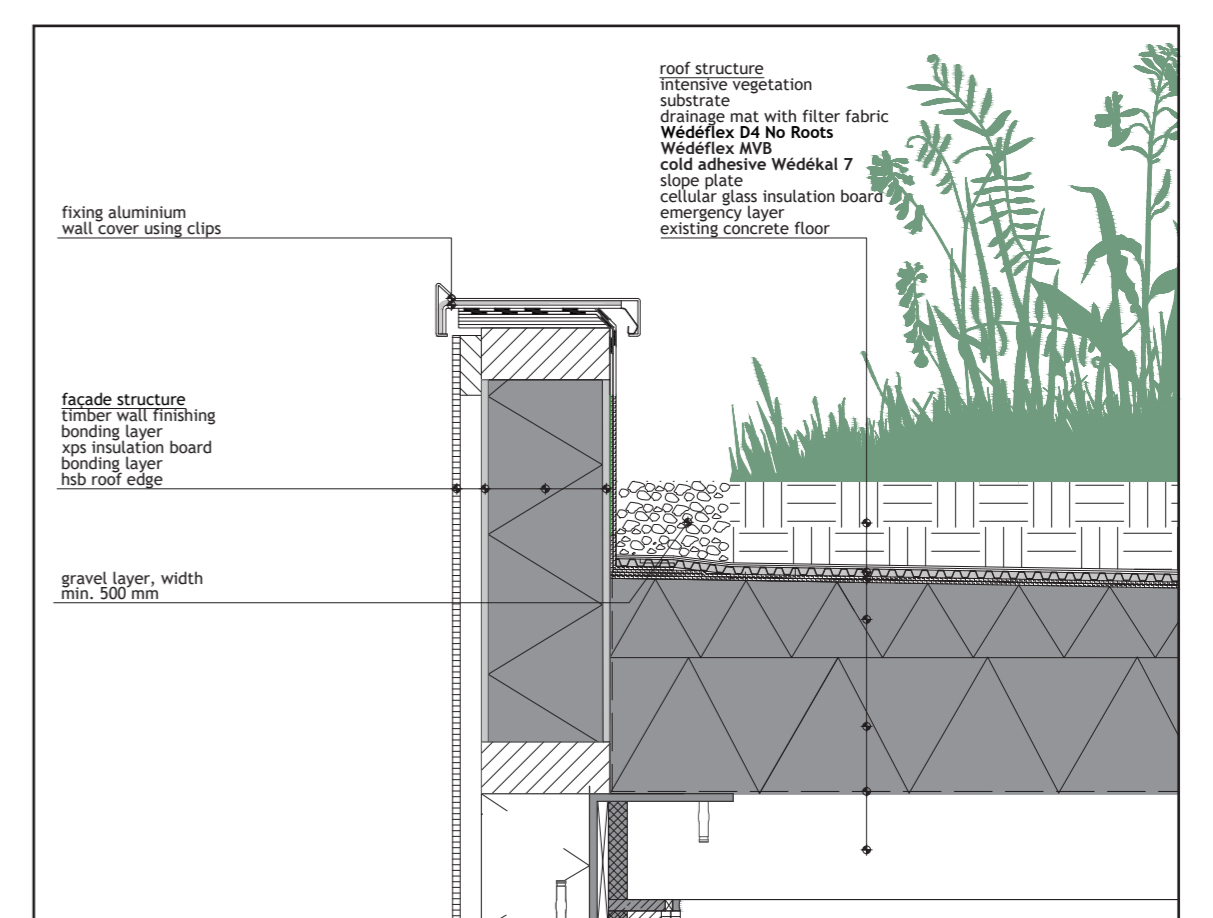

Detail 6

FAÇADE FRAGMENT



Elevation 1:20

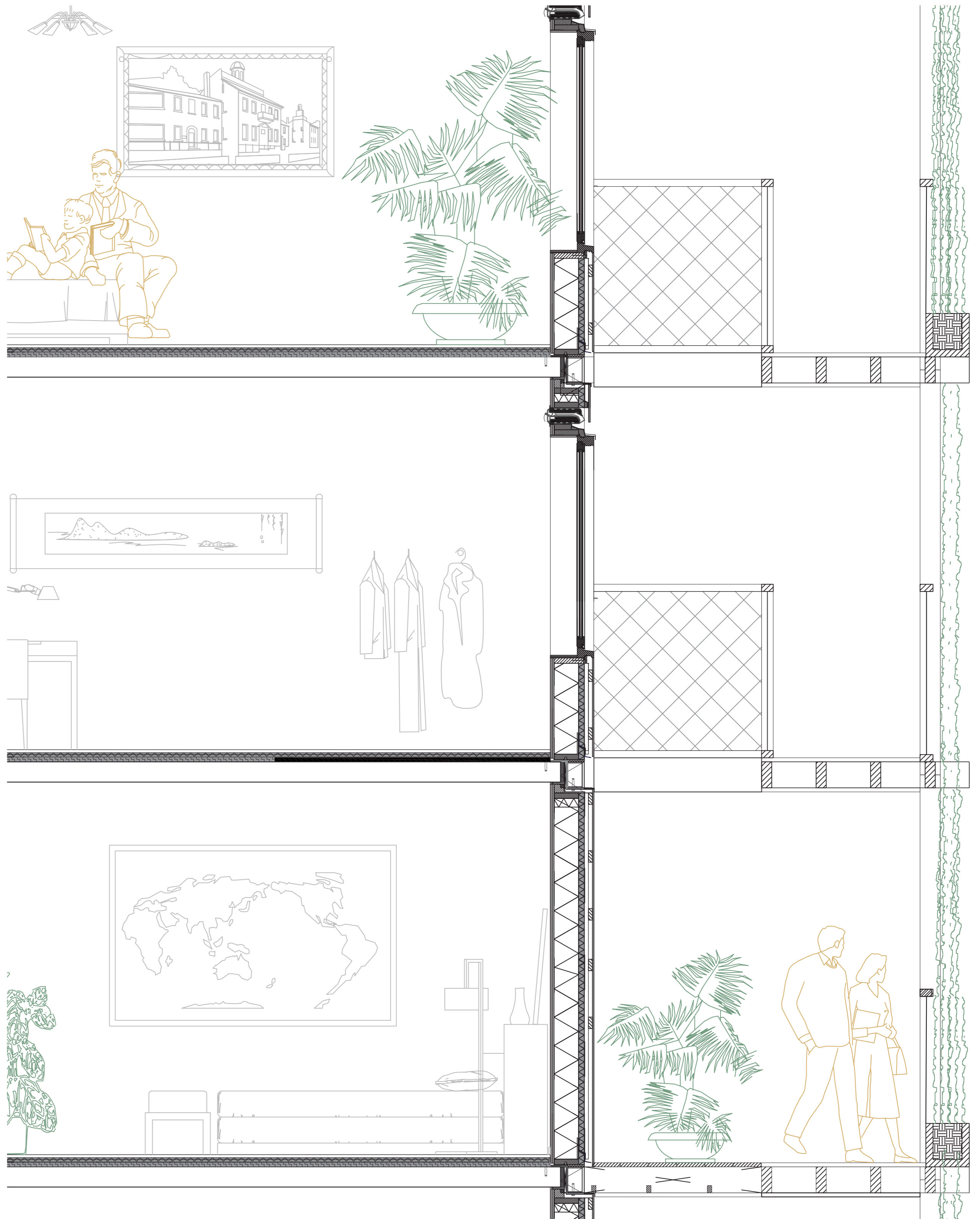

Vertical section 1:20

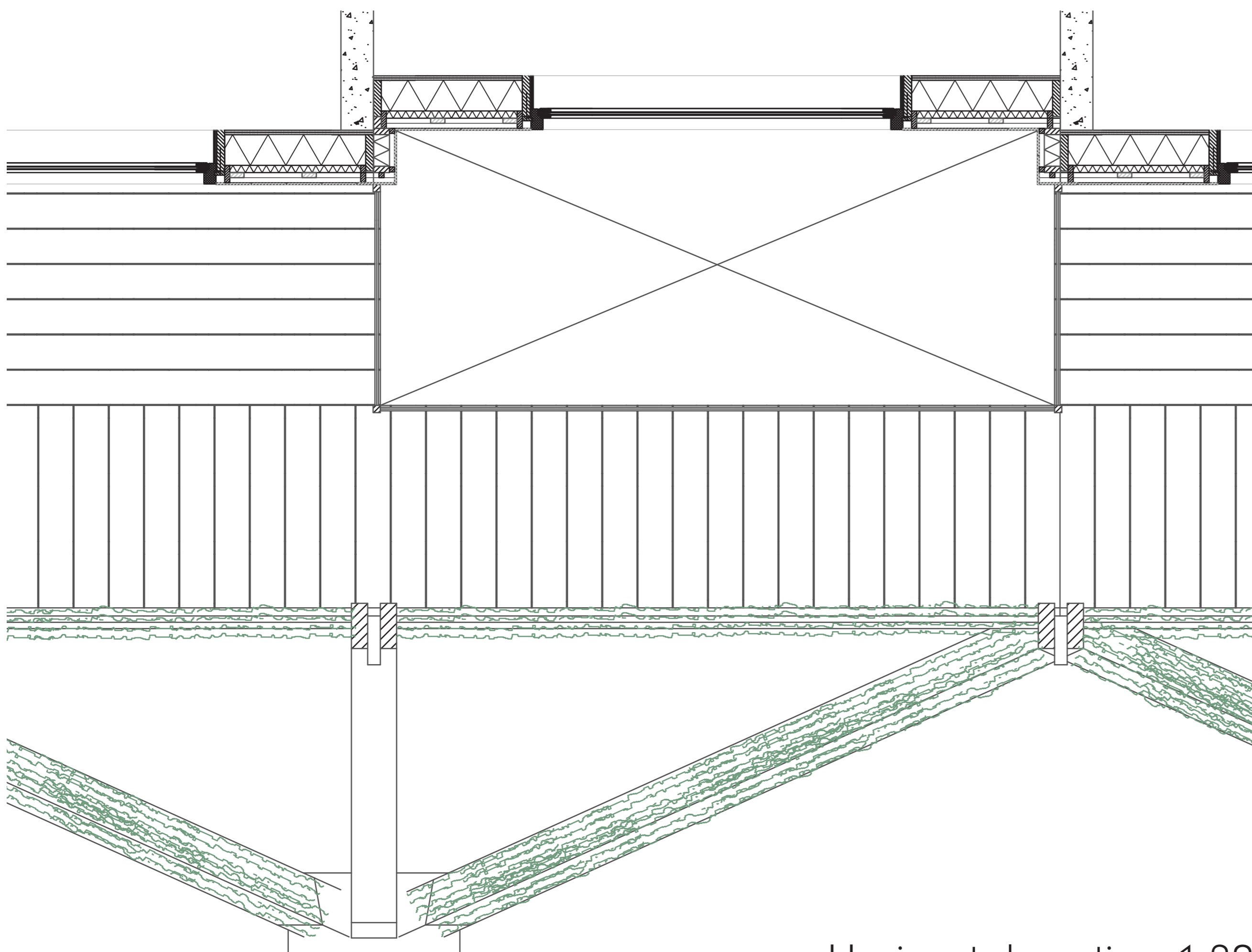

Horizontal section 1:20

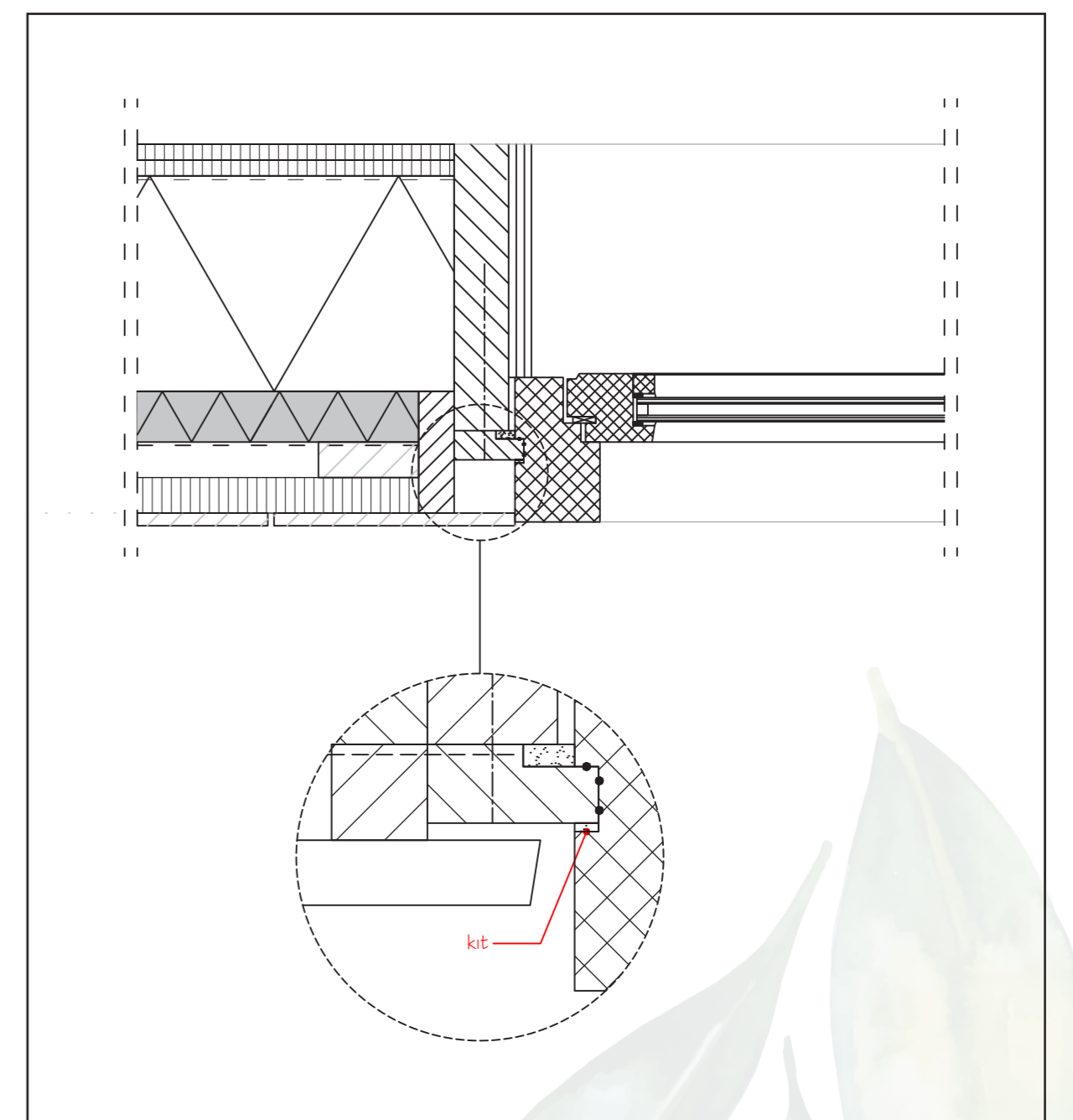

Horizontal detail 1:5

REWILDING STRATEGIES

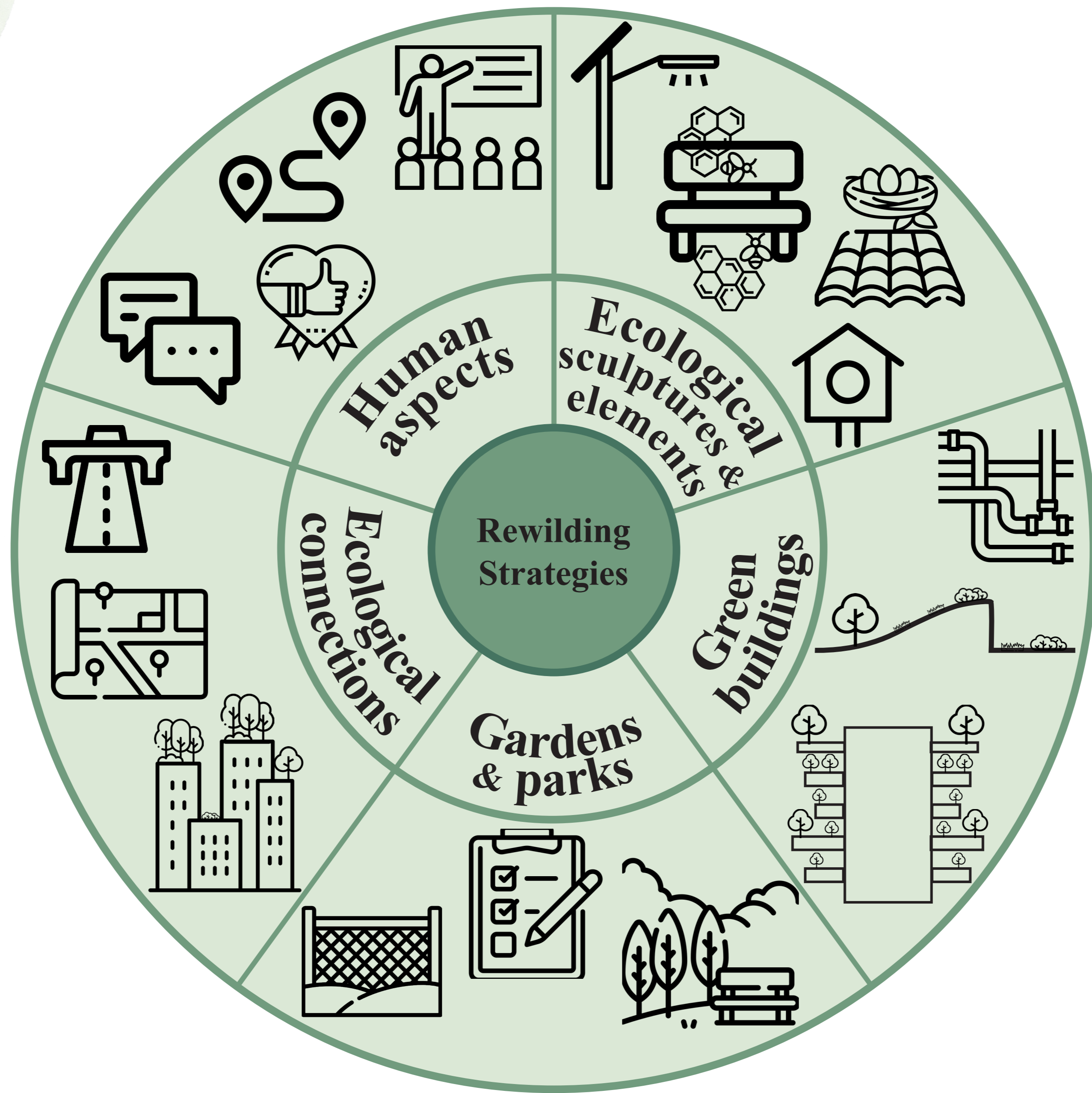

NATURE-INCLUSIVE DESIGN TOOLBOX:
Categorisation of nature-inclusive designs stimulating rewilding in the built environment

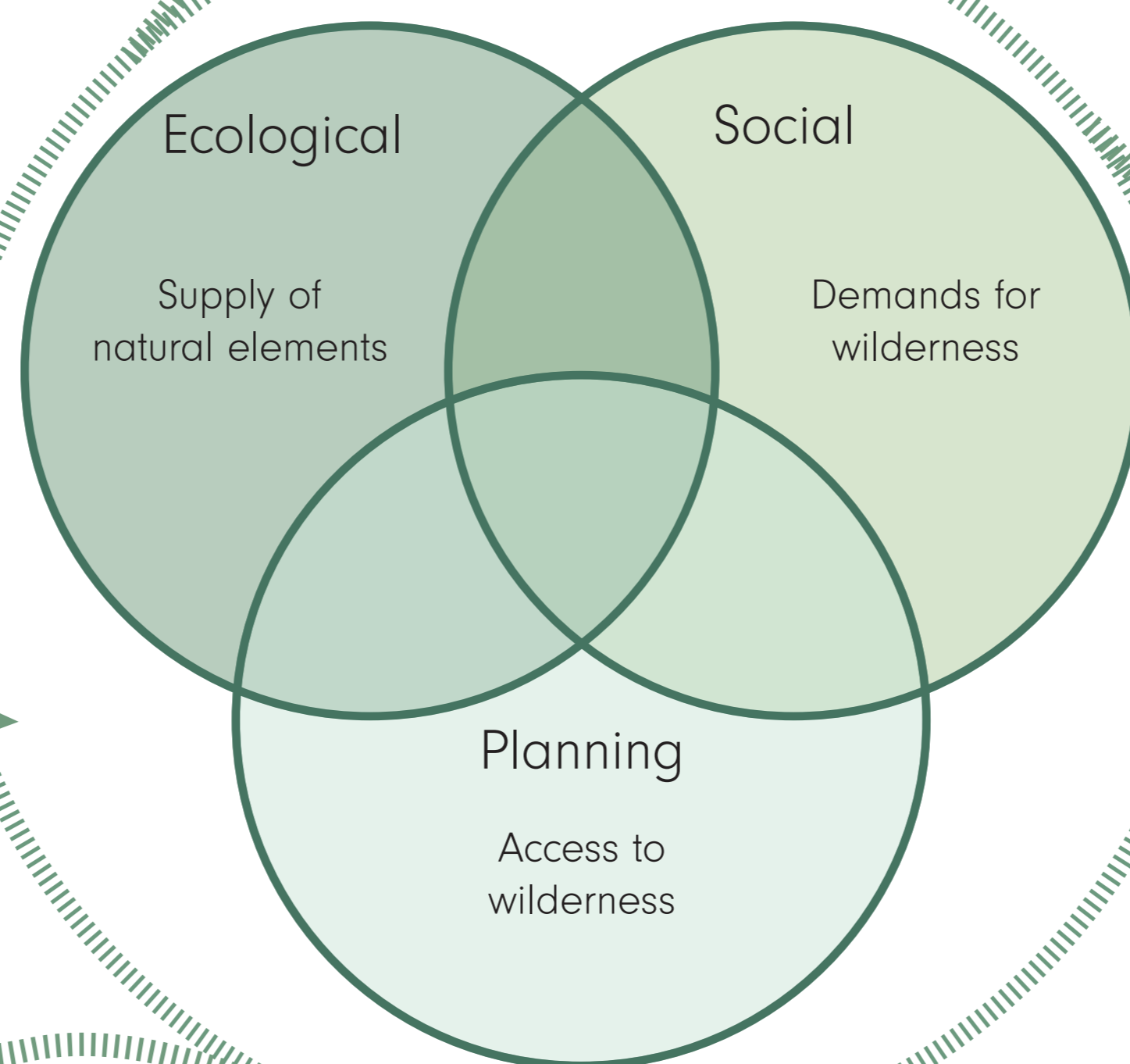
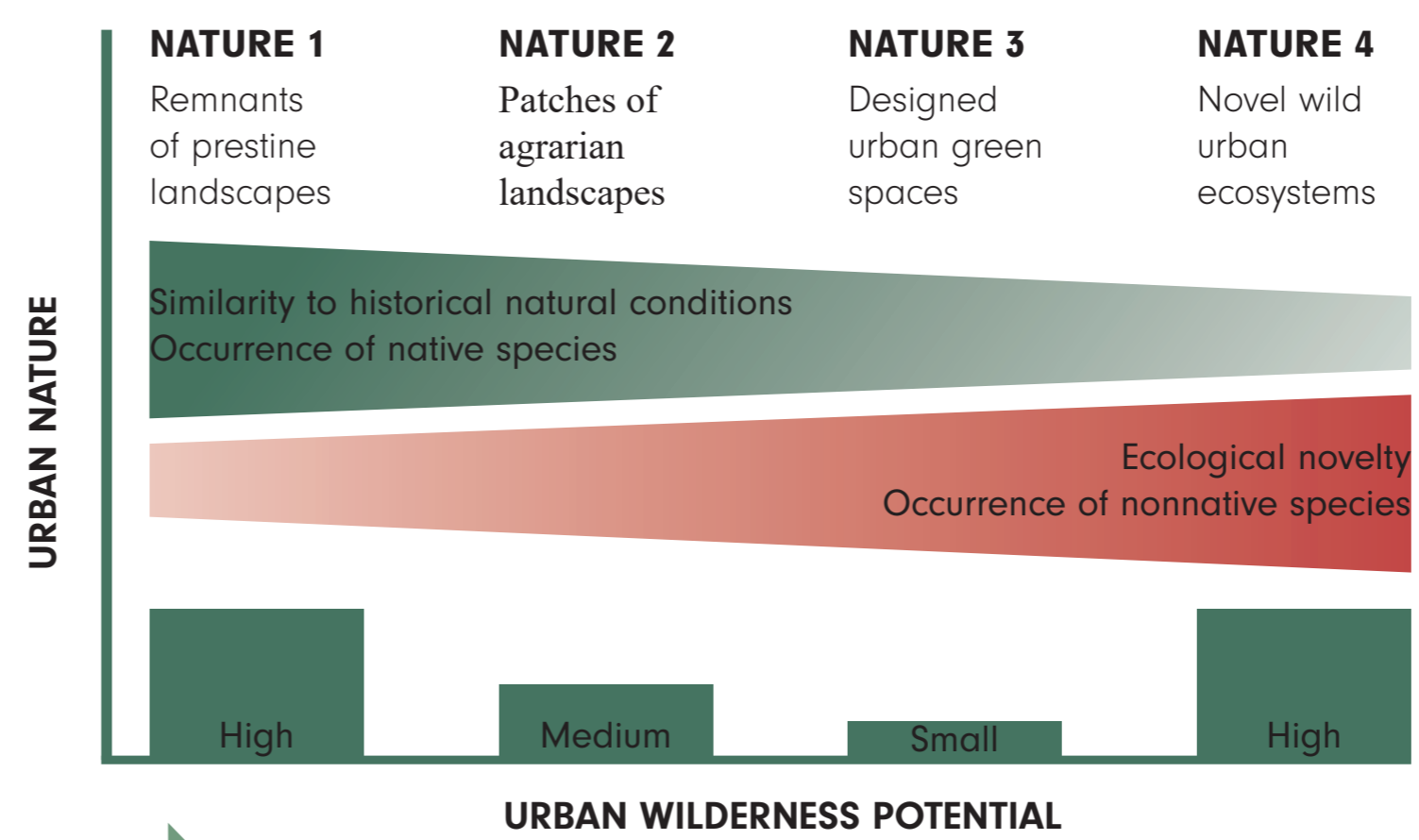

the 3-30-300 rule:



LARGE-SCALE STRATEGY:
Urban Wilderness as Social-Ecological System

SPECIES BOERHAAVEWIJK

