



1 : 200







1 : 5000

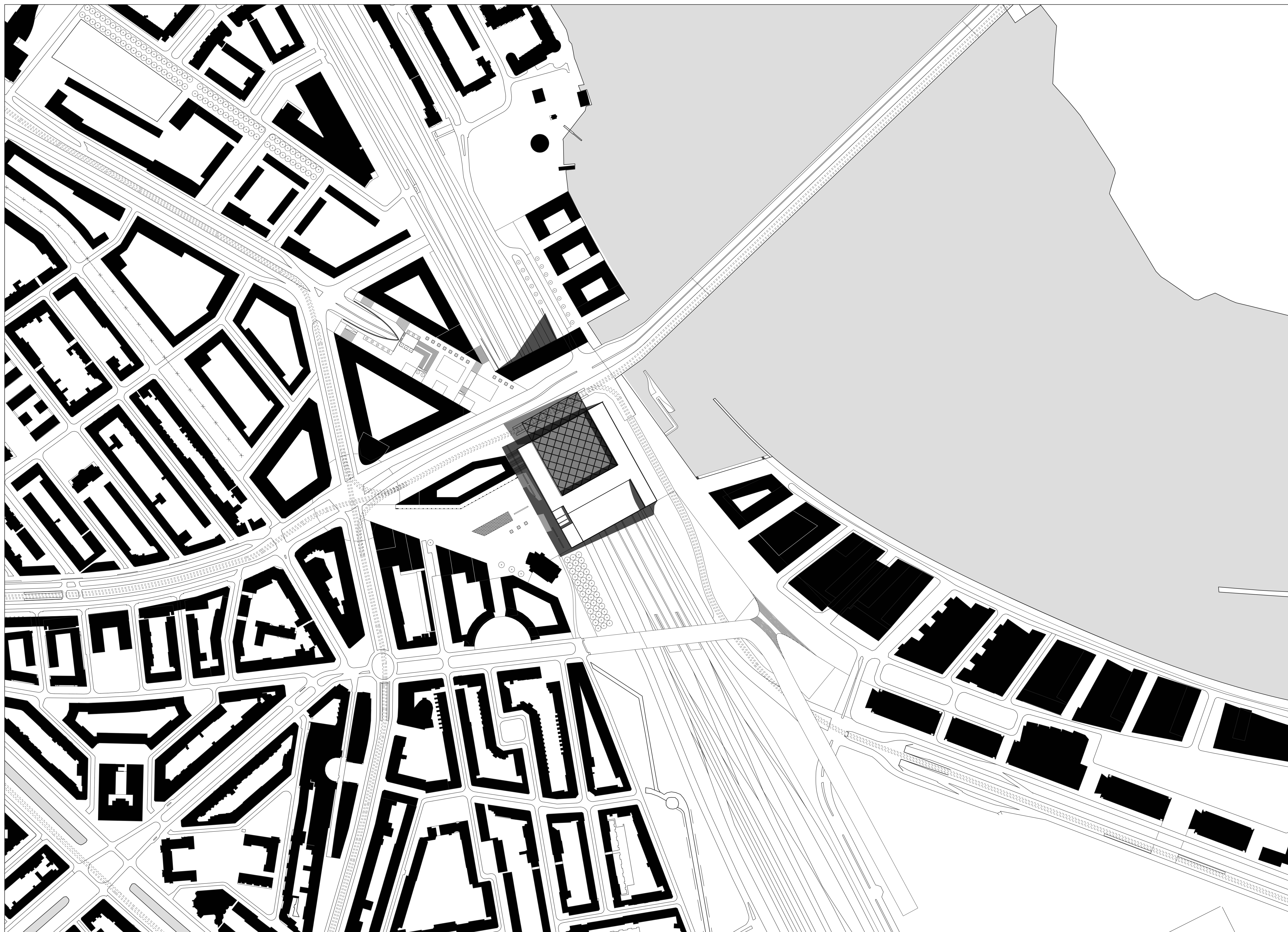

Situatie Rotterdam-Zuid

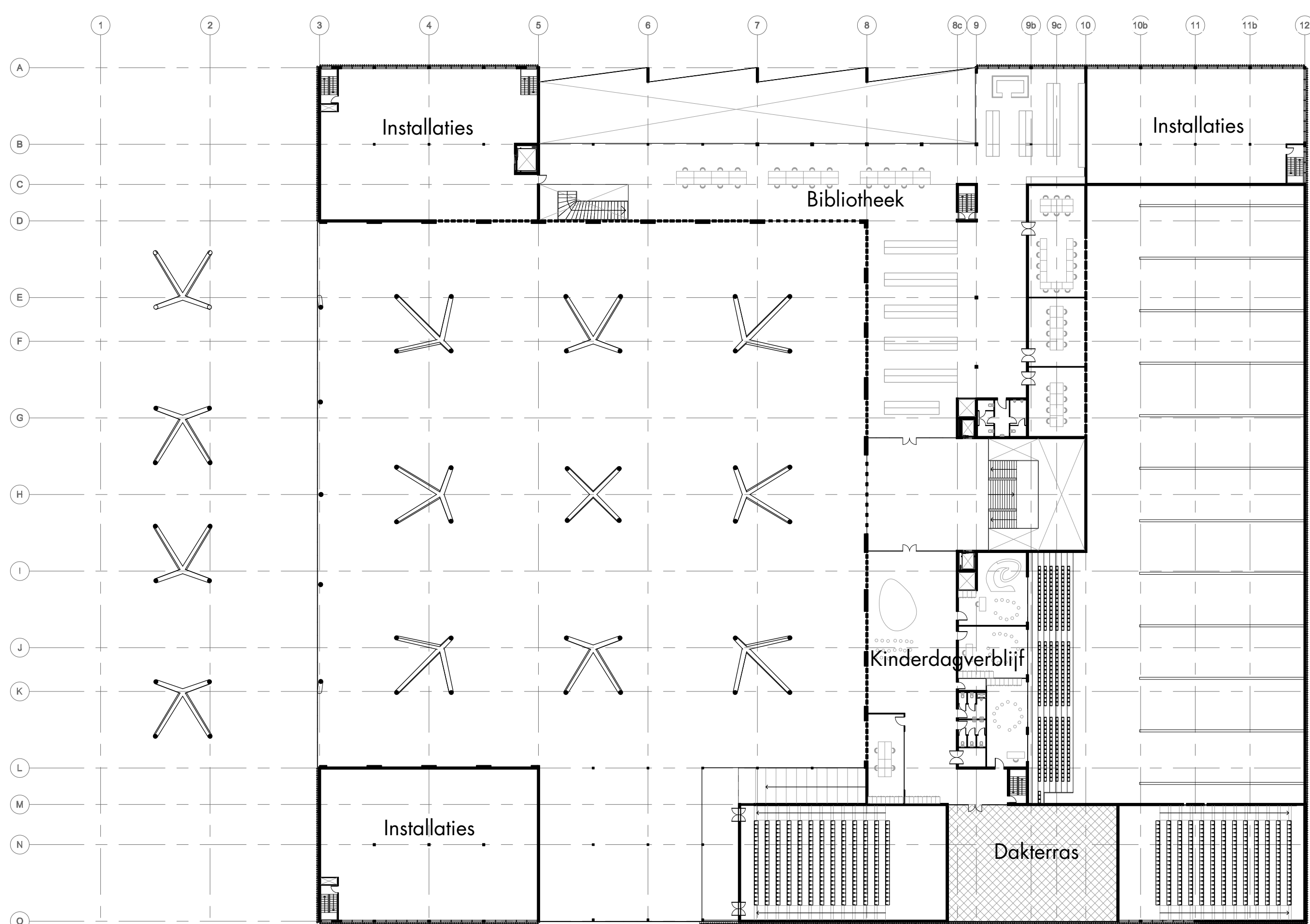

Niveau 4: Kinderopvang



1 : 500

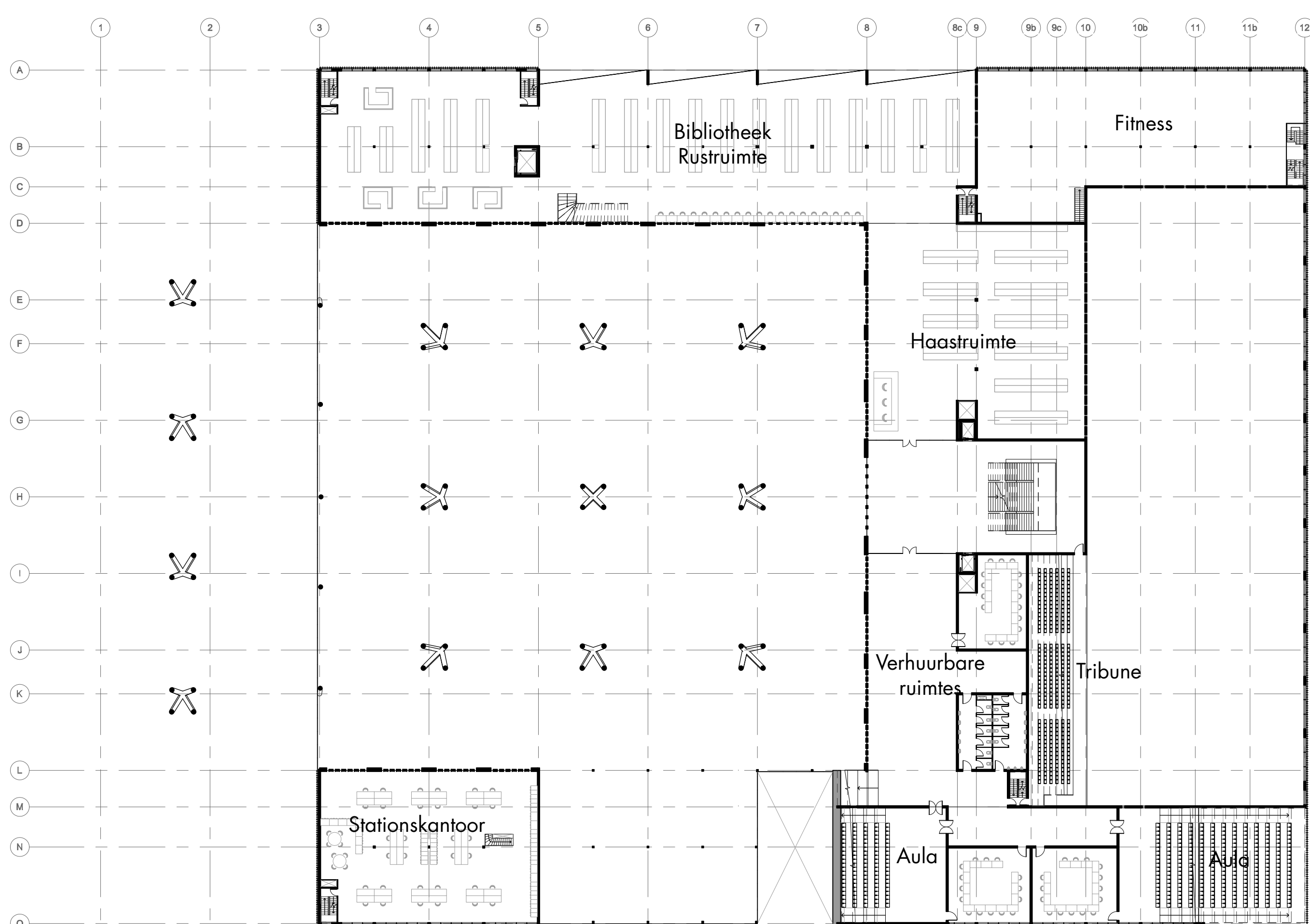

Niveau 3: Bibliotheek

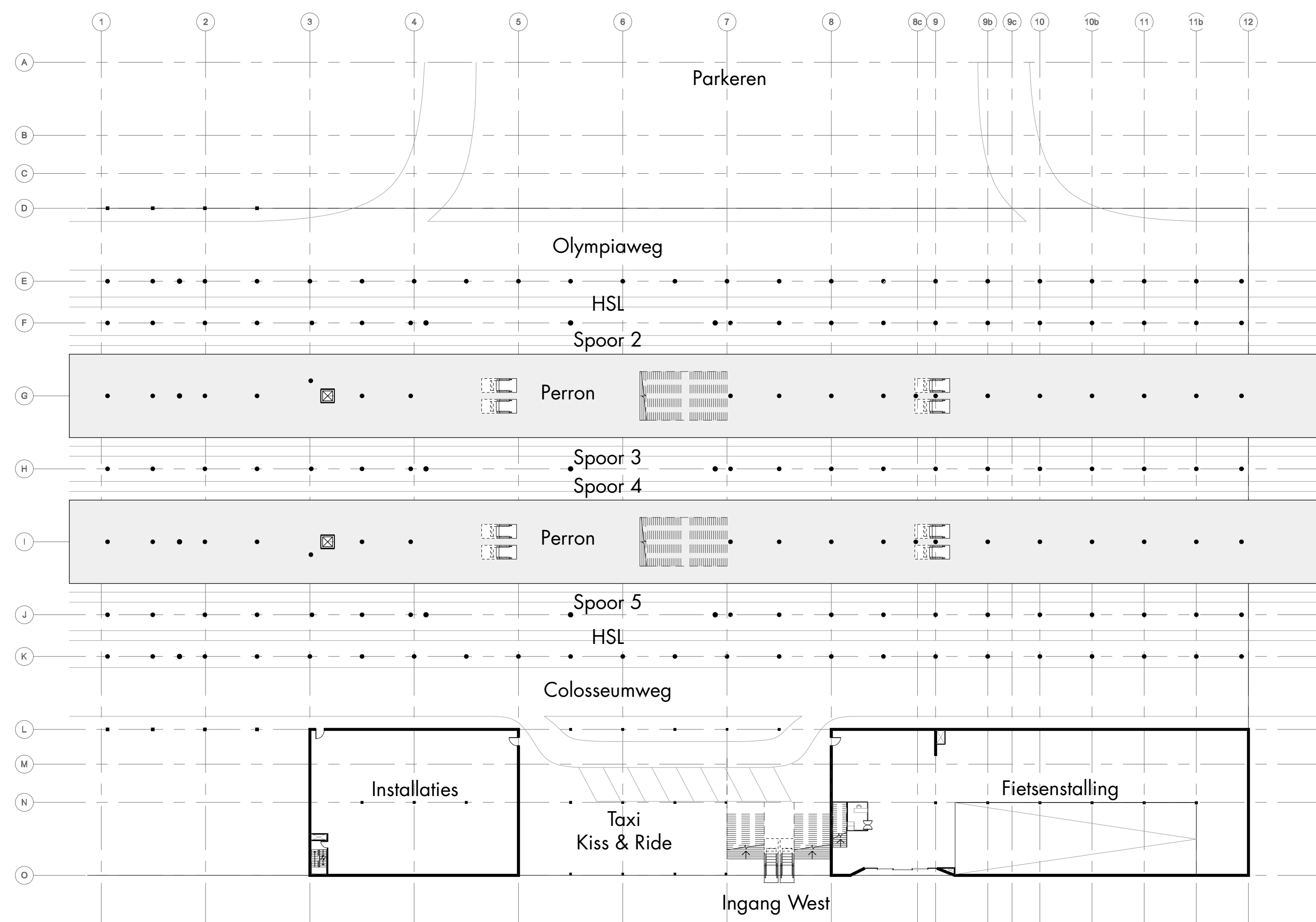

Niveau 1: Entree Maaszijde

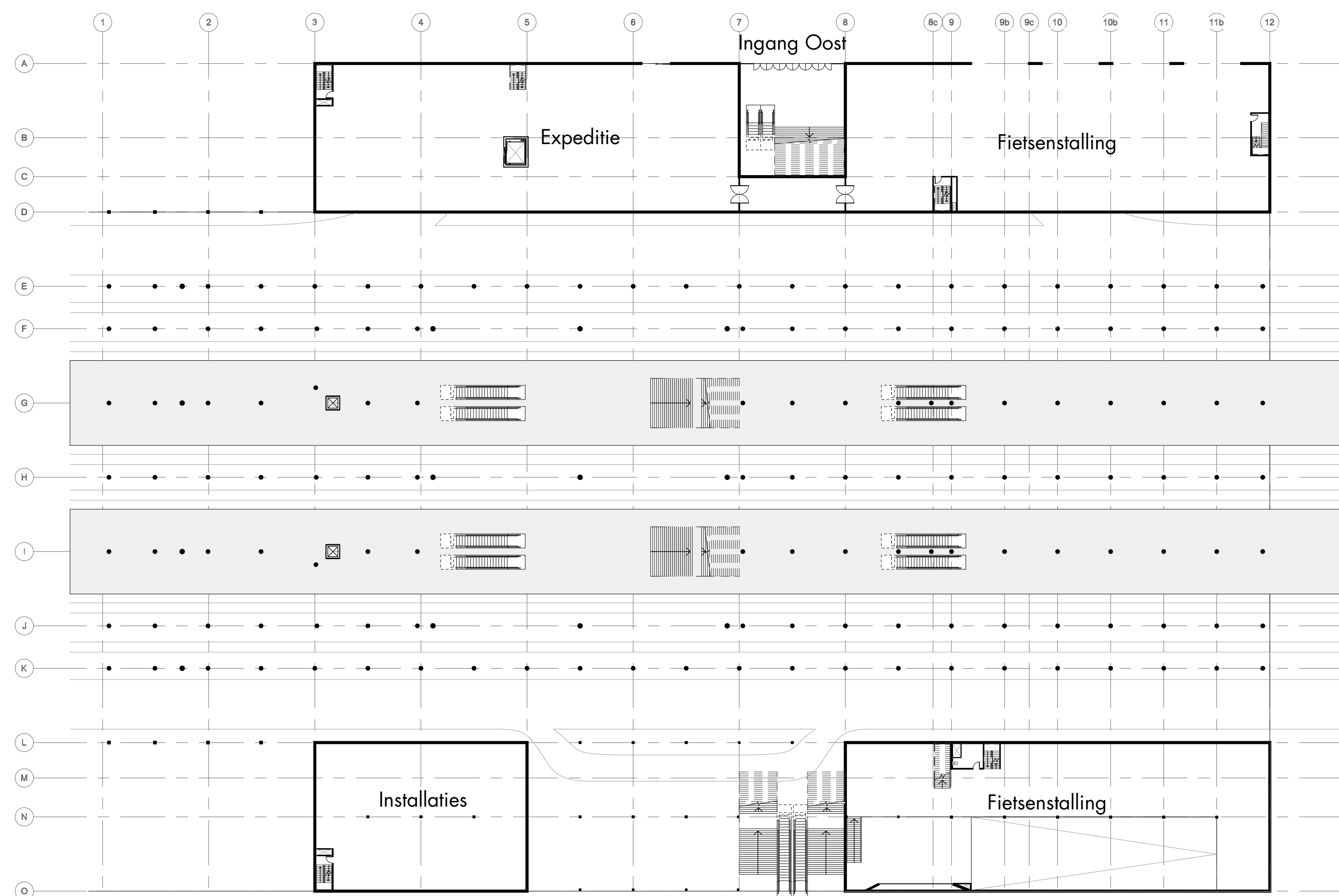

Niveau 0: Entree Moskeezijde & Perrons





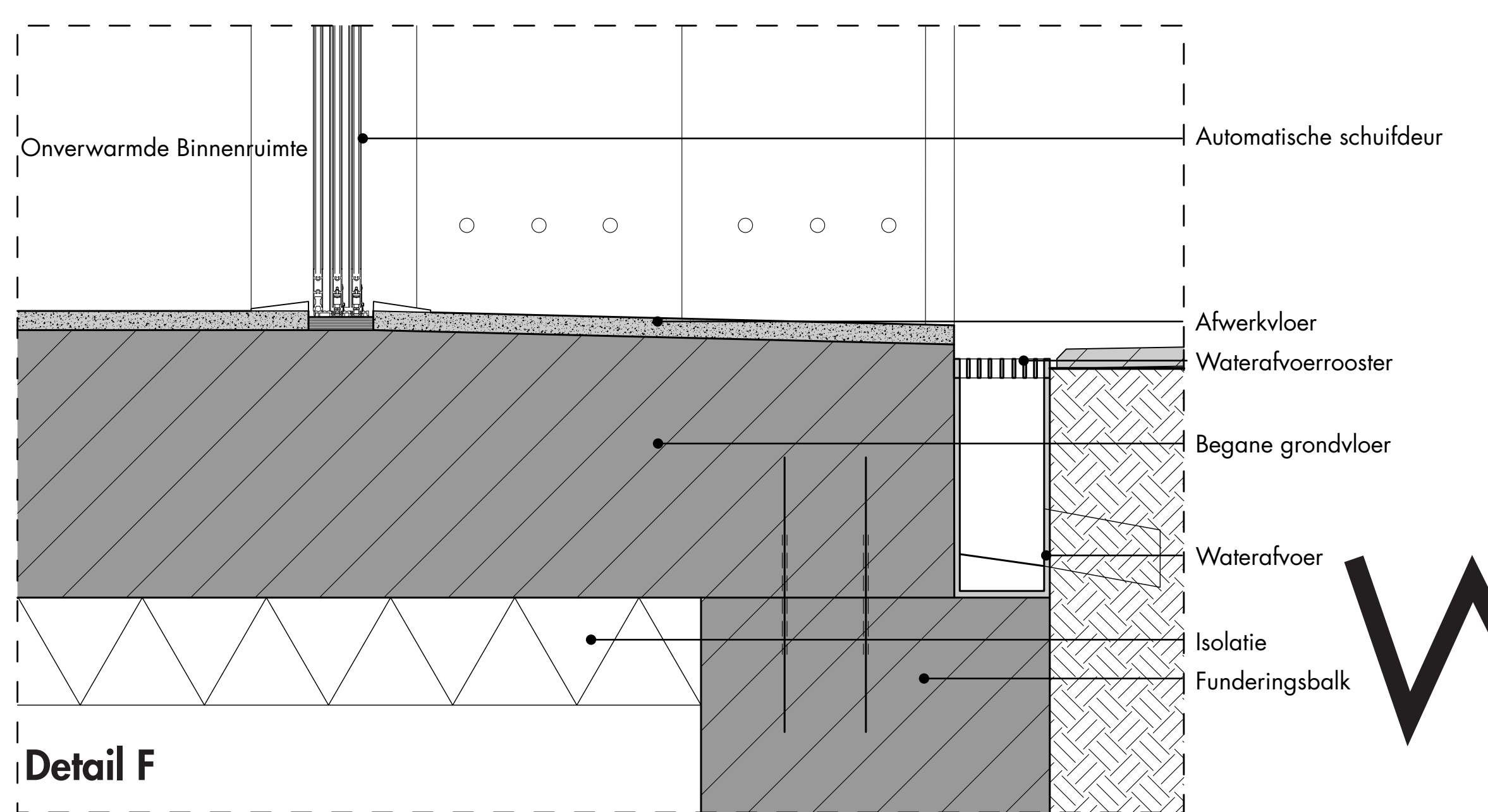
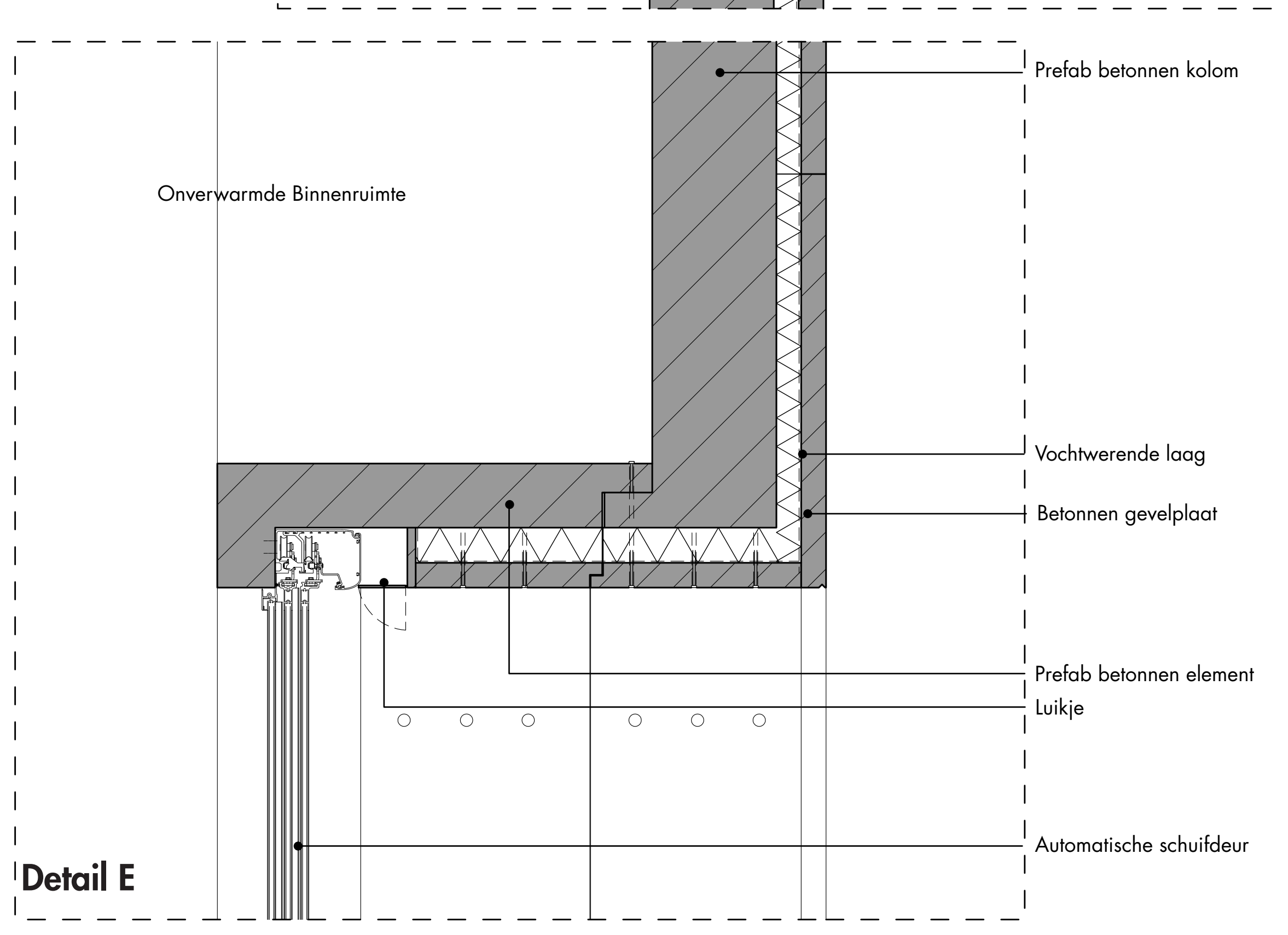
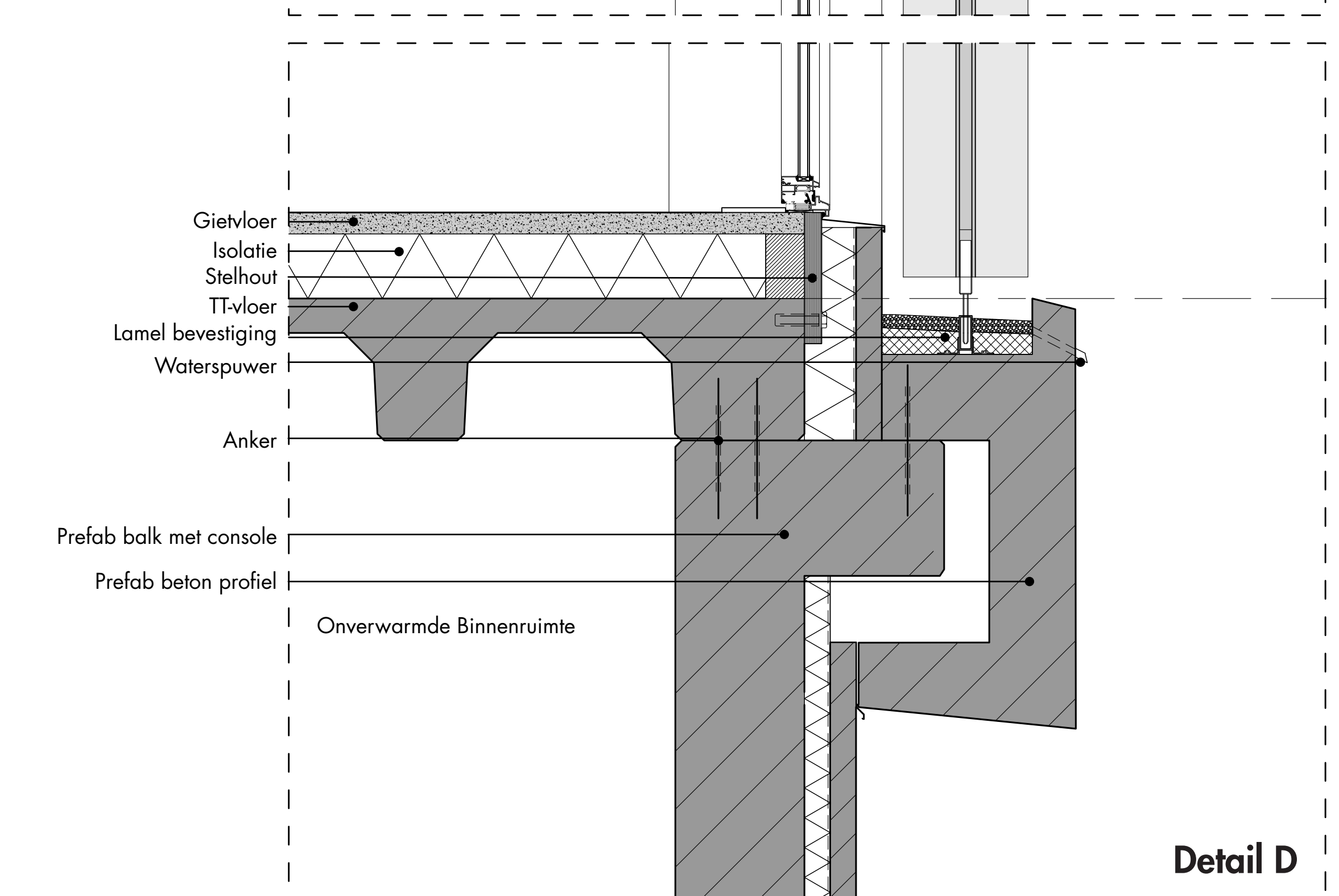
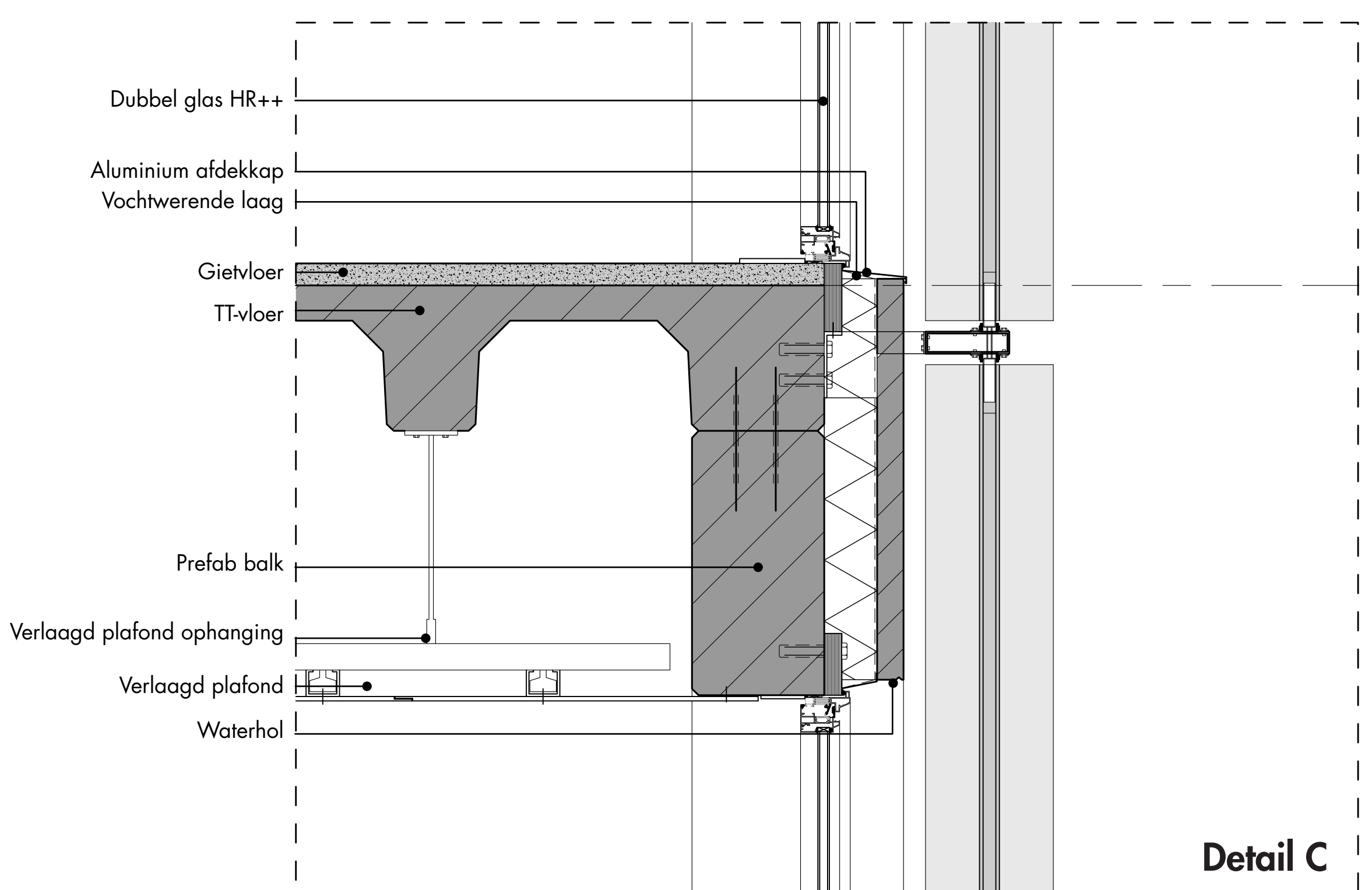
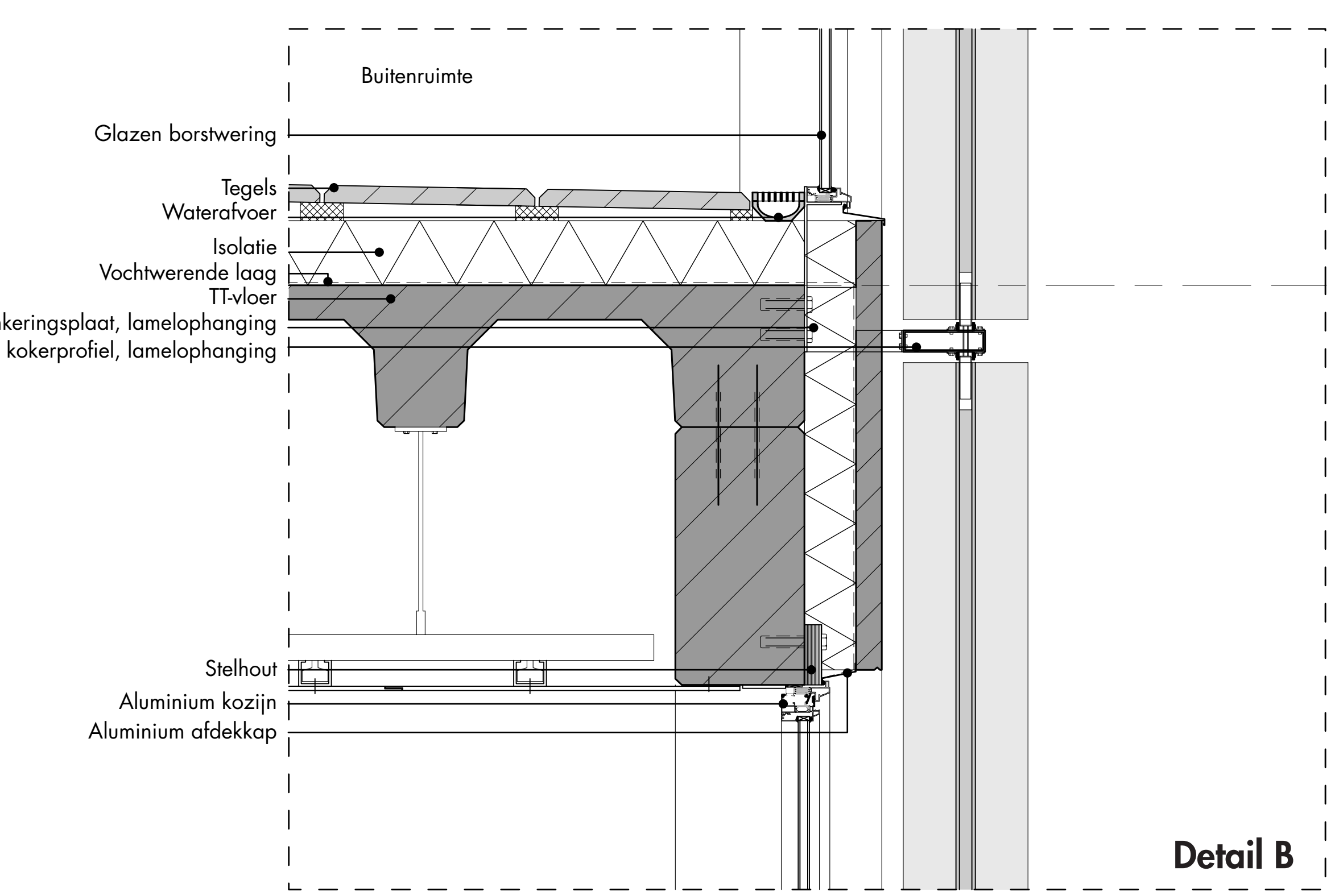
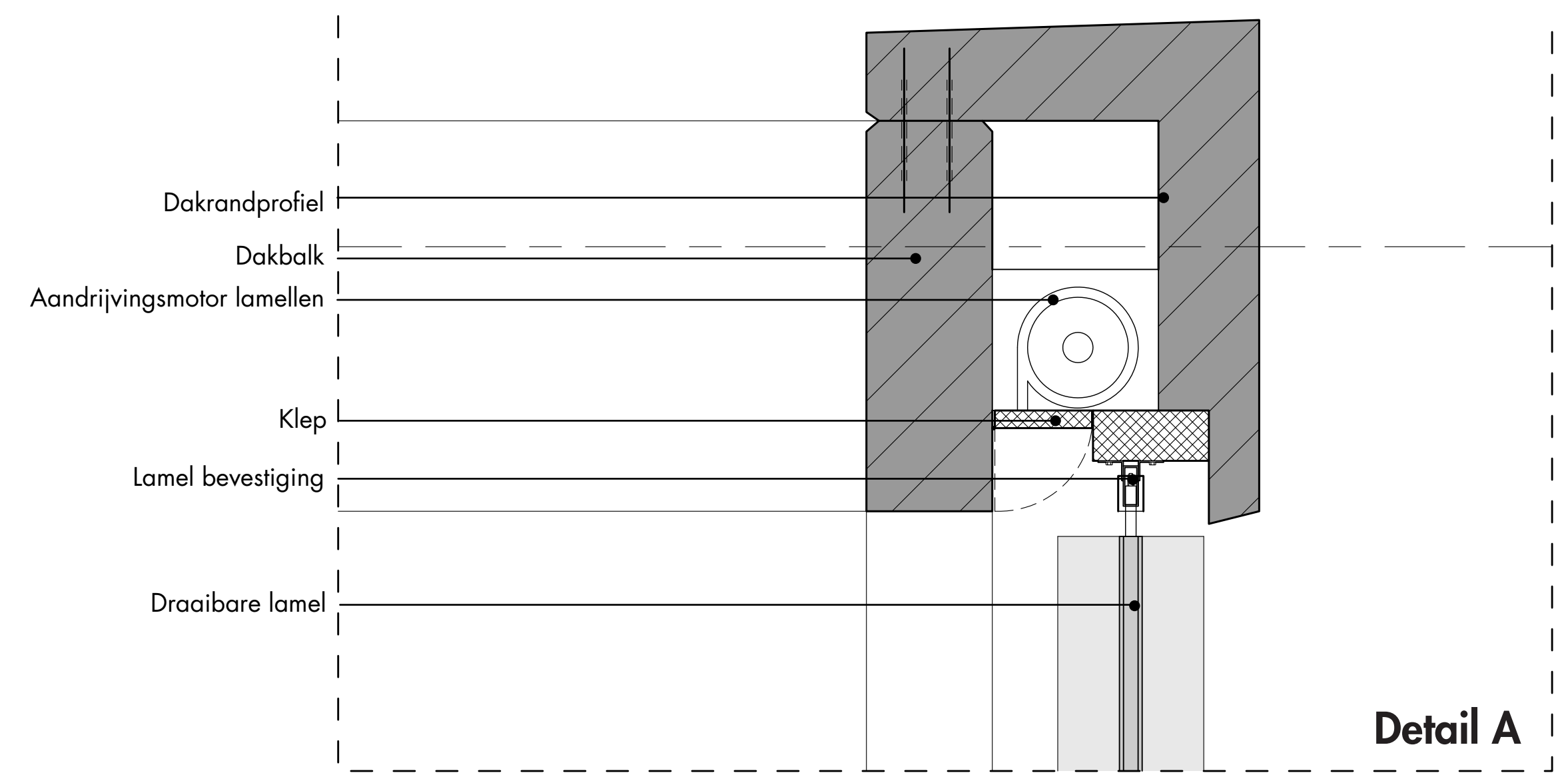
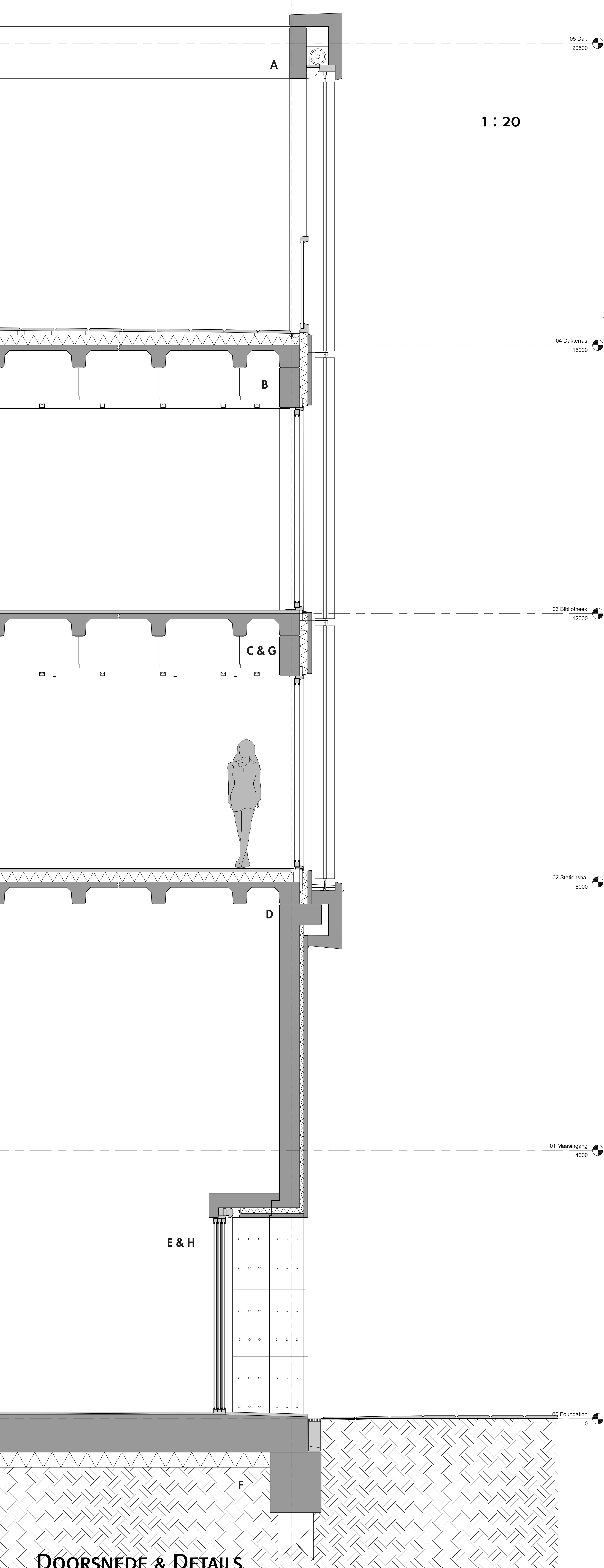

1 : 10

DOORSNEDE & DETAILS





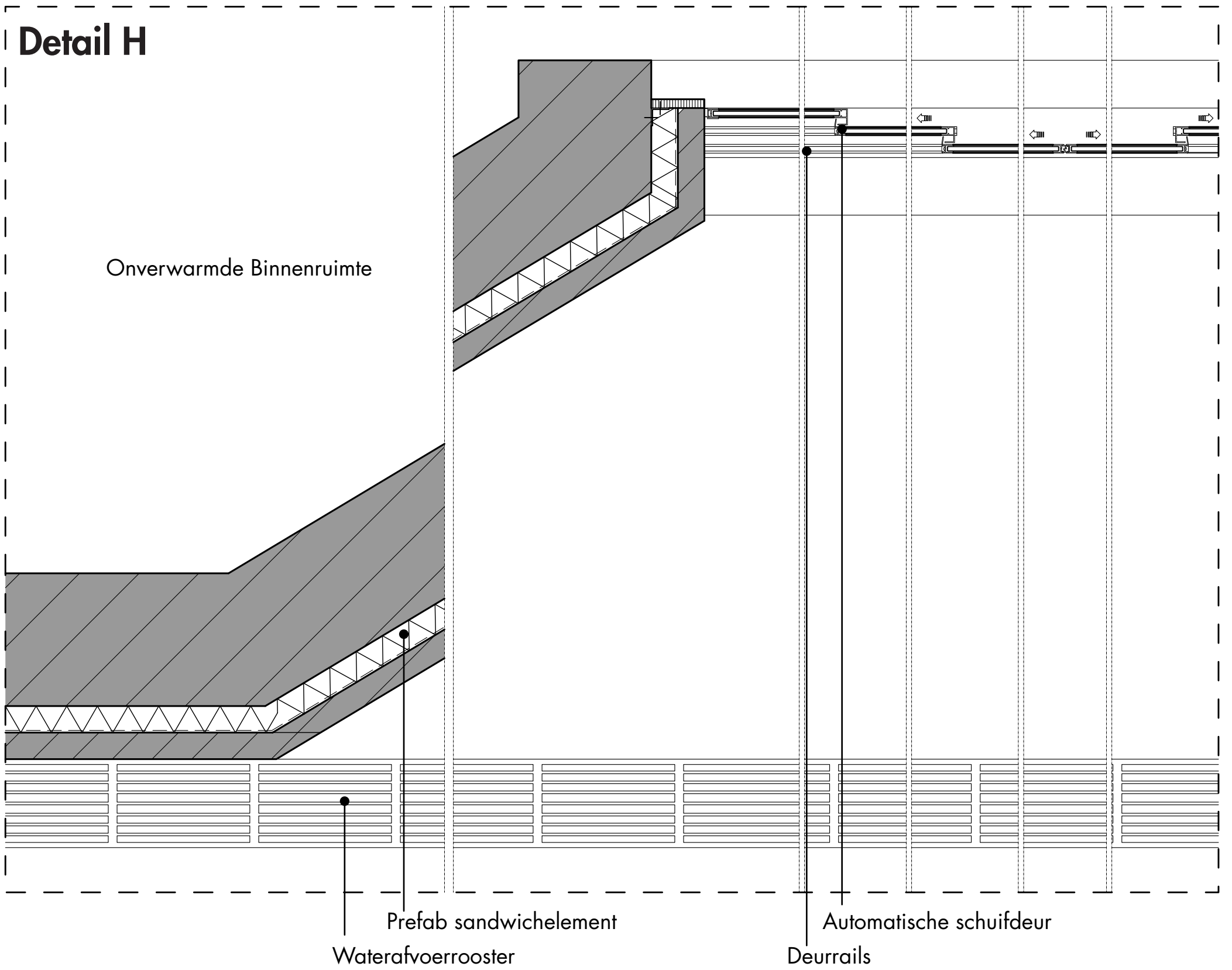
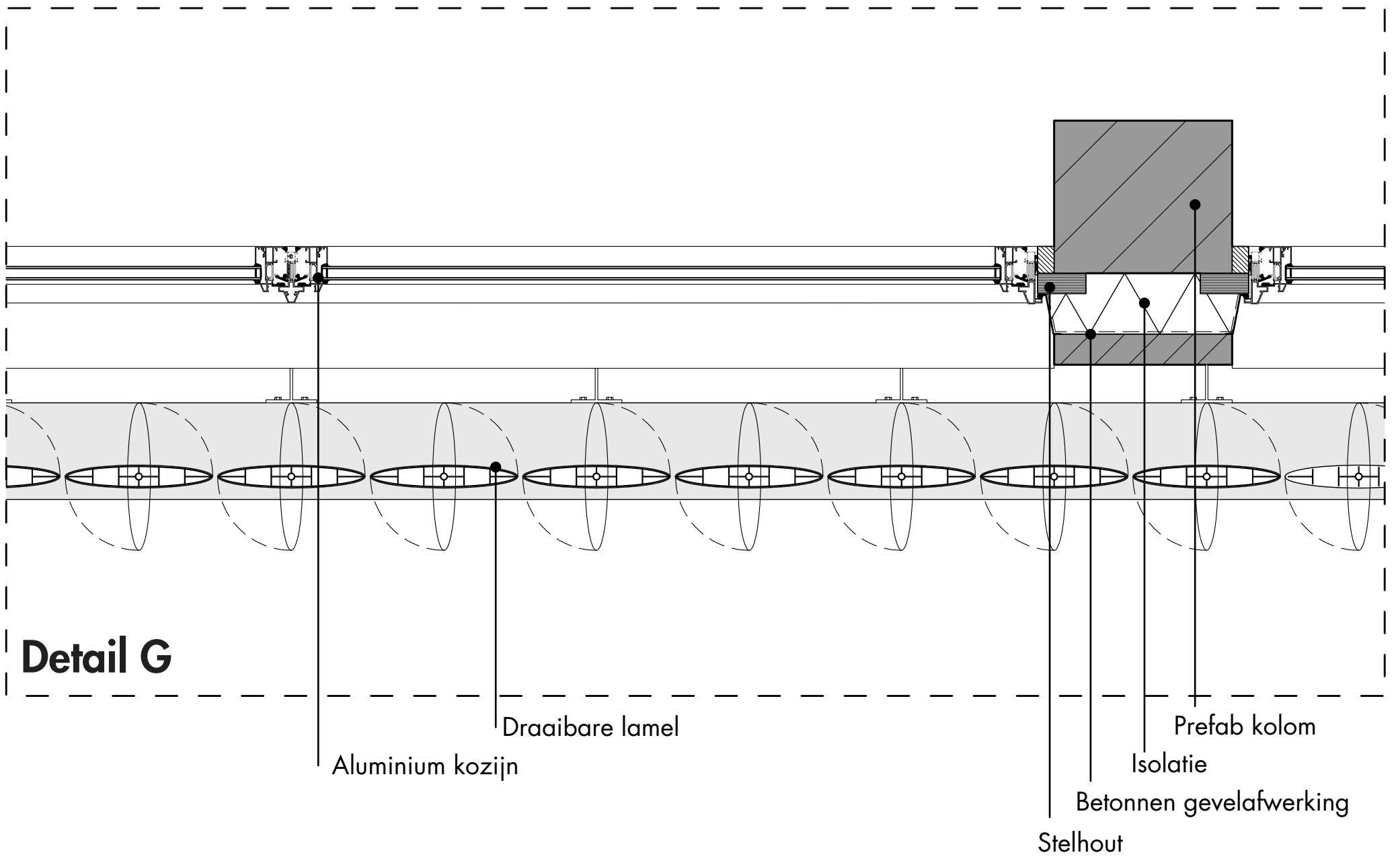





Gevelaanzicht Ingang Moskeezijde (West)

1 : 50

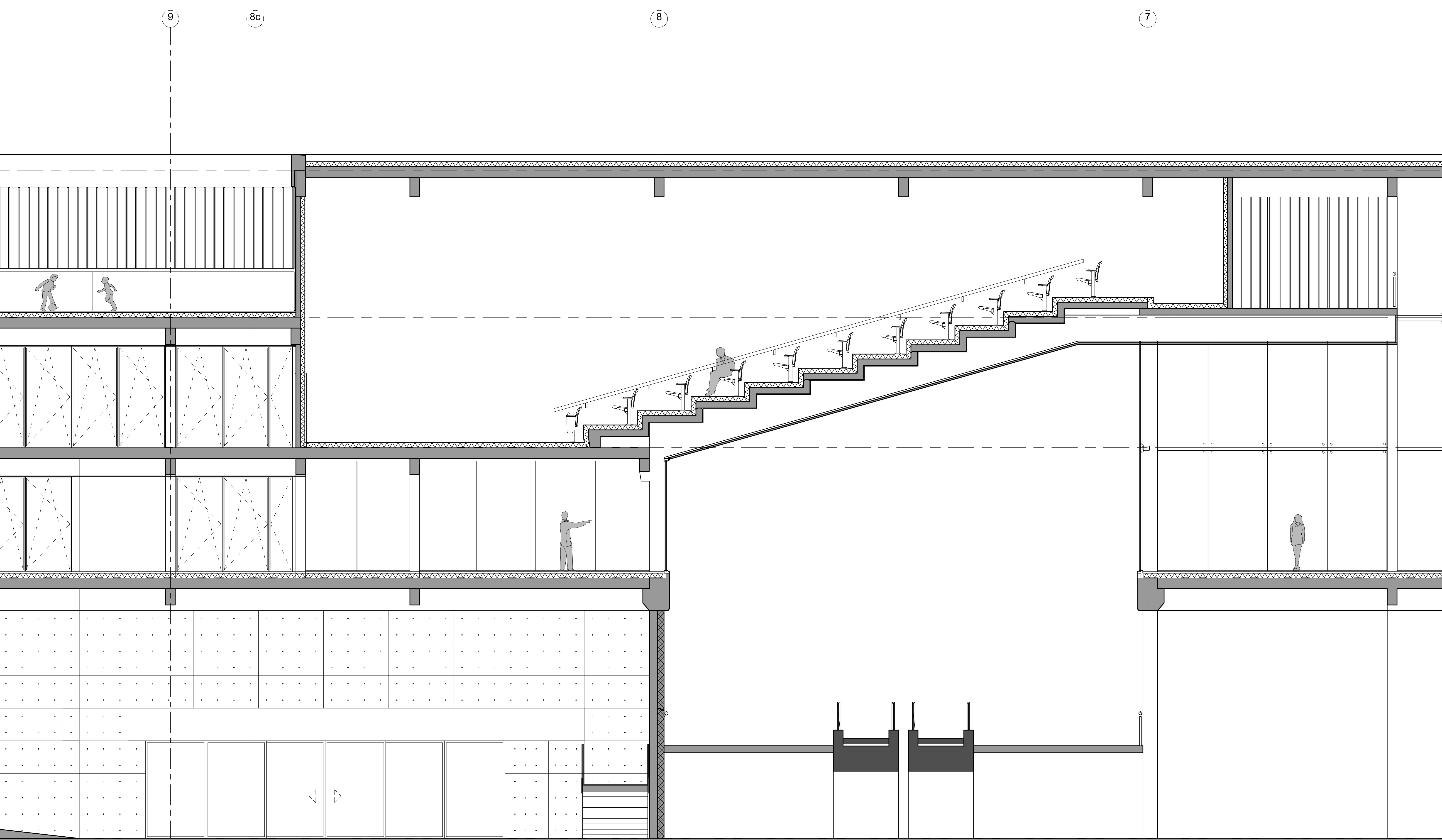

Langsdoorsnede Ingang Moskeezijde



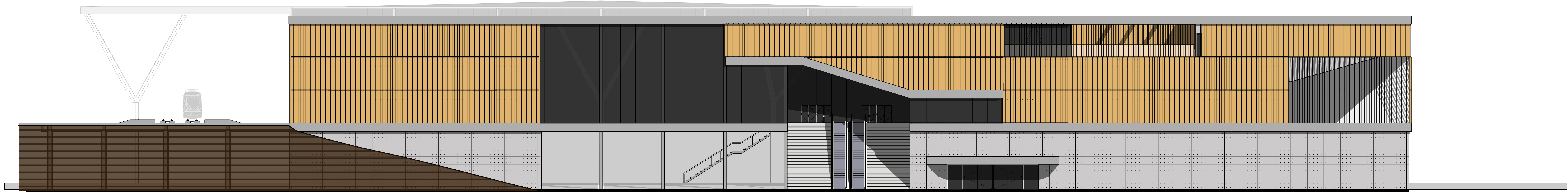

Westgevel

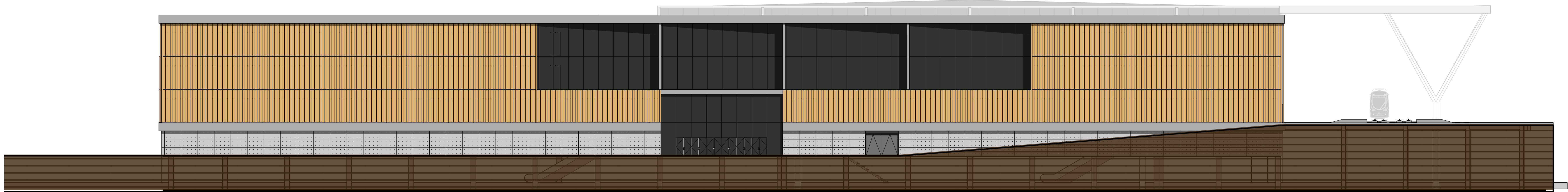

Oostgevel

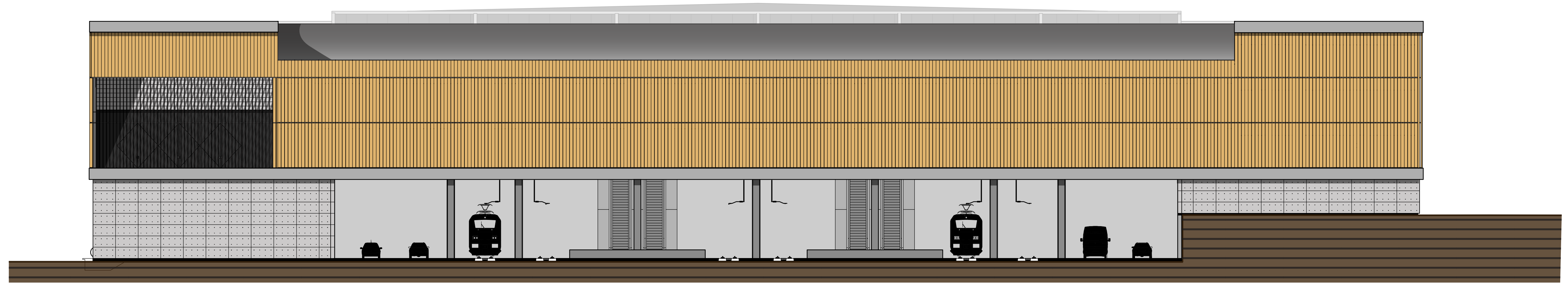

Zuidgevel

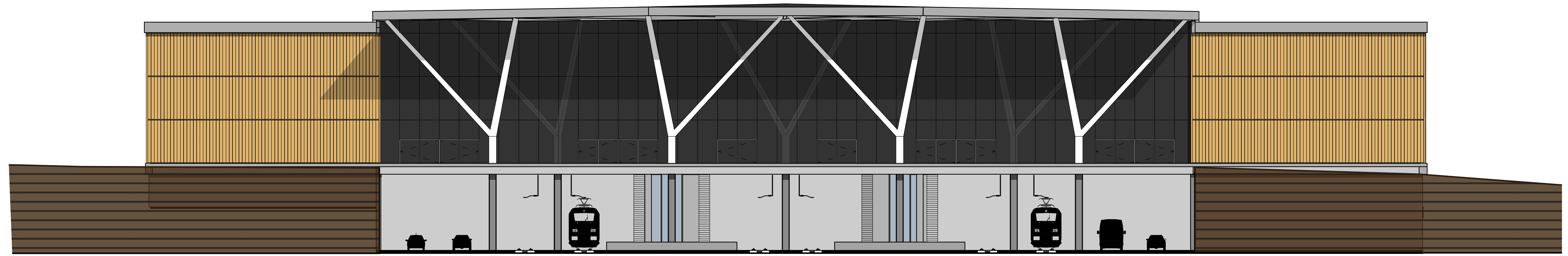

Noordgevel

GEVELS

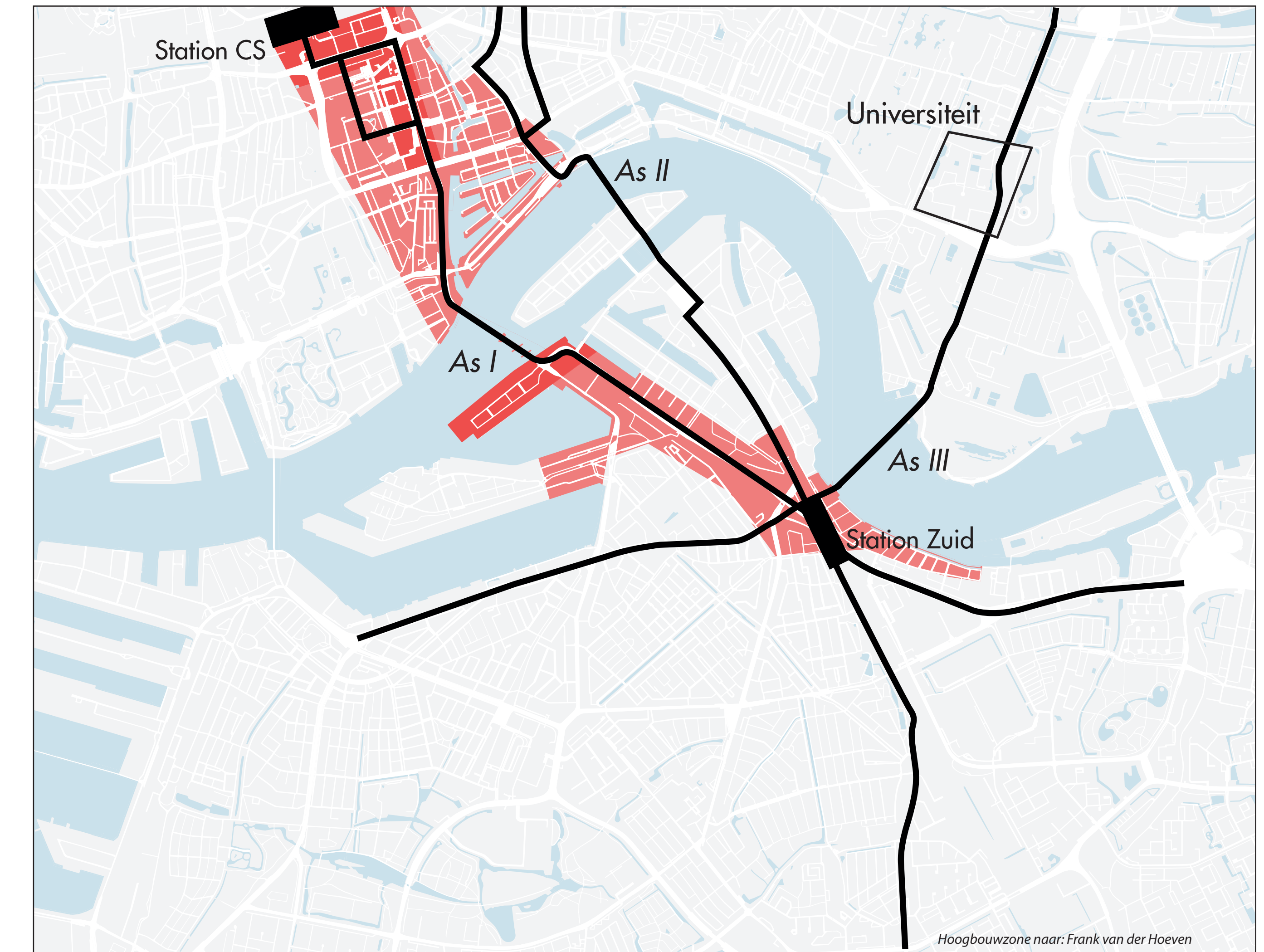

Stadsassen & hoogbouwvisie

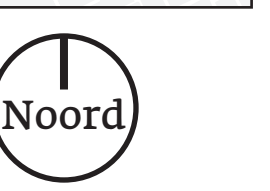





1 : 5000



Plangebied

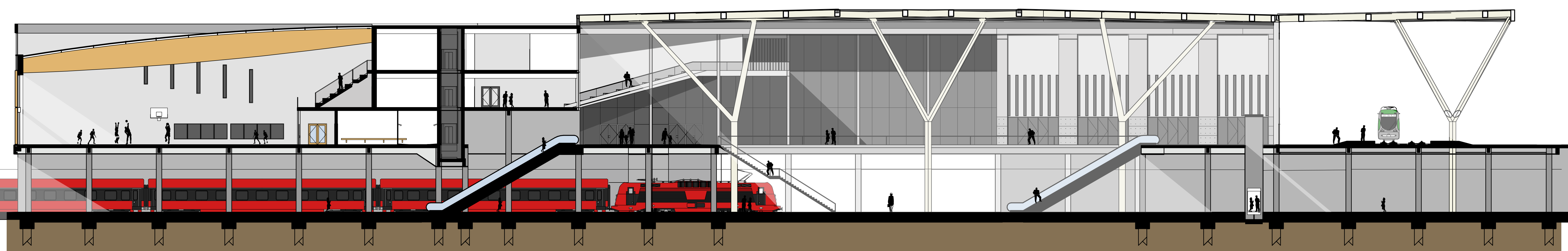

Langsdoorsnede

1 : 200

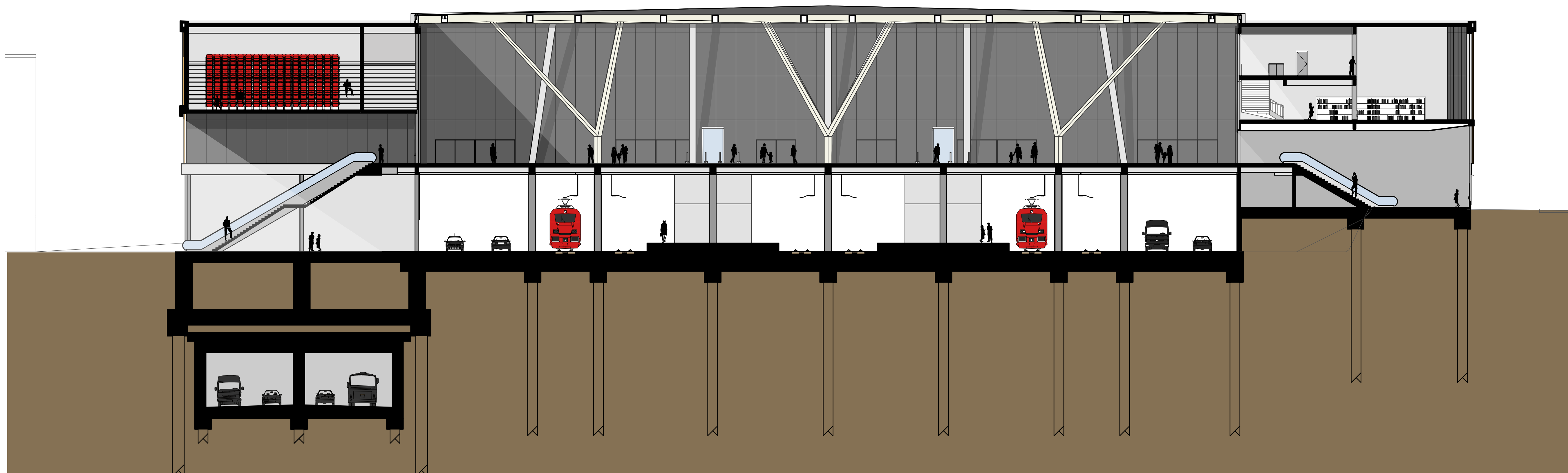

Dwarsdoorsnede





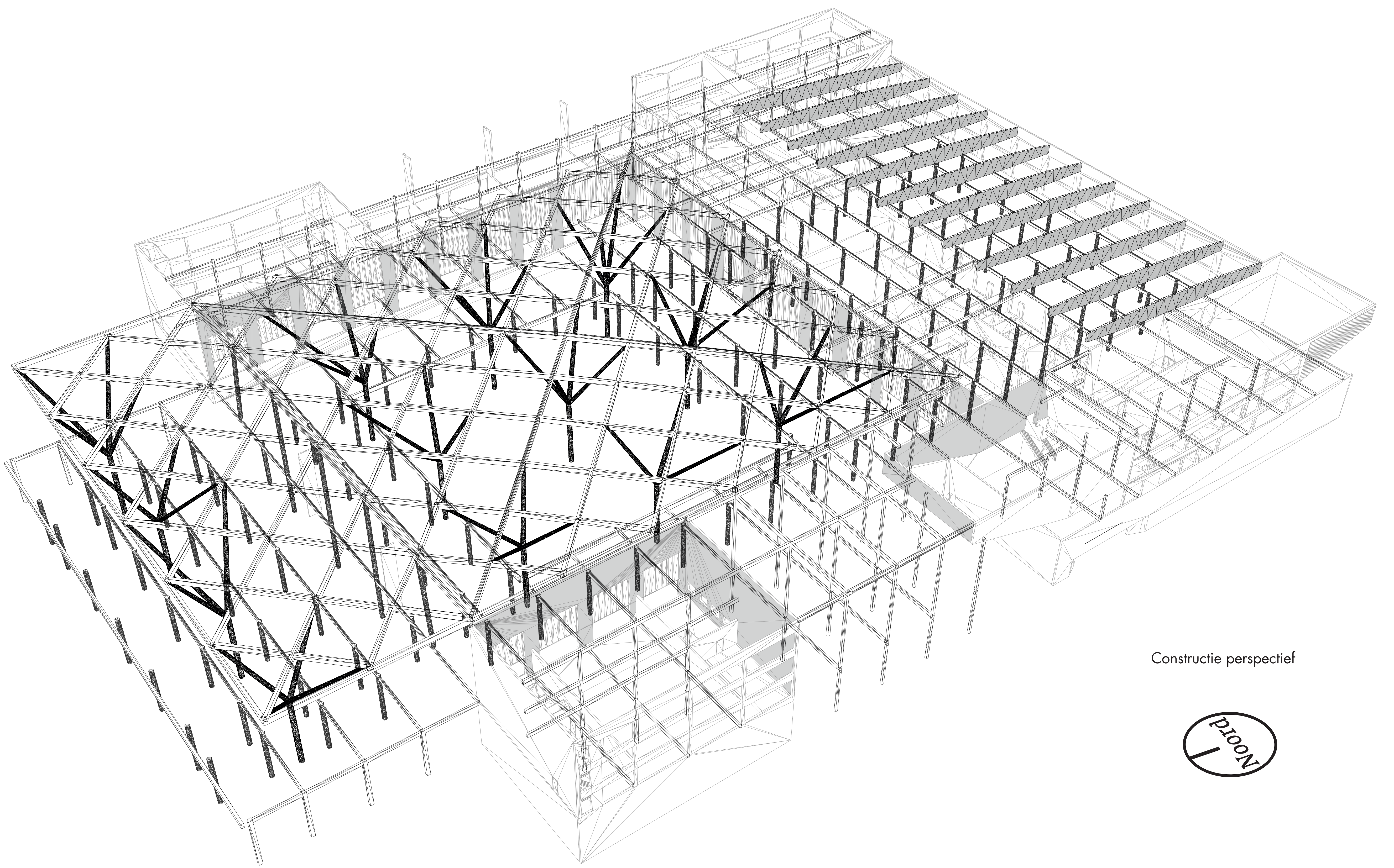

Constructie perspectief



1 : 1000

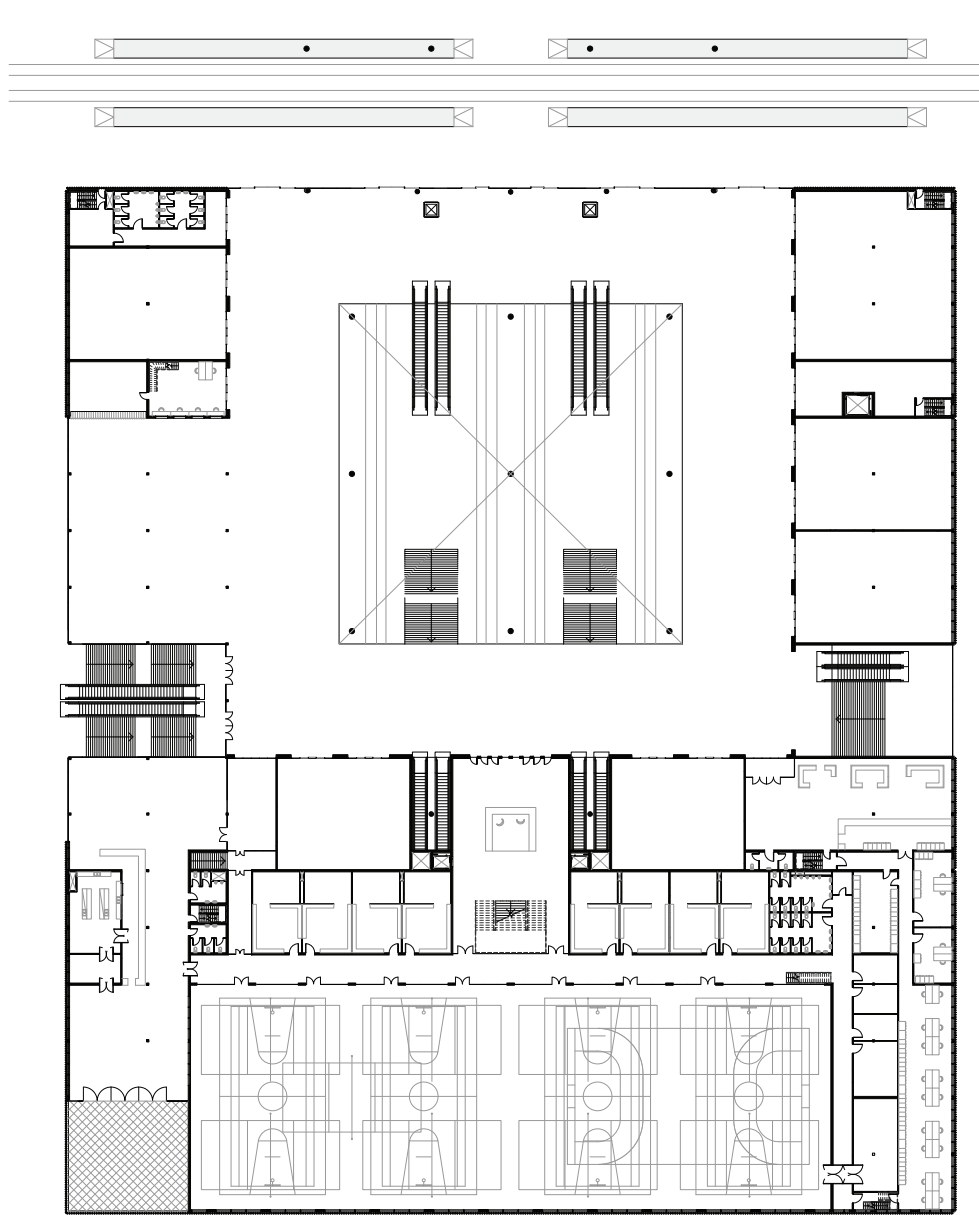

Constructieve opzet stationshal

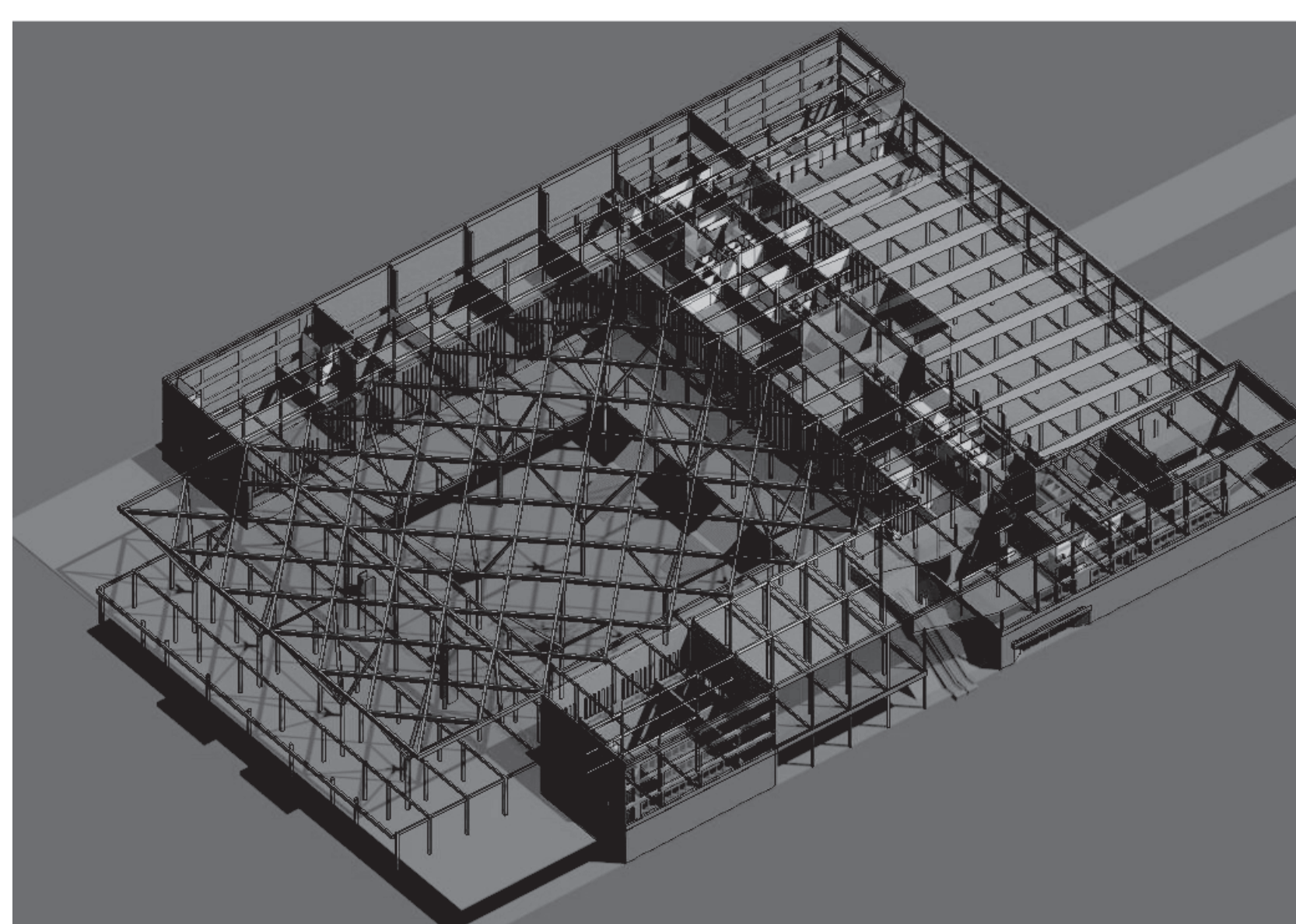

Ruimtelijke werking constructie

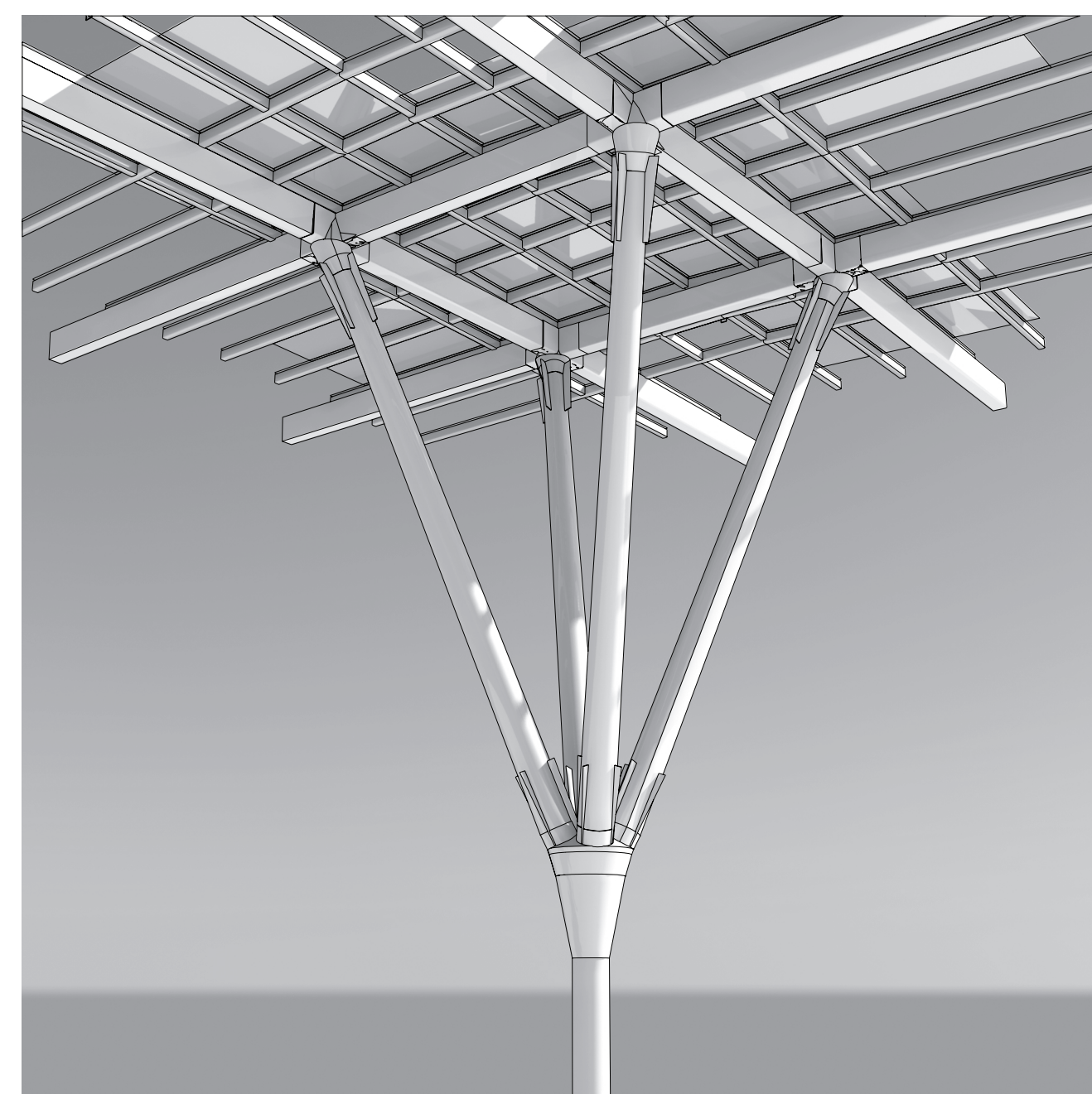

Isolering middenkolom stationshal

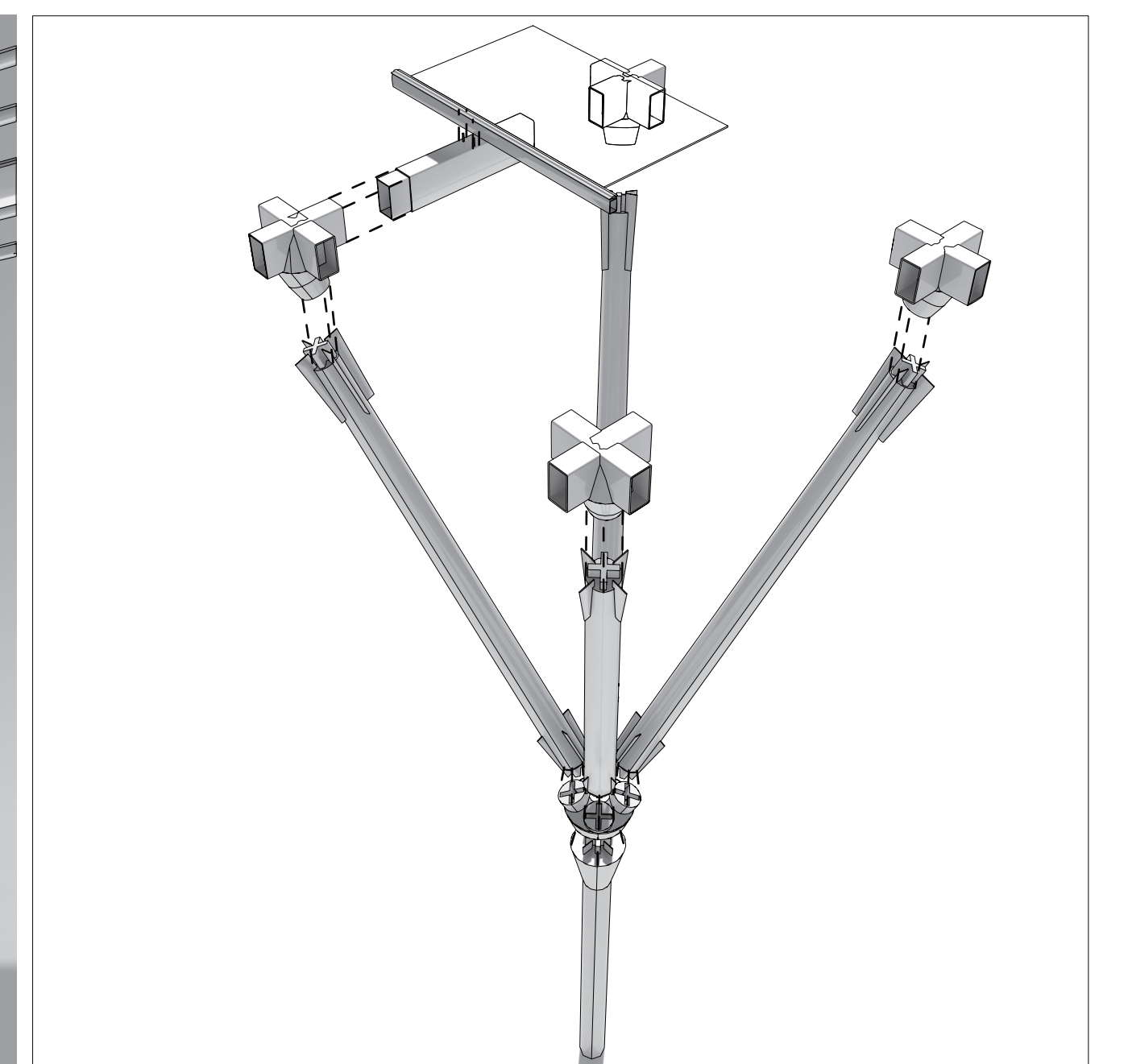

Axonometrie stationshalkolom

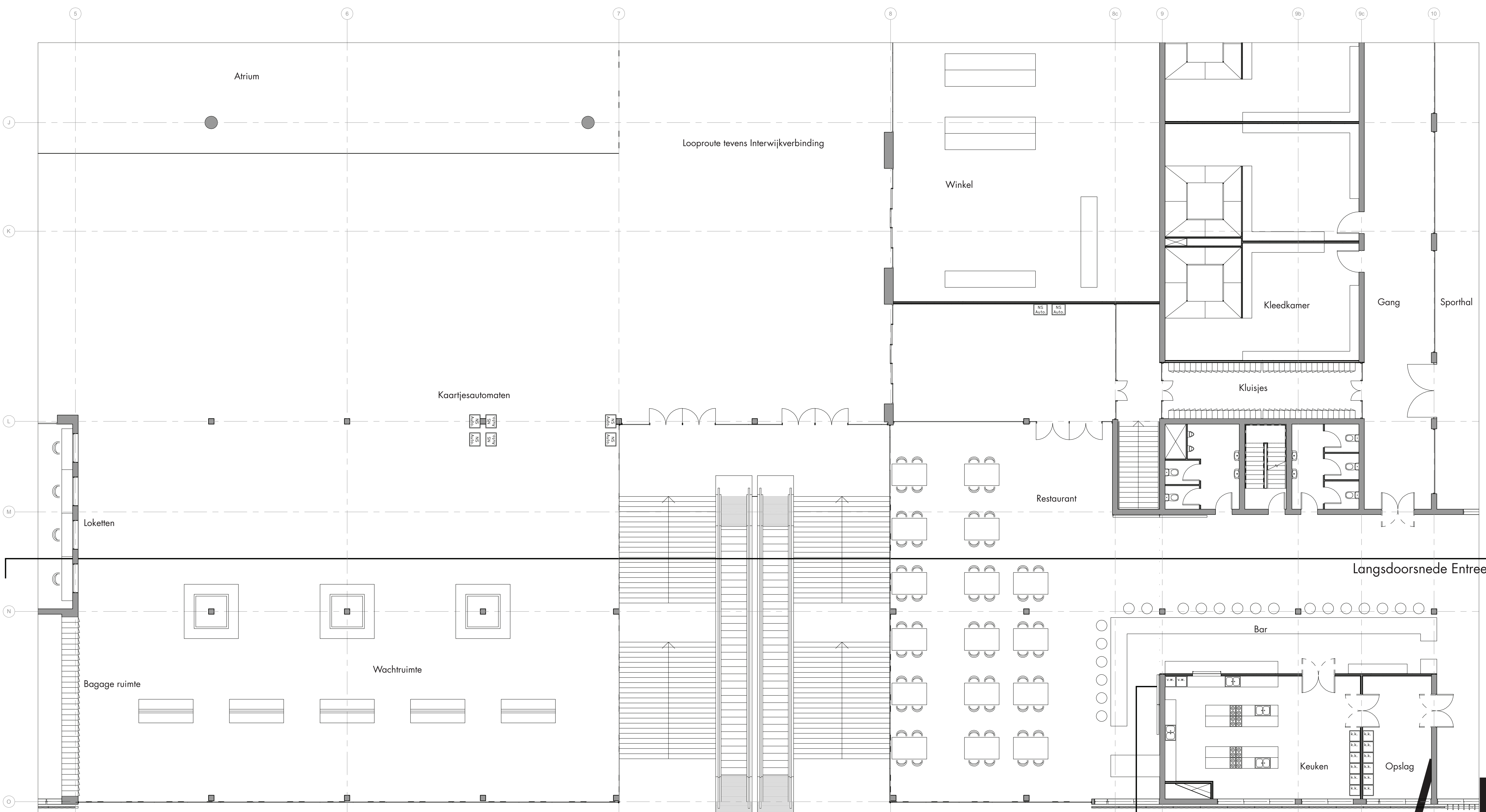

Uitvergroting Westingang

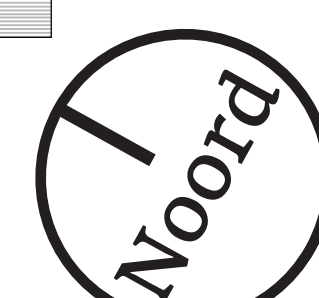

1 : 50

Geveldetails



CONSTRUCTIE



