

ITS EDU LAB

Shortening signal timings of vehicle-actuated controllers by using communicating, automated vehicles, in the transition period from fully human-driven vehicles to fully autonomous vehicles

F. van Giessen

13 August 2021



Rijkswaterstaat
*Ministry of Infrastructure
and Water Management*

TU Delft

Colophon

| | |
|----------------------|--|
| Author | F. van Giessen |
| Graduation Committee | Prof. dr. ir. B. De Schutter Chairman TU Delft, DCSC Dr. ir. A. Hegyi Daily supervisor TU Delft, CiTG, Transport & Planning Dr. ir. A. Salomons Daily supervisor TU Delft, CiTG, Transport & Planning Dr. ir. H. Taale Daily supervisor Rijkswaterstaat, dienst WVL TU Delft, CiTG, Transport & Planning |
| Published by | ITS Edulab, Delft |
| Date | August 31st, 2021 |
| Status | Final report |
| Version number | 1.0 |
| Information | Henk Taale |

ITS Edulab is a cooperation between
Rijkswaterstaat and Delft University
of Technology

Abbreviations

In the list below, the meaning of each abbreviation in this proposal can be found.

| Abbreviation | Meaning |
|---------------------|---|
| 4EG | 4 th extension green |
| AV | Autonomous vehicle |
| CAM | Cooperative Awareness message |
| FV | index for the follower vehicle of an AV |
| HDV | Human driven vehicle |
| IC | Intersection controller |
| iVRI | intelligent traffic controller |
| LV | index for the Leader vehicle of an AV |
| RBG | Red before green phase |
| SPat | Signal Phase and timing |

The list below states the meaning of technical terms used in the report.

| Technical term | Meaning |
|-----------------------|--|
| Conflict area | The area where two directions interfere with each other and a vehicle from both direction could collide with each other. |
| Gap time | The time between the last leaving vehicle clearing the the conflict area and the first entering vehicle reaching the conflict are of two conflicting directions. |
| Delay | The difference in time between the actual travelled time and the time it would have cost a vehicle to travel a certain distance without any interference. |
| Hybrid period | When AVs and HDVs are both on the road |
| Movement | The arrival direction to the leaving direction of a vehicle |
| Penetration rate | The total amount of AVs on the road over the total vehicles on the road. |
| Phase | It is the state a traffic signal can be in on a direction. The standard phases are green, yellow and red. Sub-phases also exist. |
| Scenario | The location and speed of the present vehicles at a direction that may change their behaviour when the phase switches at that direction |
| Stage | A combination of directions that will get green phase at the same time |

The variables mentioned in this report and its meaning, are presented below.

Variables $a_{acc,comf}$
 $d_{back,FV}^k(t_i)$ $a_{dec,comf}$
 d_{enter}
 $d_{front,LV}^k(t_i)$ d_{leave} $d_{measure,AV}^{k,dir}(t_i)$ $d_{veh}^k(t_i)$ (percentile) $d_{zone1,default}$ $d_{zone1,veh}^k(t_i)$ (percentile) $d_{zone1td,veh}^k(t_i)$ (percentile) $d_{zone2,default}$ $d_{zone2,veh}^k(t_i)$ (percentile) $d_{zone2td,veh}^k(t_i)$ (percentile) k $t_{detector,gap}$ t_{enter} l_{veh}^k $t_{clearance}$ t_i $t_{inter-green}$ t_{leave} t_{react} $t_{safety,veh-veh}$ $t_{sub-phase,start}$ $t_{sub-phase,end}$ veh v_{appr} $v_{measure,veh}^k(t_i)$ $\epsilon_{LIDAR}(\mu_{LIDAR}, \sigma_{LIDAR})$ $\epsilon_{GPS}(\mu_{GPS}, \sigma_{GPS})$ $\epsilon_{speed,AV}(\mu_{speed,AV}, \sigma_{speed,AV})$ $\epsilon_{speed,HDV}(\mu_{speed,HDV}, \sigma_{speed,HDV})$ $\epsilon_{track}(\mu_{track}, \sigma_{track})$ $\Delta t_{sub-phase}$ $\Delta t_{sub-phase,default}$ **Meaning**

Desired acceleration rate

The measured location of the front of the vehicle of the FV to the stop line at time step t_i

Desired deceleration rate

Distance from the stop line to the conflict area.

The measured location of the back of the vehicle of the LV to the stop line at time step t_i

Distance from the stop line to the front of the vehicle that just left the conflict area.

The measured location to the stop line of AV k on direction dir at time step t_i Location of vehicle veh from the stopline

Distance from the stop line to the beginning of the default dilemma zone

The distance from the stop line to the most downstream part of the dilemma zone of vehicle k

The distance from the stop line to the most

downstream part of the time-dependent dilemma zone of vehicle k

The distance from the stop line to the end of the default dilemma zone

Distance from the stop line to the upstream part of the dilemma zone of vehicle k

Distance from the stop line to the upstream

part of the time-dependent dilemma zone of vehicle k

number of an AV

Measured gap time by detector loops

Time it takes the front vehicle to drive up to the conflict area at the

intersection starting from the stop line

Length of vehicle k

The time between two directions to clear the conflict area.

Time step i

Time between two conflicting directions obtained green phase

Time it takes the last vehicle to drive from the stop line till it clears

the conflict zone

Reaction time before a driver acts

Safety clearance time

The start time of a phase

The end time of a phase

Indication for type of vehicle

Approach speed

The measured speed of veh k at time t_i

Percentile of distribution of error in measurement of LIDAR

Distribution of error in measurement of GPS

Percentile of distribution of error in measurement of speed of an AV

Percentile of distribution of error in measurement of speed of an HDV

Percentile of distribution of error in tracking a planned trajectory

Duration of the sub-phase

The default duration of a phase

Summary

In the Netherlands, over 5500 intersection control systems were present in 2019 [53]. Many improvements have been made in the last couple of years to decrease the delay of traffic crossing the intersections, as delay is expensive. One of the improvements implemented, is that most intersection control systems in the Netherlands change the duration of the green sub-phases based on the presence of vehicles [27] (vehicle-actuated control), instead of having fixed times per sub-phase. Still, intersections remain the bottleneck of traffic flow [6]. For the duration of yellow and for the minimal inter-green time of two directions, fixed times are used to guarantee safety. These fixed times are necessary because intentions of specific human-driven vehicles (HDVs) remain unknown, and measurements of the behaviour of HDVs at crucial moments are not provided by currently used data sources (detector loops).

All over the world, research is done to enable connected autonomous vehicles (AVs) to use our road network safely. We will have a transition (hybrid) period, where HDVs and AVs share the road. The connectivity and predictability of AVs provide opportunities to control intersections based on more real-time data. Every additional AV on the road can provide additional information; so the more AVs, the more information is accumulated. For this hybrid period, some new intersection control systems have been proposed but none of them improve the throughput when the penetration rate of AVs is low [2] [11] [38]. Some of them even deteriorate the throughput of the intersection at low penetration rates.

The throughput of an intersection is influenced by the amount of utilized green phase time of all directions in a complete cycle. Vehicle-actuated control is able to contribute to more utilized green phase as it extends the green phase as long as demand is measured to be present. Moreover, the red and yellow phase also influence the utilization of the green phase. Nowadays, the length of the yellow and red phase is calculated before the controller is installed. [27] uses standard equations to calculate these durations which include stochastic behaviour of drivers (HDVs) defined as distributions. The percentiles are set in such a way that for 99% of the time, a safe situation is guaranteed. This also means that for some vehicles the calculated times are longer than needed to cross the intersection. The gap time in these situations could then be higher than needed. The duration of the variable green sub-phases, are based on input data of detectors.

No research has been performed on how to decrease signal timings, using the information from AVs to predict the trajectories of present vehicles for the hybrid period. Research should be undertaken to investigate in which scenarios additional information of AVs could be useful to decide the duration of the phases. Furthermore, research needs to be carried out on which models can be used to predict the trajectories of HDVs and AVs and with what accuracy. This will provide the basis to be able to meet the research goal of this master thesis:

Designing a signalized vehicle-actuated intersection controller without compromising safety, for an isolated intersection with multiple conflict areas, by using the additional information of AVs, to shorten the timings of the phases according to the situation at the intersection, for the hybrid period (AVs and HDVs).

To be able to meet the goal, the research was divided into three sections: literature review, control system design and evaluation of the control system.

From the literature review in chapter 2, it can be concluded that AVs can provide information to an intersection controller about themselves, and their leader and follower vehicle. Furthermore, the calculations used by [27] to calculate the zone in which a vehicle can decide to stop or continue when the yellow light appears (the dilemma zone) and the clearance time (the time which the last vehicle of the leaving direction needs from the stop line till it leaves the conflict area minus the time it takes the first vehicle of the entering direction to reach the conflict area) can be adjusted to be able to include the measurements and behavioural parameters of the AVs. Moreover, it was identified that the tactics of the 4th extension green, the yellow phase and the red before green phase of the vehicle-actuated control as defined by [27] can be shortened, using the additional data of AVs.

A rule-based controller is generated for each of these phases, that first identifies the scenario at the intersection and then uses the adjusted prediction equations to calculate and apply the needed duration of the phases. The scenarios are identified based on where AVs and their follower and leader vehicle are and when these locations and speeds could be used in the prediction equations. Identification of the last vehicle to cross the intersection is key here, and this information comes from the dilemma zone. If all needed information can be obtained from the AV(s) around the dilemma zone, the duration of the 4th extension green, the yellow phase and the red before green phase can be adjusted accordingly, and the AV (or AVs) is given the assignment to stop before the intersection or continue driving. The desired outcome, is to make all phases as short as possible.

Errors and distributions of behaviour are taken into account in the prediction equations and measurements. Via sampling, the 99 percentile of the solution of the equations can be found. This is used to decide the control actions.

Via simulation it is concluded that the proposed controller indeed is able to truncate the duration of the phases based on the information of the AVs at all levels of penetration rates. It could also be observed that at low penetration ratios (< 2%) it does not influence the delay of the intersection (or even makes the delay worse) compared to the original controller. In general it is observed that the higher the penetration rate and demand, the more the delay decreases compared to the original controller. The range of average delay change per vehicle at penetration rates above 10%, is in the range of 0 to 3.5 s. The frequency of number of times the yellow phase and clearance time could be shortened increases linearly with an increase of the penetration rate. Via this it can be concluded that even when phases are shortened, the delay does not necessarily decrease as well.

In further research, it should be explored how the decrease in delay can be optimized further (also at lower penetration rates). This can be done by considering the scenarios at all directions in the same stage, with identical conflict areas with other directions, at the same time to decide the control actions. In the proposed controller in this research the control actions are only based on the scenario for each direction separately. This addresses that the most critical direction combination determines when phases can start the green phase. This becomes even more relevant when the proposed controller is adjusted to work for more complex intersections (where up to 5 conflict areas per direction can exist). At last, the proposed controller assumes the measurement errors and behavioural distributions to be known. This might not be the situation in reality. Therefore, a sensitivity analysis should be performed on what happens when the set distributions do not represent the actual behaviour and what the effect is on the performance when the deviation of the errors increases or decreases.

Preface

This master thesis is my final step towards graduation at the TU Delft. I have enjoyed my years as a student, and I would like to thank my friends, roommates and family for making that.

I would like to thank my supervisors for their guidance during this process. The discussions we had and their support and feedback helped me to improve and be critical about my work.

Delft, August 2021

Contents

| | | |
|-------|---|----|
| 1 | Introduction | 1 |
| 1.1 | Factors influencing the throughput of signalized intersections | 1 |
| 1.2 | Research gap | 2 |
| 1.3 | Problem definition and description | 4 |
| 1.4 | Objective | 5 |
| 1.5 | Research goal | 6 |
| 1.6 | Research methodology | 6 |
| 1.6.1 | Literature review | 7 |
| 1.6.2 | Design of the intersection control system | 7 |
| 1.6.3 | Evaluation of the controller | 7 |
| 2 | Literature review | 9 |
| 2.1 | Performance of an intersection | 9 |
| 2.2 | Communication means | 10 |
| 2.2.1 | Communication between the IC and HDVs | 10 |
| 2.2.2 | Communication between the IC and AVs | 11 |
| 2.2.3 | Measurements of equipement in an AV | 11 |
| 2.3 | Current vehicle-actuated intersection control systems | 11 |
| 2.3.1 | Sub-phases of vehicle-actuated control explained | 12 |
| 2.3.2 | Sub-phases that can be shortened using additional data from AVs | 13 |
| 2.4 | Trajectory prediction of leader AV and HDV | 17 |
| 2.4.1 | HDV as leader vehicle | 17 |
| 2.4.2 | AV at the front of the queue | 17 |
| 2.5 | Uncertainty of trajectory of the last vehicle in the queue | 18 |
| 2.5.1 | Uncertainty of trajectory of an HDV in a queue | 18 |
| 2.5.2 | Uncertainty of trajectory of an AV in a queue | 19 |
| 2.5.3 | Behaviour platoon with AV and HDV | 20 |
| 2.6 | Conclusion | 20 |
| 3 | Control system design | 22 |
| 3.1 | Identification performance indicators | 22 |
| 3.2 | Assumptions | 22 |
| 3.3 | Problem analysis in traffic engineering terms | 23 |
| 3.3.1 | Connection between (sub-)phases of conflicting directions | 24 |
| 3.3.2 | 4 th extension green | 24 |
| 3.3.3 | Yellow phase | 27 |
| 3.3.4 | Red before Green | 32 |
| 3.4 | Problem analysis in control engineering terms | 37 |
| 3.4.1 | Input | 37 |
| 3.4.2 | 4 th extension green | 39 |
| 3.4.3 | Yellow phase | 41 |
| 3.4.4 | Red before green phase | 43 |
| 3.4.5 | Obtain numerical of percentile of distribution | 44 |
| 3.5 | Selection of the type of controller | 44 |
| 4 | Control system evaluation | 46 |
| 4.1 | Selection of input | 46 |
| 4.1.1 | Penetration rate | 46 |
| 4.1.2 | Traffic demand | 47 |
| 4.2 | Selection of simulation tool | 48 |

| | | |
|-------|---|-----|
| 4.3 | Set-up of simulation | 50 |
| 4.3.1 | Modelling AVs and HDVs. | 50 |
| 4.3.2 | Lay-out of the intersection and parameters of the control system | 51 |
| 4.3.3 | Control system in matlab | 52 |
| 4.3.4 | Verification | 54 |
| 4.4 | Interpretation results | 55 |
| 4.5 | Discussion | 63 |
| 5 | Discussion and conclusion | 64 |
| 5.1 | Results and importance | 64 |
| 5.2 | Shortcomings of the research | 64 |
| 5.3 | Future research | 65 |
| 5.4 | Conclusion | 67 |
| A | Academic paper | 68 |
| B | Design of the controller | 82 |
| B.1 | Prediction equations | 82 |
| B.2 | Algorithm for sampling | 85 |
| B.3 | Equations for which sampling is not needed | 85 |
| B.4 | Sub-phases in rule-based controller format | 85 |
| B.5 | Rule-based controller in mathematical terms | 90 |
| B.5.1 | 4 th extension green | 92 |
| B.5.2 | Yellow phase | 94 |
| B.5.3 | Red before green phase | 98 |
| B.6 | Vehicle-actuated control based on data of detector loops in rule based format | 99 |
| C | Simulation settings | 102 |
| C.1 | Parameters of the lay-out of the intersection | 102 |
| C.2 | Settings in VISSIM | 102 |
| C.3 | Parameters used for offline tables for sampling for the needed percentile with variable input | 105 |
| D | Simulation results | 106 |
| D.1 | Total delay and total traveled time per input | 106 |
| D.2 | Trajectories of vehicles | 106 |
| | Bibliography | 109 |

Introduction

In the Netherlands, in 2019 over 5500 intersection control systems are present [53]. Many improvements have been made in the previous years to increase the throughput and decrease the delay of intersections, as delay is costly for society. Every hour of lost time costs 10 euros [59]. Even with all improvements, intersections remain the bottleneck of traffic flow in urban networks [6].

New technologies are researched, that make vehicles more autonomous, with a future goal: mostly having connected and autonomous vehicles (AVs) on the road. The reason for this is that AVs have shown to increase the throughput on the road (including intersections) and decrease emissions compared to conventional cars [5]. New intersection control systems have been proposed, that use the predictability and controllability of each AV. But, before this 'only-AV' period will start, there will be a transition (hybrid) period where human-driven vehicles (HDVs) and AVs share the road.

The connectivity and predictability of AVs gives opportunities to control intersections based on more real-time data. Every additional AV on the road can provide information. It is shown what factors affect the throughput of a signalized intersection and secondly, if there is potential to use the additional information of AVs.

1.1. Factors influencing the throughput of signalized intersections

The throughput of a signalized intersection is influenced by multiple factors. These factors have been addressed in previous research, and are elaborated upon in this section. A causal diagram of all these factors can be found in figure 1.1. The content of the figure is explained in this section.

The throughput of an intersection is directly influenced by the amount of utilized green phase time and the stage structure [43]. Both these factors are explained and elaborated upon.

Utilized green phase

The utilized green phase time is the time that a direction is in the green phase and vehicles actually cross the intersection. Due to reaction time of vehicles, the first part of the green phase is not utilized green phase, as the HDVs do not yet move. The utilized green phase depends on the length of the green phase but also on the length of the red and yellow phase. As long as a direction is in the red or the yellow phase, automatically, no utilized green time is occurring.

Green phase

Most intersection controllers in the Netherlands use variable green phase duration [27]. This factor is included in figure 1.1 as (1). The green phase is affected by other factors. These are addressed in this section. The duration of the green phase can be determined via multiple tactics. Minimal and maximal green times are set for intersection control to maintain fairness among all directions. For variations in demand, flexible maximum and minimum green time could also provide a decrease in delay [47]. Furthermore, to optimize the throughput, the demand at the intersection can be used to give green according to (future) present vehicles [27] [53]. This demand could either be measured by sensors at the intersection (vehicle-actuated control) or be predicted by sensors more upstream of the intersection (traffic demand). Vehicle-actuated controllers use detectors to identify the presence of vehicles. It consists of a detector at the stop line and an extension detector. At the stop line, the detector measures if vehicles are present. There could also be a detector more upstream to request green earlier than at the stop line of the intersection [28]. The extension detector is used to identify the length of the queue. The measurements of the detector loops are limited because the loops are at fixed locations [27].

Other controllers predict the demand based on a combination of sensor data. Researched mechanisms for intersection control to predict traffic demand are described next.

- Currently, about 800 intelligent intersection controllers (iVRIs) have been installed in the Netherlands. Cooperative Awareness Messages (CAM) are received by the iVRIs. CAM messages come from in-car devices and provide information on where the car is. Not all vehicles use this in-car device to generate CAM messages. Therefore, this information is incomplete, and predictions have to be made by the iVRI on the demand. These messages provides additional information from vehicles to the intersection (connected vehicles), next to induction detector loops [53].
- Data of different sensors can be fused to provide a more accurate prediction. These sensors could be either induction loops (that are used mostly nowadays) but also CAM or wireless sensors [55]. [52] uses GPS data to estimate queue lengths as an additional source next to induction loops.

Yellow and red phase

While waiting at a red light to cross the intersection, at most times it can be reasoned why waiting is necessary. Sometimes though, when waiting in the queue, especially when the direction is about to continue to the green phase, the intersection is already cleared some time before the next direction obtains the green phase. The reason for this is that there is a fixed waiting time set, before the next direction can obtain green. This fixed time is based on predictive equations for the clearance time and the duration of the yellow phase. The clearance time is the time it takes the last vehicle to drive from the stop line to leave the area where the two directions collide (the conflict area) and the first upcoming vehicle of the conflicting direction to reach this area from the stop line. This can be seen in figure 1.1 as (2). Research has been performed on how to predict the needed fixed clearance time [27] [33] [36] [41]. None of them explores the possibility of variable clearance time. These researches focused on finding a fixed clearance time that fits with the stochastic behaviour of HDVs only.

Besides the predictions on the fixed times for these two phases, the time in which vehicles cross the intersection could also be decreased. This can be seen in figure 1.1 as (4). The time it takes for the first vehicle, from the upcoming direction that will obtain green, to reach the conflict area can be different per situation. From either standstill or an approaching speed, a driver has a reaction time [57]. This reaction time is the time they need to process the change of the phases mentally and react to it physically. It could also be due to a driver being distracted [27]. When applying a countdown before green, this lost time decreases [30] [56]. At iVRIs, this count down can be provided via in-car devices [53]. Furthermore, it was researched that the approaching speed of the vehicle or the knowledge of when the phase would turn green, could increase the speed in which the vehicle is able to reach the conflict area [67] [69]. In the research of [67] AVs were given a speed advise so stopping completely at the stop line is not necessary anymore. If HDVs are following an AV, they get enforced too, to follow this speed advice, unless the HDV will overtake the AV. The speed advice could also be directly communicated via in-car devices to the HDVs but it is unknown what percentage will use the advice [53].

Stage structure

All directions at an intersection belong to one ore more stages. Each stage can only contain directions that have no conflict with each other. Directions can be distributed into different stages in many different ways. A direction can belong to multiple stages. Different distributions of directions in stages (stage structure) can have different delay results. The stage structure should thus be chosen strategically. This can be seen in figure 1.1 as (3). Directions in the same stage will go through the cycles at about the same time. The end time of green can be slightly different per direction of the same stage. With a control structure that has some flexibility (the combination of directions that obtain the green phase at the same time), all non-conflicting directions that are possible, are in the green phase at the same time while the cycle time is not unnecessarily increased [27] [43]. This flexibility is for example added in vehicle-actuated control with fixed control stages. If a direction has a demand but does not belong to the stage that is in the green phase and has no conflict with one of the directions that is currently in the green phase, it can already be given green (if the direction in the next stage would obtain green). This is sub-green phase is called the induced green phase [43].

1.2. Research gap

Many different control mechanisms have been explored for the period when all vehicles can communicate, and all trajectories can be controlled. Most proposed systems find the best trajectory of each AV to cross the

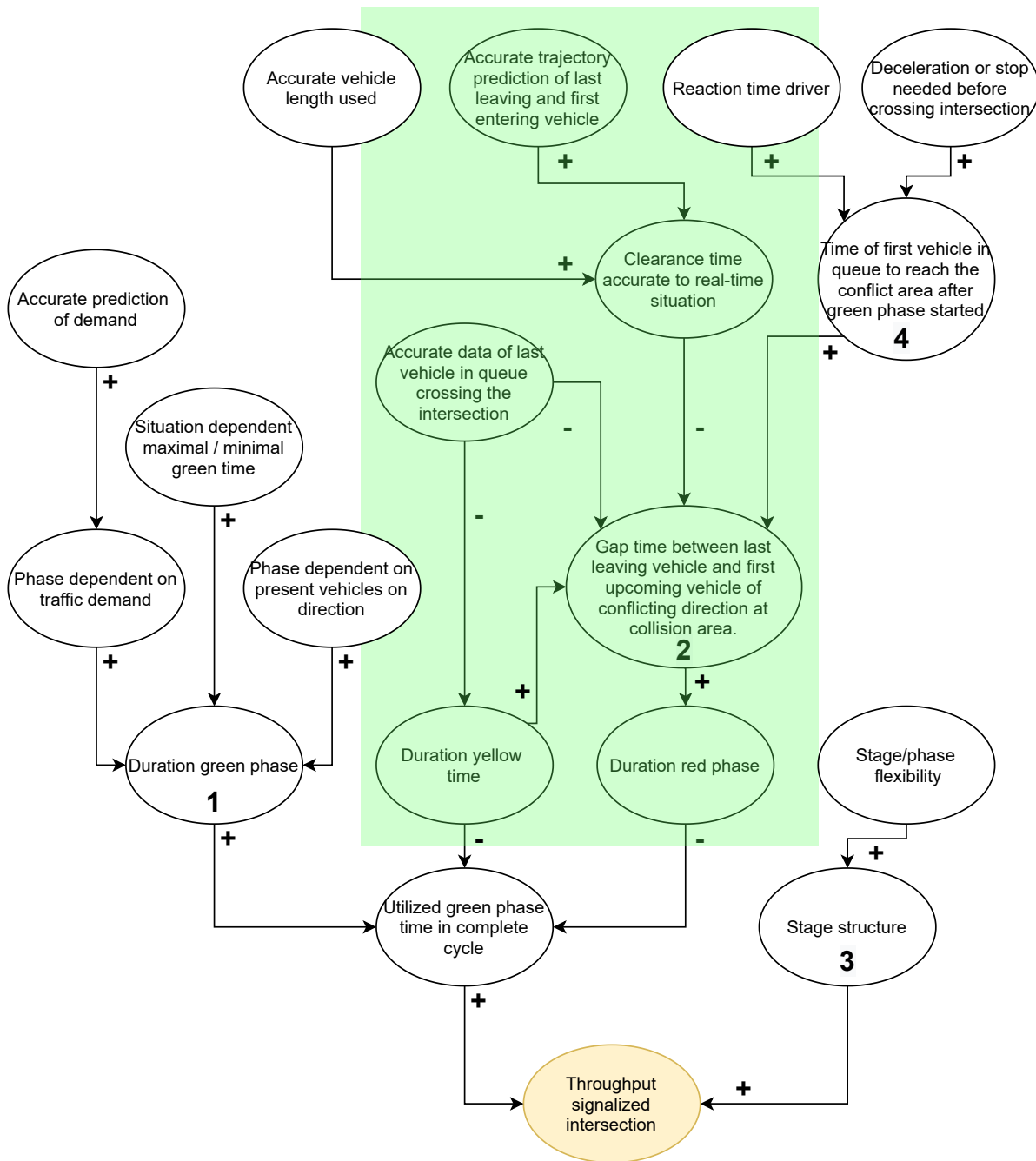

Figure 1.1: Causal diagram of factors influencing the throughput of signalized intersections. - A plus between two factors means that if one increases, the other also increases. It also means that when one decreases, the other one will decrease as well. When a minus is presented it means that if one goes up the other one decreases.

intersection without collision. Accurate predictions of the trajectories means that AV can cross each other with a short gap time in between [3] [4] [16] [34]. In this way, the vehicles are weaving across the intersection. But before this can happen, a hybrid period of HDV and AV will be the reality.

For the hybrid period, some intersection control systems have been proposed but none of them improve the throughput when the penetration rate of AVs is low [2] [11] [38] [46]. In these systems, HDVs still follow the directions of the traffic lights while AVs negotiate with the intersection controller (IC) directly about the path they should take on the intersection at what time (and ignore traffic lights). In the control system proposed in [38], platoons of vehicles in one direction are formed with an AV leader. The leaders of all platoons negotiate when to cross the intersection. For this, the leader predicts and plans the trajectory of his complete platoon.

Only when the penetration rate of the AVs is high enough, this part of the system will be activated. Before that penetration rate is obtained, no gains will be provided by the extra information AVs provide. [11] uses a fixed sequence of directions that will be in the green phase, without optimization of the stage structure, and a fixed green time. AVs do not cross the intersection based on the phase of the direction they are in, but directly communicate about the availability of their proposed trajectories in time with the intersection controller. This limits the HDV. [46] provided an improvement on this controller. Based on sensor data, the duration of the green phase could be adjusted. When the penetration rate is low, still this means most area on the intersection is not in use most of the time. This controller therefore performs less than the current controller at low penetration rates.

As shown in section 1.1, many improvements have been proposed to be able to increase the throughput of vehicle-actuated control. In vehicle-actuated control research has been performed on variable duration of the green phase based on sensors. Variable green phases have shown an increase in throughput of the intersection. For the other phases, yellow and red, research has been done on how to determine the fixed duration of these phases. These fixed times are needed due to the stochastic behaviour of HDVs. But no research has been done on how to use sensor data (potentially from AVs) to make these phases variable during the use of the intersection, to comply more to what actually happens at the intersection. Every additional AV on the road could therefore possibly provide data for the controller to be able to shorten the signal timings. This thus implies that this approach can already deviate from the original vehicle-actuated controller from a low penetration rate.

This research therefore focuses on making a controller for the complete range of penetration rates by shortening the timings of the phases, if the situation allows.

1.3. Problem definition and description

Above is stated what the research gap is. The factors and the problems therein that are addressed in this research, are highlighted in figure 1.1.

The timings of the phases are predetermined before the controller is in action. The yellow phase in the Netherlands means that drivers need to stop at the intersection when possible [27]. For the yellow phase, a duration is taken in which all vehicles that could decide to cross, are able to do so, within the duration of yellow phase. To determine the time when red of the upcoming direction can be actuated, the predicted clearance time is added to the end time of the yellow phase of the leaving direction. The stochastic behaviour of vehicles is taken into account in these predictive equations. Based on observations from many vehicles, a certain distribution of behavior is identified. For a given HDV, it is not clear what the behavior on this distribution will be. The fixed times are therefore determined with parameters of vehicles that cause more critical situations [27]. These fixed times are needed because intentions of specific human-driven vehicles (HDV) remain unknown, and measurements of the behaviour of HDVs at crucial moments are not be provided by currently used data sources.

This means that for some vehicles the fixed time between green of two directions, overestimates the time that is actually needed for both vehicles to cross the intersection safely. This means that the gap time between conflicting directions is sometimes bigger than needed (it cannot become 0 or collisions will occur). The gap time is shown in figure 1.2.

[28] shows that the fraction used yellow time for roads with a maximum speed of 40-80 km/h is between 40-41%. For a 50 km/h road yellow time is 3.5 s which means about 2 s are not used. Knowing exactly when the last vehicle of a direction enters the intersection means yellow time could be shortened accordingly. Not all drivers use yellow light the same way. Some will start breaking when receiving yellow light where others would have continued driving [21]. This means the it is not always known what the last driver to cross the intersection will be. The last vehicle entering the intersection during yellow light, will thus not always be precisely when yellow ends.

The clearance time is calculated by predicting the possible trajectories of the last leaving vehicle and the first upcoming vehicle of conflicting directions from the stop line to reaching or leaving the conflict area. When the clearance time starts, it can be that the last vehicle has already passed the intersection.

Furthermore, the Dutch government has set rules that the green phase of two conflicting directions is not allowed at the same time. So, even if the clearance time is a negative number that is higher than the yellow phase default time, according to the law it should be at least 0. The yellow and green phase of two conflicting directions is allowed at the same time [27] [49]. The clearance time could for example be a negative when the

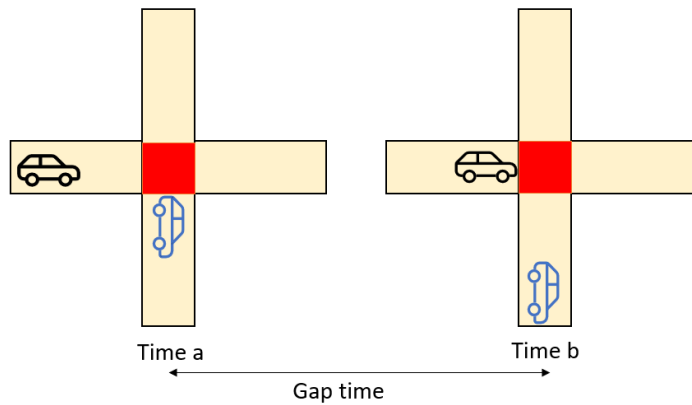

Figure 1.2: Gap time between the last leaving vehicle and the first upcoming vehicle on conflicting directions

upcoming direction has a long distance to cover from the stop line to the conflict area.

When future trajectories of vehicles are accurately predicted, more information about future traffic states is known and the clearance time can be predicted according to that knowledge. Also, the knowledge of what the last vehicle will be when the yellow phase starts would provide more information to the controller, to re-examine its control actions. Uncertainty of the trajectories of HDV will always remain due to irregular behaviour of drivers [44] [6]. But additional measurement by AVs could provide more information on the behaviour of the vehicles on crucial moments to predict the intentions of the HDVs.

1.4. Objective

The objective is thus to decrease the delay of a signalized vehicle-actuated intersection, by the design of a control system that uses real-time information of AVs to adjust the timings of the phases, without compromising safety in a hybrid situation where AVs and HDVs share the road.

The additional information of AVs can be used to more accurately predict the possible trajectories during the above mentioned phases. With these predictions on trajectories, control actions could be provided to shorten the signal timings. To give an overview of where the additional information of an AV can effectively be used, a few scenarios are regarded below. These are elaborated upon in chapter 3.

- *When the last leaving vehicle is an AV* - The AV communicates additional information to the controller. With this information the variance of the possible trajectories of the last vehicle decreases, compared to when it would have been an HDV. The vehicles in front of the AV might also have an effect on the trajectory of the AV. Therefore, the prediction of the trajectory of the last AV should also possibly take the irregularities of HDVs in front into account.
- *When the first upcoming vehicle is an AV* - This is about the same as the above mentioned scenario. Only here, the trajectory of the first upcoming vehicle is not influenced by vehicles in front of it.
- *When the last leaving vehicle can be observed by an AV* - Additional information of an HDV can be obtained when an AV in the same direction, is behind or in front of the HDV. The additional information that an AV can provide of another vehicle is more limited than the information about itself. The scenario where an AV is last and the scenario where an HDV is last, should therefore be regarded separately. Here, again, the behaviour of the predecessors and their influence on the trajectory of the HDV should be explored.
- *When the first upcoming vehicle can be observed by an AV* - This again is similar to the above mentioned scenario. The exception here is that the first vehicle is not influenced by predecessors.

Based on more elaborate scenarios, it is researched to what extent predictions about trajectories can be made and what control actions could be applied to shorten the signal timings.

1.5. Research goal

The main research goal of this master thesis is thus:

Designing a signalized vehicle-actuated intersection controller, for an isolated intersection with multiple conflict areas, by using the additional information of AVs, to shorten the timings of the phases according to the situation at the intersection, for the hybrid period (AVs and HDVs), without compromising safety

To obtain the main research goal, the following sub-questions (SQ) needed to be answered:

1. SQ1: What scenarios at intersections could benefit from additional real-time information to decrease the duration of the phases?
2. SQ2: What additional information from AVs decrease the uncertainty in the predicted trajectories of the vehicles?
3. SQ3: What parts of the proposed controller have most impact on the performance of the intersection at different penetration rates?

The methodology in section 1.6 elaborates on how to answer the main research goal and the research questions.

1.6. Research methodology

This chapter describes the methodology for obtaining the main research goal, as formulated in section 1.4. The proposed controller of this research is used to solve the problem defined in section 1.3. The main research goal is solved in three phases: the literature review, the design of the control system, and the evaluation of the control system. The first phase is used to learn about the relevant current and future features that are/will be used in intersection controllers. This provides the basis of information that is needed for designing the controller. The second phase is a step wise design methodology of the intersection control system. The final phase concludes, through simulation, if the proposed design meets the expectation and performance indicators, which are specified later. The complete methodology can be found in figure 1.3. This figure also includes what sub-question is addressed in each part. Each phase is described in detail in the rest of this section.

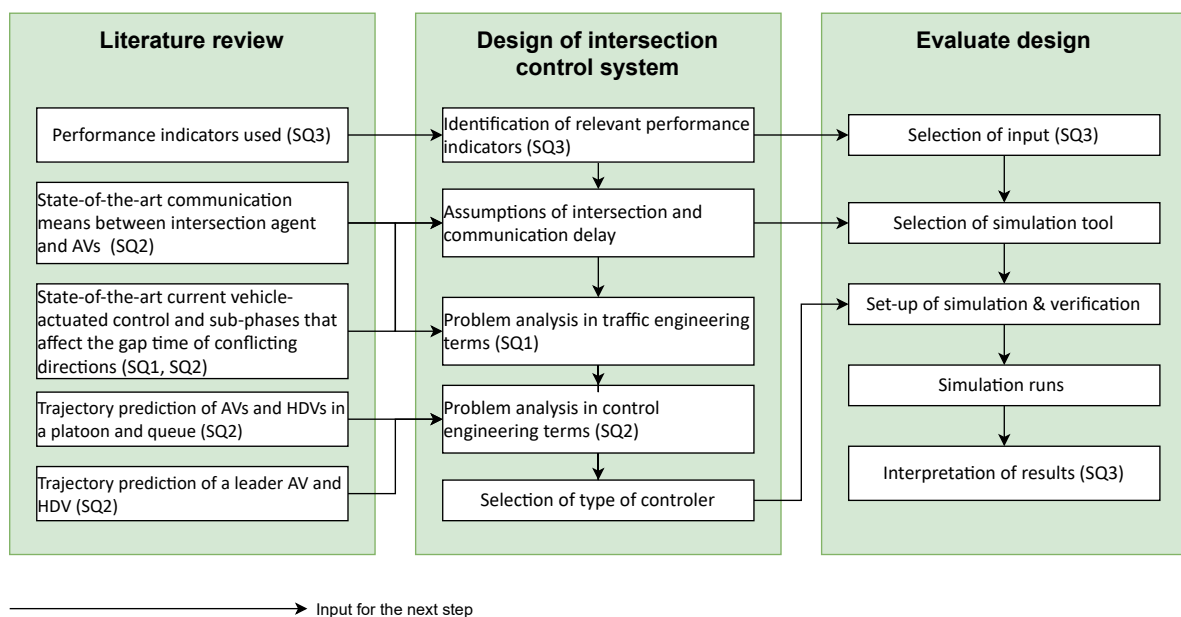

Figure 1.3: Phase wise methodology to obtain the main research goal

1.6.1. Literature review

Multiple topics are explored in the literature review. The first part focuses on how the performance of current intersection controllers can be defined. Performance indicators are needed to be able to define the goal to which the controller is created and to quantify to what extent the design of the controller results in improvements compared to the original controller. Secondly, the state-of-the-art of possible communication at the intersection is explored. This can be either by sensors, in or around the road, or between AVs and the IC. The technologies to make this possible are described briefly and are accompanied with an analysis of the pitfalls and errors they might bring. This section provides what the additional information of AVs can be, that can be included in the predictions of the controller. Third, the working principles of vehicle-actuated control are explored, as these are the basis of the new control system. The (sub-)phases influencing the timings of the red and yellow phase are explored, as well as the prediction models currently used. The data and parameters in these prediction models are used to obtain insight in where the new data of AVs might be relevant in the proposed control system. Then, the behaviour of HDVs and AVs and the mix of both at intersections is elaborated upon. It is explored how trajectories of vehicles could be predicted and in what accuracy. The results can be used in the prediction model of the proposed controller and in the set-up of the simulation. This topic is divided in two parts. One part explains the behaviour of a leader vehicle (a vehicle that has no vehicle in front of it). The other part goes into details about behaviour of vehicles in platoons. This is explored to find out to what extent the trajectory of the last leaving vehicle is influenced by its predecessors.

1.6.2. Design of the intersection control system

With the conclusions of the literature review, the design phase is started. A methodology for the design is applied to give structure to the process and make sure all aspects of the proposed controller are analysed. The design phase is divided in steps. These steps are:

Identification of relevant performance indicators This step provides the exact definition of the performance indicators to which the design is created and evaluated. A selection is made from the relevant performance indicators as described in the literature review.

Assumptions Here the assumption on the environment of the intersection are elaborated upon. These assumptions follow from the literature review on communication technology and assumptions on predicting trajectories of HDVs and AVs.

Problem analysis in traffic engineering terms In this step it is decided what the control strategy of the proposed controller is. This strategy is based upon an analysis exploring possible scenarios at the intersection and what control actions are needed in these scenarios. From the literature review it can be concluded what the problems and uncertainties are in traffic flow at intersections. The effect of these on the desired outcome at the intersection is analysed. It is addressed what measurements could be provided on the state at the intersection by the AVs and the loop detectors and how this should be used to decide the control actions.

Problem analysis in control engineering terms This step contains the translation of the control strategy to mathematical terms. It is explored how the measurements of AVs (and other sensors) can be used to obtain insight in the current state at the intersection. Also, based on the findings of the literature review, a model is made to predict the future state of the intersection. Lastly, it is defined how the measurements and predictions of the state of the intersection are used to define control actions. Moreover, it is also decided how to account for errors in predictions and measurements.

Selection of the type of controller In this step the type of controller is chosen.

1.6.3. Evaluation of the controller

In this phase the proposed controller is evaluated based on the performance indicators. This is done to obtain insight in what parts of the proposed controller shows most effect on the state at the intersection and how this then again influences the performance indicators. This evaluation is done via simulations of the proposed control system. As this is only the first step towards concluding whether the performance at the intersection would increase with the new control system, a simulation is sufficient. Before the control system can actually be brought to practice, the system needs to be tested via gaming and then real-life experiments. The evaluation via simulation consists of:

Selection of input The different variants of relevant input data of the simulation is discussed in this section. The input data consists of traffic demand and the AV penetration rate. This is decided based on what gives relevant results, to conclude on the performance of the controller.

Selection of simulation tool A simulation tool that contains the features that are needed to verify and validate the control design needs to be selected. This is done by formulating the features that are required and then finding the tool that can meet these requirements.

Set-up of simulation In this section, it is explained how the model is created in the simulation tool and how the parameters of the system are set. The literature review is the basis for this. It is also explained what tests are performed to verify the simulation.

Simulation runs When the simulation tool is selected and the models of the current control system and the proposed control system are set-up, the simulations are run with the chosen relevant variants of traffic demand and AV penetration rate.

Interpretation of results The raw data of the simulation is transformed to the chosen performance indicators. It is also concluded what actions of the controller are used most frequently and to what extent this effects the results of the performance indicators.

Chapter 2 presents the literature review. Chapter 3 provides the step wise design process of the controller and chapter 4 shows the evaluation of the proposed controller. Finally, the results are discussed and concluded in chapter 5.

2

Literature review

This literature review is performed to obtain the basic knowledge that is needed to start the design phase. It should be explored how the performance of an intersection is defined in other research. Later, a selection is made of the performance indicators with which the proposed controller is evaluated. Furthermore, for the proposed design, information of AVs is used as the data source of the IC. Therefore, communication needs to happen between the intersection agent and the AVs, and between the AVs themselves. The existing communication means for this are explored as well as the measurements the AVs are able to provide. Next, the current vehicle-actuated control systems (in the Netherlands and abroad) are explored and explained briefly. The sub-phases that are currently fixed but could be shortened with measurement from equipment of the AVs are identified. These sub-phases are described in detail, including the equations used for predictions. Attention here is given to procedures used to maintain safety. Furthermore, when AVs enter the road they do not only provide additional information to the IC, they might also change behaviour on the road. This change in behaviour and its predictability at intersections is explored last.

2.1. Performance of an intersection

There are many identifications of performance for intersections. Some examples are; the amount of emissions, delay time, fairness, occupancy of conflict areas, safety, fuel consumption, communication complexity and so on.

Safety

As is explained in section 2.3, in current vehicle-actuated controllers, equations are used to calculate the fixed clearance time and yellow duration. This fixed time is set with numerical values that make sure that in 99% of the situations a safe crossing is obtained. This is a trade-off with regard to the efficiency of the needed clearance time.

Occupancy of conflict area

[31] looks at the occupancy of all conflict areas. While it remains true that it is preferred that these areas are occupied as much as possible, it will not always provide useful results. When a vehicle is at standstill at the conflict area, it is continuously occupied, while the vehicle blocks all other vehicles including itself from crossing the intersection.

Fuel consumption

Less fuel consumption means less environmental impact. This performance indicator is used as objective in multiple designs of control systems for intersection management [22] [23] [63] [69].

Delay time

Delay time is expensive. Every hour of lost time cost 10 euros [59]. [3], [11], [38], [46], [62] and [69] use this as performance indicator.

Fairness

In current intersection control, the rule is applied that all vehicles should be able to cross the intersection within a certain time [27]. This fairness is becoming even more important in a hybrid situation. The reason for this is that AVs will always be able to obtain higher throughput [51]. So, for optimizing throughput, AVs would get priority in many situations. While optimizing the control, fairness should thus be taken into ac-

count, otherwise HDVs would be disregarded by the controller. Fairness will thus sometimes conflict with traffic delay. In some proposed intersection control systems the 'first come first serve' rule is applied [10].

Communication complexity

In [11] it was concluded that communication complexity should be low for future intersection control systems.

2.2. Communication means

It used to be only detector loops in the road, that could communicate with an IC about vehicles' presence. Multiple other mechanisms have been designed in the meantime to be able to communicate with HDVs or to extract measurement from them. This is presented first. Secondly, possible future communication between AVs and IC is discussed. This section closes with an elaboration on what AVs are able to measure.

2.2.1. Communication between the IC and HDVs

The communication from the IC to HDVs is straightforward. These are the traffic lights. The communication the other way around, from HDVs to the IC, is never directly from the vehicle to the IC. Detectors on the road can sense the vehicles and pass on information to the IC. Also, currently, apps exist, that can be activated by a driver while driving, that can send information to iVRIs, and the other way around. First, the detectors are discussed and then the working principle of the iVRIs.

Many types of fixed detectors around the road exist. Examples of these detectors are Electromagnetic loop detectors, Selective detector, Radar detection, Laser detection and Camera detection. Each of them has its own advantages and disadvantages. These are mostly concerned with the accuracy of the measurement in general and under different weather conditions, the location where the sensor needs to be placed, and the costs [27]. The purpose for which the sensor is needed is also relevant when selecting what type of sensor is the best fit. Some are not able to provide information in real-time for example and some might not be able to provide the information that is needed (e.g. speed cannot be measured by all sensors). Generally, for all these sensors, the location at which they are installed is of most importance. As the location cannot easily be changed, it should be placed where the information it can provide is most relevant. In the Netherlands, electromagnetic loop detectors are mostly used to provide information to the IC [27].

Electromagnetic loop detector This detector measures the presence of the vehicles. The detector only measures the vehicle parts that consist of metal. So, the length of the vehicle that is measured is not per definition the whole vehicle as not all vehicles consist of metal only. It is widely used in the Netherlands [27] and is placed in the surface of road. A binary signal is used by the detector loops to communicate if a vehicle is on the loop. This also means that if two vehicles would be on the loop (this means the loop is long enough for a part of two vehicles to be on it and the gap between them), that the binary signal stays 1 and not becomes 2. The two vehicles are then thus measured as one vehicle. The detector loop should thus not be too long. The location of the detector loops is fixed and is relevant for the purpose of use. More about the useful placement of the detector loops can be found in 2.3.

As stated above earlier, iVRIs are also able to communicate with approaching HDVs via mobile phones. Among others, Dynniq, Royal HaskoningDHV and Rijkswaterstaat are currently installing about 800 iVRIs in the Netherlands [53]. Via this communication the intersection can be controlled more efficiently (more throughput, less delay). The iVRIs consist of a certain architecture to be able to receive messages from the vehicles and control the duration of the green phase. The hardware and software of the iVRI systems are separated. Meaning different software packages can be installed. The software that regulates the duration of the green phase is the ITS application. This software controls the hardware of the iVRI to regulate the traffic signals physically. It is also connected with the RIS facility. The RIS facility is the part that can receive messages of the vehicles, which is done via Traffic Light Exchange (TLEX). The messages between the RIS facility and the vehicles follow the ETSI ITS standards. The standardized messages used are [20]:

CAM . These are messages from apps on mobile phones within vehicles to the iVRI. The speed, location, and direction (in degrees) can be included in the message.

Signal Phase and Timing (SPaT) These are messages informing the vehicles what phase their direction is in or, potentially, the time till the next phase starts.

MAP This is a message from the iVRI to the vehicles in which the lay-out of the intersection is presented. In this way, the phone can compare its measurement to the layout and pin point itself at the intersection.

2.2.2. Communication between the IC and AVs

In the future, communication between AVs and the IC will be possible. This is described in this section. In many proposed ICs, assumptions are made that communication transmission delay is negligible and that the message will always be received [68]. Others include solutions for dropped messages [9]. The technical means that are used for communication are described here, including their capabilities.

First of all, the technologies are described that can send messages from one agent to another (so also AV to AV):

Wifi Communication via wifi can reach a maximum distance of 100 m [27].

Dedicated short-range communication (DSRC) [54] researched the delay and probability of the messages being received. When 140 vehicles send a message every 200 ms it can be received with a small delay and high probability. Furthermore, [65] found that the delay in receiving the message is about 100 nano seconds in urban areas. Sending messages here was possible in a range of 30-300 m.

4g/5g cellular interfaces [37] found cellular works better on longer ranges than DSRC. Phones can use apps that can send messages via 4G. The IC can use this to track the number of vehicles on the road.

2.2.3. Measurements of equipment in an AV

Next to detector loops, AVs can be equipped with sensors to also obtain measurements. These can be velocity, acceleration but also information from other vehicles around the AV. The technologies that can be used to obtain the measurement are:

LIDAR This is a sensor that can detect other vehicles [50]. It can be used for a distance up to 200 m away, and it measures velocity and distance to the object [18]. [15] found that LIDAR technology can have errors in the front and width of the measurements. [60] found an uncertainty estimation error of 0.1 m with a standard deviation of 0.12 m.

GPS The location of a vehicle is tracked based on signals to satellites. The location can be measured with an accuracy of 50 m. When using differential GPS (which also uses signals to devices on the earth), this is 2 m [27].

Speedometer The sensor used to measure the speed of the vehicle can be a speedometer. [61] assessed the accuracy of this sensor. It was found that 45 % of the measurement errors were within 0.2 m/s away from the true speed of the vehicle and. Another 19% of measurement errors were found to be within 0.4 m/s.

As shown, measurement errors are possible. [54] therefore proposed to use a Kalman filter to account for the errors. The filter was made for measurements of position, velocity, and acceleration. [2] used a fusion of different sensor data to locate other vehicles more accurately. More accuracy results in less variance in prediction models.

2.3. Current vehicle-actuated intersection control systems

Signalized intersections use three phases: Green, yellow and red. These phases always happen in the same order. In vehicle-actuated controllers these main phases can also be divided into sub-phases. The duration of the green phase depends on which sub-phases and tactics are in use in the control system. In vehicle-actuated control, these tactics depend on the presence of vehicles at the intersection. The yellow phase is a safety measure that aids vehicles not to enter the intersection when the red phase starts. During the red phase vehicles are not permitted to cross the intersection. First, all sub-phases and tactics of vehicle-actuated control are presented. Different types of vehicle-actuated control exist. The vehicle-actuated control as described by [27] is the basis of this research. Tactics of other sources are explored to obtain all pertinent knowledge available about tactics that could be used. Secondly, sub-phases that could be shortened with additional data of AVs, are identified. At last, a detailed description is provided on the used predictions models and equations used by [27] to decide control actions within these sub-phases.

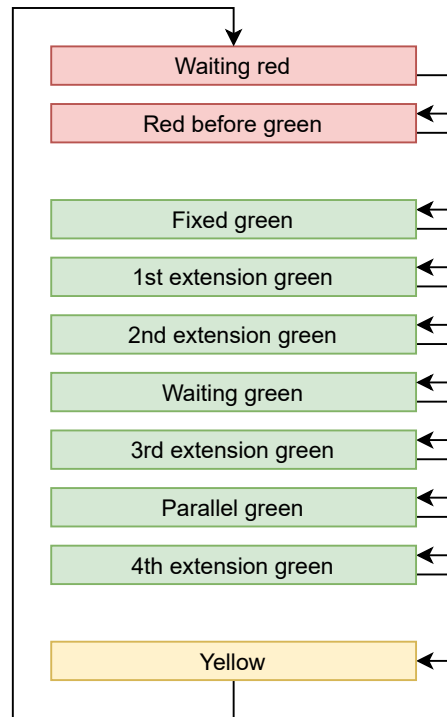

Figure 2.1: Sub-phases of the Dutch vehicle-actuated intersection control system [27]

2.3.1. Sub-phases of vehicle-actuated control explained

Sub-phases have a different tactic to regulate the vehicle-actuated control based on the situation on the road. These situations are identified using detector loops. Different types of vehicle-actuated controllers exist. The sub-phases defined in the Netherlands are similar to this system [17] [27]. In figure 2.1, the system is presented. The purpose and tactics per sub-phase are explained below. It must be stated that multiple detector loops are used in this system. Generally, three detector loops are installed per direction with different offsets from the stop line. Two short detectors are located at the stop line and at a distance more upstream. A longer detector is located in between these short ones. This is called the extension detector.

Waiting red This is waiting red. The direction will enter the next phase (Red before green) when a vehicle was measured to be present at any time within this sub-phase. The detector loops are used to identify if there is demand at each direction.

Red before green (RBG) This phase will be ended when it is safe for the direction to obtain the green phase. This means that this phase should be at least the length of the minimal inter-green time. The minimal inter-green time is defined as the end time of the yellow phase of the conflicting directions minus the clearance time between the conflicting direction and the direction in the RBG phase.

Fixed green Fixed green time provides enough time for the first few vehicles, to cross the intersection. These are the vehicles that are in between the detector at the stop line and the extension detector. This means fixed time green is always long enough to let the first few vehicles pass the intersection.

1th, 2nd and 3rd extension green These are extension green sub-phases. Multiple detectors are placed in the road to identify if there is still demand in the direction. Each of these sub-phases uses a different detector to identify this demand. These detectors are placed at different distances from the stop line. These phases can be truncated when the time between two vehicles on the detector surpasses a certain gap threshold ($t_{\text{threshold,gap}}$). The gap measured by the detector is shorter than the actual gap between two vehicles due to the length of the detector. The threshold of the measured gap by the detector ($t_{\text{detector,gap}}$) can be calculated with:
$$t_{\text{detector,gap}} = t_{\text{threshold,gap}} - \frac{l_{\text{detector}}}{v_{\text{veh}}} \quad (2.1), \text{ where:}$$

l_{detector} is the length of the detector loop
 v_{veh} is the speed of the leader vehicle passing the detector loop

The location of these detectors for the extension green phases decides the minimal time of the duration of these phases. All vehicles that pass the extension should be able to pass the intersection. This time is calculated with a standard formula. Real-time this could mean that some of the green-time is not used by vehicles to pass the intersection, as they may drive faster than the numerical value for speed used in the formula.

Parallel green When another direction of the same stage still has demand, green will still be provided to this direction without a demand.

4th extension green (4EG) This is extension green used for a safe transition to the yellow phase. When the decision for two vehicles close to each other to stop or continue, can go both ways, the green phase should be extended. This will make sure that no head-tail collisions will occur between the two vehicles based on their decisions to stop or go.

Yellow This is the yellow phase. This is a fixed-time. When vehicles approach the intersection the law in the Netherlands is to stop if it is possible when yellow light appears. The next stage can only obtain green after the yellow phase of the previous conflicting direction has ended. This is due to the Dutch law.

The above structure is performed for each direction in a stage. A central controller combines these cycles in a complete control structure.

According to [17] five green phases, Advance Green, Fixed Time Green, Waiting Green, Extension Green, Parallel Green exist. All but advanced green are equal to what is used by the controller defined by [27]. If one direction of the same stage does not have demand while that stage is in the green phase, that direction could get red, and a conflicting direction of the next block could already go to the advanced green phase.

2.3.2. Sub-phases that can be shortened using additional data from AVs

Three sub-phases can be identified that can be shortened based on additional input of AVs. These sub-phases are the 4EG phase, the yellow phase and the RBG phase. Except for the 4EG phase, these phases have a fixed time as detectors are not able to obtain the correct information. This could potentially be provided by an AV. The 4EG could also influence the needed RBG phase duration and is therefore also investigated.

4EG uses data provided by the detector loops to decide when to end the phase. Yellow and RBG use fixed times and do not look at information provided by the detectors. These phases have the potential to use the data that is provided by other sources (an AV) if made adaptable to what data is needed.

A detailed description of the tactics of each sub-phase is provided below. The equations and predictions used in deciding the control actions are also elaborated upon.

4EG phase

This sub-phase is added to decrease the chance of head-tail collisions. At a certain region before the stop line, it is unclear if vehicles will decide to stop or cross the intersection when the yellow light would appear. This region is called the dilemma zone. If multiple vehicles are in the dilemma zone this could cause dangerous situations if the most upstream vehicle decides to cross and the vehicle in front of it decides to stop. Extension detectors are used to measure if two vehicles are in the dilemma zone. If this is the situation, green is extended for some time [17] [27] [28].

The dilemma zone is the zone in which the front of a vehicle is at a certain distance from the stop line in which a vehicle should be able to stop completely before the stop line. The upstream part of the dilemma zone is the most upstream distance from the stop line a vehicle can be when the yellow phase starts and still cross the stop line before the red phase starts. It depends on the behaviour/intention of the driver in the dilemma zone whether it will stop or not.

The location of the dilemma zone is related to a few factors:

Approaching speed (v_{appr} in m/s) The approaching speed most of the time will be around the speed limit. The approaching speed of the first few vehicles that waited in a queue to cross the intersection will be lower [33] [36] [41].

Deceleration (a_{dec} in m/s^2) A driver wants to stop using a comfortable deceleration rate. Also, there are technical limitations to the possible deceleration rate [33] [36] [41].

Reaction time (t_{react} in s) When the phase changes to yellow, it takes a driver some time to react to this [36] [33] [41].

Grade of the road (\circ) The inclination of the road can affect the deceleration capabilities of the vehicle [33].

For different vehicles/drivers and situations the dilemma zone could be different due to the distribution of the factors above.

In the Netherlands, the following formula is used to calculate the downstream part of the dilemma zone (d_{zone1}) [27]:
$$d_{\text{zone1}} = t_{\text{react}} \cdot v_{\text{appr}} + \frac{v_{\text{appr}}^2}{2 \cdot a_{\text{dec}}} \quad (2.2)$$

In [40] it is defined that the reaction time used in this calculation should be 1 s, and a desired deceleration of 2.8 m/s^2 should be used.

The upstream part of the dilemma zone (d_{zone2}) is defined as [27]:
$$d_{\text{zone2}} = \Delta t_{\text{yellow}} \cdot v_{\text{appr}} \quad (2.3), \text{ where:}$$

Δt_{yellow} is the duration of the yellow phase

The grade of the road is thus not taken into account by [27]. Furthermore, the duration of the yellow phase decides the size of the dilemma zone. Though, it must be mentioned that HDVs do not know the duration of the phase. Their perception of the dilemma zone can thus be different than the above-formulated dilemma zone. Furthermore, as can be seen in the equation, the assumption is made that acceleration remains constant during the yellow phase.

A default dilemma zone is calculated based on a certain distribution of observed behaviour from drivers.

The location of the dilemma zone is used to decide when to end the 4EG phase or to continue it for safety reasons.

The detector loop most upstream of the intersection measures the detector gap time between two vehicles when the 3rd extension green ends. When this measurement passes a certain threshold it means the distance between the vehicles is sufficient (the two vehicles are not both in the dilemma zone) and the yellow phase can be started. The minimal detector gap time can be calculated via [27]:

$$t_{\text{threshold,gap}} = \frac{d_{\text{zone2}} - d_{\text{zone1}}}{v_{n+1}} - t_{\text{gaptime}} \quad (2.4), \text{ where:}$$

$t_{\text{threshold,gap}}$ is the gap time threshold that should be measured by the detector

v_{n+1} is the speed of the leader vehicle

t_{gaptime} is the time distance that should be in between two vehicles to provide a safe situation

Yellow phase

The yellow phase is used for safety. It gives a warning to drivers they need to stop because the red phase is about to begin. The regulations in the Netherlands state that if a driver is able to stop when yellow phase starts, it should. The perception per driver is different of when they are able to stop (or want to stop). Making the yellow time too short can therefore cause vehicles to cross the stop line after the red phase started.

As it is unknown, and would be hard to measure using detector loops, what vehicle will be the last to cross the intersection, a default yellow duration is always applied.

In [40] it was concluded that the yellow time should be 3.5 s for a 50 km/h road for a straight direction. Using equations 2.2 and 2.3 this means the length of the dilemma zone in this situation would only be: 0.27 m for a vehicle driving 50 km/h. But not all vehicles drive the same speed.

RBG phase

The end of the red phase ($t_{\text{red,end}}$) of a direction is at least the end time of the green phase ($t_{\text{green,end}}$) of the previous conflicting direction plus the inter-green time ($t_{\text{inter-green}}$) of the two involved directions. The inter-green time is based on the clearance time and the duration of the yellow phase (Δt_{yellow}). This can be summarized in the following equations:
$$t_{\text{inter-green}}^{n,m} = \Delta t_{\text{yellow}}^n + t_{\text{leave}}^n - t_{\text{enter}}^m \quad (2.5) \text{ and}$$

$$t_{\text{red,end}}^m = t_{\text{yellow,start}}^n + t_{\text{inter-green}}^{n,m} \quad (2.6), \text{ where:}$$

- n is the direction that obtains green right before direction m
- t_{leave} is the time it takes a vehicle to drive from the stop line till it passed the conflict area
- t_{enter} is the time it takes an upcoming vehicle to drive from the stop line to the beginning of the conflict area

In the current intersection control, clearance time is predicted to regulate that the gap time between two conflicting directions is never too short to prevent collisions. The clearance time is specific for two conflicting directions.

Clearance time ($t_{clearance}$) is calculated by subtracting the time it take the the first entering vehicle to drive from the stop line to the conflict area (t_{enter}), from the time the last vehicles in the queue to drive from the stop line till it leaves the conflict area (t_{leave}), $t_{clearance} = t_{leave} - t_{enter}$ (2.7).

The following percentiles of these behaviours are used to calculate the fixed clearance time between two conflicting directions in the Netherlands:

- 2% of all entering vehicles drive faster than the t_{enter} that is used to calculate the clearance time.
- 50% of the vehicles drive slower than the t_{leave} that is used to calculate the clearance time [26].

In literature, different formulas can be found to calculate these times [33] [36] [41] . [26] provides information on what formulas and standard parameters are used in the Netherlands.

t_{leave}

There are several factors influencing t_{leave} [33] [36] [41] :

- *Distance from the stop line to the end of the collision area in m* - This is d_1 in figure 2.2.
- *Length of the vehicle (l_{veh}) in m* - This is the additional length that needs to be driven to clear the collision area. d_1 and the length of the vehicle make the clearance distance of the last leaving vehicle (d_{leave}).
- *Speed when crossing the intersection (v_{leave} in m/s)* - Different situations decide what the speed is. Mostly it is assumed that the last vehicle entering from a direction is in free-flow conditions and does not or barely need to decelerate before entering the intersection [33]. This is not the situation when only a few vehicles are waiting in a direction, and no downstream vehicles join the queue during the green phase. In the research of [57] it was found that the first vehicle in a waiting queue does not reach the maximum speed possible to cross the intersection when passing the stop line.

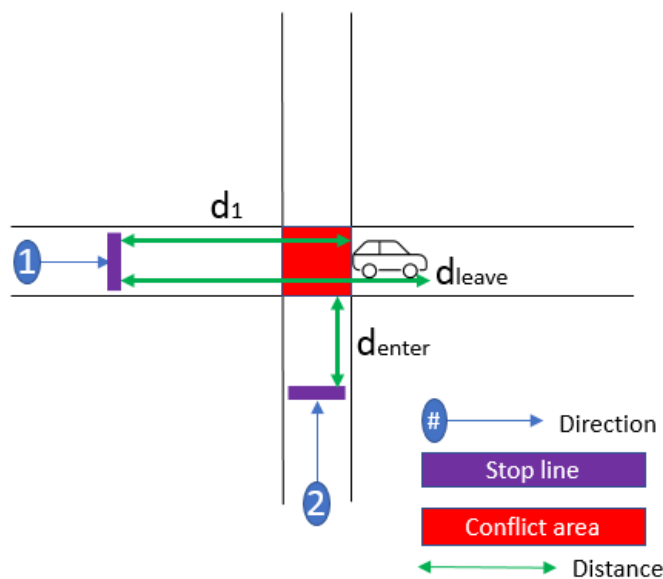

Figure 2.2: Leave (direction 1) and enter (direction 2) distance of two conflicting areas

The vehicle length, as well as the speed while being at the intersection, is different per driver. The speed also depends on the situation. To calculate the clearance time, a t_{leave} is used that represents the situation in which the last vehicle reaches the intersection without having to decelerate due to vehicles in front of it. In the Netherlands, 50% of the drivers drive slower than the t_{leave} that is used to calculate the clearance time. The length of vehicles that is used depends on the penetration of trucks on the road. Specific standards are set per penetration rate. When only passenger vehicles are present, a length of 6 meters is used [27].

The following formula is used to calculate t_{leave} for vehicles:
$$t_{\text{leave}} = \frac{d_{\text{leave}}}{v_{\text{leave}}} \quad (2.8).$$

[33] proposes to use the 85th percentile of v_{leave} as can be measured by observing drivers. This is thus different than [26] proposes.

It must be stated that for turns the leaving speed is lower than for straight roads. This is due to the fact that most turns cannot be taken safely at maximum speed, where at straight roads this is possible [27].

t_{enter}

Multiple scenarios are possible that influence this time. If the front vehicle has come to a standstill before the intersection, it will take the vehicle longer to reach the collision area as it needs to accelerate from zero speed instead of maintaining its arrival speed. If it approaches the intersection when the green phase begins, the vehicle will have a certain speed and accelerate again. This provides a shorter enter time. Note that the speed at the stop line here (v_{enter}) will not be the maximum speed (v_{max}) as vehicles currently do not know when the phase will turn to green and will need to stop if it does not change [41]. The speed v_{enter} could be higher range when AVs know the phase will change.

[36] states that due to safety reasons, an aggressive driver should be used to calculate t_{enter} to decide the clearance time. The Netherlands uses t_{enter} so that only 2% of the drivers drive faster [26].

The parameters that influence t_{enter} are:

- *Distance from the stop line to the beginning of the conflict area (d_{enter} in m)* - The first vehicle that reaches the collision area could cause a collision from the moment the front bumper enters the collision area [36] [41].
- *Distance of front vehicle from the stop line when the red phase turns to green (d_{appr} in m)* - The distance from the stop line is important to know for a vehicle that is approaching the intersection. The acceleration/deceleration timing depends on when the phase turns to green [36] [41].
- *The speed on the intersection ($v_{\text{veh}}(t)$) and the approach speed (v_{appr} in m/s)* - From a standstill, the speed on the intersection of a vehicle will keep on increasing till it reaches the desired speed. When the first vehicle approaches the intersection when the phase turns green, its speed gives away how fast it will reach the stop line and the desired speed on the intersection [36] [41].
- *The acceleration (a_{acc} in m/s^2) and deceleration (a_{dec})* - Each vehicle has its own technological capabilities to accelerate and decelerate. The used acceleration and deceleration also depend on the comfort of the driver and the passengers [36] [41].
- *Reaction time (t_{react} in s)* - When signals turn green, a driver has some reaction time to act according to the phase. The reaction time can either be from a standstill or from deceleration to acceleration. The longer the reaction time, the longer it will take the vehicle to reach the collision area [36].

The formula that is used in the Netherlands to calculate the t_{enter} for the clearance time is:

$$t_{\text{enter}} = \frac{d_{\text{enter}}}{v_{\text{enter}}} + \frac{v_{\text{enter}}}{2 \cdot (a_{\text{acc}} + a_{\text{dec}})} \quad (2.9).$$

Only 2% of the drivers drive faster than the used t_{enter} in the Netherlands. Furthermore, due to safety reasons, it is not allowed in the Netherlands to calculate the t_{enter} with the observed reaction time of drivers [26].

Furthermore, it should be mentioned that all default settings of a vehicle-actuated control are calculated before applying the control system at an intersection in real life. When the control system is in place some

parameters might be adjusted based on observations of behaviour at the intersection. The parameters are not changed for each individual vehicle at the intersection.

At last it should be mentioned that causes of delay in the current system are, safety measures that are needed because of the uncertainty around the intentions and behaviour of HDVs and the inflexibility of the measure points at fixed locations (the sensor is at most times not able to provide the needed information due to this). Examples of the behaviour and intentions of the HDV are the decision to stop or cross the intersection when yellow light appears, the reaction time, the desired headway and the desired acceleration and deceleration rate. For AVs and their surrounding HDVs, part of this behaviour can be measured and intentions can be communicated.

2.4. Trajectory prediction of leader AV and HDV

In section 2.3.2 is explained what factors are taken into account in the equation to calculate the entry time of the first vehicle entering from a direction in the green phase. From all entering vehicles (which are HDVs) a distribution of the entry time is generated and the default enter time used in the control system is based on the 2 percentile of all observed behaviour. The entry time is thus not based on behaviour measured real-time. Additional factors that could influence the trajectory of the first vehicle entering, when it is an HDV, are described first. Moreover, the prediction of the trajectory of an AV with no vehicles influencing its behaviour is elaborated upon.

2.4.1. HDV as leader vehicle

Section 2.3.2 gives the influencing factors for the time it takes the front vehicle to drive from the stop line till it leaves the conflict area. One of the factors (that is not used in the current calculation of the inter-green time) is the reaction time. [57] researched the reaction time of the first vehicle in the queue. For a straight road, it was found that the first vehicle in the queue had a reaction time of 1.34 s (SD=0.97).

2.4.2. AV at the front of the queue

AVs are able to plan their future trajectory based on their desired speed, acceleration, deceleration and path. When an AV is at the front of a queue it is not influenced by the behaviour of a vehicle in front of it on the same direction.

Some proposed intersection control systems for the AV-only period, assume that AVs can plan (according to their limits of acceleration etc.) and track their planned trajectory with 100% accuracy [3] [6] [22]. This means that the pre-planned trajectories can be driven exactly as planned without any deviations.

Other research about the accuracy of tracking the planned trajectory shows that this is not realistic. [66] uses an MPC controller for trajectory tracking. The objective used here is to minimize the speed error. A difference in the error was found between an aggressive and normal driving style (which can be set by the manufacturer). The RMS of the controller for the aggressive drivers was found to be 0.11 m with a maximum measured error of 0.49 m. The RMS of a normal driver style was found to be 0.06 m with a maximum of 0.21 m. [45] proposed a motion planning system that uses a complex mathematical model of the vehicle dynamics. This system was tested and showed a relative error under different environmental conditions within 12%. [24] designed a trajectory tracking controller where results show a position error between 0 and 4 ft (1.22 m). [25], proposed a robust trajectory tracking error-based MPC for autonomous tractors and trailers. At low speed, the mean value of the euclidian distance errors on straight trajectories was respectively equal to 23.49 and 21.21 cm of the tractors and trailers.

From the above research we can conclude that, the planned trajectories can never be tracked without any error.

When using any model to predict the behaviour of an AV, a tracking error should thus always be included. Even when no vehicles affect the tracking behaviour and all parameter settings (e.g. preferred acceleration and speed) are known.

2.5. Uncertainty of trajectory of the last vehicle in the queue

The prediction equations used by [27] assume a constant speed of the last vehicle that crosses the intersection. This means it is assumed that the last vehicle will not fluctuate its acceleration due to external factors (e.g. other vehicles or the inclination of the road). It is explored to what extent (2.2), (2.3), (2.7), (2.8) and (2.9) represent the behaviour at intersections.

The objective for any driver is to drive at a desired speed without causing a crash [51]. This affects the trajectory of a vehicle. Traffic can either be in congested and free-flow conditions. In congested situations the trajectory of the a vehicle depends strongly on the behaviour of its predecessor. This does not hold under free-flow conditions [62]. A queue at an intersection is in a congested situation. After the first few vehicles in a queue have passed the stop line the speed of the rest of the vehicles in the queue most of the time reached the preferred speed for crossing [57]. At this point, the queue can be labelled a platoon again. These conditions resemble free-flow conditions, which means the vehicles are able to drive the preferred speed and their behaviour is influenced more by their own preferences than their leader vehicle. Following behaviour is thus different under different conditions. The assumption of (2.2), (2.3), (2.7), (2.8) and (2.9) that the vehicle is not influenced by its leader when crossing the intersection, does most of the time hold from the 6th vehicle onward. When a leader vehicle would make a sudden break while driving in the platoon this would influence the behaviour of the follower vehicle. Behaviour of vehicles is thus different under different road conditions (congested or free-flow).

The last vehicle to cross the intersection will follow other vehicles. Therefore, the behaviour of the queue crossing the intersection is explored. For this, insight is provided on the behaviour of HDVs that influence the leaving time of the HDVs and to what extent this can be predicted. The same is done for AVs. Both are explored in the situation where both HDVs and AVs are on the road in front of this last crossing vehicle. The behaviour of the HDV is also explored in current situations on the road (where only HDVs are present).

2.5.1. Uncertainty of trajectory of an HDV in a queue

The trajectory of a vehicle is influenced by the preference and capabilities of the vehicle itself. Vehicles in a queue could also be influenced by the behaviour of vehicles around them. Car-following models are made to describe the following behaviour of vehicles. As discussed above, this behaviour is different when a vehicle is in a congested or free-flow situation. A simple model can be created by stating that a vehicle follows its predecessor with a certain delay in time and distance in location. As each driver is different, these unknown delays vary among the HDVs [16]. One person has a quicker response than another and/or has a higher desired headway between him and his predecessor. The basis of the generally known and used Newells car-following model, is that each vehicle will maintain a certain minimum space and time gap between itself and the vehicle in front of it [62]. Other models include the maximum speed and acceleration of a driver. Via experiments, it was shown that car-following model could capture the behaviour of an HDV qualitatively but it can not fully describe all its behaviour [14]. The Wiedemann car-following model uses a normal distribution for preferred acceleration, deceleration, speed, gap acceptance with its leader to perform any actions [1]. The distance of the gap can be different for congested and uncongested situations. The Wiedemann model also includes parameters that define a perception of the speed and distance between the vehicle itself and its leader [1]. [13] explored what the variables of the Wiedemann model should be, based on empirical data, for different types of HDVs (e.g. trucks, passenger cars). Parameters of any car-following model should be set with empirical behaviour. In the research of [38] a car-following model was used that included some of the previous aspects of car-following models and also included that the vehicles had a reaction to traffic lights but only before the vehicle passed the stop line. As the traffic signals are located above the stop line, and will not be visible anymore. Following behaviour thus depends on many different factors. The reaction time of HDVs was explored by [51]. The reaction time is higher than the reaction time of robots. Further more, HDVs are uncertain of the behaviour of other vehicles. Drivers keep an eye on multiple vehicles ahead to signalise early on, if an event is about to happen. This compensates for this reaction time and uncertainty. Furthermore, there is a distribution in the preferred headway of a driver. [48] found that at a speed of 50 km/h about 50% of the drivers feel comfortable with a headway of 2 s. For 4 s this becomes 72.5%. [35] found an average gap between vehicles of 36 m (SD=20.4) for a 45-50 km/h road. As stated before [57] researched behaviour of vehicles in the first part of the queue crossing the intersection starting from a standstill. The headway between the first 4 vehicles increases, while the headway between 4 and 5 decreases again. An explanation could be that these drivers can already anticipate on the changed phase of their direction. Furthermore, it was found that the standard deviation of the headway between the first 5 vehicles was high (e.g. between the first and second vehicle an average headway of 1.79 m was found with a deviation of 0.68 m). The behaviour after the

first 5 vehicles is fluctuating less than the first few vehicles. Car-following models can be used for predictions for longer horizons than one time step, but only if the leader's trajectory is known for that horizon. The new location of the vehicles depends on the state at the previous time step.

The accuracy of a trajectory that is generated by a car-following model compared to real-life data, is different per car-following model. [35] found that the Wiedemann model predicts the real-life data well. [19] stated that Wiedemann also includes different aggression levels in the behaviour of drivers at different speeds. [12] found that the Newell's model has an RMSE of 2.6 m with a maximum of 5.4 m (the used time step was 1.2 s). [39] compared different models to real-life data and found a maximum error of 4 meters at a 50 km/h road for both IDM and Wiedemann. Wiedemann more often showed deviation from the actual driven trajectory. The time step used here was 0.1 s. At each time step, the next state of the vehicle was predicted based on the state of the leader vehicle.

The behaviour of HDVs can thus to a certain extent be modelled with car-following models but the uncertainties due to an observed distribution of behaviour will always be present. Also, when predicting the trajectory of vehicles, the trajectory of the leader vehicle should be known or the possible trajectories should be known. When a platoon of HDVs is moving a sudden break and acceleration of the leader vehicle thus has an influence on all vehicles behind it. If the trajectory of the leader vehicle cannot be predicted, a car-following model cannot be used to predict the following behaviour. It can be used in a simulation to model the behaviour of vehicles, as this behaviour and the behaviour is modelled each time step. Furthermore, car-following models do not include decisions of HDVs for different traffic signals.

Furthermore, when the yellow phase appears drivers can decide to continue driving or stop before the stop line. This decision depends on the personality of the driver and its driving style or mood. [44] stated two categories of drivers: compliant and aggressive. These categories are used to predict the future trajectories of HDVs. This was done by [44], with a Hidden Markov model. This model uses past observations of the state of the vehicle (speed, location) to identify the personality of a driver in order to predict the future states. This was tested on a T-junction and showed that predictions were not always correct. It also stated more real-life data could potentially improve the accuracy of the prediction.

2.5.2. Uncertainty of trajectory of an AV in a queue

The behaviour of AVs can also be modelled using car-following models. [62] uses kinematic wave theory and Newell's car-following model for these predictions. [51] uses the intelligent driver model (IDM). This is a deterministic model, using acceleration, comfortable deceleration, desired speed and time headway as parameters. Using V2V communication, AVs can be certain about other drivers' situations but also about conditions downstream and environment conditions. In the research of [38] all vehicles could communicate (but not negotiate). Current and past locations can then be used to predict future behaviours. [32] was able to maintain stability in a platoon of 8 AVs on the highway with a 0.18 sec gap between all of them. As AVs know each other's intentions this gap is possible. This is different when AVs follow an HDV. [32] found that in a saturated situation at a signalized intersection the following distance of an AV following an HDV should be 0.6 s (to account for unknown behaviour). When following another AV this number could be halved.

Parameters of these models should be set differently to apply to the behaviour of an AV. In the master thesis of [7], parameters for the Wiedemann model were set based on literature for both AVs and HDVs. The main conclusion is that the Wiedemann model obtains parameters that include the perception of a driver of speed difference or distance. An HDV only has a perception of these differences. An AV on the other hand can measure (with some potential errors) what these differences are. The perceived difference is thus closer to the actual value of the differences. Furthermore, whilst for HDVs an normal distribution is set for some values, these could be programmed for the AVs e.g. max acceleration, preferred acceleration etc. Furthermore, AVs are able to communicate their planned trajectories. This means that they are able to know more in advance what their leader vehicle will do and plan their own trajectory accordingly.

The above research only included AVs. For AVs to drive their optimal trajectories while following other vehicles, future trajectories of other vehicles around them should be known. The future planned behaviour of a leader AV can be communicated. This is not possible when an HDV is the leader. The mix of the behaviour of the two is elaborated upon below.

2.5.3. Behaviour platoon with AV and HDV

A mix of HDVs and AVs cause a certain behaviour of a platoon. AVs are able to communicate with each other while the intentions of the HDVs are unknown. If HDVs are not able to communicate, it is unknown what the number of HDVs is around an AV. [16] uses a curve matching algorithm and Newell's car-following model to predict the amount of HDVs in between two AVs. The predecessor AV states its location. The predecessor AV then knows the distance between them. The curve matching algorithm then finds the possible amount of vehicles in between them using trajectory predictions with randomized parameters via Newell's model. The AVs are then controlled by an MPC using these models as predictors for the future situation. The MPC is designed to maintain string stability. This research does not include the influence of changing maximum acceleration/deceleration due to weather conditions, slope and speed limits.

One of the problems that will remain in this mixed environment, is that a vehicle's motion can never be fully predicted [54]. The longer the prediction horizon the less reliable predictions will be made [42]. [29] states that interaction aware predictions (these are more complex formulas that take multiple road users into consideration), as would need to be used in the prediction model of the location of an HDV multiple time steps ahead, would mean a high computational complexity. It is mentioned that this might not be compatible with real-time assessment. As the behaviour of AVs depends on the HDVs in front of it, these models cannot be used in the control system.

Furthermore, the fundamental diagram on the road changes when AVs are added. When the penetration rate of the AVs is below 50% the fundamental diagram is scattered while the throughput increases with a growing amount of AVs [51]. These results were found via simulations. [64] also derived fundamental diagrams for the mixed situation (analytically). For this, it used different car-following models to model the HDV and the AV. The AV was modelled by the IDM with some extra calibrations. This model combination was able to describe behaviour in all traffic conditions. The research showed that throughput can be increased when the desired headway of the AVs is low. This indicates that the performance of the current vehicle-actuated control might already improve with the presence of AVs in the network. Moreover, it could mean that the behaviour of HDVs will change and prediction models need to be calibrated accordingly.

When testing the control model via simulations, the AVs and HDVs can be modelled using car-following methods. The parameters of the model should be set according to the different behaviours between HDVs and AVs.

2.6. Conclusion

In this section of the literature review, a conclusion is given per topic. This generates the relevant facts that are needed to start with the design phase.

Performance

Many different performance indicators exist to assess an intersection control system. Depending on the situation, one could be more relevant to use for assessment than others. Providing a safe controller is a requirement. Another performance indicator needs to be chosen for assessment.

Communication

The proposed IC can communicate with HDVs via traffic lights and can receive information from all vehicles via detector loops at fixed locations and from specific vehicles via AVs. An AV is able to measure the location and speed of itself and the direct vehicles around it. Intentions and specifications of the AV can also be communicated to the IC. The errors of the measurements need to be included when the controller uses measurements of the AVs in its prediction models of the trajectories of the vehicles. The communication between the IC and the AVs is quick and can be done in a range further away than the upstream part of the dilemma zone. When no negotiations happens, the communication can be assumed to be instant.

Current vehicle-actuated control systems

In vehicle-actuated control, the standard phases green and red are divided into sub-phases. The phases that can be shortened using data of AVs are the 4EG, the yellow and the RBG phase. 4EG uses information from the detector loops and set thresholds to decide if the phase can be ended. The yellow and RBG phase use fixed timings as the needed information of the vehicles cannot currently be measured by the detectors. The

equations used to calculate these fixed times are based on a chosen percentile of the behaviour of vehicles as observed at intersections. These equations included variables that an AV is able to measure.

For the 4EG phase, the dilemma zone of a vehicle is calculated via (2.2) and (2.3). When multiple vehicles are in the dilemma zone, the yellow phase should not be started to make sure no head-tail collision is able to happen.

The yellow phase is used in the Netherlands to communicate that if vehicles are able to, they need to stop. Currently, it cannot be predicted what vehicle will be the last to enter the intersection. Furthermore, in [40] it was concluded that the yellow time should be about 3.5 s for 50 km/h.

The end time of the red before green phase decides the time between the green phase of two conflicting directions. The minimal inter-green time of the two conflicting directions is calculated by adding the duration of the yellow phase and the clearance time (fixed time). The clearance time here depends on the predicted time it takes the last vehicle to leave the conflict area and the first vehicle in the upcoming direction to reach the conflict area from the stop line. The equations as used by [27] are (2.5), (2.6), (2.8) and (2.9). The percentiles of behaviour included to maintain a safe clearance time in most situations is 99%.

Trajectory prediction of leader AV and HDV

When the controllers uses (2.2), (2.3), (2.8) or (2.9) for predictions of trajectories, a tracking error should always be included. Even when no vehicles affect the tracking behaviour and all parameter (e.g. preferred acceleration and speed) settings are known. This needs to be included because the equations assume constant acceleration which is not always true in reality. When an HDV is the first vehicle in the queue it was found that the reaction time to start accelerate is 1.34 sec (sd = 0.97).

Uncertainty of trajectory of the last vehicle in the queue

It was found that vehicles when leaving the intersection (when it is at least the 6th vehicle in the queue) obtain their desired speed to cross the intersection when passing the stop line. This means the behaviour depends more on the desired speed of a vehicle than the behaviour of the leader vehicle. Acceleration will then thus minimally fluctuate due to the leader vehicle.

The decisions of drivers to stop or go when a traffic light turns yellow remain unpredictable. The personality of the driver does have an influence on its decisions to stop or go.

The car-following models include more variables than the prediction equations (2.2), (2.3), (2.8) and (2.9). A car-following models could be used to model the behaviour of AVs and HDVs in simulations. The effect of traffic lights is not included in car-following models. The predictions made by the controller need this information. Therefore, car-following models are not used by the controller for predictions.

3

Control system design

In this section, the control system is designed. First, the relevant performance indicators of the intersection control system are selected. Then, the environmental assumptions are presented. Furthermore, an analysis of the control system in traffic engineering terms is performed. Using this, the control system is defined in mathematical terms in the analysis in control engineering terms. Finally, the type of controller is decided.

3.1. Identification performance indicators

Multiple performance indicators were identified in section 2.1. From these performance indicators the most relevant one for the assessment of the proposed controller is identified.

As the scope of this research is not on the type of energy (electrical, gasoline, diesel, hydrogen, sun, etc) that is used by an HDV/AV, the intersection controller is not assessed on its total fuel consumption or decrease of emission (as this depends on the type of energy used per vehicle). The occupancy of the conflict areas is not used as a performance indicator because the occupancy also depends on the demand at the intersection. When there is low demand, the occupancy will also be low while the chance of all vehicles being able to pass the intersection without delay is higher than with a high demand. It would therefore be difficult to compare the performance of the intersection in scenarios with different traffic demands with the occupancy of conflict areas. Therefore, the used performance indicator for the proposed controller is the delay only.

Definition of delay

The average delay per vehicle is used as performance indicator. The delay of a single vehicle is calculated by subtracting the time it has cost the vehicle to cross the intersection from the time it would have cost the vehicle to cross the intersection without interference of other vehicles/traffic lights (driving at its desired speed). The average delay per vehicle is calculated by adding the delay of all single vehicles over a given time interval and dividing it by the total number of vehicles. The delay could also be defined as the total delay. This is the total seconds of delay over a given time interval.

The comparison of average delay per vehicle of the proposed intersection controller and the current intersection controller can provide insight in the performance of the proposed controller.

3.2. Assumptions

Below a description is given of the environment the controller is designed for. This is about the movements the vehicles are able to make at the intersection:

- The controller uses all relevant information of vehicles approaching the intersection, provided by AVs or detectors. The data taken from detectors is the detector gap time and the time the detector gap time was last measured. The data from an AV is its own location and speed and its follower vehicle (FV) and its leader vehicle (LV) location and speed. This data also includes the length and desired acceleration and deceleration of the AV. The traffic lights influence the movements of the vehicles.
- The controller can give a task to an AV to keep on driving or to stop. The controller does not provide a complete trajectory to realize this task. The AV performs the steps towards the task based on its own insights and information of the vehicles around it. In this research, it is assumed that AVs will only receive a task they are able to perform and that AVs will always comply to the task.
- Only cars are present at the intersection. This does not represent reality, as intersections are also used by trucks and, in case of an urban intersections, usually by pedestrians and bikes.

- Only one lane is present for each movement. This means no overtaking occurs and it is clear in what direction the vehicles will go before crossing the intersection. In reality, often multiple lanes are used for the same movement.
- When a direction obtains green phase no conflicting directions obtains green and AVs are not allowed to cross the intersection during the red phase of their direction. AVs know when their direction changes phase. This means AVs have no reaction time, and start to accelerate as soon as the phase switches.
- An intersection is considered where turns are not allowed. In reality, most intersections do include turns.
- The proposed controller is an extension of currently used tactics within the sub-phase of the intersection controller used in the Netherlands as defined by [27]. This means that the currently existing system decides when it is time to change phases and which direction obtains green next. The proposed control design thus only focuses on a safe and efficient transition in between the green phase of two cycles of the same direction.

The above-mentioned environment describes a simple intersection. In reality, most of the time more complex intersections are in use. The point include what can be done to make them more accurate with reality. This is further discussed in chapter 5.

The following assumptions are about the IC, the communication, the errors and the capabilities of the AVs:

- AVs are able to communicate with the IC without any delay within a radius, R m, from the centre of the intersection. This radius should be at least the length of the most upstream part of the dilemma zone to the centre of the intersection (from this point the information of the AV becomes crucial to determine the control actions). An AV is able to send a message every T_{AV} seconds. An IC can do this every T_{IC} seconds. No negotiations are included in the control system. T_{AV} is smaller than T_{IC} . In this way, the IC will not have to wait longer than its own update time to obtain new information from the AVs. In reality, delay can exist and messages could not be received.
- AVs can communicate with each other and therefore identify if their LV or FV is another AV or not. The IC will not obtain this information. It will only obtain the location and speed of the LV and FV.
- Current states of an AV can be measured with errors in the speed and location.
- All AVs are able to measure the distance between themselves and their FV and LV, using LIDAR sensors. The speed of the LV and FV can also be measured (with errors). These vehicles thus have multiple errors in their measurements of location and speed: the error of the position of the AV and the error of the location of the LV or FV via the LIDAR sensors on the AV.
- AVs plan their trajectories. These trajectories are planned by the AVs based on desired behaviour (desired acceleration rate etc.). These trajectories can not always be tracked precisely due to external factors influencing the acceleration of the vehicle. To account for this, a tracking error is included when the speed measurement of an AV is included and a constant acceleration is assumed.
- HDVs are not able to communicate. Most proposed intersection controllers in the literature review do assume all HDVs are connected but this will not be realistic in the first part of the transition period.

3.3. Problem analysis in traffic engineering terms

In this section, a problem analysis in traffic engineering terms is performed. In section 2.3, the causes of delay were discussed and also what additional information of AVs could be used to decrease the delay. In this chapter, this is analyzed in detail. First, the connection between the three (sub-)phases, that affect the timing between the green phase of two conflicting directions, as identified in section 2.3, is elaborated upon. Then, each (sub-)phase is discussed separately. For each of these (sub-)phases the desired outcome is identified, as well as factors that decide to what extent this desired outcome is met. Also, possible scenarios at the intersection, based on the additional input of the AVs, are identified and the control actions that are needed in these scenarios, are described. Based on this, the tactics of the original (sub-)phases of the vehicle-actuated controller as defined by [27] are extended.

3.3.1. Connection between (sub-)phases of conflicting directions

The (sub-)phases analysed are influenced by each other. This is explained via conflicting directions n and m . When direction n is given as index, it means that this direction starts in the 4EG phase and continues to yellow and then waiting red. Direction m is in the RBG phase and continues to fixed green. The scenarios happening in a direction, decide what control actions should be taken. Which then consequently influences the scenario during the next phase. In the proposed controller, the yellow phase duration and the clearance time become variable. Each time step, the controller calculates when the yellow phase of direction n could be ended. The outcome of this calculation needs to be used to decide when the RBG phase of direction m , should be ended in the future. When the action of ending the RBG phase is performed while the yellow phase of direction n is not ended, the last calculation of when to end the yellow phase should be used to decide the end time. This is shown in figure 3.1.

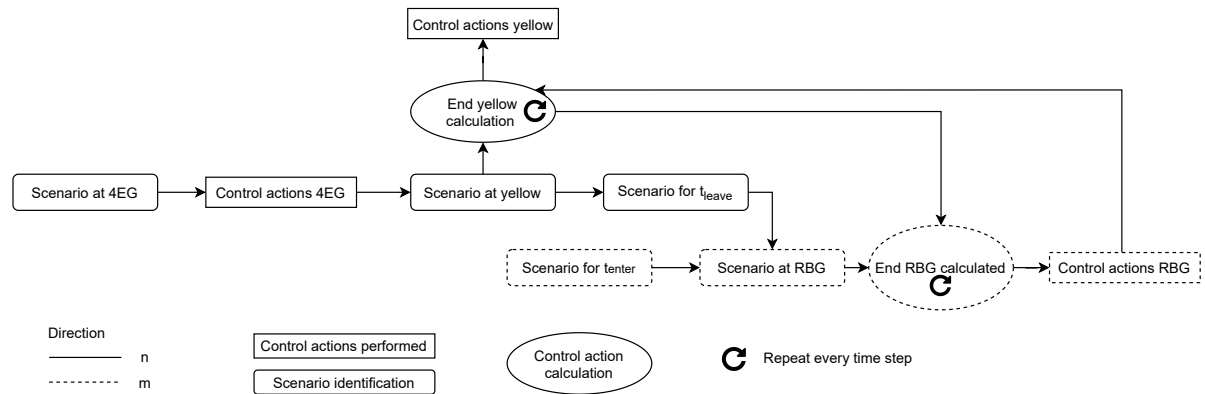

Figure 3.1: The connection between (sub-)phases of conflicting directions

A different scenario is possible during each cycle of a direction. The scenarios should therefore be reset. For direction n , the scenario should be reset at the start of the 4EG in the next cycle. For direction m , the scenario should be reset at the start of the RBG phase.

The state of the intersection is the combination of the locations and movements of all vehicles approaching the intersection. The state also includes the (sub-)phases the directions are in.

Lastly, the desired outcome of all phases is to make them as short as possible while maintaining safety.

3.3.2. 4th extension green

The first sub-phase that is discussed is the 4EG. To understand the working principles of this sub-phase, the concept of the dilemma zone needs to be clear and this is therefore discussed first.

Dilemma zone

The default dilemma zone as described in section 2.3.2, represents the general dilemma zone based on standard numerical values for all variables in the equations. This thus only represents the dilemma zone for a certain part of the vehicles, as the variables are different per vehicle. According to (2.2) and (2.3), the dilemma zone depends on each vehicle's preferences (e.g. desired acceleration or deceleration) and behaviour (e.g. reaction time) but also on the situation on the road (e.g. their speed). The speed of vehicles can be measured by AVs. Also, behaviour and preferences of AVs can be communicated. These measurements and communication, in contrast with detector loops, can provide vehicle specific dilemma zones. The meaning of the dilemma zone is slightly different for both AVs and HDVs. An HDV in the dilemma zone means it is unclear whether it will stop or continue. The dilemma zone of an AV is defined as the zone in which the controller is able to give a task and the AV is able to comply. This is illustrated in figure 3.2. Also, it is assumed AVs have no reaction time. This means with equal speed the dilemma zone of the AV is bigger than an HDV. Without reaction time, less distance is needed to come to a complete stop at the stop line. This is also shown in figure 3.2.

It is assumed that only 2 vehicles can be present in their dilemma zone at the same time. This can be proven by taking two vehicles that both have opposing extreme location of the dilemma zone. A vehicle with a high speed has a dilemma zone more upstream than a vehicles with a lower speed. An AV with a low speed has a dilemma zone most downstream. Using equation 2.3 with a vehicle with a speed of 55 km/h (high

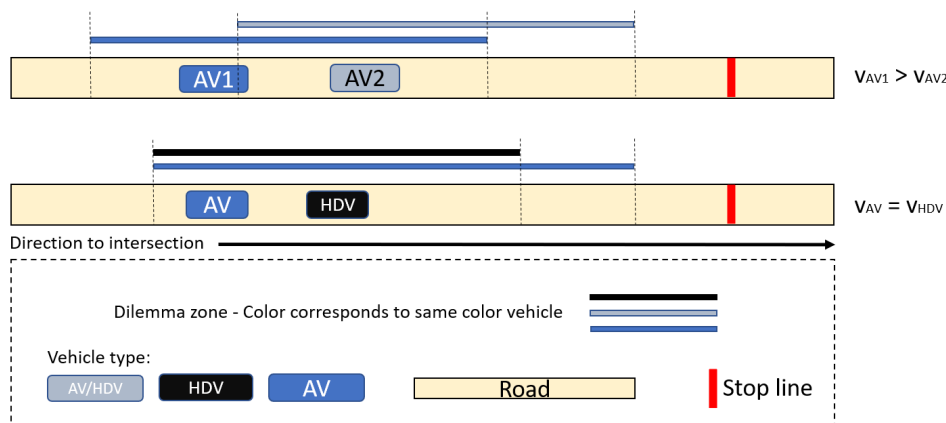

Figure 3.2: An example of the dilemma zones measured by an AV(s)

speed) and a yellow duration of 3.5 s, the vehicle is still in its dilemma zone at 53 meters from the stop line. If an AV in front of it, drives 45 km/h (slow speed), a deceleration rate of 2.8 m/s^2 the most downstream part of its dilemma zone is 28 m. This means these vehicles can be 25 m apart. Only two vehicles and their headway (0.9 s) could fit in this distance. When the maximum speed at the road is higher than 50 km/h, it could be possible that more than 2 vehicles could be in their dilemma zone at the same time. This could be explored in future research, see chapter 5. With this assumption it means that if an AV is in its dilemma zone, it is able to measure if the vehicles around it are too. It provides full knowledge of all vehicles in the dilemma zone. When the AV is upstream or downstream its dilemma zone it could only measure one other vehicle to be in its dilemma zone. This will not provide full knowledge of all vehicles in their dilemma zone.

The system

Below all relevant aspects of the system are described. Also, the 4EG phase should also have a maximum duration, as is already present in the tactics in the current vehicle-actuated control system. This system is concluded in figure 3.3.

Causes of the undesired situation When two HDVs are in their dilemma zone, green is extended to make sure no head-tail collisions occur due to the decisions the HDVs make, to stop or cross the intersection. If two vehicles are in their dilemma zone for which one can be given a task to avoid the possibility of a head-tail collision, this phase can be ended immediately.

Current and new control actions An AV can be assigned the task to either stop or go at the intersection. This means a change in risk when two vehicles are in the dilemma zone and one of these vehicle is an AV. In the original controller two vehicles in the dilemma zone would mean that the sub-phases needs to be extended. For the proposed controller, in this scenario, the AV can get the task to stop or continue, to make sure safety is maintained whatever the HDV will decide to do. The end time of the 4EG phase can be extended or ended accordingly.

Disturbances The disturbance of the system is the appearance of HDVs on their dilemma zone. The decision of these HDVs, whether to stop or continue, if yellow light would appear, remains unknown.

Measurements Only the information the relevant AVs will be used to decide what scenario is happening. This could either be an AV in its dilemma zone or an AV upstream or downstream of its dilemma zone when no other vehicle is present in its dilemma zone. Detector data will be used otherwise.

Possible scenarios and control tactics

The arrival times of HDVs and AVs will generate different scenarios for which the duration of this sub-phase will need different control tactics. As explained in section 2.5, it can be assumed that the vehicles arriving at the intersection during the 4EG phase, will not be in a congested situation and their behaviour is influenced little by the behaviour of their predecessor. The vehicles that will be in the dilemma zone when the yellow phase starts, are thus likely to maintain the speed they are driving at the beginning of the 4EG, till they pass the stop line. With this as starting point, different scenarios are possible. In figure 3.4 the possible scenarios

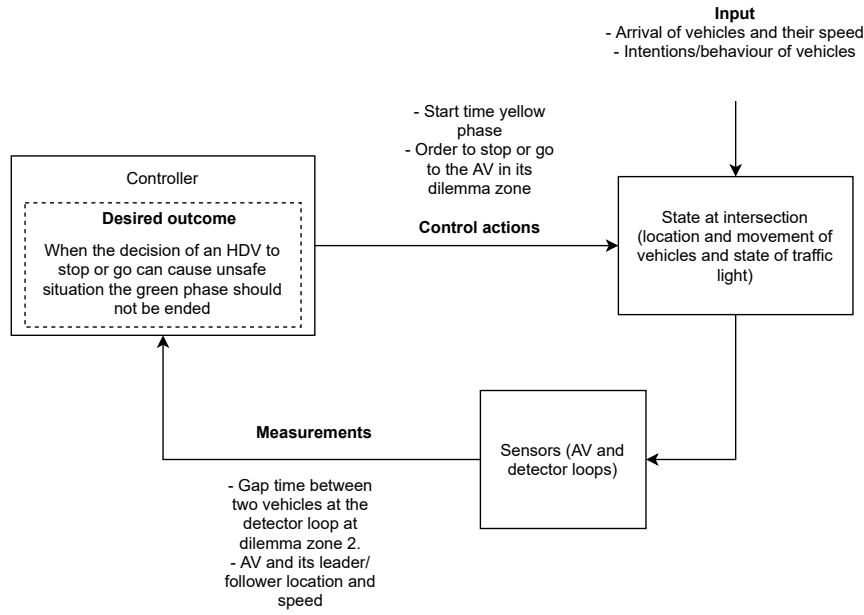

Figure 3.3: Control system '4th extension green' and its in and outputs

are illustrated. Only the vehicles that are in their dilemma zone (which varies per vehicle) are relevant for the scenario identification. Per scenario, the needed control actions are described below.

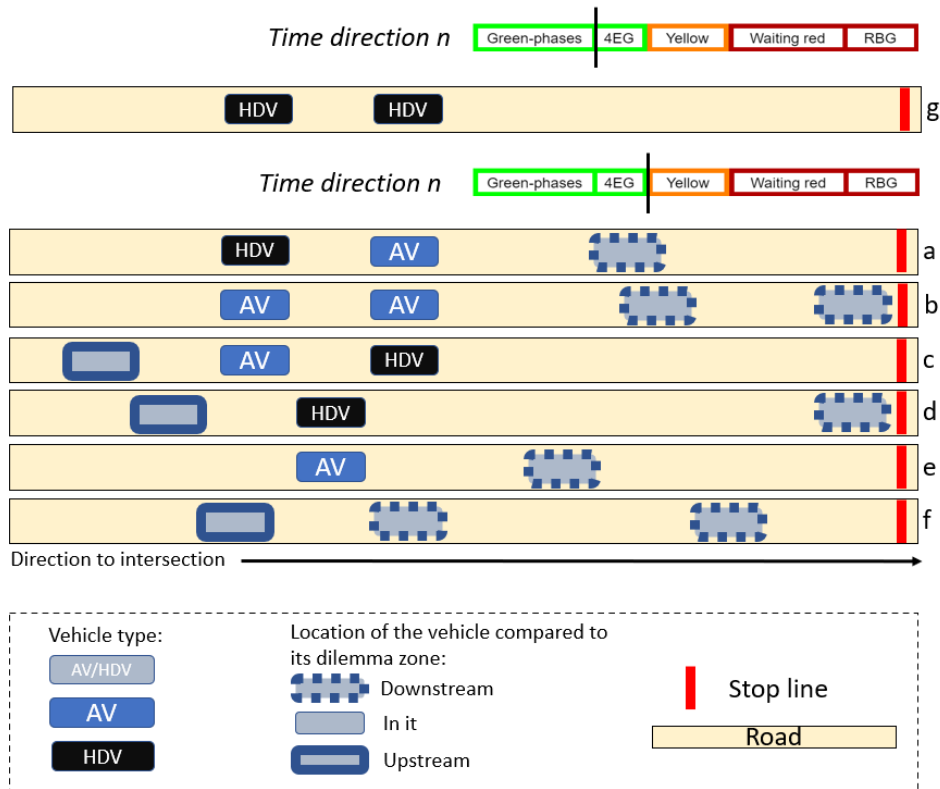

Figure 3.4: Possible scenarios at the start of the 4EG phase and what actions to take

Scenario a The AV should be ordered to cross the intersection so that if the HDV decides to cross as well, no

collision can occur. The 4EG phase can be ended directly, while maintaining safety.

Scenario b Both AVs should receive the same task to stop or continue. Whatever task is given, the 4EG can be ended directly. The task that will be provided to the AVs is decided based on the desired output of the yellow phase. To make the yellow phase as short as possible, the AVs will be given the task to stop. This will be further explained in section 3.3.3.

Scenario c In this scenario the AV should receive the order to stop. Under that condition, the 4EG can be ended directly.

Scenario d Only one vehicle is in its dilemma zone. 4EG can be ended directly.

Scenario e Only one AV is in its dilemma zone. 4EG can be ended directly while guaranteeing a safe situation. For the same reason as in scenario b the AV should be given the task to stop.

Scenario f No vehicles are in the dilemma zone. 4EG can be ended directly. This scenario can be measured by an AV when it is outside of its own dilemma zone and can observe no other vehicles in their dilemma zone. If this cannot be measured by an AV, the detector loops could provide this information. When the last measured detector gap time is longer ago than the set threshold for the detector gap time it means no vehicle is in the default dilemma zone.

Scenario g When no information can be provided by AVs, detectors are used to identify this scenario. When the measured detector gap time is lower than the set detector threshold it means two vehicles are in the default dilemma zone. Just as in the current vehicle-actuated control system the end of the 4EG can not be given. The sub-phase can be truncated when another measurement (either of an AV or the detector) has shown that it is safe to end the 4EG.

In figure 3.5 a flow chart is provided to identify the scenarios and apply the needed control actions. The scenarios identified, will evolve in the next phase. The identification of the evolved scenarios is needed in the next phase.

Expected effectiveness

When the penetration rate of AVs becomes higher the amount of times scenario g occurs, will decrease. This means, 4EG can be ended immediately, more often in the proposed controller than in the original controller.

3.3.3. Yellow phase

The yellow phase will be variable in the proposed controller instead of fixed as it is in the original controller. The time of the yellow phase can never become higher than the default yellow time. The time-dependent dilemma zone is a relevant aspect for this phase and is therefore, discussed first.

Time-dependent dilemma zone

If an HDV at the start of the yellow phase is in its dilemma zone, it is unknown what decision to stop or continue the HDV will make. It is assumed that the HDV will make this decision at the start of the yellow phase and sticks to it. The time-dependent yellow phase is used to assess what decision the HDV has made. The time-dependent dilemma zone is similar to the dilemma zone defined for 4EG. The difference is that the start time of the yellow phase is included in the time-dependent dilemma zone. At the start of the phase the default yellow duration is assumed. When time continues, the assumed distance the HDV can drive within the yellow phase decreases. But, only after the reaction time of the HDV, the location/deceleration of the vehicle will be visible. This is also included in the time-dependent dilemma zone. When during the yellow phase, the location of the HDV is measured to be outside of its time-dependent dilemma zone of that time instance, it can be concluded whether the HDV will stop or continue. In section 3.4.3 this will be explained in more detail.

The system

This system of the yellow phase is explained below and is summarized in figure 3.6.

Desired outcome Making this phase as short as possible would result in the last vehicle crossing the intersection passing the stop line exactly when the yellow phase ends.

Causes of the undesired outcome If the last vehicle to cross the intersection is unknown, the yellow phase can not be truncated.

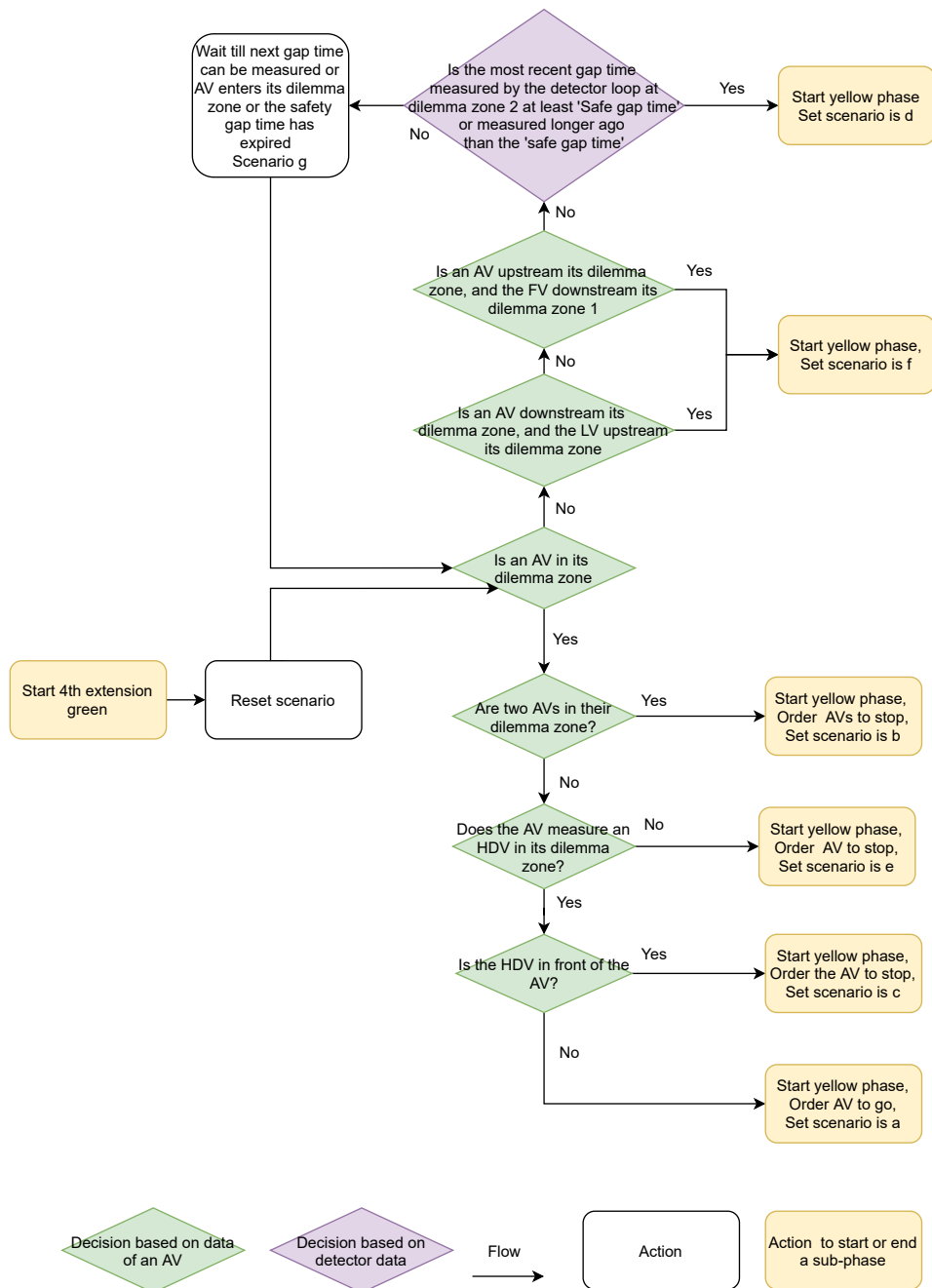

Figure 3.5: The flow of the controller in the 4EG phase

Current and new control actions The duration of the yellow phase and thus the end time of yellow can be controlled.

Disturbances The decision to stop or continue of the HDV in its dilemma zone is unknown.

Measurements AVs that were in their dilemma zone at the start of the yellow phase, can provide information about HDVs in their (time-dependent) dilemma zone during the whole duration of the yellow phase. The AVs can also provide measurements of the location of itself and its surrounding vehicles. Therefore, the AV is also able to measure when a vehicle has passed the stop line.

The scenarios identified in the previous phase (4EG, figure 3.4) evolve to scenarios in the yellow phase. Each scenario has its own specific control solution, with a different approach to find effective control actions.

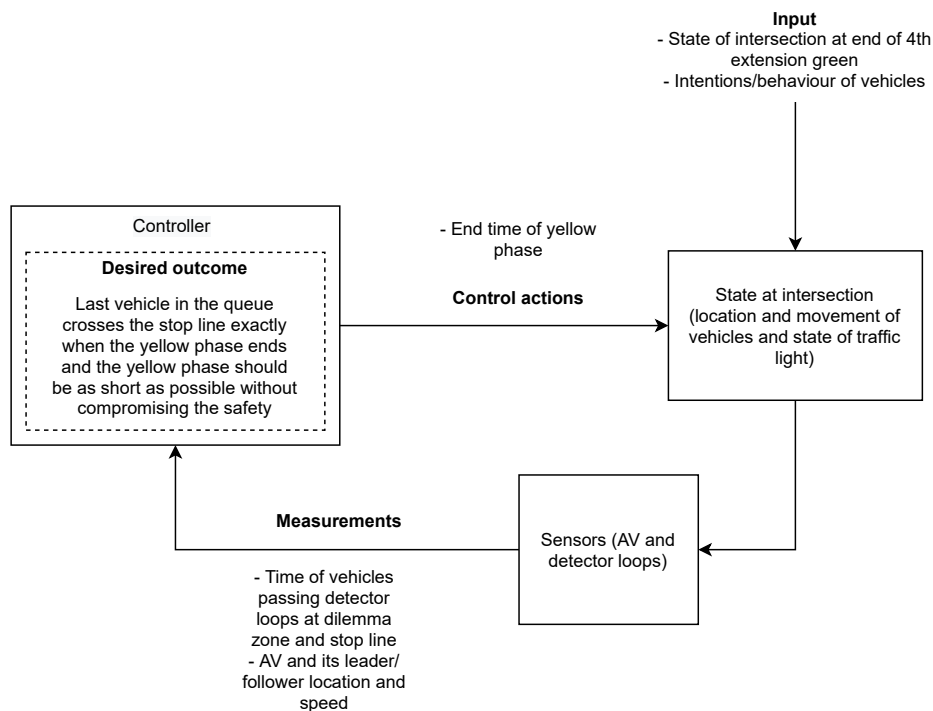

Figure 3.6: Control system yellow phase and its in and outputs

The scenarios and the solutions per scenario is identified in the next section.

Possible scenarios and control tactics

The control system should identify how the scenarios of the 4EG evolve. According to that evolved scenario, the last vehicle to cross the intersection can be predicted. According to this, the yellow phase duration can be predicted. It must be noted, that it is preferred to apply the end of the yellow phase when the last vehicle is measured to have passed the stop line instead of predicted. This measurement includes fewer errors than a prediction of when the vehicle will pass the stop line. When the clearance time with the conflicting direction is negative, measuring when the last vehicle passes the stop line is too late to be able to provide fixed green to direction n as soon as possible.

Scenario a If an AV is in front of an HDV in its dilemma zone at the start of yellow. It is unknown whether the HDV will continue or stop. The AV will need to compare the location of the HDV with its time-dependent dilemma zone each time step till the HDV is outside its time-dependent dilemma zone. If the HDV is upstream the time-dependent dilemma zone scenario a has evolved to scenario a.1. The AV will be the last to cross the intersection. If the HDV is measured to be downstream of its time-dependent dilemma zone it can be concluded that the scenario is evolved to a.2. The HDV will be the last vehicle to cross the intersection. The yellow phase can be truncated according to when the last vehicle will/has passed the stop line, based on measurement of the AV that was in its dilemma zone at the start of the yellow phase.

Scenario b To make the yellow phase as short as possible, both AVs will stop upstream of the stop line. The LV of the leader AV in the dilemma zone at the start of yellow will be the last to cross the intersection.

Scenario c This scenario is similar to scenario a. Based on the decision of the LV the scenario can evolve to c.1 or c.2. Scenario c.1 happens when the LV's location is downstream of its time-dependent dilemma zone. The predecessor of the LV will be the last vehicle to cross the stop line. The AV is not able to provide information on this vehicle. The end of yellow will be decided on the LV and when it would have crossed the stop line if it would have continued driving.

Scenario d In this scenario, the default duration of the yellow phase should be used to maintain safety.

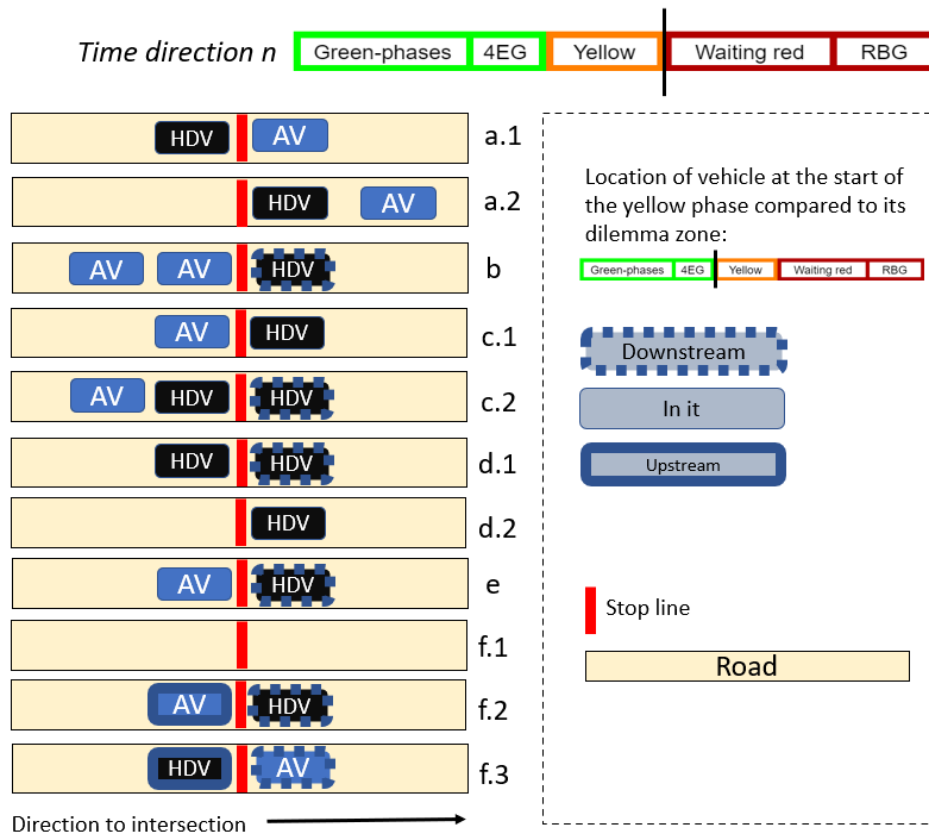

Figure 3.7: Scenarios at the end of the yellow phase

Scenario e The LV of the AV, that was the only vehicle in its dilemma zone at the start of the yellow phase, will be the last to cross the intersection.

Scenario f This scenario can evolve to three scenarios. The closest AV upstream of its dilemma zone at the start of the yellow phase should be used to assess if scenario f.2 is happening. This is the case when this AV measures its LV to be downstream of its dilemma zone. The LV will be the last vehicle to cross the intersection. f.3 happens when the most upstream AV, that is downstream its own dilemma zone measures its FV to be upstream of its dilemma zone. The AV will be the last vehicle to cross the intersection. When neither of these scenarios are happening the scenario is concluded to be f.1. As no measurements are provided here by an AV the default yellow duration should be used.

In figure 3.8 the identification for the scenario can be found as well as on what measurement source (detector loops or AVs) the decisions should be made. What actions should be performed in what scenario, is also presented.

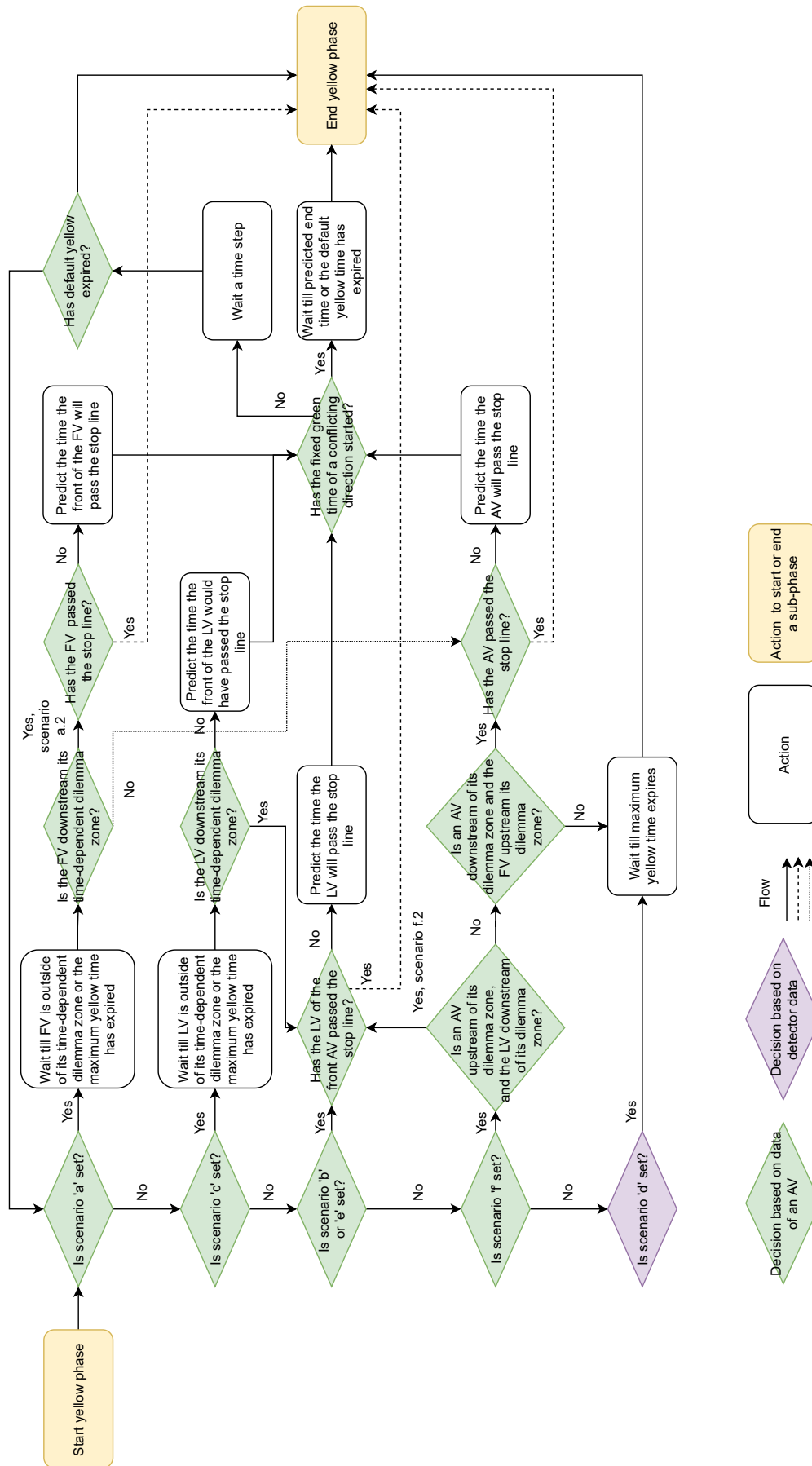

Figure 3.8: Decisions to identify scenarios during start of yellow time and its control actions

Expected effectiveness

This control system will especially be useful when the penetration rate of AVs increases. When more AVs enter the road, more information will be available and the chance of an AV being around the dilemma zone when the phase is about to switch to yellow will be higher. This will provide more effect of the control system. As the dilemma zone is only a short part of the road leading to the intersection, it is expected that scenario f will happen most often, and will thus affect the outcome of a state closer to the desired outcome more often than the other scenarios.

3.3.4. Red before Green

The third phase that is analysed is the RBG phase. The inter-green time cannot be lower than 0 seconds (according to the Dutch law). When an AV can provide information about the first or last leaving vehicle to predict t_{leave} and t_{enter} this information should be used. If this is not the situation, the default times should be used.

The system

The system of this phase will be described below and is summarized in figure 3.9.

Desired outcome Making the phase as short as possible will result in a clearance time that is as small as possible but no more than a minimum clearance time to avoid collisions. The minimal clearance time for two AVs ($t_{\text{clearance,AV-AV}}$), is different than for an AV and an HDV ($t_{\text{clearance,HDV-AV}}$) that will alternate on the conflict area. When HDVs are involved, this minimal clearance time should be provided, to make the drivers feel and be safe. Feeling safe is subjective but relevant for both the people within the AV as the driver of the HDV [8]. In the current control system, safety margins of the clearance time are automatically applied by setting the percentiles of variables.

Causes of the undesired situation The exact behaviour of an HDV is unknown. When traffic lights change phase from red to green it takes a few seconds before a vehicle from the upcoming direction will reach the conflict area. The control action (timing of the red phase) will thus only show its effect on the gap time after these few seconds and after a vehicle passed the stop line it cannot be controlled by the traffic light anymore. Furthermore, based on what scenario is happening at the intersection the AV can provide additional information about the approaching speed or its location on the road and its surrounding vehicles to decrease the uncertainty of behaviour that is possible when entering/ leaving the intersection. Furthermore, with the new control tactic for the yellow phase, it means the yellow time of the leaving direction is variable. If the calculated clearance time is a negative value, red of the upcoming direction should be ended in the yellow phase of the previous direction. This can only be done from the moment the duration of yellow is certain. This also means that for some situations, the yellow time should be predicted instead of real-time be measured to be able to provide an optimal end time of the RBG phase.

Current and new control actions The clearance time in the proposed control system is variable. This means the end time of the RBG phase is not based on a fixed time anymore.

Disturbances Errors in prediction of t_{enter} and t_{leave} might be present. In all situations, these values need to be predicted. In some situations, they will need to be predicted based on the information at the start of the yellow phase and in some situations (which is more accurate) it needs to be predicted with the input at the end of the yellow phase. The end of the yellow phase is not always known at the time the RBG phase starts. Only when this is known the end of the RBG phase can be calculated. It could be possible that at the first possible moment of calculating the end time, this end time has already passed. The end time of RBG should then be provided immediately.

Measurements AVs provide additional information to more real-time be able to predict the leaving time of the last leaving vehicle and the first upcoming vehicle of the conflicting direction. An AV can provide the speed, and location of itself and its surrounding vehicles. Furthermore, it can provide its length, maximum acceleration, preferred headway, and preferred deceleration rate. No detector data is used to provide information to be able to calculate the needed clearance time to calculate the end time of the RBG phase.

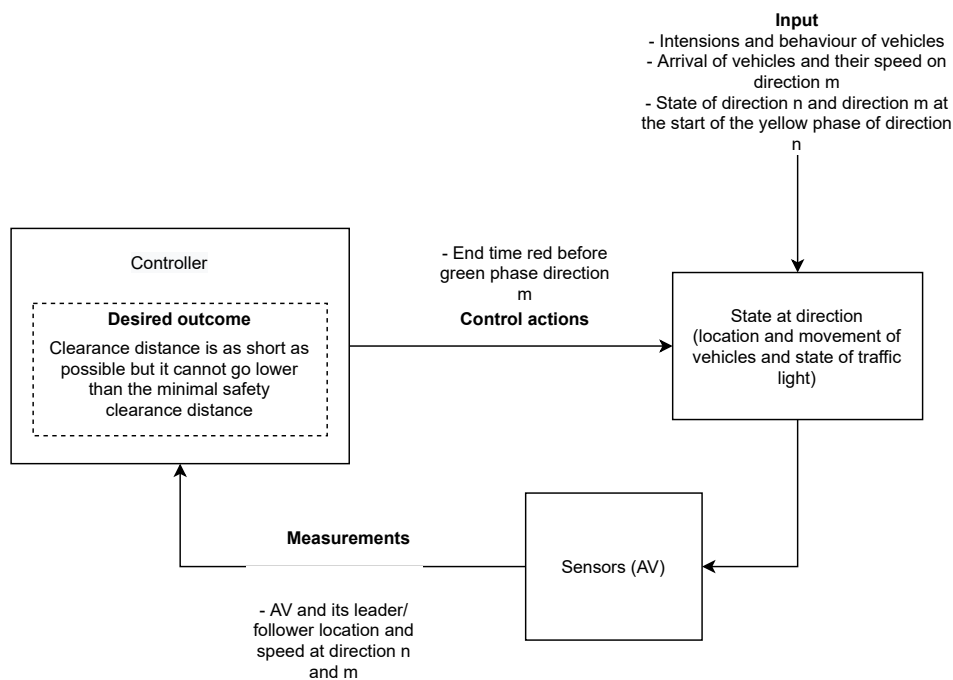

Figure 3.9: The input and output of the sub-phase: RBG

Possible scenarios and control tactics

The controller needs to identify the scenario at direction m and all conflicting directions n. The scenarios at each conflicting direction n comes from the scenario identification of the yellow phase as here the last vehicle to cross the intersection is identified. This, is used to calculate t_{leave} . The possible scenarios at direction m, to calculate t_{enter} , are identified below. The combination of these scenarios will provide the needed control action.

For the first entering vehicle three scenarios can be identified in which the AV is able to provide additional information. These are the following:

LV is first entering vehicle (from standstill) When an AV is at standstill within 10 m (which is about the size of one vehicle and two times the standstill distance) of the stop line it can be assumed that the AV is the second in the queue. It can provide information to the IC, that the first vehicle entering starts from a standstill instead of with a certain speed. This changes the possible trajectories in which the vehicle is able to cross the intersection.

AV is first entering vehicle (from standstill) When an AV is at standstill at the stop line it can be concluded it is the first vehicle to enter the intersection. The preferences and behaviour of the AV can be used to predict the possible trajectories.

AV is first entering vehicle (with approaching speed) An AV approaching the intersection with a certain speed and its LV upstream of the stop line, is not able to measure vehicles in front of the LV. It will thus not be able to conclude whether the LV, is the first entering vehicle. When it measures its LV to be upstream the stop line, it can be concluded that the AV is the first entering vehicle on direction m.

For t_{leave} , 4 scenarios can be identified in which the additional information of the AV can be used. It is assumed that the last vehicle to cross the intersection has reached its desired speed during the yellow phase and the speed will remain constant while crossing the intersection.

AV is the last vehicle The speed and length of the AV is known, with this t_{leave} can be calculated. This scenario results from scenario a.1 and f.3 of the yellow phase.

LV is the last vehicle The speed of the LV can be measured by the AV. This scenario results from scenario b, c.1, e and f.2 of the yellow phase.

Predecessor of LV is the last vehicle The speed of the LV can be used here as approximate speed of the predecessor. This scenario results from scenario c.2 of the yellow phase.

FV is the last vehicle This scenario results from scenario a.2 of the yellow phase.

When no additional information is provided by an AV about the last or first vehicle, t_{leave} and t_{enter} should be set to the default value.

With t_{leave} and t_{enter} , the clearance time can be calculated. The clearance time of two directions can be calculated from the time the last vehicle is known (otherwise t_{leave} cannot be calculated). Also, based on the type of the last and first vehicles the safety clearance time is added.

With the predicted clearance time and end time of yellow of all conflicting directions, the end time of the RBG can be decided. The critical time here should be used as the actual end time. The critical end time is the highest predicted end time of all conflicting directions. The critical end time of the RBG phase is explained in figure 3.10. If the predicted critical end of the RBG time has not expired, each time step the calculation of the clearance time can be performed again. The later in time the clearance time is calculated, the more accurate it is to the behaviour of the vehicles while crossing the intersection.

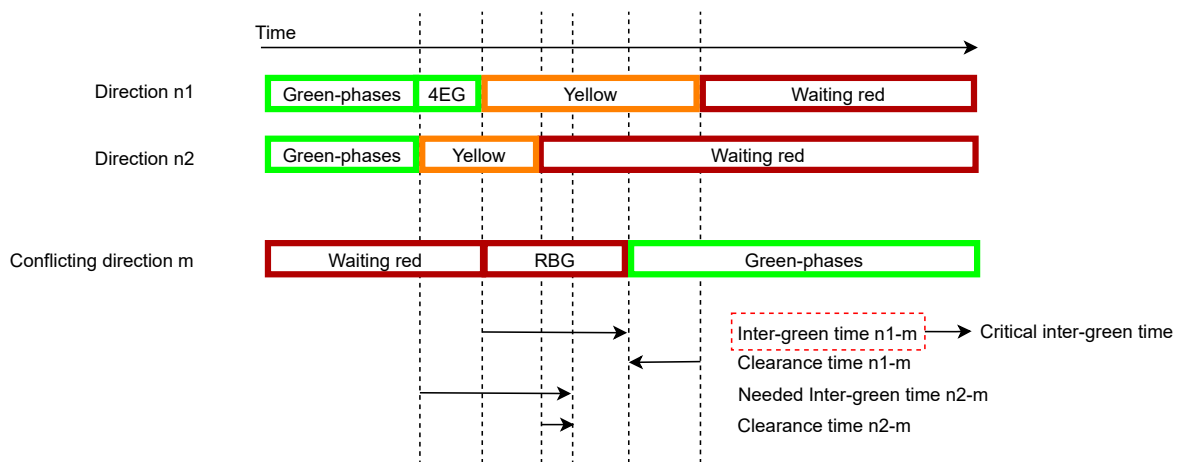

Figure 3.10: The critical inter-green time

In figure 3.11 the flowchart to decide the end time of the RBG phase, is given. Within this flowchart, the flow chart to calculate t_{leave} of the leaving direction n is calculated via figure 3.12. T_{enter} of the entering direction m is calculated via figure 3.13.

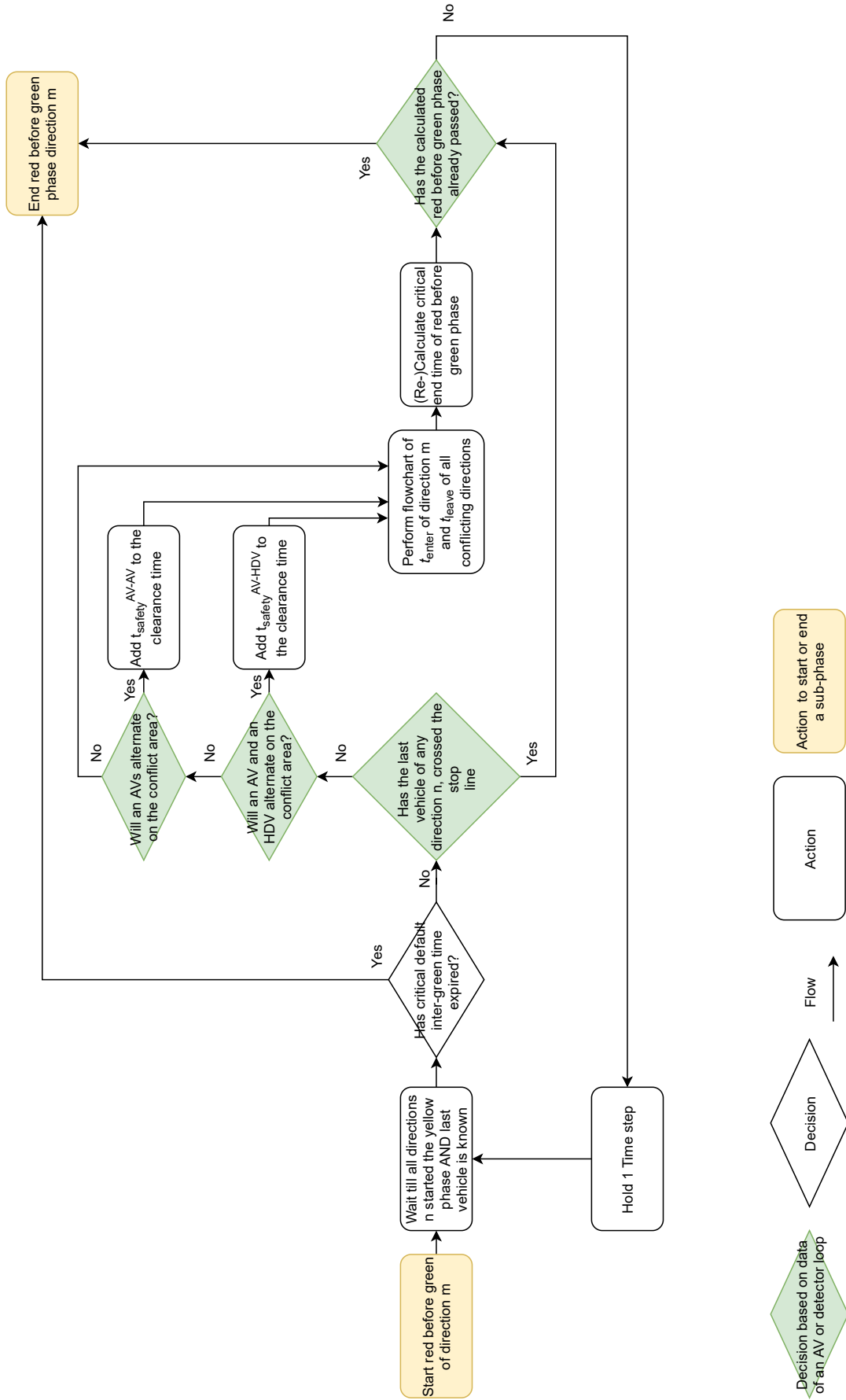

Figure 3.11: Flow chart to decide the end of the RBG phase

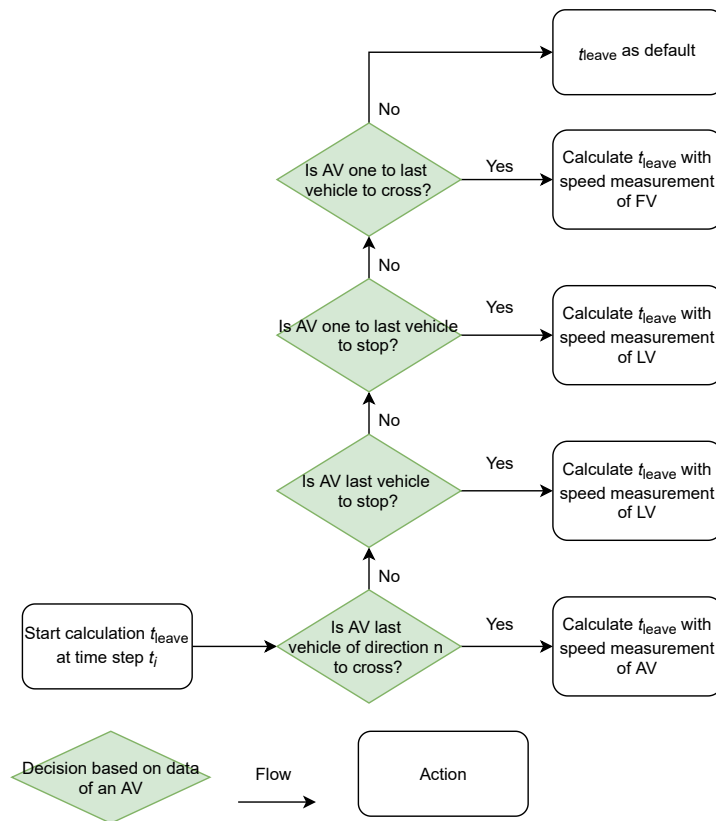

Figure 3.12: Decisions to identify scenarios for t_{leave} and its control actions

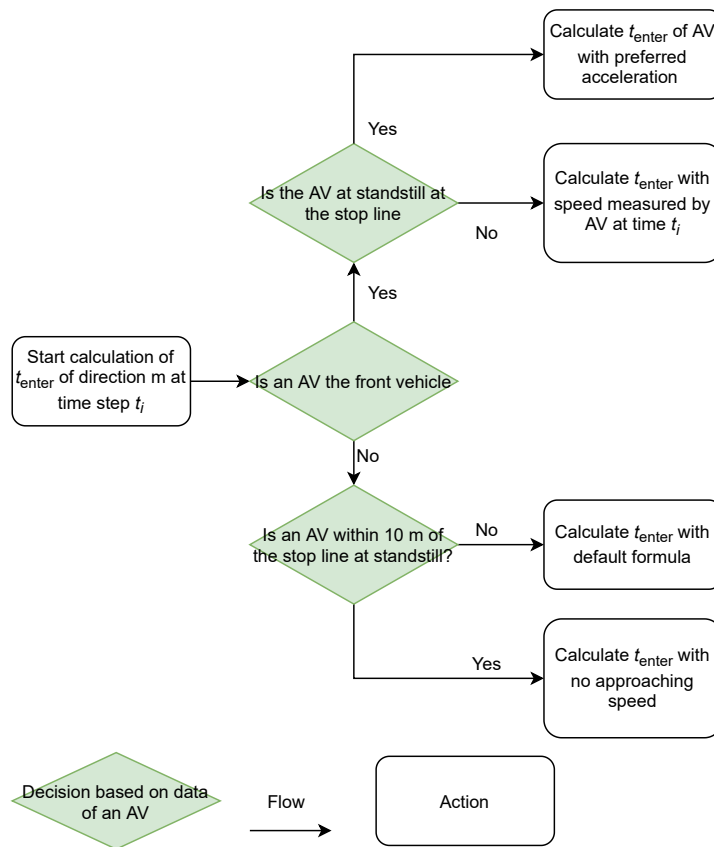

Figure 3.13: Decisions to identify scenarios for t_{enter} and its control actions

Expected effectiveness

When the penetration rate is low the duration of the RBG phase will only in a few situations be as the desired outcome. This might provide a small decrease in delay time. When the penetration rate becomes higher, the delay time will probably decrease more.

3.4. Problem analysis in control engineering terms

In this section, first, the input of the control system is discussed. Next, it is discussed what transformation needs to be done with the input measurements for decision making when identifying the scenario but also of the approach to obtain the (numerical) needed control actions. This is done per sub-phase of the controller.

3.4.1. Input

In this section the layout is elaborated upon. Furthermore, the default settings, data from sensors and the equations for prediction of the needed control actions are discussed. Where needed, the drawbacks are discussed and explained how this is taken into account.

Lay-out of intersection in mathematical terms

Each direction is indexed by cardinal directions. For each of these directions, the distance of the stop line to the middle of the intersection, the distance from the stop line to the conflict area and the width of the lanes should be known. Furthermore, the stage flow scheme should be provided to the intersection.

In figure 3.14 the frame in which the location of the vehicles is expressed, is shown. The origin of the frame is located at the stop line. As the vehicles are driving on a predefined path, only the longitudinal coordinate of the vehicles has to be provided.

Default settings

The pre-calculated inter-green time, the standard duration and start time of the yellow phase should be

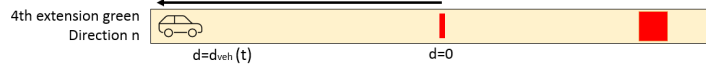

Figure 3.14: Frame to use for the 4EG phase and the yellow phase

known (as is currently used). Furthermore, the thresholds of the gap times used by detector loops for extension greens should be used.

Data from sensors

The measurements of the state of the system (of the vehicles) are provided by the AVs and the detector loops. It is explained what the input information consists of and what the possible errors might be. In the flowcharts 3.8, 3.12, 3.13 and 3.11, it can be found via what data source the decisions are made.

Information from an AV

The information of all AVs in range R , each time step (t_i) is saved. With this information, the controller can extract the AV driving at a specific direction or within a certain range (e.g. the dilemma zone).

To write the information from an AV in mathematical terms, the following sets are defined:

- K is the set of AVs within range R of the intersection
- DIR is the set of directions {EW, WE, NS, SN}
- I is the total amount of time steps

For each AV, $k \in K$ the following variables are provided, during each time step t_i for $i \in I$:

- $d_{\text{measure,AV}}^{k,dir}(t_i)$ The measured location to the stop line of AV k on direction dir at time step t_i
- $v_{\text{measure,AV}}^k(t_i)$ The measured speed of the AV at time t_i
- $a_{\text{dec,comf}}^k$ The comfortable deceleration rate of AV k
- $a_{\text{acc,comf}}^k$ The comfortable acceleration rate of AV k
- l_{veh}^k The length of AV k
- $d_{\text{front,LV}}^k(t_i)$ The measured location of the back of the vehicle of the LV to the stop line at time step t_i
- $d_{\text{back,FV}}^k(t_i)$ The measured location of the front of the vehicle of the FV to the stop line at time step t_i
- $v_{\text{measure,LV}}^k(t_i)$ The measured speed of the LV at time step t_i
- $v_{\text{measure,FV}}^k(t_i)$ The measured speed of the FV at time step t_i

In reality, the IC should provide a MAP to the AVs for them to be able to locate themselves at the intersection in the above-mentioned frame. How this is done, is not elaborated upon in this research.

Information from a detector loops

The detector gap time between two vehicles passing the detector loop ($t_{\text{detector,gap}}$), and the time step the detector gap time was measured ($t_{\text{measurement}}$) can be obtained. The distance of the detector loops from the stop line is known. Each direction has three detectors, defined as the set DET with {1, 2, 3}. Each detector is defined as $D_{\text{det}}^{\text{dir}}$ where $\text{det} \in DET$ and $\text{dir} \in DIR$. Each detector has its threshold gap time set as $t_{\text{gap,safety}}$.

Error in measurements

In section 2.2 it was found there are errors in the measurements an AV provides. First of all, there is the error of its location via GPS. The error is not always the same but is defined as a distribution. The location error of the LV and FV consists of the error caused by LIDAR ϵ_{LIDAR} and GPS ϵ_{GPS} . The error in the location of an HDV is more than for an AV due to this. There is also an error present in the measured speed of the vehicles ($\epsilon_{\text{speed,AV}}$) and ($\epsilon_{\text{speed,AV}}$). The error of the speed for AVs is smaller than for HDVs. This is due to the fact that both the error caused by the LIDAR and the error in the speed measurement of the AV, will also affect the speed error of the HDV. It is assumed that all the above-mentioned errors are normally distributed around 0. Furthermore, it is assumed that when a speed of 0 is measured by the AV, the AV is at standstill without a doubt.

Equations for predictions of trajectories

As stated in section 2, multiple equations are used to predict how vehicles move around the intersection. It was concluded that the equations introduced by [27], are also used in the proposed control system. To be able to use these equations some changes need to be made according to the new information of the AVs. The variables used in these original equations are almost all distributions. These distributions originate from behaviour as observed at intersections of many HDVs. To find a solution to the equations a certain percentile of the distribution of the variables is set.

As stated in section 1.3, the variables are set so that in 99 percent of the cases a safe situation is obtained. With the measurements of the AVs and the possibility of the AV to communicate with the IC, some of the variables from the mentioned equations in the current control system can be replaced by the measurement of the AV (or fixed variables as for example the length of the AV). The measurement errors still provide variables with a distribution in the equations but the range of the distribution is smaller. Note that not all variables in the original equation can be replaced by a measurement of an AV. The length of an HDV for example cannot be measured by an AV, therefore this variable should stay the original variable that is defined as a distribution. It is assumed that the distribution of all variables used in the original equation are normally distributed. In this research, trucks are not assumed to be at the intersection. If this would be the situation the distribution of the length of the vehicles is not normally distributed anymore.

Some assumptions are made in the original equations of [27] that should be taken into account when applying the equations for AVs (and HDVs of which additional information is provided by the AV). In the equations where a vehicle does not slow down or speeds up on purpose (e.g. to stop when yellow light appears), it is assumed that no acceleration occurs. Also, when a vehicle is slowing down or pulling up, it is assumed to have a constant acceleration rate. Due to external factors, this is not always realistic (e.g. an inclination of the road, vehicle mechanics). In the original equation the error of this assumption is included while setting the percentile of the distribution of the acceleration or speed. When the variables for speed or acceleration in the original equation are replaced by input measurement from the AV (the AV can communicate its desired acceleration rate, which is assumed to be a fixed and set variable) this deviation to external factors should be taken into account. This is done by adding a tracking error to the trajectory the AV planned for itself. The planned trajectory of the AV is assumed to be generated with the desired speed and acceleration rate. For the same reason, an HDV will also have a tracking error when in the original equation it is assumed the acceleration is 0.

To maintain the same safety standards as in the current system 99 percent of the situations should be safe. A percentile per variable (measurement error or immeasurable variable) should be set to obtain this. Per sub-phase it is provided how the prediction equations are changed with the new input from the AVs and what percentiles need to be set.

The variables of which the 99 percentile is necessary, is in most cases expressed with multiple normal distributed variables using different operators (e.g. added or multiplied). When these variables are added the resulting distribution remains a normal distribution and can be found with simple mathematics. When there are normal distribution X with (μ_X, σ_X^2) and Y with (μ_Y, σ_Y^2) , adding the two distributions will give a normal distribution with $(\mu_X + \mu_Y, \sigma_Y^2 + \sigma_X^2)$. When the operator of two normally distributed variables is multiplying or dividing the new distribution is not a normal distribution and is more complex to find analytically. For these variables, the percentile is found by sampling. This means that n times a numerical is obtained from the distribution of the variables used in the equation. the answers to the equation for each of these n samples are saved. With the 10000 solutions, the required percentile can be obtained. These samples could be done in real-time by a controller but it is also possible to do the sampling offline and create a table for different input variables. If the amount of variables that change input is high, the sampling could rather be done in real-time, as otherwise big tables need to be created for all different input variables. If a percentile of a variable need to be obtained every time step, a table would be preferred as a continuously sampling would require a high computation time. In the appendix in section B.2 a work plan can be found for sampling.

3.4.2. 4th extension green

To identify the scenario, the questions in figure 3.5 need to be answered. All these questions and how to answer them is explained below.

Transformation equations for scenario identification

For the 4EG phase it needs to be evaluated whether vehicles are in their dilemma zone. For this the dilemma zone of the vehicle need to be obtained as well as the location of the vehicle. The most downstream part of

the dilemma zone is $d_{\text{zone1,veh}}^k(t)$ and the upstream part of the dilemma zone is $d_{\text{zone2,veh}}^k(t)$ where veh is AV, LV or FV. The location needs to be compared with the location of the dilemma zone to conclude whether a vehicle is in its dilemma zone. As explained above the percentiles of the variables should be set to guarantee a safe situation in 99 percent of the situations. 99% of the conclusion of equations (3.1) and (3.2) whether a vehicle is in its dilemma zone should thus be correct. As stated above the dilemma zone and the location of the dilemma zone per vehicle are defined as variables with a distribution due to errors in the equations. The actual dilemma zone and location lays somewhere in the defined distribution. For dilemma zone 2 the 98 percentile is used in the equation to determine whether a vehicle is in the dilemma zone and the 50 percentile of the $d_{\text{veh}}^k(t_i)$ is set to be used in the equation. In this way there is a 2% chance that actual dilemma zone of the vehicle is bigger than the used value in the equation. Together with the 50-percentile used as value for the location this brings a chance of 99% that the correct conclusion is made about a vehicle being in its dilemma zone. The same is done for dilemma zone 1, but the 2-percentile is used (the smaller the value for dilemma zone 1, the bigger the dilemma zone is). This is done via the following equations: $d_{\text{zone1,veh}}^k(t_i)(2) \leq d_{\text{veh}}^k(t_i)(50)$ (3.1) and $d_{\text{veh}}^k(t_i)(98) \leq d_{\text{zone2,veh}}^k(t_i)(50)$ (3.2).

How to determine the value of these variables is discussed below.

Dilemma zone based on measurements AV

Currently, the default dilemma zone is calculated with equation 2.2 and 2.3.

These equations can be filled in with the standard parameters for the default dilemma zone (by which the location of one of the detector loops is decided) or filled in by input of an AV. Not all variables in these equations can be obtained from the input of the AV. For these parameters, a percentile of the known distributions will still need to be used. Note that for HDVs that are not surrounded by an AV, the equations are filled in with standardized parameters only with the default percentiles. In table 3.2 it can be found what variables are present in the original equations for the dilemma zone for an AV, a LV and a FV and which of these original variables can be replaced by new information from the AVs and by what variable it is replaced. Furthermore, the default yellow duration will be used in (2.3). Even if yellow in the next phase would be truncated, HDVs expect the yellow time to be around the default time. They could base their decision to stop or continue (so being in their dilemma zone) on this information.

Table 3.1: The change of variables from the original equations of the dilemma zone for the AV, LV and FV with the additional variables provided by the AVs (and its errors).

| Variables from original equation (2.2) to $d_{\text{zone1,veh}}^k(t_i)$ | Vehicle type (veh) | | |
|---|--|--|--|
| | AV | FV | LV |
| $t_{\text{react}}(\mu, \sigma)$ | 0 | $t_{\text{react}}(\mu, \sigma)$ | $t_{\text{react}}(\mu, \sigma)$ |
| $v_{\text{appr}}(\mu, \sigma)$ | $v_{\text{measure,AV}}^k(t_i) + \epsilon_{\text{speed,AV}}$ | $v_{\text{measure,FV}}^k(t_i) + \epsilon_{\text{speed,HDV}}$ | $v_{\text{measure,LV}}^k(t_i) + \epsilon_{\text{speed,HDV}}$ |
| $(a_{\text{dec,comf}}(\mu, \sigma))$ | $a_{\text{dec,comf}}^k$ and adding ϵ_{track} | $a_{\text{dec,comf}}(\mu, \sigma)$ | $a_{\text{dec,comf}}(\mu, \sigma)$ |

Table 3.2: The change of variables from the original equations of the dilemma zone for the AV, LV and FV with the additional variables provided by the AVs (and its errors)

| Variables from original equation (2.3) to $d_{\text{zone2,veh}}^k(t_i)$ | Vehicle type (veh) | | |
|---|---|--|--|
| | AV | FV | LV |
| $v_{\text{appr}}(\mu, \sigma)$ | $v_{\text{measure,AV}}^k(t_i) + \epsilon_{\text{speed,AV}}$ | $v_{\text{measure,FV}}^k(t_i) + \epsilon_{\text{speed,HDV}}$ | $v_{\text{measure,LV}}^k(t_i) + \epsilon_{\text{speed,HDV}}$ |
| Assumption of no a_{dec} | add ϵ_{track} | add ϵ_{track} | add ϵ_{track} |

The complete equations transformation of the default equation to the equation used for an AV, a FV or LV with the input of an AV can be found in appendix B in section B.1.

Location vehicles based on input of AV

The actual location of AV k ($d_{\text{AV}}^k(t_i)$), its FV ($d_{\text{FV}}^k(t_i)$) and the LV ($d_{\text{LV}}^k(t_i)$) lays within a certain distribution from the measured location by the AV. The measurement errors by the GPS and the LIDAR should be added to the measured location by the AV. The distribution that results from this includes the actual location of the vehicle.

The LIDAR error should be included for the LV and FV only and the GPS is added for all types of vehicles. The measured location of the LV is from the back of the vehicle. To decide the location of the vehicle to the stop line from the front of the vehicle the length of the vehicle should thus be added. The equations to find the location of a type of vehicle are presented in appendix B in section B.1.

Transformation to obtain the control actions

When an AVs is found to be in its dilemma zone, its LV and FV should be assessed. If no AV is found to be in the dilemma zone the closest AVs to the dilemma zone on the upstream side and downstream side are searched for. When the scenario is obtained by this, the actions as explained in figure 3.8 should be applied. An AV needs to confirm that the order to stop or go was received. Then the IC can start the yellow phase.

3.4.3. Yellow phase

How to identify the scenario and calculate the needed end time of yellow is discussed here.

Transformation for scenario identification

Again, a 99 percent guarantee should be provided that the last vehicle passed the stop line. For the time-dependent dilemma zones the comparison is made with the 50 percentile of the $d_{veh}(t)$ to decide whether a vehicle is in the time-dependent dilemma zone. For the time-dependent dilemma zone 2, this means the same as for the dilemma zone defined in 4EG phase. The downstream part of the dilemma zone, depends on two separate factors, the reaction time and the distance of the downstream part of the dilemma zone from the stop line. For this distance the percentile can be set to 4 percentile when a 50 percentile of the reaction time has passed before being able to calculate the time-dependent dilemma zone. this provides a 2 percentile of the distance of the dilemma zone that is compared to the distance of the vehicle.

When no AV has presented information, the information from the detector loops is used. When an AV has presented itself in the dilemma zone, it is known in almost all cases what the last vehicle to pass the stop line will be. Only when an LV or FV is also in the dilemma zone (scenario a and c), it is unknown at the time the yellow phase starts what the HDV will do. At some point during the yellow phase this might become clear. This assumption is elaborated upon with the use of the time-dependent dilemma zone of a vehicle.

Time-dependent dilemma zone based on measurements AV

The dilemma zone after yellow has started should be calculated in a different way. Only after the reaction time of the HDV to the yellow light, changes might occur in its behaviour. Starting from this time, the IC should recalculate the time-dependent dilemma zone of the HDV using the measurements from the AV and compare this with the measured location of the HDV. If the location of the HDVs at some time instance, is upstream its time-dependent dilemma zone of that same time instance, it can be concluded that the HDV will stop. When the HDV is downstream its dilemma zone at the some time instance, the vehicle can be concluded to cross the intersection.

The equations to determine the size of the time-dependent dilemma zone are based on the dilemma zone equations used in the yellow phase of the proposed controller.

The upstream part of the time-dependent dilemma zone can be defined by taking the default yellow time (as this is what the HDV assumes to be the duration of the yellow phase) and the time the direction has already been in the yellow phase. The time left in the yellow phase and the speed of the HDV will provide dilemma zone 2. The distance the vehicle can still travel during the yellow phase at time t then becomes:

Dilemma zone 1 includes the reaction time of the HDV starting at $t_i = t_{yellow,start}$. Before this reaction time has passed, the behaviour of the HDV will not show any signs of stopping. The dilemma zone 1 can thus only provides new insights if it is reassessed after this reaction time has passed.

Note that if the last vehicle is not known at the start time of the yellow phase, it can only be predicted to be outside of its dilemma zone after its reaction time to the yellow signal.

Transformation to obtain the control actions

As explained, $t_{yellow,end}$ will be reassessed each time step during a range of time steps. $t_{yellow,end}$ is decided based on the last vehicle crossing the intersection. In 99 % of the situations the vehicle should have crossed the stop line before yellow ends, to guarantee the same safety standard as in the original controller. The last vehicle could either be unknown, an AV, an LV, the predecessor of an LV or an FV. $t_{yellow,end}$ can either be decided based on a prediction of when the last vehicle will cross the stop line or when it is

measured to have crossed the stop line. In figure 3.15 distances for the last vehicle are indicated for both the prediction and the measurement of when a vehicle passes the stop line. The basis of the formula that is changed to decide $t_{\text{yellow, end}}$ via predicting when the last vehicle will cross the stop line, comes from t_{leave} of the original equation. As the duration of the yellow phase is fixed in the original equation, no equation was used in the original controller. The end time of the yellow phase can only be predicted when the last vehicle of the direction is known.

The duration of the yellow phase can be calculated with the following formula:

$$\Delta t_{\text{yellow}} = t_{\text{end, yellow}} - t_{\text{start, yellow}} \quad (3.3)$$

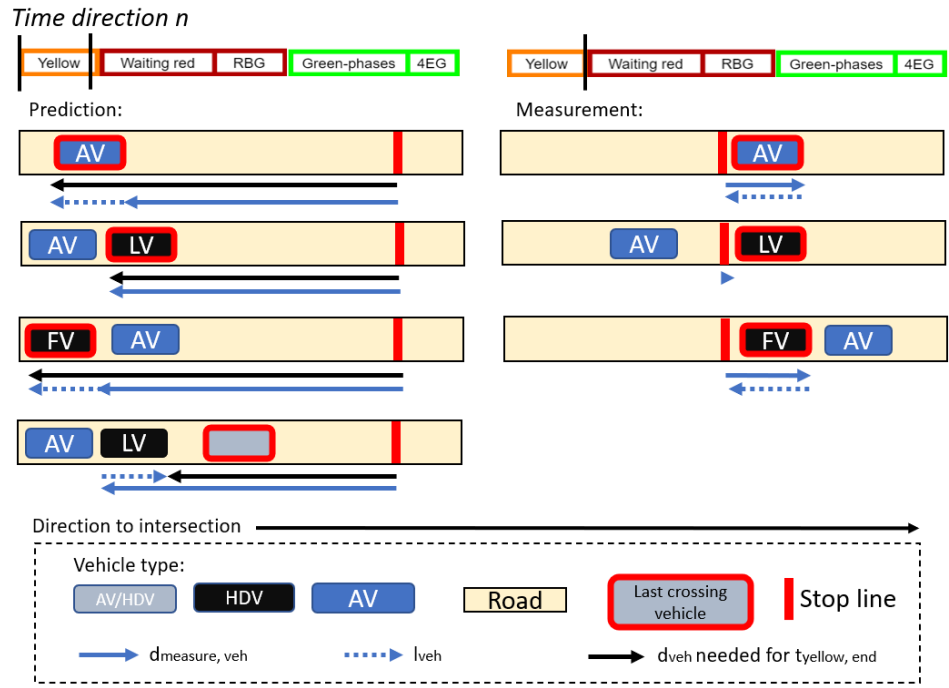

Figure 3.15: Distances used in the formulas to calculate the needed control action

$t_{\text{yellow, end}}$ via prediction of when last vehicle crossed the stop line

The distance of the vehicle to the stop line and how the measurement errors should be included is explained in the previous section 3.4.2. For the yellow phase this distance is not complete yet. The yellow phase should be ended when the back part of the vehicle has passed the stop line. For the FV and AV the location is provided to the front of the vehicle. Here, the length of the vehicle should thus be included. For the LV the measurement of the location is given to the back of the vehicle. The length of the vehicle here thus does not need to be added to the equation. Again, it is assumed in the equation that the acceleration remains constant, therefore the tracking error (ϵ_{track}) is included as well. If the LV decided to stop at the stop line it means the vehicle in front of the LV is the last to cross the intersection. This vehicle's location cannot be measured by the AV. The distance between the LV and its leader vehicle is unknown. The yellow phase should be truncated at the moment the front of the LV would reach the stop line if it would have crossed the intersection. The change of the variables of equation t_{leave} to $t_{\text{yellow, end}}$ (*percentile*) is provided in table 3.3.

$t_{\text{end, yellow}}$ via measurement of when last vehicle has just crossed the stop line

The distance of the actual back part of a vehicle is 0 when it just passed the stop line. Again, the location measurement of the last vehicle by the AV is used here and again the length of the vehicles. The speed and fluctuation do not change the outcome of the measurement. No measurement can be done when the predecessor of the LV is the last vehicle, to obtain the time to truncate the yellow phase as this vehicle cannot be measured.

The complete equations can be found in appendix B in section B.1.

Table 3.3: The change of variables from the original equations of t_{leave} for the AV, LV and FV with the additional variables provided by the AVs (and its errors)

| Variables from original equation (2.8) to $t_{\text{yellow,end}}$ | Vehicle type | | | |
|---|---|--|--|--|
| | AV | FV | LV | Leader of LV |
| $v_{\text{appr}}(\mu, \sigma)$ | $v_{\text{measure,AV}}^k(t_i) + \epsilon_{\text{speed,AV}}$ | $v_{\text{meas,FV}}^k(t_i) + \epsilon_{\text{speed,HDV}}$ | $v_{\text{measure,LV}}^k(t_i) + \epsilon_{\text{speed,HDV}}$ | $v_{\text{measure,LV}}^k(t_i) + \epsilon_{\text{speed,HDV}}$ |
| Assumption of no a_{dec} | add ϵ_{track} | add ϵ_{track} | add ϵ_{track} | ϵ_{track} |
| d | $d_{\text{measure,AV}}^k(t_i) + \epsilon_{\text{GPS}} + l_{\text{veh}}^k$ | $d_{\text{front,FV}}^k(t_i) + \epsilon_{\text{GPS}} + \epsilon_{\text{LIDAR}} + l_{\text{veh}}(\sigma, \mu)$ | $d_{\text{front,LV}}^k(t_i) + \epsilon_{\text{GPS}} + \epsilon_{\text{LIDAR}}$ | $d_{\text{front,LV}}^k(t_i) + \epsilon_{\text{GPS}} + \epsilon_{\text{LIDAR}} + l_{\text{veh}}(\sigma, \mu)$ |

3.4.4. Red before green phase

How to identify the scenario and calculate the end time of red (the control action) is discussed here.

Transformation for scenario identification

When no input is obtained from AVs within the dilemma zone it means only HDVs are involved. In the previous phase, the last vehicle is identified. This is used for scenario identification of the leaving conflicting directions n in the RBG phase.

The scenario for the entering direction m , is identified by input from the AVs. If an AV is at standstill the following condition is met: $v_{\text{measure,AV}}(t_i) = 0$. When $d_{\text{measure,AV}}^k(t_i) \leq 2 + \epsilon_{\text{GPS}}$ then the AV is the first vehicle in the queue. 2 is taken here because not all vehicle drive to the stop line exactly. When $d_{\text{measure,AV}}^k(t) \leq 4 + l_{\text{veh}}(\sigma, \mu) + \epsilon_{\text{GPS}}$, it shows the vehicle is second in the queue. 4 is the sum of the standstill distance between two vehicles and the 2 m the front vehicle is away from the stop line. The 99 percentile of the GPS error and length distribution should be used here.

Transformation to obtain the control actions

The same as is used for percentiles in the current system, is used for the proposed control system. A 98 percentile of $t_{\text{enter}}(98)$ is set and the 50 percentile of $t_{\text{leave}}(50)$.

In this section, the approach to calculating the control action per scenario is elaborated. The times to leave or reach the intersection are predictions that are made when the last/first vehicles of a queue are either at the stop line or approaching it. In tables 3.4 and 3.5 the variables of the original equation for the enter and leaving time are presented. With the new data from the AVs some of these variables are changed to measurements. This can also be found in the table. The explanations are provided in the section below. When no information is provided by an AV the default equations should be used (2.8, 2.9).

t_{enter}

The original equation to calculate the enter time is equation 2.9. When the first entering vehicle is at standstill at the intersection it mean the approaching speed of the vehicle should not be included. When the first vehicle is an AV or a LV, the speed can be measured by the AV at each time instance before crossing the stop line. The closer the AV is to the stop line, the more chance that the measured speed there will also be the speed on the intersection.

When an AV is the first vehicle in a queue it does not have any reaction time, as it knows when the phase will change to green.

The acceleration and deceleration for the LV and FV are taken from a distribution of observed behaviour. For the AV the acceleration and deceleration are changed to the comfortable acceleration and deceleration of the vehicle. The AV is assumed to want to drive these given preferred acceleration and deceleration. But, due to external factors, it might not always be possible. Therefore, the tracking error is included.

t_{leave}

The speed of an LV, FV or AV can be obtained by the measurement of the AV. The distance from the stop line till the back of the vehicle leaves the conflict area is known. The distance of the FV and AV is provided to the front of the vehicle. Therefore, the length of the FV and AV have to be included in the equation.

$t_{\text{clearance}}$

With the calculated t_{enter} of direction m and t_{leave} of direction n the clearance time can be calculated with equation 2.7. The safety clearance time is added according to the combination of alternating vehicles. When the upcoming direction has multiple conflict areas, the critical inter-green end time should be decided.

When $t_{\text{yellow,end}}$ and $t_{\text{yellow,start}}$ of the leaving direction (direction n) and the clearance time of direction n to the entering direction (m) are known the end time of RBG of direction m can be calculated using equations 2.5 and 2.6.

Table 3.4: Original variables and new variables to calculate the enter time

| Variables from original equation (2.9) | $t_{\text{enter,veh}}$ from AV | standstill LV | $t_{\text{enter,veh}}$ from AV | approaching speed LV |
|--|--|-------------------------------|---|--|
| d_{enter} (fixed) | d_{enter} (fixed) | d_{enter} (fixed) | d_{enter} (fixed) | d_{enter} (fixed) |
| $v_{\text{enter}}(\mu, \sigma)$ | 0 | 0 | $v_{\text{AV}}^k(t_i) + \epsilon_{\text{speed,AV}}$ | $v_{\text{LV}}^k(t_i) + \epsilon_{\text{speed,HDV}}$ |
| $a_{\text{acc}}(\mu, \sigma)$ | a_{acc} with adding ϵ_{track} | $a_{\text{acc}}(\mu, \sigma)$ | $a_{\text{acc,comf}}$ With adding ϵ_{track} | $a_{\text{acc}}(\mu, \sigma)$ |
| $a_{\text{dec}}(\mu, \sigma)$ | $a_{\text{dec,comf}}^k$ | $a_{\text{dec}}(\mu, \sigma)$ | $a_{\text{dec,comf}}^k$ | $a_{\text{dec}}(\mu, \sigma)$ |

Table 3.5: Original variables and new variables to calculate the leaving time

| Variables from original equation (2.8) | $t_{\text{leave,veh}}$ | | |
|--|---|--|--|
| | AV | LV | FV |
| d_{leave} | $d_{\text{leave}} + l_{\text{veh}}^k + \epsilon_{\text{track}}$ | $d_{\text{leave}} + l_{\text{veh}}(\mu, \sigma) + \epsilon_{\text{track}}$ | $d_{\text{leave}} + l_{\text{veh}}(\mu, \sigma) + \epsilon_{\text{track}}$ |
| $v_{\text{leave}}(\mu, \sigma)$ | $v_{\text{measure,AV}}^k(t_i) + \epsilon_{\text{speed,AV}}$ | $v_{\text{measure,LV}}^k(t_i) + \epsilon_{\text{speed,HDV}}$ | $v_{\text{measure,FV}}^k(t_i) + \epsilon_{\text{speed,HDV}}$ |

The complete equations to identify the scenario, as well as the control action, can be found in appendix B in section B.1.

3.4.5. Obtain numerical of percentile of distribution

The solution of the equations used by the controller that only contain summation of variables can analytically be decided. These calculations are provided in the appendix in section B.3.

To find the numerical of a percentile of $t_{\text{yellow,end}}$, $d_{\text{zone1,veh}}^k(t_i)$, $d_{\text{zone2,veh}}^k(t_i)$, $d_{\text{zone1td,veh}}^k(t_i)$, $d_{\text{zone2td,veh}}^k(t_i)$, t_{leave} and t_{enter} sampling needs to be done. This could either be done offline or online.

3.5. Selection of the type of controller

Due to the unpredictable behaviour of an HDV and the need to conclude certain control actions in the future (e.g. when the yellow phase will end so that the red before green phase of the conflicting direction can be ended on time) an MPC for the system would be difficult to define. The prediction model of the MPC would have to include if an HDV would stop or go when yellow appears. When the vehicle is outside the dilemma zone this could be concluded but if this does not hold, it can only be observed at a future time step. Furthermore, the following behaviour of an HDV cannot only be described by the existing car-following models as reactions to traffic lights are not included. For this, it should be explored whether HDVs lay more priority/focus on following their predecessor or complying to the traffic light. [29] states that interaction aware predictions, as would need to be used in the prediction model of the location of an HDV within an MPC, would mean a high computational complexity. It is mentioned that this might not be compatible for real-time assessment. As the control system needs to work in a real-time setting, this could potentially not be the right controller for the situation.

A rule-based controller is most applicable for each sub-phase. As seen in the previous chapters there are quite some rules that need to be implemented in the controller. The more rules exist within other rules the higher the possibility of making mistakes in the design of the controller. The design should thus be done with care. The rule-based controller is compatible with the available measurement from either the detector loops and the AVs. This kind of controller is already used, to define how to handle the sub-phases of the current

Dutch vehicle-actuated intersection control. The controller of the new sub-phases would thus comply with the format for the other already existing sub-phases.

A rule-based controller presents the rules of what needs to be done when a certain condition is met via an if-then statement. The rule-based algorithm of the (sub-)phases of the proposed controller can be found in the appendix in section B.4 in descriptive form and in B.4 in mathematical terms.

4

Control system evaluation

In this chapter, the proposed controller is tested via simulations. This provides insight into the improvement of the delay. The evaluation also provides what part of the controller has the most effect on the results, and to what extent the desired outcomes for each of the sub-phases are obtained. For this, the relevant input for the simulations is discussed, to be able to interpret the functioning of the controller. But before the controller is tested, a simulation tool is selected and the model is created. For this, the simulation model is verified and validated. In this chapter, first, the simulation tool is selected. Then, all aspects of the simulation are elaborated upon in detail. This chapter closes, with the results from the simulations.

4.1. Selection of input

Multiple variants at equal test intersection lay-out need to be compared to state if the proposed controller decreases delay compared to the current used vehicle-actuated controller in the Netherlands. To test this, the delay of the original controller is compared to the delay of the proposed controller under the same input conditions (variants). This means the same random seed is used (vehicles enter the intersection at equal arrival times). This means, the original controller is evaluated in the situation AVs enter the road and when they have not entered the road. As AVs have different behaviour than HDVs, they might already improve the delay at an intersection with the original controller. The input of the system is the penetration rate of AVs and the traffic demand. The selection of the relevant demand and penetration rate to test are explained next.

4.1.1. Penetration rate

The penetration rate gives the chance that an AV will be at the front or back of a queue at an intersection. Each time this happens there is a probability the AV can provide information to which the controller can shorten a phase compared to the default setting. For a penetration rate of 50%, for example, 25% of the time two AVs will alter on the conflict area, 50% of the time, at least one AV is involved and 25% of the time no AVs are involved. Not all of these times, default durations can be truncated.

A penetration rate of 0% and 100% is included in the evaluation, to show what happens when only AVs or only HDVs are included in the simulation. In previously proposed intersection control systems for the hybrid period, the performance at a low penetration rate was little or even worse than when vehicle-actuated control would have been used. The proposed intersection control system in this research aims to decrease the delay, even at low penetration rates. Therefore, low penetration rates are tested. A penetration rate of 2% is therefore used. To explore which penetration rates between 2% and 100% are also relevant to explore, the delay of one random seed (of only 300 s) is taken to get an idea of the slope of the change in delay. How the delay is calculated can be found in section 4.2. This result can deviate from the results of other random seeds, as the simulation is only short and the chance of an AV alternating on the intersection is therefore not per se the penetration rate. The graph of the random seed is provided in figure 4.1. The demand in the simulation is set to 400 vehicles per lane and the penetration rate is changed. This is done for both the original and the proposed controller.

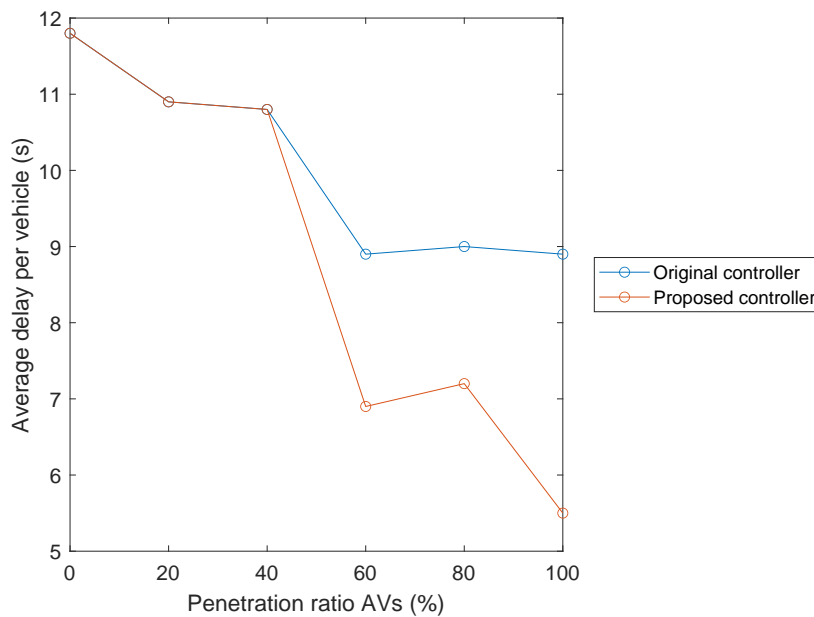

Figure 4.1: The average delay of one random seed over different penetration rates

In the figure the delay does not seem to change drastically before a 50% penetration rate. At 50% the delay seems to drop fastest (which can also be due to this certain random seed). Two percentages before this steep drop are included, namely 10% and 20%. 50% is selected to explore further to get insight into this gradient of delay decrease (and if also happens in longer situations). For higher demand 75% penetration rate is also tested.

The maximum throughput that can be reached with the proposed control system, happens when the penetration rate is 100%. To obtain an overview of the maximal potential of the system, this is also tested. The penetration rate percentages that are tested are thus 0, 2, 10, 20, 50, 75 and 100%.

4.1.2. Traffic demand

A broad range of demand is tested. In this way, the full range of the capabilities of the control system is illustrated.

To determine what demand is high or low for the intersection the loss time, the saturation and the cycle length is estimated. First the saturation of the lanes is estimated. This is about 1800 veh/h for one lane. There are also some loss times at the intersection. These are caused by the start up time, the clearance time and the unused yellow time. The start up time is the extra time it takes a vehicle to cross the intersection, when it starts from the stop line after a complete stop instead of the maximal speed during its complete crossing. A vehicle needs to drive 17 m to pass the conflict area. When driving 50 km/h this takes 1.2 s. This same distance takes $(\sqrt{\frac{17m}{0.5 \cdot 2.8m/s^2}} =) 3.5$ s from standstill. The difference is thus 2.3 s. Adding the reaction time of the driver, the start up time becomes 3.3 s. The unused fraction of yellow is $\frac{2}{5}$. When the default duration of yellow is 4 seconds. This is about 2.4 s. The clearance time is presented for the intersection in appendix C.1. This is -0.1 s. The total loss time then becomes 5.6 s.

The equation to calculate the minimal cycle time is $\frac{\sum losstime_{dir}}{1 - \sum \frac{d_{dir}}{s_{dir}}}$ where d is demand, s is saturation and dir are all directions. When a cycle is used that is lower than the minimum calculated cycle time, the intersection will be over-saturated. The minimal cycle time per demand is shown in figure 4.2. This graphs shows that from 775 veh/h, the minimal cycle time becomes more than 80 s ($\frac{2 \cdot 5.6}{1 - \frac{775}{1800} + \frac{775}{1800}}$) and the minimal cycle time increases significantly after. A demand somewhat lower than this point is therefore used in the simulation (700 veh/h). Also, an over saturated demand is used (850 veh/h). Two lower demands are also

tested (100 and 400 veh/h).

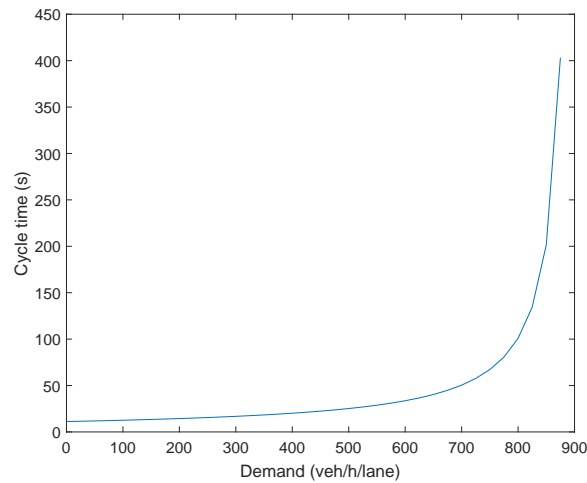

Figure 4.2: The minimal cycle time for the corresponding demand

Furthermore, in real-life the demand at intersections will not always be the same at each direction. Therefore, simulations are run that have different demand at different directions. One variant is a different demand for the directions in each stage and one variant is different demand for directions within the same stage. The demands used here are 700 veh/h and 400 veh/h. Also, a simulation is run where the demand increases from and decreases again. This is done from 100 veh/h to 400 veh/h to 700 veh/h to 850 veh/h and back again. Each demand is present during 500 s.

The variants of the demand are summarized in figure 4.3 and 4.4. Figure 4.3 shows the variants where all directions have the same demand. Figure 4.4 shows the variant where directions have different demands.

4.2. Selection of simulation tool

The simulation tool that is used, needs to have certain functionalities to be able to conclude the improvement in the delay and the working principles of the controller based on the results. The following functionalities need to be included in the tool:

- *The simulation should model each vehicle separately (microscopic simulation)* - The proposed controller looks at individual vehicles. It would therefore not work to model aggregate groups of vehicles. This is also needed to calculate the delay per vehicle.
- *Deviation between the behaviour of AVs and HDVs should be modelled* - As found in section 2.5 and 2.4, the behaviour of HDVs and AVs is different. The equations, as defined in section 3, to predict trajectories is also based on the difference in behaviour. This behaviour therefore thus also needs to be presented in the model. Also, the introduction of AVs on the road will already increase the throughput. This is needed, to be able to conclude that the effect of the controller is based on its working principle and not the addition of AVs on the road.
- *Detectors should be included in the model and the data of them can be extracted* - Detectors are needed in the simulation as they are also part of the input information of the controller. The detector gap time and the time of the measurement is needed.
- *The layout of an intersection can be modelled in detail* - An isolated intersection will be simulated. The intersection layout, therefore, needs to be modelled in detail. The width of the road and the locations of the traffic signals (and stop line) need to be modelled.
- *The simulation tool and an external controller should be able to communicate* - As the proposed controller is not a standard one, the controller needs to be modelled completely in software where it can be

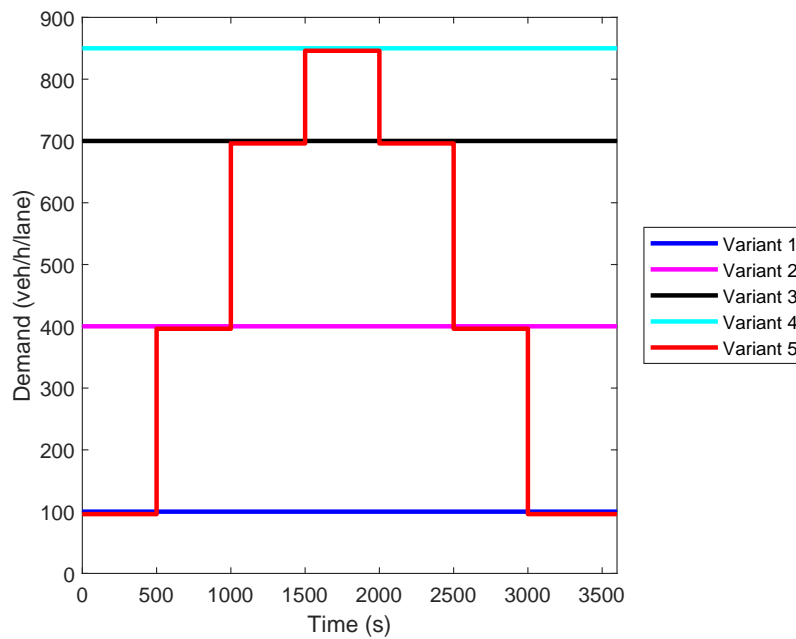

Figure 4.3: The demand variants for simulation where demand is equal for each direction.

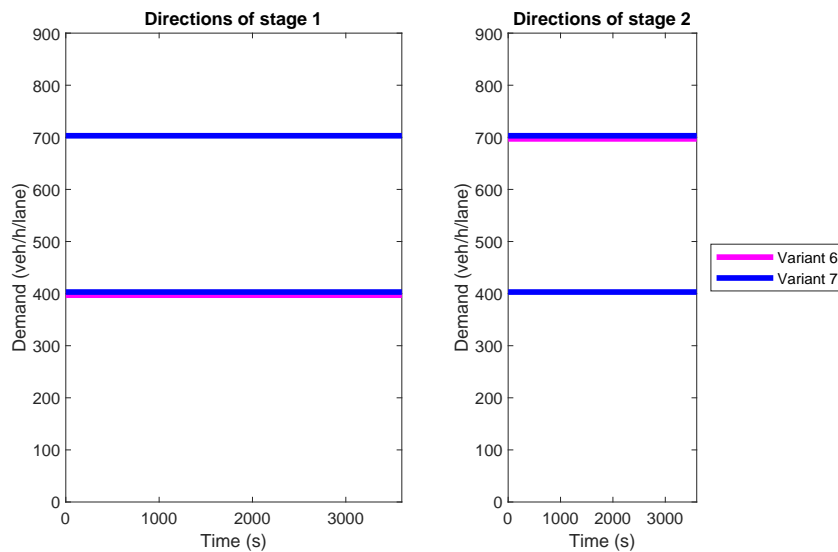

Figure 4.4: The demand variants for simulation where demand is different for directions.

adjusted. To be able to let the controller work with the simulation tool, a connection needs to be made between the two. This will make it able to extract 'real-time' data from the simulation to the controller and actuate the traffic signals and give tasks to AVs from the controller to the simulation.

- *The position and speed of each vehicle should be known each time step and should be extracted* - To be able to obtain results and obtain the measurement of the AVs in the simulation, information of the state of vehicles should be able to be extracted from the simulation tool.

- The delay per vehicle should be measurable - The delay should be calculated per time step by taking the desired speed of a vehicle and the actual driven speed. The difference in time it takes to cross with this desired speed an actual speed, is the delay over its whole trajectory.
- *The penetration rate of AVs and the demand of the road should be changeable* - As different penetration rates and demands might have a different effect on the delay, both need to be able to be changes in the simulation tool.

Based on these requirements, VISSIM 11 is used to create the simulation model. Within VISSIM each vehicle is modelled separately and the intersection layout can be created in detail. Per type of vehicle a type of behaviour can be assigned. For car-following behaviour, the Wiedemann 1999 is used. The parameters of the Wiedemann tool can also be changed. As stated in section 2.5, the Wiedemann model can be tuned to fit with the behaviour of AVs and HDVs. This is explained further in section 4.3.1. Furthermore, a COM interface can be used to connect Matlab with VISSIM. Data from the vehicles, the detectors and the traffic signals can be extracted by VISSIM and be communicated to Matlab and Matlab can actuate the traffic signals and order AVs to stop or continue within VISSIM.

4.3. Set-up of simulation

In this section the set-up of the simulation is explained in detail. Within all aspects, decisions are made to make a model that resembles the real-life situation as good as possible, where needed. First, it is explained how the behaviour of the AVs and HDVs is modelled. Then the layout of the intersection is explained. At last, the controller is elaborated upon.

4.3.1. Modelling AVs and HDVs

As long as the behaviour is similar to the behaviour of the vehicles in the equations used by the controller, it works to validate the results. The most important aspect that is added to the control system is that data can be obtained from the AVs.

The behaviour of vehicles can be set in multiple ways in VISSIM. These ways are: assign a car-following model, assign decision making and probability of stopping when yellow light appears, turn stochastic (random behaviour) on or off and functions and distributions of preferences. These will be explained one by one. Lane-change behaviour could also be adjusted in VISSIM, but this is irrelevant for this research (as no lane-changing can occur).

VISSIM has a car-following model Wiedemann 1999 by default set for AVs. The parameters are taken from their CoEXist research [58]. Additionally, the headway preference could be set differently, dependent on the predecessor. The headway for an AV following an HDV was set to 0.9s and for an AV 0.5 s. In section 2.5, it was shown that lower headways were obtained for AVs, but because many actors are involved and intersections cause more stop and go behaviour than on a straight ongoing road, this headway is set higher. In VISSIM, by default, the Wiedemann 74 model was used for HDVs. In comparison to the behaviour of the AV, this brought lower headway by the HDVs than AVs. The Wiedemann 74 model only contains 3 parameters, making adjustments of these parameters less accurate then when there are more parameters to calibrate. Therefore, the car-following model was changed to the Wiedemann 1999 model. The difference between the parameters of the AV and the HDV is the perception of speed and location difference with the leader vehicle.

The behaviour at the start of yellow is different for AVs and HDVs. The parameters for the HDV are set so that they make the decision to stop or go when yellow appears and with a small chance that red light is run. AVs need to be assigned a task by the controller. This was done by changing the parameters that give the chance that a vehicle will stop. VISSIM provides each vehicle with a chance of continuing or stopping. For this an equation is used. This way cannot be changed in VISSIM but the parameters of this equation can be changed via Matlab. The equation used by VISSIM to decide the chance that a vehicle will stop is

$$p = \frac{1}{1 + e^{-\alpha - \beta_1 \cdot v - \beta_2 \cdot dx}}$$

Where α , β_1 and β_2 are parameters that can be changed during the simulation per vehicle type. v is the speed and dx is the distance of the vehicle to the stop line. If $p=1$, the vehicle will stop definitely, if $p=0$ the vehicle will certainly continue. The chance of stopping or going thus depends on the speed and distance (only if β_1 and β_2 are not set to zero). The parameters can thus be set, that from a certain distance, vehicles would decide to stop. When $\beta_1 = 0$, the assigned tasks will only be provided with the input location of the vehicle. Take the exponential part of the equation $g = -\alpha - \beta_1 \cdot v - \beta_2 \cdot dx$. If $g \geq 6$ the chance of stopping is $p \approx 1$. If $g \leq -6$ the chance of stopping is about $p \approx 0$. When $\beta_2 = -1$ and $\alpha = dx + 2$, with dx the

distance from which the vehicles need to stop. The vehicle downstream of that distance will continue driving and the vehicles upstream will stop. With these parameters, the task will thus only be provided to the targeted AV of that moment. The parameters can after the start of yellow be set to the standards again.

VISSIM has a feature called 'implicit stochastic'. This gives fluctuating behaviour of the vehicles. This is activated for the HDVs. Furthermore, the desired acceleration and deceleration, and desired speed is defined as a distribution for the HDVs. For AVs this is the same for each vehicle. The desired speed of the HDVs lays between 48-58 km/h (default distribution in VISSIM), the desired speed of the AV is 50 km/h. In reality the desired speed per AV could be different. For simplicity, all AVs have the same desired speed. The desired acceleration of an AV is 2.8 m/s^2 , while that of the HDV is a distribution around this number. The same applies for the deceleration, where this is set as -2.8 m/s^2 for the AVs. The length of the AVs are all the same and set to 4.1 m. The length of an HDV lays within 3.75 to 4.76 m in the simulation. These setting in VISSIM can be found in appendix C.2.

4.3.2. Lay-out of the intersection and parameters of the control system

An intersection is used to evaluate the proposed control system. This intersection consists of 2 roads that are perpendicular to each other. Each of these roads has 2 lanes, one for each direction. The four lanes are indexed: EW, SN, WE, NS. Turns are not allowed. Vehicles can thus only drive straight at the intersection. The width of the lanes is 3.5 m. The stop line is located 13.5 m away from the core of the intersection for all lanes and the speed limit of the roads 50 km/h. In figure 4.5.

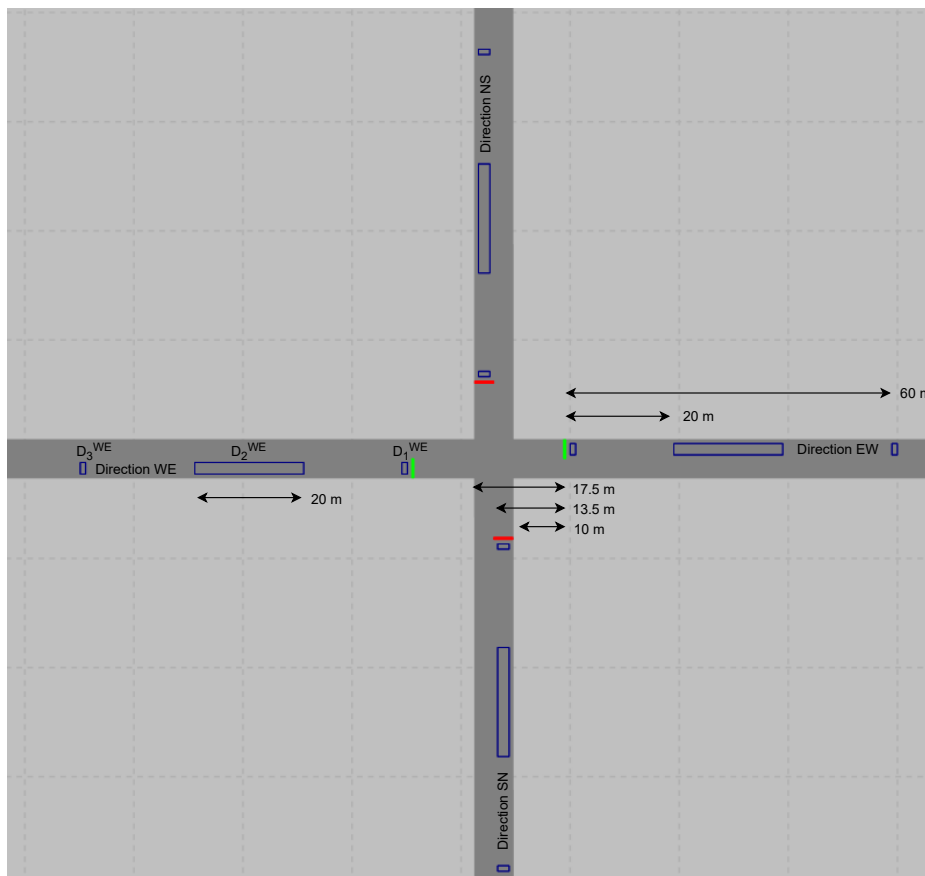

Figure 4.5: Lay-out of the simulation in VISSIM with the dimensions

Location of detector loops and gap time

Each direction has three detector loops: d_{det}^{dir} where $det \in DET$, with $DET = \{1, 2, 3\}$ and $dir \in DIR$, with $DIR = \{EW, WE, NS, SN\}$. Each of them is present for different purposes. The length and the location of the detectors are calculated based on the principles used [27]. The use of the detectors, the location and length and the critical gap times will be explained. These detectors are part of the layout of the intersection in the simula-

tion (in both the original controller as the proposed controller variant)

$$D_1^{dir}$$

This detector is located 1 m away from the stop line and is 1 m long [27]. It is there, to request the green phase and to measure if the first extension green can be truncated based on the measured gap time. If a detector gap time is measured of more than 3 s [27], this phase will be truncated.

$$D_2^{dir}$$

This detector loop is 20 meters long and starts 20 meters away from the stop line, which is standard used in vehicle-actuated control [27]. The maximal gap time of two vehicles before truncating the phase should be 2,5 s. Using the formula to calculate the detector gap (equation 2.1) time the maximal measured gap time by D2 is 1 second [27].

$$D_3^{dir} \text{ for the 3}^{rd} \text{ extension green phase}$$

This detector is located at the end of the default dilemma zone 2. When a yellow phase of 4 seconds is used and a fast-driving vehicle 55 km/h is present the dilemma zone is at 60 m away from the stop line. The maximum gap time of the 3rd extension green is 3 seconds [27]. With a detector of only 1 meter, this also gives the maximal measured gap time of D3 of 3 seconds.

$$D_3^{dir} \text{ for the 4EG phase}$$

Dilemma zone 2 is based on a vehicle with a speed of 55 km/h and dilemma zone 1 is based on a vehicle with a speed of 45 km/h. The minimal gap time of the 4th extension green can then be calculated using equation 2.4. The minimal gap time should then be 0.6 seconds [27].

Conflict areas and flow scheme stages

The flow scheme of this intersection is quite straightforward. The stages and their sequence are illustrated in the flow scheme in figure 4.6. There is one clear optimal flow scheme. The conflict matrix is given in table C.1 in appendix C.1. The matrix is filled in with the distance of the leaving and the distance of the entering direction to the conflict area. A conflict does not exist if no distances are presented. With these distances, the standard equations 2.7, 2.8 and 2.9 and the set parameters, the default clearance time is calculated. This is presented in the appendix C.1 in table C.2

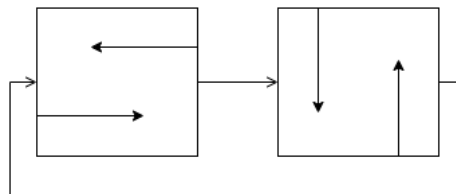

Figure 4.6: Flow scheme of sequence of stages

4.3.3. Control system in matlab

The control system is created in Matlab and needs to be able to communicate with VISSIM. The traffic lights and detectors are therefore placed in the layout of the intersection in the simulation tool. The traffic lights and decision making for AVs are controlled via a Matlab script using the COM interface. The current used vehicle-actuated control system (the one defined by [27] is used) is also created in Matlab. To obtain the correct script for control in Matlab first the current vehicle-actuated control system is defined in a rule-based format. This can be found in the appendix B.6. From this format, the Matlab code is created. The script used for the current vehicle-actuated control system can be activated in the controller code. The vehicle-actuated controller consist of the phases in figure 2.1. This means induced green is not used. As each directions in the same stage have exactly the same conflicts this would not be relevant. Directions in the same stage can start and end green at the same time. Parallel green makes sure green the directions of the same stage have most green time at the same time. Wait green makes sure that if there is no demand in the directions of the next stage, the current stage will remain in green even if extension green measures the queue to be finished.

Parameters of current control system

The parameters used in the current vehicle-actuated control system are also used in the proposed system. Furthermore, there are some additional parameters for the proposed control system. The standard parameters are:

- *Maximal gap times* - The above mentioned maximal gap times for the extension greens.
- *The default clearance times* - As given in the appendix C.1.
- *Maximal phase times* - The maximal time of the first extension green will be 12 sec. In this way, all vehicles till detector D_2 will be able to cross the intersection. The maximal green time is 35 sec. The maximal 4EG time should be 4 seconds [27].
- *Fixed green time* - The fixed green time will be 4 seconds [27].
- *The default yellow time* - This will be 4 seconds[27].
- *Guaranteed red time* - Will not be used in the mentioned simulation as only two stages are present that will sequentially be given green [27].
- *Guaranteed green time* - The guaranteed green time is 7 seconds in total. This is according to standards of [27].

Parameters of proposed control system

The proposed controller needs additional parameters to be set compared to the parameters as mentioned above of the current control system. Both of these parameters are included by the proposed controller. The value that is taken for each parameter is addressed below.

The parameters of the measurement errors are discussed first. In VISSIM the actual location and speed of a vehicle can be extracted from the simulation. Per data point, a random value from the error distribution was taken and added to the data point extracted from VISSIM. The data with the included error was defined as the input data from the AVs. This means that the measurement errors are known (as they are added to the accurate data). In real life these error distributions might not be known. Also, this error might change over the years due to improvement in technology of measuring speed and location. The errors are assigned based on the information of section 2.2.

- *Speed error* ($\epsilon_{\text{speed,AV}}(\mu_{\text{speed,AV}}, \sigma_{\text{speed,AV}})$ and $\epsilon_{\text{speed,HDV}}(\mu_{\text{speed,HDV}}, \sigma_{\text{speed,HDV}})$) - The speed measurement of a speedometer were explained in section 2.2. This was used to assign the speed error in the simulation. Here ($\mu_{\text{speed,AV}} = 0$, and ($\mu_{\text{speed,HDV}} = 0$. Furthermore $\sigma_{\text{speed,AV}} = 0.5$ m/s and $\sigma_{\text{speed,HDV}} = 1$ m/s (as the LIDAR error is also included in this).
- *LIDAR error* ($\epsilon_{\text{LIDAR}}(\mu_{\text{LIDAR}}, \sigma_{\text{LIDAR}})$) - In the simulation and in the calculations of the controller $\mu_{\text{LIDAR}} = 0$ and $\sigma_{\text{LIDAR}} = 0.12$ m
- *GPS error* ($\epsilon_{\text{GPS}}(\mu_{\text{GPS}}, \sigma_{\text{GPS}})$) - The maximal error is found to be 2 m. So, this would mean the 99 percentile of the normal distribution would be about 2. Dividing 2 by 2.30 would then provide the standard deviation (assuming the parameter is normally distributed). This brings $\mu_{\text{GPS}} = 0$ and $\sigma_{\text{GPS}} = 0.9$ m.

Below the parameters on the behaviour of the vehicles are discussed. These are based on sections 2.5 and section 2.4.

- *Tracking error* ($\epsilon_{\text{track}}(\mu_{\text{track}}, \sigma_{\text{track}})$) - $\mu_{\text{track}} = 0$ and $\sigma_{\text{track}} = 0.21$ m. The track error is due to external factors influencing the driving behaviour of a vehicle (not caused by other vehicles). In the simulation, no road inclinations or vehicle dynamics (that cause delay in acceleration) are included (except for the options stochastics' for the HDVs).
- *Reaction time HDV* ($t_{\text{react}}(\mu_{\text{react}}, \sigma_{\text{react}})$) The reaction time used in the predictions has $\mu_{\text{react}} = 1$ s and $\sigma_{\text{react}} = 0.3$ s. The reaction time could not be adjusted in the simulation tool. This means that the used reaction time might deviate somewhat from the behaviour of the vehicles. This could also be the situation in real life.
- *Desired deceleration* ($a_{\text{acc,comf}}$) - The desired deceleration rate in VISSIM is a distribution around 2.8

m/s^2 for HDVs. For AVs there is no distribution for this. All AV's are set to have desired deceleration of 2.8 m/s^2 . In the predictions, a deceleration rate with a mean of 2.4 m/s^2 and a standard deviation of 0.35 m/s^2 is used for the HDVs. A 2.8 m/s^2 rate is used for AVs.

- *Desired acceleration ($a_{\text{dec,comf}}$)* - For the acceleration, the same variable are applied. Only the mean in VISSIM is set to be 2.8 m/s^2 for the HDVs.
- *Vehicle length (l_{veh})* - The vehicle length of all AVs in VISSIM is 4.21 m. This is also used in the prediction models. HDVs in VISSIM have a length between 3.75 and 4.75 m. The length used in the predictions is used by taking the average vehicle length as used by [27]. The length is defined with a mean of 4.25 m and a standard deviation of 0.22 m.
- *Safety clearance time ($t_{\text{safety,veh-veh}}$)* - The safety clearance time of an AV-AV alternation is set as 0.2 s. For an HDV-AV alternation it is set as 0.5 s.

4.3.4. Verification

While creating a model many small mistakes can be made. Due to these mistakes, the model may not work as planned. Therefore, the simulation is verified each step while creating it. The tests performed for verification of the model are presented in the lists below. All of these (some after needed iterations) are confirmed. The tests are performed in 6 different parts of the set-up of the simulation. What the test confirms and how the test is performed, is included.

Behaviour of the vehicles

First, the behaviour of AVs and HDVs was tested via the following test:

- *The following behaviour of AVs and HDVs is according to the reasoning behind the set parameters of the car-following model* - Before implementing the car-following behaviour at the intersection for the simulation, a separate model was created to test the behaviour. The demand on this separate lane was set over-saturated. In this was the vehicles entered the intersection with their preferred gap with the leader. It could be observed that the gap between two AVs was smaller than between a combination of other vehicles.
- *The set functions of preferred speed are seen in the behaviour* - The speed of the AV is observed to never be over 50 km/h. For HDVs higher speeds can be observed. Also, the size of AVs is always the same. the size of the HDVs can be observed to be variable for each HDV.

Original controller

Second, the original controller was created in matlab and verified via the following tests:

- *The phases are given in the correct order* - It was found that the right order was always given and that the default duration's were always maintained. All the phases were at least their minimal duration.
- *Two conflicting direction cannot have green at the same time* - It was observed that two direction never had green lights at the same time. The direction of the same stage did. Sometimes with some slight difference in the duration of green due to the 4EG.
- *The green phase of the other direction still goes to red after the end of the maximal green time, even if no green is requested by a conflicting direction* - The input demand on the directions of one stage was set to zero and the other to 700 veh/h. The directions with demand changed to red after the maximal green phase time.
- *If a request from the conflicting direction comes in, the green phase of the other stage should be stopped when all vehicles have cleared* - The same test as above was done but then with a small demand input at one of the stages instead of 0.

The proposed controller is implemented per (sub-)phase. This is added to the script of the original controller. The code includes whether the proposed controller is turned on or off. After each phase, the results were obtained to see if the results stayed the same when the proposed controller was turned off.

4EG

- *The AVs follow the assigned tasks* - To test this the location of the vehicle and its dilemma zone was plotted, as well as the task the AV gave. It was observed whether the vehicle acted according to the task.
- *The sub-phase is only rarely provided when AVs only are present on the road* - The phase will not happen often as this can only happen when an AV is in the dilemma zone and measures the AV behind to be in it as well, while the AV behind according to itself, is not in the dilemma zone.

Yellow

- *The yellow phase can never be negative* - The start of the yellow time was per cycle compared to the start time of the waiting red sub- phase.
- *The yellow phase is never higher than the default yellow phase duration* - The duration of all yellow phases was plotted and found to be at most 4 seconds.
- *Truncating can happen only during the scenarios in which it is possible* - The set scenario and the resulting duration of yellow are plotted to check whether the truncation only happens during the scenarios in which it should.
- *The yellow phase duration is reexamined each time step* - The calculated yellow time was plotted and found to be iterated
- *The yellow phase is truncated more often when more AVs are assigned on the road* - The distance of the last vehicle is plotted at multiple rates of AVs. It can be found that indeed the average distance is decreasing. In the simulation, it can be observed that most of the time the yellow phase turns to red when an AV crossed the stop line. (Not in all situations)

Red before green phase

- *The clearance time is recalculated each time step* - The calculated enter time, the leaving time and the clearance time as the resulting outcome are plotted. They are being calculated by the controller.

Finally, some test were run to verify the complete code:

- *A penetration rate of 0% in the new proposed control system should result in the same as the original controller* - Both variants are tested and the resulting start time of phases and delay are compared and concluded to be equal.
- *Behaviour of the complete system is as expected* - This was done by observing the simulation while running. A glance was given at when the phases of the same stage and conflicting directions obtained their phases and to the behaviour of the vehicles.

4.4. Interpretation results

In this section the results of the simulations are presented. As stated above, multiple variants are tested. For all input variants a simulation of 3600 s is ran. The same seed is used per demand level. This means that all vehicles in a variant with equal demand arrive at the same time. The type of vehicle differs per penetration rate. As the maximum cycle time is about 80 s, this provides data on at least 45 cycles per seed. First, the results of what parts of the controller are most active are presented, followed by the results of the delay. The first 50 seconds are not included in the results of the delay of the simulations. During these 50 seconds, the simulation needs to start up and the results are not representative. At this time, vehicles have reached the

intersection. For the same reason, the first two cycles are not included in the results.

Number of times the controller is acting according to the substituted tactics

To understand how the controller acts, it is relevant to identify what parts of the controller are the most dominant cause of the improvement of delay, per penetration rate. In appendix D.2, the trajectories of one input variant is presented, to show the difference in the state of the intersection in the proposed controller and the original controller. Furthermore, to identify how the controller acts, the number of times the yellow phase and the RBG phase are truncated are found, and compared to the total possible number of times the phase could be truncated. Also the time won in each of these number of times it could be truncated, is compared to the total amount of time it could be shortened. If the yellow phase is truncated for example, the number of times the yellow phase is truncated increases with one. The additional time won can then maximally be 4 s, depending on what time step the yellow phase is truncated. Also, the frequency of the duration of the phases is presented.

Figure 4.7 consists of two sub figures, one representing the results at a demand of 400 veh/h and the other 700 veh/h. In each of these figures, two different graphs are shown of the number of times the controller was able to act. The other two graphs represent the total time the phases are shortened. The 4EG phase is not included, as this phase does not have a default time.

These are:

- The percentage of the number of times the yellow phase is truncated, over the total number of times the yellow phase started. The yellow phase started 500 to 644 times in the simulation depending on the input.
- The percentage of the number of times the inter-green is truncated, over the total number of times the inter-green happens in the simulation.
- The percentage of time shortened in the yellow phase, over the total default yellow time. The total default yellow time is between 2000 and 2576 s.
- The percentage of the time shortened of the clearance time over the total default clearance time. The total default clearance time in the simulation is between -350 and 450 s.

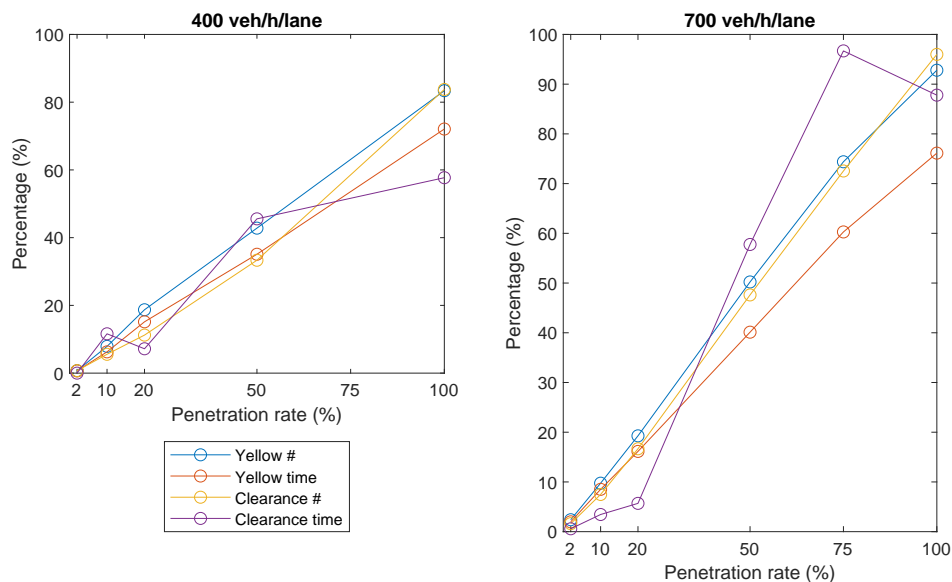

Figure 4.7: Percentages of actions of the controller over the total times the action could be given at different penetration rate for all adjusted phases at a demand of 400 and 700 veh/h/lane

The number of time the yellow phase and clearance time are truncated, shows signs of a linear increase with the penetration rate increase. At 100% penetration rate, neither the inter-green time nor the yellow phase can always be truncated. The percentage of yellow time compared to the percentage of clearance time shortened, is higher or lower depending on the penetration rate. It must be stated that the the total default time of the yellow phase is about 6 times higher than the default clearance time. The absolute shortened time is thus therefore influenced most by the truncations of the yellow phase, at all penetration rates.

It is also relevant to explore the frequency of the duration of the phases in the proposed controller compared to the original controller. This is presented per phase for a demand of 700 veh/h/lane for a penetration rate of 20 or 50% in figure 4.8, 4.9 and 4.10.

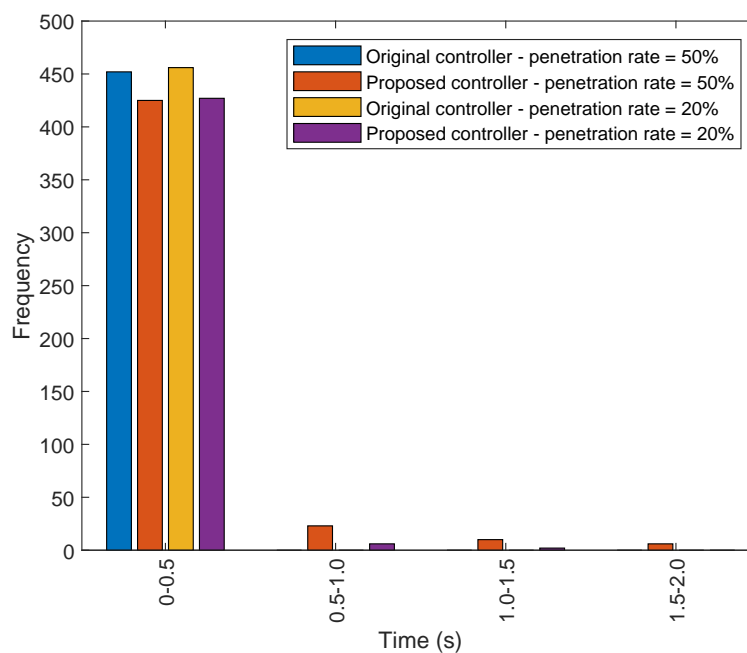

Figure 4.8: Frequency of the duration of the 4EG phase at different variants

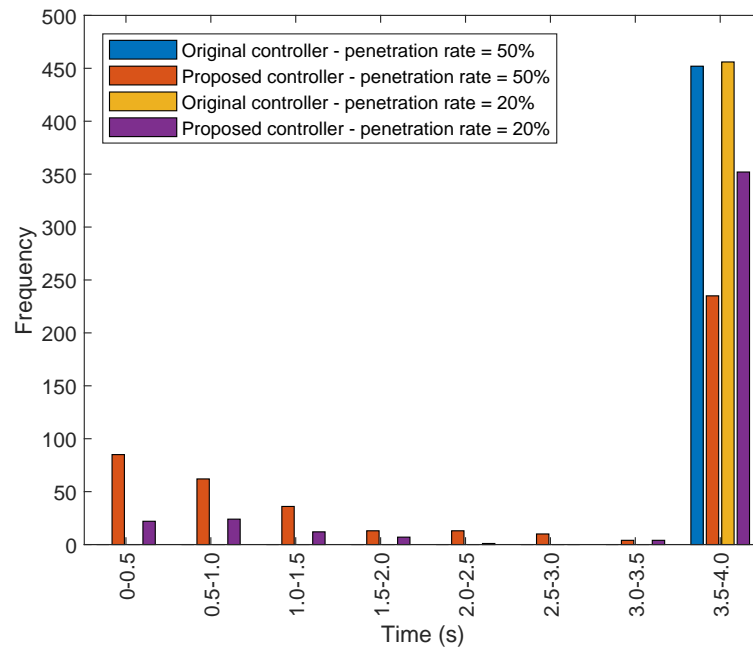

Figure 4.9: Frequency of the duration of the yellow phase at different variants

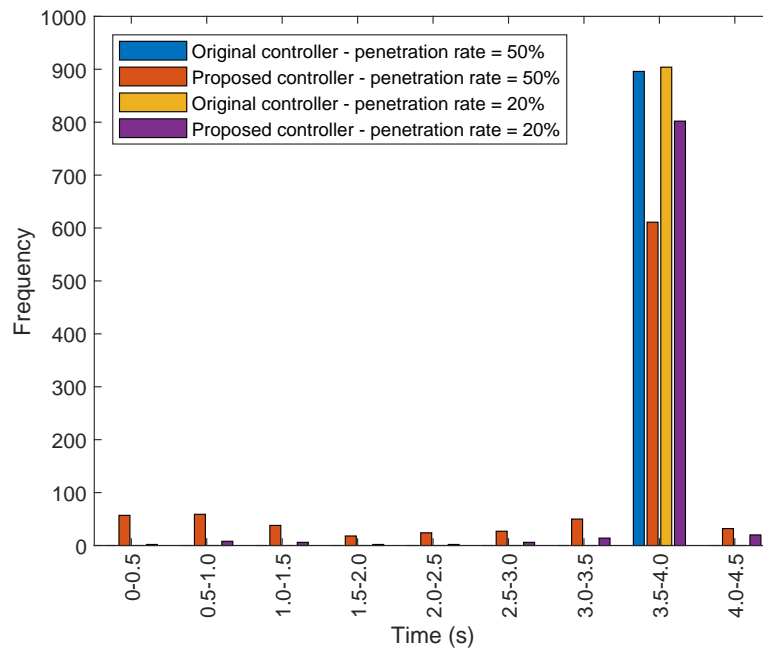

Figure 4.10: Frequency of the duration of the inter-green time at different variants

It can be observed that the 4EG phase more often is longer in the proposed control system than in the original one. This is not desired for efficiency but it is for the safety. It could be that some more unsafe

situations appear at the intersection but the original controller is not able to identify these and the proposed controller is. The frequency of the yellow phase shows that when the phase is truncated it most often is shortened 3 to 4 s. The frequency of the duration of the inter-green time shows a change when comparing the original and new controller. It shows that the inter-green time is sometimes shortened and sometimes extended. The frequency of the extended inter-green time compared to the default green time could be due to an increase of the duration of the 4EG phase. When one direction in a stage obtains a longer 4EG phase, the other direction automatically starts its inter-green time while the other direction most probably is the critical factor to decide when the next directions of the next stage obtain the green phase.

Furthermore, the percentage of measured scenarios as mentioned in figure 3.4, over all cycles are provided per penetration rate in figure 4.11.

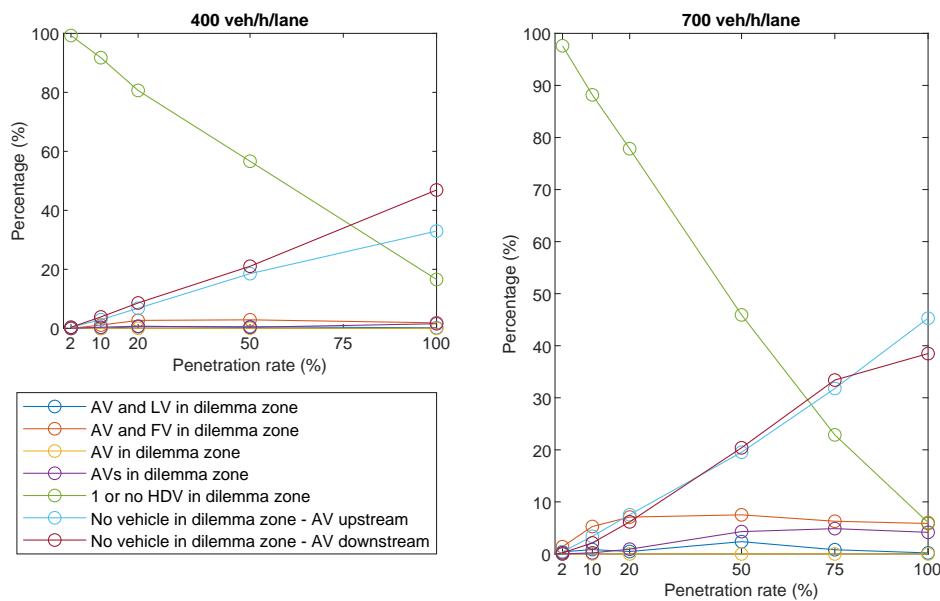

Figure 4.11: Percentages of each scenarios over total times a scenario was set at different penetration rates

It is found that the number of times an AV measures no vehicles to be in the dilemma zone, is increasing with increasing penetration rate. Even at a penetration rate of 100%, the controller still sometimes concludes that one or no HDV is at the intersection. The errors included in the predictions used by the controller could be the cause of this. It almost never happens that only an AV is measured to be in the dilemma zone at any penetration rate.

Desired outcome

Each phase has a desired outcome as described in section 3. In this part, it is provided to what extent the controller was able to obtain the desired outcome. This is done by comparing the desired outcome, each cycle of each direction, of the new and original controller. The desired outcome of the 4EG phase is already covered in the previous section. The desired outcome of the yellow phase is to have the time of the last vehicle passing the stop line as close as possible to the end time of the yellow phase, but the last vehicle should not be upstream of the yellow phase when it is truncated. The desired outcome of the RBG phase is, to make the gap time as short as possible. In figure 4.12, the time difference of the last vehicle crossing the stop line an the end time of yellow and the gap time are therefore presented. At different penetration rates, the actions of the proposed controller give different results closer to the desired outcome.

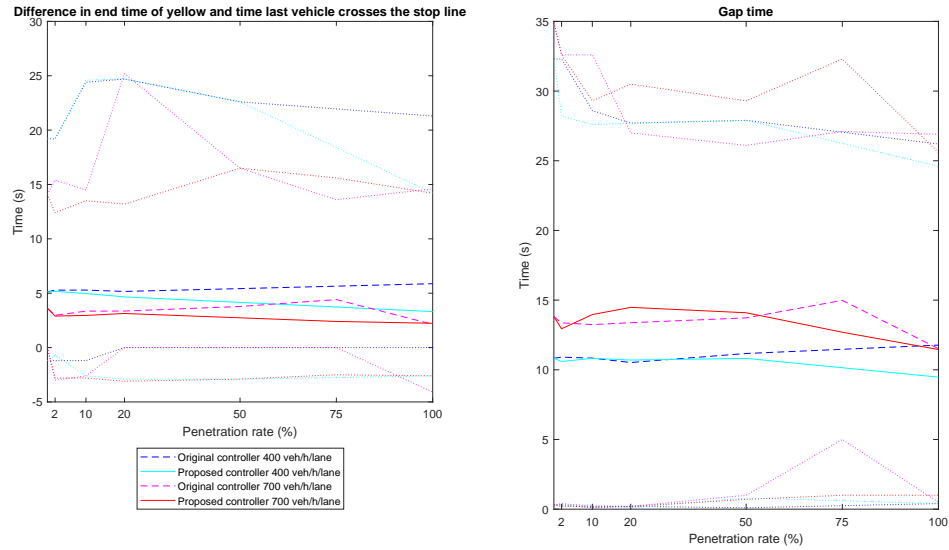

Figure 4.12: The average and minimal and maximal time difference between the end of the yellow phase and the time the last vehicle passes the stop line and the gap time

As can be seen, the average time difference of the last leaving vehicle and the start time of yellow decreases at all penetration rates by the proposed controller compared to the original one. The maximum measured time difference on average, is higher during the use of the original controller. The minimal value for the proposed controller, on average is lower. In the original controller having a negative time difference means someone has run a red light. For the proposed controller this could mean that the prediction used by the controller was not able to predict according to the actual situation (which is possible due to the errors included in the prediction models). Furthermore, it can be observed that the average gap time only decreases after a 50% penetration rate. The minimal gap times measured, are never observed to be lower than 0 s.

Delay

For each controller, the difference in average delay per vehicle (in s) between the original controller and the proposed controller, is calculated for variants where the demand remains constant and is equal on all directions. This is done for all vehicles but also for AVs separately and HDVs separately. In figure ?? a contour plot is provided, showing the percentage of increase in average delay per vehicle over the average delay per vehicle of the original controller. In this contour plot the ticks show at what points the measurements are provided via simulations. The other parts of the contour plot are filled in by interpolation. Additionally, in the appendix D.1 the the total delay and total travelled distance is presented. Furthermore, the total number of vehicles in the simulations with a demand of 100, 400, 700 and 850 veh/h are respectively, 404, 1580, 2722 and 3330. At the demand of 850 veh/h not all vehicles were able to enter the intersection.

Figure 4.13 does not provide the absolute decrease (or increase) of delay between the original and the new controller. Also it shows a significant difference in the improved delay at higher demands than 700 veh/h. Therefore, a zoom in that does not show a higher demand than 700 veh/h is provided. This shows the difference in delay of the controllers in more detail. A positive difference delay means an improvement in delay by the proposed controller. This is presented in the contour plots in figure 4.14.

In general the contour plot show that the higher the demand and penetration rate, the more the delay decreases. The exception is that at a demand of 700 veh/h/lane and a penetration rate of 100%, this difference in delay becomes negative. This could be cause by all AVs stopping when in their dilemma zone while the other direction of the same stage cannot end the yellow phase yet. The stopping AV could easily have passed in this time.

It can be seen that even though the average delay difference increases at higher demands and penetration rates, the average delay difference of the HDVs decreases again after a penetration rate of 75%.

At a high demand (700 veh/h) and a low penetration rate (2-10%), it can be observed that the delay time increases compared to the original controller. At an over saturated demand and the same low penetration

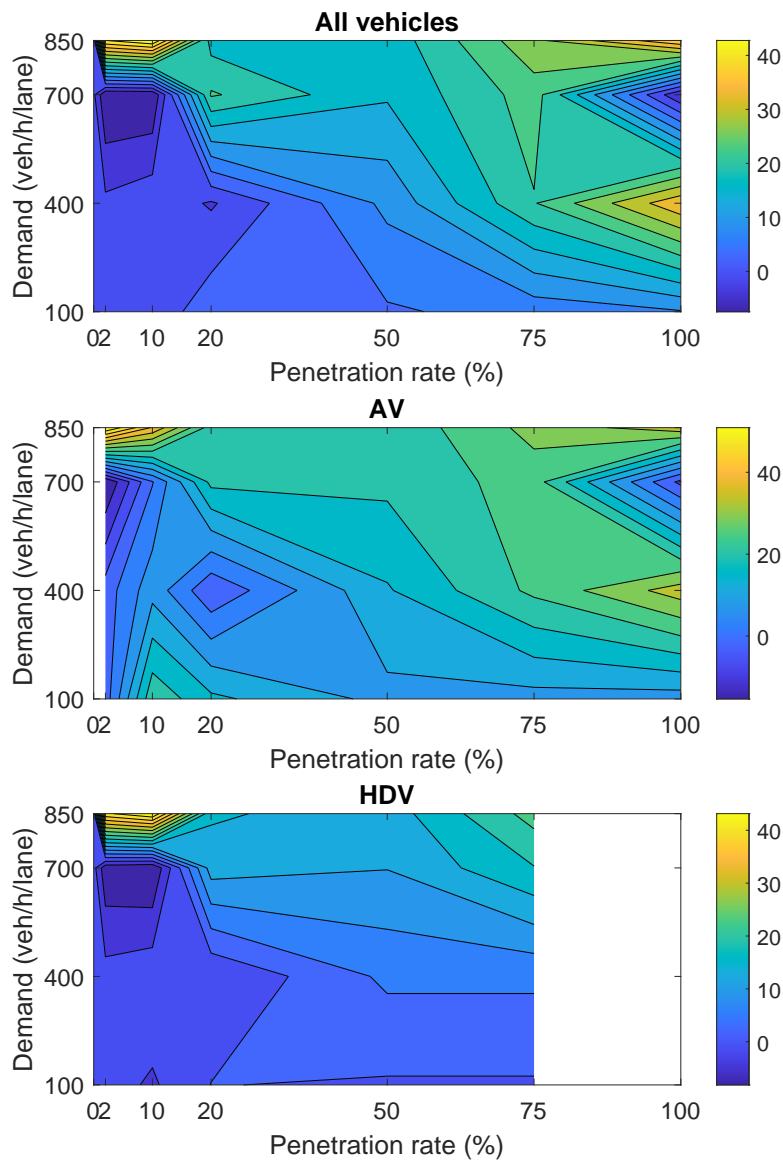

Figure 4.13: Contour plot of percentage of improvement of average delay over the average delay per vehicle of the original system, of all vehicle types, AVs-only and HDVs only at different penetration rate and a demand range from 100 to 850 veh/h

rate, the difference in delay on the other hand, improves significantly again.

At a demand of 400 veh/h and a penetration rate of 20% the average delay of an AV increases compared to the original controller. The reason for this could again be that AVs stop at the stop line while the other direction does not end yellow. At 20% there are already quite some AVs but the change of two AVs being the last to cross on both directions in the same stage is small.

For variants with different demand on different directions and for the variant with changing demand during the simulation, the average delay per vehicle results are plotted in figure 4.15.

It can be seen that bigger differences appear, between the original and proposed controller at a penetration rate of 20%. In the variant, when direction of the same stage have different demand, the delay time even increases for the proposed controller compared to the original one. The decrease in average delay at 50% is

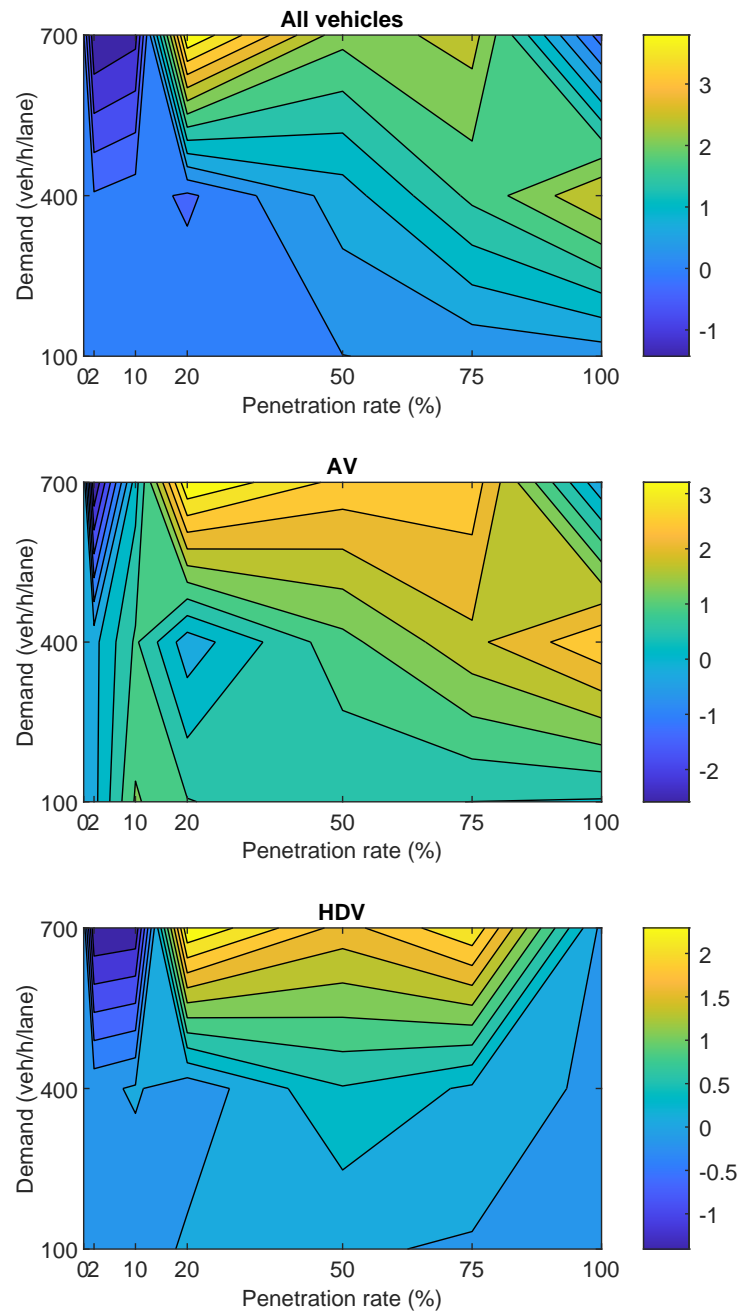

Figure 4.14: Contour plot of average delay per vehicle (in s) of all vehicle types, AVs-only and HDVs only at different penetration rate and demand range from 100 to 700 veh/h

more constant, for all demand variants, then at a penetration rate of 20%.

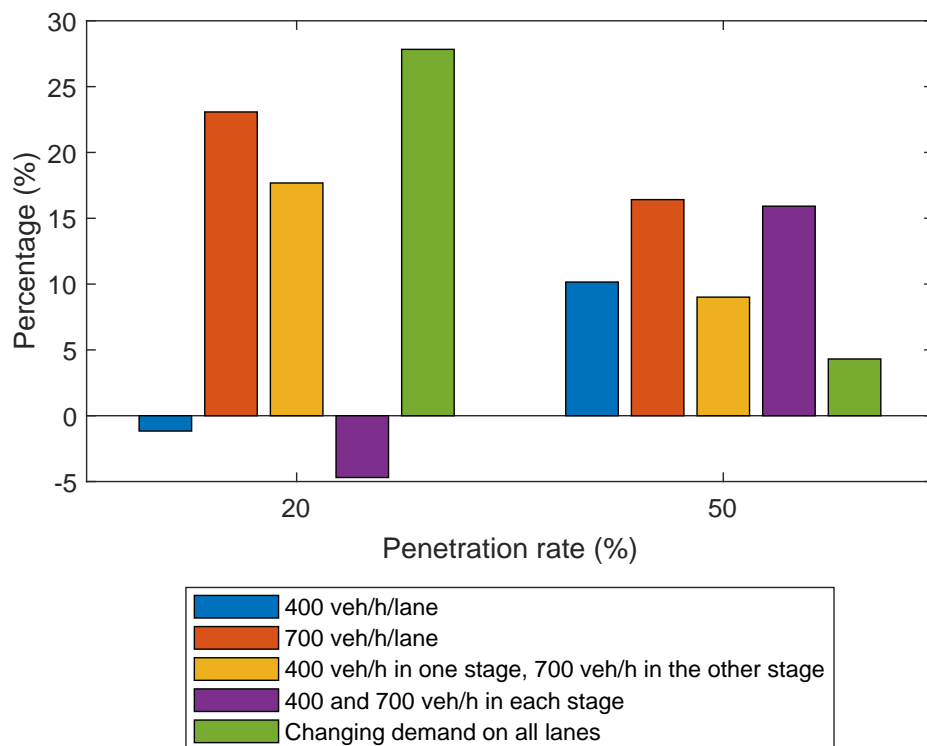

Figure 4.15: Percentage of the decrease in average delay per vehicle over the delay of the original controller of all vehicle types at different penetration rate for equal and different fixed demands at multiple directions and variable demand between original and proposed controller.

4.5. Discussion

The measurement errors used by the controller are assumed to be known. This might not always be the case in real life. These measurement errors as well as distributions of behaviour are used in the prediction models to decide the control actions. The equations originate from [27] and are adjusted to be able to use them with real-time measurements. To be able to do this, errors were included to account for slightly incorrect predictions. These equations are not real-life tested to work for actual AVs or HDVs. In the simulation, the measurement errors could be included in the information provided by the AVs. Therefore the measurement errors are fully known and the accurate errors are thus also used in the equations of the controller. On the other hand, not all behavioural or other characteristics of HDVs/AVs could be included in the simulation, which are included in the equations of the controller that are used in the simulation. The reaction time of HDVs and AVs could not be changed in VISSIM. Also, it is unknown what the tracking error of the AVs in the simulation is. Even with these unknown parameters, the model (that includes assumptions on the distribution of these parameters) provided safe crossings. The distributions and measurement errors used could have an influence on the actions of the controller, as decided via the equations. Furthermore, it is also possible that the parameters used in the simulation do not completely represent the real-life situation.

The outcome of the simulations shows that the equations used in the current vehicle-actuated control system, with adjustments, can be used for predictions generated with measurements from AVs in simulations, where the measurement errors are known.

5

Discussion and conclusion

In this chapter, an overview of the results is provided, followed by the significance of the results. Furthermore, the shortcomings of the research and the potential for future research are elaborated upon.

5.1. Results and importance

The equations used by [27], to predict trajectories, can be adjusted, to include additional measurements from AVs. These measurements include the speed and location of both the AV itself, but also of the vehicles around it. Errors are included in these equations to maintain safety. The information of AVs in or around the dilemma zone can be used to predict trajectories of crucial vehicles to be able to shorten the signal timings.

For low demands and penetration rates below 10%, the controller has not proven to decrease the average delay of the intersection. This could be due to the fact that AVs in one direction of a stage are able to provide information to shorten the signal timings but in the other direction of the stage they are not. The most critical direction of these two is the latter. The RBG of the directions in the next stage will be regulated according to this last mentioned direction. The information provided by the AV was thus not used fully to decrease the duration of the RBG phase of a direction of the next stage. Additionally, this means that the AV (who always stops if possible) could have crossed the intersection without causing the next directions to obtain the green phase later. The AV now has to wait for an additional cycle. At a higher demand, the average delay already decrease at a lower penetration rate. At neither a high or low demand, the controller affects the delay below a penetration rate of 2% (it can even make the delay worse).

At increasing penetration rates, it can be observed that the yellow phase and the clearance time are linearly increasing the frequency it is being truncated. The total time truncated does not necessarily increase linearly. Most time can be won by truncating the yellow phase as this phases originally is 6 times longer than the clearance time.

It can be observed that the controller mainly performs actions when the penetration rates increase. Most frequently the data to obtain control actions from, is gathered from AVs that are not in their own dilemma zone and can measure no other vehicle in the dilemma zone. This could be different at intersections with higher speed limits, as the dilemma zone then becomes bigger.

The percentage of times the controller was able to truncate the inter-green time or the yellow phase, even when only AVs are on the road, has not reached a 100%. This could be due to the AVs needing the default time to make a safe crossing or the measurement errors that are incorporated in the prediction models. One AV could for example measure itself to be outside of the dilemma zone while the AV behind or in-front measures the same AV to be inside the dilemma zone. It could also be that no vehicles are present at the intersection (as they have already crossed the stop line), in that situation no information is taken from the AVs (after the stop line the information is not extracted anymore).

Previous research has shown that AVs will increase the throughput on the road. The results of the simulation of the proposed controller show the potential that an even bigger decrease in delay can be achieved when using the additional information from the AVs to control the state at an intersection. This control system can be added to the currently existing infrastructure and hardware.

5.2. Shortcomings of the research

The intersection used to test the control system is not the most realistic intersection. Intersections in real life mostly include multiple lanes for a direction, turning lanes or lanes for multiple directions (e.g. right turn and straight). These more complex intersections bring more uncertainties, as lane-changes can occur, and

different prediction models or errors might need to be used for turning vehicles. When multiple directions are pre-sorting on the same lane this also adds to the complexity, because it is unknown what path an HDV will follow and thus also what the conflict areas will be of that HDV. In these complex intersections, the controller would need to be able to identify scenarios that are cannot occur in the simple intersection of this research. These possible scenarios would first need to be explored, after which the manner in which the controller could include these scenarios in its decisions should be explored. Furthermore, only cars are included at the intersection in this research. This does not represent reality, as intersections also include trucks. Urban intersections usually also include pedestrians and bikes.

Furthermore, assumptions were made on the behaviour of HDVs and AVs, which might not hold at all times. One example is that it is assumed that the last vehicle crossing the intersection is not influenced by the vehicles in front of it, as the desired speed of the last vehicles is then already reached. Car-following models might conclude that this behaviour, at some times, is still influenced by the predecessors of the vehicles. Also, in the prediction model it is assumed that an HDV makes its decision to stop or continue only once at the start of the yellow phase. An HDV might reconsider this decision during the yellow phase in reality. Moreover, some assumptions on the parameters used in the prediction models might not represent reality. For example, the reaction time of an AV is assumed to be zero. Furthermore, it is assumed that all measurement errors and parameters used by the controller are known. The effect on safety and efficiency of mismatched set parameters in the controller to what happens in real-life is unknown.

In the results it could also be observed that, even when truncations happen, the delay is not necessarily decreased. This is due to the fact that a direction of the next stage has multiple conflict areas. To optimize the delay time, the combination of timings of multiple directions at the same time should be considered. Only then, it might be possible to decrease the delay also at low penetration rates. To fill the research gap of creating a controller that is able to increase delay at low penetration rates, as mentioned in section 1.2, this should be further explored. Especially when more complex intersections will be considered where a direction can have up to 5 conflict areas, this optimization should be explored.

The controller needs to process a lot of data each time step. The useful information is found via filtering during the phases from 4EG to the RBG phase. Each time step in these phases (except the waiting red phase), the controller needs to recalculate when it will perform its actions. It needs to do this for each direction. This possibly means that the computation time could become too high to do predictions real-time. This was not explored in this research. To decrease the computation time, the frequency of the calculations could be decreased. This would mean that less accurate predictions will be used. Additionally, it was not considered that communication with AVs could fail, which in reality could happen.

5.3. Future research

Resulting from this research, some topics have arisen that should be explored in further research.

Sensitivity analysis of parameters of the prediction model

This research did not include a sensitivity analysis of either the errors or the behavioural distributions that are assumed to be known. Research should be done to test what happens if these parameters do not represent reality and what happens if the deviation of the distribution of the parameters decreases or increases. To validate this, a short investigation is done to obtain some insight in the effect of mismatched parameters. In two short simulations of 300 seconds (these are simulations that are not used previously in this research), where the measurement errors were known, the delays were obtained. One simulation included no measurement errors while the other simulation included the errors as defined in this research. This showed that when no measurement errors are present and also not included in the predictions of the controller, the delay was actually slightly increased compared to when the errors are included in the measurements and in the predictions of the controller. This also shows that the controller could be made more efficient in terms of decreasing the delay, and shows that changing these errors and distributions might have an effect on the results. It could also be that these set parameters in this research represent the current behaviour and the errors accurately, but due to technological improvements and changing behaviour when AVs emerge on the road, the parameters might change. These parameters would thus need to be calibrated once in a while. Parameters of behaviour of HDVs can also change due to the additional AVs on the road. The behaviour of an HDV used in the prediction model, is based on current observed behaviour. A few examples of where the behaviour might change is when an AV is in front of the HDV at the front of a queue that has just obtained the green phase. The AV has no assumed reaction therefore the HDV could start driving earlier then when an HDV is the front vehicle.

It would be useful to know whether the HDVs reaction time decrease in this situation. Also, when the yellow light appears the decision of an HDV to stop or go might partly be made on what the driver in front decides to do. It should be researched what the share of influence is on the decision based on the behaviour of the leader and what the share is on the start time/speed/distance to the stop line of the HDV. This change in behaviour will also change the parameters used by the controller.

Fusion of input data

[2] fused data from different sensors. This could also be done in the proposed controller, by using data of multiple AVs about the same HDV. This could decrease measurement errors. Additionally, the data of the detectors could be fused with the data of the AVs. The information of one AV could also be extended with for example, LIDAR technology which could be placed on the sides of the AVs to be able to provide information about conflicting directions.

Extension controller for other intersections

Moreover, the proposed controller could be extended for more complex intersections. In the previous section it was explained what assumptions could be changed for a more complex intersection. Intersections located at higher speed roads should also be analysed. At higher speeds, the dilemma zone will become bigger. It would need to be explored if at higher speeds more than two vehicles would be able to fit in the dilemma zone. If this is true, the identification of the scenarios needs to be reassessed. The proposed controller could also be used in other types of signalized intersection controllers as long as it is possible to change signal timings that might be fixed currently and the hardware of the intersection is applying actions according to the controller.

Optimization delay

The proposed controller uses the additional information to truncate as much time as possible from the signal timings. This has shown to not always provide most optimal situations to decreased the delay time. For example, when yellow can be truncated in one direction but not the other (of the same stage), it might be more optimal (for the average delay) to let the AV, in the direction where yellow can be truncated cross the intersection instead of stopping (as is now the action provided by the controller). Also, when an AV is the first vehicle in the upcoming direction and the second vehicle an HDV, it is unknown what the reaction time of the HDV will be. If this remains as long as currently, a gap could arise between the AV and HDV. In this situation the AV could rather be assigned to wait to cross the intersection after the green light appears. The green light is then provided before the critical green-time has expired, so that the reaction time of the HDV has passed before the actual green phase starts.

Another efficiency improvement could be to add previously addressed solutions in literature to this controller. For example, the approaching speed of an AV could be regulated by the controller starting from a long distance from the intersection. It could be regulated in such a way that it will not have to come to a complete stop before being able to enter the intersection. To be able to add this in the proposed controller, prediction models would be needed to predict when what phase will be provided by the controller. This is already a difficult thing to do for current vehicle-actuated control. This would be even more challenging for the proposed controller. Furthermore, as researched by [10], AVs could be allowed to cross the intersection during the red phase of their direction by negotiating on their trajectory with the controller. This would need an assessment of safety and efficiency.

Moreover, the data provided by the AVs could also be used to regulate the other phases within vehicle-actuated control. Currently, the green sub-phases (except for the 4EG phase) use information from the detector loops. Data from AVs could be added to this information to provide more insight on the situation at the intersection.

Real-life experiment of the controller

Before the proposed controller can be tested via real-life experiments, some additional research is needed. First of all, the parameters used in the prediction models should be found via real-life experiments. Next, the prediction models used by the controller should be verified by experiments. In these experiments, only one road without an actual conflict area should be used, to guarantee safety. Furthermore, it should be researched if all data measured by AVs will always arrive at the IC at all or on time. The controller should get an extension on what to do when information of AVs has not arrived. At last, the efficiency improvement should be added

to the proposed controller before the research is worthwhile to bring to real-life experiments.

5.4. Conclusion

The Research goal of the project is:

Designing a signalized vehicle-actuated intersection controller, for an isolated intersection with multiple conflict areas, by using the additional information of AVs, to shorten the timings of the phases according to the situation at the intersection, for the hybrid period (AVs and HDVs), without compromising safety

Information of AVs can be used to identify scenarios at the intersection in which the 4EG, the yellow phase and the RBG phase can be truncated. These scenarios can be identified only when an AV is able to identify the last leaving vehicle or first upcoming vehicle on a direction. The last vehicle to cross the intersection can be identified when the AV is in the dilemma zone or around the dilemma zone and no vehicle is in the dilemma zone. In the entering direction, the information of an AV can be used when it is the first vehicle to enter, or when it is the second and is already at standstill in front of the stop line.

The speed and location of the AV itself and its FV and LV can be used by including them in adjusted equations, as defined by [27], to predict the needed duration of the yellow phase, the clearance time and the dilemma zone. The speed behavioural distribution in the formula can be replaced by the measurement of the AV when including measurement errors. Some behavioural distributions in the equations cannot be replaced with measurements. These behavioural parameters for an AV are assumed to be a known fixed parameter. For HDVs the original behavioural distributions, as used in the original vehicle-actuated control, remain. Fluctuations in acceleration due to external factors is captured via the addition of a tracking error. This means that the solution of the clearance time, end yellow time and dilemma zone is a certain distribution. A pre-defined 99 percentile of these solutions is used to base control actions upon to maintain safety. This is the same percentile that is currently used in the prediction equations of vehicle-actuated control.

The simulations show that, even at low penetration rates of AVs, the controller is able to truncate the 4EG phase, the yellow phase and the clearance time (and with that the inter-green time) in the simulation. But, only after a 20 % penetration rate, this will decrease the delay of the intersection. When the intersection is not over-saturated, the controller has shown via the simulations to decrease the average delay per vehicle in a range from -2 s to 3.5 s compared to the original controller. After a penetration rate of 20% the range of the average delay change per vehicle compared to the original control is between 0 and 3.5 s. The only exception here is when the demand is 700 veh/h/lane and the penetration rate is 100%. The percentage of the number of times the yellow phase and the clearance time can be shortened seems to be increasing linearly with the increase of the penetration rate, but they never reach 100%. The truncation of the yellow phase has the most effect on the decrease in delay. The gap time and the difference in time when the last vehicle crosses the stop line and yellow ends decrease after a penetration rate of 50% has been reached.

A

Academic paper

Shortening signal timings of vehicle-actuated controllers by using communicating, automated vehicles, in the transition period from fully human-driven vehicles to fully autonomous vehicles

F. van Giessen^{a,*}

^a Technical University of Delft and Rijkswaterstaat (ITS Edulab)

Abstract

Intersections are the bottleneck of traffic flow. Vehicle-actuated control improved the delay at an intersection by making the green phase variable based on the presence of vehicles as measured by detector loops. The duration of the yellow and red phase remains fixed times because intentions of specific human-driven vehicles (HDVs) are unknown, and measurements of the behaviour of HDVs at crucial moments can not be provided by detector loops. The introduction of connected autonomous vehicles (AVs) will bring a transition (hybrid) period, where HDVs and AVs share the road. Intersection controllers for this period have been proposed, but none of them improve delay at low penetration rates. The AVs could be used to provide additional information at crucial moments. This research proposes a new controller for the complete range of penetration rates of AVs, in which the controller aims to shorten the yellow and red phase. The information of the AVs is used to identify the scenario at the intersection and apply control actions based on predictions. Simulations revealed that the yellow and red phase are shortened from low penetration rates (2%) onwards but that the delay compared to the original controller only decreases after at penetration rates of 10% and higher.

Keywords: Autonomous vehicles, Human-driven vehicles, Vehicle-Actuated control, real-time measurements, variable inter-green, variable clearance time, variable yellow phase, transition period.

1. Introduction

In the Netherlands, over 5500 intersection control systems were present in 2019 (TalkingTraffic, 2019). Many improvements have been made in the last couple of years to decrease the delay of traffic crossing the intersections. Still, intersections remain the bottleneck of traffic flow (Chen and Englund, 2015). One of the improvements implemented is that most intersection control systems in the Netherlands change the duration of the green phase based on the presence of vehicles measured by detector loops (Koster et al., 2019; Hakkesteege, 1988) (vehicle-actuated control), instead of having a fixed time for this phase. Fixed times are used to guarantee safety for the duration of yellow and red phase. These fixed times are necessary because intentions of specific human-driven vehicles (HDVs) remain unknown, and measurements of the behaviour of HDVs at crucial moments are not provided by the currently used detector loops.

Research is done to enable connected autonomous vehicles (AVs) to use our road network safely. This will lead to a transition (hybrid) period, where HDVs and AVs share the road.

These AVs could be used to provide additional information at these crucial moments (which the detector loops are not able to do). The connectivity and predictability of AVs give opportunities to control intersections based on more real-time data. Every additional AV on the road can provide more information than what was available before. This information could be used to adjust the the duration of the yellow and red phase when the situation at the intersection allows it. This could potentially improve the delay of intersections. The goal of this research is: *designing a signalized vehicle-actuated intersection controller, for an isolated intersection with multiple conflict areas, by using the additional information of AVs, to shorten the timings of the yellow and red phase according to the situation at the intersection, for the transition period from fully HDV to fully AV, without compromising safety.*

Section 2 elaborates on the research gap and the state-of-the-art of the research topic. The method of the research is described in section 3. Section 4 elaborates on the proposed controller, followed by section 5 in which the results of the simulation of the controller are presented. Finally, the conclusion are presented and discussed in section 6.

* Author and correspondence.

2. Literature review

Future intersection control has been researched for years. Most of them focus on intersection control when only AVs are on the road. These controllers navigate each AV separately across the intersection. Each vehicle gets a time reservation on the path they want to drive across the intersection. For this, no traffic lights are needed any more as the communication is done directly between the intersection controller and each vehicle (Au and Stone, 2010; Au et al., 2015; Gong and Du, 2018; Medina et al., 2017). This will not work for the hybrid period, as HDVs would need to be able to communicate and be certain to comply to the task the controller gives. For this communication the traffic lights are used currently. For the hybrid period, a few intersection control systems have been proposed, that use traffic lights for HDVs and direct communication with AVs. These systems either use a fixed time for all phases as basis, or only apply the additional part of the controller when the penetration rate is above a certain percentage. These previous proposed controllers have not provided improvements in delay at low penetration ratios of AVs (Aoki and Rajkumar, 2019; Dresner and Stone, 2008; Niroumand et al., 2020; Sharon and Stone, 2017). No research has been performed for the hybrid period on how to shorten the red or yellow phase for currently used vehicle-actuated control. In the full range of penetration rates, AVs are able to provide additional information to shorten these phases.

Vehicle-actuated control uses the three generally known phases red, green and yellow and divides them in sub-phases. The sub-phases of green and their corresponding tactics aim to make the total green phase as long as is necessary for the detected vehicles on the road. The last sub-phase of green: 4th extension green (4EG) is used as safety measure to prevent collisions. This is due to the decision to stop or continue driving when the yellow phase would appear. If the predecessor would decide to stop but the vehicle behind him does not, an unsafe situation occurs. The zone in which it is uncertain what an HDV would do, is called the dilemma zone. The most upstream part of the dilemma zone ($d_{zone,1}$) is the last location a vehicle is able to come to a complete stop before the stop line. The downstream part of the dilemma zone ($d_{zone,2}$) is the furthest distance a vehicle is able to drive to cross the stop line within the yellow phase. The location of the dilemma zone is calculated via (Koster et al., 2019):

$$d_{zone1} = t_{react} \cdot v_{appr} + \frac{v_{appr}^2}{2 \cdot a_{dec}} \quad (1)$$

$$d_{zone2} = \Delta t_{yellow} \cdot v_{appr} \quad (2)$$

Where

| | |
|---------------------|----------------------------------|
| a_{dec} | Deceleration of the vehicle |
| t_{react} | Reaction time of the driver |
| Δt_{yellow} | Duration of the yellow phase |
| v_{appr} | Approaching speed of the vehicle |

The red phase is divided into two sub-phases. It starts in waiting red. Only when a vehicle is detected and therewith requests green, the next sub-phase of red starts: red before green (RBG). It depends on when the conflicting direction switches from the green to the yellow phase and the clearance time of the two directions to decided the duration of the RBG phase. Clearance time ($t_{clearance}$) is calculated by subtracting the time it take the the first entering vehicle to drive from the stop line to the conflict area (t_{enter}), from the time the last vehicles in the queue to drive from the stop line till it leaves the conflict area (t_{leave}), $t_{clearance} = t_{leave} - t_{enter}$ (3). Where t_{leave} and t_{enter} are calculated via:

$$t_{leave} = \frac{d_{leave}}{v_{leave}} \quad (4)$$

$$t_{enter} = \frac{d_{enter}}{v_{enter}} + \frac{v_{enter}}{2 \cdot (a_{acc} + a_{dec})} \quad (5)$$

Where

| | |
|-------------|--|
| a_{acc} | Acceleration of the vehicle |
| a_{dec} | Deceleration of the vehicle |
| d_{leave} | Distance of the stop line to the end of the conflict area plus the length of the vehicle |
| d_{enter} | Distance from the stop line to the beginning of the conflict area |
| v_{leave} | Speed of the vehicle when crossing the stop line |
| v_{enter} | Speed of the vehicle when crossing the stop line |

The time between the green phase of two conflicting directions is as least as long as the inter-green time. The RBG phase is at least this inter-green time. The inter-green time is calculated via:

$$t_{inter-green}^{n,m} = \Delta t_{yellow}^n + t_{leave}^n - t_{enter}^m \quad (6)$$

The solutions to (1), (2), (4) and (5) can be different per vehicle. For vehicle-actuated control a 99-percentile of observations of these variables is therefore used (Koster et al., 2019) to determine the fixed times or thresholds. Some of the variables that are unknown for a specific vehicle can be obtained by measurement of AVs. AV are able to measure their own speed and location (Koster et al., 2019; Witte and Wilson, 2004), but also of their follower vehicle (FV) and leader vehicle (LV) via LIDAR technology (Hecht, 2018; Glennie, 2008; Wen et al., 2019). The AV is able to communicate (Tu and Huang, 2010; Yin et al., 2004; Nguyen, 2018) this and also its length and desired acceleration and deceleration to the intersection controller (IC). The currently used equations in vehicle-actuated control can be transformed to be able to use information from AVs and predict the trajectories of relevant vehicles. The errors of the measurements of the AV need to be included when the controller uses these measurements in its prediction models of the trajectories of the vehicles. The equations assume constant acceleration which is not always true in reality, therefore a tracking error should be included (Shadrin et al., 2017;

Kaminer et al., 1998; Kayacan et al., 2016). This tracking error translates the fluctuation in acceleration to an error in the distance travelled.

Furthermore, previous research has provided mostly the same variables to determine the clearance time (McGee et al., 2012; Muller et al., 2004; Retzko and Boltze, 1987).

3. Method

The main research goal is tackled in three phases: the literature review, the design of the control system, and the evaluation of the proposed control system. The first phase is used to learn about the relevant current and future features that are/will be used in intersection controllers. This provides the basis of information that is needed for designing the controller. The second phase is a step-wise design methodology of the intersection control system. The final phase concludes, through simulation, if the proposed controller decreases the delay. Each phase is described in detail in the rest of this section.

3.1. Literature review

Multiple topics are explored in the literature review, as can be found in section 2. Here it is explored how currently vehicle-actuated control works and which equations are used for the 4EG, yellow and RBG phase. The communication between the IC and AVs and the additional information of the AVs is elaborated upon. The data and parameters in the prediction models of vehicle-actuated control are used to obtain insight in where the new data of AVs might be relevant in the proposed control system.

3.2. Design of the intersection control system

With the conclusions of the literature review, the design phase is started. A methodology for the design is applied to give structure to the process and make sure all aspects of the proposed controller are analysed. The design phase is divided in steps. These steps are:

Problem analysis in traffic engineering terms - In this step it is decided what the control strategy of the proposed controller is. This strategy is based upon an analysis exploring possible scenarios at the intersection and what control actions are needed in these scenarios.

Problem analysis in control engineering terms - This step contains the translation of the control strategy to mathematical terms. It is explored how the measurements of AVs (and other sensors) can be used to obtain insight in the current scenarios at the intersection. Also, based on the findings of the literature review, a model is made to predict the future state of the intersection. Lastly, it is defined how the measurements and predictions of the state of the intersection are used to define control actions. Moreover, it is also decided how to account for errors in predictions and measurements.

Selection of the type of controller - In this step the type of controller is chosen.

3.3. Evaluation of the controller

In this phase the proposed controller is evaluated via simulations in VISSIM where the intersection is controlled via Matlab. This is done to obtain insight in what parts of the proposed controller show most effect on the state at the intersection and how this then again influences the delay. Different variants of relevant demand and penetration rates are included in the simulations. The intersection in the simulation consists of one lane from each cardinal direction. The simulation run time is 3600 seconds per input variant with a start-up time of 50s.

4. Design

The desired outcome is making the phases as short as possible without compromising the safety. This is elaborated upon under the following assumptions:

- No delay or failure in communication between AVs and the IC
- Only cars are present at the intersection (no trucks)
- An intersection is considered with a maximum speed of 50 km/h
- Only one lane is present per direction and only straight going directions are included at the intersection. This means no overtaking happens.
- AVs only obtain task of the IC that they are able to perform. The AVs always comply to these tasks.
- It is assumed the AVs have no reaction time.
- The maximum speed at the intersection is 50 km/h.
- HDVs make the decision to stop or continue only at the start of the yellow phase.

The section first discusses the connection between all (sub-)phases, followed by an elaboration of each separate (sub-)phase.

4.1. Connection between sub-phases

The (sub-)phases analysed are influenced by each other. This is explained via conflicting directions n and m . When direction n is given as index, it means that this direction starts in the 4EG phase and continues to yellow and then waiting red. Direction m is in the RBG phase and continues to fixed green. The scenarios happening in a direction decide what control actions should be taken. Which then consequently influences the scenario during the next phase. In the proposed controller, the yellow phase duration and the clearance time become variable. Each time step, the controller calculates when the yellow phase of direction n could be ended. The outcome of this calculation needs to be used to decide when the RBG phase of direction m , should be ended in the future. When the action of ending the RBG phase is performed while the yellow phase of direction n is not ended, the last calculation of when to end the yellow phase should be used to decide the end time. This is shown in figure 1.

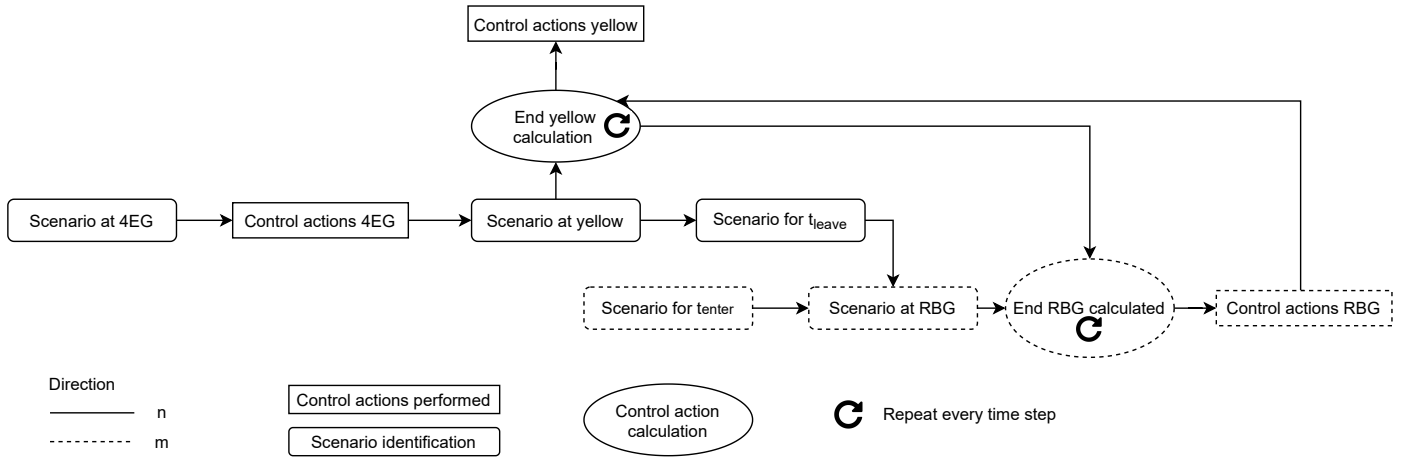

Figure 1: The connection between (sub-)phases of conflicting directions. This shows that scenario and the control actions of the same direction but also of conflicting directions are influenced by each other. The RBG phase of direction m can only be calculated when the end of yellow of direction n can be calculated.

4.2. 4EG phase

To decide whether the 4EG phase can be ended, it needs to be known what vehicles are in the dilemma zone. The dilemma zone as described by (1) and (2) depends on each vehicle’s preferences (e.g. desired acceleration or deceleration) and behaviour (e.g. reaction time) but also on the situation on the road (e.g. their speed). As these variables cannot be obtained in the current system, a default dilemma zone is used instead of a vehicle-specific dilemma zone. Some of these variables can be obtained from AVs. The speed and location of the LV, FV and AV and the behaviour and preferences of the AVs can be communicated. These measurements and communication, in contrast with detector loops, can provide vehicle specific dilemma zones. In this new situation, the meaning of the dilemma zone is slightly different for both AVs and HDVs. An HDV in the dilemma zone means it is unclear whether it will stop or continue. The dilemma zone of an AV is defined as the zone in which the controller is able to give a task and the AV is able to comply. This is illustrated in Figure 2. Also, it is assumed AVs have no reaction time. This means with equal speed the dilemma zone of the AV is bigger than an HDV. Without reaction time, less distance is needed to come to a complete stop at the stop line. This is also shown in Figure 2.

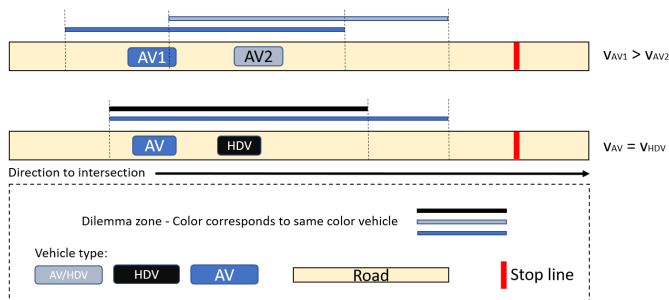

Figure 2: An example of the dilemma zones measured by an AV(s). This shows the dilemma zone is vehicle-specific.

It is assumed that only 2 vehicles can be present in their dilemma zone at the same time. This can be proven by taking two vehicles that both have opposing extreme location of the dilemma zone. With this assumption it means that if an AV is in its dilemma zone, it is able to measure if the vehicles around it are too. It provides full knowledge of all vehicles in the dilemma zone. When the AV is upstream or downstream its dilemma zone it could only measure one other vehicle to be in its dilemma zone. This will not provide full knowledge of all vehicles in their dilemma zone. In this way multiple scenarios can be identified in which an AV can give additional information about the last leaving vehicle(s). These scenarios are presented in Figure 3.

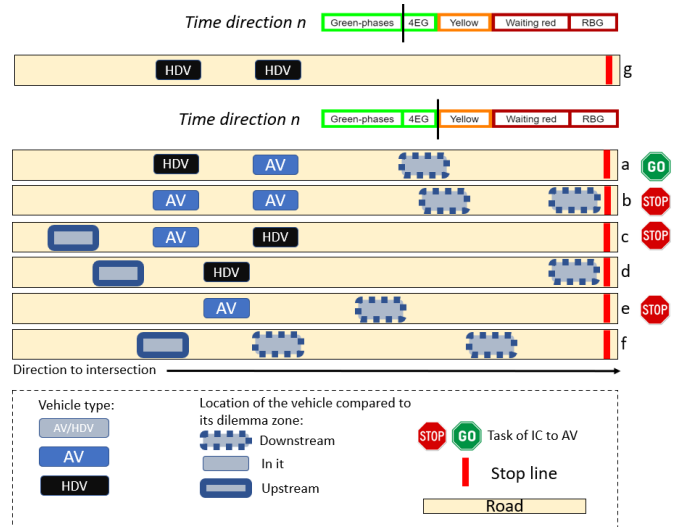

Figure 3: Possible scenarios at the start of the 4EG phase and what actions to take

In scenarios A, B, C and E, AVs are able to provide infor-

mation on all vehicles in their dilemma zone. AVs can be given the task to stop or continue. In scenario A and C this is done to make sure no collision will occur between the HDV and the AV while the 4EG phase can be ended directly. The task given to the AV in scenario B and E is not provided for safety reasons but only for making the 4EG phase as short as possible. Scenario D, G and F are identified from data from the detector loops (as is currently done). The other scenarios are identified based on the data of AVs.

To identify the scenario it should be concluded if a vehicle is in its dilemma zone or not. The location of a vehicle should therefore be measured and its dilemma zone should be predicted. This prediction is done by redefining the variables of (1) and (2) with the available measurements of the AV, as is explained in section 4.5.

4.3. Yellow phase

The yellow phase can be truncated when the last leaving vehicle is predicted or measured to pass the stop line. To be able to make predictions about this, it should be predicted what the last vehicle will be. The scenarios referred to in the 4EG phase (in Figure 3) evolve to scenarios in the yellow phase, as can be seen in Figure 4.

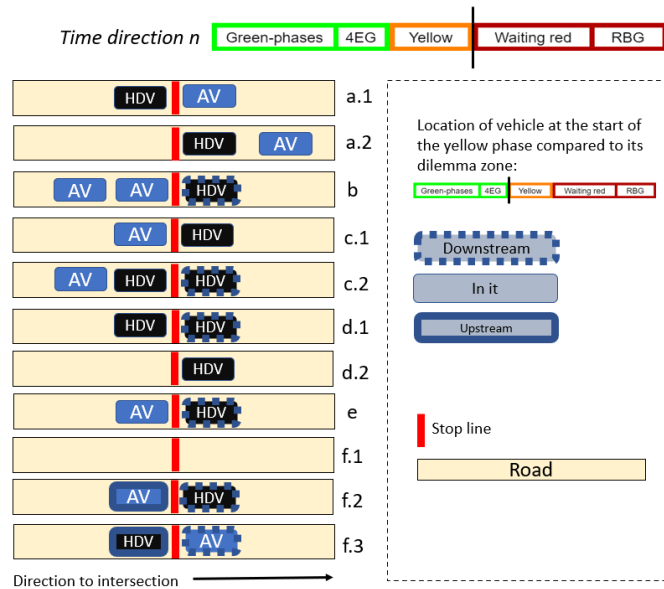

Figure 4: Scenarios at the end of the yellow phase

Only of the HDVs in their dilemma zone at the beginning of the yellow phase it is unknown whether they will stop or continue. The behaviour of these vehicles will change according to what they have decided to do. (1) and (2) are reformulated to the time-dependent dilemma zone to conclude what the HDV will do at any point after the start of the yellow phase. The end time of the yellow phase is based on the prediction of when the last vehicle will pass the stop line or when it is measured to have passed it. (4) is used in the original controller to predict when a vehicle will leave the conflict area. This equation will

be reformulated to predict when the last vehicle will pass the stop line.

4.4. RBG phase

The end of the RBG phase of direction m is decided based on the yellow phase of direction n , and the clearance time. The equations to calculate the clearance time can be reformulated to be measured for the specific vehicle that will be the last to cross the intersection of direction n or the first upcoming vehicle in direction m . This can only be done when it is clear what the last vehicle is and what the duration of the yellow phase will be. When direction m has multiple conflicting direction n , the critical inter-green time, as explained in Figure 5, should be used to determine when the RBG phase ends.

4.5. Mathematical translation

As stated in the previous sections, the variables in (1), (2), (4) and (5) should be reformulated to be able to use the measurements of the AV to conclude what scenario is happening and what control action should be performed. More information is known of an AV compared to a FV or LV. Therefore, the reformulation is different for an AV and an HDV. All mentioned variables of the formulas are enumerated below with an explanation of how the variable is rearranged to make predictions for the proposed controller.

a_{acc} and a_{dec} - For an AV this variable will be changed to the desired acceleration or deceleration of the AV. An AV is not able to provide additional information of the desired acceleration or deceleration of an HDV. The tracking error is also included for an AV as the desired acceleration will not always be met. For an HDV the tracking error will be added when the acceleration is assumed to be 0.

d_{leave} - When calculating t_{leave} of an AV, the exact length of the AV is known. This can be used instead of a certain percentile of the length of vehicles to calculate d_{leave} in the RBG phase. When used to predict the time the last vehicle passes the stop line in the yellow phase, this variable should be changed to the distance of the vehicle to the stop line. This location can be measured by the AV of itself and the FV and LV.

t_{react} - The reaction time of an AV is assumed to be zero. The reaction time of a specific HDV remains unknown. When determining the time-dependent dilemma zone, this reaction time should have passed because before this time no difference in behaviour will be observed.

v_{leave} , v_{enter} and v_{appr} - These variables can be substituted by the speed measured by the AV and the measurement error.

Δt_{yellow} - For the time dependent dilemma zone, the time passed in the yellow phase should be subtracted from the duration of the yellow phase, to predict what the most upstream location of the vehicle is in which it is able to cross the stop line within the yellow phase.

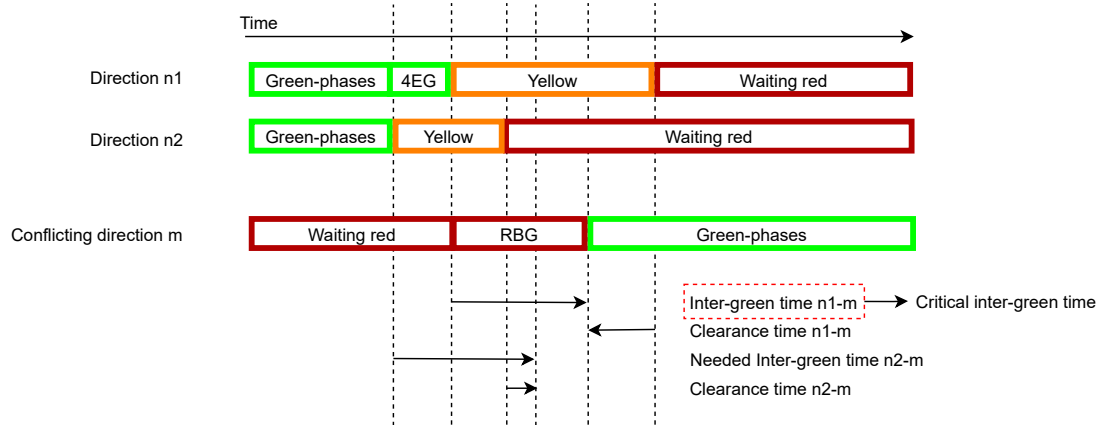

Figure 5: The critical inter-green time explained

The resulting equations will still include distributions and errors. Therefore, again a 99-percentile of the solution of the equation should be used by the controller.

Whenever AVs are not able to provide information about relevant vehicles, the default durations as currently used in vehicle-actuated control should be used.

A rule-based controller is designed of the above mentioned phases. This can be found in the form of a flow chart in the appendix.

5. Evaluation

The evaluation of the controller is done via simulations in VISSIM. To identify how the controller acts, the number of times the yellow phase and the RBG phase are truncated are found, and compared to the total possible number of times the phase could be truncated. Also the time shortened is compared to the total amount of time it could be shortened.

The number of times the yellow phase and inter-green time are truncated shows signs of a linear increase with the penetration rate increase and shows effect from 2% penetration rate onwards. At 100% penetration rate, neither the inter-green time nor the yellow phase can always be truncated.

The 4EG phase does not have a default time. Therefore, the frequency of the duration of the 4EG phase between the original and proposed controller with the same input random seed is compared in figure 7.

It can be observed that the 4EG phase is longer more frequently in the proposed control system than in the original one. This is not desired for efficiency but it does increase the safety.

The difference in the average delay per vehicle in the original and the proposed controller is shown in Figure 8. A positive difference delay means an improvement in delay by the proposed controller. Again, the same random seed is used in the simulation of the original and proposed controller.

In general the contour plot shows that the higher the demand and penetration rate, the more the delay decreases. Only after a 10% penetration rate the proposed controller seems to decrease the delay. The figure also shows a difference between the delay for AVs and HDVs.

6. Conclusion and Recommendations

Information of AVs can be used to identify scenarios at the intersection in which the 4EG, the yellow phase and the RBG phase can be truncated. These scenarios can be identified only when an AV is able to identify the last leaving vehicle or first upcoming vehicle on a direction. In the simulation it was found that shortening signal timings already happens at low penetration rates. The delay, in contrary, only decreases after a 10 % penetration rate. This could be due to the fact that AVs in one direction of a stage are able to provide information to shorten the signal timings but in the other direction of the stage they are not. The most critical direction of these two is the latter. The RBG of the directions in the next stage will be regulated according to this last mentioned direction. This means that the AV (who always stops if possible) could have crossed the intersection without affecting the start time of the green phase of a direction in the next stage. For optimization of the delay, all directions should thus be regarded at the same time instead of shortening the phases of each direction separately. This could then be used for even more complex intersections with more conflict areas. This research did not include a sensitivity analysis of either the errors or the behavioural distributions that are assumed to be known. Research should be done to test what happens if these parameters do not represent reality and what happens if the deviation of the distribution of the parameters decreases or increases.

References

- Aoki, S. and Rajkumar, R. (2019). 2v-based synchronous intersection protocols for mixed traffic of human-driven and self-driving vehicles.
- Au, T. and Stone, P. (2010). Motion planning algorithms for autonomous intersection management. pages 2–9, Atlanta, Georgia, USA.
- Au, T., Zhang, S., and Stone, P. (2015). *Autonomous intersection management for semiautonomous vehicles*. Routledge.
- Chen, L. and Englund, C. (2015). Cooperative intersection management: A survey. *IEEE Transactions on Intelligent Transportation Systems*, 17(2):570–586.
- Dresner, K. and Stone, P. (2008). A multiagent approach to autonomous intersection management. *Journal of Artificial Intelligence Research*, 31:591–656.

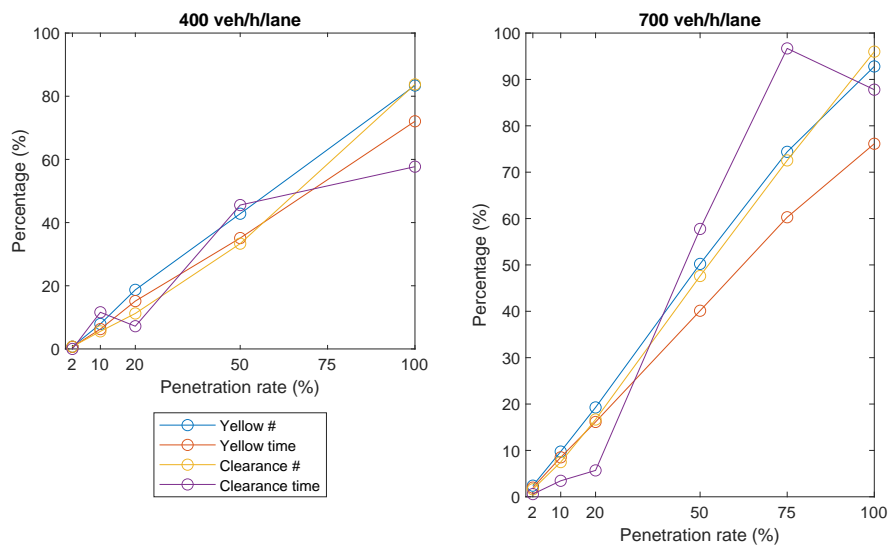

Figure 6: Percentages of actions of the controller over the total times the action could be given at different penetration rate for all adjusted phases at a demand of 400 and 700 veh/h/lane

- Glennie, C. (2008). Rigorous 3D error analysis of kinematic scanning LIDAR systems. *Journal of Applied Geodesy*, 1(3):147–157.
- Gong, S. and Du, L. (2018). Cooperative platoon control for a mixed traffic flow including human drive vehicles and connected and autonomous vehicles. *Transportation research part B: methodological*, 116:25–61.
- Hakkesteegt, P. (1988). TRAF COD: Method for systematic traffic control design.
- Hecht, J. (2018). Lidar for Self-Driving Cars. *Optics & Photonics News*, 29(January):26–33.
- Kaminer, I., Pascoal, A., Hallberg, E., and Silvestre, C. (1998). Trajectory tracking for autonomous vehicles: An integrated approach to guidance and control. *Journal of Guidance, Control, and Dynamics*, 21(1):29–38.
- Kayacan, E., Ramon, H., and Saeys, W. (2016). Robust trajectory tracking error model-based predictive control for unmanned ground vehicles. *IEEE/ASME Transactions on Mechatronics*, 21(2):806–814.
- Koster, I., Wilson, A., Oostenbrink, E., Y., G., and werkgroep âHandboek verkeerslichtenregelingenâ (2019). Handboek verkeerslichtenregelingen 2014.
- McGee, H., Moriarty, K., and Gates, T. (2012). Guidelines for timing yellow and red intervals at signalized intersections. *Transportation Research Record*, (2298):1–8.
- Medina, A., van de Wouw, N., and Nijmeijer, H. (2017). Cooperative intersection control based on virtual platooning. *IEEE Transactions on Intelligent Transportation Systems*, 19(6):1727–1740.
- Muller, T., Dijkster, T., and Furth, P. (2004). Red clearance intervals: theory and practice. *Transportation research record*, 1867(1):132–143.
- Nguyen, T. (2018). A comparison of cellular vehicle-to-everything and dedicated short range communication. volume January, pages 101–108.
- Niroumand, R., Tajalli, M., Hajibabai, L., and Hajbabaie, A. (2020). The Effects of the âWhite Phaseâ on Intersection Performance with Mixed-Autonomy Traffic Stream. pages 1–6.
- Retzko, H. and Boltze, M. (1987). Timing of intergreen periods at signalized intersections: the german method. *ITE Journal (Institute of Transportation Engineers)*, 57(9):23–26.
- Shadrin, S., Varlamov, O., and Ivanov, A. (2017). Experimental autonomous road vehicle with logical artificial intelligence. *Journal of Advanced Transportation*, 2017:10.
- Sharon, G. and Stone, P. (November-2017). A Protocol for Mixed Autonomous and Human-Operated Vehicles at Intersections. pages 151–167.
- TalkingTraffic (2019). Hoe staat het met de iVRI?
- Tu, L. and Huang, C. (2010). Forwards: A map-free intersection collision-warning system for all road patterns. *IEEE Transactions on Vehicular Technology*, 59(7):3233–3248.
- Wen, W., Bai, X., Zhan, W., Tomizuka, M., and Hsu, L. T. (2019). Uncertainty estimation of LiDAR matching aided by dynamic vehicle detection and high definition map. *Electronics Letters*, 55(6):348–349.
- Witte, T. H. and Wilson, A. M. (2004). Accuracy of non-differential GPS for the determination of speed over ground. *Journal of Biomechanics*, 37(12):1891–1898.
- Yin, J., ElBatt, T., Yeung, G., Ryu, B., Habermas, S., Krishnan, H., and Talty, T. (2004). Performance evaluation of safety applications over dsrc vehicular ad hoc networks. In *Proceedings of the 1st ACM international workshop on Vehicular ad hoc networks*, pages 1–9.

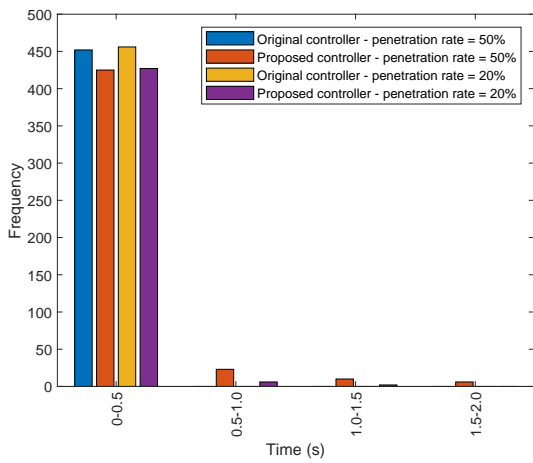

Figure 7: Frequency of the duration of the 4EG phase at different variants. This shows the difference in the frequency of the phase between the original and proposed controller.

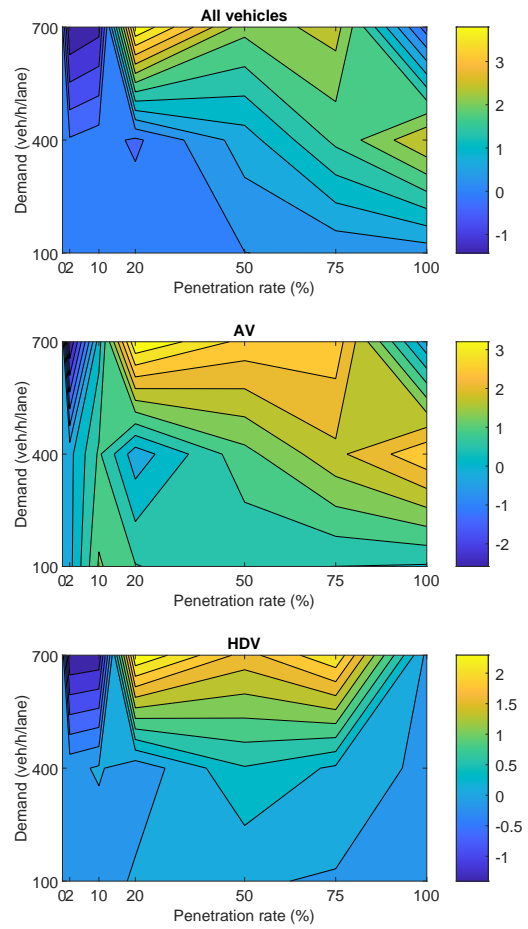

Figure 8: Contour plot of average delay difference per vehicle (in s) between the original and proposed controller, of all vehicle types, AVs-only and HDVs only at different penetration rate and demand range from 100 to 700 veh/h.

Appendix

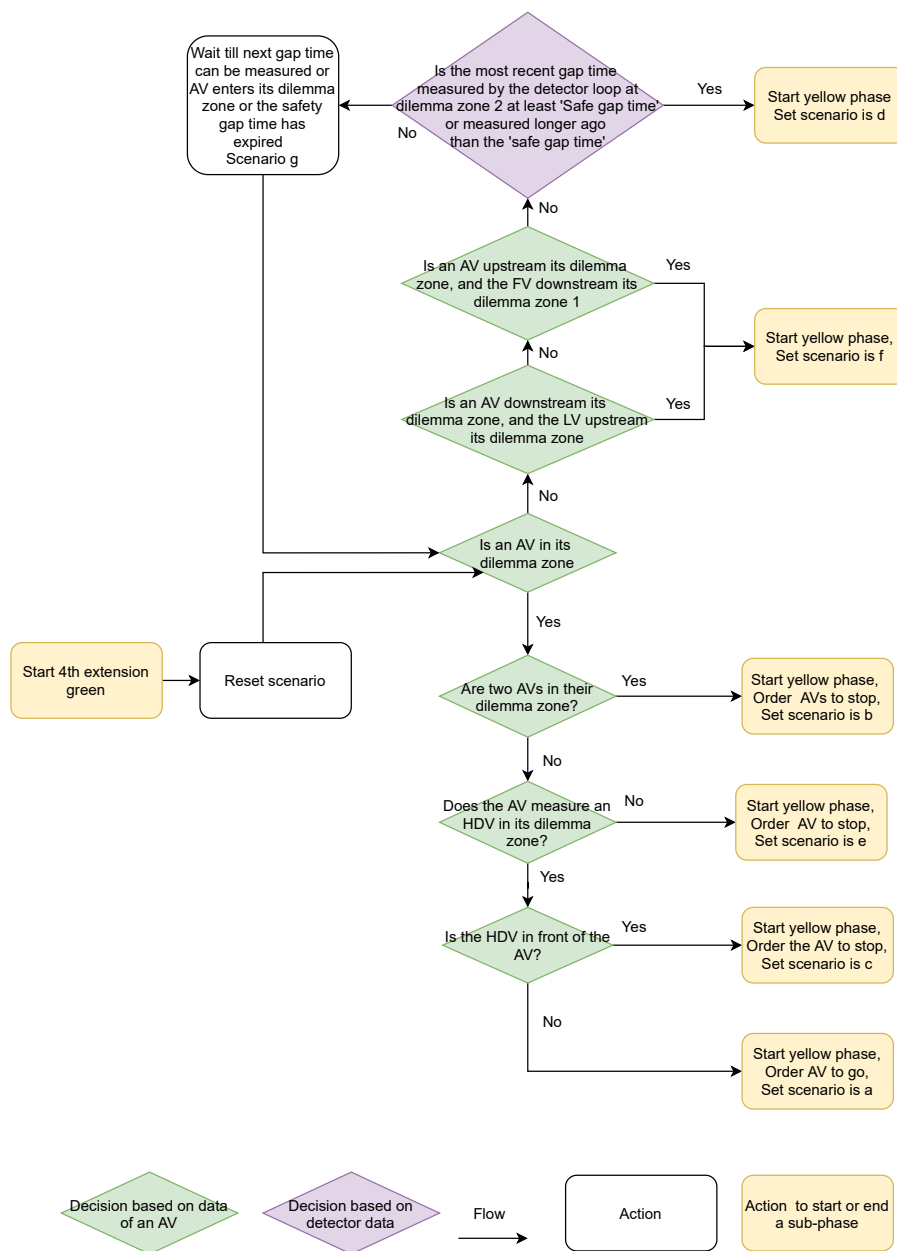

Figure 9: The flow of the controller in the 4EG phase

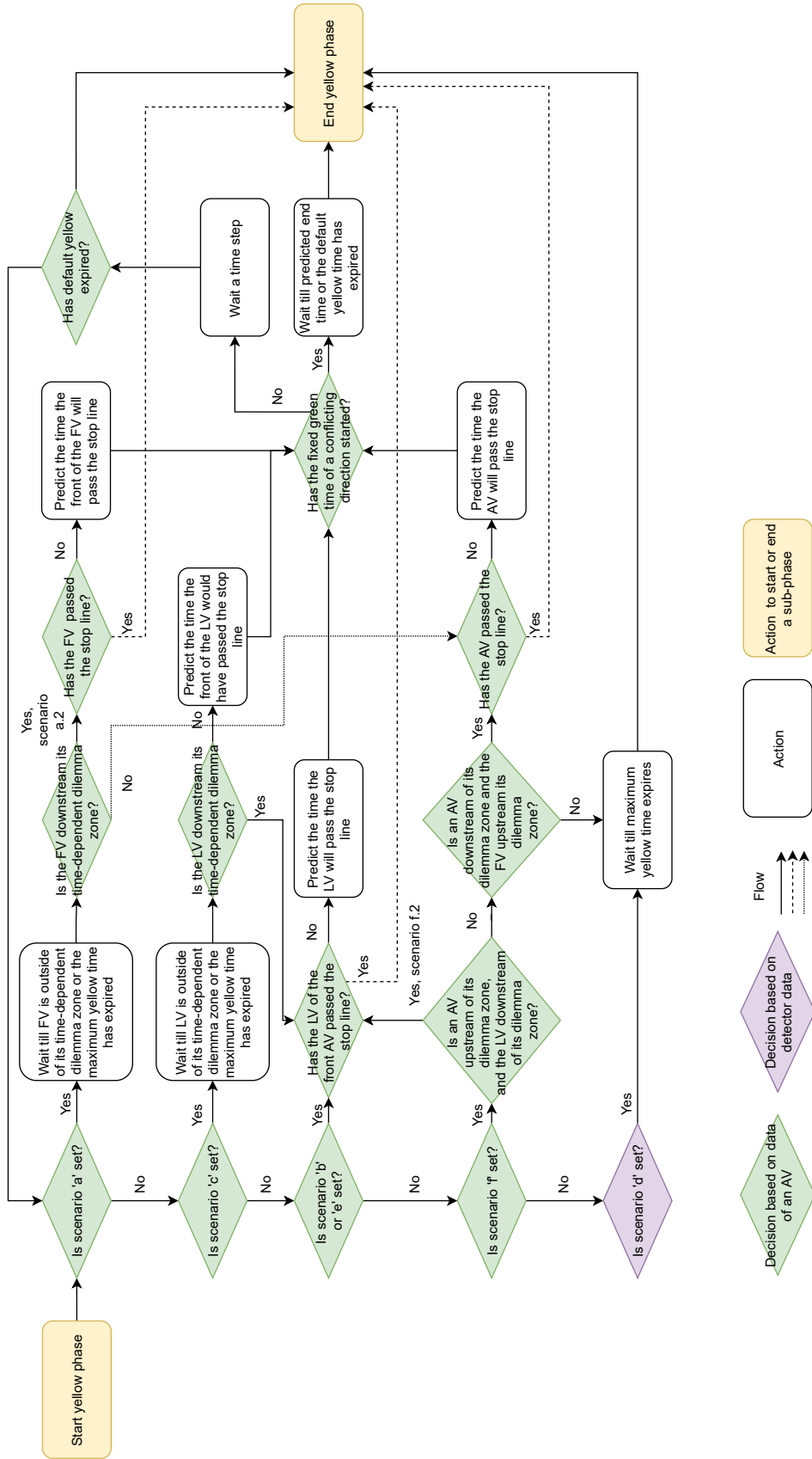

Figure 10: Decisions to identify scenarios during start of yellow time and its control actions

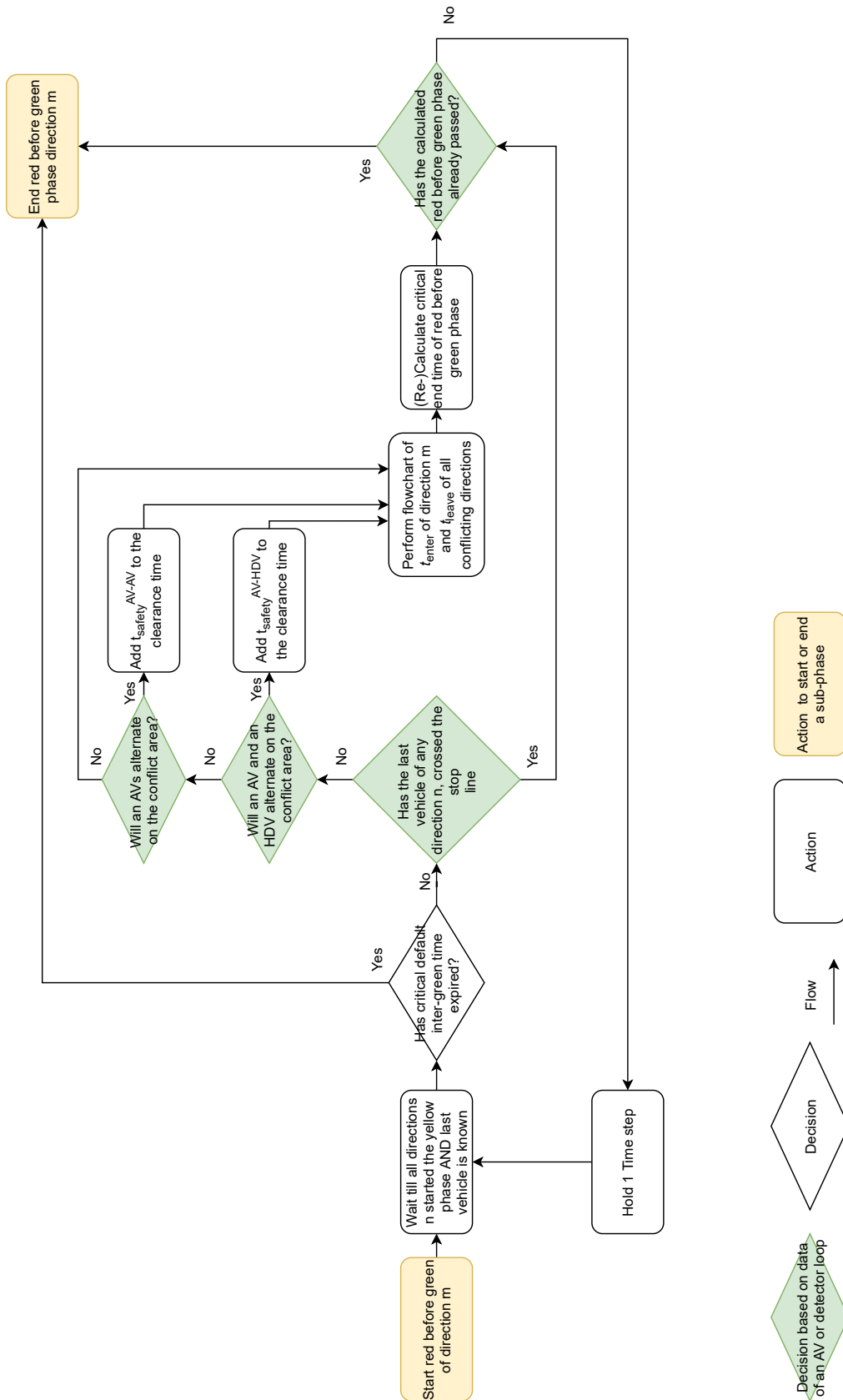

Figure 11: Flow chart to decide the end of the RBG phase

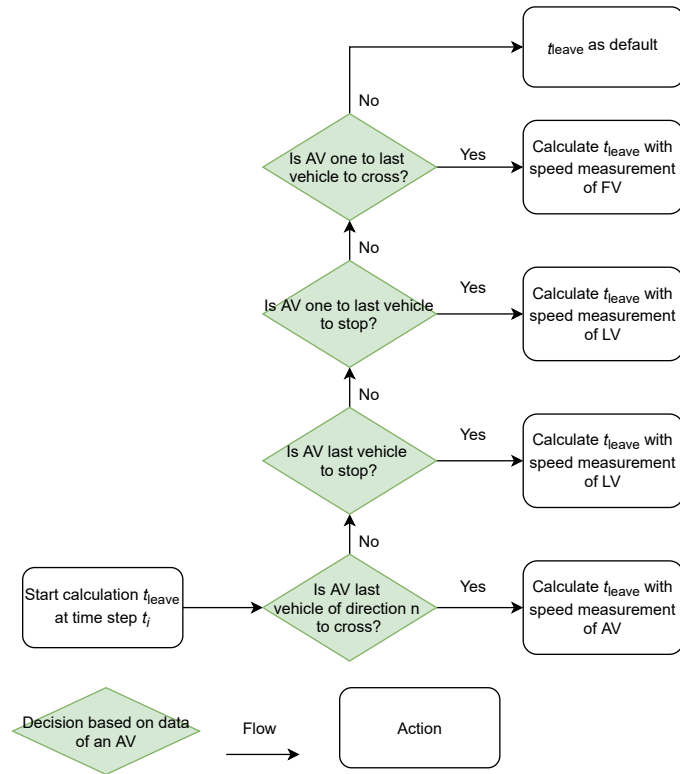
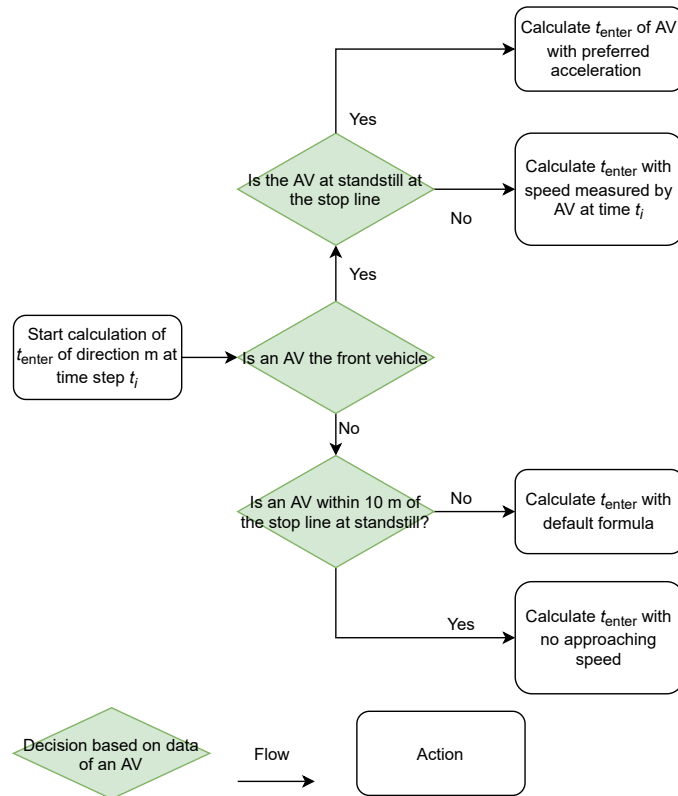

Figure 12: Decisions to identify scenarios for t_{leave} and its control actions

Figure 13: Decisions to identify scenarios for t_{enter} and its control actions

B

Design of the controller

B.1. Prediction equations

In (B.1) all equations that will be used in the control system for an AV can be found. In (B.2) the same can be found for a FV, in (B.3) for a LV and in B.4 for the leader of an LV.

In gray the variables that are obtained from measurements of an AV are presented. In light blue the known variables from an AV are shown and in red the variables of which an distribution is known but not the specific numerical of that vehicle is shown.

Equations for an AV

$$\begin{aligned}
 d_{\text{zone1,AV}}^k(t_i)(perc) &= \frac{(v_{\text{measure,AV}}^k(t_i) - \epsilon_{\text{speed,AV}})^2}{2 \cdot a_{\text{dec,comf}}^k} - \epsilon_{\text{track}} \\
 d_{\text{zone2,AV}}^k(t_i)(perc) &= \Delta t_{\text{yellow,default}} \cdot (v_{\text{measure,AV}}^k(t_i) + \epsilon_{\text{speed,AV}}) - \epsilon_{\text{track}} \\
 d_{\text{zone1td,AV}}^k(t_i)(perc) &= - \\
 d_{\text{zone2td,AV}}^k(t_i)(perc) &= - \\
 d_{\text{veh}}^k(t_i)(perc) &= d_{\text{measure,AV}}^k(t_i) + l_{\text{veh}}^k + \epsilon_{\text{GPS}} \\
 t_{\text{yellow,end}}(perc) &= \frac{d_{\text{measure,AV}}^k(t_i) + \epsilon_{\text{track}} + \epsilon_{\text{GPS}}}{v_{\text{measure,AV}}^k(t_i) + \epsilon_{\text{speed,AV}}} + t_{\text{yellow,start}}^n \quad (\text{prediction}) \\
 &= t_i \quad \text{when } l_{\text{veh}}^k \geq d_{\text{measure,AV}}^k(t_i) - \epsilon_{\text{GPS}} \quad (\text{measurement}) \\
 t_{\text{leave}}^n(perc) &= \frac{d_{\text{leave}}^{n,m} + l_{\text{veh}}^k + \epsilon_{\text{track}}}{v_{\text{measure,AV}}^k(t_i) - \epsilon_{\text{speed,AV}}} + t_{\text{safety,veh-veh}} \\
 t_{\text{enter}}^m(perc) &= \sqrt{2 \cdot (d_{\text{enter}}^{n,m} - \epsilon_{\text{track}}) \cdot a_{\text{acc,comf}}^k} \quad (\text{from standstill}) \\
 &= \frac{d_{\text{enter}}^{n,m} - \epsilon_{\text{track}}}{v_{\text{measure,AV}}^k(t_i) + \epsilon_{\text{speed,AV}}} + \frac{v_{\text{measure,AV}}^k(t_i) + \epsilon_{\text{speed,AV}}}{2 \cdot (a_{\text{acc,comf}}^k + a_{\text{dec,comf}}^k)} + t_{\text{safety}} \quad (\text{from approaching speed})
 \end{aligned} \tag{B.1}$$

Equations for an FV

$$\begin{aligned}
d_{\text{zone1,FV}}^k(t_i)(perc) &= t_{\text{react}} \cdot (v_{\text{measure,FV}}^k(t_i) - \epsilon_{\text{speed,HDV}}) + \frac{(v_{\text{measure,FV}}^k(t_i) - \epsilon_{\text{speed,HDV}})^2}{2 \cdot a_{\text{dec}}} \\
d_{\text{zone2,FV}}^k(t_i)(perc) &= \Delta t_{\text{yellow,default}} \cdot (v_{\text{measure,FV}}^k(t_i) + \epsilon_{\text{speed,HDV}}) + \epsilon_{\text{track}} \\
d_{\text{zone1td,FV}}^k(t_i)(perc) &= \frac{(v_{\text{measure,FV}}^k(t_i) - \epsilon_{\text{speed}})^2}{2 \cdot a_{\text{dec}}} \\
d_{\text{zone2td,FV}}^k(t_i)(perc) &= (v_{\text{measure,FV}}^k(t_i) + \epsilon_{\text{speed}}) \cdot (\Delta t_{\text{yellow,default}} + t_{\text{yellow,start}}^n - t_i) + \epsilon_{\text{track}} \\
d_{\text{FV}}^k(t_i)(perc) &= d_{\text{front,FV}}^k(t_i) + \epsilon_{\text{GPS}} + \epsilon_{\text{LIDAR}} \\
t_{\text{yellow,end}}^n(perc) &= \frac{d_{\text{front,FV}}^k(t_i) + l_{\text{veh,FV}} + \epsilon_{\text{GPS}} + \epsilon_{\text{LIDAR}} + \epsilon_{\text{track}}}{v_{\text{measure,FV}}^k(t_i) - \epsilon_{\text{speed,HDV}}} + t_{\text{yellow,start}}^n \quad (\text{prediction}) \\
&= t_i \quad \text{when} \quad 0 \geq d_{\text{front,FV}}^k(t_i) + l_{\text{veh}} - \epsilon_{\text{LIDAR}} - \epsilon_{\text{GPS}} \quad (\text{measurement}) \\
t_{\text{leave}}^n(perc) &= \frac{d_{\text{leave}}^{n,m} + l_{\text{veh}}}{v_{\text{measure,FV}}^k(t_i) - \epsilon_{\text{speed,HDV}}} \\
t_{\text{enter}}^m &= -
\end{aligned} \tag{B.2}$$

Equations for an LV

$$\begin{aligned}
d_{\text{zone1,LV}}^k(t_i)(perc) &= t_{\text{react}} \cdot (v_{\text{measure,LV}}^k(t_i) - \epsilon_{\text{speed,HDV}}) + \frac{(v_{\text{measure,LV}}^k(t_i) - \epsilon_{\text{speed,HDV}})^2}{2 \cdot a_{\text{dec}}} \\
d_{\text{zone2,LV}}^k(t_i)(perc) &= \Delta t_{\text{yellow,default}} \cdot (v_{\text{measure,LV}}^k(t_i) + \epsilon_{\text{speed,HDV}}) + \epsilon_{\text{track}} \\
d_{\text{zone1,LV}}^k(t_i)(perc) &= \frac{(v_{\text{measure,LV}}^k(t_i) - \epsilon_{\text{speed}})^2}{2 \cdot a_{\text{dec}}} \\
d_{\text{zone2,LV}}^k(t_i)(perc) &= (v_{\text{measure,LV}}^k(t_i) + \epsilon_{\text{speed}}) \cdot (\Delta t_{\text{yellow,default}} + t_{\text{yellow,start}}^n - t_i) + \epsilon_{\text{track}} \\
d_{\text{LV}}^k(t_i)(perc) &= d_{\text{back,LV}}^k(t_i) + \epsilon_{\text{GPS}} + \epsilon_{\text{LIDAR}} \\
t_{\text{yellow,end}}^n(perc) &= \frac{d_{\text{back,LV}}^k(t_i) + \epsilon_{\text{GPS}} + \epsilon_{\text{LIDAR}}}{v_{\text{measure,LV}}^k(t_i) - \epsilon_{\text{speed,HDV}}} + t_{\text{yellow,start}}^n \quad (\text{prediction}) \\
&= t_i \quad \text{when} \quad 0 \geq d_{\text{back,LV}}^k(t_i) - \epsilon_{\text{LIDAR}} - \epsilon_{\text{GPS}} \quad (\text{measurement}) \\
t_{\text{leave}}^n(perc) &= \frac{d_{\text{leave}}^{n,m} + l_{\text{veh}} + \epsilon_{\text{track}}}{v_{\text{measure,AV}}^k(t_i) - \epsilon_{\text{speed,AV}}} \\
t_{\text{enter}}^n(perc) &= \sqrt{2 \cdot d_{\text{enter}}^{n,m} \cdot a_{\text{acc}}} \quad (\text{from standstill}) \\
&= \frac{d_{\text{enter}}^{n,m}}{v_{\text{measure,LV}}^k(t_i) + \epsilon_{\text{speed,HDV}}} + \frac{v_{\text{measure,LV}}^k(t_i) + \epsilon_{\text{speed,HDV}}}{2 \cdot (a_{\text{acc}} + a_{\text{dec}})} \quad (\text{from approaching speed})
\end{aligned} \tag{B.3}$$

Leader of LV

$$t_{\text{end,yellow}}^n = \frac{d_{\text{back,LV}}^k(t_i) + \epsilon_{\text{GPS}} + \epsilon_{\text{LIDAR}} + \epsilon_{\text{track}} - l_{\text{veh}}}{v_{\text{measure,LV}}^k(t_i) - \epsilon_{\text{speed,HDV}}} + t_{\text{start,yellow}}^n \tag{B.4}$$

Variables

The variables used in the equations are defined below:

Sets

| | |
|-----|--|
| K | is the set of AVs within range R of the intersection |
| DIR | is the set of directions {EW, WE, NS, SN} |
| I | is the total amount of time steps |
| VEH | set of types of vehicles {AV, LV, FV, leader of LV} |

Measurements (gray)

For each AV, $k \in K$ the following variables are provided, during each time step t_i for $i \in I$: This is done for each direction n or $m \in \text{DIR}$

| | |
|--------------------------------|---|
| $d_{\text{measure,AV}}^k(t_i)$ | The measured location to the stop line of AV k at time step t_i |
| $v_{\text{measure,AV}}^k(t_i)$ | The measured speed of the AV at time t_i |
| $d_{\text{back,LV}}^k(t_i)$ | The measured location of the back of the vehicle of the LV to the stop line at time step t_i |
| $d_{\text{front,FV}}^k(t_i)$ | The measured location of the front of the vehicle of the FV to the stop line at time step t_i |
| $v_{\text{measure,LV}}^k(t_i)$ | The measured speed of the LV at time step t_i |
| $v_{\text{measure,FV}}^k(t_i)$ | The measured speed of the FV at time step t_i |

Preferences of AVs (light blue)

| | |
|-------------------------|---|
| $a_{\text{dec,comf}}^k$ | The comfortable deceleration rate of AV k |
| $a_{\text{acc,comf}}^k$ | The comfortable acceleration rate of AV k |
| l_{veh}^k | The length of AV k |

Distributions of HDVs (red)

| | |
|--------------------|---|
| a_{dec} | The comfortable deceleration rate of HDVs |
| a_{acc} | The comfortable acceleration rate of HDVs |
| l_{veh} | The length of HDVs |
| t_{react} | The reaction time of HDVs |

Solution of equations

For each solution a percentile (perc) is set for each $\text{veh} \in \text{VEH}$.

| | |
|---|---|
| $d_{\text{veh}}^k(t_i)(\text{perc})$ | The location of veh k |
| $d_{\text{dzone1}}^k(t_i)(\text{perc})$ | The downstream part of the dilemma zone |
| $d_{\text{dzone2}}^k(t_i)(\text{perc})$ | The upstream part of the dilemma zone |
| $d_{\text{dzone1td}}^k(t_i)(\text{perc})$ | The downstream part of the time-dependent dilemma zone |
| $d_{\text{dzone2td}}^k(t_i)(\text{perc})$ | The upstream part of the time-dependent dilemma zone |
| $t_{\text{yellow,end}}^n(\text{perc})$ | The end time of the yellow phase |
| $t_{\text{leave}}^n(\text{perc})$ | Leaving time of stop line till vehicle passes conflict area |
| $t_{\text{enter}}^n(\text{perc})$ | Time of stop line till vehicle reaches conflict area |

Fixed variables

| | |
|--------------------------|--|
| $d_{\text{enter}}^{n,m}$ | Distance of stop line to conflict area of direction m of conflict n,m |
| $d_{\text{leave}}^{n,m}$ | Distance of stop line to end of the conflict area of direction n of conflict n,m |

Errors

| | |
|-------------------------------|--------------------|
| ϵ_{GPS} | GPS error |
| ϵ_{LIDAR} | LIDAR error |
| ϵ_{track} | Tracking error |
| $\epsilon_{\text{Speed,AV}}$ | Speed error of AV |
| $\epsilon_{\text{Speed,HDV}}$ | Speed error of HDV |

B.2. Algorithm for sampling

The script below can be used to to sample to obtain a certain percentile for an equation. This script can be adjusted to any formula with known input variables.

Algorithm 1: Obtain numerical of percentile of variable defined by an equation

Result: Numerical of percentile of a variable

Set number of samples to take (10000);

Set percentile needed as percentile;

for each number from 1 to number of samples to take **do**

Randomly sample a numerical from the distribution of variable₁;
 Randomly sample a numerical from the distribution of variable₂s;
 Continue till all variables from the equations are sampled ;
 Find solution for the equation using the sampled variables;

end

Sort all solutions from high to low;

Take the solution that is the needed percentile;

where variable_x is a variable used in the equation to define the variable the percentile needs to be found for

B.3. Equations for which sampling is not needed

For the variables in table B.1 below the calculations to obtain the needed percentile is described.

Table B.1: Calculations to obtain the needed percentile of a variable that is described by an equation

| Variable | Needed percentile | Value of the needed percentile |
|--|-------------------|---|
| d_{AV}^k | 50 | $d_{\text{measure,AV}}^k + 0 \cdot \sigma_{\text{GPS}}$ |
| d_{LV}^k | 50 | $d_{\text{measure,LV}}^k + \mu_{\text{veh}} + 0 \cdot (\sigma_{\text{GPS}} + \sigma_{\text{LIDAR}} + \sigma_{\text{I_{veh}}})$ |
| d_{FV}^k | 50 | $d_{\text{measure,FV}}^k + 0 \cdot (\sigma_{\text{GPS}} + \sigma_{\text{LIDAR}})$ |
| $t_{\text{yellow,end}}^n$ (prediction) | 99 | $d_{\text{measure,AV}}^k + \mu_{\text{veh}} + 2.33 \cdot \sigma_{\text{GPS}}$ |
| $t_{\text{yellow,end}}$ (measurement) | 99 | $d_{\text{measure,LV}}^k + 2.33 \cdot (\sigma_{\text{LIDAR}} + \sigma_{\text{GPS}})$ |
| $t_{\text{yellow,end}}$ (measurement) | 99 | $d_{\text{measure,LV}}^k + \mu_{\text{veh}} + 2.33 \cdot (\sigma_{\text{LIDAR}} + \sigma_{\text{GPS}} + \sigma_{\text{I_{veh}}})$ |
| t_{react} (HDV) | 50 | $\mu_{\text{t_{react}}} + 0 \cdot \sigma_{\text{t_{react}}}$ |

B.4. Sub-phases in rule-based controller format

Each sub-phase will be presented below in a rule-based controller format in words. The controller will repeat its whole script at each time step (with time step size ΔT_{IC}). Each direction goes through the same script each time step. The scripts interact with each other, as decisions are made based on the status of the direction in the same stage and the conflicting directions.

Algorithm 2: 4th extension green

Result: End time of 4th extension green, orders to AVs

if *current time is after start of the 4EG phase AND time is before the start of yellow time AND the duration of 4EG phase is not over its maximum duration** **then**

Extract input of AVs (location, speed and comfortable deceleration rate) on direction n;

if *one AV is in its dilemma zone* **then**

extract data AV from LV / FV(location and speed) ;

if *LV, of AV in dilemma zone, is in its dilemma zone* **then**

Order AV to stop;

end

if *FV, of AV in dilemma zone, is in its dilemma zone* **then**

Order AV to go;

end

if *FV and LV, of AV in dilemma zone, not in their dilemma zone* **then**

Order AV to stop;

end

if *AV confirms order* **then**

Set current time step as end time of the 4EG;

end

end

if *two AVs provide information of being in the dilemma zone* **then**

Order front AV to stop;

Order follower AV to stop;

if *AVs confirms order* **then**

Set current time step as end time of the 4EG;

end

end

if *no AV provides information* **then**

if *an AV is in between the stop line and its dilemma zone AND its FV is upstream its dilemma zone 2* **then**

Set current time step as end time of the 4EG;

end

if *the LV of the first AV upstream its dilemma zone is downstream its dilemma zone* **then**

Set current time step as end time of the 4EG;

end

extract data from detector loop D₃ (detector gap time and time of measurement);

if *measured detector gap time is higher than safety gap OR last measurement is longer ago than safety gap* **then**

Set current time step as end time of the 4EG;

end

end

end

*When no input is obtained from AVs and the minimal safety gap time is not reached by the measurement of the detector, this script will be repeated till one of these data types is provided or when the maximal time of the sub-phase has expired.

Algorithm 3: Yellow phase**Result:** End time of the yellow phase**if** *current time step is after start time of the yellow phase AND current time step is before the end time of the yellow phase* **then** **if** *current time step is higher than start of yellow phase plus default yellow* **then**

Set current time step as the end time of yellow ;

end **if** *fixed green of neither of the conflicting directions n has started* **then**

Perform algorithm 'Yellow phase - Scenario a' (4);

Perform algorithm 'Yellow phase - Scenario c' (5);

if *AV is the only vehicle in the dilemma zone at the start of the yellow phase* **then**

Set that end yellow time can be calculated;

if *the LV is measured to have passed the stop line* **then**

Set current time step as end time of yellow;

end

Predict when LV will pass stop line and set that time step as end time of yellow;

end **if** *two AVs are in their dilemma zone* **then**

Set that end yellow time can be calculated;

if *LV of front AV is measured to have passed the stop line* **then**

Set the current time step as end time of yellow;

end

Predict when LV of front AV will pass stop line and set that time step as end time of yellow,;

end **end** **if** *no AV is in their dilemma zone at the start of the yellow phase* **then**

Set that end yellow time can be calculated;

if *AV is upstream the stop line AND AV is downstream its dilemma zone AND FV of the AV is upstream its dilemma zone* **then** **if** *AV is measured to have passed the stop line* **then**

Set the current time as end time of yellow;

end

Predict AV will pass stop line and set that time as end time of yellow;

end **if** *AV is upstream its dilemma zone AND its LV is downstream its dilemma zone AND LV is not an AV* **then** **if** *LV is measured to have passed the stop line* **then**

Set the current time step as end time of yellow;

end

Predict when LV will pass stop line and set that time as end time of yellow;

end

Set the end time of yellow as the default duration ;

end**end**

Algorithm 4: Yellow phase - Scenario a

```

if FV and AV in their dilemma zones at start of the yellow phase then
  extract data from FV of AV (location and speed);
  if FV location is upstream its time-dependent dilemma zone then
    Set that end yellow time can be calculated;
    if AV is measured to have passed the stop line then
      Set current time step as end time of yellow;
    end
    Predict when AV will pass stop line and set that time as end time of yellow;
  end
  if FV location is downstream its time-dependent dilemma zone then
    Set that end yellow time can be calculated;
    if FV is measured to have passed the stop line then
      Set the current time step as end time of yellow;
    end
    Predict when FV will pass stop line and set that time step as end time of yellow;
  end
end

```

Algorithm 5: Yellow phase - Scenario c

```

if LV and AV in their dilemma zones at start of the yellow phase then
  extract data from LV of AV (location and speed);
  if LV location is upstream time-dependent dilemma zone then
    Set that end yellow time can be calculated;
    Set calculated prediction of yellow time of leader of the LV as end yellow time;
  end
  if LV location is downstream the time-dependent dilemma zone then
    Set that end yellow time can be calculated;
    if LV is measured to have passed the stop line then
      Set current time step as end yellow time;
    end
    Predict the end time of yellow at current time step when LV will have passed the stop line;
  end
end

```

Algorithm 6: Red before green phase

Result: End time of the red before green phase

if *current time step is higher than the start time of the RBG phase AND current time step is lower than end time of the RBG phase* **then**

if *critical default inter-green time has expired* **then**

 | Set current time step as end time of red before green;

end

if *start of the yellow phase of all the leaving directions are earlier than the current time step AND end of yellow of both conflicting direction can be predicted* **then**

if *current time step is lower than end time of yellow of both conflicting directions n* **then**

 | Extract information of AV that was in dilemma zone at start of yellow phase and from AVs in direction m (location, speed, comfortable acceleration and deceleration and the length of the vehicle);

 | Perform algorithm ' t_{leave} ' (7);

 | Perform algorithm ' t_{enter} ' (8);

if *two AVs alternate on the conflict area from conflicting direction n and m* **then**

 | Calculate the clearance times with t_{leave} of directions n and t_{enter} of direction m and the safety clearance time AV-AV;

end

if *if an AV and a HDV alternate on the conflict area from conflicting direction n and m* **then**

 | Calculate the clearance times with t_{leave} of directions n and t_{enter} of direction m and the safety clearance time AV-HDV;

end

if *if two HDVs alternate on the conflict area from conflicting direction n and m* **then**

 | Calculate the clearance times with t_{leave} of directions n and t_{enter} of direction m ;

end

 | Set the highest predicted end yellow plus clearance time of conflicting directions as start time of rbg;

end

if *the current time step is or is higher than the predicted red before green time* **then**

 | set current time step as end time of red before green;

end

end

end

Algorithm 7: Red before green phase - t_{leave}

Result: t_{leave}
 Set t_{leave} as default;
if AV is last vehicle to cross in direction n **then**
 | Set t_{leave} via $t_{\text{leave,AV}}$;
end
if FV is last vehicle to cross in direction n **then**
 | Set t_{leave} via $t_{\text{leave,FV}}$;
end
if LV is last to cross the intersection **then**
 | Set t_{leave} via $t_{\text{leave,LV}}$;
end

Algorithm 8: Red before green phase - t_{enter}

Result: t_{enter}
if AV is first vehicle in direction m **then**
 | Calculate t_{enter} via $t_{\text{enter,AV}}$;
end
if AV is second vehicle AND its speed is 0 AND the speed of the LV is 0 **then**
 | Calculate t_{enter} via $t_{\text{enter,LV}}$;
end
if AV is not last or one to last **then**
 | t_{enter} is default;
end

Where:

- n is the leaving direction
- m the upcoming direction

B.5. Rule-based controller in mathematical terms

The rule based controller per sub-phase is presented below.

The following parameters are used in the mathematical formulation:

Control actions:

$t_{\text{yellow,start}}$
 $t_{\text{waitingred,start}}$
 $t_{\text{fixedgreen,start}}$
 Order AV stop or go

Variables of controller:

| | |
|-------------------------------------|--|
| t_i | current time |
| $Nr_vehicles_in_dilemma_zone_n$ | Number of vehicles in the dilemma zone on direction n |
| $ID_front_AV_n$ | k of front vehicle in the dilemma zone |
| $last_vehicle_n$ | k of last vehicle to enter the intersection in direction n |
| $End_yellow_is_known_n$ | Binary, 1 when the duration of the yellow phase of direction n can be calculated |
| $Scenario_n$ | Scenario on direction n |
| $Conflict_n$ | The set of directions that have a conflict with direction n |

| | |
|-------------------------------|---|
| $first_vehicle_m$ | k of the first vehicle to enter the intersection in direction m |
| AV_after_n | The first vehicle upstream its dilemma zone on direction n |
| AV_before_n | The most upstream vehicle downstream its dilemma zone |
| $d_{measure,AV}^{k,dir}(t_i)$ | The measured location to the stop line of AV k on direction dir at time step t_i |
| $v_{measure,AV}^k(t_i)$ | The measured speed of the AV at time t_i |
| $a_{dec,comf}^k$ | The comfortable deceleration rate of AV k |
| $a_{acc,comf}^k$ | The comfortable acceleration rate of AV k |
| l_{veh}^k | The length of AV k |
| $d_{front,LV}^k(t_i)$ | The measured location of the back of the vehicle of the LV to the stop line at time step t_i |
| $d_{back,FV}^k(t_i)$ | The measured location of the front of the vehicle of the FV to the stop line at time step t_i |
| $v_{measure,LV}^k(t_i)$ | The measured speed of the LV at time step t_i |
| $v_{measure,FV}^k(t_i)$ | The measured speed of the FV at time step t_i |

B.5.1. 4th extension green

Algorithm 9: 4EG - proposed controller - mathematical terms

Result: $t_{\text{yellow,start}}$

```

if  $t_i \leq t_{\text{yellow,start}}$  AND  $t_i \geq t_{4\text{EG,start}}$  AND  $t_i - t_{4\text{EG,start}} \leq t_{4\text{EG,max}}$  then
  if  $t_i = t_{4\text{EG,start}}$  then
     $\text{Scenario}_n = 0$ ;
    Reset  $\text{AV\_first}_n$ ;
    Reset  $\text{AV\_after}_n$ ;
    Reset  $\text{ID\_front\_AV}_n$ ;
  end
  Extract:  $d_{\text{measure,AV}}^{k,\text{dir}}(t_i), v_{\text{measure,AV}}^k(t_i), a_{\text{dec,comf}}^k, l_{\text{veh}}^k$  for all  $k \in K^n$ ;
  for each  $k \in K^n$  do
    if  $d_{\text{AV}}(50) \geq d_{\text{zone1,AV}}(2)$  AND  $d_{\text{AV}}(50) \leq d_{\text{zone2,AV}}(98)$  then
       $\text{Nr\_vehicles\_in\_dilemma\_zone}_n = 1 + \text{Nr\_vehicles\_in\_dilemma\_zone}_n$ ;
      Save ID k of front AV in dilemma zone as  $\text{ID\_front\_AV}_n$ ;
    end
  end
  Perform algorithm '10';
  Perform algorithm '11';
  if  $\text{Nr\_vehicles\_in\_dilemma\_zone}_n = 0$  then
    for  $k \in K^n$  do
      if  $d_{\text{AV}}^k(50) \leq d_{\text{zone1,AV}}^k(2)$  AND  $k \geq \text{AV\_first}_n$  then
         $\text{AV\_first}_n = k$ ;
      end
    end
    Extract  $(d_{\text{front,FV}}^{\text{AV\_first}_n}(t_i), v_{\text{measure,FV}}^{\text{AV\_first}_n}(t_i))$ ;
    Extract data from first AV before stop line, tag AV_first and its FV;
    if  $d_{\text{FV}}^{\text{AV\_first}_n}(50) \geq d_{\text{zone2,FV}}^{\text{AV\_first}_n}(98)$  then
       $\text{Scenario}_n = \text{f.3}$ ;
       $t_{\text{yellow,start}}^n = t_i$ ;
    end
    for  $k \in K^n$  do
      if  $d_{\text{AV}}^k(50) \geq d_{\text{zone2,AV}}^k(2)$  AND  $k \leq \text{AV\_after}_n$  then
         $\text{AV\_after}_n = k$ ;
      end
    end
    Extract  $(d_{\text{back,LV}}^{\text{AV\_after}_n}(t_i), v_{\text{measure,LV}}^{\text{AV\_after}_n}(t_i))$ ;
    Extract data from first AV before stop line, tag AV_after and its LV;
    if  $d_{\text{LV}}^{\text{AV\_after}_n}(50) \leq d_{\text{zone1,LV}}^{\text{AV\_after}_n}(98)$  then
       $\text{Scenario}_n = \text{f.2}$ ;
       $t_{\text{yellow,start}}^n = t_i$ ;
    end
    Extract  $(t_{\text{detector,gap}}, t_{\text{measurement}})$  from detector loop  $D_3^{\text{dir}}$ ;
    if  $t_{\text{detector,gap}} \geq t_{\text{gap,safety}}$  then
       $\text{Scenario}_n = \text{d}$ ;
       $t_{\text{yellow,start}}^n = t_i$ ;
    end
    if  $t_{\text{measurement}} \geq t_{\text{gap,safety}}$  then
       $\text{Scenario}_n = \text{f.1}$ ;
       $t_{\text{yellow,start}}^n = t_i$ ;
    end
  end
end

```

Algorithm 10: 4EG - one AV in dilemma zone- proposed controller - mathematical terms**Result:** $t_{\text{yellow,start}}$ **if** $Nr_vehicles_in_dilemma_zone = 1$ **then**Extract $d_{\text{front,LV}}^{ID_front_AV_n}(t_i), d_{\text{back,FV}}^{ID_front_AV_n}(t_i), v_{\text{measure,LV}}^{ID_front_AV_n}(t_i), v_{\text{measure,FV}}^{ID_front_AV_n}(t_i)$;**if** $d_{\text{LV}}^{ID_front_AV_n}(50) \geq d_{\text{zone1,LV}}^{ID_front_AV_n}(2)$ **AND** $d_{\text{LV}}^{ID_front_AV_n}(50) \leq d_{\text{zone2,LV}}^{ID_front_AV_n}(98)$ **then**| $Scenario_n = c$;

| Order AV to stop ;

end**if** $d_{\text{FV}}^{ID_front_AV_n}(50) \geq d_{\text{zone1,FV}}^{ID_front_AV_n}(2)$ **AND** $d_{\text{FV}}^{ID_front_AV_n}(50) \leq d_{\text{zone2,FV}}^{ID_front_AV_n}(98)$ **then**| $Scenario_n = a$;

| Order AV to go;

end**if** $d_{\text{LV}}^{ID_front_AV_n}(50) \leq d_{\text{zone1,LV}}^{ID_front_AV_n}(2)$ **AND** $d_{\text{LV}}^{ID_front_AV_n}(50) \geq d_{\text{zone2,LV}}^{ID_front_AV_n}(98)$ **AND**
 $d_{\text{FV}}^{ID_front_AV_n}(50) < d_{\text{zone1,FV}}^{ID_front_AV_n}(2)$ **AND** $d_{\text{FV}}^{ID_front_AV_n}(50) > d_{\text{zone1,FV}}^{ID_front_AV_n}(2)$ **then**| $Scenario_n = e$;

| Order AV to stop;

end**if** AV confirms order **then**| $t_{\text{yellow,start}}^n = t_i$;**end****end****Algorithm 11:** 4EG - two AV in dilemma zone- proposed controller - mathematical terms**Result:** $t_{\text{yellow,start}}$ **if** $Nr_vehicles_in_dilemma_zone = 2$ **then**| $Scenario_n = b$;

| Order front AV to stop;

| Order follower AV to stop;

if AVs confirms order **then**| $t_{\text{yellow,start}}^n = t_i$;**end****end**

B.5.2. Yellow phase

Algorithm 12: Yellow phase complete - proposed controller

```

Result:  $t_{\text{waitingred,start}}^n$ 
if  $t_i \leq t_{\text{yellow,end}}^n$  AND  $t_i \geq t_{\text{yellow,start}}^n$  AND  $t_i - t_{\text{yellow,start}}^n \leq t_{\text{yellow,default}}$  then
  if  $t_{\text{fixedgreen,start}}^{\text{conflictdirection1}} \leq t_i$  AND  $t_{\text{fixedgreen,start}}^{\text{conflictdirection2}} \leq t_i$  then
    New prediction of end yellow will only be made when rgb allows;
    Perform algorithm 13;
    Perform algorithm 14;
    if  $\text{scenario}_n = e$  then
       $\text{End\_yellow\_is\_known}_n = 1;$ 
      LV of  $\text{ID\_front\_AV}_n = \text{last\_vehicle}_n;$ 
      Extract ( $d_{\text{back,LV}}^{\text{ID\_front\_AV}_n}(t_i), v_{\text{measure,LV}}^{\text{ID\_front\_AV}_n}(t_i)$ );
      if  $d_{\text{LV}}^{\text{ID\_front\_AV}_n}(50) < 0$  then
         $t_{\text{yellow,end}}^n = t_i;$ 
      end
       $t_{\text{yellow,end}}^n = t_{\text{yellow,end,LV}}(99);$ 
    end
    if  $\text{scenario}_n = b$  then
       $\text{End\_yellow\_is\_known}_n = 1;$ 
      LV of  $\text{ID\_front\_AV}_n = \text{last\_vehicle}_n$  Extract( $d_{\text{back,LV}}^{\text{ID\_front\_AV}_n}(t_i), v_{\text{measure,LV}}^{\text{ID\_front\_AV}_n}(t_i)$ );
      if  $d_{\text{LV}}^{\text{ID\_front\_AV}_n}(50) \leq 0$  then
         $t_{\text{yellow,end}}^n = t_i;$ 
      end
       $t_{\text{yellow,end}}^n = t_{\text{yellow,end,LV}}(99);$ 
    end
  end
  Perform algorithm 15 if  $t_i \geq t_{\text{yellow,start}}^n + t_{\text{yellow,default}}$  then
     $t_{\text{yellow,end}}^n = t_i;$ 
  end
end

```

Algorithm 13: Yellow phase - Scenario a - proposed controller

Result: $t_{\text{waitingred,start}}^n$

if $\text{scenario}_n = a$ **then**

 Extract ($d_{\text{front,FV}}^{ID_front_AV_n}(t_i), v_{\text{measure,FV}}^{ID_front_AV_n}(t_i)$);

if $d_{\text{FV}}^{ID_front_AV_n}(t_i)(50) \geq d_{\text{zone2td,FV}}^{ID_front_AV_n}(t_i)(98)$ **then**

$\text{End_yellow_is_known}_n = 1$;

$\text{AV}^{ID_front_AV_n} = \text{last_vehicle}_n$;

if $d_{\text{AV}}^{ID_front_AV_n}(50)(t_i) \leq 0$ **then**

$t_{\text{yellow,end}}^n = t_i$;

end

$t_{\text{yellow,end}}^n = t_{\text{yellow,end,AV}}(t_i)(99)$;

end

if $d_{\text{FV}}^{ID_front_AV_n}(50) \leq d_{\text{zone1td,FV}}^{ID_front_AV_n}(t_i)(98)$ **then**

$\text{End_yellow_is_known}_n = 1$;

$\text{FV}^{ID_front_AV_n} = \text{last_vehicle}_n$ **if** $d_{\text{FV}}^{ID_front_AV_n}(50) \leq 0$ **then**

$t_{\text{yellow,end}}^n = t_i$;

end

$t_{\text{yellow,end}}^n = t_{\text{yellow,end,FV}}(99)$;

end

end

Algorithm 14: Yellow phase - Scenario c - proposed controller

Result: $t_{\text{waitingred,start}}^n$

if $\text{scenario}_n = c$ **then**

Extract ($d_{\text{back,LV}}^{ID_front_AV_n}(t_i), v_{\text{measure,LV}}^{ID_front_AV_n}(t_i)$);

if $d_{\text{LV}}(50) \geq d_{\text{zone2td,LV}}(t_i)$ (98) **then**

$\text{End_yellow_is_known}_n = 1$;

Leader of LV $^{ID_front_AV_n} = \text{last_vehicle}_n$ $t_{\text{yellow,end}}^n = t_{\text{yellow,end,LeaderofLV}}(t_i)$ (99) ;

end

if $d_{\text{LV}}^{ID_front_AV_n}(t_i)$ (50) $\leq d_{\text{zone1td,LV}}^{ID_front_AV_n}(t_i)$ (98) **then**

$\text{End_yellow_is_known} = 1$;

$\text{LV}^{ID_front_AV_n} = \text{last_vehicle}_n$;

if $d_{\text{LV}}^{ID_front_AV_n}$ (99) ≤ 0 **then**

$t_{\text{yellow,end}}^n = t_i$;

end

$t_{\text{yellow,end}}^n = t_{\text{yellow,end,LV}}(99)$;

end

end

Algorithm 15: Yellow phase - Scenario f - proposed controller

Result: $t_{waitingred,start}^n$

if $scenario_n = f.3$ **then**

$End_yellow_is_known_n = 1;$

$AV^{AV_first_n} = last_vehicle_n;$

if $d_{AV}^{AV_first_n}(99) < 0$ **then**

$t_{yellow,end}^n = t_i;$

end

$t_{yellow,end}^n = t_{yellow,end,AV}^{AV_first_n}(99);$

end

if $scenario_n = f.2$ **then**

$LV^{AV_after_n} = last_vehicle_n;$

if $d_{LV}^{AV_after_n}(99) \leq 0$ **then**

$t_{yellow,end}^n = t_i;$

end

$t_{yellow,end}^n = t_{yellow,end,LV}^{AV_after_n}(99);$

end

$t_{yellow,end}^n = t_{yellow,start} + t_{yellow,default};$

B.5.3. Red before green phase

Algorithm 16: Red before green phase - proposed controller

Result: $t_{\text{fixedgreen,start}}^m$

```

if  $t_i \leq t_{\text{fixedgreen,start}}^m$  and  $t_i \geq t_{\text{RGB,start}}^m$  then
  if  $\text{maximum}(t_{\text{yellow,end}}^n + t_{\text{clearance,default}}^{n,m}) \geq t_i$  then
     $t_{\text{fixedgreen,start}}^m = t_i$ ;
  end
  if  $t_i \geq t_{\text{yellow,start}}^n$  for  $n \in \text{conflict}_m$  AND  $\text{End\_yellow\_is\_known}_n = 1$  for
     $n \in \text{conflict}_m$  then
      if  $t_i \leq t_{\text{yellow,end}}^n$  for  $n \in \text{conflict}_m$  then
        Extract
         $(v_{\text{measure,veh}}^{\text{first\_vehicle}_m}(t_i), a_{\text{dec,comf}}^{\text{first\_vehicle}_m}, a_{\text{acc,comf}}^{\text{first\_vehicle}_m}, l_{\text{veh}}^{\text{first\_vehicle}_m}, l_{\text{veh}}^{\text{last\_vehicle}_n}, v_{\text{measure,veh}}^{\text{last\_vehicle}_n}(t_i))$ ;

        Perform algorithm 18 for all  $n \in \text{conflict}_m$  Perform algorithm 17 for all  $m, n$  combinations;
        for all  $n \in \text{conflict}_m$  do
           $t_{\text{clearance},m} = t^n - t_{\text{enter}}^m$ ;
          if  $\text{last\_vehicle}_n = \text{AV}$  AND  $\text{first\_vehicle}_m = \text{AV}$  then
             $t_{\text{clearance},m} = t^n - t_{\text{enter}}^m + t_{\text{safety,AV-AV}}$ ;
          end
          if  $\text{last\_vehicle}_n = \text{AV}$  AND  $\text{first\_vehicle}_m = \text{HDV}$  then
             $t_{\text{clearance},m} = t^n - t_{\text{enter}}^m + t_{\text{safety,AV-HDV}}$ ;
          end
          if  $\text{last\_vehicle}_n = \text{HDV}$  AND  $\text{first\_vehicle}_m = \text{AV}$  then
             $t_{\text{clearance},m} = t^n - t_{\text{enter}}^m + t_{\text{safety,AV-HDV}}$ ;
          end
        end
         $t_{\text{fixedgreen,start}}^m = \text{Maximum}(t_{\text{yellow,end}}^m + t_{\text{clearance}}^{m,n})$  for all  $n \in \text{conflict}_m$ ;
      end
    end
  end

```

Algorithm 17: t_{leave}^n

Result: t_{leave}^n

```

 $t_{\text{leave}}^n = t_{\text{leave,default}}^{n,m}(50)$ ;
if  $\text{last\_vehicle}_n = \text{AV}$  AND  $\text{first\_vehicle}_m = \text{HDV}$  then
   $t_{\text{leave}}^n = t_{\text{leave,AV}}(d = d_{\text{leave,AV}}(50)(n, m))$ ;
end
if  $\text{last\_vehicle}_n = \text{AV}$  AND  $\text{first\_vehicle}_m = \text{AV}$  then
   $t_{\text{leave}}^n = t_{\text{leave,AV}}(d = d_{\text{leave,AV}}^{n,m}(50))$ ;
end
if  $\text{last\_vehicle}_n = \text{LV or FV}$  then
   $t_{\text{leave}}^n = t_{\text{leave,HDV}}(50)$ ;
end

```

Algorithm 18: t_{enter}^m

Result: t_{enter}^m

```

 $t_{\text{enter}}^m = t_{\text{enter,default}}^{n,m}(2)$ ;
if  $\text{last\_vehicle}_n = \text{HDV}$  AND  $\text{first\_vehicle}_m = \text{AV}$  then
   $t_{\text{enter}}^m = t_{\text{enter,AV}}(d = d_{\text{enter}}(2))$ ;
end
if  $\text{last\_vehicle}_n = \text{AV}$  AND  $\text{first\_vehicle}_m = \text{AV}$  then
   $t_{\text{enter}}^m = t_{\text{enter,AV}}(2)$ ;
end
if  $\text{first\_vehicle}_m = \text{LV}$  AND  $v_{\text{measure,AV}}^{\text{first\_vehicle}_m} = 0$  then
   $t_{\text{enter}}^m = t_{\text{enter,LV}}(2)$ ;
end

```

B.6. Vehicle-actuated control based on data of detector loops in rule based format

The rule based controller tactics of all sub-phases in the current vehicles-actuated are defined in the text below.

Algorithm 19: Fixed green

Result: End time fixed green

if *current time is after start time fixed green AND current time is before time of 1st extension green* **then**
 Set start of 1st extension green by adding the fixed green time by the start time of the fixed green phase;
end

Algorithm 20: 1st extension green

Result: End time of 1st extension green

if *current time is after start time of 1st extension green AND current time is before start time of 2nd extension green AND maximum time of 1st extension green has not expired* **then**
 if *last measured gap time by D1 is higher than set gap time D1 OR if last measurement was minimal gap time ago* **then**
 Set current time as start time of 2nd extension green;
 end
end

Algorithm 21: 2nd extension green

Result: End time of 2nd extension green

if *current time is after start time of 2nd extension green AND current time is before start time waiting green AND maximum time of 2nd extension green has not expired* **then**
 if *last measured gap time by D2 is higher than set gap time D2 OR if last measurement was minimal gap time ago* **then**
 Set current time as start time of waiting green;
 end
end

Algorithm 22: Waiting green

Result: End time of waiting green

if *current time is after start time of waiting green AND current time is before start of 3rd extension green AND maximum time has not expired* **then**
 if *a direction from another stage is in red before green phase* **then**
 Set current time as start time of 3rd extension green;
 end
end

Algorithm 23: 3rd extension green

Result: End time of 3rd extension green**3rd extension green**

```

if current time is after start time of 3rd extension green AND current time is before start parallel AND
maximum time has not expired then
  if last measured gap time by D3 is higher than set gap time D3 OR if last measurement was minimal
gap time ago then
    Set current time as start time of parallel green;
  end
end

```

Algorithm 24: Parallel green

Result: End time of parallel green*

```

if current time is after start time parallel green AND current time is before start 4EG AND guaranteed
green time has not expired then

```

```

  Wait till the other direction in the same stage has ended the 3rd extension green;
  Set current time as start time of the 4EG phase;
end

```

* Has been simplified in the code. It does not check whether the direction from another stage that requested green has a conflict with the direction in the same stage that has not ended the 3rd extension green. In the intersection that will be simulated each direction from another stage has a conflict area with the directions in the current stage. This means parallel green will always be given to a direction of which the other direction in the same stage still is in the 3rd extension green phase.

Algorithm 25: 4EG

Result: End time of 4EG

```

if current time is after start time of 4EG AND current time is before start yellow phase AND guaranteed
green has expired then

```

```

  if last measured gap time by D3 is higher than minimal gap time OR if last measurement was
minimal gap time ago then
    Set current time as start time of the yellow phase ;
  end
end

```

Algorithm 26: Yellow Phase

Result: End time of yellow Phase

```

if current time is after start time yellow AND current time is before start waiting red then

```

```

  Set start waiting red by adding default yellow time to start time yellow phase;
end

```

Algorithm 27: Waiting red

Result: End time of waiting red

```

if current time is after start time waiting red AND current time is before start red before green then

```

```

  if detector detects a vehicle OR all conflicting direction started the yellow phase** then
    Set current time as start red before green;
  end
end

```

** Only two stages exist in the intersection used for the simulation. This means that a stage cannot be skipped. Therefore, an extra statement is added to make sure a stage will be given green, even if no vehicles were present on the detector loops of the directions.

Algorithm 28: Red before green

Result: End time red before green

if *current time is after start time red before green AND current time is before start fixed green* **then**

if *guaranteed red time has expired* **then**

 Wait till start yellow of all conflicting directions m;

 Wait the critical clearance time;

end

end

C

Simulation settings

C.1. Parameters of the lay-out of the intersection

The parameters of the lay-out of the intersection are provided below.

Table C.1: Conflict matrix of distances (in m) to conflict area for leaving and entering direction

| | | To (direction) | | | |
|------------------|---|----------------|------------|------------|------------|
| | | 1 | 2 | 3 | 4 |
| From (direction) | 1 | - | 17, 10 | - | 13.5, 13.5 |
| | 2 | 13.5, 13.5 | - | 17, 10 | - |
| | 3 | - | 13.5, 13.5 | - | 17, 10 |
| | 4 | 17,10 | - | 13.5, 13.5 | - |

Table C.2: Conflict matrix of default clearance time (in s)

| | | To (direction) | | | |
|------------------|---|----------------|------|------|------|
| | | 1 | 2 | 3 | 4 |
| From (direction) | 1 | - | -0.1 | - | -0.6 |
| | 2 | -0.6 | - | -0.1 | - |
| | 3 | - | -0.6 | - | -0.1 |
| | 4 | -0.1 | - | -0.6 | - |

The default clearance times in table C.2 are calculated with the following values for the variables and the distances as given in table C.1. These following default values are provided by [27]. The values are rounded to the highest decimal.

- $v_{\text{enter}} = 14\text{m/s}$
- $v_{\text{leave}} = 12\text{m/s}$
- $a_{\text{dec}} = 2.5\text{m/s}^2$
- $a_{\text{acc}} = 2.8\text{m/s}^2$
- $l_{\text{veh}} = 6\text{m}$

C.2. Settings in VISSIM

| Link Behavior Types / Driving Behaviors By Vehicle Class | | | |
|--|----|-----------------------------|--------------------------------|
| Count | No | Name | DrivBehavDef |
| 1 | 1 | Urban (motorized) AV go | 1: Urban (motorized) |
| 2 | 2 | Right-side rule (motorized) | 2: Right-side rule (motorized) |

| Count | VehClass | DrivBehav |
|-------|----------|---------------------------------|
| 1 | 10: Car | 1: Urban (motorized) |
| 2 | 70: AV | 102: AV normal (CoExist) normal |

The link behaviour type is set different for AVs and HDVs.

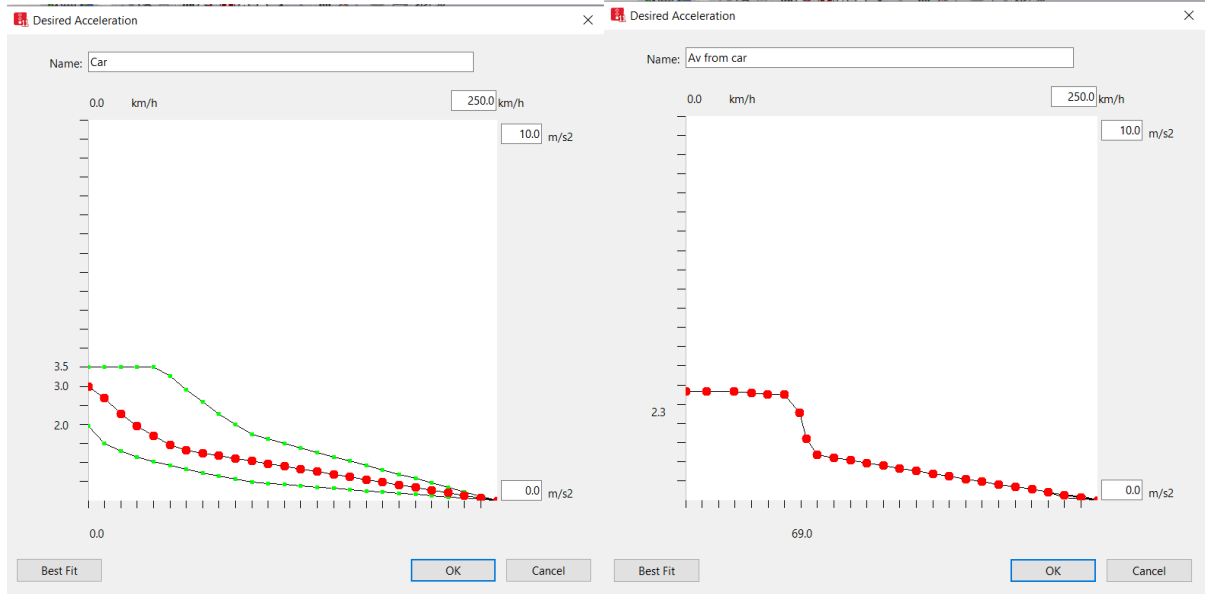

The desired acceleration of AVs and HDVs. The green line is the maximum or minimum. The red dotter line is the average.

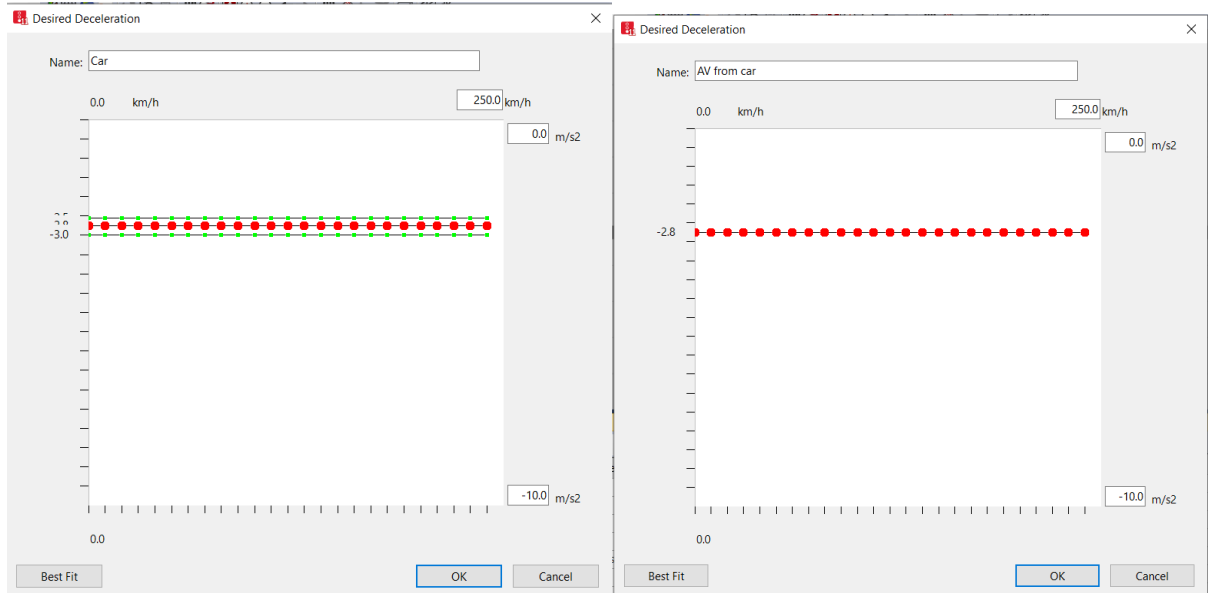

The desired deceleration of AVs and HDVs. The green line is the maximum or minimum. The red dotter line is the average.

Vehicle type ? X

No.: Name:

Static | **Functions & Distributions** | Special | External Driver Model

Category:

Vehicle Model:

Length: from 3.75 m to 4.76 m

Width: from 1.85 m to 2.07 m

Vehicle type ? X

No.: Name:

Static | **Functions & Distributions** | Special | External Driver Model

Category:

Vehicle Model:

Length: 4.21 m

Width: 2 m

The parameters of the vehicle type

Driving Behavior ? X

Simulation is running. Some changes of network objects are not possible.

No.: Name:

Following | **Car following model** | Lane Change | Lateral | Signal Control | Meso

Model parameters

CC0 (Standstill Distance): CC5 (Positive 'Following' Threshold):

CC1 (Headway Time): CC6 (Speed dependency of Oscillation):

CC2 ('Following' Variation): CC7 (Oscillation Acceleration):

CC3 (Threshold for Entering 'Following'): CC8 (Standstill Acceleration):

CC4 (Negative 'Following' Threshold): CC9 (Acceleration with 80 km/h):

Following behavior depending on the vehicle class of the leading vehicle:

| Count: 0 | VehClass | W74ax | W74bxAdd | W74bxMult | W99cc0 | W99cc1Distr | IncrsAccel |
|----------|----------|-------|----------|-----------|--------|-------------|------------|
| | | | | | | | |

Driving Behavior ? X

Simulation is running. Some changes of network objects are not possible.

No.: Name:

Following | **Car following model** | Lane Change | Lateral | Signal Control | Meso

Model parameters

CC0 (Standstill Distance): CC5 (Positive 'Following' Threshold):

CC1 (Headway Time): CC6 (Speed dependency of Oscillation):

CC2 ('Following' Variation): CC7 (Oscillation Acceleration):

CC3 (Threshold for Entering 'Following'): CC8 (Standstill Acceleration):

CC4 (Negative 'Following' Threshold): CC9 (Acceleration with 80 km/h):

Following behavior depending on the vehicle class of the leading vehicle:

| Count: 2 | VehClass | W74ax | W74bxAdd | W74bxMult | W99cc0 | W99cc1Distr | IncrsAccel |
|----------|----------|-------|----------|-----------|--------|-------------|------------|
| 1 | 10: Car | 2.00 | 2.00 | 3.00 | 1.50 | 2: 0.9 s | 100.0 % |
| 2 | 70: AV | 2.00 | 2.00 | 3.00 | 1.50 | 1: 0.5 s | 100.0 % |

The driving behaviour (car-following model) of the AV and the HDV

C.3. Parameters used for offline tables for sampling for the needed percentile with variable input

| | |
|---------------------------------------|---------------------------|
| $d_{veh}^k(t_i)(perc)$ | perc = 50 |
| $d_{dzone1}^k(t_i)(perc)$ | perc = 98 |
| $d_{dzone2}^k(t_i)(perc)$ | perc = 2 |
| $d_{dzone1td}^k(t_i)(perc)$ | perc = 4 |
| $d_{dzone2td}^k(t_i)(perc)$ | perc = 96 |
| $t_{yellow,end}^n(perc)$ | perc = 99 |
| $t_{leave}^n(perc)$ | perc = 50 |
| $t_{enter}^m(perc)$ | perc = 2 |
| μ_{GPS}, σ_{GPS} | 0, 0.9 m |
| $\mu_{LIDAR}, \sigma_{LIDAR}$ | 0, 0.12 m |
| $\mu_{track}, \sigma_{track}$ | 0, 0.21 m |
| $\mu_{Speed,AV}, \sigma_{Speed,AV}$ | 0, 0.5 m/s |
| $\mu_{Speed,HDV}, \sigma_{Speed,HDV}$ | 0, 1 m/s |
| $\mu_{t_{react}}, \sigma_{t_{react}}$ | 1, 0.3 s |
| $\mu_{a_{acc}}, \sigma_{a_{acc}}$ | 2.8, 0.4 m/s ² |
| $\mu_{a_{dec}}, \sigma_{a_{dec}}$ | 2.8, 0.2 m |
| $\mu_{l_{veh}}, \sigma_{l_{veh}}$ | 4.26, 0.22 m |
| $t_{safety,AV-AV}$ | 2 s |
| $t_{safety,HDV-AV}$ | 4 s |
| TimestepIC | 0.1 s |

D

Simulation results

D.1. Total delay and total traveled time per input

The total time delay and travelled distance per simulation can be found in table D.1 for all input scenarios of and proposed controller controller.

Table D.1: Total delay and distance travelled per input scenario of the proposed controller

| Demand (veh/h/lane) | Penetration rate (%) | Total delay (s) x10 ⁴ | Total travelled distance (km) x10 ³ |
|---------------------|----------------------|----------------------------------|--|
| 100 | 0 | 0.24 | 0.40 |
| 100 | 2 | 0.24 | 0.40 |
| 100 | 10 | 0.23 | 0.40 |
| 100 | 20 | 0.22 | 0.40 |
| 100 | 50 | 0.21 | 0.40 |
| 100 | 100 | 0.19 | 0.40 |
| 400 | 0 | 1.54 | 1.56 |
| 400 | 2 | 1.53 | 1.56 |
| 400 | 10 | 1.43 | 1.56 |
| 400 | 20 | 1.44 | 1.56 |
| 400 | 50 | 1.17 | 1.56 |
| 400 | 100 | 0.79 | 1.56 |
| 700 | 0 | 4.43 | 2.69 |
| 700 | 2 | 5.60 | 2.69 |
| 700 | 10 | 4.82 | 2.69 |
| 700 | 20 | 0.12 | 2.69 |
| 700 | 50 | 3.02 | 2.69 |
| 700 | 75 | 2.18 | 2.69 |
| 700 | 100 | 1.66 | 2.69 |
| 850 | 0 | 4.43 | 3.15 |
| 850 | 2 | 20.2 | 3.08 |
| 850 | 10 | 12.6 | 3.30 |
| 850 | 20 | 7.67 | 3.30 |
| 850 | 50 | 4.88 | 3.30 |
| 850 | 75 | 3.16 | 3.31 |
| 850 | 100 | 2.14 | 3.31 |

D.2. Trajectories of vehicles

To give an overview of the difference between cycles of the original and the proposed controller, the trajectories of vehicles in both are obtained. In figures D.1 and D.2 the trajectories of 6-7 cycles are provided of a simulation with an input demand of 700 vehicles per hour on each lane and a penetration rate of 20%. In each figure, the trajectories are provided for direction WE. In the figure lines are added at the times the controller switches phases. When a yellow line appears it means the yellow phase has started. The same applies to a red line for the red phase and a green one when the green phase starts. The dotted blue line is the location of the stop line.

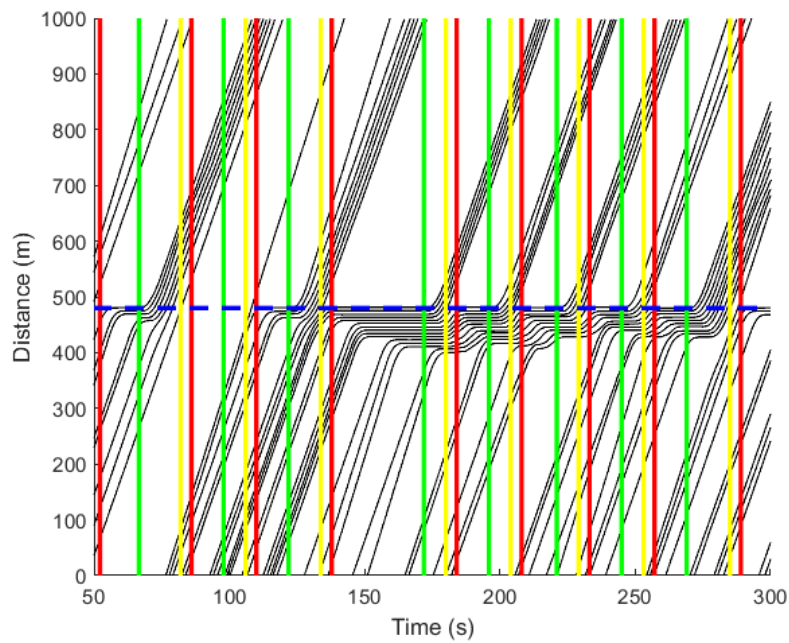

Figure D.1: The trajectories of the original control system of direction WE

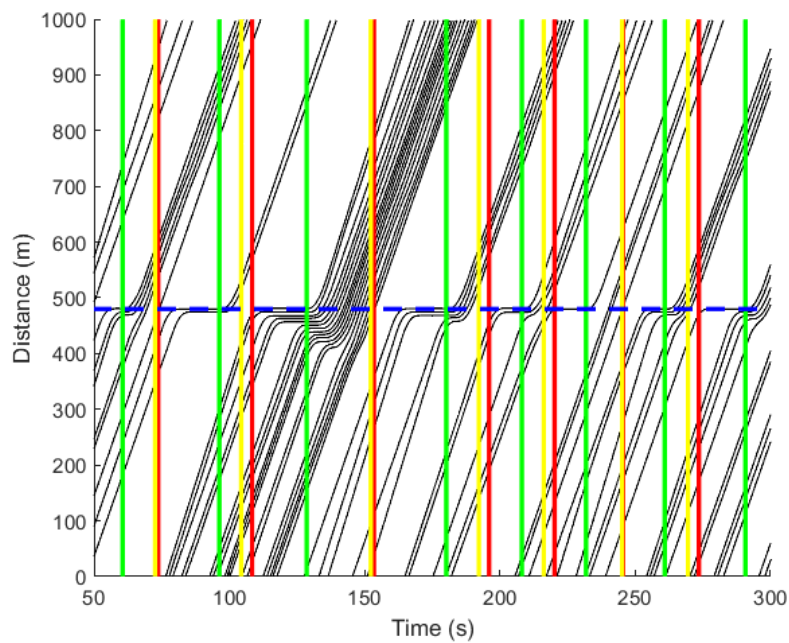

Figure D.2: The trajectories of the proposed control system of direction WE

It can be observed, that only at a multiple times the yellow line and red line are closer together in the proposed controller than the original controller. Furthermore, it can be observed that the green phase of the

original controller starts at different times than the proposed controller.

Bibliography

- [1] H.U. Ahmed, Y. Huang, and P. Lu. A Review of Car-Following Models and Modeling Tools for Human and Autonomous-Ready Driving Behaviors in Micro-Simulation. *Smart Cities*, 4(1):314–335, 2021. doi: 10.3390/smartcities4010019.
- [2] S. Aoki and R. Rajkumar. 2v-based synchronous intersection protocols for mixed traffic of human-driven and self-driving vehicles, 2019.
- [3] T.C. Au and P. Stone. Motion planning algorithms for autonomous intersection management. pages 2–9, Atlanta, Georgia, USA, 2010. ISBN 9781577354673.
- [4] T.C. Au, S. Zhang, and P. Stone. *Autonomous intersection management for semiautonomous vehicles*. Routledge, 2015. doi: 10.4324/9781315756684.
- [5] A. Brown, J. Gonder, and B. Repac. *Road vehicle automation*. Springer, 2014. doi: 10.1007/978-3-319-05990-7_13.
- [6] L. Chen and C. Englund. Cooperative intersection management: A survey. *IEEE Transactions on Intelligent Transportation Systems*, 17(2):570–586, 2015. doi: 10.1109/TITS.2015.2471812.
- [7] S. Dharaneppanavar. Addressing traffic breakdown at merge sections in mixed traffic, 2021. URL <http://resolver.tudelft.nl/uuid:6e8a34f4-3b08-49f0-b55e-c2d580b990ed>.
- [8] S.I. Dijkhuizen. Safety Margin Development for a Space-Time Reservation Traffic Control System. *TU Delft repository*, 2020.
- [9] K. Dresner and P. Stone. Multiagent traffic management: An improved intersection control mechanism. In *Proceedings of the fourth international joint conference on Autonomous agents and multiagent systems*, pages 471–477, 2005. doi: 10.1145/1082473.1082545.
- [10] K. Dresner and P. Stone. Sharing the road: Autonomous vehicles meet human drivers, 2007. ISSN 10450823.
- [11] K. Dresner and P. Stone. A multiagent approach to autonomous intersection management. *Journal of Artificial Intelligence Research*, 31:591–656, 2008. doi: 10.1613/jair.2502.
- [12] A. Duret, C. Buisson, and N. Chiabaut. Estimating individual speed-spacing relationship and assessing ability of newell’s car-following model to reproduce trajectories. *Transportation Research Record*, 2088(1):188–197, 2008. doi: 10.3141/2088-20.
- [13] U. Durrani, C. Lee, and H. Moah. Calibrating the Wiedemann’s vehicle-following model using mixed vehicle-pair interactions. *Transportation Research Part C: Emerging Technologies*, 67:227–242, 2016. doi: 10.1016/j.trc.2016.02.012.
- [14] J.I. Ge, S.S. Avedisov, C.R. He, W.B. Qin, M. Sadeghpour, and G. Orosz. Experimental validation of connected automated vehicle design among human-driven vehicles. *Transportation Research Part C: Emerging Technologies*, 91(March):335–352, 2018. doi: 10.1016/j.trc.2018.04.005.
- [15] C. Glennie. Rigorous 3D error analysis of kinematic scanning LIDAR systems. *Journal of Applied Geodesy*, 1(3):147–157, 2008. ISSN 1862-9016. doi: 10.1515/jag.2007.017.
- [16] S. Gong and L. Du. Cooperative platoon control for a mixed traffic flow including human drive vehicles and connected and autonomous vehicles. *Transportation research part B: methodological*, 116:25–61, 2018. doi: <https://doi.org/10.1016/j.trb.2018.07.005>.
- [17] P. Hakkesteegt. TRAFCOD: Method for systematic traffic control design. 1988.

- [18] J. Hecht. Lidar for Self-Driving Cars. *Optics & Photonics News*, 29(January):26–33, 2018. doi: 10.1364/OPN.29.1.000026.
- [19] B. Higgs, M. Abbas, and A. Medina. Analysis of the Wiedemann Car Following Model over Different Speeds using Naturalistic Data. pages 1–22, 2011. URL <http://onlinepubs.trb.org/onlinepubs/conferences/2011/RSS/3/Higgs,B.pdf>.
- [20] J. Hormann and S. Bakker. Stappenplan ivri, 2019. URL <https://www.crow.nl/downloads/pdf/verkeer-en-vervoer/verkeersmanagement/verkeersregelinstallaties/stappenplan-ivri>.
- [21] D.S. Hurwitz, H. Wang, M.A. Knodler, D. Ni, and D. Moore. Fuzzy sets to describe driver behavior in the dilemma zone of high-speed signalized intersections. *Transportation Research Part F: Traffic Psychology and Behaviour*, 15(2):132–143, 2012. doi: 10.1016/j.trf.2011.11.003.
- [22] Q. Jin, G. Wu, K. Boriboonsomsin, and M. Barth. Platoon-based multi-agent intersection management for connected vehicle. Number ITSC, pages 1462–1467. IEEE, 2013. doi: 10.1109/ITSC.2013.6728436.
- [23] Q. Jin, G. Wu, K. Boriboonsomsin, and M. Barth. Advanced intersection management for connected vehicles using a multi-agent systems approach. Number IV, pages 932–937. IEEE, June 2012. doi: 10.1109/IVS.2012.6232287.
- [24] I. Kaminer, A. Pascoal, E. Hallberg, and C.s Silvestre. Trajectory tracking for autonomous vehicles: An integrated approach to guidance and control. *Journal of Guidance, Control, and Dynamics*, 21(1):29–38, 1998. doi: 10.2514/2.4229.
- [25] E. Kayacan, H. Ramon, and W. Saeys. Robust trajectory tracking error model-based predictive control for unmanned ground vehicles. *IEEE/ASME Transactions on Mechatronics*, 21(2):806–814, 2016. doi: 10.1109/TMECH.2015.2492984.
- [26] I.W. Koster, A. Wilson, E. Oostenbrink, Gerards Y., and werkgroep ‘Handboek verkeerslichtenregelingen’. Richtlijn ontruimingstijden verkeersregelinstallaties 2013, 2019. URL <https://kennisbank.crow.nl/kennismodule/detail/27366#27510>.
- [27] I.W. Koster, A. Wilson, E. Oostenbrink, Gerards Y., and werkgroep ‘Handboek verkeerslichtenregelingen’. Handboek verkeerslichtenregelingen 2014, 2019. URL <https://kennisbank.crow.nl/kennismodule/detail/27366#27510>.
- [28] L. Krol, L.H.A. Prinsen, and L. Misdom. Onderzoek detectieconfiguratie en signaalgroep afhandeling, 2018. URL <https://www.crow.nl/downloads/pdf/verkeer-en-vervoer/verkeersmanagement/verkeersregelinstallaties/uta276k111828-01-iver-detectieonderzoek>.
- [29] S. Lefèvre, D. Vasquez, and C. Laugier. A survey on motion prediction and risk assessment for intelligent vehicles. *Robomech*, 1(1):1–14, 2014. doi: 10.1186/s40648-014-0001-z.
- [30] T. Limanond, S. Chookerd, and N. Roubtonglang. Effects of countdown timers on queue discharge characteristics of through movement at a signalized intersection. *Transportation Research Part C: Emerging Technologies*, 17(6):662–671, 2009. doi: 10.1016/j.trc.2009.05.005.
- [31] P. Lin, J. Liu, P.J. Jin, and B. Ran. Autonomous vehicle-intersection coordination method in a connected vehicle environment. *IEEE Intelligent Transportation Systems Magazine*, 9(4):37–47, 2017. doi: 10.1109/MITS.2017.2743167.
- [32] M. Martin-Gasulla, P. Sukennik, and J. Lohmiller. Investigation of the impact on throughput of connected autonomous vehicles with headway based on the leading vehicle type. *Transportation Research Record*, 2673(5):617–626, 2019. doi: 10.1177/0361198119839989.
- [33] H. McGee, K. Moriarty, and T.J. Gates. Guidelines for timing yellow and red intervals at signalized intersections. *Transportation Research Record*, (2298):1–8, 2012. doi: 10.3141/2298-01.
- [34] A.I.M. Medina, N. van de Wouw, and H. Nijmeijer. Cooperative intersection control based on virtual platooning. *IEEE Transactions on Intelligent Transportation Systems*, 19(6):1727–1740, 2017. doi: 10.1109/TITS.2017.2735628.

- [35] M.M. Minderhoud and F. Zuurbier. Empirical data on driving behaviour in stop-and-go traffic. pages 676–681, 2004. doi: 10.1109/ivs.2004.1336465.
- [36] T.H.J. Muller, T. Dijker, and P.G. Furth. Red clearance intervals: theory and practice. *Transportation research record*, 1867(1):132–143, 2004. doi: 10.3141/1867-16.
- [37] T.E. Nguyen. A comparison of cellular vehicle-to-everything and dedicated short range communication. volume January, pages 101–108, 2018. doi: 10.1109/VNC.2017.8275618.
- [38] R. Niroumand, M. Tajalli, L. Hajibabai, and A. Hajbabaie. The Effects of the “White Phase” on Intersection Performance with Mixed-Autonomy Traffic Stream. pages 1–6, 2020. doi: 10.1109/itsc45102.2020.9294741.
- [39] M. Pourabdollah, E. Bjarkvik, F. Furer, B. Lindenberg, and K. Burgdorf. Calibration and evaluation of car following models using real-world driving data. volume 2018-March, pages 1–6, 2018. doi: 10.1109/ITSC.2017.8317836.
- [40] L.H.A. Prinsen, M. Dicke-Ogenia, Krol L., L. Zengerink, and K. Hulleman. onderzoek geeltijden, 2016. URL <https://www.crow.nl/kennis/bibliotheek-verkeer-en-vervoer/kennisdocumenten/onderzoek-geeltijden,-iver-eindrapportage#:~:text=IVER%20%28Initiatiefgroep%20Verkeersregeltechnici%29%20heeft%20door%20Goudappel%20Coffeng%20BV,formule%20te%20gebruiken.%20De%20geeltijden%20moeten%20geloofwaardig%20zijn.>
- [41] H.G. Retzko and M. Boltze. Timing of intergreen periods at signalized intersections: the german method. *ITE Journal (Institute of Transportation Engineers)*, 57(9):23–26, 1987.
- [42] A. Rudenko, L. Palmieri, M. Herman, K.M. Kitani, D.M. Gavrila, and K.O. Arras. Human motion trajectory prediction: a survey. *International Journal of Robotics Research*, 39(8):895–935, 2020. doi: 10.1177/0278364920917446.
- [43] A.M. Salomons. Lecture notes va control traffic flow modelling and control part 2, February 2020.
- [44] V. Sezer, T. Bandyopadhyay, D. Rus, E. Frazzoli, and D. Hsu. Towards autonomous navigation of unsignalized intersections under uncertainty of human driver intent. *IEEE International Conference on Intelligent Robots and Systems*, 2015-Decem:3578–3585, 2015. doi: 10.1109/IROS.2015.7353877.
- [45] S.S. Shadrin, O.O. Varlamov, and A.M. Ivanov. Experimental autonomous road vehicle with logical artificial intelligence. *Journal od Advanced Transportation*, 2017:10, 2017. doi: 10.1155/2017/2492765.
- [46] G. Sharon and P. Stone. A Protocol for Mixed Autonomous and Human-Operated Vehicles at Intersections. pages 151–167, November-2017. doi: 10.1007/978-3-319-71682-4_10.
- [47] M.J.S. Shiri and H.R. Maleki. Maximum green time settings for traffic-actuated signal control at isolated intersections using fuzzy logic. *International Journal of Fuzzy Systems*, 19(1):247–256, 2017.
- [48] F.W. Siebert and E.L. Wallis. How speed and visibility influence preferred headway distances in highly automated driving. *Transportation Research Part F: Traffic Psychology and Behaviour*, 64:485–494, 2019. doi: 10.1016/j.trf.2019.06.009.
- [49] M. Slofstra. Gewijzigde regling verkeerslichten 1 juli van kracht, 2019. URL <https://www.verkeerskunde.nl/artikel/gewijzigde-regeling-verkeerslichten-1-juli-van-kracht#:~:text=timer%204%20min.%20Minister%20van%20Nieuwenhuizen%20%28Infrastructuur%20en,een%20groot%20aantal%20voornamelijk%20technische%20eisen%20aan%20verkeerslichten.>
- [50] Takagi. Road environment recognition using on-vehicle LIDAR. *13th World Congress on Intelligent Transport Systems and Services*, pages 120–125, 2006. doi: 10.1109/IVS.2006.1689615.
- [51] A. Talebpour and H.S. Mahmassani. Influence of connected and autonomous vehicles on traffic flow stability and throughput. *Transportation Research Part C: Emerging Technologies*, 71:143–163, 2016. doi: 10.1016/j.trc.2016.07.007.

- [52] K. Tiaprasert, Y. Zhang, X.B. Wang, and X. Zeng. Queue Length Estimation Using Connected Vehicle Technology for Adaptive Signal Control. *IEEE Transactions on Intelligent Transportation Systems*, 16(4): 2129–2140, 2015. doi: 10.1109/TITS.2015.2401007.
- [53] Talking traffic. Hoe staat het met de iVRI? 2019. URL <https://www.talking-traffic.com/nl/nieuws/hoestaat-het-met-de-ivri>.
- [54] L. Tu and C.M. Huang. Forwards: A map-free intersection collision-warning system for all road patterns. *IEEE Transactions on Vehicular Technology*, 59(7):3233–3248, 2010. doi: 10.1109/TVT.2010.2051344.
- [55] M. Tubaishat, Y. Shang, and H. Shi. Adaptive traffic light control with wireless sensor networks. Number June, pages 187–191, 2007. doi: 10.1109/CCNC.2007.44.
- [56] G. Van der Burgt and E. Greweldinger. Onderzoek naar de effecten van de Afteller in 's-Hertogenbosch, 2009. URL <https://www.verkeerskunde.nl/Uploads/2018/9/De-afteller-in-de-verkeerslichten-bij-de-gemeente--s-Hertogenbosch-.pdf>.
- [57] M.L.D. van Rij. Afwikkeling eerste deel wachtrij, 2001.
- [58] VDOT. VDOT Vissim User Guide Version 2.0, 2020.
- [59] H. Voerknecht. De wegen slibben dicht. hoe komt crow tot die conclusie?, 2020. URL <https://www.crow.nl/kennis/bibliotheek-verkeer-en-vervoer/kennisdocumenten/de-wegen-slibben-dicht,-hoe-komt-crow-aan-die-info>.
- [60] W. Wen, X. Bai, W. Zhan, M. Tomizuka, and L. T. Hsu. Uncertainty estimation of LiDAR matching aided by dynamic vehicle detection and high definition map. *Electronics Letters*, 55(6):348–349, 2019. doi: 10.1049/el.2018.8075.
- [61] T. H. Witte and A. M. Wilson. Accuracy of non-differential GPS for the determination of speed over ground. *Journal of Biomechanics*, 37(12):1891–1898, 2004. doi: 10.1016/j.jbiomech.2004.02.031.
- [62] K. Yang, S. I. Guler, and M. Menendez. Isolated intersection control for various levels of vehicle technology: Conventional, connected, and automated vehicles. *Transportation Research Part C: Emerging Technologies*, 72:109–129, 2016. doi: 10.1016/j.trc.2016.08.009.
- [63] H. Yao and X. Li. Decentralized control of connected automated vehicle trajectories in mixed traffic at an isolated signalized intersection. *Transportation research part C: emerging technologies*, 121:102846, 2020. doi: 10.1016/j.trc.2020.102846.
- [64] Z. Yao, R. Hu, Y. Wang, Y. Jiang, B. Ran, and Y. Chen. Stability analysis and the fundamental diagram for mixed connected automated and human-driven vehicles. *Physica A: Statistical Mechanics and its Applications*, 533:121931, 2019. doi: 10.1016/j.physa.2019.121931.
- [65] J. Yin, T. ElBatt, G. Yeung, B. Ryu, S. Habermas, H. Krishnan, and T. Talty. Performance evaluation of safety applications over dsrc vehicular ad hoc networks. In *Proceedings of the 1st ACM international workshop on Vehicular ad hoc networks*, pages 1–9, 2004. doi: 10.1145/1023875.1023877.
- [66] C. Zhang, D. Chu, S. Liu, Z. Deng, C. Wu, and X. Su. Trajectory Planning and Tracking for Autonomous Vehicle Based on State Lattice and Model Predictive Control. *IEEE Intelligent Transportation Systems Magazine*, 11(2):29–40, 2019. doi: 10.1109/MITS.2019.2903536.
- [67] W. Zhao, D. Ngoduy, S. Shepherd, R. Liu, and M. Papageorgiou. A platoon based cooperative eco-driving model for mixed automated and human-driven vehicles at a signalised intersection. *Transportation Research Part C: Emerging Technologies*, 95:802–821, 2018. doi: <https://doi.org/10.1016/j.trc.2018.05.025>.
- [68] F. Zhu and S.V. Ukkusuri. A linear programming formulation for autonomous intersection control within a dynamic traffic assignment and connected vehicle environment. *Transportation Research Part C: Emerging Technologies*, 55:363–378, 2015. doi: 10.1016/j.trc.2015.01.006.
- [69] I.H. Zohdy and H.A. Rakha. Intersection management via vehicle connectivity: The intersection cooperative adaptive cruise control system concept. *Journal of Intelligent Transportation Systems*, 20(1):17–32, 2016. doi: 10.1080/15472450.2014.889918.