



MAQUILAPOLIS  
P5

27 january 2017

Niek van der Zwaag

MAQUILAPOLIS



THE BORDER



WHAT YOU THOUGHT OF

**THE DONALD TRUMP INTERVIEW**

**TRUMP VOWS TO MAKE MEXICO PAY FOR BORDER WALL**

**CNN**

9:20 AM ET

STATE OF THE UNION

WHAT WE THOUGHT OF

**“...The US-Mexican border, like most borders, was established by violence – and its architecture is the architecture of violence...”**

Noam Chomsky  
X05

THE BORDER REGION

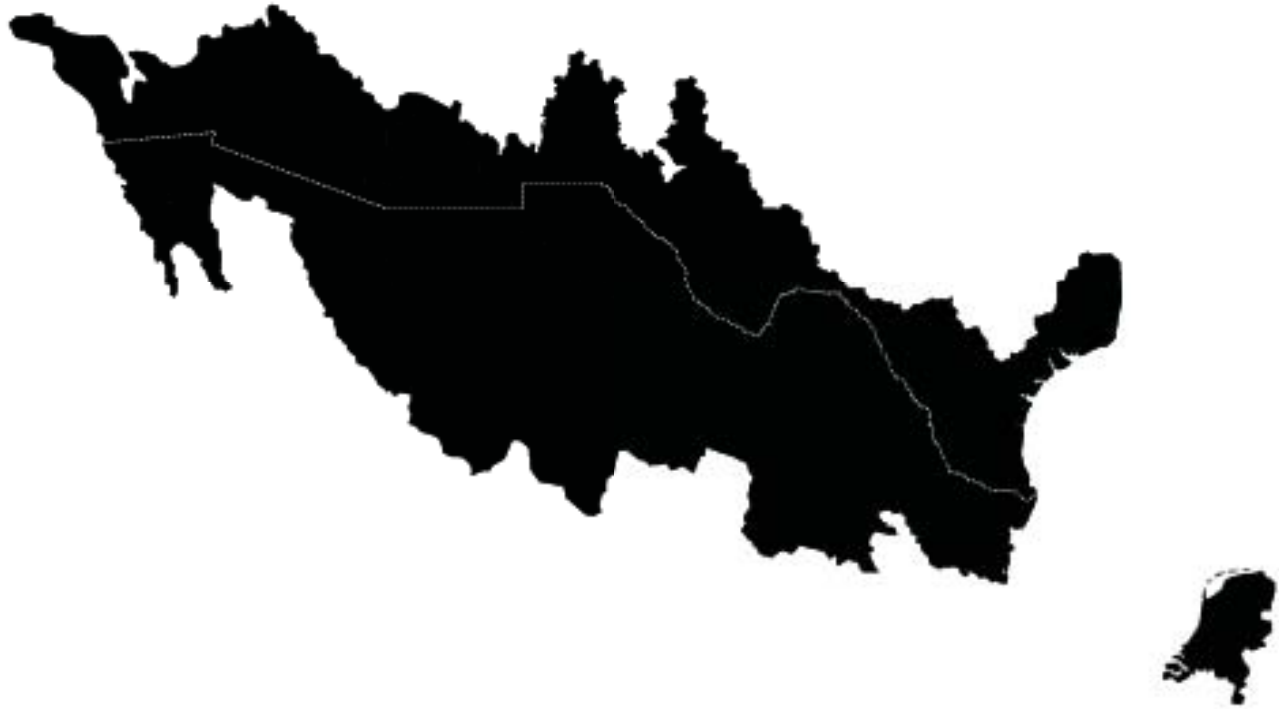

## ECOREGIONS



THE ATLAS





## THE TRIP

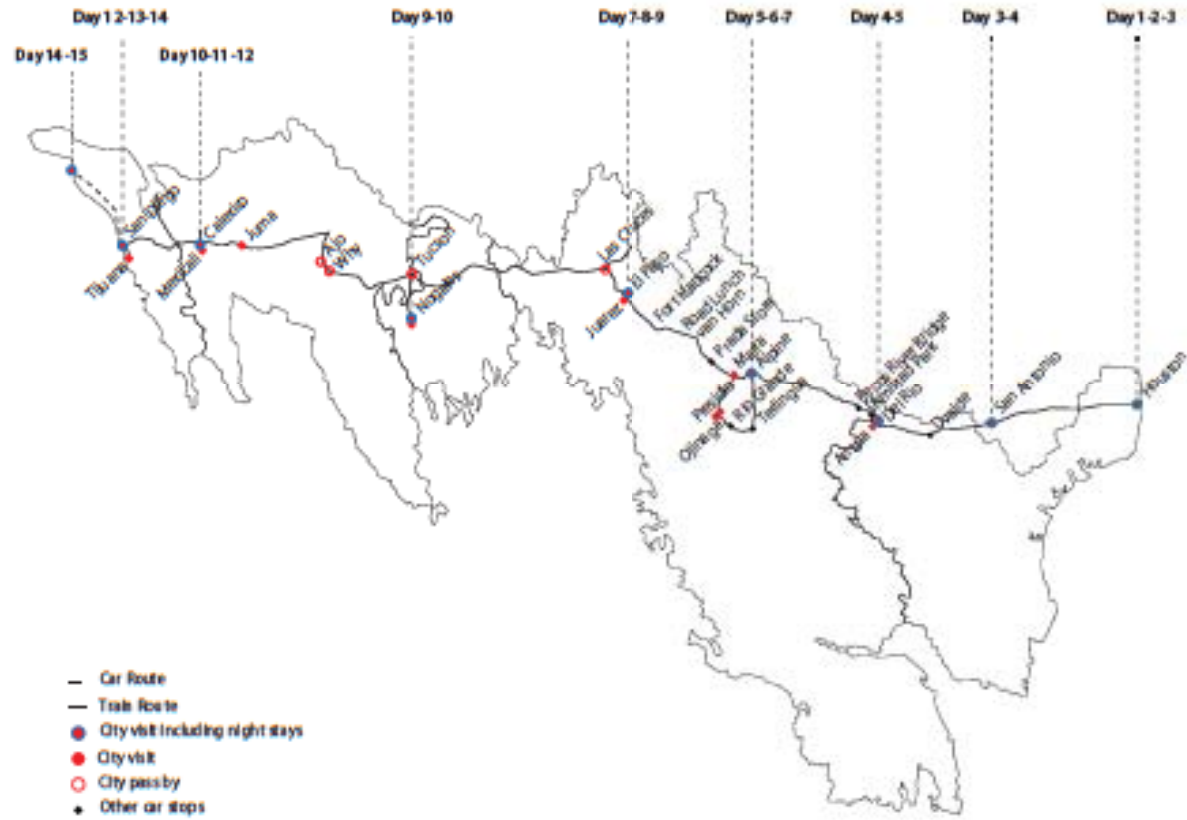

**THE REALITY**



**THE REALITY**



**THE REALITY**



AMBITION

TO MAKE APPARENT THE UNDERLYING SYSTEM OF VIOLENCE  
AGAINST MEXICAN LABORERS

REGIONAL PLAN

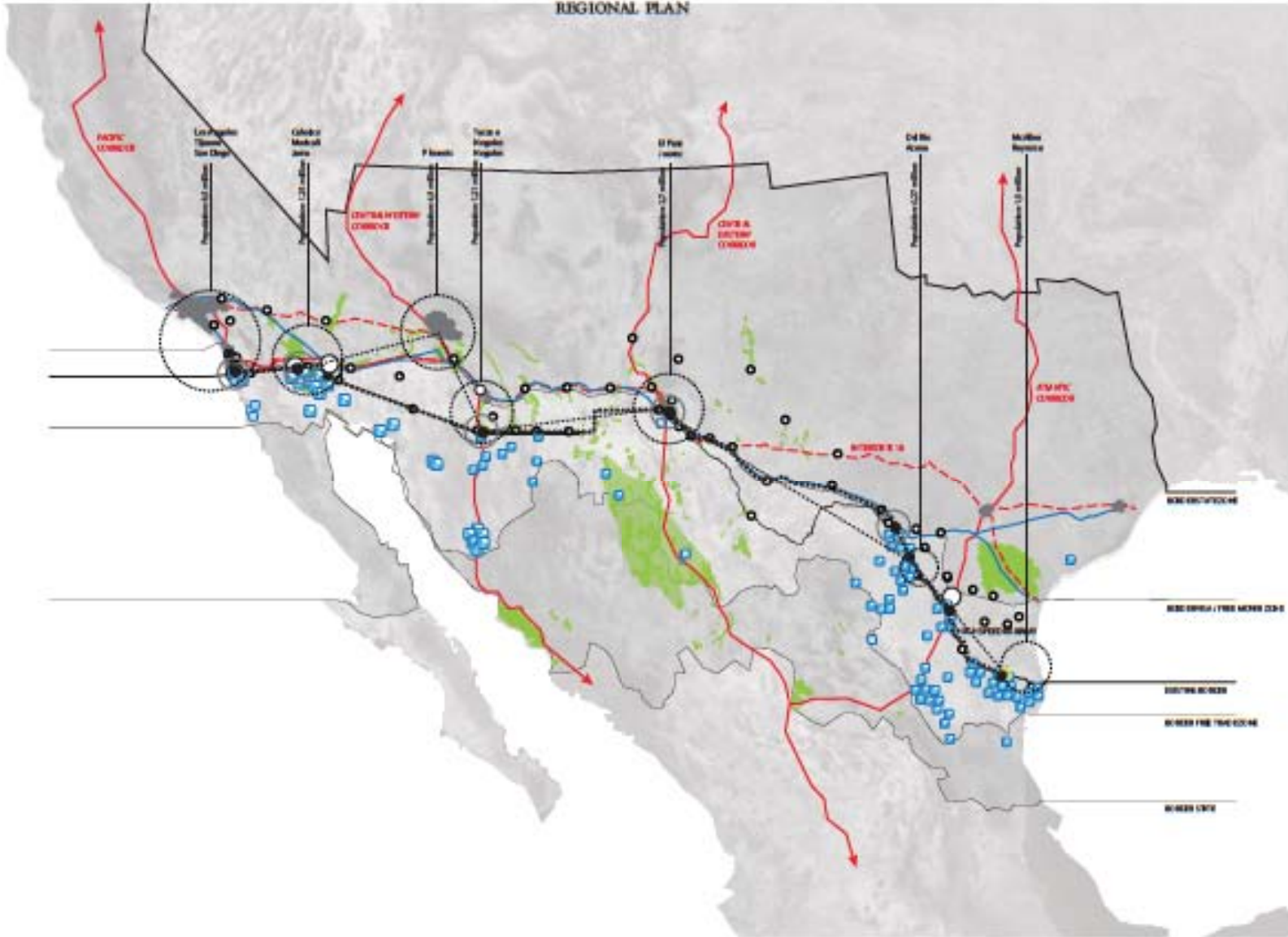

THE BORDER FREE TRADE ZONE



## MAQUILADORA





ON THE INSIDE



NAFTA



SPECIAL ECONOMIC ZONE



## SPECIAL ECONOMIC ZONE

Demarcated geographic areas contained within a country's national boundaries where the rules of business are different from those that prevail in the national territory. These differential rules principally deal with investment conditions, international trade and customs, taxation, and the regulatory environment; whereby the zone is given a business environment that is intended to be more liberal from a policy perspective and more effective from an administrative perspective than that of the national territory.

The World Bank

**LEGISLATION**

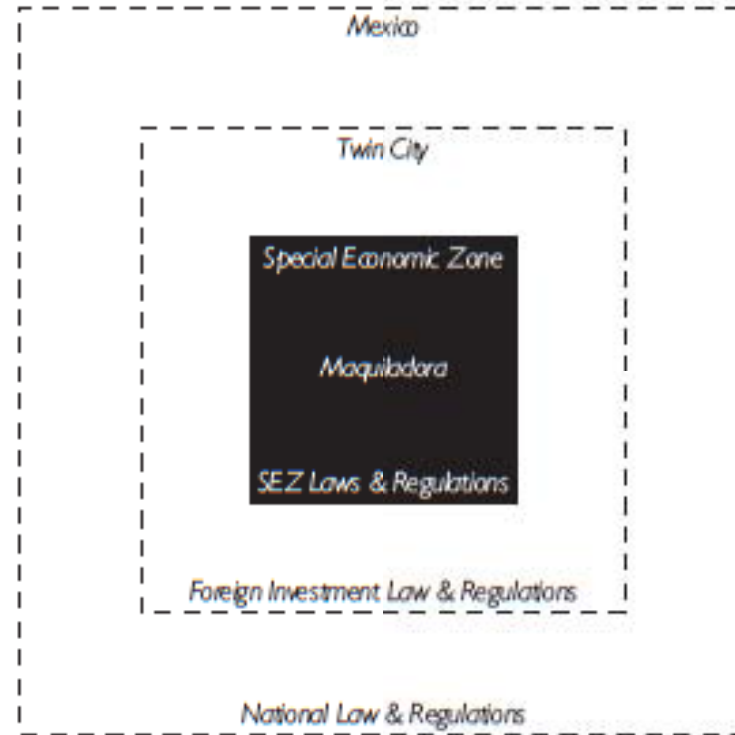

APPARENT SITUATION

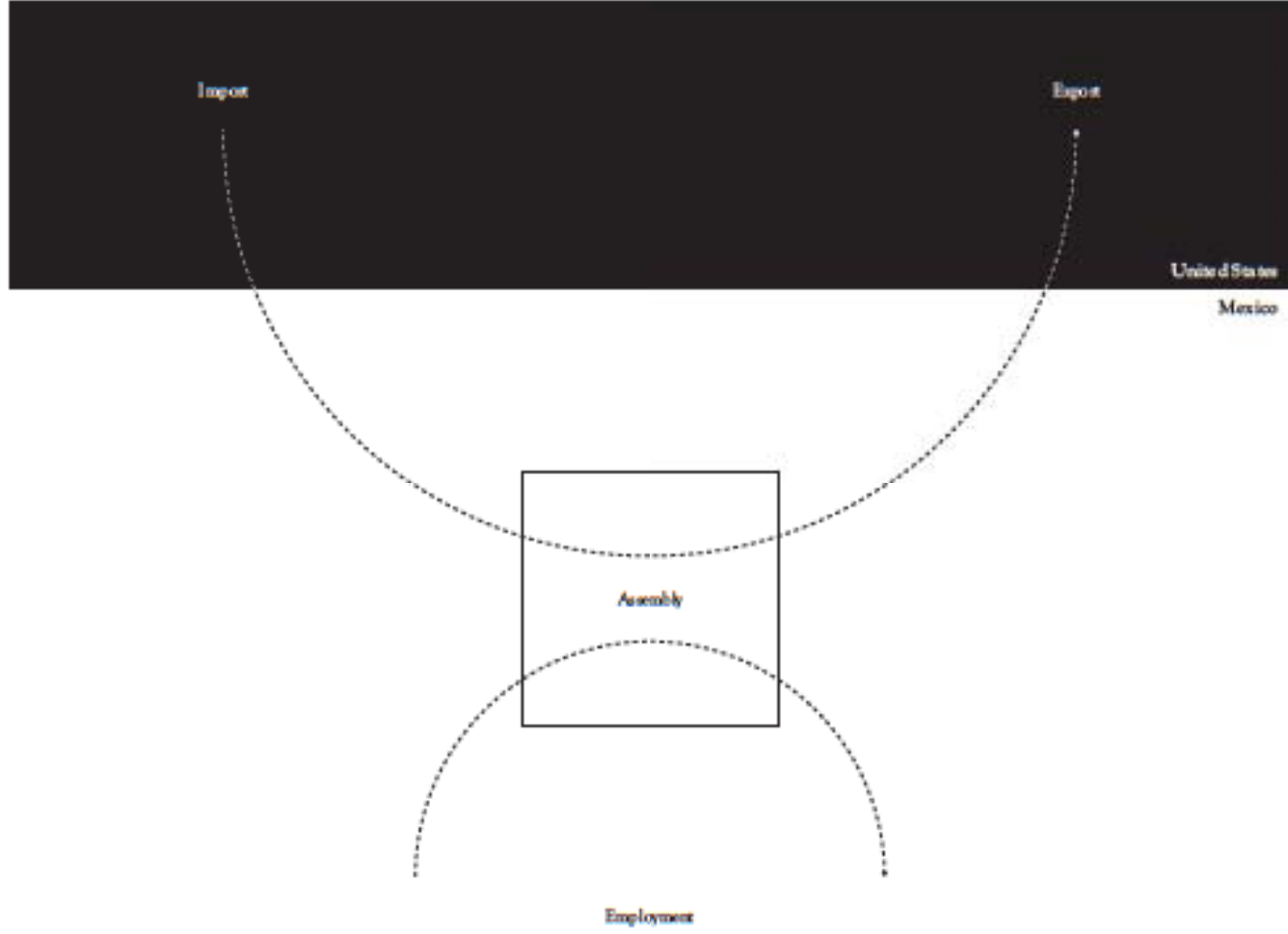

ACTUAL SITUATION

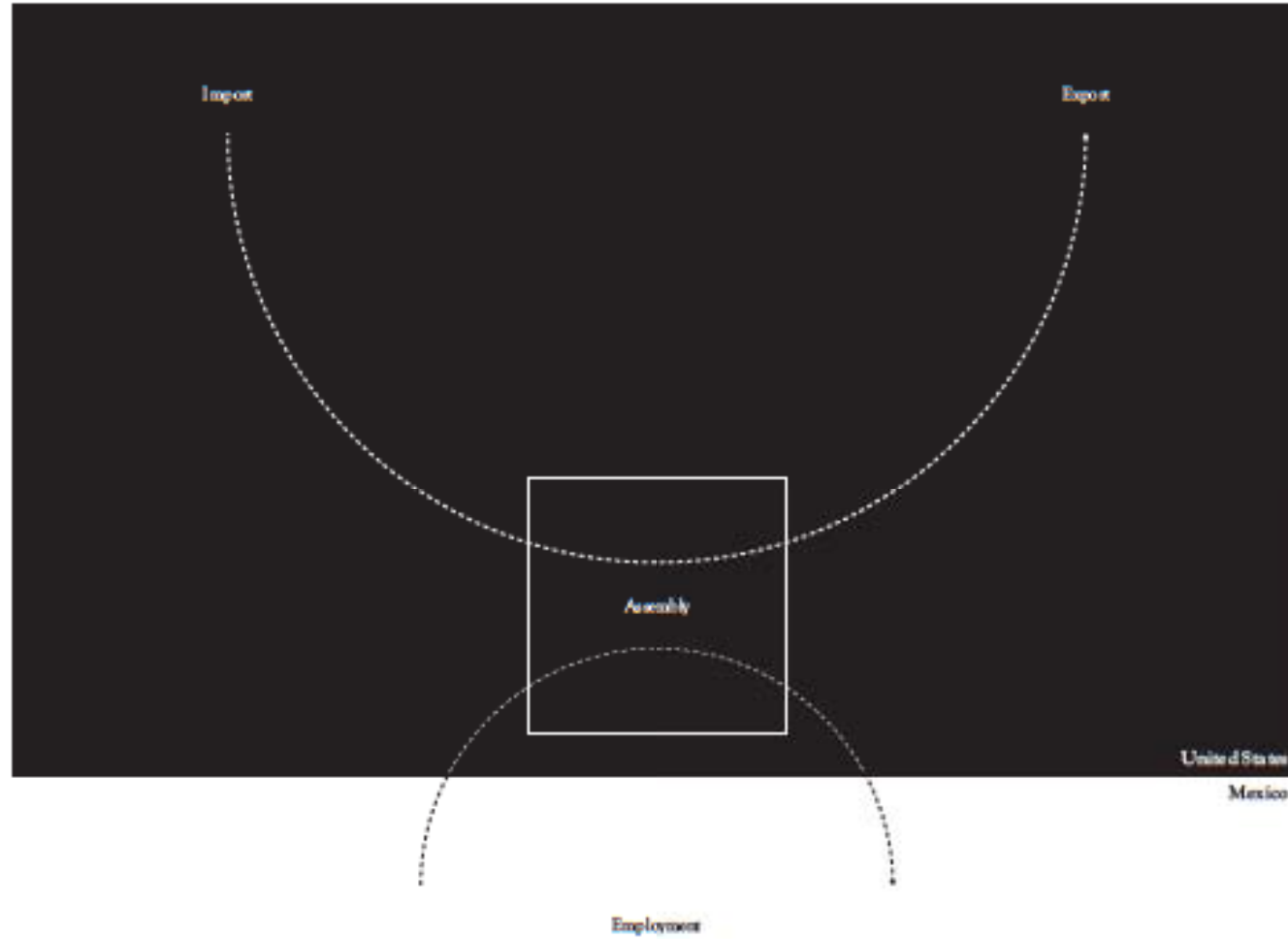

COLONIALIZATION OF THE BORDER



*American Progress*  
by John Gast, 1872



## ARCHITECTURE OF VIOLENCE

“...The US-Mexican border, like most borders, was established by violence – and its architecture is the **architecture of violence...**”

#### PROBLEM STATEMENT

How can we address the systematic violence against, and exploitation of, Mexican laborers imposed through the Maquiladora apparatus?

## A DAY IN THE LIFE



I always wake up a little before the bell rings. The universal alarm clock that signals the start of another day in this place. Four minutes might not seem like much, but it gives me the time to get ready for the day to come. I run over the important things in my mind. Where am I working? What's my station? Who are my neighbors on the line?

## A DAY IN THE LIFE



When I get out of the bedroom the hallway is crowded and there's shouting everywhere in all kinds of accents - it feels like we're trying to make up for the utter silence that was there before.

## A DAY IN THE LIFE

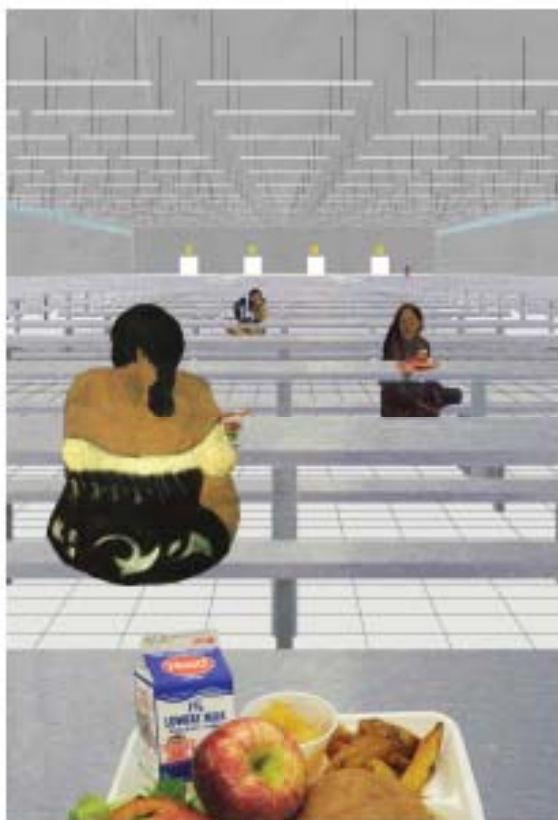

The tile floor and metal tables lined the length of the space. I never counted how many tables there were, but it must have been dozens, more than a 100 perhaps.

## A DAY IN THE LIFE



The machine's light would jump to green and the line began to move. Popular Mexican music would start playing out of the speakers for 15 minutes to freshen the minds of the girls - the managers argued this would make us more efficient. In the morning hours the line manager and supervisors were particularly strict, not tolerating any talking or joking. We worked silently until lunch.

## INSTITUTION

**“[A] total institution may be defined as a place of residence and work where a large number of like-situated individuals, cut off from the wider society for an appreciable period of time, together lead an enclosed, formally administered round of life.”**

*Asylums*  
Erving Goffman (1961)

WHICH INSTITUTIONS



**hospitals**



**prisons**



**work houses**



**insane asylums**

**monastery**

**barracks**

**schools**

**factories**



# INSTITUTIONAL TIMELINE

1300

1400

1500

1600

1700

1800

1900

2000

1388 - Poor Law Act

1601 - Act for the Relief of the Poor

1728 - Workhouse Test Act

1775 - Imprisonment as punishment

1790 - Penitentiary Act

1834 - Poor Law Amendment Act



St. Giles Hospital (1500)



St. Andrew's House (1700)



St. George's Prison (1800)



St. George's Hospital (1900)



St. Giles Hospital (1800)



St. Andrew's House (1800)



St. George's Prison (1750)



St. George's Prison (1800)



St. George's Prison (1850)



St. George's Hospital (1800)



St. Giles Hospital (1850)



St. Andrew's House (1850)



St. George's Prison (1850)



St. George's Prison (1850)



St. George's Hospital (1850)



St. Giles Hospital (1900)

— First wave

— Second wave

— Third wave  
— Fourth wave



St. George's Prison (1900)



St. George's Hospital (1900)



St. George's Hospital (1950)



St. George's Hospital (2000)

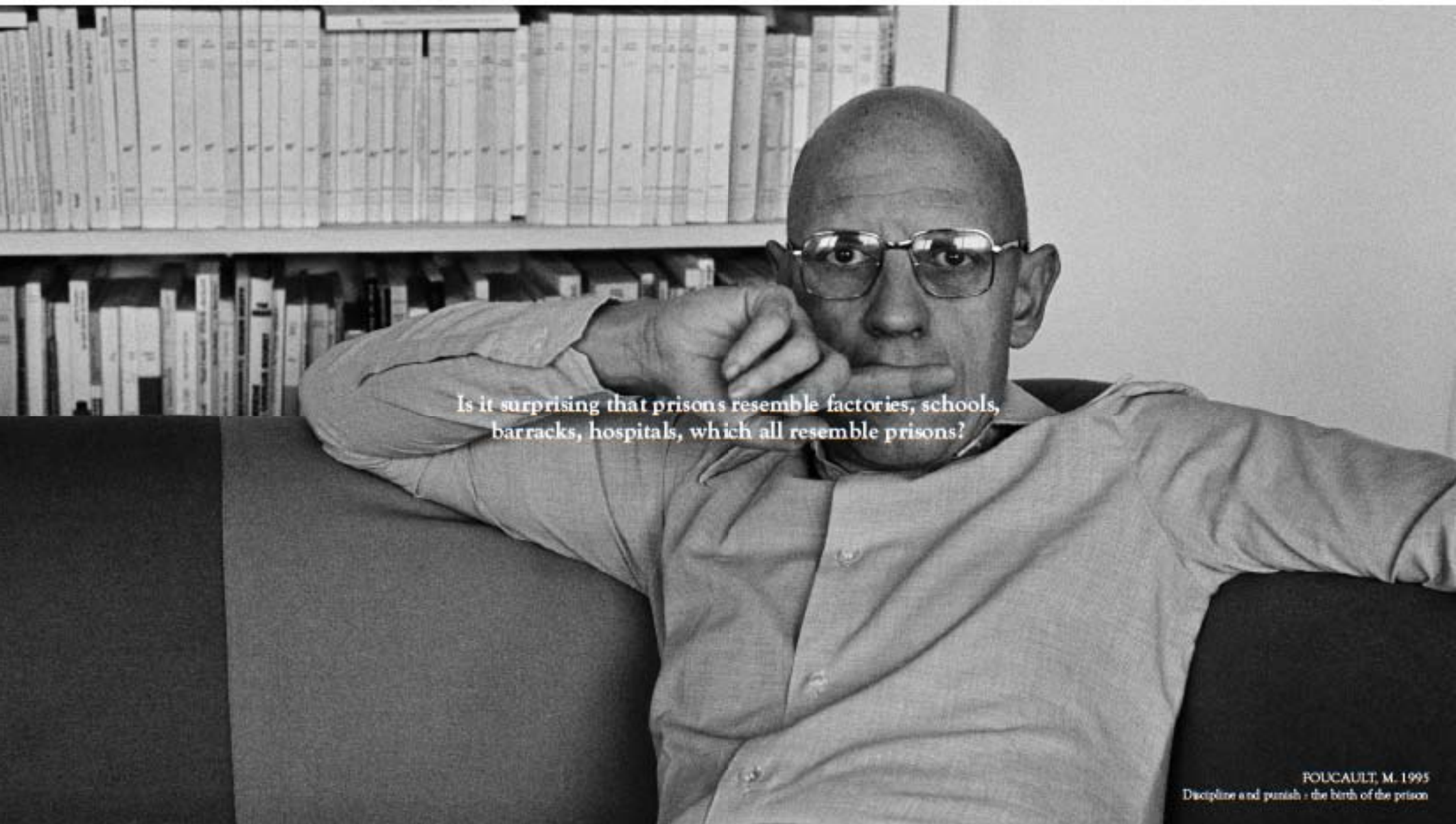

Is it surprising that prisons resemble factories, schools, barracks, hospitals, which all resemble prisons?

FOUCAULT, M. 1995  
Discipline and punish : the birth of the prison

THE PANOPTICON

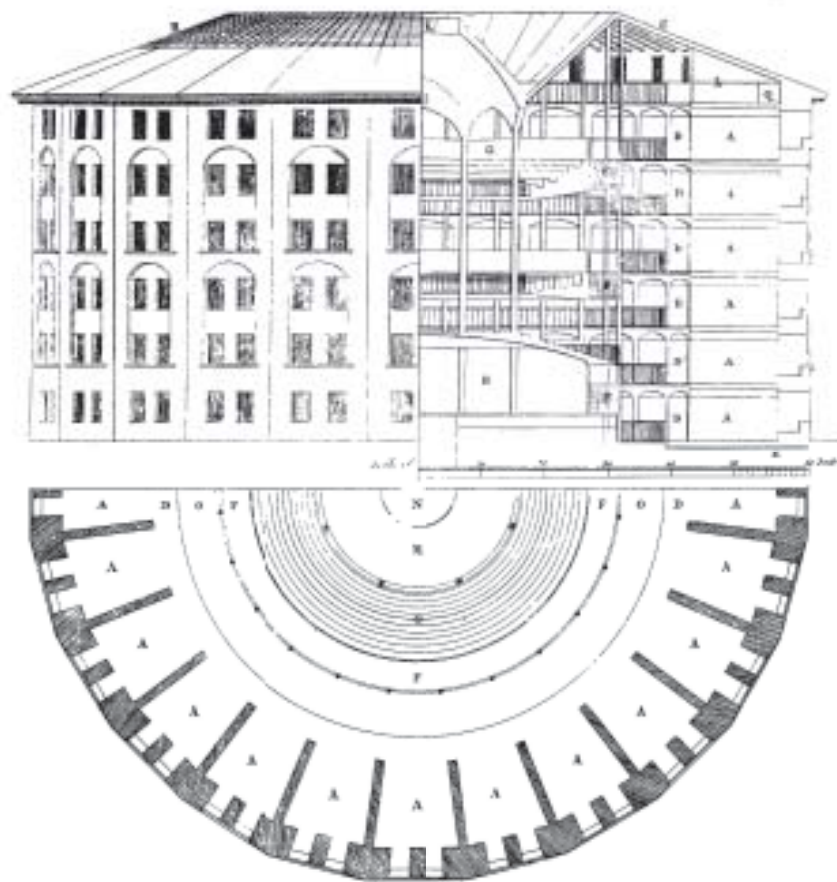

## TECHNIQUES OF POWER

### Individualization

The Cell; controlling absence and presence of the individual; allowing for supervision of conduct and to always be able to access, judge and calculate its qualities

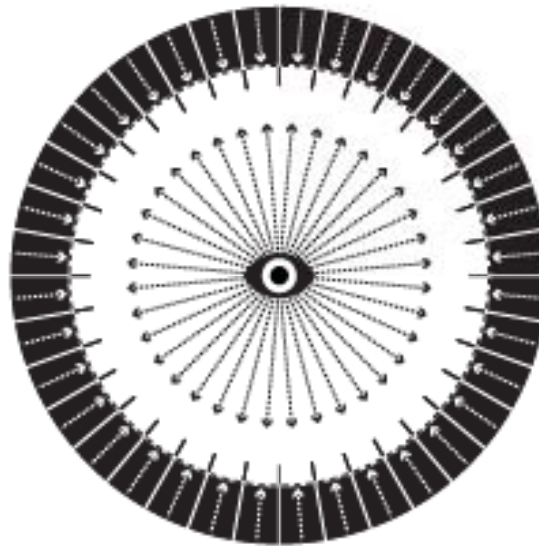

### Programming

Imposing an obligatory rhythm, controlling not only time but every single movement and action.

### Normalization

Individual actions are placed within a field of comparison, measuring in quantitative terms and hierarchizing on es abilities, skill and 'nature'.

### Hierarichal vision

To make it possible to know individuals and carry the effects of power right to them; a perfect eye which nothing would escape from.

INTERNALIZATION OF VISION

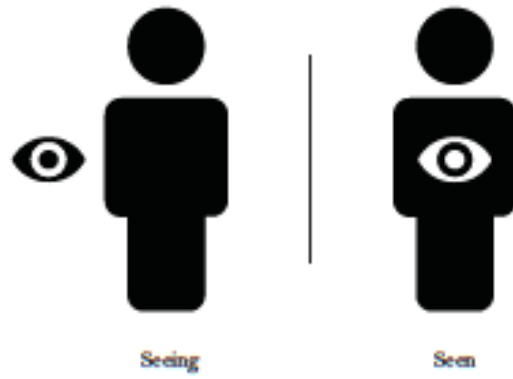

DESIGN INTENTION

**It *could* be built.**

ENCLAVE IN THE DESERT

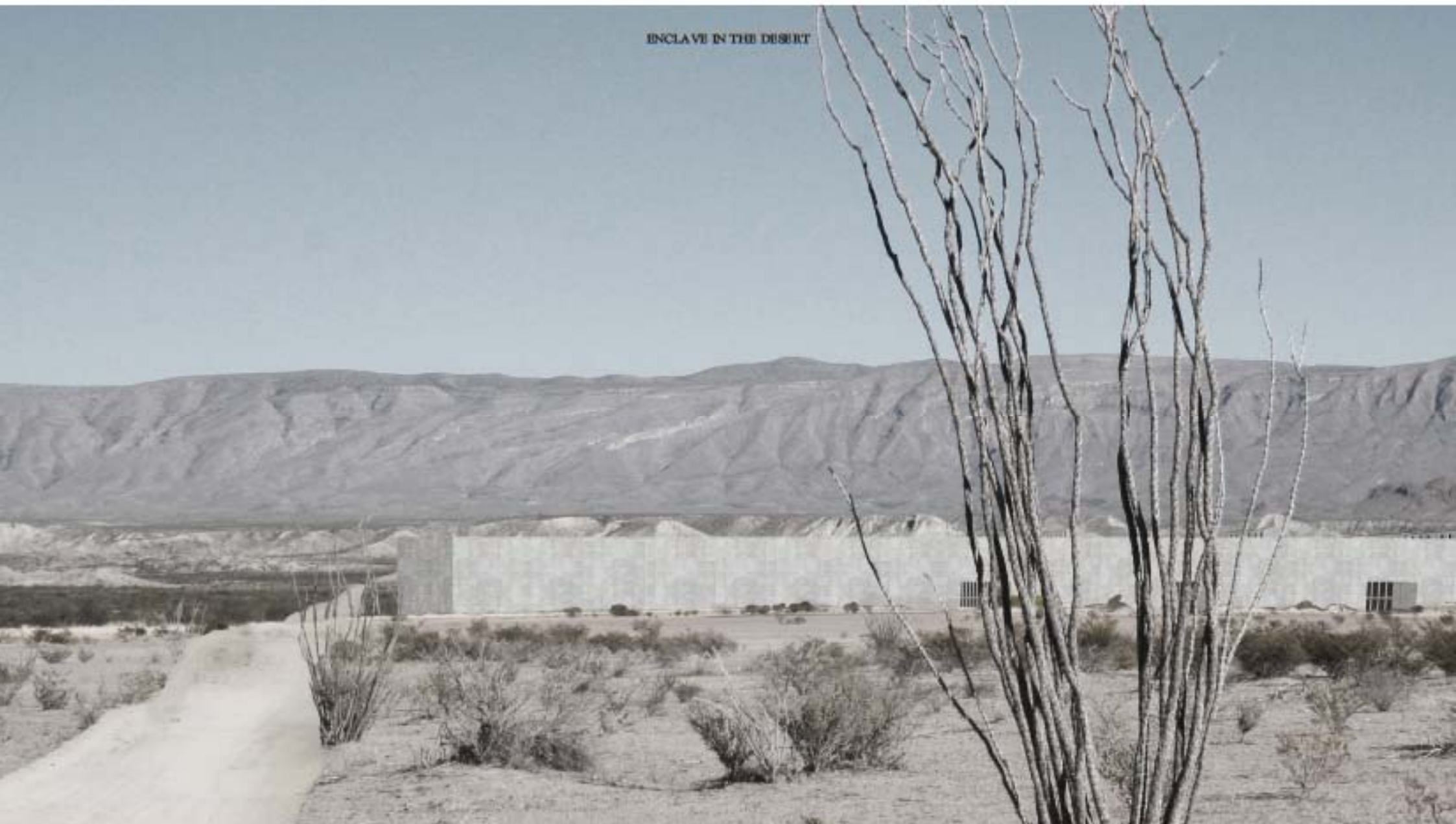

SELLING A PRODUCT



The  
Borderplex  
Alliance



Maquilapolis  
Ciudad Juárez  
St. Teresa, CH



job security

proper housing

sending money back to family



**CRUELTY**

A REPRODUCIBLE PRODUCT



MAQUILADORA CASE STUDY



MAQUILADORA CASE STUDY



1

*CUCAPI Industrial Park*



2

*Interox Campus I*



3

*Queretaro Industrial Park*



1

*CUCAPI Industrial Park*



2

*Interox Campus I*



3

*Queretaro Industrial Park*



4

*Interox Industrial Park*



5

*Oriente Industrial Park*



6

*Chihuahua Industrial Complex*



4

*Interox Industrial Park*



5

*Oriente Industrial Park*



6

*Chihuahua Industrial Complex*

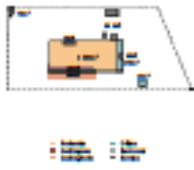

7

*Ejido Morelos a Rojas*

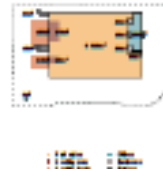

8

*Sur Industrial Park*



9

*Torreal Industrial Park*



7

*Ejido Morelos a Rojas*



8

*Sur Industrial Park*



9

*Torreal Industrial Park*

AVERAGE MAQUILADORA

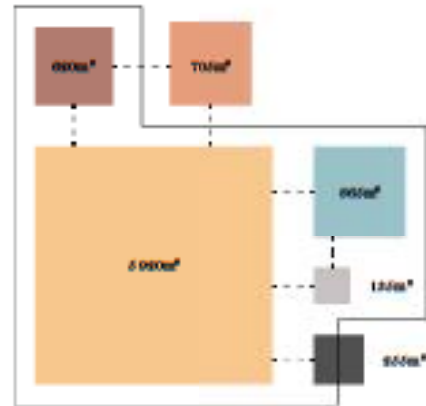



















- Production
- Office
- Loading zone
- Restrooms
- Loading docks
- Services



ECONOMY OF SCALE



INSTITUTIONS CASE STUDY

●	 The Light Box	 Wheels	 The Flower
●	 The Bowl of Wisdom	 The Shield	 The Ring of Wisdom
✕	 The Building	 The T-shaped Structure	 The Cross
■	 The Bridge	 The Staircase	 The Ladder
■	 The Grid	 The Grid	 The Grid
□	 The Grid	 The Grid	 The Grid



INSTITUTIONS CASE STUDY

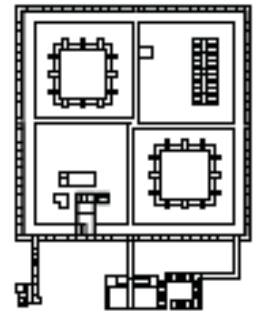
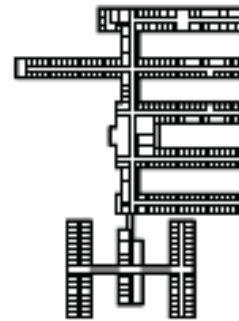
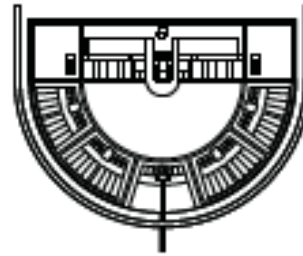
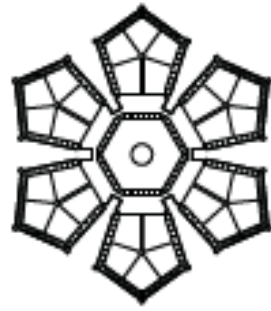

VISION

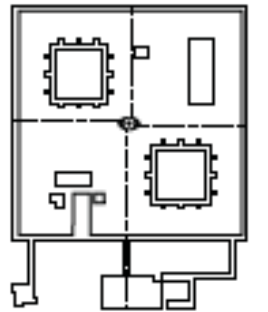
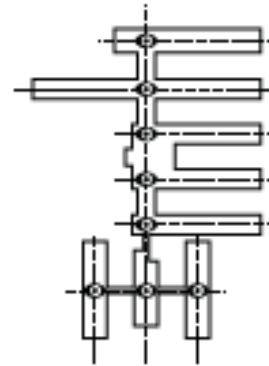
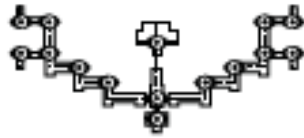
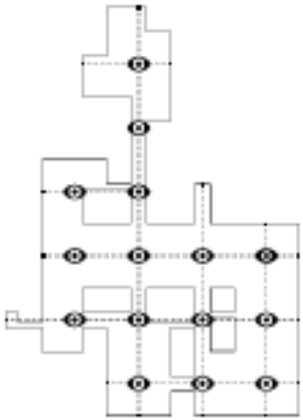
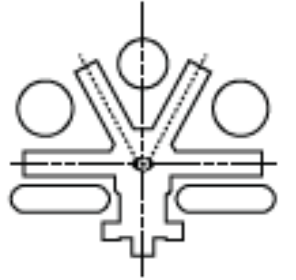
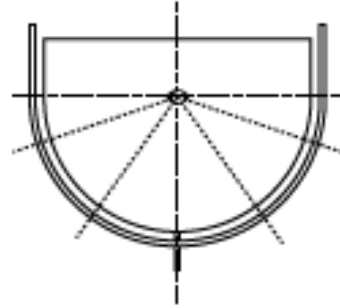
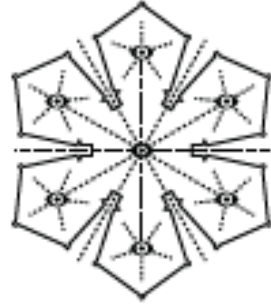
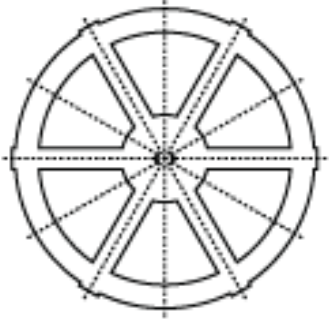

VISION AND CELL ORIENTATION

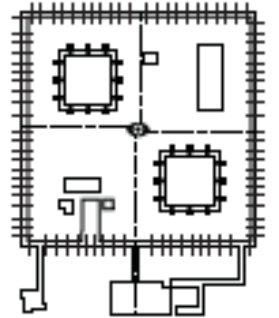
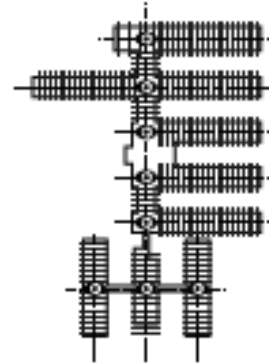
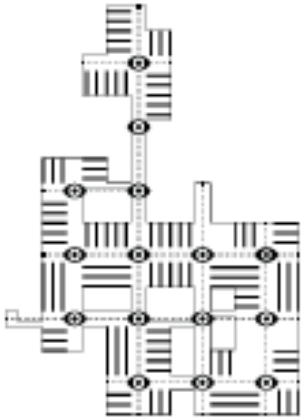
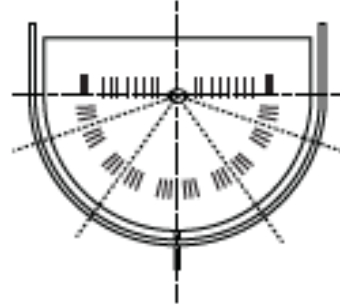
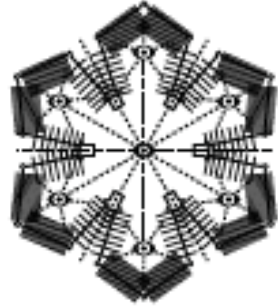
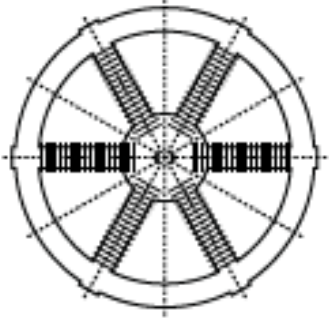

## THE CORRIDOR

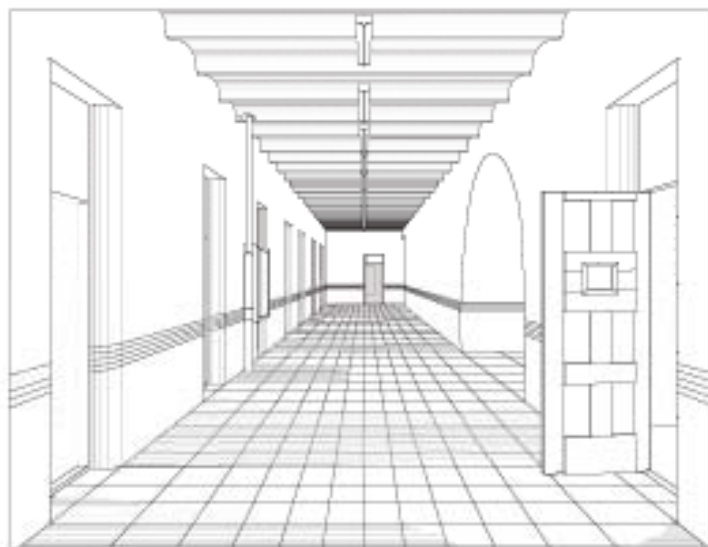

THE CORRIDOR

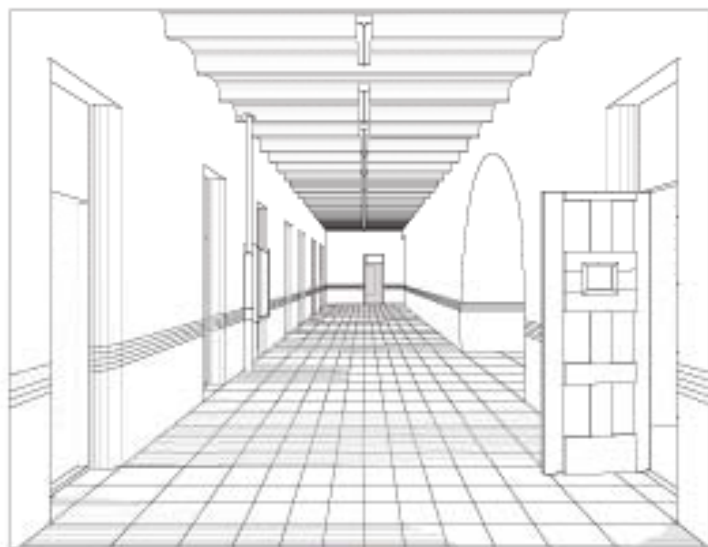

asylum



prison



hospital

Exploitation is as much a consequence of an Architecture as it is of those who use it.  
Here then Architecture is a backdrop, allowing certain forms of control and  
relations of power to exist; it enables.

URBAN CONCEPT

**Architecture as a Frame**

URBAN CONCEPT

Limiting space and defining it

Denoting inside v. outside

Specific v. Generic



FRAMING AS INDEX

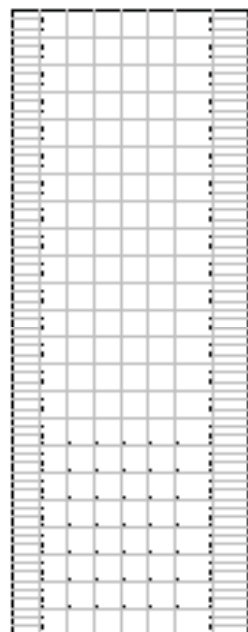

Chrysler Tank Arsenal  
Detroit, 1940

URBAN CONCEPT

**Architecture as a state of Exception**

RURAL CONTEXT

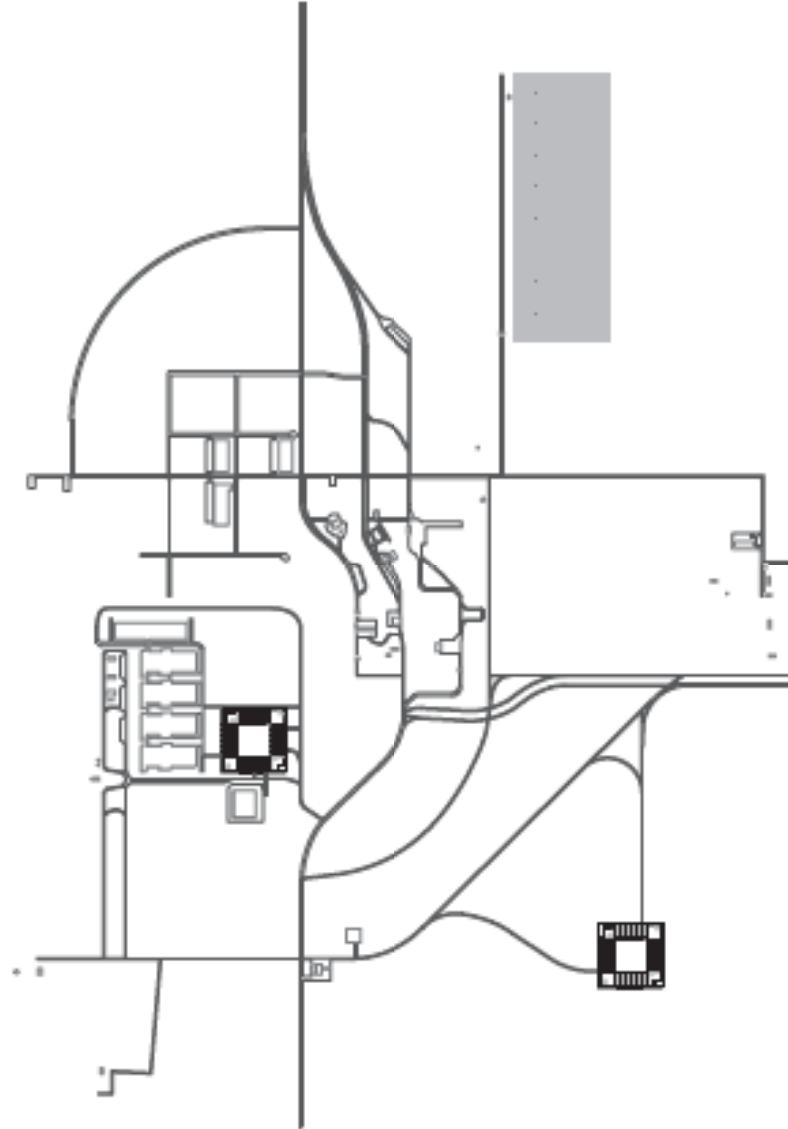

RURAL CONTEXT

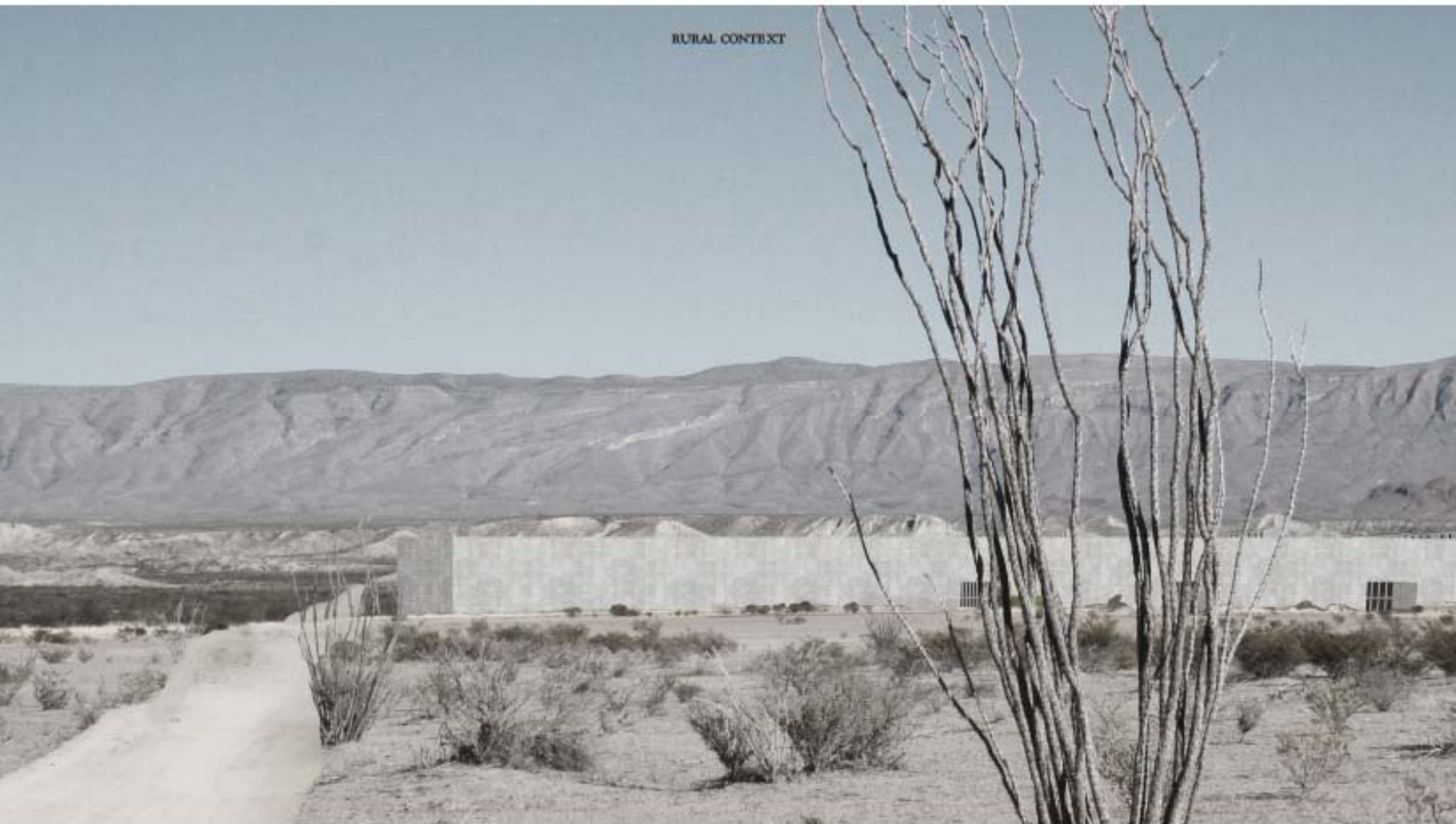

URBAN CONTEXT

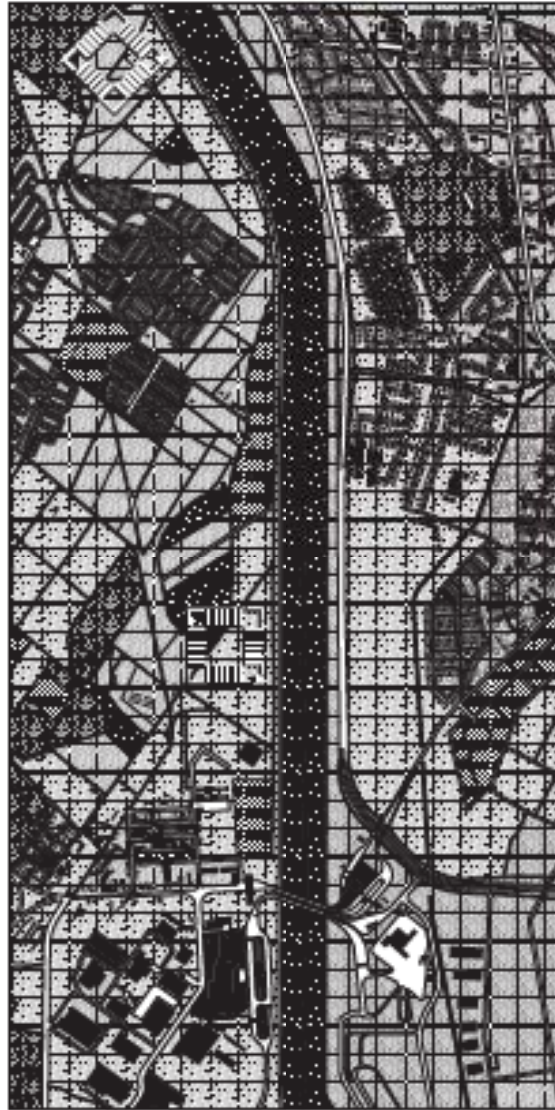

URBAN CONTEXT



GE imagination at work

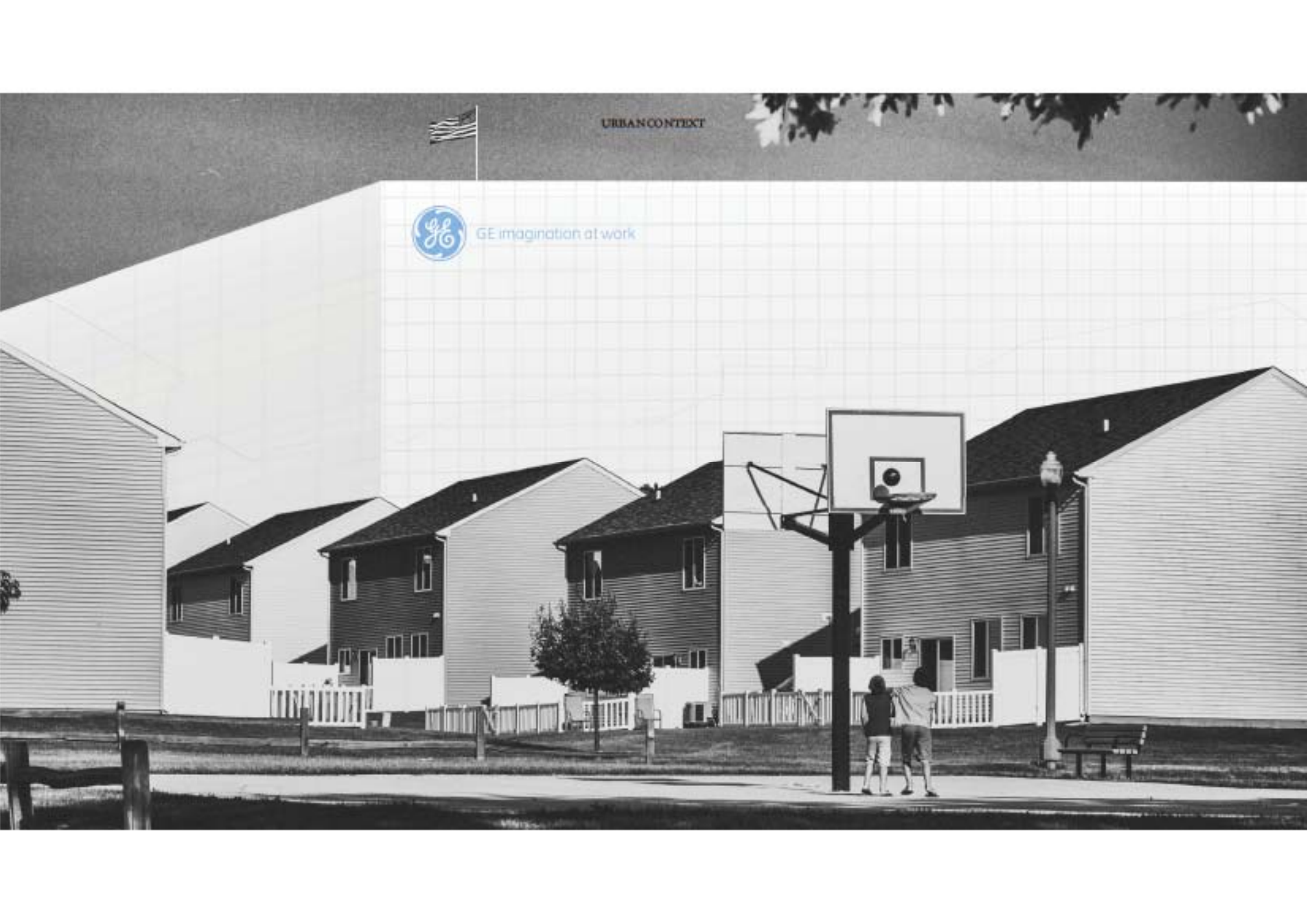

MASTER PLAN

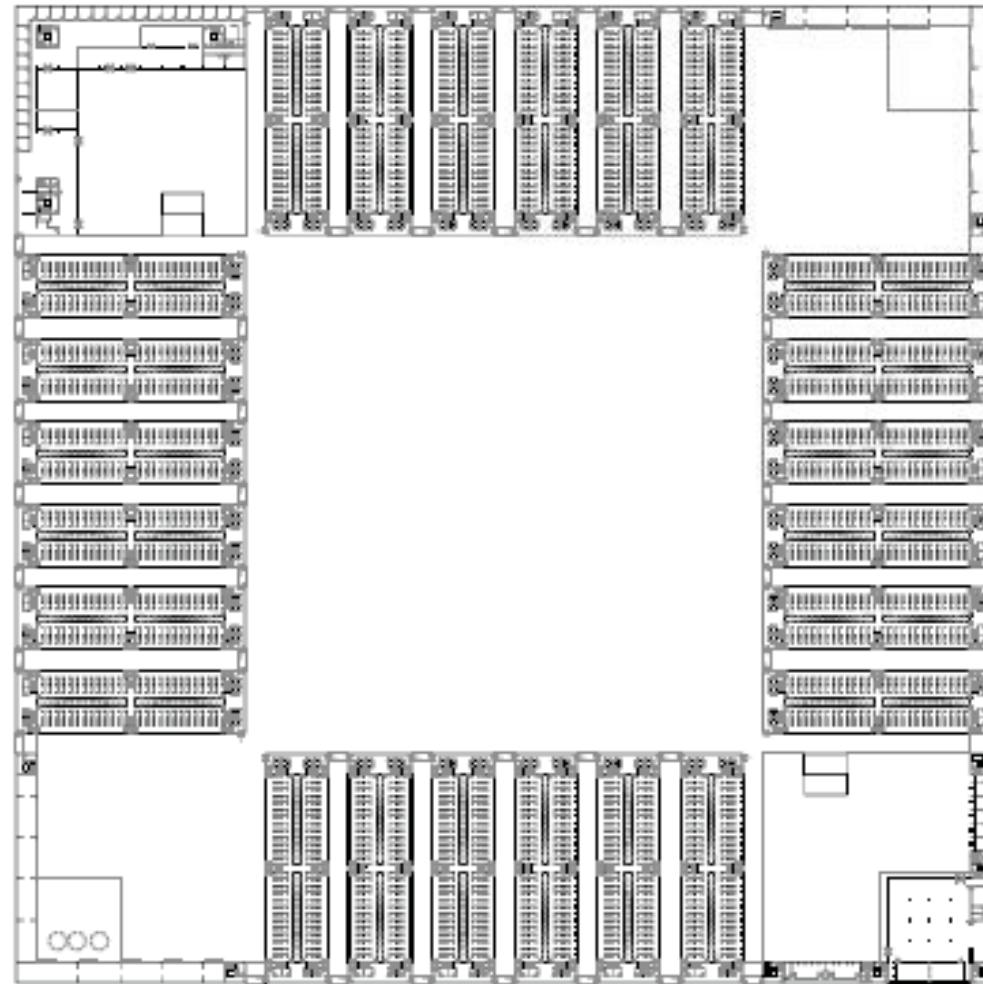

MATERIAL FLOW

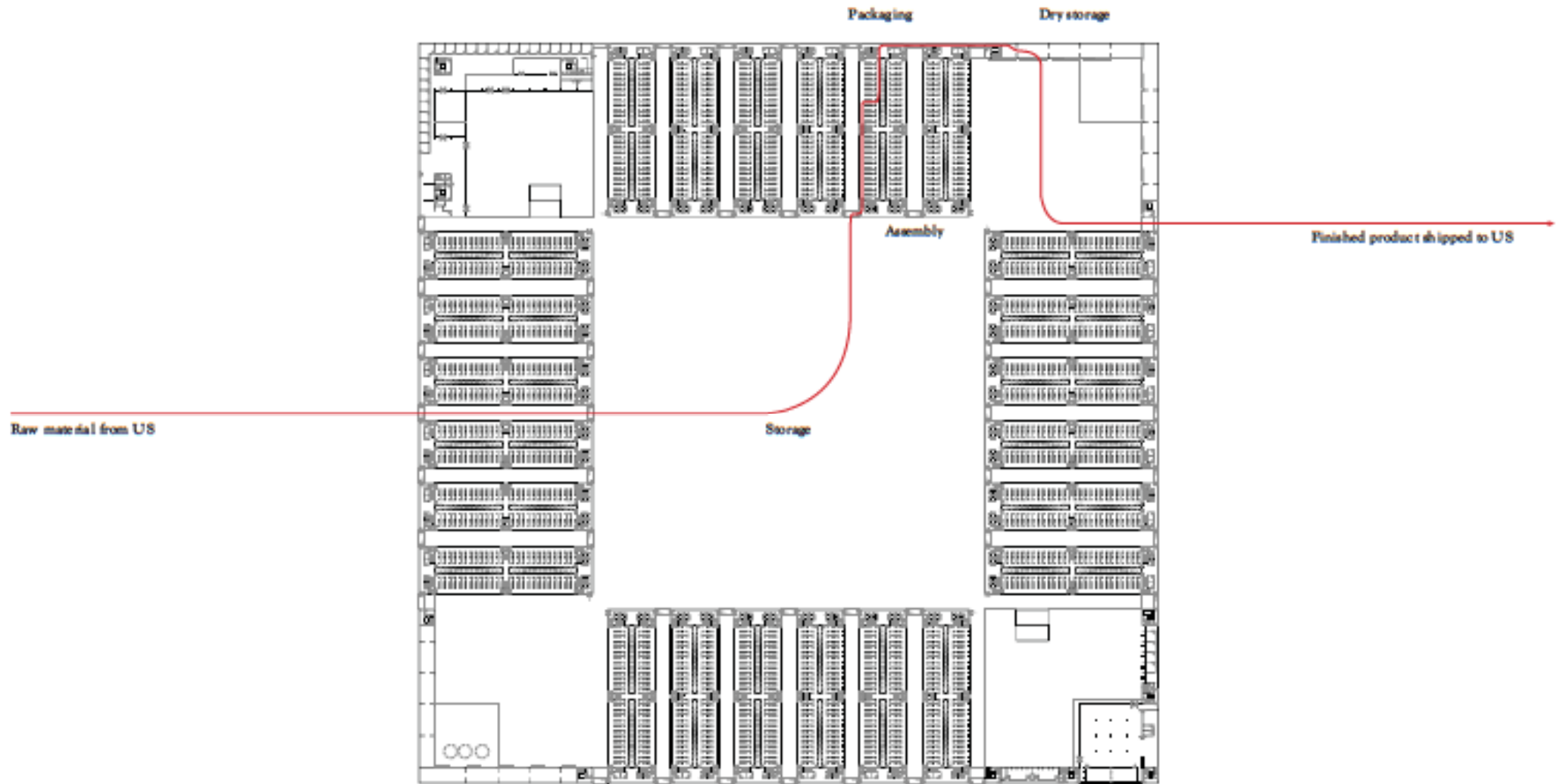



PROGRAMMATIC ELEMENTS

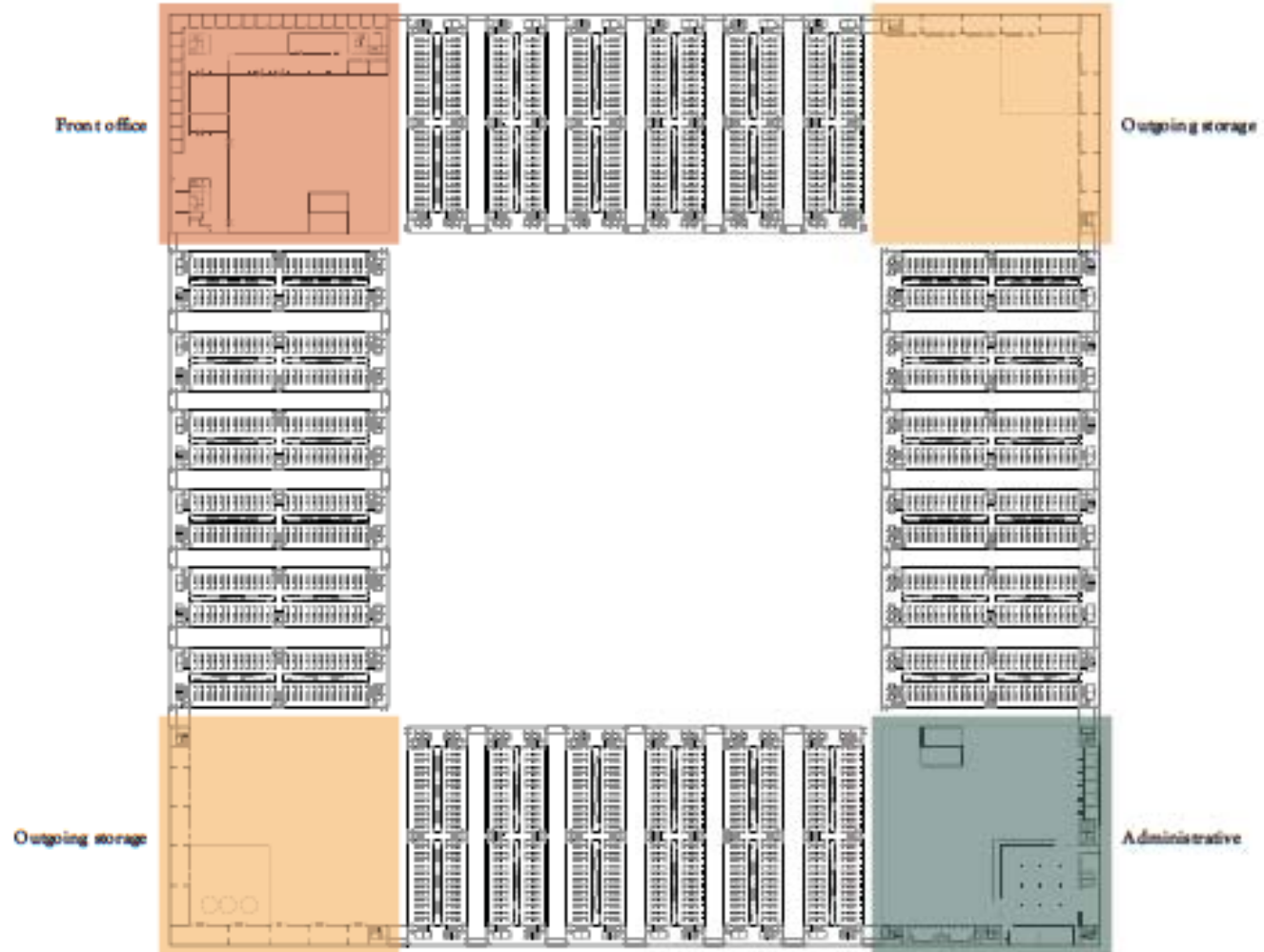

FRONT OFFICE, GROUND FLOOR

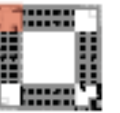
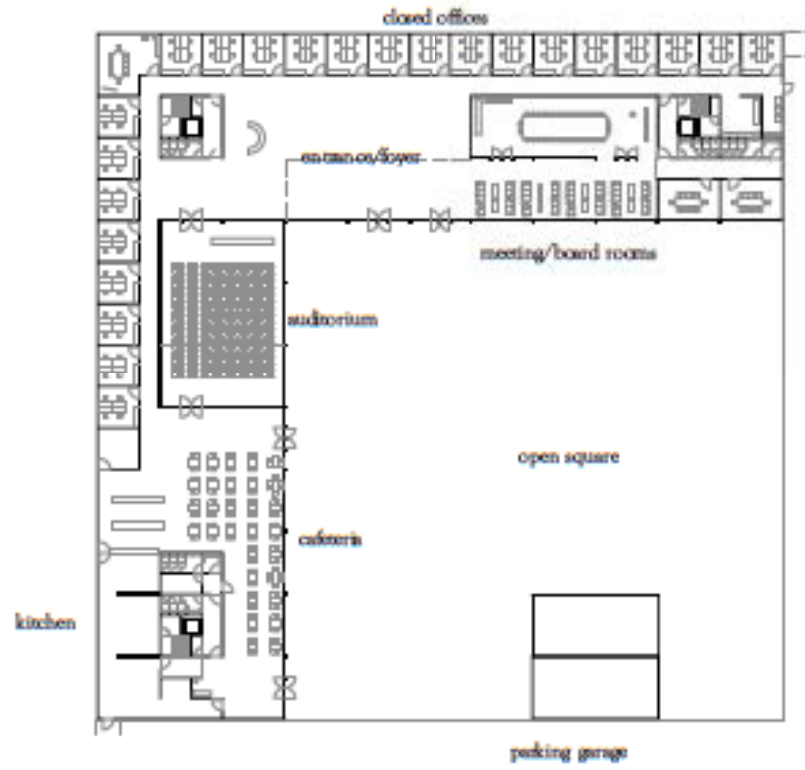

FRONT OFFICE, FIRST FLOOR

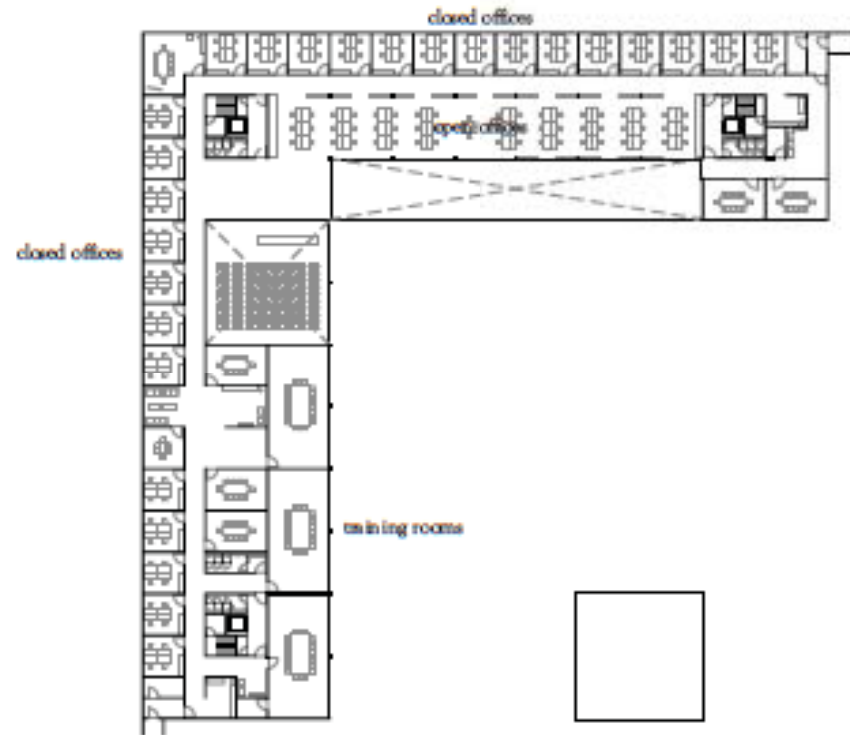

# OUTGOING STORAGE

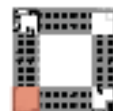
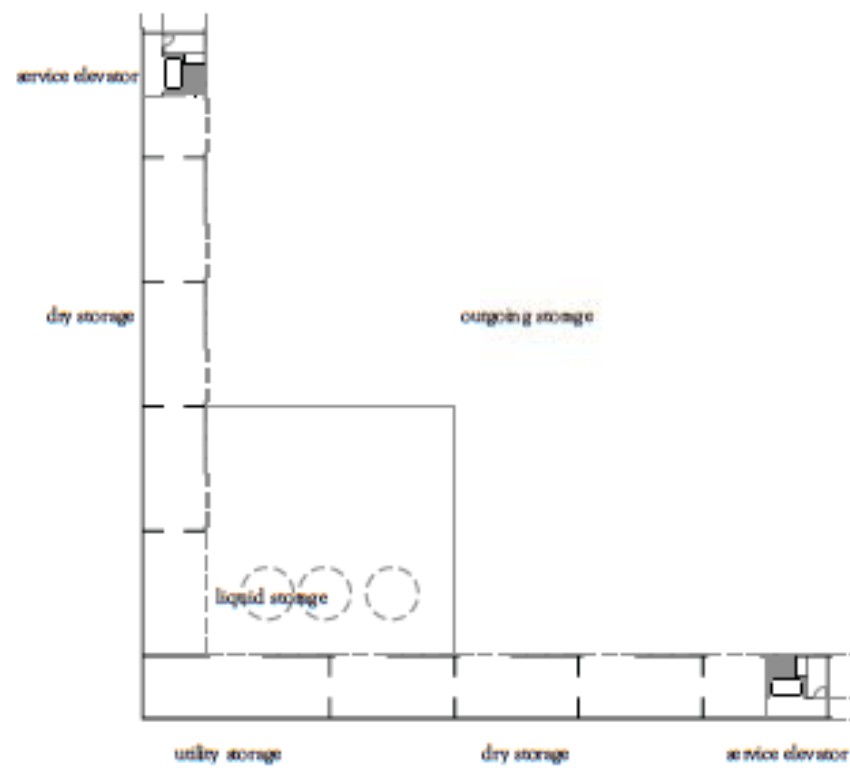

ADMINISTRATIVE



ADMINISTRATIVE

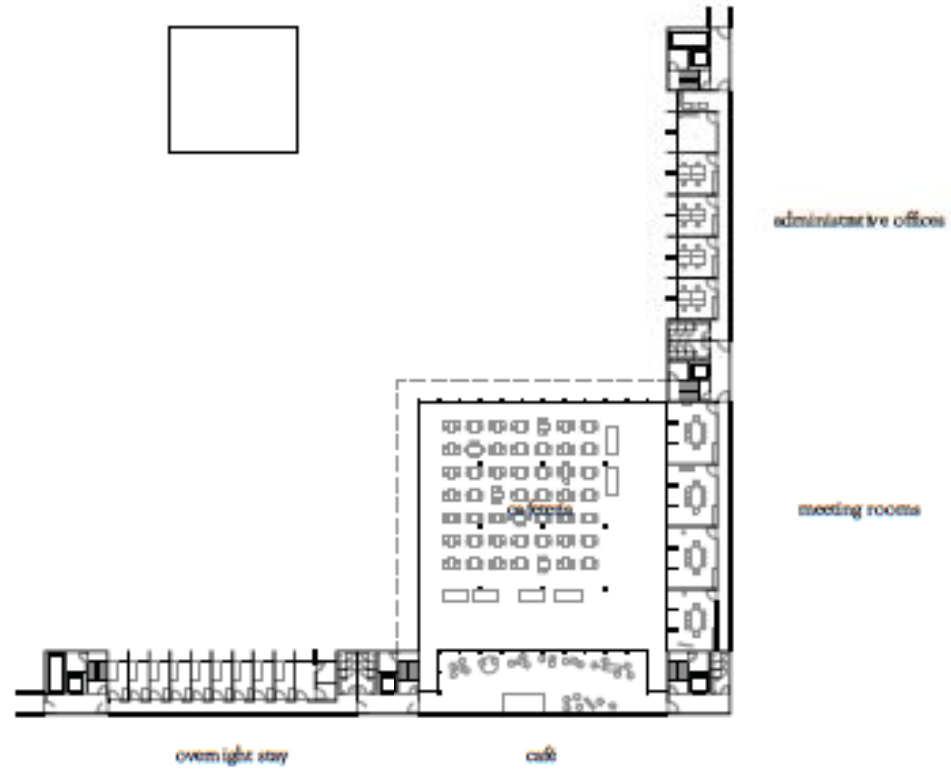

PLAN SINGLE BLOCK

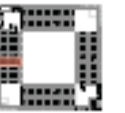
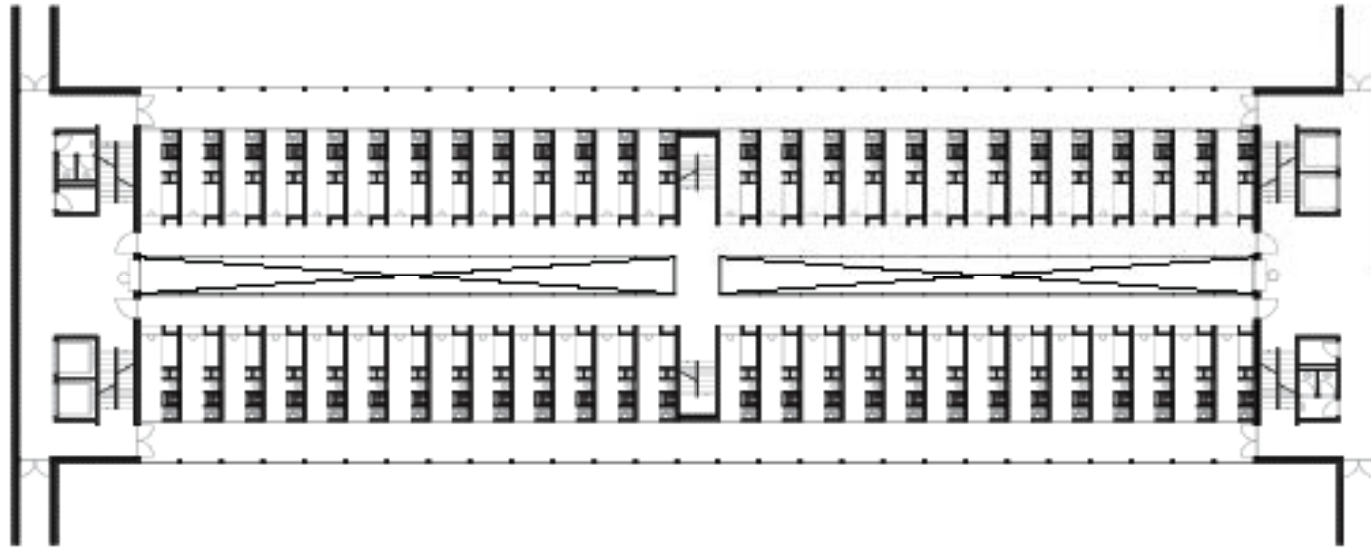

PLAN SINGLE BLOCK

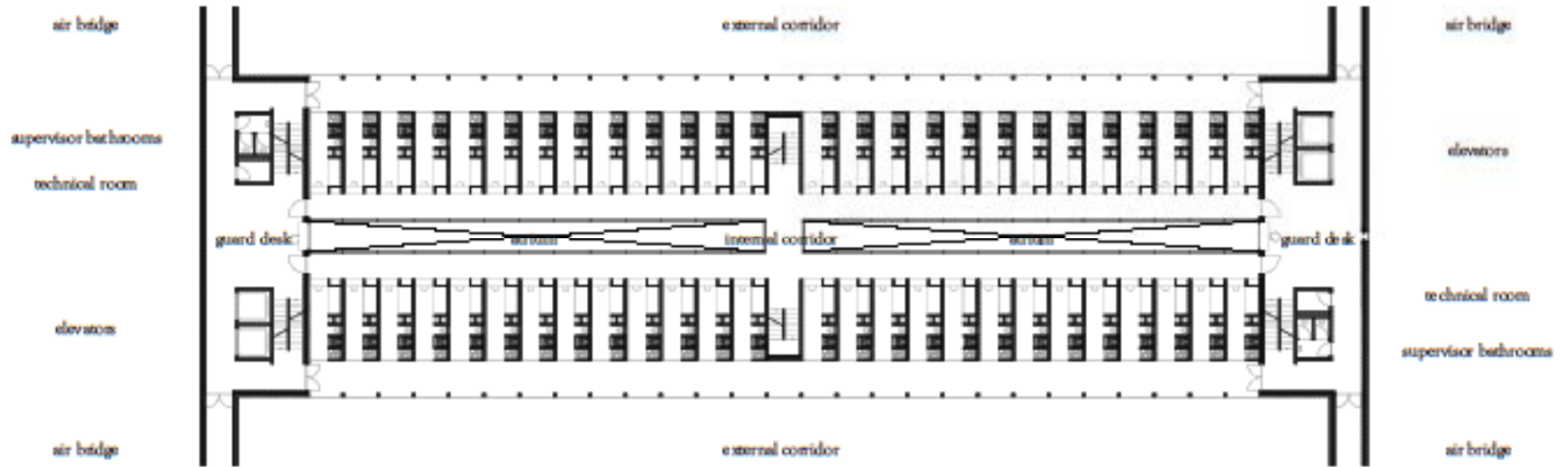



OPEN V. CLOSED AS CLIMATIC DESIGN

41

Outside Air  
Zone 2/3  
Delivery to spaces: RUPC  
Airway high temperature: RUPC

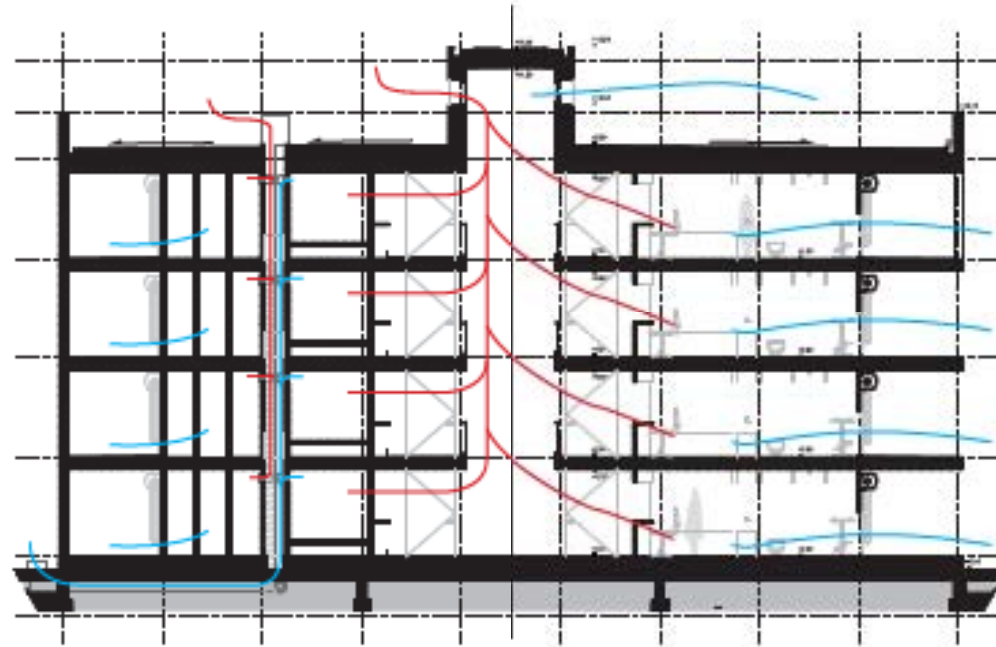

OPEN V. CLOSED AS CLIMATIC DESIGN

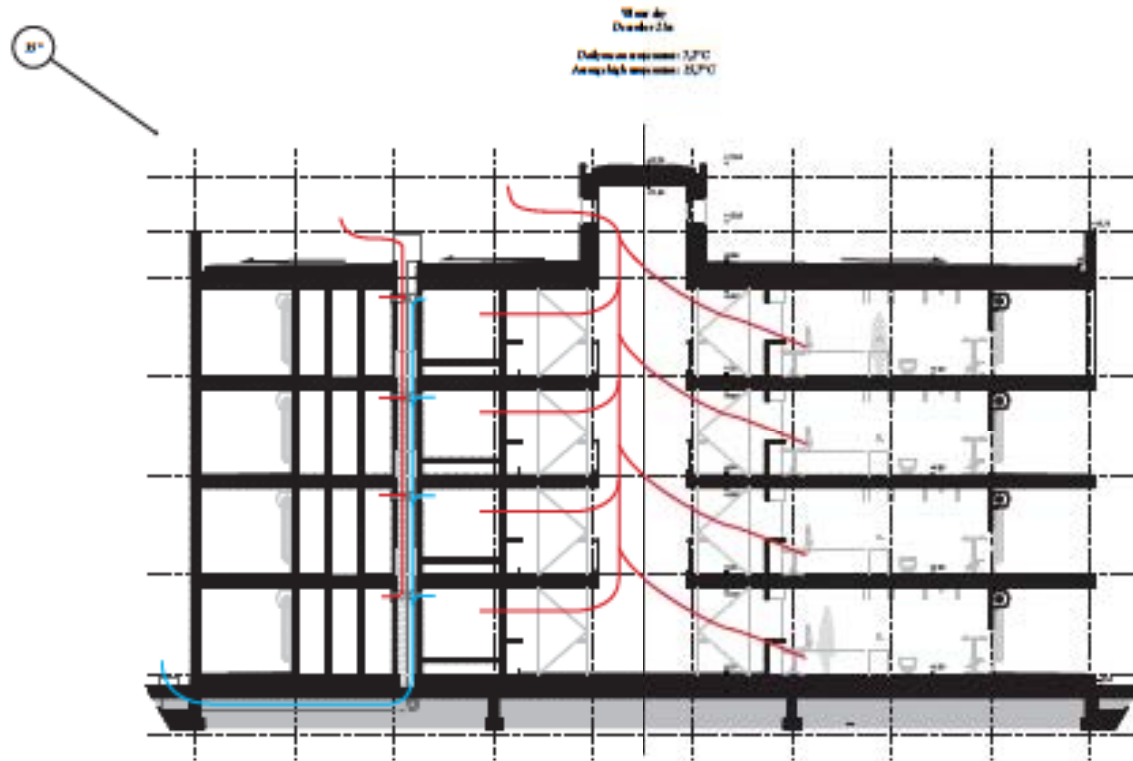

## MATERIALIZATION

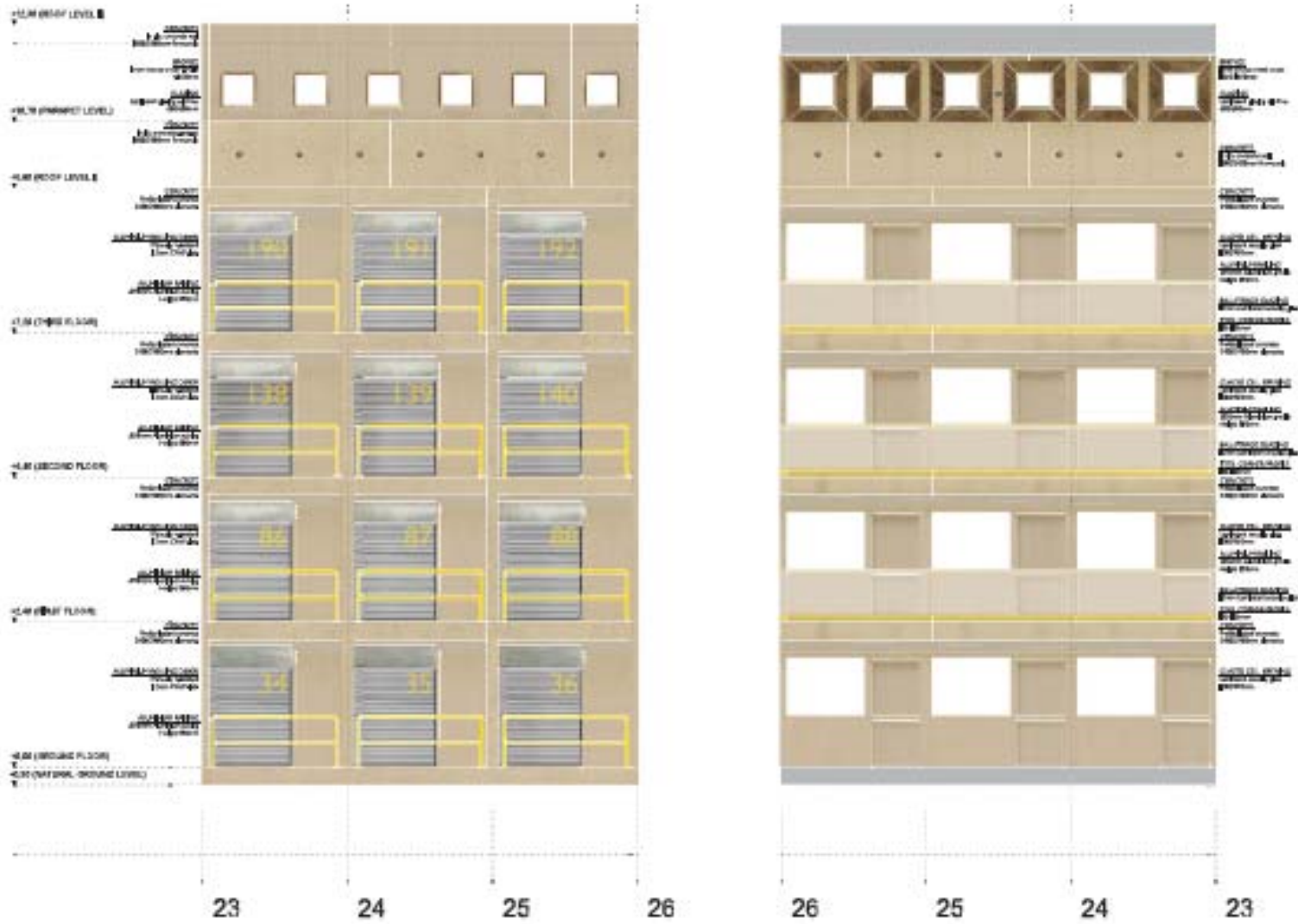

LABORER FLOW

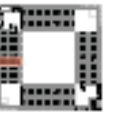
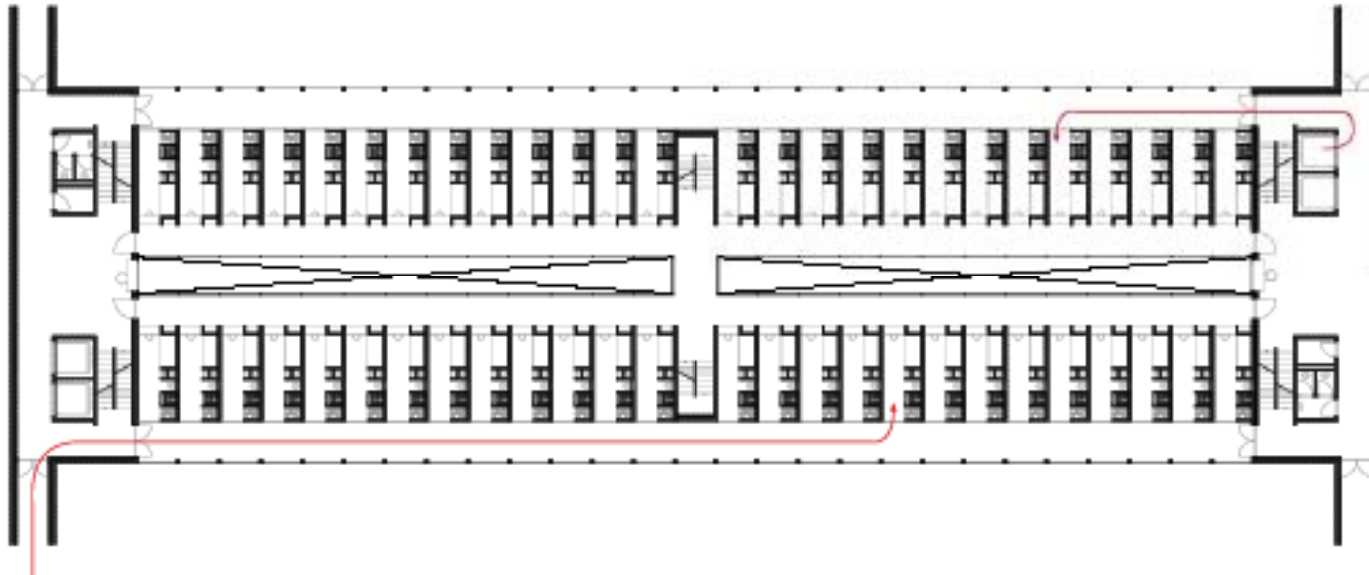

MATERIAL FLOW

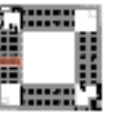
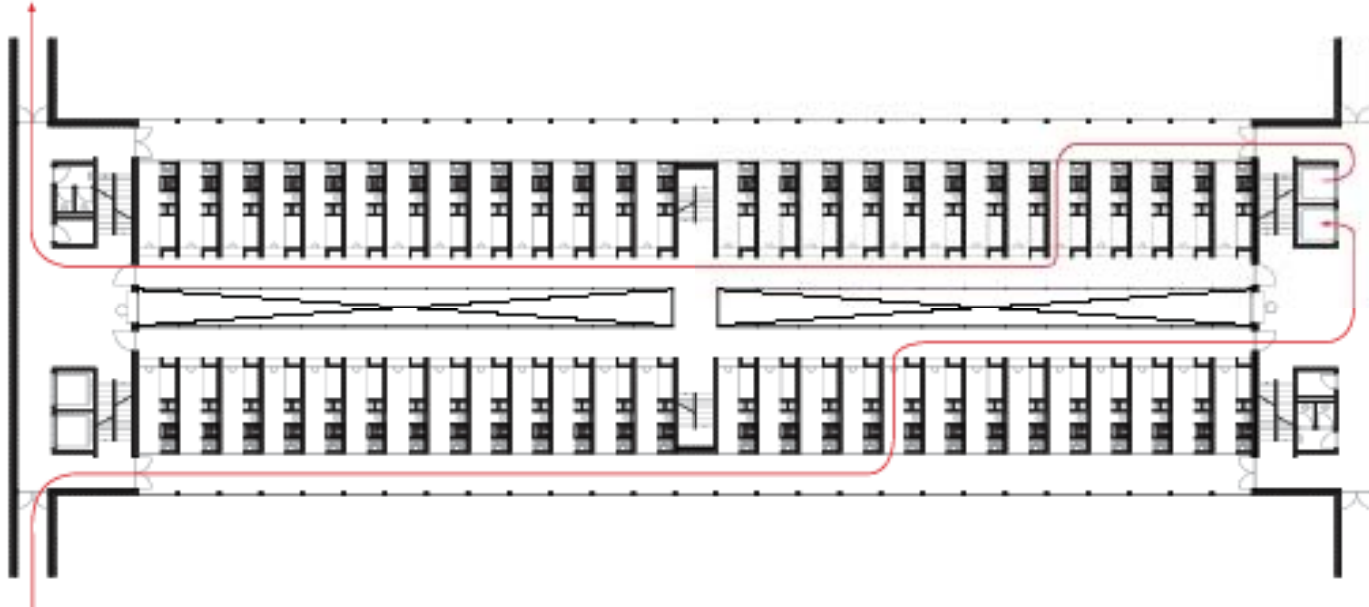

LABORERS

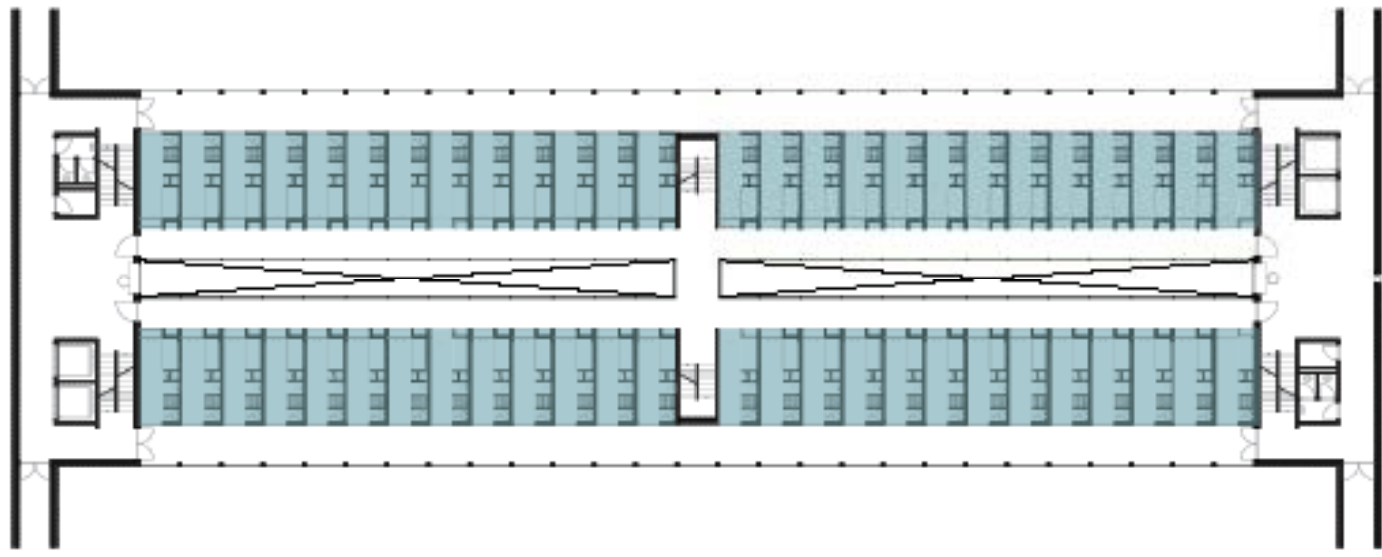

SUPERVISORS

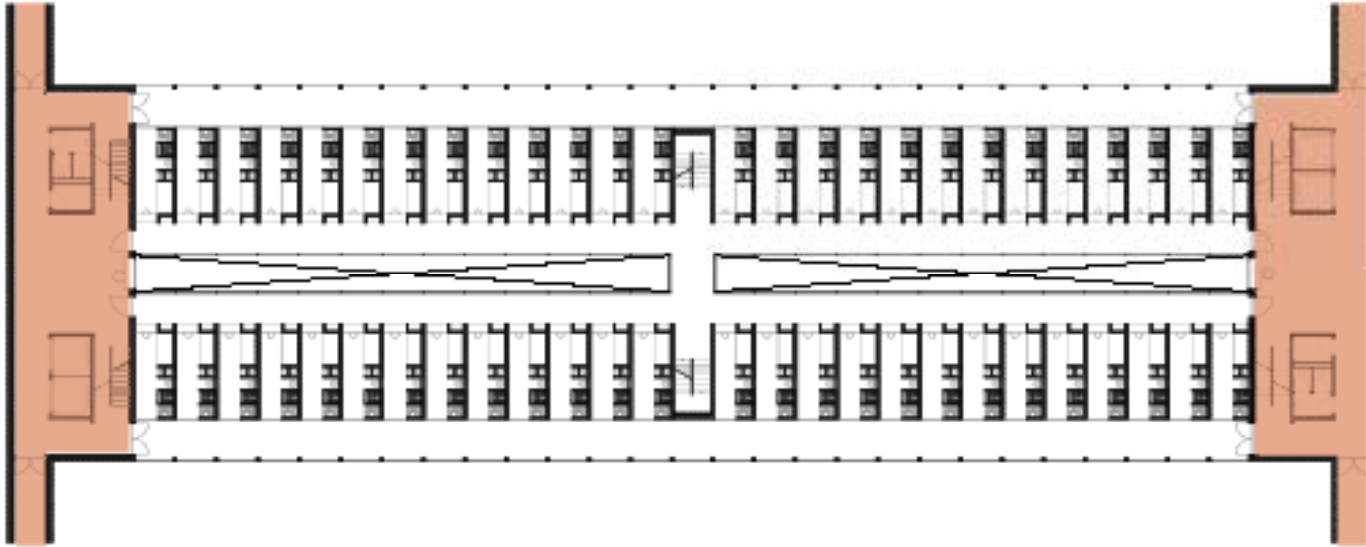

VIEW FROM GUARD'S OFFICE

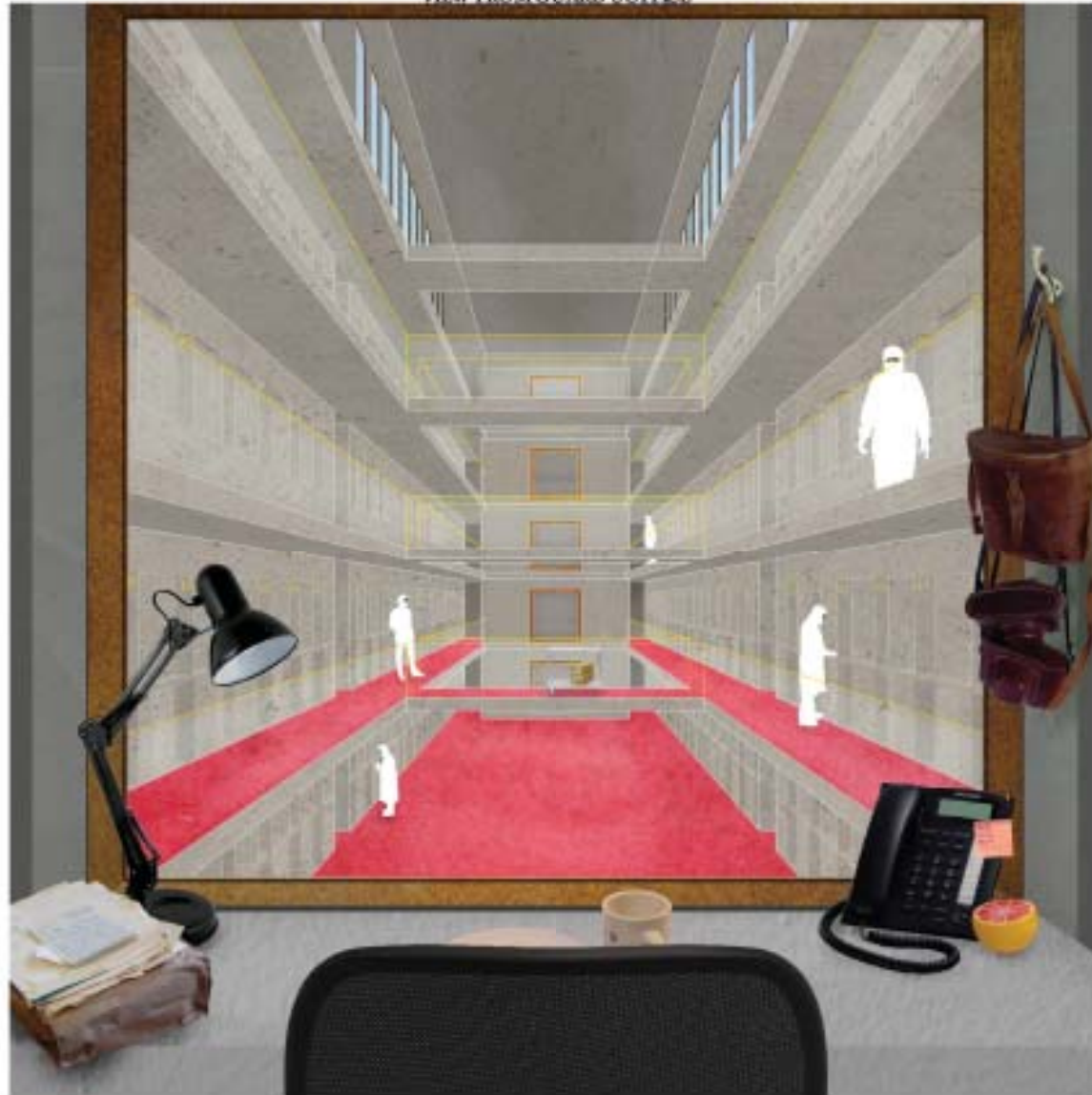



THE CELL

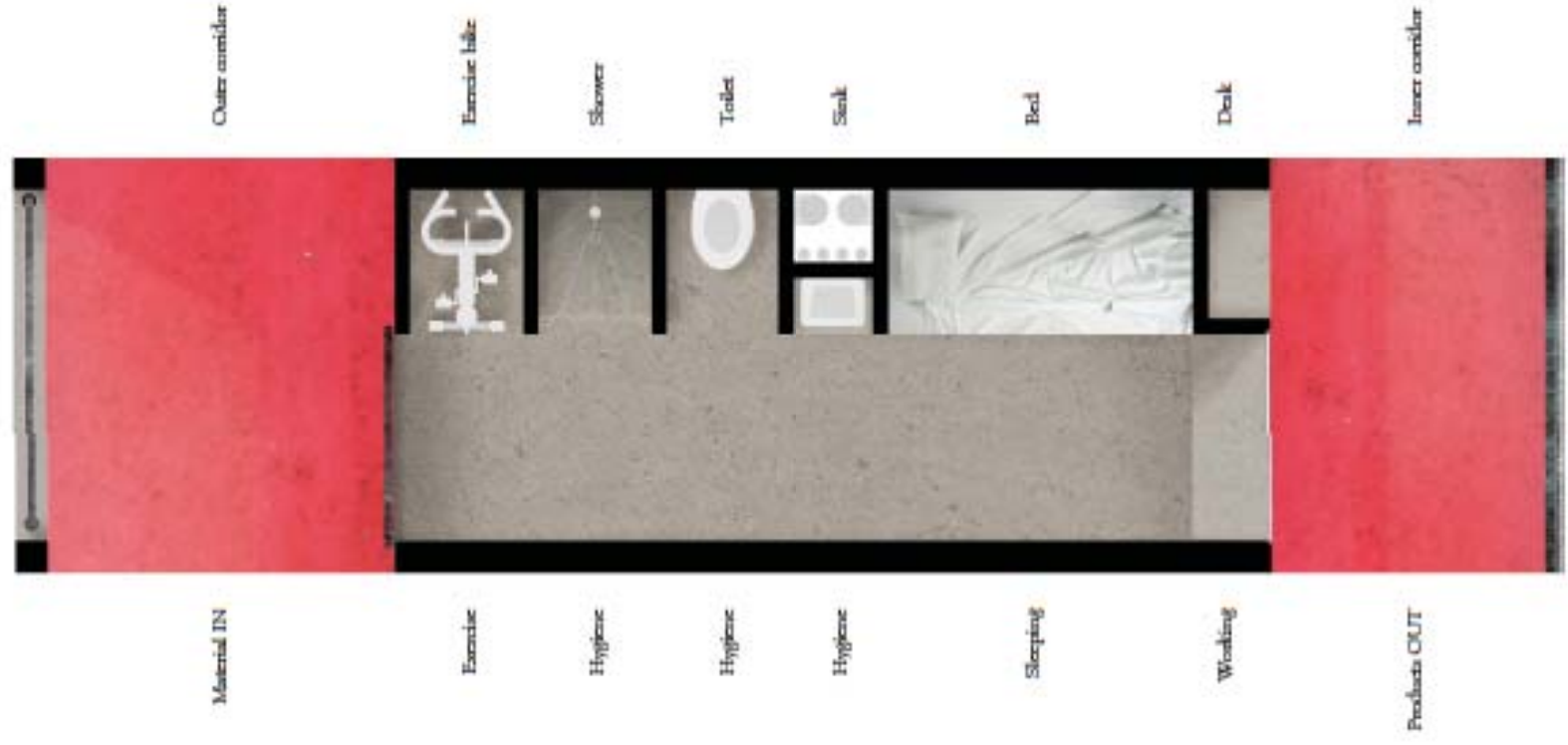

INTERIOR VIEW OF THE CELL

