

## Interactive evolutionary concept exploration in preliminary ship design

Duchateau, Etienne

**DOI**

[10.4233/uuid:27ff1635-2626-4958-bcdb-8aee282865c8](https://doi.org/10.4233/uuid:27ff1635-2626-4958-bcdb-8aee282865c8)

**Publication date**

2016

**Document Version**

Final published version

**Citation (APA)**

Duchateau, E. (2016). *Interactive evolutionary concept exploration in preliminary ship design*. [Dissertation (TU Delft), Delft University of Technology]. <https://doi.org/10.4233/uuid:27ff1635-2626-4958-bcdb-8aee282865c8>

**Important note**

To cite this publication, please use the final published version (if applicable). Please check the document version above.

**Copyright**

Other than for strictly personal use, it is not permitted to download, forward or distribute the text or part of it, without the consent of the author(s) and/or copyright holder(s), unless the work is under an open content license such as Creative Commons.

**Takedown policy**

Please contact us and provide details if you believe this document breaches copyrights. We will remove access to the work immediately and investigate your claim.

# **Interactive Evolutionary Concept Exploration in Preliminary Ship Design**

## **Proefschrift**

ter verkrijging van de graad van doctor  
aan de Technische Universiteit Delft,  
op gezag van de Rector Magnificus prof.ir. K.C.A.M. Luyben;  
voorzitter van het College voor Promoties,  
in het openbaar te verdedigen op  
donderdag 26 mei 2016 om 15:00 uur

door

**Etienne Alphonse Elisabeth DUCHATEAU**

scheepsbouwkundig ingenieur  
geboren te Breda

Dit proefschrift is goedgekeurd door de  
promotor: Prof.ir. J.J. Hopman  
copromotor: Dr.ir. B.J. van Oers

Samenstelling promotiecommissie:

Rector Magnificus	voorzitter
Prof.ir. J.J. Hopman	Technische Universiteit Delft, promotor
Dr.ir. B.J. van Oers	Defensie Materieel Organisatie, copromotor

Onafhankelijke leden:

Prof.dr. T.W. Simpson	Penn State University, USA
Prof. P.G. Wrobel	University College London, UK
Prof.dr. C. Witteveen	Technische Universiteit Delft
Prof.dr. F.M. Brazier	Technische Universiteit Delft
Prof.ir. D. Stapersma	Technische Universiteit Delft

This research was funded by the United States Navy Office of Naval Research. The views expressed in this thesis are those of the author and do not reflect the social policy or position of the United States Navy or the United States Government.

*Keywords:* preliminary ship design, concept exploration, progressive optimisation, interactive genetic algorithm, design space exploration

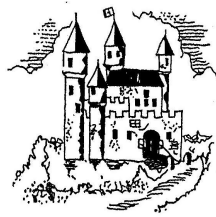
*Published by:* Gildeprint, The Netherlands

ISBN 978-94-6186-628-8

Copyright © 2016 by E.A.E. Duchateau (etiennekasteel-phd@gmail.com)

All rights reserved. No part of this publication may be reproduced, stored in a retrieval system, or transmitted, in any form or by any means, electronic, mechanical, photocopying, recording or otherwise, without the prior written permission of the author.

An electronic version of this thesis is available at:  
<http://repository.tudelft.nl/>





# Contents

<b>Summary</b>	<b>v</b>
<b>Samenvatting</b>	<b>ix</b>
<b>1 Introduction</b>	<b>1</b>
1.1 Preliminary ship design . . . . .	2
1.2 Concept exploration . . . . .	6
1.3 Challenges faced during concept exploration . . . . .	6
1.3.1 The number and diversity of design options . . . . .	6
1.3.2 Difficulty of defining and trading design objectives . . . . .	7
1.3.3 Relating design and performance space . . . . .	9
1.4 Benefits of concept exploration . . . . .	12
1.5 Characteristics of conceptual ship design tools . . . . .	13
1.6 Objective and focus of the research . . . . .	14
1.7 Layout of the dissertation . . . . .	15
<b>2 A review of concept exploration methodology</b>	<b>17</b>
2.1 Sequential versus concurrent . . . . .	17
2.2 Populating the design space . . . . .	20
2.2.1 A combinatorial problem . . . . .	20
2.2.2 Systematic sampling . . . . .	20
2.2.3 Search algorithms . . . . .	21
2.3 Exploring and evaluating the results . . . . .	27
2.3.1 Data visualisation . . . . .	27
2.3.2 Gaining insight . . . . .	29
2.4 Selecting desirable design solutions . . . . .	30
2.5 Exploration process and integration . . . . .	31
2.5.1 Sequential integration . . . . .	31
2.5.2 Iterative and progressive integration . . . . .	32
2.6 Summary . . . . .	32
<b>3 Interactive evolutionary concept exploration</b>	<b>35</b>
3.1 A generic interactive evolutionary approach . . . . .	35
3.2 Define exploration inputs . . . . .	37
3.3 (Initial) preferences . . . . .	38
3.4 Generating and searching for solutions . . . . .	39

3.5	Exploring results and gaining insight . . . . .	41
3.6	Adjusting preferences and generating new solutions . . . . .	41
3.7	Selecting desired solutions . . . . .	42
3.8	Closure . . . . .	43
<b>4</b>	<b>Generating design solutions</b>	<b>45</b>
4.1	Packing-based ship synthesis model . . . . .	45
4.1.1	Packing-algorithm . . . . .	46
4.1.2	Estimate characteristics and performance . . . . .	47
4.1.3	Genetic search algorithm . . . . .	49
4.2	Improvements to Packing . . . . .	49
4.2.1	Chromosome representation . . . . .	49
4.2.2	Speed . . . . .	51
4.2.3	Varying design options . . . . .	52
4.2.4	Maintaining diversity . . . . .	54
4.3	Further limitations and discussion . . . . .	58
<b>5</b>	<b>Exploring solutions and gaining insight</b>	<b>61</b>
5.1	A review of exploration methods from literature . . . . .	62
5.2	Exploring results of the Packing-approach . . . . .	65
5.3	Exploring numerical characteristics . . . . .	66
5.3.1	Visualising numerical characteristics and criteria . . . . .	66
5.3.2	Exploring interactions and conflicts . . . . .	68
5.4	Exploring architectural characteristics . . . . .	72
5.4.1	Visualising architectural characteristics and criteria . . . . .	72
5.4.2	Exploring interactions between architectural aspects . . . . .	76
5.5	Linking numerical and architectural characteristics . . . . .	78
5.6	Discussion and closure . . . . .	79
<b>6</b>	<b>Guiding the exploration effort</b>	<b>83</b>
6.1	From design insight to controlled steering . . . . .	83
6.2	Steering methods . . . . .	84
6.2.1	Packing-rules (synthesis model constraints) . . . . .	84
6.2.2	Search algorithm constraints and objectives . . . . .	85
6.3	Issues with steering methods . . . . .	86
6.3.1	Packing-rules . . . . .	86
6.3.2	Search algorithm constraints . . . . .	88
6.3.3	Search algorithm objectives . . . . .	88
6.3.4	Summary of steering issues . . . . .	89
6.4	Objective-based steering . . . . .	90
6.5	Steering test-case . . . . .	92
6.5.1	Set-up . . . . .	93
6.5.2	Results . . . . .	94
6.5.3	Discussion . . . . .	97
6.6	Conclusions . . . . .	98

<b>7</b>	<b>Design test-cases</b>	<b>101</b>
7.1	Test-case goals . . . . .	101
7.2	Test-case subject . . . . .	102
7.3	MCMV packing model . . . . .	103
7.4	Case 1: Damage length . . . . .	104
7.4.1	Set-up . . . . .	105
7.4.2	Exploratory run . . . . .	106
7.4.3	First steering run . . . . .	106
7.4.4	Second steering run . . . . .	108
7.4.5	Third steering run . . . . .	110
7.4.6	Summary . . . . .	111
7.4.7	Reflection and discussion . . . . .	114
7.5	Case 2: Capability versus budget . . . . .	116
7.5.1	Set-up . . . . .	116
7.5.2	Test-case strategy . . . . .	116
7.5.3	Step 1: Exploratory runs . . . . .	120
7.5.4	Step 2.1: Individual design impact studies . . . . .	123
7.5.5	Step 2.2: Identifying relevant trade-off combinations . . . . .	132
7.5.6	Step 2.3: Focussing the search effort . . . . .	138
7.5.7	Step 3: Comparing the found trade-off options . . . . .	141
7.5.8	Summary . . . . .	147
7.5.9	Reflection and discussion . . . . .	148
7.6	Conclusions and discussion . . . . .	149
<b>8</b>	<b>Conclusions and recommendations</b>	<b>153</b>
8.1	Revisiting the problem . . . . .	153
8.2	The proposed approach . . . . .	155
8.3	Implementation of the approach . . . . .	156
8.4	Conclusions . . . . .	158
8.5	Contributions . . . . .	161
8.6	Future research . . . . .	162
<b>A</b>	<b>MCMV packing model</b>	<b>165</b>
<b>B</b>	<b>Test-case 2: Design impact studies</b>	<b>175</b>
<b>C</b>	<b>Acronyms</b>	<b>179</b>
	<b>References</b>	<b>181</b>
	<b>Acknowledgements</b>	<b>191</b>
	<b>Curriculum Vitae</b>	<b>193</b>
	<b>Publications</b>	<b>195</b>





# Summary

Preliminary ship design (or early stage design in US terminology) is the very first step in designing a new ship. In this stage ship designers attempt to find an affordable balance of the future owner's (customer or operator) ambitions and operational needs. This balance is then translated into more tangible design requirements. However, the search for such a balance and the accompanying design requirements is not a trivial task.

Ships, and service vessels in particular, are considered as some of the largest, most complex, moving man-made structures which often need to operate for extended periods of time in a hostile environment. Not surprisingly, the preliminary design of such ships is also inherently complex. The search for a balanced design solution benefits from early insight into the complex interrelations and interactions between the design requirements, the accompanying solutions, and their performances and cost. Insight which is often gained by generating and studying numerous design alternatives with varying requirements, performances, and costs, in a broad and investigatory phase of preliminary design called concept exploration. However, the complexity of ships and the design problem also challenge concept exploration.

First, generating numerous design alternatives (i.e., with different characteristics, performances, and costs) is a combinatorial problem of large dimensionality. Second, the identification of promising solutions requires the naval architect to express what it is that we are looking for (i.e., what solution characteristics are desirable, and how do these contribute to the overall performance). However, defining, quantifying, and balancing such figures of merit is a challenge of its own, and this was the reason to start concept exploration in the first place. Third, the complexity of ship design creates a disconnect between the design space and the solution and performance space. These two domains are linked through complex synthesis, hence the many interrelations between them are not easily elucidated.

As a result of the above challenges, exploration efforts are currently often limited to investigating only a few alternatives. Large and potentially more desirable areas of the design space are thus left un-explored. This limits the amount of insight that can be gained from the exploration effort.

The above challenges hinder thorough concept exploration and thereby the search for affordable and well-performing designs. Hence, this dissertation presents a novel, interactive, and evolutionary (progressive) concept exploration approach that is better able to generate and explore a large number of desirable designs. The approach re-uses gained insight to interactively adjust a set of criteria that are used to gradually steer the exploration effort towards more desirable design solutions.

The proposed interactive exploration approach has several anticipated benefits. First, there is no need for a well-defined a-priori definition of “what to look for” as this is gradually defined and refined during the exploration itself. Second, the focus of the exploration can be interactively adjusted based on new emerging knowledge. The naval architect may selectively “zoom-in” or “zoom-out” on specific sets of solutions. This should promote a broader exploration, covering more and more diverse solutions. Finally, the concurrent exploration of a large (and growing) set of diverse design solutions should provide the naval architect with a better understanding of the relations between the design space and the resulting solution and performance spaces. In addition, the ability to dynamically adjust the criteria used to steer the exploration allows the naval architect to quickly assess the effects of decisions made.

The approach is centred around a progressive search work-flow consisting of five main steps. First, the naval architect defines an initial set of criteria describing desirable characteristics of the sought after design solutions. Second, these criteria are used in a search algorithm and ship synthesis model to actively search for and generate design solutions “best” matching the criteria. Third, the generated designs are interactively explored in a dedicated post-processing tool. This tool is geared towards identifying insight into the often implicit relations between the applied criteria, the resulting design solutions, and their (performance) characteristics. Fourth, this gained insight is used by the naval architect to adjust and/or expand the initial set of criteria. Finally, this new set of criteria is used to select desirable design solution(s). If these are not identified by the naval architect, the exploration process is continued by using the new set of criteria to generate a new set of designs (step 2).

Three core elements were developed to implement the proposed interactive approach. First, an existing packing-based architectural ship synthesis model was altered to enable the generation of large sets of designs, covering a broad range of varying options. The following options may be varied: the hull including its type, shape, and dimensions; systems and spaces, including their number, type, and size; overall required performances such as speed and endurance; the crew size as a function of chosen systems; and the configuration and layout of systems and spaces within and on the ship’s hull. These variations allow the naval architect to explore a large number of ship characteristics using a single integrated synthesis model.

Second, an interactive data exploration tool was developed which allows naval architects to analyse the results of the packing-based ship synthesis model in detail. The tool is geared towards gaining insight into the complex and often implicit interactions and relations between the applied variations and criteria and the resulting solutions with their characteristics and performance. It allows designers to link criteria to solutions. That is, given a set of criteria, identify which design solutions and by what characteristics these are met, or vice-versa. The tool also aids in identifying *if* and *when* criteria might conflict (i.e., their combination does not give a feasible design solution). Dynamic filtering sets and interactive data brushing techniques allow a designer to study which criteria require changes to resolve a conflict and remain feasible. Moreover, each generated design is available as a 3D model that can be interrogated by the user. This proved valuable in identifying the underlying mechanisms of *why* conflicts occur.

Third, an objective-based feedback mechanism was developed which uses the (gradually) adjusted criteria to steer the ship synthesis model towards more and more

desirable design solutions. In each iteration of the progressive approach, the adjusted criteria are used to update the objective functions of the (genetic) search algorithm that is coupled with the synthesis model. These continuously updated objectives give incentive to design solutions which: (i) meet as many of the current criteria as possible, and (ii) almost meet the current criteria (e.g., this is implemented by adaptable fuzzy utility functions for each criterion). In addition, criteria for numerical design characteristics (e.g., speed, length, or centre of gravity) are separated from more architectural characteristics (e.g., relative or global system positions, or the number or type of a system) in two distinct objectives. Hence, the multi-objective formulation also gives incentive towards identifying solutions with a trade-off of architectural and numerical criteria.

The integrated interactive evolutionary concept exploration approach was applied in two test-cases. The first assessed the impact and interactions of a single design criterion (damage length) on the size and arrangement of a mine-countermeasures vessel (MCMV). The second applied the approach to a full concept exploration effort for a MCMV. These test-cases showed that the developed approach was indeed able to aid a designer to generate and identify desirable well-thought through design solutions and their associated criteria and characteristics. Moreover, the test-cases proved that insights gained during the process could directly be re-used to focus or alter the exploration's "direction". For example, in the second test-case, insight of high impact design variations was used to quickly identify an initial set of affordable yet diverse solutions. Subsequent iterations of the approach could then focus on each of these in more detail.

To summarise, the novel interactive evolutionary concept exploration approach presented in this thesis, allows a naval architect to generate and select designs based on insight gained during exploration. This allows the concept exploration effort to be interactively steered towards generating and investigating designs that are deemed promising and desirable. Contrary to methods that explore towards solutions matching a perceived goal, the presented approach helps the naval architect understand the decisions and path taken towards a gradually elucidated goal with accompanying solutions. Thereby increasing acceptance of the final solutions.



# Samenvatting

Het conceptontwerp is het eerste stadium in het ontwerpen van een nieuw te bouwen schip. Deze fase richt zich op het identificeren van een technisch haalbare en betaalbare balans van de operationele ambities van de toekomstige eigenaar van het schip. De balans van deze ambities kan dan worden vertaald naar operationele en technische eisen waaraan de oplossing zou moeten voldoen. Echter, het vinden van een balans tussen de operationele ambities van de klant, de resulterende ontwerp eisen, en de daaruit volgende oplossingen (met bijbehorende prestaties en kosten) is geen eenvoudige taak.

De zoektocht naar deze balans wordt bemoeilijkt door de complexiteit van het ontwerpprobleem. Schepen, en werkschepen in het bijzonder, worden vaak gezien als 's werelds grootste en meest complexe door de mens gemaakte bewegende en drijvende systemen. Bovendien opereren ze vaak voor langere periodes autonoom in een ruige werkomgeving. Het ontwerpen van een schip is dan ook een lastige opgave waarbij verschillende complexe systemen en hun randvoorwaarden, moeten worden geïntegreerd in een coherente oplossing die als geheel goed moet presteren. Dit maakt de relaties en interacties tussen de ontwerp-eisen en de oplossingen (en hun prestaties en kosten) vaak complex en impliciet. Dit bemoeilijkt het balanceren van de operationele ambities van de klant. Het vroegtijdig inzichtelijk maken van deze relaties en interacties is dus van grote waarde.

Inzicht over de relaties en interacties tussen eisen, oplossingen en hun prestaties en kosten, wordt meestal verkregen door het genereren en bestuderen van een groot aantal ontwerpen met variërende eigenschappen en prestaties. Deze divergerende studies, die plaats vinden tijdens het vroegtijdige ontwerpproces, noemt men conceptexploratie. Echter het genereren en vergelijken van een groot aantal diverse ontwerpen tijdens conceptexploratie wordt ook bemoeilijkt door de complexiteit van het schip en het ontwerpprobleem.

Allereerst, het vervullen van een taak of operatie met een schip kan vaak op meerdere manieren, met verschillende systemen, die op andere wijze zijn ingedeeld en geïntegreerd. De ontwerpruimte is dus groot en daarmee is het aantal oplossingen een combinatorisch probleem van de mogelijke interessante variaties.

Ten tweede, om een veelbelovend ontwerp te identificeren en selecteren nadat het is gecreëerd, moet er een uitspraak worden gedaan over welke eigenschappen wenselijk zijn. Dat wil zeggen, welke, en op wat voor wijze, eigenschappen en prestaties van een ontwerp bijdragen tot de algemene doelstelling. Echter, het definiëren, kwantificeren, en balanceren van de verschillende ontwerpdoelstellingen is een probleem op zich.

Ten derde, de complexiteit van het ontwerp van een schip zorgt voor een ontkop-

peling tussen de ontwerpruimte en de oplossingen met hun prestaties en kosten (wat volgt uit de integratie van verschillende combinaties van variabelen door middel van synthese). Dit bemoeilijkt de interpretatie van de vele onderlinge verbanden die bestaan tussen variabelen, oplossingen en hun prestaties en kosten.

De bovengenoemde problemen zorgen ervoor dat ontwerpers maar een klein deel van de mogelijke ontwerpruimte en dus ook ontwerpalternatieven en hun prestaties kunnen bekijken. Dit beperkt mogelijk de hoeveelheid inzichten die kunnen worden verkregen uit conceptexploratie wat nadelig is voor het identificeren van een technisch haalbare en betaalbare balans van operationele ambities.

Dit proefschrift presenteert daarom een nieuwe interactieve en stuurbare conceptexploratie methode. Met deze methode is de ontwerper in staat om tijdens conceptexploratie veelbelovende ontwerpen te genereren, identificeren, en selecteren, op basis van de inzichten die tijdens het proces worden verkregen. De methode gebruikt een dynamische set van criteria om het genereren van ontwerpen aan te sturen. Deze set van criteria wordt geleidelijk aangepast op basis van de verkregen inzichten uit de exploratie. Hierdoor kan de richting van de conceptexploratie interactief worden aangepast al naar gelang van wat er belangrijk wordt geacht door de ontwerper.

Dit biedt enkele voordelen. Allereerst, er is geen noodzaak om vooraf een uitspraak te doen over welke karakteristieken een veelbelovend ontwerp omvat. Dit wordt geleidelijk opgebouwd en verfijnd tijdens de exploratie op basis van nieuw verkregen inzichten. Ten tweede, de richting van de exploratie kan interactief worden aangepast. Een ontwerper kan dus naar eigen inzicht op delen van de ontwerp- en oplossingsruimte in- en uitzoomen. Er kan dus zowel breed als gericht worden gezocht naar potentiële oplossingen. Tenslotte, het gelijktijdig bestuderen van een grote (groeïende) set van diverse ontwerpen, die al dan niet voldoen aan een set van wisselende criteria, stelt de ontwerper in staat om inzicht te verkrijgen in de relaties tussen de gestelde criteria, de mogelijke oplossingen en hun eigenschappen. Bovendien, door criteria te wijzigen tijdens de exploratie, kan de invloed van deze wijziging op de beschikbare oplossingen en hun prestaties snel worden bekeken.

De ontwikkelde methode is gebaseerd op een geleidelijk zoekproces wat bestaat uit vijf geïntegreerde stappen. De ontwerper begint in stap 1 met het vaststellen van een initiële set van (verwachte) veelbelovende criteria. Deze criteria worden in stap 2 door een zoekalgoritme gekoppeld aan een ontwerpsynthese model om zo actief ontwerpen te genereren die zo goed mogelijk aansluiten met de gestelde criteria. De gegenereerde ontwerpen kunnen hierna in stap 3 door de ontwerper worden bestudeerd in een post-processing exploratie tool om zo inzicht te krijgen in de relaties tussen de gestelde criteria en de daaruit volgende ontwerp oplossingen en hun eigenschappen. Dit inzicht stelt de ontwerper vervolgens in staat om in stap 4 de criteria uit te breiden of aan te passen naar gelang de verdere richting van de exploratie. Deze hernieuwde set van criteria kan worden gebruikt in de laatste stap (5) om veelbelovende ontwerpen te selecteren of, indien deze nog niet gevonden zijn, om de exploratie verder aan te sturen door een nieuwe verzameling ontwerpen te genereren (zie stap 2).

De bovengenoemde stappen zijn geïntegreerd in een conceptexploratie tool die bestaat uit drie hoofd onderdelen: een ontwerpsynthese model, een post-processing data exploratie tool, en een terugkoppeling van criteria naar het zoekalgoritme en het ontwerpmodel.

Voor het genereren van ontwerpen wordt gebruik gemaakt van een bestaand op

“packing” problemen gebaseerd ontwerpsynthese model. Dit model is aangepast zodat het in staat is om een grote variëteit aan ontwerpen met verschillende systemen, indelingen en eigenschappen te genereren. Opties die kunnen worden gevarieerd zijn: het romp type, vorm en afmetingen; systemen en ruimtes die nodig zijn in het schip, inclusief hun aantal, type en afmetingen; de algemene vereiste prestaties van het schip zoals snelheid en bereik; de hoeveelheid bemanning die weer afhangt van de geplaatste systemen; en tenslotte de indeling en configuratie van de systemen en ruimtes in het schip. Deze variaties stellen de ontwerper in staat om een zeer brede ontwerpruimte af te vangen met één geïntegreerd ontwerpmodel.

Het tweede onderdeel is een post-processing data exploratie tool waarmee de gegenereerde ontwerpen en hun eigenschappen kunnen worden bestudeerd. De tool is specifiek gericht op het verkrijgen van inzicht in de complexe (vaak impliciete) interacties tussen de gemaakte ontwerpvarianties, de gestelde criteria, en de daaruit volgende oplossingen. Allereerst kunnen criteria gekoppeld worden aan oplossingen. Met een set van criteria kan een selectie van de mogelijk oplossingen worden gemaakt, of door eigenschappen van oplossingen te beschrijven kan een set van haalbare criteria worden geïdentificeerd. Ten tweede is het ook mogelijk om te onderzoeken *of* en *wanneer* de gestelde criteria in conflict zijn (er bestaan geen technisch haalbare oplossingen die aan alle criteria voldoen). Ten derde, door gebruik te maken van dynamische filters kan er snel worden gekeken welke criteria moeten worden aangepast in het geval van een conflict. Ten slotte, ieder ontwerp is beschikbaar als coherent 3D model (en dus niet alleen als een numerieke opsomming van eigenschappen). Dit stelt de ontwerper in staat om zijn scheepsbouwkundige kennis te gebruiken om te achterhalen *waarom* een conflict zich voordoet. Dat wil zeggen, uitzoeken hoe criteria zich uiten in de integratie van de verschillende systemen en eigenschappen van het schip.

Het laatste onderdeel van de methode bestaat uit een feedback mechanisme dat in staat is om de (aangepaste) criteria te hergebruiken voor het genereren van nieuwe en meer gewenste ontwerpen. Dit gebeurt door in iedere iteratie van het geleidelijke zoekproces de doelfuncties van het zoekalgoritme aan te passen op basis van de gestelde criteria. De doelfuncties geven voorkeur aan ontwerpen die aan alle, een deel van, of bijna voldoen aan de gestelde criteria. Zo wordt er actief gezocht naar ontwerpen die voldoen aan de criteria, of indien dit niet mogelijk is, naar mogelijke compromissen. Dit bevordert op zijn beurt weer het bestuderen van de haalbaarheid van de criteria en daarmee het inzicht in de relaties tussen criteria, ontwerp oplossingen en hun eigenschappen.

De geïntegreerde conceptexploratie tool is toegepast in twee testcases. De eerste bekeek de impact van een eis gesteld aan de schadelengte op de afmetingen en globale indeling van een mijnenbestrijdingsvaartuig. De tweede casus bekeek de exploratie van een grote ontwerpruimte voor een toekomstig mijnenbestrijdingsvaartuig. Beide cases lieten zien dat de ontwikkelde methode in staat is om de ontwerper de ondersteunen in het genereren en selecteren van gewenste ontwerp oplossingen tijdens conceptexploratie. Het geleidelijk aanpassen van criteria op basis van nieuwe inzichten zorgt hierbij voor een goed doordacht en beter geaccepteerd eindresultaat. Bovendien liet de tweede testcase zien dat inzicht over “design drivers” direct kon worden (her)gebruikt om enkele betaalbare alternatieve oplossingen te selecteren. De ontwerper kon vervolgens de exploratie richting elk van deze alternatieven sturen om zo meer zekerheid over de eigenschappen en gestelde criteria van deze ontwerpen te



verkrijgen.

Samengevat, de gepresenteerde interactieve en stuurbare conceptexploratie methode stelt de ontwerper in staat om ontwerpen te genereren en selecteren door gebruik te maken van inzicht verkregen tijdens de exploratie. De exploratie kan zo geleidelijk richting veelbelovende en meer gewenste ontwerp oplossingen worden gestuurd, zonder een vooraf geformuleerde uitspraak over de wenselijke eigenschappen van een mogelijke oplossing. De methode onderscheidt zich door niet te exploreren naar oplossingen voor een gegeven doelstelling, maar door geleidelijk te exploreren richting de gewenste doelstelling en de daarbij behorende oplossingen. Dit proces bevordert bovendien de acceptatie van de uiteindelijke oplossing.

# Chapter 1

## Introduction

*“We apprehend that it is the object of our labours, as it is of science, to endeavour to produce the best effects with given means.”*

---

– Chatham Committee of Naval Architects (1842)

The epigraph above summarises what should be the core business of *naval architecture*. When designing a new vessel the ship designer supports the customer in identifying a suitable balance between the required need and the available budget (i.e., in search of a cost-effective design solution). However, searching for and describing such balance is a far from trivial task.

Ships, and service vessels in particular, are often pertained as the largest and most complex moving man-made structures that must operate autonomously in some of the harshest environments known to mankind (Andrews, 1998). Not surprisingly, the design of a ship is an inherently equally complex process involving many different engineering disciplines.

Naval architects often take an integrating and coordinating role in the design process, attempting to combine the efforts of all different engineering disciplines and project stakeholders into a coherent and cost-effective design solution. A task which may benefit from timely insight into the interrelationships of customer needs, the accompanying requirements, and matching design solutions, to support early decision making. Insight which may be gained by iteratively creating and comparing concept designs covering a range of varying needs and thus also varying design requirements. This process is known as *concept exploration*, a difficult undertaking which takes place during a design phase termed as *preliminary ship design* (or *early stage design* in US terminology).

However, due to the complex nature of ship design, and the complexity of a ship itself, the task of concept exploration can be troubled by several issues. Among these are possible issues regarding: an ill-defined problem definition, the large degree of preliminary design freedom and hence increased problem dimensionality, and the intricate interrelations between design aspects due to the complexity of the ship itself. These issues possibly limit the extent of exploration efforts, and hence may also limit the amount of insight that can be gained. This may force designers and stakeholders

to make ill-considered decisions which may cause problems down-stream in the design process.

The goal of this dissertation is to develop and demonstrate the benefits of an interactive evolutionary design approach to concept exploration. By progressively reusing gained insight from exploration, this approach should allow designers to gradually focus the exploration effort towards more desirable design solutions. Hence an initially ill-defined problem is gradually re-defined during the exploration. Also, the ability to re-focus the exploration effort during the process should help overcome the dimensionality issues. Lastly, interactive exploration should provide a means of identifying and understanding the intricate relationships between design requirements and the resulting solutions. This insight then provides a rational and informed, rather than intuitive, basis for making large and defining decisions regarding these relations at an early stage.

However, before such a novel approach can be developed, there is a need to understand the nature of complex ships, preliminary ship design, and concept exploration, in more detail. This will illustrate both the importance and challenges of concept exploration in ship design and it forms the basis and motivation for this work.

## 1.1 Preliminary ship design

Before describing the nature of *preliminary design*, it is worthwhile to consider this phase's position in the design process. Many references describe and discuss the ship design process in detail (e.g., Brown, 1991; Andrews, 1994; Erikstad, 1999). Although the terminology often varies amongst references, most describe three main consecutive design phases which take place before construction:

1. *Preliminary design*. The earliest and initial phase of design where a balance between customer ambitions (needs), available budget, and possible solutions is sought. The above references characterise this phase as *investigatory* and initially *diverging* as to consider a broad number of solutions matching varying levels of customer ambition. It is undertaken by the customer (i.e., future owner, vessel operator) often with support by (in-house) ship designers. The results of the initial investigatory studies are then used to focus towards and select one or several potential solutions which are then worked out in more detail. Finally, it is the customer who chooses which of these well thought through solution is selected for the next phase.
2. *Contract design*. A single design solution is worked out in sufficient detail to describe a contract and determine a contracted price. This phase is mostly undertaken by, or in close co-operation with, a shipyard who assesses producibility and cost.
3. *Detailed (engineering) design*. This phase involves the translation of the contract design towards a design definition suitable for production. It involves the generation of detailed engineering and production drawings. Often, this phase overlaps with the construction of the vessel itself which may start well before the last engineering drawings are completed.

As mentioned, it is in the preliminary phase where a balance between the customer's ambitions (needs) and the available budget must be found, and where possible cost-effective design solutions need to be identified. To do so, the naval architect first attempts to define and then translate the customer's ambitions into a set of design requirements which provide a more tangible description of the to-be-designed ship. These requirements often need to be traded off so that, when they are integrated, they produce a technically feasible, operationally effective, and affordable solution. However, finding such a balance between ambitions and budget, and trading off requirements so that they produce technically balanced solutions, is an involved, labour-intensive, and difficult task. This can be attributed to the complexity associated with both the product (a ship) and the process (preliminary ship design).

Ships, and service vessels in particular, are complex, multi-functional and mostly one-off designs (Figure 1.1). Service vessels perform multiple tasks in varying conditions by making use of their specialised systems and sub-systems. For example: floating production storage and offloading units (FPSOs) will use their complex on-deck facilities to separate hydrocarbons and their mooring systems to remain on station even in harsh conditions; naval ships use sensor and weapon systems for various military operations; and heavy-lift vessels use cranes for lifting large and heavy cargo, both on and off-shore. Service vessels also operate autonomously for, depending on their tasks, considerable periods of time. Hence, these vessels often have larger accommodation spaces with additional support systems compared to conventional cargo vessels, which further adds to the design's complexity (Pawling, 2007).

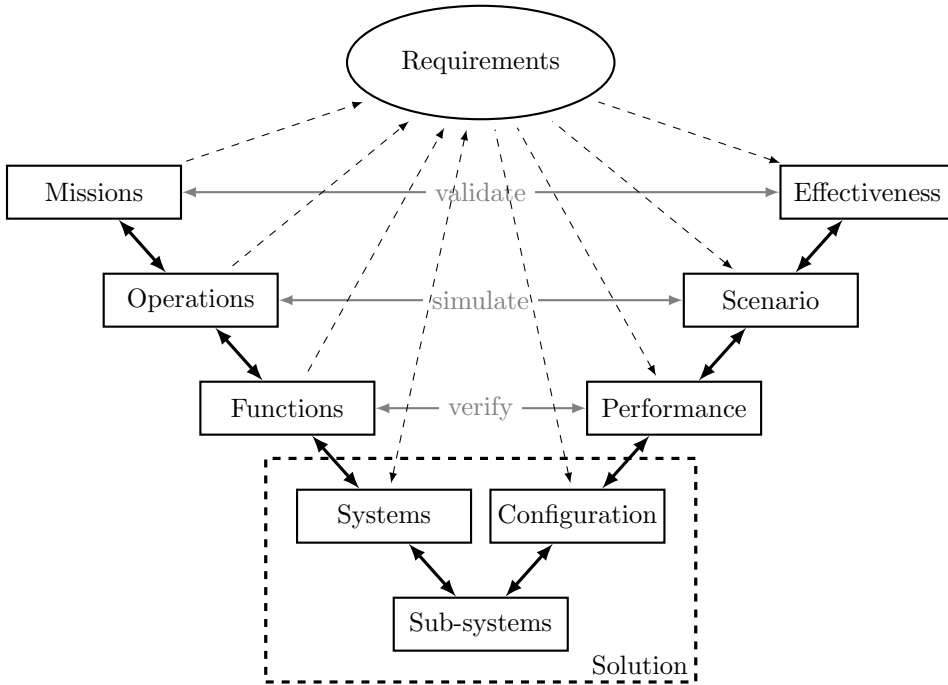


**Figure 1.1:** Two complex multi-functional service vessels: the heavy-lift crane vessel *Aegir* (left) and the Joint Logistics Support Ship HNLMS *Karel Doorman* refuelling the frigate HNLMS *Tromp* (right).

Not surprisingly, the complexity of a ship itself adds to the difficulty of identifying technically feasible solutions, which in turn complicates the search for a balance between customer ambitions and budget. Identifying “what” this balance actually should be, poses a large challenge in itself. The following characteristics illustrate why (Andrews, 1998; Erikstad, 1999; Pawling, 2007; van Oers, 2011b,a; DeNucci, 2012; Gillespie, 2012):

- *Ill-defined.* One could argue that meeting the customer ambitions and budget is a clear goal of design. Nevertheless, the initial description of the customer's ambition are often incomplete, vague, qualitative, and conflicting. There is no

clear and definitive problem formulation that, when followed, will result in a single “right” solution for the customer. This led Andrews (2003) to categorise the preliminary design problem as a *wicked problem*, a particular form of ill-defined and ill-structured problem which has no clear goal, no stopping criteria, and has no clearly definable “right” answer (Rittel and Webber, 1973; Simon, 1973; Dorst, 2003). As such, defining and understanding the problem itself, is a challenge on its own.



**Figure 1.2:** System engineering V diagram including the role of requirements, adapted from (van Oers, 2011b)

- *Dimensionality.* Identifying a balance of the customer’s ambition (needs) creates a problem of high dimensionality. This can be illustrated with the system engineering “V” diagram which is used as a tool by designers when decomposing the needs into more tangible design requirements, accompanying design solutions, and sub-solutions (e.g., systems, components, and configurations). An example of such an engineering “V” diagram is given in Figure 1.2.

At the highest level of the V diagram, finding a balance between the desired missions, their effect, and the budget is the main goal. However, a mission can be performed with different operational concepts. Similarly, different functions may perform equal operations, and different system solutions can be used to execute a function. For example, mine-hunting can be performed with a manned concept in which case a RHIB and divers can be used, or an unmanned concept in which case remotely operated vehicles (ROVs) may be used. Hence, when decomposing from missions down to systems (and sub-systems or components),

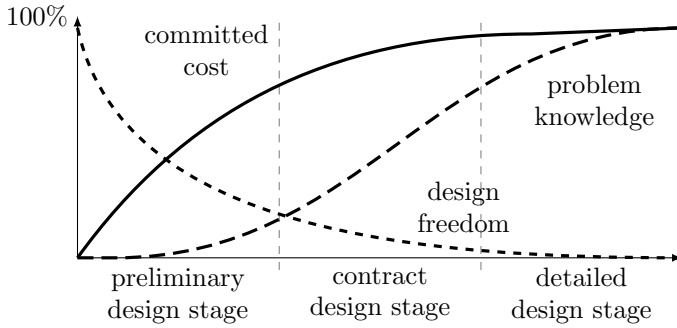
with the associated requirements, each step may introduce new variations.

This large degree of freedom at multiple levels of the design definition quickly results in a combinatorial explosion of the possible design solutions which potentially fulfil a good balance at the highest level (i.e., missions and effectiveness). Nonetheless, generating and comparing a large number of diverse design solutions provides beneficial insights which can aid in identifying such a balance.

- *Interactions.* There are many complex dependencies and interrelations between requirements which follow from the need to have a technically feasible design. That is, any design should at least obey the rules of physics, the basic principles of naval architecture, and comply with the required rules and regulations, in order to be considered as technically feasible. Hence not all combinations of requirements are possible. For example, they may conflict (e.g., high speed *and* low cost) or even turn out to be technically infeasible, or operationally useless. This indicates that requirements cannot be studied independently and are subject to changes when more (detailed) information about their interactions and their operational, technical, and cost impacts becomes available. Therefore, preliminary design calls for iterative approaches where changes to requirements and the resulting effects are assessed in various cycles. This allows designers to investigate their mutual influences, their effect on the solutions and their feasibility, and hence also how they might be changed when trade-offs are required.

Figure 1.3 adapted from Mavris and DeLaurentis (2000) illustrates the importance and influence of the preliminary design stage. Although, initially the problem knowledge is still low (e.g., the amount of detailed information available, or the level of understanding interactions of requirements), it is in the early stages where most large and defining design decisions are made. This quickly reduces the remaining freedom to adapt the design and locks in a large amount of the cost. Hence, premature decisions are likely to cause large design changes and thus may cause large cost overruns in later stages when it turns out things need to change. Several references have produced similar figures for different engineering fields (e.g., see Blanchard et al., 1990; Andrews et al., 1996; Nordin, 2014).

In the context of (preliminary) ship design Figure 1.3 does miss some relevant information. Specifically, not shown are the effects caused by major decision moments or the effects of the applied design approaches and processes. Especially during the preliminary stage, major defining decisions will cause drops in the design freedom curve, and until the next decision is made design freedom is expected to remain roughly equal. Transitions from one stage to the next will likely also cause drops in design freedom as often different approaches (and design tools) are used in each stage. Also missing is the level of definition used in each stage, which is linked to the adopted design approach. Generally, the level of definition increases from one stage to the other roughly inversely to the level of design freedom available. For example, a more detailed definition is often regarded as less flexible as it may limit making major changes to the design given finite time and resources (Andrews and Dicks, 1997; Pawling, 2007; van Oers, 2011b). In summary, although Figure 1.3 emphasizes the importance of preliminary design, the shape of its curves may differ depending on the stage and adopted design approach. Nonetheless, in support of early decision making, an increased problem knowledge is considered advantageous.



**Figure 1.3:** A generic design timeline, after (Mavris and DeLaurentis, 2000)

The preliminary design process is fed with information and insights from supporting design studies, which are used to assess the feasibility, performance, and cost of the changing requirements and accompanying solutions. The insights into the complex interrelations of requirements and the design are generally gained by iteratively creating and studying numerous concepts covering a broad range of possible options. A task which is commonly referred to as *concept exploration*.

## 1.2 Concept exploration

*Concept exploration* or *design space exploration* are terms used to describe the broad and diverging studies which support the task of finding a well-balanced set of design options and accompanying design requirements. Once integrated, these should result in the design solution the customer actually wants and needs.

Typically, during exploration designers perform a series of “what-if” scenarios to help understand the lay and limits of the design and performance space, thereby potentially revealing areas where a good balance between required performance and cost may be expected. In general, this is achieved by making systematic variations to design options and performance requirements while assessing the effect of these variations on the design and performance space (Devanathan and Ramani, 2010).

Unfortunately, there are several difficulties and challenges which currently limit the possibility of performing large and thorough concept exploration studies during the preliminary design of complex ships. These are covered first, as they form the main motivation of this dissertation. They are further discussed in Chapter 2.

## 1.3 Challenges faced during concept exploration

### 1.3.1 The number and diversity of design options

As mentioned earlier, there are many design “options” that are considered and varied during exploration. These variations follow from a higher level perturbation of the missions, operational concepts, and functions (see Figure 1.2). Down the road, this requires variations in (sub) solutions. Not only do all these variations contribute to

an increased problem dimensionality, they also require additional time to solve and evaluate. Moreover, the large diversity of the varied options can also be problematic. Methods and tools used for concept exploration must cope with this increased variety and dimensionality.

Some examples of options which are typically varied are:

- *Ship performance levels.* Variations of required whole ship performance levels which should be met by the developed solutions. Examples are, changes to required (transit) speed, range on fuel, or mission endurance. These variations follow from a higher level perturbation of operational concepts and the associated operational requirements.
- *Hull.* Variations of type, shape, and main dimensions of the hull. Different hull types and sizes can allow other general arrangements of systems and spaces. Hull shape and size also influence performance aspects, such as, calm-water resistance, motions, and added resistance in waves.
- *Systems.* Variations in type, size, and number of systems that are used to accomplish functions. Moreover, by varying systems the functional capability and performance of the design solutions can be changed. This allows the investigation of trade-offs between systems and capability.
- *Configuration and arrangement.* Integration of the above options into a coherent solution including a preliminary general arrangement of the main systems and spaces.

To assess overall ship characteristics and performance (e.g., cost, resistance and propulsion, or seakeeping and motions), these varying design options must be integrated, through synthesis, into coherent concept solutions. Only then can the performance of the integrated design solutions be compared to the required functions and desired missions. Given the number of design options under considerations, this quickly results in a combinatorial explosion of the number of possible design solutions which all need to be assessed.

Generally, designers may resort to simplifying the design problem by quickly limiting and decreasing the number of options under consideration. Yet, this directly opposes the basis of thorough and preliminary concept exploration. That is, to cover a large and diverse set of design options and thereby identify potentially unexpected, yet promising, solutions while gaining insight into the problem.

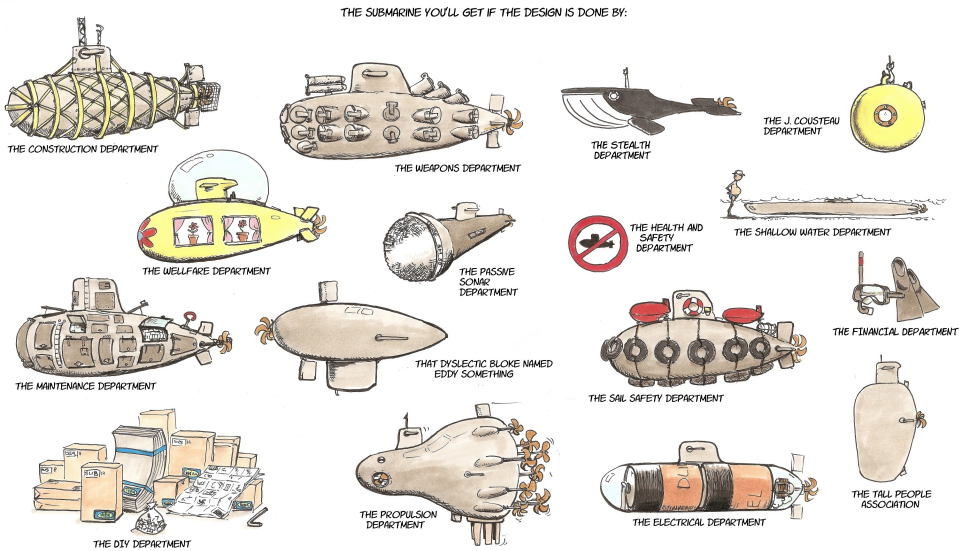
### 1.3.2 Difficulty of defining and trading design objectives

Buonanno (2005) argues that one difficulty of concept exploration is the definition of relevant figures of merit, that is, the design objectives and goals. However, the challenge lies not only in defining the objectives. Even if it is possible to define a clear set of relevant objectives, then they must still be traded among each other to describe and arrive at the “best” solution satisfying all individual objectives at their appropriate levels of performance. However, in the context of ship design, this is not a trivial task.

First, as mentioned in Section 1.1 many characteristics of a ship interact and conflict, making them difficult to combine into an overall goal. For example, a vessel



with a high required speed *and* long range will likely have a low payload capacity, while a ship with a large payload capacity *and* long range will have a lower speed. So, even if it is determined that speed, range, and payload are the individual design goals, their combined goal is not easily determined, as it requires a trade-off (i.e., *what* are acceptable levels for each individual objective). This concept of multiple (often conflicting) design objectives is easily explained through a classical illustration (Figure 1.4). Defining *how* to trade all these conflicting objectives (and their required levels) such that their combination defines a desirable design solution, is a challenge.



**Figure 1.4:** Submarine design for different “objectives”, courtesy of Commander Boomstra (RNLN)

In addition, many performance indicators cannot easily be calculated. The operational performance of a frigate, for instance, depends on many aspects, such as: the (future) mission scenario; the number and type of weapon systems; the sensor capability; crew size and readiness; environmental conditions; and so on. Hence, the evaluation of performance measures often requires complex calculations and simulations to analyse even simple operational scenarios (e.g., see Decraene et al., 2010; McKeown, 2012; Kaymal, 2013). Moreover, even when these performance figures are obtained, it is still a challenge to evaluate the combined “added value” of those figures (Brown, 1987). For example, consider the added value of a day of patrolling of a coastguard cutter? In this case, simply considering the best merits as an objective is clearly infeasible. This is something which is particularly relevant when assessing the effectiveness of a naval ship concepts.

Also, some objectives or criteria are not easily quantified, that is, they may be based on subjective evaluation of “softer” characteristics. Aesthetics is a prime example. For example, Roach and Meier (1979) discuss the role of aesthetics in Cold War warship design. Also, DeNucci (2012) showed that designer preference and even company policies can play a large role in the design of ships and their general ar-

rangements.

Andrews (2007) refers to such “softer” aspects of ship design as *style*, which differ from the more traditional, and also more easily quantified, characteristics such as: stability, speed (resistance and propulsion), seakeeping, and strength (structures). Nonetheless, style aspects are not only typified as unquantifiable information. Pawling et al. (2013, 2014) argue that style aspects are also characterised by their cross-cutting nature. That is, they have many interactions with, and therefore also influence, multiple other design aspects. Examples are; warship survivability, arrangement configuration (layout), and manning. For more examples refer to Pawling et al. (2013, 2014) who extensively discuss the role and use of style in the preliminary design process.

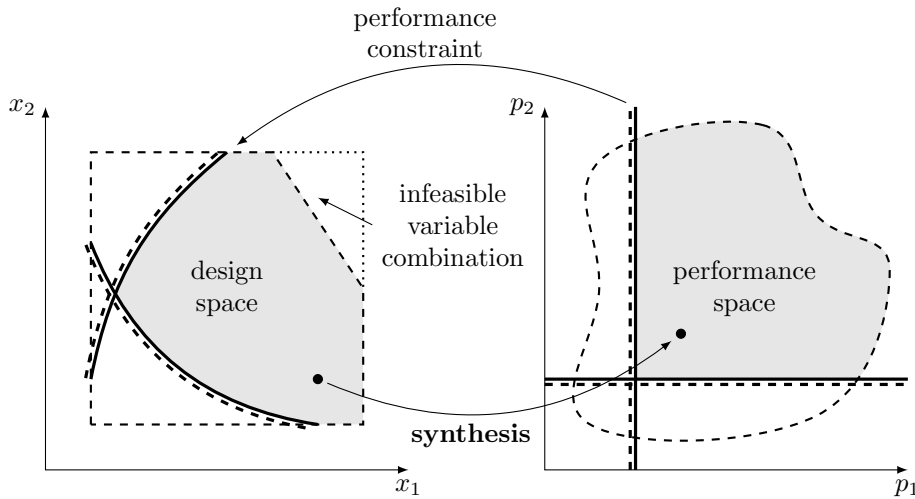
To summarise, the complexity of a ship, and of ship design, implies that it is difficult to define a single objective which when followed gives the “best” design solution. Decisions regarding the choice and trade-offs of relevant objectives are influenced by many factors (e.g., economical, environmental, political, policies, or simply designer preference). Therefore, it is highly unlikely that solutions are reproducible at other times, or with different decision makers. Hence, final design solutions of this complex “wicked” problem are compared and assessed as “better” or “worse” and not as “optimal” or “best” (Rittel and Webber, 1973; Simon, 1973). So, assessing alternatives in concept exploration at the very least gives the opportunity to compare multiple options. Thereby, allowing stakeholders to consider solutions deemed most desirable that were created within the bounds of finite resources.

### 1.3.3 Relating design and performance space

The variables which can be altered by the naval architect generate a multi-dimensional *design space*. Each design variable has a certain limit or range within which it can vary either in discrete steps (e.g., type of hull shape or number of helicopters) or continuously (e.g., length, beam, draft). A combination of variables *through synthesis*, produces a design with measurable performance attributes (e.g., speed, range, stability, etc.) which gives a resulting multi-dimensional *performance space*. An essential goal of concept exploration is to determine the useful and feasible limits of these design and performance spaces as well as the underlying relations between these two domains which determine these limits.

The design space, however, is not only constricted by the limits of each design variable. First, not all combinations of variables will produce a technically feasible design solution. Where technically feasible refers to a design which floats upright and adheres to other basic laws of physics and principles of naval architecture. This blocks some combinations of variables from the potential design space. Second, even when such a technically feasible design solution can be found, additional requirements on performance can still render a combination of design variables as unwanted. For example, some solutions may fall outside of the budget while others, although technically feasible, do not meet specific motion and acceleration criteria. Hence, the design space is also cut off by performance constraints.

The above relations can be visually illustrated in a simple theoretical example of a 2D design and performance space (Figure 1.5). Each potential combination of variables in the design space is mapped through design synthesis to a location in the performance space. Also, the variable limits and constraints directly influence the



**Figure 1.5:** Complex interactions between design and performance space, after (Devanathan and Ramani, 2010)

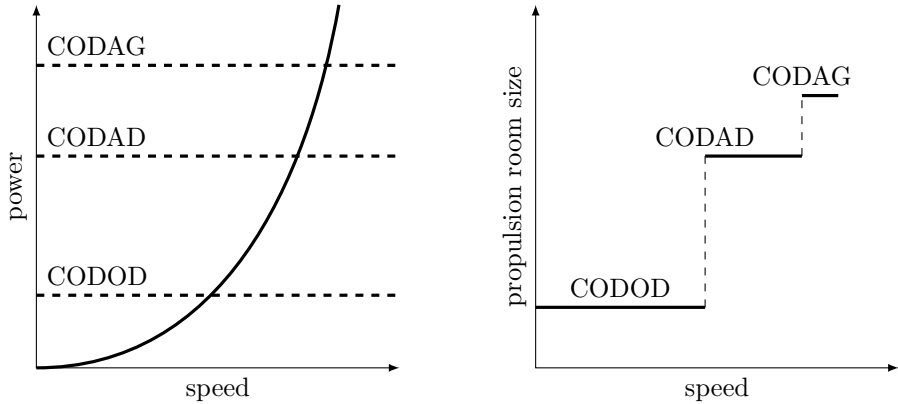
shape and size of both the design and performance space.

Understanding the relations between input (design options and variables) and output (solutions and associated performance) is further complicated by the many discrete variables used in the preliminary ship design. For example: the number of engines, type of propulsion plant configuration, the number of decks, or the type of sensor system, are all discrete choices. Hence, although resistance generally has a smooth and continuous response as a function of ship main dimensions and speed<sup>1</sup>, the selection of a suitable propulsion plant is discrete. Engine sizes, and their combinations into a suitable propulsion concept, come at discrete intervals, which in turn causes discontinuous behaviour in other parts of the design, for example, the sizing of propulsion rooms or auxiliary machinery rooms (Figure 1.6).

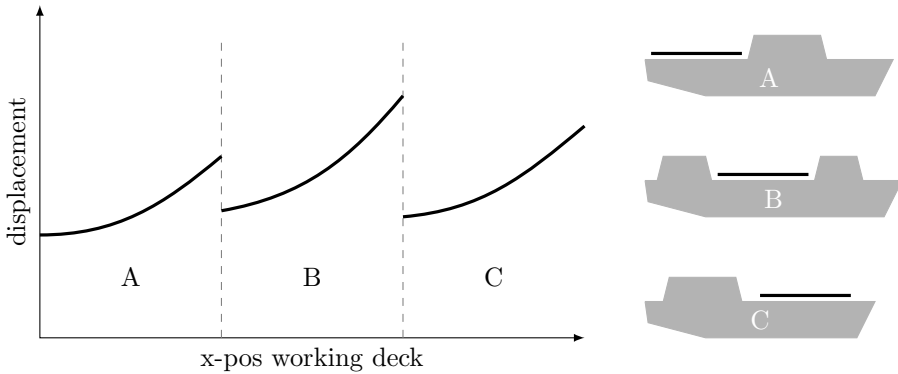
More complicated is the discontinuous response behaviour caused by changes to the design which result from continuous input variables. For example, Figure 1.7 illustrates the response behaviour of ship displacement as a result of changing the longitudinal position of the working deck (i.e., note this is a continuous input variable). In this example, moving the working deck forward, first changes the top-deck layout to a split superstructure configuration. While moving it further forward will change the configuration to a forward working deck layout. Hence, though locally the response of displacement can be considered smooth and continuous, the abrupt changes in layout cause large and distinct jumps in main dimensions and displacement. The challenge lies in identifying when these jumps occur, something which cannot easily be predicted without evaluating many working deck positions.

Also, many calculations in design synthesis are iterative (e.g., space, weight, volume and power balances). These calculation often rely on an iterative process to converge towards a technically feasible solution. Hence, when this convergence is

<sup>1</sup>This is true for a single given hull type, if the hull type is allowed to vary, then the response of resistance will become non-smooth due to discrete jumps when the hull type changes.



**Figure 1.6:** Discrete choice of propulsion plant configuration at different speeds, resulting in discrete propulsion room sizes



**Figure 1.7:** Discrete and continuous response of ship displacement caused by a large change in top-deck layout due to a continuous change of working deck position

not perfect and consistent for every design concept, a noisy and non-smooth response behaviour emerges (Buonanno, 2005). For example, computational fluid dynamics (CFD) calculations at different ship speeds may have different convergence rates, which creates a non-smooth resistance versus speed curve.

The discrete and noisy nature of input variables and especially the response behaviour of outputs as explained above, poses problems for analytical techniques that can aid designers in understanding the complex behaviour between the design and performance space. For example: fast *gradient-based optimisation* techniques, *response surface methodology* (RSM), and *gradient-based sensitivity analysis*, all of which rely on a relatively smooth and continuous model behaviour to work properly and with benefit. Fitting more complex discrete or discontinuous responses is possible, but requires specialised techniques which often rely heavily on a-priori knowledge of the expected response behaviour (see Meckesheimer et al., 2001; Nixon, 2006; Natrella, 2013).

Several of the earlier mentioned model behaviour issues could be overcome by using purely numerical geometric design models. These models often use continuous functions to relate input and output variables (e.g., space and weight) and thereby size the ship accordingly. Some examples of such models are presented and/or applied in (Reed, 1976; Hyde and Andrews, 1992; Stepanchick and Brown, 2007; Perra et al., 2012). Nonetheless, assuming that continuous functions can capture the full nature of early stage ship design (e.g., especially considering the impact of general arrangements and architectural issues as explained above) can result in larger model errors and uncertainty. This may cause sub-optimal overall solutions resulting in designs which, once the design process evolves, turn out to be infeasible once initial simplifications are worked out in more detail.

For example, often in these models the general arrangement of the vessel is taken into account by applying a baseline concept (i.e., from which the numerical space and weight relations were originally derived). Changes to the general arrangement naturally influence these derived relations causing the found design to become infeasible, or less optimal, as they no longer have the required available space to fit the adapted arrangement (e.g., see Purton et al., 2015). The illustrated problems limit the applicability of numerical geometric models in preliminary ship design as they have difficulty in covering large changes to general arrangements (Andrews, 2003; van Oers, 2011b).

In reality, the number of variables and constraints (e.g., requirements or rules and regulations) far exceeds the simple example of Figure 1.5. This, combined with the many discrete variables and non-smooth response, limits the ability to easily relate the design and performance spaces. In summary, both covering and exploring the limits and relations between the multi-dimensional design and performance spaces is a difficult task.

## 1.4 Benefits of concept exploration

The previous section elaborated on the major difficulties associated with large concept exploration studies. However, if done properly, there are several key benefits of exploration that can aid designers, project stakeholders, and decision makers (van der Nat, 1999; Andrews, 2003; van Oers, 2011a):

- First, concept exploration can provide a broad overview of the design and solution space fitting different balances of customer needs and budget (Section 1.3). This allows decision makers to quickly filter-out design solutions and associated requirements that lie out-of-reach (e.g., from a technical, cost, and/or operational perspective). Or, if these solutions and requirements are really desirable, it gives naval architects an opportunity to trade-off other options in an informed dialogue with project stakeholders.
- Second, concept exploration should allow decision makers to shift their effort towards design aspects that are of real importance and not those (traditionally) thought of as important. That is, focus must be put on those aspects which, from exploration, have been identified as important design drivers for the design project, in terms of technical feasibility, performance, and cost.

- Third, though difficult in itself, concept exploration has the potential to help identify the complex interactions and relations between the design space and resulting solutions and performance space (1.3.3). This insight provides the naval architect with the necessary understanding as to *why* and *how* the combined design requirements result in a certain solution with associated performance, again in terms of technical feasibility, performance, and cost.

Ultimately, the above provides the naval architect with a better understanding of the lay of the design landscape. That is, knowledge of the complex interrelations between the many design aspects and *why* and *how* they together result in the performance and cost of the integrated design. This, in turn, gives decision makers an informed basis for making trade-offs in the search of a solution which balances customer ambitions and their budget.

Given the challenges of concept exploration in the preliminary design of complex ships presented in Section 1.3, three key issues, which currently limit the benefits of concept exploration, are identified that must be addressed. These are:

1. To successfully cover the extent of the possible design and performance space, one must generate and explore a broad range of varying design options (Section 1.3.1). This implies that, although the number of possible combinations of these options is extremely large, as many as possible should be considered. Thus, increasing the chance of finding unexpected solutions and allowing the naval architect to create a more detailed picture of the interrelations between the design and performance space (Section 1.3.3). The ability to generate and explore a larger and broader set of options is therefore relevant to all challenges of Section 1.3.
2. The ability to identify the complex interrelations between the design variables, resulting solutions, (required) performance, and their cost, must be improved (Section 1.3.3). This insight is needed to decide on the balance of design objectives. This includes decisions regarding which aspects drive performance and cost, and trade-off decisions for those aspects which conflict. The ability to identify this type of insight helps the designer tackle the specific issue of defining the design goals (Section 1.3.2). That is, “what is it we are actually looking for?”
3. In addition, addressing the above issues provides a direction in which to focus further concept exploration. That is, once it has been identified “what it is we are looking for,” further attention can be focused to this specific part of the design space. Though this does not primarily reduce the number of design options under consideration, it does allow the designer to shift the exploration effort from uninteresting options towards the identified as more relevant options.

## 1.5 Characteristics of conceptual ship design tools

The dynamic and exploratory nature of preliminary ship design and the task of “requirements elucidation” led Andrews (2011) to draw up a set of desirable characteristics of conceptual ship design tools. Characteristics, which according to Andrews,

tools should strive to meet if they are to truly aid designers in the early stages of design. These characteristics are:

- *Believable solutions*, that is, generated solutions should be technically feasible and sufficiently descriptive (e.g., they must obey the laws of physics, the basic principles of naval architecture, and the necessary rules and regulations).
- *Coherent solutions*, that is, a tool should produce more than a solely numerical description of performance and cost (e.g., a 3D visual representation of the solution).
- *Open and responsive methods*, that is, the opposite of a “black-box” or rigid decision systems. Tools and methods should respond to those issues that are deemed important to the stakeholders.
- *Revelatory insights*, that is, identifying likely design drivers early on to aid the concept exploration process.
- *Creative approach*, that is, encouraging radical “out-of-the-box” solutions and a wide design exploration to push requirement elucidation boundaries.

This list directly relates to the specific challenges and goals of concept exploration Section 1.3 and 1.4. A diverse set of design options must be integrated into technically feasible and coherent solutions that are sufficiently descriptive so they provide insight into the true design objective, while still maintaining a broad perspective. Hence, tools should aid designers and stakeholders in answering the question: “what is actually wanted?” These desired tool characteristics are used throughout this dissertation; both as a means of evaluating current methods from literature, as well as for the development of the proposed approach.

## 1.6 Objective and focus of the research

The research presented in this dissertation aims at improving the task of concept exploration during the preliminary design of complex ships. It does so, by improving the actual process of concept exploration models. That is, design options must be integrated into coherent ship designs to evaluate their performance and cost. Assessing a large number of designs provides insights into the interrelations between the input (design options) and output (design solutions, performance and cost). Insights which in turn should be used to steer the exploration process.

Given the challenges, benefits, and improvements to the process of concept exploration elaborated in the previous sections, the main research question of this dissertation is defined as:

*How to generate and select the “right” design(s) using insight gained during concept exploration?*

The specific terms used in the research question are defined as follows:

- *The right design(s)*, refer to the designs that the customer and stakeholders actually want. That is, designs that have a desirable balance of operational performance (needs) for a given budget while safeguarding technical feasibility (e.g., a cost-effective design).

- *Insight*, refers to understanding *how* the design and performance space relate, that is, how and why the input (e.g., design options, requirements, preferences, and constraints) and the output (e.g., design solutions, performance, and cost) interact.
- *Generate*, refers to applying insight to ensure that *the right design* is actually generated during concept exploration (i.e., it actually exists).
- *Select*, refers to the confirmation, through selection based on the current insights gained, that indeed the right design exists and that it is found to be desirable. These selected design(s) can then be used for further, possibly more detailed, analysis in later stages of the design process.

Though it is considered to be an essential part of any concept exploration effort, this research does not attempt to develop a new type of ship synthesis model. Rather, the focus is on *how* to best *use* and *integrate* a ship synthesis model as part of the concept exploration process during preliminary ship design.

The scope of the research is also further limited by the following choices:

- Focus on naval architecture related performance (e.g., speed, range, and cost). Operational performance, though it forms an essential role in finding a truly balanced design solutions (Section 1.1), is not taken into account numerically (e.g., through the use of operational simulation models). However, the developed approach should allow such numbers to be included if available.
- The approach is applied, through test-cases, to the design of naval ships. Though these ships form a particularly challenging and unique preliminary design problem (Andrews and Dicks, 1997), the design of other complex ships (e.g., yachts, offshore support vessels, drilling ships, or pipe-laying vessels) should benefit similarly from the developed approach.
- A functional decomposition of the design problem is assumed to be available (e.g., see Wolf, 2000; Klein Woud and Stapersma, 2002). Hence, a selection of viable and interesting design options (e.g., different systems, sub-systems, and required performance levels) is available which, when integrated, should provide specified functional capabilities. Naturally, depending on the variability of the design options chosen, the resulting design's capability can be at different levels of performance (e.g., two main guns of a different calibre can cover the same capability at varying level of performance). Even so, in theory new insights acquired during concept exploration can uncover the need for new capabilities and thus design options.

## 1.7 Layout of the dissertation

This dissertation first explores the nature of complex ships and the preliminary design of such vessels. The challenges this poses for concept exploration are then analysed (Chapter 1). Next, a review of current literature on various approaches to concept exploration of different engineering design fields is made to assess their applicability in the challenging context of preliminary ship design (Chapter 2).



The problem analysis and literature review were used as input to develop a theoretical work-flow of an interactive and progressive concept exploration approach (Chapter 3). The key steps of this work-flow were then addressed separately and developed as proof-of-concepts to assess their individual workings. Next, the individual proof-of-concepts were further developed and combined into a prototype concept exploration tool based on the work-flow of Figure 3.2 (Chapters 4, 5, and 6).

The final interactive and evolutionary concept exploration tool is used in two design test-cases to demonstrate its ability to assist a designer in uncovering essential preliminary insights that aid in the search of a technically feasible and affordable design solution (Chapter 7). Finally, conclusions regarding the benefits of the developed approach to ship design are drawn and several recommendations for future work are discussed in Chapter 8.

# Chapter 2

## A review of concept exploration methodology

*“You cannot have everything. If you attempt it, you will lose everything. On a given tonnage there cannot be the highest speed, and the heaviest battery, and the thickest armour, and the longest coal endurance.”*

---

– Alfred Mahan (1911, p. 44)

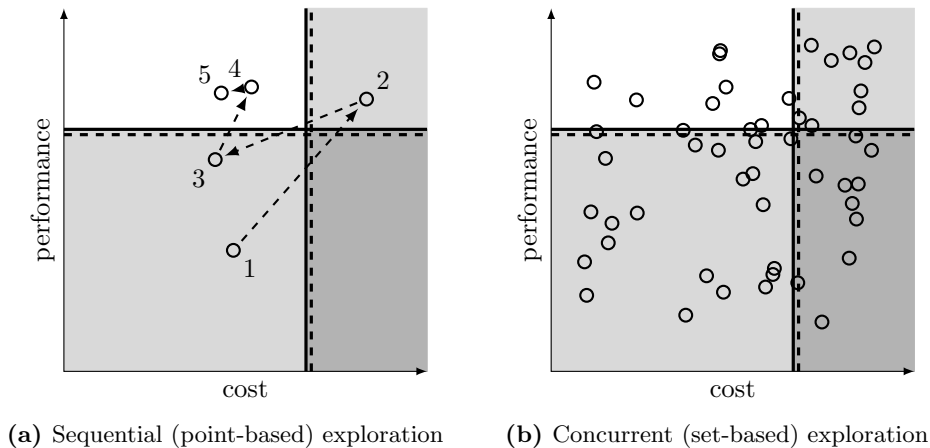
Chapter 1 focussed on the main challenges and potential benefits of large and thorough concept exploration studies in the preliminary design of complex ships. This chapter provides a more in-depth and detailed overview of concept exploration methodology. It covers relevant methods from literature which attempt to overcome the challenges presented in Chapter 1 and thereby improve the concept exploration process in ship design and other engineering design fields. Finally, based on the results of the literature analysis the outline for a novel interactive concept exploration approach is introduced.

### 2.1 Sequential versus concurrent

When studying various references, two main approaches to performing concept exploration can be distinguished. The first is *sequential* (or *point-based*) exploration, and the second is *concurrent* (or *set-based*) exploration (e.g., see van der Nat, 1999; Buonanno, 2005; Stepanchick and Brown, 2007; Pawling, 2007; Strock and Brown, 2008; Singer et al., 2009; Lamerton et al., 2010; van Oers, 2011a). In the exploration of ship designs, sequential exploration follows the concept of the traditional design spiral. A single design is manually developed and altered in several iterations until a suitable balance of desired design properties is achieved (Figure 2.1a). At each iteration the lessons learned are used to decide on the next actions and decisions to make. However, the number and diversity of options considered during preliminary design pose a problem for this method.

Though various numerical approaches and tools have been developed to aid manual preliminary design<sup>1</sup>, generating and balancing a single design solution, both technically and operationally, still requires considerable effort (Pawling, 2007; van Oers, 2011b). Consequently, only one or several combinations of design options can be investigated at an early stage. This leaves large and potentially high performance areas of the design space unexplored. In addition, the final result of sequential exploration relies heavily on the chosen starting point (baseline or parent design) and experience of the naval architect. Moreover, sequentially making changes to a single parent design can result in distorted final solutions (van Oers, 2011a). In this case it is often best to start-over and incorporate lessons learned into a new vastly different solution. For example, during the preliminary design of the second RNLN landing platform dock ship, the HNLMS *Johan de Witt*, lessons learned from several design iterations were used to start a final new “clean-sheet” design concept, which allowed the designers to step away from decisions restricting the first iterations (Hopman, J.J. personal communication, December 2, 2015).

In concurrent (or set-based) concept exploration a large number of design solutions are generated, in parallel, with computerised ship synthesis models. These models allow naval architects to automatically integrate a large number of different options into a set of design alternatives (Figure 2.1b). In comparison to sequential exploration, this large set of designs provides a much broader overview of a the potential solutions space.



**Figure 2.1:** Two main approaches to concept exploration

Nonetheless, as the ship synthesis models used in a concurrent approach must deal with large numbers of designs, they often have less detail per design in comparison to tools used for sequential exploration. This lack of detail in the synthesis model is balanced by the larger number of designs covering more design variations of interest, thereby still allowing more knowledge to be extracted from the result. In later stages, a selection of these low-detail designs can be worked out in more detail to verify

<sup>1</sup>Examples are the Building Block Approach implemented in SURFCON (Andrews, 1984; Andrews and Dicks, 1997; Pawling, 2007) or GCD<sup>2</sup> (Takken, 2008)

whether their performance still holds.

Concurrent exploration has many additional benefits. First, a large set of designs covering a broader area of the design and performance space allows a designer to analyse trade-offs. For example, within a set of designs it is possible to study multiple solutions which have similar cost yet varying performance, or vice-versa (van Oers, 2011a; Zandstra et al., 2015). Second, unattainable performance and cost can be identified by exploring the extent of the design and performance space. This can indicate whether current design options are even able to meet the required need and budget, which in turn may aid in identifying possible improvements or other, unthought-of, options.

Numerous ship design studies have shown the potential benefits of a concurrent or set-based approach for early concept exploration. For example, Strock and Brown (2008) use the Advanced Ship and Submarine Evaluation Tool (ASSET) and a Simplified Ship Synthesis Model (SSSM) to study a broad range of propulsion plant concepts for a surface combatant. Wagner et al. (2010a) apply a packing-based ship synthesis model to explore the conceptual design of a deep-water drillship. McKenney et al. (2011) use a set-based design approach to explore design options for a mine-countermeasures vessel.

To summarise, advances in computational power and ship synthesis models have shifted concept exploration methods from point-based approaches, where only few design solutions can be generated and explored, to more automated concurrent approaches, where many solutions can be generated and assessed simultaneously. This allows designers to explore a greater set of varying design options covering a larger area of the potential design and performance space. Thus, aiding the search for a balanced solution which best matches customer needs within a given budget.

The subsequent sections of this chapter cover concurrent concept exploration method in more detail. Various approaches to concurrent concept exploration from current literature are discussed to assess their benefits and applicability to the challenging field of preliminary ship design. In particular, the presented approaches are assessed based on the challenges covered in Chapter 1.

Generally, a concurrent exploration approach encompasses the following steps:

1. Generate a set of concept solutions covering varying design options to populate the design and performance space.
2. Explore and analyse the set of generated concept designs to identify which combinations of design options result, when integrated, in good “performers” (i.e., gaining problem insight).
3. Select those solutions and their accompanying design options that suit the need (e.g., for further, more detailed, analysis).
4. The integration of the above steps into an exploration process.

An initial step is missing from the list above, that is, preparing the necessary prerequisites to perform an exploration study. It is not listed here as it depends highly on the specific problem context (see Chapter 3 for a discussion). For example, this step may involve the gathering of data and the choice and development of a synthesis model (i.e., which integrates variations of design options and variables into a design solution with associated performances).

The mentioned steps can be achieved in various ways: manually, by making

use of designer interaction; automatically, by using computer algorithms; or semi-automatically, by mixing computer algorithms with designer interaction. The following sections elaborate each step in more detail and discuss current methods and techniques available.

## 2.2 Populating the design space

The first step, generating a set of concept solutions, can be performed manually. For example, a designer can repeatedly use a manual synthesis tool to generate multiple concepts for different sets of design options (e.g., see Pawling, 2007). However, because of their ability to generate a much larger set of designs in a short time-frame, this section only presents (semi) automated ship synthesis models.

### 2.2.1 A combinatorial problem

The first problem, is to consider which design options (variables) should be combined and synthesised. That is, to assess if they produce feasible design solutions. Ideally, it would be best to try all possible combinations of design options covering the full design space. This approach is commonly referred to as a *brute-force*, *exhaustive* or *full factorial* search. However, for many complex engineering design problems these approaches are impractical. The dimensionality of these problems is extremely large and in theory can be considered as infinite due to the many continuous variables. Thus, even with a short evaluation time of a single combination of options, the time required to analyse *all* combinations of options is extremely long.

Nonetheless, the dimensionality issues of continuous variables could be solved by using variables with a fixed range at discrete intervals (e.g., vary length from  $50-100m$  in steps of  $2m$ ). Still, even with discrete interval steps, the problem dimensionality issues remain. Consider a problem with  $n$  variables which each have  $m$  different values. In this case the number of possible combinations is:

$$\mathcal{O}(m^n) \tag{2.1}$$

Hence, for a problem with 20 variables, each varied over 10 values, this amounts to  $10^{20}$  possible solution combinations. Even with an evaluation time of 1 second, this would still mean well over 13.7 billion years of computing time. Clearly, this makes brute-force approaches unsuitable for complex high dimensional engineering design problems.

### 2.2.2 Systematic sampling

Simply attempting to generate all combinations of design options is not practical. A possible solution is to systematically generate designs for only a limited number of combinations of options such that they “best” cover the design and performance space. The goal is to maximise the amount of information that can be obtained for a limited number of generated designs. Figuring out which combinations of options to run is called a *design of experiments* or DOE. For example, refer to Natrella (2013) for an introduction to design of experiments for engineering applications.

There are, however, some limitations to the application of design of experiments to complex engineering design problems. First, there is no guarantee that a combination of design options found using a DOE will produce a feasible solution. This is something which is particularly valid for the design of complex ships due to the delicate technical balances of weight, space, and power. Nonetheless, sequential sampling methods are available which are able to account for infeasible regions within the design space (see Nixon, 2006).

Second, the number of variables and their individual variations, depending on the synthesis model used, can still be extremely large. Early stage architectural ship synthesis models such as the packing-based model by van Oers (2011b), or space allocation based model by Nick (2008), use large numbers of continuous and discrete variables as well as constraints to define the variations of general arrangement. Moreover, the number of variations of variables regarding the general arrangement (architecture) of the vessel cannot easily be reduced. For example, the longitudinal position of a space or system may have a resolution step of  $1m$ . Increasing this step to limit the number of variations (e.g., towards  $5m$ ) can result in a large change in the models' behaviour (see Section 1.3.3). This problem limits the application of a DOE approach in combination with early stage architectural synthesis models.

Even so, systematic sampling using design of experiments is still a powerful tool. Especially when coupled with regression-based methods (e.g., response surface methodology) to create surrogate-models which represent the design and performance space (see Stepanchick and Brown, 2007). These surrogate models, which are relatively simple mathematical formulations, can then be interrogated at a far lesser computational cost compared to the original synthesis model. This allows many more design points to be sampled in the design and performance space. Khuri and Mukhopadhyay (2010) provide a historical overview of the field of response surface methodology over the last decades.

### 2.2.3 Search algorithms

Another approach to sampling the possible design space is to apply a *search algorithm*<sup>2</sup>. The idea of this approach is to actively seek combinations of design options giving a desired effect. This effect is represented in the form of an *objective function*. The selection of which design options to combine is left to the search algorithm that attempts to minimise (or maximise) the objective function.

Search algorithms are based on a variety of concepts. The two main concepts which are widely used within engineering design are: (i) *gradient-based*, or (ii) *heuristic-based* algorithms. To work properly, gradient-based algorithms require a continuous, smooth, and differentiable objective function. Gradient information is then used to determine the next step in the process, that is, a new combinations of design options to try. Heuristic approaches do not guarantee an "optimal" solution, yet for problems for which no efficient algorithms are mathematically possible, they can provide relatively good answers in a reasonable time-frame. There is, however, no guarantee that the final answer is the "best" solution.

---

<sup>2</sup>Search algorithms are more often referred to as *optimisation algorithms*, however, because concept exploration does not deal with optimising a single design, the term *search algorithm* is used in this dissertation.

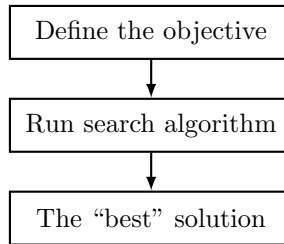
Gradient-based approaches have been successfully applied in various areas of ship design. Examples are: the optimisation of hull forms for hydrodynamic performance (Percival et al., 2001), or the optimisation of ship structures (Rigo, 2001). Some examples applying heuristic based methods are (e.g., Nick, 2008; Wagner et al., 2010a; van Bruinessen, 2010; van Oers, 2011b).

A key challenge when applying search algorithms, besides determining which type of algorithm to use, is how to define the objective function. That is, what is it the algorithm should actually be searching for, what are the main objectives? Unfortunately, defining what the main objectives are, is actually one of the goals of preliminary design and concept exploration (Section 1.3). Thus, setting up such algorithms for use in concurrent concept exploration is not a straightforward task.

Nonetheless, the initial design requirements, constraints, and designer/customer preferences can provide a starting point for determining the objectives of a search algorithm. Methods for combining and applying these multiple, often conflicting, types of information to search algorithms are threefold (Horn, 1996; Collette and Siarry, 2003; Kumar and Bauer, 2009): (i) *a-priori*, (ii) *a-posteriori*, (iii) *progressively* or *gradually*. Each method warrants some additional elaboration as they may provide the basis for a concept exploration approach.

### A-priori methods

A-priori methods attempt to combine multiple design objectives into a single overall objective function, which can then be used by a search algorithm to search for the single “best” solution (Figure 2.2).



**Figure 2.2:** The basic process of an a-priori search approach

As the term suggests, they rely on a-priori information about *which* objectives to combine and at *what* relative importance. For example, a-priori methods often use a system of weightings to represent the relative importance of each individual objective to the overall problem. One commonly used example is the weighted sum method, which is defined as follows:

$$F(x) = \sum_{i=1}^n w_i f_i(x) \quad (2.2)$$

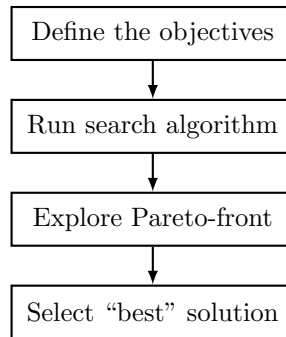
where  $w_i$  is the weight factor which represents the relative contribution of objective  $f_i$  to the overall aggregated objective  $F(x)$ .

Multi-criteria decision making techniques are often used to define the individual weightings of each objective based on stake-holder preferences (e.g., the *analytical*

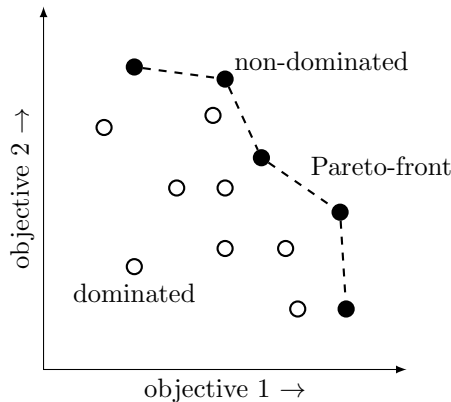
*hierarchy process* developed by Saaty, 1988). Still, the difficulties of determining a-priori *which* objectives should be used and combined (and at what level) remain.

### A-posteriori methods

While a-priori methods attempt to combine multiple design objectives, a-posteriori methods leave them separated. Instead, they attempt to find a set of non-dominated solutions, which represent a Pareto-front from which the decision makers can then choose the preferred solution (Figure 2.3 and 2.4). Hence, there is no need for *a-priori* information about the relative importance, or weighting, of the individual objectives. Even so, it is still necessary to define *which* objectives are to be used.



**Figure 2.3:** The basic process of an a-posteriori search approach



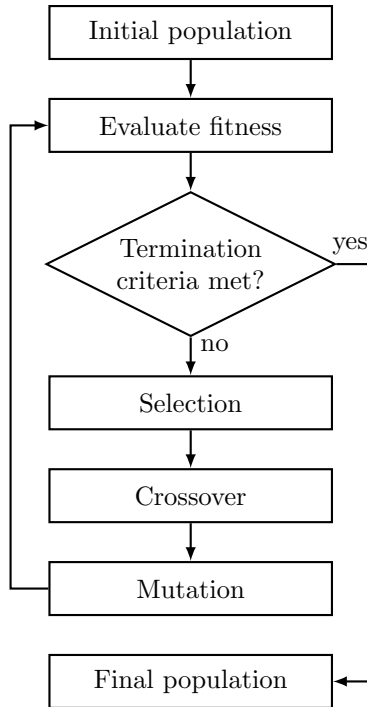
**Figure 2.4:** Concept of (non-)dominated solutions and the Pareto-front

A simple a-posteriori technique is to apply the a-priori methods (e.g., the weighted sum method) but systematically vary the individual weightings used in several runs. In this way it is possible to obtain a set of non-dominated solutions representing a Pareto-front. However, as illustrated by Das and Dennis (1997), it can be mathematically proven that this method will never find a well distributed Pareto-front in



non-convex situations. For example, it would not find and populate the middle of the Pareto-front in Figure 2.4 as this is a convex region.

Popular a-posteriori approaches apply multi-objective *genetic algorithms*. The basic principle of a genetic algorithm applies a process inspired by natural evolution and survival-of-the-fittest to gradually evolve and improve a set of solutions (Figure 2.5). Solutions with a better “fitness” rating are more likely to survive within the algorithm, thus making it more likely for them to pass-on their favourable properties to offspring. Since these algorithms work with sets of solutions, rather than trying to alter one solution, makes them well suited for a-posteriori approaches.



**Figure 2.5:** Scheme of a simple genetic search algorithm

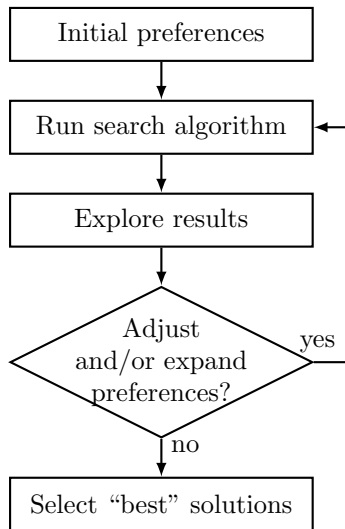
Two prime examples of multi-objective genetic algorithms are the Non-dominated Sorting Genetic Algorithm II (NSGA-II, Deb et al., 2002), and the Strength Pareto Evolutionary Algorithm 2 (SPEA2, Zitzler and Lothar, 1998). Both apply the concept of non-dominated solutions in an attempt to search for a well defined Pareto-front for a multi-objective problem.

Though a-posteriori methods do not require information regarding the relevant importance of objectives, they still require the user to a-priori define *which* objectives are to be used. Simply attempting a large number of objectives is impracticable and, as various studies have shown, even hampers with the performance of the algorithm to a point where it becomes comparable to random search methods (e.g., Deb, 2001; Köppen and Yoshida, 2007). This requires the user to apply engineering judgement when selecting which objectives to include in the search criteria, and in case new information or insight emerges, to re-run the algorithm to include this.

### Progressive (evolutionary) methods

Progressive methods combine principles from both a-priori and a-posteriori methods. Collette and Siarry (2003) refer to this method as, “...having a dialogue with the optimisation method so that we can make our preferences precise.” Where the term *preferences* can refer to the type and relative importance of the objective functions, constraints, variable bounds, or even a combination of the those three.

Essentially, a progressive method makes use of insight which the user or decision maker has gained during the search algorithm’s progress. Thus, it is possible to *steer* or *guide* the search process based on new information gained, by interacting with the search algorithm itself (Figure 2.6). In essence, manual sequential concept exploration is also a progressive method. But, instead of using a search algorithms, the designer decides on the next step in the search process, and then applies this step to a single design. In the progressive case, however, such a decision is used to generate multiple new designs.



**Figure 2.6:** The basic process of a progressive search approach

Progressive methods can make use of elements from both a-priori and a-posteriori approaches. For example, the weighted sum method may be used with gradually and interactively adjusted individual weightings of the objective functions. Alternatively, a-posteriori methods may be applied in which the number and/or definition of the multiple objectives are gradually and interactively expanded and/or adjusted.

When combined with evolutionary algorithms, progressive approaches become very flexible search tools which allow subjective user input, preferences, and engineering judgement to be included in the search process. This has opened up an entire field of optimisation methods referred to as *interactive evolutionary computation* (IEC). When genetic algorithms are used, progressive approaches are often referred to as *interactive genetic algorithms* (IGA).

Because progressive methods allow human interaction based on insights gained during the design exploration process, this has led to many applications in design

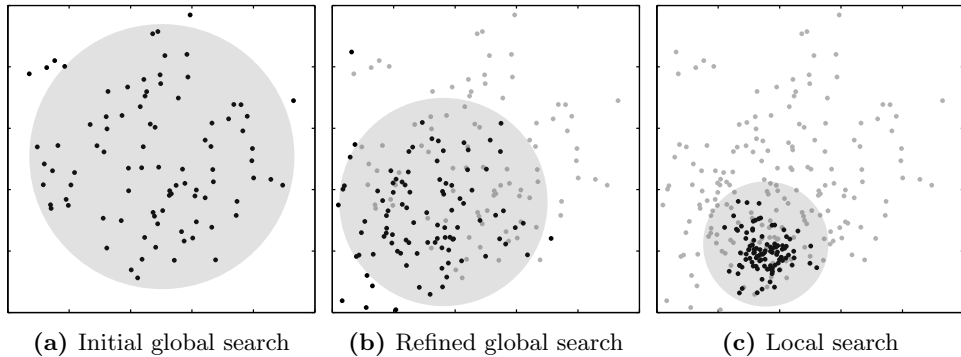
(Kim and Cho, 2000; Buonanno, 2005; Kim et al., 2006; Kumar and Bauer, 2009; Rafiq et al., 2006; Cluzel et al., 2012). Many applications benefit from the guidance provided through progressively adding engineering judgement and newly discovered insights in the concept exploration and search process. Some notable examples are:

- Buonanno (2005) uses a type of IGA to perform a concept exploration study for the design of a supersonic jet, using a combination of human evaluation and numerical optimisation to assess the “acceptance level” (e.g., an assessment of producibility based on engineering judgement) and performance of the found designs. This allowed him to ensure technical feasibility without over-constraining the problem.
- DeNucci et al. (2009) and DeNucci (2012) use a type of IGA to produce strange and “out-of-the-box” concept designs for a US Coast Guard cutter in an attempt to trigger naval architects to express implicit design rationales for the general arrangement of systems and spaces. He then uses the captured design rationale to force the underlying ship synthesis model to generate designs which are more likely to trigger the naval architect. He also showed that the captured rationales can be used within a search algorithm to actively search for general arrangement which include these design rationales.
- Singer et al. (2009) use a different approach, which they also call set-based design, to gradually evolve and balance requirements, constraints, and preferences, of the design. In this case “set-based” refers to sets which represent different aspects of the design (e.g., propulsion, hull form and hydrodynamics, or general arrangement). The approach, which finds its origin in the automotive and aerospace industry, intends to keep options for these individual aspects of the design open for as-long-as possible, thus allowing quick adaptation to changing requirements or new design insight. It also allows different design disciplines to work together to create a common set of designs by regularly reviewing and agreeing upon updating the variable bounds and requirements of their individual respective sub-sets.

Progressive methods are also shown to be advantageous in cases where the creative aspect of design is very relevant, an element which Andrews (2007, 2012) argues is key in the (preliminary) design of complex ships (e.g., Kim and Cho, 2000; Cho, 2002; Buonanno, 2005; Cluzel et al., 2012). Nonetheless, their current applications to ship design is limited. For example, DeNucci (2012) applied a progressive approach but primarily uses it to focus the extraction of general arrangement rationales. Further applications in other (engineering) design fields lack many properties which are relevant for ship design. For example, the human evaluation and interaction is limited to only one or two aspects of the problem such as, general appearance (Kim and Cho, 2000; Cluzel et al., 2012), or feasibility and “acceptance level” (Buonanno, 2005). Moreover, these aspects were determined as being important *a-priori* to creating the approaches, which means the adopted approaches could be specifically tailored to match that kind of preference information. Considering the challenges of Section 1.3, this is unwanted in an environment of ever changing goals.

To summarise, a progressive search process has a broad initial starting point after which, through human evaluation and feedback, subsequently more refined steps lead

the exploration effort towards those solutions which are deemed as relevant and best (Figure 2.7). Hence, they are in-line with the specific challenges of concept exploration in the preliminary design of ships mentioned in Section 1.3. Nonetheless, the success of a progressive approach relies heavily on the ability of a user to first gain, and then re-apply, insight and problem knowledge through adjusted and/or expanded preferences about the number, definition, and relative importance of the search objectives. Considering the nature of preliminary ship design and ship concept exploration as elaborated in Section 1.3, this is a difficult, yet novel, process.



**Figure 2.7:** Graphical representation of a type of progressive search process

## 2.3 Exploring and evaluating the results

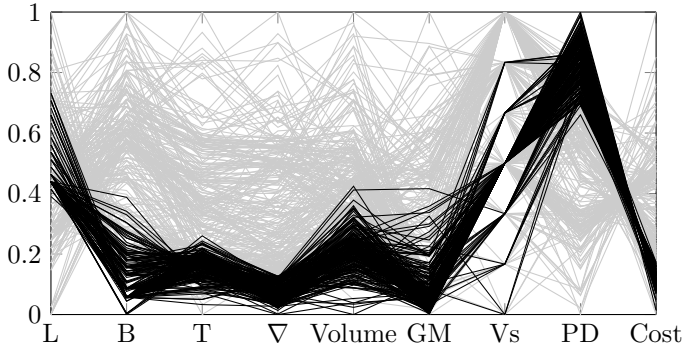
After designs have been generated, the next step in a generic concept exploration approach is to analyse the results. That is, exploration of the generated design and solution space to gain insight into the design problem. For example, insights into inter-relations between design variables or characteristics, identifying trends and clusters, and identifying the extent of achievable performance. These insights, in turn, provide the necessary understanding required to make decisions regarding the *true* design objectives and their relative importance. The task of this type of result data analysis is also known as *exploratory data analysis* or *data mining*.

### 2.3.1 Data visualisation

Data visualisation techniques play an important role in this exploration step. Again, the dimensionality of the ship design problem, coupled with the large number of continuous and discrete variables, makes visualising and interpreting concept exploration results a challenging and demanding task. Several multi-variate data visualisation methods, such as, scatter plot matrices (e.g., Carr et al., 1987), parallel coordinate plots (e.g., Inselberg, 1985), s-Pareto fronts (Mattson and Messac, 2003), have been developed to aid humans in performing this task.

Moreover, when coupled with user interaction, such as, interactive data brushing, or interactive user selection, multi-variate data visualisation is regarded as a powerful tool that aids in uncovering useful insights (Stump et al., 2004; van Oers et al., 2008;

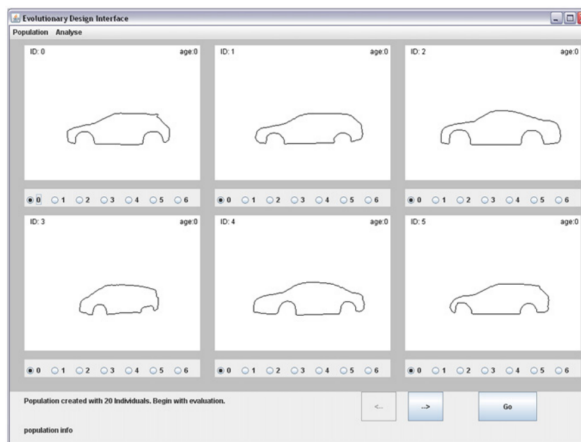
Gaspar et al., 2014). For example, see Figure 2.8 for a parallel coordinate plot with data brushing.



**Figure 2.8:** Parallel coordinate plot with data brushing ( $\nabla \leq 1300m^3$ )

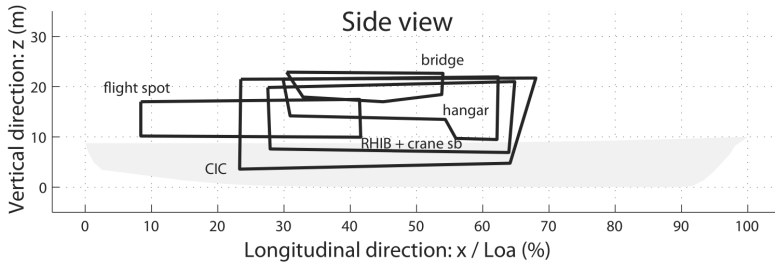
There are several notable examples of interactive data visualisation and exploration in current literature. For example, Stump et al. (2004, 2009) use different types of interactive visualisation techniques, such as, data brushing and filtering, to extract insights that aid decision-making within a generic interactive data exploration tool-set they call the Trade Space Visualiser (TSV).

Cluzel et al. (2012) take a different approach and rather than displaying numerical data use visualisation of the artefact itself to have people interactively evaluate the preference for a particular car shape (Figure 2.9), for example, how sporty it looks? This method is particularly suitable for assessing subjective measures of the design artefact as a whole, for example, aesthetics, overall form, or even “sportiness”. Another example of such an approach is presented by Kim and Cho (2000); Kim et al. (2006) who use a similar technique in fashion design.



**Figure 2.9:** Interactively exploring and evaluating a set of car silhouettes (Cluzel et al., 2012)

Nonetheless, when the to-be-rated artefact becomes more complex or contains more information (e.g., as it the case with the general arrangement of a ship, or even a part of the ship) simply presenting the arrangement and asking designer to evaluate it with a score of 0-10 is impractical. Hence, van Oers et al. (2008); van Oers (2011b) apply a different interactive and layered visualisation technique to exploring ship general arrangement designs. 2D scatter plots with user manipulation are used to sequentially down-select and filter ship designs with specific general arrangement aspects from a larger set (Figure 2.10).



**Figure 2.10:** Interactively down-selecting a ship general arrangement through preferred system positions (van Oers, 2011b)

### 2.3.2 Gaining insight

As argued in Section 1.3.3 a key objective of concept exploration is gaining an understanding of the complex relations between the design and performance space. Interactive data visualisation techniques, such as those introduced in the previous section, play an important role in this task. Insight is only gained when actually exploring, working with, or even “playing” with data, that is, it is not formed by it self and must be extracted and made explicit by a human (DeNucci, 2012).

Insights which are of particular importance and interest during early stage design are related to the interactions between the design requirements (e.g., what the customer wants performance wise) and between requirements and the resulting design solutions (e.g., what the customer can afford). As such, the following information is deemed essential in elucidating insights into these interactions (Duchateau et al., 2013, 2015; Pawling et al., 2013, 2014):

- *Linking* requirements (functional, operational, regulatory, or even designer preferences) to solutions, and vice-versa. That is, given a set of requirements what potential solutions will fit these, or given a specified solution what performance may be expected (and thus what requirements met). In addition, understanding the links and relations between requirements and solutions allows the designer to identify possible design drivers (e.g., linkages which may drive the cost, performance, or feasibility of solutions).
- Identify *if* and *when* requirements/criteria conflict. This provides feedback on the existence of trade-offs between requirements.

- Identify *how* these conflicts and trade-offs might be resolved or avoided. Decisions must be made on *which* requirements to change, and by *how much* in order to maintain a technically feasible, operationally effective, and affordable solution.
- Identify *why* a conflict exists, that is, to understand the underlying mechanisms causing the conflict so it may be avoided in the future.

Collectively, the above insights should aid the designer in understanding and elucidating the initial design requirements, thereby forming an informed understanding of the design problem at hand (e.g., perform “requirements elucidation” Andrews, 2003; Andrews et al., 2012). Hence, there is sufficient cause for improving the exploration of designs and accompanied data produced during concept exploration.

## 2.4 Selecting desirable design solutions

The final step in a generic concept exploration process is the task of selecting promising solutions. This step closely ties in with the first step (populating the design space) and the second step (exploring the design space). When, for example, search algorithms are used to populate the design space, then already the algorithm needs some indication of what a “desired” design solutions should look like (i.e., an objective). That same objective could then of course also be used to identify the “best” design from the final set. However, it was already extensively discussed that, in most cases, this objective cannot easily be defined (Section 1.3.2). Actually, it is the process of concept exploration itself which should aid a designer and provide insight into “what it is we are looking for?”

A possible solution to the above issue was presented, that is, instead of combining objectives, leave them separated. Then, a *set* of designs is sought in an attempt to maximise a *set* of objectives. Nonetheless, even if such a set is found, then the often conflicting objectives will cause a non-dominated Pareto-front of design solutions. From this non-dominated set, a user must then still select a suitable trade-off between the conflicting objectives (van Oers et al., 2008). Moreover, when additional information is added to the selection, e.g., in the form of a constraint or an additional objective, the original front will likely change shape or shift (i.e., as the original set will be further reduced by the constraint or different designs become non-dominated with respect to the new objective).

More recently, the use of “dashboards” has been presented (e.g., Perra et al., 2012). These decision support tools allow the user to interactively manipulate a selection of design characteristics and required performance measures in search of a balanced design. They often rely on fast underlying meta-models which represent the often complex and slow simulation and synthesis models used to estimate operational performance and effectiveness. Information from these meta-models is then linked using a value system combining measures of performance (MOP), measures of effectiveness (MOE) and design performance characteristics such as speed and range (e.g., Strock and Brown, 2008). The dashboard then allows decision makers to vary the required MOPs and MOEs while keeping track of required design characteristics, or vice-versa.

However, as discussed in Section 1.3.3, meta-models do not always capture the true response of synthesis or simulation models. An identified solution may therefore become infeasible once it is re-evaluated using the actual models used. In addition, the use of meta-models makes the underlying workings of the dashboard a “black box” for the user. The direct link between input and output is broken by the regression techniques used, limiting the ability of investigating the *why* of identified relations or balances (i.e., refer to Andrews’ list of desired characteristics of preliminary ship design tools in Section 1.5).

Progressive methods (Section 2.2.3) again seem a promising approach in the selection of a balanced set of options. They allow a designer to re-use and add gained insights to gradually define and alter selection criteria during the process. This is important because it gives the designer a gradually built-up picture of *how* a certain solution has become preferable through decisions made. This increases the *sense of acceptance* for the end result, which both van Oers (2011b) and Andrews (2011) discuss as an important aspect lacking in many automated methods. This does, however, require that some form of “decision trail” needs to be recorded which captures the selection process (DeNucci, 2012).

## 2.5 Exploration process and integration

Finally, the last step integrates the first three steps into an exploration process. These are:

1. Populating the design space (i.e., generating a set of solutions).
2. Exploring and evaluating solutions to gain insight into the design problem.
3. Selecting desirable (“best”) design solutions.

Depending on the approach adopted for each step, they can be combined and integrated in various ways. From studying the referenced literature in the previous sections, two different adopted exploration processes can be identified.

The first is a sequential execution of the three steps mentioned above with limited to no integrated feedback of lessons learned. This approach is applied when the generation of solutions is based on a-priori or a-posteriori methods (Section 2.2.3 and 2.2.3). The second is an iterative and progressive approach which allows integrated feedback to occur between the steps, this approach is applied when adapting progressive methods to generate solutions (Section 2.2.3). Both are described in more detail below.

### 2.5.1 Sequential integration

Sequential integration of the exploration steps is characterised by a lack of integral feedback of lessons learned and insight gained. Any information and insight gained during the exploration can be re-used, yet this requires a new execution of the search process, with a re-defined description of the search (optimisation) problem used, to populate the design space. That is, in case of an a-priori and a-posteriori approach the objective(s), constraints, and variable bounds are altered, and the entire process of Figure 2.2 and 2.3 must be repeated.

For example, consider the a-posteriori based exploration efforts using the Packing-approach by van Oers (2011b); Wagner et al. (2010b) and Zandstra et al. (2015). In



these studies, any gained insight into how to continue or alter the exploration effort resulted in the need to manually change the inputs, objectives, constraints, or even the design model itself, before re-generate a new set of design solutions hopefully more fitting the preferences of the user. Hence, although their adopted exploration process contained all three steps of this chapter, the exploration effort remained somewhat cumbersome because of the way these were integrated. This may unintentionally limit the extent in which the design space could be explored.

## 2.5.2 Iterative and progressive integration

An iterative and progressive integration of the three exploration steps follows the basic process as shown in Figure 2.6. First, based on initial preferences a set of design solutions is generated. Next, through exploration of these solutions the user may decide to adjust the original preferences, in which case these new preferences are used to generate new more desirable solutions. Hence, allowing the user to guide the exploration process based on integral feedback of insight gained and lessons learned.

Since the integration of the three steps (i.e., generation, exploration, and selection) are already an integral part of progressive search methods, the references of Section 2.2.3 have already shown how such integration with integral feedback of preferences benefits design exploration. However, they are quickly summarised here to illustrate which information was used as feedback to guide the exploration.

- Buonanno (2005) applies user feedback of preferences regarding the producibility of aircraft to steer design generation.
- DeNucci (2012) applies user feedback on rationales in ship general arrangements to promote the user exploration of arrangement options.
- Cluzel et al. (2012) apply user feedback of preferences regarding the general appearance and “sportiness” of car silhouettes to generate new solutions.
- Kim and Cho (2000) apply user feedback on the general appearance of fashion items to identify interesting combination of fashion items.

In summary, these references all use a progressive integration of the three basic steps of any exploration effort to allow integral feedback of new insight and information regarding the preferences defining the exploration’s focus.

## 2.6 Summary

Section 1.4 listed several beneficial aspects of thorough concept exploration studies. In addition, three main problems were elaborated that must be overcome to fully benefit from concept exploration in the search of technically feasible and cost-effective solutions in the preliminary design of ships (Section 1.4). These are briefly summarised here again:

1. The ability to explore a large and diverse set of design options. Options which are combined and integrated into technically feasible (basic naval architecture) and believable solutions through design synthesis.

2. The ability to identify the complex interrelations between design variables, resulting solutions, their (required) performance, and cost. Insight which aids when deciding on *what* a good balance between those design aspects should be.
3. The ability to (re)use gained insight to focus concept exploration effort on those design options and integrated solutions which are deemed of *real* interest, without the need to physically limit the number of options under consideration.

Both in the introduction and literature review, several relevant research efforts and methods have been discussed which attempt to resolve the above problems.

Much effort has been spent on advanced ship synthesis models which provide the ability to concurrently generate many solutions for the number and diversity of design options mentioned in Section 1.3.1 (e.g., Nick, 2008; van Oers, 2011b). As such, the first problem mentioned above has been partially solved. Nonetheless, the actual process of how such tools should be used in concept exploration warrants more attention. Especially considering the research question presented in Section 1.6: “How to generate and select the ‘right’ designs based on insight gained during concept exploration?” Solely generating a large number of possible solutions is clearly insufficient. Efficiently exploring those solutions in search of answer to the other problems presented above is considered to be equally important.

Within a generic concept exploration process four key steps were identified: (i) populating the design space, (ii) exploring and evaluating the results, (iii) selecting a balanced set of options, and (iv) the integration of the first steps into a exploration process. Much research effort has gone into these steps, as can be seen by the multitude of references covered in this Chapter. Yet, only progressive evolutionary methods truly combine the first three steps into one integrated exploration process where the benefits of human evaluation and decision making is married with the power of evolutionary search algorithms (step iv).

Nonetheless, as elaborated in Section 2.2.3 their applications to (preliminary) ship design are limited. The overall process of how such method is to be used in preliminary ship design warrants further attention. In addition, the underlying mechanisms of progressive approaches (e.g., visualisation of information, gaining insights, feedback of preferences) require further improvements and developments in order for them to be applied during preliminary ship design. Hence, a new type of interactive evolutionary exploration approach, better fitting the nature of preliminary ship design and ship concept exploration, is required and must be developed.



# Chapter 3

## Interactive evolutionary concept exploration

*“Design is an iterative process. The necessary number of iterations is one more than the number you have currently done. This is true at any point in time.”*

---

– David L. Akin

Chapter 1 has elaborated the importance, need, and challenges of thorough concept exploration in the preliminary design of complex ships in light of early “requirements elucidation” (Andrews, 2012). Chapter 2 reviewed several methods used for concept exploration in various (engineering) design fields. It concluded with the need for a new interactive and evolutionary (progressive) approach to early concept exploration in ship design as an answer to the challenges and questions presented both in Chapter 1 and 2.

This chapter outlines the process of the proposed interactive evolutionary approach. First, the key steps and elements of a generic approach are discussed. Then, each step is covered in more detail to assess the issues encountered when applying it to preliminary ship concept exploration. Next, the overall process, which has been adapted to the context of preliminary ship design, is presented. Chapter 4-6 then further develop and test the most important steps of the proposed approach. Finally, the full integrated approach is demonstrated using several test-cases in Chapter 7.

### 3.1 A generic interactive evolutionary approach

Figure 3.1 shows the generic process of an interactive progressive (evolutionary) concept exploration approach as proposed by Horn (1996) and by Kumar and Bauer (2009). This process comprises several steps:

0. Collect and define the problem inputs. Though this step is not mentioned by Horn (1996) and Kumar and Bauer (2009), input is required to start a progressive process. Depending on the problem under investigation, collecting

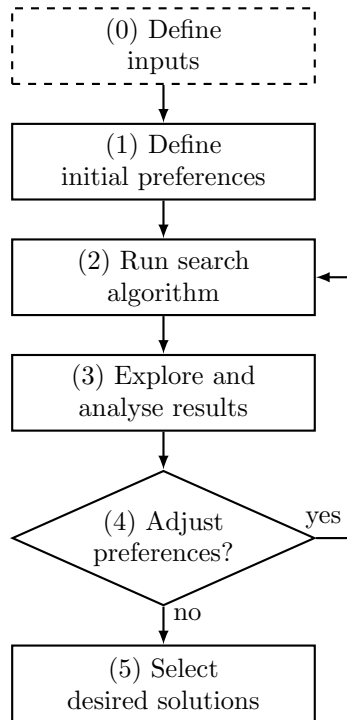
and defining this input is a considerable investment of time and resources. For example, defining a model suitable for use in the process (e.g., one that takes initial inputs and preferences, and produces results that can be assessed by the user) is not straightforward (see Chapter 4 and Appendix A).

1. First, the user describes a set of preferences which define the problem goal, that is, “what are we looking for?” Initially this set may be limited and based purely on past experiences. It can even be empty if no initial preferences are defined or known, in which case randomly generated solutions can provide a starting point.
2. Second, these initial preferences and criteria are used within a search algorithm to identify and generate an initial set of possible solutions. This is usually achieved by evaluating some form of (computer) model based on the initial inputs and preferences.
3. Third, the results of the search algorithm are explored by the user to evaluate *if* and *how* they meet the initially perceived preferences.
4. Fourth, the exploration step will most likely provide new knowledge and insights on the basis of which the initial set of preferences and criteria can be adjusted (i.e., re-evaluate our initial criteria). This new set is then re-used in the search algorithm to produce a new set of solutions matching the new problem goals.
5. If the resulting solution(s) are satisfactory, the iterative process can be stopped. Then the final desired solution(s) may be selected based on the progressively adjusted criteria and preferences and by applying the gained problem knowledge and insight.

The described steps are very much similar to a generic design (exploration) process in which there is a constant iterative process of *generate* → *analyse* → *evaluate* → *decide* (e.g., see Erikstad, 1999). Nonetheless, a key difference is that a computational search algorithm, with coupled synthesis model, takes over the *generate* step. This has several benefits:

1. The use of an automated design synthesis model allows the generation of many more design alternatives by reducing the effort traditionally required to manually create concept designs (van Oers, 2011b). Hence, more variations of design options may be assessed opening up a larger part of the potential design and performance space (see Section 1.3).
2. By reducing the effort required to produce concepts, the designer may focus more on the other design steps: *analyse*, *evaluate*, and *decide*, thereby increasing the potential of uncovering insights that aid in understanding the true design problem. This knowledge is essential for making informed trade-off decisions in search of a balanced design solution (see Section 1.3).

To take advantage of these benefits we must first address any issues encountered when applying an interactive progressive concept exploration approach to preliminary ship design. Hence, a more detailed explanation of each step of the generic process including the applicability to ship concept exploration is further elaborated in the remainder of this chapter.



**Figure 3.1:** The process of a generic interactive and progressive (evolutionary) search approach

## 3.2 Define exploration inputs

This step was not specifically mentioned in Section 2.1, however, before any exploration can take place, several elements are required as input. These include:

- *Design variations.* That is, variations which follow from design options under consideration. What is being varied follows the exploration problem itself. For example, in the case of Cluzel et al. (2012), who explore different car silhouettes, the variations represent changes to the silhouette shape. While for Buonanno (2005), the variations represent different sizes and types of aeroplane configuration options (including wing shapes, fuselage shapes, wing configurations, and engine number and configurations). Section 1.3.1 already discussed design variations in the context of preliminary ship design which often follow from a functional decomposition based on the needs of the customer (e.g., refer to Strock and Brown, 2008; van Oers, 2011b; Zandstra et al., 2015).
- *Synthesis model.* That is, a model which can integrate design variations into a technically feasible solution with associated performances. Again, depending on the exploration problem the synthesis model can be simple or very complex. For example, in the case of (Kim and Cho, 2000; Cluzel et al., 2012) the synthesis models are, due to the nature of the design problems, quite simple. While in

the case of (Buonanno, 2005; Strock and Brown, 2008; van Oers, 2011b) the complexity of the engineering design problems, coupled with the large degree of variations, already requires a complex synthesis model and performance measuring tools.

Clearly, depending on the exploration problem, defining and setting up the prerequisites for a concept exploration effort, are not trivial tasks. They can require considerable time and resources. For instance, the exploration effort for a mine-countermeasures vessel performed by Zandstra et al. (2015) took more than a year to set-up. Where, most time and resources was spent on defining relevant design variations and creating the design model to be used in the Packing-approach of van Oers (2011b).

### 3.3 (Initial) preferences

In the generic approach the term preferences relates to the expression of the problem goals and their interrelations, that is, the specific objectives and their relative importance. Preferences also represent trade-offs that are defined for conflicting goals. Several references (Kim and Cho, 2000; Buonanno, 2005; Cluzel et al., 2012) apply this concept and make use of user interaction to evolve preferences that are entirely of a subjective nature (e.g., aesthetics or trendiness) or which rely heavily on human (engineering) judgement (e.g., producibility).

In the context of preliminary ship design the generic characterisation of preferences is, however, insufficient. Consider the generic description of the (ship) design activity, that is, iteratively generate, analyse, evaluate, and decide. In this iterative cycle far more than solely the design goals and their relative importance (weightings) constantly evolve due to progressively gained knowledge. The list of varying design options of Section 1.3.1 provides a starting point for what the term *preferences* can encompass in the context of ship design. Hence, in this dissertation the following relevant characteristics are considered to be typified as preferences within a progressive approach:

- *Performance requirements*, that is, requirements regarding the performance of the system as a whole. Examples are: ship speed, range on fuel, endurance, and seakeeping characteristics. These are prone to vary due to the constantly evolving trade-offs of conflicting aspects (e.g., high speed versus seakeeping).
- *Technical (system) requirements* and *design options*, that is, specific (sub-) solutions (including their, size, shape, and number) for achieving a desired functionality (see Section 1.3.1). These include the hull, systems, and the configuration or layout of the vessel. For example, exploration might start with a slipway as the preferred solution option for the launch and recovery of a RHIB but, due to new insights into the large design impact of the slipway, davits may later be preferred. In addition, the preferred arrangement and layout of the systems and spaces may also change based on gained insight (DeNucci, 2012).
- *Constraints* and *bounds* of the design space. That is, the performance requirements, technical system requirements, and design options mentioned above may include bounds. For example, a hull-shape has an upper and lower limit to its

length, beam and depth, or might have limits to length/beam ratios. Also, the number of a type of system can be limited to a discrete amount (e.g., one or two cranes). New insight may result in the need to add or adjust such constraints and variable bounds.

Nonetheless, limiting the extent of the design space should only be undertaken once it is certain that no potential solutions are cut-off. For example, variable ranges might gradually be reduced once the designer is certain that their limits are not of interest. However, the opposite might also occur. Design exploration can also emphasize the need to enlarge variable ranges. This occurs when the exploration approaches the current limits of the design space. Hence, variable ranges must be extended to enlarge the design space into the general search direction.

The above illustrates that there are a multitude of characteristics which could be considered as preferences in the context of ship design. Because these characteristics represent more than solely the preferences of the user, hereafter the broader term of *criteria* is used to describe the evolving set of user controlled characteristics relevant in the early concept exploration stage.

In addition to the above, there are also characteristics which do not vary within the process. In theory any characteristic could be changed based on new insight (even the model itself), yet in practice many aspects are still fixed throughout the exploration. This may be due to limitations of the model used (see a discussion in Section 4.2.3) or simply due to a limited scope of the problem (e.g., see the test-cases in Chapter 7). A further discussion is provided in the Conclusions (Chapter 8).

### 3.4 Generating and searching for solutions

Within the generic process of a progressive search approach generating solutions refers to the task of integrating user preferences in an algorithm to search for and generate new design solutions. This implies the need for a synthesis model capable of creating and assessing solutions for relevant performance characteristics which are then used in a search algorithm to generate new solutions. As mentioned in Section 3.2, the synthesis model can be either simple or complex depending on the complexity of the design artefact.

In the context of this dissertation the ship synthesis model has several required abilities (e.g., also see Andrews' list of preliminary ship design tool characteristics in Section 1.5):

- *Architectural description*, that is, in addition to a numerical description of the vessel the synthesis model should also provide an architectural description including the general layout of systems and spaces in a 3D arrangement<sup>1</sup>. This is important because systems, their layout, and the overall general arrangement of the vessel, have a large influence on the design solution, its performance and the cost.
- *Diverse solutions*, that is, considering the many different design options that may be varied at an early stage (Section 1.3.1) the synthesis model should be

---

<sup>1</sup>Andrews (2011) refers to this as the need for coherent solutions (also see Section 1.5).



able to (i) integrate these varying options into believable and technically feasible solutions, and (ii) maintain a diverse set of solution options. A very similar set of solutions will only limit the extent of the exploration effort. Preferably, the synthesis model should also not be bounded by many traditional rules-of-thumb or other implicit constraints that may limit diversity and hence the broadness of the exploration (see Section 6.3).

- *Speed*, that is, the speed at which design solutions are generated should be fast. In a progressive search approach human interaction is focussed on the evaluation and exploration of a large set of solutions. The generation of these solutions is left up to an automated computer model. If the user has to wait for long periods between each iteration of the progressive approach (e.g., days), because a synthesis model is slow at generating design solutions, he or she will likely lose focus or fail to keep track of the decision steps in each consecutive iteration. Hence, to keep time between consecutive decision making steps short, the synthesis model should be able to quickly generate solutions without much human intervention. Hence, ideally a large set of varying design solutions should be available in hours.

In recent years the need for more detail earlier in the design process to support concept exploration, has led to the development of several novel architectural ship synthesis models, see Andrews et al. (2012) for a recent overview. These are: the *Design Building Block* (DBB) approach (Andrews, 1981; Pawling, 2007), the *Intelligent Ship Arrangement* (ISA) approach (Nick, 2008; Daniels and Parsons, 2008), and the *Packing-based* approach (van Oers et al., 2009; van Oers, 2011b; van Oers and Hopman, 2012). Their relevant characteristics are summarised in Table 3.1.

**Table 3.1:** Architectural synthesis models for preliminary ship design, adapted from Gillespie (2012)

	<i>DBB</i>	<i>ISA</i>	<i>Packing</i>
Driver	volume	area	volume
Architectural	3D full ship	2D deck	2.5/3D full ship
Diversity	overall	arrangement	overall
Speed	days/manual	hours/automated	hours/automated
Num. of solutions	few	hundreds	thousands

All three approaches provide an architectural description of the vessel. However, only the DBB and Packing approach allow full variation of both layout as well as overall ship characteristics. Both ISA and Packing are capable of generating a large set of solutions in a matter of hours, yet the manual DBB approach only allows a few solutions to be generated (at a higher level of detail) in the course of several days. Thus, only the Packing approach allows both a variation of the layout as well as the overall ship characteristics while still maintaining the ability to generate a large (thousands) set of diverse design solutions in a matter of hours. Hence, the Packing-based ship synthesis model is considered to best fit the requirements mentioned earlier, that is, those required for application within a progressive concept exploration approach.

In summary, the Packing approach is capable of quickly generating a large set of diverse design solutions integrating a multitude of varying options (e.g., different systems, performances, hull sizes). Its capabilities as a preliminary ship design tool have been demonstrated in several applications (Wagner, 2009; van Bruinessen, 2010; van Oers, 2011b; Zandstra, 2014; Baudeweyn, 2014; Zandstra et al., 2015). A further description of the Packing-based ship synthesis model, including its limitations and modifications for the purpose of applying it in a progressive exploration approach, are dealt with in Chapter 4 and in Appendix A.

### 3.5 Exploring results and gaining insight

The next step in the generic progressive process is exploring the results. The main goal of this step is to gain insight into *how* and *why* the (currently) defined preferences are reflected into particular solutions. This insight can then be used to decide on *if* and *how* to adjust preferences in subsequent iterations of the progressive approach.

Depending on the complexity of the solution itself, this step can be a relatively straightforward or extremely complicated task. For example, consider the differences in complexity of exploring and evaluating the silhouette of several (tens) car shapes (Cluzel et al., 2012) versus exploring the arrangement and performance of several thousand ship designs (van Oers et al., 2008; Pawling et al., 2014). Moreover, although a ship concept has many attributes that can be explored (e.g., main dimensions, general arrangement, performance, cost), the design impact of these aspects cannot be studied independently (Section 1.1). For example, a criterion for a bigger helicopter will result in a larger required helicopter landing deck, increasing the main dimensions of the vessel, thereby influencing weight and finally the balance of resistance and powering and range on fuel.

The complex interdependencies between different design aspects cannot always easily and clearly be defined early-on. It is in the exploration step of the progressive approach where insights regarding these interdependencies is to be gained. After which this insight will aid the designer in evaluating *how* and *why* the currently defined criteria (preferences) are interacting.

Clearly, exploring the results and gaining insight within an progressive exploration approach for preliminary ship design is important and therefore warrants special attention. Chapter 5 further discusses the need and development of specific exploration methods to enable useful insight to be gained from concept exploration.

### 3.6 Adjusting preferences and generating new solutions

The insight gained from exploring the results of the generated solutions is used to make decisions regarding the currently defined preferences. In general, a user can choose to adjust, remove, or add preferences. These are then used in the next iteration of the progressive approach to generate a better matching and more desirable new set of solutions. The search algorithm plays an important role in this step. The generation of solutions is automated, hence a search algorithm should guide the generation of these solutions towards the currently defined user preferences.

Evolutionary search algorithms (e.g., genetic algorithms) are often used to steer a progressive process (Section 2.2.3). Their work-flow (Figure 2.5) easily fits into the progressive search process described in Figure 3.1. In addition, individual solutions are rated based on their “fitness”. This allows a very flexible definition of the objective function(s) ranging from simple human evaluation (e.g., rating individuals on a scale of 1 to 10, 1 being very undesirable or unfit, and 10 being very desirable and fit) to hybrid functions which combine human evaluation and more traditional objectives containing numerical performance measures to define individual fitness (e.g., as in Buonanno, 2005).

It was discussed that the term preferences in the context of ship concept exploration is not sufficient. A naval architect, based on new insight, may choose to adjust preferences of multiple aspects of the exploration problem such as: performance and technical requirements, constraints, and variable limits (Section 3.3). These should then be fed to the ship synthesis model and search algorithm to generate a new set of more relevant and more desirable design solutions. This is a critical step, for failing to guide the exploration effort towards more desirable solutions diminishes all benefits of a progressive exploration approach. Hence, Chapter 6 will further discuss how adjusted criteria (preferences) can be used to generate relevant design solutions and thereby steer the concept exploration effort towards more desirable results.

### 3.7 Selecting desired solutions

The last step in a generic progressive approach is the selection of the final desired solutions, that is, those which warrant further analysis in subsequent (possibly more detailed) design stages. In this step, the user is mostly aided by the gradually built up understanding of the problem gained by the iterative applications of steps 1 through 4 of Figure 3.1. In addition, assuming the user is confident that all relevant aspects have been covered in the exploration, the final set of preferences provides a mechanism that can be used for selection.

Depending on the complexity of the problem to which the progressive approach is applied the selection step can be very simple or quite complex. For example, some applications only use a single subjective preference (e.g., the “coolness” of a fashion item) to evolve a set of designs using an interactive genetic algorithm (Kim and Cho, 2000; Cho, 2002). Others combine a single user selection representing the fitness of a solution with additional numerical characteristics to help the user select the best design in each iteration (Lameijer et al., 2006). In these cases, selection of the final “best” option was simply done by the user from the last set of solutions (i.e., by selecting the one preferred most). Naturally, the user considers more information at the final stage than at the beginning of the process. A considerable amount of knowledge has been gradually built up during the process, all of which helps in the final selection, both explicitly or implicitly.

A more complex case is a selection from a Pareto-front, that is, selecting design solutions evolved over more than one preference. In these cases the final selection is made after having evaluated the non-dominated solutions of the final set. For example, (Buonanno, 2005) combines several numerical characteristics in one objective, and one subjective measure for producibility in a second objective. Again, the final selection from the non-dominated front is left to the user. Buonanno comments that the

final selection could actually not be made from this set. Exploration revealed that, although these designs represented a good numerical performance score, they were undesirable based on engineering judgement.

Van Oers et al. (2008) also recognise issues that are faced when selecting designs from a Pareto-optimal set (also see Chapter 5). They explain two main issues:

- First, non-dominated solutions often lack explanatory nature because the objectives used to find them are usually unfamiliar to designers. For example, an objective may represent multiple combined design characteristics. In Buonanno (2005) the numerical objective is comprised of several traditional design characteristics which makes it difficult for a designer to select or evaluate based on this compound and often unfamiliar number.
- Second, algorithms used to produce non-dominated sets have a finite ability to distinguish between designs. Additional engineering judgement is required to identify that designs may in fact turn out to be infeasible due to as of yet unconsidered aspects, even though they have a good numerical score (e.g., assessment might reveal they are not producible). This issue could be solved by adding additional objectives to better differentiate solutions. However, adding more objectives for each distinguishing measure is considered undesirable as this reduces algorithm performance and may result in every solution being non-dominated (see Section 2.2.3 and Köppen and Yoshida, 2007). Hence, other methods are required if additional engineering judgement must be added (see Chapter 6).

The above indicates that selection in a concept exploration context should not solely be based on the objectives used by the search algorithm, but rather on all relevant design properties. Again, a thorough exploration approach should aid in this respect. Gained insights can be used, together with the evolved set of preferences in the interactive progressive approach, to select the final desired design solutions.

### 3.8 Closure

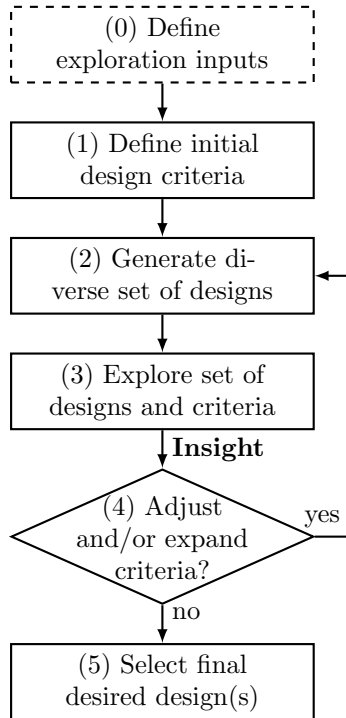
This chapter has provided a process description of a generic progressive exploration approach as depicted in Figure 3.1. The applicability of each step in the context of preliminary ship design and concept exploration was discussed. As such, the steps of the generic process must be adjusted to suit the application to ship design. Figure 3.2 presents the proposed adjusted work-flow of the interactive approach.

As with the generic approach, the proposed process evolves around a set of preferences which are, in the context of this dissertation, referred to as design criteria (Section 3.3). This set of criteria gradually evolves throughout the course of applying the progressive iterations in the evolutionary approach. Hence, initially the set is often limited and different compared to the final criteria after exploration (step 1). Criteria which are deemed relevant and desired by the naval architect are then used within the Packing-based ship synthesis model, and its genetic algorithm, to generate a new set of designs best fitting those criteria (step 2). Hence, the user can, by adjusting the design criteria in each iteration, interactively steer the focus of the ship synthesis model towards different areas of the solution space (step 4). Of course,

*which, how, and why* criteria must be adjusted should follow from insights gained during the design exploration step (step 3).

The critical steps in the proposed approach are identified as: (i) generating a diverse set of designs; (ii) exploring sets of designs and criteria to gain insight; and (iii) using this insight to adjust criteria and thereby, through feedback, create a new set of more relevant designs. The final step, selecting desired design solutions, is also important, but it relies heavily on the insight and understanding gained from applying the first critical steps. That is, the gradually evolved set of criteria and accompanying design insight can be used to select final desired solutions. That said, the focus of the development of the proposed approach will be towards the critical steps mentioned earlier (step 2, 3 and 4 in Figure 3.2).

Chapter 4 covers developments and changes made to the Packing-approach for it to work within an interactive progressive approach (step 0 and step 2). Chapter 5 covers the exploration of a large set of design solutions with the aim of gaining insight (step 3). Chapter 6 covers the use of insight to adjust criteria which are then used within the Packing-approach to produce a new more relevant set of designs (step 4).



**Figure 3.2:** Proposed work-flow and process for an interactive and progressive concept exploration approach for preliminary ship design

# Chapter 4

## Generating design solutions

*“There are two ways of constructing a software design: One way is to make it so simple that there are obviously no deficiencies, and the other way is to make it so complicated that there are no obvious deficiencies.”*

---

– Tony Hoare (1980)

Section 3.4 elaborated the choice for the Packing-based ship synthesis model. This chapter covers the underlying principles of the approach. Also, it addresses several aspects of the synthesis model that must be improved to make it applicable for use within the proposed interactive and progressive exploration approach (Chapter 3).

### 4.1 Packing-based ship synthesis model

The need for early requirements elucidations, and hence the need for generating concept designs quickly and at a higher level of detail, led to the development of a packing-based ship synthesis model. This approach is able to rapidly generate a large and diverse set of feasible ship designs covering a wide range of possible trade-off options. This set may then be explored by the naval architect in search of promising design alternatives. The workings of the Packing-based ship synthesis model are extensively discussed and documented in van Oers et al. (2009); van Oers (2011b); van Oers and Hopman (2012).

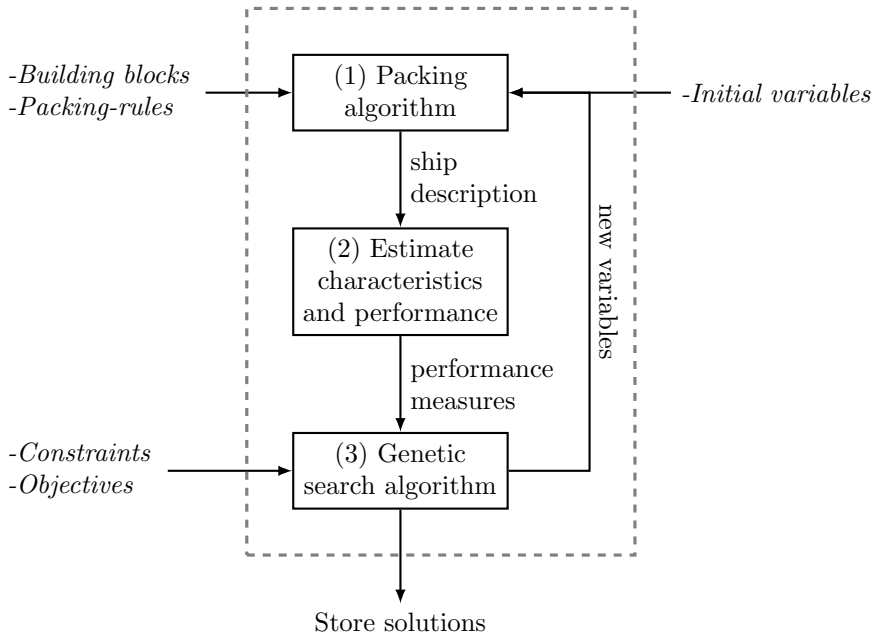
The basic process of the packing-based ship design model is shown in Figure 4.1, it consists of three main steps:

1. *Packing algorithm.* The basic inputs of the packing-approach, that is, the individual building blocks (systems and spaces), Packing-rules, and the (initial) input variables, are combined in the packing-algorithm to produce an architectural description of the ship.
2. *Estimate technical characteristics and performance.* The architectural description of the ship allows us to apply various tools and prediction models to estim-

ate performance measures and technical characteristics of each design solution. Examples are: cost, weight, resistance, speed, (fuel) range, hydrostatics, and simple (damage) stability.

3. *Genetic search algorithm.* The constraints and objectives combine several characteristics and performances of each design to help search for more promising and feasible solutions. Constraints also ensure that non-negotiable requirements are met. These are typically: all building blocks must be packed, the vessel floats upright, there is sufficient intact and damage stability, and the ship meets its speed and range. The output of the genetic search algorithm is a new list of input variables which is then fed-back to the packing algorithm to create a new design. When a design alternative meets the constraints, it is stored in a database.

Using these three steps, the Packing-approach can generate design solutions, which depending on the inputs (i.e., building blocks and Packing-rules) can be very diverse. That is, in terms of the type and number of building blocks used (e.g., different blocks to represent different system options) and in terms of ship characteristics (e.g., hull shape, length, beam, depth, and layout). Each step is described in more detail below.



**Figure 4.1:** Packing-approach process with required inputs

#### 4.1.1 Packing-algorithm

The packing algorithm combines several elements to produce a so called packing-based ship description. These are (taken from van Oers, 2011b; Zandstra et al., 2015):

- *Objects*. These represent systems and/or spaces which may or may not change shape. For a more extensive overview of how they are modelled see (van Oers, 2011b). The available object types include:
  - *Envelope object* to model the hull and superstructure shape
  - *Subdivision objects* to model decks and bulkheads
  - *Hard objects* to model physical objects which may not change shape (e.g., a weapon system or diesel engine).
  - *Soft objects* to model physical objects which may change shape (e.g., fuel tanks, or area-based accommodation spaces).
  - *Free space objects* to model spaces which may not be occupied by other object types (e.g., a free path of flight above a helicopter deck or line of sight of a radar system).
  - *Connection objects* to model connection between other spaces (e.g., access shafts, elevators, up and down-takes, or passageways).
- *Positioning space*. This is the space into which all objects are placed using the packing algorithm. All objects must fit in this square-shaped space without violating the user-defined overlap rules. The positioning space is further subdivided into a grid of small square shaped voxels. These form the basic building-block from which all objects (excluding the envelope and subdivision) are built.
- *Overlap rules*. These rules define whether objects are or are not allowed to overlap. For example, a diesel engine may not overlap with a fuel tank, while a fuel tank may overlap with a bulkhead in which case it is split.
- *Design changes and overlap management*. If overlap rules are not met, an object may, depending on its type and user-defined constraints, change position and/or shape to comply with the overlap rules. Once an object is placed it no longer changes shape and position.
- *Packing process*. This process integrates the above elements into a three dimensional ship description. The pseudo code for the Packing process is shown in Algorithm 1. Van Oers (2011b) gives a more detailed description of each step.

Together the above elements provide a three dimensional ship description which can be used by performance prediction tools to assess various characteristics of the ship.

More recently van Oers and Hopman (2012) developed a faster 2.5D version of the original 3D packing-approach presented in (van Oers, 2011b). This version has a limited “resolution” in transverse direction, that is, it is limited to three objects being placed adjacent in transverse direction (i.e., one on port side, one on starboard, and one at the centreline). Nonetheless, the 2.5D version still applies the same basic packing process and elements as described above.

#### 4.1.2 Estimate characteristics and performance

The Packing-approach uses several tools to assess basic feasibility and naval architecture practices. The model used in this dissertation includes the following technical characteristic and performance estimates (see Appendix A and Zandstra et al., 2015):



```
define all objects and the packing sequence using input parameters from the
search algorithm and naval architect;
```

```
foreach object in sequence do
| retrieve information of current object;
| build up-to-date positioning space for current object;
| detect possible overlap;
| apply overlap management to pack current object while meeting relevant
| user-defined constraints;
| if current object is packed then
| | store results and continue to next object;
| else
| | fail elegantly and stop the packing process;
| end
end
```

**Algorithm 1:** Packing process from (van Oers, 2011b)

- A density-based weight estimate for SWBS groups 100 tot 700 with correction for hull and deck-house material choice, hull length, and discrete weights for larger pieces of equipment (see Takken, 2008).
- An estimate of initial stability based on hydrostatics, centre of gravity, and loading condition. Trim is kept within reasonable bounds by limiting the longitudinal separation of the centre of gravity (*LCG*) and centre of buoyancy (*LCB*).
- Resistance and propulsion estimate at the design draft using a regression model of Royal Netherlands Navy (RNLN) model test data.
- Reserve buoyancy through a floodable length calculation and required damage length percentage.
- An estimate of procurement cost based on the procedures described in NATO standard ANEP-41.

The list of tools above may change depending on the design project (e.g., ship motions, sea-keeping, or operational simulations can also be added). However, because for every successfully packed design these tools are executed, a trade-off must be sought between the execution time of the added analysis and the relevance of its predicted measure to the exploration effort. Already the currently included prediction tools take up most of the evaluation time for one design (i.e., the packing process itself only represents a relatively small part).

Some simple speed improvement have been made by changing the order and dependency between performance and technical characteristics prediction tools. For example, there is no use in calculating procurement cost if the initial stability of the vessel is insufficient for it to float upright. Nonetheless, some performance measures and characteristics are required for all designs. Examples are: the resistance and propulsion, which is used for sizing the propulsion plant; and a reserve buoyancy calculation which is used to define the bulkhead placements.

### 4.1.3 Genetic search algorithm

The implemented genetic search algorithm, NSGA-II by Deb et al. (2002), is used together with constraints and objectives to search for and generate design solutions. To ensure basic technical feasibility, several non-negotiable requirements are applied as constraints. These are further discussed in Chapter 6.

The objective function is used to *guide* the search process. By default a single objective, *packing-density*, attempts to minimise the unused volume in the envelope. As such, it guides the search towards relatively small and compact design solutions. Nonetheless, the randomness introduced by the search algorithm's genetic operations ensures sufficient diversity in overall size and arrangement of the vessels. Again, the goal is to create a large and diverse set design solutions from which a designer can explore and pick interesting options. Hence, the objective is not to find the design which solely maximises packing-density.

Chapter 6 provides a more detailed discussions on the definition of the objective function. In addition, van Oers (2011b) also provides several studies showing the effect of using different, or multiple, objective functions. This chapter also presents a short study to show the effects of the genetic algorithm mutation rate on the yield and diversity of the packing-approach (Section 4.2.4).

## 4.2 Improvements to Packing

Although the Packing-approach synthesis model has proven itself in various studies (e.g., see van Oers, 2011b; van Oers and Hopman, 2012; Wagner, 2009; Wagner et al., 2010b,a; van Bruinessen, 2010), the specific use of the Packing-approach within an interactive progressive design approach warrants additional improvements and development. The aspects which are discussed and addressed are:

- The consistency of the chromosome representation (i.e., how the Packing-based ship description is represented within the genetic algorithm). The Packing-approach's overlap management changes system positions, hence the genetic algorithm representation of the design has to reflect these changes in order to remain consistent.
- The speed with which the Packing-approach generates a set of designs. This is relevant for the proposed interactive approach where a designer should not have to wait for results (see Section 3.4).
- The ability of a Packing-approach design model to have diverse and varying design options (see Section 1.3.1).
- The ability to maintain diversity, that is, generating a set of designs covering a diverse set of varying design options (also see Chapter 6).

The remainder of this chapter covers the above aspects and develops solutions that are incorporated in the Packing-approach.

### 4.2.1 Chromosome representation

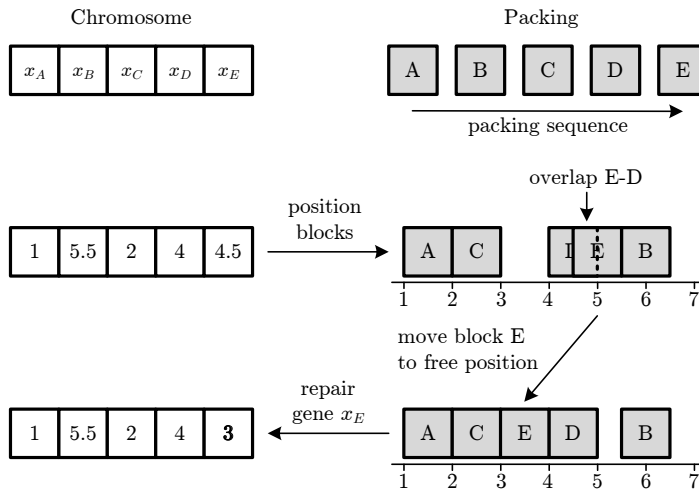
Due to the nature of the packing algorithm there may be a discrepancy between the chromosome representation within the genetic algorithm and the final description of

the ship after packing. This can be caused by the overlap management routines in packing.

For example, consider blocks A through E in Figure 4.2. In the genetic algorithm the chromosome representation of the (longitudinal) locations of the blocks is given as a vector  $x = [x_A, x_B, \dots, x_E]$ . The packing process then attempts to place each block, in sequence, at its initial location and checks for any overlap (Algorithm 1). In the example, overlap between E and D is detected when placing the last block E. Packing will then move block E to the closest free position in order to remove the overlap and remain feasible. Hence, there may be a difference between the initial and final position of each block. This behaviour of the packing process poses several problems:

- First, it reduces the efficiency of the genetic algorithm. That is, the genetic algorithm is working with a “false” representation of the actual ship. Any genetic operations (e.g., crossover and mutation) can thus result in different expected outcomes. For example, consider two vessels where the chromosome representations places a certain system on deck one for both vessels. After packing, however, one of the ships has the system shifted to deck two because of a lack of space on deck one. The genetic algorithm, however, still assumes that both systems are positioned on deck one. Hence, a crossover operation is likely to produce new designs with the system on deck one.
- Second, the user or naval architect is working with the actual description of the ship. So, once a certain system position is considered desirable, the naval architect will want to steer based on this preference. However, if the location of the system is not correctly represented in the chromosome representation of a design, the genetic algorithm will promote the wrong position.  
Consider the example in Figure 4.2. If position 3 for block E is favourable, this solution would be considered as *better* by the naval architect, who would then assign a higher rating to this design. The genetic algorithm, however, still believes that block E is at position 4.5 (i.e., from the original chromosome representation). Again, this causes problems when genetic operations are applied to this chromosome and others which *do* actually have system E in position 4.5.
- Third, the discrepancy should in theory also effect the speed of the packing algorithm. The overlap management routines, which detect and remove overlaps, use computational resources. Hence, when a repaired chromosome is re-evaluated, time should be saved as the algorithm does not need to remove overlaps again. A short study, however, found that the speed increase is negligible. This is because the relative amount of computational resources spent on overlap management is low compared to calculating ship characteristics such as hydrostatics, weight, and floodable length.

The problems above illustrate the need to repair the chromosome representation of a design after it has been successfully packed. This repair step is also shown in Figure 4.2. It ensures each blocks final, as packed, position is used in the chromosome representation and within the genetic algorithm’s operations.



**Figure 4.2:** Chromosome representation, packing operations and gene repair

## 4.2.2 Speed

When integrating synthesis models into an interactive progressive approach, speed is an important aspect (Section 3.4). Consider the following:

- First, the approach is intended for the preliminary design stage where time and resources are limited. In addition, the iterative process of design changes, design reviews, and consequently further changes, requires a quick “turnaround time”.
- Second, and this is in-line with Andrews’ list of tool characteristics (see Section 1.5), tools or methods in early stage design should be responsive and non-rigid. Slow tools can damage the dynamic design process, in which case designers may fall-back to quicker, but not necessarily better, tools to keep up and support decision making.
- Thirdly, within the proposed progressive approach the human user plays a centric role. That is, within each iteration of the process of Figure 3.2 a user is tasked and responsible for analysing results, making decisions, and adjusting criteria. This may cause problems (e.g., fatigue and loss of focus) when interaction moments follow in quick succession, especially when dealing with a large amount of complex results, as is expected in this research. On the contrary, too long of an interval between interaction moments is also unwanted. In such case a user might require valuable additional time to re-familiarize with the problem at hand.

Already, several of the above considerations led to the development of a faster 2.5D version of the original 3D Packing-approach (van Oers and Hopman, 2012). Most importantly, this 2.5D versions has a limited resolution in transverse ( $y$ ) direction which reduced the computation effort required for the packing process.

Even so, considering the importance of the speed of the Packing-approach for use in the proposed progressive and interactive approach, an extensive review of the program code was performed to check if further speed improvements could be made. Fortunately, van Oers and Hopman (2012) provide a table of speeds of various versions of the Packing-approach. The fastest speeds from this reference are compared with the newest Packing-approach version.

Table 4.1 presents the differences in Packing-approach speed, that is, the time required to evaluate a single design. As in the original table of van Oers, the times have been scaled to one CPU thread, thus on a modern day octa-core machine (i.e., used for the last 2.5D MCMV 2015 cases) the times are divided by eight. Hence a full run of 6464 designs, using the latest 2.5D version, requires only 44 minutes (0.4 seconds per attempted design), or roughly 352 minutes (3.2 seconds per attempted design) if scaled to a single CPU thread. This is considered sufficiently fast, as the model is able to generate sets of designs in the iterative approach in a matter of hours (depending on the size of the set). In addition, the latest available desktop processors should allow further improvements by a factor of two to three without requiring the need for expensive supercomputing power.

**Table 4.1:** Comparison of Packing-approach speeds. The time per designs is scaled by the number of CPU threads used (i.e., the actual time is multiplied by the number of CPU threads used). The values for first three cases are the fastest times as recorded in (van Oers and Hopman, 2012)

<i>Case and version</i>	<i># Vars.</i>	<i># Obj.</i>	<i>Designs total</i>	<i>Designs feasible</i>	<i>Time/ design [s]</i>	<i>Time/ feasible design [s]</i>
3D drill-ship 2010	75	50	11200	5922	86.8	164.2
3D frigate 2010	238	113	23580	1407	73.3	1229.2
2.5D MCMV 2012	75	38	972	184	8.4	44.3
2.5D MCMV 2015 <sup>1</sup>	268	86	6464	1889	5.8	19.8
2.5D MCMV 2015 <sup>2</sup>	268	86	6464	1545	2.0	8.4

Note, the presented comparison of speeds is not meant to be used in the quantitative sense. Thoroughly measuring the exact speeds improvements, would call for a comparison of the different versions of the code in a controlled environment with a single design model running on the same computer with equal problem set-ups.

### 4.2.3 Varying design options

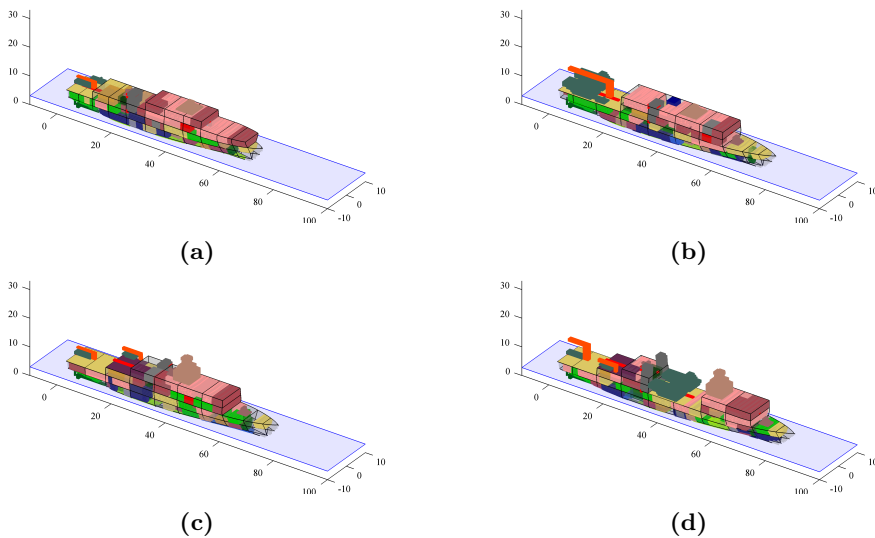
Until recently, presented applications of the Packing-approach were only able to vary several of the design options listed in Section 1.3.1 concurrently (i.e., within a single run of the Packing-approach tool). For example, though van Oers (2011b) concurrently varies three hull types in his frigate application, variation of other aspects (e.g., those mostly related to varying systems), such as the weapons and sensor suite where attempted, but required a new run with a manually altered design model.

<sup>1</sup>Laptop, Intel Core i7-2760QM, 8GB RAM

<sup>2</sup>Workstation, Intel XEON E5-1620, 16GB RAM

To investigate if and how the Packing-approach could use a single design model to generate a large and diverse set of designs concurrently (e.g., a set with many varying design options such as those listed in Section 1.3.1), a MSc. research project was undertaken by Zandstra (2014).

Zandstra developed a Packing-approach design model for a mine-countermeasures vessel (MCMV) which includes the ability to concurrently alter a large number of design characteristics. The MCMV model supports variations in: required ship performance (e.g., transit, maximum and operational speeds and ranges); platform systems (e.g., propulsion configuration, engine types); combat systems (e.g., type and number of weapon systems); and MCM related systems (e.g., type and number of unmanned surface and underwater vehicles, launch and recovery systems, diver support, and slipway). In addition, a simple crew model was developed which keeps track of the chosen system configuration for a design, and then updates the required crew capacity as well as other platform characteristics accordingly (e.g., capacities for the grey and fresh-water tanks, the areas for crew facilities and auxiliary spaces, and the sizes of stores). Refer to Appendix A for more detail on the applied MCMV packing model.



**Figure 4.3:** Four designs with different design options generated by a single MCMV packing model

Figure 4.3 displays four very different design configurations produced with Zandstra's MCMV model. Each design has a different set of options. They were all produced without the need for manually altering the packing model's settings (e.g., as was the case in earlier Packing-approach models). It is thus possible to generate a diverse set of designs using a single model in the Packing-approach.

Zandstra's results do however show that such a model comes at a cost. First, the yield (e.g., number of successfully packed designs) was found to be lower compared to a design model without such variations. The varying design options makes it more difficult for the Packing-approach to find feasible design configurations. Second,

Zandstra found that the average attained packing density (i.e., the used objective function value) of the produced designs is lower compared to a design model with fixed design options. The increase of the problem dimensionality somewhat decreases the performance of the search algorithm. That is, instead of searching for compact configurations for one combination of design options, it now has to search for multiple compact configurations for many combinations of design options.

#### 4.2.4 Maintaining diversity

Van Oers (2011b) studied the performance of the Packing-approach genetic algorithm (NSGA-II by Deb et al., 2002) to search for and generate new ship configurations. Van Oers investigates the use of two objective functions, one to promote compact designs (e.g., by maximising *packing density*), and one to promote diversity among the design configurations (e.g., by using a specially developed diversity measure). He concludes with the hypothesis that the use of a diversity objective will cause the genetic algorithm to focus more on creating diverse designs than on finding compact designs. Hence, he recommends to use only a single objective (i.e., *packing density*) to search for new ship configurations. The diversity of the created designs is then left to the randomness of the genetic algorithm's mutation and crossover operations.

Various applications of the Packing-approach have shown that indeed the genetic algorithm's operations (mainly mutation) are sufficient to generate a large set of feasible, diverse, yet compact designs (e.g., see van Oers, 2011b; van Oers and Hopman, 2012; Wagner, 2009; Wagner et al., 2010b; van Bruinessen, 2010; Zandstra, 2014; Baudeweyn, 2014; Zandstra et al., 2015). These studies have provided some practical values for the genetic algorithm settings that seem to produce desired results. What is lacking, however, is a more thorough investigation of the influence of mutation rate<sup>1</sup> on the number and diversity of the designs found by the Packing-approach. Mainly the diversity (or spread) of the resulting design solutions is considered relevant for exploring and covering a wide design space. Hence, as a part of this research, a short study was undertaken to investigate the effects of mutation rate.

#### Set-up

A packing model of a mine counter-measures vessel (MCMV) which was developed by Zandstra (2014) is used (see Chapter 7 and Appendix A). The problem definition for the genetic algorithm is defined in Equation (4.1), Chapter 6 and 7 give a thorough explanation of this problem definition. Further settings of NSGA-II used are: population size  $pop=128$ , number of generation  $gen=100$ , crossover probability  $p_c=1$ , crossover distribution index  $\eta_c=2$ , and mutation distribution index  $\eta_m=5$ . The crossover index, mutation index and crossover probability match settings that are used in literature (Deb and Agarwal, 1994; Deb and Goyal, 1996). The population and generation size are chosen equal to settings often applied and found practical for the Packing-approach (van Oers, 2011b; Baudeweyn, 2014; Zandstra, 2014; Duchateau et al., 2015). In total seven tests ( $n=7$ ) were performed for each setting of mutation rate  $p_m=\{0, 0.025, 0.05, 0.1, 0.2, \dots, 0.7\}$ .

<sup>1</sup>Mutation rate is the parameter which maintains diversity and counters convergence to local optima within genetic algorithms

$$\begin{aligned}
& \min_x f && -PD(x) \\
& s.t. && h_1 \text{ systems}_{\text{placed}}(x) = \text{systems}_{\text{total}}(x) \\
& && g_1 \quad T(x) \leq T_{des}(x) \\
& && g_2 \quad \|LCB(x) - LCG(x)\| \leq 2.0m \\
& && g_3 \quad GM(x) \geq 0.75m \\
& && g_4 \quad GM(x) \leq 3.50m \\
& && \underline{x} \leq x \leq \bar{x}
\end{aligned} \tag{4.1}$$

For each mutation rate  $p_m$ , the average number of feasible designs, average number of unique designs, and best objective score (*packing density*) was determined. The number of unique designs was determined by using a simple filter which identifies duplicates based on several similar design characteristics. The filtering characteristics used are: length, draft, displacement,  $GM$ , speed, range, endurance, installed power, type of combat suite, propulsion concept; as well as the location of several key systems including the bridge, radar, weapon systems, working deck, engine room. Any two designs which have equal values (with a small margin) for these characteristics are considered as equal.

## Results

Figure 4.4 and Table 4.2 show the averaged results obtained from all runs. On average, with no mutation  $p_m=0$  the Packing-approach found 84% feasible designs (i.e., out of  $12928 = 128 \times 101$  designs attempted per run) whereas only 12% of the attempted designs is unique. Hence, over 70% of the feasible designs are considered as very similar. On the contrary, a higher mutation rate  $p_m=0.2$  produces a significantly lower amount of feasible designs, that is, 13% compared to 84% with no mutation. The amount of unique designs found, however, remains similar at around 13%, compared to 12% with no mutation. The maximum number of unique designs are found at a mutation rate of  $p_m=0.025$ . Here the Packing-approach produced 47% feasible designs and 23% unique designs (out of the 12928 total), yet with a slightly lower packing density of 90.6%. The maximum packing density of 91.6% was found at a mutation rate of  $p_m=0.05$ . However, at higher mutation rates (up to  $p_m=0.5$ ) the search algorithm was still able to find better packed designs than with zero mutation. As expected, without mutation, or at very low mutation rates, the genetic algorithm shows premature convergence to a local optimum (e.g., design solution). This is further confirmed by the larger number of similar designs found with low mutation.

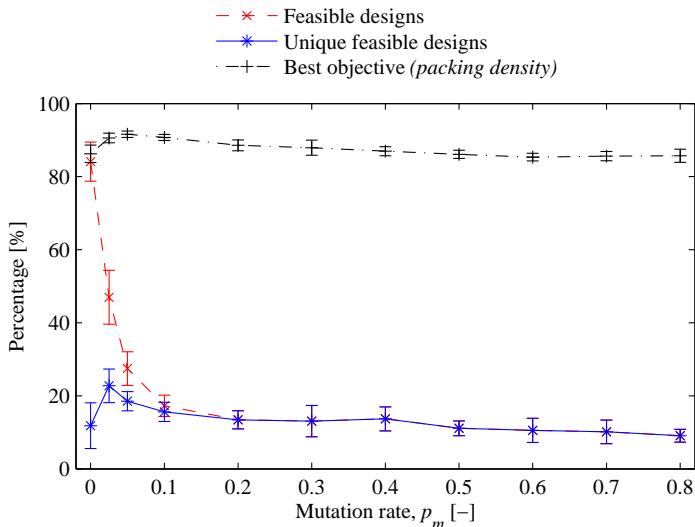
Figure 4.5 shows the “spread” of the designs found with respect to the objective function, packing density, and one ship characteristic, displacement. Note the displacement of a design results from many other characteristics, such as, main dimensions, arrangement, installed systems, or the installed power. Hence, if displacement shows a large variation, then these characteristics should consequently also show a large spread.

Clearly, a higher mutation rate results in a larger spread of the results. Compare the plots of a  $p_m=0$  and  $p_m=0.2$ , where the first indicates that a large amount of the

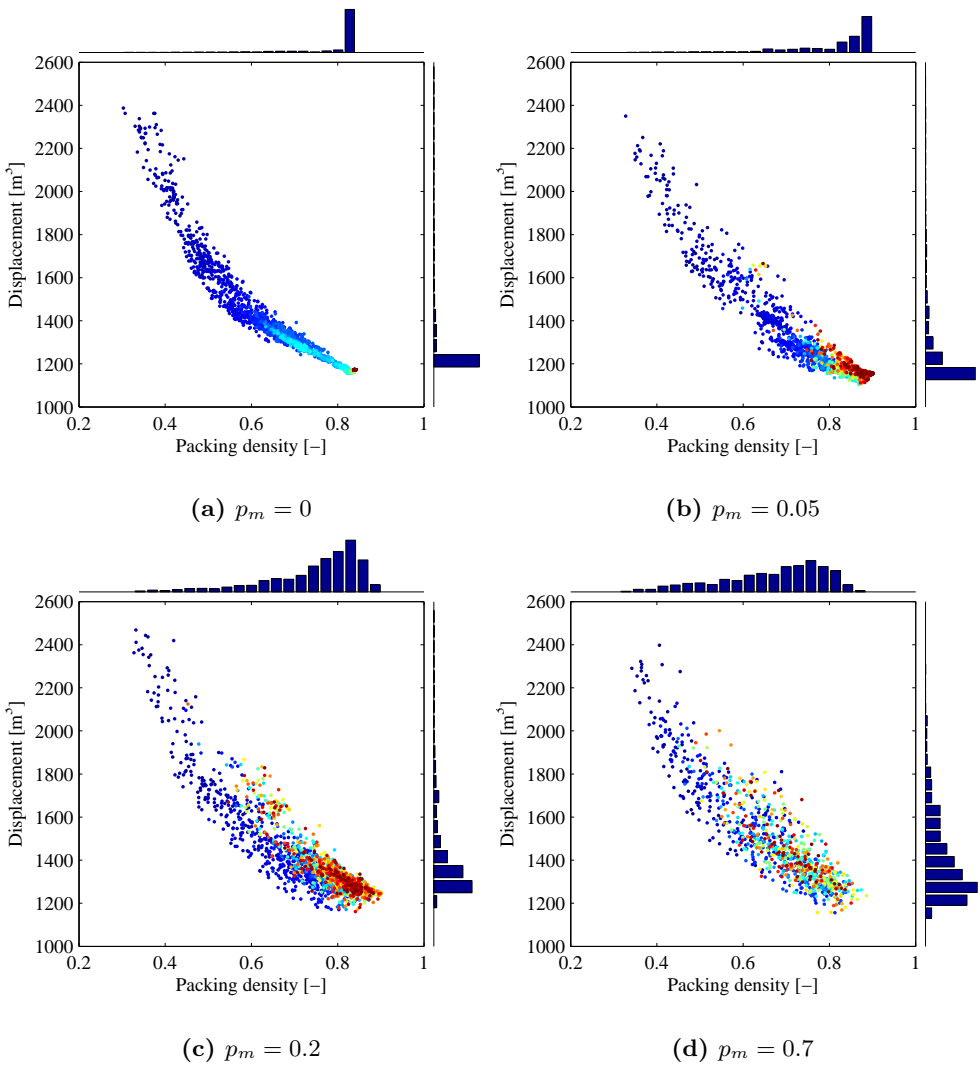


**Table 4.2:** Effect of varying mutation rate on the number of designs found (each run attempted 12928 designs, results are the average of 7 test).

<i>Mutation rate <math>p_m</math></i>	<i>Feasible designs</i>	<i>Unique feasible designs</i>	<i>Best objective (packing density)</i>
0	<b>10873 (84.1%)</b>	1529 (11.8%)	86.2%
0.025	6073 (47.0%)	<b>2940 (22.7%)</b>	90.6%
0.05	3550 (27.5%)	2395 (18.5%)	<b>91.6%</b>
0.1	2230 (17.2%)	2016 (15.6%)	90.7%
0.2	1739 (13.5%)	1733 (13.4%)	88.6%
0.3	1692 (13.1%)	1692 (13.1%)	87.9%
0.4	1770 (13.7%)	1770 (13.7%)	87.0%
0.5	1437 (11.1%)	1437 (11.1%)	86.1%
0.6	1363 (10.5%)	1363 (10.5%)	85.3%
0.7	1310 (10.1%)	1310 (10.1%)	85.6%

**Figure 4.4:** Effect of varying mutation rate on the percentage of designs found (each run attempted 12928 designs, bars show standard deviation of mean,  $n=7$ )

genetic algorithm's effort was located in only a very small area of the plot. That is, there is convergence towards a particular design solution. This was also confirmed in Table 4.2. At some point designs are only produced close to this local optimum, whereas in the plot for  $p_m=0.2$  even very late in the search (indicated by a more red colour) there is still a significant spread in packing density and displacement of the designs being generated. Although, the spread for a  $p_m=0.7$  is large, only a limited amount of designs are generated with packing densities higher than 0.8 (or 80%). The genetic algorithm fails to evolve those designs further.



**Figure 4.5:** Influence of various mutation rates on the “spread” and diversity of characteristics of the found solutions. The colour indicates age of the solutions within the genetic algorithm (red=young, blue=old). The histograms indicate the spread of results.

## Discussion

The presented results should be interpreted with some care. First, the effects of mutation rate depend on several aspects, such as, the number of variables of the Packing model, the objective and constraint functions, and the chosen size of the population and generation. All of these parameters were fixed in this simple study. A different design model, or other NSGA-II settings are likely to change the presented results. Second, the method of filtering the number of unique designs found within each set is also subject to changes. Another set of filtering parameters will also give different results. Finally, as can be seen by the standard deviation bars in Figure 4.4, at lower mutation rates the convergence behaviour of the genetic algorithm can cause a slightly larger spread in the results.

Nonetheless, the effects of mutation rate do agree with practical experiences from earlier studies (van Oers, 2011b; Zandstra, 2014; Baudeweyn, 2014; Zandstra et al., 2015). In these studies a mutation rate of  $p_m=0.3$  was often used as a rule of thumb to start the exploration process. The results of Figure 4.4 and 4.5 confirm that with this mutation rate the model is indeed likely to find a good distribution of unique designs. However, the results show that a lower mutation rate should be more beneficial, providing better objective scores without losing diversity. Nonetheless, the results depend heavily on the Packing-model used, so a higher mutation rate ensures there is no premature convergence towards a single design solution.

## 4.3 Further limitations and discussion

Currently, there are still some drawbacks of the Packing-approach which limit the application to early stage design and concept exploration studies. The following aspects, which were not addressed as part of this research, should further increase the potential of the Packing-approach in an evolutionary concept exploration approach:

- In its current form the Packing-approach is limited to mono-hull type vessels. The application to more unconventional or advanced hull shapes (e.g., catamarans, trimarans, SWATHs) is still considered possible (van Oers, 2011b). For these less common hull-shapes the insight that can be gained from exploration is considered to be even more important as designers can rely less on past experiences. Moreover, unconventional hull shapes are worthwhile candidates in cases where operability, large deck (layout) area, or high stability are required (e.g., see Brown, 1991; Andrews and Zhang, 1995).
- Currently the Packing-approach requires the naval architect to identify relevant variations of design options a-priori, e.g., refer to the process described in (Zandstra et al., 2015). These varying design options are then combined, by the naval architect, in a Packing design model such as the one developed by Zandstra (2014). In theory though, new insight uncovered through a progressive concept explorations study potentially reveals the need for new, or previously thought of as irrelevant, design options (e.g., an additional weapon system, or the need for an alternative hull-shape). This would require that the new design option can be added in-between iterations of the progressive approach. That is, in addition to adjusting and/or expanding criteria, the naval architect would

also adjust and/or expand the Packing model itself with the new design option (e.g., see the work-flow in Figure 3.2). Although this is considered possible, the Packing-approach does not currently support this type of model interaction.

Nonetheless, although new systems cannot currently be added during the exploration process, it is currently already possible to add novel systems as a place-holder a-priori. Thus, in case new technology or systems might be expected in the near future or (as is often the case for warships) are under development in parallel to the design process of the ship, place-holder systems can be used to quickly assess design impacts of such future technology. For example, the design impacts of using alternative energy sources such as LNG, alternative power sources such as fuel-cells, or new types of high power weapon systems could be quickly assessed. In these cases it is nevertheless essential that the designer does not limit the design model based on existing best-practices as these might impair the insight that can be gained when judging a new piece of technology.



## Chapter 5

# Exploring solutions and gaining insight

*“There are known knowns; there are things we know we know. We also know there are known unknowns, that is to say, we know there are some things we do not know. But there are also unknown unknowns – the ones we don’t know we don’t know.”*

---

– Donald Rumsfeld (2002)

This chapter covers the third step of the proposed work-flow of the interactive approach presented in Chapter 3, that is, exploring a large set of diverse design solutions and the criteria imposed on them. The goal of this step is to gain insights that provide the naval architect with the means to make decisions regarding the current set of design criteria.

As mentioned in Section 2.3, the following tasks are deemed essential for understanding and gaining insight into the early stage ship design problem (i.e., performing requirements elucidation):

1. *Linking criteria to solutions and vice-versa*, i.e., given a set of desired criteria what potential solutions meet these, or given a prescribed solution what type performance may be expected.
2. *Identify if and when criteria conflict*, i.e., this provides feedback on the existence of trade-offs between criteria.
3. *Identify how to avoid or resolve a conflict*, i.e., identify which criteria need to change, and by how much to stay balanced and feasible?
4. *Identify why criteria conflict*, i.e., to understand the underlying mechanisms causing the conflicts so they may be avoided and documented for future projects.

This chapter develops methods which should aid the naval architect in performing these tasks.

The chapter starts with a review of several existing exploration tools and techniques from literature which are geared toward providing design insight. Elements

from these existing tools are combined to create an interactive data exploration tool tailored to exploring the interactions between numerical and architectural related data, and the criteria imposed on this data, produced by the interactive approach and the Packing-approach ship synthesis model (Chapter 3 and 4).

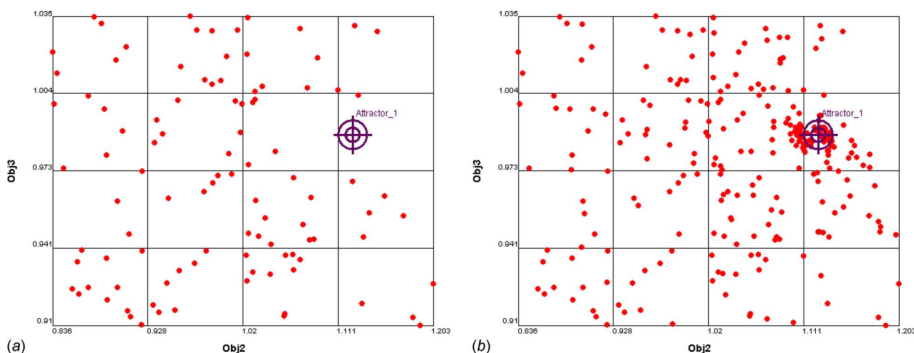
## 5.1 A review of exploration methods from literature

Section 2.3 has already briefly elaborated on the aspect of exploring results (design solutions). Nonetheless, a more extensive overview of data exploration techniques geared towards gaining insight is wanted. Especially considering the importance of exploring and identifying new insights in an attempt to push the boundaries of the exploration effort (e.g., see Section 1.5 and Andrews, 2011).

### Trade space visualiser

Pennsylvania State University has an extensive research background into exploring high-dimensional data (e.g., see Stump et al., 2003, 2004, 2009; Kim et al., 2006). Through their trade space exploration research they have developed an extensive data exploration tool-set called the *Trade Space Visualiser* (TSV). Various methods of visualising high-dimensional data are included in the TSV tool-set, such as, glyph plots, matrix scatter plots, parallel coördinate plots, and histograms. In addition, various interactive data manipulation techniques are used to facilitate exploration, such as, data brushing, filtering, and Pareto-front visualisation.

Together, the visualisation and data exploration tools are intended to facilitate an (a-posteriori) design-by-shopping paradigm which allows decision makers to select from a large set of design solutions. More recently, Stump et al. (2009) have added the ability to guide exploration through various techniques called *steering samplers*. For example, an attractor sampler attempts to generate new design points in a certain preferred area of the current trade-space, or close to a preferred design point (see Figure 5.1). These steering approaches are also centred around the idea of a progressive design frame-work as was proposed for early ship concept exploration in Chapter 3.

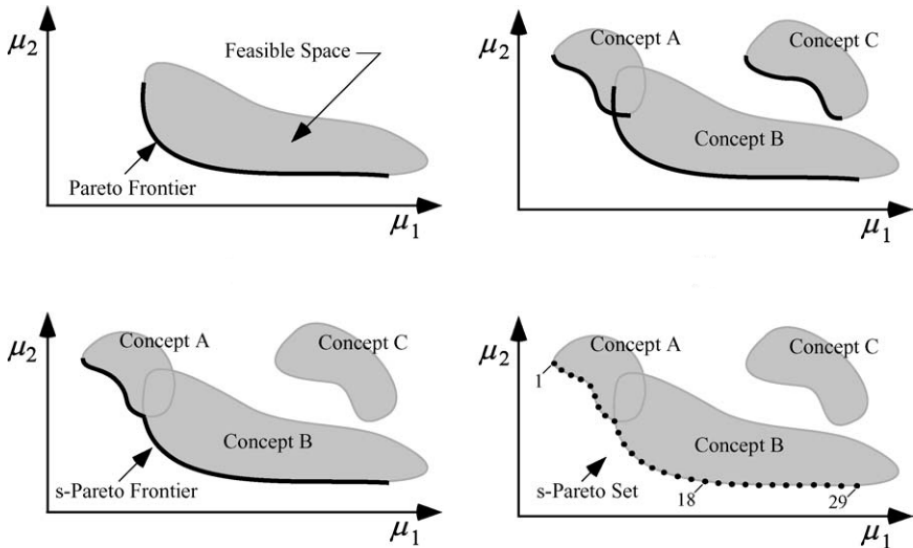


**Figure 5.1:** Example of TSV steering by generating new design points (right versus left) in a potential region of interest using attractor sampling (Stump et al., 2009)

### Pareto-fronts and cluster boundaries

The concept of Pareto-fronts was elaborated in Section 2.2.3. Mattson and Messac (2003) combine several Pareto frontiers for different concepts into an s-Pareto frontier (Figure 5.2). This combined Pareto optimal set can then be used in selecting the best alternative concept. However, to retrieve a well-defined s-Pareto frontier, each concept should be equally explored. For example, this method may give different solutions when one or more sets are ill-defined, and therefore have an inaccurate representation of their individual Pareto-front location.

Vasudevan (2008) acknowledges this problem and therefore proposes a more insightful approach to generating multiple Pareto-fronts for ship concepts. By first generating, then analysing, and finally re-generating Pareto-fronts, any gained insight (e.g., recognising an ill-defined front, identified need for additional constraints, or changes to requirements) may be added to the problem. Hence, this method may be characterised as a progressive approach to generating and exploring Pareto-frontiers.

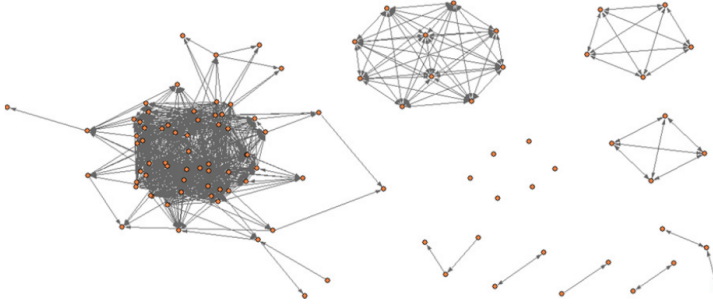


**Figure 5.2:** Defining the s-Pareto frontier for several design concepts (Mattson and Messac, 2005)

### Network representation and analysis

In recent work at University of Michigan, Gillespie (2012) applies elements of network science to exploring and generating general arrangements early on. By capturing arrangement constraints as relations in a network, a new type of representation of the ship layout problem is created. By applying network analysis on the relational layout network, embedded layout drivers can be identified either pre-layout or post-layout. This aids the naval architect in evaluating general arrangements and their embedded rationales.





**Figure 5.3:** A network representation of dependencies of spaces within a general arrangement. Some spaces have no dependencies while others show many interactions (Gillespie and Singer, 2013).

Gillespie acknowledges that setting-up the relational layout network is an involved task. This is especially relevant since a physical ship layout will constantly influence the relative importance and even existence of relations in general arrangements (e.g., when it changes during the design process). For example, the relation between a machinery room and crew quarters may be very important when these spaces are close, but less so, or even irrelevant, when far apart (e.g., due to less impact of noise and vibration). In such cases, a pre-layout driver may turn out to be of lesser importance when actually laid-out within an arrangement.

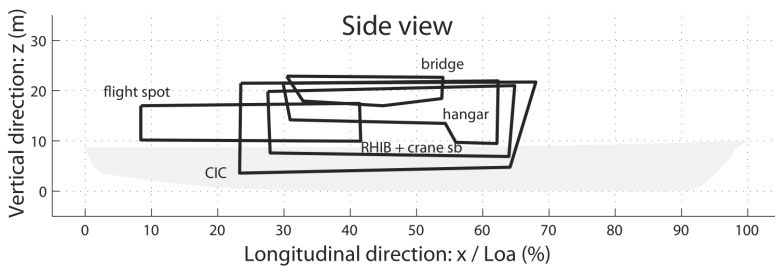
### Selection approach

Section 2.3 briefly introduced the selection approach by van Oers et al. (2008), a more detailed discussion is provided here. Van Oers recognises several important aspects of visualising results of optimisation-based architectural synthesis tools when attempting to uncover design insight. These are:

1. Include *all* results in the exploration and decision making process. That is, do not limit exploration of results to non-dominated design points. When adding additional knowledge (e.g., in the form of constraints or objectives) it is likely that the original non-dominated front will shift backwards (e.g., see van Oers et al., 2008; Purton et al., 2015). Hence, dominated design points are equally important when making decisions.
2. The need for a proper context and reference frame to display information. Different reference frames are required for different exploration problems. For example, when exploring the global positions of systems, a side-view scatterplot of system positions with respect to the hull provides an easy-to-understand and familiar spatial overview of the design. Yet, when exploring relative positions of two systems a different reference frame is required. Second, a familiar reference frame allows the designer to apply engineering-judgement during exploration. That is, it can provide a check as to whether the consequences of applying criteria is as expected or warrants further investigation (Zandstra et al., 2015).

3. The need to filter the display of information based on the deemed importance to the problem by the designer. That is, it is impracticable and even unwanted to display *all* information at once as this only obfuscates potentially relevant insights from the user (Pawling et al., 2014). Hence, van Oers also recognized the importance of priority based filtering starting from exploration of the most relevant information (e.g., as deemed by the designer) to lesser important aspects.
4. The use of ranges of preferred values when selecting designs based on criteria. Most often, a designer will impose a range of preferred values for ship characteristics. For example, a minimum desired level of stability ( $GM \geq 0.5m$ ), or a longitudinal position of a system within certain relative bounds ( $0.2 \leq x_{sys}/L \leq 0.6$ ). To this purpose, van Oers applies a method involving hand-drawn polygons surrounding those design options that are of interest (Figure 5.4).

Together, these aspects should improve the explanatory nature of the results of an optimisation-based architectural synthesis tool, thereby also increasing the level of acceptance of the obtained results, and decisions made.



**Figure 5.4:** Interactively down-selecting a ship general arrangement through preferred system positions (van Oers et al., 2008; van Oers, 2011b)

Because of its insightful ability to aid a designer in selecting from a large (and diverse) set of ship designs including general arrangements, the selection approach is used as a basis for the design exploration step of the proposed progressive approach of Chapter 3. However, there is area for improvement.

Although, there is already some user interaction through the drawing of selection polygons, the selection approach could further benefit from techniques used in the other presented methods from literature. For example, data brushing and filtering as applied in the TSV (Stump et al., 2003) or the visualisation of Pareto-fronts and cluster boundaries (Mattson and Messac, 2003). This chapter further elaborates on changes and improvements made to the selection approach to facilitate the exploration of a large set of diverse design solutions as well as the criteria imposed on them through the progressive approach.

## 5.2 Exploring results of the Packing-approach

Section 1.3.3 and 2.3 discussed the challenges and relevance of exploring a large number of design solutions and their characteristics in search of insight into the complex

interactions between various design criteria and accompanying solutions. Even more so, as discussed earlier in reviewing the selection-approach, the exploration of architectural ship characteristics benefits from other visualisation and exploration methods than those used for numerical aspects. Henceforth, a distinction is made between the exploration of predominantly numerical or predominantly architectural aspects.

Arguably, there are more than just these two “types” of characteristics which benefit from bespoke visualisation techniques. For example, to gain insight from operational effectiveness characteristics, which follow from operational analysis or simulations, different visualisation techniques are beneficial (Veldhuis, 2015). Also, Andrews (1981); Pawling et al. (2013) discuss the topic of style as being a typifying characteristic of design representing various aspects which cannot be considered as one of the traditional naval architecture domains (e.g., structures, stability, seakeeping, resistance and propulsion). In their definition, style can both represent global aspects such as, aesthetics or naval ship survivability, and local aspects such as, the internal layout of a compartment. Hence, the exploration of architectural characteristics (e.g., layout, system solution options) which influence the design both globally and locally, can be considered as a form of exploring style in design (Pawling et al., 2014). However, in this dissertation it was chosen to make a distinction between numerical and architectural characteristics (refer to a discussion and recommendation in Chapter 8).

Section 5.3 covers the visualisation of numerical characteristics, the criteria imposed on them, as well as the exploration of interactions between these aspects. Section 5.4 does the same for architectural characteristics. Finally, Section 5.5 covers the exploration of interactions between numerical and architectural aspects and their criteria.

## 5.3 Exploring numerical characteristics

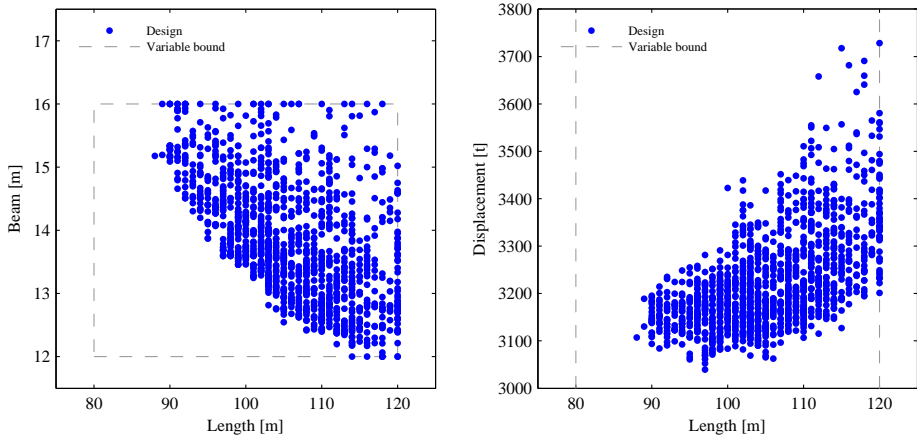
### 5.3.1 Visualising numerical characteristics and criteria

Numerical ship characteristics, such as, length, speed, and range, are displayed using 2D scatter plots (Figure 5.5). 2D scatter plots provide a simple and familiar visualisation of all the designs in the current set with respect to two relevant characteristics (e.g., length versus beam, and length versus displacement, are used in the example). Each dot represents one ship description with multiple numerical characteristics. In the example of Figure 5.5 length and beam are inputs bounded by an upper and lower bound, while displacement is an output variable of the model.

Already some insight may be obtained from Figure 5.5. For example, there is a large unoccupied area of the plot at lower length and beam values. In this area the combinations of length and beam do not produce feasible design points, that is, with these main dimensions the size of the hull-envelope is insufficient to place all systems and spaces while meeting the basic non-negotiable constraints (see Section 6.3.2). This type of insight is useful to check the validity of the set variable bounds (e.g., are the bounds too tight or loose?).

To explore the influence of design criteria on the technical characteristics of the plot in Figure 5.5 the following (semi-automated) process is used:

1. Choose several relevant characteristics based on the type of exploration being performed. For example: technical characteristics such as displacement, length,



**Figure 5.5:** 2D scatter plots of ship characteristics length versus beam (left) and length versus displacement (right). Each dot represents a 3D ship description produced by the Packing-approach ship synthesis model.

or enclosed volume; or monetary characteristics such as procurement cost. This provides the naval architect with a reference frame to which the impact of criteria changes and design choices can be checked (Zandstra et al., 2015).

2. Plot all designs with respect to the chosen relevant characteristics (Figure 5.5).
3. Find the feasible set of design points for the criterion and identify the regional Pareto-based boundary of this set of points (Figure 5.6a). A convex hull representation of the set boundary was also considered, however this could not reveal the concave nature of some of the feasible sets (e.g., see the right plot in Figure 5.6a).
4. Repeat steps 2 and 3 for multiple criteria (Figure 5.6b)

This process can be repeated for any number of criteria but also for any number of different 2D scatter plots (although the number is ultimately limited by a humans ability to differentiate the data). Hence, the designer is free in choosing different combinations of relevant characteristics to investigate possible design impacts caused by criteria. For example, one could investigate the influence of several criteria on length, displacement, and cost simultaneously. In which case three scatter plots can be used to cover all options: cost and length, cost and displacement, and length and displacement (for more examples refer to the test-cases in Chapter 7).

The individual and combined criteria bounds offer several relevant insights.

- They depict the extents of the feasible area for the current criterion (or set of criteria). Consider the example of Figure 5.6a, where the boundary of the criterion  $GM \geq 1.0m$  is plotted. Designs with a beam lower than 14 meters will not meet the  $GM$  limit. Naturally, not all designs with a higher beam meet the stability criterion, because there are other varying characteristics not shown here (e.g., a general arrangement with high vertical centre of gravity). In addition, since the bounds for each criteria are maintained and overlaid within

the current plots, they also provide a means of tracking *which* criteria cut-off *what* parts of the solution space (e.g., this was also an important consideration for the use of selection polygons in the approach of van Oers and Hopman, 2012).

- The location and shape of the criteria boundaries indicate in which “direction” each boundary is likely to change when its criterion is changed. For example, consider the *GM* boundary in the left plot of Figure 5.6a. Several things are expected to happen when the required *GM* is relaxed:
  1. Based on the type of criterion (in this case  $\geq$ ), and the observation that a part of the design space is cut-off by the *GM* boundary, a relaxation is expected to shift the boundary downwards (and vice-versa when a higher *GM* is required).
  2. Our engineering judgement indeed confirms that relaxing *GM* should allow narrower vessels.
  3. A 3D version of the plot further confirms this expected behaviour (Figure 5.7).
  4. By actually changing the *GM* criterion and reviewing the plots we confirm that the change is as was expected from the insight above (Figure 5.8).

Similarly, we elucidate that the range boundary in Figure 5.6b should move upwards towards higher beams when relaxed, and that the displacement boundary should move to the upper-right with higher length and beam values when relaxed.

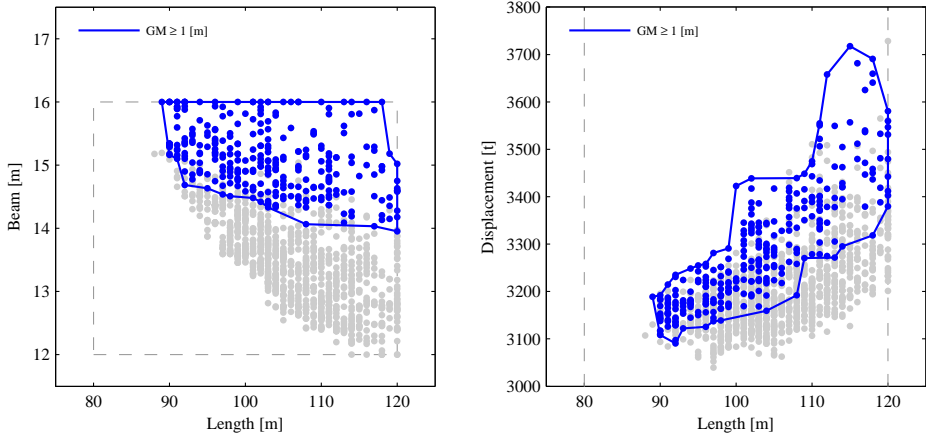
- By comparing the directions in which different criteria are “moving,” it is possible to identify opposing and/or conflicting criteria. For example, in Figure 5.6b the *GM* and Range criteria are opposing. That is, designs with a higher range likely have a lower *GM* because of a lower beam, and vice-versa. This also indicates, which criteria might need to be changed to maintain feasibility. By interactively “playing around” with the different criteria and their values (Figure 5.8), a designer can quickly identify such conflicts, and the possible options available to solve the conflict (e.g., which criterion to relax).

### 5.3.2 Exploring interactions and conflicts

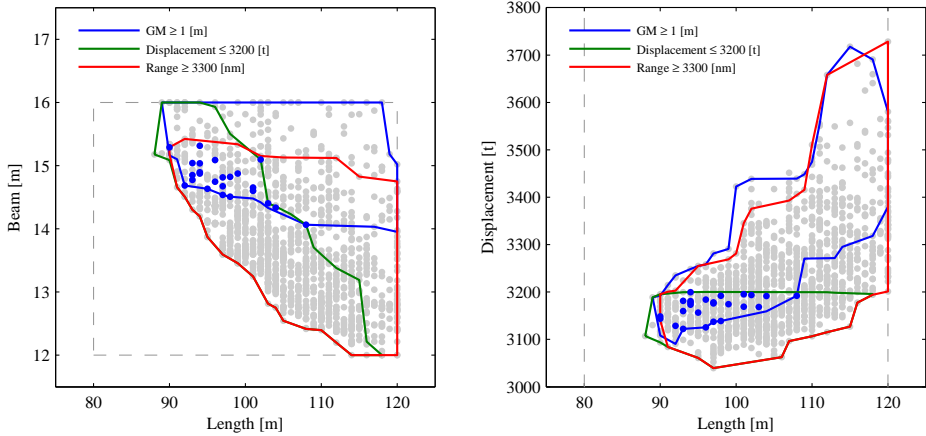
For a numerical characteristic and its accompanying criterion, the designs which meet the criterion is defined as the set of designs  $r$ . Hence, the feasible set of designs for the combination of any number of numerical criteria may be defined as:

$$R = \bigcap_{i=1}^n r_i \tag{5.1}$$

where  $R$  denotes the set of designs meeting all numerical criteria  $r_i$  with  $i = (1, 2, \dots, n)$ . This is the feasible set of designs shown in Figure 5.6b. However, due to interactions between criteria, often the feasible set  $R$  does not exist. In this case interactions and conflicts between criteria must be identified and explored.



(a) Filtered designs and criterion boundary



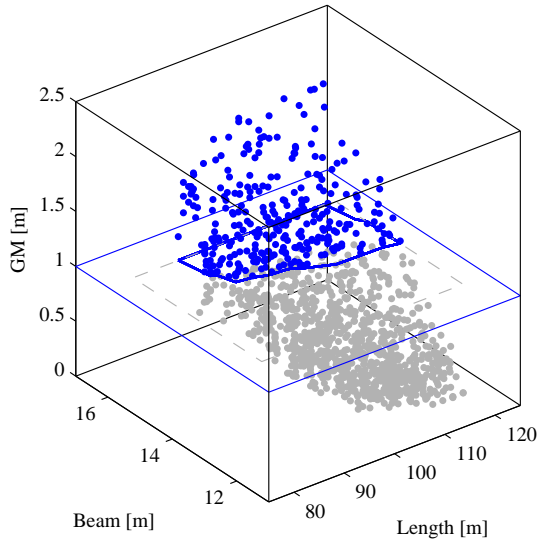
(b) Multiple criteria boundaries

**Figure 5.6:** Visualising numerical design characteristics and criteria

It was mentioned that interactively changing criteria values can provide insight into which “direction” their bounds are likely to shift. For example, by relaxing a criterion until a feasible combined set  $R$  is obtained may identify the need for altering one or more criteria. However, this simple method does not help in identifying which criteria are actually interacting with one-another in the case of a conflict.

First, consider the different types of conflicts which may occur between criteria. These are shown in Figure 5.9, where individual criteria are represented as a parametric solutions space (refer to Burcher and Rydill, 1994). The different types of conflicts that can occur are:

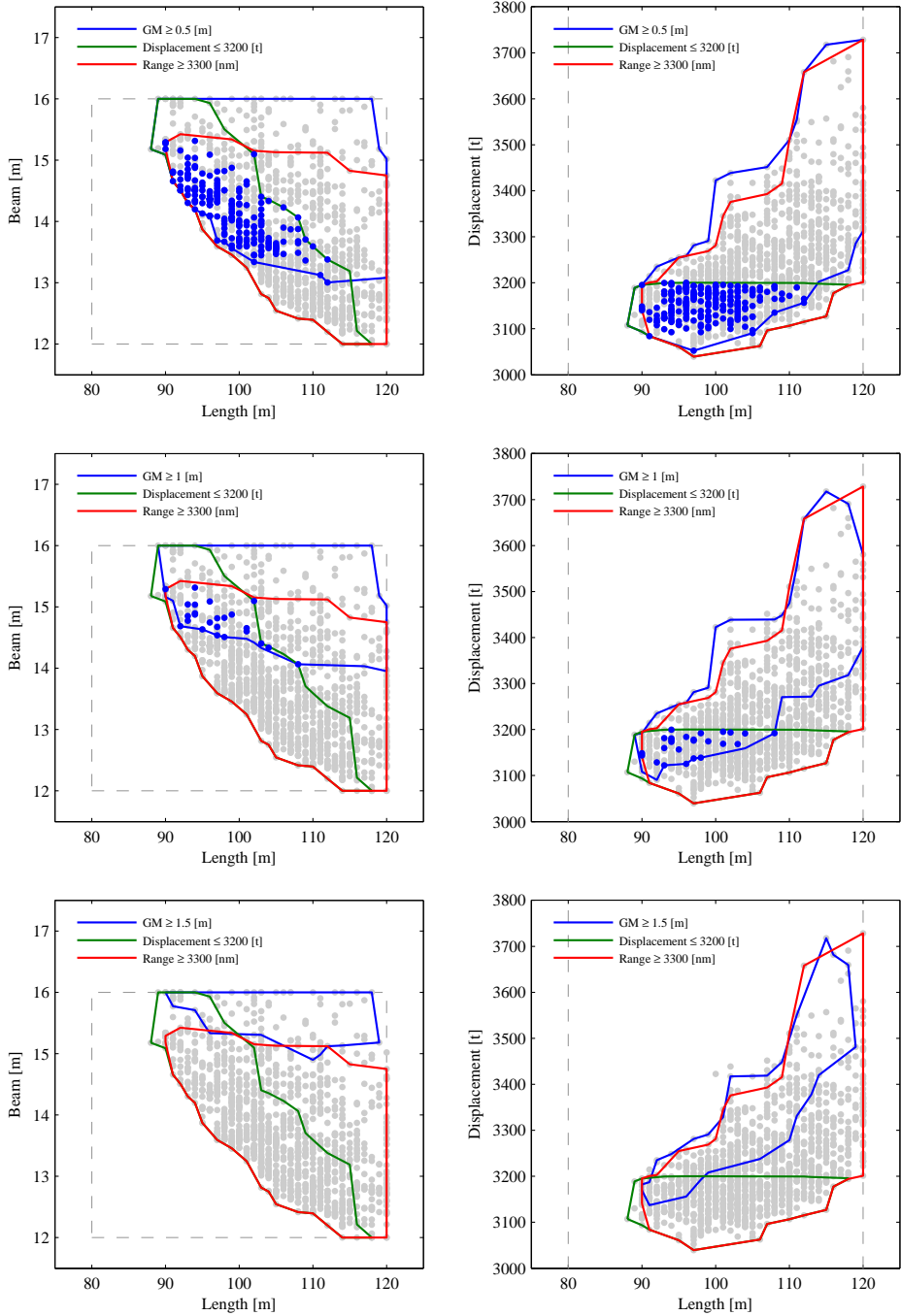
- First, a conflict between one and all other criteria. That is, all but one criteria form a feasible set (Figure 5.9b).



**Figure 5.7:** 3D representation of how a criterion boundary is obtained using a Pareto-front approach on the feasible set ( $GM \geq 1.0m$ ). This type of 3D plot can be used to visually check the found front and response with respect to the reference characteristics (e.g., length and beam).

- Second, a conflict between two criteria (Figure 5.9c). That is, there is no feasible set  $R$ , yet all but one of the sub-sets of criteria produce feasible designs ( $r_1 \cap r_2$  and  $r_1 \cap r_3$ ). This is the case in the example of Figure 5.8. In this example the bottom situation (with  $GM \geq 1.5m$ ) shows no feasible set, yet both sub-sets of still produce feasible designs. So, in this case there is a conflict between Range and  $GM$ . This can also be confirmed by the opposing criteria boundaries. Hence, in resolving this conflict, changing the Displacement criterion will have no effect, the solution must be sought by either relaxing the required  $GM$  or Range (or by relaxing both).
- Third, a conflict between multiple criteria (Figure 5.9d and 5.9e). Even when all sub-sets of criteria produce feasible designs there might be no combined feasible set  $R$ . For example, consider a speed, range and payload criteria. Though the separate combinations of speed and range, speed and payload, and range and payload are feasible, the overall combination of the three can very well be infeasible due to the mutual interaction effects of these three ship characteristics (see Figure 5.9d). In addition, there are also situations in which none of the criteria overlap (Figure 5.9e). That is, not even the sub-sets of criteria produce feasible sets.

Although identifying which type of conflict a designer is dealing with is complicated by the interactions between criteria (i.e., changing or removing one criteria can alter the interactions between other criteria), there is a simple strategy which can help aid in understanding which type of criteria is encountered. That is, by systematically



**Figure 5.8:** Interactively changing the  $GM$  criteria;  $GM \geq 0.5m$  (top),  $GM \geq 1.0m$  (middle),  $GM \geq 1.5m$  (bottom).



turning-off criteria, while noting the existence of feasible sub-sets of the other criteria, it is usually possible to quickly identify the interactions.

For example, if no feasible set  $R$  exists, and turning-off each individual criterion does provide a feasible sub-set, then there is a conflict of the type displayed in Figure 5.9d. This can be written in terms of sets as:

$$R = r_1 \cap r_2 \cap r_3 = \emptyset \quad \text{while} \quad \begin{array}{l} r_1 \cap r_2 \neq \emptyset \\ r_1 \cap r_3 \neq \emptyset \\ r_2 \cap r_3 \neq \emptyset. \end{array} \quad (5.2)$$

The conflict of the type displayed in Figure 5.9c may be written as:

$$R = r_1 \cap r_2 \cap r_3 = \emptyset \quad \text{while} \quad \begin{array}{l} r_1 \cap r_2 \neq \emptyset \\ r_1 \cap r_3 \neq \emptyset \\ r_2 \cap r_3 = \emptyset. \end{array} \quad (5.3)$$

This conflict can also easily be identified by systematically turning-off criteria. That is, turning-off  $r_3$  or  $r_2$  does not give an empty sub-set, whereas, turning-off  $r_1$  gives an empty set.

Nonetheless, the explained technique of systematically turning-off individual criteria, though insightful, quickly becomes complicated when the number of criteria is more than four or five. However, the combination of, (i) the visual aids and insight provided by individual criteria boundaries with respect to relevant ship characteristics, and (ii) the systematic turning-off of criteria or sets of criteria, provides a tool-set that the naval architect can use to explore the influence of combining different criteria. Still, the engineering judgement and expertise of the naval architect must not be underestimated, and is essential in “tying together” (integrating) the various pieces of information obtained by the exploration methods explained above.

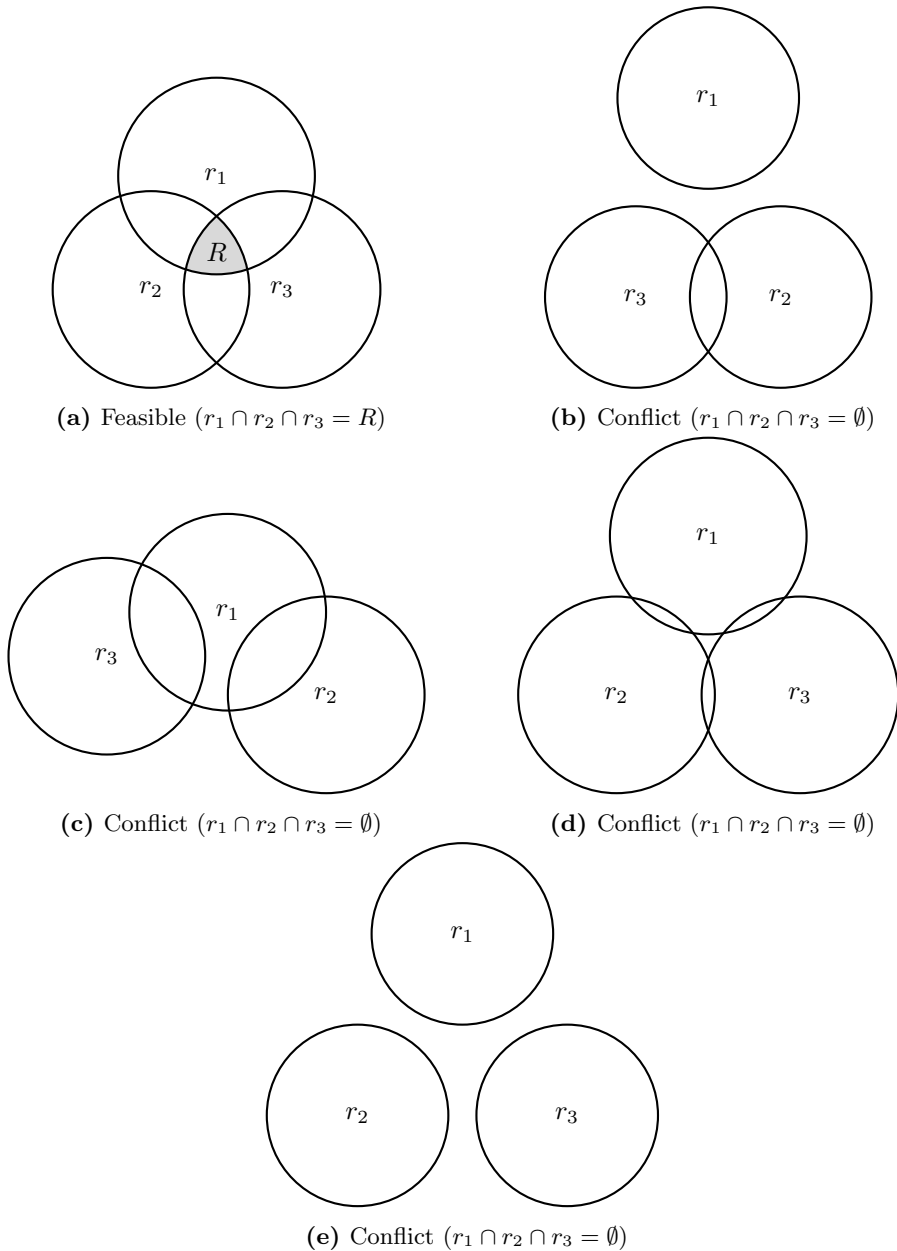
## 5.4 Exploring architectural characteristics

### 5.4.1 Visualising architectural characteristics and criteria

Architectural characteristics (e.g., global and relative positions of systems, separation of systems) and the criteria imposed on them (e.g., position preferences and required separation between spaces) require a different visualisation approach than numerical characteristics of a design (van Oers et al., 2008; Duchateau et al., 2013; Pawling et al., 2014).

Commonly, the positions of systems and spaces within a ship are visualised through a 2D general arrangement drawing (e.g., mostly using a side-view of the vessel and a top-view of each deck, see Figure 5.10). However, such representation is very impractical when attempting to visualise, compare, and explore interactions between, many different system positions concurrently (Pawling et al., 2014):

- First, the number of general arrangements which can be reviewed and compared concurrently using traditional visualisation is low. Typically not more than a few can be compared before the designer will lose the ability to maintain a clear overview due to the sheer amount of information being presented (e.g., consider comparing more than ten different general arrangement drawings at the level of detail presented in Figure 5.10).



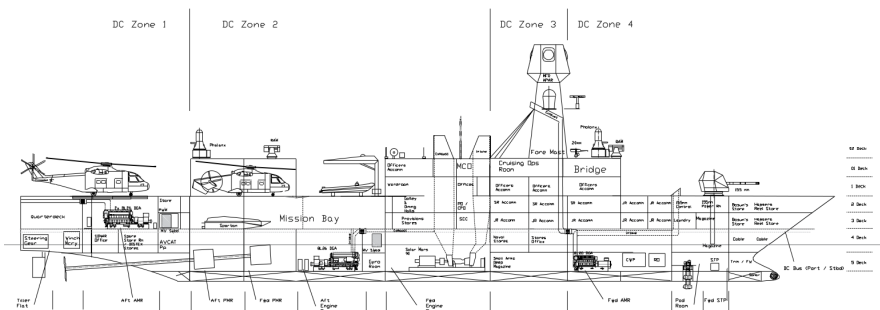
**Figure 5.9:** Feasible or conflicting sets of criteria ( $r_i$ ) represented as a parametric solution space

- Second, the amount of information that is being displayed within traditional general arrangement drawings is too high. That is, *all* systems and spaces are shown at a high level of detail. A level which is not required for evaluating the global and relative positions of key systems and spaces. Something which can simply be visualised by a global or relative  $x, y$ , and  $z$  position of the centroid of a space (van Oers et al., 2008). A high level of detail, in this case, is only distracting.

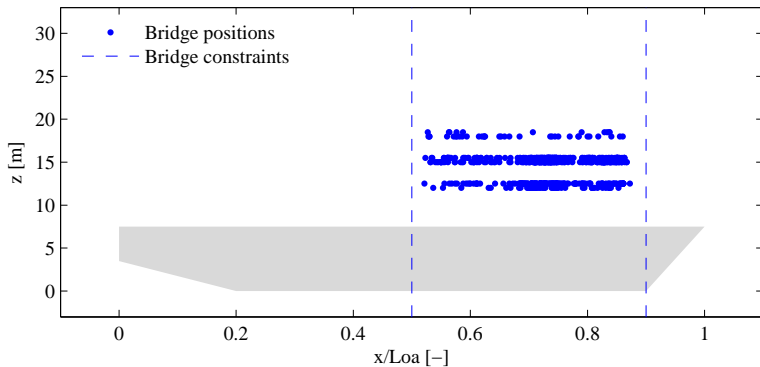
The problems mentioned above led van Oers et al. (2008) to use a simple 2D side-view (or top-view) to plot global or relative positions of systems and spaces using only the  $x, y$  and  $z$  coordinates of the centroids of each system or space. Figure 5.11 shows such a reference frame used to plot all the different bridge positions for a set of some 600 designs. Note, the longitudinal axis is made relative to the ships length as this varies between designs. Also, the constraints applying to the bridge position within the Packing-approach synthesis model, and the current user selection of preferred bridge positions, are added. Figure 5.12 shows a similar representation but now with multiple systems and Figure 5.13 shows the relative separation between two systems.

A side-view plot as in Figure 5.11 and 5.12 already provides various insights to the user. Comparing the actual positions of the system with respect to its constraints may indicate that it is being bounded by interactions with other systems or spaces. For example, see the positions of the generator room in Figure 5.12. This space has no longitudinal positioning constraints, yet it is bounded aft due to a combination of hull shape and the presence of a propulsion room (not shown), and it is bounded forward due to the hull shape and interactions with topside systems (e.g., radar and bridge) through the intake and exhaust.

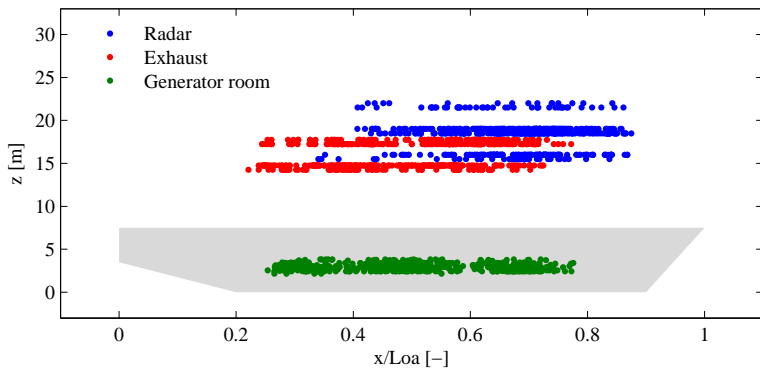
Figure 5.14 again shows the available positions for the bridge space, but now with an added user defined global position preference criterion. Similar to the original selection approach, the user can draw a selection polygon to express a preference or criterion for the position of a system. New however, is the ability to alter the selection by interactively resizing and/or dragging the polygon. This interaction automatically updates the applied criterion filter  $s_j$  and thus also the set  $S$  (i.e., similar to the process used for numerical characteristics in Section 5.3).



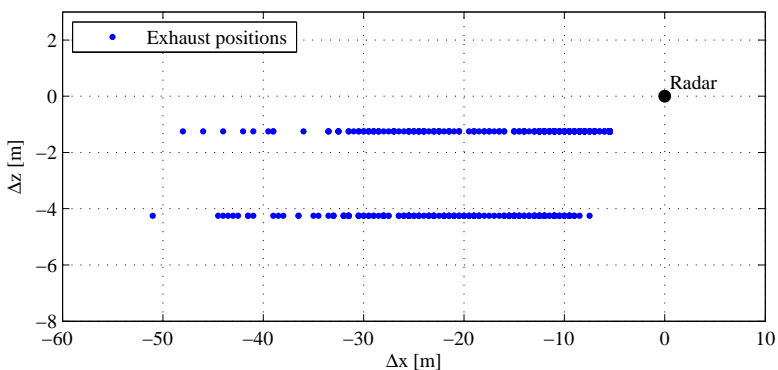
**Figure 5.10:** Example of typical 2D side-view general arrangement drawing, taken from (Goddard et al., 2011)



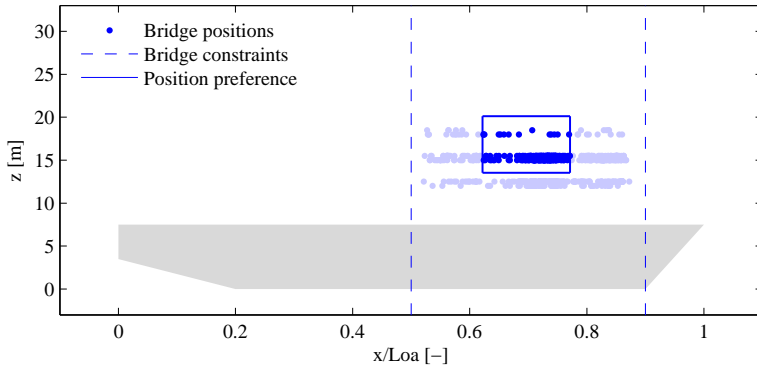
**Figure 5.11:** Available global positions for the bridge space and its longitudinal positioning bounds



**Figure 5.12:** Available global positions for multiple systems: radar, exhaust, and generator room.



**Figure 5.13:** Available relative positions of systems: exhaust with respect to the radar.



**Figure 5.14:** Available and preferred global positions for the bridge space after the designer has applied a criterion on the preferred location

### 5.4.2 Exploring interactions between architectural aspects

There are various options for visualising interactions between architectural aspects. For example, interactions between longitudinal or vertical positions of multiple systems can be explored using a matrix-plot representation (Figure 5.15). These plots are very use-full to quickly identify trends and patterns within the data.

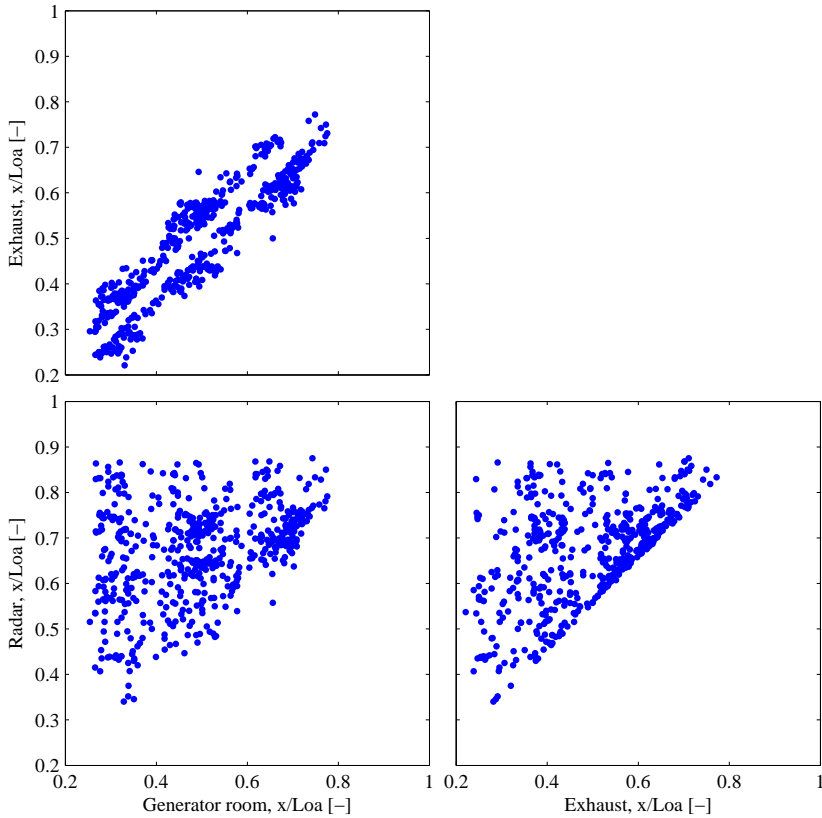
In Figure 5.15, for instance, some interesting trends are displayed. First, there is a distinct relation between the exhaust and radar. This is caused by a packing rule (see Section 4.1.1) which states that the exhaust should be placed aft of the radar. Second, the exhaust and generator room are coupled due to a vertical connection. That is, the exhaust is should always be connected to the generator room through a vertical connection object (see Section 4.1.1). The two distinct lines are caused by the exhaust being placed at either the aft or forward bulkhead of the generator room. Finally, the two explained direct linkages cause an indirect interaction between the longitudinal position of the generator room and radar.

The identified interaction explored above are not directly apparent from the plot of the same systems (i.e., radar, exhaust, and generator room) shown earlier in Figure 5.12. Although this plot does gives a familiar spatial representation of *where* the systems are with respect to the hull, it does not easily allow the extraction of interactions *between* systems. If the familiar spatial representation is to be maintained, then there is need for a different method of exploring the interactions between locations of multiple systems. Again filtering based on applied criteria can be used in combination with the interactive selection preferences from the selection-approach (Figure 5.14).

As with numerical criteria (Section 5.3), the set of designs which meets an architectural criterion may be defined as  $s$  (e.g., the set of designs which complies with the global position preference expressed in Figure 5.14). Again, any number of architectural criteria can then be combined using:

$$S = \bigcap_{j=1}^m s_j \quad (5.4)$$

where  $S$  denotes the set of designs which meets all expressed architectural criteria  $s_j$



**Figure 5.15:** Matrix-plot representation of multiple longitudinal system positions

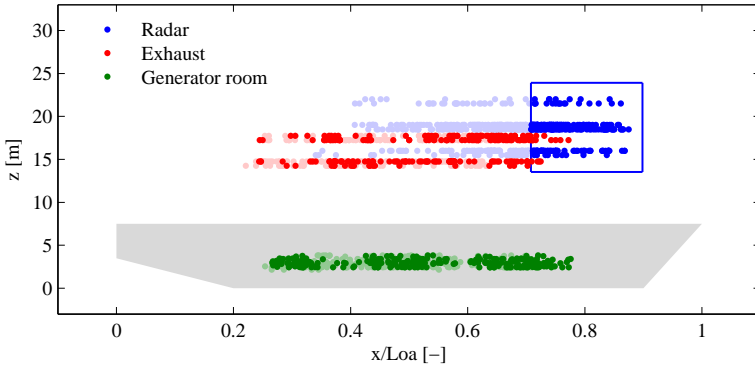
with  $j = (1, 2, \dots, m)$ . The feasible set  $S$  can now be used to filter any visualisation plots with respect to the current set of user-defined criteria.

For example, consider Figure 5.16 which applies an interactive selection criterion to the radar position and uses the filtering set  $S$  to filter available positions of the exhaust and generator room. Compared to the plot of Figure 5.12, this approach using dynamic filtering and interactive selection is considered more insightful.

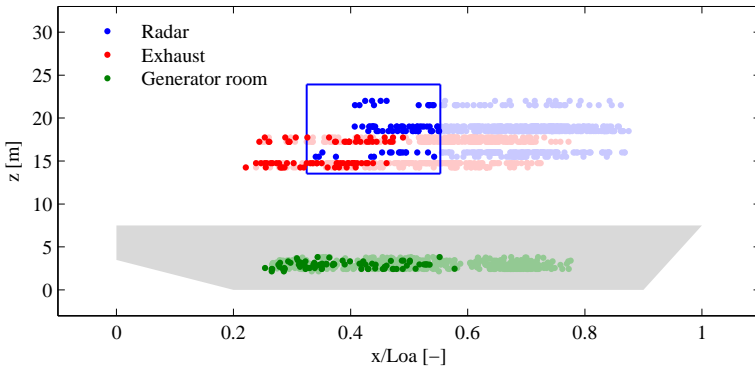
- First, manipulating the selection of preferred radar positions (e.g., moving it forward or aft) provides insight into interactions with available positions of the other systems, that is, similarly to the static representation of Figure 5.15. For example, moving the radar aft reveals that the generator room consequently also must be placed aft due to the interaction with the exhaust.
- Second, it combines both longitudinal and vertical positioning information. Hence, interactions between both these properties can be explored concurrently (e.g., the naval architect might select the top-most aft-most radar positions). These interaction are much more difficult to explore using two matrix-plots as in Figure 5.15.

- Third, this interactive visualisation maintains the familiar spatial reference frame of a 2D side-view general arrangement plot which allows a naval architect to better apply engineering judgement while elucidating interactions and expressing preferences for global systems positions (van Oers et al., 2008).

Similar filtering can be used in visualising interaction in multiple plots. Thus, a relative position plot can be linked through data filters to a global positioning plot which allows the user to explore interactions between different architectural properties.



(a) Forward radar location preference



(b) Aft radar location preference

**Figure 5.16:** Interactions between different global position preferences for the radar and resulting, still available, global positions for the exhaust and generator room

## 5.5 Linking numerical and architectural characteristics

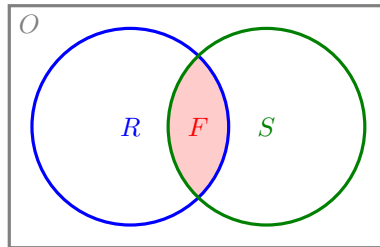
Section 5.3 and 5.4 have shown how the selection approach can be adapted to interactively explore interaction between either numerical or architectural characteristics and the criteria imposed on them. This section combines the developed techniques

to link the visualisation of numerical and architectural aspects while maintaining the the insightful user interaction and filtering presented earlier.

First, the filter sets defined in Equations (5.1) and (5.4) are combined to create a filter for the *overall* feasible set of designs  $F$ . That is, the set of designs which meet *all* user-defined numerical and architectural criteria  $r$  or  $s$ :

$$F = R \cap S \quad (5.5)$$

Now, the sets  $R$ ,  $S$ , and  $F$  can be used to filter mutual interaction between numerical and architectural aspects (see Figure 5.17).



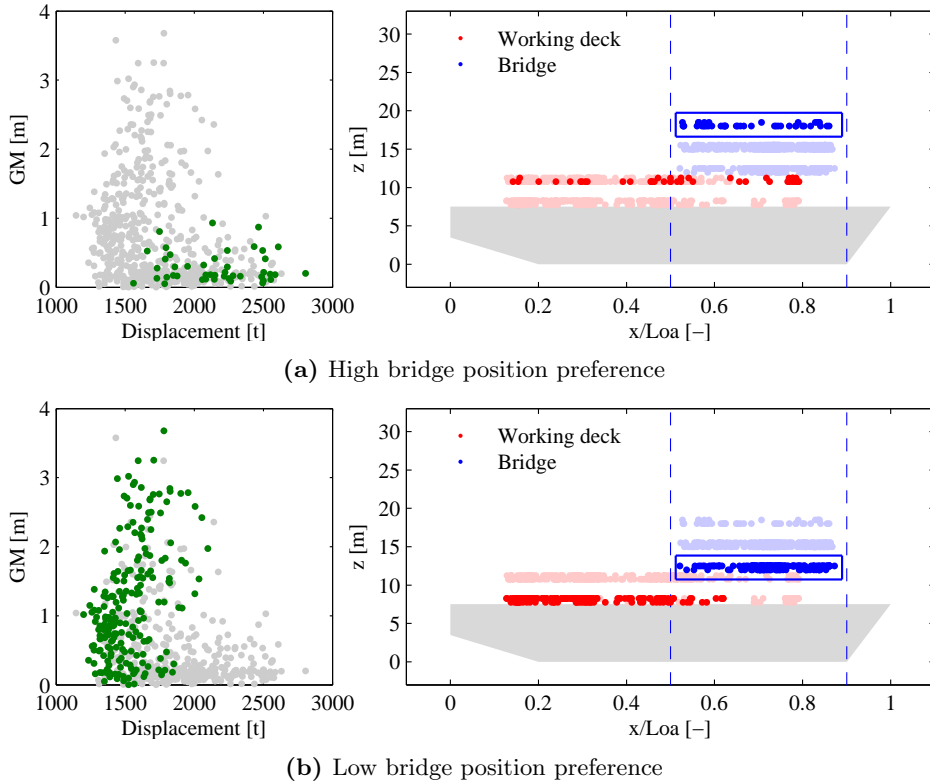
**Figure 5.17:** Set of all designs  $O$ , design feasible with respect to numerical criteria  $R$ , designs feasible with respect to architectural criteria  $S$ , and feasible combinations of  $F = R \cap S$ .

Figure 5.18 illustrates how a criterion applied to an architectural characteristic (i.e., a preferred location for the bridge) can affect both other systems positions, as well as numerical characteristics. The opposite is also possible. Figure 5.19 shows how changing a numerical criterion (i.e., the required value for  $GM$ ) affects the available global positions of the bridge and working deck. Finally the combination allows a designer to link criteria (i.e., for numerical and architectural aspects) and the resulting design solutions (e.g., what the resulting solution looks like). This mutual interaction is shown in Figure 5.20. It is either possible to start with identifying required performance criteria and then checking the available solutions in terms of layout and systems, or to start with a preferred set of systems and accompanying layout and then check attainable performance.

## 5.6 Discussion and closure

The chapter started with a list of tasks which were considered important for gaining relevant insight from concept exploration to aid requirements elucidation (Section 2.3). These tasks included: (i) linking criteria and solutions, (ii) identifying conflicts between criteria, (iii) identifying how to resolve or avoid those conflicts, and (iv) identify why they occur. These tasks, due to the implicit and complex nature of the interrelations between criteria, can only be accomplished by visually exploring concept designs and their accompanying characteristics and criteria. To this extent, several interactive visualisation methods were developed to aid designers in identifying relevant insights.

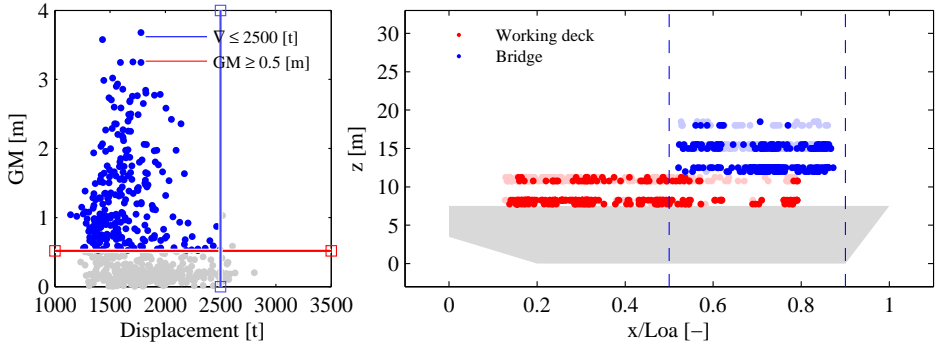




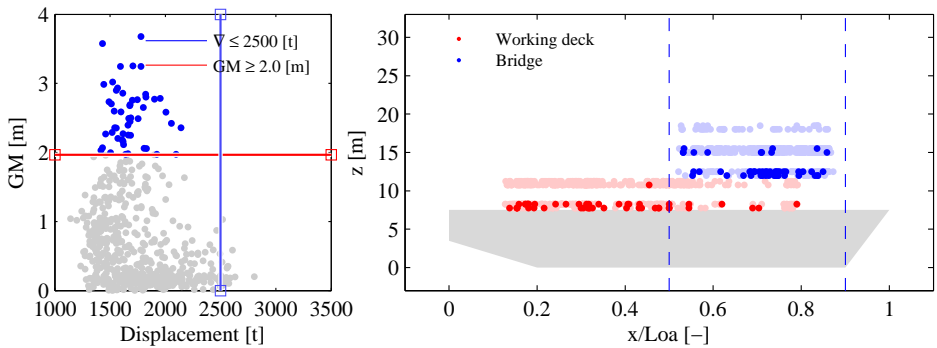
**Figure 5.18:** Interactions between the selection of a preferred bridge position and attainable numerical characteristics of displacement and  $GM$

Sections 5.3, 5.4, and 5.5 showed how visual aids (e.g., dynamic set-based filtering, data brushing, criteria bounds) aid in linking individual criteria to attainable solutions (task 1). The criteria boundaries and filtering provide a visual aid to identify the existence of possible conflicts between criteria, and how these might be resolved (task 2 and 3). Finally, because the resulting design concepts are readily available to the naval architect (e.g., as a full 3D ship description backed up with detailed naval architecture analysis) a designer can apply expertise and engineering judgement to interpret *why* criteria conflict (task 4).

Nonetheless, exploring design solutions is still an involved task where knowledge of the underlying synthesis model together with its assumptions and limitations is required. Also, since the set of designs is always limited (e.g., compared to the number of theoretically possible solutions), some care must be taken when drawing conclusions. Conflicts may exist simply because designs which might disprove the conflict have not yet been explored. However, in such cases the interactive progressive approach can help. The identified criteria can be used to focus design generation towards more relevant areas of the design space in search of the actual criteria boundaries (e.g., to test if they are still true). This interactive steering of the synthesis tool based on the identified insight and criteria is the subject of the next chapter.

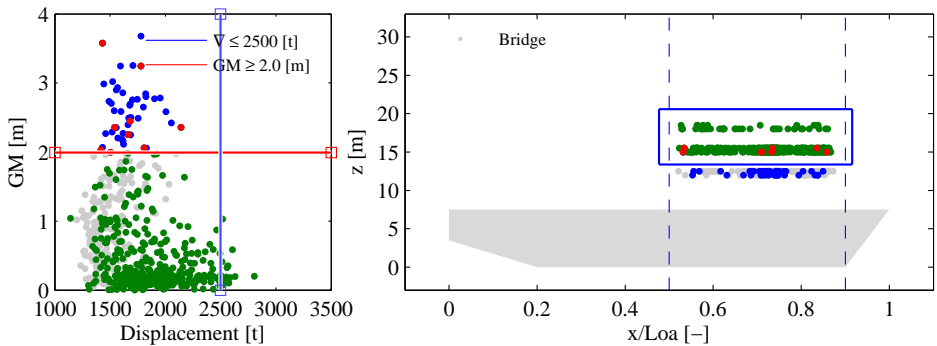


(a) Low required  $GM$



(b) High required  $GM$

**Figure 5.19:** Interactions between a changing performance criterion ( $GM$ ) and resulting attainable system positions



**Figure 5.20:** Mutual interactions between numerical criteria and bridge position criterion. Note the colour coding used is consistent with Figure 5.17. The red dots comply with *all* criteria, the green dots with the bridge selection criterion, and the blue dots with the numerical performance criteria for displacement and stability.



# Chapter 6

## Guiding the exploration effort

*“The naval architect does not start with a preconceived idea of what is ‘right’ and then fit his design into it.”*

---

– David Brown (1991)

This chapter covers the final step of the interactive steering approach described in Chapter 3 and Figure 3.2, that is, the task of steering the concept exploration effort towards desired design solutions. The main input for this step was uncovered by the designer while interactively exploring the solution properties of the preceding iteration, i.e., through design insight (Chapter 5). First, how this new knowledge can be used to steer the process is covered. Next, the merits of several steering mechanisms are explored. Finally, a suitable steering mechanism is chosen, developed, tested, and implemented in the overall interactive concept exploration process described in Chapter 3.

This chapter is based on work published by the author in Pawling et al. (2014) and Duchateau et al. (2015).

### 6.1 From design insight to controlled steering

Chapter 5 elaborated on how various insights could be gained from exploring a large set of diverse design solutions (i.e., concept exploration). Chapter 3 explained that insight (and the understanding it provides the naval architect) may be used to adjust, expand, or reduce a continuously evolving set of design criteria. Criteria which, in turn, allow the naval architect to steer the “direction” of further exploration efforts. However, this implies that the synthesis model, and how this model generates designs, should respond to changes to those criteria. Hence, the main question regarding this chapter becomes:

*How to use the set of adjusted criteria from the exploration effort to guide a (optimisation-based) ship synthesis model in the search for new and more relevant designs?*

## 6.2 Steering methods

The basic Packing-approach process (repeated here in Figure 6.1) contains several information flows that can be used to include new insights, in the form of a set of criteria, to steer the synthesis model. These are (also highlighted in Figure 6.1):

1. *Packing-rules (synthesis model constraints)*
2. *Search algorithm constraints*
3. *Search algorithm objectives*

The other Packing-approach inputs are: the list of building blocks (i.e., the components and spaces of the MCMV model, see Appendix A), and the initial input variables to start the first population of the genetic algorithm.

The initial input variables (i.e., first genetic algorithm population) cannot be used to directly steer the approach based on new criteria. However, the initial population can be adjusted to a suitable starting point in subsequent iterations of the interactive exploration process. Hence, desirable designs from the previous exploration run(s) can provide an initial starting point for the next run.

Technically, also the building blocks could be adapted and adjusted based on insight gained during the interactive exploration process. However, as was discussed in Chapter 4, the technical implementation of Packing (i.e., the way building blocks are described and sequentially packed) currently limits the possibility for adding new building blocks (e.g., systems and spaces) later on. The other possibilities of steering, that is, (i) with the use of packing-rules, (ii) using search algorithm constraints, or (iii) using search algorithm objectives, are described in more detail below.

### 6.2.1 Packing-rules (synthesis model constraints)

*Packing-rules* determine *how* the Packing-approach places individual building blocks (e.g., spaces and systems) within the positioning space. Packing-rules allow the following aspects of systems and space positioning to be controlled:

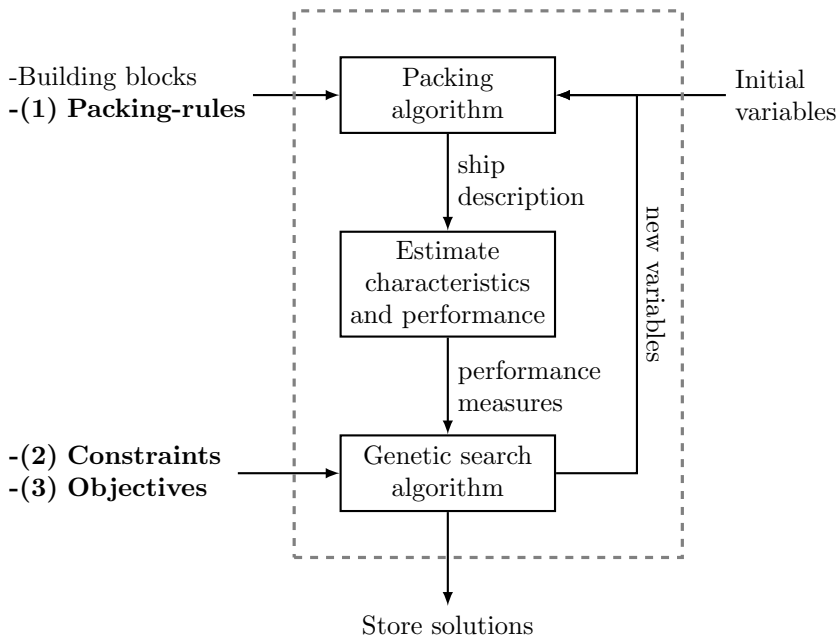
- *Global positioning*, that is, the position constraints of objects relative to a fixed point of the hull (e.g., the aft-most point at the base-line is considered the zero-point in Packing). For example, the bridge might be restricted horizontally between 50 – 80% of the overall length, while an engine room compartment is often vertically restricted to a certain deck number.
- *Relative positioning*, that is, the positioning constraints of objects relative to each other. For example, a helicopter landing platform can be restricted to the same deck as the helicopter hangar. Generally this constraint is in the form of:

$$\textit{System A must be on the same deck as System B} \quad (6.1)$$

- *Adjacency or separation*, that is, in either absolute distance (e.g., meters separation) or number of compartments<sup>1</sup>. For example, for vulnerability reasons

---

<sup>1</sup>A compartment is defined as the space between two consecutive bulkheads and decks



**Figure 6.1:** Packing-approach process and highlighted inputs that can be used to control the generation of design solutions

it could be chosen to separate the main engine room from the diesel generator room by at least a compartment. Other examples are:

$$\begin{aligned} \textit{System A} &\text{ must be separated by 2 compartments from } \textit{System B} \\ \textit{System C} &\text{ must be within } 10\textit{m} \text{ of } \textit{System D} \end{aligned} \quad (6.2)$$

- *Connectivity*, that is, connections between objects. Examples are: up-takes, down-takes, access shafts, and elevators or lifts.
- *Free-space*, that is, space surrounding certain systems which may not be occupied by other objects. Examples are, a helicopter landing platform requiring free-space to ensure a safe flight approach, or a combat system requiring a free line-of-sight to operate (e.g., naval gun or radar system).

Together, the above Packing-rules offer a great amount of control in *how* systems and spaces are placed in the synthesis model, that is, the architectural aspects of the design problem.

### 6.2.2 Search algorithm constraints and objectives

Although, in principal, the naval architect is free to choose the search algorithm constraints and objectives, various studies have shown that it is practical to use a default problem set-up which combines non-negotiable constraints and a simple objective (e.g., Wagner et al., 2010a; van Bruinessen, 2010; van Oers, 2011b; DeNucci,

2012; Zandstra, 2014). This default problem definition used within Packing’s search algorithm is as follows:

$$\begin{aligned}
\min_x \quad & f \quad -PD(x) \\
s.t. \quad & h_1 \quad \text{systems}_{\text{placed}}(x) = \text{systems}_{\text{total}}(x) \\
& g_1 \quad T(x) \leq T_{des}(x) \\
& g_2 \quad \|LCB(x) - LCG(x)\| \leq \delta_{req} \\
& g_3 \quad GM(x) \geq GM_{req} \\
& \underline{x} \leq x \leq \bar{x}
\end{aligned} \tag{6.3}$$

where the negative of packing density  $PD$  of a design is minimised<sup>2</sup> in the single objective function  $f$ . This ensures that the Packing-approach searches for compact designs. The equality constraint  $h_1$  states that all systems must be packed. The other constraints safeguard several non-negotiable requirements such as, buoyancy  $g_1$ , trim  $g_2$ , and initial intact stability  $g_3$ .

In addition,  $g_1$  ensures a design will meet its required speed and range. This is because the estimates for required propulsion power and fuel capacity are made at the design draft  $T_{des}$ . Thus, if the final draft  $T$  is smaller than or equal to the design draft (i.e., the draft at which resistance is estimated) we assume that the required propulsion power will be lower and thus that the design has sufficient installed power and fuel to meet its required speed and transit range.

## 6.3 Issues with steering methods

The steering methods of Section 6.2 have several drawbacks which limit their applicability within the proposed interactive approach. The drawbacks of each method are covered below. Next, based on these drawbacks, a new steering method is proposed and developed in Section 6.4.

### 6.3.1 Packing-rules

The Packing-approach uses packing-rules to control the placement of systems through positioning constraints and logical relations. However, the use of these packing-rules may result in different outcomes. Within the parametric design model created in the Packing-approach, finding a correct balance of the number and type of constraints and/or logical relations versus the desired diversity of the resulting solutions, is not an easy task. This issue was demonstrated through various projects undertaken with the Packing-approach:

- First, Wagner (2009); Wagner et al. (2010a) used the Packing-approach to examine different layout possibilities for a deep-water drillship. Wagner showed that, depending on the number of used positioning constraints, the diversity of

---

<sup>2</sup>Hence, the use of a minus in the objective function to maximise.

the resulting solutions within the design space can vary considerably. In addition, there is a high chance of over-constraining the model, which would result in only a limited exploration.

- Van Bruinessen (2010), contrary to Wagner, used a limited number of constraints to develop a model for a coast-guard cutter. This resulted in very diverse design solutions covering a broad area of the design space. However, many designs needed to be filtered from the design space due to undesirable and impractical arrangements. Relational packing-rules could fix these problems as they allow control over relative system positions without limiting their global placement on the design.
- Zandstra (2014) went one step further and used logical system properties and dependencies to develop a generic set of constraints, which dynamically adapt to the presence of systems within the design. This constraining method reduces the chance of over-constraining while maintaining an acceptable level of constraints ensuring a logical and practical layout of the ship. However, its steering ability is still limited to the correct and logical placement of systems and not to desired whole ship performance. Moreover, setting up the dynamic constraints is an involved task, especially for a design model which has many varying design options.
- Baudeweyn (2014) demonstrated that the use of positioning constraints on the deck-layout of a Floating Production Storage and Offloading vessel (FPSO) limited the broadness and diversity of the resulting design space. These constraints were traditionally used to ease the tedious task of manually creating a safe and feasible deck-layout. However, by changing these constraints into more flexible objective functions (that are then used in the Packing-approach search process) Baudeweyn illustrated that relaxing these positioning constraints was actually beneficial for several relevant design characteristics (e.g., overall safety level, overall required deck space, and gross amount of piping).

To summarise their findings, when using packing-rules, a designer should avoid using hard positioning constraints as these limit design solution diversity. Instead, logical relations should be used to incorporate arrangement rationales in the parametric model (DeNucci, 2012). Zandstra (2014) applies dynamic constraints, while Baudeweyn (2014) removes layout constraints altogether and applies more flexible objective functions to maintain diversity.

Still, packing-rules must currently be provided a-priori when developing the parametric ship description. This requires considerable effort and expertise, and there is a high risk of over-constraining and premature convergence. As such, they may unintentionally limit concept exploration. Moreover, packing-rules are also *hard-coded* into the synthesis model. Thus, when the Packing-algorithm cannot satisfy these rules, the design fails to pack and consequently will not meet the default search algorithm constraints of (6.3). This reduces the performance of the search algorithm, because more designs within each population can become infeasible. Also, valuable insight about *why* the design has failed is then lost, which means a trial-and-error approach is required to find out which packing-rules are causing problems. Because



of these multiple issues, the use of packing-rules to incorporate new criteria *during* exploration is considered unwanted.

### 6.3.2 Search algorithm constraints

For subsequent exploration runs, new criteria could also be added as additional search algorithm constraints. That is, for each criterion an additional constraint could be added to the default Packing-problem defined in (6.3) as follows:

$$\begin{aligned}
 \min_x \quad & f \quad -PD(x) \\
 \text{s.t.} \quad & h_1 \quad \text{systems}_{\text{placed}}(x) = \text{systems}_{\text{total}}(x) \\
 & g_1 \quad T(x) \leq T_{des}(x) \\
 & g_2 \quad \|LCB(x) - LCG(x)\| \leq \delta_{req} \\
 & g_3 \quad GM(x) \geq GM_{req} \\
 & g_4 \quad \text{Speed}(x) \geq 16kts \\
 & g_5 \quad \text{Range}(x) \geq 3000nm
 \end{aligned} \tag{6.4}$$

where two criteria for a minimum speed ( $g_4$ ) and transit range ( $g_5$ ) are added to the default problem of (6.3).

In the Packing-approach search algorithm, constraints are normally used to express non-negotiable requirements which ensure that the designs remain basically feasible. Hence, constraints are treated as *hard* within the genetic search algorithm. That is, not meeting the constraints renders the design infeasible. Thus, when *non-negotiable* criteria are added as additional search algorithm constraints, they become non-negotiable (hard). Hence, they *must* all be satisfied for a design to be deemed feasible by the search algorithm. This makes identifying conflicts between negotiable criteria more difficult as designs with conflicts between criteria are more likely to be discarded during the optimisation. Furthermore, the genetic search algorithm is then challenged by a large number of infeasible solutions in each generation, hampering the search for better feasible options.

Take Equation (6.4) where two criteria (speed and range) are added as constraints to the search algorithm. This means both the speed and the range criterion *must* be met to make a design feasible from the genetic algorithm's point of view. If this turns out to be impossible, due to a conflict between these two aspects, zero feasible designs will be generated and found by the Packing-approach (even though a designer might still be satisfied with a solutions which lies close to the desired criteria values). With multiple constraints it is also difficult to trace-back the conflicting criteria, as any combination of the constraints might have caused the original conflict.

### 6.3.3 Search algorithm objectives

New criteria could also be added as additional objective functions. For example one could add stability and range criteria as two additional objectives as follows:

$$F(x) = - \begin{bmatrix} PD(x) \\ GM(x) \\ Range(x) \end{bmatrix} \tag{6.5}$$

where the default single-objective function  $f(x) = -PD(x)$  is changed to a multi-objective function maximising stability ( $GM$ ) and (fuel) range as well. However, this multi-objective function may include individual objectives, each with different sensitivities toward the used input variables  $x$ .

For example, for mono-hull vessels,  $GM$  (through  $BM = I_t/\nabla$ ) is roughly proportional to the beam squared  $B^2$ , whereas the range (through resistance) is inversely proportional to beam through the length to beam ratio  $L/B$ . Hence, as beam is an input variable to the Packing-approach, the search algorithm will put more emphasis on the  $GM$  objective favouring beamy vessels over long and slender vessels. This ultimately results in an uneven search of the design space. The described behaviour of sensitive objective functions may be avoided, but only if these possible sensitivity issues are known to the designer a-priori.

Moreover, adding a large number of criteria as individual objectives can be problematic for the optimisation algorithm. The NSGA-II algorithm which is used in the Packing-approach applies non-dominated sorting of individual design solutions to guide the optimisation (Deb et al., 2002). When multiple objective are defined, this particular sorting method results in a loss of performance of the genetic algorithm due to a decrease in probability of having multiple Pareto-fronts. Various studies show this can be partially solved by changing the sorting method of the NSGA-II algorithm (e.g., Köppen and Yoshida, 2007). However, if a large number of objectives can be averted, for example by aggregating criteria into one or a few objectives functions, then this is a favourable solution.

Contrary to packing-rules and search algorithm constraints, objectives have no problems with possible conflicts between identified criteria. Within an objective, individual criteria are treated as *nice-to-have* properties. Hence, a design will never become infeasible if it cannot meet the criteria. Instead, it will simply be treated as more or less desirable by the search algorithm. Because not all interactions between criteria are known up-front, an objective method seems well suited for application in the proposed mechanism to feed insight gained during the exploration effort back into the generation process.

### 6.3.4 Summary of steering issues

To summarize, the Packing-approach provides several mechanisms to include new adjusted criteria necessary to create a progressive design approach: (i) packing-rules, (ii) constraints, or (iii) objectives. However, both packing-rules and search algorithm constraints are used in such a way that they are deemed unsuitable or impractical for use as a steering mechanism in a progressive design approach.

Packing-rules tend to over-constrain the parametric model of the ship design, which results in less diversity in the resulting design set and thus provides only a limited exploration of the design space. They also require a large a-priori effort to set-up. Most importantly, packing-rules are dealt with as non-negotiable constraints, which means they must be fulfilled during the packing process in order for a design to be generated successfully. Hence, a trade-off of conflicting criteria will not be generated or identified.

Search algorithm constraints are used to express non-negotiable criteria. This means they cannot be used to express negotiable criteria (e.g., which might require a

trade-off). A conflict between two negotiable criteria will thus indicate that the design does not meet the constraints, which in turn results in an infeasible and discarded design from the search algorithm's point of view.

Finally, search algorithm objectives seem the most promising steering mechanism. However, as discussed in Section 6.3.3 and in Chapter 2, they cannot be used without modification. Instead, a new type of multi-objective steering function must be developed. That is, one where the separate objectives are less sensitive towards the input variables, and which can easily adapt to varying numbers and types of criteria (e.g., criteria on layout, systems, technical characteristics, as well as performance).

## 6.4 Objective-based steering

Considering the issues of the constraint or Packing-rule based steering mechanisms, the objective-based mechanism is favourable. However, several aspects must be considered and dealt with before a suitable steering objective can be developed and implemented in the overall interactive approach:

- First, the steering objective function should provide the search algorithm with enough incentive to actually search for and generate relevant and more desirable designs during design exploration. That is, a design which meets the adjusted criteria as identified from design space exploration. Hence, the objective function should target for designs which meet all, or as many as possible, of the identified criteria. It is then possible to check whether indeed the identified criteria and resulting solutions are balanced.
- Second, the objective must be robust. Typically an objective function is highly tailored to its optimisation problem, however, for use in the interactive approach it must cope with both varying number and types of criteria. At the start of design exploration the number of criteria is typically low, but this will likely increase as the exploration progresses. In addition, the objective must be sufficiently robust to deal with various types of criteria. For example, the objective might include simple criteria such as transit range or speed requirements, or more complex criteria depicting a required relative layout of two systems.
- Third, the objective should promote compromise designs, that is, designs which almost meet the criteria, or which meet a subset of the identified criteria. If, for any reason, not all criteria can be met, then these compromise designs will contain valuable information for the designer on why these criteria were not met. For example, the designer may have defined two criteria which conflict and over-constrain the problem. However, a slight change to one of the criteria would have produced a feasible solution. In such an event, compromise designs reveal what trade-off options are available, allowing the naval architect to evaluate and choose the most desirable option.

The above aspects led to the development of two different multi-objective steering functions that use the adjusted and/or expanded criteria. That is, the criteria which originate from step 3 and 4 of the interactive approach in Figure 3.2. These criteria provide the search algorithm with a description of the, at that moment, desirable properties of a design.

It was chosen to group the identified criteria into two distinct categories. The first category ( $r$ ) includes numerical performance criteria, and the second category ( $s$ ) includes system and arrangement criteria. This grouping is identical to that of the exploration filtering sets (see Chapter 5). Examples of these criteria groups are shown in (6.13). The reasons for this grouping are twofold:

1. It allows criteria to easily be aggregated into groups of individual objectives to mitigate the effects of using a large number of objectives (e.g., as was explained in Section 6.3.3 about the possible issues when using search algorithm objectives). Note, in Chapter 2 a-priori aggregation of objectives was considered as unwanted. However, we are now dealing with progressively (and thus not a-priori) defined criteria. Hence, the criteria represent what we are actively searching for, not what we think we are searching for.
2. Grouping numerical and architectural aspects also fits the two types of characteristics distinguished during the exploration step in Chapter 5. Hence, any filtering criteria applied and deemed as desirable from design exploration are easily transformed into different steering criteria that can be used for objective-based steering.

Based on this grouping two objective steering function were developed. Each is described below.

The first proposed multi-objective steering function is as follows:

$$F(x) = - \begin{bmatrix} PD(x) \\ C(x) \end{bmatrix} \quad (6.6)$$

where the first objective attempts to maximise the packing density  $PD(x)$  of each design, while the second objective  $C(x)$  maximises the fraction of criteria met by each design.  $C(x)$  is further defined as follows:

$$C(x) = \frac{1}{2} \left( \frac{1}{n} \sum_{i=1}^n r_i(x) + \frac{1}{m} \sum_{j=1}^m s_j(x) \right) \quad (6.7)$$

where  $r_i(x)$  is the utility score of each performance related criterion based on the utility function shown in Figure 6.2, and where  $s_j(x)$  is the utility score for each system related criterion. The default utility score for system criteria is defined as:

$$s_j(x) = \begin{cases} 1 & \text{if system criterion met,} \\ 0 & \text{otherwise.} \end{cases} \quad (6.8)$$

The second proposed multi-objective steering function is defined as follows:

$$F(x) = - \begin{bmatrix} PD(x) \\ R(x) \\ S(x) \end{bmatrix} \quad (6.9)$$

where the first objective is equal to (6.6), the second objective  $R(x)$  maximises the fraction of performance criteria met, and the third objective  $S(x)$  maximises the

fraction of system criteria met.  $R(x)$  and  $S(x)$  are further defined as:

$$R(x) = \frac{1}{n} \sum_{i=1}^n r_i(x) \quad (6.10)$$

$$S(x) = \frac{1}{m} \sum_{j=1}^m s_j(x) \quad (6.11)$$

in which  $r_i(x)$  and  $s_j(x)$  are equal to the utility functions used in equation (6.6).

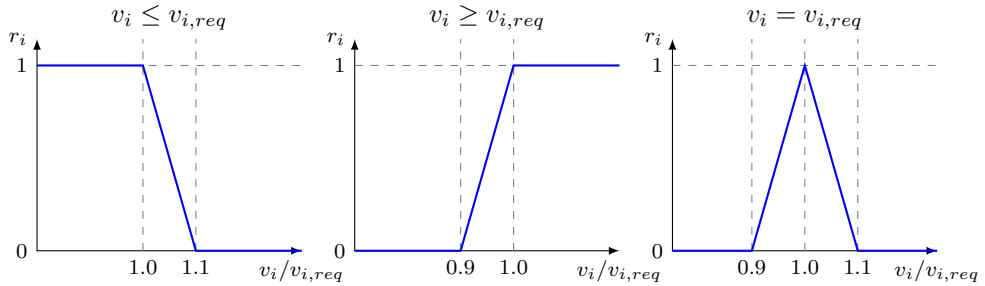
The first multi-objective steering function (6.6) combines performance and system criteria into one single objective  $C(x)$ , whereas in the second proposed steering function (6.9), they are kept separate as  $R(x)$  and  $S(x)$ . This separation was deliberately introduced to help investigate possible conflicts and trade-offs between performance and system criteria. The second proposed function should allow the search algorithm to better focus on a Pareto-front should a conflict between  $R(x)$  and  $S(x)$  exist. When the number of performance criteria  $n$  and system criteria  $m$  show a large difference, then simply summing and averaging all criteria would give an unbalanced contribution. Hence, in equation (6.6) an equal weighting is given to meeting either performance or system related criteria.

The aspect of robustness and the issues regarding sensitivity towards input variables are partially resolved by using the fraction of criteria met ( $R(x)$ ,  $S(x)$  and  $C(x)$ ) within the objective function, as opposed to the actual performance aspects as in (6.5). Hence, a single criterion cannot drive the entire optimisation, instead the impact of each criterion is considered more equally. Also, the criteria are not defined as hard, that is, if a design cannot meet all criteria it is simply less attractive for the search algorithm but it will never be labelled as infeasible, as was the case when using search algorithm constraints.

The customizable utility functions (Figure 6.2) give some flexibility to make sure that designs which *almost* meet a criterion are rated higher by the search algorithm. For example, in Figure 6.2 a 10% margin of the required criteria value is used. Similar margins can also be defined for the global and relative position criteria of systems and spaces (e.g., a margin on the preferred position bounds). This can prove useful when studying the influence of slight changes in a criterion or when assessing trade-offs between different criteria. It can also be argued that the shape of the utility functions may be changed to accommodate the level of uncertainty related to a particular requirement given the maturity of the design problem. In addition, the utility functions also help the search algorithm by making the objective function less discrete.

## 6.5 Steering test-case

This test-case investigates whether the developed objective-based steering mechanisms, with user added criteria, helps the Packing-approach to search for more, and more relevant, design solutions. To do so, first a simplified model of a mine counter-measures vessel (MCMV) with 45 building blocks representing various systems and spaces was used. The number of search algorithm constraints and Packing-rules was kept to a minimum to make sure that diverse design solutions could be generated.



**Figure 6.2:** Utility functions used to determine the objective contribution  $r_i$  of each identified performance aspect and its criterion, where  $v_i/v_{i,req}$  is the ratio of the current and required value of criterion  $i$ .

### 6.5.1 Set-up

The Packing problem definition was set-up according to (6.12) where the default problem definition of (6.3) is adjusted with a minimum required  $GM$  of  $0.5m$  and a maximum  $LCB$  and  $LCG$  separation of  $2m$ .

$$\begin{aligned}
 \min_x \quad & f \quad -PD(x) \\
 \text{s.t.} \quad & h_1 \quad \text{systems}_{\text{placed}}(x) = \text{systems}_{\text{total}}(x) \\
 & g_1 \quad T(x) \leq T_{des}(x) \\
 & g_2 \quad \|LCB(x) - LCG(x)\| \leq 2m \\
 & g_3 \quad GM(x) \geq 0.5m
 \end{aligned} \tag{6.12}$$

By exploring an initial set of designs which was generated before the test-case was started, seven relevant criteria were identified. Three performance related criteria, and four related to systems and arrangement. These were chosen such that, when combined, they are not easily met. This was done to increase the challenge for the search algorithm and to study the ability of both proposed steering objectives to find compromise design solutions (i.e., that meet a sub-set of the seven criteria). The criteria were used to simulate the addition of new criteria in the steering test-case. They are defined as follows:

$$\begin{aligned}
 r_1 \quad & \text{Displacement} && \leq 1200m^3 \\
 r_2 \quad & \text{GM} && \geq 1.2m \\
 r_3 \quad & \text{Speed(max)} && \geq 16kts \\
 \\ 
 s_1 \quad & \# \text{ of USV} && = 2 \\
 s_2 \quad & \# \text{ of Main Gun} && = 1 \\
 s_3 \quad & \text{Global position of Bridge} && \\
 s_4 \quad & \text{Propulsion Room separated by} && \geq 1 \\
 & \text{compartment from Generator Room,} && 
 \end{aligned} \tag{6.13}$$

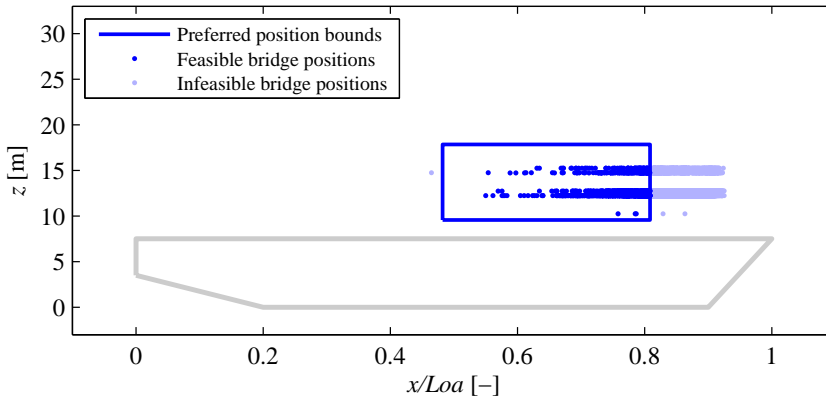
where  $r_i$  represent three performance related criteria, and  $s_j$  represent four system related criteria. The global position preference criterion for the *Bridge* ( $s_3$ ) is shown in

Figure 6.3. A USV is a large manned or unmanned surface vehicle which can perform various mine-counter measure (MCM) tasks, it is deployed from the main deck with the help of a dedicated launch and recovery system.

The testing procedure comprised the following three steps:

1. Generate one set of designs with no steering and no criteria (e.g., to serve as a benchmark).
2. Generate one set of designs using the combined steering objective of (6.6) and the criteria of (6.13).
3. Generate one set of designs using the separated steering objective of (6.9) and the criteria of (6.13).

This procedure was repeated 10 times to mitigate the “random” effects introduced by the search algorithm’s genetic operations (e.g., cross-over, mutation, and selection). A population size of 64 designs was evolved over 100 generations. Thus, including the initial population, 6464 designs were attempted per set.



**Figure 6.3:** Preferred global position criterion of the *Bridge* ( $s_3$ ). The blue rectangle represents the desired position bounds with respect to the hull (grey). The darker points represent solutions that comply with the criterion.

## 6.5.2 Results

The initial test runs with no steering produced, on average, 1395 unique<sup>3</sup> designs in a set that meet the basic constraints of (6.3). When steering was applied, the number of unique designs increased to 1889 with combined steering and 2043 with separated steering, an increase of 35% and 46% respectively (Table 6.1). In addition, with no steering, zero designs that meet all of the defined criteria were found. With steering on, an average of 20 feasible designs were found in each set.

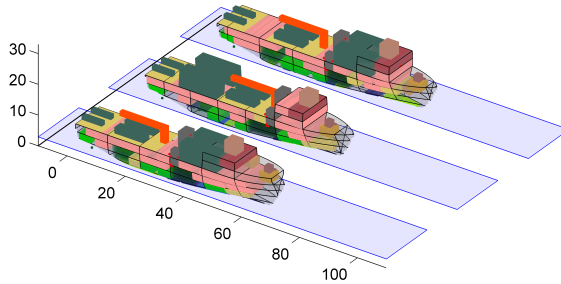
The use of steering has a profound effect on the percentage of designs that meet at least a number of criteria (Table 6.2 and Figure 6.5). On average, a set generated with

<sup>3</sup>There is a check for unique designs within each set. Duplicate designs are removed from the set as these do not offer additional information for the designer.

**Table 6.1:** Average number of feasible designs per set (10 runs per objective)

	<i>Steering OFF</i> (benchmark)	<i>Steering ON</i> combined	<i>Steering ON</i> separated
attempted	6464	6464	6464
meet constraints	1395 (21.6%)	1889 (29.2%)	2043 (31.6%)
meet all criteria	0	16	24

steering contains more feasible designs compared to a set with no steering, regardless of how many criteria are met. Additionally, the tests with steering contain designs which meet all seven criteria of (6.13), as opposed to tests without steering which failed to produce designs that meet more than five criteria (Table 6.2). Three randomly picked designs which meet all identified criteria are shown in Figure 6.4.

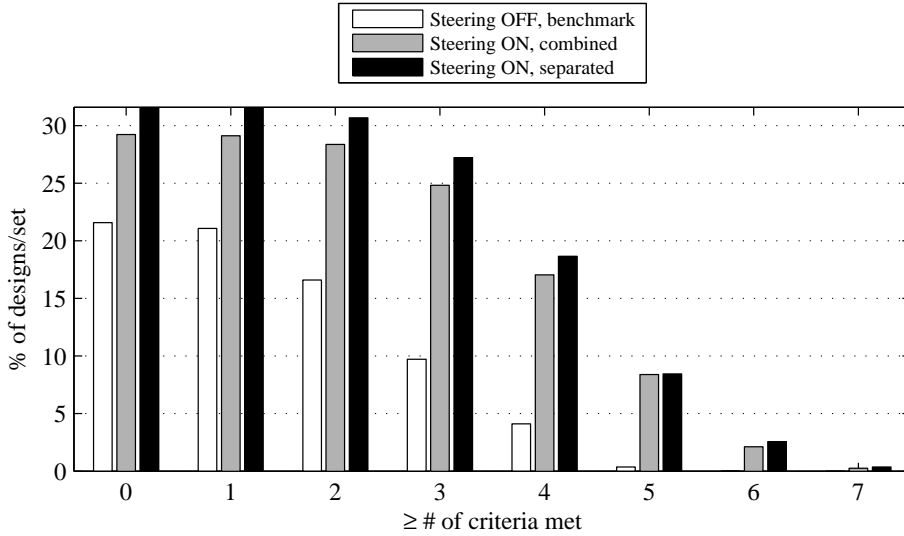
**Figure 6.4:** Three randomly picked MCMV concepts which meet all criteria. Although these designs meet the same criteria, the concepts still have different layouts.

Combining or separating criteria within the steering objective function does not show a large difference on the number of feasible designs in a set (Table 6.2). For example, if at least six criteria are to be met; the combined objective steering method (6.6) produced 2.1% feasible designs within the set, whereas the separated objective (6.9) found 2.6% feasible. For at least four criteria the combined objective found 17.0% feasible designs, whereas the separated objective found 18.7% feasible.

**Table 6.2:** Average percentage of designs per set that meet the criteria of (6.13), out of a total number of 6464 design per set (10 runs per objective)

# criteria met $k$	<i>Steering OFF</i> benchmark [%]	<i>Steering ON</i> combined [%]	<i>Steering ON</i> separated [%]
1	21.1	29.1	31.5
2	16.6	28.4	30.7
3	9.7	24.8	27.2
4	4.1	17.0	18.7
5	0.4	8.4	8.47
6	-	2.1	2.6
7	-	0.3	0.4





**Figure 6.5:** Average percentage of designs per set that meet the criteria of (6.13), out of a total number of 6464 designs per set (10 runs per objective)

Although the results of Figure 6.5 show that both proposed steering objectives were able to find more designs that meet (a subset of) the criteria, it does not show how many different trade-off combinations of criteria were found. For example, consider that there are  $\binom{7}{3} = 35$  possible ways of meeting three out of the total of seven criteria. It could be that the steering objectives only managed to find one of those possible combinations. However, when considering trade-offs, all combinations could be interesting options. Hence, the number of combinations of criteria found must also be considered in determining the performance of the steering objective functions.

There are  $\binom{m+n}{k}$  possible combinations for meeting exactly  $k$  criteria out of the total number of performance and system criteria  $m+n$ . Hence, for meeting  $k$  or more criteria the number of possible combination can be written as:

$$\sum_{l=k}^{m+n} \binom{m+n}{l} \quad (6.14)$$

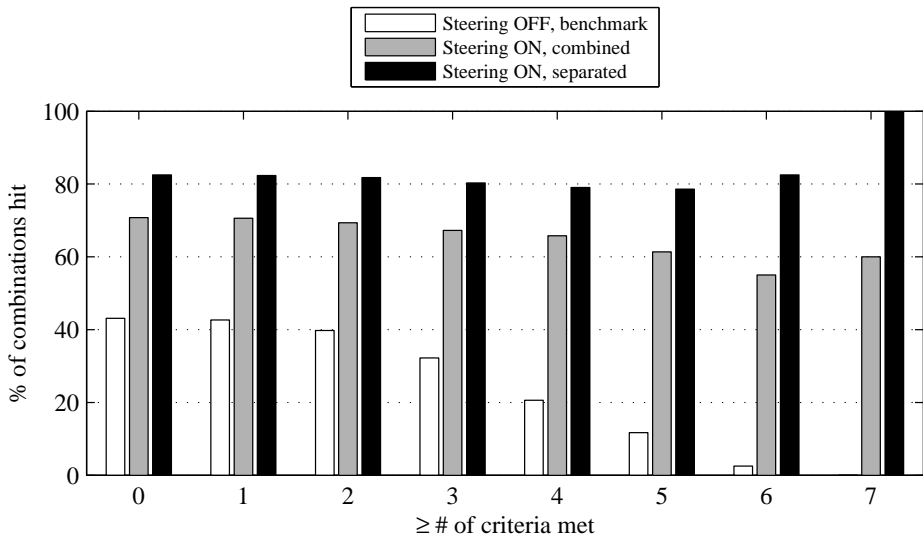
For a total number of seven criteria the theoretically possible number of combinations are shown in Table 6.3.

Lets consider an example, Figure 6.5 showed that both steering objectives found roughly 18% feasible design per set that meet four or more criteria. Using (6.14) it can be calculated that there are 64 possible ways of meeting four or more criteria. Table 6.3 and Figure 6.6 shows, on average, what number and percentage of those 64 possible combinations was found in each set of designs. When no steering is applied, on average only 13.2 (12%) of the 64 combinations were identified. Combined steering managed to find 42.1 (61%) combinations, whereas separated steering found 50.6 (79%) combinations. Of the overall 128 possible combinations of criteria, no steering found 55.2 (43%), combined steering found 90.6 (71%), and separated steering found

**Table 6.3:** Possible and average found number of combinations for meeting  $k$  or more criteria (10 runs per objective)

$\#$ criteria met $k$	Possible comb. to meet $k$	Possible comb. to meet $k$ or more	Steering OFF benchmark	Steering ON combined	Steering ON separated
0	1	128	55.2	90.6	105.6
1	7	127	54.2	89.7	104.6
2	21	120	47.7	83.2	98.1
3	35	99	31.9	66.6	79.5
4	35	64	13.2	42.1	50.6
5	21	29	3.4	17.8	22.8
6	7	8	0.2	4.4	6.6
7	1	1	-	0.6	1

105.6 (83%). Hence, it may be concluded that the separated steering function was able to find not only slightly more designs, but also more designs which represent different trade-off combinations of the desired criteria.

**Figure 6.6:** Average percentage of possible combinations of criteria found within a set of designs, see Table 6.3 (10 runs per objective).

### 6.5.3 Discussion

The results show that the objective-based steering mechanisms, when provided with criteria by the naval architect, can direct the synthesis model towards relevant high

performance designs deemed of interest. Both proposed steering objectives in (6.6) and (6.9) significantly increased the number of feasible designs found by the synthesis model. However, the benchmark case without steering naturally should find less relevant designs as its focus is directed elsewhere (i.e., in this case maximising the Packing-density of the designs). Nonetheless, without steering still some relevant solutions meeting several criteria are found. These are most likely criteria which have a direct relation to the objective Packing-density (e.g., the displacement criterion). In addition, both steering objectives were capable of identifying compromise designs, that is, where not all, but a sub-set of, the identified criteria are met. These designs may be interesting when possible trade-offs occur.

The results indicated that it is challenging to meet all set criteria, hence a constraint-based steering method would probably fail to find any feasible designs. Although objective-based steering only produced a small number of feasible designs, it does provide many compromise alternatives that meet not all, but a subset of the identified criteria. Compromise solutions which a constraint-based method would simply fail to identify as these are regarded as infeasible by the search algorithm.

Although, both proposed steering objectives produced an equal number of feasible designs per set, the separated objective function identifies more designs with different combinations of criteria. These designs are very useful when examining possible trade-off options, especially when not *all* can be met due to the existence of a conflict between one-or-more criteria. Hence, the separated objective steering function (6.9) is considered better and should be preferred.

## 6.6 Conclusions

The main goal of this chapter was to develop a steering mechanism capable of guiding the Packing approach towards designs deemed as more desirable by the naval architect. That is, designs that meet criteria identified as desirable by the naval architect during the interactive design exploration approach presented in Chapter 3.

Three possible steering methods were examined: packing-rules (i.e., constraints within the synthesis model), search algorithm constraints, and search algorithm objectives. Objective-based steering was chosen mainly due to its ability to handle unforeseen conflicts between identified criteria which would otherwise render a design as infeasible. Two variants of objective-based steering functions were developed and implemented in the interactive approach. The first variant combines all criteria in one sub-objective function, whereas the second variant separates the performance and system/arrangement criteria in two sub-objectives. These variants were then tested for their ability to direct the synthesis model based on a (simulated) list of identified and relevant design criteria.

Both objective-based steering variants were successful at guiding the synthesis model towards more relevant designs that met all identified criteria. The separated objective mechanism was, however, able to identify more different combinations of criteria which is considered a benefit when exploring trade-off options. Hence, the separated objective is chosen for implementation within the overall interactive approach of Chapter 3.

Naturally, the possibilities for alternative and more elaborate (objective-based) steering mechanisms are endless. For example, refer to the various visual steering

aids developed by Stump et al. (2009) also see Section 5.1. The shape of the applied utility functions (see Figure 6.2) can also be changed to better suit the needs of individual criteria. For example, the shape can represent a more elaborate weighting of an individual criterion. It might even change during the course of the exploration, based on the changing relevant importance of that criterion.

The author also envisions future possibilities for a hybrid interactive approach where steering takes place using both objective-based steering mechanisms as well as synthesis model constraints (e.g., packing-rules). This would allow early and broader exploration of the design space to be based on objective-based mechanisms, while later more focussed exploration of small parts of the design space could make use of the benefits of fixing design options through model constraints. For example, if through the first few iterations of the progressive approach a certain design option (e.g., weapon system) has been ruled out, then there is no real benefit in considering it later in more focussed exploration efforts. In that case it might as well be eliminated using adjusted model constraints. Even so, it is the naval architect responsibility to ensure that no design options are constrained prematurely in the exploration.



# Chapter 7

## Design test-cases

*“The purpose of computing is insight not numbers”*

---

– Richard W. Hamming (1962)

Chapters 4-6 have developed the individual steps required to produce the interactive evolutionary concept exploration approach proposed in Chapter 3. This chapter applies the fully developed approach to a design case to demonstrate how it aids designers during preliminary concept exploration. The specific goals of the design case are first elaborated before two test-cases are performed and discussed. The chapter concludes by discussing how the test-case process and results have illustrated the benefits of the approach.

### 7.1 Test-case goals

The main research question and objective of this dissertation is (Chapter 1):

*How to generate and select the “right” design(s) using insight gained during design exploration?*

As such, the main goal of the design test-cases is to demonstrate how the developed interactive and progressive design space exploration approach aids the naval architect in generating and selecting desirable design solutions. Insight which is identified during the exploration process plays an important role in this. It should aid in generating and selecting the right design by providing the understanding which is necessary to identify and balance relevant design criteria.

In Section 2.3 and Chapter 5, it was determined the following tasks are deemed essential for understanding and gaining this insight:

1. *Linking criteria to solutions and vice-versa*, i.e., given a set of desired criteria what potential solutions meet these, or given a prescribed solution what type performance may be expected.
2. *Identify if and when criteria conflict*, i.e., this provides feedback on the existence of trade-offs between criteria.

3. *Identify how to avoid or resolve a conflict*, i.e., identify which criteria need to change, and by how much to stay balanced and feasible?
4. *Identify why criteria conflict*, i.e., to understand the underlying mechanisms causing these conflicts so they may be avoided and documented for future projects.

Two individual test-cases are performed to demonstrate the potential of the interactive concept exploration approach at aiding a designer in performing the above tasks in search of desirable criteria and accompanying design solutions. Each test-case ends with a reflection on how it has demonstrated that the approach is capable of aiding a designer in performing the above tasks.

## 7.2 Test-case subject

The subject for the test-case is the design of a mine-countermeasures vessel or MCMV. This design project is currently ongoing at DMO and was initiated to replace the RNLN *Alkmaar Class* mine-hunter, which has been in commission since 1983 (Figure 7.1). Some interesting facts about the MCMV replacement program, which make it an interesting candidate for the concept exploration test-cases, are listed below.



**Figure 7.1:** The HNLMS *Alkmaar* under way, first-of-class of fifteen RNLN “Tripartite” class mine-hunters of which six remain in service today (Netherlands Institute for Military History, 2015)

### Operational concepts

Recent advances in the mine-countermeasures community show a shift towards the heavy use of unmanned systems, launched from a mothership platform, to perform identification, classification, and disposal of mines (e.g., see Freedberg, 2015). However, this shift has also brought up discussions about the operational concept(s) of the new generation of mine-countermeasure vessels. That is, can we rely solely on unmanned systems, or should manned options stay available (e.g., with the use of

divers)? Also, is the operation performed at stand-off distance (i.e., with the mothership at a safe distance outside the mine-field) or from within the mine-field (e.g., see Marineschepen.nl, 2015)?

These different concepts affect both the types of system solutions as well as the mothership characteristics. For example, operating at stand-off distance can reduce the need for signature reduction measures, while the increased distance will likely require more or different unmanned systems to maintain performance. Also, requirements such as, the transit speed, range, and propulsion plant concepts, will influence both the MCM operation and the timely world-wide availability of the vessels capability. Moreover, although the unmanned systems can be small, their supporting facilities and required additional crew are not.

The above system options and requirements naturally result in large impacts on the ship design and its cost. This then leads to a discussion about which operational concept(s) are wanted and affordable, and using what level of technology? A discussion which benefits from an integrated concept exploration analysis. Hence, the MCMV as a test-case subject.

### Disclaimer

The work performed as part of the test-cases presented in this chapter were undertaken in parallel to MCMV procurement studies at the Defence Materiel Organisation. This had the added benefit of a readily available design model with associated design data, the ability to cross-check results and analysis, as well as the availability to a dedicated cost model. **However, it must be emphasized that the design model, design variations, budget, criteria, and choices made in this dissertation *do not* reflect the MCMV procurement program at DMO. Both the design and cost model were altered in such a way that they are realistic, yet not representative of the actual MCMV procurement project at DMO.**

## 7.3 MCMV packing model

The MCMV packing model initially developed by Zandstra (2014) and Zandstra et al. (2015) can vary many relevant design characteristics (see Table 7.1 and 7.2). The total number of possible combinations from the presented variations of MCM and platform characteristics is 790272. In addition to the main options, the design model also varies: hull main-dimensions; crew size as a function of weapon/sensor systems and MCM systems; accommodation size; machinery space size; engine types; and the general arrangement of systems and spaces. For a more elaborate description of the applied MCMV packing model, its main assumption, and a brief list of calculation models used, refer to Appendix A.

The default Packing-approach optimisation problem of Equation (6.3), used in the genetic search algorithm, is altered according to Equation (7.1) where initially  $R(x) = 0$  and  $S(x) = 0$  as no performance and system criteria are defined at the start of the exploration. The required  $GM$  is set to a minimum of  $0.75m$  and the longitudinal separation of the centre of gravity and buoyancy is set to maximum of  $2m$ . Additionally, the user may choose to change the default packing density  $-PD(x)$



objective to a cost objective  $Cost(x)$  if this is more fitting with the exploration's purpose (e.g., as in the second test-case of Section 7.5).

$$\begin{aligned}
 \min_x \quad & f \quad [-PD(x) \quad -R(x) \quad -S(x)] \\
 \text{s.t.} \quad & h_1 \quad \text{systems}_{\text{placed}}(x) = \text{systems}_{\text{total}}(x) \\
 & g_1 \quad T(x) \leq T_{des}(x) \\
 & g_2 \quad \|LCB(x) - LCG(x)\| \leq 2m \\
 & g_3 \quad GM(x) \geq 0.75m \\
 & g_4 \quad GM(x) \leq 3.50m
 \end{aligned} \tag{7.1}$$

**Table 7.1:** Variations of MCM related characteristics

<i>Name</i>	<i>Variations (step)</i>	<i>Number</i>
Hull material	GRP, AMS, Steel	3
Divers	Yes, No	2
# Stingers	1 – 2	2
# USV	0 – 1 – 2	3
USV type	12m	-
# UUV (large)	3	-
# UUV (medium)	4	-
# ROV (disposable)	48	-
Endurance MCM operation	$\geq 20$ days	-
Speed MCM operation	8kts	-

**Table 7.2:** Variations of platform characteristics

<i>Name</i>	<i>Variations (step)</i>	<i>Number</i>
Speed (max)	12 – 18kts (+1)	7
Speed (transit)	12 – 18kts (+1)	7
Range (transit)	1500 – 4500nm (+500)	7
Sensor/weapon suite	A (heavy), B (light)	2
UAV (rotary wing)	Yes, No	2
Extra working deck	Yes, No	2
Extra crew (staff)	0 – 15 (+5)	4
Propulsion arrangement	CODELOD, CODELAD	2

## 7.4 Case 1: Damage length

This first case study aims at investigating the influence of a minimal damage length criterion on the overall size of the ship (e.g., the required survivable damage length is 15% of  $L_{oa}$ ). It is expected that a high damage length criterion results in larger overall ship sizes. For a relatively small vessel, such as a MCMV, this damage length

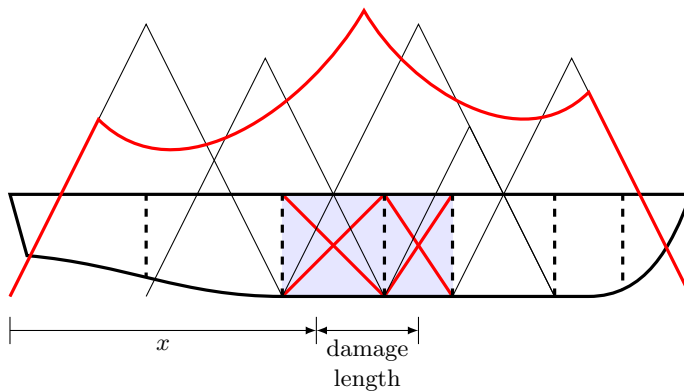
criterion can conflict with other size drivers such as cost, or a size and displacement criteria due to pressure signature reductions.

### 7.4.1 Set-up

For this test-case scenario the MCMV packing model was set-up with the following notable settings (see Table 7.1, 7.2 and Appendix A):

- A fixed MCM payload of: one 7m USV; three large UUVs; four medium UUVs; 48 small disposable ROVs, used for mine identification and disposal; and one diveteam.
- A fixed weapon and sensor suite (type A) which includes; an integrated sensor mast with 2D search radar; one 30mm remote controlled gun (RCG); and one .50" RCG.
- A fixed propulsion plant concept (CODELOD) with two diesel engines providing power for sustained transit speed and three small diesel generator sets providing propulsion and auxiliary power during mine-hunting<sup>1</sup>.
- A variable maximum and transit speed of 12 – 18kts at 1kt increments
- A variable transit range of 1500 – 4500nm at 500nm increments

These settings were chosen specifically to keep the payload (MCM and combat systems) equal so that designs remain comparable. Nevertheless, speed and range are varied as the individual sizing of the components, and thus spaces, for the CODELOD propulsion plant may possibly interfere with the bulkhead spacing and thereby damage-length criterion.



**Figure 7.2:** Illustration of the concept damage length. At any longitudinal position  $x$  the ship should be able to survive the flooding of compartments due to the damaged length.

The damage length criterion is defined using the concept of Figure 7.2. The black triangles represent the worst-case maximum flooded length between bulkheads due

<sup>1</sup>Note the plant concept is fixed, while the sizes of individual components are matched to the required propulsion power at maximum, transit and operational speed. The physical configuration of the propulsion plant concept may vary within the ship as-well.

to the damage length. For the design to pass the criterion, all these black triangles should fall below the floodable length curve (red). In this case the design fails at multiple positions. In the Packing-approach each design starts with a damage length criterion of 16% of the overall length. When the design fails to meet this criterion, the damage length is iteratively reduced by 1% until it passes.

### 7.4.2 Exploratory run

The initial run of the interactive approach is intended as an exploratory effort. Besides the default Packing-approach optimisation settings of (7.1) no additional criteria are used to steer design generation. This should provide a broad exploration of the design and solution space. Once a large set of initial designs has been generated, the results can be explored by the designer. The displacement and length are of particular interest as these parameters are expected to be driven by a damage length criterion.

In the run a total of 51328 designs were attempted of which 2120 (4%) met the set non-negotiable constraints of (7.1). A total of 50 designs meet a damage length criterion of 15% of the length. Figure 7.3 shows the scatterplot matrix for length, displacement, freeboard, and damage length. The plots include the 15% damage length criterion boundary (i.e., the blue lines).

Several observations can be made. First, the designs which meet the damage length criterion have lengths ranging from 74–100m and displacement between 1600–2400m<sup>3</sup> (Figure 7.4). Both length and displacement seem limited on the lower-bound due to the damage length criterion. Second, there are two distinct clusters of designs with respect to freeboard. One cluster with a freeboard of around 3m and the other around 5m. All designs meeting the damage length criterion fall inside this last cluster. Designs in the cluster with a lower freeboard have at most a damage length of 12%.

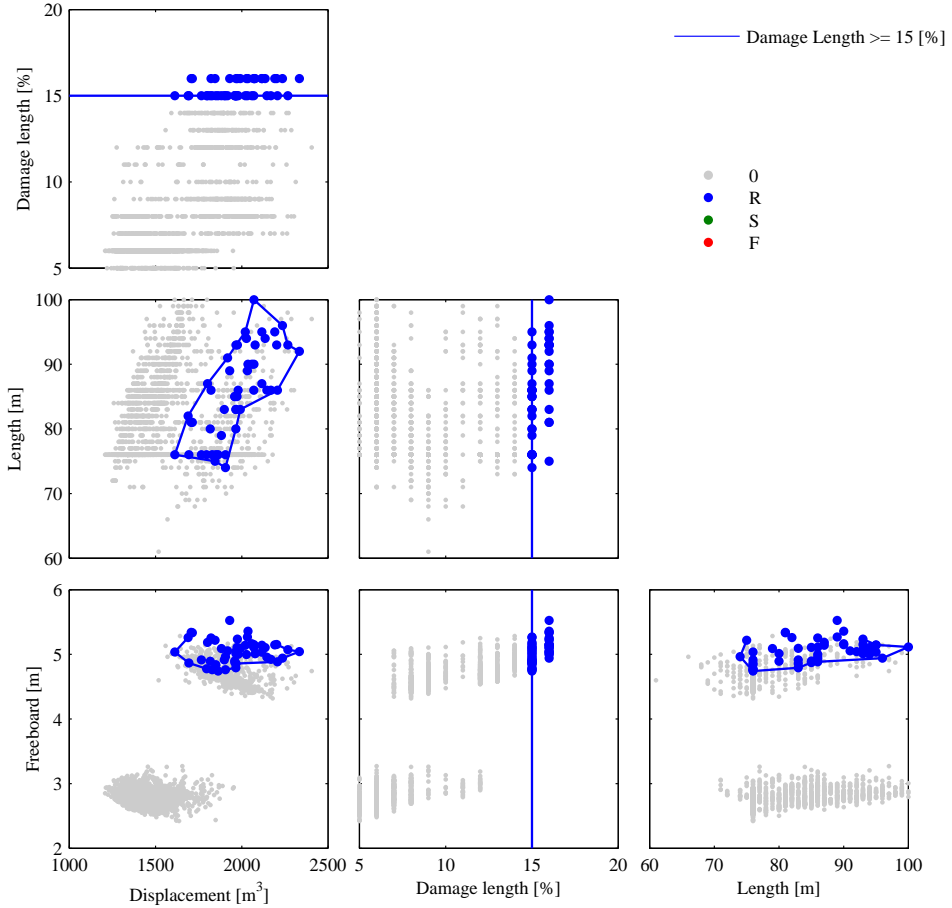
The clustering behaviour with respect to freeboard is easily explained. The cluster with a freeboard of around 5m corresponds to designs with an extra deck within the hull (i.e., three instead of two decks). The Packing-approach MCMV model has a fixed deck height which implies there are two possible depths. Nonetheless, the extra freeboard makes it easier to meet the damage length criterion, which explains why all feasible designs are located in this cluster. Also, this cluster has a higher average displacement, which is caused by the added volume and weight of an extra deck within the hull<sup>2</sup>.

The initial exploratory run seems to indicate that a high damage length criterion is in fact limiting the size of the ship. However, in this initial exploratory run no effort was made to *actively* search for designs meeting the 15% damage length criterion. The run only produced 50 feasible designs, potentially leaving a large parts of the design space unexplored (see Table 7.3). More and smaller designs might exist, which is something a steering run can reveal.

### 7.4.3 First steering run

A steering run was made to investigate whether more, and potentially smaller and lighter, designs exist with a damage length criterion of 15%. A single steering criterion

<sup>2</sup>The Packing-Approach MCMV model uses a density-based weight calculation



**Figure 7.3:** Results of the initial exploratory run including the 15% damage length criterion boundaries and brushed feasible set  $R$  (blue)

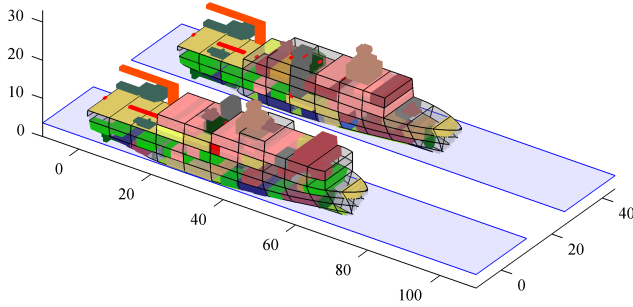
was interactively added to the objective function:

$$r_1 \quad \text{Damage length} \geq 15\%. \quad (7.2)$$

By default the Packing-approach objective will already attempt to reduce the displacement of the designs through the maximisation of the packing density (e.g., the ratio between used and available volume within the hull and superstructure).

In the first steering run a total of 51328 designs were attempted of which 5001 (10%) met the set non-negotiable constraints of (7.1). In the steering run a total of 2168 designs meet the damage length criterion of 15% of the length, a substantial increase to the 50 designs found in the initial run (see Table 7.3).

The resulting scatterplot matrix of the steering run combined with the results of the initial run is shown in Figure 7.5. Again, several observations may be made. First, the steering run has managed to find a considerably larger number of design solutions



**Figure 7.4:** Minimum length (front) and minimum displacement (aft) feasible design solutions from the set of Figure 7.3

meeting the damage length criterion (i.e., 2168 compared to 50 in the first run). Actively searching for design with a high damage length has resulted in 43% of the generated design meeting the 15% criterion. The feasible area within the scatterplot of length and displacement has grown considerably. The lightest feasible design now has a displacement of  $1375m^3$  compared to  $1613m^3$  in the first run. The shortest design now has a length of  $68m$  compared to  $74m$  in the first run (Figure 7.6). However, the range of feasible displacements and length still do not cover the extent of the design space. There are now also a few design points located further from the main cluster, these have a lower displacement coupled with a high length and they fall within the lower freeboard cluster.

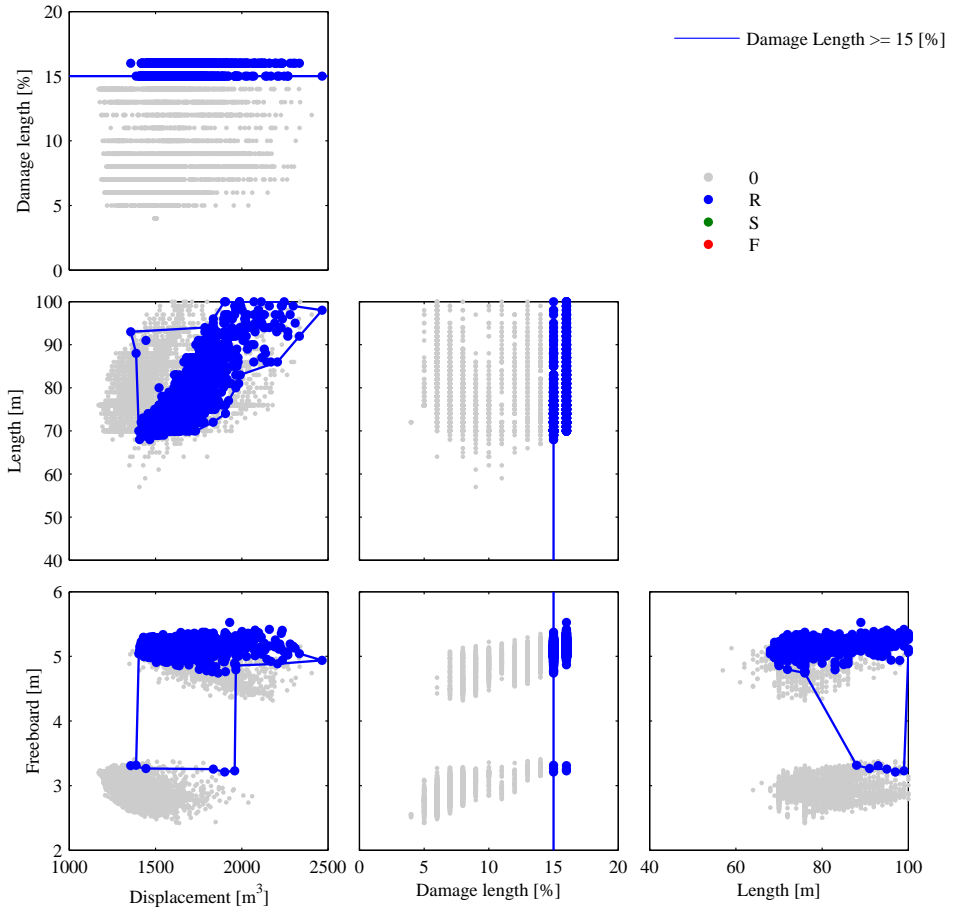
Still, it is unsure that the found lower limits for displacement and length are actually a result of the damage length criterion or whether still small design might exist. Therefore it is chosen to perform two more steering runs, the first with an added steering criterion for minimising length, and the second with a steering criterion for minimising displacement.

#### 7.4.4 Second steering run

The second steering run will investigate the accuracy of the found lower bound for length, which after the first steering run was  $68m$  for designs meeting the 15% damage length criterion. To do so, one extra criterion was interactively added to the steering objective function:

$$\begin{aligned} r_1 \quad \text{Damage length} &\geq 15\% \\ r_2 \quad \text{Length} &\leq 70m \end{aligned} \quad (7.3)$$

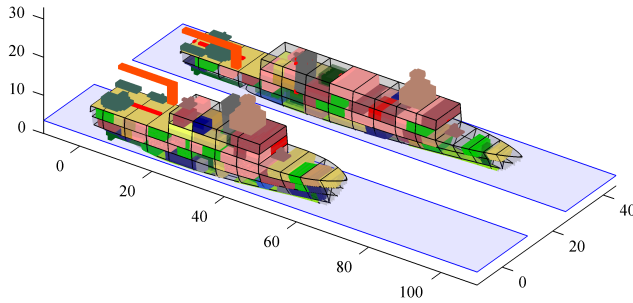
We could have chosen to also add a third criterion for minimising displacement in this steering run. However, the results of the first steering run indicated that there might be a possible trade-off between length and displacement. That is, some longer but lighter designs were generated in a relatively unexplored area of the design space (Figure 7.5). Combining three criteria to search for small lengths, small displacements, and a high damage length simultaneously might therefore hamper the optimiser's effort. Hence, we split this exploration into two subsequent steering runs, one for length and one for displacement.



**Figure 7.5:** Combined results of the exploratory run and first steering run including the 15% damage length criterion boundaries and brushed feasible set  $R$  (blue)

Figure 7.7 shows the resulting scatterplot matrix for the second steering run. Of the 51328 designs attempted 4022 (8%) were successfully packed and 136 met the required damage length (see Table 7.3). The shortest feasible design now has a length of 64m compared to 68m in the previous sets (Figure 7.8). No designs with smaller feasible displacements were found in this run.

The number of generated feasible designs (136) is substantially lower than the number generated in the previous run (2168). The combination of searching for a large damage length and a small overall length, with steering, is apparently more “difficult” for the search algorithm than solely searching for a large damage length. This could indicate that the feasible lower limit for length has been reached. The next run therefore focuses on finding lighter designs.



**Figure 7.6:** Minimum length (front) and minimum displacement (aft) feasible design solutions from the set of Figure 7.5. Note the extra deck and larger freeboard of the small design.

### 7.4.5 Third steering run

The third steering run is intended to investigate the lower-bound of displacement. The first steering run also indicated that potentially low displacement but long vessels exist meeting a 15% damage length criterion (Figure 7.5 and 7.6). To steer for a lower displacement, the length criterion used in the previous run is changed for a displacement criterion:

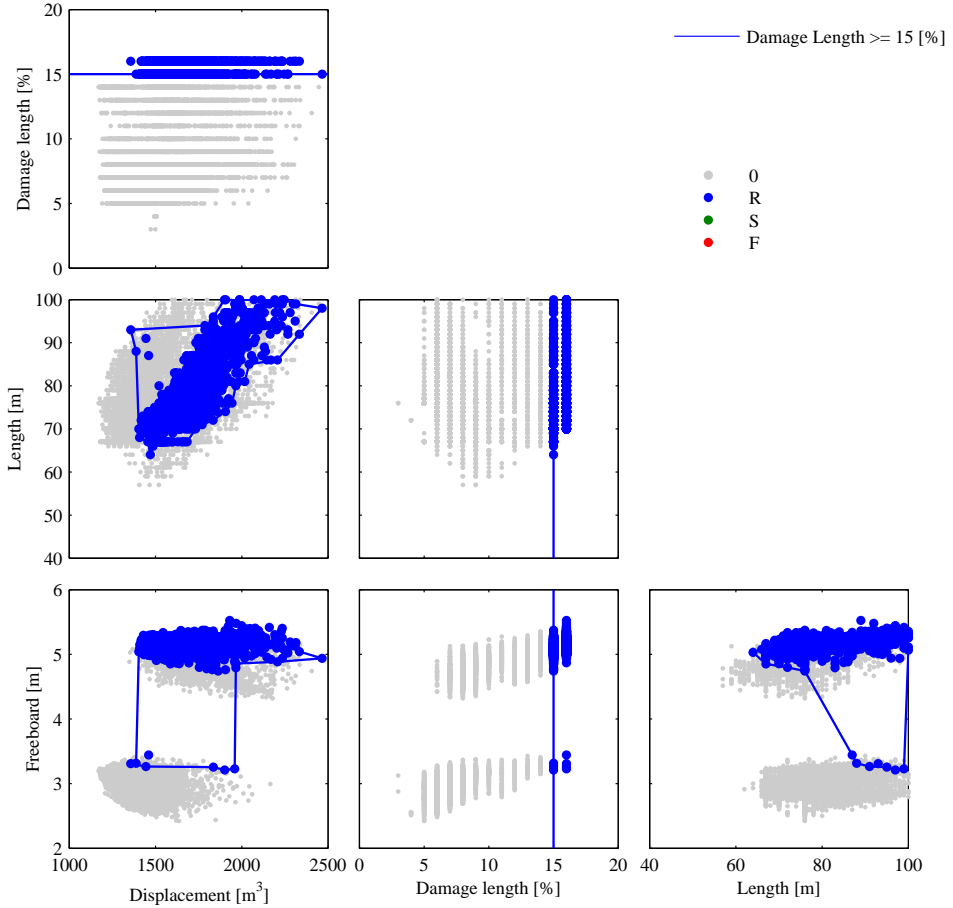
$$\begin{aligned} r_1 \quad \text{Damage length} &\geq 15\% \\ r_2 \quad \text{Displacement} &\leq 1370m^3. \end{aligned} \tag{7.4}$$

The value of  $1370m^3$  was chosen because it is close to the displacement of the lightest feasible design in the previous sets. The fuzzy utility functions described in Chapter 6 ensure that designs close to this displacement are rated as more relevant in the generation process.

Figure 7.9 shows the scatterplot matrix for the third steering run. Again 51328 design were attempted, of which 2723 (5%) were successfully packed. 618 design meet the damage length criterion of 15% (see Table 7.3). The shortest design has not changed and is still  $64m$ . However, the lightest feasible design found is now  $1202m^3$  compared to  $1357m^3$  from the first steering run (Figure 7.6). The shortest and lightest design are both displayed in Figure 7.10.

The feasible designs now span the entire range of generated displacements. This last steering run confirms the trade-off initially found in the first steering run, that is, the Pareto-front in the plot of displacement versus length. To meet the damage length criterion with a reasonable displacement, a design is either long with a low depth or short with a higher depth (i.e., at the cost of more displacement due to the excess volume within the hull). This difference can be seen in the figure comparing the shortest and lightest feasible designs found in the entire exploration (Figure 7.10).

At a displacement of about  $1300m^3$  a gap in the Pareto-front of displacement and length can be observed (Figure 7.9). At this displacement the minimum feasible length jumps from  $68m$  to about  $87m$ . This gap is caused by the discrete number of decks within the hull of the designs combined with a fixed deck height of  $2.50m$ , which causes the distinct clustering of depth and freeboard. Lighter shorter designs are only



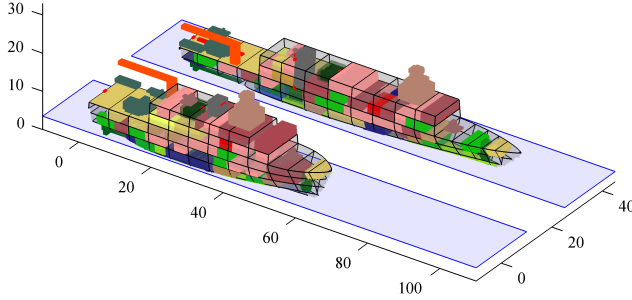
**Figure 7.7:** Combined results of the exploratory run and two steering runs including the 15% damage length criterion boundaries and brushed feasible set  $R$  (blue)

possible with a lower depth and freeboard as this eliminates the excess volume within the hull currently present in the shorter feasible designs. It is plausible that a design model with a variable deck height will produce “intermediate” solutions filling the gap now present in the Pareto-front. In which case more compromise solutions would be present in the front for the designer to choose from.

#### 7.4.6 Summary

This first test-case has given an idea of how a naval architect can use the interactive concept exploration approach to identify and investigate possible trade-offs caused by a damage length requirement. Steering was used extensively to make sure the exploration effort focussed on generating and uncovering designs meeting the damage length criterion while reducing ship size and displacement. Though their relation





**Figure 7.8:** Minimum length (front) and minimum displacement (aft) feasible design solution from the set of Figure 7.7. The minimum displacement design is still equal to the one found in the first steering run (Figure 7.6).

with cost is not absolutely clear, ship size and displacement, combined with the fixed payload in this test-case, are considered as indicators for cost<sup>3</sup>.

In total four runs were made, one initial exploratory run without criteria, and three consecutive steering runs with a criterion for damage length and changing criteria for ship size (length) and displacement. A summary of the number of attempted, generated and feasible designs is presented in Table 7.3.

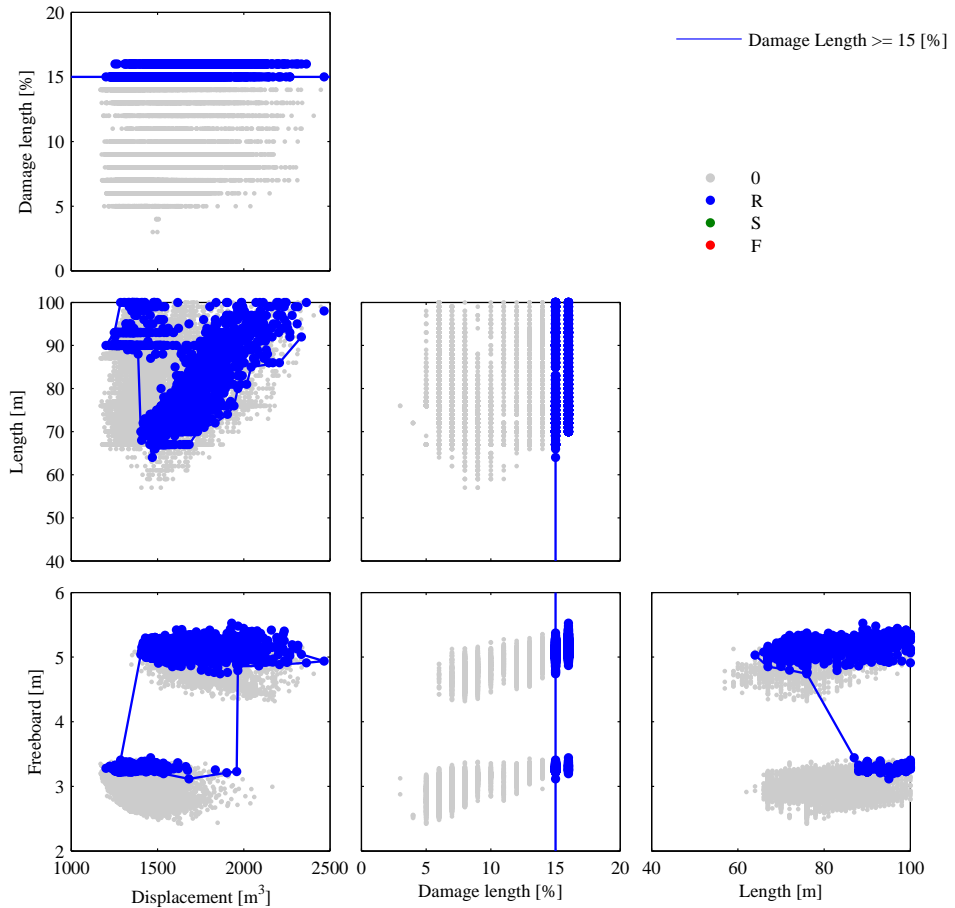
**Table 7.3:** Number of designs per run ( $dL$  refers to the damaged length)

<i>Run</i>	<i>Attempted</i>	<i>Generated</i>	<i>Feasible</i> ( $dL \geq 15\%$ )	<i>Criteria used</i>
1	51328	2120 (4%)	50 (2.4%)	-
2	51328	5001 (10%)	2168 (43.4%)	$dL \geq 15\%$
3	51328	4022 (8%)	136 (3.4%)	$dL \geq 15\%, L \leq 70m$
4	51328	2723 (5%)	618 (22.7%)	$dL \geq 15\%, \nabla \leq 1370m^3$
-	-	-	-	-
Total	205312	13866 (7%)	2972 (21.4%)	-

The number of designs per run that meet the damage length criterion illustrate an important point (Table 7.3). The initial exploratory run provided only a small amount of feasible designs (i.e., 50 out of 2120 generated). Insights regarding the influence of damage length on ship size and displacement would have been premature, and even incorrect, would the designer have solely used this initial set. The 50 initial feasible designs are only present in a small part of the design space representing rather large and heavy designs.

However, as was also extensively discussed by van Oers (2011b, Ch. 7), this increase of ship size and weight could simply be an artefact of a static and ill-defined set of designs. That is, the set was generated with no effort to actively search for, and generate, designs that meet the set 15% criterion. Hence, smaller designs could exist, yet they have simply not been generated and explored yet. The consecutive steering runs

<sup>3</sup>For this test-case the integrated cost model was not yet available (see Appendix A)

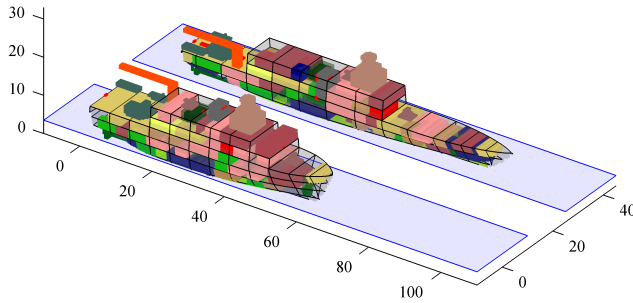


**Figure 7.9:** Combined results of the exploratory run and three steering runs including the 15% damage length criterion boundaries and brushed feasible set  $R$  (blue)

(2-4), which do have incentive to actively search for the sought after damage length, indeed confirm this artefact. That is, the initial set showed an artificial increase in size and displacement and incorrect representation of the lower-bounds.

The final design space plots confirmed the existence of a clear trade-off in the current design model between a long hull combined with a low depth or a smaller hull paired with a higher depth and displacement (Figure 7.9 and 7.10). By studying the actual design solution at the extremes and along the Pareto-front provides the designer with an understanding of why the trade-off actually exists. In this case, it turns out to be an effect caused by the discrete number of decks within the hull with a fixed deck height. These are set within the Packing model.

A variable deck height will bring the two extreme solutions closer together (Figure 7.10). That is, the long and slender design, when fitted with a slightly higher



**Figure 7.10:** Minimum length (front) and minimum displacement (aft) feasible design solution from the set of Figure 7.9.

decks, will meet the damage length criterion at a smaller length without creating too much excess volume within the hull. These solutions are expected to fill in the large gap and jump which exists in the design space caused by the distinct clusters of freeboard and depth. This hypothesis was not tested, as it would require significant alterations to the used MCMV design model.

#### 7.4.7 Reflection and discussion

Section 7.1 presented several tasks deemed essential for understanding and gaining insight during concept exploration. These tasks are:

- Task 1: linking design criteria to (system) solutions and vice-versa;
- Task 2: identify if and when criteria interact or conflict and show a trade-off;
- Task 3: identify how to avoid or resolve such conflicts;
- Task 4: identify why criteria interact and conflict.

If and how the damage length test-case has shown the possibility of performing the above tasks using the interactive approach is discussed below.

This test-case has aided in identifying that, for a given damage length criterion, and considering the limitations of the Packing-approach MCMV model, two main solutions exist (Task 1). The first is a design solution with high length, lower freeboard and depth, and, due to a low amount of excess volume, a low displacement. The second, is a design solutions with lower length, higher freeboard and depth, and due to the added deck and associated excess volume within the hull a higher displacement.

The results indicated a clear trade-off between these two main design solutions (Task 2). It was identified that this trade-off originates from the distinct clustering of freeboard and depth, caused by a fixed deck height coupled with a discrete number of decks within the hull. Shorter designs are only able to meet the damage length criterion with the extra freeboard of three decks within the hull. However, this adds excess volume to the hull, thus increasing its displacement. The interactive approach, together with an experienced user with knowledge of the underlying design model, can thus aid in identifying why the original trade-off between the two extreme solutions occurs (Task 4).

It was hypothesised, that a variable (higher) deck height should resolve the distinct trade-off now existing. Shorter designs would then have a higher deck height thereby increasing freeboard at only a slight increase of hull volume. In addition, currently the margin line used in the floodable length calculation does not vary in height over the length of the hull. For concepts which have a higher freeboard at the bow, this leads to a lower allowable floodable length in the forward part of the vessel. These modifications are expected to resolve the large trade-off which is now caused by the distinct clustering of freeboard and depth (Task 3 and 4).

In conclusion, this test-case has demonstrated how the developed interactive approach can be used to explore in detail the design impact of a specific criterion (e.g., in this case a required minimum damage length). The final trade-off represents two very different design solutions, hence the ability to guide the exploration effort towards those specific solutions is of great benefit. In addition, although the damage length criterion is considered a numerical characteristic of the design, the consequences of architectural elements, such as, the internal arrangement, deck-layout, and bulkhead spacing, are clearly at the basis of the damage length criterion's design impact.

Although this test-case has shown several benefits of the developed interactive approach for exploring design impacts of a criterion, it has not covered the exploration of a balance of multiple varying design criteria. That is, as would be the case in a more practical real-world preliminary design situation where multiple criteria must be balanced for a given budget (e.g., see Zandstra et al., 2015). Also, this first test-case has not dealt with criteria representing discrete options (e.g., such as the choice for a type or number of a system or multiple systems). Hence, a second test-case is needed which explores such variations and criteria.

## 7.5 Case 2: Capability versus budget

The second test-case aims at investigating possible trade-offs between MCM system capabilities and other ship characteristics for a given budget (e.g., trade-offs in the number and type of MCM systems, platform signature reduction through different hull materials, type of weapon and sensor suite). In addition, it is worthwhile to investigate logical combinations of options. That is, some combinations of options are more easily obtained than others due to their different design impacts. Finding such combinations is important, as it helps designers understand the design impacts and budgetary consequence of desired design criteria.

### 7.5.1 Set-up

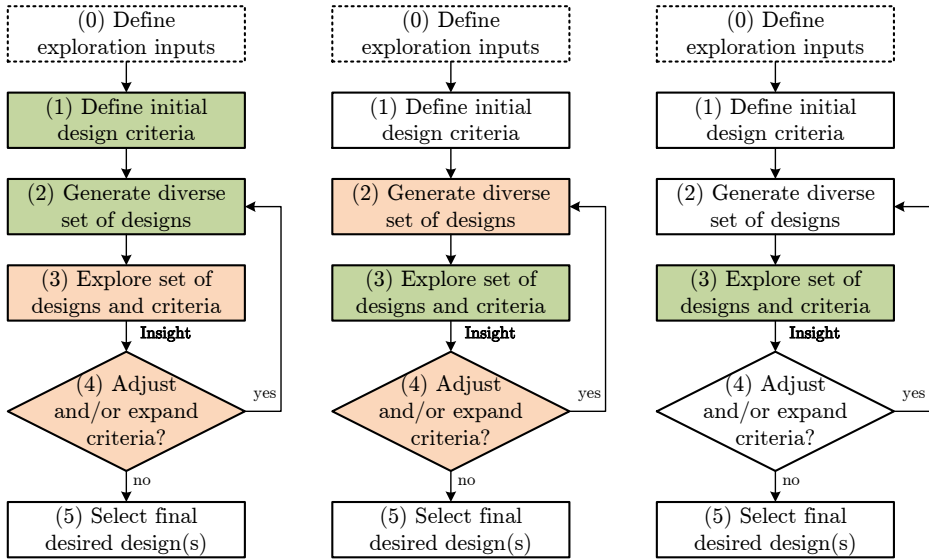
This test-case makes use of the full variability present in the MCMV synthesis model. The model varies: main MCM systems, signature reduction measures through hull material, crew as function of systems plus extra provisions for varying staff size, weapons and sensor suite. In addition there are variations of mothership platform characteristics such as speed, range, and food endurance (see Table 7.1 and 7.2 and Appendix A).

For this particular test-case an integrated procurement cost estimation model was kindly provided by DMO (see Appendix A). This cost model is weight-based and follows the NATO ANEP-41 standard on ship costing (NATO, 2006). **The costing data has been altered and scrambled so that figures may be presented in this dissertation. Thus, both the absolute and relative costs of different design options do not reflect actual real-world numbers. Nonetheless, the cost model was altered such that the trend it produces remains representative of the design options chosen.**

A fixed project budget of €19 million is used throughout the test-case. This is the average budget for a single vessel out of a class of four. Furthermore, it is assumed that all four vessels in the class are equal. In reality there is also the option to mix a different number of vessels with varying capability for the given budget. However, this test-case will not explore such class mixing. Nonetheless, especially for larger navies, exploring the influences of requirements may also be interesting from a fleet perspective (e.g., see Doerry and Fireman, 2009).

### 7.5.2 Test-case strategy

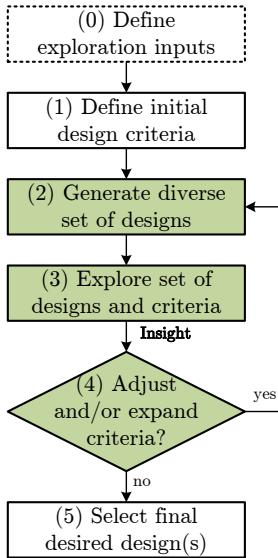
Before elaborating on the actual execution of the test-case, the strategy adopted when using the interactive approach work-flow of Figure 3.2 is explained. To achieve the final goal of the test-case (i.e., identifying desirable combinations of MCM and platform characteristics for a given budget) several iterations of the interactive approach work-flow are made. These iterations are split into several strategy steps, each with a specific purpose in the test-case exploration effort. They are further covered in this Section before the full detailed execution of the test-case strategy is elaborated in Sections 7.5.3 to 7.5.7. A compacted summary and discussion of the main findings of each step is presented in Section 7.5.8.



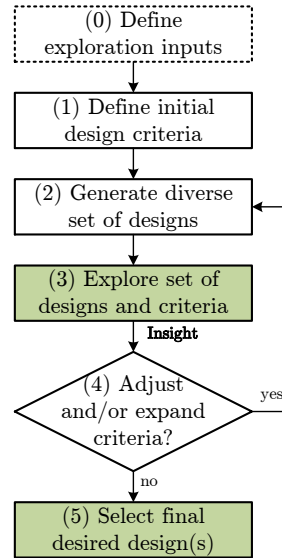
(a) Strategy Step 1

(b) Strategy step 2.1

(c) Strategy Step 2.2



(d) Strategy Step 2.3



(e) Strategy Step 3

**Figure 7.11:** Link between the steps of the test-case strategy and the interactive approach work-flow presented in Figure 3.2 (green indicates a primary use of that part of the developed interactive approach, while red indicates secondary use). Together these strategy steps form the work-flow of the test-case.

### Step 1: Exploratory runs

The first step of the test-case strategy is to generate a diverse set of designs. Initially, the goal of the exploration effort is to identify the limits of the design and performance space as described by the current design model and its implemented MCM system options and platform variations (Tables 7.1 and 7.2 and Appendix A). That is, given these variations, what are the lowest cost and most capable solutions. This not only provides reference values for technical and cost characteristics, it also forces a broad exploration of the design space by the search algorithm. First focussing on minimum cost and then on the maximum capability provides a simple method of filling the potential solution space with diverse candidate designs. This is due to the randomness introduced by the search algorithm's crossover and mutation operations (see Chapter 4 and 6).

For this step of the test-case strategy the focus lies on using the interactive approach to generate a diverse set of designs based on several a-priori defined criteria (e.g., those associated with a design with maximum capability). Figure 7.11a shows that mostly the first and second step of the proposed interactive approach are relevant in achieving this initial exploration (shown in green). The exploration and steering steps (shown in red) are only used to verify whether a sufficiently large and diverse set is achieved, after which the designer may choose to slightly adjust the criteria and generate additional designs.

### Step 2: Steering runs

Where Step 1 focusses on identifying the upper and lower bounds of the design and performance space and on generating a large and diverse set of designs, Step 2 focusses on finding affordable trade-off solutions which have different combinations of the varying design options from Tables 7.1 and 7.2. To do so, requires several sub-steps which make use of the interactive exploration and steering ability of the approach work-flow presented in Figure 3.2 and repeated here in Figure 7.11. The sub-steps of the strategy are:

#### Step 2.1: Individual design impact studies

This first sub-step aims at determining which individual, and combinations of, design variations have a high design impact. That is, the impact with respect to technical characteristics (e.g., ship size and weight) and cost. This sub-step of the strategy makes primary use of the exploration part of the proposed interactive approach (green in Figure 7.11b and see Chapter 5).

In addition to gaining insight about design impacts, the explorations performed in this sub-step may also reveal design options which are, as of yet, not very well represented within the design space. That is, designs with those specific options have simply not been generated and explored yet. At this point, individual steering runs with targeted steering criteria can focus the search effort towards those specific parts of the design space (see the red steps of Figure 7.11b). This allows the designer to selectively fill-in the desired yet missing parts of the design space which followed from Step 1 of the strategy.

**Step 2.2: Identify affordable trade-off solutions**

In the next sub-step, the insight gained from the design impact studies of Step 2.1 is used to explore and identify promising trade-off solutions lying within limits of the project budget. The high impact (driving) design options that are identified in Step 2.1 are of primary interest in identifying these trade-off solutions.

In this sub-step no additional designs are generated. Instead, the initial diverse set of designs that was generated in Step 1 and the additional designs that are generated in Step 2.1 are explored in search for the affordable trade-off solutions. Hence, only the interactive exploration part of the proposed approach is applied in this part of the test-case (green in Figure 7.11c and see Chapter 5).

**Step 2.3: Focus search effort towards identified trade-offs**

Step 2.2 only explored and identified relevant trade-off solutions. However, the broader exploratory nature of the initial strategy steps means that the identified trade-off options are probably ill-defined within the current set of designs. Most likely, only several designs which match the found trade-off options have been generated so-far. Hence, further focussing is needed to verify whether the identified trade-off options remain valid and desirable.

The main characteristics of each design solution identified in Step 2.2 are used as steering criteria to focus design generation towards the solution space surrounding each concept. The designer can then explore the differences between the design space before and after steering to verify whether the identified concept is still desired or if new more promising concepts have been generated. So, for each identified solution the following three parts of the interactive approach are executed (green in Figure 7.11d):

1. Adjust the steering criteria to match main properties of the identified solution that is currently under investigation.
2. Generate an additional set of designs targeting these newly adjusted criteria.
3. Explore the expanded set of designs to verify whether the original solution is still valid or if more desirable designs have been generated.

To demonstrate how focussing of the exploration effort works, this test-case performs only one steering iteration step for each trade-off solution (the three points above). However, in practice a designer might choose to run more than one iteration for the most interesting design solutions. These subsequent iterations could focus on more detailed or secondary aspects of the design solution. For example, criteria which are initially of secondary importance (i.e., in the example of this test-case these criteria concerned speed, range or the number of additional staff).

**Step 3: Compare final solutions**

The final step in the test-case strategy is to select and compare the final desired trade-off solutions. At this point they should all represent affordable trade-offs of the varying design options from Tables 7.1 and 7.2. Further comparison and selection should therefore be based on other design characteristics, such as, operational performance or producibility aspects. These types of performance aspects were not considered in



this dissertation (see Section 1.6). However, a qualitative comparison is made based on the operational concepts presented in Section 7.2.

This step of overall strategy makes use of the design exploration and selection parts of the proposed interactive approach work-flow (indicated green in Figure 7.11e). No additional steering runs based on adjusted criteria are performed at this time.

### 7.5.3 Step 1: Exploratory runs

The first couple of exploratory runs focus on generating a large set of diverse designs and on finding minimal cost and maximal capability solutions. That is, given the non-negotiable design criteria and minimum or maximum options for the design variations (e.g., speed, range, payload, MCM and weapons systems) what are the lower and upper bounds of cost? These runs will give an indication of minimum and maximum bounds of the design space. Additionally, first leaving all variations options open and then fixing them to their maximum “values”, creates a large set of diverse designs. This is caused, by the nature of the genetic algorithm’s evolutionary operations.

In total five exploratory runs were executed (Table 7.4). Each run attempted to generate a total of 12625 designs. The runs used a population of 128 designs over 101 generations, except for the fourth run which used 201 generations. This was done in an attempt to increase designs with two USVs. The first run solely minimised cost as an objective. The four subsequent runs attempted to minimise cost including the following added criteria to maximise capability:

$$\begin{array}{lll}
 r_1 & \text{Staff provisions} & = 15 \\
 s_1 & \text{\#USV} & \geq 2 \\
 s_2 & \text{UAV} & = \text{Yes} \\
 s_3 & \text{Divers} & = \text{Yes} \\
 s_4 & \text{Sensor/weapon suite} & = \text{A (heavy)} \\
 s_5 & \text{Hull material} & = \text{GRP}
 \end{array} \tag{7.5}$$

In total the five runs produced 10464 (14%) packed designs which met the default non-negotiable criteria as defined in (7.1).

Table 7.4 also indicates why in total four runs (runs 2-5) were made attempting to maximise capability. Initially, in run 2, no solutions were found that satisfied the criteria of (7.5), hence several iterative runs were needed to increase this number and provide more diversity in the results. This was achieved by executing the iterative feedback loop in the exploration work-flow (red in Figure 7.11a) without adjusting the criteria. Run 3 is an exception, here the criterion for the number of USVs was dropped to at least one in a further effort to aid the generation of high capability designs.

The resulting design space plot of the five exploratory runs is shown in Figure 7.12. The individual plots compare total unit cost, enclosed volume of the hull and super-structure, and displaced volume. Enclosed volume allows comparison across designs with different types of hull material. For example a design with a GRP hull which is similar to a design with a steel hull will have a lower displacement but similar enclosed volume.

**Table 7.4:** Number of designs attempted, successfully generated (packed and meeting constraints), and that met the used criteria for the first five exploratory runs.

<i>Run</i>	<i>Attempted</i>	<i>Generated</i>	<i>Feasible wrt. criteria</i>	<i>Criteria used</i>
1	12928	2464 (19.1%)	-	-
2	12928	1883 (14.6%)	0	as (7.5)
3	12928	1547 (12%)	77 (5.0%)	as (7.5) but 1 USV
4	25728	2812 (10.9%)	90 (3.2%)	as (7.5)
5	12928	1758 (13.6%)	136 (7.7%)	as (7.5)
-	-	-	-	-
Total	77440	10464 (13.5%)	-	-

Note, the bulk of the design points are located in the lower-left corner of all the design space plots. This is where the focus of the search algorithm was located due to minimising cost. Hence, both displacement and enclosed volume have been reduced. The designs with higher displacements and volumes naturally have lower packing densities. These designs have a large amount of unused volume within the hull and superstructure and are thus considered as less realistic.

### Minimum cost (least capable) solutions

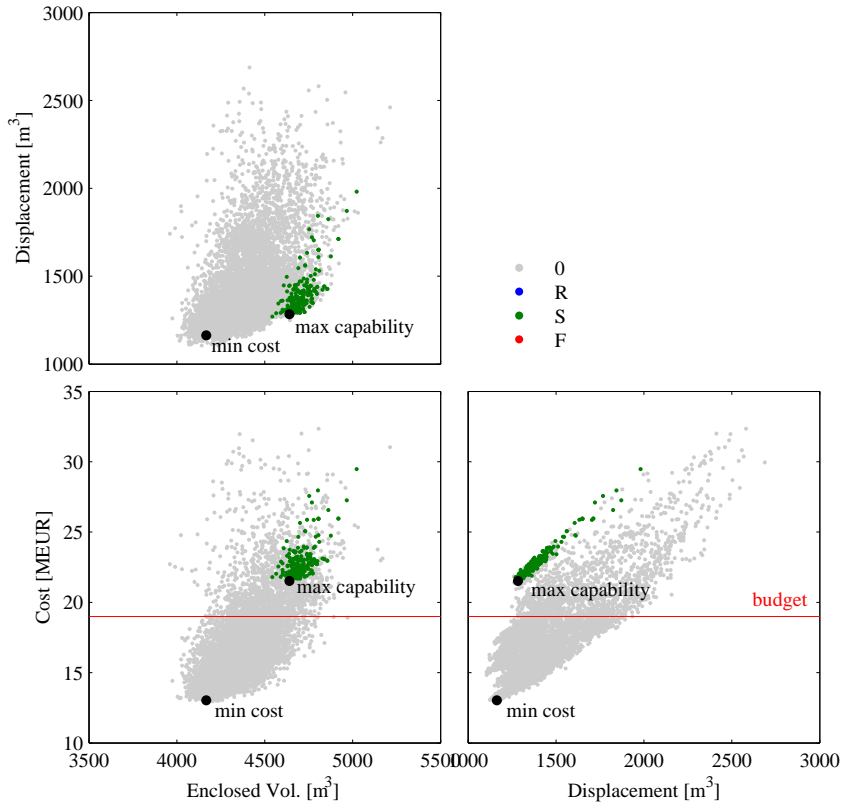
Table 7.5 shows a selection of low cost solutions from the first exploratory runs. All cost around €13 million. They have an ordinary steel hull, weapons and sensor suite type B (light), in addition none have any USVs or UAVs. However, though they have the lowest cost, these designs do not have the lowest options for transit speed or range. *LC2* and *LC4* have a transit speed of 12*kts* and a range  $\geq 3500nm$ . The two longer and more slender *LC1* and *LC3* designs have a higher transit speed of 14*kts* and a range of 4500*nm*. The higher speed is probably due to their more favourable resistance properties, allowing a higher speed with the same installed engine power. Also, all designs have provisions for a dive team.

There are two different global general arrangement solutions. One longer vessel with elongated superstructure and aft facing machine gun (concept *LC1* and *LC3*) and one shorter vessel with a larger superstructure and either a forward or aft facing machine gun (concept *LC2* and *LC4*). The packing densities of these designs are around 86% for the longer vessels and 84% for the shorter vessels.

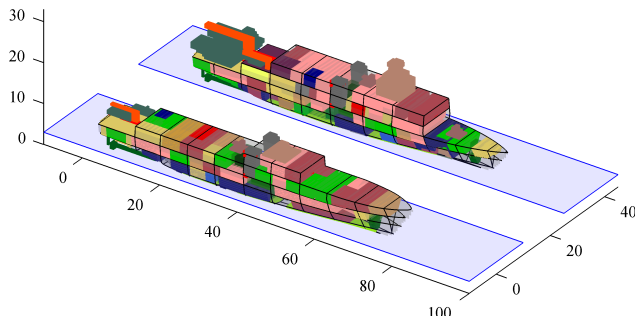
### Most capable solutions

Table 7.6 shows a selection of the lowest cost maximum capability solutions, that is, designs with criteria as defined in (7.5). All these designs cost around €22 million, which is around €9 million more than the least capable low cost solutions of Table 7.5.

Contrary to the minimal capability low cost solutions, the global general arrangements for the four maximum capability designs does not show much difference. The USV deck and UAV launch and recovery deck are located aft. The UAV deck and adjacent hangar pushes the up and down-takes for the engine room forward. This, in turn, limits the placement of the radar mast and causes the similar longitudinal



**Figure 7.12:** Design space resulting from first five exploratory runs with highlighted (green) designs that meet the steering criteria of (7.5). The two black dots represent the minimum cost and maximum capability solutions (see Figure 7.13).



**Figure 7.13:** The minimum cost design (front) and maximum capability design (aft) as highlighted in Figure 7.12, the first costs around €13 million while the most capable design costs around €22 million.

topside layout. In addition, the type A (heavy) weapons suite has both a forward and aft firing machine gun, limiting superstructure forward. The packing density of the designs is around 84%, slightly lower than for the low cost solutions (86%).

To summarise, the initial exploratory runs have provided an understanding of the boundaries of the possible design space. Based on the non-negotiable requirements a minimum solution is expected to cost around €13 million, whereas a design solutions with maximum system options costs around €22 million. The project budget was set at €19 million, so although the maximum option design falls outside of the scope, additional exploration is required to identify trade-off combinations of design options that do fall closer to, or within, the project budget. These additional exploration steps of the test-case strategy (see Section 7.5.2) are covered in the following sections.

#### 7.5.4 Step 2.1: Individual design impact studies

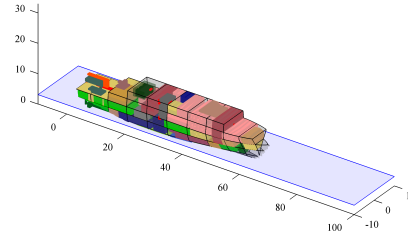
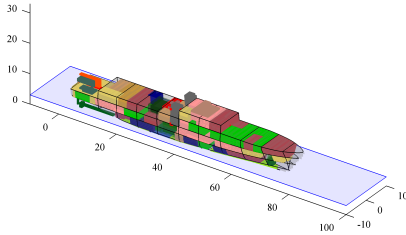
As was concluded from the first exploratory runs, it is necessary to perform additional exploration efforts to identify trade-off design. That is, designs which have different combinations of MCM systems, weapon and sensor suite, and platform characteristics (e.g., hull material, speed, range, staff capability). The exploratory runs have provided a broad range of design options covering a large area of the design space. However, due to the broad focus of the search algorithm in the first few runs, it is unlikely that many combinations of design options has been explored in equal detail by the search-algorithm. For example, for many combinations of design options none or only a few solutions have been generated.

To continue the exploration effort, several steps that involve steering runs are needed (refer to the strategy in Section 7.5.2). First, the design impact in terms of size and cost of the individual design options should be assessed. This provides useful insights for the next step, which is to identify relevant trade-off designs which lie close to the budget. Third, these relevant designs are then further explored by focussing the search-algorithm effort at these designs' characteristics. Finally, in a non-steering step, the possible trade-offs between the desired solutions, their individual options, cost, and the available budget can be distinguished.

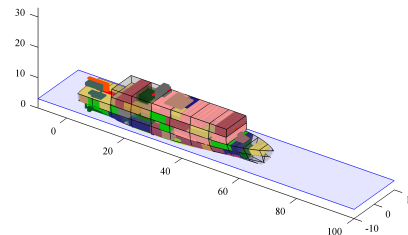
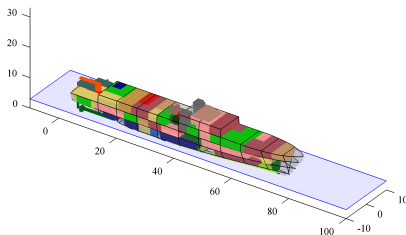
Nonetheless, before relevant trade-off combinations of options can be identified, it is worthwhile to investigate the design impact (in terms of size, weight, and cost) of individual design options (see Step 2.1 of the strategy in Section 7.5.2). Although such design options cannot strictly be assessed independently, for the sum of the individual impacts does not necessarily represent the actual combined design impact of integrated options, the individual option studies do provide understanding as to *why* the design impact of combined options may behave differently.

Moreover, studying individual options may reveal the existence of ill-defined options in the current set of designs, thereby indicating the need to add information by performing additional targeted steering runs. For example, initially the option of two USV systems was only present in 405 (3.9%) of the 10464 generated designs from the first five exploratory runs. Hence, it was decided to perform an additional targeted steering run which focussed on generating designs with two USVs (i.e., without any other criteria as was the case in the exploratory runs of Section 7.5.3). This increased the amount of designs with two USVs to 1007 (8.2%) of the 12271 total designs after six runs.

**Table 7.5:** Four different low cost minimal option design solutions. All have 0 USVs, no UAV, a steel hull, and the type B (light) weapons/sensor package.

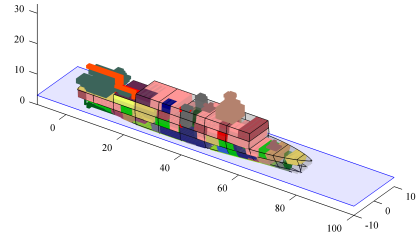
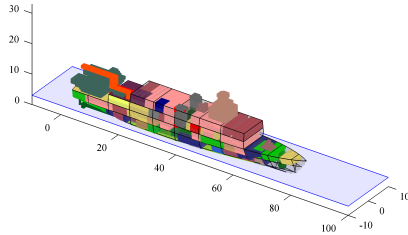


<i>Design concept</i>	<i>LC1</i>	<i>LC2</i>
Divers	Yes	Yes
Extra staff	10	5
Speed (max) [kts]	16	16
Speed (cruise) [kts]	14	12
Range [nm]	4500	3643
Mission [days]	28.0	20
Packing density	85.4%	84.8%
Displacement [ $m^3$ ]	1171	1119
Encl. Volume [ $m^3$ ]	4186	4073
Power $P_b/P_e$ [kW]	2780/1775	2780/1775
Propulsion concept	CODELAD	CODELOD
Cost [M€]	13.1	13.1

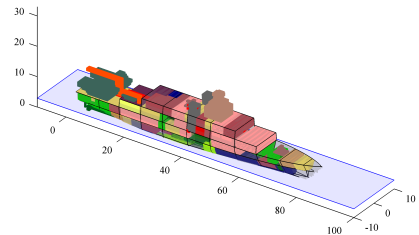
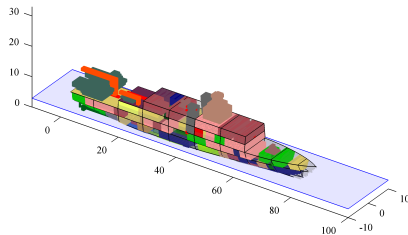


<i>Design concept</i>	<i>LC3</i>	<i>LC4</i>
Divers	Yes	Yes
Extra staff	5	5
Speed (max) [kts]	14	17
Speed (cruise) [kts]	14	12
Range [nm]	4500	4000
Mission [days]	28.0	22.2
Packing density	85.6%	82.6%
Displacement [ $m^3$ ]	1164	1133
Encl. Volume [ $m^3$ ]	4167	4015
Power $P_b/P_e$ [kW]	2780/1775	2780/1775
Propulsion concept	CODELOD	CODELOD
Cost [M€]	13.0	13.2

**Table 7.6:** Four different low cost maximum capability design solutions. All have two USVs, a UAV, a GRP hull, a type A (heavy) weapons/sensor package, support for divers, and provisions for 15 staff.



<i>Design concept</i>	<i>MC1</i>	<i>MC2</i>
Speed (max) [kts]	17	17
Speed (cruise) [kts]	15	15
Range [nm]	4500	4500
Mission [days]	23.5	23.4
Packing density	85.4%	85.0%
Displacement [ $m^3$ ]	1284	1287
Encl. Volume [ $m^3$ ]	4640	4630
Power $P_b/P_e$ [kW]	2780/1775	2780/1775
Propulsion concept	CODELOD	CODELOD
Cost [M€]	21.5	21.6



<i>Design concept</i>	<i>MC3</i>	<i>MC4</i>
Speed (max) [kts]	17	17
Speed (cruise) [kts]	15	15
Range [nm]	4500	4500
Mission [days]	23.3	23.3
Packing density	84.2%	83.7%
Displacement [ $m^3$ ]	1292	1299
Encl. Volume [ $m^3$ ]	4701	4678
Power $P_b/P_e$ [kW]	2780/1775	2780/1775
Propulsion concept	CODELOD	CODELOD
Cost [M€]	21.7	21.7

Table 7.7 presents a summary of these three additional targeted steering runs that were performed during the design impact studies. Similar to the example concerning the USVs above, the design impact studies indicated that so-far not many designs with a AMS hull had been generated. Hence, a targeted steering run with maximum criteria but now with a AMS hull was initiated (run 7). Also, design solutions with a secondary working deck were not well represented in the current set, hence run 8 was initiated with criteria for at least one USV and a secondary working-deck<sup>4</sup>.

**Table 7.7:** Number of designs for the three additional steering runs performed during the individual design impact studies (continuing from Table 7.4)

<i>Run</i>	<i>Attempted</i>	<i>Generated</i>	<i>Feasible wrt. criteria</i>	<i>Criteria used</i>
1-5	77440	10464 (13.5%)	-	-
-	-	-	-	-
6	12928	1807 (13.9%)	602 (33.3%)	#USV $\geq 2$
7	12928	1340 (10.4%)	145 (10.8%)	as (7.5) but AMS hull, Staff $\geq 10$
8	12928	1297 (10%)	464 (35.8%)	#USV $\geq 1$ , 2nd work-deck

The individual design impact studies for: the number of UVSs, the hull material choice, and the interactions of speed, range and endurance, are elaborated below.

### Impact of number of USV systems

The design impact of the number of USV systems (zero, one, or two) is shown in Figure 7.14. The plots in Figure 7.14 display several pieces of information:

1. Three criteria boundary curves are shown for the design sets which contain solution with either zero, one, or two USVs. This provides the designer with an overall idea of the characteristics of designs with the different number of USV systems.
2. The budget limit of €19 million is plotted. This provides a reference when judging the cost impact of design changes.
3. For each set, one design with the lowest cost is selected and highlighted (e.g., see the black dots). To correctly assess the impact of adding one or two USV systems, the reference designs should be similar. That is, comparing a design with one USV and no UAV to a design with two USVs *and* a UAV is not very useful. The extra UAV changes the relative difference with the first design as it will also impact the cost and technical characteristics of the design. A simple way to overcome this issue, is to select the lowest cost design from each set as a representative solution. In addition, the designer may check to make sure the designs are comparable and that no large differences exist aside from the characteristic(s) under investigation.

<sup>4</sup>see design *H* in Table 7.12 for an example of the secondary working-deck

4. For clarity, arrows have been added which link the three design sets and their representative designs. This helps indicate the design impact of changing the number of USVs (i.e., when switching from  $0 \rightarrow 1 \rightarrow 2$ ).

Based on the above information in the plot of Figure 7.14 the following can be deduced. First, there is a large impact on ship size when changing from zero to one USV. There is a notable increase in volume, length, and displacement. Second, the impact of adding a second USV is more related to cost. There is only a relatively small volume and displacement increase and no length increase.

**Table 7.8:** Design characteristics of the highlighted USV impact designs of Figure 7.14

# USV	0	1	2
Length [m]	71	79	79
Displacement [ $m^3$ ]	1111	1249	1257
Enclosed Vol. [ $m^3$ ]	4109	4310	4444
Cost [M€]	12.9	16.1	17.8
Packing density	85%	79%	83%
Crew(staff)	45(10)	45(10)	52(10)
Divers	No	Yes	Yes

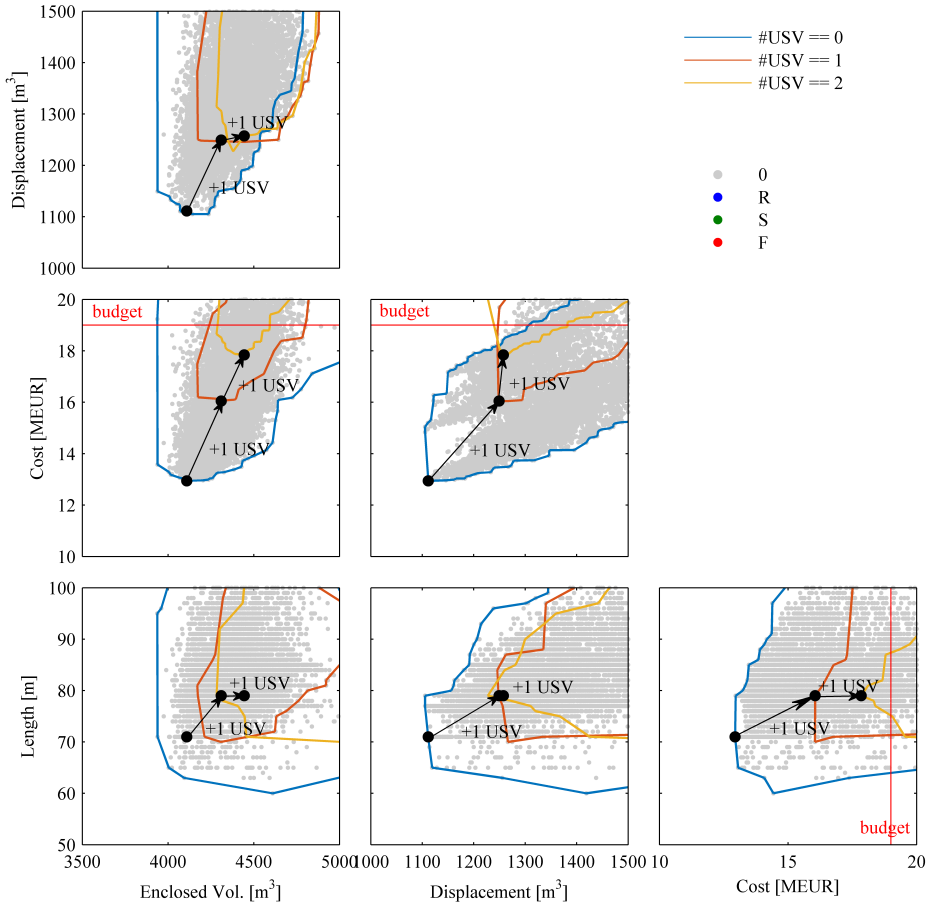
The increases in ship size are easily explained. A 12m USV requires considerable extra working deck length aft, increasing the overall length of the design by 8m (see Table 7.8). This extra deck length is also seen in the actual design arrangements in Figure 7.15. The designs with one or two USV's (middle and aft in the figure) clearly have a longer working deck than the foremost design which does not have a USV. In addition, the arrangements show that the USV's (green objects on the aft deck) do not take-up much additional length, yet they do require the need for the working-deck to be lengthened by one bulkhead spacing. Hence, the added length of around 8m in case of one or two USV's.

The increase in length also increases the internal volume of the hull by about  $200m^3$  from  $4100m^3$  to  $4300m^3$ . This added volume remains unused as can be noted by the decrease in packing density from 85% to 79%. A second USV is more easily added alongside the first without the need for additional length (i.e., compare the middle and aft designs in Figure 7.15). However, based on the manning model included within the design model, there is an increase in required crew of seven PAX when a second USV is added. Hence, some of the added volume as a result of the initial length increase is compensated by a growth in crew areas. The different packing densities of the three options confirms this observation. The design with zero USVs has a packing density of 85% compared to 79% or 83% for one or two USVs respectively.

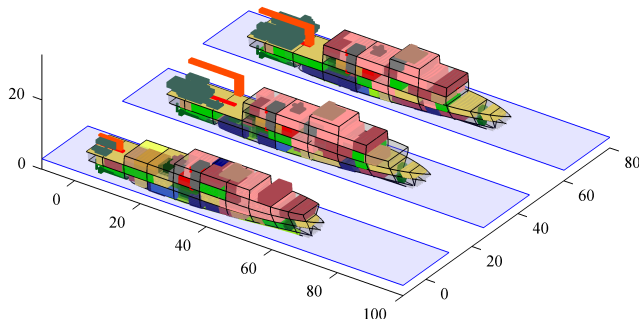
### Impact of hull material option

Similarly to the impact of the number of USVs, the design impact for the choice of hull material was investigated. Three different types of hull material, providing different levels of signature reduction, are considered: ordinary shipbuilding steel,





**Figure 7.14:** Design impact of number of USV options, properties of the highlighted designs are shown in Table 7.8



**Figure 7.15:** Representative design solutions for zero (front), one (middle), and two (back) USVs, as highlighted in Figure 7.14 and Table 7.8. Note the additional length of the working deck for the designs with one or two USVs (middle and back).

anti-magnetic steel (AMS), and glass reinforced plastics (GRP). The design impact of changing the hull material criterion is shown in Figure 7.16.

As with the USV study, this figure displays several relevant pieces of information. Three sets of designs, one for each material option, including their criterion boundaries are plotted. Also, to judge the impact of changing the hull material, three comparable and representative design solutions (one for each set) are highlighted (see Figure 7.17 and Table 7.9). Care was taken to make sure that, apart from the hull material, the three representative designs have similar numerical and system characteristics (e.g., speed, range, MCM systems, crew). The arrows display the criterion change between the representative design (i.e., when switching from Steel  $\rightarrow$  AMS  $\rightarrow$  GRP).

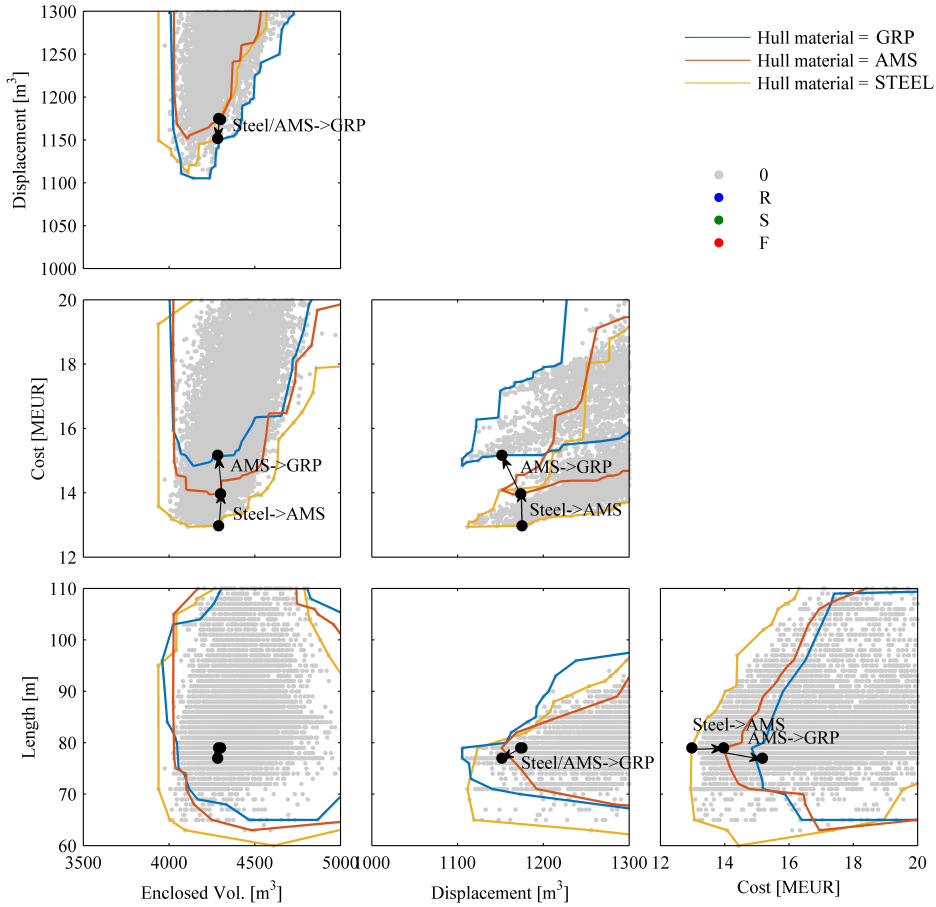
**Table 7.9:** Design characteristics of the highlighted hull material impact designs of Figure 7.16

<i>Hull material</i>	<i>Steel</i>	<i>AMS</i>	<i>GRP</i>
Length [m]	79	79	77
Displacement [ $m^3$ ]	1175	1174	1152
Enclosed Vol. [ $m^3$ ]	4289	4301	4284
Cost [M€]	13.0	14.0	15.2
Packing density	88%	88%	84%
Crew(staff)	50(15)	50(15)	50(15)
Divers	Yes	Yes	Yes

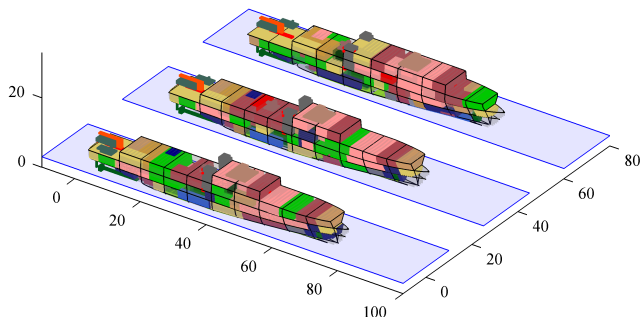
Several insights may be deduced from the plot. First, the cost impact of changing from steel to AMS is similar to the impact of changing from AMS to GRP (i.e., a cost increase of €1 million). Next, as the representative design have similar characteristics (i.e., in terms of MCM systems, sensor and weapon systems, crew size, and global layout) their enclosed volumes and length are comparable. Figure 7.17 further confirms this, as also the overall layout of the vessels are comparable. Naturally, displacement for the GRP design is lower, though not by much. The displacement versus cost plot (centre of Figure 7.16) shows that lower displacement GRP designs do exist, however, they do not compare to the AMS and steel representative designs selected. In addition, the packing density of the GRP design is lower than the other two representative designs (Table 7.9). This indicates potentially better packed (with a lower volume and displacement) GRP designs exist but have not yet been generated.

**Table 7.10:** Comparison of the initially identified GRP and steered GRP\* design as part of the hull material impact side-study

<i>Hull material</i>	<i>GRP</i>	<i>GRP*</i>
Length [m]	77	77
Displacement [ $m^3$ ]	1152	1135
Enclosed Vol. [ $m^3$ ]	4284	4276
Cost [M€]	15.2	14.9
Packing density	83.9%	85.4%
Crew(staff)	50(15)	50(15)
Divers	Yes	Yes



**Figure 7.16:** Design impact of hull material choice



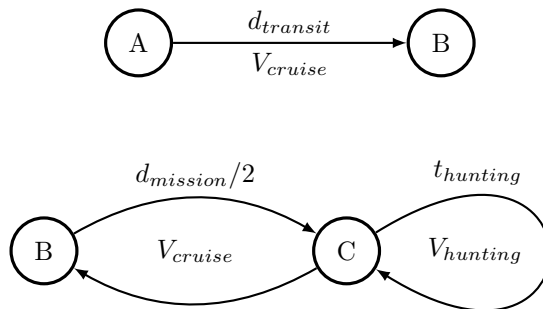
**Figure 7.17:** Representative design solutions for the hull material choice as highlighted in Figure 7.16. Steel (front), AMS (middle), and GRP (back).

A short side-study (outside of this test-case) was later performed to check whether indeed lighter (and cheaper) GRP designs exist. To confirm this, one additional steering run was performed which focussed on generating more designs with a GRP hull and equal characteristics to the AMS and steel designs identified above (i.e., with similar criteria for speed, range, staff provisions, and divers support). This indeed produced a lighter design with a more similar arrangement and packing density compared to the steel and AMS designs. Its properties are displayed together with the initial GRP design in Table 7.10.

### Interactions of cruise speed, range, and mission endurance

During the initial exploration (Step 1 of the exploration strategy) it was noticed that the maximum speed, cruise speed, and range of the concepts is not always equal to the lower bound value of  $12kts$  and  $1500nm$ . This observations warrants some attention as it illustrates how the interactive exploration approach, coupled with engineering judgement and design model knowledge, allows the designer to investigate *why* this is happening.

First, all designs have a CODELOD or CODELAD engine configuration (see Appendix A). For mine-hunting operations an electric motor and two diesel-generator sets provide (silent) propulsion power. For transit and maximum speed two diesel engines, or a combination of diesels *and* electric motors, is used. These engine configurations, coupled with a minimum diesel engine size of  $1390kW$  in the design database, provides sufficient power to propel the concepts at more than the minimum required cruise speed of  $12kts$ . Second, for redundancy reasons two shaft-lines are required which results in a minimum installed propulsion power of  $2780kW$  (in CODELOD configuration). This indicates that other propulsion concepts and components could, at lower speeds, provide smaller solutions for this type of vessel. For example, the integrated full electric propulsion as applied in the model of Zandstra et al. (2015). If so, the design impact of required maximum and cruise speed may again be more important. In addition, the low power requirements at cruise speed together with the available volume in the double bottom (due to the ships' size) also means range is at, or more than, the required maximum of  $4500nm$ .



**Figure 7.18:** A simple transit range (top) and a mission range/endurance (bottom). One can overrule the other in required fuel, this then increases either the transit range or the available hunting time (as mission range is constant).

Also, when the cruise speed is less than  $13kts$ , the fuel endurance of the design was found to be dictated by the hunting mission profile. In this profile the total mission endurance is 20 days. This includes the time required to sail a transit (at cruise speed) to-and-from a hypothetical staging area of in total  $1000nm$ . The remainder of the 20 day mission endurance is then left for mine-hunting operations. Thus, when fuel is dictated by the 20 day mission profile, the transit range can be higher (Figure 7.19a). Or, when fuel is dictated by the transit range, the mission duration may be longer than 20 days (with a maximum of 30 days due to food/part stores, Figure 7.19b). This explains why, at lower cruise speeds, the transit range exceeds the maximum required value of  $4500nm$  (see design concepts *A, B, C, E*, and *F*). Figure 7.18 provides a graphical illustration of the two fuel endurance requirements, also refer to Appendix A for more detail on the speed, range and endurance calculations.

### Closing remarks of impact studies

Studying individual design options and their impacts, as was performed with the USVs, hull material choice, and the range/endurance interactions, provides insight into *why* and *how* these impacts occurs. In addition, the design options with the highest impacts provide a basis for identifying trade-off design options in the next step of the exploration effort (Step 2.2). Two additional plots for the design impacts of the UAV system and the choice of combat and sensor system suite can be found in Appendix B.

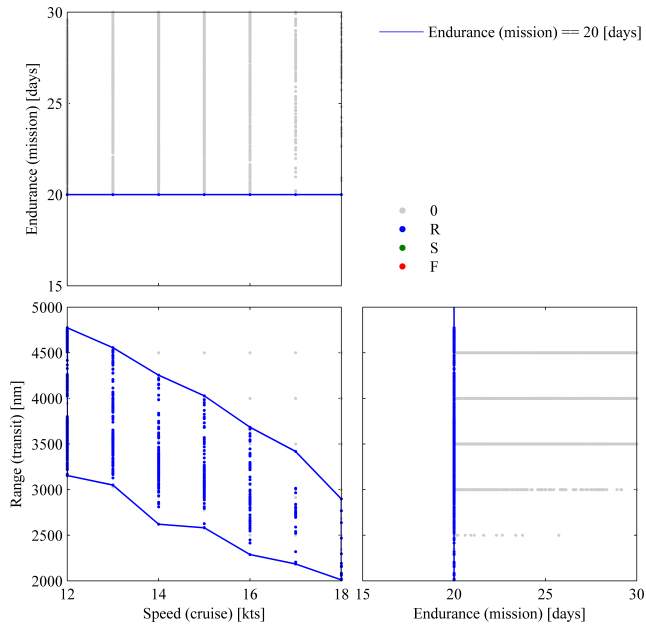
Similarly to the first damage length test-case, the impact studies also aided in identifying areas of the MCMV design model where changes and improvements could be made. For this, the detailed exploration of individual criteria, and specifically *why* and *how* the model behaves to these criteria, forces the user to reflect on the underlying assumptions and constraints. For example, the impact study of the interactions between range, speed, and endurance indicated that the current propulsion plant concept and its assumed component sizing could be improved and that the chosen operational profiles have an inherent interaction.

### 7.5.5 Step 2.2: Identifying relevant trade-off combinations

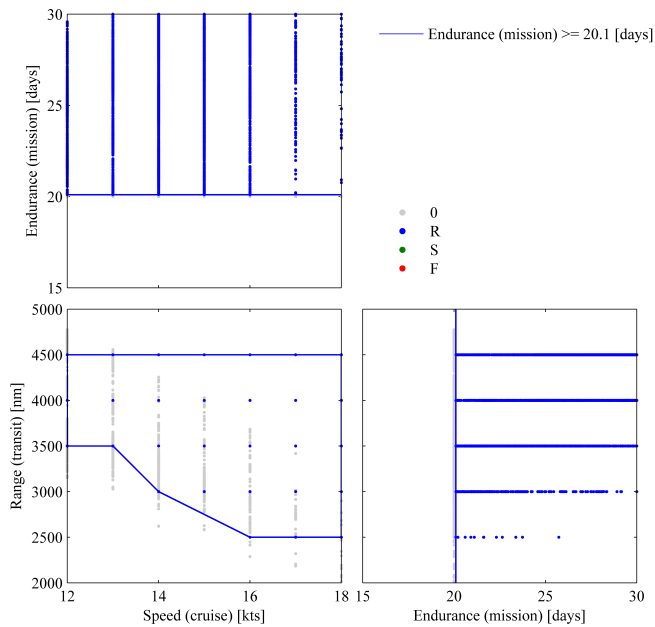
The individual impact studies of the Step 2.1 indicated that the largest design and cost impacts are to be expected from: the USVs, the UAV, hull material choice, and the chosen weapons and sensor suite. For these options promising combinations lying within or close to the budget margin (€18-20 million) were explored and identified by systematically varying the criteria related to these options using the interactive exploration tool (Table 7.11). Hence, in this step of the test-case strategy no new designs were generated (see Section 7.5.2 and Figure 7.11c).

In total 36 combinations of variations of the high impact criteria were explored with the interactive approach. For each variation, first the set of designs which meet the selected combination of criteria was identified. Next, from this set the lowest cost design solution was chosen, and its cost compared to the budget margin of €18-20 million. Finally, only those solutions which had a cost within the budget margin are selected as initial affordable trade-off combinations.

The above exploration and selection process can also be partially automated when more variations of criteria must be assessed. However, only the high impact design



(a) Selected designs with fuel endurance dictated by the mission profile, hence transit range is higher than initially required.



(b) Selected designs with fuel endurance dictated by transit, hence the mission endurance is longer than initially required.

**Figure 7.19:** Interactions between cruise speed, transit range and mission endurance.

**Table 7.11:** Systematic variations of high impact design options

<i>Variation</i>	<i># USV</i>	<i># UAV</i>	<i>Combat/sensor suite</i>	<i>Hull material</i>
1	0	0	B (light)	Steel
2	1	0	B (light)	Steel
3	2	0	B (light)	Steel
-	-	-	-	-
34	0	1	A (heavy)	GRP
35	1	1	A (heavy)	GRP
36	2	1	A (heavy)	GRP

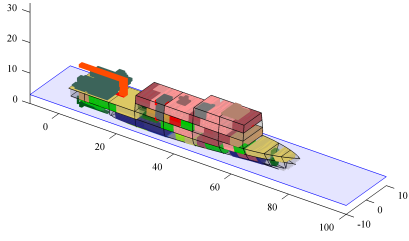
variations, as identified in Step 2.1, are used to select designs. In addition, often the design options under consideration can be logically grouped, reducing the need to cover individual options (e.g., as was done for the combat and sensor systems suite in this design).

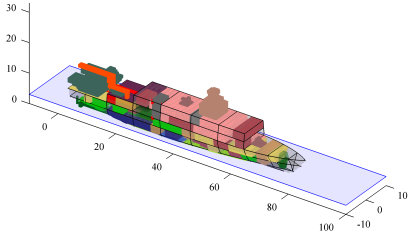
The 12 selected affordable design combinations are shown in Table 7.12. Each design concept was identified by first selecting the main preferred criteria, that is, the design options for the number of USV and UAV systems, type of hull material, and weapons and sensor fit. Based on the lowest cost design concept meeting these preferred criteria, other attainable design characteristics may be derived (e.g., speed, range, staff provisions and diver support). From Table 7.12 several interesting observations may be noted:

- First, all affordable design concepts have at least one USV system. Without this option, even with all other options selected (e.g., a UAV, GRP hull, and heavy combat system suite), the design concepts do not reach the lower budget margin of €18 million.
- The option of 2 USVs *and* signature reduction measures (AMS or GRP hull) only seems affordable without a UAV and with only the basic light combat and sensor suite (see design concepts *A*, *B*, *C*, *E*, *and F*). Hence, if signature reduction *and* a heavy combat sensor suite are desired, this requires dropping one USV system (see design concepts *D*, *G*, *I*, *and J*).
- Design concept *H* has the USV working deck forward of the superstructure. Although, this was initially also an available design option, the forward USV deck in this arrangement is considered undesirable. Launch and recovery is expected to be difficult due to higher vertical motions at the bow when compared to the stern. In addition, the forward working deck also restricts the placement of a forward firing main gun (e.g., design *H* has the light combat systems suite with one aft firing machine gun).

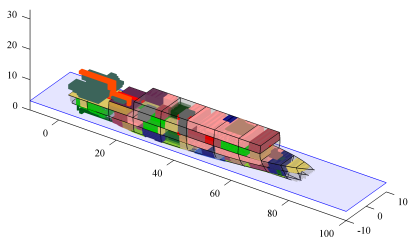
In addition, the packing densities of the identified design concepts vary considerably (between 75-85%). This indicates not all concepts have been equally explored. Further focussing on the individual concepts will likely reveal more dense arrangements with less unused space, hence resulting in a lower cost solution. Hence, the need for Step 2.3 where the exploration will focus towards the 12 individual concepts and their characteristics.

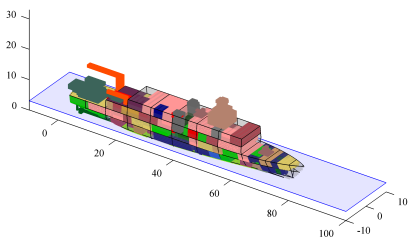
**Table 7.12:** Initial identified trade-off combinations of design options for a budget of around €19 million. The highlighted options were used as criteria to select the concept as a baseline. The other options resulted from the lowest cost design for the selected baseline characteristics.





<i>Design concept</i>	<i>A</i>	<i>B</i>
#USV	<b>2</b>	<b>2</b>
#UAV	0	<b>1</b>
Hull material	<b>GRP</b>	Steel
Weapon suite	B (light)	<b>A (heavy)</b>
Divers	Yes	Yes
Extra staff	10	15
Speed (max) [kts]	17	17
Speed (cruise) [kts]	12	12
Range [nm]	4750	4740
Mission [days]	20	20
Packing density	79.1%	81.3%
Cost [M€]	20.0	20.0

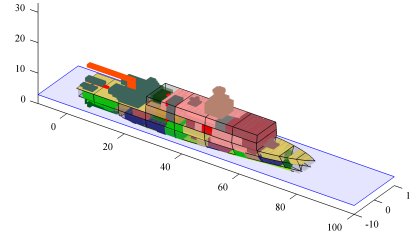
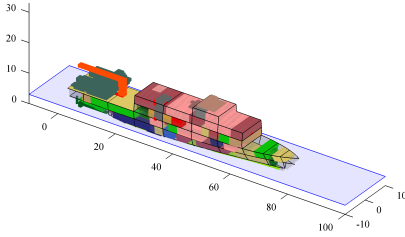




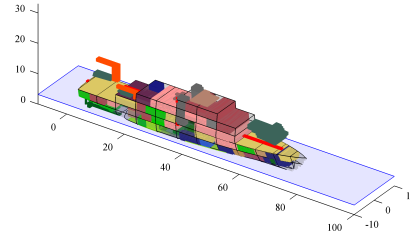
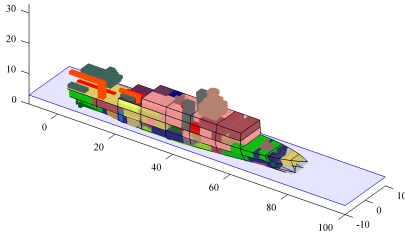
<i>Design concept</i>	<i>C</i>	<i>D</i>
#USV	<b>2</b>	<b>1</b>
#UAV	<b>1</b>	<b>1</b>
Hull material	Steel	<b>GRP</b>
Weapon suite	B (light)	<b>A (heavy)</b>
Divers	Yes	Yes
Extra staff	15	15
Speed (max) [kts]	16	17
Speed (cruise) [kts]	12	15
Range [nm]	4680	4500
Mission [days]	20	26.6
Packing density	75.4%	84.9%
Cost [M€]	19.6	19.5



Continued from previous page...

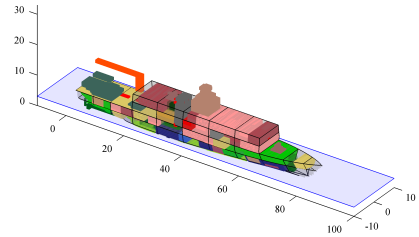
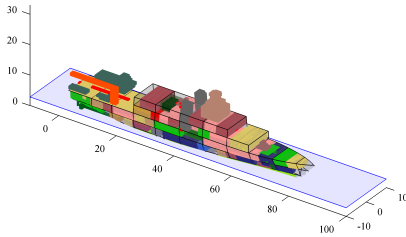


<i>Design concept</i>	<i>E</i>	<i>F</i>
#USV	<b>2</b>	<b>2</b>
#UAV	0	0
Hull material	<b>AMS</b>	Steel
Weapon suite	B (light)	<b>A (heavy)</b>
Divers	Yes	Yes
Extra staff	10	15
Speed (max) [ <i>kts</i> ]	18	17
Speed (cruise) [ <i>kts</i> ]	12	12
Range [ <i>nm</i> ]	4770	4740
Mission [ <i>days</i> ]	20	20
Packing density	81.4%	84.7%
Cost [ <i>M€</i> ]	19.1	18.8

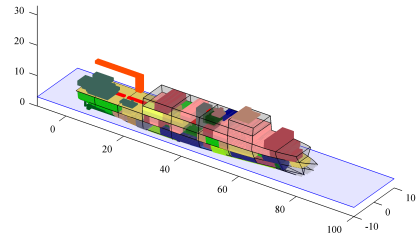
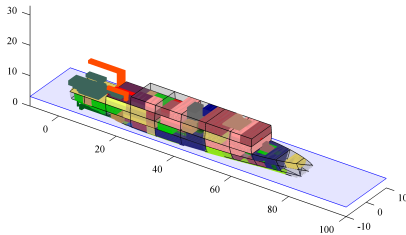


<i>Design concept</i>	<i>G</i>	<i>H</i>
#USV	<b>1</b>	<b>1</b>
#UAV	<b>1</b>	<b>1</b>
Hull material	<b>AMS</b>	<b>GRP</b>
Weapon suite	<b>A (heavy)</b>	B (light)
Divers	Yes	No
Extra staff	5	10
Speed (max) [ <i>kts</i> ]	15	18
Speed (cruise) [ <i>kts</i> ]	15	18
Range [ <i>nm</i> ]	4500	3500
Mission [ <i>days</i> ]	26.5	24.5
Packing density	84.1%	80.6%
Cost [ <i>M€</i> ]	18.8	18.7

Continued from previous page...



<i>Design concept</i>	<i>I</i>	<i>J</i>
#USV	<b>1</b>	<b>1</b>
#UAV	0	0
Hull material	<b>GRP</b>	<b>AMS</b>
Weapon suite	<b>A (heavy)</b>	<b>A (heavy)</b>
Divers	Yes	Yes
Extra staff	10	15
Speed (max) [ <i>kts</i> ]	17	15
Speed (cruise) [ <i>kts</i> ]	15	15
Range [ <i>nm</i> ]	4500	4500
Mission [ <i>days</i> ]	23.6	23.5
Packing density	82.3%	78.6%
Cost [ <i>M€</i> ]	18.7	18.6



<i>Design concept</i>	<i>K</i>	<i>L</i>
#USV	<b>1</b>	<b>1</b>
#UAV	<b>1</b>	0
Hull material	<b>AMS</b>	<b>GRP</b>
Weapon suite	B (light)	B (light)
Divers	Yes	Yes
Extra staff	10	15
Speed (max) [ <i>kts</i> ]	17	17
Speed (cruise) [ <i>kts</i> ]	17	16
Range [ <i>nm</i> ]	4500	4500
Mission [ <i>days</i> ]	30	28.7
Packing density	79.0%	76.6%
Cost [ <i>M€</i> ]	18.5	18.5

### 7.5.6 Step 2.3: Focussing the search effort

Step 1 of the test-case strategy explored the extent of the design space and attempted to generate a diverse set of designs covering a broad set of design options (Section 7.5.2). From these exploratory runs several promising design concepts which lie close to the project budget were identified (Step 2.1 and 2.2 in Section 7.5.2). However, not all of these concepts have been fully explored in the current set of designs. That is, in Step 2.2 they are selected from the static set of designs that was thus-far generated. The initial exploration runs did not focus the search effort *directly* at the identified concepts and their characteristics. Therefore, it is likely that some may turn out to have a lower cost, or changes in performance, once they are further explored. To investigate whether this is indeed the case, the subsequent exploratory effort is focussed on the 12 initial affordable design concepts (Step 2.3 in the strategy of Section 7.5.2).

In total 12 steering runs were performed in this step, one for each affordable design concept identified in Step 2.2. A summary of all runs is provided in Table 7.13. Each run uses steering criteria which are further highlighted in Table 7.12. For example, the criteria used for the steering run of design *L* (run 9) are:

$$\begin{aligned} s_1 \quad \#USV &\geq 1 \\ s_2 \quad \text{Hull material} &= \text{GRP}. \end{aligned} \quad (7.6)$$

The steering process for design *J* (run 11) is elaborated in more detail below. The other runs follow this same process and are hence not further discussed.

**Table 7.13:** Number of designs attempted, successfully generated (packed and meeting constraints), and that met the used criteria for all steering runs of Step 2.3 (continuing from Table 7.4 and 7.7).

<i>Run</i>	<i>Attempted</i>	<i>Generated</i>	<i>Feasible wrt. criteria</i>	<i>Criteria used</i>
1-8	116224	14908 (12.8%)	-	-
-	-	-	-	-
9	12928	2157 (16.7%)	595 (27.6%)	see <i>L</i>
10	12928	1547 (12.0%)	314 (20.3%)	see <i>K</i>
<b>11</b>	<b>12928</b>	<b>1744 (13.5%)</b>	<b>282 (16.2%)</b>	<b>see <i>J</i></b>
12	12928	1943 (15.0%)	325 (16.7%)	see <i>I</i>
13	6528	995 (15.2%)	227 (22.8%)	see <i>H</i>
14	12928	1658 (12.8%)	239 (14.4%)	see <i>G</i>
15	12928	1402 (10.8%)	315 (22.5%)	see <i>F</i>
16	12928	1892 (14.6%)	261 (13.8%)	see <i>E</i>
17	12928	2054 (15.9%)	350 (17.0%)	see <i>D</i>
18	12928	1538 (12.0%)	454 (29.5%)	see <i>C</i>
19	12928	1692 (13.1%)	330 (19.5%)	see <i>B</i>
20	12928	1771 (13.7%)	433 (13.7%)	see <i>A</i>
-	-	-	-	-
Total	264960	35301 (13.3%)	-	-

### Steering design J (run 11)

Design concept  $J$ , which as a baseline was selected with at least 1 USV, 0 UAVs, an AMS hull, and the heavy weapons suite at a cost of €18.5 million, was not well represented in the early runs (see Figure 7.20a). Initially the set contained mostly designs with 2 USVs, these can be seen clustered slightly above concept  $J$  in the displacement versus cost plot in Figure 7.20a. Only a limited number of 29 designs with only 1 USV (out of 250 with more than 1 USV) can be seen present in the set surrounding concept  $J$ . In addition, the relatively low packing density of concept  $J$  of 78.2% further indicates that this concept should be further explored.

A steering run focussing on the characteristics of concept  $J$  should improve the low cost boundary of the cluster of design meeting these characteristics. A steering run, minimising cost with the following added criteria, was therefore performed (see run 11 in Table 7.13):

$$\begin{array}{lll}
 s_1 & \#USV & \geq 1 \\
 s_2 & \text{Sensors/weapons} & = A \text{ (heavy)} \\
 s_3 & \text{Hull material} & = \text{AMS.}
 \end{array} \tag{7.7}$$

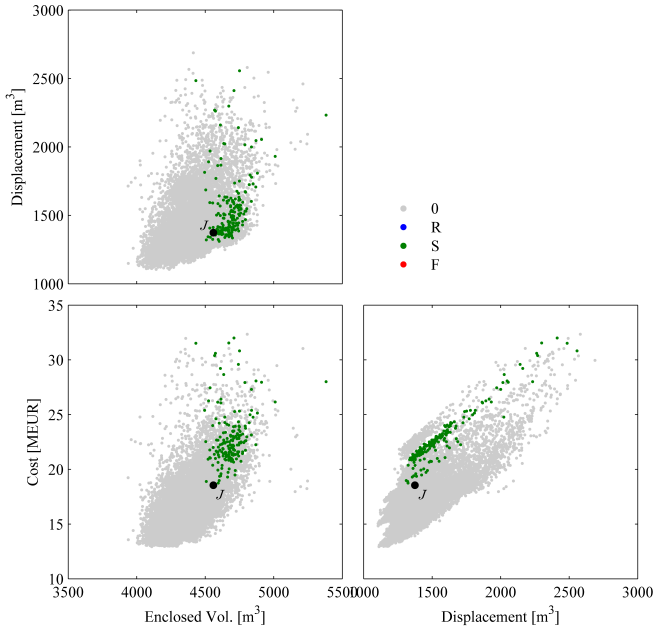
Figure 7.20b shows the resulting design space of the steering run. When compared with the initial design space of Figure 7.20a, considerably more design points were generated closer to the initial concept  $J$ . Now 302 design have exactly 1 USV compared to 29 initially and 636 designs have more than 1 USV compared to 250 initially. In addition, from this new set of designs a cheaper design concept  $J^*$  which meets the criteria defined in (7.7) was identified. Both concepts are compared in Table 7.14. The new design costs €17.2 million compared to €18.6 million for  $J$ .

Contrary to  $J$ , the new design has no support for a dive team or extra staff. However, it was already found that these last two options will only marginally increase cost if desired. Interestingly, concept  $J^*$  has a CODELAD propulsion plant. So with equal mechanical and electrical power the maximum speed can be slightly higher (17kts versus 16kts). The cruise speed is slightly higher at 16kts compared to 15kts for the initial concept. This has however lowered the transit range to 4000nm. If the original higher transit range, support for divers, and support for staff of  $J$  is desired, then the design will cost €17.7 million (€0.5 million extra). Note that this is still lower than the original €18.6 million of  $J$ .

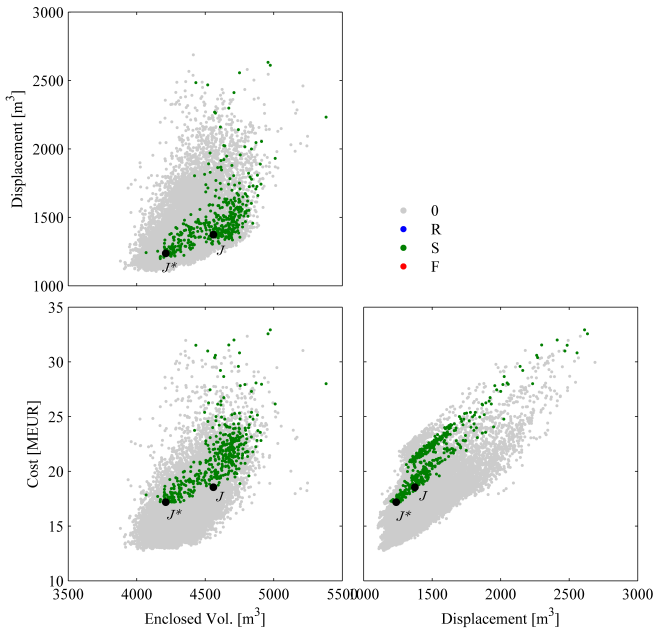
### Closing remarks Step 2.3

For all the other initial designs concepts presented in Table 7.12 a similar steering process, as described for concept  $J$  and  $J^*$ , was performed. In total this meant performing 12 steering runs, one for each initial concept. Each run approximately took 90 minutes to complete.

In addition to targeting the 12 concepts, two more relevant design concepts falling within the budget margin of €18-20 million were identified among the extra designs generated by the steering runs. These design concepts ( $M$  and  $N$ ) initially cost well above the €20 million upper budget bound. Hence, they were initially not selected as relevant trade-offs in Step 2.2. The two new concepts are presented in Table 7.15. The fact that these new design options have now been identified, indicates that further steering runs have the added benefit of targeting unexplored areas of the design space

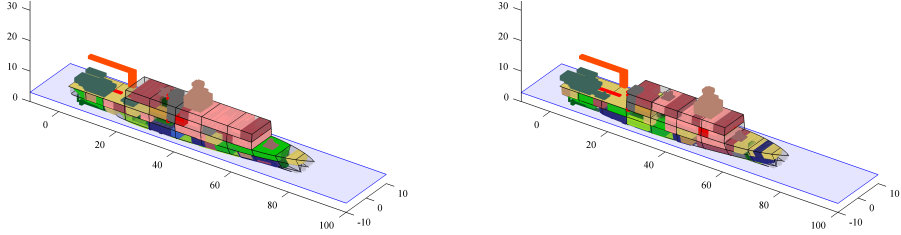


(a) Pre steering design space with concept  $J$  selected. The green set of designs meets the criteria of (7.7). Most have 2 USVs, hence their higher cost.



(b) Post steering design space with concept  $J$  and  $J^*$  selected. The green set of designs meets the criteria of (7.7).

**Figure 7.20:** Design space plots to illustrate effect of steering

**Table 7.14:** Main characteristics of concept  $J$  and  $J^*$ 


<i>Design concept</i>	$J$	$J^*$
#USV	<b>1</b>	<b>1</b>
#UAV	0	0
Hull material	<b>AMS</b>	<b>AMS</b>
Weapon suite	<b>A (heavy)</b>	<b>A (heavy)</b>
Divers	Yes	No
Extra staff	15	0
Speed (max) [ <i>kts</i> ]	15	17
Speed (cruise) [ <i>kts</i> ]	15	16
Range [ <i>nm</i> ]	4500	4000
Mission [ <i>days</i> ]	23.5	25.4
Packing density [%]	78.6	83.9
Displacement [ $m^3$ ]	1374	1237
Encl. Volume [ $m^3$ ]	4559	4212
Power $P_b/P_e$ [ <i>kW</i> ]	2780/1775	2780/1775
Propulsion concept	CODELOD	CODELAD
Cost [ $M\text{€}$ ]	18.6	17.2

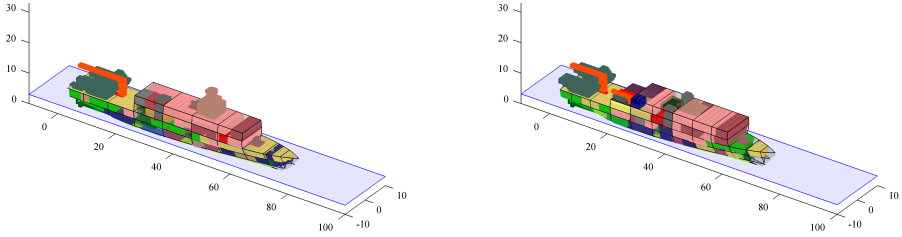
surrounding the already identified concepts. Thereby increasing the chance of finding further as-of-yet unexplored design solutions which closely match the desired criteria.

### 7.5.7 Step 3: Comparing the found trade-off options

Step 2.3 focussed the effort on each initial design concept. Next, the selection, comparison and assessment of the final found trade-off designs is performed. This forms the basis for the final selection of the desired design concepts (Figure 7.11e). The new identified design concepts ( $M$  and  $N$ ) and the resulting design concept for all steering-runs ( $A^* - L^*$ ) can be found in Table 7.15 and 7.16 and in Figure 7.21.

As a first observations, concepts  $I^*$  through  $K^*$  are no longer very relevant trade-off options. After steering, these concepts have fallen below the lower budget margin of €18 million. Hence, a more capable design should easily be attainable with the given budget margin. This also illustrates the effect of steering. These designs were initially not very well explored which, as a result, gave them a high initial cost estimate. So, although initially they represented interesting trade-off options, further focussing on these concepts has rendered them irrelevant.

The comparison starts by assessing the design with a high expected MCM per-

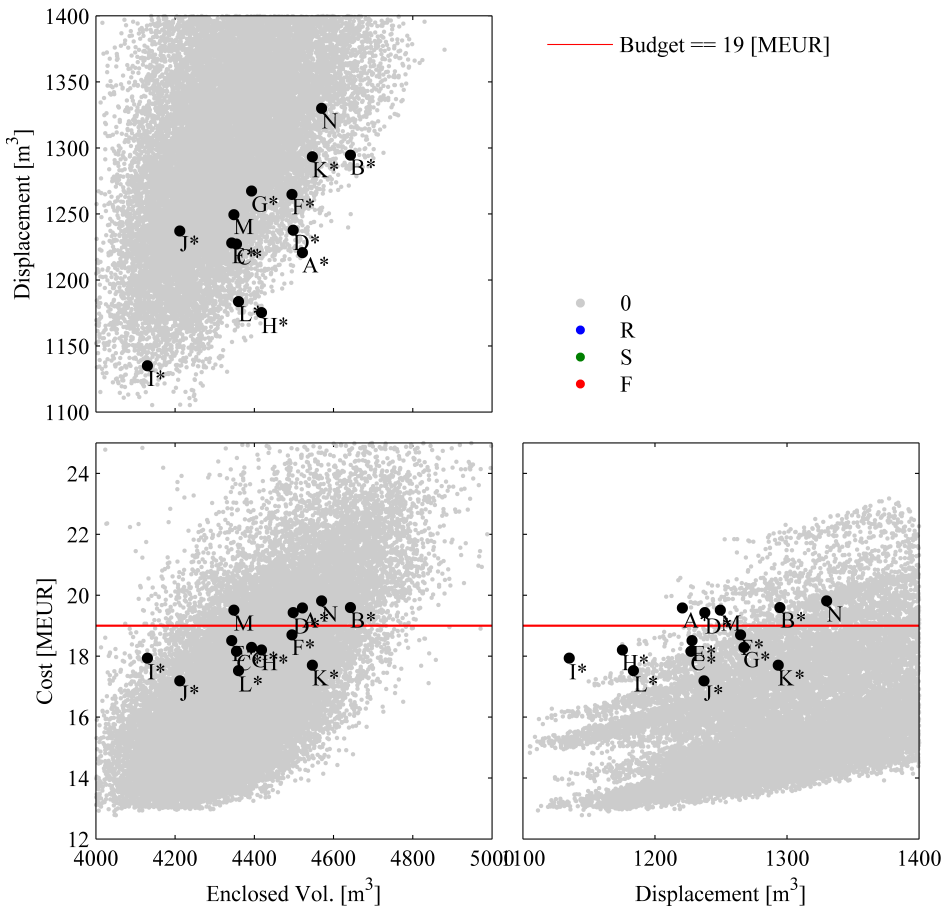
**Table 7.15:** Main characteristics of concept  $M$  and  $N$ 


<i>Design concept</i>	$M$	$N$
#USV	<b>2</b>	<b>2</b>
#UAV	0	<b>1</b>
Hull material	<b>AMS</b>	<b>AMS</b>
Weapon suite	<b>A (heavy)</b>	B (light)
Divers	No	Yes
Extra staff	10	5
Speed (max) [kts]	16	15
Speed (cruise) [kts]	12	15
Range [nm]	4746	4000
Mission [days]	20	23.5
Packing density	83.9%	84.9%
Cost[M€]	19.5	19.8

formance. For this the number of USVs and hull material choice are considered most important. Moreover, the individual impact studies indicated that these two design aspects had a very high cost impact. Consider the design options with 2 USVs. Only 7 of the 14 concepts have this option ( $A^*$ ,  $B^*$ ,  $C^*$ ,  $E^*$ ,  $F^*$ ,  $M$  and  $N$ ). Three of these ( $C^*$ ,  $E^*$  and  $F^*$ ) fall within the budget of €19 million. None of these have a GRP hull,  $E^*$  has an AMS hull, and the others are steel hulls. Concepts  $F^*$  and  $M$  are linked as the only main difference is the hull material (AMS versus steel), the same holds for concepts  $C^*$  and  $N$ .

There is only one concept  $A^*$  which has 2 USVs *and* a GRP hull. Nonetheless, even after steering, this concept remains expensive at €19.5 million. It also has no UAV and only a light weapons and sensor package. So, though it excels at MCM capability, its other capabilities are low. If GRP is really desired then the number of USVs must be dropped (e.g., concept  $D^*$  or  $H^*$ ). Thus, if 2 USVs *and* good hull signatures are desired, then there appear to be only two affordable solution concepts: (i) concept  $E^*$  with two USVs, AMS hull, but with a limited weapons and sensors package, and no UAV at a cost slightly under budget of €18.5 million; and (ii) concept  $M$  with two USVs, no UAV, an AMS hull, and a heavy weapons package at a cost slightly over budget of €19.5 million.

If a balance between MCM operations and other capabilities is sought, then some further trade-offs must be made. First, adding a UAV is only affordable if either hull signatures are dropped (i.e., to a steel hull in concept  $C^*$ ) or the requirement of two USVs is dropped to one (e.g., concept  $D^*$  or  $H^*$ ). For example, consider concept  $N$



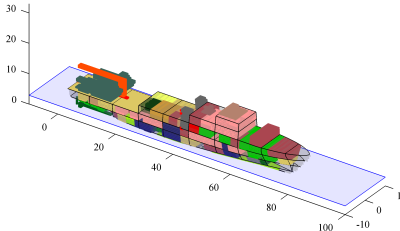
**Figure 7.21:** Final 14 design concepts ( $A^* - L^*$  and  $M, N$ ) and their relative positions within the design space.

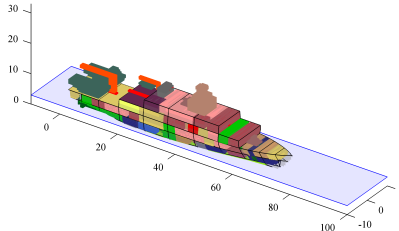
and  $K^*$  where removing one USV reduces the cost by almost €2 million. This freed budget can then be used to add a heavy weapons/sensor suite while staying within budget (concept  $G^*$  at €18.3 million). If a GRP hull is really desired then the only real balanced option is concept  $D^*$ , which at a cost of €19.4 million is slightly over budget. Concept  $G^*$  is also the cheapest option if only non-MCM related capabilities are maximised, that is, if a UAV and heavy weapons/sensor suite are required. Even so, it does have an AMS hull and one USV.

To summarise, if maximum MCM capabilities are required then concept  $E^*$  (€18.5 million) or  $M$  (€19.5 million) are the best trade-offs. If non-MCM capabilities should be maximised then concept  $G^*$  (€18.3 million) is the cheapest option. A good balance between MCM and non-MCM capabilities are found either in concept  $G^*$  or  $D^*$  (€18.3 or €19.4 million respectively).

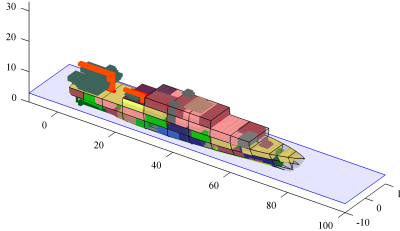


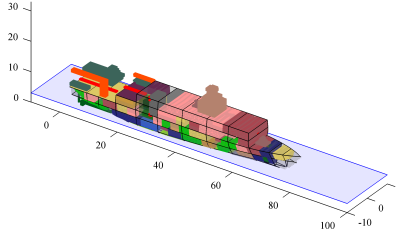
**Table 7.16:** Final identified trade-off combinations of design options for a budget of around €19 million. The highlighted options were used to steer the concept as a baseline. The other options resulted from the lowest cost design for the baseline.





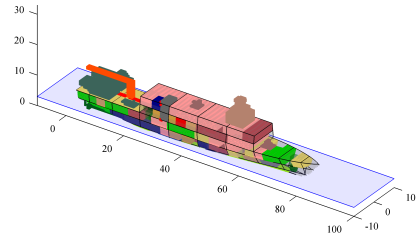
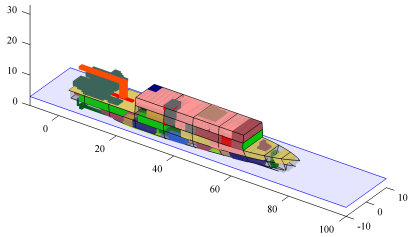
<i>Design concept</i>	<i>A*</i>	<i>B*</i>
#USV	<b>2</b>	<b>2</b>
#UAV	0	<b>1</b>
Hull material	<b>GRP</b>	Steel
Weapon suite	B (light)	<b>A (heavy)</b>
Divers	Yes	Yes
Extra staff	10	15
Speed (max) [kts]	17	12
Speed (cruise) [kts]	15	12
Range [nm]	4500	4507
Mission [days]	23.2	20
Packing density	84.5%	86.0%
Cost [M€]	19.6	19.6



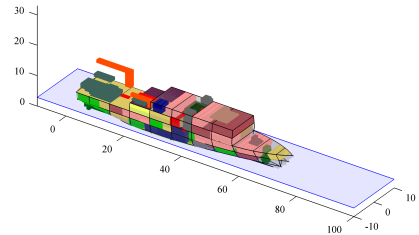
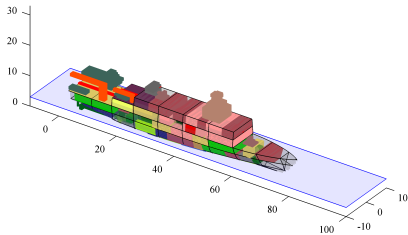


<i>Design concept</i>	<i>C*</i>	<i>D*</i>
#USV	<b>2</b>	<b>1</b>
#UAV	<b>1</b>	<b>1</b>
Hull material	Steel	<b>GRP</b>
Weapon suite	B (light)	<b>A (heavy)</b>
Divers	No	Yes
Extra staff	5	5
Speed (max) [kts]	14	16
Speed (cruise) [kts]	13	16
Range [nm]	4489	3500
Mission [days]	20	21.8
Packing density	86.0%	83.5%
Cost [M€]	18.2	19.4

Continued from previous page...

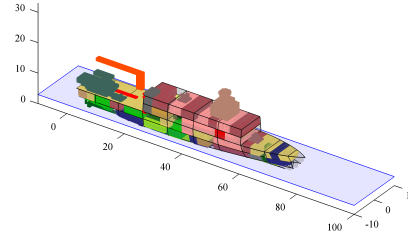
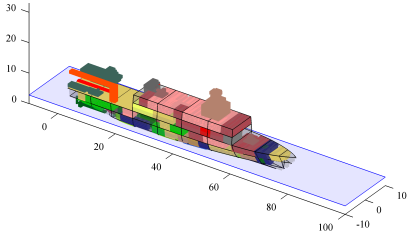


<i>Design concept</i>	$E^*$	$F^*$
#USV	<b>2</b>	<b>2</b>
#UAV	0	0
Hull material	<b>AMS</b>	Steel
Weapon suite	B (light)	<b>A (heavy)</b>
Divers	No	Yes
Extra staff	10	15
Speed (max) [kts]	16	17
Speed (cruise) [kts]	12	13
Range [nm]	4745	4569
Mission [days]	20	20
Packing density	83.8%	84.8%
Cost [M€]	18.5	18.7

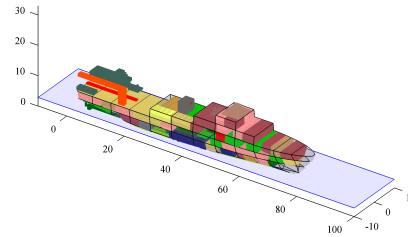
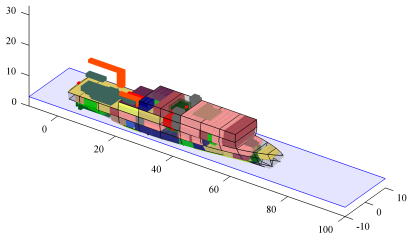


<i>Design concept</i>	$G^*$	$H^*$
#USV	<b>1</b>	<b>1</b>
#UAV	<b>1</b>	<b>1</b>
Hull material	<b>AMS</b>	<b>GRP</b>
Weapon suite	<b>A (heavy)</b>	B (light)
Divers	No	Yes
Extra staff	0	0
Speed (max) [kts]	15	16
Speed (cruise) [kts]	15	13
Range [nm]	4000	3782
Mission [days]	23.3	20
Packing density	84.1%	85.2%
Cost [M€]	18.3	18.2

Continued from previous page...



<i>Design concept</i>	$I^*$	$J^*$
#USV	<b>1</b>	<b>1</b>
#UAV	0	0
Hull material	<b>GRP</b>	<b>AMS</b>
Weapon suite	<b>A (heavy)</b>	<b>A (heavy)</b>
Divers	No	No
Extra staff	0	0
Speed (max) [kts]	16	17
Speed (cruise) [kts]	13	16
Range [nm]	4058	4000
Mission [days]	20	25.4
Packing density	83.0%	83.9%
Cost [M€]	17.9	17.2



<i>Design concept</i>	$K^*$	$L^*$
#USV	<b>1</b>	<b>1</b>
#UAV	<b>1</b>	0
Hull material	<b>AMS</b>	<b>GRP</b>
Weapon suite	<b>B (light)</b>	<b>B (light)</b>
Divers	Yes	No
Extra staff	10	15
Speed (max) [kts]	14	16
Speed (cruise) [kts]	14	15
Range [nm]	4000	3469
Mission [days]	23.7	20
Packing density	84.1%	80.8%
Cost [M€]	17.7	17.5

### 7.5.8 Summary

This test-case has shown how the interactive approach can be used to find a balance between capability (i.e., through variations of systems and ship characteristics) and budget for a mine countermeasures vessel. Nonetheless, a purely qualitative assessment of operational performance is used in the trade-off comparison and in the selection of concept solutions. That is, the test-case has shown how the approach can be used to steer towards a set of technically feasible solutions with different capabilities for a given budget. The test-case strategy of Section 7.5.2 was used to arrive at this set of design solutions. A summary of the specific steps of this strategy and the main findings per step is provided here.

1. In Step 1 both a diverse set of designs was generated and an initial exploration of the extents of the design space was performed (Section 7.5.3). This indicated the upper and lower bounds of cost given none or maximum set of desirable design options (criteria). Also, the budget of €19 million was considered insufficient to procure a design with maximum capability. Hence, a further balancing of desirable design variation options and budget was required.
2. In Step 2.1 the initial exploratory results were used to explore and assess the design impacts, in terms of size and cost, for different design criteria (e.g., criteria about design options regarding MCM systems, hull material, combat and sensor systems, and other platform characteristics). An example for the impact of changing the criteria for: the number of USVs, the hull material, and the speed and range are elaborated in Section 7.5.4. The insight gained from these design impact studies was used to identify which criteria have the largest expected impact. These were identified as: (i) the number of USVs, (ii) the choice of a UAV, (iii) the choice for the combat system suite, and (iv) the type of hull material used for signature reduction measures. Also, for the purpose of the impact studies three additional steering runs were performed in order to increase the number of designs with one USV, an AMS hull material, and a secondary working deck. These types were ill-defined within the initial set of designs generated in Step 1.
3. In Step 2.2 the high impact criteria were systematically varied and combined within the interactive exploration approach to identify and select 12 affordable design solutions, each combining different options of those high impact criteria (Section 7.5.5).
4. Step 2.3, further focussed the exploration effort towards the identified design solutions found in Step 2.2 with 12 targeted steering runs. This was done to validate whether indeed the solutions remained affordable and desirable once they were further explored. As a by-product, this final step, identified two additional feasible solutions matching the budget. Initially, these two concepts were well above the budget due to a lack of convergence (Section 7.5.6).
5. Finally, Step 3 combined all results and identified affordable design solutions to qualitatively assess the existing trade-offs (Section 7.5.7). From the final 14 design concepts several significant trade-offs were identified. First, regardless of the other design options chosen, the combination of 2 USVs *and* a GRP hull is

not affordable. Thus, if a GRP hull is desired, then the number of USVs must be reduced. Second, a UAV can only be added by either, dropping the hull signature requirement and accepting a steel hull, or by reducing the number of USVs to 1. Third, reducing the number of USVs to 1 saves up to €2 million, which can be used to acquire a heavy weapons/sensor suite and an AMS hull with signature reduction properties, or other options.

In total all steps produced 35302 designs in 19 individual iterations of the approach, 20 runs in total (Tables 7.4, 7.7, and 7.13). This included 5 initial exploratory runs, 3 further steered runs for the design impact studies, and 12 steering runs for the individual design concepts. On average, each run produced 1765 packed designs out of 13248 attempted (13% yield) in 126 minutes. That is, 0.6 seconds per attempted design and on average 4.2 seconds per packed design<sup>5</sup>.

### 7.5.9 Reflection and discussion

Section 7.1 presented several tasks deemed essential for understanding and gaining insight during concept exploration. These tasks are:

- Task 1: linking design criteria to (system) solutions and vice-versa;
- Task 2: identify if and when criteria interact or conflict and show a trade-off;
- Task 3: identify how to avoid or resolve such conflicts;
- Task 4: identify why criteria interact and conflict.

If and how the cost versus capability test-case has shown the possibility of performing the above tasks using the developed interactive approach is discussed here.

The interactive approach has aided in identifying a set of 14 different technically feasible and affordable design solutions for a given budget criterion of €19 million (Task 1). Each concept combines different design criteria (variation options) regarding the platform characteristics (e.g., speed, range, crew capacity) and combat systems (e.g., sensors, weapons, MCM equipment). Other solutions, combining other variation options are available but are either over or under the set budget margin of €18-20 million (i.e., and if they are under, they may lack potential capability).

Through exploration of several initial exploratory runs it was identified that, to meet the set budget criteria, a trade-off between design criteria had to be made (Task 2). In addition, the main design criteria (design drivers) with the highest size and cost impact were identified. This new insight allowed us to study which trade-off combinations of these driving design criteria would fit the budget (Task 3). Also, the interactive exploration of individual and combinations of design criteria revealed why and how these interact (Task 4). For example, several interesting interactions between speed, range, mission/fuel endurance, and the propulsion plant concept were elucidated in Section 7.5.4.

Steering was used to focus the effort at the identified trade-offs in an attempt to further explore the limits of those combinations of criteria and their cost. This focussing had two results, (i) several concepts which initially were just within budget turned out to be cheaper when further explored, and (ii) several new design concepts

---

<sup>5</sup>The test-case was performed on a laptop PC with a Intel i7-2760QM quad-core (eight thread) 2.4GHz processor with 8GB RAM

were identified which were initially too expensive. This illustrates that steering was able to focus concept exploration effort on further converging several designs deemed of interest. Nonetheless, though steering focusses the search effort, still new affordable design solutions (e.g., of other combinations of criteria) were found.

The test-case ended with a thorough comparison of the final identified designs (14 in total). A qualitative recommendation of three most desirable designs from this set was made, yet no single “best” design was selected using the approach. Although the final set of designs is technically feasible and affordable, the designs are still expected to perform differently in a operational context due to their varying platform characteristics (e.g., hull material, speed, and range) and systems (e.g., number of USVs, availability of a UAV, and type of weapons/sensors suite). Hence, a further down-selection amongst these technically feasible and affordable concepts calls for additional (quantitative) information to evaluate and balance aspects such as operational performance or vulnerability. This information was not available as part of this research. Nonetheless, a similar approach and strategy as was used in this test-case can be used to further explore and balance designs regarding operational performance.

The applied strategy of the second test-case (Section 7.5.2 and Figure 7.11) proved useful in gaining insight. First making a broad exploration and then focussing on some specific behaviour of the model (e.g., the design impact studies, the general arrangements and the properties of the initial set of selected trade-off designs) forces the gradual build-up of insights and knowledge of the underlying problems before selecting the final desired design solutions. This is reinforced by the fact that the interactive approach requires the user to identify, and then reflect on, each next step in the exploration (e.g., trough constantly experimenting and reflecting on the adjusted criteria).

In conclusion, this test-case has demonstrated how a designer can use the interactive evolutionary approach to explore a large set of criteria (options) in search of affordable and technically feasible design solutions. The ability to perform multiple successive iterations of the interactive approach work-flow, with varying purposes (see Figure 7.11) and the specific insights gained when using the tool are thereby of great importance. These provide the designer with the required understanding necessary to focus the search effort on those design criteria and concepts deemed desirable and of real relevance to the overall design problem.

## 7.6 Conclusions and discussion

This chapter started by stating the main goal of the test-cases, that is, to demonstrate how the developed interactive and progressive design space exploration approach aids the naval architect in identifying various insights during concept exploration. Insight which aids in both generating and selecting desired designs by giving the naval architect the understanding necessary to identify and balance relevant design criteria. Sections 7.4.7 and 7.5.9 have already discussed how the developed approach was successfully used to this extent. Several more general aspects are discussed below.

## Sequential or concurrent concept exploration

Section 2.1 discussed the need to step away from sequential exploration to an approach in which a set of designs is considered concurrently (i.e., concurrent or set-based exploration). The developed approach and the presented test-cases shows that it is in fact, less black-and-white. The interactive approach to concept exploration actually combines sequential and concurrent exploration. A concurrently generated set of designs is sequentially evolved and explored based on lessons learned and insight gained during the exploration process. As the set of designs grows over time, the exploration becomes more concurrent. Moreover, since the entire set of designs is considered at each step of the exploration it is much easier to alter selections and revert earlier decisions made.

The first test-case is a good example, here the decision making in the iterations of the progressive process was very much sequential, that is, how to proceed in the next iteration? However, the concurrent nature of the generation of solutions made sure that a broad exploration took place, thereby also uncovering new interesting designs in other regions of the design space (Section 7.4). The second test-case is more concurrent in that respect. Once the initial set of desired affordable designs is found the progressive method further explores each design in individually with steering runs. Again, because we are working with set-based exploration, several new and different designs are identified in-between iterations (Section 7.5.4).

## Preliminary ship design tool characteristics

Section 1.5 listed several desirable characteristics for design tools, and their output, if they are intended to be used for concept exploration in the preliminary ship design stage (Andrews, 2011). These characteristics are repeated here with a discussion on how the developed interactive approach fits each.

- *Believable and coherent solutions.* As discussed in Chapter 3, the Packing-approach ship synthesis model produces a large and diverse set of technically feasible design solutions. In addition, the test-cases show that both a numerical and architectural description of all design solutions is readily available for use by the naval architect.
- *Open and responsive methods.* A key characteristic of the interactive concept exploration approach is its ability to adapt towards the needs of the designer during the exploration process. The tool can be focused on any particular aspect of the solutions which warrants more attention (e.g., considering a detailed analysis such as in the first test-case, or a broader less detailed global analysis as in the second test-case). As such, the interactive exploration approach is considered to be a step forwards in more responsive methods.
- *Revelatory insights.* Gaining and re-using insight are a key part of the developed approach. This insight, and the understanding it provides, guides the entire exploration process. Additionally, the broadness of the exploration coupled with the interactive user steering has the potential of revealing interesting, often initially unexpected, results. For example: refer to the distinctly different solutions in the first test-case; the elucidated interactions between speed, range, endur-

ance in the second test-case; and the identification of the main driving design options, and their interactions, also in the second test-case.

- *Creative approach.* First and foremost, it must be recognised that the naval architect remains in control of the creativeness of the developed approach. That is, in terms of the choice of design options that are integrated in the design model (e.g., modelled system solutions, propulsion concepts). Neither the Packing-approach synthesis model or the developed interactive approach will automatically, without user input, create or invent new design options. However, within the user-defined margins (e.g., model constraints or variable ranges) the Packing-approach does combine and configure the different existing design options into new and novel solutions.

Hence, the questions becomes: “can a computational approach which combines existing elements into novel solutions be regarded as creative or inventive?” There are numerous examples of methods applying forms of evolutionary computation to combine existing elements into “creative” solutions. It is hard to argue against the creativity of evolutionary approaches which, for instance, combine existing elements into new art or music (e.g., see Gibson and Byrne, 1991; Romero and Mechado, 2008). Nonetheless, often still human intervention in the form of expressed preferences is required for evolution to occur. Youn et al. (2015) reason that the term *invention* can also be conceptualized as a search process over a space of combinatorial possibilities. A fact which they supported by the finding that the majority of new patents filed in the US Patent Office combine two or more existing technologies to invent something new.

Considering the short discussion above, and because indeed the developed approach combines existing elements into novel solutions (i.e., within user-defined bounds) the Packing-approach synthesis model and the developed interactive approach can be considered as a type of *creative approach*. Nonetheless, the currently lacking ability for the designer to include new design options based on new insight during the interactive process (see Section 4.3), does limit the *creativity* of the approach.

However, although the approach will not *invent* new sub-solutions and design options (e.g., new systems or hull types), it can provide insight to the user about *what* such new solutions might look like (e.g., *what* is needed to solve an emerging problems?). For example, stability issues can indicate the need for a lower weight radar system. Also, while using the MCMV model for the test-cases, it was found that the smallest electric motor and the smallest diesel engine (in terms of power output) were still too large for the actual required propulsion power. Hence, designs would easily meet their required transit and maximum speed requirements.





# Chapter 8

## Conclusions and recommendations

*“If our brains were simple enough for us to understand them, we’d be so simple that we couldn’t”*

---

– Ian Stewart

This Chapter first revisits the practical problem of preliminary ship design and the need and challenges of early concept exploration, as introduced in Chapter 1. Next, the proposed solution approach is described before commenting on the specific implementation of the approach for concept exploration of complex (naval) ships, as developed in this dissertation. The main conclusions which followed from the application of the developed approach in several test-cases is then discussed. Finally, recommendation for further research and development are made.

### 8.1 Revisiting the problem

Chapter 1 described the “practical” problem of preliminary ship design. That is, searching for a set of requirements and accompanying design solutions which provide a good balance of operational performance (effectiveness) and affordability (cost) while safeguarding technical feasibility. To do so, requires a process of “requirements elucidation” in which a broad exploration of the design and solution space is wanted (Andrews, 2011).

Chapter 1 also elaborated on three challenges encountered when attempting to perform such broad concept exploration studies for the purpose of “requirements elucidation” at an early stage. These are:

- First, the need to generate a large and diverse set of design solutions covering a broad range of varying options, is hampered by the dimensionality of the early stage concept exploration problem (Section 1.3.1). A problem which often forces naval architects to make ill-considered decision regarding the focus of the exploration (i.e., reducing the scope of the problem in order to continue the

exploration effort), thereby potentially eliminating interesting design solutions. Insight into the design problem would aid in making such decisions, yet gaining such insight was the *raison d'être* of concept exploration and requirements elucidation in the first place.

- Second, the difficulty of defining and balancing relevant design objectives (Section 1.3.2). That is, objectives which would aid in solving part of the first challenge by allowing the naval architect to focus the exploration effort on only those options which produce desired solutions. Simply put, the problem would be greatly simplified if we could define *what* we are looking for. However, complex interactions between objectives and not easily quantifiable objectives are holding us back in doing so (e.g., they require complex detailed simulations or are the result of subjective evaluation).
- Third, the complex nature of ship design and ships themselves, makes it difficult to relate the design and solution space (Section 1.3.3). Not only are there endless solution possibilities in combining a large set of varying design options, these solutions are also constrained by multiple varying and interacting design criteria for different design characteristics (i.e., technical, performance, and cost). In addition, the often discrete nature of many ship characteristics further complicates the elucidation of such interactions in search of insight. Insight which would aid in generating, identifying, and balancing relevant design criteria.

The above challenges are interlinked. The first two challenges require each other to resolve them. First, to overcome the dimensionality issues, relevant objectives and design characteristics are required which can provide focus (the second challenge). Second, to properly evaluate which objectives and design characteristics are relevant, a diverse and broad set of design options and solutions must be generated and explored (the first challenge). Meanwhile, the third issue (i.e., the complexity of the ship design problem) further complicates elucidating the interactions between design options and solutions.

The problems identified above led to the formulation of the main research question which must be solved (Section 1.6):

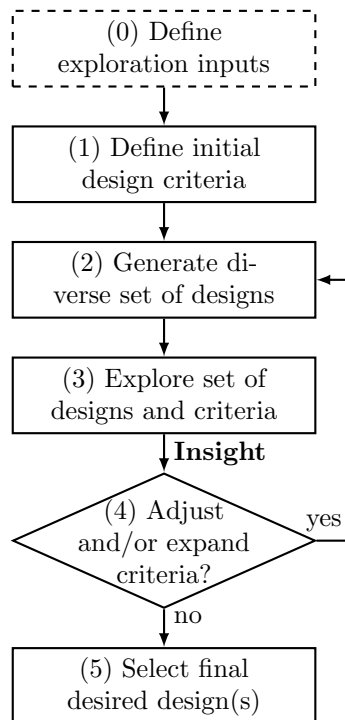
*How to generate and select the right design(s) using insight gained during concept exploration?*

In which, *the right design*, refers to the design the customer actually wants, that is, which has a desirable balance between technical feasibility, (operational) performance, and cost. *Insight*, refers to understanding how the design and performance space relate, that is, how and why the input to the process (e.g., design options, requirements, preferences) interacts with the output (e.g., the solutions, their performances, and their costs). *Generate*, is applying insight to ensure the right design is actually generated, and *selection* refers to the ability to confirm that indeed the right design can be identified (e.g., based on a balanced set of identified criteria).

## 8.2 The proposed approach

Chapter 2 concluded with the proposed approach, namely, *an interactive progressive approach to concept exploration*. It integrates the three basic steps of any concept exploration effort: (i) generating and assessing design concepts and their performance; (ii) exploring and analysing design concepts and their criteria in search for good performers and problem insight; and (iii) using the gained insight to select those high performance concepts for further analysis. Through iteratively performing these steps in an integrated and interactive process, a progressive concept exploration process is created (e.g., see the process description in Chapter 3).

The proposed progressive exploration approach allows the user to constantly use gained insight from exploration to adjust the criteria describing a balanced solution. These evolving criteria are used to gradually focus the generation of new solutions (Figure 8.1). Hence, in each iteration of the approach the following steps take place: first a set of solutions is generated using the current set of criteria as guidance; next these designs and the criteria are explored by the user to gain insight into the relations between the current criteria and the found solutions; finally, this insight provides the necessary understanding required to adjust and or expand the current criteria in search for more relevant and balanced solutions. The implementation and application of the proposed approach in the field of preliminary ship design is dealt with in Section 8.3.



**Figure 8.1:** Proposed work-flow and process for an interactive and progressive concept exploration approach for preliminary ship design

## 8.3 Implementation of the approach

Chapter 3 discussed several issues that had to be overcome when implementing and applying the proposed interactive approach in the context of preliminary ship design and early concept exploration. The issues identified were related to: (i) the generation of a large set of architecturally balanced design solutions covering a large and diverse set of options; (ii) the exploration of the large set of design solutions, their characteristics, and the criteria imposed on them, to gain insight into the design problem; and (iii) the feedback and application of this gained insights to steer the ship synthesis model towards more, and more relevant design solutions.

### Generating a large and diverse set of designs

Section 3.4 discussed the choice for the Packing-approach architectural ship synthesis model with which to generate a large and diverse set of design solutions within reasonable time. Chapter 4 gave a more detailed description of the Packing-approach and also discussed and resolved some limitation of the approach which potentially limit its applicability within the proposed exploration approach of this dissertation. The issues and their developed solution are discussed below:

- *The consistency of the chromosome representation (Section 4.2.1).* The output of the Packing-algorithm (e.g., the design and its characteristics which a naval architect explores and judges) should match the input (e.g., what is controlled by the search-algorithm). The Packing-algorithm changes the initial input through overlap-management, hence there is a discrepancy between the initial input and the final solution. This does not matter for one design solution, yet it can cause problems in the genetic algorithms evolutionary operation. This issue was remedied by repairing the initial input (genetic algorithm chromosome) to match the output of the Packing-algorithm. That is, the initial positions of systems are repaired to match the final “as packed” positions.
- *The speed of the approach (Section 4.2.2).* The proposed approach relies heavily on human interaction, hence a review of the Packing-approach model was undertaken to find speed improvements. Section 4.2.2 presented a short comparison of Packing-approach speeds over several versions. Both this comparison, and the test-cases of Chapter 7, discussed and concluded that the Packing-approach is considered fast enough for use in the interactive approach. The second test-case demonstrated that, on average, the generation of a new set of design solutions took about two hours<sup>1</sup>. Time during which the exploration of the previous sets of designs can still be continued by the naval architect.
- *The ability to generate designs with varying design options concurrently (Section 4.2.3).* The need to vary a broad set of design options (e.g., systems and capability, hull-shape and size, required performance, and arrangement) was discussed in Section 1.3.1. Hence, a MSc research study was initiated to develop a Packing-approach design model which is capable of covering such diversity in options (Zandstra, 2014).

---

<sup>1</sup>Note that this depends heavily on the complexity of the used design model, as well as the technical specifications of the used PC.

The developed model was indeed able to vary the required options, however, currently hull types are still limited to mono-hulls. Zandstra also found that the increased model diversity did come at the expected cost of yield (e.g., relative number of feasible designs found per run of the Packing-approach). This is related to the increased problem dimensionality. This finding further strengthened the case for the approach developed in this dissertation. In addition, Section 4.2.4 gave a short study on the effects of the added dimensionality on the ability to maintain a diverse set of initial solutions using the genetic algorithm's mutation operation.

### Exploring designs and gaining insight

Section 1.3.3, 2.3 and 3.5 discussed several issues of exploring a large and diverse number of architectural ship design solutions and their associated design criteria. The issues and their solutions are discussed below.

- *Dealing with discontinuous and non-smooth response.* The response behaviour of an architectural ship synthesis tools, such as the Packing-approach, does not readily allow the use of analytical data analysis techniques (Section 1.3.3). Regression techniques break the discrete link between the ship's arrangement and its numerical characteristics. Hence, the developed design exploration approach in Chapter 5 uses the actual numerical data points, and the linked architectural layout information. This includes a detailed 3D representation of every design solution.
- *Linking numerical and architectural information and the criteria imposed on them (Section 2.3.2 and 5.2).* These different "domains" or types of information require a different exploration approach to maintain context and a familiar reference frame for the user. A layered approach was developed allowing a user to explore and filter solutions, characteristics (numerical and architectural), and criteria in these different information domains. By applying set-based filtering techniques, they can then be linked based on user defined criteria, which allows the exploration of mutual interactions (see Section 5.3 to 5.5).
- *Gaining insight into the complex interactions between design criteria and the solutions (Section 2.3.2).* Several data exploration techniques, tailored to the specific problem of exploring architectural ship design solutions, were developed to aid the designer in uncovering insight into the interactions between criteria and designs. These methods include (see Chapter 5): interactive filtering, dynamic criteria boundaries, interactive selection boxes, and cross-linking between different types of information (e.g., numerical and architectural). Specific examples of how these aids were used to gain insight can be found in Section 7.4 and 7.5.

### Applying insight to guide the exploration effort

A key step in the proposed progressive approach, is the re-use of gained insight to continue further exploration. That is, insight which is used by the naval architect when making decisions about the set of criteria in each iteration of the approach (see

Figure 8.1). The goal is to then use these criteria to generate more, and more relevant, design solutions. Again, for the implementation of this step several issues had to be resolved, they are discussed below.

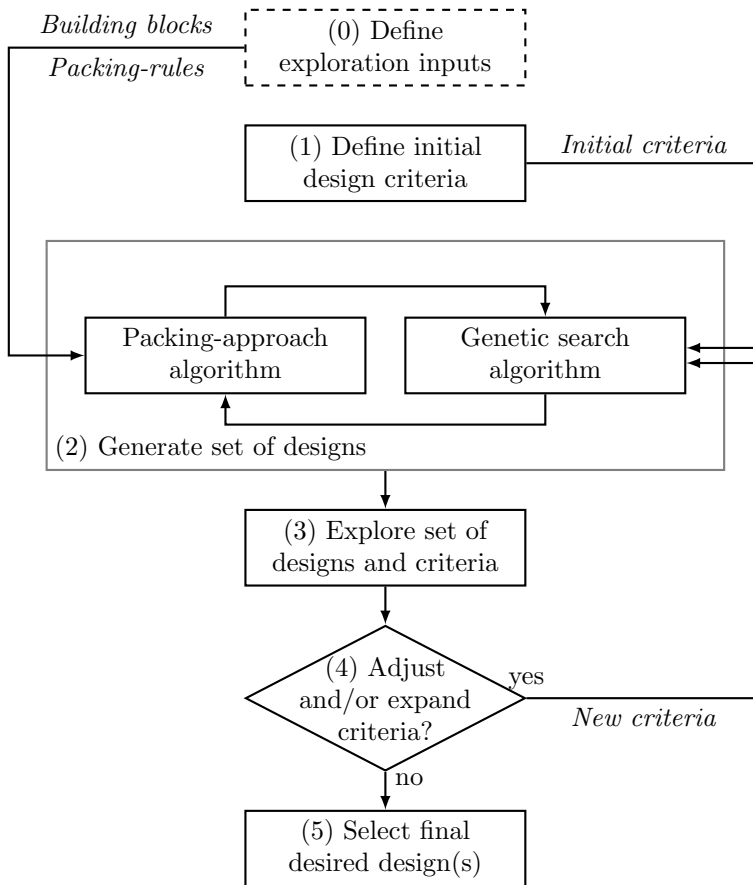
- *Using criteria to steer design generation.* Section 6.2 discussed several methods, and their drawback, that can steer design generation based on criteria. Mainly, criteria should not be treated as must-have items. That is, because they are subject to changes and might show conflicts, they should be treated as nice-to-have properties. To this extent, an objective-based steering mechanism was developed in Section 6.4. The developed steering mechanism allows criteria to be used to steer the generation of new designs, without enforcing that every single criterion should be met. Hence, when a conflict should occur, trade-off solutions are still identified (e.g., this is illustrated in Section 6.5 and 7.4). In addition, utility functions were added which promote the search for designs which almost meet the criteria (Section 6.4).

The developed approaches to the three steps, (i) generating, (ii) exploring, and (iii) steering or guiding, were combined and integrated within the proposed interactive and progressive approach work-flow of Figure 8.1. The work-flow of the final integrated interactive and progressive concept exploration approach is shown in Figure 8.2.

## 8.4 Conclusions

Section 8.1 restated the research question regarding concept exploration during the preliminary design of complex vessels. This section considers if and how this question has been answered. That is, “*Does the developed approach allow a naval architect to generate and select the ‘right’ design using insight gained during design exploration?*”

- *Broad concept exploration efforts require a concurrent (or set-based) approach where designs are generated and evaluated in parallel.* Section 7.6 discussed that this claim is actually somewhat less black and white. The developed progressive approach combines concurrent and sequential exploration, that is, a concurrently generated set of designs is sequentially explored. Hence, the benefits of sequentially applying lessons learned are added to the benefits of a broad exploration through the large set of designs.
- *To overcome the challenges of, (i) dimensionality, (ii) defining relevant objectives, and (iii) the complexity of the ship design problem (see Section 8.1), a progressive approach to exploration is required (i.e., based on a progressive decision making framework).* Chapter 2 claimed that a progressive approach combines the essential steps of concept exploration to overcome these challenges.
  1. *Dimensionality.* The gradually evolving set of criteria is used to focus design generation towards relevant designs (i.e., that meet or lie close to the criteria) by an objective-based steering mechanism. Thus, though the dimensionality remains large, a naval architect can focus the exploration effort towards those areas of the design space that are found interesting. This process is demonstrated in both test-cases of Chapter 7.



**Figure 8.2:** Implemented integrated work-flow of the interactive concept exploration approach

2. *Defining relevant objectives.* Instead of attempting to define the objectives a-priori, the progressive approach gradually defines and refines the “objective” by re-using insight gained during exploration. Hence, a well thought-through set of criteria is used to define both the exploration direction and to select designs. This aspect is illustrated in the second test-case (Section 7.5), where gradually built up sets of criteria are used to define, generate, and select promising candidates fitting the set budget criterion.
3. *Gaining insight into complex interactions.* The two test-cases of Chapter 7 demonstrated the ability to uncover insight into the complex interaction between criteria and the design solutions. The first test-case elucidated several interactions between a floodable length criterion and the resulting impact on the size and layout of the resulting solutions. In the second test-case several interactions regarding systems, budget and platform characteristics were identified. Three example are: the interactions between transit speed, range, and MCM operation endurance; the design impact of the



number of USVs; and the design impact of hull material. In these cases, the developed approach and its design exploration aids, coupled with engineering judgement, aided in understanding not only *that* criteria interact, but also *how* and *why* they interact.

- *Generating desirable designs by re-applying gained insight.* The developed approach allows the naval architect to directly and interactively re-apply insight gained during design exploration to steer the ship synthesis model towards generating more, and more relevant, design solutions (see the results of the test-cases in Chapter 6 and 7). Hence, in contrast to a prematurely limited exploration, the approach allows a naval architect to cover a broader set of options from the start. Filtering relevant criteria and design options as the exploration progresses, and if necessary reverting earlier decisions made if new insight requires a step-back. Both test-cases illustrated that during exploration new, initially unexplored, design solutions were generated and identified during the process of interactive exploration.
- *Selecting desirable designs.* In the approach, insight and a gradually evolved set of well thought-through criteria, are used to select (from a larger set) those designs that are considered desirable (e.g., refer to the design solutions of both test-cases). However, as discussed in Section 7.6 the selection of the “final” desired design solution(s) requires additional information. That is, within the scope of this dissertation selection of desirable designs stopped at identifying technically feasible and affordable solutions. Their, operational performance (or effectiveness) was not taken into consideration due to a lack of performance measures (i.e., measures which require additional analysis to evaluate the operational merits of design characteristics such as speed, or the number and type of combat systems).

Nonetheless, when such operational measures are available, the developed approach should allow the incorporation of such information into the exploration process. As such, it is also a recommendation to explore this possibility in further work. Even so, this final selection does depend on several other aspects, (i) *who* finally chooses the most desirable solution, (ii) what information is required, and (iii) if multiple end concept are desired. For example, is it the ship designer using the developed concept exploration approach of this dissertation, or are multiple affordable concepts with different levels of performance presented to the stakeholders (i.e., as is often the case in warship procurement). In the later case, a set of concepts may be sufficient (e.g. such as was identified in the test-case of Chapter 7). Also, assessing the merits of operational performance may require a different analysis and value system for decision making. That is, it requires the stakeholders to make a statement about *how* the merit of a more operational performance is valued, and how it should be traded against other performances?

Based on the discussion above, and considering the scope of the dissertation, it is concluded that by using the developed interactive exploration approach it is indeed possible to generate and select desirable design solutions by making use of insight gained during the exploration process. Hence, the approach improves the ability to perform thorough concept exploration studies during preliminary design, and thus

facilitates better *requirements elucidation* in the search for balanced design solutions.

## 8.5 Contributions

The main contributions of the work presented in this dissertation to the field of naval architecture and preliminary ship design are:

- *Development and application of a novel interactive and steerable concept exploration tool (Chapter 3-7).* The tool is based on a progressive design approach which combines elements of a-priori and a-posteriori decision making. This allows gradual decision making during the exploration process. Hence, the exploration's focus can be changed on-the-fly while new information and insight become available. This allows naval architects to gradually build-up a well thought-through set of design criteria (e.g., requirements, constraints, and preferences) describing a desirable balanced design solution.
- *Development of an interactive flexible data exploration tool to visualise and evaluate results of an architectural ship synthesis model (Chapter 5).* This data exploration tool was specifically developed to help explore the complex interactions between various ship characteristics and the criteria imposed on them. The tool uses interactive data visualisation techniques (e.g., dynamic data brushing and filtering) to aid a naval architect in uncovering insight into the interaction between various ship characteristics and the criteria imposed on them. In addition, a clear distinction between visualising predominantly numerical (e.g., length, beam, speed, range) or architectural characteristics (e.g., arrangement) of a design was made which allowed the exploration of mutual interactions between these domains, while maintaining context through a familiar reference frame for the naval architect.
- *Development of a feed-back mechanism to interactively steer the generation of designs using an optimisation-based ship synthesis model (Chapter 6).* Ship characteristics and their desired criteria (as expressed and deemed relevant by the naval architect) are used to interactively update a genetic algorithm's objective function. This interactive genetic algorithm steers the architectural ship synthesis model towards generating more, and more relevant, design solutions, thereby increasing the potential of uncovering new initially unexplored design solutions.
- *The application of the developed interactive concept exploration approach to a preliminary design problem (Chapter 7).* Two design test-cases were performed to demonstrate both the use and benefits of the developed approach. Specifically the second test-case illustrated how the approach aids a designer in generating, exploring, and selecting a large number of desirable design alternatives.

As a closing remark, the developed approach is considered a step forwards in concept exploration methods. That is, contrary to methods which explore with respect to a perceived goal, it helps the naval architect to understand the decisions and path taken towards a gradually elucidated goal. Hence, moving from the idea of "knowing

that we got *somewhere*,” towards “understanding *why* and *how* we got *there*.” Thus, providing a much better acceptance of *there* as the end results.

## 8.6 Future research

The following improvements to the developed approach are recommended:

- Incorporate results of operational analysis to facilitate a further balance of technical feasibility, *operational performance*, and cost. As discussed in Chapter 5 this will likely require a further breakdown of the types of characteristics considered during exploration. That is, (i) numerical characteristics representing the technical feasibility and performance, (ii) architectural characteristics representing layout and system aspects, and (iii) operational characteristics representing performances and effectiveness. This does however, add another layer of complexity in exploring the result and gaining insight.
- The possibility of combining the approach of this dissertation with rationale capturing techniques, such as those developed by DeNucci (2012) should be investigated. Such an approach could not only capture the evolving criteria, but also capture the reasoning behind the decision made by the naval architect during exploration and manipulation of the criteria. Ultimately, trade-offs between criteria are still resolved by a decision of the naval architect, supported by the insight gained from the approach. Better capturing and storage of this insight, and analysis of how it influences the decisions of the naval architect, should provide a more transparent design process. In addition, it allows lessons learned to be re-visited for future projects.
- Chapter 6 gave a recommendation to investigate a hybrid steering of design generation. This method would combine “nice-to-have” criteria in objectives, and “must-have” criteria as synthesis model constraints (Section 6.6). In this way, as the exploration progresses, criteria can be gradually moved from the *nice-to-have* set towards the *must-have* set, based on the maturity of the exploration. This would further reduce the effort required for the synthesis model and search algorithm to generate new designs when focussing, as the dimensionality of the problem is gradually reduced. Naturally, it remains the responsibility of the naval architect to ensure criteria are not pre-maturely moved from the “nice-to-have” to the “must-have” set as this limits the broadness and diversity of the initial exploration.
- As mentioned in Section 4.3, one of the current limitations of the Packing-approach synthesis model used in this dissertation, is that new *objects* (e.g., systems and spaces) cannot easily be added later-on. Hence, insight gained during exploration cannot be used to adapt the actual design model itself. However, this problem could be solved by using a similar progressive approach as developed in this dissertation to actually gradually define and build the design description used in Packing.

In such a way, the naval architect could gradually build-up the design model, applying insight into interaction between newly added systems and spaces to re-define applied constraints (packing-rules) or variable limits (e.g., limits on

main-dimensions for instance). Such a dynamic design model would also allow designers to investigate if traditional rules-of-thumb, which are often modelled as constraints within design models, are restricting the possible solutions (e.g., as was the case with the fixed deck height in the first test-case of Chapter 7). This is considered a step forwards towards a more responsive, creative, and sketching-based architectural design approach as advocated by Andrews (1994, 2011) and Pawling and Andrews (2011).

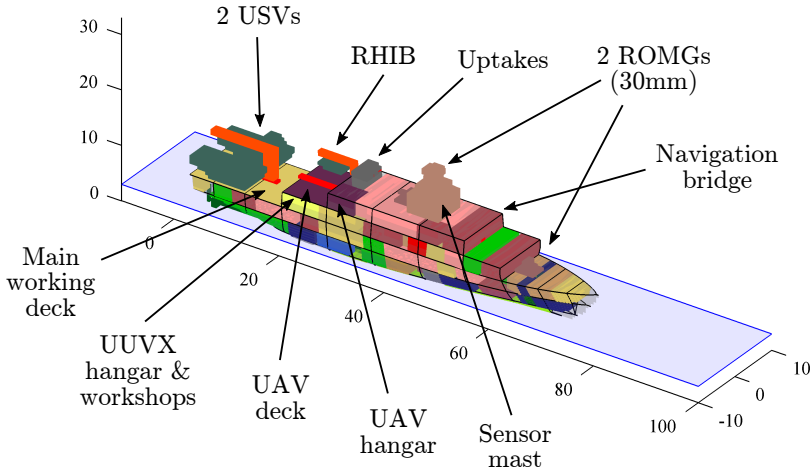
- Section 4.2.4 talked about the issue of maintaining diversity of designs in the initial generated set when the design model contains a large number of options. Van Oers (2011b) steps away from using diversity metrics in his work, however, considering that the new Packing design models contain a large number of discrete design options (e.g., varying hull types, systems, or speeds), the use of a metric to promote design diversity should be reconsidered. Such metric could be implemented as a separate objective (e.g., the NSGA-II algorithm already attempts to maximise diversity in the objective space, see Deb et al., 2002), or even within the search algorithms' genetic operations (e.g., as in Toffolo and Benini, 2003; Shir et al., 2009).
- Investigate the applications of the developed approach outside the field of ship design. Already, the Packing-approach ship synthesis model has been applied in exploration of, for example, the top-deck arrangement for a FPSO (floating production storage and offloading unit), see (Baudeweyn, 2014). Though, in this study exploration was undertaken manually, the interactive approach developed in this dissertation is seen to provide benefits here, in addition to other complex engineering design problems with many negotiable criteria, as well.



# Appendix A

## MCMV packing model

Before a description of the applied MCMV packing model is given, it must be emphasized that the MCMV model, design variations, budget, criteria, and choices made in this dissertation *do not* reflect the MCMV procurement program at DMO. Both the design model and cost model were altered in such a way that they are realistic, yet not representative of the ongoing MCMV design project.



**Figure A.1:** Example of a design generated with the MCMV packing model. Several important top-side systems are labelled.

This appendix provides a description of the MCMV packing model used in the two test-cases of Chapter 7. The model was originally developed for the DMO by Zandstra (2014) as part of a MSc thesis project at Delft University of Technology. Later this model was further refined and extensively verified for internal use at DMO (Zandstra et al., 2015). This same MCMV model is used within this dissertation, however, some elements have been changed for reasons of confidentiality. Unfortunately, because the core elements of the applied MCMV model of this dissertation remain equal to

that of the DMO model, a full detailed description of its underlying calculations and list of spaces cannot be provided. Nonetheless, this appendix provides some more insight into the used packing-based MCMV design model and most of its underlying assumptions and calculations.

## Variations

The available and used design variations of the MCMV packing model are mentioned in Chapter 7. They are repeated in Tables A.1-A.3, a further description of the systems is given in subsequent sections.

**Table A.1:** Variations of MCM related characteristics

<i>Name</i>	<i>Variations (step)</i>	<i>Number</i>
Hull material	GRP, AMS, Steel	3
Divers	Yes, No	2
# Stingers	1 – 2	2
# USV	0 – 1 – 2	3
USV type	12m	-
# UUV (large)	3	-
# UUV (medium)	4	-
# ROV (disposable)	48	-
Endurance MCM operation	$\geq 20$ days	-
Speed MCM operation	8kts	-

**Table A.2:** Variations of platform characteristics

<i>Name</i>	<i>Variations (step)</i>	<i>Number</i>
Speed (max)	12 – 18kts (+1)	7
Speed (transit)	12 – 18kts (+1)	7
Range (transit)	1500 – 4500nm (+500)	7
Sensor/weapon suite	A (heavy), B (light)	2
UAV (rotary wing)	Yes, No	2
Extra working deck	Yes, No	2
Extra crew (staff)	0 – 15 (+5)	4
Propulsion arrangement	CODELOD, CODELAD	2

## Crew model

A simple crew model, which was provided by DMO, was used to estimate the total required crew as a function of the chosen configuration of MCM systems and the additional sensor and weapon systems (Table A.4). Requirements for added crew (e.g., staff capabilities) are added to the total. The precise composition of the crew cannot be displayed for reasons of confidentiality. However, the crew composition is

**Table A.3:** Variations of hull-form and deck characteristics

<i>Name</i>	<i>Variations (step)</i>	<i>Number</i>
Length	50 – 110m (+0.5)	120
Beam	9 – 14m	cont.
Draft (design)	2 – 5m	cont.
Shape factor stern	0 – 1	cont.
Shape factor bow	0 – 1	cont.
# decks in hull	3 – 4 (+1)	2
Height double bottom	1m	-
Height deck	2.5m	-

used in the sizing of the various spaces for the different ranks (e.g., officers cabins, rating cabins).

**Table A.4:** Crew sizes for different combinations of weapons/sensor suite and MCM capability. The choice for a small, medium, or reduced crew is dictated by the number of USVs, the number of UAVs. If the type A (heavy) sensor and weapon system suite is chosen then 3 extra crew members are added.

<i>Crew</i>	<i>Suite B (light)</i>	<i>Suite A (heavy)</i>
Small	36	39
Medium	43	46
Large	47	50

## Systems, spaces and areas

This section provides information on the dimensions and sizing used for systems, spaces, and areas. The mass of spaces and areas is calculated through the weight calculation as this varies based on the location and size of the space or area within the hull it is not mentioned in the tables below.

### Crew related spaces

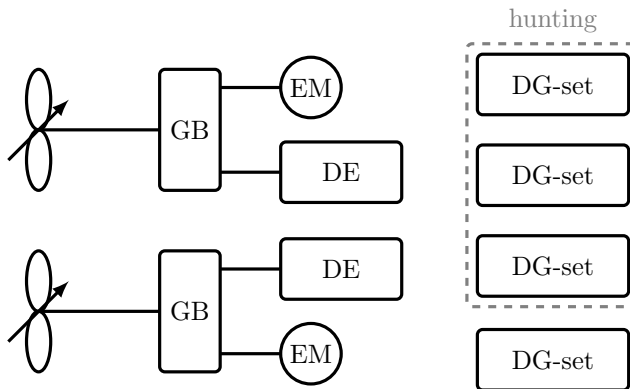
The main sizing of crew related spaces (i.e., accommodation, offices, mess and galley, laundry, food-stores, medical area, and the auxiliary machinery room) are based on the amount and composition of the crew. Most of these areas are sized based on a minimum required floor area ( $m^2$ ) and one deck high (2.5m). The sizing models and list of spaces was provided by DMO.

### Propulsion plant concept and components

A schematic representation of the propulsion plant concept (CODLOD or CODLAD) is given in Figure A.2. Figure A.3 gives an indication of how this is modelled within an actual packed design. Its different operating modes are intended as follows:



- **Mine-hunting:** Both propulsion and auxiliary power is provided by two of the three hunting DG-sets located above the waterline (one equal extra set is added for redundancy reasons). The propulsors are driven by the electric motors (EM) only.
- **Transit:** Auxiliary power is proved by the below-deck DG-set, propulsion power is provided by the two main diesel engines (DE). If maximum speed and transit speed happen to be equal (through the packing model variations), then in case of the CODLAD configuration both the electric motors (EM) and diesel engines (DE) can provide power to the propulsor.
- **Maximum speed:** Auxiliary power is proved by the below-deck DG-set, propulsion power is provided by the two main diesel engines (DE). In case of a CODLAD system the electric motors (EM) and diesel engine (DE) power can be combined to reach the required sustained maximum speed.

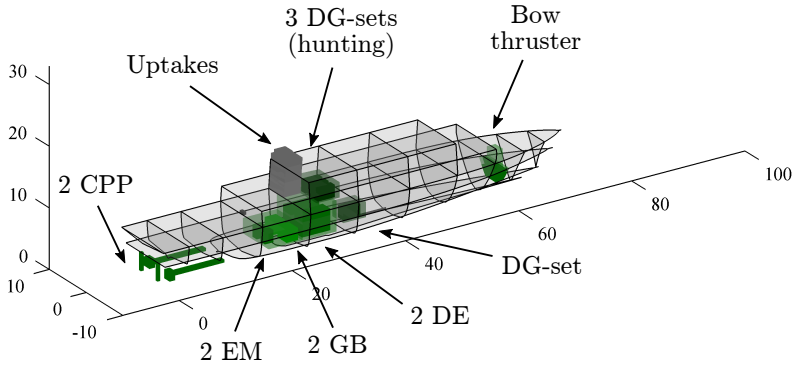


**Figure A.2:** Propulsion concept applied in the MCMV packing model. The DG-sets used during mine-hunting operation are located well above the waterline for signature reduction reasons.

The individual components of the propulsion plant concept (CODLAD/CODLOD) are sized using several databases. These component databases are given in Tables A.5-A.7<sup>1</sup>. Components are selected solely on the basis of a required power per component (MCR).

The required power for the auxiliary DG-set was assumed constant, whereas the three hunting DG-sets are sized according to the required electric motor MCR and the auxiliary electric power during mine-hunting. The gross size and weight of the gearbox is assumed constant and hence does not vary with the chosen configuration or selected engine sizes and rpms. Hence, a rather heavy and large gearbox from a patrol ship was used a worst-case estimate. No specific attention was further given to the matching of components based on rpms and delivered or consumed power. Nonetheless, the simple propulsion plant model gives an initial estimate of the gross

<sup>1</sup>Note that notional engine types are displayed



**Figure A.3:** Example of the modelled propulsion plant in the design of Figure A.1

component and plant sizes and weights. This provides further input for modelling the surrounding engine room spaces.

The author acknowledges that the sizing approach for this propulsion configuration is very basic and rough, specifically when considering the DE and DG-set databases used. Both L and V-type, as well as medium and high speed engines are contained in the database which causes deviations in dimensions when selecting on the basis of MCR only. Stapersma and de Vos (2015) have proposed a better method of sizing such components based on a combination of first-principle and regression analysis. Also, Van der Nat (1999) provides accurate sizing models for electric motors.

## MCM related systems

The dimensions of the main MCM systems (e.g., USV, UUVX, and ROV systems and their extra working-deck or hangar spaces) are given in Table A.8. The sizing of the UUVM and ROV storage and handling hangar is based on the number of UUVMs, the number of ROVs, their stacking height, extra handling space, and required aspect ratio of the hangar. This object is modelled as a soft object with a minimum required area based on the above parameters.

**Table A.8:** Dimensions and sizing of MCM related systems

<i>Item</i>	<i>Length [m]</i>	<i>Breadth [m]</i>	<i>Height [m]</i>	<i>Mass [t]</i>
USV (7m)	7	3	4.5	6
USV (12m)	12	4	4.5	10.3
UUVL (large)	5.2	0.75	0.75	1
UUVM (medium)	2	0.4	0.4	0.75
ROV (disposable)	1.3	0.4	0.4	0.04
UUVL store	7	$f(\#UUVL)$	2.5	$f(\#UUVL)$
MCM sonar	2	3.5	2	10.6
Decompression tank	5	3	2.5	3.4

**Table A.5:** Database of notional diesel engine types used in the propulsion plant sizing model, sorted by maximum continuous rating (MCR). Only the first four engines are used and selected by the model, the others provide too much power for the different loading profiles.

<i>Model</i>	<i>L [m]</i>	<i>B [m]</i>	<i>H [m]</i>	<i>Mass [t]</i>	<i>MCR [kW]</i>
DE 1390kW V12	4.68	2.05	3.06	10.2	1390
DE 2100kW V12	3.97	1.80	2.55	14.7	2100
DE 2800kW V16	4.58	1.87	2.83	17.9	2800
DE 3000kW L6	5.94	2.63	4.01	38.0	3000
DE 3060kW L9	4.76	1.86	2.84	25.0	3060
DE 3150kW L18	4.88	1.87	2.83	19.1	3150
DE 3360kW L6	6.16	2.36	4.17	39.0	3360
DE 3500kW L7	6.47	2.63	4.01	42.0	3500

**Table A.6:** Database of notional diesel generator sets used in the propulsion plant sizing model, sorted by maximum continuous rating (MCR). Only two are actually selected and used by the model (the 425kW and 500kW models).

<i>Model</i>	<i>L [m]</i>	<i>B [m]</i>	<i>H [m]</i>	<i>Mass [t]</i>	<i>MCR [kW]</i>
DG-set 275kW HS	4.26	1.11	2.15	3.1	275
DG-set 340kW HS	3.04	1.15	1.56	3.8	340
DG-set 425kW HS	3.04	1.15	1.56	4.1	425
DG-set 500kW HS	3.04	1.15	1.56	4.3	500
DG-set 520kW MS	3.84	1.72	2.24	13.4	520
DG-set 550kW HS	3.04	1.15	1.56	4.6	550
DG-set 650kW MS	4.39	1.72	2.24	14.0	650
DG-set 700kW MS	4.91	1.92	2.34	14.0	700

**Table A.7:** Database of notional electric motors used in the propulsion plant sizing model, sorted by maximum continuous rating (MCR). These are all DC-motors for reasons of favourable (magnetic) signatures compared to their AC counterparts. Only the smallest two are actually selected and used by the model.

<i>Model</i>	<i>L [m]</i>	<i>B [m]</i>	<i>H [m]</i>	<i>Mass [t]</i>	<i>MCR [kW]</i>
DC EM 65rpm	1.39	1.15	1.81	4.3	150
DC EM 65rpm	1.53	1.27	2.00	5.8	200
DC EM 65rpm	1.64	1.37	2.15	7.3	250
DC EM 70rpm	2.02	1.68	2.64	13.5	500

## Sensor and weapon systems

The dimensions of the used sensor and weapon systems are shown in Table A.9. The UAV deck and UAV hangar weight are determined through the weight calculation.

**Table A.9:** Dimensions and sizing of notional sensor and weapon systems

<i>Item</i>	<i>Length [m]</i>	<i>Breadth [m]</i>	<i>Height [m]</i>	<i>Mass [t]</i>
UAV deck	7	Beam	-	-
UAV hangar	5	4	2.5	-
Sensor mast (suite A)	6	6	8	25
Sensor mast (suite B)	3	3	3	13.5
ROMG (30mm)	3	3	2	1.35
ROMG (.50")	3	3	2	0.3

## (Performance) calculation models

A brief summary of the main calculation models and their associated assumptions is provided below.

### Floodable length

The permissible floodable length curve is estimated at the design draft  $T_{des}$ . The curve is determined assuming a permeability of 1 for all volumes within the hull using the method of Herner (1939). In reality the actual permeability can be considerably lower due to the structure and internal items.

Bulkheads are placed using this permissible floodable length reference (van Diesen, 2007). Three checks are performed to determine if the bulkhead placement is allowed:

1. The relative distance between two bulkheads should be larger than the prescribed minimum delta bulkhead spacing.
2. Bulkheads are not allowed to overlap with non-dividable packing objects (van Oers, 2011b).
3. The actual flooded length due to an assumed damage length percentage is not allowed to exceed the calculated permissible floodable length curve (also see Chapter 7).

If the bulkheads cannot be placed due to any of the above reasons, the required damage length is iteratively reduced by a fixed amount until the design passes or it becomes zero (in which case the design fails). For more information refer to (van Diesen, 2007).

### Weights and centres

The applied weight calculation is equal to that of another DMO ship design tool, GCD2, which was developed by Takken (2008). Several aspects and assumptions of this weight calculation are listed below:

- The calculation is volume or area based and applies weight factors ( $t/m^3$  or  $t/m^2$ ) for the different ship work breakdown structure (SWBS) groups (e.g., structure, propulsion, electric, command and surveillance, auxiliary, outfitting, and armament). Different space types use different weight factors for these groups (e.g., accommodation spaces have a lighter outfitting group than an auxiliary space). The weight factors are derived from existing naval ships and exclude several large pieces of equipment which are added as discrete weights (e.g., diesel engines, generator sets, propulsors, weapon and sensor systems).
- The structural weight of a space or area (SWBS 100 group) is adjusted for its vertical position within the hull. This compensates for the increased structural integrity near the bottom and top of the hull that is required to create sufficient section modulus to withstand longitudinal bending moments (i.e., at the keel and strength deck). Hence, a space located near the keel (e.g., a bilge tank) will have a relatively higher structural weight than a space located within the superstructure.
- For most items the centre of gravity is assumed to coincide with the centroid of volume (or the centroid of area for area objects such as a working-deck). Adjustments to this assumption are made for objects types such as stores or ammunition rooms where the payload centre of gravity is user defined (e.g.,  $1m$  above the floor area centroid).
- The weight factors for the structure (SWBS 100 group) are also adjusted for the length of the ship. Shorter ships tend to have a relatively heavier structural weight.

It is further assumed that the unoccupied or void space in the packing model has weight. A packed design with a packing density  $< 100\%$  has a certain amount of unoccupied volume within the hull and superstructure. Since the weight calculation is volume based, this void space must be included to accurately determine the ships weight. To illustrate, consider a loosely packed large design to a tightly packed small design with the exact same occupied volume. If the void space is not accounted as weight then these design would have an equal structural weight.

Furthermore, it is assumed that when a packing-based design is worked out in more detail that the spaces and areas within the hull are re-sized by a designer to fit within the total hull envelope (e.g., spaces will eventually become larger than their minimum required size to “fill in the gaps”). Hence, at this stage it is assumed that void space has a specific weight roughly equal to the average specific weight of the other spaces.

Unfortunately, the applied SWBS weight factors cannot be displayed due to reasons of confidentiality.

## Resistance and powering

The resistance and powering estimation is calculated at the initial design draft ( $T_{des}$ ) with matching hydrostatics assuming an even trim. Hence, it is assumed that the required speed can always be met if the final draft is smaller than or equal to the

design draft ( $T \leq T_{des}$ ). This is safeguarded using a constraint within the Packing-approach NSGA-II search algorithm (see Chapter 4).

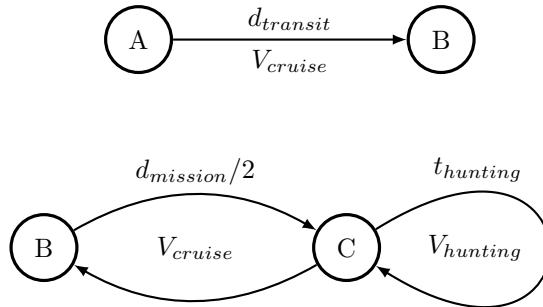
Resistance curves are estimated using with an internal DMO tool that applies a regression model based on a generalized set of RNLN model test results. Ship resistance ( $R$ ) is translated to required propulsive brake power ( $P_B$ ) by applying the following calculation:

$$P_B = \frac{R \cdot V_s}{\underbrace{\eta_O \cdot \eta_R \cdot \eta_H}_{\eta_D} \cdot \underbrace{\eta_S \cdot \eta_{GB}}_{\eta_{TRM}}} \quad (\text{A.1})$$

where,  $V_s$  is the speed,  $\eta_O$  the open water efficiency of the propulsor,  $\eta_R$  the relative rotational efficiency,  $\eta_H$  the hull efficiency,  $\eta_S$  the shaft efficiency, and  $\eta_{GB}$  the gearbox or transmission efficiency. In the MCMV packing model these are combined into a propulsive efficiency  $\eta_D=0.65$  and a transmission efficiency  $\eta_{TRM}=0.92$ . These values are assumed constant, however in reality they will vary depending on several factors (e.g., ship speed, displacement, hull form, propeller geometry, and shaft rpm). In addition to the above efficiencies a (large) sea-margin of 25% is assumed.

## Speed, range and fuel endurance

Within the MCMV packing model the required speed and range are given as input. These are matched with two operational usage profiles to calculate the required fuel capacity. These profiles are: (i) a transit, and (ii) a mission scenario (Figure A.4).



**Figure A.4:** The two operational profiles that are used to determine the required fuel capacity

The sailing time for the transit or mission, assuming a constant speed, is equal to:

$$t_{transit} = \frac{d_{transit}}{V_{cruise}} \quad (\text{A.2})$$

and for the mission profile:

$$t_{mission} = t_{trans,mission} + t_{hunting} = (20 \cdot 24)hrs \quad (\text{A.3})$$

where,

$$t_{trans,mission} = \frac{d_{mission}}{V_{cruise}} \quad (\text{A.4})$$

The total fuel weight ( $m_f$ ) required for the transit profile then becomes:

$$m_{f,transit} = \frac{SFC}{1 \cdot 10^6} \cdot (P_{B,transit} + P_{Aux}) \cdot t_{transit} \quad (A.5)$$

where,  $P_{b,transit}$  is the required brake power at cruise speed in  $kW$ ,  $SFC$  is chosen as a combined specific fuel consumption of all diesel engines in  $gr/kWh$ , and  $P_{Aux}$  is the auxiliary power required by the platform in  $kW$ . The auxiliary power is assumed to be constant and is small compared to the brake power at cruise speed (refer to the Propulsion plant concept system).

Note that a single  $SFC$  value is used for all engines, and that it is assumed to be constant. In reality the  $SFC$  will change as a function of engine loading. More accuracy could be gained by using a changing  $SFC$  per engine as a function of the actual loading. For example, by using a fit  $SFC$  curve as a function of  $\%MCR$  (Stapersma, 1994).

The fuel weight for the mission profile becomes:

$$m_{f,mission} = m_{f,trans,mission} + m_{f,hunting} \quad (A.6)$$

where,

$$m_{f,trans,mission} = \frac{SFC}{1 \cdot 10^6} \cdot (P_{B,trans,mission} + P_{Aux}) \cdot t_{trans,mission} \quad (A.7)$$

and,

$$m_{f,hunting} = m_{f,USV} + \frac{SFC}{1 \cdot 10^6} \cdot (P_{B,hunting} + P_{Aux}) \cdot t_{hunting} \quad (A.8)$$

The  $m_{f,USV}$  is the required fuel during the hunting time for the USV systems on board a fixed amount of fuel per day of hunting is accounted for each USV. Again a fixed  $SFC$  is used (see the comment above).

As mentioned in Chapter 7 the two profiles may differ in required fuel capacity. Hence, one may overrule the other in the total amount of required fuel  $m_{f,total}$ . If  $m_{f,transit} > m_{f,mission}$  then the total hunting time can be increased, thereby increasing the total mission endurance. However, if  $m_{f,transit} < m_{f,mission}$  then the transit profile range is increased.

## Cost model

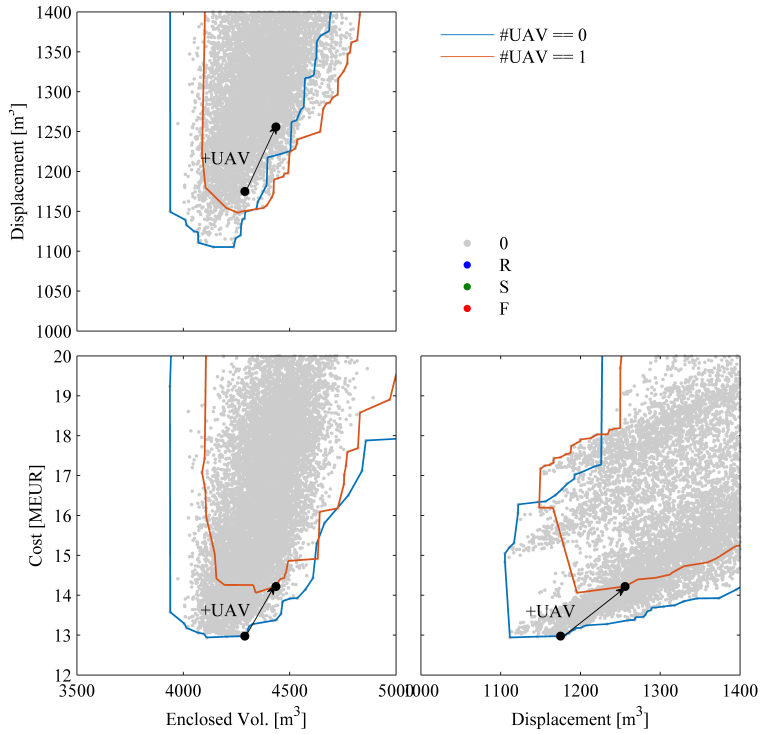
A weight based cost estimation model was kindly provided by DMO. It applies the NATO ANEP-41 standard on costing. The calculation uses specific costs (e.g.,  $\text{€}/kg$ ,  $\text{€}/kW$ ) for estimating the cost of the different SWBS groups of the weight calculation. Discrete costs are added for large items where applicable (e.g., weapons and sensors). For more information refer to the NATO ANEP-41 report (NATO, 2006).

## Appendix B

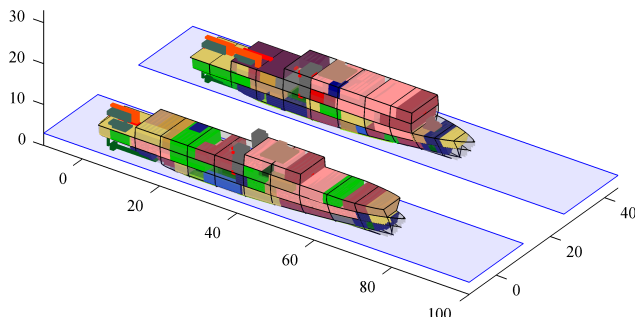
### Test-case 2: Design impact studies



## Impact of UAV

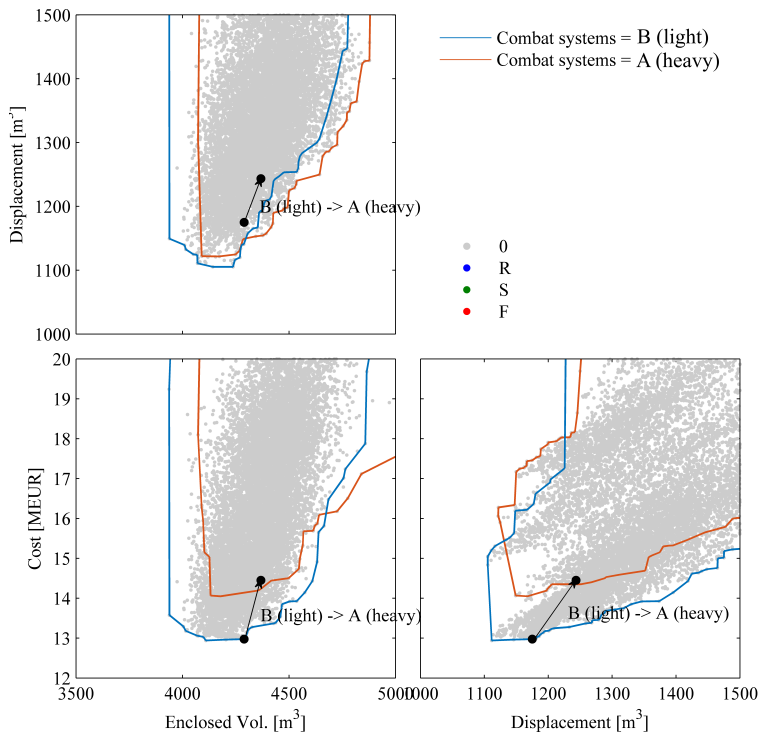


**Figure B.1:** Design and cost impact of adding a UAV system

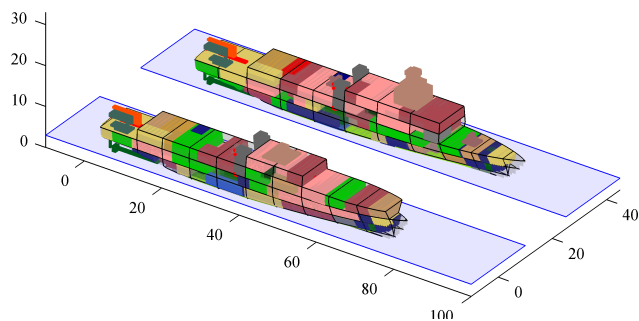


**Figure B.2:** Highlighted representative designs for the UAV system impact study (Figure B.1). No UAV (front) and with UAV and landing platform (back). Note that the design with a UAV landing deck (aft) has the 30mm main gun positioned at the bow as it cannot be placed aft of or forwards of the UAV deck. Hence, the different superstructure shapes.

## Impact of combat/sensor system suite



**Figure B.3:** Design and cost impact of combat/sensor system suite



**Figure B.4:** Highlighted representative designs for the combat and sensor suite impact study (Figure B.3). Light suite (front) and heavy (back). Note the position of the 30mm ROMG on the bow for the vessel with a heavy suite (back), while for the light suite (which only has one 0.50" ROMG) the weapon system is positioned just aft of the uptakes. Hence, the different superstructure arrangements.



# Appendix C

## Acronyms

A list of commonly used acronyms and their explanations is provided below.

<b>AUV</b>	Unmanned aerial vehicle
<b>AMS</b>	Anti-magnetic steel
<b>CODELAD</b>	Combined diesel-electric <i>and</i> diesel propulsion, where the highest power output is provided by <i>both</i> the diesel engines and electric motors (which are supplied with current from diesel-generator sets) simultaneously.
<b>CODELOD</b>	Combined diesel-electric <i>or</i> diesel propulsion, where the highest power output is provided by <i>either</i> the electric-motors or direct drive diesel engines (depending on the motor/engine sizes applied).
<b>DOE</b>	Design of experiments
<b>GA</b>	Genetic algorithm, a type of evolutionary search algorithm that applies a search heuristic based on natural selection (survival of the fittest).
<b>GM</b>	Vertical distance between the centre of gravity and metacentric height for a design. This value is a measure for the initial intact stability of the design.
<b>GRP</b>	Glass reinforced plastics
<b>IEC</b>	Interactive evolutionary computation
<b>IGA</b>	Interactive genetic algorithm, a genetic algorithm wherein user interaction is required to evaluate fitness of the individuals.
<b>MCM</b>	Mine counter-measures
<b>MCMV</b>	Mine counter-measures vessel
<b>PA</b>	Packing-approach
<b>PAX</b>	Number of passengers
<b>PD</b>	Packing-density, the ratio of occupied and unoccupied volume within the hull and superstructure of a packed design.
<b>RHIB</b>	Rigid hull inflatable boat
<b>RNLN</b>	Royal Netherlands Navy
<b>ROMG</b>	Remotely operated machine gun
<b>ROV</b>	Remotely operated vehicle

<b>RSM</b>	Response surface model
<b>USV</b>	Unmanned surface vehicle
<b>UUV</b>	Unmanned underwater vehicle

# References

- Andrews, D. J. Creative ship design. *Trans. RINA*, 123:447–471, 1981.
- Andrews, D. J. *Synthesis in ship design*. PhD thesis, University College London, London, UK, 1984.
- Andrews, D. J. A comprehensive methodology for the design of ships (and other complex systems). In *Proc. R. Soc. Lond. A*, volume 454, pages 187–211, 1998.
- Andrews, D. J. Marine design - Requirements elucidation rather than requirements engineering. In *Proc. 8th Int. Marine Des. Conf. (IMDC)*, 2003.
- Andrews, D. J. The art and science of ship design. *Int. J. Maritime Engineering*, 149(A1):1–14, 2007.
- Andrews, D. J. Marine requirements elucidation and the nature of preliminary ship design. *International Journal of Maritime Engineering*, 153:A23–A39, 2011.
- Andrews, D. J. Art and science in the design of physically large and complex systems. *Proc. R. Soc. A.*, 468(2139):891–912, 2012. doi: 10.1098/rspa.2011.0590.
- Andrews, D. J. and Dicks, C. The building block design methodology applied to advanced naval ship design. In *Proc. 6th Int. Marine Des. Conf. (IMDC)*, pages 3–19, Newcastle, UK, 1997.
- Andrews, D. Preliminary warship design. *Trans. RINA*, 136:37–55, 1994.
- Andrews, D. and Zhang, J. Trimaran ships: The configuration for the frigate of the future. *Naval Engineers Journal*, 107(3):77–94, 1995.
- Andrews, D., Cudmore, A., Humble, P., and Wilson, D. SUBCON - A new approach to submarine concept design. In *Proc. Symp. Naval Submarines 5: The Total Weapons System*, London, UK, 1996. RINA.
- Andrews, D., Duchateau, E., Gillespie, J., Hopman, J., Pawling, R., and Singer, D. State of the art report: Design for layout. In *Proc. 11th Int. Marine Design Conf. (IMDC)*, volume 1, pages 111–137, Glasgow, UK, 2012.
- Baudeweyn, P. A packing approach in the early-stage design of FPSOs. Master’s thesis, Delft University of Technology, Delft, The Netherlands, 2014.

- Blanchard, B. S., Fabrycky, W. J., and Fabrycky, W. J. *Systems engineering and analysis*, volume 4. Prentice Hall Englewood Cliffs, New Jersey, 1990.
- Brown, D. K. The architecture of frigates. In *Proc. Warship '87: Int. Conf. on ASW*, volume I, London, UK, 1987. RINA.
- Brown, D. K. *The future british surface fleet: Options for medium-sized navies*. Conway Maritime Press, 1991.
- Buonanno, M. A. *A method for aircraft concept exploration using multicriteria interactive genetic algorithms*. PhD thesis, Georgia Institute of Technology, Atlanta, USA, 2005.
- Burcher, R. and Rydill, L. *Concepts in submarine design*. Cambridge University Press, 1994.
- Carr, D. B., Littlefield, R. J., Nicholson, W. L., and Littlefield, J. S. Scatterplot matrix techniques for large N. *Journal of the American Statistical Association*, 82 (398):424–436, 1987. doi: 10.1080/01621459.1987.10478445.
- Cho, S. Towards creative evolutionary systems with interactive genetic algorithm. *Applied Intelligence*, 16:129–138, 2002.
- Cluzel, F., Yannou, B., and Dihlmann, M. Using evolutionary design to interactively sketch car silhouettes and stimulate designer’s creativity. *Engineering Applications of Artificial Intelligence*, 25:1413–1424, 2012.
- Collette, Y. and Siarry, P. *Multiobjective optimization: Principles and case studies*. Springer, 2003. ISBN 3-540-40182-2.
- Daniels, A. and Parsons, M. Development of a hybrid agent-genetic algorithm approach to ship arrangements. *Ship Technology Research*, 55(2):78–86, 2008.
- Das, I. and Dennis, J. E. A closer look at drawbacks of minimizing weighted sums of objectives for Pareto set generation in multicriteria optimization problems. *Structural Optimization*, 14(1):63–69, 1997.
- Deb, K. *Multi-objective optimization using evolutionary algorithms*, volume 16. John Wiley & Sons., 2001.
- Deb, K. and Agarwal, R. Simulated binary crossover for continuous search space. *Complex Systems*, 3(9):1–15, 1994.
- Deb, K. and Goyal, M. A combined genetic adaptive search (GeneAS) for engineering design. *Computer Science and Informatics*, (26):30–45, 1996.
- Deb, K., Pratap, A., Agarwal, S., and Meyarivan, T. A fast and elitist multiobjective genetic algorithm: NSGA-II. *IEEE Trans. on Evolutionary Computation*, 6(2):182–197, 2002.
- Decraene, J., Anderson, M., and Low, M. Maritime counter-piracy study using agent-based simulations. In *Proc. of the 2010 Spring Simulation Multiconference*, page 165. Society for Computer Simulation International, 2010.

- DeNucci, T. W. *Capturing design: Improving conceptual ship design through the capture of design rationale*. PhD thesis, Delft University of Technology, Delft, The Netherlands, 2012.
- DeNucci, T. W., Hopman, J. J., and van Oers, B. J. Capturing trade-off rationale during design selection. In *Proc. 8th Int. Conf. of Comp. Appl. and IT in the Maritime Ind. (COMPIT)*, Budapest, April 2009.
- Devanathan, S. and Ramani, K. Creating polytope representations of design spaces for visual exploration using consistency techniques. *Journal of Mechanical Design*, 132(8):1–8, 2010.
- Doerry, N. and Fireman, H. Fleet capabilities-based assessment. *Naval Engineers Journal*, 121(4):107–116, 2009.
- Dorst, C. H. The problem of design problems. In *Expertise in Design: Design Thinking Research Symposium (DTRS6)*, pages 135–147, Sydney, Australia, 2003. URL <http://research.it.uts.edu.au/creative/design/acceptedPapers.html>.
- Duchateau, E. A. E., van Oers, B. J., and Hopman, J. J. Interactive steering of a ship synthesis model for early requirements elucidation. In *Proc. 16th Int. Conf. on Comp. Appl. in Shipbuilding (ICCAS)*, pages 83–95, Busan, Korea, 2013. doi: ISBN:978-1-909024-18-2.
- Duchateau, E. A. E., van Oers, B. J., and Hopman, J. J. Interactive steering of an optimisation-based ship synthesis model for concept exploration. In *Proc. 12th Int. Marine Design Conf. (IMDC)*, volume 2, pages 29–42, Tokyo, Japan, 2015.
- Erikstad, S. O. *A decision support system for preliminary ship design*. PhD thesis, NTNU, Trondheim, Norway, 1999.
- Freedberg, S. J. From sailors to robots: A revolution in clearing mines, April 2015. URL <http://breakingdefense.com/2015/04/from-sailors-to-robots-a-revolution-in-clearing-mines/>.
- Gaspar, H., Olaf Brett, P., Ebrahim, A., and Keane, A. Data-driven documents (d3) applied to conceptual ship design knowledge. In *Proc. 13th Int. Conf. of Comp. Appl. and IT in the Maritime Ind. (COMPIT)*, pages 569–583, Redworth, UK, 2014.
- Gibson, P. and Byrne, J. NEUROGEN: Musical composition using genetic algorithms and cooperating neural networks. In *2nd International Conference on Artificial Neural Networks*, pages 309–313, Bournemouth, UK, 1991. IET.
- Gillespie, J. *A network science approach to understanding and generating ship arrangements in early-stage design*. PhD thesis, University of Michigan, Ann Arbor, USA, 2012.
- Gillespie, J. and Singer, D. Identifying drivers of general arrangements through the use of network measures of centrality and hierarchy. *Ocean Engineering*, 57: 230–239, 2013. doi: <http://dx.doi.org/10.1016/j.oceaneng.2012.09.002>.



- Goddard, R., Randles, I., C., G., and McDonald, T. Stretching the future surface combatant: Examining the affordability benefits of a twin-variant ship. *Journal of Marine Engineering & Technology*, 10(2):17–28, 2011.
- Herner, H. *Die Theorie des Schiffes*. Salzwasser-Verlag GmbH, 1939. ISBN 978-3864440304.
- Horn, J. Multicriteria decision making and evolutionary computation. Technical report, Northern Michigan University, Marquette, United States, 1996.
- Hyde, K. M. and Andrews, D. J. CONDES: A preliminary warship design tool to aid customer decision making. In *Proc. Pract. Des. of Ship and Mobile Units (PRADS)*, volume 2, pages 1298–1310, Newcastle upon Tyne, UK, 1992. Elsevier Applied Science.
- Inselberg, A. The plane with parallel coordinates. *The Visual Computer*, 1(2): 69–91, 1985. doi: 10.1007/BF01898350.
- Kaymal, T. Assessing the operational effectiveness of a small surface combat ship in an anti-surface warfare environment. Msc., Naval Postgraduate School, 2013.
- Khuri, A. I. and Mukhopadhyay, S. Response surface methodology. *Wiley Interdisciplinary Reviews: Computational Statistics*, 2(2):128–149, 2010. doi: 10.1002/wics.73.
- Kim, H. and Cho, S. Application of interactive genetic algorithm to fashion design. *Engineering Applications of Artificial Intelligence*, 13:635–644, 2000.
- Kim, H., Ragon, S., and Stump, G. Interactive design selection process through visualization and user guided search. In *Proc. 11th AIAA/ISSMO Multidisciplinary Analysis and Opt. Conf.*, Portsmouth, Virginia, September 2006. American Institute of Aeronautics and Astronautics.
- Klein Woud, H. and Stapersma, D. *Design of Propulsion and Electric Power Generation Systems*. IMarEST, 2002.
- Köppen, M. and Yoshida, K. Substitute distance assignments in NSGA-II for handling many-objective optimization problems. In Obayashi, S., Deb, K., Poloni, C., Hiroyasu, T., and Murata, T., editors, *Evolutionary Multi-Criterion Optimization*, volume 4403 of *Lecture Notes in Computer Science*, pages 727–741. Springer Berlin Heidelberg, 2007.
- Kumar, P. and Bauer, P. Progressive design methodology for complex engineering systems based on multiobjective genetic algorithms and linguistic decision making. *Soft Computing - A Fusion of Foundations, Methodologies and Applications*, 13(7):649–679, 2009.
- Lameijer, E., Kok, J. N., Back, T., and IJzerman, A. P. The molecule evaluator: An interactive evolutionary algorithm for the design of drug-like molecules. *J. of Chem. Inf. Model.*, 46:545–552, 2006.

- Lamerton, R. F., Cudmore, A., and Leach, I. M. Future surface combatant C1 concept phase - bounding the requirement. In *Proc. 10th Int. Naval Eng. Conf. (INEC)*, volume 1, pages 15–27. INEC, 2010.
- Mahan, A. *Naval strategy compared and contrasted with the principles and practice of military operations on land*. Little, Brown and Co., 1911. URL <http://books.google.nl/books?id=K0g3AAAAMAAJ>.
- Marineschepen.nl. Onderwaterbeurs in Rotterdam van start (press release about Undersea Defence Technology UDT exhibition and conference), 2015. URL <http://marineschepen.nl/nieuws/UDT-in-Rotterdam-040615.html>.
- Mattson, C. A. and Messac, A. Concept selection using s-Pareto frontiers. *AIAA Journal*, 41(6):1190–1198, 2003.
- Mattson, C. A. and Messac, A. Pareto frontier based concept selection under uncertainty, with visualization. *OPTE: Optimization and Engineering*, 6(1): 85–115, 2005.
- Mavris, D. N. and DeLaurentis, D. Methodology for examining the simultaneous impact of requirements, vehicle characteristics, and technologies on military aircraft design. In *Proc. 22nd Congress of the Int. Coun. on Aeronautical Sci. (ICAS)*, pages 145.1–145.10, Harrogate, UK, 2000.
- McKenney, T. A., Kemink, L. F., and Singer, D. J. Adapting to changes in design requirements using set-based design. *Naval Engineers Journal*, 123(3):67–77, 2011. doi: 10.1111/j.1559-3584.2011.00331.x.
- McKeown, J. Analyzing the surface warfare operational effectiveness of an offshore patrol vessel using agent based modeling. Master’s thesis, Naval Post Graduate School, 2012.
- Meckesheimer, M., Barton, R., Simpson, T., Limayem, F., and Yannou, B. Metamodeling of combined discrete/continuous responses. *AIAA Journal*, 39(10):1950–1959, 2001.
- NATO. ANEP-41 ship costing. Technical report, NATO, 2006.
- Natrella, M. *NIST/SEMATECH e-Handbook of Statistical Methods*. NIST/SEMATECH, 2013. URL <http://www.itl.nist.gov/div898/handbook/>.
- Nick, E. K. *Fuzzy optimal allocation and arrangement of spaces in naval surface ship design*. PhD thesis, University of Michigan, Ann Arbor, USA, 2008.
- Nieuwenhuis, J. J. *Evaluating the appropriateness of product platforms for engineered-to-order ships*. PhD thesis, Delft University of Technology, 2013.
- Nixon, J. N. *A Systematic Process for Adaptive Concept Exploration*. PhD thesis, Georgia Institute of Technology, Atlanta, USA, 2006.
- van Bruinessen, T. M. Concept generation during the design - exploration phase. Master’s thesis, Delft University of Technology, Delft, The Netherlands, 2010.

- van Diesen, M. The implementation of a bulkhead positioning routine in a conceptual design. Bsc, Royal Netherlands Naval College, 2007.
- van der Nat, C. G. J. M. *A knowledge-based concept exploration model for submarine design*. PhD thesis, Delft University of Technology, Delft, The Netherlands, 1999.
- van Oers, B. J. Designing the process and tools to design affordable warships. Technical report, NATO-RTO-MP AVT-173 Workshop on virtual prototyping of affordable military vehicles, Sofia, Bulgaria, 2011a.
- van Oers, B. J. and Hopman, J. J. Simpler and faster: A 2.5D packing-based approach for early stage ship design. In *Proc. 11th Int. Marine Design Conf. (IMDC)*, volume 1, pages 297–315, Glasgow, UK, 2012.
- van Oers, B. J., Stapersma, D., and Hopman, J. J. Issues when selecting naval ship configurations from a pareto-optimal set. In *Proc. 12th AIAA/ISSMO Multidisciplinary Analysis and Opt. Conf.*, Victoria, British Columbia, Canada, September 2008.
- van Oers, B. J., Stapersma, D., and Hopman, J. J. An optimisation-based space allocation routine for the generation of feasible ship designs. *Ship Technology Research*, 56:31 – 48, 2009.
- van Oers, B. *A packing approach for the early stage design of service vessels*. PhD thesis, Delft University of Technology, Delft, The Netherlands, 2011b.
- Nordin, M. *A Novel Submarine Design Method Based on Technical, Economical and Operational Factors of Influence*. PhD thesis, Chalmers University of Technology, Göteborg, Sweden, 2014.
- Pawling, R. J. *The application of the design building block approach to innovative ship design*. PhD thesis, University College London, 2007.
- Pawling, R. J. and Andrews, D. J. Design sketching - the next advance in computer aided preliminary ship design? In *Proc. 10th Int. Conf. of Comp. Appl. and IT in the Maritime Ind. (COMPIT)*, pages 426–441, Berlin, Germany, May 2011.
- Pawling, R. J., Andrews, D. J., Piks, R., Singer, D. J., Duchateau, E. A. E., and Hopman, J. J. An integrated approach to style definition in early stage design. In *Proc. 12th Int. Conf. of Comp. Appl. and IT in the Maritime Ind. (COMPIT)*, pages 248 – 263, Cortona, Italy, 2013.
- Pawling, R. J., Morandi, R., Andrews, D. J., Shields, C., Singer, D. J., Duchateau, E. A. E., and Hopman, J. J. Manifestation of style and its use in the design process. In *Proc. 13th Int. Conf. of Comp. Appl. and IT in the Maritime Ind. (COMPIT)*, Redworth, UK, 2014.
- Percival, S., Hendrix, D., and Noblesse, F. Hydrodynamic optimization of ship hull forms. *Applied Ocean Research*, 23(6):337–355, 2001. doi: 10.1016/S0141-1187(02)00002-0.

- Perra, F., Guagnano, A., Bonvicini, A., Bracco, F., Barresi, G., and Chiorri, C. A graphical user interface to link ship design characteristics and naval task effectiveness. In *Proc. 11th Int. Marine Design Conf. (IMDC)*, volume 1, pages 169–182, Glasgow, UK, 2012.
- Purton, I. M., Pawling, R. J., and Andrews, D. J. The use of computer tools in early stage design concept exploration to explore a novel submarine concept. In *Proc. 12th Int. Marine Design Conf. (IMDC)*, volume 3, pages 127–145, Tokyo, Japan, 2015.
- Rafiq, M. Y., Packham, I. S. J., Easterbrook, D. J., and Denham, S. L. Visualizing search and solutions spaces in the optimum design of biaxial columns. *Journal of Computing in Civil Engineering*, 20:88–98, 2006.
- Reed, M. R. Ship synthesis model for naval surface ships. Master’s thesis, Massachusetts Institute of Technology, Cambridge, USA, 1976.
- Rigo, P. Least-cost structural optimization oriented preliminary design. *Journal of Ship Production*, 17(4):202–2015, 2001.
- Rittel, H. W. J. and Webber, M. M. Dilemmas in a general theory of planning. *Policy sciences*, 4(2):155–169, 1973.
- Roach, J. C. and Meier, H. A. Visual effectiveness in modern warship design. *Naval Engineers Journal*, 91(6):19–32, 1979. doi: 10.1111/j.1559-3584.1979.tb04718.x.
- Romero, J. and Mechado, P., editors. *The Art of Artificial Evolution: A Handbook on Evolutionary Art and Music*. Springer Berlin Heidelberg, 2008. ISBN 978-3-540-72876-4.
- Saaty, T. L. What is the analytic hierarchy process? In *Mathematical Models for Decision Support*, volume 48 of *NATO ASI Series*, pages 109–121. Springer Berlin Heidelberg, 1988. doi: 10.1007/978-3-642-83555-1\_5.
- Shir, O. M., Preuss, M., Naujoks, B., and Emmerich, M. Enhancing decision space diversity in evolutionary multi-objective algorithms. In *5th Int. Conf. on Evolutionary Multi-criterion Optimization*, pages 95–109. Springer, 2009.
- Simon, A. The structure of ill-structured problems. *Artificial Intelligence*, 4: 181–201, 1973.
- Singer, D. J., Doerry, N., and Buckley, M. E. What is set-based design? *Naval Engineers Journal*, 121(4):31–43, 2009.
- Stapersma, D. The importance of (e)mission profiles for naval ships. In *Proc. Int. Naval Eng. Conf. (INEC)*, 1994.
- Stapersma, D. and de Vos, P. Dimension prediction models of ship system components based on first principles. In *Proc. 12th Int. Marine Design Conf. (IMDC)*, volume 3, pages 391–405, Tokyo, Japan, 2015.
- Stepanchick, J. and Brown, A. Revisiting DDGX/DDG-51 concept exploration. *Naval Engineers Journal*, 119(3):67–88, 2007.

- Strock, J. and Brown, A. Methods for naval ship concept and propulsion technology exploration in a CGX case study. *Naval Engineers Journal*, 120(4):95–122, 2008. doi: 10.1111/j.1559-3584.2008.00169.x.
- Stump, G., Yukish, M., Simpson, T. W., and Nathan Harris, E. Design space visualization and its application to a design by shopping paradigm. In *Proc. of DETC03 ASME 2003 Design Engineering Technical Conferences and Computers and Information in Engineering Conference*, Chicago, Illinois USA, 2003.
- Stump, G., Yukish, M., and Martin, J. The ARL trade space visualizer: An engineering decision-making tool. In *Proc. 10th AIAA/ISSMO Multidisciplinary Analysis and Opt. Conf.*, volume 30, 2004.
- Stump, G., Lego, S., Yukish, M., Simpson, T. W., and Donndelinger, J. A. Visual steering commands for trade space exploration: User-guided sampling with example. *Journal of Computing and Information Science in Engineering*, 9(4): 044501, 2009.
- Takken, E. Concept design by using functional volume blocks with variable resolution. Master’s thesis, Delft University of Technology, Delft, The Netherlands, 2008.
- Toffolo, A. and Benini, E. Genetic diversity as an objective in multi-objective evolutionary algorithms. *Evolutionary Computation*, 11(2):151–167, 2003.
- Vasudevan, S. *Utility of the Pareto-front Approach in Elucidating Ship Requirements During Concept Design*. Phd, University College London, 2008.
- Veldhuis, G. HOLON ASW testcase and MCM replacement study. In *Presented at the NATO-AVT-RTG 238 meeting*, The Hague, The Netherlands, 2015.
- Wagner, K. Applicability of a configuration optimization routine to the conceptual design of deepwater drilling vessels. Master’s thesis, Delft University of Technology, Delft, The Netherlands, 2009.
- Wagner, K., van Oers, B. J., Wassing, A., and Hopman, J. J. Practical application of early stage ship configuration optimization: Deepwater drillship design. In *Proc. Pract. Des. of Ship and Offshore Struct. Conf. (PRADS)*, Portsmouth, United Kingdom, September 2010a.
- Wagner, K., Wassing, A., van Oers, B. J., and Hopman, J. J. Modeling complex vessels for use in a 3D packing approach: An application to deepwater drilling vessel design. In *Proc. 10th Int. Conf. of Comp. Appl. and IT in the Maritime Ind. (COMPIT)*, Gubbio, Italy, April 2010b.
- Wolf, P. A. *Conceptual design of warships: Functional analysis, information management and decision making applied to the conceptual design of human-machine systems*. PhD thesis, University of Twente, Twente, The Netherlands, 2000.

- Youn, H., Strumsky, D., Bettencourt, L., and Lobo, J. Invention as a combinatorial process: Evidence from us patents. *Journal of the Royal Society Interface*, 12 (106):1–8, 2015.
- Zandstra, R. J. Generating a large and diverse set of designs. Master’s thesis, Delft University of Technology, Delft, The Netherlands, 2014.
- Zandstra, R. J., Duchateau, E. A. E., and van Oers, B. J. Concept exploration for a mine-countermeasures vessel using a packing-based ship synthesis model. In *Proc. 5th World Maritime Technolgoy Conf. (WMTC)*, Providence, RI, USA, 2015. SNAME.
- Zitzler, E. and Lothar, T. An evolutionary algorithm for multiobjective optimization: The strength Pareto approach. Technical Report 43, Computer Engineering and Communication Networks Lab (TIK), Swiss Federal Institute of Technology (ETH), 1998.



# Acknowledgements

Pursuing a PhD is considered by many as a largely individual endeavour, however it would not have been possible without the support of several organisations, my colleagues, and my dear friends and family. I appreciate and thank everyone who has helped me during the last four years. I would like to mention a couple here.

First, I thank the US Navy’s Office of Naval Research and Kelly Cooper for providing the funding that made this research possible. Also, I would like to thank the people at the Defence Materiel Organisation (DMO) for providing me with relevant design data, software, supervision, and a second work-place amongst a talented group of practitioners. Without this support the research would not have been possible. Further, I would like to express my gratitude towards several people in particular.

The doctoral committee for reading and reviewing my dissertation. Your comments and suggestions were greatly appreciated.

I thank the members of the NATO AVT-ET-132 and AVT-RTG-238 panels for allowing me to present my ideas and developments of my research during your workshops and meetings. Your feedback and suggestions were very valuable in developing and integrating the “pieces of the puzzle”. As a PhD student I felt lucky to present before such a interested and experienced audience.

My colleagues at the DMO department for Technology Integration. Your help with obtaining a relevant and accurate test-case for my research is greatly appreciated.

My fellow NICOP team members from University College London and University of Michigan: Rachel Pawling, Colin Shields, Justin Gillespie, Austin Kana, Alexander Piparakis, Becky Piks, and Roberto Morandi. I will not forget the conferences and many meetings that we visited and had together, as well as the memorable stays that we had in Glasgow, Cortona, Michigan, Hamburg, London, Redworth, Tokyo, and off course Ann Arbor.

Prof. David Andrews and prof. David Singer for the many discussions and anecdotes about naval ship design, as well as the many memorable stories about life as an engineer and naval architect in general.

My friends and office mates at Delft. Especially Peter de Vos and Chris Rose, with whom I had many discussions about ship design, optimisation methods, and our experiences as PhD students. Peter, our games of squash were a great way to clear my head and blow-off some steam.

Pepijn Baudeweyn for his excellent MSc project on a challenging application of the Packing-approach to the design of an FPSO deck-layout. Special thanks to Ruben Zandstra for his exceptional job of creating and analysing the MCMV packing model that was used in my test-cases. I thoroughly enjoyed working together with you and



supervising your MSc projects.

Prof. Hans Hopman for helping me to pursue a PhD after my MSc graduation. I enjoyed our discussion about your past experiences as a naval ship designer, as well as theorising about the future of ship design and ship design education, especially regarding the inevitable increase of complexity of future ships.

Bart van Oers for all your support and supervision during the project. You, above all, taught me to be thorough and critical about my work. Already as a student, your lectures during the Naval Ship Design course at the TU Delft (both about design methodology as well as your own PhD about the Packing-approach) got me interested in complex ship design problems and preliminary ship design tools. I cannot help but think that these lectures started what ultimately became the work presented in this dissertation.

I thank all of my friends for their patience when hearing me out whenever I got stuck. In particular I thank Steve Claes and Martijn Hoornaert who have endured hour-after-hour of discussions about my work. I only hope that I was just as much of a help to you and your work as you were to me.

My parents for their unconditional support during my studies and my PhD. Dad, it was you who taught me to think out-of-the-box and to not take anything for granted, something which has always been an inspiration during my life. Dare to think different...

Finally I want to thank my wife Gillian, who I met exactly 10 years ago to the day of the defence of this work. Your love and patience over these last couple of years has been invaluable to me.

# Curriculum Vitae

Etienne Duchateau was born on August 26, 1988 in Breda, The Netherlands. In addition to the standard Dutch elementary education, from 1996 to 1999 he attended elementary school at the Travel Elementary School in Ridgewood, New Jersey, USA. From 2001 to 2006 he attended secondary school at the CSG Jacob van Liesveldt College in Hellevoetsluis, The Netherlands.

From 2006 to 2011 Etienne studied Maritime Technology at Delft University of Technology in Delft, The Netherlands. He graduated for his MSc degree in November 2011, specializing in ship design. His graduation research project was titled *The merits of a bow designed for low added resistance*, and was undertaken at Maritime Research Institute Netherlands (MARIN) in cooperation with Wagenborg Shipping B.V., Conoship International B.V. and DAMEN Shipyards Group.

Etienne started work as a PhD researcher at Delft University in January 2012. His research, presented in this dissertation, was part of a collaborative research project between Delft University of Technology, University College London and University of Michigan sponsored by the US Navy's Office of Naval Research (ONR Global). The project titled *Preliminary Ship General Arrangement Design NICOP* looked into the effect of assessing and including general arrangement variations and metrics into the early stage design process.

The work presented in this dissertation was performed both at Delft University of Technology and at the Defence Materiel Organisation (DMO) in The Hague. During his time at DMO Etienne also assisted with further developments to their early stage warship design tools.

In addition to the research presented in this dissertation, Etienne was also involved with several educational tasks at Delft University. These included the coordination and support for the Masters course on Naval Ship Design (later Design of Complex Specials), and the freshman introductory MATLAB programming course. Etienne also supervised two students with their MSc graduation projects both related to the research presented in this dissertation.



# Publications

1. D.J. Andrews, E.A.E. Duchateau, J.W. Gillespe, J.J. Hopman, R.G. Pawling, B. Piks, D.J. Singer, *IMDC state of the art report: Design for layout*, Proc. of the 11th Int. Marine Design Conf. (IMDC), Vol. I, pp. 111–137, Glasgow UK, 2012
2. R.G. Pawling, D.J. Andrews, B. Piks, D.J. Singer, E.A.E. Duchateau, J.J. Hopman, *An integrated approach to style definition in early stage design*, Proc. of the 12th Int. Conf. on Computer Applications and IT in the Maritime Industries (COMPIT), pp. 248–263, ISBN: 978-3-89220-663-7, Cortona Italy, 2013
3. E.A.E. Duchateau, B.J. van Oers, J.J. Hopman, *Interactive steering of a ship synthesis model for early requirements elucidation*, Proc. of the 16th Int. Conf. on Computer Applications in Shipbuilding (ICCAS), Vol. I, pp. 83–95, ISBN: 978-1-909024-18-2, Busan Korea, 2013
4. R.G. Pawling, R. Morandi, D.J. Andrews, C. Shields, D.J. Singer, E.A.E. Duchateau, J.J. Hopman, *Manifestation of style and its use in the design process*, Proc. of the 13th Int. Conf. on Computer Applications and IT in the Maritime Industries (COMPIT), pp. 209–223, ISBN: 978-3-89220-672-9, Redworth UK, 2014
5. E.A.E. Duchateau, B.J. van Oers, J.J. Hopman, *Interactive steering of an optimisation based ship synthesis model for concept exploration*, Proc. of the 12th Int. Marine Design Conf. (IMDC), Vol. II, pp. 29–42, ISBN: 978-4-930966-04-9, Tokyo Japan, 2015
6. R.J. Zandstra, E.A.E. Duchateau, B.J. van Oers, *Concept exploration of a mine-countermeasures vessel using a packing-based ship synthesis model*, Proc. of the 5th World Maritime Technology Conference (WMTC), pp. 1–12, Rhode Island USA, 2015

