

# A heuristic method for the distribution of freight wagons on a rail yard taking into account dangerous goods

B.L.K. Kwee



DELFT UNIVERSITY OF TECHNOLOGY  
MASTER TRACK: TRANSPORT & PLANNING  
MSC THESIS

---

# A heuristic method for the distribution of freight wagons on a rail yard taking into account dangerous goods

---

by

*Author:* B.L.K. (Brian) Kwee  
*Student number:* 4459512

in accordance with the requirements for obtaining the degree of

**Master of Science**  
in Civil Engineering

at the Delft University of Technology,  
to be defended publicly on Thursday, May 12, 2022 at 17:00

*Thesis Committee:*

Prof. Dr. R.M.P. Goverde,	Transport & Planning	TU Delft, Committee chair
Dr. A.A. Núñez Vicencio,	Railway Engineering	TU Delft
B. Godziejewski, MSc, MBA		Mott MacDonald

*Company supervisor:*

Ir. M. van Hesse	Mott MacDonald
------------------	----------------

An electronic version of this thesis is available at <http://repository.tudelft.nl/>.







# PREFACE

In front of you is my master's thesis called 'A heuristic method for the distribution of freight wagons on a rail yard taking into account dangerous goods'. This thesis brings an end to my wonderful study period in Delft, where I have learned, organized, and experienced a lot. The thesis is written as part of my graduation from the Civil Engineering master track Transport and Planning from the Delft University of Technology. The research is about sorting individual wagons on a rail yard in an innovative way. Buffer distances are applied on the same track to comply with mandatory regulations concerning dangerous goods in wagons. This research was conducted in collaboration with my internship company Mott MacDonald. There have been a number of people who have helped me to bring this research to a successful end.

I am profoundly grateful to Alfredo Núñez Vicencio, my daily supervisor from the university, for all our meetings where I could express all my questions and worries. Especially in times of COVID-19, it was nice to have discussions and to have someone to talk to. Next, I would like to thank Rob Goverde, my committee chair, for all the feedback and critical questions during the meetings with the committee.

I want to thank my company supervisors Bogdan Godziejewski and Mark van Hesse for the weekly meetings and your commitment and willingness to help me despite your busy schedules. You helped me to see the bigger picture by thinking of the storyline. Your critical questions made me think about other methods and approaches I had not thought of. Also, I want to express my gratitude to the members of Mott MacDonald, who made me feel welcome in their team while working from home.

As I mentioned, this research was conducted during the COVID-19 pandemic, and I would like to thank all my fellow students, friends, and housemates for your support and presence during this period. A special thanks to Thomas and Eline, for keeping me company and that we went on this adventure together. You were my great example and could help me whenever I needed it. Together with Sebastiaan and Isa we had nice coffee breaks, discussions, and a lot of fun, which made my graduation a great time.

Furthermore, I would like to thank my aunt Eileen for the time you put into reading and improving the text where necessary. Finally, I would like to thank my parents and brother for your love and support during my studies.

Enjoy reading!

*Brian Kwee  
Delft, 2022*

# SUMMARY

The aim of this thesis entitled *'A heuristic method for the distribution of freight wagons on a rail yard taking into account dangerous goods'* is to create a heuristic model for the operation of shunting yards, taking into account the sorting process of dangerous goods in the wagons over the tracks. This concerns shunting yards where the wagons are distributed manually and communication takes place by telephone. The first problem is that an entire train is considered dangerous if there is a wagon with dangerous goods on the accompanying wagon list (W-LIS). The W-LIS shows where each wagon is positioned within a train composition. Due to safety regulations, a certain distance must be kept between wagons for certain dangerous goods classes. Because entire trains are considered dangerous, adjacent tracks must be left empty. This is at the expense of the capacity of the yard. The second problem at this moment is that W-LIS is not 100% correct, due to human errors. Random checks show that the W-LIS does not always turn out to be correct and that mistakes are made in creating the list. Therefore, smart camera techniques have been developed to detect which wagon contains which dangerous goods on arrival to confirm the W-LIS. This opens up new possibilities concerning the sorting strategy of wagons from the arrival track onto the classification tracks in accordance with their destination.

The purpose of this research is to find out what this new sorting strategy should look like. Therefore, the following research question is formulated: *'What kind of method can distribute wagons, including wagons carrying dangerous goods, on a rail yard, considering safety?'* In order to answer the research question, qualitative research was carried out into the various existing strategies and methods that could be applied.

A model is created in which wagons are sorted over classification tracks. The model chooses the track on which the wagons should be placed based on the destination. A specific attention is given to wagons with dangerous goods, for which the model ensures that a specific distance is kept from other wagons on the (neighboring) classification tracks. The model then determines the most appropriate departure time and the train departs. Different scenarios are tested which the model has to deal with. A distinction is made here between whether the number of classification tracks is equal or not equal to the number of destinations, and whether the rate of dangerous goods over the destinations is equal or not. This makes a total of four scenarios that have been tested.

The model should determine which strategy should be applied for specific scenarios. A strategy is created for each scenario. The assignment of destinations to tracks is determined on the basis of the amount of hazardous substances for that destination and the hazard class. Next, the destinations with different hazardous substances are separated as far as possible. To ensure safety, 'The Regulation concerning the International Carriage of Dangerous Goods by Rail' (RID) and the 'Boiling liquid expanding vapor explosion' (BLEVE) rules have been taken into account which specifies the mandatory distances between certain classes of dangerous substances. Next, the effect of using a buffer on the track was examined so that a wagon carrying dangerous goods never stands next to another wagon carrying dangerous goods of a different class if they are not allowed to stand together. This was tested in the model and the output showed the placement of the wagons and the processing times.

The result shows that there is a decrease in processing times as the percentage of dangerous goods in the trains increases. This can be explained by the fact that more buffers are used, as a result the track fills up faster, so that fewer wagons can connect to a track. As a result, the departure of trains can be initiated more quickly. The same effect can be seen when the available track occupancy goes up. This means that less available track occupancy is required to initiate the departure of a train.

To conclude, the heuristic was tested under different percentages of dangerous goods. When the percentage is lower than 60%, the tested simulations provided solutions that maintain the safety requirements. When the percentage of dangerous goods was higher than 60%, the heuristic did not manage to accommodate the wagons without compromising safety. When most of the wagons contain dangerous goods, a higher amount of buffers is needed to maintain safety.

# LIST OF FIGURES

1.1	Flowchart of Chapter 2	3
2.1	Figures showing the routes of dangerous goods and overview of regulation	7
2.2	Dangerous cargo identification number (Source: [1])	8
2.3	Segregation chart of dangerous goods “1” – “away from” (normally, CTUs at least 3 meters apart), “2” – “separated from” (normally, CTUs at least 6 meters apart), “3” – “separated by a complete compartment or hold from”, “4” – “separated longitudinally by an intervening complete compartment or hold from”. The "X" indicates that there is no segregation needed between the two classes. (Source: [2])	9
2.4	Schematic layout of a hump yard (Source: [3])	10
2.5	Aerial photo of Kijfhoek shunting yard. On the left is the arrival yard, then the wagons are pushed over a hump to the classification yard, which can be seen on the right. (Source: [4])	11
2.6	Two last-mile infrastructure variants	12
2.7	Example of last-mile infrastructure: Westpoort Amsterdam	13
2.8	Circle of disaster management (source: [5])	16
3.1	Assignment plan of trains in Waalhaven Zuid. The wagons, indicated by the boxes with number, are sorted over 9 tracks. The white color indicates available space. (Source: Schasfoort <i>et al.</i> [6])	20
3.2	Cumulative arrival and departure curves (based on Figure 2 of [7])	20
4.1	Proposed layout for the model	28
4.2	Arrival time, departure time and processing time as function of cumulative count. Each slice $i$ is an individual wagon that has its own processing time on the yard.	30
4.3	Overview of the general conceptual model	30
4.4	Algorithm step 2, Identifying the scenario	32
4.5	Step 3, strategy 1: Each track has its own destination and the share of dangerous goods is equal	33
4.6	Strategy 2: Each track has its own destination and the share of dangerous goods is not equal	34
4.7	Algorithm: Change the lateral order of destinations of the tracks if there is a destination without dangerous goods	35
4.8	Algorithm: Change the lateral order of destinations of the tracks if the destinations with a lot of dangerous goods are next to each other	36
4.9	Algorithm of Scenario 3 in which destinations with the same DG class are sorted on the same track	37
4.10	Algorithm of Scenario 4 in which destinations with the same DG class are sorted on the same track and the destination with least/no DG are placed in the middle as buffer track	38
4.11	Proposed algorithm 4.1 for checking the compatibility of dangerous goods	39
4.12	Example of the working of algorithm 4.1 for checking the compatibility of wagons with dangerous goods	39
4.13	Example to show the buffer distance	40
4.14	Proposed algorithm to check if a train is ready to depart	41
5.1	Scenario 1: Cumulative curves of classification tracks 1 and 2	46
5.2	Scenario 1: Cumulative curves of classification tracks 3 and 4	47
5.3	Scenario 2: Cumulative curves of classification tracks 1 and 2	48
5.4	Scenario 2: Cumulative curves of classification tracks 3 and 4	48
5.5	Scenario 3: Cumulative curves of classification tracks 1 and 2	50
5.6	Scenario 3: Cumulative curves of classification tracks 3 and 4	51
5.7	Scenario 4: Cumulative curves of classification tracks 1 and 2	53
5.8	Scenario 4: Cumulative curves of classification tracks 3 and 4	53
5.9	Scenario 4, simulation 2: Cumulative curves of classification tracks 1 and 2	54

5.10 Scenario 4, simulation 2: Cumulative curves of classification tracks 3 and 4 . . . . .	54
5.11 Example of a cumulative curve of track 4 of Scenario 1 with $p=15$ and $w=15$ . . . . .	55
5.12 Bar chart of Scenario 1 with the different input values for parameter $w$ and $p$ . . . . .	56
5.13 Bar chart of Scenario 2 with the different input values for parameter $w$ and $p$ . . . . .	57
5.14 Bar chart of Scenario 3 with the different input values for parameter $w$ and $p$ . . . . .	57
5.15 Bar chart of Scenario 4 with the different input values for parameter $w$ and $p$ . . . . .	57
6.1 Two Cumulative curves of classification tracks 4 with different train arrival patterns . . . . .	60
6.2 Two Cumulative curves of classification tracks 4 with different train arrival pattern . . . . .	60
6.3 Results of sensitivity analysis for different percentage of dangerous goods, starting from 0 to 50% . . . . .	62
6.4 Cumulative curve of Scenario 3 with 20% dangerous goods over the trains . . . . .	63
6.5 Cumulative curve of Scenario 3 with 50% dangerous goods over the trains . . . . .	64
C.1 Overview of the general model . . . . .	79

# LIST OF TABLES

1	Nomenclature . . . . .	ix
3.1	Overview of methods and objective functions proposed in the literature . . . . .	22
3.2	Overview risk assessment methods . . . . .	24
3.3	Extended overview of papers with single-stage sorting strategies from Chapter 3 considered in the definition of the proposed methodology . . . . .	25
4.1	Overview of scenarios for the case study . . . . .	29
5.1	Example of Scenario 1: Arrival times of the first 8 incoming trains . . . . .	44
5.2	Example: Choices for determining the departure time of a train on track 1 . . . . .	45
5.3	Example: Output of model indicating the wagon ID, wagon length, dangerous goods class, position of the front and back of the wagon, arrival time and the departure time of classification track 4. The '∅' indicates an empty space. . . . .	46
5.4	Number of simulations for model parameter fine-tuning with $w$ =maximum waiting time, $p$ =available track occupancy . . . . .	55
5.5	Results of different parameters $w$ and $p$ . . . . .	56
6.1	Different arrival times schedules for a scenario with 20% dangerous goods in the trains: no fixed schedule, every 15 minutes, every 30 minutes, every 45 minutes and every 60 minutes. . . . .	61
6.2	Total processing times in minutes for extra runs of Scenario 1 with 30% and 40% dangerous goods . . . . .	63
D.1	Overview of all processing times per track per scenario (SC) for different available track occupation parameter $p$ and maximum waiting time parameter $w$ . . . . .	81
D.2	Results of sensitivity analysis 0% - 30%: Different percentage of dangerous goods in the wagons per scenario . . . . .	82
D.3	Results of sensitivity analysis 40% - 70%: Different percentage of dangerous goods in the wagons per scenario . . . . .	83



# LIST OF DEFINITIONS

## **BLEVE (Boiling liquid expanding vapor explosion)**

"BLEVE is an explosion that is caused by the bursting of a vessel containing a pressurized liquid that has reached a temperature above its boiling point." [8]

## **Buffer**

"A buffer is an empty space between two wagons on the same track."

## **CBG ('Centraal Bediend Gebied')**

"A centralized traffic control area is an area where all train or shunting movements are controlled in a safe way from one central point. The traffic operator is supported by means of interlocking to safely operate infrastructure elements and set the routes. The area is equipped with train detection by means of axle counters or track circuits."

## **COTIF (Convention concerning International Carriage by Rail)**

## **CTU (Cargo Transport Unit)**

"A freight container, swap body, vehicle, railway wagon or any other similar unit in particular when used in intermodal transport." [9]

## **DG (Dangerous goods)**

"Dangerous goods are substances that are corrosive, flammable, combustible, explosive, oxidizing or water-reactive or have other hazardous properties. Dangerous goods can cause explosions or fires, serious injury, death and large-scale damage." [10]

## **ERA (European Agency for Railways)**

## **Heuristic**

"A heuristic is any approach to problem solving or self-discovery that employs a practical method that is not guaranteed to be optimal, perfect, or rational, but is nevertheless sufficient for reaching an immediate, short-term goal or approximation."

## **ILT (Human Environment and Transport Inspectorate)**

"The ILT is the supervising authority of the Ministry of Infrastructure and Water Management. The ILT works on a sustainable and safe living environment, safe transport, and reliability of the housing corporations." [11]

## **Last-mile**

"The last (or first) part of a freight wagon journey by rail."

## **Last-mile infrastructure**

"The last-mile infrastructure is at the place of delivery (or shipment) and consists of a transfer station, connecting lines and a loading facility."

## **NCBG ('Niet Centraal Bediend Gebied')**

"A non-centralized traffic control area is an area where train or shunting movements are controlled by a shunter, who is directly responsible for safe operation. No train detection or interlocking is in use."

## **OTIF (Intergovernmental Organisation for International Carriage by Rail)**

## **Performance**

"Performance is defined as the fulfillment of a stated goal or objective."

**RID (The Regulation concerning the International Carriage of Dangerous Goods by Rail)**

"The Regulation concerning the International Carriage of Dangerous Goods by Rail (RID) forms Appendix C to COTIF, and has an annex. This Regulation applies to international traffic." [12]

**Risk**

"Risk is defined as the product of the probability of an undesirable event and its consequence."

**Safety**

"Safety is defined as the absence of events which cause harm, but if the hazard is present there is always a chance of loss of control."

**SC (Scenario)**

"A scenario is an assumed or planned course of events."

**Strategy**

"A strategy is a plan to achieve objectives."

**TDG (Transport of Dangerous Goods)****UNECE (The United Nations Economic Commission for Europe)****W-LIS ('Wagen Lading Informatie Systeem')**

"The Wagon Load Information System shows in real-time (with a processing time of 2 to 5 minutes) the location of all freight wagons on railway yards in the Netherlands, including information on the dangerous goods present in the wagons." [13]

# NOMENCLATURE

Table 1: Nomenclature

<i>General subscripts</i>	
Symbol	Description
$t$	Time index $\{0, 1, 2, \dots, T\}$
$i$	Inbound wagon index $\{1, 2, \dots, I\}$
$b$	Destination index of wagons $\{1, 2, \dots, B\}$
$k$	Classification track index $\{1, 2, \dots, K\}$
$g$	Dangerous goods classes $\{0, 1, 2, \dots, G\}$
<i>Input parameters</i>	
$T^{\text{ARR}}(i)$	Inbound wagon $i$ arrival [minutes]
$H^{\text{ARR}}(i)$	Headway time between consecutive wagons [minutes]
$L_k$	Track length [meters]
$p$	Available track occupancy parameter [%]
$w$	Maximum waiting time parameter [minutes]
$l_i$	Length of wagon $i$ [meters]
<i>Variables</i>	
$T^{\text{DEP}}(i)$	Outbound wagon departure [minutes]
$C(i)$	Classification time of wagon $i$ from the arrival track to the classification track [minutes]
$t^{\text{wait}}(i)$	Waiting time before wagon $i$ is going to the classification track [minutes]
$t^{\text{waitclass}}(i)$	Waiting time before wagon $i$ is going to departure track [minutes]
$p_{i,k}$	Location of the head of wagon $i$ on track $k$ [meters]

# CONTENTS

<b>Preface</b>	<b>ii</b>
<b>Summary</b>	<b>iii</b>
<b>List of Figures</b>	<b>iv</b>
<b>List of Tables</b>	<b>vi</b>
<b>List of Definitions</b>	<b>vii</b>
<b>Nomenclature</b>	<b>ix</b>
<b>1 Introduction</b>	<b>1</b>
1.1 Problem statement . . . . .	1
1.2 Research objective . . . . .	2
1.3 Research questions . . . . .	2
1.4 Research methodology . . . . .	3
1.5 Project scope and limitations . . . . .	4
1.6 Relevance for Mott MacDonald . . . . .	5
<b>2 Background information on shunting yards</b>	<b>6</b>
2.1 Dutch law and International law on transport level and railway level . . . . .	6
2.2 Overview of dangerous goods . . . . .	7
2.3 Background information on shunting yards. . . . .	9
2.3.1 Types of shunting yards . . . . .	10
2.3.2 Centralized traffic control area vs non-centralized traffic control area . . . . .	11
2.3.3 Last-mile infrastructure for rail freight . . . . .	12
2.4 Risks regarding processing of dangerous goods on shunting yards . . . . .	13
2.5 Indicators to assess the performance of rail yard processes . . . . .	14
2.5.1 Safety performance indicators . . . . .	14
2.5.2 Performance indicators . . . . .	15
2.6 Management of possible calamities . . . . .	15
2.7 Conclusion . . . . .	16
<b>3 Qualitative analysis on shunting yard operations</b>	<b>18</b>
3.1 General shunting strategies . . . . .	18
3.2 Single-stage sorting and multistage sorting . . . . .	19
3.3 Shunting strategies including dangerous goods . . . . .	22
3.4 Risk assessment methods . . . . .	23
3.5 Discussion . . . . .	24
<b>4 Model design</b>	<b>26</b>
4.1 Model development approach . . . . .	26
4.2 Problem statement and analysis . . . . .	27
4.3 Model formulation . . . . .	28
4.3.1 High level structure of the model. . . . .	28
4.3.2 List of assumptions . . . . .	28
4.4 Simulation modelling steps . . . . .	30
4.4.1 Input of the model . . . . .	31
4.4.2 Step 1: Arrival of trains . . . . .	31
4.4.3 Step 2: Identifying the scenario . . . . .	31
4.4.4 Step 3: Assigning the destination of wagons to classification tracks . . . . .	32

4.4.5	Step 4: Checking the compatibility of wagons with dangerous goods and wagon placement . . . . .	38
4.4.6	Step 5: Wagons to departure track and departing strategy . . . . .	40
4.4.7	Output of the model . . . . .	41
4.5	Conclusion . . . . .	42
<b>5</b>	<b>Scenario modelling</b>	<b>43</b>
5.1	Scenario 1: Each track has its own destination and the share of dangerous goods is equal . . . . .	44
5.2	Scenario 2: Each track has its own destination and the share of dangerous goods is unequal . . . . .	47
5.3	Scenario 3: There are more destinations than tracks available and the share of dangerous goods is equal . . . . .	49
5.4	Scenario 4: There are more destinations than tracks available, and the share of dangerous goods is unequal. . . . .	51
5.5	Calibrating the model for parameters $p$ and $w$ . . . . .	54
5.6	Conclusion . . . . .	58
<b>6</b>	<b>Results</b>	<b>59</b>
6.1	Sensitivity analysis . . . . .	59
6.1.1	The effect of different arrival times of the incoming trains . . . . .	59
6.1.2	The effect of the percentage of dangerous goods in the wagons . . . . .	61
6.2	Conclusion . . . . .	64
<b>7</b>	<b>Conclusion and Discussion</b>	<b>66</b>
7.1	Conclusions. . . . .	66
7.2	Discussion . . . . .	68
7.2.1	Limitations. . . . .	69
7.3	Recommendations for future research . . . . .	70
	<b>Bibliography</b>	<b>71</b>
<b>A</b>	<b>Interviews</b>	<b>75</b>
A.1	Interview with traffic controller ProRail (in Dutch) . . . . .	75
A.2	Interview calamity manager ProRail (in Dutch) . . . . .	77
<b>B</b>	<b>Keywords for the qualitative analysis</b>	<b>78</b>
<b>C</b>	<b>Model development</b>	<b>79</b>
<b>D</b>	<b>Sensitivity analysis results</b>	<b>80</b>
D.1	Influence of different available track occupancy and maximum waiting time parameters. . . . .	81
D.2	Influence of different percentages of dangerous goods . . . . .	82



# 1

## INTRODUCTION

Almost every day, freight trains carrying dangerous goods are sent from their origin to destination. This requires trains to be safely assembled and operated, according to strict regulations. Therefore, the content and location of any wagon with dangerous goods should be known at any time during transport. This information is available when trains enter the central network, managed by ProRail, using the W-LIS (Wagon Loading Information System) [14]. However, this information is unknown before the departure of a train from the shunting yard and after the sorting of the trains on the shunting yard. During this period, there is missing and often incorrect information about the location of the wagons, the content in the wagon, and their position to other wagons. This situation makes it impossible to guarantee safety for everyone involved. A solution must be found to guarantee the safety on such railway yard.

The literature has reported that more insights into the rail yards are needed, especially on tracking wagons with dangerous goods on the non-centralized traffic control area. There is no train detection or sensors installed in the tracks in this area. As there are no train detection or sensors installed in this area, the transmission of information is done manually, resulting in (possible) errors. Current technological challenges include the validation of cameras and smart sensors for the location and content of wagons with dangerous goods. A video system can read the codes on the freight wagons that indicate the content. The smart sensors in the yard 'trace' the journey of the wagons on the track. Analysis of the collected data can be used to improve operations and increase safety [15][16].

### 1.1. PROBLEM STATEMENT

The traffic controller will consider the wagons' content (i.e. dangerous goods) when planning the journey of a train. The information is again communicated before the train enters the non-centralized traffic control area. However, there are human errors in the real-time information about the location of the wagons with dangerous goods in the 'last-mile' infrastructures in the Netherlands [14]. Last-mile, in transportation planning, is the last leg of a journey comprising the movement of, in this case, dangerous goods to a final destination. The last-mile infrastructure does not include the entire transport chain in the railway industry. Focus is on the first or last part of the journey of the freight train. Last-mile infrastructure refers to access points to or from rail freight transport. This infrastructure includes loading facilities and shunting areas and is an example of non-centralized traffic control areas. When a train leaves the shunting area (or loading facility), the wagon lists determine the content of the wagons before they enter the centralized traffic control area [17]. The last-mile infrastructure is an example of non-centralized traffic control areas and consists of a loading facility and a shunting area. When a train leaves the shunting yard, the wagon lists determine what is carried in the train before entering the centrally controlled area. This makes the traffic controller aware of what kind of dangerous goods are carried to be taken into account when planning the train's journey. This information is also communicated before a train enters the non-central area again. However, an investigation report by the Human Environment and Transport Inspectorate (ILT) showed that in 2019, 1 in 3 tracks on a railway yard investigated had incorrect information about the dangerous substances [18]. The investigation concluded that:

- The wagon lists are not complete
- Preparing of the wagon lists still relies on manual processes, which is tedious, time-consuming, and

error-prone [19]

- The wagons are not placed in the correct order according to the list

As the W-LIS can contain incorrect information, it was decided that if a train contains one or more wagons with dangerous goods, the whole train is considered dangerous. This decision leads to empty tracks to maintain the correct distance between dangerous marked trains and a significant loss of capacity. This correct distance is based on the rules in the 'Boiling Liquid Expanding Vapour Explosion' (BLEVE) regulation. 'BLEVE' is an explosion that is caused by the bursting of a vessel containing a pressurized liquid that has reached a temperature above its boiling point [8]. This is extremely dangerous and for this reason, certain substances may not be located near each other or only at specific distances from each other.

## 1.2. RESEARCH OBJECTIVE

The research objective of this thesis is to investigate whether the distribution of individual wagons on a last-mile infrastructure can be done in a new way. The smart cameras make it possible to know the exact contents of wagons, because it verifies the wagon list. This enables the shunter not to consider the entire train to be dangerous, but only certain wagons, possibly resulting in a new shunting strategy. The current shunting strategies and distribution of dangerous goods should be examined first to decide whether this new shunting strategy works. The aim is to create a method that considers individual wagons and can recognize the most appropriate strategy in different scenarios. The strategy aims to process the wagons as quickly as possible without compromising the yard's performance. To achieve this, the shunter needs an application that indicates where a wagon must be placed and at what time this must be done. The application applies all safety regulations concerning dangerous goods.

## 1.3. RESEARCH QUESTIONS

To find out whether it is possible to create a new heuristic method for distributing wagons in an NCBG area, the following main question must be answered:

***What kind of method can distribute wagons, including wagons carrying dangerous goods, on a rail yard, considering safety?***

The following sub-questions are set up to guide the research in answering the main research question:

*Sub-Question 1: What kind of regulations exists for the distribution of dangerous goods and which processes take place in a rail yard? (Problem understanding)*

*Sub-Question 2: Which requirements of a model will capture essential characteristics of a rail yard to allow evaluation of safety and performance? (Model requirements)*

*Sub-Question 3: Which steps are needed to develop the model? (Model design)*

*Sub-Question 4: How can the model be applied and tested? (Model application)*

*Sub-Question 5: How can the model and strategy be verified? (Model verification)*

## 1.4. RESEARCH METHODOLOGY

In this section, the research steps are explained, and an overview is given of the different methods and goals that belong to each research sub-question.

### Problem understanding

Chapter 2 provides background information needed to answer the first sub-question: ‘What kind of regulations exists for the distribution of dangerous goods and what kind of processes take place in a rail yard?’.

The first sub-question consists of two aspects, it deals with dangerous substances and the way a shunting yard works. The European and national legislation for the transport of dangerous goods is described in the first section. The next section describes the knowledge of the different kinds of substances and an identification method. This is necessary to get a sense of the information needed from the smart camera. This section is followed by some background information about shunting yards infrastructure. Also, different activities that may take place on the yard are described. The following section looks more closely at what happens when dangerous goods and shunting yards operations are combined. Dangerous goods in the shunting yard pose a risk, which have to be identified through indicators. Finally, Chapter 2 looks at how possible calamities can be avoided. For the sake of my research, practical experience and a better picture of what actually happens at a shunting yard, I have conducted interviews with a ProRail Traffic Controller and a ProRail Calamity Manager, which can be found in Appendix A. To summarize these research steps, an overview in the form of a flowchart of Chapter 2 activities is given in Figure 1.1.

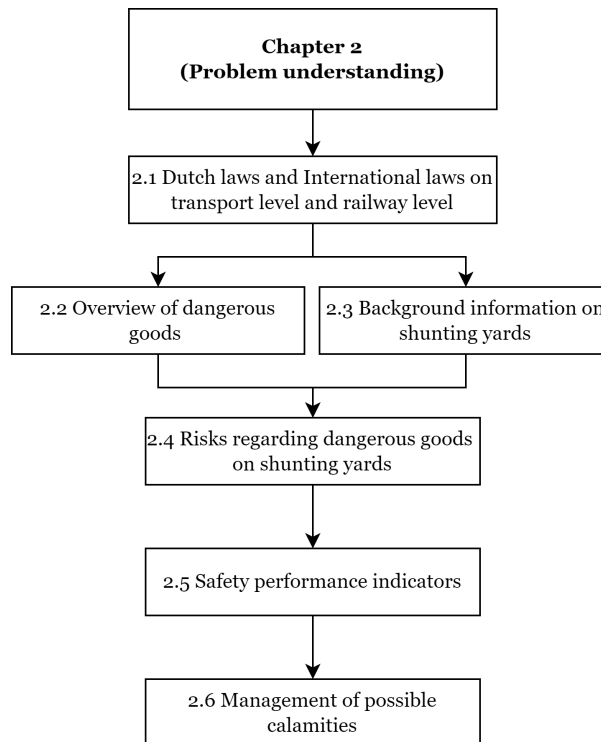

Figure 1.1: Flowchart of Chapter 2

### Model requirements

Chapter 3 provides the qualitative analysis of different methods and strategies to answer Sub-Question 2: ‘Which requirements of a model will capture essential characteristics of a rail yard to allow evaluation of safety and performance?’. Various methods which are described in different papers are discussed in this chapter. The most suited method found is applied to this research. In order to include safety in the model, not only shunting methods are considered, but also various risk models. It is important to know how safety and performance are quantified in the literature. These indicators play a role in this research and are included as an output in the proposed model.

For the qualitative analysis, only scientific articles are considered. For this purpose, keywords are devised to search for relevant literature. Examples of these keywords are ‘shunting yards’ and ‘dangerous goods’. An overview of the keywords is listed in [Appendix B](#). The snowballing effect is used to find more and more sources during the literature search. While reading the papers, remarks are included when earlier studies could influence the research reported in this thesis. The results of the qualitative analysis are used in the preparation of the model (Chapter 4).

### **Model design**

[Chapter 4](#) presents the necessary steps to build the model and thereby answers Sub-Question 3: ‘Which steps are needed to develop the model?’. The model considers the information to be given to the shunter and traffic controller, including the application of the discussed strategies and the models described in the previous chapter. The assumptions needed for the model and the different scenarios to which the model must respond are made and discussed. Finally, the model is presented with the necessary constraints, and the algorithms are explained.

### **Model application**

[Chapter 5](#) gives an answer to Sub-Question 4: ‘How can the model be applied and tested?’. By running the different scenarios as designed in Chapter 4 the application of the model is explained. A case study has been carried out from which various scenarios emerge. The input differs per scenario and the infrastructure remains the same. It is essential to show that the model can react to different inputs. The outcome of each scenario must be compared to find out if the model works, the way it is supposed to. A Performance indicator is required to show whether the outcome of one scenario is better than another. In addition to this performance indicator, an overview will be given of the placement of each wagon, including the dangerous goods classes. This should help the shunter place the wagons on the classification tracks. The model is implemented in the computer program MATLAB. After defining the assumptions, constraints and mathematical formulas in the previous chapter, the model is applied. Finally, the model is used to solve the problem by running different scenarios.

### **Model verification**

[Chapter 6](#) answers sub-question 5: ‘How can the model and strategy be verified?’. The results of the different scenarios are discussed here. No real data is available to verify the model. Therefore, a sensitivity analysis is performed to check the consistency of the model and whether the model works for all scenarios. By using this method, the impact of various input parameters on the model results can be determined.

### **Conclusion and discussion**

Finally, in [Chapter 7](#) the conclusions and discussion of this thesis are reported.

## **1.5. PROJECT SCOPE AND LIMITATIONS**

This research focuses on the planning phase of the last-mile infrastructure. The planning phase is the phase in which timetables and work schedules are established. The performance indicators and requirements of the area are defined. For a shunting yard, this means determining which strategy is used for shunting and which classification strategy is applied. In addition, contingency plans are established in this phase. The calamity manager makes his plan to ensure that as few accidents as possible occur by following rules. These rules can be seen as the constraints for planning and implementation in the model.

This thesis focuses on a freight train yard that is not centrally controlled. To answer the main question, a model is created in which the performance of the yard is expressed in the total processing time of all wagons, while the positions of the wagons are also considered. Listed below are the various assumptions relevant to this project.

#### Data availability

1. It is assumed that the technology exists and that the data is available. The technology of the data collection is beyond the scope of this project.
2. There is real data available on the lay-out of a specific yard, that is used in the case-study. This includes the track lengths and the number of tracks. The type of dangerous good is also known.

3. The applied data format is only for modelling purposes and do not correspond with W-LIS data structure.

#### Consideration on the model layout

4. There are many possible types of last-mile infrastructure layouts possible. In this research, we consider a model that includes arrival tracks, classification tracks and departure tracks. For the purpose of this thesis, the layout of the yard has been predefined, i.e. the number of tracks and their length are fixed.
5. The infrastructure is only used by freight trains and is located at a last-mile infrastructure.
6. The trains go to the factories, meaning they make the last part of the journey, from the CBG to NCBG. The formation of the trains which will depart towards CBG network is not considered. Because of this, there is no departure schedule to take into account.

## **1.6. RELEVANCE FOR MOTT MACDONALD**

This research is conducted under the supervision of Mott MacDonald, an international engineering consultancy. In the Netherlands, Mott MacDonald specializes in transportation, infrastructure finance, energy and project management. The company is involved in many rail projects in the Netherlands and abroad. Several employees are involved in advisory activities related to safety aspects on and around the railway tracks and in the innovation of current technologies. This research will add to the knowledge of how dangerous goods are transported and stored in wagons on a rail yard. In addition, the model could be used in a study at planning level to create new strategies for rail yards where dangerous goods are handled. The model could also be used to test the current strategy and to see if safety is guaranteed. Mott MacDonald expects to use the results of this work in advisory works regarding the optimization of railway yard operations.



# 2

## BACKGROUND INFORMATION ON SHUNTING YARDS

This chapter provides a deeper problem understanding by answering Sub-Question 1:

*Sub-Question 1: What kind of regulations exists for the distribution of dangerous goods and which processes take place in a rail yard? (Problem understanding)*

The main concepts and theories used and discussed in this research are reviewed and shortly presented. The chapter starts with an outline of the legislation in the Netherlands and in Europe. Rail freight transport is often international, making it of the utmost importance that the train complies with international standards. The chapter continues with an overview of the different classes of dangerous goods and general information on shunting yards. Then general information on shunting yards is given. Different methods are used to show the safety for people in terms of risks. Finally, the methods of wagon sorting and the associated computer programs for the wagons over the yard are described.

### 2.1. DUTCH LAW AND INTERNATIONAL LAW ON TRANSPORT LEVEL AND RAILWAY LEVEL

#### *Dutch law*

For the railway sector in the Netherlands, the Carriage of Dangerous Goods Act for all transport over land and water [20] is applicable. In addition, there is a regulation for transport of dangerous goods over land and this regulation sets out the requirements for the packaging method and quantities of land transport. The Environment and Transport Inspectorate (ILT) checks whether actual safety is retained when transporting dangerous goods [21].

#### *International law*

In addition to the Dutch law, International law governs transporters. The ‘European Agency for Railways’ (ERA) assists the European Commission in the development of the legislation concerning the ‘Transport of Dangerous Goods’ (TDG) in order to continuously improve its safety and interoperability cost-effectively and to ensure the consistency of the legislation developed at EU level and at international level. In order to achieve these objectives, ERA participates to the coordination of the Inland TDG Risk Management Framework and develops various positions, guides, recommendations or other initiatives, under the auspices of ‘The United Nations Economic Commission for Europe’ (UNECE) and ‘Intergovernmental Organisation for International Carriage by Rail’ (OTIF), to further harmonize the approach to safety and interoperability of TDG [22].

The ‘Regulation concerning the International Carriage of Dangerous Goods by Rail’ (RID) is part of the Appendix of the ‘Convention concerning International Carriage by Rail’ (COTIF). It is adjusted and supplemented every two years [12]. The RID classifies dangerous goods based on their hazard characteristics and has specific transport conditions related to the packaging, labeling and transport documents [23]. There are 44 existing RID contracting States in Europe, Asia and Africa, to which this regulation applies [24]. In order to transport dangerous goods, a rail carrier needs to have the notation ‘transport of dangerous goods’ on its safety certifi-

cate. The ILT assesses whether the transporter meets the safety requirements. For every dangerous good, rules are applicable to the design and material of tank wagons, periodic tank inspections, packaging regulations, documents, staff training, and inspections. Only if the transporter complies with all requirements will the ILT grant the endorsement [25].

### Guidelines

In addition to laws, there is also a guide for companies that produce, transport, store or use dangerous goods and for authorities charged with the supervision and licensing of these companies. This is summarized in the 'Publicatiereeks Gevaarlijke Stoffen' (PGS).

### Basisnet

Finally, the regulation 'Basisnet' is also part of National Law. In 'Basisnet', rules are defined to make the transport of dangerous goods as safe as possible by offering certain limits within which the dangerous goods may be transported. By setting a level of protection through rules related to spatial ordering, safety for the local environment can be increased. For example, houses may not be built too close to a railway track where dangerous goods are transported [26]. Figure 2.1a shows a map of all the routes along which dangerous goods may be transported [27]. Figure 2.1b gives an overview of the regulations.

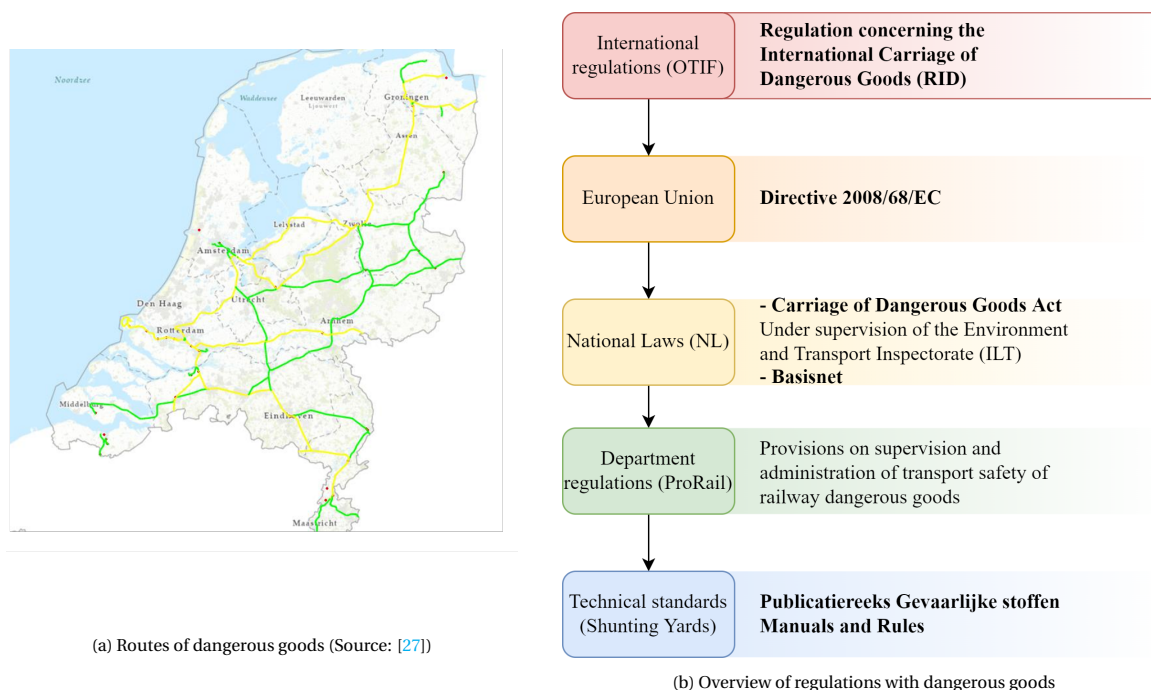

Figure 2.1: Figures showing the routes of dangerous goods and overview of regulation

This section presented an overview of the various regulations related to transporting dangerous goods that must be considered when developing a new method.

## 2.2. OVERVIEW OF DANGEROUS GOODS

The previously described regulations relate to dangerous goods. There are different types of dangerous goods and they can be divided into different classes. These classes are internationally recognized, and therefore it is easy to distinguish which substance is being transported. The classes of dangerous goods according to RID [12] are as follows:

- Class 1.3: Explosives with a fire
- Class 1.4: Minor fire or projection hazard
- Class 1.5: An insensitive substance with a mass explosion hazard
- Class 1.6: Extremely insensitive articles
- Class 2.1: Flammable gas
- Class 2.2: Non-flammable gas
- Class 2.3: Poisonous gases
- Class 3: Flammable liquids
- Class 4.1: Flammable solids, self-reactive substances, polymerizing substances and solid desensitized explosives
- Class 4.2: Substances liable to spontaneous combustion
- Class 4.3: Substances which, in contact with water, emit flammable gases
- Class 5.1: Oxidizing substances
- Class 5.2: Organic peroxides
- Class 6.1: Toxic substances
- Class 6.2: Infectious substances
- Class 7: Radioactive material
- Class 8: Corrosive substances
- Class 9: Miscellaneous dangerous substances and articles

Each wagon has a unique identification number, the UIC number (Union International des Chemins de fer) for the type of wagon, the maximum speed, and tonnage. If the wagon contains dangerous goods, an orange plate is mandatory. The plate is shown in [Figure 2.2](#). The upper number is the GEVI code ('Gevaarsidentificatienummer', Hazard Identification Number), and the lower number is the UN code (Substance Identification Numbers). The first digit of the GEVI code indicates the main hazard, as indicated according to the RID classes, and the second digit indicates the other hazard. If both digits match, it means that there is an increase in the main hazard. In the example, 33 means highly flammable liquid [28]. The UN code is the substance identification number. This code consists of 4 digits and stands for the substance being transported. In this case 1203 stands for gasoline or motor fuel [29].



Figure 2.2: Dangerous cargo identification number (Source: [1])

### Covenant 'BLEVE'

An important covenant that has been laid down in Section 7.5.3. of the RID is the covenant 'BLEVE' (Boiling Liquid Expanding Vapour Explosion) [8]. During the transport of dangerous goods by rail, a fire may be caused by the leakage of a wagon containing flammable liquid resulting from an ignition. If there is a tank wagon with flammable gas in the immediate vicinity, a giant fireball may occur that can reach a diameter of 200 meters. This could result in many victims and therefore this occurrence must be prevented. Safety distances have been included to keep the substances apart. For this purpose, a segregation chart states whether certain substances may be located together at a certain distance or whether certain substances may never be located together on the site. These safety distances are also used in introducing the 'Basisnet' to demarcate the risk area around the main railways. In [Figure 2.3](#) the segregation of dangerous goods can be seen. To determine the segregation of two classes, read off a row for one class and a column for the other. There is either the letter "X" or a number where they intersect. The numbers (1, 2, 3, or 4) represent the required minimum distance between the two wagons, as follows [2]:

"1" – "away from" (normally, Cargo Transport Units (CTUs) at least 3 meters apart)

“2” – “separated from” (normally, CTUs at least 6 meters apart)

“3” – “separated by a complete compartment or hold from”

“4” – “separated longitudinally by an intervening complete compartment or hold from”

Note that “1” indicates the smallest required separation, and “4” the greatest. In reality, the result is that if a shipper sees a number in Figure 2.3, the two wagons will not be placed in the same CTU regardless of which number. The "X" indicates that no segregation is needed between the two classes. It can be seen that there are "\*" between the subclasses 1.3, 1.4, 1.5, and 1.6. Class 1 (explosive) materials shall not be loaded, transported, or stored together, except for some cases and therefore another compatibility table is used.

In The Netherlands, the distance between tracks centers is 4.50 m for new rail yards. The distances vary for the current rail yards and are assumed to be 4 meters [30]. Therefore, it is not usual to place trains carrying dangerous goods next to each other in the shunting yard, but to leave a track between them where there are no dangerous goods. In addition, some yards have special areas where dangerous goods are allowed to be stored, so that there are no dangerous goods in the rest of the yard. Here, the carriers are free to shunt the wagons as they wish, but must report each movement to the train traffic controller.

CLASS	1.1 1.2 1.5	1.3 1.6	1.4	2.1	2.2	2.3	3	4.1	4.2	4.3	5.1	5.2	6.1	6.2	7	8	9
Explosives 1.1, 1.2, 1.5	*	*	*	4	2	2	4	4	4	4	4	4	2	4	2	4	X
Explosives 1.3, 1.6	*	*	*	4	2	2	4	3	3	4	4	4	2	4	2	2	X
Explosives 1.4	*	*	*	2	1	1	2	2	2	2	2	2	X	4	2	2	X
Flammable gases 2.1	4	4	2	X	X	X	2	1	2	X	2	2	X	4	2	1	X
Non-toxic, non-flammable gases 2.2	2	2	1	X	X	X	1	X	1	X	X	1	X	2	1	X	X
Toxic gases 2.3	2	2	1	X	X	X	2	X	2	X	X	2	X	2	1	X	X
Flammable liquids 3	4	4	2	2	1	2	X	X	2	1	2	2	X	3	2	X	X
Flammable solids (including self-reactive and related substances and desensitized explosives) 4.1	4	3	2	1	X	X	X	X	1	X	1	2	X	3	2	1	X
Substances liable to spontaneous combustion 4.2	4	3	2	2	1	2	2	1	X	1	2	2	1	3	2	1	X
Substances which, in contact with water, emit flammable gases 4.3	4	4	2	X	X	X	1	X	1	X	2	2	X	2	2	1	X
Oxidizing substances (agents) 5.1	4	4	2	2	X	X	2	1	2	2	X	2	1	3	1	2	X
Organic peroxides 5.2	4	4	2	2	1	2	2	2	2	2	2	X	1	3	2	2	X
Toxic substances 6.1	2	2	X	X	X	X	X	X	1	X	1	1	X	1	X	X	X
Infectious substances 6.2	4	4	4	4	2	2	3	3	3	2	3	3	1	X	3	3	X
Radioactive materials 7	2	2	2	2	1	1	2	2	2	2	1	2	X	3	X	2	X
Corrosives 8	4	2	2	1	X	X	X	1	1	1	2	2	X	3	2	X	X
Miscellaneous dangerous substances and articles 9	X	X	X	X	X	X	X	X	X	X	X	X	X	X	X	X	X

Figure 2.3: Segregation chart of dangerous goods “1” – “away from” (normally, CTUs at least 3 meters apart), “2” – “separated from” (normally, CTUs at least 6 meters apart), “3” – “separated by a complete compartment or hold from”, “4” – “separated longitudinally by an intervening complete compartment or hold from”. The "X" indicates that there is no segregation needed between the two classes. (Source: [2])

## 2.3. BACKGROUND INFORMATION ON SHUNTING YARDS

A shunting yard, also known as marshalling yard is a facility with multiple tracks where wagons are sorted for different destinations. According to [31] the definition of a shunting yard is the following:

*“A Shunting yard is a railway facility equipped with tracks with special layout and technical facilities, where sorting, formation and splitting-up of trains takes place; wagons are sorted for a variety of destinations, using a number of rail tracks.”*

At a freight shunting yard, they perform the following actions [32], [33]:

- **Arrival of wagons:** The operation in a shunting yard starts with the arrival of a train. The wagons are checked on damages and decoupled. The main locomotive is removed and a shunting locomotive is coupled at the end of the train. The wagons are ready for the following operations.
- **Classification of wagons:** The wagons are sorted by departure direction. This is done by pushing the wagons over the hump and changing the position of the switches so that the wagons are directed to the right tracks. Not all shunting yards have a hump, instead they use locomotives to pull or push the wagons in the correct tracks.
- **Ordering of wagons:** The wagons are ordered by destination station within the same direction. This is done so that the wagons can be easily separated at the next destination.
- **Departure of trains:** As a final step, the train is prepared for departure and has to wait until the departure can take place. In this step, the wagons are coupled and the main locomotive is coupled to the wagons. Then the brakes of the train are tested. Finally, the train can leave for the next destination. There are two types of strategies for regulating outbound trains. Either a fixed schedule of train departures can be used, or a flexible schedule can be used. With a flexible schedule, trains can depart within a wide time window. There is no specific arrival/departure time, but a minimum/maximum arrival/departure time.

The actions above should be considered in the development of the model, and this is described in [Chapter 4](#).

### 2.3.1. TYPES OF SHUNTING YARDS

There are in general three types of freight shunting yards [34]:

1. Flat-shunted yards – These yards are constructed on flat ground. Freight wagons are pushed and pulled by a shunting locomotive to sort the wagons into the assigned tracks. This often requires several actions, as the correct order of the trains cannot be applied at once.
2. Hump yards – Freight wagons are pushed over a hump by a locomotive. The wagons are uncoupled just before or at the crest of the hump and roll by gravity into their assigned tracks in the classification yard. The speed of the wagons is calculated beforehand and is regulated, because of the different natural speed of the wagons. In [Figure 2.4](#) an overview of a hump yard is shown.
3. Gravity yards – The yard works similar to hump yards, but there is no hump. Instead the whole yard is set up on a continuous falling gradient and there is less use of locomotives. Gravity yards have a large capacity, but they need more staff than hump yards and thus they are the most uneconomical classification yards [35].

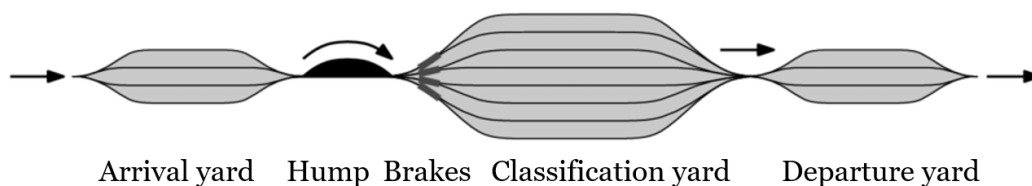

Figure 2.4: Schematic layout of a hump yard (Source: [3])



In the Netherlands there are actually very few yards that look like [Figure 2.4](#). There is only one hump yard and that is Kijfhoek, shown in [Figure 2.5](#). Other shunting yards often consist of only one or two yards instead of three. The sorting process take place on those yards. This often requires the use of multi-stage sorting, because of the limited number of tracks available. In this study, the focus is on a hump yard, because otherwise there is a lot of pushing back and pulling forwards with wagons and there is no room for it.



Figure 2.5: Aerial photo of Kijfhoek shunting yard. On the left is the arrival yard, then the wagons are pushed over a hump to the classification yard, which can be seen on the right. (Source: [\[4\]](#))

### 2.3.2. CENTRALIZED TRAFFIC CONTROL AREA VS NON-CENTRALIZED TRAFFIC CONTROL AREA

In terms of safety on the shunting yard, the network can be divided into two areas:

- Centralized traffic control area ('Centraal Bediend Gebied', referred to as CBG) [\[36\]](#)
- Non-centralized traffic control area ('Niet Centraal Bediend Gebied', referred to as NCBG) [\[36\]](#)

A **CBG** is an area where all train or shunting movements are controlled in a safe way from one central point. The traffic operator is supported by means of interlocking to safely operate infrastructure elements and set the routes. The area is equipped with train detection by means of axle counters or track circuits [\[37\]](#). In The Netherlands, the CBG is controlled and supervised by ProRail. In the CBG, the train route is controlled automatically:

- Automatic Route Setting is a major subsystem of railway traffic management systems and automatically sets routes in accordance with timetables, train descriptions and facility situations [\[38\]](#)
- Signalling system ensures the safe route setting
- Route locking is enabled to display the signals and route is released when the train has passed
- The dispatcher can influence the process above by manual intervention, but that does not apply to the interlocking.

A **NCBG** is an area where train or shunting movements are controlled by a shunter, who is directly responsible for safe operation. No train detection or interlocking is in use. Shunting operations requires a lot of verbal communication between the employees. Before a shunting or train movement takes place on an NCBG, the driver of the train must report to the traffic manager via a logged speech connection to request permission and make arrangements for the exchange of safety information. The traffic manager may give the driver instructions on how to use the system. The driver shall follow these instructions. Also for the parking of vehicles on tracks in non-centrally served areas require prior permission from the traffic manager. To use a Time-space slot ('TijdRuimteSlot', referred to as TRS) within which several consecutive movements take place, the area shall consist of signals, track numbers and/or point numbers and clearances and the time limits via desired start and end points. After terminating the use of the TSR, the driver shall report to the traffic manager that the lock has been used as requested, on which track the driver and his traction unit are located [\[39\]](#).

The focus of this research is on an NCBG, because there may be problems keeping track of where wagons are placed. The last-mile infrastructure is an example of an NCBG and is described in the next section.

### 2.3.3. LAST-MILE INFRASTRUCTURE FOR RAIL FREIGHT

The last-mile for rail freight focuses on the last (or first) part of a wagons journey. This part could be at industrial sites, warehouses, rail ports, ports or intermodal terminals. Therefore, the following infrastructure is needed [17]:

- Loading facility: This is the nucleus of last-mile infrastructure where all necessary infrastructural, technical and operational components to tranship cargo from or to rail is located.
- Shunting facility: These are smaller, local shunting yards for the formation of trains, so that wagons/-trains can be picked up and delivered at specific locations.
- Connecting rail lines: These lines are used to connect the loading facilities with the shunting facility.

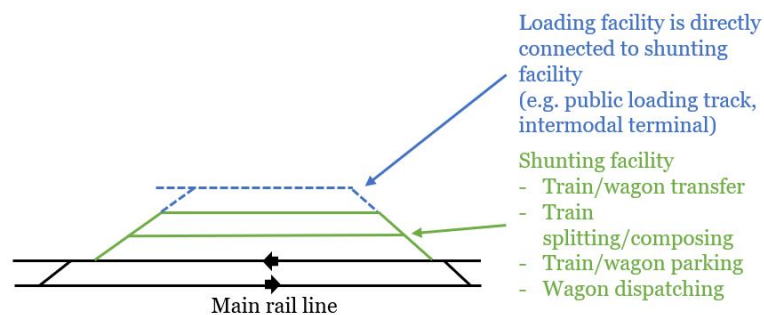

(a) Variant 1: Loading facility directly connected with shunting facility [17]

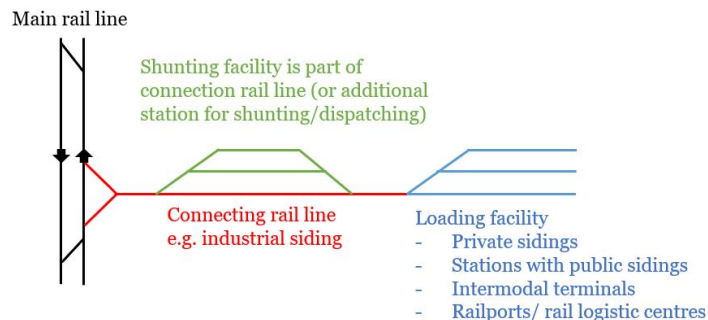

(b) Variant 2: shunting facility is part of connection rail line [17]

Figure 2.6: Two last-mile infrastructure variants

Two types of last-mile infrastructures can be seen in [Figure 2.6a](#) and [Figure 2.6b](#). The first type has the loading facility directly connected to the shunting facility. The second type has the loading facility and shunting facility separate from each other and this will be used in the model development in [Chapter 4](#). An example of such last-mile infrastructure in Amsterdam is shown in [Figure 2.7](#). The last-mile infrastructure differs not that much of a general shunting yard. It is smaller and more dedicated towards the same type of goods and directions. The focus of this research is on the second variant of the last-mile infrastructure; the shunting facility as part of the connection rail line.

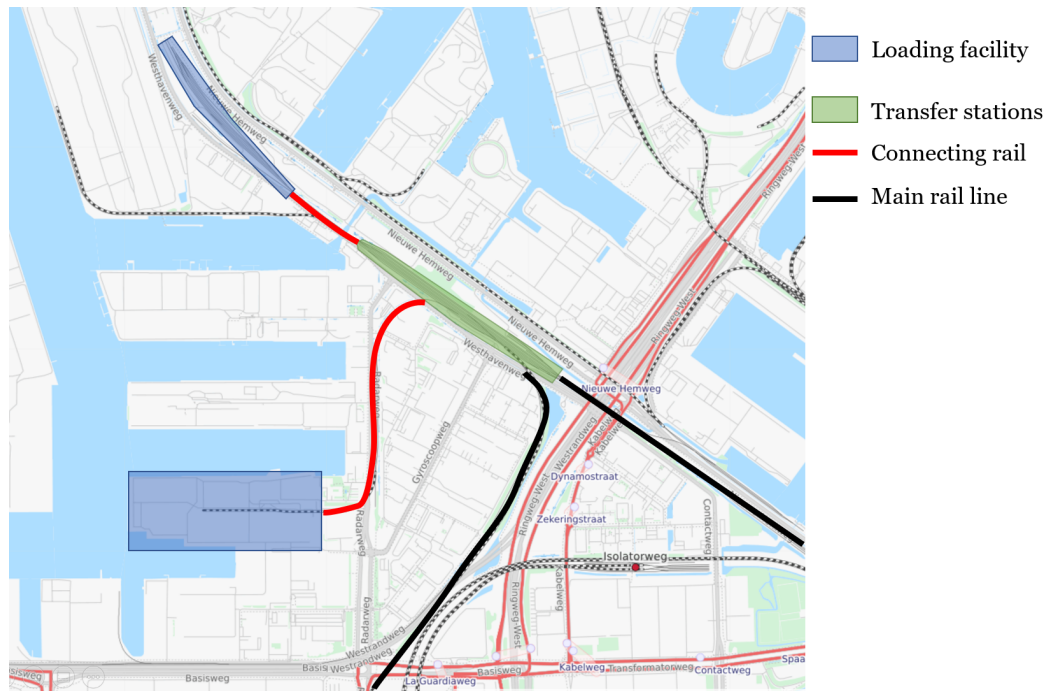

Figure 2.7: Example of last-mile infrastructure: Westpoort Amsterdam

## 2.4. RISKS REGARDING PROCESSING OF DANGEROUS GOODS ON SHUNTING YARDS

According to Glickman and Erkut [40], *risk* is defined as the product of the probability of an undesirable event and its consequence. Many studies have been carried out on the transport of dangerous goods and the associated risks [41]. However, Glickman and Erkut [40] stated that little research had been done into the risks at the rail yards themselves. This is because few accidents happened on the yards. This gives the feeling that rail yards are safe. Low probability and high consequence events characterize the major hazard industries. The following list summarizes the various ways an accident may occur on shunting yards [42]:

1. Collisions of moving trains and collisions between moving and stationary trains: This probability increases with the number of trains that go on a track. In addition, the speed of the train is an important factor, as the higher the speed, the greater the risk of dangerous goods being released.
2. Derailment of the train or some wagons: The derailment of trains usually occurs at switches or other critical points on the track. This may also be because a track is damaged, or material is broken. It can also be caused by a person operating a switch incorrectly. The probability of derailment increases as the train or wagon has to pass through several switches to reach certain tracks.
3. Puncture of a wagon by the locomotive during the change-over of locomotive: This probability increases as the quantity of locomotive change-overs increases.
4. Intrinsic mechanical failures, such as corrosion, presence of undesirable substances in the tank (addition of wrong substances), omissions during modification/repair works, overfilling of the tank, and fatigue fractures: This risk is always present, but good maintenance and training reduces the chance of occurrence. Each dangerous good has its own risk impact.
5. External events, such as external fire (which, under certain circumstances, can also lead to a boiling liquid expanding vapour explosion) or external explosion. Also leakage of tank wagons is a general cause of incidents with dangerous goods: This type of accident leads to exposure risks. The risk to the surrounding area depends on the distance between the wagon containing the dangerous good and the other wagons. This also poses a risk to the population, but also here the distance plays an important role.

Accidents of this kind can lead to risks for various groups. These include fatalities and harm to people, damage to equipment, environmental pollution and the risk that a yard may not be used anymore and this will involve high costs.

In the Netherlands, to calculate risks with dangerous goods, various criteria are used. The criteria for assessing the acceptability of risks for a large number of categories of establishments have been laid down in the 'Besluit externe veiligheid inrichtingen' (Decree on external safety of establishments, BEVI) [43]. Safeti-NL is the prescribed calculation package for the calculation of environmental safety risks for establishments where hazardous substances are used, packaged, processed or stored [44].

## 2.5. INDICATORS TO ASSESS THE PERFORMANCE OF RAIL YARD PROCESSES

In addition to risks, there must also be opportunities to see what the safety situation is at a yard or what the performance of a yard is. For this purpose, so-called performance indicators are used. There are several performance indicators. On the one hand, it is about the safety of the system (Safety performance indicators) and on the other hand, it is about the efficient use of the yard in terms of capacity (Performance indicators). The two different indicators are discussed in detail below.

### 2.5.1. SAFETY PERFORMANCE INDICATORS

Safety Performance Indicators are developed to assess safety management system performance in controlling major hazards [45]. According to Bellamy and Sol [45], *safety* is defined as the absence of events which cause harm, but if the hazard is present there is always a chance of loss of control. The indicators should provide information about safety within a company and can highlight important risk factors. This helps the calamity manager focusing on important risk factors and helps to determine how well the yard is managing its risk controls and whether it is improving. In order to determine whether the risks are kept as low as possible, a measuring system is needed that shows whether certain safety targets are being met. Usually, managers set targets and the key performance indicators are linked to these targets. From this they can determine whether they are going in the right direction of the goal and objective and what actions still need to be taken in order to achieve them. The information is key to the company objective [45].

Safety Performance Indicators are used for quantitative risk assessment. For this purpose, it is important to determine the frequencies and impact of the various dangerous goods that are transported. The Dutch guide, also known as the purple book [46], can be used as reference for these numbers. It is important to note that this guide dates from 2005 and has not been modified since then. This is because the paid calculation package SAFETI-NL is now used for the calculation of safety risks.

The type of safety indicators depends on the type of risk that can take place. So the risks that take place in [Section 2.4](#) all have their own type of indicator, in order to be measured.

Collision risks:

- Number of times a wagon is shunted extra
- Number of accidents (based on historical data)
- Number of times, wagons with different type of dangerous goods are placed behind each other

Derailment risks:

- Number of times a wagon passes a switch

Exposure risks:

- Number of times an employee is in contact with dangerous goods

- Number of times an employee has to come nearby the wagons with dangerous goods
- Distance to the nearest building with people
- Weather conditions
- Number of times, wagons with different type of dangerous goods are placed next to each other
- Duration of the wagon with dangerous goods on the yard

### 2.5.2. PERFORMANCE INDICATORS

Performance is defined as the fulfillment of a stated goal or objective [47]. Performance can also be measured by means of indicators. For this purpose, several objective functions have been outlined that can serve as targets for the model. The performance indicators are the following:

- Capacity of the classification yard: This is defined as the number of wagons per classification track per minute. The higher the number, the bigger the capacity and the better the throughput of the yard. This indicator is also influencing the duration of the wagon with dangerous goods on the yard, which is a safety indicator. The classification yard is the main yard, where the wagons with dangerous goods are stored side by side for long periods of time. Therefore, the indication of this capacity is leading.
- Number of classification tracks used: This indicator is often minimized to lower the number of tracks that are used for classification of the wagons. If this number is very high, it could mean that the classification yard is not used effectively. This depends on the number of destinations and the number of incoming trains. On the other hand, if there are many destinations and only one track is used, this can lead to many delays, which cannot be seen from this performance indicator.
- Duration of delay: The delay of a wagon in relation to the scheduled time of departure is always to be kept as small as possible. However, this should not be at the expense of a compact timetable, a timetable without a lot of buffer times. Setting the timetable broadly to ensure that there is no delay will have a negative impact on the performance of the yard, because fewer trains can then use the yard and that costs capacity.
- Waiting time for the wagons on the yard: It takes time to process all the wagons and sort them according destination. The waiting time of a wagon is the idle time of the wagon on the classification yard.
- Processing time of the wagons for the total yard: This is time between arrival and departure of each wagon. This total time shows how long it takes for all wagons to pass through the yard and can also be viewed per track to see if certain tracks take longer to process wagons. This indicator is suitable for comparing multiple scenarios where the amount of trains is the same, but the composition of destinations or content differs.

The qualitative research in [Chapter 3](#) will show which performance indicator is the most suitable to use for this study.

## 2.6. MANAGEMENT OF POSSIBLE CALAMITIES

For this research, a calamity manager of ProRail was interviewed. The main point of the conversation was that the calamity managers carry out physical checks in the yard to ensure that the wagons are as they were reported and that everything is in order with the wagons. In the event of a dangerous goods disaster, they need to know as soon as possible what kind of dangerous good is in the wagon, where it is located and what kind of response plan there is for it.

Calamity managers are responsible for the management of possible disasters. They must know the process of gathering information if they want to deal with disasters. The process is shown in [Figure 2.8](#). The circle



exists of the following phases: preparation, mitigation, prevention, response, resume and reconstruction. The first three phases are part of the control before a disaster happens and the last three phases take place after a disaster has occurred. It is therefore important that the calamity manager knows what information is needed for each phase [5].



Figure 2.8: Circle of disaster management (source: [5])

**Preparation** - In the preparation phase, the manager needs an overview of the potential risks that may occur in the yard. This may involve dangerous goods in wagons exploding or leaking, but it may also involve collisions between trains. Also, a geographic component is needed to determine the risks and hazards to the environment. This requires the probability of occurrence and can be calculated using a model. The outcome of this model can be used to evaluate the possible scenarios and then plans can be made for the design of mitigation plans.

**Mitigation** – Mitigation means to reduce the severity of the human and material damage caused by the disaster [48]. In the mitigation phase, the manager tries to reduce the probability of loss of life or property damage for events that cannot be prevented. The manager can do this by applying measures in advance. An example is that it takes into account where people live and that a rail yard is built at a certain distance from the inhabited area.

**Prevention** – Prevention is to ensure that human action or natural phenomena do not result in disaster or emergency [48]. In the prevention phase, the manager tries to decrease the likelihood that a disaster will occur. The actions that cannot be carried out in the mitigation phase can still be carried out in the prevention phase.

**Response** – In the response phase, the calamity manager has to act to save human lives and to limit further damage. Therefore it is useful to know what kind of scenarios can occur, so that they know what to do to solve the problem as quickly as possible and limit further damage. This requires prescribed scenarios that shows who is responsible for which part and which installations are intended for certain conditions. An example could be extinguishing a fire in a rail yard.

**Resume & Reconstruction** – This phase can also be seen as the recovery phase after the incident has taken place. It is important that operations are restarted as soon as possible (resume). The infrastructure that has been destroyed must be repaired so that the operations of the yard can be brought back to the same level as before the incident (reconstruction).

## 2.7. CONCLUSION

This chapter was based on literature overview and interviews, aiming to provide information about corresponding regulations and processes for the railway yards and how this information is used in this study. These are not only national laws, but also European regulations. The most important rules that must be taken into account in this investigation have been incorporated in the ‘BLEVE’ covenant established by the RID. In addition, this chapter shows how a shunting yard is structured and what kind of activities take place on the yard.

The main focus in this research is on a NCBG shunting yard with a hump. A lot of influence can be exerted on mainly the classification of wagons from the arrival yard to the classification yard and the departure initiation on which a train leaves. With the appropriate strategy the performance can be improved. In order to be able to quantify the improved performance, performance indicator must be further investigated. In the next chapter, the safety and performance indicators will be studied.

# 3

## QUALITATIVE ANALYSIS ON SHUNTING YARD OPERATIONS

The previous chapter dealt with the basic knowledge needed to understand what elements compose a shunting yard and to understand the rules that govern the handling of dangerous goods. In this chapter, the various shunting operations required in the model are considered. Different methods are shown with the performance indicator as objective for the model. Further, this chapter analyzes what strategies and methods are in place to distribute the trains over the tracks. Several papers and studies are evaluated in order to get an answer to sub question 2:

*Sub-Question 2: Which requirements of a model will capture essential characteristics of a rail yard to allow evaluation of safety and performance? (Model requirements)*

In order to find an answer to this sub-question, general shunting strategies will be considered first, after which specific strategies that take dangerous goods into account will be investigated. The goal is to find a method in the literature that can be used for the development of a heuristic model. There are various strategies for optimizing the performance of the shunting process at a shunting yard. There are also multiple methods for evaluating safety in the yard. In this chapter, the various strategies and methods will be discussed.

### 3.1. GENERAL SHUNTING STRATEGIES

The shunting process is a process in which incoming wagons (or containers) are sorted from different origins and form outgoing trains towards other destinations. It is essential to decide which train or wagons are sorted first from the arrival yard to the classification yard, because this can influence the efficiency of the shunting operation. There are different strategies for choosing which train or wagon to sort first, namely [49]:

- **First Come First Served:** The first incoming train is shunted first in this strategy. This strategy is easy to apply, but is not the most optimal choice in terms of the efficiency of the operation. There is no information beforehand needed for this strategy.
- **Shorter Train First:** This strategy does have the information in advance about the incoming trains and knows which train is the shortest. Therefore this could free up the arrival track faster.
- **Longest Train First:** This strategy also has the information in advance about the incoming trains and knows which train is the longest. Applying this strategy provides more wagons available for the departing trains.
- **Critical Train First:** This strategy determines which train has the highest priority in advance. It has a mixture of the above strategies and is difficult to model.
- **Last In, First Out [50]:** At yards where trains can only enter and leave from one side, this strategy is applied. This is similar to stacking containers.

The shunting strategy can be changed due to irregularities. It could be the case that there is a delay in train arrival and that another strategy is better for the operations.

### 3.2. SINGLE-STAGE SORTING AND MULTISTAGE SORTING

There is a distinction between single-stage sorting and multistage sorting. In single-stage sorting, the main challenge is determining the order of the wagons and where different wagons are divided into blocks before they go to the classification tracks. A block is a group of wagons with the same origin and destination or belong to the same train and will not be separated until they reach their assigned blocks [51]. During single-stage sorting, the wagons are distributed all at once in the yard, without any redistribution. If single-stage sorting is used, the number of classification tracks is very high, if every destination needs its own track, but the length of these tracks is shorter because they have fewer wagons. In multistage sorting, the wagons may be rearranged by pushing the wagons back and redistributing them in the classification yard.

#### Single-stage sorting

In the papers of Dahlhaus *et al.* [52] and Di Stefano and Koči [53] they used a single-stage sorting strategy and tried to minimize the number of tracks used for classification. This means that there are multiple destinations on a track, instead of one destination per track. This must be done without distributing wagons several times throughout the yard. So the order of placing is essential. In the research of Di Stefano and Koči [53], four strategies are used to optimize the problem. The scenarios differ by the number of entrances and exits the trains have. This creates several situations, which are all solved by a graph-theoretical approach. Jaehn *et al.* [54] performed single-stage sorting with the objective to minimize the weighted departure times. This is about reducing the delay compared to the scheduled departure time that is fixed. In this method, trains can depart at any time.

In the research of Saeednia *et al.* [33], an event-based model for single-stage sorting at a hump shunting yard was proposed. This model is capable of handling real-time changes in the system. The objective is to maximize the throughput of the shunting yard. The First Come First Served strategy was applied. Marinov and Viegas [55] used the event-based model for a flat-shunted yard with the same objective. Schasfoort *et al.* [6] used the event-based model to minimize the total weighted delay of trains in the yard. There is a difference between maximizing throughput and minimizing the total weighted delay, because if a train arrives too early, with maximizing throughput this train will have priority to depart over a delayed train. When minimizing the total weighted delay, the delayed train will have priority over the early arriving train. If there is no late arrival, it does not matter which objective function is chosen.

Event-based modeling is a method of representing knowledge about a discrete-event system, in which the dynamics of the system are represented by an event graph [56]. At each time step, the optimal sequence of trains for shunting is determined to maximize the throughput of the shunting yard. An interesting way of visualizing was presented in the paper of Schasfoort *et al.* [6] and is shown in Figure 3.1. This assignment plan can be used by the shunter to indicate where the wagon was placed and to verify that this corresponds to the location indicated.

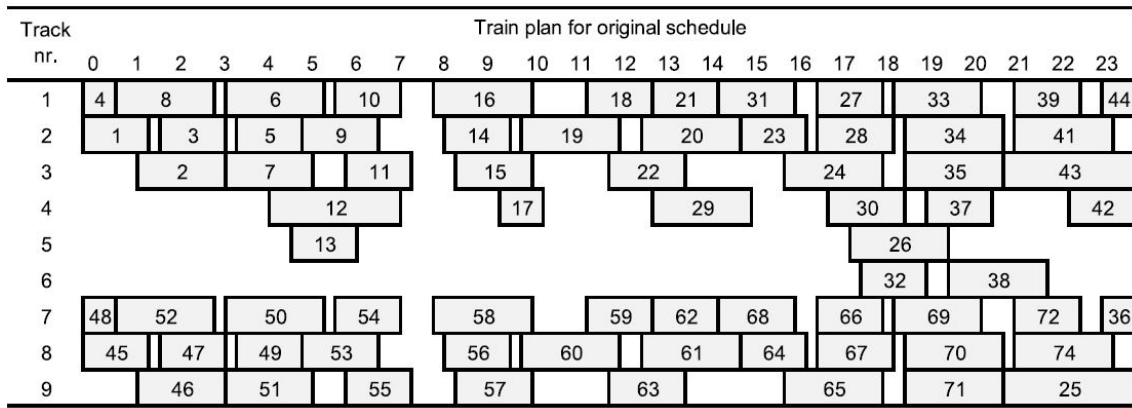

Figure 3.1: Assignment plan of trains in Waalhaven Zuid. The wagons, indicated by the boxes with number, are sorted over 9 tracks. The white color indicates available space. (Source: Schasfoort *et al.* [6])

In the research of Shi and Zhou [7], cumulative curves are used to model the number of wagons in the yard per time instance. For each yard type (arrival track, classification tracks, destination track), cumulative curves can be used to capture the arrival and departure activities of the wagons. Figure 3.2 shows an example of two cumulative curves. In the figure, the difference between the arrival time and departure time can be seen as a wagon's processing time. The area between the arrival and departure curves is the total processing time of the yard. A mixed-integer programming model is used to optimize the overall performance of the yard by minimizing the total processing times of the wagons.

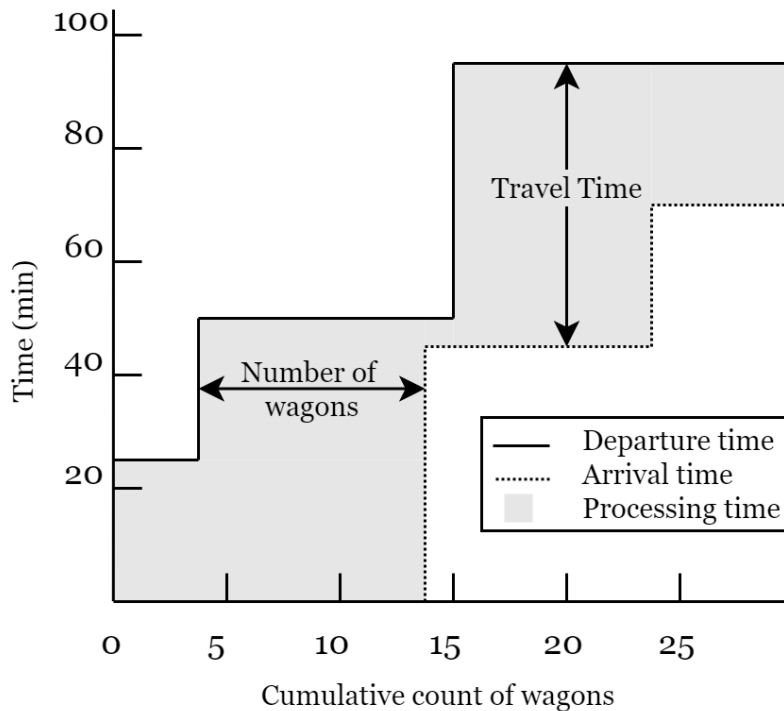

Figure 3.2: Cumulative arrival and departure curves (based on Figure 2 of [7])

### Multistage sorting

Multistage sorting is used when there is insufficient capacity to sort the trains in one sequence to the desired track in the preferred order. As a result, wagons must be pulled back or pushed forward and are reassigned to the correct tracks. There have been several studies on doing this as efficiently as possible. As a result, different

optimization strategies have been applied. Several multistage sorting strategies were described by Daganzo *et al.* [57]:

- Sort-by-train strategy: The arriving wagons are sorted according to departing trains on a set of tracks. When the departure time of one of the trains approaches, the wagons from the corresponding classification tracks are taken to the departing tracks and put together into an outgoing train.
- Sort-by-block strategy: The wagons are first sorted by block number. The block nearest the locomotive on all trains receive number 1, the next block is 2, etc. A second stage sort is done after a while and all the blocks with the same number are sorted according to train, starting from number 1. This strategy requires more tracks than the sort-by-train strategy, and it takes extra time to sort every wagon.
- Triangular sorting: This strategy is more complex than the strategies above, but require less classification tracks. The sequence number of the wagon groups is changed according to the total length of the corresponding trains departing with their total number of wagon groups.
- Geometric sorting: This strategy is similar to Triangular sorting, but the procedure uses a different renumbering and is followed by the same repetition process as in Triangular sorting [58]. Due to different assignment schemes, less classification tracks are occupied, but wagons groups are pulled back more frequently [59]. This strategy can make working with dangerous substances more difficult because too many actions are carried out with the wagons. This increases the risk of a leakage or collision, which must be avoided.

Of the four sorting strategies, sort-by-train is the most efficient, because the wagons are distributed faster, and fewer operations are needed to sort the wagons. This method takes into account the outgoing order in which the wagons should be placed. When working with dangerous goods, all dangerous goods of the same class could be sorted together on the same track with the same destination. An outbound train can then be made from these blocks, separating the wagons in the train. Sorting can be done without pullbacks and therefore there is less risk of collisions and leaks.

The dynamic block-to-track assignment is investigated by Kraft [60]. The main focus is on how to get the trains ready to leave for their next destination as early as possible. For this purpose, an algorithm was created that prioritizes wagons to ensure connections. The principle of Kraft [60] can come in handy when it is applied to wagons carrying dangerous goods. If these wagons are given priority, the probability of an accident occurring in the yard is reduced. It is important to note that in the Netherlands, the infrastructure manager (ProRail) is not allowed to give priority to particular trains in the expense of another train [6]. Therefore the strategy of Kraft [60] is not usable in this thesis.

Hauser and Maue [61] used deterministic multistage sorting to minimize the number of track pulls of the wagons. In the research, three new algorithms were developed and applied for the optimization problem of train classification. Gestrelus *et al.* [62] presented a novel optimization method for wagon sorting with the objective to minimize the number of extra track pulls of the wagons. The method is based on an integer programming formulation that is solved using column generation and branch and price. Büsing and Maue [63] had the same objective to minimize the number of track pulls of the wagons, but used a robust algorithm. This means that the algorithm can deal with errors at the execution time. When handling dangerous goods, it is good to reduce the number of track pulls of wagons, in order to reduce the probability of leakage.

Belošević and Ivić [64] presented an optimization model that minimized the number of steps and number of movements of wagons on the yard. The main optimization problem in this paper was to find the optimum between the number of sorting steps and the total number of wagon movements that indicate the length and complexity of the schedule.

A metric is proposed by Dirnberger *et al.* [65] to measure the quality of sorting strategies. The train assembly process is identified as the bottleneck in a classification yard. The study aims to minimize the dwell time of the wagons, as they spend half of the total processing time in a yard [66]. The dwell time is the time buffer between processes. This strategy is a good method for working with dangerous goods because it reduces the exposure risk (duration of the wagon with dangerous goods on the yard).



### Real-time management

Dimitrov *et al.* [67] proposed a real-time shunting yard management system that optimizes the available resources, and planning of the operations to decrease overall transport time and costs associated with cargo handling. For this, they considered the best heuristic or meta-heuristics optimization algorithm used for the optimization module. The available resources can be the locomotives and workers who ensure that trains can be distributed over the classification tracks. The planning of the operation can be seen as the assignment of trains to the tracks. They did this research for a large and complex yard.

Table 3.1: Overview of methods and objective functions proposed in the literature

Method	Objective functions
Single-stage sorting [68],[53], [7]	Number of tracks used for classification (minimize) Delay of wagons with fixed departure schedule (minimize) Total processing time (minimize)
Multi-stage sorting strategies [57], [61], [65],[62], [63],[60]	Number of tracks used for classification (minimize) Dwell times (minimize) Number of track pulls (minimize)
Event-based [55], [33],[49], [6]	Throughput of the shunting yard (maximize)
Real-time management [67]	Available resources and time planning (maximize)

### 3.3. SHUNTING STRATEGIES INCLUDING DANGEROUS GOODS

In the section above, the general shunting methods were examined. Now it will be investigated whether there is literature on shunting that also includes dangerous goods. In literature, two papers were found about shunting operations involving dangerous goods. These are discussed below first. In order to get more information about working with dangerous substances, an alternative has been searched for, namely the storage yard where containers with dangerous goods are stored. Here, a method is also used to store the containers with taking dangerous goods into account.

#### Dynamic risks

Dynamic risks are risks which may occur during shunting, for example due to an accident. During shunting, various things can happen, such as a wagon derailing or a wagon colliding with another wagon. Bagheri *et al.* [69] have done a study to evaluate different risk-based approaches for derailment during shunting of wagons with dangerous goods. In the research, a comprehensive risk minimization model is developed. The objective of the research is to minimize derailments of wagons with dangerous goods. This can be done by placing the wagons along a less prone route to derail along a given route. The first-come, first-served strategy does not consider the potential effect of the location of wagons with dangerous goods and is therefore not used. Instead, there is a two-step strategy applied. First, the best combination of wagons within each block needs to be determined. Second, the order of the blocks along a given train must be established. The optimal order of wagons within a block depends on the probability of derailment. This probability subsequently relies on the order of the blocks.

In a follow-up study of Bagheri *et al.* [70], a distinction is made between wagons with dangerous goods and wagons without dangerous goods in the sorting process. The first-come, first-served strategy is applied. Each classification track contains a continuous block of wagons sharing a common destination. When a block of wagons is ready for departure, it is taken in its entirety to the departure yard. This process involves the placement of wagons containing dangerous goods. Including looking at how the risk of derailment can be kept as small as possible. The risk is expressed in the probability of derailment on a specific track and the conditional probability of derailment on a specific wagon is also considered here.

Both studies considered the derailment probability of a wagon to determine the shunting strategy. They did not look at how the shunting process can be used optimally so that there are fewer delays in the schedule, or whether wagons with dangerous goods are on the yard for as short a time as possible. That is why static risks are now being considered below. These are risks that are related to wagons that have been placed. Because if wagons are stored somewhere, accidents can still happen, for example the leakage of gases or liquids. This

was also seen in the rules of RID [12]. Wagons that are incompatible with each other must be separated in the yard.

### Static risks

Xinmei *et al.* [71] proposed an optimization model for placing dangerous goods containers at a storage yard. There are decision variables for placing the containers with dangerous goods, which can be optimized. The first decision variable is to store different types of dangerous goods at different locations. If certain dangerous goods can be stored in multiple locations for selection, it is necessary to calculate whether they become more dangerous. The second decision variable is the number of times a container is moved. If a container is moved too often, it is likely to cause more internal damage and other problems. Therefore this needs to be minimized. This problem is solved using multi-objective Pareto optimization.

This study is based on a container yard, where containers are stacked on top of each other. Thus differing from a rail yard, where everything remains at the same height. But the method of determining whether dangerous goods belong together and therefore belong to the same location can be included in the model that will be built for this research. The 3D problem of this paper can be simplified to a 2D problem. In addition, the time a container stays at a location is longer than a wagon in a yard. This has a different exposure time and therefore the probability of occurrence is also different.

## 3.4. RISK ASSESSMENT METHODS

Erkut and Verter [72] found that most risk models use the concept of a danger zone. This is a geographical method to assess the risks for citizens living within a certain radius from the railway site. Risks are defined as the probability of an incident multiplied by the consequence of the incident. The risks are expressed in a number of fatalities. To determine the impact of escaping gas, the toxic concentration is determined, and then the topographical layout and current wind directions are considered. It is necessary to mention that it is unknown for each substance what the dose should be to be fatal for humans. Therefore, it is difficult to determine under which conditions fatalities will occur.

The risk assessment at a rail yard has features in common with the risk assessment for transport routes and fixed facilities [40]. As stated before, the risk is defined as the product of the probability of an undesirable event and its consequence. The probability can be estimated from historical data or calculated in stages using event tree analysis. In the report of Glickman and Erkut [40], six different chemicals are used in the risk assessment. The average volume per month and the critical levels are determined for each of these chemicals. Then the probability of a major spill is calculated and finally the worst-case impact radius is estimated.

Chu and Lyu [73] evaluated dangerous goods storage at a container yard. The event-tree technique is used to analyze accident scenarios. Each path of the event tree represents a scenario in which the probability can be calculated.

Bagheri [74] investigated the threat of stationary wagons with dangerous goods in sidings. Five types of accidents can occur: derailment on the mainline, collision on mainline, direct collision, braking failure and terrorist attack. The derailment and collision on the mainline can lead to collisions with the stationary wagons if it happens close. The report uses fault tree analysis and event tree analysis to evaluate scenarios.

Ke [75] did a risk assessment with the traditional bandwidth method. The risk of fatalities is based on the population exposure within a 400-meter radius considered a danger zone. The number of wagons is included in calculating the population exposure in the danger zone.

Table 3.2: Overview risk assessment methods

No.	Paper	Method	Risks
1	Glickman and Erkut [40]	Event tree analysis	Population exposure risk
2	Chu and Lyu [73]	Event tree analysis	Individual and social risks of LPG tank container
3	Erkut and Verter [72]	Bicriterion approach	Population exposure risk
4	Bagheri [74]	Fault tree analysis and Event tree analysis	Detonation of wrecked wagons
5	Ke [75]	Bandwidth method	Population exposure risk

### 3.5. DISCUSSION

This research focuses on the distribution of trains on a last-mile infrastructure. This chapter analyzes which train should be distributed first if there were multiple trains at the same time in the arrival yard. It turns out that the First Come First Served strategy does not require any advance information, which is helpful if the arrival time is unknown. There must be prior information about the length of the train for the other strategies and their contents. If this information is missing, these strategies cannot be appropriately applied.

Next, there is a crucial choice to be made between single-stage sorting and multistage sorting. The yard managers is required to choose the appropriate strategy for the distribution of the wagons on the classification yard. The train is divided into blocks that have a common classification scheme.

With single-stage sorting, the blocks are sorted to a destination track at once, and this requires many sorting tracks to sort all blocks to the right destination. This number of sorting tracks depends on the number of destinations that will be needed. So single-stage sorting is suitable for assembling fewer blocks for the different destinations.

In multistage sorting, a higher number of blocks can be achieved and it is less dependent on the number of sorting tracks. In this strategy, several blocks are placed on one sorting track, after which this specific track is sorted again. In this way ultimately there is a train with the right blocks present. Thus, multistage sorting reduces the number of tracks used to sort the blocks, but requires more work for the shunters and, therefore, takes longer before the trains are ready for departure. For this reason multistage sorting is mainly used at yards with many different final destinations. In addition, the wagons have to be moved more often which results in a higher risk of leakage of dangerous substances. In this study, the focus is on the last-mile infrastructure and limited destinations. Also it is assumed that there are enough tracks to carry out the single-stage sorting strategy.

To conclude, the **Single-stage sorting** is most suitable for this research because there are only a few destinations in the considered simulations, and in this way requires fewer operations for the movement of wagons, including the movement of the ones carrying dangerous goods. This reduces the probability of an accident occurring. In addition, the time a wagon spends in the yard is shorter compared to multistage sorting. [Table 3.3](#) shows the papers with single-stage sorting strategies and the methods that are most suitable for the simulation.

In the single-stage sorting, multiple papers used the event-based method. Saeednia *et al.* [33] used it for a humping yard and Marinov and Viegas [34] used the method for a flat-shunted yard. Schasfoort *et al.* [6] used an event-based optimization approach to minimize the total weighted delay of trains. The event-based model is capable of handling real-time changes in the system. Various events are designed for managing changes in the system over time. Apart from this event-based optimization, the idea of using cumulative curves [7] is an excellent method to show how long the wagons stay in the yard. Their optimization problem could reduce the processing time of the wagons in the yard. The main difference between the papers by Saeednia *et al.* [33] and Shi and Zhou [7] is that in the former, the optimal sequence of trains to be shunted is the most decisive factor in maximizing throughput. In the paper by Shi and Zhou [7] it is more about the timetable and the times when the wagons can be shunted.

To conclude, the performance indicator: total processing time from the research of Shi and Zhou [7] is con-

sidered in this research. The impact of having buffers can be well illustrated by the cumulative curves. The arrival and departure times of the wagons must be monitored and the formulas for this will be included in the creation of the model. In addition, it is assumed that no trains are arriving simultaneously in the last-mile infrastructure. Therefore, the order in which the trains are shunted cannot be chosen. The development of the model with this information is discussed in the next chapter.

Table 3.3: Extended overview of papers with single-stage sorting strategies from [Chapter 3](#) considered in the definition of the proposed methodology

Paper	Method	Objective	How	Pros	Cons
Saeednia <i>et al.</i> [33]	Event-based	Maximize throughput of the yard	Optimal hump sequence	Model is capable of handling real-time changes in the system	The model assumes multiple arrival tracks
Shi and Zhou [7]	Mixed integer programming, cumulative flow count	Minimize processing time	Designing efficient operational plans	The model has different ways for reducing the system waiting time given the fixed schedules	The model uses fixed train schedules
Schasfoort <i>et al.</i> [6]	Event-based	Minimize total weighted delay of trains	Optimal train to track assignment	The model can minimize the delay from the fixed departure schedule	The model does not take into account the shunting of wagons
This thesis	Heuristic-based	Minimizing total processing time and satisfy safety constraints due to dangerous goods	Designed a set of strategies triggered by scenarios dependent of percentage of dangerous goods and number of destinations	Solution approach is interpretable and requires few calculations. Capable of dealing with simulated scenarios up to 60% of dangerous.	Global optimal solution not guaranteed. Scalability for inclusion of a very high number of tracks destinations was not tested.

# 4

## MODEL DESIGN

In the previous chapters, research is described on which processes occur in a rail yard and what methods are used to distribute the trains over the different tracks. There have been many studies with varying strategies of shunting. However, in the literature, limited information is found on the distribution of wagons considering safety related to dangerous goods. In this chapter, the background information and qualitative literature study are brought together to support the definition and creation of the model, in which trains are distributed to specific tracks, while considering the safety in relation to transport of dangerous goods. With the help of the new video gate technology, more information is known about the contents of individual wagons. This information can be used to place wagons on the classification tracks without skipping entire tracks if there are types of dangerous goods that should not be together. Interviews with experts dealing with calamities at shunting yards indicated that the precise location of wagons with dangerous goods was unknown within the composition of a train. Therefore, all wagons from an arriving train that all still need to be allocated to the tracks, were considered to be hazardous. As a result, adjacent tracks may not contain any other dangerous goods class. The 'BLEVE' covenant shows that sometimes only a mandatory distance of 3 or 6 meters must be kept between stationary wagons. This makes it possible to place a buffer on the same track, i.e., leaving a space empty, thus guaranteeing the mandatory distances between wagons. Based on the research in Chapter 3 a single-stage sorting strategy was selected for this study as the most appropriate approach. The paper of Shi and Zhou [7] is used as a reference paper for the model development. This chapter answers the following sub-question:

*Sub-Question 3: Which steps are needed to develop the model? (Model design)*

The Sub-Question 3 is addressed first by the model development approach. In this chapter, the model development approach, problem statement and analysis, assumptions, and model structure are presented and explained.

### 4.1. MODEL DEVELOPMENT APPROACH

A model is a simplification of reality in which all the characteristics that are important for the description of the problem can be found. The model development that is used for this research exists of four steps [76]:

1. **Problem statement and analysis:** First, a clear problem statement is needed. This problem statement is defined in the introduction of this research. Then a problem analysis can be made. This step is partly done in the qualitative analysis and background information. It is essential to identify the problem precisely and understand the goal of the model. The characteristics of the model must be defined. In [Section 4.2](#), the problem statement and analysis is described further.
2. **Model formulation:** Create a mathematical model that fits the problem definition. This includes defining the decision variables, constraints, objectives, and input parameters. Provide clear explanations of the quantities and describe the connection between the problem and the portions. It is also important to make assumptions to set limits on what should be considered and make the research feasible. To build and solve the model for given problem instances, all formulas and assumptions must be entered into computer software. This second model step approach is described in [Section 4.3](#).

3. **Problem-solving with the model:** The model is applied in a case study with different scenarios. This case study helps to answer the main question of this research. Using different numerical values for the parameters makes it possible to analyze how the model is structured and whether it works for the other values. It is essential to define these scenarios in advance. The scenario assumptions are discussed in this chapter and the specific scenario description is elaborated in [Section 5.1](#).
4. **Verify and interpret the model's solution:** As a final step, it is essential to check whether the answer corresponds to reality. This is done in the sensitivity analysis in [Section 6.1](#). When the model does not match the research problem, the model must be adjusted. This can be done by taking a step back in the development process or by starting the whole development process again. After the problem is verified and solved, the results must be processed and conclusions are drawn.

## 4.2. PROBLEM STATEMENT AND ANALYSIS

The shunting process is usually addressed in the literature using optimization based approaches. Most papers have an objective function that is taken into account during the sorting of the wagons. This determines whether certain trains should be sorted earlier than others, for example. In that case, there are also several arrival tracks where the trains wait before they are sorted. The shunting process used in this thesis is based on the shunting process described by the paper of Shi and Zhou [7]. When a train arrives at the arriving track, a technical inspection is performed. A new element is that the train passes a video gate and the contents of the wagons are compared with the wagon list to verify its correctness. Then, the wagons and locomotive are uncoupled, and the wagons are pushed over a hump. This allows the wagons to be divided over several classification tracks. All wagons have a destination, which is also assigned to a particular classification track. In the paper of Shi and Zhou [7], it is possible to have only one destination on a classification track, but in this thesis there could be two destinations on one track. This limits the number of tracks needed. The shunting process continues until the wagons on the classification tracks can form an outbound train. For this purpose, all wagons are pushed to the departure track and coupled together. There are specific requirements for the number of wagons in a departing train. A locomotive is connected and the train is ready for departure.

In this model, the allocation of a destination to a classification track is done by a regulator. The total processing time is used as an important performance indicator for the decision-making.

Further, various strategies are used for deciding on a moment to let the train depart from classification track, depending on the degree of the track occupancy. In this research, a choice is made between letting a train depart with fewer wagons or waiting a little longer for the next incoming train so that a train with more wagons departs. Moreover, different threshold values are set to decide when a train waits or departs.

The purpose of the model is to choose the right strategy for analyzed scenarios. The model must provide the best possible performance by keeping the processing times of the wagons short. The model must consider the mandatory distances of 6 meters between certain dangerous goods classes, as indicated by the 'BLEVE' covenant laid down in the RID. These distances between the specific goods are indicated in [Figure 2.3](#). In this research, this is translated into compliance with the rules that have been established for the rail yard.

Two main constraints are defined for the placing of the wagons with dangerous goods [70]:

1. Keeping incompatible wagons with different types of dangerous goods separated from each other on adjacent tracks.
2. Maintaining a minimum wagon buffer between wagons with dangerous goods and occupied areas of the train on the same track.

This means that a certain action is required to maintain these constraints if two trains with incompatible substances are placed next to each other. This action is explained in [Section 4.3](#) modelling formulation. The second step of the model development approach is presented in the next sections.

### 4.3. MODEL FORMULATION

In this section, a high level structure of the model used in this study is introduced, followed by the assumptions set for this model and related scenarios.

#### 4.3.1. HIGH LEVEL STRUCTURE OF THE MODEL

The focus is on a last-mile infrastructure, which can be seen as a small shunting yard. The proposed layout of the model is shown in Figure 4.1. For distribution, there is a hump, over which the wagons are pushed and assigned to their destination by the switches. The model will have multiple tracks for classification. In this case, one arrival track, four classification tracks and four destination tracks are shown. During the case study, the specific track layout will be specified. The trains go to the loading facility, which can be seen as the train's destination. It is assumed that a train is authenticated by the smart cameras placed at the beginning of the yard, to show exactly which wagons contain dangerous goods. There is also a wagon list provided in advance, but as mentioned before, this can contain human errors. It is assumed that the amount of dangerous goods on the wagon list is correct.

For planning purposes, an estimated time of arrival of the trains is known. The trains must arrive within specific time slots according to the timetable. If a train arrives too early, a buffer time must be added so that the arrival is still cumulative.

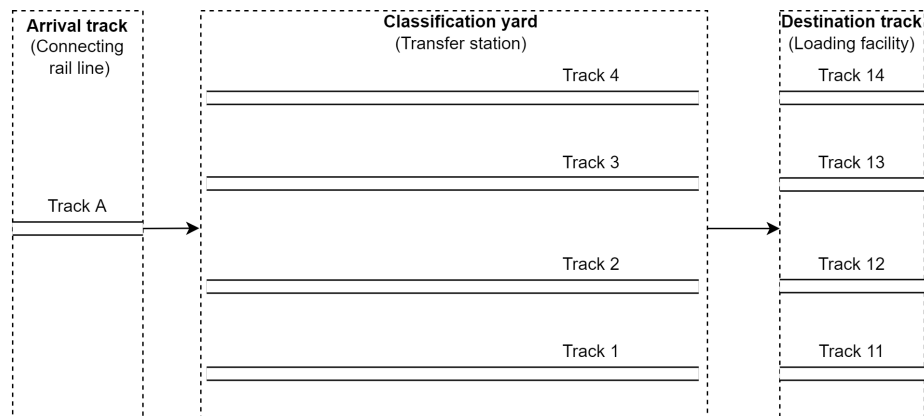

Figure 4.1: Proposed layout for the model

#### 4.3.2. LIST OF ASSUMPTIONS

In this section, the assumptions are formulated that are necessary for the development of the model.

##### Track layout

- The yard has a hump for classification purposes
- There is one arrival track
- The arrival track is long enough for one incoming train, and trains can enter the arrival track when the previous train is sorted. It is impossible to have more than one train on the arrival track
- It is assumed that on the arrival tracks it is allowed that two incompatible wagons are next to each other
- There are four classification tracks, and the tracks have the same lengths
- There are four destination tracks



### Time

- The arrival time of trains is known
- The shunting time duration is 1 minute per wagon
- The wagons are not allowed to stay longer than 48 hours in the yard

### Input data of the model

- The data is generated with a tool and ensures that the same number of trains is used in various scenarios
- There are minimal two different dangerous goods classes in the data set
- It is not possible that a destination has several dangerous goods classes
- Each incoming train contains all destinations
- There are always as many or more destinations than available classification tracks
- According to RIVM [77], the average number of wagons per freight train is 26.6. The model will specify a parameter for the wagon's length by allowing the train to take several wagon lengths.

### Application of the model

- Only one strategy is applied for an input data set
- The First Come First Served strategy is used for sorting
- The performance indicator is the total processing time of the yard
- The shunter knows exactly where to place the wagons on the yard
- The wagons on the classification track should immediately depart if the track becomes full

### Assumptions for the scenarios

After the model has been created, it will be subjected to a case study in which different scenarios will be tested. The model has different strategies built-in to ensure that it will respond to certain scenarios:

Scenario 1: Each track has its own destination and the share of dangerous goods per destination is equally distributed

Scenario 2: There are more destinations than tracks available and the share of dangerous goods per destination is equally distributed

Scenario 3: Each track has its own destination and the share of dangerous goods per destination is unequally distributed

Scenario 4: There are more destinations than tracks available and the share of dangerous goods per destination is unequally distributed

It is essential to indicate what proportion of the distribution of dangerous goods can be regarded as 'equal'. This model parameter can be changed during testing to see what impact this has on the model's outcome. It is important that there are always at least two different classes of dangerous goods present in order to clearly see the difference between the scenarios.

Four scenarios are tested, for which different strategies are required. The model can adapt to the scenario and thus recognizes what is going on and determines its strategy accordingly.

Table 4.1: Overview of scenarios for the case study

	Each track has its own destination	There are more destinations than tracks available
Share of dangerous goods per destination is equally distributed	Scenario 1	Scenario 3
Distribution is not equal	Scenario 2	Scenario 4

#### 4.4. SIMULATION MODELLING STEPS

In this section, the modelling is explained step by step. Chapter 2 addresses key performance indicators, which are expressed in measurable targets. In Chapter 3 the papers with the different performance indicators are discussed and the performance indicator of Shi and Zhou [7] is chosen. The capacity of the yard is represented by a cumulative flow count that is used for modelling general queuing systems [7]. This visual representation of the spatial capacity is shown by the shaded area in Figure 4.2. The same figure shows how the grey area comprises different wagons. The entire grey block consists of the blue slices indicated in the figure with an  $i$  and this an individual wagon that has its own processing time. This should show that taking the sum of processing times of all wagons  $i$ , equals the total processing time of the yard.

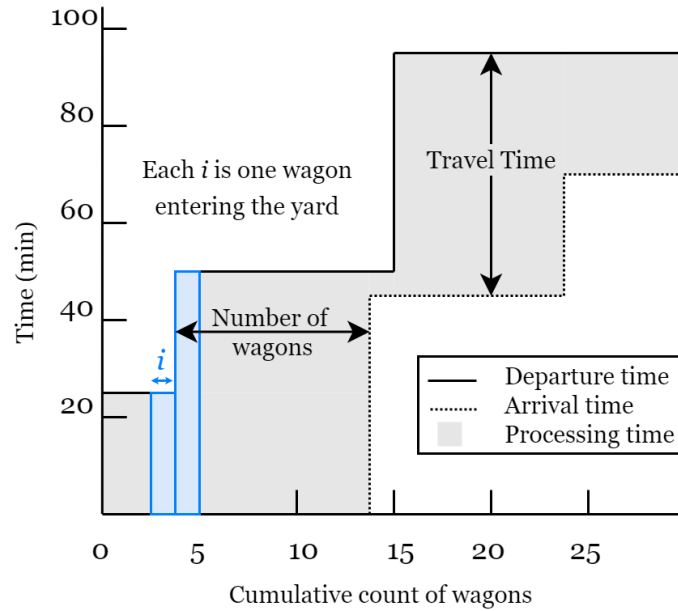

Figure 4.2: Arrival time, departure time and processing time as function of cumulative count. Each slice  $i$  is an individual wagon that has its own processing time on the yard.

The constraints and formulas of Shi and Zhou [7] are used as inspiration for creating the new algorithms. First, the general subscripts are described. These are the time index  $t = 0, 1, 2, \dots, T$ . The inbound wagons and outbound wagons are identified as  $i \in \{1, 2, 3, \dots, I\}$  and  $o \in \{1, 2, 3, \dots, O\}$  respectively. The destination index of the wagons is defined by  $b \in \{1, 2, \dots, B\}$ . Each classification track has its own number and this is defined by  $k \in \{1, 2, \dots, K\}$ .

The model will sort wagons over different classification tracks to their destination. The model has built-in algorithms that will apply the most suitable sorting strategy. The generic model consists of arrival of trains, identification of scenario, assigning the destinations of wagons to the classification tracks, compatibility check and placement of wagons, and finally departure of trains. The complete overview of the general conceptual model can be found in Figure C.1, in Appendix C. In Figure 4.3, the simplified conceptual model is shown as seven different blocks, and in the next sections these model blocks are discussed.

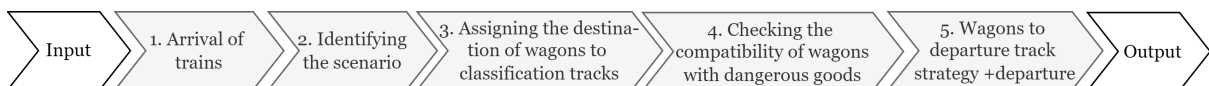

Figure 4.3: Overview of the general conceptual model

#### 4.4.1. INPUT OF THE MODEL

The first block of the model is the input of data. The number of trains remains the same for the different scenarios. The model must process this input to recognize the strategy to be applied to sort the incoming trains over the classification tracks. The data input for the model consists of:

- Wagon ID
- Wagon Length
- Dangerous good class
- Destination of the wagon
- Arrival time of the wagon

In the case study, the values for these input data are defined. Assumptions are made for the input data: it is not possible that a destination has several dangerous goods classes. There are minimal two different dangerous goods classes in the dataset. In addition, there are also parameters that can be defined. These are the following parameters:

- Length of the classification track
- Number of tracks
- Parameter  $p$  is the available track occupancy of a classification track. When the availability becomes smaller than this parameter, the departure of the wagons on the track can be initiated.
- Parameter  $w$  is the maximum waiting time for the next wagon to connect. If the next wagon connects later than the maximum waiting time, early departure of the train can be considered.

#### 4.4.2. STEP 1: ARRIVAL OF TRAINS

The input data indicates when a train will arrive on the arrival track and provides the data on the train composition. The given arrival time is assumed to be the scheduled arrival time without delay. Only one train at the time can stand on the arrival track. If the arrival time of trains is too close to each other, it is possible that the next train should wait on the main track. Therefore, extra time must be added to the arrival of the later train.

In the conceptual model, this is applied for the arrival time  $T^{\text{ARR}}(i)$  in the following function:

$$0 \leq T^{\text{ARR}}(i) < T^{\text{ARR}}(i+1) \quad (4.1)$$

To ensure that the arrival time is incremental in the model, a headway  $H^{\text{ARR}}$  is used which is defined by the following function:

$$T^{\text{ARR}}(i+1) - T^{\text{ARR}}(i) \leq H^{\text{ARR}} \quad (4.2)$$

The input data takes into account the increasing arrival times, so that trains do not arrive at the same time. The data therefore satisfies the constraints above.

#### 4.4.3. STEP 2: IDENTIFYING THE SCENARIO

In the second step, the input data is analyzed on the number of destinations and contents for a day. As indicated, the model will be tested against different scenarios. A scenario is the given input data to which the model must respond. Therefore, the model contains a regulator that understands what kind of scenario is taking place and can choose the corresponding strategy. First, the regulator checks whether there are as many classification tracks as destinations. If that is the case, scenario 1 or 2 is happening, and the regulator should

apply strategy 1 or 2. Next, the information on proportion of dangerous goods per destination is required. The share of the dangerous goods per direction is calculated by the total number of dangerous goods for destination  $b$ , divided by the total number of wagons of destination  $b$ . It is assumed that each incoming train contains all destinations. It is also assumed that there are always as many or more destinations than available classification tracks. The algorithm to identify the scenario is shown in Figure 4.4.

After the scenario has been determined, the strategy with the corresponding number is applied. This has to do with the amount of destinations of the wagons in the train and the amount of hazardous substances taken into account by the algorithm. It is thus not possible to have another strategy for a scenario.

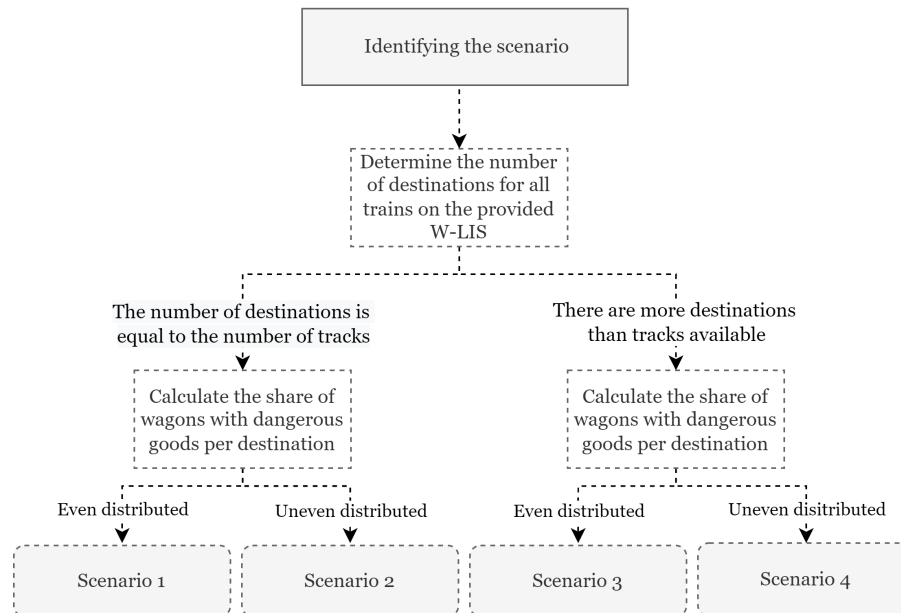

Figure 4.4: Algorithm step 2, Identifying the scenario

If each destination has the same number of dangerous goods, strategy 1 must be applied. If one destination has no dangerous goods, strategy 2 must be implemented. There is little difference between strategy 1 and 2 if there are not at least two destinations with dangerous goods present.

There may be more destinations than classification tracks. In that case, the regulator chooses between strategy 3 or strategy 4. This depends on the distribution of dangerous goods over the various destinations. If the destinations contain the same number of dangerous goods, then strategy 3 is applied. If, one destination has no dangerous goods at all and the others do, the model should assume strategy 4. If there are more destinations than classification tracks, two destinations may be sorted onto the same track. These should not be destinations with different dangerous goods classes. The two destinations with the smallest share of dangerous goods in the same class are then sorted onto the same track.

If it appears that no scenario is recognized by the algorithm, strategy 4 is automatically executed. It may happen that no two hazardous materials classes are present, so that the model cannot recognize which scenario it should apply.

#### 4.4.4. STEP 3: ASSIGNING THE DESTINATION OF WAGONS TO CLASSIFICATION TRACKS

After determining which scenario is applicable, the corresponding strategy will be applied. This strategy is important for assigning the destinations on the classification yard. Only 1 of the 4 strategies for sorting wagons in the classification yard is applied each time. All strategies apply the sorting according to the First Come First Served strategy. In this process, a wagon with a particular destination goes to the assigned track in the order of the position in the train. The wagons in the front of the train are sorted first. The location of the front and back of the wagon are calculated in relation to the end of the track. In the case of the first wagon, the front is

equal to the track length. The back is equal to the track length minus the wagon length. The front end of the next wagon is equal to the back end of the last wagon. This second wagon's back is again equal to the previous position minus the current wagon length. This is calculated for all wagons until the track is full.

The shunting time  $C(i)$  of the wagons from the arrival track to the classification track is cumulative and is indicated as the classification time. The classification time of the wagons is the arrival time of the train plus the waiting time before the actual wagon is sent to the classification yard. So suppose the 28th wagon of the first train is arriving at time  $T^{ARR} = 0$ , then the 28th wagon has to wait for the shunting movements of all wagons before and therefore gets a waiting time  $t^{wait}(i)$  of 28 minutes. The classification time becomes  $C(i) = 0 + 28 = 28$  min.

$$0 \leq C(i) \leq C(i + 1) \quad (4.3)$$

$$C(i) = T^{ARR}(i) + t^{wait}(i) \quad (4.4)$$

As indicated before, there are different strategies that the model could apply. The strategies are discussed below.

*Strategy 1: Each track has its own destination and the share of dangerous goods is equal*

In the first strategy, destinations are assigned to a classification track. Since the share of dangerous goods is equal, the order of destinations does not change. This means that each destination has a specific classification track with the corresponding number. In the model, this is called 'sort wagons according to destination' and is shown in Figure 4.5. In step 4, the position of the wagon on the classification track is calculated and a compatibility check is performed.

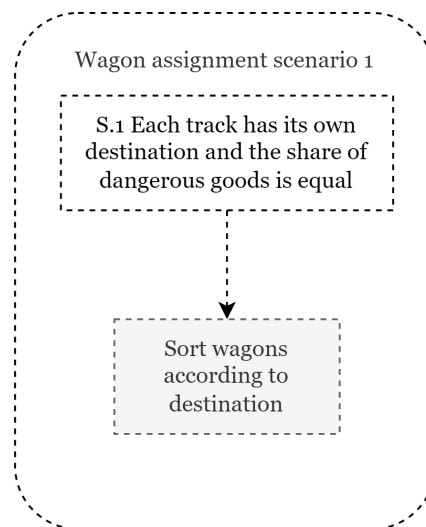

Figure 4.5: Step 3, strategy 1: Each track has its own destination and the share of dangerous goods is equal

*Strategy 2: Each track has its own destination and the share of dangerous goods is unequal*

In the second strategy, it is necessary to check if the destinations with different dangerous goods classes are not located next to each other. In step 2, the calculation of the percentage of dangerous goods per destination was done.

The model uses the data to determine which track is assigned to which destination. The model first determines which destinations have the least amount of dangerous goods and which have the most. Then the destinations with the most dangerous goods are separated if it also appears that these are goods that should not be together. In Figure 4.6, this is called 'Change the lateral order of destinations of the tracks'. If there is a destination

without dangerous goods, then that destination is placed on a track in the middle, automatically forming a buffer. This specific algorithm is shown in [Figure 4.7](#). If there is no destination without dangerous goods, then the algorithm shown in [Figure 4.8](#) is used. This scheme shows all possible cases on the left and solutions on the right.

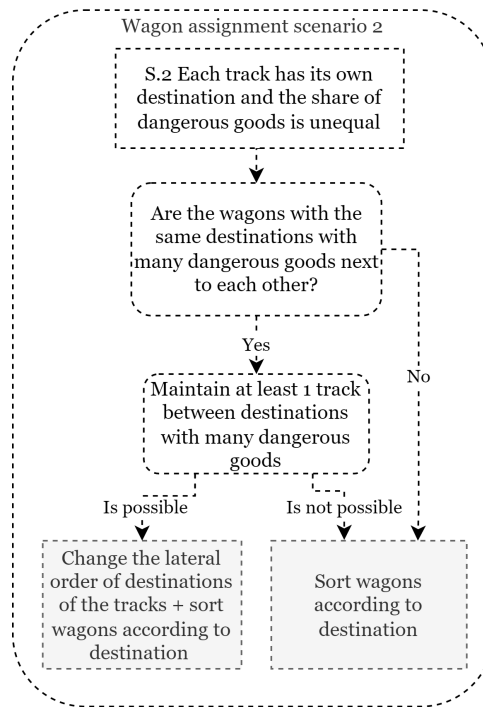

Figure 4.6: Strategy 2: Each track has its own destination and the share of dangerous goods is not equal

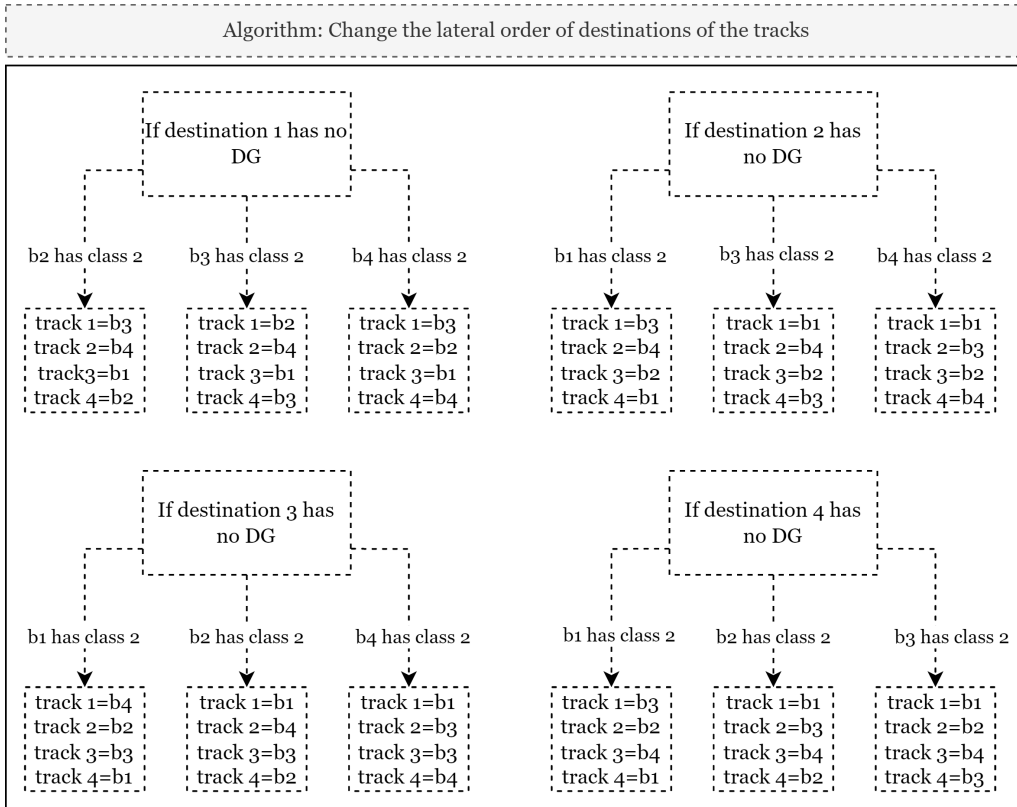

Figure 4.7: Algorithm: Change the lateral order of destinations of the tracks if there is a destination without dangerous goods



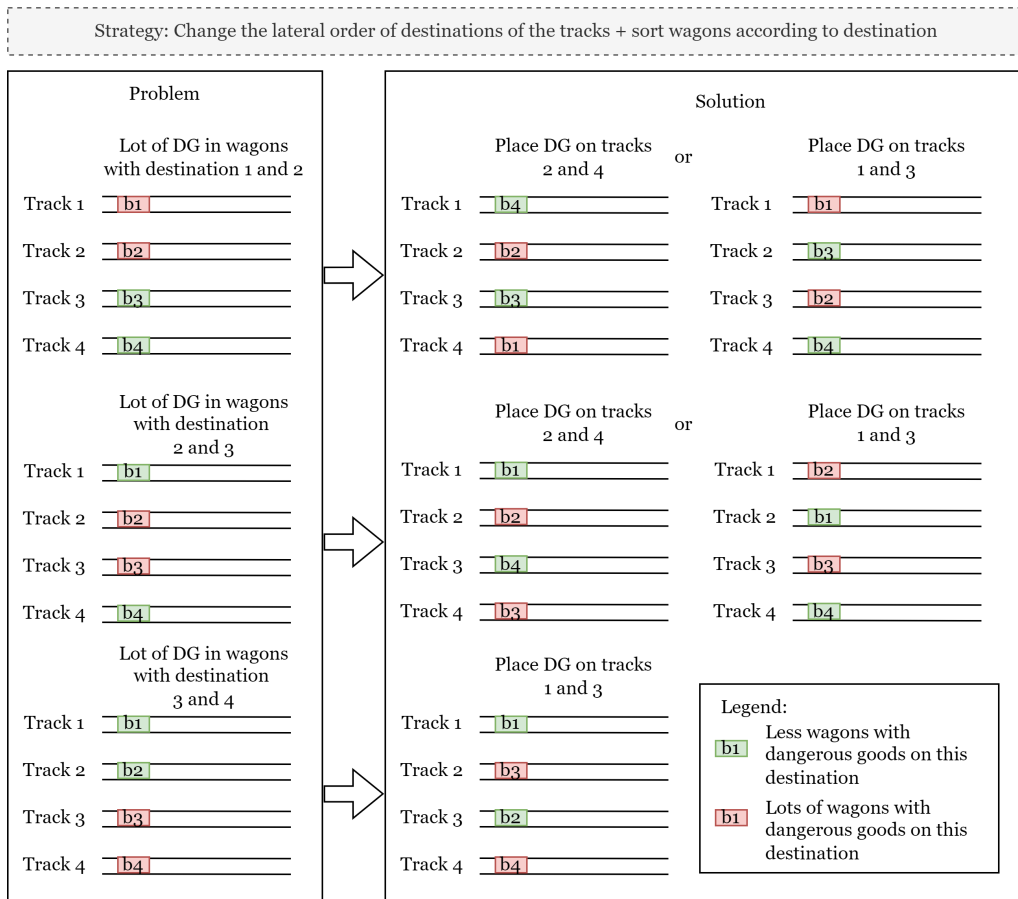

Figure 4.8: Algorithm: Change the lateral order of destinations of the tracks if the destinations with a lot of dangerous goods are next to each other

*Strategy 3: There are more destinations than tracks, and the distribution of dangerous goods over the destinations is equal*

First, this strategy must determine how many destinations there are in total in the supplied data. If there are more destinations than tracks for classification purposes, then destinations must be sorted together on the same track. It is important to decide which destinations should be placed together on the same track. The destinations with the same dangerous goods classes may be grouped, if the adjacent track has the same dangerous goods class. It is assumed that the destinations have approximately the same number of dangerous goods wagons in this scenario. In [Figure 4.9](#), the algorithm is shown for choosing which destinations are sorted on the same track.

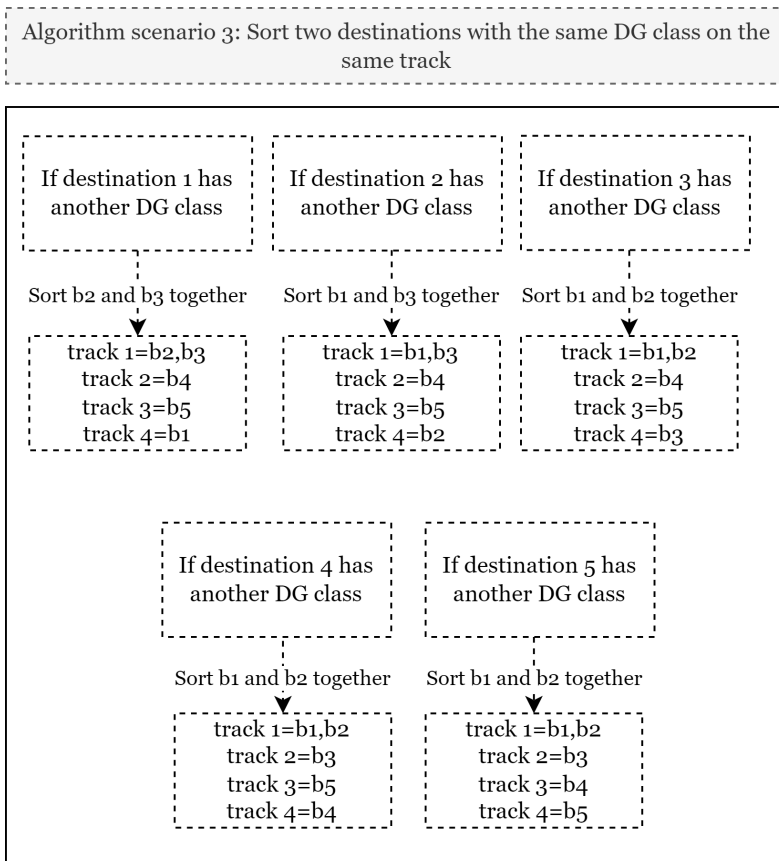

Figure 4.9: Algorithm of Scenario 3 in which destinations with the same DG class are sorted on the same track

*Strategy 4: There are more destinations than tracks and the distribution of dangerous goods over the destinations is unequal*

This scenario is different from Scenario 3 because the proportion of dangerous goods per destination is not the same. It is possible that some destinations contain no dangerous goods at all, or that there are dangerous goods in limited quantities. This provides an option to put the destination without dangerous goods in between the destinations with dangerous goods. This automatically creates a separation between the goods. There must be at least two destinations containing dangerous goods and different classes. The first step is to determine how many destinations there are in total for this strategy. Then the number of dangerous goods present per destination is considered. This is necessary to determine on which tracks the destinations will be located. The destinations with the same dangerous goods class may be sorted together. As much distance as possible should be kept between the different hazard classes. So, ideally, there should be two destinations with the same hazard class on track 1 and the other hazard class on the furthest track. In between should be a track with less or none dangerous goods, so that fewer buffers are needed. This algorithm is illustrated in [Figure 4.10](#).

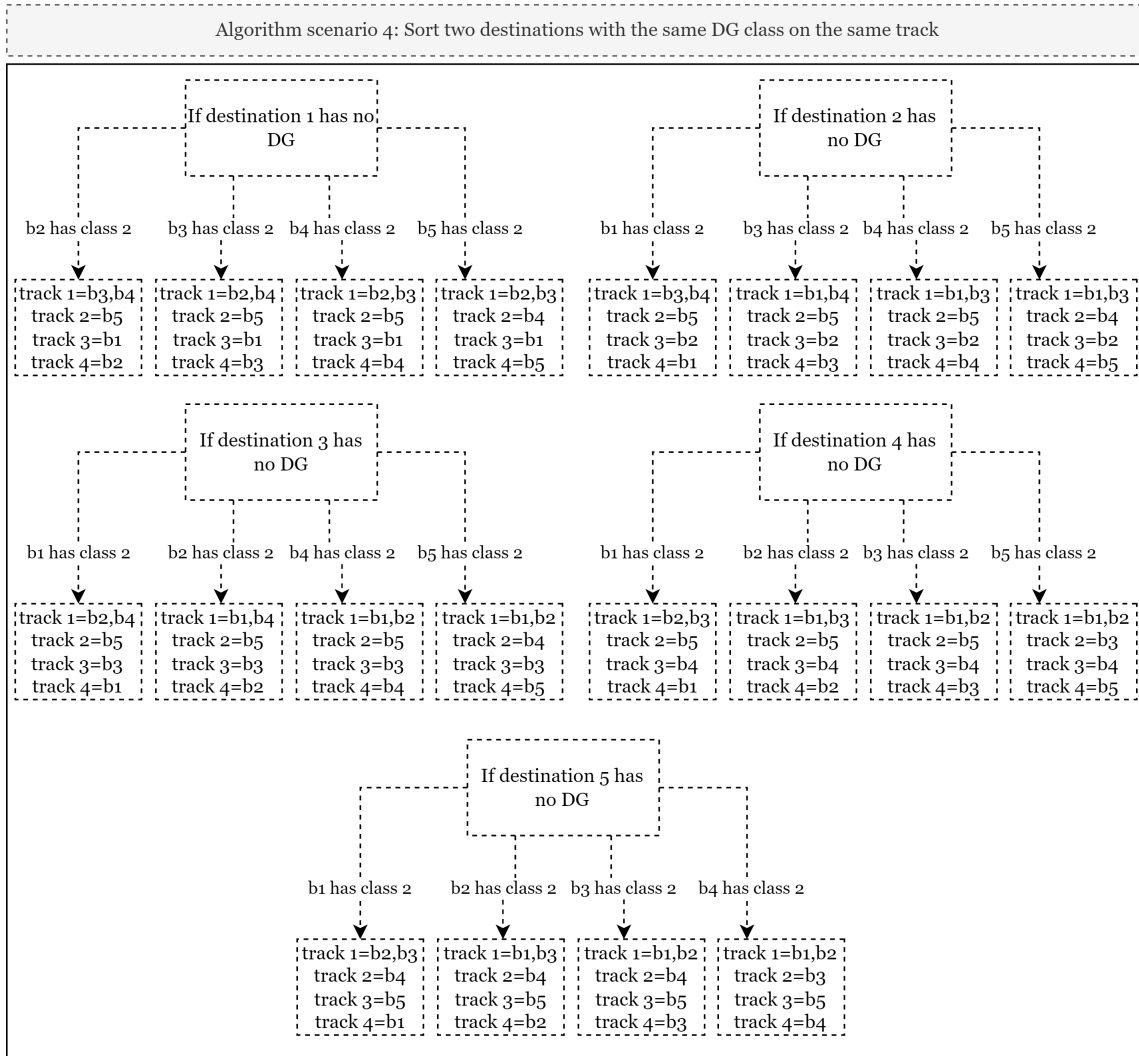

Figure 4.10: Algorithm of Scenario 4 in which destinations with the same DG class are sorted on the same track and the destination with least/no DG are placed in the middle as buffer track

#### 4.4.5. STEP 4: CHECKING THE COMPATIBILITY OF WAGONS WITH DANGEROUS GOODS AND WAGON PLACEMENT

In the previous step, the destinations of the wagons were assigned to the tracks. In this step, the positions of the wagons on the track are determined. Here the wagons without dangerous goods can be shunted and immediately connected to the wagons already in position. For wagons carrying dangerous goods, it must be ensured that no incident occurs if the wagons are placed on the track without a buffer. The wagon's position with dangerous goods in relation to the other wagons containing dangerous goods on the next track must be determined. This is done using overlapping intervals. The position of the front and back of each wagon is logged. If it turns out that the wagon has an overlapping interval, they could be incompatible with each other. Therefore, it must be checked if the segregation table allows them to be next to each other. If that is not the case, the wagons must be separated. In the model, there is a function that counts the amount of buffers and the incidents prevented with them.

##### Algorithm: Buffer on the same track

The algorithm uses a buffer on the same track. The length of the wagons plays an important role here, as does the distance between the tracks. The algorithm to check the distances and compatibility of the goods is shown in Figure 4.11. An example of the working of the algorithm is shown in Figure 4.12.

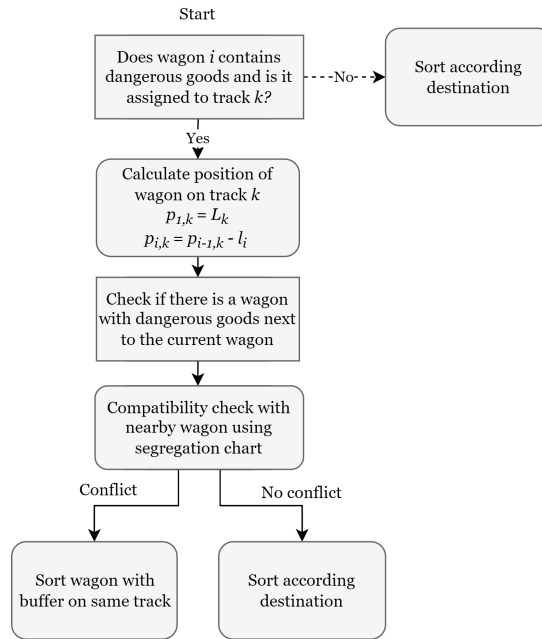

Figure 4.11: Proposed algorithm 4.1 for checking the compatibility of dangerous goods

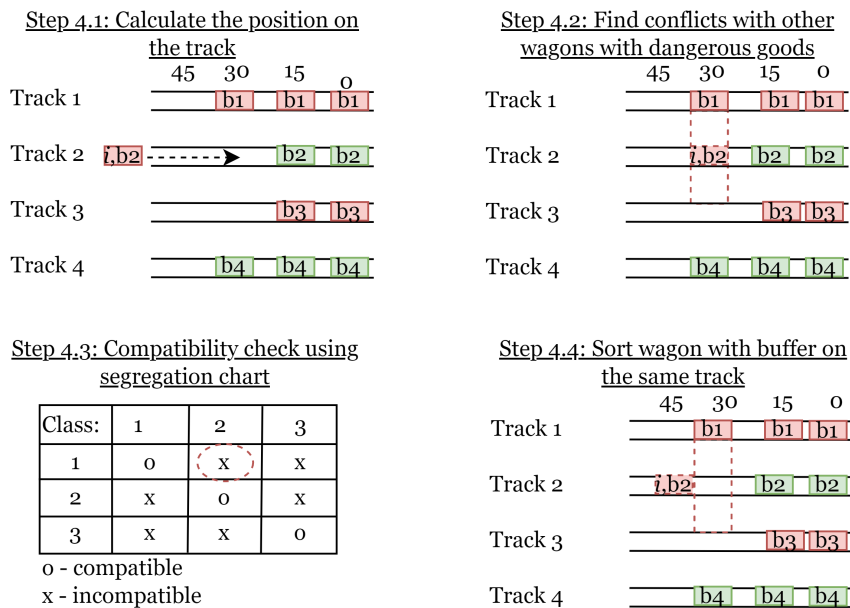

Figure 4.12: Example of the working of algorithm 4.1 for checking the compatibility of wagons with dangerous goods

An essential element of the Figure 4.11 is the length of the buffer to be determined. It is essential to choose the correct buffer, which is not too large, so that the capacity of the track becomes smaller than necessary. The buffer cannot be too small either; otherwise, the wagons' distance will not be large enough. The buffer distance depends on the wagon with dangerous goods next to it, see Figure 4.13. If a buffer must be placed between wagons carrying dangerous goods, it is marked with  $\emptyset$  as ID to indicate that it is a buffer and not a wagon.

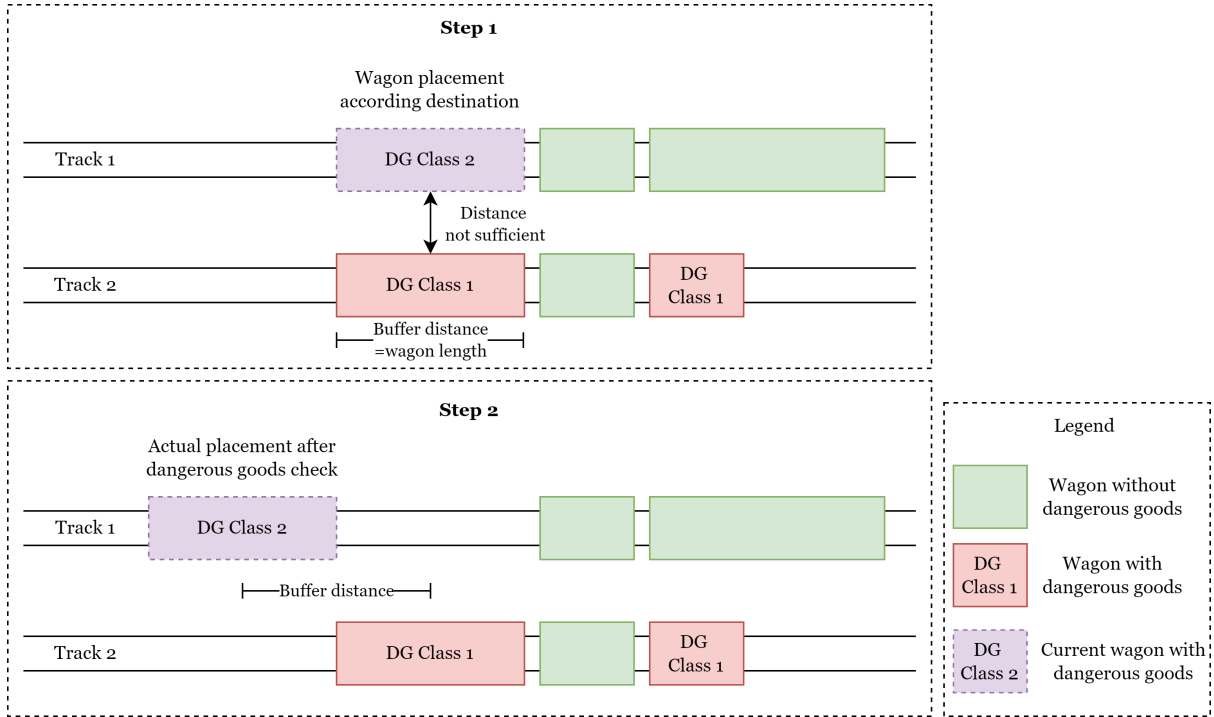

Figure 4.13: Example to show the buffer distance

#### 4.4.6. STEP 5: WAGONS TO DEPARTURE TRACK AND DEPARTING STRATEGY

After the compatibility check, the wagons are placed in the correct position on the track. When the tracks start to get full, the departure procedure can be initiated. The wagons are pushed together and sent to the departure track. Here, the wagons are coupled and a locomotive is connected. The train then departs. The departure time of the wagons on the classification track depends on the amount of track occupied and the time before the next wagon can connect. The departure time of a wagon is therefore the sum of the time of classification and the waiting time on the classification track  $t^{\text{waitclass}}(i)$ .

$$T^{\text{DEP}}(i) = C(i) + t^{\text{waitclass}}(i) \quad (4.5)$$

The algorithm for sending the wagons to the departure tracks is shown in Figure 4.14.

As described before, there are two parameters that must be met before a train is allowed to depart:

- Parameter  $p$  is the available track occupancy of a classification track.
- Parameter  $w$  is the maximum waiting time for the next wagon to connect.

First, it is checked whether the classification track becomes full during classification of the incoming train. If during classification the classification track reaches capacity, all the wagons are moved to the departure track. After the last wagon is sorted on the classification track the model determines again the track occupancy. If the available track occupancy  $p$  is 0%, all the wagons should depart. Next, a specific threshold should be defined for available track occupancy parameter  $p$ . If the available track occupancy is less than the threshold, the wagons may go to the departure tracks, provided that the maximum waiting time parameter  $w$  is met. If the next wagon arrives within the specific maximum waiting time, departure will be delayed. If it takes longer than the maximum waiting time  $w$ , the wagons will depart earlier. The parameters  $p$  and  $w$  should be fine-tuned to find the lowest processing times.

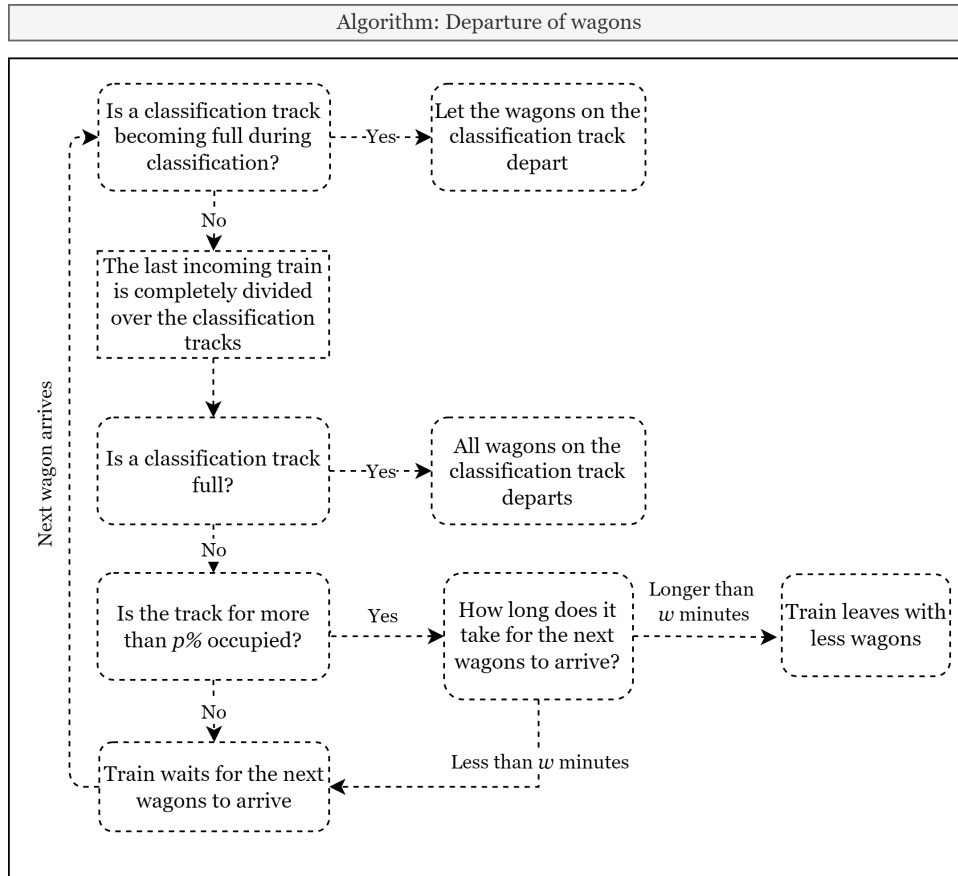

Figure 4.14: Proposed algorithm to check if a train is ready to depart

#### 4.4.7. OUTPUT OF THE MODEL

The model gives the placement of the wagons on the correct location on the track, with the correct buffer distance. The following elements are shown per track in a table:

- Wagon ID
- Wagon length
- Dangerous class
- Position of the head of wagon
- Position of the back of wagon
- Arrival time
- Departure time

The second output are graphs similar to Figure 4.2 and shows the processing time of all the wagons per classification track. The processing time of an individual wagon is calculated by the absolute value of arrival time minus the departure time of each wagon. This is the total time a wagon spends on the yard. The total processing time for the whole yard is calculated by taking the sum of all the individual processing times. The equation to calculate the total performance is the following:

$$W = \sum_{i=0}^I |T^{\text{ARR}}(i) - T^{\text{DEP}}(i)| \quad (4.6)$$

## 4.5. CONCLUSION

This chapter presented the model. Assumptions have been made to delineate the model. As an answer to the sub-question: ‘Which steps are needed to develop the model?’, the following steps are presented in this chapter with algorithms:

- Step 1: Arrival of trains
- Step 2: Identifying the scenario
- Step 3: Assigning the destination of wagons to classification tracks
- Step 4: Checking the compatibility of wagons with dangerous goods and wagon placement
- Step 5: Wagons to departure track and departing strategy

There are crucial decisions that the model has to make. The first decision is to choose the right strategy for assigning a destination to a classification track. The second decision is the position of a wagon on the classification track. The third decision is the time at which a wagon leaves the departure tracks and proceeds to its final destination. The formulas for determining the arrival time, classification time and departure time are formulated, as well as the algorithms that describe the shunting process.

The aim here is to keep the processing time of the wagons short to reduce the risk of an accident. The model can be used in practice when rolling out smart cameras in the future. It is essential to also consider how realistic all assumptions are. First of all, the model assumes that the shunter always knows the exact distances in the yard. So the model assumes that a wagon will be placed exactly at a position relative to the beginning or end of a track. In reality, distances are not marked on the yard, but blocks are made on the track where wagons fit. Here the shunter reports the position of a wagon in relation to another wagon. The length of the wagon does not necessarily matter. For the application of this model, some kind of distance indication on the yard would be necessary to see if the wagons keep the proper distances.

In the next chapter, the model is applied and tested in a case-study. Different scenarios are used to show that the model is capable to adapt to that specific scenario.



# 5

## SCENARIO MODELLING

A model to sort freight wagons considering dangerous goods was presented in the previous chapters. The model is used in this chapter to perform numerical simulations to understand two key parameters: available track occupation  $p$  and maximum waiting time  $w$ . The aim is to see what effects these parameters have on the performance of the whole system and how the model works for different input scenarios. The sub-question answered in this chapter is the following:

*Sub-Question 4: How can the model be applied and tested? (Model application)*

This chapter shows a case study with different scenarios and explains how the model works for each scenario. Numerical experiments are conducted to test the computational efficiency and effectiveness of the model. A section of a rail yard in the Netherlands is considered for the case study. At the Westhaven in Amsterdam, there are small yards where the wine industry works with dangerous substances. The case study is based on this area and includes wagons with ethanol that are stored and processed [78]. Ethanol is a flammable liquid with dangerous good class 3 and GEVI number 33. There is also another dangerous goods class included in the case study, class 5.1. The segregation table states that class 5.1 is incompatible with class 3 and therefore compulsory distance is needed between the two classes. Based on Sporenplan.nl [79], the layout of the number of tracks are considered in the model.

This case study allows the evaluation of different strategies for the sorting process of wagons. The simulations consider about 13 hours of operation, and the total simulation time is given by the moment when the last train arrived (at minute 775) leaves the yard. All the scenarios have the same amount of trains with the same arrival times. The content of the wagons is different per scenario and defined by a rate, from which the total number of wagons with dangerous goods is obtained for the scenario. Then, a uniformly distributed random process defines which wagon will contain the dangerous goods. In the analysis, conclusions can be made on the effect of the percentages of dangerous goods in the sorting process. Finally, we can determine the performance and the limitations of the model under different scenarios.

For the case study, the layout and input data are examined. The model consists of the following elements:

- 1 arrival track: long enough for one incoming train.
- 4 classification tracks: the length of all classification tracks are the same, 650 meters. The accepted length of a freight train in the Netherlands is 650 meters.
- We assume six switches and crossings are available in the yard (three at the arrival zone and three at the departure zone); however, for simplicity, their operation is not considered in the model.
- 4 destination tracks: long enough for one departing train.
- We evaluate the case when there is no track available for the sorting operations. Thus, once a wagon is assigned to a track, there is no possibility to revert this decision. Further, a queue is formed at the single track before the arrival zone, for example when the arrival times of consecutive trains are short and the arrival track is still occupied.

The required input data are the following:

- Number of wagons: A train can be 20 or 30 wagons long.
- Wagon lengths: There are two possible lengths: 6 and 15 meters.
- Destination of each wagon: Depending on the scenario, there are 4 or 5 different destinations.
- Arrival time of each train: A number between 0 and 775 minutes.
- Content of each wagon: There are three types of contents, of which two types of dangerous goods class are present that are incompatible with each other and must be placed at least 5 meters apart: DG 0=non-dangerous, DG 1=dangerous class 3. DG 2=dangerous class 5.1. We assume only one dangerous goods class is present per destination.
- Input parameters: The available track occupancy  $p=15\%$  and maximum waiting time  $w=15$  minutes for all scenarios

## 5.1. SCENARIO 1: EACH TRACK HAS ITS OWN DESTINATION AND THE SHARE OF DANGEROUS GOODS IS EQUAL

### Input data

The train is divided over 4 destinations. In the first scenario, 32 incoming trains with 840 wagons are used. The destinations have 224, 188, 176, and 232 wagons. Of these, 132, 104, 84, and 104 wagons contain dangerous goods per destination. The choice was made not to do the same number of dangerous goods per destination but to distribute them more or less equally in proportion to the number of wagons. Destination 3 is the only destination with dangerous goods class 5.1; the other destinations have class 3. In the model, class 3 is indicated as DG 1, and class 5.1 is indicated as DG 2.

### Step 1: Arrival of trains

For the arrival times of the trains, there is no fixed interval. This was chosen because it gives the extra option of allowing trains that are not yet complete to depart if it takes too long for the next train to arrive. Step 1 in the model is the same for all other scenarios. They all have the same arrival times and a number of trains.

Table 5.1: Example of Scenario 1: Arrival times of the first 8 incoming trains

Train id	1	2	3	4	5	6	7	8
Time (min)	0	73	85	102	119	141	173	183

### Step 2: Identifying the scenario

The model calculates the share of dangerous goods per destination based on the input data. Together with the number of tracks, the model can determine which strategy should be applied. In this case, the rates of dangerous goods per destination are: 54, 55, 48, and 45%. Therefore, the model recognizes a scenario in which there are as many tracks as destinations and the rates of hazardous substances per direction are more or less the same. The model, therefore, produces strategy 1 as output.

### Step 3 & Step 4: Wagons to classification yard strategy & Checking the compatibility of wagons with dangerous goods

The model now executes strategy 1 and keeps the order of the destinations over the tracks. Destination 1 goes to track 1, destination 2 to track 2, destination to track 3 and destination to track 4. In the model, there is a function which counts the number of buffers that prevents incidents between two wagons with different dangerous goods classes. No buffers are placed on track 1 as track 2 has the same class of dangerous goods.

Track 2 has 7 buffers. Track 3 has a different class of dangerous goods and there are 67 buffers. Track 4 contains 2 buffers.

### Step 5: Wagons to departure track and departing strategy

The model determines when tracks are reaching their capacity. This is possible because the position of each wagon is calculated, including the length of the buffer spaces between wagons. The model determines when the wagons can depart. Classification track 1 is used as an example to show the process of departure of wagons. A choice has to be made, whether the wagons leave when the track is complete or after an incoming train has been distributed and does not wait until the track is entirely full. The model calculates the available track occupancy after the last wagon is sorted from an incoming train. If the available track occupancy is lower than the defined parameter  $p=15\%$ , the departure of the wagons is triggered. The exact departure time depends on the maximum waiting time parameter  $w$ . This parameter is equal to  $w=15$  minutes. If it takes longer than 15 minutes before the next wagon arrives, the train can depart. This ensures that the waiting time is not too long for the wagons already on the classification track.

In Scenario 1, there are 32 trains arriving. The model determines how often the tracks will be full and thus how many trains will have to leave. There are three moments when the tracks are completely filled with wagons. So there will be three decision moments to determine whether the wagons can leave on the classification tracks or are still waiting for the next wagon. In Table 5.2, the three departure choices are shown. Based on the first departure of the wagons, the table is explained. When the last wagon arrives of one incoming train, at the classification track, the time equals 231 minutes. The condition for available track occupancy  $p$  is less than 15% and meets the requirement. The time at which the next wagons connect so that the track is completely filled is 238 minutes, which takes an additional 7 minutes. This waiting time is lower than the maximum waiting time of 15 minutes, so it is decided to wait so that the full capacity is used of a classification track.

Thus, a trade-off must be considered when deciding on the actual departure choices. In this case, the model chooses to wait for connecting wagons because it takes less than 15 minutes for the last wagons to connect. So the departure times of the trains on classification track 1 are representative at 238, 475, and 695 minutes. When the last incoming train has been distributed and the last wagons have been sorted on this track, the wagons that are still there may also depart.

Table 5.2: Example: Choices for determining the departure time of a train on track 1

	Departure time outbound train 1	Departure time outbound train 2	Departure time outbound train 3
Option 1: Time when track is full (min)	238	475	695
Option 2: Time when last wagon of incoming train arrives (min)	231	471	681
Differences between options in time (min)	7	4	14
Maximum waiting time $w$ (min)	15	15	15
Chosen departure time (min)	238	475	695

### Output

The first output of the model are tables with information about which wagon was where on the classification track, including its contents, wagon position, arrival time and departure time. There is a table for each classification track. An example of what the output table looks like is shown in Table 5.3.

Table 5.3: Example: Output of model indicating the wagon ID, wagon length, dangerous goods class, position of the front and back of the wagon, arrival time and the departure time of classification track 4. The '∅' indicates an empty space.

Wagon ID	Wagon length(m)	DG class	Front of wagon (m)	Back of wagon (m)	Arrival time (min)	Departure time (min)
7	15	0	650	635	0	227
13	6	0	635	629	0	227
∅	6	∅	629	623	∅	∅
15	6	1	623	617	0	227
19	6	0	617	611	0	227
21	6	0	611	605	0	227
22	6	0	605	599	0	227
∅	6	∅	599	593	∅	∅
24	6	1	593	587	0	227
25	6	1	587	581	0	227

The model calculates the performance of the different classification tracks by taking the absolute value of the arrival time of each wagon minus the departure time. This gives the following result per classification track:

- Track 1: 39523 minutes
- Track 2: 36004 minutes
- Track 3: 29357 minutes
- Track 4: 34751 minutes

The corresponding cumulative curves of the classification tracks are shown below. The result of this scenario is a performance time of a total processing time of 139635 minutes. The number is converted to 2.77 hours per wagon on average that a wagon was on the yard. This is calculated by dividing the total time by 60 and the total number of wagons.

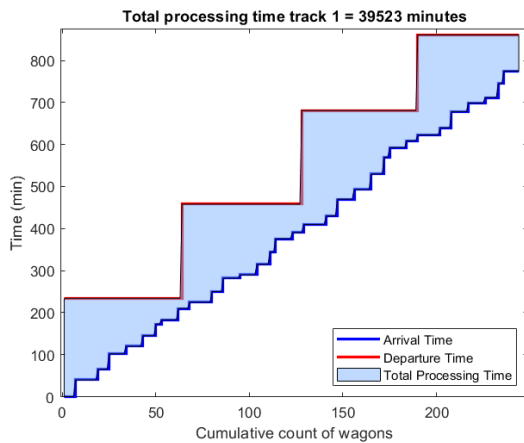

(a) Scenario 1: Cumulative curve showing the processing time of track 1

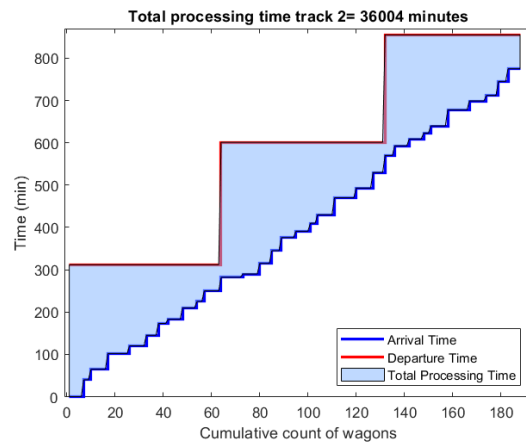

(b) Scenario 1: Cumulative curve showing the processing time of track 2

Figure 5.1: Scenario 1: Cumulative curves of classification tracks 1 and 2

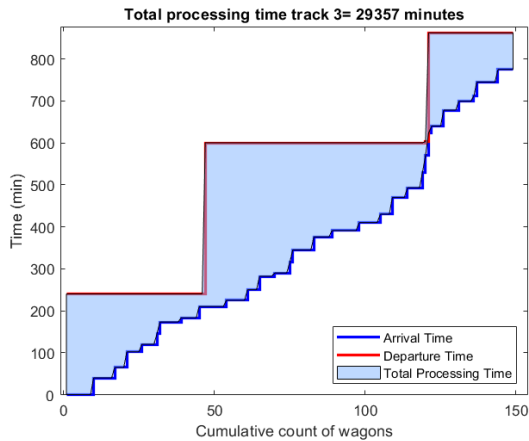

(a) Scenario 1: Cumulative curve showing the processing time of track 3

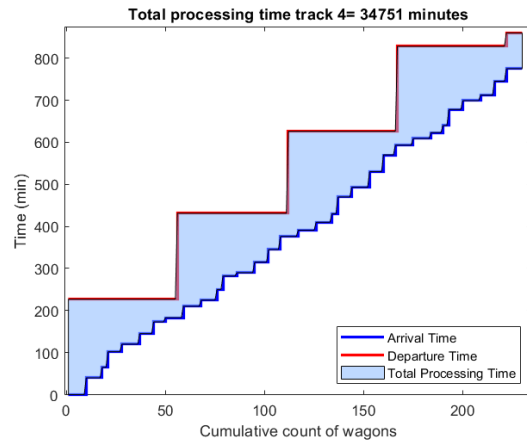

(b) Scenario 1: Cumulative curve showing the processing time of track 4

Figure 5.2: Scenario 1: Cumulative curves of classification tracks 3 and 4

## 5.2. SCENARIO 2: EACH TRACK HAS ITS OWN DESTINATION AND THE SHARE OF DANGEROUS GOODS IS UNEQUAL

In this scenario, it must be taken into account that there is a different distribution of dangerous goods among the destinations. It is assumed that there is at least one destination to which no dangerous goods go. This has been chosen in order to have a clear distinction between Scenario 1 and Scenario 2.

### Input data

There are four destinations and the same number of incoming trains as for Scenario 1. Destination 1 has 62% dangerous goods of class 3. Destination 2 also has 62% dangerous goods of a different class than destination 1. Destination 3 has no dangerous goods at all. Destination 4 has 45% dangerous goods of class 3.

### Step 1: Arrival of trains

The arrival times of the trains are the same as in Scenario 1. The only thing that has changed is the content of the wagons. So again, there are 32 trains with a total of 840 wagons arriving at the yard over 775 minutes.

### Step 2: Identifying the scenario

The percentage of dangerous goods per destination is different. The model must recognize that this is the case because destination 3 does not contain any dangerous goods. The classes from destinations 1 and 2 are incompatible and must therefore be separated by the model. The model does indeed give as output Scenario 2. With this, the model confirms that it has been understood that a different strategy must be applied.

### Step 3 & Step 4: Wagons to classification yard strategy & Checking the compatibility of wagons with dangerous goods

In Scenario 2, there is a destination to which no dangerous goods are destined. This makes it possible to use this destination on a track to separate the various dangerous goods classes on the other tracks from each other. Wagons without dangerous goods may stand next to wagons with dangerous goods. This eliminates the need for buffers on the classification tracks and allows more wagons to be parked. The order of destinations on the tracks is as follows:

- Track 1: Destination 1 (DG class 3)
- Track 2: Destination 4 (DG class 3)
- Track 3: Destination 3 (no DG class)

- Track 4: Destination 2 (DG class 5)

### Step 5: Wagons to departure track and departing strategy

Due to the fact that no buffers are placed on the classification tracks, more wagons can be placed on the classification tracks. The effect of this is that it takes longer for the track to be filled with wagons, thereby increasing the processing time. The model shows no problems in finding the most suitable departure time.

### Output

The total processing times per classification track are calculated and are the following:

- Track 1: 39523 minutes
- Track 2: 34389 minutes
- Track 3: 34907 minutes
- Track 4: 35822 minutes

The total processing time of all tracks added together equals 144641 minutes.

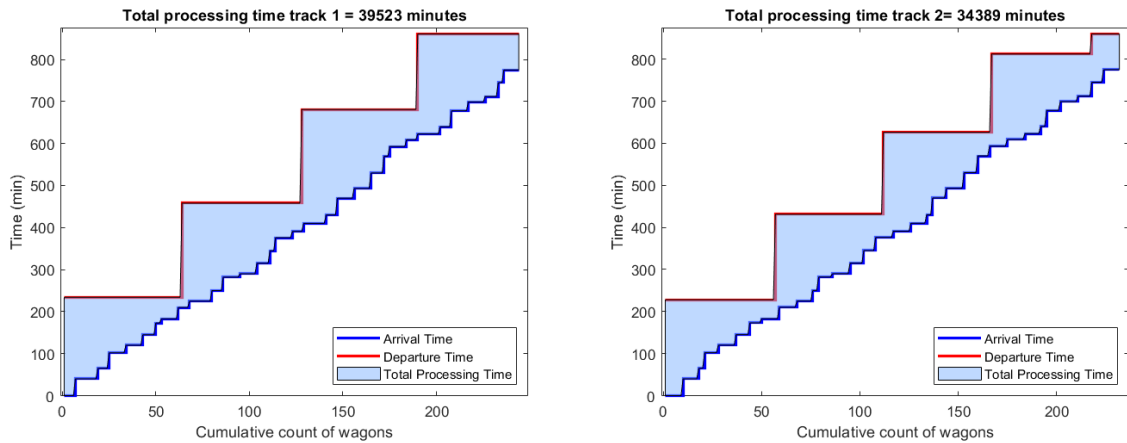

(a) Scenario 2: Cumulative curve showing the processing time of track 1

(b) Scenario 2: Cumulative curve showing the processing time of track 2

Figure 5.3: Scenario 2: Cumulative curves of classification tracks 1 and 2

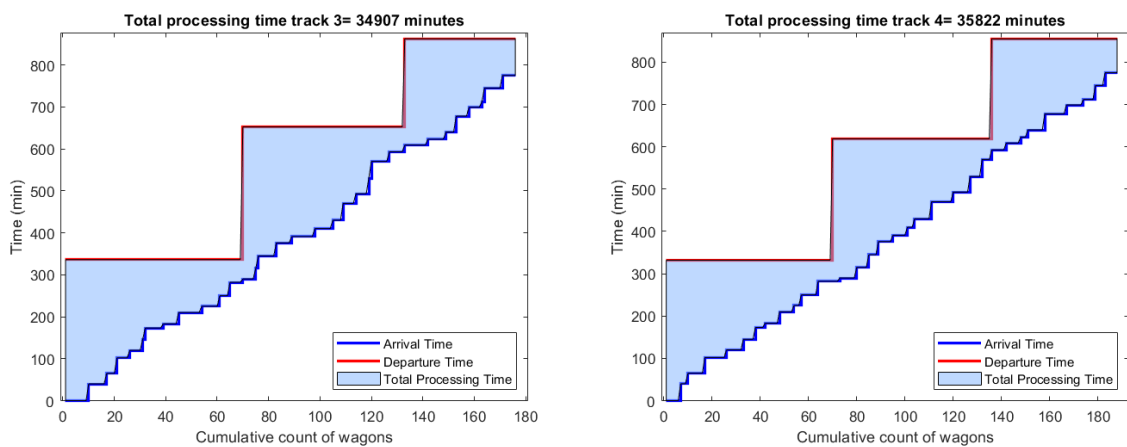

(a) Scenario 2: Cumulative curve showing the processing time of track 3

(b) Scenario 2: Cumulative curve showing the processing time of track 4

Figure 5.4: Scenario 2: Cumulative curves of classification tracks 3 and 4

### 5.3. SCENARIO 3: THERE ARE MORE DESTINATIONS THAN TRACKS AVAILABLE AND THE SHARE OF DANGEROUS GOODS IS EQUAL

In this scenario, it must be taken into account that there are more destinations than available tracks, and the distribution of dangerous goods among the destinations is the same. So there is at least one track where multiple destinations are sorted on.

#### Input data

There are five destinations and the same number of incoming trains as for Scenario 1.

- Destination 1: 49% dangerous goods of class 3
- Destination 2: 50% dangerous goods of class 5.1
- Destination 3: 48% dangerous goods of class 3
- Destination 4: 51% dangerous goods of class 3
- Destination 5: 50% dangerous goods of class 3

#### Step 1: Arrival of trains

The arrival times of the trains are the same as in Scenario 1. The only thing that has changed is the content of the wagons. So again, there are 32 trains with a total of 840 wagons arriving at the yard over 775 minutes.

#### Step 2: Identifying the scenario

The model registers that there are five destinations and only four classification tracks. Because of this, the model already knows that it must look at scenarios 3 or 4. Next, the model must distinguish between equal distribution of dangerous goods and unequal distribution. To do this, the model calculates the percentages of dangerous goods present per destination and concludes that it is evenly distributed. There is no destination without dangerous goods, as a result, the model indicates that this is Scenario 3.

#### Step 3 & Step 4: Wagons to classification yard strategy & Checking the compatibility of wagons with dangerous goods

There are more destinations than classification tracks, and therefore two destinations must be sorted together on the same classification track. There are constraints on this. Only two destinations with the same class may be sorted together. In addition, these must be the destinations with the smallest share of dangerous goods. Next, the destination with a different dangerous class must be positioned as far away from this track as possible. As a result, the distribution of tracks is as follows:

- Track 1: Destination 3 (DG 1) & Destination 5 (DG 1), total 320 wagons
- Track 2: Destination 4 (DG 1), total 168 wagons
- Track 3: Destination 1 (DG 1), total 168 wagons
- Track 4: Destination 2 (DG 2), total 184 wagons

#### Step 5: Wagons to departure track and departing strategy

Track 1 is filled more often than the other tracks, because more wagons are sorted on it. In total, the wagons depart six times from classification track 1, three times from track 2, four times from track 3 and three times from track 4. What is noticeable in the cumulative curve is that the departure of the wagons on track 1 is faster than the departure of wagons on the other tracks. As an example is the first departure time shown below of the different tracks. As a result, the processing time of track 1 is also lower than expected.



- First departure from track 1: 183 minutes
- First departure from track 2: 358 minutes
- First departure from track 3: 258 minutes
- First departure from track 4: 300 minutes

At 183 minutes, the first wagons leave the classification track 1 for the departure tracks. This is not the case for track 2 until 358 minutes, for track 3 until 285 minutes and for track 4 until 300 minutes. This is because fewer incoming trains are needed to fill the track with wagons.

### Output

The total processing times per classification track are calculated and are the following:

- Track 1: 41862 minutes
- Track 2: 33557 minutes
- Track 3: 29245 minutes
- Track 4: 35560 minutes

It was expected that the processing time of track 1 would be double that of track 2, as almost twice as many wagons are sorted there, but it is now only a third more than it was before. The total processing time of all tracks added together equals 140224 minutes.

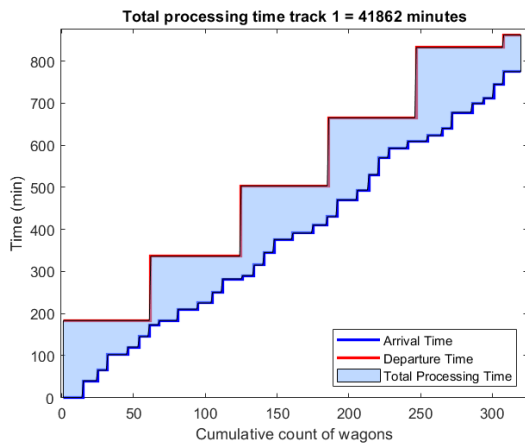

(a) Scenario 3: Cumulative curve showing the processing time of track 1

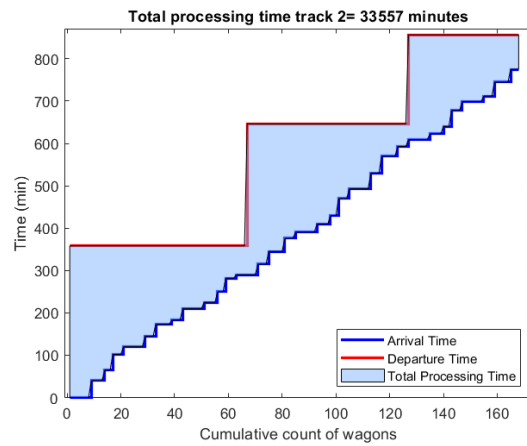

(b) Scenario 3: Cumulative curve showing the processing time of track 2

Figure 5.5: Scenario 3: Cumulative curves of classification tracks 1 and 2

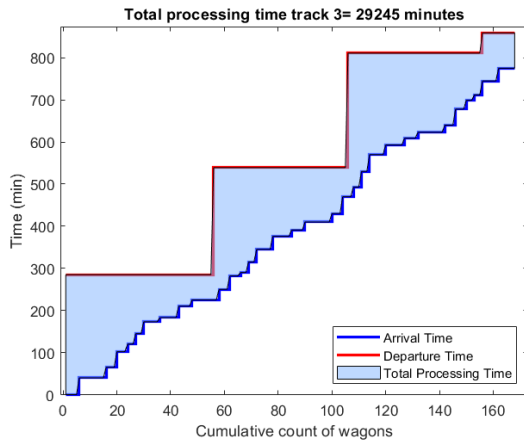

(a) Scenario 3: Cumulative curve showing the processing time of track 3

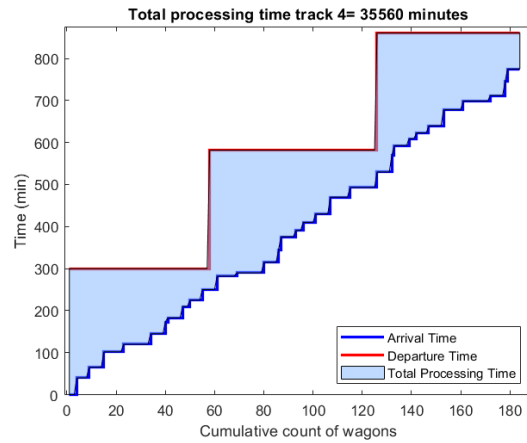

(b) Scenario 3: Cumulative curve showing the processing time of track 4

Figure 5.6: Scenario 3: Cumulative curves of classification tracks 3 and 4

## 5.4. SCENARIO 4: THERE ARE MORE DESTINATIONS THAN TRACKS AVAILABLE, AND THE SHARE OF DANGEROUS GOODS IS UNEQUAL

In this scenario, it must be taken into account that there are more destinations than available tracks, and the distribution of dangerous goods among the destinations is not the same. There is one destination without dangerous goods. There is at least one track where multiple destinations are sorted on.

### Input data

There are five destinations, and the same number of incoming trains as for Scenario 1.

- Destination 1: 50% dangerous goods of class 3
- Destination 2: 50% dangerous goods of class 3
- Destination 3: 0% dangerous goods
- Destination 4: 52% dangerous goods of class 5.1
- Destination 5: 50% dangerous goods of class 3

### Step 1: Arrival of trains

The arrival times of the trains are the same as in Scenario 1.

### Step 2: Identifying the scenario

The model registers five destinations and only four classification tracks available. The model knows that it should consider scenario 3 or 4. Therefore it calculates the share of dangerous goods among all destinations. The model sees a destination to which no dangerous goods go and therefore decides that this must be Scenario 4. The dangerous goods are not distributed evenly.

### Step 3 & Step 4: Wagons to classification yard strategy & Checking the compatibility of wagons with dangerous goods

As in Scenario 3, there are again more destinations than classification tracks. In this case, there is an unequal distribution of dangerous goods. In this case, there is an uneven distribution of hazardous goods, which could be handled more cleverly in the distribution of destinations over the tracks. It is now even the case that no dangerous goods are assigned to a destination. As a result, this destination can function as a buffer track. This

provides extra capacity on the track, but at the same time at the expense of processing time. Because of the buffers, trains are sent off earlier.

To validate this finding, two simulations were conducted and investigated considering Scenario 4. In the first simulation, the destination without hazardous substances acts as a buffer track. In the second simulation, no buffer is considered. In the second simulation, all the tracks have dangerous goods.

The first simulation has the following order of destinations:

- Track 1: Destination 1 (DG 1) & Destination 5 (DG 1)
- Track 2: Destination 2 (DG 1)
- Track 3: Destination 3 (Non DG)
- Track 4: Destination 4 (DG 2)

The second simulation has the following order of destinations:

- Track 1: Destination 3 (Non DG) & Destination 5 (DG 1)
- Track 2: Destination 1 (DG 1)
- Track 3: Destination 2 (DG 1)
- Track 4: Destination 4 (DG 2)

#### **Step 5: Wagons to departure track and departing strategy**

The departure times of both simulations differ for track 3. In the first simulation with the track used as a buffer, the departure times are 351, 650, and 860 minutes. The departure times are earlier in the second simulation with the buffers on the track. Due to the buffers on the track, the buffer track is filled earlier, resulting in the train being sent off earlier. This results in the following departure times: 317, 611, and 850 minutes. This will result in shorter processing times for the second simulation with buffers on the track.

#### **Output**

The output of the first simulation shows that the total processing time is equal to 139562 minutes. Track 3 does not contain any wagons with dangerous goods. As a result, no buffers are needed on the track to separate the different hazardous goods. Below are the processing times per track:

- Track 1: 44679 minutes
- Track 2: 33557 minutes
- Track 3: 29703 minutes
- Track 4: 31623 minutes

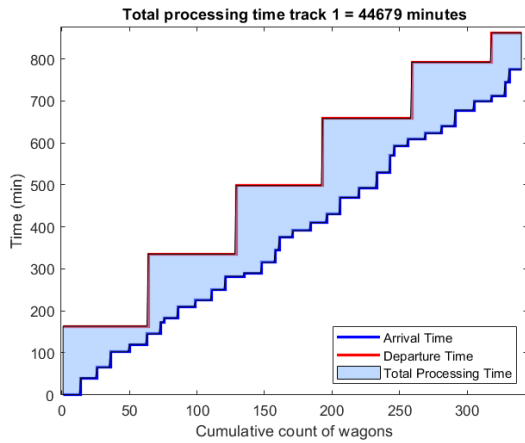

(a) Scenario 4: Cumulative curve showing the processing time of track 1

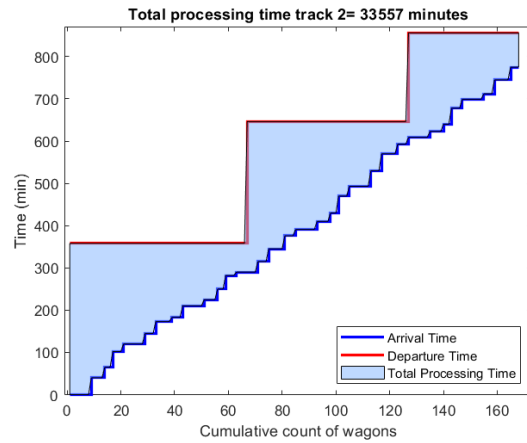

(b) Scenario 4: Cumulative curve showing the processing time of track 2

Figure 5.7: Scenario 4: Cumulative curves of classification tracks 1 and 2

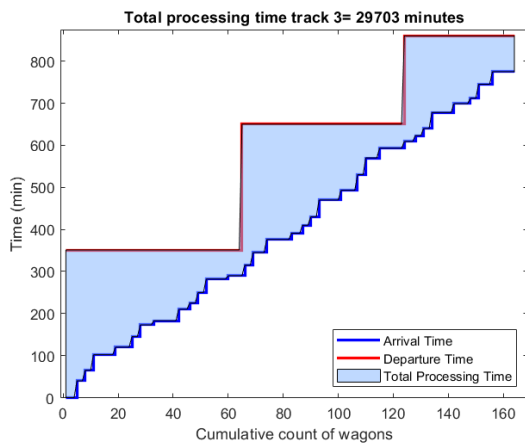

(a) Scenario 4: Cumulative curve showing the processing time of track 3

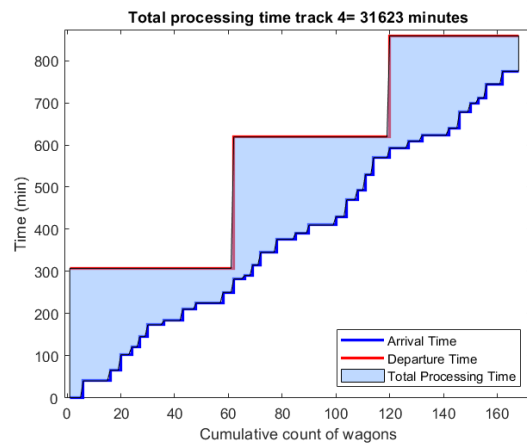

(b) Scenario 4: Cumulative curve showing the processing time of track 4

Figure 5.8: Scenario 4: Cumulative curves of classification tracks 3 and 4

In the second simulation, wagons containing dangerous goods were placed on track 3. As a result, buffers are required on tracks 3 and 4. A total of 31 buffers were installed on track 4 and 9 buffers on track 3. The process time on track 4 shows that more buffers have been installed, as the process time is very low. The processing times per track are shown below:

- Track 1: 42121 minutes
- Track 2: 33557 minutes
- Track 3: 34483 minutes
- Track 4: 27889 minutes

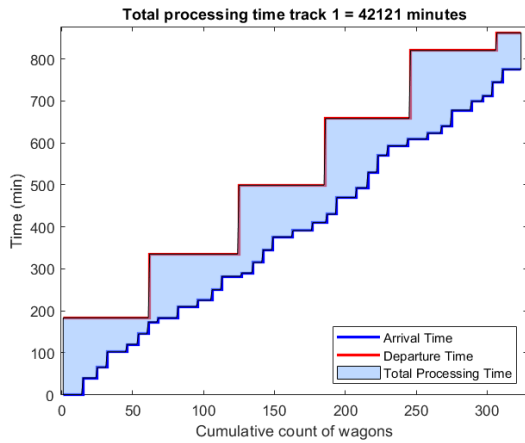

(a) Scenario 4: Cumulative curve showing the processing time of track 1

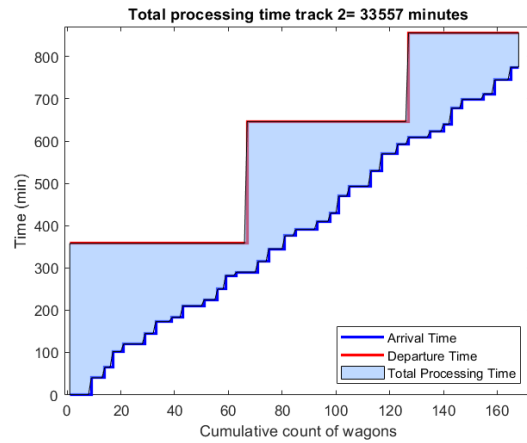

(b) Scenario 4: Cumulative curve showing the processing time of track 2

Figure 5.9: Scenario 4, simulation 2: Cumulative curves of classification tracks 1 and 2

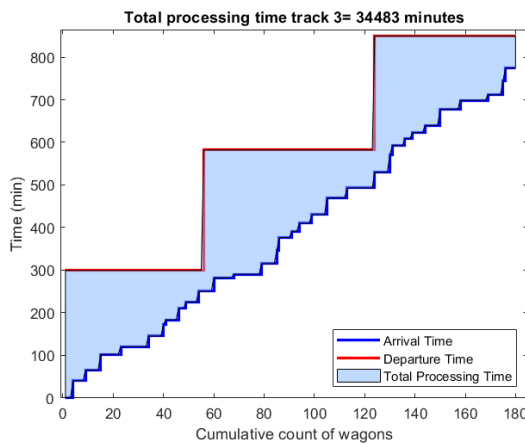

(a) Scenario 4: Cumulative curve showing the processing time of track 3

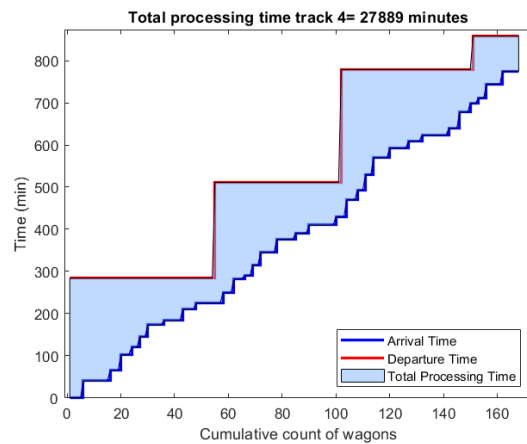

(b) Scenario 4: Cumulative curve showing the processing time of track 4

Figure 5.10: Scenario 4, simulation 2: Cumulative curves of classification tracks 3 and 4

The total processing time of the second simulation is equal to 137516 minutes. This is a difference of 2046 minutes. It can be concluded that a trade-off must be made between safety and processing time. This must be done by choosing whether it is wiser to keep the various dangerous substances as far apart as possible using a buffer track, or to put the trains next to each other, which means that buffers must be kept on the track, so that the train can depart earlier. On the other hand, there are fewer wagons in the outgoing train.

## 5.5. CALIBRATING THE MODEL FOR PARAMETERS $p$ AND $w$

This section analyzes the influence of the parameters  $p$  and  $w$  on the outcome of the model. The aim is to find if there is a value for which the model gives the lowest processing time. The parameter  $p$  stands for the available space of how complete a track must be before a train is allowed to depart. The parameter  $p$  represents the percentage of available classification track. If there is less than  $p$  track available, the wagons can depart. So the higher the number, the sooner a train can depart. The parameter  $w$  represents the maximum waiting time that a train must hold so that wagons can still connect with the outgoing train. The smaller this number  $w$ , the smaller the waiting time, and the sooner the train will depart, is the assumption. In order to limit the number of simulations, the effect of a maximum waiting time  $w$  of 10, 15 and 20 minutes is examined per scenario. An available track occupancy percentage  $p$  of 0, 10 and 20 is considered. A total of 36 simulations are carried out

to analyze the effect of the parameters on the different scenarios. For each scenario, a 50% share of dangerous goods over the trains is considered.

Table 5.4: Number of simulations for model parameter fine-tuning with  $w$ =maximum waiting time,  $p$ =available track occupancy

	$w=10$	$w=15$	$w=20$
$p=0$	1	2	3
$p=10$	4	5	6
$p=20$	7	8	9

## Results

After running the simulations, several outputs are created by the model. The output is the total processing time of all 840 wagons summed together in minutes. The average of all outputs is 131790 minutes, which is 157 minutes per wagon. This number is logical when looking at the cumulative curve graph. Figure 5.11 is an example of Scenario 1, and shows that the first wagon to arrive has to wait more than 220 minutes before the first train leaves. The last wagon to arrive has to wait the shortest time. The blue area between the two curves is the total processing time.

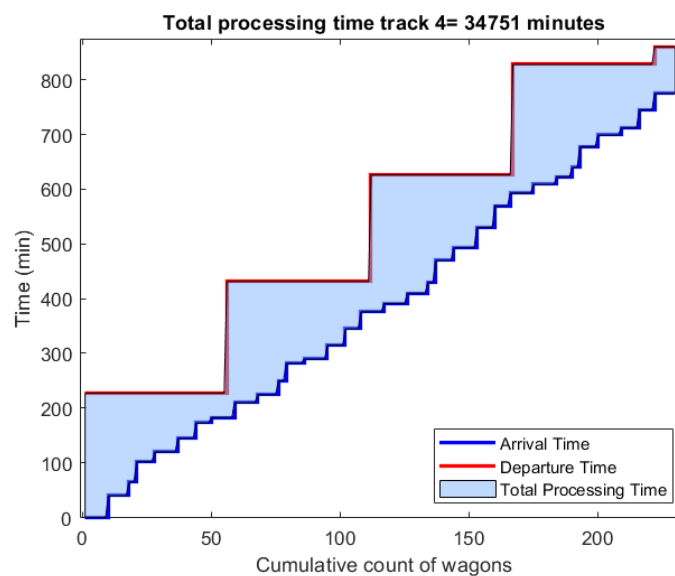

Figure 5.11: Example of a cumulative curve of track 4 of Scenario 1 with  $p=15$  and  $w=15$

Adjusting the parameters  $p$  and  $w$  changes the total processing time. It can be seen that each graph (Figure 5.12-5.15) shows the same pattern in a decrease of processing time as the minimum available track occupancy increases. If there are more wagons to connect, the processing time will be longer since the departure time will be later, and the arrival time is the same. The total processing time, a summation over these values, therefore also gives a higher number. A trade-off must be made between the length of an outgoing train and the length of stay of the wagons on the yard. So if the outgoing train is shorter, fewer wagons can connect and therefore the departure will be quicker. It should not be the case that the wagons that arrive leave immediately. That would not be realistic because there would have to be so many locomotives to cope with that. The difference between 80% track occupancy and 100% track occupancy is about 20,000 minutes. This is because between 9 and 20 wagons less need to be connected per outgoing train. This can conclude that  $20,000/840 = 23.8$  minutes extra waiting time is per wagon if the whole classification track is used.

Table 5.5: Results of different parameters  $w$  and  $p$

Scenario1	$w=10$	$w=15$	$w=20$
$p=0$	139635	139635	139635
$p=10$	130604	129902	129902
$p=20$	116631	116493	116493

Scenario 2	$w=10$	$w=15$	$w=20$
$p=0$	145236	144641	144641
$p=10$	137824	137824	136908
$p=20$	125169	124567	124567

Scenario 3	$w=10$	$w=15$	$w=20$
$p=0$	138633	138633	137879
$p=10$	132440	132440	131524
$p=20$	123057	122510	122510

Scenario 4	$w=10$	$w=15$	$w=20$
$p=0$	138050	138050	136290
$p=10$	134260	134254	132856
$p=20$	123891	123344	122804

Differences can also be seen when the  $w$  parameter is made larger. In all cases, the processing time is lower when  $w$  is made larger. The difference in processing times is smaller for different values of  $w$  than for different values of  $p$ . In the figures 5.12 - 5.15 can be seen that the parameter  $p$  has more influence than the parameter  $w$ .

What is also interesting about the results in the table is that the processing times of  $w=15$  and  $w=20$  matches five times, and the processing times of  $w=10$  and  $w=15$  match four times. This matching processing time depends on the arrival times and the classification time. The closer the arrival times are, the sooner the model says it will wait for the next wagon. The processing times are lowest when the parameters have the following value:  $w = 20$  minutes and  $p = 20\%$ .

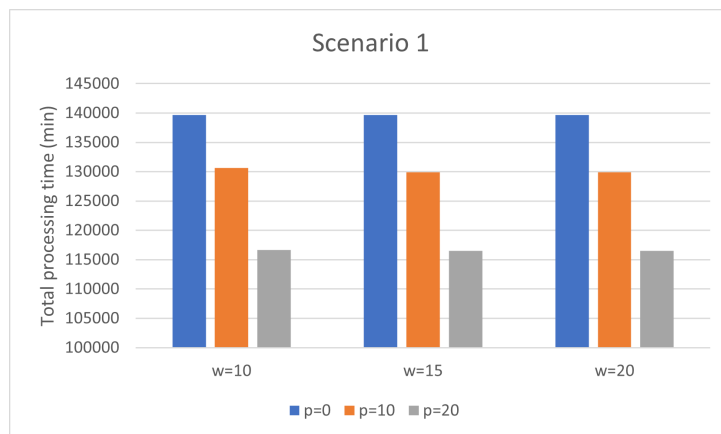

Figure 5.12: Bar chart of Scenario 1 with the different input values for parameter  $w$  and  $p$



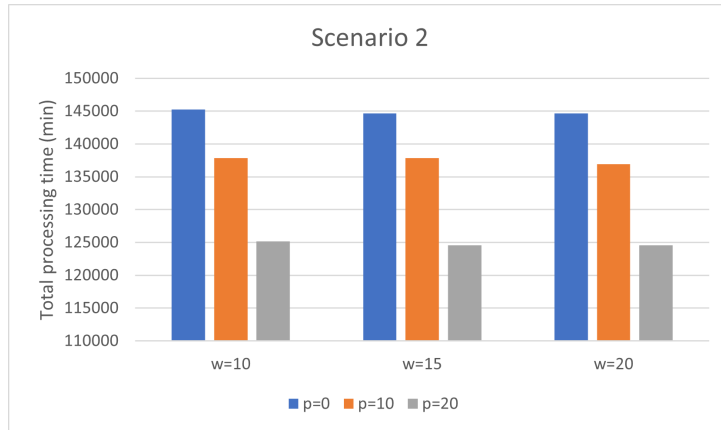

Figure 5.13: Bar chart of Scenario 2 with the different input values for parameter  $w$  and  $p$

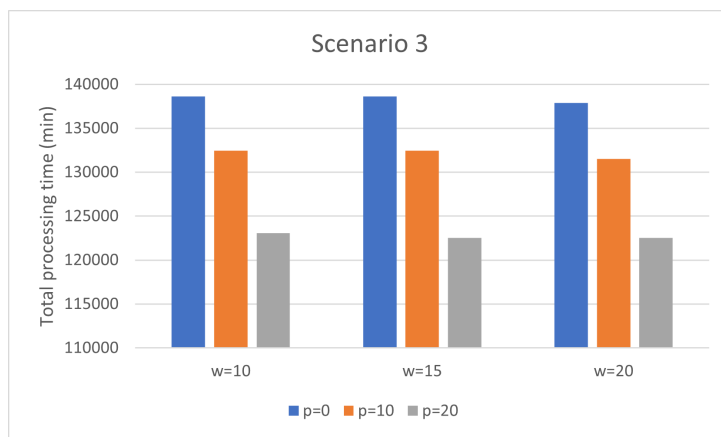

Figure 5.14: Bar chart of Scenario 3 with the different input values for parameter  $w$  and  $p$

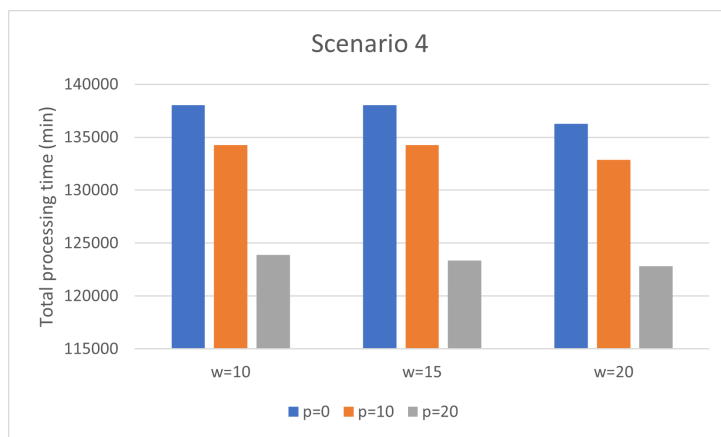

Figure 5.15: Bar chart of Scenario 4 with the different input values for parameter  $w$  and  $p$

## 5.6. CONCLUSION

This chapter has answered how the model is applied and tested. This has been done by applying the model in a case study and fine-tuning parameters. As this research aims to design a heuristic for wagons sorting on a shunting yard, considering dangerous goods, this section draws conclusions related to the implementation of the model. Applying the model to four scenarios has been examined what exactly the model does and why it does this. The total processing time of all the tracks was added up, resulting in the following times per scenario:

- Scenario 1: 139635 minutes
- Scenario 2: 144641 minutes
- Scenario 3: 140224 minutes
- Scenario 4: 137516 minutes

From this it can be concluded that Scenario 4 has the shortest processing time of all scenarios.

Next, two parameters in the model were fine-tuned by running multiple simulations and looking at the influence of the parameters. This allows the model to give the best performance. The values found for the parameters for which the processing times are the lowest were equal to:  $p=20\%$  and  $w=20$  minutes. Higher numbers are not tested, because otherwise an outgoing train would have too few wagons.

For conducting this research, there was no access to real-life data from any yard in the Netherlands regarding the number of trains, amount of dangerous goods, how long they are in the yard, and where they are exactly. What is available is the layout of a yard in Amsterdam. The length of the tracks are based on this. Next, the simulations were run, and an output of the model was obtained.

In Scenario 4, an important definition in the strategy is to be considered: Should the dangerous goods be separated as much as possible by using a buffer track on which no dangerous goods are sorted or should the dangerous goods be sorted next to each other? This would require buffers between wagons on the same track, leading to faster processing times. Further research can address the definition of solutions that consider a reasonable trade-off between the two options, that is considering both safety and processing times.

To conclude, when fine-tuning the parameters for available track occupancy  $p$  and the maximum waiting time  $w$ ,  $p$  turned out to have more influence than  $w$ . The shortest processing times are achieved with an available track occupancy of 20%. The values for the parameters will be kept at  $p=20\%$  and  $w=20$  minutes when running further simulations.

# 6

## RESULTS

In the previous chapter, a case study was carried out in which different scenarios were simulated. In this chapter, the different scenarios are analyzed in more detail by running additional simulations and by looking at the effect of different inputs through a sensitivity analysis. This chapter aims to verify the conditions under which the model will work and its performance by presenting the results of the scenarios and performing a sensitivity analysis by answering Sub-Question 5, as seen below.

*Sub-Question 5: How can the model and strategy be verified? (Model verification)*

### 6.1. SENSITIVITY ANALYSIS

Sensitivity analysis is defined as the study of how uncertainty in the output of a model can be attributed to different sources of uncertainty in the model input [80]. This section will look at the impact of uncertainties of different variables on the functioning of the model and how this can lead to uncertainties in the output variables. This analysis helps to improve the predictions of the model. It works by changing the input variables to understand their impact on the interaction with the rest of the model. This is not necessarily about the output of the model but about how the model responds to the changed input. The expected values of different parameters can predict the robustness of the model. In [Chapter 3](#), the total processing time was chosen as the performance indicator for the model and is also considered now. The following two aspects are considered during the sensitivity analysis:

- Different arrival times for the incoming trains
- The percentage of dangerous goods in the wagons

#### 6.1.1. THE EFFECT OF DIFFERENT ARRIVAL TIMES OF THE INCOMING TRAINS

This subsection looks at what happens to the processing times when arrival times are following a time pattern. Until now, there was no fixed time pattern in the arrival of trains. The following arrival time patterns are considered and compared with each other:

- Train arrives every 15 minutes
- Train arrives every 30 minutes
- Train arrives every 45 minutes
- Train arrives every 60 minutes

First, a train arrives every quarter of an hour and then a train arrives every half hour. With a quarter-hourly schedule, there is always an overlap between the sorting time of the train on the arrival track and the next arriving train. The model must respond to this by including the buffer time. In the half-hour schedule, this is

less likely to go wrong. For the execution of the scenarios, a percentage of 20 dangerous goods is considered. This was chosen because it considers how the model responds to the arrival time rather than what it does to the dangerous goods. By keeping the percentage low, the focus is more on the processing.

In [Table 6.1](#) an overview of the results is shown. It can be seen that the 30-minute schedule has the lowest processing times and thus shows the best performance. The 15-minute schedule, on the other hand, has the highest processing times. This is because the area of the cumulative curve becomes larger, as the arrival times remain very low compared to the departure times. As a result, the area between the arrival and departure curve is large. What is meant by this is illustrated in [Figure 6.1a](#). Here it can be seen that the departure curve does not get close to the arrival curve. As a result, processing times have almost doubled.

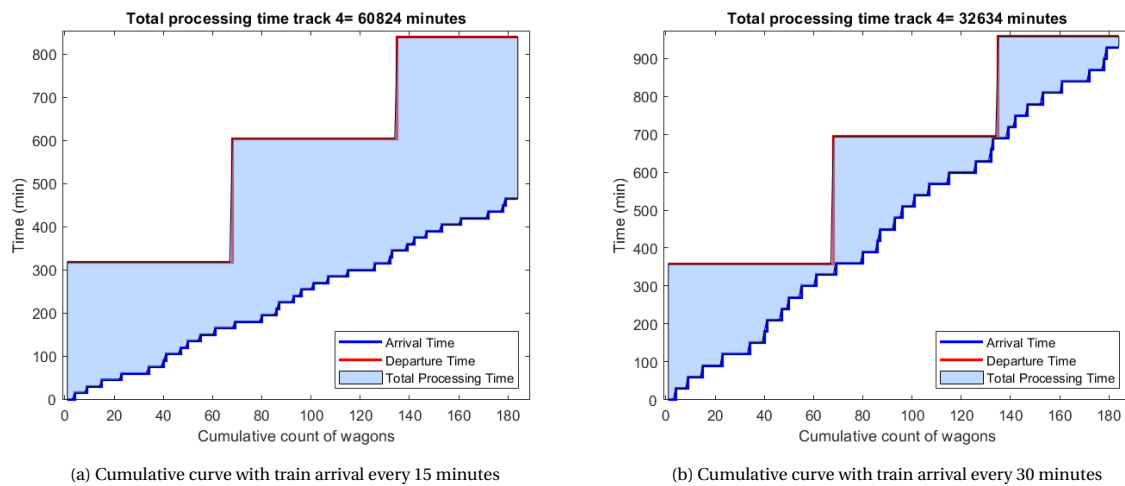

Figure 6.1: Two Cumulative curves of classification tracks 4 with different train arrival patterns

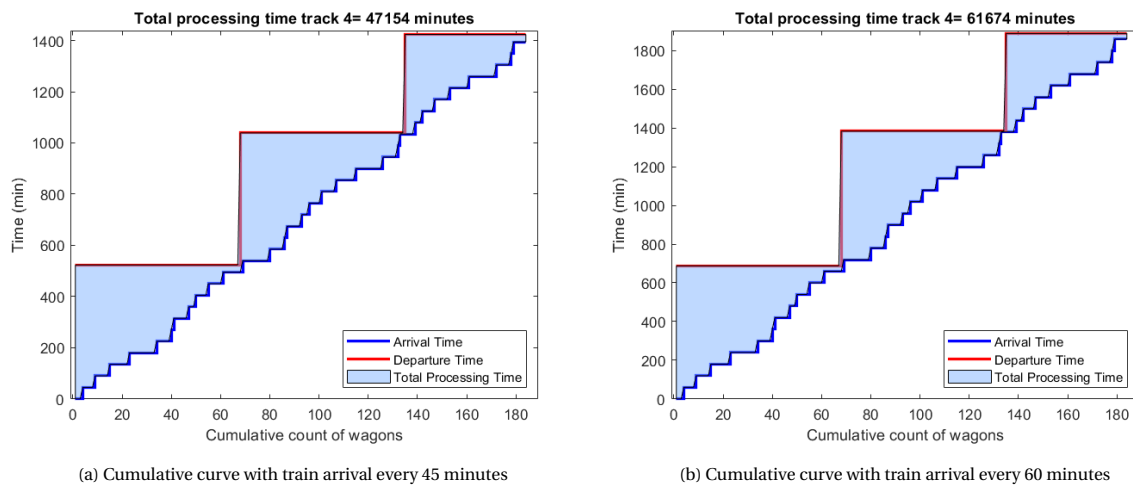

Figure 6.2: Two Cumulative curves of classification tracks 4 with different train arrival pattern

A 30-minute schedule shows that it gives the lowest processing times. This is in line with expectations, as the classification of wagons takes either 30 minutes or 20 minutes each, depending on the length of the arriving train. This allows the next arriving train to take its place on the arrival track as soon as the last train is fully distributed. This is the least amount of time.

The result of schedule without a strict arriving pattern is second best. Sometimes, the intervals between incoming trains are very short, but this can be compensated if there are large intervals between incoming trains. This is the case in the schedule without fixed intervals. Here there is an alternation between large and smaller

intervals in which the model has time to recover.

Next, the performance of the 45-minute schedule is the next best and the poorest performance is from the 60-minute schedule. It appears that 45 and 60 minutes result in too much waiting time. This is also logical because after the train has been distributed, it must wait at least 15 minutes before the next train is distributed for a 45-minute schedule and even 30 minutes for a 60-minute schedule.

Table 6.1: Different arrival times schedules for a scenario with 20% dangerous goods in the trains: no fixed schedule, every 15 minutes, every 30 minutes, every 45 minutes and every 60 minutes.

Arrival		no fixed schedule			
20%	Scenario 1	Scenario 2	Scenario 3	Scenario 4	
<b>Track 1</b>	39523	39523	41881	41862	
<b>Track 2</b>	35701	34389	33557	31623	
<b>Track 3</b>	34094	34907	29905	32953	
<b>Track 4</b>	34200	35822	35352	35352	
<b>Total</b>	143518	144641	140695	141790	

Arrival		every 15 minutes			
20%	Scenario 1	Scenario 2	Scenario 3	Scenario 4	
<b>Track 1</b>	72163	72163	84254	84937	
<b>Track 2</b>	61200	66051	56064	54264	
<b>Track 3</b>	57483	58296	53248	55460	
<b>Track 4</b>	65636	61321	60824	60824	
<b>Total</b>	256482	257831	254390	255485	

Arrival		every 30 minutes			
20%	Scenario 1	Scenario 2	Scenario 3	Scenario 4	
<b>Track 1</b>	33973	33973	23174	32537	
<b>Track 2</b>	32779	29825	30564	28734	
<b>Track 3</b>	30383	31986	26748	30504	
<b>Track 4</b>	29661	32722	32634	32634	
<b>Total</b>	126796	128506	113120	124409	

Arrival		every 45 minutes			
20%	Scenario 1	Scenario 2	Scenario 3	Scenario 4	
<b>Track 1</b>	49594	49594	46668	46787	
<b>Track 2</b>	47899	42845	45076	41679	
<b>Track 3</b>	43808	46466	38718	44724	
<b>Track 4</b>	42606	47542	47154	47154	
<b>Total</b>	183907	186447	177616	180344	

Arrival		every 60 minutes			
20%	Scenario 1	Scenario 2	Scenario 3	Scenario 4	
<b>Track 1</b>	65059	65059	60858	61037	
<b>Track 2</b>	63019	55865	59401	54624	
<b>Track 3</b>	57233	60866	50688	58944	
<b>Track 4</b>	55551	62362	61674	61674	
<b>Total</b>	240862	244152	232621	236279	

### 6.1.2. THE EFFECT OF THE PERCENTAGE OF DANGEROUS GOODS IN THE WAGONS

This subsection analyzes at what happens when the percentage of dangerous goods varies over the trains. The aim is to see if there is a connection between the number of dangerous goods and the performance.

The result of the simulations can be found in [Table D.3](#), in [Appendix D](#). For all scenarios, the percentage of dangerous goods was chosen to alternate between 0% and 50% with intervals of 10%. Simulations had been done with 60% and 70%, but then the model could not process it properly. There were too many buffers, so setting the correct departure times was no longer possible. In [Figure 6.3](#) an overview is shown of the different performances belonging to the scenarios and the number of percentages. It is essential to realize that the performance is higher when the processing time is lower.



Figure 6.3: Results of sensitivity analysis for different percentage of dangerous goods, starting from 0 to 50%

## Findings

If no dangerous goods are present, the distribution of dangerous goods is the same. Scenarios 2 and 4 are therefore not applicable. There is a large difference in processing time for scenarios 1 and scenarios 3 when no dangerous goods are present. This difference is because there are several destinations on a track, so that track is filled earlier, and therefore the processing time decreases. This is because there are still the same number of wagons distributed and have the same arrival time. From this, it can be concluded that when several wagons are sent to a track, it is filled earlier, thus reducing the processing time. So it is advantageous for the filling of tracks to have several wagons together.

### Scenario 1

The processing times of Scenario 1 descend when higher percentages of dangerous are included, except for a percentage of 30%. For this purpose, several runs are made with 30% and 40% dangerous goods, with different orders of the dangerous goods in the arriving trains. Consideration is given to when the wagons with dangerous goods are close to each other and when the dangerous goods are not placed at the end of a train. An average can be calculated from this, which will show whether the bar in this figure is representative. The input is changed manually, leaving the order of the destinations the same, but changing the dangerous class of the wagons. So in some places where there used to be a wagon with dangerous goods, there is now a wagon without dangerous goods. This changes the number of buffers and this impacts the total processing time.

Due to the four extra runs in Scenario 1 with 30% dangerous goods, the processing time has an average of 139707 minutes. For Scenario 1 with 40% dangerous goods, the average is now 138859 minutes. This is a lower average than for 30%. The most significant difference can be seen on track 3. There, all new runs score much lower than in the first case. So the order of the dangerous goods in the train affects the processing time. From the result of these additional simulations, it can be concluded that the processing time indeed decreases as more dangerous goods percentages are present in the arrival trains.

Table 6.2: Total processing times in minutes for extra runs of Scenario 1 with 30% and 40% dangerous goods

30%	Scenario 1	Scenario 1	Scenario 1	Scenario 1	average (min)
<b>Track 1</b>	39523	39523	39523	39523	<b>39523</b>
<b>Track 2</b>	36169	36004	36004	36107	<b>36071</b>
<b>Track 3</b>	30039	29086	30388	30039	<b>29888</b>
<b>Track 4</b>	34751	33987	34389	33773	<b>34225</b>
<b>Total</b>	140482	138600	140304	139442	<b>139707</b>

40%	Scenario 1	Scenario 1	Scenario 1	Scenario 1	average (min)
<b>Track 1</b>	39523	39523	39523	39523	<b>39523</b>
<b>Track 2</b>	36614	36107	36004	36004	<b>36182.25</b>
<b>Track 3</b>	28322	28234	29628	29064	<b>28812</b>
<b>Track 4</b>	34200	34389	34389	34389	<b>34341.75</b>
<b>Total</b>	138659	138253	139544	138980	<b>138859</b>

### Scenario 2

Performance of Scenario 2 remains similar under the evaluated percentages of dangerous goods. This is because the separation of classes is done by the track on which no dangerous goods are sorted. In this case, it does not matter how many dangerous goods there are; the goods are separated at all times. As a result, the processing time is also the same.

### Scenario 3

The performance of Scenario 3 is around 140,000 minutes, except for the 0%. There is no clear trend between the quantities of dangerous goods and the processing time. However, the amount of dangerous goods does influence the processing time. For this, tracks 3 and 4 must be considered where buffers are created, as different classes of dangerous goods end up on these tracks. Figure 6.5 and 6.4 shows the difference in processing time between 20% and 50%. The figures show that the processing times are close, but different.

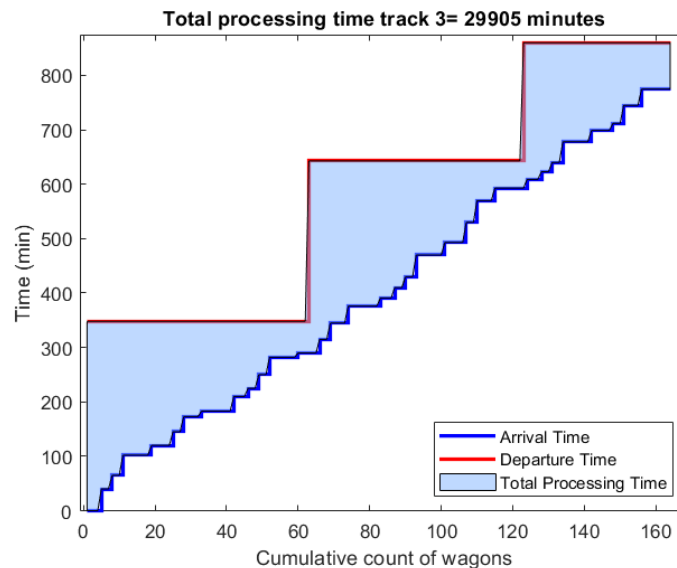

Figure 6.4: Cumulative curve of Scenario 3 with 20% dangerous goods over the trains



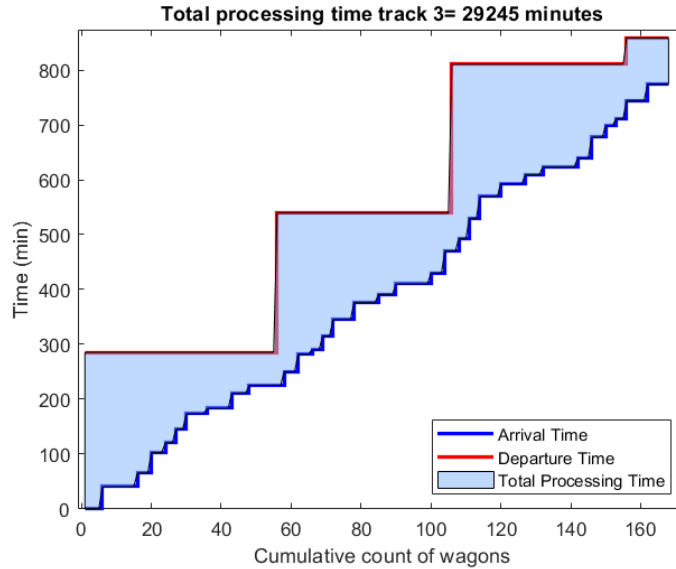

Figure 6.5: Cumulative curve of Scenario 3 with 50% dangerous goods over the trains

#### Scenario 4

Scenario 4 always has a lower processing time than Scenario 1, except for a 30% share of dangerous goods. The total processing time of Scenario 4 is smallest for a rate of 0% dangerous goods and then fluctuates. From a rate of 40%, the processing time is lowering. It may be that the value for the processing time is higher in this simulation, while it may be lower in other simulations with other datasets. This depends on the position of the dangerous goods spread over the trains. If the dangerous goods are close to each other, many track sections have to be skipped, which results in fewer wagons to connect and, therefore, a shorter processing time. This same phenomenon was seen in Scenario 1.

## 6.2. CONCLUSION

In this chapter, two aspects have been tested: different arrival times of trains and different percentages of dangerous goods in the wagons. This has been done to verify the model by seeing how it reacts to different inputs.

#### Different arrival times of trains

The total processing time was the shortest for a schedule in which a train arrives every 30 minutes. This was the case for each scenario with a rate of 20% dangerous goods in the wagons. This is because a train does not have to wait until the arrival track is empty, because within 30 minutes a train of 30 or 20 wagons is distributed over the classification track. The total processing time was the longest for a schedule in which a train arrives every 15 minutes. This is because a train has to wait in front of the arrival track, which causes many delays. As a result, the time between arrival and departure is very long, which is reflected in the total processing time.

#### Different percentages of dangerous goods in the wagons

The result for different values of dangerous goods rate in the simulations showed that a higher percentage of dangerous goods reduced the total processing time. This can be explained by the fact that the tracks are filled faster due to the many buffers needed to maintain the minimum distance from each other. Scenario 4 has the lowest processing time for a percentage of 50%, if the 0% simulations are not included. The difference in total processing time between a percentage of 10% and 50% is 6602 minutes. Calculated backward, this is a saving of 7.9 minutes per wagon. Scenario 3 has the shortest total average processing times if all processing times are considered. The averages per scenario are as follows:

- Total average Scenario 1: 142178.5 min
- Total average Scenario 2: 144641 min
- Total average Scenario 3: 138983.7 min
- Total average Scenario 4: 139197 min

Extra simulations were performed with a different order of dangerous goods in the trains. It can be concluded that the position of the dangerous goods in the train makes a difference in the processing time, because the number of buffers may increase or decrease as wagons with dangerous goods are placed more or less side by side.

The model worked well up to the 50% dangerous goods. From a percentage of 60%, too many buffers were placed on the track, so the model could not link a departure time to the last wagon. Therefore, this had to be done manually. Therefore, the simulation results are not included from a percentage higher than 60%.

# 7

## CONCLUSION AND DISCUSSION

This chapter concludes the research on developing heuristic methods for sorting individual wagons, including dangerous goods on a rail yard, by answering the research questions from [Chapter 1](#). Then the results and methods are discussed in [Section 7.2](#).

### 7.1. CONCLUSIONS

This research considers both scientific and practical aspects when designing heuristics for sorting wagons with dangerous goods on a rail yard. This heuristic is devised in response to new projects such as the intelligent video gate, that checks whether wagon contents match the provided wagon list. The heuristic method is developed in order to answer the main research question:

***What kind of method can distribute wagons, including wagons carrying dangerous goods, on a rail yard, considering safety?***

Before answering the main question, the sub-questions are answered. These sub-questions are designed to guide the research process.

*Sub-Question 1: What kind of regulations exists for the distribution of dangerous goods and which processes take place in a rail yard? (Problem understanding)*

First, the result of the literature research is described to address the problem understanding. The 'Regulation concerning the International Carriage of Dangerous Goods by Rail' (RID) is internationally recognized and has set specific conditions for transporting and storing dangerous goods in trains. One of these regulations is laid down in the 'Boiling Liquid Expanding Vapour Explosion' (BLEVE) covenant. This covenant is also a guiding principle in the research for the mandatory distance between wagons on the classification tracks. Together with the new information about the individual wagons, this has led to a new sorting strategy. Instead of considering the entire train as dangerous, each wagon is examined to determine whether it is dangerous and with which content class. As a result, trains can be parked next to each other, provided the required distances between wagons of different hazard classes are observed. This is a new strategy for distributing wagons to different final destinations.

The infrastructure of a rail yard has been examined to determine the shunting processes. The elements of a shunting yard are analyzed. In theory, these elements consist of three different yards, but this differs in reality, especially in smaller yards. Nevertheless, the model assumes a shunting yard consisting of an arrival yard, a hump, a classification yard, and a departure yard. The hump is necessary to sort the wagons to the correct classification track by pushing the wagons over the hump and adjusting the switches in the correct settings.

*Sub-Question 2: Which requirements of a model will capture essential characteristics of a rail yard to allow evaluation of safety and performance? (Model requirements)*

Based on the qualitative research, it can be concluded that there are two main sorting strategies; single-stage and multistage sorting, each of which has its advantages and disadvantages. Single-stage sorting was chosen to distribute everything as quickly as possible so that the trains are ready to depart as soon as possible. Although,

multistage sorting is needed if two destinations are assigned on one classification track. The two destinations must be separated from each other. So there is a mix between single-stage and multistage sorting. The thesis shows that the cumulative curve method is an excellent method to calculate the performance and detect errors. The chosen performance indicator is the total processing time of the wagons on the yard. This is the difference in arrival and departure time between wagons.

*Sub-Question 3: Which steps are needed to develop the model? (Model design)*

The steps are the arrival of trains, identifying the scenario, destination allocation to the classification tracks, checking the compatibility of wagons, and the departure of wagons. There are crucial decisions that the model has to make. The first decision is to choose the right strategy for assigning a destination to a classification track. Four different train sorting strategies are built into the model and can be applied to four scenarios. The second decision is the position of a wagon on the classification track. The third decision is when a wagon leaves the departure track and proceeds to its final destination. The formulas for determining the arrival, classification, and departure times are formulated, and the algorithms that describe the shunting process.

*Sub-Question 4: How can the model be applied and tested? (Model application)*

The model is applied to a case study where four scenarios are tested. By applying the model with different simulations, the available track occupancy parameter  $p$  and maximum waiting time parameter  $w$  were fine-tuned. The values found for the parameters for which the processing times are the lowest were equal to:  $p=20\%$  and  $w=20$  minutes. Higher numbers are not tested, otherwise an outgoing train would have too few wagons. It can be concluded that  $p$  has a more positive influence on the processing time than  $w$ . While the differences are in the tens of thousands for  $p$ , there is only a difference of hundreds for  $w$ . So it is more beneficial to let a train depart when the track is not yet filled. The departure time is earlier, resulting in shorter processing times.

*Sub-Question 5: How can the model and strategy be verified? (Model verification)*

After achieving results in the case study, it can be concluded that the model recognizes the different scenarios and determines which strategy to apply for distributing the wagons. Subsequently, the sensitivity analysis was carried out, focussing at two different aspects. The first aspect is the different arrival times of the trains. The second aspect is the different rates of dangerous goods in the wagons. The results show that a 30-minute schedule gives the lowest processing times, which was also in line with expectations. From the results, it can be concluded that a high percentage of dangerous goods leads to shorter processing times. This applies to the dangerous goods percentage of 10% to 50%. From 60% upwards, there are too many buffers in the model, which causes the model to function incorrectly. During the simulations with percentages over 60%, occasionally manual adjustment was needed. This is only the case if too many buffers are placed at the end of a track, making it difficult for the model to determine which departure time should be used.

*Research question: What kind of method can distribute wagons, including wagons carrying dangerous goods, on a rail yard, considering safety?*

Finally, a model is created in which wagons are sorted over classification tracks. The model chooses the track on which the wagons should be placed based on the destination. Specific attention is given to wagons with dangerous goods, for which the model ensures that a minimum distance is kept from other wagons on the (neighboring) classification tracks. The model then determines the most appropriate departure time for the train. The model works under most of the evaluated conditions. Unfeasible results were obtained with percentages of dangerous goods over 60%, due to the many buffers needed to maintain safety. The sorting strategy with more destinations than available classification tracks and equal distribution of dangerous goods has the shortest processing time on average. The heuristics created in this study show how the wagons can be sorted on the classification tracks, considering the dangerous goods contained in the wagons.

## 7.2. DISCUSSION

In this section, the major findings are presented, and the chosen methods of chapters 3 and 4 are discussed. Then the results of chapters 5 and 6 are discussed and interpreted.

### Major findings

All the chapters in this study contribute to answering the main research question ‘What kind of method can distribute wagons, including wagons carrying dangerous goods, on a rail yard, considering safety?’. The result of the model shows that the processing times become shorter as more dangerous goods are in the trains. This is caused by the buffers filling up the tracks sooner, making trains depart faster. At the same time, there is less room for wagons on the classification track because many buffers are placed. This reduces the capacity of a track. Therefore, it is necessary to critically examine whether the right performance indicator has been chosen.

### Qualitative research

Three performance indicators were considered in the qualitative research: throughput of the yard [33], total processing time [7] en total weighted delay of trains [6]. These were included as objectives in the papers which were weighed against each other. The main difference between the throughput of the yard and total processing time is that the first looks at how much capacity a yard has delivered, so the number of wagons per hour on the tracks. The higher the number, the better the capacity of the yard and the better the throughput of the yard. The duration of the wagons on the yard is kept as short as possible, to process as many wagons as possible. This therefore indicates that buffers, empty spaces on the tracks, have a negative effect on capacity. This is not the right approach to use buffers; they should be used where necessary to ensure the mandatory distances between wagons.

The third performance indicator was the total weighted delay of trains. This is a delay in relation to a fixed timetable on which trains depart. A fixed schedule should be determined before the departure procedures can be adjusted accordingly. The departures can be taken very widely, as a result of which the wagons remain on the classification tracks for a long time, and therefore pose a greater risk of exposure. In addition, there is less space for wagons if wide departure schedules are chosen. However, if the departure schedule is selected so that it guarantees a short stay for the wagons on the classification tracks, it could be a suitable performance indicator for the model. Nevertheless, the performance indicator does not show whether the wagons with dangerous goods influence the departure. Neither does it show whether the buffers required on the yard affect the departure.

### Assumptions

To create the model, assumptions are made. There is a hump in the shunting yard because otherwise, problems arise with pushing and pulling individual wagons with the locomotives. Suppose a wagon is pulled to track 2, but there are already wagons on track 2. If the locomotive has correctly positioned the wagon, the locomotive cannot leave because there is also a wagon on the other side. Therefore, a wagon must be pulled from the arrival track, and pushed with an other locomotive to the right classification track. A longer classification time must be taken into account, which in this case is not included in the model. By applying breaks in the tracks, a wagon can be stopped at the proper distance from the wagon next to it. This is why a hump was chosen on this small yard.

It is assumed that there is enough equipment and workers available to distribute all wagons and move them to the next destination. There must be enough locomotives to move the wagons. This depends on a locomotive cycle plan that indicates which locomotive is assigned to which train. If there is no equipment to move the wagons from the classification tracks, this will also cause delays. This has not been taken into account to simplify the problem.

### Scenario results

The outcomes of the simulations are reliable up to 50% dangerous goods in a destination. After a rate of 60% dangerous goods, there are too many buffers on the tracks, causing departure moments to be missed. This occurs if the model has more than two buffers at the end of a track. The algorithm cannot recognize the

departure time of the train, and the model misses the departure. The missed departures are detectable in the cumulative curve figures. The departure time can easily be changed manually in the model by entering the correct departure time in the departure table. This will change the cumulative departure curve in the graph and the processing times.

How this can be prevented is by not placing the wagons with dangerous goods in the last two positions in the train. It must also be prevented that the first wagon of a train contains hazardous goods. As a result, there will be no buffer at the end of the track, but a wagon.

### **Calibrating results for $p$ and $w$**

The result of the different values for available track occupancy  $p$  and maximum waiting time  $w$  showed that a higher value results in a lower processing time. However, it was only tested to a value of  $p=20\%$  and  $w=20$  minutes. It appears that the parameter  $p$  has the greatest influence. When  $p$  becomes even larger than 20 %, the processing time also becomes shorter. Resulting in outbound trains with very few wagons, and not being profitable, because too many locomotives are needed to drive all wagons. Therefore, the assumption was made that there must be a minimum number of wagons connected before the train is allowed to depart.

### **Sensitivity analysis results**

When running the scenarios for different percentages of dangerous goods, only one simulation was done for each percentage per scenario. This is a total of 22 simulations. In general, there was a decrease in total processing time as the number of dangerous goods increased. However, there were results in which the processing time was not lower when the percentage of dangerous goods was higher. This is because the order in which the dangerous goods came in influences the processing time. Therefore, more simulations could be done with the same percentage of dangerous goods, but in a different order in the train.

### **Final product**

The model made in this study gives an overview of the placement of the wagons that are sorted on a shunting yard. The shunters can use this overview to maintain safety distances. The model can be used as a decision support tool for shunters. The model indicates the locations, where the wagons can be placed. The view from the calamity manager is included in the approach and this reduces the risks for the whole team that works on the shunting yard.

## **7.2.1. LIMITATIONS**

First, the model has not become an optimization model, so no optimal outcome has been found for which the processing times are the lowest. The processing times are influenced by the departure time of the train. This limits the model's outcome, as every later departure time has a major impact on the processing time. This is reflected in the result of the calibration of the parameter  $w$ .

The model is limited because not all aspects could be included in the modelling process, due to limited timescale. One example is the inclusion of the speed at which a wagon is sent from the arrival track to the classification track. This time is not taken into account in the model, while this can result in longer processing times as the hump can still be seen as occupied, because the operation is not yet completed.

Another limitation of the model is the approach for assigning destinations to tracks in Step 3. It requires full enumeration of combinations. Then, for a large number of tracks, the method might not be tractable.

The planning for the workers and locomotives needed in the yard is not taken into account. It is assumed that enough are present and available when needed. Normally there would be a planning for the locomotives, a locomotive cycle plan.

The model does not consider broken wagons or wagons that need maintenance. There is no room in the model for wagons that are broken and should be taken to another track for technical maintenance. In reality, the inspection checks whether the wagons are in good condition and can proceed to the next destination. If not, they are sent to special tracks or to places where the wagons are repaired.

What is noticeable in the model is the order in which wagons with dangerous goods are set up, influence the processing time of the trains. This could be seen in the extra runs done for a percentage of 30% and 40% dangerous goods. Here, the share of dangerous goods remained the same, but they changed the order in which they arrived. The model does not take into account any sequences for the outgoing trains. However, this could be useful if they were to travel to the next yard. In addition, there are also certain rules for the positioning of outgoing trains, especially if there are dangerous goods on board. The model does not take this into account.

Finally, the best time for the train to depart is considered. There is a fixed departure schedule that states when trains may enter the network in real life. However, in the other direction, there are no fixed departures towards the factories/last-mile of the goods. Therefore, no account is taken of a departure schedule. This limits the model if it is used for trains that want to enter the network. What could be done is to make a fixed time schedule and then look at how often the model lets trains depart earlier or later than the fixed time schedule. From this, consideration could then be given to creating the fixed time schedule.

### 7.3. RECOMMENDATIONS FOR FUTURE RESEARCH

In this research, the single-stage sorting method was mainly used. In practice, multistage sorting can also be used if there are more destinations than tracks. In that case, the order of the arrangement within a train is important. This order within a train can be considered in follow-up research. This order has consequences for the placement of wagons with dangerous goods which are not compatible with each other. This allows the wagons with dangerous goods to be placed optimal, without a buffer. This impacts the time a wagon stays in the yard.

This research is based on one arrival track whereby the First Come First Served strategy is applied. In the future, research could be done into when there are multiple arrival tracks and therefore multiple trains arrive at the same time. This would allow the application of other strategies such as Critical Train First, or Shorter Train First. The effect of the different strategies would be interesting to study.

In this research, the focus was on a traditional yard with three distinct functionalities. In reality, the different yards may have a less specific function. Think of a track that can be used for both shunting and parking wagons. In this case, shunting is required between parked wagons. This also involves multistage sorting. The impact of different layouts, including different track lengths and several tracks, should be considered.

The time it takes for a wagon to travel from the arrival track to the classification track has not been considered in this study. This depends on the distance the wagon has to travel. If it is the first wagon, it will have to cover more distance and it will take longer. This may affect the departure time.

An extra time for the second sorting process has not been considered when wagons come off a track where several destinations have been sorted. These must be dismantled again before they can leave. This time is not included in the model. This could mean extra processing time and this influence should also be investigated.

What has now been simulated are equal quantities of dangerous goods per destination per scenario. It would be interesting to see how the model reacts if there is not the same percentage of dangerous goods everywhere. It would also be interesting if there were not only two hazard classes, but more. This would result in even more tracks where buffers keep the proper distance between wagons.

In the model, only two wagon lengths are used. It would be interesting to investigate the impact of having several wagon lengths, requiring different buffer lengths. Resulting in different total processing times.

# BIBLIOGRAPHY

- [1] [Gevaarsidentificatienummer](#), (2010).
- [2] B. Foster, [Segregating Dangerous Goods under the IMDG Code](#), (2021).
- [3] M. Bohlin, S. Gestrelus, F. Dahms, M. Mihalák, and H. Flier, [Optimization Methods for Multistage Freight Train Formation](#), *Transportation Science* **50**, 823 (2016).
- [4] ProRail, [Basisbeheerkaart ProRail](#), (2022).
- [5] L. Bin and L. Jiping, [Application of Remote Sensing Technique for Disaster Management](#), *International Geoscience and Remote Sensing Symposium (IGARSS)*, 283 (2006).
- [6] B. B. Schasfoort, K. Gkiotsalitis, O. A. Eikenbroek, and E. C. van Berkum, [A Dynamic Model for Real-Time Track Assignment at Railway Yards](#), *Journal of Rail Transport Planning & Management* **14**, 100198 (2020).
- [7] T. Shi and X. Zhou, [A Mixed Integer Programming Model for Optimizing Multi-Level Operations Process in Railroad Yards](#), *Transportation Research Part B: Methodological* **80**, 19 (2015).
- [8] M. van Infrastructuur en Waterstaat, [Convenant warme-BLEVE-vrij \(Boiling Liquid Expanding Vapour Explosion\) samenstellen en rijden van treinen bij het vervoer van gevaarlijke stoffen per spoor](#). (2012).
- [9] U. T. Division, [Chapter 2. Definitions](#), (2022).
- [10] W. Victoria, [Dangerous Goods: Safety Basics](#), (2021).
- [11] ILT, [About the ILT](#), (2022).
- [12] RID, [RID 2021 – OTIF – Intergovernmental Organisation for International Carriage by Rail](#), (2021).
- [13] Portbase, [Wagen Lading Informatie Systeem](#), (2022).
- [14] S. v. Veldhoven, [Veiligheid van het spoor - Omgevingsweb](#), (2020).
- [15] FR8HUB, [WP4 : Intelligent Video Gate D4 . 2 Technical Proof of Concept and Roll-out and Implementation Plan](#), (2020).
- [16] B. Kordnejad and B. Mitrovic, [Intelligent Video Gate -A Conceptual Application of Emerging Technologies in Intelligent Video Gate](#), (2020).
- [17] N. Galonske, D. J. Hildebrandt, A. Zanardelli, L. Deiterding, A. Magnien, P. Mantell, M. Hennigson, L.-O. Fällbom, and E. Feyen, [User-Friendly Access to Information About Last-Mile Infrastructure for Rail Freight](#), Tech. Rep. (2016).
- [18] Inspectie Verkeer en Waterstaat, [Weten wat er staat](#), Tech. Rep. (2011).
- [19] M. C. Chang, G. Zhao, A. K. Pandey, A. Pulver, and P. Tu, [Railcar Detection, Identification and Tracking for Rail Yard Management](#), in *Proceedings - International Conference on Image Processing, ICIP*, Vol. 2020-October (IEEE Computer Society, 2020) pp. 2271–2275.
- [20] Ministerie van Infrastructuur en Waterstaat, [Vervoer van gevaarlijke stoffen over het spoor | Goederenvervoer | Rijksoverheid.nl](#), (2021).
- [21] Ministerie van Infrastructuur en Waterstaat, [wetten.nl - Regeling - Regeling vervoer over de spoorweg van gevaarlijke stoffen - BWBR0010053](#), (2021).



- [22] ERA, [Transport of Dangerous Goods](#), (2022).
- [23] Dutch Safety Board, [Dutch Safety Board, 2005 Risk Management for the Transport of Dangerous Goods by Rail.pdf](#), (2015).
- [24] COTIF, [RID Convention Concerning International Carriage by Rail \(COTIF\) Appendix C- Regulations Concerning International Carriage of Dangerous Goods by Rail](#), (2015).
- [25] ILT, [Gevaarlijke Stoffen Rail | Inspectie Leefomgeving en Transport \(ILT\)](#), (2021).
- [26] InfoMil, [Basisnet - Kenniscentrum InfoMil](#), (2021).
- [27] Risicokaart.nl, [GeoWeb 5.3](#), (2021).
- [28] RIVM, [Gevaarsnummers | Risico's van stoffen](#), (2021).
- [29] Sdu, [Stoffen | Gevaarlijke Lading](#), (2021).
- [30] N. Rosmuller, R. Boeree, and H. Spobeck, [Bereikbaarheid op Industriële Emplacementen](#), (2014).
- [31] TNO, ['Marshalling Yard'](#), (2021).
- [32] M. Marinov, I. Şahin, S. Ricci, and G. Vasic-Franklin, [Railway Operations, Time-Tabling and Control](#), [Research in Transportation Economics](#) **41**, 59 (2012).
- [33] M. Saeednia, D. Bruckmann, and U. Weidmann, [Event-Based Model for Optimizing Shunting Yard Operations](#), [Transportation Research Record](#) **2475**, 90 (2015).
- [34] M. Marinov and J. Viegas, [A Mesoscopic Simulation Modelling Methodology for Analyzing and Evaluating Freight Train Operations in a Rail Network](#), [Simulation Modelling Practice and Theory](#) **19**, 516 (2010).
- [35] M. Shanmugaraj, [UNIT-IV Railway Engineering](#), (2014).
- [36] VVRV, [VVRV cluster Beveiligingssytemen](#), Tech. Rep. (2021).
- [37] ProRail, [Begrippenlijst "Spoorse begrippen"](#), (2011).
- [38] H. Teshima, S. Hori, A. Shimura, and . N. Sato, [Railway Track Layout Modelling and its Application to an Automatic Route Setting System](#), [Transactions on The Built Environment](#) **135**, 1743 (2014).
- [39] ProRail, [Netverklaring 2020](#), (2020).
- [40] T. S. Glickman and E. Erkut, [Assessment of Hazardous Material Risks for Rail Yard Safety](#), [Safety Science](#) **45**, 813 (2007).
- [41] N. Batarlienè, [Improving Safety of Transportation of Dangerous Goods by Railway Transport](#), [Infrastructures](#) **5** (2020), 10.3390/infrastructures5070054.
- [42] M. Christou, [Analysis and Control of Major Accident From the Intermediate Temporary Storage of Dangerous Substances in Marshalling Yards and Port Areas](#), (1999).
- [43] RIVM, [Handleiding Risicoberekeningen Bevi versie 4.2 | RIVM](#), (2020).
- [44] RIVM, [SAFETI-NL](#), (2011).
- [45] L. J. Bellamy and V. M. Sol, [A Literature Review on Safety Performance Indicators Supporting the Control of Major Hazards](#), (2012).
- [46] Publicatiereeks gevaarlijke stoffen, [Guidelines for Quantitative Risk Assessment 3](#), (2005).
- [47] V. Dale, [Betekenis 'Prestatie'](#), (2021).
- [48] Panafrican Emergency Training Centre, [1.6. Disaster Prevention & Mitigation](#), (1999).
- [49] M. Saeednia, [A Framework for Managing Resources at Hump Shunting Yards](#), [2020 IEEE 23rd International Conference on Intelligent Transportation Systems, ITSC 2020](#) (2020), 10.1109/ITSC45102.2020.9294657.

- [50] J. T. Haahr, R. M. Lusby, and J. C. Wagenaar, *Optimization Methods for the Train Unit Shunting Problem*, *European Journal of Operational Research* **262**, 981 (2017).
- [51] Y. Zhang, R. Song, S. He, H. Li, and X. Guo, *Optimization of Classification Track Assignment Considering Block Sequence at Train Marshaling Yard*, *Journal of Advanced Transportation* **2018** (2018), 10.1155/2018/3802032.
- [52] E. Dahlhaus, P. Horak, M. Miller, and J. F. Ryan, *The Train Marshalling Problem*, *Discrete Applied Mathematics* **103**, 41 (2000).
- [53] G. Di Stefano and M. L. Koči, *A Graph Theoretical Approach to the Shunting Problem*, in *Electronic Notes in Theoretical Computer Science*, Vol. 92 (Elsevier, 2004) pp. 16–33.
- [54] F. Jaehn, J. Rieder, and A. Wiehl, *Minimizing Delays in a Shunting Yard*, *OR Spectrum* 2015 37:2 **37**, 407 (2015).
- [55] M. Marinov and J. Viegas, *A Simulation Modelling Methodology for Evaluating Flat-Shunted Yard Operations*, *Simulation Modelling Practice and Theory* **17**, 1106 (2009).
- [56] B. K. Choi and D. Kang, *Introduction to Event-Based Modeling and Simulation*, in *Modeling and Simulation of Discrete-Event Systems* (John Wiley & Sons, Ltd, 2013) pp. 69–106.
- [57] C. F. Daganzo, R. G. Dowling, and R. W. Hall, *Railroad Classification Yard Throughput: The Case of Multi-stage Triangular Sorting*, *Transportation Research Part A: General* **17**, 95 (1983).
- [58] N. Boysen, M. Fließner, F. Jaehn, and E. Pesch, *Shunting Yard Operations: Theoretical Aspects and Applications*, *European Journal of Operational Research* **220**, 1 (2012).
- [59] M. Gatto, J. Maue, M. Mihalák, and P. Widmayer, *Shunting for Dummies: An Introductory Algorithmic Survey*, *Lecture Notes in Computer Science (including subseries Lecture Notes in Artificial Intelligence and Lecture Notes in Bioinformatics)* **5868 LNCS**, 310 (2009).
- [60] E. Kraft, *Priority-Based Classification for Improving Connection Reliability in Railroad Yards-Part I: Integration With Car scheduling Railway Track Circuits and Signalling Systems View project Rail Line Capacity Analysis View project*, Tech. Rep. (2002).
- [61] A. Hauser and J. Maue, *Experimental Evaluation of Approximation and Heuristic Algorithms for Sorting Railway Cars*, in *Lecture Notes in Computer Science (including subseries Lecture Notes in Artificial Intelligence and Lecture Notes in Bioinformatics)*, Vol. 6049 LNCS (Springer, Berlin, Heidelberg, 2010) pp. 154–165.
- [62] S. Gestrelus, F. Dahms, and M. Bohlin, *Optimisation of Simultaneous Train Formation and Car Sorting at Marshalling Yards*, **1** (2013).
- [63] C. Büsing and J. Maue, *Robust Algorithms for Sorting Railway Cars*, in *Lecture Notes in Computer Science (including subseries Lecture Notes in Artificial Intelligence and Lecture Notes in Bioinformatics)*, Vol. 6346 LNCS (Springer, Berlin, Heidelberg, 2010) pp. 350–361.
- [64] I. Belošević and M. Ivić, *Variable Neighborhood Search for Multistage Train Classification at Strategic Planning Level*, *Computer-Aided Civil and Infrastructure Engineering* **33**, 220 (2018).
- [65] J. R. Dirnberger, G. C. Square, and C. Barkan, *Improving Railroad Classification Yard Performance Through Bottleneck Management Methods*, *Transportation Research Record Journal of the Transportation Research Board* (2006).
- [66] J. R. Dirnberger and C. P. Barkan, *Lean Railroad for Improving Railroad Classification Terminal Performance: Bottleneck Management Methods*, *Transportation Research Record*, 52 (2007).
- [67] L. Dimitrov, S. Purgic, P. Tomov, and M. Todorova, *Approach for Development of Real-Time Marshalling Yard Management System*, in *International Conference on High Technology for Sustainable Development, HiTech 2018 - Proceedings* (Institute of Electrical and Electronics Engineers Inc., 2018).

- [68] T. Bektaş, T. G. Crainic, and V. Morency, *Improving the Performance of Rail Yards Through Dynamic Reassignments of Empty Cars*, [Transportation Research Part C: Emerging Technologies](#) **17**, 259 (2009).
- [69] M. Bagheri, F. E. Saccomanno, and L. Fu, *Effective Placement of Dangerous Goods Cars in Rail Yard Marshaling Operation*, [Canadian Journal of Civil Engineering](#) **37**, 753 (2010).
- [70] M. Bagheri, F. Saccomanno, and L. Fu, *Modeling Hazardous Materials Risks for Different Train Make-Up Plans*, [Transportation Research Part E: Logistics and Transportation Review](#) **48**, 907 (2012).
- [71] Z. Xinmei, Z. Junjie, W. Mengtong, and C. Chen, *Research on Multi-objective Storage Optimization of Dangerous Goods in Ports*, [Proceedings - 2020 2nd International Conference on Machine Learning, Big Data and Business Intelligence, MLBDBI 2020](#), 131 (2020).
- [72] E. Erkut and V. Verter, *Modeling of Transport Risk for Hazardous Materials*, [Operations Research](#) **46** (1998), 10.1287/opre.46.5.625.
- [73] G. Chu and G. Lyu, *Critical Assessment on Dangerous Goods Storage Container Yard of Port: Case Study of LPG Tank Container*, [IEEE International Conference on Industrial Engineering and Engineering Management 2019-December](#), 1751 (2019).
- [74] M. Bagheri, *Risk Analysis of Stationary Dangerous Goods Railway Cars: a case study*, [Journal of Transportation Security](#) (2009), 10.1007/s12198-009-0029-0.
- [75] G. Y. Ke, *Managing rail-truck intermodal transportation for hazardous materials with random yard disruptions*, [Annals of Operations Research](#) 2020, 1 (2020).
- [76] A. B. Shiflet and G. W. Shiflet, *The Modeling Process*, (2006).
- [77] RIVM, *Towards a New Risk-Calculation Method for the Transport of Dangerous Goods by Rail*, (2014).
- [78] S. RailWiki, *Amsterdam Westelijk Havengebied*, (2022).
- [79] [SporenplanOnline](#), (2022).
- [80] A. Saltelli, M. Ratto, T. Andres, F. Campolongo, J. Cariboni, D. Gatelli, M. Saisana, and S. Tarantola, *Global Sensitivity Analysis. The Primer*, (2008), 10.1002/9780470725184.

# A

## INTERVIEWS

Two interviews were conducted for this research. The first interview was with a traffic controller of ProRail and is responsible for the shunting yard in Kijfhoek. The second interview was with a calamity manager of ProRail and is an expert on the W-LIS.

### A.1. INTERVIEW WITH TRAFFIC CONTROLLER PRORAIL (IN DUTCH)

Trein verkeersleider ProRail, 24/9/2021, 10:00 – 11:00

Belangrijk: Bij een trein met gevaarlijke goederen wordt de gehele trein beschouwd als gevaarlijk. Deze trein mag op het hele terrein staan, mits het binnen de bluscontouren ligt. Dit is geclusterd.

*Wat voor achterliggende strategie wordt er toegepast op de emplacements in Nederland? Is de doorstroming belangrijk, of juist de mogelijkheid tot zoveel mogelijk capaciteit behouden van het emplacement?*

Zoveel mogelijk rijden, zo min mogelijk overstand hebben op de sporen. Het is afhankelijk van de terminals die achter het emplacement ligt, hoeveel plek er is. De vervoerder moet bij de planningsafdeling van ProRail de dienstregeling aanvragen. Daarbij hoeft alleen de trein met de lengte en het aantal locomotieven doorgegeven te worden. De inhoud van de trein hoeft niet doorgegeven te worden, alleen als het gaat om specifieke gevaarsklasse/GEVI zoals bv klasse 1 en 7. Vervolgens wordt de dienstregeling gemaakt van A naar B en wordt er opstel gevraagd op het emplacement. Daarna wordt er logistiek gekeken of het past.

ProRail is dus niet verantwoordelijk voor de inhoud van de treinen. De vervoerder is verantwoordelijk voor de inhoud van de trein. ProRail krijgt een wagenlijst deze moet voor vertrek ingediend zijn, maar is niet verplicht om na te lopen om die te controleren, want die verantwoording ligt bij de vervoerder. Wij dienen alleen in geval van een calamiteit door te geven aan de meldkamer wat waar staat en dat wordt uit de systemen gehaald

Bij emplacement Waalhaven is er een beperking voor treinen met gevaarlijke stoffen, doordat de brandblusinstallatie niet goed functioneert wat betreft de worplengte. Hierdoor zijn er beperkingen met handelingen met wagons met gevaarlijke stoffen. Een trein met gevaarlijke stoffen en getrokken wordt door een e-loc mag dus alleen van locomotief wisselen als men binnen de bluscontouren staat. Anders mag alleen de trein met gevaarlijke stoffen met een diesel locomotief buiten deze contouren staan maar niet langer dan 4 uur. Op dit moment worden alle treinen die aankomen beschouwd als gevaarlijk, omdat er geen informatie over beschikbaar is. Dit belemmert de capaciteit van het emplacement. Er is alleen van een vervoerder bekend dat er helemaal niet met gevaarlijke stoffen wordt gewerkt, omdat dat het in het contract is vast gelegd. Er zijn nu 6 sporen op Waalhaven waar alles mag zoals rangeren en locomotieven, dus langer dan 4 uur staan met gevaarlijke stoffen, wisselen van locomotief, etc. Dat mag op de andere sporen niet, omdat er geen brandblusinstallatie is.

*Met wat voor specifieke handelingen moet rekening gehouden worden als er gevaarlijke stoffen in de wagon zitten?*

Als er gevaarlijke stoffen in de wagon zit, moet er rekening gehouden worden met:

- Het stoten van de trein
- Het af- en aankoppelen van de locomotief
- Er moeten twee wagons zonder gevaarlijke stoffen zitten achter de locomotief. Dit staat ook beschreven in de BLEVE-vrij rijden regeling. Hierdoor worden de treinen niet meer uitgerangeerd en samengesteld op het emplacement, maar vooral in de terminal zelf worden de treinen vaak samengesteld en op het raccordement. Lineas bij de Maasvlakte doet wel echt aan rangeren.

*Zijn er technische ontwikkelingen bezig die jullie kunnen helpen in het planproces?*

Dynamisch plannen is het doel, maar daar is te weinig personeel voor. Er zijn wel stukken spoor waar het gebeurt, maar dan moeten de terminals zelf plannen in de avond. ProRail is bezig met het ontwikkelen van een software, die kan na gaan hoelang de bewegingen duren en daarmee kunnen ze een algoritme ontwikkelen om het plannen van de bewegingen makkelijker te maken. Let op: processen op het ene emplacement werken heel anders op een ander emplacement. Voorbeeld hiervoor is het plaatsen van de sensoren werkt wel op het ene emplacement, maar kunnen niet zomaar op het andere emplacement geïnstalleerd worden.

*Houden jullie rekening met wagons met gevaarlijke stoffen? Zo ja, hoe? Zo nee, Waarom niet?*

Dat is allemaal de verantwoordelijkheid van de vervoerder. Treinen moeten op een bepaalde manier samengesteld worden en volgens het BLEVE-vrij rijden. Het samenstellen van een trein gebeurt op een terminal en het is niet de verantwoordelijkheid van ProRail, dus kan het voorkomen dat treinen naast elkaar komen te staan die eigenlijk volgens de regels niet naast elkaar mogen staan, omdat ProRail niet weet wat precies waar staat. Dus binnen een samengestelde trein wordt er rekening gehouden met gevaarlijke stoffen, maar met treinen naast elkaar niet. Omdat ProRail van te voren niet weet of er al dan niet gevaarlijke stoffen in de trein zit beschouwen ze de complete trein als gevaarlijk mits de vervoerder heeft aangegeven dat de trein geen gevaarlijke stoffen bevat. De vervoerders hebben de plicht om de wagons met gevaarlijke stoffen in te voeren in een systeem genaamd W-LIS. Waarmee ProRail wanneer er een calamiteit is binnen 5 minuten aan de bevoegde instantie door te geven wat en waar staat. Dit systeem mogen zij niet gebruiken om planmatig rekening te houden met de gevaarlijke stoffen.

In Amsterdam heb je de Wijnhandel die gevaarlijke goederen gebruiken. Amsterdam is een nieuwe omgeving, die de afdeling optimalisatie spoorgoederen van ProRail gaat exporteren. ProRail moet een vergunning aanvragen aan de hand van het soorten bedrijven die gebruik gaat maken van het spoor. De Wijnhandel gebruikt een stof die niet in de vergunning stond en mocht daarom niet gebruik maken van het spoor. De Wijnhandel zou handig kunnen zijn om mee te praten, om erachter te komen welke gebreken ze nu ondervinden en waar ze tegen aan lopen als vervoerder zijnde.

*Hoe werkt de dienstregeling?*

Er wordt jaarlijks een basis uur plan gemaakt dit zijn de paden waar de treinen planmatig worden opgelegd en die liggen vast. Dit is noodzakelijk omdat er op het hoofd spoor weg infrastructuur geen treinen zonder dat ze een dienstregeling hebben. Om zeker van te zijn dat de internationale treinen een goede grensafstemming hebben wordt het van tevoren gepland. Bij goederenvervoer is er bijna altijd vertraging en dat wordt dan door verkeersleiding bijgestuurd. Alleen vanaf het emplacement kan er gereden worden zonder een dienstregeling men krijgt dan van de treindienstleider een rijweg naar het betreffende gebied. Omdat het vaak naar een NCBG is krijgt de vervoerder een TRS – Tijd Ruimte Slot, omdat er dan geen andere vervoerder het gebied in kan. Daar kan een trein losgekoppeld, gerangeerd en samengesteld worden.

## A.2. INTERVIEW CALAMITY MANAGER PRORAIL (IN DUTCH)

Incidenten bestrijder ProRail, 8/11/2021, 14:00 – 15:00

*Wat houdt je functie precies in?*

“Ik ben verantwoordelijk voor de landelijke coördinatie van W-LIS. Dat is het ICT systeem waar ze kunnen bijhouden waar de treinen zijn neergezet op een emplacement. De wagenlijst van de vervoerder kan in W-LIS gezet worden en zo kan er makkelijk een overzicht komen met waar de wagons zich bevinden en wat er in de wagon zich bevindt. Dit gebeurt handmatig door mensen.”

“De kwaliteit van de W-LIS is de laatste jaren erg vooruit gegaan mede door de hulp van mij. In 2015 was de registratie 63% en in 2020 was dit percentage zo een 93%. Dit grote verschil komt doordat er aan het begin veel problemen waren met de applicatie. Er zaten veel bugs in en de gebruikers konden nog niet goed overweg met de applicatie.”

*Wat houdt de functie incidentenbestrijder in?*

“De incidentenbestrijder van ProRail heeft de taak om de veiligheid te bewaken, dat doen ze doormiddel van steekproeven om te controleren of de aangeleverde lijst ook klopt met de werkelijkheid. Zo een steekproef doen ze wekelijks per emplacement. Tijdens het controleren loopt iemand de wagons na die gecontroleerd moeten worden (deze worden random gekozen), en heeft daarbij een applicatie met een lijst waaraan voldaan moet worden. Alle fouten die ze daarbij tegenkomen worden gemeld met die app. De W-LIS weet precies welke stoffen er in welke wagon zit en waar de wagons staan. Deze posities van de wagons moet doorgegeven worden aan de verkeersleiding van ProRail telkens nadat deze zich verplaatst hebben.”

*Hoe vaak klopt het wel en hoe vaak blijkt het niet te kloppen? Nemen jullie dan extra maatregelen?*

“De registratie klopt voor 93% nu en dat blijkt uit steekproeven die we random afnemen. De overige 7% ligt puur aan het menselijk handelen. Mensen maken nu eenmaal fouten. Er wordt precies bijgehouden welke steekproeven niet blijken te kloppen en bij welke vervoerder dat is en op welk emplacement het gebeurd. Als blijkt dat telkens dezelfde vervoerder iets doet wat niet klopt dan wordt er in het maandelijks overleg aandacht aanbesteed.”

*Wie bepaald waar de wagons komen te staan? Hoelang van te voren wordt dat bepaald?*

“De vervoerders reserveren als het ware de sporen waarop de treinen mogen staan ver van te voren. Er is een jaarplanning voor de goederentreinen in combinatie met de NS en daarnaast is er ook een dagplanning. Hierin wordt er planmatig gekeken of er bijvoorbeeld genoeg afstand wordt behouden tussen bepaalde treinen. Dit is weer afhankelijk van de lay-out van het emplacement. De afdeling capaciteitsverdeling weet waar de treinen komen te staan.”

# B

## KEYWORDS FOR THE QUALITATIVE ANALYSIS

The keywords that have been used for the qualitative analysis are shown below.

- To find papers over shunting yard operations including dangerous goods:
  - 'Shunting yard' AND 'Dangerous goods'
  - 'Shunting yard' AND 'Risk assessment'
- To find papers over shunting yard operations in general:
  - 'Shunting yard' AND 'Performance'
  - 'Shunting yard' AND 'Optimization strategies'
  - 'Shunting yard' AND 'Single-stage sorting'
  - 'Shunting yard' AND 'Multi-stage sorting'
  - 'Shunting yard' AND 'Capacity'

# C

## MODEL DEVELOPMENT

In this appendix, the steps of the main model are shown.

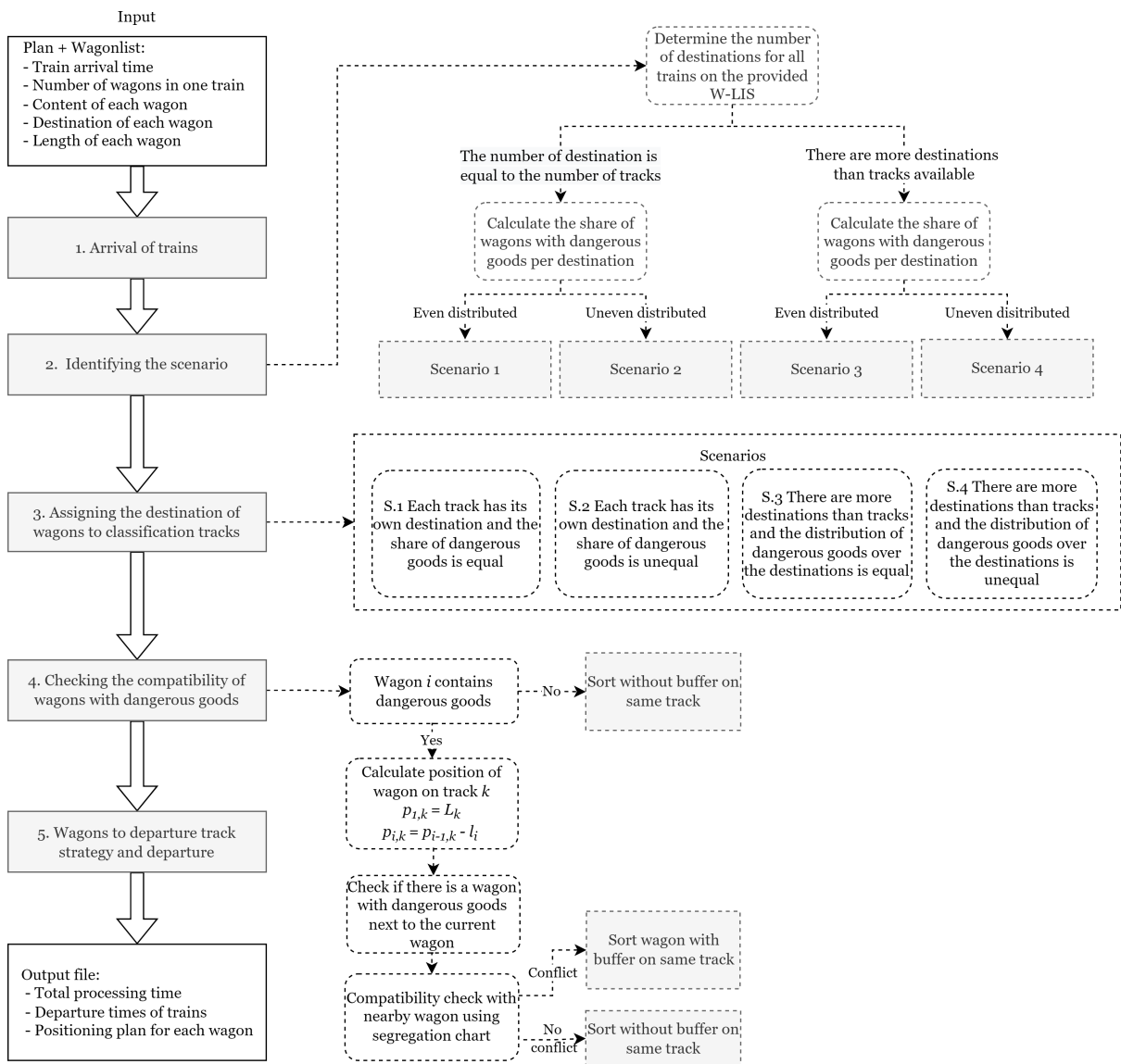

Figure C.1: Overview of the general model



# D

## SENSITIVITY ANALYSIS RESULTS

## D.1. INFLUENCE OF DIFFERENT AVAILABLE TRACK OCCUPANCY AND MAXIMUM WAITING TIME PARAMETERS

Table D.1: Overview of all processing times per track per scenario (SC) for different available track occupation parameter  $p$  and maximum waiting time parameter  $w$

w=10	p=0			
50%	SC1	SC2	SC3	SC4
<b>Track 1</b>	39523	39523	41862	42121
<b>Track 2</b>	36004	34933	33557	33557
<b>Track 3</b>	29357	34907	27687	34483
<b>Track 4</b>	34751	35873	35527	27889
<b>Total</b>	139635	145236	138633	138050

w=15	p=0			
50%	SC1	SC2	SC3	SC4
<b>Track 1</b>	39523	39523	41862	42121
<b>Track 2</b>	36004	34389	33557	33557
<b>Track 3</b>	29357	34907	27687	34483
<b>Track 4</b>	34751	35822	35527	27889
<b>Total</b>	139635	144641	138633	138050

w=20	p=0			
50%	SC1	SC2	SC3	SC4
<b>Track 1</b>	39523	39523	41862	41145
<b>Track 2</b>	36004	34389	33557	33557
<b>Track 3</b>	29357	34907	26933	34483
<b>Track 4</b>	34751	35822	35527	27105
<b>Total</b>	139635	144641	137879	136290

w=10	p=10			
50%	SC1	SC2	SC3	SC4
<b>Track 1</b>	36050	35386	39803	40268
<b>Track 2</b>	30960	32368	32641	32641
<b>Track 3</b>	31052	34533	26394	34468
<b>Track 4</b>	32542	35537	33602	26883
<b>Total</b>	129902	137824	132440	134260

w=15	p=10			
50%	SC1	SC2	SC3	SC4
<b>Track 1</b>	36050	35386	39803	40262
<b>Track 2</b>	30960	32368	32641	32641
<b>Track 3</b>	30350	34533	26394	34468
<b>Track 4</b>	32542	35537	33602	26883
<b>Total</b>	130604	137824	132440	134254

w=20	p=10			
50%	SC1	SC2	SC3	SC4
<b>Track 1</b>	36050	35386	39244	40262
<b>Track 2</b>	30960	32368	32641	32641
<b>Track 3</b>	30350	34533	26037	33611
<b>Track 4</b>	32542	34621	33602	26342
<b>Total</b>	130604	136908	131524	132856

w=10	p=20			
50%	SC1	SC2	SC3	SC4
<b>Track 1</b>	33594	33594	35908	36682
<b>Track 2</b>	31046	30295	29242	29242
<b>Track 3</b>	21651	29776	26514	31842
<b>Track 4</b>	30340	31504	31393	26125
<b>Total</b>	116631	125169	123057	123891

w=15	p=20			
50%	SC1	SC2	SC3	SC4
<b>Track 1</b>	33456	33456	35908	36682
<b>Track 2</b>	31046	30295	28695	28695
<b>Track 3</b>	21651	29776	26514	31842
<b>Track 4</b>	30340	31040	31393	26125
<b>Total</b>	116493	124567	122510	123344

w=20	p=20			
50%	SC1	SC2	SC3	SC4
<b>Track 1</b>	33456	33456	35908	36682
<b>Track 2</b>	31046	30295	28695	28695
<b>Track 3</b>	21651	29776	26514	31842
<b>Track 4</b>	30340	31040	31393	25585
<b>Total</b>	116493	124567	122510	122804

## D.2. INFLUENCE OF DIFFERENT PERCENTAGES OF DANGEROUS GOODS

Table D.2: Results of sensitivity analysis 0% - 30%: Different percentage of dangerous goods in the wagons per scenario

<b>0%</b>	<b>Scenario 1</b>	<b>Scenario 2</b>	<b>Scenario 3</b>	<b>Scenario 4</b>
<b>Track 1</b>	39523	-	33557	-
<b>Track 2</b>	35822	-	35352	-
<b>Track 3</b>	34907	-	29703	-
<b>Track 4</b>	34389	-	31623	-
<b>Total</b>	144641	-	130235	-

<b>10%</b>	<b>Scenario 1</b>	<b>Scenario 2</b>	<b>Scenario 3</b>	<b>Scenario 4</b>
<b>Track 1</b>	39523	39523	41881	41862
<b>Track 2</b>	35822	34389	33557	33557
<b>Track 3</b>	34539	34907	29703	32371
<b>Track 4</b>	34389	35822	35491	35352
<b>Total</b>	144273	144641	140632	143142

<b>20%</b>	<b>Scenario 1</b>	<b>Scenario 2</b>	<b>Scenario 3</b>	<b>Scenario 4</b>
<b>Track 1</b>	39523	39523	41881	41862
<b>Track 2</b>	35701	34389	33557	31623
<b>Track 3</b>	34094	34907	29905	32953
<b>Track 4</b>	34200	35822	35352	35352
<b>Total</b>	143518	144641	140695	141790

<b>30%</b>	<b>Scenario 1</b>	<b>Scenario 2</b>	<b>Scenario 3</b>	<b>Scenario 4</b>
<b>Track 1</b>	39523	39523	41862	41862
<b>Track 2</b>	36004	34389	31623	33557
<b>Track 3</b>	30304	34907	42238	32371
<b>Track 4</b>	33584	35822	35254	35352
<b>Total</b>	139415	144641	150977	143142

Table D.3: Results of sensitivity analysis 40% - 70%: Different percentage of dangerous goods in the wagons per scenario

<b>40%</b>	<b>SC1</b>	<b>SC2</b>	<b>SC3</b>	<b>SC4</b>
<b>Track 1</b>	39523	39523	41862	41862
<b>Track 2</b>	36004	34389	31623	33557
<b>Track 3</b>	31673	34907	32714	29325
<b>Track 4</b>	34389	35822	35254	35589
<b>Total</b>	141589	144641	141453	140333

<b>50%</b>	<b>SC1</b>	<b>SC2</b>	<b>SC3</b>	<b>SC4</b>
<b>Track 1</b>	39523	39523	41862	41145
<b>Track 2</b>	36004	34389	33557	33557
<b>Track 3</b>	29357	34907	29245	34008
<b>Track 4</b>	34751	35822	35560	27830
<b>Total</b>	139635	144641	140224	136540

<b>60%</b>	<b>SC1</b>	<b>SC2</b>	<b>SC3</b>	<b>SC4</b>
<b>Track 1</b>	39523	39523	41862	41862
<b>Track 2</b>	36268	34389	36123	31623
<b>Track 3</b>	infeasible	34907	45979	28484
<b>Track 4</b>	33816	35822	36379	35452
<b>Total</b>	109607	144641	160343	137421

<b>70%</b>	<b>SC1</b>	<b>SC2</b>	<b>SC3</b>	<b>SC4</b>
<b>Track 1</b>	39523	39523	41881	41862
<b>Track 2</b>	34845	34389	33557	33557
<b>Track 3</b>	infeasible	34907	29703	28749
<b>Track 4</b>	33085	35822	33557	36079
<b>Total</b>	107453	144641	138698	140247