

A Tractable Failure Probability Prediction Model for Predictive Maintenance Scheduling of Large-Scale Modular-Multilevel-Converters

Fu, J.; Peyghami, Saeed; Nunez, Alfredo; Blaabjerg, Frede; De Schutter, B.H.K.

DOI

[10.1109/TPEL.2023.3241317](https://doi.org/10.1109/TPEL.2023.3241317)

Publication date

2023

Document Version

Final published version

Published in

IEEE Transactions on Power Electronics

Citation (APA)

Fu, J., Peyghami, S., Nunez, A., Blaabjerg, F., & De Schutter, B. H. K. (2023). A Tractable Failure Probability Prediction Model for Predictive Maintenance Scheduling of Large-Scale Modular-Multilevel-Converters. *IEEE Transactions on Power Electronics*, 38(5), 6533-6544.
<https://doi.org/10.1109/TPEL.2023.3241317>

Important note

To cite this publication, please use the final published version (if applicable).
Please check the document version above.

Copyright

Other than for strictly personal use, it is not permitted to download, forward or distribute the text or part of it, without the consent of the author(s) and/or copyright holder(s), unless the work is under an open content license such as Creative Commons.

Takedown policy

Please contact us and provide details if you believe this document breaches copyrights.
We will remove access to the work immediately and investigate your claim.

Green Open Access added to TU Delft Institutional Repository

'You share, we take care!' - Taverne project

<https://www.openaccess.nl/en/you-share-we-take-care>

Otherwise as indicated in the copyright section: the publisher is the copyright holder of this work and the author uses the Dutch legislation to make this work public.

A Tractable Failure Probability Prediction Model for Predictive Maintenance Scheduling of Large-Scale Modular-Multilevel-Converters

Jianfeng Fu ¹, Saeed Peyghami ², *Senior Member, IEEE*, Alfredo Núñez ³, *Senior Member, IEEE*, Frede Blaabjerg ⁴, *Fellow, IEEE*, and Bart De Schutter ⁵, *Fellow, IEEE*

Abstract—Predictive maintenance scheduling of modular-multilevel-converters (MMCs) requires estimations of the failure probabilities of MMCs during a period of time in the future. Particularly, the predicted future failure probabilities are influenced by two main factors, the mission profiles of the MMCs and the maintenance decisions on the MMCs during the prediction period. This paper proposes a failure probability prediction model (FPM) for MMCs by considering these two factors. First, the expectations of the failure probabilities of the components for all the scenarios of mission profiles are obtained. Second, in predictive maintenance scheduling problems, the decisions to perform the maintenance actions are represented by binary variables. When the number of submodules is very large, using the binomial probability form currently used in reliability engineering to express the “r-out-of-n” failure probability of arms of the MMCs is intractable. Thus, this paper proposes a tractable form (T-form) in FPM by observing that the submodules on one arm are homogeneous. Furthermore, an approximation method, i.e., clustering and assignment (C&A), is proposed to reduce the computation times for calculating the parameters needed by the proposed T-form. Then, we perform a case study that assesses the accuracy and computation time of the C&A approach. The results show that the accuracy of the C&A approach is high and that the computation time is reduced significantly compared with the accurate method. We also show that the computation time for solving the predictive maintenance scheduling problem can be reduced hugely by using the T-form instead of the binomial probability form.

Index Terms—Direct current transmission network, large-scale modular multilevel converters (MMCs), predictive maintenance

Manuscript received 30 June 2022; revised 17 October 2022 and 18 December 2022; accepted 29 January 2023. Date of publication 1 February 2023; date of current version 10 March 2023. This work was supported by the CSC (China Scholarship Council) under Grant 201806280023. Recommended for publication by Associate Editor J. R. Espinoza. (*Corresponding author: Jianfeng Fu.*)

Jianfeng Fu is with the College of Marine Electrical Engineering, Dalian Maritime University, Dalian 116026, China, and also with the Delft Center for Systems and Control, Delft University of Technology, 2628 Delft, The Netherlands (e-mail: 1543580611@qq.com).

Saeed Peyghami and Frede Blaabjerg are with AU Energy, Aalborg University, 9220 Aalborg, Denmark (e-mail: sap@energy.aau.dk; fbl@energy.aau.dk).

Alfredo Núñez is with the Department of Engineering Structures, Delft University of Technology, 2628 Delft, The Netherlands (e-mail: a.a.nunezvicencio@tudelft.nl).

Bart De Schutter is with the Delft Center for Systems and Control, Delft University of Technology, 2628 Delft, The Netherlands (e-mail: b.deschutter@tudelft.nl).

Color versions of one or more figures in this article are available at <https://doi.org/10.1109/TPEL.2023.3241317>.

Digital Object Identifier 10.1109/TPEL.2023.3241317

scheduling, r-out-of-n reliability model, uncertainty of renewable energy generation.

I. INTRODUCTION

LARGE-SCALE renewable energy farms are established or planned around the world [1]. These farms integrate many renewable energy generators, e.g., wind turbines and solar panels. Due to the large distances between renewable energy farms and load centers, transmitting the generated renewable energy using alternating current transmission lines results in considerable energy losses [2], [3]. Consequently, direct current transmission lines are leveraged to transmit the generated energy to the load centers. Because of their advantages, e.g., high modularity and high power quality [4], modular multilevel converters (MMCs) are widely selected as power conversion devices in direct current transmission networks.

In direct current transmission networks, sudden failures on MMCs may result in large-scale outages. Thus, preventive maintenance actions should be scheduled to avoid sudden failures. For example, in [5], a method is proposed to estimate the preventive maintenance period for MMCs. In [6], a periodical preventive maintenance strategy is proposed regarding random-chance failure probabilities, wear-out failure distributions, etc. Although periodic preventive maintenance can efficiently avoid the occurrence of failures, over-maintenance and also lack of maintenance may occur because of improper maintenance periods [7], [8]. Predictive maintenance is characterized by predicting the health conditions of the converters and then scheduling the maintenance actions if the actions are necessary. So, predictive maintenance can avoid over-maintenance and lack of maintenance. At each time step, the current health conditions of the MMCs are diagnosed, then the health conditions are predicted over a period of time according to the predicted mission profiles of the MMCs. In this article, this period of time is called the prediction horizon. Afterward, the maintenance actions are scheduled and performed during this prediction horizon, considering that the predicted health conditions of MMCs at the end of the prediction horizon should be high enough to guarantee the reliability of the MMCs. Then, at the next time step, the process is repeated. Thus, the predictive maintenance scheduling relies on the health condition prediction model.

In some of our previous works [9], [10], two factors, i.e., the mission profiles and performance of maintenance actions, were

determined as the ones that will mostly influence the reliability of the converters. In the literature, the influence of mission profiles on the health condition prediction model of converters has been widely studied [11], [12], [13], [14], [15]. Furthermore, the influence of performing maintenance actions on the health condition prediction model has also been widely studied, e.g., [5], [16], and [17]. However, these papers focus on periodic maintenance. In periodic maintenance, the maintenance intervals of the MMCs are predetermined; so whether and when to perform maintenance actions during the prediction horizon is known. On the contrary, in predictive maintenance scheduling, since the maintenance intervals are not fixed as periodic maintenance, so whether and when to perform maintenance actions are decision variables to be determined dynamically over time.

Thus, this article proposes a failure probability¹ prediction model (FPM) related to the mission profiles and the maintenance decision variables of the MMCs. Furthermore, one specific challenge, i.e., the tractability of FPM for large-scale MMCs containing huge numbers of submodules, is handled in the newly proposed FPM. Moreover, the uncertainty of the mission profiles resulting from the renewable energy generation is included in the proposed FPM.

The challenge of the tractability of FPM emerges, especially when the numbers of submodules on the arms of the MMCs are huge. Since an arm with submodules follows a “r-out-of-n” configuration [18], a direct form to express the failure probability of an arm is the binomial probability [19], as indicated in (3) in Section IV. The failure probability of an arm related to the maintenance decision variables in binomial probability form is either nonlinear or involves a significant number of auxiliary variables when recasting the nonlinear constraints into linear ones. Therefore, the predictive maintenance scheduling problem including the failure probabilities of arms in binomial probability form is intractable. To address this challenge, by observing that the submodules are homogeneous (see the explanation of homogeneity in Section V-A), this article proposes a tractable form (T-form) to express the failure probability of an arm.

When obtaining the T-form for large-scale MMCs, the computation times for calculating the parameters of the T-form will be extremely long. Thus, a clustering and assignment (C&A) approximation approach is proposed to calculate offline the parameters of the proposed T-form efficiently. The key idea of the proposed C&A approximation approach is first to cluster the submodules whose failure probabilities are nearly the same. Then, the failure probabilities of the submodules in one group are approximated by the mean failure probability of submodules in this group. The idea of C&A originates from using clustering methods to compress the images in the literature on signal processing, e.g., [20] and [21].

Moreover, since the generation powers of the renewable energy generators are uncertain, the mission profiles for MMCs in transmission networks with renewable energy generations are also uncertain. Thus, in our proposed FPM, the uncertainties of renewable energy generation are also considered. Specifically, scenarios are adopted to reflect these uncertainties as is also done in [22] and [23].

¹This article adopts the failure probability to describe the health condition.

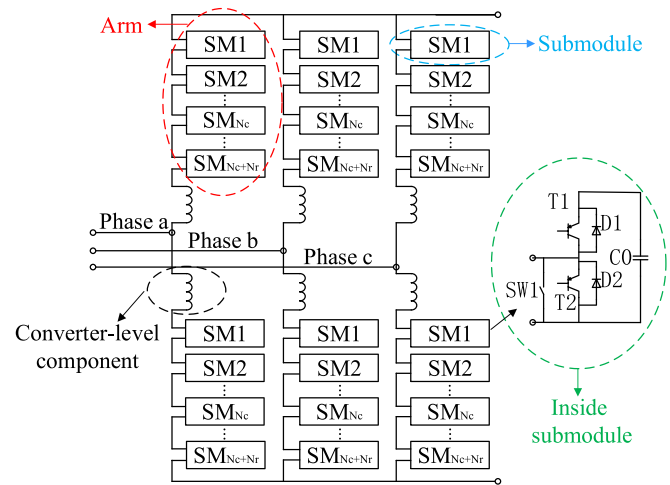

Fig. 1. Layout of a half-bridge-based MMC converter.

The contributions of this article are as follows.

- 1) An FPM for large-scale MMC converters is proposed. The relationship between the predicted failure probability, the maintenance decision variables, and the mission profiles is obtained.
- 2) By observing that the submodules on the arm of MMCs are homogeneous, this article proposes a T-form to express the relationship between the failure probability and the maintenance decision variables. The proposed T-form is linear and without using many auxiliary variables compared with the binomial probability form.
- 3) The parameters of the T-form can be calculated offline. To tackle the long computation time for the parameters, we propose a C&A approach to obtain approximate values of the parameters.

The rest of this article is organized as follows. Section II explains the failure mechanism of MMCs and the main steps for obtaining the proposed FPM. Section III presents the proposed method to calculate the failure probabilities of the submodules. Section IV explains the method to calculate the failure probabilities of arms using the binomial probability form. Section V illustrates the method to calculate the failure probabilities of arms in the proposed T-form with the proposed C&A approximation approach. In Section VI, the predictive maintenance scheduling problems of converters are formulated. In Section VII, the proposed C&A approach is compared with the conventional (accurate) approach and the proposed T-form is compared with the binomial probability form via tests. Finally, Section VIII concludes this article and presents possible topics for future work.

II. FAILURE MECHANISM OF MMCs AND MAIN STEPS FOR OBTAINING THE PROPOSED FPM

A. Half-Bridge MMC Failure Mechanism

This article studies the half-bridge MMCs which are widely applied in practical engineering as a representative of MMCs. As illustrated in Fig. 1, an MMC comprises converter-level components and arms. For large-scale MMCs, each arm links hundreds

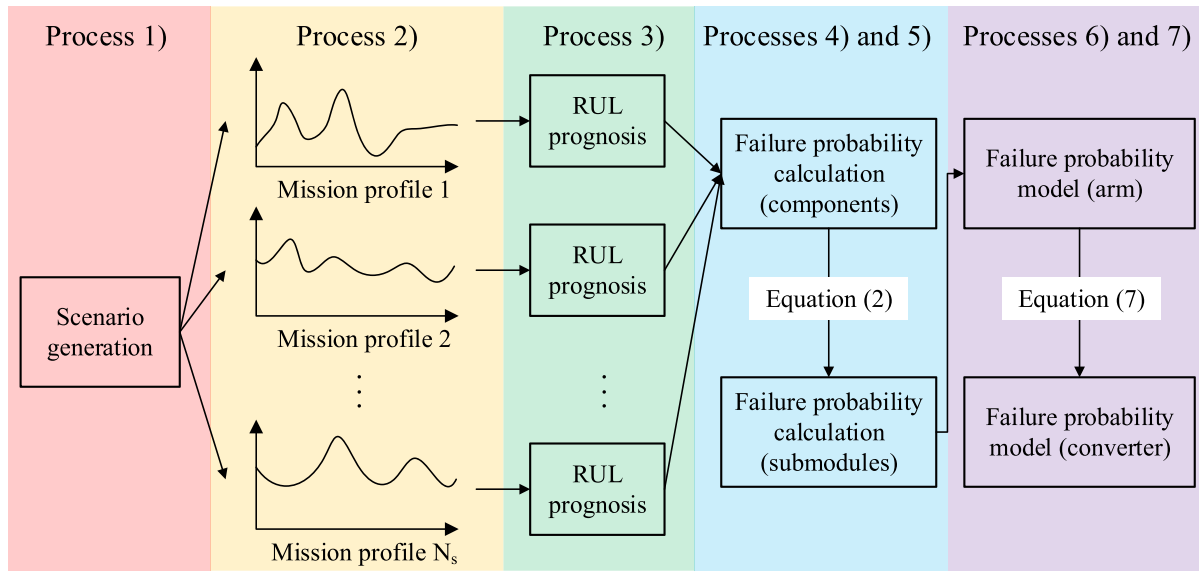

Fig. 2. Main processes for obtaining the failure probability model of complete MMCs.

of submodules in series. Each submodule comprises several components, i.e., insulated gate bipolar transistors (IGBTs), diodes, and capacitors, as shown in Fig. 1. The failures in half-bridge MMCs involve the following four levels:

- 1) failed components in submodules;
- 2) failed submodules;
- 3) failed arms;
- 4) failed converter.

The relationships between these four levels are as follows.

If any component in a submodule has failed, the submodule is considered to fail too. Moreover, failed submodules will not necessarily result in failed arms. In practice, the submodules on arms follow the “r-out-of-n” configuration. That is, there are some redundant submodules on each arm. Because of the “r-out-of-n” configuration, the failed submodules on arms can be bypassed and replaced by the redundant submodules on the same arm without interrupting the operation of the converter. However, if the number of failed submodules on one arm exceeds the number of redundant submodules, this arm will fail. If any of the arms and converter-level components in the MMC has failed, the converter will fail [24].

B. Main Processes for Obtaining the Proposed FPM

The main processes for obtaining the proposed FPM are shown in Fig. 2. Seven processes are involved, as follows.

- 1) Multiple scenarios of renewable energy generation and load profiles are generated to reflect the uncertainties during prediction.
- 2) Then, according to the load and generation profiles of each scenario, the corresponding loading profiles of the converters, i.e., the power flow passing through MMC, can be obtained by solving the optimal power flow equations. Moreover, the predicted ambient temperature profiles of MMCs can be obtained by historical temperature data. In this way, the predicted mission profile of MMCs including

the predicted loading and ambient temperature profiles can be obtained.

- 3) For each scenario, the predicted mission profiles of MMCs are used for remaining useful life (RUL) prediction for the components in submodules, i.e., IGBTs, diodes, and capacitors.
- 4) According to the predicted RUL for all scenarios, the failure probabilities of components in submodules can be estimated.
- 5) Afterwards, the failure probabilities of submodules are obtained.
- 6) According to the failure probabilities of the submodules, the relationship between the failure probabilities of the arms and the maintenance decision variables can be obtained. Here, the proposed T-form and C&A approach are applied.
- 7) The relationship between the failure probability of the whole converter and the maintenance decision variables, i.e., FPM, is obtained.

In the following sections, we will introduce the details of the processes. Specifically, in Section III, Processes 1) to 5) will be introduced. Then, in Sections IV and V, the binomial probability form, the proposed T-form, and the C&A approach will be introduced for Process 6). In Section VI, Process 7) is introduced and the predictive maintenance scheduling problem for MMCs is formulated.

III. FAILURE PROBABILITY CALCULATION FOR SUBMODULES

Since Processes 1) to 3) in Section II-B have been studied in the literature, the current article does not focus on these processes. In detail, for Process 1), the scenarios can be generated by an autoregressive integrated moving average model and the scenario tree reduction method of [22]. Regarding Process 2), modeling of the optimal power flow problem and the solution methods can be found in [25]. Afterwards, the loading profiles of

the converters can be obtained by solving the optimal power flow problems. Furthermore, for Process 3), RUL prediction methods for the IGBTs, diodes, and capacitors can be found in [14], [26], and [27], respectively. Since the RUL prediction methods of the components in submodules are not the core topic of this article, this article assumes that the RUL prediction methods mentioned in [14], [26], and [27] can accurately predict the RULs of the components. Afterwards, the predicted RUL cumulative distribution functions of the components in the submodules can be obtained.

Then, the failure probabilities of the components in the submodules, i.e., IGBTs, diodes, and capacitors, can be obtained, such that

$$\lambda_{i,j}^\theta = \sum_{s \in \mathcal{S}} p_s \Phi_s^\theta(T_D), \forall \theta \in \Theta_{i,j}, \forall i \in \mathcal{I}, \forall j \in \mathcal{J}_i \quad (1)$$

where $\Theta_{i,j}$ represents the set of components in submodule j on arm i , $\mathcal{S} = \{1, \dots, N_s\}$ represents the set of scenarios, \mathcal{I} is the set of arms, \mathcal{J}_i is the set of submodules on arm i , $\lambda_{i,j}^\theta$ is the failure probability of component θ in submodule j of arm i , p_s represents the probability of the occurrence of scenario s , Φ_s^θ is the predictive RUL cumulative distribution function of component θ for scenario s obtained from Process 3), and T_D is the prediction horizon for predictive maintenance scheduling. For a given scenario s , (1) expresses that if the RUL of a component in a submodule is less than the prediction horizon T_D , a failure will happen on the component. Then, recalling the failure mechanism of submodules given in Section II-A, the failure probability of submodule j on arm i can be obtained by

$$\lambda_{i,j}^{\text{sm}} = 1 - \prod_{\theta \in \Theta} (1 - \lambda_{i,j}^\theta), \forall i \in \mathcal{I}, \forall j \in \mathcal{J}_i \quad (2)$$

where $\lambda_{i,j}^{\text{sm}}$ is the failure probability of submodule j on arm i .

IV. FAILURE PROBABILITY MODEL OF AN ARM IN BINOMIAL PROBABILITY FORM

In general, a half-bridge MMC has several arms. On each arm, there are $N^c + N^r$ submodules in total, where N^c is the minimum number of modules to guarantee the regular operation of the converter [28]. In addition, N^r is the number of

redundant submodules. Recalling the failure mechanism given in Section II-A, when the number of failed submodules on one arm is smaller than N^r , the arm can still work well. However, when the number of failed submodules on one arm exceeds N^r , the arm will fail. Hence, the failure probability of arm i of the converter in binomial probability form can be expressed as

$$\lambda_i^{\text{ar}} = 1 - \sum_{\mathcal{J}'_i \in \mathbb{J}_i} \left(\prod_{j \in \mathcal{J}'_i} ((1 - \delta_{i,j}^{\text{sm}}) \lambda_{i,j}^{\text{sm}} + \delta_{i,j}^{\text{sm}} \lambda^{\text{sm}0}) \cdot \prod_{j \in \mathcal{J}_i \setminus \mathcal{J}'_i} (1 - ((1 - \delta_{i,j}^{\text{sm}}) \lambda_{i,j}^{\text{sm}} + \delta_{i,j}^{\text{sm}} \lambda^{\text{sm}0})) \right) \quad (3)$$

where $\delta_{i,j}^{\text{sm}} = 1$ represents that maintenance is being performed on submodule j on arm i during the prediction horizon; otherwise, it equals 0. In this article, the maintenance action for a submodule is to replace the submodule with a new one. In (3), λ_i^{ar} is the failure probability of arm i , $\lambda^{\text{sm}0}$ is the initial failure probability of a newly replaced submodule. The initial failure probability can be set as a small real value, as widely reported in the literatures [29] and [30], or it can be set to 0 by rationally assuming ‘‘as good as new.’’ Furthermore, \mathcal{J}'_i is the set of failed submodules on arm i , and set \mathbb{J}_i contains all the possible sets of failed submodules whose cardinality is no larger than N^r , i.e., $\text{card}(\mathcal{J}'_i) \leq N^r$. Moreover, the cardinality of \mathbb{J}_i is $\sum_{j \in \{0,1,\dots,N^r\}} \binom{N^c + N^r}{j}$. Equation (3) implies that the failure probability equals 1 minus the survival rate. For example, if $N^c = 2$ and $N^r = 1$, and assuming three submodules ($N^c + N^r = 3$) on arm i are marked as ‘‘1, 2, 3,’’ the cardinality of the sets in \mathbb{J}_i should be no larger than $N^r = 1$, so $\mathbb{J}_i = \{\emptyset, \{1\}, \{2\}, \{3\}\}$. Then, based on the example and (3), the failure probability of arm i is shown as (4) shown at the bottom of this page.

From (3) and (4), it can be observed that modeling the failure probability of an arm including the maintenance decision variables $\delta_{i,j}^{\text{sm}}$ in binomial probability form is too complex. The following are the two main reasons: 1) in (3) or (4), the products of maintenance decision variables yield nonlinear

$$\lambda_i^{\text{ar}} = 1 - \left((1 - \lambda_{i,1}^{\text{sm}'}) (1 - \lambda_{i,2}^{\text{sm}'}) (1 - \lambda_{i,3}^{\text{sm}'}) + \lambda_{i,1}^{\text{sm}'} (1 - \lambda_{i,2}^{\text{sm}'}) (1 - \lambda_{i,3}^{\text{sm}'}) + (1 - \lambda_{i,1}^{\text{sm}'}) \lambda_{i,2}^{\text{sm}'} (1 - \lambda_{i,3}^{\text{sm}'}) + (1 - \lambda_{i,1}^{\text{sm}'}) (1 - \lambda_{i,2}^{\text{sm}'}) \lambda_{i,3}^{\text{sm}'} \right),$$

$$\text{where, } \lambda_{i,1}^{\text{sm}'} = (1 - \delta_{i,1}^{\text{sm}}) \lambda_{i,1}^{\text{sm}} + \delta_{i,1}^{\text{sm}} \lambda^{\text{sm}0}, \lambda_{i,2}^{\text{sm}'} = (1 - \delta_{i,2}^{\text{sm}}) \lambda_{i,2}^{\text{sm}} + \delta_{i,2}^{\text{sm}} \lambda^{\text{sm}0}, \lambda_{i,3}^{\text{sm}'} = (1 - \delta_{i,3}^{\text{sm}}) \lambda_{i,3}^{\text{sm}} + \delta_{i,3}^{\text{sm}} \lambda^{\text{sm}0} \quad (4)$$

$$\lambda_i^{\text{ar}} = 1 - \left(z_{i,0} \left((1 - \lambda_{i,1}^{\text{sm}}) (1 - \lambda_{i,2}^{\text{sm}}) (1 - \lambda_{i,3}^{\text{sm}}) + \lambda_{i,1}^{\text{sm}} (1 - \lambda_{i,2}^{\text{sm}}) (1 - \lambda_{i,3}^{\text{sm}}) + (1 - \lambda_{i,1}^{\text{sm}}) \lambda_{i,2}^{\text{sm}} (1 - \lambda_{i,3}^{\text{sm}}) + (1 - \lambda_{i,1}^{\text{sm}}) (1 - \lambda_{i,2}^{\text{sm}}) \lambda_{i,3}^{\text{sm}} \right) + z_{i,1} \left((1 - \lambda_{i,1}^{\text{sm}0}) (1 - \lambda_{i,2}^{\text{sm}}) (1 - \lambda_{i,3}^{\text{sm}}) + \lambda_{i,1}^{\text{sm}0} (1 - \lambda_{i,2}^{\text{sm}}) (1 - \lambda_{i,3}^{\text{sm}}) + (1 - \lambda_{i,1}^{\text{sm}0}) \lambda_{i,2}^{\text{sm}} (1 - \lambda_{i,3}^{\text{sm}}) + (1 - \lambda_{i,1}^{\text{sm}0}) (1 - \lambda_{i,2}^{\text{sm}}) \lambda_{i,3}^{\text{sm}} \right) + z_{i,2} \left((1 - \lambda_{i,1}^{\text{sm}0}) (1 - \lambda_{i,2}^{\text{sm}0}) (1 - \lambda_{i,3}^{\text{sm}}) + \lambda_{i,1}^{\text{sm}0} (1 - \lambda_{i,2}^{\text{sm}0}) (1 - \lambda_{i,3}^{\text{sm}}) + (1 - \lambda_{i,1}^{\text{sm}0}) \lambda_{i,2}^{\text{sm}0} (1 - \lambda_{i,3}^{\text{sm}}) + (1 - \lambda_{i,1}^{\text{sm}0}) (1 - \lambda_{i,2}^{\text{sm}0}) \lambda_{i,3}^{\text{sm}} \right) + z_{i,3} \left((1 - \lambda_{i,1}^{\text{sm}0}) (1 - \lambda_{i,2}^{\text{sm}0}) (1 - \lambda_{i,3}^{\text{sm}0}) + \lambda_{i,1}^{\text{sm}0} (1 - \lambda_{i,2}^{\text{sm}0}) (1 - \lambda_{i,3}^{\text{sm}0}) + (1 - \lambda_{i,1}^{\text{sm}0}) \lambda_{i,2}^{\text{sm}0} (1 - \lambda_{i,3}^{\text{sm}0}) + (1 - \lambda_{i,1}^{\text{sm}0}) (1 - \lambda_{i,2}^{\text{sm}0}) \lambda_{i,3}^{\text{sm}0} \right) \right),$$

and $z_{i,0} + z_{i,1} + z_{i,2} + z_{i,3} = 1$ (5)

terms; 2) recasting nonlinear products of binary decision variables into a linear form² requires a large number of auxiliary binary variables (i.e., $\binom{N^r+N^c}{2} + \binom{N^r+N^c}{3} + \dots + \binom{N^r+N^c}{N^r+N^c}$ auxiliary variables). For example, for (4) the auxiliary binary variables are $a_{i,1} = \delta_{i,1}^{\text{sm}} \delta_{i,2}^{\text{sm}}$, $a_{i,2} = \delta_{i,1}^{\text{sm}} \delta_{i,3}^{\text{sm}}$, $a_{i,3} = \delta_{i,2}^{\text{sm}} \delta_{i,3}^{\text{sm}}$, and $a_{i,4} = \delta_{i,1}^{\text{sm}} \delta_{i,2}^{\text{sm}} \delta_{i,3}^{\text{sm}} = a_{i,1} \delta_{i,3}^{\text{sm}}$. In practice, N^c and N^r for large-scale MMCs usually range from tens to hundreds. Thus, the complexity makes the binomial probability form intractable, especially when N^c and N^r are large values. To tackle the nonlinearity and to avoid introducing a huge number of auxiliary variables, we propose to model the failure probability of arms in MMCs in T-form.

V. FAILURE PROBABILITY MODEL OF AN ARM IN THE PROPOSED T-FORM

A. Proposed T-Form

The submodules on an arm in MMCs are *homogeneous* because the maintenance costs for submodules are the same (i.e., the costs for replacing submodules by new ones) and the submodules on the same arm have the same weight when calculating the failure probability of an arm. Here “the same weight” does not mean that the failure probabilities of submodules are the same, but the submodules on an arm are with the same importance when calculating the failure probability of an arm. If only β_i submodules can be replaced with new ones because of budget constraints, then to minimize the failure probability of the arm, the strategy must be to replace the β_i submodules with the highest failure probabilities. For example, if $N^c + N^r = 3$ and $\beta_i = 1$, then $\delta_{i,1}^{\text{sm}} = 1$ and $\delta_{i,2}^{\text{sm}} = \delta_{i,3}^{\text{sm}} = 0$, as the failure probability of submodule 1 is the highest.

Then, regarding the example of (4), after ranking the failure probabilities of submodules 1 to 3 from the highest to the lowest, using the homogeneity of submodules, (4) can be equivalently written in T-form as shown in (5). In (5), the binary variables $z_{i,0} = 1$ to $z_{i,3} = 1$ represent replacing submodules 0 to 3 by new ones, respectively. Compared with (4), (5) contains two linear equations. Furthermore, there are only $N^c + N^r + 1 = 4$ binary variables without using any auxiliary variables to represent the products of the binary decision variables. Then, we expand the T-form to general MMCs for calculating the failure probability of arm i , such that

$$\lambda_i^{\text{ar}} = \sum_{x \in \mathcal{X}_i} z_{i,x} \gamma_{i,x}, \quad i \in \mathcal{I} \quad (6)$$

$$\sum_{x \in \mathcal{X}_i} z_{i,x} = 1, \quad i \in \mathcal{I}$$

where $\mathcal{X}_i = \{0, 1, \dots, N^c + N^r\}$, $\gamma_{i,x}$ is the failure probability of arm i after x submodules are replaced. The parameters $\gamma_{i,x}$ in the T-form can be obtained *offline* by Algorithm 1.

Note that in Algorithm 1, the “C&A” approach mentioned in Code lines 6 and 11 will be introduced in Section V-B.

²According to the method in [31], the product of two binary variables α_1 and α_2 , i.e., $\alpha = \alpha_1 \alpha_2$, can be equivalently recast as the bundle of linear constraints $-\alpha_1 + \alpha \leq 0$, $-\alpha_2 + \alpha \leq 0$, and $\alpha_1 + \alpha_2 - \alpha \leq 1$, where α is an auxiliary binary variable.

Algorithm 1: Pseudo Code for Offline Obtaining Parameters

$\gamma_{i,x}$ in T-form.

- 1: According to N^c and N^r , formulate set \mathbb{J}_i .
- 2: Use (1) and (2) to calculate $\lambda_{i,j}^{\text{sm}}$.
- 3: Rank submodules from the one with the highest failure probability (i.e., $\lambda_{i,j}^{\text{sm}}$) to that with the lowest one.
- 4: Initialize $x = 0$.
- 5: $\delta_{i,j}^{\text{sm}} \leftarrow 0, \forall j \in \{1, \dots, N^c + N^r\}$.
- 6: Calculate λ_i^{ar} via (3) for an accurate result or via the proposed C&A for fast and approximated result.
- 7: $\gamma_{i,0} \leftarrow \lambda_i^{\text{ar}}$.
- 8: $x \leftarrow x + 1$.
- 9: $\delta_{i,j}^{\text{sm}} \leftarrow 1, \forall j \in \{1, \dots, x\}$.
- 10: $\delta_{i,j}^{\text{sm}} \leftarrow 0, \forall j \in \{x+1, \dots, N^c + N^r\}$.
- 11: Calculate λ_i^{ar} via (3) for an accurate result or via C&A for fast and approximated result.
- 12: $\gamma_{i,x} \leftarrow \lambda_i^{\text{ar}}$. If $x < N^c + N^r$, return Line 8. Otherwise, end.

B. Approximation Method for Calculating Parameters in T-Form

In Code lines 6 and 11 of Algorithm 1, λ_i^{ar} is calculated via (3) for accurate results. However, when $N^r + N^c$ and N^r are large, e.g., $N^r + N^c = 100$ and $N^r = 20$, the cardinality of \mathbb{J}_i in (3) will be $\sum_{j \in \{0,1,\dots,20\}} \binom{N^r+N^c}{j}$, which is a number around 10^{20} . Thus, to directly calculate the failure probability by summing all the possibilities in \mathbb{J}_i as (3) may be very time-costly.

To avoid long computation times for obtaining the parameters in the T-form, this article proposes a C&A approach to calculate the probability that there are D failed submodules on an arm, where the probability is marked as μ_i^D for arm i and $D \in \{0, 1, \dots, N^r\}$. Then, the failure probability of arm i can be obtained by $\lambda_i^{\text{ar}} = 1 - \sum_{D \in \{0, \dots, N^r\}} \mu_i^D$. The steps of the proposed C&A approach will be introduced first and then followed by an example. The steps of the C&A approach are:

1) *Step I-Reset* $\lambda_{i,j}^{\text{sm}}$: Recalling Code line 5 or lines 9–10 in Algorithm 1, if $\delta_{i,j}^{\text{sm}} = 1$, $\lambda_{i,j}^{\text{sm}} \leftarrow \lambda_i^{\text{sm}0}$. If $\delta_{i,j}^{\text{sm}} = 0$, keep $\lambda_{i,j}^{\text{sm}}$.

2) *Step II-Clustering*: Cluster $N^c + N^r$ submodules into N groups. The clustering strategy is to leverage the k-means approach to cluster the submodules with the similar failure probabilities, i.e., $\lambda_{i,j}^{\text{sm}}$, into groups. Assume that after clustering, group n contains m_n submodules, for $n \in \{1, \dots, N\}$. In addition, the mean failure probability of submodules in each group is calculated. Define $\bar{\lambda}_{i,n}$ as the mean failure probability of submodules in group n . In the C&A approach, the failure probabilities of submodules in group n are all approximated by $\bar{\lambda}_{i,n}$.

3) *Step III-Assignment*: After clustering $N^c + N^r$ submodules into N groups, in this step, we assign D failed submodules to these N groups. When assigning, the number of failed submodules assigned to each group should not exceed the number of submodules in that group. Since the assignment may have more than one possibility, define the number of possibilities for assignment as W . Then, define d_n^w as the number of

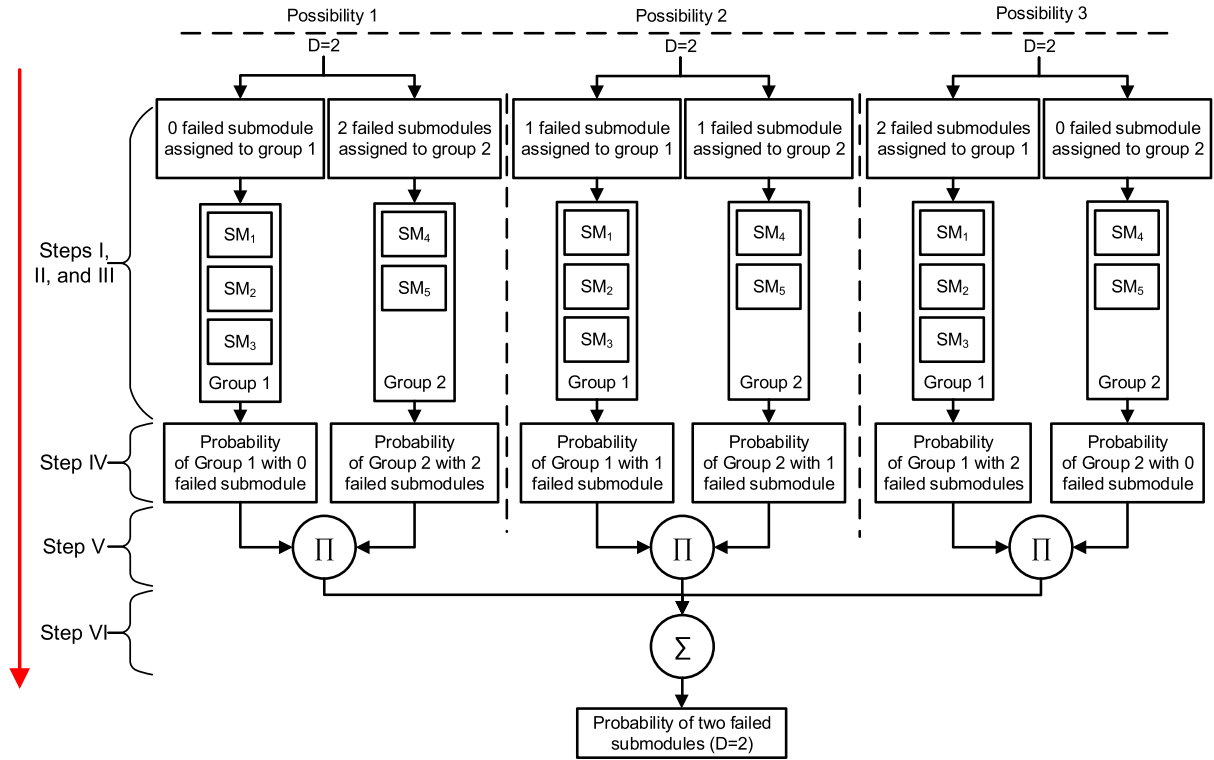

Fig. 3. Clustering and assignment for the example in Section V-B.

failed submodules assigned to group n for possibility w , where $w \in \{1, \dots, W\}$. Accordingly, we have $\sum_{n \in \{1, \dots, N\}} d_n^w = D$, where $w \in \{1, \dots, W\}$, and $d_n^w \leq m_n$, where $n \in \{1, \dots, N\}$ and $w \in \{1, \dots, W\}$.

4) *Step IV- Calculation of Probabilities of Groups:* For group n with possibility w , the probability that there are d_n^w failed submodules among m_n submodules can be calculated by $p_{w,n}^G = \binom{m_n}{d_n^w} \cdot (\bar{\lambda}_{i,n})^{d_n^w} \cdot (1 - \bar{\lambda}_{i,n})^{m_n - d_n^w}$.

5) *Step V- Calculation of Probabilities of Possibilities:* The probability of possibility w is obtained by multiplying the probabilities of groups, i.e., $p_w^P = \prod_{n \in \{1, \dots, N\}} p_{w,n}^G$.

6) *Step VI- Calculation of Survival Rate:* The survival rate with D failed submodules can be obtained by summing up the probabilities of the possibilities, i.e., $\mu_i^D = \sum_{w \in \{1, \dots, W\}} p_w^P$.

Hereby follows an example for illustrating the steps of C&A.

Example: Assume arm i has five submodules in total and two redundant submodules, i.e., $N^c + N^r = 5$ and $N^r = 2$. The example is to calculate the possibility that there are two failed submodules on arm i , i.e., $D = 2$. Assume that, $\lambda_{i,1}^{\text{sm}}$ to $\lambda_{i,5}^{\text{sm}}$ equal 0.55, 0.5, 0.45, 0.15, and 0.9, respectively. Furthermore, after executing Code lines 9 to 10 of Algorithm 1, $\delta_{i,1}^{\text{sm}}$ to $\delta_{i,5}^{\text{sm}}$ equal 0, 0, 0, 0, and 1, respectively. The initial failure probability of a newly replaced submodule is 0.05. The C&A steps for this example are illustrated in Fig. 3.

Step I: Based on the δ values, it can be obtained that $\lambda_{i,1}^{\text{sm}}$ to $\lambda_{i,5}^{\text{sm}}$ equal 0.55, 0.5, 0.45, 0.15, and 0.05, respectively.

Step II: Five submodules are clustered into two groups, i.e., three for group 1 (submodules 1 to 3) and two for group 2 (submodules 4 and 5), via k-means approach. That is, $N = 2$,

$m_1 = 3$, and $m_2 = 2$. The mean failure probabilities of the submodules in the groups are $\bar{\lambda}_{i,1} = 0.55$ and $\bar{\lambda}_{i,2} = 0.15$.

Step III: There are three possibilities, i.e., $W = 3$, to assign two failed submodules into two groups, with the satisfaction of $d_1^w \leq m_1$, $d_2^w \leq m_2$, and $d_1^w + d_2^w = D$. That is, $(d_1^w = 0) \wedge (d_2^w = 2)$, $(d_1^w = 1) \wedge (d_2^w = 1)$, and $(d_1^w = 2) \wedge (d_2^w = 0)$.

Step IV: For possibility 3, i.e., $(d_1^w = 2) \wedge (d_2^w = 0)$, the probability that group 1 has two failed submodules is $p_{3,1}^G = \binom{3}{2} \cdot 0.55^2 \cdot (1 - 0.55)^1 = 0.375$. The probability that group 2 has no failed submodules is $p_{3,2}^G = \binom{2}{0} \cdot (1 - 0.15)^2 = 0.81$. Accordingly, we can obtain the probabilities of other possibilities, such that: $p_{1,1}^G = \binom{3}{0} \cdot (1 - 0.55)^3 = 0.125$, $p_{1,2}^G = \binom{2}{2} \cdot 0.15^2 = 0.01$, $p_{2,1}^G = \binom{3}{1} \cdot 0.55 \cdot (1 - 0.55)^2 = 0.375$, and $p_{2,2}^G = \binom{2}{1} \cdot 0.9 \cdot 0.15 = 0.18$.

Step V: The probabilities of three possibilities are $p_1^P = 0.125 \cdot 0.01 = 0.00125$, $p_2^P = 0.375 \cdot 0.18 = 0.0675$, and $p_3^P = 0.375 \cdot 0.81 = 0.30375$.

Step VI: The probability of having two failed submodules can be obtained by $\mu_i^2 = 0.00125 + 0.0675 + 0.30375 = 0.3725$. \square

In the C&A approach, the failure probabilities of submodules in one group are approximated by the mean failure probability of submodules in this group. Thus, the calculation of the probabilities of groups is simplified significantly (see Step IV). Then, in theory, the computational burden for calculating the probability of having a certain number of failed submodules can be reduced. The computation time reduction and the gap of the failure probabilities using the C&A approach and the accurate approach will be studied in Section VII.

VI. PREDICTIVE MAINTENANCE SCHEDULING PROBLEM OF A CONVERTER

Recall that when there is a failed converter-level component or a failed arm, the operation of the MMC should be interrupted. Then, the failure probability of an MMC is

$$\lambda^{\text{cv}} = 1 - \prod_{i \in \mathcal{I}} (1 - \lambda_i^{\text{ar}}) \cdot \prod_{\omega \in \Omega} (1 - \lambda_{\omega}^{\text{cn}} (1 - \delta_{\omega}^{\text{cn}}) - \lambda_{\omega}^{\text{cn}0} \delta_{\omega}^{\text{cn}}) \quad (7)$$

where Ω represents the set of converter-level components, the binary variable $\delta_{\omega}^{\text{cn}}$ represents whether to maintain converter-level component ω (where $\delta_{\omega}^{\text{cn}} = 1$ represents to maintain the component), λ^{cv} is the failure probability of the converter, and $\lambda_{\omega}^{\text{cn}}$ and $\lambda_{\omega}^{\text{cn}0}$ are the failure probability and the initial failure probability after maintenance of converter-level component ω , respectively.

The predictive maintenance scheduling problem (P) can now be formulated, as follows:

$$\begin{aligned} \min_{z_{i,x}, \delta_{\omega}^{\text{cn}}} \sum_{i \in \mathcal{I}} \sum_{x \in \mathcal{X}_i} x \cdot z_{i,x} \cdot C^{\text{sm}} + \sum_{\omega \in \Omega} \delta_{\omega}^{\text{cn}} \cdot C_{\omega}^{\text{cn}} + \lambda^{\text{cv}} \cdot C^{\text{pen}} \\ \text{s.t. } \lambda^{\text{cv}} \leq \lambda^{\text{set}} \text{ and (6) - (7)} \end{aligned} \quad (\text{P})$$

where C^{sm} is the cost for replacing one submodule, C_{ω}^{cn} is the maintenance cost of the converter-level component ω , C^{pen} is the break-down penalty fee of the converter, and λ^{set} is the tolerable failure probability. In predictive maintenance scheduling, the tolerable failure probabilities of the converters, i.e., λ^{set} , can be set by the operators of MMCs and the power system operators. The value of λ^{set} should consider how reliable the MMC should or must be. If the reliability of the MMC significantly impacts the reliability of the power system, λ^{set} should be set higher, and vice versa. The goal of (P) is to schedule the predictive maintenance actions so as to minimize the maintenance costs over the prediction horizon and to ensure that the failure probability of the converter will not exceed the tolerable failure probability. According to the solution of (P), the submodules to be replaced can be determined. For example, if the solution shows that $z_{3,2} = 1$, the submodules with the first two highest failure rates on Arm 3 will be replaced.

VII. NUMERICAL ANALYSIS

In this section, a case study is presented to test the proposed FPM for MMCs in transmission networks integrated with renewable energy generation. More specifically, two tests are performed to assess for the proposed C&A approach and T-form. Both tests are performed on the MATLAB platform on a laptop with an Intel Core i5-8250 U CPU and 8 GB of RAM. The computation times of both tests are collected by the “tic and toc” functions in MATLAB.

The first test is to compare the proposed C&A approximation approach with the conventional approach (accurate approach) that directly calculates the failure probability by summing up all the possibilities in \mathbb{J} as shown in (3). The computation time and the gap between the results obtained using C&A and the conventional approach will be studied.

TABLE I
PARAMETERS OF CONVERTERS FOR THE TESTS OF C&A

Arm	A1	A2	A3	A4	A5
$N^{\text{r}} + N^{\text{c}}$ (Total)	60	70	80	90	100
N^{r} (10% redundancy)	6	7	8	9	10
N^{r} (8% redundancy)	5	6	6	7	8
N^{r} (6% redundancy)	4	4	5	5	6

The second test is to compare the CPU times for solving the predictive maintenance scheduling problems with the proposed T-form and the binomial probability form.

A. Test for the Proposed C&A Approach

In this test, the proposed C&A approach and the conventional approach are compared by calculating the failure probabilities of arms. This test studies five arms, named A1 to A5, with different total numbers of submodules and different percentages of redundant submodules on the arms. In Table I, the parameters of the arms for the test are listed. Furthermore, this test studies five cases with different failure probabilities of the submodules, as shown in Fig. 4. The failure probabilities of submodules in this test are obtained by (2), where the failure probabilities of the components in submodules are sampled from the Weibull distributions as is also done in [32]. Furthermore, in Fig. 4, failure probabilities for the 100 submodules for converter A5 are shown. Regarding the failure probabilities of the submodules of A4 to A1, the first 90 to 60 failure probabilities in Fig. 4 are adopted. Ten groups are clustered in the proposed C&A approach via the k-means approach.

The comparison results of the conventional approach and the proposed C&A approach are shown in Tables II and III. In Table II, column “Conven” represents the conventional approach. In Table III, the gaps of failure rates are expressed as values rather than percentages. For all five tested arms with different percentages of redundancy in five cases, the CPU time reductions for using C&A are significant, and the gaps of failure rates between the conventional approach and C&A are minor. Fig. 5 further illustrates the numerical analysis of these results. Fig. 5(a), (c), and (d)–(f) show the CPU time ratios and accuracy ratios with different redundant submodule percentages. The CPU time ratios are the CPU times calculated by the C&A approach divided by the CPU times calculated by the conventional (accurate) approach. Moreover, the accuracy ratios are obtained by $|\varphi - \phi|/\varphi$, where φ and ϕ are the failure probabilities obtained for the conventional approach and C&A, respectively.

From Fig. 5(a)–(c), it can be observed that the CPU time reductions using C&A are very large compared to those using the conventional approach. From the simulation results, the worst CPU time ratio is 0.13, which implies that the CPU time reduction can be at least 87%. The average CPU time reduction for all the arms of all the cases with different redundancy percentages is 95.85%. Furthermore, from Fig. 5(d)–(f), it can be observed that the gap between the failure probabilities using the proposed C&A approach and the conventional approach

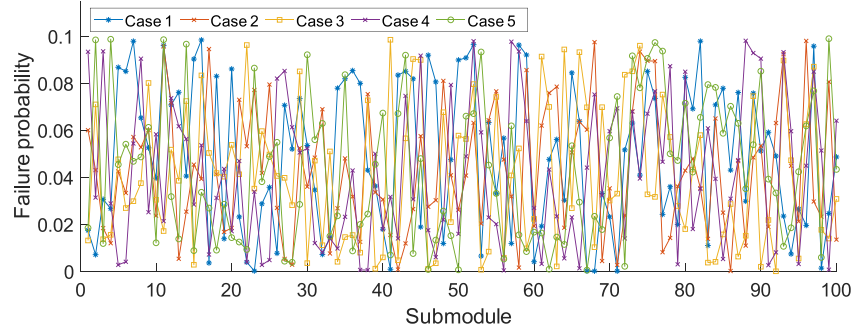

Fig. 4. Failure probability parameters of submodules for the proposed C&A and conventional approaches.

TABLE II
COMPARISON OF CPU TIMES BETWEEN THE CONVENTIONAL APPROACH AND THE PROPOSED C&A APPROACH

Arm (10% redundancy)	A1		A2		A3		A4		A5	
	Conven	C&A	Conven	C&A	Conven	C&A	Conven	C&A	Conven	C&A
Case 1	3.74 s	0.27 s	40.85 s	1.34 s	135.23 s	6.57 s	539.35 s	42.36 s	3715.07 s	241.69 s
Case 2	10.31 s	0.26 s	34.95 s	1.21 s	127.80 s	5.38 s	385.83 s	26.41 s	1956.78 s	233.80 s
Case 3	9.17 s	0.26 s	25.66 s	1.15 s	129.24 s	5.89 s	465.91 s	40.98 s	6902.14 s	243.92 s
Case 4	4.64 s	0.29 s	36.17 s	1.26 s	164.73 s	5.72 s	734.10 s	40.23 s	6413.10 s	237.45 s
Case 5	5.88 s	0.29 s	97.09 s	1.23 s	184.74 s	5.32 s	2113.13 s	51.08 s	2746.51 s	246.65 s
Arm (8% redundancy)	A1		A2		A3		A4		A5	
	Conven	C&A	Conven	C&A	Conven	C&A	Conven	C&A	Conven	C&A
Case 1	1.34 s	0.06 s	11.92 s	0.31 s	20.80 s	0.27 s	60.89 s	1.18 s	431.46 s	12.82 s
Case 2	1.36 s	0.07 s	5.75 s	0.29 s	23.99 s	0.27 s	81.80 s	1.20 s	384.26 s	8.34 s
Case 3	1.13 s	0.07 s	5.28 s	0.26 s	61.56 s	0.27 s	72.70 s	1.21 s	308.46 s	5.57 s
Case 4	1.07 s	0.07 s	7.93 s	0.30 s	22.85 s	0.27 s	55.25 s	1.19 s	243.55 s	5.63 s
Case 5	1.38 s	0.07 s	20.56 s	0.25 s	21.34 s	0.27 s	77.96 s	1.21 s	260.62 s	5.66 s
Arm (6% redundancy)	A1		A2		A3		A4		A5	
	Conven	C&A	Conven	C&A	Conven	C&A	Conven	C&A	Conven	C&A
Case 1	0.61 s	0.03 s	0.48 s	0.03 s	5.53 s	0.08 s	4.54 s	0.08 s	28.02 s	0.28 s
Case 2	0.46 s	0.03 s	0.55 s	0.03 s	3.36 s	0.07 s	4.21 s	0.08 s	38.98 s	0.30 s
Case 3	0.36 s	0.03 s	0.54 s	0.04 s	3.50 s	0.09 s	4.24 s	0.08 s	31.18 s	0.28 s
Case 4	0.32 s	0.04 s	0.37 s	0.03 s	2.61 s	0.08 s	5.13 s	0.08 s	44.61 s	0.27 s
Case 5	0.37 s	0.03 s	0.54 s	0.03 s	3.24 s	0.09 s	5.31 s	0.07 s	21.72 s	0.28 s

(accurate approach) is low. The accuracy ratio is always less than 1.6%. Thus, the relative difference in accuracy between the proposed C&A approach and the conventional approach is less than 1.6%.

From the analysis of the CPU time reductions and the accuracy, we can conclude that for this case study, the failure probabilities of arms obtained by the proposed C&A approach are accurate. Furthermore, the CPU time reductions are significant for the proposed C&A approach compared with the conventional approach.

B. Test for the Proposed T-Form

The second test is based on the direct current transmission network of [33], as shown in Fig. 6. Wind farms 1 and 2 contain 34 and 28 wind turbines, respectively. The parameters of the wind

turbines are given in Table IV. This case study adopts mission profiles from [34]. The direct current voltage of the transmission line is ± 200 kV and the generation powers of wind turbines follow the maximum power point tracking control strategy [35]. Furthermore, in the tests for the proposed T-form, ten different converters with different numbers of redundant submodules are considered. The parameters of these ten converters are listed in Table V. The failure probabilities of the arms of the converters C6 to C10 after different numbers of submodules have been replaced are shown in Fig. 7.

The values in Fig. 7, i.e., $\gamma_{i,x}$, are obtained offline from Algorithm 1. These values provide the parameters for the test for the proposed T-form, i.e., $\gamma_{i,x}$ in (6) of maintenance scheduling problem (P). Furthermore, in Fig. 7, the point nearest to but smaller than $\gamma = 0.1$ for each arm is labeled. These points illustrate that, e.g., in Fig. 7(a), 82 submodules should be

TABLE III
GAPS OF FAILURE RATES BETWEEN THE CONVENTIONAL APPROACH AND THE PROPOSED C&A APPROACH

Arm (10% redundancy)	A1	A2	A3	A4	A5
Case 1	1.12×10^{-5}	1.05×10^{-5}	9.04×10^{-5}	1.98×10^{-5}	1.28×10^{-5}
Case 2	0.78×10^{-5}	0.63×10^{-5}	0.63×10^{-5}	1.87×10^{-5}	0.83×10^{-5}
Case 3	0.75×10^{-5}	0.60×10^{-5}	0.37×10^{-5}	3.12×10^{-5}	3.89×10^{-5}
Case 4	0.61×10^{-5}	0.34×10^{-5}	0.39×10^{-5}	2.36×10^{-5}	0.62×10^{-5}
Case 5	0.41×10^{-5}	0.26×10^{-5}	0.47×10^{-5}	0.41×10^{-5}	3.87×10^{-5}
Arm (8% redundancy)	A1	A2	A3	A4	A5
Case 1	1.86×10^{-5}	1.79×10^{-5}	1.92×10^{-5}	2.34×10^{-5}	1.55×10^{-5}
Case 2	1.41×10^{-5}	1.12×10^{-5}	1.79×10^{-5}	1.31×10^{-5}	1.32×10^{-5}
Case 3	1.13×10^{-5}	0.91×10^{-5}	1.43×10^{-5}	1.22×10^{-5}	0.94×10^{-5}
Case 4	2.80×10^{-5}	0.75×10^{-5}	1.37×10^{-5}	1.88×10^{-5}	1.14×10^{-5}
Case 5	1.28×10^{-5}	0.98×10^{-5}	1.81×10^{-5}	1.48×10^{-5}	1.35×10^{-5}
Arm (6% redundancy)	A1	A2	A3	A4	A5
Case 1	0.66×10^{-5}	0.92×10^{-5}	1.27×10^{-5}	0.74×10^{-5}	1.35×10^{-5}
Case 2	1.39×10^{-5}	1.41×10^{-5}	1.89×10^{-5}	2.01×10^{-5}	1.81×10^{-5}
Case 3	4.69×10^{-5}	1.15×10^{-5}	4.10×10^{-5}	2.38×10^{-5}	1.51×10^{-5}
Case 4	1.88×10^{-5}	1.35×10^{-5}	1.75×10^{-5}	1.82×10^{-5}	1.77×10^{-5}
Case 5	1.33×10^{-5}	1.50×10^{-5}	1.98×10^{-5}	1.69×10^{-5}	1.92×10^{-5}

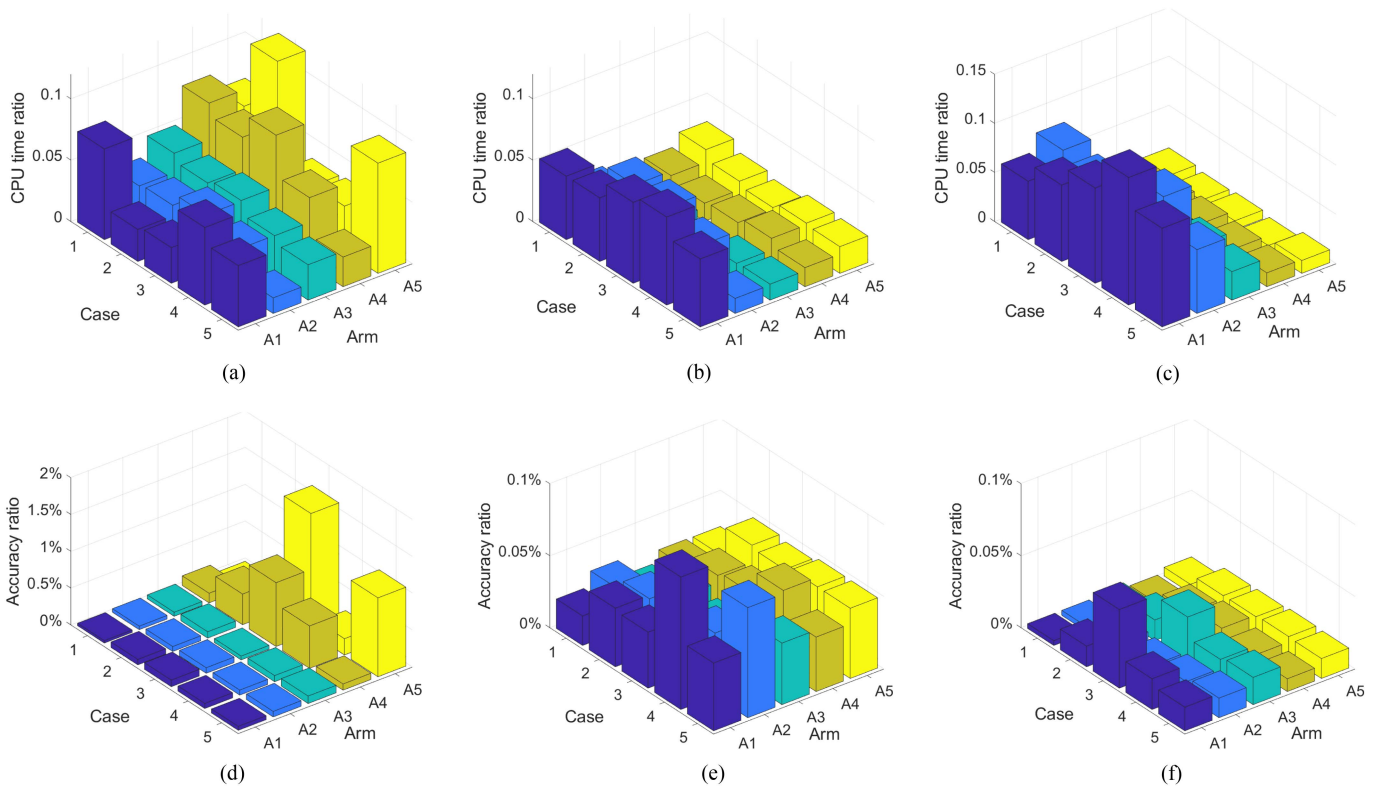

Fig. 5. CPU time and accuracy ratios between the conventional approach and the proposed C&A approach. (a) CPU time ratios 10% redundant submodules. (b) CPU time ratios 8% redundant submodules. (c) CPU time ratios 6% redundant submodules. (d) Accuracy ratios 10% redundant submodules. (e) Accuracy ratios 8% redundant submodules. (f) Accuracy ratios 6% redundant submodules.

TABLE IV
PARAMETERS OF WIND TURBINES IN THE TEST FOR THE PROPOSED T-FORM

Rated power	Rated wind speed	Cut-in wind speed
4 MW	12 m/s	3 m/s

replaced to ensure that the failure probability of Arm 1 is lower than 0.1. From these labeled points, it can be observed that with the increase of N^r fewer submodules should be replaced to ensure that the failure probability of the arms is below 0.1.

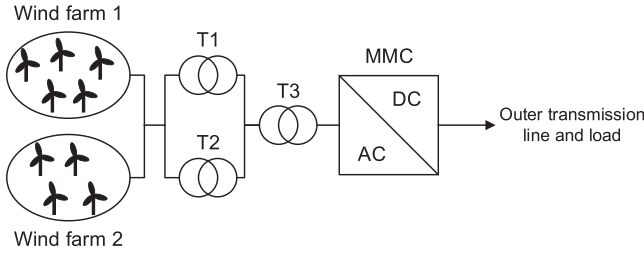

Fig. 6. Transmission network topology for tests for the proposed T-form.

TABLE V
PARAMETERS OF CONVERTERS C1 TO C10 IN THE TEST FOR THE PROPOSED T-FORM

Converter	C1	C2	C3	C4	C5
N^r	1	2	3	4	5
$N^r + N^c$	5	10	15	20	25
Converter	C6	C7	C8	C9	C10
N^r	5	10	15	20	25
$N^r + N^c$	100	100	100	100	100

TABLE VI
CPU TIMES OF CASES C1 TO C10 IN THE TESTS OF THE PROPOSED T-FORM

Converters	C1	C2	C3	C4	C5
Binomial probability	0.293 s	1.085 s	5.69 s	27.1 s	82 s
Proposed T-form	0.028 s	0.031 s	0.033 s	0.043 s	0.045 s
Converters	C6	C7	C8	C9	C10
Binomial probability	409 s	372 s	466 s	478 s	264 s
Proposed T-form	0.153 s	0.133 s	0.120 s	0.112 s	0.114 s

For comparison with the predictive maintenance scheduling problem with the proposed T-form [i.e., (P)], the following predictive maintenance scheduling problem with the binomial probability form is considered:

$$\begin{aligned} \min_{\delta_{i,j}^{\text{sm}}, \delta_{i,j}^{\text{cn}}} \quad & \sum_{i \in \mathcal{I}} \sum_{j \in \mathcal{J}_i} \delta_{i,j}^{\text{sm}} \cdot C^{\text{sm}} + \sum_{\omega \in \Omega} \delta_{\omega}^{\text{cn}} \cdot C_{\omega}^{\text{cn}} + \lambda^{\text{cv}} \cdot C^{\text{pen}} \\ \text{s.t.} \quad & \lambda^{\text{cv}} \leq \lambda^{\text{set}}, \quad (3), \text{ and } (7). \end{aligned} \quad (\text{CP})$$

The problems (P) and (CP) are both solved by the “intlinprog” function via MATLAB platform. Moreover, in predictive maintenance scheduling, the tolerable failure probabilities of the converters, i.e., λ^{set} , are set to 0.2 in this case study.

The CPU time results for solving (P) and (CP) for different converters are shown in Table VI. It can be observed that the CPU times for solving the predictive maintenance scheduling problems with the proposed T-form are much smaller than those with the binomial probability form. The CPU time reduction for converters C1 and C2 can be more than 90%. Furthermore, with the increase of N^r and N^c , the increase of the CPU times for solving the predictive maintenance scheduling problems with a binomial probability form is significant. However, the increase

of CPU times for solving the predictive maintenance scheduling problems with the T-form is not much less significant.

Furthermore, the numbers of the replaced submodules on the arms for converters C6 to C10 are shown in Table VII. It can be observed that when the total number of the submodules is the same and the number of redundant submodules increases, the number of the replaced submodules on arms decreases. This implies that when $N^c / (N^r + N^c)$ increases, fewer submodules are required to be replaced in the predictive maintenance scheduling of MMCs.

Moreover, this article compares the optimal solutions and the optimal objective function values of the maintenance scheduling problem (P) with the T-form and the C&A and with T-form and the conventional approach. In maintenance scheduling problems with T-form, i.e., (P), $\gamma_{i,x}$ values are parameters. The conventional approach obtains the exact $\gamma_{i,x}$ values, while the C&A approach obtains the approximations of $\gamma_{i,x}$ values. Thus, the comparison of T-form+C&A and T-form+conventional approach is to compare the optimal solutions and the optimal objective function values of two optimization problems, i.e., maintenance scheduling problems (P) with approximated and exact $\gamma_{i,x}$ parameters. The comparison results are shown in Table VIII. In Table VIII, the optimal solutions, i.e., the numbers of the submodules to be replaced for converters C6 to C10, are shown in the “Number” row. Furthermore, “Cost” and “Penalty” for T-form+C&A represent the values of $\sum_{i \in \mathcal{I}} \sum_{x \in \mathcal{X}_i} x \cdot z_{i,x} \cdot C^{\text{sm}} + \sum_{\omega \in \Omega} \delta_{\omega}^{\text{cn}} \cdot C_{\omega}^{\text{cn}}$ and $\lambda^{\text{cv}} \cdot C^{\text{pen}}$ regarding the optimal solution, respectively. In addition, “Cost” and “Penalty” for T-form+conventional approach represent the values of $\sum_{i \in \mathcal{I}} \sum_{j \in \mathcal{J}_i} \delta_{i,j}^{\text{sm}} \cdot C^{\text{sm}} + \sum_{\omega \in \Omega} \delta_{\omega}^{\text{cn}} \cdot C_{\omega}^{\text{cn}}$ and $\lambda^{\text{cv}} \cdot C^{\text{pen}}$ regarding the optimal solution, respectively.

From Table VIII, it can be observed that the gaps of the optimal objective function values between T-form+C&A and T-form+conventional approach are caused by the gaps of “Penalty.” Furthermore, the gaps of the optimal objective function values between the T-form+C&A and the T-form+conventional approach are very small, i.e., 1.26%, 2.13%, 4%, 3.59%, and 3.54%, of the optimal objective function values using the T-form+conventional approach for C6 to C10, respectively. In addition, from Table VIII, it can be observed that the optimal solutions, i.e., the numbers of the submodules to be replaced on arms, of the T-form+C&A and the T-form+conventional approach are the same. So the maintenance schedules of the converters with the T-form+C&A and the T-form+conventional approach are the same. This phenomenon most likely occurs because the approximated and exact $\gamma_{i,x}$ parameters are nearly the same (as seen in Fig. 5), so the maintenance scheduling problems (P) with the T-form+C&A and with the T-form+conventional approach are slightly different. Consequently, in this case, solving two different optimization problems with slightly different parameters results in the same optimal solutions but slightly different optimal objective function values. Therefore, with the T-form+C&A and the T-form+conventional approach, the optimal objective function values of the maintenance scheduling problems are slightly different, while the optimal maintenance schedules are the same.

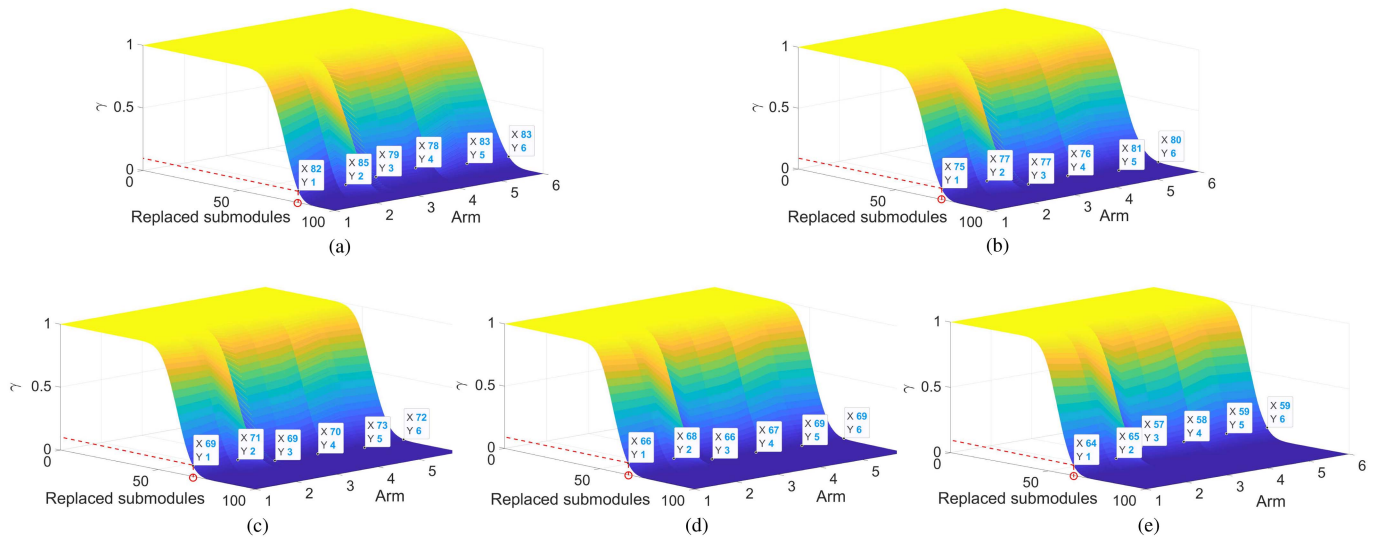

Fig. 7. Failure probability values (i.e., γ) with different numbers of redundant submodules with $N^c + N^r = 100$. (a) γ values with $N^r = 5$. (b) γ values with $N^r = 10$. (c) γ values with $N^r = 15$. (d) γ values with $N^r = 20$. (e) γ values with $N^r = 25$.

TABLE VII
NUMBERS OF THE REPLACED SUBMODULES ON ARMS FOR CASES C6 TO C10

Converters	Arm 1	Arm 2	Arm 3	Arm 4	Arm 5	Arm 6	Total
C6	80	83	76	75	79	79	472
C7	72	74	66	66	68	68	414
C8	65	67	59	60	61	61	373
C9	64	65	57	58	59	59	362
C10	60	61	54	54	55	55	339

TABLE VIII
COMPARISON OF OPTIMALITY BETWEEN T-FORM+C&A AND T-FORM+CONVENTIONAL APPROACH

Converter		C6	C7	C8	C9	C10
T-form+ C&A	Number	80/83/76 /75/79/79	73/75/67 /67/69/69	66/68/60 /61/62/62	64/65/57 /58/59/59	61/62/55 /55/56/56
	Cost	5.49×10^6	4.88×10^6	4.41×10^6	4.21×10^6	4.01×10^6
	Penalty	2.35×10^6	2.30×10^6	2.34×10^6	2.31×10^6	2.34×10^6
T-form+ Conventional approach	Number	80/83/76 /75/79/79	73/75/67 /67/69/69	66/68/60 /61/62/62	64/65/57 /58/59/59	61/62/55 /55/56/56
	Cost	5.49×10^6	4.88×10^6	4.41×10^6	4.21×10^6	4.01×10^6
	Penalty	2.38×10^6	2.35×10^6	2.25×10^6	2.23×10^6	2.26×10^6

VIII. CONCLUSION AND FUTURE WORK

This article has proposed a FPM for predictive maintenance scheduling for large-scale half-bridge MMCs. The uncertainty of the predicted mission profiles and the maintenance decision variables are considered in the proposed FPM. The proposed FPM is characterized by tractability. More specifically, a T-form is proposed to make the relationship between the failure probability of an arm and the maintenance decision variables easy to be tackled. In addition, an approximation method, i.e., C&A, has been proposed to reduce the computation times for calculating the parameters for the proposed T-form. The simulation results have shown that the proposed C&A approach

can reduce the CPU time with 95.85% on average compared to the conventional approach. Furthermore, for the given case study, the gaps between the failure probabilities of arms obtained by the C&A approach and the accurate approach are less than 1.6%. Moreover, predictive maintenance scheduling problems with the proposed T-form can be solved 90% faster than those with the binomial probability form.

Regarding the impacts on engineering practice, the proposed FPM provides a tractable tool for MMC managers or operators to determine predictive maintenance actions. Although the period for predictive maintenance scheduling for MMCs may be as long as several months, there are still necessities for adopting the proposed tractable tool. First, the computation times increase

prohibitively with the number of submodules (see Tables II and VI). If the number of submodules increases to, e.g., 300 or more, the computation times for solving the maintenance scheduling problems increase drastically. Thus, the tractable tool is needed to handle the “curse of dimensionality.” Second, when solving maintenance scheduling problems, the energy consumption of computers can be largely reduced by using the proposed tractable tool because of the significant computation time reduction. The computation complexity reduction by using the proposed T-form and C&A approach may be favored by the large-scale MMC managers or operators.

In practice, sometimes some high-risk submodules may be misjudged as low-risk submodules. Then, the misjudged high-risk submodules may fail during operation. However, the modular design and the redundant submodules of MMCs can avoid catastrophic consequences by bypassing the failed submodules, and in this way the operation of MMCs will not be interrupted.

Future work will study other nonoptimization-based, e.g., parametric and maintenance scheduling strategies for MMCs. In addition, mission-profile-based control strategies for reliability will be developed for large-scale MMCs. Moreover, experimental analysis in laboratory and actual power system conditions will help to validate and quantify the contribution in practice of the proposed methodology. For instance, a comparison between the accuracy of the proposed FPM and the conventional methods can be tested in practical power systems.

REFERENCES

- [1] Z. Yang, W. Liao, Q. Zhang, C. Leth Bak, and Z. Chen, “Fault coordination control for converter-interfaced sources compatible with distance protection during asymmetrical faults,” *IEEE Trans. Ind. Electron.*, early access, doi: [10.1109/TIE.2022.3204946](https://doi.org/10.1109/TIE.2022.3204946).
- [2] A. Swetapadma, S. Chakrabarti, A. Y. Abdelaziz, and H. H. Alhelou, “A novel relaying scheme using long short term memory for bipolar high voltage direct current transmission lines,” *IEEE Access*, vol. 9, pp. 119894–119906, 2021.
- [3] J. Li, G. Song, J. Yan, Y. Li, and Z. Xu, “Data-driven fault detection and classification for MTDC systems by integrating HCTSA and softmax regression,” *IEEE Trans. Power Deliv.*, vol. 37, no. 2, pp. 893–904, Apr. 2022.
- [4] J. Kucka, D. Karwatzki, and A. Mertens, “Enhancing the reliability of modular multilevel converters using neutral shift,” *IEEE Trans. Power Electron.*, vol. 32, no. 12, pp. 8953–8957, Dec. 2017.
- [5] B. Wang, X. Wang, Z. Bie, P. D. Judge, X. Wang, and T. C. Green, “Reliability model of MMC considering periodic preventive maintenance,” *IEEE Trans. Power Deliv.*, vol. 32, no. 3, pp. 1535–1544, Jun. 2017.
- [6] A. Davoodi, S. Peyghami, Y. Yang, T. Dragičević, and F. Blaabjerg, “A preventive maintenance planning approach for wind converters,” in *Proc. IEEE 5th Workshop Electron. Grid*, 2020, pp. 1–8.
- [7] R. Mena, P. Viveros, E. Zio, and S. Campos, “An optimization framework for opportunistic planning of preventive maintenance activities,” *Reliab. Eng. Syst. Saf.*, vol. 215, 2021, Art. no. 107801.
- [8] M. Villarini, V. Cesarotti, L. Alfonsi, and V. Introna, “Optimization of photovoltaic maintenance plan by means of a FMEA approach based on real data,” *Energy Conv. Manag.*, vol. 152, pp. 1–12, 2017.
- [9] S. Peyghami, Z. Wang, and F. Blaabjerg, “A guideline for reliability prediction in power electronic converters,” *IEEE Trans. Power Electron.*, vol. 35, no. 10, pp. 10958–10968, Oct. 2020.
- [10] S. Peyghami, F. Blaabjerg, J. R. Torres, and P. Palensky, “Maintenance scheduling in power electronic converters considering wear-out failures,” in *Proc. IEEE 22nd Eur. Conf. Power Electron. Appl.*, 2020, pp. 1–10.
- [11] C. Lv, J. Liu, Y. Zhang, W. Lei, R. Cao, and G. Lv, “Reliability modeling for metallized film capacitors based on time-varying stress mission profile and aging of ESR,” *IEEE J. Emerg. Sel. Top. Power Electron.*, vol. 9, no. 4, pp. 4311–4319, Aug. 2021.
- [12] B. Zhang, M. Wang, and W. Su, “Reliability analysis of power systems integrated with high-penetration of power converters,” *IEEE Trans. Power Syst.*, vol. 36, no. 3, pp. 1998–2009, May 2021.
- [13] L. Guo, Y. Ding, M. Bao, C. Shao, P. Wang, and L. Goel, “Nodal reliability evaluation for a VSC-MTDC-based hybrid AC/DC power system,” *IEEE Trans. Power Syst.*, vol. 35, no. 3, pp. 2300–2312, May 2020.
- [14] M. S. Haque, S. Choi, and J. Baek, “Auxiliary particle filtering-based estimation of remaining useful life of IGBT,” *IEEE Trans. Ind. Electron.*, vol. 65, no. 3, pp. 2693–2703, Mar. 2018.
- [15] P. Sun, C. Gong, X. Du, Q. Luo, H. Wang, and L. Zhou, “Online condition monitoring for both IGBT module and DC-link capacitor of power converter based on short-circuit current simultaneously,” *IEEE Trans. Ind. Electron.*, vol. 64, no. 5, pp. 3662–3671, May 2017.
- [16] P. Tu, S. Yang, and P. Wang, “Reliability-and cost-based redundancy design for modular multilevel converter,” *IEEE Trans. Ind. Electron.*, vol. 66, no. 3, pp. 2333–2342, Mar. 2019.
- [17] P. Yu, W. Fu, L. Wang, Z. Zhou, G. Wang, and Z. Zhang, “Reliability-centered maintenance for modular multilevel converter in HVDC transmission application,” *IEEE J. Emerg. Sel. Top. Power Electron.*, vol. 9, no. 3, pp. 3166–3176, Jun. 2021.
- [18] Y. Barron, “Group maintenance policies for an r-out-of-n system with phase-type distribution,” *Ann. Oper. Res.*, vol. 261, no. 1, pp. 79–105, 2018.
- [19] A. M. A. Rushdi and M. Al-Amoudi, “Recursively-defined combinatorial functions: The case of binomial and multinomial coefficients and probabilities,” *J. Adv. Math. Comput. Sci.*, vol. 27, no. 4, pp. 1–16, 2018.
- [20] X. Sun, H. Ma, Y. Sun, and M. Liu, “A novel point cloud compression algorithm based on clustering,” *IEEE Robot. Autom. Lett.*, vol. 4, no. 2, pp. 2132–2139, Apr. 2019.
- [21] Ł. Struski, J. Tabor, and P. Spurek, “Lossy compression approach to subspace clustering,” *Inf. Sci.*, vol. 435, pp. 161–183, 2018.
- [22] J. Fu, A. Núñez, and B. D. Schutter, “A short-term preventive maintenance scheduling method for distribution networks with distributed generators and batteries,” *IEEE Trans. Power Syst.*, vol. 36, no. 3, pp. 2516–2531, May 2021.
- [23] W. Liao, L. Ge, B. Bak-Jensen, J. R. Pillai, and Z. Yang, “Scenario prediction for power loads using a pixel convolutional neural network and an optimization strategy,” *Energy Rep.*, vol. 8, pp. 6659–6671, 2022.
- [24] G. Lv, W. Lei, M. Wang, C. Lv, and J. Zhao, “Reliability analysis and design of MMC based on mission profile for the components degradation,” *IEEE Access*, vol. 8, pp. 149940–149951, 2020.
- [25] L. Gan and S. H. Low, “Optimal power flow in direct current networks,” *IEEE Trans. Power Syst.*, vol. 29, no. 6, pp. 2892–2904, Dec. 2014.
- [26] Y. Zhou, X. Li, X. Ye, and G. Zhai, “A remaining useful life prediction method based on condition monitoring for LED driver,” in *Proc. IEEE Prognostics System Health Manage. Conf.*, 2012, pp. 1–5.
- [27] A. R. Khandebharad, R. B. Dhumale, S. S. Lokhande, and S. D. Lokhande, “Real time remaining useful life prediction of the electrolytic capacitor,” in *Proc. Int. Conf. Inf. Process.*, 2015, pp. 631–636.
- [28] J. Xu, P. Zhao, and C. Zhao, “Reliability analysis and redundancy configuration of MMC with hybrid submodule topologies,” *IEEE Trans. Power Electron.*, vol. 31, no. 4, pp. 2720–2729, Apr. 2016.
- [29] H. Wang, M. Liserre, and F. Blaabjerg, “Toward reliable power electronics: Challenges, design tools, and opportunities,” *IEEE Ind. Electron. Mag.*, vol. 7, no. 2, pp. 17–26, Jun. 2013.
- [30] K. Ma, U.-M. Choi, and F. Blaabjerg, “Prediction and validation of wear-out reliability metrics for power semiconductor devices with mission profiles in motor drive application,” *IEEE Trans. Power Electron.*, vol. 33, no. 11, pp. 9843–9853, Nov. 2018.
- [31] A. Bemporad and M. Morari, “Control of systems integrating logic, dynamics, and constraints,” *Automatica*, vol. 35, no. 3, pp. 407–427, 1999.
- [32] J. Xu, L. Wang, Y. Li, Z. Zhang, G. Wang, and C. Hong, “A unified MMC reliability evaluation based on physics-of-failure and SM lifetime correlation,” *Int. J. Electr. Power Energy Syst.*, vol. 106, pp. 158–168, 2019.
- [33] W. Li, M. Zhu, P. Chao, X. Liang, and D. Xu, “Enhanced FRT and postfault recovery control for MMC-HVDC connected offshore wind farms,” *IEEE Trans. Power Syst.*, vol. 35, no. 2, pp. 1606–1617, Mar. 2020.
- [34] D. Zhou, Y. Song, Y. Liu, and F. Blaabjerg, “Mission profile based reliability evaluation of capacitor banks in wind power converters,” *IEEE Trans. Power Electron.*, vol. 34, no. 5, pp. 4665–4677, May 2019.
- [35] J. Fu, G. Song, and Y. Gong, “Exploration of a DC wind farm integrated by variable-speed squirrel cage induction generator (SCIGs),” *J. Eng.*, vol. 2017, no. 13, pp. 1488–1493, 2017.