

796 Nov '92 HGP

**SSC-349**

**(Phase I)**

**DEVELOPMENT OF A  
GENERALIZED ONBOARD  
RESPONSE MONITORING  
SYSTEM**



This document has been approved  
for public release and sale; its  
distribution is unlimited

**SHIP STRUCTURE COMMITTEE**

**1990**

### SHIP STRUCTURE COMMITTEE

The SHIP STRUCTURE COMMITTEE is constituted to prosecute a research program to improve the hull structures of ships and other marine structures by an extension of knowledge pertaining to design, materials, and methods of construction.

RADM J. D. Sipes, USCG, (Chairman)  
Chief, Office of Marine Safety, Security  
and Environmental Protection  
U. S. Coast Guard

Mr. H. T. Haller  
Associate Administrator for Ship-  
building and Ship Operations  
Maritime Administration

Mr. Alexander Malakhoff  
Director, Structural Integrity  
Subgroup (SEA 55Y)  
Naval Sea Systems Command

Mr. Thomas W. Allen  
Engineering Officer (N7)  
Military Sealift Command

Dr. Donald Liu  
Senior Vice President  
American Bureau of Shipping

CDR Michael K. Parmelee, USCG,  
Secretary, Ship Structure Committee  
U. S. Coast Guard

### CONTRACTING OFFICER TECHNICAL REPRESENTATIVES

Mr. William J. Siekierka  
SEA 55Y3  
Naval Sea Systems Command

Mr. Greg D. Woods  
SEA 55Y3  
Naval Sea Systems Command

### SHIP STRUCTURE SUBCOMMITTEE

The SHIP STRUCTURE SUBCOMMITTEE acts for the Ship Structure Committee on technical matters by providing technical coordination for determining the goals and objectives of the program and by evaluating and interpreting the results in terms of structural design, construction, and operation.

#### AMERICAN BUREAU OF SHIPPING

Mr. Stephen G. Arntson (Chairman)  
Mr. John F. Conlon  
Mr. William Hanzalek  
Mr. Philip G. Rynn

#### NAVAL SEA SYSTEMS COMMAND

Mr. Robert A. Sielski  
Mr. Charles L. Null  
Mr. W. Thomas Packard  
Mr. Allen H. Engle

#### MILITARY SEALIFT COMMAND

Mr. Albert J. Attermeyer  
Mr. Michael W. Touma  
Mr. Jeffery E. Beach

#### U. S. COAST GUARD

CAPT T. E. Thompson  
CAPT Donald S. Jensen  
CDR Mark E. Noll

#### MARITIME ADMINISTRATION

Mr. Frederick Seibold  
Mr. Norman O. Hammer  
Mr. Chao H. Lin  
Dr. Walter M. Maclean

### SHIP STRUCTURE SUBCOMMITTEE LIAISON MEMBERS

#### U. S. COAST GUARD ACADEMY

LT Bruce Mustain

#### NATIONAL ACADEMY OF SCIENCES - MARINE BOARD

Mr. Alexander B. Stavovy

#### U. S. MERCHANT MARINE ACADEMY

Dr. C. B. Kim

#### NATIONAL ACADEMY OF SCIENCES - COMMITTEE ON MARINE STRUCTURES

Mr. Stanley G. Stiansen

#### U. S. NAVAL ACADEMY

Dr. Ramswar Bhattacharyya

#### SOCIETY OF NAVAL ARCHITECTS AND MARINE ENGINEERS - HYDRODYNAMICS COMMITTEE

Dr. William Sandberg

#### STATE UNIVERSITY OF NEW YORK MARITIME COLLEGE

Dr. W. R. Porter

#### AMERICAN IRON AND STEEL INSTITUTE

#### WELDING RESEARCH COUNCIL

Dr. Martin Prager

Mr. Alexander D. Wilson

## Member Agencies:

United States Coast Guard  
Naval Sea Systems Command  
Maritime Administration  
American Bureau of Shipping  
Military Sealift Command



## Ship Structure Committee

An Interagency Advisory Committee  
Dedicated to the Improvement of Marine Structures

## Address Correspondence to:

Secretary, Ship Structure Committee  
U.S. Coast Guard (G-MTH)  
2100 Second Street S.W.  
Washington, D.C. 20593-0001  
PH: (202) 267-0003  
FAX: (202) 267-0025

December 3, 1990

SSC-349  
SR-1300

### DEVELOPMENT OF A GENERALIZED ONBOARD RESPONSE MONITORING SYSTEM

This report presents the results from the first phase of a two phase project concerning the development of a standard Ship Response Monitor (SRM). It is intended that the SRM will provide sufficient information to ships' officers to assess the potential for structural damage due to undesirable loading conditions. Although considerable work has been done in this area, a set of standard performance criteria for monitoring equipment have not developed and accepted by the marine industry. The design specifications developed for the SRM during this first phase were based on an analysis of performance requirements. During the second phase of the project, a prototype unit will be built and evaluated under service conditions.

J. D. SIPES

Rear Admiral, U.S. Coast Guard  
Chairman, Ship Structure Committee

1. Report No. SSC-349		2. Government Accession No.		3. Recipient's Catalog No.	
4. Title and Subtitle Development of a Generalized Onboard Response Monitoring System - Phase I				5. Report Date May 1987	
				6. Performing Organization Code	
7. Author(s) F. W. DeBord, Jr. and B. Hennessy				8. Performing Organization Report No. OTC-84-24, SR-1300	
9. Performing Organization Name and Address OFFSHORE TECHNOLOGY CORPORATION 578 Enterprise Street Escondido, CA 92025				10. Work Unit No. (TRAIS)	
				11. Contract or Grant No. DTCG23-85-C-20080	
12. Sponsoring Agency Name and Address Commandant U.S. Coast Guard 2100 Second Street, SW Washington, DC 20593				13. Type of Report and Period Covered Final Report Phase I	
				14. Sponsoring Agency Code G-M	
15. Supplementary Notes  Sponsored by the Ship Structure Committee and its member agencies.					
16. Abstract Design specifications for a standard Ship Response Monitor (SRM) are developed on the basis of an analysis of performance requirements. Issues addressed in the analysis of performance requirements include major and optional system functions, sensors and interfacing, packaging, displays and controls, and selection of an appropriate controller. Cost implications for the options reviewed are discussed and recommendations for the basic SRM are developed. It is concluded that to insure acceptance by operating companies, the SRM should be designed as a single function bridge instrument which can be purchased and installed for between \$30,000 and \$40,000. Based on these conclusions a design is developed and specifications are given for the unit to be evaluated during Phase II of the project. The recommended design consists of standard industrial measurement and control hardware operating under control of software written in a high level language. This will provide transportability to alternate hardware if so desired in the future. The evaluation unit should be provided with two standard accelerometers and two to four additional sensors to be selected by the operating company. The unit should be configured such that variations in packaging, displays and controls are evaluated.					
17. Key Words Ship Response Shipboard Instrumentation Ship Operations			18. Distribution Statement Available from: Nat'l Technical Information Service Springfield, VA 22161 or Nat'l Technical Information Facility National Maritime Research Center Kings Point, NY 10024-1699		
19. Security Classif. (of this report) Unclassified		20. Security Classif. (of this page) Unclassified		21. No. of Pages	22. Price



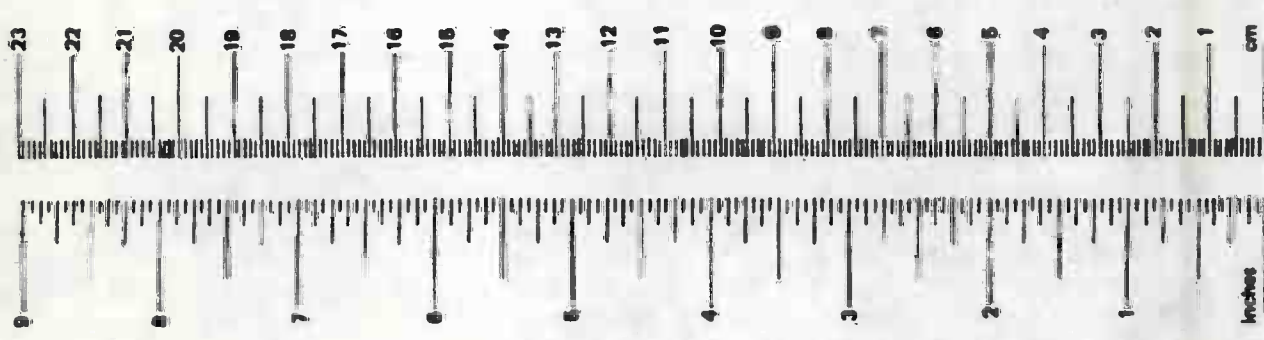
# METRIC CONVERSION FACTORS

## Approximate Conversions to Metric Measures

Symbol	When You Know	Multiply by	To Find	Symbol
<b>LENGTH</b>				
in	inches	2.5	centimeters	cm
ft	feet	30	centimeters	cm
yd	yards	0.9	meters	m
mi	miles	1.6	kilometers	km
<b>AREA</b>				
in <sup>2</sup>	square inches	6.5	square centimeters	cm <sup>2</sup>
ft <sup>2</sup>	square feet	0.09	square meters	m <sup>2</sup>
yd <sup>2</sup>	square yards	0.8	square meters	m <sup>2</sup>
mi <sup>2</sup>	square miles	2.6	square kilometers	km <sup>2</sup>
	acres	0.4	hectares	ha
<b>MASS (weight)</b>				
oz	ounces	28	grams	g
lb	pounds	0.45	kilograms	kg
	short tons (2000 lb)	0.9	tonnes	t
<b>VOLUME</b>				
teaspoon	teaspoons	5	milliliters	ml
Tablespoon	tablespoons	15	milliliters	ml
fl oz	fluid ounces	30	milliliters	ml
c	cups	0.24	liters	l
pt	pints	0.47	liters	l
qt	quarts	0.95	liters	l
gal	gallons	3.8	liters	l
ft <sup>3</sup>	cubic feet	0.03	cubic meters	m <sup>3</sup>
yd <sup>3</sup>	cubic yards	0.76	cubic meters	m <sup>3</sup>
<b>TEMPERATURE (exact)</b>				
°F	Fahrenheit temperature	5/9 (after subtracting 32)	Celsius temperature	°C

## Approximate Conversions from Metric Measures

Symbol	When You Know	Multiply by	To Find	Symbol
<b>LENGTH</b>				
mm	millimeters	0.04	inches	in
cm	centimeters	0.4	inches	in
m	meters	3.3	feet	ft
m	meters	1.1	yards	yd
km	kilometers	0.6	miles	mi
<b>AREA</b>				
cm <sup>2</sup>	square centimeters	0.16	square inches	in <sup>2</sup>
m <sup>2</sup>	square meters	1.2	square yards	yd <sup>2</sup>
km <sup>2</sup>	square kilometers	0.4	square miles	mi <sup>2</sup>
ha	hectares (10,000 m <sup>2</sup> )	2.5	acres	ac
<b>MASS (weight)</b>				
g	grams	0.035	ounces	oz
kg	kilograms	2.2	pounds	lb
t	tonnes (1000 kg)	1.1	short tons	st
<b>VOLUME</b>				
ml	milliliters	0.03	fluid ounces	fl oz
l	liters	2.1	pints	pt
l	liters	1.06	quarts	qt
l	liters	0.26	gallons	gal
m <sup>3</sup>	cubic meters	36	cubic feet	ft <sup>3</sup>
m <sup>3</sup>	cubic meters	1.3	cubic yards	yd <sup>3</sup>
<b>TEMPERATURE (exact)</b>				
°C	Celsius temperature	9/5 (then add 32)	Fahrenheit temperature	°F



1 in. = 2.54 cm (exactly). For other exact conversions and more detail tables see NBS Mon. Publ. 288, Units of Weight and Measure. Price \$2.25 SD Catalog No. C13 18 288.

## PREFACE

For approximately twenty-five years, various government agencies and private organizations have completed projects where ship responses in heavy weather were monitored and displayed. Although most of these were research projects, over the years the concept of displaying these measurements for the navigating officer has been recognized as a means to improve operations and minimize damage in heavy weather.

In 1985, the interagency Ship Structure Committee initiated a project to develop a generalized onboard response monitoring system. The objective of this project is to design a commercially producible response monitoring system that will have application on any vessel. This report presents results of the first phase of the project. Based on a review of previous work, performance requirements were finalized and a design specification was prepared. During Phase II, three prototype units will be built, and these will be evaluated during use on several types of ships.

## TABLE OF CONTENTS

	<u>Page</u>
1. INTRODUCTION	1
1.1 Background	1
1.2 Objectives	1
2. APPLICATIONS FOR RESPONSE MONITORING	3
3. REVIEW OF PREVIOUS WORK	5
4. ANALYSIS OF PERFORMANCE REQUIREMENTS	10
4.1 Major System Functions	10
4.2 Sensors	11
4.3 Sensor Interfacing and Cabling	15
4.4 Functions in Addition to Response Monitoring	16
4.5 Packaging	17
4.6 Display Methodologies	18
4.7 Controls	19
4.8 Computer and Peripheral Selection	19
4.9 Summary of Cost Implications	21
4.10 Recommendations	23
5. HARDWARE SPECIFICATION	25
5.1 General Description	25
5.2 Regulations, Codes and Standards	25
5.3 Sensors	27
5.4 Signal Conditioning and Conversion	28
5.5 Interfacing and Cabling	28
5.6 Control and Display Console	28
5.7 Operator Controls	32
5.8 Packaging and Ship Interface Requirements	33
5.9 Input/Output Devices	33
5.10 Spare Parts	33
5.11 Testing and Support	35
6. SOFTWARE SPECIFICATION	37
6.1 General Description	37
6.2 Supervisory Software	37
6.3 Application Software	38
6.4 Displays	38
6.5 Testing and Support	42
7. FUTURE ENHANCEMENTS	43
8. CONCLUSIONS AND RECOMMENDATIONS	44
9. REFERENCES	45
APPENDIX A - Performance Requirements as Developed by SNAME HS-12 Panel	
APPENDIX B - Drawings and Parts List	
APPENDIX C - Manufacturer's Specifications	

LIST OF FIGURES

<u>NUMBER</u>	<u>TITLE</u>	<u>PAGE</u>
5-1	STD Bus Implementation of the Standard Response Monitor	26
5-2	Preliminary Console Layout	34
6-1	Typical Graphical Displays	39
6-2	Characteristic Statistics Display	41

LIST OF TABLES

<u>NUMBER</u>	<u>TITLE</u>	<u>PAGE</u>
1	Partial Listing of Previously Completed Response Monitoring Projects	6
2	Summary of User-Selectable Sensors	14
3	Comparison of Alternate Computer Hardware	20
4	Summary of Costs for Standard System and Some Options	22
5	Typical Sensor Interfacing and Sampling Requirements	30



## 1. INTRODUCTION

### 1.1 Background

For approximately 25 years various organizations in the U.S., Europe and Japan have been investigating the use of shipboard instrumentation systems to aid mariners in making decisions related to safe and efficient operation of their ships. These "Ship Response Monitors" typically provide ship motions and/or hull stress data on a near real-time basis to permit the navigating officer to assess the severity of the environment and the way the ship is responding to that environment. The majority of these projects have been developmental in nature, and although they have demonstrated the concept of using response monitoring, to date the idea has not been commercialized to the point where standard equipment is available and used on a large number of vessels.

In an attempt to bridge the gap between the previously completed development projects and custom installations, and a standard, commercially available ship response monitor, the Ship Structure Committee is currently sponsoring a project to develop a generalized onboard response monitoring system. As a starting point for this work, performance requirements were provided by the Society of Naval Architects and Marine Engineers' HS-12 Panel on Hull Instrumentation (see Appendix A) based on a review of previous work. The concept given in these performance requirements is to develop a standardized response monitor (SRM) with two standard sensors, several user-selectable sensors, necessary signal conditioning and standard displays for presentation of the information to ship's personnel. The provision of several user-selectable sensors will permit configurations of the system for different ship types and operating company preferences, while maintaining the standardization necessary for commercial production. In addition, the system will be adaptable to optional enhancements for vessel or trade applications where these are desirable.

The current project is divided into two phases. During Phase I these performance requirements were evaluated and the design of a standardized ship response monitor (SRM) was completed. Phase II work will include fabrication of three prototype units and evaluation of these aboard vessels in service. This report presents the results of the Phase I work.

### 1.2 Objectives

The primary objective of the Phase I work reported herein was the development of specifications for the prototype Ship Response Monitors to be built and tested during Phase II. Although a significant amount of previous work has been completed in the area of ship response monitoring, a concise set of standard performance requirements have not previously been developed or accepted by the marine industry. Therefore, the first task completed was definition and review of these performance requirements. Subsequently, design specifications were developed. Results of these two tasks are discussed in the following sections of this report.

During Phase II the primary objective will be evaluation of the SRM concept by producing, installing and using three systems aboard ships. In addition to providing operator feedback on the concept and usefulness of the system, this phase will provide critical review of the specific design features incorporated in the prototypes and an opportunity to evaluate alternate design features. At the conclusion of Phase II, a final design incorporating comments of navigating officers and operating companies will be available to industry.

## 2. APPLICATIONS FOR RESPONSE MONITORING

The need to supplement a master's feel of ship response with measured response has been commented on by a number of researchers including Chazal et al (1) and Hoffman et al (10). Assessment of the potential for damage or the capability to safely complete a task depends on the experience of the navigating officer and his experience with a specific class of vessel. In the case of very large vessels this assessment may in fact not be possible. Instrumentation which is sufficiently sensitive and reliable has the capability to detect ship responses which may be difficult to otherwise detect, and provide this information for navigating officers.

Operations-oriented response monitoring equipment is intended to provide this information in a form that can readily be used by navigating officers to avoid damage to the vessel or cargo and injuries to personnel, while at the same time operating as efficiently as possible in the existing sea conditions.

Typical types of damage caused by wave-induced motions and accelerations include:

1. Bottom slamming
2. Flare immersion impact (or slamming)
3. Damage due to shipping water
4. Cargo shifting
5. Damage due to fluid sloshing
6. Damage due to hull girder bending (infrequent)

In most of the above cases, the motions or accelerations which cause damage can be controlled through changes in speed and/or heading relative to the seas. These actions must, however, be traded off against their cost due to increased voyage time and fuel. An effective operations-oriented response monitoring system should accurately measure some aspect of ship response that is related to the potential for damage or the ability to safely complete a task, and display the information in a form that can be easily understood. The navigating officer can then use the displayed information in conjunction with other observations to decide on the appropriate course of action.

Due to the wide variety of vessel types in service, their design features and operational profiles, problems experienced in heavy weather and information required to detect the severity of response may vary significantly depending on ship type. Many vessels are subject to structural damage due to bottom slamming and crew discomfort or injury due to heavy rolling. Bottom slamming is a problem of primary importance for high speed vessels or vessels in ballast with reduced draft. Container vessels are particularly susceptible to damage to above deck containers caused by large accelerations and RO/RO vessels are subject to cargo shifting, damage due to the nature of cargo and tie-downs. Similarly, cargo shifting due to accelerations may be a problem for dry bulk carriers, and liquid sloshing due to accelerations may be problem

1. Numbers in brackets refer to references in Section 9.

for liquid bulk carriers. Also, for bulk carriers where loading can be highly variable, longitudinal bending moments might be significant. Other vessels such as RO/ROs may be susceptible to damage due to torsional loads based on the arrangement of their structure. In certain cases such as some LASH ships, afterbody slamming and propeller racing can be a problem area. On passenger and ferry vessels the key requirement is to keep motions and accelerations to a comfortable level.

Government service vessels are susceptible to the above problems, but they also pose some unique problems. High speed surface combatants such as destroyers are subject to damage due to shipping water and damage to weapons and antenna systems due to large accelerations. Vessels with highly flared bows are subject to flare impact damage. In addition to damage considerations for these vessels, successful completion of operations such as search and rescue, flight operations, replenishment at sea and even use of weapons is affected by motions and accelerations, and thus provide an opportunity for application of response monitoring.

In all of the above cases the important considerations are measurement of relevant responses, provision of sufficient accuracy and reliability to insure that changes can be adequately detected, and presentation of the resulting information in a form which is meaningful. If these criteria can be met, response monitoring equipment should provide valuable assistance to the navigating officer. Analysis of performance requirements and development of the SRM design presented in the following sections are based on these considerations and previously completed work.



### 3. REVIEW OF PREVIOUS WORK

Since 1960, various government agencies, educational institutions and private companies have conducted research programs to develop shipboard instrumentation systems intended to provide indications of dynamic hull stresses. Table 1 lists a number of these projects and describes the measurements that were made. The table begins with a reference that describes the instrumentation system. This is followed by the name and type of vessel and a listing of the sensors installed to monitor or infer hull stresses.

A review of the projects listed in the table and other references provide no clear direction for selection of an optimum sensor suite for a Standard Response Monitor. Some researchers contend that it is adequate for certain types of ships to monitor bow motions (15). Others argue in favor of a more comprehensive sensor suite including vibration measurements and direct measurement of stresses (actually strains) at a number of locations. These additional measurements have been strongly recommended for certain ship types (27).

Previous projects have included a number of alternate measurements to monitor ship response. In most cases, these were research efforts and sensor suites therefore could be more complex than those necessary for operational response monitoring. A representative listing of measurements made during these previous projects or identified by the SNAME Panel HS-12 includes:

- \* Bow Vertical Accelerations
- \* Midship Biaxial Accelerations
- \* Aft Lateral Accelerations
- \* Midship Deck Stresses (longitudinal and shear)
- \* Longitudinal Bending Moment Stresses
- \* Shaft Torque and RPM
- \* Speed and Heading
- \* Roll and Pitch (period and angle)

There is even less agreement from prior work regarding data processing and presentation. One researcher suggests that in most cases relative Root Mean Square (RMS) values of accelerations in analog form provide adequate information (15). Others have proposed that watchstanders should be given comprehensive tabular data in engineering units displayed on a video display unit (9,12). Still others contend that trend displays should be provided to give information on whether or not a situation is worsening (25). Most researchers recognize the need to provide accurate information which is not misleading since it will be used in stressful situations (17). The update rate of displays is another matter which must be given consideration. One



TABLE 1

## Partial Listing of Previously Completed Response Monitoring Projects

<u>REF.</u>	<u>YEAR</u>	<u>SHIP</u>	<u>TYPE</u>	<u>NO. OF SENSORS</u>	<u>SENSOR SUITE</u>	<u>REMARKS</u>
42	1961		Destroyer	2	Strains in strength deck port and starboard	
43	1973		Container	2	Strains in strength deck port and starboard	
44	1969		Container	6	2 bow emergence, 3 bottom deflections, 1 vertical acceleration	
15	1970	Booga-billa	R0/R0	3	Lateral Acceleration, Roll Rate, Pitch Rate	
28	1973	SeaLand McLean	SL-7 Container	65	Vertical Bending Port and STBD Midship Torsional Shear, Port & STBD Roll, Pitch, Vertical Accel. at CG FWD, Transverse Accel. at CG & FWD RPM, Rudder Angle, Wind speed & direct. Horizontal bending Port. & Starboard Real Sidewall Shear Port, STBD & Amidships Long. Stress Port & STBD at Deck Level, Neutral Axis Bottom. Aft Shear Deckhouse Vert. & Trans. Accelerations After Hatch Corner Shear (12 channels) Assorted Other Shear (14 channels), Transverse Stress (7 channels), Transverse Deck Girder Stress (4 channels)	Research for a New Class of Ship
45	1975		Container	6	Bending Strains	
27	1976	J. G. Munson	Great Lakes Bulk Carrier	6	Forward Hull Stress, Port and STBD Amidships Hull Stress, Port & STBD Aft Hull Stress, Port & Starboard	Converted from a Research System

TABLE 1 (cont'd.)

Partial Listing of Previously Completed Response Monitoring Projects

<u>REF.</u>	<u>YEAR</u>	<u>SHIP</u>	<u>TYPE</u>	<u>NO. OF SENSORS</u>	<u>SENSOR SUITE</u>	<u>REMARKS</u>
27	1976	C. J. Callaway	Great Lakes Bulk Carrier	6	Forward Hull Stress, Port & STBD Amidships Hull Stress, Port & STBD Aft Hull Stress, Port & STBD	Converted from a Research System
19	1976	American Aquarius	Lancer Class Container	59	Draft, Tank Pressures, Ballast Tank Status, Hold Flooding, Bow Accel., Roll, Pitch, Hull Stresses	
15	1976 - 1980	3 vessels		5	Vertical Accelerations (2) Lateral Acceleration Roll Pitch	Evaluation of Operational Monitoring and Guidance System
3,12	1977	Lash Italia	Barge Carrying	9	Long, Stress Amidships Port & STBD, Vertical & Lateral Accel. in Forward Deck House, Vertical Stress Fwd. of the Deck House (3 channels), Vertical Stress Aft of Deck House (2 channels)	Qualitative Guidance Feature
27	1977	S. J. Cort	Great Lakes Bulk Carrier	6	Fwd. Hull Stress, Port & STBD. Amidships Stress, Port & STBD Hull Stress, Port and Starboard	
8	1978	Hollandia	Container			Research Project
3.16	1980	Furman	Victory Cargo Ship	15	Bow Stress, Port and Starboard Bow Biaxial Accelerometers, Roll Angle Midship Hull Stress (2)	
32	1980	Burns Harbor	Bulk	15	Bending Stress (10) FWD., Amidships & Aft, Hatch Corner Stress (3), Vertical Accelerometer, Lateral Accelerometer	

TABLE 1 (cont'd)

## Partial Listing of Previously Completed Response Monitoring Projects

<u>REF.</u>	<u>YEAR</u>	<u>SHIP</u>	<u>TYPE</u>	<u>NO. OF SENSORS</u>	<u>SENSOR SUITE</u>	<u>REMARKS</u>
30	1978	Antonio Johnson		4	Midship Stress (Port & STBD) Forward Quarter Point Stress (Port and STBD)	Information did not answer Captain's needs, Wanted "Guidance" in Pitching and Rolling
30	1978	SeaLand Economy		3	Bow Accelerometer, Amidship Strain Gage Bridges (2)	
20	1978	SS Esso Bonn	Tanker (VLCC)	19	Midship Deck Strain Gage Bridges (4), Midship Vertical Acceleration (2), Bow Axial Acceleration (3), Bow Fluid Pressure Sensors (4) Relative Ship/Sea Motion Sensors (5), Pitch, Roll	Research Project
39	1980		RN Frigates (2)		Vertical Acceleration on Bridge	Research Project
21	1983	Pierre Radisson	Icebreaker	32	Strain Gages in Bow Structure	Used to Aid Navigation In Ice
22	1985		Container	1	Single Strain Gage Bridge	
22	1985		Car Carrier	8	Midship Hull Stress (3), Bow Biaxial Accelerometers, RPM, Governor Notch, E.M. Log	
22	1985		Bulk Carrier	8	Midship Hull Stress (3), Bow Biaxial Accelerometers, RPM, Gov. Notch, E.M. Log	
24	1985		Container Ships (2)	9	Bow Vertical Accel., Midships Vertical Accel., Midships Transverse Accel., Wind Speed & Direction, Propeller Torque RPM, Ship Course and Speed	

recent project (21) provided updates every 4 seconds. However, operational experience suggested that an update every 10 seconds would be more appropriate for proper assimilation of the data. Some researchers have suggested that the master should be provided with predictive capabilities and guidance on action to be taken, in addition to instantaneous information on stress levels (30, 38).

Most researchers agree that a response monitor should include alert functions. There is, however, little agreement on acceptable levels of response or the specific measurements to be monitored (1). One researcher recommends variable levels that can be set by individual masters based on experience with a specific ship (17). This is consistent with the view that alert levels should not be absolute, but instead should represent an indication for growing concern. This approach is consistent with the objectives of most response monitoring projects to provide information that can be used for decision making by the navigating officer. It also permits knowledge transfer between masters and junior officers or between individuals experienced with a certain vessel class and those without this experience.

In an effort to resolve these varying views, a classic paper on stress and motion monitoring for merchant vessels was presented at the 1980 SNAME STAR Symposium by Chazal et al (1). From the paper and resulting discussions a consensus seemed to emerge. What is needed is "a simple system consisting of no more than two or three sensing devices that could be installed on different ships", with indicators having a common element of presentation (17). This suggests that the SRM should have a basic configuration applicable to a range of vessels. This configuration should support several standard sensors and several user-specified sensors selected based on vessel type or service. In addition, it should provide a capability for future enhancement on a custom basis.

Other areas where a review of the literature provides general guidance are reliability and maintenance, dependability with respect to accuracy, flexibility with respect to sensors and sensor locations and benefit versus cost. Reliability in a shipboard environment is critical for several reasons. First, incorrect information could pose a safety hazard. Also, repair capabilities will be limited and systems with even moderate failure rates will not be readily accepted. The system must be dependable. Should the system fail, all failures must be graceful. That is, if failures occur they should not result in the display of erroneous data, and the system should provide an indication of the extent of the failure and validity of remaining displays. This is a key factor in acceptance by operators since they must "trust" the system. The system should be adaptable to a wide variety of sensor locations and sensor types since measurements that are relevant on one vessel may be of little value on another. Finally, the cost of the system must be such that operating companies feel the investment is justified in light of benefits.



## 4. ANALYSIS OF REQUIREMENTS

### 4.1 Major System Functions

The major system function for the standard response monitor (SRM) is presentation of information to navigating officers which permits real-time assessment of the potential for damage. This objective is well within the current state-of-the-art in instrumentation and computer applications. However in the past most applications were oriented toward research, as compared to the operations orientation desired for the SRM. The operational aspects of the system must be the primary consideration in all decisions regarding performance requirements and design if the system is to be accepted by the industry.

Issues discussed in the following sections address two major areas; (1) what capabilities should be included in the SRM and (2) how should navigating officers interact with the system? Throughout the definition of these performance factors, capabilities and flexibility must be traded off against cost. Operating company acceptance of the SRM will be a function of cost and perceived utility, and the cost will be a function of basic capability and the potential for expansion. Two questions related to cost must be addressed when defining performance requirements. First, what is the minimum cost that will provide installation of a satisfactory SRM? Secondly, what will operating companies be willing to pay for an SRM?

Given the current state-of-the-art in instrumentation systems, basic equipment that measures and displays up to two parameters could be installed on a ship for as little as \$20,000. This approach would include analog (meter) displays and would provide little if any capability to process the measurements and configure displays for ease of interpretation. This approach would certainly not meet the requirements developed by the SNAME HS-12 panel (Appendix A). These requirements can probably be met for between \$25,000 and \$40,000, depending upon the capability for expansion built into the system. At the high end of the available range of capabilities, very sophisticated systems could be installed for costs in excess of \$100,000. This type of system would provide capabilities for complex calculations, highly variable displays, expansion to a very large number of sensors and potential for application to other shipboard computing tasks.

The price that owners should be willing to pay for the SRM can be evaluated in several ways. First, a system that has a cost comparable to other bridge equipment such as radar (\$25,000 - \$75,000) would probably be acceptable, provided that it is perceived to be useful. A more precise way to evaluate acceptability of cost is to estimate the savings that could be attributed to use of the 0000 system. Hoffman and Lewis (10) completed an analysis of cost



savings for a modern containership making 17 trans-Atlantic voyages per year. They estimated the annual savings due to use of a heavy weather damage avoidance system to be:

1. Annual Savings in Repair Costs	\$18,000
2. Annual Savings Due to Lost Time	\$75,000
3. Annual Savings in Fuel	<u>\$30,000</u>
Total Annual Savings	\$123,000

These estimates were completed in 1975. In 1986 the total savings would be approximately \$211,000, based on the consumer price index increases over this time period.

This analysis assumed that the monitoring system would eliminate 67% of the damage and that the equipment would reduce voluntary delays due to speed reductions by 50%. These assumptions appear to be reasonable and indicate that the cost of even a sophisticated SRM could be recovered in one year.

Considering all of the above, it is recommended that the target cost for the basic SRM with standard sensors, user-selectable sensors and installation be set at \$30,000 to \$40,000. This will provide all capabilities specified by the SNAME panel and it will require a capital investment by the ship owner which is similar to that required for other bridge equipment. Although based on the analysis of savings given by Hoffman and Lewis (10) it would appear that a more expensive system could be justified, it is felt that the recommended target cost will result in wider acceptance by the industry. It must be remembered that the ability of an SRM to reduce damage by 67% and delays by 50% has not been demonstrated, and owners are more likely to try the equipment if the capital cost is maintained at a level where even small reductions in damage and delays result in an economic benefit.

#### 4.2 Sensors

As discussed in Section 2, specific sensors incorporated in the SRM should probably vary depending on the type of vessel to be instrumented, however previous work (15) suggests that several "standard" measurements are relevant for most vessels. With these considerations in mind the SNAME HS-12 Panel recommended incorporating two standard sensors and several additional sensors to be specified by the specific operating company, depending on the type of vessel and service. This approach provides two benefits. The inclusion of standard sensors provides consistency from ship to ship such that navigating officers moving from one vessel to another have familiar output available from the SRM. In addition, these two standard sensors should provide relevant information on any vessel, even if they are not supplemented with user selectable sensors. The two to four user-selectable sensors can be used to tailor the SRM to the needs of a specific vessel. These could be specified such that known problem areas are addressed or simply to provide other desired displays.

#### 4.2.1 Standard Sensors

Performance requirements developed by the SNAME HS-12 Panel specify a vertical accelerometer at the bow and a lateral accelerometer in the pilot house as standard sensors for the SRM. These sensors are believed to provide sufficient information to give an indication of the potential for the types of damage discussed in Section 2, on most vessels. Bottom slamming, flare immersion impact, damage due to shipping water and damage due to longitudinal bending can be related, at least indirectly, to vertical accelerations at the bow. Cargo shifting and fluid sloshing damage are in most cases caused by lateral accelerations due to heavy rolling, and therefore can be related to lateral acceleration in the pilot house.

Sensors to provide the specified acceleration measurements are commercially available in a variety of types, cost ranges and qualities. These include strain gage, piezoelectric and force-balance (servo) devices with costs ranging from several hundred to several thousand dollars each. Selection of the specific accelerometers for the SRM should be based primarily on their ability to provide the required accuracy and reliability. In addition, due to possible variations in vessel sizes and types, a capability to provide variable sensitivity is desirable. Based on these considerations, the servo-type devices are recommended. These accelerometers are force-balance devices in that they measure the current required to magnetically suspend a seismic mass at a fixed point. As compared with strain gage or piezoelectric sensors, these devices provide superior linearity, frequency response, cross-axis sensitivity, resolution, stability and reliability. Even at the intermediate price range, servo accelerometers provide sufficient accuracy and stability for use in inertial navigation systems, an application that is significantly more demanding than the SRM. In addition, sensitivity can typically be programmed such that one sensor type can be used for the complete range of vessel types and measurements expected. Since most of these devices were originally designed for application in navigation systems, the designs are rugged and suitable for operation in relatively harsh environments.

#### 4.2.2 User-Selectable Sensors

A list of typical user-selectable sensors that could be included to tailor the SRM for a specific application is given in Table 2. It should be noted that other measurements or sensors are possible; however, the list given in the table represents a fairly complete description of the types of measurements made in the past and those believed to be relevant for response monitoring.

Roll angle is a measurement that could be used to supplement lateral acceleration measurements on vessels such as containerships, RO/ROs or tankers where cargo tiedowns or fluid sloshing are critical. In addition, this would be a relevant measurement on military vessels where operations are affected by rolling. Roll angles can be sensed by interconnection to most modern ship's gyrocompasses or by using pendulums, instrumentation gyros, or vertical reference sensors. Pendulums are not recommended since accelerations can cause errors in the measured angles. Instrumentation gyros are not subject to these errors, they have limited life (500-1000 hours) due to moving parts. The vertical reference sensors do not suffer from either of these problems, but they are relatively expensive. Most roll sensors are two-axis devices and would therefore also provide measurement of pitch angle. This measurement

This measurement could be used to supplement the bow vertical acceleration on high speed or shallow draft vessels subject to bottom slamming. These sensors would provide measurement of roll and/or pitch periods if proper analysis routines are included. In particular, roll period measurement can be used to monitor changes in stability and are recommended by the SNAME panel. This measurement could also be obtained from the lateral acceleration.

Shaft torque might be of interest to provide bridge personnel with a measure of propulsion plant loading or to give an indication of propeller racing in a seaway. On vessels equipped with torque meters, interfacing to these would be relatively simple. On other vessels, commercially available torque meters could be installed, or the shaft could be strain gaged. This latter approach would require installation of a telemetry system or slip rings. The preferred approach would be installation of a commercially available torque meter.

Installation of strain gage arrays could be used to address a number of potential problems. On vessels with specific local problems, such as hatch corners or foundations, one or more strain gage bridges could be installed at specific locations. Local strain gage installations would also be useful on vessels with flare immersion damage problems or for unusual cargo tie down arrangements. Arrays of strain gages can also be used to provide more direct measurement of hull bending or torsional loadings. The simplest of these would include longitudinal strain measurements at the sides of the strength deck, near the location of expected maximum bending moment. If desired, these installations could be expanded to provide measurements at several longitudinal and/or vertical locations.

On container or RO/RO vessels where tie down loads are critical, these could be measured with load cells or inferred from accelerations. Load cells are available that could monitor cable tensions or compression loads between cargo and the ship's structure. In addition, container dogs or other special fasteners could be designed and built to incorporate a direct load measurement. Tie down loads can also be monitored in an indirect manner by monitoring accelerations of the cargo. If the weight of the cargo and geometry of tie downs are known, loads can be calculated. These could be equipped with cables that permit installation at any desirable location. Accelerometers could be similar to the standard sensors and would be installed in portable enclosures such that they could be attached to the cargo of interest.

Vessels with severe bottom or flare slamming problems could be instrumented for more direct measurement of these loads with strain gage arrays or deflection sensors. Strain gage arrays could be installed to monitor shell plating loads or stiffener loads at relevant locations, depending on the vessel design. Alternately, direct measurement of deflections in shell plating or stiffeners could be made using linear displacement transducers. Either of these approaches would probably require sampling rates higher than standard measurements and some design work to insure that the installation is satisfactory for the specific ship.

In cases where vibrations due to slamming or machinery-excited vibrations are of interest, these could be monitored with either accelerometers or strain gages. Accelerometers similar to the standard sensors could be mounted as necessary for the vibration mode of interest. Adjustment of the scale would



TABLE 2  
SUMMARY OF USER-SELECTABLE SENSORS

<u>Variable</u>	<u>Available Sensor</u>	<u>Cost Range (Installed)</u>
1. Roll and Pitch Angles	Interface to Ships' Gyrocompass	\$ 1,000-1,500
	Pendulums	1,000-2,000
	Instrumentation Gyro	5,000-10,000
	Vertical Reference Sensor	15,000-35,000
2. Roll and Pitch Periods	Same as Roll and Pitch Angles or Accelerometers	
3. Shaft Torque	Interface to Existing Torque Meter	1,000-2,000
	Commercial Torque Meter	10,000-20,000
	Strain Gage Array	10,000-15,000
4. Local Stress	Strain Gage Array	2,000-5,000
5. Vertical Bending Moment	Strain Gage Array	5,000-15,000
6. Hull Torsion	Strain Gage Array	5,000-15,000
7. Tie Down Loads	Load Cells	1,000-2,000 ea
	Accelerometers	1,000-2,000 ea
8. Extra Accelerometers	Accelerometers	1,000-2,000 ea
9. Vibrations	Accelerometers	1,000-2,000 ea
	Strain Gage Array	2,000-5,000 ea
10. Slamming Loads	Strain Gage Array	5,000-15,000
	Deflection Sensors	10,000-25,000
	Accelerometer	1,000-2,000
11. Vessel Speed	Interface to Ships Log	1,000-2,000
12. Heading Angle	Interface to Ship Gyro Compass	1,000-2,000
13. Wave Height Sensor	Sensor for Underway Wave Measurement Not Yet Available	

probably be required and sampling rates would probably be higher than those for the standard sensors. These factors would have to be analyzed on a case-by-case basis. Strain measurements from gages installed specifically for vibration monitoring or from other gages could also be used to monitor vibrations. Again, adjustment of the sampling rate would probably be required. For certain modes of vibration such as hull bending, the standard sensors could be sampled such that vibrations are monitored. Sampling rate would be increased and measurements could be analyzed to display the high and low frequency responses separately.

In addition to the sensors described above, other relevant parameters could be monitored by interfacing the SRM to existing ship systems. Examples would include ship speed, heading or shaft RPM. These installations could be easily accomplished, and could be used to monitor and reduce operating costs. Such additions would also be valuable, for example, on vessels susceptible to propeller racing in a seaway.

It is recommended that the SRM be designed such that any two to four of the above sensors could be user-specified for inclusion along with the standard accelerometers. The design should be developed such that the device is "configured" for these without requiring custom hardware or software. The system should include provisions for configurations that require higher than standard sampling rates.

#### 4.3 Sensor Interfacing and Cabling

All standard and user-selectable sensors require interfacing and most require digitization of analog signals. Modularized hardware is commercially available which permits interfacing with a wide variety of sensors, and most of these permit installation of the hardware required for the basic system and incremental expansion for optional sensors. The features to be provided include signal amplification, low pass filtering and digitization. The system selected should permit voltage inputs, current inputs and digital inputs such that interfacing with other ships equipment as well as specially installed sensors is possible.

The primary decision to be made is the location of the interfacing hardware. This equipment could be located in the SRM console, or it could be located near sensors or groups of sensors. If equipment is located in the SRM console, required excitation to sensors would be transmitted to sensors and analog sensor outputs would be transmitted to the SRM using multi-pair cables run from the SRM to each sensor or group of sensors. Remote location of interfacing hardware could be accomplished using a variety of commercially available Remote Acquisition Units (RAUs). These small, stand-alone, modular units could be installed at locations near groups of sensors to provide interfacing with one to several dozen sensors. The RAUs provide signal conditioning and digitization of data under control of a dedicated microprocessor. This data would then be transmitted serially to the SRM console on the bridge. RAUs are well suited to applications where a number of sensors are clustered at areas remote from the main computer.



Considerations in selecting the location for interfacing hardware include cost, expected number of channels and sensor locations, computing power available in the SRM, cabling requirements, space requirements in the SRM console, signal quality, system reliability and maintenance, and power at remote locations. Based on requirements developed in the previous sections, the SRM will include up to six sensors located primarily in the bow, on the bridge and either amidships or in engineering spaces. Cabling can be a major expense; however, installation of a cable for one or two analog signals (interfacing hardware in SRM console) is no more expensive than installation of a cable for serial digital signals (RAU at sensor location). Installation of a large cable for many analog signals or multiple cables to a large number of locations would however be significantly more costly.

For the basic system, space in the SRM console is not an issue, however if space must be provided for interfacing equipment necessary for all possible system expansions, a much larger console would be required. Another consideration is transmission of analog data in a noisy environment. If cables are properly shielded and only high level signals are transmitted, analog cabling to the SRM console will be acceptable. Low level signals would be subject to degradation due to long cable runs. If RAUs are installed at remote locations system reliability will be affected and maintenance will be complicated, since electronic equipment will be located throughout the ship.

Computing power is not really an issue in the decision to locate interfacing hardware in the SRM console since the main processor must either digitize sensor data or communicate with the RAUs. The primary tasks that will be required from the SRM processor are data conversion and generation of displays, which must be completed in either case. This assumes that the Remote Acquisition Units are basic interfacing and digitizing units, rather than Remote Processors which complete calculations and transmit formatted data for display. The more sophisticated units would cost between \$4,000 and \$8,000 each as compared to approximately \$700 each for the basic RAUs and could be used to add computing power to the system. Even with the most basic processor in the SRM, this would not be required unless extensive expansion is necessary.

For the basic SRM, installation of interfacing hardware in the SRM console is recommended since a small number of sensors are located at widely separated areas of the ship. The cost of cabling would be similar with or without RAUs, and the cost of the RAUs would add to the installed cost of the system. Since modular signal conditioning that could be used in the SRM console typically is available in units capable of 16 channels, the approach of keeping all electronics in the console would permit expansion to at least this number of sensors with no increase in console size. If future enhancements require expansion beyond this number of channels, or if these result in a large number of sensors grouped at specific locations, the use of RAUs should be considered, primarily as means to reduce cabling cost and space required in the SRM console.

#### 4.4 Functions in Addition to Response Monitoring

It has been suggested that other capabilities, in addition to response monitoring, might be built into the system. Two primary motivations exist for including additional functions. The first of these is the possibility that

navigating officers will accept the system more readily if additional, useful functions are provided. The second is related to additional justification of the cost. Ideas which have been suggested include:

1. Text display for steaming orders or short messages/reminders.
2. True wind calculator.
3. Capabilities built-in to provide guidance.
4. Loading Calculator
5. Administrative functions such as complete word processing, bookkeeping or inventory.

Any of these functions could be included. However they affect system complexity and cost to varying degrees. Simple message displays could be implemented on almost any machine capable of monitoring function, but this would require a keyboard. A capability to calculate true wind speed and direction from apparent wind, ship speed and heading input by navigating officers, would be useful and could be easily implemented. Guidance could take many forms ranging from a simple system which the operator could query with "what if's" to complex systems that recommend action. The simplest system could again be implemented on most machines but more complicated systems require additional computing power and elaborate software development. In addition, these systems are typically ship specific, and are therefore not consistent with the concept of a generic SRM. The loading calculator interface and administrative functions would require software and computing power which is completely different from the monitoring function. These administrative tasks could best be completed using a desktop computer with commercial applications software.

In addition to cost and complexity, provision of additional functions will affect the way the system is viewed by navigating officers and the ease with which it can be used. If the system begins to take on the look and functions of a desktop computer, it will not look like a piece of bridge equipment and will then probably not be used as such. Also, the provision of a complete keyboard, disk drives, printer and applications software will increase the knowledge that an operator must have to use the system. This would be totally different than a system which requires pressing function keys or turning selector switches to operate.

Based on the above, it is recommended that the SRM be configured as bridge equipment and that capabilities be limited to bridge functions. The display of messages is not recommended since this would require a full keyboard and the unit would then resemble a computer. The true wind calculator poses no problems and can be included in the SRM. At this time, guidance capabilities should not be included, but should be considered as a future enhancement. The loading calculator interface could also be included as a future enhancement. Other administrative functions are not recommended.

#### 4.5 Packaging

The principal issue to be addressed is the type of console specified for the SRM hardware on the bridge. The key requirement is that the system must look like ship's equipment rather than a computer system. Based on recommendations in the previous sections, the hardware could be packaged in an enclosure as small as 22" x 18" x 13". This size would be similar to other bridge

equipment such as LORAN C and SATNAV equipment, and would permit flexibility in location such that the equipment could be mounted from overhead, placed in a standard deck mounted console or mounted on a table or shelf. There are advantages and disadvantages for each of these options including space requirements, visibility, ease of service and access to controls. The type of mounting could in fact be left to the preference of a particular operating company.

Other considerations related to packaging include interfacing with the ship and maintenance. The SRM must be compatible with shipboard electrical systems. The power supply should include an uninterruptible power supply (UPS) and should be capable of being configured for alternate voltages and frequencies. The packaging should be designed for ease of access for service, and provisions for "board swap" repairs should be provided.

The recommended approach for packaging is to provide an enclosure for the SRM that is as small as is practical and can be mounted from the overhead or inside a deck console. Both of these arrangements should be evaluated during the prototype testing. The system must be compatible with shipboard electrical systems and must include a UPS.

#### 4.6 Display Methodologies

Performance requirements developed by the SNAME HS-12 Panel specify a video display unit for the SRM. The exact format of displayed data is therefore completely flexible at this time. The questions to be addressed during definition of performance requirements are (1) would a color display be worthwhile and (2) what displays should be included in the basic unit. Use of a high resolution color display rather than a monochrome display will increase costs by approximately \$1,500 to \$3,000 per unit. This must be evaluated in light of the advantages and disadvantages. Typically, a well designed color display provides the user with an improved capability to assimilate information quickly, and attention is quickly directed to alerts or changes in status. In the case of the SRM these features are thought to be valuable in light of the fact that the system will be most useful during stressful situations. On the negative side, colors must be carefully evaluated to insure good visibility in both bright sunlight and bridge night lighting. Also, since color displays are not typical on most ships, the use of color may cause the SRM to be perceived as not being standard shipboard equipment.

The manner of presentation will be equally important to the usefulness of the system. Options include display of numerical data, graphical data, data in engineering units or "normalized" data. Typically, a simple bar chart type graphical display is the most quickly understood. However, for certain types of measurements the navigating officer(s) may need numerical displays to improve resolution. Similarly, some navigating officer(s) may find data in engineering units valuable. The specifications given in the SNAME HS-12 Performance Requirement provides for all of these capabilities and would allow navigating officer(s) to select the formats that are most useful. These must be implemented with ease of understanding and usefulness given primary consideration.



The recommended approach for displays is to provide a number of displays that can be selected by an owner or operator. These must be kept simple with the most meaningful data highlighted. Any alerts provided in the displays should be configured such that masters set the alert levels. The SRM should at a minimum include a high resolution monochrome display with brightness and contrast controls. However, during development, software should be written such that color can be added as a future enhancement. This should not require additional effort during development of the prototypes.

#### 4.7 Controls

Two primary requirements for controls are ease of use and simplicity. The basic requirement is that actions by the navigating officer prior to use should only include turning the power on. The approach proposed by the SNAME HS-12 Panel includes the use of function keys and rotary switches for all operator controls. Such an approach provides single key press or switch control of all functions, and the keys are labeled such that the navigating officer does not have to remember a sequence of commands. This will provide interaction with the navigating officer similar to other bridge instruments such as LORAN or SATNAV units. One feature which should also be included is provision of diagnostics such that the validity of displays can be assessed. The exact layout of the control panel should be carefully designed using human engineering principles to insure that it can be easily learned and used. Still, an infinite number of possibilities exist and the only final evaluation may come during actual use.

The SRM design should proceed in a manner that keeps the control panel as simple as possible. During the Phase II fabrication, mockups of several control arrangements should be reviewed by the Project Technical Committee and at least one mariner prior to finalizing the design. The final design should permit control of any function with single key presses or by selecting a switch position, and controls should be included that permit testing the unit for proper operation.

#### 4.8 Computer and Peripheral Selection

The selection of a specific processor for the SRM is not really a performance requirement but rather results from the performance requirements. The objective should be to use the most inexpensive system that will meet the performance requirements and will provide reliability and maintainability. A large number of systems are available which would satisfy any of the levels of performance and expandability discussed above. Several have been selected for consideration and these are summarized in Table 3. Included are systems that satisfy basic requirements and provide for various levels of expandability. All of these units are available in a form suitable for installation in an instrument, and parts and service are available worldwide. In addition, most have been successfully used in shipboard applications.

If the recommendations given in the previous sections are accepted, any of the processors considered would provide adequate performance. It should be noted at this point that two approaches to providing any of the processors discussed in the table are available. These include adapting an existing computer such

as an IBM PC to the SRM, or basing the system on industrial measurement and control equipment. This latter approach provides a large selection of processors and interfacing equipment in a convenient modular system designed for use in measurement and control applications.

Table 3 also provides information on capabilities for adding future enhancements. Even the least capable processor would permit expansion to up to 32 channels at a 20 Hz sampling rate or increases in sampling rate up to 200 Hz for six sensors. These could be achieved without additional processing capabilities. If capabilities for expansion of the number of sensors or use of sensors requiring sampling rates greater than these must be provided, then the three more expensive systems should be considered or RAUs should be included. If word processing and administrative functions are desired, the IBM PC system would provide the widest range of applications software. The major difference between the two least expensive systems is the capability to provide adequate guidance capabilities as a future enhancement. This is thought to be an important enhancement based on previous response monitoring projects and the 8-bit processor should, therefore, be eliminated from consideration.

It is recommended that the system be designed around one of the commercial measurement and control bus systems using an 16-bit processor. This is the most cost effective approach and provides hardware that is designed for operation in an industrial environment. All basic system capabilities recommended in the previous sections could be achieved with this hardware and most future enhancements, including guidance, would be possible. Software should be developed such that it is transportable from one processor to another to permit future manufacturers to base the system on hardware that they routinely use in their instrumentation. This could be achieved by programming in the "C" language, standard FORTRAN, or PASCAL. The basic SRM should include provisions for communication with other devices such that future enhancements beyond the installed capability could be provided by interfacing with RAUs or other computer systems.

#### 4.9 Summary of Cost Implications

Table 4 provides a summary of the cost implications associated with all of the options discussed in the previous sections. These are approximate since complete specification of every system is not possible at this time. Relative costs should however be meaningful. The basic system costs assume that user selectable sensors are a pair of strain gage bridges or additional accelerometers. These would increase if the more expensive user-selectable sensors are selected (see Table 2 for cost ranges). The cost of future enhancements varies depending on the processor selected. Guidance requires software development in all cases, and a capability for simple text requires a keyboard and elementary word processing software. Administrative software would be purchased and would require a keyboard and disk drive(s). Loading calculator software could probably be purchased for the IBM PC or HP 9816 machines; however, purchase and translation would be required for the others.



TABLE 4

Summary of Costs for Standard System and Some Options

<u>ITEM</u>	<u>6502 Apple or STD BUS</u>	<u>8088 IBM PC</u>	<u>68000 HP</u>	<u>68000 MOTOROLA</u>	<u>LSI-11 DIGITAL</u>
Basic System with Software & Capability for 4 Channels	\$20,000	\$25,000	\$35,000	\$30,000	\$40,000
Two Accelerometers and Two User Selectable Sensors	\$ 6,000	\$ 6,000	\$ 6,000	\$ 6,000	\$ 6,000
Installation	\$10,000	\$10,000	\$10,000	\$10,000	\$10,000
TOTAL BASIC SYSTEM	\$36,000	\$41,000	\$51,000	\$46,000	\$56,000
Future SRM Enhancement Capability Cost:					
Color Displays - Each Unit	\$ 1,500	\$ 1,500	\$ 4,000	\$ 4,000	\$ 6,000
Simple Guidance - One Time Cost	N/A	\$ 5,500	\$ 4,000	\$ 4,000	\$ 6,000
Simple Text - One Time Cost	\$ 1,000	\$1,000	\$1,000	\$ 1,000	\$ 1,000
Administrative Software - Each Unit	\$1,500	\$1,500	\$3,000	N/A	\$ 5,000
Loading Calculator Each Unit	N/A	\$10,000	\$10,000	\$15,000	\$15,000

Note: Per Unit Cost Given Above Assumes Three Units; Production Costs for Final Design Should Be Less

#### 4.10 Summary of Recommendations

The key issues addressed in the previous sections are definition of requirements for an SRM, provisions for expandability of the SRM which should be included, use of the system for purposes other than response monitoring and cost implications due to these. Principal conclusions are as follows:

1. The basic SRM with a capability to monitor and display data from up to six channels can be achieved within a budget of approximately \$35,000 per unit, including installation.
2. The true wind calculator should be included in the basic SRM.
3. Display of simple text messages should be considered to be a future enhancement since provision of a full keyboard is not recommended. The units should be capable of communicating with terminals, other shipboard equipment, or other computers to permit future enhancements.
4. More elaborate additional features such as administrative software or a loading calculator would significantly add to system cost and complexity and are not recommended for the basic SRM.
5. Expandability beyond the six channels discussed above, up to a certain limiting number of channels, is possible with any of the systems reviewed without a requirement for additional processing power. Additional capabilities could be provided in any system by using distributed processing as the system became more complex. There are limitations to this in terms of update rate for screen displays.

Based on a review of past work and analysis of alternate performance requirements the following recommendations are offered:

1. The primary objective of this project should be to produce a design which is accepted by the industry. This will require continued focus on COST, PERCEIVED UTILITY, and SIMPLICITY. In addition, the SRM must be perceived as a bridge instrument rather than a computer system. This leads to the recommendations that additional functions not be included, packaging should be very carefully reviewed and controls should be designed similar to other bridge instruments.
2. With respect to detailed design, adherence to the Performance Requirements developed by the SNAME HS-12 Panel, included in Appendix A, is recommended with the following exceptions:
  - a. During Phase II several mockups of the controls should be built and reviewed with the PTC and at least one mariner.
  - b. Alternate packages (desk console and overhead console) could be included in the three prototype SRMs. It is hoped that both of these can be evaluated.

3. The display methodologies given in Appendix A should be used with the exception that minor changes should be implemented as problems are noted during software development. Critical review of displays should be a primary objective of the at-sea testing. It is hoped that the use of color in displays can be evaluated on at least one of the prototype units.
4. One of the two least expensive processors discussed should be selected for detailed design. Either of these will provide adequate capability for the basic SRM and some expansion capability.

## 5. HARDWARE SPECIFICATION

### 5.1 General Description

The Standard Response Monitor (SRM) system design developed based on requirements discussed in the previous sections uses current sixteen-bit microprocessor technology. The computer system is based on the standard (STD) measurement and control bus system. The concept of using a standard industrial measurement and control bus such as the STD bus provides a large selection of off-the-shelf components, modular design and components designed for application in harsher environments. Components selected for the system are all complementary metal-oxide semi-conductors (CMOS) to provide low power consumption and heat generation, high ambient noise immunity and reliability.

The SRM package can range from a self-contained desktop or overhead mounted unit to a free standing console. Total system weight (excluding transducers and Uninterruptible Power Supply) should be less than 30 pounds. Stand alone system dimensions should be approximately 22"W x 18"D x 13"H.

Two standard acceleration sensors for the SRM system will be packaged in weather and oil tight NEMA-4X enclosures. Each accelerometer enclosure will measure approximately 6"W x 6"D x 4"H and weigh approximately 4 pounds.

Figure 5.1 shows a functional diagram of the SRM system as implemented on the STD bus system. This system is easily expandable from the six channel base unit to 16 channels, and may be expanded to 32 channels with additional boards. The following sections provide specifications for hardware. Appendix B includes the following drawings:

- B-1 Preliminary Console Drawing
- B-2 Preliminary Console Assembly
- B-3 Wiring Diagram
- B-4 Parts List

Manufacturers' specifications for major system components are included in Appendix C.

### 5.2 Rules, Regulations, Codes and Standards

The equipment and materials shall be designed, manufactured, inspected and tested in accordance with the Classification Society, regulations, and codes or standards as specified herein.

Classification Society:

- American Bureau of Shipping, Rules for Building and Classing Steel Vessels, current edition.



## Regulations:

- U.S. Coast Guard

## Codes and Standards:

- IEEE-45 Standards and Practices, Institute of Electrical and Electronics Engineers
- Standards and Practices, Instrument Society of America
- UL 1012 Power Supplies, Underwriters Laboratories
- UL 478 Electronic Data Processing Units and Systems, Underwriters Laboratories
- National Electrical Manufacturers Association (NEMA)
- CSA 22.2 No. 154-1975 Data Processing Equipment, Canadian Standards Association
- IEC 435 Safety of Data Processing Equipment, International Electro-Technical Commission

## 5.3 Sensors

The basic SRM system will include a capability for six sensors. These include the two standard sensors, vertical bow accelerometer and transverse bridge accelerometer, and up to four user-selectable sensors. Servo type accelerometers have been selected for standard and user-selectable acceleration measurements due to their overall reliability and resolution. Specifications for these accelerometers (Sundstrand Data Control Model QA-1200) are as follows:

Nominal Range:	2 g (can be changed for different applications)
Non-Linearity:	0.05% of full scale
Natural Frequency:	100 Hz
Hysteresis:	0.22% of full scale
Resolution:	0.0005% of full scale
Cross Axis Sensitivity:	0.002 g per g
Damping Ratio:	0.6 typical
Operating Temperature:	-55° C to 95° C
Shock Survival:	100 g for 11 ms

A test coil is also provided on the accelerometers for the purpose of offsetting the accelerometer against gravity in the case of the vertical unit. This test coil is also used for testing the accelerometers from the control and display unit by inducing a known current into the coil.

The list of user-selectable sensors given in Table 2 includes strain gages, additional accelerometers and roll/pitch sensors. Strain gage bridges will be configured depending on the specific application using AILTECH SG 158 weldable gages. These gages are hermetically sealed and have the following specifications:

Rated Strain Level	± 20,000 microinches per inch
Nominal Gage Factor	1.9
Maximum Excitation Current	50 ma continuous
Temperature Range	0 to 180 degrees F
Static Acceleration	50 g
Sinusoidal Vibration	35 g, 20 to 2000 cps
Shock	100 g, 7 millisecond duration
Active Gage Length	0.21 inches

The recommended approach for measurement of roll and/or pitch is to interface the SRM to existing ship's gyrocompass when possible. This would be accomplished with complete isolation such that operation or failure of the SRM would in no way affect the gyrocompass.

The Datawell Hippy 120 vertical reference unit is recommended for user-selectable measurement of roll and pitch if interfacing to the ship's gyrocompass cannot provide these measurements. This unit has indefinite life and is not subject to errors due to accelerations. In addition, it is considerably less expensive than other sensors with these features. Specifications are:

Pitch and Roll Range	± 60 degrees
Linearity	0.05 degrees up to 5 degrees 0.15 degrees up to 30 degrees 1.0 degree
Stability	<1 degree over 1 year
Zero Offset	<0.5 degrees
Operating Temperature	0 - 35 degrees C
Vibration	<16 Hz - 1 mm peak amplitude >16 Hz - 1 g max acceleration

Other user-selectable sensors, such as torque meters will be selected on a case by case basis and complete specifications can therefore not be provided at this time.

#### 5.4 Signal Conditioning and Conversion

Analog signals from the accelerometers and other selected sensors will be processed by the signal conditioning card on the STD bus system. This card is capable of amplifying and filtering up to 16 discrete analog input channels. Each input channel may be individually amplified at gains ranging from 1 to 1000. Similarly, each input channel is individually low-pass filtered at cut-off ranges ranging from 0.1 Hz to 10 kHz. Specific gains and filter frequencies will be set at the factory depending on the sensor suite and type of vessel under consideration. Typical gains and cut-off frequencies are given in Table 5.1. The basic SRM system will be configured with only six of the possible 16 channels active.

After analog signals are amplified to  $\pm 10$  vdc and filtered, they are passed via ribbon cable to a 12-bit analog to digital (A/D) converter. The unit selected has resolution of 0.024% and accuracy of  $\pm 0.032\%$ . It is capable of accepting 16 inputs and can convert data at rates up to 5000 channels per second.

#### 5.5 Interfacing and Cabling

Cabling to each of the accelerometer packages is accomplished with a single eight conductor shielded cable from the SRM display unit to the sensor enclosure. Mil-Spec type connectors will be provided on the rear of the SRM display for this purpose. A similar waterproof connector will be provided on each of the accelerometer enclosures.

Interfacing and cabling to the user-selectable sensors and any optional sensors will be similar, although certain sensors will require wiring different from that required for the accelerometers. As an example, strain gage type sensors would again require an eight conductor shielded cable run from the SRM display unit to the strain gage junction box location. However, connections would be different. Interfacing to various ship sensors such as LORAN or NAVSAT will require the addition of a serial interface card to the SRM computer. Interfacing to other ship systems could require simple two-wire voltage or current connections or addition of frequency counters. In all cases, isolation must be provided when the SRM is connected to ship systems. The approach taken for cabling is specification of one type of cable and connectors, to be used with any sensor. Wiring at the sensor junction box and in the SRM will then be varied depending on the sensor requirements.

#### 5.6 Control and Display Console

All of the system components except the transducers themselves are housed in the display console. Included in the console are the STD bus computer system, the keypad interface, the CRT display, and the system power supply. Included

TABLE 5

Typical Sensor Interfacing and Sampling Requirements

<u>Measurement</u>	<u>Sensor</u>	<u>Sensor Output</u>	<u>Signal Conditioning</u>	<u>Required Gain</u>	<u>Filter Freq.</u>	<u>Sample Rate</u>	<u>Comments</u>
1. Standard Accelerations or Cargo Accelerations	Servo Accelerometer	± 10VDC	± 15VDC Supply	1	2	10	
2. Hull Stress	Strain Gage Bridge				2	10	
	1 Active Gage	± 5mV	± 5VDC Excit.	2000	2	10	Assumes 30,000 psi stress (1000 E) full scale (1000 E) full scale
	2 Act. Gages	± 7.5mV	± 5VDC Excit.	1300	2	10	
3 Act. Gages	± 10mV	± 5VDC Excit.	1000	2	10		
3. Pitch & Lo-Roll	Hippy Vert. Reference	± 10VDC	± 15VDC	1	2	10	
4. Shaft Torque	Accurex	± 5VDC	None	2	2	10	
5. Vibrations	a. Acceler.	± 10VDC	± 15VDC Supply	1	100	500	Assumes 10,000 psi stress (333 E) full scale
	b. Strain Gage	± 2.5mV	± 5VDC Excit.	4000	100	500	
	c. Act. Gages						

- 1 Assumes 2-pole Butterworth filter with 6 db/octave roll-off; specified frequency is "Corner" (-3db) frequency
- 2 Specific values for gain and filter frequency will be specified based on the specific requirements of the measurement and vessel.



in a recessed area on the back of the enclosure are the power sensor, printer/terminal, and external display connectors.

The SRM enclosure is designed such that it can be mounted in any of three configurations. First, providing that 13 inches of vertical rack space is available, the system may be mounted in an existing standard 19 inch rack cabinet. Secondly, the system may be mounted hanging from the overhead or table bottom on its gimbal style mount. Thirdly, the system may be mounted on any existing table or console space, again on its gimbal style mount.

The control and display console will provide the following functions accessible to operating personnel:

- Controls for power up/down, CRT brightness and contrast, keypad back lighting dimmer
- Numerical data entry keypad
- Function keypad for selecting major system operations
- Visual alerts when selected levels exceed pre-set values
- True wind calculator to calculate true wind speed and direction from user input data
- Display of sensor data and statistics in alphanumeric and graphical formats
- Display current ships time

In addition, the following controls are provided for use by factory and service personnel:

- System set-up menu for setting default operating parameters such as sensor calibration data, data display options (i.e. 0-10 scale or engineering units, RMS and peak values etc.)
- Diagnostic functions to identify component failure or malfunction

The CRT will be non-glare, monochrome, green, unless color specified, and capable of graphic representation of data and flashing or highlighted characters for alert conditions. The design will include a 13 inch (diagonal) CRT. This size was selected to minimize the size of the SRM console, and still provide adequate visibility. Graphic displays and alerts will be visible as far away as 20 ft and all data will be legible at a distance of 8 ft. The size of the CRT does not affect resolution for graphics or number of lines available for characters. An external CRT connector is provided for the optional addition of an external display unit.

Power requirements for the basic unit are minimal. It is estimated that the system should consume no more than 100 to 200 watts of power at 120 volts AC supplied by the ship's service. Provisions to adapt to alternate voltages and frequencies are included in the uninterruptible power supply (UPS). The UPS will provide filtering for power surges and will maintain power to the SRM for

approximately 6 minutes in the event of a power failure. This period may be extended with the addition of an external battery. This time period will permit the SRM to power down gracefully, and then restart with the same displays and memory condition that existed prior to loss of power.

## 5.7 Operator Controls

Controls for the SRM system have been modeled closely after those outlined in Appendix A. All of the controls except the CRT brightness and contrast, keypad dimmer and ON/OFF power switch are implemented in the form of a custom designed membrane switch keypad. The keypad is translucent and will have incandescent backlighting controlled by a dimmer. Feedback of key presses will be in the form of an audible beep with each keystroke. Each of the switch pads on the key pad will have its function printed on it and in the case of major functions a graphical symbol depicting the function will be included (i.e. a "wind sock" for the true wind calculator mode). Extra switch pad area will be designed into the standard keypad to accommodate additional sensors or the expansion of the SRM system functions at a later date. Though on "standard" units this extra switch area will appear as blank panel space, switch "zones" will only be printed if used. The following is a list of standard operator controls and a brief description of their operation:

- Vertical Bow: Displays bow vertical acceleration data
- Transverse Bridge: Displays bridge transverse acceleration data
- User Sensors (up to 4): Displays data for a particular user-selected sensor. Up to four of these can be included and the keypad would be labelled with the actual sensor descriptions.
  
- True Wind: Accepts user input ships heading and speed, and apparent wind direction and speed, then displays corrected (true) wind direction and speed
- Alert Set: Allows user to define alert levels
- Clock Set: Allows user to set real-time system clock
- Alpha/Graphic: Allows user to select between graphical and numerical data
- Long: Sample length selector for 15 minute sample
- Medium: Sample length selector for 5 minute sample
- Short: Sample length selector for 1 minute sample
- Enter 1-0: Numerical Data Entry
- Brightness: CRT brightness control
- Contrast: CRT Contrast Control

- Dimmer:                                   Keypad backlighting dimmer
- Power:                                    Master power switch
- System Check:                           Allows the user to execute a full system checkout. This function will perform such operations as calculate the checksum of the system ROM, execute a RAM test, check the transducer operation. Can be used by operator when system malfunction is suspected.
- System Set-up:                         Password protected function. Enters menu driven mode for entry of sensor calibration factors, default display modes, etc. To be used by factory or service personnel.

### 5.8 Packaging and Ship Interface Requirements

As previously mentioned in Section 5.1 the SRM system may be packaged in a number of ways and different ships may require different packaging requirements. The basic SRM system can fit into a space or enclosure as small as 22 inches wide by 18 inches deep and 13 inches high. In the case of available existing ships console space it could be slipped into the blank panel space of an existing instrument console. If desired, a free standing console can be provided for the sole purpose of containing the SRM system. In other applications it may be packaged in a self-contained unit that may be mounted and hung from the overhead or shelf above a navigation table. Similarly, it may be pedestal mounted on the navigation table or other flat space. One possible package arrangement is illustrated in Figure 5.2. Note that this design is preliminary since several mockups are to be prepared and evaluated during Phase II, prior to finalizing the design.

### 5.9 Input/Output Devices

The SRM will be equipped such that input and output devices can be added as options or as future enhancements. In addition to interfacing with an operator through the display and front panel controls as discussed above, the system will have input/output ports for an optional printer or remote CRT. The printer port is a bi-directional serial port and future enhancements could therefore include interfacing to other external devices (LORAN C, SATNAV, other computers) using this port. These are future enhancements as opposed to options since they will require software development. Due to the modular nature of the system, additional serial or parallel input/output ports could be added as enhancements. These could be used to add data storage capability or to permit communication with several external devices.

### 5.10 Spare Parts

The SRM will be configured such that most failures can be corrected by replacing circuit boards or certain transducer assemblies. Board swap repairs could

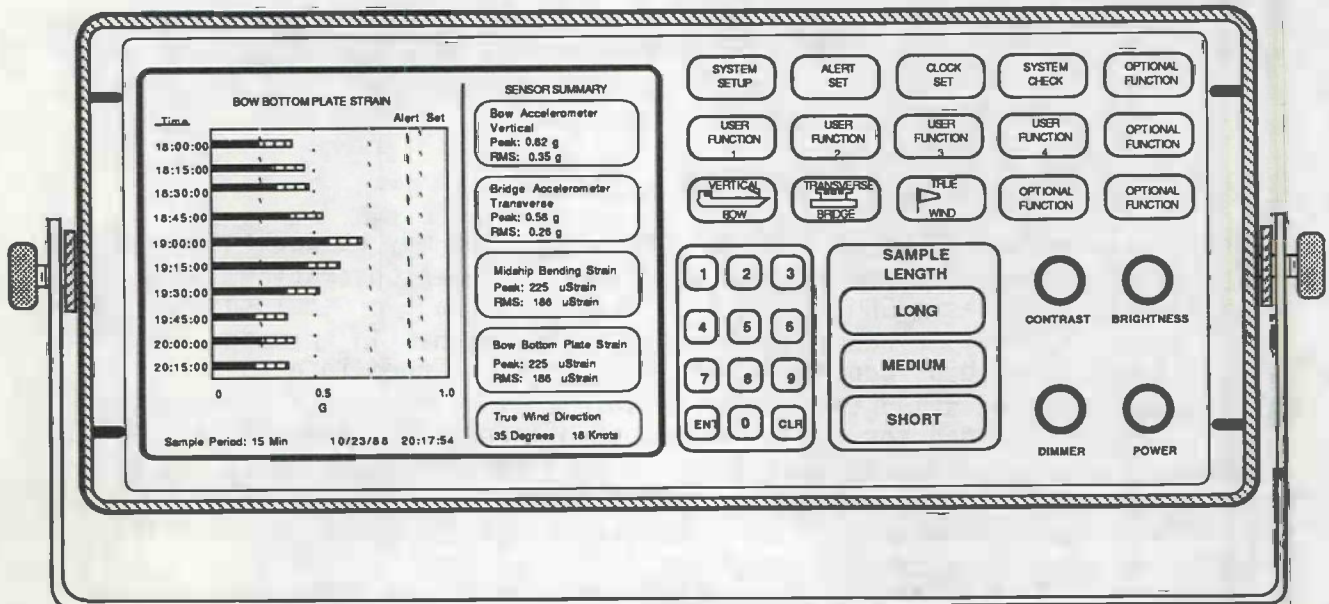


Figure 5.2 Preliminary Console Layout



be completed on the SRM console by any qualified electronics technician. Standard transducers and other transducers mounted in packages could be replaced in a similar manner. Sensors such as strain gages would require special installation and would therefore have to be replaced by specialized personnel. Since board swap repairs are possible, and parts could be delivered to a vessel at almost any port within 48 hours, spare parts are not recommended. The system will be designed such that if a failure occurs, the SRM will fail gracefully. For transducers, a single failure would be noted on the display and other sensors would continue to operate normally. In the event of a processor failure, internal diagnostics should detect the problem and notify the navigating officer that data is erroneous.

The electronics components to be used in the SRM console have extremely good reliabilities, with typical mean time between failure (MTBF) ranging from 30 to 40 years. Standard accelerometers have an approximate MTBF of 10 years and strain gage installations using the sealed, weldable gages typically have a MTBF of 5 years. If a system was configured with 2 strain gage bridges in addition to the 2 standard sensors, the overall MTBF would be approximately 2 years for the entire system and 6 years for the console electronics. During the evaluation of three units in Phase II, any failures that occur will be carefully analyzed and problem parts will either be replaced or spares will be provided.

#### 5.11 Testing and Support

Achieving satisfactory reliability of the SRM will be dependent on the testing procedures employed, as well as the reliability of system components. At the beginning of Phase II, a quality assurance procedure will be prepared which specifies testing to be completed on each unit. Tests will include acceptance tests of incoming components, burn-in of the entire system with temperature cycles, and a final system acceptance test that checks operation of all components and features. Each unit delivered will undergo all tests and logs will be maintained on each unit's history.

Manuals to be delivered with each system will include:

1. User's Manual
2. Software Documentation
3. Service Manual

The User's Manual and Software Manual are described in Section 6.5. The service manual will provide all information necessary to understand system configuration, troubleshoot problems, and make any necessary repairs. It will include a complete wiring diagram, part numbers and vendor service contacts, and procedures to be used when replacing parts or diagnosing problems. Each set of manuals will be configured with the documentation appropriate to the specific sensors and options used on a particular vessel.

In addition to instructions and the tutorial included in the User's Manual, training courses will be conducted for ship's personnel upon completion of each installation. These will include approximately 2 hours of class-room

type instruction and 2 hours of demonstrations using the SRM. In addition, during voyages, instructor/observer staff members will provide continued review and explanation of course materials and principles of use for the SRM. Ten sets of course notes will be delivered to each ship. In addition to features and operation of the SRM, the training course will include a review of how the system can be used to aid shiphandling in heavy weather. This will be based on course materials developed by Lindemann [41].

## 6. SOFTWARE

### 6.1 General Description

Software developed for the SRM should meet three basic requirements. First, it must be invisible to the navigating officer such that he only has to turn on the power to start system operation, and all functions are available with a key press. Secondly, since the systems include user-specified sensors and some future systems may include optional sensors, the software must provide built-in capabilities for flexibility in the number and type of sensors scanned and in displays. Finally, to permit transportability of software to different hardware that the eventual manufacturers may use, source code should be written in a standard high-level language such as FORTRAN 77, C, or PASCAL.

Software should be modular and contain two basic packages or routines. The supervisory package will control system initialization and self-test on startup, and will then monitor the system control panel and call the appropriate applications to complete the requested operations. Applications software will consist of all subroutines necessary for data collection, calculations and display generation. The approach in software development will be such that software is not ship or application specific.

### 6.2 Supervisory Software

Supervisory software will control system operation. On power up the software will perform a self-test of memory and sensors, and will report any faults on the display. The system will then be initialized to provide the default display and data collection and display will be initiated. From this point on the software will execute a loop which collects one scan of data, checks the keypad for a key press, and updates the display as necessary. If a key press is detected, the supervisory software will call the subroutine necessary to respond to the keypress and then return to the normal operating loop. In addition to checking for a key press, the system will also monitor the external device connector to see if any commands are generated from an external keyboard or other device. This feature will be included to permit future expansion for operation with a keyboard or other external device and to permit special diagnostics by service personnel.

### 6.3 Applications Software

Application software will consist of a library of routines that execute all system functions and provide the appropriate response to all operator commands. An abbreviated listing of these includes:

- \* Sample all channels at the specified rate and store readings
- \* Convert readings to engineering units
- \* Calculate Max, RMS, and normalized values
- \* Format Displays
- \* Calculate true wind
- \* Modify system setup when requested with proper password (service personnel)
- \* Modify alert levels (master or navigating officer)
- \* Set the real-time clock
- \* Perform system self-test
- \* Communicate with an external device (RS-232)

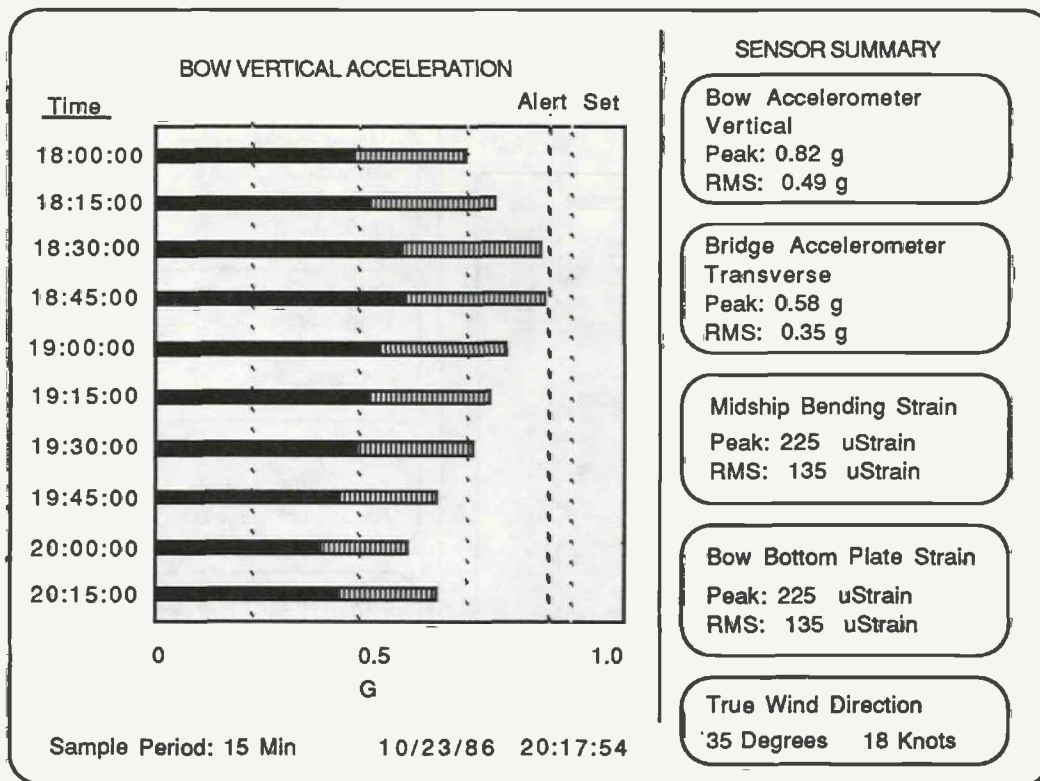
The software must be designed such that the system can be configured for any of the proposed sensors. Also, software should be truly modular such that future manufacturers can add or change functions simply by adding an application module and changing several lines of code in the supervisory software.

### 6.4 Displays

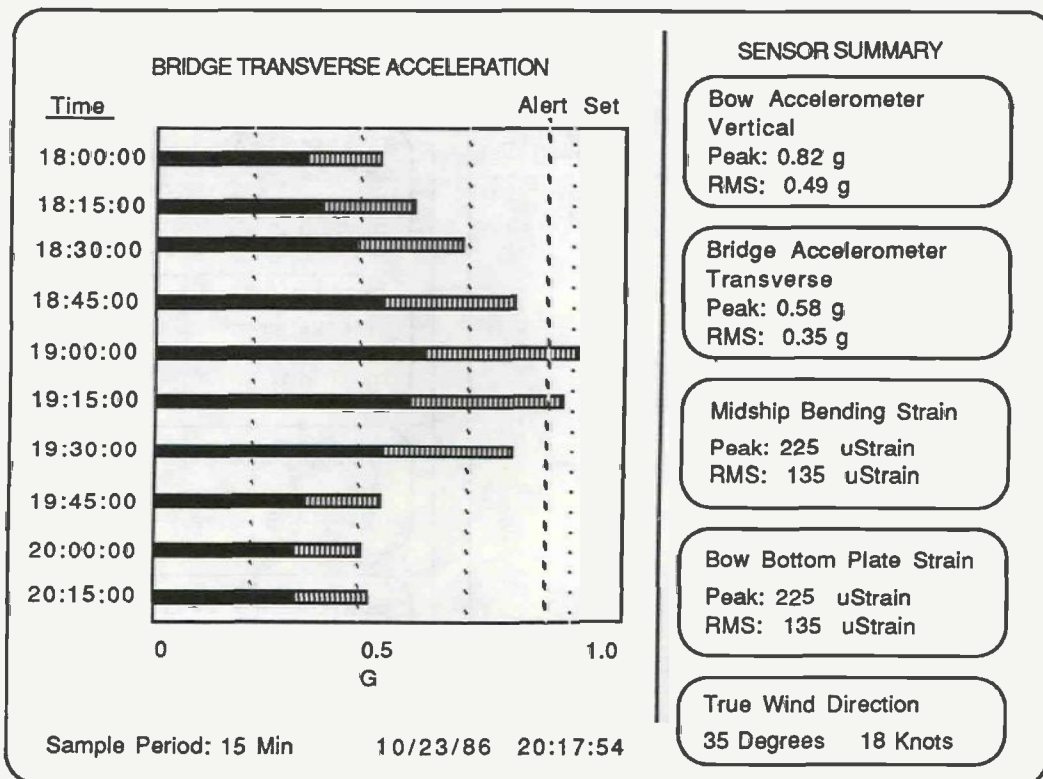
Two basic types of displays will be provided and several optional formats will be available for each. The basic graphical display is illustrated in Figure 6.1 for several sensors. This example assumes that the user-specified sensors are bending strain amidship and strain in a bow bottom plate. This will include a bar-chart time history of any channel selected by the operator along with a simple statistical summary of all other channels. The values can be displayed in engineering units or normalized (0-10) values. Also, the displays will show both peak and RMS values. If alert levels set by the navigating officer are exceeded these will be indicated on the display. The period of time which the display is based on is operator selectable and can be 15, 5 or 1 minute.

Figure 6.2 illustrates the numeric display. This display includes statistics for all channels for the previous sample period. It also includes a listing of the alert levels. This display will be useful when a navigating officer wants a complete description of the previous sample period or when a sensor malfunction is suspected. All displays will include other pertinent information such as system time and the sample period currently in use. If system or sensor errors are detected, an error message will also be displayed.

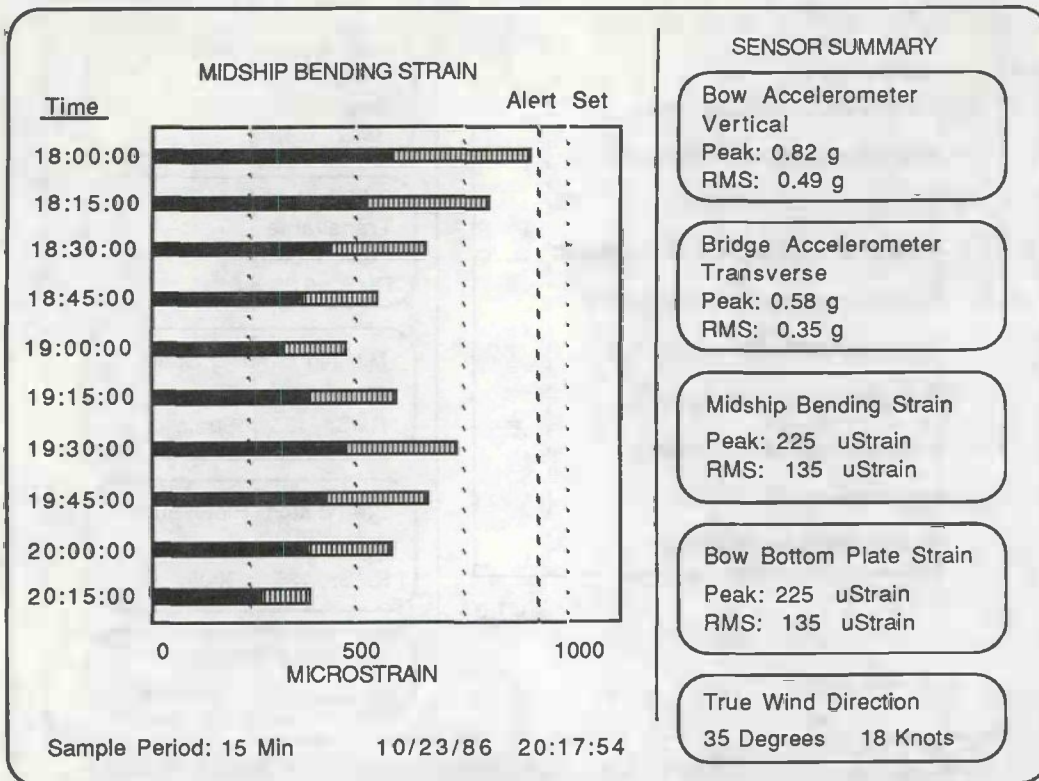




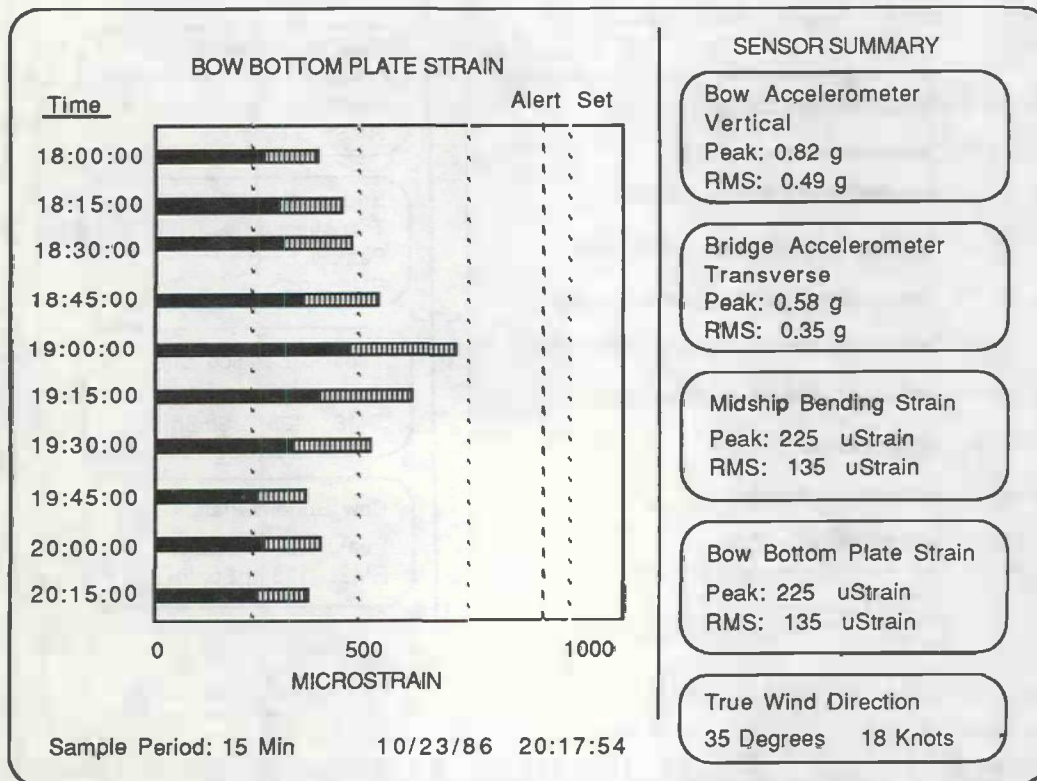
**Figure 6.1a Bow Vertical Acceleration Trend Chart**



**Figure 6.1b Bridge Transverse Acceleration Trend Chart**



**Figure 6.1c Midship Bending Strain Trend Chart**



**Figure 6.1d Bow Bottom Plate Strain Trend Chart**

<u>SENSOR STATISTICS DISPLAY</u>						
<u>SENSOR</u>	<u>MAX</u>	<u>MIN</u>	<u>AVG</u>	<u>RMS</u>	<u>UNITS</u>	<u>ALERT SET</u>
Bow Accel Vert	0.55	-0.50	0.01	0.41	G	0.6
Bridge Accel Transv.	0.40	-0.42	0.02	0.30	G	0.5
Midship Bending Strain	225	-100	50	186	uStrain	800
Bow Bottom Plate Strain	800	2	10	450	uStrain	1000

**Figure 6.2 Characteristic Statistics Display**

## 6.5 Testing and Support

All supervisory and applications software must be completely tested and documented. Extensive software testing is necessary to insure that the system operates free of "bugs", and any failures that might occur are graceful. A formal test plan must be developed and submitted for approval at the beginning of the Phase II work. The procedure that should be followed is testing of each individual software module and subsequent testing of the system as each module is added, until proper operation of the entire system is verified. In addition, the software should be tested at each stage to insure proper operation after a power failure or improper inputs from operators. Each unit delivered must be tested as per the formal test plan, after the system has been configured for the specific application.

Documentation provided with the units will include a User's Manual and a Software Manual in addition to the hardware manuals discussed in Section 5. The User's Manual will provide all information necessary to effectively operate the SRM. It will give a brief description of the system, including objectives for using the SRM, and will instruct the user in all system functions. Included in the manual will be a tutorial that can be followed to gain familiarity with all features and functions. The Software Manual will document system software and provide detailed descriptions of the methods for all calculations. It will include several levels of flow charts and a complete source listing of all software modules.



## 7. FUTURE ENHANCEMENTS

The specification given in the previous sections defines the Standard Ship Response Monitor in its basic configuration. Since some operating companies may have a desire to add features and capabilities, a discussion of features which could be supported by the design as future enhancements is thought to be worthwhile. These optional features are not included in the SRM but they could be supported by the system and if requested by a particular operating company, they could be included on an extra cost basis.

The SRM as defined in the previous sections includes interfacing for 6 sensors. As many as 26 additional sensors could be added within the specified enclosure size and sufficient computing power is available to process this data. If a large number of sensors are added as options, some type of data storage media would probably also be required. This could be included as an optional internal floppy or hard disc drive.

The SRM includes a serial communications port and a capability to communicate with a keyboard or other device. The input/output format will be specified in the system manuals and the device could be interconnected to other equipment supporting NEMA standards, similar to the communications capability provided for in most LORAN and SATNAV units. As an option, data output to another ship system could be custom formatted to permit transfer of any required information. Also, as an option, a printer could be added. The SRM includes an auxiliary CRT output. As an option, a second display could be provided at a remote location such as the captain's office. This display would duplicate the display on the bridge.

As developed during this Phase I study, the SRM is simply a response monitor and does not provide any guidance to navigating officers. As discussed by Lindemann [15] and Chazal [1], a logical future enhancement is incorporating this guidance. Using Lindemann's definitions, the basic SRM is a Level 1 instrument that provides monitoring to supplement the navigating officer's feel of ship response. A Level 2 instrument would include a capability to provide guidance on the effects of actions intended to reduce wave response. For example, if a course or speed change is contemplated, the navigating officer would be provided with data on the probable effects, and he could use the information to decide on a course of action. The basic SRM could be enhanced in the future to provide this capability. A Level 3 instrument would not only predict the effects of planned actions, but would also provide recommendations on the optimum actions that should be taken. These recommendations would attempt to keep wave response within an acceptable level while at the same time minimizing the loss of speed toward the vessel's destination and fuel consumption. At the present time, adequate technology does not exist to develop a level 3 capability. However, when accurate methods to predict added resistance, non-linear response and response in combined sea conditions are available, the SRM design could be enhanced to incorporate this feature.

## 8. CONCLUSIONS AND RECOMMENDATIONS

Based on the performance requirements developed in Section 4, a design specification for the Standard Ship Response Monitor has been developed. This design meets all of the requirements developed by SNAME HS-12 Panel and provides sufficient capacity for adding future enhancements. The design specified in the previous section meets the cost criteria of \$30,000 to \$40,000 per unit including four sensors and installation. The modular nature of this design will provide opportunity for eventual manufacturers to make modifications prior to production, based on findings from the the Phase II shipboard evaluation. It is recommended that Phase II of the project proceed as planned, using the design specified herein for evaluation aboard three vessels.

The Phase II evaluation aboard vessels in service should concentrate on applicability of the SRM to different vessel types, acceptance by navigating officers and training required to insure acceptance and proper use, and evaluation of the SRM design and functions. In order to assess applicability to different vessel types, the three ships should provide an opportunity to evaluate effectiveness of the SRM in helping navigation officers deal with different types of ship responses. For example, use of the SRM on a high-speed container ship, a RO/RO, and a tanker or bulk carrier would permit evaluation of the SRM for a variety of vessel sizes and response problems. The high-speed container ship would provide a platform to assess effectiveness when dealing with bottom slamming and cargo tiedown problems. The RO/RO would also address cargo tiedown problems and could, in addition, be used to address torsional hull loads. The tanker or bulk carrier could provide evaluation in the presence of flare slamming and cargo shifting (or sloshing) problems.

During these evaluations, emphasis should also be placed on the training required to insure understanding and proper use of the SRM by navigating officers. This should include both formal training and continued interaction with project personnel during and between voyages. This process will not only provide navigating officers with an improved understanding of the use of the SRM for shiphandling in heavy weather, and thus benefit the operating companies, but it should also define the level of training required for future SRM installations.

Detailed evaluation of the prototype SRM design should focus on three primary areas. First, since an infinite number of variations in control arrangement are possible, it is recommended that several mockups of possible arrangements be developed and reviewed with at least one master mariner and personnel familiar with previous response monitoring projects. Secondly, the Phase II onboard evaluations should place a heavy emphasis on display formats. This is probably the most important aspect of the design in terms of the usefulness of the unit and the way that it is perceived by navigating officers. Criticism from all shipboard personnel who use the system should be solicited and included in the final report. Finally, the use of color should be evaluated on at least one of the units. This can be accomplished by letting one ship operate a monochrome unit and then change it to color.

## 9. REFERENCES

1. Chazal, et al, "Status Report on the Application of Stress and Motion Monitoring in Merchant Vessels", SNAME Spring Meeting/STAR Symposium, Coronado, California, June 4-6, 1980.
2. Hoffman D. & Garzke W.H., Jr., "Heavy Weather Monitoring and Guidance System on the S.S. Lash Italia", U.S. National Maritime Research Center, July 1980.
3. Hoffman D. & Zubaly R.B., "Design of a Ship Response Monitoring and Guidance System for U.S.N.S. FURMAN", U.S. National Maritime Research Center, December 1980.
4. Korvin-Kroukovsky, B.V., Theory of Seakeeping , SNAME, New York, 1961.
5. "Minimum Software Specification, Ship Response Monitoring & Guidance System USNS FURMAN", CMS, 9 November 1978.
6. Oakley, O.H., et al, "A Summary of Wave Data Needs and Availability", Ship Research Committee, Washington, D.C. 1979.
7. Robertsson S. & Lindeman K., "An Introduction to Ship Handling in Rough Weather", DNV Report No. 81-0215. (also see Reference No. 41).
8. Taylor K.V., "Onboard Guidance for Heavy Weather Operation", Institute of Marine Engineers, Operation of Ships in Rough Weather, London, England, February, 1980.
9. Dickey R.L., DeLong R.C. & Gregov Z., "A Hull Monitoring System for Safe and Economic Operations", Ship Automation II, Volume 5.
10. Hoffman D., & Lewis E.V., "Heavy Weather Damage Warning Systems", Technical Report, National Maritime Research Center, September 1975.
11. Hoffman D., "Heavy Weather Damage Avoidance System (HWDAS) On the S.S. Lash Italia", Technical Paper, National Maritime Research Center, December 1977.
12. "Preparation and Evaluation of Extended Software for the SMGS Onboard U.S.N.S. FURMAN and S.S. Lash Italia", prepared for NMRC, Kings Point, New York, by Hoffman Maritime Consultants, Inc.
13. Edwards, G., "Monitoring Ship Systems for Optimum Efficiency and Safety", Technical Paper, Sydney Technical College.
14. Lindemann K., Odland J., Strengehagen J., "On the Application of Hull Surveillance Systems for Increased Safety and Improved Structural Utilization in Rough Weather", Transactions SNAME, Volume 85, 1977.

15. Lindemann K. & Robertsson S., "S03-Prosjektet", U.S. Department of Transportation Report CG-M-9-81, 1981. (NTIS PB 82265281).
16. Breit S., "The Test and Evaluation of the Ship Monitoring and Guidance System Onboard the USNS FURMAN", National Research Center, August 1981.
17. Cojeen H.P., & Chazal E.A., Jr., "Help for Human Beings - It's Instrumental", Proceedings of the Marine Safety Council, Volume 39, April 1982.
18. Boylston J.W., Boentgen R.R., & Wheaton J.W., "Instrumentation - The Only Way", The Ship Structure Symposium 75 and SNAME.
19. Dickey R.L. & DeLong R.C., "A Hull Monitoring System for Safe and Economic Operations", Ship Operation Automation, Second International Symposium.
20. Gran S.I., "Measuring Ship Behavior In Waves", Veritas, No. 91, February 1978.
21. Gauvin D., "NAWS - A Hull Response Monitor for Navigation in Ice - An Operator's Perspective", Marine Engineering Digest Revue Technique Maritime, July 1985.
22. Nitta A., Jumana A., Yuasa M., Suzuki K., & Tataru Y., "On Board Test Of Hull Strength Monitoring System", Technical Bulletin of Nippon Kaiji Kyokai, Volume 3, 1985.
23. Petrie G.L., MacLean W.M., Cojeen H.P., Schudel G., "The Usefulness of Response Monitoring for Estimation of Bow Structural Loadings", SNAME, April 1985.
24. Hachmann D., & Westram A., "A German Ship's Motion/Load Indicator", Germanischer Lloyd, Hamburg, October 1985.
25. Strengenhagen J., "Hull Surveillance Experience and Possibilities", Veritas No. 89, July 1977.
26. Carleton H. & Winton H., "Heavy Weather Damage Instrumentation Systems", Technical Report, National Maritime Research Center, 1974.
27. Great Lakes Carriers Hull Stress Monitoring System, by Center for Maritime Studies, December 1978.
28. Fain R.A., "Design and Installations of a Ship Response Instrumentation System Aboard the SL-7 Class Containership S.S. SeaLand McLean", Technical Report, National Maritime Research Center, 1973.
29. "What's A Human Factor", Proceedings of the Marine Safety Council, Volume 39, No. 4, April 1982.



30. Hoffman, D., & MacLean W.M., "Ship Response Control During Heavy Weather Operations", Proceedings Fifth Ship Control Systems Symposium, Volume 4, 1978.
31. Lindemann K., "The Navigator, Ship Handling In Rough Weather and Hull Surveillance Systems", Proceedings of the First International Conference on Human Factors in the Design and Operation of Ships, February, 1977.
32. Hoffman Maritime Consultants, "Specifications for the Hull Stress Monitoring and Guidance System". January 1980.
33. Oswald, James, "The Cruel Sea and the Seakindly System", Sea Technology. July 1976.
34. Safety at Sea International, "Reducing Damage to the Hull in Rough Weather". Vol. 105, December 1977.
35. Anonymous, "New Technology for Improved Operating Economics", International Symposium on Ship Operations Proceedings, Sept. 23-24, 1980.
36. Ditchburem, J., "Operation of Ships in Rough Weather", Seaways, June 1980.
37. Fraser, Gordon, "Stress Limits", The Naval Architect, May 1981.
38. Hoffman, D., & Petrie, G.L., "Shipboard Guidance for Operations in Heavy Weather", Satellite Applications to Marine Technology Conference. American Institute of Aeronautics and Astronautics (AIAA) et al. New Orleans, Louisiana, November 15-17, 1977.
39. Lloyd, ARJM, "Statistical Ship Motion Recorders", The Naval Architect, May 1981.
40. Hoffman, D., & Petrie, G.L., "Integrated Computer Systems for Weather Bound Vessel Operations", Computers in Industry. Vol. 1, 1980.
41. Lindemann, K., "Summary of a Course in Shipbuilding in Rough Weather", U.S. Department of Transportation Report, CG-M-7-81. September, 1981. (NTIS AD A115176).
42. Chuang, S.L., "The TMB Flexing Stress Monitor", DTMB Report 1560, February, 1962.
43. "Evaluation of a Prototype Stress Warning System" LOCKHEED Report, Sea Use Program Test C-5, October 1973.
44. "Bow Slamming Indicators", Brown Brothers Co., Ltd. Edinburgh, Scotland.
45. "Auto Ship Bridge - Navigation Monitor System", Mitsui Engineering and Shipbuilding Co. Ltd., Japan.

APPENDIX A

Performance Requirements  
Developed By:

SNAME HS-12 Panel on Hull Instrumentation

## PERFORMANCE REQUIREMENTS

(a) The SRM shall be composed of a console, display unit, function controls and keypad, micro-computer, signal conditioners, sensors and cables, and should be configured as a navigation console as shown in Exhibit B, Figure 1.

(b) The computer Exhibit B, Figure 2 shall be of adequate capacity to support the analysis of output from the standard and optional sensors, provide formatted displays, user information, system status, sensor calibration and diagnostic aids, and have a back-up power supply, which will not cause program loss during power supply interruptions.

(c) Expandability shall be considered so that capacity could be added at a later date to support guidance and predictive functions relative to monitored responses and other functions, such as loading calculator or vessel administrative applications.

(d) Controls and function switches shall be based on human engineering principles.

(e) Basic sensors shall be selected to implement displays of vertical acceleration at the bow, and lateral acceleration in the pilot house.

(f) Optional sensors, to satisfy owner-specified requirements, shall be selected to implement displays which as a minimum include:

Roll period

Roll angle

Pitch period

Pitch angle

Shaft torque

Local stress

Vertical bending moment

Still-water bending moment

Yaw angle

Tie-down tension (container lashings, etc.)

Hull torsion

Vertical acceleration of bridge aft

Vertical acceleration of midships

Heave period

Heave amplitude

Slamming loads at the bow

Vibrations

Vessel speed and heading

(g) Sensing units shall be selected with due consideration of the working environment.

(h) Suitable enclosures or protective devices shall be provided for the sensing units.

(i) Sensors shall be selected to provide 2 years minimum service life. Redundancy of sensors may be provided to satisfy the need for long-term service.

(j) Function controls and keypad shall be provided as shown in Exhibit B, Figure 3 (representative optional configuration), and described as follows:

General - The user interface shall consist of a control panel which furnishes single-key function switches to select instruction, menu and display modes and other functions, a numerical keypad, a multi-position switch for selection of sample length, lighted control switches and buttons, and a dimmer to control illumination intensity.

Function keys and keypad shall be laid out with simplicity and clarity as main priorities in order to make the mechanics of SRM operation simple, clear and easy to carry out under extreme conditions of user fatigue and vessel motions.

The true wind calculator function shall contain a straight forward interactive routine for calculating true wind from measured wind speed and direction, and vessel speed and heading. It is intended as a means of encouraging the officers to use the SRM so as to develop experience, confidence and familiarity with the display and the keyboard.

The alert set function shall be provided so that alert levels may be set, changed or cancelled in this mode.

The clock set function shall initialize the time of day to provide accurate time points on the time-history, monitoring displays.

The numerical display function shall provide for single key selection of numerical or graphical display while in monitoring mode to provide a choice of display format, which will apply to each parameter.

Other function keys shall provide for entry and display of night messages, standing orders, work lists or other items of interest to the officers.



(k) A Visual Display Unit (VDU) shall be provided with the capability of flashing and highlighting individual characters and providing variable display intensity. The VDU may have color display capability but, in this case, care must be exercised to avoid hues which may become invisible under artificial ambient light, such as red bridge illumination.

(l) While additional remote "slave" displays will be optional, provision for future remote display shall be made by incorporating plug-in connectors in the console.

(m) Each parameter display, such as one shown in Exhibit B, Figure 4, shall be accessed by means of a single-function button.

(n) Each display shall be laid out with particular attention to simplicity, clarity and ease of interpretation.

(o) Each display shall provide a capsule status of all monitored parameters in addition to a time-history for the selected parameter.

(p) Each display shall reflect the following options:

Sample length - long sample length (15 minute), short (5 minute) or immediate (1 minute) intervals for display update may be selected by means of a 3-position switch on the control panel (user option);

Graphical or numerical data - selection shall be made by operating a single-function button on the control panel (user option);

Alert function - parameter values which exceed set values shall be indicated by either flashing characters, highlighting, or variation of background intensity, etc. (software option);

Data reduction - parameter data shall indicate peak values and either Root Mean Square (RMS) or significant values (software option);

Units - data shall be presented in either engineering or generalized (say 0-10 scale) units (software option with potential as a user option);

Status line/other information - each display shall show some indicators of system status and some other key information such as ship heading, speed, rpm (software option).

(q) The menu display shall list each monitoring function (vertical acceleration, lateral acceleration, two optical parameters), and the other selected functions.

(r) Diagnostic functions shall provide means to better define the symptoms associated with any obvious irregularity in the system and provide a means of self-checking to confirm the validity of data when no problems may be evident. This shall include automatic internal open-circuit checks and automatic sensor calibration checks, for example as a minimum.

(t) Means shall be provided to interrogate the system to isolate problems and determine check-off points of potentially correctible faults.

(u) The design and construction of the SRM system shall reflect consideration of the need for reliability and diagnostics so that the system may fail "gracefully", i.e., certain components or subsystems may fail without making the unaffected functions inoperative. Bearing in mind the inability of a service technician to carry spares of all components and parts, it is of special importance that the officers be able to carry out a reasonably thorough diagnosis, even covering items beyond their own ability to repair, so as to better ensure the effectiveness of a technician when he arrives.

(v) Specifications shall indicate areas which may be affected by government regulations, and other codes and standards.

EXHIBIT B

Figures 1, 2, 3 and 4

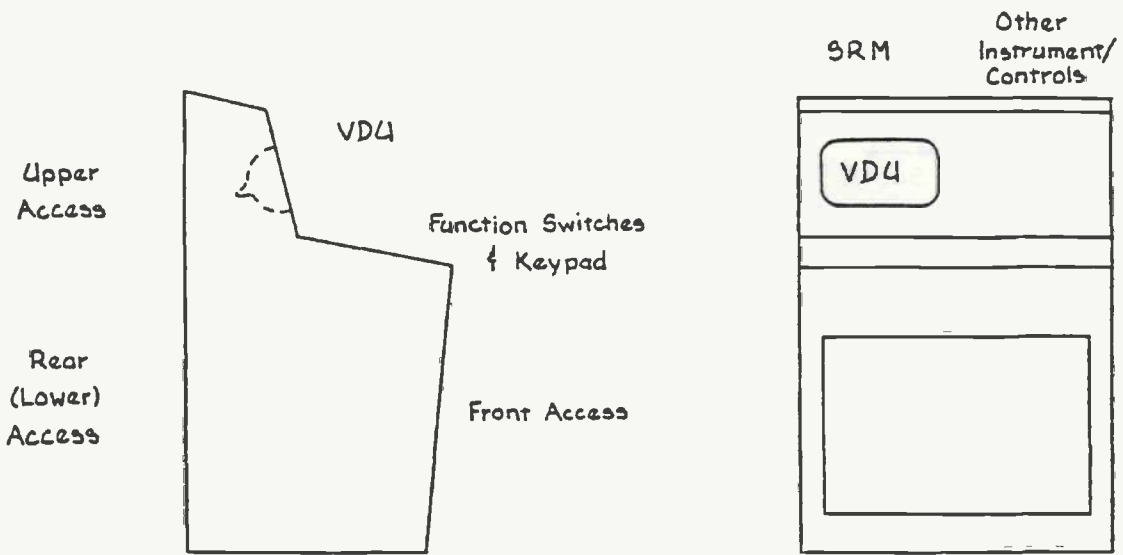


FIGURE 1  
 CONSOLE FOR THE SRM: CONTROLS, FUNCTION SWITCHES, KEYPAD, AND  
 COLOR CRT ON BACK

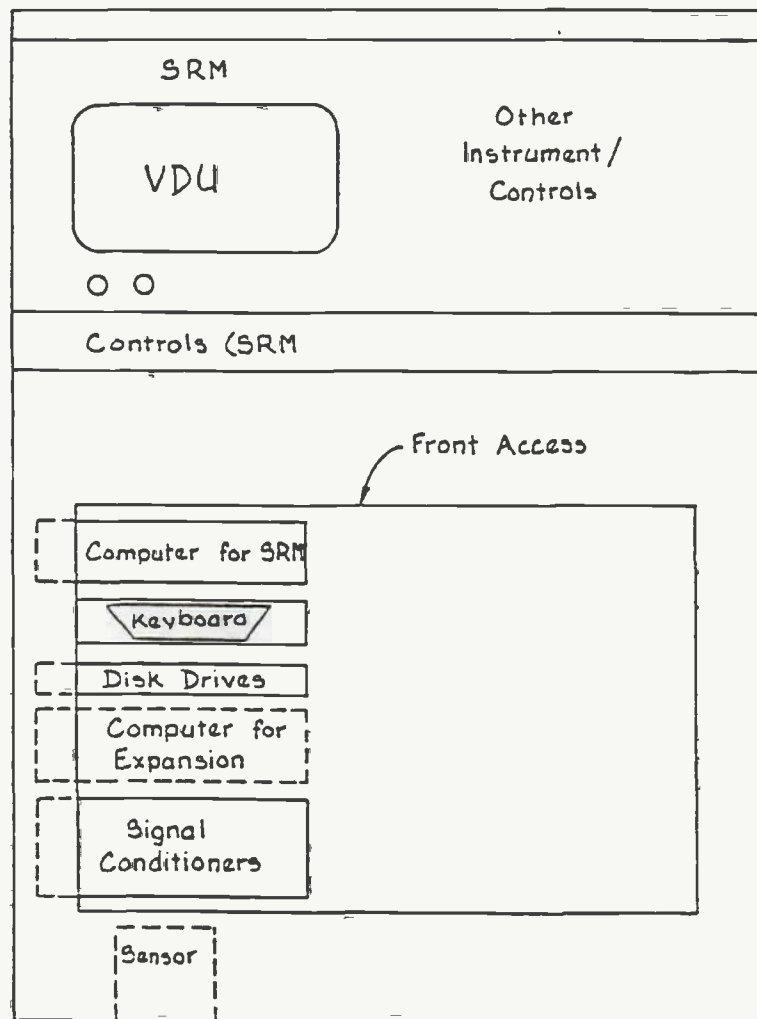


FIGURE 2  
 LAYOUT OF CONSOLE CABINET CONTAINING COMPUTER, SENSORS, KEYBOARD  
 AND DISK DRIVES



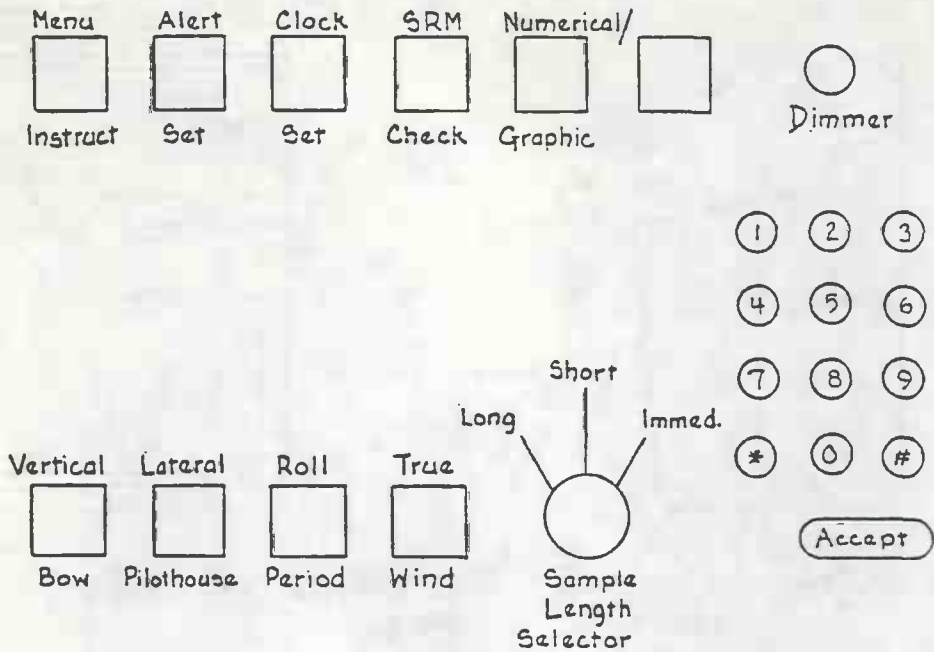


FIGURE 3  
LAYOUT OF SRM CONTROLS WITH LIGHTED FUNCTION SWITCHES

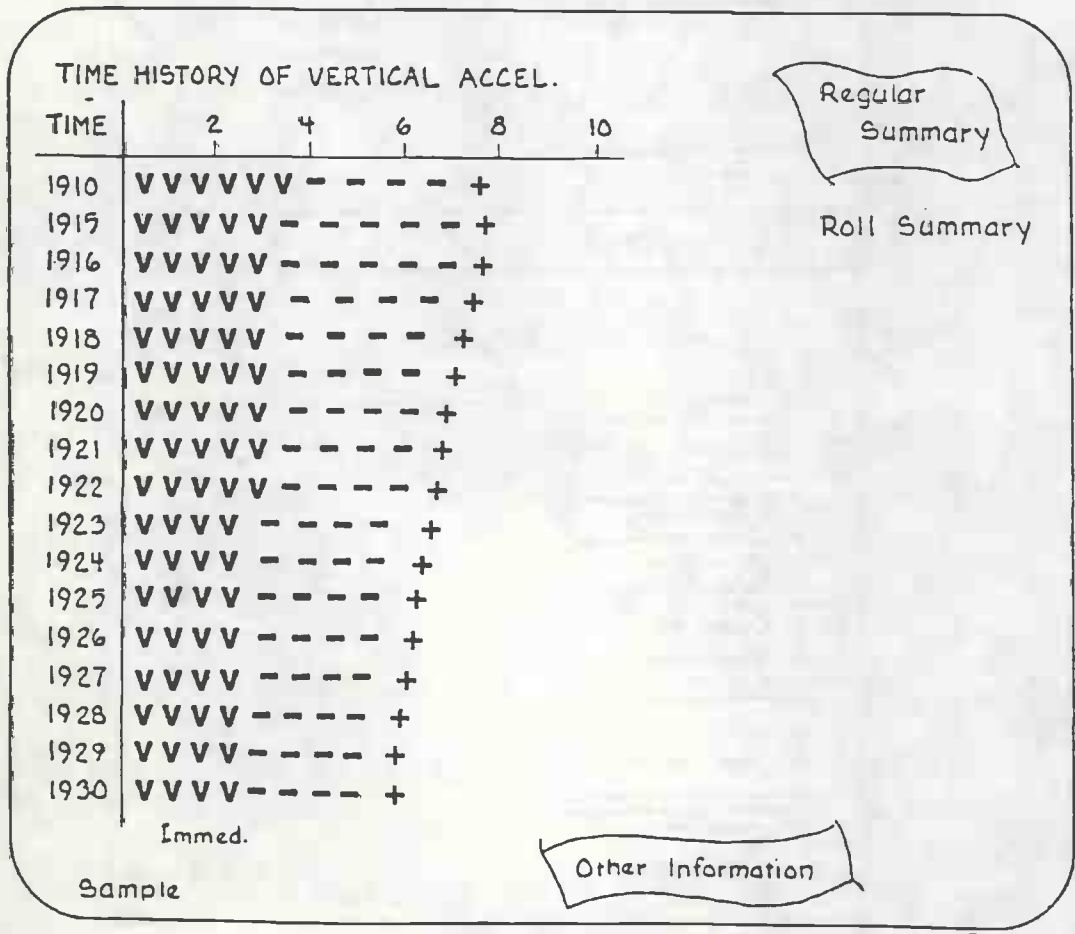
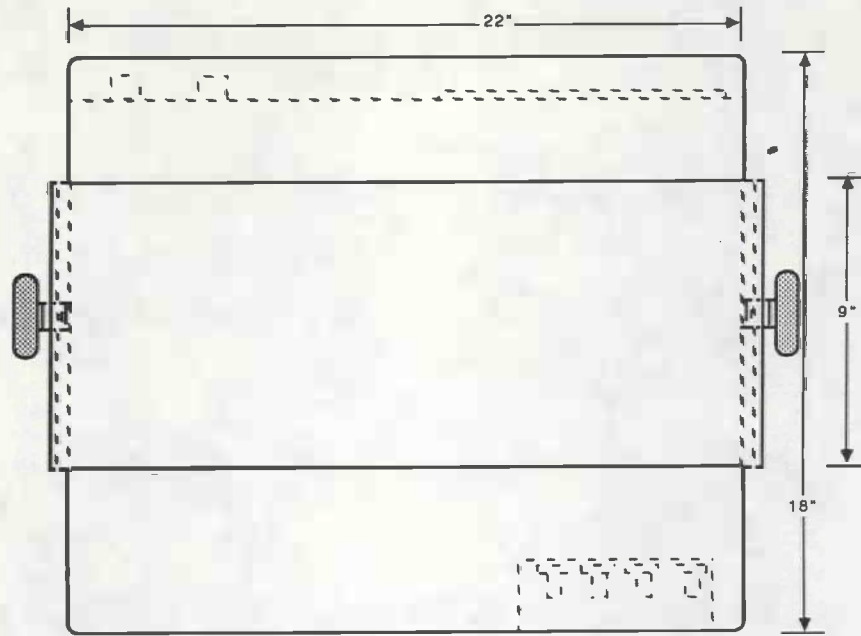


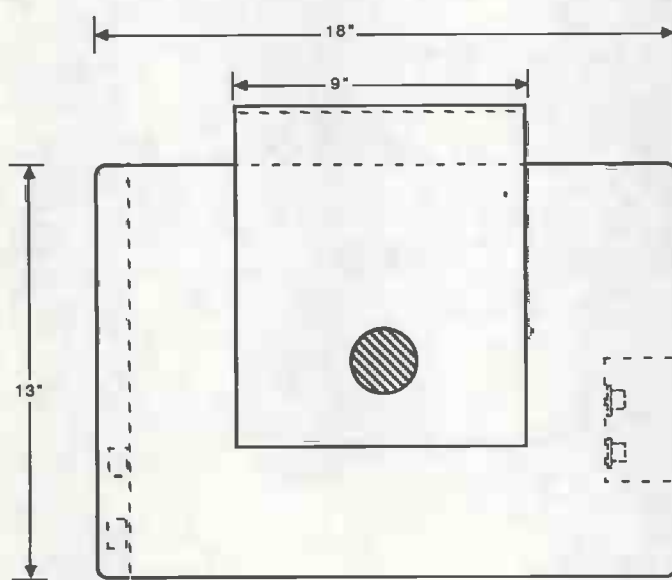
FIGURE 4  
TIME HISTORY OF VERTICAL ACCELERATIONS AT THE BOW  
A-8

APPENDIX B

Drawings and Parts List



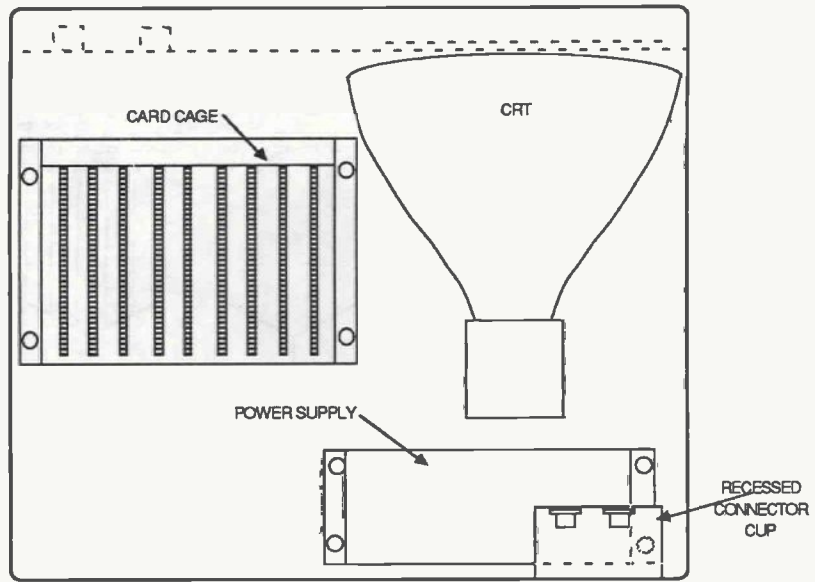
TOP (OR BOTTOM) VIEW



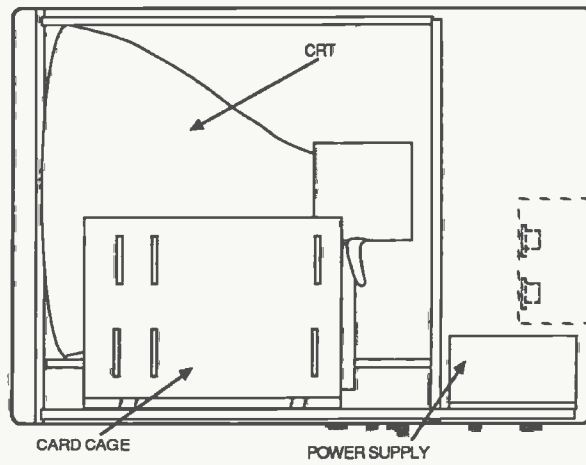
SIDE VIEW

FIGURE B-1

PRELIMINARY CONSOLE ARRANGEMENT



TOP VIEW



SIDE VIEW

FIGURE B-2  
PRELIMINARY CONSOLE ASSEMBLY



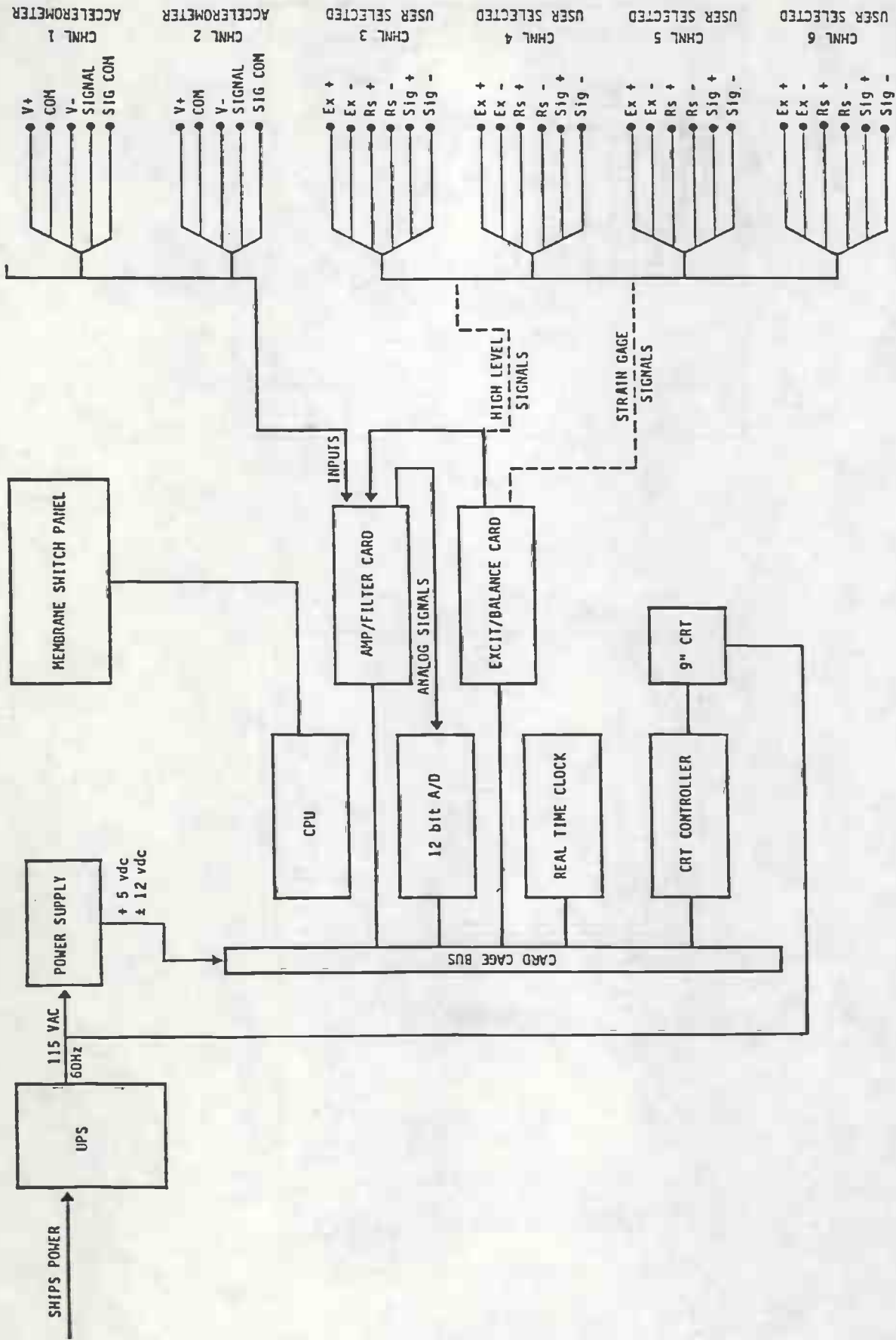


Figure B-3 SYSTEM WIRING DIAGRAM

TABLE B-4

PARTS LIST FOR SRM  
(User Selectable Sensors Not Included)

<u>Qty</u>	<u>Item</u>	<u>Model Number</u>	<u>Vendor</u>
1	8088 CPU Card	8816	Ziatech
1	CRT Controller	ZT-8844	Ziatech
1	512K Memory Card	ZT-8824-512	Ziatech
1	12Bit A/D Card	LPM-AD12	WinSystems
1	Amp/Filter Card	AF16-1	Arctec Offshore
1	Parallel	zSBX-30	Ziatech
1	Card Cage	BR08	Pro-Log
1	Power Supply	M281	Pro-Log
1	Cabinet	Custom Console Series	TA Instrument Case Co.
4-6	Remote Enclosures	NEMA-4X Series	Hoffman
1	UPS Power Supply	----	Questa Systems
1	Video Monitor	CHM-1290	Sony
1	Memb. Switch Panel	Custom Design	Jayco
8-12	Cable Connectors	PT07-A-10-6P	Bendix
8-12	Bulkhead Connectors	PT08-A-10-6S	Bendix
As Needed	Cable	#9783	Belden

APPENDIX C

Manufacturer's Specifications

# STD Bus Computers

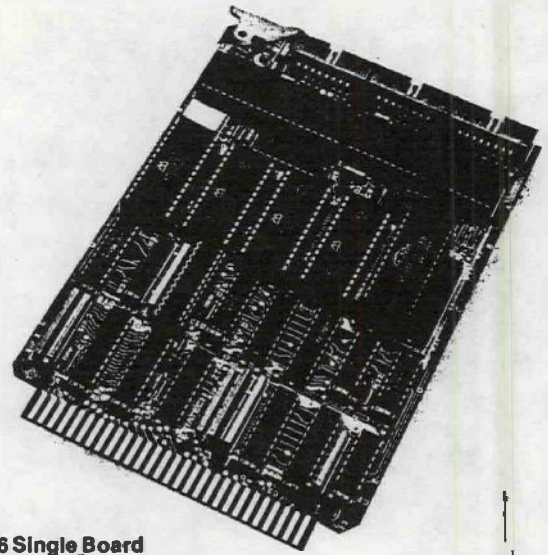


Ziatech's line of STD-8088 processor boards contains a candidate for just about any test and control application. Featuring Intel's 8088/86 family of processors, these single board computers have been designed with reliability and operating system support in mind.

The ZT 8806, Ziatech's most popular SBC, combines the world's most widely used processor, the 8088, with five memory sockets and basic I/O functions. Supported by four operating systems and many development tools, the ZT 8806 comes in 5 and 8 MHz speeds and, if required, can host the 8087 math co-processor.

Featuring the 80188 processor, Ziatech's ZT 8814 contains a number of sophisticated systems-level features including on-board DMA, processor instruction overlap, interrupt control, and timer functions. Five memory sockets on-board and an SBX connector make the ZT 8814 ideal for many OEM applications featuring user-written operating systems or STD VRTX.

The most recent member of Ziatech's SBC family is the ZT 8816. Featuring the extensive use of surface mount devices for compactness, and NEC's new V50 for computational power, the ZT 8816 is a self-contained system requiring only the addition of purchased or user designed I/O. Incorporating a full 16-bit data path on-board, the ZT 8816 conforms to the existing STD-8088 specification. The ZT 8816 processor was designed with operating systems support in mind.



**ZT 8806 Single Board  
8088 Computer**

Ziatech also offers multiprocessing capability for demanding real-time requirements. One or more ZT 8830 Intelligent Control Processors can be used to reduce intense STD Bus backplane activity found in demanding control applications.

All of Ziatech's processor boards come with a firmware option for simple development functions.

	Micro-processor	LSI Components	Clock Speed	ROM Capacity (Kbytes)	RAM Capacity (Kbytes)	Memory Addressing	Serial I/O	Parallel I/O	Counter/ Timers	Interrupts	SBX I/O
ZT 8806/8807 Single Board 8088 Computer	8088	8256 8087*	5/8 MHz	320	128	1 Mb	(1) RS-232 422/449	16	(5) 8-bit	8	
ZT 8814/8815 Single Board 80188 Computer	80188		5/8 MHz	64	32	1 Mb			(3) 16-bit	3	Yes
ZT 8816/8817 Single Board NEC V50 Computer	NEC V50 PD70216	NS16450 FPP*	5/8 MHz	256	512 + 16 battery backed	1 Mb	RS-232 422/485		(3) 16-bit	8	
ZT 8830 Intelligent I/O Control Processor	8088-2	8256	8 MHz	32	32	64K**	(1) RS-232 422/449	16	(5) 8-bit	8	Yes
ZT 7805 Single Board GPIB Computer	8085A	8250 9914A	3 MHz	8		64K	(2) RS-232			4	

\* optional

\*\* on-board memory addressing only



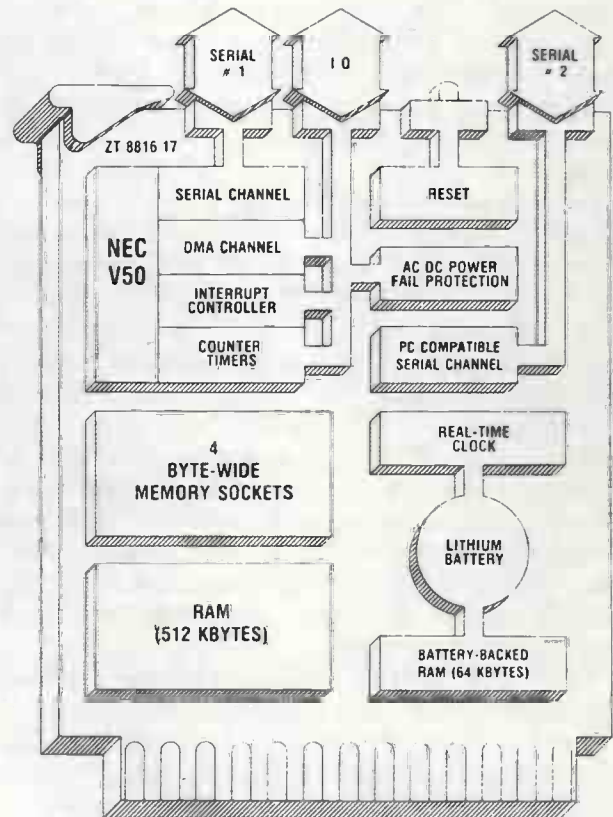
# ZT 8816/8817

Single Board Computer

STD Bus Single Board Computers offer 16-bit processor and data bus, 832K on-board memory capacity and execute IBM PC software on board.

The ZT 8816/8817 Single Board Computers implement the full 16-bit data bus operation of the NEC V50 microprocessor, while conforming to the STD Bus Manufacturer's Group IEEE P961 specification. Through the extensive use of surface mount devices on both sides of the PCB, these single board computers provide the functionality of three or more "through hole" component based STD Bus boards.

When used with Ziatech's STD DOS V50 operating system and the new ZT 8844 Video/Keyboard Controller, the ZT 8816/8817 will execute many of the IBM PC's wide range of development tools and applications programs on-board. The new SBCs are also supported by Ziatech's IBM PC-based development systems for use in applications without operating systems.



## STD BUS

- \*STD-8088 Bus compatible
- \*8088/8086 & 80188/80186 code compatible
- \*256 Kbyte EPROM capacity
- \*512 Kbyte DRAM
- \*64 Kbyte battery-backed RAM capacity
- \*Real-time clock with battery backup (58274)
- \*AC/DC power-fail protection
- \*Latching user connectors
- \*Programmable wait-states
- \*16-bit data bus on board

- \*8-bit accesses off-board
- \*8080 emulation mode (V50)
- \*DMA channel (V50)
- \*Interrupt controller (V50)
- \*Two serial channels (V50, NS16450)
- \*Three counter/timers (V50)
- \*Optional development/debug monitor PROM
- \*Burned in at 55° C and tested to guarantee reliability
- \*Two-year warranty

## FUNCTIONAL CONSIDERATIONS

### V50 (uPD70216) Processor

The NEC V50 is a full 16-bit microprocessor that is code compatible with the 8088/8086 & 80188/80186 line of microprocessors. In addition, the V50 includes both performance and instruction set enhancements. Increased performance is primarily due to two internal 16-bit data buses and special hardware dedicated to effective address calculation. Added instructions include string I/O, expanded rotate and shift, bit and nibble manipulation, and an 8080 emulation mode. The emulation mode instructions enable existing 8-bit applications to be upgraded to 16-bit with little or no software modification.

### Memory and I/O Addressing

The ZT 8816/8817 is populated with 512 Kbytes of DRAM, up to 64 Kbytes of battery-backed RAM and four 28-pin JEDEC compatible byte-wide sockets. The byte-wide sockets accept 8K, 16K, 32K and 64K ROM devices. All memory local to the ZT 8816/8817 is addressed with full 16-bit operation. Additional memory can be accessed through the STD-8088 Bus to meet system requirements. Memory transfers to and from the STD Bus are automatically reduced from 16-bit to 8-bit operations for full bus compatibility. The ZT 8816/8817 directly addresses up to 1 Mbyte of memory.

The ZT 8816/8817 includes some of the most commonly used I/O functions. Additional I/O functions can be accessed through the STD Bus. The ZT 8816/8817 directly addresses up to 64 Kbytes of I/O for 16-bit addressing, or 256 bytes for 8-bit I/O addressing.

### Direct Memory Access (DMA)

The ZT 8816/8817 provides one DMA channel to the user through a connector for high-speed transfer between memory and I/O. The DMA channel includes 20-bit address registers and 16-bit count registers. Byte and word transfers in single, block and demand modes are supported. The ZT 8816/8817 also supports DMA from an external STD Bus controller to local memory.

### Serial Communications

The ZT 8816/8817 includes two asynchronous serial communication channels, each with a programmable baud rate generator. The V50 provides one serial channel (a subset of the 8251A) configured as RS-232C. The National NS16450 (functionally equivalent to the 8250A and 16450 used in IBM PCs and ATs) provides the second serial channel configured as RS-232C or RS-422/485. Other fea-

tures include loopback diagnostics, maskable interrupt generation and jumper selectable DCE or DTE configuration.

### Counter/Timers

The ZT 8816/8817 has three independent 16-bit counter/timers (8254 architecture) that can be used as timers or event counters. There are six programmable counter/timer modes: interrupt on end of count, frequency divider, square wave generator, software triggered, hardware triggered and retriggerable one-shot. One counter/timer is connected as an interrupt source internal to the V50 and is used to generate timed or periodic interrupts. A second counter/timer is programmed as an interrupt source or as a baud rate generator for the V50 serial channel. The third counter/timer is available through a front plane connector.

### Interrupts

The ZT 8816/8817 includes one programmable interrupt controller (8259A architecture) with eight interrupts. One input is dedicated to a counter timer for timed or periodic interrupts. Another input is programmably connected to a second counter timer or a front plane connector. A third input is programmed for connection to the V50 serial controller or a front plane connector. Three more inputs are dedicated to the 16450 serial controller, optional floating point processor and STD Bus INTRQ\* signal. The last two inputs are dedicated for use through a front plane connector. Three sources of non-maskable interrupts are the STD Bus NMIRQ\* signal, and optionally, the power fail protection and parity error detector circuitry. The ZT 8816/8817 supports the STD-8088 Bus address-cascade protocol for slave interrupt controller expansion. Cascading interrupt controllers provide up to 40 additional interrupt inputs.

### Real-Time Clock and Battery

The ZT 8816/8817 includes a battery backed-up real-time clock (National MM 58274 RTC). The RTC provides time information for year, month, day, hours, minutes, seconds and 1/10 seconds. A data-changed flag allows simple testing for time rollover. A 3.9V, 1AH lithium battery supplies backup power for the RTC and static RAM. Refer to the electrical specifications below for data retention times.

### AC/DC Power Fail Protection

The ZT 8816/8817 can monitor both AC and DC, allowing for an orderly shut down during a power failure. The ZT 8816/8817 can be jumper programmed to detect AC power failure by monitoring a 24V AC signal derived



from the same supply that powers the STD Bus. See ordering information for 24V AC transformer. When the AC power drops, an NMI is generated to notify the processor of an impending failure. The processor can then save critical data before the DC monitor generates a reset. The DC monitor resets the V50 and activates the DCPWRDWN\* signal (STD pin 6) when the +5V supply (STD pins 1&2) drops below operating range.

### Development Considerations

Ziatech offers two software development tools for ZT 8816/8817 applications, STD PDS and STD DOS V50. The STD Prototype Development System uses an IBM or compatible PC as a development station to create, download and debug stand-alone application programs written in assembly and selected other popular languages.

The second development tool, STD-DOS V50, is an adaptation of the IBM PC DOS operating system that resides on the STD Bus. Applications can be developed much faster because: 1) programmers familiar with PC DOS do not have to learn a new operating system, 2) the operating system includes software that is easily integrated into the application, and 3) extensive industry support of PC DOS makes available a large number of development tools such as program editors, compilers, assemblers and debuggers. STD DOS can also be executed in the target system to provide the user's application with services such as file memory and I/O management. Multitasking target systems featuring VRTX and Multi-DOS are available for these SBCs also. For more information on these development tools and target system options, refer to Ziatech's Technical Data Book.

## SPECIFICATIONS

### Environmental

0° to 65° C operating temperature range  
15% to 95% relative non-condensing humidity

### Electrical

STD-8088 Bus compatible for 5 MHz (ZT 8816) and 8 MHz (ZT 8817)

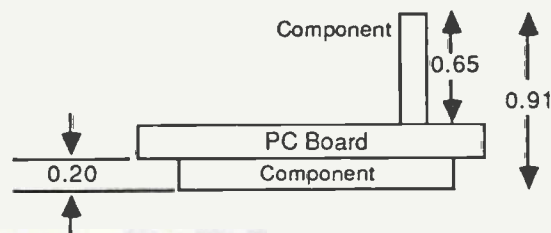
### Power supply requirements:

+5V +/- 5% @ 2A maximum and 1A typical  
add 0.30A maximum and 0.15A typical  
with four ROM devices  
+12V @ 0.25A maximum and 0.2A typical  
-12V @ 0.25A maximum and 0.2A typical

Data retention for RTC and battery-backed RAM:  
5 years typical and 2 years minimum

### Mechanical

STD-8088 Bus compatible except requires two 1/2" or 5/8" card slots at either end of a standard STD Bus card cage  
Measures 4.5" (11.3 cm) x 6.5" (16.5 cm)  
Height = 0.91" (2.3 cm)



### Connectors

Three latching user connectors:

- J1 14-pin serial channel
  - J2 14-pin serial channel
  - J3 26-pin DMA, counter/timer, interrupt, and AC input
- P1 56-pin STD Bus connector:

### Ordering Information

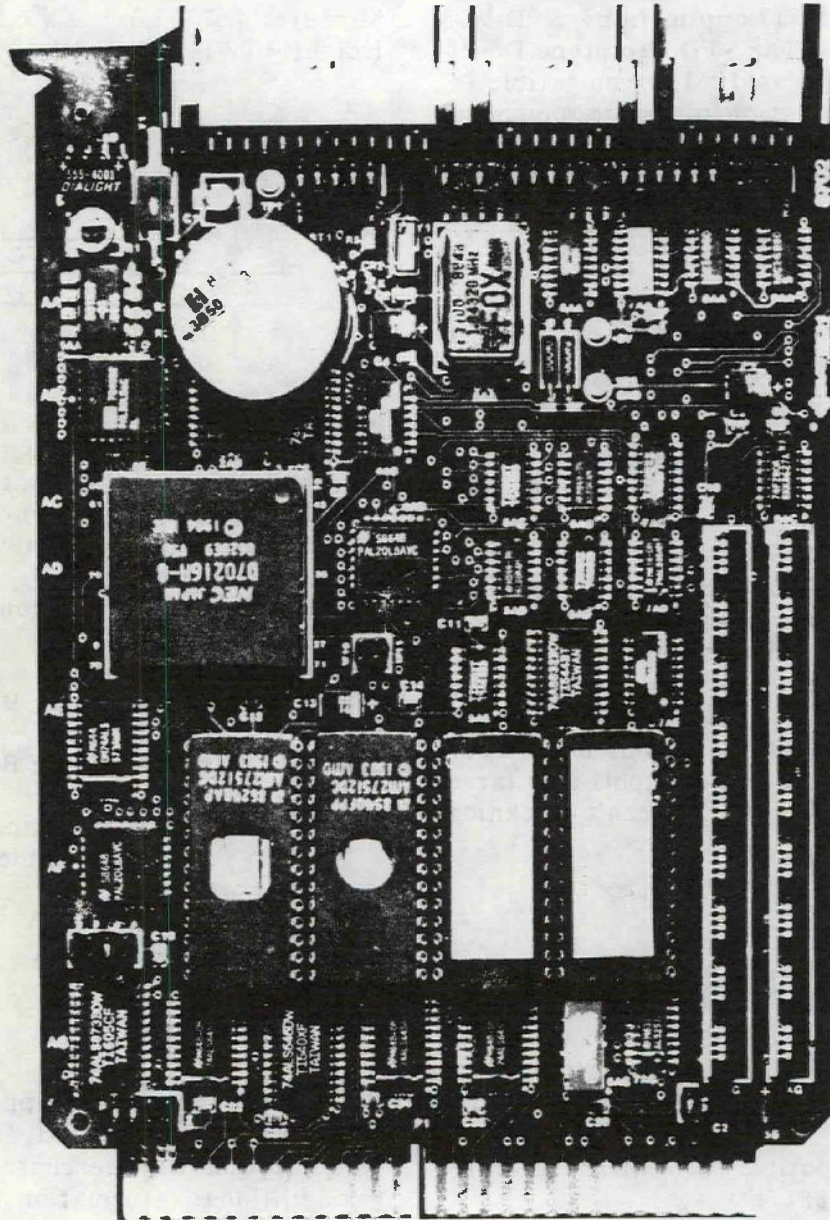
- |         |   |
|---------|---|
| ZT 8816 | 5 MHz Single Board V50 computer and manual      |
| ZT 8817 | 8 MHz Single Board V50 computer and manual      |
| Opt 01  | DEBUG 88 system including PROM and serial cable |
| Opt 02  | Serial Cable                                    |
| Opt 03  | Wall plug 24V AC Transformer with 2 meter cord. |

All products are shipped FOB San Luis Obispo, CA, U.S.A. OEM discounts are available for quantity purchases. Contact Ziatech for additional information.

**Warranty: Two years** from shipping date, covering all defects in materials and workmanship. Ziatech will repair or replace products which prove to be defective during the warranty period provided they are promptly returned to Ziatech at customer's expense and have not been repaired, altered or damaged by non-Ziatech personnel. No other warranty is expressed or implied. Service after warranty is available at a predesignated service charge. We are not liable for consequential damages.

**ZIATECH**  
CORPORATION

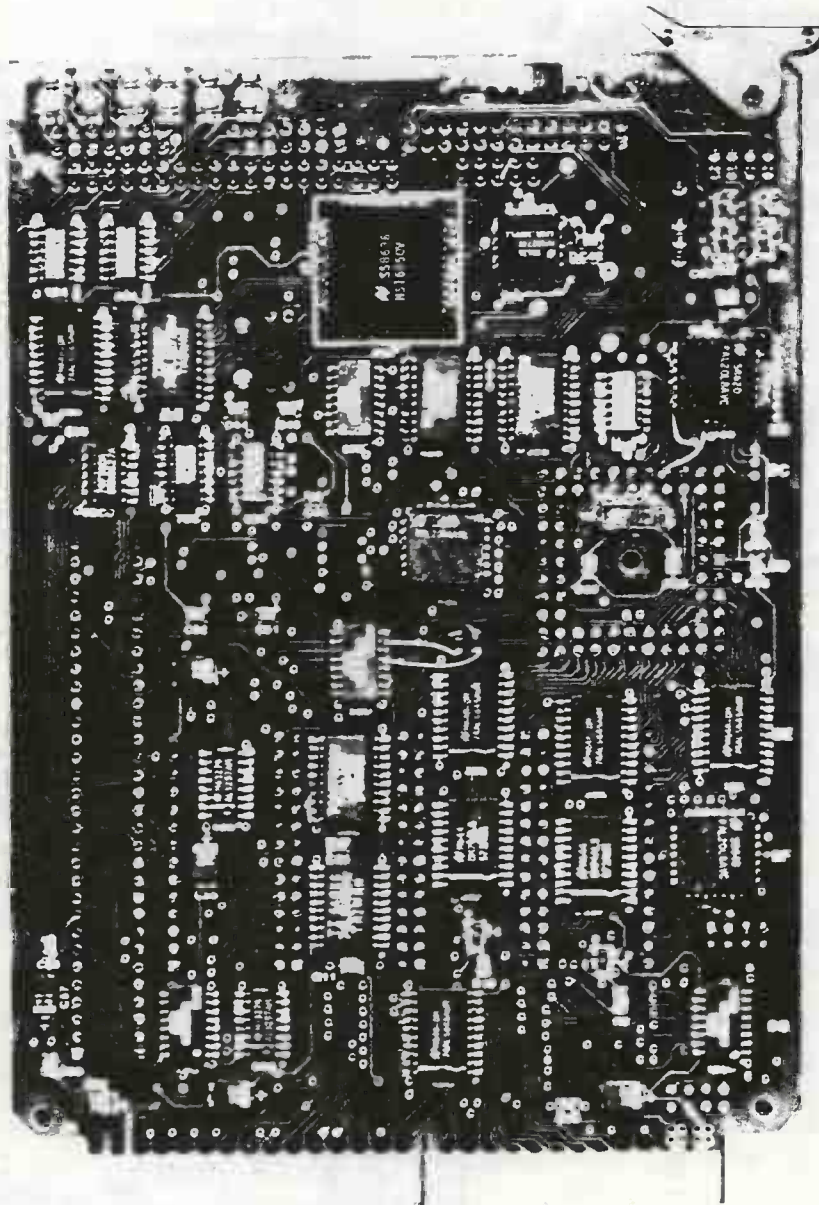
3433 Roberto Court  
San Luis Obispo, California 93401 USA  
(805) 541-0488 • ITT Telex 4992316



**ZT 8816 Single Board NEC V50 Computer**  
(Front View - for another point of view, turn the page)

Ziatech Corporation  
3433 Roberto Court. San Luis Obispo, CA 93401 (805) 541-0488





**ZT 8816 Single Board NEC V50 Computer**  
(Rear View - for another point of view, turn the page)

Ziatech Corporation  
3433 Roberto Court. San Luis Obispo. CA 93401 (805) 541-0488



# ZT 8844

Video/Keyboard Controller

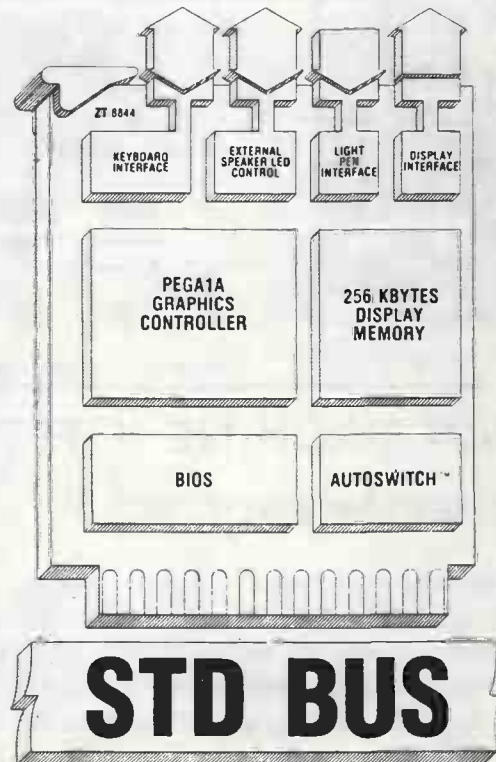
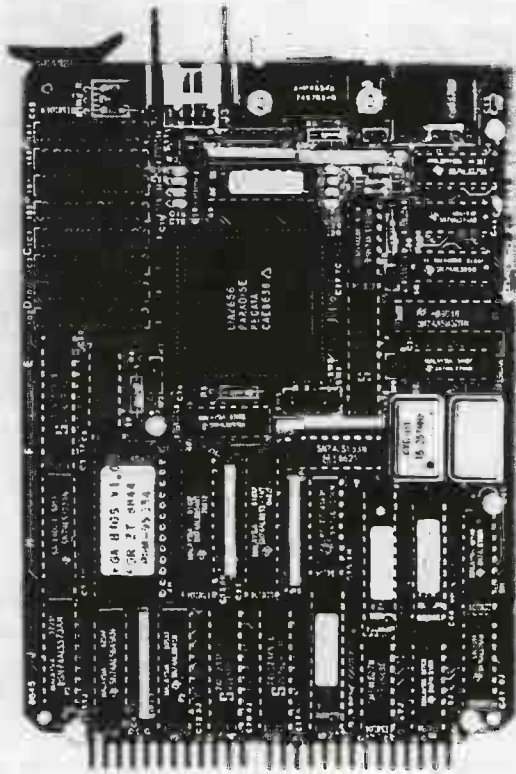
**IBM PC-equivalent EGA video controller brings high resolution and color graphic displays to STD-8088 based systems.**

The ZT 8844 provides IBM PC-equivalent graphics capability on a single STD Bus Controller. This controller enables Ziatech's STD DOS system to execute most existing graphics-oriented IBM PC software tools and applications (i.e., Lotus 1-2-3, GEM, Turbo Pascal, and Flight Simulator).

The ZT 8844 automatically changes

between IBM Enhanced Graphics Adaptor (EGA), Color Graphics Adaptor (CGA), Monochrome Display Adaptor (MDA), and other popular PC video modes depending on the application software being run at the time.

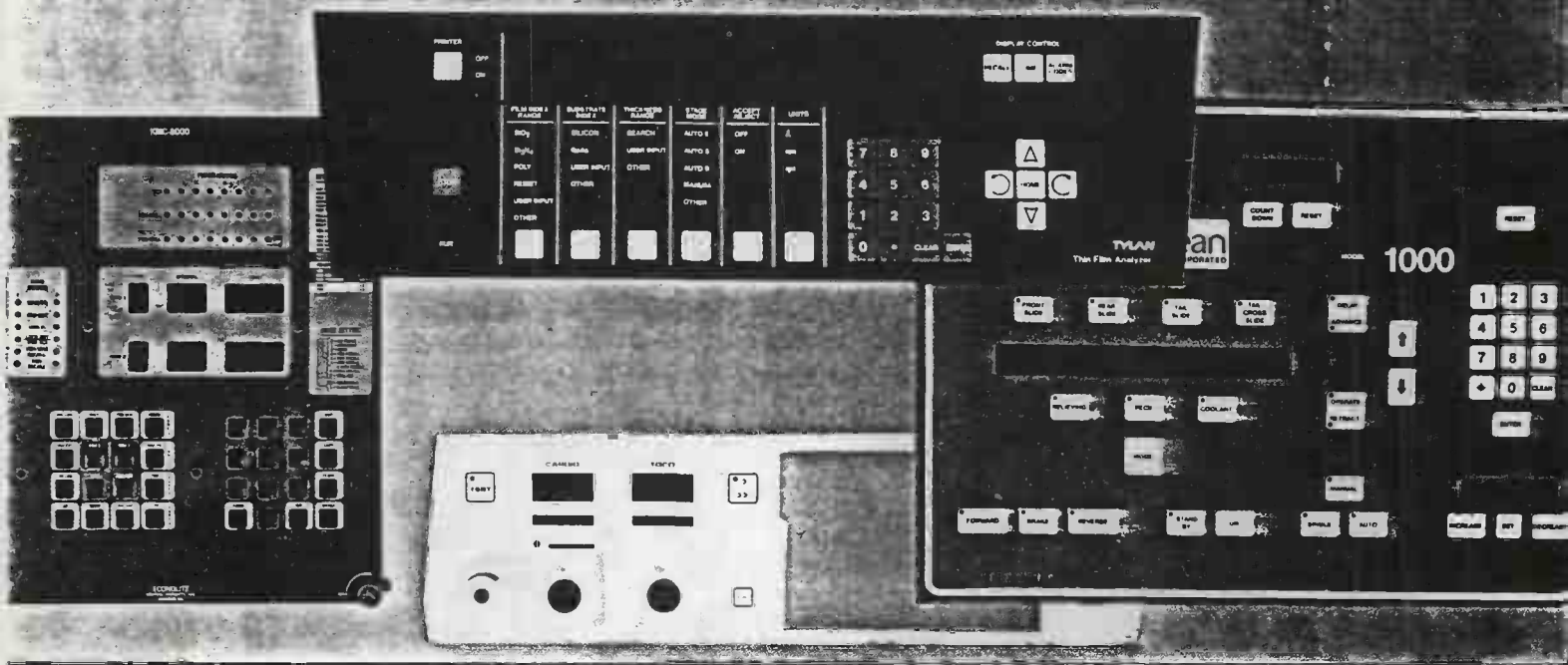
The ZT 8844 is supported in Ziatech's STD DOS and STD Multi-DOS development and target environments.



- \*IBM PC video software compatibility
- \*STD-8088 compatible (5 or 8 MHz CPU)
- \*Compatible with IBM's EGA, CGA and MDA
- \*Full support of Hercules Monochrome Graphics mode and Plantronics Colorplus mode
- \*Automatic Video Mode Switch (Paradise Systems' AutoSwitch™ feature)
- \*IBM PC/XT compatible keyboard interface
- \*Support of off-board speaker and LEDs

- \*Two user configurable (loadable) 8 Kbyte character generators for a total of 1024 characters
- \*256 Kbytes dual-port memory for display and CPU access
- \*16 colors supported from a 64-color palette
- \*Light pen interface
- \*Supported by on-board 16 Kbyte BIOS
- \*Burned in at 55° C and tested to guarantee reliability
- \*Two-year warranty





## MAN-MACHINE INTERFACES

### MEMBRANE SWITCHES

Membrane switches are normally open, momentary contact switches. Their light weight and low profile (0.030" - 0.040" thick) make them ideal for use on portable equipment and on rack, console and desktop units where space may be limited. Membrane switches are more reliable and economical than conventional switching systems. Further, they add design flexibility which simply isn't available with any other switch technology.

Simplicity = dependability. The switch consists of two contacts, one above the other, separated by a specific volume of air. Finger pressure on the top contacts closes the switch, and release of pressure opens it. The contacts are usually made of printed conductive ink. Therefore, membrane switches are designed specifically for low voltage and low current applications (see technical specifications).

### HYBRID SWITCH PANELS

Membrane switches are made of flexible materials. Hybrid switch panels utilize some aspect of membrane switch construction, but are built on printed circuit boards. They are therefore a hybrid of membrane and PCB technology.

All hybrid switch circuitry is usually contained on the PCB and switch closure is performed by either a printed membrane or a metal dome (as in a tactile switch). Hybrid switches can be mounted directly to your chassis with no additional sub-panel required. They can also be supplied as a sub-assembly complete with connectors, hardware and LEDs mounted and ready for installation. Significant savings result from the reduction of the amount of components necessary to order, stock and assemble. Hybrid switches provide all the advantages of design freedom offered by membrane switches as well as conventional mounting and connection techniques.

## FRONT DISPLAY PANELS & OVERLAYS

Most membrane switches incorporate a front display panel. Overlays are usually printed on polycarbonate or polyester materials, with all printing subsurface for durability. The surface of the overlays can be treated with special coatings to improve chemical and abrasion resistance and to vary the surface texture. Any color or combination of colors are possible. JAYCO can match to federal standard, Pantone or your supplied color chips.

Various adhesives are available for different applications or the panel can be supplied as assemblies complete with hardware.

## KEYBOARDS AND KEYPADS

These simple switch arrays usually do not incorporate all the design features available with custom membrane switch panels. Since JAYCO manufactures custom keyboards and keypads to your precise design there are no limitations regarding size, layout, number of switches, circuitry or graphic design. You receive an economical keyboard with no standard keyboard compromises.

## SILICONE RUBBER KEYPADS

Refer to separate data sheet for full information.

## SPECIAL PROJECTS

JAYCO manufactures man-machine interfaces for a variety of applications. Occasionally, an application requires a solution best provided by resources in addition to JAYCO. JAYCO will then pool their resources, expertise and contacts throughout the industry on your behalf to create the ideal solution for you. As a project leader, JAYCO will assume full responsibility for the project from design to delivery. You receive technical help, service and commitment of the same caliber as if JAYCO was manufacturing the part. And, there is no risk. JAYCO will only accept projects that are within their capabilities.

---

## TECHNICAL SPECIFICATIONS

### Typical Values

#### CURRENT RATING

50mA at 30VDC

#### CIRCUIT RESISTANCE

Less than 100 Ohms

#### CONTACT BOUNCE

Less than 5 Milliseconds

(non-tactile)

Less than 20 Milliseconds

(tactile)

#### INSULATION RESISTANCE

1 Gohm Min at 100 VDC

#### DIELECTRIC STRENGTH

250 VRMS Min

#### CAPACITANCE

27 pf between any

two traces

#### ACTUATION FORCE

Variable from 80 Grams

#### OPERATING TEMPERATURE

-40°C to +80°C

#### OPERATIONAL LIFE

Greater than 5 Million Operations

(non-tactile)

Greater than 1 Million Operations

(tactile)

#### TERMINATION

Berg "Clincher" offered as standard

#### TOLERANCES

+ or -0.010" as standard

EMBOSS HEIGHT

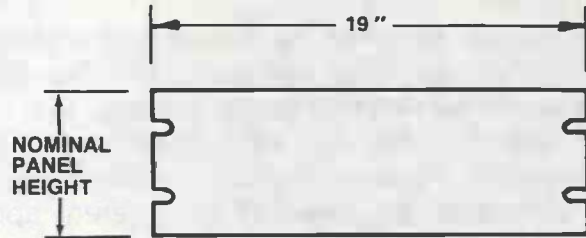
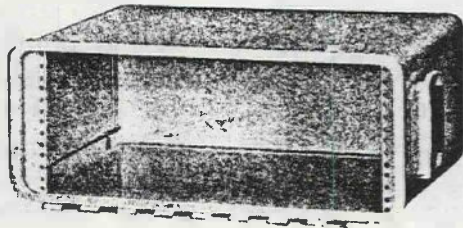
0.010-0.015"

\* The information contained herein is believed to be accurate and reliable, but is for guidance only. Customers should verify performance to specifications in actual conditions of use.



# CONSOLINER

For 19" PANEL MOUNTED EQUIPMENT



Consoliner may be used as storage, transit or permanent housing for 19" rack equipment with panel heights from 5¼" to 26¼" high. Like most TA cases, Consoliner are watertight and can be produced to conform to any applicable military specification.

## Standard Consoliner Features

(INCLUDED IN STANDARD CONSOLINER PART NUMBER)

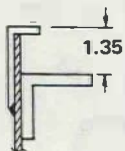
- Watertight neoprene Chevron seal
- Either 2 or 4 chest handles (TC81Y09 on pg 26) for ease of carrying
- Panel mounting rails with pre-punched EIA/NEMA hole pattern
- 10-32 panel-mounting clipnuts supplied loose for customer installation
- Manual pressure relief valve (TC78V01 on pg 26) located within handle for protection
- Choice of 0.10" (Code P) or 1.35" (Code U) panel rail recess locations
- Toggle latches (TC82Z13 on pg 26) located on cover so they don't interfere with equipment operation (except on body on cases with minimum (1.59") cover height)
- Spherical bumpers on hinge side of case (except 7" deep bodies) as well as either dimples or bumpers opposite opening
- Storage tray assembly available in cover (or both covers if dual cover case) see page 14
- Choice of 12 panel heights, 3 cover heights, 4 body depths, 4 finishes
- Continuous separable hinge for cover removal
- Available in fabricated construction only (see page 8) from 0.071" thick 6061-T4 aluminum

## Consoliner Options

(CANNOT BE SPECIFIED BY STANDARD CONSOLINER PART NUMBER. CONTACT TA SALES DEPARTMENT FOR ORDERING INFORMATION)

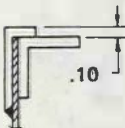
- Dual covers available with or without panel mounting rails at either or both openings as shown on page 14
- Panel mounting rails available in cover as well as case body for mounting additional instruments
- Automatic Breather Valve (TC78V07 on pg 26) in place of manual pressure relief valve
- Watertight access doors, recessed cups and recessed brackets as shown on page 15
- Continuous panel rail to fill gap between top and bottom of customer panel and inside of case body
- Shear lugs, guarded handles and latches, and silicone Chevron seal for extremely rough use
- Provisions for chassis slide mounting or rear chassis support
- Stacking receptacles can be added to allow stacking several Consoliner on top of each other
- Foam inserts or lining in cover above storage tray assembly

## PANEL RAILS



### RECESSED RAIL CODE U

PANEL MOUNTING SURFACE RECESSED 1.35" BELOW PARTING LINE TO PROTECT PANEL MOUNTED COMPONENTS SUCH AS KNOBS, SWITCHES AND METERS. OTHER RECESS DEPTHS AVAILABLE. CONTACT TA SALES DEPARTMENT FOR MODIFICATION SUFFIX. NOTE: ALL RECESSED PANEL RAILS ARE CODE U REGARDLESS OF RECESS DIMENSION.



### FLUSH RAIL CODE P

PANEL MOUNTING SURFACE RECESSED 0.10" BELOW PARTING LINE POSITIONS CUSTOMER PANEL APPROX FLUSH TO TOP OF STRIKER R.I.M\*

TABLE 1

NOMINAL PANEL HEIGHT	TA CASE NUMBER	H CASE HEIGHT	E MINIMUM PANEL CLEARANCE	NO. OF LATCHES	NO. OF HANDLES	NO. OF CLIPNUTS SUPPLIED PER COVER	TYPE OF BUMPER OPPOSITE PANEL OPENING
5¼"	33	6.34	5.45	2	2	4	DIMPLE
7"	34	8.09	7.21	2	2	4	DIMPLE
8¾"	35	9.84	8.95	2	2	4	TC01E75-1
10½"	36	11.59	10.70	2	2	8	TC01E75-1
12¼"	37	13.34	12.45	2	2	8	TC01E75-1
14"	38	15.09	14.20	4	2	8	TC01E75-1
15¾"	39	16.84	15.95	4	2	8	TC01E75-1
17½"	40	18.59	17.70	4	2	8	TC01E75-1
19¼"	41	20.34	19.45	4	4	8	TC01E75-1
21"	42	22.09	21.20	4	4	8	TC01E75-1
24½"	43	25.59	24.70	4	4	8	TC01E75-1
26¼"	44	27.34	26.45	4	4	8	TC01E75-1

# OPTIONS

The optional features shown below cannot be ordered by standard TA part number code shown on page 6, but require a modification suffix be added by TA Sales Department upon receipt of order.

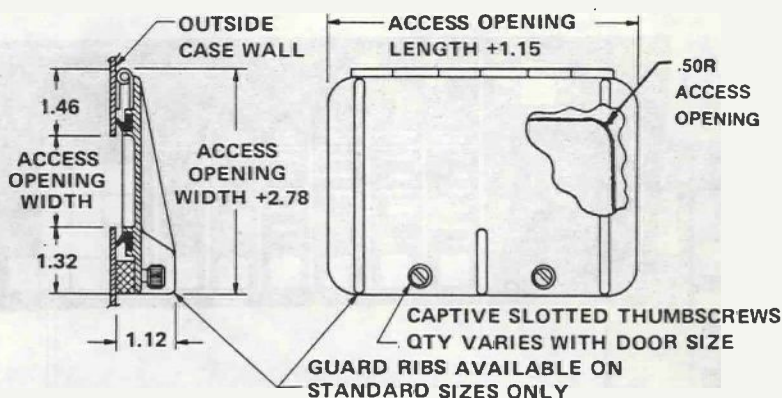
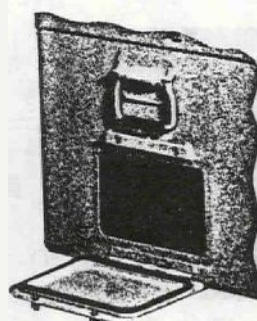
## ACCESS DOORS

The exclusive TA access door can be added to most standard instrument cases, provided enough clearance is allowed for hardware mounting and corner radii. The access door is particularly useful for ventilating electronic equipment when in operation or

equipment requiring frequent maintenance. It allows quick access to test leads or power cables when direct connection into instrument panel is impractical. Custom sizes available on special order. See Technical Data Sheets 8142 and 8143 for details.

Sizes tooled as of date of Publication. Contact TA Sales Department for additional information.

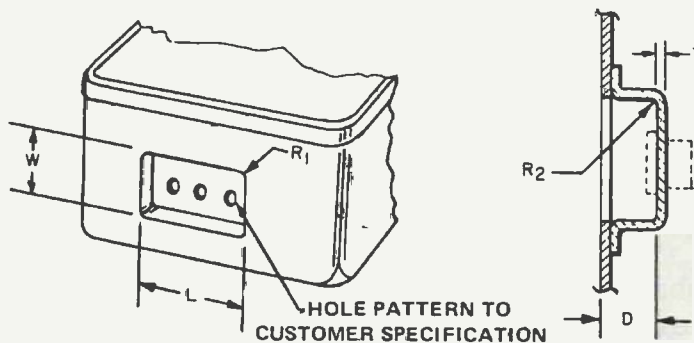
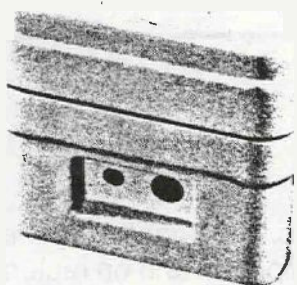
PART NO.	ACCESS OPENING	
	WIDTH	LENGTH
-02	3.00	8.00
-03	4.00	5.50
-04	4.38	8.00
-06	5.00	9.00



## RECESSED CUPS

TA offers recessed cups which can be used either alone or in combination with an access door. These cups allow for the mounting of fittings and connectors in the sides of a case without compromising the watertight integrity, providing the connectors

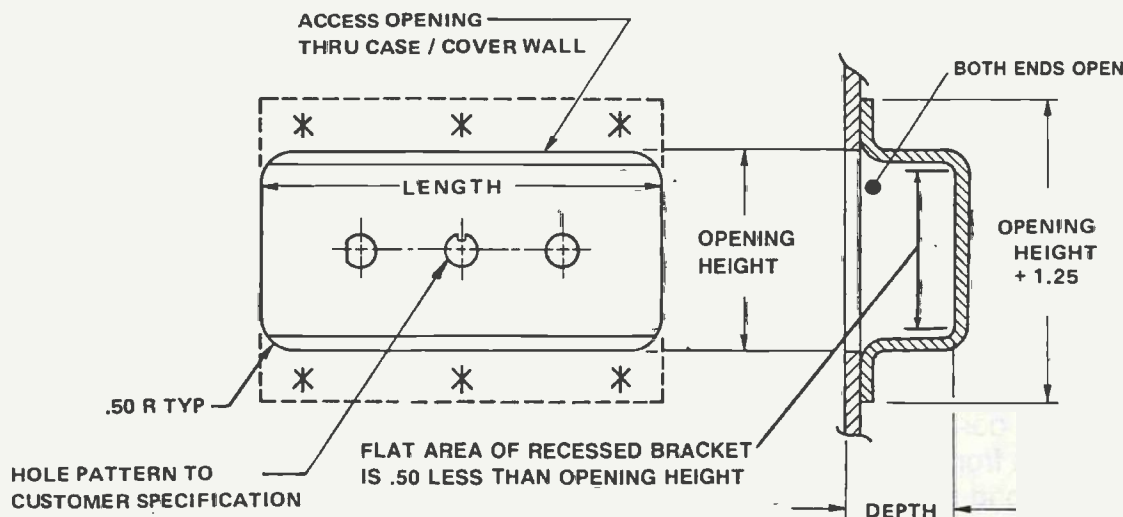
and fittings are watertight. If not, an access door can be provided to cover the cup when not in use. Contact TA sales department for list of standard sizes available. Custom sizes available on special order. See Technical Data Sheet 8129 for further details.



## RECESSED BRACKET

TA's recessed bracket is used with a watertight access door to mount controls, connectors, indicators, etc. in a protected recess on the sides, front, or rear of a case, when watertight integrity is

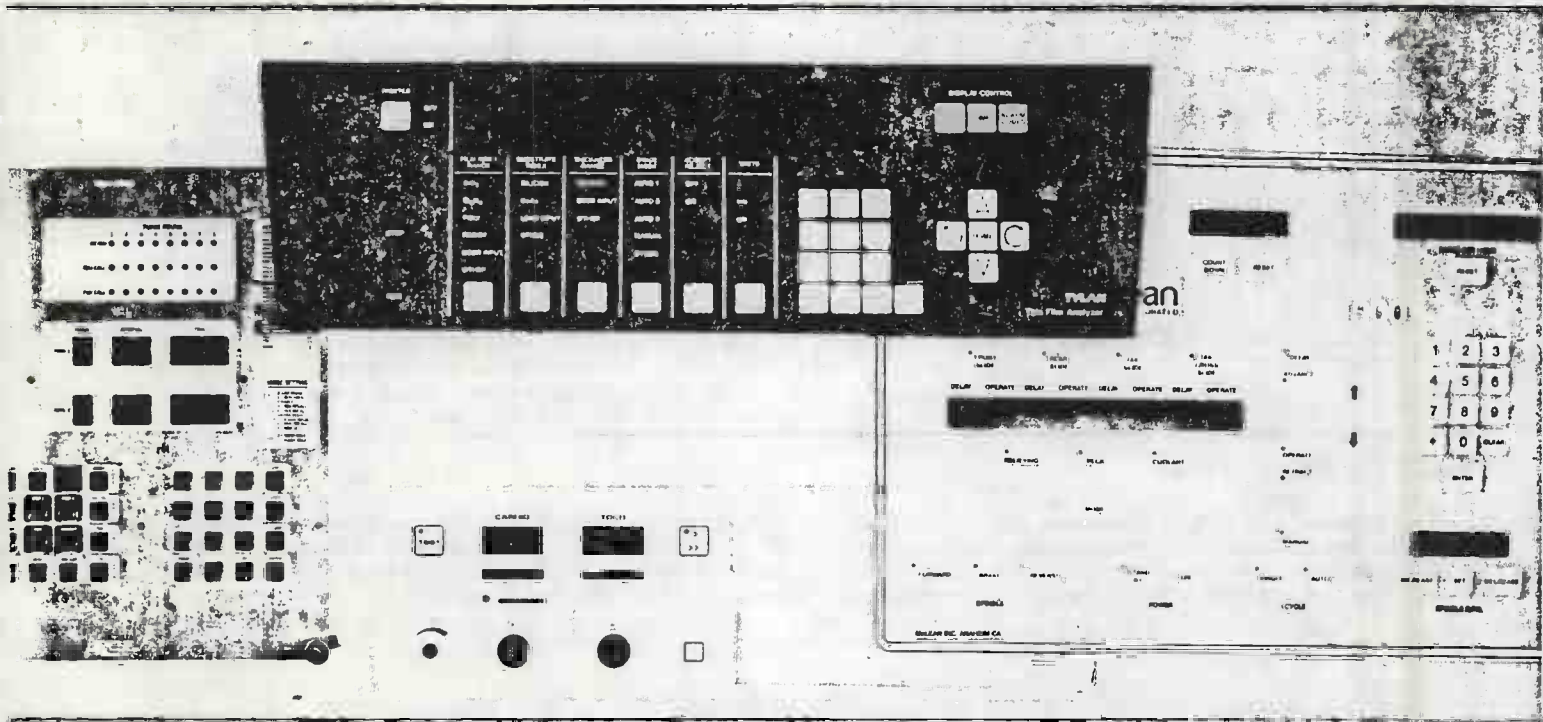
not required with the door open. Openings at each end allow cooling for internal components. See Technical Data Sheet 8131 for further details.





# JAYCO

Jayco Plastics of California, Inc.  
507 W. Blueridge Ave.  
Orange, CA 92665 U.S.A.  
Telephone: (714) 974-1701



## MAN-MACHINE INTERFACES

### MEMBRANE SWITCHES

Membrane switches are normally open, momentary contact switches. Their light weight and low profile (0.030" - 0.040" thick) make them ideal for use on portable equipment and on rack, console and desktop units where space may be limited. Membrane switches are more reliable and economical than conventional switching systems. Further, they add design flexibility which simply isn't available with any other switch technology.

Simplicity = dependability. The switch consists of two contacts, one above the other, separated by a specific volume of air. Finger pressure on the top contacts closes the switch, and release of pressure opens it. The contacts are usually made of printed conductive ink. Therefore, membrane switches are designed specifically for low voltage and low current applications (see technical specifications).

### HYBRID SWITCH PANELS

Membrane switches are made of flexible materials. Hybrid switch panels utilize some aspect of membrane switch construction, but are built on printed circuit boards. They are therefore a hybrid of membrane and PCB technology.

All hybrid switch circuitry is usually contained on the PCB and switch closure is performed by either a printed membrane or a metal dome (as in a tactile switch). Hybrid switches can be mounted directly to your chassis with no additional sub-panel required. They can also be supplied as a sub-assembly complete with connectors, hardware and LEDs mounted and ready for installation. Significant savings result from the reduction of the amount of components necessary to order, stock and assemble. Hybrid switches provide all the advantages of design freedom offered by membrane switches as well as conventional mounting and connection techniques.

# OPTIONS

The optional features shown below cannot be ordered by standard TA part number code shown on page 6, but require a modification suffix be added by TA Sales Department upon receipt of order.

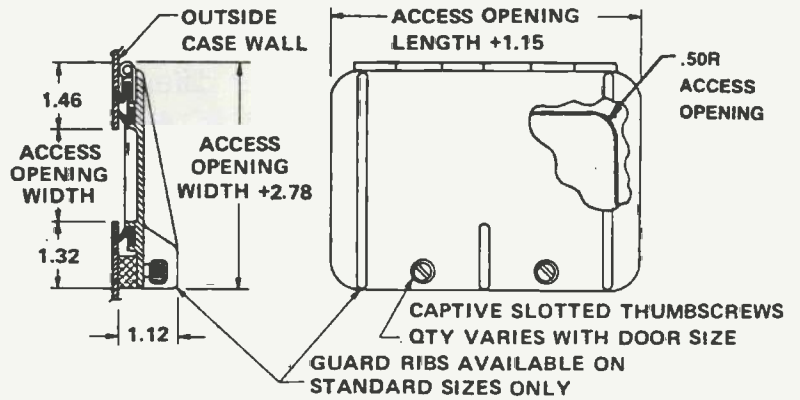
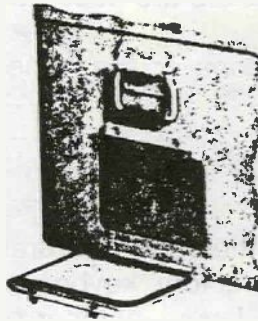
## ACCESS DOORS

The exclusive TA access door can be added to most standard instrument cases, provided enough clearance is allowed for hardware mounting and corner radii. The access door is particularly useful for ventilating electronic equipment when in operation or

equipment requiring frequent maintenance. It allows quick access to test leads or power cables when direct connection into instrument panel is impractical. Custom sizes available on special order. See Technical Data Sheets 8142 and 8143 for details.

Sizes tooled as of date of Publication. Contact TA Sales Department for additional information.

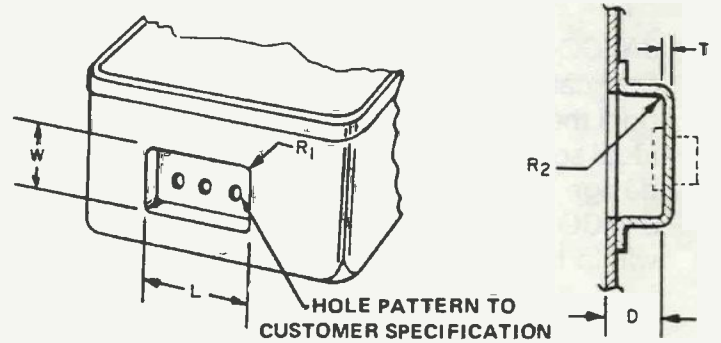
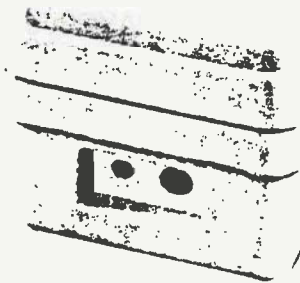
PART NO.	ACCESS OPENING	
	WIDTH	LENGTH
TC63D15		
-02	3.00	8.00
-03	4.00	5.50
-04	4.38	8.00
-06	5.00	9.00



## RECESSED CUPS

TA offers recessed cups which can be used either alone or in combination with an access door. These cups allow for the mounting of fittings and connectors in the sides of a case without compromising the watertight integrity, providing the connectors

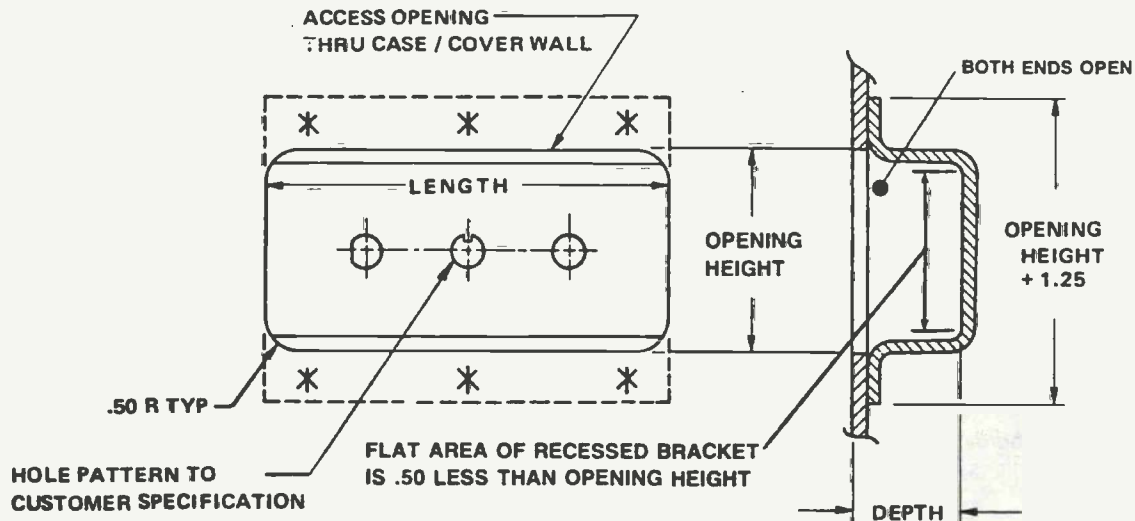
and fittings are watertight. If not, an access door can be provided to cover the cup when not in use. Contact TA sales department for list of standard sizes available. Custom sizes available on special order. See Technical Data Sheet 8129 for further details.



## RECESSED BRACKET

TA's recessed bracket is used with a watertight access door to mount controls, connectors, indicators, etc. in a protected recess on the sides, front, or rear of a case, when watertight integrity is

not required with the door open. Openings at each end allow cooling for internal components. See Technical Data Sheet 8131 for further details.



## FRONT DISPLAY PANELS & OVERLAYS

Most membrane switches incorporate a front display panel. Overlays are usually printed on polycarbonate or polyester materials, with all printing subsurface for durability. The surface of the overlays can be treated with special coatings to improve chemical and abrasion resistance and to vary the surface texture. Any color or combination of colors are possible. JAYCO can match to federal standard, Pantone or your supplied color chips.

Various adhesives are available for different applications or the panel can be supplied as assemblies complete with hardware.

## KEYBOARDS AND KEYPADS

These simple switch arrays usually do not incorporate all the design features available with custom membrane switch panels. Since JAYCO manufactures custom keyboards and keypads to your precise design there are no limitations regarding size, layout, number of switches, circuitry or graphic design. You receive an economical keyboard with no standard keyboard compromises.

## SILICONE RUBBER KEYPADS

Refer to separate data sheet for full information.

## SPECIAL PROJECTS

JAYCO manufactures man-machine interfaces for a variety of applications. Occasionally, an application requires a solution best provided by resources in addition to JAYCO. JAYCO will then pool their resources, expertise and contacts throughout the industry on your behalf to create the ideal solution for you. As a project leader, JAYCO will assume full responsibility for the project from design to delivery. You receive technical help, service and commitment of the same caliber as if JAYCO was manufacturing the part. And, there is no risk. JAYCO will only accept projects that are within their capabilities.

---

## TECHNICAL SPECIFICATIONS

### Typical Values

#### CURRENT RATING

50mA at 30VDC

#### CIRCUIT RESISTANCE

Less than 100 Ohms

#### CONTACT BOUNCE

Less than 5 Milliseconds

(non-tactile)

Less than 20 Milliseconds

(tactile)

#### INSULATION RESISTANCE

1 Gohm Min at 100 VDC

#### DIELECTRIC STRENGTH

250 VRMS Min

#### CAPACITANCE

27 pf between any

two traces

#### ACTUATION FORCE

Variable from 80 Grams

#### OPERATING TEMPERATURE

-40°C to +80°C

#### OPERATIONAL LIFE

Greater than 5 Million Operations

(non-tactile)

Greater than 1 Million Operations

(tactile)

#### TERMINATION

Berg "Clincher" offered as standard

#### TOLERANCES

+ or -0.010" as standard

#### EMBOSS HEIGHT

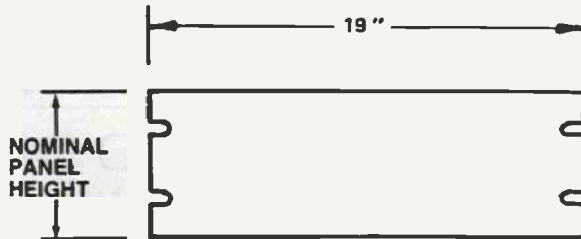
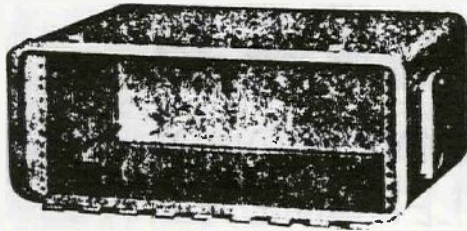
0.010-0.015"

\* The information contained herein is believed to be accurate and reliable, but is for guidance only. Customers should verify performance to specifications in actual conditions of use.



# CONSOLINER

For 19" PANEL MOUNTED EQUIPMENT



Consoliners may be used as storage, transit or permanent housing for 19" rack equipment with panel heights from 5 1/4" to 26 1/4" high. Like most TA cases, Consoliners are watertight and can be produced to conform to any applicable military specification.

## Standard Consoliner Features

(INCLUDED IN STANDARD CONSOLINER PART NUMBER)

- Watertight neoprene Chevron seal
- Either 2 or 4 chest handles (TC81Y09 on pg 26) for ease of carrying
- Panel mounting rails with pre-punched EIA/NEMA hole pattern
- 10-32 panel-mounting clipnuts supplied loose for customer installation
- Manual pressure relief valve (TC78V01 on pg 26) located within handle for protection
- Choice of 0.10" (Code P) or 1.35" (Code U) panel rail recess locations
- Toggle latches (TC82Z13 on pg 26) located on cover so they don't interfere with equipment operation (except on body on cases with minimum (1.59") cover height)
- Spherical bumpers on hinge side of case (except 7" deep bodies) as well as either dimples or bumpers opposite opening
- Storage tray assembly available in cover (or both covers if dual cover case) see page 14
- Choice of 12 panel heights, 3 cover heights, 4 body depths, 4 finishes
- Continuous separable hinge for cover removal
- Available in fabricated construction only (see page 8) from 0.071" thick 6061-T4 aluminum

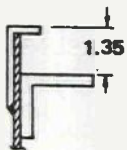
## Optional Features

(CANNOT BE SPECIFIED BY STANDARD CONSOLINER PART NUMBER. CONTACT TA SALES DEPARTMENT FOR ORDERING INFORMATION)

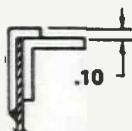
- Dual covers available with or without panel mounting rails at either or both openings as shown on page 14
- Panel mounting rails available in cover as well as case body for mounting additional instruments
- Automatic Breather Valve (TC78V07 on pg 26) in place of manual pressure relief valve
- Watertight access doors, recessed cups and recessed brackets as shown on page 15
- Continuous panel rail to fill gap between top and bottom of customer panel and inside of case body
- Shear lugs, guarded handles and latches, and silicone Chevron seal for extremely rough use
- Provisions for chassis slide mounting or rear chassis support
- Stacking receptacles can be added to allow stacking several Consoliners on top of each other
- Foam inserts or lining in cover above storage tray assembly

## PANEL RAILS

TABLE 1



RECESSED RAIL CODE U  
PANEL MOUNTING SURFACE RECESSED 1.35" BELOW PARTING LINE TO PROTECT PANEL MOUNTED COMPONENTS SUCH AS KNOBS, SWITCHES AND METERS. OTHER RECESS DEPTHS AVAILABLE. CONTACT TA SALES DEPARTMENT FOR MODIFICATION SUFFIX. NOTE: ALL RECESSED PANEL RAILS ARE CODE U REGARDLESS OF RECESS DIMENSION.

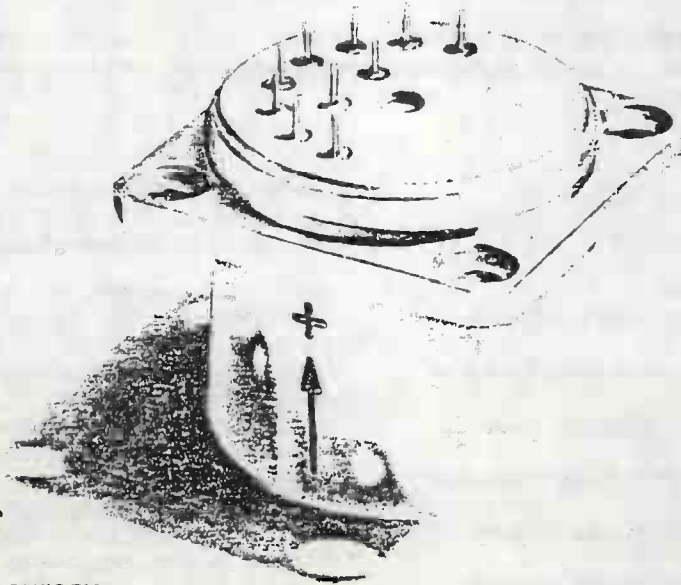


FLUSH RAIL CODE P  
PANEL MOUNTING SURFACE RECESSED 0.10" BELOW PARTING LINE POSITIONS CUSTOMER PANEL APPROX FLUSH TO TOP OF STRIKER RIM

NOMINAL PANEL HEIGHT	TA CASE NUMBER	H CASE HEIGHT	E MINIMUM PANEL CLEARANCE	NO. OF LATCHES	NO. OF HANDLES	NO. OF CLIPNUTS SUPPLIED PER COVER	TYPE OF BUMPER OPPOSITE PANEL OPENING
5 1/4"	33	6.34	5.45	2	2	4	DIMPLE
7"	34	8.09	7.21	2	2	4	DIMPLE
8 3/4"	35	9.84	8.95	2	2	4	TC01E75-1
10 1/4"	36	11.59	10.70	2	2	8	TC01E75-1
12"	37	13.34	12.45	2	2	8	TC01E75-1
14"	38	15.09	14.20	4	2	8	TC01E75-1
15 3/4"	39	16.84	15.95	4	2	8	TC01E75-1
17 1/4"	40	18.59	17.70	4	2	8	TC01E75-1
19 1/4"	41	20.34	19.45	4	4	8	TC01E75-1
21"	42	22.09	21.20	4	4	8	TC01E75-1
24 1/4"	43	25.59	24.70	4	4	8	TC01E75-1
26 1/4"	44	27.34	26.45	4	4	8	TC01E75-1

# QA-900

## SUNDSTRAND DATA CONTROL'S Q-FLEX® SERVO ACCELEROMETER



### **Features**

- Cost-Effective High Accuracy
- Field-Adjustable Voltage Sensitivity and Range
- Consistently Repeatable Accuracy and Stability
- Self-Contained Sensor and Electronics in One Small Hermetic Package
- Better than 5 micro g Threshold and Resolution
- Dual Built-In Test Capability
- Wide Dynamic Range

### **Applications**

High Accuracy, Low Frequency Environments:

- Laboratories
- Research Centers
- Equipment Monitoring Stations
- Instrumentation Facilities

Sundstrand Data Control's QA-900 Q-Flex® servo accelerometer is specifically designed for the high accuracy, low frequency application.

The Q-Flex® accelerometer is the only linear servo instrument with a patented etched quartz seismic system for completely elastic non-wearing suspension. This seismic system and a specially designed solid-state hybrid electronics module are contained in one miniature hermetic package.

The QA-900 electronics develops an acceleration-proportional servoed current when in operation. This current keeps the seismic element in a position-captured mode. In this mode, the accelerometer provides an accurate and continuous measure of both static and dynamic acceleration with no low frequency roll-off errors.

The QA-900's voltage sensitivity and/or range may be changed at any time by simply changing the external, user-supplied load resistor. Changing the load resistor will not affect the QA-900's performance characteristics or frequency response.



# QA-900 Technical Data

## PERFORMANCE

Linear Output Range	±20g
Frequency Response	
0 - 10 Hz	±0.1% max
10 - 300 Hz	±5% max
Natural Frequency	500 Hz min
Resolution/Threshold	5μg max
Current Sensitivity	1.3mA/g nom
Current Thermal Coefficient	180 ppm/°C nom
Bias	10mg max
Bias Thermal Coefficient	90μg/°C nom
Transverse Sensitivity	0.002g/g max
Linearity Error	30μg/g <sup>2</sup> max
Damping Ratio	0.3 to 0.8

## ELECTRICAL

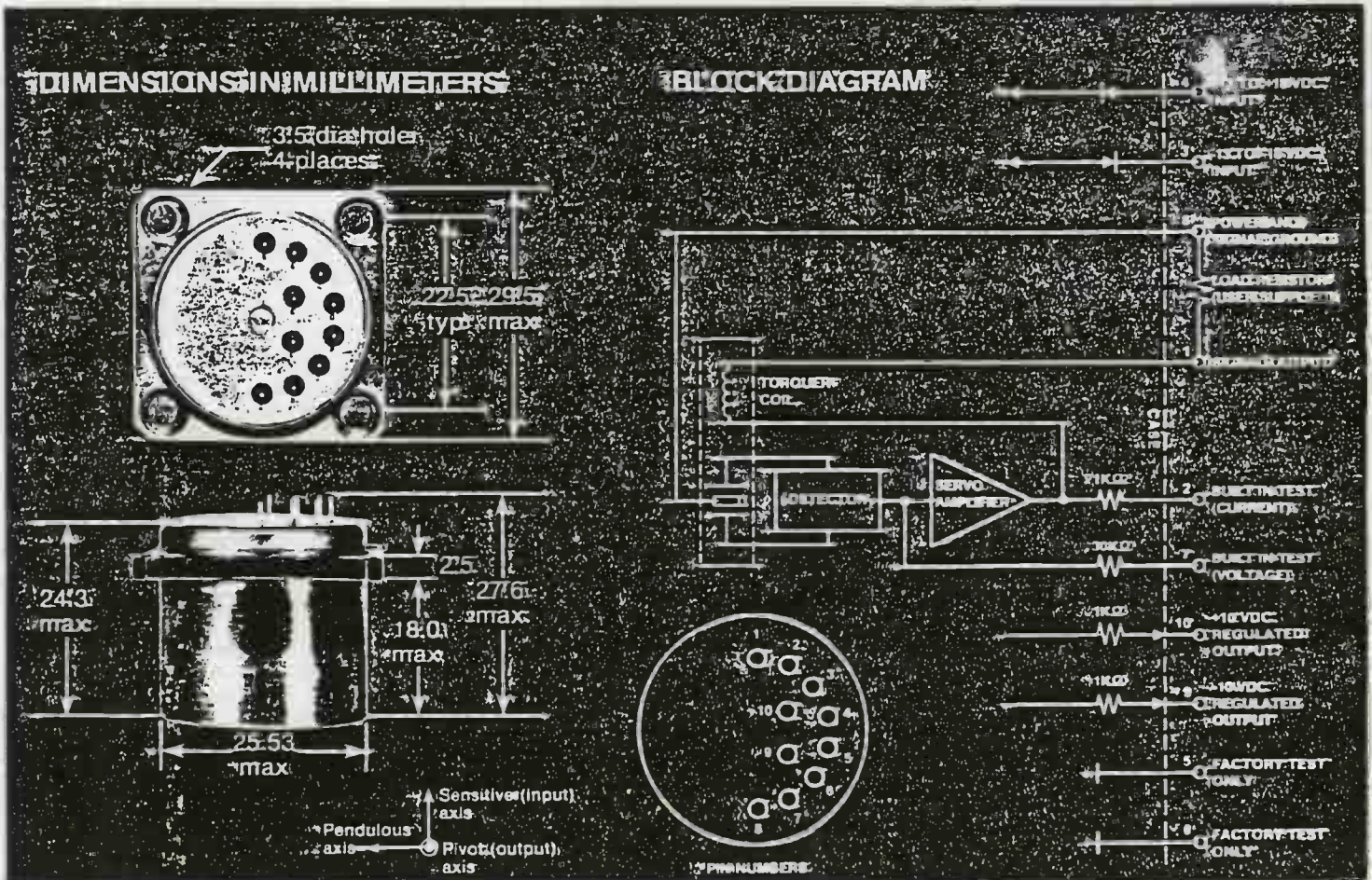
Input Voltage	±13 VDC to ±18 VDC
Quiescent Current Max	15mA per supply
Isolation, case to all pins	10 megohms at 50 VDC

## ENVIRONMENTAL

Specified Performance Temperature Range	-40°C to +85°C
Storage Temperature Range	-54°C to +107°C
Static Acceleration Overrange Limit	100g peak
Shock Limit	250g peak, 6 msec
Sine Vibration Limit	30g peak, 20 to 1800 Hz

## PHYSICAL

Weight	65 grams
Case Material	Stainless Steel



For additional information on specific requirements, direct all inquiries to the Marketing Department, Instrument Systems Division, Sundstrand Data Control, Inc. 206/885-3711.

**Sundstrand Data Control, Inc.**  
 REDMOND, WASHINGTON 98052  
 unit of Sundstrand Corporation



SG 158 - 11 H -

PAGES

# SG 128, MG 128, SG 158 Series 120 and 350 OHM Quarter Bridge For Static and Dynamic Measurements from $-452^{\circ}$ to $600^{\circ}$ F.

**FEATURES**

- HIGH TEMPERATURE
- 600 F STATIC AND DYNAMIC
- SELF TEMPERATURE COMPENSATED
- NICKEL-CHROME ALLOY
- 120 AND 350 OHM RESISTANCE
- ALL WELDED CONSTRUCTION
- INTEGRAL CABLE
- NO ADHESIVES REQUIRED
- SIMPLE RAPID INSTALLATION

**DESCRIPTION**

AILTECH Sealed Strain Gages are quickly installed in the field, providing immediate, reliable strain data — in almost any environment — at the lowest overall cost by eliminating hours of tedious preparation, installation and gage protection procedures.

AILTECH Weldable Strain Gages are available with 120 and 350 ohm, quarter bridge, nickel-chrome filaments, and are suitable for static and dynamic measurements from  $-452^{\circ}$  to  $-600^{\circ}$  F. They provide minimum apparent strains and are self-temperature compensated for your material. Quarter bridge gages are normally used from  $75^{\circ}$  to  $600^{\circ}$  F for static measurements. Half bridge configurations provide more precise compensation in temperature spans from  $-452^{\circ}$  to  $-75^{\circ}$  F and other cryogenic ranges.

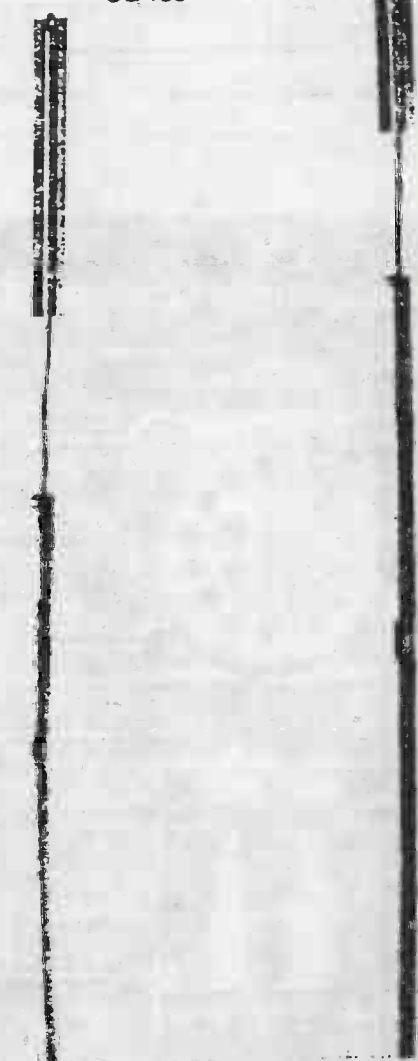
The 350 ohm filament permits higher excitation voltages and reduces errors associated with long leads. All closures on these strain gages are welded. This all-welded construction is the only type gage readily usable in hostile environments such as nuclear reactors, steam turbines, and pressurized chambers.

Every Ailtech Strain Gage is pre-tested at the factory to its maximum operating temperature to assure proper operation in its intended application.

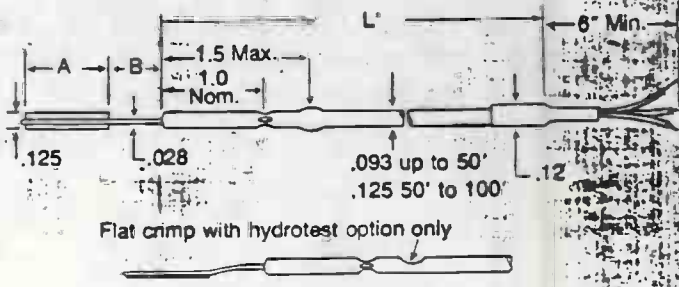
Ailtech Weldable Strain Gages are easily installed using low energy capacitive discharge spot welding equipment. A series of spot welds quickly makes the gage an integral part of the test structure, assuring complete strain transmission.

SG 128  
SG 158

MG 128



	SG 128	SG 158	MG 128
A	1.09		.50
B	.63		.50





**ELECTRICAL SPECIFICATIONS**

**Strain Gage Resistance**

Model: SG 128 SG 158 MG 128  
Resistance: 120 ohms  $\pm$  1% 350 ohms  $\pm$  10% 120 ohms  $\pm$  5%

\*When compensated for materials with thermal coefficient of expansion between 6.0 and 10.5 ppm/ $^{\circ}$ F.  $\pm$  3 ohms when compensated for other expansion ranges.

**Integral Lead Wire Resistance**

.09 ohms/ft. at 75 $^{\circ}$ F

**Excitation Current**

Continuous: 50 ma maximum  
Pulsed: To 300 ma Depending on operating temperature and test structure.

**Insulation Resistance**

Greater than 1000 megohms at 50 vdc measured at 75 $^{\circ}$ F.

**PERFORMANCE SPECIFICATIONS**

**Gage Factor**

SG 128 and SG 158 1.9 Nominal  
MG 128 1.7 Nominal

Actual gage factor is reported for each lot.  
Gage factor for all gages within a particular lot is within  $\pm$ 3%

**Rated Strain Level:**

$\pm$  20,000 microinches per inch

**Fatigue Life:**

Exceeds 10<sup>6</sup> cycles at  $\pm$  1,000 microinches per inch.

**Transverse Sensitivity:**

Negligible (Line weld between strain tube and mounting flange)

**ENVIRONMENTAL SPECIFICATIONS**

**Operable Temperature Range**

Static and dynamic measurements -452 to 600 $^{\circ}$ F.

**Compensated Temperature Range**

Gages are individually temperature compensated

Designation	Temperature Range
-01	75 to 600 $^{\circ}$ F.
-11	0 to 180 $^{\circ}$ F.
-09	Special Range (Specify on order)

**Caution:** If the temperature of the strain gage exceeds 650 F, the temperature compensation will be irreversibly affected.

**Apparent Strain vs. Temperature**

Each gage is adjusted to an optimum unmounted terminal slope value, depending upon the material on which the gage is to be mounted, within a strain tolerance of 50 microinches per inch. When the gage is installed, the mounted terminal slope will be zero within a strain tolerance consisting of the summation of  $\pm$  75 microinches per inch and  $\pm$  3% of the unmounted terminal slope.

**Gage Factor Change with Temperature:**

Gage Factor varies inversely with temperature approximately 1% per 100 $^{\circ}$ F over the compensated temperature range.

**Additional Environments:**

The strain gages have been subjected to the following environments and levels without deterioration of performance.

- Linear Sinusoidal Vibration: 35g, 20 to 2000 cps
- Static Acceleration: 50g
- Shock: 100g half sine, 7 millisecond duration
- Acoustic Noise: 150 db
- Ambient Pressure: Vacuum to 4000 psi (2500 psi for .125 dia. cable)

**MECHANICAL SPECIFICATIONS**

**Strain Gage Configurations:**

Refer to dimensional outline drawings shown on front.

**Electrical Connections:**

Red — Active, Black — Dummy, White — Common

**Strain Gage Center:**

of the gage, gage center is at the center of the mounting flange.

**Active Gage Length:**

0.91" for SG 128, 0.61" for SG 158 and 0.21" for MG 128

**Strain Gage and Mounting Flange Material:**

AISI Type 321, Stainless steel. Intended for mounting on weldable ferrous and nonferrous materials excluding aluminum and magnesium.

**Lead Wire:**

Three No. 28 AWG nickel-clad solid copper wires individually insulated with braided fiberglass sleeving that are installed in a 0.093" diameter Type 321 stainless steel tube for up to 50 foot lengths and .125 dia. to 100 feet.

**ORDERING INFORMATION**

Detailed ordering information and available options are shown on a separate instruction sheet.

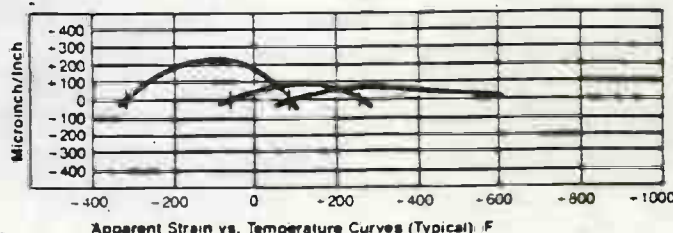
**Standard Gages**

Standard Gages are stocked in limited quantities for immediate shipment. These gages solve the majority of strain measurement problems encountered. They include ten feet of integral cable, and are compensated to match 1018 steel (6S) or 321 stainless steel (9S) over the temperature range of 75 to 600 $^{\circ}$ F.

**Custom Gages**

Ordering of Custom Gages with other cable lengths, temperature ranges, options, compensations etc., requires a detailed build-up of the custom model number.

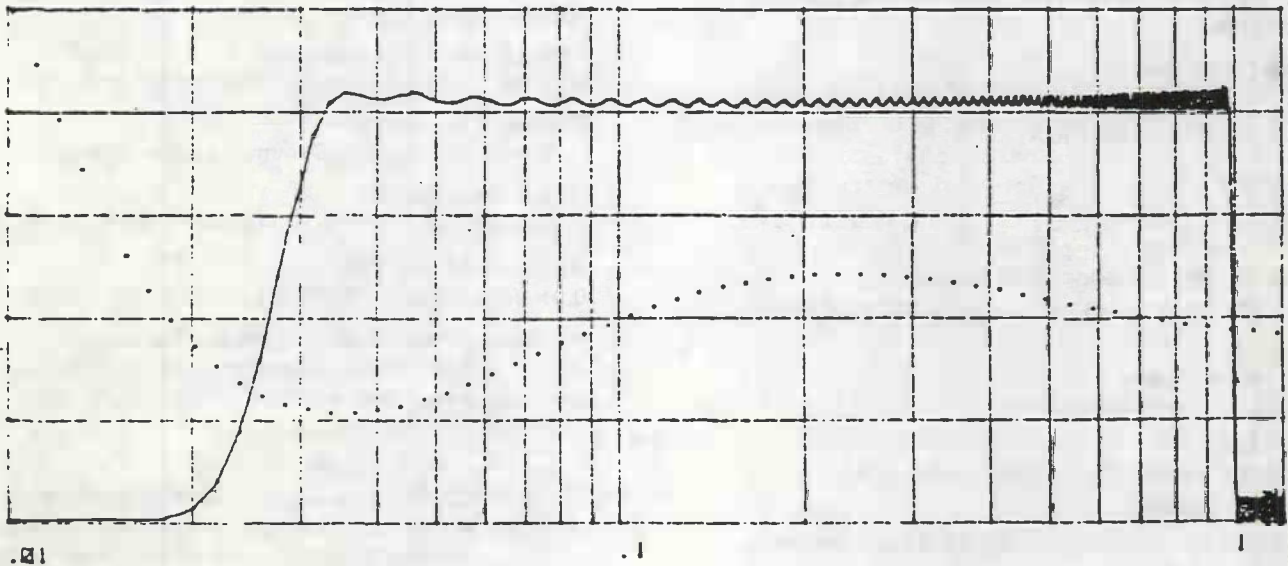
Consult factory for further information or applications assistance.



# DATAWELL

## HIPPY 120

# HEAVE COMPENSATOR



### summary

The Hippy-120 heave compensator has been designed to give a satisfying answer to the conflicting demands of a large frequency working range and a low ship manoeuvring sensitivity, maintaining the conception of an instrument which does not need attendance, except a yearly check.

To this purpose a pendulum stabilizer is used with which we have long experience in a much tougher environment (wave measuring buoy).

The pendulum system, natural period 120 seconds, attenuates ship manoeuvring effects and the remainder, appearing at frequencies around 1/120 or 1/60 Hz, is filtered out by a digital band pass filter.

This filter allows true phase and amplitude transfer in the frequency range down to 1/30 Hz together with sufficient suppression of ship manoeuvring effects at 1/60 and 1/120 Hz.

The lowest frequency in the working range is of utmost importance when sailing has to be with the wave direction, as in this case the encounter frequencies can be substantially lower than wave frequencies.

The system does not contain moving parts, except gimbal rings, so lifetime is not limited by wear.

After power up, communication (on RS232 or RS422) is either automatically initiated by the end of selftest (fixed), or by a message specifying baud rate, data sequence, scales and format.

### Datawell bv

laboratory for instrumentation  
Zomerluststraat 4  
2012 LM Haarlem - The Netherlands  
tel. 023-31 60 53  
telex: 41415 datel nl

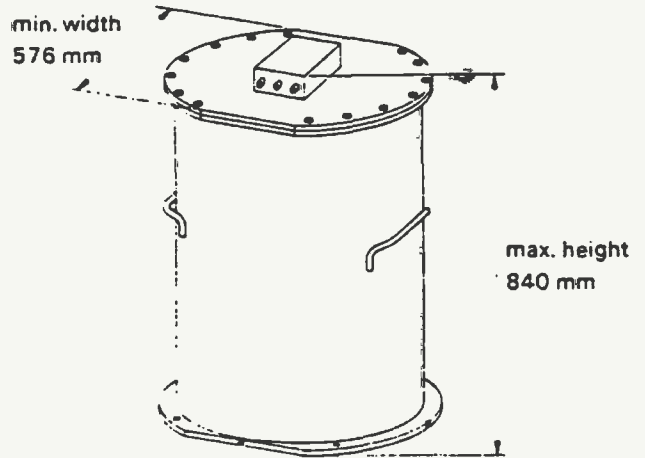
**Description of heave compensators versions B and C**

The heave compensator can be delivered in two versions B (analog) and C (analog + digital). Acceleration is measured by an accelerometer mounted on a gravity stabilized platform with a natural period of 120 sec or an equivalent pendulum length of 3.6 km. The same platform is used as a reference for pitch/roll measurements.

*The analog version* is intended only for slow manoeuvring use. It delivers real time heave (obtained by analog double integration of acceleration) pitch, roll and acceleration. For compensation purposes, both amplitude and phase must be true in the working range. One degree phase error is equivalent to 1.7% amplitude error. The resulting compensation error can be expressed in the 'error vector' i.e. the relative vectorial difference between true and indicated displacement vector.

If ship speed, with wave direction, increases to a value comparable with wave velocity, the encounter frequencies are lowered due to Doppler shift. Further the turn around effects increase proportional to the ship speed squared. Turn around means 180° course change. The Doppler shift asks for an extension of the working range to lower frequencies. However, filter theory dictates a larger sensitivity for turn around effects proportional to the square of the longest period in the working range. The resulting compromise limits the applicability.

*The digital version (delayed filtering)* gives an improvement of about 70 times in the compromise between working range and turn around problems of which 4 times is used for a two times frequency range extension (from 15 to 30 sec period) leaving for turn around false output suppression, an improvement of about seventeen times. An automatic warning is given when, due to Doppler shift, too much heave energy is present below 0.033 Hz. Version C is an extension of the B version.



**specifications for heave pitch roll sensor, Hippy-120**

The Hippy-120 outputs:

			Version	
			B	C
<i>Heave</i>	real time Heave.	analog	x	x
	77.2 sec delayed Heave (digitally filtered)	digitized		x
	Programmable scale	analog digitized		x
<i>Pitch/roll</i>	Real time SIN (pitch/roll)	analog	x	x
	Programmable (degrees/SIN)	digitized		x
<i>Vertical acceleration</i>	0.32 sec delayed	analog digitized	x	x
<i>Error Heave</i>	± 80 sec delayed – Heave between 1/60 and 1/30 Hz	analog digitized		x
<i>Error warning</i>	Error Heave level detector	Flag		x
<i>Supply</i>	Any voltage between Power consumption	10 - 30 V dc	x	x
		7.5 W		x
		0.25 W	x	
<i>Temperature range</i>	Storage	-5 - +40° C	x	x
	Working range	0 - 35° C	x	x
<i>Vibration</i>	< 16 Hz	1 mm peak max.	x	x
	> 16 Hz	1 g peak max.	x	x
<i>Size</i>	see figure			
<i>Weight</i>		120 kg	x	x

## heave/acceleration

	Analog filtered Heave	Digital filtered Heave	Acceleration
Error vector	3.5%(0.067-1.0Hz)	3%(0.033-0.5Hz)	< 1% for <0.5 Hz 1.6 Hz cut off, 5th order
Scale digitized output	programmable	programmable	programmable
Scale analog output	1 V/m	1 V/m	1 V/m/sec <sup>2</sup>
Scale accuracy (within temp. range)	< 1.5%	< 2%	< 1.5%
Range	-10 -+10 V (2048 bits)	-10 -+10 V (2048 bits)	-10 -+10 V (2048 bits)
Change in accuracy during 1 year	< 1%	< 1%	< 1%
Zero offset	< 5 cm	zero	< 1 m/sec <sup>2</sup>
Time delay	version C zero	77.20 sec	0.32 sec
	version B zero	-	0.32 sec
Turn around (180° course change): false heave output (cm)	4x [ship speed (m/sec)] <sup>2</sup>	0.24x [ship speed (m/sec)] <sup>2</sup>	
For other course and speed changes see next page			

### Update cycle of analog outputs (version C)

Digitally filtered Heave	160 msec
Acceleration	10 msec
Analog filtered Heave	10 msec
Pitch/roll	10 msec
Error/Heave	2.72 sec

## pitch/roll

### Definition

Pitch angle is angle between *roll* axis and horizontal plane.

Roll angle is angle between *pitch* axis and horizontal plane.

Scale analog  
digitized  
Output range  
Linearity

10 SIN (pitch/roll angle) V  
Programmable

-10 - +10 V (2048 bits)

< 0.05° up to 5°

< 0.15° up to 30°

< 1° up to 60°

Zero offset  
Zero stability  
Noise

Within temp. range < 0.5°

Within time over 1 year < 1°

< 0.05°

A temporary offset  $\Delta\alpha$  is caused by horizontal acceleration:

For sinusoidal accelerations and period time  $T \gg 120$  sec:

$$\Delta\alpha = a/g \text{ (radian). } a \text{ is peak value of horizontal acceleration (m/sec}^2\text{.)}$$

For sinusoidal accelerations and period time  $T \ll 120$  sec:

$$\Delta\alpha = \Delta s/3600 \text{ (radian) } \Delta s \text{ is peak value of horizontal displacement (m.)}$$

For sudden change in ship speed (V m/sec):

$$\Delta\alpha = \Delta V/180 \text{ (radian).}$$

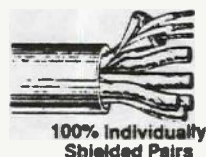




MULTIPLE PAIR INDIVIDUALLY SHIELDED (cont'd.)

Description	Trade & U.L. Styles Number	Standard Lengths		Pkg. Wt. Lbs. ea.	Nom. D.C.R.		Nom. of Pairs	Nominal G.D.C.		Nom. Imp. (ohms)	Ndrr. Vols. per Pair	Nominal Capacitance				Gnd. Lead Lmm. Thous. ord.
		ft.	m.		Cable	Strajer		Inchs.	mm.			per ft.	per m.	per ft.	per m.	

**22 GAGE (cont'd.)**  
**STRANDED CONDUCTORS (7 x 30) .76 mm diam.**



<b>9767</b> †  <b>2493</b> <b>60C</b>	100	30.5	44.2	<b>22 (7x30)</b> [ .76 ] tinned copper <b>15Ω/M'</b> 49.2Ω/km	<b>11.3Ω/M'</b> 37.1Ω/km	<b>37</b>	<b>.850</b>	<b>21.6</b>	<b>50</b>	<b>66%</b>	<b>30</b>	<b>98</b>	<b>55</b>	<b>180</b>	<b>1.7</b>
	250	76.2	112.4												
	500	152.4	228.8												
	1000	304.8	487.6												

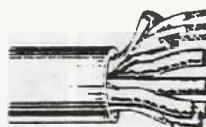
**PRODUCT DESCRIPTION:** Tinned copper, polypropylene insulated, twisted pairs, each pair and its stranded tinned copper drain wire (22 AWG on 22 AWG and 20 AWG series, 20 AWG on 18 AWG series) under BELDFOIL (aluminum-polyester shield, overall chrome PVC jacket. 300 volts suggested for 22 AWG, 350 volts for 20 AWG, 400 volts for 18 AWG. Color code chart 1. Technical Information Section.

**20 GAGE STRANDED CONDUCTORS (10 x 30) .94 mm diam.**

**PRODUCT DESCRIPTION:**

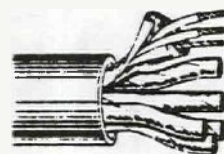
Tinned copper, polypropylene insulated, twisted pairs, each pair and its stranded tinned copper drain wire (20 AWG on 20 AWG and 18 AWG series, 18 AWG on 16 AWG series) under BELDFOIL (aluminum-polyester shield, overall chrome PVC jacket. Color code chart 1. Technical Information Section. Insulation resistance between strands 100 megohms/M nom. Capacitance between adjacent shields 115 pF/ft nom. Voltage breakdown between adjacent shields 3000 volts.

Recommended for use in applications where the cable will be subjected to severe environmental conditions. Frequency properties and mechanical properties.



<b>9873</b> †  <b>2493</b> <b>60C</b>	100	30.5	6.7	<b>20 (10x30)</b> [ .94 ] tinned copper <b>10.5Ω/M'</b> 34.4Ω/km	<b>11.3Ω/M'</b> 37.1Ω/km	<b>3</b>	<b>.355</b>	<b>9.04</b>	<b>50</b>	<b>66%</b>	<b>30</b>	<b>98</b>	<b>55</b>	<b>180</b>	<b>2.4</b>
	250	76.2	16.8												
	500	152.4	32.1												
	1000	304.8	67.7												
<b>9874</b> †  <b>2493</b> <b>60C</b>	100	30.5	12.8	<b>22 (10x30)</b> [ .94 ] tinned copper <b>10.5Ω/M'</b> 34.4Ω/km	<b>11.3Ω/M'</b> 37.1Ω/km	<b>6</b>	<b>.471</b>	<b>11.96</b>	<b>50</b>	<b>66%</b>	<b>30</b>	<b>98</b>	<b>55</b>	<b>180</b>	<b>2.4</b>
	250	76.2	29.8												
	500	152.4	63.2												
	1000	304.8	123.4												
<b>9875</b> †  <b>2493</b> <b>60C</b>	100	30.5	18.3	<b>22 (10x30)</b> [ .94 ] tinned copper <b>10.5Ω/M'</b> 34.4Ω/km	<b>11.3Ω/M'</b> 37.1Ω/km	<b>9</b>	<b>.555</b>	<b>14.10</b>	<b>50</b>	<b>66%</b>	<b>30</b>	<b>98</b>	<b>55</b>	<b>180</b>	<b>2.4</b>
	250	76.2	46.3												
	500	152.4	90.6												
	1000	304.8	182.2												
<b>9876</b> †  <b>2493</b> <b>60C</b>	100	30.5	20.5	<b>20 (10x30)</b> [ .94 ] tinned copper <b>10.5Ω/M'</b> 34.4Ω/km	<b>11.3Ω/M'</b> 37.1Ω/km	<b>11</b>	<b>.580</b>	<b>14.73</b>	<b>50</b>	<b>66%</b>	<b>30</b>	<b>98</b>	<b>55</b>	<b>180</b>	<b>2.4</b>
	250	76.2	51.8												
	500	152.4	101.6												
	1000	304.8	201.2												
<b>9877</b> †  <b>2493</b> <b>60C</b>	100	30.5	21.8	<b>20 (10x30)</b> [ .94 ] tinned copper <b>10.5Ω/M'</b> 34.4Ω/km	<b>11.3Ω/M'</b> 37.1Ω/km	<b>12</b>	<b>.600</b>	<b>15.24</b>	<b>50</b>	<b>66%</b>	<b>30</b>	<b>98</b>	<b>55</b>	<b>180</b>	<b>2.4</b>
	250	76.2	55.2												
	500	152.4	112.3												
	1000	304.8	217.6												
<b>9879</b> †  <b>2493</b> <b>60C</b>	100	30.5	28.0	<b>20 (10x30)</b> [ .94 ] tinned copper <b>10.5Ω/M'</b> 34.4Ω/km	<b>11.3Ω/M'</b> 37.1Ω/km	<b>15</b>	<b>.655</b>	<b>16.64</b>	<b>50</b>	<b>66%</b>	<b>30</b>	<b>98</b>	<b>55</b>	<b>180</b>	<b>2.4</b>
	250	76.2	67.5												
	500	152.4	132.1												
	1000	304.8	251.2												

**18 GAGE STRANDED CONDUCTORS (16 x 30) 1.19 mm diam.**



<b>9773</b> †  <b>2493</b> <b>60C</b>	100	30.5	9.1	<b>18 (16x30)</b> [ 1.19 ] tinned copper <b>6.4Ω/M'</b> 21Ω/km	<b>8.3Ω/M'</b> 27.2Ω/km	<b>3</b>	<b>.398</b>	<b>9.96</b>	<b>50</b>	<b>66%</b>	<b>30</b>	<b>98</b>	<b>55</b>	<b>180</b>	<b>3.9</b>
	500	152.4	46.3												
	1000	304.8	91.5												
<b>9774</b> †  <b>2493</b> <b>60C</b>	100	30.5	19.3	<b>18 (16x30)</b> [ 1.19 ] tinned copper <b>6.4Ω/M'</b> 21Ω/km	<b>8.3Ω/M'</b> 27.2Ω/km	<b>6</b>	<b>.570</b>	<b>14.48</b>	<b>50</b>	<b>66%</b>	<b>30</b>	<b>98</b>	<b>55</b>	<b>180</b>	<b>3.9</b>
	500	152.4	97.8												
	1000	304.8	192.5												
<b>9775</b> †  <b>2493</b> <b>60C</b>	100	30.5	29.1	<b>18 (16x30)</b> [ 1.19 ] tinned copper <b>6.4Ω/M'</b> 21Ω/km	<b>8.3Ω/M'</b> 27.2Ω/km	<b>9</b>	<b>.655</b>	<b>15.88</b>	<b>50</b>	<b>66%</b>	<b>30</b>	<b>98</b>	<b>55</b>	<b>180</b>	<b>3.9</b>
	500	152.4	73.3												
	1000	304.8	143.5												