

Public Involvement and Continuous Change

Architectural Framework for
Change: Cultural Community
Center Grasbrook

Explore Lab
Graduation Studio
TU Delft
2021 - 2022

P5
13.01.2022
Leon Thormann





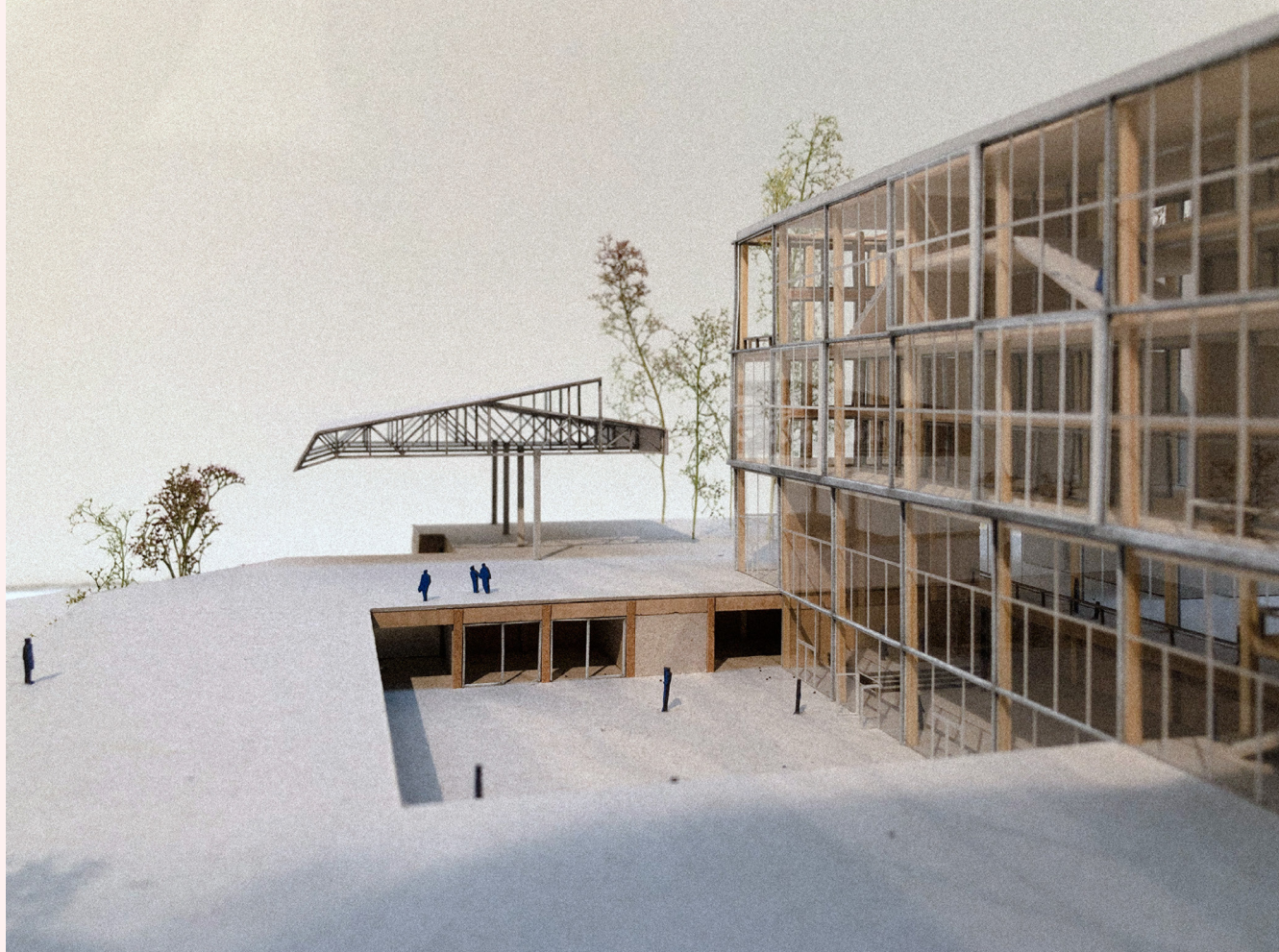

Overall Question

How does architecture find its form in accommodating public involvement and in becoming something that evolves continuously (change)?



Literature Review

Public Stage



„Architecture is the stage upon which public life can develop. Only citizens can make society.“

„A real public realm is characterized by the simultaneity of countless perspectives.“

Hans Teerds about
Hannah Arendt
(2008)

Literature Review

Engaging Spaces



SESC Pompeia Sao Paulo
Lina Bo Bardi (1986)



De Meerpaal Dronen
Frank van Klingeren (1965)

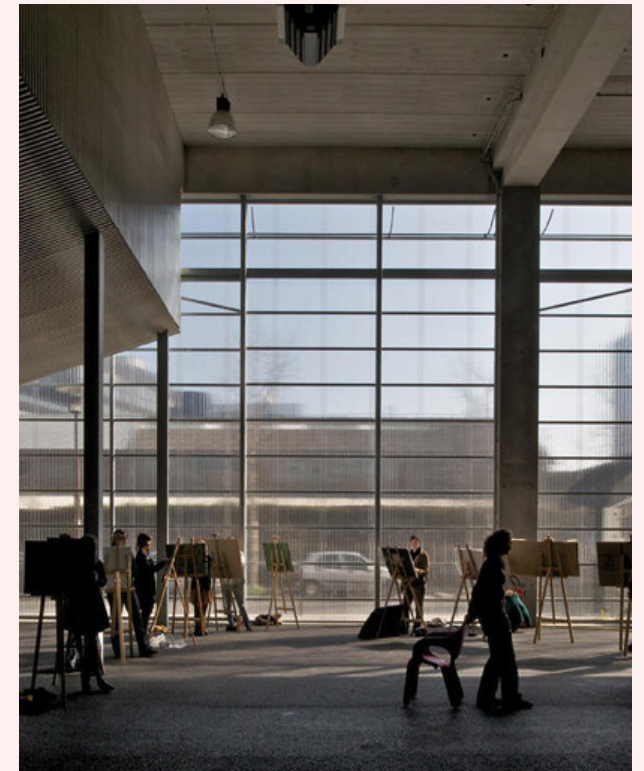

Nantes School of Architecture
Lacaton & Vassal (2009)

Research Case Berlijn-Plein

Impressions

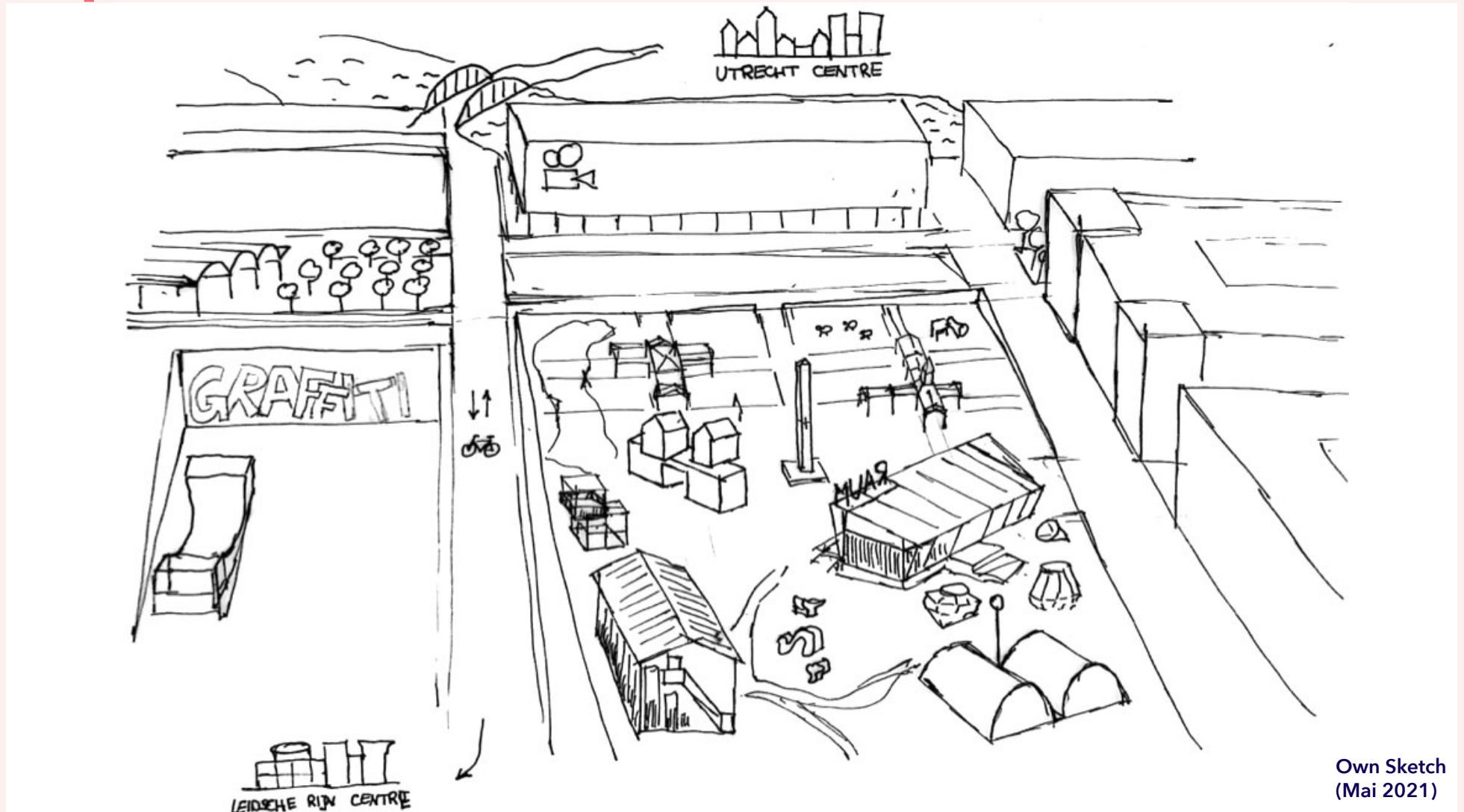

Research Case Berlin-Plein

Impressions

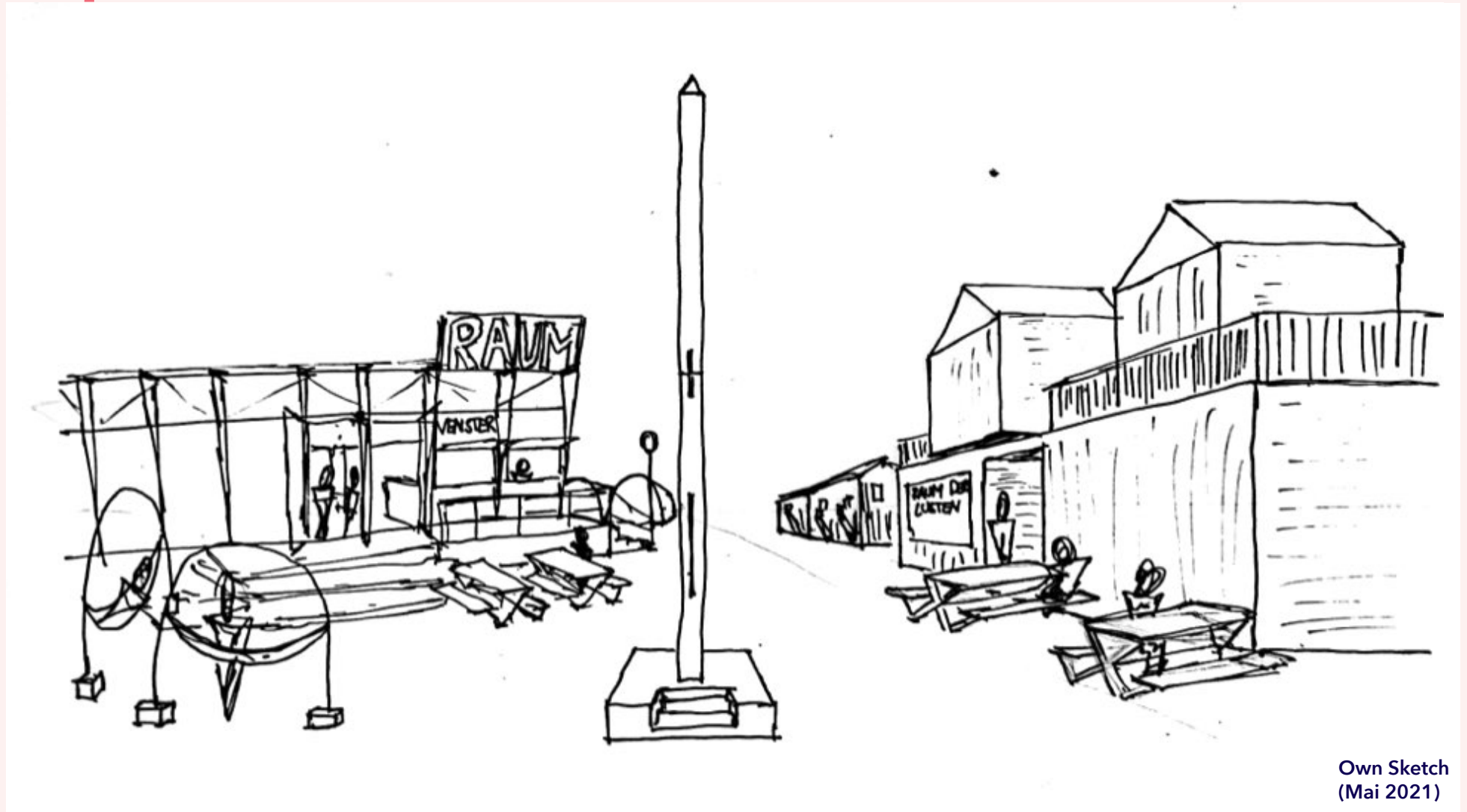

Own Sketch
(Mai 2021)

Research Case Berlin-Plein „Circus“ and „Maker as Pioneer“



Idea of the Glazen Circus (April 2016)



Programe Strategy by State of Flux (2016)

Site Case Grasbrook

Active Citizen



Community House Losepark



Hamburg votes NO! to Olympia





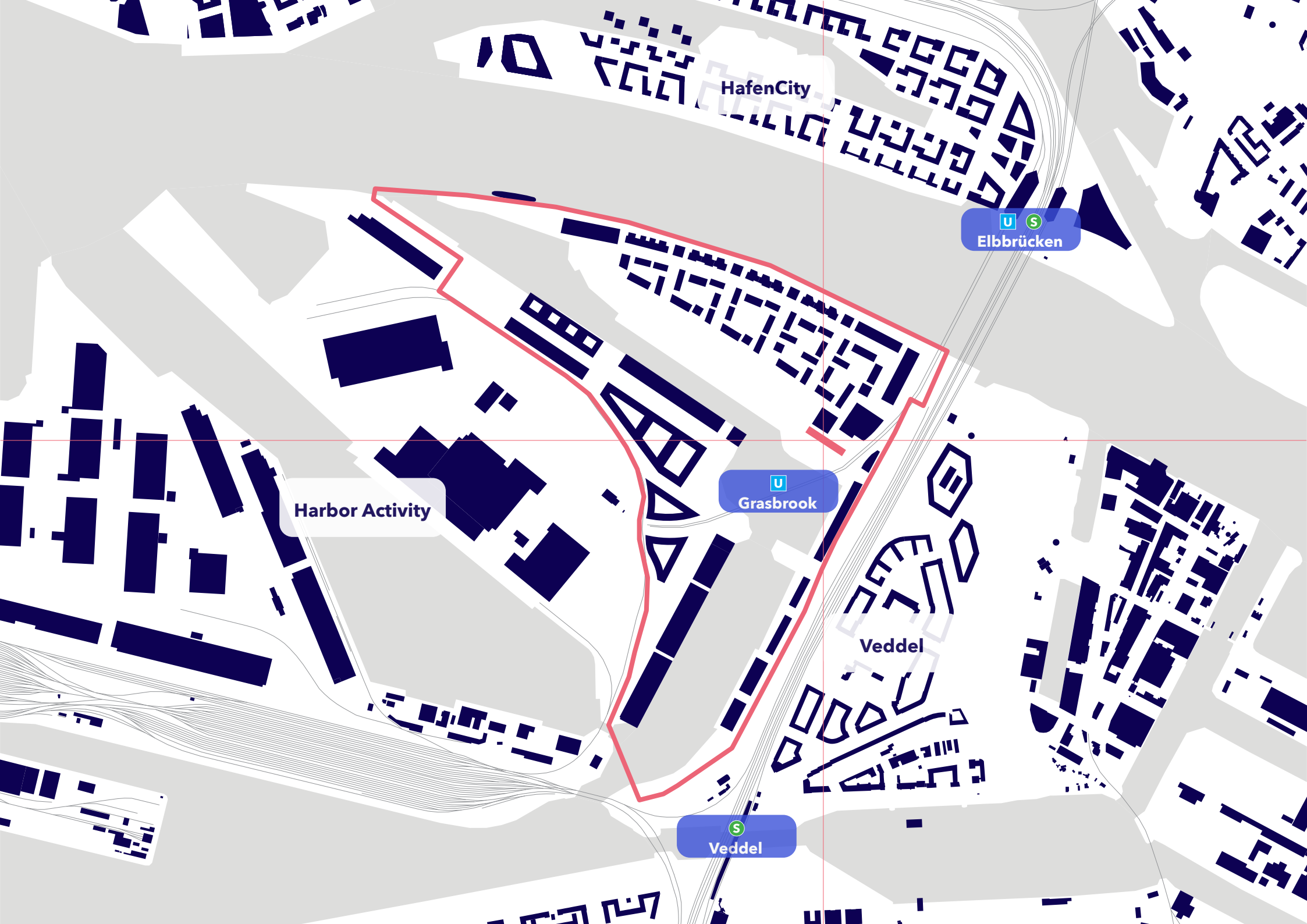

HafenCity

U S
Elbbrücken

Harbor Activity

U
Grasbrook

Veddel

S
Veddel



View to Elbphilharmonie



View to Train Stop Elbbrücken



Site

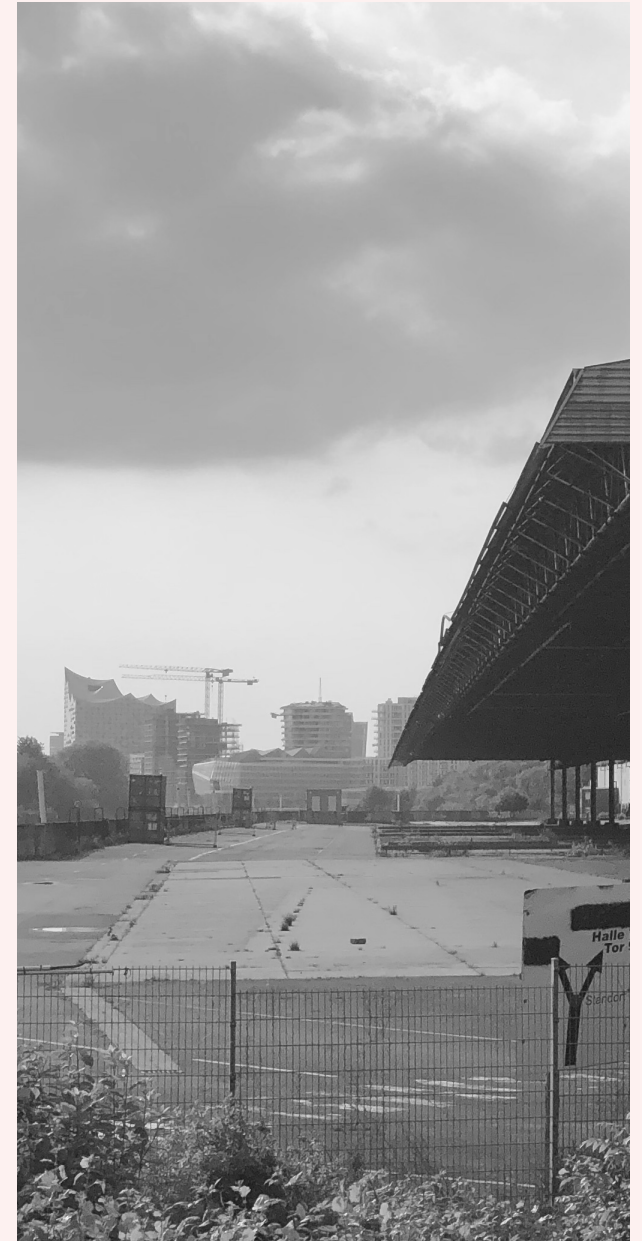

View from Site to Elbphilharmonie



- Community Centre
- School
- Roof

Competition
Masterplan
2020

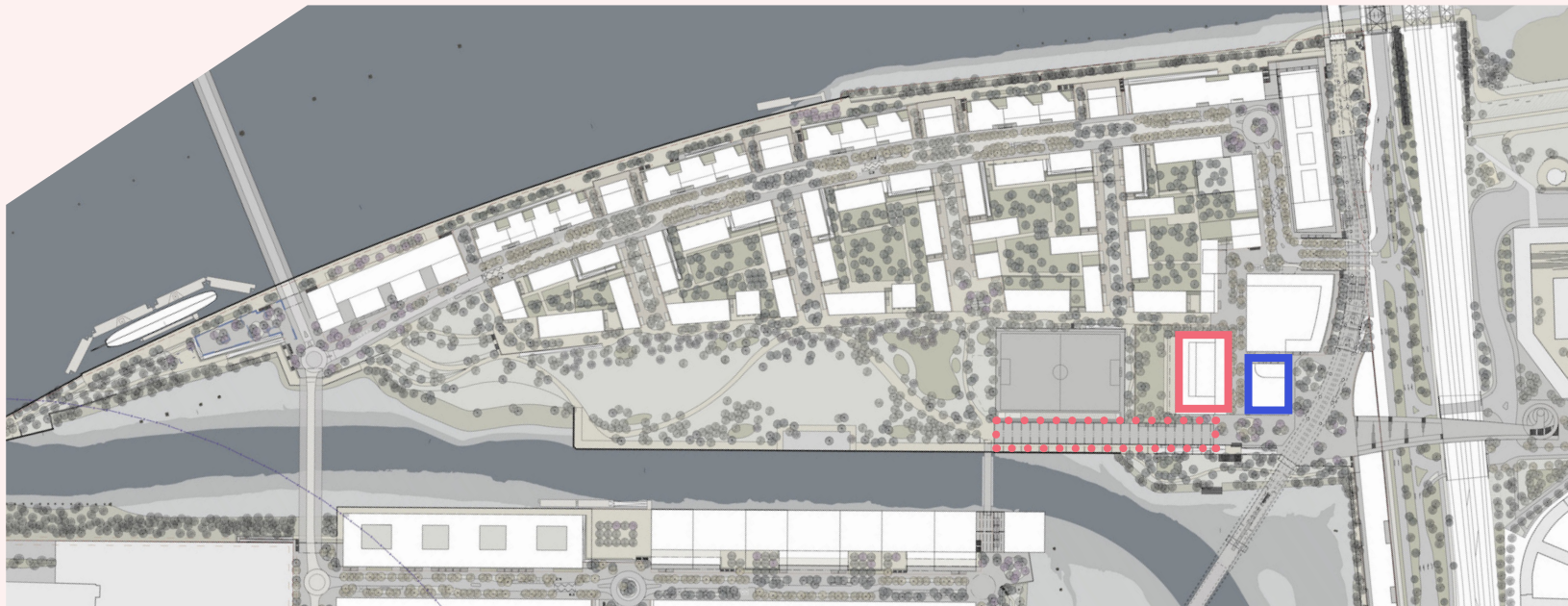

Updated
Masterplan
2021



Model of old masterplan

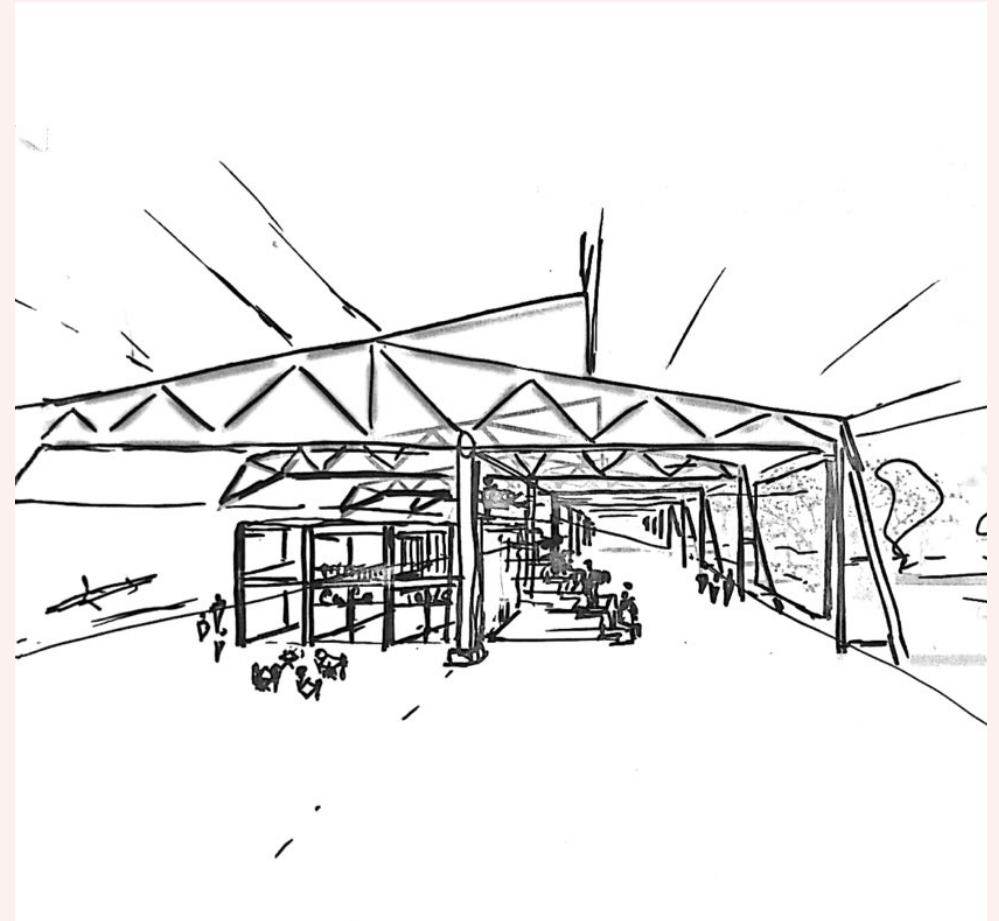

Potential Sketch



Old roof
Überseezentrum





Webcam
Grasbrook
29th Nov. 2021



Webcam
Grasbrook
08th Jan. 2022

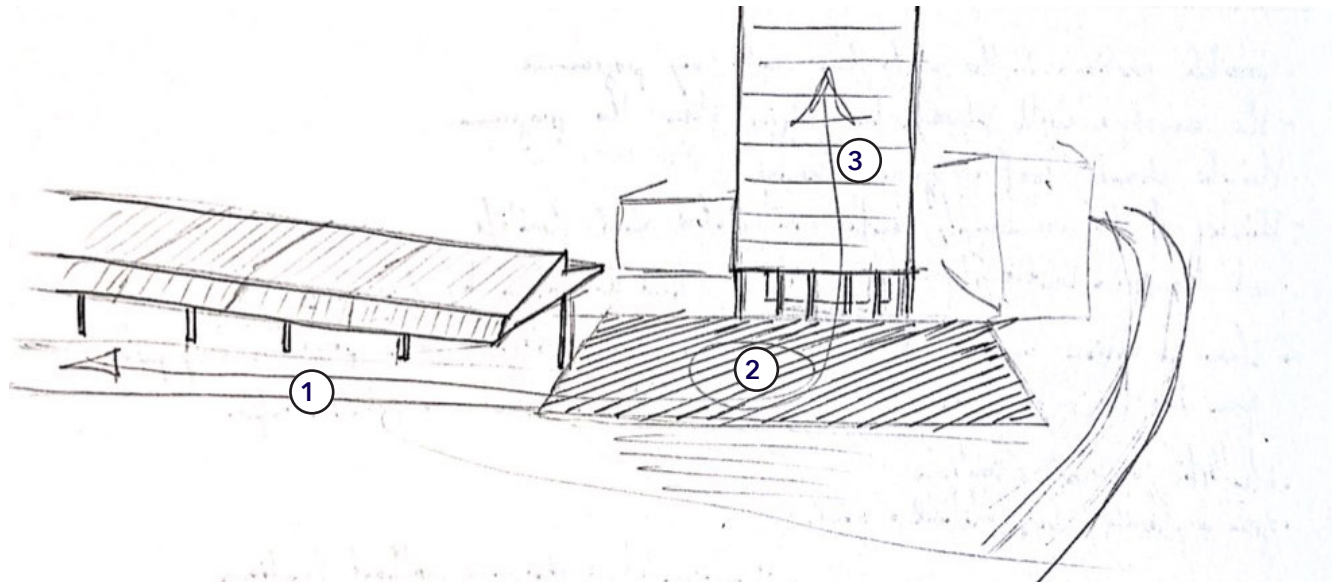

Experiment
Sketch + Model

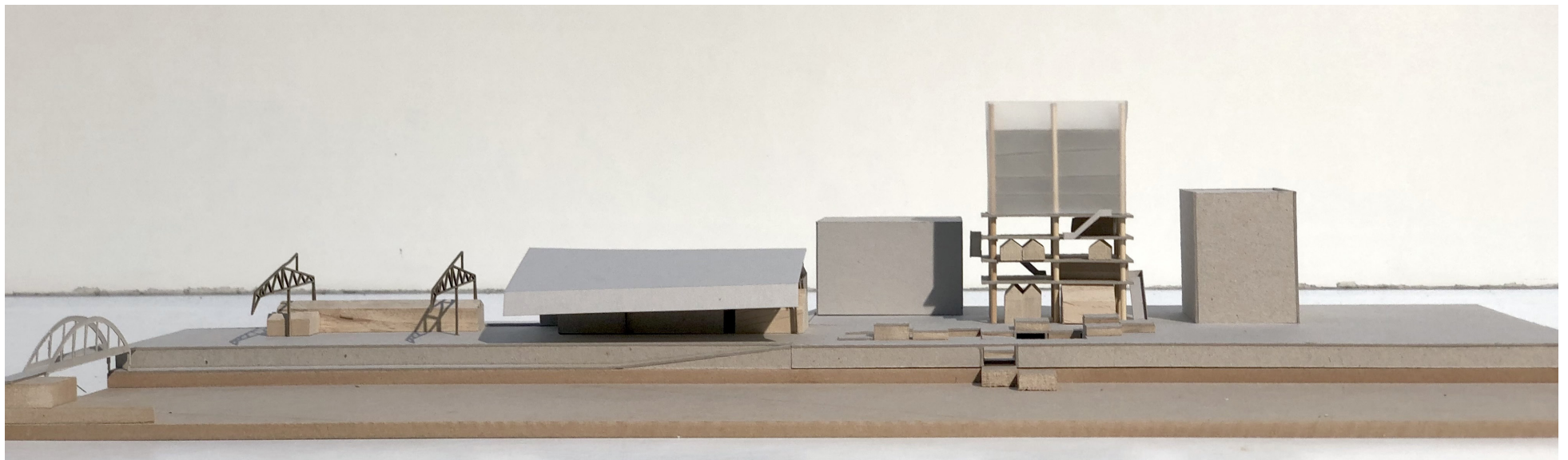

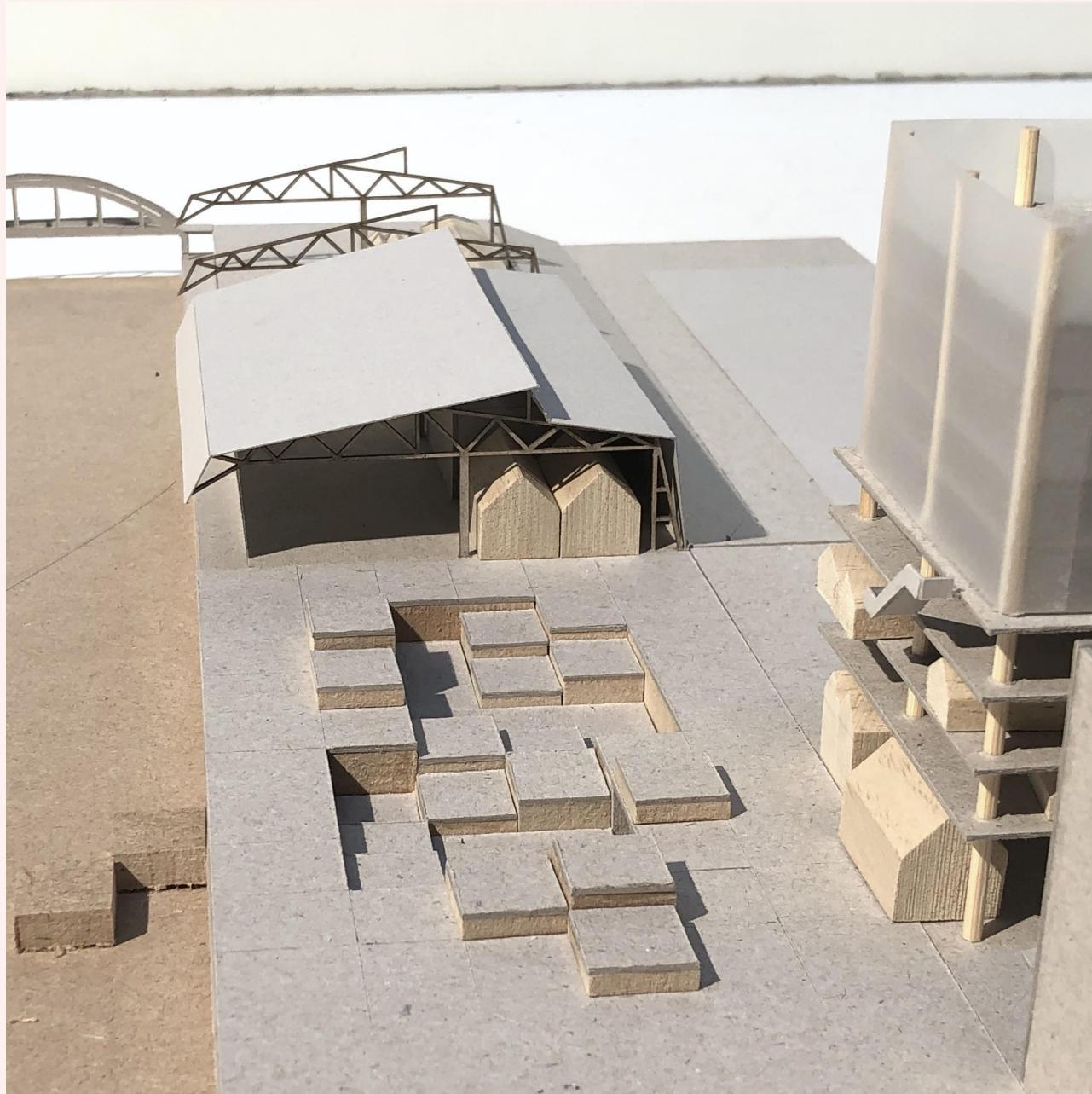

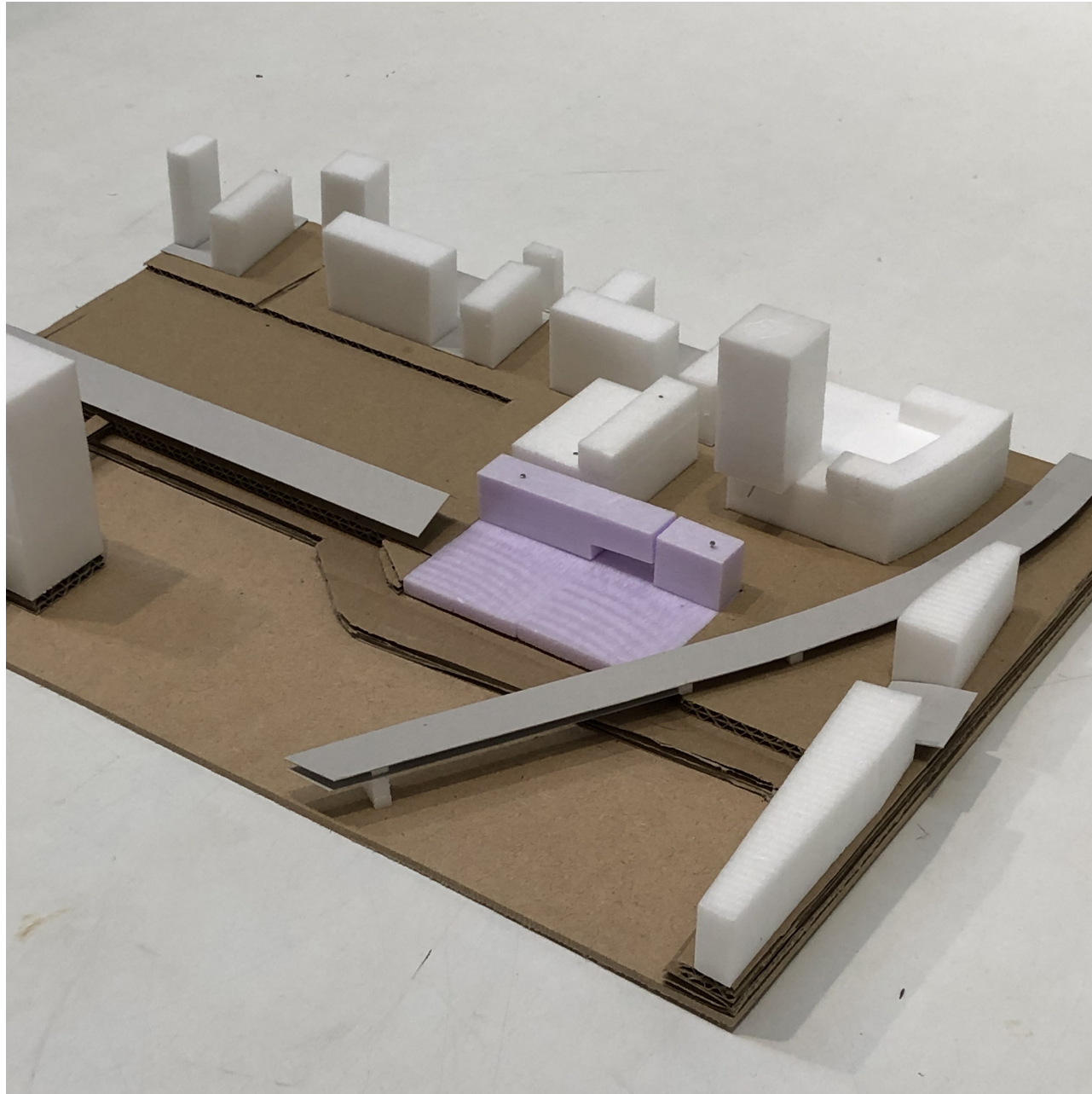

Urban Strategy
Model 1:1000

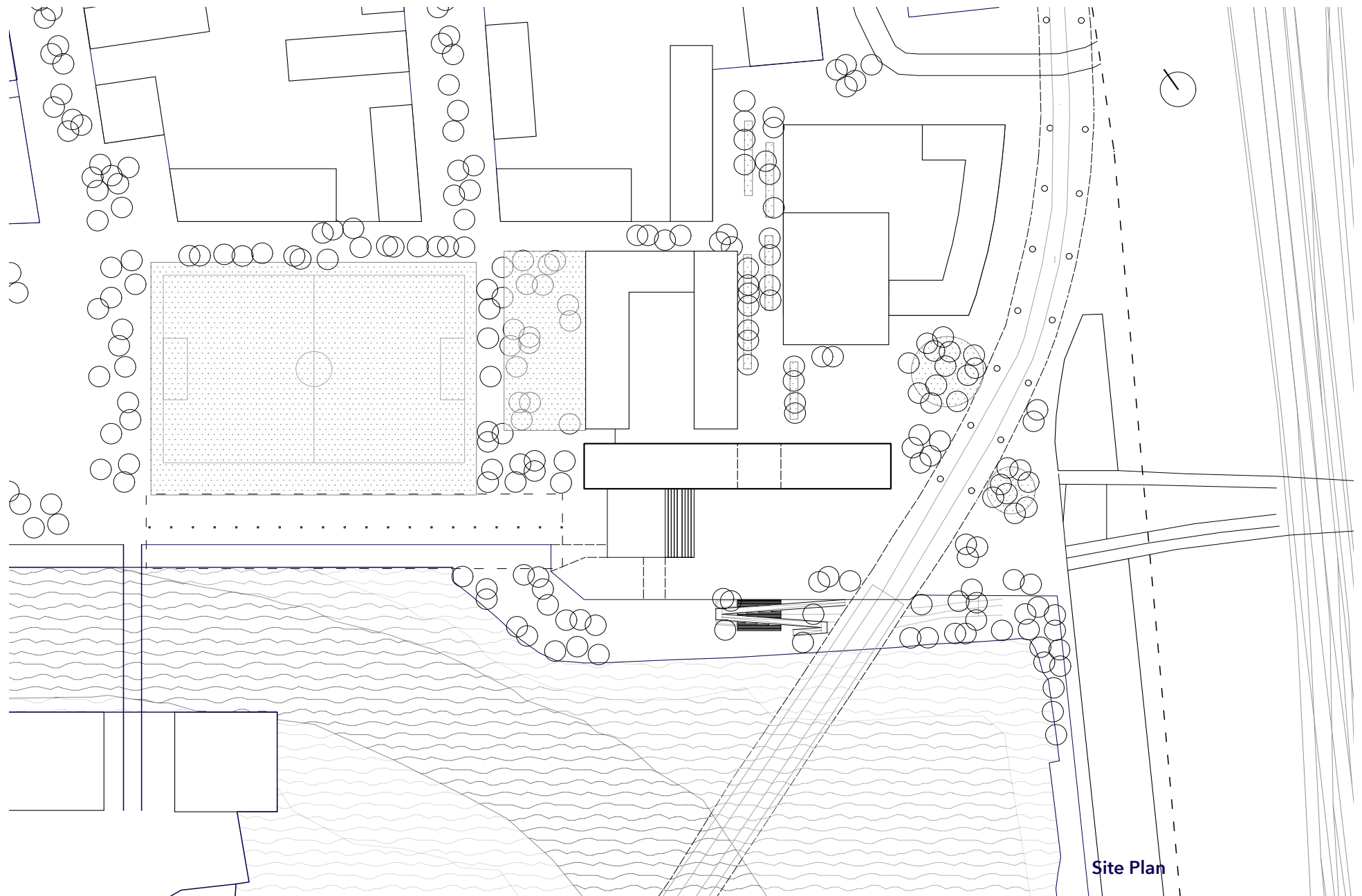

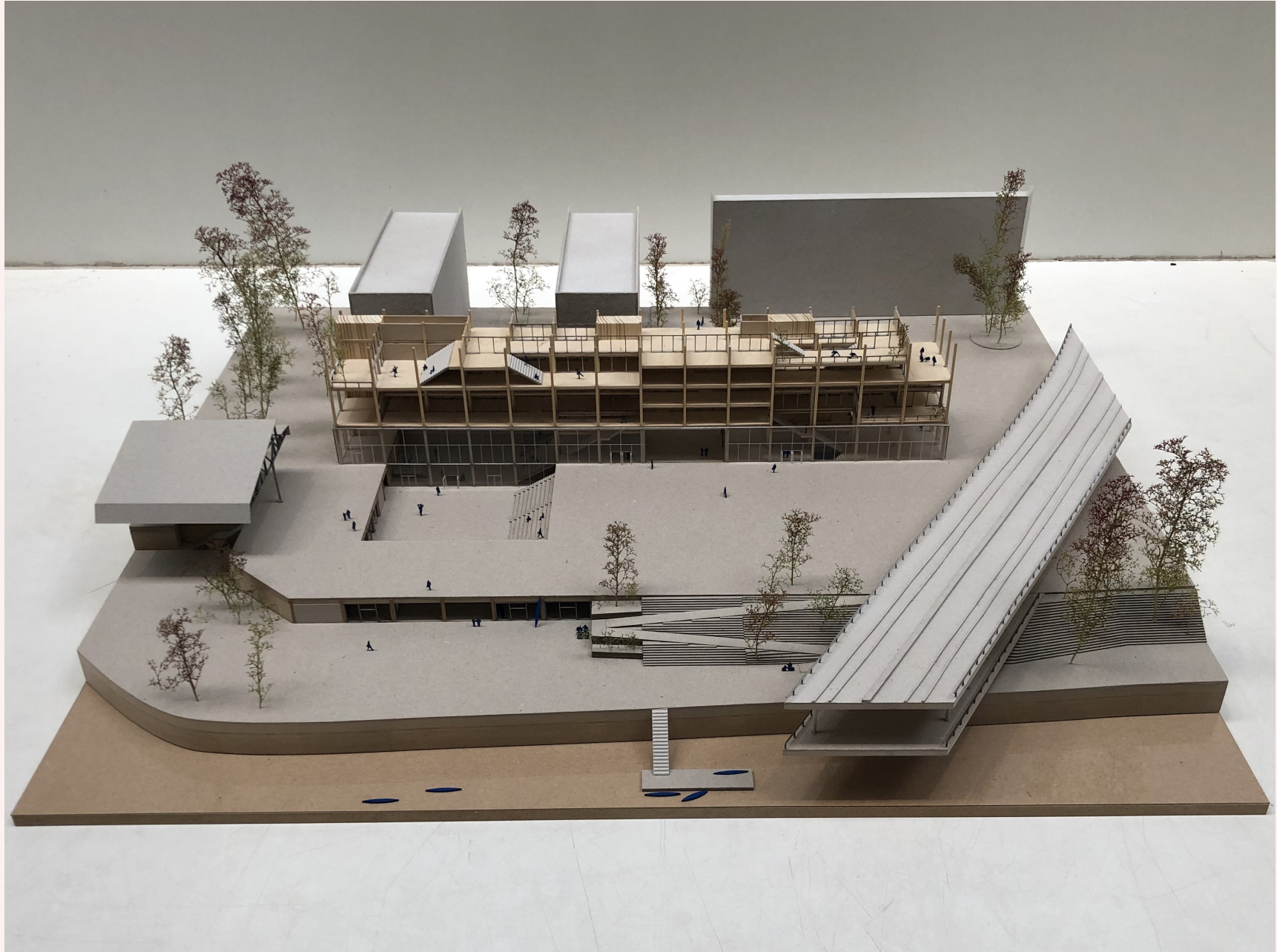

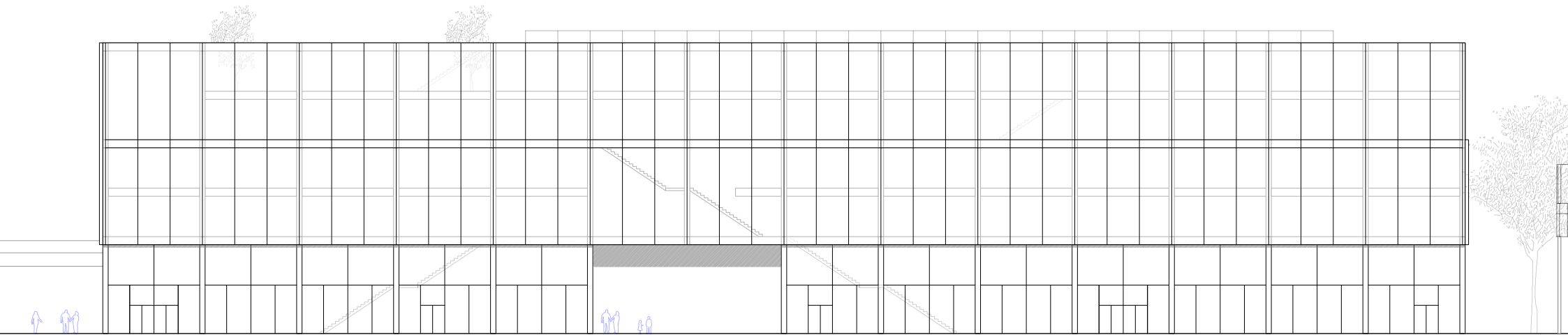

Elevation North
1:200

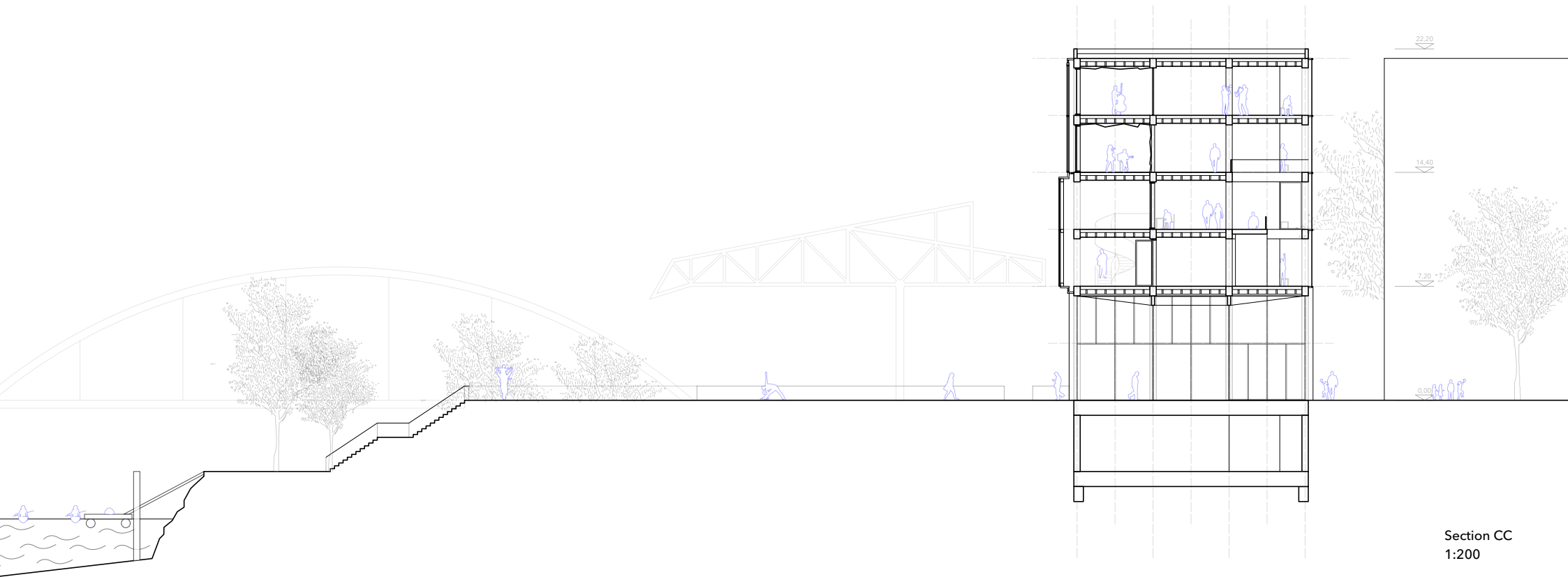

Section CC
1:200

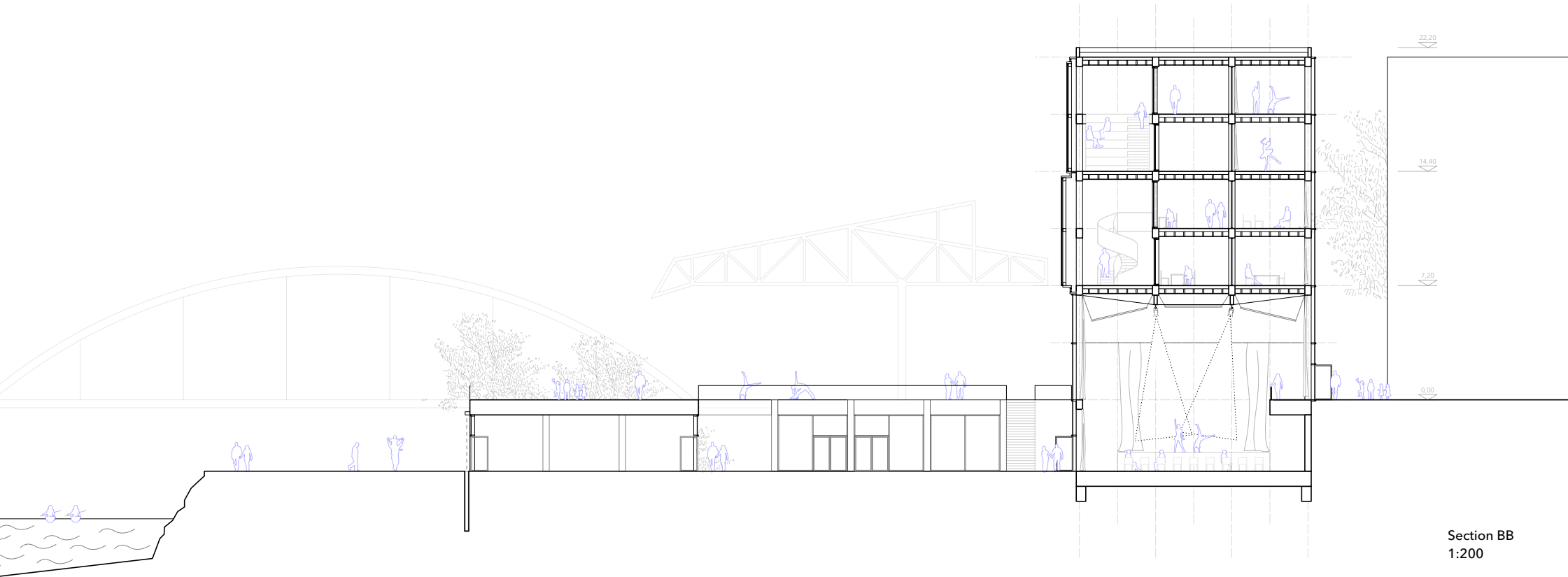



View East



View Upper
Plaza

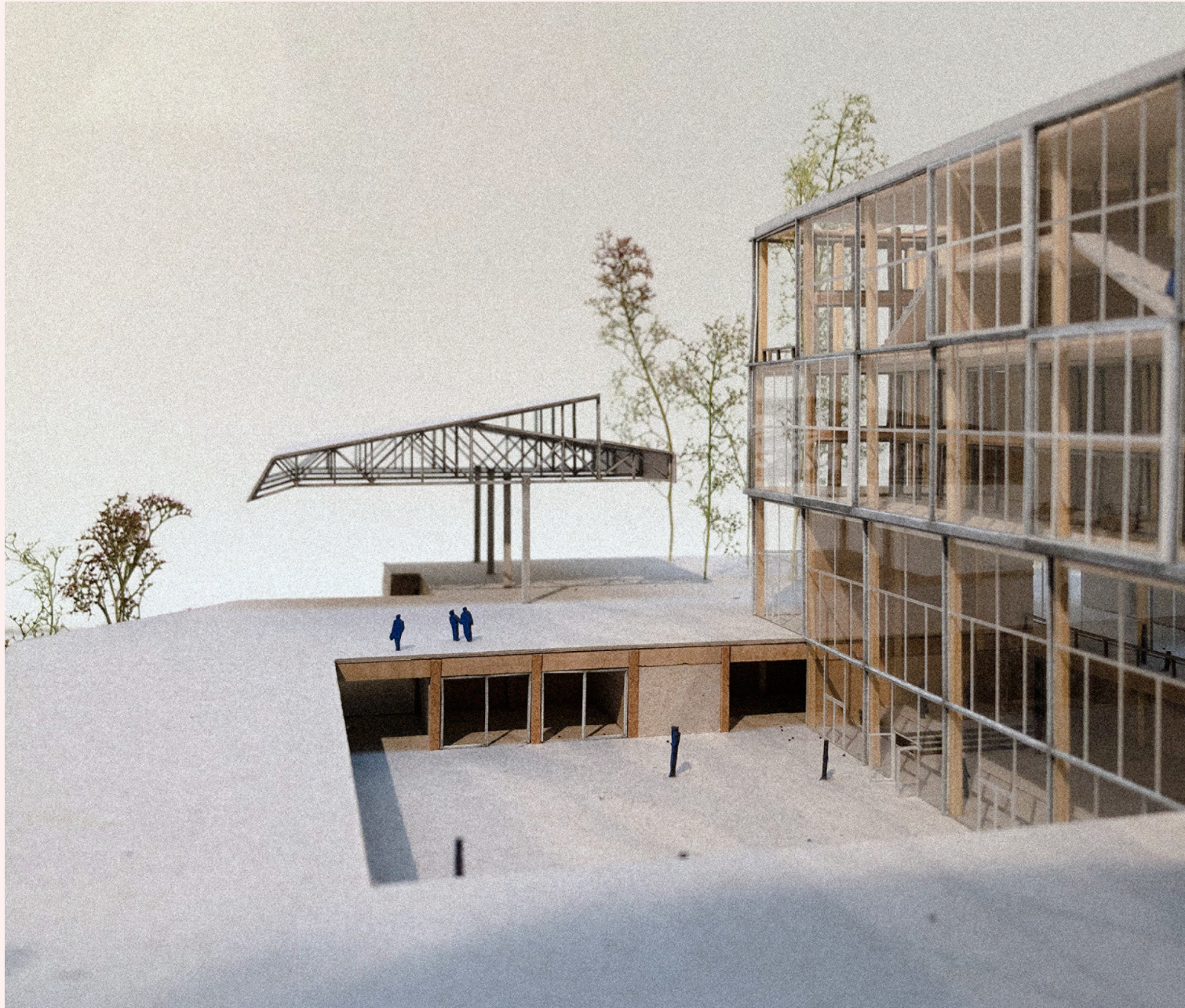

View Lower
Plaza

Mixed Functions

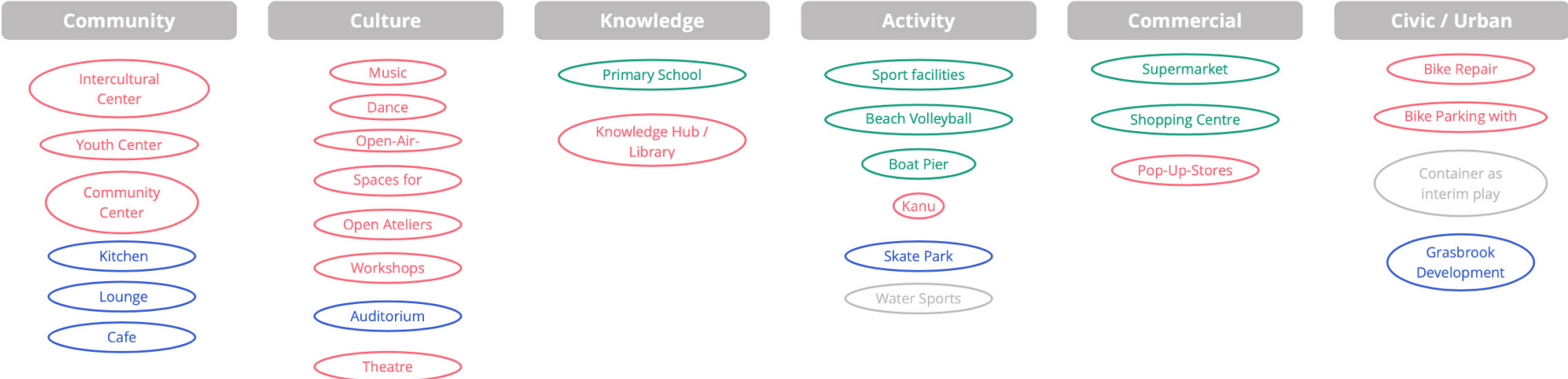

Mixed Functions

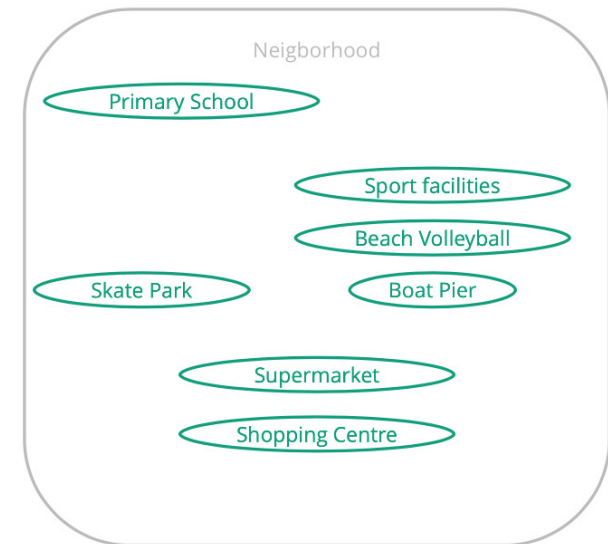
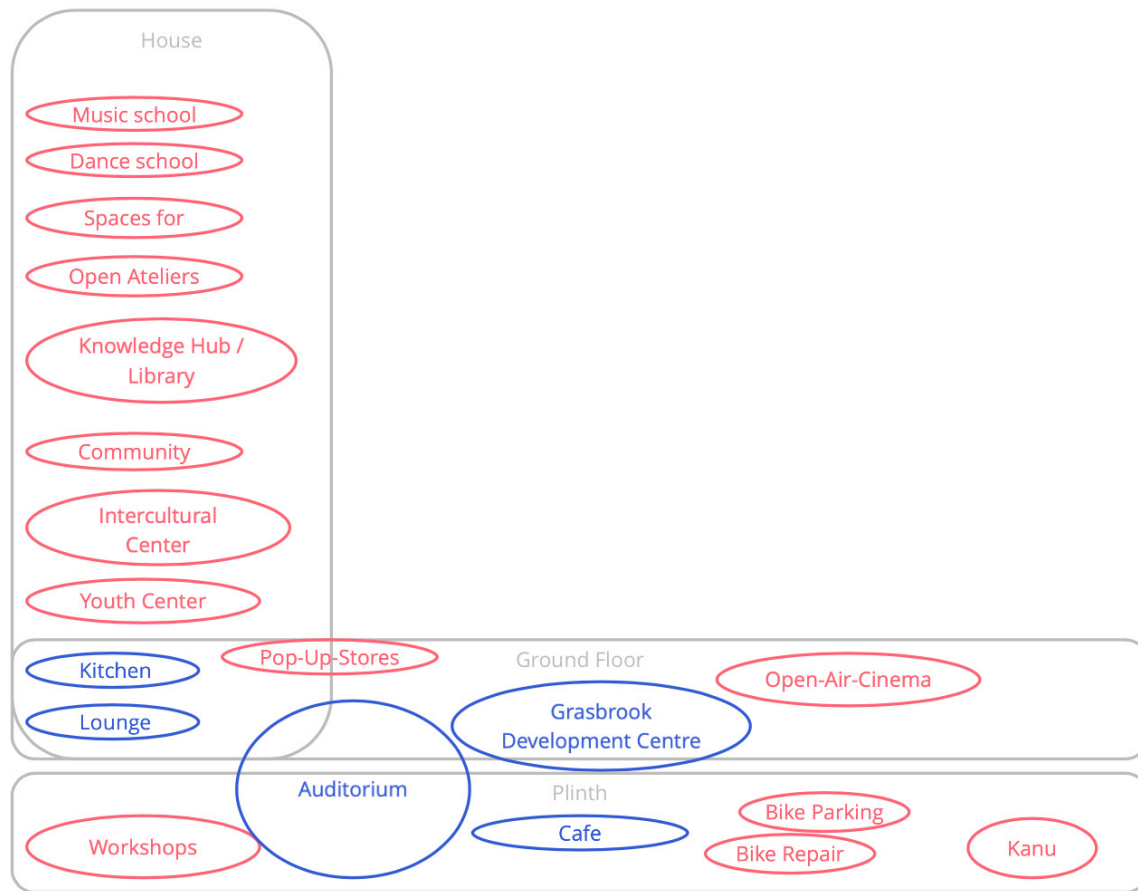





Sequence Axo
Functions



Sequence Axo
Functions

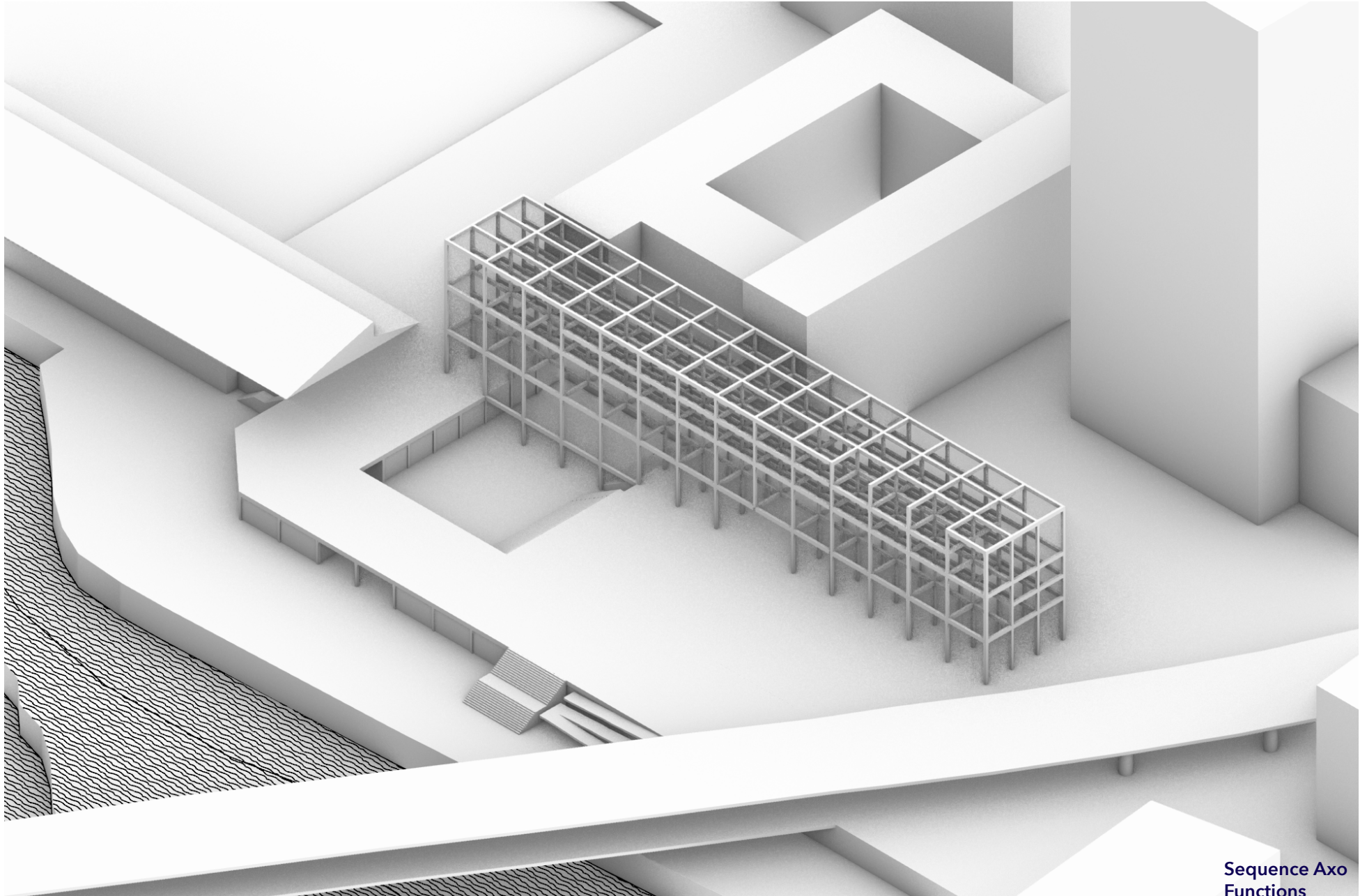

Sequence Axo
Functions

■ Circulation

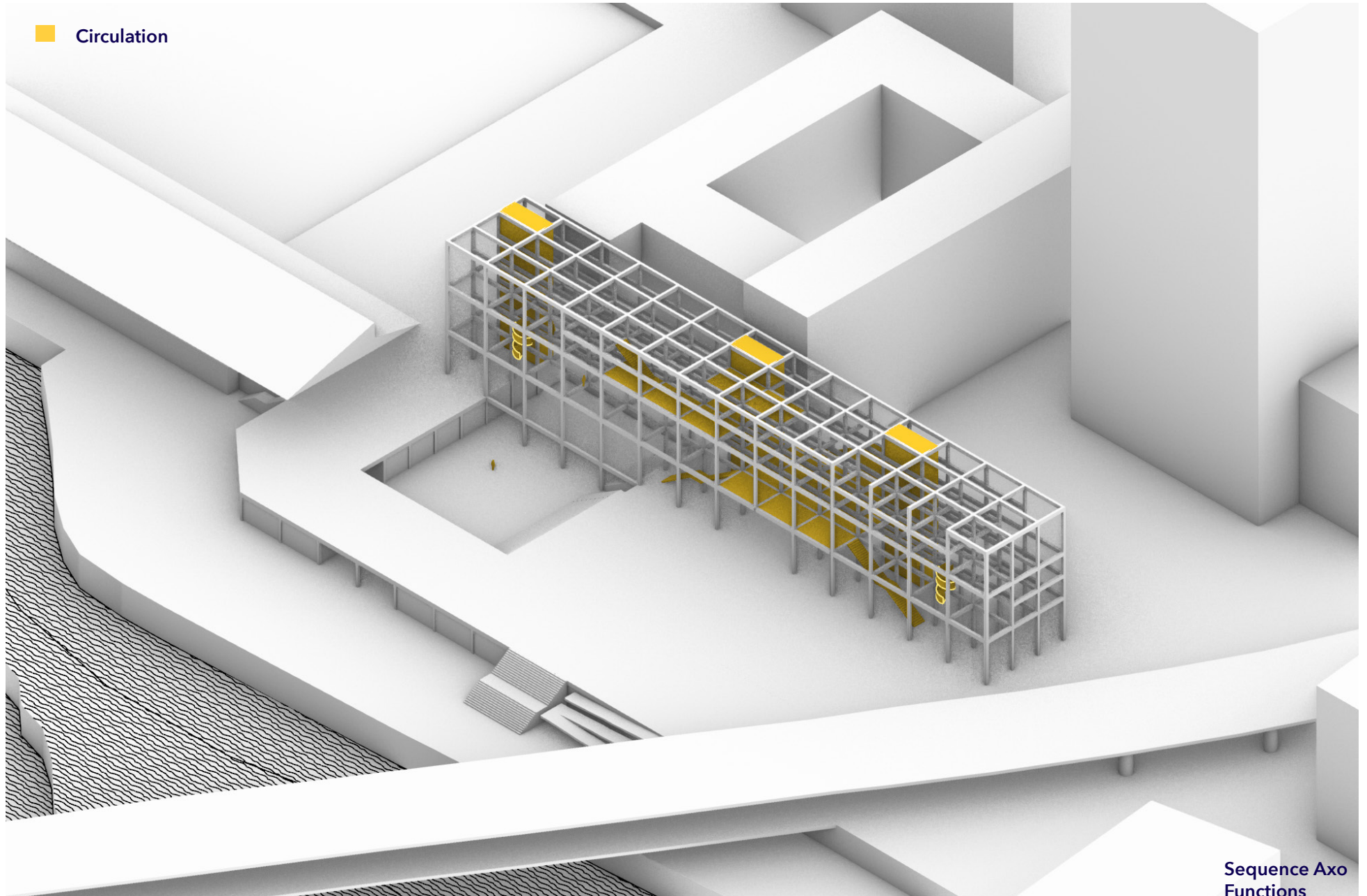

Sequence Axo
Functions

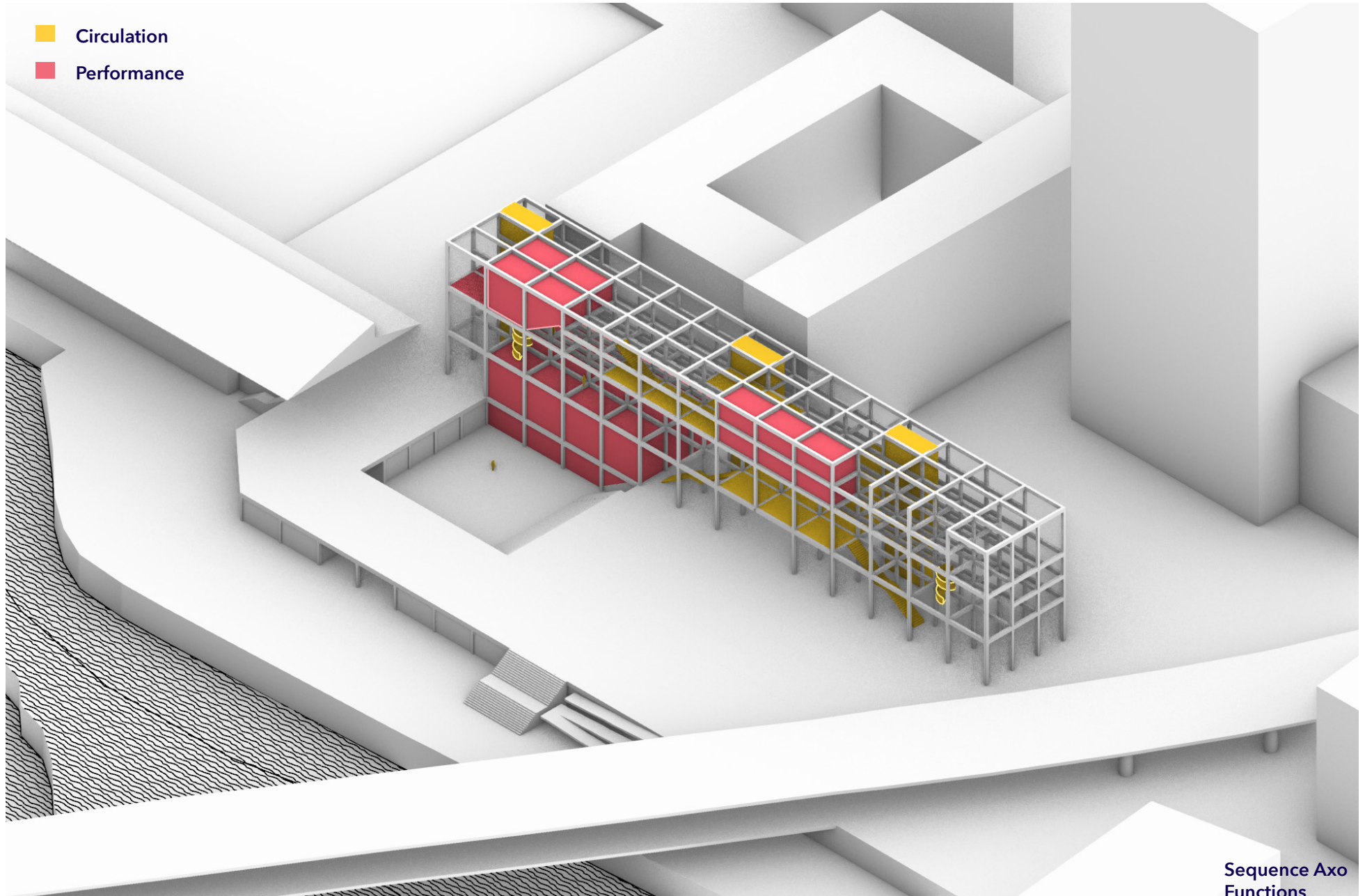

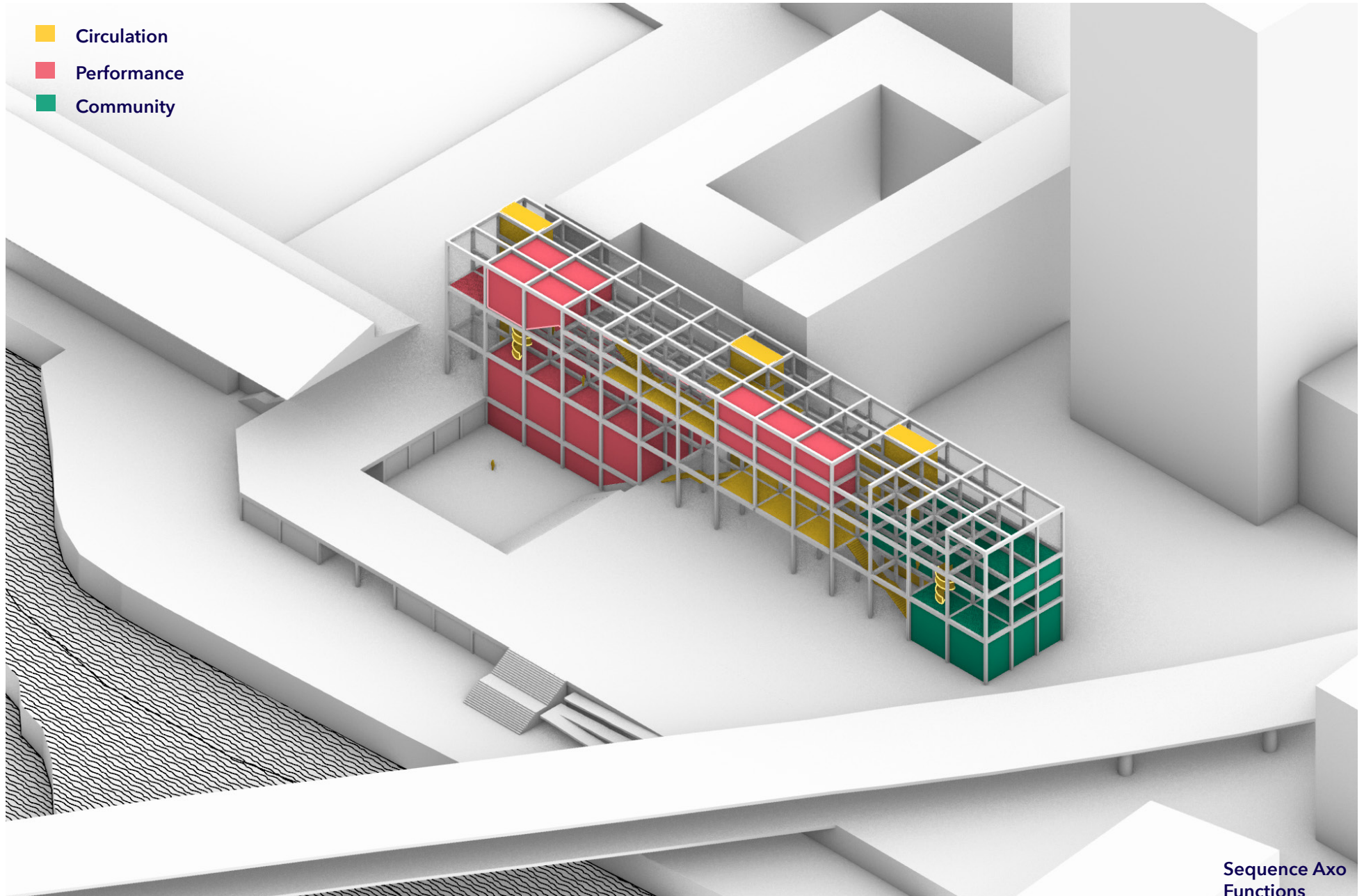

Sequence Axo
Functions

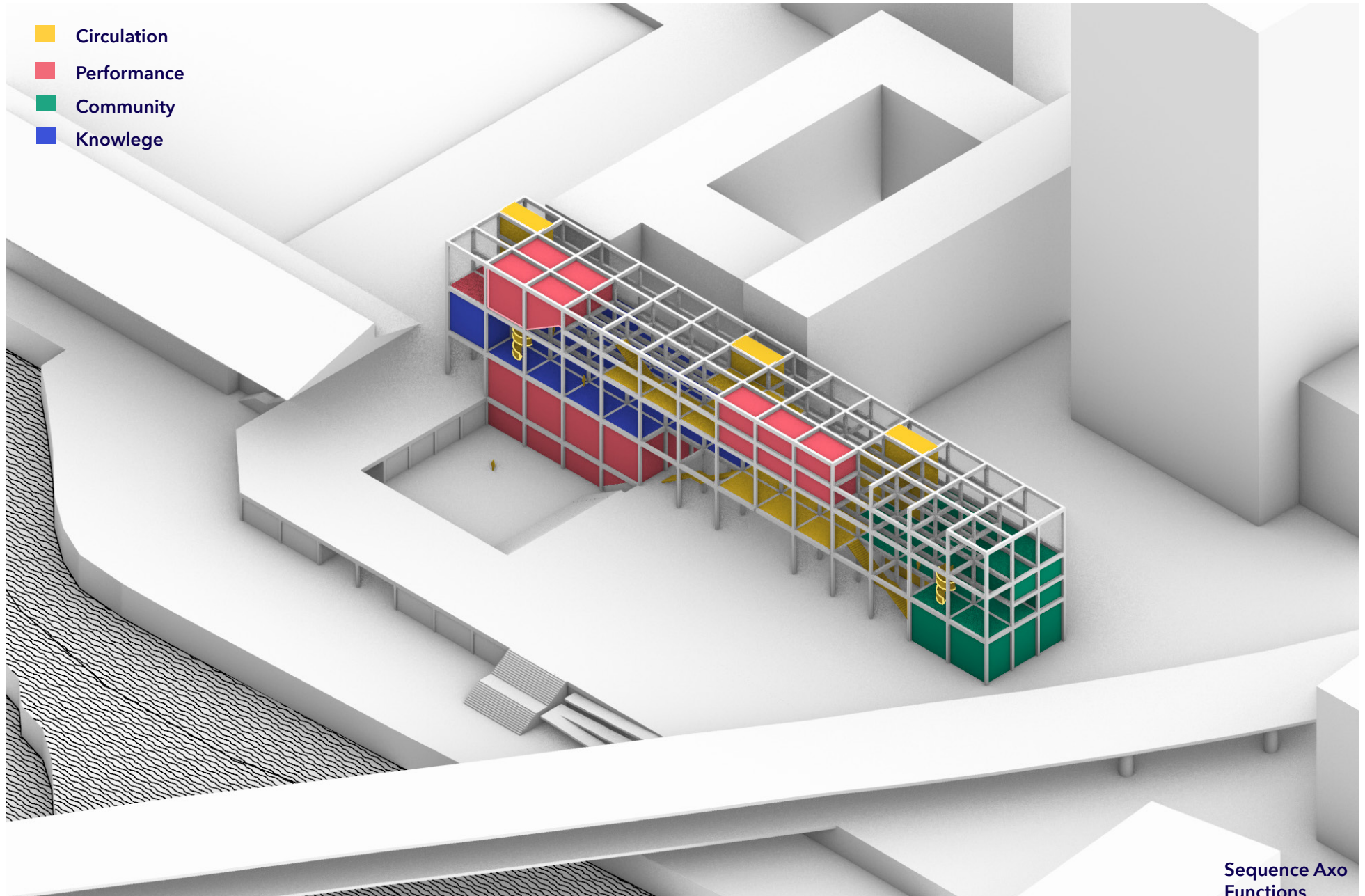

Sequence Axo
Functions

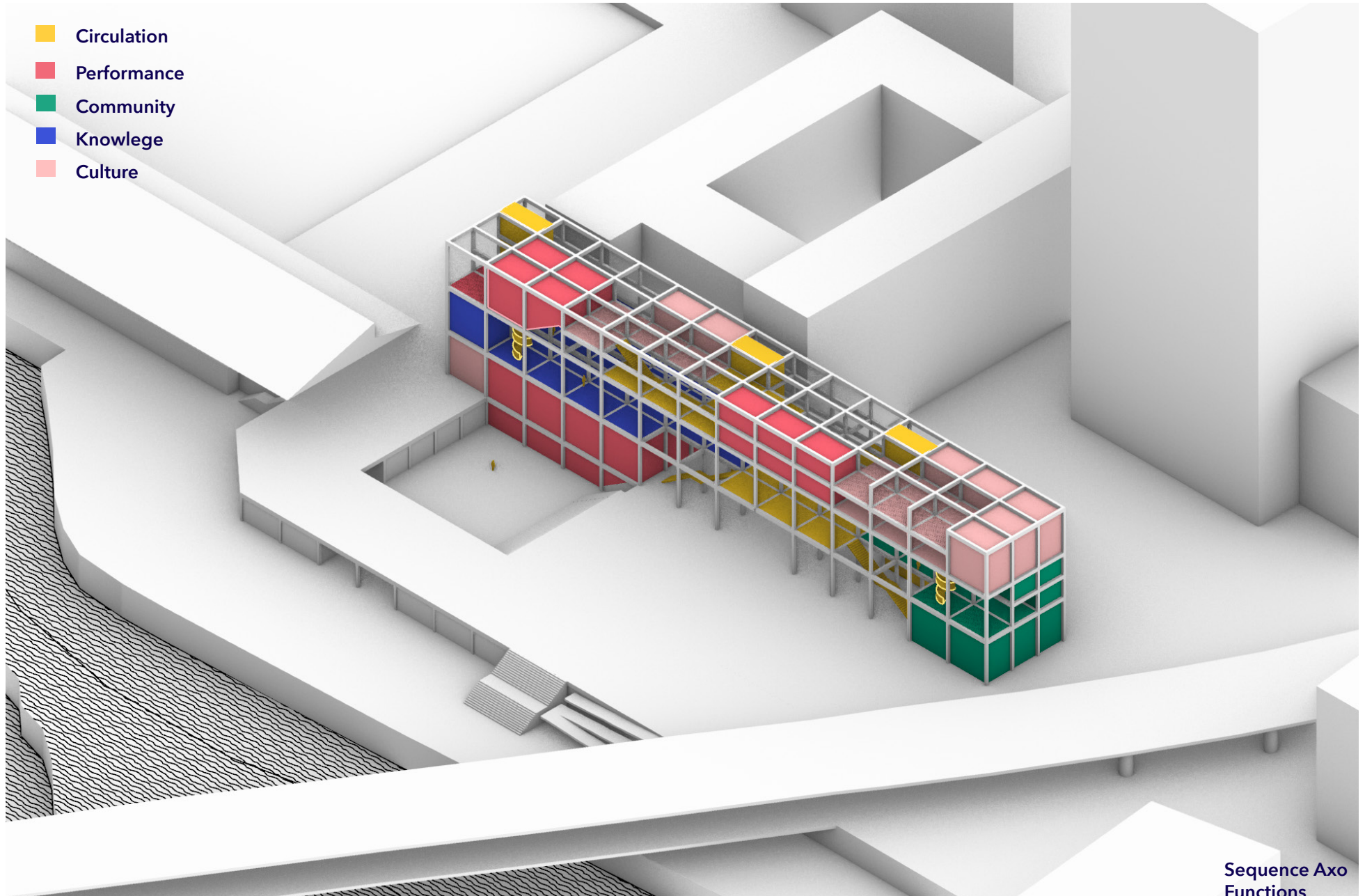

Sequence Axo
Functions

- Circulation
- Performance
- Community
- Knowledge
- Culture

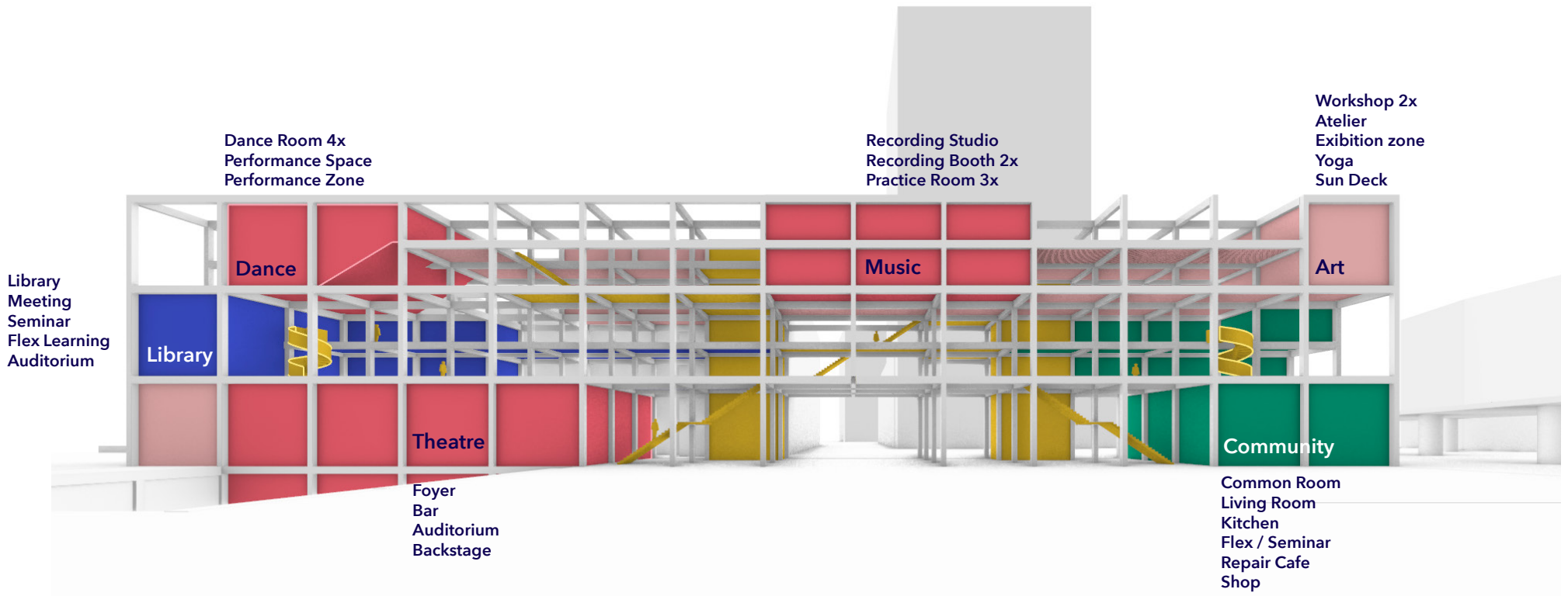
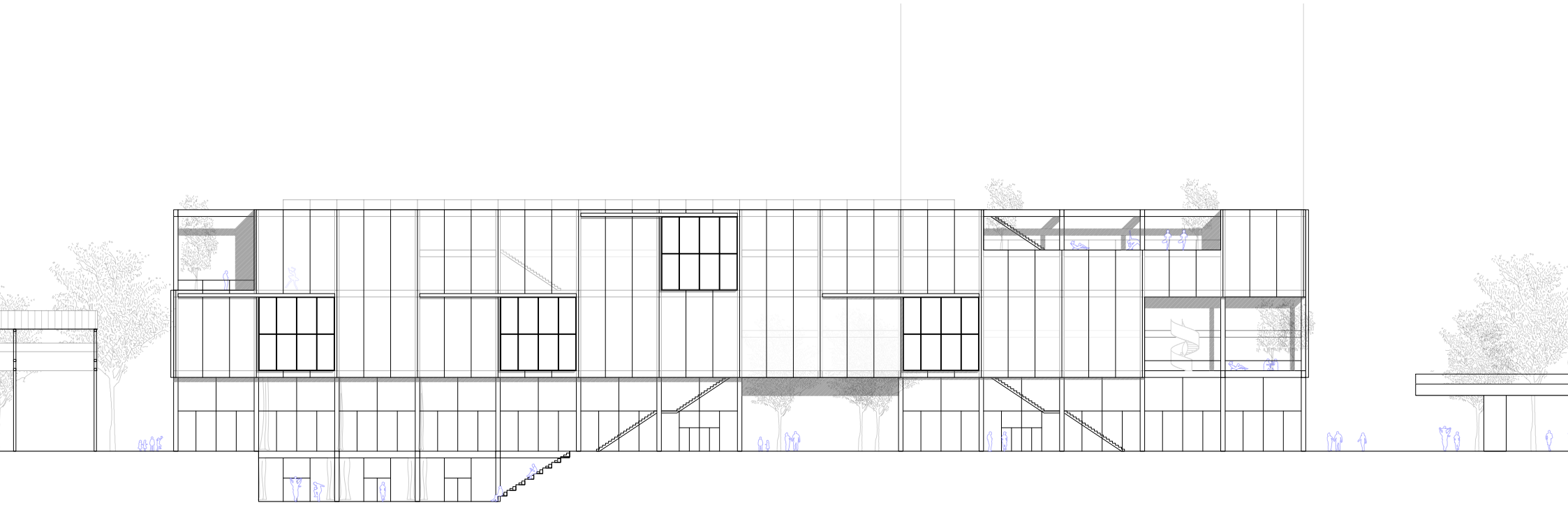
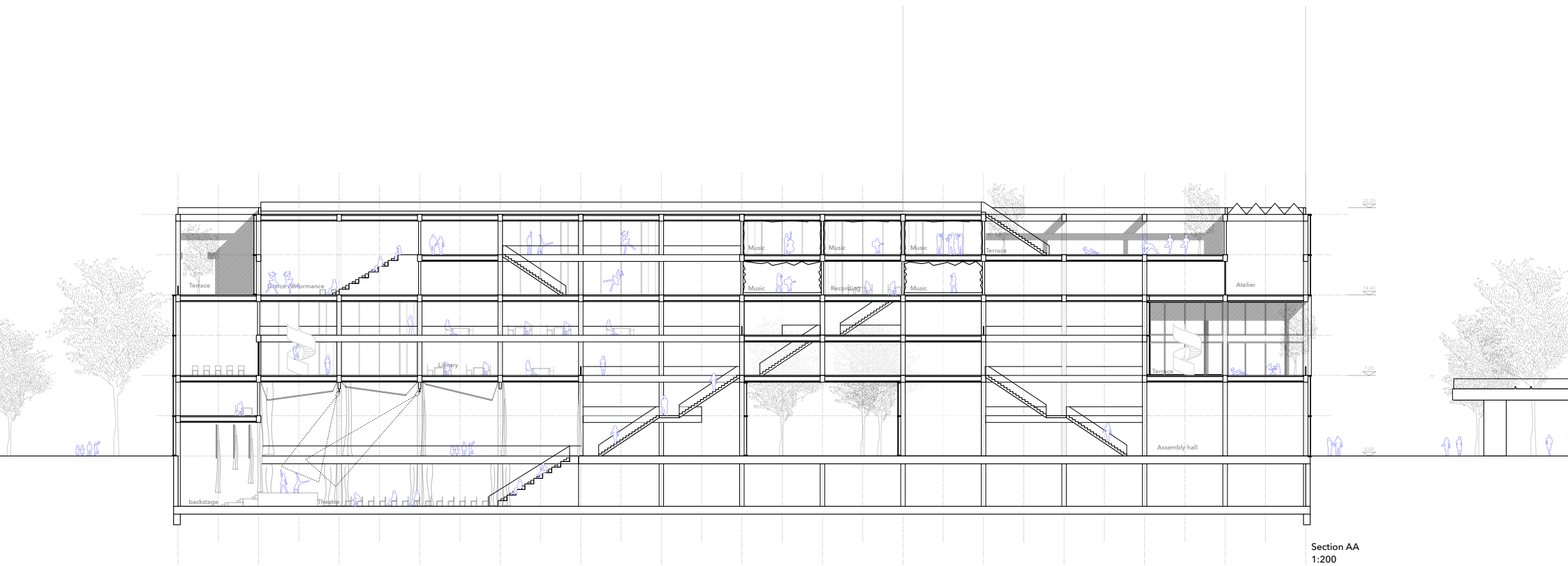
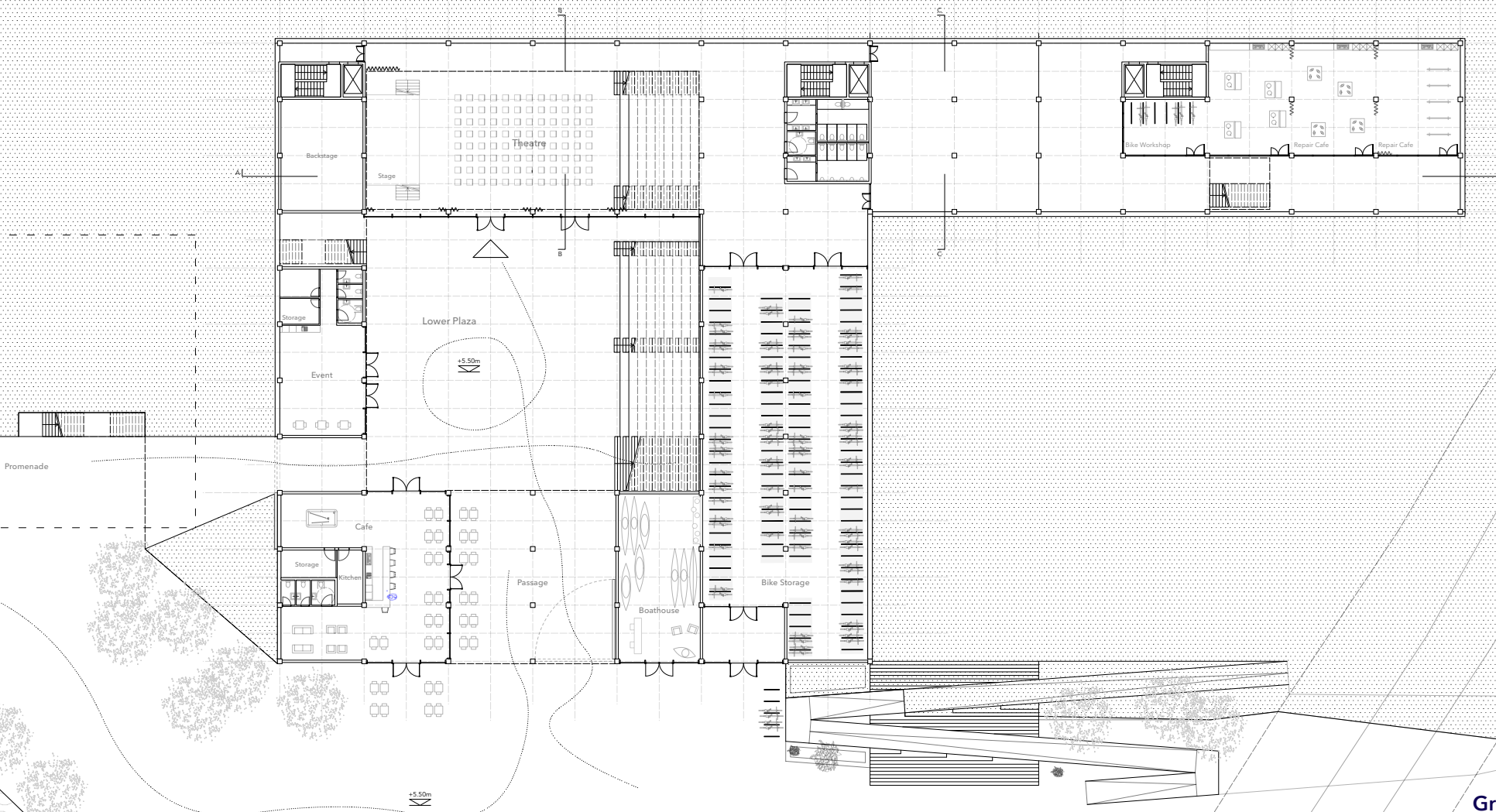

Diagram
Functions



Elevation South
1:200





Ground Floor Plan

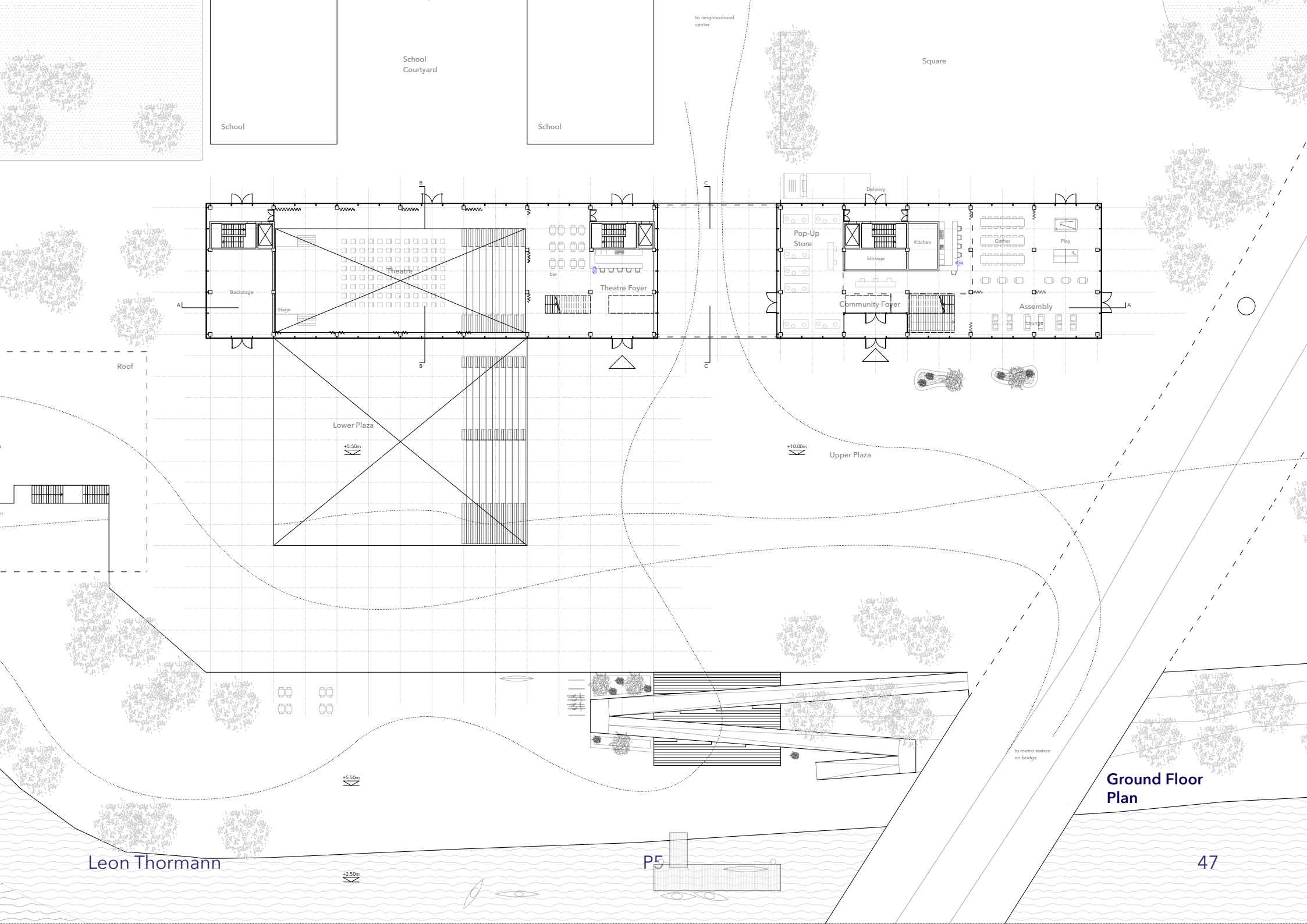

School
School Courtyard

School

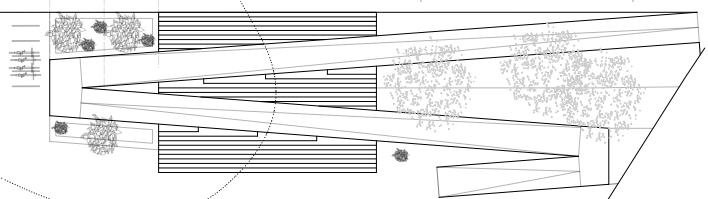
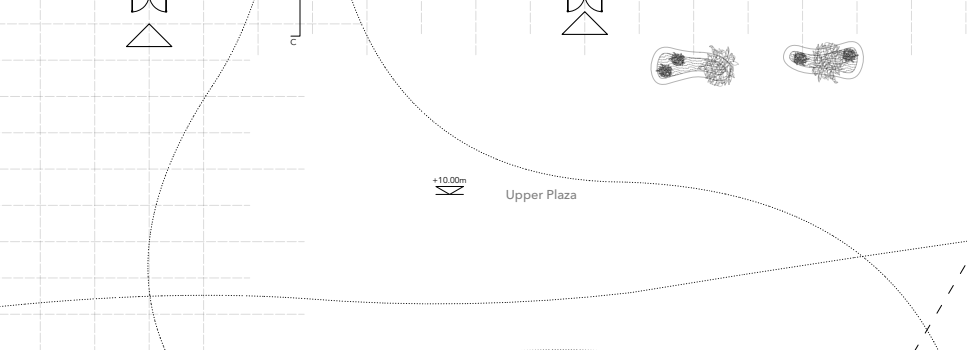
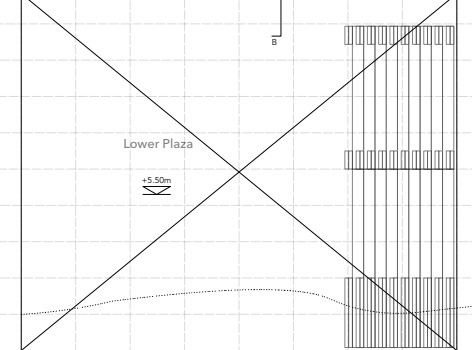
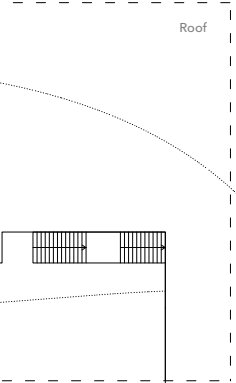
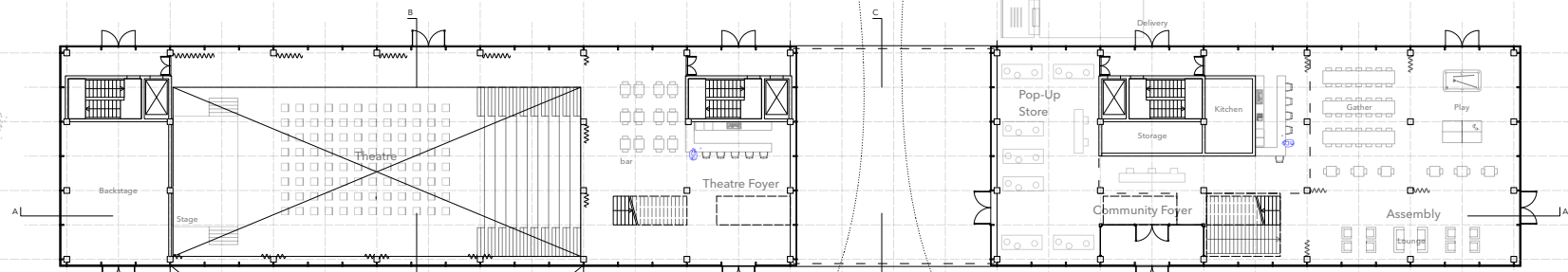

Ground Floor Plan

Leon Thormann

P5

47

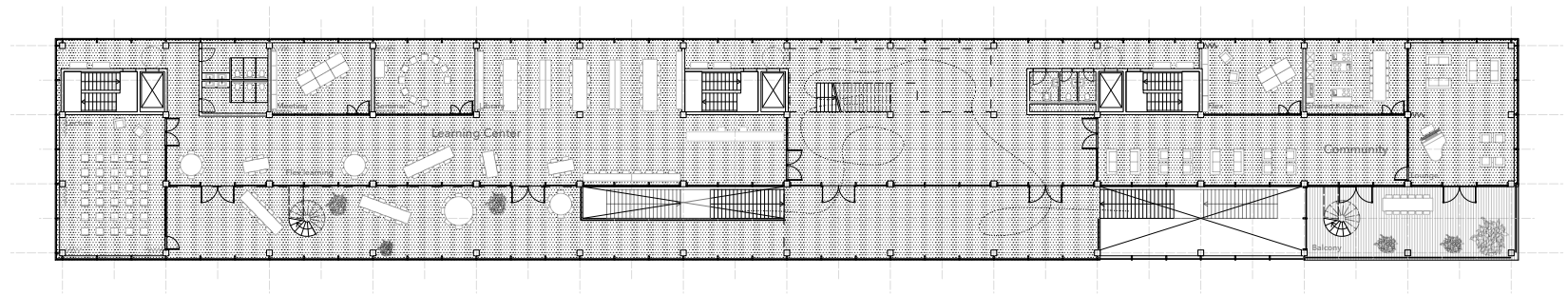

First Floor
1:200

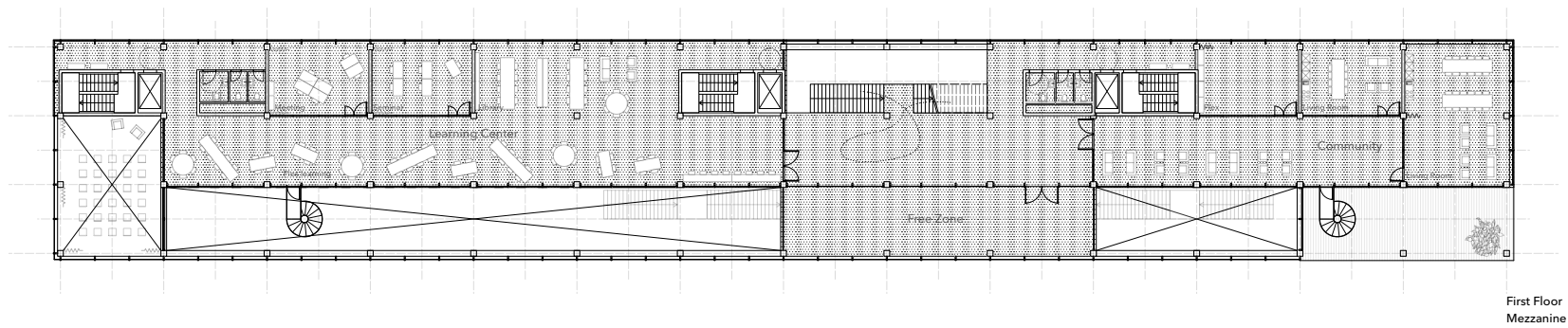

First Floor
Mezzanine

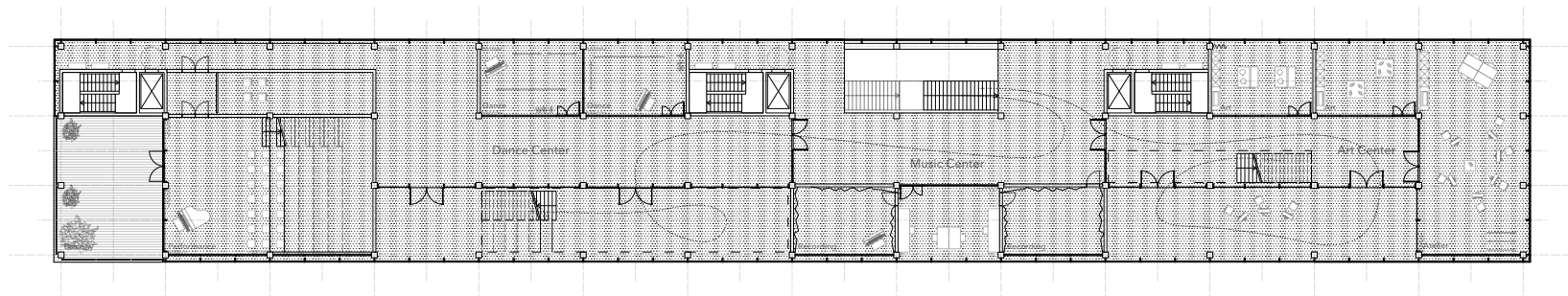

Second Floor
1:200

- Circulation Cores
- Flex Spaces
- Specific Space
- Buffer Zone

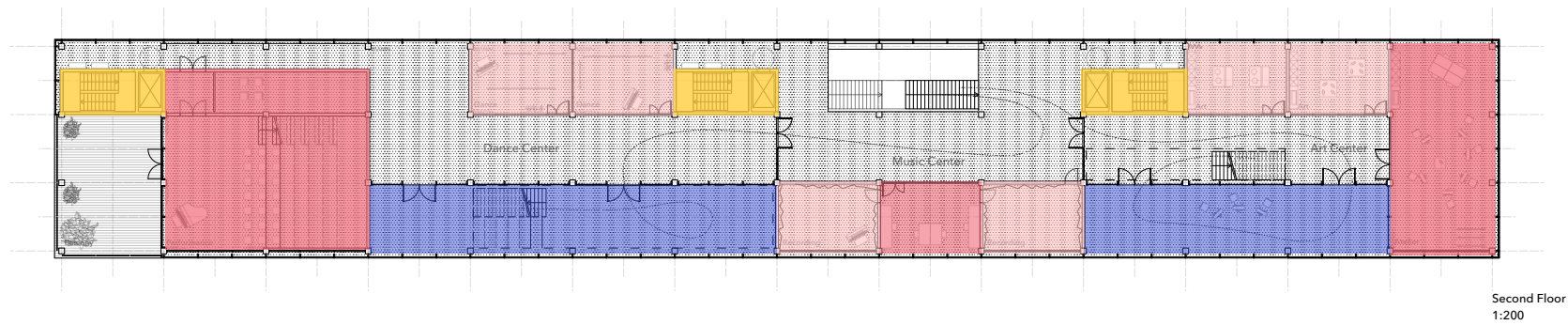

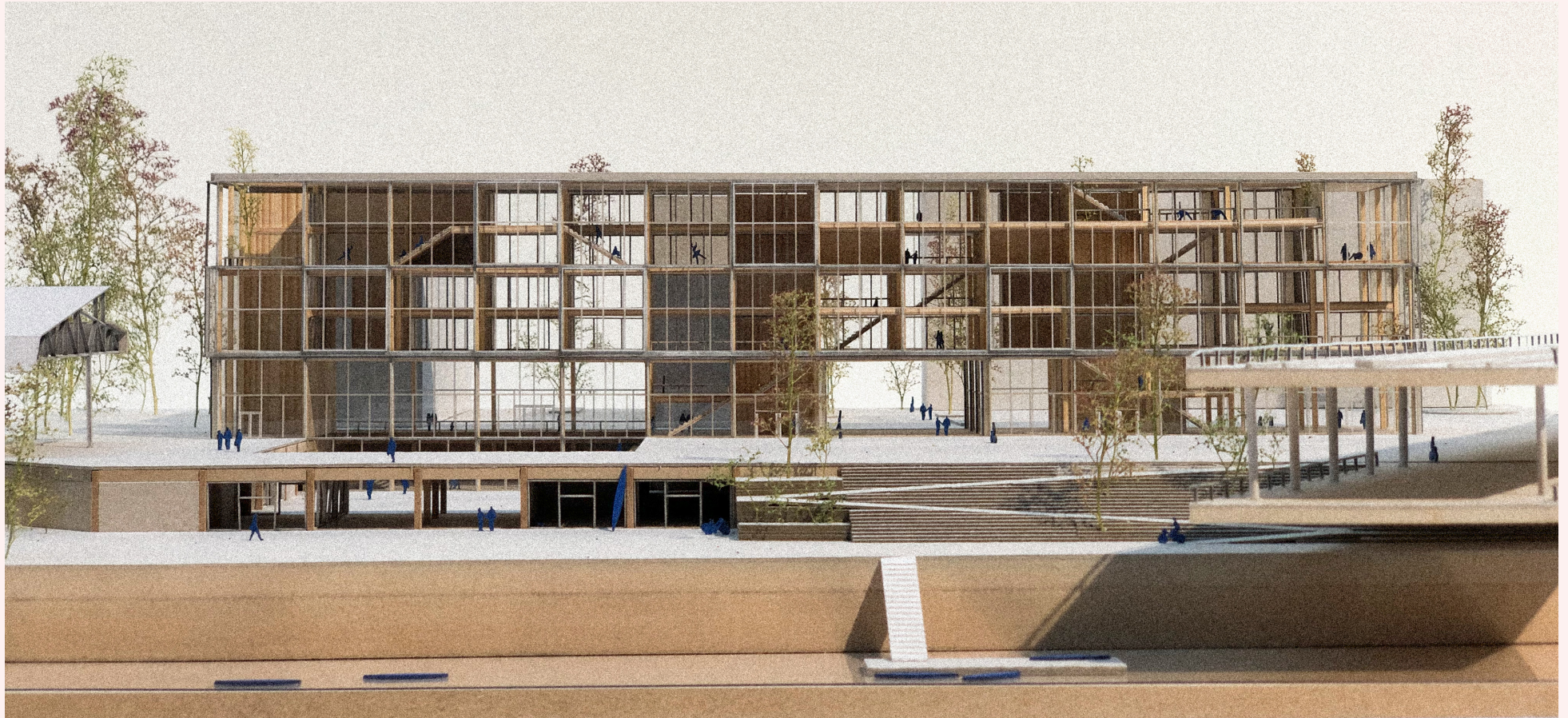

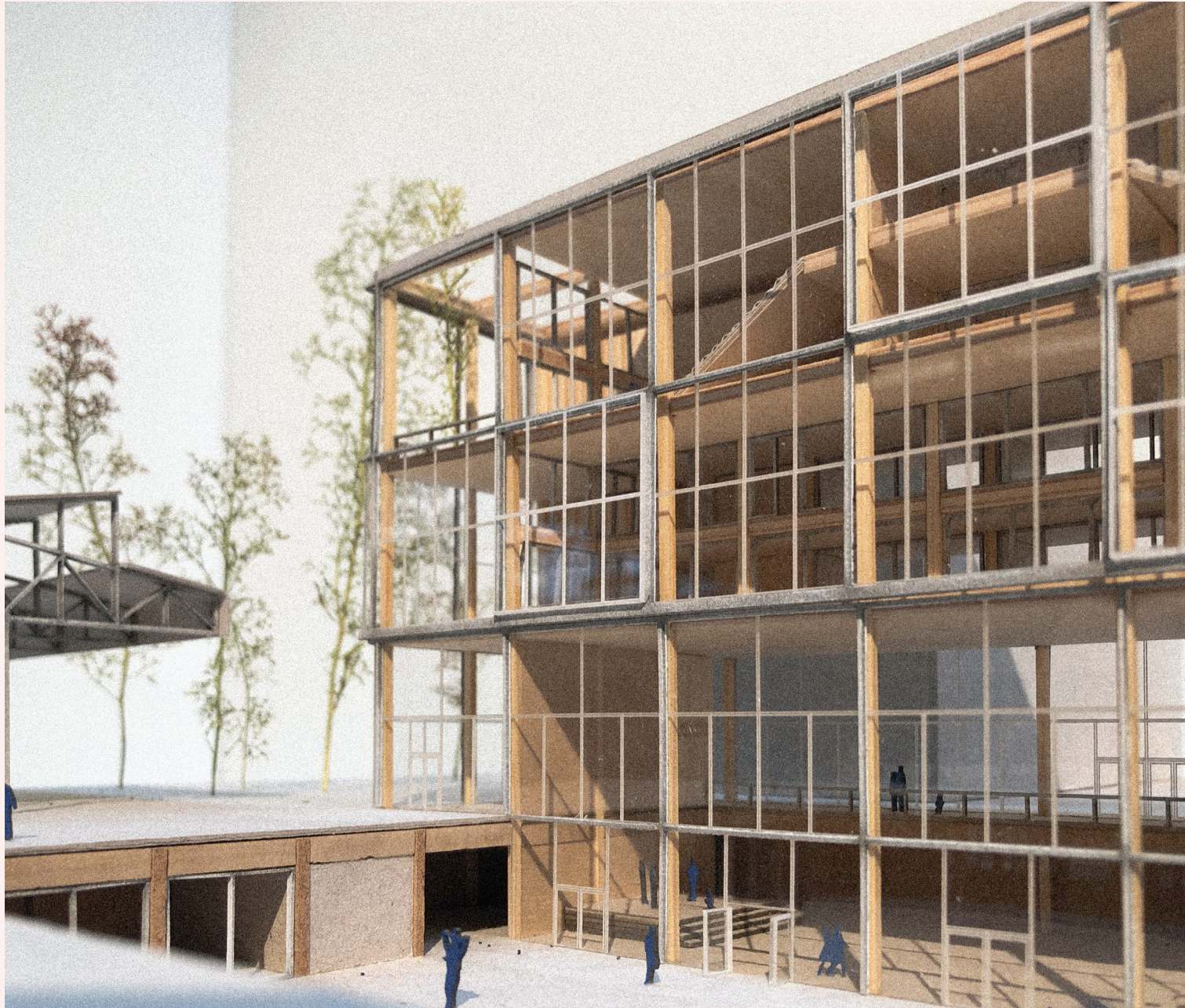

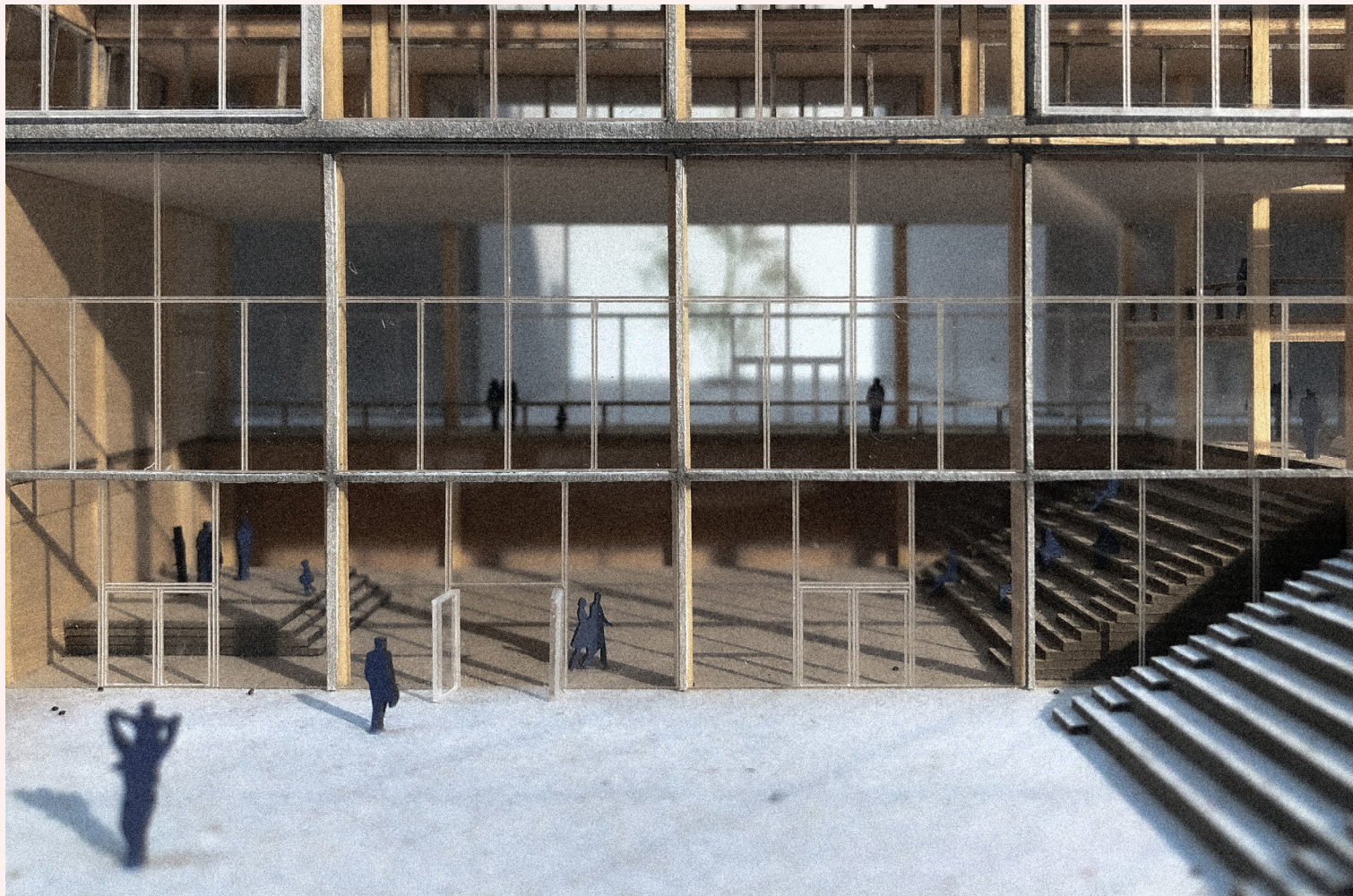

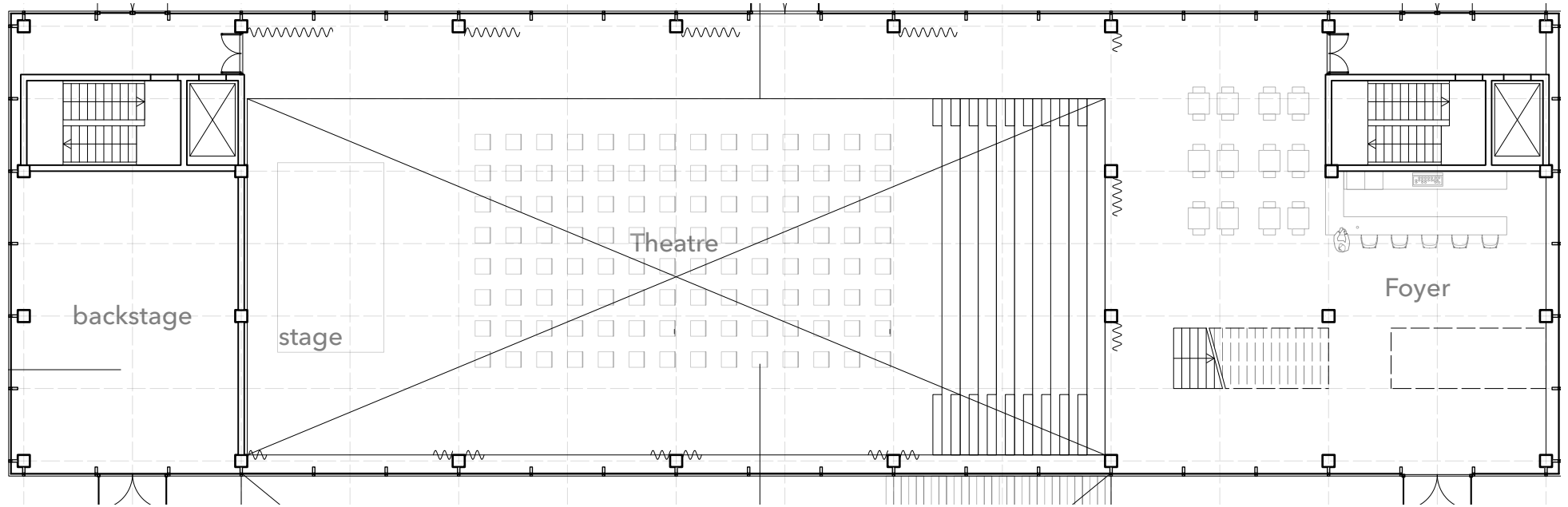

Ground Floor
Plan 0

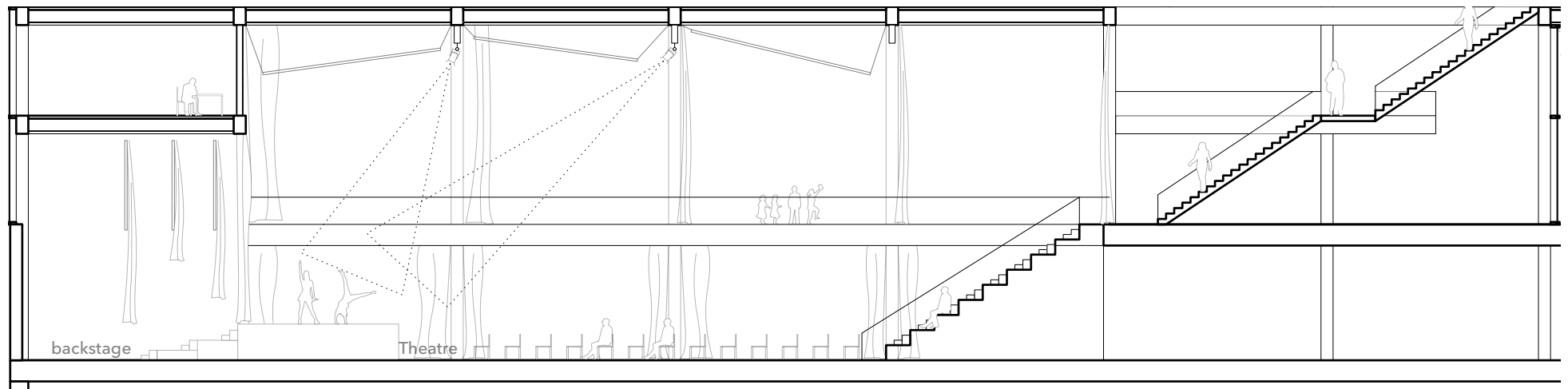

Section



Impression
Theatre

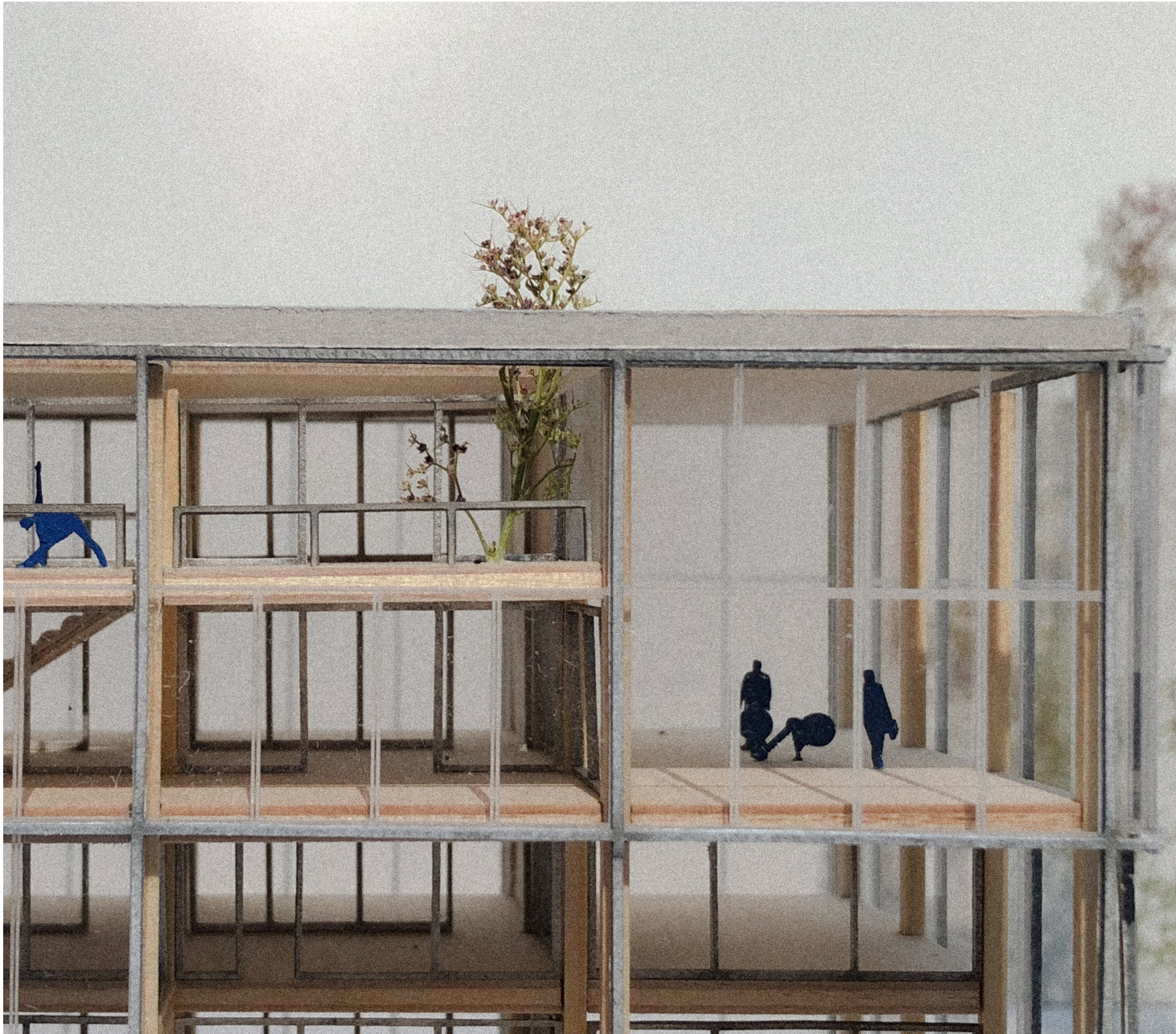

Art

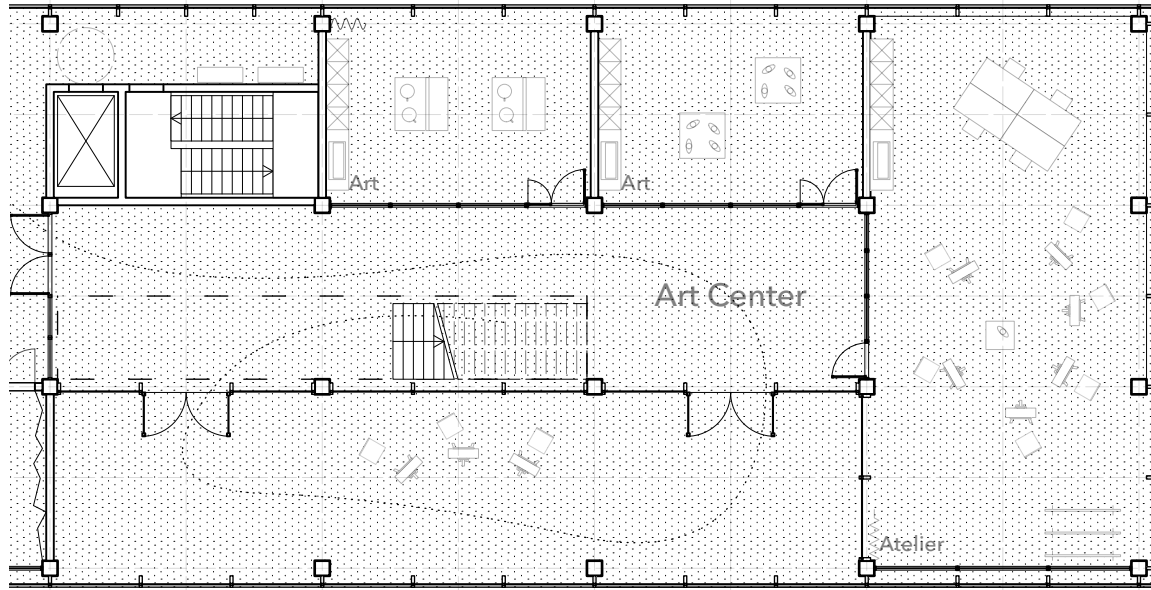

Upper Floor
Plan +2

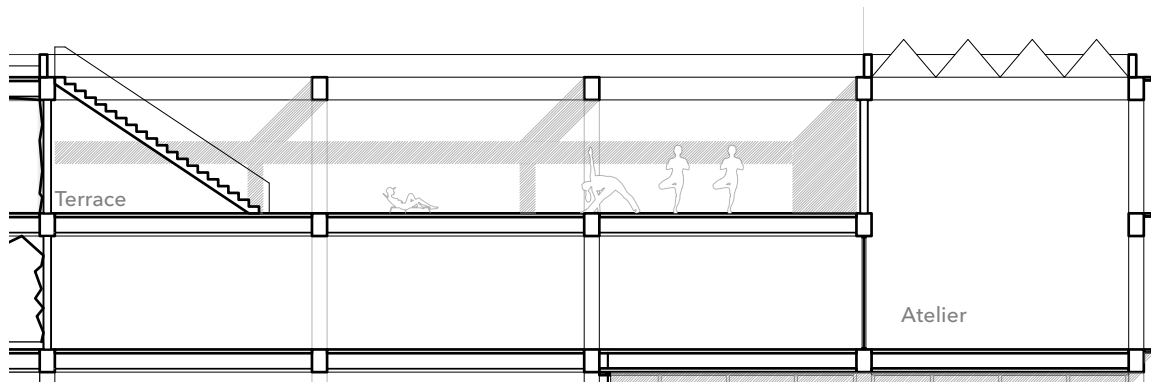

Upper Floor
Section

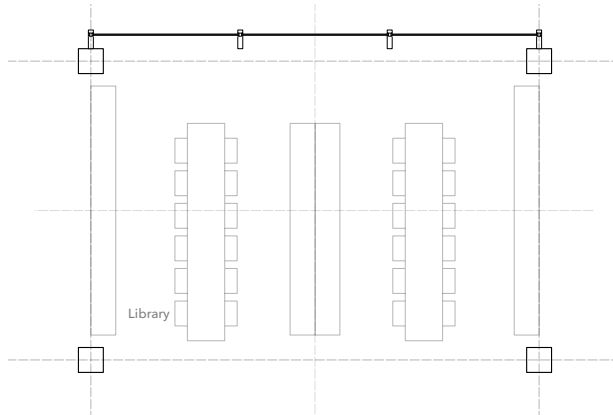
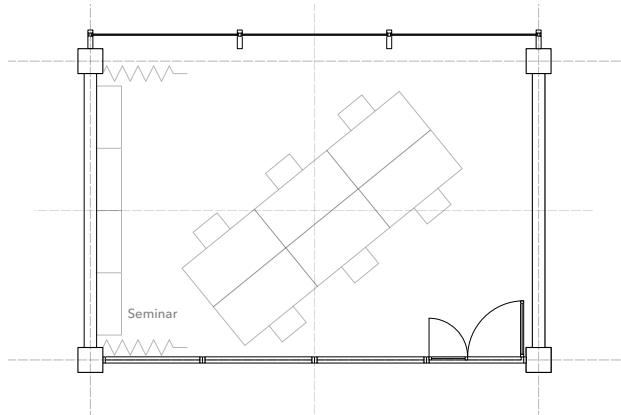
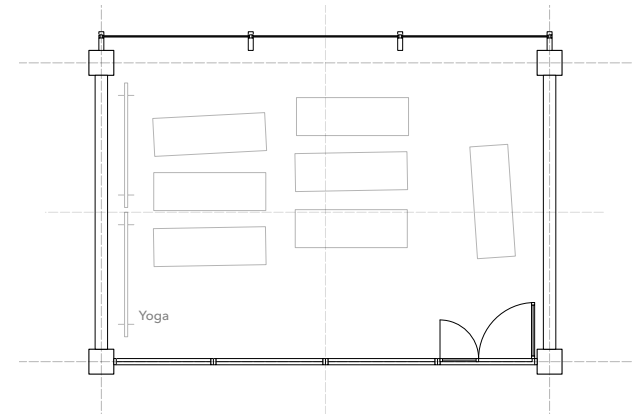
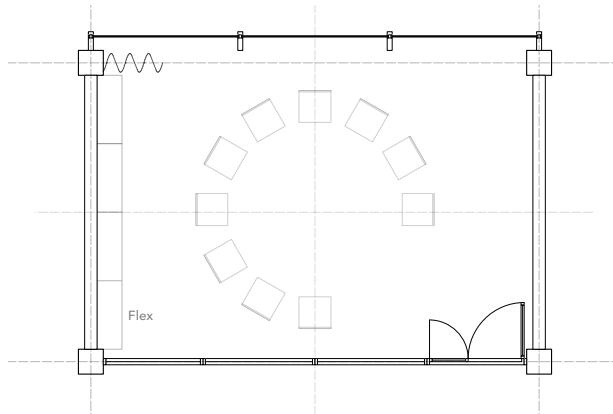
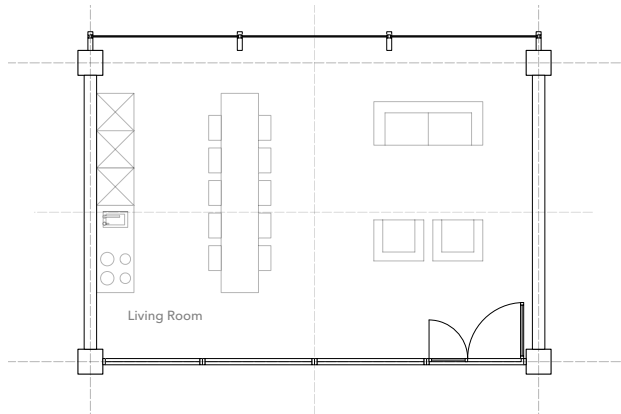
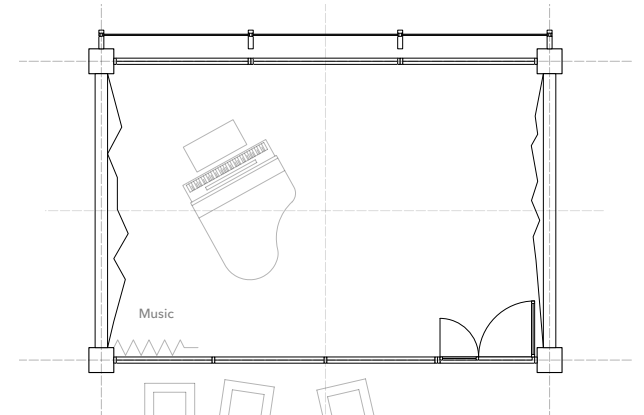
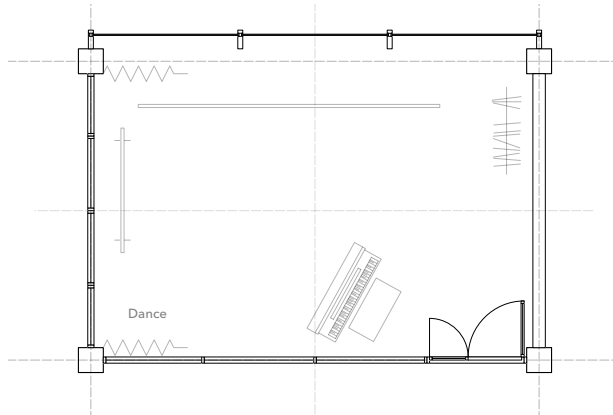
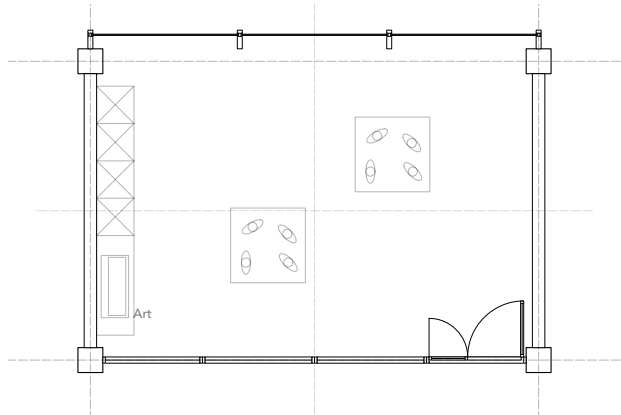

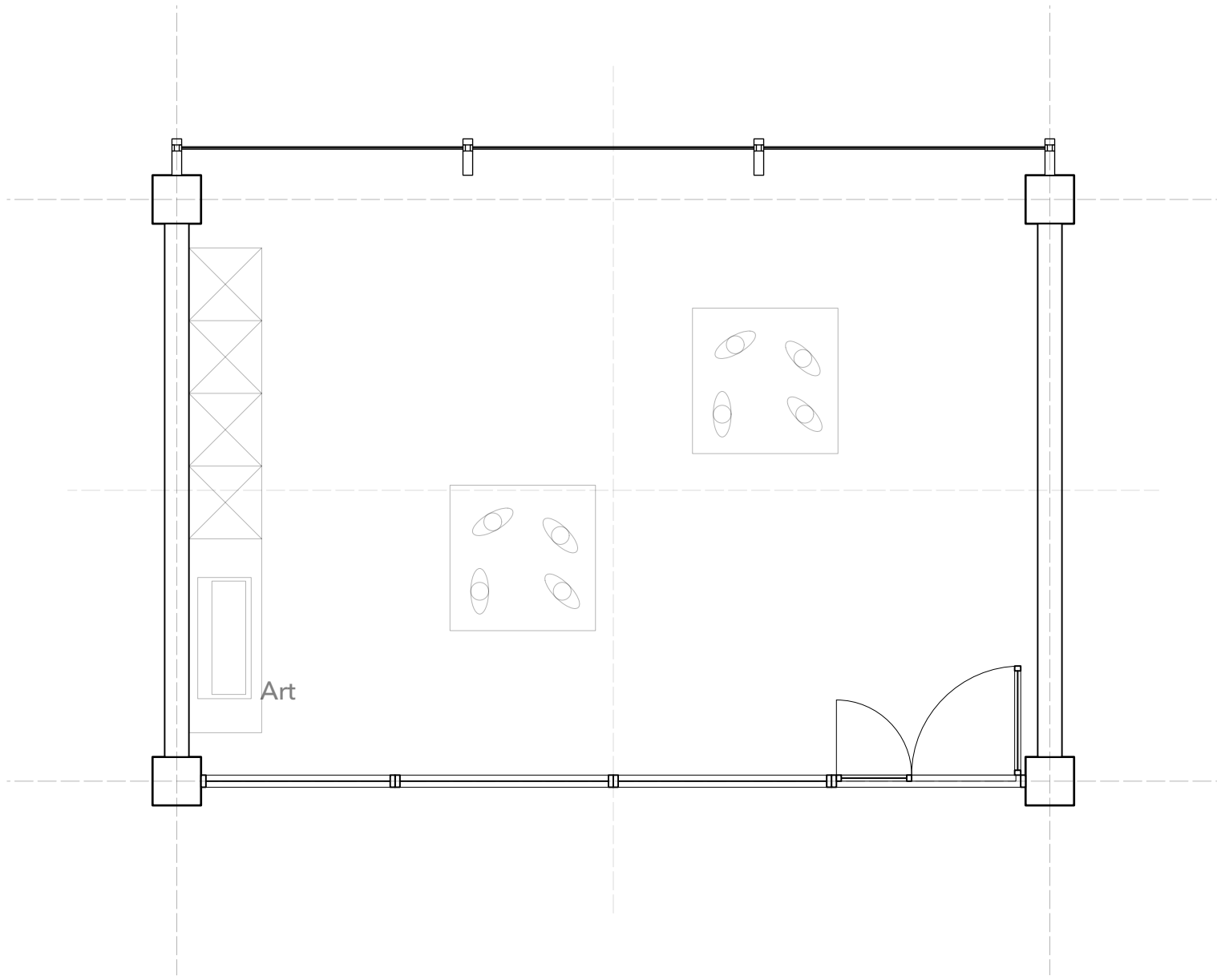

1:50

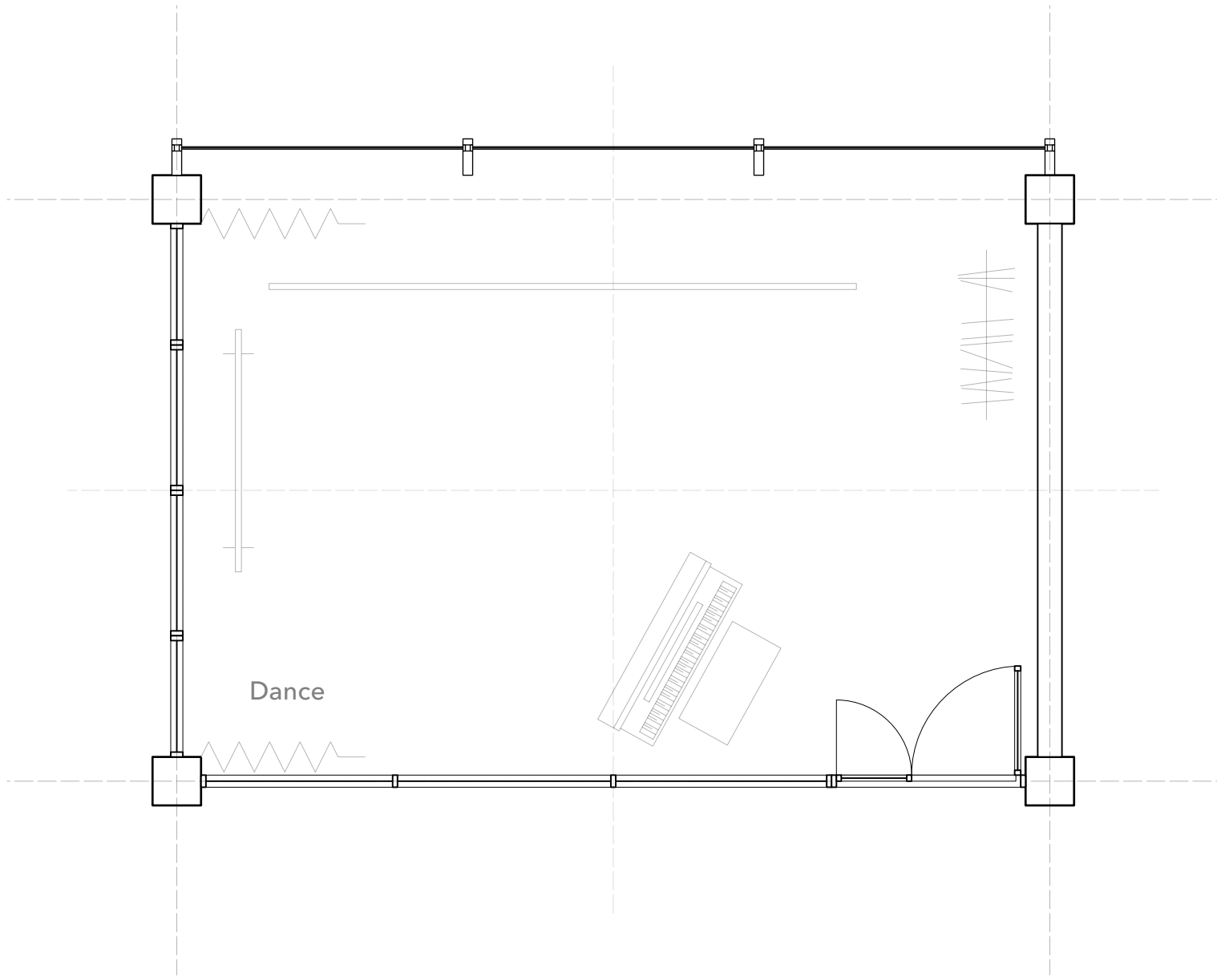

1:50

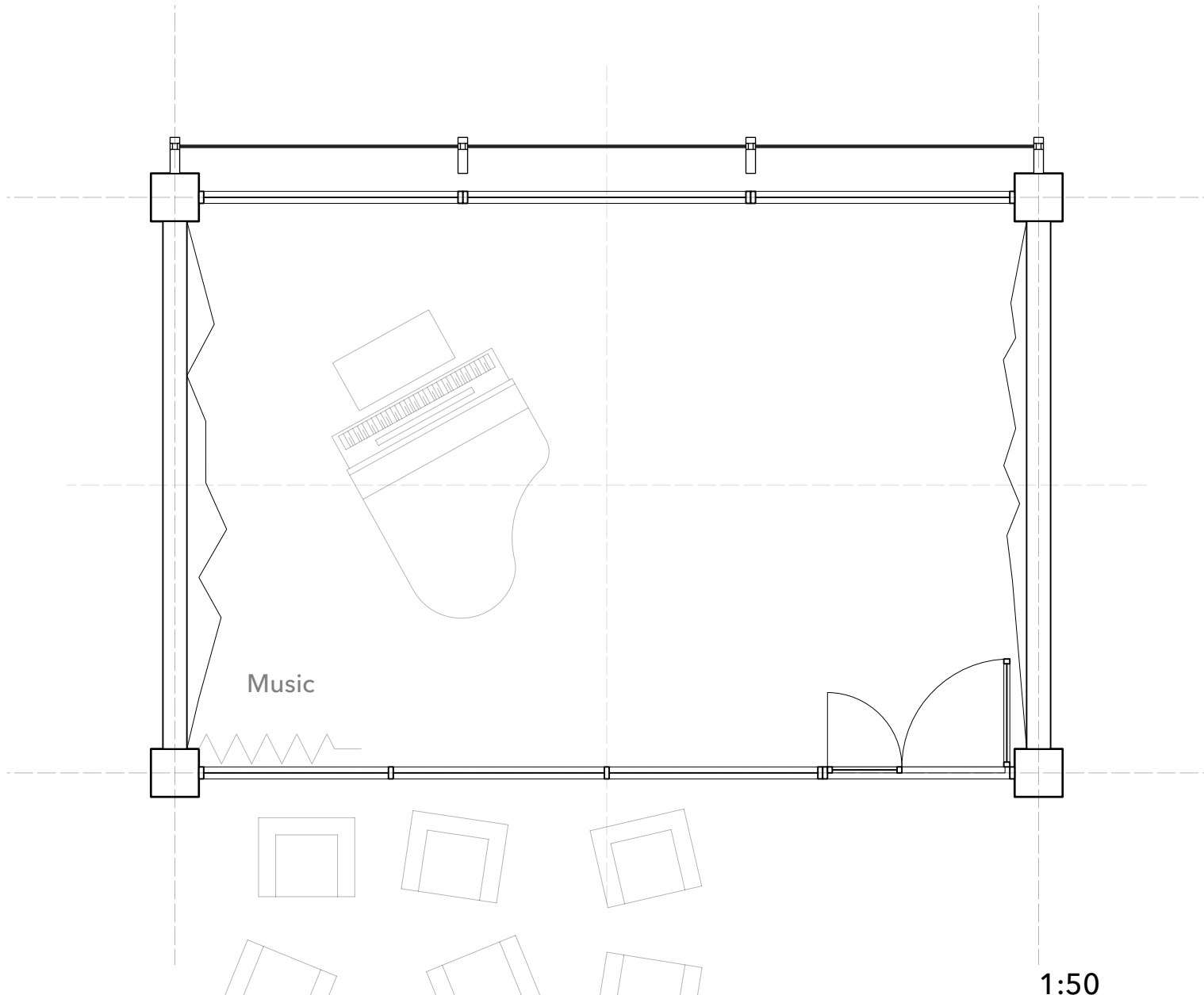

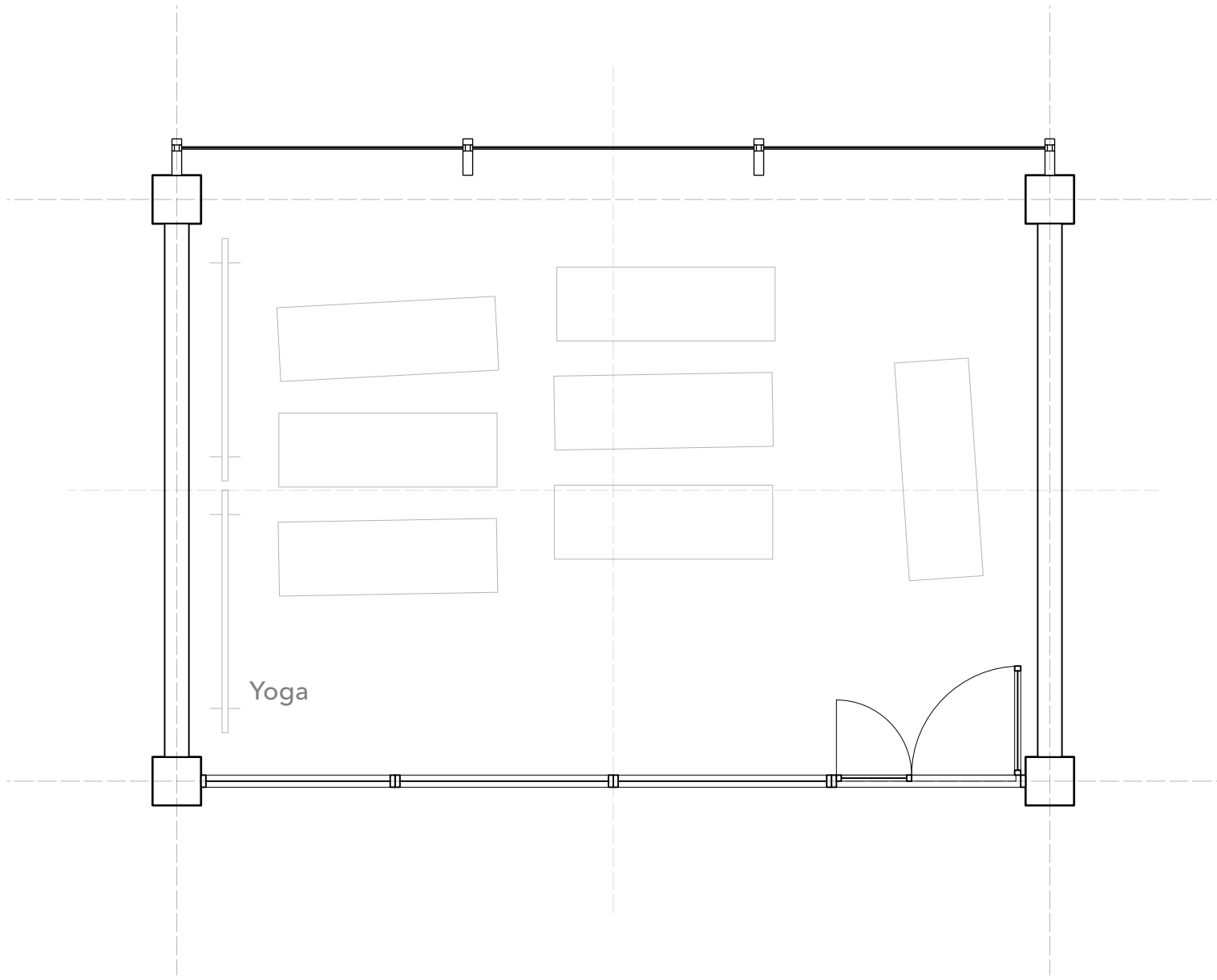

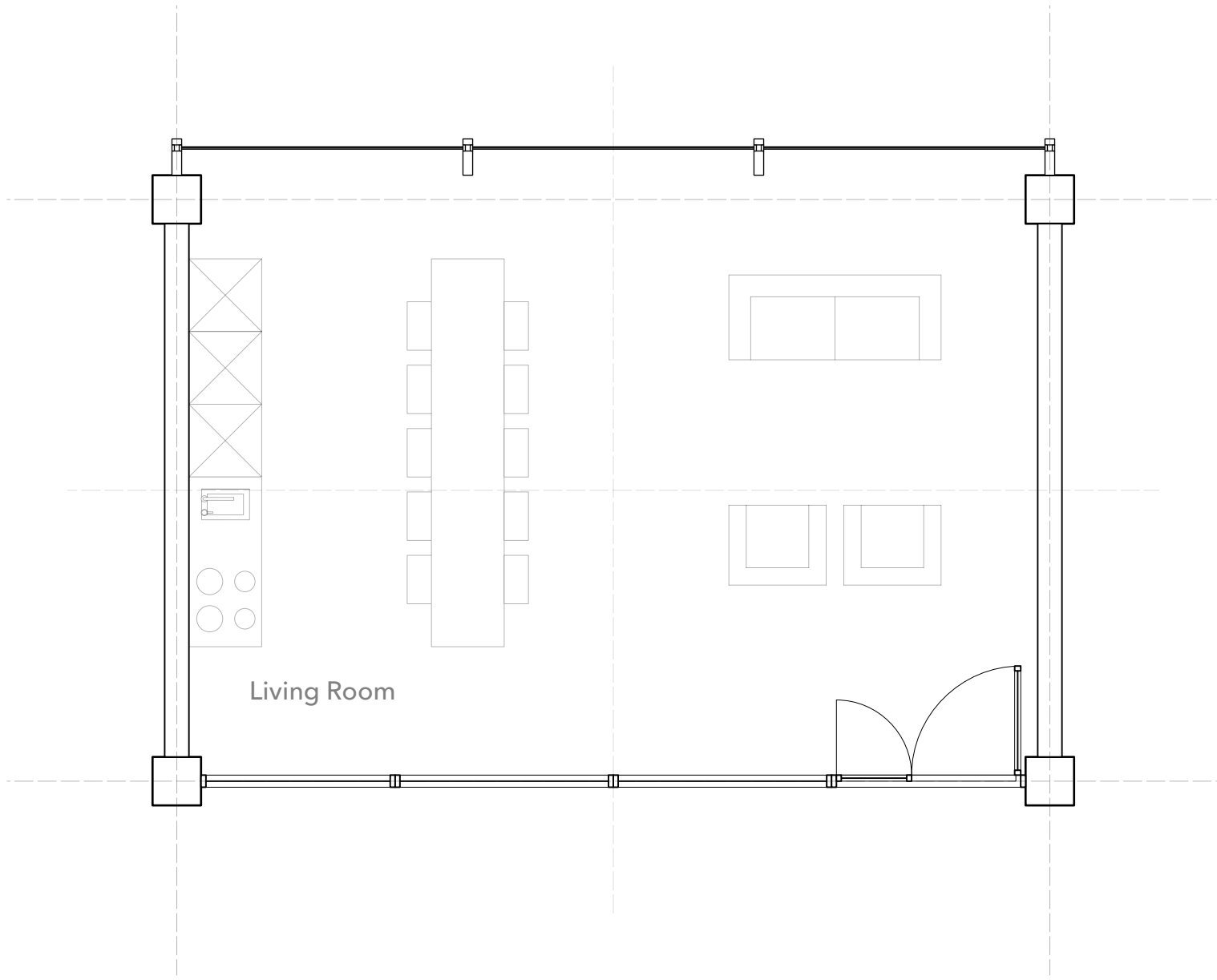

Living Room

1:50

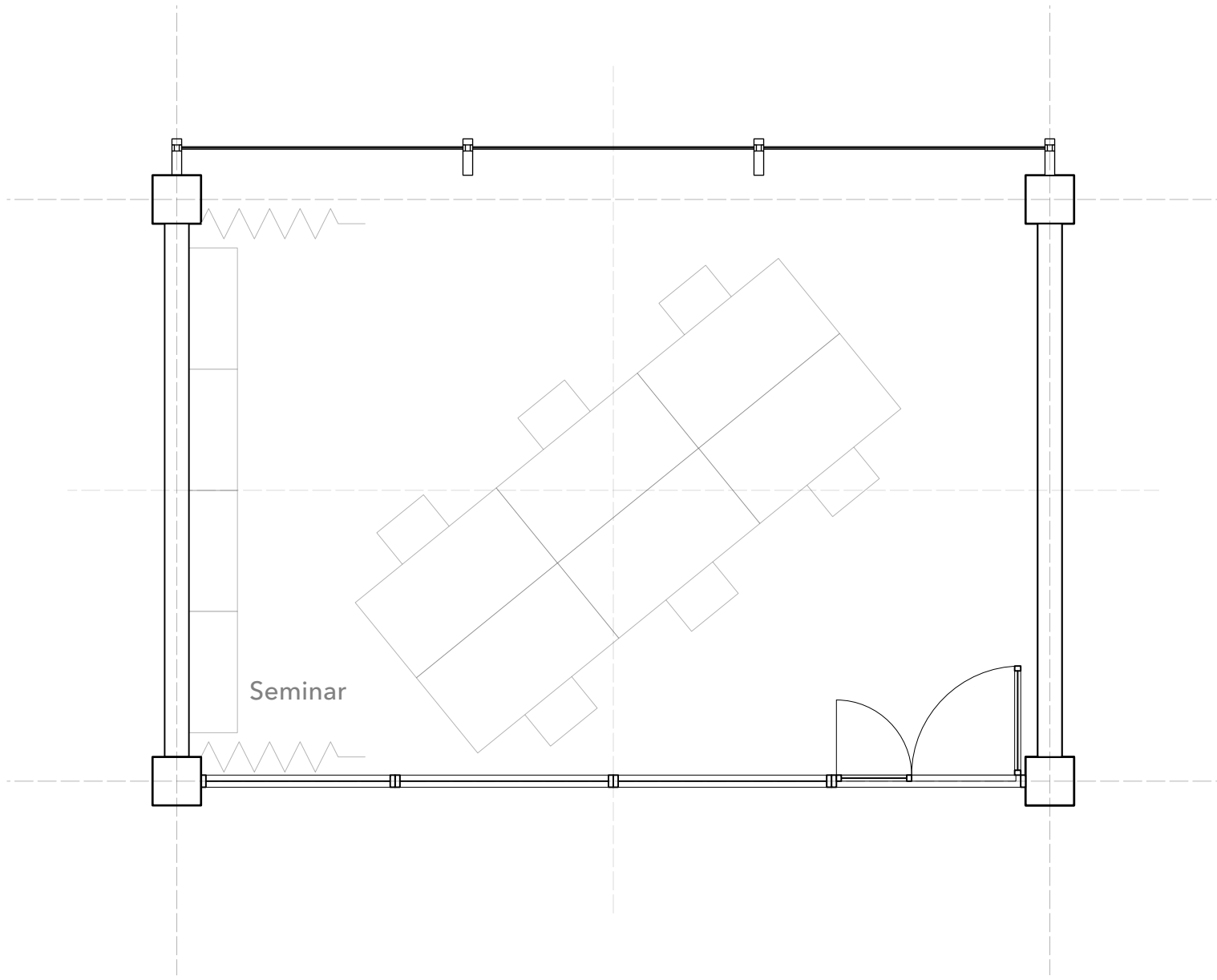

1:50

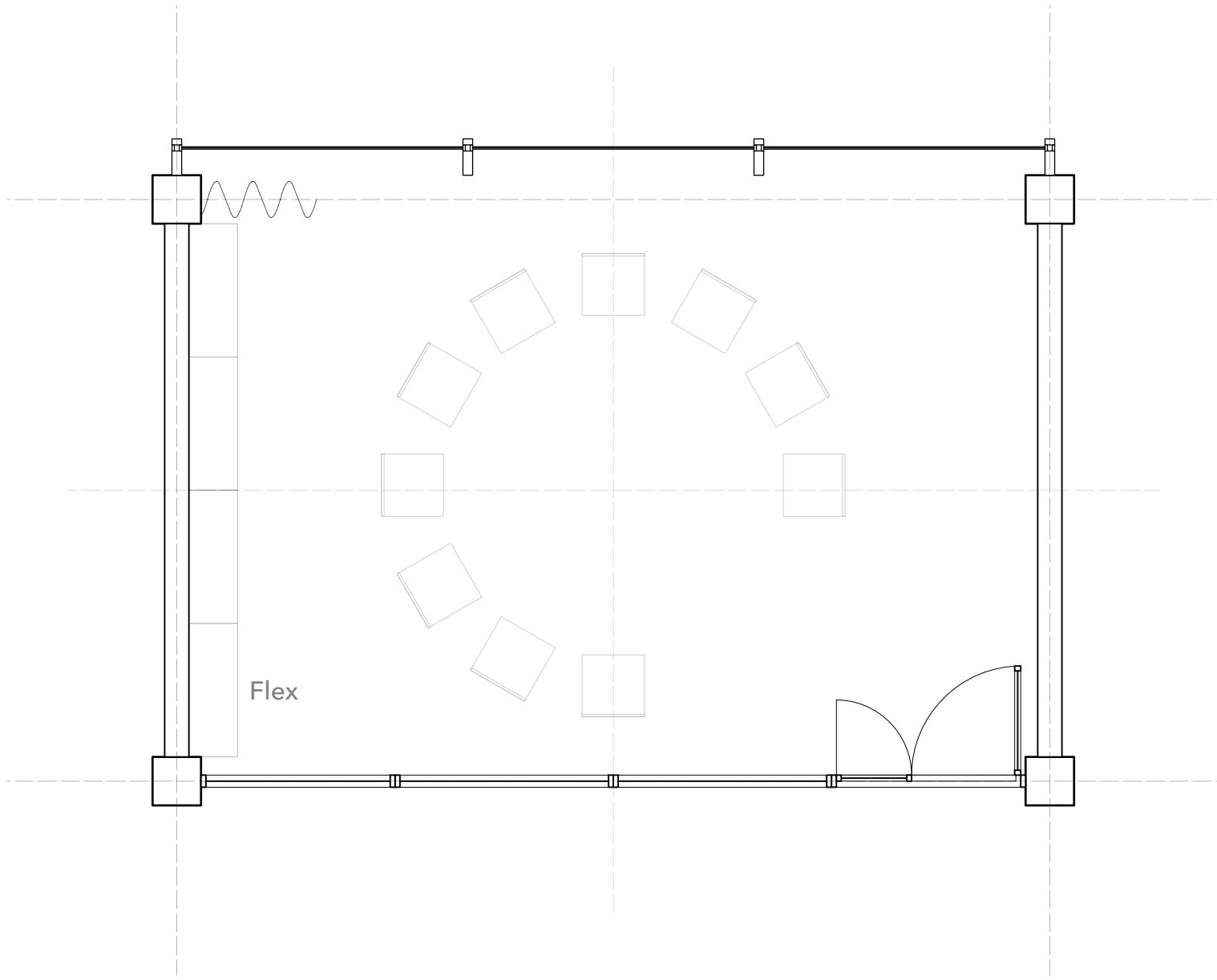

1:50



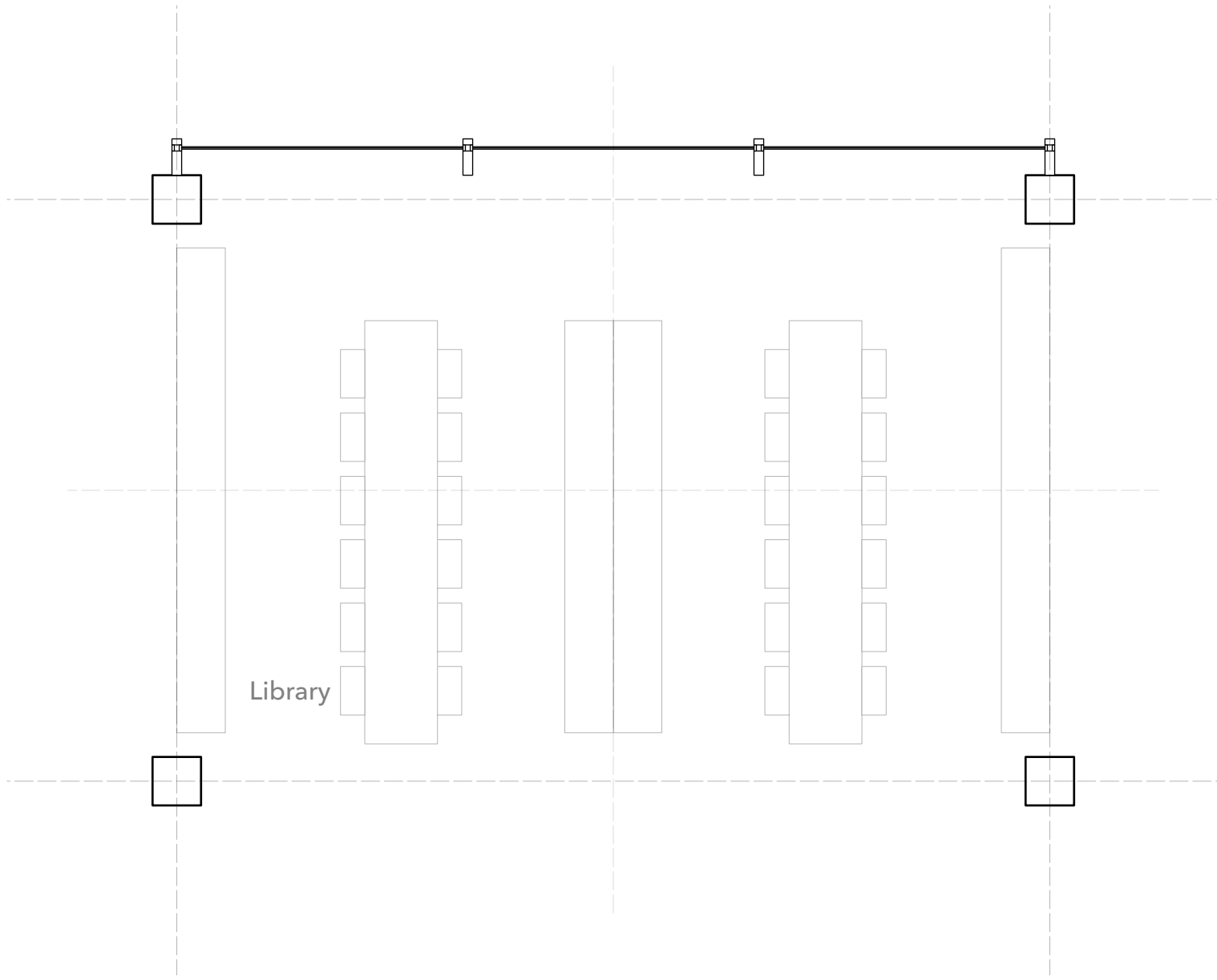

1:50

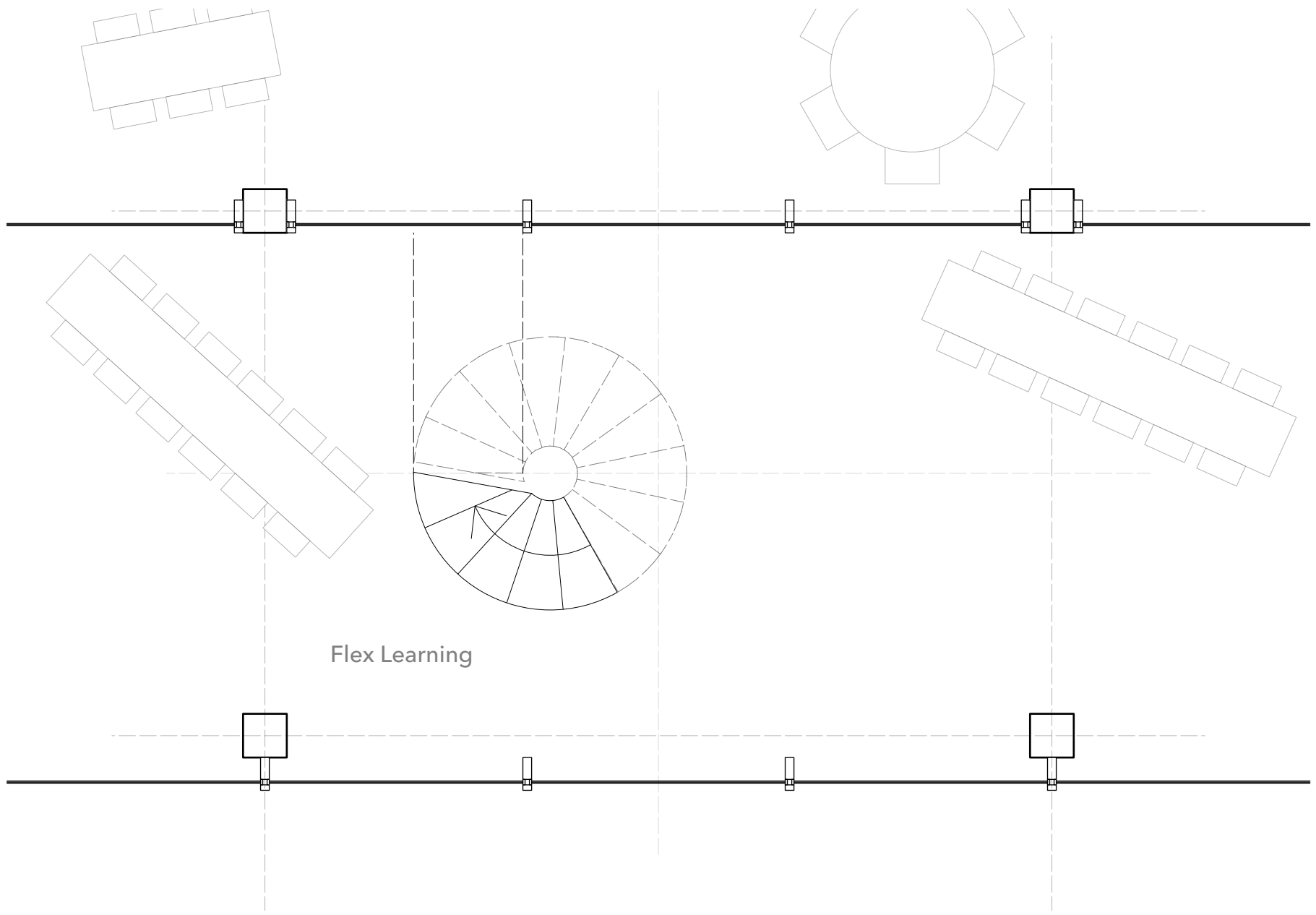



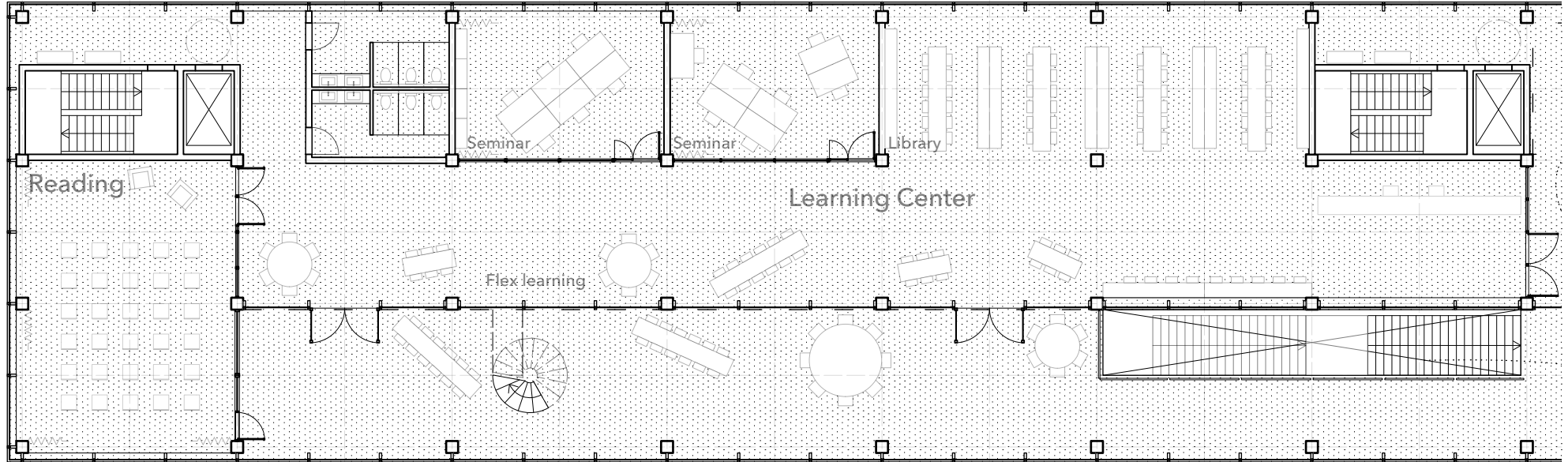

Upper Level
Plan +1

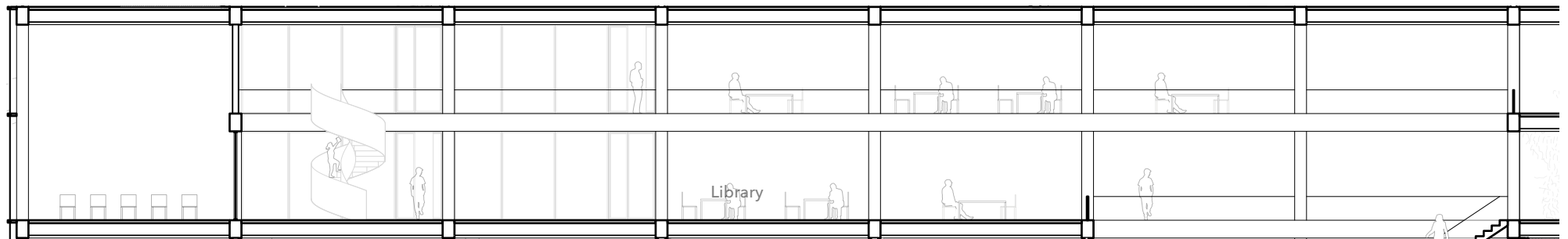

Upper Level
Section

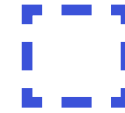
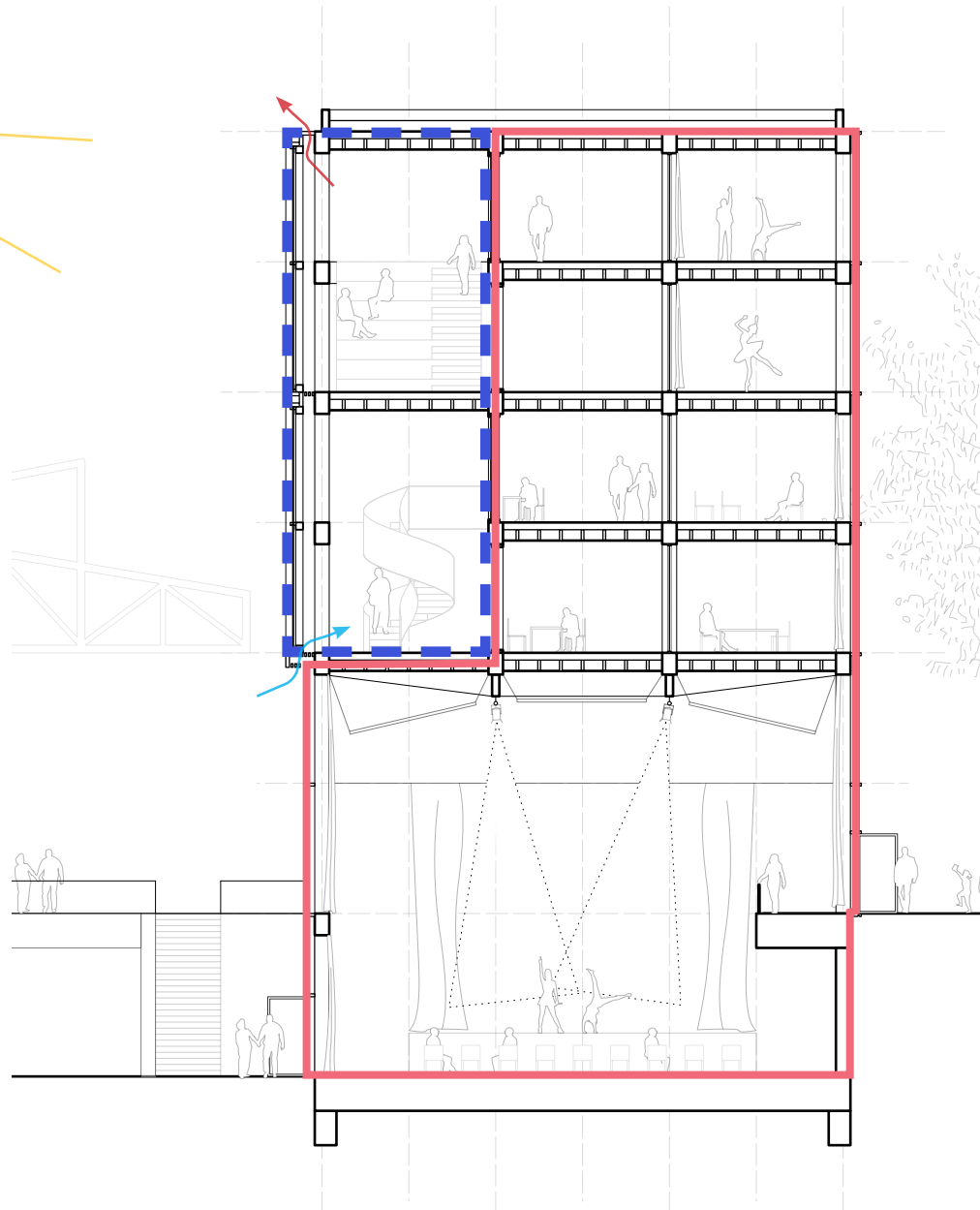
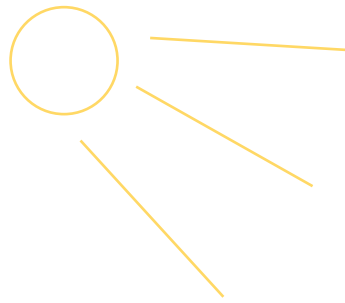

Buffer Zone
(Wintergarden)



Thermal Envelope

Climate
Concept

Winter

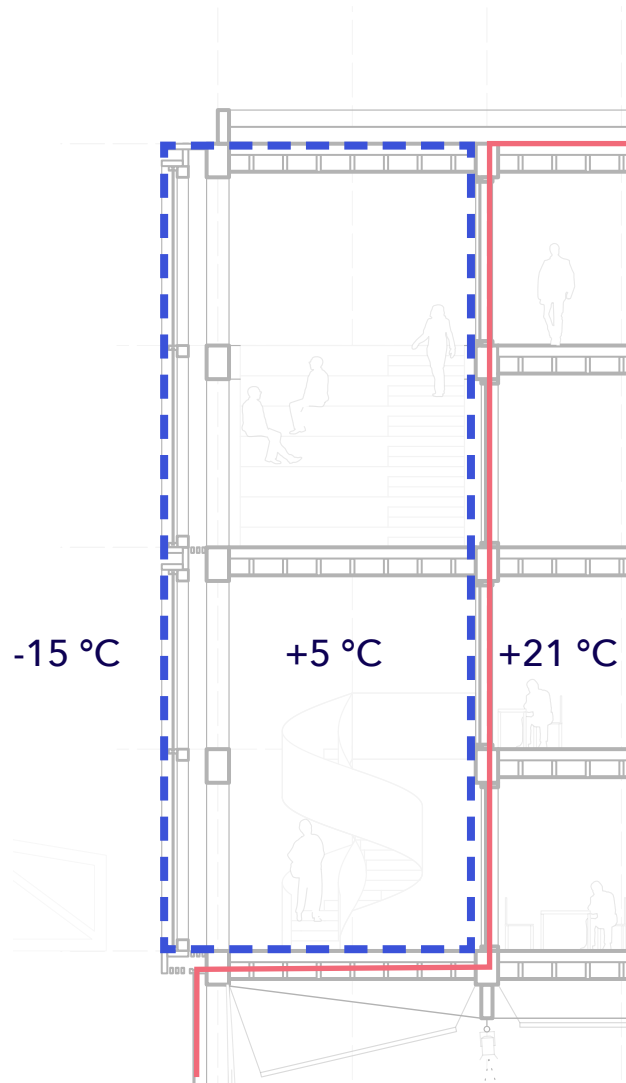

Spring

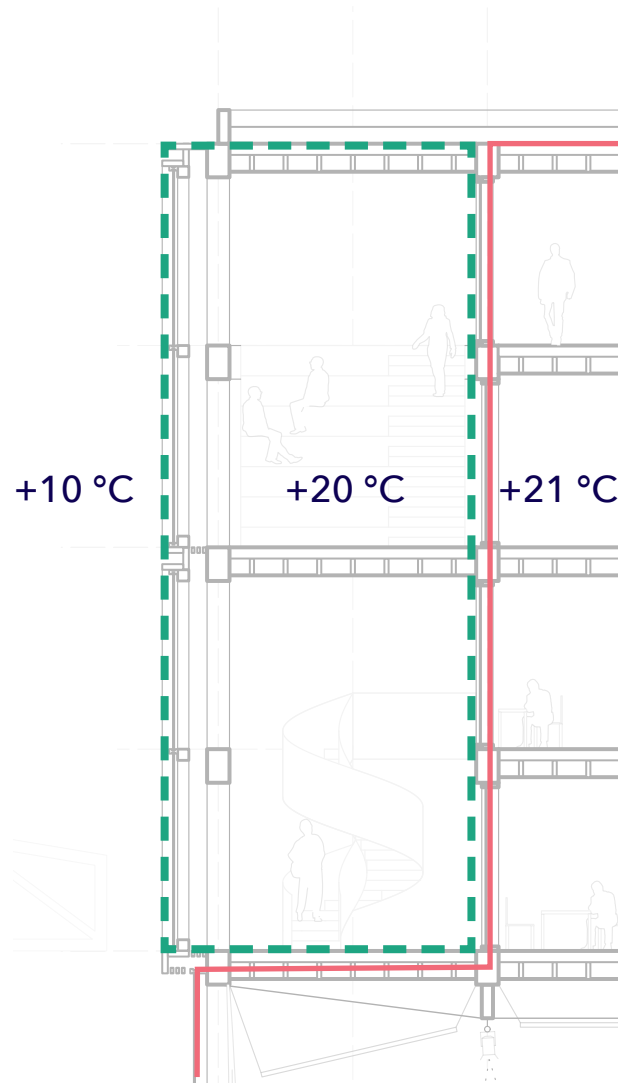

Summer

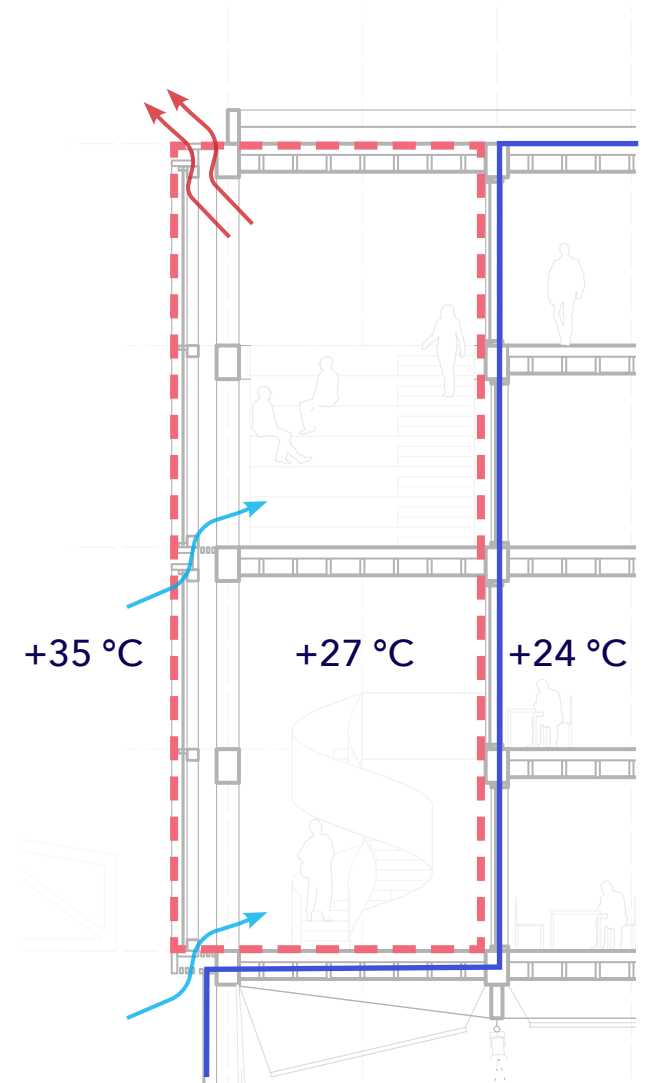

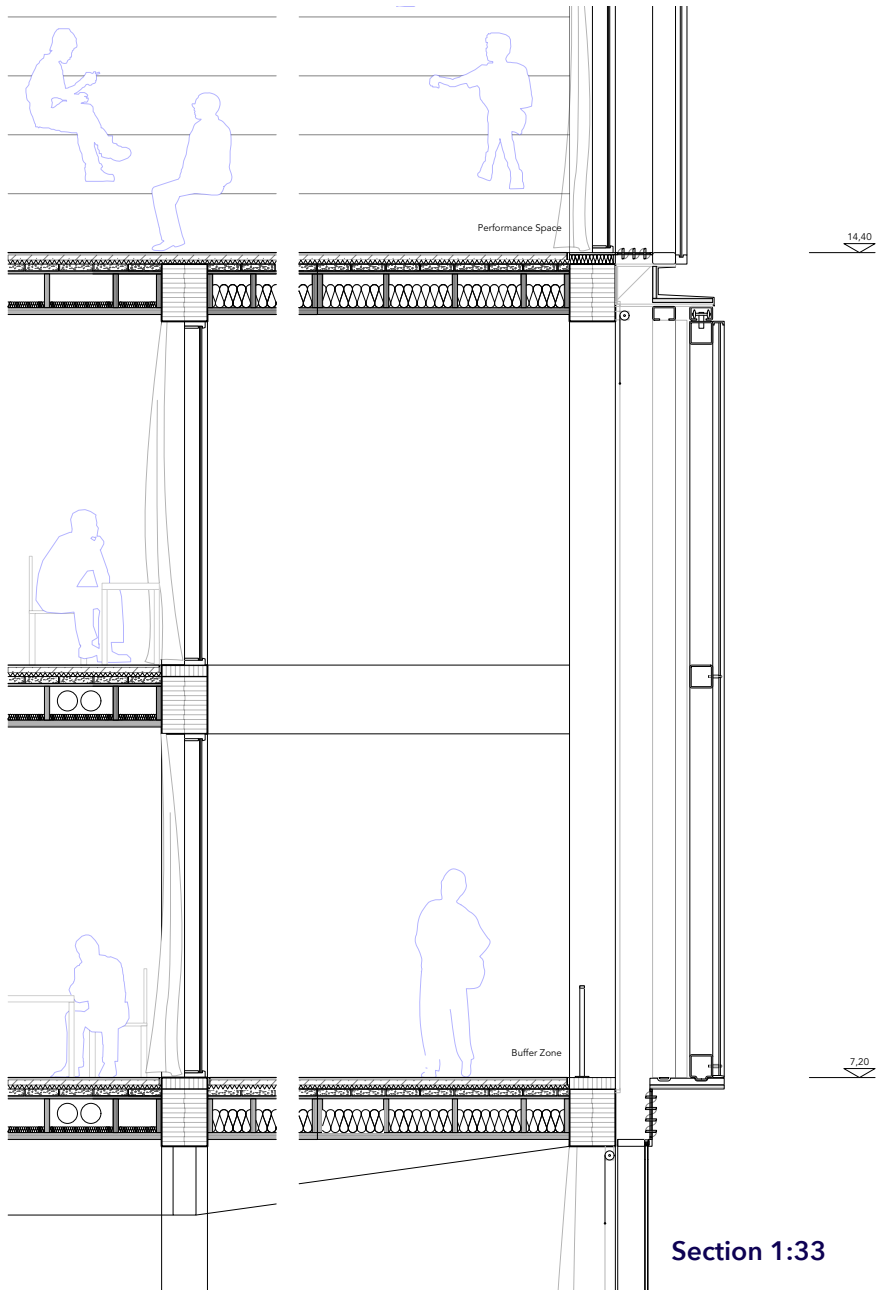

Section 1:33

Leon Thormann

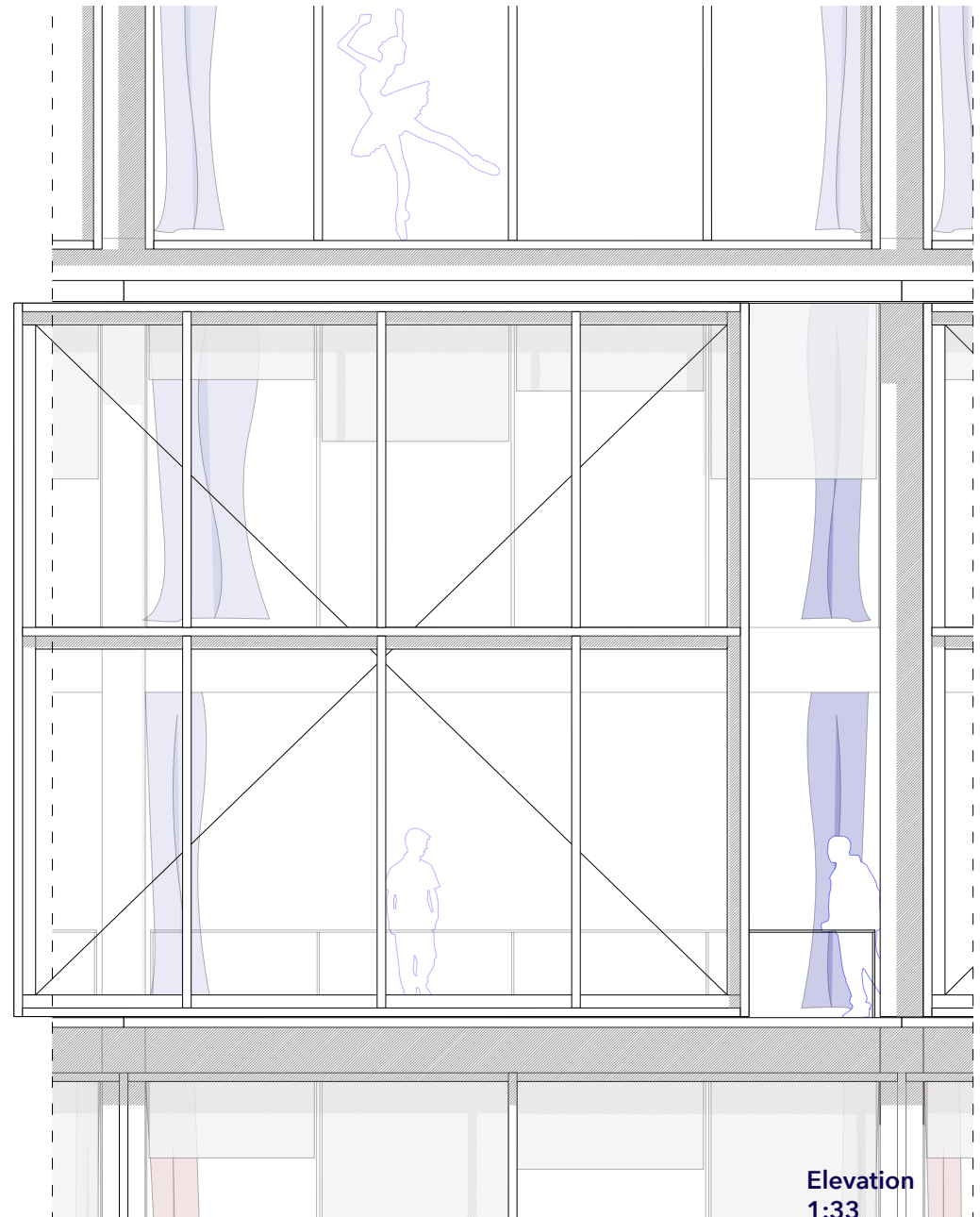

Elevation 1:33

P5

74



Model
1:50

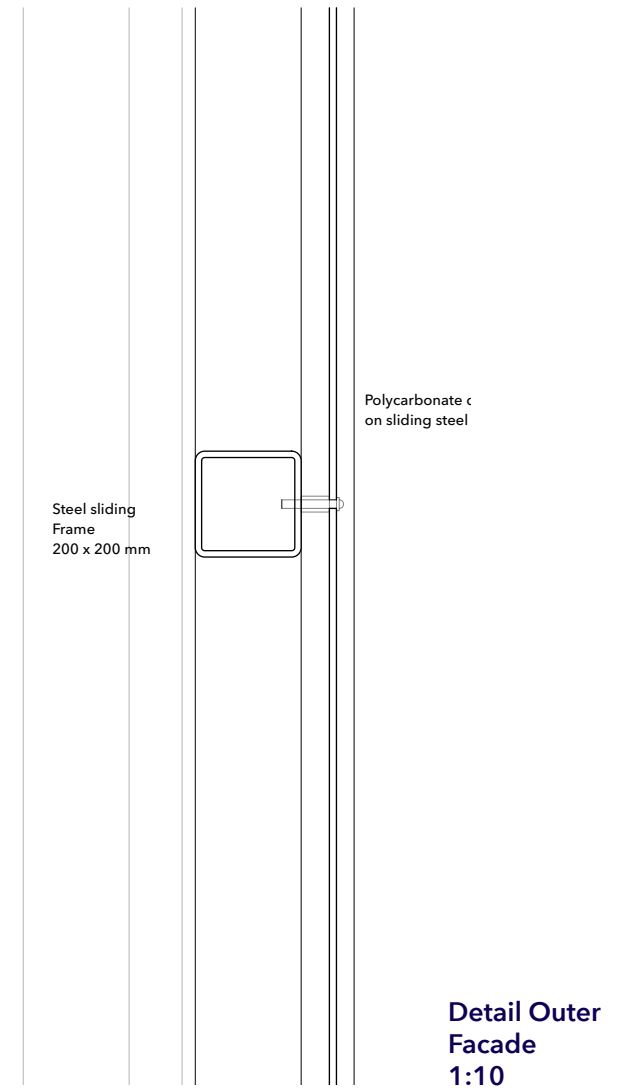
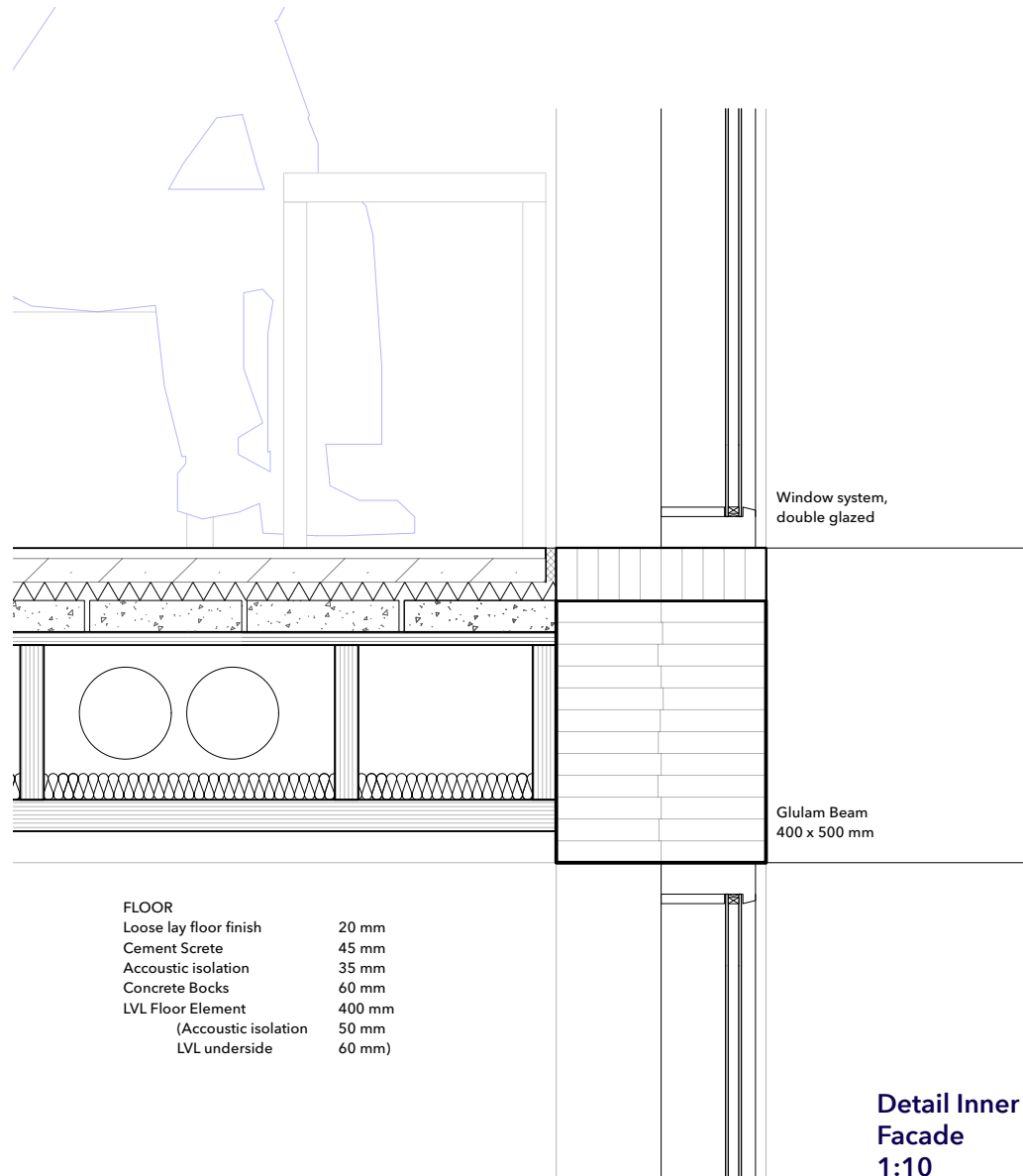

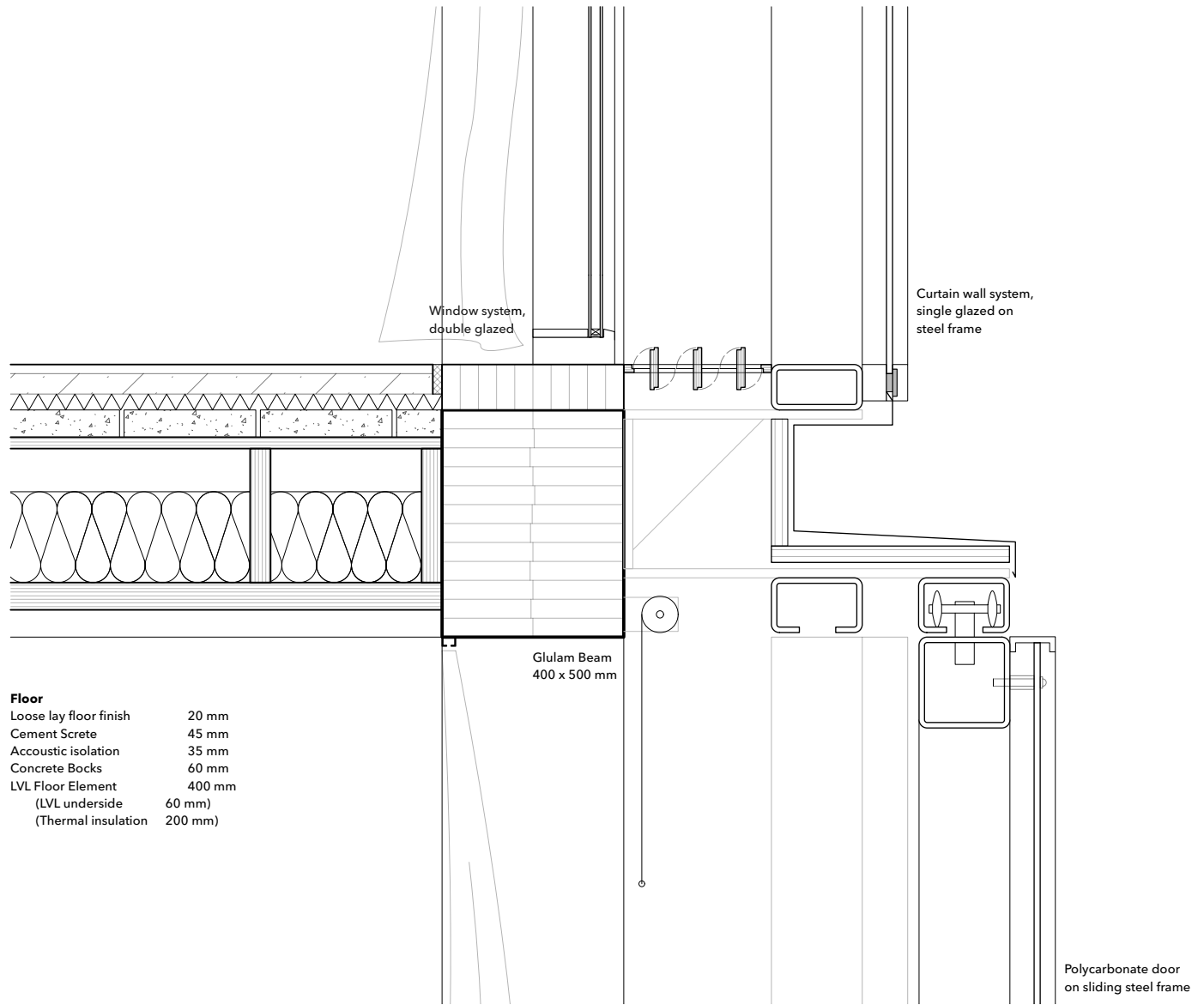

Detail 2
1:10

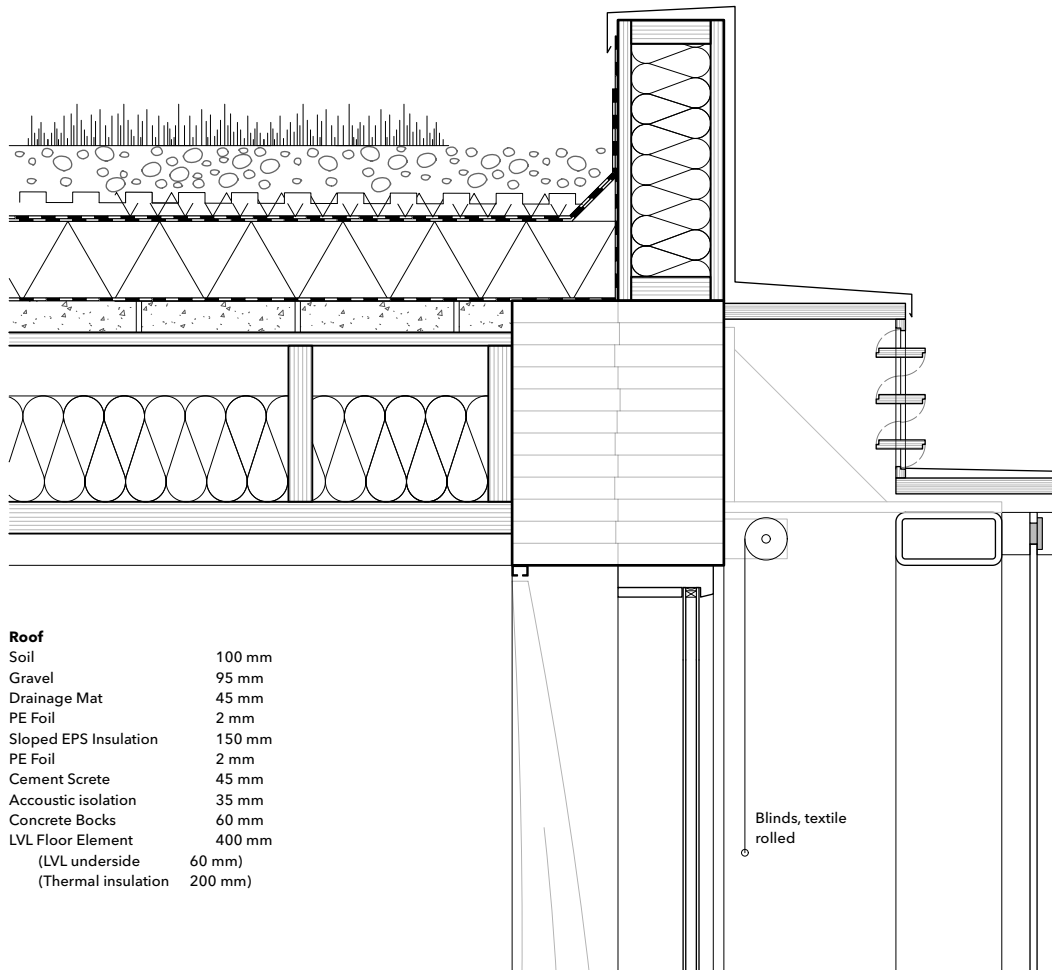

Roof	
Soil	100 mm
Gravel	95 mm
Drainage Mat	45 mm
PE Foil	2 mm
Sloped EPS Insulation	150 mm
PE Foil	2 mm
Cement Screte	45 mm
Acoustic isolation	35 mm
Concrete Bocks	60 mm
LVL Floor Element	400 mm
(LVL underside	60 mm)
(Thermal insulation	200 mm)

Blinds, textile rolled

Detail 3
1:10



Model
1:50



Layer of
Spaces



Layer of Spaces

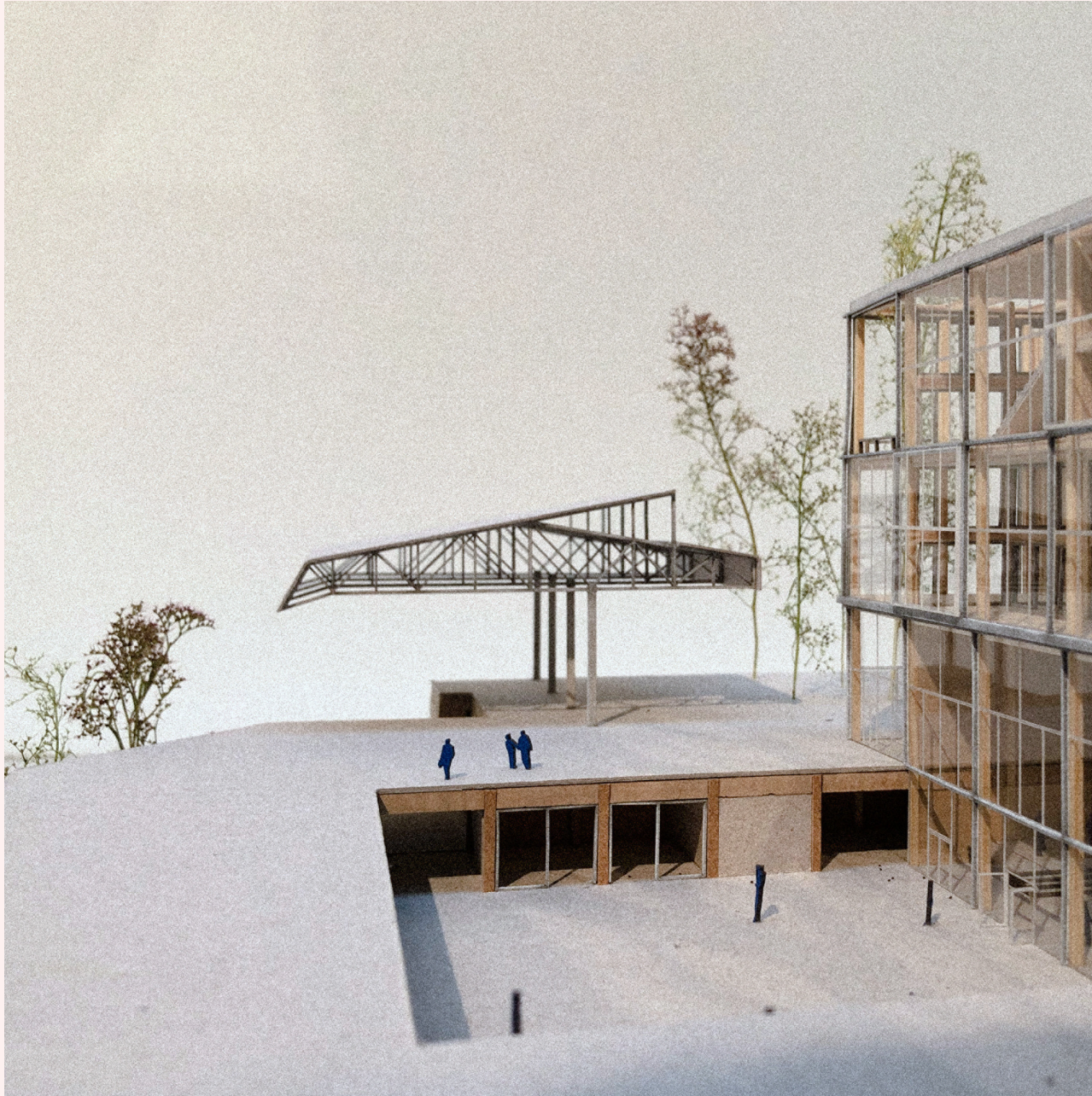

Lower Palaza



Outdoor Cinema



Theatre
Space

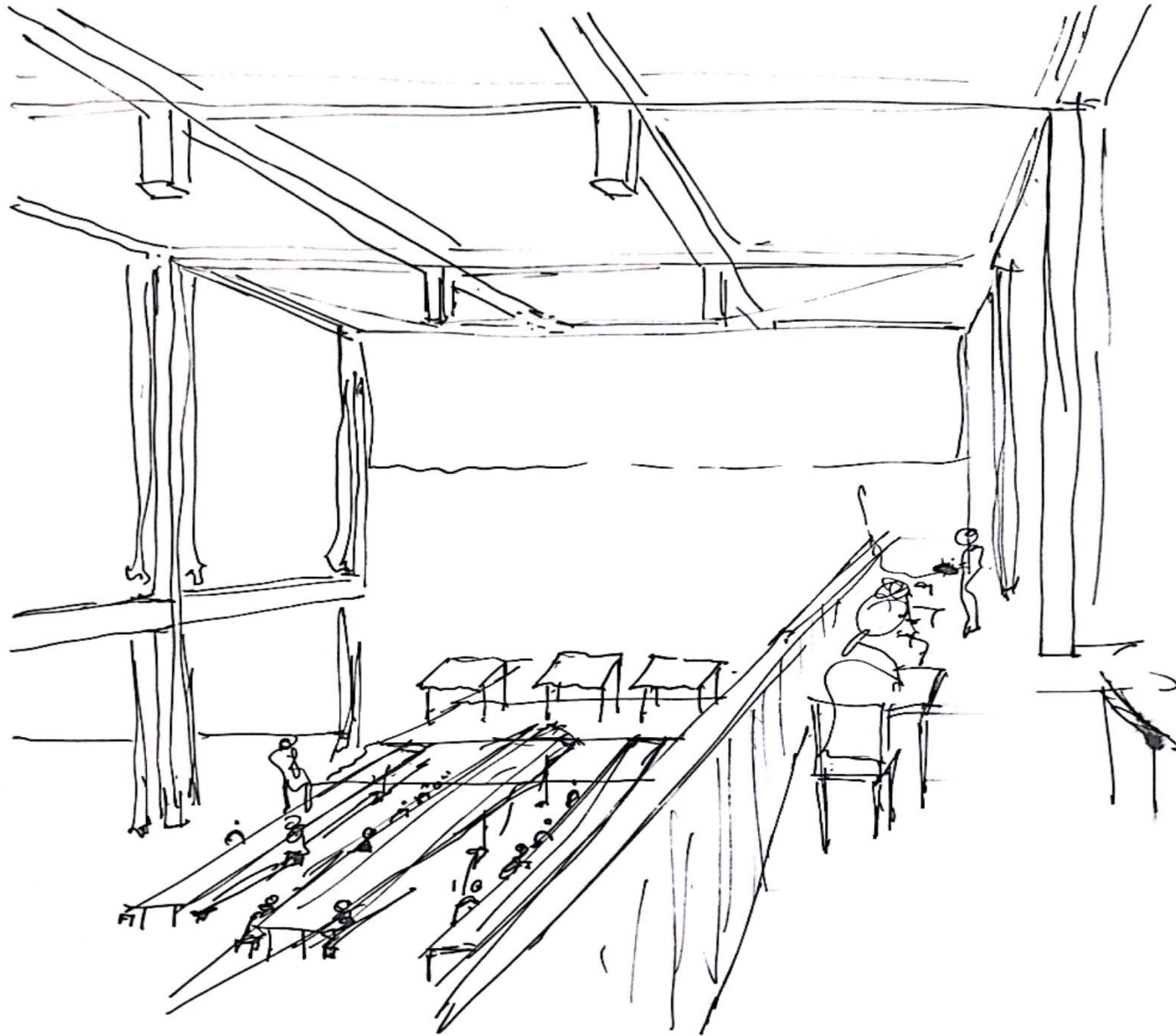



Library Meeting



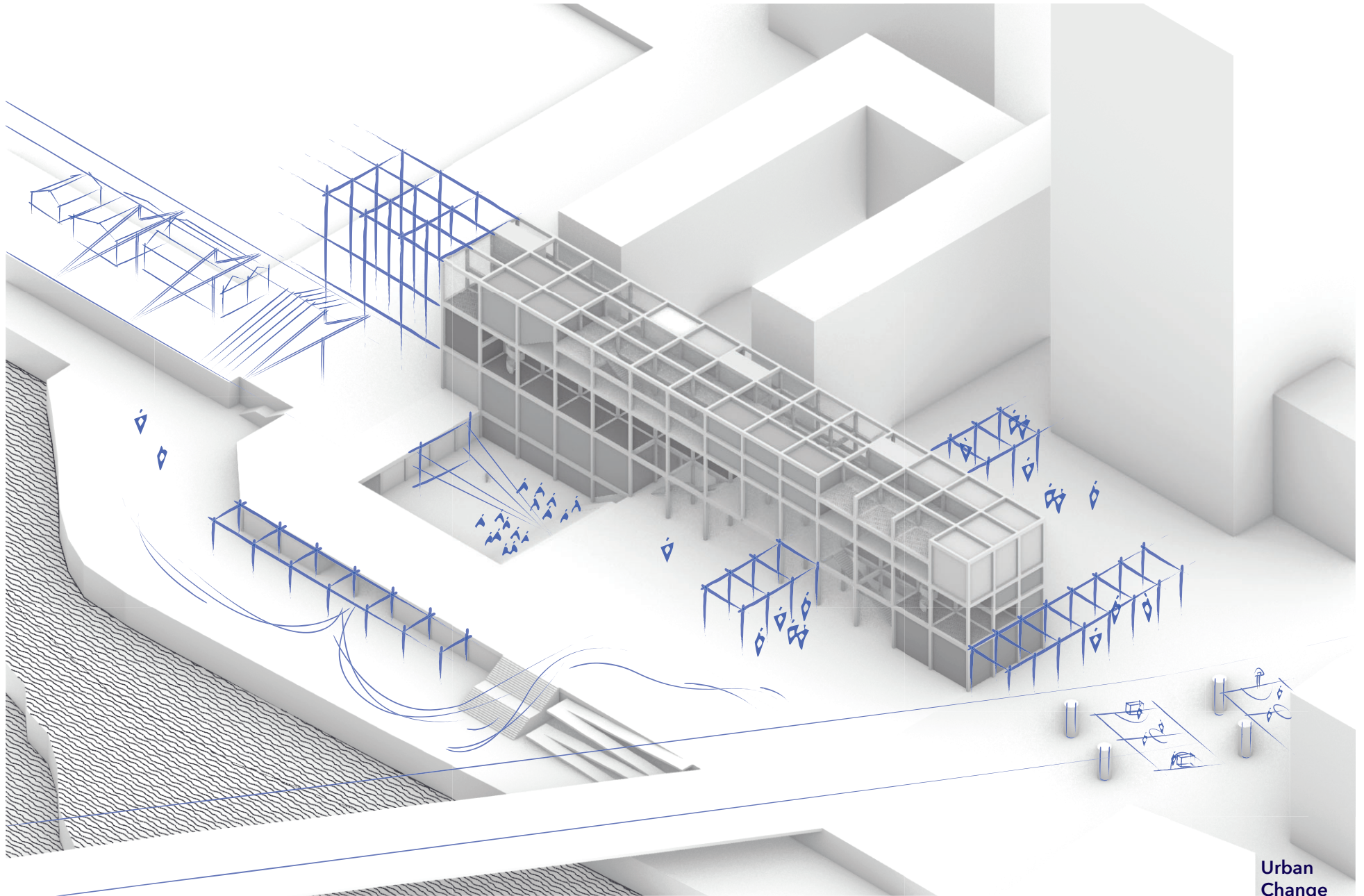



View Street
North

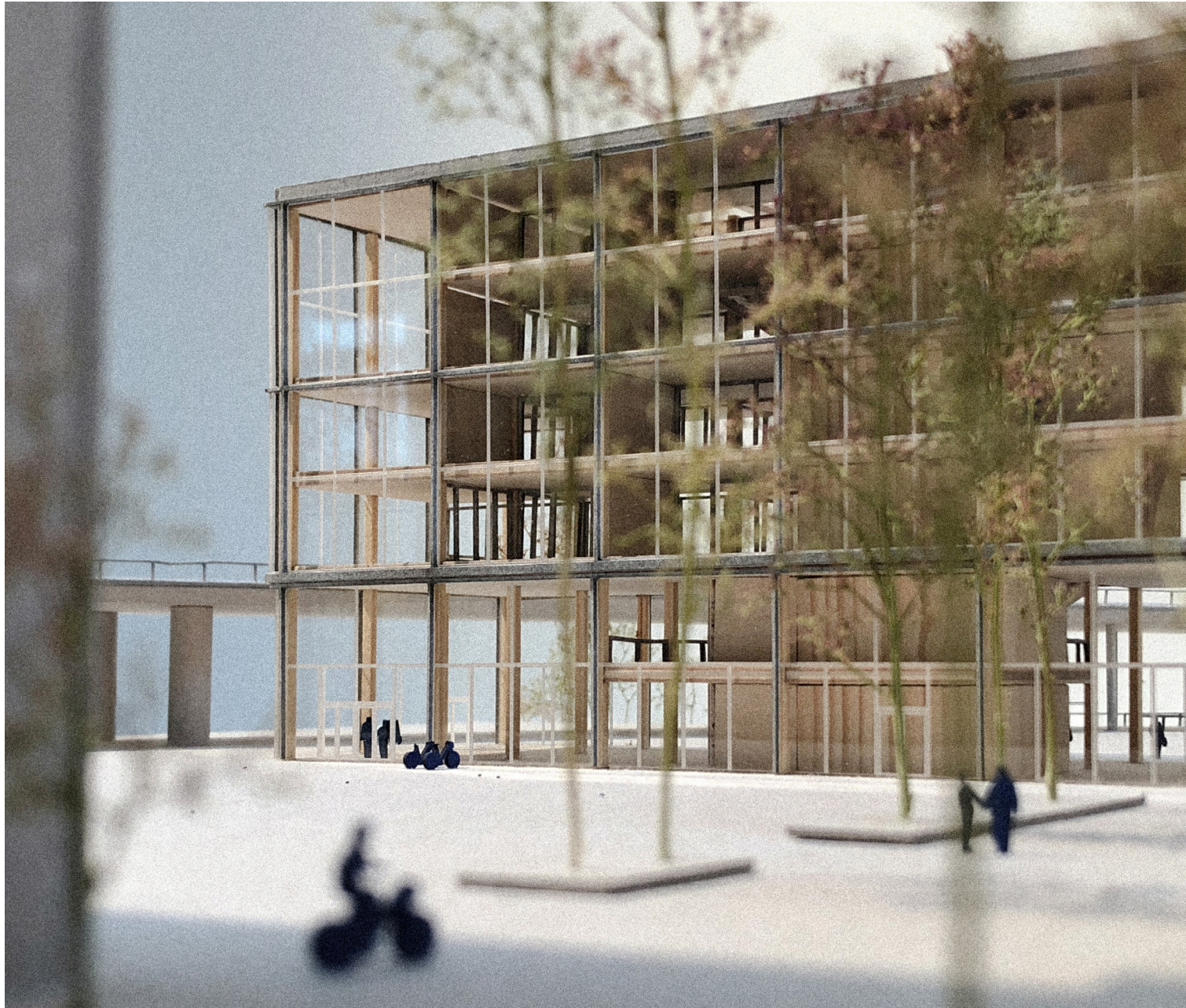

View Square
North

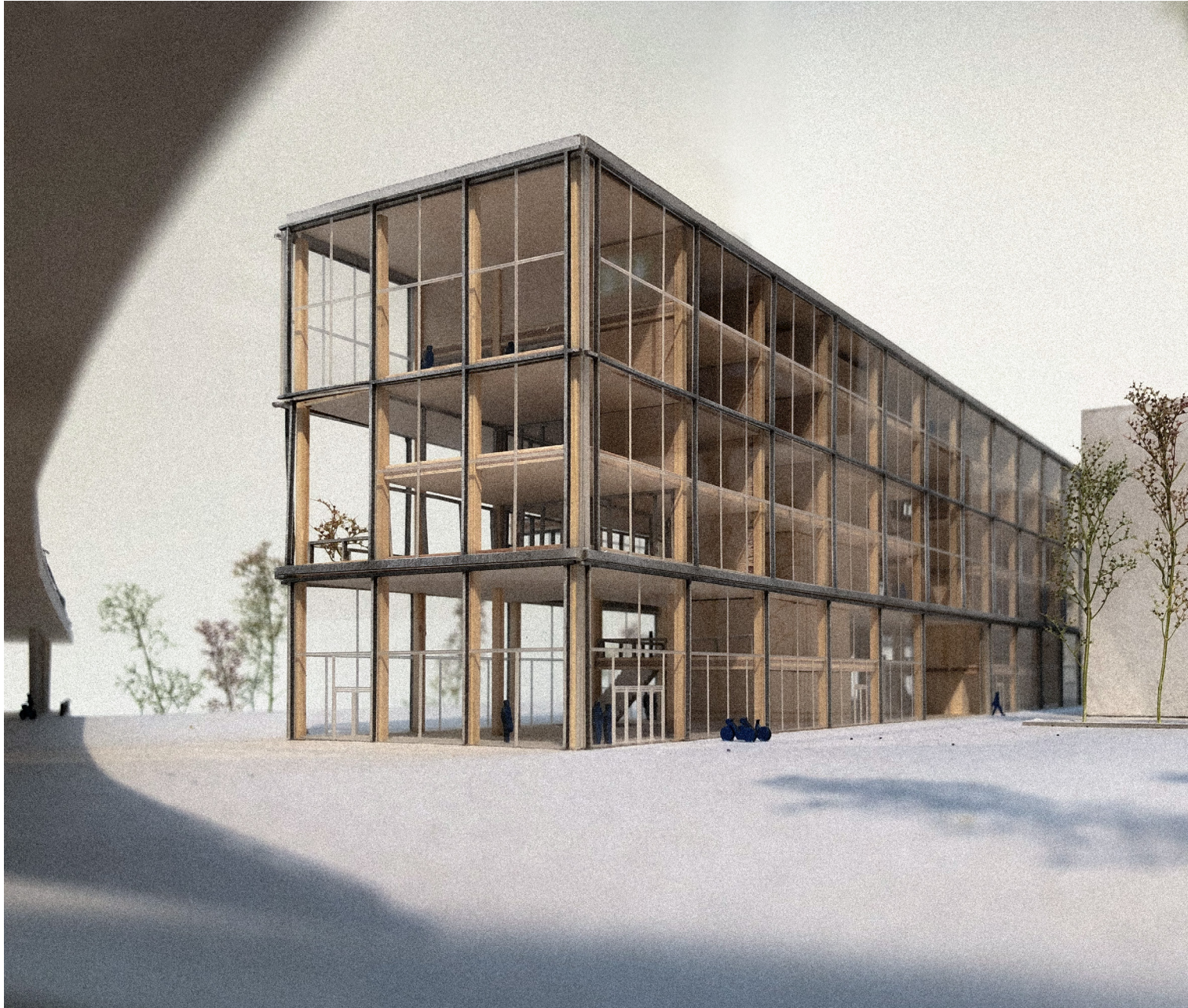

View Square
North



View under
Bridge



View Dance
Performance



View
Promenade

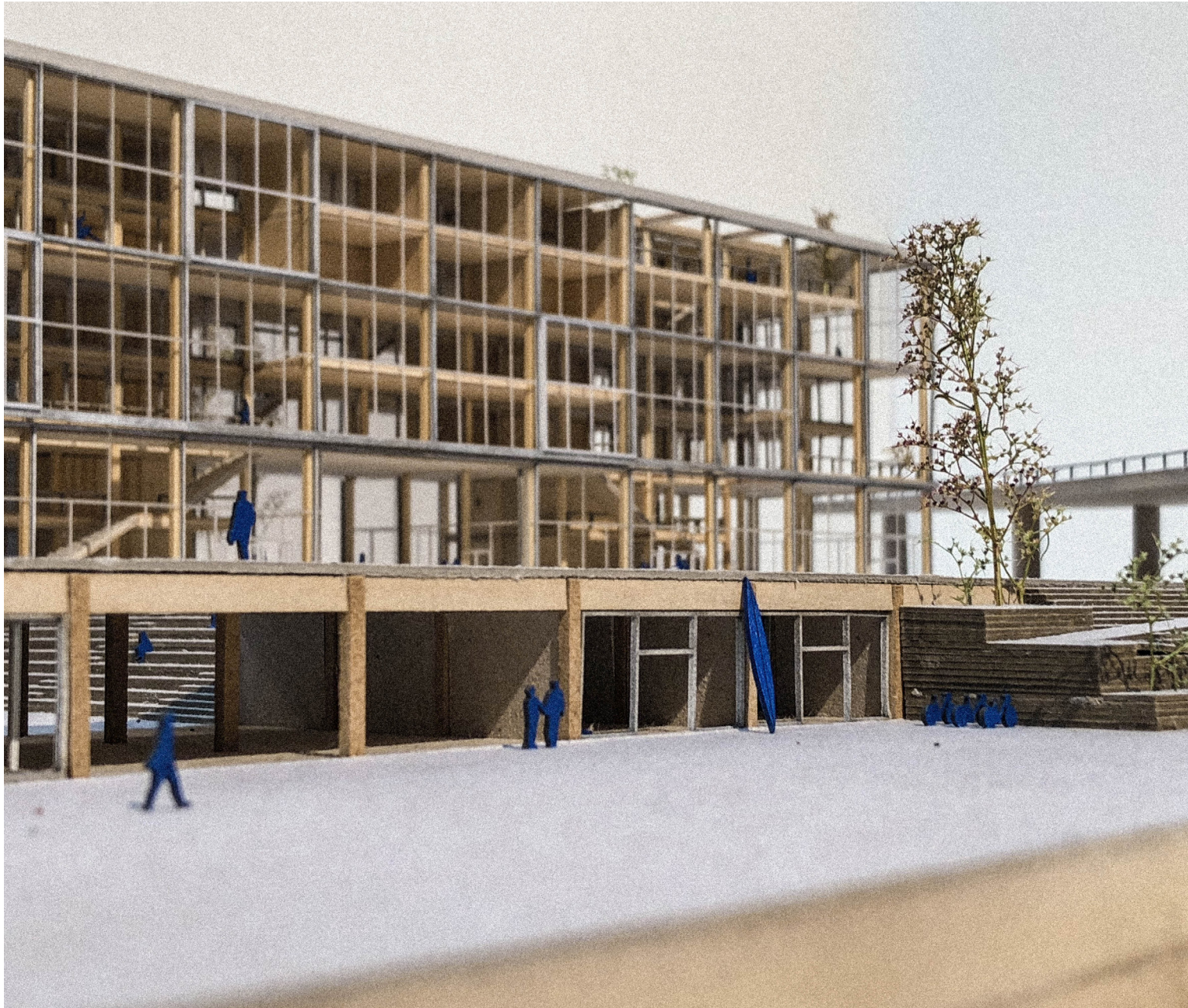

View
Promenade



View Passage

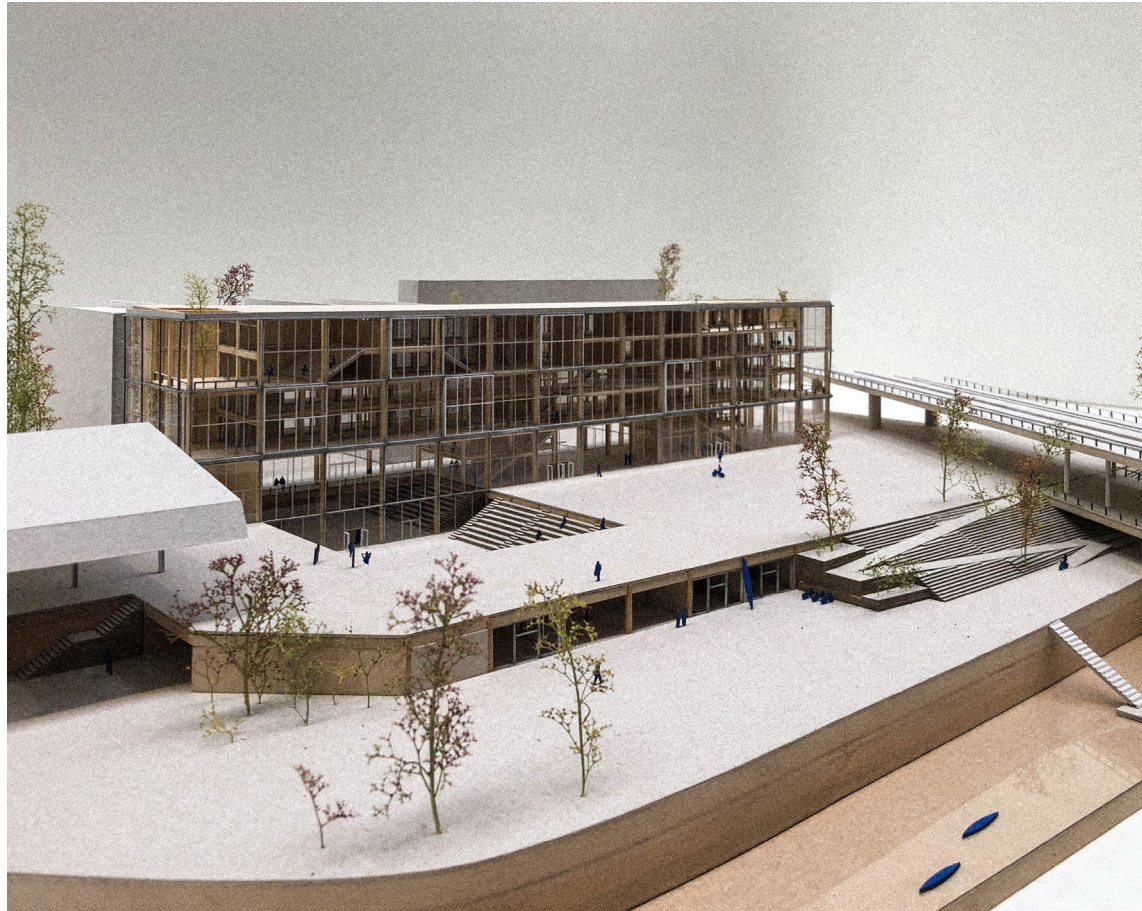

Thank you!