

2100 **FUN** **UNIVERSE**

Vertical Entertaining Complex

P5

LI TAN
4700570

Complex Project Graduation Studio

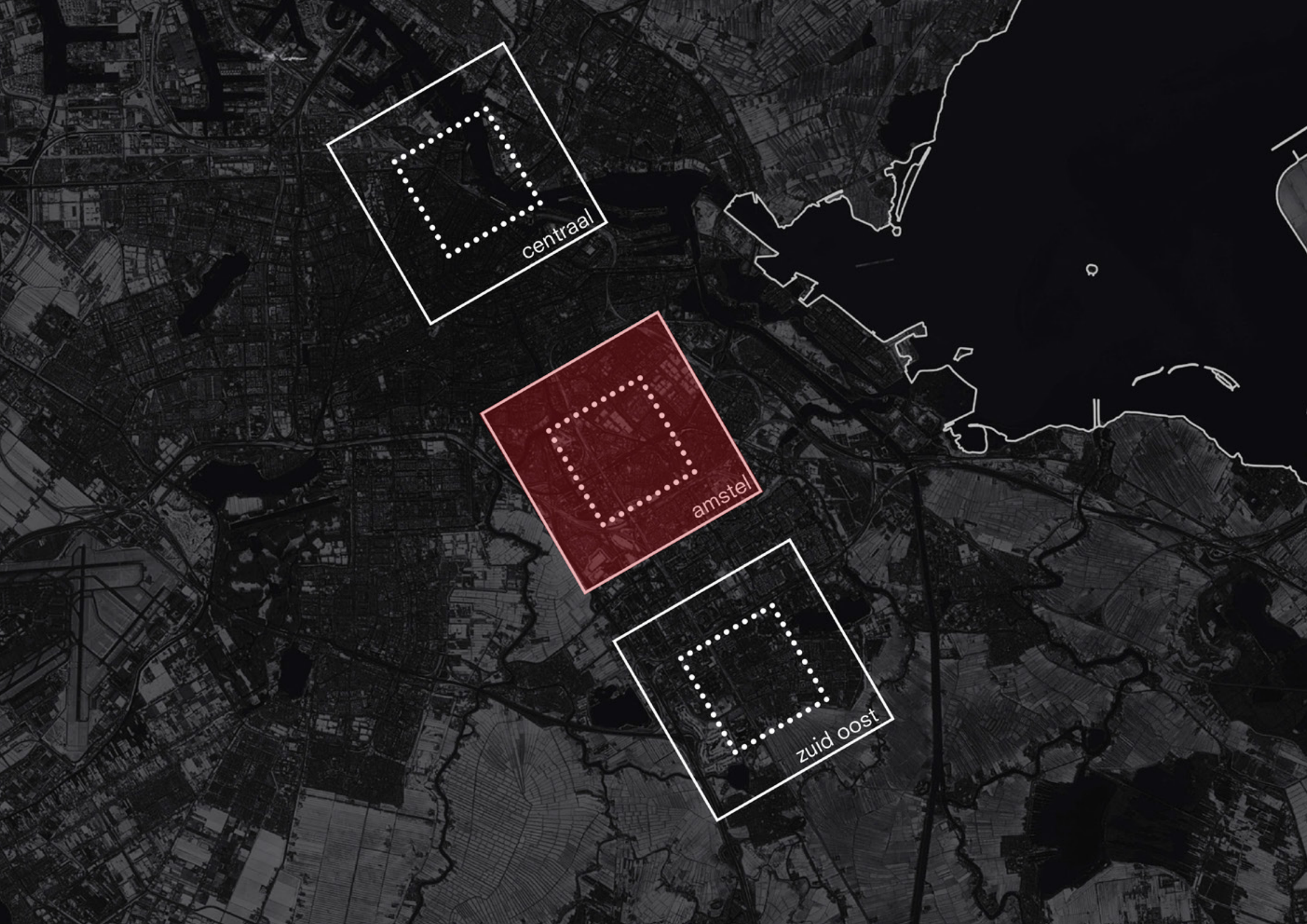

centraal

amstel

zuid oost

INTRODUCTION
TOWARDS (P)LEISURE CITY

2100?



*RISE OF
PRODUCTIVITY*

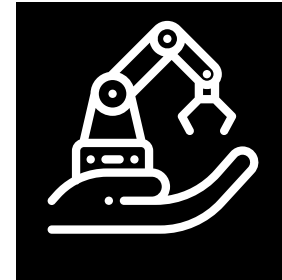
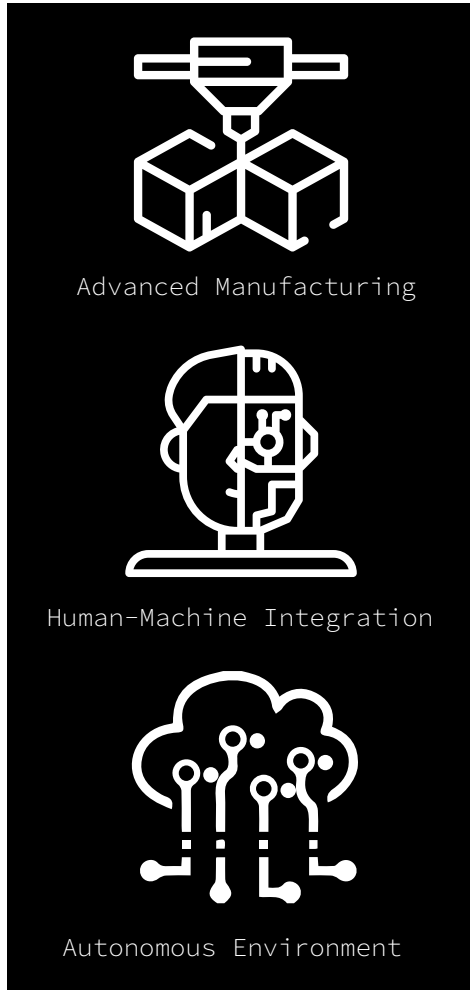

*DECENTRALIZATION OF
WORK AND PRODUCTION*

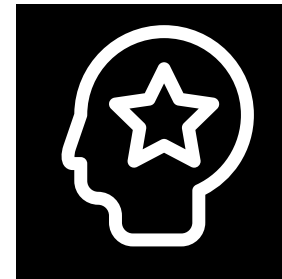

*ECONOMY TURN ITS
FOCUS TOWARDS HUMAN
EMOTION AND WELLNESS*

2000



Clothing



Electronics

Materialism



Housing



Cars

2000



2100



Clothing



Electronics

Materialism



Housing



Cars



Sports

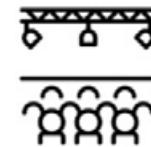

Live events

Experiences



Theater



Travel

“
Pleasure and Leisure are becoming the next leading economy.”

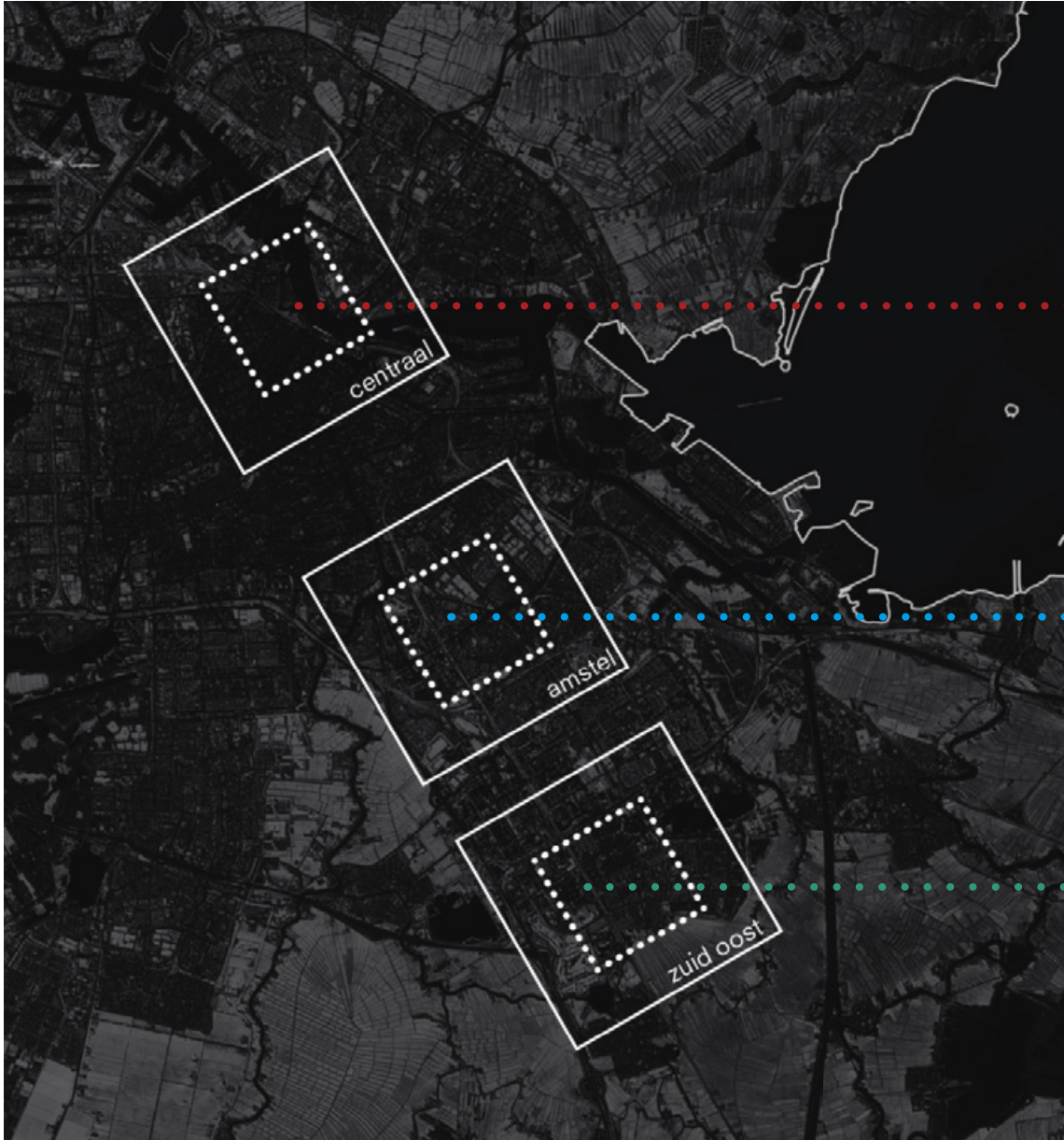

City of Museum

City of (P)leisure

City of Green

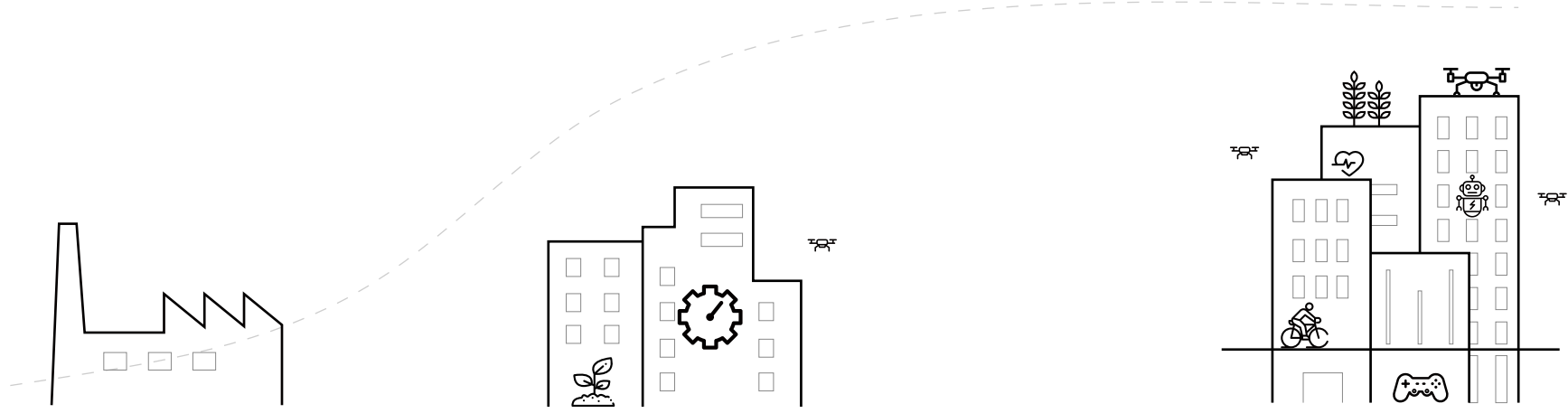

20th Century
Industrial

2050
Productive

2100
(P)leisure

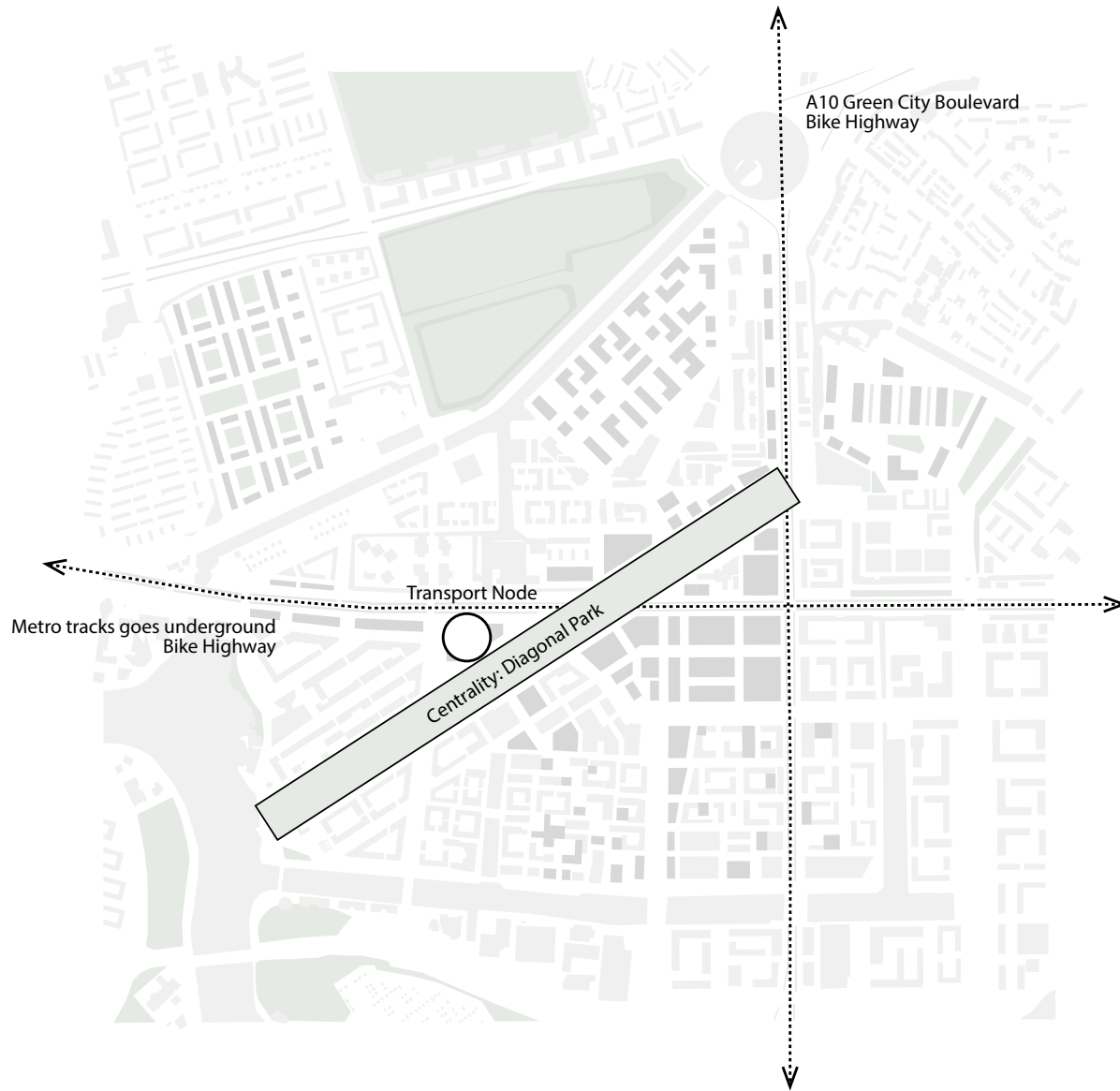

2100 Amstel Schematic Strategy

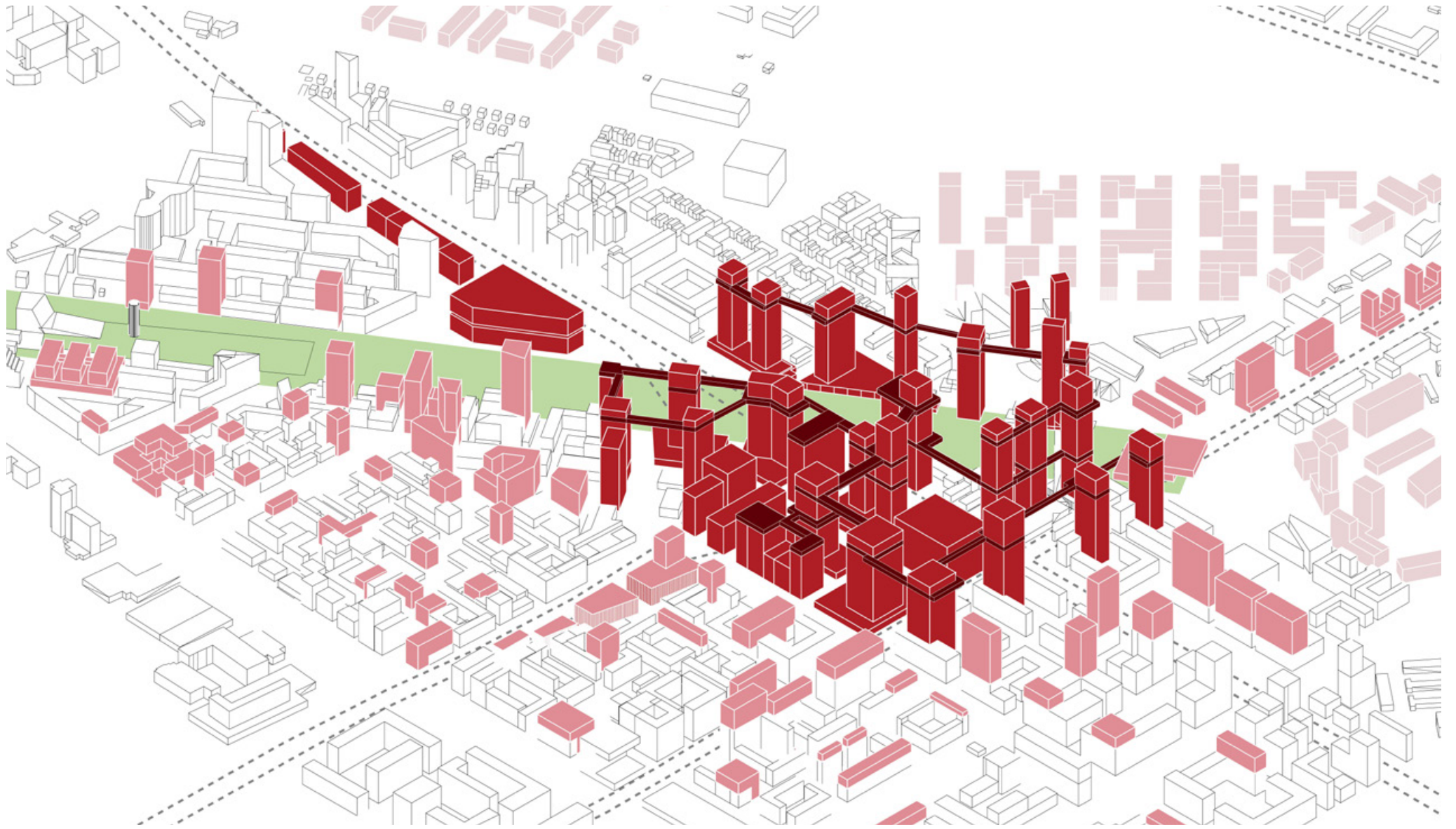

What are the problems and conflicts stopping Amstel from reaching the (P)Leisure City?

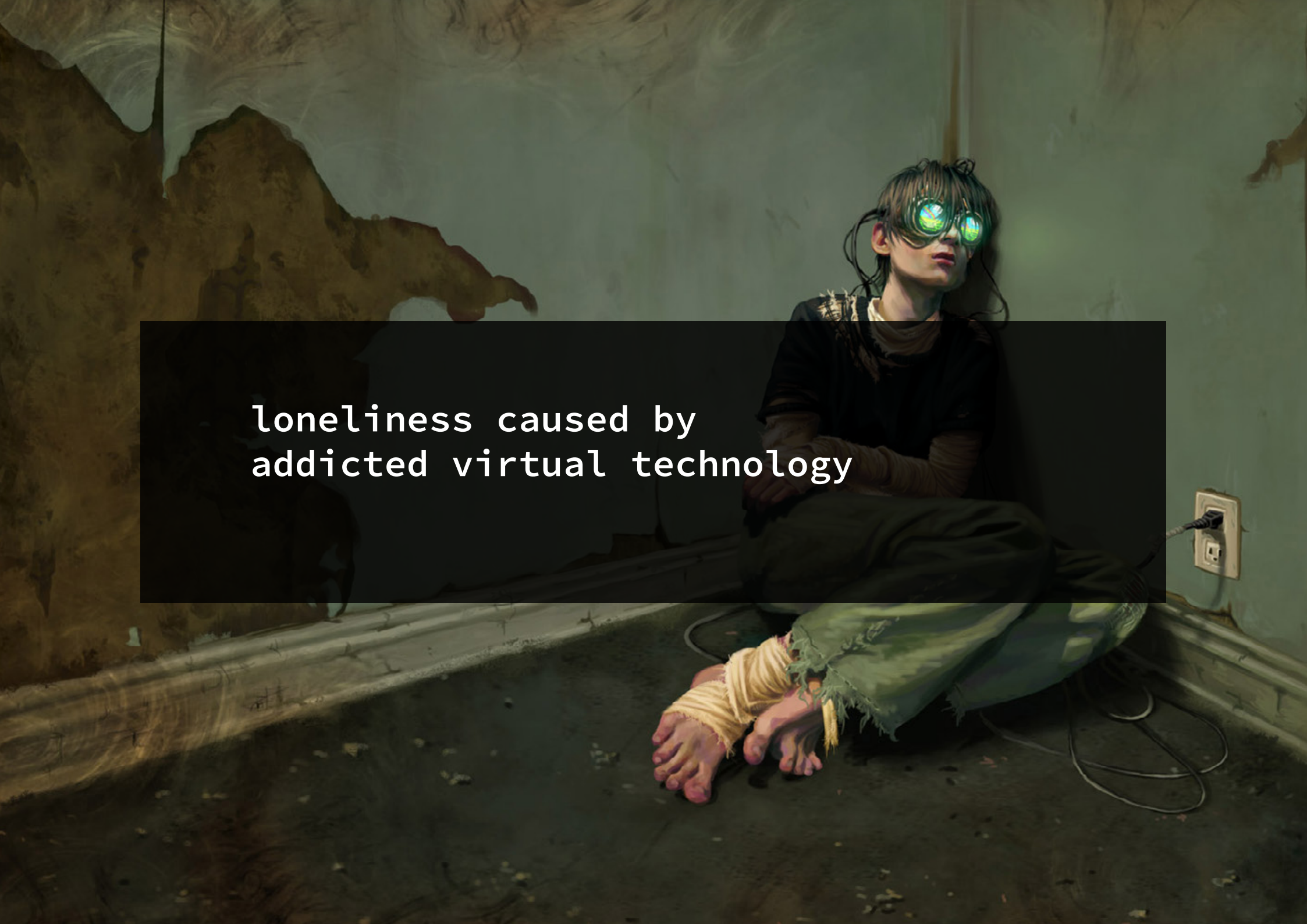

high entertainment demand in dense
urban environment

A person with long dark hair and glowing green eyes, wearing a black long-sleeved shirt and dark pants, sits on a dark floor in a dilapidated room. The walls are peeling and stained. A power outlet is visible on the wall to the right, with a cord plugged into it. The person's feet are wrapped in yellow tape. The overall atmosphere is one of isolation and technological dependency.

loneliness caused by
addicted virtual technology



offline-space undergo a transformation
in creating more experience



Core Research Question

How can we respond to the growing needs of social entertaining experience within dense urban area, and address the issue through an architectural space that fuses the virtual and the physical environment?

RESEARCH

THE FUTURE OF ENTERTAINMENT

The Changing Concept of Leisure

more innovative, immersive, hyper-connected and age-inclusive



**Purchasing
Experience**



Socializing



New Physical Space

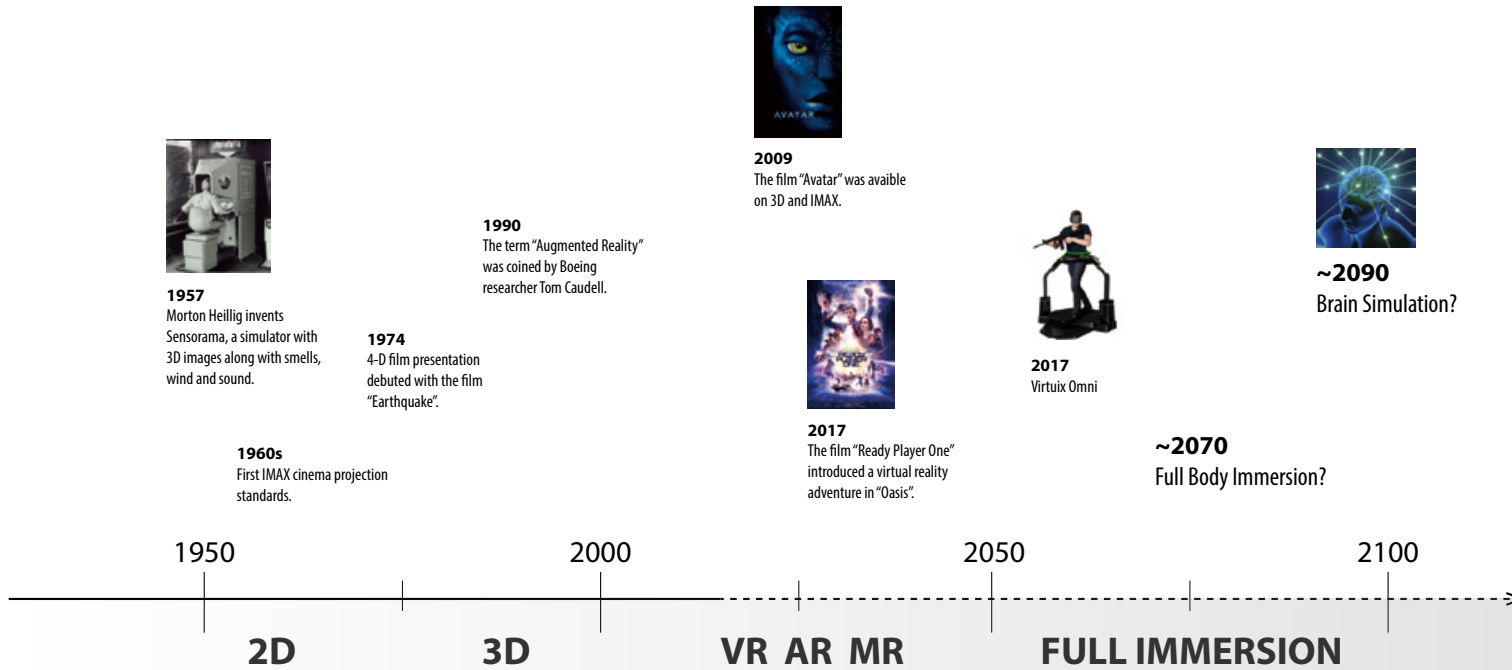

1947
Dennis Gabor developed the theory of holography.

1982
Hollywood movie "Iron" was first to depict virtual reality.



1993
Sega introduced its wrap-around VR glasses.



1999
The film "The Matrix", featuring a computer-generated world where citizens of the future are imprisoned from birth.



2012
Oculus

2014
Wearable Google Glass

2016
Pokémon GO



~2080
Hologram Projection?



Sensory Technology Timeline

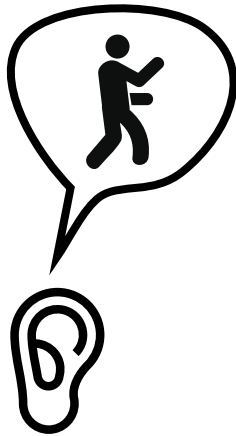

Hear

3rd-person

subject described
by others

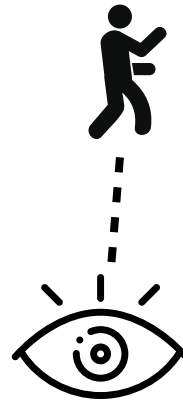

Watch

2nd-person

directly observe
the subject



Participate

1st-person

the audience is
the subject



Linear
Storyline

- fully traditonal stories
- Interactive Tradtional stories

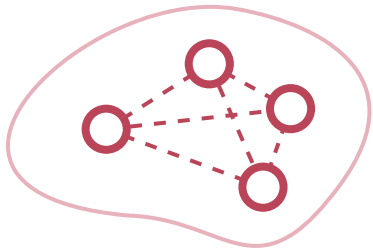

Dynamic &
Non-linear
Storyline

- Multi-Ending stories
- Branching Path stories
- Fully Player Driven Stories
- Open-ended stories

SECRET CINEMA PRESENTS







Inspiration:
A Complex Entertaining Product- **Westworld**

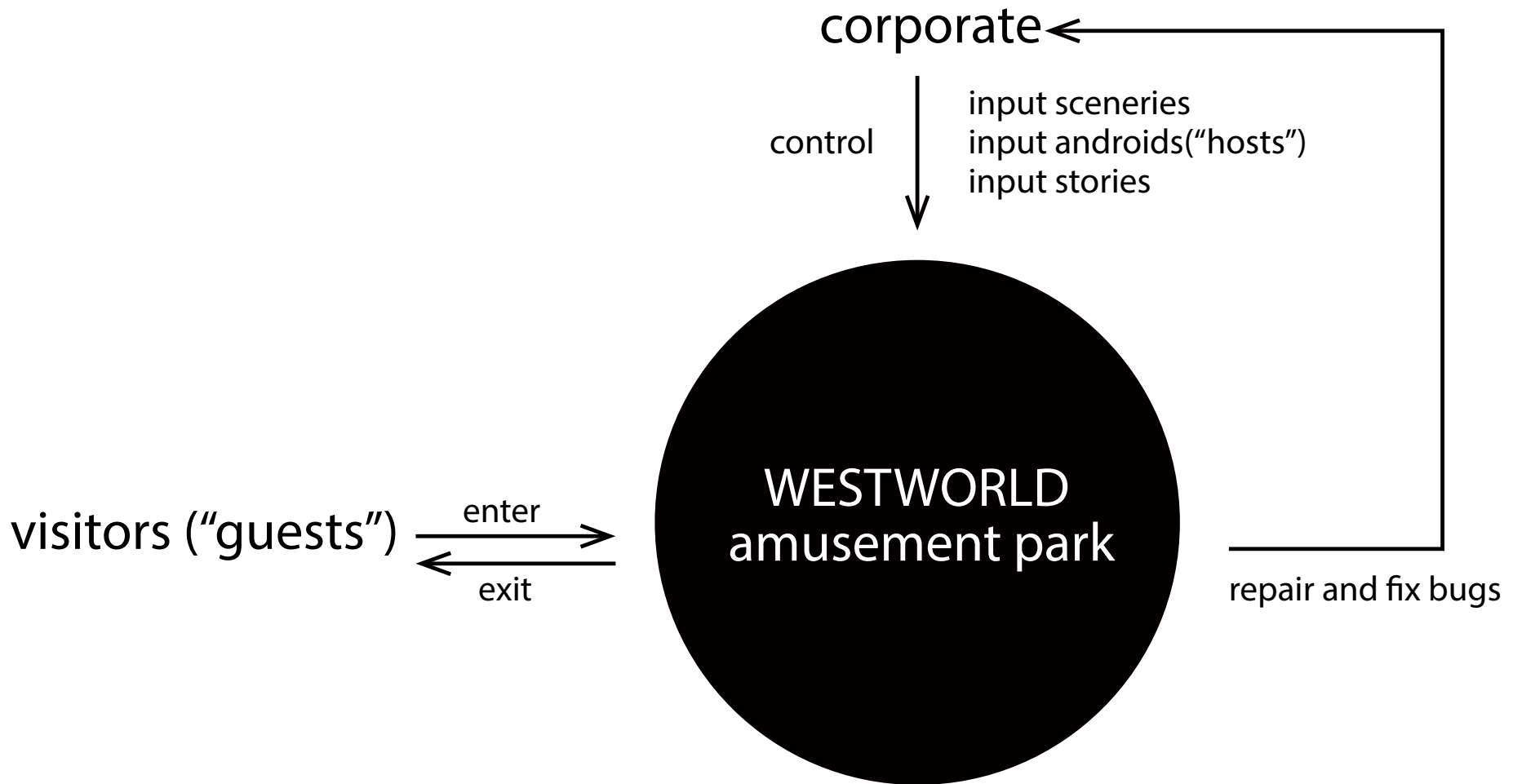

Visitors' Perspective

Arrival



Dressing Up



Entering



Amusement Park



Possible Experiences inside

Street View



Sexual
Activities



Riding Horse



Gun Fighting



Corporate's Perspective

Manufacturing



Narrative
Building



Acting in
Amusement Park



Repair



NOW



FUTURE

+more realistic

+more immersive

+more interactive

WATCH A FILM



**ENJOY A CINEMATIC
EXPERIENCE**

+more realistic

+more immersive

+more interactive



+more realistic

+more immersive

+more interactive



purchasing products ----> purchasing experiences

What can **architects** do?

Can we design an entertaining complex in the city that offers rapidly updating social and recreational activities fusing the virtual and the physical environment?

Can we create a routing that connect these immersive activities?

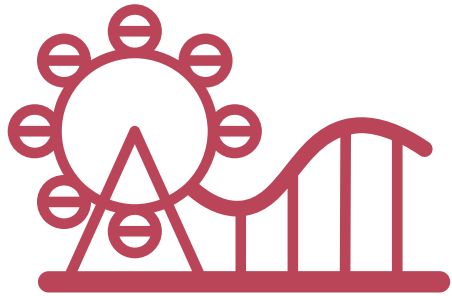

theme park

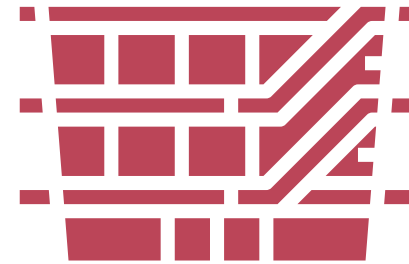
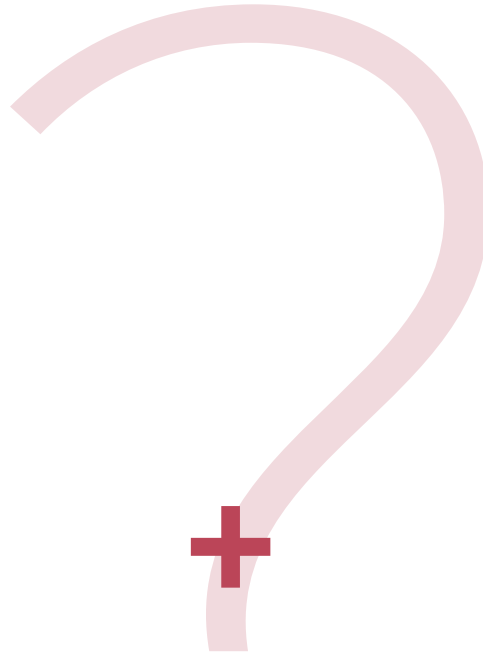

shopping mall

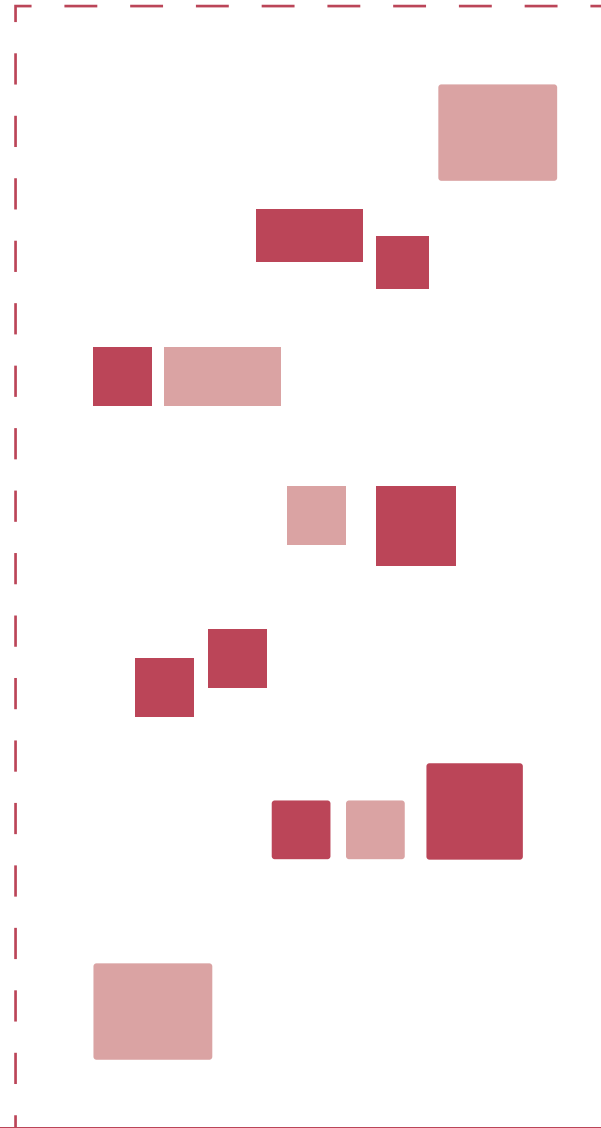

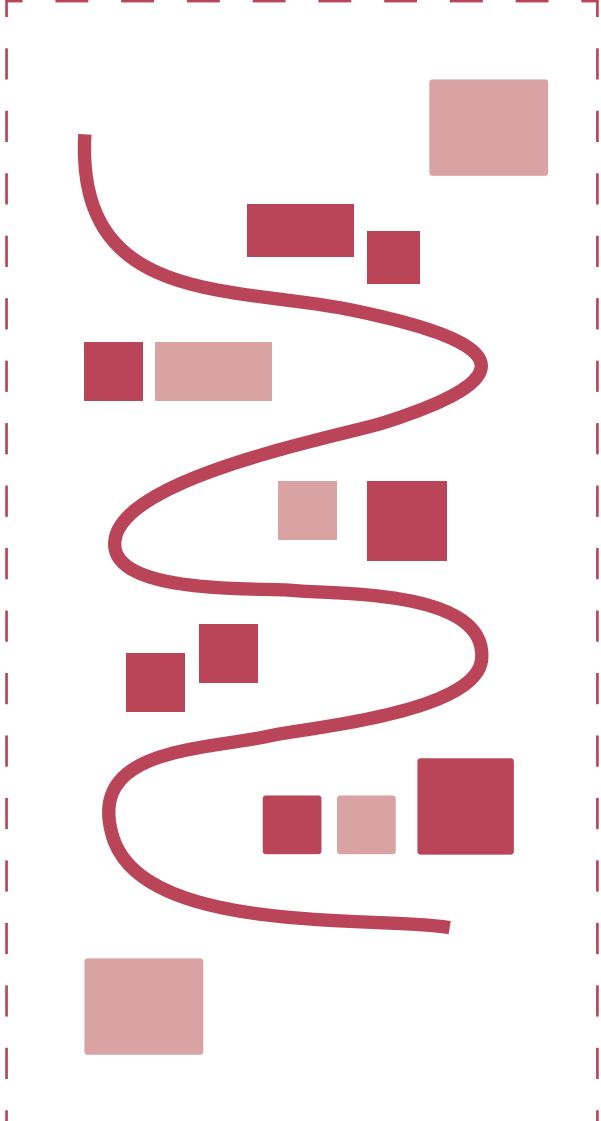



Three Minutes to Nirvana, Eugenia Loli

Precedents Study Program



Vendsyssel Theatre
SHL

Location: 9800 Hjørring,
Denmark
Year: 2017
Area: 4,200 m²



Lideta Market
Vilalta Arquitectura

Location: Addis Ababa,
Ethiopia
Year: 2016
Area: 14,200 m²



The Shed
DS+R

Location: Hudson Yard,
New York
Year: 2019
Area: 18,500 m²



Bunjil Place
FJMT

Location: 2 Patrick
Northeast Drive, Narre
Warren, Australia
Year: 2017
Area: 24,500 m²

Precedents Study

Theme Park Organization



Disneyland Anaheim

Location: California,
USA
Year: 1955
Area: 343,982 m²



Universal's Islands of Adventure

Location: Florida, USA
Year: 1999
Area: 450,000 m²



Universal Osaka

Location: Osaka, Japan
Year: 2001
Area: 540,000 m²



EXPO Milan 2015

Location: Milan, Italy
Year: 2015
Area: 1,100,000 m²



Hub and Spoke

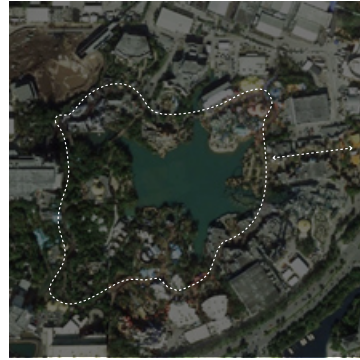
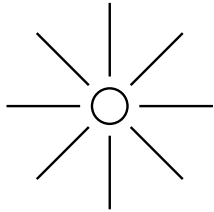

Circular

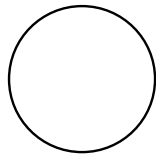

Grid

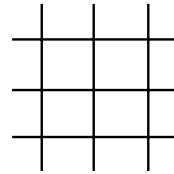

Axis

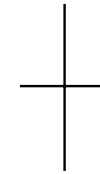

from plan to 3D

from plan to 3D

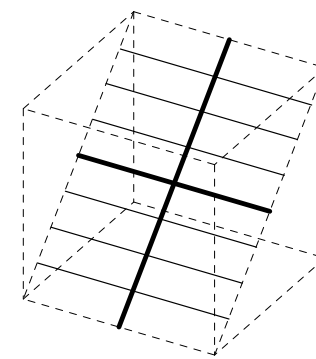
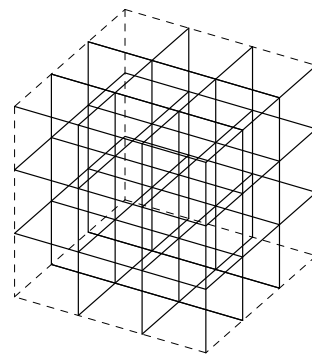
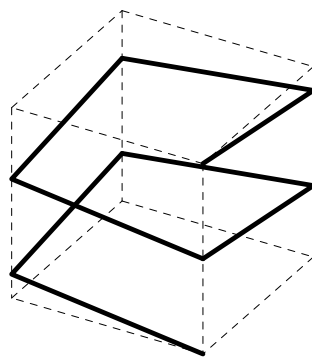
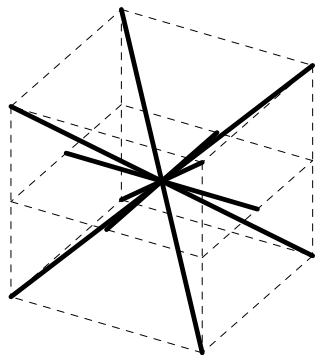



DESIGN
THE FUN UNIVERSE

Program

***Traditional
Digital Film***

Screenplay, Financing, Casting

Pre-Production

Cameras, Studios, Lighting, Sound

Production

Editing, Rendering, Sound Track

Post-Production

Advertising, Packaging,
Transportation

Distribution

Cinema Playing

Cinema Presentation

DVD/TV/ Online

Secondary Presentation

***Traditional
Digital Film***

Screenplay, Financing, Casting

Pre-Production

Cameras, Studios, Lighting, Sound

Production

Editing, Rendering, Sound Track

Post-Production

Advertising, Packaging,
Transportation

Distribution

Cinema Playing

Cinema Presentation

DVD/TV/ Online

Secondary Presentation

***Future
Interactive Cinematic Experience***

Screenplay, Financing, Testing

Programming, Scene Design

Sensory Design

Download,
Additive Printing, Robotics Manufacturing

Augmented Experiential Spaces,
Visitors Participation

Live Broadcasting

realtime updating

How to construct an immersive Scenography?



physical settings



environmental control

androids



augmented virtual projection



.....

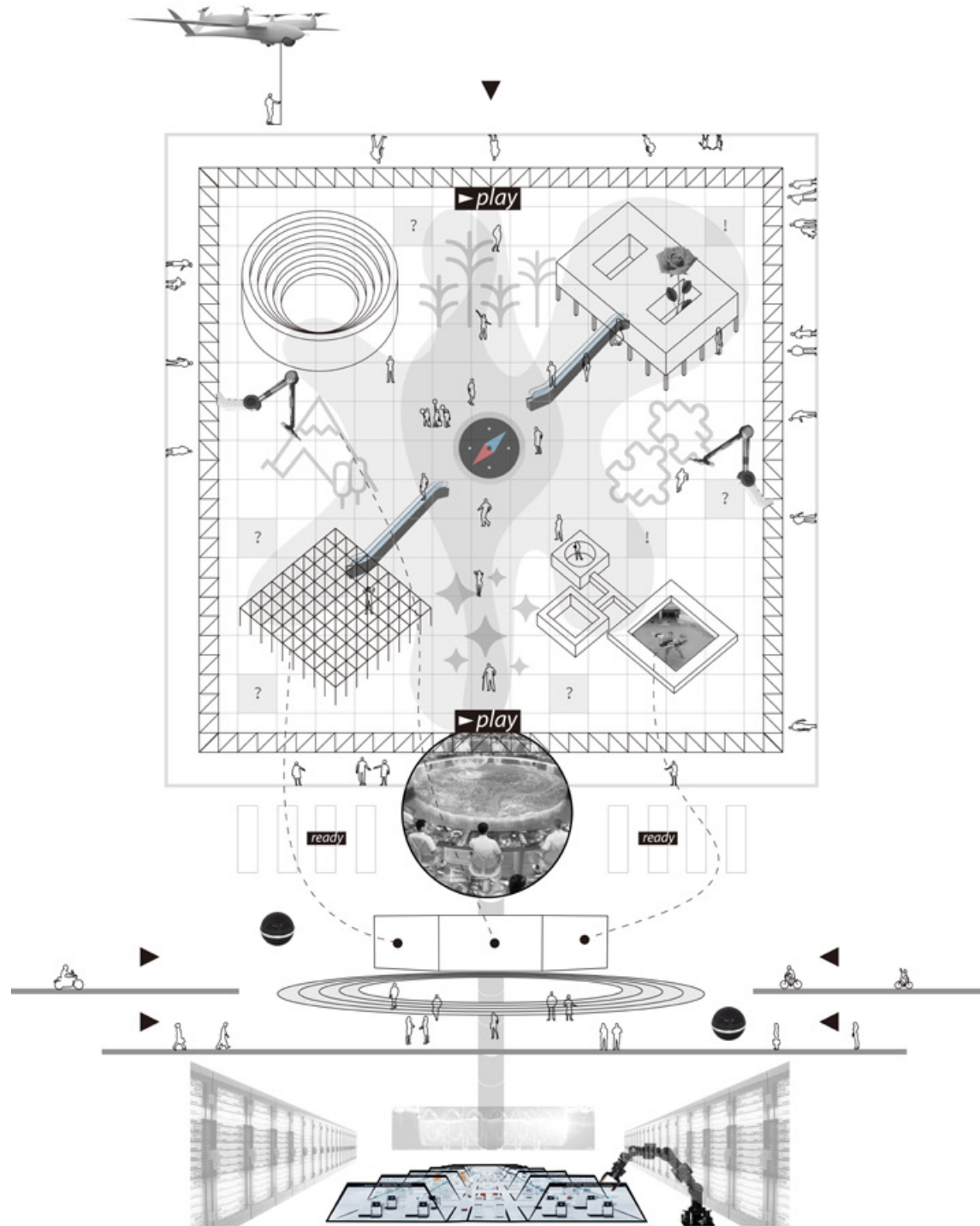

The Fun Universe is an entertainment complex dedicated to producing, presenting and broadcasting all types of social entertaining and visual augmented activities including cinematic experience, interactive performing arts, immersive gaming etc.

It is an urban scale "Westworld", a vertical theme park that contains various popular destinations.

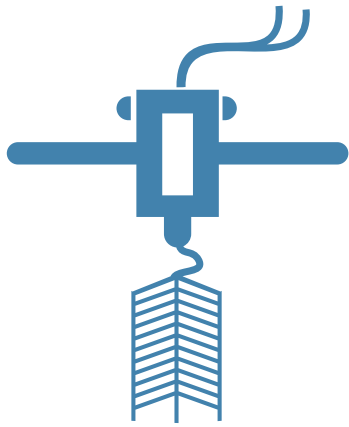

producing

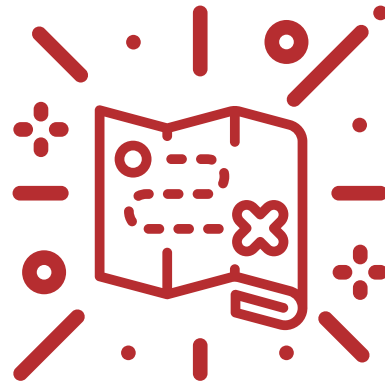

presenting



broadcasting

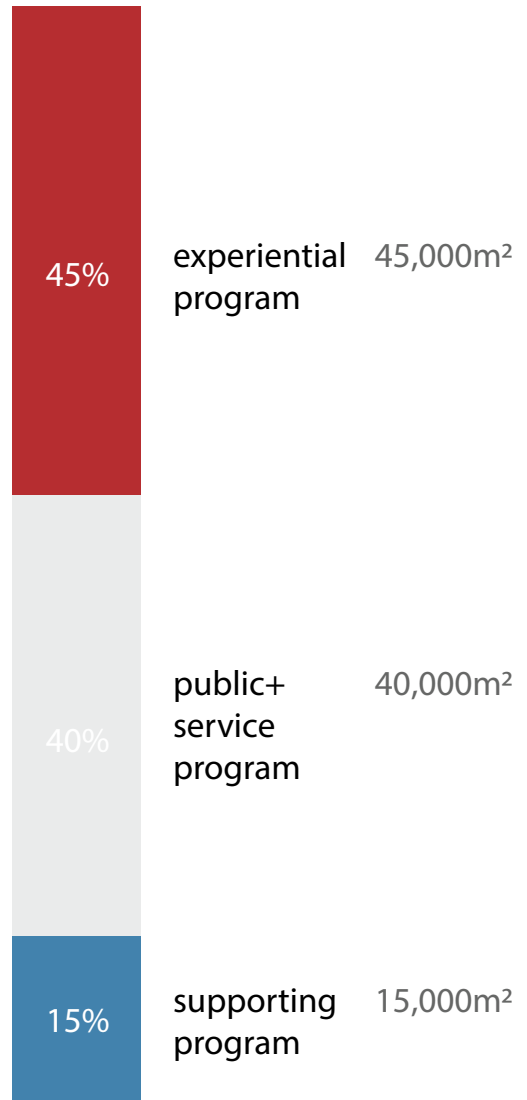

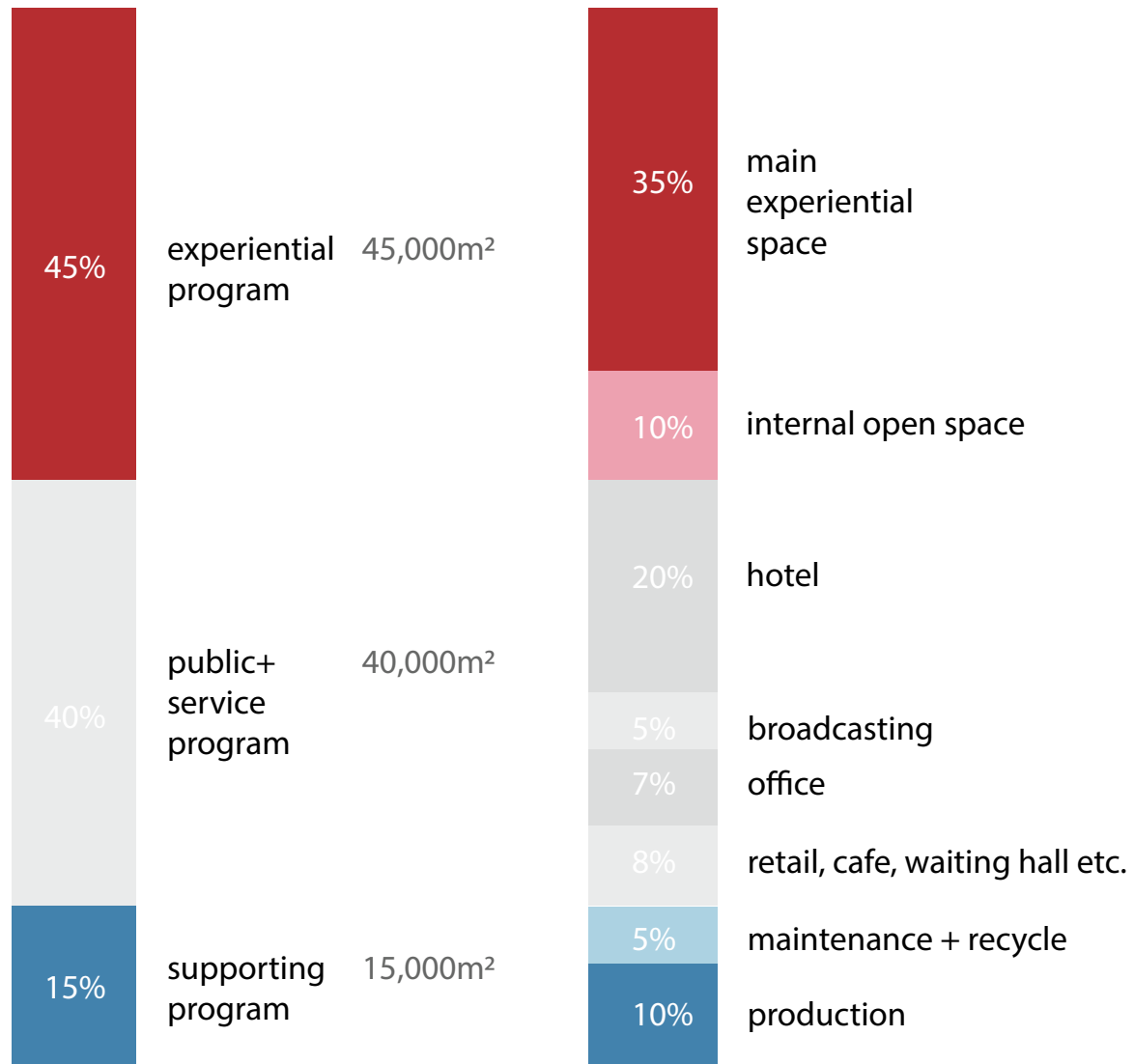

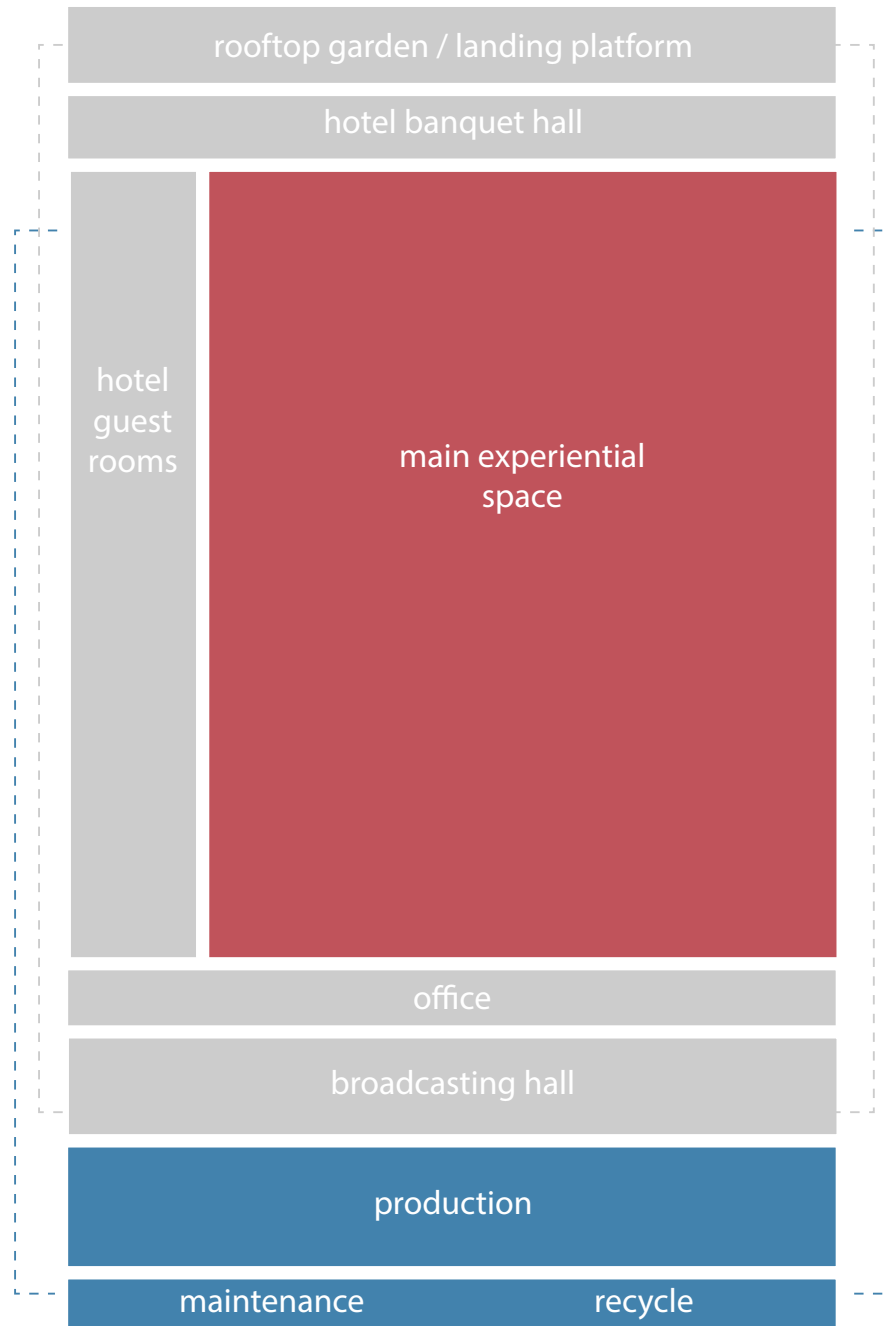

Building's Operating Flow

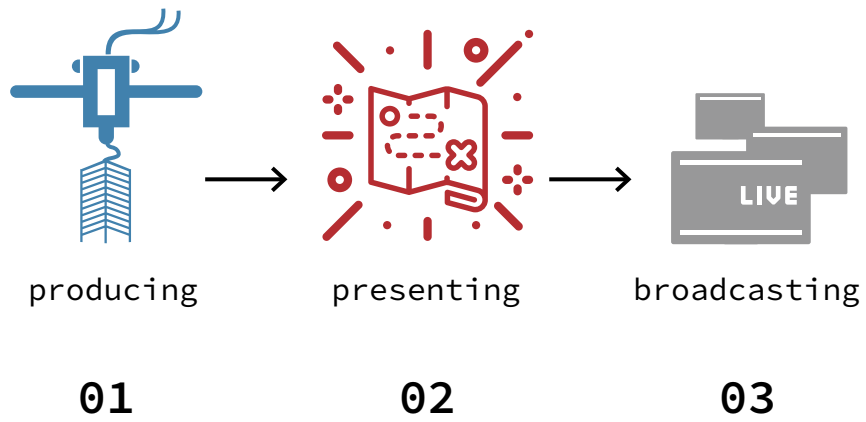

Visitors' Flow

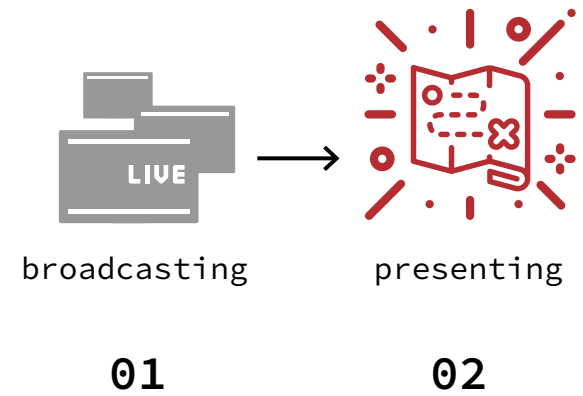

Location



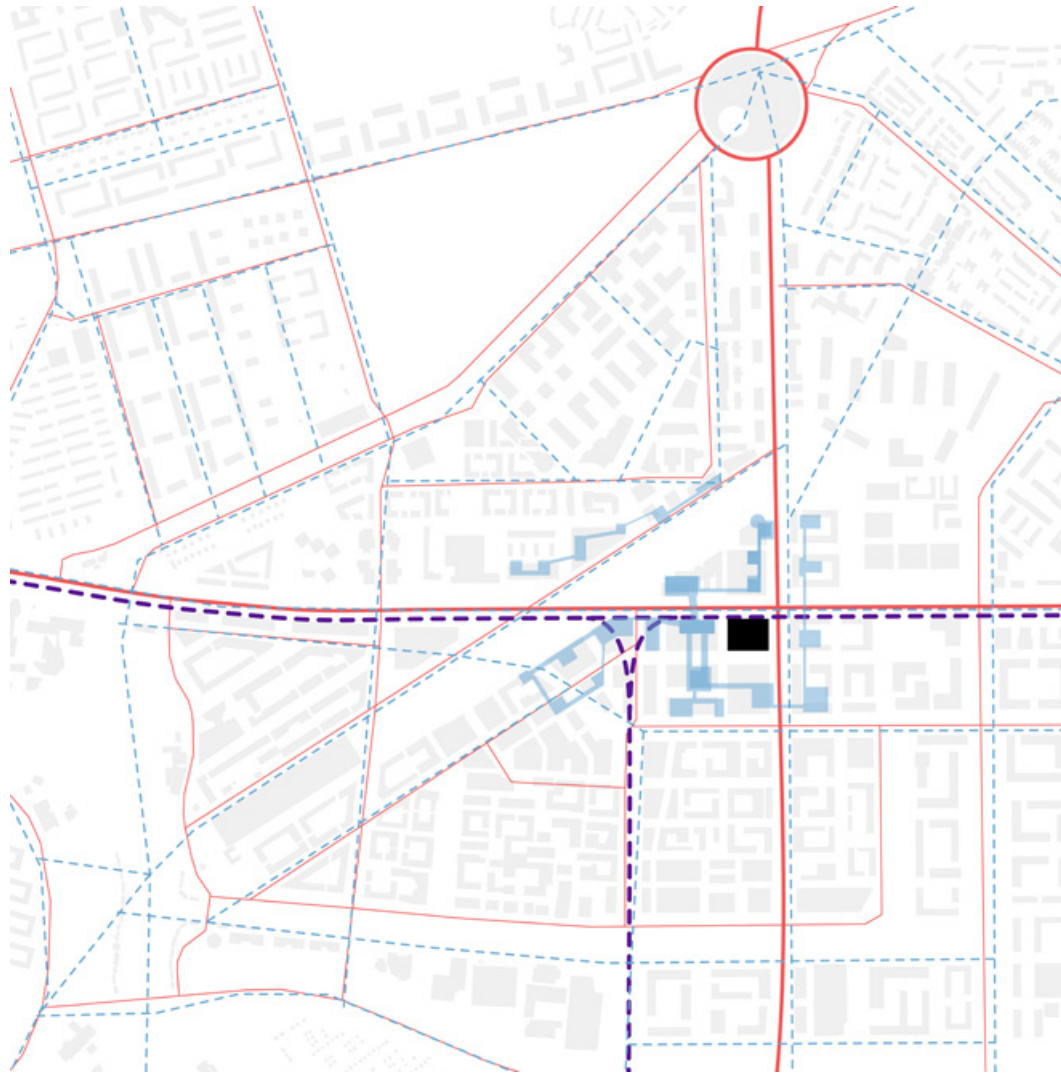

Principle1:

Great Connectivity: Easily accessible to the visitors
and convenient for logistics.



Principle2:

High Passenger Flow: Density leads to enough demand

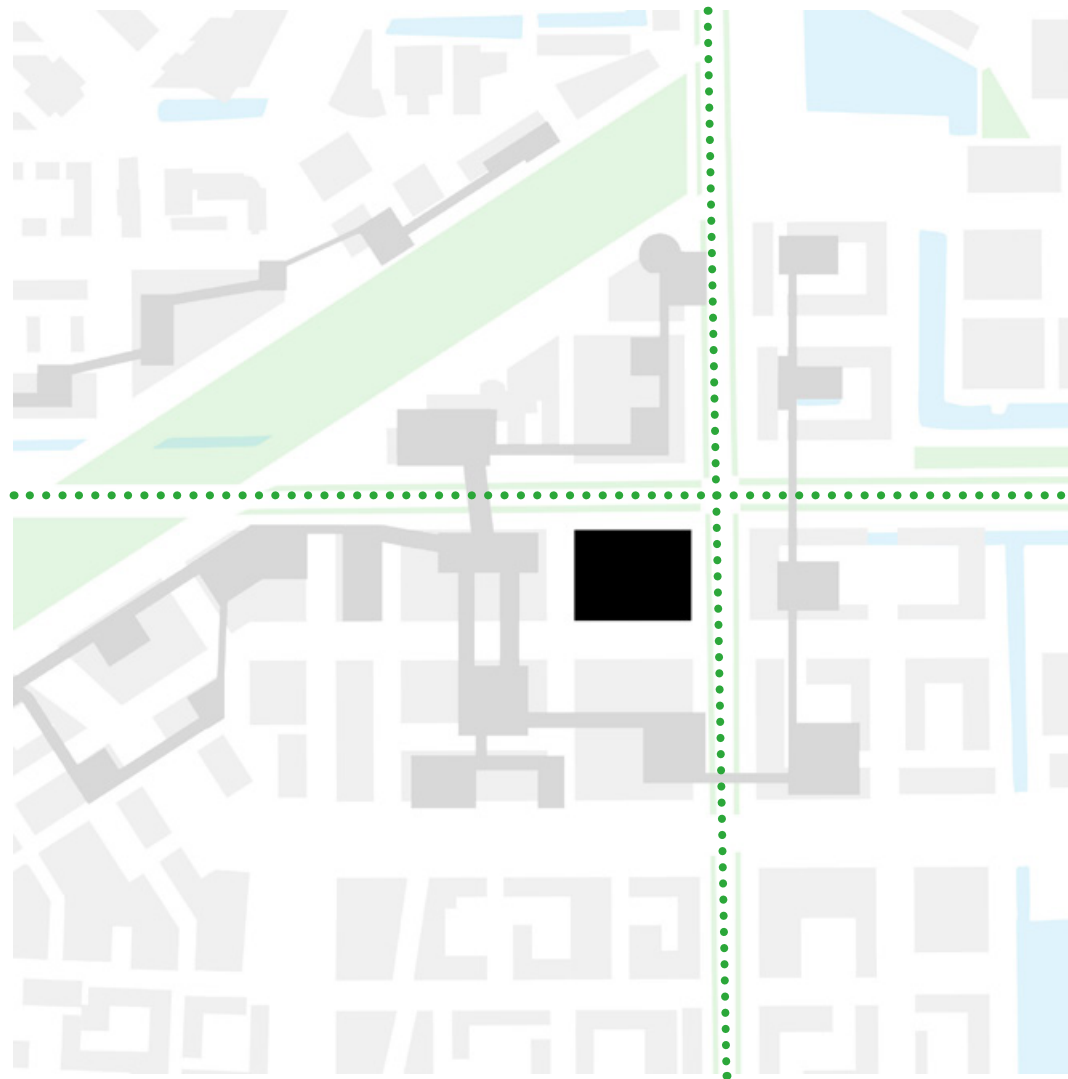

Principle3:

Great Visibility: Represents a FrontPage of the area. For upper level, there is a visual contact directly to the Diagonal Park.

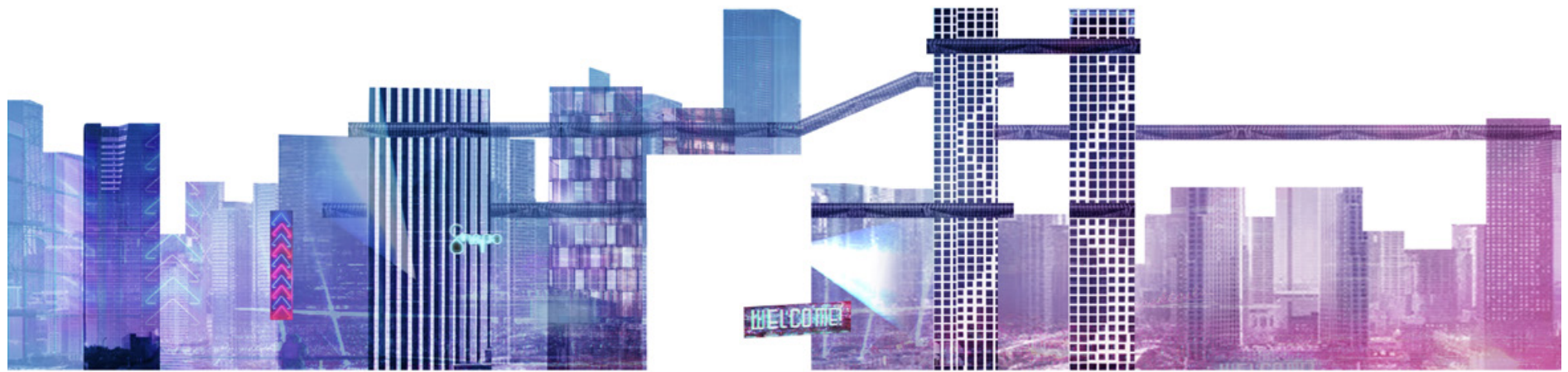

Mass Study

Decentralized

Compact

Mega Structure

Modular

Organic

Layering

Centrality

Courtyard

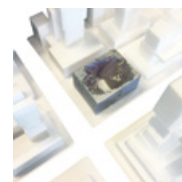
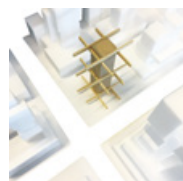
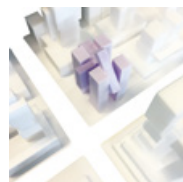
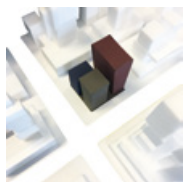

Final Principles

-Integrated Functions

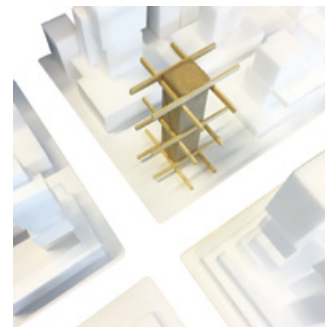
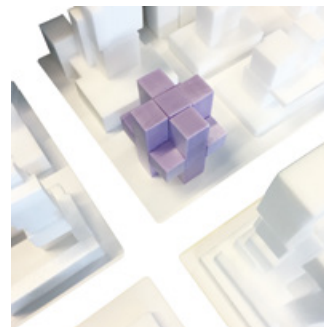
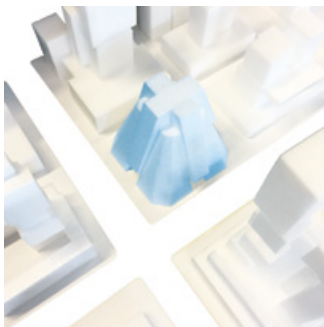
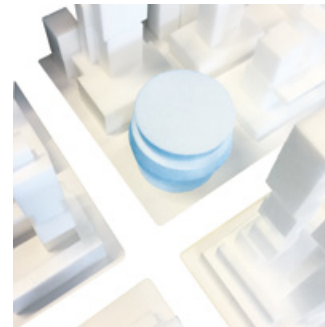
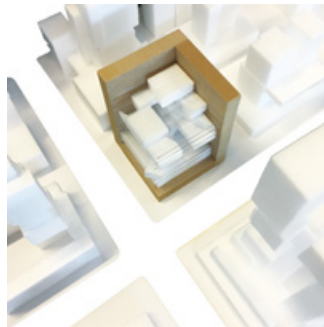
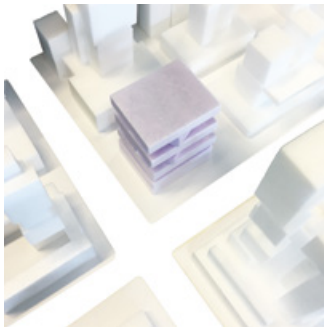
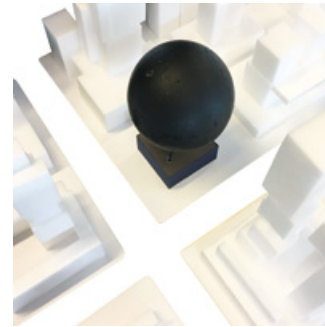
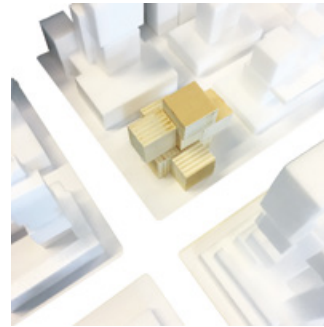
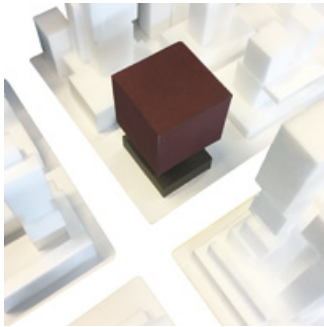

Final Principles

- Integrated Functions
- Large Open Space

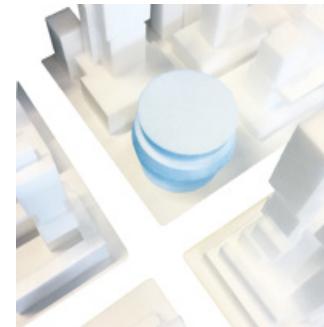
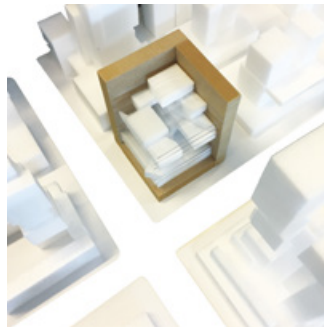
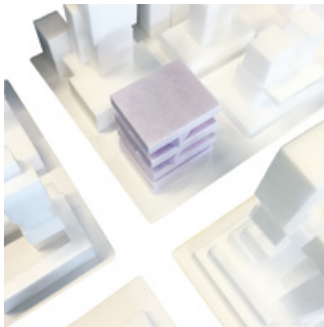
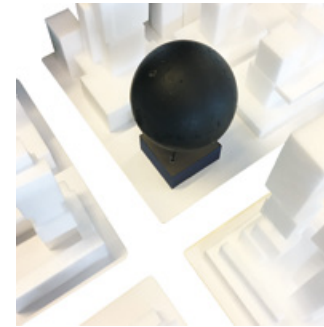
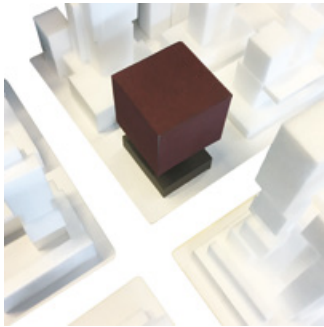

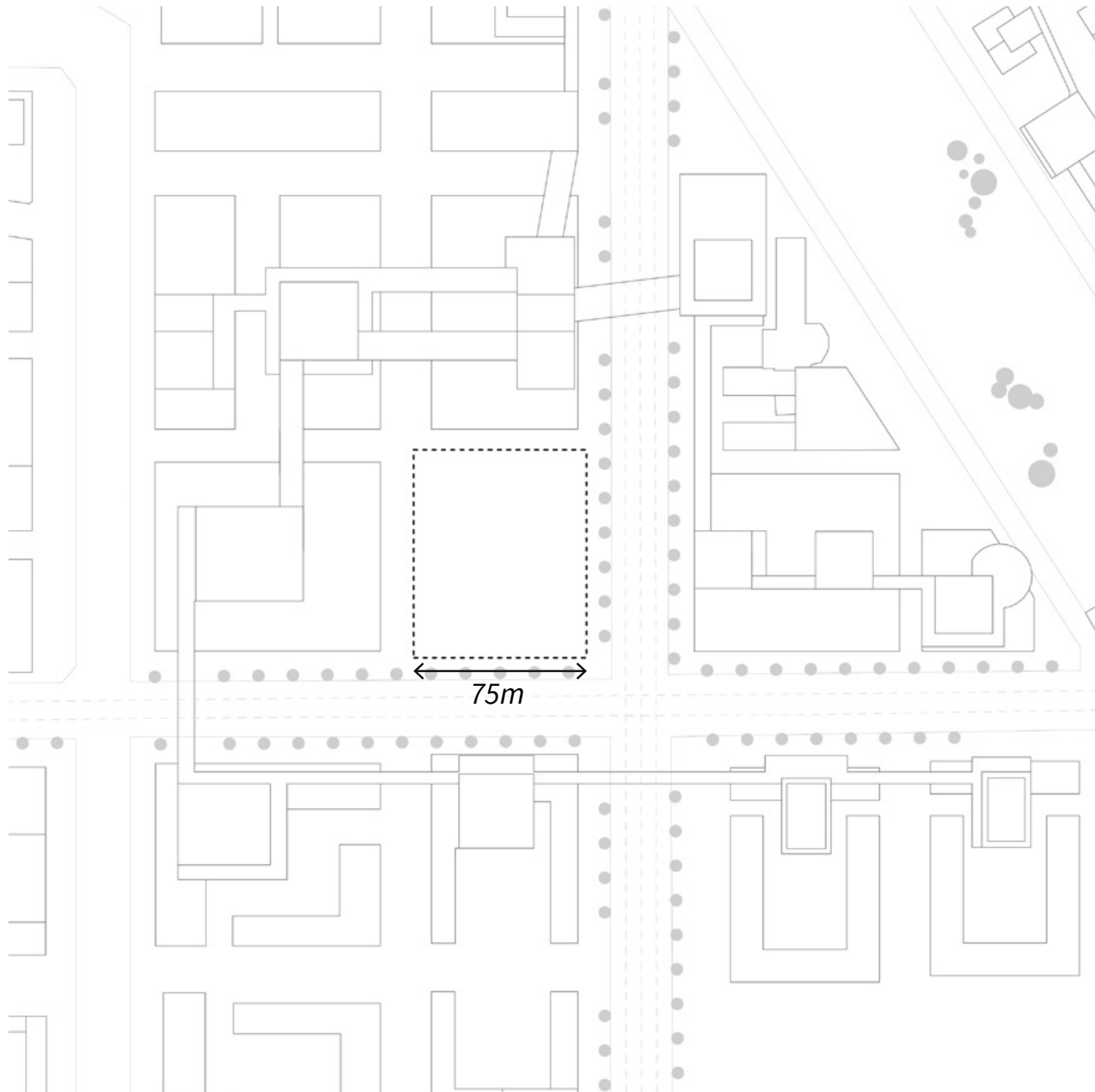

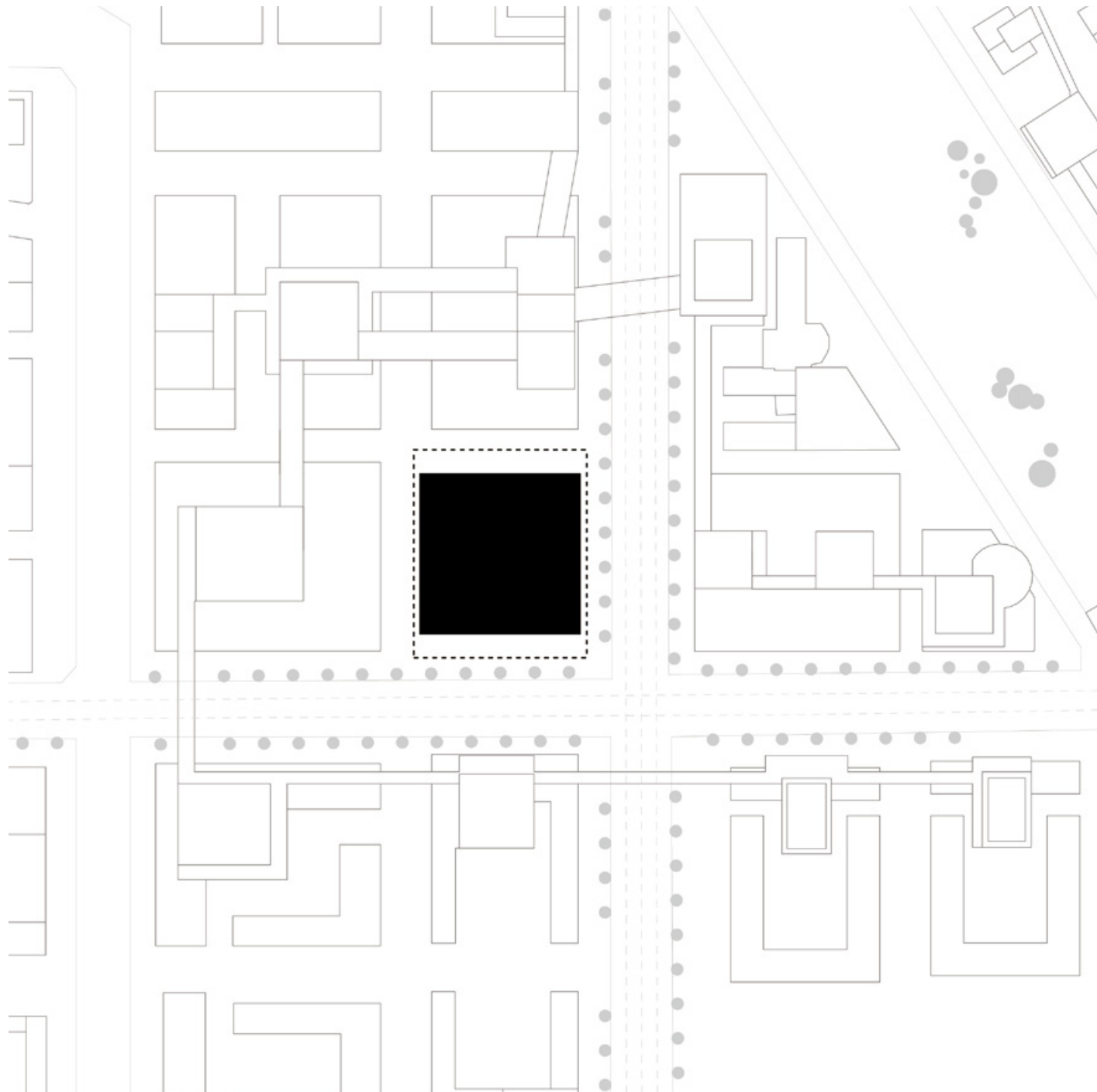

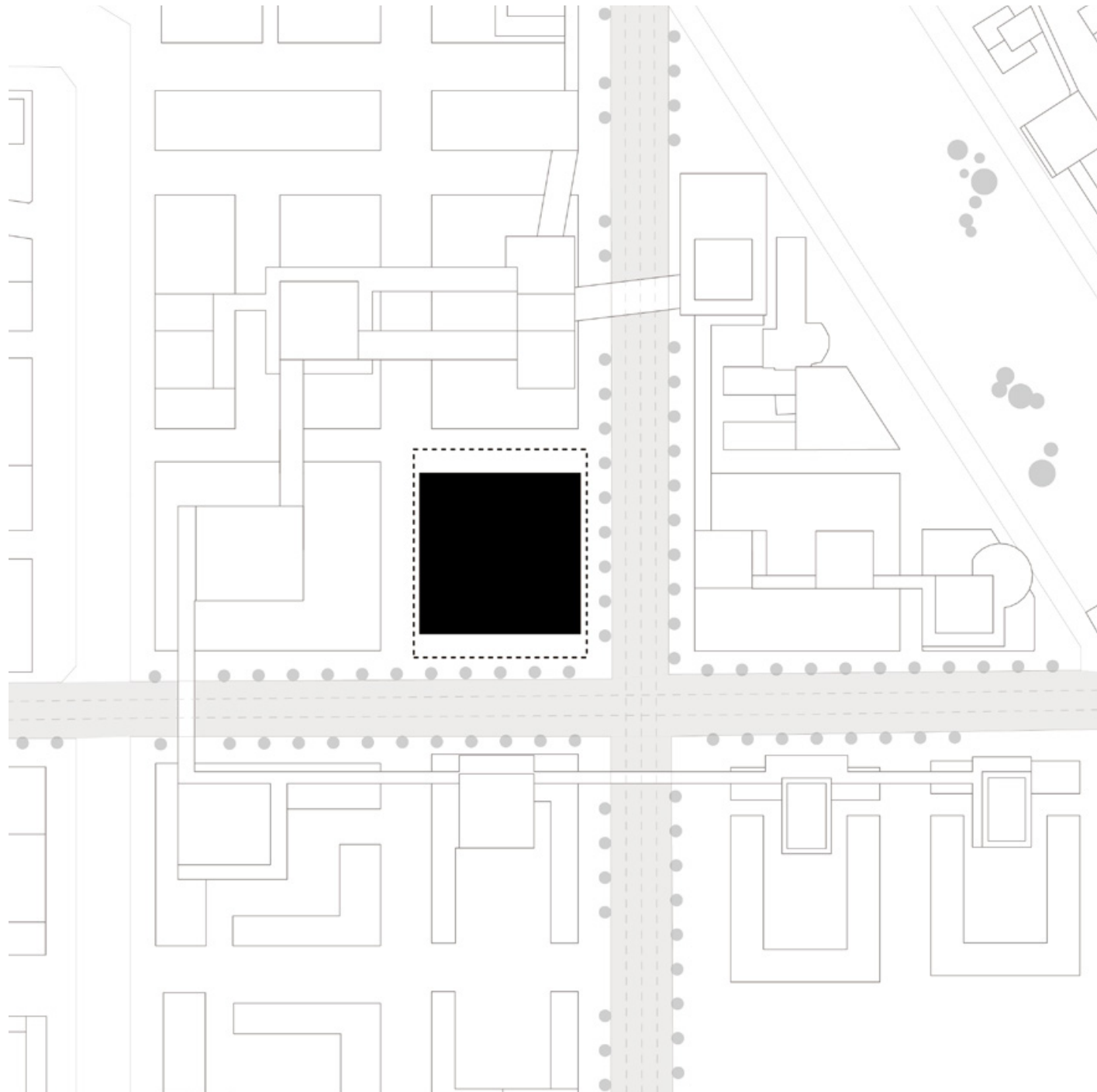

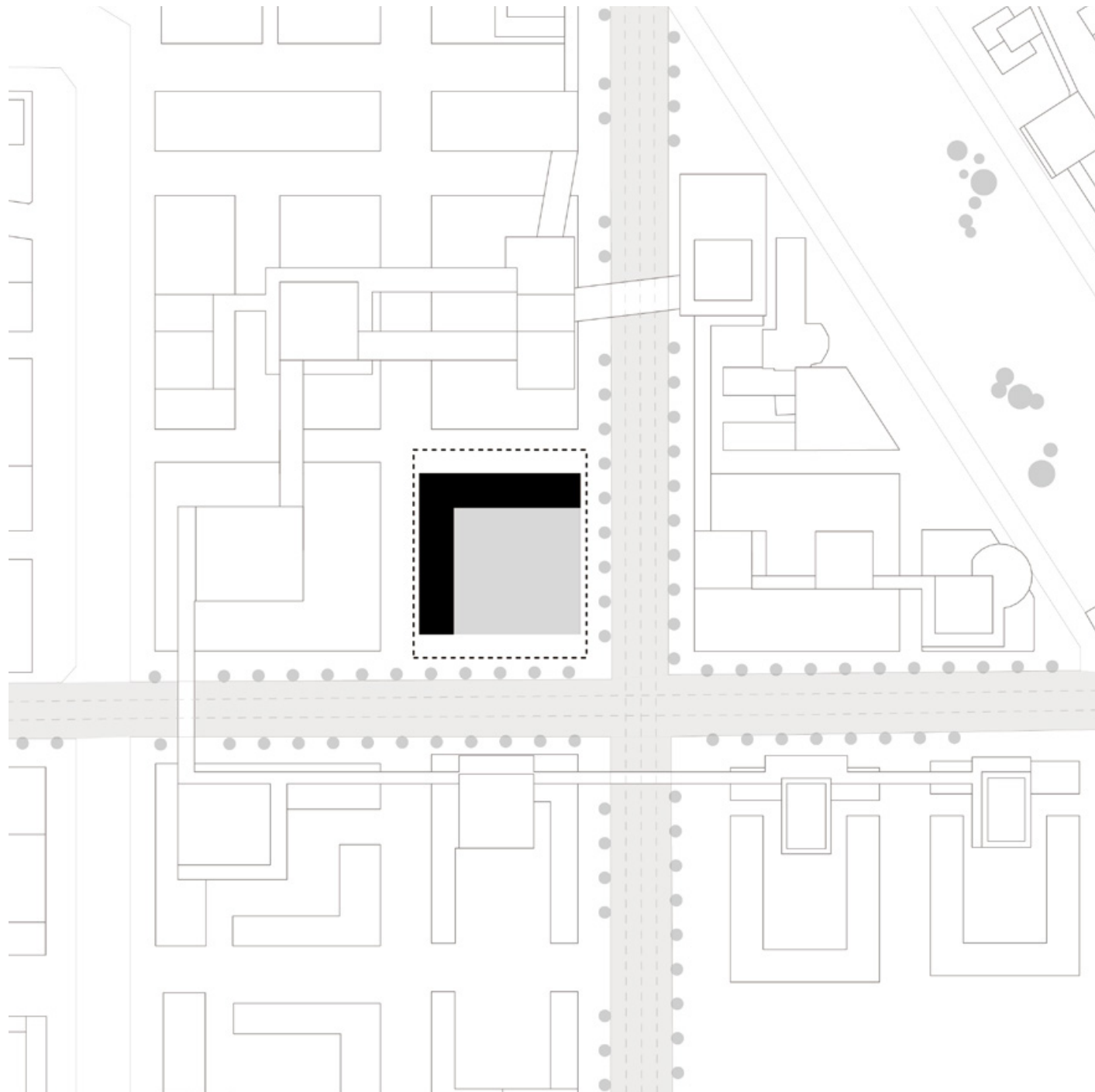

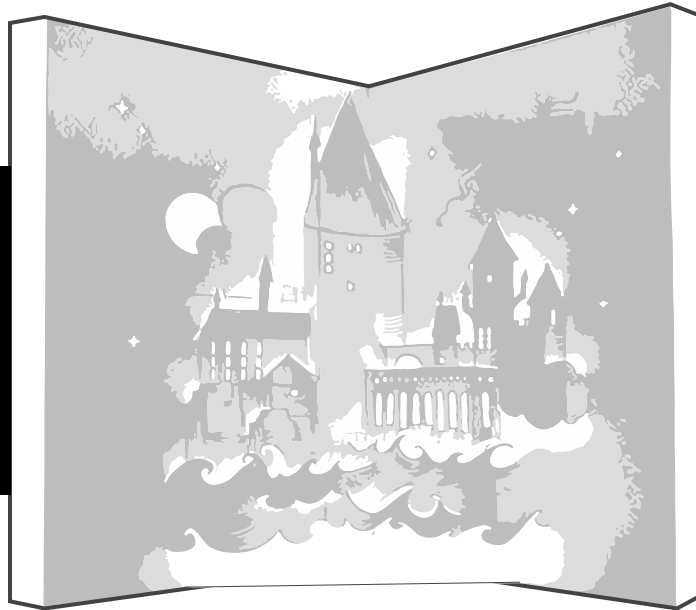

Fun Universe as an
“URBAN STORYBOOK”

Design

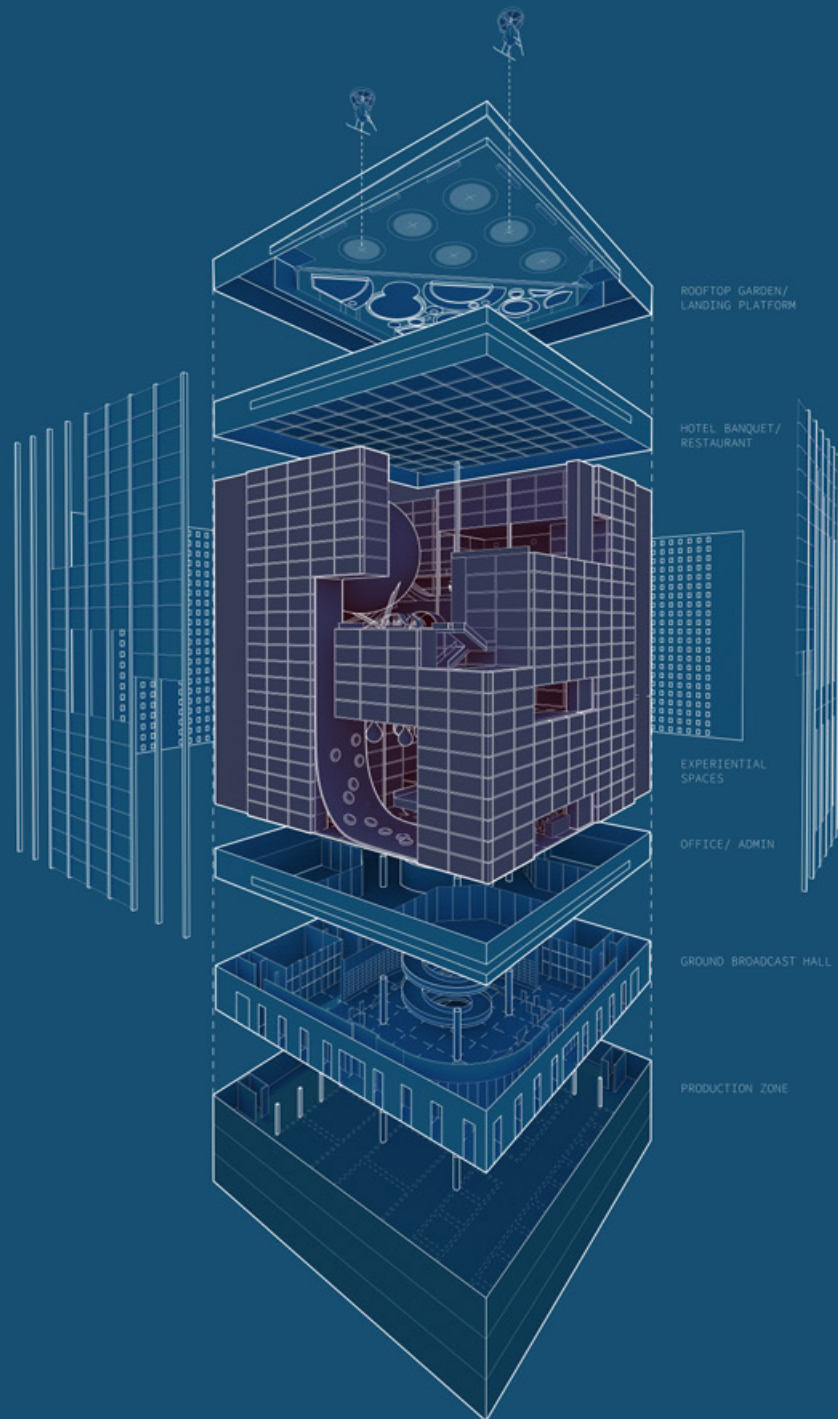

ROOFTOP GARDEN/
LANDING PLATFORM

HOTEL BANQUET/
RESTAURANT

EXPERIENTIAL
SPACES

OFFICE/ ADMIN

GROUND BROADCAST HALL

PRODUCTION ZONE

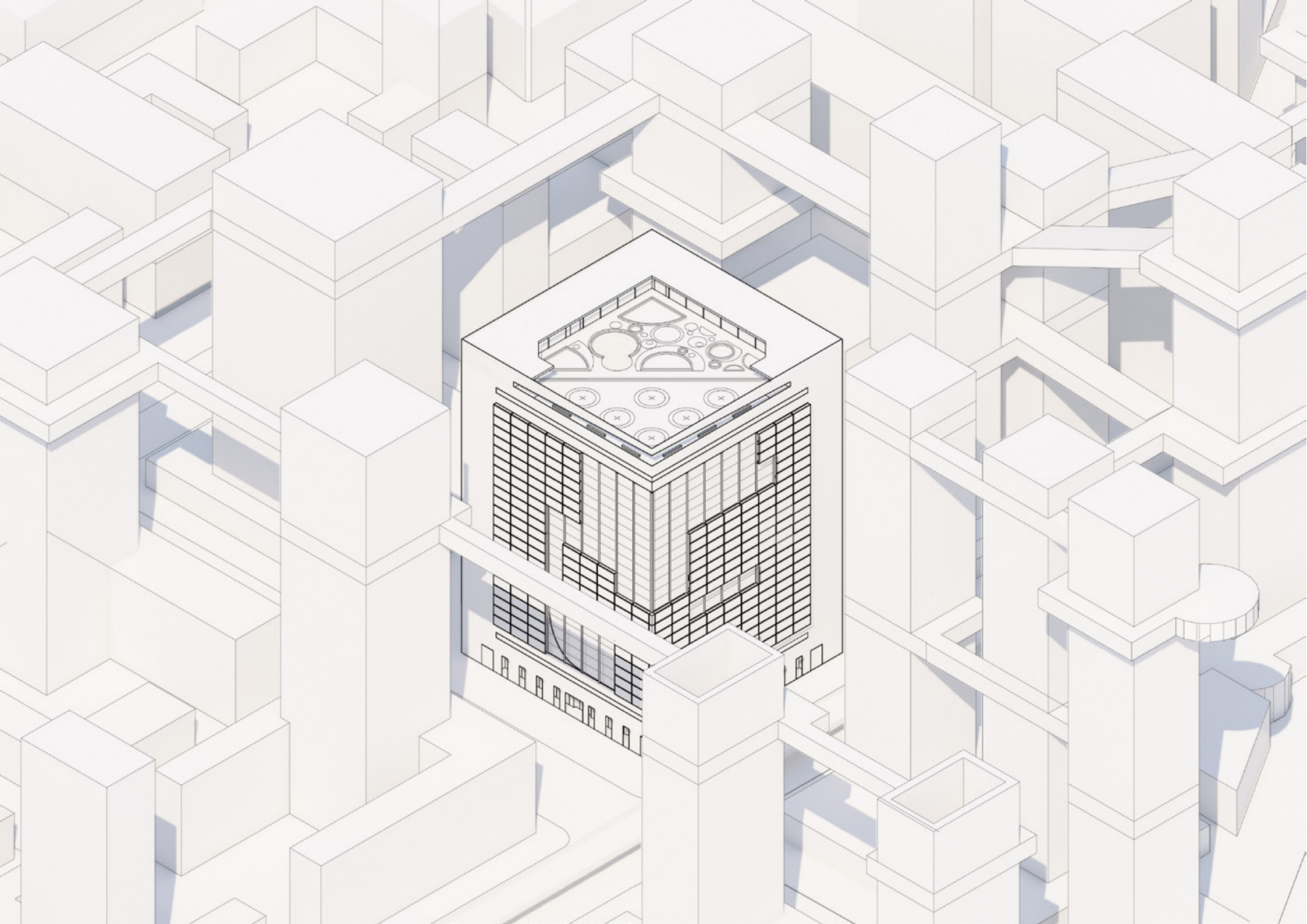

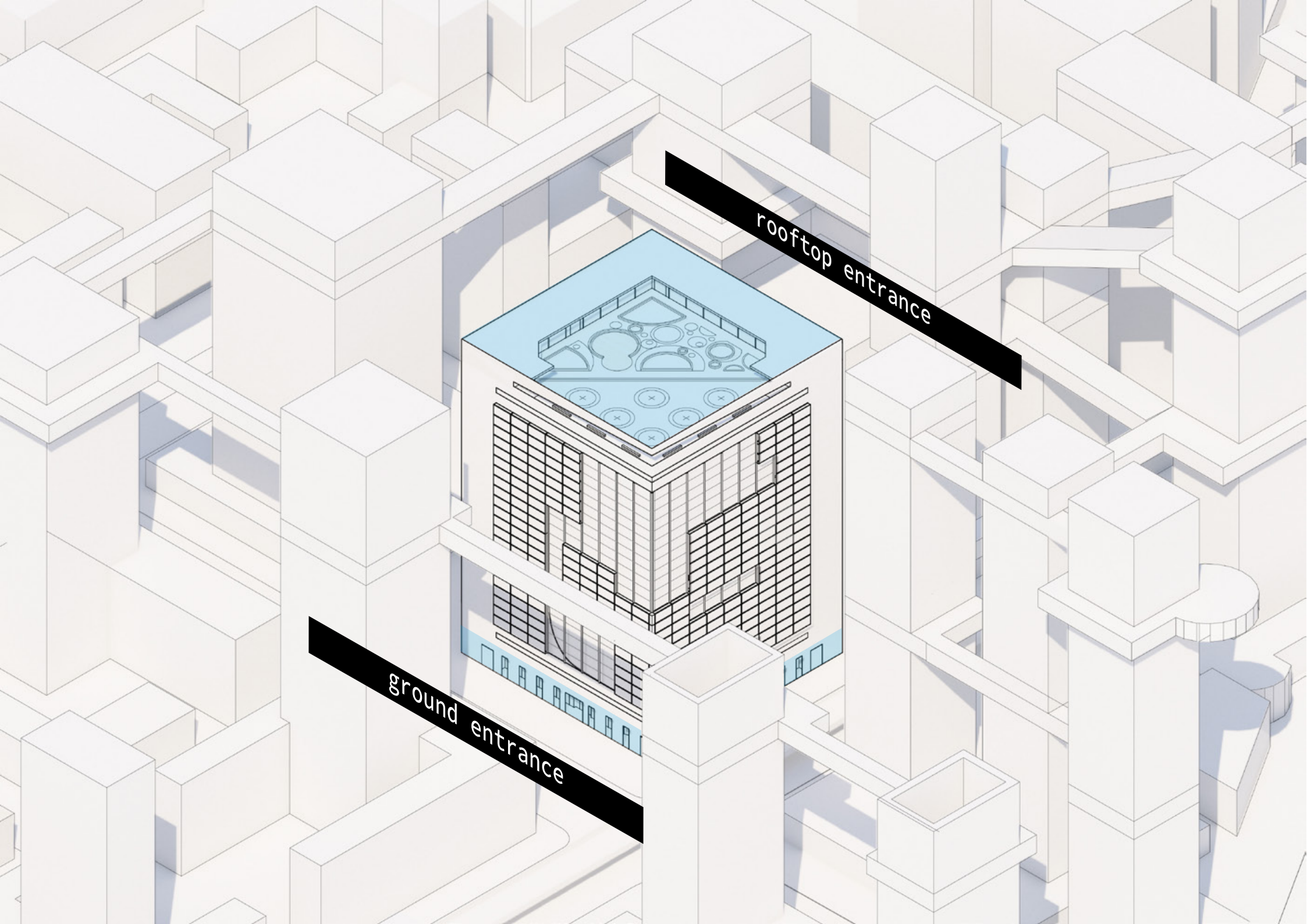

rooftop entrance

ground entrance

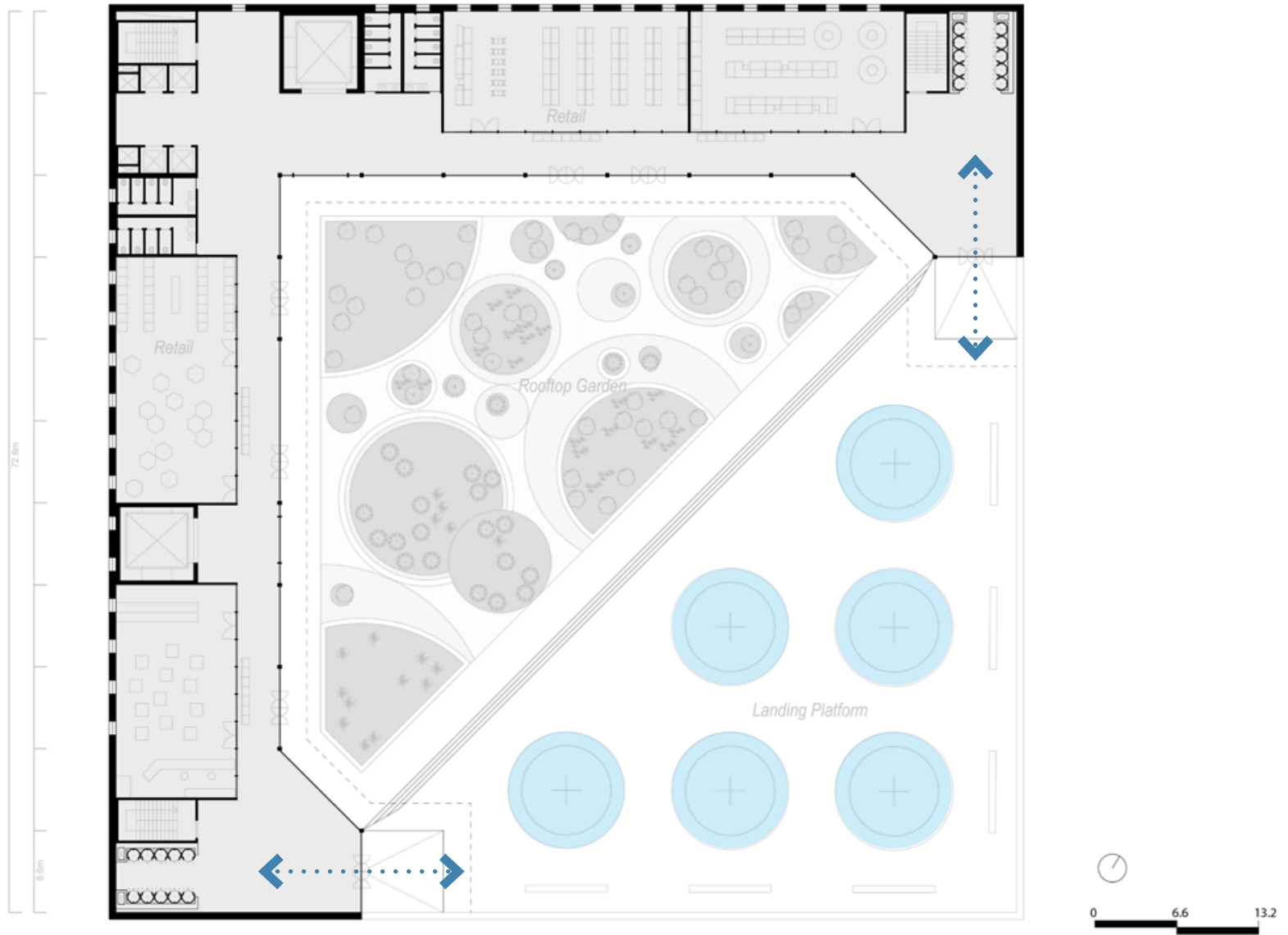

Rooftop - Landing Platforms

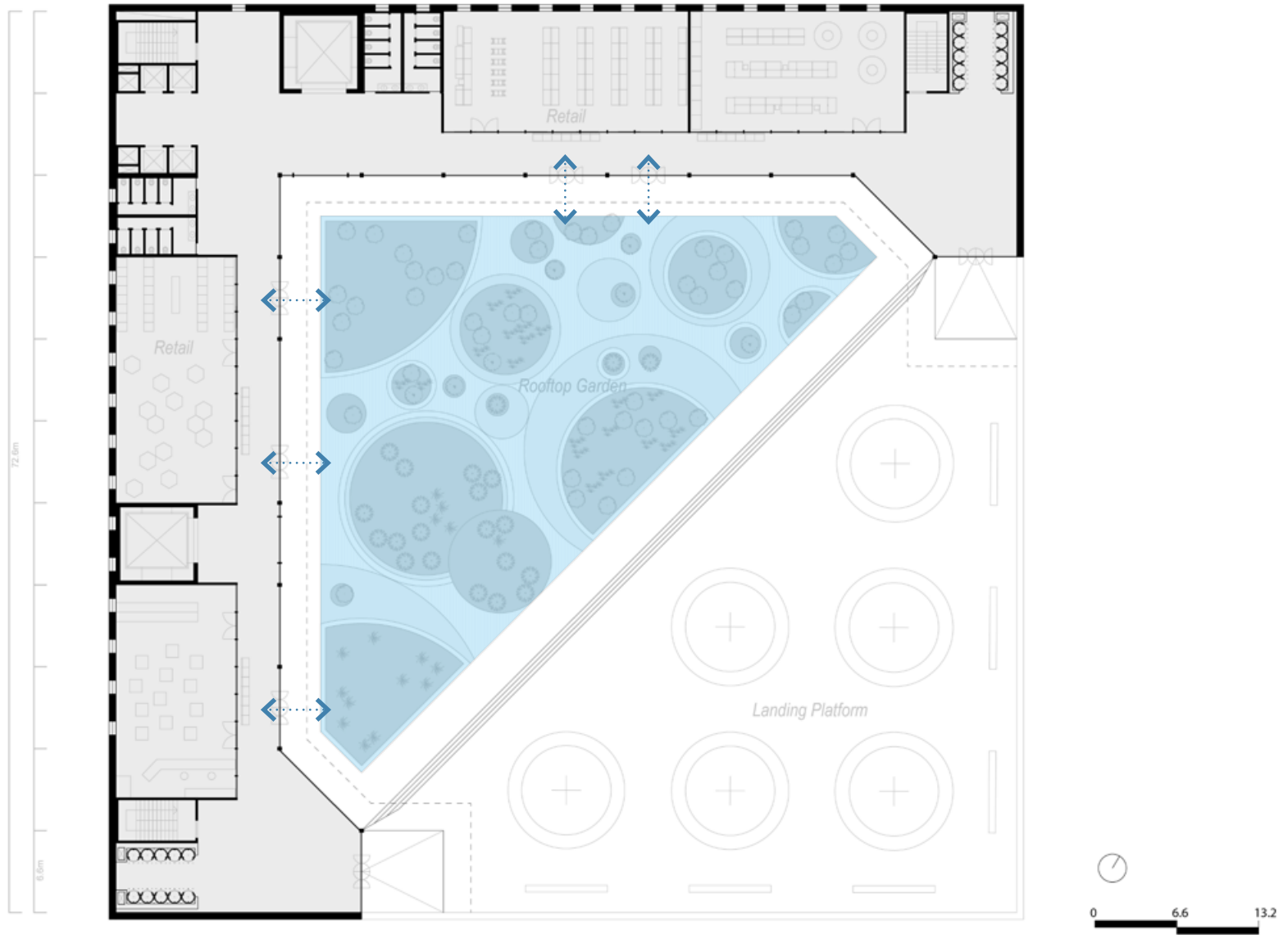

Rooftop - Garden Landscape

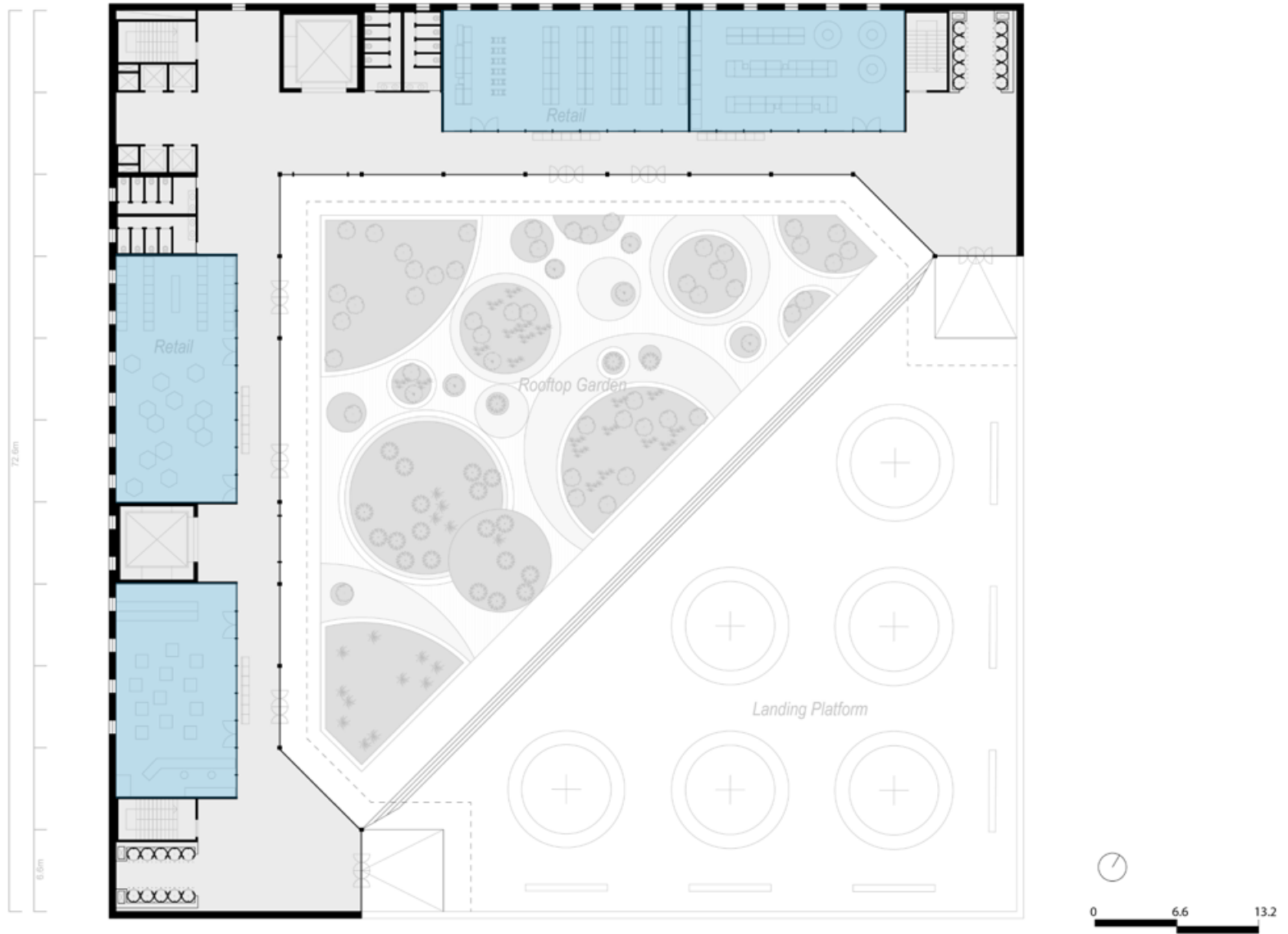

Rooftop - Retail



The "Fifth Facade"



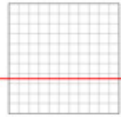

0 6.6 13.2 26.4

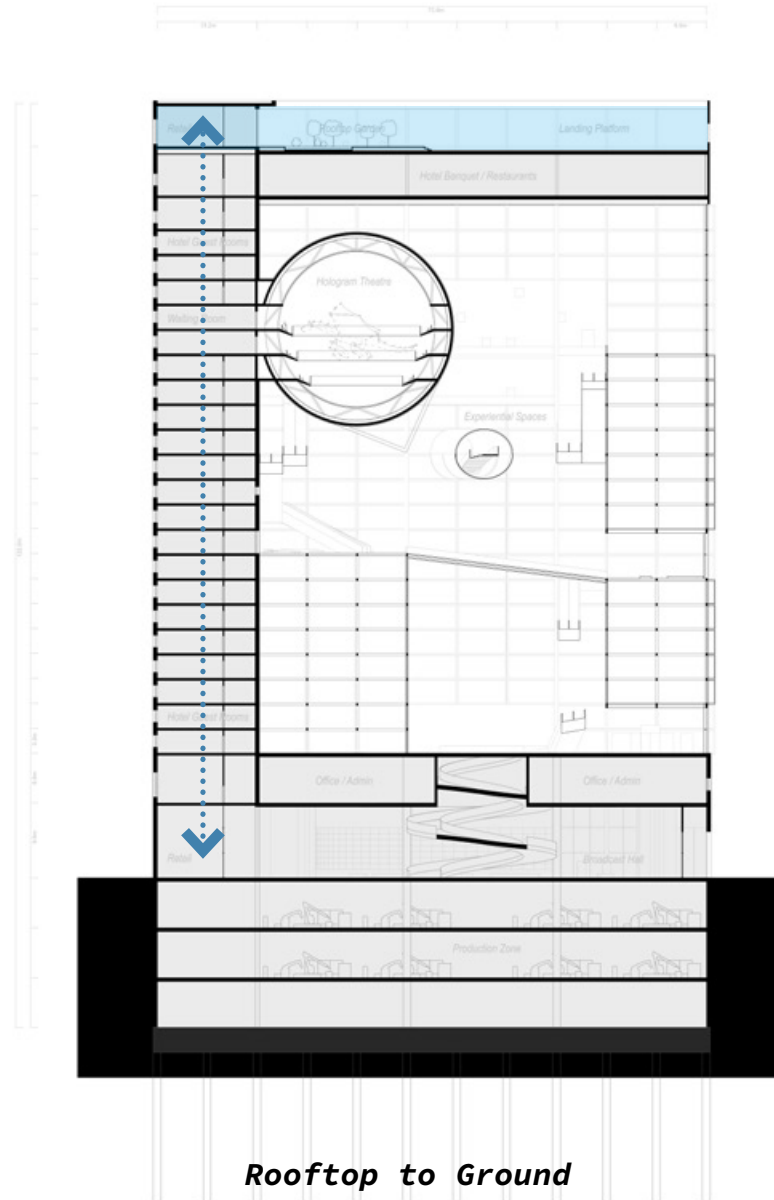

rooftop
platform

hotel

office
broadcast hall

production

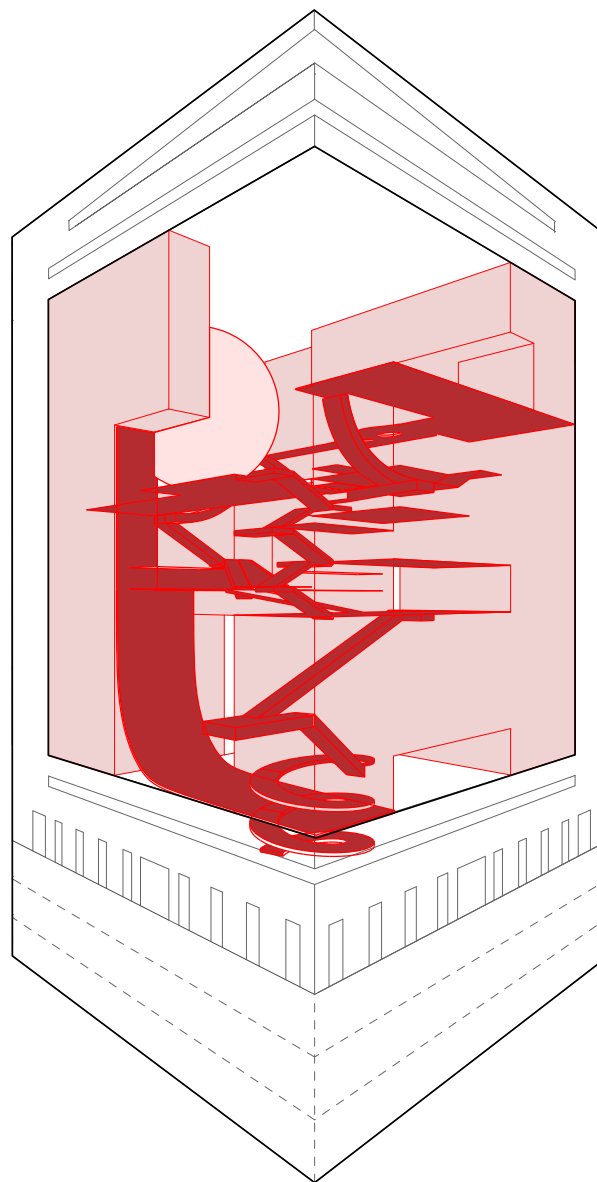
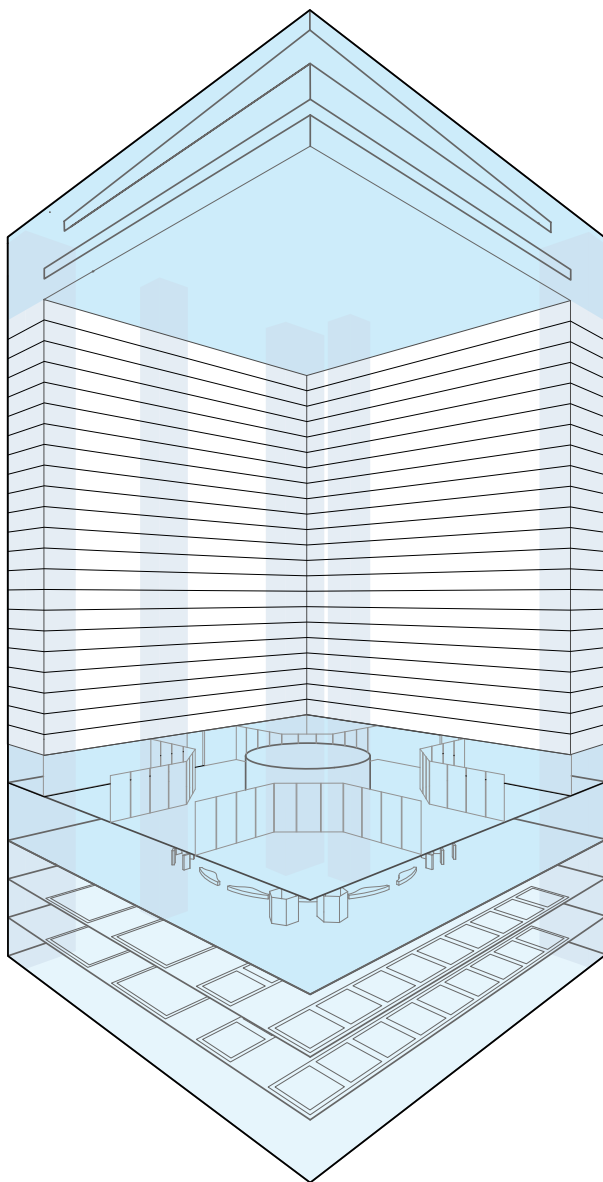

main
experiential
space

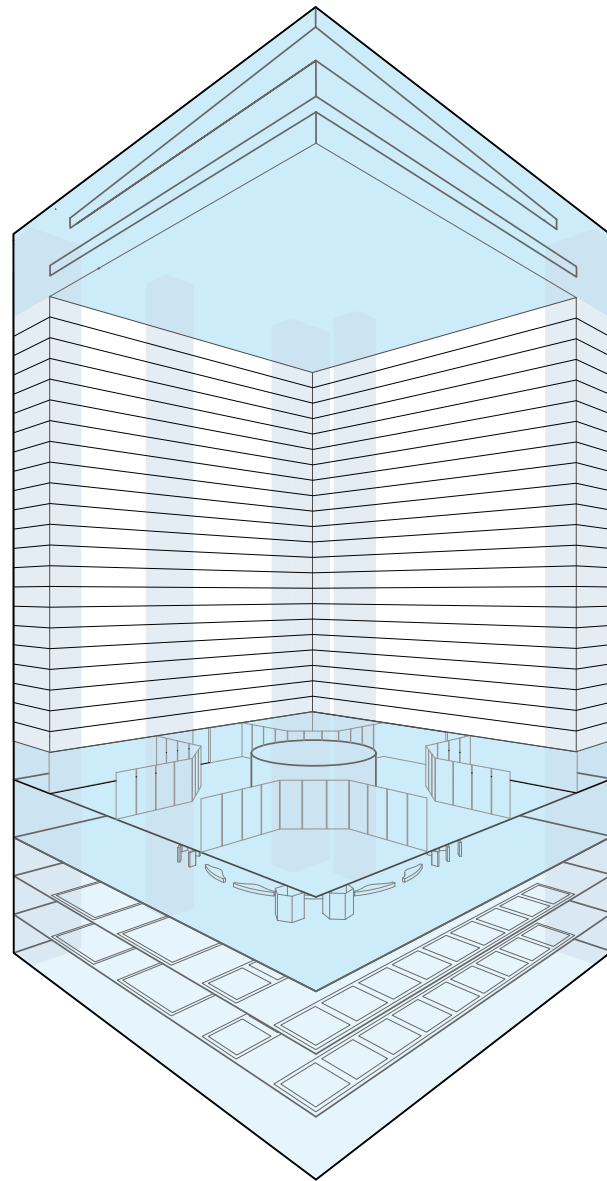

production

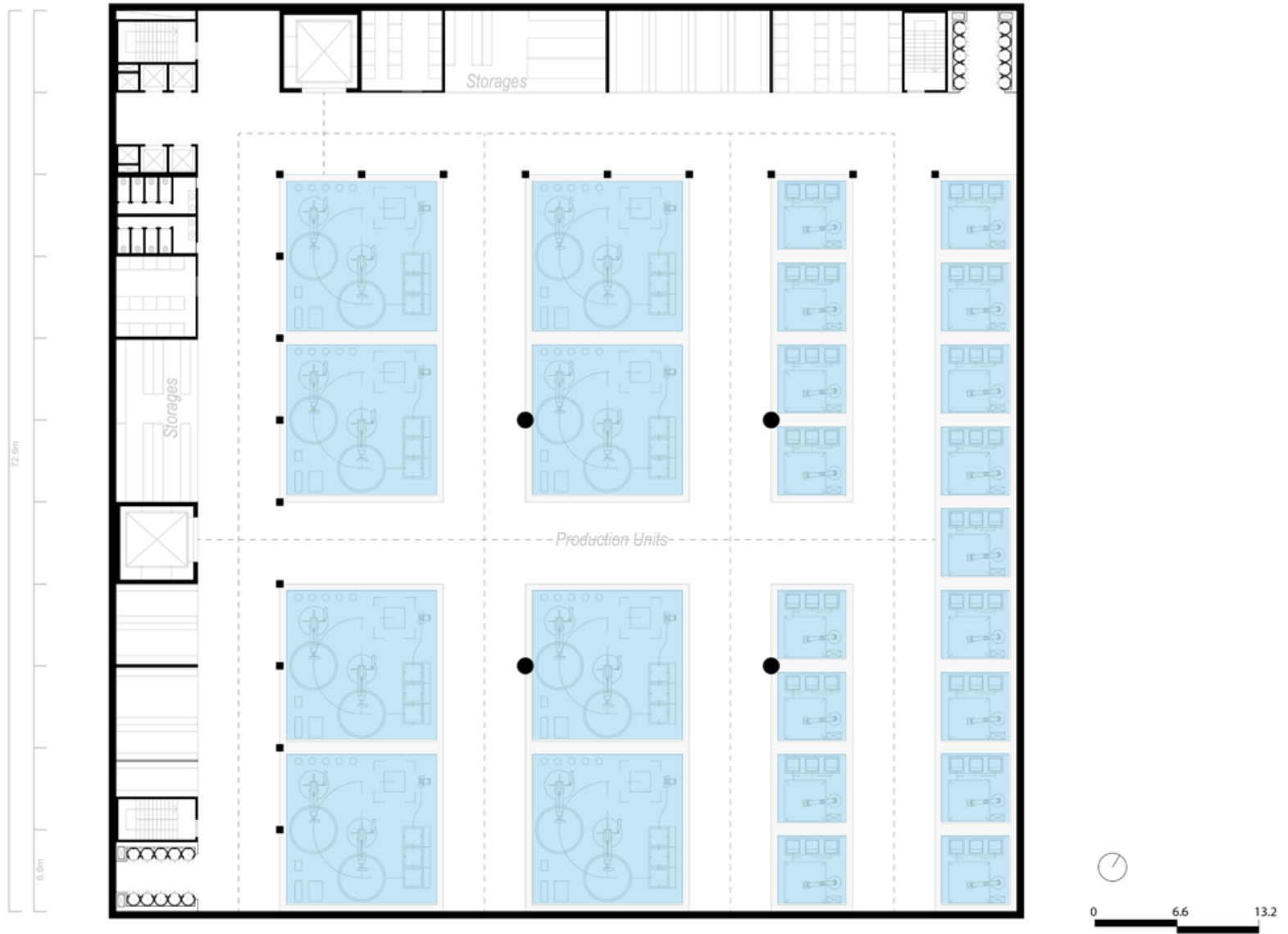

Underground - Production Units



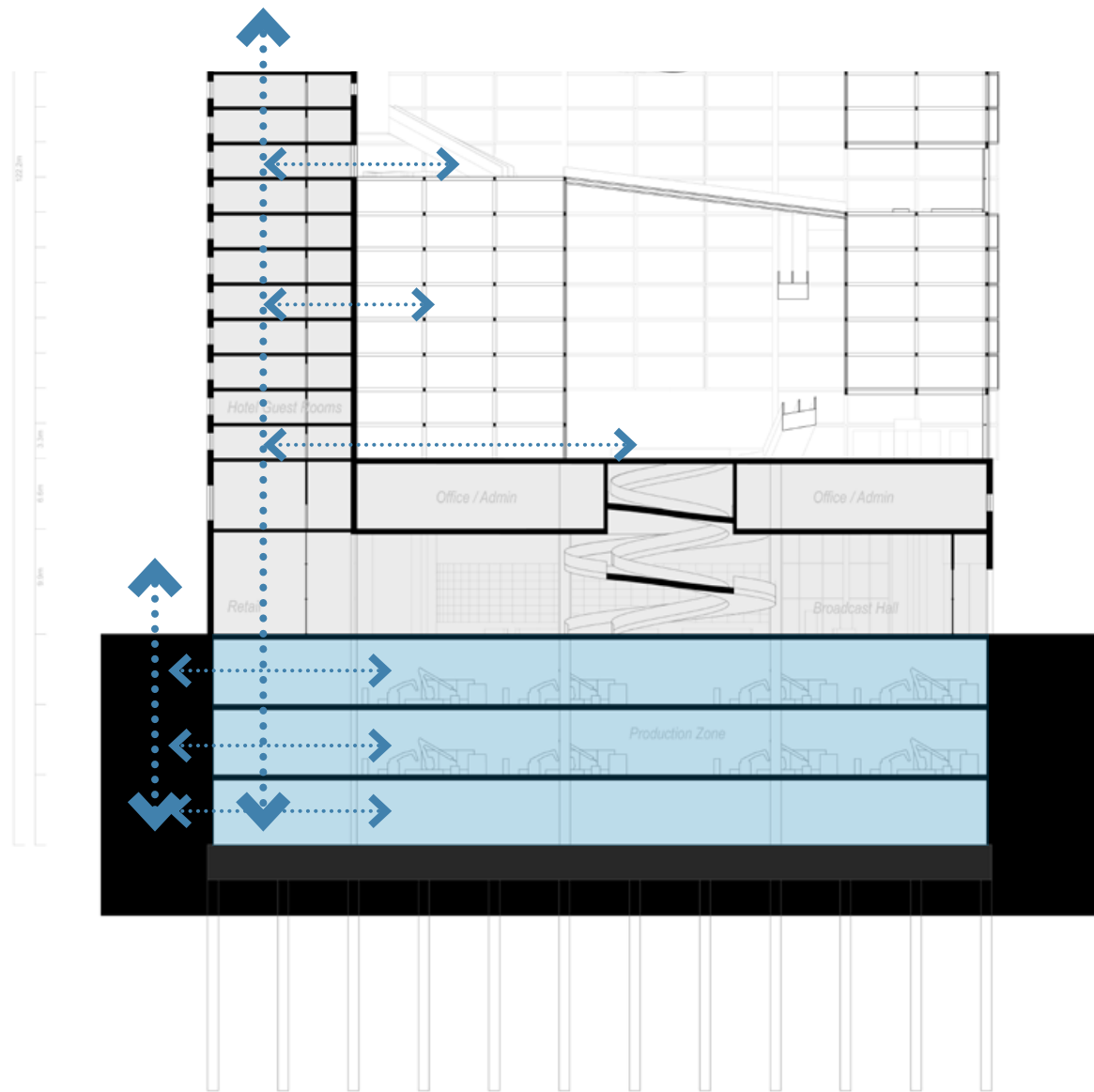

Underground

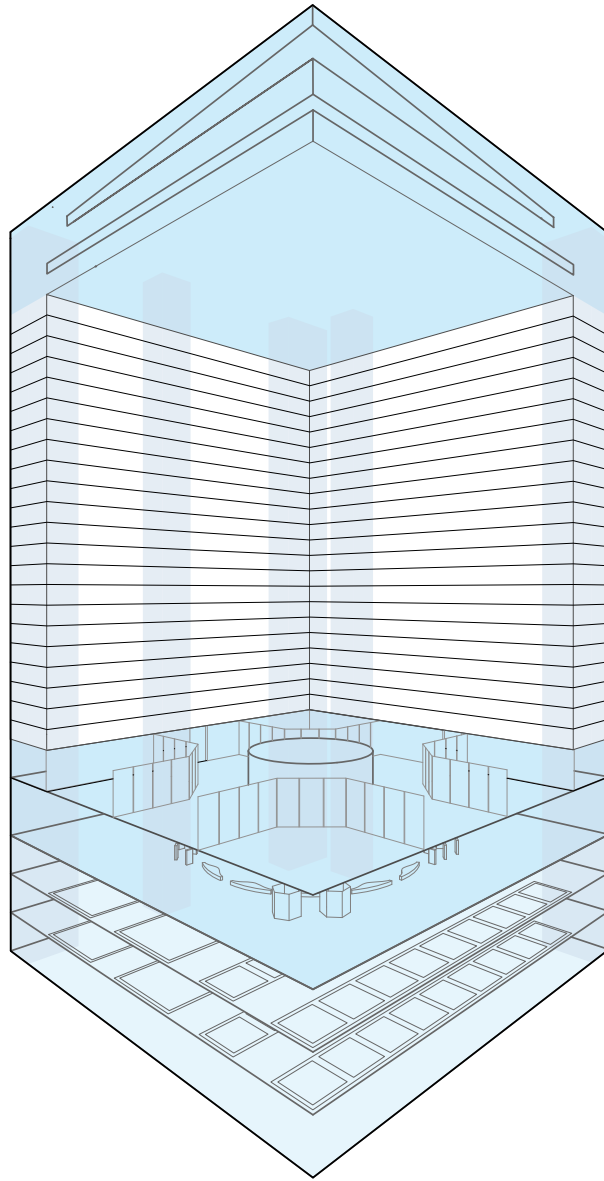

broadcastcast hall

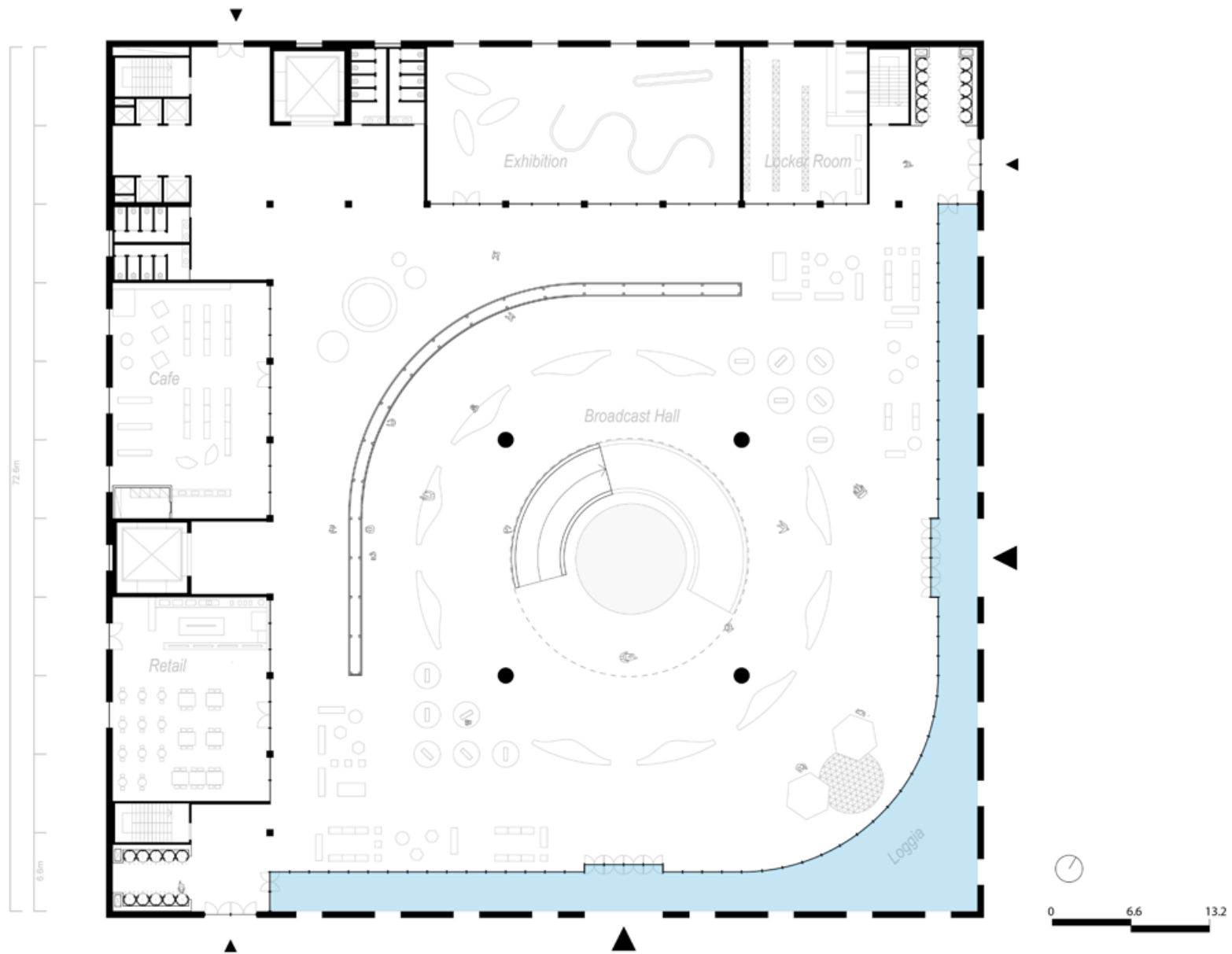

Ground Floor - Loggia

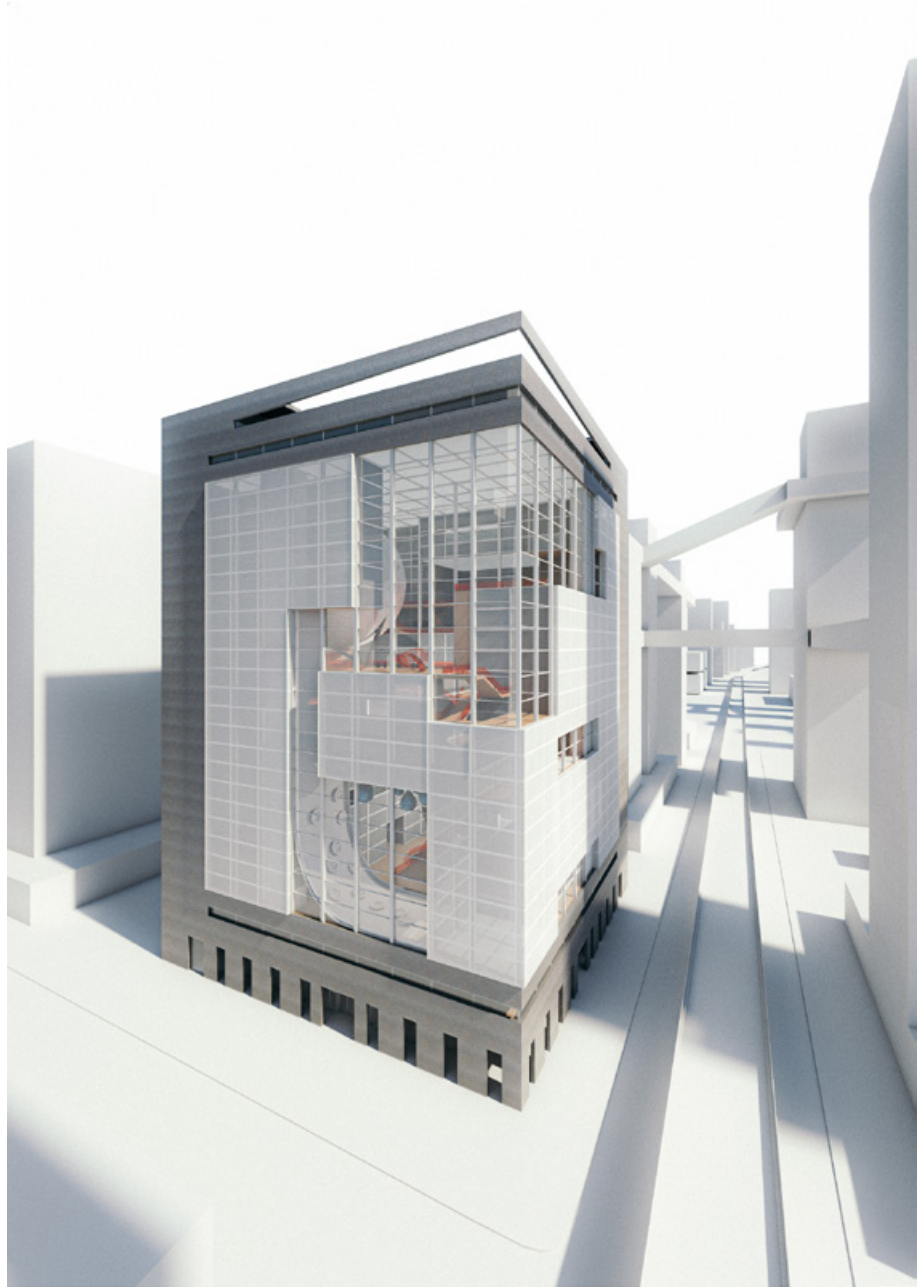

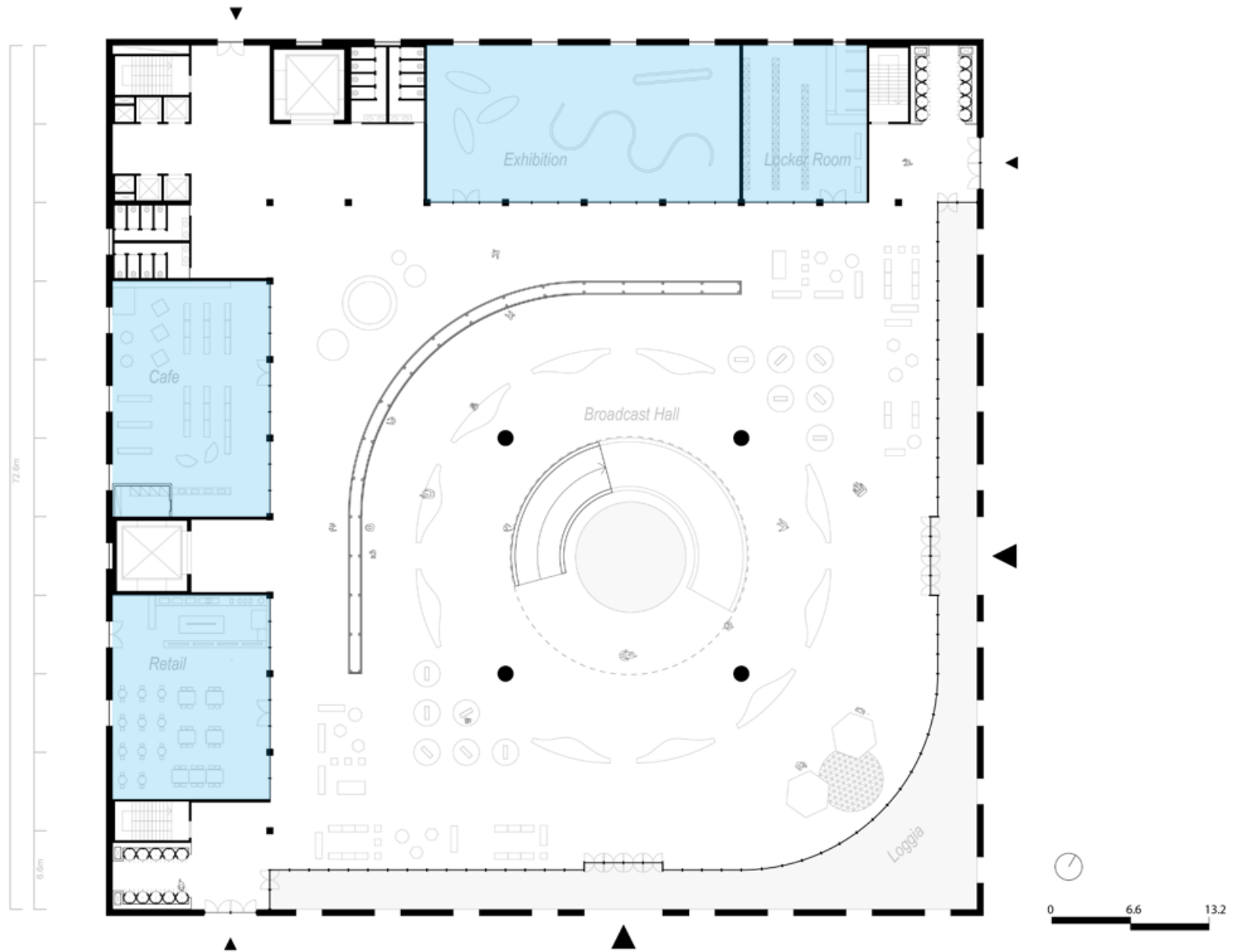

Ground Floor - Retail, Cafe, Exhibition

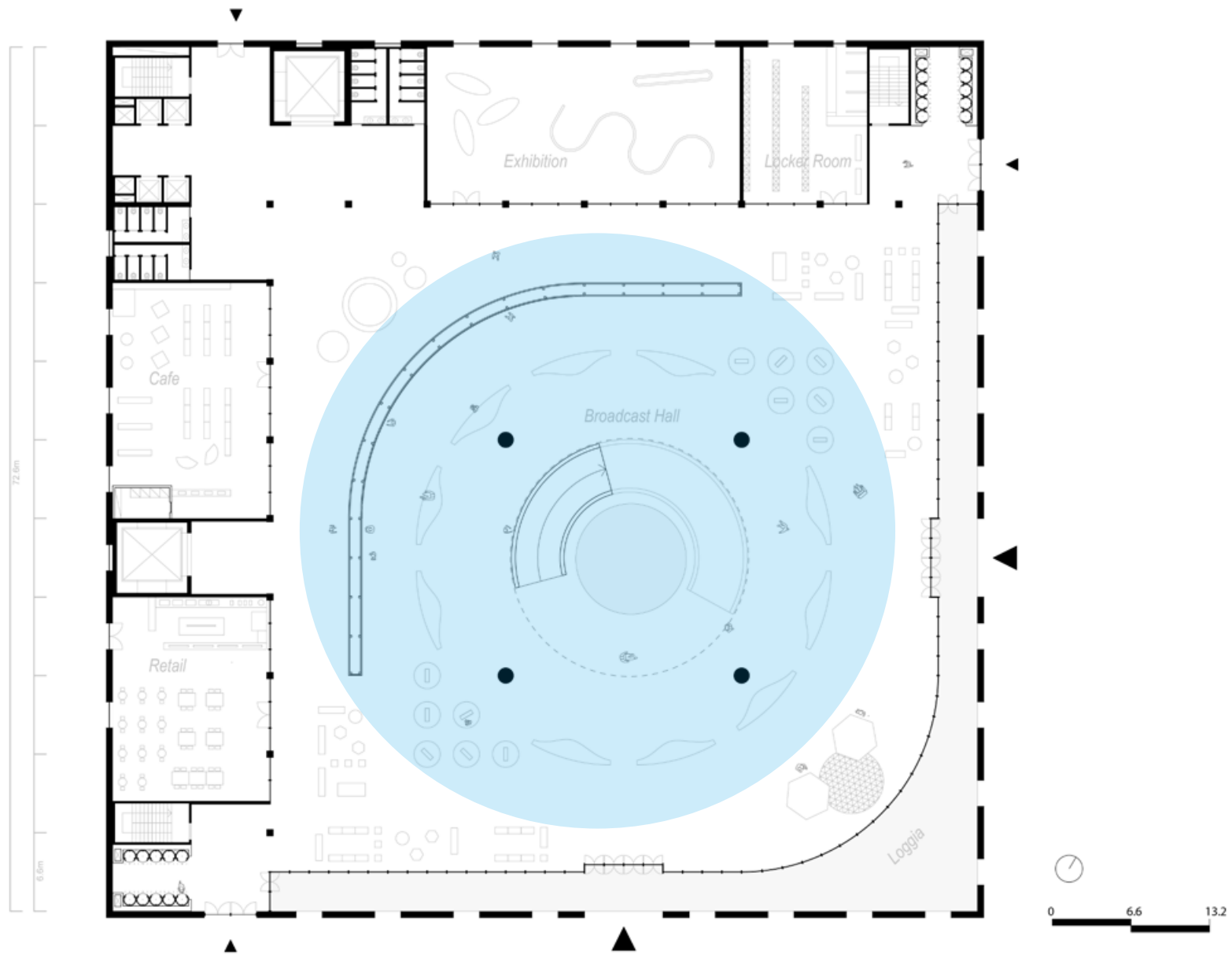

Ground Floor - Broadcast Hall



CAMERA C-2-11

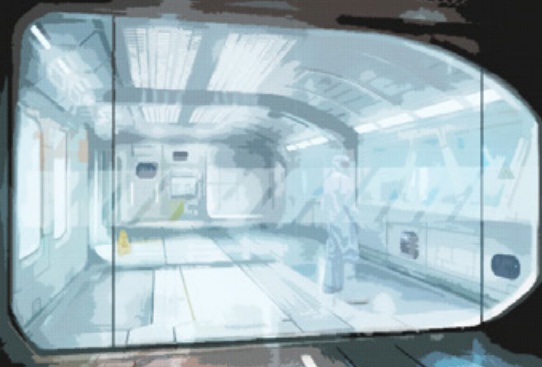

THE SECRET LAB
on sale!

Next Entry: 16:35, Gate C-2
Duration: 45m—2h15m

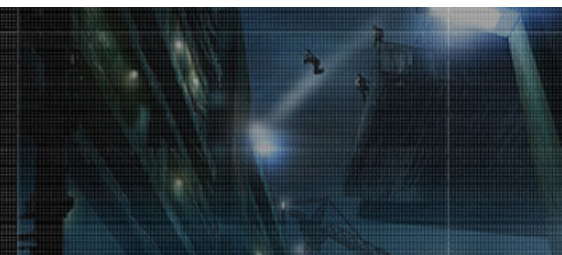

CAMERA F-6-2



CAMERA F-6-5



1967 Underground

Next Entry: 16:35, Gate F-e
Duration: 1h10m—1h40m

over 12 years only



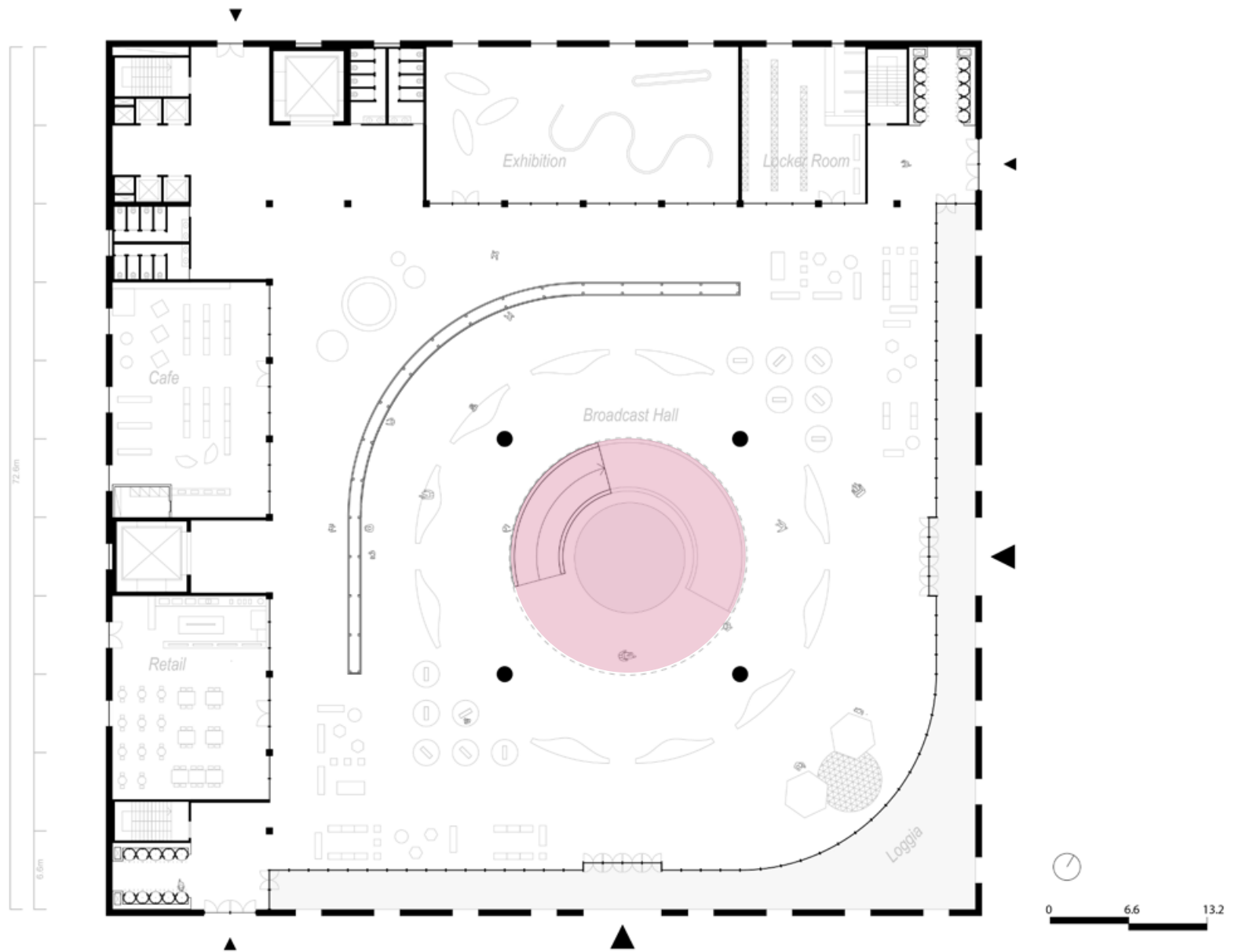

Ground Floor - Broadcast Hall

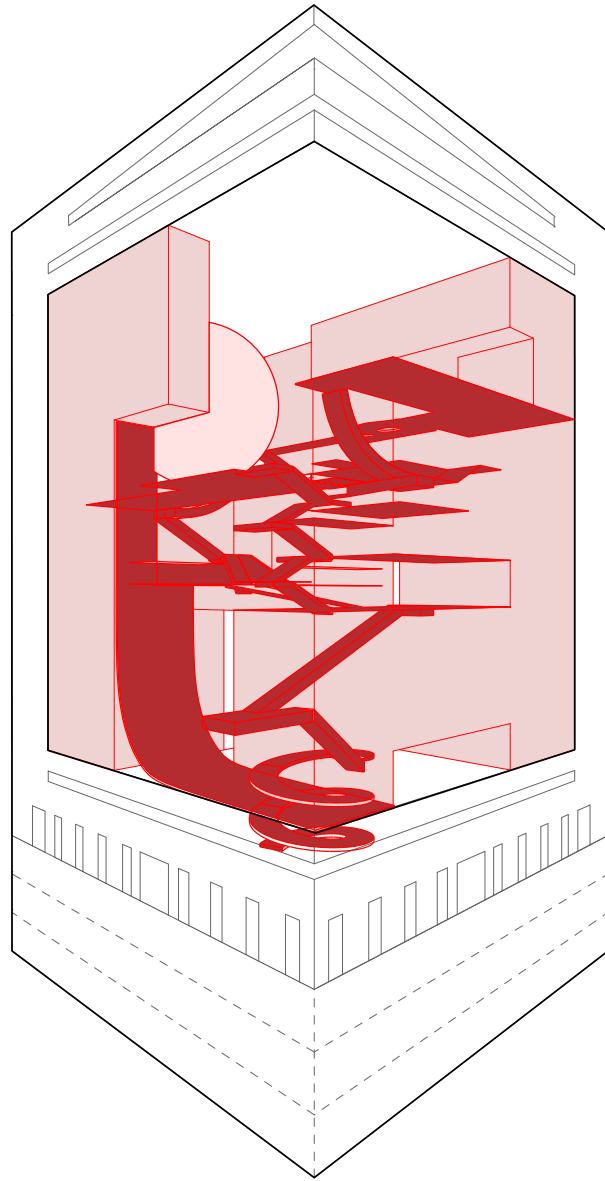

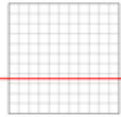

0 6.6 13.2 26.4

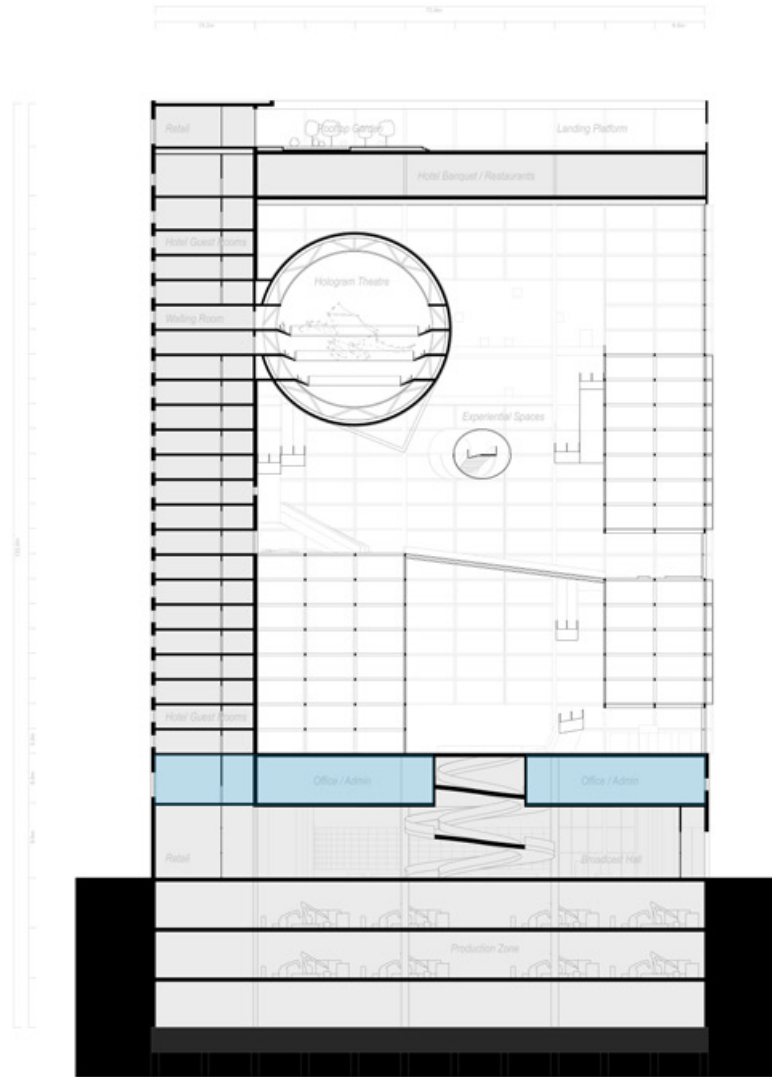

First Floor - Office & Administration

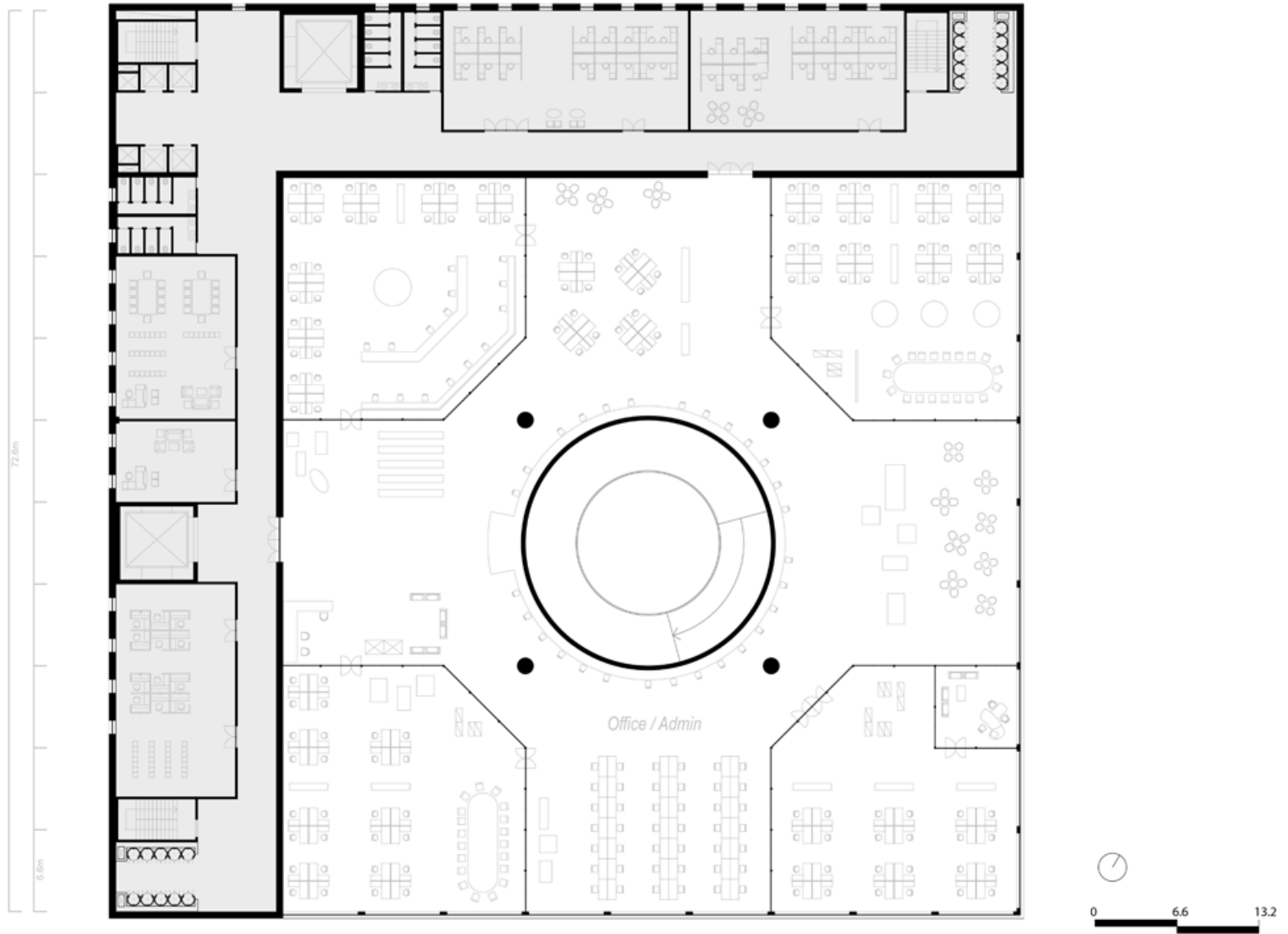

First Floor - Office & Administration

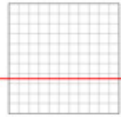

0 6.6 13.2 26.4

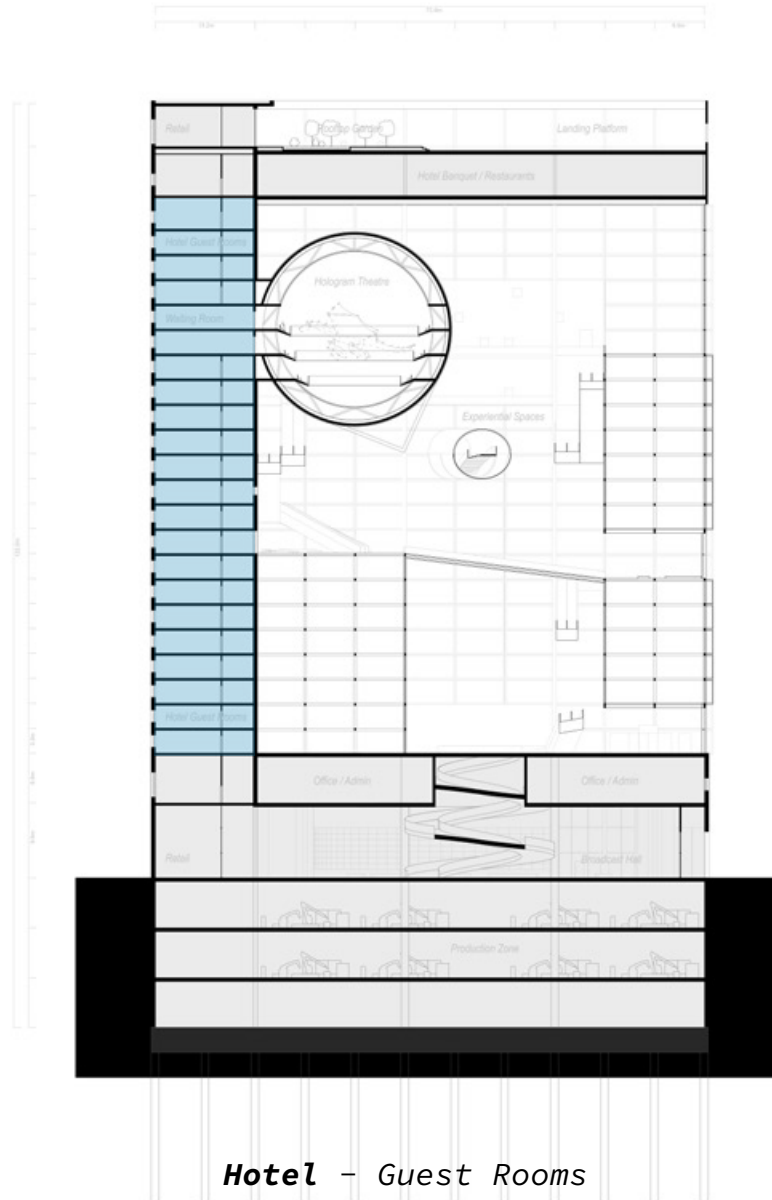

Hotel - Guest Rooms

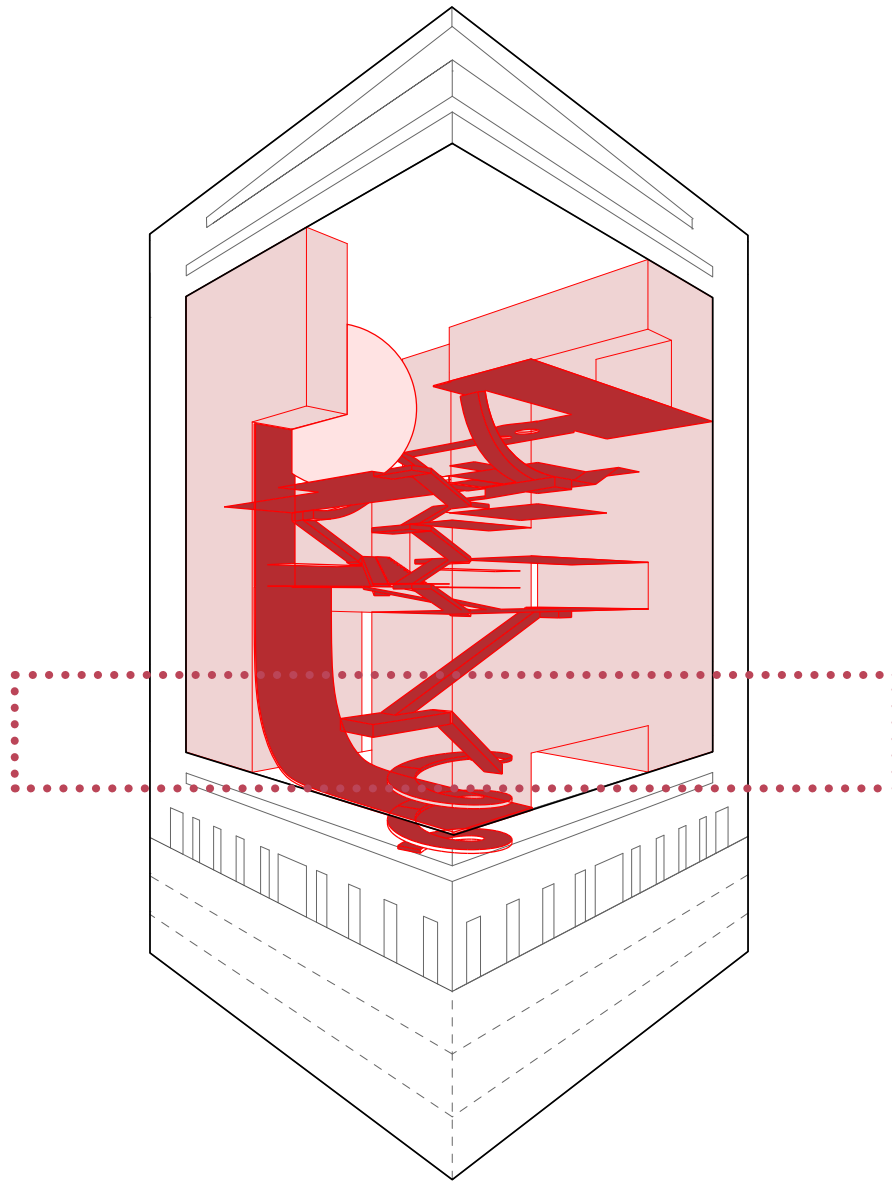

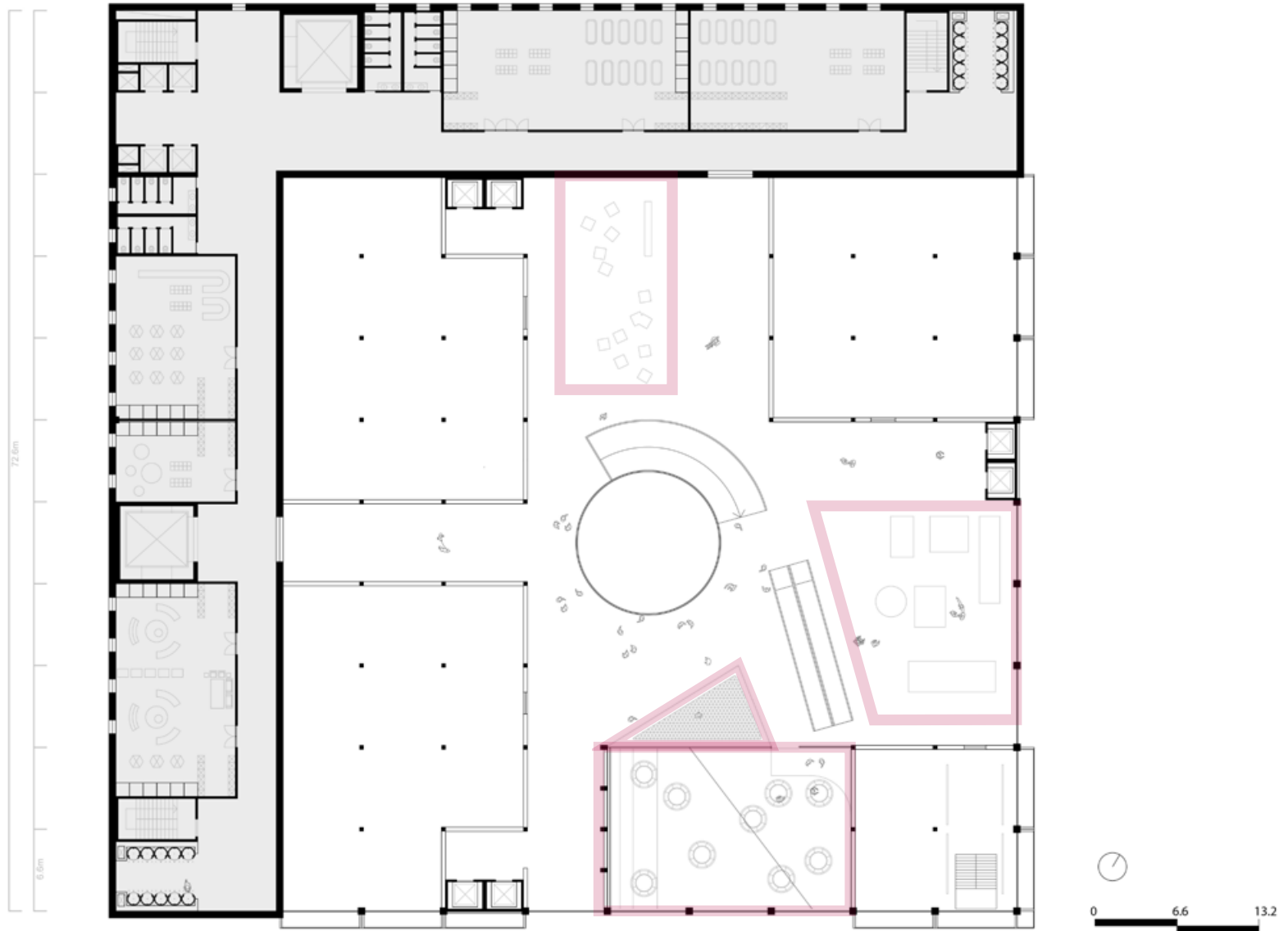

Main Experiential Space - Open Space





0 6.6 13.2 26.4

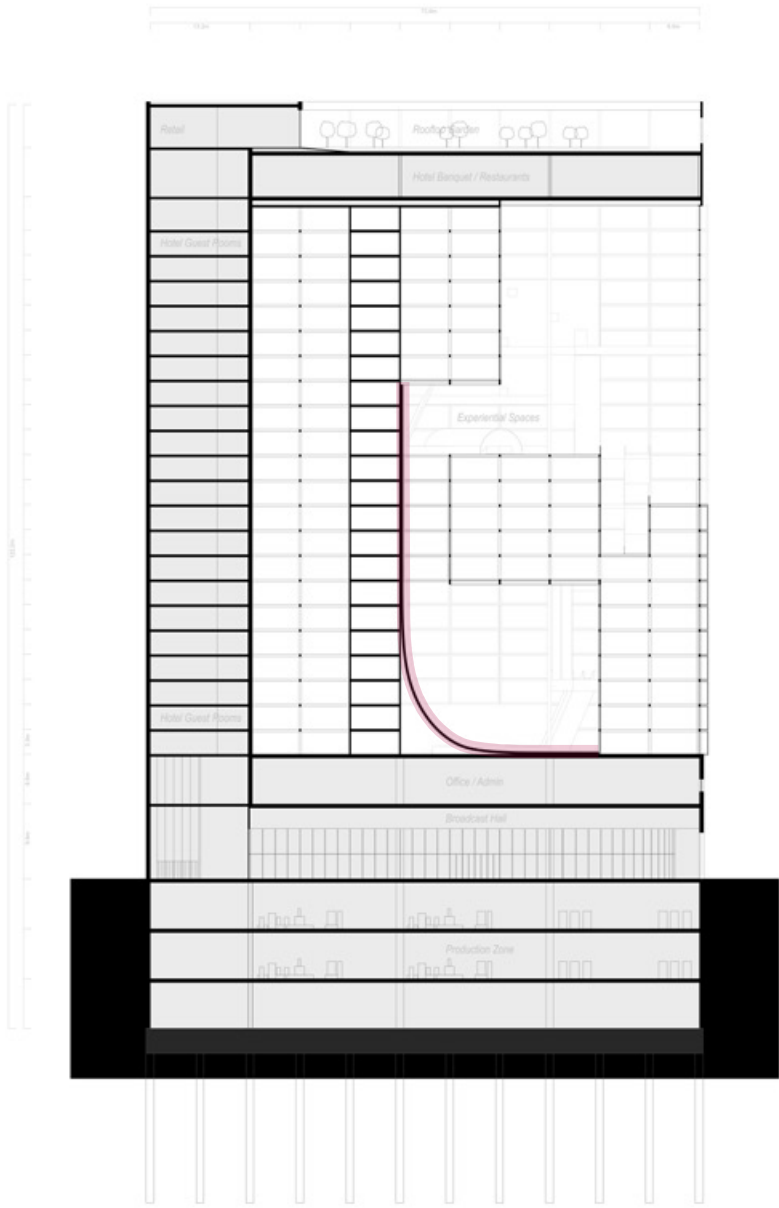

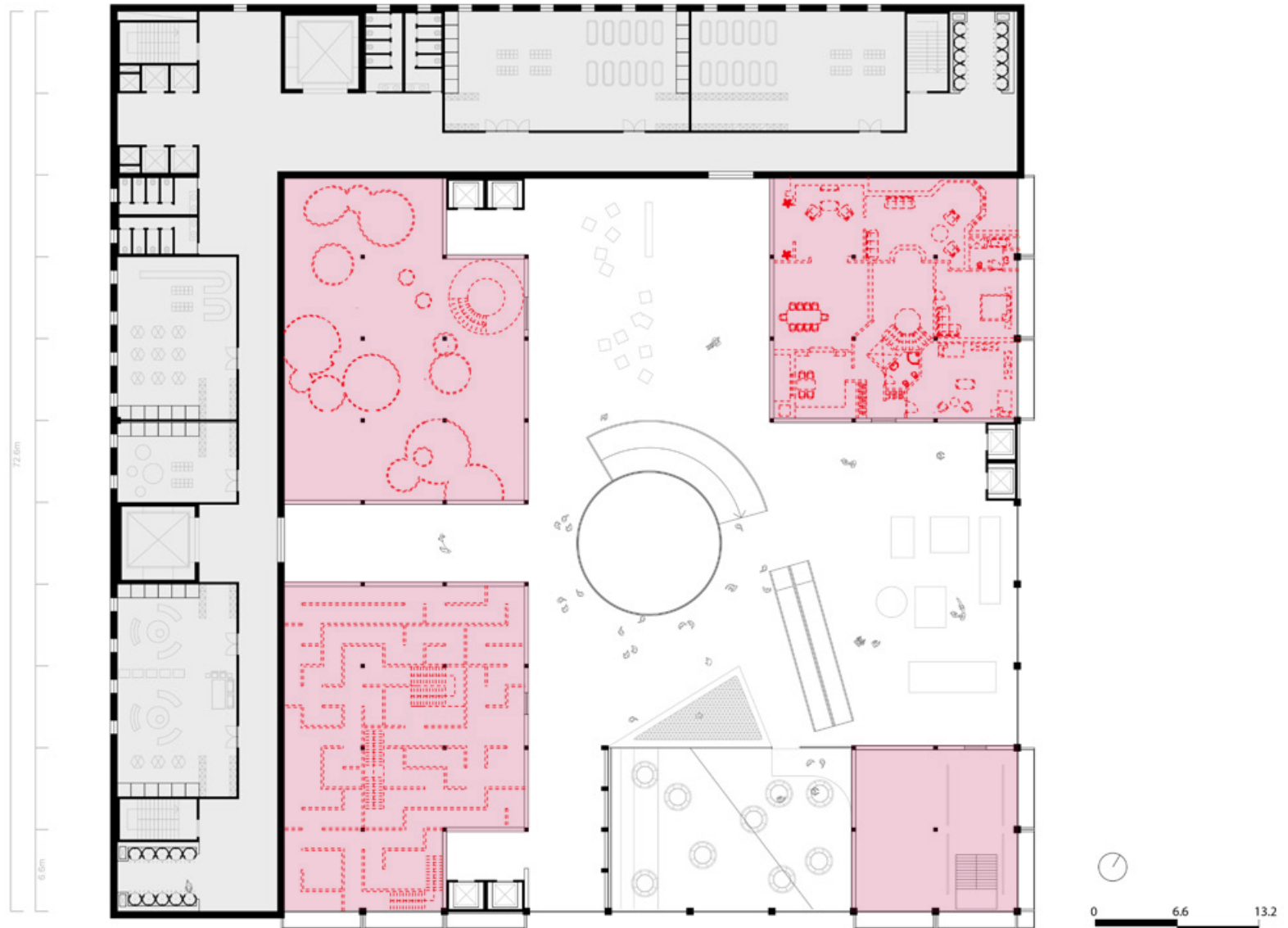

Main Experiential Space - Rooms

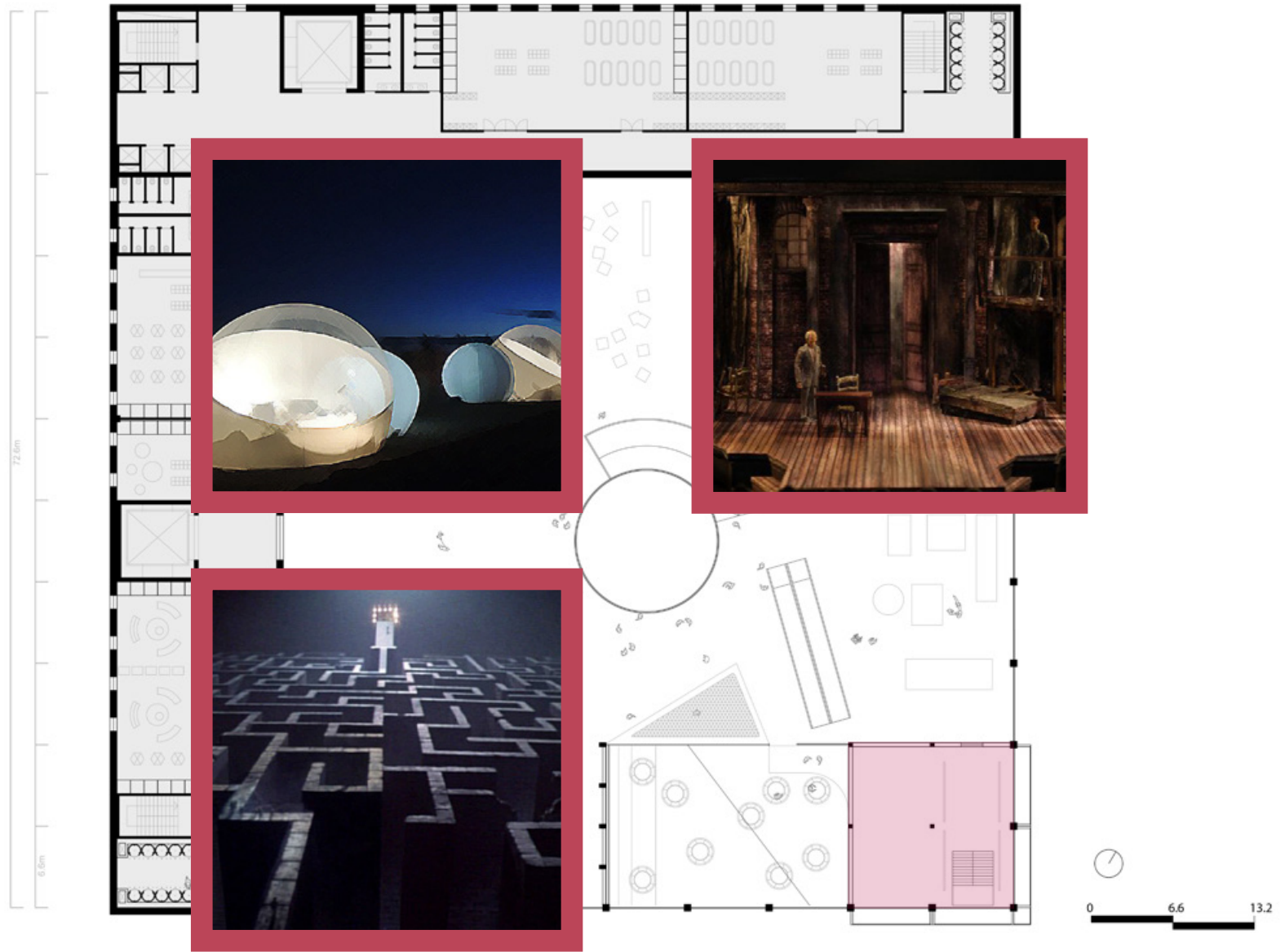

Main Experiential Space - Rooms

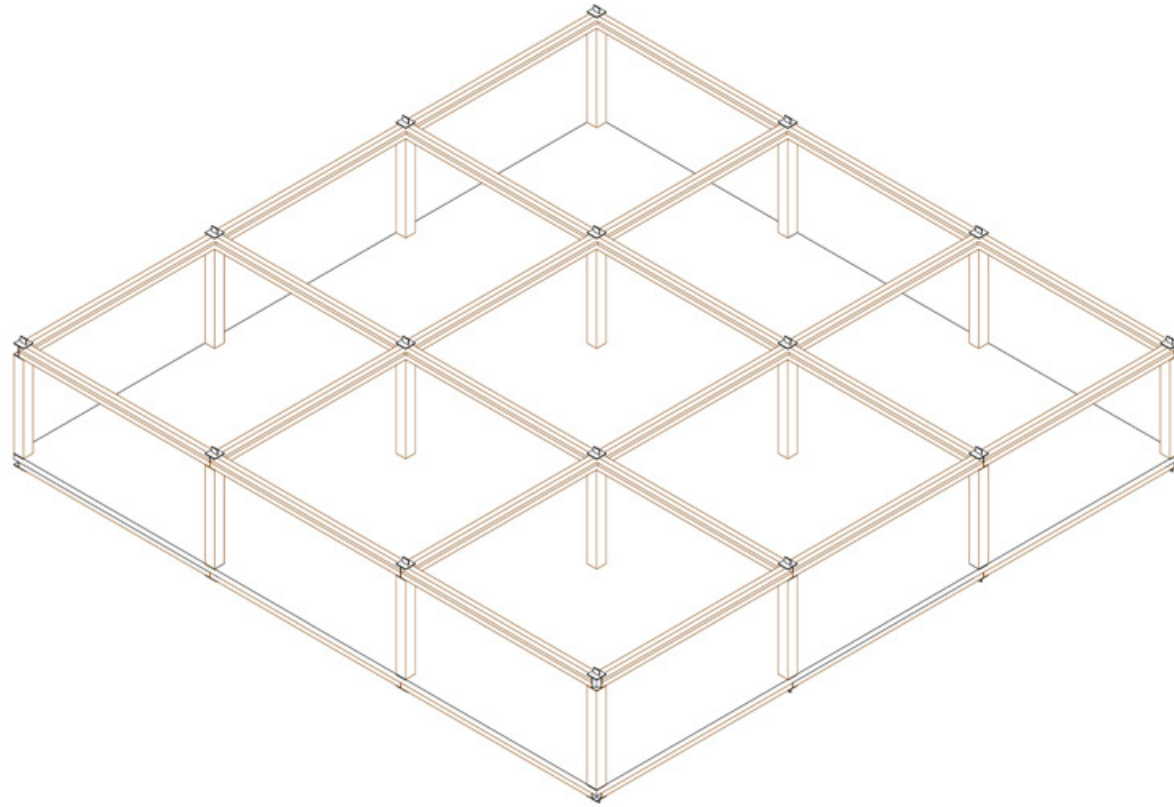

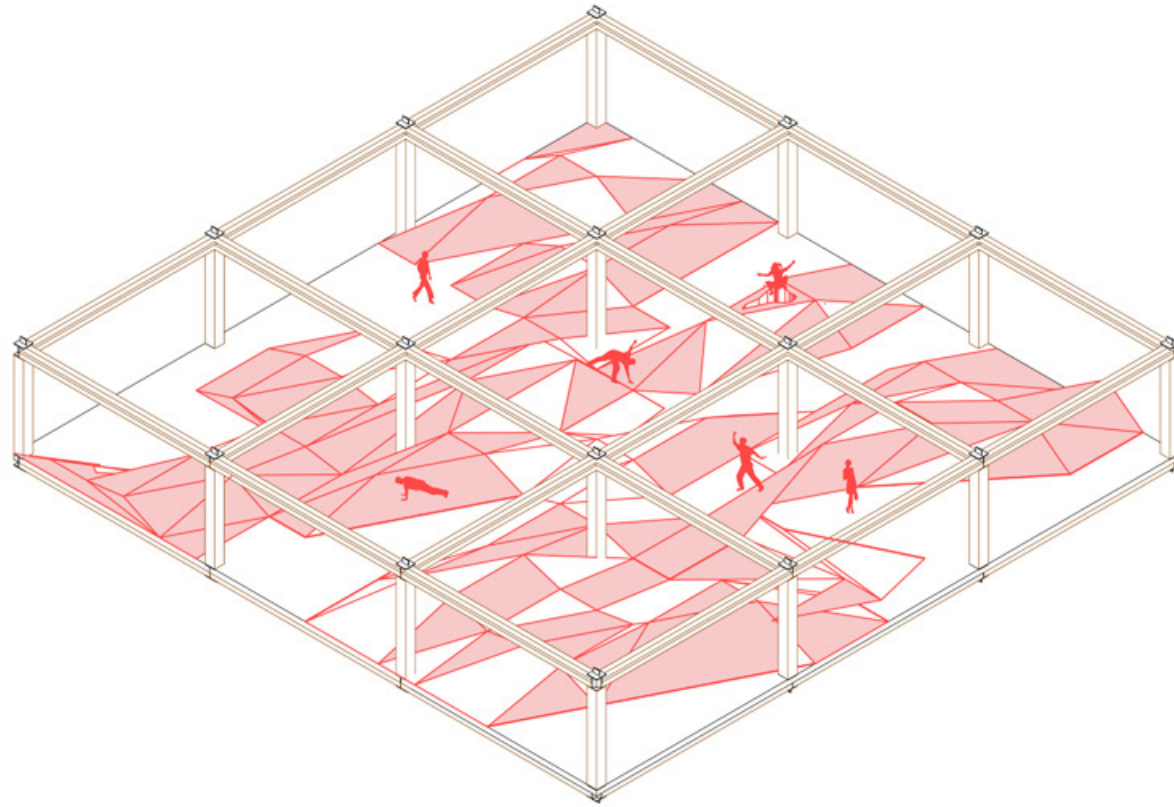

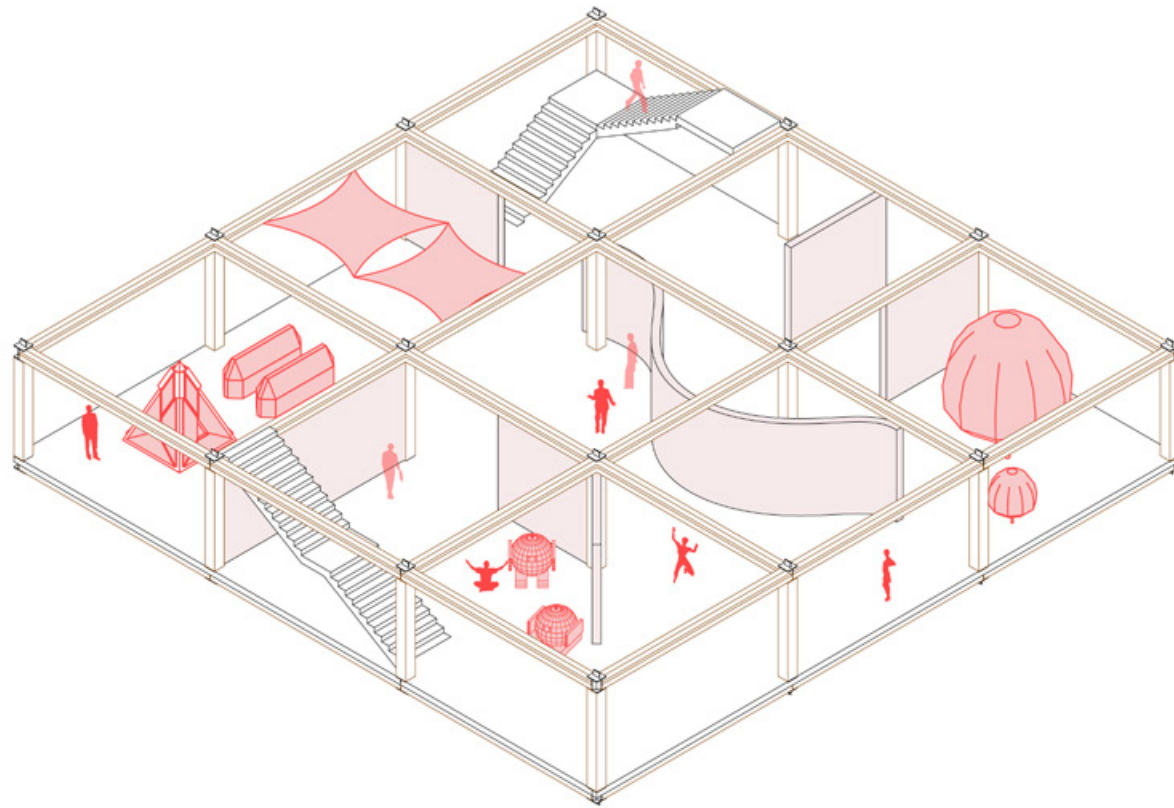

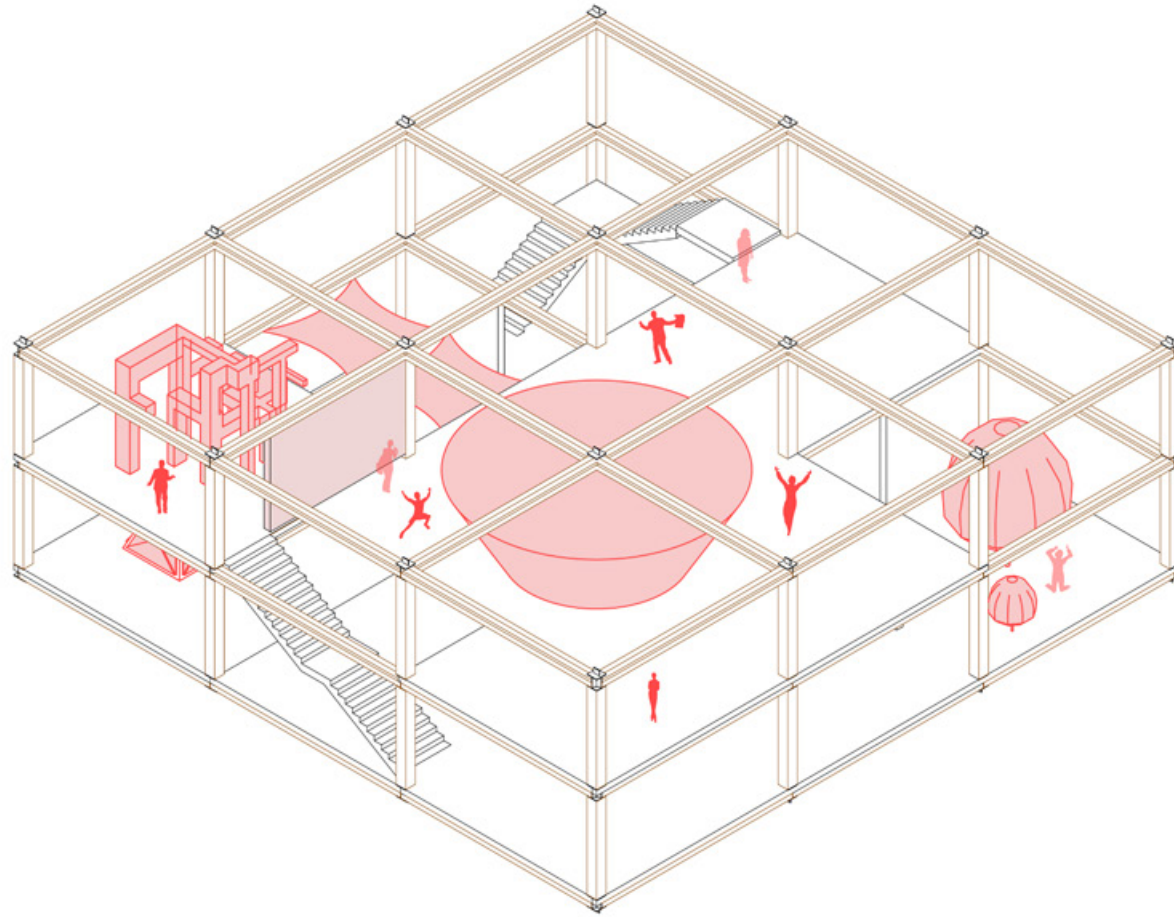

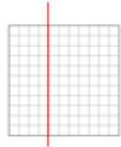

0 6.6 13.2 26.4

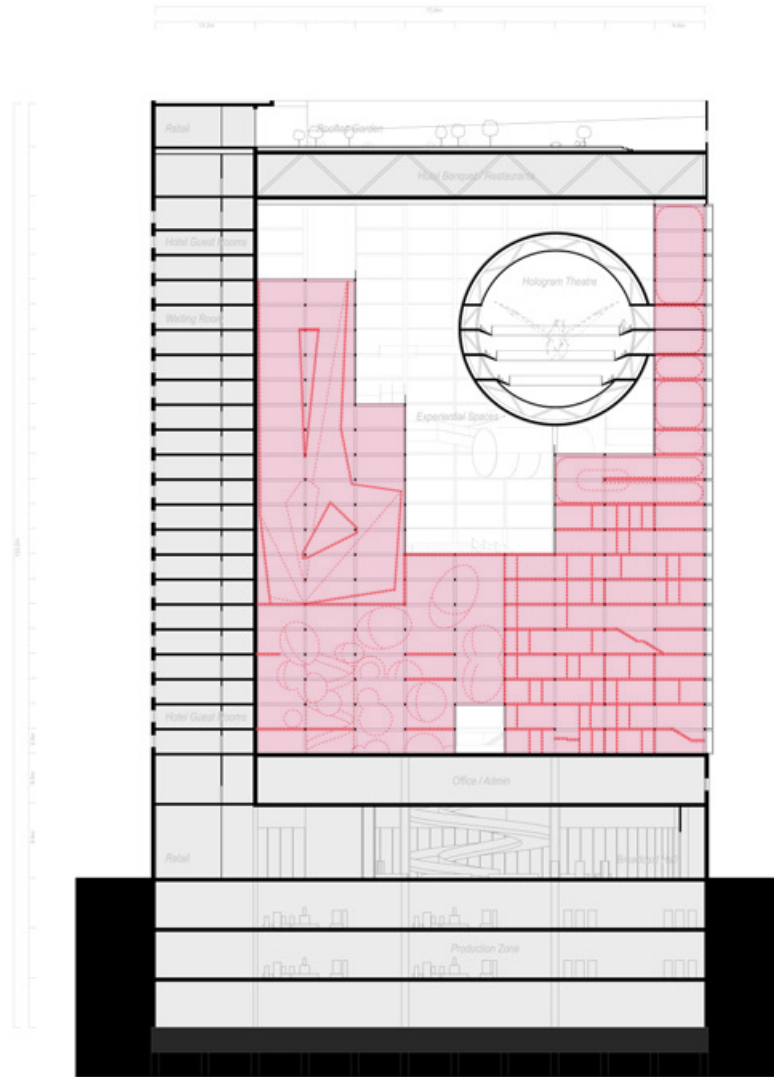

Main Experiential Space - Rooms

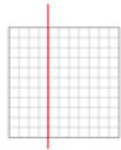

0 6.6 13.2 26.4

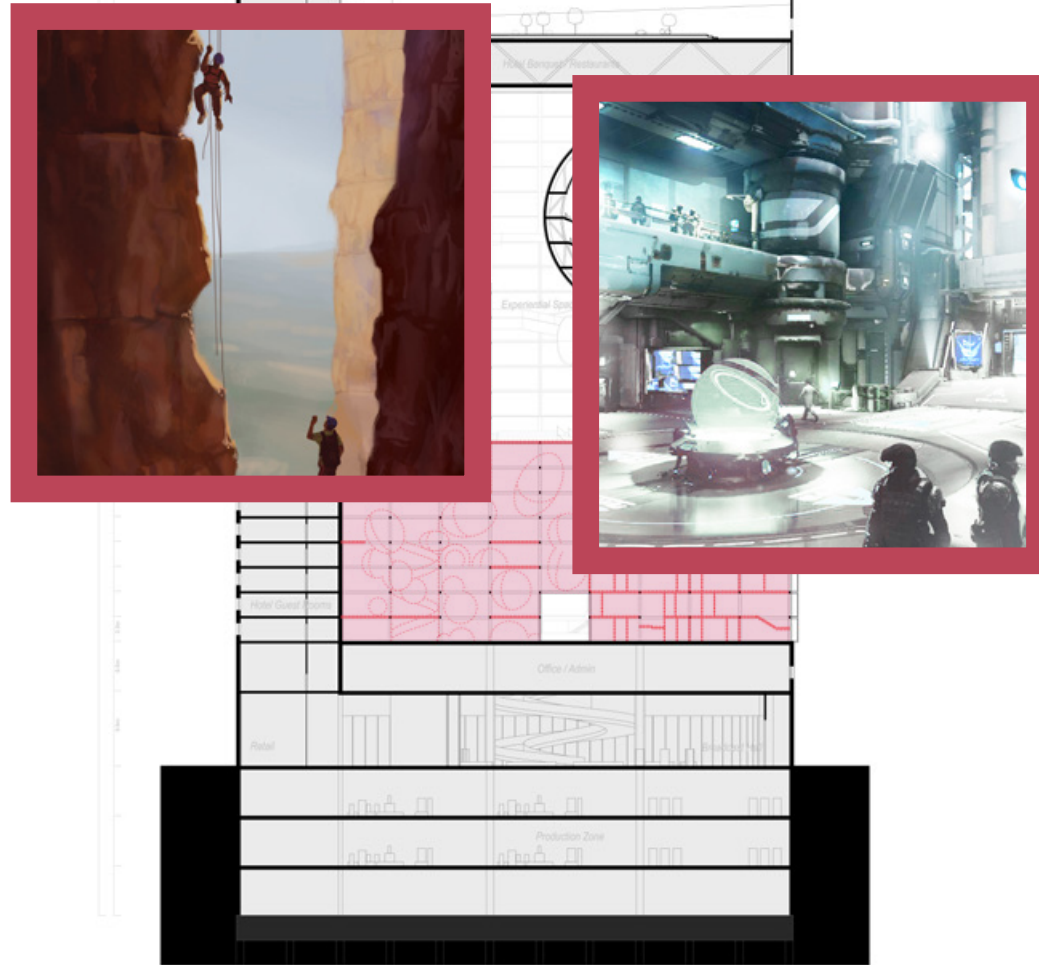

Main Experiential Space - Rooms

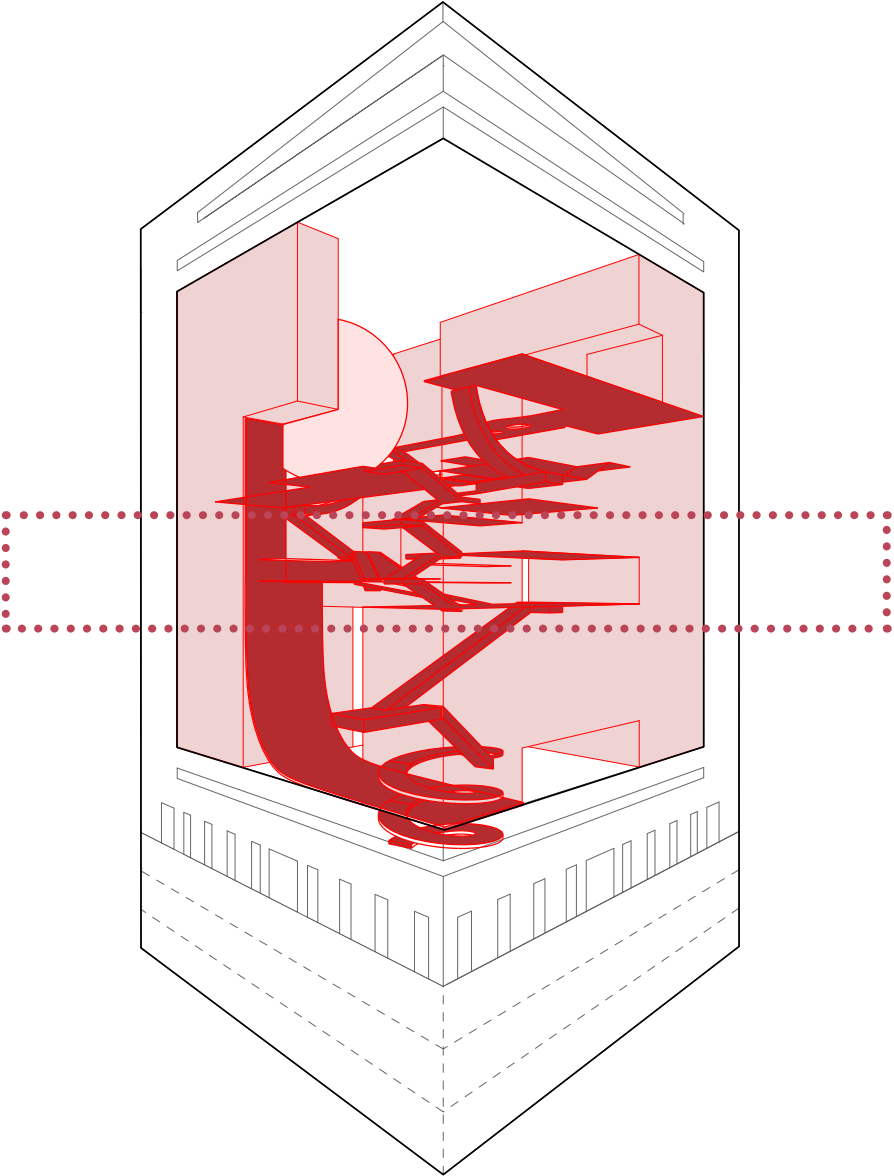



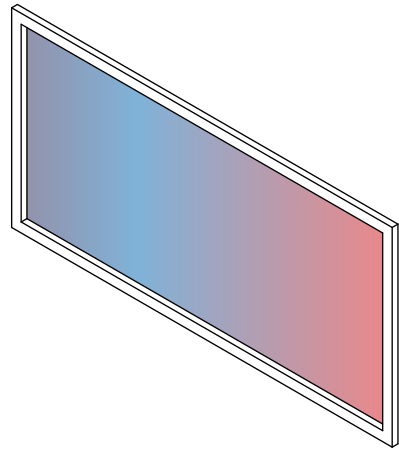

Transparent LED Panel

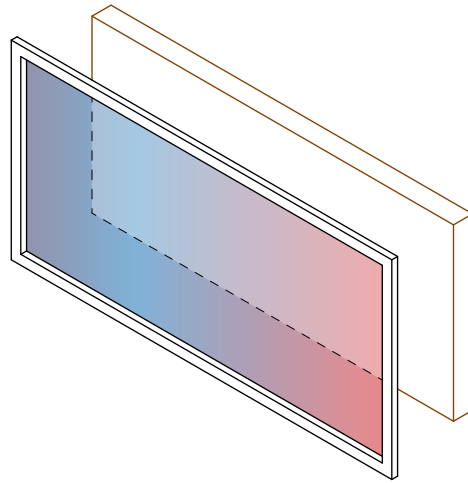

Transparent LED Panel
+
Mass Timber Wall

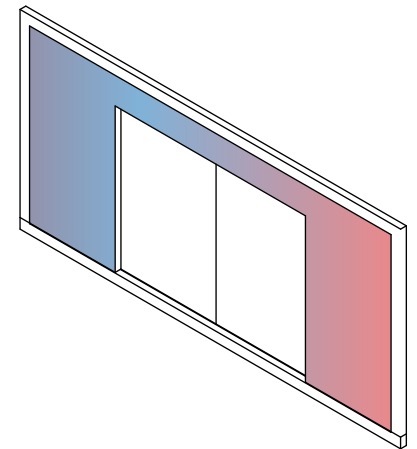

Opening, Entrance/Exit

Various Panel Infill



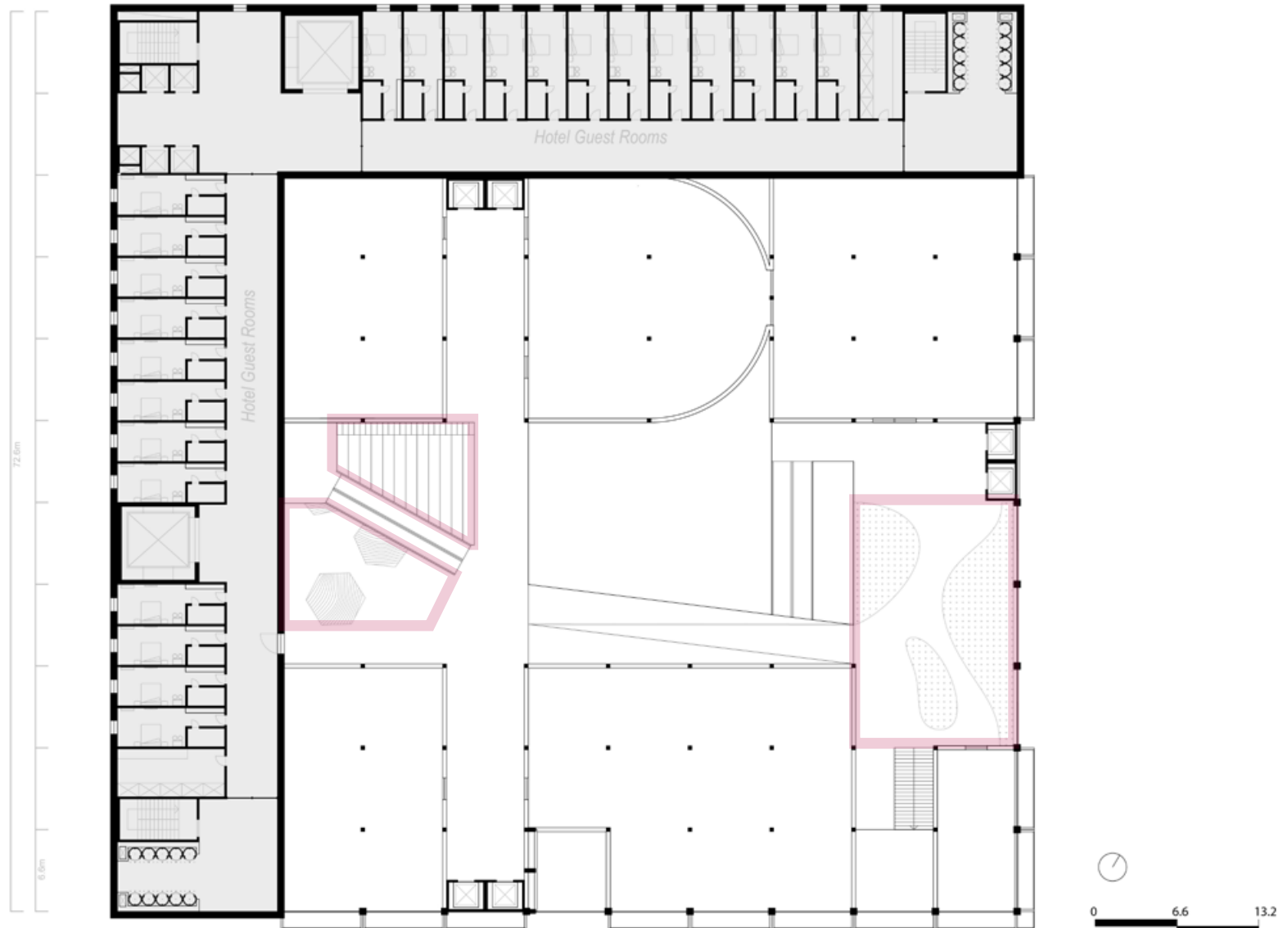

Main Experiential Space - Open Space

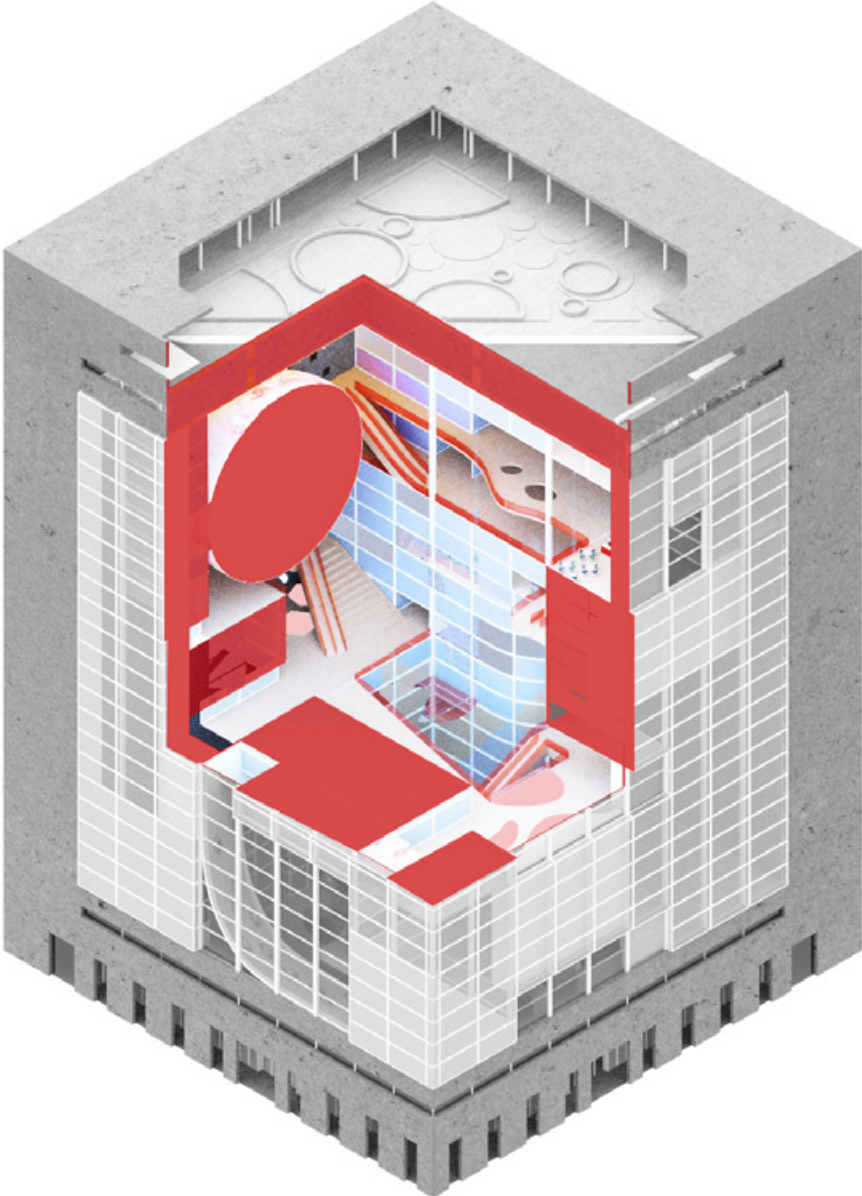

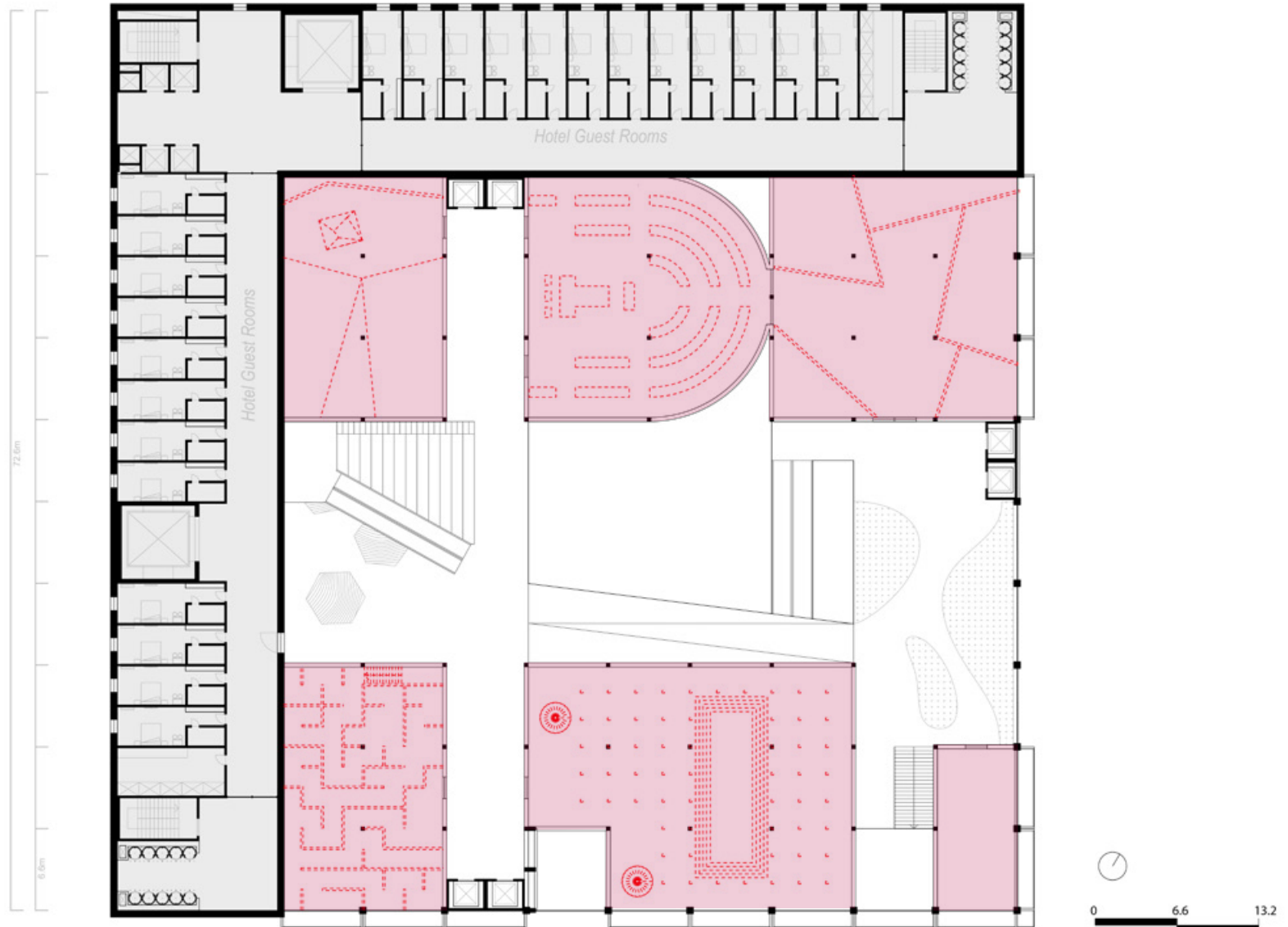

Main Experiential Space - Rooms

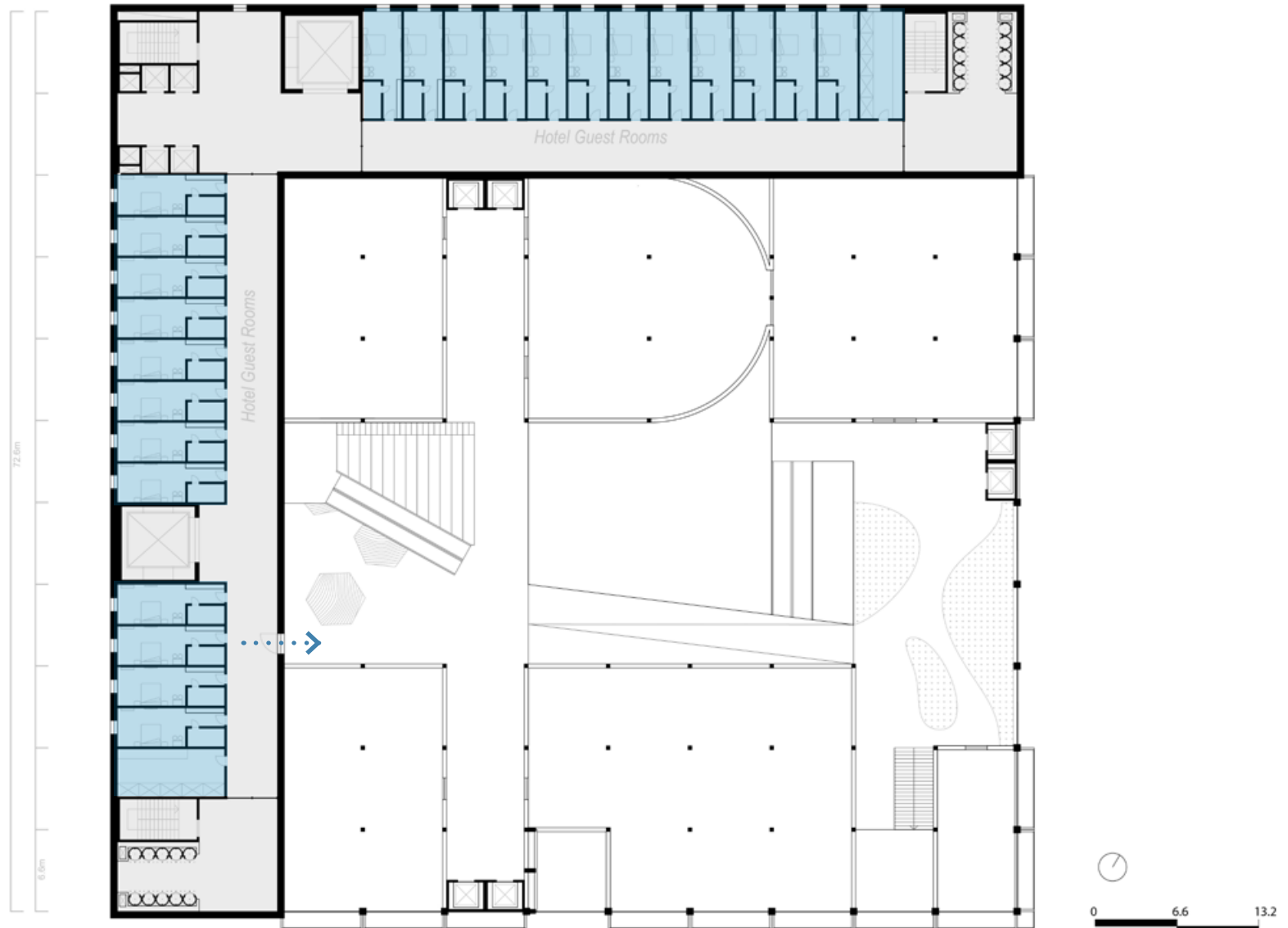

Hotel - Guest Rooms

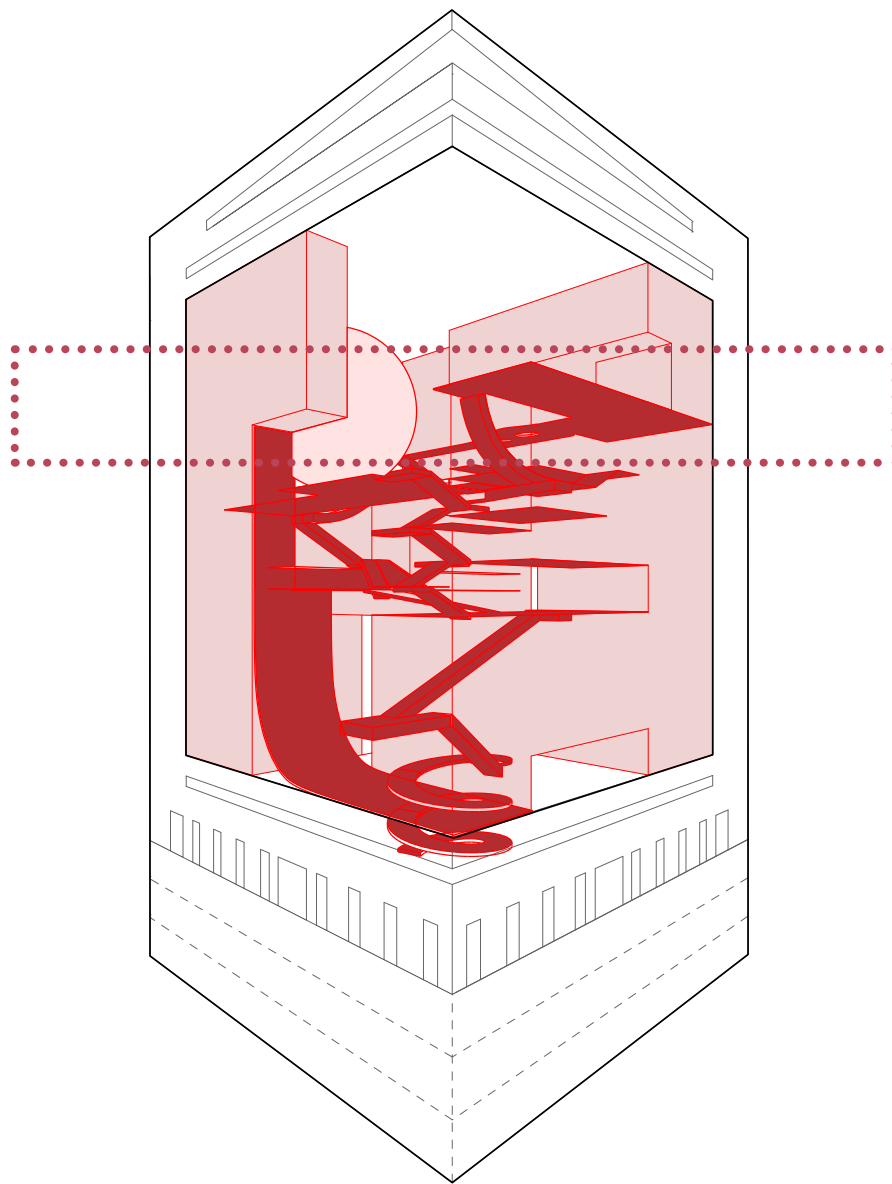

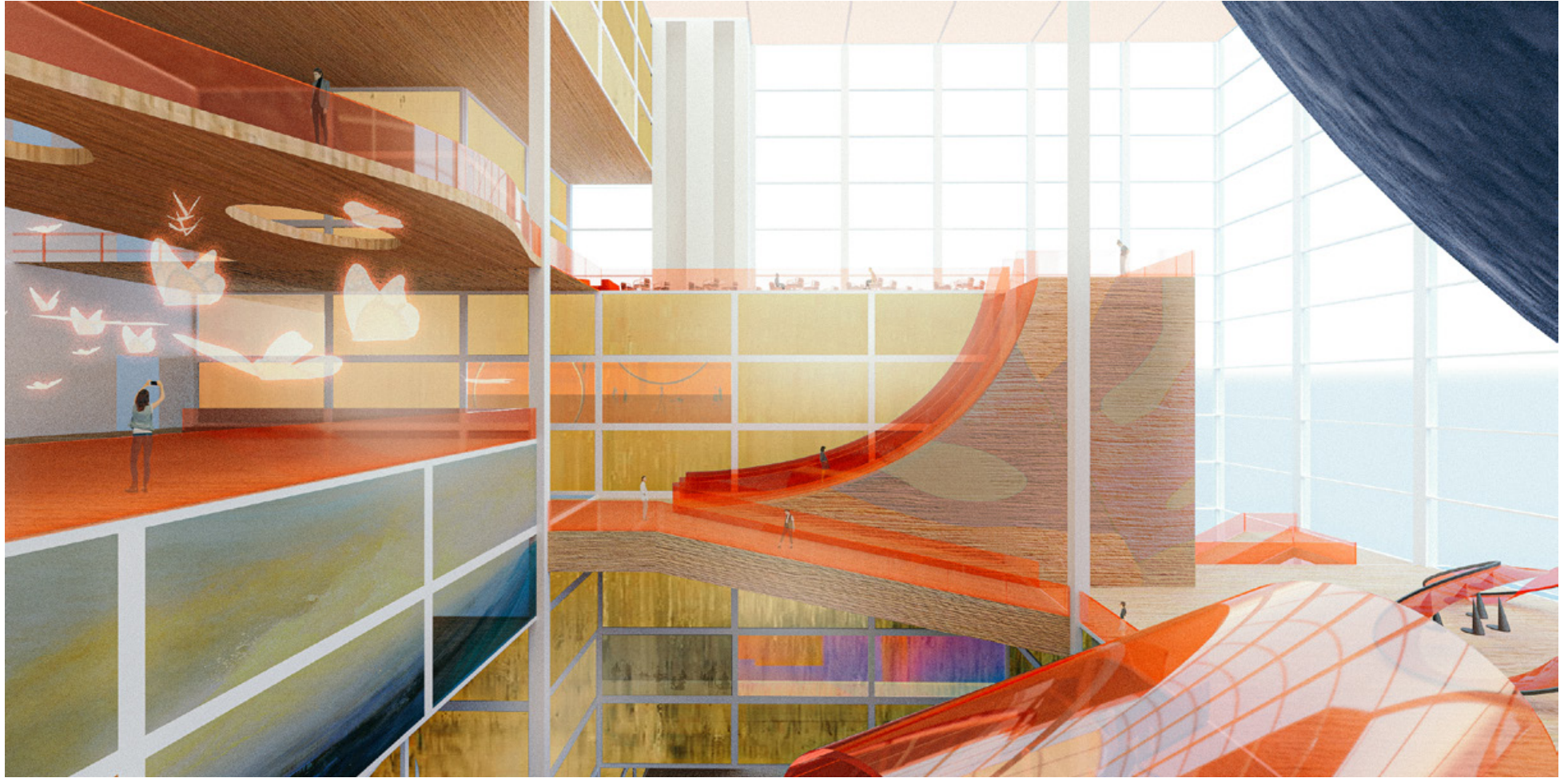

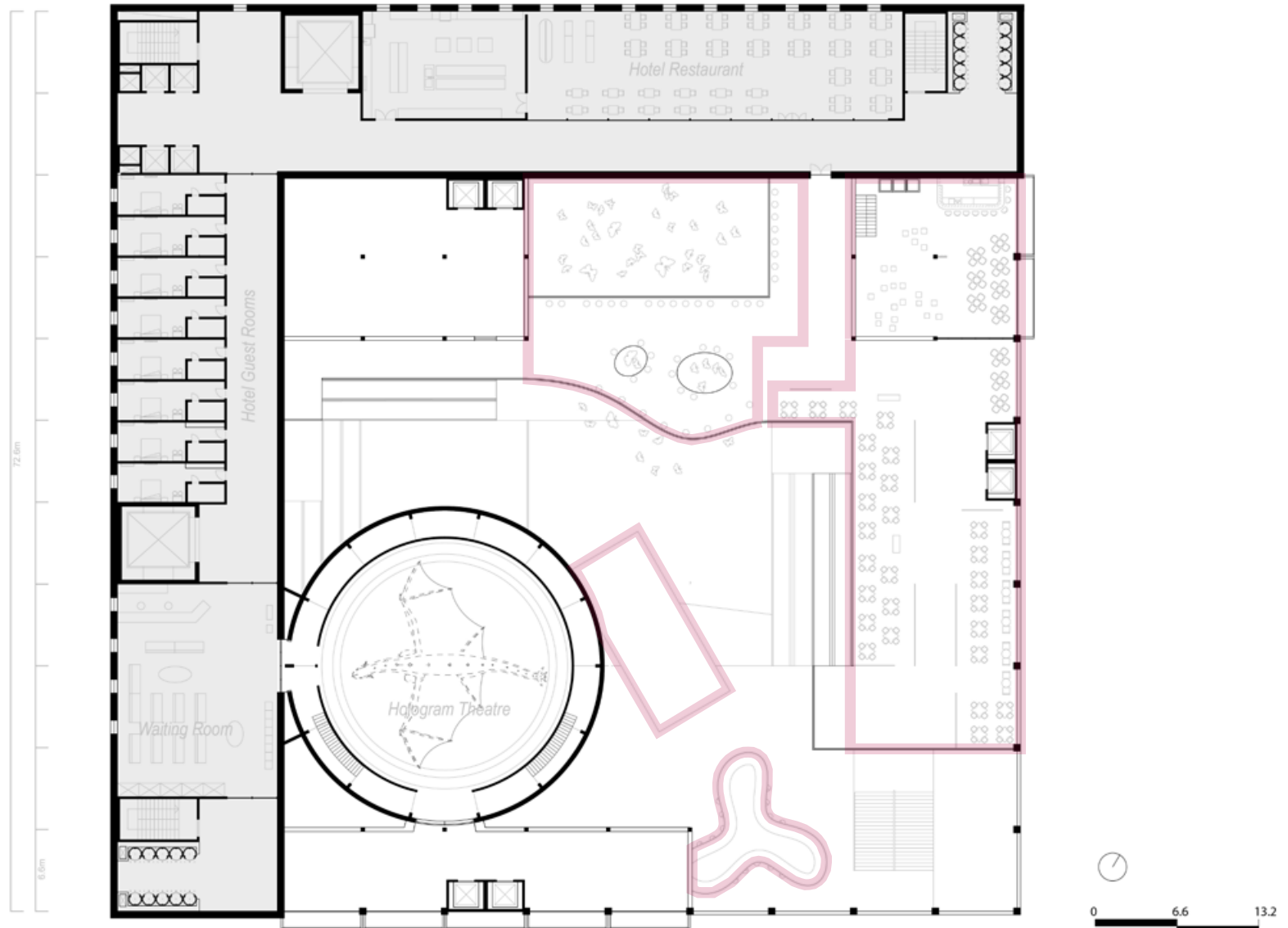

Main Experiential Space - Open Space



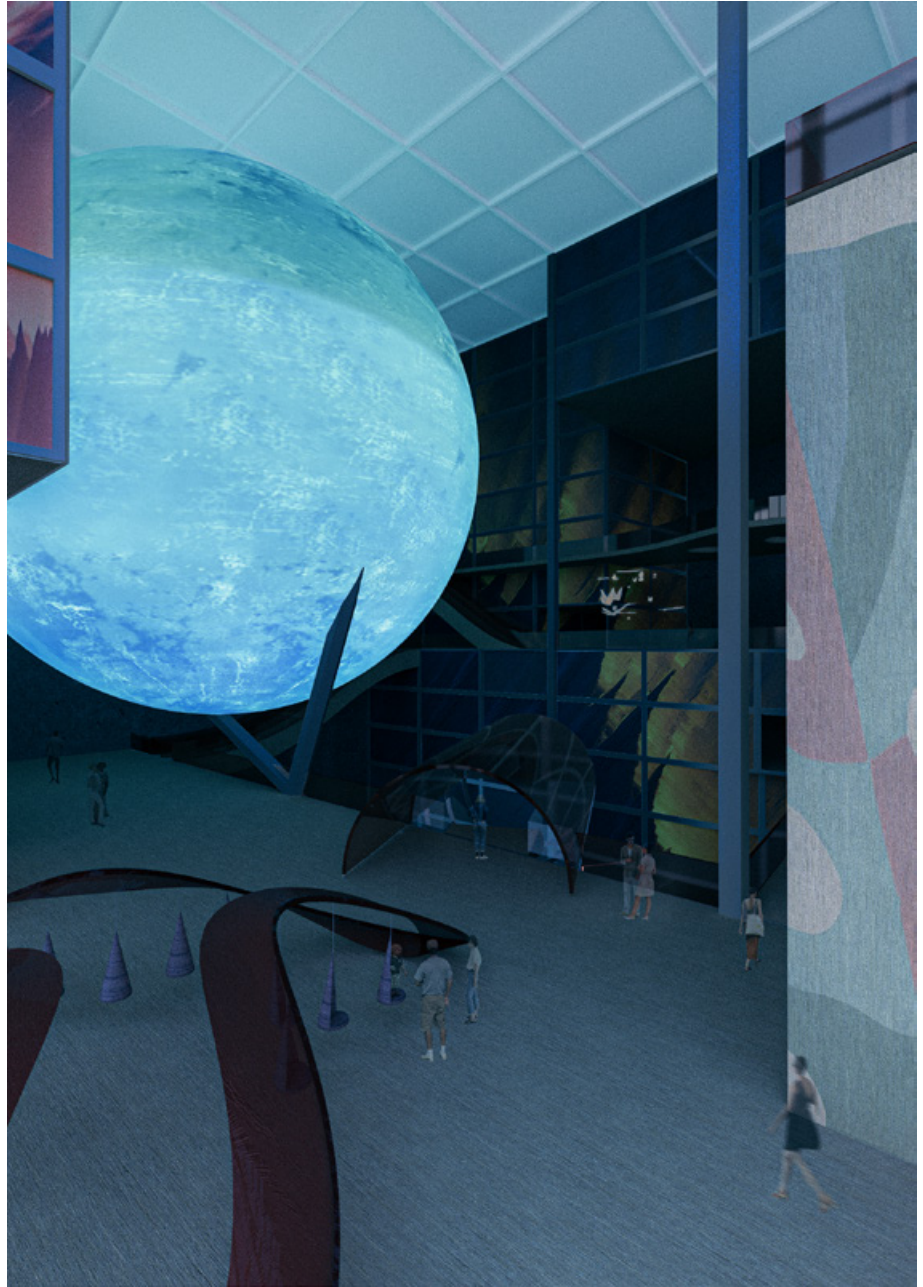

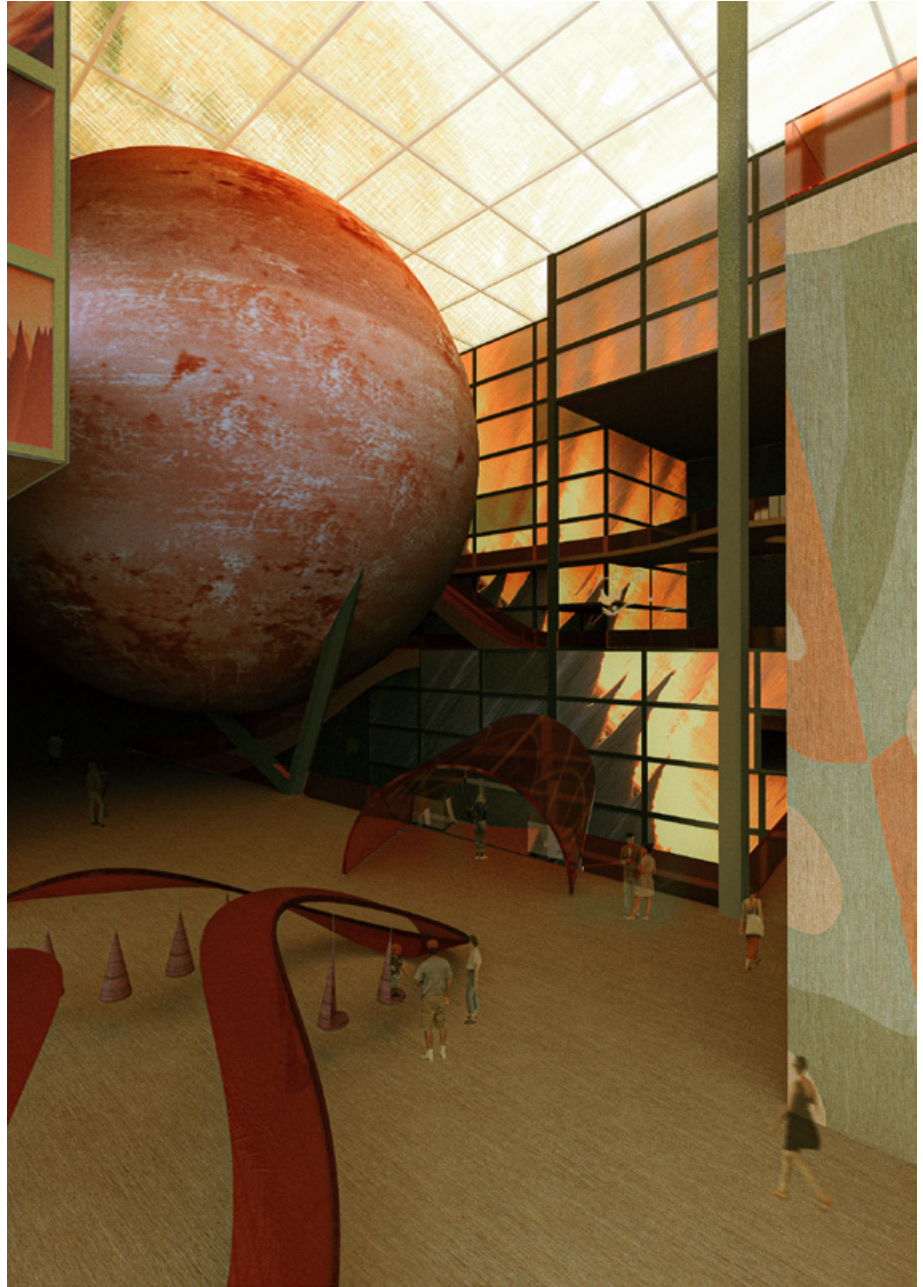



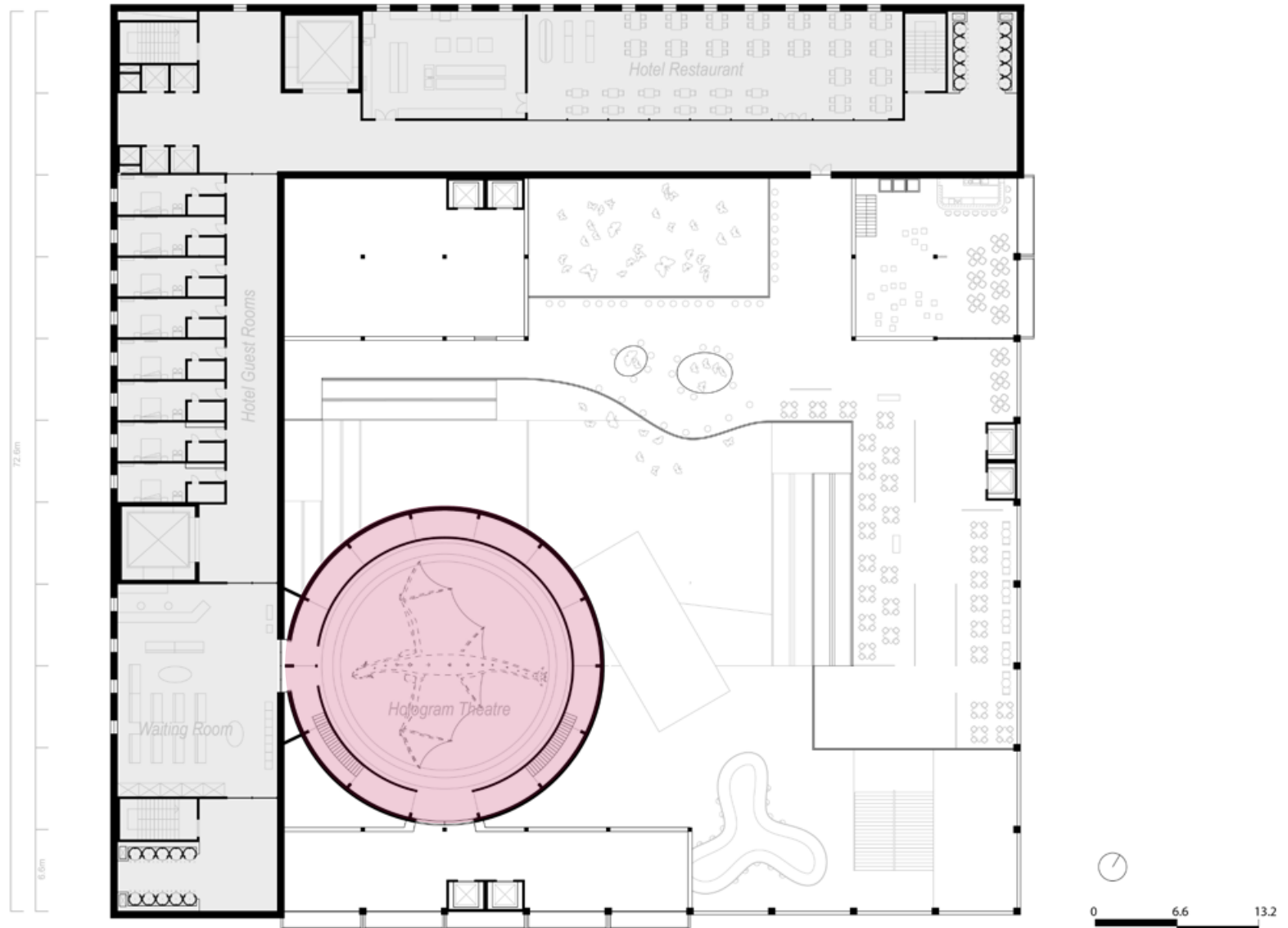

Main Experiential Space - Hologram Sphere Theatre

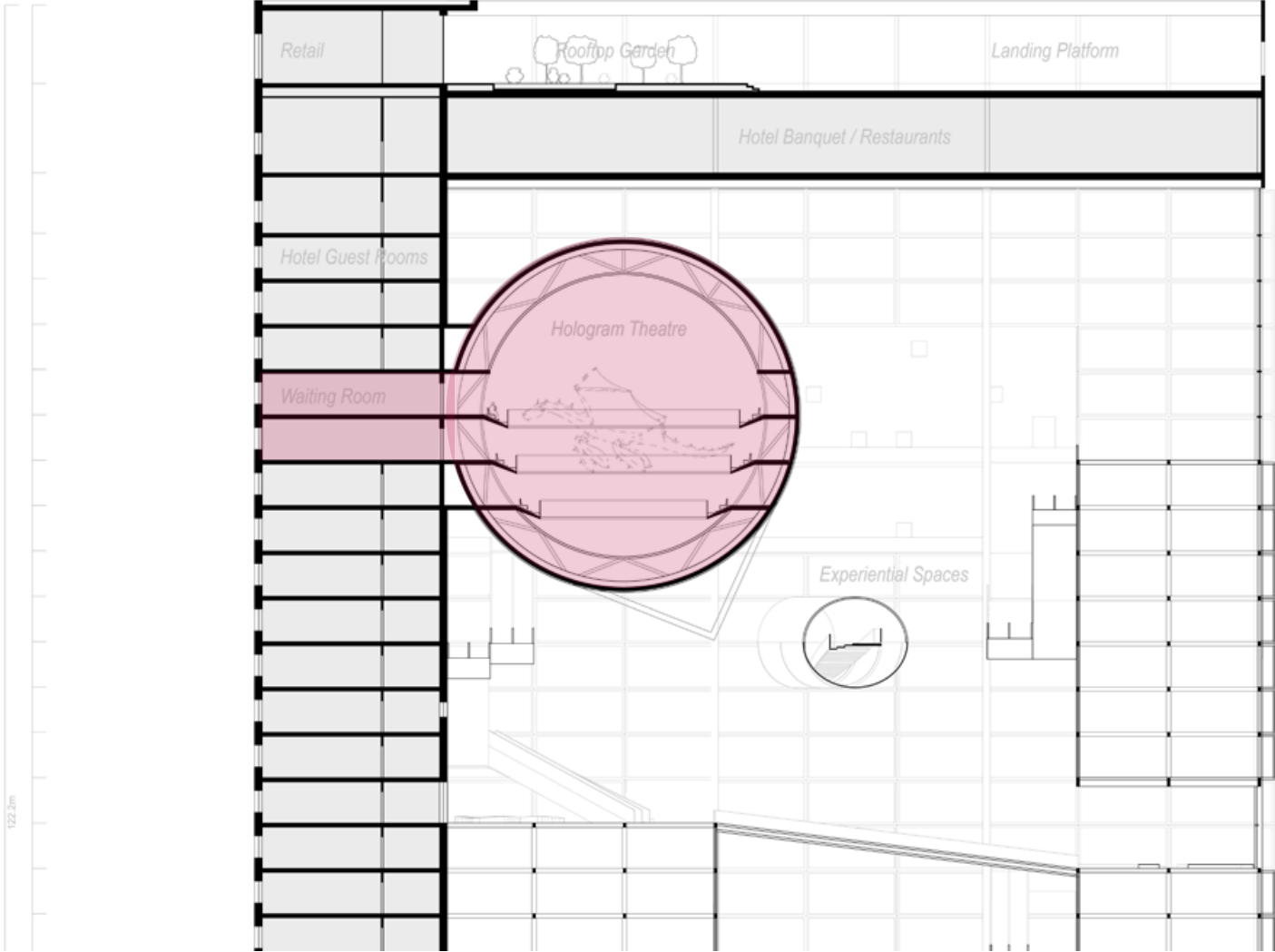

Main Experiential Space - Hologram Sphere Theatre

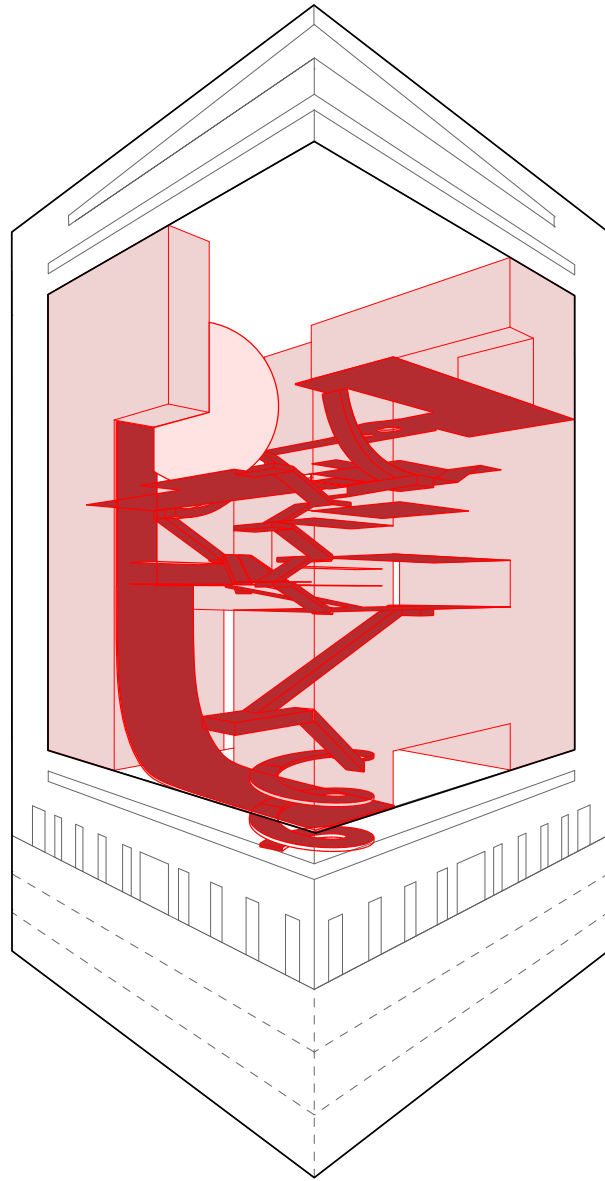

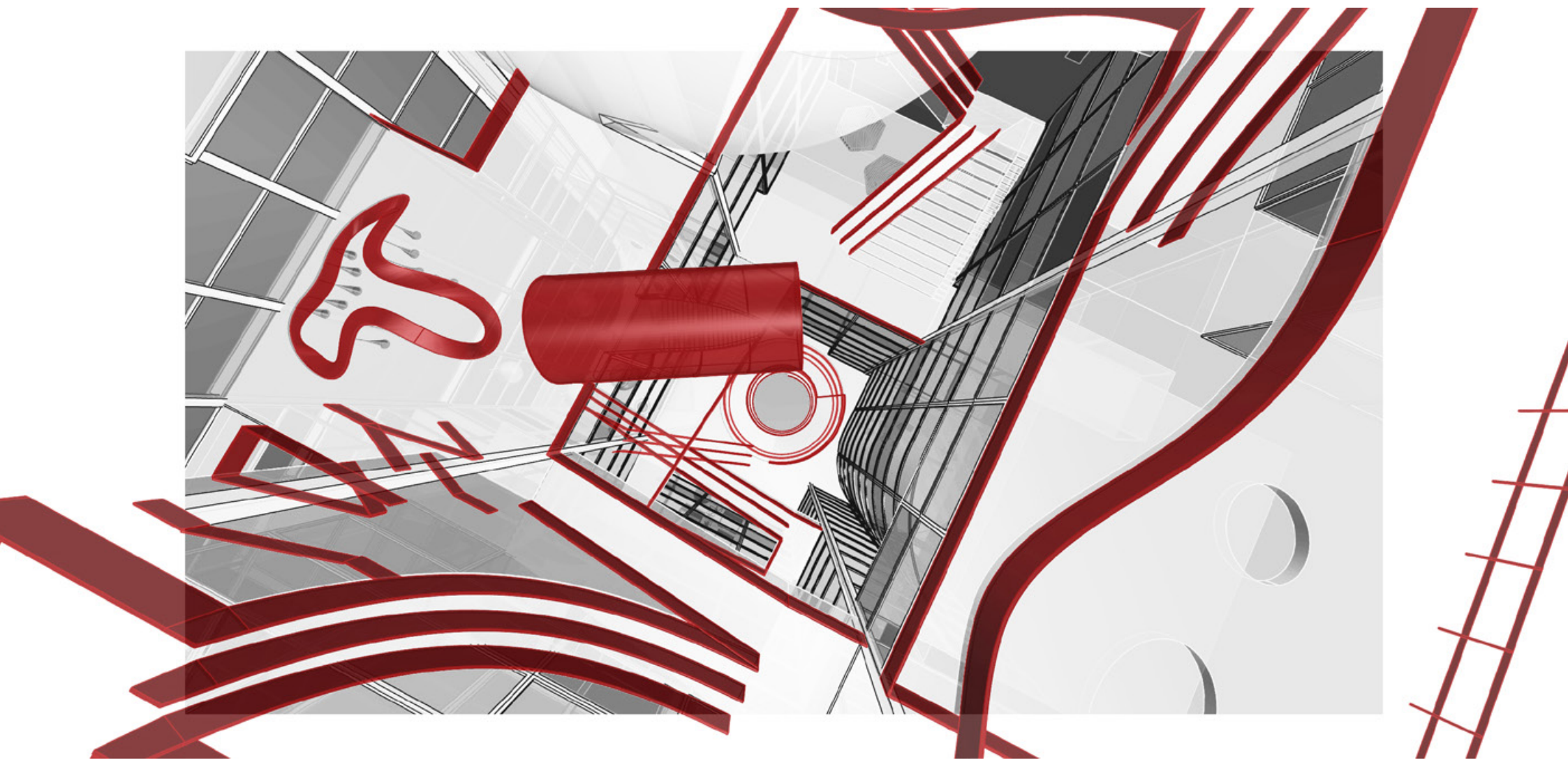

Construction

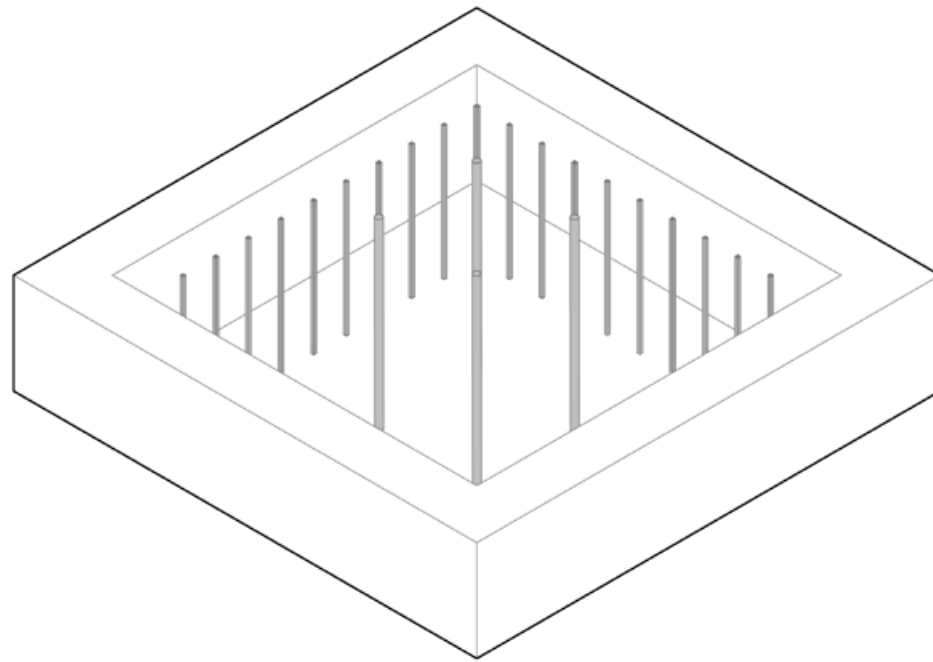

Underground- Concrete Columns

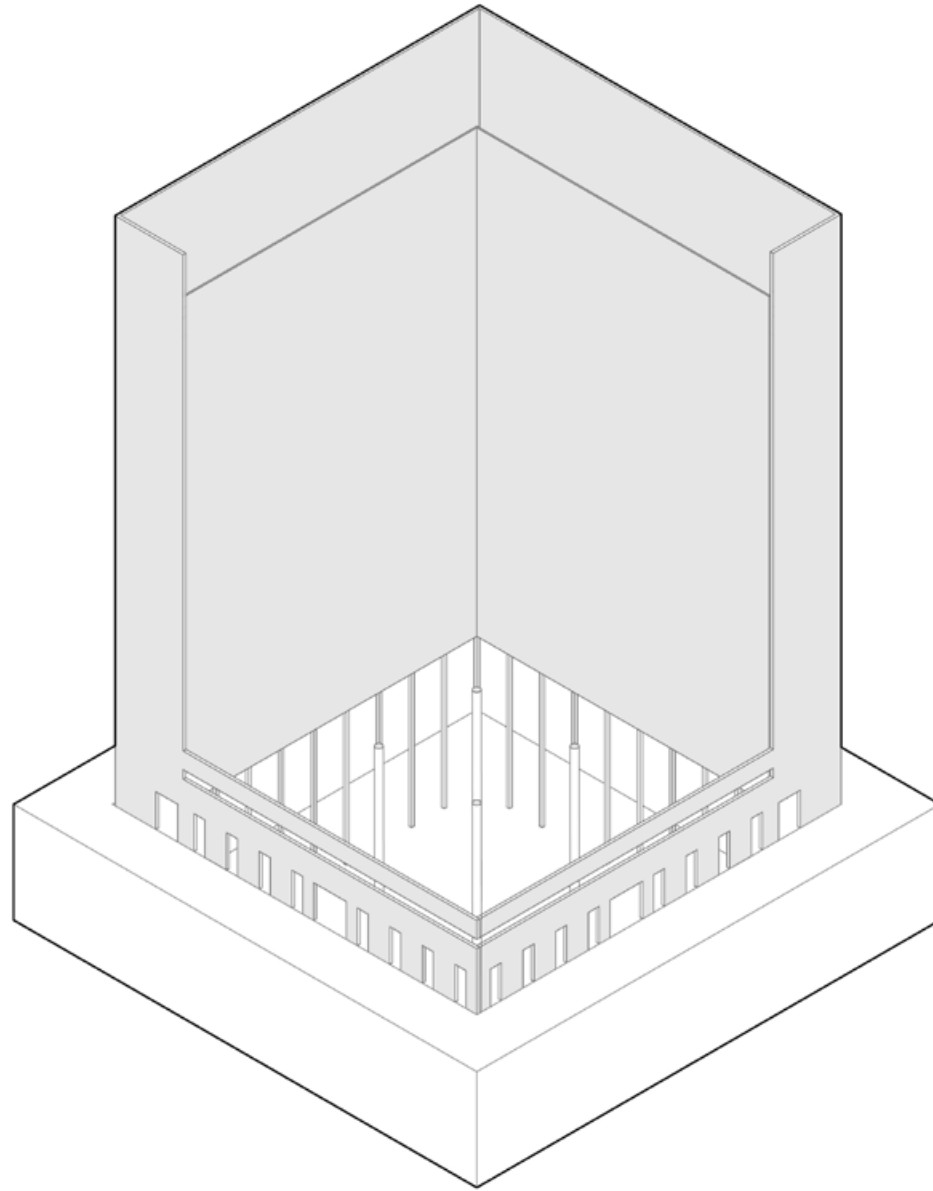

Insulating Concrete Wall

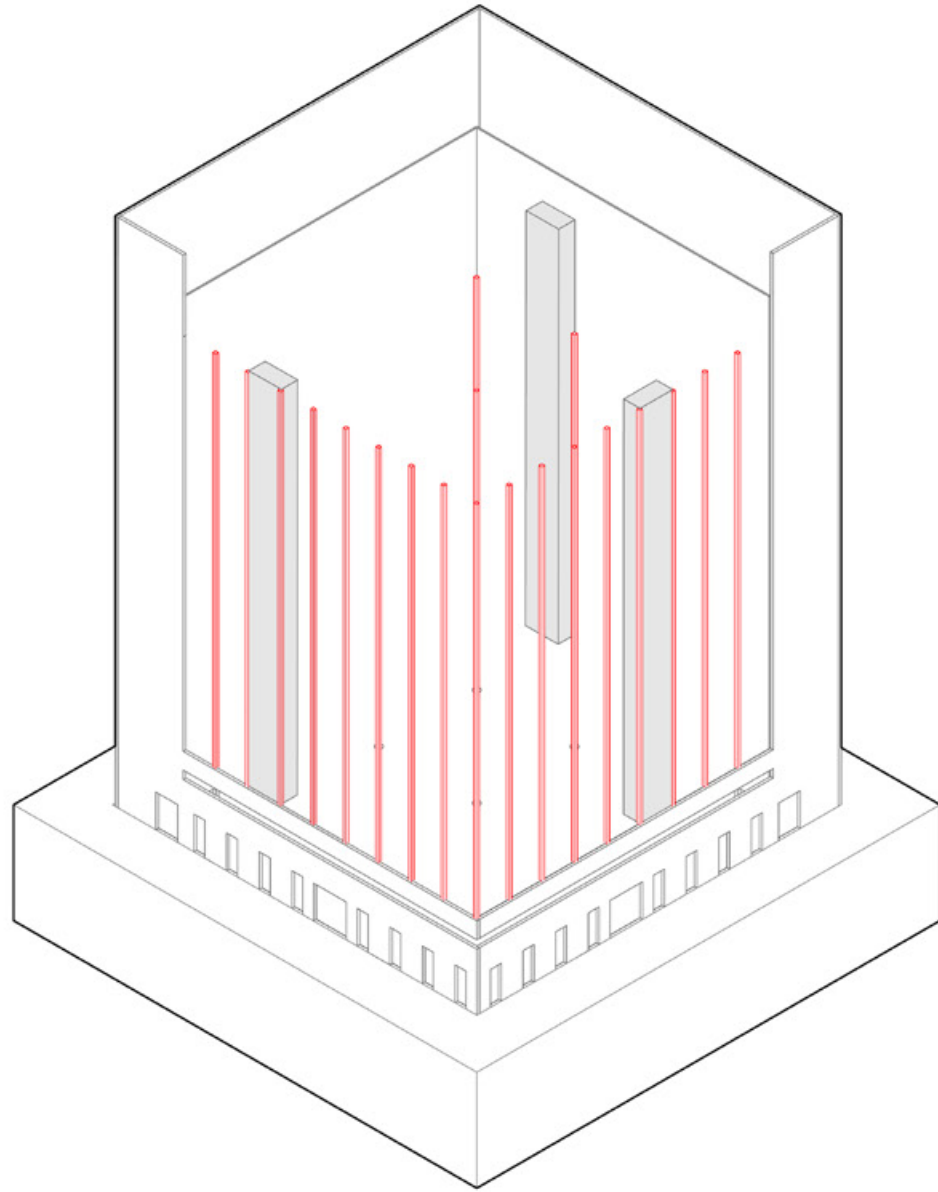

Columns / Elevator Cores

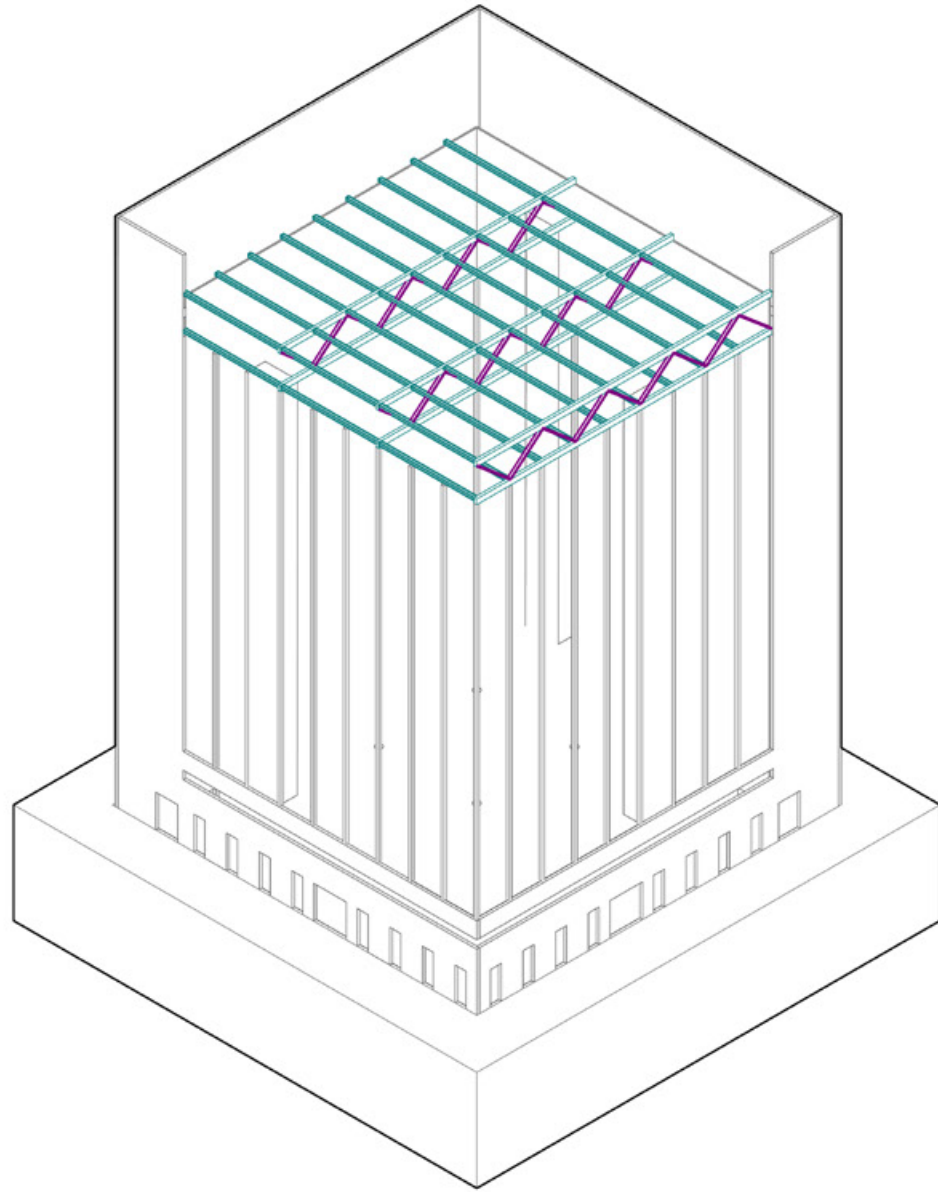

Roof Truss

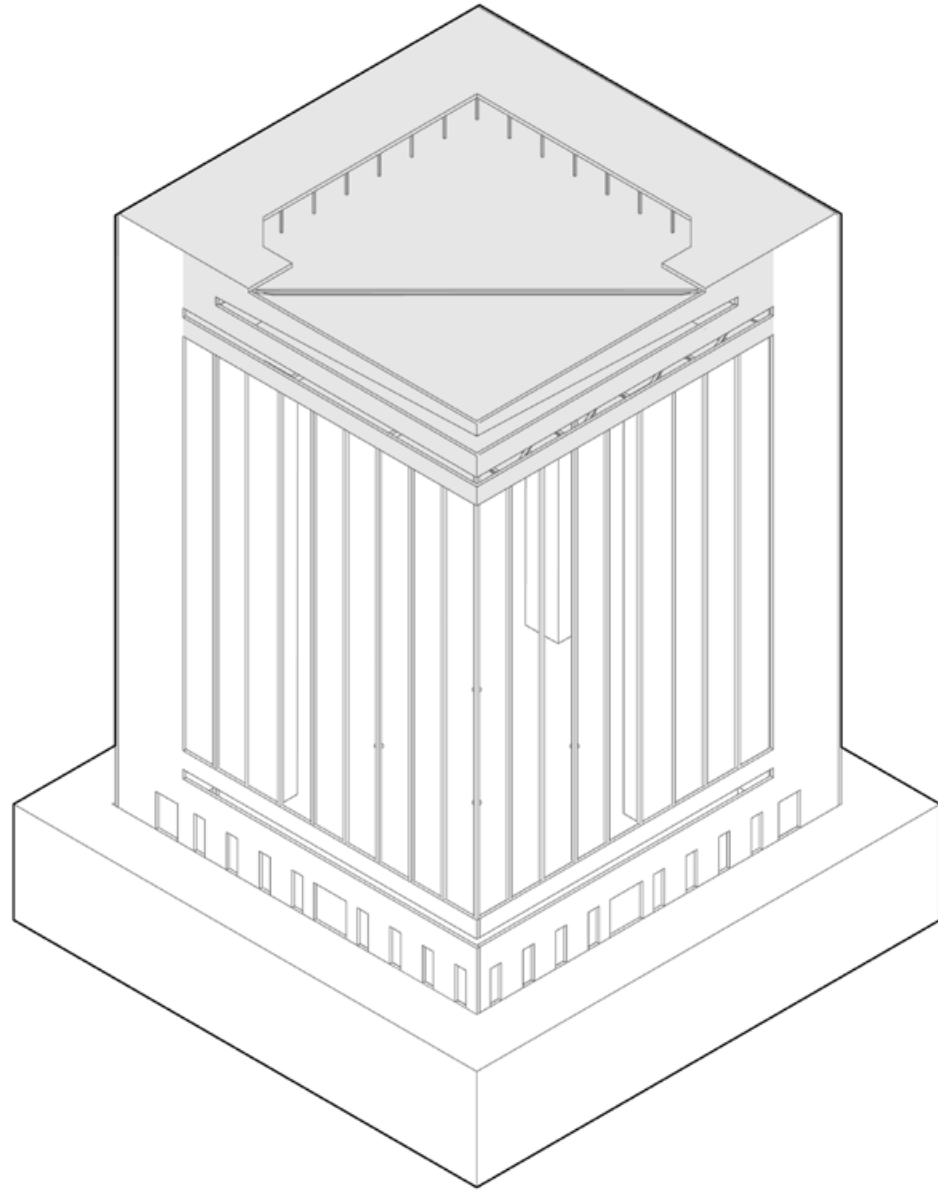

Rooftop Landing Platform

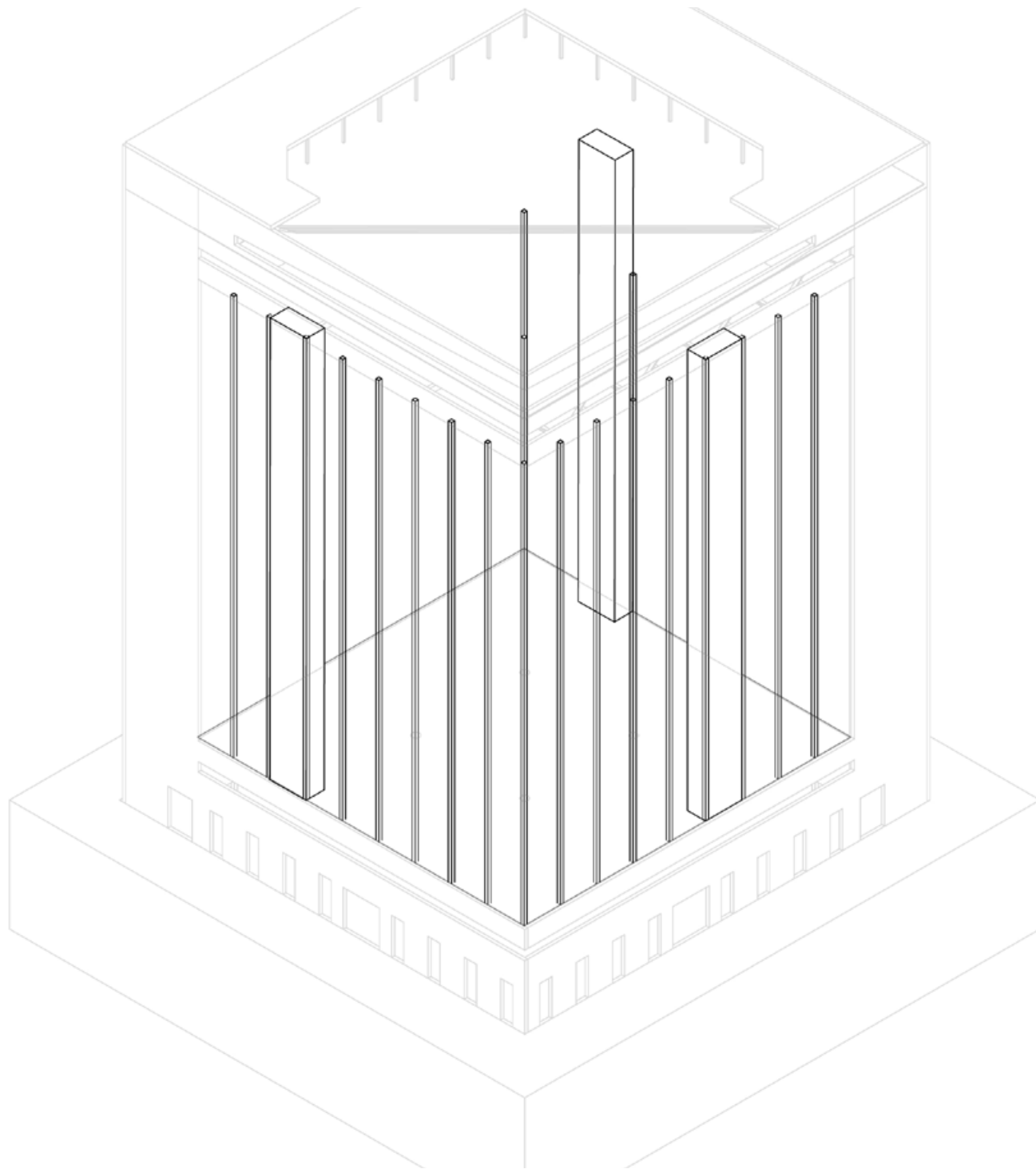

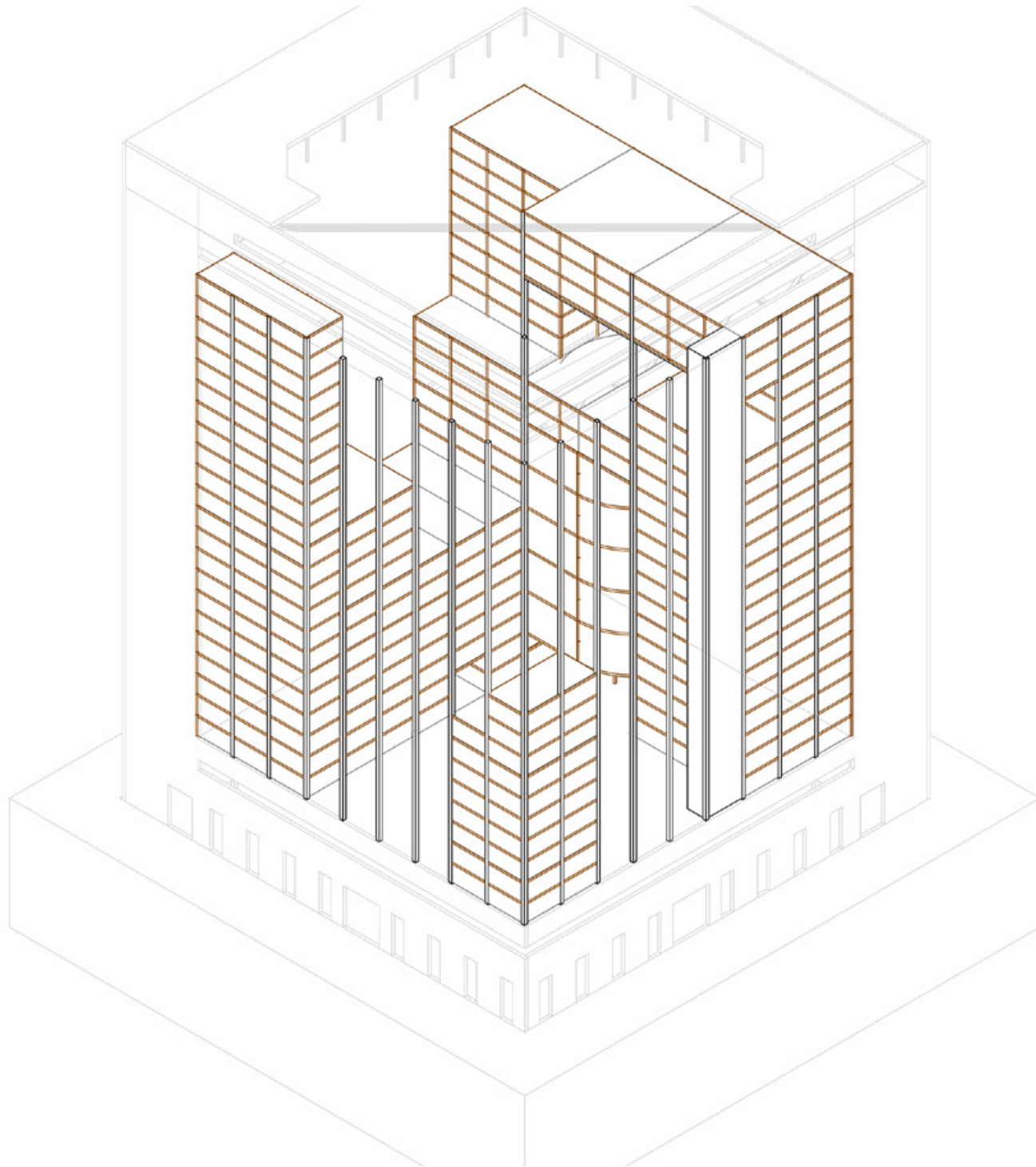

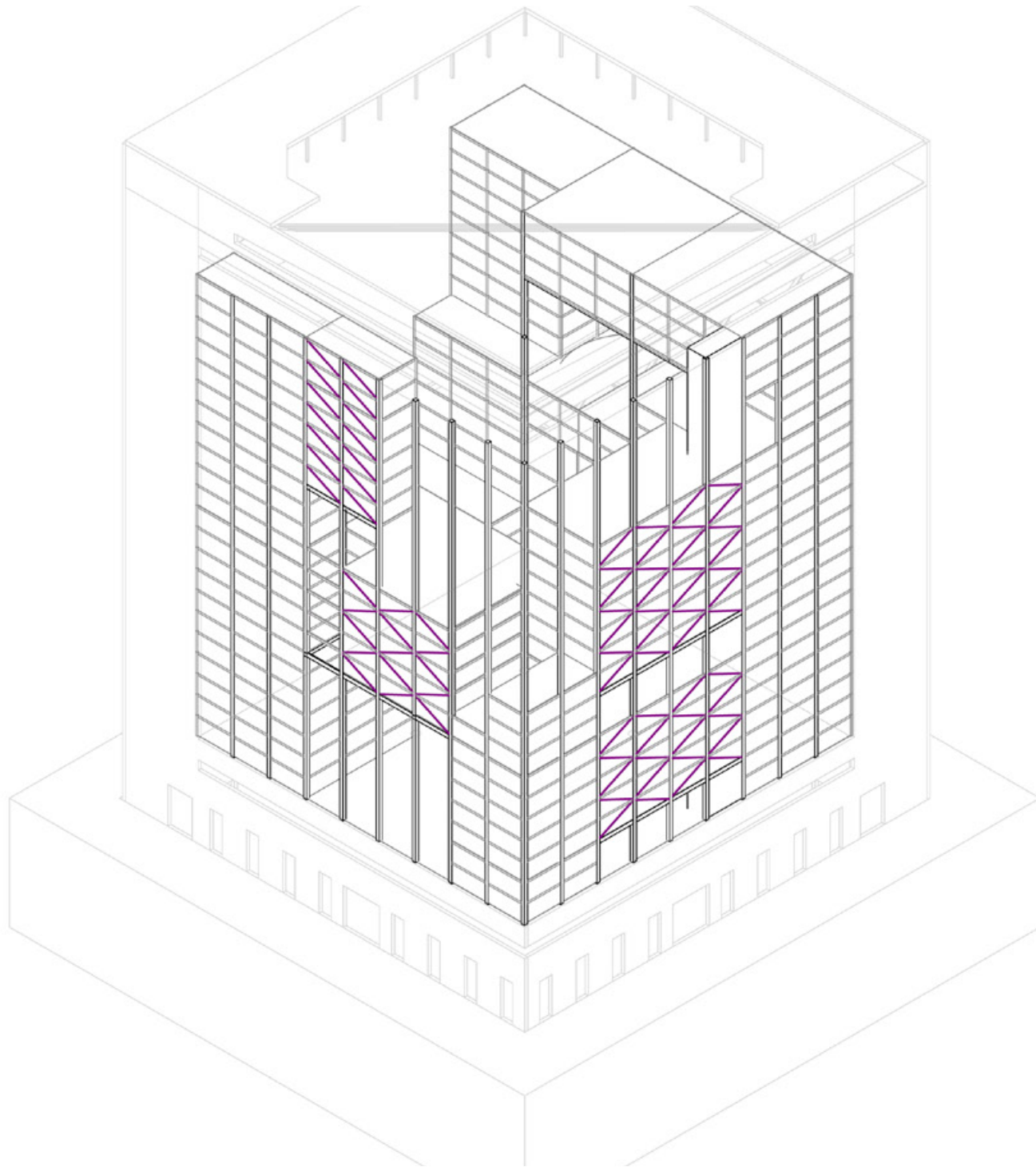

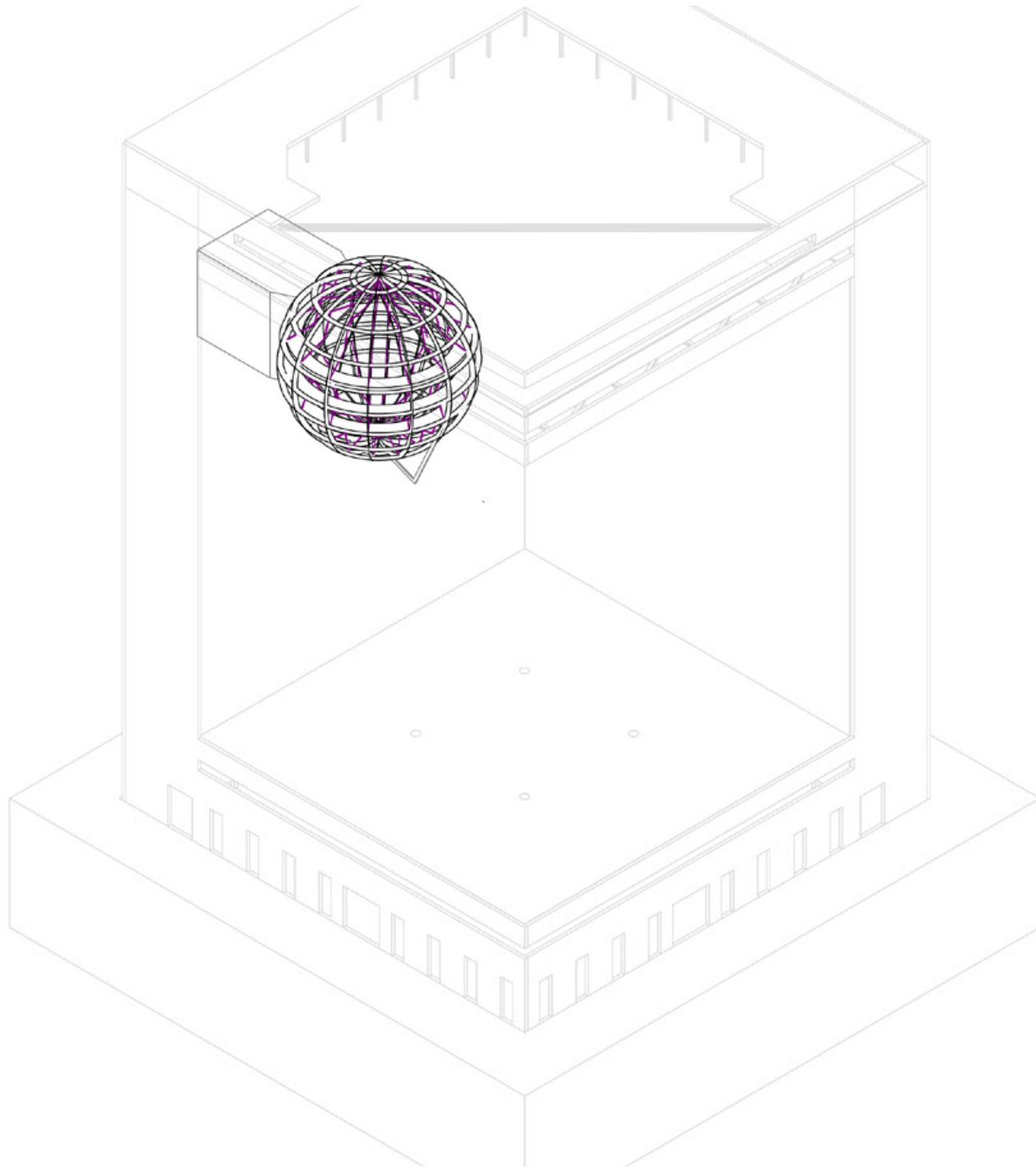

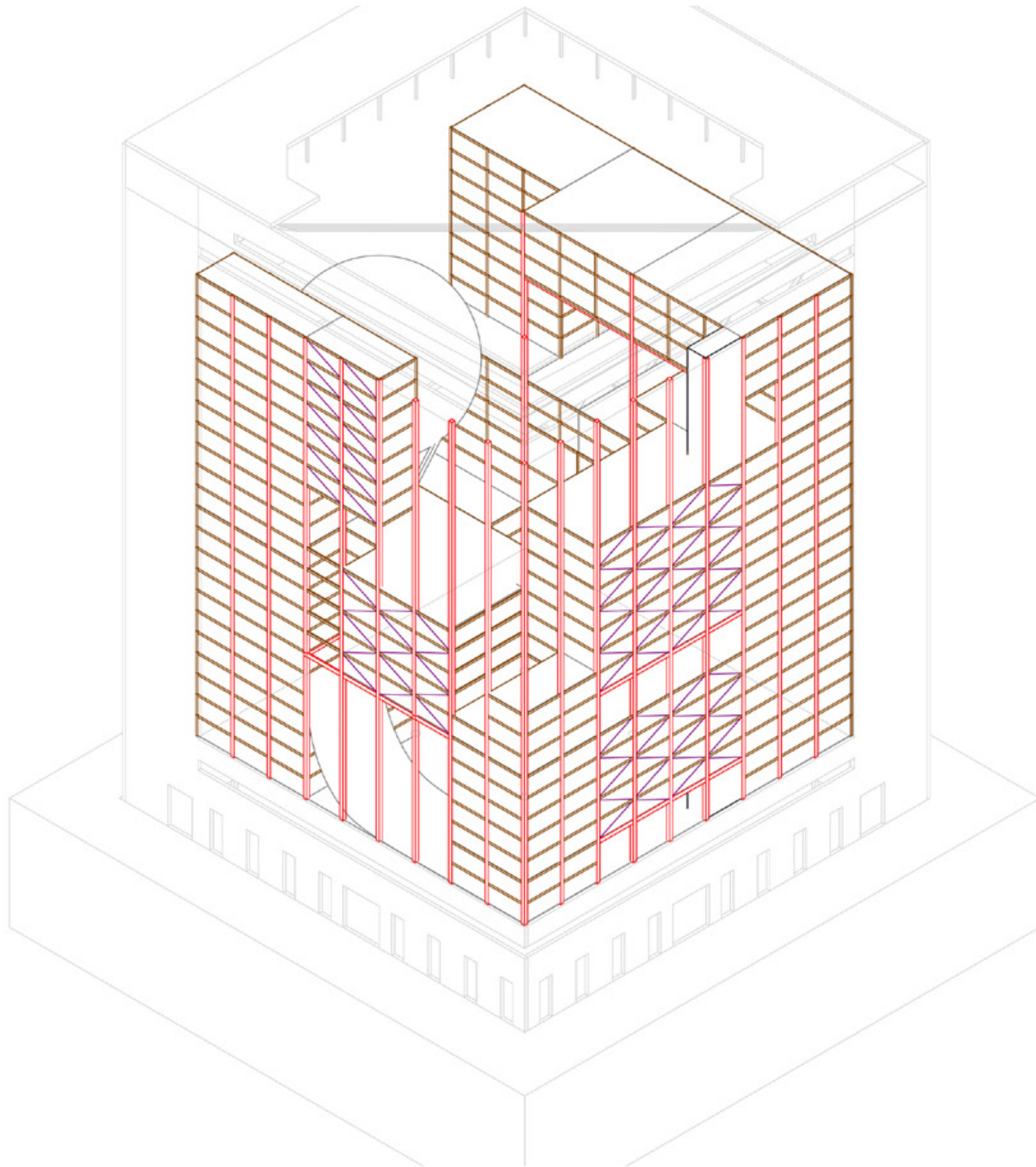

How internal scenography is arranged
in a dynamic system?

ensures the fundamental
physical movement of human
rather than visibility

maximize the freedom of
later arrangement of
the space by giving a
structure/restrain

convenient in arranging
staircases (vertical
circulation)

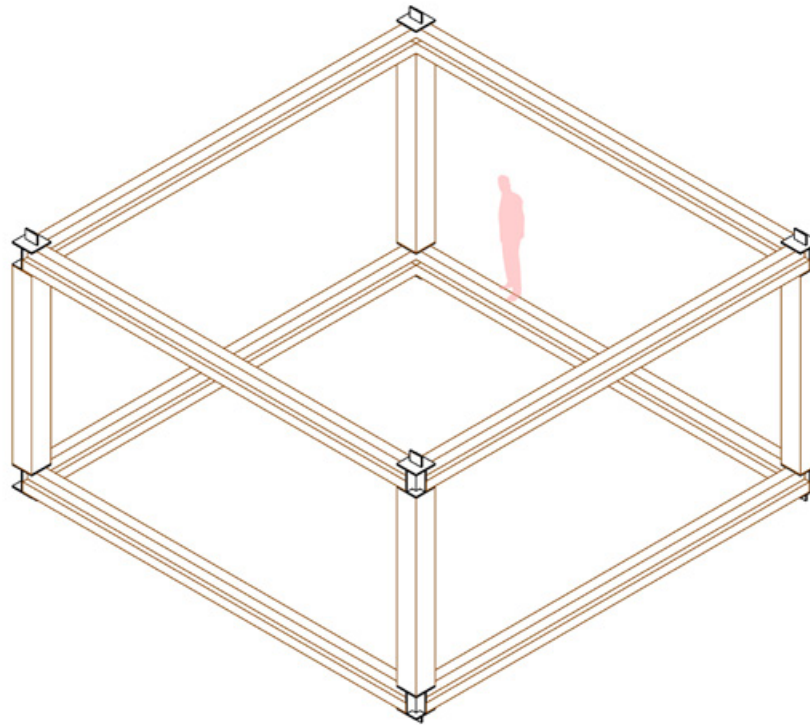

modular of 6.6*6.6*3.3m

ensures the fundamental
physical movement of human
rather than visibility

maximize the freedom of
later arrangement of
the space by giving a
structure/restrain

convenient in arranging
staircases (vertical
circulation)

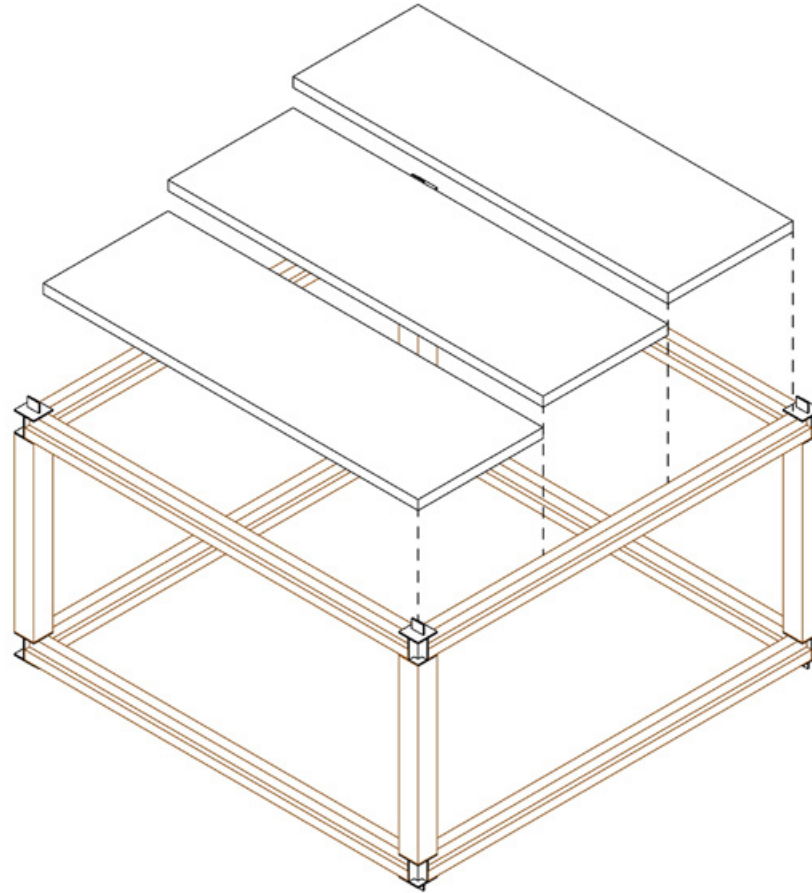

modular of 6.6*6.6*3.3m

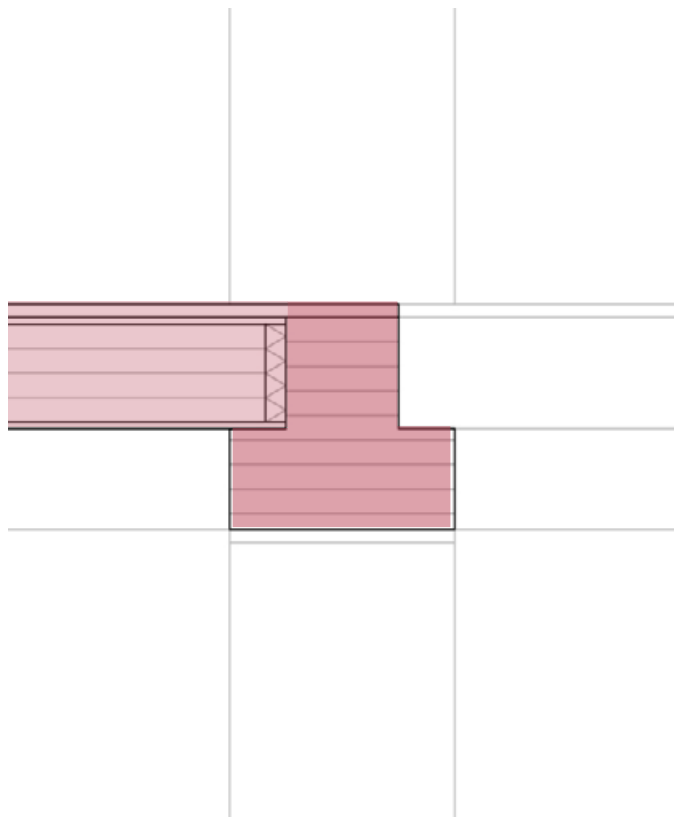

ensures the fundamental
physical movement of human
rather than visibility

maximize the freedom of
later arrangement of
the space by giving a
structure/restrain

convenient in arranging
staircases (vertical
circulation)

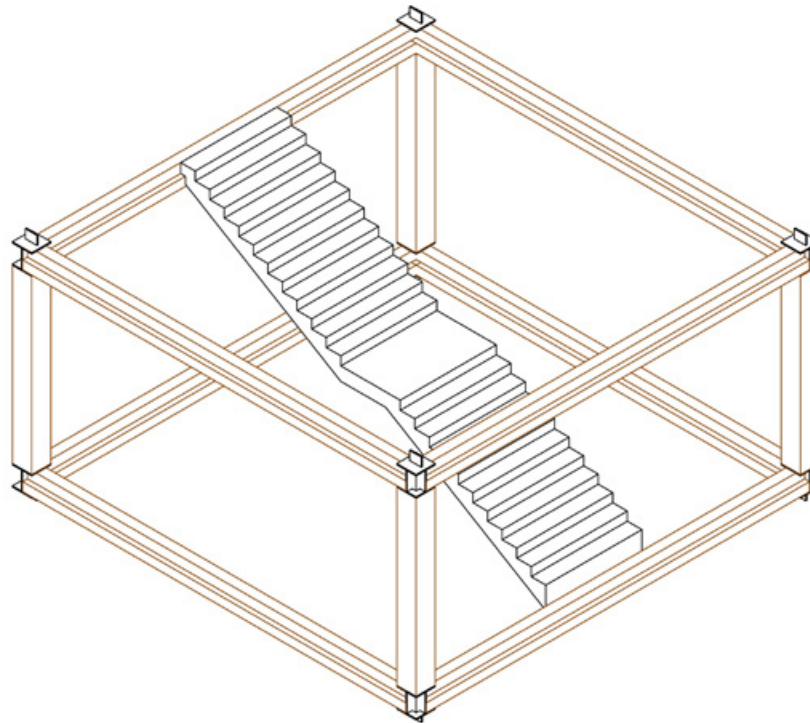

modular of 6.6*6.6*3.3m

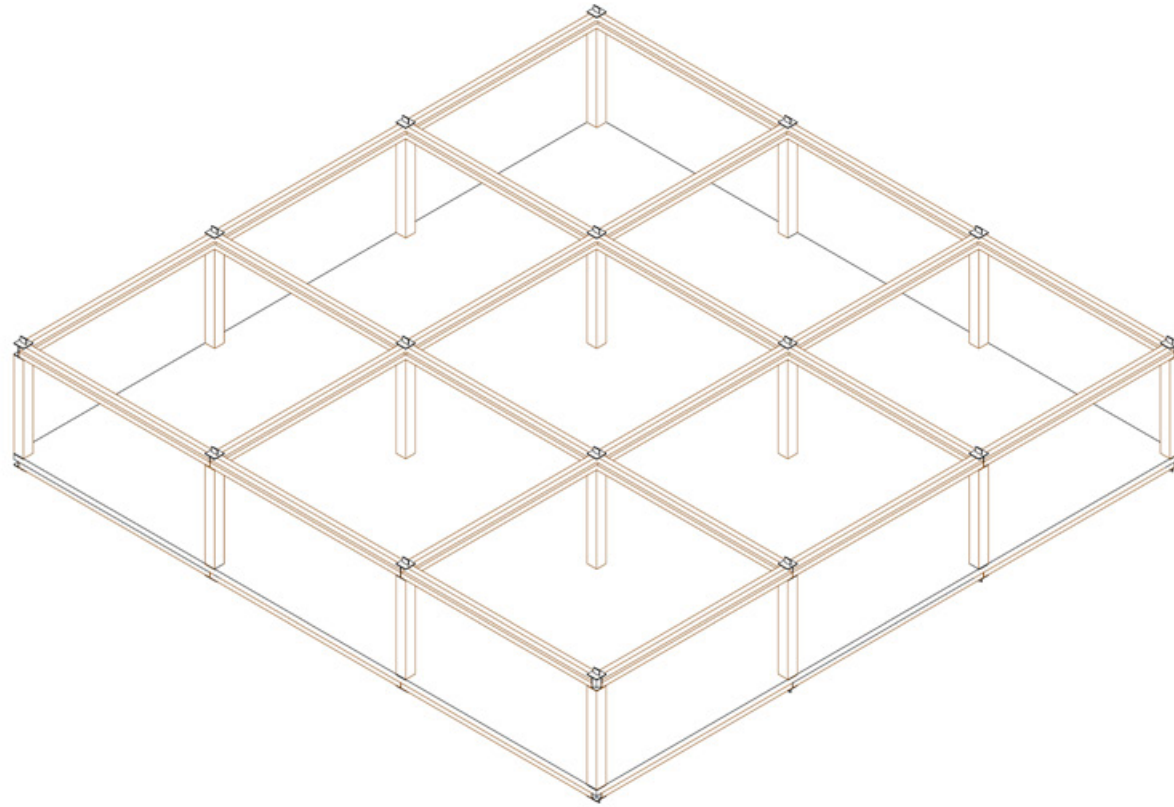

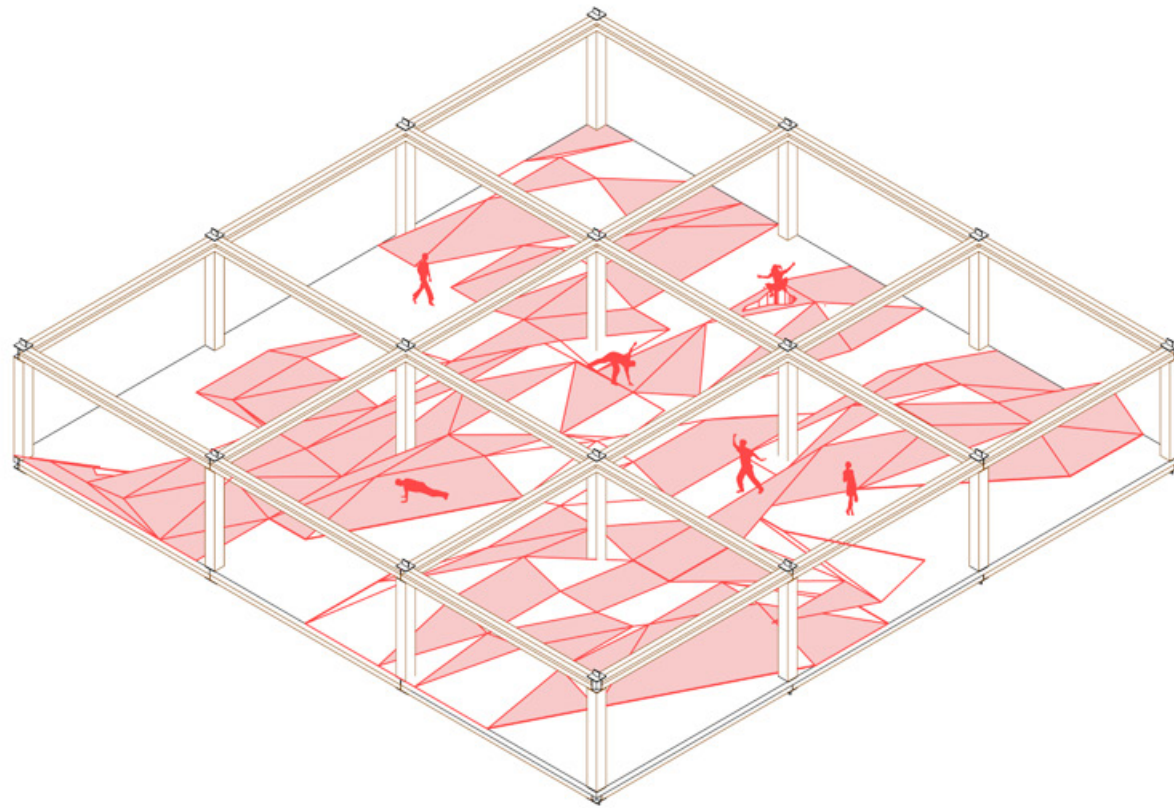

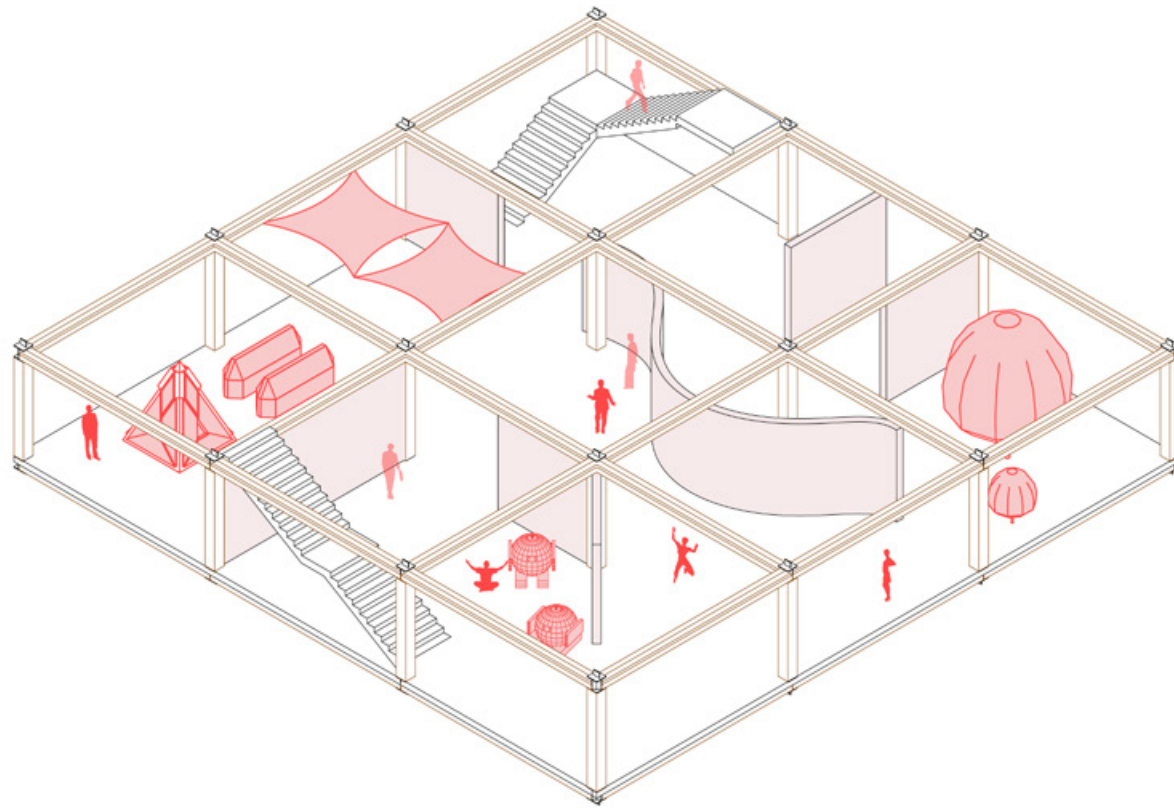

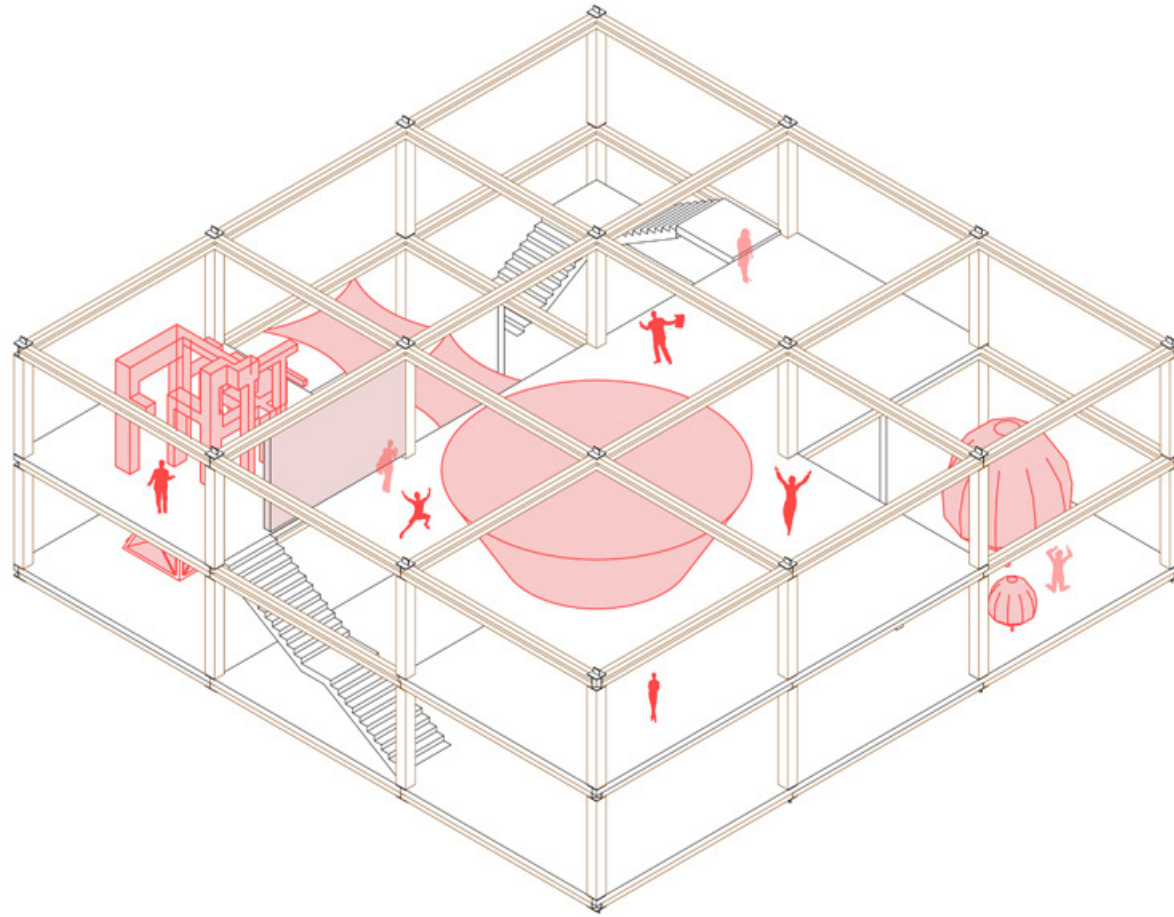



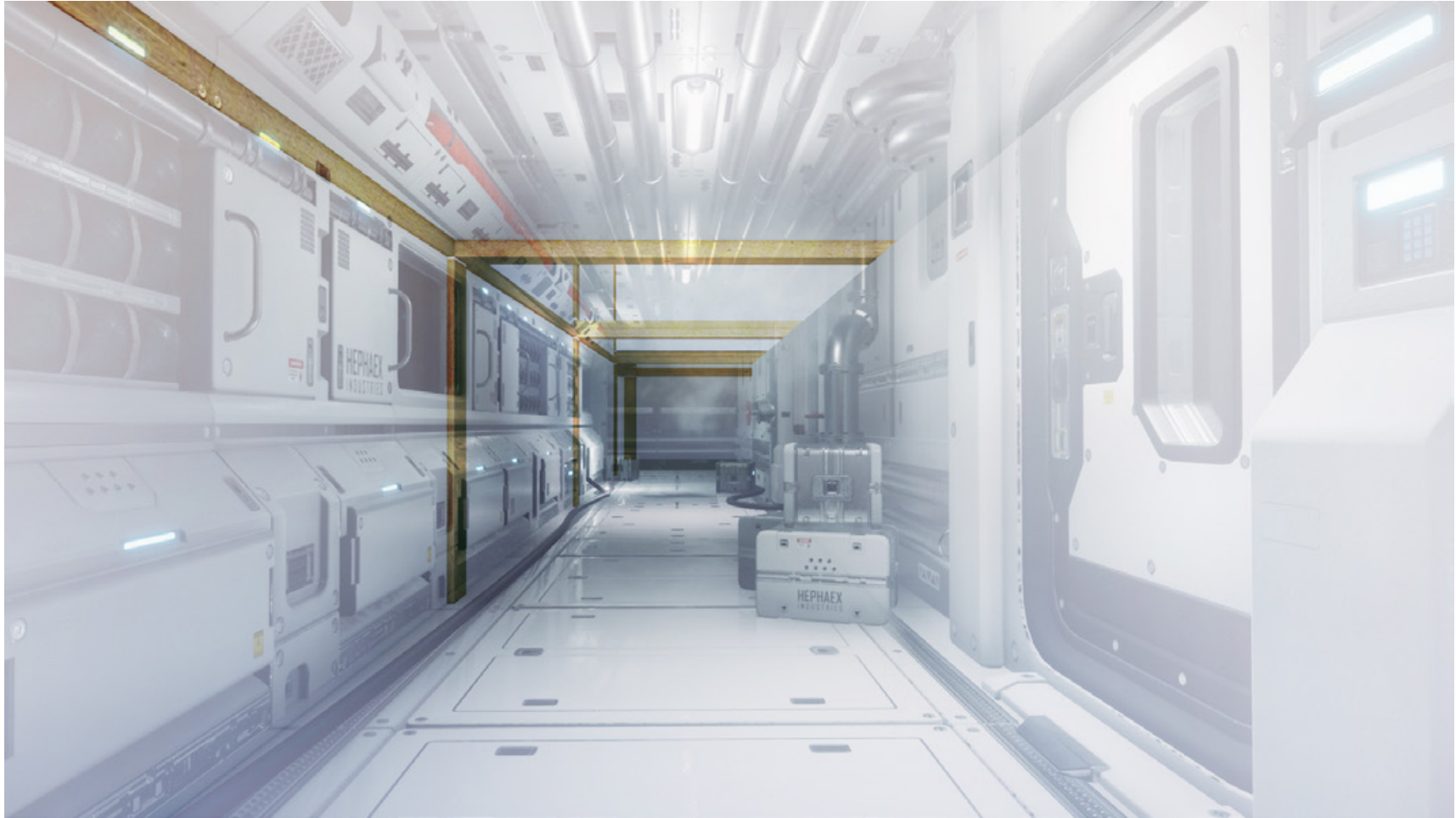

Augmented Interior Scenography

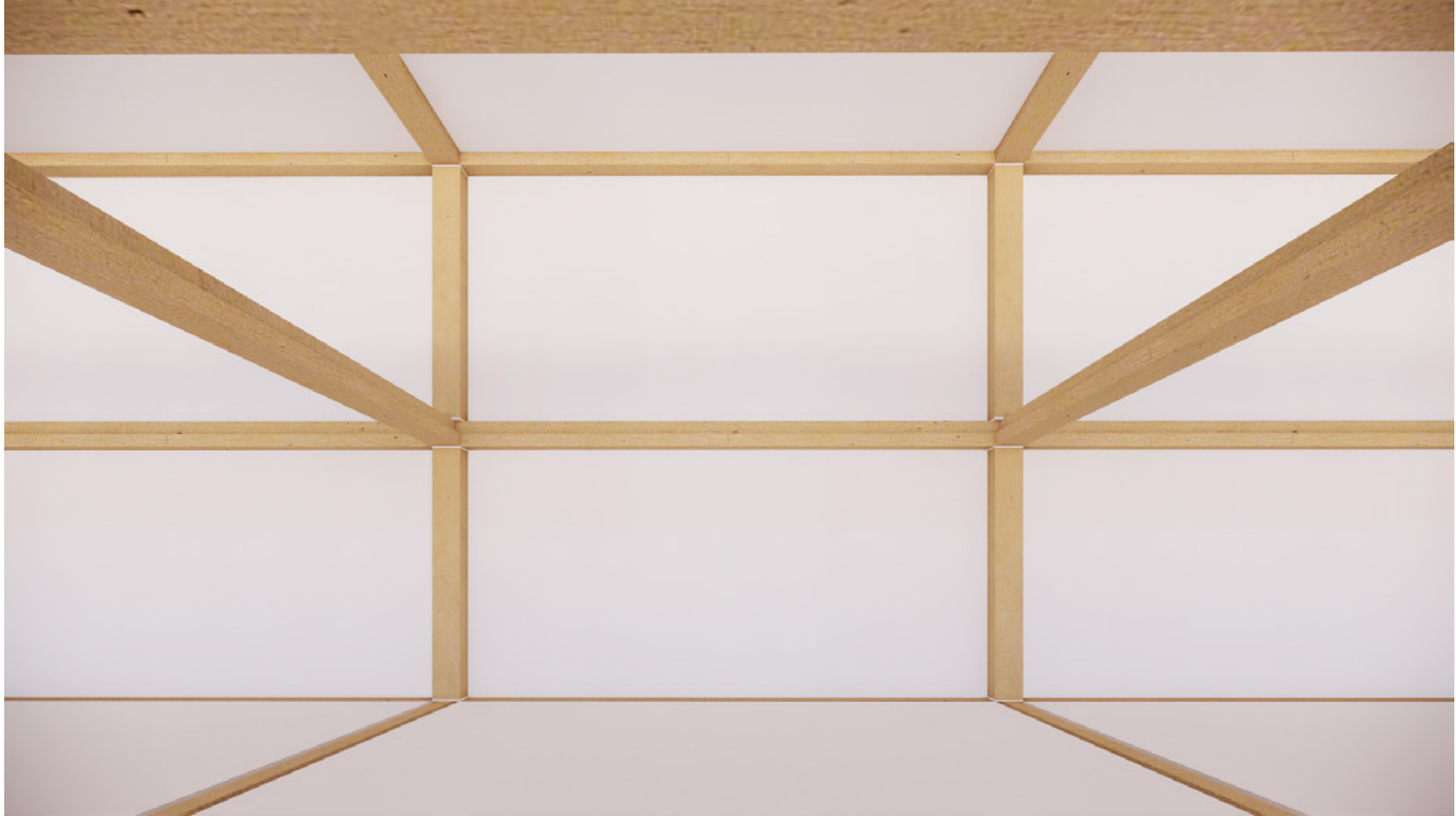



Augmented Interior Scenography



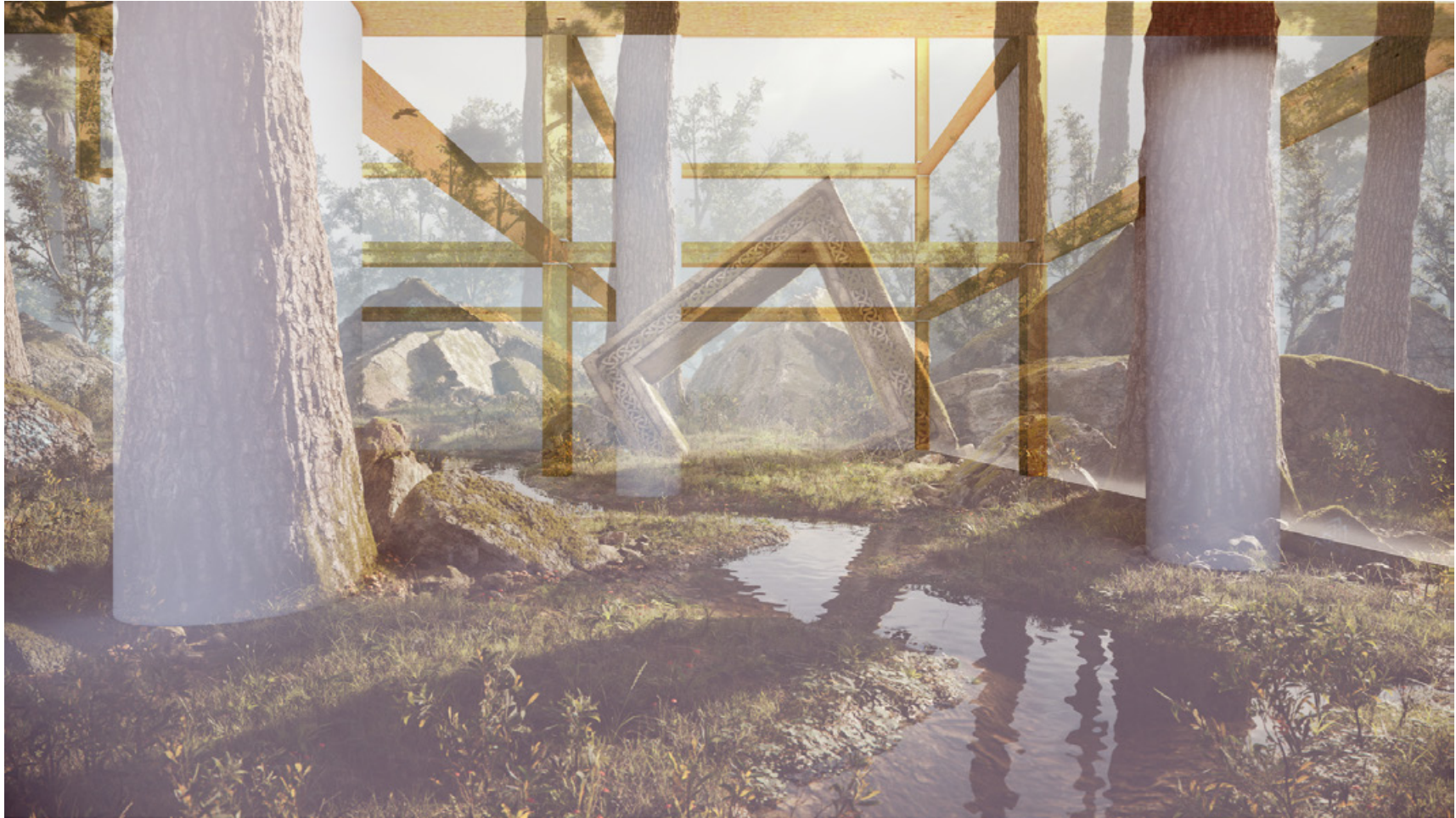

Augmented Interior Scenography

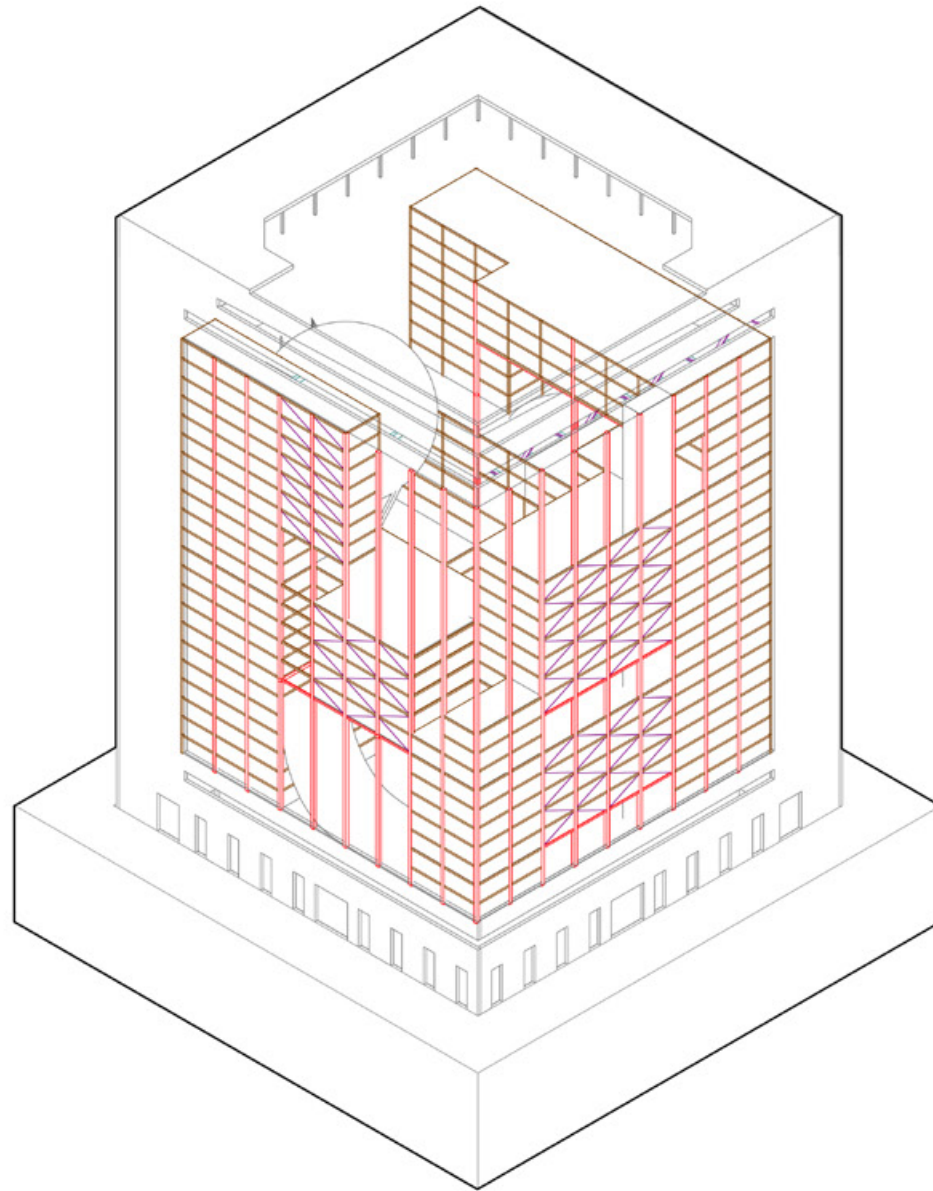

Timber Modular Structures with Bracing

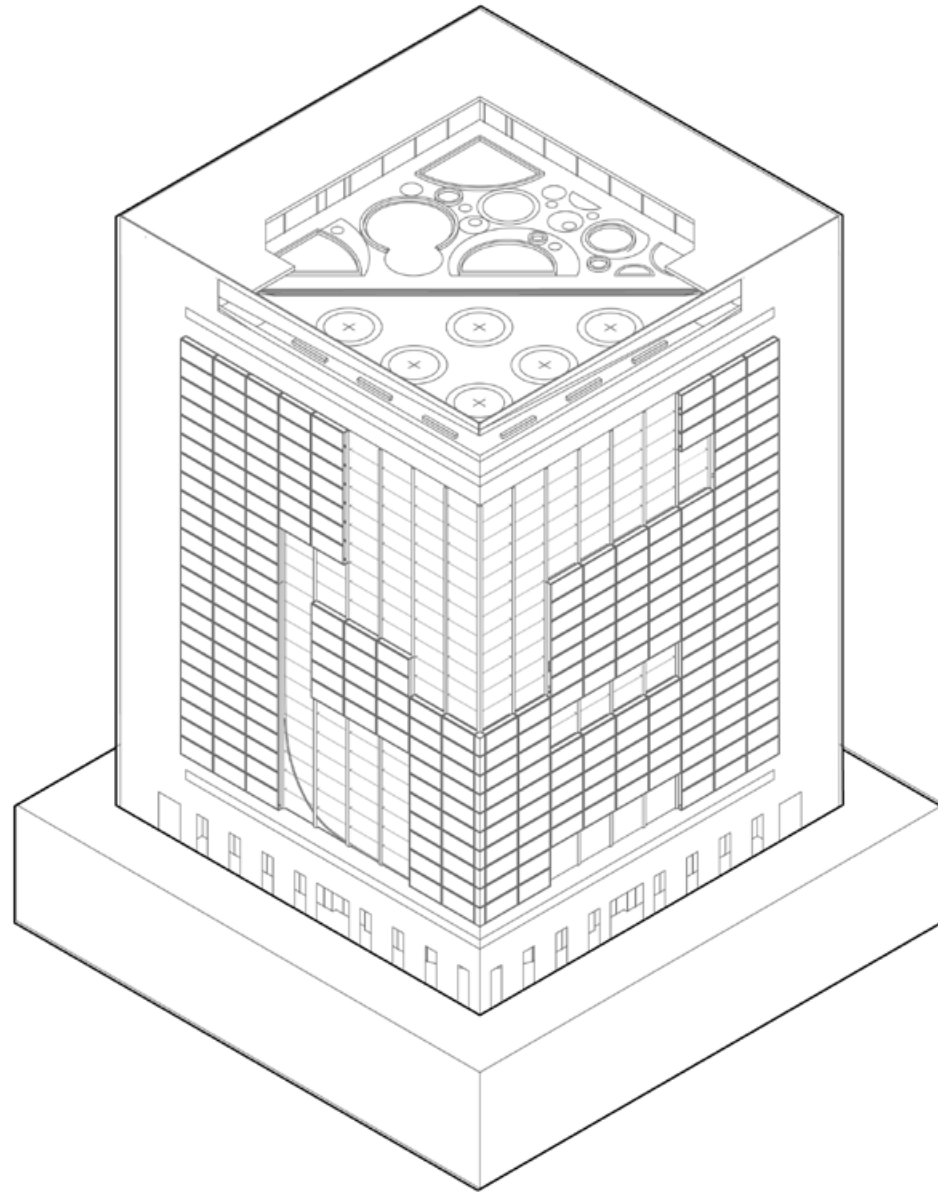

Completed Facade

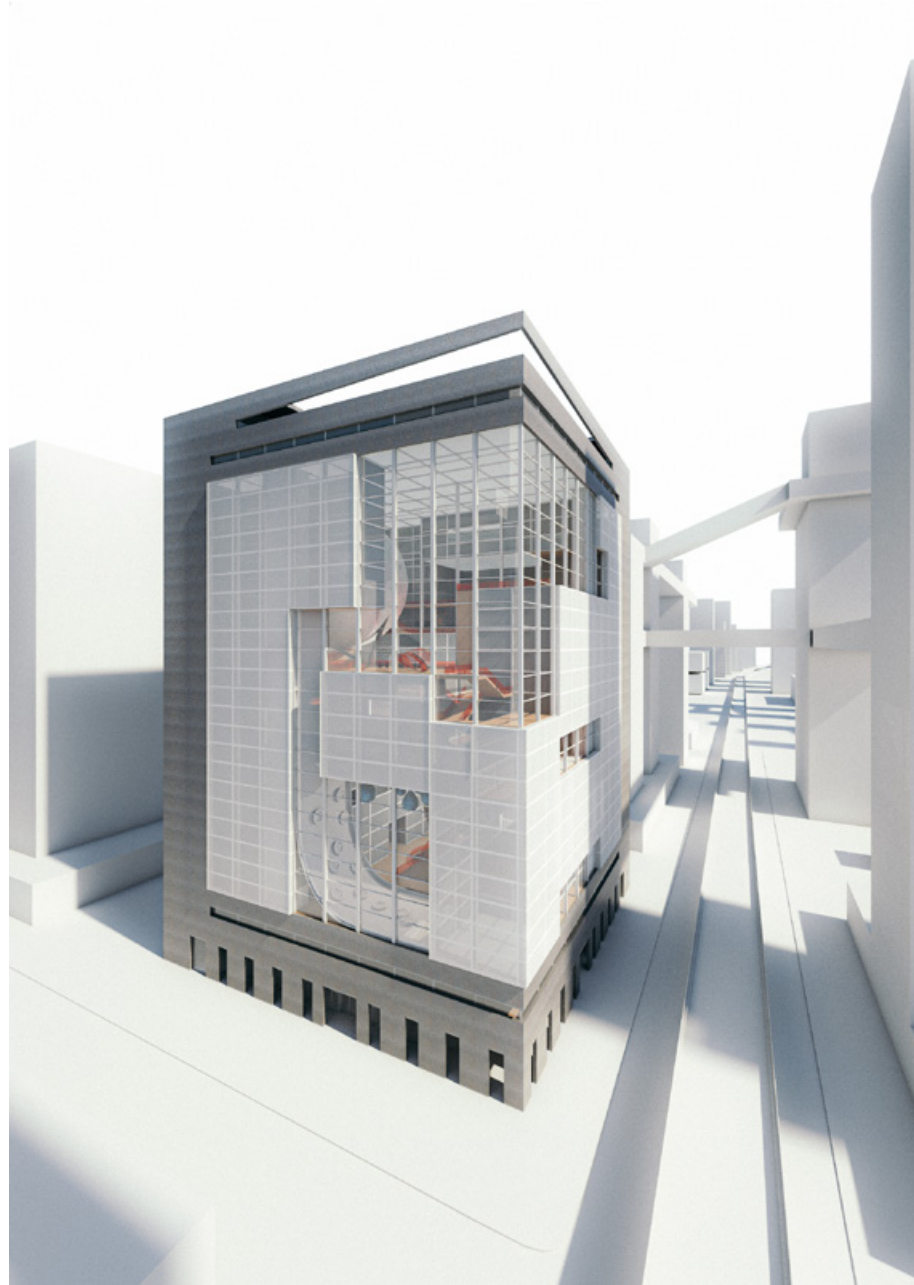

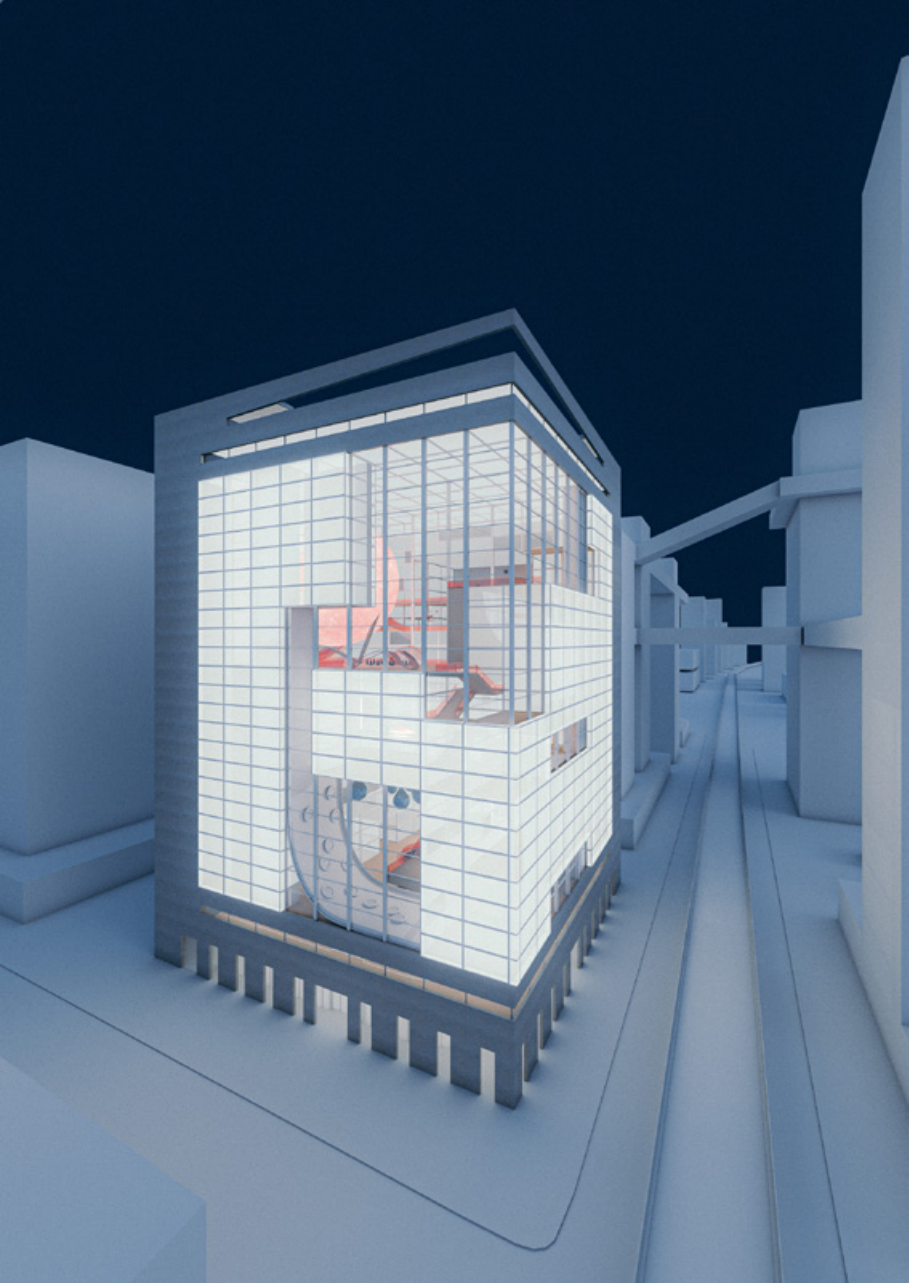

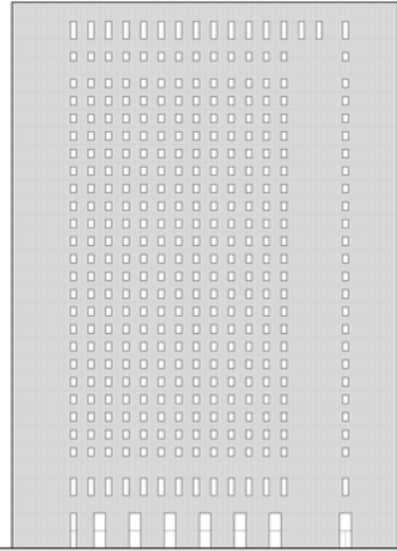
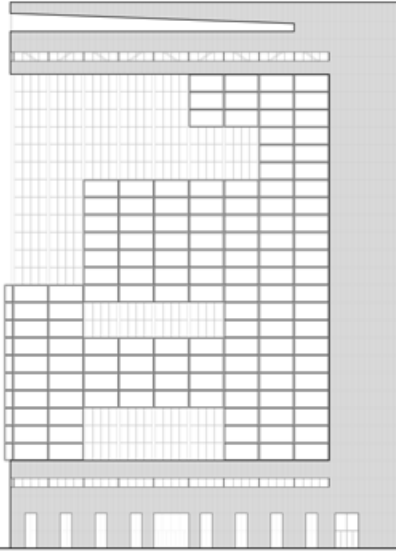
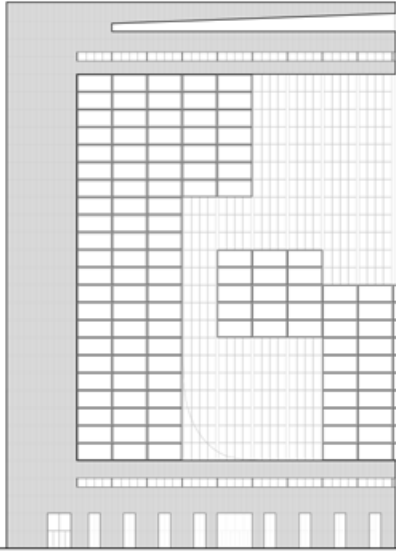
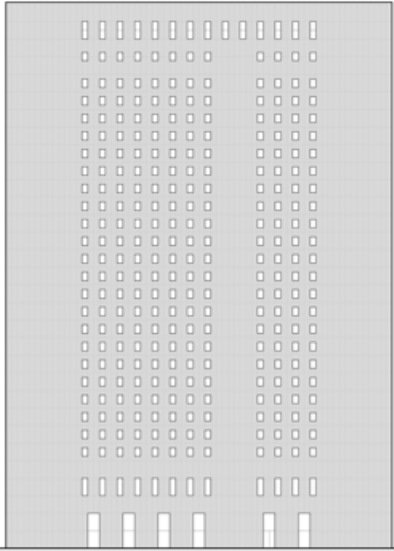

Exterior Materialization



Glass



Translucent Double Facade



Insulating Concrete

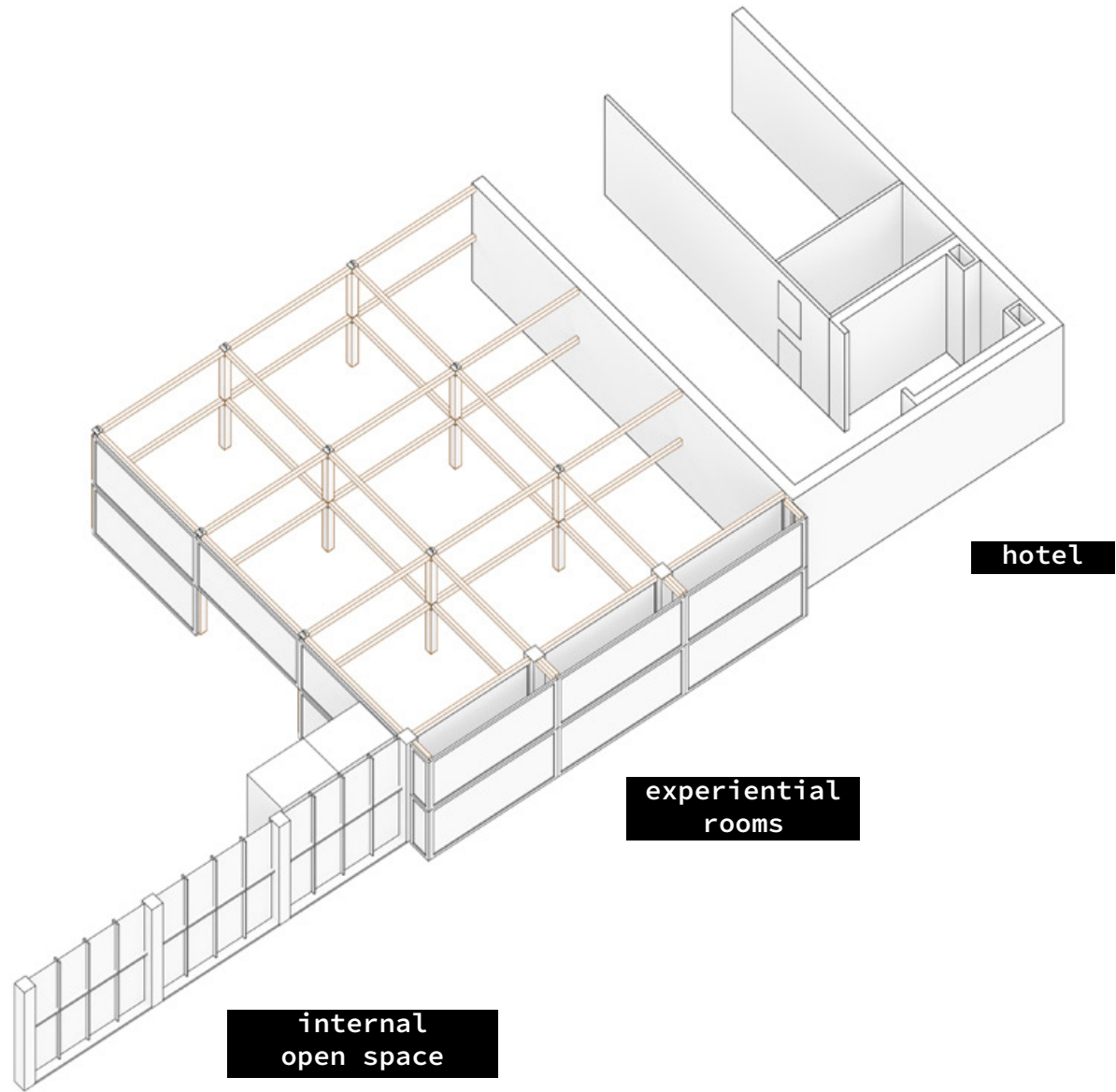

internal
open space

experiential
rooms

hotel

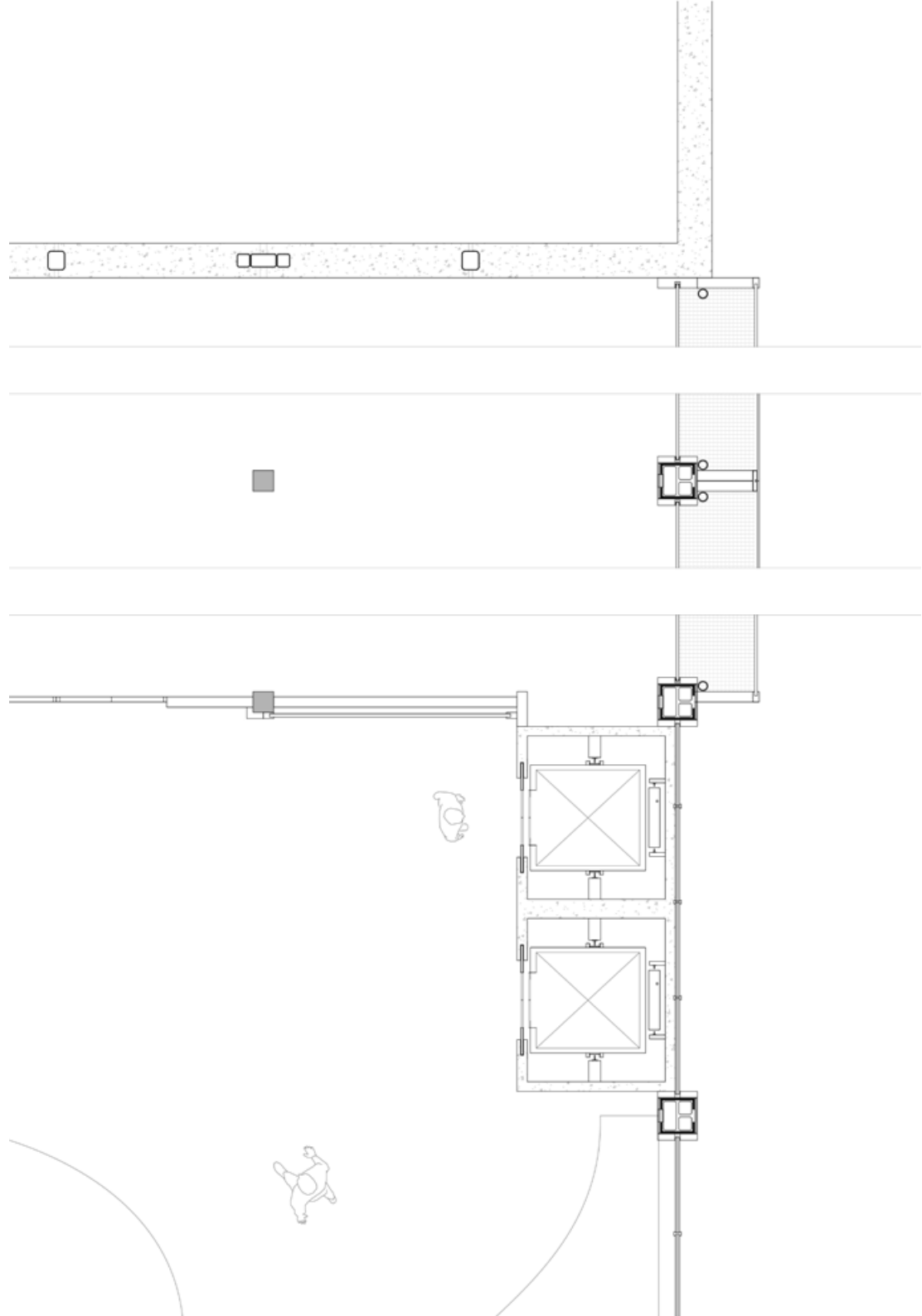

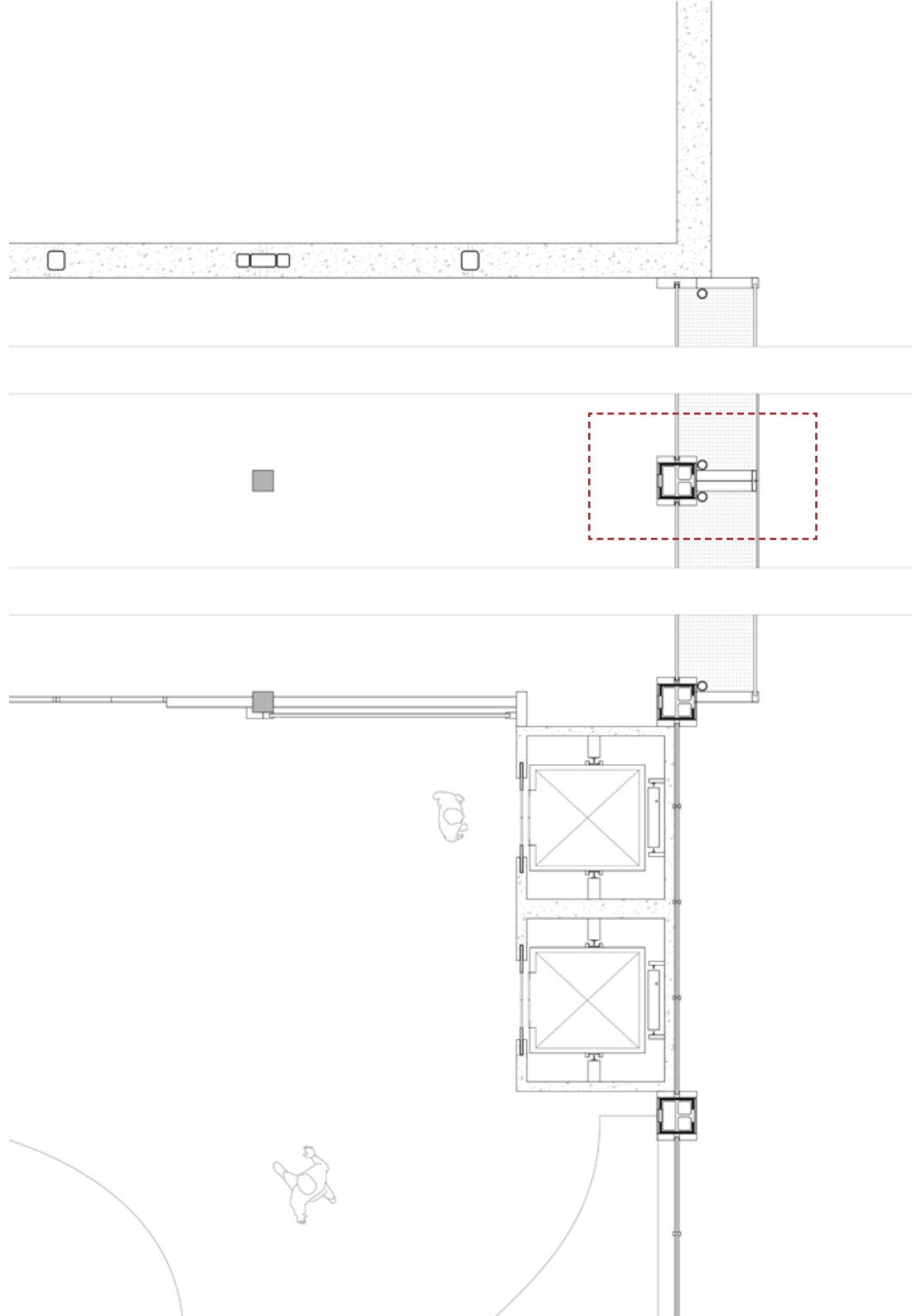

INTERIOR

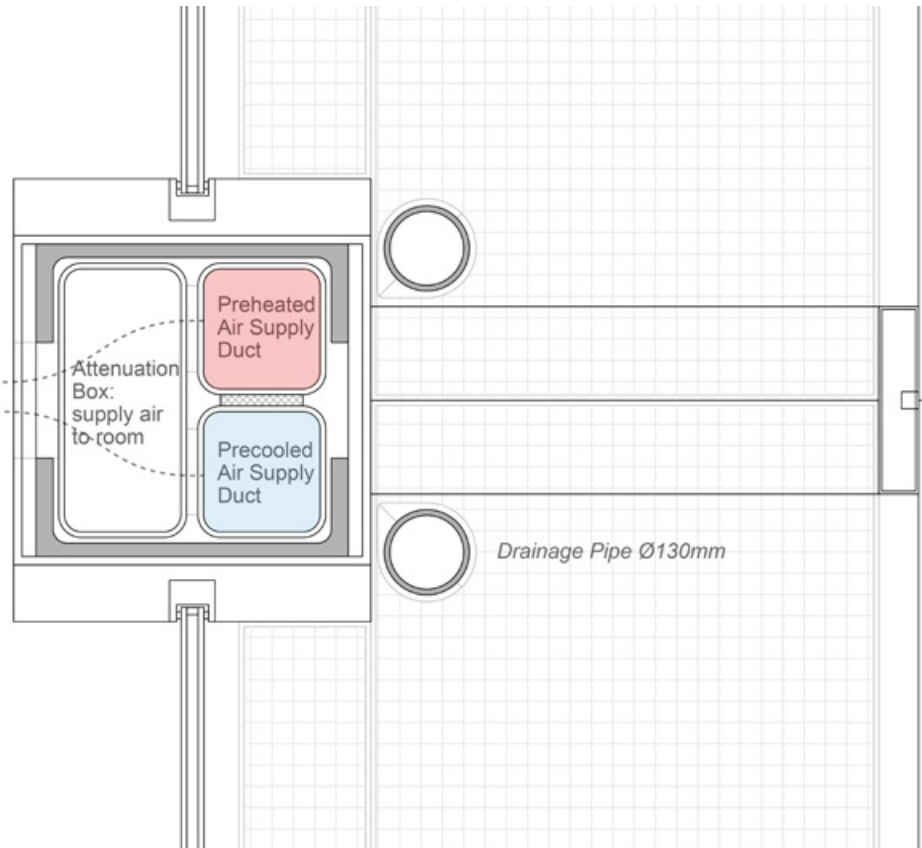

EXTERIOR

Summer

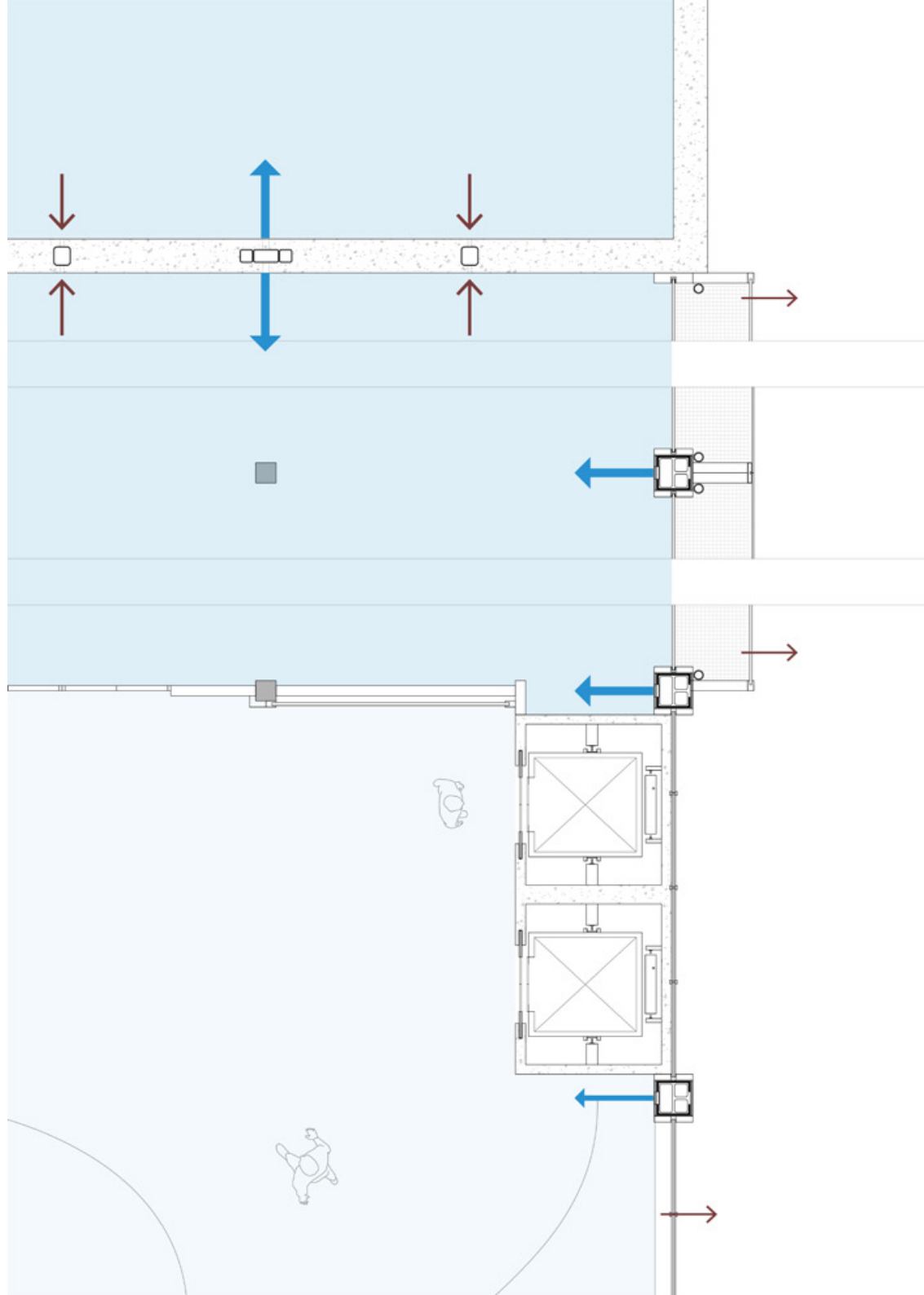

Winter

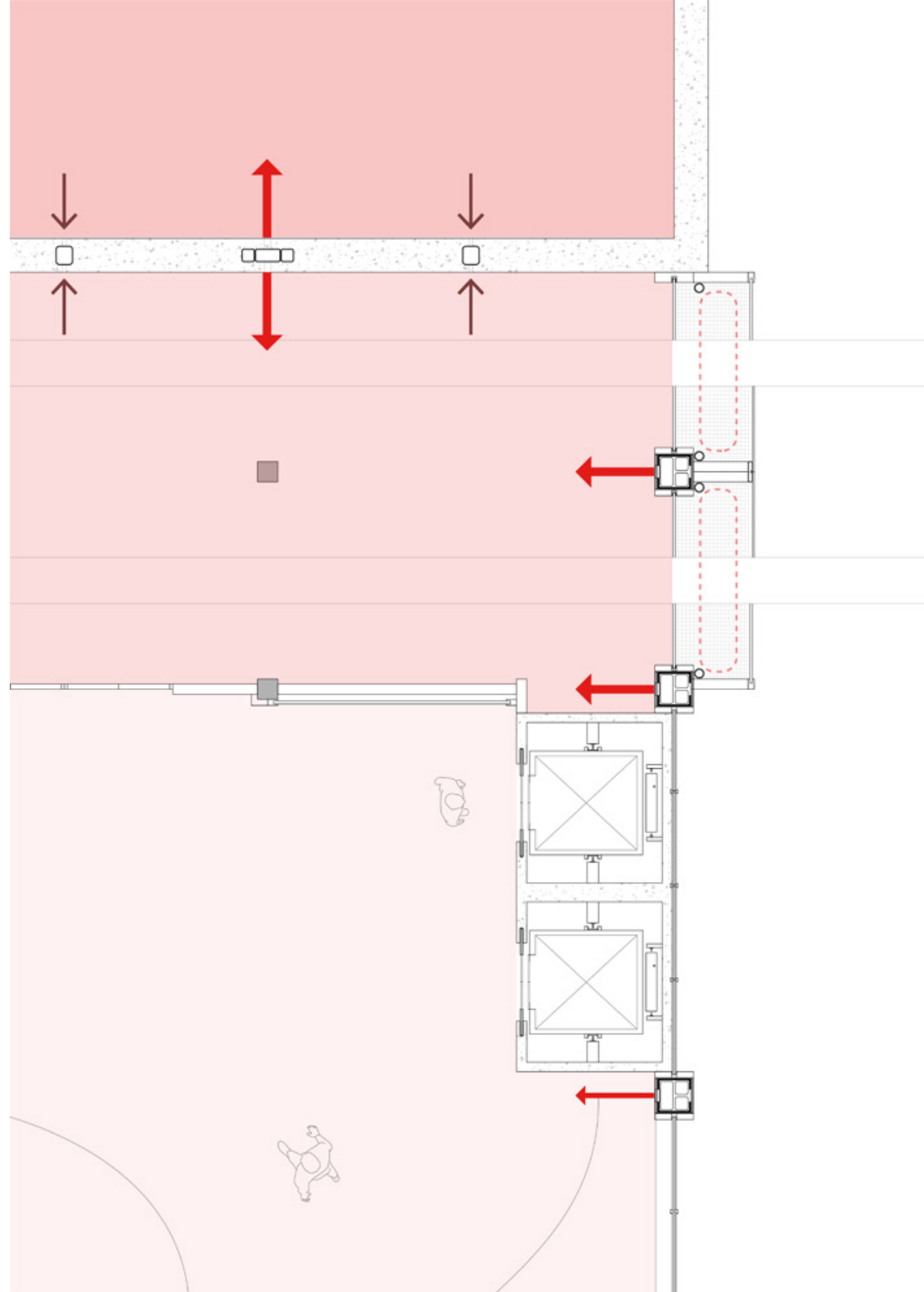

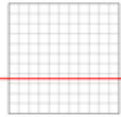

0 6.6 13.2 26.4

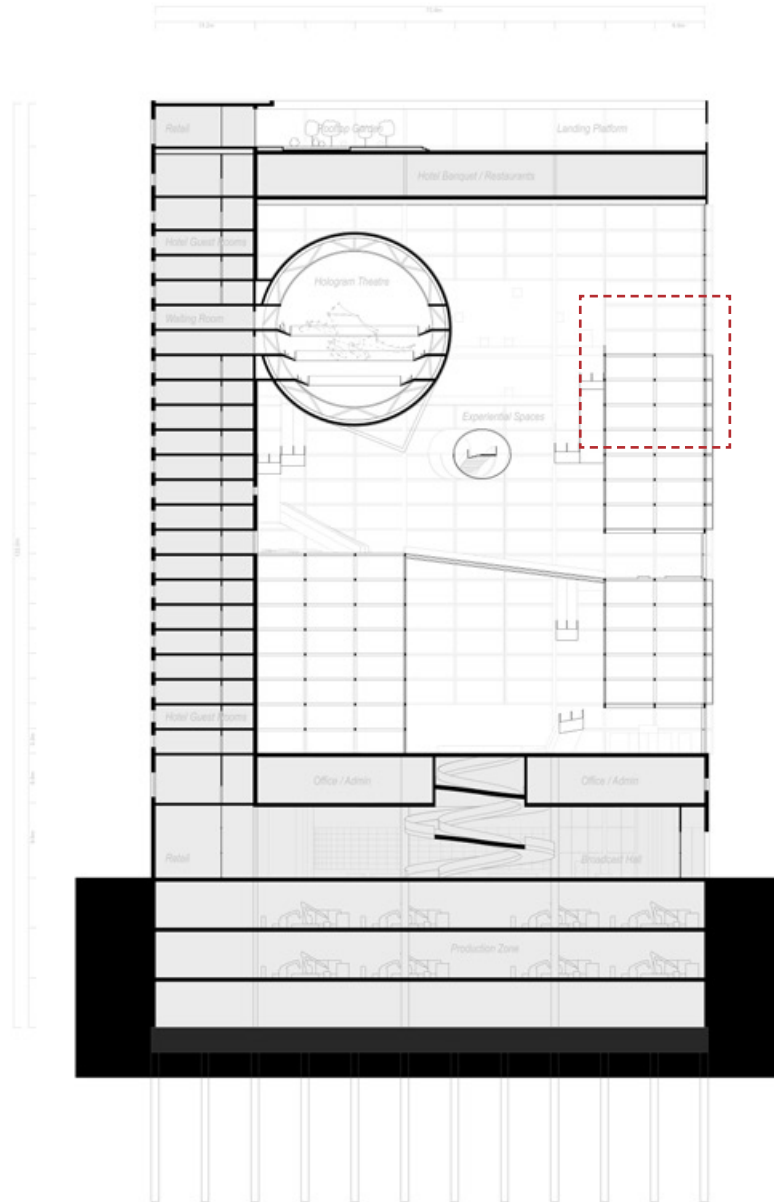

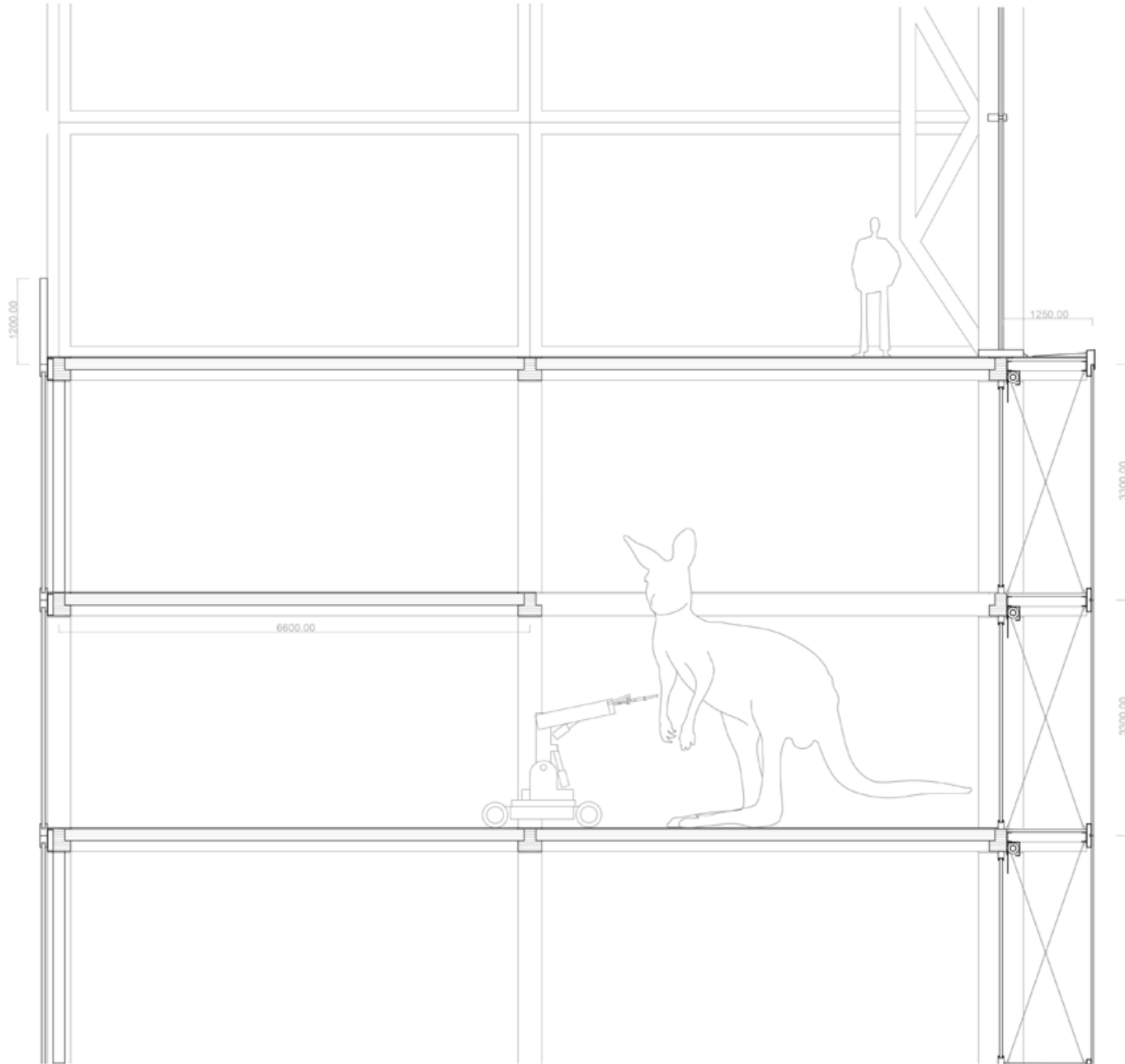

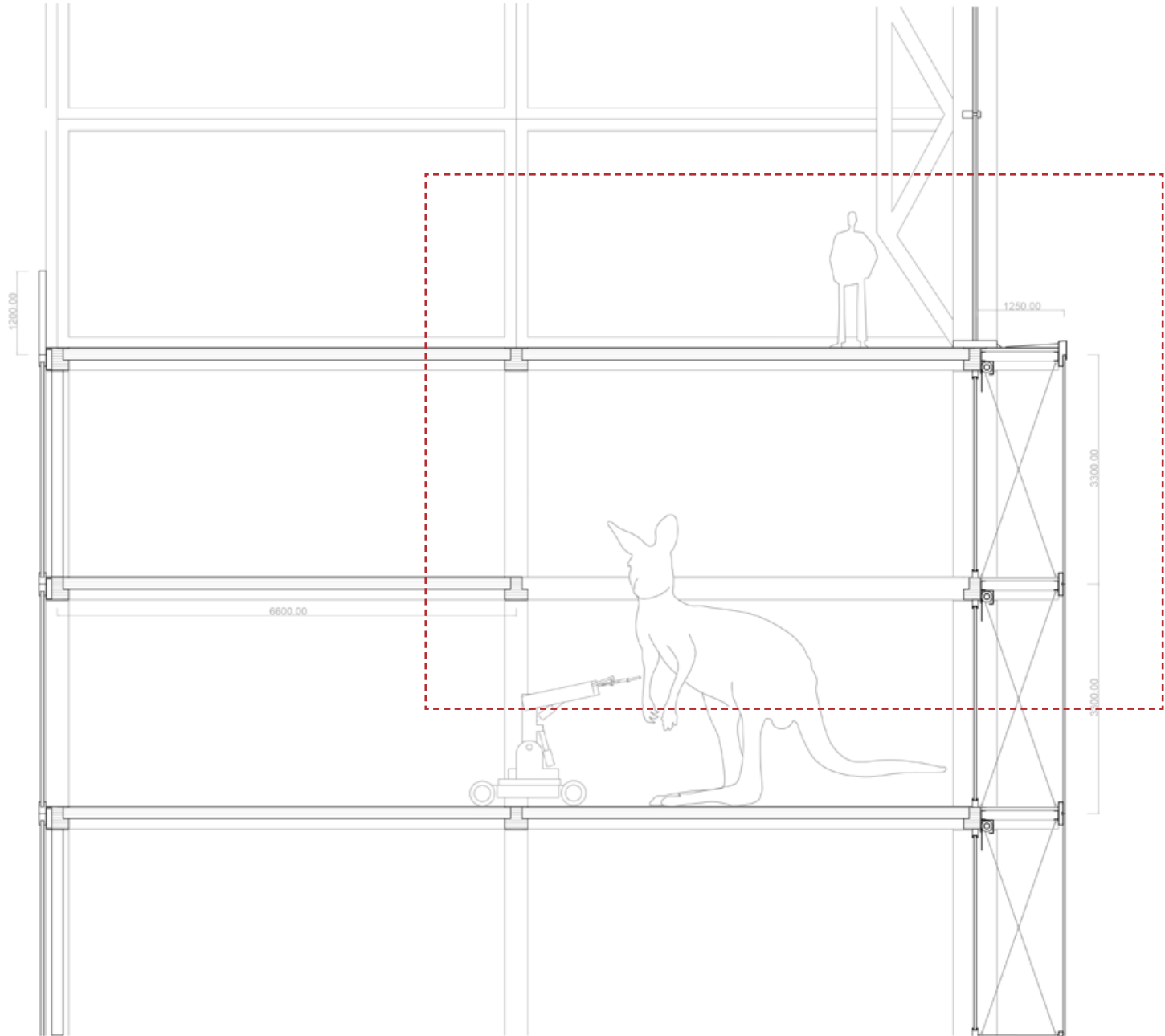

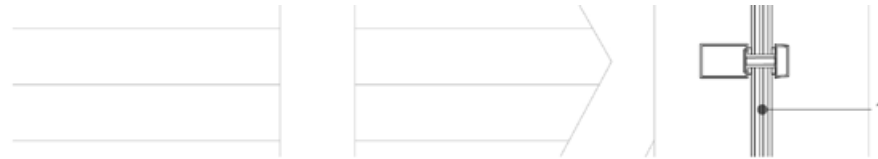
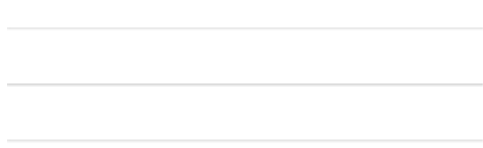

0 100 500 1000 (mm)

- 1. Triple Glazed Glass 60mm , Profile Depth 260mm
- 2. Electronic Roller Shutter Curtain
- 3. Translucent polycarbonate panel 30mm
- 4. Drainage Pipe
- 5. Vertical Cross Bracing Cables
- 6. Double Glazed Glass 40mm
- 7. Galvanized Grid 40 mm
- 8. Finishing, Screed 20mm
Cross Lam. Timber Floor 144mm (36mm*4)
- 9. Glulam Beam 330mm

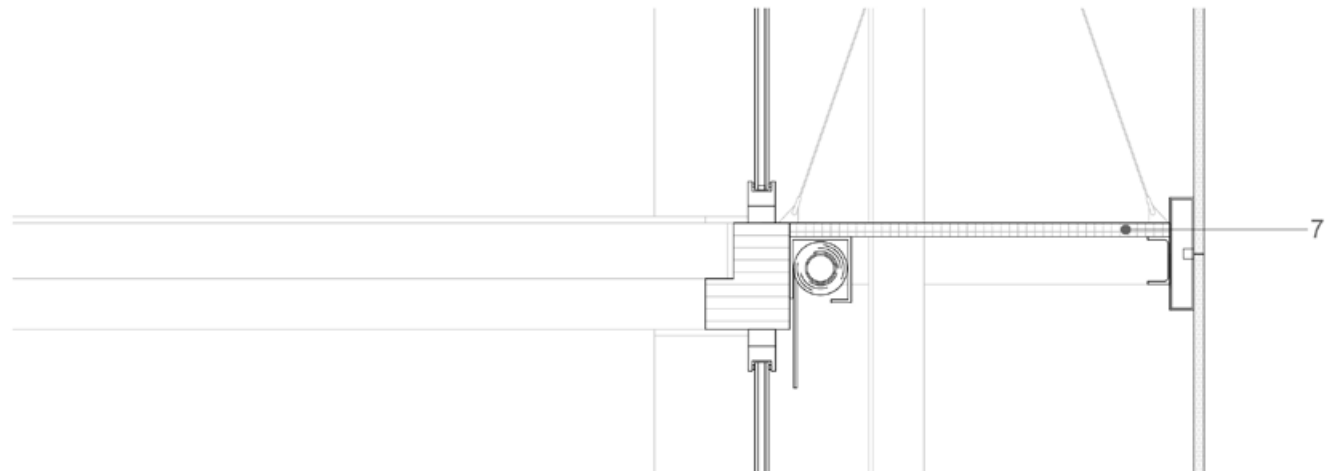
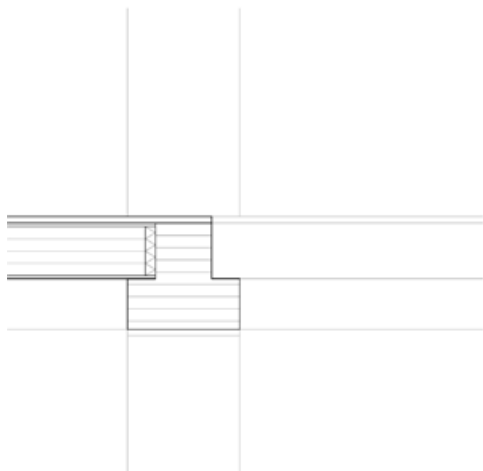
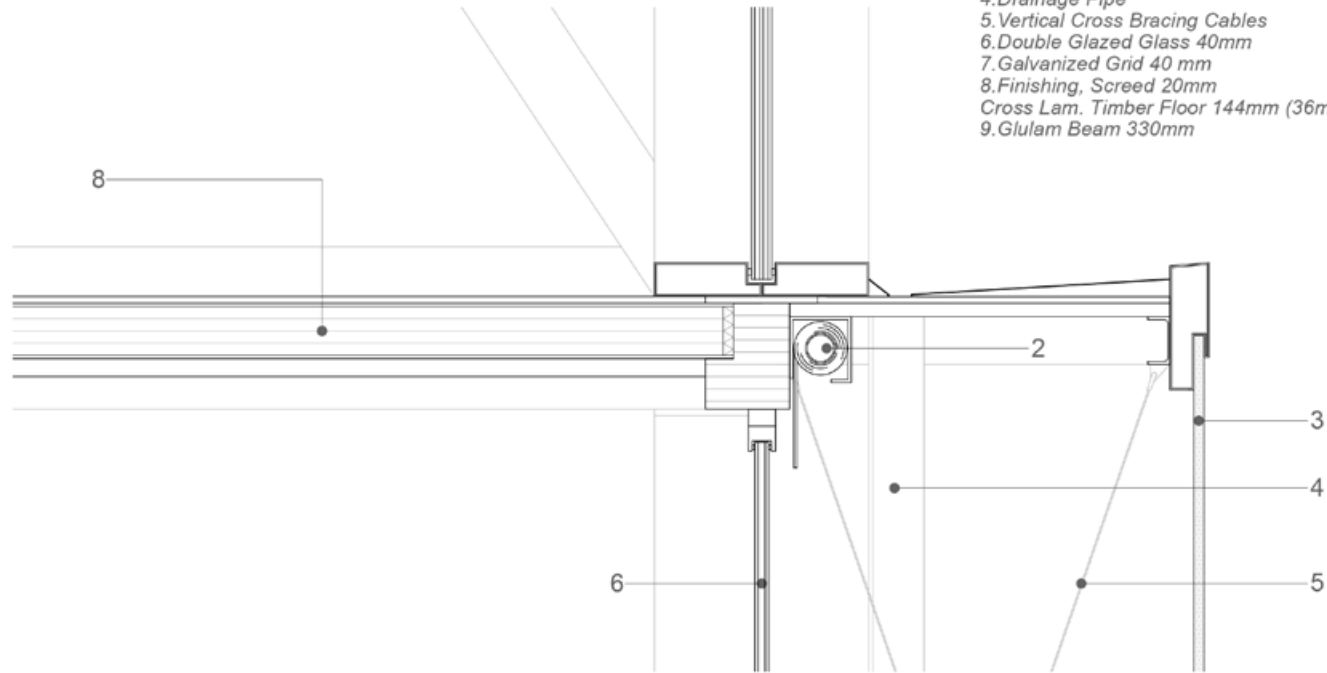
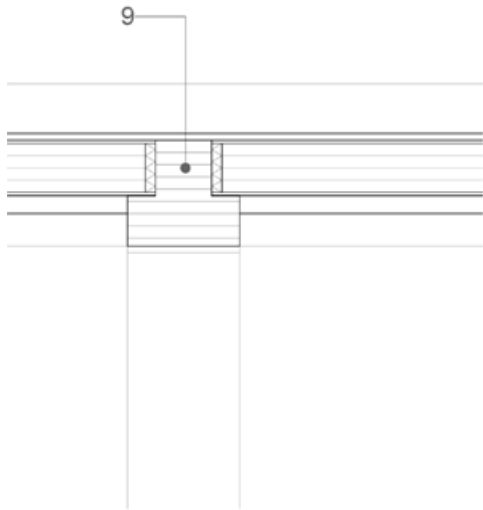

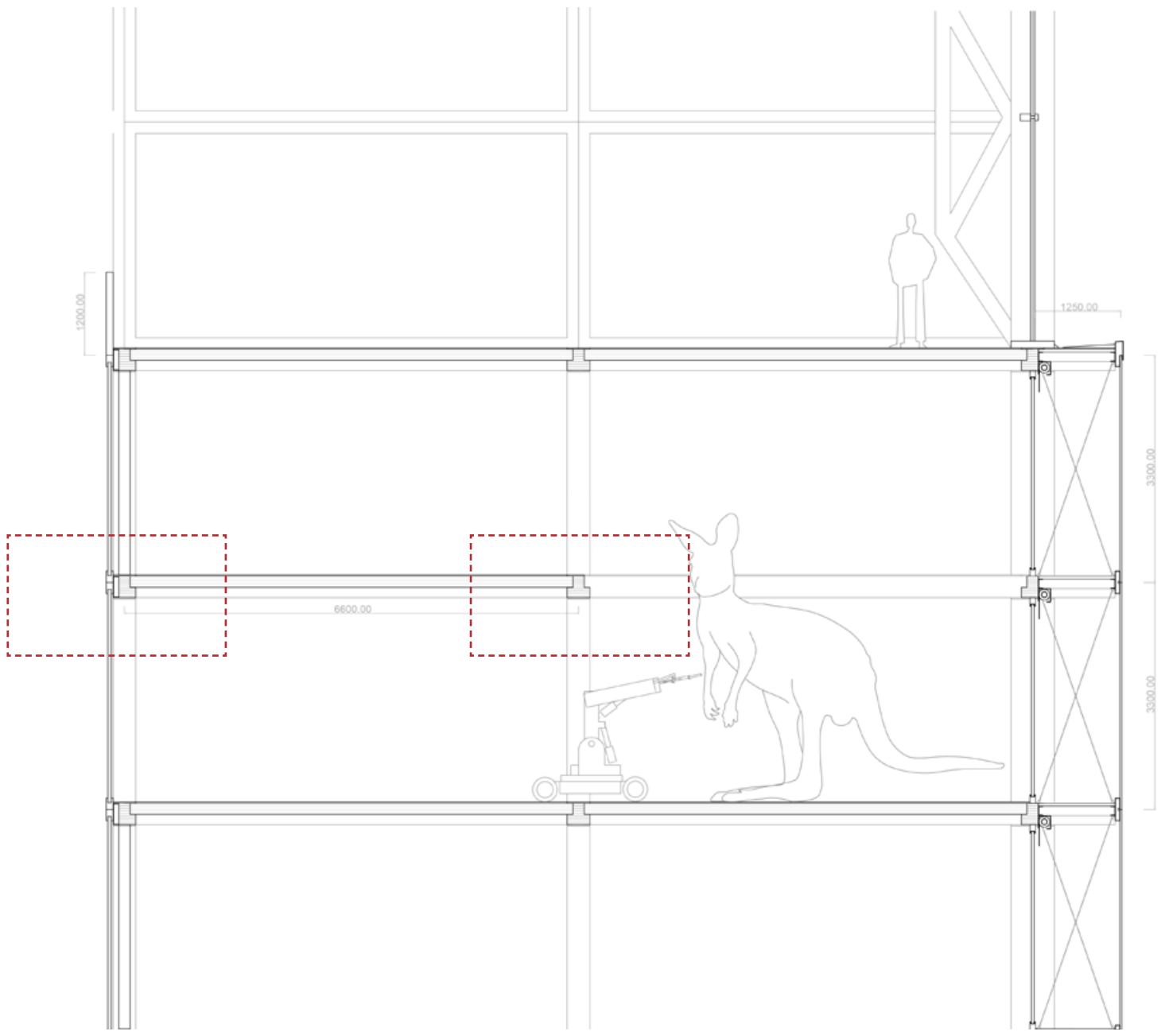

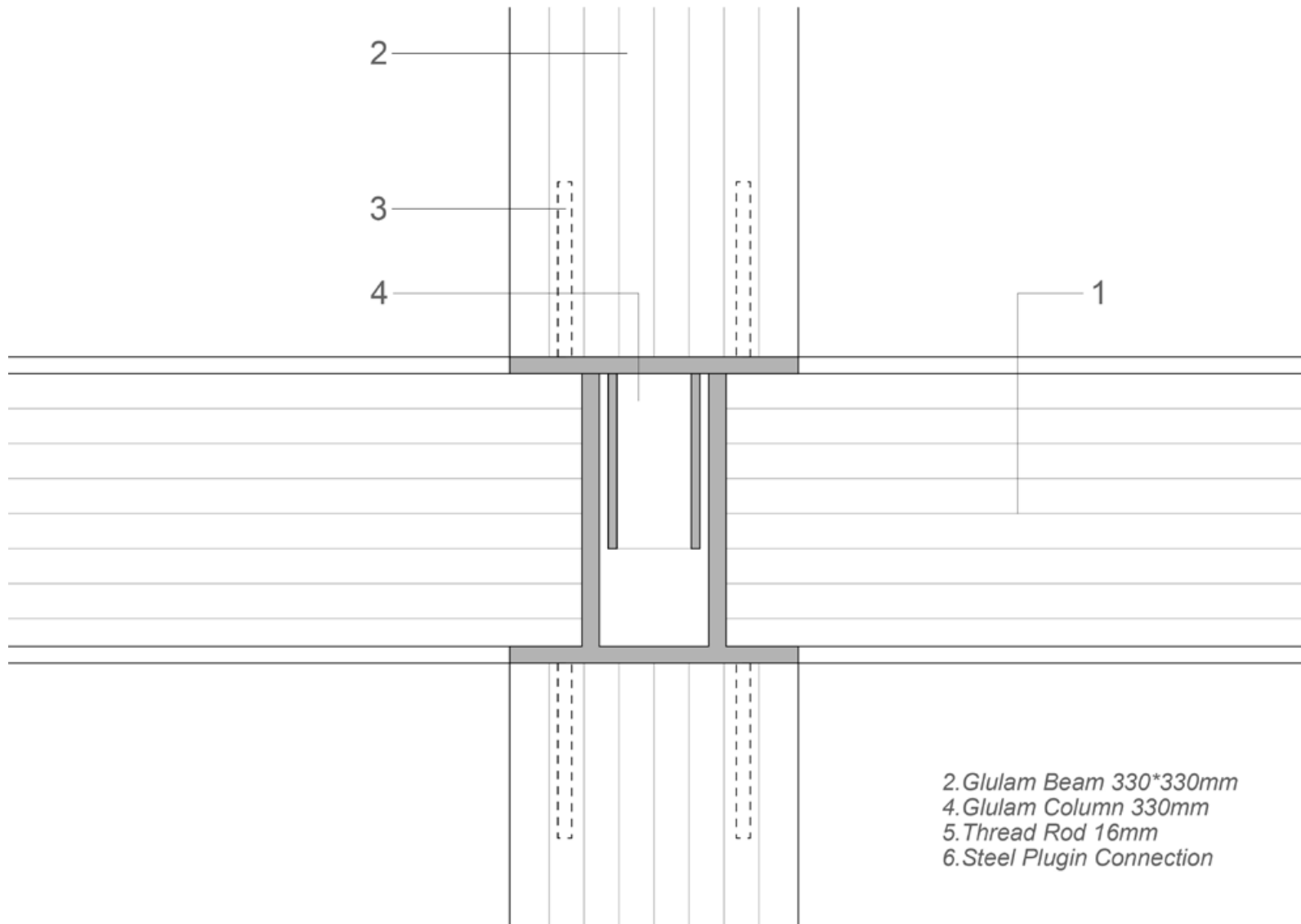

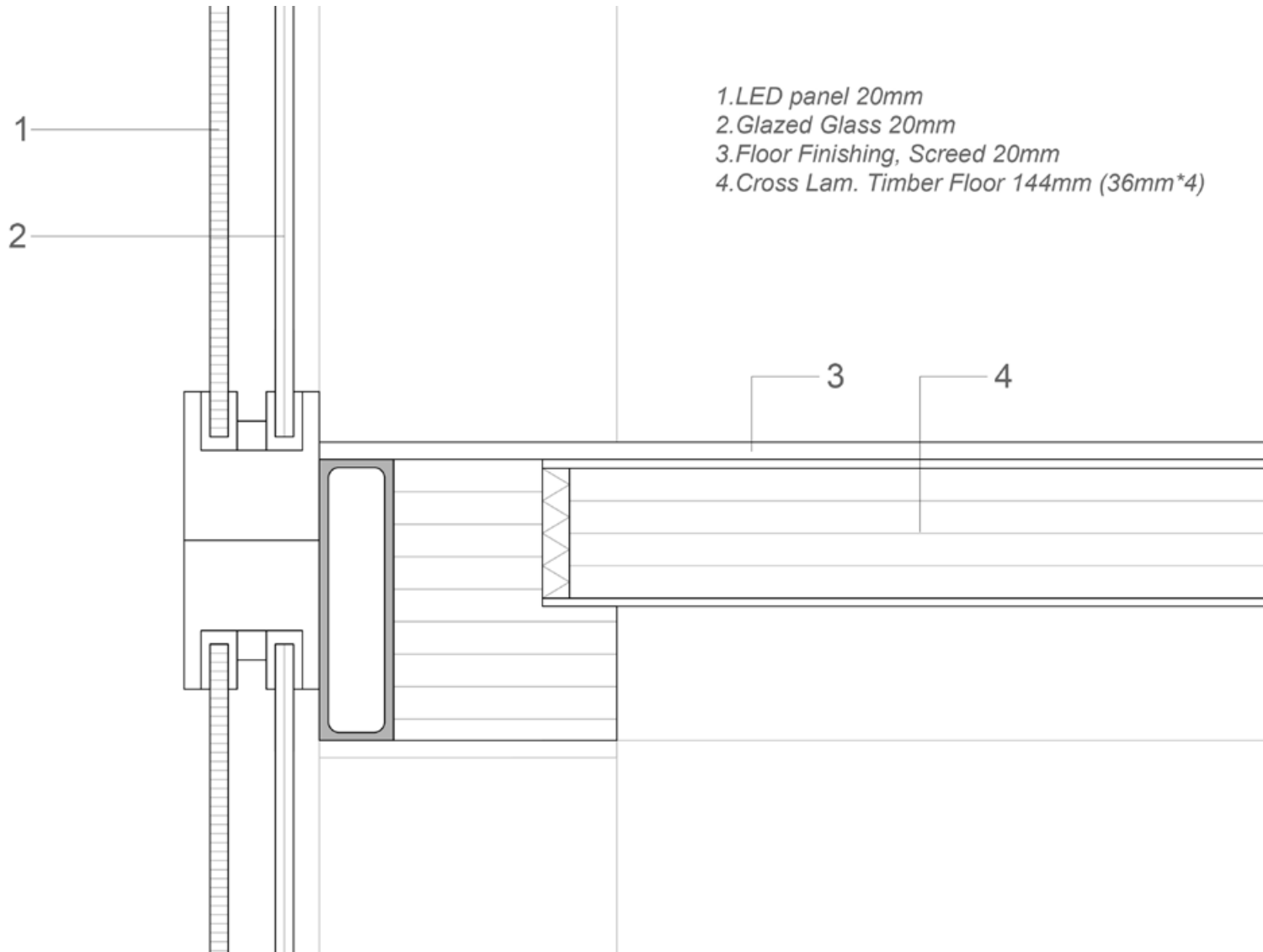

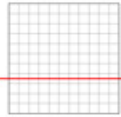

0 6.6 13.2 26.4

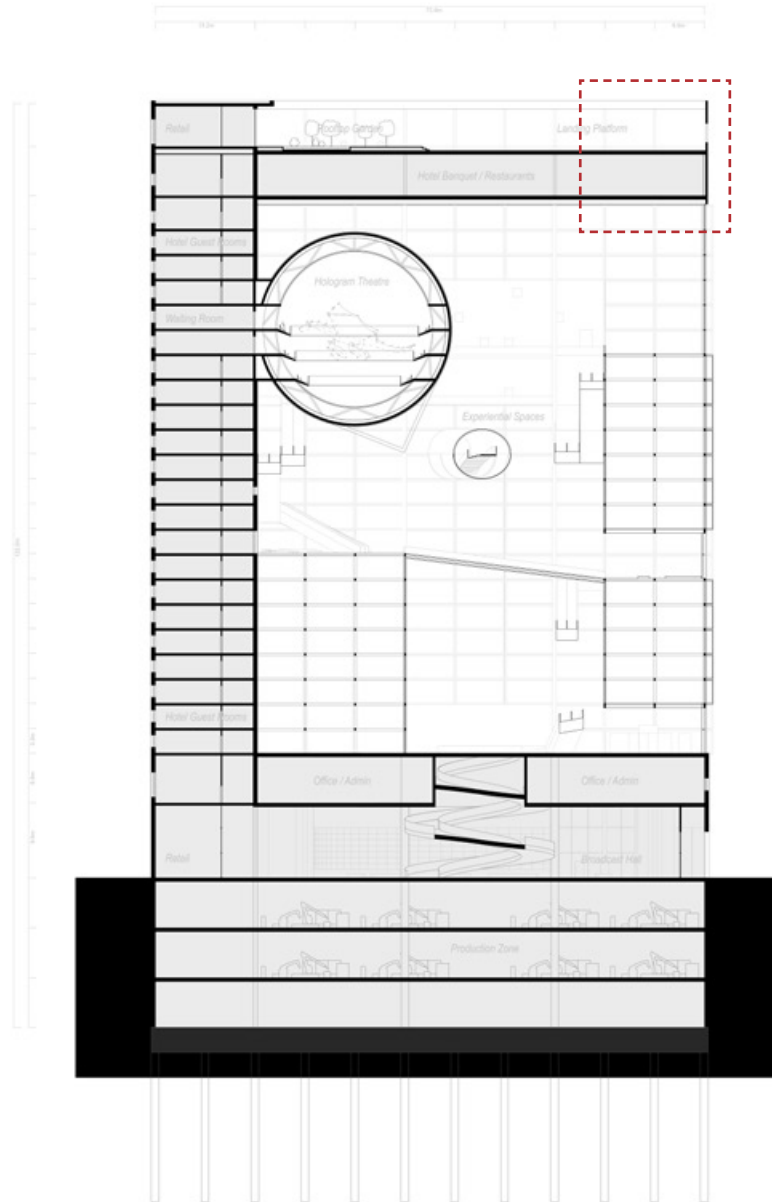

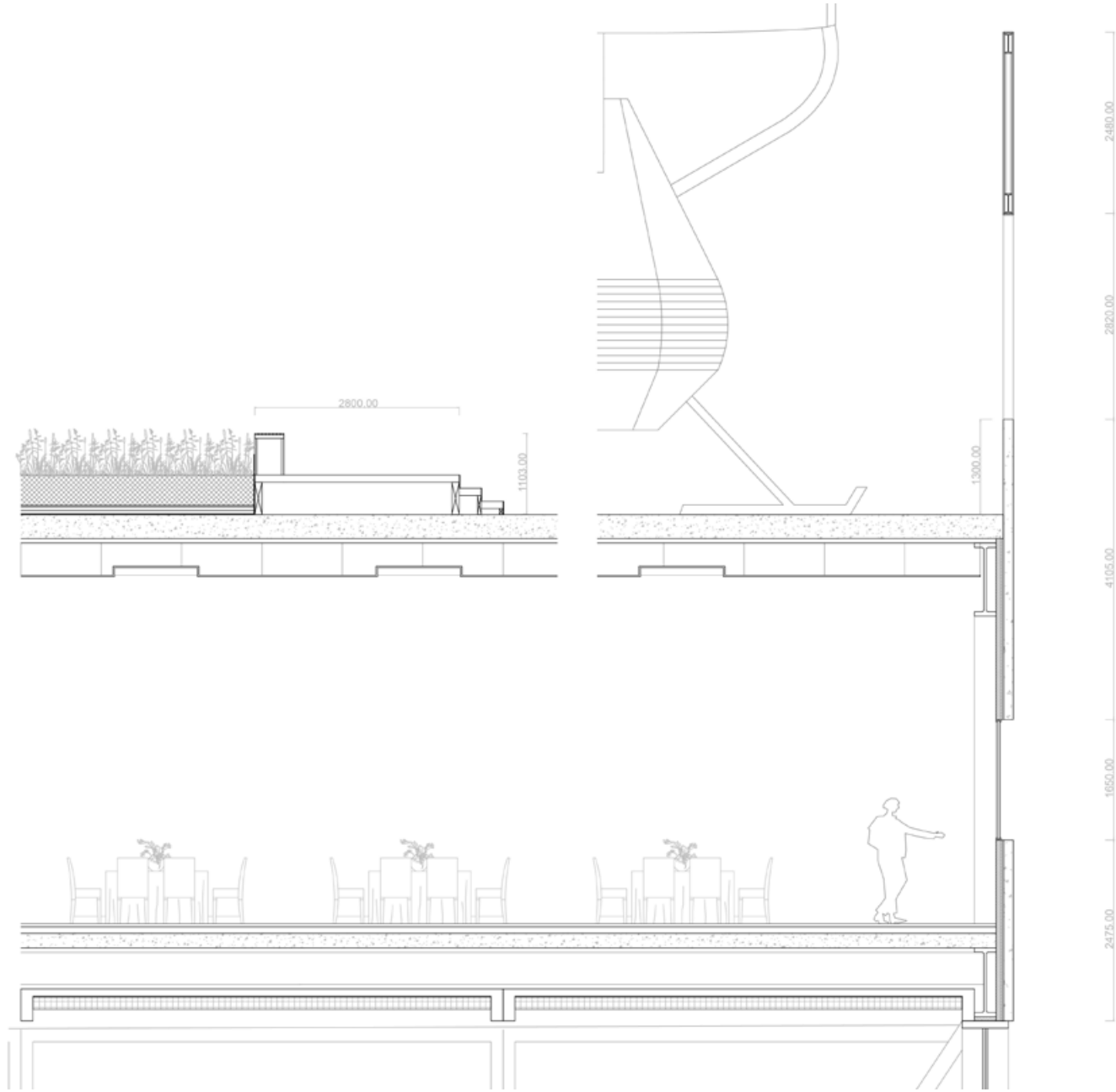

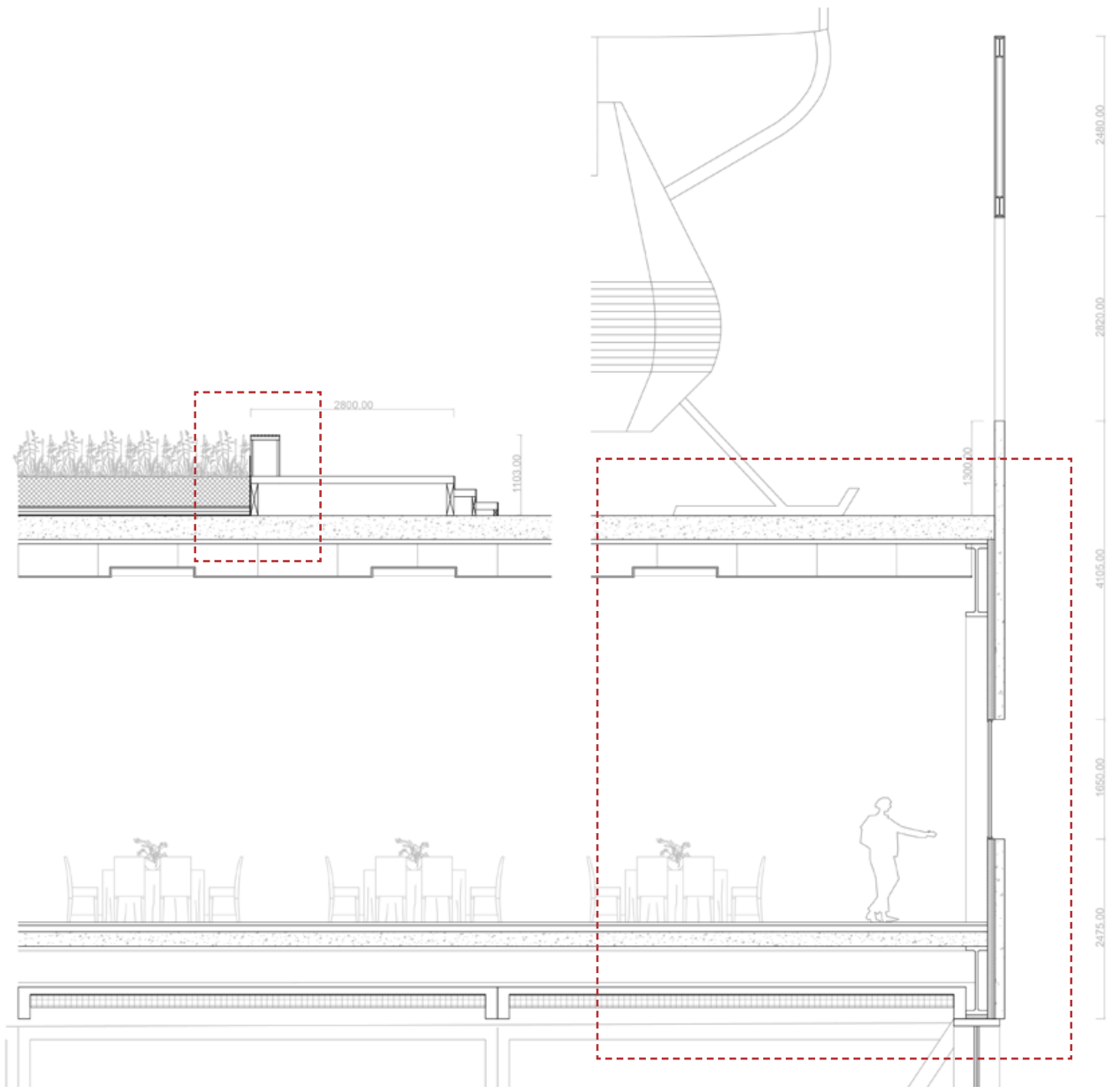

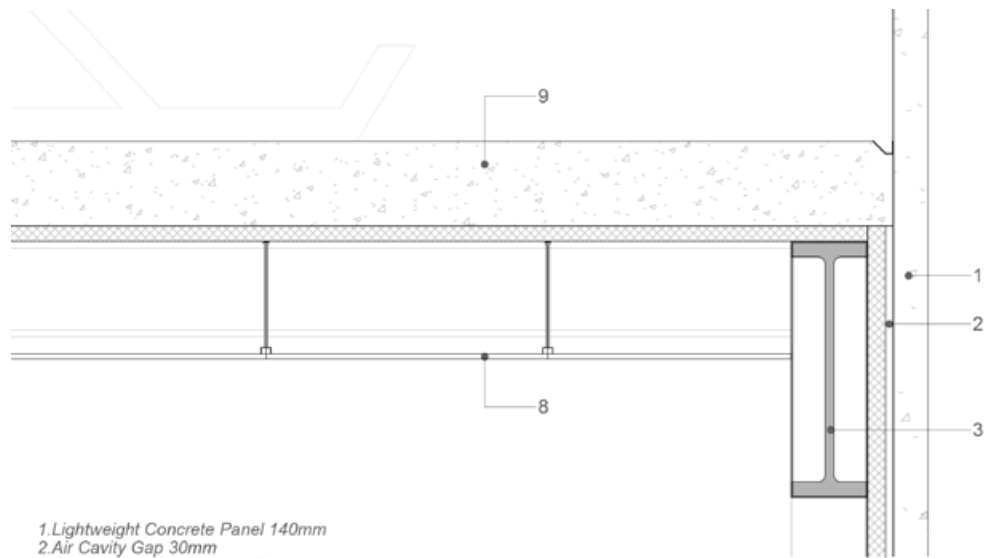

- 1. Lightweight Concrete Panel 140mm
- 2. Air Cavity Gap 30mm
- 3. Fibre Reinforced Polymer Truss
- 4. Glazing 20mm
- 5. Rigid Air Permeable Thermal Insulation 70mm
- 6. LED Ceiling Lighting Panels 170mm
- 7. Carpet Finishing, Timber Floorboard 36mm
- 8. Ceiling Gypsum Board 20mm
- 9. Reinforced Concrete Slab 330mm

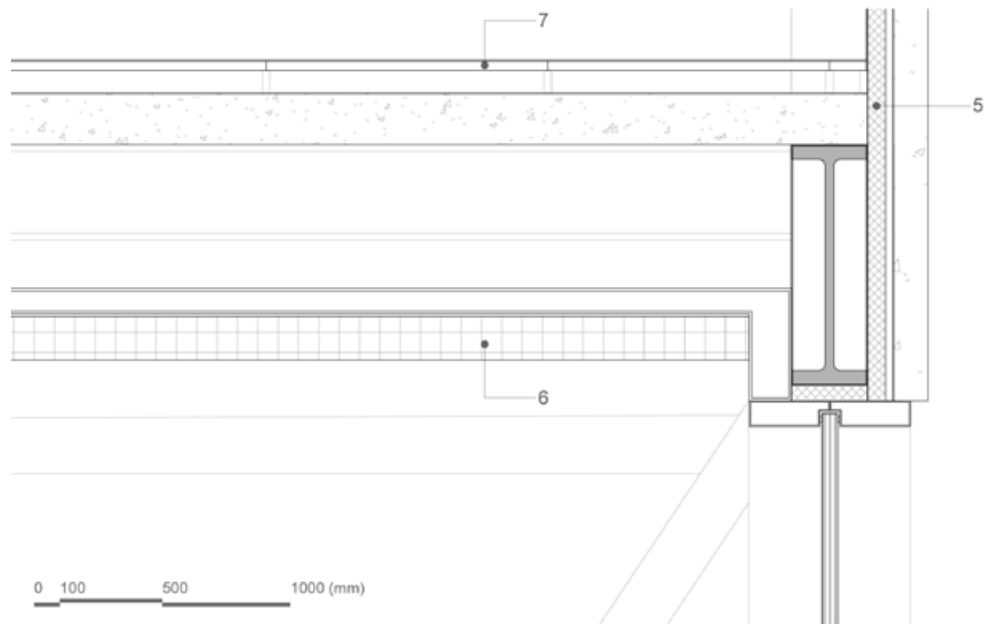
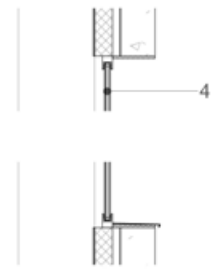

0 100 500 1000 (mm)

1.
-Growing medium 415mm
-Filter 5mm
-Drainage 50mm
-Root Barrier 5mm
-Thermal insulation 40mm
-Waterproof Sheet 10mm

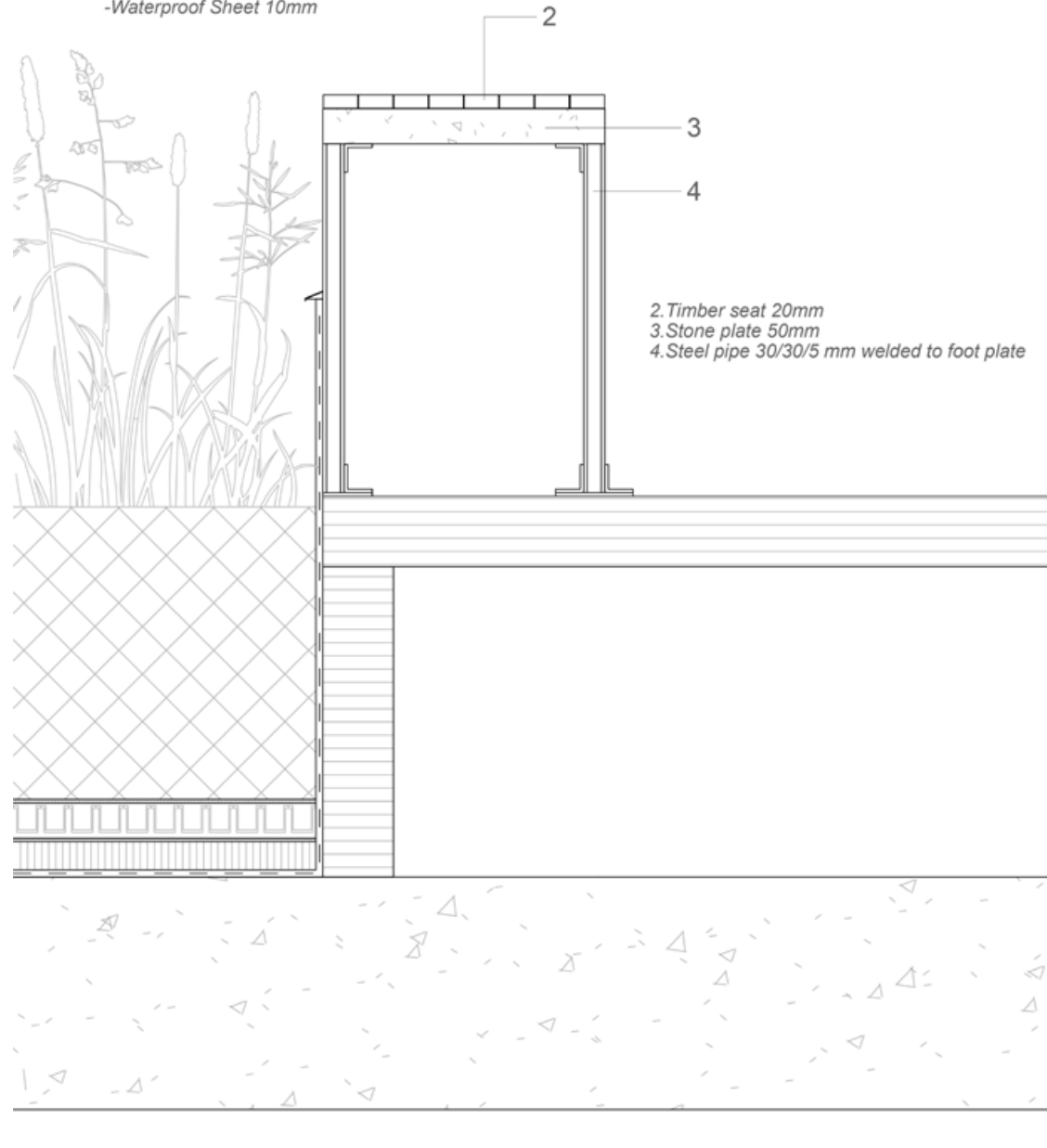

Roof Materialization

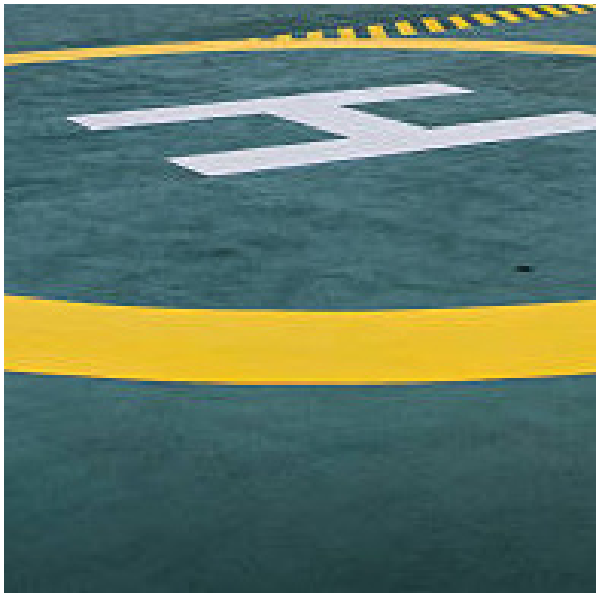

Painted Concrete Floor



Vegetation



Timber Deck



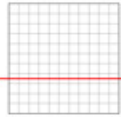

0 6.6 13.2 26.4

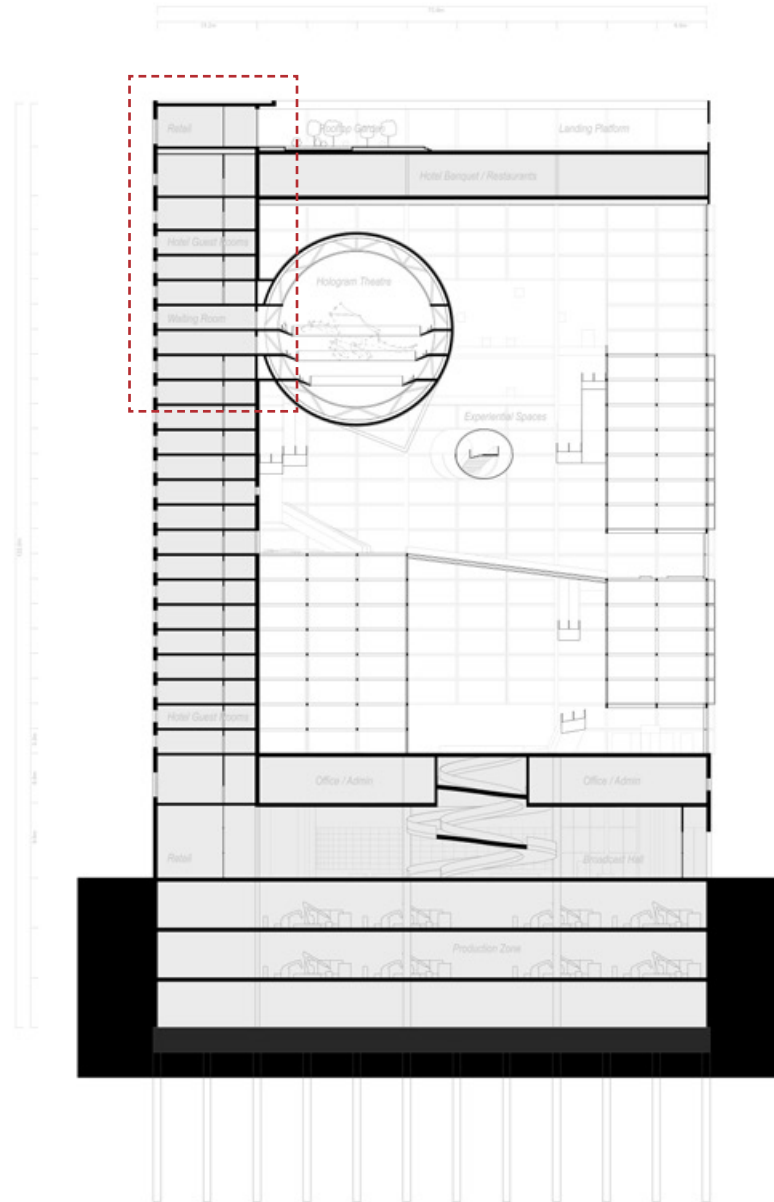

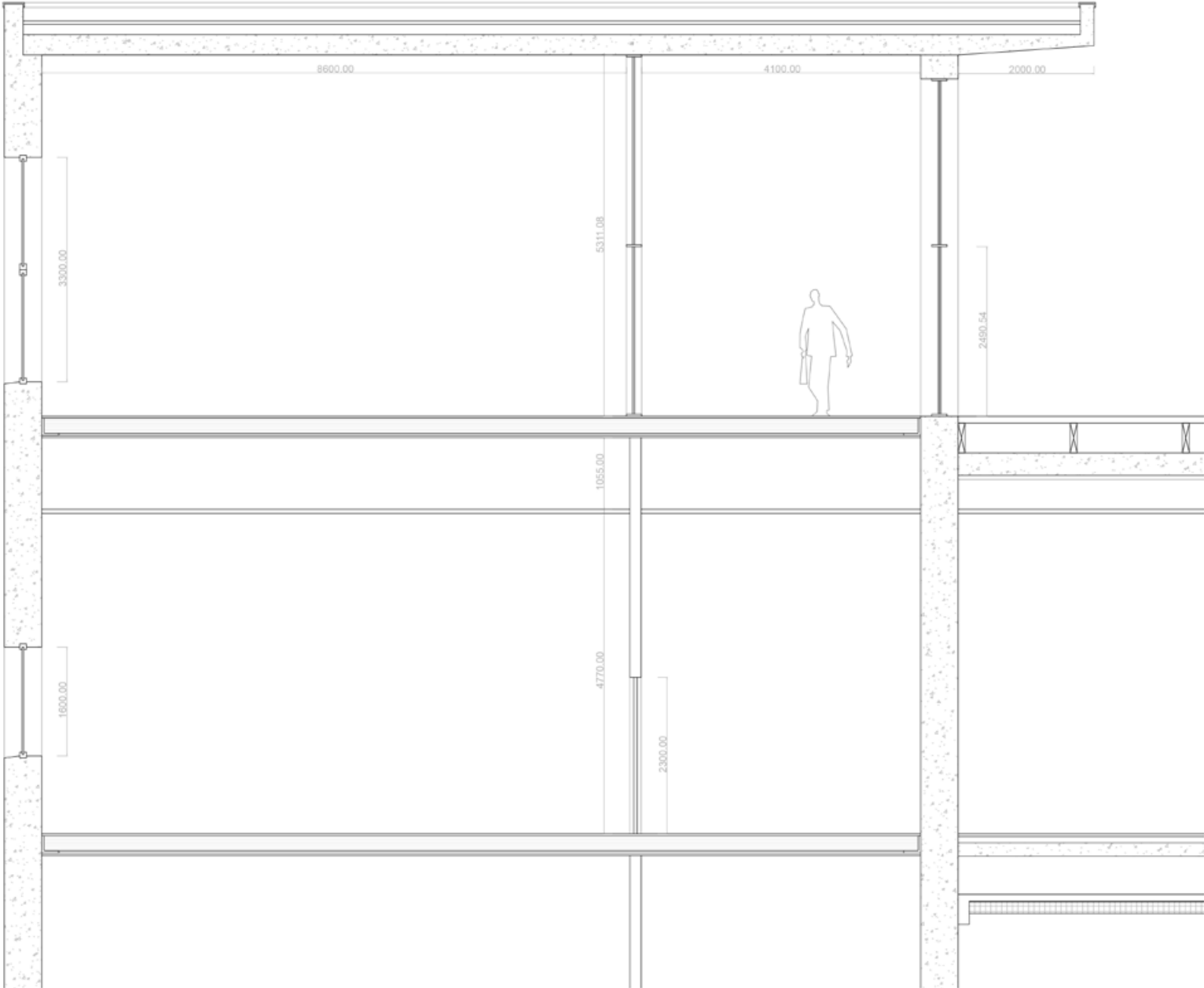

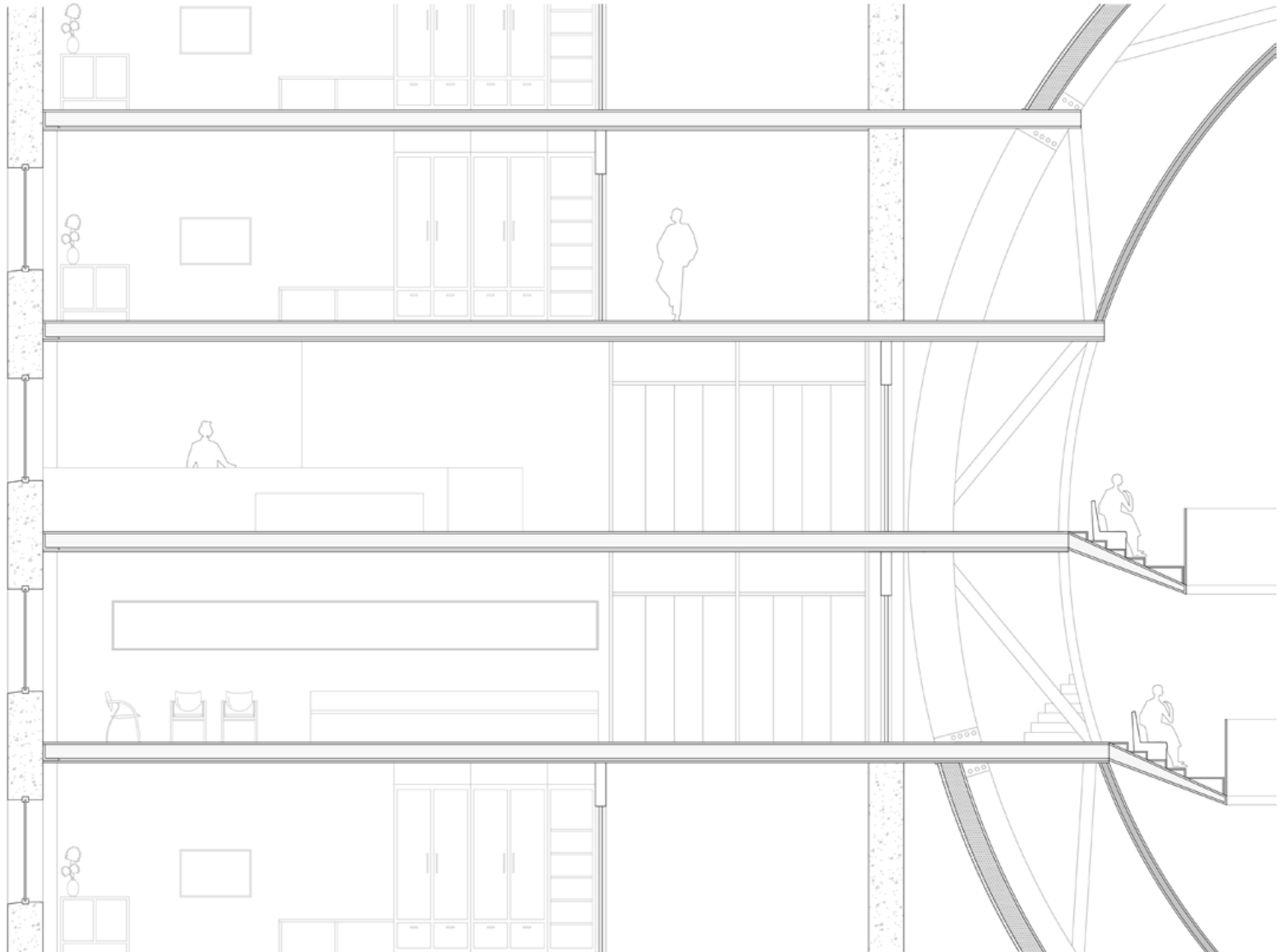

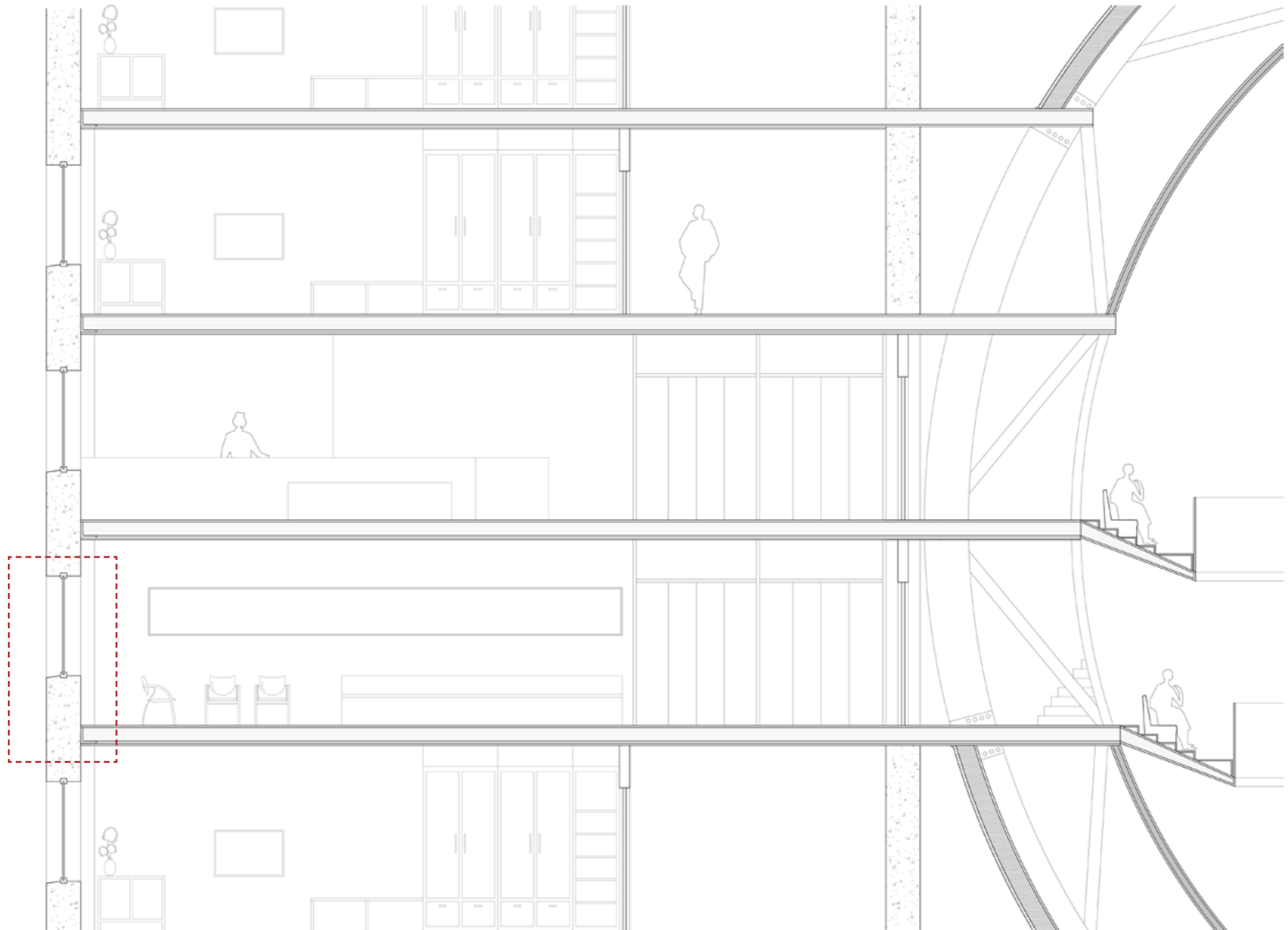

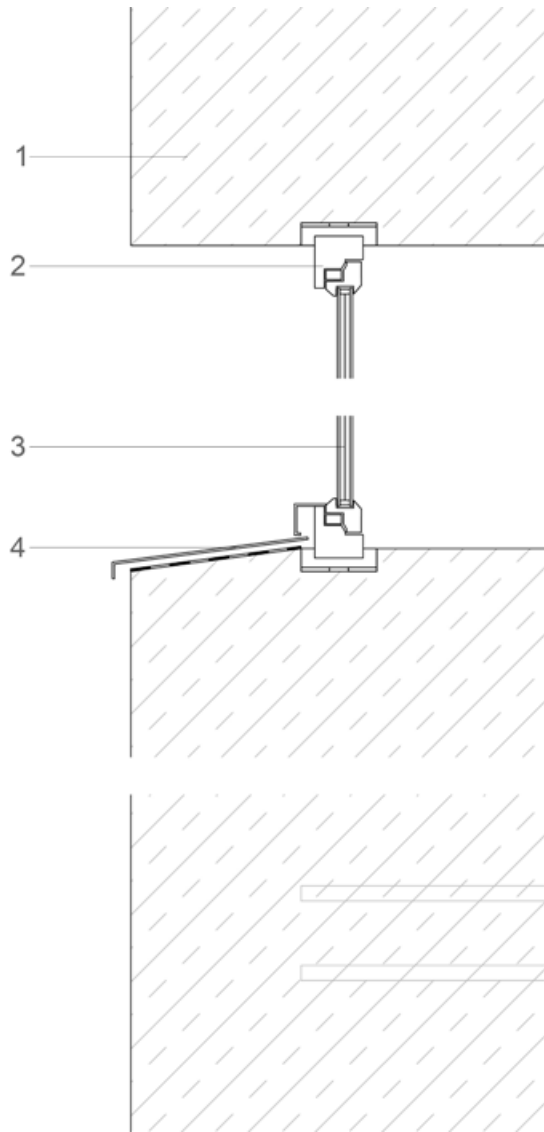

- 1. Insulating concrete as exposed concrete min. 550 mm
- 2. Wooden windows Larch
- 3. Triple glazed glass 20mm
- 4. Steel sheet coated 3 mm

- 5. Floor finishing screed 40 mm
- 6. Separating layer cross laminated timber decking 200 mm
- 7. Plasterboard moisture resistant 16 mm
Gypsum plaster board 16 mm , Interior painting

Climate - Summer

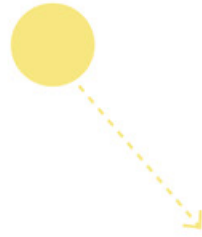

30°C

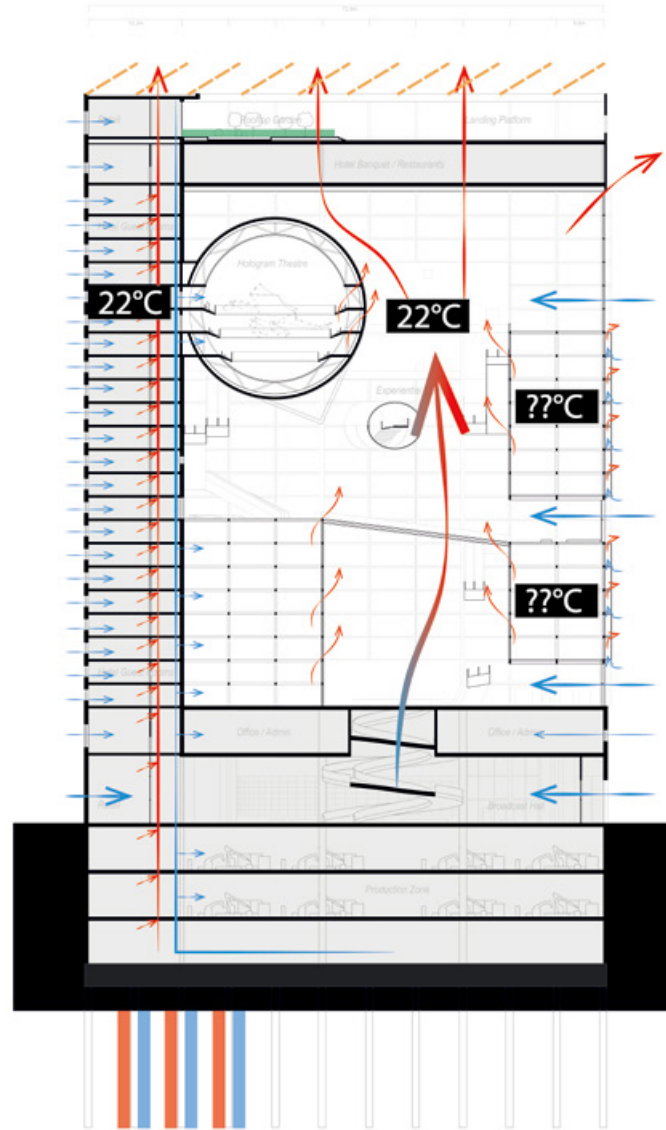



Climate - Winter

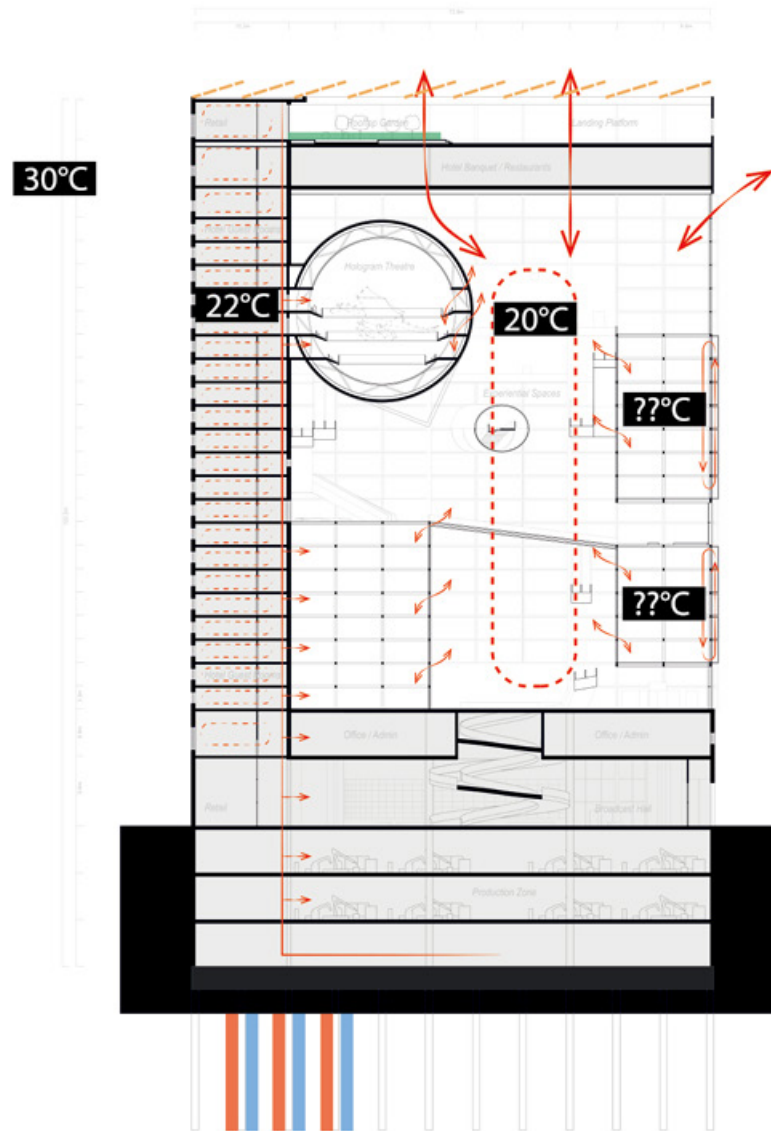

Air Conditioning System

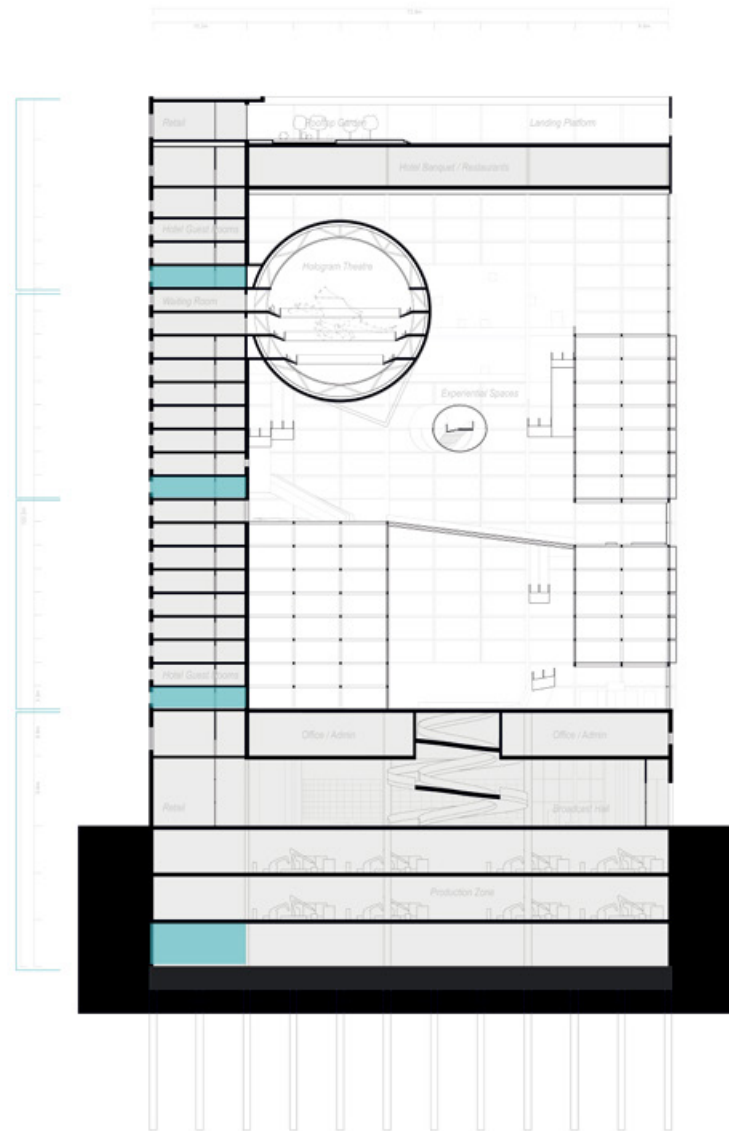

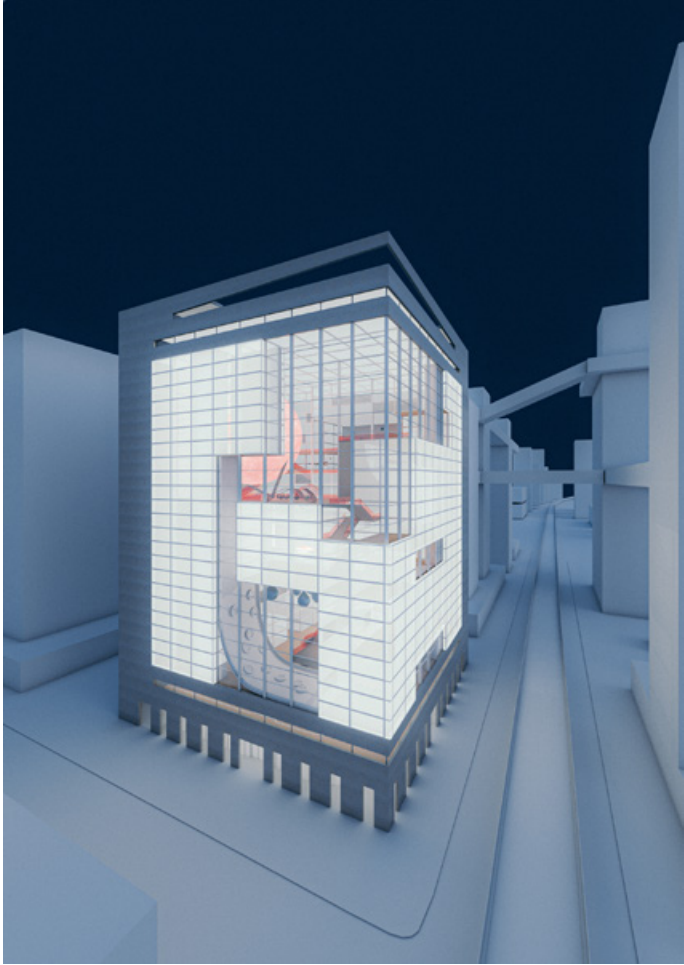

— THE END —

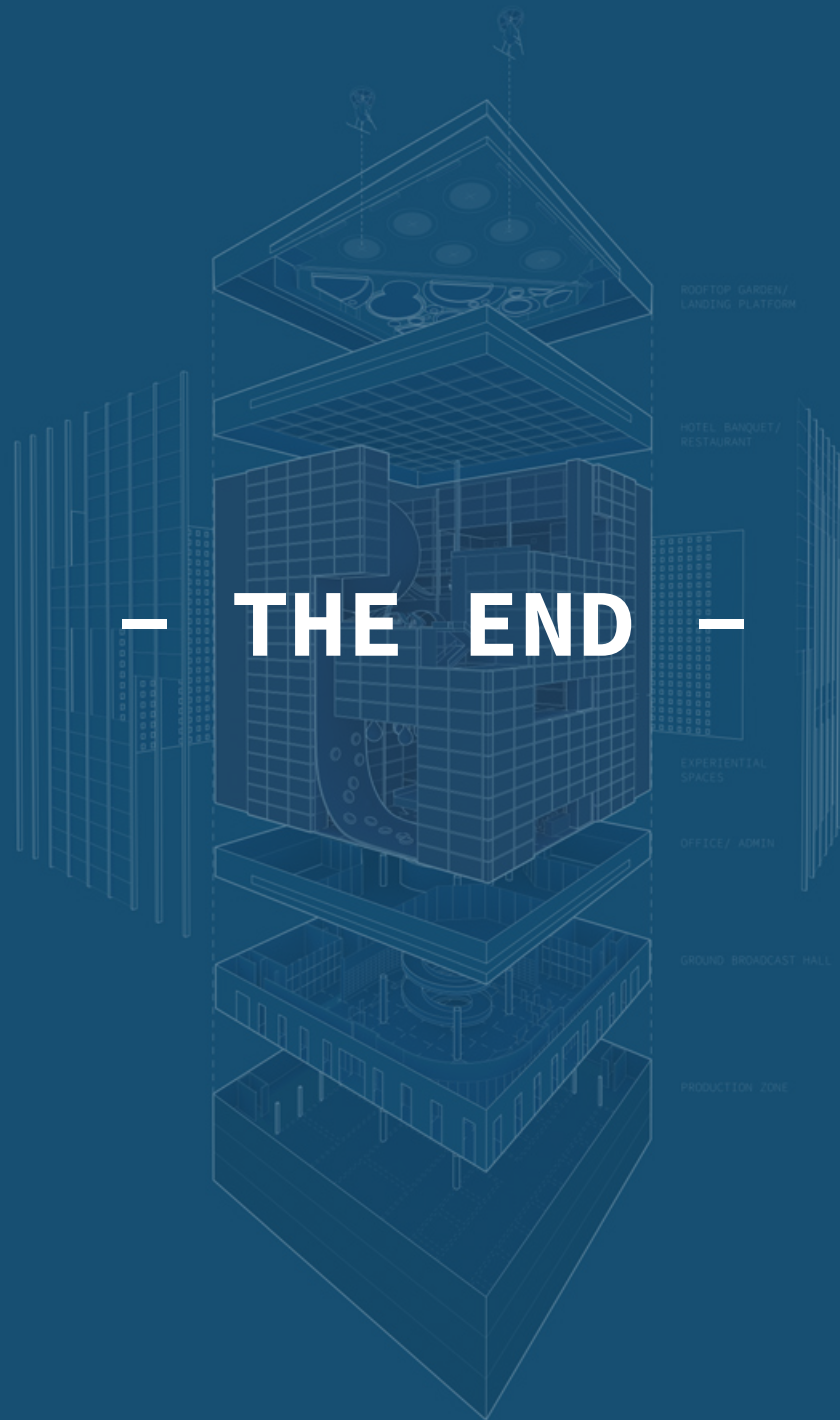

ROOFTOP GARDEN /
LANDING PLATFORM

HOTEL BANQUET /
RESTAURANT

EXPERIENTIAL
SPACES

OFFICE / ADMIN

GROUND BROADCAST HALL

PRODUCTION ZONE