

A state-of-art review on development and progress of backfill grouting materials for shield tunneling

Jiang, Xi; Zhu, Hehua; Yan, Zhiguo; Zhang, Fengshou; Ye, Fei; Li, Peinan; Zhang, Xuehui; Dai, Zhiren; Bai, Yun; Huang, Baoshan

DOI

[10.1016/j.dibe.2023.100250](https://doi.org/10.1016/j.dibe.2023.100250)

Publication date

2023

Document Version

Final published version

Published in

Developments in the Built Environment

Citation (APA)

Jiang, X., Zhu, H., Yan, Z., Zhang, F., Ye, F., Li, P., Zhang, X., Dai, Z., Bai, Y., & Huang, B. (2023). A state-of-art review on development and progress of backfill grouting materials for shield tunneling. *Developments in the Built Environment*, 16, Article 100250. <https://doi.org/10.1016/j.dibe.2023.100250>

Important note

To cite this publication, please use the final published version (if applicable).
Please check the document version above.

Copyright

Other than for strictly personal use, it is not permitted to download, forward or distribute the text or part of it, without the consent of the author(s) and/or copyright holder(s), unless the work is under an open content license such as Creative Commons.

Takedown policy

Please contact us and provide details if you believe this document breaches copyrights.
We will remove access to the work immediately and investigate your claim.

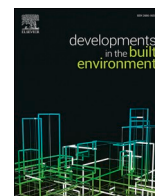

A state-of-art review on development and progress of backfill grouting materials for shield tunneling

Xi Jiang^{a,*}, Hehua Zhu^b, Zhiguo Yan^b, Fengshou Zhang^b, Fei Ye^c, Peinan Li^e, Xuehui Zhang^f, Zhiren Dai^g, Yun Bai^b, Baoshan Huang^{d,**}

^a Department of Civil and Environmental Engineering, The Hong Kong Polytechnic University, Kowloon, Hong Kong

^b Department of Geotechnical Engineering, Tongji University, 1239 Siping Road, Shanghai, 200092, China

^c School of Highway, Chang'an University, Xi'an, 710064, China

^d Department of Civil and Environmental Engineering, The University of Tennessee, Knoxville, TN, 37909, USA

^e College of Environmental Science and Engineering, Donghua University, Shanghai, 201620, China

^f Geo-Engineering Section, Delft University of Technology, Stevinweg 1, 2600 GA, Delft, the Netherlands

^g China Railway First Survey & Design Institute Group Co., Ltd., Xi'an, 710043, China

ARTICLE INFO

Keywords:

Backfill grouting
Shield tunneling
Grouts
Underground space
Resilient infrastructure

ABSTRACT

Backfill grouting plays a vital role in shield tunneling. This paper aims to present a comprehensive review of the development and progress of backfill grouting materials specifically designed for shield tunneling. Initially, the various components of grouts, such as pozzolanic materials, filling fine aggregates, and chemical additives, are introduced and discussed in detail. Subsequently, this study investigates critical properties including workability, mechanical properties, and durability of the grouts. Additionally, the principal factors influencing the properties are summarized, along with recommended ranges for specific geological conditions. Furthermore, the paper elucidates the diffusion mechanism of grouting mortars by presenting the current grouting models employed in shield tunneling. Recent advancements in grouting materials are extensively studied and extended, offering new perspectives for future grouting technology in shield tunneling. This study provides valuable insights into overcoming the existing challenges associated with shield tunnel grouting and promoting the evolution of current grouting materials.

1. Introduction

The development of modern cities is expanding in two dimensions: upward into the sky and downward below the surface. Utilizing underground space has become essential in addressing space scarcity and enhancing urban resilience. Shield tunneling, particularly for metro and road tunnels, plays a pivotal role in alleviating the challenges of urbanization and ensuring the integrity of major cities. In addition to transportation tunnels, the construction of utility tunnels, including those for water, gas, and electrical cables, is crucial for the sustainable development of metropolises like Shanghai, Tokyo, Hong Kong, and New York. During the construction of tunnels, grouting emerges as a vital process. Grouting serves as an imperative step in reinforcing tunnel structures and ensuring their stability and durability. By injecting grout into the surrounding soil or rock, the tunnel's foundation can be

strengthened, preventing potential issues such as soil settlement and water infiltration. Effective grouting techniques contribute significantly to the safety and longevity of tunnel infrastructure.

The term "grout" originated from the Middle English word "grūt," which referred to coarsely ground meal and was later used to describe porridge (Littlejohn, 2003a). The history of grouting technology dates back to 1802 when Charles Bérigny introduced it. Bérigny invented a mallet-driven wooden percussion pump to inject puddle clay into permeable gravel voids beneath the scouring sluice at the Port of Dieppe in France. Hydraulic lime was later employed to fill significant foundation cavities after experiencing severe subsidence and arch collapses. In the United States, grouting was systematically implemented on a large scale between 1896 and 1899 to address the karstic limestone beneath the Croton masonry dam in New York State, reducing seepage and hydrostatic uplift. By the late 19th century, cement mixes became the

* Corresponding author.

** Corresponding author.

E-mail addresses: xijiang@polyu.edu.hk (X. Jiang), bhuang@utk.edu (B. Huang).

primary materials used for grouting. The mixing of cement grouts was further enhanced in 1934 with the invention of the colloidal mill by J.P. Morgan. During the 1930s, low-viscosity single-fluid grouts gained prominence as the main product. Sodium silicate served as the foundation for many early commercial grouting materials. In 1992, cement/bentonite grouts were first utilized in the UK by the grouting specialist company Keller-Colcrete. Chemical grouts have also been employed to enhance compensation grouting in subsequent geotechnical projects. Grouting technology has since seen advancements in various infrastructure constructions, including pavements, railways, and tunnels.

The first documented instance of cement grouting used in a tunnel dates back to 1880, when Couverat-Desvergnès employed it at the Maret tunnel in France (Littlejohn, 2003b). Cement-based grouts have since remained widely popular in tunnel construction. However, in complex geological conditions such as water-sealed storage caverns, cement-based grouting may not always be suitable (Wei et al., 2017). To address this limitation, additional additives are often employed to enhance grouting quality, efficiency, and cost-effectiveness. Grouting materials, therefore, play a crucial role in both tunnel construction and the development of underground spaces. The primary objective of this paper is to provide a comprehensive review and practical guide on backfill grouting materials in tunnel engineering, with a particular focus on shield tunneling. The paper aims to bridge the existing knowledge gap and highlight the challenges that need to be addressed for further research and development in this field. By addressing these gaps and challenges, the paper seeks to contribute to the advancement and improvement of backfill grouting practices in tunnel engineering.

Shield tunneling was first successfully introduced by French tunnel engineer Marc Isambard Brunel in the early 19th century in London. He drew inspiration from the burrowing technique of shipworms, which led to the development of a novel tunneling method. Over the following 200 years, modern shield tunneling methods evolved based on his insights. Shield tunneling has become the primary tunneling method in many countries, including Japan, the United States, and China, particularly in areas with soft soil. Its advantages include rapid construction, minimal disruption, and increased automation. In China, a significant portion of metro tunnels has been constructed using shield tunneling. As of the end of 2021, the total length of metro tunnels in China exceeded 7000 km across 40 cities (Aijun, 2022). Grouting plays a critical role during shield tunneling, and many construction accidents, such as surface subsidence, segment drift, and adverse loading conditions of segmental rings, in shield tunneling, are related to improper grouting, especially in areas with high water content. However, proper grouting materials, particularly backfill grouting, can significantly improve the conditions of the surrounding strata and contribute to a safer tunneling process (He et al., 2020). Despite the importance of this topic, limited research is available to provide a comprehensive review and systematic summary.

To address this research gap, this paper aims to provide a comprehensive guideline and reference on grouting materials for shield tunneling. The study first introduces grouting techniques in shield tunneling, including different methods and control measures. It then summarizes the compositions of grouting materials and investigates their effects on grouting performance. The study also examines testing methods for properties such as fresh properties, mechanical properties, and durability of grouting materials and compositions. Additionally, the paper introduces the diffusion mechanisms of grouts in shield tunneling and identifies their limitations. Building on this comprehensive review, the paper presents and discusses recent developments in grouting materials for shield tunneling. Finally, it offers a prospect for the future development of grouting materials in this field.

2. Grouting technology in shield tunneling

2.1. Grouting methods

In shield tunneling, grouting can be categorized into three distinct types according to the Chinese Code GB 50446-2017: synchronous grouting, instant grouting, and secondary grouting. Synchronous grouting refers to the backfill grouting method utilized during shield tunneling. It involves injecting grout through grouting holes situated on the shield tail and segmental linings. This simultaneous grouting process ensures the stability of the surrounding strata by controlling ground settlement, preventing water ingress, and enhancing the overall structural integrity of the tunnel. Instant grouting, on the other hand, entails backfill grouting through injection holes located in the segments immediately after they emerge from the shield tail. This prompt grouting procedure aims to fill any voids or gaps that may exist between the segments and the surrounding ground. Instant grouting can be considered a simplified synchronous grouting, which can also improve the tunnel lining's waterproofing capabilities and enhances its load-bearing capacity. Secondary grouting serves as a supplementary phase to synchronous grouting. Its primary purpose is to fill any remaining voids or gaps that might have been left by the initial grouting process. By conducting secondary grouting, these voids are effectively filled, ensuring the comprehensive consolidation of the surrounding strata. These distinct grouting methods play crucial roles in shield tunneling, contributing to the overall safety, stability, and durability of tunnel structures (Bai, 2013, 2019; Wang et al., 2021).

2.1.1. Synchronous grouting

During shield tunneling, as the segmental lining is moved away from the shield tail, an annular gap is formed between the segment and the surrounding strata. Simultaneously, grouting materials are injected into the annular tail void located between the cutting profile and the outer segmental lining (Ye et al., 2019; Zhang et al., 2020a), as shown in Fig. 1. The primary functions of synchronous grouting in this context include:

- (1) Settlement control. Synchronous grouting plays a crucial role in controlling settlement. When the shield headcutter's excavation profile exceeds the outer diameter of the segment, a ring-shaped void is created between the segmental lining and the surrounding strata. Without immediate grouting to fill this void, ground deformation can occur, leading to settlement and deflection of nearby structures. Thus, synchronous grouting is essential to minimize ground disturbance and effectively control ground deformation, ensuring the stability of the surrounding area.
- (2) Improved tunnel waterproofing. The grouting materials injected into the annular tail void during synchronous grouting contribute to enhancing the tunnel's waterproofing. The set grouts act as the initial waterproof layer, effectively sealing the void between the segmental lining and the strata. This process helps to prevent water ingress, safeguarding the tunnel against potential water-related issues and maintaining its structural integrity.
- (3) Segmental ring stability. Synchronous grouting is crucial for ensuring the stability of the segmental ring. The grouting materials, when coupled with the surrounding soil, create a structurally stable matrix. The dense and uniform grouts provide additional support to the segmental ring, preventing uplift and maintaining its stability during and after tunnel excavation.

2.1.2. Secondary grouting

After the setting of the synchronous grouting mortars, the shrinkage volume of grouts would lead to extra voids between the segments and strata (Jin-long et al., 2018). These voids can lead to water leakage, resulting in water seepage and further ground settlement (Li et al., 2016). Furthermore, the grouting material infiltrates the surrounding

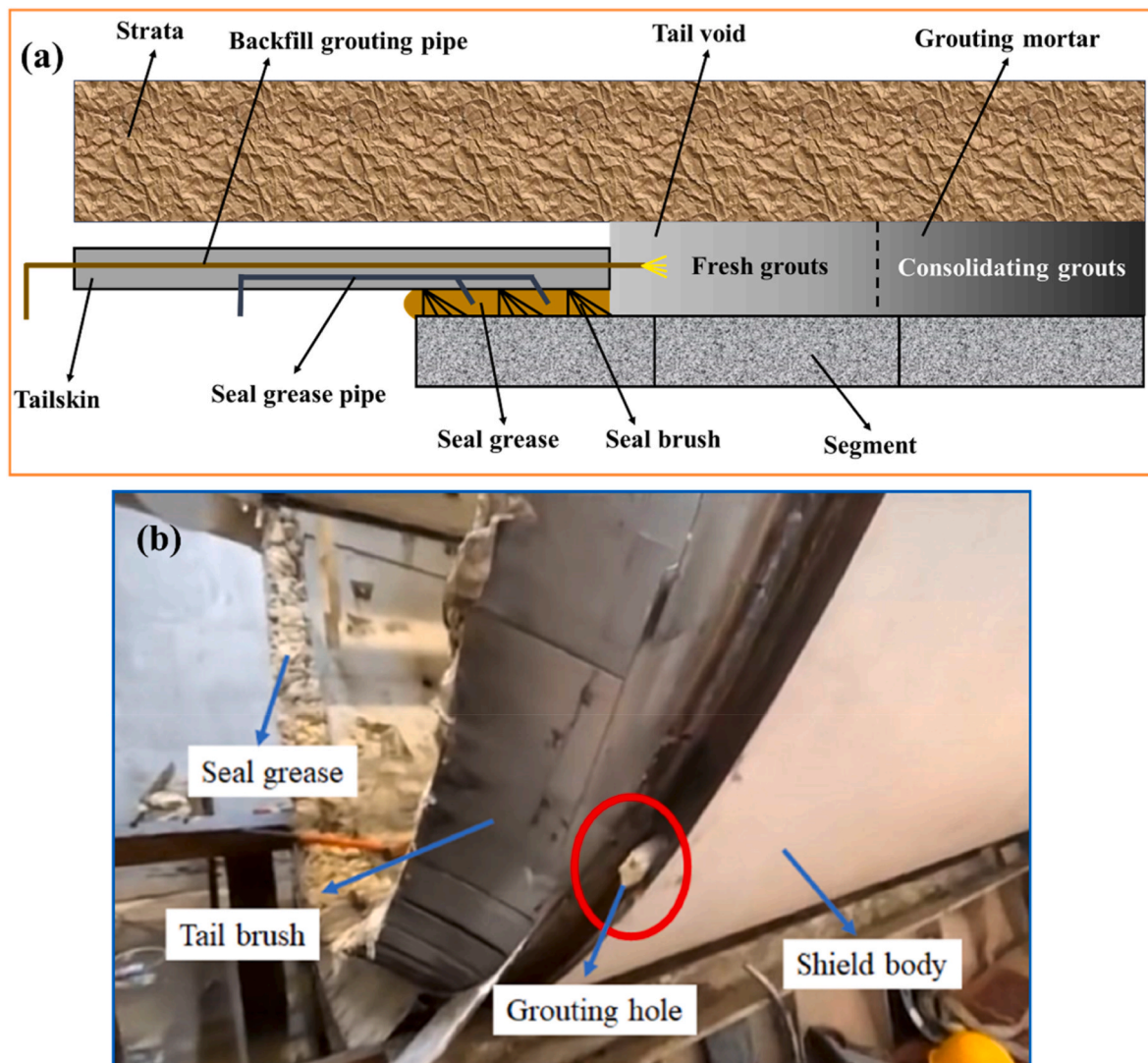

Fig. 1. Schematic of synchronous backfill grouting (Liu et al., 2023; Suwansawat and Einstein, 2007).

soil, significantly strengthening the structural integrity of the tunnel and effectively preventing any potential ground movement (Yong et al., 2014). In addition, secondary grouting plays a crucial role in minimizing potential settlement caused by uneven grouting distribution and volume shrinkage that occurs after the solidification of the synchronous grouting material. This process also helps to mitigate the risk of ground surface subsidence. Consequently, the implementation of supplemental grouting through precast grouting holes in the segments becomes a critical necessity.

2.2. Grouting control

In order to examine the thickness of the grouting layer and understand its diffusion mechanism behind the segment linings, various methods were employed, including direct observation, geophysical prospecting (utilizing nondestructive technology), and the use of buried instruments. A comparative study was conducted to evaluate the effectiveness of these three methods, as depicted in Table 1.

Ground penetrating radar (GPR) is a rapidly emerging technology in geophysical prospecting and non-destructive testing (NDT). It has been extensively utilized in the detection of backfill grouting in shield tunnel constructions, thanks to its remarkable precision and efficiency (Zeng et al., 2023). As mentioned before, the injection of insufficient grouting during tunneling could lead to excessive ground settlement (see Fig. 2).

In the past, engineers relied on experiential knowledge for controlling the annular thickness of the backfill grouting, by managing both grouting volume and pressure. When intolerable settlements were observed, additional grouting was performed to mitigate ground settlement, which was a time-consuming process. Moreover, for complex geological conditions, such as permeable sand layers, determining the necessary amount of backfill grouting and appropriate grouting pressure was challenging. However, GPR has emerged as an effective method for detecting backfill grouting in shield tunnels and providing real-time and valuable information to engineers during the grouting process (Cui et al., 2023; Li et al., 2023c; Xie et al., 2021; Zeng et al., 2020).

The GPR monitoring of grouting involves emitting electromagnetic waves and analyzing their echoes. However, electromagnetic losses occur during wave propagation, which can diminish the quality of monitoring. Understanding the characteristics of electromagnetic losses is essential in choosing the appropriate central frequency for GPR. Furthermore, selecting the suitable antenna central frequency is also crucial. Currently, selecting the right type of GPR is imperative for effectively controlling grouting quality during shield tunneling. Additionally, ensuring proper handling of GPR during the grouting process is vital for achieving accurate monitoring results, as shown in Fig. 3.

Table 1
Comparison of three monitoring methods.

Methods	Advantages	Disadvantages
Direct observation	Direct observation provides a visual means to detect the uniformity of the grouting behind the segments, assess the diffusion range of the grouts, and evaluate the degree of consolidation achieved by the grout.	In cases where certain segments need to be removed, it becomes impossible to directly observe the diffusion process of the slurry.
Geophysical prospecting	Non-destructive testing (NDT) is a valuable method as it avoids causing damage to the tunnel structure. It offers several advantages, including ease of operation, rapid and continuous testing, and the ability to provide relatively accurate reflections of the grouting distribution.	It is worth noting that the electrical properties of the formation medium can be complex and subject to changes, making the detection results susceptible to disturbances. Additionally, data processing for non-destructive testing can be intricate, and the interpretation of scanning images can pose challenges.
Buried instruments	It can provide the advantage of long-term collection of pressure values from the segments. This allows for continuous monitoring and evaluation of the pressure levels over an extended period.	It is important to note that it does not directly reflect the distribution of the grout behind the segments.

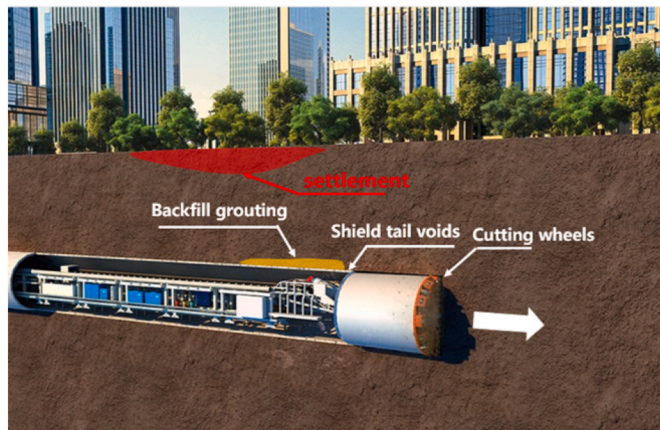

Fig. 2. Surface settlement caused by improper backfill grouting (Zeng et al., 2020).

3. Compositions of grouting materials during shield tunneling

During the grouting process, grouting materials play a crucial role in ensuring the safety of shield tunneling. With the advent of more challenging geotechnical conditions, the complexity of grouting materials has increased. Fig. 4 illustrates the primary categories and compositions of grouting materials used in shield backfill grouting. Single-liquid grouts can be further classified into inert and stiffening grouts. Inert grouts primarily comprise fly ash, sand, bentonite, water, and other additives. These inert grouts do not contain cementitious materials and have relatively low grouting requirements. However, they exhibit low strength and longer setting times, which can negatively impact ground stability. As a result, they were primarily used in the early stages of shield tunnel construction. In contrast, stiffening grouts incorporate cementitious materials such as lime or cement, along with fly ash, sand, cement or lime, bentonite, water, and chemical additives like superplasticizers (Wang et al., 2018). Stiffening grouts possess satisfactory early strength and are commonly employed in contemporary shield

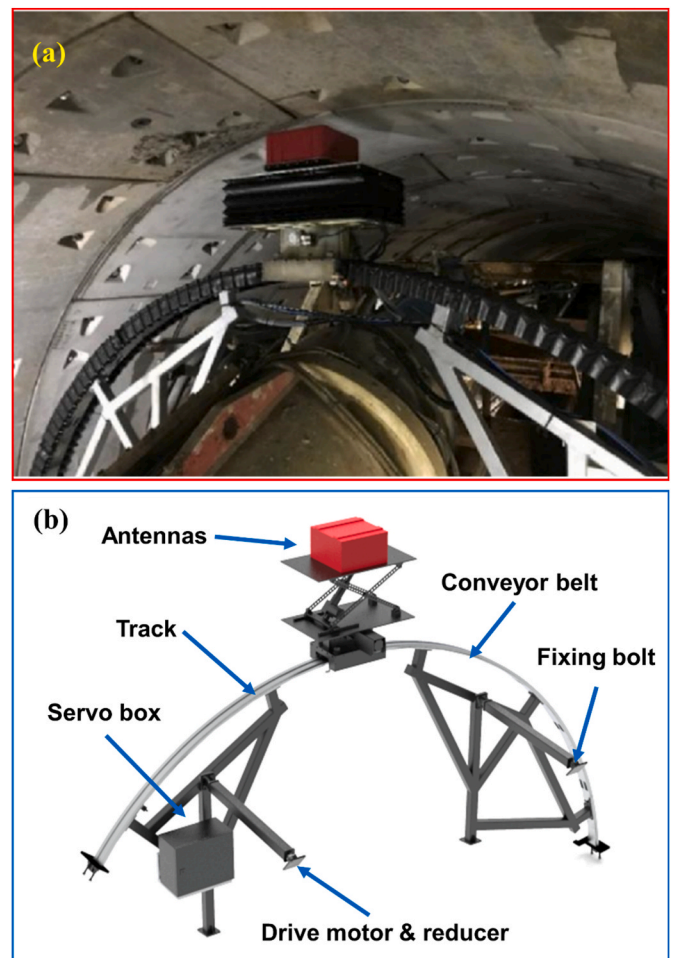

Fig. 3. Layout of the GPR backfill monitoring system (Zeng et al., 2020).

tunnel construction. To provide a comprehensive overview of these grouting compositions, the main characteristics of the grouting constituents are discussed as follows.

Table 2 provides an overview of the typical backfill grouting mixtures utilized in recent shield tunnel constructions and research articles. This section will discuss all the main compositions of backfill grouts for shield tunnels, including the examination of several special grouting components employed in grouting materials.

3.1. Lime

Lime, an air-hardening inorganic cementitious material, primarily consists of calcium oxide as its main component. It is produced by calcining raw materials such as limestone, dolomite, chalk, and shells with high calcium carbonate content at temperatures ranging from 900 to 1100 °C. Lime can be categorized into two forms: quicklime and slaked lime. It is widely utilized in geotechnical engineering due to its abundant raw material sources, simple production process, and cost-effectiveness. In the configuration of synchronous grouts, lime serves as a catalyst for the hydration reaction with fly ash, thereby playing a crucial role in enhancing the early shear yield strength of the grouting slurry. Compared to cement, the hydration reaction of lime and fly ash is slower, resulting in a longer setting time, which is advantageous for projects with extended construction durations. Slaked lime exhibits a higher degree of hydrolysis and a greater content of Ca(OH)₂. When combined with fly ash, it facilitates a faster hydration reaction, enabling the grouting slurry to achieve higher yield strength at an early stage. However, the use of lime additives, particularly quicklime, can lead to

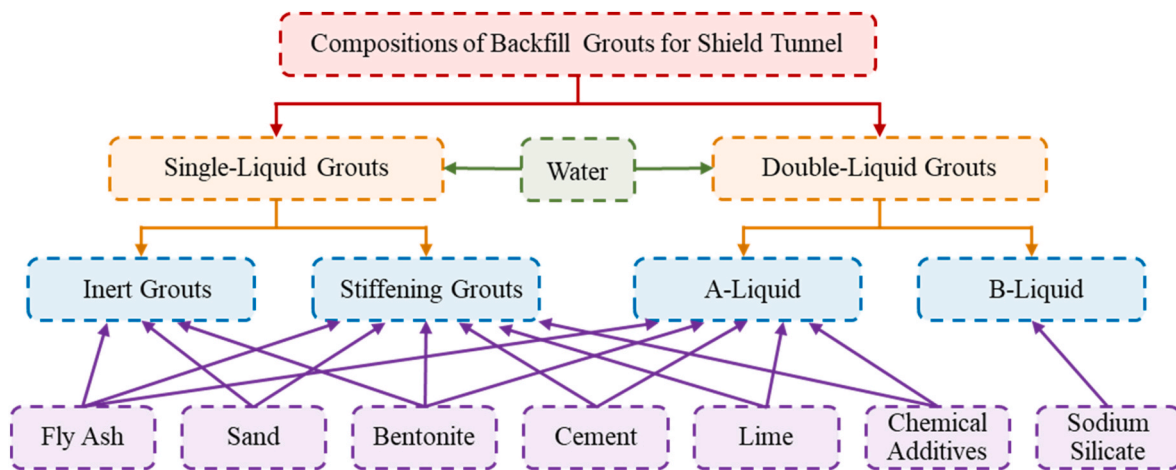

Fig. 4. Main categories and compositions of grouting materials during shield tunneling.

Table 2
Compositions of backfill grouts in the recent shield tunnel constructions or research.

Year	Locations	Main compositions	Strata properties	Reference
2015	Jiangsu, China	FA, Inorganic calcium, sodium bentonite, Sand, Water, Water reducer	Underwater	(Yao et al., 2015a)
2018	Hunan, China	42.5 OPC (30%), sodium bentonite (1.30%), Meta-aluminate (1.25%), Lignin (0.20%), Sand, Water, Water reducer	Karst area	(Zhang et al., 2018a)
2018	Shandong, China	OPC, Water glass solution, Sand, Water, Water reducer	Coastline of Yellow Sea	Yu et al. (2018)
2020	Henan, China	OPC, FA, Sand, Discharged soil	Clay layer and fine sand layer	(Zhang et al., 2020a)
2022	Research	OPC, FA, Sodium bentonite, Sand, Water, Water reducer	/	Song et al. (2022)
2022	Research	OPC, FA, Sand, Water, Flocculant (Hydroxyethyl methyl cellulose and Sodium bentonite)	/	Wang et al. (2022)
2022	Suzhou, China	Slag, OPC, gypsum, activator, water	Silty clay layer	Wu et al. (2022)
2022	Research	OPC, FA, Sodium bentonite, Sand, Water, Water reducer	/	Wu et al. (2022)
2022	Nanjing, China	OPC, FA, Yellow sand, Water reducer, Bentonite, Silty find sand	Clay layer	(Zhang et al., 2022b)
2022	Nanchang, China	OPC, Cement, FA, Sand, Bentonite	Moderately weathered argillaceous siltstone	(Jiang et al., 2022b)

volume shrinkage and a reduction in compressive strength (Zhang et al., 2017a; Zhu et al., 2021). Therefore, the quantity of lime should be carefully controlled based on the characteristics of the grouting formations.

3.2. Cement

Cement-based grouting materials have found widespread use in various engineering applications. In comparison to chemical grouts,

cement-based grouts offer several advantages, including cost-effectiveness, non-toxicity, easy availability, and favorable mechanical properties (Rahman et al., 2015; Zhang et al., 2018a). Currently, ordinary Portland cement (OPC) is the primary source material for cement-based grouting materials (Anagnostopoulos, 2014; Celik and Canakci, 2015; Juenger et al., 2011; Nguyen et al., 2011; Zheng et al., 2021). However, OPC possesses certain characteristics that can give rise to engineering challenges, such as a long setting time, low early strength, and susceptibility to shrinkage cracks in the hardened state (Krishnamoorthy et al., 2002). These drawbacks can undermine the effectiveness of grouting reinforcement. To address these limitations, sulfoaluminate cement (CSA) was developed as an alternative. CSA cement exhibits several advantages over Portland cement, including a shorter setting time, higher early strength, and micro-expansion properties. The hydration process of CSA cement differs from that of Portland cement, with ettringite being one of the primary hydration products in CSA cement. The presence of a substantial quantity of ettringite in CSA cement contributes to its superior early strength and expansion performance. As a result, CSA cement has gained popularity as the preferred choice for cementitious grouting materials in contemporary applications.

3.3. Fly ash

Fly ash is an industrial solid waste primarily generated from coal combustion. The significant increase in coal consumption driven by growing energy demands has resulted in a substantial rise in coal fly ash production, from 500 million tons in 2005 to 750 million tons in 2015 (Jiang et al., 2020b; Yao et al., 2015b). Unlike typical industrial solid waste, coal fly ash is a highly complex man-made material comprising over 100 individual mineral groups (Jiang et al., 2020a). Presently, fly ash is extensively used as a partial replacement for cement. The main components of fly ash include SiO₂, Al₂O₃, CaO, and Fe₂O₃. When subjected to hydrothermal treatment, fly ash can react with calcium hydroxide and other alkaline hydroxides like NaOH and KOH, forming hardened cementitious compounds. Consequently, fly ash has become a popular source material for alkali-activated materials such as geopolymers. According to the AASHTO M295-98 standard and GB/T 50146-2014 standard, fly ash can be classified into two classes: Class C and Class F. Class F fly ash (FFA) is primarily derived from the combustion of bituminous and anthracite coals, with a total content of SiO₂, Al₂O₃, and Fe₂O₃ exceeding 70%, and a CaO content below 10%. On the other hand, Class C fly ash (CFA) is mainly derived from the combustion of lignite and sub-bituminous coals, with a total content of SiO₂, Al₂O₃, and Fe₂O₃ exceeding 50%, and a CaO content above 10%. In grouting materials, Class F fly ash is commonly employed due to its lower

hydration heat and longer setting time, which are beneficial for long-distance transportation in shield machines. Furthermore, the addition of fly ash as an additive contributes to the workability and impermeability of grouts, as well as enhances their resistance to water corrosion (Huang, 1997; Mirza et al., 2002; Pastor et al., 2016). The particle size distribution of fly ash also plays a crucial role in the properties of grouts. Finer fly ash particles exhibit better activity and can improve the pumpability of grouts while reducing the secretion and segregation of the grouting slurry.

3.4. Bentonite

Cement-based materials have been extensively used as grouts or jet grouting because they are low-cost and easy to work with. However, cement-based grouts have their limitations in grouting media with low permeability to penetrate micropores (Shen et al., 2013). Additionally, cement can react with groundwater, resulting in the generation of hyper-alkaline leachate, which can impact the long-term durability and homogeneity of the in-situ medium. As an alternative, bentonite grouting has gained attention due to its environmentally friendly nature and long-term safety (Chegbeleh et al., 2014). Bentonite is a non-metallic clay primarily composed of montmorillonite, which possesses unique adsorption properties contributing to the swelling characteristic of bentonite (Li et al., 2021; Mahmoud et al., 2021; Sha et al., 2018). Based on its chemical composition, bentonite can be categorized into sodium-based and calcium-based bentonite (Bezuijen et al., 2009). Sodium-based bentonite exhibits higher water absorption capacity and greater expansion compared to calcium-based bentonite. During the grouting process, bentonite can expand more than ten times its original volume. Moreover, sodium-based bentonite surpasses calcium-based bentonite in suspension, thixotropy, thermal stability, adhesion, and mechanical properties such as compressive and tensile strengths (Dela-leux et al., 2012; Tiedje and Guo, 2014). Therefore, sodium-based bentonite is currently chosen as a “lubricant” for grouting materials in shield tunneling, given its favorable properties and suitability for the current construction stage. During the backfilling of shield tunnels, bentonite plays a critical role in ensuring the stability, safety, and durability of shield tunnels by providing fluid loss control, lubrication, soil stabilization, sealing, and groundwater control. Bentonite has excellent fluid loss control properties, which means it can minimize the loss of water from the grout mixture during placement. This helps in maintaining the consistency and stability of the grout, preventing excessive water loss or bleeding. During the tunneling process, the shield tunneling machine requires smooth and easy movement as it passes through the soil. Bentonite helps in providing lubrication between the soil and the shield machine, reducing friction, and facilitating smooth tunneling. Bentonite can act as a soil stabilizer by improving the structure and cohesive properties of the surrounding soil. This is especially important in shield tunnels as it helps maintain the stability and integrity of the tunnel during and after construction. Bentonite can swell when in contact with water, forming a gel-like substance. This property allows it to seal cracks, voids, or gaps in the surrounding soil or tunnel lining, preventing water ingress and potential instability. Bentonite has low permeability, which means it can limit the flow of groundwater into the tunnel. This is crucial for preventing water accumulation, and reducing the risk of water-related issues such as erosion, settlement, or corrosion.

3.5. Sand

Sand serves as fine aggregates to be the skeleton of the grouts. The particle gradation of sand plays a crucial role in determining various properties of the grouts, including density, workability, and bleeding rate. Additionally, the grading of sand can impact dimensional stability and the modulus of elasticity during compression of cementitious-based mortars (Haach et al., 2011; Venkatarama Reddy and Gupta, 2008).

According to the Standard GB/T 14684-2001, a fineness modulus range of 2.2–2.6 (medium sand) is considered suitable for grouts. When the fineness modulus is smaller than 1.5, the grouts are prone to precipitation, and the dispersion of the grouting slurry during long-distance transportation can result in lower strength. Moreover, the permeability of the grouts decreases with the increase in the fineness modulus of the sand. Therefore, medium sand is commonly preferred as the optimal choice for grouting due to its balanced properties.

3.6. Chemical additives

Sodium silicate (Na_2SiO_3) serves as the primary component of liquid B in double-liquid grouts and is highly favored as a source material due to its environmental compatibility and safety (Moayedi, 2012). It is also a crucial alkaline activator in alkaline-activated materials (AAM). When sodium silicate reacts, the active silicate solution forms a colloidal substance that further polymerizes, generating a gel matrix that binds soil particles and fills voids. In grouting applications, sodium silicate plays a role in reducing the setting time and enhancing the water-proofing ability, particularly in water-rich strata. Additionally, sodium silicate accelerates the activity of fly ash and improves the mechanical properties of hardened grouting mortar (Hemalatha and Ramaswamy, 2017; Lee and Van Deventer, 2002). Grouts containing sodium silicate exhibit a short initial setting time, high strength, and good resistance to dilution when exposed to groundwater. However, the incorporation of sodium silicate may lead to mortar shrinkage, impacting its long-term durability. To address this, double-liquid grouts are typically employed in conjunction with chemical additives to enhance scour resistance and improve the durability of the grouting slurry (Zhang et al., 2018e). While double-liquid grouts are widely used in Japan, their application in current shield tunnel constructions in China is limited due to issues such as pipe clogging, excessive grouting, and inadequate grout filling.

To enhance the injectability of grouting materials in shield tunneling, chemical additives, particularly polymeric dispersant admixtures, are introduced to improve the fluidity, water retention, and stability of the fresh grouts, as well as to prevent particle agglomeration. Superplasticizers (SPs), known as water reducers, have been widely utilized in modern concrete to customize its properties and meet various construction requirements (Duran et al., 2018; Ley-Hernández and Feys, 2021). Common types of SPs include polycarboxylate ethers (PCEs), poly-naphthalene sulfonate (PNS), and lignosulfonate (LS) (Jorne et al., 2015). PCEs operate through electrostatic repulsion and steric hindrance mechanisms. The negatively charged backbone of PCEs attaches to cement particles, altering their surface charge, while the non-absorbing side chains induce steric repulsion, increasing the average distance between cement particles. This improves dispersion and prevents re-agglomeration, facilitating the release of water trapped within the flocculated structure and reducing the material’s viscosity (Uchikawa et al., 1997; Yoshioka et al., 1997). PNS employs short-range steric repulsive forces and sulfonate groups to negatively charge cement surfaces. These repulsive forces hinder cement particle agglomeration and enhance the fluidity of cement pastes. An advantage of PNS is that its use does not affect the stability of the entrained air pore network. Typically, multiple SPs are combined for improved efficiency. Lignin is another water-reducing agent employed in grouting mortar (Zhang et al., 2018a). Table 3 provides an overview of commonly used chemical additives in grouts during shield tunneling and their respective functions.

The ratios between source materials are crucial in determining the performance of grouts. Several key ratios, such as Water/Cement (W/C), Water/Binder (W/B), Bentonite/Water (Ben/W), and Cement/Fly ash (C/F), need to be carefully controlled within appropriate ranges, considering the geological conditions. Table 4 presents a summary of ratio ranges in different formations based on previous studies (Gan et al., 2022a; Liang et al., 2022; Ou et al., 2022; Yang et al., 2022c; Zhang et al., 2022c; 2022d).

Table 3
Common chemical additives of grouts during shield tunneling.

Chemical additives	Types	Functions
Water reducer	Naphthalene sulfonate; Sulfonate formaldehyde; Modified lignosulfonate; Heterocyclic polymer; Amino sulfonic acid; Multi-carboxylic acid	Promote dispersion of cement particles; improve fluidity of grouts; and keep the consistency and strength of grouts
Expansive agent	Calcium sulphoaluminate; CaO and MgO series	Increase the volume and density of solidified grouts
Retarder	Organic series (Tartaric acid, propionate alcohol); Inorganic series (Sodium polyphosphate, calcium nitrate, disodium hydrogen phosphate)	Delay the hydration reaction of cement and improve the pumpability of grouts
Flocculating agent	Hydroxypropyl methylcellulose; Polyacrylamide; Styrol copolymer; Silica fume, Slaked lime	Limit grout dispersion and segregation

Table 4
Reasonable ratios' ranges (Liang et al., 2022).

Formations	W/B	B/S	Ben/W	C/F
Rock	0.75–1.05	0.45–0.65	0.12–0.17	0.20–0.55
Gravel	0.87–1.03	0.62–1.41	0.13–0.29	0.32–0.78
Sand	0.85–0.98	0.49–0.92	0.12–0.25	0.22–0.52
Clay	0.63–1.00	0.59–0.89	0.10–0.25	0.25–1.22

To achieve resilient, sustainable, and environmentally friendly underground structures, it is important to consider low-carbon properties when selecting source materials for grouts during shield tunneling. This involves choosing materials that have a reduced carbon footprint and contribute to lower greenhouse gas emissions throughout their lifecycle. Alternative cementitious materials, such as supplementary cementitious materials (SCMs) like fly ash or slag, can be used as partial replacements for traditional cement to reduce the carbon intensity of the grouts. Furthermore, the chemical additives used in grouts should be chosen with a focus on lowering their environmental impact while ensuring that their performance is not compromised. This can involve selecting additives that have a lower ecological footprint, are derived from renewable sources, or have minimal adverse effects on the environment during production and application. Additionally, efforts can be made to minimize the use of harmful substances and prioritize additives that are biodegradable and non-toxic. By integrating low-carbon source materials and environmentally friendly chemical additives into grout formulations, the construction of underground structures can contribute to sustainable development goals, reduce carbon emissions, and promote the overall environmental performance of shield tunnel projects.

4. Testing methods and typical characteristics of grouting materials in shield tunneling

In order to ensure the suitability and performance of grouting materials for shield tunneling in different geological conditions, it is essential to conduct thorough testing and investigation of their properties (Jiang et al., 2022b; Zhou et al., 2018). Various properties of both fresh and hardened grouting mortar need to be evaluated to assess their effectiveness in tunneling applications. The efficiency of grout delivery and pumping, as well as the prevention of uplift, greatly rely on the properties of fresh mortar such as workability, density, fluidity, setting time, bleeding rate, and viscosity (Cheng et al., 2018; Di et al., 2021; Zhang et al., 2018c). These properties can be measured using appropriate test methods and standards to ensure consistency and reliability in the assessment. On the other hand, the characteristics of hardened grouting mortar, such as compressive strength, flexural strength,

shrinkage, shear yield strength, scour resistance, waterproof ability, and durability, are important indicators of its long-term performance and stability. These properties can be evaluated through various testing techniques and standards to ensure that the grouting mortar meets the required specifications for shield tunneling applications. By conducting comprehensive investigations and evaluations of the grouting mortar's properties, engineers and practitioners can make informed decisions and select materials that align with the specific requirements of the project. This approach helps to ensure the reliability and effectiveness of the grouting materials during shield tunnel construction. Table 5 and Fig. 5 show a summary of the typical characteristics, test methods, and standards for the backfill grouts of shield tunneling in recent studies. Based on the practical engineering cases, the typical properties of grouting mortar are discussed below.

4.1. Fresh properties

The workability of fresh grouting mortar plays a crucial role in ensuring its uniformity, homogeneity, and consistency during shield tunneling (Vafaei and Allahverdi, 2017). Workability refers to the ease with which the grouting mortar can be handled, placed, and compacted. It is commonly measured using the slump cone test, which is conducted according to the ASTM C143 standard. The workability of grouting mortar is often indicated by the diffusion radius exhibited during the slump cone test. A larger diffusion radius indicates higher workability, while a smaller diffusion radius suggests higher cohesion of the grouts. It is desirable to have suitable workability that allows for the pumpability of the grouting material. Controlling the workability is also important in preventing the uplift of the segmental lining of the tunnel (Draganović and Stille, 2011; Pascual-Muñoz et al., 2018; Wang et al., 2018). The water-to-cement ratio (W/C) or water-to-binder ratio (W/B), particularly for cement-based grouting materials, is a significant factor influencing the workability of the mortar. Increasing the W/C or W/B ratio generally leads to a higher workability of the grouts. Additionally, chemical additives such as superplasticizers (SP), fly ash, metakaolin, and sodium silicate (double liquid) can also influence the workability of grouts (Sonebi et al., 2013). These additives can modify the rheological properties of the grouting mortar, affecting its flowability, viscosity, and cohesiveness. By carefully controlling the W/C or W/B ratio and incorporating appropriate chemical additives, the workability of grouting mortar can be optimized to meet the specific requirements of shield tunneling, ensuring efficient placement and consolidation of the material.

Setting time is an important property of grouting mortar and can be divided into initial and final setting times. The Vicat needle apparatus,

Table 5
Typical characteristics, test methods and standards.

Characteristics	Test methods	Standards	Reference studies
Workability	Slump cone test	ASTM C143	(Yao et al., 2015a)
Setting time	Vicat needle test	ASTM C191	(Yu et al., 2018; Zhang et al., 2020a, 2018a)
Fluidity	Flow table test	ASTM C1437	(Zhang et al., 2020a)
Shrinkage	Length measurement	ASTM C596	Yu et al. (2018)
Bleeding rate	Vibrating test	ASTM C232	(Yao et al., 2015a; Zhang et al., 2020a)
Compressive strength	Unconfined compression test	ASTM C39	(Pelizza et al., 2010; Zhang et al., 2020a, 2018a)
Flexural strength	Third-point loading test	ASTM C78	He et al. (2020)
pH	pH test paper or pH pencil test	ASTM D4262	He et al. (2020)
Permeability	Absorption and voids measurement	ASTM C642	Yu et al. (2018)



Fig. 5. Performance test methods of grouting mortar.

following the ASTM C191 standard, is commonly used to determine these setting times. The initial setting time refers to the moment when the grouting mortar starts to harden and lose its plasticity, while the final setting time is the point at which the grouting mortar completely loses its plasticity and becomes hard (Jiang et al., 2022a). Proper control of setting time is crucial for ensuring the quality of grouting during pumping and filling operations. If the initial setting time is too short, the grouting mortar can harden quickly and may not be able to reach the entire tail void through pumping. This can result in blockages in the pumping pipes. Conversely, if the final setting time is too long, the low-strength grouting mortar may lead to settlement of the tunnel (Zhang et al., 2019; Zhuang and Chen, 2019). The setting time of grouting mortar is influenced by the properties of the raw materials used. Lime-based grouts generally require more time to set compared to cement-based grouts. The addition of Class F fly ash can also prolong the setting time of the grouting mortar. Sodium silicate is often added to form quasi-alkaline activated materials for specific geological conditions, as it has a quick-setting effect (Blissett and Rowson, 2012; Hemalatha and Ramaswamy, 2017; Lee and Van Deventer, 2002). Meta-aluminate can be used as a setting accelerator to shorten the setting time (Zhang et al., 2018a). Therefore, setting time needs to be carefully controlled based on the properties of the tunneling strata (Zhang et al., 2018b). Additionally, the water-to-cement (W/C) ratio also affects the setting time of grouts, with a higher W/C ratio generally resulting in a longer setting time. Controlling the setting time ensures that the grouting mortar can be properly placed and hardened within the required timeframe.

Fluidity is an important property that indicates the plasticity and

flowability of grouting mortars. It can be measured using a flow table test, which follows the ASTM C1437 standard (Lee et al., 2003). The fluidity of grouting mortars directly affects their pumpability and filling capacity (Khayat and Yahia, 1998; Mascarin et al., 2022). When the fluidity of grouts is too low, the grouting pipes can become blocked, impeding the proper flow of the material. In addition, the low-fluidity grouts could result in uneven grouting behind the segments. Conversely, grouts with high fluidity can experience segregation and lead to uplifting of the segmental lining (Song et al., 2019; Zhang et al., 2020b). Therefore, achieving an appropriate level of fluidity is crucial for successful grouting operations. Several factors can influence the fluidity of grouts. The water-to-cement (W/C) ratio is a significant factor, where a higher ratio generally results in increased fluidity. The particle size distribution of the constituent materials also plays a role, as it affects the packing and flowability of the grouting mortar. Additionally, the inclusion of special soil additives can impact the fluidity of grouts as well. By controlling these factors and ensuring the appropriate fluidity of grouting mortars, the material can be effectively pumped and filled, leading to successful grouting operations in shield tunneling projects.

Bleeding in fresh grouts refers to the process where free water in the mixture is displaced and rises to the surface due to the settling of heavier solid particles, such as cement and aggregates. Excessive bleeding can have an impact on the durability of the grouting mortar (Song et al., 2019). The primary factor influencing the bleeding rate is the water-to-cement (W/C) ratio. A higher W/C ratio tends to result in more bleeding. The type of cement and the characteristics of the fine aggregates also play a role in determining the bleed rate. The objective of

managing the bleeding rate is not necessarily to eliminate bleeding water completely but rather to control it to ensure the quality of the grouts. Allowing free water to migrate to the surface and evaporate can reduce the overall W/C ratio of the structure, leading to a decrease in capillary porosity, increased density, and improved durability. The bleeding of grouting mortar can be tested using the bleeding test method outlined in the ASTM C232-07 standard. This test helps measure and assess the bleeding rate of the grouting mortar. In the context of shield tunneling, the bleeding rate should typically be controlled within 5% to ensure optimal performance (He et al., 2020).

Rheology, which refers to the deformation and flow behavior of materials, plays a crucial role in understanding the properties of cement grout. Cement-based grouts, consisting of cement particles, fine aggregates, bentonite, water, and air, exhibit complex rheological characteristics due to their thixotropic nature. These grouts can be described as suspended solid particles within a viscous medium (cement paste) (Chidiac et al., 2000, 2003; Chidiac and Mahmoodzadeh, 2009; Rosh-avelov, 2005). In the context of shield tunneling, the rheological properties of fresh grouting mortar, including plastic viscosity and yield stress, are of great importance (Chidiac and Mahmoodzadeh, 2009; Han et al., 2019). Viscosity represents the frictional forces within the grouts and can be measured using a rotational rheometer following the ASTM C1749 standard. Other techniques, such as ultrasound and magnetic resonance imaging (MRI), can also be used to analyze the rheological behavior of grouting mortar (Rahman et al., 2015; Vyšvařil et al., 2018). Ultrasound Velocity Profiling (UVP) is a method for measuring the instantaneous velocity distribution along a pulsed ultrasound beam axis (Rahman et al., 2015). The viscosity of grouting mortar significantly affects its fluidity and stability (G. Zhang et al., 2017b). Therefore, it is crucial to maintain an appropriate viscosity for grouts in shield tunneling. The water-to-cement (W/C) ratio is a determining factor for viscosity, while the influence of the water-to-binder (W/B) ratio depends on the specific source materials of the grouting mortar. In lime-based grouts, viscosity generally increases with the W/B ratio when it is below 0.8. However, in cement-based grouts, viscosity decreases with the W/C ratio, and the rate of decrease slows down when the W/C ratio reaches two (Aboulayt et al., 2018). Furthermore, additives such as fly ash, metakaolin, and superplasticizers (SPs) can also affect the viscosity of grouts (Rahman et al., 2017).

4.2. Mechanical properties

Mechanical properties are crucial in assessing the performance of hardened grouting mortar during shield tunneling. Compressive strength and flexural strength are two typical mechanical properties that are often considered (Mirza et al., 2002; Torres-Carrasco and Puertas, 2015; Zhang et al., 2023b). Compressive strength is widely used as a key mechanical parameter to evaluate the quality of hardened grouting mortar. The influence of the water-to-binder (W/B) ratio is particularly significant for lime-based grouts, where the compressive strength decreases with an increasing W/B ratio (Xu et al., 2018). In cement-based grouts, the water-to-cement (W/C) ratio is the determining factor, and an increase in the W/C ratio generally leads to a decrease in compressive strength. The compressive strength is commonly measured through uniaxial compression tests following the ASTM C39 (cylinders) or C109 (cubes) standards. Flexural strength, on the other hand, represents the ability of hardened mortar to withstand bending moments. It is typically measured using the beam bend test according to the ASTM C78 standard. There is a positive linear relationship between flexural strength and compressive strength (Zhang et al., 2018d). The ratio of compressive strength to flexural strength typically falls within the range of 0.25–0.55 (Zhang et al., 2018d) and the compressive strength to flexural strength ratio is within 0.25–0.55 (Ashour, 2000; Atis et al., 2009; He et al., 2020). It is important to ensure that the early (e.g., 3 days) and late (e.g., 28 days) strengths of the grouting mortar meet the specific requirements of each shield tunnel project. These strength parameters are

essential for assessing the overall performance and durability of the grouting material in the context of shield tunneling.

4.3. Durability

During the mixing of grouts, water is added to initiate the hydration process of cement. However, controlling the accurate water content can be challenging, especially in practical construction scenarios. The presence of excess water in the grouting mortar can lead to bleeding, where the water separates from the mixture. As the water bleeds out, volume shrinkage occurs within the grouts. If the hardened cement-based grouts are not sufficiently strong to withstand the tensile forces resulting from this volume change, cracks can form inside the mortar and propagate to the surface. The shrinkage of grouts reduces their filling effect (Liu et al., 2020). The W/B ratio is a primary factor influencing grout shrinkage. For cement-based and lime-based grouting mortar, the volume shrinkage increases with a higher W/B ratio. In the case of alkaline-activated grouting mortar (double liquid), the dosage of sodium silicate is another important factor influencing shrinkage (Cheng et al., 2018; Moayedi, 2012; Yu et al., 2018). To measure the drying shrinkage of mortar, the ASTM C596-18 standard provides a test method. The average change in unit length and the percentage of the effective gage length of four samples from the same batch of mortar are reported as the drying shrinkage of the mortar. This test helps evaluate the extent of shrinkage that can occur in the grouting mortar during the drying process.

When encountering special geological conditions during shield tunneling, certain characteristics such as scour resistance, pH, durability, water corrosion resistance, and waterproof performance become crucial. Ensuring grouting mortar with good scour resistance is highly important when tunneling through water-rich strata (Li et al., 2020; Liu et al., 2019). Dilution of grouts by groundwater during excavation in such layers can hinder them from achieving the desired strength, resulting in poor grouting quality. Additionally, the grouting layer serves as a direct protective barrier for segmental linings, making it essential for the pH of the grouts to match the water environment (Pedrotti et al., 2017). Failure to maintain the pH compatibility can lead to a decrease in the strength of the hardened grouting mortar due to ion exchange between the grouts and the surrounding formation. Grouts with good durability are vital as they ensure the long-lasting effectiveness of the grouting layer in protecting the tunnel structure. The durability can be compromised by sulfate and chloride attacks, which weaken the grouting layer's resilience (Li et al., 2023a; 2023b). The waterproof performance of hardened grouts is crucial for the safety and operation of the tunnel. The resistance of grouts to water pressure and penetration depends on the impermeability of the hardened grouting mortar. Adequate waterproof performance not only safeguards the tunnel construction but also enhances the overall durability of the tunnel structure (Fang et al., 2017).

In the past, many scholars and engineers tried to summarize the laws for optimum selection of backfill grouting materials and ratios for shield tunneling considering stratum suitability (He et al., 2020; Liang et al., 2022; Mao et al., 2020; Yang et al., 2022a; Ying et al., 2022; Zhang et al., 2022a; 2022b). Table 6 provides a summary of reasonable property ranges for grouts in different formations based on the previous studies. However, these ranges can just serve as general guidelines and should be adjusted based on specific project requirements and the geological conditions encountered during shield tunneling. It is important to conduct site-specific testing and evaluations to determine the optimal properties of grouts for each individual shield tunneling project.

Ye et al. (Liang et al., 2022) provided a comprehensive overview of the applications of modified grouts in various geological strata, drawing from a study of 109 shield tunnel projects in China (see Fig. 6). However, selecting the appropriate grouting materials can be challenging when relying solely on general formation classifications. Other factors, such as groundwater, can significantly impact the selection process. Moreover,

Table 6
Reasonable properties' ranges of grouts for different formations (Liang et al., 2022).

Formations	Density (g/cm ³)	Bleeding rate (%)	Consistency (mm)	Setting time (h)	3-day compressive strength (MPa)	28-day compressive strength (MPa)
Rock	1.72–1.86	<15	90–120	9–25	>0.5	>2.5
Gravel	1.47–1.84	<10	120–140	10–22	>1.0	>2.5
Sand	1.69–1.86	<5	90–130	10–24	>0.6	>2.5
Clay	1.72–1.93	<5	70–130	4–24	>0.6	>2.5

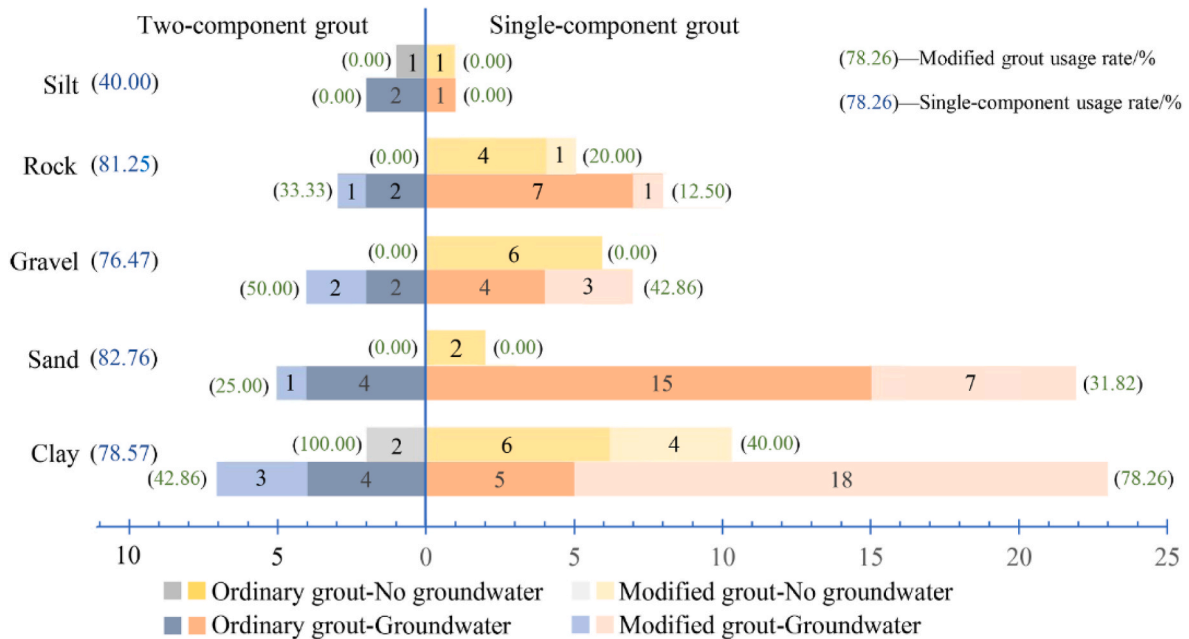

Fig. 6. Applications of modified grouts in different strata (Liang et al., 2022).

strata are often characterized by non-uniformity and comprise multiple formations. Therefore, there is a pressing need for a more detailed and all-encompassing approach to grout mixture selection, which considers the specific characteristics of different formations.

5. Diffusion mechanism of grouts in shield tunneling

The grouting mechanism, particularly the diffusion theory of penetration grouting in shield tunneling, is crucial for the design and optimization of the grouting mixtures (Bezuijen et al., 2004; Ye et al., 2020, 2021). In addition, the calculation of the loading condition using a reliable diffusion can ensure the safety of the excavation and segmental structure. The movement of grouts during grouting can cause soil expansion and excess pore water pressure, which may disturb the surrounding area. The stability of the tail voids is also influenced by the changing interface between the soil and grouts as pressurized grouts diffuse through the surrounding soil. Therefore, it is essential to develop reliable grout diffusion mechanisms to address these issues. Several theories have been proposed, including the spherical diffusion theory, columnar diffusion theory, and sleeve valve pipe penetration grouting theory, which consider grouts as Newtonian fluids with shear rate-dependent shear stress (Jiang et al., 2018).

Previous studies have often treated the soil and grouts as homogeneous single-phase media, neglecting the interactions between soil pores and the solid-liquid constituents of the grouts. This oversimplification may lead to inaccurate results that do not reflect the actual properties of grouting mortar. Moreover, the complex interactions among the different layers of the strata, segmental linings, and grouts present additional challenges in developing a more accurate diffusion model. To address these limitations, Ye et al. (2019) developed a half-spherical surface diffusion model to investigate the influence of various

parameters on the grouting effect, taking into account the infiltration effect of soil (as shown in Figs. 7 and 8). The soil, being a typical porous medium, has the capability to capture grain deposits in its pores and prevent their movement with the grouting mortar, thanks to its infiltration function. By considering this infiltration effect, the magnitudes of grouting pressure on the segment are found to be larger compared to conditions without considering the infiltration effect. Additionally, percolation effects become evident in the loading of the segment. The development of more accurate diffusion models that consider the complex interactions and infiltration effects between the soil, grouting mortar, and surrounding structures is crucial for improving the understanding and control of the grouting process in shield tunneling.

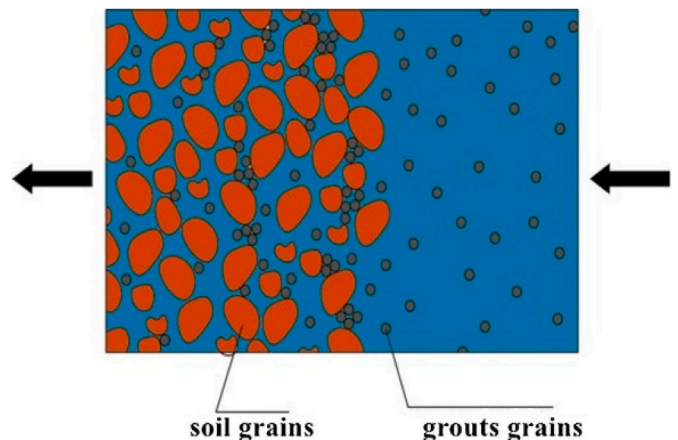

Fig. 7. Infiltration effect (Ye et al., 2019).

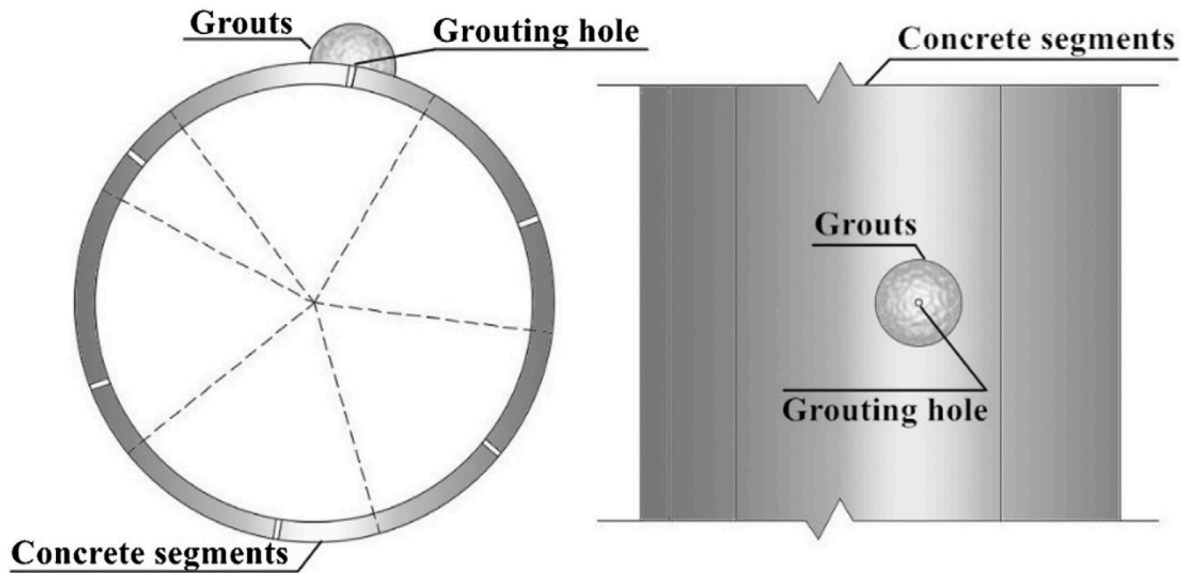

Fig. 8. Half-spherical surface diffusion (Ye et al., 2019).

Liu et al. (2021b) proposed a grouting diffusion model specifically for backfilling grouts along the radial direction of segmental linings under hydrostatic pressure. The model incorporates the force-equilibrium principle, Darcy’s law, and momentum conservation, as illustrated in Fig. 9. In this model, the backfill grouts are treated as Bingham fluids, which possess a yield stress that resists initial movement. The study found that the distance of grouting diffusion decreases as the yield stress of the backfill grouts increases. Additionally, the initial grouting pressure has a significant impact on the diffusion distance. These findings highlight the influence of the rheological properties of the grouting material, particularly its yield stress, on the extent of grout diffusion during the backfilling process. This diffusion model provides valuable insights into the behavior of grouting materials under hydrostatic pressure, aiding in the understanding and optimization of the grouting process for segmental linings in shield tunneling applications.

theory of capillary tubes in infiltration grouting theories. However, these theories make the simplifying assumption that groundwater has a well-defined boundary and often overlook the distinctions between grouts and groundwater (Ye et al., 2020). As a result, it becomes essential to consider the interaction between groups and groundwater for more realistic and practical outcomes. To address this issue, researchers have explored cylindrical and spherical infiltration diffusion models for backfill grouting using power-law fluids as grout in a gravel soil layer, as depicted in Fig. 10. These models aim to account for the inter-reaction between the grouts and underground water, providing a more accurate representation of the grouting process. The findings from these investigations highlight the importance of considering the actual interaction between grouts and groundwater to obtain practical and reliable results. By incorporating this aspect into the infiltration diffusion models, researchers can enhance the understanding and effectiveness of grouting processes in real-world scenarios.

Many previous studies have relied heavily on Darcy’s law and the

The current research on the diffusion mechanism of grouts in shield

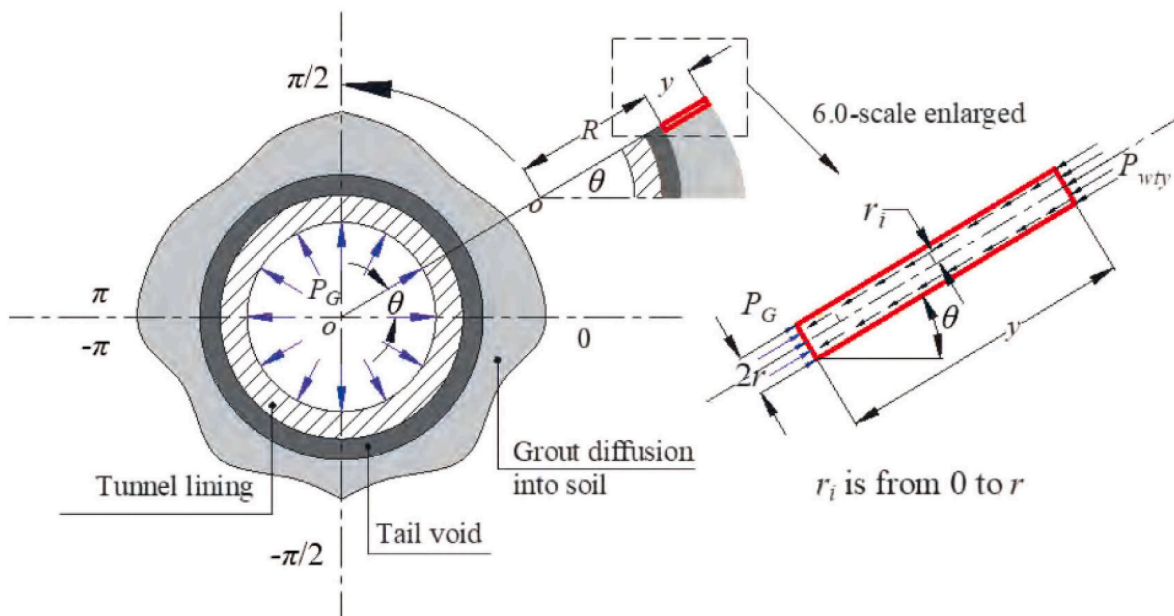

Fig. 9. Force equilibrium at a given angle θ along the direction of distance y (Liu et al., 2021b).

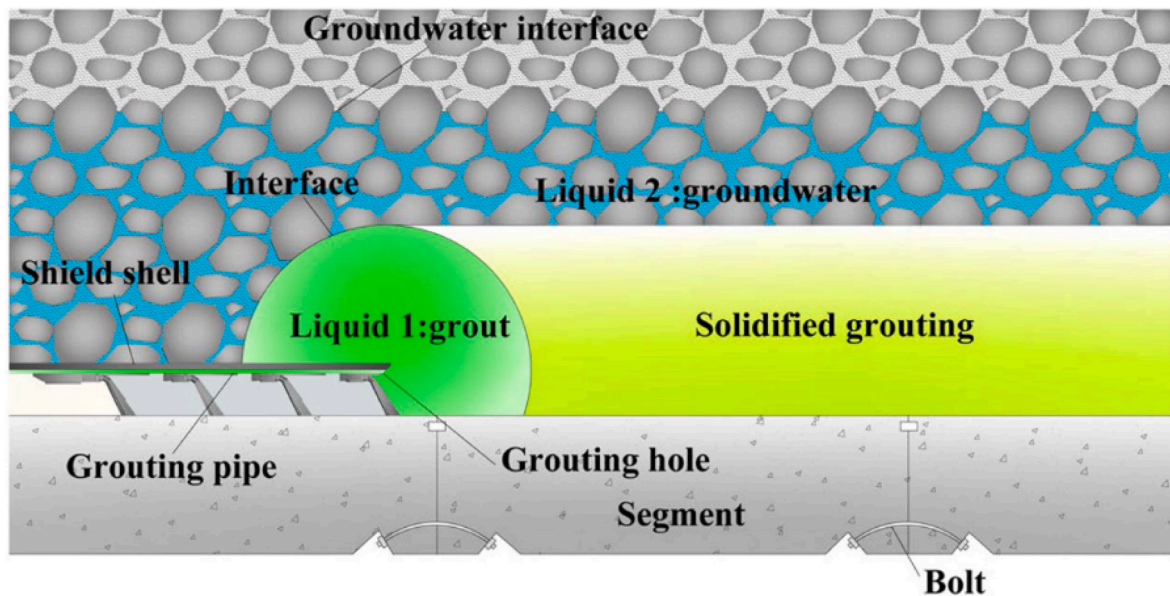

Fig. 10. Grouts diffusion and underground water migration in backfill grouting of shield tunnel.

tunneling has certain limitations that need to be addressed. One notable limitation is that existing studies have primarily relied on construction experience rather than establishing a direct connection between detailed geological conditions and specific diffusion mechanisms. This gap prevents a comprehensive understanding of how grouts diffuse in different geological strata. In recent shield tunnel constructions, increasingly complex geological formations, such as composite and water-rich formations, have been encountered. It is crucial to develop a comprehensive matching system that links engineering geology with specific grouting diffusion mechanisms. By establishing this system, both industry and academia can benefit significantly. The development of a matching system that considers the specific geological conditions and diffusion mechanisms would enhance the efficiency and safety of the construction process. It would enable engineers and researchers to tailor grouting techniques and parameters according to the unique characteristics of each geological formation, leading to improved outcomes and reduced risks. In conclusion, bridging the gap between engineering geology and grouting diffusion mechanisms through a comprehensive matching system holds great potential for advancements in the field. It would contribute to the overall understanding of grouting processes in shield tunneling and pave the way for more efficient and safer construction practices in the future.

6. Recent development of grouting materials in shield tunneling

6.1. Asphalt-related grouting materials

With the rapid development of underground spaces, the construction of resilient underground structures has become essential for the advancement of sustainable society. In particular, there is a growing recognition that underground structures, including shield tunnels, should exhibit enhanced flexibility instead of rigid characteristics. The brittleness associated with the high modulus of elasticity of cement-based materials has been a major hindrance to their long-term applications, primarily due to their limited ductility and damping properties (Craeye et al., 2014; Karihaloo et al., 1993; Liu et al., 2015; Turatsinze et al., 2005). An innovative alternative to traditional cement-based grouts for shield tunneling is the use of cement emulsified asphalt mortar (CEAM), which was initially employed in the ballastless slab track system of high-speed railways, such as the renowned Shinkansen (refer to Fig. 11). CEAM holds tremendous potential for replacing

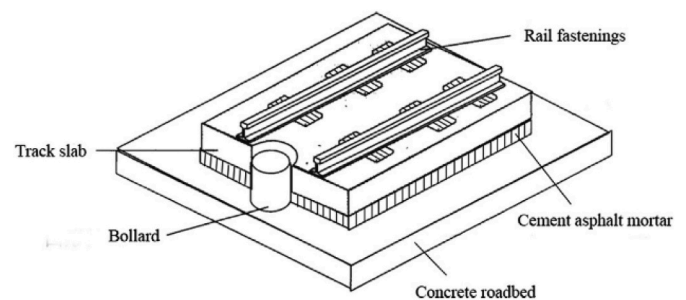

Fig. 11. Typical slab track (Jiang et al., 2021).

conventional cement-based grouts in shield tunneling applications (Gan et al., 2022b; Jiang et al., 2021; Lu et al., 2023; Tian et al., 2020). The placement of a CEAM cushion between the track slab and the concrete base is of paramount importance for ensuring the operational stability of high-speed trains (Tian et al., 2020). The CEAM layer serves multiple critical functions, acting as a supporting layer, a vibration-dissipating layer, and a slab geometry adjusting layer within the ballastless track system. Additionally, the CEAM layer can effectively function as a sealing layer, preventing moisture infiltration into the surrounding soil or subgrade. The properties of the CEAM layer significantly influence the durability, safety, stability, comfort, and maintenance requirements of slab ballastless track systems (Li et al., 2018; Liu and Liang, 2017; Liu et al., 2015; Tian et al., 2020; Wang et al., 2015).

Drawing inspiration from the successful application of CEAM in the ballastless slab track system, it is worth exploring the potential of using CEAM as grouting material for backfill grouting in shield tunneling. The grouting layer in shield tunneling bears similarities to the CEAM layer that exists between the concrete roadbed and track slab in the ballastless slab track system (as shown in Fig. 12). By drawing this analogy, we can relate the concrete segmental lining in shield tunneling to the concrete roadbed, while considering the surrounding strata and building structures as the equivalent of the track slab, rail fastenings, and high-speed trains. CEAM is a semi-rigid composite material composed of various components, including cement, asphalt emulsion, fine aggregate (sand), water, and chemical additives such as superplasticizers (SP) (Esmaeili et al., 2020; Jolicoeur and Simard, 1998; Peng et al., 2015). The asphalt emulsion, which consists of small charged asphalt droplets suspended in

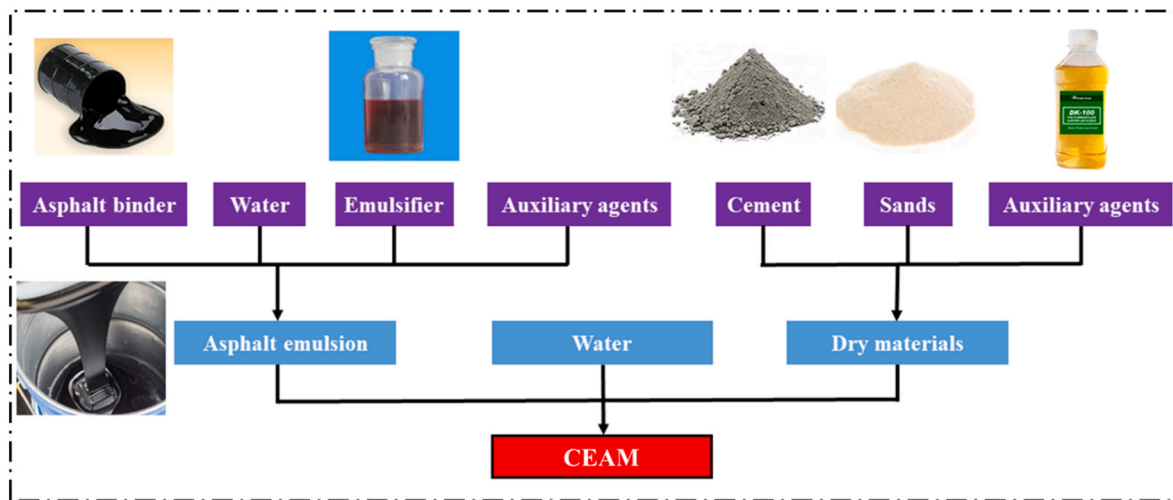

Fig. 12. The preparation process of CEAM.

water through the action of emulsifiers, plays a vital role in determining the workability, curing behavior, and mechanical performance of CEAM (Zhao et al., 2022). Asphalt emulsion can be categorized into cationic and anionic types based on the charge of the asphalt droplets. Furthermore, it can be classified as rapid-setting (RS), medium-setting (MS), or slow-setting (SS) depending on its demulsification time. The preparation process of CEAM is illustrated in Fig. 12. As an inorganic-organic composite material, CEAM combines the desirable mechanical properties of cement-based materials with the flexibility and resilience of asphalt. CEAM allows for the adjustment of its elastic modulus and damping properties, making it a versatile material. Notably, CEAM can be produced at ambient temperature, leading to a significant reduction in carbon greenhouse gas (GHG) emissions compared to hot-mix asphalt mixtures (Fang et al., 2016; Gautier, 2015; Mignini et al., 2018). By exploring the potential application of CEAM as a grouting material in shield tunneling, it is possible to leverage its unique properties, including high mechanical strength, flexibility, and adjustable damping characteristics. Additionally, the environmentally friendly nature of CEAM, with its reduced GHG emissions, aligns with sustainability goals in construction projects. Further research and development in this area can pave the way for innovative and resilient solutions in shield tunneling.

CEAM has the potential to serve as a seismic isolation layer or energy dissipation layer in shield tunnels due to its flexibility (Takeuchi et al., 2000). However, research on the anti-earthquake properties of CEAM in shield tunnels is currently limited. To address this, Yang et al. (2022b) conducted laboratory tests to investigate various characteristics of CEAM, such as density, fluidity, 28-day compressive strength, consistency, and elastic modulus. They also performed a numerical simulation using the engineering context of the Shantou Bay Subsea Tunnel to compare the displacement (peak) of tunnel linings with CEAM and conventional cement-based layers. Artificial seismic waves were introduced into the ABAQUS software, as shown in Fig. 13, and the computational calculations produced displacement time-history curves of the segmental linings, as shown in Fig. 14. The results of the study demonstrated that the application of CEAM as the grouting mortar could reduce the maximum principal stress peaks in the tunnel lining by up to 54% compared with the results using traditional grouting materials. This reduction in stress peaks indicates that CEAM is beneficial for enhancing the durability of shield tunnels, particularly in high-frequency earthquake-prone areas like Sichuan, China. Moreover, the viscoelastic nature of asphalt in the CEAM grouting mortar contributes to the improved resilience of shield tunnels. This viscoelasticity helps mitigate and prevent vibrations induced by the interaction between the track, tunnel, and soil from propagating to the ground surface. As a result, the

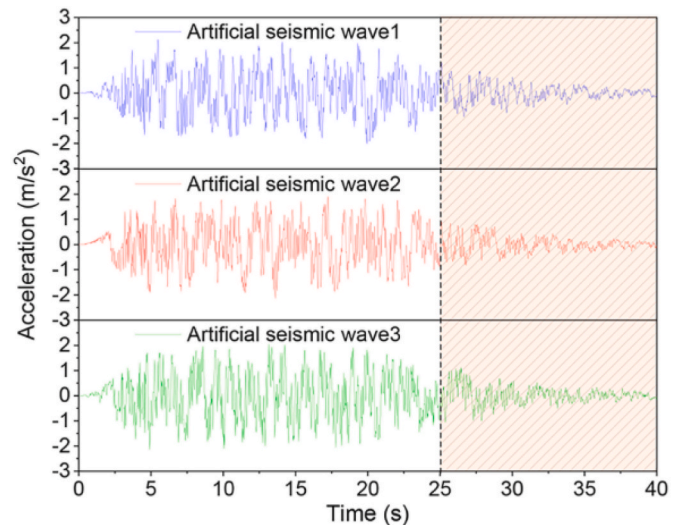
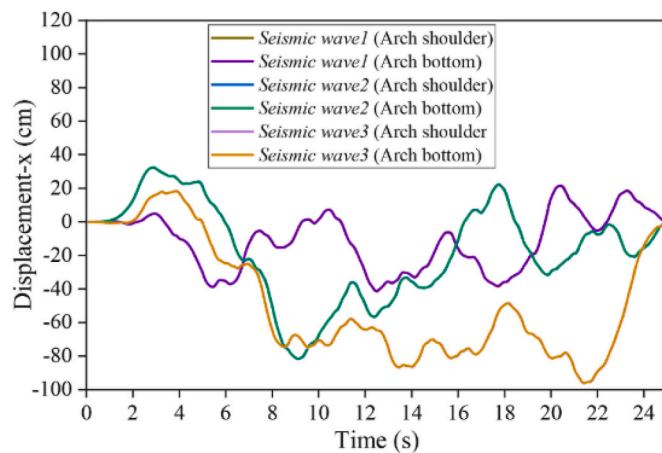

Fig. 13. Acceleration time histories of seismic waves (peak ground acceleration = 0.2 g) (Yang et al., 2022b).

influence of subway operations on surface buildings and precision instruments in laboratories is reduced (Ding et al., 2010; Gupta et al., 2008; Ma et al., 2020; Yang et al., 2022a, 2022c). By utilizing CEAM as a grouting material in shield tunnels, the seismic performance of these underground structures can be enhanced, thereby increasing their ability to withstand earthquakes. The improved resilience of shield tunnels provided by the viscoelastic properties of CEAM helps ensure the safety and functionality of the tunnels while minimizing the impact on surrounding structures and sensitive equipment. Further research and exploration in this field will contribute to the development of more effective and resilient shield tunnel designs.

CEAM offers the advantage of serving as a waterproof layer in shield tunnels due to its excellent waterproofing and adhesive properties (Liu et al., 2021a; Liu et al., 2018, 2014). Liu et al. (2014) conducted research on the waterproof and adhesive properties of emulsified asphalt used on cement concrete bridges. They found that styrene-butadiene-styrene (SBS) emulsified asphalt outperformed other materials, including ordinary cement concrete and traditional asphalt, in terms of waterproofing. The interfacial shear strength of the emulsified asphalt also exhibited superior performance. Since the cement concrete bridge deck shares similarities with the cement concrete segments in shield tunnels, the



(a)

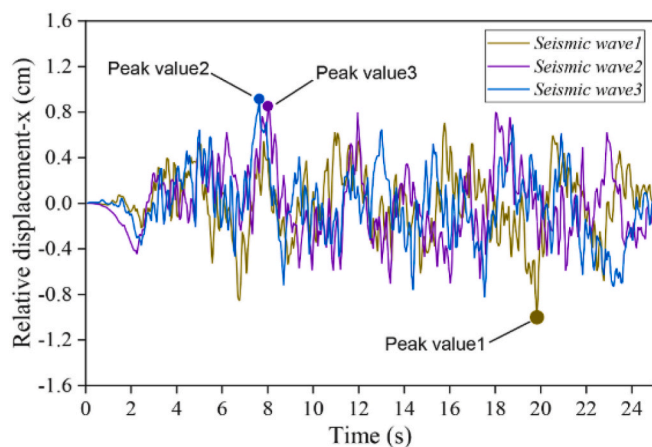

(b)

Fig. 14. (a) Displacement time-history curves; (b) Relative-dis time-history curves of the segmental linings (Yang et al., 2022b).

CEAM has significant potential to be used as a grouting material during shield tunneling, offering superior waterproofing properties compared to cement-based grouts.

The CEAM as backfill grouts could strengthen the grouting effect of the shield tunnel (Chen et al., 2018; Zhang et al., 2021). Zhang et al. (2021) investigated the water erosion resistance, bonding performance, and isolation effect of a waterborne epoxy-SBR asphalt emulsion (WESE)-based CEAM. The CEAM demonstrated excellent resistance to water erosion, strong bonding performance, and effective isolation compared to other materials. These properties make CEAM a suitable grouting material for shield tunneling, providing enhanced grouting effects and improving the overall performance of the tunnels. By utilizing CEAM as a grouting material in shield tunnels, not only can its superior waterproofing and adhesive properties contribute to preventing water ingress, but it can also strengthen the grouting effect within the tunnels. This further enhances the durability, safety, and overall performance of shield tunnels, making them more resilient and reliable in various underground construction projects.

6.2. Recycling discharged soil as grouting materials

The issue of soil or muck discharge from shield tunnel constructions

has emerged as a significant environmental concern. In China alone, with over 50 cities having metro tunnels and a total tunnel length exceeding 1100 km by the end of 2020, the annual amount of shield muck generated has exceeded 119 million tons (Ou et al., 2022; Zhang et al., 2022a; 2022b). The conventional practice of extensive landfilling and stockpiling of this discharged soil or muck poses a substantial threat to the environment, as illustrated in Fig. 15. Consequently, there is a growing interest among academia and industry in exploring the potential for recycling this soil or muck as backfill grouts for shield tunnels.

In a study conducted by Zhang et al. (2022a), the feasibility of recycling discharged soil (ds) from shield tunnel construction for use in synchronous grouts was explored. The research was carried out at a road tunnel construction site located in Hangzhou, China. Different proportions of discharged soil were utilized to produce grouts, as depicted in Fig. 16. The study investigated the influence of the water-to-binder ratio (w/b), binder-to-sand ratio (b/s), discharged soil-to-water ratio (ds/w), and fly ash-to-cement ratio (fly ash/c) on the performance of the modified grouting materials. The findings of the study indicated that the discharged soil from shield tunnel construction had the potential to serve as an environmentally friendly alternative to conventional synchronous grouts. This recycling approach not only had the potential to reduce costs but also offered environmental benefits (Zhang et al., 2023a).

6.3. Using alkali-activated materials (AAMs) as grouting materials

The mechanical properties of conventional grouting materials used in shield tunnels are predominantly reliant on Ordinary Portland Cement (OPC), which contributes to high greenhouse gas (GHG) emissions and the depletion of non-renewable natural resources. To address these environmental concerns, there is a growing need for more sustainable and eco-friendly grouting materials. Alkali-activated materials (AAMs) have emerged as a potential alternative due to their green and low-carbon nature, as they make use of solid waste materials such as municipal, industrial, and agricultural waste.

Song et al. (2022) conducted a study to investigate the engineering properties of AAMs as grouting materials for shield tunnels. The preparation process of AAMs-based grouts is depicted in Fig. 17. In this research, a sodium silicate solution with a modulus of 1.6 was employed as the alkaline activator to create an alkaline environment. A ground blast furnace slag (GGBS), and steel slag (SS) were utilized as pozzolan materials and solid precursors. Various physical properties including density, pH, fluidity, setting time, bleeding ratio, impermeability, pore structures, as well as mechanical properties such as compressive strength and water dispersion resistance, were investigated. The results of the study demonstrated that the AAMs-based grouts exhibited superior engineering properties compared to conventional OPC-based



Fig. 15. Stockpiling of discharged soil from shield tunnel construction (Zhang et al., 2022a).

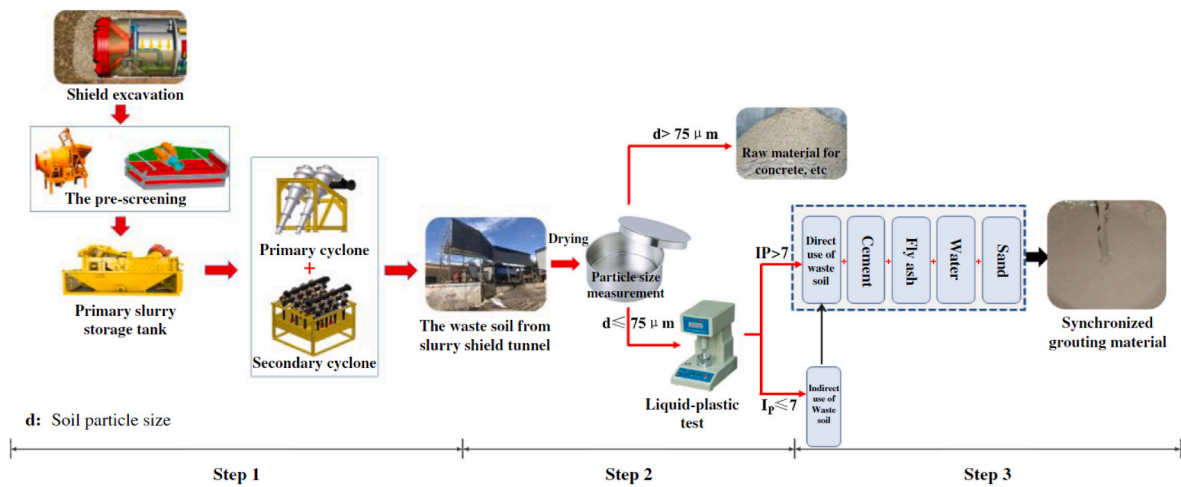

Fig. 16. Recycling discharged soil to make synchronous grouting materials (Zhang et al., 2022a).

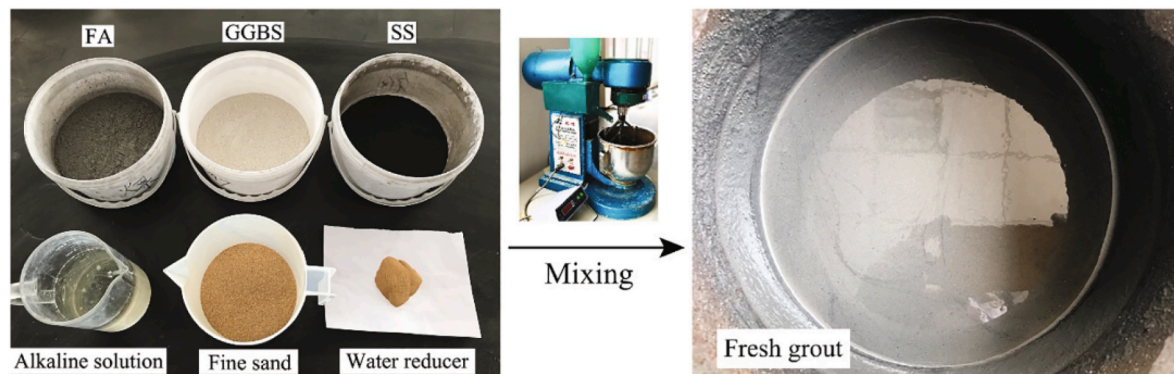

Fig. 17. Preparation of AAMs-based grouts.

grouts. Furthermore, the AAMs-based grouting materials were capable of meeting the requirements of specific geological conditions encountered during tunneling while simultaneously reducing carbon emissions associated with grout production. Thus, AAMs hold promise as sustainable alternatives for grouting in shield tunneling applications.

Song et al. (2020) focused on the application of ground granulated blast furnace slag (GGBS) and fly ash (FA) to develop two-component alkali-activated materials (AAMs)-based grouts for shield tunnels. The study involved testing various properties of the grouts, including gel time, flowability, bleeding ratio, compressive strength, and resistance to water corrosion. Additionally, microstructural analysis using techniques such as XRD (X-ray diffraction), SEM (scanning electron microscopy), and EDS (energy-dispersive X-ray spectroscopy) was conducted to compare the new AAMs-based grouts with traditional cement-sodium silicate grouts. Based on their findings, the authors concluded that the AAMs-based two-component grouts exhibited comparable or even superior performance compared to conventional grouting materials used in shield tunneling. This research contributes to the advancement of sustainable and low-carbon development in the construction of resilient underground structures. By utilizing GGBS and FA as key components in the grouts, the study highlights the potential of AAMs as environmentally friendly alternatives for grouting applications in shield tunnels.

Liu et al. (2022) investigated the impact of flowing 5% NaHCO_3 (sodium bicarbonate) solution on alkali-activated materials-based grouting materials (AASGMs). The researchers employed various techniques including energy-dispersive X-ray spectroscopy (SEM/EDS), differential thermogravimetry (DTG), X-ray diffraction (XRD), Barrett–Joyner–Halenda (BJH) pore-size distribution, Fourier-transform

infrared spectroscopy (FTIR), and solid-state magic-angle spinning nuclear magnetic resonance (MAS-NMR). SEM analysis, as shown in Fig. 18 (a), revealed the formation of three layers on the surface of the AASGMs specimen. This indicated a significant decrease in calcium (Ca) and silicon (Si) content due to the decalcification of the C-A-S-H (calcium-alumino-silicate-hydrate) gel. Microstructural examinations in Fig. 18 (b–f) demonstrated that Ca from the C-A-S-H gels transformed into $\text{Ca}(\text{HCO}_3)_2$, and the gel pores were blocked by CaCO_3 (calcium carbonate). XRD patterns and HRTEM (high-resolution transmission electron microscopy) coupled with SAED (selected-area electron diffraction) analysis shown in Fig. 19 revealed the conversion of some vaterite (CaCO_3) to Ca during the decalcification process. The MAS-NMR analysis in Fig. 20 indicated that the inner layer of the paste sample did not react with NaHCO_3 due to the presence of main components Q_0 , Q_1 , and Q_2 . The higher content of Q_3 in the surface and middle layers was attributed to the decalcification of C-A-S-H gel, which released a significant amount of Si. The lower Si content in the surface layer was a result of dissolved Si in the flowing NaHCO_3 solution. This study demonstrates a modified approach to AAMs-based grouting materials using alternative solutions, such as NaHCO_3 , for shield tunnels. This direction represents an important development in the field of grouts for future applications.

7. Conclusions and perspectives

This paper serves as a comprehensive review that investigates the development and advancements in backfill grouting materials specifically designed for shield tunneling. It begins by introducing the components and characteristics of grouting materials used in shield

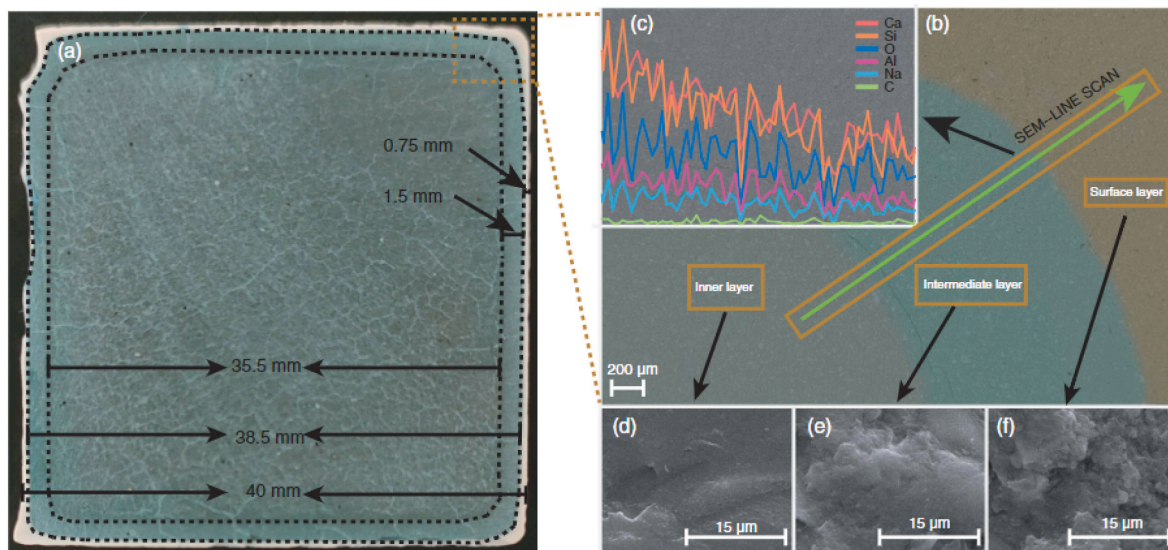

Fig. 18. Macrostructures (a) and microstructures (b–f) of AASGMs samples immersed in 5% flowing NaHCO_3 solution.

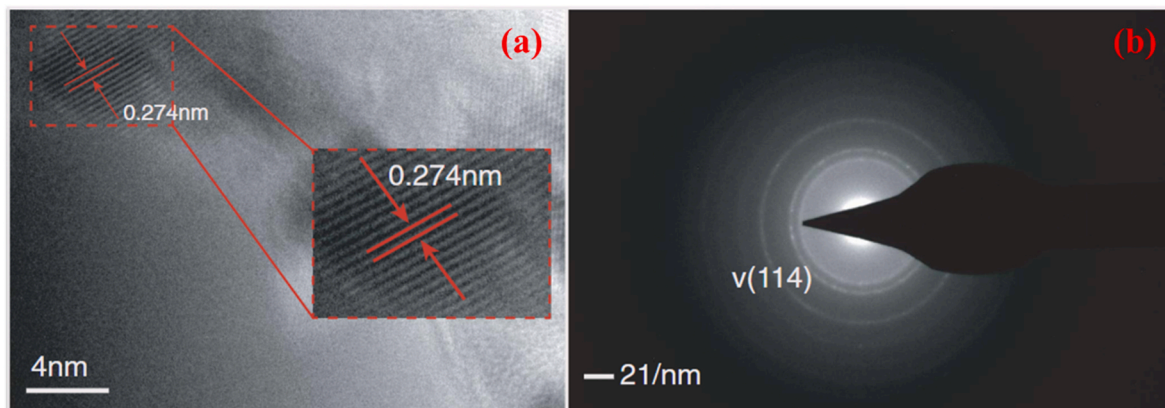

Fig. 19. HRTEM image and SAED analysis (Liu et al., 2022).

tunneling. The properties and functions of grouts are then discussed, shedding light on their key features and applications. The study also highlights the main factors that influence the properties of grouting mortar, along with the corresponding testing methods employed for evaluation. Additionally, the paper delves into the various grouting mechanisms or models that are commonly employed to understand the grouting process in shield tunneling. These models provide insights into the behavior and performance of grouts in different scenarios. Furthermore, the review covers the recent developments in grouting materials and explores potential alternatives that could be used for grouting purposes in the future. The aim is to present and discuss the advancements in grouts and identify promising materials that could enhance the effectiveness and sustainability of shield tunneling projects.

To advance the progress of grouting materials for shield tunneling and facilitate the construction of more resilient shield tunnels, further research is required in the following areas:

- (1) The current mixtures of grouting mortar used for backfilling during shield tunneling primarily rely on the experience of tunnel engineers. However, the lack of standardization in grout compositions introduces uncertainty and makes it time-consuming to determine the appropriate grouting mortar for each shield tunnel construction. To address this issue, it is necessary to establish a standardized framework for grouts in shield tunneling. This

standard would provide clear guidelines and specifications for the composition and properties of grouting materials, streamlining the selection process and ensuring consistency and reliability in shield tunnel construction.

- (2) The existing studies on grout diffusion in shield tunneling have predominantly focused on generic models that may not accurately represent the actual diffusion mechanism of grouting mortar. It is important to recognize that the diffusion behavior of cement-based grouts differs from that of other types of grouts, such as double-liquid grouts and lime-based grouts. Therefore, there is a need to develop a more comprehensive diffusion model that can effectively categorize and capture the specific diffusion characteristics of different types of grouting mortars. This model should consider the unique properties and behaviors of each grout type, enabling a more accurate understanding of grout diffusion during shield tunneling and facilitating improved design and performance evaluation of grouting materials. Furthermore, the development of large-diameter non-circular shield tunnels has seen significant progress in recent years, necessitating the advancement of suitable diffusion mechanisms for grouting mortar.
- (3) The exorbitant expenses associated with high-performance novel backfill grouting materials pose a significant obstacle to widespread adoption. Hence, it becomes imperative to intensify

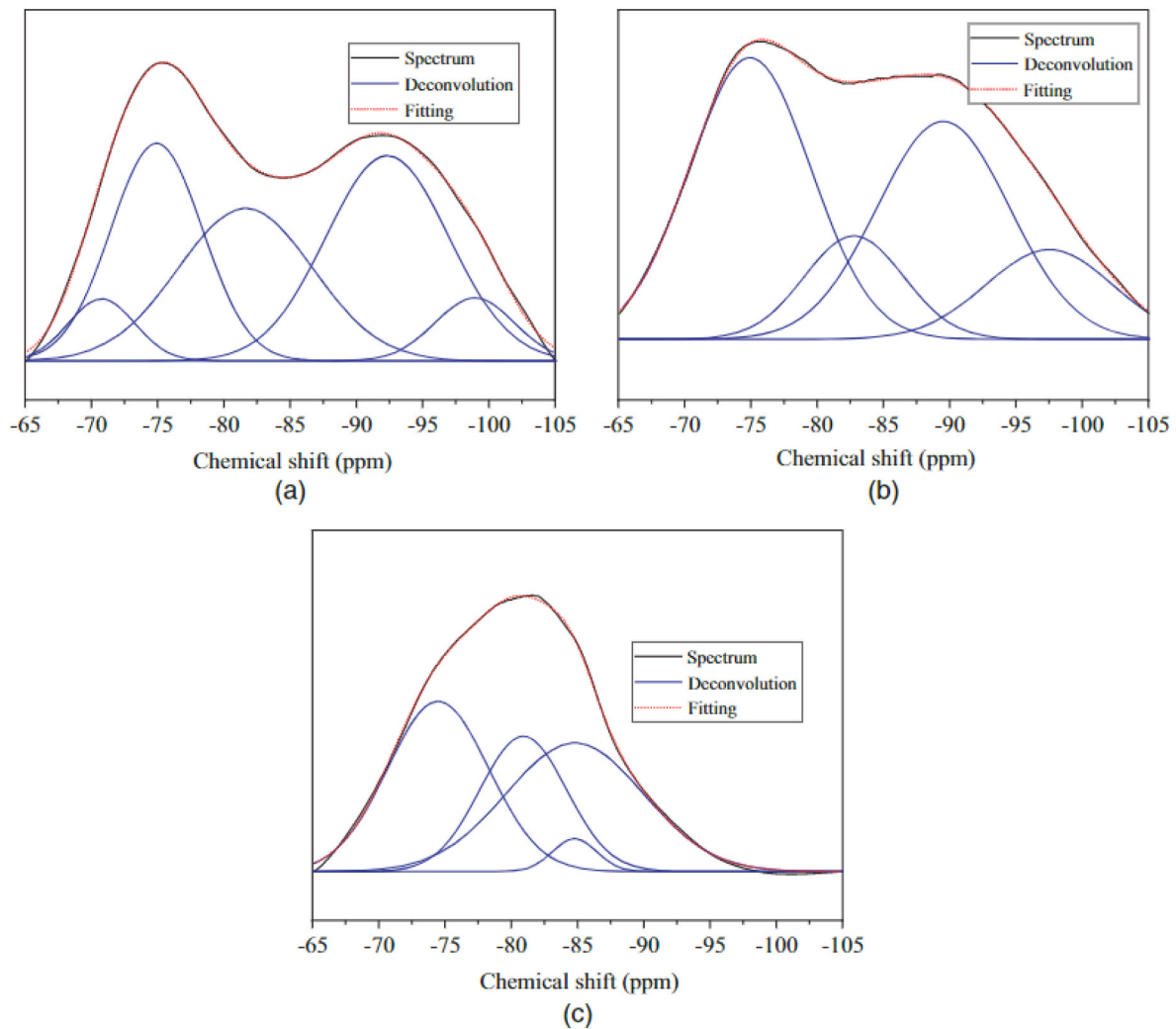

Fig. 20. MAS-NMR results (a) Surface; (b) Middle layer; (c) Inter layer (Liu et al., 2022).

research in grouting diffusion theory and grouting volume calculation. Additionally, the development of optimization methods for grouting material ratios is essential to effectively address the cost control aspect of grouting materials.

- (4) The existing grouting mortars used in shield tunneling primarily consist of conventional single-liquid or double-liquid grouts. However, as the development of underground space progresses, there is a growing demand for grouting materials that offer enhanced resilience and low carbon footprint to meet sustainability requirements. In order to keep pace with the rapid pace of urban construction, it is crucial to conduct further research on novel grouts specifically designed for shield tunneling. These innovative grouting materials should not only meet the technical performance criteria but also align with the principles of sustainability, resilience, and low environmental impact. By exploring and developing new grout formulations, we can ensure that the evolving needs of underground infrastructure are effectively addressed and contribute to the advancement of urban development in a more sustainable and resilient manner.

CRediT authorship contribution statement

Xi Jiang: Methodology, Investigation, Formal analysis, Visualization, Writing - original draft, Writing - review & editing. Hehua Zhu: Conceptualization, Methodology. Zhiguo Yan: Conceptualization,

Methodology. Fengshou Zhang: Methodology, Writing - review & editing. Fei Ye: Methodology, Investigation, Writing - review & editing. Peinan Li: Investigation, Writing - review & editing. Xuehui Zhang: Investigation, Writing - review & editing. Zhiren Dai: Investigation, Writing - review & editing. Yun Bai: Conceptualization, Investigation, Formal analysis, Writing - review & editing. Baoshan Huang: General supervision, Conceptualization, Writing - review & editing.

Declaration of competing interest

The authors declare that they have no known competing financial interests or personal relationships that could have appeared to influence the work reported in this paper.

Data availability

Data will be made available on request.

Acknowledgements

The authors would like to express their sincere gratitude for the valuable comments and suggestions provided by professionals in the tunnel industry.

References

- Aboulayt, A., Jaafri, R., Samouh, H., Cherki El Drissi, A., Roziere, E., Moussa, R., Loukili, A., 2018. Stability of a new geopolymer grout: rheological and mechanical performances of metakaolin-fly ash binary mixtures. *Construct. Build. Mater.* 181, 420–436. <https://doi.org/10.1016/j.conbuildmat.2018.06.025>.
- Aijun, F., 2022. Data statistics and development analysis of urban rail transit in China in 2021. *Tunnel Constr.* 42.
- Anagnostopoulos, C.A., 2014. Effect of different superplasticisers on the physical and mechanical properties of cement grouts. *Construct. Build. Mater.* 50, 162–168. <https://doi.org/10.1016/j.conbuildmat.2013.09.050>.
- Ashour, S.A., 2000. Effect of compressive strength and tensile reinforcement ratio on flexural behavior of high-strength concrete beams. *Eng. Struct.* 22, 413–423. [https://doi.org/10.1016/S0141-0296\(98\)00135-7](https://doi.org/10.1016/S0141-0296(98)00135-7).
- Atis, C.D., Karahan, O., Ari, K., Celik Sola, Ö., Bilim, C., 2009. Relation between strength properties (flexural and compressive) and abrasion resistance of fiber (steel and polypropylene)-reinforced fly ash concrete. *J. Mater. Civ. Eng.* 21, 402–408. [https://doi.org/10.1061/\(asce\)0899-1561\(2009\)21:8\(402\)](https://doi.org/10.1061/(asce)0899-1561(2009)21:8(402)).
- Bai, Y., 2013. *Tunnel Boring Machine Construction Technology (Chinese Edition)*, second ed. China Building Industry Press.
- Bai, Y., 2019. Underground construction. In: *Underground Engineering*. Elsevier, pp. 117–204. <https://doi.org/10.1016/B978-0-12-812702-5.00004-9>.
- Bezuïjen, A., Talmon, A.M., Kaalberg, F.J., Plugge, R., 2004. Field measurements of grout pressures during tunnelling of the Sophia Rail Tunnel. *Soils Found.* 44, 39–48. <https://doi.org/10.3208/sandf.44.39>.
- Bezuïjen, A., Sanders, M.P.M., Hamer, D. Den, 2009. Parameters that influence the pressure filtration characteristics of bentonite grouts. *Geotechnique* 59, 717–721. <https://doi.org/10.1680/geot.7.00111>.
- Blissett, R.S., Rowson, N.A., 2012. A review of the multi-component utilisation of coal fly ash. *Fuel*. <https://doi.org/10.1016/j.fuel.2012.03.024>.
- Celik, F., Canakci, H., 2015. An investigation of rheological properties of cement-based grout mixed with rice husk ash (RHA). *Construct. Build. Mater.* 91, 187–194. <https://doi.org/10.1016/j.conbuildmat.2015.05.025>.
- Chegbeleh, L.P., Yidana, S.M., Nishigaki, M., Achampong, F., 2014. Comparative study on the application of ethanol-bentonite slurry and salt-bentonite slurry as effective injection materials for barrier sealing. *Appl. Clay Sci.* 87, 40–45. <https://doi.org/10.1016/j.clay.2013.11.026>.
- Chen, Q., Wang, C., Fu, H., Zhang, L., 2018. Durability evaluation of road cooling coating. *Construct. Build. Mater.* 190, 13–23. <https://doi.org/10.1016/j.conbuildmat.2018.09.071>.
- Cheng, W.C., Song, Z.P., Tian, W., Wang, Z.F., 2018. Shield tunnel uplift and deformation characterisation: a case study from Zhengzhou metro. *Tunn. Undergr. Space Technol.* 79, 83–95. <https://doi.org/10.1016/j.tust.2018.05.002>.
- Chidiac, S.E., Mahmoodzadeh, F., 2009. Plastic viscosity of fresh concrete – a critical review of prediction methods. *Cem. Concr. Compos.* 31, 535–544. <https://doi.org/10.1016/j.cemconcomp.2009.02.004>.
- Chidiac, S.E., Maadani, O., Razaqpur, A.G., Mailvaganam, N.P., 2000. Controlling the quality of fresh concrete - a new approach. *Mag. Concr. Res.* 52, 353–363. <https://doi.org/10.1680/macr.2000.52.5.353>.
- Chidiac, S.E., Maadani, O., Razaqpur, A.G., Mailvaganam, N.P., 2003. Correlation of rheological properties to durability and strength of hardened concrete. *J. Mater. Civ. Eng.* 15, 391–399. [https://doi.org/10.1061/\(asce\)0899-1561\(2003\)15:4\(391\)](https://doi.org/10.1061/(asce)0899-1561(2003)15:4(391)).
- Craeye, B., Van Isterbeeck, P., Desnerck, P., Boel, V., De Schutter, G., 2014. Modulus of elasticity and tensile strength of self-compacting concrete: survey of experimental data and structural design codes. *Cem. Concr. Compos.* 54, 53–61. <https://doi.org/10.1016/j.cemconcomp.2014.03.011>.
- Cui, H., Kou, L., Xiong, Z., Zhao, J., 2023. Detection and analysis of slurry jacket for pipe jacking construction in soft ground. *J. Civ. Struct. Health Monit* 13, 309–317. <https://doi.org/10.1007/s13349-022-00639-4>.
- Delaleux, F., Py, X., Olives, R., Dominguez, A., 2012. Enhancement of geothermal borehole heat exchangers performances by improvement of bentonite grouts conductivity. *Appl. Therm. Eng.* 33 (34), 92–99. <https://doi.org/10.1016/j.applthermaleng.2011.09.017>.
- Di, H., Zhou, S., Yao, X., Tian, Z., 2021. In situ grouting tests for differential settlement treatment of a cut-and-cover metro tunnel in soft soils. *Bull. Eng. Geol. Environ.* 80, 6415–6427. <https://doi.org/10.1007/s10064-021-02276-5>.
- Ding, D.Y., Gupta, S., Liu, W.N., Lombaert, G., Degrande, G., 2010. Prediction of vibrations induced by trains on line 8 of Beijing metro. *J. Zhejiang Univ. - Sci.* 11, 280–293. <https://doi.org/10.1631/jzus.A0900304>.
- Draganović, A., Stille, H., 2011. Filtration and penetrability of cement-based grout: study performed with a short slot. *Tunn. Undergr. Space Technol.* 26, 548–559. <https://doi.org/10.1016/j.tust.2011.02.007>.
- Duran, A., González-Sánchez, J.F., Fernández, J.M., Siraera, R., Navarro-Blasco, Í., Alvarez, J.I., 2018. Influence of two polymer-based superplasticizers (polynaphthalene sulfonate, PNS, and lignosulfonate, LS) on compressive and flexural strength, freeze-thaw, and sulphate attack resistance of lime-metakaolin grouts. *Polymers* 10. <https://doi.org/10.3390/polym10080824>.
- Esmaili, M., Paricheh, M., Esfahani, M.H., 2020. Laboratory investigation on the behavior of ballast stabilized with bitumen-cement mortar. *Construct. Build. Mater.* 245. <https://doi.org/10.1016/j.conbuildmat.2020.118389>.
- Fang, X., Garcia-Hernandez, A., Lura, P., 2016. Overview on cold cement bitumen emulsion asphalt. *RILEM Tech. Lett.* 1, 116. <https://doi.org/10.21809/rilemtechlett.2016.23>.
- Fang, Y., He, C., Nazem, A., Yao, Z., Grasmick, J., 2017. Surface settlement prediction for EPB shield tunneling in sandy ground. *KSCSE J. Civ. Eng.* 21, 2908–2918. <https://doi.org/10.1007/s12205-017-0989-8>.
- Gan, X., Yu, J., Gong, X., Hou, Y., Liu, N., Zhu, M., 2022a. Response of operating metro tunnels to compensation grouting of an underlying large-diameter shield tunnel: a case study in Hangzhou. *Undergr. Space* 7, 219–232. <https://doi.org/10.1016/J.UNDSP.2021.07.006>.
- Gan, Y., Zhang, X., Jiang, Z., Lu, D., Xu, N., Han, L., Han, X., 2022b. Cementitious fillers in cement asphalt emulsion mixtures: long-term performance and microstructure. *Arabian J. Sci. Eng.* 47, 4943–4953. <https://doi.org/10.1007/s13369-021-06266-3>.
- Gautier, P.E., 2015. Slab track: review of existing systems and optimization potentials including very high speed. *Construct. Build. Mater.* 92, 9–15. <https://doi.org/10.1016/j.conbuildmat.2015.03.102>.
- Gupta, S., Liu, W.F., Degrande, G., Lombaert, G., Liu, W.N., 2008. Prediction of vibrations induced by underground railway traffic in Beijing. *J. Sound Vib.* 310, 608–630. <https://doi.org/10.1016/j.jsv.2007.07.016>.
- Haach, V.G., Vasconcelos, G., Loureno, P.B., 2011. Influence of aggregates grading and water/cement ratio in workability and hardened properties of mortars. *Construct. Build. Mater.* 25, 2980–2987. <https://doi.org/10.1016/j.conbuildmat.2010.11.011>.
- Han, D., Yoon, J.Y., Kim, J.H., 2019. Control of viscosity of cementitious materials using waste limestone powder. *Int. J. Concr. Struct. Mater.* 13. <https://doi.org/10.1186/s40069-018-0325-9>.
- He, S., Lai, J., Wang, L., Wang, K., 2020. A literature review on properties and applications of grouts for shield tunnel. *Construct. Build. Mater.* <https://doi.org/10.1016/j.conbuildmat.2019.117782>.
- Hemalatha, T., Ramaswamy, A., 2017. A review on fly ash characteristics – towards promoting high volume utilization in developing sustainable concrete. *J. Clean. Prod.* <https://doi.org/10.1016/j.jclepro.2017.01.114>.
- Huang, W.H., 1997. Properties of cement-fly ash grout admixed with bentonite, silica fume, or organic fiber. *Cement Concr. Res.* 27, 395–406. [https://doi.org/10.1016/S0008-8846\(97\)00032-X](https://doi.org/10.1016/S0008-8846(97)00032-X).
- Jiang, D., Cheng, X., Luan, H., Wang, T., Zhang, M., Hao, R., 2018. Experimental investigation on the law of grout diffusion in fractured porous rock mass and its application. *Processes* 6. <https://doi.org/10.3390/pr6100191>.
- Jiang, X., Xiao, R., Zhang, M., Hu, W., Bai, Y., Huang, B., 2020a. A laboratory investigation of steel to fly ash-based geopolymer paste bonding behavior after exposure to elevated temperatures. *Construct. Build. Mater.* 254, 119267. <https://doi.org/10.1016/j.conbuildmat.2020.119267>.
- Jiang, X., Zhang, Y., Xiao, R., Polaczyk, P., Zhang, M., Hu, W., Bai, Y., Huang, B., 2020b. A comparative study on geopolymers synthesized by different classes of fly ash after exposure to elevated temperatures. *J. Clean. Prod.* 122500. <https://doi.org/10.1016/j.jclepro.2020.122500>.
- Jiang, S., Li, J., Zhang, Z., Wu, H., Liu, G., 2021. Factors influencing the performance of cement emulsified asphalt mortar – a review. *Construct. Build. Mater.* 279, 122479. <https://doi.org/10.1016/j.conbuildmat.2021.122479>.
- Jiang, X., Xiao, R., Bai, Y., Huang, B., Ma, Y., 2022a. Influence of waste glass powder as a supplementary cementitious material (SCM) on physical and mechanical properties of cement paste under high temperatures. *J. Clean. Prod.* 340. <https://doi.org/10.1016/j.jclepro.2022.130778>.
- Jiang, Y., Xu, Z., Geng, D., Dong, J., Liao, Y., 2022b. Optimization of grouting material for shield tunnel antifloating in full-face rock stratum in nanchang metro construction in China. *Int. J. GeoMech.* 22. [https://doi.org/10.1061/\(asce\)gm.1943-5622.0002312](https://doi.org/10.1061/(asce)gm.1943-5622.0002312).
- Jin-long, L., Hamza, O., Sian Davies-Vollum, K., Jie-qun, L., 2018. Repairing a shield tunnel damaged by secondary grouting. *Tunn. Undergr. Space Technol.* 80, 313–321. <https://doi.org/10.1016/j.tust.2018.07.016>.
- Jolicoeur, C., Simard, M.A., 1998. Chemical admixture-cement interactions: phenomenology and physico-chemical concepts. *Cem. Concr. Compos.* 20, 87–101. [https://doi.org/10.1016/S0958-9465\(97\)00062-0](https://doi.org/10.1016/S0958-9465(97)00062-0).
- Jorne, F., Henriques, F.M.A., Baltazar, L.G., 2015. Influence of superplasticizer, temperature, resting time and injection pressure on hydraulic lime grout injectability. Correlation analysis between fresh grout parameters and grout injectability. *J. Build. Eng.* 4, 140–151. <https://doi.org/10.1016/j.jobe.2015.08.007>.
- Juenger, M.C.G., Winnefeld, F., Provis, J.L., Ideker, J.H., 2011. Advances in alternative cementitious binders. *Cement Concr. Res.* <https://doi.org/10.1016/j.cemconres.2010.11.012>.
- Karihaloo, B.L., Carpinteri, A., Elices, M., 1993. Fracture mechanics of cement mortar and plain concrete. *Adv. Cement Base Mater.* 1, 92–105. [https://doi.org/10.1016/1065-7355\(93\)90014-F](https://doi.org/10.1016/1065-7355(93)90014-F).
- Khayat, K.H., Yahia, A., 1998. Simple field tests to characterize fluidity and washout resistance of structural cement grout. *Cem. Concr. Aggregates* 20, 145–156.
- Krishnamoorthy, T.S., Gopalakrishnan, S., Balasubramanian, K., Bharatkumar, B.H., Rama Mohan Rao, P., 2002. Investigations on the cementitious grouts containing supplementary cementitious materials. *Cement Concr. Res.* 32, 1395–1405. [https://doi.org/10.1016/S0008-8846\(02\)00799-8](https://doi.org/10.1016/S0008-8846(02)00799-8).
- Lee, W.K.W., Van Deventer, J.S.J., 2002. Structural reorganisation of class F fly ash in alkaline silicate solutions. *Colloids Surf. A Physicochem. Eng. Asp.* 211, 49–66. [https://doi.org/10.1016/S0927-7757\(02\)00237-6](https://doi.org/10.1016/S0927-7757(02)00237-6).
- Lee, S.H., Kim, H.J., Sakai, E., Daimon, M., 2003. Effect of particle size distribution of fly ash-cement system on the fluidity of cement pastes. *Cement Concr. Res.* 33, 763–768. [https://doi.org/10.1016/S0008-8846\(02\)01054-2](https://doi.org/10.1016/S0008-8846(02)01054-2).
- Ley-Hernández, A.M., Feys, D., 2021. Resting time effect on the rheological behavior of cement paste in presence of superplasticizer. *Cement Concr. Res.* 142. <https://doi.org/10.1016/j.cemconres.2020.106347>.
- Li, S., Liu, R., Zhang, Q., Zhang, X., 2016. Protection against water or mud inrush in tunnels by grouting: a review. *J. Rock Mech. Geotech. Eng.* <https://doi.org/10.1016/j.jrmge.2016.05.002>.

- Li, W., Hong, J., Zhu, X., Yang, D., Bai, Y., Liu, J., Miao, C., 2018. Retardation mechanism of anionic asphalt emulsion on the hydration of Portland cement. *Construct. Build. Mater.* 163, 714–723. <https://doi.org/10.1016/j.conbuildmat.2017.12.150>.
- Li, Y., Zhang, G., Jiang, H., Liu, Y., Kuang, C., 2020. Performance assessment of a newly developed and highly stable sandy cementitious grout for karst aquifers in China. *Environ. Earth Sci.* 79, 153. <https://doi.org/10.1007/s12665-020-8894-8>.
- Li, Q., Jia, Z., Zhao, Y., 2021. Laboratory evaluation of hydraulic conductivity and chemical compatibility of bentonite slurry for grouting walls. *Environ. Earth Sci.* 80, 569. <https://doi.org/10.1007/s12665-021-09847-5>.
- Li, Gen, Akbar, A., Zhang, L.W., Rosei, F., Liew, K.M., 2023a. Surface modification strategy for controlling wettability and ionic diffusion behaviors of calcium silicate hydrate. *Appl. Surf. Sci.* 622 <https://doi.org/10.1016/j.apsusc.2023.156993>.
- Li, G., Yin, B.B., Zhang, L.W., Liew, K.M., 2023b. The hydraulic interface towards the anti-fatigue performance of fiber-calcium silicate hydrate composites under cyclic loading. *Compos. Part A Appl. Sci. Manuf.* 171, 107579 <https://doi.org/10.1016/j.compositesa.2023.107579>.
- Li, K., Xie, X., Huang, C., Zhou, B., Duan, W., Lin, H., Wang, C., 2023c. Study on the penetration capability of GPR for the steel-fibre reinforced concrete (SFRC) segment based on numerical simulations and model test. *Construct. Build. Mater.* 400, 132719 <https://doi.org/10.1016/j.conbuildmat.2023.132719>.
- Liang, X., Ying, K., Ye, F., Su, E., Xia, T., Han, X., 2022. Selection of backfill grouting materials and ratios for shield tunnel considering stratum suitability. *Construct. Build. Mater.* 314, 125431 <https://doi.org/10.1016/j.conbuildmat.2021.125431>.
- Littlejohn, S., 2003a. The development of practice in permeation and compensation grouting: a historical review (1802–2002): Part 1 permeation grouting. In: *Grouting and Ground Treatment*. American Society of Civil Engineers, Reston, VA, pp. 50–99. [https://doi.org/10.1061/40663\(2003\)3](https://doi.org/10.1061/40663(2003)3).
- Littlejohn, S., 2003b. The development of practice in permeation and compensation grouting: a historical review (1802–2002): Part 2 compensation grouting. In: *Grouting and Ground Treatment*. American Society of Civil Engineers, Reston, VA, pp. 100–144. [https://doi.org/10.1061/40663\(2003\)4](https://doi.org/10.1061/40663(2003)4).
- Liu, B., Liang, D., 2017. Effect of mass ratio of asphalt to cement on the properties of cement modified asphalt emulsion mortar. *Construct. Build. Mater.* 134, 39–43. <https://doi.org/10.1016/j.conbuildmat.2016.12.137>.
- Liu, Y., Wu, J., Chen, J., 2014. Mechanical properties of a waterproofing adhesive layer used on concrete bridges under heavy traffic and temperature loading. *Int. J. Adhesion Adhes.* 48, 102–109. <https://doi.org/10.1016/j.ijadhadh.2013.09.015>.
- Liu, J., Zheng, X., Li, S., Ding, R., Zeng, Z., Weng, Z., Yang, D., 2015. Effect of the stabilizer on bubble stability and homogeneity of cement emulsified asphalt mortar in slab ballastless track. *Construct. Build. Mater.* 96, 135–146. <https://doi.org/10.1016/j.conbuildmat.2015.08.001>.
- Liu, M., Han, S., Pan, J., Ren, W., 2018. Study on cohesion performance of waterborne epoxy resin emulsified asphalt as interlayer materials. *Construct. Build. Mater.* 177, 72–82. <https://doi.org/10.1016/j.conbuildmat.2018.05.043>.
- Liu, J., Li, Y., Zhang, G., Liu, Y., 2019. Effects of cementitious grout components on rheological properties. *Construct. Build. Mater.* 227 <https://doi.org/10.1016/j.conbuildmat.2019.08.035>.
- Liu, T., Zhong, Y., Feng, Z., Xu, W., Song, F., Li, C., 2020. New construction technology of a shallow tunnel in boulder-cobble mixed grounds. *Adv. Civil Eng.* 2020 <https://doi.org/10.1155/2020/5686042>.
- Liu, H., Yuan, G., Zhang, Q., Hao, P., Dong, S., Zhang, H., 2021a. Study on influence factors of asphalt mixtures pavement blistering on Portland cement concrete bridge deck. *Int. J. Pavement Eng.* 22, 249–256. <https://doi.org/10.1080/10298436.2019.1600691>.
- Liu, X.X., Shen, S.L., Xu, Y.S., Zhou, A., 2021b. A diffusion model for backfill grout behind shield tunnel lining. *Int. J. Numer. Anal. Methods Geomech.* 45, 457–477. <https://doi.org/10.1002/nag.3164>.
- Liu, L., Liu, H., Xu, Y., Xiang, J., He, Y., Zheng, G., 2022. Mechanical properties and microstructure of alkali-activated slag grouting materials exposed to flowing NaHCO₃ solution. *J. Mater. Civ. Eng.* 34 [https://doi.org/10.1061/\(ASCE\)MT.1943-5533.0004500](https://doi.org/10.1061/(ASCE)MT.1943-5533.0004500).
- Liu, W., Liang, J., Xu, T., 2023. Tunnelling-induced ground deformation subjected to the behavior of tail grouting materials. *Tunn. Undergr. Space Technol.* 140 <https://doi.org/10.1016/j.tust.2023.105253>.
- Lu, D., Jiang, X., Tan, Z., Yin, B., Leng, Z., Zhong, J., 2023. Enhancing Sustainability in Pavement Engineering: A State-Of-The-Art Review of Cement Asphalt Emulsion Mixtures. <https://doi.org/10.1016/j.clema.2023.100204>.
- Ma, M., Jiang, B., Liu, W., Liu, K., 2020. Control of metro train-induced vibrations in a laboratory using periodic piles. *Sustainability* 12. <https://doi.org/10.3390/su12145871>.
- Mahmoud, M., Ramadan, M., Pullen, K., Abdelkareem, M.A., Wilberforce, T., Olabi, A.G., Naher, S., 2021. A review of grout materials in geothermal energy applications. *Int. J. Thermofluids* 10. <https://doi.org/10.1016/j.ijft.2021.100070>.
- Mao, J. hua, Yuan, D. jun, Jin, D. long, Zeng, J. feng, 2020. Optimization and application of backfill grouting material for submarine tunnel. *Construct. Build. Mater.* 265, 120281 <https://doi.org/10.1016/j.conbuildmat.2020.120281>.
- Mascarin, L., Garbin, E., di Sipio, E., Dalla Santa, G., Bertermann, D., Artioli, G., Bernardi, A., Galgaro, A., 2022. Selection of backfill grout for shallow geothermal systems: materials investigation and thermo-physical analysis. *Construct. Build. Mater.* 318 <https://doi.org/10.1016/j.conbuildmat.2021.125832>.
- Mignini, C., Cardone, F., Graziani, A., 2018. Experimental study of bitumen emulsion–cement mortars: mechanical behaviour and relation to mixtures. *Mater. Struct./Materiaux et Constructions* 51. <https://doi.org/10.1617/s11527-018-1276-y>.
- Mirza, J., Mirza, M.S., Roy, V., Saleh, K., 2002. Basic rheological and mechanical properties of high-volume fly ash grouts. *Construct. Build. Mater.* 16, 353–363. [https://doi.org/10.1016/S0950-0618\(02\)00026-0](https://doi.org/10.1016/S0950-0618(02)00026-0).
- Moayed, Hossein, 2012. Stabilization of organic soil using sodium silicate system grout. *Int. J. Phys. Sci.* 7, 1395–1402. <https://doi.org/10.5897/ijps11.1509>.
- Nguyen, V.H., Remond, S., Gallias, J.L., 2011. Influence of cement grouts composition on the rheological behaviour. *Cement Concr. Res.* 41, 292–300. <https://doi.org/10.1016/j.cemconres.2010.11.015>.
- Ou, Y., Tian, G., Chen, J., Chen, G., Chen, X., Li, H., Liu, B., Huang, T., Qiang, M., Satyanaga, A., Zhai, Q., 2022. Feasibility studies on the utilization of recycled slag in grouting material for tunneling engineering. *Sustainability* 2022 14. <https://doi.org/10.3390/SU141711013>. Page 11013 14, 11013.
- Pascual-Muñoz, P., Indacochea-Vega, I., Zamora-Barraza, D., Castro-Fresno, D., 2018. Experimental analysis of enhanced cement-sand-based geothermal grouting materials. *Construct. Build. Mater.* 185, 481–488. <https://doi.org/10.1016/j.conbuildmat.2018.07.076>.
- Pastor, J.L., Ortega, J.M., Flor, M., López, M.P., Sánchez, I., Climent, M.A., 2016. Microstructure and durability of fly ash cement grouts for micropiles. *Construct. Build. Mater.* 117, 47–57. <https://doi.org/10.1016/j.conbuildmat.2016.04.154>.
- Pedrotti, M., Wong, C., El Mountassir, G., Lunn, R.J., 2017. An analytical model for the control of silica grout penetration in natural groundwater systems. *Tunn. Undergr. Space Technol.* 70, 105–113. <https://doi.org/10.1016/j.tust.2017.06.023>.
- Pelizza, S., Peila, D., Borio, L., Dal Negro, E., Schulkins, R., Boscaro, A., 2010. Analysis of the performance of two component back-filling grout in tunnel boring machines operating under face pressure. *Tunnel Vision towards 2020* 1–8.
- Peng, Jianwei, Deng, D., Huang, H., Yuan, Q., Peng, Jianguo, 2015. Influence of superplasticizer on the rheology of fresh cement asphalt paste. *Case Stud. Constr. Mater.* 3, 9–18. <https://doi.org/10.1016/J.CSCM.2015.05.002>.
- Rahman, M., Håkansson, U., Wiklund, J., 2015. In-line rheological measurements of cement grouts: effects of water/cement ratio and hydration. *Tunn. Undergr. Space Technol.* 45, 34–42. <https://doi.org/10.1016/j.tust.2014.09.003>.
- Rahman, M., Wiklund, J., Kotzé, R., Håkansson, U., 2017. Yield stress of cement grouts. *Tunn. Undergr. Space Technol.* 61, 50–60. <https://doi.org/10.1016/J.TUST.2016.09.009>.
- Roshavelov, T., 2005. Prediction of fresh concrete flow behavior based on analytical model for mixture proportioning. *Cement Concr. Res.* 35, 831–835. <https://doi.org/10.1016/j.cemconres.2004.09.019>.
- Sha, F., Li, S., Liu, R., Li, Z., Zhang, Q., 2018. Experimental study on performance of cement-based grouts admixed with fly ash, bentonite, superplasticizer and water glass. *Construct. Build. Mater.* 161, 282–291. <https://doi.org/10.1016/j.conbuildmat.2017.11.034>.
- Shen, S.L., Wang, Z.F., Horpibulsuk, S., Kim, Y.H., 2013. Jet grouting with a newly developed technology: the Twin-Jet method. *Eng. Geol.* 152, 87–95. <https://doi.org/10.1016/j.enggeo.2012.10.018>.
- Sonebi, M., Lachemi, M., Hossain, K.M.A., 2013. Optimisation of rheological parameters and mechanical properties of superplasticised cement grouts containing metakaolin and viscosity modifying admixture. *Construct. Build. Mater.* 38, 126–138. <https://doi.org/10.1016/j.conbuildmat.2012.07.102>.
- Song, Z., Mao, J., Tian, X., Zhang, Y., Wang, J., 2019. Optimization analysis of controlled blasting for passing through houses at close range in super-large section tunnels. *Shock Vib.* 2019 <https://doi.org/10.1155/2019/1941436>.
- Song, W., Zhu, Z., Pu, S., Wan, Y., Huo, W., Song, S., Zhang, J., Yao, K., Hu, L., 2020. Synthesis and characterization of eco-friendly alkali-activated industrial solid waste-based two-component backfilling grouts for shield tunnelling. *J. Clean. Prod.* 266, 121974 <https://doi.org/10.1016/j.jclepro.2020.121974>.
- Song, W., Zhu, Z., Pu, S., Wan, Y., Huo, W., Peng, Y., 2022. Preparation and engineering properties of alkali-activated filling grouts for shield tunnel. *Construct. Build. Mater.* 314 <https://doi.org/10.1016/j.conbuildmat.2021.125620>.
- Suwansawat, S., Einstein, H.H., 2007. Describing settlement troughs over twin tunnels using a superposition technique. *J. Geotech. Geoenviron. Eng.* 133, 445–468. [https://doi.org/10.1061/\(asce\)1090-0241\(2007\)133:4\(445\)](https://doi.org/10.1061/(asce)1090-0241(2007)133:4(445)).
- Takeuchi, M., Kameda, S., Misawa, T., Oosumi, T., Sakuma, K., Satoh, S., Kurita, A., 2000. The characteristics of asphalt-based material for the seismic isolation applied to the underground structure. *Doboku Gakkai Ronbunshu* 2000, 93–106. <https://doi.org/10.2208/JSEJ.2000.658.93>.
- Tian, Y., Lu, D., Ma, R., Zhang, J., Li, W., Yan, X., 2020. Effects of cement contents on the performance of cement asphalt emulsion mixtures with rapidly developed early-age strength. *Construct. Build. Mater.* 244, 118365 <https://doi.org/10.1016/j.conbuildmat.2020.118365>.
- Tiedje, E., Guo, P., 2014. Thermal conductivity of bentonite grout containing graphite or chopped carbon fibers. *J. Mater. Civ. Eng.* 26, 06014013 [https://doi.org/10.1061/\(asce\)mt.1943-5533.0000977](https://doi.org/10.1061/(asce)mt.1943-5533.0000977).
- Torres-Carrasco, M., Puertas, F., 2015. Waste glass in the geopolymer preparation. Mechanical and microstructural characterisation. *J. Clean. Prod.* 90, 397–408. <https://doi.org/10.1016/j.jclepro.2014.11.074>.
- Turatsinze, A., Bonnet, S., Granju, J.L., 2005. Mechanical characterisation of cement-based mortar incorporating rubber aggregates from recycled worn tyres. *Build. Environ.* 40, 221–226. <https://doi.org/10.1016/j.buildenv.2004.05.012>.
- Uchikawa, H., Hanehara, S., Sawaki, D., 1997. The role of steric repulsive force in the dispersion of cement particles in fresh paste prepared with organic admixture. *Cement Concr. Res.* 27, 37–50. [https://doi.org/10.1016/S0008-8846\(96\)00207-4](https://doi.org/10.1016/S0008-8846(96)00207-4).
- Vafaei, M., Allahverdi, A., 2017. High strength geopolymer binder based on waste-glass powder. *Adv. Powder Technol.* 28, 215–222. <https://doi.org/10.1016/j.apt.2016.09.034>.

- Venkatarama Reddy, B.V., Gupta, A., 2008. Influence of sand grading on the characteristics of mortars and soil-cement block masonry. *Construct. Build. Mater.* 22, 1614–1623. <https://doi.org/10.1016/j.conbuildmat.2007.06.014>.
- Vyšvářil, M., Hegrová, M., Žizlavský, T., 2018. Rheological properties of lime mortars with Guar gum derivatives. *Key Eng. Mater.* 760 KEM 257–265. <https://doi.org/10.4028/www.scientific.net/KEM.760.257>.
- Wang, Z., Shu, X., Rutherford, T., Huang, B., Clarke, D., 2015. Effects of asphalt emulsion on properties of fresh cement emulsified asphalt mortar. *Construct. Build. Mater.* 75, 25–30. <https://doi.org/10.1016/j.conbuildmat.2014.11.013>.
- Wang, S., Wang, J. fei, Yuan, C. peng, Chen, L. yi, Xu, S. tong, Guo, K. bin, 2018. Development of the nano-composite cement: application in regulating grouting in complex ground conditions. *J. Mt. Sci.* 15, 1572–1584. <https://doi.org/10.1007/s11629-017-4729-9>.
- Wang, S., Fu, J., Zhang, C., Yang, J., 2021. *Shield Tunnel Engineering: from Theory to Practice*. Elsevier.
- Wang, S., Lin, Z., Peng, X., Wang, X., Tu, G., Song, Z., 2022. Research and evaluation on Water-dispersion resistance of synchronous grouting slurry in shield tunnel. *Tunn. Undergr. Space Technol.* 129 <https://doi.org/10.1016/j.tust.2022.104679>.
- Wei, L., Liu, X., Duan, Y., Feng, J., 2017. Property transformation of a modified sulfoaluminate grouting material under pressure circulation for a water-sealed underground oil cavern. *Construct. Build. Mater.* 140, 210–220. <https://doi.org/10.1016/j.conbuildmat.2017.02.137>.
- Wu, T., Gao, Y., Zhou, Y., 2022. Application of a novel grouting material for prereinforcement of shield tunnelling adjacent to existing piles in a soft soil area. *Tunn. Undergr. Space Technol.* 128 <https://doi.org/10.1016/j.tust.2022.104646>.
- Xie, X., Zhai, J., Zhou, B., 2021. Back-fill grouting quality evaluation of the shield tunnel using ground penetrating radar with bi-frequency back projection method. *Autom. Construct.* <https://doi.org/10.1016/j.autcon.2020.103435>.
- Xu, S., Ma, Q., Wang, J., Wang, L., 2018. Grouting performance improvement for natural hydraulic lime-based grout via incorporating silica fume and silicon-acrylic latex. *Construct. Build. Mater.* 186, 652–659. <https://doi.org/10.1016/j.conbuildmat.2018.07.056>.
- Yang, Q., Geng, P., Chen, P., 2022a. Study on the influence of back-fill grouting parameters in unsaturated strata on the seismic performance of shield tunnels. *KSCE J. Civ. Eng.* 26, 4863–4876. <https://doi.org/10.1007/s12205-022-0574-7>.
- Yang, Q., Geng, P., Wang, J., Chen, P., He, C., 2022b. Research of asphalt-cement materials used for shield tunnel backfill grouting and effect on anti-seismic performance of tunnels. *Construct. Build. Mater.* 318 <https://doi.org/10.1016/j.conbuildmat.2021.125866>.
- Yang, Q., Geng, P., Wang, L., Liu, G., Tang, R., 2022c. Study on asphalt-cement isolation layer for shield tunnels using seismic fragility curves. *J. Earthq. Eng.* 1–20. <https://doi.org/10.1080/13632469.2022.2113003>.
- Yao, Z., Zhang, B., Chen, Y., Shao, H., Tian, Y., 2015a. Study and application of synchronous grouting techniques in the launching section of an extra-large diameter shield tunnel. *Modern Tunnelling Technol.* 52, 101–105. <https://doi.org/10.13807/j.cnki.mtt.2015.04.015>.
- Yao, Z.T., Ji, X.S., Sarker, P.K., Tang, J.H., Ge, L.Q., Xia, M.S., Xi, Y.Q., 2015b. A comprehensive review on the applications of coal fly ash. *Earth Sci. Rev.* <https://doi.org/10.1016/j.earscirev.2014.11.016>.
- Ye, F., Yang, T., Mao, J. hua, Qin, X. zhuo, Zhao, R. liang, 2019. Half-spherical surface diffusion model of shield tunnel back-fill grouting based on infiltration effect. *Tunn. Undergr. Space Technol.* 83, 274–281. <https://doi.org/10.1016/j.tust.2018.10.004>.
- Ye, F., Qin, N., Han, X., Liang, X., Gao, X., Ying, K., 2020. Displacement infiltration diffusion model of power-law grout as backfill grouting of a shield tunnel. *Eur. J. Environ. Civil Eng.* <https://doi.org/10.1080/19648189.2020.1735524>.
- Ye, F., Liang, Xing, Liang, Xiaoming, Zhang, W., Liu, C., Feng, H., 2021. Grouting technology and construction schemes of a tunnel in aeolian stratum: a case study of Shenmu No. 1 tunnel. *Sci. Rep.* 11, 23552 <https://doi.org/10.1038/s41598-021-03021-4>.
- Ying, K., Ye, F., Li, Y., Liang, X., Su, E., Han, X., 2022. Backfill grouting diffusion law of shield tunnel considering porous media with nonuniform porosity. *Tunn. Undergr. Space Technol.* 127, 104607 <https://doi.org/10.1016/j.tust.2022.104607>.
- Yong, R.N., Mulligan, C.N., Fukue, M., 2014. Coastal marine environment sustainability. *Sustain. Pract. Geoenviron. Eng.* 290–331. <https://doi.org/10.1201/b17443-12>.
- Yoshioka, K., Sakai, E., Daimon, M., Kitahara, A., 1997. Role of steric hindrance in the performance of superplasticizers for concrete. *J. Am. Ceram. Soc.* 80, 2667–2671. <https://doi.org/10.1111/j.1151-2916.1997.tb03169.x>.
- Yu, Z., Yang, L., Zhou, S., Gong, Q., Zhu, H., 2018. Durability of cement-sodium silicate grouts with a high water to binder ratio in marine environments. *Construct. Build. Mater.* 189, 550–559. <https://doi.org/10.1016/j.conbuildmat.2018.09.040>.
- Zeng, L., Zhou, B., Xie, X., Zhao, Y., Liu, H., Zhang, Y., Shahroui, I., 2020. A novel real-time monitoring system for the measurement of the annular grout thickness during simultaneous backfill grouting. *Tunn. Undergr. Space Technol.* 105 <https://doi.org/10.1016/j.tust.2020.103567>.
- Zeng, L., Zhang, X., Xie, X., Zhou, B., Xu, C., Lambot, S., 2023. Measuring annular thickness of backfill grouting behind shield tunnel lining based on GPR monitoring and data mining. *Autom. Construct.* 150, 104811 <https://doi.org/10.1016/j.autcon.2023.104811>.
- Zhang, G., Liu, J., Li, Y., Liang, J., 2017a. A pasty clay-cement grouting material for soft and loose ground under groundwater conditions. *Adv. Cement Res.* 29, 54–62. <https://doi.org/10.1680/jadcr.16.00079>.
- Zhang, J., Guan, X., Li, H., Liu, X., 2017b. Performance and hydration study of ultra-fine sulfoaluminate cement-based double liquid grouting material. *Construct. Build. Mater.* 132, 262–270. <https://doi.org/10.1016/j.conbuildmat.2016.11.135>.
- Zhang, D.M., Huang, Z.K., Wang, R.L., Yan, J.Y., Zhang, J., 2018c. Grouting-based treatment of tunnel settlement: practice in Shanghai. *Tunn. Undergr. Space Technol.* 80, 181–196. <https://doi.org/10.1016/j.tust.2018.06.017>.
- Zhang, W., Li, S., Wei, J., Zhang, Q., Liu, R., Zhang, X., Yin, H., 2018e. Grouting rock fractures with cement and sodium silicate grout. *Carbonates Evaporites* 33, 211–222. <https://doi.org/10.1007/s13146-016-0332-3>.
- Zhang, C., Fu, J., Yang, J., Ou, X., Ye, X., Zhang, Y., 2018a. Formulation and Performance of Grouting Materials for Underwater Shield Tunnel Construction in Karst Ground. <https://doi.org/10.1016/j.conbuildmat.2018.07.054>.
- Zhang, C., Yang, J., Ou, X., Fu, J., Xie, Y., Liang, X., 2018b. Clay dosage and water/cement ratio of clay-cement grout for optimal engineering performance. *Appl. Clay Sci.* 163, 312–318. <https://doi.org/10.1016/j.clay.2018.07.035>.
- Zhang, L., Han, X.X., Ge, J., Wang, C.H., 2018d. The relationship between compressive strength and flexural strength of pavement geopolymer grouting material. In: *IOP Conference Series: Materials Science and Engineering*. <https://doi.org/10.1088/1757-899X/292/1/012114>.
- Zhang, W., Zhu, X., Xu, S., Wang, Z., Li, W., 2019. Experimental study on properties of a new type of grouting material for the reinforcement of fractured seam floor. *J. Mater. Res. Technol.* 8, 5271–5282. <https://doi.org/10.1016/j.jmrt.2019.08.049>.
- Zhang, C., Yang, J., Fu, J., Wang, S., Yin, J., Xie, Y., 2020a. Recycling of discharged soil from EPB shield tunnels as a sustainable raw material for synchronous grouting. *J. Clean. Prod.* 268, 121947 <https://doi.org/10.1016/j.jclepro.2020.121947>.
- Zhang, S., He, S., Qiu, J., Xu, W., Garnes, R.S., Wang, L., 2020b. Displacement characteristics of an urban tunnel in silty soil by the shallow tunnelling method. *Adv. Civil Eng.* 2020 <https://doi.org/10.1155/2020/3975745>.
- Zhang, Z., Yang, J., Fang, Y., Luo, Y., 2021. Design and performance of waterborne epoxy-SBR asphalt emulsion (WESE) slurry seal as under-seal coat in rigid pavement. *Construct. Build. Mater.* 270, 121467 <https://doi.org/10.1016/j.conbuildmat.2020.121467>.
- Zhang, C., Chen, K., Yang, Junsheng, Fu, J., Wang, S., Xie, Y., 2022a. Reuse of discharged soil from slurry shield tunnel construction as synchronous grouting. *Material. J. Constr. Eng. Manag.* 148 [https://doi.org/10.1061/\(ASCE\)CO.1943-7862.0002231](https://doi.org/10.1061/(ASCE)CO.1943-7862.0002231).
- Zhang, J., Lu, S., Peng, T., Yi, B., Liu, J., 2022b. Research on reuse of silty fine sand in backfill grouting material and optimization of backfill grouting material proportions. *Tunn. Undergr. Space Technol.* 130, 104751 <https://doi.org/10.1016/j.tust.2022.104751>.
- Zhang, Q., Zhang, X.-P., Wang, H.-J., Liu, Q.-S., Xu, D., Tang, S.-H., 2022c. Numerical study of the effect of grout material properties on ground deformation during shallow TBM tunneling. *KSCE J. Civ. Eng.* 26, 3590–3599. <https://doi.org/10.1007/s12205-022-1028-y>.
- Zhang, W., Liu, X., Liu, Z., Zhu, Y., Huang, Y., Taerwe, L., de Corte, W., 2022d. Investigation of the pressure distributions around quasi-rectangular shield tunnels in soft soils with a shallow overburden: a field study. *Tunn. Undergr. Space Technol.* 130, 104742 <https://doi.org/10.1016/j.tust.2022.104742>.
- Zhang, T., Chen, M., Wang, Y., Zhang, M., 2023a. Roles of carbonated recycled fines and aggregates in hydration, microstructure and mechanical properties of concrete: a critical review. *Cem. Concr. Compos.* 138, 104994 <https://doi.org/10.1016/j.cemconcomp.2023.104994>.
- Zhang, T., Zhang, M., Chen, Q., Zhu, H., Yan, Z., 2023b. Enhancing the thermo-mechanical properties of calcium aluminate concrete at elevated temperatures using synergistic flame-retardant polymer fibres. *Cem. Concr. Compos.* 140, 105088 <https://doi.org/10.1016/j.cemconcomp.2023.105088>.
- Zhao, Z., Jiang, J., Chen, Z., Ni, F., 2022. Moisture migration of bitumen emulsion-based cold in-place recycling pavement after compaction: real-time field measurement and laboratory investigation. *J. Clean. Prod.* 360, 132213 <https://doi.org/10.1016/j.jclepro.2022.132213>.
- Zheng, G., Huang, J., Diao, Y., Ma, A., Su, Y., Chen, H., 2021. Formulation and performance of slow-setting cement-based grouting paste (SCGP) for capsule grouting technology using orthogonal test. *Construct. Build. Mater.* 302 <https://doi.org/10.1016/j.conbuildmat.2021.124204>.
- Zhou, S., Xiao, J., Di, H., Zhu, Y., 2018. Differential settlement remediation for new shield metro tunnel in soft soils using corrective grouting method: case study. *Can. Geotech. J.* 55, 1877–1887. <https://doi.org/10.1139/cgj-2017-0382>.
- Zhu, J., Hui, J., Luo, H., Zhang, B., Wei, X., Wang, F., Li, Y., 2021. Effects of polycarboxylate superplasticizer on rheological properties and early hydration of natural hydraulic lime. *Cem. Concr. Compos.* 122 <https://doi.org/10.1016/j.cemconcomp.2021.104052>.
- Zhuang, C., Chen, Y., 2019. The effect of nano-SiO₂ on concrete properties: a review. *Nanotechnol. Rev.* 8, 562–572. https://doi.org/10.1515/NTREV-2019-0050/ASSET/GRAPHIC/JNTREV-2019-0050_FIG_003.JPG.