

Free Flight

Designing for Safety

the Free Flight Air Traffic
Management Concept

Jacco Hoekstra

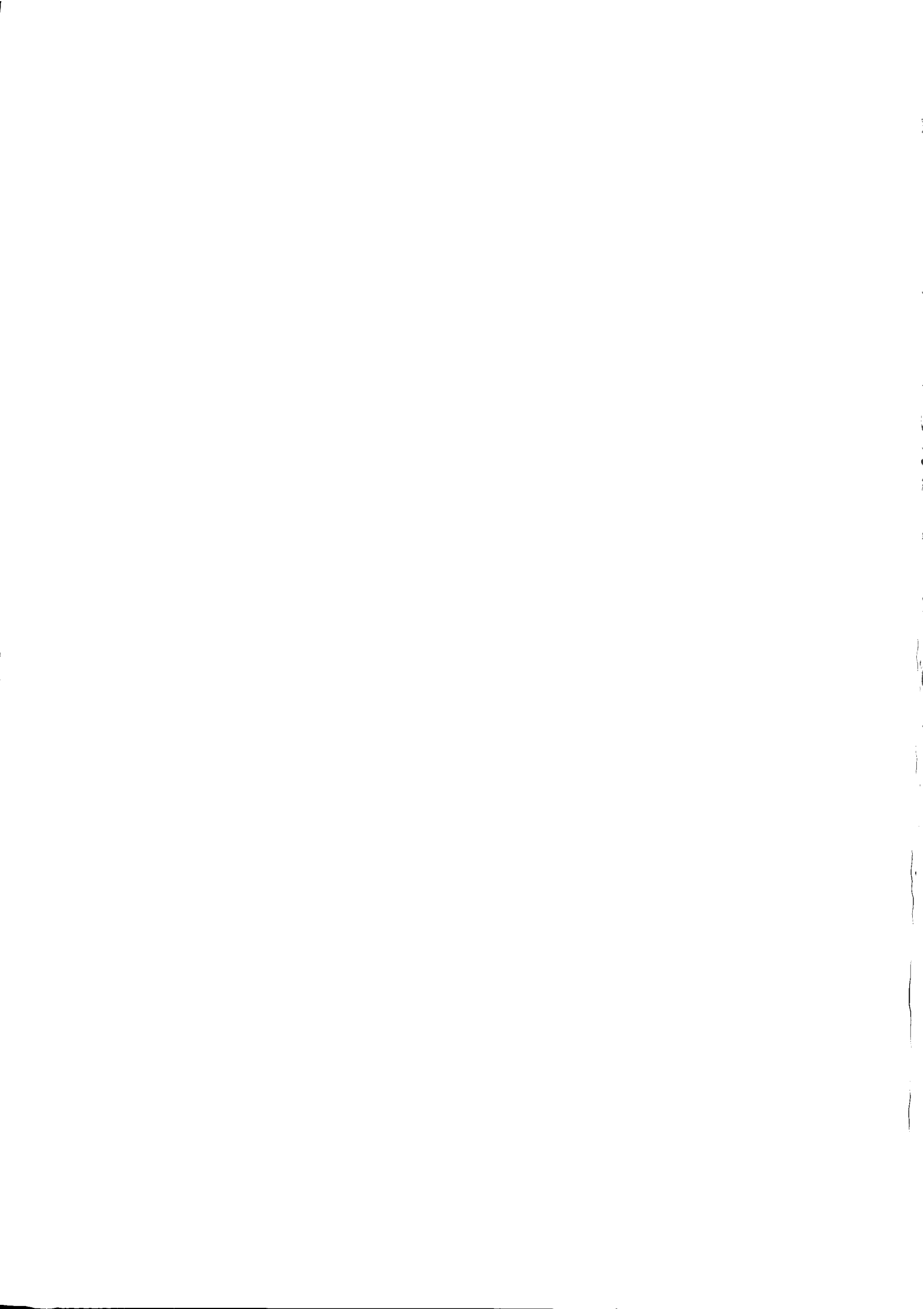

Stellingen

Free Flight met airborne separation is potentieel veiliger, krachtiger en efficiënter dan het huidige verkeersleidingssysteem. (*Dit proefschrift*)

Free Flight is bijna te veilig om goede experimenten op te kunnen zetten. Gedurende het gehele Free Flight onderzoek bleek het creëren van conflicten vele malen moeilijker dan het ontwijken ervan. (*Dit proefschrift*)

Het nadeel van voorrang hebben is, dat je er op moet vertrouwen dat de ander dat ook zo ziet.

Het is voor mensen vaak moeilijk te begrijpen hoe eenvoudige wetten of regels zonder verdere inmenging kunnen zorgen voor complex gedrag één of meerdere aggregatieniveaus hoger.

Eén experimenteel resultaat is meer waard dan de meningen van 1000 experts (*Werner von Braun*), en vaak nog goedkoper ook.

Goede functionele eisen resulteren niet automatisch in één keer in een goed ontwerp.

Gezien de frequentie van grote uitstervingen, klimaatveranderingen en meteorietinslagen op onze planeet is bemande ruimtevaart geen verspilling maar noodzakelijk voor het voortbestaan van de mensheid.

Voor nieuwe ideeën zijn veel betere argumenten nodig dan om oude ideeën in stand te houden.

Liever een veilige chaos dan een gevaarlijke orde.

Historisch gezien kan de Nederlandse taal worden beschouwd als een uit de hand gelopen grensdialect van het Fries.

In de zin "Een woordspeling maak je zelf, een wordspeling is wat er soms opeens met je document gebeurt." is het woord "wordspeling" niet recursief.

Propositions

The Free Flight Air Traffic Management concept has potential economic, capacity and safety benefits.

Free Flight is nearly too safe to set up experiments. During the whole project it proved harder to create conflicts than to avoid them.

The disadvantage of having right of way is that you have to trust the other to see it the same way.

For the human mind it is often hard to understand how simple rules at micro-level without further co-ordination can generate complex behaviour one or two aggregation levels higher.

One test result is worth more than a thousand expert opinions (Werner Von Braun) and often a lot cheaper as well.

Excellent functional requirements do not automatically result in an excellent design.

Considering the frequency of mass extinctions, climate changes and meteorite impacts on our planet, manned space flight is not a waste of money but essential for the survival of mankind.

You need to make a much better case for a new idea, than for keeping old ones in place.

Better a safe chaos than a dangerous order.

Historically, Dutch can be regarded as a border dialect of the Friesian language that got out of hand.

When a program is called "Word" instead of "Words", this should be regarded as a warning to avoid making large documents with this program.
(Variation upon Dutch version which does not translate well)

Erratum

On page 63 the length of the avoidance vector is defined as:

$$v_{\text{avoid}}(1) = \frac{\text{intrude}}{t_{\text{manv}}} = \frac{R - \text{dist}}{t_{\text{manv}}}$$

This should be:

$$v_{\text{avoid}}(1) = \frac{\epsilon \cdot R - \text{dist}}{t_{\text{manv}}}$$

In which ϵ is a factor that compensates for the small angle α between the line to the relative position of the intruder at CPA and the line to the position where the relative resolution speed vector touches the protected zone of the own ship (see figure below). This makes OX slightly longer than R.

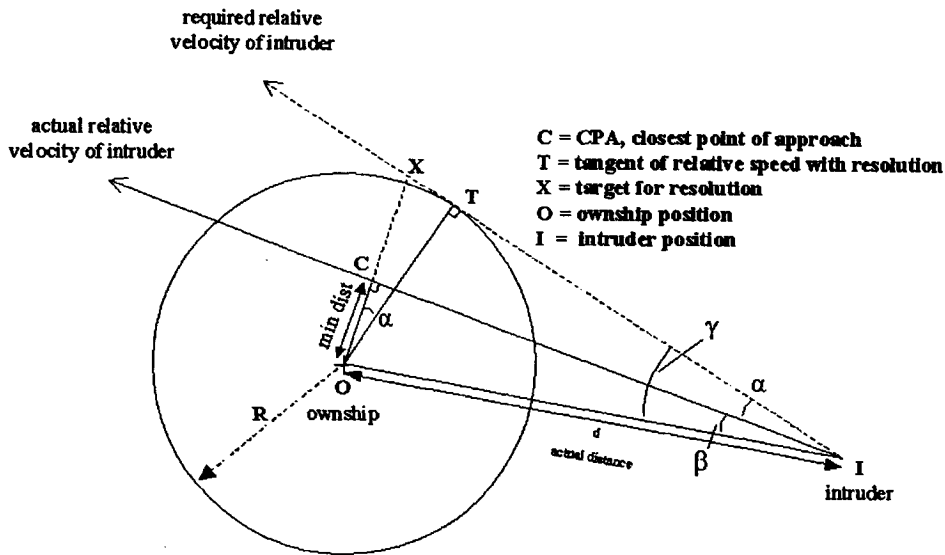

Figure 1 Conflict resolution geometry based on the relative speed of the intruder

Normally this factor is close to 1.0, but when an aircraft is close (thus the relative speed is minimal) and the intrusion is large, it can become significant. In these cases, the margin that exists between the protected zone dimensions used in the resolution and the detection will not compensate for this factor.

The correct length of the avoidance vector $\epsilon \cdot R$ can be calculated as follows:

$\alpha = \angle CIT = \angle COT$ because $OC \perp IC$ and $OT \perp IT$

$\beta = \angle OIC$

$\gamma = \angle OIX = \alpha + \beta$

$d = \text{actual distance}$ $\text{dist} = \text{minimum distance}$

To calculate $OX = \varepsilon R$, we need α :

$$\Delta OIC : \sin \beta = \frac{OC}{OI} = \frac{\text{dist}}{d}$$

$$\Delta OIT : \sin \gamma = \frac{OT}{OI} = \frac{R}{d}$$

$$\alpha = \gamma - \beta = \arcsin\left(\frac{R}{d}\right) - \arcsin\left(\frac{\text{dist}}{d}\right)$$

$$\Delta OTX : \varepsilon \cdot R = OX = \frac{OT}{|\cos \alpha|} = \frac{R}{\left| \cos\left(\arcsin\left(\frac{R}{d}\right) - \arcsin\left(\frac{\text{dist}}{d}\right)\right) \right|}$$

It can be seen that if the actual distance d is much larger than R (which usually is the case) or if the minimum distance dist is close to R (hence a minimal intrusion), the cosine will be close to 1.0 and hence $\varepsilon \cdot R \sim R$.

A typical situation where this factor makes an important difference, is a nearly parallel track with a severe intrusion.

TR 3766

3766
762733
3104021

**“ Designing for Safety:
the Free Flight Air Traffic Management Concept”**

Proefschrift

ter verkrijging van de graad van doctor
aan de Technische Universiteit Delft,
op gezag van de Rector Magnificus prof. ir. K.F. Wakker,
voorzitter van het College voor Promoties,
in het openbaar te verdedigen op dinsdag 6 november 2001 te 13:30 uur
door Jacob Marten HOEKSTRA
ingenieur luchtvaart en ruimtevaart
geboren te Leeuwarden

Dit proefschrift is goedgekeurd door de promotor:
Prof. dr. A.R. Hale

Samenstelling promotiecommissie:

Rector Magnificus Technische Universiteit Delft, voorzitter
Prof. dr. A.R. Hale, Technische Universiteit Delft, promotor
Prof. dr. ir. J.A. Mulder, Technische Universiteit Delft
Prof. dr. ir. P.A. Wieringa, Technische Universiteit Delft
Prof. drs. P.G.A.M. Jorna, Cranfield Institute of Technology/NLR
Prof. dr. ir. M.H.G. Verhaegen, Technische Universiteit Twente
S. Zerkowitz, Assistant director Operations & Infrastructure Europe, IATA

Ir. F.J. Abbink en de heer ir. T. Heijer hebben als begeleiders in belangrijke mate bijgedragen bij de totstandkoming van het proefschrift

Deze studie is gerealiseerd dankzij het Nationaal Lucht- en Ruimtevaartlaboratorium (NLR), de National Aeronautics and Space Agency (NASA), de Federal Aviation Administration (FAA) en de Rijksluchtvaartdienst (RLD).

ISBN 90-806343-2-8

SUMMARY

Designing for Safety: the Free Flight Air Traffic Management Concept by J. M. Hoekstra

The Air Traffic Management System, as it is used today, is a centrally organised system. One controller, sometimes assisted by a planner, is responsible for maintaining the separation between all aircraft in his/her sector. Pilots merely follow the directions received from the controller and have no active role in the separation assurance. To maintain an orderly traffic pattern, airways are used to structure the traffic flow and flight levels are used as layers to separate aircraft. This often inhibits a more optimal direct route at the optimal altitude. The need for maintaining situational awareness also limits the number of aircraft a controller can handle. This is a limiting factor for airspace capacity and contributes to delays.

The study described in this thesis investigates a revolutionary alternative for this system, called the Free Flight concept. In Free Flight Airspace aircraft fly their own preferred route at their preferred altitude. They only need to deviate from this route if it conflicts with the route of another aircraft. The aircraft transmit their position via a data link. These data are presented on the traffic display in the cockpit. Maintaining separation now becomes the responsibility of the cockpit crew assisted by an Airborne Separation Assurance System (ASAS) that alerts and advises the crew.

When this study started in 1996 the area of Free Flight was practically unexplored. In general it was thought to be a dangerous idea. The initial goal was to explore the human factors issues in the cockpit, which result from moving the separation task to the cockpit. However, since hardly any Free Flight research was available to build upon, the study first had to incorporate designing a feasible operational concept. The operational concept describes in what way the Free Flight concept should be implemented. What is the role of the pilot? What is the role of the systems? What procedures should be used? What should be the rules-of-the-sky? Consequently, the study became broader and investigated the feasibility of the operational concept based on the Free Flight idea.

In addition to literature surveys and analysis, two experimental methods have been used to investigate the feasibility: off-line traffic simulations, using a tool developed especially for this study, called the Traffic Manager, and human-in-the-loop simulations with airline pilots in NLR's Research Flight Simulator.

Using the operational concept designed, several issues have been investigated: acceptability and workload resulting from adding the separation task to the flying task and navigation task; the effect of lack of a global picture and central co-ordination on the traffic pattern and the effect on the capacity of a sector.

Evidence has been found that Free Flight is not only a promising concept for airspace with a relatively low traffic density, but that it is also capable of handling much higher traffic densities than today's centrally organised ATM system. As a result of this study Free Flight has become more acceptable to the aeronautical research community. Several other studies since then have found results that confirm the conclusions of this study. The study also presents a direction in which future Free Flight research and

implementation efforts should be heading. The results indicate that the introduction of Free Flight potentially offers economic, capacity and safety benefits. The author is using these results to play an active role in the decision process that is ongoing in several organisations.

SAMENVATTING

Designing for Safety: the Free Flight Air Traffic Management Concept door J. M. Hoekstra

De huidige luchtverkeersleiding is een centraal georganiseerd systeem. Eén verkeersleider, soms geassisteerd door een planner, is verantwoordelijk voor het separeren (bij elkaar vandaan houden) van alle vliegtuigen in zijn/haar sector. Piloten volgen slechts de aanwijzingen op, die ze van de verkeersleider ontvangen, en spelen verder geen actieve rol in de separatie. Om een ordelijk verkeerspatroon te creëren worden zogenaamde 'luchtwegen' (airways) gebruikt. Verschillende hoogten, de zogenaamde flight levels, worden gebruikt als verschillende lagen om verkeer te separeren. Dit maakt het vliegen van een optimale, directe route op een optimale hoogte vaak onmogelijk. Om de situatie te kunnen blijven beheersen is er bovendien een bovengrens aan het aantal vliegtuigen in een sector. Dit beperkt de capaciteit van het luchtruim en is verantwoordelijk voor vertragingen.

De in dit proefschrift beschreven studie onderzoekt een revolutionair alternatief voor dit systeem, het zogenaamde Free Flight concept. In een Free Flight sector kunnen vliegtuigen een optimale, geprefereerde route vliegen op hun optimale hoogte. Van deze route hoeven zij slechts af te wijken indien het conflicteert met de route van een ander vliegtuig. Alle vliegtuigen zenden hun positie digitaal uit. De ontvangen gegevens worden in de cockpit getoond op een verkeersdisplay. Het separeren van vliegtuigen is nu de verantwoordelijkheid van de vliegers. Zij worden hierin bijgestaan door een Airborne Separation Assurance System (ASAS) dat de vliegers waarschuwt en hen adviseert.

Toen deze studie in 1996 begon was Free Flight nog onverkend terrein. In het algemeen werd het beschouwd als een gevaarlijk idee. In het begin was het doel van de studie slechts het onderzoeken van de human factors problemen, die worden veroorzaakt door het verplaatsen van de separatietaak naar de cockpit. Omdat er praktisch geen andere studies op dit gebied waren gedaan, moest er ook nog een operationeel concept worden ontworpen. Dit operationele concept beschrijft hoe Free Flight uitgevoerd zou moeten worden. Wat is de rol van de vliegers? Wat is de rol van de systemen? Welke procedures moeten er gebruikt worden? Welke verkeersregels kunnen gebruikt worden? Als gevolg van deze vragen werd de studie breder en heeft de haalbaarheid van het Free Flight concept onderzocht.

Naast literatuuronderzoek en analyse is gebruik gemaakt van twee soorten experimenten: off-line verkeerssimulaties, met behulp van een speciaal voor deze studie ontwikkeld programma, Traffic Manager geheten, en met experimenten met behulp van NLR's research flight simulator waaraan lijnvliegers hebben deelgenomen.

Met het ontworpen operationele concept zijn diverse onderwerpen onderzocht: de vlieger-acceptatie en werkbelasting ten gevolge van de extra taak, het effect van het ontbreken van het overzicht en centrale coördinatie op het verkeerspatroon en op de capaciteit van een sector.

Er zijn aanwijzingen gevonden, dat Free Flight niet alleen geschikt is voor relatief rustige delen van het luchtruim, maar dat het ook geschikt is voor verkeersdichtheden die vele

malen hoger zijn dan wat het huidige verkeersleidingssysteem aankan. Als gevolg van deze studie is het Free Flight idee nu geaccepteerd door de luchtvaart onderzoekswereld. Diverse andere studies hebben sindsdien de resultaten van dit onderzoek bevestigd. Deze studie presenteert bovendien een richting voor de toekomstige Free Flight onderzoeks- en implementatie-activiteiten. Het onderzoek laat zien dat Free Flight potentiële voordelen heeft voor de efficiency, capaciteit en veiligheid. De auteur gebruikt deze resultaten om een actieve rol te spelen in het beslissingsproces in diverse organisaties.

Table of Contents

SUMMARY	3
SAMENVATTING	5
PART I INTRODUCTION: CONCEPT & ISSUES	13
1 INTRODUCTION FREE FLIGHT STUDY.....	14
1.1 What is the Free Flight concept?.....	14
1.1.1 Today's Air Traffic Management Concept.....	14
1.1.2 Free Flight: a revolutionary change.....	17
1.2 Functional description.....	20
Controlled Flight.....	20
1.2.2 Free Flight.....	22
1.3 NASA/NLR Free Flight project.....	24
2 HYPOTHESIS TREE.....	26
2.1 General.....	26
2.2 What is a hypothesis tree diagram?.....	26
2.3 Description of the free flight hypothesis diagram.....	29
2.3.1 Feasibility.....	29
2.3.2 Safety > Human Factors.....	30
2.3.3 Safety > Central co-ordination.....	30
2.3.4 Safety > Technical > Bandwidth.....	30
2.3.5 Safety > Technical > Certification.....	31
2.3.6 Safety > Technical > Navigation Performance.....	31
2.3.7 Safety > Technical > New FMS.....	31
2.3.8 Safety > Technical > Display.....	32
2.3.9 Safety > Technical > ADS-B.....	32
2.3.10 Economics.....	33
2.3.11 Economics > Airlines motivation.....	33
2.3.12 Economics > Resolution efficiency.....	33
2.3.13 Economics > Local optimisation.....	33
2.3.14 Politics.....	34
2.3.15 Political > Mandatory equipage.....	34
2.3.16 Political > Pilot acceptability.....	34
2.3.17 Political > Controller acceptability.....	34
2.3.18 Political > Mixed Equipage procedures.....	35
2.3.19 Political > Eurocontrol ATM 2000+ concept.....	35
3 CONCEPTUAL DESIGN.....	36
3.1 Introduction.....	36
3.2 Flight Plan Information Exchange.....	36
3.3 Using Priority Rules.....	38
3.4 Implicit or Explicit Co-ordination.....	39
3.5 Miscellaneous.....	39
3.5.1 Role of ATC.....	39
3.5.2 Protected Zones.....	40
PART II AIRBORNE SEPARATION ASSURANCE SYSTEM	43
4 CONFLICT DETECTION & RESOLUTION.....	44
4.1 Introduction.....	44
4.2 Choosing a conflict detection and resolution method.....	44
4.2.1 Criteria.....	44
4.2.2 Survey of methods.....	45
4.2.3 Conflict detection.....	45
4.2.4 Resolution methods.....	47
4.3 ASAS software implementation.....	52
4.4 Conflict Detection Module.....	55
4.5 Conflict Resolution Module.....	62
4.6 Straight lines.....	64
4.7 Effect of CAS/Mach climb or descent.....	66

4.7.1	Definition of CAS and Mach	66
4.7.2	Climb with constant Mach	67
4.7.3	Climb with constant calibrated airspeed	68
4.7.4	Scenario (I) of CAS, Mach climb/descent	69
4.7.5	Scenario (II) of CAS, Mach climb/descent	72
4.7.6	Conclusion of climb/descent scenarios	75
4.8	Effect of 2D CPA outside protected zone	76
4.9	Effect of vertical direction of relative speed	77
4.10	Effect of singularities	78
4.11	Summary	79
5	CONFLICT PREVENTION: PREDICTIVE ASAS	81
5.1	Introduction	81
5.2	Need for conflict prevention system	81
5.3	Algorithms	84
5.3.1	Calculating vertical speed bands	84
5.3.2	Calculating indicated airspeed bands	85
5.3.3	Calculating heading bands	86
5.3.4	Output	87
5.4	Miscellaneous remarks	88
6	HUMAN MACHINE INTERFACE	90
6.1	Introduction	90
6.2	Task analysis	90
6.2.1	Traffic Monitoring	90
6.2.2	Conflict Detection	91
6.2.3	Conflict Resolution	92
6.2.4	Recovery Manoeuvre	93
6.2.5	Inter Traffic Radiotelephony	93
6.3	Requirements	93
6.4	Cockpit Display of Traffic information	94
6.4.1	Predecessor: TCAS display	94
6.5	NLR Traffic Display	97
6.5.1	Display Layout	97
6.5.2	Traffic Information	98
6.5.3	Conflict Symbology	98
6.5.4	Resolution Symbology	100
6.5.5	Additional Features	100
6.5.6	Snapshots of CDTI	101
6.6	Aural Alerts	104
6.7	Predictive ASAS	105
6.8	Autopilot Resolution Modes	106
	PART III OFFLINE TRAFFIC SIMULATION STUDIES	107
7	TRAFFIC MANAGER	108
7.1	Purpose	108
7.2	Features of the Traffic Manager	109
7.2.1	Graphical User Interface	109
7.2.2	Scenario file recording and playing	110
7.2.3	Scenario Generation Functions	110
7.2.4	Environment Simulation	110
7.2.5	Experiment Manager Station	110
7.2.6	Aircraft Models	110
7.2.7	Fast-time simulation	111
7.2.8	Large-Scale Traffic simulations	111
7.2.9	ASAS Test Platform	111
7.2.10	Architecture	112
7.2.11	Game domain	113
8	COMPLEX CONFLICT GEOMETRIES STUDY	114
8.1	Introduction	114
8.2	Purpose	114
8.3	Super-conflicts	114
8.4	Wall scenarios	120

8.5	Conclusion.....	120
9	COSTS OF AIRBORNE CONFLICT RESOLUTION.....	122
9.1	Introduction.....	122
9.2	Cost-Benefit Study of Free Flight with Airborne Separation Assurance.....	123
9.2.1	One-on-one conflict experiments.....	123
9.2.2	Modifications to Resolution Module.....	123
9.2.3	Experiment set-up.....	124
9.2.4	Horizontal Conflict Experiments.....	125
9.2.5	Vertical Conflict Experiment.....	127
9.2.6	Aircraft Performance Validation.....	127
9.2.7	Experiment Matrix.....	128
9.2.8	Results of Vertical Conflict Experiments.....	128
9.2.9	Results of Horizontal Conflict Experiment.....	129
9.2.10	Discussion of resolution costs.....	131
9.3	Decision model for conflict resolution.....	132
9.4	Passenger comfort aspects of conflict resolution.....	133
9.5	Conclusion and Remaining Issues.....	134
PART IV HUMAN-IN-THE-LOOP EXPERIMENTS.....		135
10	PHASE I FLIGHT SIMULATOR TRIALS.....	136
10.1	Goal of the Trials.....	136
10.2	Research Questions.....	136
10.3	Experimental Design.....	137
10.4	Experiment scenarios.....	141
10.5	Experimental Configuration.....	144
10.6	Results.....	146
10.6.1	Questionnaires.....	146
10.6.2	Workload.....	148
10.6.3	Pilot Acceptability & Traffic Density.....	152
10.6.4	Effect of events in non-nominal runs.....	154
10.6.5	Autopilot mode preference.....	156
10.6.6	Conflict Resolution effectiveness.....	157
10.6.7	Display clutter by traffic symbols.....	160
10.6.8	Analyses of Resolution Manoeuvres.....	161
10.7	Miscellaneous pilot comments.....	162
10.8	Conclusions.....	162
11	PHASE II FLIGHT SIMULATOR TRIALS.....	164
11.1	Research Questions.....	164
11.2	Mixed Equipage Procedure Options.....	165
11.2.1	Transition Issue.....	165
11.2.2	Concept F: Flight Level Split.....	166
11.2.3	Concept A: Protected Airways ATM concept.....	168
11.2.4	Concept M: Fully Mixed.....	169
11.2.5	Other mixed equipage procedures.....	170
11.3	Experimental Configuration.....	170
11.4	Experimental ATC station.....	172
11.5	Subjects.....	173
11.6	Experiment matrix.....	173
11.7	Measures.....	175
11.8	Results.....	175
11.8.1	Subjective data.....	175
11.9	Objective data.....	194
11.9.1	Intrusions.....	194
11.9.2	Workload.....	195
11.10	Conclusion.....	197
PART V DISCUSSION AND CONCLUSIONS.....		199
12	NON-NOMINAL SITUATIONS.....	200
12.1	Introduction.....	200
12.2	Functional system diagram.....	200
12.2.1	Conflict Detection and Resolution.....	200

12.2.2	Today's ATC system	200
12.2.3	Free Flight with Airborne Separation Assurance	202
12.3	Fault Tree analysis of Free Flight	204
12.4	Conclusion	207
13	DISTRIBUTED SYSTEMS VS. CENTRAL SYSTEMS	209
13.1	Introduction	209
13.2	(Un)Predictability of a Distributed System	209
13.3	Safety as a result of distributing separation assurance	211
13.4	Capacity as a result of distributing separation assurance	213
13.5	Conclusion	216
14	DISCUSSION	217
14.1	Introduction	217
14.2	Discussion of results obtained	220
14.2.1	Operational Concept > Flight Plan Information	220
14.2.2	Operational Concept > Explicit co-ordination	222
14.2.3	Operational Concept > Priority rules	223
14.2.4	Operational concept	224
14.2.5	Safety > Human Factors > Workload	224
14.2.6	Safety > Human Factors > Situational Awareness	225
14.2.7	Safety > Human Factors	225
14.2.8	Safety > Central Co-ordination > Conflict Geometries	225
14.2.9	Safety > Central Co-ordination	226
14.2.10	Safety > Technical > Bandwidth > Operational Concept	227
14.2.11	Safety > Technical > Strategic FMS > Reactive System	228
14.2.12	Safety > Technical > Display Clutter > CDTI Design > High Traffic Densities	229
14.2.13	Safety > Technical > Display Clutter > CDTI Design	229
14.2.14	Safety > Technical > Display Clutter	229
14.2.15	Economics > Resolution Costs	229
14.2.16	Economics > Local Optimisation	230
14.2.17	Politics > Pilots' Acceptability	230
14.2.18	Politics > Mixed Equipage with Intrinsic Benefits	231
14.2.19	Politics > Eurocontrol's ATM 2000+ Concept	231
14.3	Open Issues	231
14.4	Future work	232
15	CONCLUSIONS AND RECOMMENDATIONS	234
15.1	Conclusions	234
15.1.1	Feasibility	234
15.1.2	Operational Concept	234
15.1.3	Capacity Benefits	234
15.1.4	Economic Benefits	234
15.1.5	Safety Benefits	235
15.2	Recommendations	235
15.2.1	Keep It Simple,	235
15.2.2	Technology Testing	235
15.2.3	Standardisation of Rules-of-the-sky	235
15.2.4	Integrated Display Design	236
15.2.5	Lower Cockpit Technology Threshold	236

ACRONYMS AND ABBREVIATIONS.

DEFINITIONS

REFERENCES & BIBLIOGRAPHY

ACKNOWLEDGEMENTS

CURRICULUM VITAE

Preface

In the early days of flying, all pilots navigated using ground features such as roads, rail tracks and coastlines. Since there were not many aircraft flying in those days, collision avoidance was only an issue near airfields. By keeping a sharp look out, collisions were avoided by the pilot. In the case where there was another aircraft nearby, a set of rules indicating who had right of way were used. This see & avoid way of flying was very much restricted to weather conditions allowing the visibility of the ground and the other aircraft (visual meteorological conditions, VMC).

Radio navigation later allowed flying in and above clouds without getting lost. Radar and radio communication allowed control towers to separate traffic near the airports in weather conditions previously inhibiting flight. With beacons placed all over the country, a route in instrument meteorological conditions (IMC) consisted of flying from one beacon to another. This created a route structure in the sky consisting of so-called airways (see figure below).

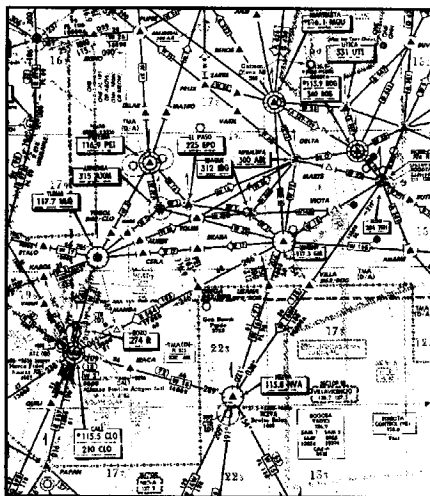

Figure 0.1 Example of airway structure

This increased the local traffic density and thereby the probability of mid-air collisions on these airways. Therefore to maintain a safe separation of the traffic, air traffic control was now no longer restricted to the area around an airport. Air Traffic Control became responsible for the separation of aircraft during the complete flight except for some general aviation, which still uses visual separation today. First procedural separation was used, while later the radar covered the en-route airspace as well.

The route structure of airways is still being used today despite the fact that modern navigation no longer relies on flying to and from a beacon. Any route can be flown by the automatic pilot using a variety of navigation aids such as omni-directional radio beacons, inertial navigation systems and satellite navigation.

In many situations, aircraft are allowed to 'fly direct' and cut off turns of their route. This so-called 'direct routing' yields time and fuel savings. Direct routing is currently only applied under radar coverage in relatively quiet airspace. In high traffic densities, the airways aid the air traffic controller in sequencing the traffic and in maintaining a mental picture of the complete traffic situation. This mental picture is essential to ensure the separation of the traffic.

Free Flight is a concept where the separation task has been moved to the cockpit. This changes the air traffic management system from a centrally organised system to a distributed system. It is therefore a fundamental and revolutionary change of the air transport system. Whether it is feasible and safe to decentralise this task of separation is the central question in this thesis.

PART I INTRODUCTION: CONCEPT & ISSUES

1 Introduction Free Flight study

1.1 What is the Free Flight concept?

1.1.1 *Today's Air Traffic Management Concept*

The way the airspace is divided and organised and which procedures are applied is generally known as Air Traffic Management or ATM. To understand the change Free Flight proposes for Air Traffic Management, a general understanding of today's situation is essential. In this section a description of today's operations and some definitions will be given.

All flights, except those of some smaller general aviation aircraft, are controlled by an air traffic controller from gate to gate. Air Traffic Control (ATC) is responsible for maintaining a sufficiently large distance between aircraft to avoid dangerous situations and ultimately collisions. To prevent these dangerous situations a required minimum distance between two aircraft has been defined: the so-called "separation minima". The separation minima are typically 5 nautical miles (9 km, since 1 nautical mile = 1852 m) horizontally and 1000 feet (300 m) vertically (Ross Russell, 1995). The task of maintaining the separation minima is called "separation assurance". The task of separation assurance is performed by an air traffic controller during the whole flight.

Separation assurance is the most important but not the only task of ATC. Air Traffic Control is a part of the Air Traffic Services (ATS) provided by the authorities. The complete list of tasks of the Air Traffic Services is defined in the International Civil Aviation Organization (ICAO) Annex 11 as:

- Airborne aircraft collision avoidance (ATC)
- Collision avoidance for aircraft on the ground (ATC)
- Initiating and maintaining orderly processing of air-traffic (ATC)
- Providing flight information for a safe and efficient traffic flow (Flight Information)
- Alerting and assisting necessary authorities for aircraft in need of search and rescue (Alerting)

The first three tasks are part of Air Traffic Control. Capturing this in one sentence gives:

Air Traffic Control is responsible for the safe, orderly and expeditious flow of traffic.

Taxiing and landing aircraft, as well as aircraft taking off, fall under the responsibility of Aerodrome Control (TWR – 'Tower'). Aircraft entering or leaving the area around an airport are controlled by Approach Control (APP – 'Approach'). In all other phases of flight, even during cruise, an Area Control Centre (ACC) controls the aircraft.

A Flight Information Centre (FIC) is an air traffic centre providing flight information and, if required, the alerting of other authorities (e.g. search and rescue). Flight information is information required for safe and efficient execution of the flight such as information on dangerous weather situations, changes in the availability of navigational aids, condition of airports, etc.

The procedures used for the controlled flights are called Instrument Flight Rules (IFR). These rules are applicable to aircraft using instruments to navigate instead of visual navigation based on landmarks. Only smaller general aviation aircraft flying at lower altitudes in unmanaged airspace use the complementary set of rules called Visual Flight Rules (VFR). When flying under Visual Flight Rules aircraft are responsible for maintaining their own separation for the main part of the flight. Commercial aircraft continuously fly under Instrument Flight Rules. These rules allow the aircraft to operate even when the visibility is low. Because under IFR Air Traffic Control is responsible for maintaining the separation, the IFR procedures are generally also used in good visibility. Relying on maintaining separation visually would be dangerous during most phases of the flight, because of the high speeds of most commercial airliners.

When flying IFR, the complete route is requested and a route clearance is required before take-off. This route information is then sent out via the Aeronautical Telecommunications Network (ATN) to all air traffic control centres, which will have the flight under control in their sector.

When there is a need for a route change this has to be requested during the flight and, if the traffic and weather situation permit, the aircraft will receive a clearance for this route change. Further, any altitude change (e.g. to climb to a higher, more economic flight level) requires a clearance from ATC. Therefore, there is no freedom for the crew to change their route to a more optimal route without a negotiation cycle with the ground.

Apart from requests for a route or altitude change, there are several other procedures requiring communication with the ground: when crossing a sector boundary, the controller of the former sector 'hands off' the aircraft to the next controller. This requires a new position and/or route report to the new controller as a confirmation or log-on to the sector. Maintaining the separation of all traffic under his/her control is the responsibility of the controller of the sector.

Initially air traffic control was based on procedural separation. Since World War II, radar has been used to monitor the traffic situation. At first it was only used around the airport, but with the increasing amount of air traffic, en-route traffic is also monitored via radar. Aircraft today are also equipped with a transponder that automatically responds to an interrogation by providing extra information to the radar such as an identification code (mode A) and the altitude (mode C) for the air traffic controller. The result is a complete overview of the three-dimensional traffic situation. Trailing blips on the screen even provide an impression of the direction and magnitude of the ground speed. Using the mode C transponder ensures an accurate vertical position estimate. However, the angular nature of the radar may not provide a very accurate horizontal position estimate especially at larger distances (Ross Russel, 1995). This explains the typical separation minima in these circumstances of 5 nautical mile horizontally and only 1000 feet vertically.

In areas where there is no radar surveillance (e.g. large areas of Africa and Asia) procedural separation replaces radar-controlled separation. Procedural separation means that every aircraft reports its position and by issuing the appropriate clearances, the separation is ensured by ATC. The situational awareness of the controller is clearly lower in this situation compared to radar surveillance. The result is the use of larger margins and therefore less optimal flights as well as an inherently more dangerous situation.

A special form of procedural separation takes place over the Atlantic Ocean (FAA, 1999; ICAO, 1992). Here so-called 'tracks' work similar to a railway system: aircraft are positioned, already separated, at the beginning of a track with intervals of 10 minutes and will arrive at the end of that same track. So lateral route changes are inhibited over the ocean. These tracks are changed regularly based on the weather situation and are labelled for reference. The distance between the tracks is one degree latitude, which equals 60 nautical miles. The vertical separation used to be 2000 ft but has recently been reduced to 1000 ft over the Atlantic Ocean due to the increased traffic density between Europe and North America. This enormous difference between the vertical and horizontal separation is due to possible (different) navigation errors caused by the inertial navigation system during the long flight over the ocean, while the altitude is determined via a common reference (air pressure) ensuring a very accurate estimation of the *relative* vertical position. Using satellite navigation to enhance and replace inertial navigation might improve the *relative* lateral navigation and provide a way to reduce the distances between the tracks.

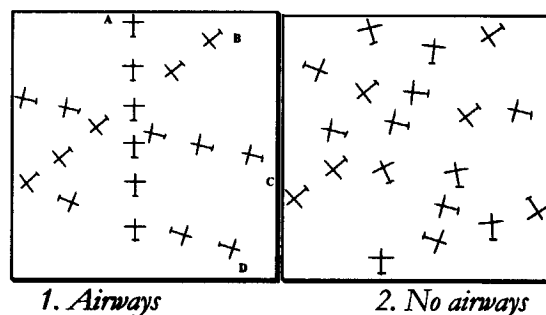

figure 1.1 Schematic representation of how airways aid organisation of traffic

Under radar coverage, traffic flows are normally structured into airways. Airways originally consisted of routes flying from one beacon to the next one. In the old days, this was the standard way to navigate under IFR. Although today's navigation equipment no longer requires flying from one beacon to the next, the airways are still in place. One reason for this is that a structured traffic pattern enables one controller to monitor a complete sector, which would look chaotic if all aircraft were to fly direct (see figure 1.1). Possible separation problems are limited to intersections, aircraft changing altitude or overtaking each other in an airway. Apart from this benefit there are clearly some drawbacks to airways as well:

1. airways are often not the most optimal route
2. the local traffic density is artificially increased by concentrating the traffic on lines instead of using the full airspace
3. flying on the same route might inhibit flying the optimal flight level or speed as a result of the traffic concentration in the airway

When the traffic density is low (e.g. during the night) aircraft are often cleared for direct flights to a waypoint further along the route.

The air traffic controller's highest priority is safety. Most of the time, actions are based on preventing conflicts far before they could become imminent. For instance, keeping two aircraft that are flying in the same airway in the same direction at a different altitude (always a value rounded to a multiple of 1000 feet) even when they will not overtake each other,

ensures he/she will not have to monitor for a possible conflict between those two aircraft. If not adequately anticipated, more than one dangerous situation might develop simultaneously, all of which might require instantaneous action. The preventive actions allow the controller to keep his workload at an acceptable level even during high-density traffic situations. The price for this safety is the suboptimal airspace usage due to the capacity limit this method imposes on a sector.

In 1999 Eurocontrol's Performance Review Committee (PRC) wrote in their annual report, that about 75% of the ATC related delays were caused by en-route ATC and not by the tower or approach ('Airport ATC capacity'). In contrast, the year before this number was only 28% ! In total the ATC related delays were 140% compared to the year before. The air traffic growth was, just as the years before, only 5%. The fact that a normal minor increase of air traffic results in an excessive increase of en-route ATC delays indicates the limits of the en-route ATM system have been reached. In the conclusions the PRC states 'revolutionary changes' are required to fix Europe's ATM system performance (Eurocontrol PRC, 1999). Free Flight is potentially such a change.

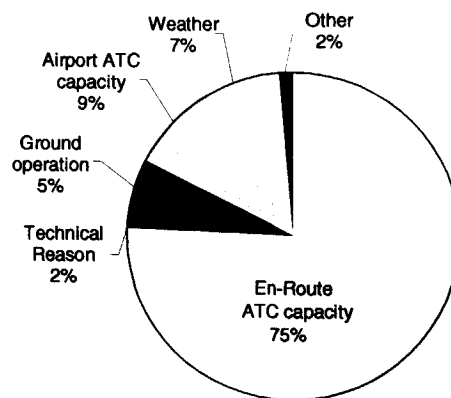

figure 1.2 European ATC delay causes (Source: Eurocontrol)

1.1.2 *Free Flight: a revolutionary change*

Today's ATM concept as described in the previous section is often not the most optimal way of flying from an airline point of view. Often aircraft trajectories are determined by the required order on the radar screen to enable the controller to maintain sufficient situational awareness. When the traffic situation allows it, the controller will allow the traffic to optimise their flight based on their requests. Airlines would prefer a more optimal way of flying with respect to fuel and time within the safety margins if possible. Assuming the aircrew is able to perform the separation task, they might be able to fly more optimal routes. Self-optimisation therefore could provide a more optimal, while still safe, and apparently more chaotic traffic pattern. This idea of self-optimisation forms the basis of Free Flight (RTCA TF 3, 1995)

In the Free Flight concept, the separation assurance task is moved to the cockpit. The aircrew can ensure the separation if they are aware of the traffic around the aircraft. Visual acquisition of traffic is not possible due to the high speeds and sometimes bad weather. Just like the air traffic controller's radar display a traffic display is required. This display,

generally referred to as CDTI (Cockpit Display of Traffic Information) could, like most instruments in modern cockpits, be integrated in the navigation display.

If a system would broadcast not only identification and altitude but also the position, velocity and maybe even a part of the intended route, every aircraft could use these data to ensure the separation themselves. Such a system is becoming available: the so-called ADS-B (Automatic Dependent Surveillance - Broadcast). The effect of this system is that all aircraft in range receive the data broadcast by all other aircraft in the area. The data of the other aircraft are processed by an on-board system and this is displayed on the Cockpit Display of Traffic Information (CDTI). Several display formats are currently being developed to present the traffic situation to the crew in an optimal way.

Free Flight might also provide a more efficient airspace usage for areas without any surveillance, which use procedural separation, for instance over the ocean or other areas without radar coverage and maybe even in the areas currently controlled using radar. In general the separation assurance method as described in the previous section, and not the airspace volume itself, is the limiting factor on capacity (except maybe in the terminal area around airports, where runway availability becomes critical). At this moment the air traffic controller's workload and situational awareness is the limiting factor for the capacity of an en-route sector (Wickens, C.D. et al., 1997). The question is whether airborne separation assurance is possible under higher traffic densities than currently can be achieved by an air traffic controller at an Area Control Centre.

The effect of moving the separation task to the cockpit is more radical than it sounds. The task is not simply moved, it is distributed among the aircrews in the sector. This means a radical change in the structure of the system. From a centrally controlled system the ATM system becomes a distributed system with inter-acting elements. The central node in the system disappears (See figure 1.3 and figure 1.4).

There are some general aspects to decentralisation of a system. For the centrally organised ATM system, the addition of another aircraft puts more strain on the central node and its capacity, since the controller is the only actor and aircraft are passive elements increasing the dimension of the problem (in a dramatic way as will be discussed in chapter 13). In a distributed system the addition of another aircraft also adds an extra potential problem solver to the sector, since the aircraft are no longer passive elements.

Another effect is the data flow: in a centrally controlled system all data of all aircraft has to be available to the central node for a good global optimisation. In the case of self-optimisation these data are already locally available allowing more specific but local optimisation. On the other hand, instability and chaos can in principle lead to catastrophic situations in a distributed system (Wolfram S., 1984; Langton, C.G., 1997), which could have been prevented in an orderly, centrally controlled system. This study investigates which of these effects will occur in practice.

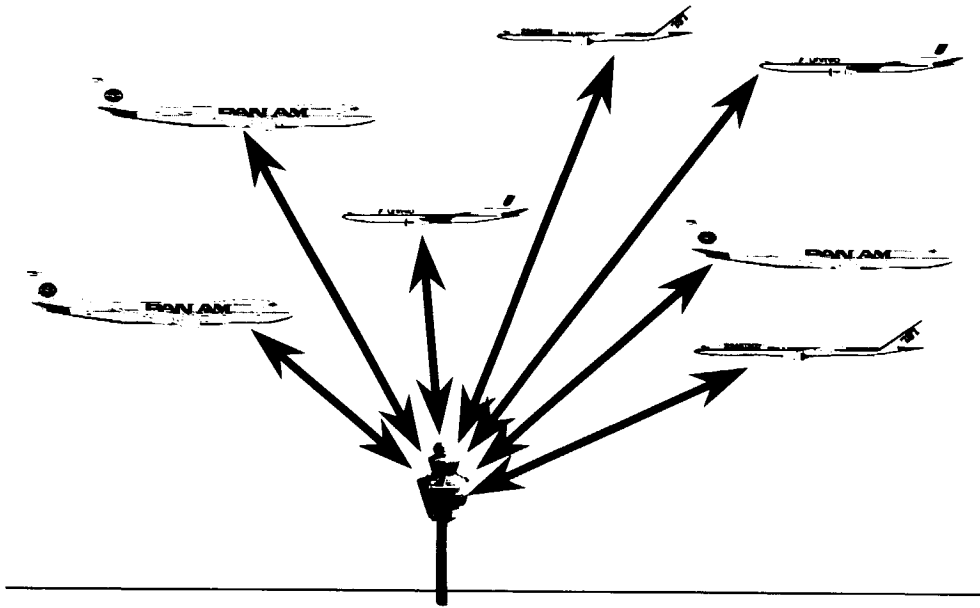

figure 1.3 Current centralised ATM system

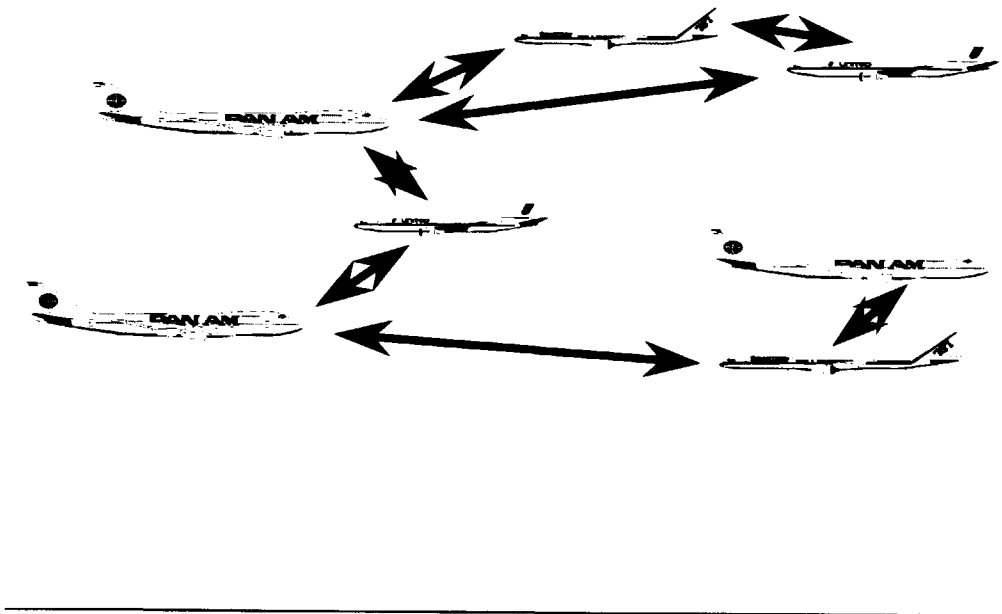

figure 1.4 Distributed system resulting from Free Flight with Airborne Separation Assurance

1.2 Functional description

The previous section describes the difference between the two concepts at the conceptual level. It describes how the operations could change and the reasoning behind this change. This section describes the change in more detail by looking at how the various components of the system interact in both situations: Controlled Flight and Free Flight.

1.2.1 *Controlled Flight*

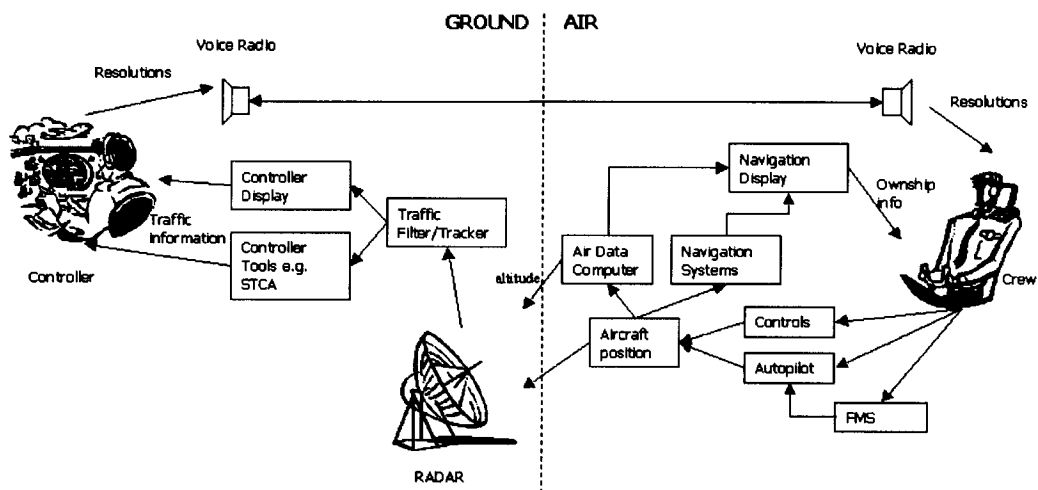

figure 1.5 Functional overview of Controlled Flight

In Controlled Flight the pilot does not fully control the flown trajectory. He merely follows the route for which a route clearance has been received. This route is therefore known to the controller and he decides the speed and altitude the aircraft will follow while flying this route. The route has been entered into the Flight Management System (FMS) by the pilot(s). The FMS is connected to the autopilot and autothrottle. When the autopilot's Lateral NAVigation (LNAV) mode is enabled, the heading is controlled by the FMS ensuring the aircraft will fly over the waypoints that form the FMS route. Similarly when the Vertical NAVigation (VNAV) mode has been selected, the altitude, speed and vertical speed will be controlled by the FMS. Most of the time, especially during the cruise phase, LNAV and VNAV are enabled.

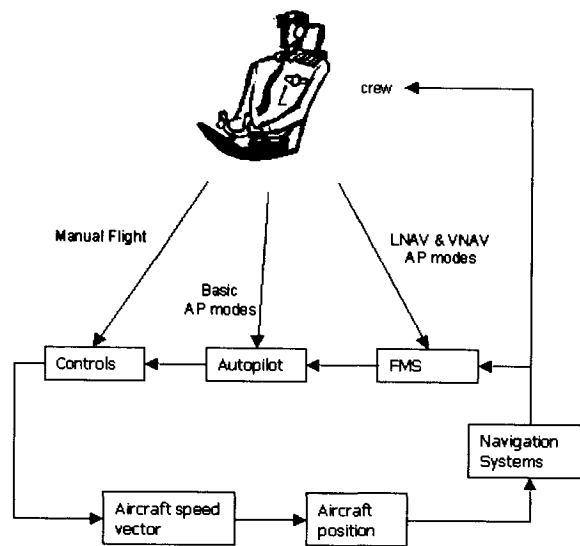

figure 1.6 Control modes of a crew: Manual Flight, Basic autopilot modes and Flight Management System autopilot modes

The FMS route is also shown on the navigation display so the crew can also fly the route using the more basic autopilot modes like 'Heading Select' and 'Altitude Select'. These modes are also used for short diversions from the route, especially during the climb and descent phase. When flying these basic modes, the pilot closes the navigation control loop instead of the FMS.

In manual flight the autothrottle and autopilot are disconnected and the pilot also closes the flight control loop by controlling the speed vector himself. For instance the take-off is always performed manually and often the approach and landing are also flown manually.

From the ground the radar monitors the aircraft's position during the complete flight as long as the aircraft is under radar coverage. Remote and less developed areas as well as the oceans lack en-route radar coverage although the aircraft remain under ground control (see also section 1.1.1 on procedural separation). The radar determines the aircraft's position every rotation. The rotation rate varies with the range of the radar and can typically be once per 4 seconds. The aircraft's lateral position is determined by the radar independent of the aircraft's navigation system ("independent surveillance"). The altitude as well as a four-digit identification code ("squawk") are transmitted by the aircraft's transponder ("dependent surveillance"). Since all aircraft use the same reference atmospheric pressure to determine the altitude, the relative altitude is determined quite accurately. This ensures two aircraft that are transmitting a sufficiently different altitude, will indeed be separated vertically.

These data as received by the radar are fed into a filter program called 'tracker'. This tracker can receive information from several radars and combines the data into one traffic picture,

which is shown to the controller on his/her display together with labels indicating the altitude, identification and other data available on the specific aircraft.

The controller separates the aircraft by assigning different altitudes as well as speed and heading directions. In this way conflicts are prevented long before they could occur. Several tools are used by the controller. If a controller failing to prevent a conflict or a pilot failing to obey the directions leads to a conflict, there is a potential loss of separation. In that case a Short Term Conflict Alert (STCA) will alert the controller of a predicted loss of separation if it is within 5 minutes. If the conflict is not prevented in this way then there is also another independent safety net called TCAS (Traffic Collision Avoidance System) onboard the aircraft. This system will alert the crew of an aircraft about 45 seconds before a predicted collision, allowing them to manoeuvre before it could result in an actual collision.

The directions of the controller are transmitted to the pilot by voice radiotelephony (R/T). The pilot has to read back a received clearance to confirm that it has been received and understood. This communication process takes a certain time and this is the cause of the sequential nature of the controller's actions. This sequential nature requires the prevention of simultaneously developing dangerous situations. This time management is an essential part of the 'art of air traffic control'.

A controller can only handle a limited number of aircraft at the same time. Therefore the airspace is divided in sectors. The sector size and shape are determined by the traffic flow. Typically a sector will contain anything from 5 to 20 aircraft. When an aircraft leaves a sector, it is handed off to the next controller, an action which also takes time.

1.2.2 Free Flight

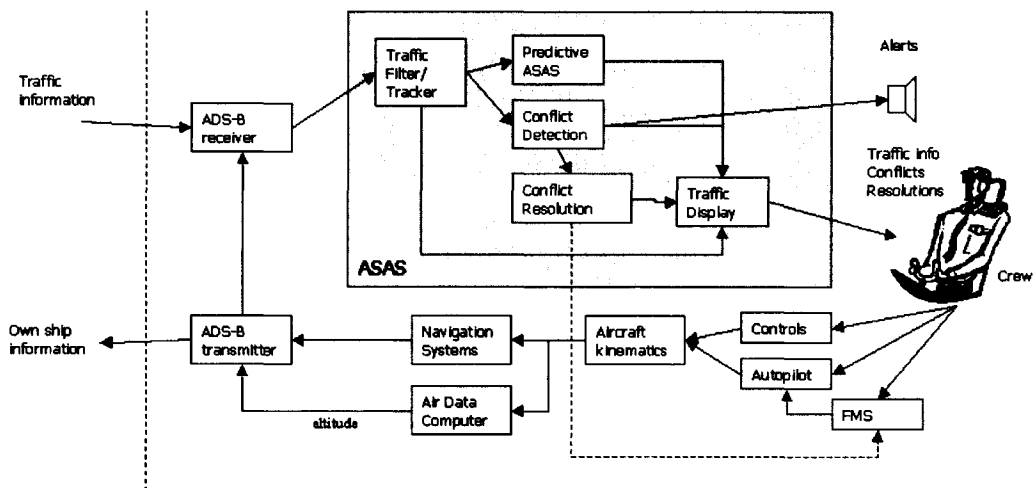

figure 1.7 Functional overview of Free Flight systems

In Free Flight there is no longer a need to provide a controller with an orderly traffic picture. All of the other information previously routed via ATC now goes directly to the crew, including conflict alerts. The pilot does not need the overall picture as long as the separation of his own ship can be maintained. This could allow more optimal routing. In

this situation the route in the FMS will be more direct and typically consist of longer legs between the waypoints. Depending on constraints of weather and the inhibited SUA (Special Use Airspace – typically reserved for military flights) it could consist of one leg following the direct route ('great circle') between the entry point and exit point of the Free Flight sector. The aircraft will probably still use the LNAV and VNAV mode to follow this route. The aircraft will gradually climb during cruise to optimise fuel consumption, instead of the discrete step climb during controlled flight, which is now required to order the traffic picture for the controller. There will be fewer bends in the route both horizontally and vertically.

The aircraft's position, as determined by the aircraft's navigation systems, is broadcast by the ADS-B transmitter. This position is received by all aircraft (and ground stations) within range (which can vary from 80 nm to 200 nm). The aircraft receives all these messages containing identification, position, velocity and maybe even information on the intended route ('dependent surveillance'). The update rate can vary from once per second to once per 25 seconds depending on the ADS-B system and possibly the range. These data are filtered (similar to a radar tracker) and shown to the pilot on the traffic display, which in modern aircraft will be integrated in the navigation display. The tracker will be part of the ASAS system. Similar to a controller's STCA an ASAS system will also contain a function called Conflict Detection.

The Conflict Detection module predicts the future trajectory of both the own ship and the traffic using the received data on position, velocity and possibly the intended route. As soon as a future loss of separation, a so-called conflict, has been detected within the lookahead time, the pilot will be alerted aurally and by symbology on the traffic display.

If the ASAS is fitted with a Conflict Resolution function, this subsystem will calculate one or more advised manoeuvres to avoid the loss of separation or 'resolve' the conflict. This advisory is shown on the navigation (and traffic) display and primary flight display. In some proposed implementations the advisory consists of a route change which is transferred to the flight management system to be activated by the crew. The crew selects one of the proposed resolutions, or creates their own resolution, and solves the conflict. If required, TCAS might still be present to provide an independent safety net. Voice R/T can also be regarded as an independent safety net, allowing the crew to report a failure and their position to the other aircraft in the vicinity.

The study described in this thesis examines the safety consequences and feasibility of making this shift of the separation assurance task. In chapter 2 the resulting issues are organised in a hypothesis tree.

1.3 NASA/NLR Free Flight project

The work described in this thesis has been carried out at the National Aerospace Laboratory NLR. The project has been funded by NLR and NASA in co-operation with the Federal Aviation Administration (FAA) and the Dutch Civil Aviation Authority (RLD, Rijksluchtvaartdienst).

NASA is coordinating a large US government funded program called the Advanced Air Transport Technology (AATT) program. In this program several US companies are performing research on, among other topics, Free Flight. NLR was invited to propose a Free Flight study at the AATT meeting and the result was a co-operation with NASA, the Federal Aviation Authority (FAA) and the Dutch Civil Aviation Authority (RLD). In this co-operation NASA, the FAA, the RLD and NLR have supported a proposed five-year program to investigate the human factors and feasibility of Free Flight with Airborne Separation Assurance. Currently the program is being expanded with another five-year period.

The Airborne Separation aspect of Free Flight has to be stressed, since the definition of Free Flight has been undergoing some change in the last few years, especially in the US. Any upgrade or ATC tool supporting flying more direct routes or increasing the flexibility of the ATM system is now dubbed 'Free Flight' in order to be able to develop this as a part of Free Flight studies. Especially since 'Free Flight' has become a buzzword, the definition has become less clear. In this thesis the words 'Free Flight' always refer to a concept incorporating two main elements:

- **Airborne separation** for a substantial part of the flight
- **Direct routing** horizontally (no airways) and vertically (flying at any level, not just at rounded values)

The NLR Free Flight study officially started in January 1997, though some initial concept definition and design was already in progress in 1996. As NLR is now considered to have a leading position in the Free Flight research, the three members of the project's core team are participating in several panels and consortia (RTCA, ICAO, European consortia, avionics industry, FAA, Eurocontrol) advising the authorities and industry on airborne separation assurance. The results have been presented at numerous conferences, workshops and committee meetings. The Dutch national press has shown interest in the study as well, resulting in articles in newspapers and items on national television and radio (see appendix F). The results of the study have also been published in the Journal of Reliability Engineering and System Safety and other journals. The dissemination of the project results is an ongoing process.

In the first years of the study, the NLR Free Flight project was performed in co-operation with NASA Ames. As a part of the AATT program, NASA is conducting the so-called Distributed Air-Ground concept work. Because of the airborne focus of the NLR studies, NLR is now co-operating with the group responsible for the airborne systems and operations at NASA Langley.

The focus of the study shifted as a result of the lack of results of previous Free Flight research to build upon when the study started. In the first year, the focus was the human factors of airborne separation, as this was considered one of the crucial factors of the

feasibility of Free Flight. To conduct a flight simulator experiment to explore this, several other aspects needed attention as well. The operational environment had to be created, meaning that an operational concept was required. In much the same way, the fidelity of the simulation had to be increased so that the tools of the pilots could be simulated in a realistic way. Therefore prototypes of these tools were developed as well. They are now used for several research projects and by avionics manufacturers, as possible guidelines for the future avionics required for Free Flight.

As a result of this diverging start of the study, the focus quickly shifted from human factors to the overall feasibility of Free Flight with airborne separation assurance. The human factors issues are just one element in the overall feasibility. Safety is a key element of the feasibility. How these elements are connected and tie into the overall picture will be described on the next section that attempts to order all sub-hypotheses that refute or support the hypothesis: 'Free Flight is feasible'. This thesis is designed to answer several questions concerning the feasibility of Free Flight. It also describes the design process of a proposed operational concept.

2 Hypothesis Tree

2.1 General

This chapter provides an overview of the issues surrounding the question of the feasibility of Free Flight. By using a variation of the hypothesis tree format as described by Horn, R.E. (1998), this section attempts to provide the reader with a road map for Free Flight research. The study in this thesis can only address a portion of this tree, mainly in the "Safety" and "Conceptual Design" sub-trees (see figure 2.1 and figure 2.2). In these sub-trees there was a clear need for experimental data. This study is aimed at providing objective data to resolve these issues.

The complete hypothesis tree can be used as a map of the issues during the reading of the remainder of the thesis. In chapter 14 for the round up of the results, the same tree will be used to assess the progress made by the study.

This chapter will describe this hypothesis tree and refer the reader to where the issues are investigated in the sub-studies in the following chapters.

2.2 What is a hypothesis tree diagram?

A hypothesis diagram orders the issues in a structured way. The diagram starts with the main hypothesis in the upper left corner. This hypothesis is supported or refuted by several sub-hypotheses. These sub-hypotheses in turn can be supported or refuted by sub-sub-hypotheses and so on.

Every box contains a hypothesis and the supporting hypotheses are connected to this box by green arrows with pointed arrowheads pointing to the sub-hypotheses. The refuting sub-hypotheses are found at the end of red arrows with a diamond shaped arrowhead pointing to the sub-hypotheses.

This graphical syntax is aimed at providing the reader with an oversight of the issues in the field of free flight research.

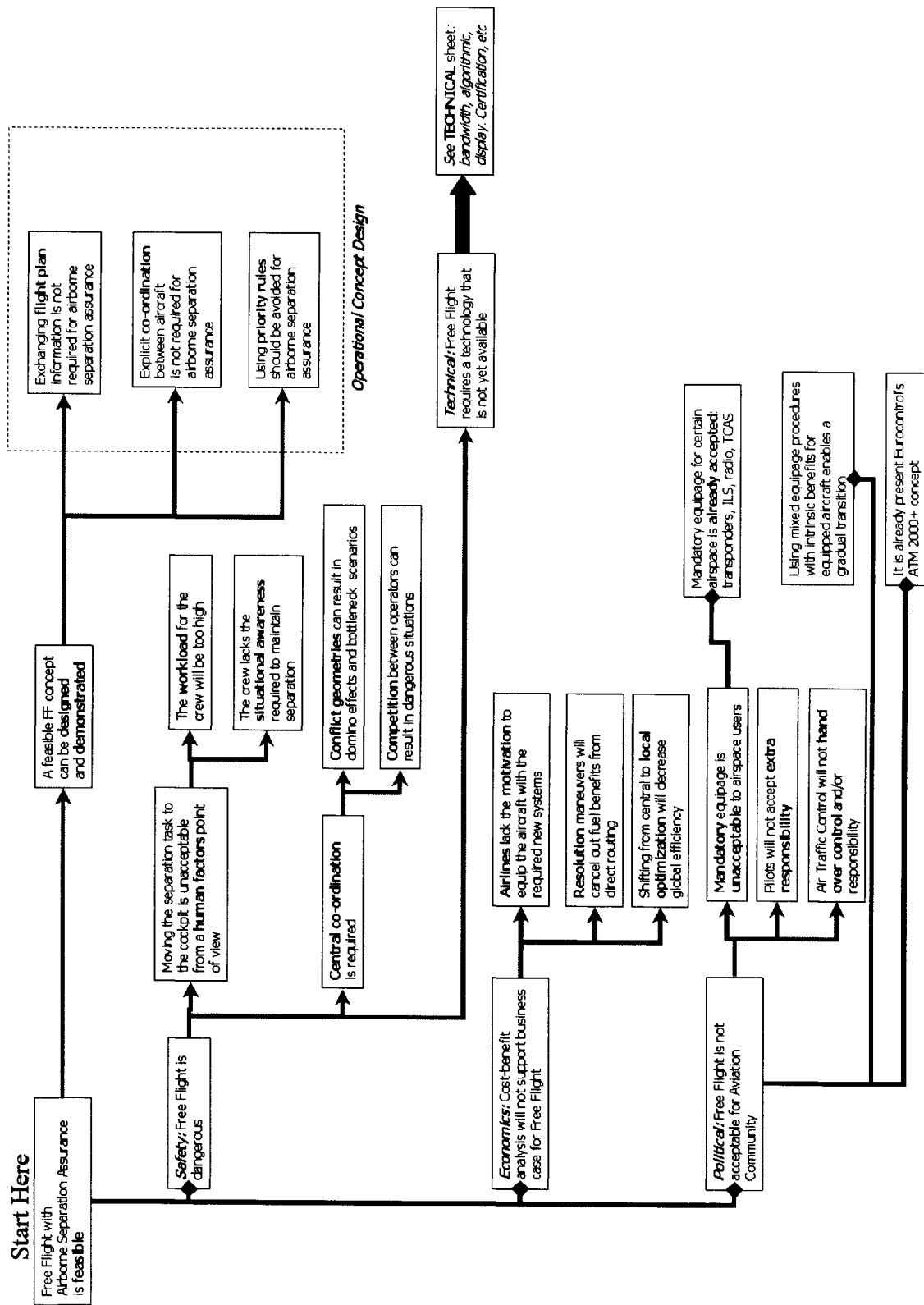

figure 2.1 Hypothesis tree diagram

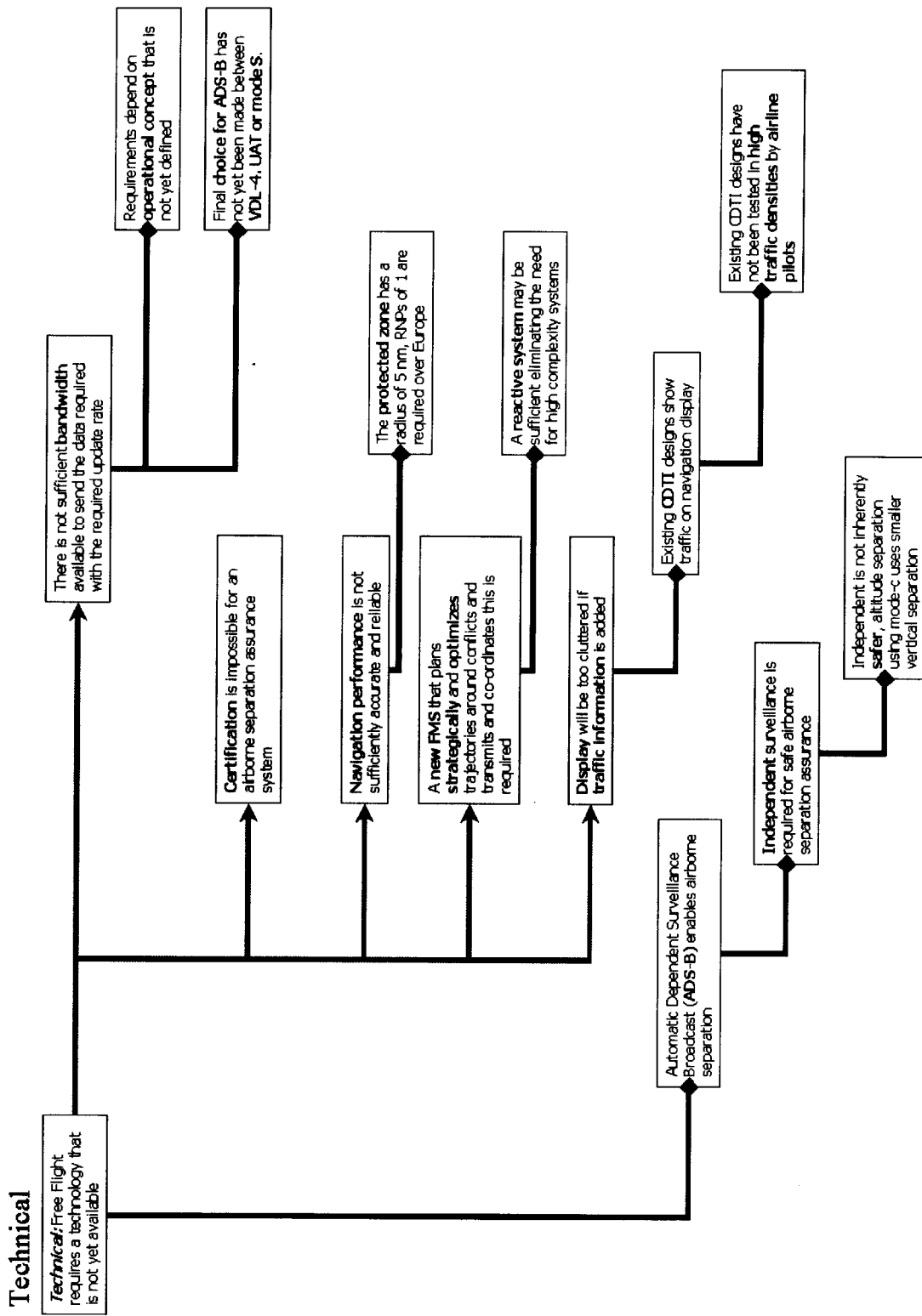

figure 2.2 Technical subhypothesis subtree

2.3 Description of the free flight hypothesis diagram

The sub-hypotheses in the tree diagram are not meant to provide a complete overview. As the research continues, more branches will be added. However, it is meant to provide an overview of most of the issues raised so far. The tree does not only list these hypotheses but also orders and connects them. The ordering of the free flight hypotheses, as shown here, is not the only possible order but was in the opinion of the author the most logical way to order all issues. The author believes this specific order is quite effective to understand the connection between the different issues and it is an order that is based on literature review (see bibliography) and discussions with many representatives from different domains over the course of the project.

The hypothesis tree reflects the issues before any results of the study, as described in this thesis, were known. Every hypothesis is described in the paragraphs below. Some are refuting the feasibility and some are supporting the feasibility or refute refuting sub-hypotheses. Most hypotheses are stated in a way that refutes Free Flight. The study will explore whether these hypotheses indeed mean Free Flight is not feasible. Some of these hypotheses also reflect the opinion of the author at the time of the start of the project. This study has changed the author's opinion on a lot of these issues. The descriptions in this chapter do not necessarily all reflect the (current) opinion of the author. Most do not. They are only provided here to clarify the boxes in the hypothesis tree diagram.

2.3.1 Feasibility

The central main hypothesis of this study is (see figure 2.1):

Free Flight is feasible.

This hypothesis clearly needs refinement to be able to test it with analysis and experiments. One approach is to design and demonstrate a free flight concept. This conceptual design is required for the other issues as well, and therefore is indeed the first step in this study. The three main choices for the conceptual design are shown in hypothesis form as well and reflect the choices made in this study. These choices are in fact minimalisations: so to find out whether co-ordination is required, no co-ordination was included in the conceptual design; to investigate whether priority rules are required, no priority rules were used and to see whether exchanging flight plan information was required, it was left out of the initial conceptual design as well. This conceptual design is described in the next chapter.

Adversaries of Free flight could argue:

- Free Flight is unsafe (Safety)
- Free Flight is not efficient (Economics)
- Free Flight politically unacceptable (Politics)

These statements form the three main refuting hypotheses of Free Flight. That it is technically impossible is regarded here as a sub-hypotheses of the safety tree as it is in fact equivalent to saying that there is no way to supply the technology to *safely* conduct Free Flight.

2.3.2 *Safety > Human Factors*

Since pilots are not trained to function as air traffic controllers, moving the separation task to the cockpit could be dangerous. It might yield a workload that is too high, leaving pilots unable to maintain sufficient situational awareness to adequately maintain separation. These are the two human factors issues which could refute the feasibility of free Flight. They are addressed in the two flight simulator experiments described in chapters 10 and 11.

2.3.3 *Safety > Central co-ordination*

Another major worry is whether air traffic will still be safe without the central co-ordination an air traffic controller normally provides. On paper a centrally co-ordinated system often seems better than a distributed system in which every element tries to optimise its own situation without taking the complete picture into account. With much the same reasoning it could be stated that a planned economy based on a five-year period prediction of resources would be much more efficient than a capitalistic economy based on an infinite number of companies that only optimise their own benefits¹. The first problem that could occur due to the lack of central co-ordination is that the local independent problem solving leads to conflict geometries that become increasingly dense, creating an unsolvable bottleneck. This situation can be compared to a room filled with people where everybody at the same time tries to leave the room. The traffic density, the number of aircraft per volume of airspace is important for the probability of the occurrence of bottlenecks. But even under nominal traffic situations an unpredicted weather situation could result in bottleneck scenarios. This can only be addressed by simulating scenarios with a high number of aircraft. Artificially created critical geometries and their consequences in a free flight environment are described in chapter 8. The general effect of a central node is also analysed in chapter 13.

The second problem that could occur is that competition between airlines results in aggressive behaviour. In the national route program, in which free routing with ground controlled separation assurance has been applied, there are cases where an airline disproportionately requested routes over airports that function as a hub of a competing airline. This resulted in delays for the competing airline (Donovan, Joseph et al, 1998). This "central co-ordination avoids competition" argument is again very similar to the analogue case against capitalism: Competition leading to a waste of resources and elimination of the weak. In reality, every airline will benefit from efficient airspace usage, which might prevent "cowboy" behaviour. The concept might also be robust enough to deal with an occasional competitive effect without sacrificing safety. A simulation study should be able to address this. Such a study is planned for the near future and the set-up is described in chapter 14.

2.3.4 *Safety > Technical > Bandwidth*

The technical feasibility to safely execute Free flight has its own separate sub-tree in figure 2.2.

Refuting the feasibility of Free Flight is the notion that there will not be sufficient bandwidth available to exchange all data required. This is of course related to the amount of data that is required. If the operational concept without co-ordination and without the exchange of flight plan data can be demonstrated to be feasible, the bandwidth

¹ In the 1960s Krushev stated that the Soviet Union's economy would overtake the US economy within five years. He said this was inevitable due to the lack of central co-ordination in a capitalistic economy and the wasting of resources that would follow.

requirements should decrease to a manageable level. This issue is discussed using data from the study in section 14.2.10.

Just as the requirements have not been determined, the actual ADS-B performance, which can be expected, also remains a mystery. There are three candidate technologies for ADS-B: VDL mode 4 (European/Scandinavian development), UAT (US) and mode S (already present in most transponders, also used for TCAS). The manufacturers are reluctant to provide data on this issue. There have been some tests on the performance but none of these tests have included a high number of equipped aircraft in one airspace. This subject is therefore still under investigation as discussed in the future work in chapter 14 and chapter 15.

2.3.5 *Safety > Technical > Certification*

The large amount of interaction between aircraft could make it extremely hard to certify an ASAS and Free Flight. TCAS has a similar problem. The interaction and infinite number of possible geometries makes it impossible to verify all possible cases in a systematic manner. Therefore a number of TCAS test scenarios have been defined which are used to verify TCAS.

Whether a similar approach will be acceptable for Airborne Separation Assurance Systems remains to be seen. TCAS is merely a safety net, which is only active in exceptional cases when normal air traffic control has failed. An ASAS system is not a safety net but a primary means for separation assurance. The related unpredictability of a distributed system is discussed in chapter 13.

2.3.6 *Safety > Technical > Navigation Performance*

The navigation performance, the ability to determine the position of the own ship, is very important for a system based on dependent surveillance aircraft. An aircraft that is transmitting an erroneous position, causing the aircraft be more off the navigated position than half the separation minima, causes an inherently dangerous situation. The separation minima determine the zone around the aircraft that should be avoided ("protected zone"). The protected zone of an aircraft should therefore be dependent on the navigation accuracy and if necessary, wake turbulence. The required navigation performance over Europe is 1 nautical mile and this requirement is already met. The current lateral separation minimum is 5 nautical miles.

Furthermore, if aircraft use the same reference for their navigation, as in satellite navigation (GPS), the relative navigation becomes as accurate as for instance differential GPS. This might result in even lower separation minima, just as today's relative altitude results in a vertical separation of only 1000 ft. This would remove all concern regarding this issue. Hence this objection can be rejected without further explanation.

2.3.7 *Safety > Technical > New FMS*

Another major technological obstacle could be that a completely new Flight Management System is required to be able to perform Free Flight. This would make the introduction of Free flight much harder than a much simpler separate system based on the exchange of only position and velocity data.

In the European PHARE program a concept has been proposed in which a new flight management system (EFMS-experimental flight management system) negotiates automatically with a ground station on the basis of flight plans. This tight integration is

possibly one of the factors that has prevented the introduction of PHARE². An airline will not easily install a new FMS to be able to communicate with a ground-based controller only when flying over Europe. It also means that the low end of the market (general aviation, small airlines) will not be able to benefit from Free Flight.

If the operational concept without the requirement for flight plan data exchange is shown to be feasible this could make the introduction easier and increase the technical feasibility. The issue of flight plan exchange is discussed in both the operational concept design (chapter 3), in the discussion (chapter 14) and conclusions (chapter 15).

2.3.8 *Safety > Technical > Display*

Another area of research should address the feasibility of integrating the Cockpit Display of Traffic Information (CDTI) in the current display system. Since similar efforts are ongoing in displaying the terrain, weather and map information, there is a risk of cluttering the navigation display in a modern cockpit. Even without the extra features, traffic information together with conflict detection and resolution advisories could easily clutter the display.

Several initial CDTI designs with symbology based on TCAS were being developed elsewhere at the start of the project. However they had not been tested at all and especially high-density traffic scenarios could perhaps clutter the display. This issue will be addressed in chapters 6, 10 and 11.

2.3.9 *Safety > Technical > ADS-B*

A major supporting technology for Free Flight is Automatic Dependent Surveillance Broadcast (ADS-B). This is a proposed transmission protocol that broadcasts the navigated position to the ground and all aircraft within the range of the transmitter. This is a different approach to surveillance compared to radar. With radar (like a military air-to-air radar) the position data of the target is obtained without co-operation of the target (especially in the military situations). It is therefore independent. With dependent surveillance, like ADS-B, the quality of the position data becomes dependent on the quality of the navigation performance of the other aircraft and the quality of the transmission of the data. Some people therefore argue that because of this dependence it is less safe and requires an extra independent back up.

Such a back up could consist of a ground station (if present) sending out the radar position via a protocol known as TIS-B (Traffic Information Service Broadcast). TIS-B could also be used in mixed equipage environments, to make sure aircraft without ADS-B transmitters would be shown on the traffic display. The notion that independent surveillance is *always* safer than dependent surveillance is easily refuted by an example:

When looking at today's separation minima, especially over the ocean, there is a different order of magnitude for the lateral separation (5 nautical mile), than for the vertical separation (1000 ft). This is because the altitude separation is based on the pressure altitude. Under radar coverage this is sent out via Mode C. The result of this dependent vertical surveillance is a very low vertical separation minimum. This contradicts the notion that dependent surveillance is always less safe than independent surveillance.

² PHARE = Programme for Harmonised ATM REsearch, European Research program investigating direct routing in a controlled environment using advanced controller tools and an Experimental FMS (EFMS)

The dependency has consequences for the non-nominal cases as will be discussed in chapter 12.

2.3.10 *Economics*

The economics argument is very important but mostly out of the scope of this study. However, since the author as a result of this study has played an active role in the committees that advise the authorities on these issues, there has been a limited effort to address some of these issues. These are mentioned in the hypothesis tree: it is also relevant because the study has produced data that will be required for performing the full cost-benefit analysis (see chapters 9 and 14) in the future when more is known about the realisation of Free Flight.

2.3.11 *Economics > Airlines motivation*

Airlines will benefit from free routing. In low traffic densities, free routing can be obtained without airborne separation assurance. In those situations, controllers are still able to maintain situational awareness due to the low number of aircraft in the sector. If one believes Free Flight will only work in low traffic densities, the economic benefits of equipping aircraft might not be sufficient to build a business case. Therefore, investigating Free Flight in high traffic densities will, if shown to be feasible, provide an economic benefit through allowing free (direct) routing in these situations.

Currently en-route delays are increasing in a dramatic way (see section 1.1.1). This at least provides a global motivation for airlines to equip their aircraft.

Extra attention needs to be paid to the benefit in mixed equipage scenarios. When a few aircraft are equipped, the benefits should be for the equipped aircraft primarily. This could be realised through establishing mixed equipage procedures with this need for an incentive integrated in the design of the procedure. This mixed equipage issue has been addressed in the second human-in-the-loop experiment described in chapter 11.

2.3.12 *Economics > Resolution efficiency*

Another worry is that by reacting to conflict alerts a non-optimal route will occur because an aircraft is ricocheting around the protected zones of all the aircraft. At first glance the airspace seems too empty to cause this to happen, and the costs of a conflict resolution manoeuvre is also unknown. This needs analysis in the form of simulation. Both the off-line simulations in chapter 8 and 9 as well as the human-in-the-loop trials described in chapter 10 and 11 provide more insight into this issue.

2.3.13 *Economics > Local optimisation*

When comparing the distributed Free Flight systems with a centralised free routing concept (like PHARE) one could object that there will be a lower optimisation. This is the result of having all aircraft optimise their own trajectory. This local optimisation does not take the optimisation of the other trajectories into account and could potentially result in a lower overall optimisation. In reality this overall optimisation will remain a utopia. The argument is comparable to preferring a plan-economy to a capitalistic system where all companies only optimise their own benefit. Even in the multi-year program PHARE no data has been generated that global optimisation in general will not work. Similarly, in a dramatic way history has proven that centralised plan-economies also will not work, no matter how good they look on paper. For complex systems local, tailored, customised optimisation will always exceed the optimisations of a central system based on generalisations required to sufficiently simplify the system to enable a global optimisation

process. The costs of conflict resolution have been addressed in the study described in chapter 9.

2.3.14 *Politics*

The civil aviation community is, in contrast with its image of advanced technology, very conservative. An infinite number of panels, committees, will typically meet a few times a year. The avionics industry and the authorities base their decisions on the documents published by these organisations. These organisations like RTCA and ICAO are in this way determining what should be the next step in aviation technology. Since the guidelines are only published when everybody in a panel accepts the contents, the result is often a conservative compromise. This resulted for instance in rejecting satellite navigation until everybody else had already been using GPS for years. Slowing down technology in this way in the name of safety often results in decreasing the safety by inhibiting new technology entering the aircraft. In the panel meetings on Free Flight several arguments have come up with respect to the political unacceptability of airborne separation assurance, which will be described briefly in the following paragraphs.

2.3.15 *Political > Mandatory equipage*

Mandatory equipage for a certain airspace is a way to provide an incentive to equip. For Free Flight airspace it is at least required to be visible via ADS-B or TIS-B and probably to have an ASAS. According to some people, this mandatory equipage is an obstacle. One could also argue that it is not different from requiring a 8.33 kHz radio, TCAS or a transponder, which is already required for certain airspace over Europe and the United States. So mandatory equipage is a viable solution.

2.3.16 *Political > Pilot acceptability*

The pilot community, especially IFALPA, have expressed on several occasions that airborne separation is unacceptable because the workload would be too high (see appendix E). The workload issue has been addressed in chapter 10. The data do not support the IFALPA view. The real reason might be the fear of the responsibility and legal consequences of a loss of separation. One should not forget that today the ultimate responsibility for complying to an advisory (now by ATC) already lies with the captain. In today's situation ATC is, just as the ASAS in Free Flight, merely advising how to resolve potential conflicts. Therefore this issue should not hinder the introduction of Free Flight.

2.3.17 *Political > Controller acceptability*

On the other side the controllers fear loss of control and being responsible for a situation they cannot manage or monitor. Ultimately there is also the fear of losing jobs if airborne separation assurance proves to be very effective. This argument is never explicitly made, because clearly few would advocate keeping an old system in place to provide jobs at the cost of safety. This fear of losing controller's jobs may be unjustified. In the end, there will probably always be control required around airports. With air traffic growing exponentially the fear for losing jobs seems ungrounded. Further, looking at the speed of changes in the civil aviation world, most controllers could be retired by the time Free Flight dominates the ATM world globally. Controller acceptability is less of an issue than pilot acceptability, since the pilots will have to perform the separation assurance task in Free Flight. Only when they are required to monitor the situation this will become an issue. In this study it is assumed that normally ATC plays no active role in Free Flight airspace.

2.3.18 *Political > Mixed Equipage procedures*

Mixed equipage procedure with benefits for the equipped aircraft support the acceptability of Free Flight (see also 2.3.11). These procedures should combine an incentive to equip with safe procedures dealing with the unequipped aircraft. Whether this allows ASAS-equipped and unequipped aircraft to share the same airspace is an issue that is under investigation. This mixed equipage issue has been addressed in the second human-in-the-loop experiment described in chapter 11.

2.3.19 *Political > Eurocontrol ATM 2000+ concept*

The concept of Free Flight Airspace is already present in documents of Eurocontrol describing the goals for ATM in Europe (Eurocontrol, 1998). In this document Free Flight airspace is envisioned for en-route segments, while managed airspace still surrounds the airport. The description of how Free Flight airspace fits in the overall airspace structure as described in this document is in line with the operational concept as developed and used in this study.

3 Conceptual Design

3.1 Introduction

The operational concept drives the requirements for the systems. On the other hand, the technology drives the possibilities for operational concepts. Aviation innovation is often technology driven instead of requirements driven. Still, several choices have to be made before the analysis and simulations can be performed. Apart from some common elements, which will be described in the last section of this chapter, there are three main choices that characterise the operational concepts for airborne separation assurance.

- Is flight plan data exchanged via ADS-B?
- Are priority rules used?
- Is co-ordination required?

These choices will be described in the following sections.

3.2 Flight Plan Information Exchange

To predict a conflict, the trajectory of the “own ship” and the surrounding traffic needs to be predicted. There are several approaches possible depending largely on the look-ahead time. The most important issue is which level of intent information to use (and how):

1. No intent, state-based only (just position and extrapolate with velocity)
2. Mode control panel intent (autopilot info)
3. The next trajectory change point
4. Complete flight plan as stored in the flight management system (FMS) of the aircraft.

Except for option 1 all other information supplies some form of future state, which could be altered by the human crew at any time. Therefore confirmation of this future state will become necessary with all levels of intent except option 1. The future trajectory of the aircraft might not always be the route as stored in the FMS and the selected altitude value in the mode control panel might merely be a reminder to switch from IAS climb to Mach climb or some other action. So using more intent information not only enhances the prediction, it also excludes a number of predictions and may be inaccurate. Using only position and velocity information is only useful with limited look-ahead times and depends on the route structure. In a direct route environment this will often match the future trajectory, whereas in an airway-like route structure more turns might limit the useful look-ahead time based on state information alone. An overview of some of the advantages and drawbacks of each method is given in the table below.

Intent level	Pro	Con
None	<ul style="list-style-type: none">• Simple, thus easy to implement (retrofit)• Transparent to the crew	<ul style="list-style-type: none">• Will miss conflicts due to short term turning into traffic or leaving or arriving at a level

	<ul style="list-style-type: none"> • Low bandwidth • High update rate • No requirements to change avionics infrastructure 	<ul style="list-style-type: none"> • (only without predictive ASAS) • Not accurate for longer look-ahead times
Mode control panel (autopilot)	<ul style="list-style-type: none"> • Relatively simple compared to FMS flight plans 	<ul style="list-style-type: none"> • Enhancement compared with no intent might be limited when in FMS modes LNAV or VNAV
One trajectory change point	<ul style="list-style-type: none"> • Compared to full route, this has limited bandwidth requirements 	<ul style="list-style-type: none"> • Will miss conflicts when not flying in LNAV or VNAV unless predictions are adjusted • Accuracy with relation to look-ahead time might vary depending on distance to next trajectory change point
Route	<ul style="list-style-type: none"> • Will be able to use long look-ahead time • Provides an reasonably accurate prediction in LNAV and VNAV, which are often only used during the cruise phase (in which case a/c will fly mostly direct) 	<ul style="list-style-type: none"> • Only works in LNAV and VNAV mode unless predictions are adjusted • Complex systems • Requires priority rules due to discontinuous resolution • Hard to understand (not transparent to crews) • Lowest update rate • Compatibility problems between different brands of FMS and their trajectory generation

From the table it is clear there are some drawbacks to every method. Using extra information adds complexity and this introduces some problems. The route information in the FMS is only accurate when flying in the FMS controlled autopilot modes (LNAV and VNAV).

The most complex solution has the strongest advantages and disadvantages. NLR has studied both extremes of the intent spectrum: no intent and using route intent. Initially the no intent option was explored. Note that in the table both approaches require extra precautions. In case of using intent it might mean you also use the state based system as an add-on. In case of the state based system, a system like predictive ASAS (PASAS) might “seal the leak” caused by not using intent information. Both options also have their specific problems in the conflict resolution module.

At this point an important step was made in the study:

First step: How far can you get without intent?

As previously mentioned, the ‘no intent’ option has been explored most extensively in the study. Adding features, which add to the complexity, should only be done when

required. Using no intent was thought to be the best way to find out how intent might be required to improve the system. If it is possible to fly safely without exchanging intent information, this has huge benefits (see previous table) in terms of:

- Low complexity
- No negotiation required
- Conflict alerts transparent to crew
- No compatibility problems
- Faster than a complete route which requires more time to be transmitted when it suddenly changes
- Lower risk of instability due to shorter look-ahead time
- Implementation of ADS-B with low bandwidth (likely) will still allow realisation of concept

For these reasons it was considered sensible to explore the no-intent option first.

3.3 Using Priority Rules

When establishing the rules of the sky, one important choice is which type of rules should be used:

- **priority rules:** using the 'right of way' principle, so only one aircraft manoeuvres
- **co-operative rules** where both aircraft manoeuvre simultaneously in a co-operative way

Priority rules decide which aircraft should move and which aircraft should not manoeuvre. This can prevent the adverse effect of co-operative rules that is often observed when two pedestrians meet. Both move in the same direction, creating an impasse. Unlike pedestrians, aircraft can not "wait". To avoid counteractive behaviour, rules are required to co-ordinate the manoeuvre or to establish a priority.

Several studies have used priority-type rules. However, NASA Ames has found (Lozito, S. & McGann, A. et al (1997)) in a simulator study that crews, even when they had right of way, felt uneasy when waiting for the other aircraft to resolve a conflict. Consequently, they would often initiate some resolution manoeuvre, although they did not have to. This means there clearly still is a need to co-ordinate and confirm the agreement on the priority situation even in unambiguous situations. Without this co-ordination, using priority rules might not be acceptable to pilots. This means the priority rules may still require co-ordination, even though they are aimed at replacing this co-ordination.

Another drawback of using priority rules is that this removes away a fail-safe element, which is present in a non-priority system. Assume both aircraft manoeuvre co-operatively and monitor the situation while resolving the conflict. This would mean both aircraft manoeuvre at the same time and one aircraft could compensate when the other aircraft fails to execute the resolution manoeuvre, due to a non-nominal situation like a system failure.

Co-operative rules allow both aircraft to manoeuvre. This is more acceptable to humans, because they don't have to 'sit and wait' during a conflict alert for the other to solve it. It

can also be used to provide a fail-safe element. An issue that arises specifically with co-operative rules is the co-ordination of the conflict resolution manoeuvre.

This co-ordination issue (of priority for the priority rules and of resolution for the co-operative rules) is discussed in the next section.

3.4 Implicit or Explicit Co-ordination

There are different types of co-ordination. Conflict confirmation is a form of co-ordination that may be required if the transmitting system is unreliable. In general co-ordination means conflict resolution co-ordination. Establishing traffic rules ('rules-of-the-sky') can replace the need for explicit co-ordination.

In case of using priority rules, one could argue it is important to verify the understanding of who has right of way, for instance by explicitly co-ordinating this either on a system-level or on a human level.

In case of no priority rules, one can imagine it is required to avoid counteracting manoeuvres by explicit (by communication) or implicit (by rules) co-ordination (again on a system level or crew level).

Drawbacks of explicit co-ordination exist in both the priority and no-priority concept:

- **The wait traps**, extra time is consumed while waiting for the co-ordination cycle which could be a missed message or other asymmetries
- **Bandwidth**, it requires a peer-to-peer connection. By broadcasting co-ordination messages valuable bandwidth of all aircraft in range is spilled.
- **Added complexity**, this has numerous drawbacks: lack of transparency for the user, higher probability of failures, harder to certificate.

Therefore co-ordination should only be implemented when required. In car traffic a common understanding of the rules of the road avoids extra co-ordination. Similarly this could be achieved in the air if the conflict resolution module can use the geometry of a conflict and apply rules to it. This co-ordination by rules is called "implicit co-ordination". The co-ordination takes place when the rules are accepted. "Explicit co-ordination" means that the co-ordination takes place at the moment of the conflict. Implicit resolution co-ordination could prevent explicit resolution co-ordination as will be described in chapter 4.

3.5 Miscellaneous

3.5.1 *Role of ATC*

In the case of airborne separation, the separation task is moved to the cockpit completely. There is a range of concepts with shared responsibilities between completely ground controlled separation and airborne separation. These include techniques like station keeping, merging, collaborative separation, etc. These are however not the focus of this study. In the operational scenario that forms the basis for this study, there is no air traffic control and no radar coverage required in the Free Flight airspace.

3.5.2 Protected Zones

In the original RTCA Free Flight document (RTCA TF 3, 1995), two zones were defined: a protected zone and an alert zone.

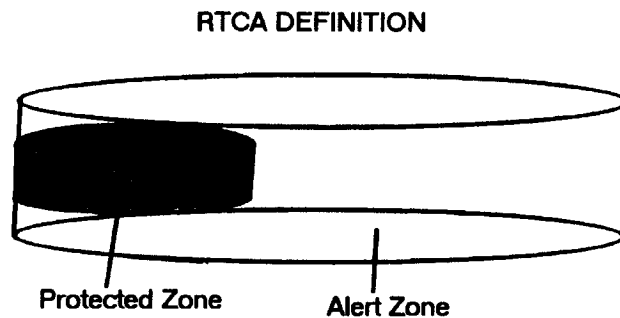

figure 3.1 RTCA definition of zones

In the RTCA definition, the protected zone is the zone that should not be touched by the protected zone of other aircraft. It is a 'hockey puck'-shaped zone determined by the position determination accuracy. The radius is half the required separation minimum. The height is equal to the required vertical separation.

In this project, the protected zone is defined slightly differently: It is defined as the zone that should remain clear of the other aircraft. This makes the zone twice as big as in the definition above (in case of a cylinder). The radius is then equal to the required separation. The height of this zone is twice the required vertical separation. Operationally there is no difference. The advantage of this definition is that it is easier to handle for the crew, the algorithms and the display designers. The conflict resolution problem is now changed into the problem of a point mass avoiding obstacles with a certain size in a 4 dimensional space.

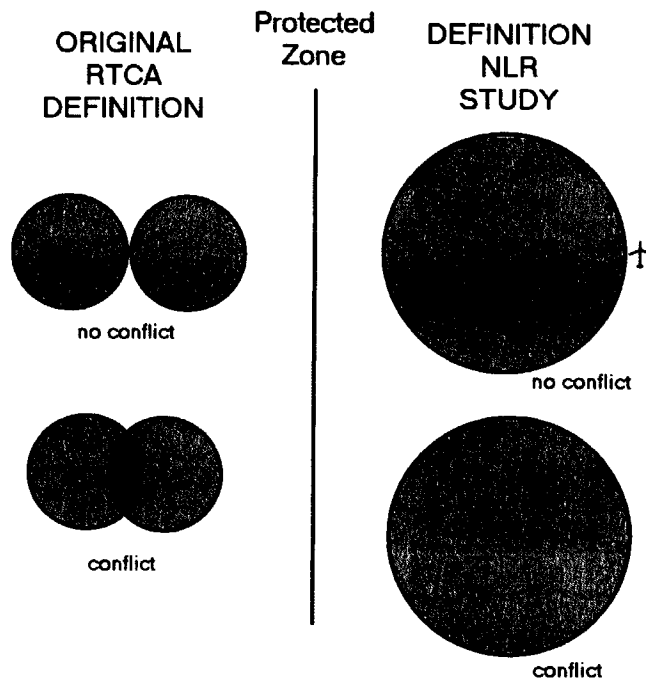

figure 3.2 Same situation with two definitions of protected zone.

In the RTCA definition, the alert zone is used to indicate a condition requiring intervention. The size of this zone is determined by aircraft speed and performance and by the CNS/ATM situation. The zone is also determined by the look-ahead time. The idea is that this alert zone spans that part of the airspace where the own ship could be within the look-ahead time.

In this study, the only alert zone that exists is the so-called look-ahead time. The quality of the path prediction, the resulting number of alerts and the stability of the traffic situation determine the look-ahead time. The limited ADS-B range also poses a physical limitation in the order of 85 -180 nm (based on maximum line of 'sight' for transceivers).

Using a range of 100 nm means with today's cruise speeds that the maximum guaranteed look-ahead time based on the worst case (head-on conflict) is about 5½ minutes. In this study the look-ahead time has been set at 5 minutes.

The protected zone in this study is defined as a cylinder with a radius of 5 nautical mile and a height of 2000 ft. This reflects the currently used separation minima of 5 nautical mile horizontally and 1000 ft vertically. These numbers are based on the accuracy of radar tracking. Therefore, they may not be applicable to the Free Flight situation using the navigation data as sent out by the aircraft with ADS-B. If the navigation performance is better, an accuracy of 1 nautical mile is no longer uncommon. The dimensions could probably be decreased, although with smaller protected zones the wake turbulence could become an issue. Decreasing the protected zone will increase the capacity of an airspace under Free Flight conditions. In this study, the current 'radar'-values (5 nm and 1000 ft separation) are still used to be able to separate the effect of airborne separation from the effect of ADS-B based surveillance.

The odd, extremely flat shape of the today's protected zone is in fact a strong argument for the use of ADS-B. The relatively small vertical separation, as used by ATC today, is caused by the fact that ATC uses the altitude as determined by the aircraft and that is received via mode-C. Although the barometric altitude may not be correct, both aircraft use the same reference and therefore the relative altitude can be determined with a high accuracy. If the lateral position is also determined via the same reference, for example GPS or the same ground based navaid, the relative lateral position will also be more accurate. In a way GPS is turned into differential GPS, even over the ocean, getting more accurate as the aircraft get closer to each other. This navigated position is sent out via ADS-B, thereby improving the lateral surveillance in much the same way as the vertical separation already is. The 1 to 30 ratio of vertical to horizontal separation minima therefore indicates the apparently accepted advantage of relative navigation, which is used in airborne separation.

Both the airborne separation assurance and the increased surveillance accuracy are a result of the use of ADS-B. The benefits in terms of airspace capacity of equipping aircraft will therefore probably be more than indicated by this study that only investigates the effect of airborne separation assurance.

PART II AIRBORNE SEPARATION ASSURANCE SYSTEM

4 Conflict Detection & Resolution

4.1 Introduction

In the hypothesis tree in chapter 2, it is suggested that a feasible Free Flight concept can be designed and demonstrated. Elsewhere in the tree a lot of issues have been raised which can be investigated by simulation (off-line and/or human-in-the-loop).

For the conceptual design several choices have been made in chapter 3 resulting in a conceptual design. This initial operational concept can be summarised as:

- Avoid exchanging flight plan information by using state-based conflict detection
- Avoid priority rules by using co-operative concept in which both aircraft manoeuvre
- Avoid explicit co-operation by using implicit co-ordination by rules

And also:

- 100 % airborne separation assurance, no active role for ATC
- Use current separation minima to be able to investigate effect of airborne separation separately from the effect of ADS-B surveillance

To be able to simulate the Free Flight concept, the logical next step is to design an Airborne Separation Assurance system based on this operational concept. The ASAS system is divided in three parts: the conflict detection & resolution algorithm, the conflict prevention system (added after first human-in-the-loop experiments) and the human-machine interface. This chapter describes the conflict detection and resolution part. The next two chapters deal with the other parts of the ASAS design.

4.2 Choosing a conflict detection and resolution method

4.2.1 *Criteria*

Two types of criteria form the basis of the selection of the conflict detection and resolution method. First, the method should fit in the designed overall operational concept. Secondly, when possible and applicable, some general criteria are used to validate the quality of the method.

The criteria resulting from the operational concept are:

- State vector (position & velocity) based
- No priority rules
- No explicit co-ordination

The relevant general criteria are:

- Safety criteria:
 - Does it cover all geometries?

- Fail safe options?
- Transparent to the crew?
- Advisory should contain several sufficiently different options to choose from to account for other hazards.
- Option to modify resolution manoeuvre to account for other hazards?
- Efficiency criteria:
 - Fuel efficient?
 - Time efficient?
 - Passenger comfort?
- Human Factors criteria:
 - Conflict detection display symbology
 - Conflict resolution display symbology
 - Transparency of CD&R algorithm
- Technological criterium:
 - Avoid complex systems with a high technological impact on the cockpit

4.2.2 *Survey of methods*

From a literature and Internet survey, several Conflict Detection and Resolution (CD&R) methods were collected (see also Kuchar J.K. & Yang, L.C. (1997)). For the conflict detection there were several options:

- State (position and velocity) based conflict detection
- Enhanced state (position, velocity and mode control panel) based conflict detection
- Route based (flight plan) based conflict detection

The main drawback of not using flight plan data, turning into conflicts, seems to disappear when as an add-on the CD&R the so-called “predictive ASAS” is added. This provides additional data on the traffic situation to the pilot using only state-based data. This system has been developed after the first human-in-the-loop trials and is described separately in chapter 5. This chapter describes the system as designed before the first human-in-the-loop trials.

For the conflict resolution method three classes of methods were found:

- None (leaving it up to the pilot to manoeuvre)
- Geometrical methods
- Numerical optimisation methods
- Genetic Algorithms

In the following two sections, first the conflict detection method will be discussed and then the conflict resolution method.

4.2.3 *Conflict detection*

State-based conflict detection can be implemented in a straightforward way: use the velocity vector to extrapolate in a straight line starting from the current position for a certain amount of time.

Due to the more efficient usage of the sky when flying direct routes and at optimal altitudes, the number of conflicts (defined as a predicted intrusion of protected zone within the lookahead time, not a mid-air collision) is already very low when no conflict avoiding action is undertaken. Therefore, the required avoidance manoeuvres are so rare, that most flights are very predictable using only current trend information. Consequently the accuracy of the prediction rarely changes when using track angle (no intent) instead of using route information (destination or next waypoint), because most of the times the intended route is the current track when flying direct routes. Especially with a typical look-ahead time of five minutes, increasing the level of intent hardly improves the quality of the predictions. This notion was confirmed by the first off-line traffic simulation trials where the conflict detection & resolution already proved to be very effective without using any intent information. This of course would be different in the current ATC controlled situation where the use of airways introduces sudden turns when passing a waypoint or where an altitude clearance introduces a sudden climb or descent.

A state-based conflict detection module only has to look at the current state (position and altitude) and trend vector (ground speed, track, and vertical speed) to predict a conflict. Using vector calculations, the predicted minimum distance with other traffic is calculated. When less than the required separation and if the time of intrusion is within the look-ahead time, it is stored in the conflict database, together with time of intrusion, predicted positions of both own and other aircraft. This information is presented to the crew on the navigation display graphically, triggers an aural alert and is also passed on to the resolution module.

A conflict is defined as a predicted minimum distance within the lookahead time, which is less than the required minimum separation distance. The conflict detection module only detects conflicts with aircraft for which the intrusion of the protected zone takes place in the near future. What should be the lookahead time of the conflict detection module?

In a head-on conflict with cruise speeds, the intruder's message can only be received five minutes before the conflict (based on a line-of-sight range of the transceiver of 85 - 100 nm and a ground speed of 500 kts) (range based on operational data from Cargo Airlines Association trials). This limits the guaranteed lookahead time to a maximum of 5 minutes.

Other studies indicated that in an ATC environment, actions to resolve conflicts beyond a five-minute prediction were not useful because of the high false alarm rate (Magill (1997)). This indicates that prediction accuracy also limits the lookahead time to a maximum of 5 minutes.

From calculating a nominal turn to avoid a protected zone of five miles, it was found that three minutes was an absolute minimum leaving one for the decision making. By simulating a traffic pattern on the traffic manager (see chapter 7) with 12 minutes, it was noted that the traffic pattern became less stable with high traffic densities, probably because of the high false alarm rate, which confirms the findings of Magill (1997).

After some off-line simulations with varying traffic densities the so-called lookahead time was therefore set at five minutes.

4.2.4 *Resolution methods*

From the classes of resolution methods identified in the survey in section 4.2.2, two can be discarded based on the criteria following from the operational concept as mentioned in section 4.2.1.

No resolution advisory

Not providing a resolution advisory is only useful if there is no rule-of-the-sky for conflict resolution. If there is no rule for conflict resolution, the crew has complete freedom to manoeuvre. This induces the risk of counteracting manoeuvres. Therefore, this option is only applicable in situations where priority rules are used. Since using priority rules should be avoided we can reject the option of not advising and prescribing a resolution advisory for now.

Numerically optimised flight plan

This option is only applicable in a flight plan based de-confliction concept. Since in the operational concept, the choice has been made to focus on state based conflict detection and resolution, this option is not applicable within the framework of this operational concept and can be left out for now.

Two classes of resolution methods remain:

- Genetic Algorithms
- Geometrical algorithms

The genetic algorithms option was explored. Genetic algorithms are also known under the name 'Evolutionary Computation' or 'Evolutionary Programming'. For more information on genetic algorithms see Goldberg (1989) or Heitkoetter & Beasley (1994).

The application of genetic algorithms is relatively new and is still a subject of study. The gene-analogy is based on the apparent effectiveness seen in the evolution of species. The idea is that applying the same mechanism that led to the evolution of animals and humans might also be an effective way to find a solution for complex problems. First, a random population of possible solutions, in this case manoeuvres or routes, is generated. Then a fitness function is applied to select solutions that are allowed to "breed". To evaluate the fitness function every solution in the sample has to be simulated (yielding a high computer processor load). Mutations and crossovers are applied during the breeding of the next generation of solutions. Then the fitness function is applied again and the process starts all over. The population becomes fitter with every iteration (or generation). The fitness level of the fittest solution in the population can be used to decide when to stop the process. This fittest sample is then used as the final solution. During this process, some random elements are present in the selection and mutation function to ensure a variety of solutions. Tuning the mutation and fitness function influences the solution to which the population converges.

After reading the literature on genetic algorithms, I contacted a group of experts on genetic algorithms at NLR that was looking at the feasibility of genetic algorithms assisting the air traffic controller. The demonstration of what had been developed for air traffic controllers showed that the effect of the 'genes' was very limited to ensure an effective solution. The result was a nearly deterministic process. This group was also trying to develop a resolution module using genetic algorithms. In the end, no module

has been produced because the tools developed so far have not proved mature enough for practical application.

Applying this method on conflict resolution has important drawbacks. The process is not very transparent to the crew, since random effects might have caused the direction in which the solution evolved. All members of the population of solutions need to be evaluated for all generations (in conflict resolution typically at least 50 generations will be used). Therefore it is quite computationally intensive. High computing power in the cockpit is not as common as on desktop computers. To make sure an efficient solution will result within a reasonable number of iterations (or generations), many restrictions need to be applied on the mutation process. This in fact removes the advantage of using genetic algorithms: finding a previously unforeseen solution. Very often the result of the restrictions is a very deterministic process, which results in the same solution as a less computationally intensive and more transparent old-fashioned mathematical algorithm.

This leaves only the geometrical methods. Several geometrical methods for conflict detection and resolution were considered for implementation in the Traffic Manager in the off-line study:

- I. altitude step
- II. cross product of speed vectors
- III. extended VFR rules
- IV. variations on TCAS manoeuvres
- V. different implementations of the so-called voltage potential.

(I) ALTITUDE STEP & (IV) TCAS MANEUVERS

The altitude step calculates the required altitude, which will have to be reached before the conflict occurs. By climbing or descending, the conflict is resolved. Via implicit or automatic explicit negotiation, it is resolved which aircraft manoeuvres in which direction. The method is similar to the TCAS II manoeuvres. Advantages of these methods are the effective manoeuvre, because of the shape of the protected zone (see chapter 3). It also prevents large deviations from the route. Disadvantages of this method are the need for resolution co-ordination, which also requires extra hardware or sharing the same device as the TCAS module, and extra bandwidth. On top of that there is a clear lack of transparency: the pilot is out of the loop, even though the look-ahead time of several minutes now would permit active decision making by the crew. The main disadvantage is that it only produces one solution in one dimension not allowing more options to the crew to select from.

(II) CROSS PRODUCT OF SPEED VECTORS

This resolution method has been developed based on the cross product of the two speed vectors. The resolution method uses the non-commutative property of a cross product combined with the result of the product to establish the direction of the adjustment in the aircraft's speed vector. Considering two speed-vectors for aircraft A and B respectively V_a and V_b , the non-commutative property is the following: $V_a \times V_b = - (V_b \times V_a)$. The effect of this is that both aircraft will manoeuvre co-operatively to prevent the conflict. The result of the cross product is a vector perpendicular to the plane defined by the aircraft's speed-vectors. This ensures an effective and clear resolution for all vertical and horizontal characteristics of the geometry of a predicted conflict. Of course there are singularities, where the cross product becomes zero: the

exact head-on or exact head-tail conflict. These were therefore covered separately to ensure an opposite sign of the avoidance manoeuvre for the two aircraft involved.

The magnitude of the heading, vertical speed and /or speed adjustments depends on the distances from the aircraft to the predicted point of conflict, the size of the protected zones and the current airspeeds and not on the result of the cross product.

An advantage of this method is the co-operative manoeuvre and the transparency to the pilot. A disadvantage is that it only produces one solution in one dimension not allowing the crew much choice when selecting a resolution manoeuvre. Vertical conflicts are solved horizontally and vice versa.

(III) EXTENDED VFR RULES

These rules basically use VFR-like system to judge, who has right of way. Eurocontrol Experimental Centre has looked into this set of rules and constructed some variations (Duong, V. & Floc'hic, L., 1996). These rules do not only take into account the direction the other aircraft is coming from but also the current flight phase (initial climb, climb, final climb, cruise, initial descent, descent) to judge which aircraft has right of way. They consist of a matrix where the flight phases of the aircraft determine the row and column. The corresponding cell of the matrix then advises the rule that should be used to decide who should manoeuvre. There still is a complete freedom to choose the manoeuvre to avoid the aircraft. This complicates the automatic calculation of a resolution advisory. It needs an extra algorithm to decide upon the resolution manoeuvre. Therefore it was concluded this method could not be used on its own in an automatic resolution advisory system. Another disadvantage of the system is the priority rule, i.e. the concept of only one aircraft manoeuvring to avoid the conflict. As noted before a typical human response of the crew, who has right of way, is to still avoid the conflict instead of waiting for the other aircraft to manoeuvre. This is similar to behaviour of car traffic in cases where the right-of-way rule is not very obvious.

(V) VOLTAGE POTENTIAL LIKE

The voltage potential is an analogy, which compares traffic with electrically charged particles. Suppose all aircraft would be regarded as negatively charged particles and the destination as positively charged. Summing all the repulsive forces of the traffic and the attracting force of the destination is a way to determine a vector, which maintains separation with other aircraft and will bring the aircraft to its destination. See figure 4.1 below.

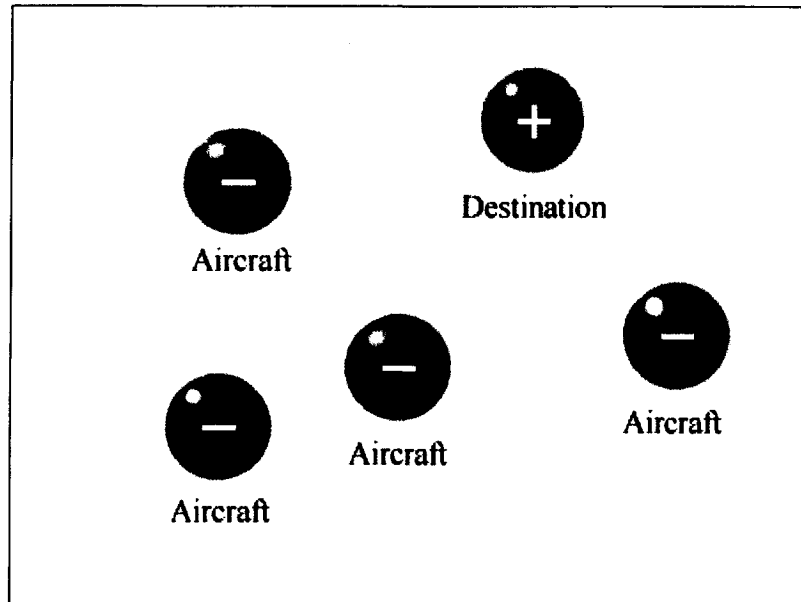

figure 4.1 Simplistic view of voltage potential

This resolution method is much too simplistic to be used in free flight. For example, no minimum separation is guaranteed and the attraction to destination varies with distance to destination. It is also quite impractical to sum the repulsive forces of all aircraft, especially the ones with which no conflict currently is predicted.

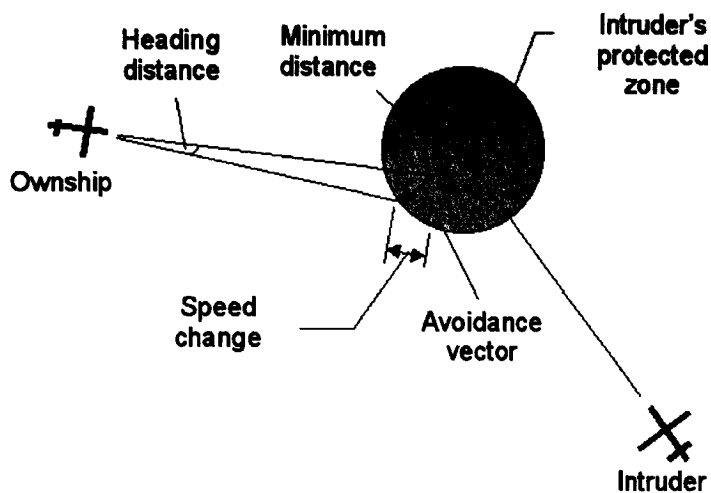

figure 4.2 Geometry of modified voltage potential resolution method

At the Lincoln Laboratory (Massachusetts Institute of Technology (MIT), USA) an algorithm has been developed as part of an ATC tool, which retains the basic repulsion feature of the voltage potential but has a more pragmatic approach to solving conflicts (Eby, 1994). This method has been slightly modified for use in the airborne resolution module (see figure 4.2).

When a predicted conflict with traffic has been detected by the conflict detection module, the resolution module uses the predicted future position of the own ship and

the traffic or obstacle aircraft (will be called intruder) at the moment of minimum distance. The minimum distance vector is the vector from the predicted position of the intruder to the predicted position of the own ship. The avoidance vector is calculated as the vector starting at the future position of the own ship and ending at the edge of the intruder's protected zone, in the direction of the minimum distance vector. The length of the avoidance vector is the amount of intrusion of the own ship in the intruder's protected zone and reflects the severity of our conflict. It is also the shortest way out of the protected zone. Therefore, the own ship should try to accomplish this displacement in the time left until the conflict. Dividing the avoidance vector by the time left yields a speed vector which should be summed to the current speed vector to determine the advised speed vector. The result is an advised track and a ground speed. In the case of multiple conflicts within the look-ahead time, the avoidance vectors are summed.

The same principle is used vertically. This means a horizontal and a vertical resolution manoeuvre is calculated. Because of the cylindrical shape of the protected zone, these two resolution manoeuvres will both independently completely solve the conflict. Both resolution manoeuvres are presented to the pilot allowing him/her to choose one (or both) manoeuvres.

Each geometrical resolution method has its singularities in which the avoidance vector becomes zero or the sign can not be determined. This could be regarded as a purely theoretical problem, since in reality, noise will prevent these singularities lasting long. Still, numerical techniques like integer calculations or limited resolution in numbers could make it happen. Several provisions have been made to solve the singularities. For example in the case of an exact head-on collision course on the same altitude with no vertical speed, both aircraft will be advised to turn right.

This resolution method assumes the intruder does not manoeuvre to avoid the conflict. This is part of the fail safe principle of the concept. Normally however, the intruder will also manoeuvre. Using the same principle will always result in an avoidance vector in the opposite direction because of the geometry of the conflict (compare the future positions with the charged particles). In this way an effective co-operation is achieved without negotiation or additional communication. This also means the initially calculated advised heading and/or speed changes will normally not be required. As soon as the conflict disappears, the current heading, speed and/or vertical speed can be maintained. This means both aircraft 'suffer' equally due to the conflict, provided that both pilots accept the proposed resolutions. There is of course a danger of 'playing chicken' and wait for the other aircraft to solve the conflict. On the other hand, the route deviations caused by resolution manoeuvres are so small that there is not much to gain from risking this dangerous situation.

Both aircraft can choose whether they solve the conflict horizontally or vertically and they initially calculate the resolution advisory as if the other aircraft does not avoid the conflict. This means a total of four manoeuvres are available, which all are able to solve the conflict independently. Performance limits, weather, restricted airspace will sometimes inhibit one or two manoeuvres but hardly ever all four. When this would happen, the backup modes like TCAS could become critical or the crew monitoring the situation could negotiate an acceptable solution via radiotelephony. Using a look-ahead time of five minutes ensures there is sufficient time to identify the problem and solve it.

FINAL CHOICE: MODIFIED VOLTAGE POTENTIAL

In the off-line traffic simulations with the traffic manager several methods for traffic resolution have been implemented: the TCAS-like altitude step, a cross product of speed vectors and two different implementations of the voltage potential (one specially modified to manoeuvre without speed changes). They all proved effective. Looking at the criteria as described in the previous paragraphs, the modified voltage potential method as described by Martin Eby (Eby, 1994) was chosen for the man-in-the-loop experiment. One modification on the description of applying the algorithm for ATC in the article of Eby is that not the intended route is used to predict a conflict but rather the currently expected track based on current trend information.

4.3 ASAS software implementation

The traffic manager has been written in FORTRAN (more information of FORTRAN can be found in (Nyhoff & Leestma, 1996)). The ASAS modules were implemented by the author as FORTRAN subroutines communicating via in-line arguments and so-called common blocks, grouping global variables. The different modules and the calling tree in the traffic manager are shown in the figure below.

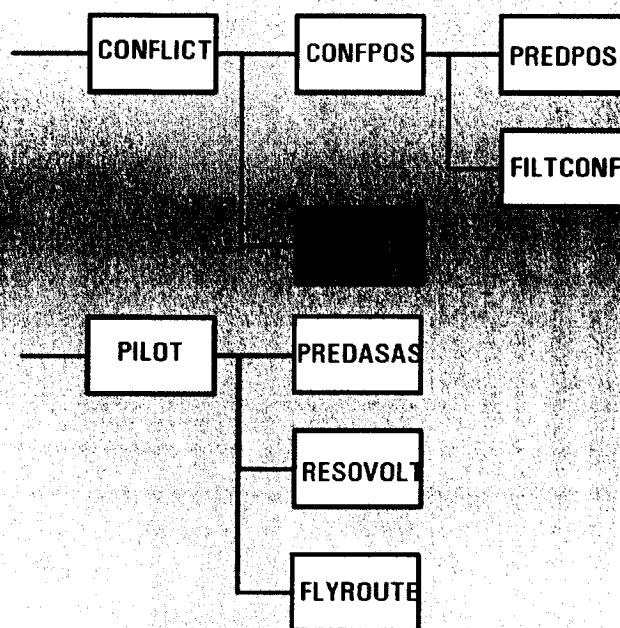

figure 4.3 Calling tree of ASAS modules in Traffic Manager program

The abbreviations in the calling tree are the names of the modules:

CONFLICT – Main module performing scheduling and selection of conflict detection method

CONFPOS – Conflict Detection based on position & velocity data. Build conflict database using traffic position and velocity data.

CONFWP – Conflict Detection based on flight plan data (this has been investigated later for an FMS manufacturer and falls out of the scope of this study)

PREDPOS – Module that predicts position of traffic for a given time

FILTCONF – Filter applied on conflicts to prevent conflicts for example due to turning aircraft at long range or due to data anomalies

PILOT – Scheduling and calling routine that also performs the selection of the resolution module to be called

PREDASAS – Predictive ASAS module (see chapter 5) only used for display of flight simulator

RESOVOLT – Resolution module containing the modified voltage potential algorithms variants

FLYROUTE – Flight Management and navigation model of aircraft

This calling tree represents the off-line simulation. Colour coding of the modules has been used to distinguish: traffic manager modelling & scheduling parts (yellow), ASAS modules (white) and later additions for other studies (red). The CONFWP module contains the conflict detection that will be described in the next section. The RESOVOLT module is one of the resolution modules available in the traffic manager, containing various versions of the modified voltage potential resolution algorithm.

The data flow inside the ASAS modules is shown in the figure below.

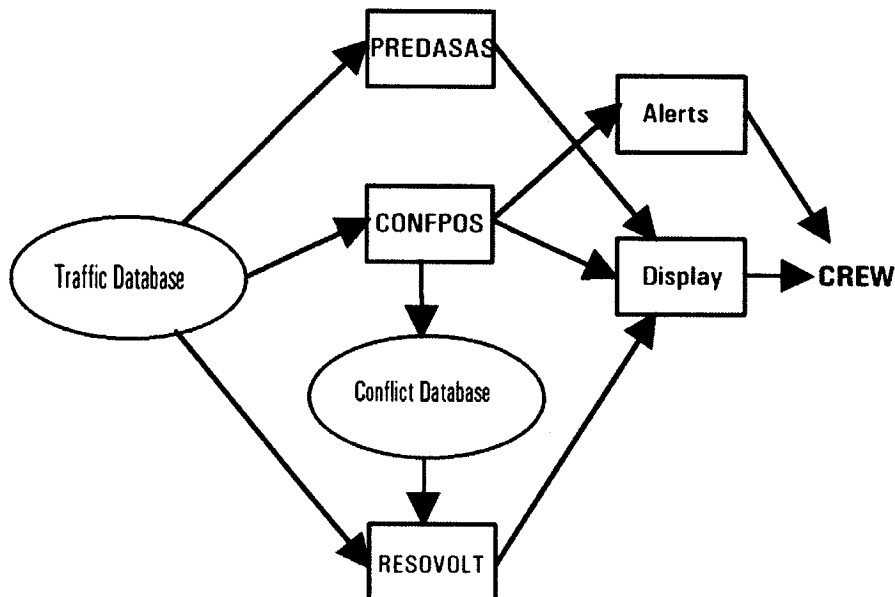

figure 4.4 Overview of modules in ASAS system

The input to the ASAS consists of data on the traffic within range derived from the traffic database:

- Traffic id (call sign)
- Position: latitude, longitude, altitude
- Velocity: ground speed, track, vertical speed

Other inputs are the position of the own ship (also from the traffic database) and the clock time.

The output of the conflict detection module (CONFPOS or CONFWP) is the conflict database for a conflict to be used by each aircraft of the conflict pair.

- Reference to the aircraft of the conflict
- Time to loss-of-separation
- Time to minimum distance point, the Closest Point of Approach (CPA)
- Positions of both aircraft at CPA: latitude, longitude, altitude
- * Velocities of both aircraft at CPA: ground speed, track, vertical speed (= actual speed in state based variant, only used in flight plan version)
- * Real waypoint index reference (for example 3.231) to route database (only used in CONFWP) to indicate position of conflict on flight plan legs

(* The last two items in the list are only used on the flight plan based variant CONFWP used in the FMS study that falls outside the scope of this study)

The minimum time to loss-of-separation is used to determine the alerting level by the alert module. It is also reflected by the colour of the conflict symbology on the display (see chapter 6).

The output of RESOVOLT is the resolution advisory:

- Advised track
- Advised vertical speed
- Advised ground speed
- (Optional: Advised target altitude)

The output of Predictive ASAS is:

- Series of no-go track bands
- Series of no-go vertical speed bands
- Series of no-go ground speed bands

The actual algorithms and calculations are derived and described in the next sections. The predictive ASAS was developed after the phase I human-in-the-loop flight simulator trials and is therefore described later in chapter 5.

4.4 Conflict Detection Module

The conflict detection module uses the position and velocity data from the traffic database. It calculates whether the separation minima (in this study 5 nautical mile and 1000 ft) will be violated within the look-ahead time. If so, it calculates the position of both aircraft at the closest point of approach (which is not necessarily within the look-ahead time) for the resolution module. Along with these data, it calculates the time at which the separation is lost (protected zone intrusion time) and the time of the minimum distance point (or closest point of approach). The closest point of approach is clearly defined in the two-dimensional case as shown in figure 4.2. In the three-dimensional case, it is slightly more complex. The two-dimensional minimum distance point could even be outside the three-dimensional conflict interval (see figure 4.5). Therefore the conflict detection first calculates the conflict intervals for the horizontal and vertical dimension and then combines them (see figure 4.6).

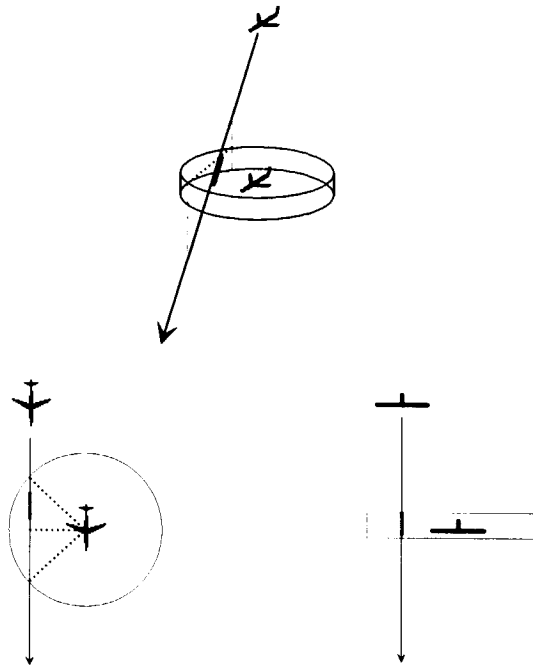

figure 4.5 Geometry of a 3D conflict with relative speed of intruder

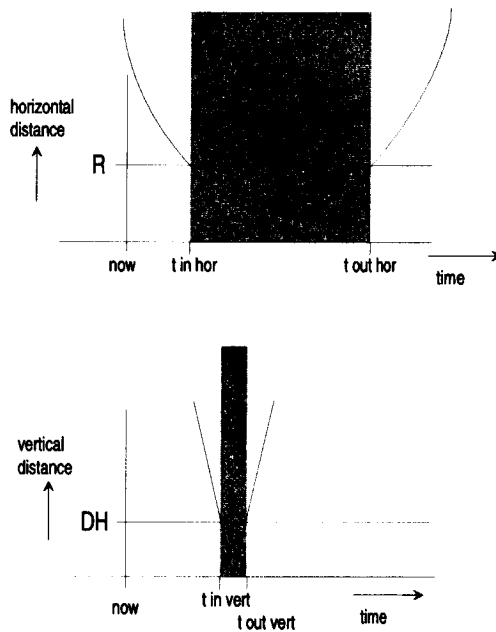

figure 4.6 Distance versus time diagrams horizontal and vertical

The conflict detection modules uses the following parameters:

- DH = vertical separation, half the height of the protected zone (about 1000 ft)
- R = horizontal separation, the radius of the protected zone (about 5 nautical mile)
- $dtlook$ = lookahead time in seconds, typically 300 seconds (5 minutes)

And the following input data from the traffic database:

- lat_{own} = latitude of own ship
- lon_{own} = longitude of own ship
- h_{own} = altitude of own ship
- V_{own} = speed of own ship (absolute, incl. vertical speed)
- crs_{own} = track of own ship
- vs_{own} = vertical speed
- $lat_{intruder}$ = latitude of intruder
- $lon_{intruder}$ = longitude of intruder
- $h_{intruder}$ = altitude of intruder
- $V_{intruder}$ = speed of intruder (absolute, incl. vertical speed)
- $crs_{intruder}$ = track of intruder

And apart from this information, the module also needs a reference time which is also known to the resolution module, to enable storing the conflict data with an absolute time reference for loss of separation and minimum distance position.

$$t_{now} = \text{clock time [s]}$$

To calculate the conflict intervals the relative position and speed of the intruder is calculated in Cartesian co-ordinates for the vector calculations:

$$\begin{aligned} \text{Calculate bearing of intruder: } & qdr(lat_{own}, lon_{own}, lat_{intruder}, lon_{intruder}) \\ \text{Calculate distance of intruder: } & dist(lat_{own}, lon_{own}, lat_{intruder}, lon_{intruder}) \end{aligned}$$

The calculation of bearing and distance is performed using the WGS'84 co-ordinate system.

With the distance, bearing and altitudes the initial relative position \underline{dx} of the intruder can be calculated:

$$\begin{aligned} dx(1) &= dist \cdot \sin(qdr) \\ dx(2) &= dist \cdot \cos(qdr) \\ dx(3) &= h_{intruder} - h_{own} \end{aligned}$$

The first element of \underline{dx} is the relative position in the Easterly direction, the second element is the relative position in the Northerly direction and the third element is the relative altitude, positive up. The result is the right-handed reference frame with the origin at the own ship position. This reference frame will be used in the conflict detection calculations. In the conflict detection module, all elements of this vector are expressed in metres.

To calculate the relative speed, the velocities are first converted to Cartesian co-ordinates:

$$\begin{aligned} \gamma_{own} &= \arcsin\left(\frac{vs_{own}}{V_{own}}\right) \\ v_{own}(1) &= V_{own} \sin(crs_{own}) \cos(\gamma_{own}) \\ v_{own}(2) &= V_{own} \cos(crs_{own}) \cos(\gamma_{own}) \\ v_{own}(3) &= vs_{own} \end{aligned}$$

The speed vector of the intruder $v_{intruder}$ is calculated in the same way.

In contrast to the speed in the traffic manager program, normally the speed derived from ADS-B messages will already represent the horizontal speed without the vertical component, alleviating the need for the cosine of γ in the first two formulae for the intruder. Depending on the format, the message may already contain the north/south and east/west velocity, facilitating the vector calculations.

The relative speed of the intruder is obtained by subtracting the own ship's speed vector:

$$\begin{aligned} dv(1) &= v_{intruder}(1) - v_{own}(1) \\ dv(2) &= v_{intruder}(2) - v_{own}(2) \\ dv(3) &= v_{intruder}(3) - v_{own}(3) \end{aligned}$$

The equation for the relative motion of the intruder is now:

$$\begin{pmatrix} x_1 \\ x_2 \\ x_3 \end{pmatrix} = \begin{pmatrix} dx_1 \\ dx_2 \\ dx_3 \end{pmatrix} + t \begin{pmatrix} dv_1 \\ dv_2 \\ dv_3 \end{pmatrix}$$

The time t in this equation is also relative, meaning $t=0$ is now. The conflict detection is now simplified to straightforward vector calculations. Find the vertical conflict interval $[t_{in\ vert}, t_{out\ vert}]$ first by solving for t :

$$\begin{aligned} |x_3| &= DH \\ |dx_3 + t \cdot dv_3| &= DH \\ dx_3 + t \cdot dv_3 &= DH \quad \cup \quad dx_3 + t \cdot dv_3 = -DH \end{aligned}$$

$$t_1 = \frac{DH - dx_3}{dv_3} \quad t_2 = \frac{-DH - dx_3}{dv_3}$$

$$t_{in\ vert} = \min(t_1, t_2)$$

$$t_{out\ vert} = \max(t_1, t_2)$$

The case where the relative vertical speed is close to zero needs special care to prevent division by zero. In this case the relative position determines the conflict and the vertical interval limits t_{in} and t_{out} are set accordingly: either to 'now' and 'infinity' or this pair of aircraft is skipped since there is no conflict possible if there is no vertical conflict interval.

The horizontal conflict interval is calculated as the intersection of a line and a circle in the horizontal plane (see figure 4.5). To find these times the following equation is solved for t :

$$\begin{aligned} x_1^2 + x_2^2 &= R^2 \\ (dx_1 + t \, dv_1)^2 + (dx_2 + t \, dv_2)^2 &= R^2 \\ (dv_1^2 + dv_2^2) t^2 + 2(dx_1 \, dv_1 + dx_2 \, dv_2) t + (dx_1^2 + dx_2^2 - R^2) &= 0 \end{aligned}$$

$$a = dv_1^2 + dv_2^2$$

$$b = 2(dx_1 \, dv_1 + dx_2 \, dv_2)$$

$$c = dx_1^2 + dx_2^2 - R^2$$

$$D = b^2 - 4ac$$

Note that a is always positive (if not equal to zero). If a is equal to zero, the relative speed is zero. This is handled in the same way as the vertical conflict interval with a zero relative vertical speed. If the discriminant D is negative there is no intersection and hence no conflict.

$$t_{in_{hor}} = \frac{-b - \sqrt{D}}{2a}$$

$$t_{out_{hor}} = \frac{-b + \sqrt{D}}{2a}$$

This is the interval of the horizontal conflict. Negative results refer to times in the past.

The vertical and horizontal interval are combined and checked for overlap (see figure 4.6). For the combined t_{in} the maximum of both values is used (it is a conflict only if it has simultaneously intruded the protected zone horizontally AND vertically).

$$t_{in} = \max(t_{in_{vert}}, t_{in_{hor}})$$

For the time of leaving the zone t_{out} , the minimum time of the horizontal and vertical values is used, since the conflict ends when one of the separation minima is no longer violated.

$$t_{out} = \min(t_{out_{vert}}, t_{out_{hor}})$$

When t_{out} is before t_{in} , this means there is no overlap and hence no conflict. The beginning of the conflict interval needs to be less than the look-ahead time (if less than zero we are already in conflict).

If a conflict has been found the conflict is registered in the conflict database. The data of the conflict that is stored are:

- $t_{intru} = t_{in} + t_{now}$ = intrusion time, moment at which loss of separation occurs
- $t_{conflict} = t_{mindist} + t_{now}$ = minimum distance time or CPA time (absolute)

Data of both aircraft at minimum distance position (CPA):

- Positions of both aircraft at CPA: latitude, longitude, altitude

The minimum distance position can be determined in different ways.

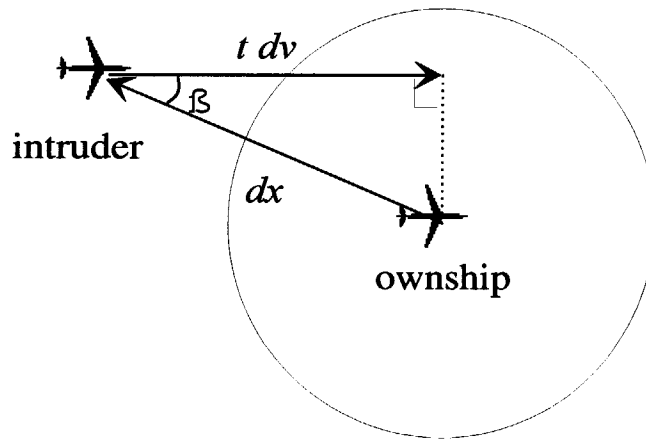

figure 4.7 Minimum distance position is at the end of the $t dv$ vector

From figure 4.7 it can be seen that by using two definitions for the angle β from the inproduct and the triangle, the formula for $t_{min dist}$ is easily found:

$$\cos \beta = \frac{(-dx) \cdot dv}{|-dx| |dv|} = \frac{t |dv|}{|dx|}$$

$$t |dv| |dx| |dv| = -dx \cdot dv |dx|$$

$$t_{min dist} = \frac{-dv \cdot dx}{|dv|^2}$$

Since the horizontal conflict interval is already calculated, the minimum distance time can also be calculated using the average of $t_{in bor}$ and $t_{out bor}$, if these have not been limited in the process.

This minimum distance time is used in a call to the predictor module PREDPOS to basically evaluate the absolute equations of motion, yielding the position and velocities of both aircraft at the minimum distance point. These values are used by the resolution module.

In the traffic manager, the conflict detection process is called for all combinations of aircraft. Because of the symmetry of the conflict detection, there are potentially $\frac{1}{2}n(n-1)$ conflict polls required in case of a scenario with n aircraft. To reduce computation power requirements several enhancements will make this process faster:

- Calculate every **sine and cosine only once** per aircraft. Sines and cosines are in general calculated using Taylor-series that are relatively computationally intensive.

- Before any calculation of distance or bearing, check whether the **vertical speed and altitude difference** allow the possibility for a conflict within the look-ahead time
- Estimate the **distance** (using a less computationally intensive distance estimation routine) and verify whether the **magnitude of the speed** allows a conflict close to the look-ahead time
- **Skip** further calculation of the current pair of aircraft at any stage of the calculation when it is clear there is no conflict

These measures optimise for fast execution, especially important with a global off-line simulation of a scenario with a large number of aircraft.

When a conflict is detected using already filtered ADS-B data, it can still cause nuisance alerts. For example, when an aircraft is turning, using the straight line will cause nuisance alerts. (Using the prediction based on turn rate would cause a similar effect.) To avoid these and similar nuisance alerts, detected conflicts are delayed via a conflict filter implemented in the module FILTCONF.

The conflict filter maintains a table that contains all starting times of a conflict per pair of call signs. Every time the conflict detection calculation has been performed, a new table is zeroed and only the times of the current conflicts are copied. If a conflict is new, the current clock time is stored in the two cells of the table for this pair of aircraft.

	KL204	HV296	MP101
KL204	-	12:22:45.03	0.0
HV296	12:22:45.03	-	0.0	
MP101	0.0	0.0	-
			
....

The result is a table with the starting times of all conflicting pairs of aircraft. This new table is then used to delete all conflicts, which are not 'on' long enough in relation to their time-to-conflict to be passed on the display, the alerting system and the resolution module. Currently there are two urgency levels defined (see also chapter 6 on the man-machine interface):

- Red: conflicts with a loss of separation within 3 minutes
- Amber: conflicts with a loss of separation between 3 to 5 minutes from now

For red conflicts a filter time of 4 seconds is used, for amber conflicts this is 10 seconds. These parameters are adjustable via scenario files or data files. The look-ahead time of the conflict detection module is increased with these values to ensure conflicts will be shown when within the specified look-ahead time of 5 minutes.

When a conflict has not yet been 'on' long enough, its starting time in the conflict filter table will be kept, but the actual conflict will be invalidated in the conflict database.

4.5 Conflict Resolution Module

The filtered conflict database is the input for the conflict resolution module. While the conflict detection module is a global module in the traffic manager, the resolution module is called separately for each aircraft ('own ship'). The module can be divided into three parts:

1. Check for any conflict involving the own ship, within the look-ahead time, and order the conflicts chronologically
2. Calculate the horizontal and vertical resolution manoeuvres
3. Decide which manoeuvre to pass on to the pilot model (or flight management system)

In the software the third part is also located in the resolution module. In the simulations it is dependent on the criteria specified by the user. Many variants are available:

- EBY - Initiate both manoeuvres (horizontal and vertical)
- EBYH - use only horizontal manoeuvre
- EBYV - use only vertical manoeuvre
- EBYHV - decide horizontal or vertical based on geometry and efficiency
- EBYHDG - change only heading (horizontal excluding speed changes)
- EBYDEC - decide horizontal or vertical just as EBYHV, but without speed control

Typing "RESONR <variantname>" in the traffic manager simulation will result in using one of the above mentioned variants. The calculation of the resolution manoeuvres will be described in this section.

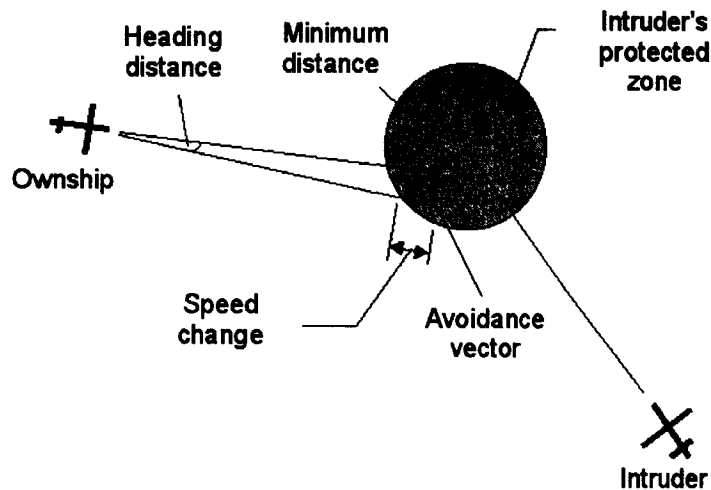

figure 4.8 Avoidance vector and resulting horizontal manoeuvre

The position of both aircraft at the minimum distance point (closest point of approach) are used to calculate the avoidance vector. This vector is translated into an avoidance manoeuvre *v_{avoid}* by using the avoidance vector divided by the available manoeuvre time t_{manu} .

Variables from conflict database used by resolution module:

t_{conf} clock time of minimum distance point

t_{intrn}	clock time of moment of loss of separation
$latconf_{own}$	latitude of own ship at minimum distance position
$lonconf_{own}$	longitude of own ship at minimum distance position
$latconf_{intruder}$	latitude of intruder at minimum distance position
$lonconf_{intruder}$	longitude of intruder at minimum distance position
$altconf_{own\ ship}$	altitude of own ship at minimum distance position
$altconf_{intruder}$	altitude of intruder at minimum distance position

Own ship data:

V_{own}	Ground speed of own ship
crs_{own}	Track angle of own ship
vs_{own}	Vertical speed
t_{now}	Clock time

The calculation of the resolution manoeuvre is straightforward from figure 4.8:

Calculate bearing from intruder to own ship:

$$qdr(latconf_{own}, lonconf_{own}, latconf_{intruder}, lonconf_{intruder})$$

Calculate minimum distance: $dist(lat_{own}, lon_{own}, lat_{intruder}, lon_{intruder})$

In case of several conflicts, the horizontal avoidance vectors are summed. Vertically the maximum and minimum altitude are stored and used for the vertical resolution.

For this reason, the advised speed vector is initialised with the current speed vector. The co-ordinates of this vector are (r, χ, dh) .

$$sumavoid(1) = V_{own} \cos \gamma$$

$$sumavoid(2) = crs_{own}$$

$$sumavoid(3) = vs_{own}$$

Calculate manoeuvre time for this conflict. This is the time to go to the minimum distance position:

$$t_{manv} = \max(30., tconf_i - t_{now})$$

Using this manoeuvre time, calculate avoidance vector addition due to this conflict:

$$intrude = R - dist$$

$$dalt = altconf_{intruder} - altconf_{own}$$

$$vavoid(1) = \frac{intrude}{t_{manv}}$$

$$vavoid(2) = qdr$$

$$vavoid(3) = \frac{DH - dalt}{t_{manv}}$$

The avoidance vector for this conflict is then summed (vector-wise) to the total *sumavoid* vector.

The third component of this vector is a vertical speed. Without extra measures, this resolution would advise to keep climbing. Therefore, by storing the altitude boundaries of the protected zones of (all) the intruder aircraft, the target altitude is set to avoid all conflicts detected.

The resulting output is:

- advised ground speed – to be converted to IAS for primary flight display (PFD)
- advised track – to be converted to magnetic track or heading for nav display
- advised vertical speed – to be displayed on the PFD
- advised altitude – to be used by pilot models

In the traffic manager, these data are output to the pilot and autopilot models in the traffic manager. The pilot models decide, depending on the logic that was selected, whether and how to execute the resolution manoeuvre. The traffic manager also performs the ASAS function for the simulator(s) connected to the traffic manager. This program sends a 'RESO' message containing the above data to display on the primary flight display and the navigation display. See chapter 6 for a description of the displays and alerting and the experiment descriptions in chapters 10 and 11 for a description of the experiment configurations.

4.6 Straight lines

One of the assumptions of the conflict detection and resolution algorithm described in this chapter is that aircraft fly in a straight line. This is obviously very often not the case as aircraft do:

- turn over **waypoints** (or avoid certain airspace, like SUA or weather)
- **level off**
- initiate a **climb** or **descent**
- resolve other **conflicts**
- normally do **not** climb or descend with a **constant vertical speed**
- change speed control from a **CAS climb** to a **Mach climb** and vice versa for a descent

From this list, it may seem ridiculous to assume the straight-line prediction. There are several reasons however why this simple approach still works. Some will be demonstrated later. The following considerations should be taken into account.

Waypoint, level off, initiate climb and descent

It is true that by not knowing the intent of the other aircraft, without any extra measures a lot of very short term conflicts could occur. Instead of appearing at the look-ahead horizon of five minutes, a turn can initiate a conflict right away. The same goes for levelling off or starting a climb or descent, which can be regarded as a turn in the vertical plane. Decelerating and accelerating might also cause false alerts or missed conflicts.

In an upper airspace designated as Free Flight airspace, free routing will reduce the amount of turns significantly compared with today's situation of following airways. The straight line is more often an adequate prediction in a direct routing especially.

If instead of rounded number flight levels flying at any altitude is allowed, the step climbs will be replaced by a shallow cruise climb, which makes the flight path also nearly a straight line in the vertical plane. Only one top-of-climb and one top-of-descent will mean a 'turn' in the vertical path.

Causing short-term conflicts can be avoided by implementing a rule that inhibits any manoeuvre, which would result in a short-term conflict. Using the CDTI it is possible to see where other aircraft are flying. On top of that, an extra conflict prevention tool is required to prevent this. In the NLR study, the predictive ASAS module shows on the primary flight display and on the navigation display bands on different scales. It shows 'no-go' zones in the track/heading scale, on the vertical speed scale and on the speed scale. The colours used for these bands, red and amber correspond to the urgency level of the conflict that would result if a value were to be selected on the autopilot in these bands. Chapter 5 explains how predictive ASAS, sometimes referred to as PASAS or PREDASAS, works. The first human-in-the-loop experiment did not yet feature the predictive ASAS. PASAS was a result of recommendations from this experiment and has been evaluated in the second human-in-the-loop experiment.

Resolving conflicts results in new conflicts

This effect is rare but can occur. In this situation, it might take more than one manoeuvre to solve the conflict. For example instead of turning back to the original heading, a vertical manoeuvre could be more effective. One could argue that the conflict resolution module should never advise to turn into a new conflict. It might be beneficial sometimes to do this as is illustrated by the 'wall' scenario where a 'wall' of aircraft at minimum separation approaches one aircraft. The effect of sequentially running into a new conflict is how in this scenario a wave-like pattern is started. This wave ensures solving the conflict geometry in an 'intelligent' way. See chapter 8 on complex conflict geometries for a description of the 'wall' pattern.

The resolution module does take multi-aircraft conflicts into account. Only currently predicted conflicts and not new conflicts due to a resolution manoeuvre are included. Still, although the resolution module initially does not take new conflicts as a result of the manoeuvre into account, the pilot can. Especially using predictive ASAS, it is clear which manoeuvre will result in a new conflict and evasive action or a better selection of the manoeuvre is possible. The ASAS system could also be adjusted to use the predictive ASAS output.

No constant vertical speed or CAS/Mach climb transitions

The approximation of a climb or descent as a straight line is a simplification. During the climb or the descent, normally the thrust setting is fixed and the speed is fixed. At a certain altitude the speed control will switch between maintaining a constant Calibrated Airspeed (CAS) or maintaining a constant Mach number. The vertical speed is a result from these settings and varies with altitude (air density). The resulting path is therefore a shallow curve instead of a straight line.

The net quantitative effect of the climb or descend mode has been analysed in co-operation with two students, Bas Gijbers and Mario Valenti Clari, and this is discussed in more detail in the next section.

4.7 Effect of CAS/Mach climb or descent

The conflict detection module of the Traffic Manager only uses a few input variables to predict a conflict. These variables include the aircraft's current position and altitude and the aircraft's trend vector (ground speed, track, and vertical speed). Hence, the aircraft's future positions are calculated by using the tangent of the flight path. However, when an aircraft performs a climb or descent, the aircraft's flight path is curved and is not a straight line. Due to the curved flight path, it is possible that the conflict detection module only detects a potential conflict at a moment the time to intrusion is (far) less than the look-ahead time of five minutes. This section primarily describes the effects of a CAS/Mach climb and descent on the conflict detection module in a Free Flight environment. The first paragraph gives some general information about the calibrated airspeed and Mach number. Paragraph 4.7.2 describes a steady climb with constant Mach while paragraph 4.7.3 describes the same climb being performed with a constant calibrated airspeed. Finally, paragraphs 4.7.4 and 4.7.5 analyse two air traffic scenario's that have been investigated using the Traffic Manager. The first is the standard situation where one aircraft flies level and the other one climbs towards his altitude. The second scenario is a worst case scenario where one aircraft is climbing and the other one descending, resulting at the largest initial altitude difference

4.7.1 Definition of CAS and Mach

The calibrated airspeed (CAS) is defined as the indicated airspeed of an aircraft, corrected for altitude and instrument error. Hence, the indicated airspeed is basically the same quantity as calibrated airspeed but includes the pressure error present in the pitot/static installation and the instrument errors present in a simple mechanical type of airspeed indicator instrument. The following formula can be used to compute the true airspeed (TAS) from the calibrated airspeed (CAS):

$$V_{TAS} = \left[\frac{2 p(H)}{\mu \rho(H)} \left\{ \left[1 + \frac{p_0}{p(H)} \left[\left(1 + \frac{\mu \rho_0}{2 p_0} V_{CAS}^2 \right)^{\frac{1}{\mu}} - 1 \right] \right]^{\mu} - 1 \right\} \right]^{1/2} \quad (4.1)$$

$$\mu = \frac{\gamma - 1}{\gamma} \quad \text{and} \quad \gamma = \frac{c_p}{c_v} \approx 1.40$$

The Mach number is defined as the ratio of the aircraft's true airspeed to the local speed of sound. The true airspeed (TAS) is defined as the speed of the aircraft relative to the surrounding air. Hence:

$$M = \frac{V_{TAS}}{a} \quad (4.2)$$

with:

$$a(H) = \sqrt{\gamma \cdot R \cdot T(H)}$$

4.7.2 Climb with constant Mach

Consider an aircraft climbing with a constant commanded vertical speed and a constant Mach number (see figure 4.9).

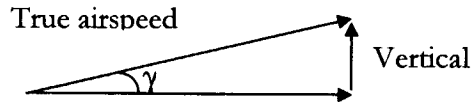

figure 4.9 Climb with constant Mach number and vertical speed

As stated earlier in the definition of Mach, the Mach number can be derived from the true airspeed (TAS) and the speed of sound (a). The speed of sound however reduces with increasing altitude as the temperature decreases until the tropopause height is reached. The variation of the speed of sound with temperature equals:

$$a = \sqrt{\gamma \cdot R \cdot T}$$

$$\gamma = 1.40$$

$$R = 287.0529 \quad (\text{note this } \gamma \text{ is not the flight path angle } \gamma !)$$

$$T = 288.15 - 0.0065 \cdot H$$

The resulting variation of the speed of sound from sea level to FL400 is shown in figure 4.10.

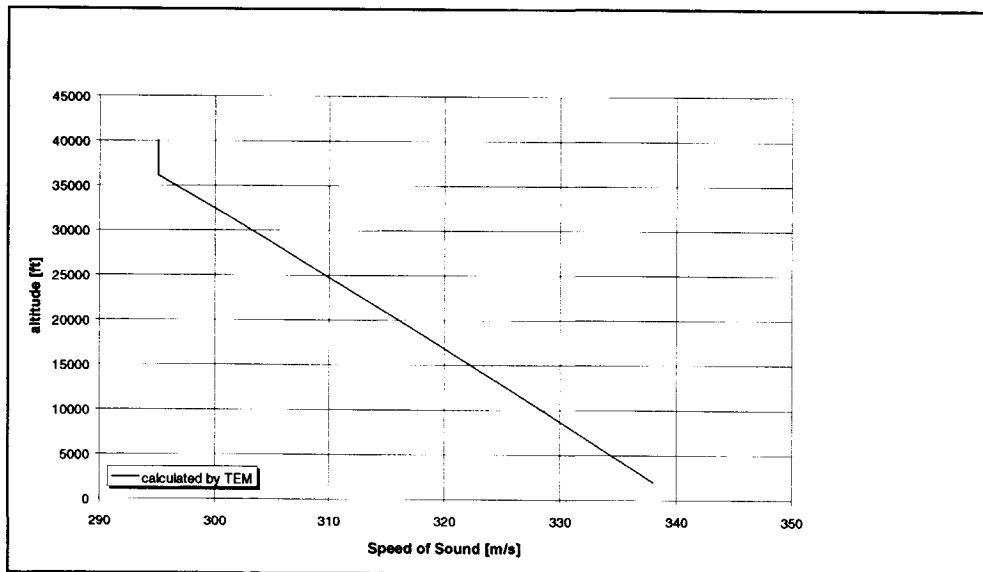

figure 4.10 Speed of sound in International Standard Atmosphere (ISA)

The equation for Mach yields:

$$V_{TAS} = Mach \cdot a$$

$$\frac{dV_{TAS}}{dH} = Mach \cdot \frac{da}{dH} \left\{ \frac{da}{dH} < 0 \right\}$$

Hence, the true airspeed decreases with increasing altitude. When climbing with a constant vertical speed, the flight path angle increases with increasing flight level.

4.7.3 Climb with constant calibrated airspeed

Consider the aircraft mentioned in paragraph 4.7.2 but then climbing with a constant calibrated airspeed. Using an approximation for CAS, the equivalent airspeed, yields:

$$V_{TAS} \approx CAS \cdot \sqrt{\frac{\rho_0}{\rho}} \quad (4.6)$$

$$\frac{dV_{TAS}}{dH} \approx CAS \cdot -\frac{1}{2} \cdot \sqrt{\frac{\rho_0}{\rho^3}} \cdot \frac{d\rho}{dH} \left\{ \frac{d\rho}{dH} < 0 \right\} \quad (4.7)$$

The relationship between the air density, ρ , and altitude, H , is shown in figure 4.11.

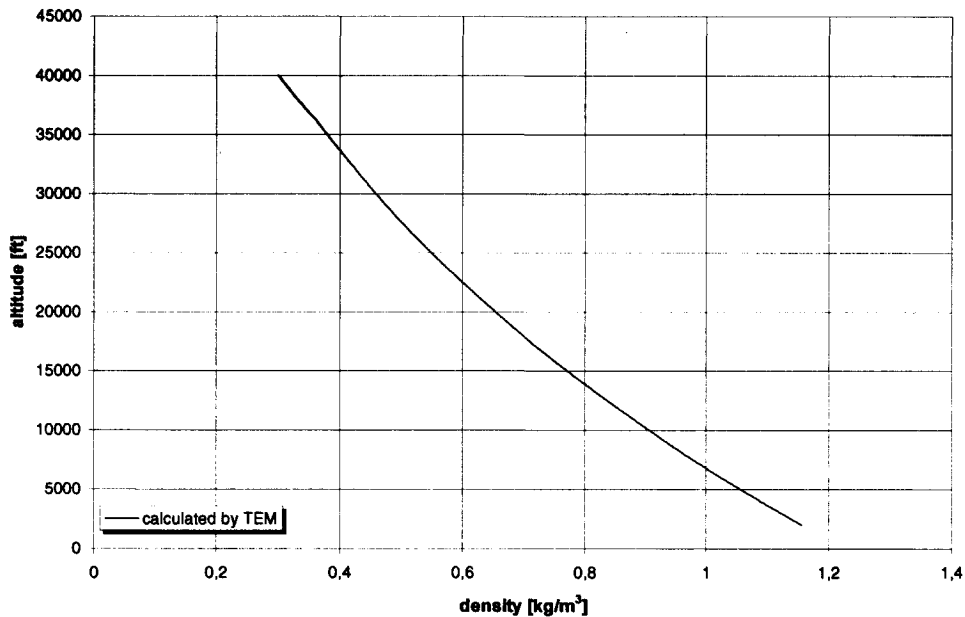

figure 4.11 Air density in ISA atmosphere

Hence, the true airspeed increases with increasing altitude. When climbing with a constant vertical speed, the flight path angle thus decreases with increasing altitude. For the simulations the more accurate relation between TAS/Mach and CAS in equation 4.1 has been used.

4.7.4 Scenario (I) of CAS, Mach climb/descent

Consider two aircraft numbered KL101 and MP747 as shown in figure 4.12. KL101 is flying at FL300 (Mach=0.80). MP747 starts a steady climb from FL250 to FL300 with a constant vertical speed of 1000 ft/min. The initial positions of both aircraft are such that the MP747 grazes the protected zone of KL101 at a flight time of approximately four minutes (see figure 4.13).

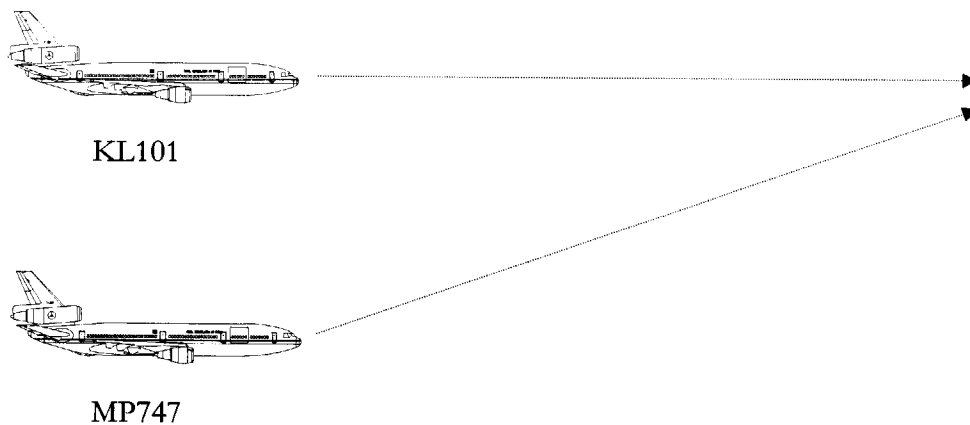

figure 4.12 Scenario I (number of aircraft = 2)

Using the Mach number equations yield for KL101:

$$T = 288.15 - 0.0065 \cdot 30000 \cdot 0.3048 = 228.7K$$

$$a = \sqrt{1.4 \cdot 287.0529 \cdot 228.7} = 303.2m/s$$

$$V_{TAS} = GS = M \cdot a = 0.80 \cdot 303.2 = 242.5m/s \cong 471kts$$

Assume a relative motion between the KL101 and MP747 as shown in figure 4.13. The ground speed of the MP747 thus equals:

$$GS = 242.5 - 5.08 = 237.42m/s$$

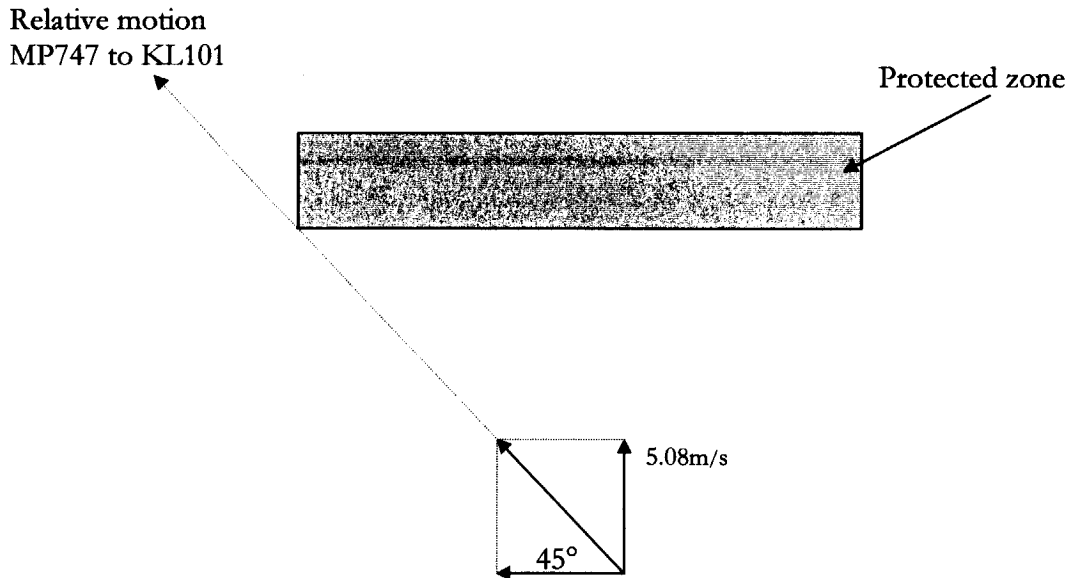

figure 4.13 Theoretical relative motion between KL101 and MP747

The following formulae are used to determine the Mach number of MP747:

$$\text{Rate of Climb: } 5.08 = V_{TAS} \cdot \sin \gamma \quad [m/s]$$

$$\text{Ground speed: } 237.42 = V_{TAS} \cdot \cos \gamma \quad [m/s]$$

Combining these equations yields the initial flight path angle γ :

$$5.08 = \frac{237.42}{\cos \gamma} \cdot \sin \gamma = 237.42 \cdot \tan \gamma \quad [m/s]$$

$$\gamma = 1.226^\circ$$

$$V_{TAS} = 237.47 \text{ m/s} \cong 462 \text{ kts}$$

Using the equations for Mach number yield for MP747:

$$T = 288.15 - 0.0065 \cdot 25000 \cdot 0.3048 = 238.6 \text{ K}$$

$$a = \sqrt{1.4 \cdot 287.0529 \cdot 238.6} = 309.7 \text{ m/s}$$

$$M = \frac{V_{TAS}}{a} = \frac{237.47}{309.7} = 0.77$$

See figure 4.14 for the absolute flight path of both the KL101 and the MP747 as calculated by the Traffic Manager (which uses formula 4.1 for CAS/TAS calculations).

Note from figure 4.14 that the flight path angle decreases when the MP747 performs a steady climb with a constant calibrated airspeed and that the flight path angle increases when the same climb is performed with a constant Mach number (see paragraphs 4.7.2 and 4.7.3).

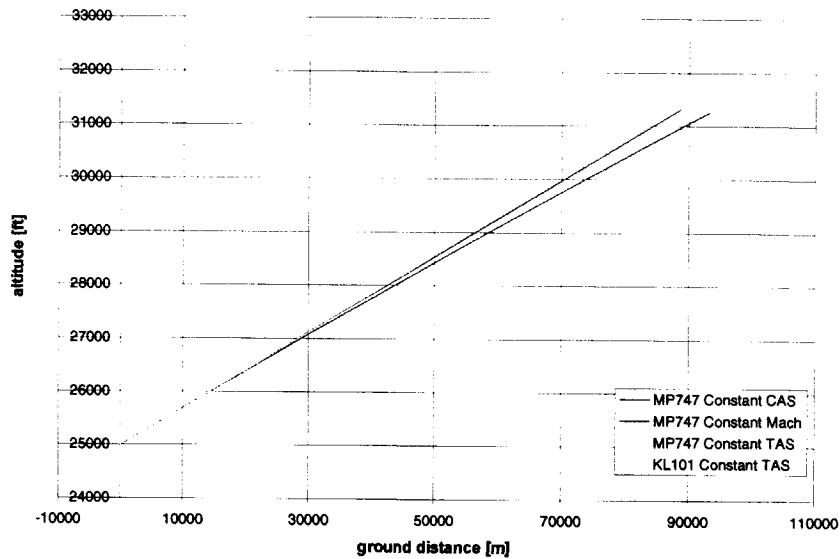

figure 4.14 Absolute Flight path KL101 and MP747

The relative motion between the MP747 and the KL101 is displayed in figure 4.15. Note that the theoretical relative motion (constant TAS) grazes the protected zone of the KL101 at a flight time of approximately four minutes (see also figure 4.13).

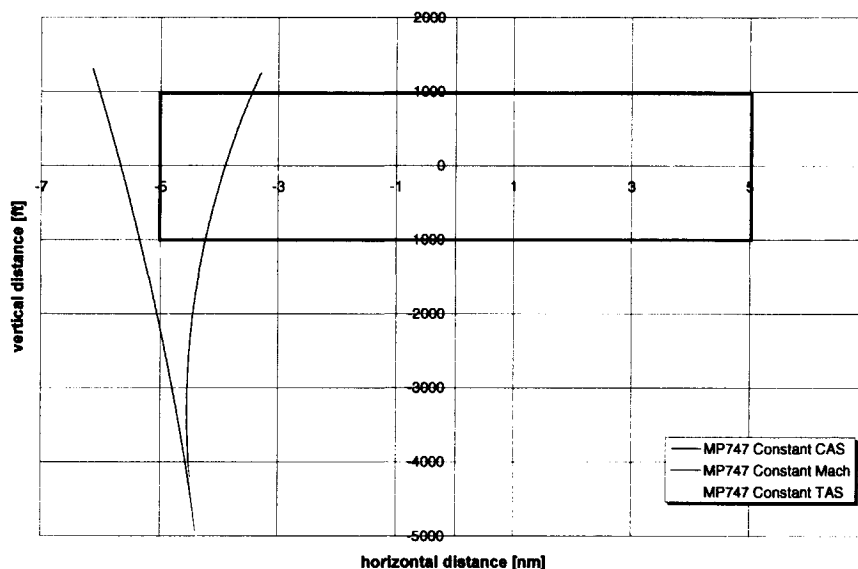

figure 4.15 Relative flight path MP747 to KL101

When the MP747 climbs with a constant Mach number in this scenario, it slowly “moves” away from the protected zone of the KL101. Therefore, a conflict is detected only once at the time the MP747 starts its climb. However, when the MP747 performs a climb with a constant calibrated airspeed, the range rate becomes negative as shown in figure 4.15. Note that the intrusion in the horizontal plane approximately equals one nautical mile at a flight time of five minutes when the MP747 climbs with a constant calibrated airspeed. When considering the theoretical relative motion between the two aircraft, the MP747 is located outside the protected zone of the KL101 at a flight time of five minutes.

In both situations there is an effect of the curved path. Mach and CAS climb both result in a deviation of the straight line in opposite direction. What this means will be discussed in section 4.7.6. First, a worst case scenario will be discussed using the same method in the next section.

4.7.5 Scenario (II) of CAS, Mach climb/descent

Consider the same two aircraft as mentioned in the paragraph 4.7.4. KL101 is flying at FL350 and starts a slow descent to FL250. MP747 is flying at FL250 and starts a steady climb to FL350 (see figure 4.16). Both aircraft use a vertical speed of 1000 ft/min to reach their desired flight level. The initial positions of both aircraft are such that the theoretical minimum distance approximately equals zero.

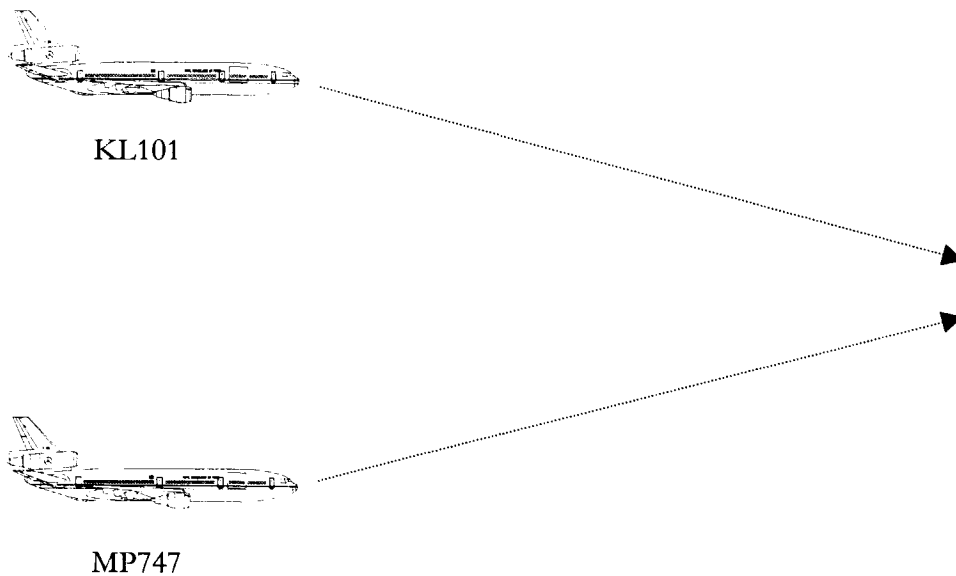

figure 4.16 Scenario II (number of aircraft = 2)

Using the atmospheric equations yield for KL101:

$$T = 288.15 - 0.0065 \cdot 35000 \cdot 0.3048 = 218.8K$$

$$a = \sqrt{1.4 \cdot 287.0529 \cdot 218.8} = 296.5m/s$$

$$V_{TAS} = M \cdot a = 0.80 \cdot 296.5 = 237.2m/s \cong 461kts$$

The calibrated airspeed of the KL101 at FL350 is calculated by the Traffic Manager using formula (4.1) and approximately equals:

$$V_{CAS} = 139.9m/s \cong 272kts$$

The same calculations performed for the MP747 yield:

$$T = 288.15 - 0.0065 \cdot 25000 \cdot 0.3048 = 238.6K$$

$$a = \sqrt{1.4 \cdot 287.0529 \cdot 238.6} = 309.7m/s$$

Due to the fact, that the theoretical minimum distance equals zero, both the KL101 and the MP747 have to fly at the same true airspeed (TAS).

$$V_{TAS} = 237.2 = M \cdot 309.7$$

$$M = 0.77$$

The calibrated airspeed calculated by the Traffic Manager equals:

$$V_{CAS} = 165.7 \text{ m/s} \cong 322 \text{ kts}$$

The graph in figure 4.17 displays a part of the absolute flight path of both the KL101 and the MP747.

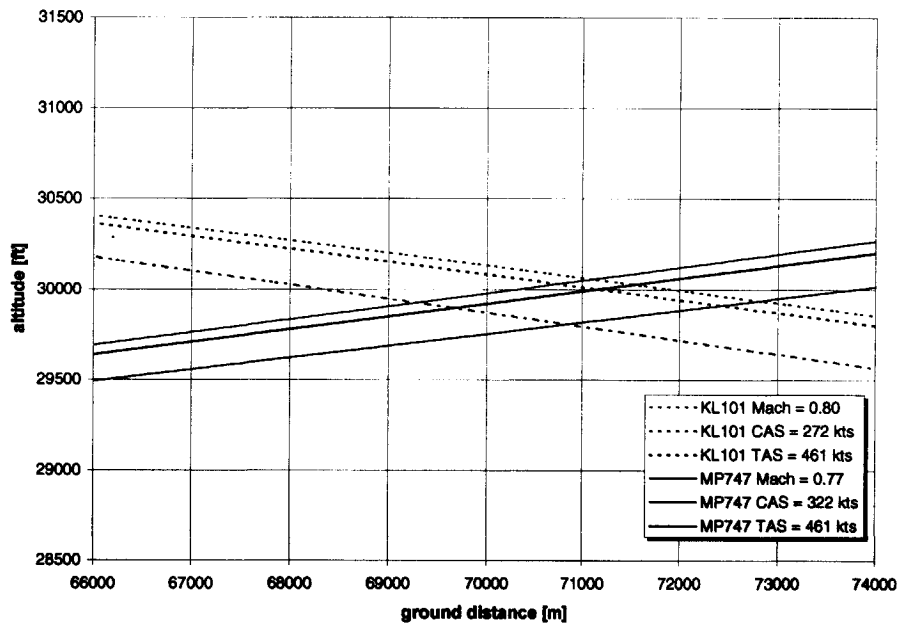

figure 4.17 Absolute Flight Path KL101 and MP747

Note from figure 4.17 that the maximum ground distance at FL300 occurs when both aircraft fly at a constant calibrated airspeed (CAS). In this case the flight path angle of the KL101 increases while the flight path angle of the MP747 decreases (see also figure 4.17). The ground distance at a flight time of five minutes approximately equals 3 nautical miles as can be seen from figure 4.18. In figure 4.18 the relative motion is shown between both aircraft when the KL101 flies at a constant calibrated airspeed.

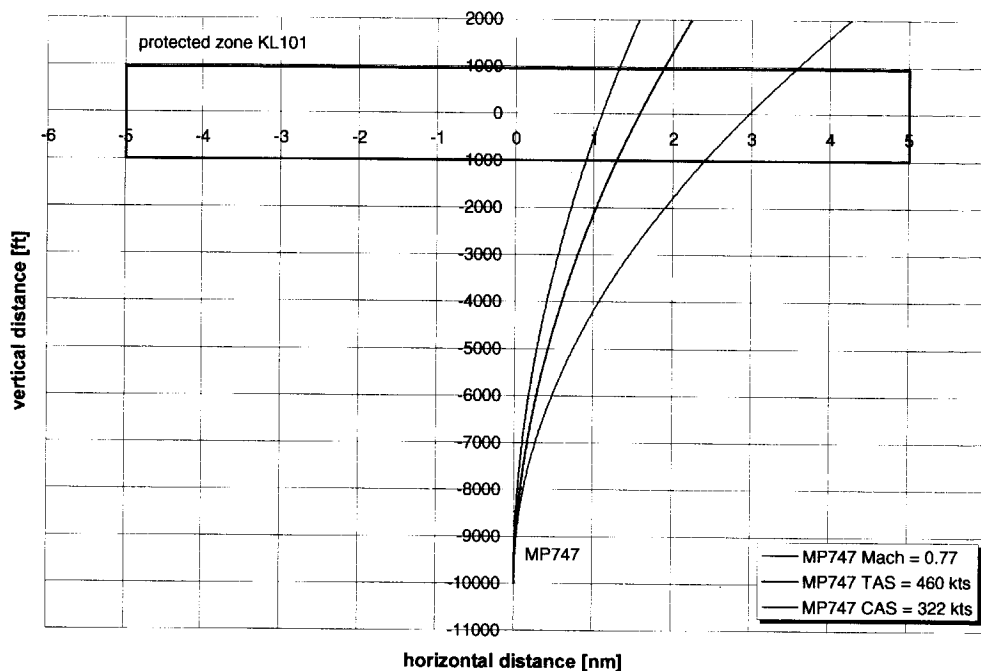

figure 4.18 Relative Flight Path MP747 to KL101 (flying at constant CAS)

These experiments with the Traffic Manager proved that the CAS, Mach climb/descent has a considerable effect on the conflict detection and resolution module. The CAS, Mach climb/descent primarily initiates uncertainties of the predicted position of the intruder aircraft in the near future. The amount of uncertainty is dependent on the curvature of the aircraft's flight path. The curvature of the aircraft's flight path depends on the gradient of the true airspeed to the aircraft's altitude. The larger the absolute value of this gradient, the larger the amount of curvature of the aircraft's flight path. The experiments with the Traffic Manager proved that the curvature of the flight path is largest when an aircraft performs a climb/descent with a constant calibrated airspeed instead of a climb/descent with a constant Mach number.

Critical air traffic situations are those in which the conflict detection module initially does not detect a potential conflict while, due to the curved flight path, there is an intrusion of the protected zone in the near future. The amount of intrusion depends on the curvature of the aircraft's flight path. Hence, the time to avoid a conflict will be less than the look-ahead time of five minutes and thus results in more immediate and perhaps costly manoeuvres of the aircraft. The impact is discussed in the next section.

4.7.6 Conclusion of climb/descent scenarios

The experiments with the Traffic Manager proved that all one-on-one conflicts resolve automatically and that no intrusions of the protected zone took place despite the effects in the previous sections. How is this possible?

Although the prediction error, when using the straight-line flight path for aircraft descending and climbing with a constant CAS or Mach number can be significant, the net effect is less dramatic. With the maximum intrusion, the reduction of the look-ahead

time is minimal. In the same way with the maximum reduction of the look-ahead time, the intrusion is minimal. See figure 4.19.

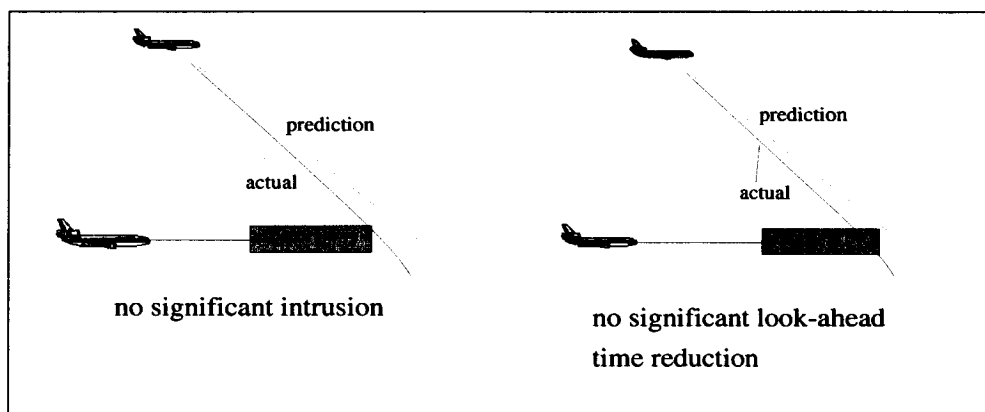

figure 4.19 Effect on conflict detection of curved descent

There are several solutions to improve the conflict detection and resolution during the climb and descent:

- estimate mode of other aircraft and correct prediction
- exchange mode or intent information
- add an extra comfort zone around protected zone

To prevent flashing conflict alerts, the conflict resolution already uses a comfort zone around the zone used by the conflict prediction. Together with the limited operational effect, this probably is the reason, it has never proven to be a problem during the off-line and on-line experiments. No further action has been undertaken for now as a result of this analysis.

4.8 Effect of 2D CPA outside protected zone

The principle of the resolution module is has been explained using the two-dimensional picture of the conflict resolution geometry (see figure 4.2). The horizontal solution is based upon an avoidance vector that moves the closest point of approach outside the protected zone of the intruder to the edge of the zone. The minimum distance is then increased to the required separation minima. The conflict detection module registers the conflict geometry, so the resolution module can perform this calculation. However, there is a situation where this will not work. And this situation is not rare due to the extremely flat shape of the protected zone. In most figures the protected zone is drawn as a hockey puck shape. The actual dimensions make it look more like a large coin. The ratio height to width is about 1 to 30. Suppose an aircraft enters the zone via the top surface and leaves the protected zone via the lower surface with a considerable vertical speed. This means the actual conflict interval is rather small. Then there is a relatively high probability that the two-dimensional closest point of approach is not located inside this conflict interval (just as the three-dimensional CPA, but that is irrelevant for the resolution module). This situation is shown in figure 4.20.

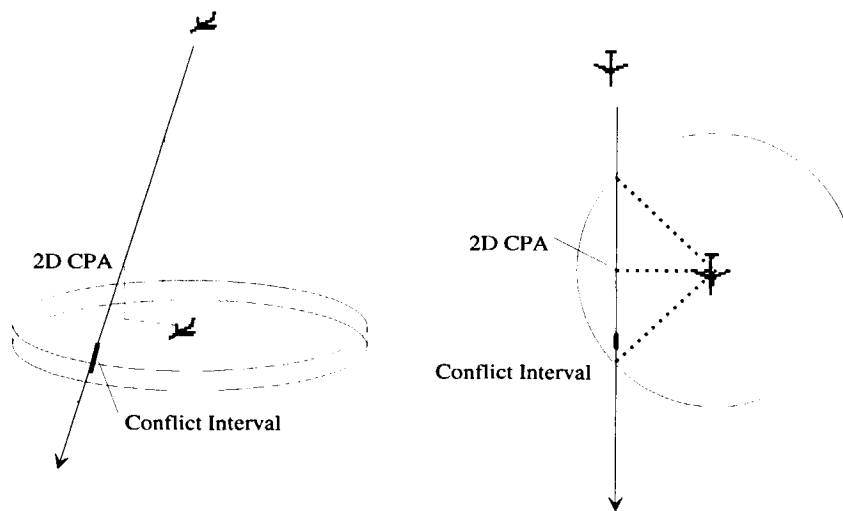

figure 4.20 In this situation the 2D CPA is outside the conflict interval

Only one minimum distance position (or CPA) should be used for both the horizontal and vertical resolution. This ensures one unambiguous speed resolution that is a part of both the horizontal and vertical resolution.

This ambiguity has been solved by changing the conflict position as registered in the conflict database from the 2D CPA to a position close to the centre of the conflict interval on the time axis. Putting it in the middle of the conflict interval would cause the vertical resolution to flip vertically, so an offset from the centre (5% percent of the conflict interval) in the original direction is added. This ensures the conflict does not flip to the other side vertically, which would destroy the implicit co-ordination ensuring a co-operative manoeuvre vertically.

4.9 Effect of vertical direction of relative speed

There is another case where the standard resolution algorithm fails to resolve the conflict. This is, just as the problem in the previous section caused by the vertical dimension of the protected zone. If the separation minima were to have been specified as a sphere, the algorithm would have been more effective without the exception handlers that now are required to resolve all geometries. Assume an intruder flies 1 mile to the left and 4000 ft below the own ship. The intruder is climbing slowly and thereby causes a conflict several minutes ahead. The resolution algorithm will calculate a horizontal resolution based on the horizontal closest point of approach, even though the loss of separation will occur several minutes before that moment. Therefore by following this resolution, the intruder will not be at a horizontal distance of five nautical miles when he enters the protected zone via the lower surface. The resolution algorithm has therefore failed to solve this conflict horizontally because it has ignored the fact that the aircraft was already within the horizontal separation minimum of five nautical miles. This observation also indicates how this had to be solved.

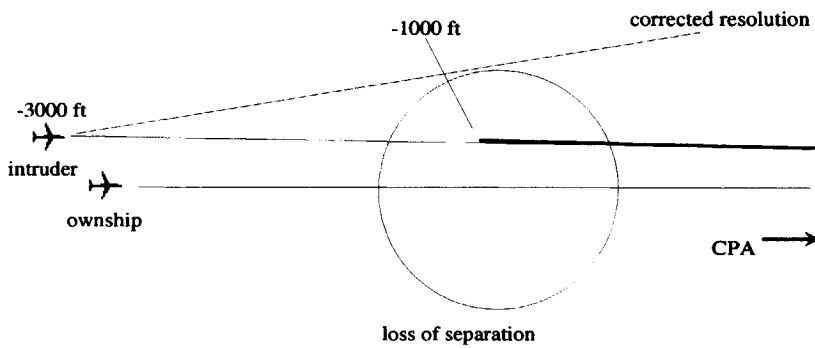

figure 4.21 Intruder is already within horizontal separation minimum => use intrusion point

The following logic has been added to the resolution algorithm to solve this:

If the intruder is already closer than 5 nm horizontally, use the time to loss of (combined) separation for the horizontal resolution calculation as manoeuvre time.

When the intruder enters the zone via the lower surface but is still not within the horizontal separation minimum, the manoeuvre time can be calculated in the standard way (*use time to closest point of approach*).

4.10 Effect of singularities

During demonstrations of the resolution algorithm, the example of an exact head-on collision was often mentioned. The modified potential resolution algorithm is a geometrical method and like most geometrical methods, it has a singularity, or borderline case, which could potentially cause trouble. The direction of the already existing minimum distance vector determines the direction of the avoidance vector. See figure below.

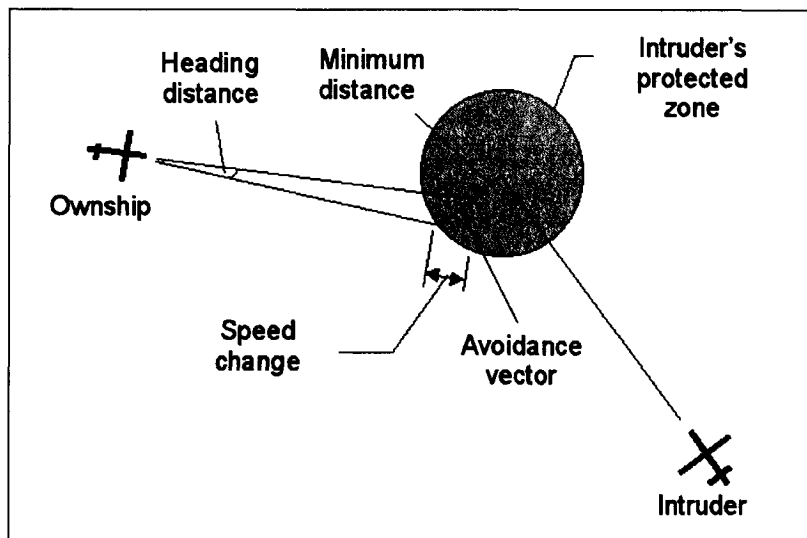

figure 4.22 Avoidance vector and resulting horizontal manoeuvre

If the minimum distance equals zero, like in the exact head-on collision, this causes a problem for the resolution algorithm. This distance is the outcome of a lat/lon calculation and a floating point value and not an integer (whole number). One will hardly ever see in a program a check for a floating point value being equal to zero or any other value. The probability for one floating point value being equal to another one, is extremely small, theoretically speaking. In this case, however it is still worth checking. This is caused by limited accuracy in which numbers are represented in the ADS-B message. Computers also have a limited number of bits that are used to represent the numbers, which already increases the chance of the distance being equal to zero. In a lot of cases a distance close to zero will already cause overflows, but in this case it is the lack of direction of the exact zero distance case that is causing the problems. In most computer programs, this problem can be handled by limiting the zero value to a lower or upper value (depending on the sign), effectively creating a dead band around zero.

In the ADS-B message the number of bits reserved for the position data is less than the number of bits generally used in computers to store floating point values. This increases the probability of creating singularities. Still, it will be rare, but maybe not rare enough to ignore this problem.

An extra rule, or exception handler has been created to take care of all cases where the distance is zero or nearly zero. The nearly zero cases may have a direction, but are prone to flipping as a result of 'process noise' (for example caused by turbulence). The logic that has been added is:

If the minimum distance is predicted to be below a the threshold value then:
If the course difference is larger than or equal to 90 degrees (opposing traffic) then both aircraft turn right
else the higher aircraft turns right or in level cases (thus overtaking) the faster aircraft turns right.

This exception handler logic in the resolution module will take care of all cases where the minimum distance is predicted to be close to zero. Because it is unambiguous it does not require any explicit resolution co-ordination or negotiation.

4.11 Summary

In this chapter some important steps towards the design of the prototype ASAS system have been covered:

- **selection** of conflict detection & resolution method
- **implementation** of conflict detection and resolution algorithms
- **analysis** of impact of using straight line predictions for conflict detection
- **exception handling** by conflict resolution module

The result is a prototype of the ASAS as it has been used in the off-line traffic simulations and the first human-in-the-loop trials. Later the predictive ASAS conflict prevention system has been added. This will be described in the next chapter.

The design of the human machine interface of the ASAS (with and without predictive ASAS) will be described in chapter 6.

5 Conflict Prevention: Predictive ASAS

5.1 Introduction

The previous chapter describes the ASAS system based on two main modules: conflict detection and conflict resolution. This version of ASAS has been used in the first flight simulator study. This study will be described in chapter 10. One of the results of this study was the need for an additional functionality inside ASAS: conflict prevention. The conflict detection & resolution is based on predictions based on the current state (position & velocity vector). The goal of the conflict prevention function is to assist the pilots in avoiding triggering new conflicts when manoeuvring. It provides the pilots for instance with the following information: Will a conflict occur if I select this heading? With the base-line ASAS this information was not available except if deduced by the crew from the traffic information on the display.

After the first simulator trials the ASAS has been expanded with the conflict prevention functionality. This expansion of ASAS is called Predictive ASAS (PASAS). The Predictive ASAS module predicts which manoeuvres will lead to a conflict. This is performed by showing no-go zones on several scales of the displays: the heading scale, the vertical speed scale and the speed scale. By showing these 'bands' on the scales, the system helps preventing new conflicts resulting from manoeuvres of the own ship before these manoeuvres are executed. Apart from this prevention, the addition of PASAS has some interesting side effects, especially if the other aircraft also uses the Predictive ASAS.

This chapter first describes how the need for Predictive ASAS originated and what the effect of using such a system on the rules of the air can be. The second part of this chapter describes the algorithms that use the received traffic information to generate the predictive ASAS information (the 'bands') on the display. The chapter ends with some remarks about the predictive effect and future refinements of the system. The display will be described in the Human-Machine Interface chapter (section 6.7).

5.2 Need for conflict prevention system

Using the Airborne Separation Assurance System (ASAS) in the way it was used during the first phase flight simulator experiments yielded some pilot comments. Because only a CD&R function was available, airborne separation was purely reactive. Pilots with an air force background had experience with air-to-air situations and were able to predict problems further ahead or due to manoeuvres, but for pilots without this background it was hard to guarantee preventing all conflicts based solely on viewing the traffic information.

In the debrief pilots noted two problems with this approach:

1. They were unable to tell what the effect of a manoeuvre (for example a recovery manoeuvre) was.
2. They missed intent information of other aircraft especially on the intended vertical path ("Will he level off below me or not?").

There was also a need for a rule to prevent turning into short-term conflicts (see chapter 10).

The following rule was adopted as an extra rule of the air:

“Manoeuvring in a way that will trigger a conflict within the lookahead time should be avoided if possible”.

To be able to do this, there clearly is a need to know which manoeuvres will lead to a predicted conflict.

The predictive ASAS system has been designed to provide this information without requiring any crew action like “probing” or “trying to manoeuvre”. Such a system is nowadays sometimes referred to as a ‘Conflict Prevention’ system.

PASAS shows amber and red bands on the heading, speed and vertical speed scale. These bands indicate “no go” zones. When a heading value is selected inside an amber band, this will lead to an amber conflict (a loss of separation between 3 and 5 minutes from now). Similarly, selecting a value in a red band will lead to an ‘urgent’ conflict, defined as a conflict within 3 minutes. In other words, selecting a value within a red band will lead to a red conflict alert, while selecting a value in an amber band will result in an amber conflict alert.

These bands can be used to implement the extra rule. It also helps to decide when it is possible to return to the original track without triggering the same conflict again (the recovery manoeuvre). This was not very well supported in the first version of the user-interface without PASAS.

If all equipped aircraft are fitted with PASAS, there is no longer a need to know intent information, because nobody will turn (or climb/descend) into a conflict. Any “false alerts” due to the lack of intent then become no longer real false alerts, since the protected zone has a temporal expansion along the velocity axis. In other words: it should be avoided to aim a speed vector at anybody in a way that would trigger a conflict even if the intention is to turn or level off soon. This will prevent near-conflicts if the intents change (‘better safe than sorry’).

How PASAS can prevent conflicts, which could result from not exchanging intent information, is best illustrated using the example in figure 5.1.

The sequence in figure 5.1 shows an example of this effect. In the picture at the top of the page a situation is depicted where an aircraft A is climbing through a level where aircraft B is flying level. However, A intends to level off just below B. Because no intent of A is transmitted and no ownship intent is used in the CD&R module, no conflict alert is issued at this moment in aircraft A or B. This is correct since according to the velocity based predictions there is no conflict. The Predictive ASAS (PASAS) of A also does not show any information, since there is no conflict with B possible within the lookahead time. Similarly B has no predictive bands with A.

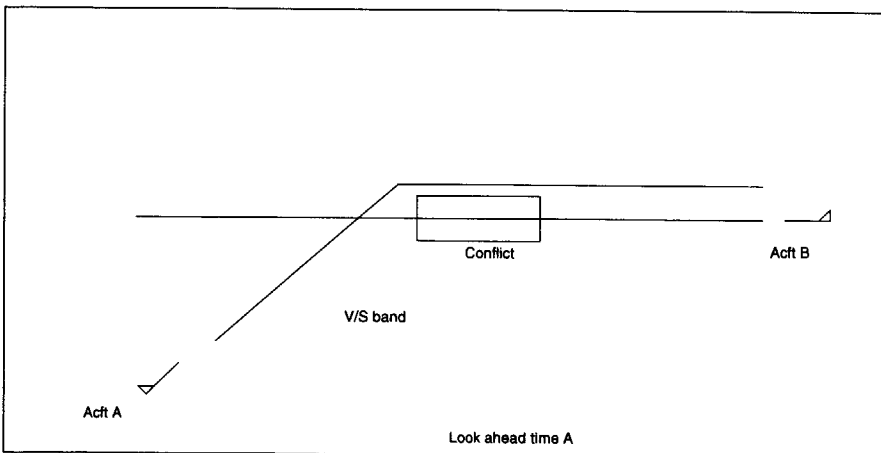
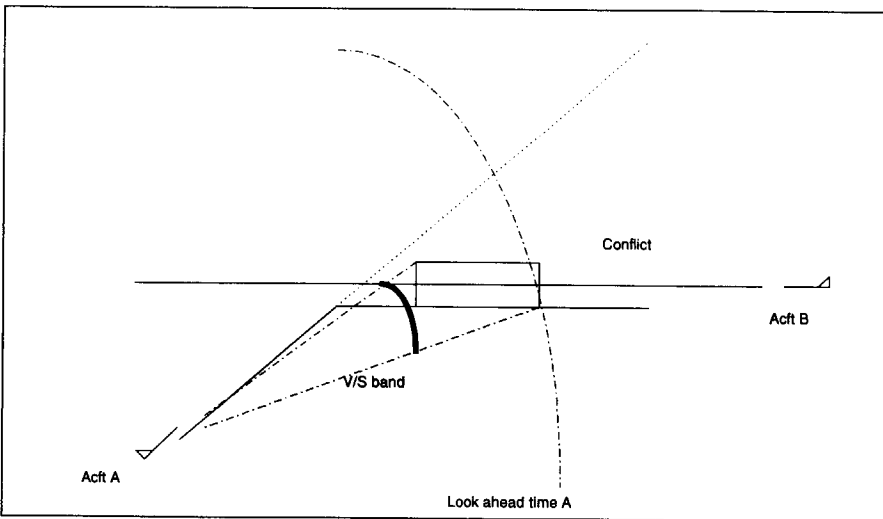
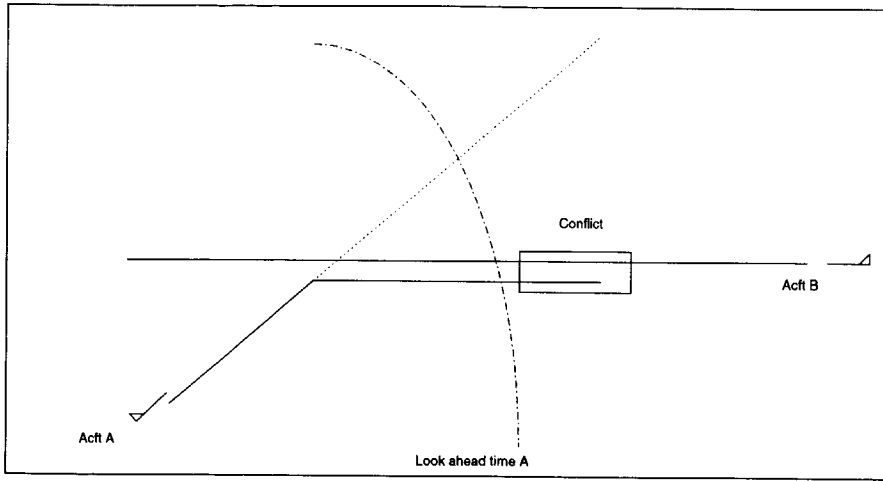

figure 5.1 Sequence illustrating effect of predictive ASAS to prevent conflicts which could otherwise only be prevented by exchanging intent information

If we focus on aircraft A, then in the next picture the PASAS of A will show an (amber) band on the vertical speed scale indicating that decreasing the vertical speed will trigger a conflict (middle picture in figure 5.1). This means decreasing the vertical speed to a value within this band is not allowed by the new rule. By the time A reaches the level of B, this vertical band will include the vertical speed of zero, clearly indicating that levelling off at this moment is not a good idea and in fact forbidden by the new rule. As a result A will only level off if well above B, in this way avoiding the short-term conflict which could otherwise result in a red conflict alert immediately (lowest picture in figure 5.1).

If A would be monitoring the PASAS bands, another option would be to level off before the band encompasses the zero vertical speed, resulting in A passing B below B's altitude.

A similar situation can be drawn for the horizontal situation. In this case the heading bands have a similar function as the vertical bands.

Applying the new rule does require the crew to monitor the bands if the aircraft changes vertical speed (levelling off or initiating a climb or descent) and while it turns over a waypoint. Similarly speed changes should be monitored as well. When using the mode control panel in the basic modes (heading change or altitude select) this is already common practice. When flying in FMS coupled modes there is a risk that the crew does not monitor the PASAS bands at the right time. This can of course be automated when flying in FMS mode, by automatically checking whether new selections fall within a PASAS band and sounding an aural alert and not selecting the new value of vertical speed or heading.

By using PASAS this way, conflicts missed by not exchanging intent information can still be prevented. This also means we do not necessarily have to rely on the intruder to follow its transmitted intent information to prevent these situations.

5.3 Algorithms

5.3.1 *Calculating vertical speed bands*

Assume our own ship is flying level. The top drawing in figure 5.2 shows a top view of the situation. As on the display the own ship is indicated by the aircraft symbol. The intruder is indicated by the arrowhead symbol. In this two-dimensional picture there is a conflict for a certain interval. However from the side view below it, it is clear that this is not a real conflict, because the intruder will pass below us during the time we are less than 5 nautical miles apart. It can also be seen that there exists a range of vertical speeds that would cause a (three-dimensional) conflict with this aircraft (indicated by the arc labelled V/S band). Calculating the lowest vertical speed (V/S 1) and highest vertical speed (V/S 2) allows us to draw a no-go band (or two if another amber and a red band is required) for when this conflict is within the look ahead time (or the part that is in the look ahead time).

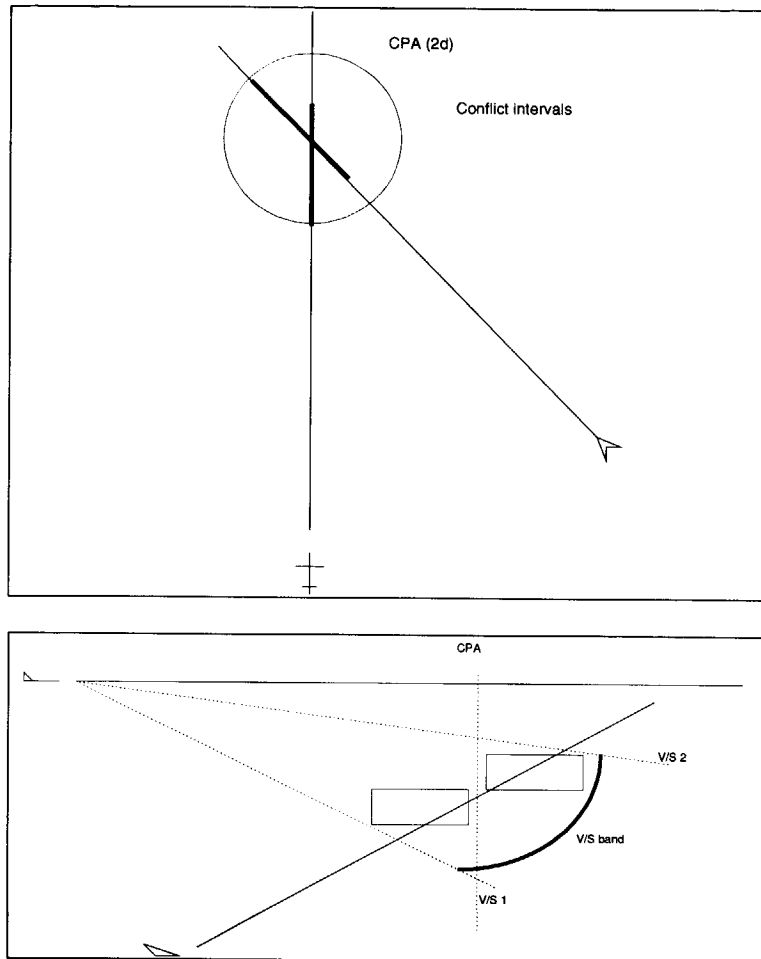

figure 5.2 Vertical speed bands result from apparent conflicts on the horizontal plane

To calculate the vertical speeds that limits the vertical speed band the following steps are required:

- Calculate relative speed and position
- Project position and speed on plane of speed vector and horizontal line perpendicular to the speed (the “gamma plane”)
- Calculate whether minimum distance is below required separation
- Calculate conflict interval
- Limit interval to lookahead time
- Calculate altitudes of both aircraft at begin and end of interval
- Calculate corresponding vertical speeds.

5.3.2 Calculating indicated airspeed bands

The indicated airspeed bands are calculated by detecting conflicts in the (vertical speed, azimuth)-plane. An apparent conflict in this plane can be translated to a ground speed, which would trigger a conflict. This is calculated by performing the following steps (see also figure below):

- Calculate vertical conflict interval within look ahead time

- Check whether there is an overlap with lateral (azimuth) conflict
- Calculate angles to edges of own protected zone in horizontal plane
- Calculate speed changes required to bend relative speed in direction of front and back edge
- Calculate resulting ground speeds
- Convert ground speeds to indicated airspeed

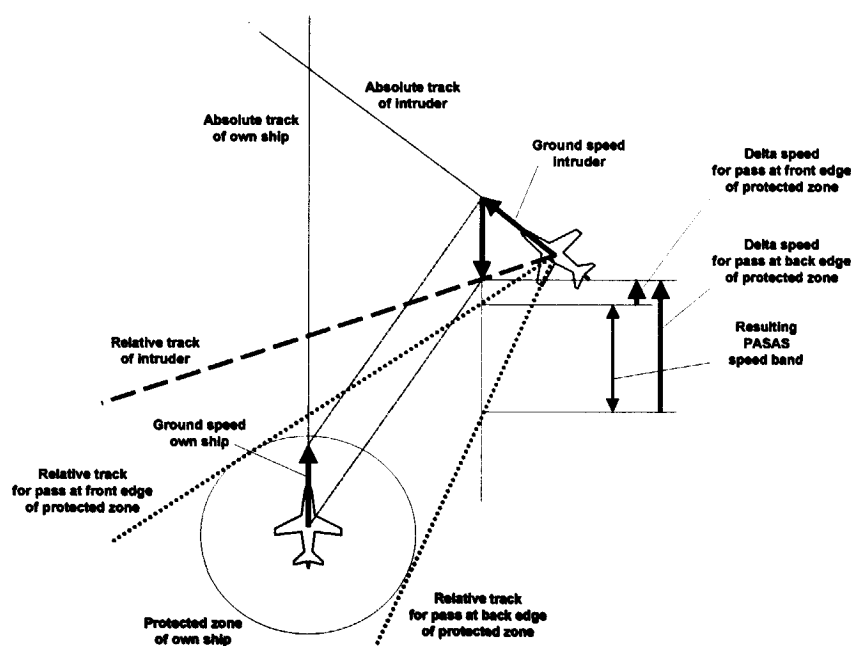

figure 5.3 Calculation of speed bands

After this calculation some checks on signs, geometric exceptions and unrealistic values (below stall speed and far above maximum operating speed) are performed. Then the band is registered. The ground speed is converted to indicated airspeed using atmospheric info and wind.

5.3.3 Calculating heading bands

For the heading bands a potential conflict in the (speed, elevation)-plane can be converted to one or two heading bands. Two potential heading bands can result caused by either turning to the aircraft or turning away from the aircraft.

For this calculation the following steps are taken:

- Calculate the one or two direct hits (collisions) headings by matching the speed component perpendicular to the bearing
- Calculate angle to front and back edge in this direction

- Convert angles to heading bands

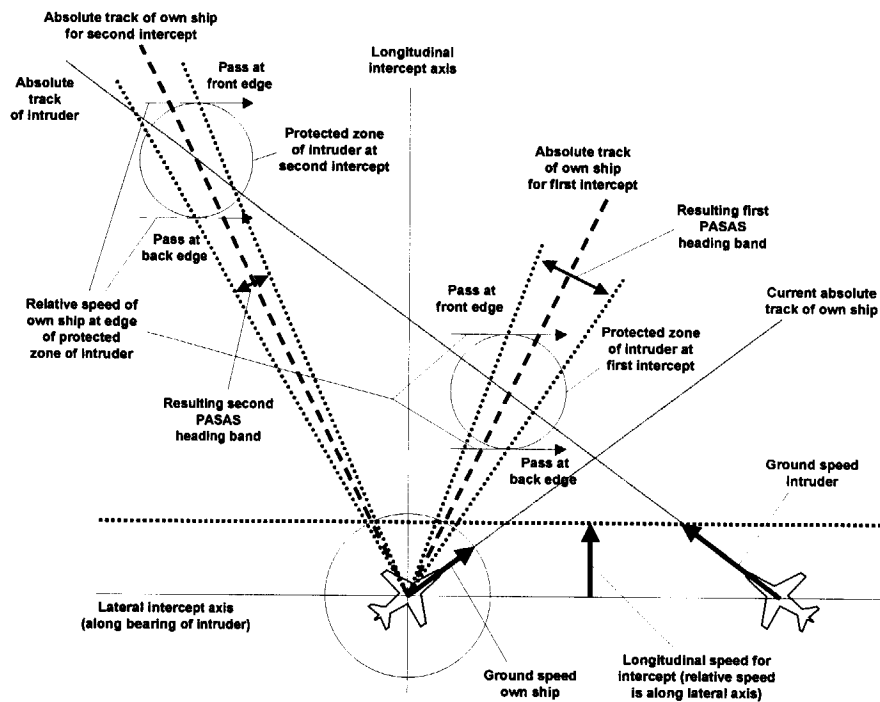

figure 5.4 Heading band calculation

The geometric calculations yield all conflicts for all vertical speeds. The limiting vertical conflict interval and lookahead time require some additional checks on signs, limits and exceptions. Finally, the band is registered.

5.3.4 Output

The resulting output is a buffer with bands for vertical speed, speed and heading for both amber and red conflicts. Unrealistic values are removed. The look ahead time for the amber bands is set slightly higher than the CD&R lookahead time: 5 minutes and 20 seconds, for the red conflicts it is equal to the corresponding CD&R threshold of 3 minutes. The amber bands should be drawn before the red ones because the $[0, 5:20]$ interval encapsulates the $[0, 3:00]$ interval.

No filter logic has been applied in the predictive ASAS system yet. The conflict detection uses a time based filter to suppress transient situations triggering an alert (see section 4.4). The predictive ASAS currently still lacks this feature. This means for instance that heading bands can suddenly appear and disappear when an aircraft's starts a climb and the speed vector was for a short while aiming at a conflict. For a prototype used in research this rare event might be acceptable but a mature conflict prevention unit should include similar filtering logic as the conflict detection module has.

Similarly, the effect of the curved trajectory towards a heading or vertical speed is ignored. Instead instant heading changes to the heading are assumed. In real life, it will take some time to get to that heading. In the mean time we continue flying in the direction we're currently flying. This means the bands are actually a bit too close to our

heading. Heading bands far from the current heading might show a minor movement during a turn due to this omission. Applying a transformation function including the speed on the heading bands could include the effect of the turn radius. This will then move the heading bands away from the current heading depending on closure rate and turn radius.

Another omission is altitude bands. The algorithm for the vertical bands calculates a flight path angle, which can together with the airspeed be expressed as a vertical speed. Because an altitude does not directly correspond to an angle, the altitude bands can only be calculated as a derivative during the vertical speed calculation assuming a standard vertical speed, followed by a level flight. This means there is no clear definition of a no-go band on the altitude scale. It requires additional assumptions on how to get to that altitude. The definition of altitude bands from the user point of view is: which altitude selection would lead to a conflict after levelling off and/or during the climb/descent to the altitude. By using an assumed vertical speed, the altitude bands could be calculated. This is considered as a possible extension of the system.

5.4 Miscellaneous remarks

The PASAS system as described so far only predicts the effect of a manoeuvre. A better name might have been "conditional ASAS" because it is used for what-if analysis. Within the RTCA SC-186 committee it is nowadays referred to as 'Conflict Prevention'. There is however a side effect of this system which makes it truly predictive. When the PASAS system is on, every conflict alert is preceded by one or more of the PASAS-bands growing towards the current value. For instance a conflict that happens a minute further away than the look ahead time, could be moved inside the look ahead time by turning towards this aircraft, hence there will be a heading band on the heading scale. When the conflict gets closer to the look ahead time, the required heading change will decrease so the band moves (or grows) towards the current heading (see figure 5.5)

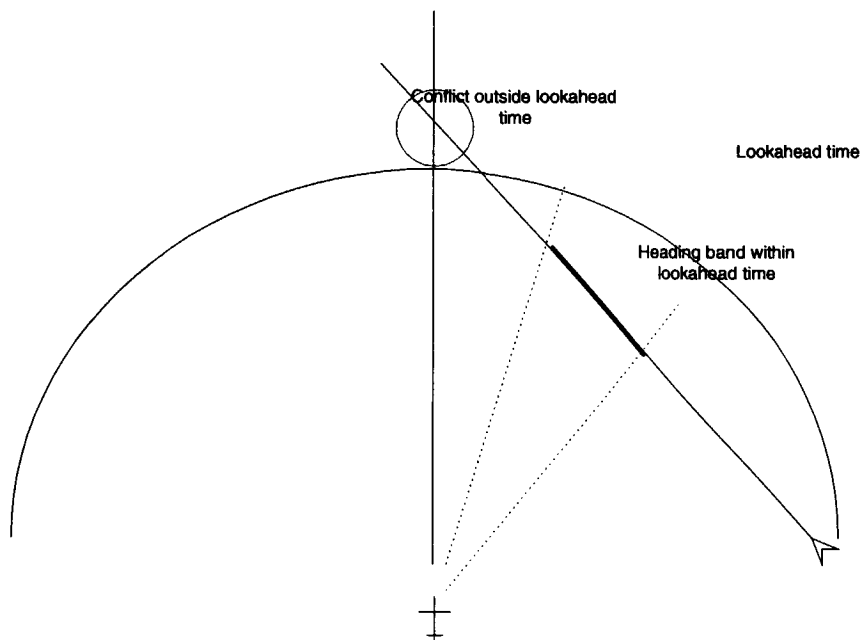

figure 5.5 A conflict is preceded by PASAS bands growing towards the current value on e.g. the track scale

In figure 5.5 such a situation is shown. The actual conflict is still beyond the current lookahead time (indicated by the circle being just outside the arc). But when we turn towards the intruder, the conflict is within the lookahead time. So in this case the heading band will already be there and will grow in the direction of our current heading.

In case of an exact head-on conflict there will not be a growing heading band, but the speed band will start to appear at higher speeds which would move the conflict inside the lookahead time. This would appear rather quickly. To avoid this short notice and to avoid missing minor intrusions, the amber lookahead time of PASAS has been increased to 5:20 minutes. This means an amber band will always appear, and enclose the current heading, speed or vertical speed, and predict a conflict.

As an addition, altitude bands may be added to the PASAS system, to enhance the situational awareness and improve the possibility to correlate bands to Traffic symbols for level flying aircraft.

Other additions to improve the correlation are still under investigation.

The PASAS still lacks the filters as are used in the conflict detection module. Because bands are merged at the end of the PASAS algorithm the connection to the traffic, causing the bands is lost. Therefore PASAS might require another type of filter.

6 Human Machine Interface

6.1 Introduction

This chapter describes the human machine interface and the rationale behind the design. The human machine interface consists of additional symbology on mainly the navigation display and the aural alerts. The design is based on an analysis of the tasks of the crew in a free flight environment and the choices described in the previous chapter on the ASAS system logic. This chapter first uses the tasks to define a number requirements of the HMI. Using these requirements the different elements of the HMI are described in the next section. Since the Predictive ASAS functionality has been added later, this will be described separately later in this chapter. In the final section, the autopilot functionality as used in the first flight simulator study (chapter 10) is discussed briefly.

6.2 Task analysis

To perform airborne separation, it is required to have adequate information on the surrounding traffic. This is not available in today's cockpit. Therefore changes in cockpit avionics are required. To determine the requirements for the human machine interface, the separation assurance task is divided in the following sub-tasks:

1. Traffic monitoring
2. Conflict detection
3. Conflict resolution
4. Recovery manoeuvre (resuming navigation)
5. Inter-Traffic radiotelephony

6.2.1 *Traffic Monitoring*

Monitoring the traffic has several goals:

- 1) build up situational awareness
- 2) check conflict detection
- 3) strategic traffic flow

The dynamics of the traffic patterns on the display, allows the crew to see the 'history' of several flights to the vicinity. This will provide the crew with the 3-D (4-D) mental model of the position and speeds of the relevant aircraft. This may seem a daunting task. During experiments however it has been shown that airline crews, without any extra means but the radiotelephony, were able to draw a sketch with the positions (bearing, distance and altitude) of up to four aircraft³. These aircraft were selected for relevancy for the flight (proximity and potentially conflicting flight path). Since airline pilots already possess this skill, there apparently is a need to do this. Indeed, over areas without radar coverage, this backup of ATC has often proven to be essential.

In Free Flight the resulting mental traffic picture also aids the crew in the decision how to resolve a conflict. An idea of where space is available or which manoeuvre will result

³ This has been tested in NLR trials investigating party line effect in basic R/T compared to Controller-Pilot Data Link (but not included in final publications)

in a bottleneck further away is helpful in the selection of the conflict resolution manoeuvre.

Observing manoeuvres of other aircraft, indicating a weather situation like thunderstorms, turbulence or favourable winds might also enhance the situational awareness.

Another goal of monitoring the traffic is to check the conflict detection module. Although detecting a conflict several minutes ahead is a calculation better suited to computers, humans can still be a last-minute backup. If there is a total failure of the conflict detection module, a traffic display might provide a way to at least avoid a near miss. The lookahead time will probably be decreased and the achieved separation may be less than required, but it is still a useful backup.

The third in the list of goals of monitoring the traffic is the strategic aspect. Being able to see the history of the traffic pattern, especially in a known route environment, might provide the crew with information enabling them to adjust the route to avoid delays or 'clouds' of traffic further away than the lookahead time of the conflict detection module. Showing the traffic information therefore also serves strategic goals.

6.2.2 *Conflict Detection*

Detecting the conflict consists of several sub-tasks:

- 1) predicting the own ship's trajectory for the lookahead time horizon
- 2) selecting potential intruders for the lookahead time horizon
- 3) predicting the intruder's trajectory
- 4) estimating the minimum distance at the closest point of approach (CPA)
- 5) comparing minimum distance with required separation

In this study the conflict detection task has been allocated to the automation as opposed to showing the traffic information on the display and leaving the detection of conflicts up to the crew.

The reasons for this allocation are:

- 1) Humans are not good at monitoring tasks, so one should not rely on them monitoring traffic for conflict detection
- 2) There is a clear computational aspect to all five identified sub-tasks. Similar to ICAO guidelines (ICAO Circular 249-AN/149 guidelines) it is the belief of the project team that computation is one task that should be left to the automation. These calculations, which can be regarded as data processing or conversion, should provide the crew with enough information for the conflict resolution decision. Decision-making is a task that should be performed by the more intelligent human operator. This also ensures the human is in the loop and avoids complacency ((Parasuraman, Molloy, & Singh, 1993; Wickens, 1992; Billings, C.E. (1997))
- 3) Scheduling advantage: a computer can run a computation continuously (that is: when new data are available), while the crew has several other tasks and is therefore not able to continuously check for conflicts based on traffic information alone during the remaining time for several hours.

Therefore in this study the five sub-tasks are performed by the conflict detection module inside the ASAS (Airborne Separation Assurance System).

As soon as a potential conflict has been detected within the lookahead time, the crew should be alerted and all information regarding the nature of conflict should be shown in a way that enables the crew to understand the conflict detection process resulting in this alert (thus providing transparency). This will also allow them to verify the alert is not a false alarm.

Moving the task of conflict detection to the cockpit changes the task nature of flying. While currently nothing happens during a long flight over the ocean, there is now a constant (albeit low level) expectation of conflicts. This means there should be a timely and discriminative alert because the crew might not be monitoring the traffic display.

6.2.3 *Conflict Resolution*

After the conflict has been detected and the crew is aware of the fact that there is a conflict, the conflict resolution process starts. The conflict resolution task consists of the following steps:

- 1) assessing conflict situation
- 2) generating options to solve the conflict
- 3) deciding how to solve the conflict
- 4) executing resolution manoeuvre
- 5) monitor until the conflict has been solved
- 6) adjust manoeuvre when necessary to most optimal conflict-free direction

The first step is to assess the conflict situation focused on the next step: generating options to solve the conflict. After several options have been generated, a decision has to be made, and in case of a two-man crew, agreed-upon, which conflict resolution manoeuvre is going to be used. The next step is actually dialling in the resolution manoeuvre into the mode control panel or keying it into the flight management system (FMS).

When the manoeuvre is being performed by the aircraft, the crew monitors not just the flight state, but also the effect on the detected conflict to determine the effectiveness of the manoeuvre. Sometimes it might be necessary to go back to step 2 of the process, though this should be avoided in the design of the systems and procedures as much as possible, since time is precious when a conflict has been detected.

In case of a co-operative manoeuvre, the conflict might already be solved halfway through the conflict resolution manoeuvre. In that case there is a sixth step: adjusting the conflict resolution manoeuvre. It might consist of for example selecting Heading Hold halfway through a Heading Select manoeuvre that initially did not assume any horizontal manoeuvring of the intruder aircraft.

The automation might provide help in the first two steps, since this involves computations without any complex decision making. The more complex decision for the resolution manoeuvre should be left up to the crew, since they might be aware of relevant factors unknown to the ASAS system.

6.2.4 Recovery Manoeuvre

A conflict resolution manoeuvre is in general a deviation from the optimal route. Though in case of direct routing there is no need to return to the original route (see figure 6.1), it is still desirable to fly to the destination (or next fix outside the free flight airspace) in the most optimal way as soon as possible. In general this is possible after passing the intruder aircraft.

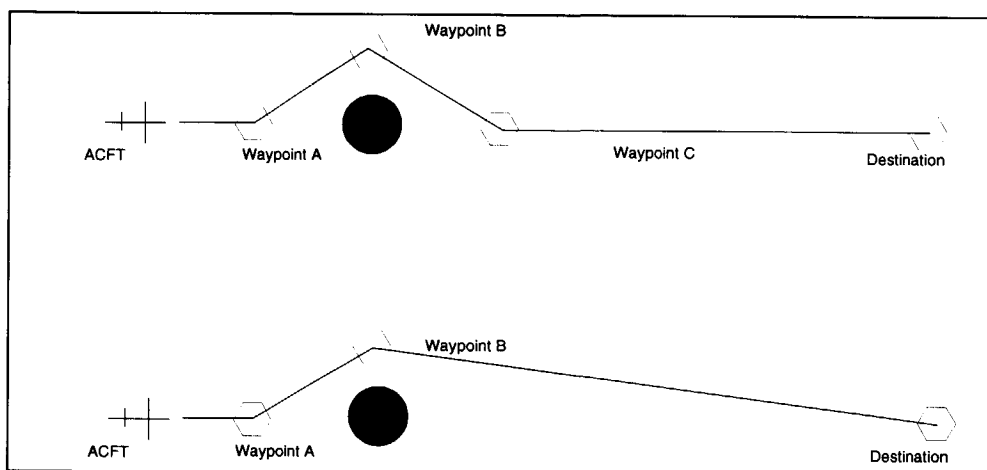

figure 6.1 The effect of a route deviation compared to a deviation in a direct route environment

From both the flight dynamics (pitching is quicker than turning) and the economical point of view, vertical resolutions are optimal. The economic advantage is caused by two effects: the magnitude of a vertical manoeuvre due to the flat shape of the protected zone (the required vertical speed is in the order of 100 feet per minute) and the exchange of potential and kinetic energy can be reversed in the recovery manoeuvre, minimising the effect on the efficiency of the flight.

6.2.5 Inter Traffic Radiotelephony

Apart from the radiotelephony between the ground based air traffic controller and the crew in the aircraft, there is often inter-traffic radiotelephony, especially in sectors without radar coverage and without a large amount of controller interference like over the oceans. The nature of this communication varies: often it is to warn following aircraft for turbulence at certain altitudes, sometimes the feasibility of a request to change altitude is verified before requesting it.

6.3 Requirements

What are the requirements for the human machine interface resulting from the task analysis in section 6.2? The sub-tasks, as identified in the previous section, are listed below together with the resulting requirements.

Traffic Monitoring:

TM1 – relative position of traffic: latitude/longitude or bearing/distance and altitude

TM2 – (relative and absolute) speeds of traffic: ground speed, track, and vertical speed

TM3 – traffic information should be in same spatial reference frame as the navigation information

Conflict Detection:

CD1 – provide alert when a conflict has been detected, that is also effective when the crew is not monitoring a specific display (thus aural)

CD2 – provide symbology with conflict information: when, where, who and geometry of closest point of approach (nature of conflict)

CD3 – provide transparency as to why the system predicts this conflict

Conflict Resolution:

CR1 – compute several options

CR2 – show options on display as advisories

CR3 – assists crew in execution of resolution manoeuvre and/or making adjustments

CR4 – provide insight into vertical situation because vertical manoeuvres are generally preferable

Recovery Manoeuvre:

RM1 – enable crew to determine moment of recovery

Inter Traffic Radiotelephony:

IR1 – provide call sign on the traffic information display to enable the crew to call the aircraft via the radio (call sign is also useful for crew co-ordination)

General requirements used in the design:

1) minimise impact on cockpit (e.g. no pointing devices required)

2) minimise clutter

3) provide crew with means to configure display

4) minimise training by being consistent with the other displays and avoiding cryptic symbology

5) minimise required crew actions

6.4 Cockpit Display of Traffic information

6.4.1 Predecessor: TCAS display

The task of the Cockpit Display of Traffic Information (CDTI) is to inform the crew of the traffic around the aircraft. It is similar to the radar screen of the air traffic controller but from the perspective of one aircraft. There is already some traffic information available in today's aircraft fitted with TCAS and a navigation display. This traffic information is shown integrated on the navigation display with the symbology as shown in figure 6.2.

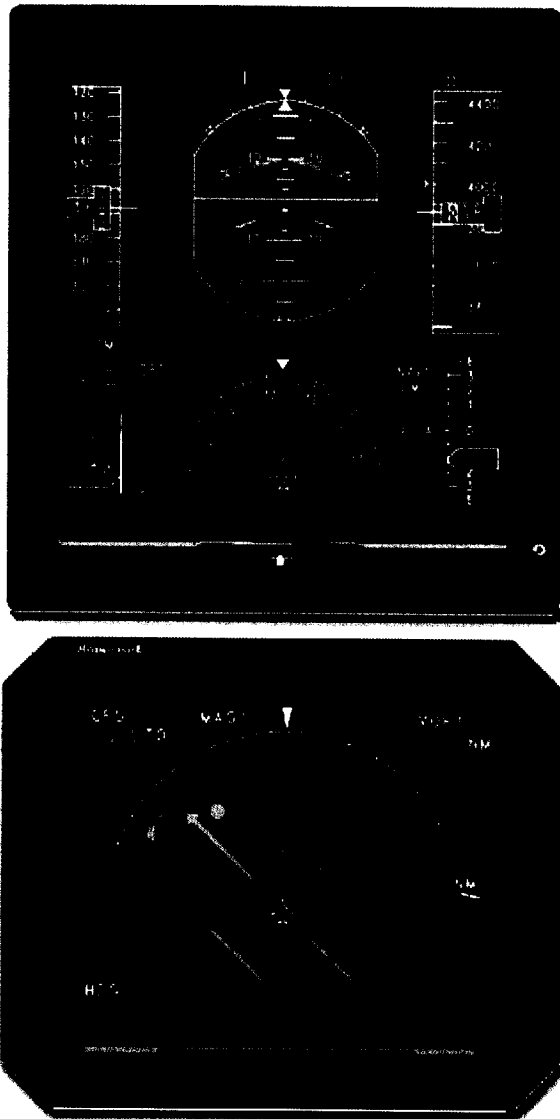

figure 6.2 Example of a TCAS displays (Honeywell TCAS 2000 display)

This Honeywell TCAS 2000 display shows the aircraft's own position by an aircraft symbol surrounded by a ring of dots representing a range of 2 nm. Four standard TCAS symbols, in increasing order of threat, indicate the status of traffic:

- an outline diamond (other traffic)
- a filled-in diamond (proximate traffic)
- an amber circle (TA – Traffic Advisory)
- and a red square (RA – Resolution Advisory)

An intruder's relative altitude, in hundreds of feet, is shown by a "+" or "-" sign followed by two digits. Altitude data are displayed above the symbol for "aircraft above" and displayed below for "aircraft below." An arrow after the altitude indicates whether the intruder is climbing or descending more than 500 feet per minute. The maximum range of traffic generating TCAS alerts is about 20 nm. Aircraft fitted with mode-S (the same medium that can be used to exchange ADS-B) are detected up to 100 nm.

The TCAS symbology formed the basis for the traffic symbology on the CDTI. There are also some differences. The way TCAS senses the position of other aircraft results in the following data:

- Bearing
- Altitude and vertical speed (derived from altitude)
- Range and range rate (derived from range)

The ADS-B position and velocity message results in a larger and more accurate data set:

- Call sign
- Latitude
- Longitude
- Altitude
- Ground speed
- Track angle ('heading')
- Vertical speed

The TCAS symbology, using diamonds, circles and squares, does not show the call sign, the ground speed and the track. For maximum TCAS compatibility adding extra text labels and a line to indicate track to the TCAS symbols is an option. An example of a CDTI based on TCAS symbology is shown in the figure below. The disadvantage of this is the resulting clutter of especially the track lines in high traffic density situations. To prevent clutter in high-density situations, instead of using a modified TCAS symbology a new symbology was chosen for the NLR Traffic Display.

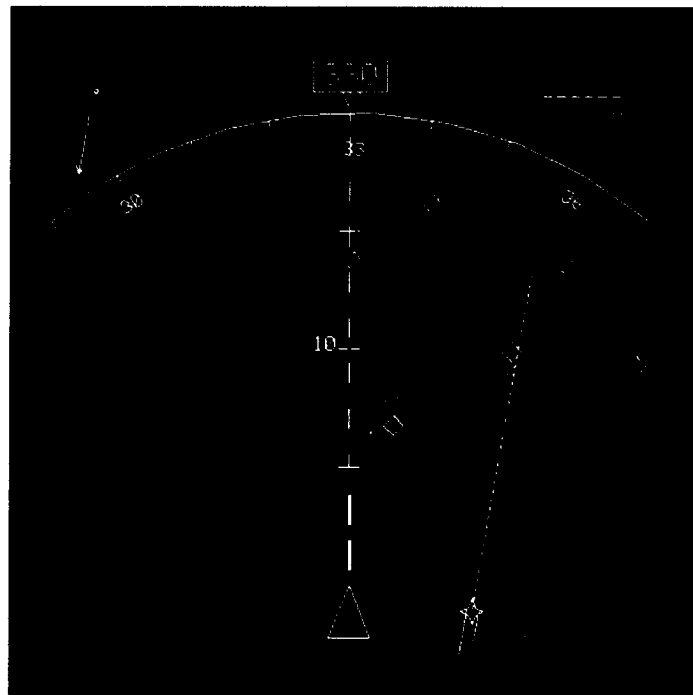

figure 6.3 CDTI based on TCAS symbology with track line
(source: MITRE)

6.5 NLR Traffic Display

6.5.1 Display Layout

Both to avoid a major impact on the cockpit and to minimise crew actions, the traffic information is shown on the navigation display in the map mode, instead of a dedicated traffic display or a separate mode. Showing the traffic symbols integrated on the navigation display also ensures the same reference frame is used for traffic information and the navigation information [requirement TM3].

To stress the vertical aspect [CR4], a vertical display has been added, resulting in the following configuration:

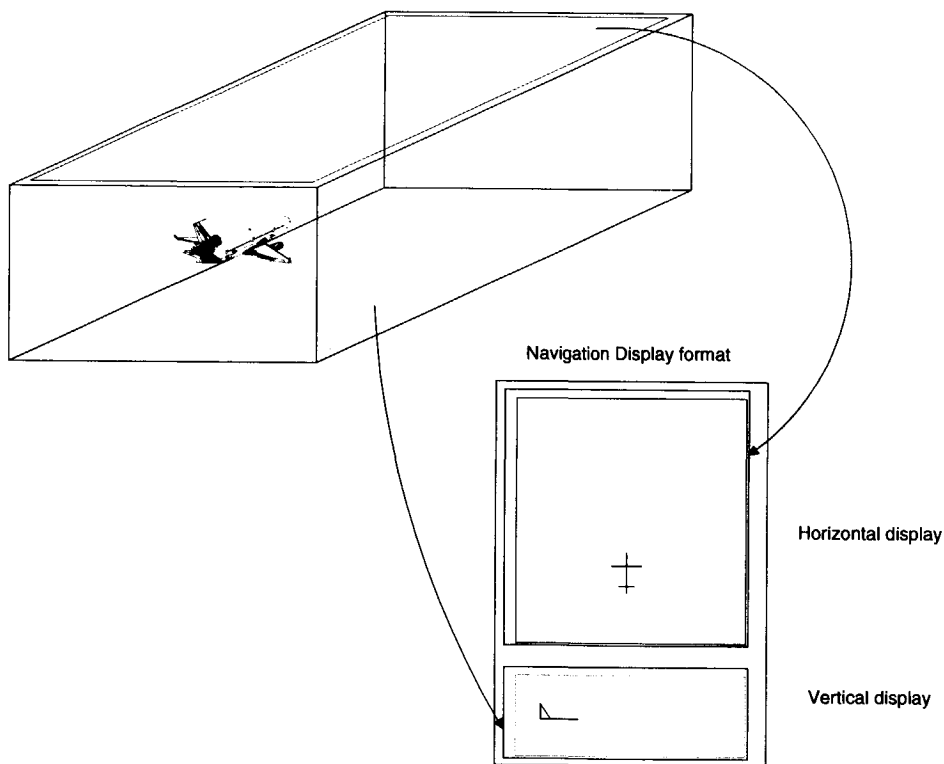

figure 6.4 Projection method of biplanar (co-planar) traffic display

The horizontal display shows the top view and the vertical display shows the side view of the block of air selected by the horizontal and vertical range. Aircraft outside the vertical range are not shown on the horizontal display and vice versa. In this way, the horizontal display can be decluttered by decreasing the vertical range.

An alternative to the side view is the view from behind the aircraft. Using this projection has been considered for the vertical display. It facilitates the correlation with the traffic symbols on the horizontal display. The reason for not using this projection for the display is the fact that the ground speed vector is perpendicular to this plane. When the ground speed lies in the plane, it provides a useful time axis for the conflict information.

In a simulator study (Merwin, D., O'Brien J. V., & Wickens, C. D., 1997) different projection methods have been compared for several tasks among which traffic monitoring. From these studies it was concluded that the co-planar projection was optimal for showing traffic information. Therefore this projection method was chosen for this study. Still, alternative display formats like a perspective display are being investigated and developed at NLR.

6.5.2 Traffic Information

The traffic symbol used in the NLR display is different from the diamonds as used by TCAS. By using a directional symbol, it is possible to show the track without cluttering the display with extra lines. To display the traffic position and speed [TM1, TM2], the following symbol was chosen for the NLR display:

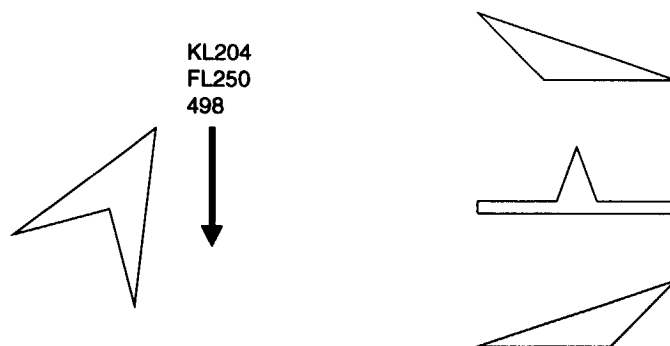

figure 6.5 Traffic symbol on horizontal display (left) and vertical display (right). The vertical symbols indicate an aircraft flying in the same direction within 30 deg (top), perpendicular to our track (center) or opposite traffic within 30 deg(bottom)

This symbol shows an aircraft with call sign KL204 flying at FL250 with a ground speed of 498. The arrow indicates that this aircraft is descending. For the vertical display one of three symbols is used depending on the angle between our track and the track of the aircraft.

6.5.3 Conflict Symbolology

The conflict symbolology should be shown in the same reference frame as the navigation information [TM3]. Therefore the absolute position of the conflict is shown on the display instead of the relative position (see figure 6.6).

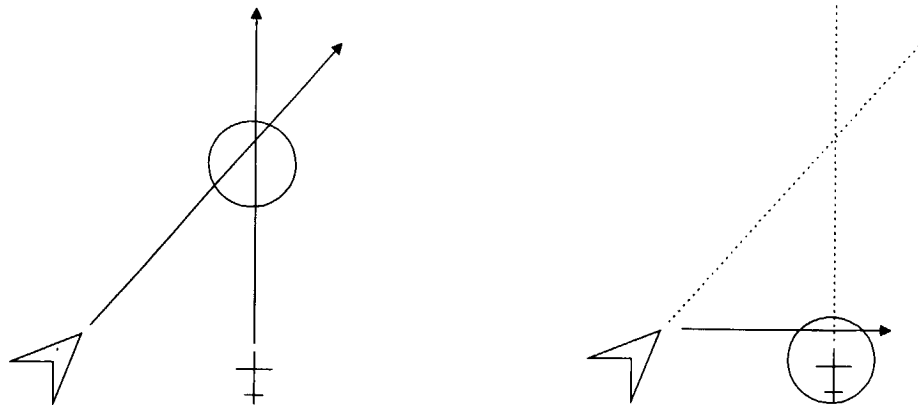

figure 6.6 Absolute (left) and relative (right) indication of conflict location

The geometry of the conflict, or more precisely the closest point of approach (CPA), is important for the conflict resolution. Therefore this geometry is shown by drawing the protected zone of the intruder aircraft at this position. The resolution manoeuvre should aim to avoid crossing this zone. Then the minimum distance will be equal to the required separation and hence the conflict will be resolved.

The conflict symbology is shown in the figure below. It is in fact the same figure as used to explain the resolution algorithm in section 4.5, providing transparency [requirement CD3]. Connecting the CPA with the intruder aircraft yields the intruder's track line and connects the conflict symbology with the problem aircraft (indicating the 'who' from requirement CD2).

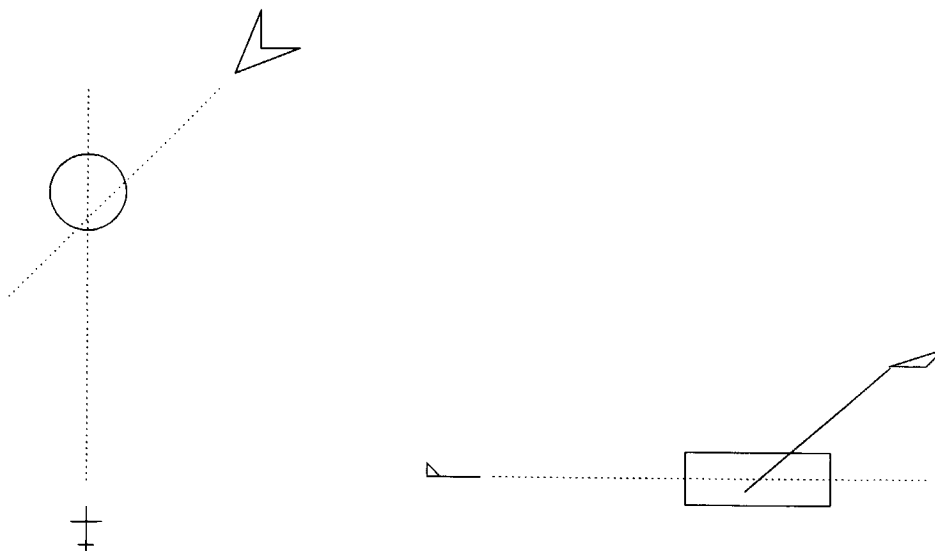

figure 6.7 Conflict symbology for horizontal (left) and vertical display (right)

In the traffic symbols of the intruder aircraft an extra text field pops up when there is a conflict. This field indicates the time to loss of separation ('when' from requirement CD2). This time can be substantially earlier than the time of CPA if the closure rate is low. The time to loss of separation is also used for determining the urgency level:

- red symbology indicates a loss of separation within 3 minutes
- amber symbology indicates a loss of separation between 3 and 5 minutes ahead

6.5.4 Resolution Symbology

Though the conflict symbology already indicates what the geometry and thus the advised resolution manoeuvre will be, there is some additional, magenta resolution symbology to assist the crew in executing the resolution manoeuvre [CR3]. The resolution advisory consists of an advised heading (or track), speed and vertical speed. The precise values of this advisory are indicated by a dashed track line, a bug on the heading scale, a dashed vertical path line and bugs on the speed and vertical speed scale. The symbology shows the effect of the manoeuvre, allowing the crew to choose between the horizontal and the vertical manoeuvre as well as to exchange a speed change with some extra heading change.

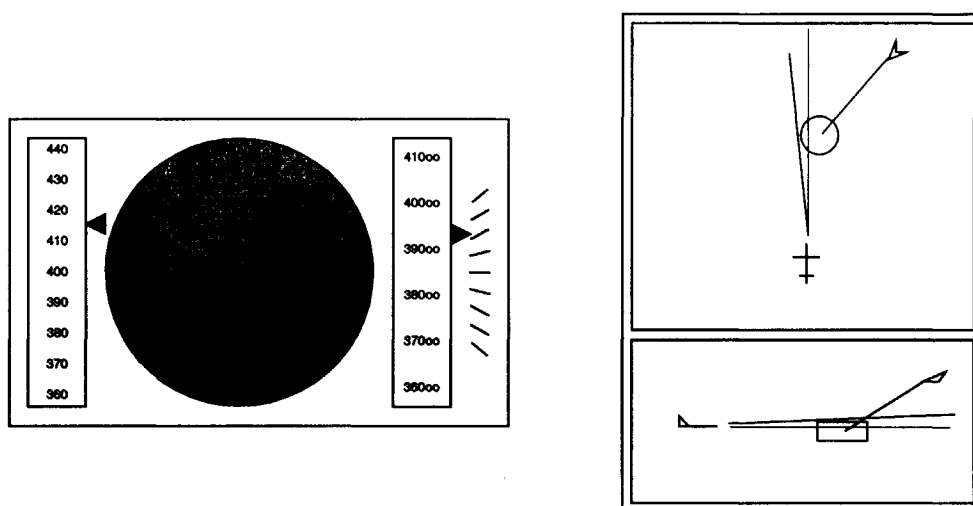

figure 6.8 Resolution symbology (in magenta) on primary flight display and navigation display

6.5.5 Additional Features

If the other aircraft manoeuvres in the same plane as the own ship, the conflict symbology will disappear halfway through the manoeuvre. At that moment the conflict is solved and the crew can select for example the Heading Hold mode to maintain the direction of the current speed vector, until the intruder aircraft has passed [RM1].

If the other aircraft would choose a different plane, the aircraft that chose the vertical dimension will in general solve the conflict. The vertical solution is the preferred solution in terms of fuel & time efficiency in most cases, especially because of the extremely low vertical speeds that are required to solve the conflict very quickly.

When a conflict consists of only a minor intrusion, the conflict symbology may appear for only a short moment. The conflict symbology can also disappear because the intruder aircraft responds quickly to a minor conflict. In these situations a crew might hear the aural alert but miss the conflict symbology. To inform the crew which aircraft caused the alert, the traffic symbol of that aircraft will remain red or amber for little while (on

average about 10 seconds). It also increases situational awareness [TM1] in general by indicating the aircraft for which the conflict has been solved.

Conflict alerts due to turning aircraft are suppressed by the filters in the conflict detection module (see section 4.4).

The horizontal display can be decluttered by decreasing the vertical range. Though the vertical display is also affected by an adjustment of the horizontal range, it does not sufficiently declutter the display. This is due to the fact that the horizontal range is in the plane of the vertical display. To provide a declutter option for the vertical display, horizontal clipping lines have been added. By adjusting the position of these lines with the display control panel, a smaller part of the horizontal display can be selected for the side view in the vertical display (see figure 6.9)

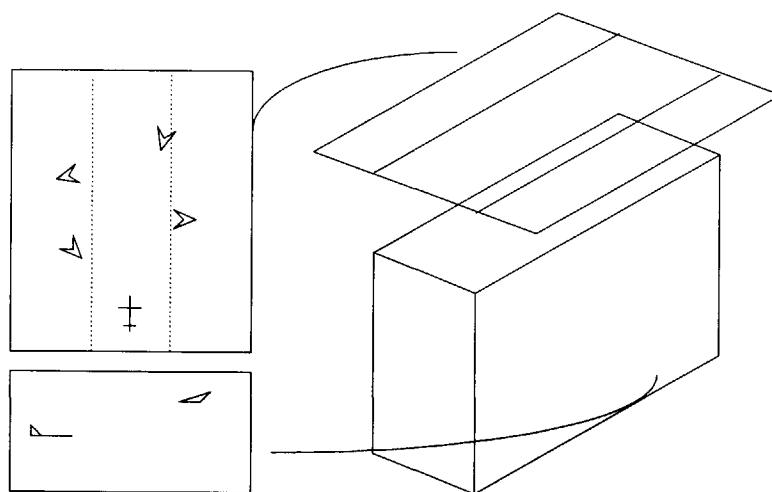

figure 6.9 Effect of horizontal clipping lines on vertical display

It provides the crew with a tool to look at a smaller cross-section straight a-head.

When an aircraft is outside the selected display range, the ASAS will still detect the conflict and it will also be shown despite the current range settings. If both the horizontal and vertical range are set too low, the lines as well as the protected zone of the own ship will show up on the display, indicating there is a conflict and indicating the azimuth and elevation angles of the CPA.

6.5.6 *Snapshots of CDTI*

The resulting navigation display with traffic and conflict information is shown in the figures on the following pages. For the colour of the traffic symbols two different conventions have been used in the study: in the first experiment blue indicated traffic with a decreasing distance (negative range rate), white traffic had an increasing distance (positive range rate). In the mixed equipage runs in the second phase trials the colour was used to indicate equipage level: white traffic was equipped, blue was not ASAS-equipped. The snapshots on the next pages show the convention where colour was based on range rate.

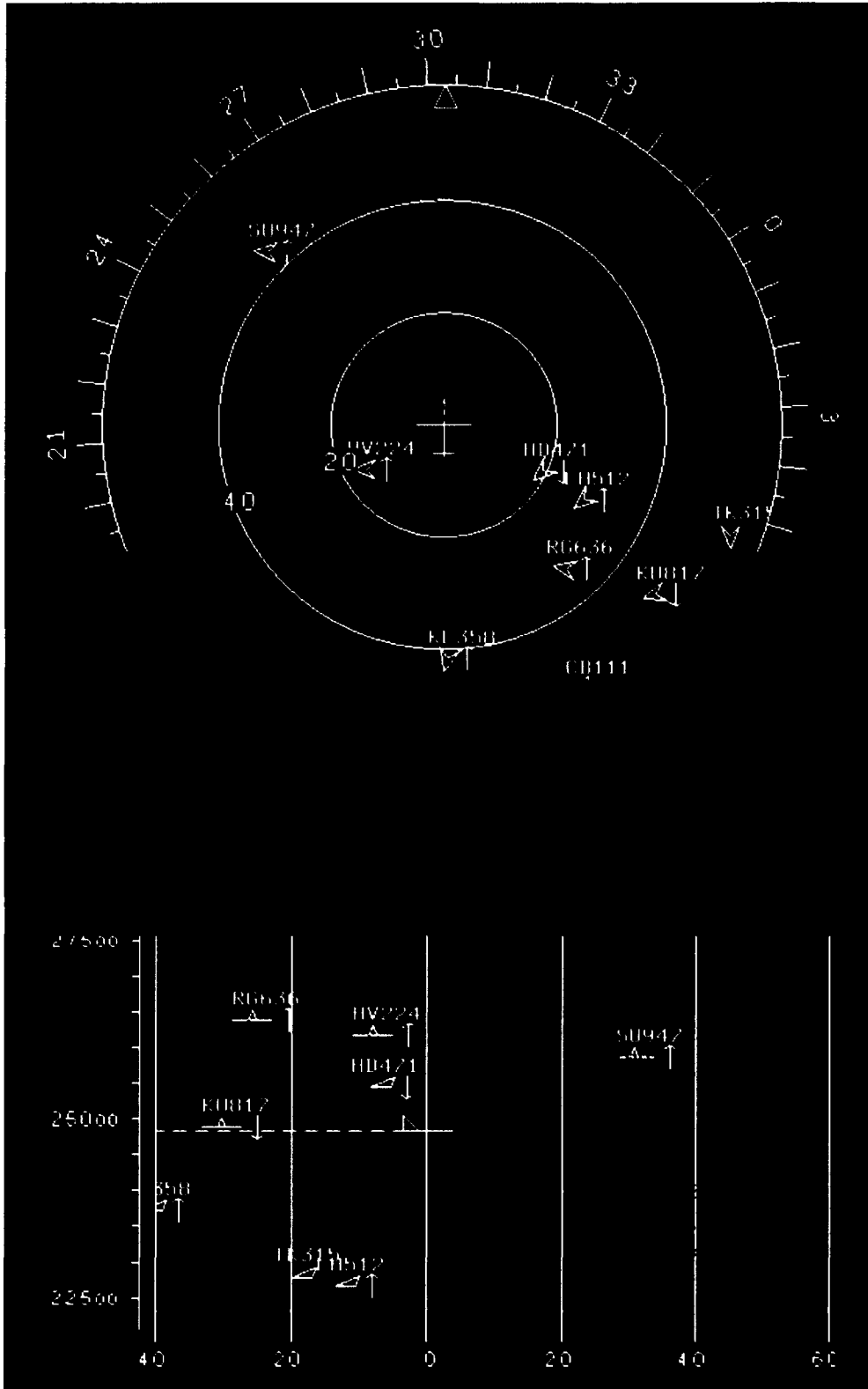

figure 6.10 In this snapshot we are descending as indicated by the green dotted line, no conflicts are present

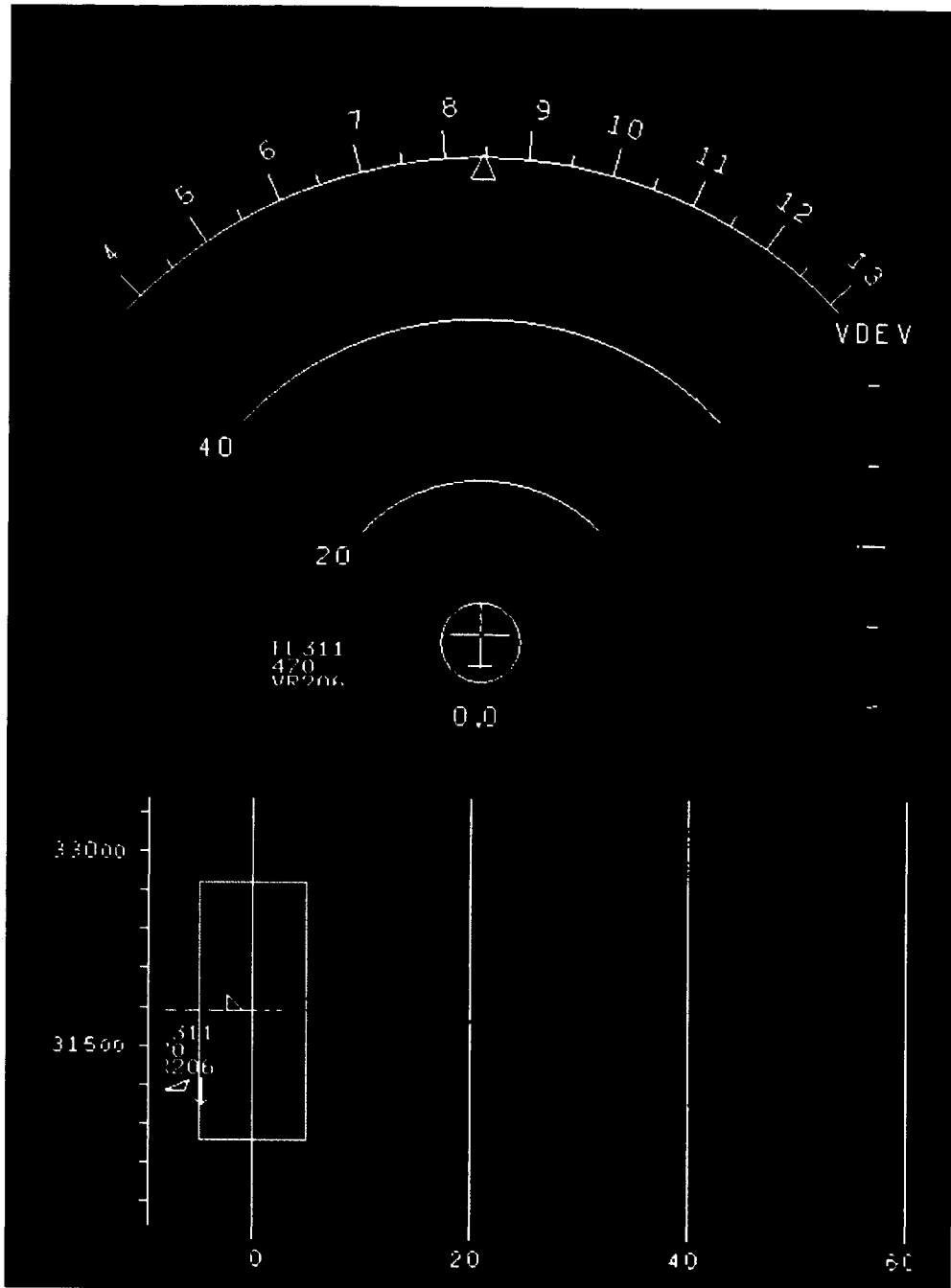

figure 6.11 A conflict alert during a climb. We have two options: to level off or turn right.

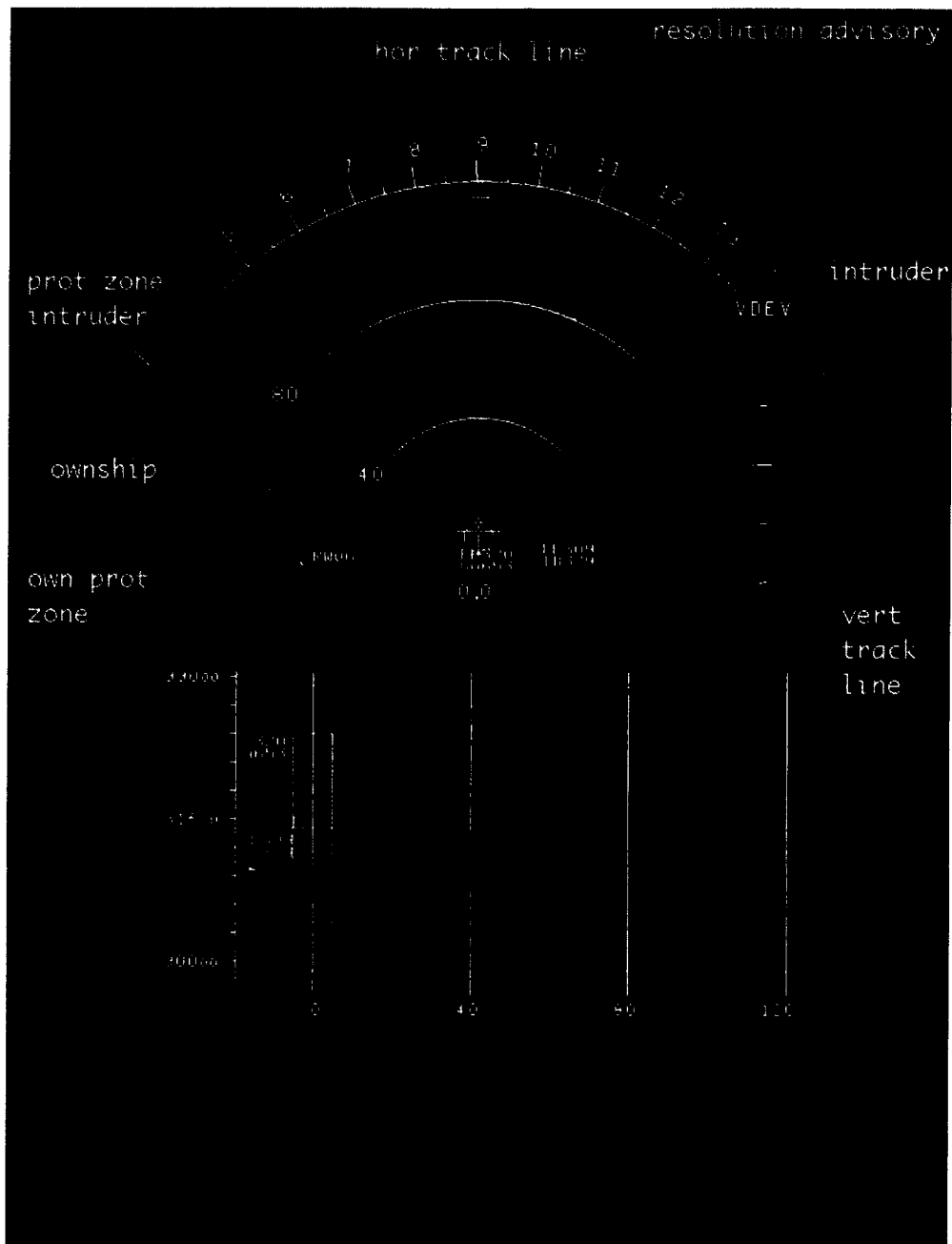

figure 6.12 Snapshot with legend of NLR CDTI

6.6 Aural Alerts

To provide an alert when the crew is not monitoring the traffic display, an alerting sound has been added to the user interface. The goal of this aural alert is to be distinctive, indicate the urgency and prompt the crew to look at the traffic display.

Two urgency levels have already been defined by the conflict symbology colour:

- red conflict symbology indicating a conflict within 3 minutes
- amber conflict symbology indicating a conflict within 3 to 5 minutes

For these two levels a different sound has been chosen. For the amber (lower) urgency signal a beep-sound is used. The same sound indicates a threatening radar lock in the F-18 Hornet. It consists of two high-pitched beeps with a low repetition rate. For the red (higher) urgency level a sound indicating a missile launch in the F-18 has been used. This sound consists of continuously repeating this same beep with a high repetition rate. These sounds are more discriminating than a voice message and not yet used in civil cockpits.

6.7 Predictive ASAS

Using the task analysis described in the previous sections the HMI has been designed, implemented and used in the first flight simulator trials. After these simulation trials an additional system called predictive ASAS has been developed. This system provides the conflict prevention function and also assists in the recovery manoeuvre [RM1] (see chapter 5). The user interface was also expanded with symbology for the system. The PASAS bands have been added to the primary flight display (PFD) (speed, heading and vertical speed) and the navigation display (ND)(heading).

The figures below show the resulting displays

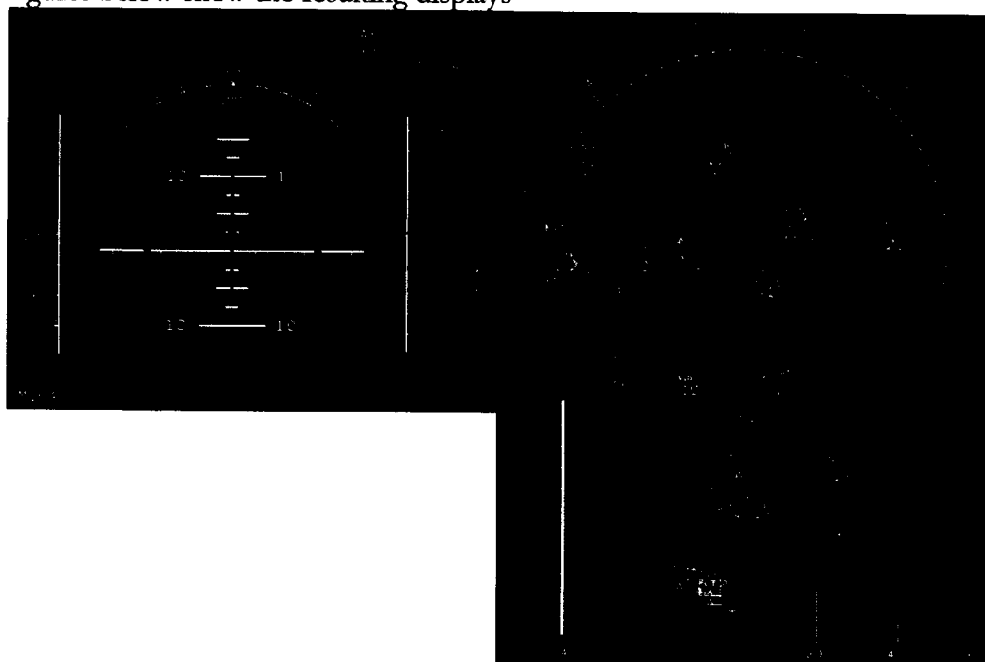

figure 6.13 Displays with PASAS symbology: amber and red bands on speed, vertical speed and track scale

There is no symbology to correlate the PASAS bands with traffic symbol of the aircraft causing the band. Though this is not required for conflict prevention, this could enhance the situational awareness. Two ways to correlate this have been considered:

1. Call signs near bands on PFD & ND
2. Lines on navigation display

Both solutions would lead to too much clutter and have not been implemented for that reason.

During flight simulator trials in most cases crews were able to judge which aircraft caused vertical speed or speed bands. The heading bands were harder to correlate.

6.8 Autopilot Resolution Modes

To investigate the usefulness of dedicated resolution autopilot modes assisting the crew in solving the conflict, two variants of new autopilot modes have been developed:

- separate: two buttons to select the horizontal (heading and speed) or the vertical (speed and vertical speed) manoeuvre.
- combined: one button to select a combined horizontal and vertical manoeuvre (heading, speed and vertical speed)

These modes were optional and manually solving the conflicts by dialling in a heading, speed or vertical speed is referred to as 'manually' solving the conflict, even though the autopilot controls the aircraft.

PART III OFFLINE TRAFFIC SIMULATION STUDIES

7 Traffic Manager

7.1 Purpose

Because Free Flight is a distributed system, a simulation of multiple aircraft flying in the same airspace was chosen as a first step to explore this concept. This would provide a platform to determine some important parameters such as the average conflict rate in an hour in a direct routing scenario. Another important aspect is the effect of certain 'rules-of-the-air' on random conflict geometries. The Traffic Manager was developed to simulate the interaction of aircraft. It has played an important role in the Free Flight study described in this thesis. The Traffic Manager is the program that has been used as an off-line traffic simulator, a scenario editor, scenario player, experiment manager station and data logging unit. It was developed by the author (initially at home), though since its introduction and use in this project has been expanded by several other persons. This chapter provides an overview of this tool, which will be referenced throughout this thesis in nearly all chapters.

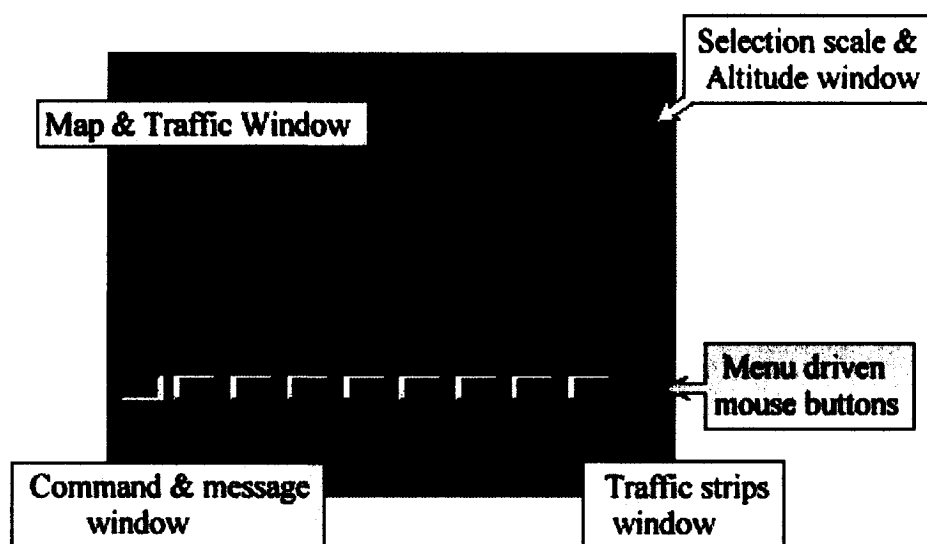

figure 7.1 Traffic Manager screen

The Traffic Manager program originated as an off-line large scale traffic simulation. An essential element of the Free Flight concept of airborne separation is the conflict resolution algorithm. Because of the interactive and parallel nature of the concept, the only way to analyse this is to simulate traffic patterns.

For earlier experiments the author had already developed a rudimentary real-time, six degrees-of-freedom, traffic simulator based only on kinematics. This traffic simulator could simulate 10 aircraft following prescribed heading, altitude and speed instructions. It was used to simulate traffic around the Research Flight Simulator (RFS) for the Data Link simulator trials (Van Gent, Bohnen et al, 1994). The simulated aircraft were visible in the out-of-the window view of the flight simulator. The aircraft model was no more than a kinematical model of aircraft motion. For the Free Flight study this traffic simulator was enhanced with a graphical user interface, optimised to be able to simulate

400 aircraft simultaneously, enhanced with BADA⁴ performance models, flight management systems and fitted with pilot models able to follow a flight plan and detect and resolve conflicts. The program was first developed on a 486 PC and has been optimised to be able to simulate a large number of aircraft without overloading the CPU.

7.2 Features of the Traffic Manager

7.2.1 Graphical User Interface

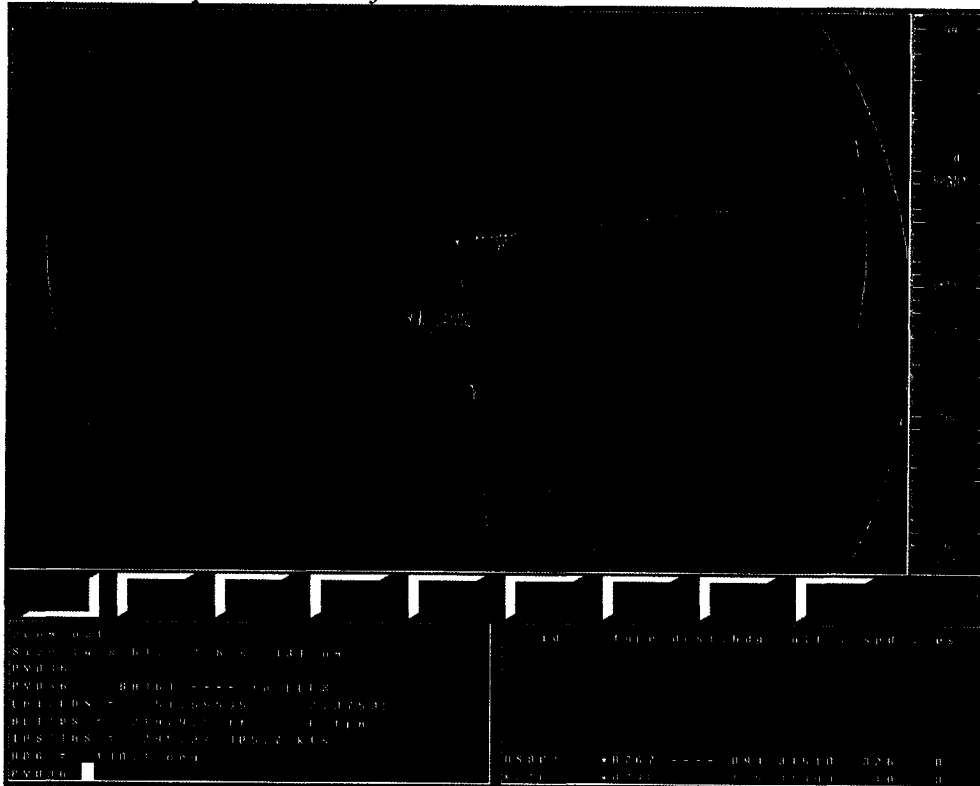

figure 7.2 Traffic Manager Graphical User Interface

The Traffic Manager's main screen is a map view on which the traffic data, the geography and navigation data are shown. This screen is also used to click on with the mouse to select aircraft, waypoints, beacons, airports, latitude/longitude positions, heading and areas. The map view can be panned and zoomed. The map window can also change to navigation display mode. In this mode, it shows the navigation display of a selected aircraft with the traffic, conflict detection and resolution and route information.

Below this view a row of multi-function buttons is available. The function of these buttons is completely configurable by the user. They depend on a menu structure described in the text file called 'buttons.dat'. The buttons can be used to store often used commands as well as complete macros.

At the bottom of the screen are two windows: the command window and an optional strip window. The strip window lists data on a number of selected aircraft similar to the paper strips used by controllers. The command window is an edit window and console, in which any command can be typed. The Command Interpreter is the most essential

⁴ User Manual for the Base of Aircraft Data (BADA) Revision 2.5, EEC Note 1/97, Eurocontrol, 1997

part of the program. After pressing ENTER this command is put on the command stack just as any command read from a scenario file, generated by the buttons or received via the network. These commands control the simulation and can be played and recorded in so-called scenario files. Implemented commands include traffic commands, display commands and simulation control.

A click on the map window usually enters a value like a lat/lon position in the command line, that is being edited in the command window. The system of button clicks and map clicks makes it possible to, for instance, create and control traffic without touching the keyboard. A 'selection bar' next to the map view can be used to select a value for altitude, speed or aircraft type. Clicking on this bar results in an entry in the command window. Any warnings or error messages will also be displayed in the command window. The command reference in appendix D gives an overview of the commands. This list also provides a more detailed overview of the functionality available in the program.

7.2.2 Scenario file recording and playing

The first question the user has to answer when starting the Traffic Manager is which scenario file to play and record. Playing and recording at the same time allow the cumulative editing of a scenario. In this way for instance a taxi scenario can be developed with pre-scripted taxi-instructions. Also creating background traffic and then adding specific geometries uses the cumulative property of simultaneously playing and recording. The recording option enables the recording of commands to generate the scenario playback files. These scenario files were used for both the off-line comparisons of the different resolution methods as well as for the man-in-the-loop simulator experiments.

7.2.3 Scenario Generation Functions

The program includes the European and US navigation data and airports. Scheduling take-offs at airports and airspace entries at the border of a user defined experiment area enables automatic generation of realistic Free Flight traffic patterns over Europe.

7.2.4 Environment Simulation

The Traffic Manager has also been used for the man-in-the-loop simulator experiments to simulate a realistic traffic environment and control the experiment scenario. Events such as weather, turbulence or failures can be recorded in and triggered by the scenario files.

7.2.5 Experiment Manager Station

The graphical user interface allows monitoring of the scenario. Events such as failures, as well as traffic control commands, can be introduced on-line. Traffic can also be handed over dynamically to a separate workstation running a flight simulation program. This allows the on-line adjustment of a scenario. The navigation display mode also enables the manual control of an aircraft in the scenario. Data logging can be monitored and controlled during the experiment. Remarks or other markers can be added to the log files while running the experiment. The configuration and other selections can be controlled by the scenario file but when required overruled by the experiment manager.

7.2.6 Aircraft Models

The aircraft models contain performance models, autopilot models, a flight management system and a rudimentary pilot model. Over 200 different aircraft types are supported. The pilot model contains the reaction times and scheduling effect. The update rate of the

aircraft model is increased to at least ten times per second when the aircraft is close to the 'master' simulator. This allows a visualisation of the traffic in the out-of-the-window view. Any routes defined in the scenario file are automatically loaded in the flight management system of a flight simulator that 'logs on' to the traffic manager.

7.2.7 *Fast-time simulation*

It is possible to run fast-time simulations by setting a real-time factor higher than 1. A real time factor of 2 will result in a scenario running twice as fast as real time. The real time factor can be set during run-time. Several modes allow both fixed time step as well as maximum update rate. The internal frequency related to the simulation time decreases when running fast-time due to the system's computation power and graphical performance. This frequency is shown at the bottom of the map screen. Monitoring the internal frequency on-line allows tuning the simulation to the specifications of the platform. Fast-time simulations also allow visualising moving patterns.

7.2.8 *Large-Scale Traffic simulations*

Though the program is perfectly capable of simulating one-on-one conflicts, it was designed with large-scale simulations in mind. The Traffic manager is capable of simulating up to 700 aircraft simultaneously. By switching on the automatic delete function when an aircraft lands or leaves the experiment area, more flights can be simulated in one scenario. This allows the simulation of extremely crowded sectors as well as the traffic around the sector that might be in reach. It also enables investigating the effect of extreme geometries involving 'walls' or 'blocks' consisting of a large number of aircraft. These scenarios are used to investigate 'flock' behaviour of traffic in an extremely busy airspace.

7.2.9 *ASAS Test Platform*

The program's original goal was to be used as an Airborne Separation Assurance System (ASAS) test platform. Various conflict detection and resolution algorithms have been implemented. Selection of the resolution algorithm can be part of the scenario file but it is also possible to select it during run-time. The ASAS indications in the flight simulator connected to the Traffic Manager are controlled by the ASAS CD&R module in the Traffic Manager.

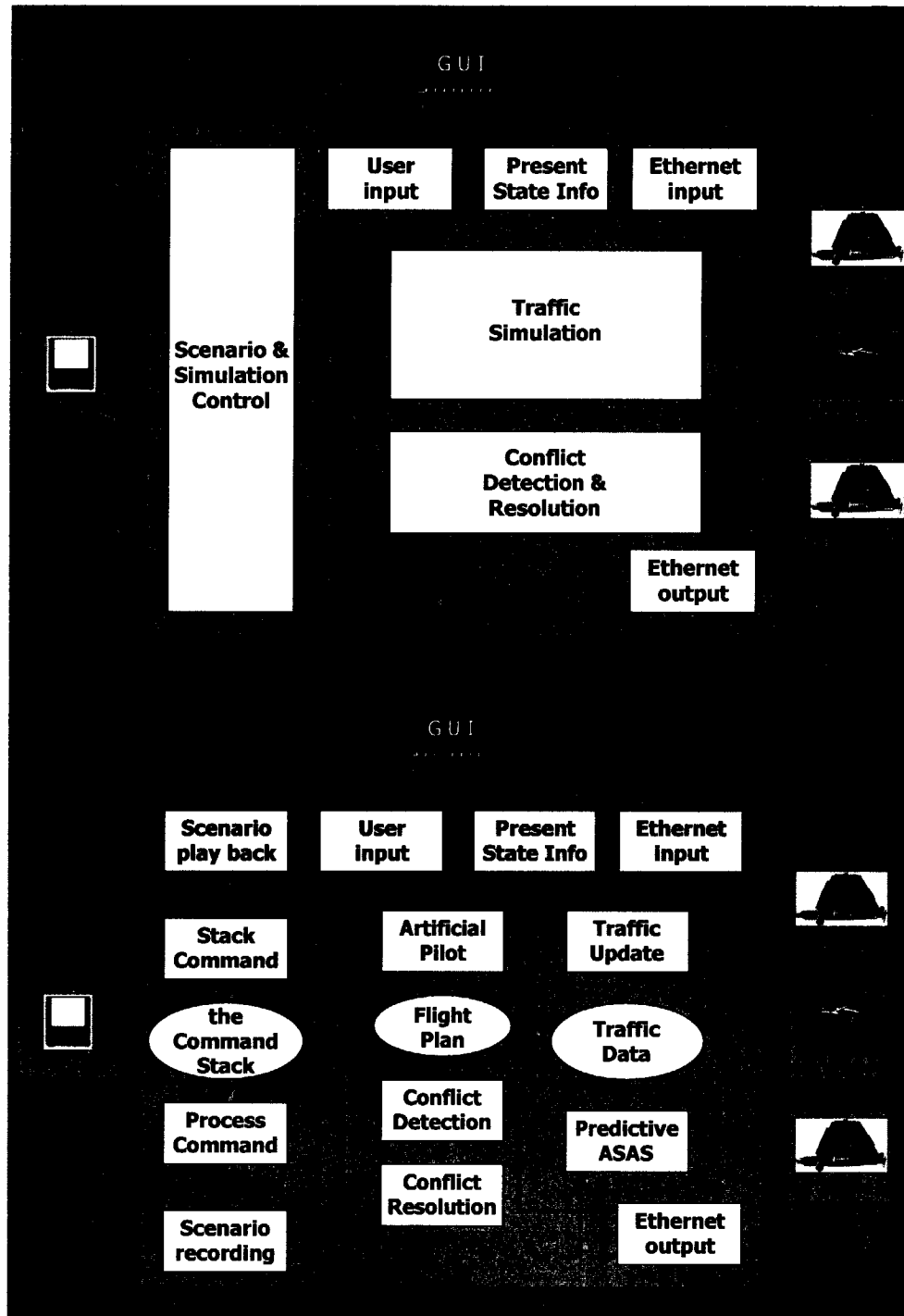

figure 7.3 Overview of architecture

The traffic manager program has a modular structure. A collection of modules is driven by commands derived from an internal command stack. This command stack is supplied with commands from various sources: the command edit window, a playback file, mouse buttons and external sources like consoles, simulators, etc. Modules can also issue commands to each other via the command stack. In addition to the event driven part of the program, there is a time scheduled part: the aircraft models, pilot models, automatic scenario generation functions and conflict detection.

There were originally three versions of the Traffic Manager: a DOS version, a Windows (based on DirectX) version and a Unix (Iris GL) version. Currently only the Windows version is still being used and supported. System dependent calls are all located in one source file with a limited size. This facilitates porting the application to any new platform.

7.2.11 *Game domain*

Game domains are servers connected to the internet allowing players of video games to participate in a multi-player game session via their internet connection. The same technology is has been implemented in the Traffic Manager and in a compatible flight simulation program. This configuration aims at conducting experiments with a large number of pilots participating using PCs connected to internet. This will allow the testing of the Free Flight concept with respect to human strategies in a commercial competitive environment via scoring systems in the near future.

8 Complex conflict geometries study

8.1 Introduction

The notion that Free Flight is not feasible because it is dangerous to distribute control is often illustrated by examples of bottleneck scenarios (see also the hypothesis tree in chapter 2). As an analogy for these situations some conflict geometries have been constructed. These situations will in general give the impression that some form of central co-ordination is required to solve them. However, if they do solve very efficiently (with minor deviations from the original track), it is an illustration of how counter-intuitive the effect of distributed control can be. It is the experience of the author that the examples described in this chapter are very persuasive concerning the feasibility of separation assurance without central control.

8.2 Purpose

In this chapter the effect of the resolution algorithm on multi-aircraft conflicts will be shown. Conflicts between two aircraft are predictable when the resolution algorithm is understood. The effect of a sequence of conflicts where solving one conflict can trigger a new one ('the domino effect') can only be investigated using simulations. The generation of new conflicts by the resolution method is not something that can always be avoided. In the cases where this effect occurs, it in fact demonstrates a very strong advantage of using the modified voltage potential resolution algorithm. The interaction can cause a chain reaction that generates a wave, creating airspace for an apparently unsolvable situation, while the number of conflicts per aircraft remains low. In this way the domino-effect is the way in which the information that airspace is needed is passed on the other aircraft.

Two types of conflicts that were regarded as very critical are described in this chapter:

- "super-conflicts"
- "the wall"

8.3 Super-conflicts

The name of super-conflicts refers to the circular type of conflicts where all aircraft involved fly towards the same position, at the same altitude, with the same speed and with an equal distance to that position. A number of these conflicts have been generated with 3, 4, 5, 6, 7, 7, 10, 12 and 16 aircraft. They can be found in the scenario files eby-3scn to eby-16.scn. (Adjusting the resolution strategy is performed by using the 'resonr' command in the traffic manager. See chapter 7 or appendix D)

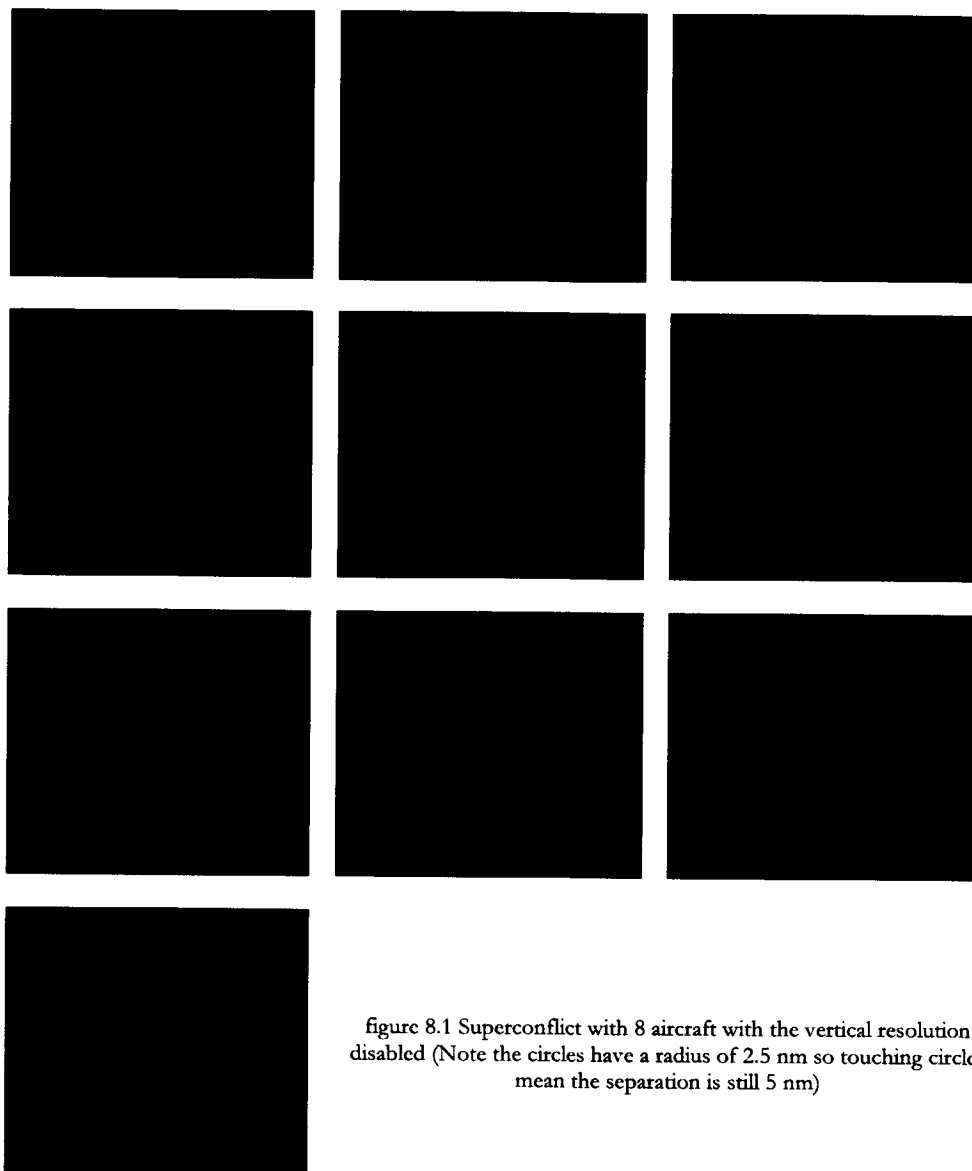

figure 8.1 Superconflict with 8 aircraft with the vertical resolution disabled (Note the circles have a radius of 2.5 nm so touching circles mean the separation is still 5 nm)

The sequence in figure 8.1 shows the traffic manager's screen with a super-conflict with 8 aircraft. Every aircraft is shown using an arrowhead and circle with a 5 nautical mile diameter. When two circles touch, the separation is exactly 5 nautical mile, and the traffic symbol will be red. On the traffic manager's screen a predicted conflict is shown by two lines from the aircraft to the position at the closest point of approach (CPA). A diamond symbol between those two positions indicates the position of the conflict. If this conflict symbology is green, the conflict has not yet been shown to the crew, due to for example filters; if it is red, the conflict will happen within 3 minutes. Amber corresponds to a time to loss of separation of 3 to 5 minutes.

The option of vertical resolutions has been disabled to add an extra constraint and make this pattern critical. In this situation, a lot of conflict resolving action takes place in parallel. After a few minutes, miles before reaching the centre, most conflicts have been solved. The interval between snapshots is 45 seconds.

This sequence shows a clear contrast with how a controller would handle this. For a central controller it is not possible to simultaneously control all 8 aircraft to solve the conflict. This situation is sometimes used in the training of air traffic controllers. One way to solve this is to request all aircraft to turn left to heading 090, and then deal with each aircraft separately. This clearly is a much less efficient way to solve this situation and illustrates the superiority of Free Flight to deal with this type of situations.

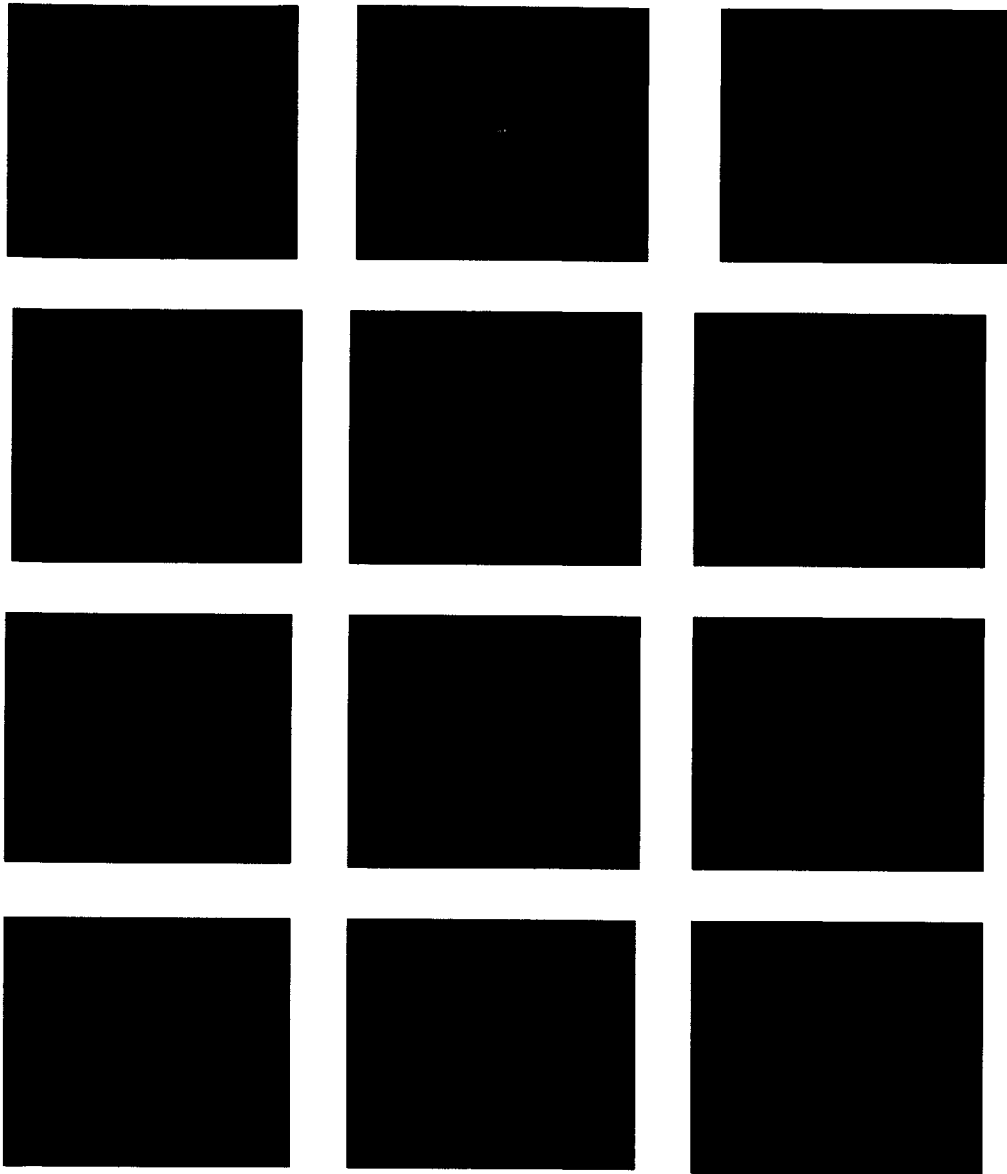

figure 8.2 Superconflict of 16 aircraft with vertical resolution disabled (Note: in all figures the lookahead time is only five minutes)

The sequence in figure 8.2 shows a similar super-conflict with 16 aircraft. Again, the vertical resolution has been disabled to complicate the situation. This takes somewhat longer to resolve but still no intrusions occur.

When vertical resolutions are allowed the sequence in the next figure occurs.

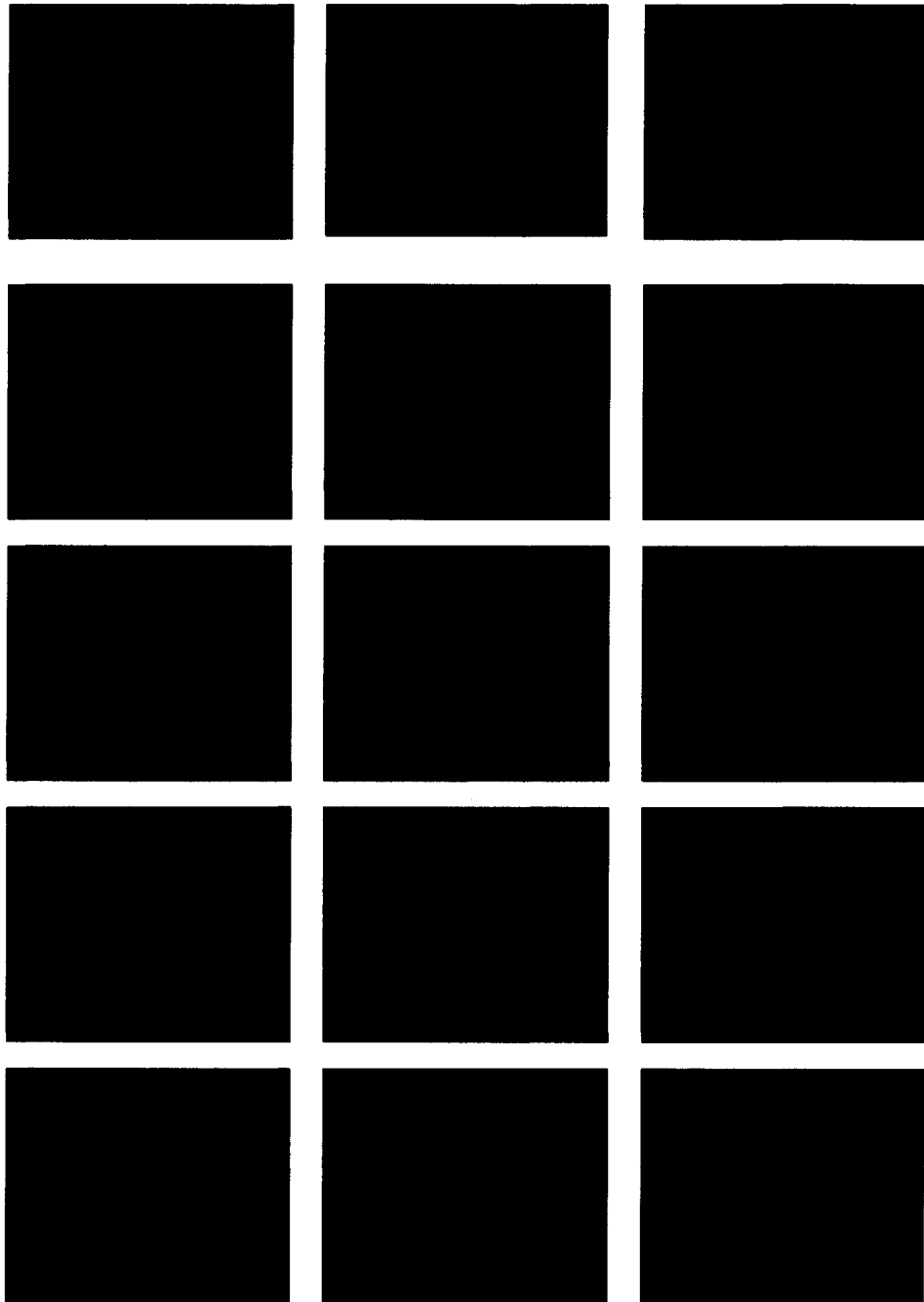

figure 8.3 The same super-conflict as in the previous figure, but now horizontal and vertical resolution are allowed. Most aircraft prefer the vertical resolution in this scenario.

Even with a superconflict of 16 aircraft, a vertical resolution is very effective. Every aircraft flies to a different level, using a different vertical speed. Though the number of conflicts detected in these cases seems unacceptably high, per aircraft it is rather low. With more intelligent crews than the pilot models in the traffic manager (very likely) this number may be reduced even further.

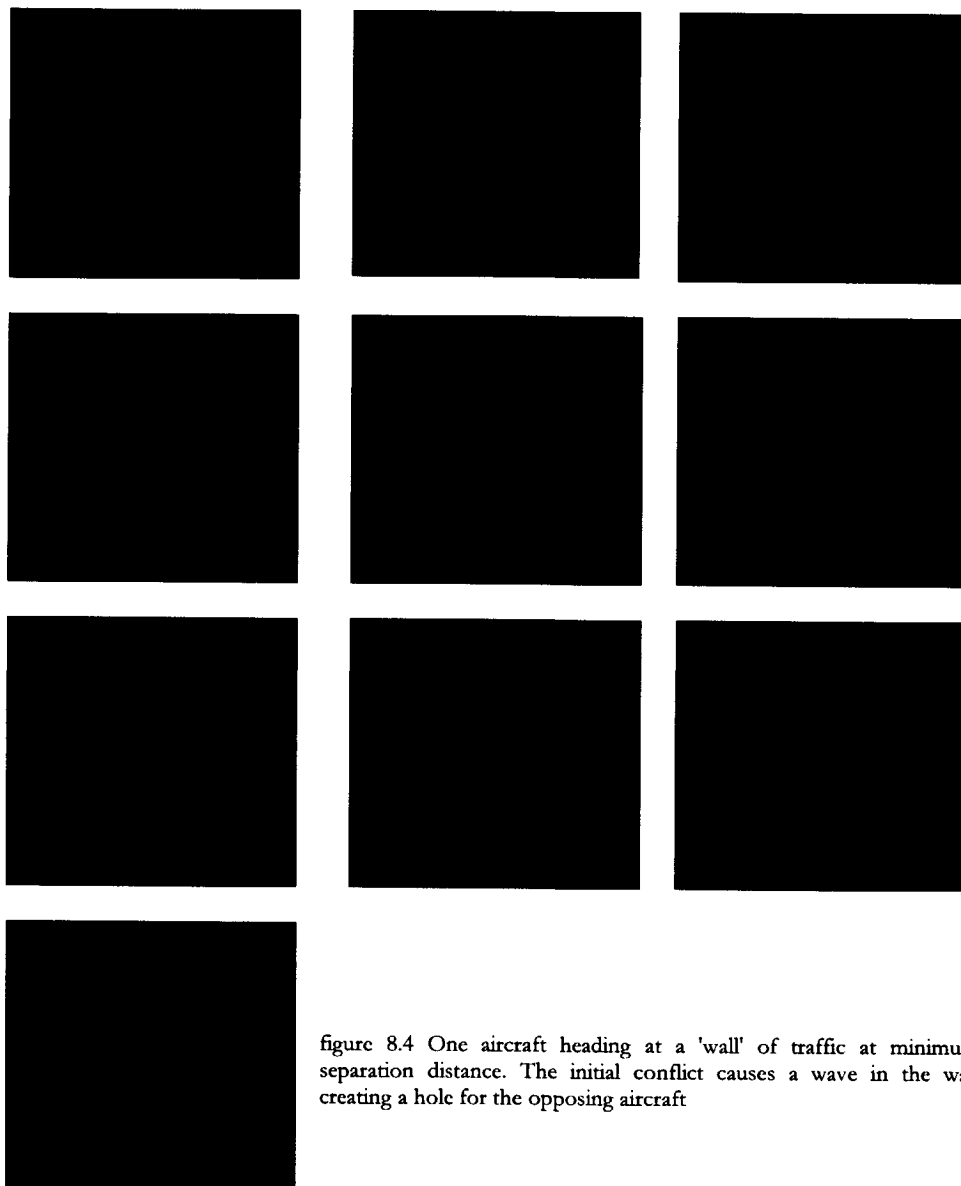

figure 8.4 One aircraft heading at a 'wall' of traffic at minimum separation distance. The initial conflict causes a wave in the wall creating a hole for the opposing aircraft

8.4 Wall scenarios

Several scenarios have been generated, in which “walls” of traffic at a distance of the separation minimum fly toward one or more aircraft. They can be found in the wall*.scn, front*.scn and block*.scn files supplied with the traffic manager. This is, just as the super-conflict, a metaphor for a highly congested airspace.

The sequence in figure 8.4 (scenario file wallh.scn) shows a wall of 19 aircraft flying at a mutual horizontal distance of about 5 nautical miles, as indicated by the 2.5 nm range circles around the aircraft. Vertical resolutions have been disabled. Just as in the super-conflicts, the noise models, accounting for e.g. turbulence, are disabled to ensure each aircraft stays at the level and just follows the advisories. This figure shows the beneficial effect of sequential conflict alerts. The single aircraft at first only has a conflict with the centre aircraft of the wall. Both aircraft then turn left. Apparently, there was already a slight separation in this direction because the exception handler for head-on conflicts would otherwise have triggered a right turn. The result of the heading adjustment to the left is two new pairs of conflicting aircraft. The two aircraft in the wall that now also have a conflict will move away from the single opposing aircraft. This is in fact the start of a wave through the wall, resulting in a global solution, which makes sense: All aircraft accelerate or decelerate slightly to be able to move away from the centre of the wall. The wall wrinkles and creates a hole in the centre to fly through.

The magnitude of the wave decreases when further away from the centre and so do the wrinkles. This is also indicated by the longer conflict lines, meaning the aspect angle is less.

Harder to show in a static 2D figure is the 3D version of the wall consisting of 190 aircraft both horizontally and vertically at minimum separation distance. When downloading the Traffic Manager from the Free Flight site⁵, it can be found in the wall.scn scenario file. A special observer aircraft has been created (KL000) whose vertical navigation display shows a full side view of the wall (“NAVDISP KL000”)

A similar wave is seen as in the 2D wall in figure 8.4. The speed of the wave is higher in the vertical direction in terms of separation distance (remember the aspect ratio of the protected zone), so the vertical wave creates the final hole, though an oval pattern moves through the complete wall of 190 aircraft.

8.5 Conclusion

The sequences show the power of the algorithm to solve conflicts involving a high number of aircraft in an extremely congested airspace. The study provides an insight into the efficiency of a distributed system to deal with constraint situations due to traffic, weather or Special Usage Airspace (SUA). The effect of these constraints is that they limit the amount of airspace available just as a high-density traffic does.

If due to a combination of airport growth and for example an unforeseen weather situation the airspace capacity is insufficient, the ASAS system has proven in the scenarios to be able to divide airspace by utilising the domino effect. So instead of

⁵ <http://www.nlr.nl/public/hosted-sites/freeflight> Select ‘Downloads’ for the Traffic Manager

showing a warning 'Unable to maintain separation', this system will continue to show resolution advisories that in the worst case result in an overall separation less than the minima, but still equally shared. No system can create airspace that is not available, so requiring that bottlenecks will never occur is not useful. The fact that only in a distributed system a lot of resolution actions can take place at the same time is an indication that solving bottlenecks may be served by changing the system from a centrally controlled system to a distributed system.

The scenarios used here are examples of potentially dangerous situations, which required some effort to develop. To make these situations critical they contain a dangerously high amount of 'order'. It is an illustration of the contradiction to the intuition that chaos is equivalent to danger. Order might be more dangerous than chaos.

Though merely testing these cases is not a proof of the overall stability in all cases, it is an indication how the capacity, efficiency, robustness and stability compare to today's situation. Just imagine how one controller should solve these conflicts by sequentially addressing all aircraft and waiting for the confirmation before dealing with the next aircraft. Testing these and other scenarios with an air traffic controller might be an exercise worth trying in further research.

9 Costs of Airborne Conflict Resolution

9.1 Introduction

In the hypothesis tree in the economics branch two arguments against free flight have been formulated:

- Resolution manoeuvres will cancel out fuel benefits from direct routing.
- Shifting from central to local optimisation will decrease global efficiency.

The economics of a CNS/ATM concept is a complex field to which many factors contribute. There is a need for more cost/benefit analyses in the field of ATM (see Allen, Haralddottir et al (1997)). The benefits will consist of fuel- and time-savings both due to reduced delays and direct routing. These aspects are influenced by factors like route structure, route length, delays, etc., which vary locally and by airline.

Though the benefits may vary, the costs of resolution manoeuvres can be investigated on a per case basis using the ASAS logic and off-line traffic simulations. The above arguments both suggest there will be a significant cost associated with solving conflicts. We have already seen that the frequency of these manoeuvres is very low. What about the magnitude of the costs associated with the manoeuvres?

This chapter is based on a preliminary analysis of the cost aspect of conflict resolution manoeuvres. This analysis was performed as a part of this project in collaboration with a student of Delft University of Technology, of the aerospace faculty, Mario Valenti Clari. The complete study is described in his graduation thesis (Valenti Clari, 1998). The analysis uses off-line traffic simulations on the Traffic Manager (see chapter 7).

From the first human-in-the-loop trials (see chapter 10) several observations as well as pilot comments were made on the subject of horizontal resolutions, speed changes and the costs of vertical resolutions. For example it was noticed during the experiments that pilots preferred to resolve conflicts by manoeuvring horizontally; meaning they preferred executing a heading change over executing an altitude or speed change to resolve conflicts with other aircraft.

This is somewhat strange because when using heading to resolve a conflict, the aircraft will often need to manoeuvre more than when using an altitude (vertical speed) change. The protected zone is a very flat disc (the width-height ratio is similar to a coin) flying through space. In the case of a conflict situation the amount of horizontal intrusion will often be of a much greater order than the vertical intrusion.

In the experiment debriefings, pilots often explained that they avoided vertical manoeuvres because they thought it would have a negative impact on both:

- the fuel efficiency of the flight (economic aspects)
- the passengers perception of the ride quality (passenger comfort aspects)

The option of using speed changes for conflict resolution was even more rarely used, because pilots thought that the available (operational) speed window in cruise flight would not allow this kind of resolutions at all.

An extra analysis was needed to give more insight into the costs and benefits of the conflict resolution manoeuvres (heading change, altitude change and speed change) in Free Flight with Airborne Separation Assurance.

9.2 Cost-Benefit Study of Free Flight with Airborne Separation Assurance

This limited cost-benefit study deals with the costs and benefits of the conflict resolution manoeuvres, especially the difference between horizontal and vertical conflict resolution manoeuvres.

The passenger comfort aspects of Free Flight with Airborne Separation Assurance will also be discussed briefly later in this chapter.

9.2.1 One-on-one conflict experiments

As a first step in understanding the economic aspects of conflict resolution manoeuvring, several one-on-one conflicts were tested on fuel and time efficiency. The one-on-one conflicts were simulated with horizontal (heading change only) and vertical resolutions (altitude change) in such a way that results could be compared. This chapter deals with the set-up, results and implications of these experiments.

9.2.2 Modifications to Resolution Module

In order to accommodate “heading-only” conflict resolution manoeuvres (constant speed) the ASAS resolution module was slightly adapted. This was necessary because, when resolving a conflict with constant speed, the speed component of the avoidance vector will have to be compensated with an extra amount of heading as illustrated in figure 9.1.

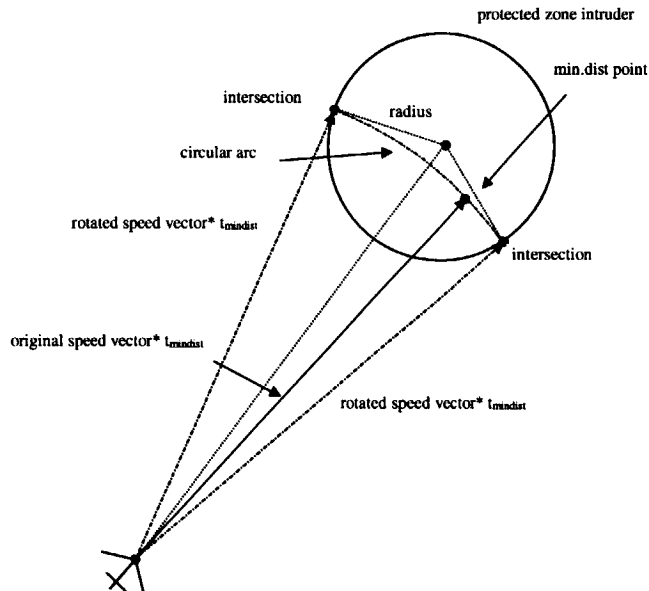

figure 9.1 Heading change only conflict resolution

9.2.3 Experiment set-up

The aim of the experiments was to compare the horizontal conflict resolution (heading change only) with the vertical conflict resolution in several one-on-one conflicts. The method that has been used for the experiments is based on the idea of choosing the position of a large number of experiment points in the protected zone of an intruder aircraft.

Each experiment point represents a minimum distance point for a conflict that will occur during an experiment. The minimum distance point is the important factor for the conflict resolution module because it indicates the amount of intrusion.

The experiment points for the horizontal conflict experiments have been chosen as shown in figure 9.2.

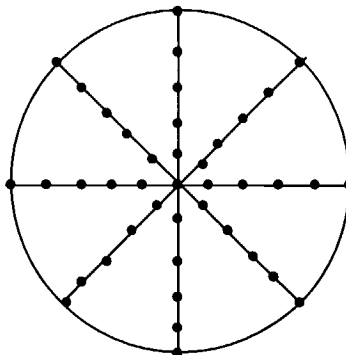

figure 9.2 Predefined experiment points in horizontal plane

The points for the vertical resolution are chosen in the vertical plane as shown in figure 9.3.

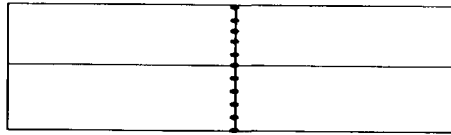

figure 9.3 Predefined experiment points in vertical plane

The points are chosen with various amounts of intrusion with an interval of 200 ft. For the horizontal resolutions the amount of horizontal intrusion is chosen with a 1 nm interval. The experiments have been subdivided like this because for the vertical resolution method only the amount of vertical intrusion will be important and for the horizontal resolution method only the horizontal amount of intrusion. This subdivision makes the task of comparing the two methods much easier compared to analysing all combinations.

9.2.4 Horizontal Conflict Experiments

The general experimental set-up was chosen as follows. Each experiment starts with two aircraft flying with constant speeds and altitudes according a prescribed scenario. One of the two aircraft is designated as experiment aircraft (own ship) the other is the intruder; see for example figure 9.4.

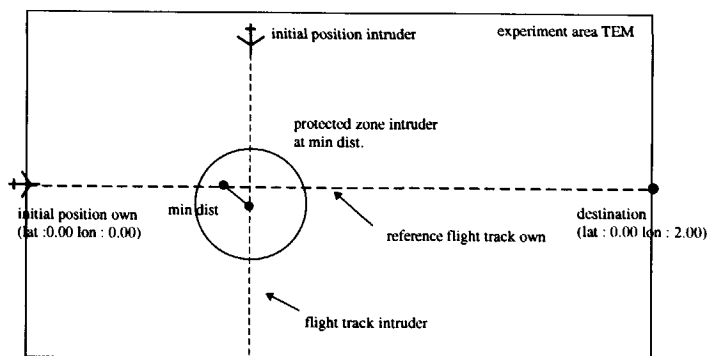

figure 9.4 Example of an experiment situation

The flight path of the own ship is a direct flight over 120 nm to a destination at the edge of the experiment area. Each experiment stops when the experiment aircraft exits the experiment area.

The initial position of the intruder is chosen in such a way that when a conflict is detected during flight, the initial point of minimum distance is located at a desired experimental point in the protected zone of the intruder.

For this purpose the horizontal experiments have been arranged in four initial experimental situations. All experimental situations are related to the position of the predefined points in the protected zone of the intruder aircraft. The points are chosen on four lines (a,b,c and d); see figure 9.5.

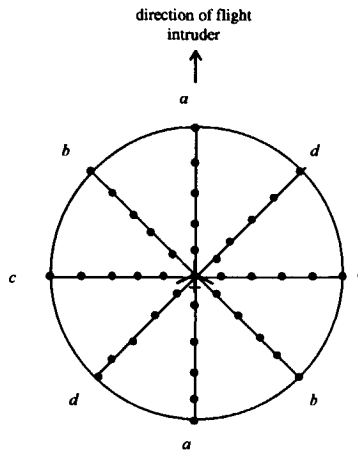

figure 9.5 Situation lines for horizontal experiments

The experimental points on, for example, lines b and d are related to the initial experimental situation b and situation d as illustrated in figure 9.6.

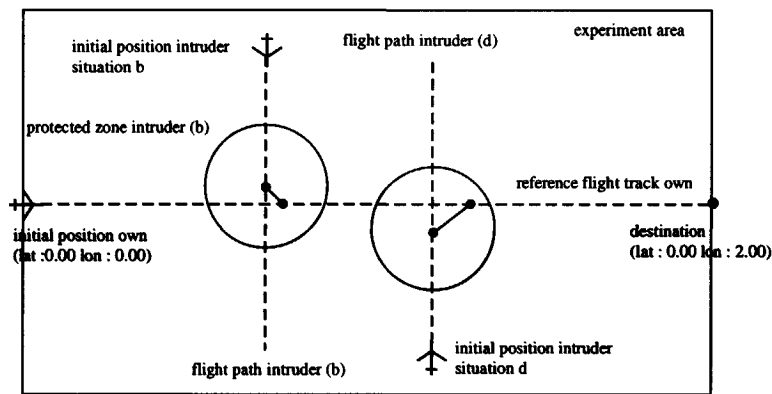

figure 9.6 Example of situation b and situation d experiments

When a conflict is detected the own ship will manoeuvre in order to resolve the conflict. The intruder will hold his track without manoeuvring; so the own ship will have to resolve the conflict completely (worst case).

When the conflict is resolved the aircraft will maintain its new course until it is time to turn back to the destination again (the so-called recovery manoeuvre); see figure 9.7. Note that there is no reason to return to the original route.

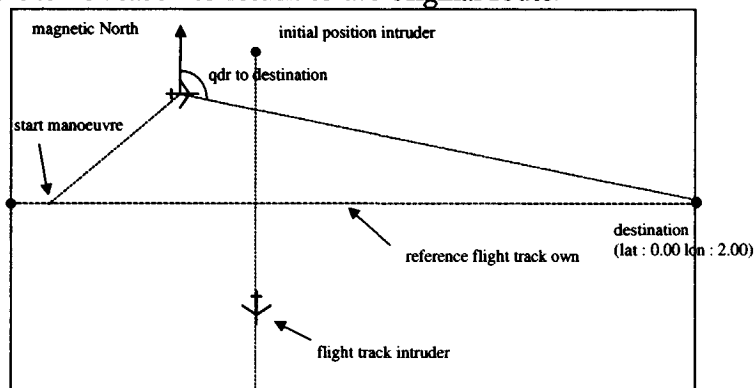

figure 9.7 After resolving the conflict with the own ship follows a direct route to the destination

9.2.5 Vertical Conflict Experiment

Vertical conflict experiments have been executed with a similar set-up as the horizontal conflict experiments. In these tests the intruder aircraft was on a head-on collision course with the own ship, because only the vertical amount of intrusion needed to be varied.

Nevertheless, only the ASAS conflict detection module (not the resolution module) has been used for the execution of the vertical experiments; a standard flight level change procedure was used for the vertical conflict resolutions. The main reason for this approach was that the study focussed on the efficiency of manoeuvres, which pilots would execute in Free Flight with airborne separation assurance. The automatic horizontal resolutions in the Traffic Manager result in heading changes similar to those executed by pilots in experiments. The first phase flight simulator trials experiments showed that the vertical conflict resolution, that ASAS can automatically execute, is a very good method of resolving conflicts.

However, there is a difference between this automatic execution of vertical resolution and the procedures preferred by pilots for flight level changes. For the relevance of the study it was decided to implement a more procedural (worst case) approach of resolving the conflicts than the vertical resolution manoeuvres.

The vertical conflict resolutions have been predefined as follows. The own ship has been constrained in such a manner that it resolves all conflicts with:

- a climb/descent with constant Mach number
- a level of altitude of 100ft above/below protected zone of the intruder aircraft
- a fixed vertical speed of 600ft/min

The vertical manoeuvre is illustrated in figure 9.8.

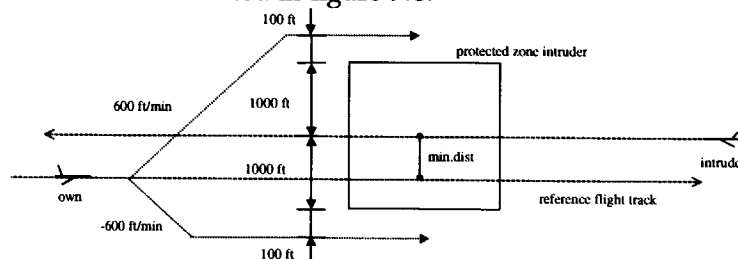

figure 9.8 Vertical conflict resolution manoeuvre (top manoeuvre is not allowed by rules of the air in this situation)

After resolving the conflict the aircraft will return to the original altitude when it has passed the conflicting aircraft (using predictive ASAS information if available).

9.2.6 Aircraft Performance Validation

All aircraft models simulated in the TMX are based on BADA aircraft performance data (Eurocontrol Experimental Centre, 1997).

All results presented in this chapter have been generated with a medium range twin-engine aircraft of the TMX. The performance of the BADA aircraft model used has been

validated by comparing it with the much more sophisticated simulation model of the same aircraft used in NLR's Research Flight Simulator (RFS). As part of this study the BADA model has also been compared with several other high fidelity models to validate the performance characteristics of the model before using it in the analysis.

9.2.7 Experiment Matrix

The complete experiment matrix of the one-on-one experiments consisted of

- 44 vertical resolution experiments
 - 11 descents at FL200 & FL300
 - 11 climbs at FL200 & FL300
- 88 horizontal resolution experiments (4 situations of 11 points at FL200 & FL300)
- 2 reference flights (without manoeuvring)

9.2.8 Results of Vertical Conflict Experiments

The results for the climb manoeuvres at FL300 are presented in figure 9.9 and figure 9.10.

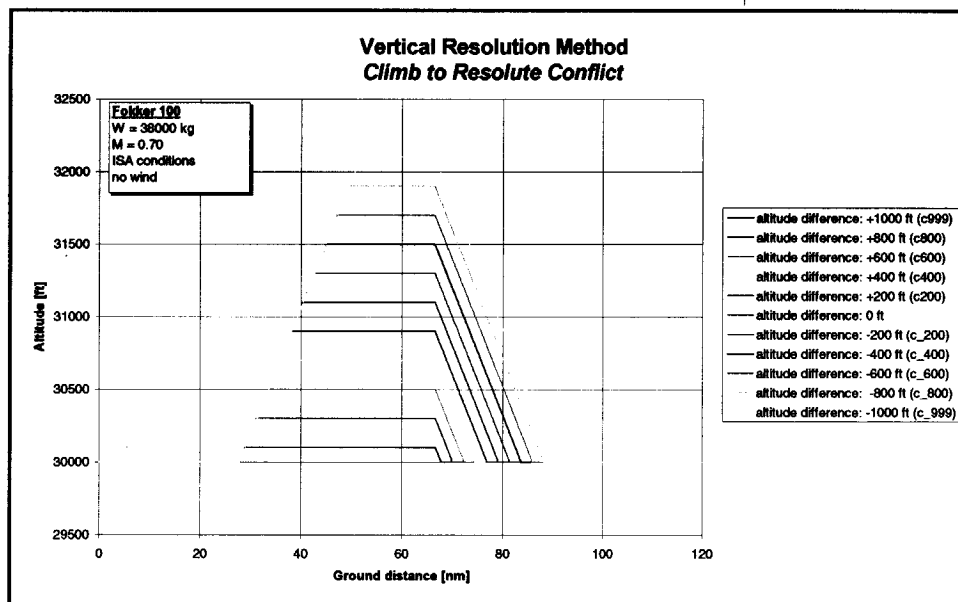

figure 9.9 Flight paths for Climb manoeuvres at FL300

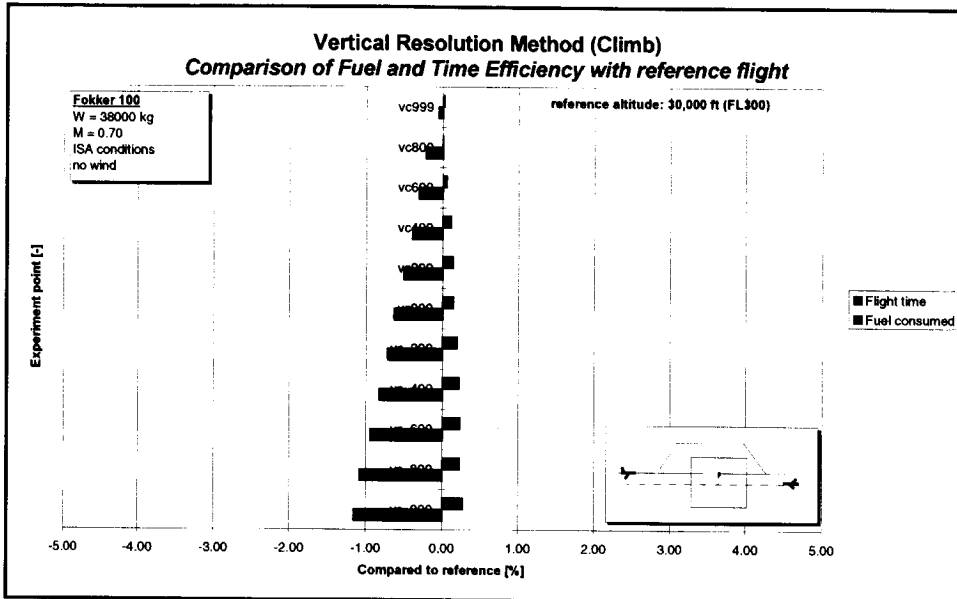

figure 9.10 Fuel burned and time used compared to the reference flight at FL300

9.2.9 Results of Horizontal Conflict Experiment

The results of the situation a and situation c are presented in figure 9.11 - figure 9.14.

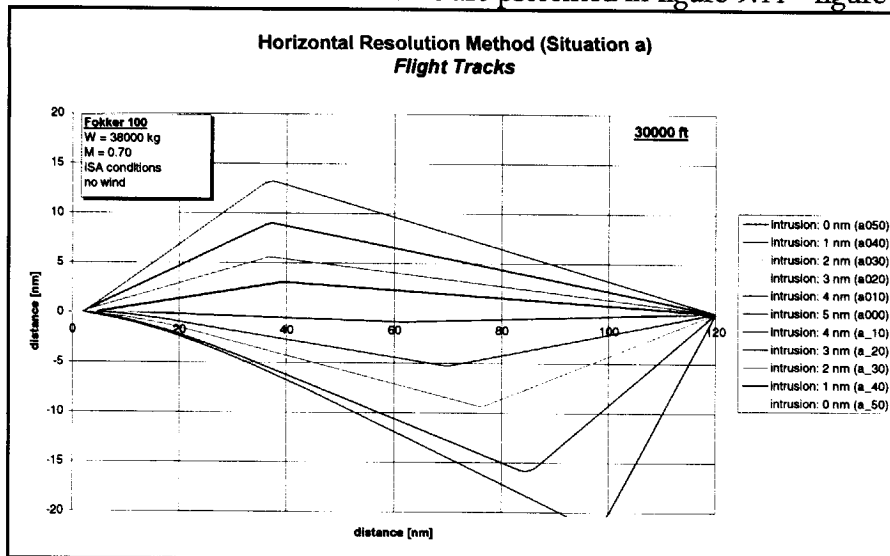

figure 9.11 Flight tracks for situation a at FL300

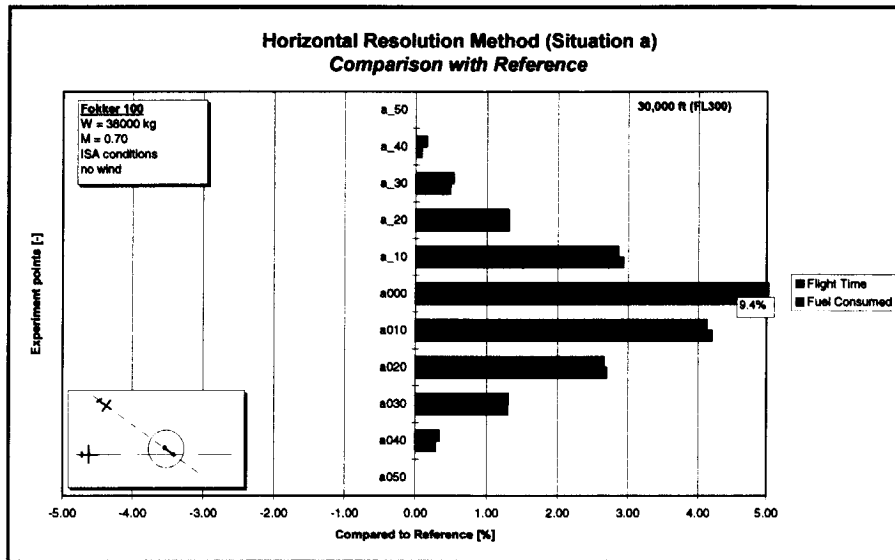

figure 9.12 Fuel burned and time used compared to the reference flight at FL300 (situation a)

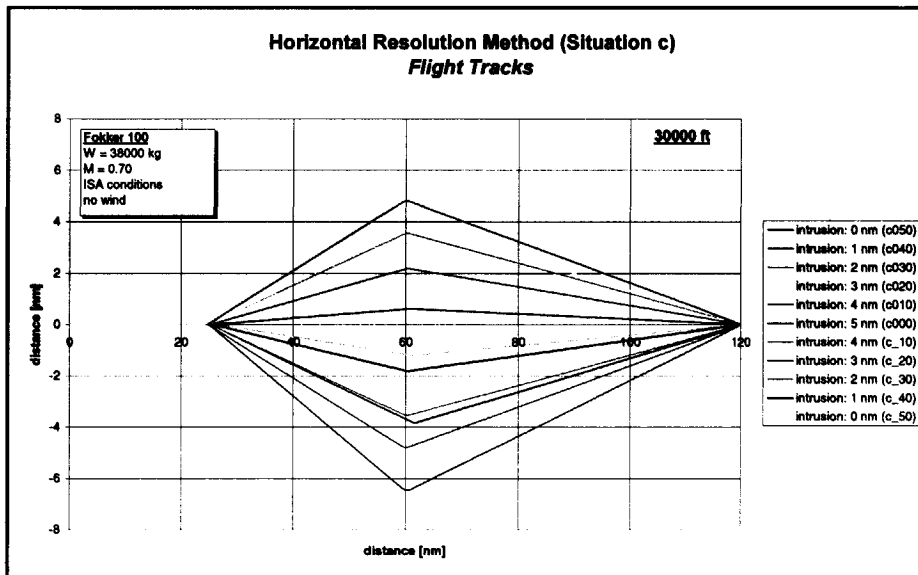

figure 9.13 Flight tracks for situation c at FL300

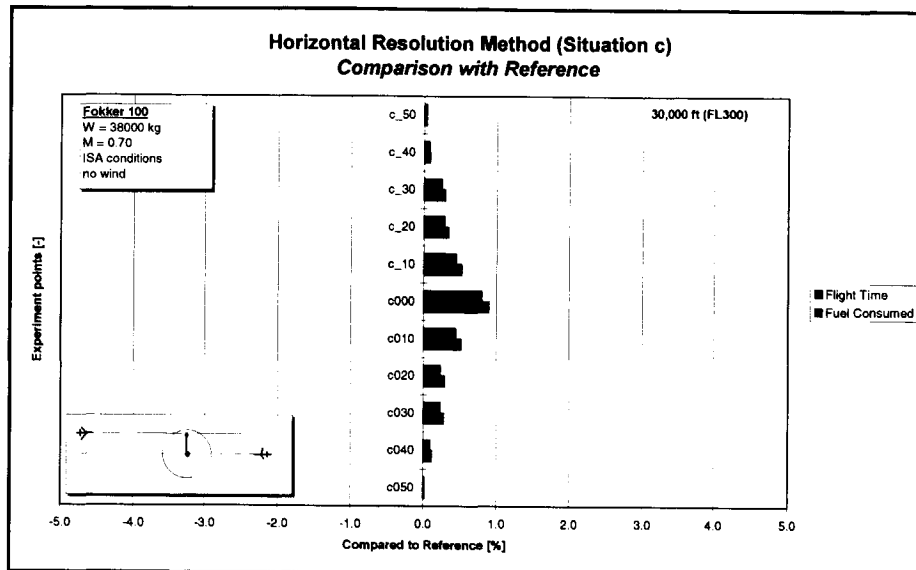

figure 9.14 Fuel burned and time used compared to the reference flight at FL300 (situation a)

Similar results were obtained from the FL200 runs and the descent runs. They use more fuel because of the higher air resistance.

9.2.10 Discussion of resolution costs

In the previous paragraph the results of the one-on-one simulations have been presented. When analysing these results it should be clear that all experiments were based on some constraining assumptions that imply a certain level of simplification. The aim of the experiments is to get a better understanding of the economic aspects of the resolution methods.

One of the most determining factors is expected to be the type of aircraft because of the relation of optimal altitude and ceiling of the aircraft. The experiments have been executed with a simulation model that estimates the behaviour of a medium range twin-engine civil aircraft. Another factor that could drastically influence the performance is the environmental condition (e.g. atmospheric condition, wind profile).

When analysing and comparing the fuel consumption of all the experiments it is clear that in only one case the experiment aircraft saves fuel with respect to the reference flight over the defined trajectory. This is when the aircraft performs a vertical climb to resolve the conflict; see figure 9.10 and figure 9.12. The diagram in figure 9.10 shows that for all experiment points (different intrusions in the protected zone of the intruder) the total fuel consumed is less than the reference value. The low points in the protected zone show the biggest gain. This is not surprising because for these low intrusions the experiment aircraft has to perform a high altitude step; bringing it to a more optimal cruise level (which is limited by the ceiling with a margin that leaves sufficient space for the minimal resolution manoeuvre). This implies that after performing the altitude step it would maybe be even more efficient to remain at the higher level. Naturally, the distance to destination also influences this decision.

Nevertheless, when assuming a constant Mach number (and flight in the troposphere), the true airspeed will decrease with the increasing altitude. This means that the aircraft

will arrive later on its destination, which can also be read from figure 9.10. The amount of time lost is however very small; in the order of a few seconds for the experiment flight over a distance of 120nm. Nevertheless the balance between time costs and fuel costs (cost index) could be, especially on the longer routes, a consideration when choosing between remaining at a higher altitude or returning back to the original cruise level. An even more practical option would be to change speed/Mach number to the value suitable for the higher altitude.

The results from the vertical climb resolution are very promising regarding the fuel consumption figures. However, there are some issues that could seriously constrain this resolution manoeuvre. It is reasonable to assume that pilots, when they are given the user-preferred routing possibility, will perform the cruise flight as close as possible to the operational ceiling of the aircraft; especially on long routes. When the pilot wants to perform a climb in order to avoid a conflict it could well be possible that this is constrained by the ceiling. Other aspects, like the rules of the air, influence of engine spool-up noises (e.g. when performing climbs near the operational ceiling) on passenger comfort, could also pose a constraint on the climb manoeuvre.

So, assuming for the moment that the climb manoeuvre is often not an option, this leaves only the horizontal heading change as a possibility to resolve the conflict. A trade-off can be found between the advantages and disadvantages of all the manoeuvres, which will briefly be presented on a simple decision model in the next paragraph for use in off-line simulations.

It can be concluded that the use of the vertical resolution method is not as bad for the fuel consumption as thought by some of the pilots who participated in the Human-in-the-Loop experiments (see chapter 10). The vertical climb manoeuvre could even lead to a more efficient flight operation. However, if the climb manoeuvre is not possible, the geometry of the conflict (the position of the minimum distance points in the protected zone) can be used to determine what is better: a descent manoeuvre or a heading change.

For the horizontal resolution the “no wind” assumption is a decisive issue. Wind vectors can have positive and negative influences on the efficiency of the horizontal resolution method. Moreover, the optimal flight from an origin to a destination will not necessarily be the shortest route via an earth great circle.

Future research should focus on these more complex influences on the conflict resolution efficiencies. They should investigate for several aircraft types, and with more sophisticated simulation models, how the fuel consumption for small altitude changes are influenced.

9.3 Decision model for conflict resolution

The results of the one-on-one simulation experiments showed that, depending on the position of the minimum distance point, a cost-effective decision could be made for a horizontal or a vertical resolution manoeuvre. However, the decision was only applicable for the vertical descent manoeuvre versus a heading change manoeuvre, because in all the experiments it was found that the vertical climb manoeuvre was the best method to resolve a conflict, with respect to fuel consumption.

Assuming that the vertical climb manoeuvre is not always a possibility, a trade-off position between the horizontal manoeuvre and the vertical manoeuvre was found. The diagram in figure 9.15 illustrates how the decision model was implemented.

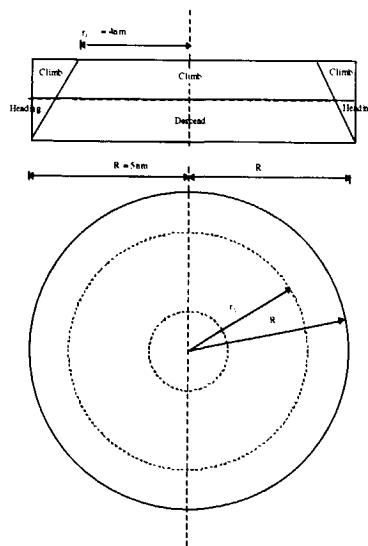

figure 9.15 Decision model for resolution method

9.4 Passenger comfort aspects of conflict resolution

A concern of pilots, which caused a preference for horizontal manoeuvres, was the impact of vertical manoeuvres on passenger comfort. In general speed changes and the initiation of a climb and/or descent cause accelerations or noticeable changes in attitude. If the conflict resolution causes climbs or descents several times per hour the concern is that this could decrease passenger comfort.

Today during cruise, in the order of once per two hours a so-called 'step-climb' is performed to a level 2000 ft higher. This is hardly ever noticed by the passengers even though it is a more dramatic manoeuvre than the minor adjustment required for conflict resolution.

Conflict resolutions will probably not decrease passenger comfort for a number of reasons:

- **The vertical speed is low.** Vertical conflict resolutions do not require a vertical speed of more than 200 ft/min, which is hardly noticeable. When this vertical speed is used instead of the standard 'level change' causing a 1500 ft/min climb or descent there is no effect on passenger comfort by attitude nor by acceleration.
- **Conflicts are rare.** Conflict resolutions are only required once per hour over busy areas, en-route over the ocean or vast continents this number will probably be even lower
- Today during the cruise, in the order of once per two hours a so-called '**step-climb**' is performed to a level 2000 ft higher. This is hardly ever noticed by the passenger even though it is a **more dramatic** manoeuvre than the minor adjustment required for conflict resolution.

- **Step climbs will disappear.** In a mature free flight environment the fixed flight levels have disappeared, so there will be no more step climbs. Instead there will be a continuous shallow climb, in reality probably several climbs in the order of 100 or 200 ft/min.

This means it is likely that overall the passenger comfort will increase due to the change in operations in a mature Free Flight environment.

9.5 Conclusion and Remaining Issues

The research presented in this chapter has attempted to make a first inquiry into the issues raised in the hypothesis tree regarding the conflict resolution costs and passenger comfort. This has been done by observing Free Flight on a very small scale, by conducting one-on-one experiments. All experiments have been executed using the Traffic Manager (TMX) for Free Flight environment simulations.

The one-on-one simulation experiments showed some interesting results. The vertical resolution method has always been regarded, especially by the pilots who flew the Human-in-the-Loop experiments, as a less efficient manoeuvre that could also have negative impact on the fuel consumption. The experiments in this chapter showed that, in all cases the vertical climb manoeuvre would save fuel. The explanation is that when climbing to resolve a conflict the overall fuel consumption will reduce because of the higher altitude.

The horizontal heading change manoeuvre and the vertical descent manoeuvre can therefore be compared on basis of fuel consumption. Dependent on the position of the minimum distance point in the protected zone of the intruder a simplified decision model has been developed that indicates if the conflict should be resolved with a heading change or with an altitude change.

It has been shown that the vertical manoeuvre is the most optimal in nearly all cases. As a result, the resolution manoeuvre costs will be minimal. In about 50% of the cases a climb manoeuvre will be used, which may even yield fuel benefits. Because vertical manoeuvres will be the nominal manoeuvre, there in general will be no noticeable time cost of resolution manoeuvres. Even in the exceptional situations where the horizontal resolution is used, the impact on fuel and time is low. Other factors like meteorological influences (wind, density) will have a higher impact on time of arrival and fuel consumption than the low ratios found here for conflict resolutions. Compared to these factors the costs of an occasional conflict resolution manoeuvre will even be negligible. The benefits of direct routing and fewer delays have not been calculated but are expected to be substantial. So even though the necessity for an exact cost-benefit analysis remains, the results of this chapter already indicate that the economic aspects of conflict resolution manoeuvres will not inhibit the implementation of Free Flight. This means that the main cost factor that now remains to be studied will be purchasing and installing the required equipment in the fleet.

PART IV HUMAN-IN-THE-LOOP EXPERIMENTS

10 Phase I Flight Simulator Trials

10.1 Goal of the Trials

In the hypothesis tree some issues have been raised that can only be solved with human-in-the-loop simulations:

- Will the workload be too high?
- Will the crew have sufficient situational awareness to be effective at separation assurance?
- Will pilots accept the task of separation assurance?
- Will the display be too cluttered in high density traffic?

To explore the human factors issues in a flight simulator experiment the initial goal was of the study. But before these questions could be addressed in a flight simulator experiment, several issues had to be solved like conceptual design, rules of the air, ASAS prototype etc. as described in the previous chapters. After the development & off-line testing of the conflict detection and resolution algorithm and the design of the human machine interface, the next step was to perform the human-in-the-loop trials. At this stage the conflict detection and resolution algorithm had been verified using several scenarios with a high traffic density. The data gathered in human-in-the-loop trials was required to validate the principle of airborne separation. Data like reaction times were used later in off-line simulations to investigate critical geometries (see chapter 8).

Because this study was the first to look at Free Flight in this detail, in the first year the study was still in an exploratory phase. At that point there was no intention to develop a mature ASAS system or free flight concept. The idea for this study was to create human factors problems by using a straightforward, basic ASAS (without predictive ASAS) system and high traffic densities. Investigating the human factors problems would give insight into the issues of performing airborne separation.

For this reason the following choices were made:

- no active ATC (mature Free Flight concept)
- no exchange of intent information
- look at cruise phase first
- high traffic densities up to three times the average Western European traffic density
- high conflict rates: nine times the average Western European conflict rate

10.2 Research Questions

The research questions have already been listed at the beginning of this chapter. Below is indicated how the questions to the answers have been investigated.

- *Will the workload be too high?*
Simulate low and high traffic densities and use workload questionnaire for which a reference for ATC as base line is known.
- *Will the crew have sufficient situational awareness to be effective at separation assurance?*
To avoid the problem of how much situational awareness they need and how this should be measured, the effectiveness of airborne separation assurance has been

investigated in the various traffic densities. Also a non-nominal situation (emergency descent of traffic) was used to test this in an exploratory way.

- *Will pilots accept the task of separation assurance?*
On a questionnaire both acceptability and subjective safety will be rated by the subject pilots.
- *Will the display be too cluttered in high density traffic to be able to use it?*
Simulate high traffic densities and check effectiveness of conflict resolution. Check workload and ask pilots in debrief.

The experiment was also used to answer some additional more open or detailed questions like:

- *What happens when pilots have to perform their own separation assurance?*
- *What happens in non-nominal situations like failures or incorrectly behaving traffic?*
- *Will an extra autopilot mode help the crews significantly in separation assurance?*

10.3 Experimental Design

The experiment matrix has two independent variables:

- 1) Traffic Density: single, double, triple
- 2) Level of autopilot assistance: manual, execute, automatic

Traffic Density

The average Western European traffic density of 1996 was used as reference. This so-called "single" traffic density corresponds to 10 - 12 aircraft per area of 100 x 100 nautical mile in the airspace of 10 000 feet (based on Magill (1997), Eurocontrol data & PHARE demonstration scenarios). During peaks the traffic density can be twice the average density at certain times of the day during the holiday season. The conflict rate for the average density in a direct routing, cruise-climbing scenario is about one conflict per hour per aircraft (this was found with off-line traffic simulations based on references for the traffic density).

Since the simulator runs only lasted 20 minutes and the goal of the experiment was to induce human factors problems, a higher conflict rate was used. For a single density scenario there was one conflict in the run of 20 minutes, for the double density two conflicts and for triple density three conflicts were prepared. This effectively means a tripling of the conflict rate. Therefore in the worst scenario of the experiment the conflict rate was nine times the average normal conflict rates.

Level of Automation

Originally three levels of automation were planned:

"manual" – manual selection of autopilot modes (no automatic resolution modes)

"execute" – activation of a resolution mode

"automatic" – automatic selection and execution of the resolution after a brief period allowing an override by the pilots

The fully automatic mode proved to be ineffective during the tryouts for several reasons:

- the human is out-of-the-loop
- the outside world effectively controls the aircraft
- the system has no knowledge of terrain, weather and SUA in the system can lead to undesirable actions like flying into terrain or bad weather

Therefore the levels of automation were redefined as follows:

“manual” – pilot selects a heading, vertical speed, altitude and/or speed on the mode control panel to solve the conflict using the advisories on the display.

“execute separate” – pilot selects a “horizontal resolution mode” or a “vertical resolution mode”, which causes the autopilot to select the advised resolution values until the conflict is solved. Then the corresponding “HOLD” mode can be selected by the pilots to freeze the speed vector. This “HOLD” selection prevents overreacting to conflicts that should be solved co-operatively.

“automatic/execute combined” – This features one combined conflict resolution mode, which will use all advisories (horizontal and vertical) simultaneously to solve the conflict

The resulting nominal experiment matrix consists of 3 densities x 3 autopilot modes = 9 cells. These 9 cells are flown twice per crew, once in the nominal situation and once in a non-nominal situation. The total experiment matrix is then: $2 \times 3 \times 3 = 18$ experimental runs per crew. Nine crews were planned in total. Nine events were placed in all nine cells by varying the place of an event in the matrix between crews.

The matrix was balanced to prevent order effects. This was especially important because of the new nature of the task, which is likely to cause a learning effect after the limited training time available in the two day schedule.

For the non-nominal runs events were required that would have an effect on the airborne separation assurance task. Therefore a brainstorm session with experts, controllers and pilots has been held. From this hazard analysis, the following events were selected for the human in the loop trials based on relevance. This selection was based on the effect on the human operator (avoid two events which will have a similar effect) and that they should be caused by or related to the difference between controlled flight and free flight. Three categories of events have been identified. They were identified with a code ranging from 21 to 29 (for software reasons):

Non nominal behaviour of other aircraft

21 = other aircraft starts an emergency descent

22 = other aircraft starts an inverse resolution manoeuvre worsening the conflict

23 = other aircraft does not manoeuvre at all to solve the conflict

Failures

24 = ADS-B overload: unreliable, flickering and disappearing traffic symbols

25 = conflict detection failure (no aural alerts or conflict symbology)

26 = conflict resolution failure (no advisories on display)

Events to induce delays

27 = captains navigation display fails after distracting company call for co-pilot

28 = conflict detection delayed until three minutes before intrusion

29 = resolution advisory delayed until three minutes before intrusion

Several other events are possible. However these events do cover the effects of a large range of events.

These events were introduced to explore the effects on the airborne separation task. For other purposes only the data of the nominal runs were used. The total experiment matrix is given in Table 10.1. The distribution of events over the experimental conditions per crew is shown in the second table.

First character: m = manual
 e = execute(separate modes)
 a = automatic (combined mode)

Second character:: s = single
 d = double
 t = triple traffic density

Third/Fourth character: n = nominal
 nn = non-nominal

After each run the crew rated the workload, acceptability and subjective safety of the run in a questionnaire. After each session of 6 runs, an extra questionnaire was filled in with some additional questions on the concept and the human-machine interface (HMI).

RUN	CREW									
		1	2	3	4	5	6	7	8	9
	1	msn	esn	asn	mtn	etn	atn	msn	esn	asn
	2	msnn	esnn	asnn	mtnn	etnn	atnn	mdnn	ednn	adnn
	3	mtnn	etnn	atnn	mdnn	ednn	adnn	mdn	edn	adn
	4	mdn	edn	adn	msn	esn	asn	mtn	etn	atn
	5	mtn	etn	atn	mdn	edn	adn	mtnn	etnn	atnn
	6	mdnn	ednn	adnn	msnn	esnn	asnn	msnn	esnn	asnn
	7	etn	atn	mtn	esn	asn	msn	esn	asn	msn
	8	etnn	atnn	mtnn	ednn	adnn	mdnn	esnn	asnn	msnn
9	edn	adn	mdn	edn	adn	mdn	etn	atn	mtn	
10	esn	asn	msn	etn	atn	mtn	edn	adn	mdn	
11	ednn	adnn	mdnn	etnn	atnn	mtnn	etnn	atnn	mtnn	
12	esnn	asnn	msnn	esnn	asnn	msnn	ednn	adnn	mdnn	
13	asnn	msnn	esnn	asnn	msnn	esnn	atnn	mtnn	etnn	
14	adn	mdn	edn	asn	msn	esn	atn	mtn	etn	
15	adnn	mdnn	ednn	atnn	mtnn	etnn	adnn	mdnn	ednn	
16	atn	mtn	etn	adn	mdn	edn	asn	msn	esn	
17	atnn	mtnn	etnn	adnn	mdnn	ednn	asnn	msnn	esnn	
18	asn	msn	esn	atn	mtn	etn	adn	mdn	edn	

SCENARIO	CREW									
		1	2	3	4	5	6	7	8	9
	msnn	21	29	28	27	26	25	24	23	22
	esnn	22	21	29	28	27	26	25	24	23
	asnn	23	22	21	29	28	27	26	25	24
	mtnn	24	23	22	21	29	28	27	26	25
	etnn	25	24	23	22	21	29	28	27	26
	atnn	26	25	24	23	22	21	29	28	27
	mdnn	27	26	25	24	23	22	21	29	28
	ednn	28	27	26	25	24	23	22	21	29
adnn	29	28	27	26	25	24	23	22	21	

Table 10.1 Experiment matrix for Phase I simulator trials

The subjects were professional, commercial airline pilots. The flight experience of the pilots varied between 490 and 20,000 hours, with an average of 5500 hours. In general they are only available for two consecutive days. The following schedule was used:

Day 1:

Morning: Briefing, Training runs

Afternoon: The first session of six experiment runs

Day 2:

Morning: Second session of six experiment runs

Afternoon: Third session of six experiment runs

In the experiment matrix it can be seen that the runs were grouped for level of automation. Every session started with a training run for this mode of operation. Changing the mode of operation for every run would be too confusing for the crews.

10.4 Experiment scenarios

For every experimental run, the crew in the Research Flight Simulator (RFS) would fly a 20 minute en-route segment starting east of England, overflying Belgium until close to Germany.

To simulate the background traffic for this flight with high traffic density requires a high number of flights to be simulated.

As a first attempt to generate the scenarios, original real-life ATC data was converted to the scenario file format of the Traffic manager. Using a tool that could sum scenario files, a double and triple density scenario could be created. Using real data would ensure a realistic scenario. The problem with this approach was that the resulting traffic patterns did not reflect a direct route environment: all aircraft flew on airways and rounded numbered flight levels. Using a relocation function based on position origin and destination, placed a lot of aircraft out of the experiment area. Due to the limited size of the sampled data, the additional aircraft that should be relocated inside the area were unknown. Another way of creating scenarios was required.

The traffic manager allows manual creation of traffic. To develop 18 scenarios this way was not possible. The volume of airspace that can be viewed during a 20 minute flight with cruise speed is quite large. This is reflected by the size (and shape) of the experimental area in figure 10.1:

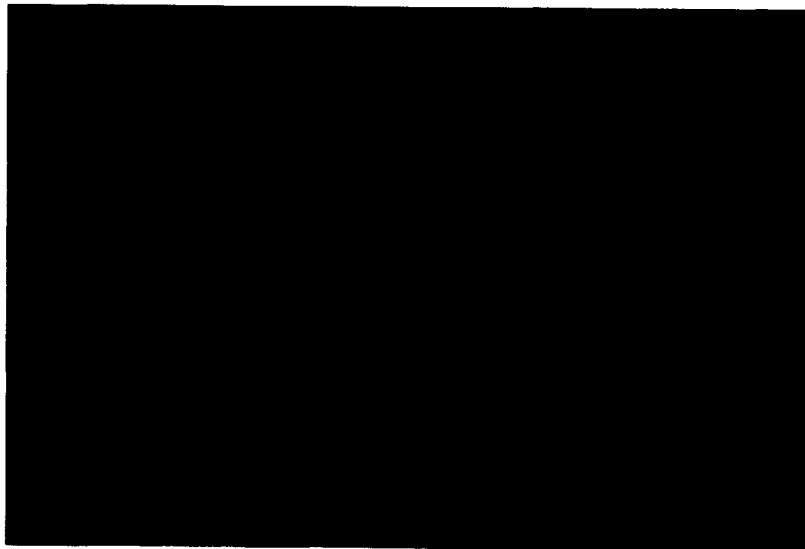

figure 10.1 Experiment area based on a 200 nautical mile ADS-B range

Since the experiment area covers 75,000 nm² on average 90 aircraft should be present in this area in a single density scenario and thus for the triple density 270 aircraft should be flying inside the experimental area. Clearly, manual creation of aircraft for all scenario files is too labour intensive.

The multiple create (“MCRE”) command creates traffic with random values for altitude, speed, heading etc. This does not simulate a realistic route environment because it is too random.

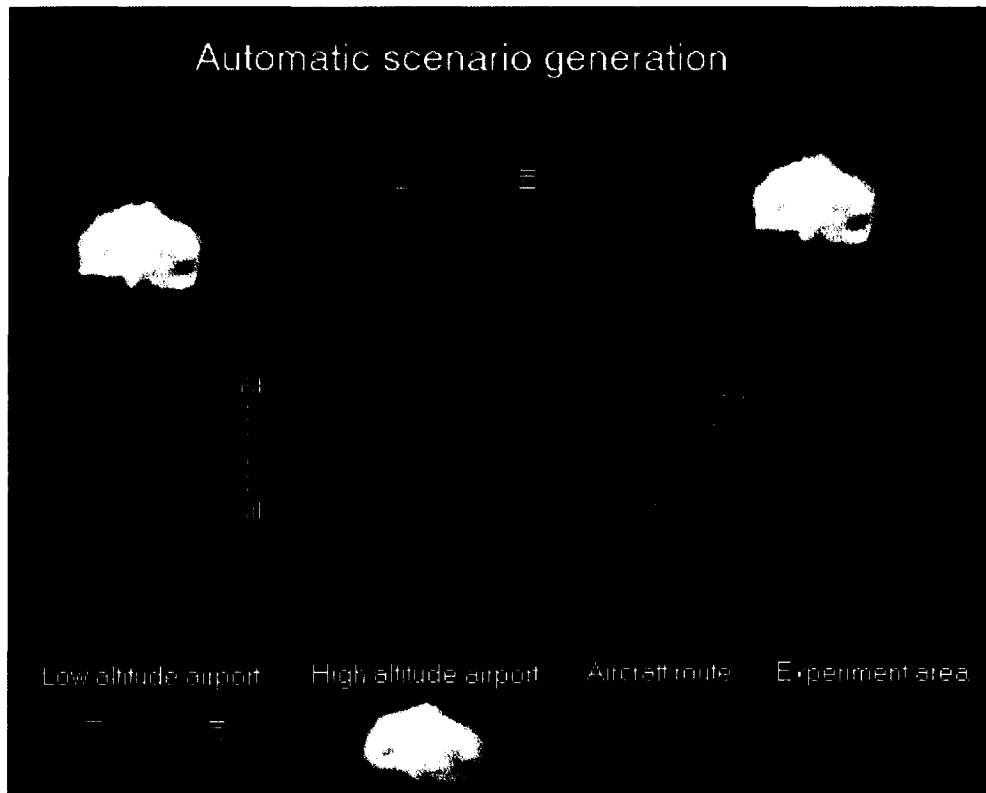

figure 10.2 Scenarios were generated by defining traffic sources on the ground (airports) and in the air (outside the experiment area)

Therefore a scenario generation function was developed. By defining airports and en-route entry points (“high altitude airports”) around and inside the experiment area, a realistic route environment was created in a pseudo random way. These scenarios were recorded from the moment the traffic density was constant. Using the measured traffic density with the references, the traffic density could be adjusted by adding airports and modifying take-off interval times (which are random within margins). Every airport and en-route point was defined in so-called “autoscen” files (extension.asc). These files were activated using the “autoscen <filename>” command.

The recorded scenario files were used as background traffic environment. During the experiment only the recorded scenario files were used to ensure repeatability. Specific aircraft on a course conflicting with the RFS route were added. Aircraft types and companies were limited to a selection from files.

An example of an airport definition in this file is:

```
##### ORIGIN #####
autoap = 'LFPG' ;Airport
swfx10 = F ;Switch FX10 special aircraft
eqpfrac = 1 ;Equippage (0 % => frac = 0, tot = 1)
eqptot = 4 ; (75 % => frac = 3, tot = 4)

# Number of runways:
# nautorw = 1 => random generated altitudes with autoaltd
# nautorw > 1 => cyclic generated altitudes with 2000 ft separation

nautorw = 1 ;Number of runways at airport

# Takeoff/start data: interval, altitude, speed, heading

autoint = 120.0 [s] ;Takeoff interval (per runway)
autointd = 20.0 [s] ;Takeoff interval delta (per runway)
autoalt = 60.0 [FL] ;Takeoff altitude (lower minimum if
cyclic)
autoaltd = 10.0 [FL] ;Takeoff altitude delta
autospd = 220.0 [kts] ;Takeoff speed
autospdd = 40.0 [kts] ;Takeoff speed delta
autohdg = 240 [deg] ;Takeoff heading (not used at low)
autohdgd = 20.0 [kts] ;Takeoff heading delta (not used at low)

# Destination:

autodest = T ;Automatic destination (otherwise continue on hdg)
ndestlst = 5
destlst = 'EHAM'
destlst = 'EKBI'
destlst = 'ENFB'
destlst = 'EHGG'
destlst = 'EDDH'
```

During the experiment an aircraft could be controlled via the traffic manager to make sure that all planned conflicts would occur despite earlier unexpected crew actions. To ensure such corrective actions would not be noted by the crew, aircraft tracks were only corrected when still outside the scanning volume of the RFS crew. For this purpose the scanning volume of the RFS was shown on the traffic manager screen.

Another way to control an aircraft was to hand it over to the AIRSIM desktop flight simulation program by issuing a "GIVE <acid>" command. This was used to simulate for example abnormal behaviour of conflicting aircraft during non-nominal runs. In figure 10.3 a snapshot of the traffic manager's map window is shown. The yellow aircraft symbol (call sign KL101) is the RFS, which is in conflict with an aircraft controlled via the AIRSIM flight simulation (white symbol OS801). The yellow and white circles correspond to the navigation display range settings.

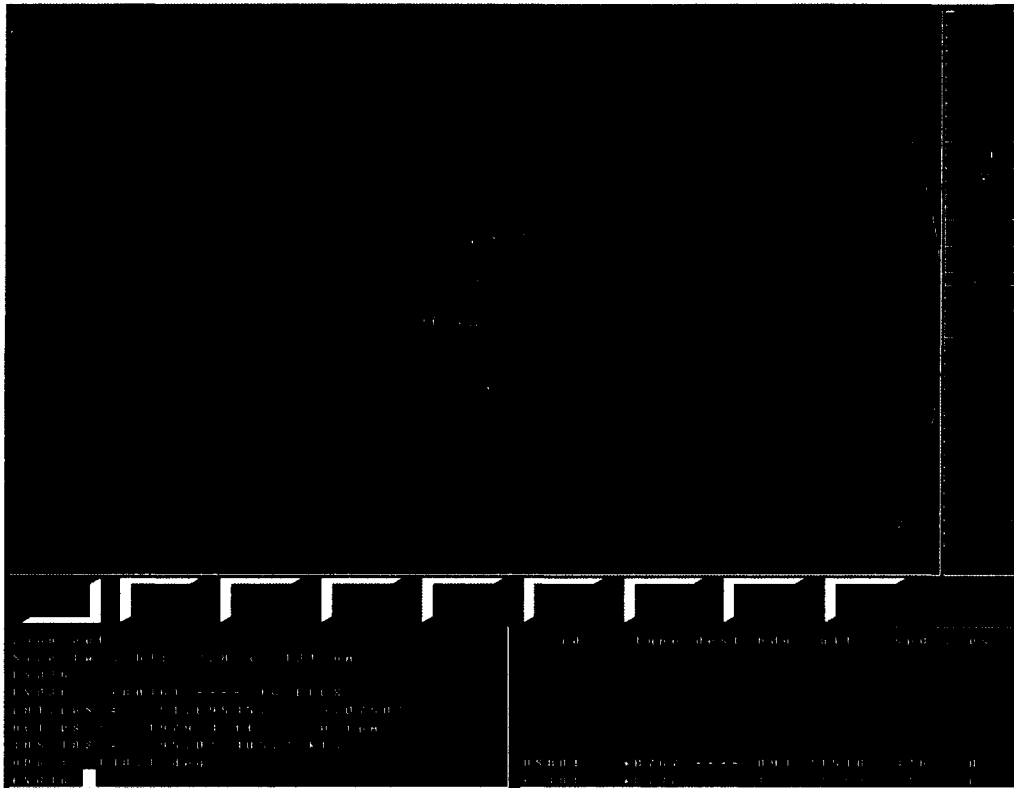

figure 10.3 Snapshot of Traffic manager map window during man-in-the-loop experiment.

10.5 Experimental Configuration

For the first phase experiments a configuration of three main components was used:

1. Research Flight Simulator
2. AIRIM Desktop Flight Simulation
3. Traffic manager

The traffic manager was the central component in the configuration. It performed the following functions:

- Experiment manager station (monitoring & controlling)
- Traffic simulation
- ASAS for traffic, RFS and AIRSIM
- Data logging (conflicts, intrusions, etc.)
- Events generation

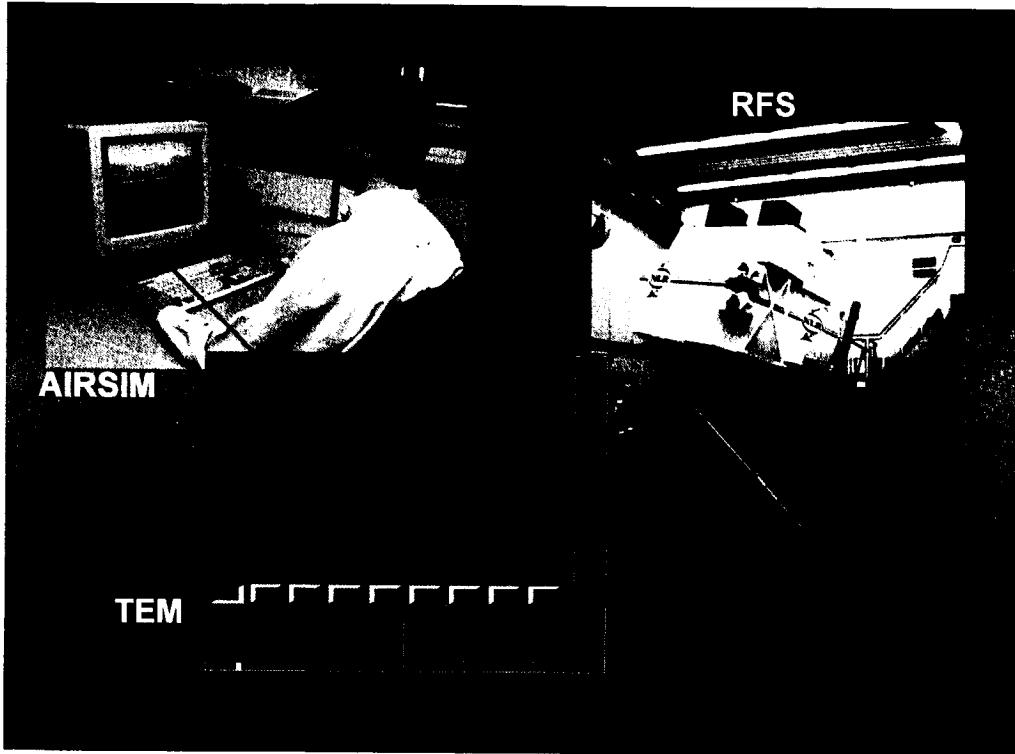

figure 10.4 Man-in-the-loop simulation configuration

The next figure shows an overview of the configuration and the communications.

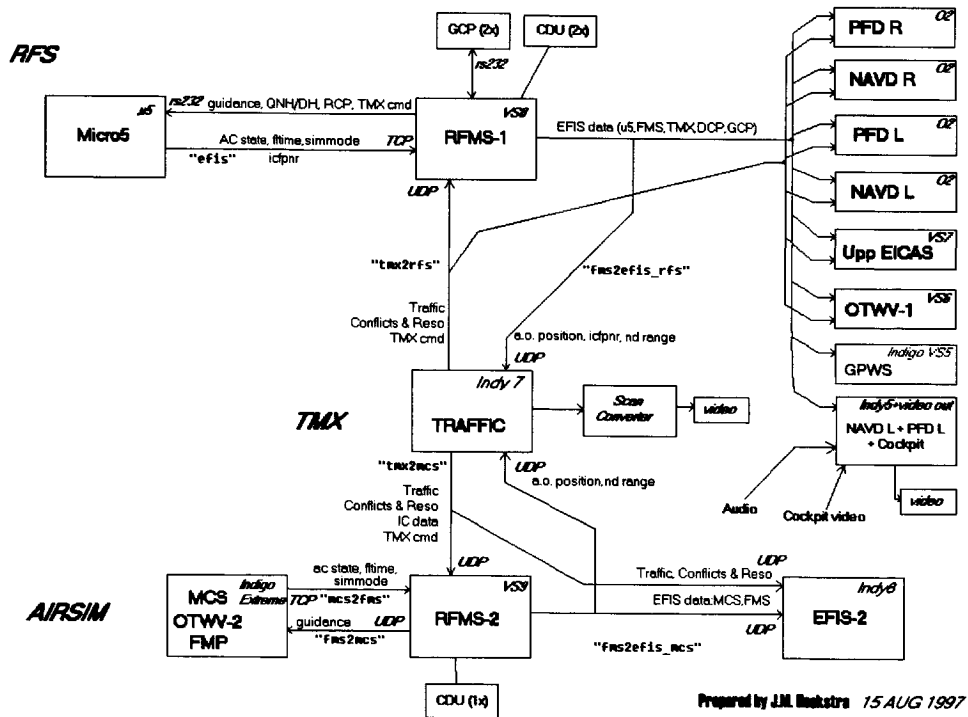

figure 10.5 Diagram as used during the development of simulation configuration, showing the computers and the communications

In the diagram every box is a single computer or piece of hardware. The abbreviations of the modules in the diagram are listed below:

SIMULATION CONFIGURATION DIAGRAM LEGEND
RFS - Research Flight Simulator
AIRSIM – Avionics Integration Research SIMulation, desktop flight simulator
TMX – Traffic Manager (or TMX)
RFMS – Research Flight Management System (FMS simulation)
PFD – Primary Flight Display (L = Left, R= Right)
NAVD – Navigation Display (L = Left, R= Right)
EICAS – Engine Indication and Crew Alerting System
GCP – Generic Control Panel (panel with CDTI settings)
CDU – Control & Display Unit, the keyboard and screen of RFMS
OTWV – Out of the Window view (with sky, clouds and traffic)
EFIS – Electronic Flight Instrument System (Collection of PFD, ND and EICAS)
FMP - Flight Mode Panel (for autopilot and autothrottle settings)
MCS - Multi-Cockpit Simulator (generic flight simulation program)
GPWS – Ground Proximity and Warning System
Micro5 – Host computer with flight simulation program
TCP, UDP, RS232 – interface types & protocols
tmx2rfs, efis, mcs2fms, fms2efis_mcs, fms2efis_rfs, tmx2mcs – names of ethernet services

In the RFS, eye-tracking was used to investigate scanning patterns and head-down time. Physiological data on pupil diameter, respiration rate and heart-rate variability was collected to correlate it to workload ratings. Video recordings of both the cockpit and the traffic manager were made. All data was synchronised using a timeserver. All mode-control panel actions as well as flight data of the RFS has been collected. Several questionnaires were used during the experiments.

10.6 Results

10.6.1 Questionnaires

Two types of questionnaires have been used: one after every flight (post-run questionnaire) and one post-trial questionnaire after every session (set of 6 runs) of the experiment. Both are included in appendix A.

The post-run questionnaire contains the following questions to be answered after every run (actual questionnaire form is included in appendix A):

1) Workload

Estimate the workload of the last run using a provided RSME-scale of 0 – 150 with descriptions (see section 10.6.2).

2) Acceptability

Rate the acceptability of the last flight (“Perfect in every way”, “Favourable”, “Acceptable”, “Undesirable”, “Completely unacceptable”)

3) True/False questions:

- I think I could safely guarantee the airborne separation with the set-up just flown

- I manoeuvred more than normal
- I exceeded passenger comfort levels
- I need better information on the traffic situation to guarantee safety
- I need more explicit rules of the road to guarantee the safety
- I need more explicit on board to guarantee the safety
- I need more training to guarantee the safety

4) How does in your opinion the safety of the set-up of the last flight compare to modern present day ATC operations? (“Free Flight (FF) much safer”, “FF safer”, “Same”, “ATC safer”, “ATC much safer”)

Since these questionnaire were answered after every run, they can be compared for all independent variables:

- Related to traffic density:
Single, double and triple i.e. once, twice and three times the “normal” density in Western-European airspace
- Nominal versus non-nominal:
Nominal (no events) sessions versus **non-nominal** (with events) sessions
- Related to the active autopilot resolution mode:
Manual, Execute combined, Execute separately
- Divided per set of runs (to investigate learning effect):
set 1 means the first 6 runs of 18 (first day afternoon)
set 2 means the second 6 runs of 18 (second day morning)
set 3 means the third 6 runs of 18 (second day afternoon)

The post-trial questionnaire had to be filled in after every set of 6 runs. As shown in the experiment matrix, the autopilot mode was only changed between sessions. This was to allow for a training run to get accustomed to the new mechanisation of the resolution mode. The post-trial questionnaire consisted of seven questions concerning the following topics (actual questionnaire form is included in appendix A):

- 1) Aspects of the Free Flight concept like resolution method, lookahead time, procedural aspects
- 2) Aspects of the alerting concept (lights and sounds)
- 3) Traffic display (presentation of traffic, vertical display, symbology for conflicts and resolution advisory)
- 4) Execution resolution manoeuvre (autopilot mode, recovery manoeuvre)
- 5) Traffic Display control panel (clipping and scaling of CDTI)
- 6) Alternative HMI concepts (perspective display, pointing device for selection)
- 7) Criticality for safety of traffic flow management, resolution advisories, TCAS backup, etc.)

As described earlier several objective measures were used as well. These results can also be found in appendix B. The recorded conflict times will be used to study the conflict resolution effectiveness of the crew.

A complete overview of the results can be found in appendix B. For this section a selection will be covered which relates to the research questions as formulated in the beginning of this chapter.

For the selected results a statistical analysis has been performed. The workload ratings have been averaged. In these figures error bars indicate the confidence interval using a standard normal distribution and an alpha of 5%:

$$\text{confidence } \Delta x = 1.96 \cdot \left(\frac{\sigma}{\sqrt{n}} \right)$$

$$\text{confidence interval : } \bar{x} \pm \Delta x$$

x = average

σ = standard deviation

n = size of sample

Δx = confidence range

Be aware that the confidence interval only means: given enough samples the *average* value will be within this interval with a 95% probability. On these means a statistical analysis was performed analysing the variances of the different calculated means, so called ANOVA techniques, to determine possible statistical significant differences between means. Main effects and two-way interactions of the different experimental variables are presented on the workload data. The mentioned p-values represent the probability of incorrectly accepting a result as valid. Statistical significance was defined, by standard convention, as $p < 0.05$.

Other ratings such as acceptability and subjective safety have been divided in two or three main categories. For the acceptability these are:

- Not acceptable (“Undesirable” and “Completely Unacceptable”)
- Acceptable (“Acceptable”, “Favourable” and “Perfect in every way”)

Note that the scale is slightly skewed towards the acceptable. Since the ratings were multiple choice and not a continuous scale, it is assumed the pilot used the descriptions correctly.

For the subjective safety three categories have been defined:

- Free Flight safer (“FF safer” and “FF much safer”)
- Neutral (“Same”)
- ATC safer (“ATC safer” and “ATC much safer”)

To verify the effect of experiment variables on these ratings, the χ^2 test (“chi squared test”) has been used. The p-value in these figures represents the probability of the wrongly assuming an effect over categories. It is calculated as the probability of the null hypothesis: the distribution does not show an effect over the groups. By standard convention, an experiment variable is assumed to have a significant effect if this probability is less than 5% ($p < 0.05$).

10.6.2 Workload

In the questionnaire a workload scale has been used that is called RSME (Rating Scale for Mental Effort, Dutch: BSMI = BeoordelingsSchaal voor Mentale Inspanning). The RSME scale is based on a scale presented in Zijlstra, F.R.H & Doorn, L. van (1985). The scale as used in the experiment is shown here

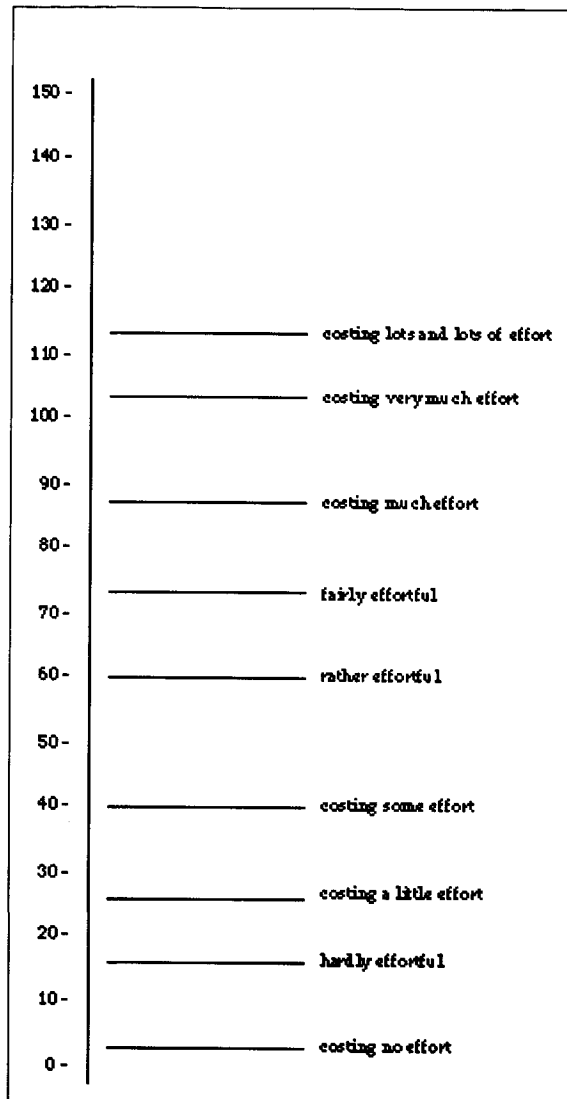

This scale has been used for years in other experiments at NLR. In this way a baseline figure was known for the ATC condition. In a conventional ATC condition in the same flight simulator, in the same flight phase (cruise) and a similar scenario the rating for a nominal (single) density was found to be 27 (“costing little effort”).

For the nominal runs, the workload ratings ordered by traffic density yield:

	Single	Double	Triple
Average	27.4	30.3	40.3
Deviation σ	19.5	18.3	24.7
Size N	46	48	48
Confidence range	5.6	5.2	7.0

Table 10.2 Workload ratings for traffic density

This is also shown in figure 10.6:

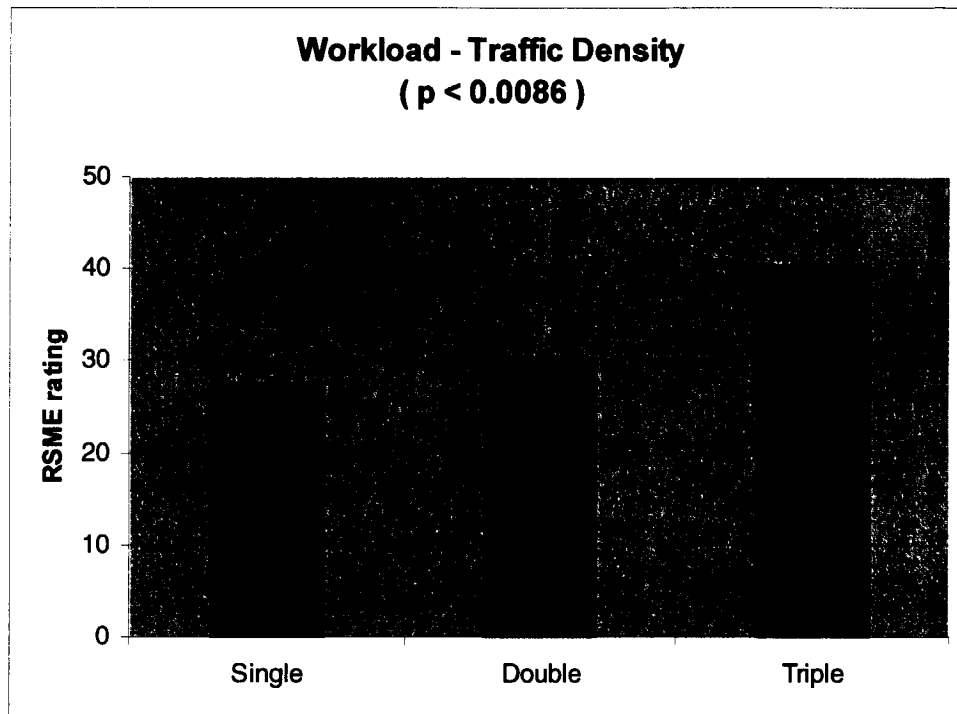

figure 10.6 Workload rating as function of traffic density.
Compare with ATC reference value: 27 for single density !

These results show that for today's density, the workload rating for flying in free flight equals that of the base line reference of flying under ATC conditions: 27. Not surprisingly, the traffic density has a significant effect on the workload rating. In the experimental design a crew experienced on average one conflict in the run in single density, two in a double density and three in a triple density. It is likely that the experienced conflict rate has a more direct effect on the workload than the local density as shown on the navigation display. This is confirmed by the significance number in this figure resulting from this experimental design ($p < 0.01$). Normally one would experience three conflicts in an hour. The runs in the experiment only lasted 20 minutes. So the conflict rate was tripled in the simulator runs. So if the conflict rate is indeed the driving factor than the results for 'Triple' should be read as 'Nine times'! See also chapter 13.

With a confidence of 95%, it can be said that the average rating will be between 22 and 33, which fits the description "costing little effort". So apparently the additional task of separation assurance does not increase the workload in a similar traffic density (but tripled conflict rate). With increasing traffic density, the workload increases. Especially the triple density case has a significantly higher workload than the single density: 40 ± 7 ("costing some effort") but is still surprisingly low on the overall scale of 0 – 150.

Because the Free Flight concept was largely new to the subjects, one could also expect an effect of the set of runs. So the workload rating results have also been divided by session. Note that every session had its own autopilot mode, but this has been balanced between subjects.

	Set 1	Set 2	Set 3
	Day 1	Day 2	Day 2
	PM	AM	PM
Average	33.9	35.2	29.0
Deviation σ	21.7	24.2	18.4
Size N	48	48	46
Confidence range	6.1	6.8	5.3

Table 10.3 Workload ratings for sessions

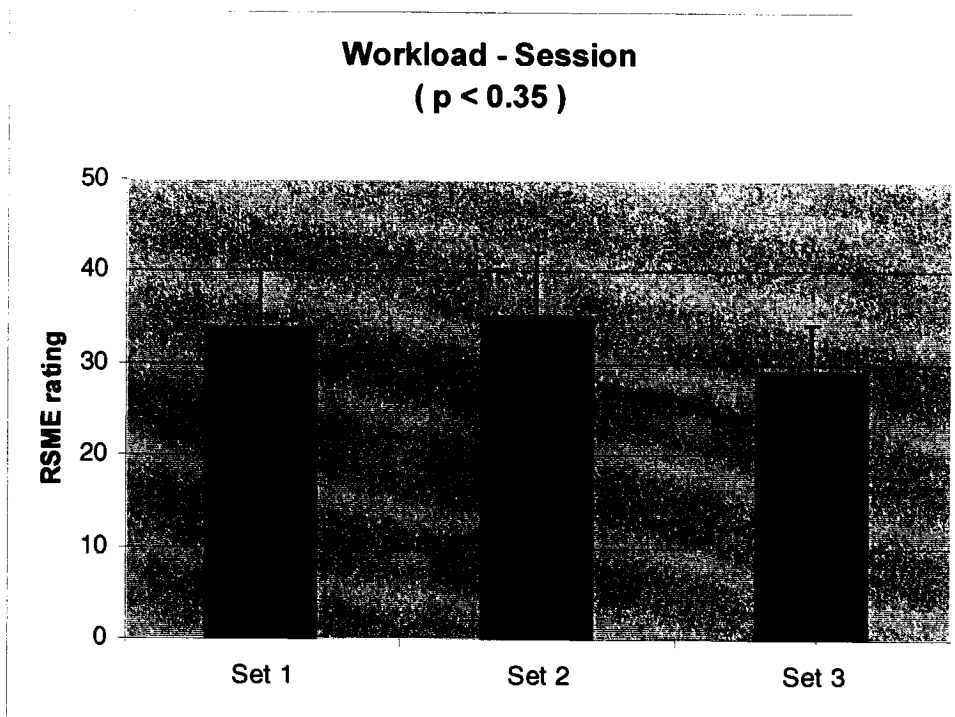

figure 10.7 Session effect is not significant. Session numbering :
set 1= Day 1 PM, set 2 = Day 2 AM, set 3 = Day 2 PM

This figure shows a trend: the workload ratings increase after the night between the two experiment days and then decrease in the third session. However, the effect of the sessions on workload ratings does not come close to significance ($p < 0.35$). This means the learning and acceptance effect was not causing too many problems for the workload, though the null hypothesis also does not reach significance. So the balancing effect that was included in the design of the experiment matrix may still have been required.

Even though the session effect is not significant, it is striking that the ratings of the third session, which includes all traffic densities, equals the rating of the single density and the baseline ATC condition with an confidence range of only 5.3 !

Overall, these workload ratings are surprisingly low. This means the workload issue as identified in the hypothesis tree that refutes the feasibility of Free Flight is not supported by the data found in the experiment. Furthermore, considering the traffic densities and the basic ASAS system (no predictive ASAS) it can be concluded that the workload data supports the feasibility of Free Flight in cruise. The traffic density, or more likely: the resulting conflict rate, has a significant effect on the workload, but even in extreme densities the workload is still very low (“costing some effort”).

10.6.3 Pilot Acceptability & Traffic Density

The question on the acceptability and the subjective safety basically deal with the same issue: pilot acceptability. The subjective safety is merely one aspect of this acceptability and should not be confused with the real safety. One can feel very safe while not able to see the radar scope of a controller under ATC control, just as one can feel very safe unknowingly walking blindfolded close to a ravine steered by directions of someone else (who can see the danger).

Both the acceptability and subjective safety measures are compared for traffic density. Also the autopilot mode preference is studied using the acceptability ratings. No session effect on acceptability was found. As mentioned before, the chi-squared test is used to verify the effect of the experiment variables.

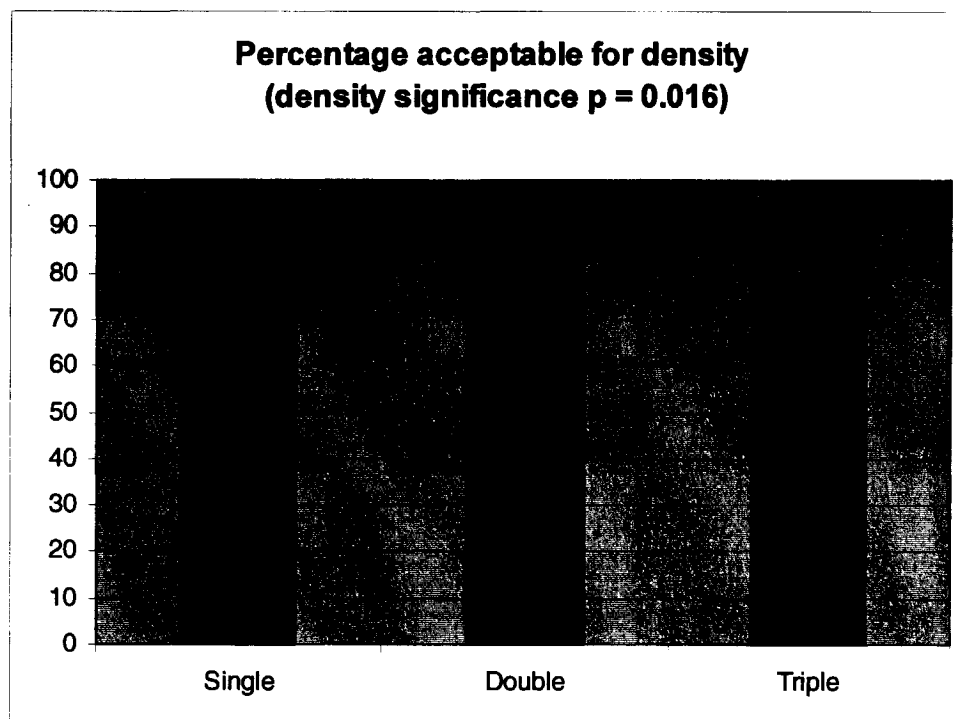

figure 10.8 Percentage of acceptable ratings decreases as the traffic density increases

The results of figure 10.8 are also shown in table form:

	Single	Double	Triple
No accept	1	5	10
Accept	45	43	38
Total	46	48	48

Table 10.4 Acceptability rating frequency for traffic density

Looking at the subjective safety ratings a similar significant effect can be seen (table below and figure 10.9):

	Single	Double	Triple
ATC safer	2	5	14
Neutral	25	28	20
FF safer	19	15	14
Total	46	48	48

Table 10.5 Subjective safety rating frequency for traffic density

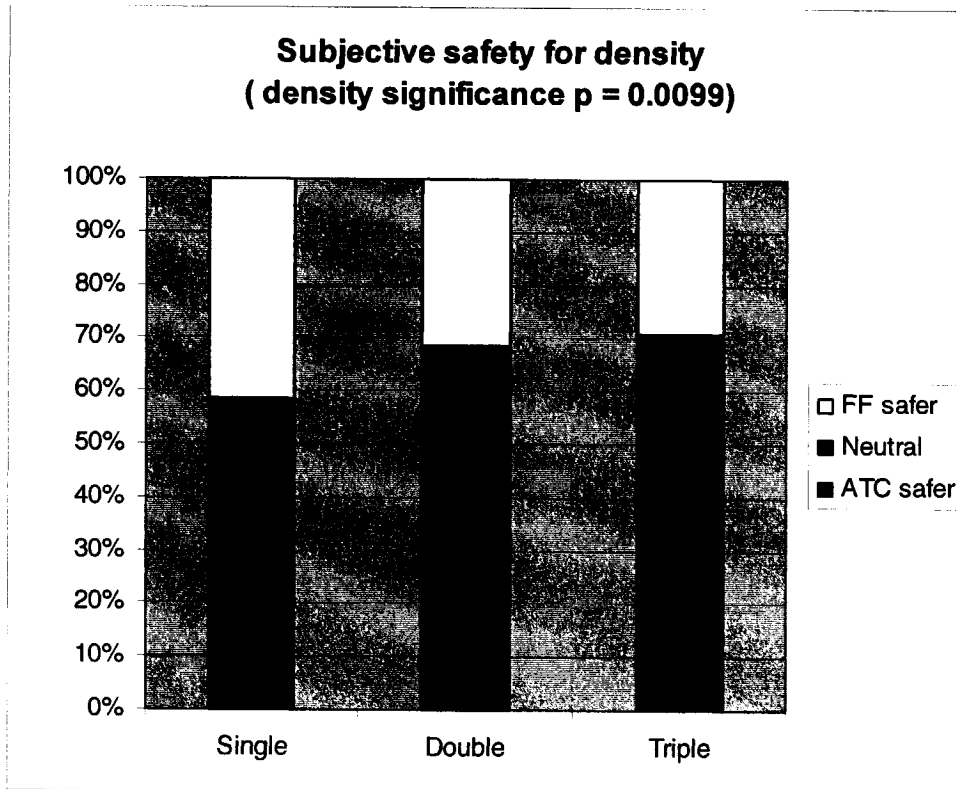

figure 10.9 Subjective safety ratings are significantly influenced by traffic densities

The traffic density does have a significant effect on the acceptability of the concept and the subjective safety. Especially the triple density causes the pilot to express that ATC would be safer here (29%). This pilot opinion is similar to the often-heard statement: "When it gets really busy, ATC should take over again." The pilots were not aware that the densities they were flying in were already beyond the densities ATC can currently handle (see also chapters 11 and 13).

Overall even in the triple density a large majority of the pilot state that Free Flight is just as safe as ATC or safer (71% for triple, 85% for all densities).

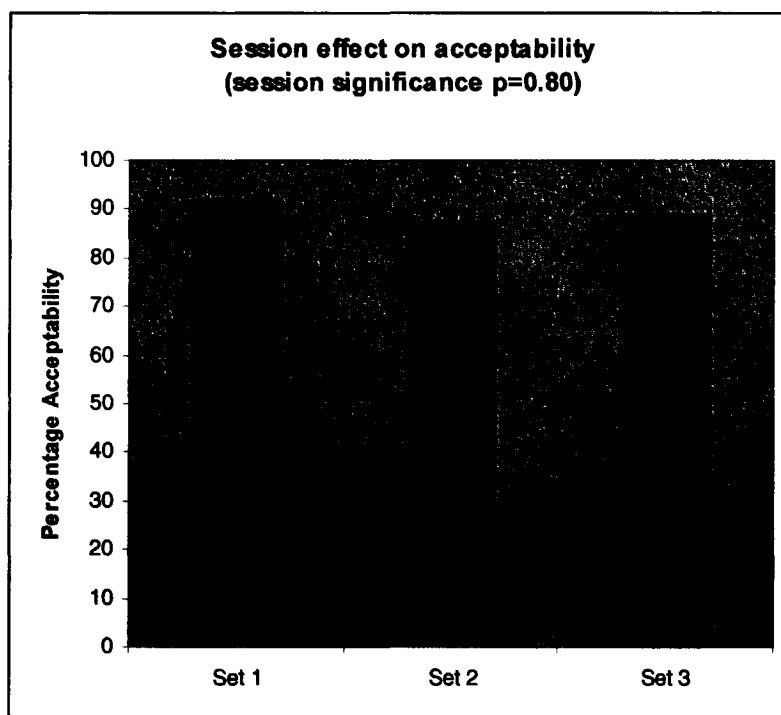

figure 10.10 Session number does not significantly influence the acceptability rating (Set 1 = Day 1 PM, Set 2 = Day 2 AM, Set 3 = Day 2 PM)

In figure 10.10 it can be seen that just as in the workload ratings the session number does not significantly influence the acceptability. It can also be noted that the null hypothesis that states that the ratings are completely equal does not reach significance either. This means it remains inconclusive whether there is an effect of session on the acceptability. From conversations with the subjects it became clear there was a clear effect of the exposure to the new task on the acceptability. However, this effect occurred mainly during the initial training runs. Unfortunately no data was gathered on the initial acceptability before and after the briefing and training runs.

10.6.4 *Effect of events in non-nominal runs*

What effect do non-nominal situations have on the workload ratings? If the nominal workload is low, the concept could still be refuted for high workload reasons if the events too quickly lead to a high workload. Averaging the nominal and non-nominal workload ratings yields the following results:

	Nominal	Non-nominal
Average	32.7	37.1
Deviation σ	21.6	23.0
Size N	142	140
Confidence range	3.6	3.8

Table 10.6 Workload ratings frequency for events

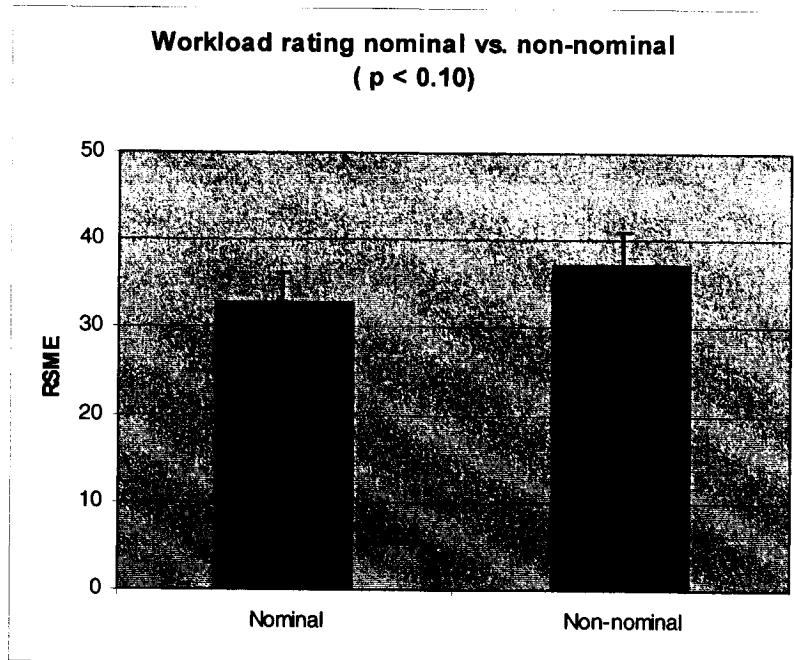

figure 10.11 Overall effect of events on workload ratings only reaches 90% probability in significance test

These data show a minor non-significant increase in workload due to the events introduced in the non-nominal runs. Considering the severity of the events, this is a significant result. Apparently the events do not cause problems that result in a significant workload increase.

The effect of the non-nominal runs with the events did not cause workload problems as seen in the previous section. Using the subjective safety ratings one can verify whether the events caused the pilots to feel less safe. The following table and figure show the result:

	Nominal	Events
ATC safer	21	40
Neutral	73	58
FF safer	48	42
Total	142	140

Table 10.7 Effect of events on subjective safety ratings

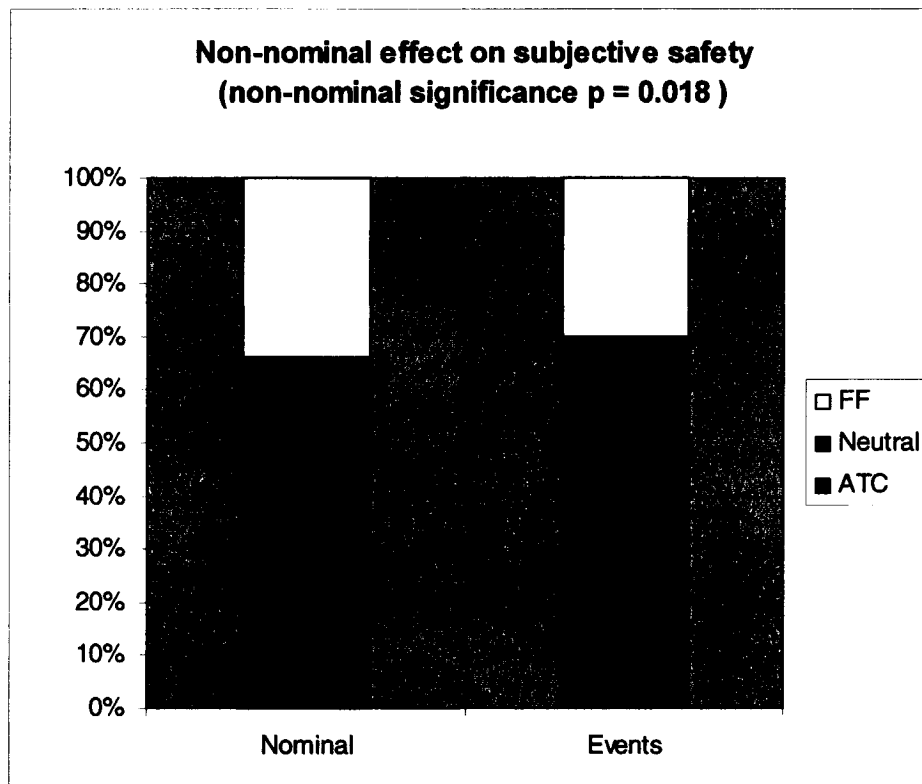

figure 10.12 Effect of events on subjective safety ratings is significant

In the figure it can also be seen that the effect of the events on the subjective safety ratings is highly significant ($p = 0.018$). This means that even though the workload ratings did not show an effect of the events, they certainly felt less safe.

10.6.5 *Autopilot mode preference*

To find an answer to the other research question, concerning a preference for an extra autopilot mode, the acceptability ratings could help. See the table below and figure 10.13.

	Manual	Combined	separately
No accept	6	5	5
Accept	42	41	41
Total	48	46	46

Table 10.8 Effect of autopilot mode on acceptability

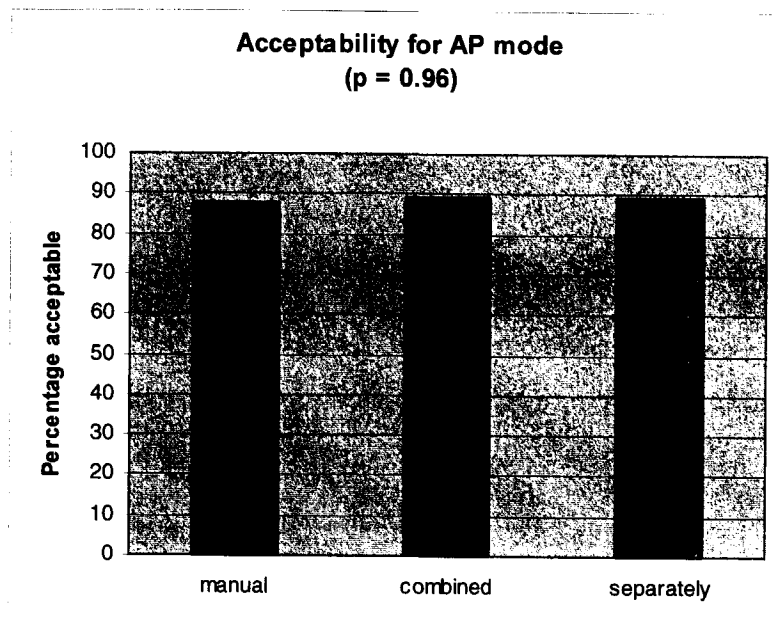

figure 10.13 Acceptability as function of autopilot mode: no clear preference

Looking at the outcome of the chi-squared test, the null hypothesis reaches significance, meaning the acceptability does not seem to be influenced by the way the autopilot is used for conflict resolution. Similarly the workload ratings do not show an effect of autopilot mode. So it can be concluded that it is likely that there is no clear preference for one autopilot mode.

10.6.6 *Conflict Resolution effectiveness*

There are several ways to look at the effectiveness of conflict resolution actions. Three types of results are presented in this section:

- Result of questionnaires
- Conflict times
- Intrusions

The main effect that will be studied is the effect of traffic density. Since the workload and acceptability do not show a significant effect of sessions, it is assumed that the traffic density is most likely to have an effect on these measures. Traffic density has been balanced in the experiment matrix to counter order effects.

The post-run questionnaire contained the following questions related to this issue:

True or false:

- I think I could safely guarantee the airborne separation with the set-up just flown.
- I need more information about the traffic situation to guarantee the safety
- I need better information about the traffic situation to guarantee the safety.

The first question seems to address the subjective effectiveness best and is used in the following figure and table looking at the effect of traffic density.

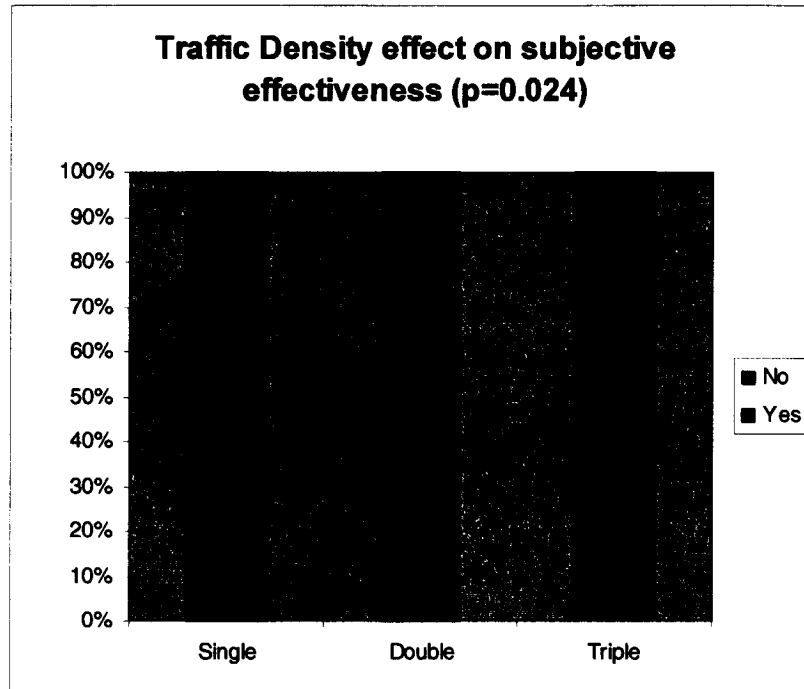

figure 10.14 Traffic density has a significant effect on the subjective effectiveness ratings

The traffic density has a significant effect on the subjective effectiveness ratings. This is in line with the results of the subjective safety question. For this figure also the non-nominal runs have been included to get a significant effect. When only the nominal ratings were used, the density effect only reached 90% significance. Since the figure is therefore made up of 50% non-nominal runs, the result is biased towards non-nominal situations such as failures. Even in the single density in 9% of the cases pilots did not feel they could perform the task effectively. This can mean two things: the pilots have to get used to it or something needs to be done to fix this. As will be seen in chapter 11, the predictive ASAS system will boost these ratings: 100% for two of the three ATM concepts for all densities.

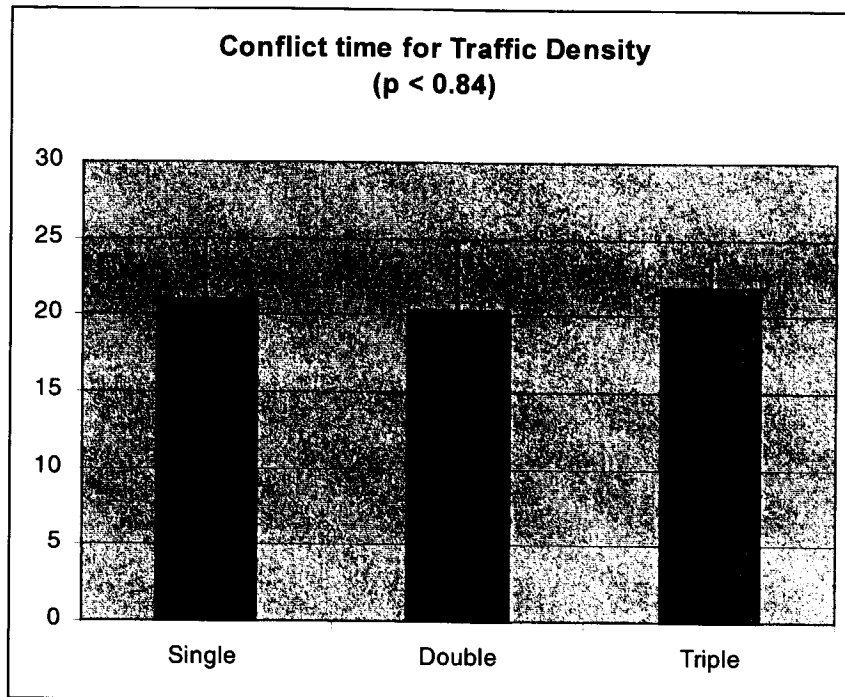

figure 10.15 Traffic Density does not seem to have a significant effect on the conflict time

The conflict times are the times that a conflict alert was present. Extremely short conflict times were taken out, since these represent predicted scrapings that do not require any action from the crews. (After the phase I trials a filter was added to the ASAS to prevent these nuisance alerts.) This means figure 10.15 basically shows the sum of the reaction time and manoeuvre time. Because (nominal, vertical) resolution manoeuvres only take a few seconds (in the order of 3 to 5 seconds) as a result of the low magnitude of the manoeuvres, the times are mainly made up of the reaction time. There is no significant effect of traffic density on the recorded conflict times. The high p-value suggests the opposite: that the reaction time might be independent of traffic density. The overall average conflict time in nominal runs was 21 seconds with a confidence interval of 2 seconds. The standard deviation was 9 seconds.

In the objective data the intrusions were recorded. Initially 12 intrusions were found! The following table lists all the intrusions of the protected zone, that were not initiated on purpose as part of the experiment. The run (called session in the table) name indicates crew (first number), run number and condition:

M=Manual Mode	S=Single Density	N=Nominal conditions
E=Execute combined	D=Double Density	NN=Non Nominal conditions
A=Execute separately	T=Triple density	

Session	min. sep. distance (nm)	min. sep. altitude (ft.)	intrusion duration (s)
107 ETN	4.29	815	18
309 MDN	3.42	914	8
814 MTN	4.77	9.7	76

Table 10.9 Intrusions of the protected zone

One of the non-nominal conditions introduced in the scenarios was an aircraft performing a sudden emergency descent through the protected zone of the subject aircraft. Apart from these deliberate intrusions, the table above shows intrusions, which were not prescribed by the scenario. The table shows the minimum separation distance, minimum separation altitude and intrusion duration. As can be seen, the intrusions are mainly grazes of the protected zone, either vertically (intrusion < 100 ft) or horizontally (intrusion < 0.8 nm)

These grazes occurred in cases of sudden manoeuvres of aircraft already close to the subject aircraft, either due to reaching top of descent of the other aircraft or lateral manoeuvring of the other aircraft due to clear-of-conflict situations. Some grazes occurred in non-nominal conditions (NN) where own conflict detection and/or resolution was failed. These intrusions have been marked red.

Note that if all intrusions of crew 7 are neglected and all intrusions in non-nominal conditions (NN) are neglected, only three grazes of the protected zone remain. Taking out the crew 7 intrusions is considered reasonable, as this crew was not properly trained due to late arrival of the crew. These intrusions have been marked in purple.

A comment from pilots was that they lacked the information to prevent short-term conflicts, which can even lead to intrusions. The traffic information on the navigation display alone was apparently not sufficient. These comments led to the development of the predictive ASAS system.

10.6.7 *Display clutter by traffic symbols*

A lot of pilots complained about the display clutter in the debriefing, so this clearly is an issue. This issue has not been addressed separately in the post-run questionnaire, so the effect of traffic density can not be studied. It was also observed that the pilots decreased the range setting of the navigation display when the traffic density increased. During

single density the selected range was mostly 120 nm. During triple density the range setting was mostly 60 nm. No intermediate setting of 90 nm (close to the ADS-B range) was available. They apparently used the range setting to de-clutter the navigation display when a lot of traffic was shown. Automatically removing less relevant aircraft symbols will likely decrease traffic awareness. Removing other items such as the labels of less relevant traffic might be a better solution to reduce clutter. The phase II trials were used to further study the clutter problem by asking for the importance of different features of the display.

10.6.8 *Analyses of Resolution Manoeuvres*

Heading, speed, altitude and combinations thereof were used to resolve conflicts. The percentages for the frequency of each parameter as a function of the three different modes across all sessions, are shown in figure 10.16. The exact results are shown in the table and figure below as percentages.

	Manual	Execute combined	Execute separately
Heading	57.9	72.0	83.0
Speed	15.4	47.5	57.9
Altitude	41.4	75.9	28.8

Table 10.10 Percentages of the use of each parameter to resolve conflicts as a function of the three different modes.

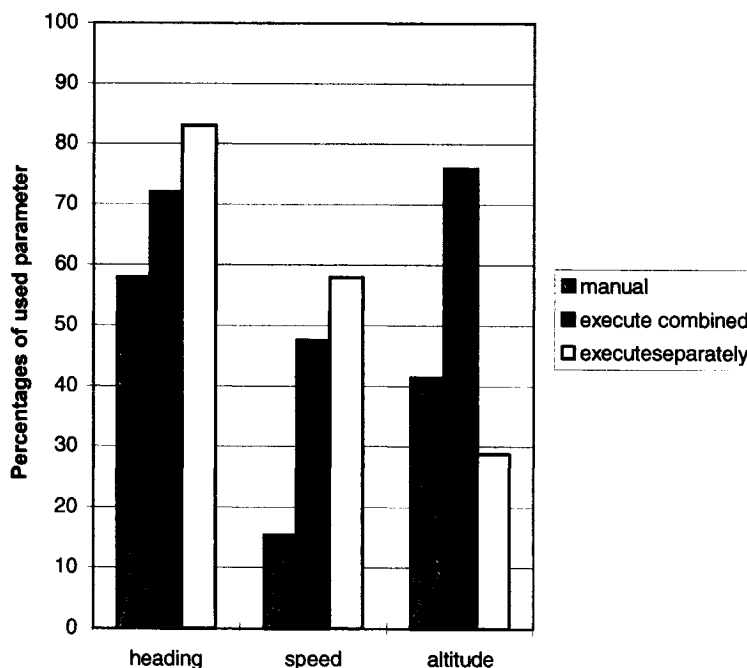

figure 10.16 Percentages of the use of each parameter to resolve conflicts as a function of the three different modes

There is a striking high amount of heading manoeuvres. Heading manoeuvres are the least cost-effective and slowest manoeuvres to solve a conflict. Apparently the pilots

were focusing on the horizontal situation displayed on a display familiar to them. In the phase II trials this aspect was given more attention during training.

10.7 Miscellaneous pilot comments

A lot of pilots were sceptical about airborne separation assurance before the experiment. They commented after the experiment that the simulator experience with airborne separation assurance changed their opinion. The main reason for their scepticism was that they had overestimated both the conflict rate and the magnitude of the resolution manoeuvres that would be required.

The overestimated conflict rate (and traffic density) is also illustrated by the reaction of the first crew. After two days of being exposed to three times the Western European traffic density and a nine times higher conflict rate, they commented: "It is a nice system, but we can't help wondering what would happen if it got busy." The pilots were not briefed on how the traffic density and conflict rate compared to today's situation. Since pilots do not regularly get a view of a radarscope with the traffic around them, they did not realise they were already flying in a very busy scenario.

One pilot was extremely sceptical towards airborne separation assurance. He was married to an air traffic controller and he was absolutely convinced it would be impossible to let pilots play the role of their own controller. After the first day of flights he was surprised about the low workload but not completely convinced. At the end of the second day he commented it had completely changed his opinion about the feasibility of airborne separation assurance.

A comment of the subject pilots was that they were lacking knowledge about the intentions of aircraft that were climbing below them (typical behaviour of the problem aircraft in the scenarios). This could even lead to intrusions. The crews often called these aircraft over the radio to verify the intended flight level. The traffic information on the navigation display alone apparently was not sufficient. Displaying the selected altitude would greatly enhance the situational awareness and reduce voice radio communications. Chapter 5 describes the additional system called predictive ASAS or PASAS that solves this problem in a different way and enables avoiding short-term conflicts and the resulting intrusions.

With this additional system in demo runs in the NLR research flight simulator I have regularly flown in a scenario referred to as 'extreme'. This scenario simulates traffic densities up to ten times the 1997 Western European traffic density. In these demo runs I controlled the aircraft, and was able to avoid conflicts while also explaining the set-up to the guests. Even though this run was not part of the experiments, it makes it hard to accept that a two-man crew without guests would not be able to handle a much lower traffic density because of the workload.

10.8 Conclusions

From the results the most striking are the low workload ratings. In a single density run (with tripled conflict rate) the workload rating equals the rating found during earlier trials on the NLR simulator using the same scale under ATC control with R/T and a low traffic density. So moving the separation task to the cockpit did not result in an increase of measured workload! There was a significant traffic density/conflict rate effect. But

even in high traffic densities, with nine times the amount of conflicts as would result today, the rating was still low ("costing some effort"). So the workload data as found in this experiment supports the feasibility of airborne separation assurance. This is the most important result of these trials.

The acceptability is relatively high considering the relatively short amount of training and exposure to the new airborne separation task. The traffic density (and tripled conflict rate?) does decrease the acceptability.

No session effect has been found on either workload or acceptability results. So the relative short training and briefing on this new task did not lead to a high workload or lower acceptability.

The non-nominal runs with events such as failures, intruder not obeying the rules, emergency descents, slightly reduce the subjective safety ratings. In the non-nominal runs 71% instead of 85% felt just as safe or safer than under ATC.

The effectiveness of the crew in solving conflicts was high. On average the reaction time (including the manoeuvre time) was 21 seconds with a standard deviation of 9 seconds. The pilots did not always feel they could safely guarantee the separation. In the single density runs they commented they did not feel certain in 9% of the runs. This is not supported by the objective data gathered. Still, after taking out experimental anomalies three intrusions remained. These intrusions were merely intruders grazing the protected zone. Closer investigation and pilot comments lead to the conclusion that an additional system was needed to prevent sudden intrusions resulting from manoeuvring into a conflict situation. This observation led to the development of the predictive ASAS or PASAS as described in chapter 5.

The pilots occasionally complained about the display clutter in the debriefing, so this clearly is an issue. Not showing aircraft will likely decrease traffic awareness. Removing the labels of less relevant traffic might be a better solution to this issue. The phase II trials were used to further study the clutter problem by asking for the importance of different features of the display.

Another observation is the high amount of horizontal manoeuvres (heading and speed). In general the vertical manoeuvre is preferable for a number of reasons: the 1:30 altitude-diameter ratio of the protected zone, the efficiency in fuel and time. In the debriefs the pilots sometimes commented they were concerned with passenger comfort, leaving the optimum flight level or, very often, only saw the 2-dimensional picture they were used to on the horizontal navigation display. The advantage of the vertical manoeuvres were often not known and should have been stressed more during the briefings.

11 Phase II Flight Simulator Trials

11.1 Research Questions

This chapter describes the 1998 human-in-the-loop simulation experiment and discusses both subjective and objective results obtained from this experiment.

One of the questions in the hypothesis tree in the safety>human factors branch is the situational awareness of the crew. In the debrief of the phase I trials pilots commented they would appreciate more information on the intentions of the other aircraft to prevent sudden conflicts or even intrusions due to aircraft initiating a descent or climb manoeuvre. Exchanging intent information might be a solution, but further analysis showed that the main problem is a task that had not been identified before, next to conflict detection and resolution: conflict prevention.

A conflict prevention system that assists the pilots in this task, called predictive ASAS or PASAS, is described in chapter 5. The phase II trials were the first human-in-the-loop trials using the ASAS system with the PASAS conflict prevention module. The module calculates no-go zones, which are displayed on the heading, vertical speed, and speed scale to prevent initiating conflicts, which were originally not foreseen by a state-based CD&R system.

In the hypothesis tree the acceptability is linked with the transition issue. A mature Free Flight concept might work, but if there is no acceptable transition path to this end-state, this decreases the feasibility of the mature concept. The main issue with respect to this transition is the mixed equipage problem: How to cope with a situation where only a fraction of the aircraft in a sector has the Airborne Separation Assurance System? Mandatory equipage is one way to avoid this problem altogether, but mixed equipage with intrinsic benefits for equipped aircraft is, if possible, a more preferable solution with a probably higher political acceptability.

When discussing the 'Free Flight Transition Issue' in general, it can refer to two kinds of transition:

1. Transition in time, a certain period (potentially twenty years or more) in which aircraft are being equipped and the transition in time from the current ATM system with only Managed Airspace and Unmanaged Airspace to a future ATM system with Managed Airspace (MAS), Unmanaged Airspace (UAS) and Free Flight Airspace (FFAS) is taking place. This period includes the introduction of FFAS.
2. Transition in space, one aircraft transitioning from Managed Airspace (MAS) to Free Flight Airspace (FFAS) and vice versa. This transition will always be there, even when the future ATM system with FFAS is in place.

This chapter deals with the transition in time, though the transition in place is addressed by one of the procedures where the airspace is divided by altitude (see section 11.2.2)

Major research questions concerning the transition in time are:

- How to cope with a mixed equipped scenario where some aircraft are ASAS equipped and others are not?

- Will the aircraft eventually all be equipped or will some remain unequipped (e.g. general aviation)?
- How to stimulate airlines to equip their fleet other than by regulatory requirement?

Major research questions concerning the transition in space are:

- What is the role and responsibility of the ground controller and pilot?
- What will the operating procedure be to transition to/from FFAS?

The aim of the 1998 human-in-the-loop experiment was to explore the human factors issues of several solutions of the future ATM system. The transition towards Free Flight in time is reflected by the percentage of equipped aircraft in the traffic scenarios used in the experiment (25% and 75%). The transition to Free Flight Airspace was studied using different ATM operational concepts or scenarios, especially designed for this study. During the 1998 experiment, the results from the 1997 phase I simulator trials and the subsequent cost/benefit analysis (chapter 9) were taken into account as well.

The HMI that was only seen as an initial prototype during the first trials, appeared to be quite adequate. So further analysis of the different elements was deemed appropriate for the phase II trials:

- Which elements of the HMI need adjustment?

The main adjustment to the ASAS equipment was the introduction of Predictive ASAS (PASAS), a system to prevent separation violation due to sudden manoeuvres. This was also part of the research question:

- Validate predictive ASAS functionality

The main result of the cost/benefit analysis was that it shows that vertical manoeuvres are the most efficient manoeuvres to use, whereas the 1997 human-in-the-loop experiment showed a clear preference for horizontal resolution manoeuvres. This observation led to explicitly training the pilots in the 1998 human-in-the-loop experiment to use vertical resolutions if possible. So another issue was:

- Will pilots use the vertical resolution more often, if trained in this way, or do they stick to solving the conflict in the two-dimensional picture they are used to?

Measures used in the trials were workload, acceptability questionnaires, HMI questionnaires, resolution manoeuvres and debriefs (preference).

11.2 Mixed Equipage Procedure Options

11.2.1 *Transition Issue*

During the phase I trials all aircraft in the sector were equipped with an airborne separation assurance system (ASAS). This simplifies the question of assessing the feasibility. If certain airspace is labelled 'Free Flight Airspace' (FFAS, see figure 11.1) and only equipped aircraft are allowed to enter this airspace, the feasibility in cruise phase is supported by the results of the phase I trials. Denying aircraft without ASAS access to this airspace needs to be supported by strong arguments. If it is possible to allow both equipped and unequipped aircraft to share the same airspace, this is preferable because it

allows a gradual introduction of airborne separation assurance. In any situation, there will be a transition (in time) to the situation where a sufficient number of aircraft is equipped to accept excluding non-equipped aircraft. In the phase II trials this transitional situation of mixing equipped with non-equipped aircraft was one of the two topics addressed.

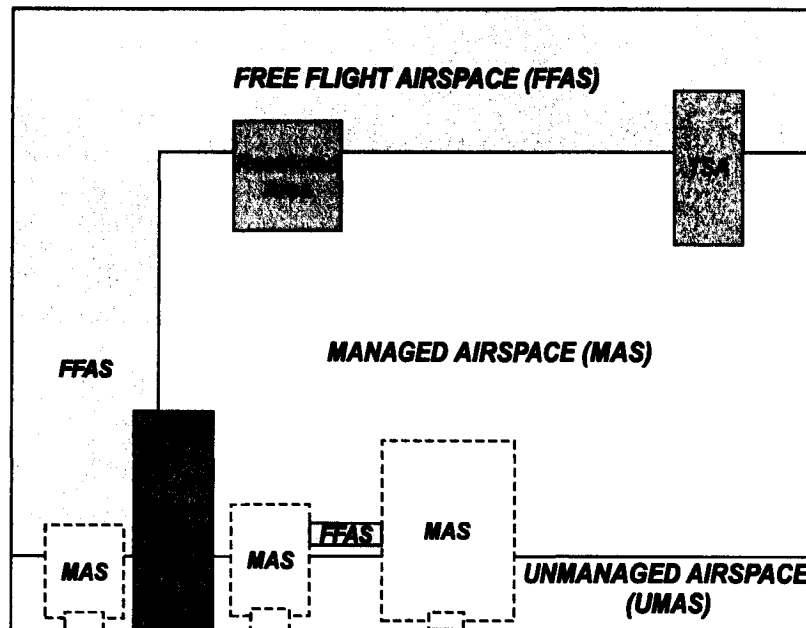

figure 11.1 EATCHIP operation concept (picture by Eurocontrol) (TSA = Temporarily Segregated Area)

In the transition phase of equipping aircraft, it should already be rewarding for an airline to equip aircraft with ASAS. If it is not economically beneficial to equip aircraft during the transition phase, there will not be a drive to equip aircraft. The procedure used to handle the mixed equipage situation should therefore provide benefits for the equipped aircraft.

The next sections will describe the three ATM procedures or concepts to handle mixed equipage that were designed for and evaluated in the phase II flight simulator trials. All three ATM concepts were designed to benefit the equipped aircraft, without excluding the unequipped aircraft.

The concepts assume the unequipped aircraft can be tracked with a certain (probably lower) accuracy on the traffic display of the equipped aircraft. The means to electronically "see" the unequipped aircraft is Traffic Information Service – Broadcast (TIS-B) rather than ADS-B. TIS-B assumes a ground station will uplink radar data of the unequipped aircraft in the same format as ADS-B does. This also means radar coverage is essential for the concepts where the equipped and unequipped aircraft share airspace.

11.2.2 Concept F: Flight Level Split

In this condition, the airspace above a certain altitude (the "Lower Free Flight level") is reserved for equipped aircraft only. A transition layer just above the Lower Free Flight level is used as a buffer zone for aircraft transitioning to and from Free Flight, see figure 11.2.

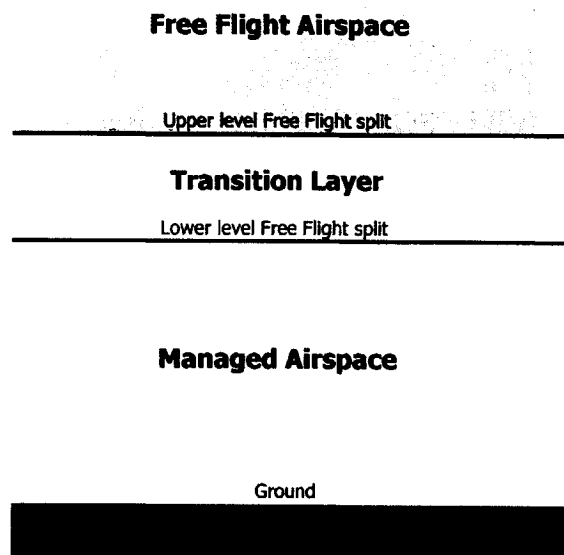

figure 11.2 Flight Level split ATM procedure

This buffer zone is used to avoid predicted conflicts and possible intrusions of protected zones between free flying and controlled aircraft, which would occur if only a single Free Flight Level were to be used. Flying high has a clear economic advantage for cruising aircraft. Another advantage of this method is that it allows a gradual transition to free flight by lowering the altitude limit, similar to the National Route Program in the US (FAA, 1992 & FAA, 1994). This gradual transition could increase the acceptability of the introduction of Free Flight.

This procedure is very different from the other mixed equipage procedures since the equipped and unequipped aircraft are separated in the vertical direction. This procedure was also included in the phase II trials to study the other transition issue: from managed airspace to unmanaged airspace and vice versa ("transition in place").

By avoiding real mixed equipage traffic, this option can be regarded as a low risk but less efficient option. It is also the only concept, which contains the transition in space. The following procedure was used for this transition:

From Managed Airspace (MAS) to Free Flight Airspace (FFAS):

- Aircrew requests to climb to Free Flight airspace below transition layer.
- Controller issues an altitude clearance, meanwhile maintaining separation and if the traffic density above and below layer allow the aircraft to enter Free Flight airspace, in the clearance the controller hands over the separation responsibility after passing the layer
- Aircrew confirms clearance
- Aircrew switches on ASAS and optionally sets parameters (lookahead time & separation minima) as specified for this Free Flight airspace (these were fixed in experiment)
- Aircrew climbs to transition layer, monitoring ASAS

- Controller also monitors aircraft while aircraft is climbing into transition layer (so both aircrew and controller are performing the separation assurance task!)
- Aircrew reports leaving managed airspace while climbing above the upper level
- Controller confirms hand-off

From Free Flight airspace (FFAS) to Managed Airspace (MAS):

- Aircrew reports position and requests permission to descend into managed airspace
- Controller issues a clearance to descend to a level below the layer ensuring the separation will be maintained when entering managed airspace
- Aircrew confirms the clearance
- Aircrew uses their ASAS to safely descend into the layer and through the layer
- Controller monitors aircraft already while in the layer and takes over responsibility for separation assurance
- Aircrew does no longer rely on ASAS when in managed airspace.

In both directions, while in the transition layer the controller not only ensures separation but also makes sure no conflict alerts will be issued in the cockpit. These procedures have been used in the flight simulator trials.

11.2.3 *Concept A: Protected Airways ATM concept*

In this concept, the airspace structure remains largely intact. Airways are still present for controlled, unequipped aircraft. The ASAS equipped aircraft, however, have the right to leave the airways for direct shortcuts to their destinations, whereas the controlled aircraft have to stay within the airways.

Free Flying aircraft have the right to cross an airway but only if they ensure conflict-free passage (as unequipped aircraft are visible on the display).

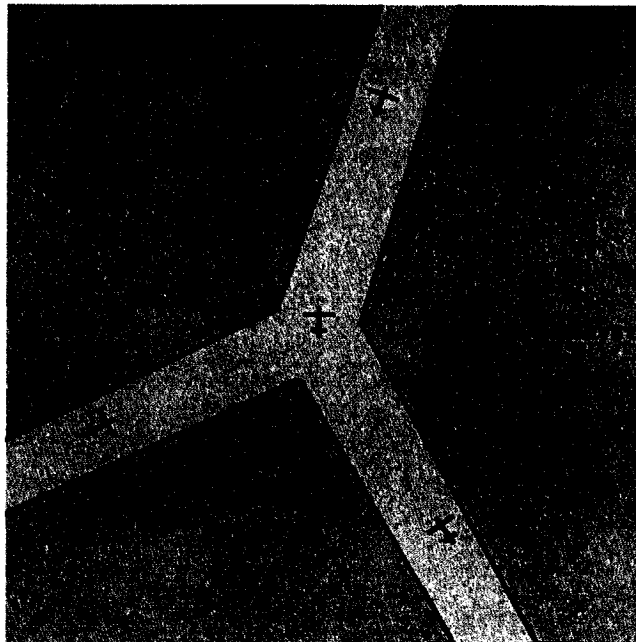

figure 11.3 Protected Airways ATM procedure

The advantage of ASAS equipage in this concept is direct routing. The magnitude of this advantage depends on the inefficiency of the conventional airway structure. This operational concept is illustrated in figure 11.3.

This option is closer to real mixed equipage and this means a slightly higher risk. It does however provide unequipped aircraft with the option of a more optimal flight profile (at least vertical). The drawback of this approach is then also that it decreases the benefits of equipage.

11.2.4 Concept M: Fully Mixed

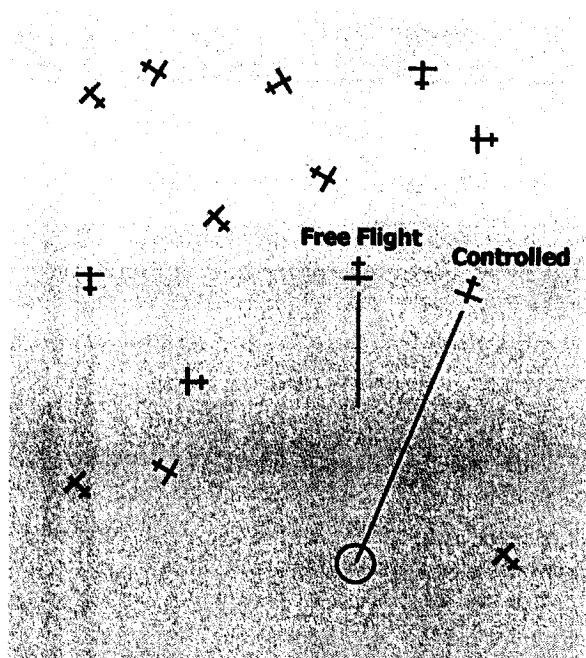

figure 11.4 Fully Mixed ATM concept: longer lookahead times for controlled flights

In this case, all aircraft are able to fly direct routing. The controlled aircraft are monitored by the ground (ATC) using the same conflict detection module as is used in the airborne ASAS. ATC performs the conflict resolution task for the unequipped aircraft. By using a substantially longer look-ahead time for the conflict probing for the unequipped aircraft, these aircraft will always avoid ASAS equipped aircraft without a need for the equipped aircraft to manoeuvre. In the experiment the ground tools used a lookahead time of 8 minutes while in the air 5 minutes lookahead time was used. If all works as intended, the equipped aircraft will never detect a conflict with an unequipped aircraft because this will be resolved before it will be in the look-ahead time of the ASAS equipped aircraft. The equipped aircraft have effectively right-of-way and will not even get a conflict alert.

This is the most beneficial concept for the unequipped aircraft and therefore provides the lowest benefits for equipage. The drawback of this approach is the high controller workload in busy areas with a low equipage ratio because of the direct routing.

11.2.5 *Other mixed equipage procedures*

The procedures described here are aimed at providing intrinsic benefits to the equipped aircraft. It is also possible to create these benefits artificially via for example ATC fees. This allows the designer of the ATM procedures to focus on other aspects like efficiency and safety without the 'benefit'-restriction as used in the ATM procedures for the phase II trials. For instance a full mixed equipage concept ("F") with right of way for the unequipped aircraft would then be an option worth considering to avoid controller workload problems.

11.3 Experimental Configuration

The configuration used for the phase II trials consists of the configuration of the phase I trials plus an ATC console. The resulting configuration is shown in figure 11.5.



figure 11.5 Experiment configuration in phase 2 trials

The architecture of the simulation configuration is shown in figure 11.6 and figure 11.7. Apart from this infrastructure several other developments were required to enable the phase 2 trials. An additional system called 'predictive ASAS' (see chapter 5) was added to the user interface. For the simulation of a mixed equipage environment the traffic manager was enhanced with several features to enable the simulation of ATC controlled traffic (equipage levels, navigation modes, conventional routes, automatic R/T generation for altitude requests, etc.).

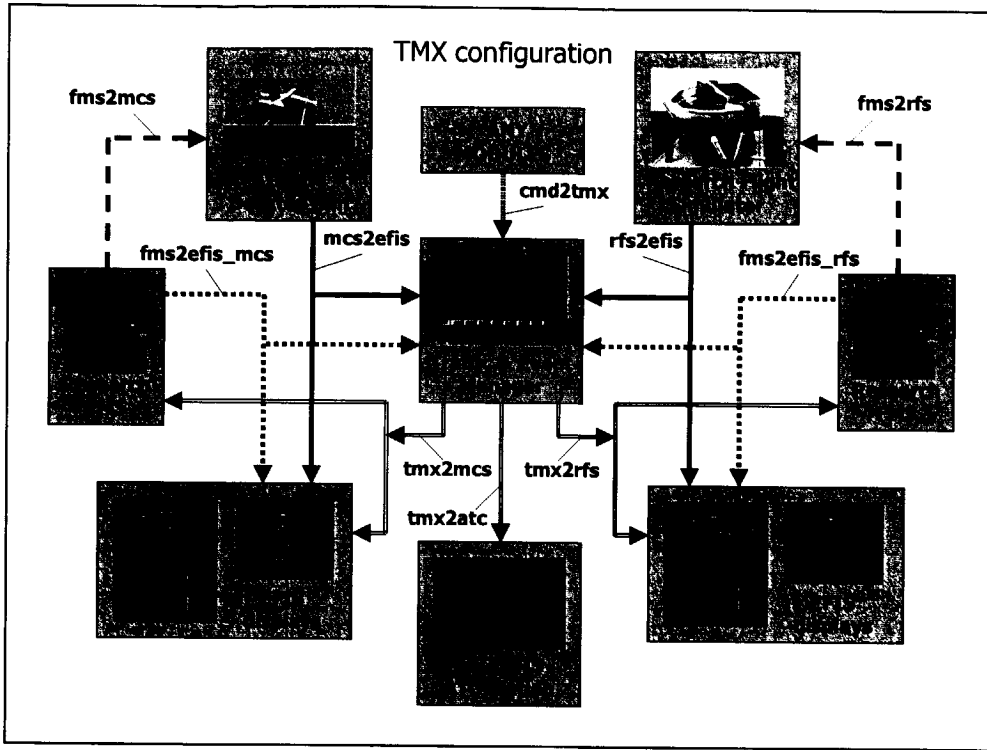

figure 11.6 Modules in simulation configuration

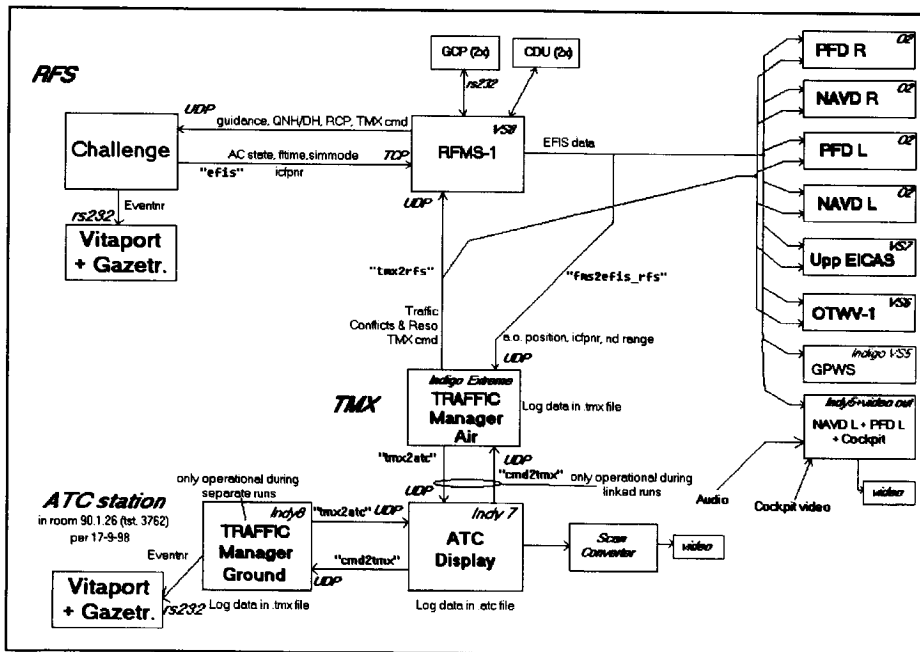

figure 11.7 Communication diagram as used in the development of the phase 2 trials

SIMULATION CONFIGURATION DIAGRAM LEGEND

RFS - Research Flight Simulator

ATCODIS – Air Traffic Controller Display

TMX – Traffic Manager (or TMX)

RFMS – Research Flight Management System (FMS simulation)

PFD – Primary Flight Display (L = Left, R= Right)

NAVD – Navigation Display (L = Left, R= Right)

EICAS – Engine Indication and Crew Alerting System

GCP – Generic Control Panel (panel with CDTI settings)

CDU – Control & Display Unit, the keyboard and screen of RFMS

OTWV – Out of the Window view (with sky, clouds and traffic)

EFIS – Electronic Flight Instrument System (Collection of PFD, ND and EICAS)

FMP - Flight Mode Panel (for autopilot and autothrottle settings)

MCS - Multi-Cockpit Simulator (generic flight simulation program)

GPWS – Ground Proximity and Warning System

Challenge – Host computer with flight simulation program

TCP, UDP, RS232 – interface types & protocols

Vitaport & Gazetracker – Physiological measurement equipment

11.4 Experimental ATC station

To investigate the mixed equipage, scenarios ground controlled aircraft were a part of the scenarios. In a part of the trials, the experiment manager would serve as ATC-er assisted by an NLR employee serving as the controlled aircraft. For another part of the trials an air traffic controller was the subject in a ground experiment. For these ground trials some runs were combined with the airborne trials. In these scenarios the research flight simulator was one of the free flying aircraft. In the case of the 'Flight Level' ATM procedure (see section 11.2.2) the hand-over from and to the Free Flight sector was performed by the air traffic controller. Apart from this situation the interaction between the subject crew in the flight simulator and the subject air traffic controller is limited. This chapter focuses on the airborne part of the experiment. For more information on the controller aspects see Hilburn & Pekela (1999).

The ground side was also included to see whether the ATM concept preferred by the airborne crew would be acceptable to the controller and vice versa. Another area of interest was the Human-Machine Interface (HMI) aspects of monitoring a Free Flight airspace. For this reason a specific HMI prototype was developed including a tool similar to the airborne ASAS to be able to separate the 'Full Mix' scenarios (see section 11.2.4). The HMI is shown in figure 11.8.

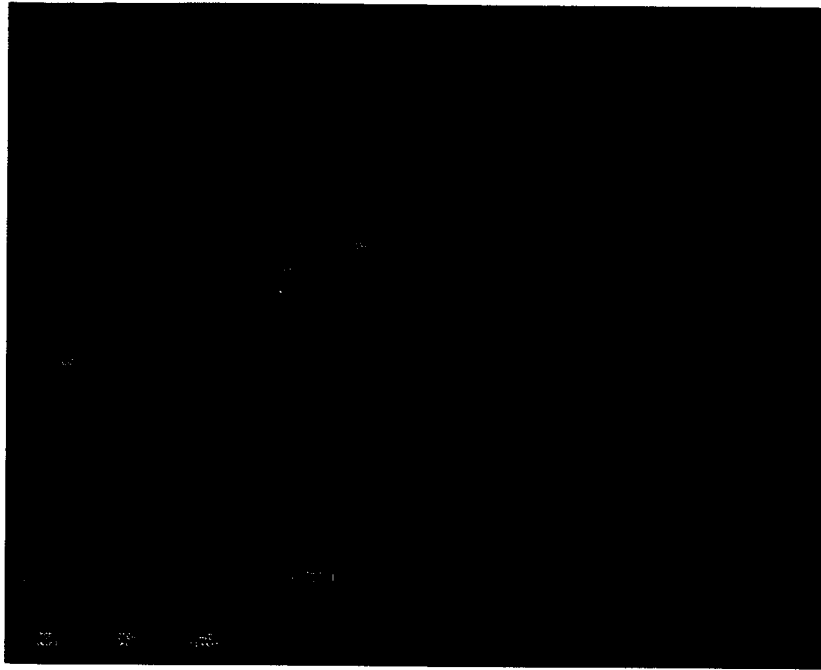

figure 11.8 Prototype controller's human machine interface

11.5 Subjects

Six subject pilots from major European airlines participated in the phase II human-in-the-loop Free Flight with Airborne Separation Assurance experiment. The subject pilot was asked to act as the captain (Pilot-Non-Flying, PNF), but to leave the control of the Mode Control Panel and the Flight Management System to the First Officer (Pilot-Flying, PF). The First Officer was a pilot hired by the NLR who was instructed to behave passively and not to influence the subject pilot. The subject pilot was instructed that the task of traffic awareness was his/hers alone.

The average subject pilot had 3500 hours flying experience, of which 2500 hours glass cockpit.

As a part of the training the pilots were instructed to use the vertical speed solution as primary conflict resolution manoeuvre, because it has shown to be the most efficient one.

Because of project constraints only a low number of simulator runs could be flown. This is the reason for the low number of participants. This also means that it is not useful to aim at gaining statistical significant data, because this will lower the range of independent variables. Instead of aiming at statistical data for only one issue, it was decided to explore all mixed equipage concepts for trends. This also means no hard conclusions are possible based on this experiment alone.

11.6 Experiment matrix

In the phase II experiment, each subject pilot was planned to fly 12 experiment runs, 4 runs with the flight level ATM procedure, 4 runs with the fully mixed ATM procedure and 4 runs with the protected airways ATM procedure. However, during the experiments with the first two subject pilots, it became clear that the high traffic density scenarios

combined with the flight level ATM procedure could not be handled by the experiment leader nor by the air traffic controller subjects. It was therefore decided after the second subject pilot to fly the remaining four subject pilots with the medium density scenario only for the flight level ATM procedure.

The high traffic density equals the medium ('double') density of the phase I trials. Initially the 'triple' density would be used but the controller subjects nor experiment leaders were able to handle this density.

Initially, the experimental scenarios used for the first two subjects were low and high density. As the low-density scenario did not cause any conflicts in the scenario, it was decided after the second subject pilot to fly the remaining 4 subject pilots with medium and high traffic densities.

Due to the changes in the experiment conditions after subject pilot 2, only the data for subject pilot 3 to 6 were considered valid for analysis. The remaining experimental matrix is therefore shown below in Table 11.1. The first character expresses the ATM procedure with "a" for protected airways (red), "f" for flight level (blue) and "m" for the mixed ATM procedure (green). The second character shows the traffic densities, "h" for high density, "m" for medium density. The numbers indicate the level of ASAS equipage, 25% and 75%. Finally the "a" is added for the "airborne" scenarios.

crew\run	1	2	3	4	5	6	7	8	9	10
3	mm75a	mh75a	mm25a	mh25a						
4							mh25a	mm25a	mm75a	mh75a
5			mh75a	mm25a	mm75a	mh25a				
6							mm25a	mh75a	mm75a	mh25a

Table 11.1 Total experiment matrix

As a consequence of the adjusted experiment matrix, the ATM procedure effect and equipage effect can only be investigated for medium traffic density, see Table 11.2. The effect of traffic density can only be investigated for the protected airways and fully mixed ATM procedure, see Table 11.3.

crew\run	1	2	3	4	5	6
3	mm75a	mm25a	fm25a	fm75a		
4			fm75a	fm25a	mm25a	mm75a
5	fm25a	fm75a	mm25a	mm75a		
6	fm75a	fm25a			mm25a	mm75a

Table 11.2 Partial experimental matrix for ATM procedure effect and equipage effect

crew\run	1	2	3	4	5	6	7	8
3	mm75a	mh75a	mm25a	mh25a				
4					mh25a	mm25a	mm75a	mh75a
5	mh75a	mm25a	mm75a	mh25a				
6					mm25a	mh75a	mm75a	mh25a

Table 11.3 Partial experimental matrix for traffic density effect

The traffic densities can not always be compared across concept and equipage rate, since procedure and equipage rate are not independent of the local traffic density. In case of protected airways for instance, a lower equipage rate corresponds to more aircraft on the protected airways and fewer in the space between. This means the density in FFAS will be different compared to for instance the 'full mix' scenario. The same is true for the flight level split concept. Density should therefore be considered as total capacity of the sector. Only on this scale there is a comparison possible.

11.7 Measures

The data recorded during the experiment was extensive. Questionnaires were used for subjective measurements. During the experiment, every subject pilot was asked to fill in the following questionnaires:

- Pilot Experience Questionnaire, once during experiment briefing
- Pilot Sleeping Questionnaire, once every day
- Run Questionnaire, once every run, giving information on:
 - Rating Scale of Mental Effort (RSME)
 - acceptability
 - true/false answers on statements
 - safety
 - conflicts and resolution manoeuvres (and why)
 - additional pilot and observer comments
- Post Trial Questionnaire, after every ATM procedure, giving information on the acceptability and criticality of the elements of the Human Machine Interface, including additional pilot and observer comments

These questionnaires can be found in Appendix C.

Apart from questionnaires, the following data were recorded during the experiment:

- intrusions of the protected zone of the subject aircraft
- Eye-Point-Of-Gaze (EPOG) data, using eye-tracking equipment

11.8 Results

11.8.1 *Subjective data*

Most subjective data are presented graphically in frequency tables. Frequency tables represent the simplest method for analysing categorical data. They are used as an exploratory procedure to review how different categories of values are distributed in the sample. Since most questionnaire results are formatted as categorical variables, these frequency tables are used to present the results.

The workload data is investigated statistically using ANOVA techniques even though the sample was small.

11.8.1.1 *Acceptability*

The bar chart in figure 11.9 shows the ATM procedure effect on the acceptability, presented as frequency table.

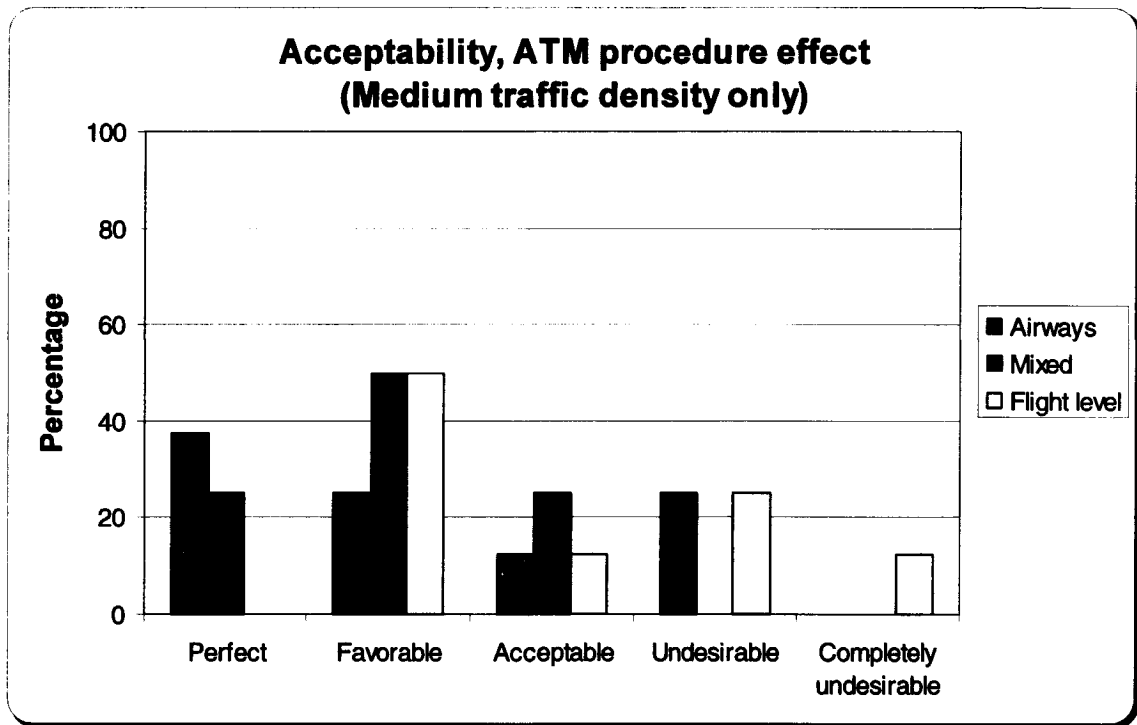

figure 11.9 ATM procedure effect on acceptability.

The bar chart in figure 11.10 shows the traffic density effect on the acceptability, presented as frequency table.

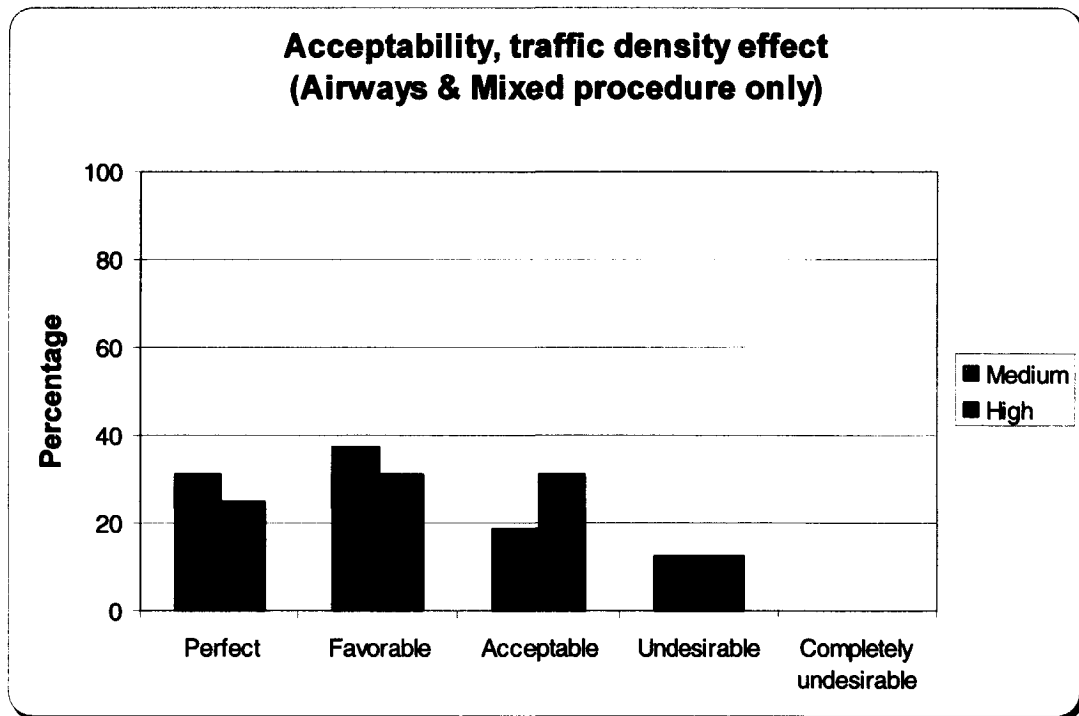

figure 11.10 Traffic density effect on acceptability

The bar chart in figure 11.11 shows the equipage effect on the acceptability, presented as frequency table.

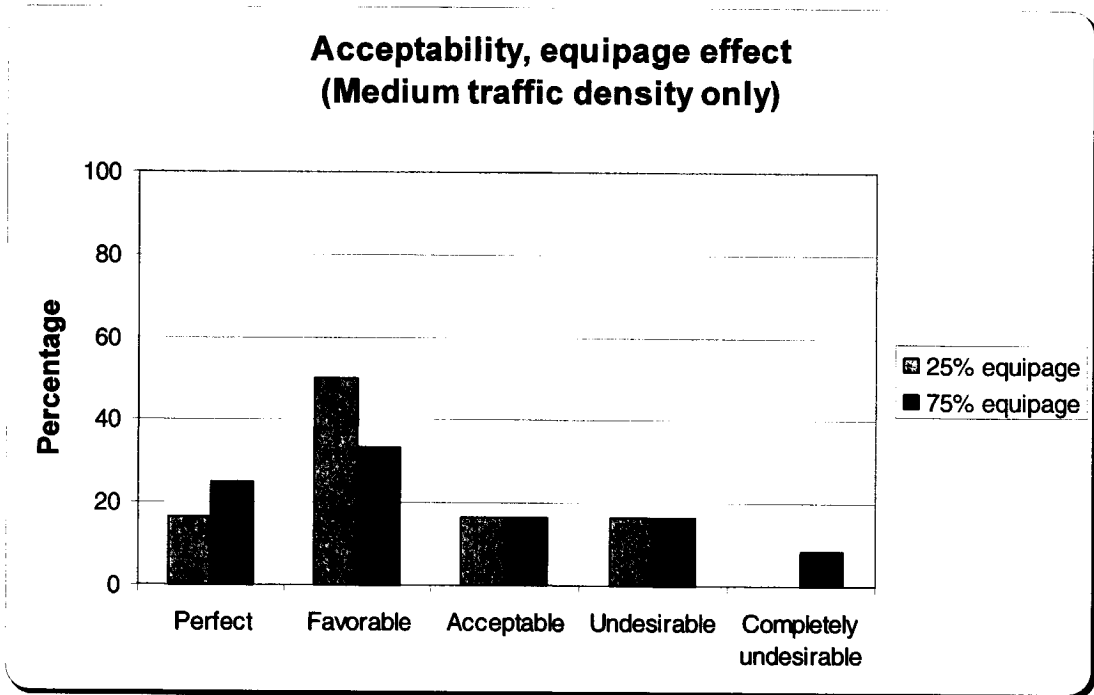

figure 11.11 Equipage effect on acceptability.

The bar charts in figure 11.12 to figure 11.14 show the ATM procedure effect, traffic density effect and equipage effect on the acceptability. These figures show the results for “acceptable or better”.

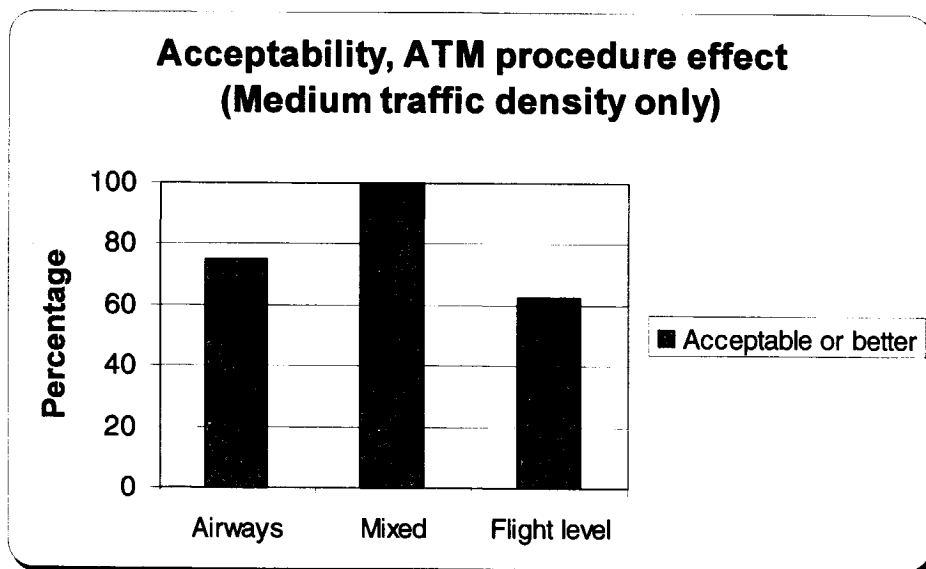

figure 11.12 ATM procedure effect on “acceptable or better” results.

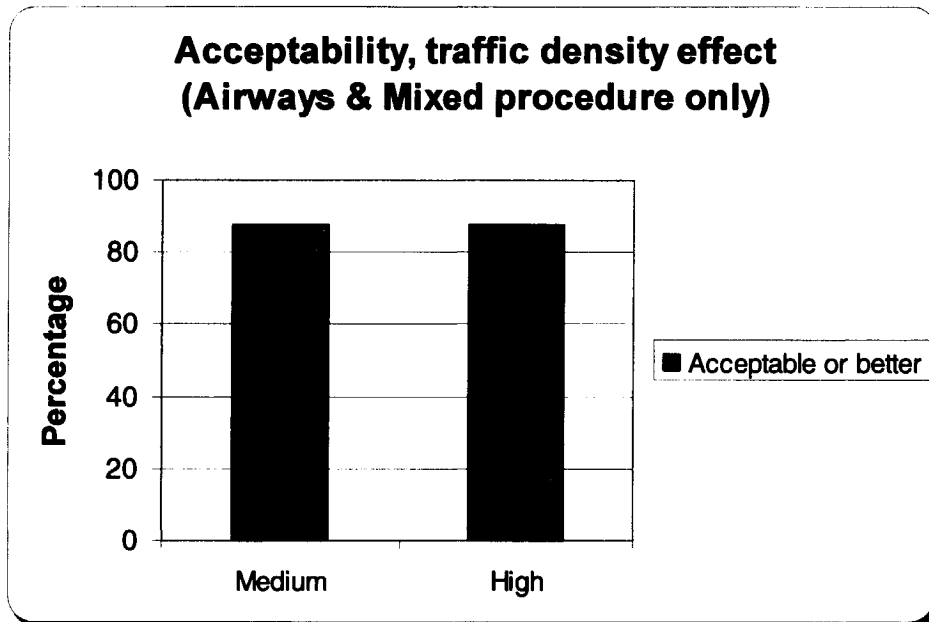

figure 11.13 Traffic density effect on "acceptable or better" results.

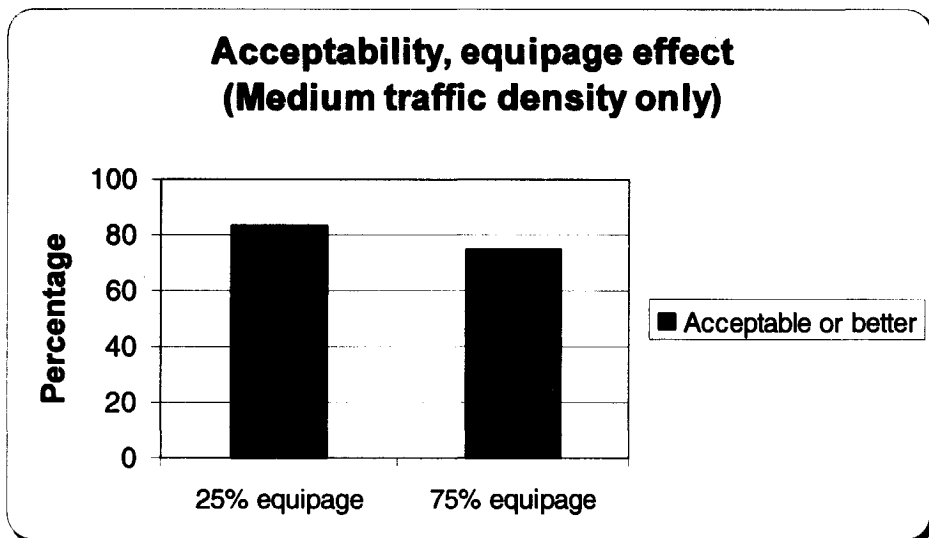

figure 11.14 Equipage effect on "acceptable or better" results.

As can be seen from these results, the ATM procedure shows an effect on the acceptability levels, indicating that the fully mixed ATM procedure is most acceptable and the flight level ATM procedure is least acceptable. The traffic density and equipage have little effect on acceptability.

11.8.1.2 True/False answers

Four True/False questions were used in the questionnaire:

- I think I could safely guarantee the airborne separation with the set-up just flown

- I manoeuvred more than normally
- I exceeded passenger comfort levels
- I flew economically

The results from the True/False questions are presented in figure 11.15 to figure 11.17, indicating the ATM procedure effect, traffic density effect and equipage effect. Shown are the frequencies of the questions answered with ‘YES’. Be aware that in question 1 and 4, ‘Yes’ is positive for the feasibility while for question 2 and 3 ‘NO’ is the positive answer for the concept.

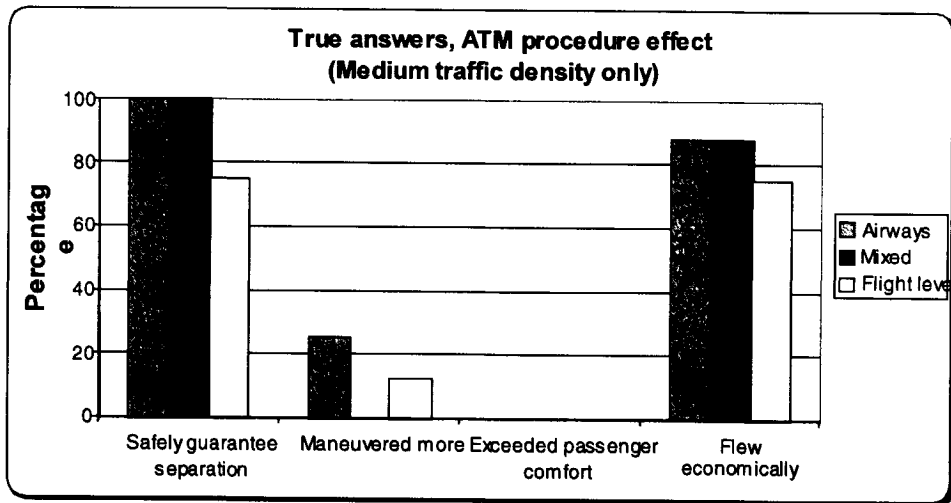

figure 11.15 ATM procedure effect on answers to True/False questions

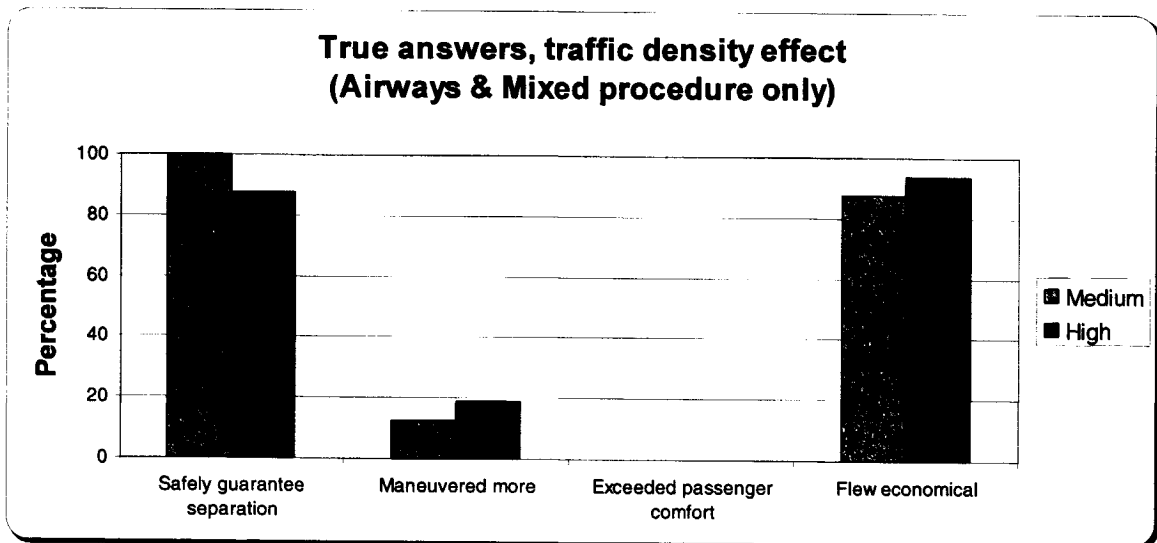

figure 11.16 Traffic density effect on answers to True/False questions

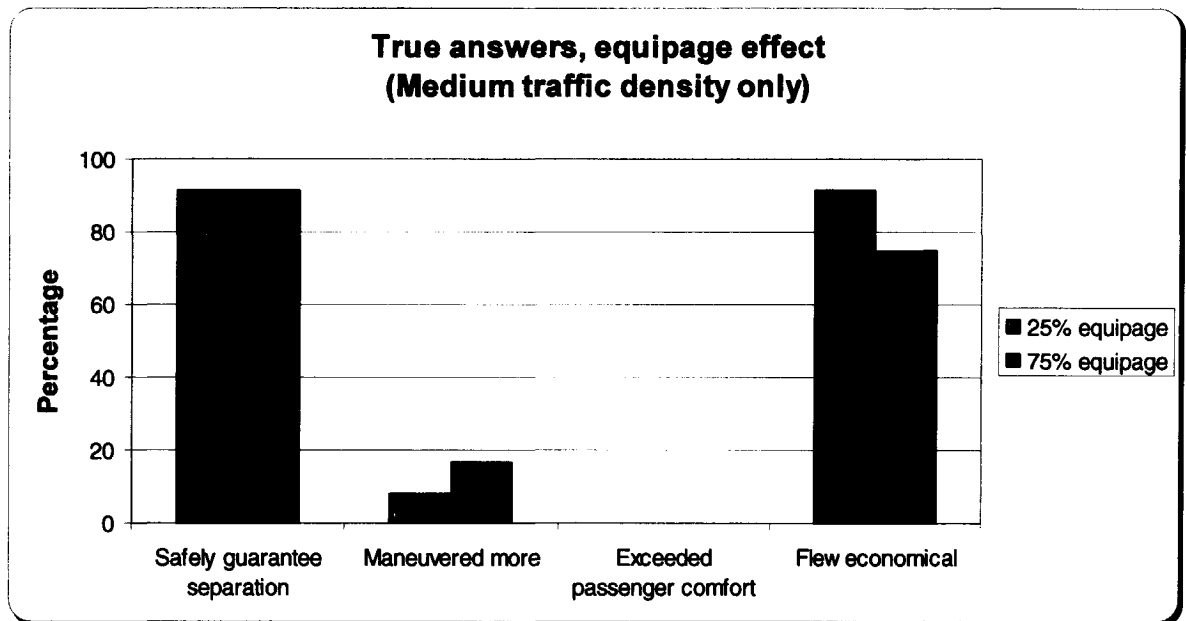

figure 11.17 Equipage effect on answers to True/False questions

It can be concluded from figure 11.15 to figure 11.17 that the ATM procedure, traffic density and equipage levels have little effect on the answers to the True/False questions. As can be seen, most pilots felt they can safely guarantee separation (>80% of responses), they did NOT manoeuvre more than normally (>90% of responses), they did NOT exceed passenger comfort levels (100% of responses), and they flew economically (>80% of responses).

11.8.1.3 Safety

The bar charts in figure 11.18 to figure 11.20 show the effect of the ATM procedure, the traffic density and equipage level on perceived safety.

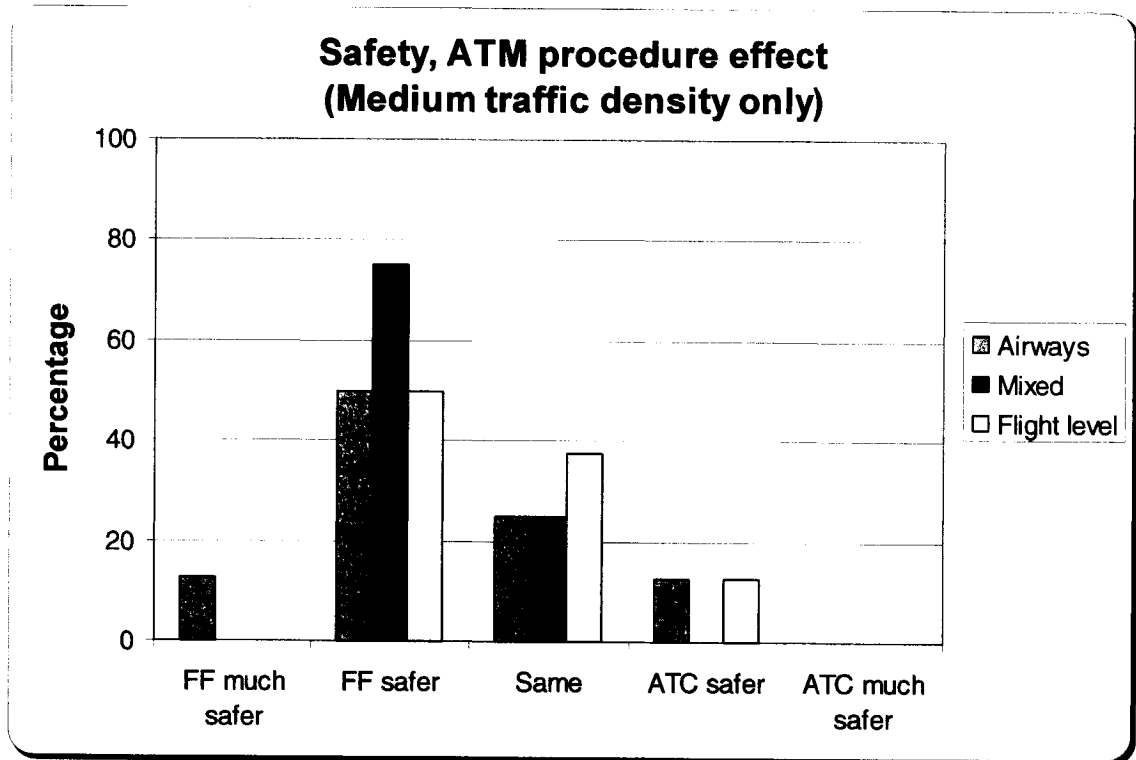

figure 11.18 ATM procedure effect on perceived safety

Safety, traffic density effect (Airways & Mixed procedure only)

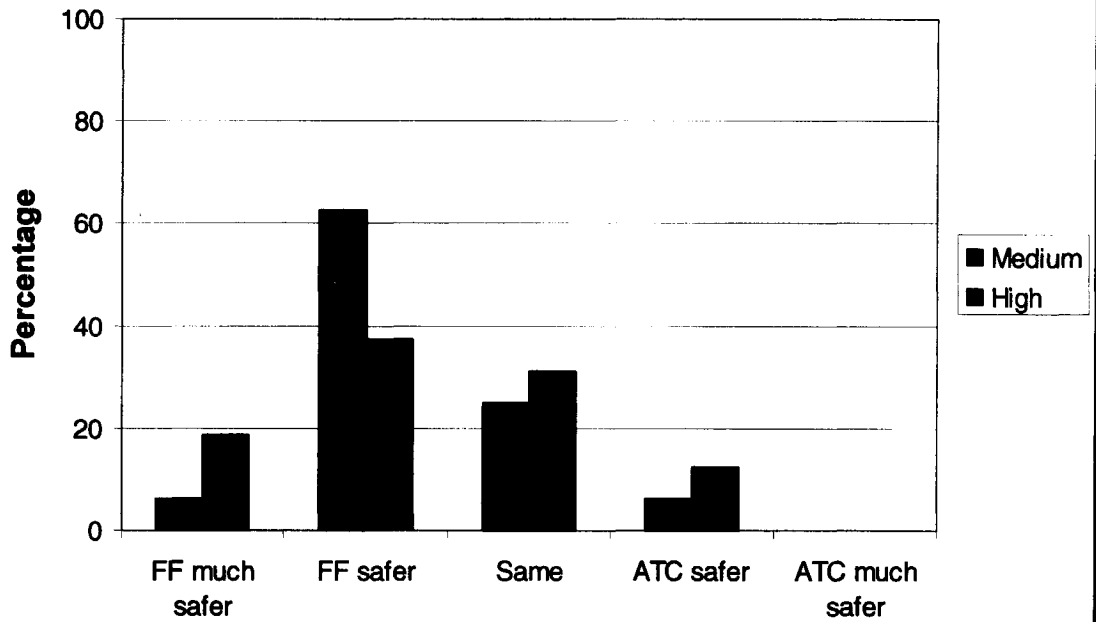

figure 11.19 Traffic density effect on perceived safety

Safety, equipage effect (Medium traffic density only)

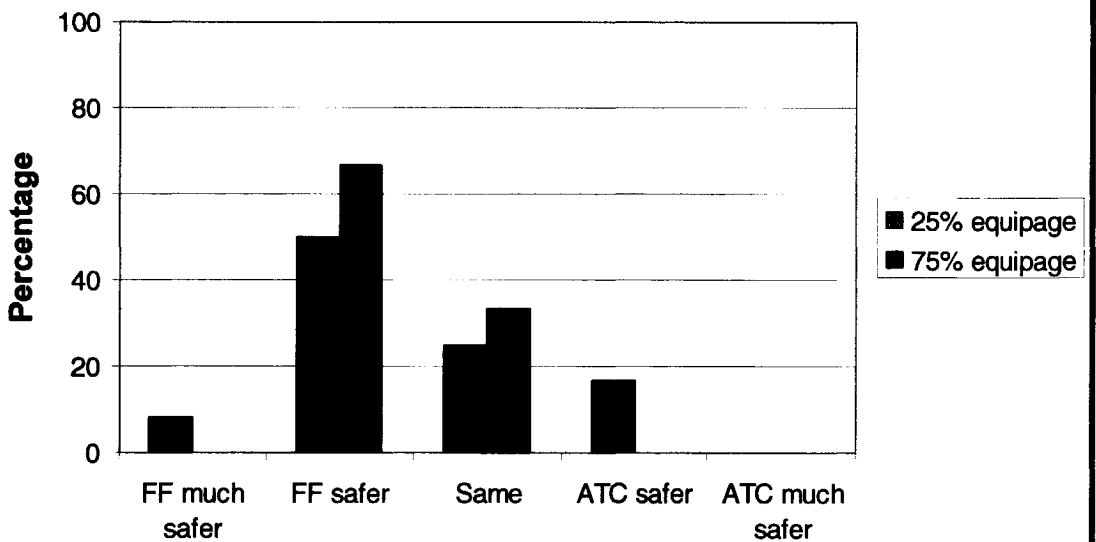

figure 11.20 Equipage level effect on perceived safety

The bar charts in figure 11.21 to figure 11.23 show the ATM procedure effect, traffic density effect and equipage effect on the perceived safety, indicating “Free Flight as safe as ATC, or better”.

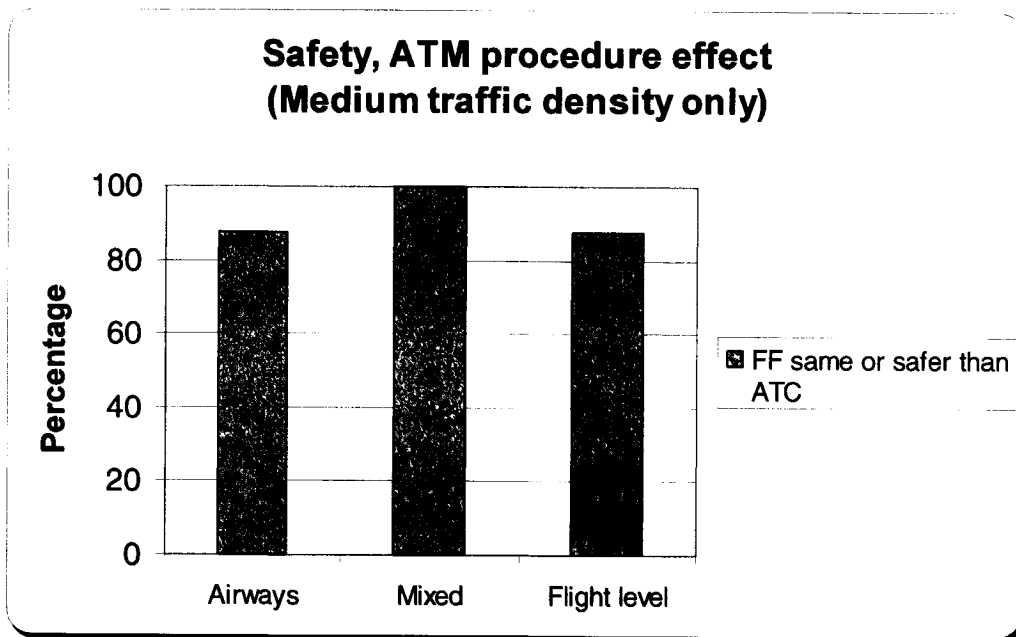

figure 11.21 ATM procedure effect on “same as ATC or better” results

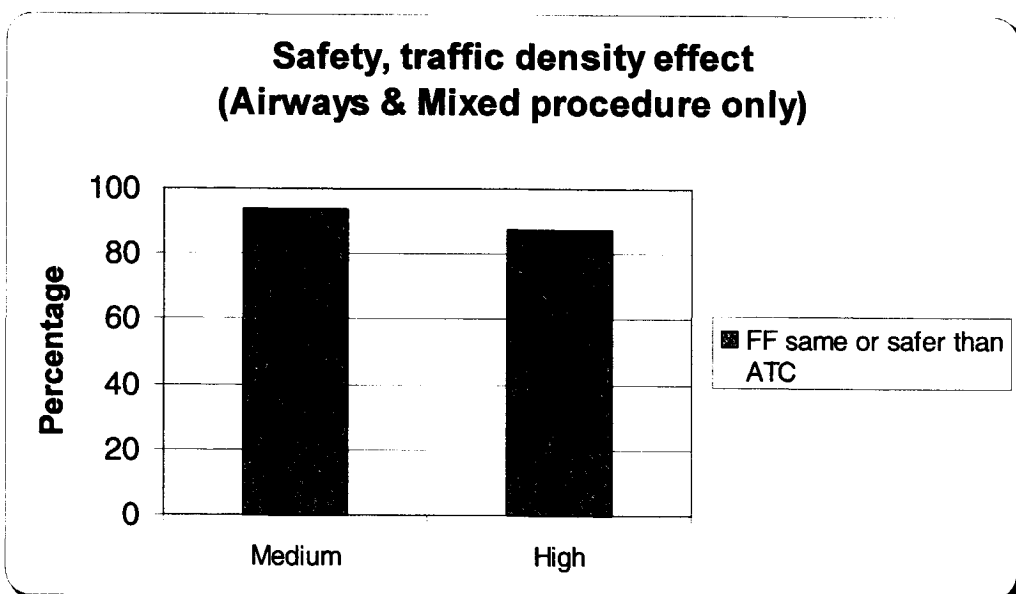

figure 11.22 Traffic density effect on “same as ATC or better” results

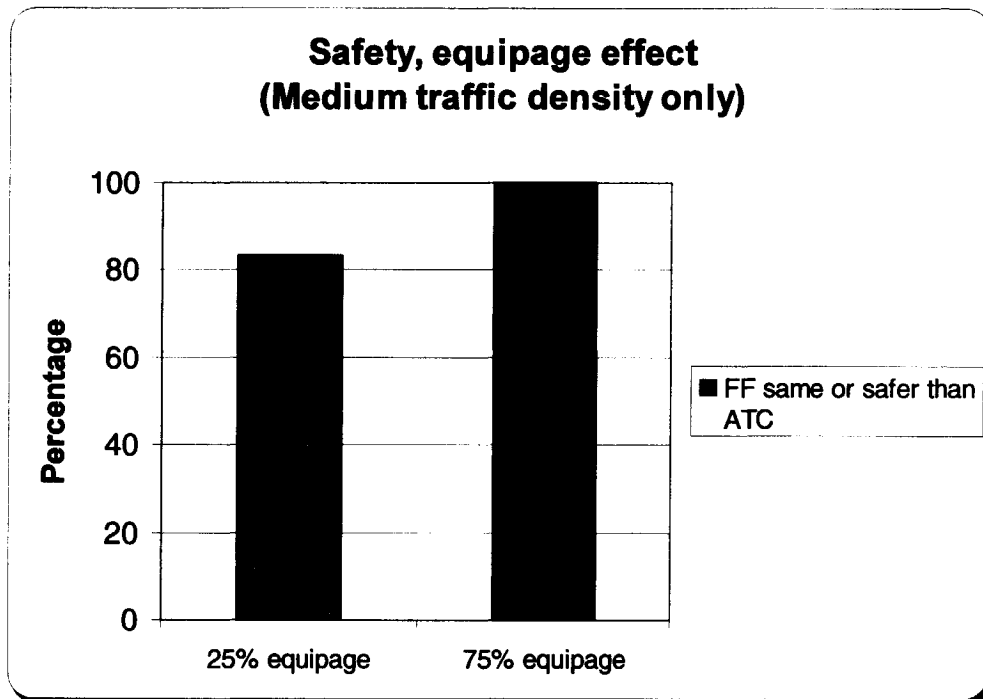

figure 11.23 Equipage effect on "same as ATC or better" results

The ATM procedure shows an effect on the perceived safety. The fully mixed ATM procedure is favoured regarding safety. Perceived safety is slightly reduced with increasing traffic density as expected, while equipage level has a clear effect on safety. Perceived safety is reduced with low equipage level. It shows that the transition towards Free Flight in time has a positive effect on the perceived safety.

11.8.1.4 Resolution manoeuvres

The bar charts in figure 11.24 to figure 11.26 show the effect of the ATM procedure, the traffic density and equipage level on the conflict resolutions.

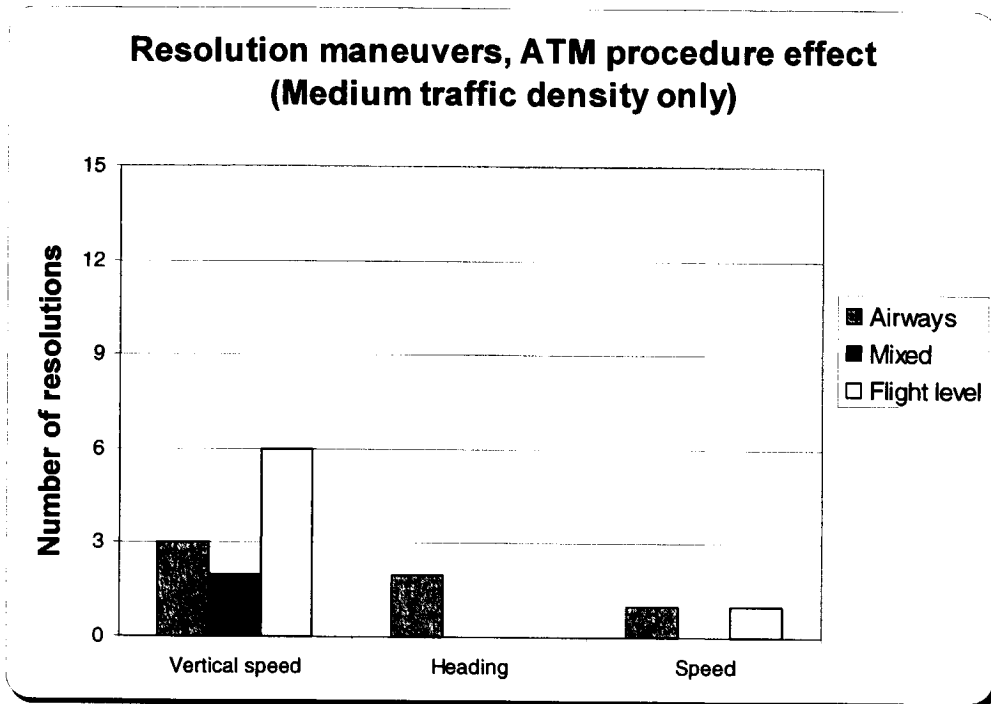

figure 11.24 ATM procedure effect on conflict resolutions

There is a noticeable difference between the total number of conflicts in the different procedures. The fact that all aircraft are flying direct apparently decreases the number of conflicts. This effect still does not cause the mixed condition to stand out in the other tables.

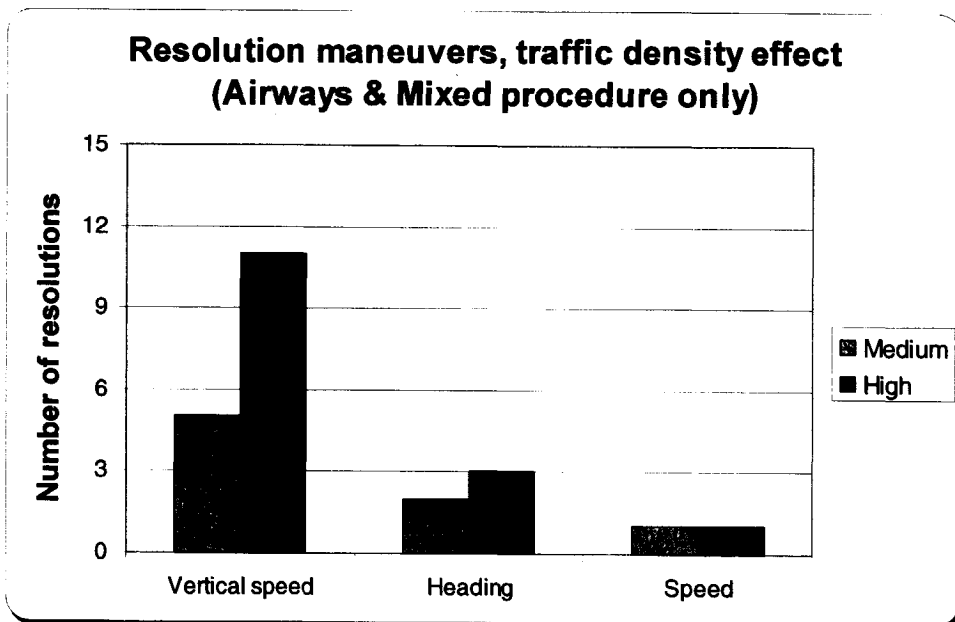

figure 11.25 Traffic density effect on conflict resolutions

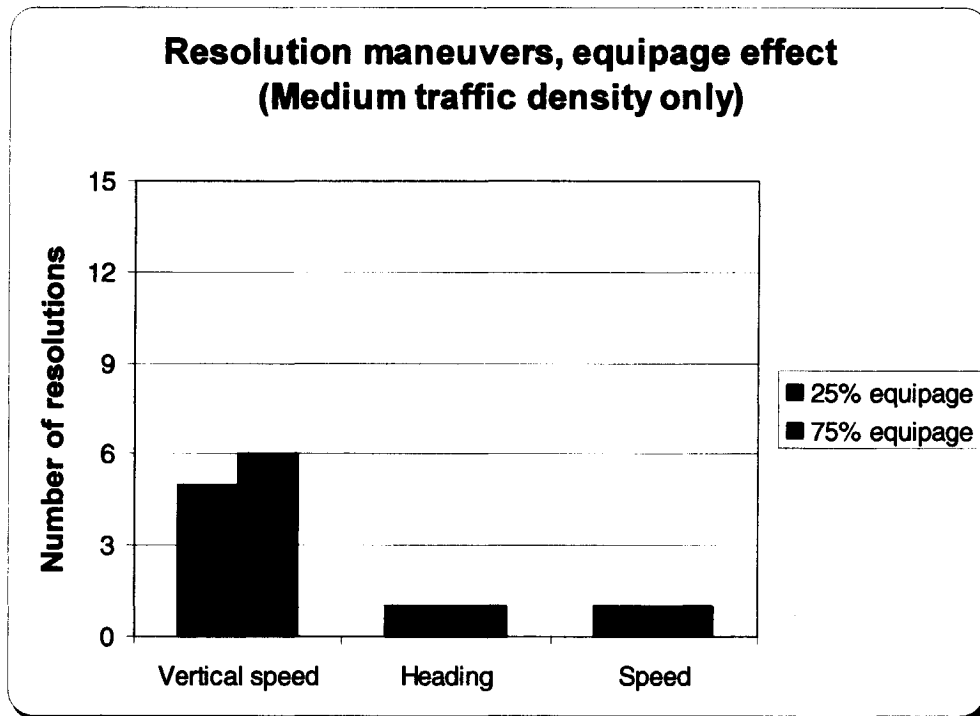

figure 11.26 Equipage effect on conflict resolutions

It can be concluded that vertical speed is the overall preferred resolution method, in contrast to the results from the 1997 Free Flight experiment where heading was the most preferred resolution manoeuvre, see figure 11.27. This can be explained by the explicit training of the subject pilots to use the vertical speed mode to resolve conflicts. The reason to train pilots this way was the economical benefit of the resolution manoeuvre over the horizontal manoeuvre, as indicated in the study described in chapter 9.

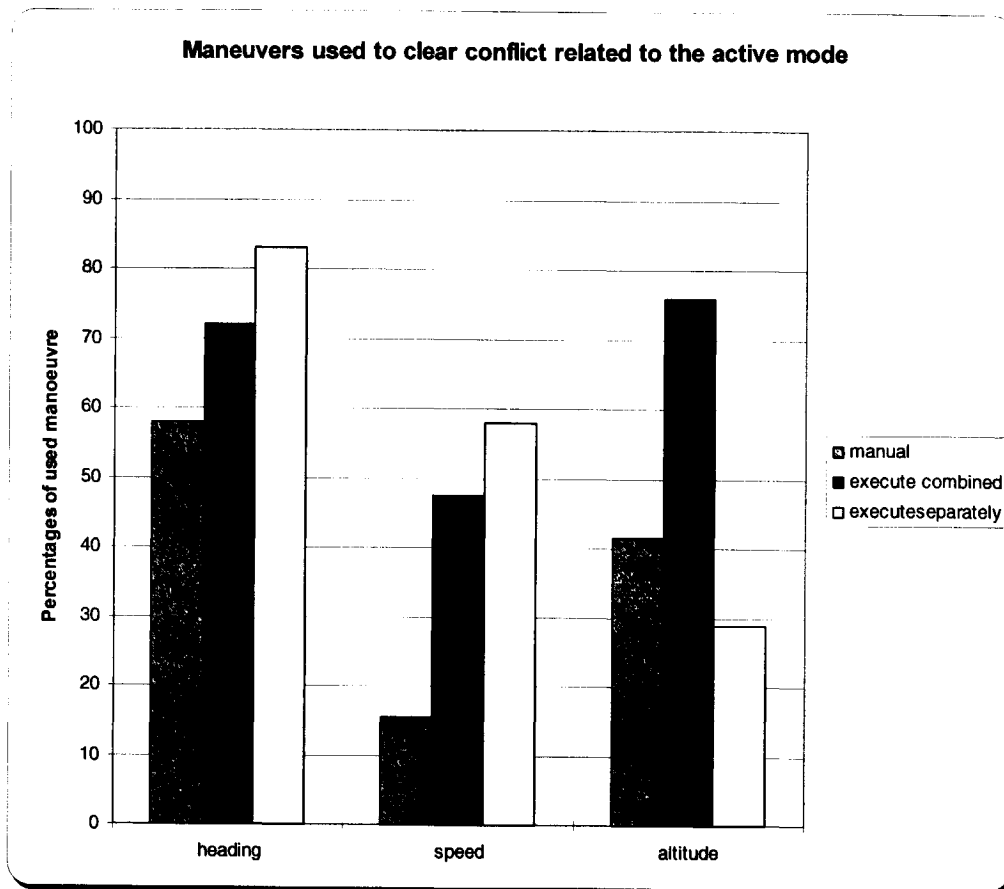

figure 11.27 Conflict resolutions from 1997 phase I experiment
(see also chapter 10 and appendix B)

As can be seen, the number of resolutions increases with traffic density as expected. The preference for vertical speed does not change. Similarly, the ATM procedure has effect on the number of conflict resolutions, but not on the vertical speed preference. As expected, the fully mixed ATM procedure results in the least conflict resolutions as the non equipped aircraft are “vectored away” from the equipped aircraft, 3 minutes prior to the moment the equipped aircraft see the conflict between equipped and non-equipped aircraft. The equipage level has little effect on the resolution manoeuvres.

11.8.1.5 Human Machine Interface (HMI)

After every ATM procedure, the subject pilots were asked to fill in a questionnaire on the Human Machine Interface acceptability and criticality (see appendix C). The results could be entered on a scale from 1 to 5:

Acceptability:

- 1 = completely unacceptable
- 2 = undesirable
- 3 = acceptable
- 4 = favourable
- 5 = perfect in every way

Criticality:

- 1 = not at all critical
- 2 = not really critical
- 3 = critical
- 4 = very critical
- 5 = extremely critical

The results are shown as a function of the ATM procedure in figure 11.28 and figure 11.29. The ATM procedure effect is shown on acceptability and criticality of the presentation of conflicts.

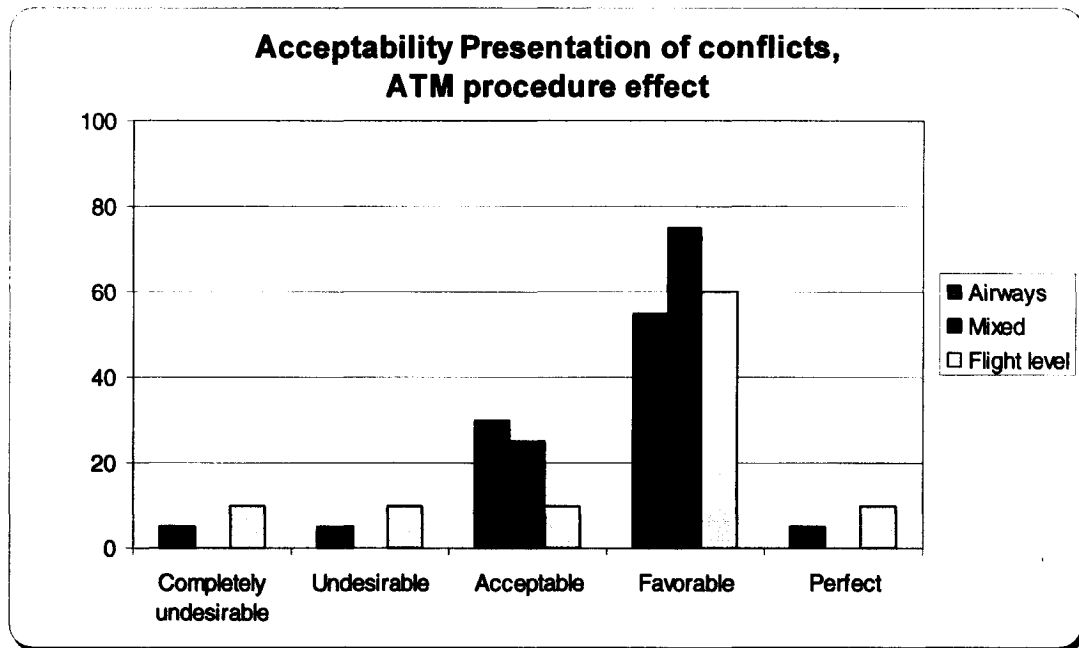

figure 11.28 ATM procedure effect on acceptability of the presentation of conflicts

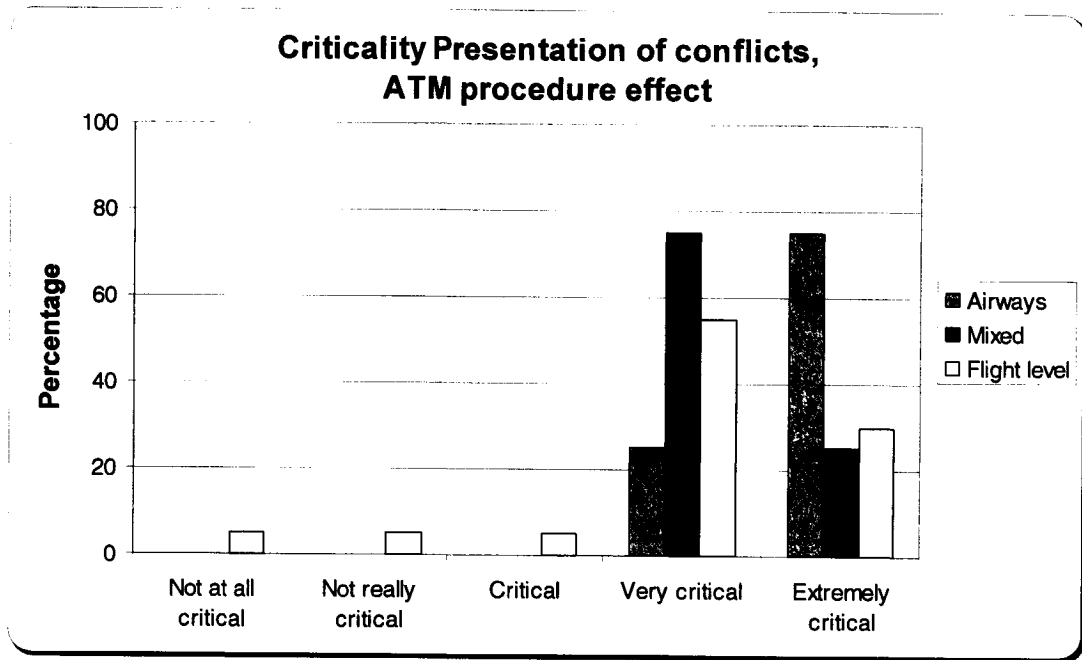

figure 11.29 ATM procedure effect on criticality of the presentation of conflicts

The HMI elements questioned were:

- Horizontal Display of Traffic
- Vertical Display of traffic
- Presentation of Conflicts
- Presentation of Resolutions
- Presentation of Predictive ASAS
- Aural Alerts
- Glare Shield Alert Light (warning/caution light for conflicts)

Based on the answers and the scale of 1 to 5 indicated to the subject pilots, relative scores can be determined of acceptable and critical HMI elements. Averaging numbers used for these categorical data is not allowed, however it is assumed to be acceptable to use the scale to derive an order. These relative scores are shown in figure 11.30 and figure 11.31.

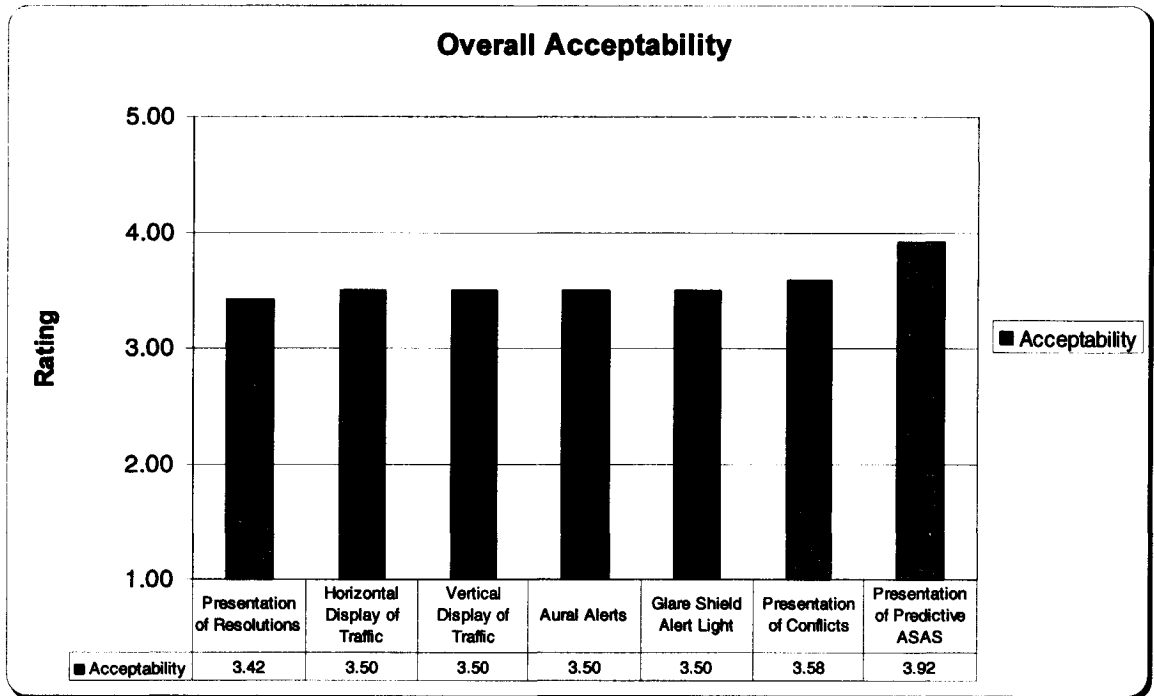

figure 11.30 Acceptability order of HMI elements

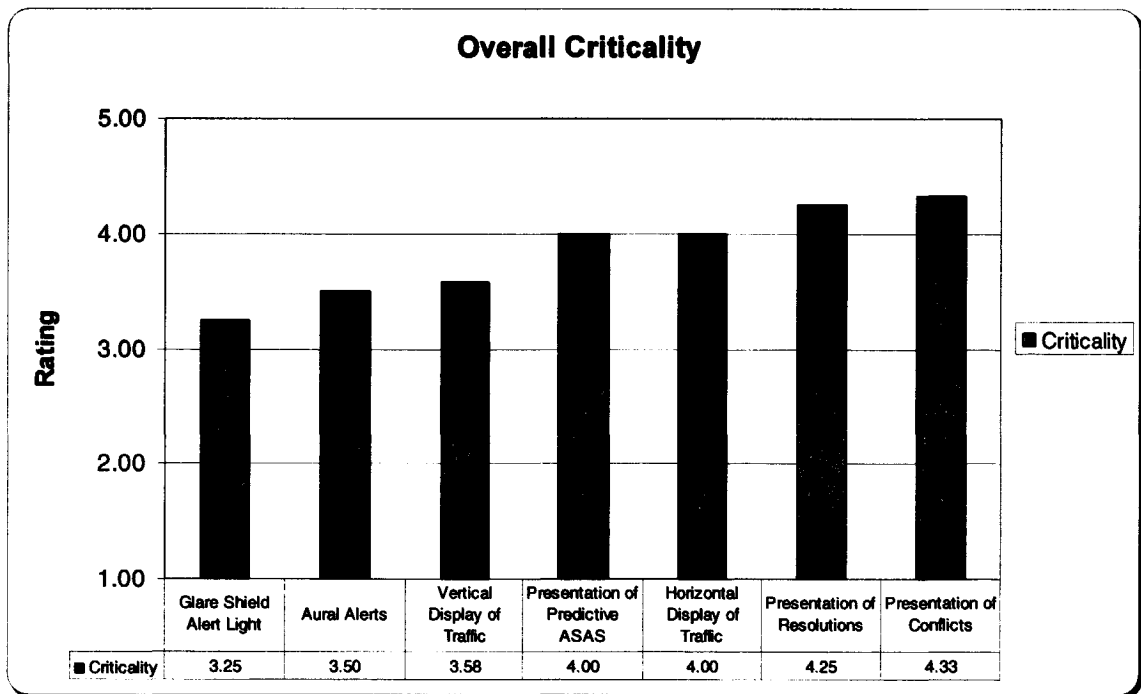

figure 11.31 Criticality order of HMI elements

These relative scores indicate that:

- Predictive ASAS is very well accepted, while very critical. Predictive ASAS presentations do not need very much further attention in future research.
- The aural alerts and glare shield alert light are the least critical, while better than acceptable. There is no need for much further attention in future research.

- The horizontal display of traffic is very critical, but just slightly better than acceptable. The horizontal display of traffic therefore needs attention in future research. Combining with the pilot comments, clutter seems to be the problem with the horizontal traffic display.
- The presentation of resolutions is least accepted, while between very and extremely critical. The presentation of resolutions clearly needs further attention.
- Although the presentation of conflicts is rated better than acceptable, it is also rated the most critical. There is no need for further change here, though it might be improved.

11.8.1.6 Workload

Workload was subjectively measured using the Rating Scale of Mental Effort (RSME), see also the questionnaires in appendix C. The RSME results are normalised to Z-scores to control for individual differences. A statistical analysis was performed analysing the variances of the different calculated means, so called ANOVA techniques, to determine possible statistical significant differences between means even though the sample size was small. Main effects and two-way interactions of the different experimental variables are presented on the workload data. The mentioned p-values represent the probability of incorrectly accepting a result as valid. Statistical significance was defined, by standard convention, as $p < 0.05$.

Due to the limited number of subjects, none of the subjective data reached significance. Trends in the data are presented, based on the data which nearly reached significance ($p < 0.10$).

Main effects are shown for traffic density (figure 11.32) and equipage level (figure 11.33) and a two-way interaction between ATC procedure and equipage is shown (figure 11.34) (all only for protected airways and mixed equipped ATC procedures).

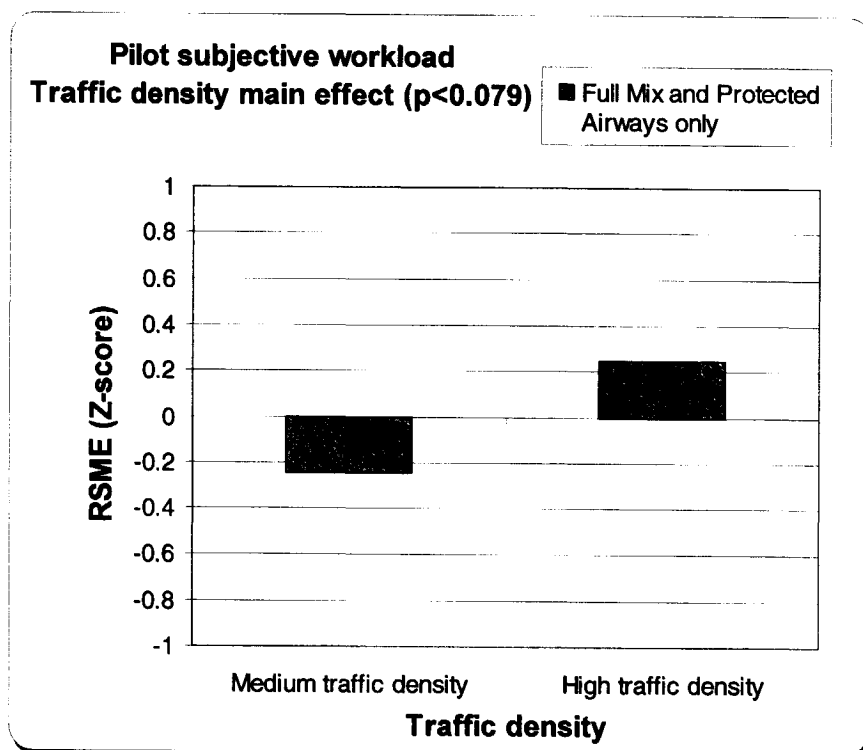

figure 11.32 Traffic density main effect on workload rating

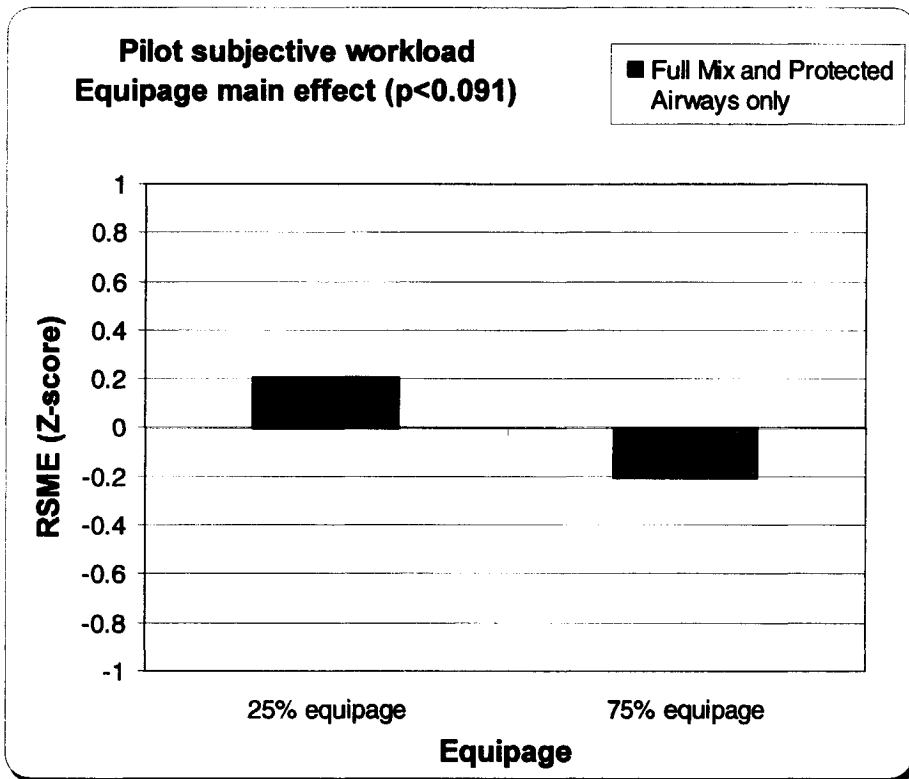

figure 11.33 Equipage main effect on workload rating

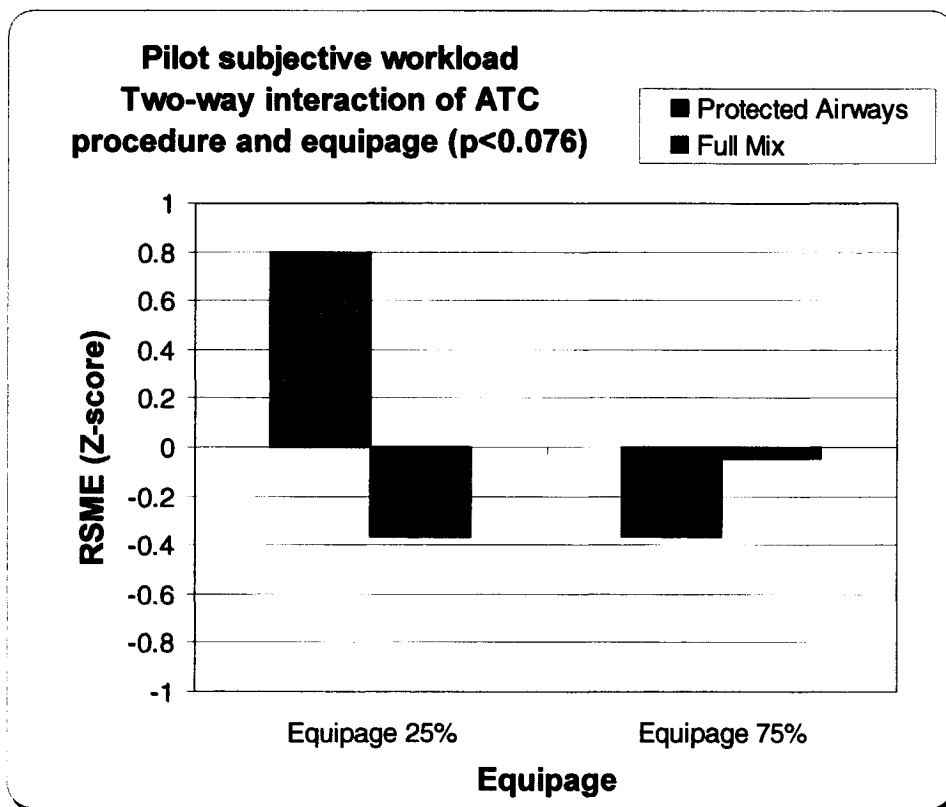

figure 11.34 Two-way interaction between ATC procedure and equipage

The ATC procedure main effect in the medium traffic density cases only is shown in figure 11.35.

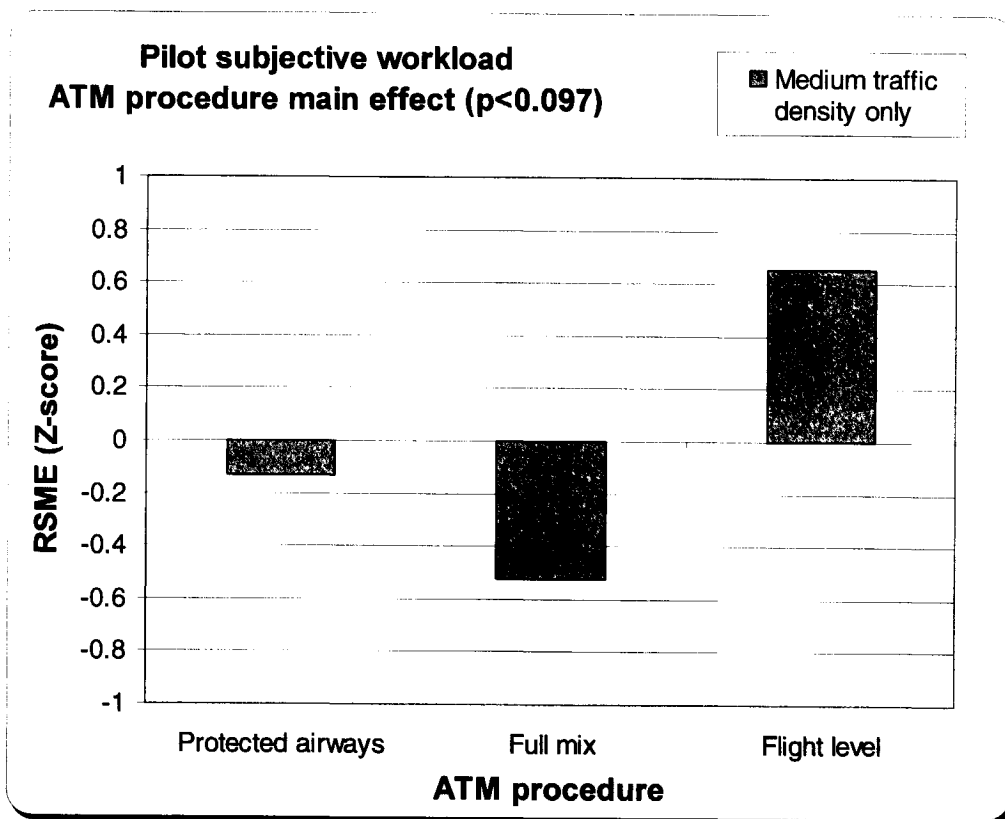

figure 11.35 ATC procedure main effect at medium traffic density only

The results shown in figure 11.32 to figure 11.35 indicate that:

- Higher traffic density results in more workload for the pilots (figure 11.32), as expected.
- Higher level of equipage results in lower workload (figure 11.33). This effect was not expected initially, but it can be explained. It was expected that in scenarios with more aircraft equipped, pilots in the equipped subject aircraft (RFS) will have to “handle” more aircraft. It was expected that pilots would neglect the unequipped aircraft controlled by ATC. This assumption has proven to be incorrect. Pilots in the subject aircraft did not neglect the unequipped aircraft since these aircraft could manoeuvre unexpectedly, especially in the protected airways ATC procedure. This effect is also clearly expressed in figure 11.34 from which it is evident that the protected airways ATC procedure is to blame for this result.
- The protected airways ATC procedure is very sensitive to equipage level (figure 11.34). Lower equipage results in more workload for the pilots as explained in the previous bullet. A transition issue (in time) is clearly addressed with the protected airways ATC procedure. The protected airways ATC procedure is therefore not a candidate for the transition to a new ATM system with Free Flight Airspace.
- The fully mixed ATC procedure is in favour over the protected airways and flight level procedure, based on the ATC procedure main effect (figure 11.35).

To conclude, based on the subjective workload measurements, the protected airways ATC procedure has some clear drawbacks regarding transition issues. The flight level procedure has the highest workload, so the fully mixed procedure is most favoured as candidate ATM system with Free Flight capabilities from a cockpit workload point of view.

11.8.1.7 Pilot and Observer Comments

Pilot comments expressed on the questionnaires and verbally have been compiled to a list of issues. This list of issues should be given attention and possibly resolved before any future experiments.

- “Which aircraft causes the PASAS bands?” was asked often.
- Clutter of overlapping labels on the ND (major comment).
Pilot suggestions:
 - option to de-clutter display and remove aircraft which can not cause a conflict logically (e.g. heading away from our heading, above our aircraft and climbing)
 - option to remove controlled aircraft from display in Flight Level scenario
- Rather relative altitude instead of absolute altitude in labels, also for de-clutter purposes
- Pilot very cautious with ATC controlled aircraft in Protected Airways scenario, due to possibly unexpected turns of ATC controlled aircraft
- Vertical ND only used when conflict is presented
- PASAS too sensitive for own aircraft manoeuvres
- Conflict with aircraft outside range setting requires range setting change => automatic range adjustment?
- Request to be able to silence a repeated conflict.
- Request to have conflict/resolution longer on ND.

The major comment of the pilots was the cluttered navigation display. All subject pilots complained about this. Of course pilots are accustomed to a nearly black display right now, but still this should be given attention in future. Furthermore it can be concluded that the Human Machine Interface is acceptable but should be further optimised and tuned.

11.9 Objective data

11.9.1 Intrusions

From the recorded data it can be concluded that the subject aircraft experienced 2 intrusions of the protected zone. The intrusions were experienced with different subject pilots, but both in a flight level ATM procedure. When analysing the intrusions further, it was found that the intrusions were both at the beginning of the scenario, when the aircraft was at FL220, well below the transition layer starting at FL260, going up. It can therefore be concluded that these intrusions were caused by the experiment leader “controlling” the subject aircraft below FL260 in the flight level ATM procedure.

Taking this ‘start-up’ effect into account, it can be concluded that there were no intrusions reported caused by the subject pilots.

11.9.2 Workload

Objective workload can be measured using various techniques. In the phase II experiment, the subject pilot's eye blink data, the pupil diameter and the so-called scan randomness were measured using Eye-Point-Of-Gaze equipment. The scan randomness appeared to be the most reliable measure for workload.

Visual scanning randomness, or *entropy* (as the term is used in thermodynamics, to describe the amount of disorder present in a system) has been used to describe the randomness present in the visual scan of the subject pilots. The rationale behind the use of the entropy measure is that visual scan patterns become more stereotyped (less random) with mental loading, so entropy should decrease with task load. The following data are based on entropy rate, which is entropy corrected for dwell time, and which is thought to be a more reliable measure than entropy.

Since indicated workload varies inversely with entropy rate, Y-axis of the figures presented in this section are inverted, so the figures can be "read" in the same way as the subjective workload figures ("high bars" mean "high workload").

The diagram in figure 11.36 shows the two-way interaction between ATC procedure and equipage, for the protected airways and fully mixed ATC procedures only, but including medium and high traffic densities. The diagram in figure 11.37 shows the same interaction, but now for the medium traffic density only, but now for all three ATC procedures.

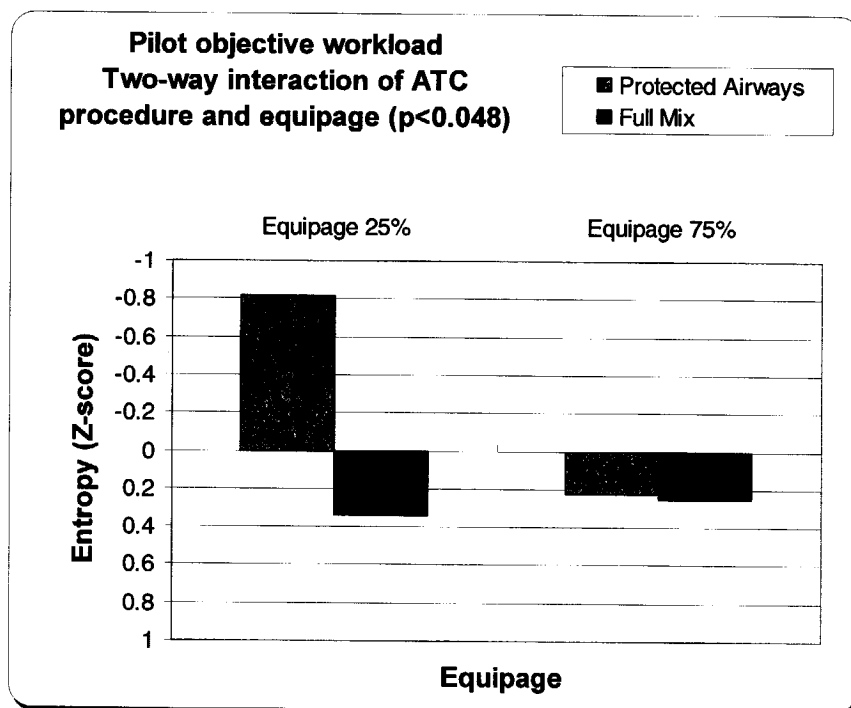

figure 11.36 Two-way interaction between ATC procedure and equipage, protected airways and fully mixed procedures only

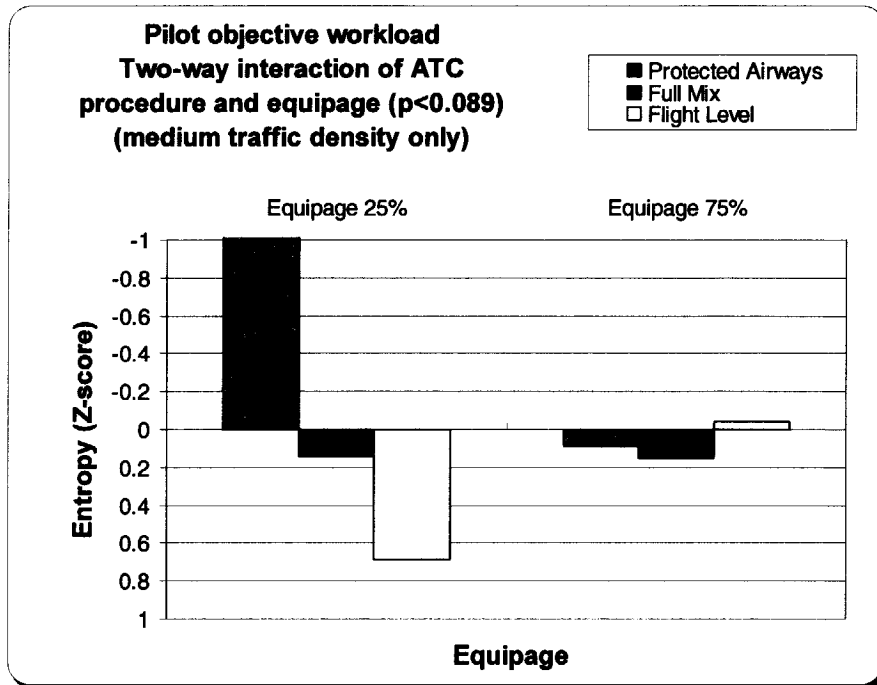

figure 11.37 Two-way interaction between ATC procedure and equipage, medium traffic density only

The results from figure 11.36 and figure 11.37 confirm the subjective workload findings. Higher level of equipage results in lower workload (figure 11.36), similar to the subjective results from figure 11.33. The graph in figure 11.37 confirms the sensitivity for equipage level of the protected airways ATC procedure and also indicates that the flight level ATC procedure follows the initial expectations, i.e. pilots in the equipped subject aircraft (RFS) will have to “handle” more aircraft and will experience more workload under high equipage.

The fully mixed ATC procedure seems not sensitive to the equipage level, and therefore, the conclusion based on the subjective workload findings holds, also after analysing the objective findings.

11.9.2.1 Comparison subjective and objective workload data

The subjective workload data and objective workload data can be compared. The diagrams in figure 11.33 and figure 11.36 present respectively the subjective and objective results. Below figure 11.38 compares these figures. These are the only figures which can be compared since only these two-way interactions reached enough significance in both analyses.

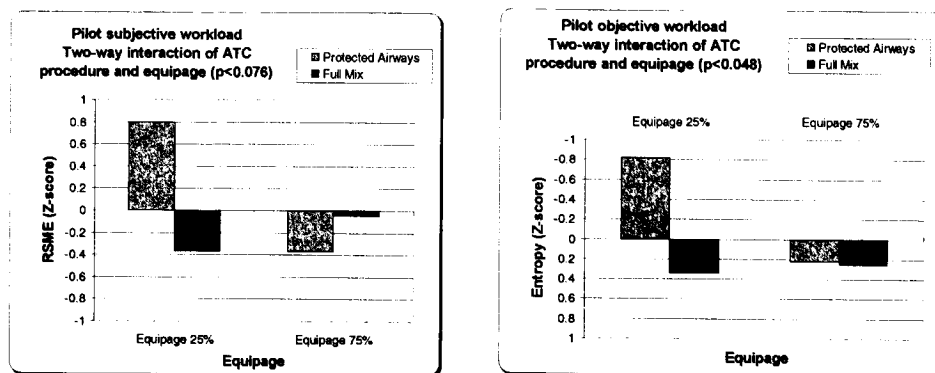

figure 11.38 Comparison of subjective and objective measurements

As can be seen from figure 11.38, subjective and objective measurements are reasonably in line with each other, given the fact that data of only four subject pilots were available for this analysis.

11.10 Conclusion

The fact that the traffic densities in the experiment matrix had to be lowered for the controller on two occasions, while the aircrew was still able to maintain separation, was an unexpected result indicating the potential airspace capacity benefits of free flight.

The ATM procedures used for mixed equipage can be seen as different levels of mixing:

- Concept F: Flight Level Split: no mixing, separate types of airspace
- Concept A: Protected Airways: partly mixing types of airspace
- Concept M: Full mix: completely share the same airspace

The results indicate concept M is preferred from the airborne perspective. It shows the highest acceptability (incl. subjective safety) and is not very sensitive to equipage level. Despite this very positive result, it should not be forgotten that this concept is the most challenging for the controller. If it is not acceptable for the controller, it might still not be a good transition procedure. Another drawback of this procedure is that the only benefit of equipping is less resolution manoeuvres. Since the financial impact of conflict resolutions is rather minimal (see chapter 9), this does not provide a strong economical incentive to equip. The other concepts deny direct routing (A) or flying at an economical level (F) and therefore provide more economic benefits for equipping the fleet.

The workload in concept A (protected airways) seems very sensitive to equipage level both in the objective and subjective data. A low equipage, thus crowded airways, apparently increases the workload.

Concept F, the flight level split, received the lowest ratings in acceptability. From the results it is not clear what caused this low acceptability. The reason for this low acceptability might be the high local traffic density just below the Free Flight transition layer that results from this procedure. This is not only causing problems for the controller but also for the crew when flying in or just above the transition layer. This means that not much can be said on the transition-in-space procedure since this local high-traffic density effect inhibits a fair evaluation.

The HMI elements were ranked by their criticality score and acceptability score. This relative scoring indicated that:

- *Predictive ASAS symbology is highly appreciated and acceptable*

This means that the addition of the conflict prevention module was acceptable and very useful. It also shows the symbology is acceptable.

- *Presentation of resolution was thought to be extremely critical and not yet very acceptable*

This is in contrast with the earlier trials. It might be caused by an apparent inconsistency caused by the addition of predictive ASAS. Since the resolution module assumes a combination of speed and heading change, while the ASAS shows no-go zones for heading only manoeuvres, resolution advisories regularly show bugs inside the no-go bands. This decreases the acceptability of the resolution advisory. Crews often chose to use only heading to manoeuvre and used the no-go zones instead of the resolution advisory to find the appropriate heading change.

- *Presentation of horizontal display of traffic suffers from clutter*

This is an ongoing problem. Further investigation shows that mainly the overlapping labels cause clutter, not the traffic symbols. Perhaps selectively showing the traffic labels will decrease this problem. One cause for this comment is the relatively high traffic densities used in the experiment. One should also not forget that it was still rated on average between "acceptable" and "favourable".

The predictive ASAS system received positive comments during debrief. It allowed pilots to not just prevent short-term conflict alerts and intrusions, but also to prevent normal conflict alerts. The incentive to solve conflicts before the actual alert is that there is still freedom to manoeuvre in any direction at that time. This allowed the crew more flexibility, which was apparently worth the extra effort of monitoring the predictive ASAS symbology while not manoeuvring.

Comparing the resolution manoeuvres of the phase II trials with the resolution manoeuvres of the phase I trials (figure 11.26 and figure 11.27) shows a clear effect of stressing the advantage of the vertical manoeuvre during training.

PART V DISCUSSION AND CONCLUSIONS

12 Non-nominal situations

12.1 Introduction

Any complex system will work when all modules and humans perform as they should. Some systems are by their nature more sensitive to failures and other non-nominal situations than others. Aspects like robustness and sensitivity influence how a system performs in these non-nominal situations. These aspects need attention in the design of the architecture of a complex system. Even though in this early stage of the design often no quantitative data on the reliability and accuracy of the individual components is known, it is useful to go through a system in a qualitative manner. In this way, one can assess the criticality of components and focus further efforts on assuring whether the requirements of these components are correct and whether they will be met.

Free Flight is a radical change in the complex Air Traffic Management (ATM) system. It also requires a number of new systems such as CD&R algorithms, ADS-B data link communication and new display symbology. On top of that the tasks of the human operators change. How the system and human operators will perform, has been explored in the studies described in several chapters of this thesis. Using these observations and the system description of chapter 1, this chapter will globally describe the way non-nominal situations influence the separation assurance in Free Flight.

First a system description at a functional level will be used to compare the sensitivity to non-nominal situations in Free Flight compared to today's ATC systems. Then a fault tree analysis will be used to look at the criticality of the different events. Finally some conclusions and recommendations will summarise the essence of this chapter.

12.2 Functional system diagram

12.2.1 *Conflict Detection and Resolution*

A conflict of aircraft A and B is defined as a predicted loss of separation of aircraft A and B within a certain look-ahead time. In a state-based system, this can be treated as a certain combination of the 3D position and velocity vectors of aircraft A and aircraft B. Therefore the conflicts will be presented in the system diagram as a relation between the position and velocity box of aircraft A and the position and velocity box of aircraft B. A conflict can be resolved by changing the velocity vector of aircraft A or the velocity vector of aircraft B or both. The conflict detection and resolution function are part of a closed loop using the position and velocity data of both aircraft to change the velocity and thus the position of the own ship.

12.2.2 *Today's ATC system*

In figure 12.1 a functional overview of today's centralised, ground-based ATC system is shown. It is a slightly simplified version of figure 1.5. When a conflict occurs, the controller selects which aircraft should manoeuvre to solve the conflict. Suppose there is a conflict between an aircraft A and B and the controller decides that aircraft A should manoeuvre. We can then see how the conflict event is processed by the system in the diagram as indicated by the red line. The radar detects the position of aircraft A and aircraft B. The tracker enhances the position data and determines (by differentiation) the velocity vector. The resulting data is shown on the systems screen and if the ATCo's system is equipped with Short Term Collision Alert (STCA), an alert will notify the controller of the conflict. These systems are all part of the radar system box. The Air

Traffic Controller (ATCo) is made aware of the conflict via the human-machine interface (screen and alert). He or she decides for instance that aircraft A should manoeuvre and broadcasts an instruction for the crew of aircraft A via the radio. The radio of aircraft A receives the instruction and the crew notices and understands the instruction. The crew then executes the resolution manoeuvre correctly using either manual control, the autopilot/autothrottle system or the flight management system (all part of the control box in the diagram). As a result the velocity vector of aircraft A is changed and the conflict is solved.

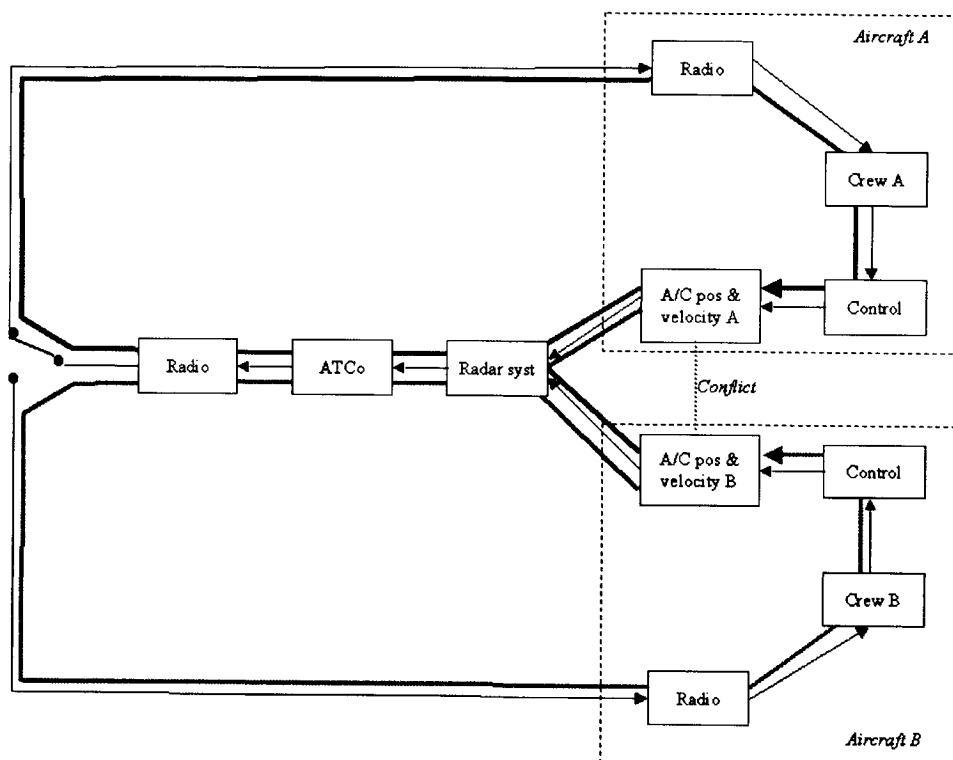

figure 12.1 Functional overview of today's ATC system of ground-based separation assurance

Using this diagram we can identify several types of events that could disturb this process starting at the radar system:

- 1 - Radar system does not correctly detect position and/or velocity of aircraft A
- 2 - Radar system does not correctly detect position and/or velocity of aircraft B
- 3 - ATCo does not notice conflict and (if available) conflict alert
- 4 - Radio transmission of ATCo fails
- 5 - Radio of aircraft A fails
- 6 - Crew A does not notice or understand radio message with resolution instruction
- 7 - Crew A does not execute resolution manoeuvre correctly and timely (due to e.g. crew and/or system failures, hazards)

Each of these events will halt the process of letting aircraft A solve the conflict. There is an alternative way of solving the conflict: let aircraft B manoeuvre. This is indicated by the blue line in the diagram. If the controller after some time notices that the conflict is

not being resolved by aircraft A, the controller can decide aircraft B should manoeuvre. This option is not used simultaneously but merely as a back-up solution. Notice how many functions both options share in this system. This can be seen in the diagram by observing the number of boxes that are part of both the red and the blue process:

- Radar system (radar, tracker, conflict detection, conflict alert, HMI)
- ATCo
- Radio of ATCo

Even though the radars are often overlapping or have back-up equipment, the tracker, other equipment and the operator (thus human error) form single points of failure without any fail-safe options.

12.2.3 *Free Flight with Airborne Separation Assurance*

The same situation in a Free Flight system is illustrated by the diagram in figure 12.2, which is based on the functional overview in figure 1.7. An important difference between figure 12.1 and figure 12.2 is that in figure 12.1 the red and blue process were options that are sequentially used by a controller if he notices that the first option fails. In figure 12.2 the red and blue lines illustrate two processes that are always executed simultaneously in the conflict detection and resolution process, thereby increasing fail-safety.

Now let us use the diagram to look at how aircraft A resolves the conflict. The position and velocity of B as determined by B's navigation (and air data) systems are sent to the ADS-B transmitter. The ADS-B transmission with these data is then received by the ADS-B receiver of aircraft A. The position and velocity of aircraft A is determined by the navigation systems (and air data computer) of A. These data of A and B are processed by the Airborne Separation Assurance System (ASAS). Inside this box the conflict detection module (CD) detects the conflict and consequently the conflict resolution module (CR) calculates an advised resolution manoeuvre. The system alerts the crew of aircraft A that a conflict has been detected and presents a resolution advisory. This manoeuvre is then executed by the crew of aircraft A using manual control, the autopilot/autothrottle or the Flight Management System ('Control' box). This changes the velocity vector of aircraft A and in this way the conflict is resolved.

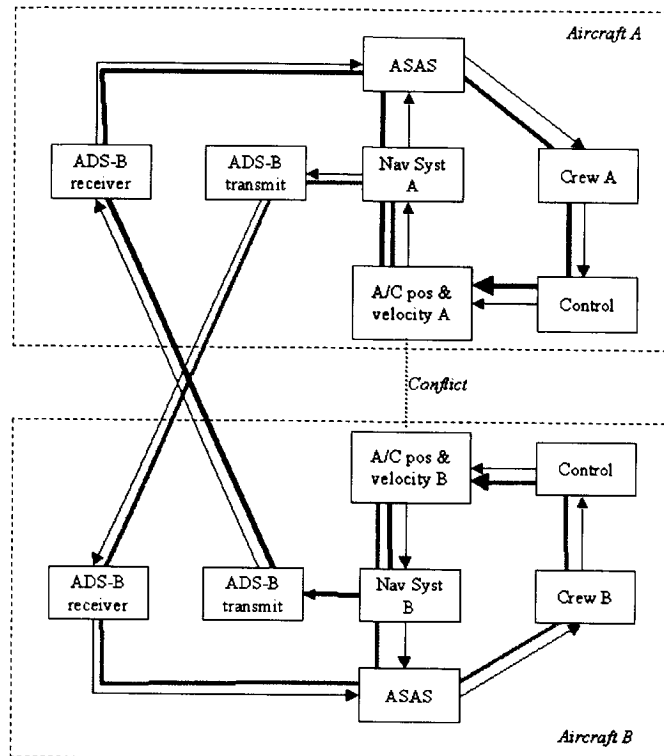

figure 12.2 Functional overview of airborne separation assurance

Using the functions mentioned in the diagram we can list categories of events that can disturb this process:

- 1 - Navigation systems do not correctly determine position and/or velocity of aircraft B
- 2 - Navigation systems do not correctly determine position and/or velocity of aircraft A
- 3 - ADS-B transmission of aircraft B fails
- 4 - ADS-B receiver of aircraft A fails
- 5 - ASAS fails (CD and/or CR)
- 6 - Crew A does not notice conflict and/or conflict alert and/or resolution advisory
- 7 - Crew A does not execute resolution manoeuvre correctly and timely

Simultaneously the back-up option of B resolving the conflict is being executed (indicated by the blue line). The only boxes shared by both processes are the navigation systems of A and B since they are the sensors of the position and velocity. This dependency on the same navigation systems for both aircraft's resolution process is a result of the dependent surveillance. Using independent surveillance (e.g. an air-to-air radar) would make both processes completely independent.

Navigation systems are already critical today and are often doubled or tripled. Also different types of systems are combined: often radio navigation (VOR/DME) is supplemented by INSs and/or GPSs. This increases the reliability. The accuracy of today's combined navigation systems is prescribed by regulations and is often in the order of one nautical mile.

Comparing the two diagrams in figure 12.1 and figure 12.2, the striking difference is that the CD&R function is only duplicated independently in Free Flight. Moreover, in the Free Flight system the human operators are part of two independent decision loops, while in the ATC system, the human operator is not only part of both loops but also the one who has to identify that a back-up option is required. This means the ATC system is more prone to human error than the Free Flight system.

We can also see that keeping the ADS-B transmission and receiving function separated maximises the independence of the two decision loops.

One should also note that the “Radar system”-“ATCo”-“Radio” sequence in the ATC case is not just shared between aircraft A and B but also with all other aircraft in the sector.

In both ATC and Free Flight the environment can form a common hazard for both options. This could for instance be frequency blocking/congestion as well as weather and other external hazards (inhibiting resolution manoeuvres).

12.3 Fault Tree analysis of Free Flight

To identify how non-nominal events can influence the separation assurance in Free Flight a fault tree can be used to identify critical events and systems.

The fault tree diagram in this section uses the notation as suggested by the U.S. Nuclear Regulatory Commission (Vesely, Goldberg, Roberts and Haasl, 1981). The diagrams use symbology based on circuit diagrams. Events are categorised in three types: basic events, intermediate events and undeveloped events. Basic events form the starting points leading to intermediate events. Undeveloped events are intermediate events, which are not further developed into basic events because of lack of information or relevance. See figure 12.3 for the event symbols.

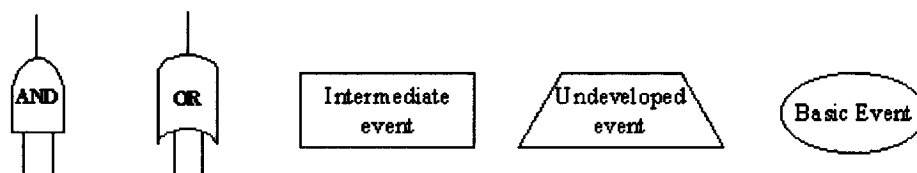

figure 12.3 Symbols of fault tree

The relation between the events uses symbols for AND and OR gates. An AND gate indicates a required combination of events for the propagation of the event. The OR gate indicates a junction of different events, which can independently lead to the next event. In figure 12.3 the AND and OR symbols are shown.

Fault tree diagrams are typically used to analyse potential errors in the design of a complex system. The diagrams are useful for determining, which events and/or systems are most critical to the overall performance of the system.

First let us zoom out of the separation assurance process. The ultimate goal of separation assurance is to prevent a mid-air collision. The mid-air collision between an aircraft A and B therefore forms the starting point of our fault tree. For a mid-air collision we need a loss of separation and the closest point of approach should be within the volume of the airframe. So a mid air collision is always preceded by a loss of separation. The separation assurance process should have prevented a loss of separation. In Free Flight this means neither aircraft A nor aircraft B did manoeuvre to resolve the conflict. Developing these two events further yields two identical trees with every A replaced by B and vice versa (symmetrical trees).

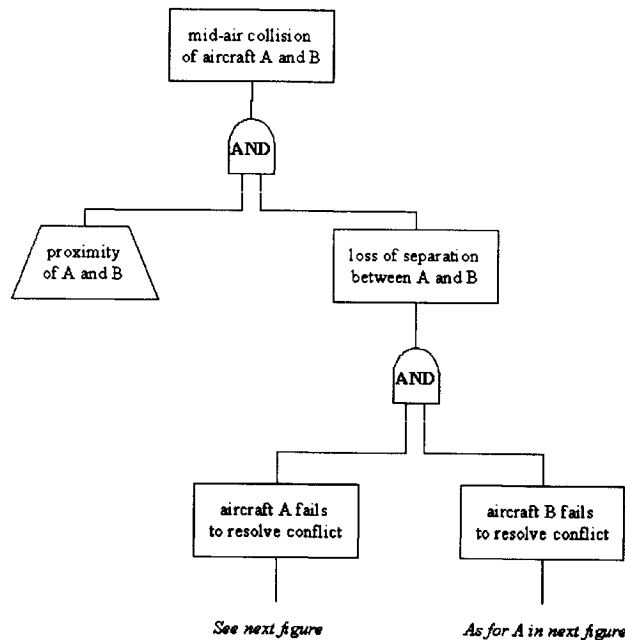

figure 12.4 Overall fault tree for mid-air collision between an aircraft A and B

Because of this symmetry only the tree diagram for one event is shown in figure 12.5. This figure shows the fault tree for the event that aircraft A does not manoeuvre (failure of the red process in figure 12.2)

From the diagram we can see the following basic (or undeveloped) events are critical:

- Navigation system A fails
- Crew A misses conflict alert
- Navigation system B fails
- ADS-B transmitter B fails
- ADS-B receiver A fails
- Crew A makes error in executing resolution manoeuvre
- ASAS CR logic A fails
- Aircraft A unable to manoeuvre

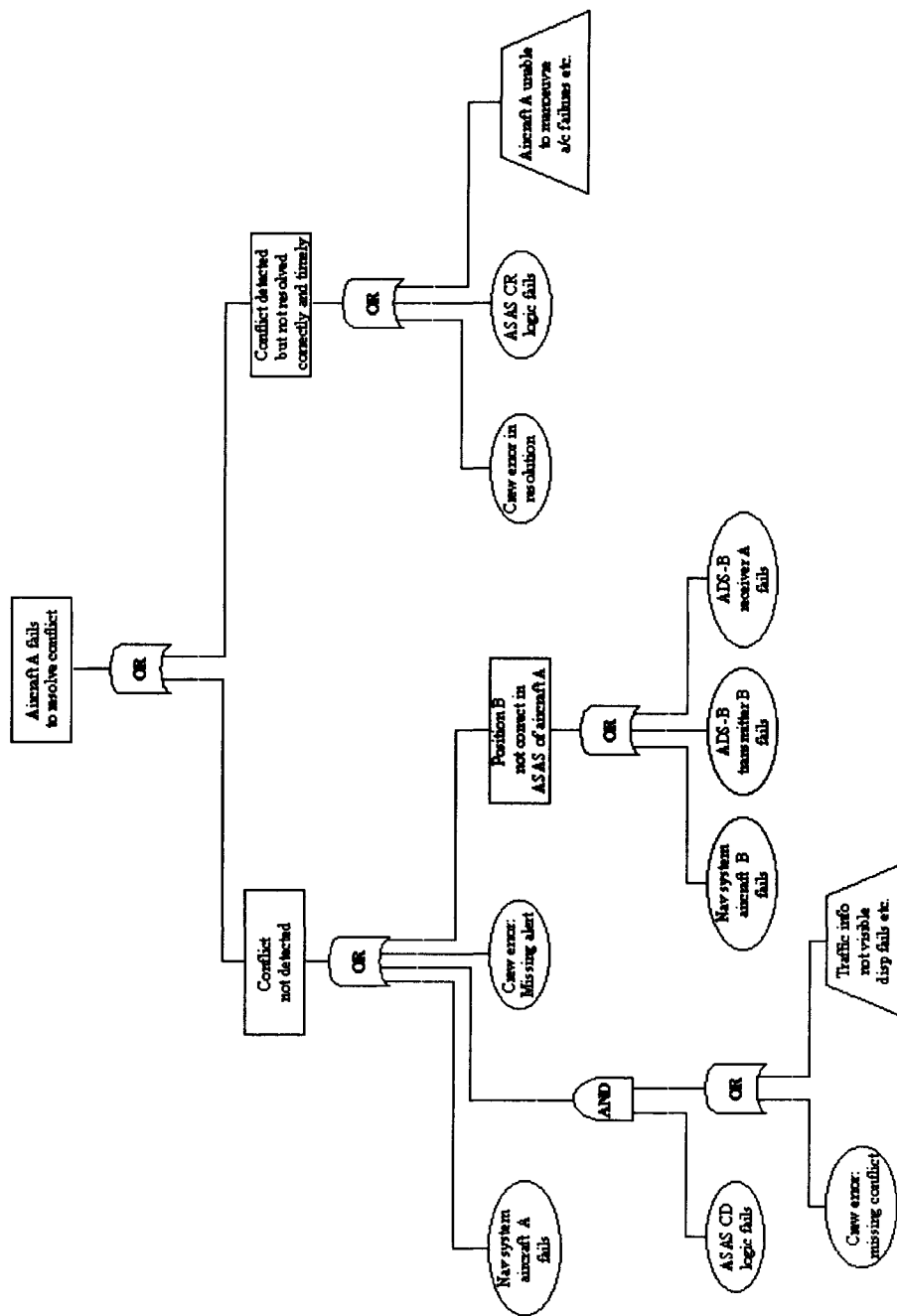

figure 12.5 Fault Tree for the event that aircraft A does not resolve conflict

Each of these events can independently lead to the event that aircraft A is not able to resolve the conflict. Using the symmetry of the tree we can generate the list of events which would disable the conflict resolving of aircraft B by replacing A with B and vice versa:

- Navigation system B fails
- Crew B misses conflict alert
- Navigation system A fails
- ADS-B transmitter A fails
- ADS-B receiver B fails
- Crew B makes error in executing resolution manoeuvre
- ASAS CR logic B fails
- Aircraft B unable to manoeuvre

Each of these events can independently lead to the event that aircraft B is not able to resolve the conflict. A navigation failure of A is listed in both trees. This means that the navigation system failure of aircraft A can lead to both A and B failing to resolve the conflict and therefore to a loss of separation and potentially to a mid-air collision. The same goes for the navigation systems of aircraft B.

If the ADS-B transmitter and receiver are combined into one transceiver (as is common) this transceiver of each aircraft is also present in both lists. This means the transceiver is just as critical for the separation assurance as the navigation systems.

Similarly if some common environmental hazard (like weather) inhibits both aircraft A and B to manoeuvre, which is probably rare, it can become critical despite the robustness provided by the two options.

Some of these events are easier to identify than others. The most critical one, the navigation error is not always easy to identify. Only in advanced cockpits disagreement between different redundant navigation systems is automatically detected and the crew is alerted.

12.4 Conclusion

Summarising, in Free Flight both the navigation systems and ADS-B transceivers become critical for the separation assurance. Today navigation systems are less critical for separation assurance because of the independent surveillance provided by radar. Navigation systems are already critical today to avoid other hazards than mid air collisions like terrain. Therefore they already consist of back-ups providing high reliability. Because of the criticality of the navigation systems, the accuracy of the navigation systems largely determines the separation minima (i.e. the size of the protected zone) requirements for airborne separation assurance.

ADS-B transceivers are just as critical for airborne separation assurance as navigation systems unless the transmitter and receiver are completely separated. This means that doubling or tripling the transceiver should be considered.

Another type of global failure that can be extremely critical occurs if the frequency of the ADS-B systems becomes blocked. Separating transmitter and receiver will not protect against this type of failure. Therefore automatic switching to back-up frequencies/channels

to avoid 'sticking mike'-type of global failures will enhance safety. The available spare bandwidth is also an issue (frequency congestion) which influences the likelihood of this type of failure.

The ADS-B transceiver criticality can also be avoided by using independent surveillance such as an air-to-air radar. Taking bearings using ADS-B signals to verify the received position is a similar, semi-dependent, but lower fidelity, technique that together with using Doppler effects of the received signal could be used to enhance safety. Military off-the-shelf declassified equipment could perhaps provide this functionality. Independent surveillance would completely separate both airborne separation assurance decision loops and thereby also reduce the criticality of the navigation systems for airborne separation assurance.

The effect of distributing the ATM system is not completely covered by the approach in this chapter. This effect does more than providing redundancy in the CD&R process. This effect will be discussed in the next chapter.

13 Distributed systems vs. central systems

13.1 Introduction

The main difference between Free Flight and today's ATM system is the structure of the system. Free Flight is a distributed system, where every aircraft solves local problems locally. Today's ATM system is centrally organised where a controller and his tools form a central controlling element. A transition towards Free Flight means a de-centralisation of the ATC system. In the hypothesis tree in chapter 2 one of the hypothesis supporting the danger of free flight is that central co-ordination is required. The current feasibility of Free Flight may be dependent on a lot of details that tie in with technical specifications of systems, economics and politics. But the key issue whether de-centralisation is appropriate is much more fundamental than that and deserves a separate discussion.

13.2 (Un)Predictability of a Distributed System

When people, experts or not, are confronted with the Free Flight concept, the first reaction is often that it sounds like a dangerous idea. This probably is a result of the way human nature reacts to the chaotic, less structured nature of the traffic flow. Chaos is usually associated with danger. Throughout the NLR study the making of conflicts proved much harder than avoiding conflicts. In other words: a random, chaotic scenario, even using existing route structures was unlikely to have a lot of conflicts. In today's traffic density, applying direct routing (horizontally and vertically) will result in a conflict rate of about once per 50-60 minutes per aircraft. A carefully, precisely constructed scenario was required for complex geometries like 'the wall' or the 'super-conflict' (see chapter on conflict geometries). These scenarios are much more orderly but also much more dangerous. The concentration of traffic at airways is also artificially increasing the local traffic density. Even though this increases the probability of a loss of separation, this orderly pattern is reassuring to the human observer.

What is the reason for this distrust in chaos? This needs to be understood. The acceptance by aviation authorities, pilots, air traffic controllers and the public is required before the free flight concept can be further developed and gradually introduced. Apart from the conditioned negative association of chaos, there probably is a rationale behind this reaction. This could be the unpredictability of a distributed system with this high level of interaction.

A one-on-one encounter can be analysed with some calculation and the manoeuvres as advised by the resolution algorithm can be derived and understood. To check all one-on-one situations already becomes harder since there are quite a lot of different possibilities with respect to the three dimensional position and three dimensional velocity of the aircraft.

However, the stability of a high-density traffic scenario really is a problem that is of a different mathematical order. It is comparable to trying to understand consciousness in terms of the characteristics of a single neuron, the threshold, firing time etc. This touches the field of mathematics called cellular automata, which deals with the maths of interacting units. How extremely simple rules for the interaction at unit level can result in very complex behaviour of the total system can be illustrated by a famous example of cellular automata: 'Conway's Life'. This is a simulation in which every state is derived

from the previous one with a fairly simple, discrete rule. It uses a two-dimensional matrix field consisting of cells. A cell is either dead or alive. By counting the number of living cells in the 8 neighbouring cells, the state of the cell in the next time step is determined. If the total is 0 or 1, then the cell dies of 'starvation'. If the number of living cells equals 2, the state of the cell remains the same ('stable'). If the total is 3, then a new cell will be therein the next step independent of the previous state ('growth') and the total higher, thus 4 to 8, results in the death of the cell due to being 'overcrowded'. No new cell grows in the empty free space unless it is surrounded by three living cells. This rule is much simpler than a geometrical conflict resolution rule. However it yields some surprising higher order effects. Some examples are shown in the figures below.

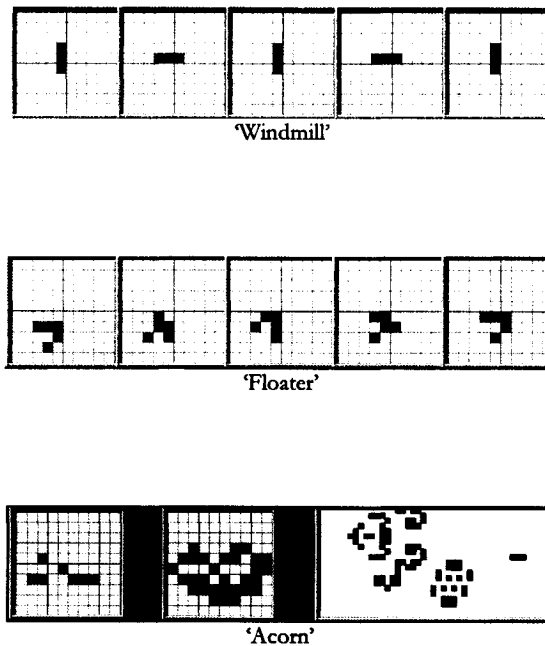

figure 13.1 Examples of sequences from the 'Life' program, illustrating the apparent lack of the relation between the micro-interaction and the macro-effects.

The 'windmill' of three cells is easy to understand. The 'floater' of only 5 cells moves one cell up and one cell left in five steps. This is something that is already a consequence not easily seen from the simple rule above. In fact, most patterns have been discovered in random patterns instead of being designed. The 'acorn' illustrates the effect of a structure of only seven cells after ten and after another hundred iterations. Also complete fleets of floating ships have been constructed as well as logical circuits (AND , OR and NOT gates). Using a large life field this logical circuit would even allow a 'thinking machine', if complex enough perhaps even with consciousness. Still, at the lowest level cells are counted and simply switch on and off based on the surrounding number of cells.

This Life program that was often used as a screen saver in the old days of computing, is an analogy of how an extremely simple mathematical formula or law of nature can result in fantastic unforeseen effects. It has some philosophical aspects when compared with the laws of nature, which are not relevant here. But the behaviour of these patterns has puzzled mathematicians for decades and still there is no theory available that describes

the phenomena shown above. It is a dramatic illustration of the magnitude of the challenge to analyse the behaviour of a distributed system.

A traffic pattern using a Free Flight conflict resolution algorithm is not a discrete, but a continuous system, with a geometric interaction as well as scheduling and reaction time effects. It is right now and will, for a long time, be impossible to mathematically guarantee the stability or risk level associated with the behaviour of a large number of aircraft in any configuration. The characteristics of an aggregation level below the behaviour of the pattern, for example a pre-scripted one-on-one conflict is more predictable. The large-scale *behaviour* of traffic patterns can only be studied using simulations. The risks of introducing a distributed system can only be analysed by comparing the effect of the change in *structure* between a centrally controlled system and a distributed system.

13.3 Safety as a result of distributing separation assurance

In this and the next section, I will analyse the effect of distributing the ATM system with some simple mathematics. For this, we use a model sector with some simplifications. Let us assume all actions of air traffic control are aimed at avoiding future conflicts. In reality, these actions are not simply conflict resolution but also include sorting the traffic in a way that avoids future problems. In addition, the airspace structure adds constraints that affect the number of actions required by both air and ground. The focus of this section however is to investigate the effect of distributing a separation assurance system. Therefore, we assume a model sector with a number of potential conflicts when no action is taken. These conflicts can be prevented by actions either by a central, ground based air traffic control or by a distributed system consisting of airborne crews using an airborne separation assurance system. It is therefore looking at just one aspect of the introduction of Free Flight and not a complete comparison of today's situation with a future Free Flight operation. Still, it provides insight into the benefits of distributing air traffic management, especially the effect on the safety and (more dramatically) on the capacity of our model sector.

We observe a sector with N aircraft. The general probability of having a conflicting route for any combination of two aircraft is p_2 . The probability of failure of the overall ground-based system is called p_g . This includes human failures and the failure of tools like radar and software. The probability of an overall airborne separation system failure is called p_a . Again this includes human failures and failures of tools. These parameters are listed below:

N	Number of aircraft simultaneously present in a sector
p_2	Probability that two given aircraft have a conflict
p_g	Probability of a failure of overall ground based separation system per conflict
p_a	Probability of a failure of overall airborne separation system per conflict

Let's assume two cases: (1) the centralised '*Ground*' case, in which a ground based air traffic controller is completely responsible for the detection of conflicts and conflict resolution, similar to today's ATM; (2) the distributed '*Air*' case, in which all aircraft in the sector perform airborne separation co-operatively (no priority rules!), similar to the mature Free Flight concept as described in chapter 3, where it is sufficient for only one aircraft's system to work for the separation to be assured.

We are then able to express the probability of a conflict resolution failure p_f for the complete sector (thus all aircraft) in the above mentioned parameters for both cases 'Ground' and 'Air'. Multiply all possible combinations of two aircraft out of N with the probability that they meet. This is the conflict probability. Then multiply this by the failure probability per conflict.

$$\begin{aligned} \text{Ground:} \quad p_{f_g} &= \binom{N}{2} \cdot p_2 \cdot p_g \\ \text{Air:} \quad p_{f_a} &= \binom{N}{2} \cdot p_2 \cdot p_a \cdot p_a \end{aligned}$$

Because for any conflict two aircraft have an airborne separation assurance system, this provides a fail-safe system. This squares the probability of a failure. When both systems have a similar reliability ($p_g = p_a$), this means the safety of a distributed system is a magnitude larger than the safety of the central based system.

For elements in the systems that would reduce the safety margins significantly probabilities of 10^{-7} times per hour are required and for safety critical (loss of aircraft) systems 10^{-9} times per hour of flight.⁶ One could argue the ASAS system fits into either one of these two categories depending on whether there is a back-up system like TCAS available.

These numbers can be used in two directions:

- Suppose we use these requirements for one aircraft without assuming anything about the reliability of the conflicting aircraft. We then get an extra reduction of the collision probability of 10^{-7} or 10^{-9} due to the squaring of failure probabilities (10^{-14} or 10^{-18}).
- Suppose we do assume a system on-board the other aircraft in the 'equipped only' airspace with a similar required reliability. In this case the squaring effect of the failure probabilities mean we only need a system about of 10^{-4} failure rate in order to be as good as the ground system with the specified rate. (It is questionable whether today's ground based systems meet this requirement that is used for airborne systems)

There is currently no reason to assume with current mechanisations that the airborne avionics would be less reliable than the current ground based equipment.

On the ground, there is a possibility of having back-up equipment just as well as in the air. The two ASAS of the conflicting aircraft are different in that they are always both actively involved in the separation and are therefore more fail-safe than a back-up system which is only active when the main system fails. The detection of a failure also plays an important role. An undetected failure has much less dramatic consequences in the air than on the ground. A detected failure may take longer to repair in the air than on the ground due the lack of in flight repair possibilities.

For the human element in the separation system there are two opposite effects in the comparison of the safety or capacity: the airborne crew might only be partially available for the separation task but also has only one aircraft to control. ATC is fully available but has multiple aircraft to control.

⁶ JAR AWO Subpart 3 – Joint Aviation Authorities Committee

This is where another interesting effect of distributing the effort occurs. Assume both the ground and the airborne systems have a limited number of conflicts they can handle. When the number of aircraft results in a conflict rate beyond this limit, the resolution failure probability increases dramatically because the system is overloaded. This means that the capacity of the system is limited by the effective or experienced conflict rate. What is the effect of this on the capacity of the system for both the 'Ground' and 'Air' case?

13.4 Capacity as a result of distributing separation assurance

The inherent overall conflict probability p_c is the same for both systems:

$$\text{Both: } p_c = \binom{N}{2} p_2 = \frac{N \cdot (N-1)}{2} \cdot p_2$$

The experienced conflict probability is substantially different:

$$\text{Ground: } p_{c_g} = \frac{1}{2} N(N-1) p_2$$

$$\text{Air: } p_{c_a} = (N-1) p_2$$

For the ground case, this is a parabolic curve, while for the airborne case this is a relatively shallow straight line. The 'Air' probability is much less because of all aircraft only $2/N$ part of the conflicts involve the 'own ship'. The resulting curves are drawn in the figure below:

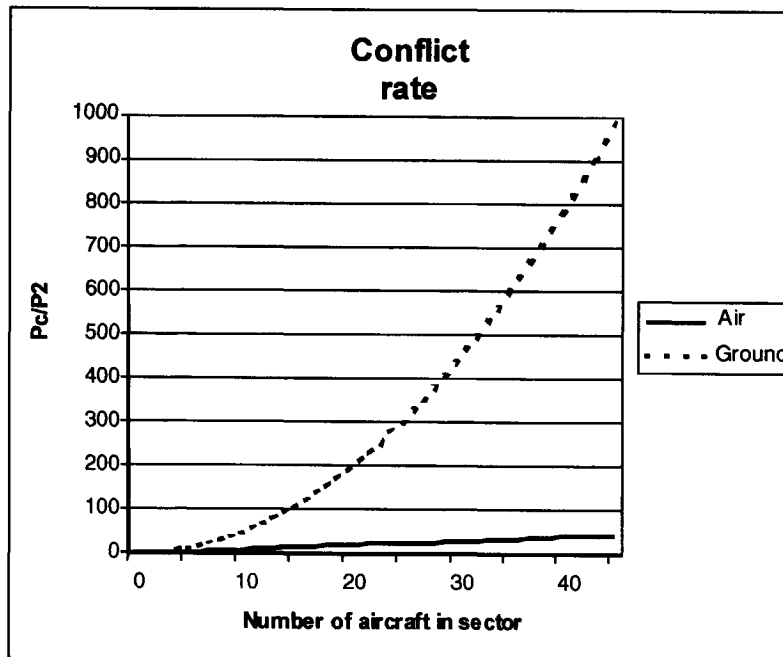

figure 13.2 Comparison of the effect of traffic density on airborne and ground based separation assurance

This figure shows the conflict rate normalised with the probability of two aircraft meeting each other (p_2). This figure shows the experienced conflict rate that is the factor that drives workload, which is a limiting factor. It is clear that the central 'Ground' system will become overloaded much earlier as traffic grows compared to the distributed 'Air' system.

From this picture, it is clear that with an increasing amount of aircraft over the coming few years, the centralised ground system will have to increase its capacity enormously. A distributed system like Free Flight with Airborne Separation is less affected by the growth of the air traffic. Today on average 10 aircraft are present in an en-route sector of 100 nm x 100 nm. Peaks are in the neighbourhood of twenty aircraft (referred to as double density). This is predicted at least to be doubled around 2015. This means that during peaks the air traffic controller will experience more than four times as many conflicts as today!

Adding values to all the parameters could provide some insight into the real effect. These numbers are however highly dependent on the size and structure of the airspace, the air traffic controller, the pilots, the equipment, etc. The numbers as experienced during the various simulations are used here as indications of the order of magnitude.

The following observations form the basis for the parameters:

- 1) Assume a European en-route sector of 100 x 100 nm
- 2) Average Western-European traffic density means about 10 aircraft simultaneously present in the sector
- 3) Peak densities double the amount of aircraft
- 4) During direct routing average conflict rate per aircraft without separation is once per hour
- 5) During an experiment both with and without airways air traffic controller were not able to handle triple the Western European traffic density (see chapter 11)
- 6) During experiments the scenario with three times the Western European average density, was experienced as 'not busy' by the pilots during airborne separation (see chapter 10)
- 7) During demonstrations 10 times the WE traffic density was still manageable by an experienced pilot

From these observations the following numbers can be deduced using the hour as a reference time unit:

4) leads to $p_{c_a} = 1.0 \frac{1}{hr}$ for an en-route sector of 100 nm x 100 nm in case of direct routing for $N = 10$ (average WE density)

With the earlier derived formulae, this yields the p_2 for this situation.

$$p_2 = \frac{p_{c_a}}{(N-1)} = \frac{1.0}{9} = 0.11 \frac{1}{hr}$$

And also the conflict rate for the controller:

$$p_{c_g} = \frac{1}{2} N(N-1)p_2 = 5.0 \frac{1}{hr}$$

In this case, the controller has to resolve 5 potential conflicts per hour. This is five times as much as the pilots in case of airborne separation. During peak hours $N=20$. With the p_2 being independent of N , we can compare the conflict rate as experienced by the air traffic controller and pilots in our scenario:

$$\text{Ground:} \quad p_{c_g} = \frac{1}{2} N(N-1)p_2 = 21 \cdot \frac{1}{hr}$$

$$\text{Air:} \quad p_{c_a} = (N-1)p_2 = 2.1 \frac{1}{hr}$$

In other words the controller already has ten times as much conflicts to handle. How will this be during a peak in 2015 with an estimated $N=40$?

$$\text{Ground:} \quad p_{c_g} = \frac{1}{2} N(N-1)p_2 = 86 \cdot \frac{1}{hr}$$

$$\text{Air:} \quad p_{c_a} = (N-1)p_2 = 4.3 \frac{1}{hr}$$

This means the controller of this example sector will have to resolve 86 potential conflicts per hour (one every 42 seconds). In the same situations the cockpit would experience one conflict per 14 minutes during the peak. This is assuming the traffic is more evenly distributed over the airspace due to the direct routing. The fact that using airways instead of direct routing increases the potential conflict rate significantly means that the real effect is even worse. It could mean one conflict every 10 to 20 seconds on average for the ground controller.

Decreasing the sector size to solve this problem would also produce more overhead due to the higher number of hand-offs and would therefore only be able to solve this partially. An advantage of decreasing sector size however is that if our square shaped example sector is divided in four squares, on average an aircraft will only cross two squares and not all four. This means the number of aircraft under control will be decreased more significantly than the number of hand-offs will grow. A smaller en-route sector size does pose a problem when a conflict is further ahead than the length of a sector. This might lead to a need for more inter-sector co-ordination: one aircraft could be in sector A, another in sector B and the conflict in sector C. So decreasing the sector size is only a very temporary solution, not a fundamental one.

The numbers in the above conflict rate example are chosen to replicate the situation in the European Airspace, though they might not be completely accurate. Most numbers heavily depend on the local situation and route structure. The real numbers might be worse. The quoted number of 1 conflict per hour is one that is already a few years old and probably should be higher. The doubling of air transport over Europe by 2015 is also quite conservative, the ratio will probably be closer to 2.5 or maybe even higher.

Thus this example illustrates that introducing direct routing and airborne separation might be the only viable solution as the air traffic grows.

Doubling or even quadrupling today's air traffic density, raises the question of whether there is enough physical airspace for these increasing number of aircraft. Assume we still use the 5 nautical miles separation standard, which was based on radar characteristics, not the navigation performance of today's aircraft. In that case, statically there is sufficient space for four hundred (20×20) aircraft at one level within the 100 nm x 100 nm block. Cruising takes place at at least 15 levels with a separation of 1000 feet. So in the case of a

traffic density of 400 aircraft in a square of 100 by 100 nautical mile the airspace is filled to about 7% with the (huge) protected zones of 5 nautical miles. Densities of 40, like the 2015 peak density, therefore still refer to a rather empty airspace.

13.5 Conclusion

Though the reality is more complex than the example situation used in the mathematics, the main conclusion holds. The fact remains that the 'conflict pressure' on a centralised system will increase in the order of N^2 and for the distributed with the order N . This means that with even completely different numbers and a different offset, the effect of the higher power of N can never be beaten by any central system when air traffic is growing.

14 Discussion

14.1 Introduction

In this chapter the results from the former chapters, as well as remaining open issues, will be summarised and discussed. What did we learn from the studies described in the previous chapters? In chapter 2 a hypothesis tree has been used to order and structure the issues. This tree will be used here to draw up the results. All results obtained in the study are connected to hypotheses in the tree.

This study went after nothing less than the question “ Is Free Flight feasible?”. Even though a substantial number of sub-hypotheses in the tree diagram have been addressed, not all of these issues have been resolved. The study has focused on the safety branch of the hypothesis tree. Within this branch the focus has been on the issues which deal with moving the separation task to the cockpit, which is the most revolutionary aspect of the Free Flight concept. Issues regarding surveillance, navigation and certification of equipment have not been addressed extensively in this study.

In figure 14.1 and figure 14.2 the complete tree from chapter 2 is shown. The boxes, which contain a hypothesis that has been addressed, have been colour coded. If a box is filled with green, it means supporting evidence has been found for this hypothesis. When the box is orange, it means refuting evidence has been found. A blue box indicates an ambiguous or incomplete result for this hypothesis, even though an attempt has been made to resolve this issue. The state of the white boxes is the same as was described in chapter two or has not yet been addressed completely individually.

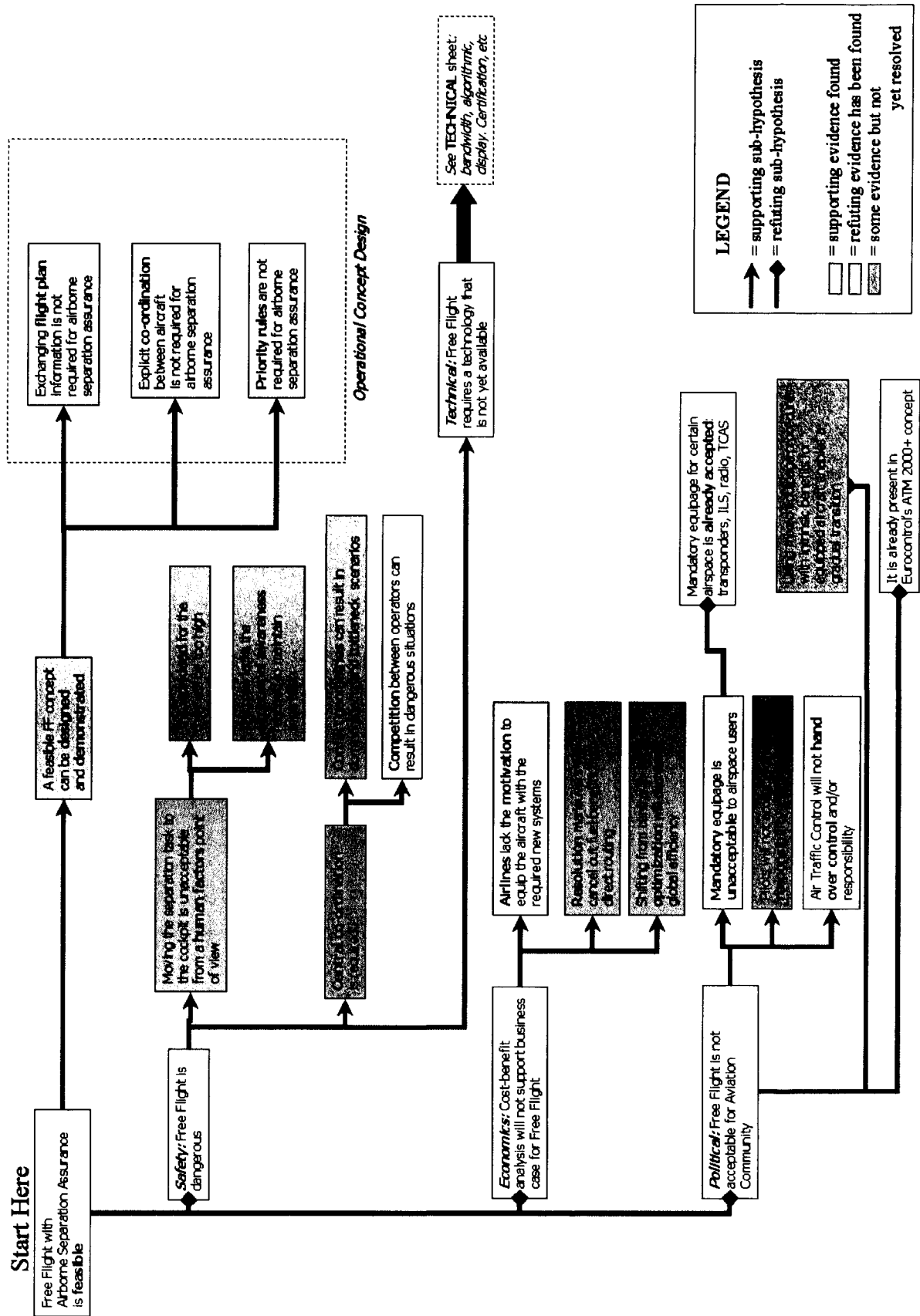

figure 14.1 Hypothesis diagram part I

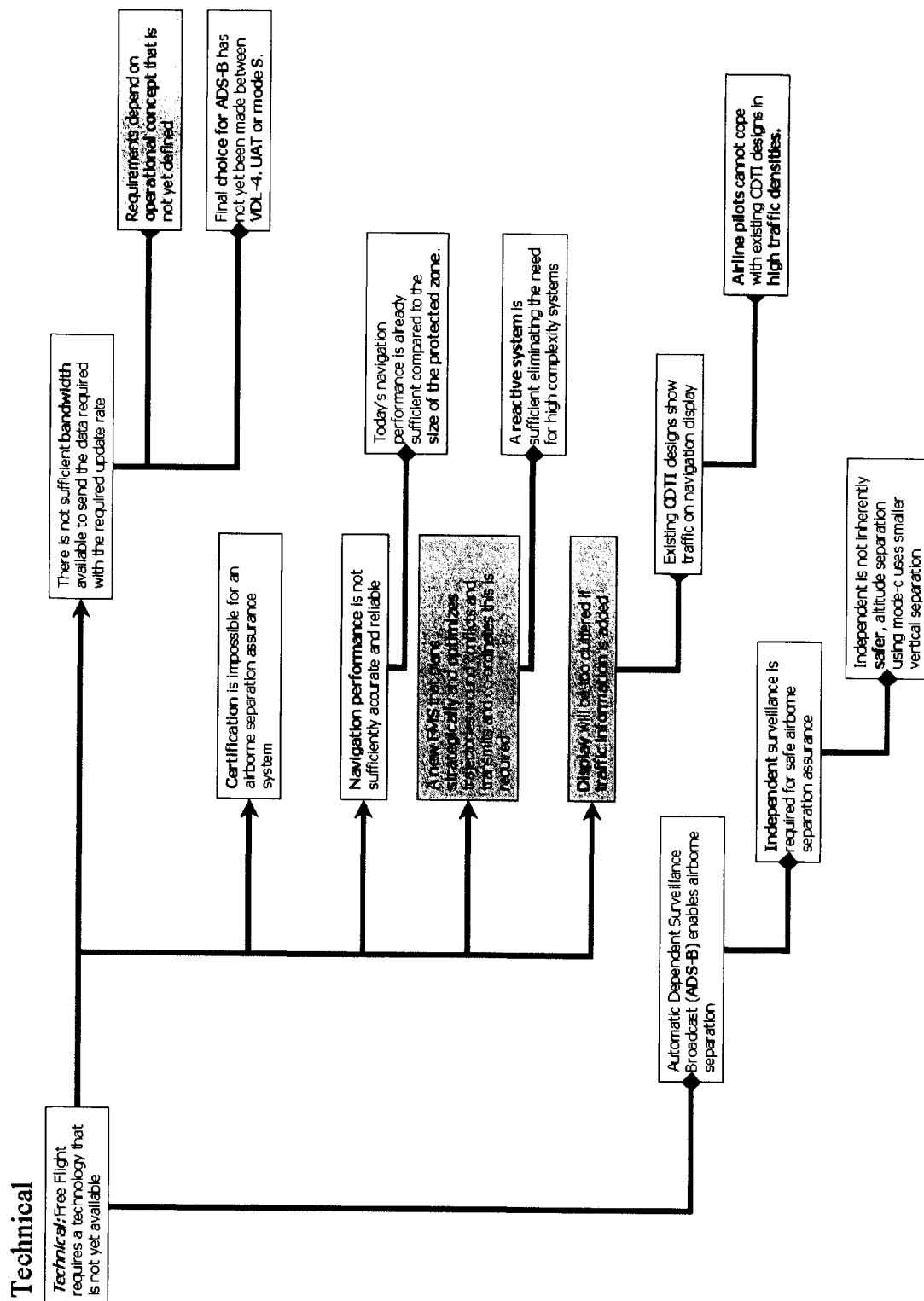

figure 14.2 Hypothesis diagram part II

14.2 Discussion of results obtained

All hypotheses, which have been addressed in one or more of the studies, will be described in the following paragraphs.

14.2.1 *Operational Concept > Flight Plan Information*

Whether it is required to exchange intent information between aircraft to be able to perform airborne separation assurance is an issue that has been addressed in the conceptual design (see chapter 3). There are a lot of practical drawbacks to using this intent information exchange, some are listed below:

- System complexity
- Compatibility of trajectory description and logic between brands and versions of Flight Management System
- Less transparent (risk of putting human out of the loop)
- Retrofit costs (change impacts Flight Management System)

For these reasons it was initially left out of the concept used in this study. In this way the feasibility of an operational concept, which does not require intent information exchange, could be investigated.

There is a strong relation between the requirement for this information and the lookahead time of the predictions for the conflict detection. In a head-on conflict with cruise speeds, the intruder's message can only be received five minutes before the conflict (based on a line-of-sight range of the transceiver of 85 – 100 nm and a ground speed of 500 kts) (Range based on operational data from the Cargo Airlines Association trials). This limits the guaranteed lookahead time to five minutes.

Other studies indicated that in an ATC environment actions to resolve conflicts beyond a five minute prediction where not useful (Magill, 1997).

In off-line simulations with the Traffic Manager (see chapter 7) it was found that three minutes lookahead was an absolute minimum not leaving much time for the decision making.

From these three observations it was decided to use a five-minute lookahead time for the state based conflict detection in the remainder of the studies.

There are three arguments for requiring the intent information exchange:

- reduce false alarms
- avoid missed alerts
- increase the lookahead time

How can it be explained that the studies results show that it's still feasible to leave it out of the operational concept?

The false alarms that are prevented by the intent option occur in situations where: (1) the state-based algorithm would predict a conflict and (2) using the intent information would

have prevented this alert. This means that the speed vector of the intruder is aiming at a conflict, while he intends to turn (or change the vertical speed) before the separation minima would be violated. In other words: the state-based alert means no more than: if nobody manoeuvres, the separation minima will be violated within a few minutes. It can be seen that even if you know the intruder's intent it might still be useful to be aware of the potential loss of separation. In this way the term false alarm loses its meaning. In a similar way, most conflict alerts could be regarded as false collision alarms, since they account for a larger zone to avoid than required for collision avoidance.

Whether an alarm is true or false depends on probability and this is not an on/off situation. There is a certain probability that the intruder will not turn, even though his intent says so. The state-based alarm provides a passive safety: situations that precede the dangerous situations are avoided. Therefore the choice could be made to avoid the inherently dangerous situation of pointing each other's speed vectors at each other since this would result in a conflict within a few minutes unless one of the aircraft manoeuvres. Formulated in this way, the state-based alerts are not false alarms, in the same way conflict alerts are not regarded as false collision alerts. It merely adds a time component to the three-dimensional protected zone. In most of the proposed concepts that do rely on exchanging intent information, a requirement for the state-based alert has been added for the last few minutes before a conflict (RTCA (2000)). This means that the so-called "false alarms" will also occur in these concepts that do use intent and state.

The missed alerts occur when an aircraft turns (or changes its vertical speed) from a course with no conflict to a course that will cause a conflict within the lookahead time. The danger of this situation lies in the fact that the conflict can be imminent and occur much sooner than the lookahead time. This is indeed a major drawback of state-based conflict detection. There is however another way to prevent this than by adding the complete intent exchange complexity: predictive ASAS. The predictive ASAS (or PASAS) is a conflict prevention system that has been added to the conflict detection and resolution system. It shows which manoeuvres will lead to a state based conflict alert. By adding an extra rule-of-the-sky to the operational concept, PASAS allows the crew to prevent these dangerous short-term conflict alerts:

It is forbidden to initiate a manoeuvre that will result in a conflict alert.

This rule and the predictive ASAS system were used in the second human-in-the-loop experiment (see chapters 5 and 11). The predictive ASAS system does not need intent information and it allows the crew to prevent missed alerts.

It is undoubtedly true that using intent information could increase the lookahead time. The question that then arises is: Is a longer lookahead time required? This study did not find any reason to increase the lookahead time beyond five minutes. There is no data indicating that this argument provides a requirement for exchanging intent information.

To make the system less reactive by using a longer lookahead time is a similar argument. This study has not found any objective data suggesting a requirement for a longer lookahead time. On the other hand pilots have sometimes stated they have a preference for a longer lookahead time and intent information, if no conflict prevention system is included. For some airlines it might therefore be a reason to add this functionality to the basic required state-based system. A longer lookahead time also increases the risk of false alarms and as shown before is not guaranteed because of the limited range of the ADS-B

system. So even though this study has shown intent is not *required*, the question whether it is *preferred* is still open.

A lookahead time of five minutes does not mean there can be a conflict alert every five minutes. The rate of the potential loss of separation itself is not affected by the lookahead time. The conflict alert rate will in general even increase with lookahead time as a result of more false alarms. A longer lookahead time will result in an equal (or higher) number of conflict alerts per hour.

From the above, it can be concluded that, in an en-route environment, this combination of state based conflict detection and the lookahead time of five minutes is feasible. This study did not find any basis for requiring exchanging intent information in an en-route, direct routing environment.

Does this mean that exchanging intent information is never needed? The answer of course is: no. The most important limitation in this study is that it has only looked at airborne separation assurance in upper airspace. Exchanging flight plan information might be required in other flight phases or be beneficial for other purposes. However, several other experiments have also found objective data in favour of the state-based CD&R (Combs, A & Rippey, L (2000); Cashion, P. & Lozito, S. (2000)). The fact that it is not required to have the equipment capable of handling and exchanging flight plan information, to perform en-route Free Flight with airborne separation assurance is an important result of this study. It could also be stated as follows:

This study did not find any evidence that an authority should require this functionality for an aircraft to enter en-route Free Flight airspace.

The study does however indicate that a conflict prevention module such as predictive ASAS should be mandatory. This is confirmed by the RTCA SC-186 ACM subgroup (RTCA, 2000) in their advised operational concept for Airborne Conflict Management as a result of this study.

The state-based solution saves considerable costs when retrofitting aircraft, which only have a conventional Flight Management System (where the flight plan information resides). By lowering system complexity this result brings the introduction of Free Flight closer.

Even though exchanging intent information is not required for airborne separation assurance, in the far future intent information may be available. In that case, it might provide a useful add-on to the basic required state-based conflict detection instead of replacing it.

14.2.2 Operational Concept > Explicit co-ordination

The question of what should be co-ordinated between the elements of a distributed system is in general an interesting and difficult issue. In a way it is, just like the flight plan issue, an information requirement issue. Do we need information on the resolution manoeuvre of the other aircraft? Do we need a confirmation that the intruder has also detected a conflict?

There is only one reason to require resolution co-ordination: to protect against counter-acting manoeuvres. The explicit co-ordination of the conflict resolution should, if not

required, be avoided not only for reasons of system complexity, compatibility and bandwidth. In addition to these disadvantages there is also the risk of systems missing a co-ordination message and getting stuck in a “wait trap”, which decreases the efficiency and safety of the system.

The counter acting manoeuvres can also be avoided in another way. By using one simple, common rule, the operational concept used in this study has avoided the need for explicit co-ordination of conflict resolution. That rule can be summarised as:

When a conflict has been predicted within the lookahead time, an aircraft should always manoeuvre in a way that does not decrease the predicted minimum distance.

Using this rule prevents the need to exchange the resolution manoeuvre, since the system in the own ship already knows the direction of the advised resolution manoeuvre of the intruder. This was referred to as implicit co-ordination. Since the proposed rule is a geometrical rule, there are singularities. In this case the rare situation where the predicted horizontal and/or vertical distance is zero is such a situation, which needs to be solved by an exception handling rule to avoid counter-acting manoeuvres. These exception handlers have been implemented in the ASAS system used in this study.

The other form of explicit co-ordination is conflict confirmation. This could be implemented as a system function (having humans communicate to resolve this may be reassuring but not very efficient). This clearly enhances the safety but does have some drawbacks. It adds interaction and thus system complexity and potential compatibility problems. Whether this is required depends on the quality of the communications. If there is a low-level protocol that ensures both aircraft’s CD&R systems always base the conflict alerts on the same data, there is no longer a need for such explicit co-ordination. In this study the effect of communications quality has not been studied, so this question remains unanswered.

14.2.3 *Operational Concept > Priority rules*

When using priority rules, it is either implicitly (by common rules) or explicitly (by communication) established that only one aircraft manoeuvres to solve the conflict. This aircraft is then free to resolve the conflict in any way because there is no risk of counter-acting manoeuvres. Using priority rules is therefore an alternative for using implicit or explicit resolution co-ordination.

In chapter 3 the two most important drawbacks of using priority rules have been discussed:

- pilots tend to solve conflicts even if they have right of way
- it lacks the fail safe aspect compared to a concept where both aircraft manoeuvre

Chapter 8 shows the power of a co-operative concept with respect to bottlenecks:

- in bottlenecks only a co-operative system will provide a means to pass on the information that extra airspace is required, with a priority rule the wave-like patterns, as for example seen in the wall geometry, can stop after one or two aircraft

Since the study indicates the implicitly co-ordinated concept is feasible for state-based conflict detection and resolution, priority rules are not required and should be avoided for the above mentioned reasons.

14.2.4 *Operational concept*

The hypothesis that an operational concept can be defined and demonstrated is supported by the study. The operational concept that has been designed and used in this study can be characterised as follows:

- All aircraft in Free Flight airspace have an ASAS with CDR&P (Conflict Detection, Resolution and Prevention) capability
- State-based conflict detection: no flight plan information exchange required
- Lookahead time of five minutes
- Implicit conflict resolution co-ordination by using only two common rules of the air (never decrease the minimum distance at CPA, prevent manoeuvring into conflicts)
- Both aircraft manoeuvre to solve a conflict
- Traffic Flow Management is the only form of central control for Free Flight Airspace

This concept has proven to be feasible in a direct route, en-route environment when all aircraft are able to exchange identity, position vector and velocity vector with sufficiently high update rate (once per 2 seconds was used in this study, but an update rate of 5 seconds was also sufficient to resolve the extreme wall scenario) and quality (100% in this study).

14.2.5 *Safety > Human Factors > Workload*

In the first human-in-the-loop study, no significant increase in workload ratings of the pilots were found for today's traffic densities with a very limited training time.

Having a Traffic Display alleviates the need to maintain a mental traffic picture based on radio messages. Together with the reduced communication this decreases the workload. This might explain why no increase in workload has been found. So the separation task is not an additional task but in a way replaces the communication task (see figure 14.3).

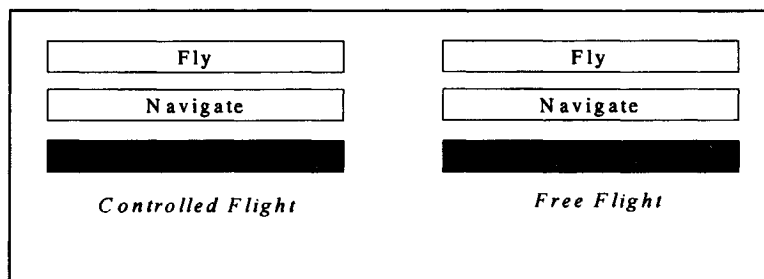

figure 14.3 Comparison main tasks during Controlled Flight and Free Flight

Based on the observations in both human-in-the-loop experiments, the hypothesis that the workload of airborne separation will be too high is refuted for the en-route environment. The workload in the cruise phase is very low in today's situation. It gradually increases when the aircraft gets closer to the airport. The approach and final approach are flight phases with a much higher workload (Boeing Commercial Aircraft Group (1994)). Therefore the workload of airborne separation assurance might be a

problem in these flight phases, but that has not been addressed in this study. In an en-route environment, the workload is not a reason to reject airborne separation assurance. The opposite seems true: the workload data found (chapter 10 & 11) and the effect of a distributed system (13) suggest a huge en-route airspace capacity increase will result from introducing airborne separation assurance.

14.2.6 *Safety > Human Factors > Situational Awareness*

This sub-hypothesis states that pilots will lack the situational awareness (or more specifically: traffic awareness) to maintain separation. Today pilots use the party-line effect to maintain a certain level of situational awareness. This is especially useful in areas without radar coverage. Clearly, having a Traffic Display (or CDTI – Cockpit Display of Traffic Information) improves the available information on the traffic situation and therefore potentially the traffic awareness, which is a part of the situational awareness.

The situational awareness that a ground controller has today is higher than is required in a cockpit with an ASAS that consists of a conflict detection, resolution and prevention system. The pilots may not have a global picture, but they also do not need it. From both the on-line (simulator) and off-line studies (especially the complex geometry study) it is shown that following the resolution advisories and avoiding the predictive ASAS bands is sufficient to avoid even bottlenecks (See chapter 8). This means that in general a conflict is a local problem, not a global problem.

Although traffic situation awareness may not be needed, still the total situational awareness of all crews with their CDTI is probably higher than the situational awareness of one controller. This is the main reason why airborne separation assurance is an enabler of direct routing in high traffic densities.

Moreover, the fact that in today's ATM system one controller is required to maintain a high level of situational awareness limits the airspace capacity (see section 11.6). As shown in chapter 13, the introduction of Free Flight is therefore a vital step to solve the current en-route airspace's capacity problems and the resulting delays and currently the only available solution.

14.2.7 *Safety > Human Factors*

The hypothesis that human factors prohibit airborne separation assurance is based on the notion that airborne separation assurance has a huge impact on cockpit operations. However, when using a CDR&P system, the only difference is that the resolution advisory is generated by this system instead of a controller's system. It also means there is no need to read back the advisory. The lack of party-line effect is easily compensated for by the CDTI. The acceptability of airborne separation assurance was shown to be quite high even after minimal training time. Based on these results and the fact that the two supporting sub-hypotheses have been refuted, the hypothesis that cockpit human factors do not allow airborne separation assurance has been refuted.

14.2.8 *Safety > Central Co-ordination > Conflict Geometries*

This sub-hypothesis suggests that two types of conflict geometries can result in dangerous situations due to the lack of central control: domino effects and bottlenecks.

The domino effect occurs when solving one conflict leads to another conflicts, which in severe cases could make things worse. However, using a conflict prevention system like predictive ASAS will allow the crew to find a resolution manoeuvre that does not result

in a new conflict, if such a manoeuvre exists. The crew can use this information to choose between the horizontal and the vertical resolution advisory as well as to choose the magnitude of the resolution manoeuvre. Filters in the conflict detection module prevent alerts due to transient conflicts caused by turning aircraft. When no conflict free manoeuvre is available, the domino effect is not a disturbing effect but an essential mechanism to create airspace. The wall scenario in chapter 8, where the vertical resolutions have been disabled, illustrates this. The domino effect is responsible for creating the hole in the wall and thus solves the apparent bottleneck. (This only works with a co-operative concept and not with priority rules.)

Traffic Flow Management should prevent unacceptable bottlenecks resulting from an overloaded, constrained Free Flight airspace. In reality, with Free Flight probably the runway availability will probably be the dominant limiting factor that results in flow constraints. If due to a combination of airport growth and for example an unforeseen weather situation the airspace capacity is not sufficient, the ASAS system has proven in the scenarios in chapter 8 capable of dividing airspace by utilising the domino effect. So instead of showing a warning 'Unable to maintain separation', this system would continue to show resolution advisories that in the worst case result in an overall separation less than the minima, but still equally shared. No system can create airspace that is not available, so requiring that bottlenecks should never occur is not useful. The fact that only in a distributed system a lot of resolution actions can take place at the same time is an indication that solving bottlenecks may be served by changing the system from a centrally controlled system to a distributed system.

In the future when air transport demands have grown to an order of magnitude higher than they are today, ideally a computer at Traffic Flow Management should be able predict the dynamic density at which the system becomes unstable. Studying this behaviour in cellular automata is therefore certainly relevant for this far future situation. For now, it is not a reason to keep a centrally organised system in place. This would be because of problems that can only occur at densities, which are much higher than can be handled by the central system. This is therefore not a reason to question the feasibility of transitioning to Free Flight from today's situation, given current and projected future traffic densities.

14.2.9 *Safety > Central Co-ordination*

In all sub-studies described in the previous chapters, no need for central co-ordination has been found. Even challenging scenarios as described in the complex geometry study (chapter 8), that serve as a metaphor for a highly constrained traffic situation, were being solved more efficiently without central co-ordination. Also the analysis in chapter 13 clearly shows the safety and capacity benefits of distributing the ATM system. Separation is in general a local, isolated problem between two aircraft and of no importance to the other aircraft in a sector. The only situation where it becomes a central problem is when the airspace available becomes an extremely scarce resource. In upper airspace, airspace is not scarce (if you don't believe this, go outside on a clear day and watch the sky, how many aircraft do you see at all these levels?). Airways, on the other hand, are sometimes scarce. That is why Free Flight should consist of the combination of direct routing and airborne separation assurance. Runways at a busy airport are a scarce resource and will probably require some form of central control, such as a form of central time slot management.

The hypothesis that central co-ordination is required can be refuted on the basis of the studies for en-route traffic densities today and in the near future. However, studying dynamic densities should continue to be prepared for the future when in some sectors Traffic Flow Management might limit access to the Free Flight sector to prevent the situation which would require central control but is beyond the capacity of the centralised system.

The fact that airborne separation assurance allows much higher densities than ground controlled separation (chapter 11 and 13) contradicts the widely held notion that Free Flight airspace should become managed airspace again when the density temporarily becomes too high for Free Flight.

14.2.10 *Safety > Technical > Bandwidth > Operational Concept*

The fact that both the operational concept and the ADS-B carrier has not yet been standardised means it is impossible to say that there is not sufficient bandwidth available. In this way the bandwidth argument is refuted. However, it is an important issue. The situation should be prevented of standardising on an ADS-B carrier that does not have the bandwidth to support airborne separation assurance, one of the most beneficial and revolutionary applications that depend on ADS-B. If the operational concept in this study is used, one can make an estimate of the required bandwidth. For state based separation assurance, the following data is required: call sign, position (latitude/longitude/altitude) and velocity (speed, course and vertical speed). Assuming the following range and precision (precision is overrated to be conservative in our estimate) one can deduce the number of bits required (rough estimates):

- Call sign, eight characters x 8 bits (5 bits would probably do) = 64 bits
- Latitude, -90 to +90 degrees, 0.000009 degree precision (=1 m), = 25 bits
- Longitude -180 to +180 degrees, resulting in twice the number of bits = 50 bits
- Altitude: -2000 to +300,000 ft (prepared for the future) precision 3 ft = 17 bits
- Speed: 0 – 2100 kts GS (allow high speeds for future), precision 1 kts = 12 bits
- Course: 360 degrees, one degree precision = 9 bits (allows 0.7 degrees precision)
- Vertical speed (should probably be replaced by flight path angle to be prepared for re-entering space vehicles): -9999 fpm to +9999 fpm precision 1 fpm (often 10 is used) : 15 bits

This results in a generous estimate of 192 bits (or 24 bytes) total. For overhead often 50 % is added. This overhead consists of counters of the lower level protocol, message identifiers and redundancy for error checks. This results in our example of one message of 36 bytes or 288 bits per aircraft. Generally a range of 100 nm is considered but in some circumstances this might be doubled and since we are looking for the worst, let us assume the transmitter's range is 200 nautical mile. Assuming a traffic density of N aircraft per 100 x 100 nm, this means there will be $4\pi N$ aircraft within range that can potentially occupy the channel(s). Let us assume we need an update every t seconds, this means the required bandwidth is:

$$\text{bandwidth} = \frac{4\pi N \cdot 288}{t} \text{ [bits/s = baud = Hz]}$$

For a triple density of 30 aircraft per 100 nm x 100 nm and an update rate of once per 2 seconds, this means a bandwidth of 54 kbit/s is required. This density was 50% more

than the peak in 1997, so it is a density that will occur as a peak density in the near future. Current proposed ADS-B technologies have a bandwidth that varies from 25 kbit/s to 1 Mbit/s! So the bandwidth clearly is an important factor for choosing the ADS-B option. It also means that for the moment the ADS-B bandwidth is the critical bottleneck for the realisation of Free Flight.

The operational concept in this study is a low bandwidth concept. Several operational concepts require more information (i.e. as a result of requiring intent information or co-ordination). Currently the message formats consist of even more bits such as long identifiers. Also some extra time is required for transmitters to switch on and off and for the receiver to tune in to the signal. Most ADS-B platforms have been tested with a variety of message formats using it for applications such as Controller-Pilot DataLink Communication (CPDLC) and weather information uplinks. Other applications also require ground vehicles to transmit ADS-B signals.

None of the tests or demonstrations have been performed with more than a handful of equipped vehicles. This is merely a tiny fraction of the number that will transmit once ADS-B has been introduced. Selecting (or developing) a high bandwidth ADS-B and testing it with high update rates for all envisioned applications at the same time is very important, but nobody plans to do this in the near future. Considering the calculation above, not glossy videos or smooth demos but bandwidth should be the most important selection criterion for an ADS-B technology.

The bandwidth requirements are ridiculous when one compares them with the bandwidth used in for instance mobile telephony or computer communications. The more advanced technology therefore is available and the aeronautical community should not adopt an old-fashioned, low bandwidth technology that prevents the application of airborne separation assurance in high-density airspace in the near future.

What is possible with the proposed ADS-B technologies? There are currently three proposed technologies for the ADS-B protocol: VDL mode 4 (VHF based), Mode S (1090 MHz, using current transponders) and UAT (UHF based). The bandwidth of VDL Mode 4 is less than 25 kbit/s per channel. The bandwidth of a transponder for Mode S is about 1 Mbit/s, of which about 4% is not available for Mode S. For UAT no data on bandwidth is available, but is said to be higher than mode S. The number of bits and update rate, as required for the operational concept as described in this study, only allows airborne separation assurance with Mode S and possibly UAT.

14.2.11 Safety > Technical > Strategic FMS > Reactive System

Requiring a completely new FMS that is able to negotiate trajectories with other airspace users would be a major obstacle for introducing Free Flight. The need for a new FMS is based on the notion that exchanging intent information and explicit resolution co-ordination are required for Free Flight.

The operational concept used in this study does not require exchanging flight plan information nor explicit co-ordination. This operational concept could not be refuted, hence there is no requirement for exchanging flight plan information (see 14.2.1) nor for explicit resolution co-ordination (see 14.2.2). Therefore fitting all aircraft with a new FMS will not be necessary. Based on this study, the only required technology is an ADS-B transceiver, new symbols on the navigation display and an aural alert.

14.2.12 Safety > Technical > Display Clutter > CDTI Design > High Traffic Densities

This sub-hypothesis states that no CDTI design has been used in experiments with high traffic densities. In both human-in-the-loop experiments, high traffic densities have been used by the subject pilots. The subject pilots were not technical pilots but regular airline pilots. Even though they were able to use the display in these densities, they did complain about the clutter caused by the traffic symbols.

14.2.13 Safety > Technical > Display Clutter > CDTI Design

Several CDTI designs have been studied for this study. The high traffic densities used in the preliminary validation were the reason to select directional traffic symbols (arrowheads) instead of adding extra clutter in the form of speed vector lines or trails.

14.2.14 Safety > Technical > Display Clutter

Most CDTI designs propose the traffic symbols integrated on the navigation display, together with flight plan information, weather, terrain and sometimes even moving maps. Integrating all information without cluttering the display is a challenge for display designers (see figure 14.4). Several research projects are studying this problem, but it is not resolved yet.

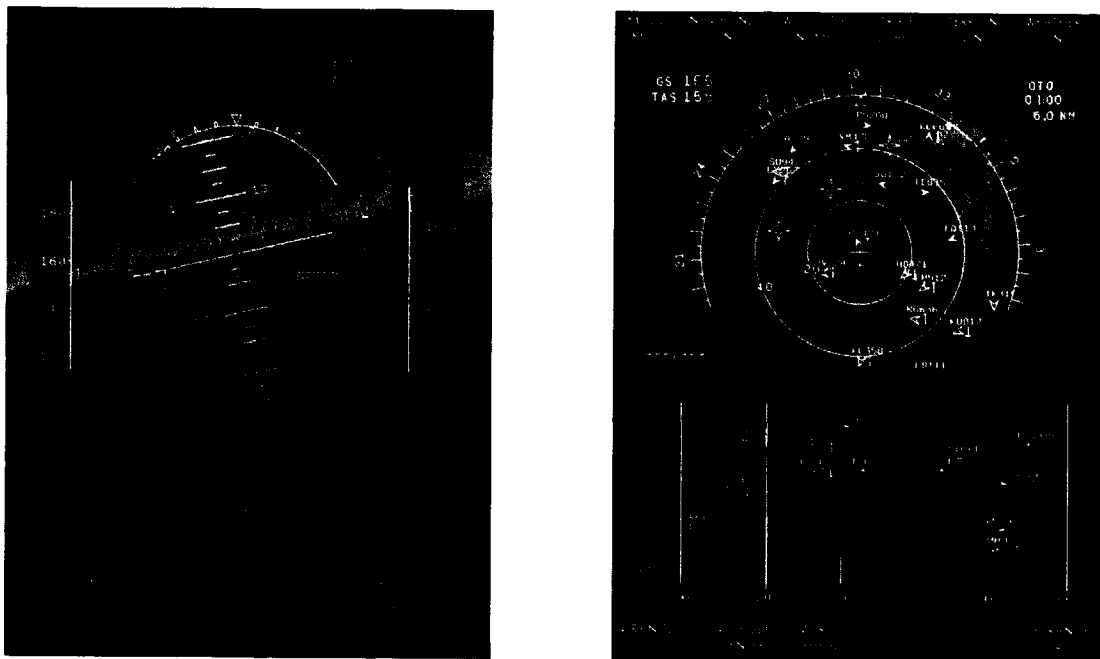

figure 14.4 New display designs will have to present a lot of information integrated on one or two screens

14.2.15 Economics > Resolution Costs

The idea that airborne separation assurance will result in inefficient trajectories can be refuted on the basis of the following results:

- The average conflict rate will be once per 50 minutes in high-density airspace
- The magnitude of the resolution manoeuvres is extremely small

- Most of the time the vertical resolution is the preferred resolution manoeuvre

In about 95% of the cases a vertical resolution manoeuvre will be used with the current separation minima. This is the quickest and most efficient way to solve a conflict. The costs of this climb or descent are negligible because of the low vertical speed required. For a maximum intrusion of 1000 ft, we will have to climb 500 ft in 5 minutes (the look-ahead time). This results in a required vertical speed of 100 fpm. Today step climbs, which will be replaced by a cruise climb in Free Flight, often use vertical speeds of 1500 fpm. Imagine we do have to solve the conflict horizontally and again the intrusion is the worst: 5 nm. This results in a course deviation of $(\arctan(2.5 \text{ nm} / 40 \text{ nm}))$ only 3.5 degrees. The total extra route flown due to this course deviation (assuming Free Flight airspace ends after 100 nm) is then in the order of 0.05%. Benefits of direct routing can reach 10 - 20% for short routes. For longer routes the benefits of direct routing will be less but still orders of magnitude higher than the costs of resolving a conflict.

14.2.16 *Economics > Local Optimisation*

This sub-hypothesis states that the global efficiency will decrease compared to global optimisation due to local optimisation. In general this is true, but as already discussed in chapter 2 a total optimisation requires a total knowledge of states and goals, which is not achievable in the real world without an enormous overhead resulting from the communication.

More practically viewed it is relevant to know whether solving one conflict does not often create one or more problems for other airspace users. In both on-line and off-line simulations it has been found that the conflict rate was rather low (once per 50 to 60 minutes) and that multi-aircraft conflicts occur rarely. As already discussed in section 14.2.9 the problem of conflict resolution is in general a local problem disconnected from the other airspace users. This is caused by the fact that even though today the airways may be full, the airspace in a direct routing environment is nearly empty.

Put in another way, in an en-route environment with traffic densities of several times today's densities, a conflict still is a local problem, which therefore does not require a global solution.

It has also been shown in chapter 13 that a centrally organised system is much more affected by traffic growth than a distributed system. This means that in a situation where en-route airspace does become rare, the densities will be beyond the capacity of any centrally organised system.

Based on these results, the global or centrally organised solution can be dismissed as a long-term solution for the ever growing air traffic demands.

14.2.17 *Politics > Pilots' Acceptability*

This hypothesis states that pilots will not accept the extra responsibility for airborne separation assurance. This is indeed the position of IFALPA, the association of air line pilots (See appendix E). They state they base this position on a number of "technical and human factors reasons". Some proposed concepts work around the responsibility problem by stating that even though the separation becomes a task of the flight crew, the responsibility remains on the ground with a monitoring air traffic controller. By adding this central element of the monitoring controller, the traffic growth allowed by a distributed system is (again) limited by the central node. Moreover, it is not practical to

place a task at one place and the responsibility at another. On top of that, today the pilot is also responsible for following the clearances of the controller.

The results of the questionnaires in the first human-in-the-loop study showed an increasing acceptability by pilots after being exposed to the concept in the flight simulator. Whether IFALPA will continue to and/or is able to stop the introduction of Free Flight remains to be seen. This might mean some key figures at IFALPA should be exposed to the experience of flying free flight in the flight simulator and the data that resulted from the off-line and on-line experiments. Also IFALPA should specify the technical and human factors reasons, preferably supported by experimental data.

This study was able to refute the hypothesis that pilots will never accept this extra task, based on experimental data and the opinions of regular airline pilots after being exposed to airborne separation assurance in a simulated high-density airspace (see chapter 10 and 11).

Although the pilot acceptability is an issue, in the end the airlines (their employer) determine whether this new mode of operation will be realised. IATA, the only global organisation of commercial airlines, has already expressed interest in the Free Flight concept as a result of this project.

14.2.18 Politics > Mixed Equipage with Intrinsic Benefits

This hypothesis states that gradual introduction of Free Flight will be possible by using mixed equipage procedures with intrinsic benefits for equipped aircraft. In the second human-in-the-loop experiment several mixed equipage procedures have been designed and validated. However, there are indications (see section 11.10) that there is a difference between mixed equipage concepts that are acceptable to pilots and concepts that are acceptable for controllers. This raises the question whether a procedure exists that will be acceptable to both.

Based on the current results of this study, the best way to introduce Free Flight is to avoid mixed equipage and declare certain areas Free Flight Airspace. Mandatory ASAS equipment will then provide the drive to equip aircraft as well as the ability to fly more optimally using this airspace.

14.2.19 Politics > Eurocontrol's ATM 2000+ Concept

The airspace division as envisioned in Eurocontrol's EATMS 2000+ places Free Flight in upper airspace. This Free Flight AirSpace (FFAS) requires ASAS equipment to derive the benefits of Free Flight. This is in line with the operational concept used in this study. The results of this study support the feasibility of Free Flight in this FFAS as described in this document.

14.3 Open Issues

When this study began in 1997, the aviation community did not consider airborne separation assurance a realistic option. The results of this study have been presented at conferences and seminars as well as in panels for RTCA, ICAO, EUROCAE, Eurocontrol and IATA. The huge impact of this study has led to the situation where Free Flight is now considered as an option for Western European airspace. As a result a lot of Free Flight studies have started and they focus on implementation issues and remaining open issues. NLR plays an active role in most of these projects.

Even though a lot of issues have been covered, still a large part of the hypothesis tree remains to be explored. A lot of these hypotheses are outside the scope of this study. Within the scope of this study several issues have been identified that need further research. A selection is listed below:

- Other flight phases: airborne separation assurance appears to be feasible in high altitudes, but how low can you go with this concept?
- System performance: will all the components perform sufficiently to meet the required characteristics for the operational concept? Especially the communication function (ADS-B) is critical in terms of bandwidth, update rate and reliability.
- What will be the effect of more humans in the loop than in the simulations so far? The effect on the traffic pattern has to be investigated.
- Competition: what will the effect of this concept be in a commercial environment with sometimes extreme competition between airlines. Ground controllers are often arbiters in these situations, what happens if they are no longer in control and people start 'bending the rules' (and other gaming effects)?
- Man Machine Interface: Though the designed MMI in this study has been evaluated with success, a thorough study of all options might result in a more optimal man machine interface in terms of symbology, alerting etc. Especially the clutter caused by the traffic symbology (especially the labels) needs attention.
- Transition: the mixed equipage study has shown that ATM procedures which handle the mixed equipage sectors are critical and need further study to avoid problems on the ground or at the flight deck.
- Flight Plan information: If flight plan information of other aircraft is available, how can this be integrated in the ASAS system without destroying all benefits of a state-based system?

14.4 Future work

In the near future several studies will be aimed at the open issues of the previous section. Within the NASA/NLR Free Flight project the following activities are currently foreseen:

A so-called human interaction experiment will explore the effect of competition and of 'bending the rules' on the operational concept. For this study a high number of participants will 'log on' to the traffic manager and control an aircraft in a scenario using their own PC and a downloaded flight simulation program including the ASAS system. A competitive effect will be introduced in the experimental design, resulting in more insight in the application of the operational concept in a commercial environment.

A simulator study will explore the effect of the operational concept in other flight phases, starting in cruise until final approach. In addition extra constraints like weather, terrain and SUA will be introduced.

System characteristics like ADS-B performance will be evaluated for several options of the ADS-B communications. The effect of bandwidth, update rate and message collisions on the flight deck and ASAS performance will be studied using both off-line and on-line (human in the loop) studies.

In co-operation with NASA Langley, the effect of the integration of flight plan information in the ASAS will be explored.

Information on these experiments will be published on the NLR/NASA Free Flight project's website: <http://www.nlr.nl/public/hosted-sites/freeflight>

Other issues are left to be solved by other projects. As a result of this study the focus of Free Flight research has shifted from feasibility issues to implementation issues.

15 Conclusions and Recommendations

15.1 Conclusions

15.1.1 *Feasibility*

Based on the results and discussion in the previous section, the most important result of this study is that the feasibility of Free Flight, the combination of direct routing and airborne separation assurance, in upper airspace could not be refuted. Even in high traffic densities Free Flight proved capable of maintaining the separation minima in a direct routing concept better than today's ATM system. This result is supported by the results of flight simulator experiments using airline pilots in simulated en-route, high traffic density airspace, by off-line traffic simulations and by analysis.

15.1.2 *Operational Concept*

This study proposes an operational concept for Free Flight in upper airspace for further research and implementation efforts. The concept requires a state-based conflict detection, resolution and prevention system and implicit co-ordination using only two straightforward, common rules-of-the-sky:

1. As soon as a state-based conflict is predicted within the specified lookahead time, an aircraft should not manoeuvre so as to decrease the distance at the predicted closest point of approach, but resolve the conflict if possible.
2. It is not allowed to initiate a manoeuvre that will result in a state that triggers a state-based conflict alert within the specified lookahead time.

Exceptions to these rules are situations where a higher priority threat, such as terrain or a more urgent conflict, can not be solved without violating these rules. This basically leaves solving this lower priority threat to the other aircraft involved. In the rules the word state refers to only the three-dimensional position and three-dimensional velocity vector.

The lookahead time is dependent on the airspace, flight phase and separation minima. For en-route traffic and the current separation minima, five minutes proved to be an acceptable value in this study.

15.1.3 *Capacity Benefits*

In a direct routing environment the airspace is used more efficiently than in a concept where aircraft have to follow one-dimensional airways. Free Flight proved to be able to handle higher traffic densities than today's centralised ATM system. Under simulated traffic loads that exceed the capacity of today's ATM system, very low pilot workload has been found and pilot acceptability was found to be high. By system analysis indications have been found that a distributed ATM system, like Free Flight, has a structural capacity advantage over any centrally organised ATM concept. Together with the observation that the majority of today's European ATC-related delays are caused by en-route congestion (Eurocontrol PRC, 1999), this means Free Flight could provide the solution for the current delay problem in Europe.

15.1.4 *Economic Benefits*

Free Flight is a potential enabler of direct routing. Direct routing has been the Holy Grail in ATM research for a long time. The economic benefits of direct routing will be substantial compared to past efforts to increase the efficiency of the ATM system.

Reducing delays is another economic benefit. The costs to upgrade the avionics will (and should) be much less than the potential benefits. The main reason why cockpit technology is expensive is because of the certification costs. By using a simple system as proposed in this study, these costs should allow to build a long-term business case for Free Flight. This long-term vision is crucial for the survival of the air transport sector and future work should focus on this.

15.1.5 *Safety Benefits*

The actual safety of Free Flight is hard to determine because of the number of open issues. Especially the specifications of the technology that will be available are still largely unknown. However, the fundamental change from a centrally organised system to a distributed system is potentially beneficial for the safety as shown in the analysis in chapter 13. This may be understood by comparing it with a simple example. How would collisions be better avoided? By having a number of blind-folded people walking in an area communicating with one monitoring controller or by taking the blindfolds away and allowing the people to walk and watch out by themselves? Another way to look at this fundamental change is to compare the situational awareness of one controller with the collective situational awareness of all pilots in a Free Flight airspace.

The de-centralisation and the inherent redundancy of the distributed system with implicit co-ordination contribute to the potential increase in safety as shown in both chapter 12 and 13.

15.2 Recommendations

15.2.1 *Keep It Simple, ...*

Using the simple, state-based operational concept proposed in this study as the first step allows the introduction of Free Flight in the near future. The fact that exchanging flight plan information is not required does not mean it will not be preferred by certain airlines. However, the increase in complexity is substantial. Therefore requiring this in an operational concept increases the risk that it is not possible to introduce Free Flight due to technological, political and economic constraints. This study could not refute the feasibility of an en-route, state-based concept, so this could and should be the direction to focus both research and implementation efforts on.

15.2.2 *Technology Testing*

Using the proposed operational concept, the required technology should be tested. Especially the ADS-B platform candidates should be validated in realistic, future scenarios based on the operational concept. Currently there is a clear difference between the European preference for an ADS-B platform developed in Europe and the US vision based on the ADS-B options developed in the US and Europe. Political bias should not prohibit accepting the technology that will allow airborne separation assurance, because enabling the long-term benefits of Free Flight exceeds any short-term political considerations regarding this issue. In other words, Europe should consider the US developed UAT and Mode S open-minded and not depend on only one candidate, the European VDL Mode 4, and vice versa.

15.2.3 *Standardisation of Rules-of-the-sky*

As a first step to focus and co-ordinate research and implementation efforts, the rules-of-the-sky should be standardised. In this study two rules have been proposed that are complete, yet leave sufficient room for individual differences and optimisations (see

15.1.2). Until now every Free Flight project or committee has started drafting its own operational concept. An institute that represents the main stakeholders, such as IATA, should take the lead and define the direction and the boundary conditions for the ongoing research and implementation efforts. As a representative of international airlines their global vision should determine the long-term goals for Free Flight.

15.2.4 Integrated Display Design

Human factors research should continue to work on designing traffic displays in an integrated way, based on the information requirements for now and the near future. There is a trend towards more autonomous cockpits, in which a cockpit is able to separate from traffic, terrain, weather and perform navigation without relying on ground based aids. This requires a display design that can show traffic, terrain, weather and navigation information without cluttering the displays. This data integration is the current challenge for display design.

15.2.5 Lower Cockpit Technology Threshold

Decades ago experiments used terrain displays, taxi displays and moving map displays in research flight simulators. Yet, today pilots fly with nearly black screens, get lost and fly over an unfriendly nation, fly into the Himalayas and take-off from the wrong runway where construction work is ongoing. For the sake of safety, not every new technology should be placed in the cockpit without reviewing it and certifying it. This attitude should however not result in the situation where a passenger with a hand-held GPS receiver and a laptop connected via GSM to the internet, has in some aspects a better situational awareness than the cockpit crew. The cockpit uses spoken or ASCII weather reports, the passenger can access moving satellite pictures and weather charts. The passenger can see he is flying towards Brussels, while in the cockpit the screens can look just as if approaching Frankfurt. While landing on the wrong airport may be innocent, nearly every year lives are lost because of the technology gap between the civil cockpit and the ground and the gap between operational, certified civil cockpit technology and what is available in the research field.

This gap is mainly caused by the time and money that is required for getting a new application certified. Consequently, it is now more cost-effective to for instance base a display on the current certified standards than to improve them based on what the technology can do. The certified standards are not sufficiently generic that they leave room for real improvement of the avionics. The fear of having new avionics introduced too quickly without thorough flight-testing has caused these rigid rules. Brand new, high-resolution screens still show dials and moving scales as if they were analogue instruments.

Certification and the process of introducing new technology should be changed in a way that allows more rapid introduction of new technologies without sacrificing the safety. Nothing can be 100% safe, but any improvement in safety should be welcome. This will require a cultural change in the aviation community. It requires a less conservative attitude that accepts that currently used avionics are not necessarily better unless proven otherwise in a very costly way by the manufacturer.

In other words: lower this Cockpit Technology Threshold that now prohibits the introduction of technology that could save lives every day.

ACRONYMS AND ABBREVIATIONS

AATT	Advanced Air Transportation Technologies
Ac, A/C	Aircraft
ADS-B	Automatic Dependent Surveillance – Broadcast
AIRSIM	Avionics Integration & Research SIMulator (desktop simulation)
ASAS	Airborne Separation Assurance System
ATC	Air Traffic Control
ATCo	Air Traffic Controller
ATM	Air Traffic Management
ATN	Aeronautical Telecommunications Network
BADA	Base of Aircraft Data
BSMI	Beoordelingsschaal voor Mentale Inspanning (Dutch name for RSME)
CAS	Calibrated Airspeed
CD	Conflict Detection
CD&R	Conflict Detection and Resolution
CDR&P	Conflict Detection, Resolution and Prevention
CDTI	Cockpit Display of Traffic Information
CNS	Communication Navigation Surveillance
CR	Conflict Resolution
DME	Distance Measuring Equipment (beacon that provides distance)
EFMS	Experimental Flight Management System
FAA	Federal Aviation Administration
FF	Free Flight
FFAS	Free Flight Airspace
FIR	Flight Information Region
FL	Flight Level (altitude in 100 ft units rel. to standard sea level pressure)
FMS	Flight Management System
fpm	feet per minute
FT, ft	feet (or foot)
GPS	Global Positioning System
GSM	Global System for Mobile communications
GUI	Graphical User Interface
HMI	Human Machine Interface
IAS	Indicated Airspeed
IATA	International Air Transport Association (global organisation of airlines)
ICAO	International Civil Aviation Organisation
ID,ACID	Identification, aircraft identification (e.g. call sign)
IFR	Instrument Flight Rules
IMC	Instrument Meteorological Conditions (when IFR should be applied)
INS	Inertial Navigation System
JAA	Joint Aviation Authorities
kHz	kilohertz
Lat	Latitude
LNAV	Lateral NAVigation mode = autopilot FMS coupled mode
Lon	Longitude
MAS	Managed Airspace
MHz	Megahertz
NASA	National Aeronautics and Space Administration

ND	Navigation Display
NLR	National Aerospace Laboratory, The Netherlands
nm	Nautical Mile (1852 m)
NRP	National Route Program
PASAS	Predictive ASAS (sometimes abbreviated as PredASAS)
PHARE	Programme for Harmonised ATM Research in Europe (Eurocontrol)
PFD	Primary Flight Display
PVD	Plan View Display (of a controller)
RFS	Research Flight Simulator
RNP	Required Navigation Performance
RSME	Rating Scale of Mental Effort
RT, R/T	Radiotelephony (voice radio)
RTCA	Radio Technical Commission for Aeronautics
RVSM	Reduced Vertical Separation Minima (1000 ft instead of 2000 ft)
STCA	Short-Term Conflict Alert
SUA	Special Use Airspace
TAS	True Airspeed
TCAS	Traffic Collision Avoidance System
TCP	Trajectory Change point
TEM	Traffic and Experiment Manager (=TMX)
TIS-B	Traffic Information Service Broadcast
TLS	Target Level of Safety
TMA	Terminal Control Area
TMX	Traffic Manager (=TEM)
TOPAZ	Traffic Organization and Perturbation AnalyZer
TSA	Temporarily Segregated Area
UAT	UHF ADS-B Transceiver (?)
UHF	Ultra-High Frequency (specified range of frequencies)
UMAS	Unmanaged Airspace
VDL Mode 4	VHF based ADS-B technology, abbreviation unknown (VHF Data Link?)
VFR	Visual Flight Rules
VHF	Very High Frequency (specified frequency range)
VMC	Visual Meteorological Conditions (when VFR can be applied)
VNAV	Vertical NAVigation mode = autopilot FMS coupled mode
VOR	VHF OmniRange navigation system (beacon that provides direction)
VS, V/S	Vertical Speed
WE	Western European
WGS'84	World Geodetic System 1984 for lat/lon coordinates

DEFINITIONS

Separation Minima	The prescribed minimum distances between two aircraft, in general specified as combination of a horizontal minimum distance and a vertical minimum distance
Separation Assurance	The act of assuring that the separation minima will not be violated
Loss of separation	The situation where the distance between two aircraft is less than the separation minima
Conflict	A predicted loss of separation
Conflict Detection	The act of or module for predicting conflicts
Conflict Resolution	Manoeuvring in a way that the predicted loss of separation disappears
Conflict Prevention	Avoiding manoeuvring into a conflict
Recovery Manoeuvre	The manoeuvre that resumes the original navigation after the conflicting aircraft has been passed
Own ship	The own or active aircraft in discussions on conflicting pairs of aircraft
Intruder	The other or passive aircraft in discussions on conflicting pairs of aircraft
Lookahead time	Time that is used as prediction window for conflict detection and resolution
Protected Zone	Area around aircraft determined by the separation minima, which should not be intruded by other aircraft.
Alert Zone	In the RTCA concept aircraft in this area are a reason to alert the crew. The concept in this study does not use an alert zone. It does use a slightly bigger protected zone for the conflict detection & resolution than the actual separation minima.
Explicit co-ordination	Co-ordinate via communication how to resolve a conflict to avoid counter-acting manoeuvres
Implicit co-ordination	Use common rules to avoid counter-acting manoeuvres
Intent	The intended trajectory of an aircraft (the flight plan)
Priority Rules	Traffic rules to determine which vehicle should manoeuvre to solve the conflict
Rules-of-the-sky	Traffic rules for air transport, analogue to rules-of-the-road

REFERENCES & BIBLIOGRAPHY

- Allen, D. L. ; Haraldsdottir, A.; Lawler, R. W. ; Pirotte, K.; Schwab, R.W. (1997). "The Economic Evaluation of CNS/ATM Transition", ATM 97 Conference paper, CNS/ATM projects, Boeing Commercial Airplane Group
- Berghuis van Woortman, H.J. & Aardoom, W. (1991). "Cursus luchtverkeersleiding (lr94)", 5th Issue, November 1991, lr94, Technical University Delft, Faculty of Aerospace Engineering
- Billings, C.E. (1997). "Aviation automation: The search for a human-centered approach." Mahwah, New Jersey: Lawrence Erlbaum Associates.
- Boeing Commercial Aircraft Group (1994). "Statistical summary of commercial jet aircraft accidents, worldwide operations 1959-1994." Seattle, WA: The Boeing Commercial Airplane Group.
- Cashion, P. & Lozito, S. (2000). "How Short- and Long-term Intent Information Affects Pilot Performance in a Free Flight Environment", San Jose State University, NASA Ames Research Center, HCI-Aero conference 2000 paper
- Combs, A. & Rippey, L. (2000). "Distributed Air Ground- Traffic Management Intent Preference Experiment"; Airborne Systems, Crew Systems and Operations Branch; NASA Langley
- Donovan, J. & Joseph, K.M. et al.(1998). "Human Factors Issues In Free Flight", SAE G-10 Aerospace Resource Document (ARD) No. 50079
- Duong, V. & Floch, L. (1996). "FREER-1 Requirement Document version 2.0 ", Eurocontrol Experimental Centre EEC Bretigny, France
- Eby, M.S. (1994). "A Self-Organizational Approach for Resolving Air Traffic Conflicts", The Lincoln Laboratory Journal, MIT, Vol. 7, Nr. 2, 1994, page 239 - 254
- Eurocontrol Experimental Centre (1997). "User Manual for the Base of Aircraft Data (BADA)" Revision 2.5, EEC Note 1/97, Eurocontrol, 1997
- Eurocontrol (1998). "Eurocontrol Air Traffic Management Strategy 2000+ Operational Concept Document", EATMS OCD (edition 1.1, 14.8.98) EATCHIP, 1998
- Eurocontrol PRC (1999). "Annual Report of Eurocontrol Performance Review Committee 1999", Eurocontrol, 1999
- FAA (1992). "National Route Program", Advisory Circular (AC) No. 90-91, ATM-100, April 24, 1992
- FAA (1994). "National Route Program (NRP)", FAA Order N7110.128 Free Flight, ATM-100, effective January 9, 1995

FAA (1999). "Interim Guidance 91-RVSM", change 1 AFS-400, June 30th 1999, FAA AFS-400

FAA (2000). "Air Traffic Control", August 2000, FAA TP 07110.65M

FAA AIM (2000). "Aeronautical Information Manual" (AIM), FAA, Edition August 2000, Chapter 4

Goldberg, D.E. (1989). "Genetic Algorithms in Search, Optimization, and Machine Learning", Addison-Wesley, 1989

Hilburn, B. ; Pekela, W. (1999). "Free Flight and the Air Traffic Controller: Results of Air-Ground Integration Experiments", SAE World Aviation Congress 1999 paper 1999-01-5563

Heitkoetter, Joerg and Beasley, David, eds. (1994). "The Hitch- Hiker's Guide to Evolutionary Computation: A list of Frequently Asked Questions (FAQ)", USENET : comp.ai.genetic. Available via anonymous FTP from <ftp://rtfm.mit.edu:/pub/usenet/news.answers/ai-faq/genetic/> About 90 pages.

Horn, R.E. (1998). "Visual Language", Robert E Horn, MacroVU Press, Washington, 1998

ICAO Annex 11. "ICAO Annex 11" International Standards and Recommended Practices - Air Traffic Services, ICAO

ICAO Circular 249-AN/149 "Guidelines for Human Centred Automation in Aviation"

ICAO (1992). "Application of Separation Minima (North Atlantic Region)", ICAO, publ. by Transport Canada, 3rd edition, Dec 1992

Kuchar J.K. & Yang, L.C. (1997). "Survey of Conflict Detection & Resolution Modelling Methods", AIAA GN&C conference 1997

Langton, C.G. (1997). "Artificial Life: An Overview (Complex Adaptive Systems)", Christopher G. Langton, Bradford Books, March 1997

Lozito, S. & McGann, A. et al (1997). "Free Flight and Self-Separation from the Flight Deck Perspective"; NASA Ames Research Center, San Jose State University, paper ATM '97 Conference

Magill, S.A.N. (1997). "Trajectory Predictability and Frequency of Conflict Avoiding Action", Defence Evaluation and Research Agency (DERA), paper CEAS Free Flight Conference 1997

Merwin, D., O'Brien J. V., & Wickens, C. D. (1997). "Perspective and coplanar representation of air traffic: Implications for conflict and weather avoidance." Proceedings of the 9th International Symposium on Aviation Psychology. Columbus, OH: Dept. of Aerospace Engineering, Applied Mechanics, and Aviation, Ohio State University

- Nyhoff, L. & Leestma, S. (1996). "Fortran 77 for Engineers & Scientists", Prentice Hall, 1996, ISBN 0-13-363003-X
- Parasuraman, R., Molloy, R., & Singh, I. (1993). "Performance consequences of automation induced "complacency"", *International Journal of Aviation Psychology*, 3(1), 1-23.
- Ross Russell, J. (1995). "The Separation Game", *IFR magazine*, Belvoir Publications Aviation Group, archived at Avweb: <http://www.avweb.com/articles/separat.html>
- RTCA TF 3 (1995). "Final report of RTCA Task Force 3: Free flight implementation" RTCA Task Force 3, 1995, RTCA Inc., Washington DC, chapter 3
- RTCA (2000). "Operational Concept for Airborne Conflict Management", RTCA SC-186 ACM subgroup, 2000, RTCA Inc., Washington DC
- Valenti Clari, M.S.V. (1998). "Cost-Benefit Analysis of Conflict Resolution Manoeuvres in Free Flight" M. Sc. Thesis Delft University of Technology, Faculty of Aerospace Engineering, Flight Mechanics group, August 1998
- Van Gent, R.N.H.W., Bohnen, H.G.M., Jorna, P.G.A.M. (1994). "Flight Simulator Evaluation of Base Line Crew Performance with Three Data Link Interfaces", NLR, 1994
- Vesely, W.E., Goldberg, F.F., Roberts, N.H., Haasl, D.F. (1981). "Fault Tree Handbook", U.S. Nuclear Regulatory Commission, 1981
- Wickens, C.D. (1992). "Engineering psychology and human performance" (2nd ed.). New York: Harper Collins
- Wickens, C.D. et al. (1997). "Flight to the Future: Human Factors in Air Traffic Control" - Christopher D. Wickens, Anne S. Mavor, and James P. McGee, Editors; Panel on Human Factors in Air Traffic Control Automation, National Research Council, National Academy Press, Washington, D.C. 1997
- Wolfram S. (1984). "Cellular Automata as Models of Complexity", S. Wolfram, *Nature*, 311, (October 1984) 419--424
- Zijlstra, F.R.H & Doorn, L. van (1985). "The construction of a scale to measure subjective effort." Technical Report, Delft University of Technology, Department of Philosophy and Social Sciences, Netherlands

ACKNOWLEDGEMENTS

First of all I would like to express my gratitude towards Rob Ruigrok and Ronald 'Skunk Works' van Gent. Working together in this project with the three of us as a core think tank was very pleasant and inspiring. Especially the loud discussions in front of the whiteboard were very useful. Ronald has also been responsible for the project management in the first years. Rob has assisted him by managing the flight simulation part of the project. This has allowed me to focus on the technical and scientific work such as developing the Traffic Manager, the CD&R algorithms, display design and off-line traffic simulations.

Rob has also developed scenario generation tools and contributed to the chapter describing the results of the data analysis of the second human-in-the-loop experiment. I also am grateful for Bart Heesbeen for his work on Predictive ASAS. In the same way, I owe a lot to several students who contributed to this work: Joakim Visscher for his work on the data analysis of the first human-in-the-loop experiment (chapter 10), Mario Valenti Clari, who is now an NLR employee, for his off-line traffic simulation analysis (section 4.7) and for contributing the results of the Cost-Benefit off-line traffic simulations (chapter 9). This work would also not have been possible without the efforts of Jaap Groeneweg, Frank Bussink, Brian Hilburn and the other people in the team during the flight simulator experiments.

I would also like to thank my beloved wife Henriëtte for her support throughout the duration of this project. It was her (and Rob's!) support that allowed me to start working on this study while still recovering from a broken spine disc.

Last but not least I would like to thank NASA, the FAA, the Rijksluchtvaartdienst and NLR for giving me the chance to work on one topic for the duration of years. This has provided me with the unique opportunity to do this work.

CURRICULUM VITAE

Jacco Hoekstra was born on April 13th 1967 in Leeuwarden, Netherlands. During high school at the age of 14 his passion for mathematics made him start programming in three computer languages including Z80 assembly. He studied Aerospace Engineering at the Delft University of Technology. The university gave him the opportunity to obtain a private pilot's license. He graduated in 1991 on developing a mathematical model and flight simulation program of a Beechcraft Super King Air 200 for a flight simulator company in Switzerland. His first position after graduation was software design engineer for a software company in the telecommunications field. But very quickly he returned to the aeronautical world when he started working at the Flight Simulation and Handling Qualities department of the National Aerospace Laboratory NLR in Amsterdam. His initial work was modelling and simulation but soon his work also included operational and human factors research with the flight simulator. Topics he worked on are advanced flight control systems, accident investigation, pilot-controller data link and human machine interface design. In 1997 he started working on the Free Flight project nearly full time. In 1998 he moved to the Human Factors department and later became project manager of the Free Flight project. In 2001 he became the head of the Civil Human Factors group of this department.

Appendix A Questionnaires phase I trials
Appendix B Complete overview results phase I trials
Appendix C Questionnaires phase II trials
Appendix D Traffic Manager Command Reference
Appendix E IFALPA Press Release
Appendix F Press coverage of study

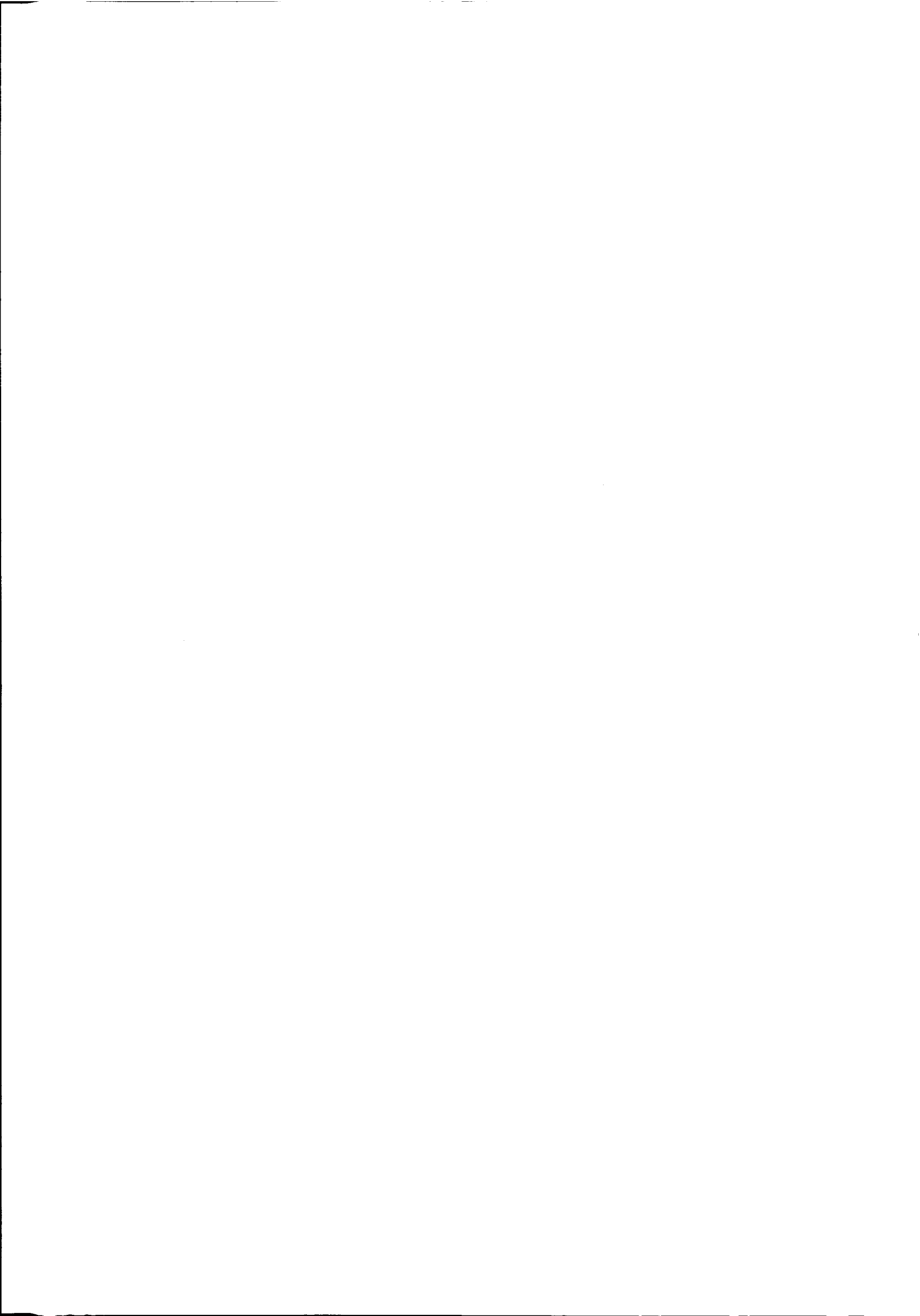

APPENDIX A QUESTIONNAIRES PHASE I TRIALS

Pilot Experience Questionnaire

Date: **Airborne Free Flight**

Name: **PF/PNF**

Date of birth:

List the type, approximate flight hours, and your position for the different transport aircraft you have flown.

AIRCRAFT FLIGHT HOURS POSITION(Capt., F/O, etc.)

AIRCRAFT	FLIGHT HOURS	POSITION(Capt., F/O, etc.)

Do you wear glasses or lenses (Yes/No)

If yes, are they bifocal (Yes/No)

Also, please provide the following information (approximate hours):

Total Flight Hours:	
Current Aircraft Flying:	
Current Airline:	
Current Ratings:	
EFIS Experience (hrs.):	
FMS Experience (hrs.):	
Military Jet Experience (hrs.):	
International Experience (hrs.):	
# of research projects as pilot participant:	

Appendix A Questionnaires phase I trials

BSMI

Date: **Airborne Free Flight**
Name: **PF/PNF**
Condition: Manual Execute combined Execute separately
Runnumber: Density: "XXXX":

Please indicate, with a cross on the vertical line, how much effort it cost to do your work in the above mentioned flight.

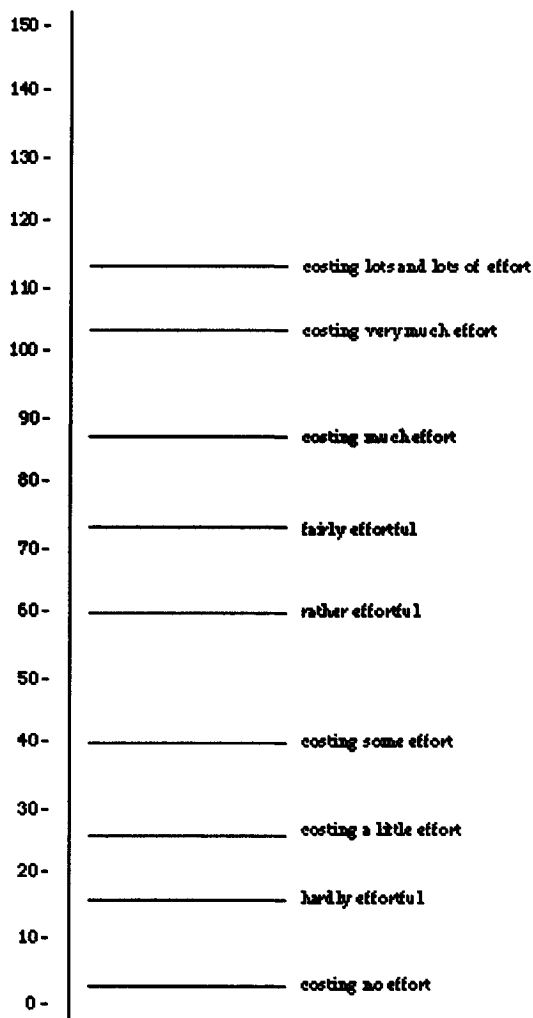

Appendix A Questionnaires phase I trials

Date: **Airborne Free Flight**
 Name: PF/PNF
 Condition: 0 Manual 0 Execute combined 0 Execute separately
 Runnumber: Density: "XXXX":

 Please rate the overall acceptability of your last flight..(one tick only)

<input type="checkbox"/>	Perfect in every way
<input type="checkbox"/>	Favorable
<input type="checkbox"/>	Acceptable
<input type="checkbox"/>	Undesirable
<input type="checkbox"/>	Completely unacceptable

 Please tick True or False to express your opinion on the statements below.

TRUE FALSE

<input type="checkbox"/>	<input type="checkbox"/>	I think I could safely guarantee the airborne separation with the set-up just flown
<input type="checkbox"/>	<input type="checkbox"/>	I manoeuvred more than normally
<input type="checkbox"/>	<input type="checkbox"/>	I exceeded passenger comfort levels
<input type="checkbox"/>	<input type="checkbox"/>	I need more information about the traffic situation to guarantee the safety
<input type="checkbox"/>	<input type="checkbox"/>	I need better information about the traffic situation to guarantee the safety
<input type="checkbox"/>	<input type="checkbox"/>	I need more explicit rules of the road to guarantee the safety
<input type="checkbox"/>	<input type="checkbox"/>	I need more explicit on board procedures to guarantee the safety
<input type="checkbox"/>	<input type="checkbox"/>	I need more training to guarantee the safety

 How does in your opinion the safety of the set-up just flown compare to modern present day ATC operations? (one tick only)

<input type="checkbox"/>	FF much safer
<input type="checkbox"/>	FF safer
<input type="checkbox"/>	Same
<input type="checkbox"/>	ATC safer
<input type="checkbox"/>	ATC much safer

Appendix A Questionnaires phase I trials

POST-TRIAL QUESTIONNAIRE

Date: **Airborne Free Flight**
 Name: **PF/PNF**
 Condition: Manual Execute combined Execute separately

1. On a scale from 1-5 rate the following aspects of the Free Flight concept.
 1 - completely unacceptable
 2 - undesirable
 3 - acceptable
 4 - favorable
 5 - perfect in every way

Free Flight concept	1	2	3	4	5
a-No ATC present					
b-No priority rules (but all acft deviate)					
c-Conflict detection based on max. intrusion prot. zone					
d-Times to conflict used (5 min amber, 3 min red)					
d-Voltage potential resolution					
e-intra flight comms					
f-Ground arbitration					

Suggestions or comments on any of these aspects?

2. On a scale from 1-5 rate the following aspects of the Alerting concept.
 1 - completely unacceptable
 2 - undesirable
 3 - acceptable
 4 - favorable
 5 - perfect in every way

Traffic alerting	1	2	3	4	5
a-The use of the glare shield indicator					
b-The repetitive use of an aural alert (conflict present)					
c-The aural used for "amber" conflict					
d-The aural used for "red" conflict					
e-The functionality of canceling an alert					

Suggestions or comments on any of these aspects?

Appendix A Questionnaires phase I trials

3. On a scale from 1-5 rate the following aspects of the Traffic Display concept.

- 1 - completely unacceptable
- 2 - undesirable
- 3 - acceptable
- 4 - favorable
- 5 - perfect in every way

Traffic Display concept	1	2	3	4	5
a-Use of Navigation display as traffic display					
b-Addition of Vertical Display					
c-Presentation of conflict at max. intrusion of prot. zone					
d-Presentation of traffic resolution in protected zone					
e-Presentation of heading bug on horizontal display					
f-Presentation of VV bug on vertical display					
g-Presentation of speed, altitude and VV bug on PFD					

Suggestions or comments on any of these aspects?

4. On a scale from 1-5 rate the following aspects of the Traffic Avoidance Control concept.

- 1 - completely unacceptable
- 2 - undesirable
- 3 - acceptable
- 4 - favorable
- 5 - perfect in every way

Traffic Avoidance Control concept	1	2	3	4	5
a-Manual (if applicable)					
b-"Execute combined" (if applicable)					
c-"Execute separate" (if applicable)					
d-Return to "no conflict" situation					
e-PF executing the manoeuvre					

Suggestions or comments on any of these aspects?

Appendix A Questionnaires phase I trials

5. On a scale from 1-5 rate the following aspects of the Generic Control Panel.

- 1 - completely unacceptable
- 2 - undesirable
- 3 - acceptable
- 4 - favorable
- 5 - perfect in every way

Generic Control Panel	1	2	3	4	5
a-Horizontal clipping range operation					
b-Vertical clipping range operation					
c-Callsign toggle					
d-Altitude toggle					
e-Airspeed toggle					
f-Time to Intrusion					
g-Performance lines					

Suggestions or comments on any of these aspects?

6. On a scale from 1-5 rate the desirability of the following alternative MMI concepts.

- 1 - completely unacceptable
- 2 - undesirable
- 3 - acceptable
- 4 - favorable
- 5 - perfect in every way

MMI concepts	1	2	3	4	5
a-Perspective display on PFD					
b-Perspective display on lower EICAS					
c-Use of pointing device for selective interrogation of target					

Suggestions or comments on any of these aspects?

Appendix A Questionnaires phase I trials

7. On a scale from 1-5 rate the criticality of the following functional elements for safety.

- 1 - extremely critical
- 2 - very critical
- 3 - critical
- 4 - not really critical
- 5 - not at all critical

Functional elements	1	2	3	4	5
a-Traffic Flow Management					
b-Traffic detection					
c-Conflict detection					
d-Resolution computation					
e-TCAS as backup					
f-ATC as backup					

Suggestions or comments on any of these aspects?

Appendix A Questionnaires phase I trials

APPENDIX B Complete overview results Phase II trials

This appendix contains a complete overview of the data gathered during the Phase I trials. The figure consist of different cross-section of these data:

The following divisions are made:

- Related to traffic density:
single, double and triple i.e. once, twice and three times the “normal” density in Western-European airspace
- Nominal versus non-nominal:
Nominal (no events) sessions versus **non-nominal** (with events) sessions
- Related to the active autopilot resolution mode:
Manual, Execute combined, Execute separately
- Divided per set of runs:
set 1 means the first 6 runs of 18 (first day afternoon)
set 2 means the second 6 runs of 18 (second day morning)
set 3 means the third 6 runs of 18 (second day afternoon)

Chapter 10 uses a similar division but uses only the nominal data for the statistical analyses unless otherwise stated. This means minor differences can occur between the figures in this appendix and the chapter describing the results. Since the non-nominal cases have been included and no significance figure is given, no hard conclusions should be based on the figures in this appendix. It is merely provided to show a more complete overview of the data. Trends could provide indications for future research.

Most subjective data is presented graphically in frequency tables. Frequency tables represent the simplest method for analysing categorical data. They are used as an exploratory procedure to review how different categories of values are distributed in the sample. Since most questionnaire results are formatted as categorical variables, these frequency tables are used to present the results.

Acceptability of free flight concept

After each run the pilots had to rate the acceptability of their last flight. The distribution of responses as a function of the three densities used during the experiment across all runs and across all subject pilots is shown in figure 1.

Appendix B Overview phase I results

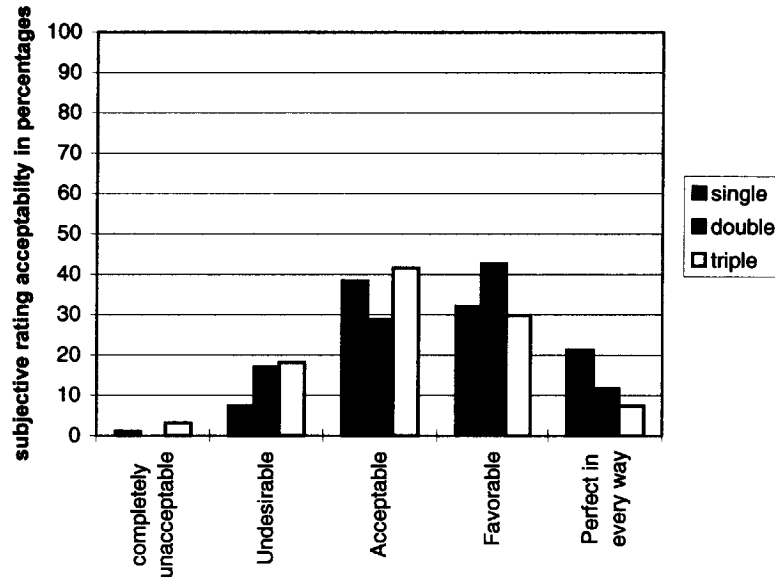

figure 1 Acceptability of free flight as a function of the traffic density

This shows an surprisingly high acceptability considering the fact that the pilots had minimal training time for this completely new task. The triple density had been included in the experiment to cause an overload situation, but that may not have happened as can be seen from this figure. The ratings do include the non-nominal cases such as failures.

The percentages of ratings at a level of acceptable or higher as a function of the three densities used during the experiment across all flights and across all subject pilots are shown in figure 2. The percentage of subject pilots rating the session as acceptable or higher during single density was 91.5, during double density was 83.0 and during triple density was 78.7.

Appendix B Overview phase I results

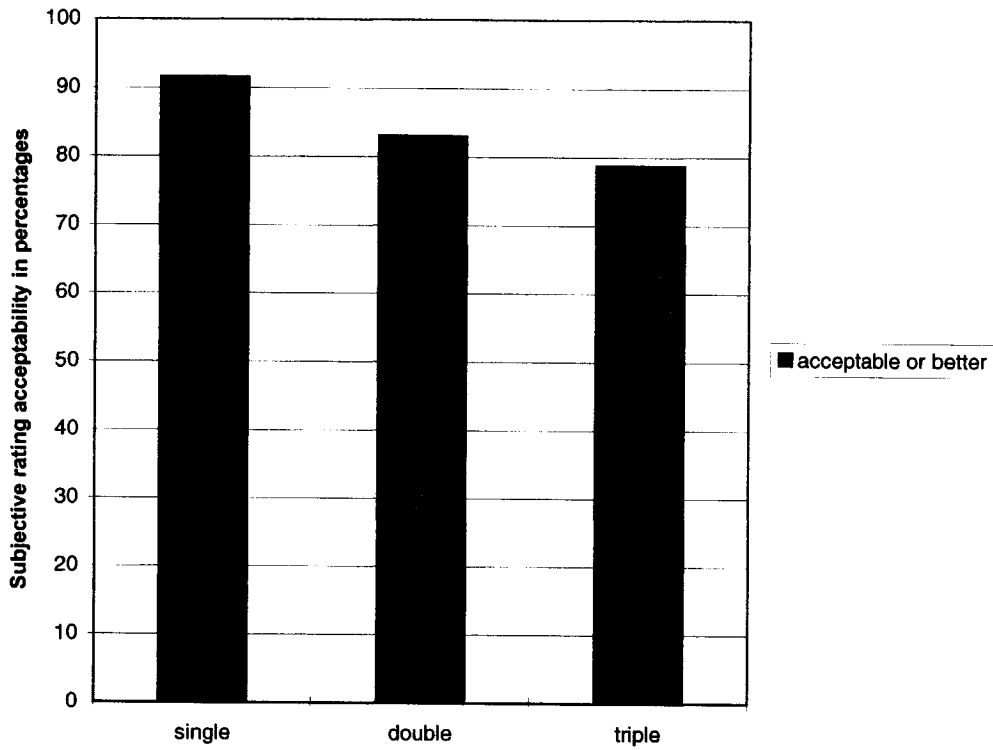

figure 2 Acceptability of free flight concept rated as acceptable or higher, as a function of the traffic density

As was expected, the acceptability ratings decrease with increasing density, but not as much as was expected. This figure does not show a clear overload in the triple density. The ratings do include the non-nominal cases such as failures.

Appendix B Overview phase I results

The distribution of responses as a function of nominal conditions versus non-nominal conditions used during the experiment across all sessions and across all subject pilots is shown in figure 3.

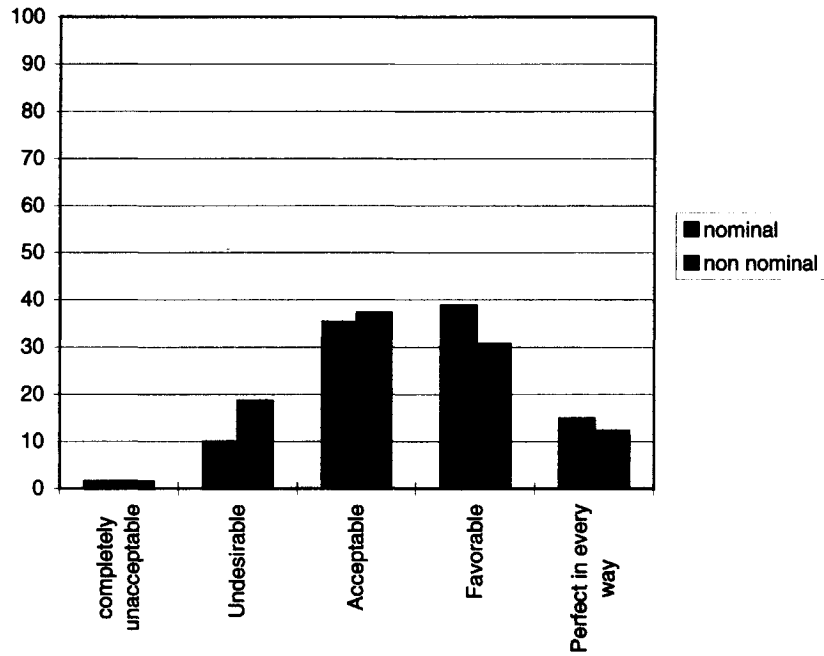

figure 3 Acceptability of free flight concept nominal conditions versus non-nominal conditions.

This figure again shows a surprisingly high acceptability even for the non-nominal runs. Still, there were also a low number of 'completely unacceptable' ratings!

Appendix B Overview phase I results

The percentages of ratings at a level of acceptable or higher as a function of nominal conditions versus non-nominal conditions used during the experiment across all flights and across all subject pilots are shown in figure 4. The percentage of subject pilots rating the session as acceptable or higher during nominal conditions was 88.7, during non-nominal conditions was 80.

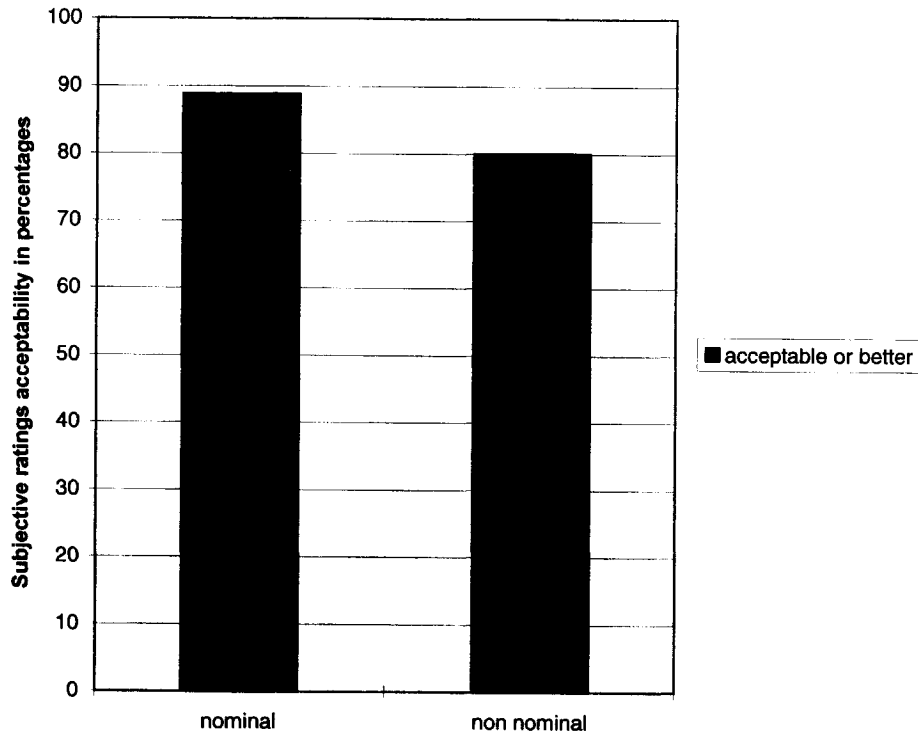

figure 4 Acceptability of free flight concept rated as acceptable or higher, nominal conditions versus non-nominal conditions

As expected, introducing failures and delays decreases the acceptability. Still, the percentage of acceptable ratings is surprisingly high for these runs.

Appendix B Overview phase I results

The distribution of responses as a function of the three different modes used during the experiment across all sessions and across all subject pilots is shown in figure 5.

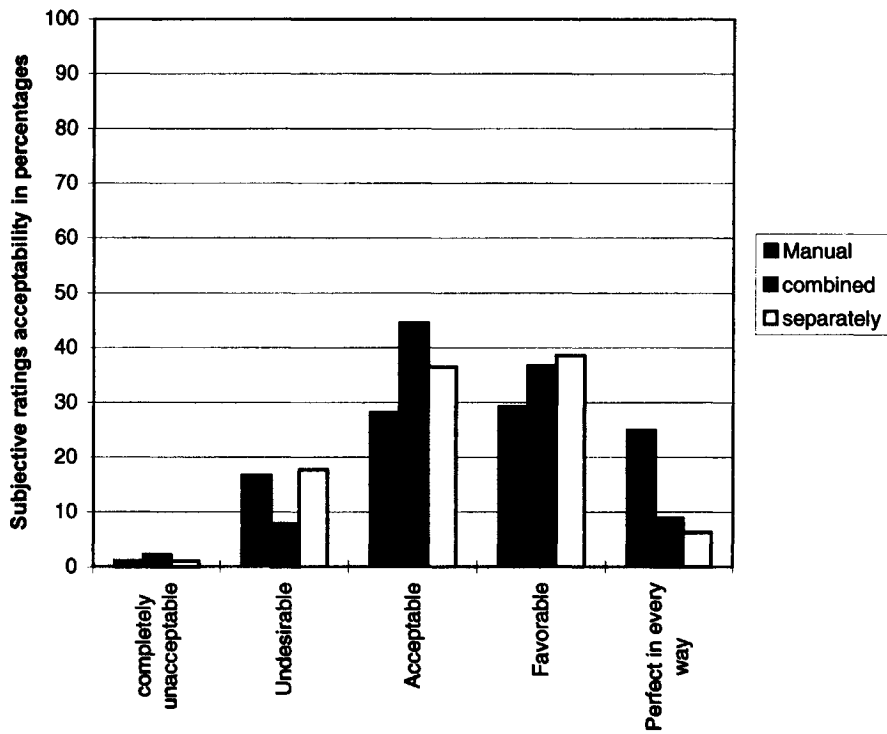

figure 5 Acceptability of free flight concept as a function of the three different modes

Note that the manual mode received most of the 'Perfect' ratings.

Appendix B Overview phase I results

The percentage of ratings at a level of acceptable or higher as a function of the three different modes used during the experiment across all flights and across all subject pilots are shown in figure 6. The percentage of subject pilots rating the session as acceptable or higher during manual mode was 82.3, during Execute combined mode was 90 and during execute separately mode was 81.3

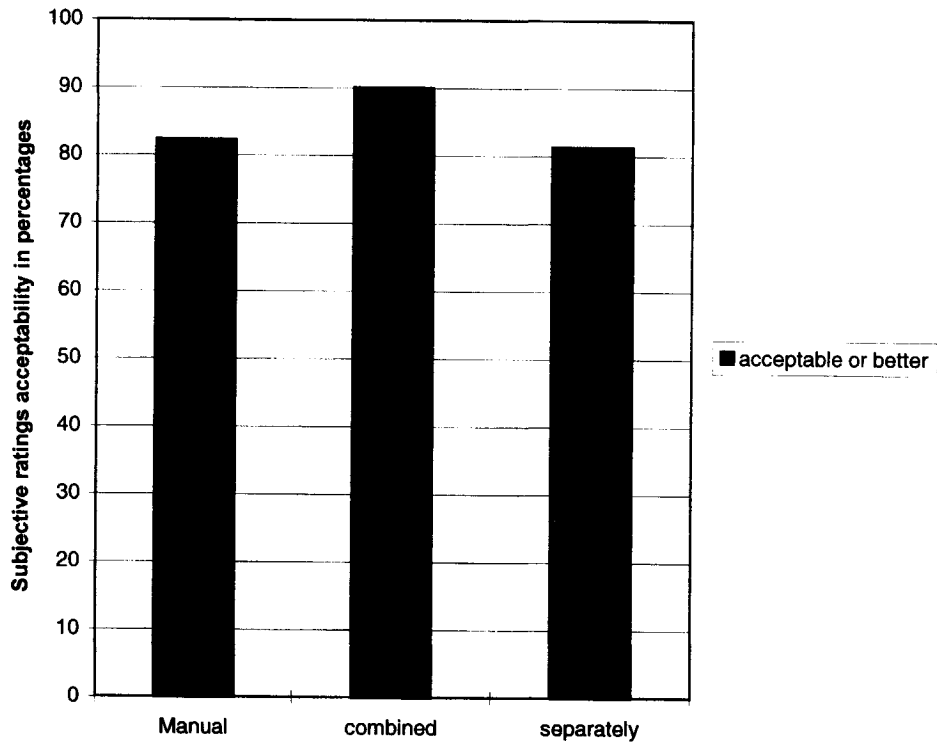

figure 6 Acceptability of free flight concept rated as acceptable or higher, as a function of the three different modes

This figure shows that even though the manual mode received most of the perfect ratings, the overall acceptability favours the combined mode.

Appendix B Overview phase I results

The distribution of responses as a function of the three following sets of 6 sessions during the experiment across all runs and across all subject pilots is shown in figure 7.

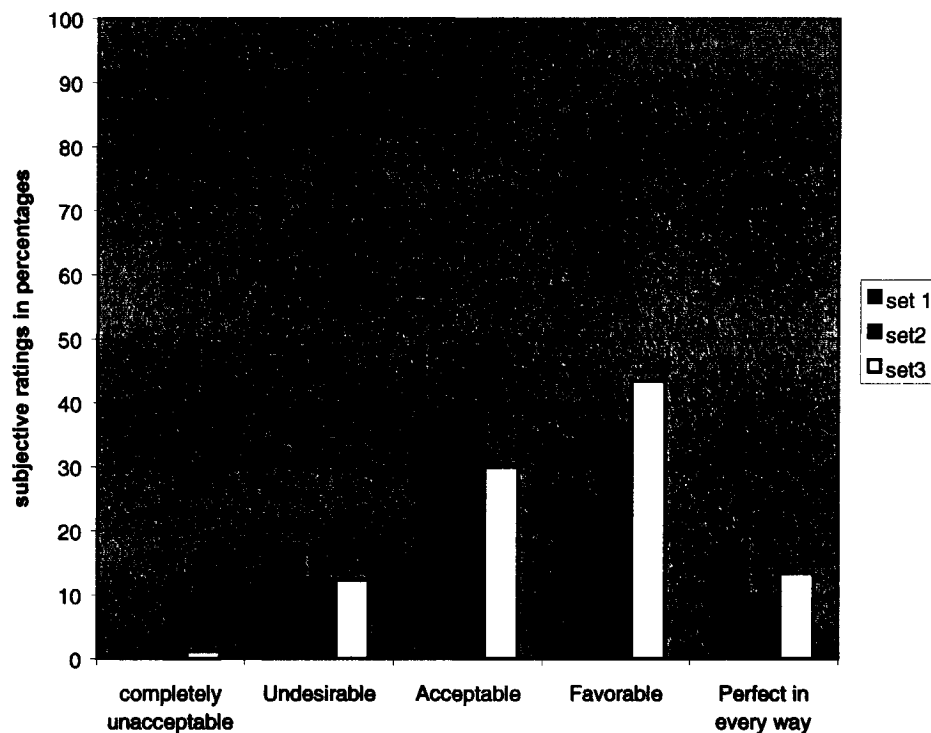

figure 7 Acceptability of free flight concept as a function of the three following sets

This figure shows the acceptability increased after more experience with Free Flight.

Appendix B Overview phase I results

The percentages of ratings at a level of acceptable or higher as a function of the three following sets during the experiment across all flights and across all subject pilots are shown in figure 8. The percentage of subject pilots rating the session as acceptable or higher during set 1 was 81.3, during set 2 was 85.4 and during set 3 was 86.6.

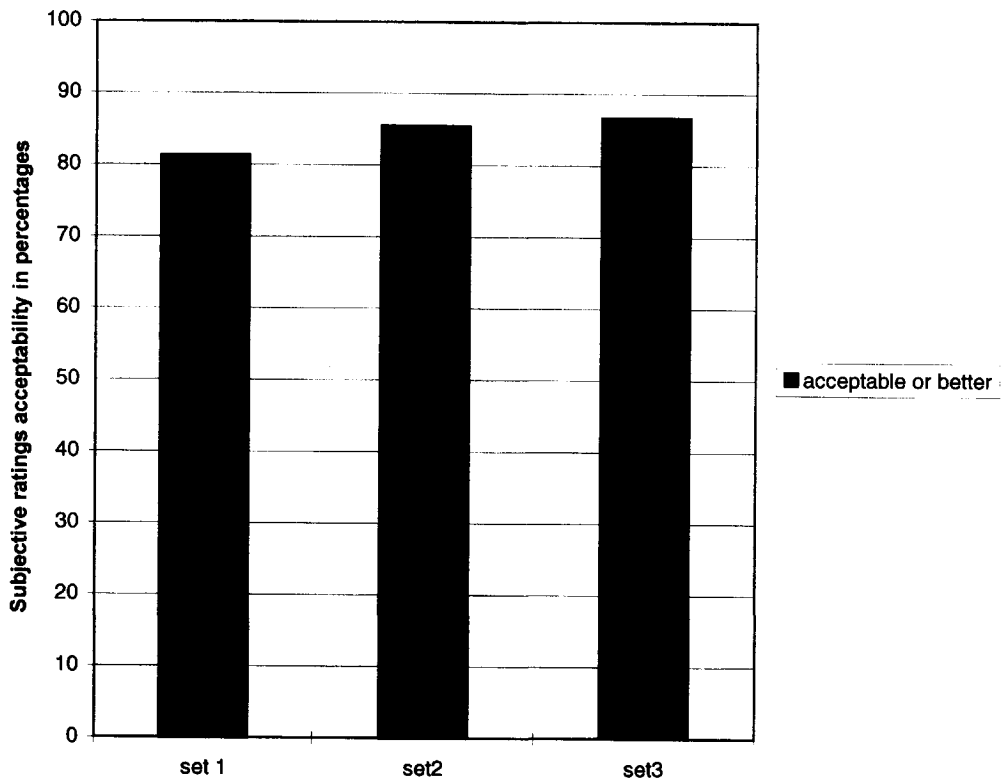

figure 8 Acceptability of free flight concept rated as acceptable or higher, as a function of the three following sets

Though not as clear as figure 7 this does show a slight increase in acceptability over the duration of the experiment.

Subjective safety compared to ATC

After each session the pilots had to rate the safety of their last flight compared to modern present day ATC operations. The distribution of responses as a function of the three densities used during the experiment across all subject pilots is shown in figure 9.

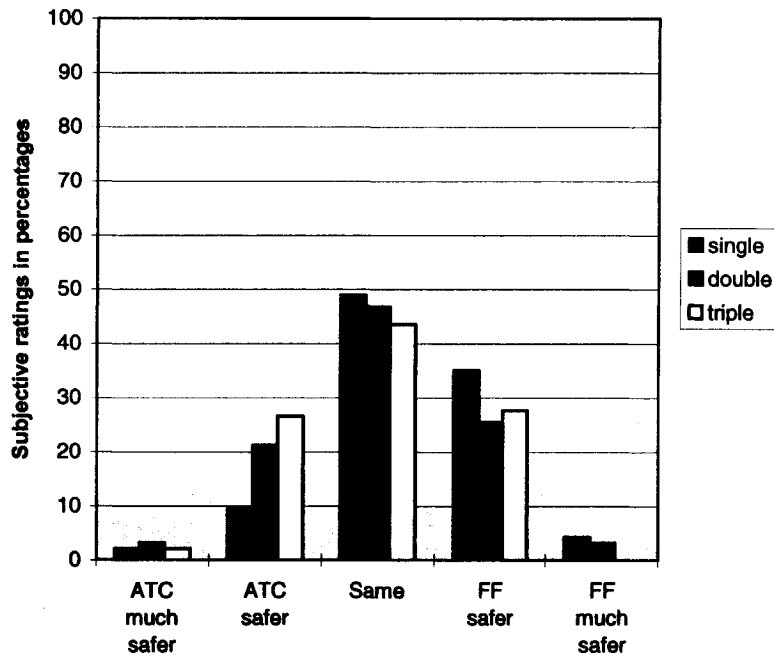

figure 9 Safety of free flight concept as a function of the traffic density

This figure show that pilots believe ATC is safer in higher traffic densities. In later experiments it was found that ATC could not handle the triple densities that were still regarded as acceptable by nearly 80% of the pilots. Remember the pilots were not aware how the experiment densities related to the real traffic densities!

Appendix B Overview phase I results

The percentages of ratings at a level of same safety as present day ATC or higher as a function of the three densities used during the experiment across all flights and across all subject pilots are shown in figure 10. The percentage of subject pilots rating the safety of the session as the same to present day ATC or higher during single density was 88.3, during double density was 75.5 and during triple density was 71.3.

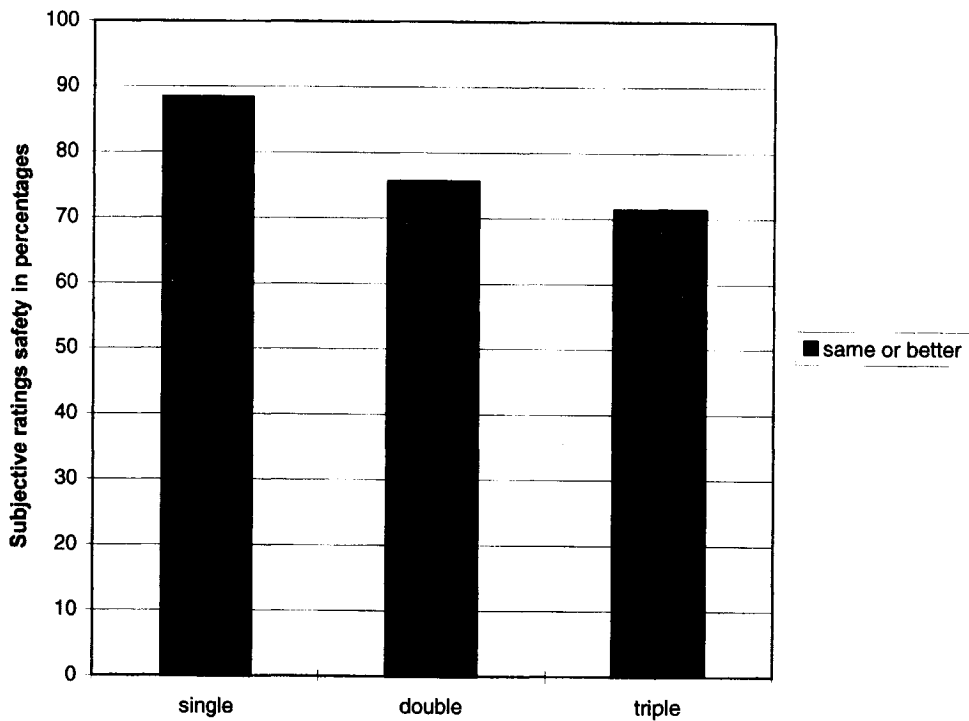

figure 10 Safety of free flight concept compared to present day ATC rated same or higher, as a function of traffic density

Appendix B Overview phase I results

The distribution of responses as a function of nominal conditions versus non-nominal conditions used during the experiment across all sessions and across all subject pilots is shown in figure 11.

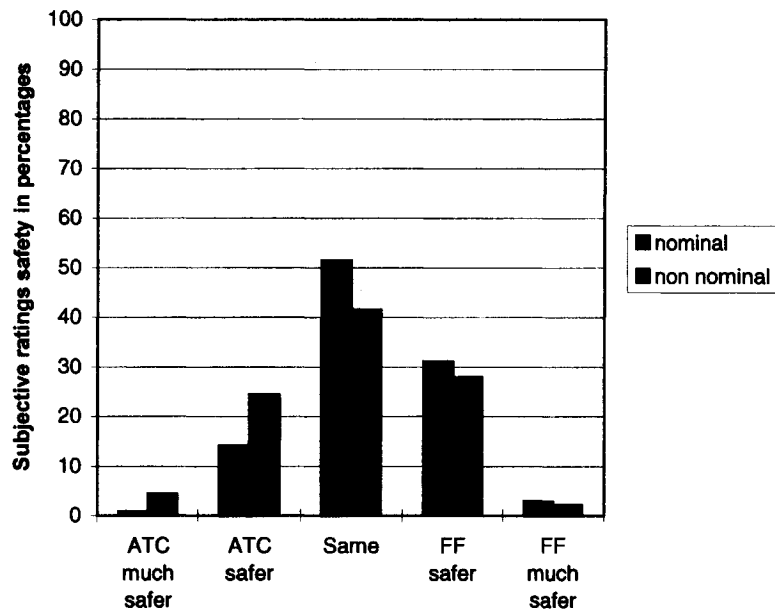

figure 11 Safety of free flight concept compared to present day ATC as a function of nominal versus non-nominal conditions

Appendix B Overview phase I results

The percentages of ratings of an equal or higher level of safety relative to present day ATC as a function of nominal conditions versus non-nominal used during the experiment across all flights and across all subject pilots are shown in figure 12. The percentage of subject pilots rating the safety of the session as the same to present day ATC or higher during nominal conditions was 85.2, during non-nominal conditions was 71.4.

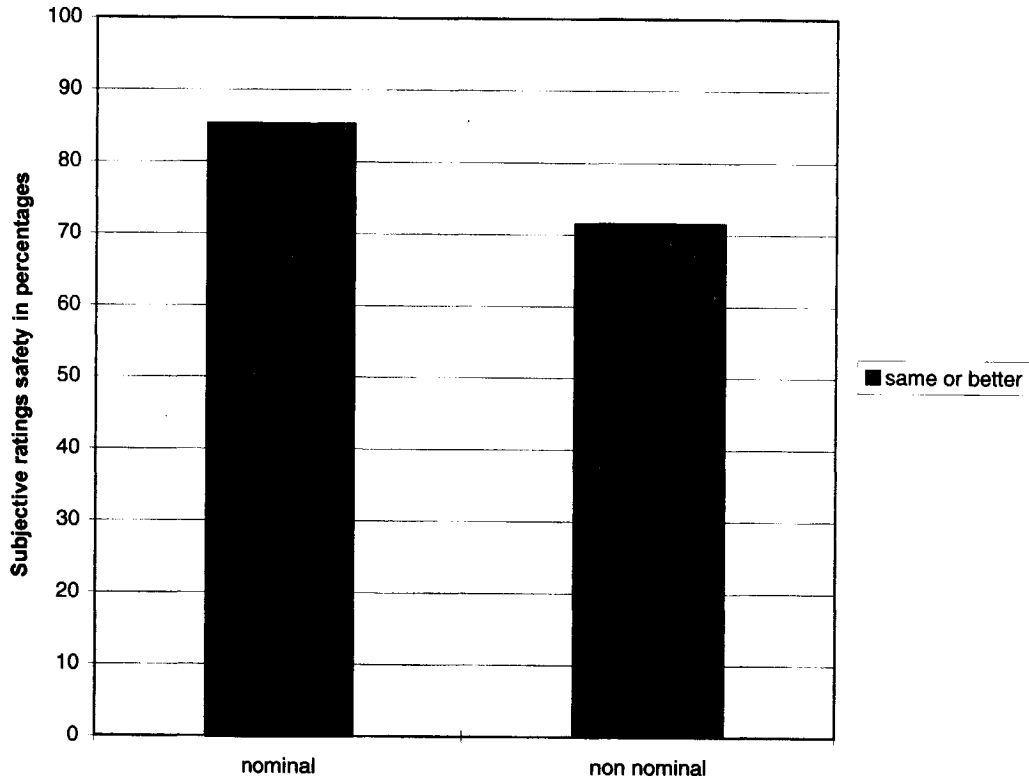

figure 12 Safety of free flight concept compared to present day ATC rated same or higher, as a function of nominal conditions versus non-nominal conditions

More than the acceptability ratings, this shows the effect of events on the confidence in Free Flight.

Appendix B Overview phase I results

The distribution of responses as a function of the three different modes used during the experiment across all sessions and across all subject pilots is shown in figure 13.

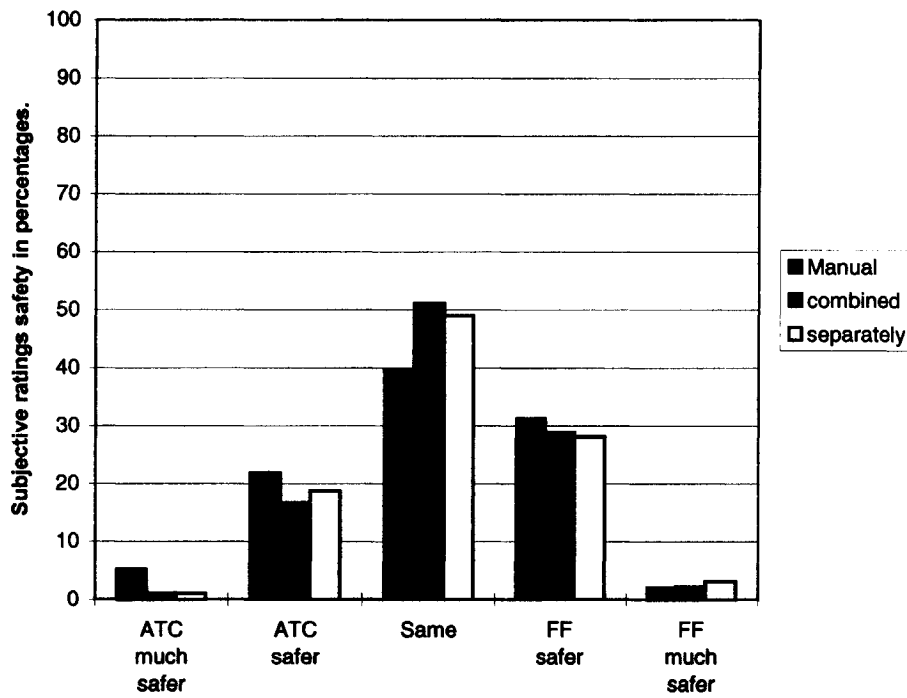

figure 13 Safety of free flight concept compared to present day ATC as a function of the three different modes

Appendix B Overview phase I results

The percentages of ratings at a level of same safety as present day ATC or higher as a function of the three different modes used during the experiment across all flights and across all subject pilots are shown in figure 14. The percentage of subject pilots rating the safety of the session as the same to present day ATC or higher during manual mode was 72.9, during Execute combined mode was 82.2 and during execute separately was 80.2.

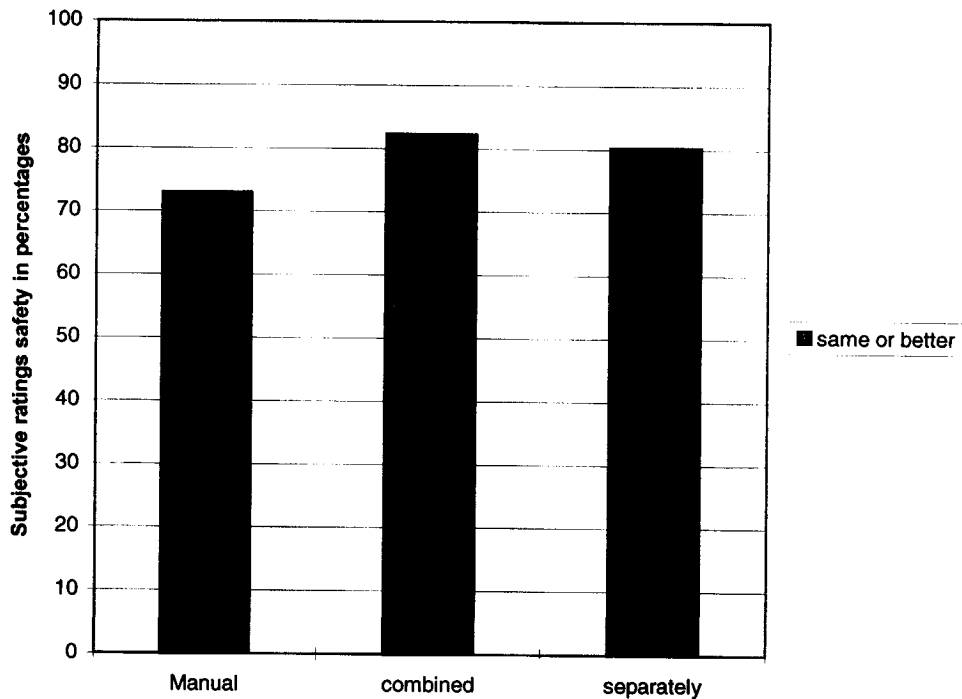

figure 14 Safety of the free flight concept compared to present day ATC rated same or higher, as a function of the three different modes

Appendix B Overview phase I results

The distribution of responses as a function of the three following sets of 6 sessions during the experiment across all sessions and across all subject pilots is shown in figure 15.

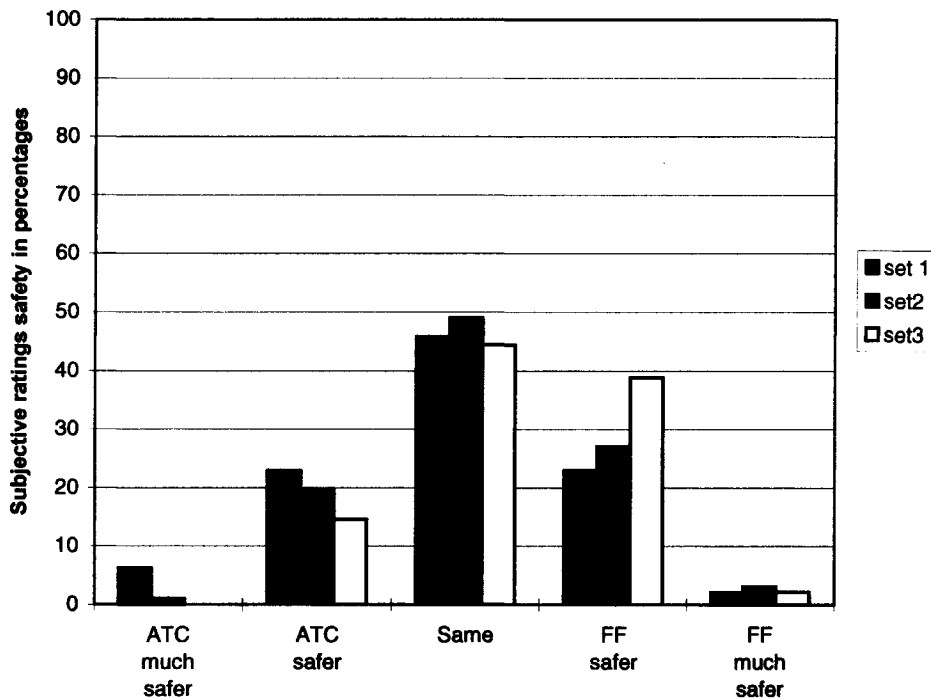

figure 15 Safety of free flight concept compared to present day ATC as a function of the three following sets

Appendix B Overview phase I results

The percentages of ratings at a level of same safety as present day ATC or higher as function of the three following sets during the experiment across all flights and across all subject pilots are shown in figure 16. The percentage of subject pilots rating the safety of the session as the same to present day ATC or higher during set 1 was 70.8, during set 2 was 79.1, during set 3 was 85.5.

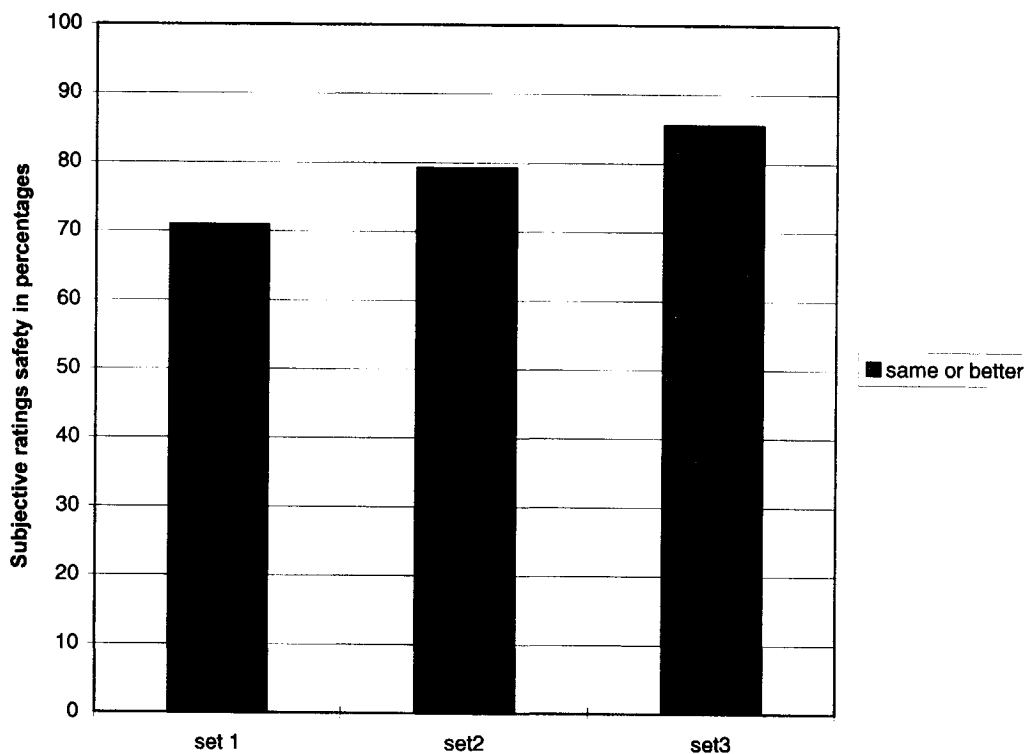

figure 16 Safety of free flight concept compared to present day ATC rated same or higher, as a function of the three following sets

Just as the previous figure, this shows the increasing confidence in Free Flight over the duration of the experiment. Unfortunately, there is no data on the subjective safety before and after the training runs.

Subjective mental workload

After each session the pilots had to rate the subjective workload of their last session on a scale from 0-150 on a RSME (Rating Scale Mental Effort). The average ratings during the experiment across all sessions and all subject pilots as a function of traffic density are shown in figure 17. The average rating during single traffic density was 30.3, during double traffic density was 35.0 and during triple density was 39.0.

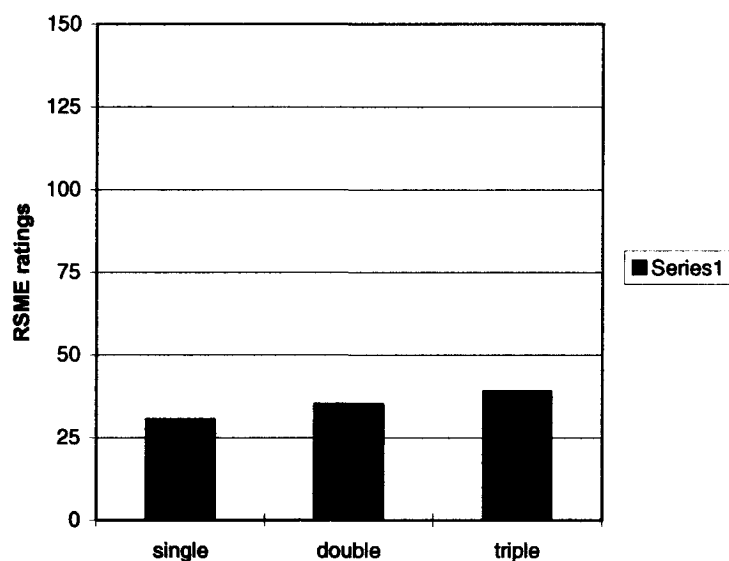

figure 17 Average ratings Subjective mental workload as a function of traffic density

The triple density was included to overload the pilots. The average rating of 39 for the triple density corresponds to 'costing some effort'. Clearly this density did not cause the amount of workload as was planned.

Appendix B Overview phase I results

The average subjective workload ratings during the experiment across all sessions and all subject pilots as a function of nominal conditions versus non-nominal conditions are shown in figure 18. The average rating during nominal conditions was 32.6, during non-nominal conditions was 36.9.

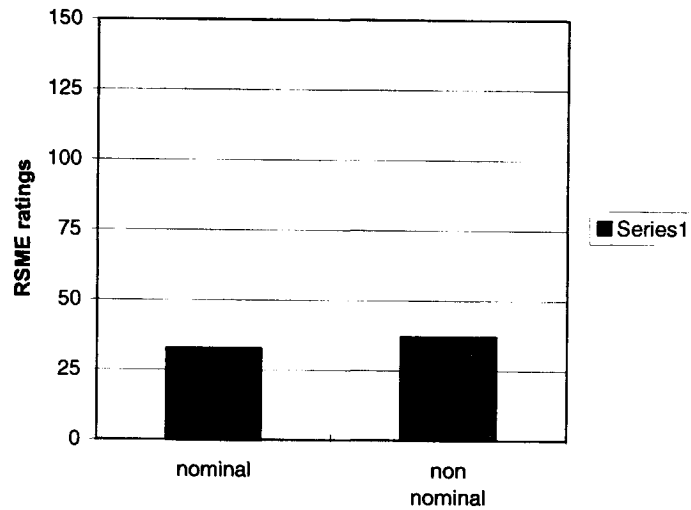

figure 18 Average ratings Subjective mental workload as a function of nominal conditions versus non-nominal conditions

The average subjective workload ratings during the experiment across all sessions and all subject pilots as a function of the three different modes are shown in figure 19. The average rating during Manual mode was 36.7, during execute combined mode was 36.0, during execute separately mode was 31.8.

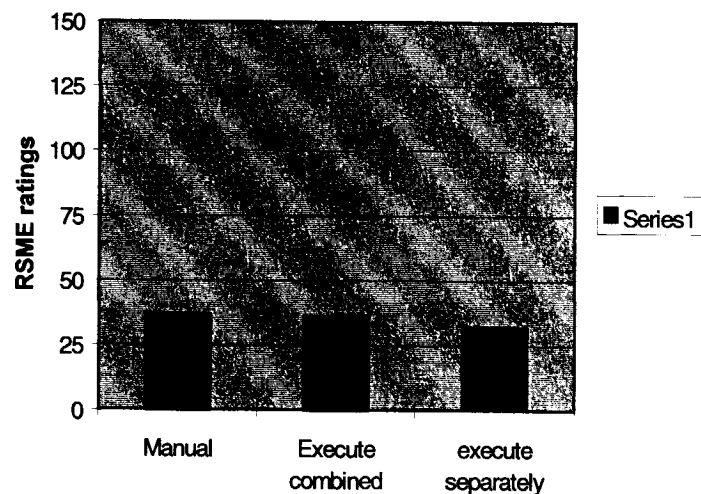

figure 19 Average ratings Subjective mental workload as a function of the three different modes

The average subjective workload ratings during the experiment across all sessions and all subject pilots as a function of the three following sets are shown in figure 20. The average rating during set 1 was 39.2, during set 2 was 36.0, during set 3 was 29.0.

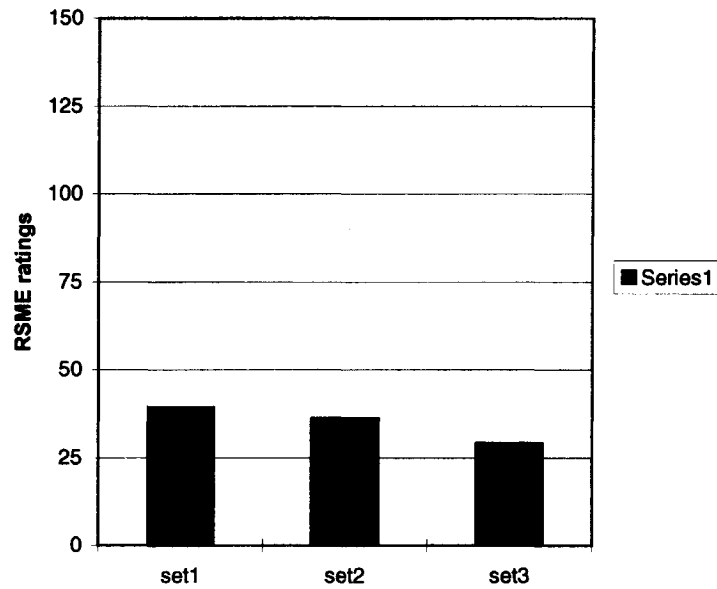

figure 20 Average ratings Subjective mental workload as a function of the three following sets

As can be seen in figure 20 the workload ratings decrease over the duration of the runs. This effect is quite strong and comparable with for instance the traffic density effect (see figure 17). This shows there still is a strong learning effect after half a day of training.

True/False questions

After each session the subject pilots had to answer a few questions with True of False.

These were the following questions:

1a: I think I could safely guarantee the airborne separation with the set-up just flown.

1b: I manoeuvred more than normally

1c: I exceeded passenger comfort levels

1d: I need more explicit rules of the road to guarantee the safety

1e: I need more explicit on board procedures to guarantee the safety

1f: I need more training to guarantee the safety.

The percentages of the subject pilots who answered the questions with true as a function of the traffic density across all sessions and all subject pilots are shown in figure 21. All answers, except for 1d, show an effect of traffic density.

The exact results are shown in the table below.

	Single	Double	Triple
Question 1a	89.4	81.0	79.9
Question 1b	17.2	35.1	43.8
Question 1c	7.9	14.7	16.1
Question 1d	18.0	24.0	21.6
Question 1e	18.0	20.2	23.4
Question 1f	23.5	26.8	32.0

Table 1 Percentage of True/False questions answered with true as a function of traffic density.

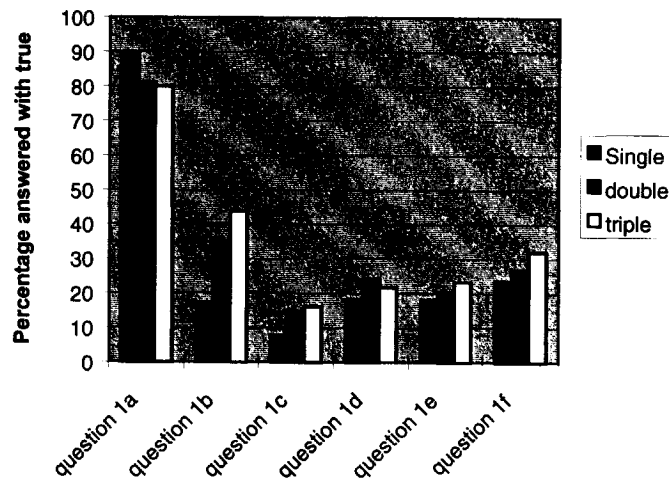

figure 21 Percentage of True/False questions answered with true as a function of traffic density

The percentages of the subject pilots who answered the questions with true as a function of nominal conditions versus non-nominal conditions across all sessions and all subject pilots are shown in figure 22.

Appendix B Overview phase I results

The exact results are shown in the table below.

	Nominal	Non-nominal
Question 1a	85.9	80.7
Question 1b	33.8	30
Question 1c	15.5	10
Question 1d	14.8	27.1
Question 1e	16.9	24.3
Question 1f	26.1	28.6

Table 2 Percentage of True/False questions answered with true as a function of nominal conditions versus non-nominal conditions.

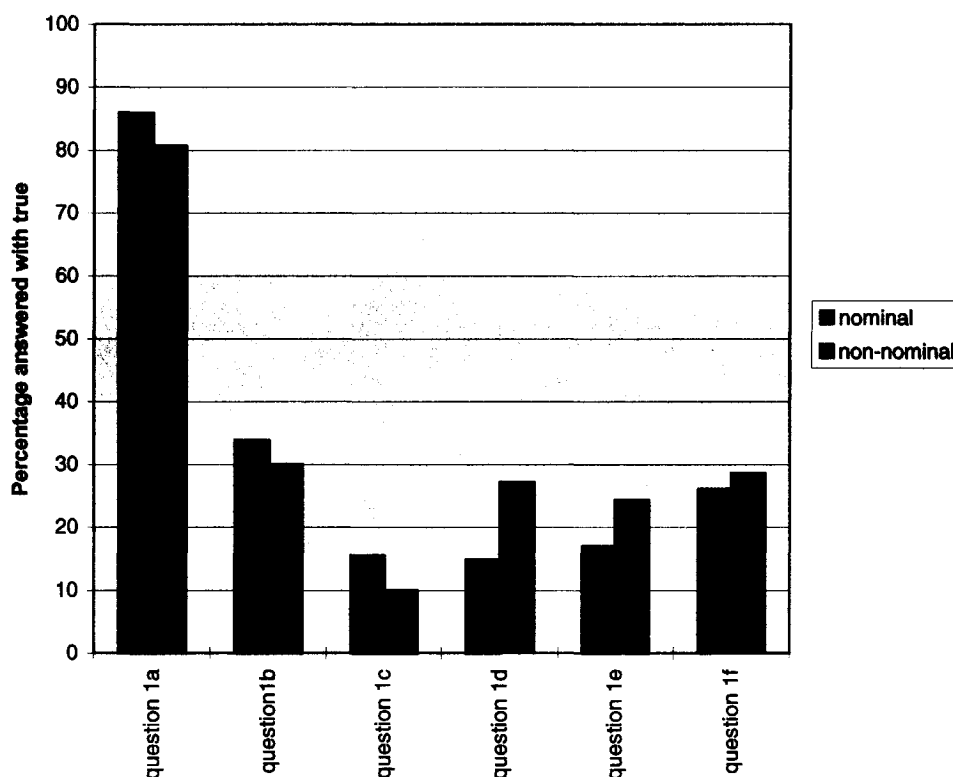

figure 22 Percentage of True/False questions answered with true as a function of nominal conditions versus non-nominal conditions

The percentages of the subject pilots who answered the questions with true as a function of the three different modes across all sessions and all subject pilots are shown in figure 23. The exact results are shown in table 3

	Manual	Execute combined	Execute separately
Question 1a	79.2	88.9	82.3
Question 1b	22.9	42.0	31.3
Question 1c	7.3	20.9	10.4

Appendix B Overview phase I results

Question 1d	19.8	22.5	20.8
Question 1e	24.0	15.7	21.8
Question 1f	28.1	30.0	24.0

Table 3 Percentage of True/False questions answered with true as a function of the three different modes.

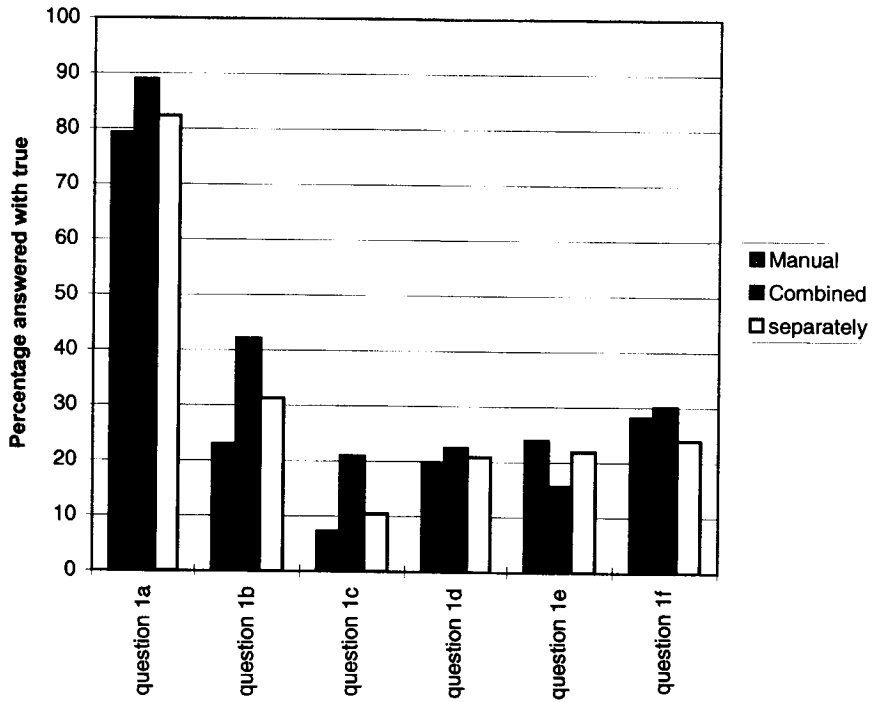

figure 23 Percentage of True/False questions answered with true as a function of the three different modes

Appendix B Overview phase I results

The percentages of the subject pilots who answered the questions with true as a function of the three following sets across all sessions and all subject pilots are shown in figure 24. The exact results are shown in table 4.

	Set 1	Set 2	Set 3
Question 1a	71.4	82.7	89.2
Question 1b	32.3	32.3	34.9
Question 1c	11.5	10.4	18.75
Question 1d	25.	19.8	16.7
Question 1e	25.	17.7	17.7
Question 1f	39.6	22.9	17.7

table 4 Percentage of True/False questions answered with true as a function of the three following sets.

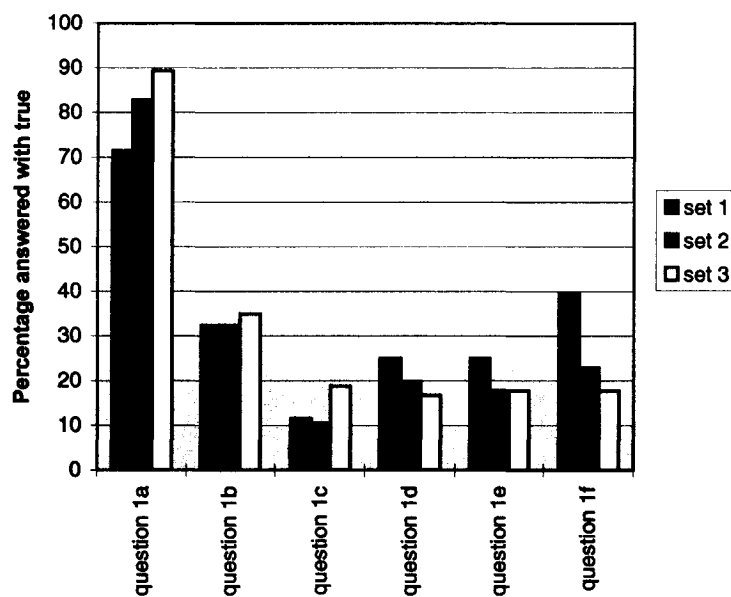

figure 24 Percentage of True/False questions answered with true as a function of the three following sets

Post trial questionnaires

After each set of 6 sessions the subject pilots had to fill in a Post trial questionnaire. The most relevant two questions are shown. The distribution of the responses across all sets and subject pilots on the question "rate the acceptability of the aspect: no ATC present" is shown in figure 25. The percentage of the subject pilots answering the question with completely unacceptable in set 1, set 2 and set 3 is 12.5, with undesirable in set 1 is 62.5, in set 2 and set 3 is 25, with acceptable in set 1 is 12.5, in set 2 and set 3 is 50, with favorable in set 1, set 2 and set 3 is 12.5, with perfect in every way in all sets is 0.

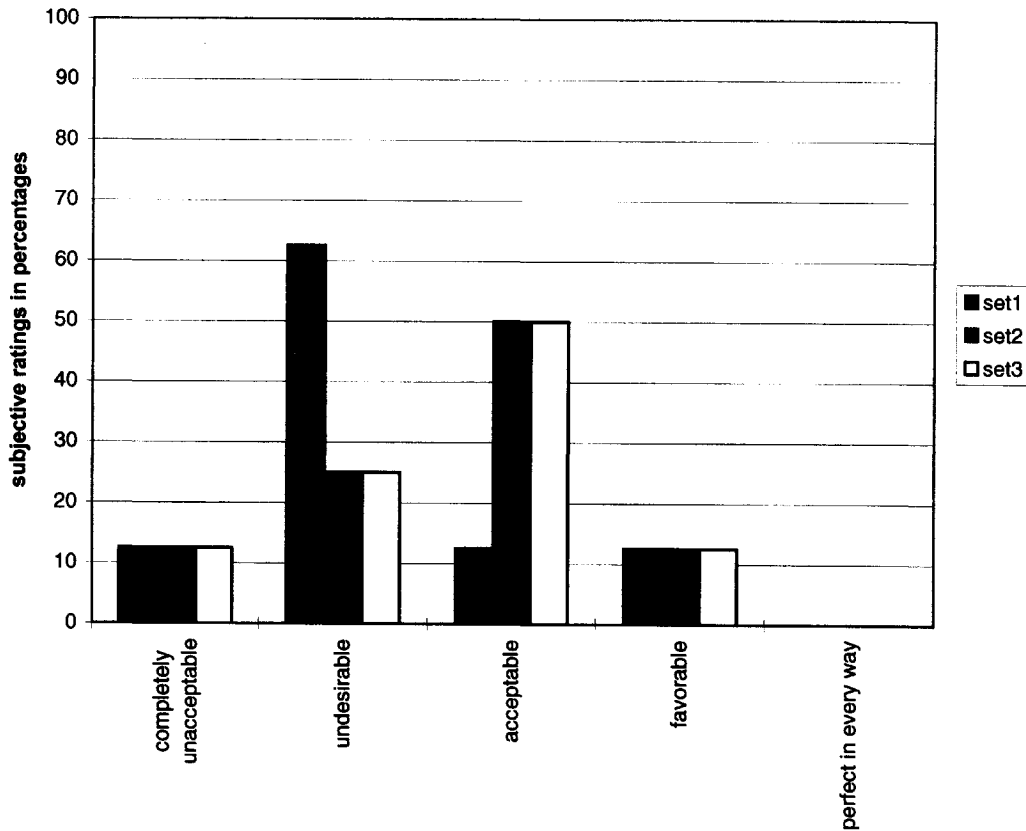

figure 25 Acceptability on the aspect that there was no ATC present

Appendix B Overview phase I results

The distribution of the responses across all sets and all subjects on the question “rate the acceptability on the aspect that there are no priority rules” is shown in figure 26. The percentage of the subject pilots answering the questions with completely unacceptable in set 1 is 6.25, in set 2 and set 3 is 0, with undesirable in set 1 is 37.5, in set 2 is 43.75, in set 3 is 31.25, with acceptable in set 1 is 18.75, in set 2 and set 3 is 25, with favourable in set 1 is 37.5, in set 2 is 31.25, in set 3 is 43.75, with perfect in every way is 0.

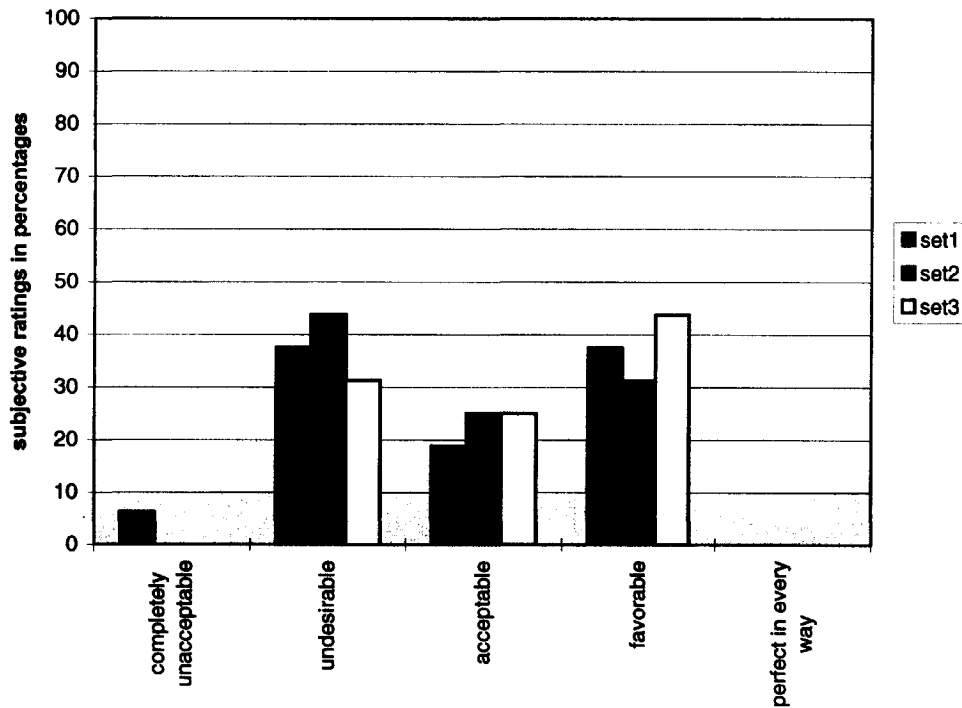

figure 26 Acceptability on the aspect that there were no priority rules (but all aircraft deviate)

Objective data

Conflict times

The conflict time is the time a predicted loss of separation exists. In other words: it is the time from the conflict alert until the conflict had been solved and disappeared from the display. The mean conflict times¹ across all sessions as a function of traffic density are shown in figure 0.27. The mean conflict time during single density was 28.8s, during double density was 25.3s, during triple density was 24.6s.

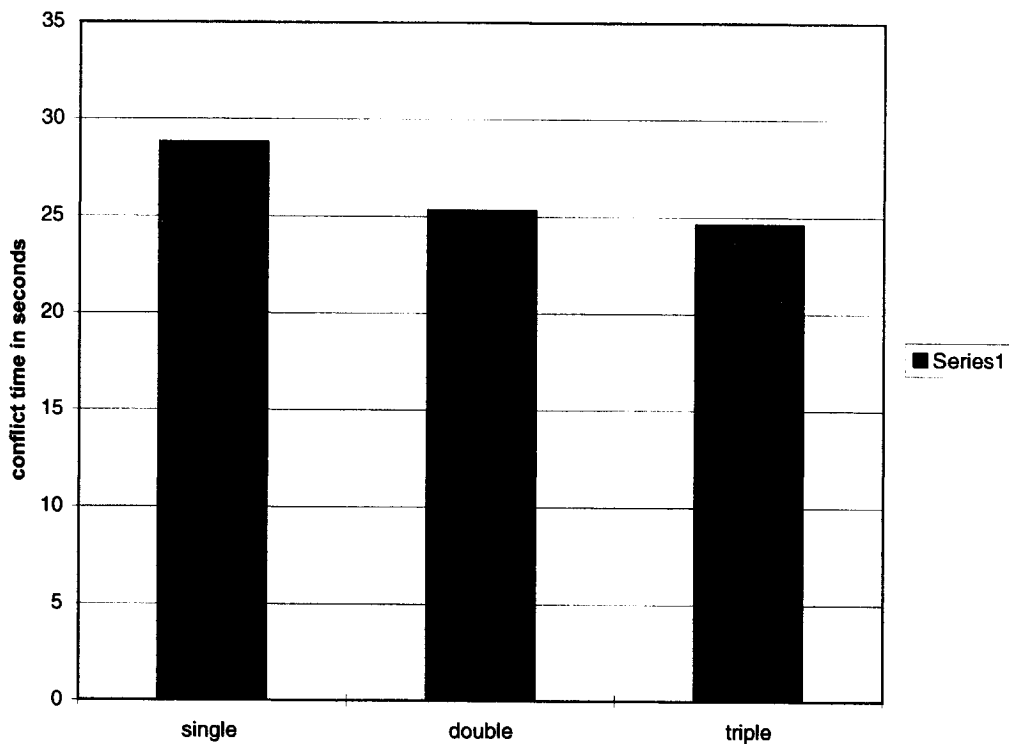

figure 0.27 Mean conflict times as a function of traffic density

This figure shows the time a conflict alert was on, which is an indication of the task time for solving the conflict, decreases with higher traffic densities. A possible explanation is that the pilots regarded the conflicts as more critical in high density situations, resulting in allowing themselves less time to solve the conflict.

¹ All conflict times below 10 seconds were filtered out, because they could represent nuisance. In this first experiment there was no filtering present in the ASAS system, yet. In the second phase trials this nuisance alerts had disappeared due to the conflict filter.

Appendix B Overview phase I results

The mean conflict times across all sessions as a function of nominal conditions versus non-nominal conditions are shown in figure 0.28. The mean conflict time during nominal conditions was 21.1s, during non-nominal conditions was 31.5s.

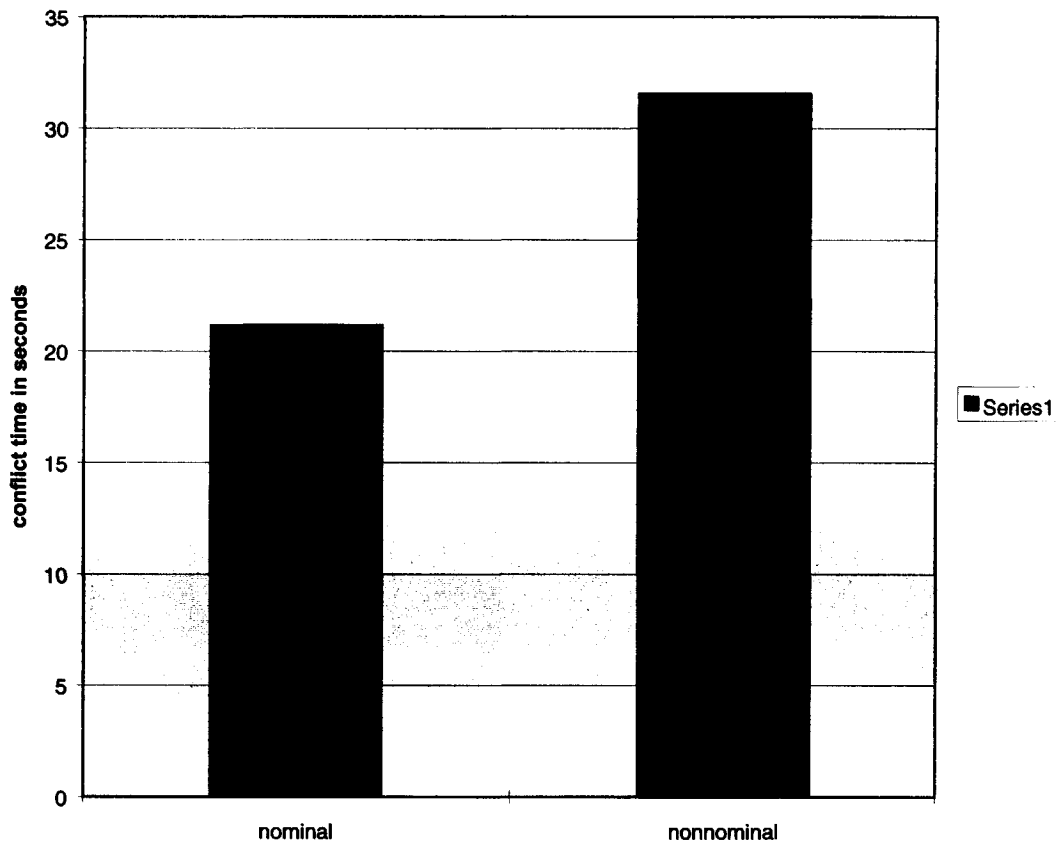

figure 0.28 Mean conflict times as a function of nominal conditions versus non-nominal conditions

This figure shows a logical consequence of the events in the non-nominal runs, which were failures and delays in the conflict solving.

Mean conflict times across all sessions as a function of the three different modes are shown in figure 0.29. The mean conflict time during Manual mode was 25.1s, during Execute combined mode was 25.8s, during execute separately mode was 28.2s.

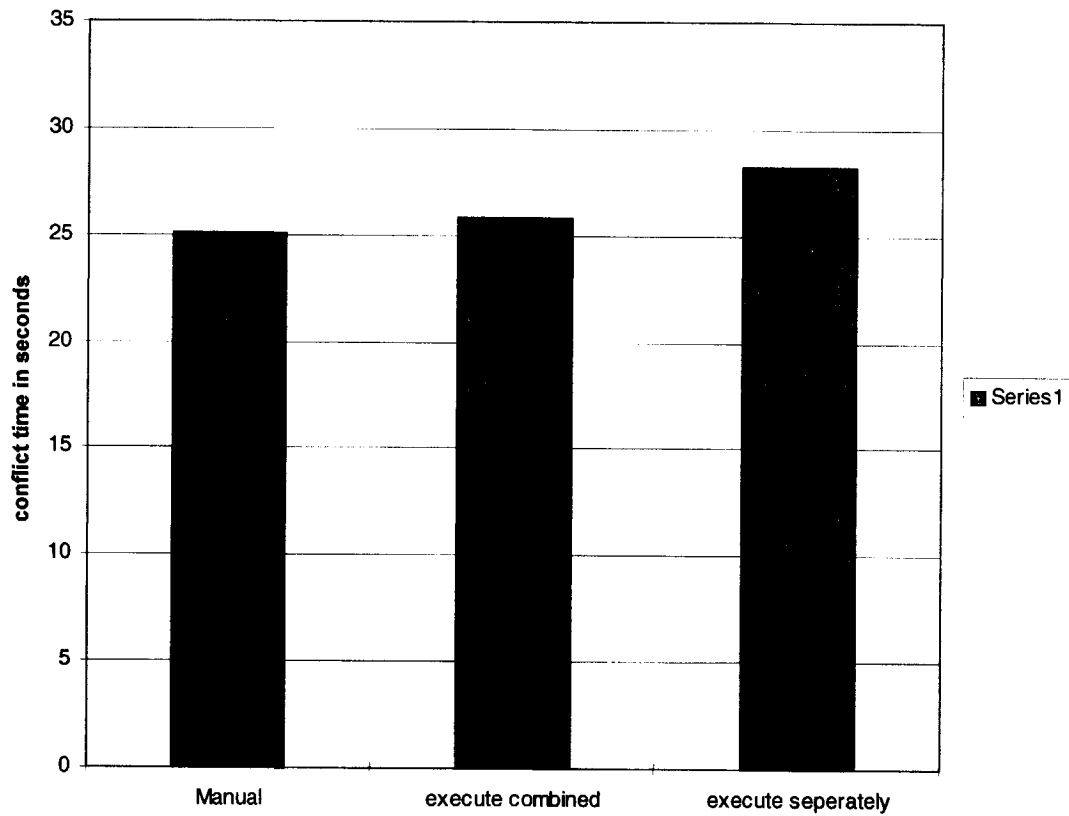

figure 0.29 Mean conflict times as a function of the three different modes

Automation of the conflict resolution task, leads to a higher task time here. Possibly a lack of trust in the automatic modes caused the crew to check the automatic resolution thoroughly.

Appendix B Overview phase I results

Mean conflict times across all sessions as a function of the three following sets are shown in figure 0.30. The mean conflict time during set 1 was 23.0s, during set 2 was 29.4s, during set 3 was 26.2s.

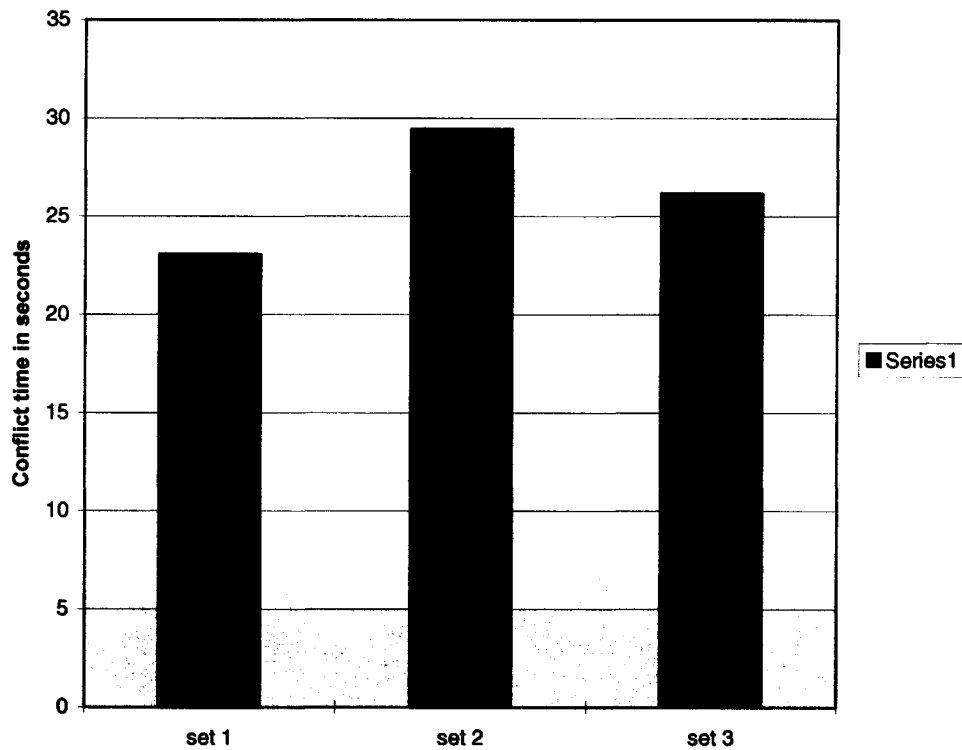

figure 0.30 Mean conflict times as a function of the three following sets

One would expect to see a steady decrease in task time over the sessions. Session 1 was on the first day directly after the briefing and training. Session 2 was at the beginning of the second day. Session 3 was the afternoon of the second day. Every session started with one or two training runs for familiarisation with the autopilot modes. These modes varied only over sessions not per run (see experiment matrix).

Eye-Point-Of-Gaze Data

The percentages of the total fixation duration of the Pilot Flying and Pilot-Non-Flying across all sessions and 13 subject pilots² on the Primary Flight Display as a function of the three following sets are shown in figure 0.31. The exact results are shown in table 5

	Set 1	Set 2	Set 3
PF	9.8	8.8	8.7
PNF	7.0	7.1	7.4

Table 5 Percentage fixation duration on the Primary Flight Display as a function of the three following sets.

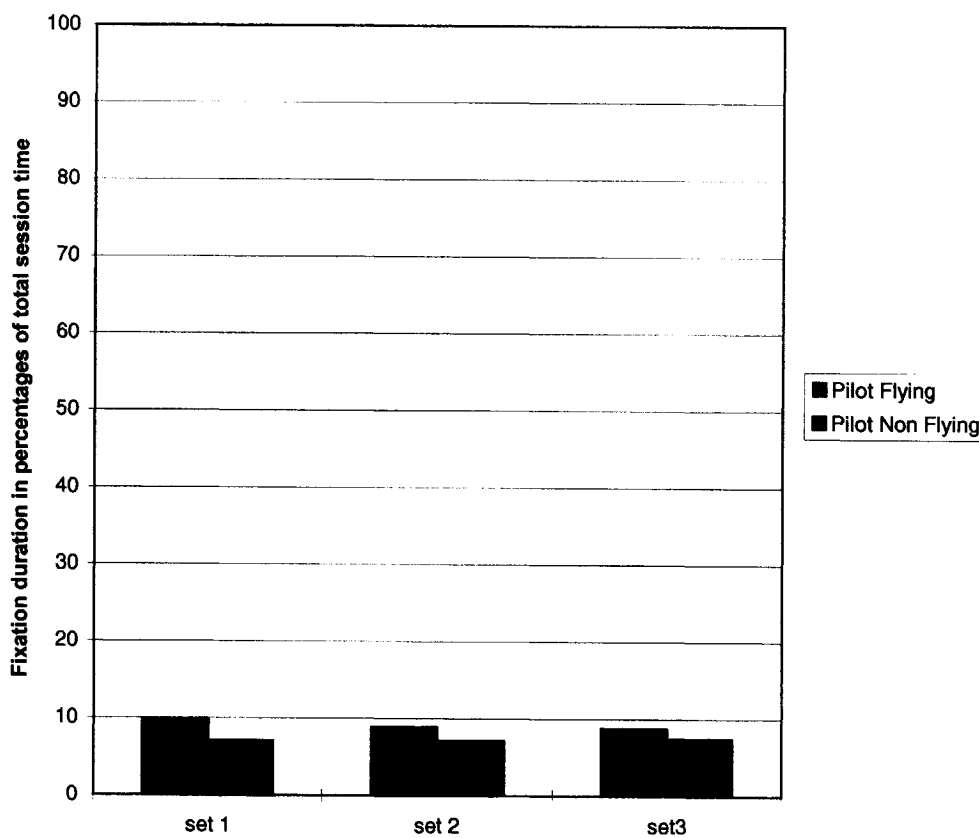

figure 0.31 Percentage fixation duration on the Primary Flight Display as a function of the three following sets

As expected, the Pilot Flying spends more time observing the primary flight display.

² 5 of 18 pilots gave inaccurate data and were therefore not used for the data analysis

Appendix B Overview phase I results

The percentages of the total fixation duration of the Pilot Flying and the Pilot-Non-Flying across all sessions and 13 subject pilots on the Navigation Display as a function of the three following sets are shown in figure 0.32. The exact results are shown in table 6.

	Set 1	Set 2	Set 3
PF	50.8	51.0	49.2
PNF	43.7	50.9	47.6

Table 6 Percentage fixation duration on the Navigation Display as a function of the three following sets

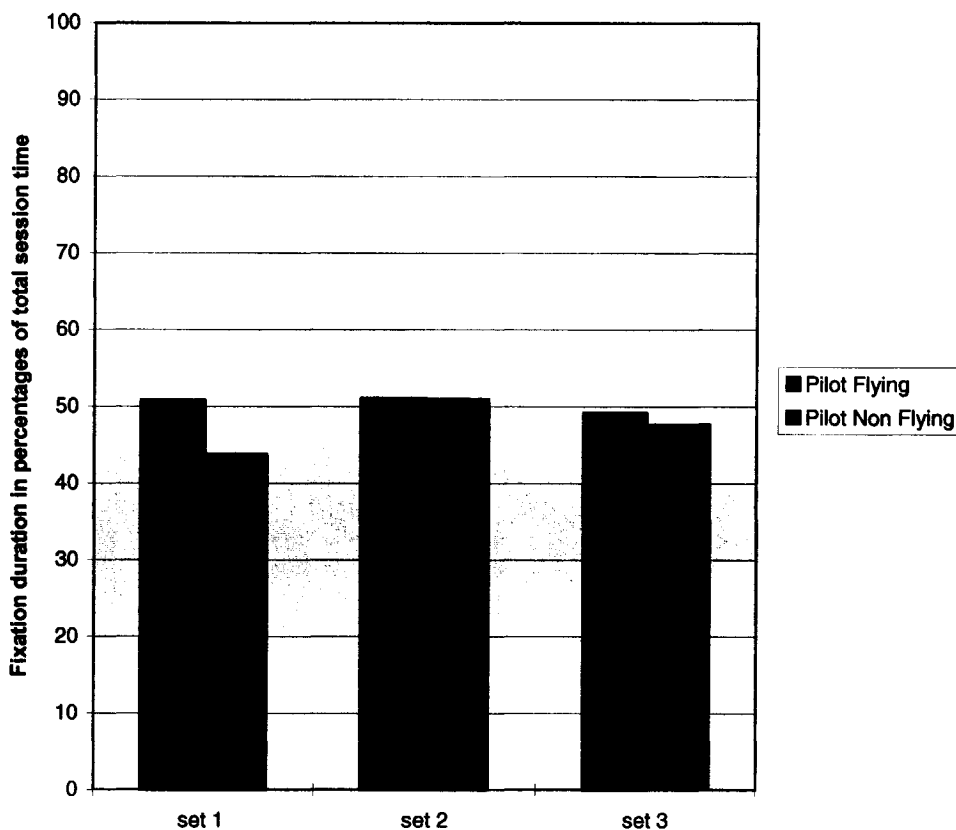

figure 0.32 Percentage fixation duration on the Navigation Display as a function of the three following sets

Surprisingly, figure 0.32 does not show that the Pilot Non-Flying spends more time observing the navigation display than the Pilot Flying. Also the fixation of both pilots on the navigation display is quite high compared to the primary flight display. This may be caused by the novelty of traffic information on the navigation display, which apparently provides an interesting picture.

Appendix B Overview phase I results

The percentages of the total fixation duration across all sessions and 13 subject pilots on the Vertical Navigation Display as a function of the three following sets are shown in figure 0.33. The percentage of the total fixation duration on the Vertical Navigation Display during set 1 was 11.4, during set 2 was 4.4, during set 3 was 7.1.

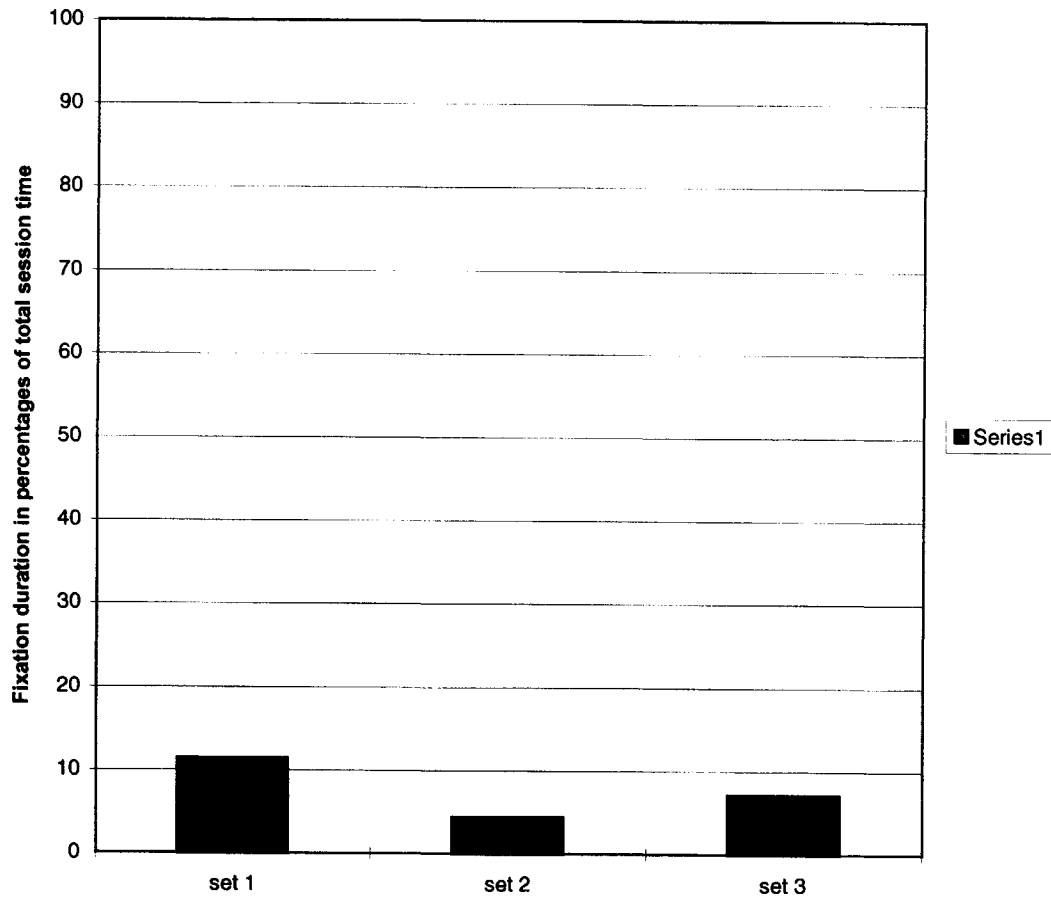

figure 0.33 Percentage fixation duration on the Vertical Navigation Display as a function of the three following sets

Appendix B Overview phase I results

The next figure shows the same as but than during conflicts. Pilots commented they used the Vertical Navigation Display for assessing the 3-dimensional situation during a conflict. The percentages of the total fixation duration across all sessions and 13 subject pilots on the Vertical Navigation Display during conflicts as a function of the three following sets are shown in figure 0.34. The percentage of the total fixation duration during conflicts on the Vertical Navigation Display during set 1 was 12.0, during set 2 was 5.8, during set 3 was 8.4.

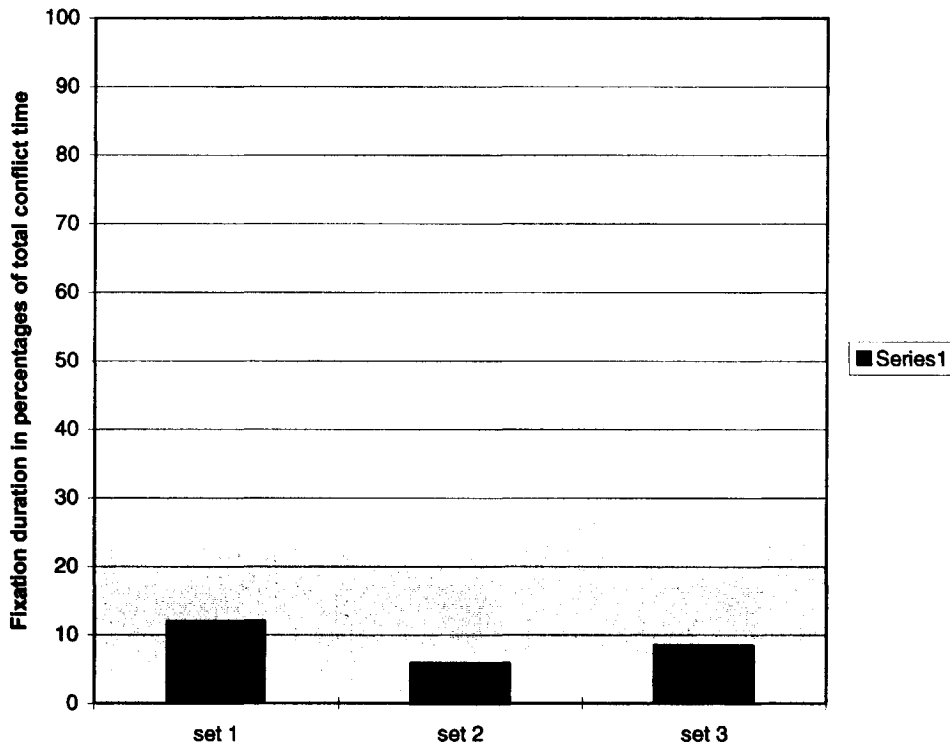

figure 0.34 Percentage fixation duration on the Vertical Navigation Display during conflicts as a function of the three following sets

Compared to figure 0.33 this shows no significant increase of Vertical Display fixation during conflicts.

Analyses of Manoeuvres

Heading, speed, altitude and combinations thereof were used to resolve conflicts. The percentages for the frequency of each parameter as a function of the three different modes across all sessions, are shown in figure 0.35. The exact results in percentages are shown in table 7.

	Manual	Execute combined	Execute separately
Heading	57.9	72.0	83.0
Speed	15.4	47.5	57.9
Altitude	41.4	75.9	28.8

Table 7 Percentages of the use of each parameter to resolve conflicts as a function of the three different modes.

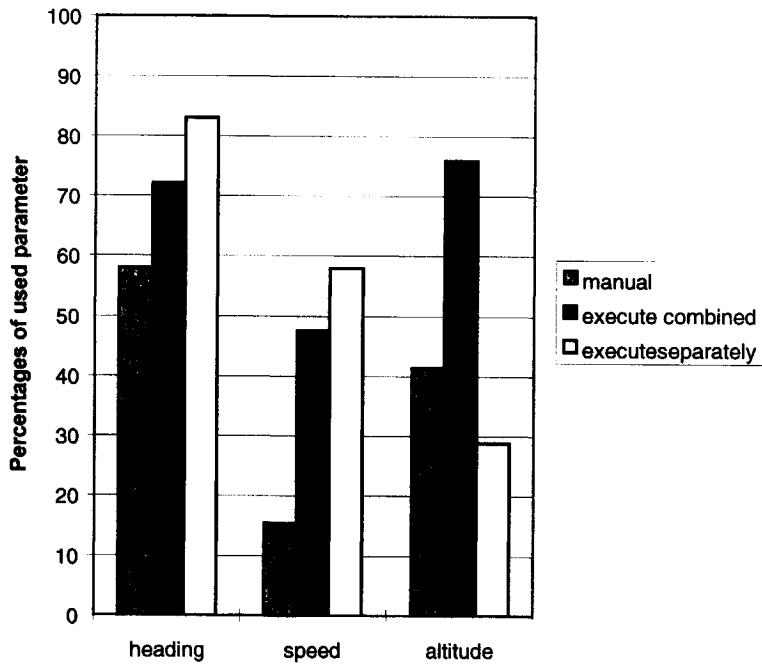

figure 0.35 Percentages of the use of each parameter to resolve conflicts as a function of the three different modes

APPENDIX C Questionnaires phase II trials

BSMI

Date: **Airborne Free Flight**

Name:

Condition: Protected Airways Fully Mixed Flight Level

Runnumber: Density: Mixage: "XXXX":

Please indicate, with a cross on the vertical line, how much effort it cost to do your work in the above mentioned flight.

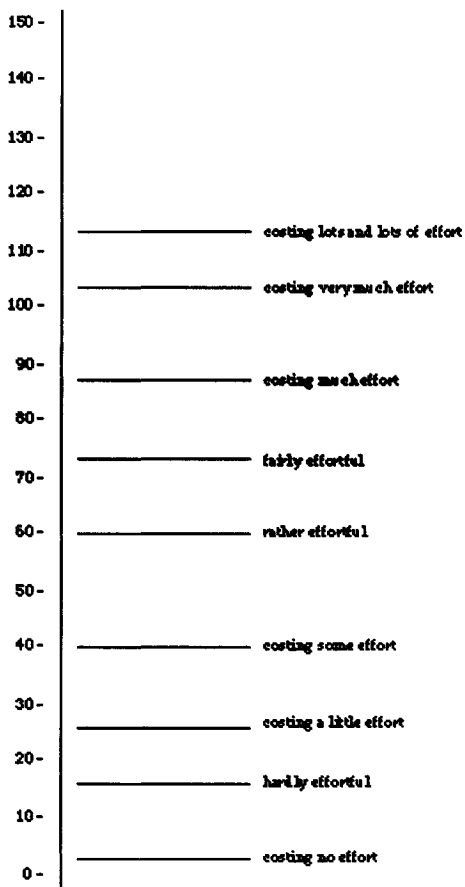

Appendix C Questionnaires phase II trials

Date: **Airborne Free Flight**

Name:

Condition: 0 Protected Airways 0 Fully Mixed 0 Flight Level

Runnumber: Density: Mixage: "XXXX":

Please rate the overall acceptability of your last flight..(one tick only)

	Perfect in every way
	Favorable
	Acceptable
	Undesirable
	Completely unacceptable

Please tick True or False to express your opinion on the statements below.

TRUE FALSE

		I think I could safely guarantee the airborne separation with the set-up just flown
		I manoeuvred more than normally
		I exceeded passenger comfort levels
		I flew economically

How does in your opinion the safety of the set-up just flown compare to modern present day ATC operations? (one tick only)

	FF much safer
	FF safer
	Same
	ATC safer
	ATC much safer

How many conflicts did you encounter during this flight ?

How did you usually resolve them ? Vertical Speed / Heading / Speed
(Please encircle the option(s) used)

Please state the reason why you used the above manoeuvre option(s) and/or why you did not use the other(s)?

Appendix C Questionnaires phase II trials

POST-TRIAL QUESTIONNAIRE

Date: **Airborne Free Flight**

Name:

Condition: Protected Airways Fully Mixed Flight Level

1. On a scale from 1-5 rate the following aspects of the Airborne Separation Assurance System ASAS.

- 1 - completely unacceptable
- 2 - undesirable
- 3 - acceptable
- 4 - favorable
- 5 - effect in every way

ASAS	1	2	3	4	5
a-Horizontal Display of traffic					
b-Vertical Display of traffic					
c-Presentation of conflicts (not the Predictive part)					
d-Presentation of resolution advisory					
e-Presentation of predictive ASAS (on PFD & NAV)					
f-The aural alerts used					
g-The glare shield alert light					

Suggestions or comments on any of these aspects?

2. On a scale from 1-5 rate the criticality of the above mentioned functional elements. (In other words rate how much they are needed to ensure airborne separation safety)

- 1 - not at all critical
- 2 - not really critical
- 3 - critical
- 4 - very critical
- 5 - extremely critical

ASAS	1	2	3	4	5
a-Horizontal Display of traffic					
b-Vertical Display of traffic					
c-Presentation of conflicts (not the Predictive part)					
d-Presentation of resolution advisory					
e-Presentation of predictive ASAS (on PFD & NAV)					
f-The aural alerts used					
g-The glare shield alert light					

Suggestions or comments on any of these aspects?

Appendix D COMMAND REFERENCE TRAFFIC MANAGER v5.3

HELP FUNCTION

? Use ? as (only) in-line argument to read help text and argument list or type command without arguments

TRAFFIC COMMANDS

CRE acid, type, lat, lon, hdg, alt, spd	Create an aircraft at specified position (use mouse)
DEL acid	Deletes an aircraft
MDEL latmin,lonmin,latmax,lonmax	Deletes all aircraft within rectangle (use mouse)
MCRE n,type,alt,spd,dest	Multiple create within current window, use '*' as wildcard
RENAME acid,newname	Rename an aircraft
MOVE acid,lat,lon,alt	Move an aircraft (use mouse)
REPOS acid, origin[,t]	reposition controlled traffic to FF position
RETYPE acid,type	Set aircraft type to different type

TAKE (acid)	Hand aircraft over to airsim
GIVE	Ask airsim to release control over aircraft

(acid) or POS acid	Retrieves position & info on aircraft (double click a/c = POS)
(acid) HDG (hdg)	Heading command
(acid) LEFT/RIGHT (delhdg)	Relative heading command
(acid) SPD (IAS/Mach)	Speed command
(acid) ALT (alt) [,vertspd]	Altitude command (optional with vertical speed)
(acid) VS (vertspd)	Vertical speed (first set commanded altitude)

LNAV acid/*, ON/OFF	Set artificial pilot (navigation & resolution) on/off (*=for all aircraft)
-----------------------------------	--

VNAV acid/*, ON/OFF	Set vertical navigation on/off (*=all aircraft)
SQ[UAWK] [acid,]code	Set transponder code

NAVDISP/ND (acid)	Show nav display for specified aircraft (TAB to toggle)
--------------------------	---

acid CHASE targetid, time	Chase target aircraft to meet at time
(acid) DEST (airportid)	Set destination for navigation purposes
(acid) ORIG (airportid)	Set origin for bookkeeping purposes
(acid) ROUTE	Display route for aircraft on/off
acid ADDWPT (name/lat,lon),[alt],[spd],[afterwpt]	Add waypoint to route of aircraft
acid ADDTUBE heightm,widthm,lat,lon,alt,iwptype,wpname	Add tube point (AWARD project)
acid AT wpname SPD spd	Set speed at waypoint
acid AT wpname ALT alt	Set altitude at waypoint
(acid) DIRECT[TO]/DIRTO (waypoint)	Set active waypoint
(acid) DELWPT wpname	Delete waypoint from route
(acid) DEL RTE	Delete entire route
LISTRTE acid[,pagenr]	List route for a/c (pagenr mainly used internally)

DEFWPT name,lat,lon	Define a waypoint temporary
UNDEFWPT wpname	Undefine waypoint
LISTWPT [pagenr]	List defined waypoints (pagenr not necessary)

FREE FLIGHT COMMANDS

ASAS acid, [ON/OFF/TOGGLE]	Equips a/c with ASAS or not
RESO acid, ON/OFF	Switch on/off ASAS resolution module
RESONR resonr/name	Set conflict resolution method (see conflict.dat)
FFLEVEL altitude	Set level above which Free Flight is allowed

DFFLEVEL deltaaltitude	Set thickness of transition layer below flevel
DTLOOK time	Set lookahead time
DTNOLOOK	Set lookahead between conflict probings
DTLOOKATC	Set lookahead time for controlled traffic
MANUAL/SEMIAUTO/FULLAUTO	Set resolution execution method for RFS
NORES0 acid	Set (one) aircraft not to avoid
PREDASAS/PA acid	Show current values of forbidden bands for given aircraft
PREDASAS/PA ON/OFF	Switch predasas function of navigation display on or off
FILTCONF ON/OFF	Set Conflict Detection time lag filter on/off
FILTRED	Set time lag for filtering 'RED' urgency conflicts
FILTAMB	Set time lag for filtering 'AMBER' urgency conflicts

DISPLAY COMMANDS

ZOOM IN/OUT	Set zoom of current display (radar or navigation display)
++++ / -----	Multiple zoom in (+) or zoom out (-)
VERZOOM IN/OUT	Set vertical range of vertical navigation display
V++++/V-----	Multiple vertical zoom in/out
PAN (LEFT / RIGHT / UP / DOWN / RFS / MCS / acid / airport / lat, lon)	Pan radar window
TRACE (acid)/OFF	Keep panning the display on specified aircraft
NAVDISP/ND (acid)	Show nav display for specified aircraft (TAB to toggle)
SWRAD GEO / GRID / APT / VOR / WPT / NDB / LABEL	toggles features on or off
LABEL	Cycles info level of labels
RADAR	Switch back to radar display (TAB toggles)
WPTLABEL ON/OFF	Switch Waypoint labels on/off
SWCOLEQP ON/OFF	Switch colour coding of traffic based on equipage on/off
VERDIST ON/OFF	Use distance or forward looking projection for vertical nav display
LOWALT altitude	Set lower altitude limit for aircraft to be shown in radar window
UPPALT altitude	Set upper altitude limit for aircraft to be shown in radar window
SYMBOL	Switch aircraft symbol in radar display

SIMULATION CONTROL

IC [playfile],[recfile]	Initialize condition, just IC runs the same file
OP	Start or continue running
HOLD	Pause or hold simulation
EXIT	Exit program (or use ESC key)
RTF rtf	Set real-time factor for fast-time simulation
FIXDT ON/OFF	Forces the Traffic and Experiment Manager to use a fixed time step
DT [dt]	Sets time step to the value dt, shows current DT without argument
TAKE (acid)	Hand aircraft over to airmim
GIVE	Ask airmim to release control over aircraft
NOISE ON/OFF	Switch noise on/off
SAVEIC filename	Save current situation as IC
AUTOSCEN [filename]	Opens filename.ASC and filename.RTE for scenario generation
AUTOSTOP [ON/OFF]	Sets start/stop recording FX10 aircraft (see autostop.dat)

DATALOGGING

DATALOG ON/OFF/filename	Set datalogging in *.tmx file on/off
LOG text	Write text timestamped to log file
TRACK ON/OFF	Open or close ATAC TCK_*.txt file (opening file is not required for TRACK command)
TRACK acid,dt/OFF	Log this aircraft in TCK file, using OFF ends logging (TCK is short version of TRACK) with interval dt seconds expressed in simulated time

TRACK acid Shows whether this aircraft is being logged and the sample time for this aircraft

TRACK ALL/*,dt[,lowalt] Used in combination with an AREA this logs all aircraft in and future aircraft entering the area in the ATAC TCK-file. Lowalt is the altitude that aircraft should pass before entering the experiment area (default value is 2000 ft) and they are tracked

WEB EXPERIMENT COMMANDS

COM WEB ON sessionname Host a web session. Session name is password to be entered by users validated in email.dat (unless password off, then all users are allowed to log in)

SHOW ALL/WEB Show all traffic or only web aircraft

WHO [IS] [acid/e-mail/*] Show who is controlling which aircraft

TAKENEXT acid Put aircraft on takelist with aircraft that will be handed over to web users

TAKE1ST acid Reset list and start with this acid as the next to take over

SAY */acid text Chat to a specific user (or to all using *) (Use Chat or Say)

CHATMODE TMX/ALL Set party-line effect of chat on (ALL) or off (TMX). Using 'chatmode TMX' allows only chat functionality between experiment manager and participants, not between FreeSim participants

KILL acid/ALL Drop connection with a user (or all users)

WEB OPEN/CLOSE Prevent or allow new users to log on

PASSWORD ON/OFF Allow all potential users to log on ('OFF') or only the e-mail addresses in email.dat file

MIXED EQUIPAGE PROCEDURES

ATM PAAIR/PAGND/PAGEN Use protected airways concept for airborne, ground or generate mode

ATM FLAIR/FLGND/FLGEN Use flight level concept for airborne, ground or generate mode

ATM FMAIR/FMGND/FMGEN Use full mix concept for airborne, ground or generate mode

MISCELLANEOUS COMMANDS

NAVDB area Select a new navigation database e.g. 'navdb usa'

DENS[ITY] Calculates traffic density of current radar window

DIST lata,lona,latb,lonb Calculate bearing and distance from A to B

QDRPOS lat,lon,qdr,dist Calculate lat/lon given bearing and distance [nm] (output also in datalogging file)

HDGREF M/T Set default headings to Magnetic or True, if no M or T is used after value of heading

TURB latmin,lonmin,latmax,lonmax,(L/M/S) Specify light medium or sever turbulence area

DEL TURB Delete turbulence area

CLOUD lat,lon Set cloud at specified location

DEL CLOUD Delete cloud

AREA lata,lona,latb,lonb[,latc,lonc] Specify experiment area (leaving a/c deleted)

AREA OFF Switch experiment area off

CLRAREA lata,lona,latb,lonb[,latc,lonc] Specify area that generates requests for clearances

CLRAREA OFF Switch clearance area off

EVENT eventcode Set eventcode

REF acid, fuel,way,time Set reference values for statistics of efficiency

INSEdit (txt) Insert a text as if edited. Meant for use in BUTTONS.DAT

MODE submenu Set submenu of mouse buttons

ECHO ON/OFF/text Set echo on/off or display text

Appendix D Command Reference TMX

GRAB example.bmp	Dump screen in BMP file
FREQ	Displays program update frequency
COM / ETH (device) ON/OFF	Switch communication to device ON or OFF. Devices: RFS, MCS, CMD, GSM, ATC
TAXI ON/OFF	Switch taxi option on or off. If off, all traffic below 1500 ft will be deleted
MOVIE START,filename,lat1,lon1,lat2,lon2,[,dtsample]	Record frames in PCX numbered files for certain area (click in map display) to generate animations
MOVIE STOP	Stop frmae bitmap generation

General command syntax

All command lines start with the command followed by command line arguments if necessary. The arguments are separated by one comma and/or space(s). When the first argument is an aircraft id that exists, it is also allowed to swap command and id. So "ALT KL104, FL250" is equivalent to "KL104 ALT FL250". This means the user can first select the aircraft with the mouse, then watch the current values at the bottom line in the strip window and then decide what command should be issued. Using the mouse in the radar window and the selection bar a lot of commands can be issued without touching the keyboard.

Mouse clicks

The button strip offers a range of commands to be selected with the mouse. Also the following arguments can be selected with a mouse click in radar window or selection bar:

acid = aircraft identification e.g. NLR001 (max. 8 characters)

(lat, lon)= position (decimal degrees)

hdg = heading by clicking in direction from reference position (true, decimal degrees)

alt = altitude (from selection bar) (xxxxx ft or FLxxx or xxx)

spd = speed (from selection bar) (CAS kts or Mach)

type = aircraft type (from selection bar)

dest = airport closest to click in radar window

Appendix E IFALPA Press Release

Appendix E IFALPA Press Release on Airborne Separation Assurance

Appendix E IFALPA Press Release



PRESS RELEASE

3rd November 2000

THE RESPONSIBILITY FOR SEPARATION

The International Federation of Air Line Pilots' Associations - IFALPA - considers that the basic purpose of air traffic rules and air traffic control is to prevent collisions with the least restriction on aircraft movements whilst providing safe, orderly and efficient use of navigable airspace.

Adequate ATC systems should provide the basic service of separation between aircraft. States should strive to establish an adequate ATC system as defined by ICAO Standards and Recommended Practices. This ATC system is ground based and controller centred. Where such a system is not yet implemented, States should endeavour to create one. IFALPA further considers that the near term investment in ATC systems should be in efforts to continuously improve this ground based, controller centred service.

In this context, it is the opinion of IFALPA that air traffic separation based solely on cockpit displays of traffic information may not constitute a safe mode of operation. The pilot community should not support the transfer of separation responsibility to pilots in any but the most regulated conditions. IFALPA feels that the possibility of pilot-induced mid-air collisions under an airborne based separation scheme may represent an increased risk that has not been recognised by the developers of airborne separation procedures. For a multitude of human factors and technical reasons, the Federation does not recognise the ability of flight crew to perform airborne based separation on a safe and orderly basis.

Therefore, IFALPA insists that separation responsibility remain with the controller on the ground and does not support the transfer of responsibility for separation to the flight crew outside the scope of current air traffic rules.

Queries should be addressed to:

Mr Peter Quintmere, Director, Safety & Technical

Tel: +44 1932 571711

Fax: +44 1932 570920

globalpilot@ifalpa.org

The International Federation of Air Line Pilots' Associations represent in excess of 100,000 pilots in almost 100 countries world-wide.

The mission of IFALPA is to be the global voice of airline pilots, promoting the highest level of aviation safety world-wide and providing services, support and representation to all of its Member Associations.

01PRL007

ADMINISTRATIVE HEADQUARTERS

Interpilot House, Gogmore Lane, Chertsey, KT16 9AP, England

www.globalpilot.org

TEL +44 1932 571711

FAX +44 1932 570920

globalpilot@ifalpa.org

Appendix E IFALPA Press Release

Appendix F Press coverage of this study

Appendix F Press coverage of this Study

International Press:

- Flight International May 20-26, 1998: "Free Flight study finds pilots' workload is not increased"
- Flight International Air Navigation Newsletter November 10, 1997 "NLR shows feasibility of Free Flight with Airborne Separation Assurance" (not included here)
- Several articles in ATC magazine, Aviation Online E-zine, etc. (not included here)

Dutch press:

- All regional newspapers in Netherlands and Belgium (GPD) on 30 July 1999 (kort artikel) "Onderzoeker bepleit chaos in luchtruim"
- Alle regional newspapers in Netherlands and Belgium (GPD) later in the summer of 1999 (long article in weekend) "Zonder verkeersleiders wordt de lucht veiliger"
- TV item on national television Ontbijtshow September 1999
- Interview Frits Spits on national radio 2
- Elsevier Magazine article on Free Flight(text only), Elsevier Magazine September 25th 1999, page 30-38

Not included:

- Presentation at press conference by Platform Nederlandse Luchtvaart
- Article in ATC magazine
- Article in Flight Navigation newsletter
- Interview Wereldomroep

Flight International May 20-26, 1998

Free flight study finds pilots' workload is not increased

IAN SHEPPARD/LONDON

A DUTCH national aerospace laboratory (NLR) study has concluded that workload does not increase when a pilot is given responsibility for separation assurance in a "free flight" air traffic control environment.

Ronald van Gent, NLR project leader, says that the conclusion surprised the research team. "We anticipated a dramatic increase in workload," he admits. The conclusion held good even with traffic density increased to levels which are never likely to be experienced.

The exercise consisted of off-line simulations and a safety analysis study, followed by man-in-the-loop flight simulations.

In the tests, eight crews each flew 18 sorties, all of 20min duration, with traffic densities ranging up to three times the average encountered in European airspace. A modification to the simulator's navigation display allowed other traffic to be superimposed.

Eye and head movements of crewmembers were tracked, along with their interaction with the avionics. Their opinions were recorded, with the

majority accepting the new concept and testifying that workload was unchanged.

Each aircraft had its own conflict detection and resolution advisory modes, the best of which was selected. Known as "voltage potential", this involves the real-time assessment of conflict possibility and calculation of an advised track, ground and vertical speed.

Conflict severity is used as a measure of the incursion of the "own ship" aircraft into another aircraft's "protected zone". An avoidance vector is added to the minimum distance vector to give the advisory based on maintaining

the protected zone. The concept has been tested using the NLR's Traffic Organisation and Perturbation Analyzer, which resulted in the NLR team's conclusion that free flight with airborne separation assurance is "at least as safe" as the current air traffic environment.

The study was part-funded by the US Federal Aviation Administration and undertaken in conjunction with NASA. The US organisations are now using the results to advance their own free flight definition work.

Van Gent says that the second stage of the project is being set up to investigate issues such as "mixed equipage". This is where various percentages of traffic are assumed to be equipped for ADS-B [Automatic Dependent Surveillance - Broadcast].

Meanwhile, an extra variable will be added to enable aircraft to see others using "new formats" based on existing or new secondary surveillance-type technologies.

Phase two will also fine tune the voltage potential rule, adding additional filters to prevent the "sudden" reactions to conflicts met in phase one. □

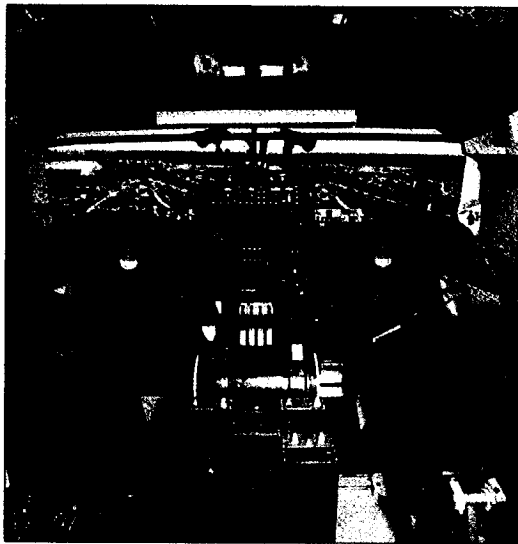

Simulator watches pilot's every move

'Vrij vliegen is sneller en veiliger'

Onderzoeker bepleit chaos in luchtruim

AMSTERDAM • RICHARD MOOYMAN

Schaf de luchtverkeersleiding af en laat piloten op eigen houtje via de kortste route naar hun bestemming vliegen. Dit is volgens onderzoeker J. Hoekstra van het Nationaal Lucht- en Ruimtevaartlaboratorium (NLR) de beste oplossing voor de toenemende drukte in het Europees luchtruim. Kriskras door elkaar vliegen bespaart volgens Hoekstra niet alleen tijd en kosten. Het zou zelfs veiliger zijn dan het volgen van de drukke vliegbanen.

Op een bijeenkomst van het Platform voor de Nederlandse Luchtvaart in Amsterdam bepleitte de NLR-projectleider 'free flight' gisteren meer anarchie in de lucht. Aanleiding voor de bijeenkomst waren de toenemende vertragingen in de luchtvaart. Op Schiphol is inmiddels eenderde van de vluchten vertraagd, met een ge-

middelde van 43 minuten.

Volgens het plan van het NLR worden vliegtuigen uitgerust met apparatuur waarmee de bemanning zelf alle andere toestellen in de wijde omtrek kan waarnemen. De gezagvoerder is dan verkeersleider voor zijn eigen toestel. Koerst hij op een ander vliegtuig af, dan kan de piloot volgens Hoekstra ruimschoots op tijd bijsturen. De kans op een botsing is volgens hem zelfs kleiner dan bij het huidige systeem, waarbij één verkeersleider op de grond een flink stuk van het luchtruim in de gaten moet houden.

Computersimulaties hebben uitgewezen dat de vrij vliegende piloot het niet drukker krijgt dan wanneer hij onder begeleiding een vliegbaan volgt, aldus Hoekstra. De gezagvoerder hoeft niet telkens te communiceren met de lappendeken van verkeersleidingscentra op de grond.

De capaciteit van het luchtruim neemt fors toe als de vliegbanen op grote hoogte worden afgeschaft. De overbelaste vliegroutes in het versnipperde Europese luchtruim zijn nu een van de belangrijkste oorzaken van de toenemende vertragingen. Luchtvaartmaatschappijen kunnen volgens Hoekstra veel kosten besparen als toestellen via de kortste route snel van A naar B kunnen vliegen.

Hoekstra erkende dat er haken en ogen zitten aan het ingrijpende plan, waaraan het NLR samen met de Rijksluchtvaartdienst en de Amerikaanse luchtvaartautoriteiten FAA en de ruimtevaartorganisatie NASA werkt. Technologisch gezien zijn er nauwelijks problemen, maar Hoekstra acht het onwaarschijnlijk dat vrij vliegen voor het jaar 2015 wordt ingevoerd. Zo moeten eerst wereldwijd afspraken worden gemaakt

over de verkeersregels in de lucht. Verkeersleidingscentra moeten bevoegdheden inleveren en vliegtuigen dienen met speciale apparatuur te worden uitgerust. Overigens blijven verkeersleiders wel nodig om het starten en landen te begeleiden.

Het NLR kwam onlangs al in de publiciteit met een studie naar een nieuwe manier van datatransmissie tussen luchtverkeersleiding en cockpit. Als gevolg daarvan zou in de verre toekomst vliegen met slechts één piloot aan boord mogelijk worden.

Pleidooi voor 'vrij vliegen' verkeersvliegers

AMSTERDAM (GPD) - Schaf de luchtverkeersleiding af en laat piloten op eigen houtje via de kortste route naar hun bestemming vliegen. Dat is volgens onderzoeker J. Hoekstra van het Nationaal Lucht- en Ruimtevaartlaboratorium (NLR) de beste oplossing voor de toenemende drukte in het Europees luchtruim. Kriskras door elkaar vliegen bespaart volgens Hoekstra niet alleen tijd en kosten. Het zou zelfs veiliger zijn dan het volgen van de drukke vliegbanen.

Op een bijeenkomst van het Platform voor de Nederlandse Luchtvaart in Amsterdam bepleitte de NLR-projectleider 'free flight' gisteren meer anarchie in de lucht. Aanleiding voor de bijeenkomst waren de toenemende vertragingen in de luchtvaart. Op Schiphol is inmiddels eenderde van de vluchten vertraagd, met een gemiddelde van 43 minuten.

Volgens het plan van het NLR worden vliegtuigen uitgerust met apparatuur waarmee de bemanning zelf alle andere toestellen in de wijde omtrek kan waarnemen. De gezagvoerder is dan verkeersleider voor zijn eigen toestel. Koerst hij op een ander vliegtuig af, dan kan de piloot volgens Hoekstra ruimschoots op tijd bijsturen.

De kans op een botsing is volgens hem zelfs kleiner dan bij het huidige systeem waarbij één verkeersleider op de grond een flink stuk van het luchtruim in de gaten moet houden. Computersimulaties hebben uitgewezen dat de vrij vliegende piloot het niet drukker krijgt dan wanneer hij onder begeleiding een vliegbaan volgt, aldus Hoekstra. De gezagvoerder hoeft niet telkens te communiceren met de lappendeken van verkeersleidingscentra op de grond.

De capaciteit van het luchtruim neemt fors toe als de vliegbanen op grote hoogte worden afgeschaft. De overbelaste vliegroutes in het versnipperde Europese luchtruim zijn nu een van de belangrijkste oorzaken van de toenemende vertragingen. Luchtvaartmaatschappijen kunnen volgens Hoekstra veel kosten besparen als toestellen via de kortste route snel van A naar B kunnen vliegen.

Hoekstra erkende dat er haken en ogen zitten aan het ingrijpende plan, waaraan het NLR samen met de Rijksluchtvaartdienst en de Amerikaanse luchtvaartautoriteiten FAA en de ruimtevaartorganisatie NASA werkt. Technologisch gezien zijn er nauwelijks problemen, maar Hoekstra acht het onwaarschijnlijk dat vrij vliegen voor het jaar 2015 wordt ingevoerd.

Zo moeten eerst wereldwijd afspraken worden gemaakt over de verkeersregels in de lucht. Verkeersleidingscentra moeten bevoegdheden inleveren en vliegtuigen dienen met speciale apparatuur te worden uitgerust. Overigens blijven verkeersleiders wel nodig om het starten en landen te begeleiden.

Zo moeten eerst wereldwijd afspraken worden gemaakt over de verkeersregels in de lucht. Verkeersleidingscentra moeten bevoegdheden inleveren en vliegtuigen dienen met speciale apparatuur te worden uitgerust. Overigens blijven verkeersleiders wel nodig om het starten en landen te begeleiden.

Zonder verkeersleiders wordt de lucht veiliger

Driekwart van alle vertragings in de luchtvaart ontstaat doordat de verkeersleiding de drukte in de lucht niet meer sankaan. Als de groei van de luchtvaart doorgaat, loopt volgens kenners het systeem over een paar jaar volledig vast. Dat roept om revolutionaire maatregelen, zoals 'Free Flight'. Schaf de luchtverkeersleiding af, laat vliegtuigen vrijuit vliegen waar zij maar willen en maak piloten de verkeersleiders voor hun eigen vliegtuig. Anarchie als oplossing voor chaos? Ja, en volgens experts zal vliegen er zelfs veiliger en sneller door worden.

Wie op Schiphol aanboord en hoort dat zijn vlucht naar de zonnige zuidvertraging heeft, zal al gauw de jumbovlieger van de luchtvaartmaatschappij de schuld geven. Maar de grootschalige vertragingen in de vlucht zijn niet het probleem, maar de drukte in het luchtruim. En hoe meer wij willen vliegen, hoe drukker het zal worden.

Vliegtuigen vliegen via vaste routes naar hun bestemming. Die raken dus propvol. Luchtverkeersleiders moeten dat verkeer in goede banen leiden, maar dat wordt steeds moeilijker. Omdat vliegtuigen op minimale afstanden van elkaar moeten vliegen, is één vliegtuig dat iets te langzaam vliegt al genoeg om een vertraging te veroorzaken.

Volgens Eurocontrol wordt dit jaar 75 procent van alle vertragingen veroorzaakt door de drukte in het luchtruim. Gebeurt daar niets aan en groeit de luchtvaart in hetzelfde tempo door, dan loopt het systeem over vijftien jaar compleet vast. Dan is op tijd vliegen onmogelijk geworden, en loopt ook de veiligheid gevaar. "Dan moet een verkeersleider elke 40 seconden een conflict oplossen", zegt Jacco Hoekstra van het Nationaal Lucht- en Ruimtevaartlaboratorium in Amsterdam. "Gemiddeld zijn er nu 100 conflicten in het luchtruim. Dat is vijf keer zoveel als er nu is." Dat is het aantal conflicten dat de verkeersleiders bij de huidige drukte al moeten oplossen.



Jacco Hoekstra, Ronald van Gent en Bob Baugrook (van op foto links) van het Nationaal Lucht- en Ruimtevaartlaboratorium. 'Free Flight', vrije vlucht, heeft toekomst.

In de VS, maar ook bij het NLR, wordt al de drukte in de lucht niet meer sankaan. Als de groei van de luchtvaart doorgaat, loopt volgens kenners het systeem over een paar jaar volledig vast. Dat roept om revolutionaire maatregelen, zoals 'Free Flight'. Schaf de luchtverkeersleiding af, laat vliegtuigen vrijuit vliegen waar zij maar willen en maak piloten de verkeersleiders voor hun eigen vliegtuig. Anarchie als oplossing voor chaos? Ja, en volgens experts zal vliegen er zelfs veiliger en sneller door worden.

Omgedraaid
De luchtverkeersleiding van nu is gebouwd op het principe dat het ene vliegtuig het andere niet kan zien. De verkeersleider bepaalt in welke corridor en op welke hoogte een vliegtuig vliegt. Hij ziet ook de andere vliegtuigen en moet de routes afstemmen. Bij het NLR wordt de vluchtverkeersleiding omgedraaid. De vluchtverkeersleiders worden weggevoerd en de vluchtverkeersleiders worden weggevoerd. De vluchtverkeersleiders worden weggevoerd en de vluchtverkeersleiders worden weggevoerd.

Muur
Samen met de Amerikaanse NASA heeft het NLR dit idee uitgewerkt. Ook de andere ingenieurs hadden twijfels. "Toen we er mee begonnen, dachten we ook dat het heel moeilijk was. Maar nu is de vluchtverkeersleiding van het NLR alomtegenwoordig een succes. Het systeem is nu in Amsterdam zijn proeven met 'Free Flight' begonnen, waarvan de resultaten heel positief zijn. Het systeem is nu in Amsterdam zijn proeven met 'Free Flight' begonnen, waarvan de resultaten heel positief zijn. Het systeem is nu in Amsterdam zijn proeven met 'Free Flight' begonnen, waarvan de resultaten heel positief zijn.



foto Ronald de Bruijn

dat hooguit één keer per uur zijn. Het doorbrekt bovendien de monotonie, die er toch is bij lange vluchten over de oceaan. De verkeersleider, die nu nog alle vliegtuigen in de gaten moet houden, zet zijn werklast echter sterk afremmen. Bij het huidige systeem neemt het aantal vluchten in de lucht kwadratisch toe in verhouding tot de groei van de luchtvaart. Het aantal vluchten zal in 2010 ongeveer 100 miljoen zijn. Het NLR heeft de piloot alleen zijn eigen conflicten op te lossen. Ook voor de luchtvaartmaatschappijen heeft 'Free Flight' - economische voordelen. Vliegtuigen hoeven niet meer door vaste corridors te vliegen en kunnen de kortste, meeste en dus goedkoopste routes kiezen. De enige flessenhal is ontstaan bij het opvliegen en landen, maar dat is nu ook zo. Zolang het vertalen van vertrek- en aankomtijden bij de verkeersleiding blijft, kan de controle onderweg gerust aan de piloot worden toevertrouwd.

Praktijkproef
Free Flight staat nog maar in de kinderschoenen. Er zal, zowel in de VS als bij het NLR, nog veel getest moeten worden. De eerste praktijkproef wordt volgend jaar in de VS gehouden. Dan wordt op een rustige zaterdag een groot stuk luchtruim boven de staat Ohio afgezet, en wordt met het door het NLR ontwikkelde systeem geëxperimenteerd in het kern kraak door elkaar laten

ter werden situaties gecreëerd waarbij tientallen vliegtuigen kris kras door elkaar vlogen. Daarbij dienden zich uiters aard tientallen potentiële conflicten - zeg maar (bijna-) botsingen - aan. Maar die londen zich verrassend simpel voor. De verkeersleider heeft geen tijd om te denken. Hij moet de vluchtverkeersleiders voorstellen, zodat: "Dat is een prima systeem", hoe werkt het al het drukke vliegtuig. Het NLR heeft de piloot alleen zijn eigen conflicten op te lossen. Ook voor de luchtvaartmaatschappijen heeft 'Free Flight' - economische voordelen. Vliegtuigen hoeven niet meer door vaste corridors te vliegen en kunnen de kortste, meeste en dus goedkoopste routes kiezen. De enige flessenhal is ontstaan bij het opvliegen en landen, maar dat is nu ook zo. Zolang het vertalen van vertrek- en aankomtijden bij de verkeersleiding blijft, kan de controle onderweg gerust aan de piloot worden toevertrouwd.

vliegen van 24 straatvliegtuigen. Die zijn van pakjesvoerder UPS, die als eerste (vrachtmachtschappij) het 'Free Flight'-concept heeft omarmd. Invoering van Free Flight zal nog wel vijftien jaar op zich laten wachten. Het heeft pas zin als alle luchtvaartmaatschappijen en verkeersleidingen willen meewerken. En dan zullen piloot, verkeersleider en controlekamer wel vliegen in dan het gemeenschappelijke vliegen van nu.

Veeliger, omdat zich minder conflicten zullen voordoen als vliegtuigen het hie luchtruim mogen gebruiken in plaats van dicht achter elkaar door vaste corridors te moeten vliegen. "En ook het vliegen boven Afrika, Oceanië of grote stukken zee, waar nu geen of nauwelijks verkeersleiding aanwezig is, zal er veiliger door worden", zegt Van Gent.

Er is te vliegen, maar eigenlijk mogen we dat niet. Het NLR heeft de piloot alleen zijn eigen conflicten op te lossen. Ook voor de luchtvaartmaatschappijen heeft 'Free Flight' - economische voordelen. Vliegtuigen hoeven niet meer door vaste corridors te vliegen en kunnen de kortste, meeste en dus goedkoopste routes kiezen. De enige flessenhal is ontstaan bij het opvliegen en landen, maar dat is nu ook zo. Zolang het vertalen van vertrek- en aankomtijden bij de verkeersleiding blijft, kan de controle onderweg gerust aan de piloot worden toevertrouwd.

Hans de Bruijn

**Ontbijt TV item over NLR Free Flight onderzoek september 1999
(Breakfast TV item on NLR Free Flight Research project in September 1999)**

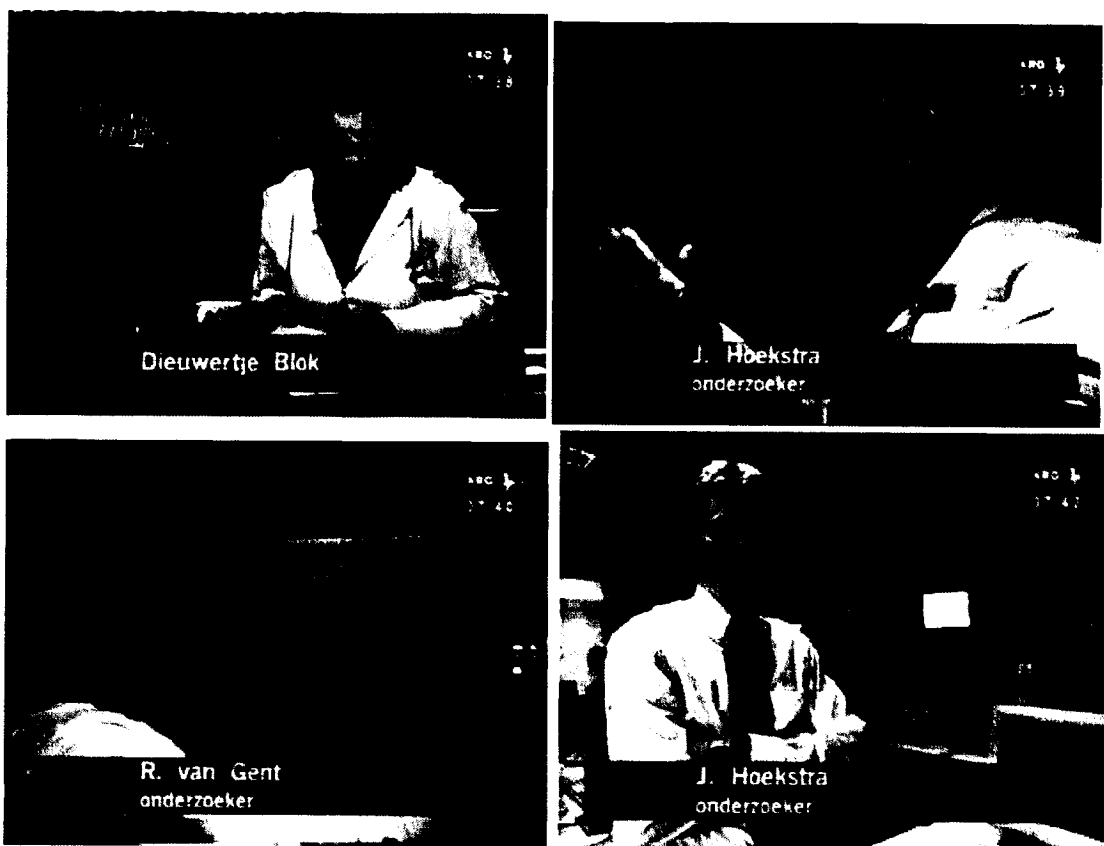

Snapshots van item op OntbijtTV op TV 1

Dieuwertje Blok:

Files, ook in de lucht. Driekwart van alle vertragingen ontstaat door drukte in het luchtruim. Deze zomer werd dat nog eens pijnlijk duidelijk. Meer vrijheid voor de piloten, dat zou de oplossing zijn. Free Flight is het toverwoord.

[Beelden van een verkeersleidingscentrum.]

Commentaarstem:

De situatie op dit moment. Verkeersleiders begeleiden elke vlucht van vertrek tot aankomst. De piloot wordt volledig gestuurd. Files in de lucht ontstaan mede doordat de verkeersleiding maar een beperkt aantal vluchten aankan. Als de groei doorgaat, dreigt het systeem vast te lopen. Daarom onderzoekt men nu of piloten de rol van verkeersleiders over kunnen nemen m.b.v. een Free Flight systeem.

Hoekstra:

Op dit moment, als die lijnen in de lucht vol zitten, wordt gezegd dat het luchtruim vol is. Maar *het luchtruim* is niet vol, het

verkeersleidingssysteem is vol. Al je nu Free Flight invoert, dan zorgt iedereen voor zichzelf. Hierdoor verdwijnt het centrale knooppunt in het hele systeem wat nu gevormd wordt door de verkeersleider met zijn scherm. Er kunnen een meerdere acties tegelijkertijd plaatsvinden en dat vergroot de capaciteit van het luchtruim.

Commentaarstem:

Free Flight wordt op dit moment getest in het Nationaal Lucht- en Ruimtevaartlaboratorium. Piloten die hun eigen route bepalen, het lijkt een gevaarlijke onderneming.

Van Gent:

In eerste instantie zou je dat verwachten, maar dat blijkt heel erg mee te vallen met de experimenten die we tot nu toe gedaan hebben.

[Beelden van de Research Flight Simulator van het NLR en navigatiedisplay.]

Van Gent:

Appendix F Press coverage of this study

We zien hier het plaatje onder normale omstandigheden, zoals je dat vandaag de dag zou zien.

Commentaarstem:

De onderzoekers creëren een situatie die tien keer zo druk is als normaal en brengen zichzelf dan bewust in de problemen.

Hoekstra:

Nu hebben we een conflict. En we zien bovendien op ons scherm dat zich hier het conflict bevindt en dat hij adviseert naar rechts te gaan.

Commentaarstem:

De computer biedt een oplossing aan en de piloot vervolgt zijn route. Free Flight zou een oplossing zijn voor het capaciteitsprobleem in het luchtruim van West-Europa. Maar de verkeersleiders zetten daar hun vraagtekens bij.

Hoogstraten:

Onze visie is dat dat wat minder geschikt daarvoor is. Dat komt met name omdat in Noord-West Europa, en in drukke gebieden van de VS, Zuid-Oost Azië, 80% van het verkeer naar grote luchthavens zakkend en klimmend is. En juist voor dat soort complexere situaties zal het systeem wat minder toepasbaar zijn.

Hoekstra:

De landingsbanen zijn een schaars middel waar iedereen tegelijk bij wil. Dus daar zal je ook altijd verkeersleiding houden, die daar ook een soort scheidsrechter speelt en zegt in welke volgorde en op welke wijze men moet landen. Maar op dit moment wordt driekwart van de vertragingen veroorzaakt niet door de beperkte capaciteit van de landings- of startbaan, maar door de beperkte capaciteit van het luchtruim.

Commentaarstem:

De techniek is er klaar voor maar in de praktijk zitten er nog veel haken en ogen aan. Free Flight functioneert alleen goed wanneer het wereldwijd wordt ingevoerd. En daar zal nog minstens 15 jaar overheengaan.

Hoogstraten:

De invoer daarvan betekent dat er in vliegtuigen een behoorlijke investering moet worden gedaan om die apparatuur aan boord te brengen. De huidige generatie vliegtuigen is daar niet mee uitgerust. En die hebben een levensduur van een jaar of 25. Dat betekent dus dat de bestaande vloot moet worden omgebouwd, of dat die functionaliteit moet worden toegevoegd. En dat zal nog wel wat tijd vergen.

Commentaarstem:

Toch verwachten de onderzoekers dat de invoering van Free Flight financieel interessant is. Efficiënter vliegen betekent brandstof besparing.

Hoekstra:

Als je de orde grootte van de brandstofbesparing vergelijkt met de aanschafkosten van zo'n systeem, die we nu alleen nog maar kunnen schatten, dan is het voor iedereen een financieel aantrekkelijk plaatje. Ook voor armere luchtvaartmaatschappijen.

[Beelden van vliegtuigen.]

Dieuwertje Blok:

De KLM vindt meer zelfstandigheid voor piloten een goede ontwikkeling maar verwacht dat een wereldstandaard nog erg lang op zich laat wachten. Ze zien meer in een samenwerkingsverband op Europees niveau.

Verslag telefonisch interview door Frits Spits met Jacco Hoekstra d.d. 4 november 1999 op Radio 2 in het KRO programma "Tijd voor Twee".

Onderwerp: Free Flight

(Een korte inleiding over de toenemende vertraging in de luchtvaart...)

...Maar het einde van de ellende is in zicht, Duitse onderzoekers hebben een systeem bedacht, waarbij meer vliegtuigen tegelijk de lucht in kunnen zonder dat dat ten koste gaat van de veiligheid.

Aan de telefoon Jacco Hoekstra. Hij is projectleider van een soortgelijk onderzoek bij het Nationaal Lucht- & Ruimtevaartlaboratorium. Meneer Hoekstra, kunt u ons uitleggen hoe zo'n systeem werkt. Het essentiële verschil met de situatie van vandaag de dag is dat de verantwoordelijkheid voor het uit elkaar houden van de vliegtuigen, die nu bij de verkeersleider ligt, wordt verplaatst naar de cockpit.

Naar een computer.

Naar de vliegers, geassisteerd door de nodige computers, ja.

Dus de vliegers hebben dan de verantwoordelijkheid. Wat doen dan de computers precies?

De computers rekenen uit of de vliegtuigen te dicht bij elkaar komen. De vliegers kunnen dit zelf ook zien op een display, maar de computers kunnen dit nog iets beter uitrekenen. En op het moment dat dit voorspeld wordt, krijgen de vliegers een signaal: "Let op, als jullie zo doorvliegen dan ontstaat er een probleem."

Dan kunnen de vliegers kijken hoe dat probleem eruit ziet en een aantal alternatieven kiezen, die door de computer worden gepresenteerd. En op die manier om het dreigende conflict, om het te dicht bij elkaar komen, heen te vliegen.

En wat is het voordeel hiervan?

Het voordeel hiervan is dat er uiteindelijk meer vliegtuigen in de lucht kunnen. Om dat te begrijpen is het goed om te weten hoe het vandaag werkt. Vandaag de dag vliegen alle vliegtuigen niet dwars door het luchtruim, maar op een paar lijnen, "luchtwegen", en dat is eigenlijk vooral voor de verkeersleider, want die houdt dan een mooi overzichtelijk plaatje op zijn scherm. Als iedereen voor zichzelf zorgt, hoeft dat niet meer. Dan kan iedereen

dwars door elkaar vliegen en op het scherm zal dat er uitzien als een soort chaos.

Maar dat is het niet, zegt u.

Jawel, maar het is een veilige chaos. Want in tegenstelling tot de normale associatie die mensen met chaos hebben: "Dat is gevaarlijk", is de vliegtuigen ordelijk op een lijntje op dezelfde hoogte laten vliegen natuurlijk veel gevaarlijker.

Waarom?

Omdat er meer kans is dat ze dicht bij elkaar komen als iedereen precies dezelfde lijnen volgt. Als de een wat sneller vliegt dan de ander, kom je gewoon te dicht bij elkaar. En er zijn kruispunten. Als je dezelfde situatie simuleert, waarbij je zegt, wat zou er gebeuren als alle verkeer rechtstreeks van a naar b vliegt, dan komen ze elkaar bijna nooit tegen.

Maar als de computer uitvalt, ik moet er niet aandenken meneer Hoekstra, maar het kan gebeuren, dan wordt het linke soep.

Dat geldt wel vaker. Dat is vandaag de dag zelfs meer het geval bij dit systeem. Als vandaag de dag de computer van de verkeersleider uitvalt, dan zijn alle vliegtuigen eigenlijk meteen blind. Ze zien zelf nu het andere verkeer niet op tijd. Uit het raam zie je het altijd te laat, want je vliegt veel te hard om elkaar op tijd te zien. Dus dan is het volledig over. Terwijl bij het systeem waar iedereen voor zichzelf zorgt, iedereen zijn eigen computersysteem heeft. Als er dan iets mis moet gaan, dan moet er niet één systeem stukgaan, want dan ziet het andere vliegtuig, waarmee een mogelijk probleem dreigt, die ziet het nog. Nee, er moeten twee systemen stuk gaan en niet zo maar twee willekeurige, maar ook nog twee die elkaar tegenkomen.

Dus als ik u goed begrijp is dit veiliger en meer vliegtuigen kunnen tegelijk vertrekken.

Ja, omdat je niet meer vast zit aan die luchtwegen, die vol zitten vandaag de dag, kunnen er meer vliegtuigen in de lucht zijn.

Wanneer kan dit systeem worden ingevoerd?

Technisch gezien kan dit binnen een paar jaar, alleen spelen er ook wat andere dingen spelen mee, politieke dingen. Je mag van een luchtvaartmaatschappij niet zomaar verwachten dat ze dat kastje nu opeens aan

Appendix F Press coverage of this study

boord hebben. Er gaat een tijd overheen, voordat je dat verplicht mag stellen. Dat is alleen al acht jaar. En dan zijn er ook nog wat andere hindernissen. Er wordt een verantwoordelijkheid verplaatst van de grond naar de cockpit. Dat is altijd een wat moeilijker te introduceren iets dan een nieuw kastje.

U bent er in ieder geval een warm voorstander van.

Jazeker, en we zijn actief in allerlei commissies die daar aan werken.

*Hartelijk dank voor uw heldere uiteenzetting.
Graag gedaan.*

Tekst Elsevier artikel Free Flight

door Erik Vrijsen
Elsevier 25-9-1999
pag. 30-38

'Alles wil op 350. Het is ongelooflijk vandaag,' zegt Chris Boesmans terwijl hij naar zijn scherm tuurt. 'Ik moet nu alles doen om die British Midland, onderweg van Londen naar Frankfurt, omhoog te krijgen en dadelijk moet-ie weer snel omlaag.' De piloot van een Air France 747 reageert niet onmiddellijk op Boesmans oproep. 'Kennelijk een beetje moe. Onderweg van Seoul naar Parijs. Da's een lange non stop vlucht.' De gezagvoerder van een Britse charter naar Newcastle wil weten of hij een stukje mag afsnijden. 'Armoedzaaiër,' mompelt Boesmans. 'Ze weten heus wel dat ze nu niet door het militaire luchtruim mogen. Toch vragen ze het. Ik zet 'm achter die Royal Jordanian naar Shannon.'

Boesmans is een van de 250 verkeersleiders van Eurocontrol in het Limburgse Beek. Dit is het zenuwcentrum van het verkeer in een van drukste stukjes luchtruim ter wereld: de hogere luchtlagen boven de Benelux, het Noordwesten van Duitsland, een deel van Denemarken en Noord-Frankrijk. Groene letters en cijfertjes op Boesmans zwarte beeldscherm markeren de circa vijftien vliegtuigen die zich op dit moment in zijn sektor bevinden. Elke vijf seconden worden de posities geactualiseerd en verspringt het beeld, zodat de vliegtuigen als vrolijke kikkertjes door het luchtruim lijken te huppelen.

Boesmans besluit een Swissair met bestemming Amsterdam alvast naar beneden te halen. Er dreigt ook een probleempje omdat een Lufthansa, tijdens een klim op de route Frankfurt-Londen, gaat kruisen met een dalende British Airways in tegenovergestelde richting, terwijl zich in diezelfde buurt al een toestel bevindt van de Duitse chartermaatschappij Condor op de terugvlucht van Las Palmas naar Düsseldorf. Boesmans beveelt de toestellen hun koers, snelheid en hoogte iets te wijzigen. Dan kan hij even later 'die Air France gewoon laten doorkachelen'.

Leegte

Vooraf in de drukke zomermaanden wordt er heel wat afgepraat over 'filevorming in de lucht'. Het is een raadselachtig vraagstuk. Er is geen plek in Nederland waar je, kijkend naar de blauwe hemel, meer dan twee of drie vliegtuigen tegelijkertijd kunt waarnemen. En wie ooit heeft plaatsgenomen in de cockpit van

een vliegtuig wordt, eenmaal in de lucht, overvallen door een sensatie van immense leegte. Toch vertrekt in de zomermaanden meer dan de helft van de vliegtuigen vanaf Schiphol met een vertraging van gemiddeld ruim een kwartier. In de wintermaanden vertrekt één op de drie toestellen gemiddeld ruim tien minuten te laat. Keer op keer heet de 'drukte in het luchtruim' de boosdoener. In feite echter, is het luchtruim leeg en verlaten. Vliegtuigen gebruiken alleen tamelijk smalle passages, de zogenoemde luchtwegen. Zelfs dan valt het zo op het blote oog met de drukte ook nog mee. De problemen ontstaan slechts doordat het vliegverkeer wordt afgewikkeld met behulp van een technologisch volkomen achterhaald systeem. Jacco Hoekstra, een specialist van het Lucht- en Ruimtevaartlaboratorium, maakt de volgende vergelijking: 'Stel dat één politieagent het verkeer op de rondweg van Amsterdam moest regelen door alle automobilisten via de radio individuele opdrachten te geven voor wat betreft hun snelheid en het eventueel veranderen van rijstrook. Dan zouden slechts enkele tientallen automobilisten van de ring gebruik kunnen maken.'

De groei van het luchtverkeer stuit dus niet op een tekort aan ruimte, maar botst voortdurend op de barrières van wat technisch haalbaar is. Eurocontrol heeft fors geïnvesteerd en binnenkort betrekken de verkeersleiders een gloednieuwe zaal die vol staat met hypermoderne en ergonomisch zeer verantwoorde computerapparatuur. Maar dit biedt hooguit tijdelijk soelaas. Het luchtverkeer neemt jaarlijks met zes procent toe, terwijl het controlesysteem nog altijd gebaseerd is het principe van kort na de Tweede Wereldoorlog: een vliegtuig beweegt zich van radiobaken naar radiobaken volgens de instructies die de piloot via de boordradio krijgt van de verkeersleiding op de grond.

De meeste passagiers hebben het idee dat de gezagvoerder de koers van het vliegtuig bepaalt. In feite verplaatst elk toestel zich doordat de luchtverkeersleiders het als een estafettestokje aan elkaar overgeven. Het luchtruim boven het continent is ingedeeld in 420 sectoren, die elk permanent bewaakt worden door een verkeersleider en zijn assistent. Aangekomen bij een sektor meldt de piloot zich bij de verkeersleider, die het toestel naar de overzijde loodst en overgeeft aan een collega. De verkeersleiders baseren zich daarbij op tamelijk onnauwkeurige radargegevens. Zij hanteren daarom een ruime

marge van vijf nautische mijlen (circa negen kilometer) rondom ieder vliegtuig. Dat lijkt heel wat, maar een normaal verkeersvliegtuig legt die negen kilometer in ongeveer 45 seconden af.

In sommige delen van Zuid-Europa moet de verkeersleiding het zonder radar stellen. Daar kijkt de verkeersleider gewoon op zijn horloge en geeft vliegtuigen om de tien minuten toestemming een sektor te betreden. Boven de oceaan is er ook geen radar en worden de toestellen ongeveer honderd kilometer achter elkaar gezet.

De hoogtemeters in de vliegtuigen zijn gelukkig zó nauwkeurig dat een verticale marge van enkele honderden meters voldoende is. Een vliegtuig dat op de Noordatlantische route tachtig kilometer achter een ander toestel vliegt, komt dus gevaarlijk dicht in de buurt. Maar als het er zeshonderd meter hoger overheen vliegt of zeshonderd meter onderdoor duikt, is er niets aan de hand.

Boven het vasteland van Europa vliegen de toestellen kris kras door elkaar, terwijl ze bijna niet anders lijken te doen dan klimmen en dalen.

Ervaren verkeersleiders vertellen dat het aflossen van een collega tijdens piekuren wel eens tien minuten kan duren. Die tijd is nodig om het patroon van vliegbewegingen volledig te doorgronden. Het drie-dimensionale luchtruim met alles wat zich daarin bevindt, wordt hen immers gepresenteerd als een plat vlak waarop zich vliegtuigen in de richtingen Noord-Zuid en Oost-West bewegen. De derde dimensie wordt in cijfertjes weergegeven: de hoogtes van de vliegtuigen. Tenslotte is er, als vierde dimensie, de snelheid van de vliegtuigen. De kern van het werk van een luchtverkeersleider is dan ook: abstrakt, vier-dimensionaal kunnen denken en daarbij niet in de stress schieten als je twintig seconden hebt om een probleem op te lossen.

Volgens een Brits onderzoek bevinden zich op een doorsnee werkdag op enig moment zo'n veertienhonderd vliegtuigen in de hogere luchtlagen van het Westeuropese luchtruim. Elk uur doen zich gemiddeld 881 potentiële 'conflicten' voor. De verkeersleiders constateren dan dat twee vliegtuigen te dicht bij elkaar dreigen te komen. Dus krijgen elk uur gemiddeld 1.762 piloten opdracht hun koers, hoogte of snelheid te wijzigen. Omgerekend per vliegtuig: elke 48 minuten moet de bemanning een instructie van de verkeersleiding opvolgen om een aanvaring of

een bijna aanvaring met een ander vliegtuig te voorkomen.

Onlogisch

De verkeersleiding moet daarbij niet alleen een veilige horizontale en verticale afstand tussen de toestellen bewaren, maar moet er ook voor zorgen dat het verkeer doelmatig is. Het is onlogisch een toestel in glijvlucht naar de plaats van bestemming opeens naar een hogere luchtlaag te sturen.

De verkeersleiders staan onophoudelijk voor economische afwegingen, daarbij aangevuurd door de piloten die voortdurend hun favoriete hoogte doorgeven. In de hoogste, ijle luchtlagen is de weerstand namelijk gering en is het vliegen zuinig. Maar om snel een grote hoogte te bereiken, moet een toestel weer extra brandstof verstoken.

Een vliegtuig dat bij voorbeeld net uit Londen is vertrokken op een non-stop vlucht naar Singapore draagt een zware last aan kerosine met zich mee. Een snelle klim kost dan hopeloos veel energie. Boesmans: 'Als ik 'm die opdracht zou geven, moet het toestel misschien in New Delhi een onvoorziene tussenlanding maken om bij te tanken.'

Onder normale omstandigheden neemt een verkeersleider zo'n tien vliegtuigen onder zijn hoede. Op drukke dagen kan dit aantal oplopen tot 25 of meer. 'Aan de bar willen verkeersleiders nog wel eens vertellen dat zich op een zeker moment veertig vliegtuigen in hun sektor bevonden, maar dat is niet erg waarschijnlijk,' zegt Fred Könnemann van de Eurocontrol-directie. Uit de cijfers blijkt echter dat het gemiddelde aantal vliegtuigen per sektor jaar op jaar toeneemt. De verkeersleiders krijgen het steeds drukker. De oplossing is simpel: meer sectoren en dus meer verkeersleiders. Langzamerhand is de rek er uit. Een sektor moet een zekere omvang hebben, want anders zijn de verkeersleiders weer teveel tijd kwijt met het aan elkaar overdragen van vliegtuigen.

Bovendien hoort bij elke sektor een radiofrequentie. Boven Europa zijn inmiddels zoveel sectoren dat het vliegverkeer door zijn beschikbare radiofrequenties heen is. In Europees verband is een plan opgesteld om op 7 oktober a.s. met fijngevoeliger radioapparatuur te gaan werken, opdat meer frequenties beschikbaar komen. Dit plaatst de luchtvaartmaatschappijen voor grote uitgaven en tot op het allerlaatste moment blijft onduidelijk of alle ondernemingen hun vloot tijdig van nieuwe apparatuur zullen voorzien. 'Ik denk niet dat we het op de afgesproken tijd

halen,' zegt Daans, voormalig verkeersvlieger en thans adjunct-directeur van Eurocontrol. De concurrentie in de luchtvaart is hevig en als het om dit soort investeringen gaat, nemen de maatschappijen graag een 'Na U'-houding aan.

Hetzelfde geldt voor de aanschaf van geperfectioneerde hoogtemeters in de vliegtuigen. Op dit moment vindt het vliegverkeer in de hogere luchtlagen (29.000 voet tot en met 41.000 voet) plaats op zeven niveau's die telkens tweeduizend voet van elkaar verschillen. Met ingang van het jaar 2002 moet dat worden teruggebracht tot een verschil van duizend voet, zodat zes extra 'flight levels' ontstaan. Indien echter ook maar één maatschappij nalaat de nieuwste generatie hoogtemeters in haar vliegtuigen te installeren, komt er van het hele plan niets terecht. Dat gegeven creëert zoveel onzekerheid dat, terwijl de invoeringsdatum met rasse schreden nadert, veel luchtvaartmaatschappijen de kat nog maar liever even uit de boom kijken.

In feite gaat het hier immers om collectieve investeringen die door iedere afzonderlijke onderneming moeten worden opgebracht. Waar het bedrijfsleven treuzelt, kunnen weliswaar de luchtvaartautoriteiten investeringen afdwingen. Maar dat doen overheden doorgaans alleen als de veiligheid in het geding is. Gaat het om het scheppen van extra capaciteit van het luchtruim, dan zijn de overheden terughoudend. Vertraging is gewoon hun probleem niet. Het is een soort natuurramp die de luchtvaartondernemingen en hun klanten treft.

De maatschappijen op hun beurt wijzen graag naar de misstanden bij de luchtverkeersleiding. In Europa functioneren 68 luchtverkeerscentra die gebruik maken van 36 verschillende systemen. De hoogste baas van de Lufthansa, J. Weber, noemde het eerder dit jaar een 'schandaal' dat de lidstaten van de Europese Unie er al decennialang niet in slagen de luchtverkeersleiding te stroomlijnen.

Krakkemikkig

Allerlei enge verhalen doen de ronde over krakkemikkige computerapparatuur en een archaïsche organisatie. Het vaktijdschrift AV Flash berichtte onlangs over een incident in maart van dit jaar in de verkeerstoren te Bournemouth, Zuid Engeland. Tijdens een eenzame nachtdienst besloot verkeersleider Greg Fanos dat het tijd werd om een kopje koffie te gaan zetten. Op de terugweg naar zijn 'positie' struikelde hij echter, viel van een trapje en kwam zo ongelukkig terecht dat hij

zijn enkel brak. Terwijl diverse vliegtuigen doelloos rondjes cirkelden boven Bournemouth lag Fanos krimpnd van pijn op de vloer. Uiteindelijk wist hij zich voort te slepen naar een telefoon en belde hij de brandweer.

Dankzij een extra investering is een dergelijk incident voortaan uitgesloten, meldt AV Flash sarcastisch. 'In de directe nabijheid van zijn werkplek in de verkeerstoren krijgt Greg Fanos op korte termijn een eigen koffiezetapparaat.' In Londen, vertellen werknemers van Eurocontrol, wordt de computer van de verkeersleiding regelmatig buiten werking gesteld, omdat de salarisadministratie het apparaat wenst te gebruiken. Het luchtverkeer wordt dan in kaart gebracht met behulp van viltstiften en overheadsheets. 'Het schijnt te werken.'

Op een woensdagavond in augustus vorig jaar sprongen zomaar de computerschermen van de verkeersleiding in Boston op tilt. De 75 verkeersleiders hadden gedurende 37 minuten geen enkel idee van wat zich boven hun hoofd afspeelde. Eén dag later vielen de computers opnieuw uit. Een van de verkeersleiders, William Jones, beschreef in de Boston Globe de gebruikte computersystemen als 'een Chevy met 485 duizend mijl op de teller'. Frankrijk is berucht om de stroeve samenwerking tussen de militaire en de civiele verkeersleiding. De 'burgers' kunnen op hun computerschermen niet eens zien of zich militaire toestellen in de lucht bevinden. De vertragingen boven Frankrijk zijn zó groot dat veel vluchten honderden kilometers worden omgeleid. 'Van Zürich naar de Algarve gaat meestal via België. En zelfs binnenlandse vluchten, bij voorbeeld van Lille naar Nice, gaan via België, Duitsland en Zwitserland,' vertelt Könnemann van Eurocontrol. 'Er zijn genoeg dagen waarop we vaststellen: twintig procent van de passerende vliegtuigen hoort hier helemaal niet voorbij te komen.'

De kwetsbaarheid van de luchtverkeersbegeleiding leidt niet zozeer tot gevaarlijke situaties, als wel tot het noodgedwongen hanteren van ruime veiligheidsmarges. En die leiden op hun beurt weer tot verlies van capaciteit in het luchtruim, vertragingen en loze vliegreuen. Op de grote luchthavens in Noord-West Europa is het geen probleem om elke minuut een vliegtuig weg te sturen naar Zuid-Europa. Daar aangekomen blijkt dat er slechts om de tien minuten een toestel de sektor mag binnenvliegen. Zo'n vliegtuig mag er dan niet in en moet noodgedwongen blijven cirkelen. Om dit

Appendix F Press coverage of this study

zoveel mogelijk te voorkomen, opereert vanuit Brussel de 'Central Flow Management Unit'. Könnemann: 'Dat zijn de jongens en meisjes die de vertragingen uitdelen.' Brussel berekent voor elke vliegreis of er ruimte is in de lucht. Desnoods wordt een omweg vastgesteld. Elk vliegtuig krijgt een 'slot': de tijd waarbinnen de vlucht moet zijn afgewikkeld. Vertrekt een vliegtuig te laat, bij voorbeeld doordat de catering treuzelt of het tanken niet wil vlotten, dan komt het 'slot' in gevaar. Ervaren passagiers weten wat dat betekent: de vlucht heeft zijn kans verspeeld, komt op een wachtlijst en loopt urenlange vertraging op.

Vandaar de negatieve bijklank van het begrip 'slot'. Ten onrechte. Door het Europese vliegverkeer in Brussel te plannen konden de vertragingen de afgelopen tien jaar tot redelijke proporties worden teruggebracht.

Maar nu is de rek eruit. De planning loopt vast. In de luchtvaart regeert nu eenmaal de vrije markt en er zijn de afgelopen zomer dagen geweest waarop alleen al vanuit Duitsland zo'n 130 vluchten op Las Palmas werden aangekondigd. In zo'n geval krijgen duizenden reizigers te horen dat ze niet om half tien 's ochtends, maar pas om vier uur 's nachts zullen vertrekken.

Onvoorziene situaties kunnen een rustige verkeersstroom danig in de war sturen. Tot de dagelijkse gang van zaken bij Eurocontrol behoren de meldingen van piloten die snel een extra tussenlanding moeten maken, omdat iemand aan boord agressief wordt of een hartaanval krijgt. Een toestel dat op kruissnelheid opeens rechtsomkeert moet maken, heeft een draaicirkel van vele tientallen kilometers. Het overige vliegverkeer moet dan onmiddellijk naar elders worden gedirigeerd. Talloze vliegtuigen moeten nu opeens voor elkaar uitwijken. Allerlei tijdschema's vallen in duigen en de vertragingen verspreiden zich als een olievlek over Europa.

Braaf blijven de piloten ondertussen via de radio hun instructies ontvangen van de verkeersleiders. Koers, hoogte, snelheid. Van radiobaken naar radiobaken. Ze repeteren de opdrachten om misverstanden uit te sluiten. Is deze vorm van communicatie nog steeds verantwoord in een tijd van satellietnavigatie en internationale datacommunicatie?

Jacco Hoekstra van het Nationaal Lucht- en Ruimtevaartlaboratorium (NLR) is in zijn vrije tijd vliegenier. Soms is hij het berichtenverkeer met de verkeersleiding spuugzat. Dan roept hij

uit tegen de blauwe hemel om hem heen: 'Ik ben verdorie PILOOT. Geen ZENDAMATEUR.'

Het wonderlijke is dat alle verkeersvliegtuigen tegenwoordig over zogenoemde datalink-apparatuur beschikken, waarmee ze in directe verbinding staan met hun thuisbasis. Gegevens over technische mankementjes en onderhoudswerkzaamheden worden elektronisch doorgeseind. Het is een koud kunstje om moderne navigatieapparatuur aan boord van het vliegtuig te koppelen aan de data-link, zodat de piloot niet meer per radio maar per beeldscherm met de verkeersleiding kan communiceren.

Volgens Hoekstra is het met de huidige stand van techniek ook mogelijk de verkeersleiding feitelijk af te schaffen. Elk vliegtuig kan - mits toegerust met de juiste computers - op eigen gelegenheid een koers bepalen. Waarbij de computer berekent wat de piloot moet doen om eventuele botsingen te vermijden. Op deze manier kunnen de bestaande luchtwegen worden opgeheven en mogen de vliegtuigen in principe overal en op elke hoogte vliegen. De 'filevorming' in de lucht is dan op slag verdwenen, want het hele luchtruim wordt gebruikt, in plaats van slechts enkele smalle corridors.

Deze piloten-idylle wordt 'free flight' genoemd. Het NLR is betrokken bij een groot onderzoek ter zake door de Amerikaanse luchtvaartautoriteiten en de NASA. Hoekstra onderzoekt, samen met zijn collega's Ronald van Gent en Rob Ruigrok, hoe de 'free flight' op het gedrag van vliegeniers moet worden afgestemd.

Een 'vlucht' in de simulator van het NLR bewijst dat free flight geen kamikaze is. Rode lijntjes op de 'primary flight display' - het beeldscherm in de cockpit - geven aan welke snelheden of hoogtes de piloot dient te vermijden om uit de buurt te blijven van naburige vliegtuigen. Voor het overige mag de piloot het zelf weten.

Sceptische verkeersvliegers stappen in de simulator van het lucht- en ruimtevaartlaboratorium en komen er redelijk enthousiast uit. Tijdens hun nagespeelde vlucht hebben ze botsingen met andere vliegtuigen zonder de hulp van de verkeersleiding kunnen vermijden. 'Maar wat nu als het druk wordt?' is meestal hun vraag. Tromfantelijk melden Hoekstra, Van Gent en Ruigrok dan dat 'U zojuist heeft gevlogen in een situatie die drie keer drukker is dan normaal.'

Appendix F Press coverage of this study

Zij hebben computersimulaties gedaan waaruit bleek dat 'free flight' een vertienvoudiging van het huidige vliegverkeer aankon. Het ligt dus voor de hand dat de wereld binnen afzienbare tijd zal overschakelen op 'free flight', zeker indien de luchtvaart ontstuimig blijft groeien. Maar ook hier zijn vertragende krachten in het spel.

Verkeersleiders zullen hun positie als regisseurs van de lucht niet makkelijk opgeven. Piloten zijn huiverig dat zij nóg vaker de schuld van ongevallen in de schoenen krijgen geschoven. Free flight vereist ook dat de luchtvaartmaatschappijen hun onderlinge concurrentie even vergeten en in één keer reusachtige bedragen investeren. Tenslotte is er nog de achterdocht van het publiek. Om mysterieuze redenen hebben de meeste mensen meer vertrouwen in een luchtverkeersleider die via de radio aanwijzingen geeft dan in een anoniem stelsel van computerverbindingen.

Het huidige systeem van luchtwegen en controle vanaf de grond scheidt bovendien een idee van orde en veiligheid, terwijl 'free flight' gevoelsmatig neerkomt op anarchie en risico's. De wiskundige kans op een botsing is echter groter in het huidige systeem - met zijn drukke kruispunten van vliegroutes - dan in een luftruim waarin 'free flight' heerst.

De luchtvaart zal vermoedelijk niet kiezen voor het meest rationele systeem, maar voor het systeem dat tijdens een overgangssituatie het best functioneert. Bij Eurocontrol wordt daarom niet gedacht aan 'free flight', maar aan 'free routing'. Dit is een soort tussenoplossing waarbij de piloot van de verkeersleiding opdracht krijgt op welk punt hij een sektor mag binnenvliegen en waar hij de sektor weer moet verlaten. In de tussentijd mag de piloot een eigen route uitstippelen. Volgens Fred Könnemann zijn de landen van de Benelux het politiek eens over een dergelijk regime, maar aarzelen de Duitsers nog. De geprivatiseerde verkeersleiders in Duitsland staan kritisch

tegenover veranderingen. Könneman verwacht echter een spoedige beslissing: 'Die had er al lang moeten zijn.'

Ook directeur Dirk Duytschaever van de Central Flow Management Unit in Brussel voorziet een beperkte vorm van free flight. Volledige vrijheid voor de piloot is volgens hem op zijn vroegst in 2015 technisch haalbaar. En de passagiers zijn er psychologisch nog helemaal niet aan toe.

Hoekstra, Van Gent en Ruigrok gaan echter vol goede moed door met computerexperimenten met free flight. In Amerika vinden binnenkort echte vliegproeven plaats. De rest van de wereld zal de Amerikanen wel weer volgen, is hun verwachting.

Voorlopig blijven de vliegtuigen echter nog van radiobaken naar radiobaken vliegen. Geheel volgens de aanwijzingen van de verkeersleiders. Op de werkvloer bij Eurocontrol ontstaat opeens commotie. Een piloot van American Airlines, onderweg van Zwitserland naar Amerika, heeft te kennen gegeven dat hij onmiddellijk een landing wil gaan maken, omdat een van zijn passagiers getroffen is door een hartaanval. Onder grote tijdsdruk gaan de verkeersleiders aan de slag. Tientallen andere vluchten worden omgeleid. De bevelen volgen elkaar in sneltempo op en aan de kordate toonhoogte is te merken dat iedereen beseft dat hier iets ernstigs aan de hand moet zijn. Op het moment dat de piloot van American Airlines vrij baan heeft, meldt hij echter dat hij zijn route naar Amerika toch maar gewoon wil vervolgen. Verbijsterd vraagt de verkeersleider of het alarm opeens is ingetrokken? Droogjes meldt de vlieger: 'Bevestiging. Ik heb aan boord 280 zielen en 281 lichamen.' <EV>

Appendix F Press coverage of this study

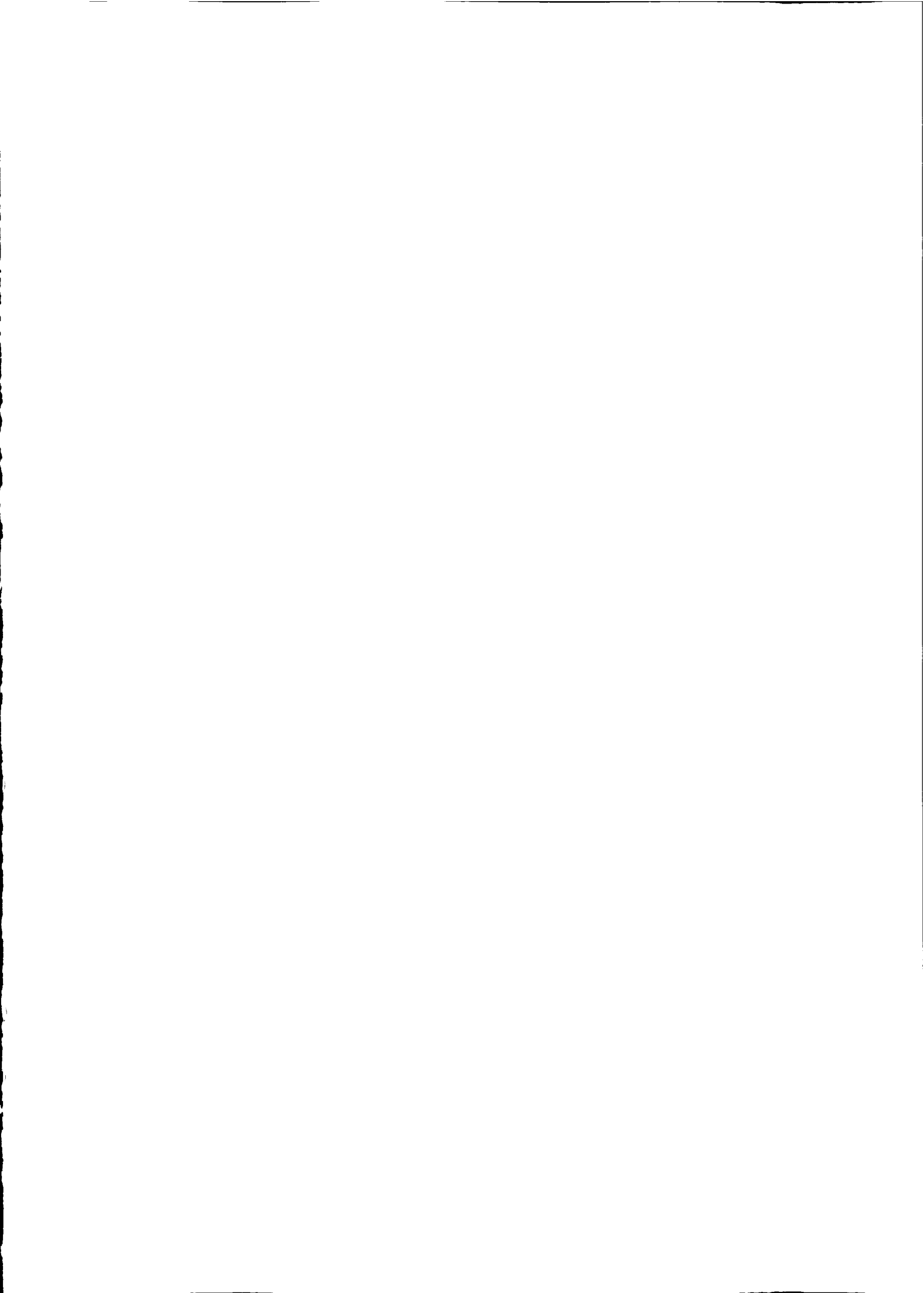



ISBN 90-806343-2-8

Nationaal Lucht- en Ruimtevaartlaboratorium **NLR Amsterdam**
www.nlr.nl