

historical museum

lublin

tomasz puszczyński

the site

TIPVS CIVITATIS LVBLINESI.
 IN REGNO POLONIAE EX OMNIBVS
 PARTIBVS MVDI EMPORIO TER IN
 AÑO CELEBRARI CÖSVETOCLARE.

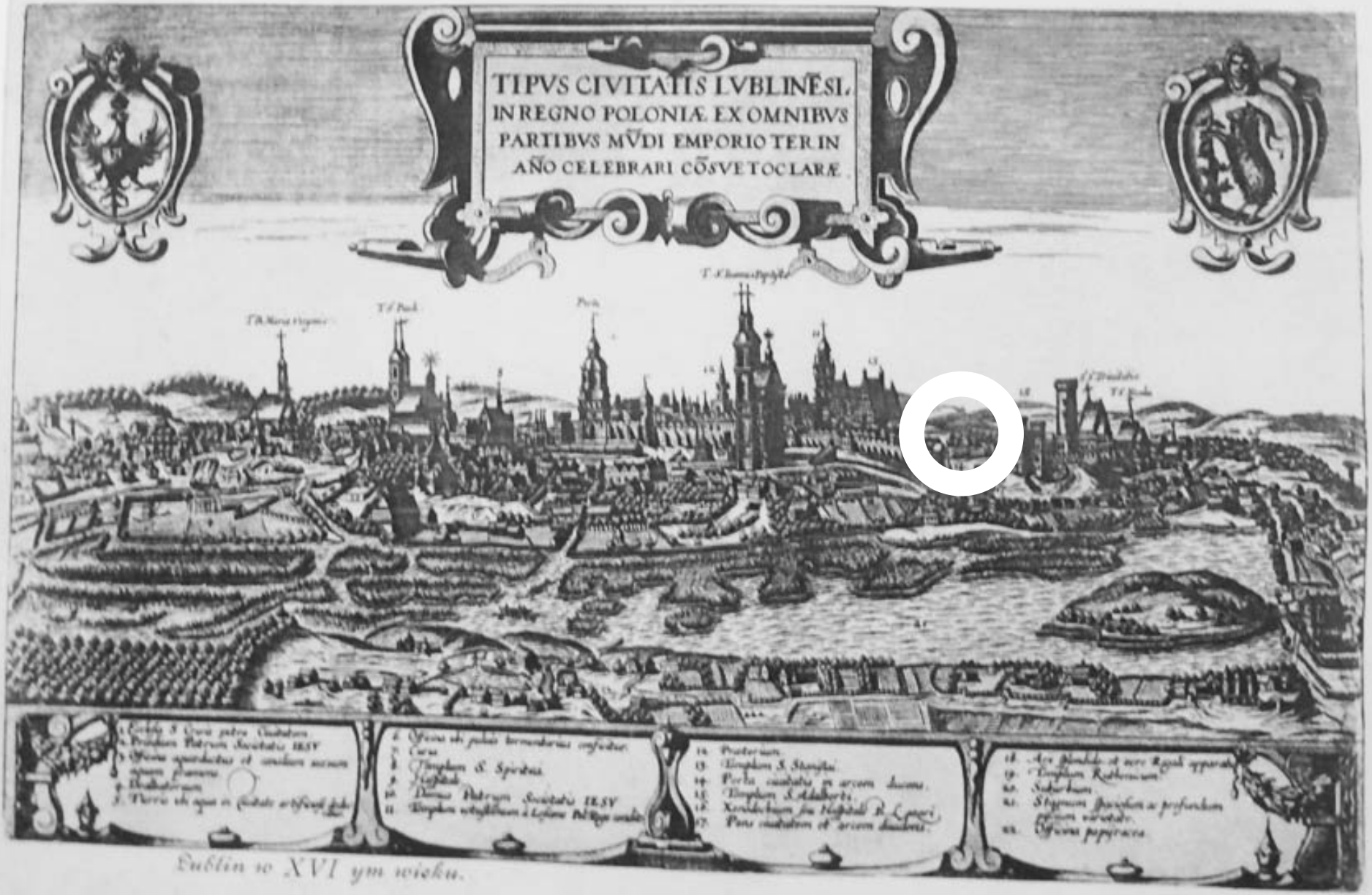

1. Ecclesia S. Crucis patris Civitatis
 2. Prædium Patrum Societatis 1854
 3. Officina apothecariorum et venditionis mercium
 4. Officina Pharmacia
 5. Theatrum
 6. Terræ ubi aqua in Civitate artificiali fons

7. Officina ubi pulvis bernardinus conficitur.
 8. Curia
 9. Templum S. Spiritus
 10. Hospitalis
 11. Domus Patrum Societatis 1854
 12. Templum virginis & Leonis Poloniæ sancti

13. Prætorium
 14. Templum S. Stanisli
 15. Porta civitatis in arcem ducens
 16. Templum S. Adalberti
 17. Xenodochium seu Hospitalis S. Leonis
 18. Pars civitatis et arcem ducens.

19. Arces blanda et nova Regia apparatus
 20. Templum Rothemann
 21. Suburbium
 22. Stipendium pascuorum et profectuum
 23. Officina papiracea

Lublin in XVI ym wieku.





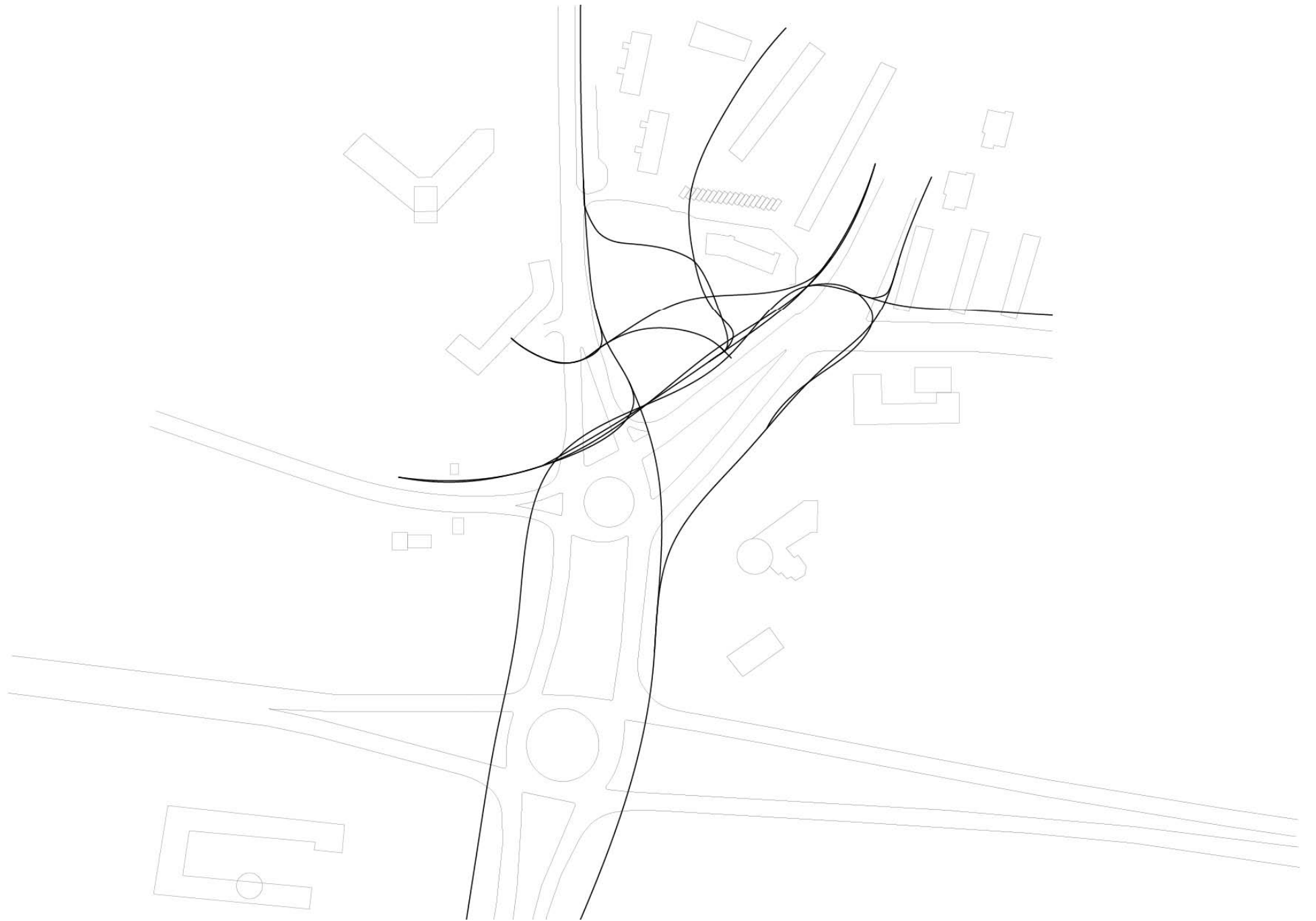

pedestrian paths



traffic



gathering areas



attractors

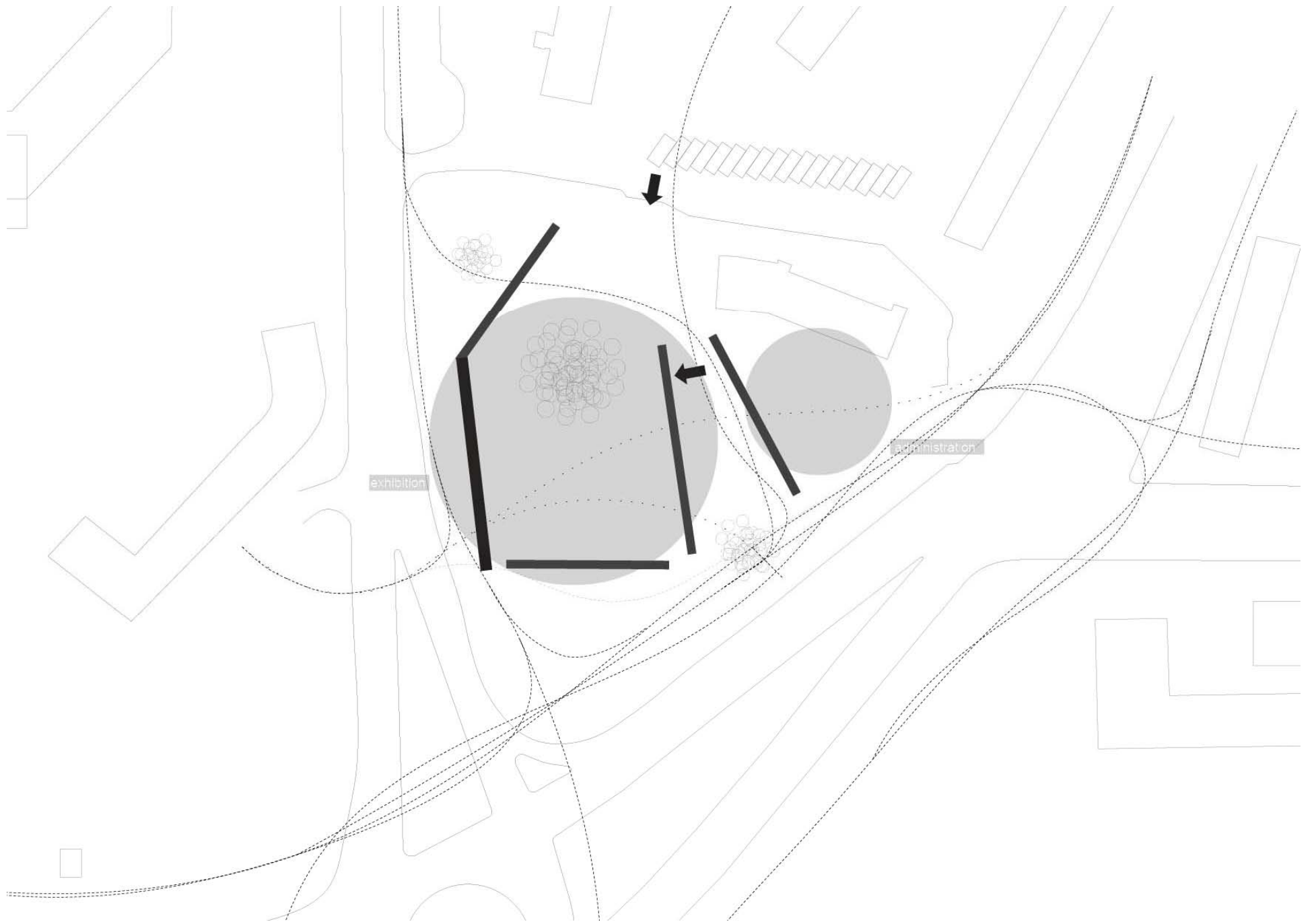

the museum

Jewish Rabbinical Academy

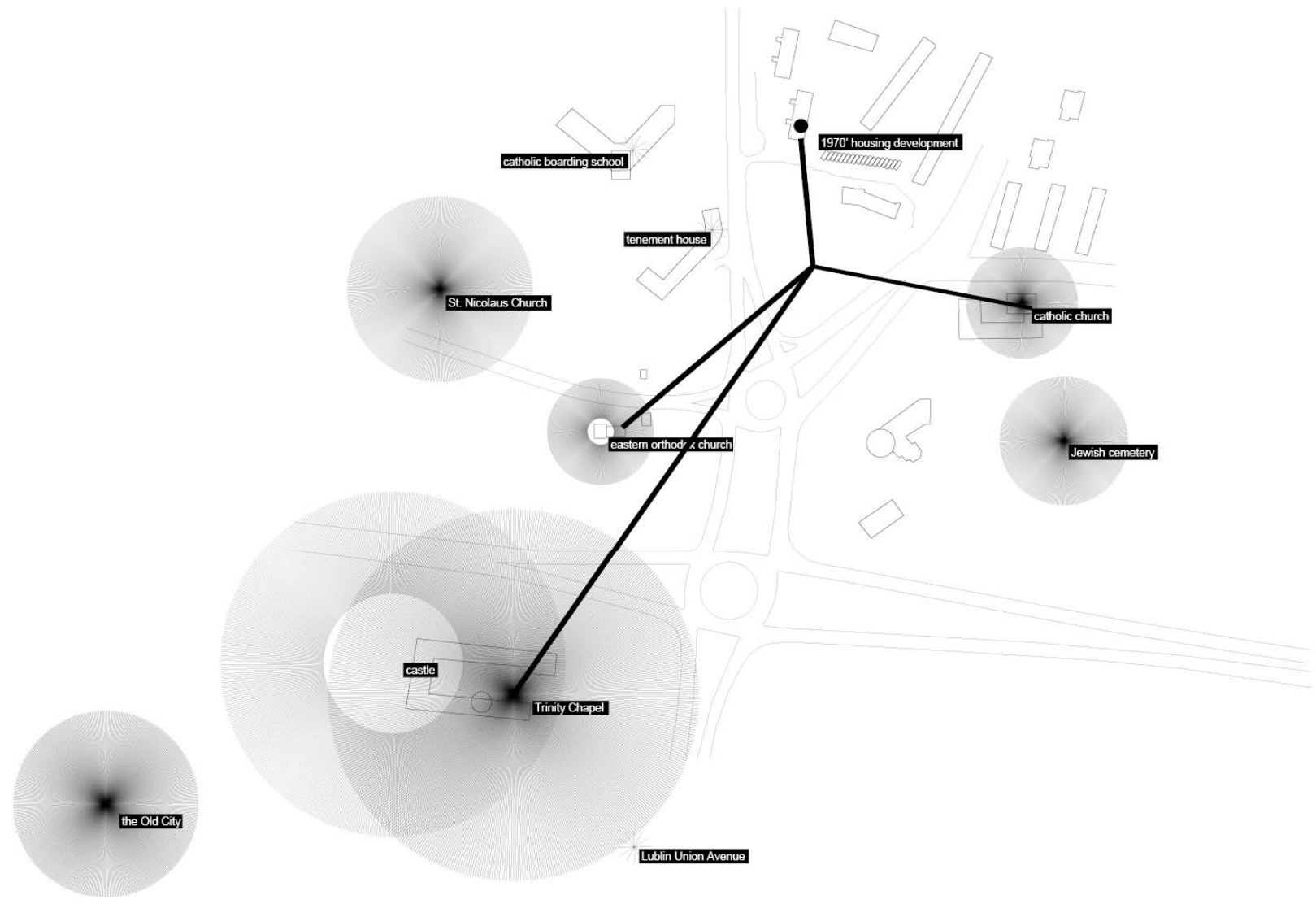

timeline

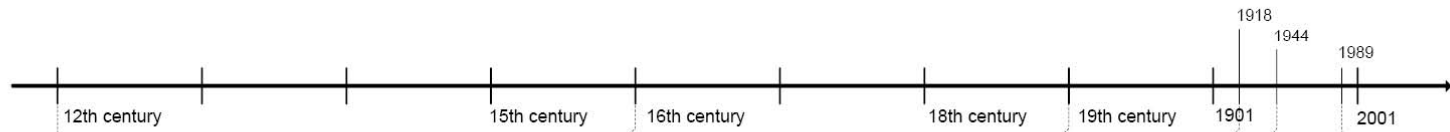

permanent exhibition sections

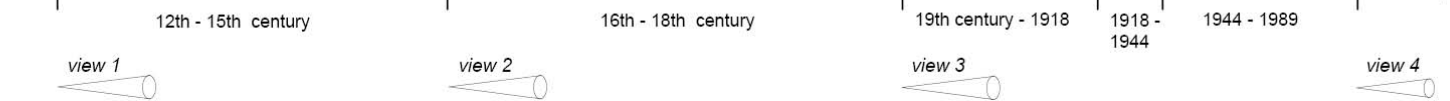

30 %

35 %

15 %

5 %

15 %

1 ---- 2 ---- 3 ---- 4

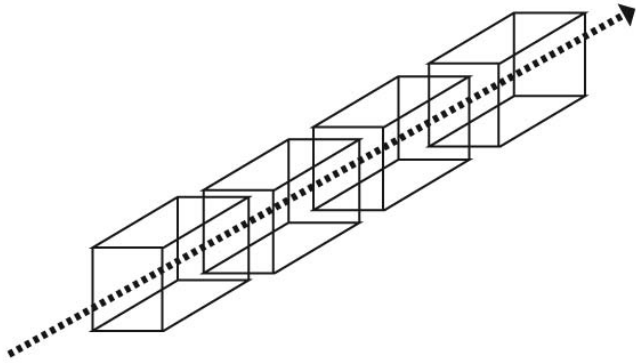

1 ---- 3 ---- 4 ---- 2
2 ---- 3 ---- 2 ---- 1
....
4 ---- 3 ---- 1 ---- 2

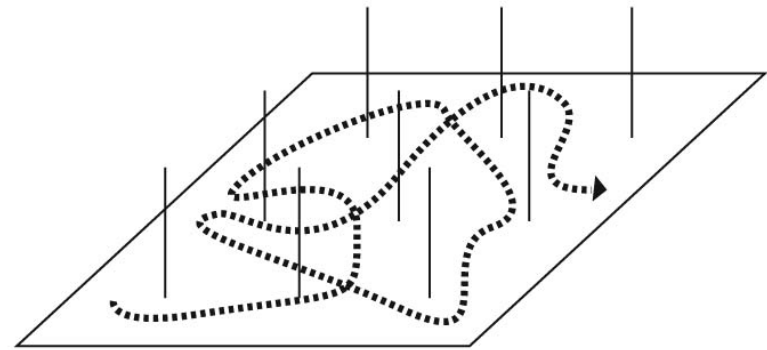

1 ---- 2 ---- 3 ---- 4

+

1 ---- 3 ---- 4 ---- 2
2 ---- 3 ---- 2 ---- 1

4 ---- 3 ---- 1 ---- 2

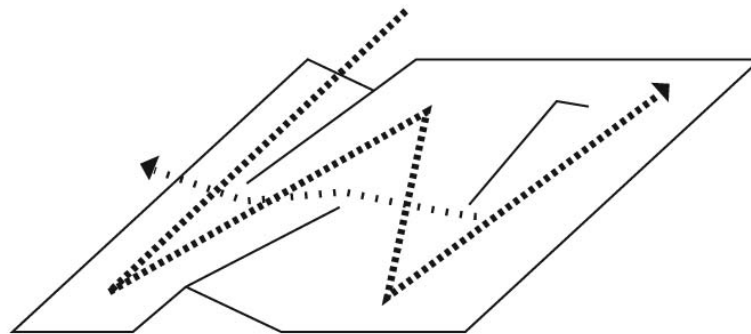

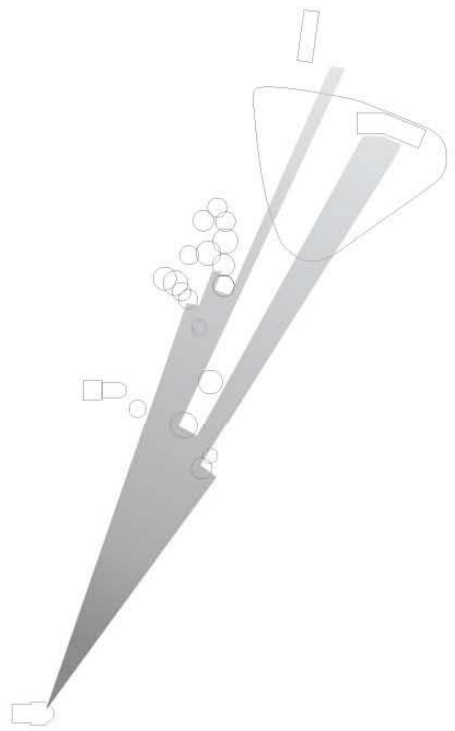

view 1



view 2

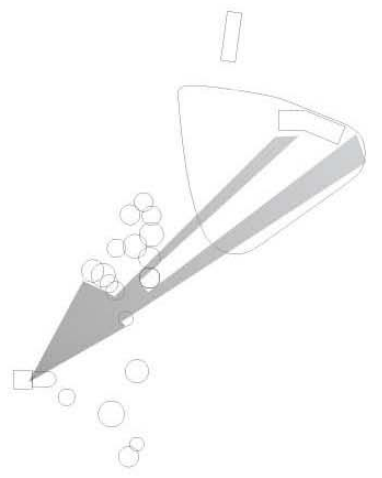
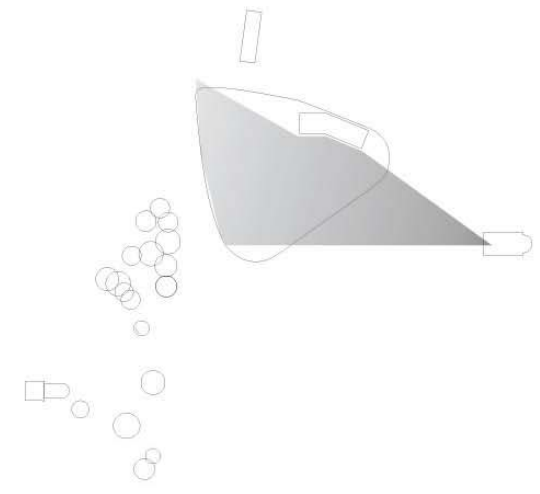

view 3

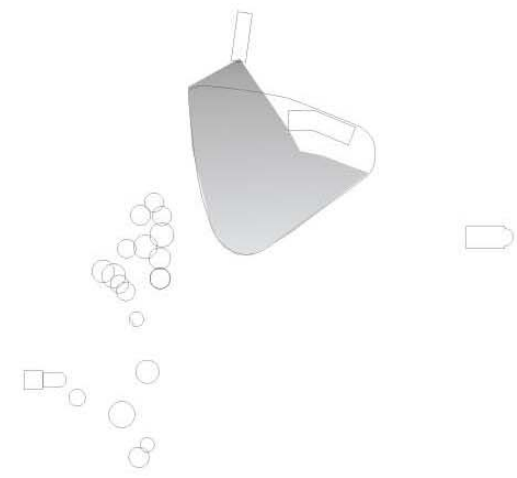

view 4

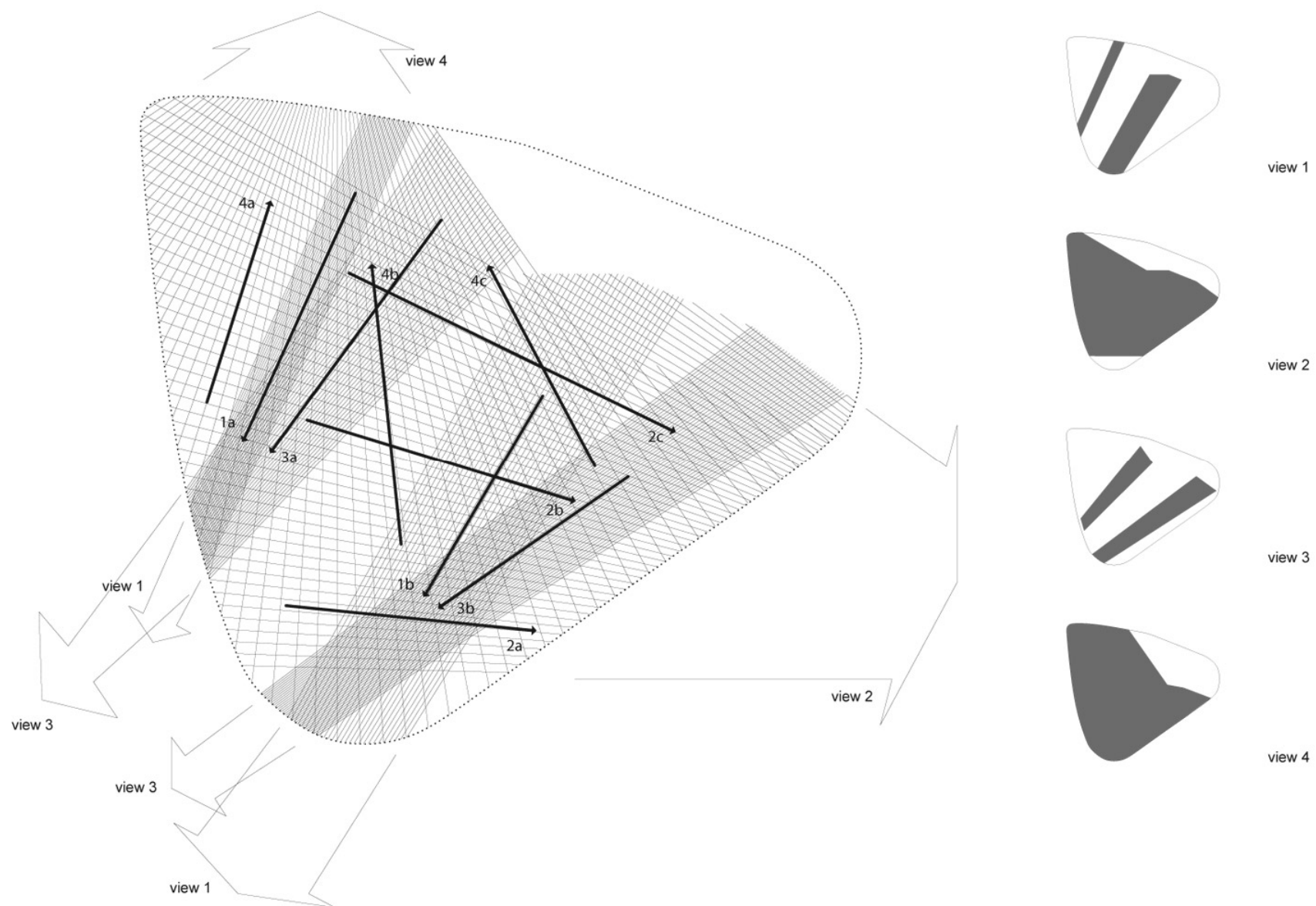

view 1

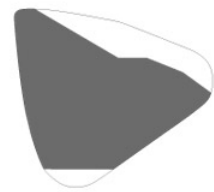

view 2



view 3

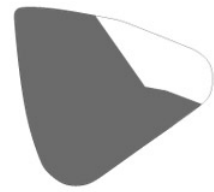

view 4

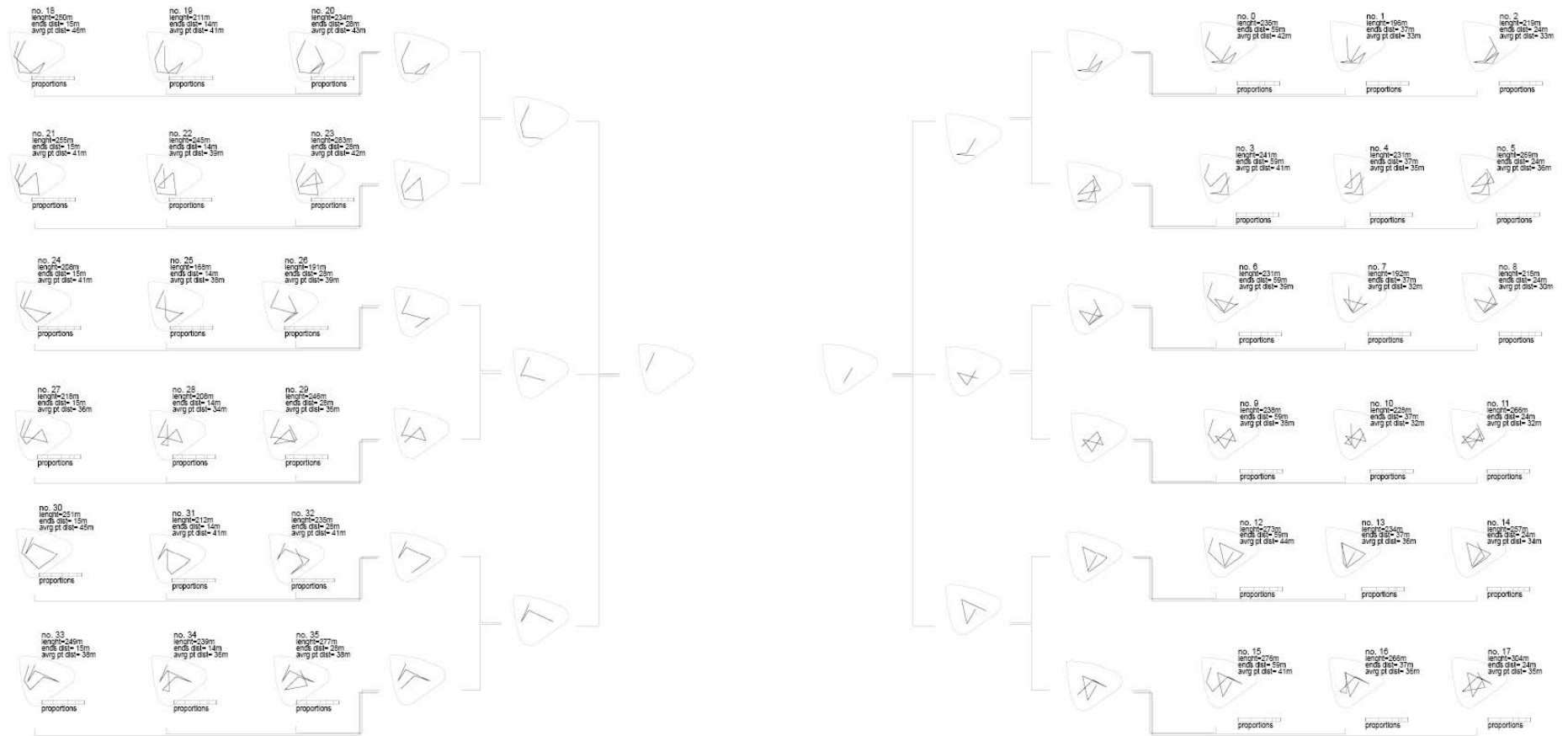

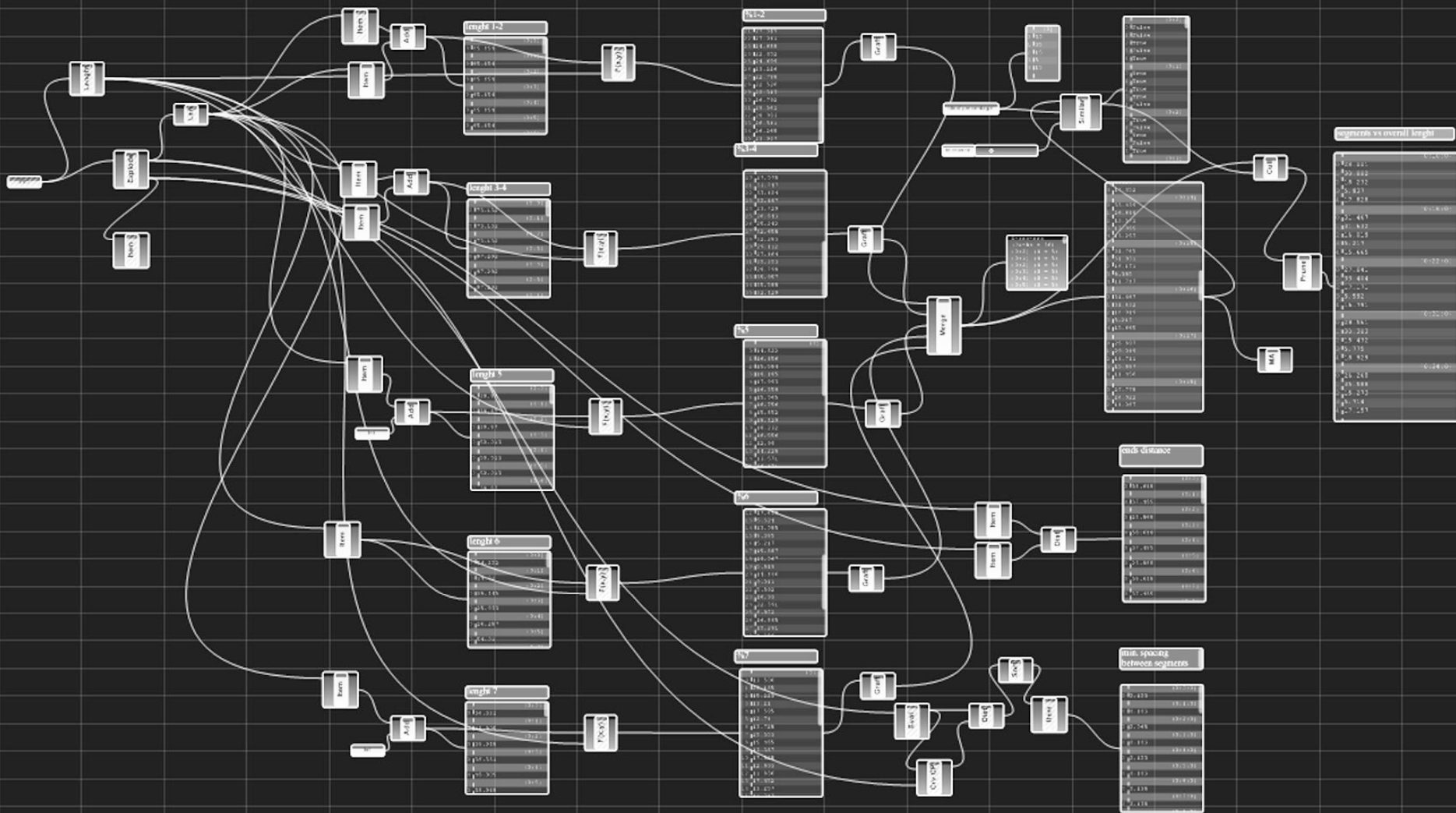

expected proportions
30 - 35 - 15 - 5 - 15 %

possible paths

comparison

tolerance 20 %

discard

no match

match

<p>no. 10</p> <p>proportions</p>	<p>no. 13</p>	<p>no. 16</p>
<p>no. 22</p>	<p>no. 31</p>	<p>no. 34</p>

smallest dist.between the ends

<p>no. 22</p> <p>ends dist= 14m</p>	<p>no. 31</p> <p>ends dist= 14m</p>	<p>no. 34</p> <p>ends dist= 14m</p>
-------------------------------------	-------------------------------------	-------------------------------------

biggest min. spacing

no. 22

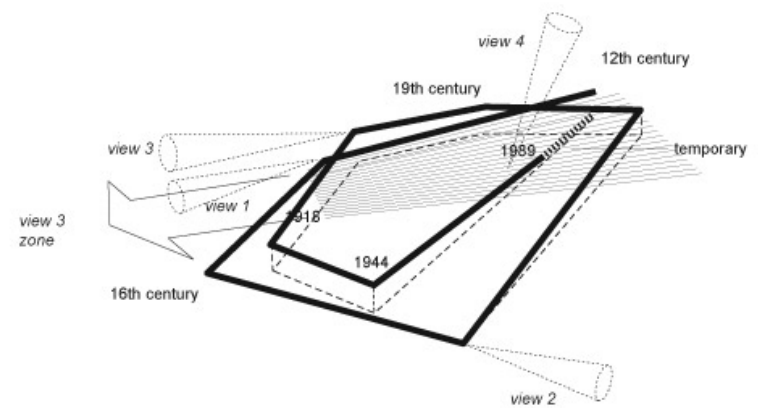
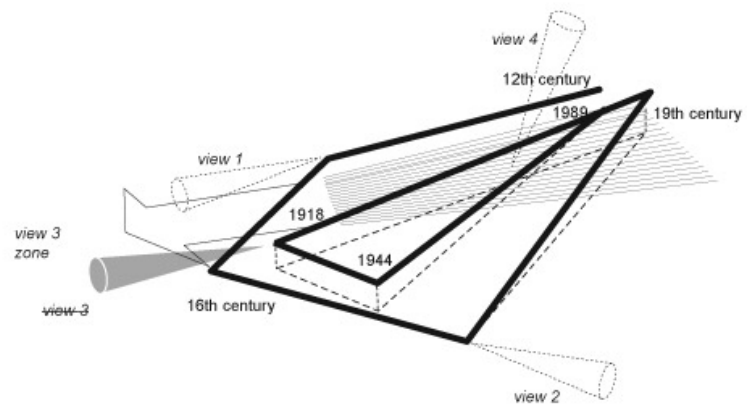
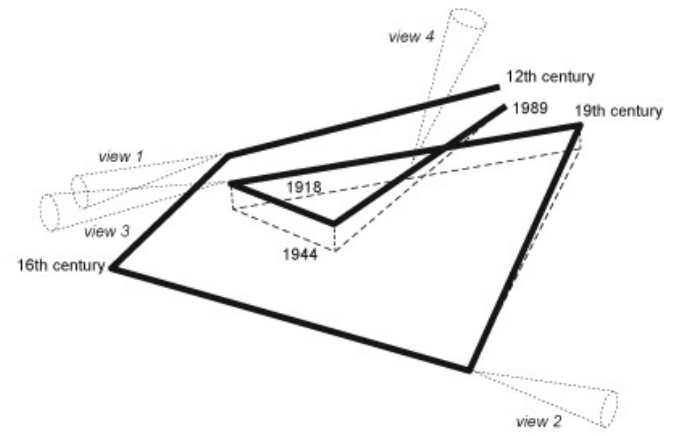
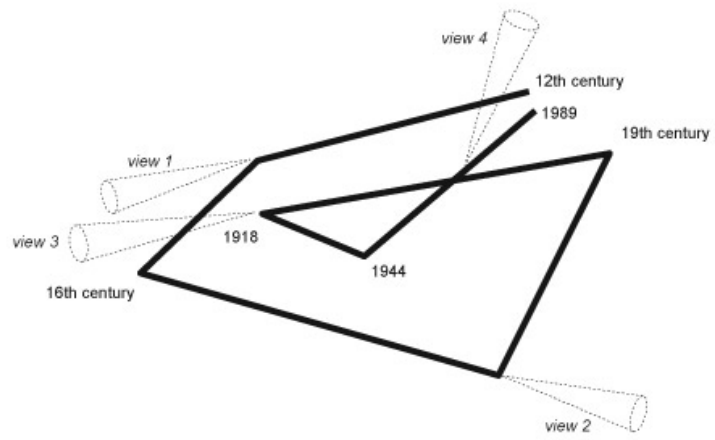

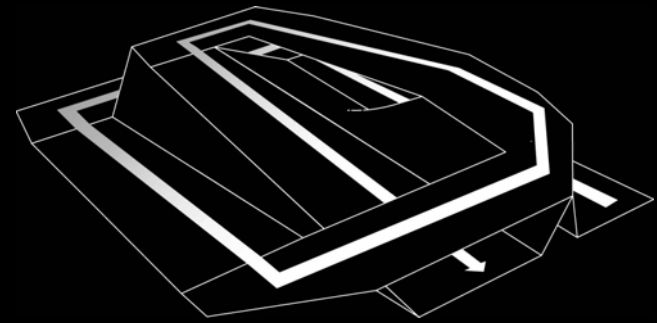

primary route

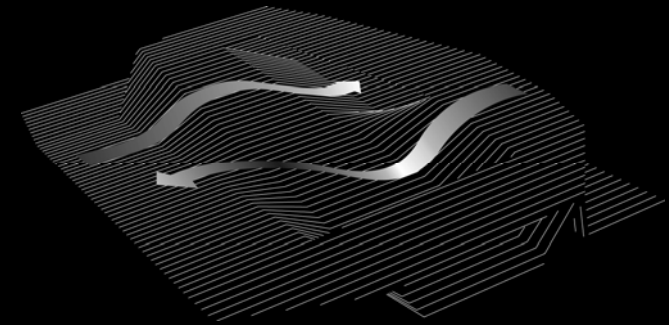
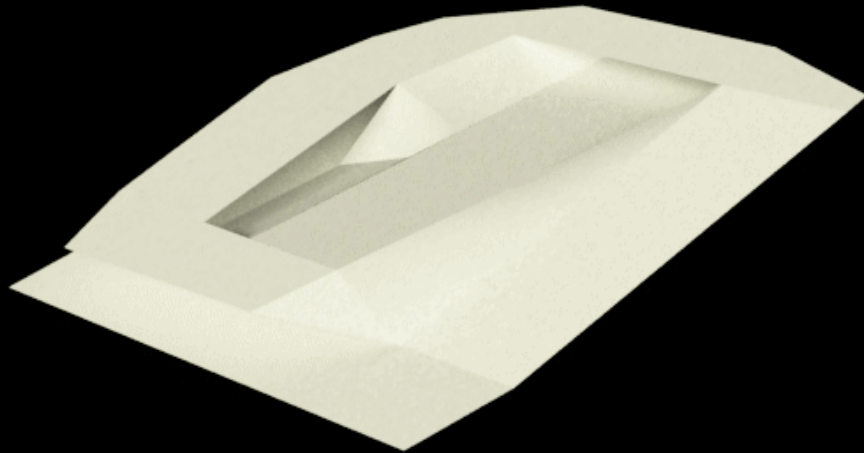

secondary routes

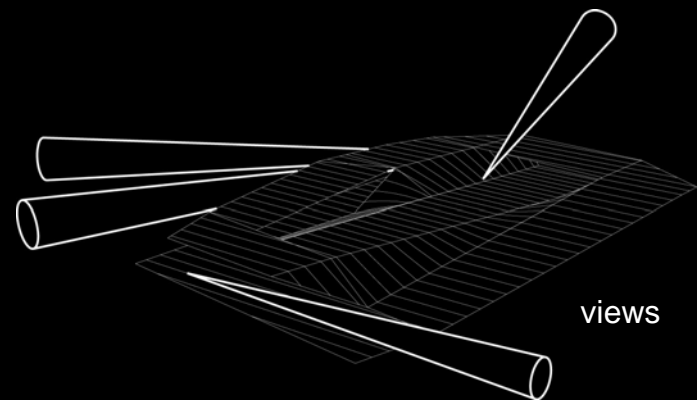

views

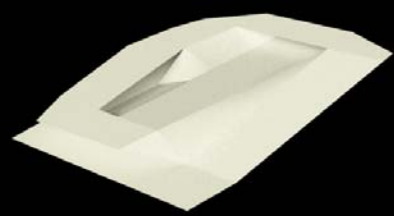
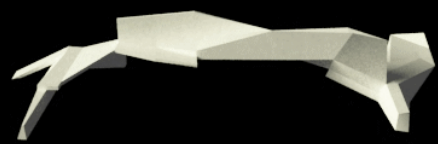
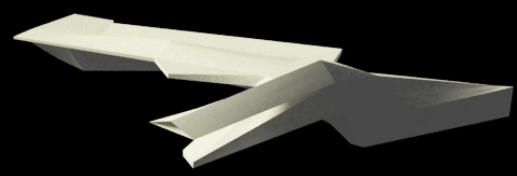
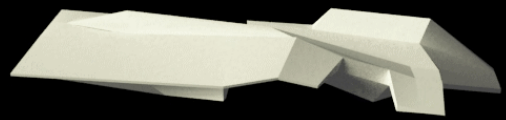

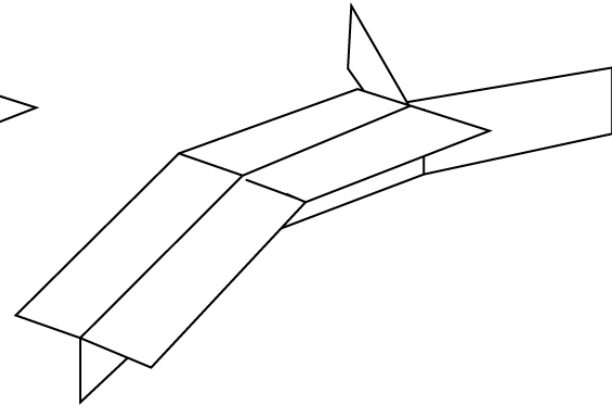
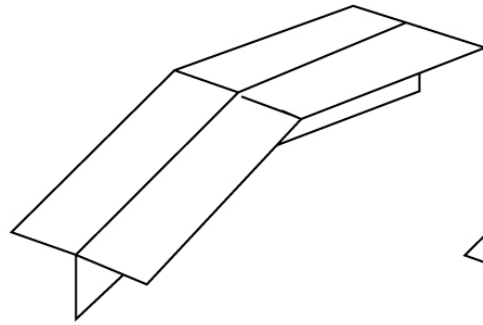
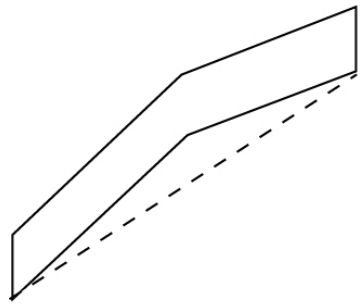

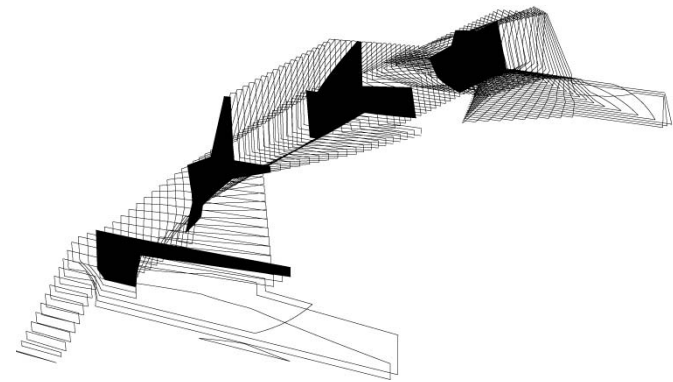
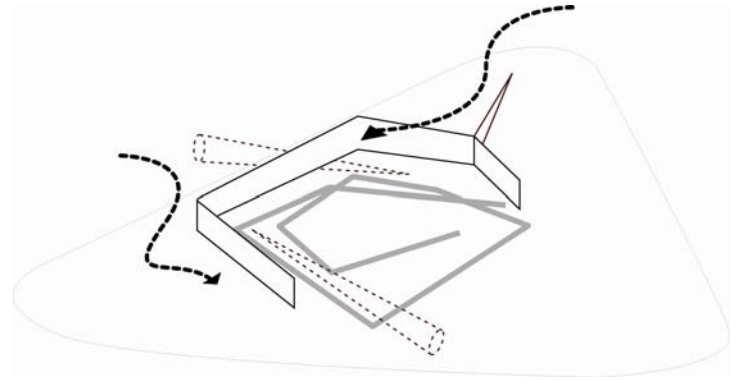
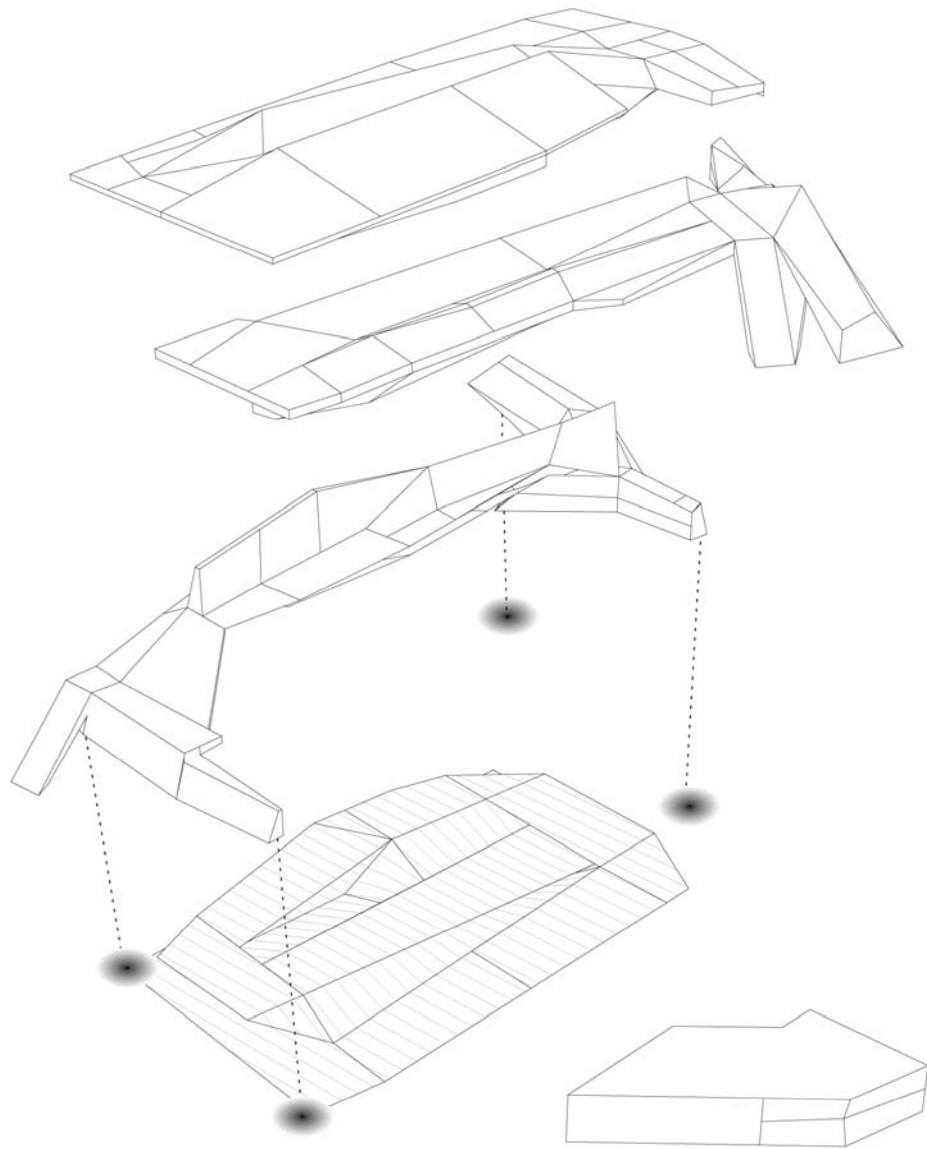

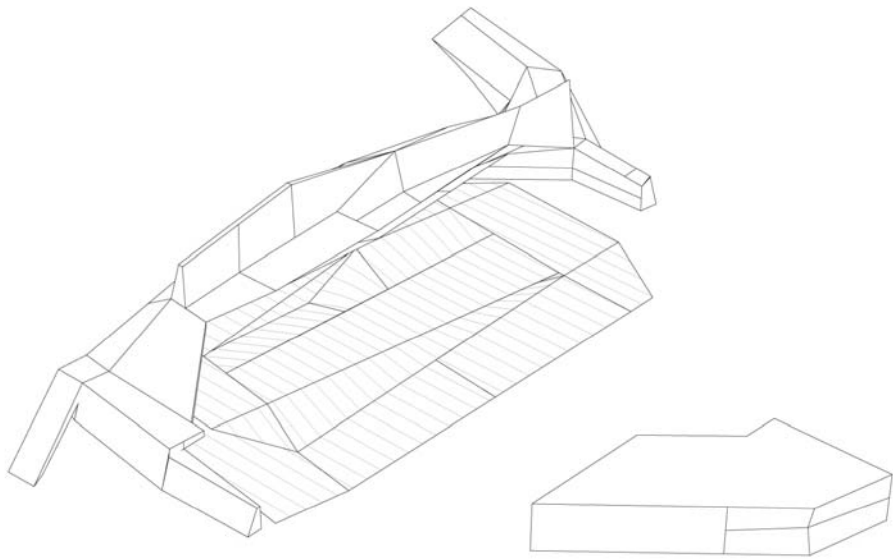
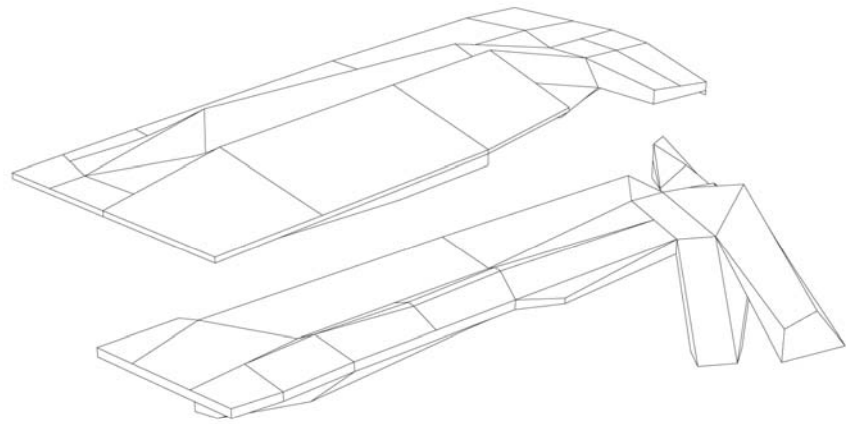

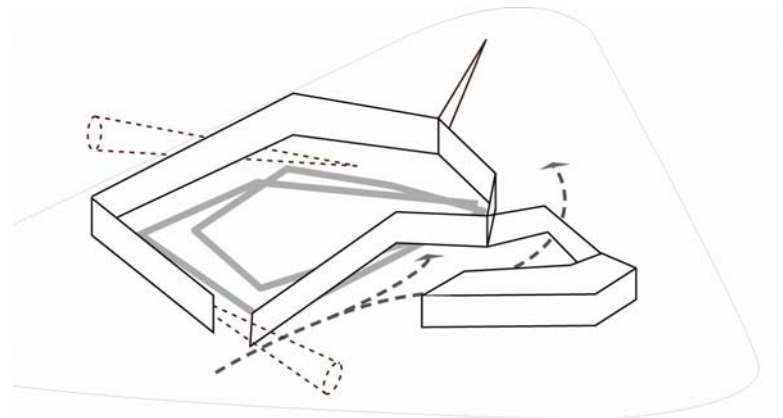
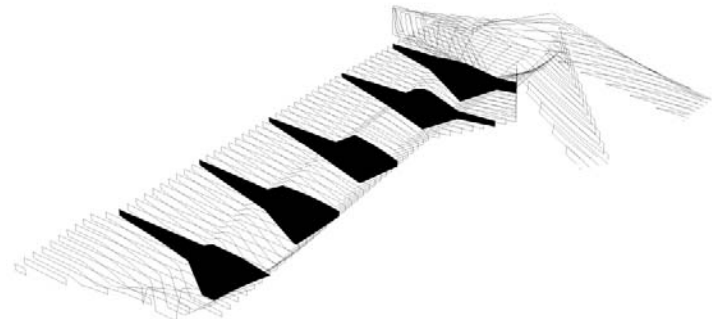
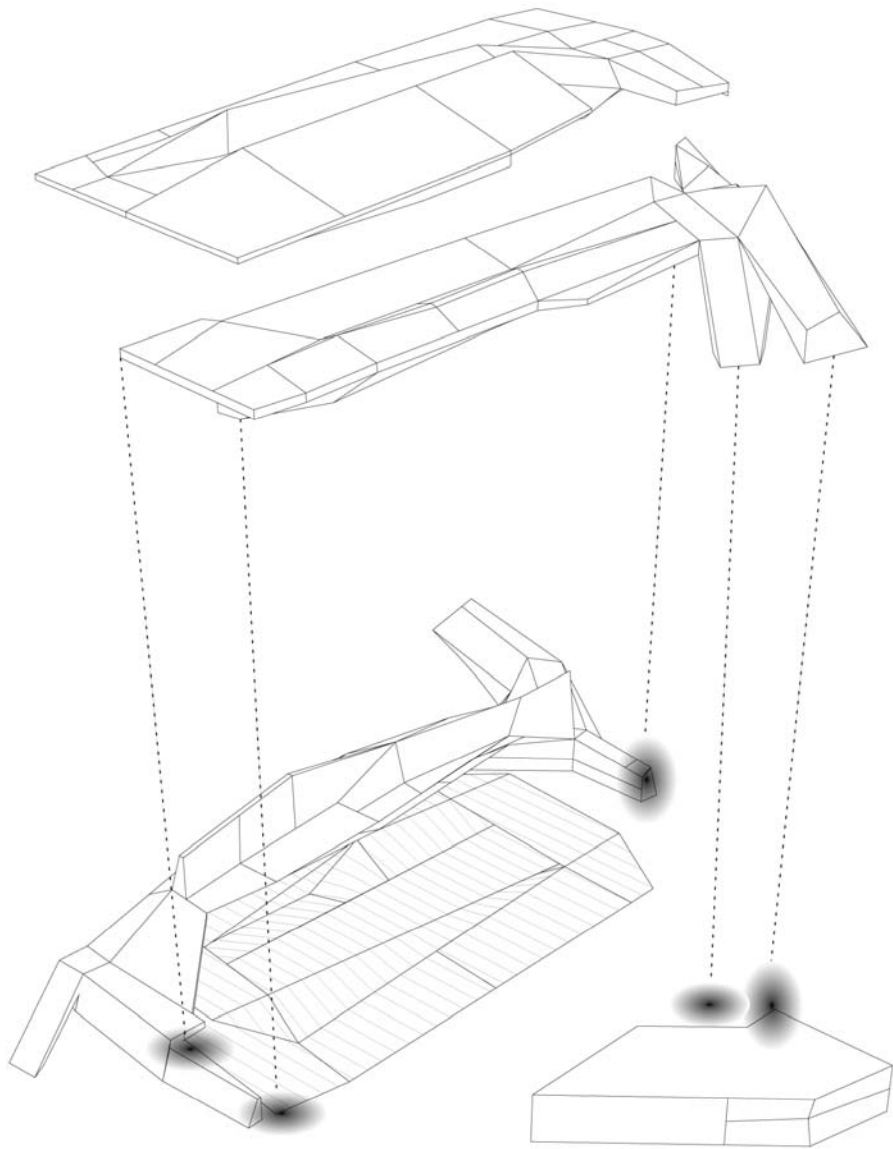

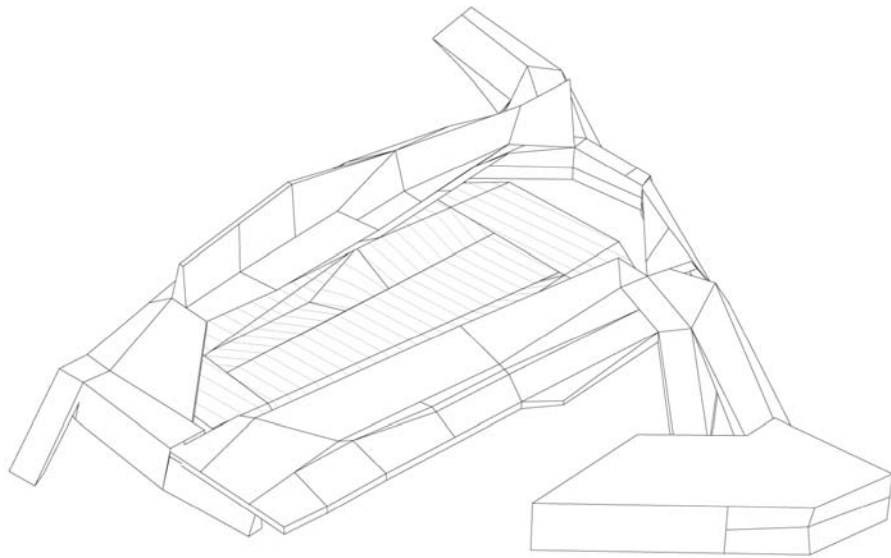
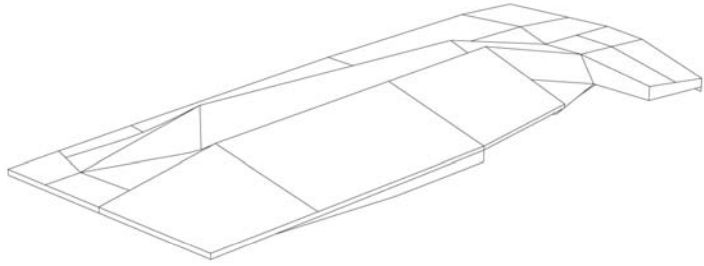

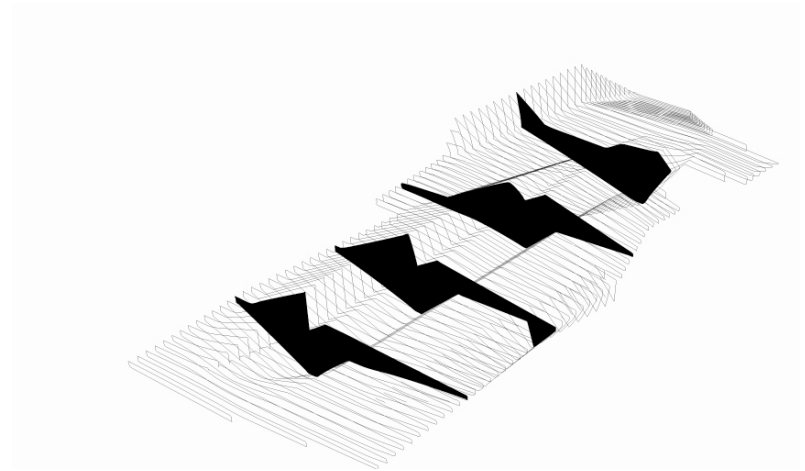
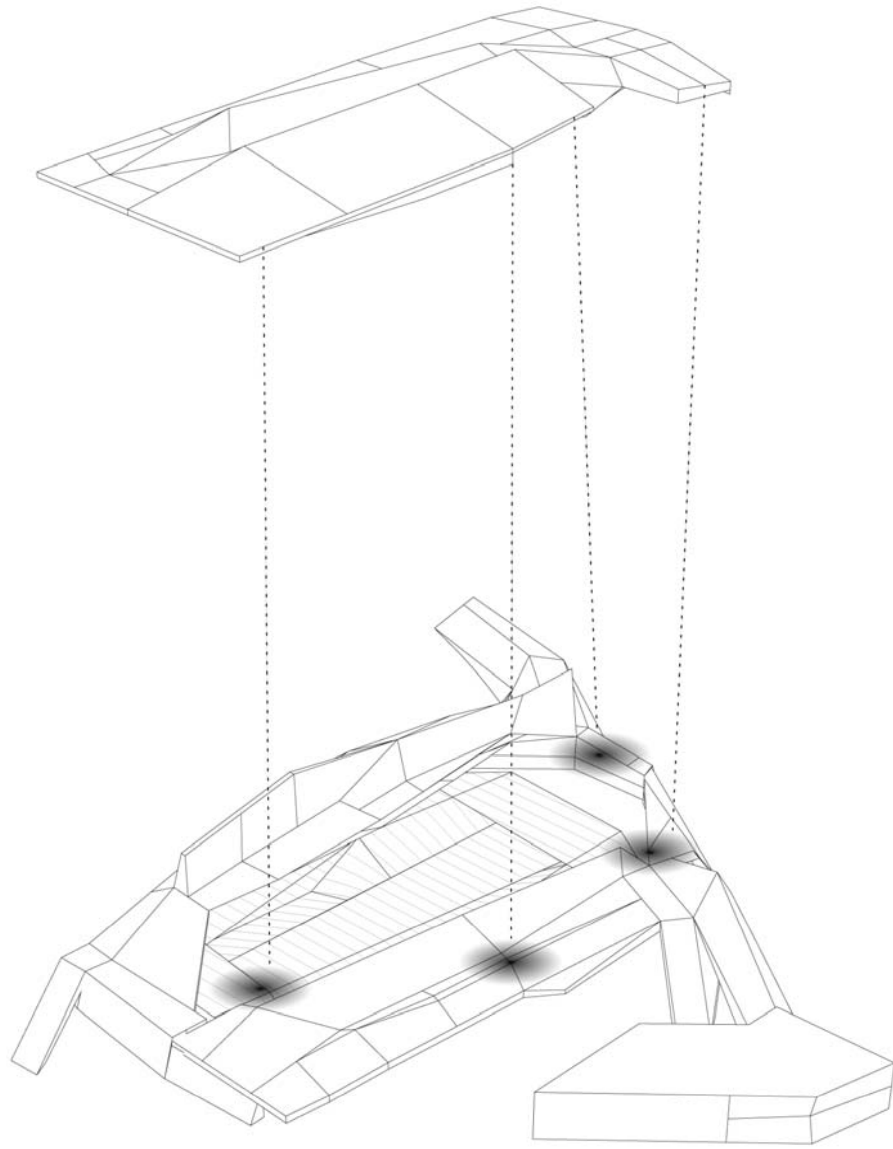

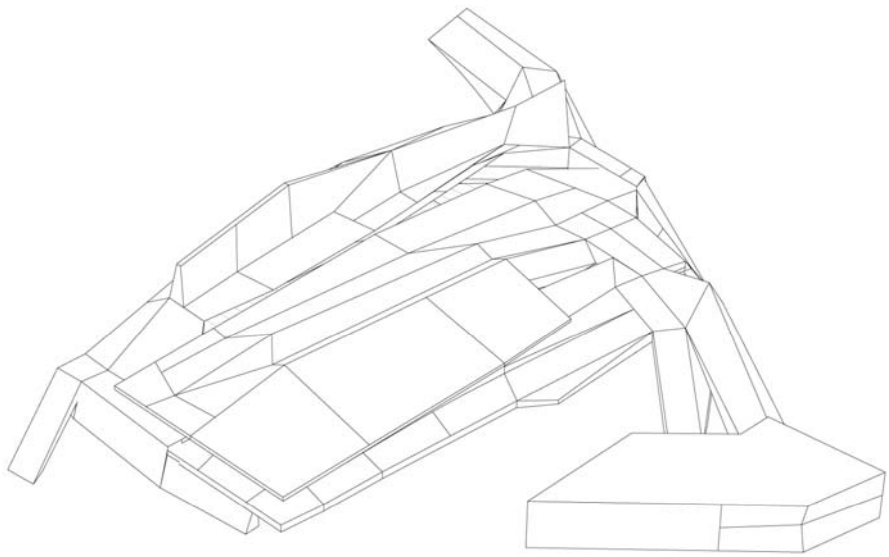

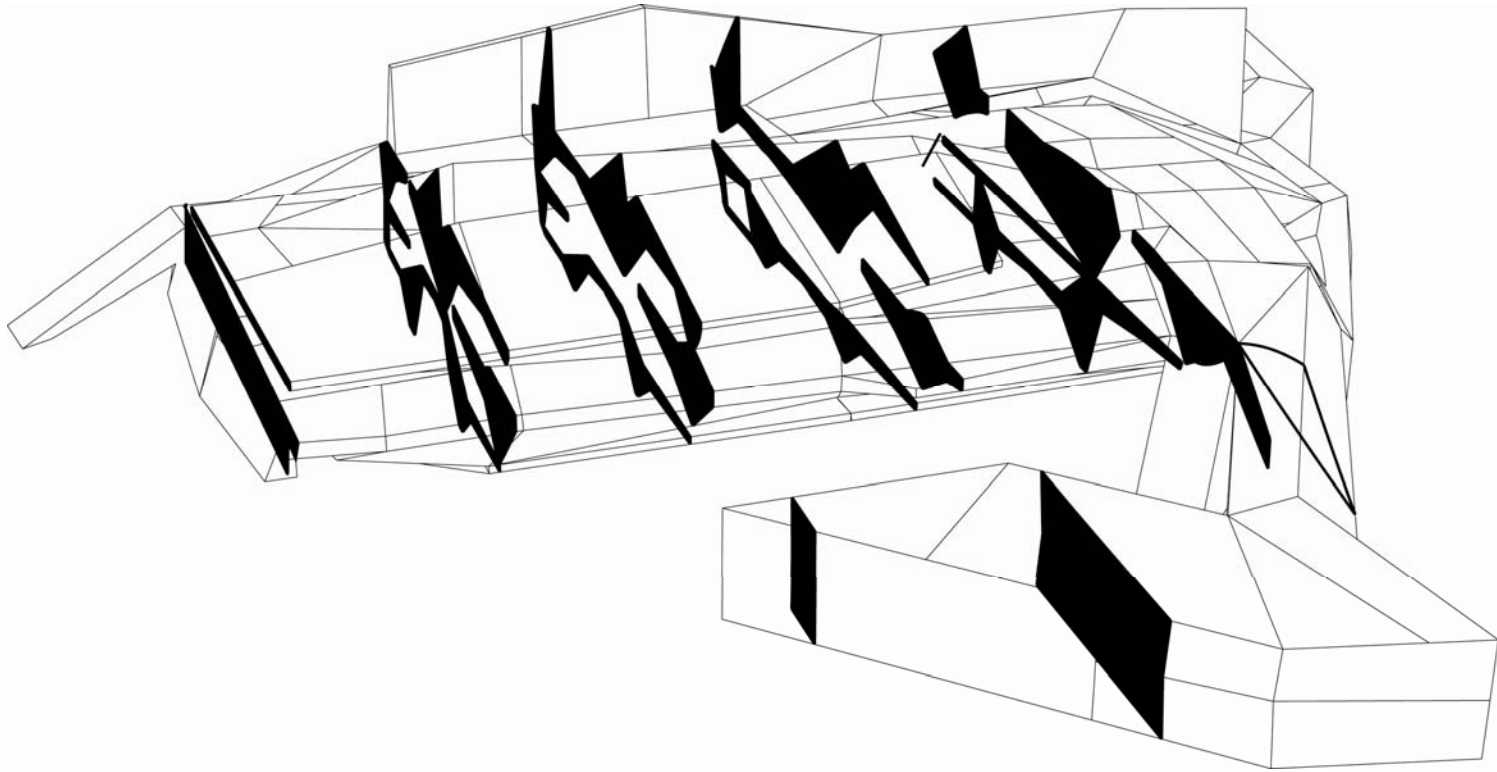

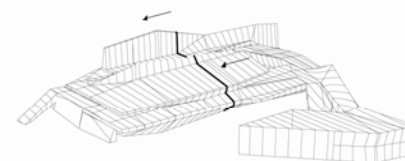
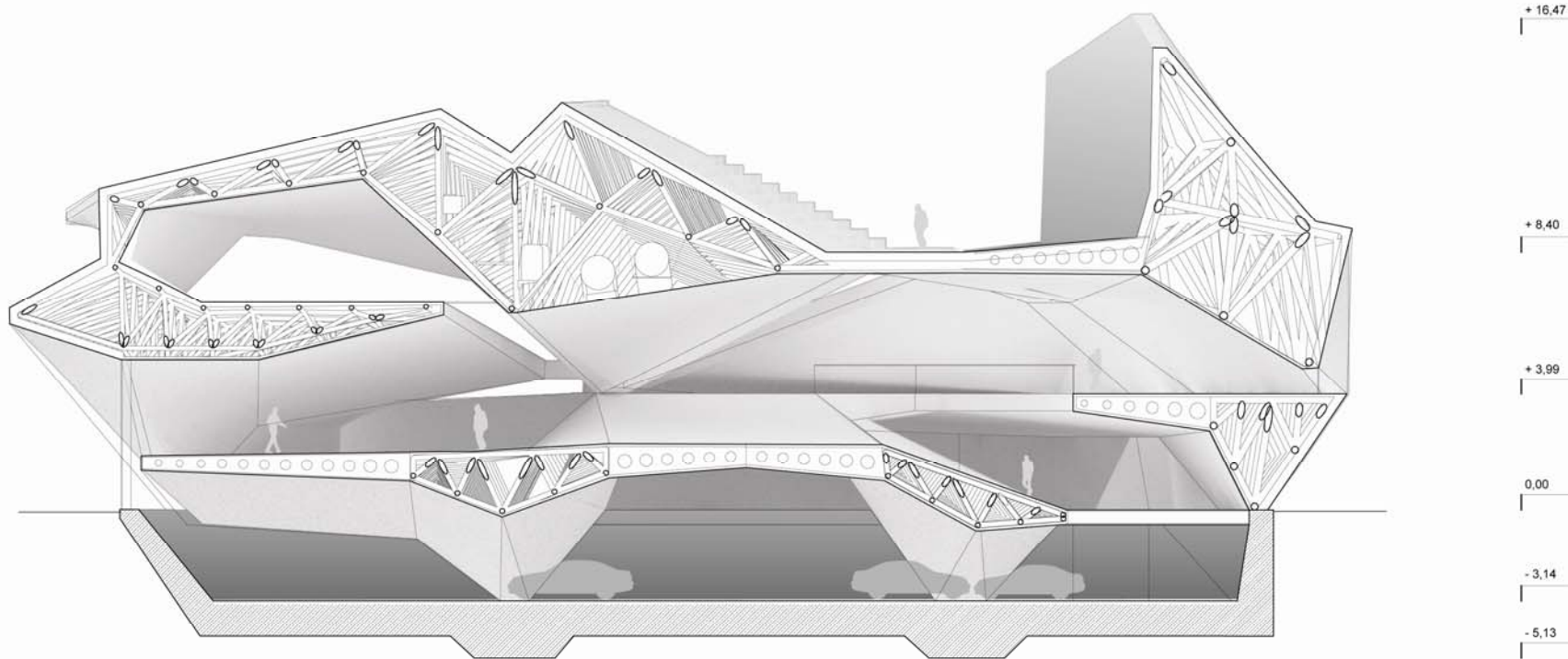

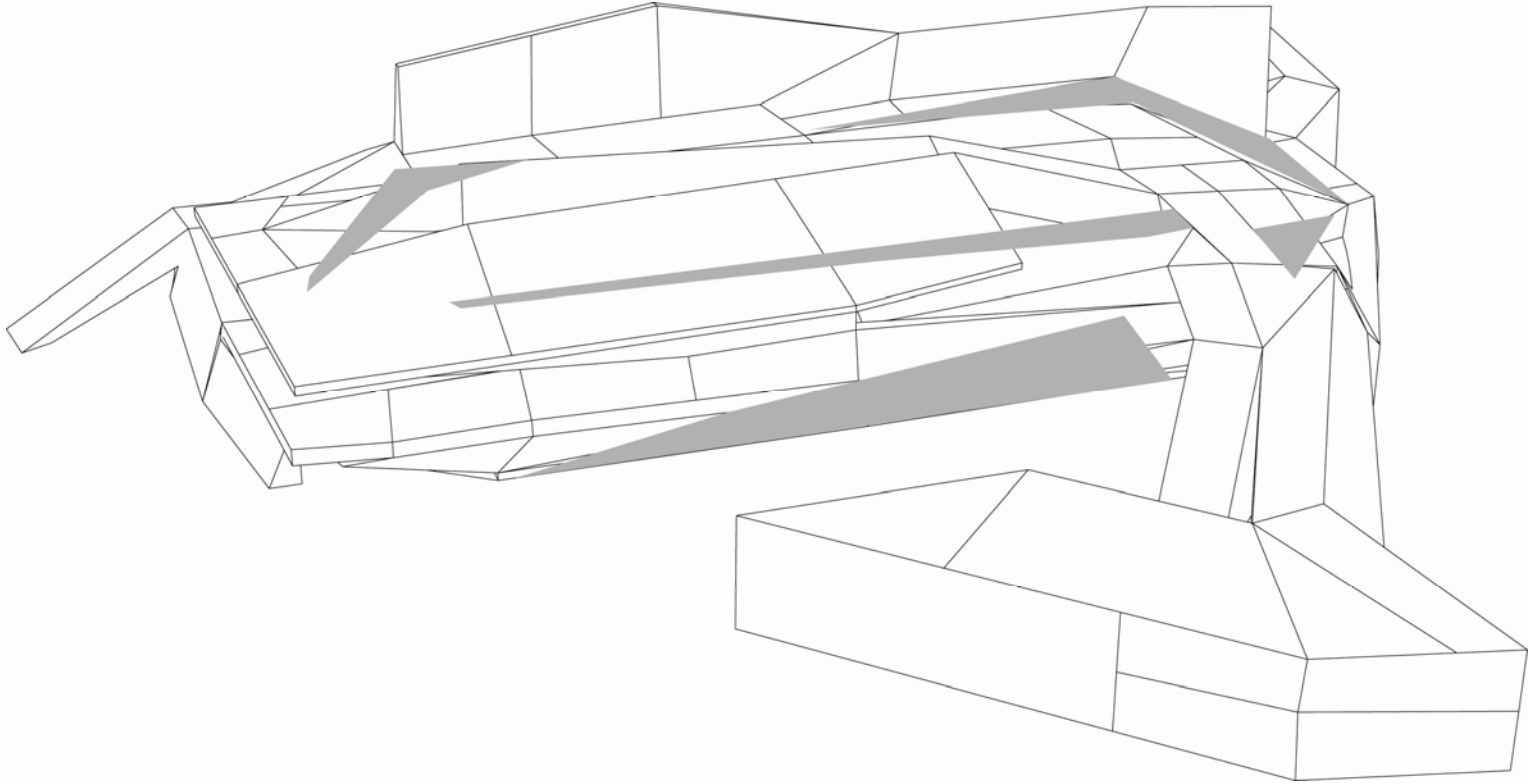

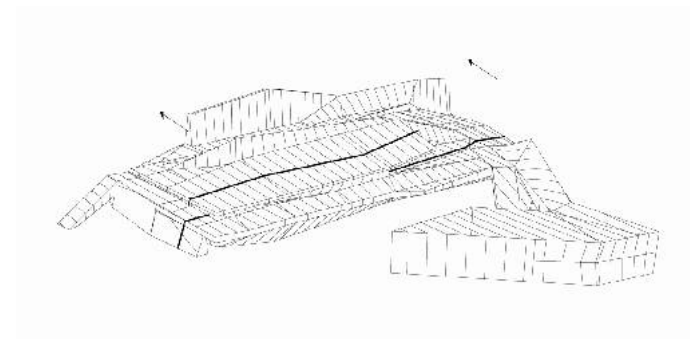
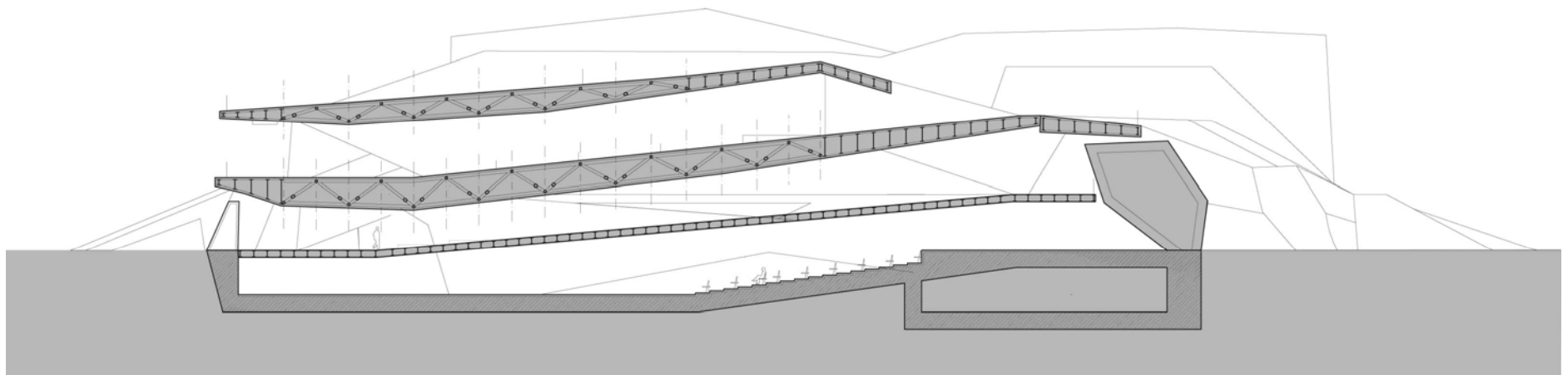

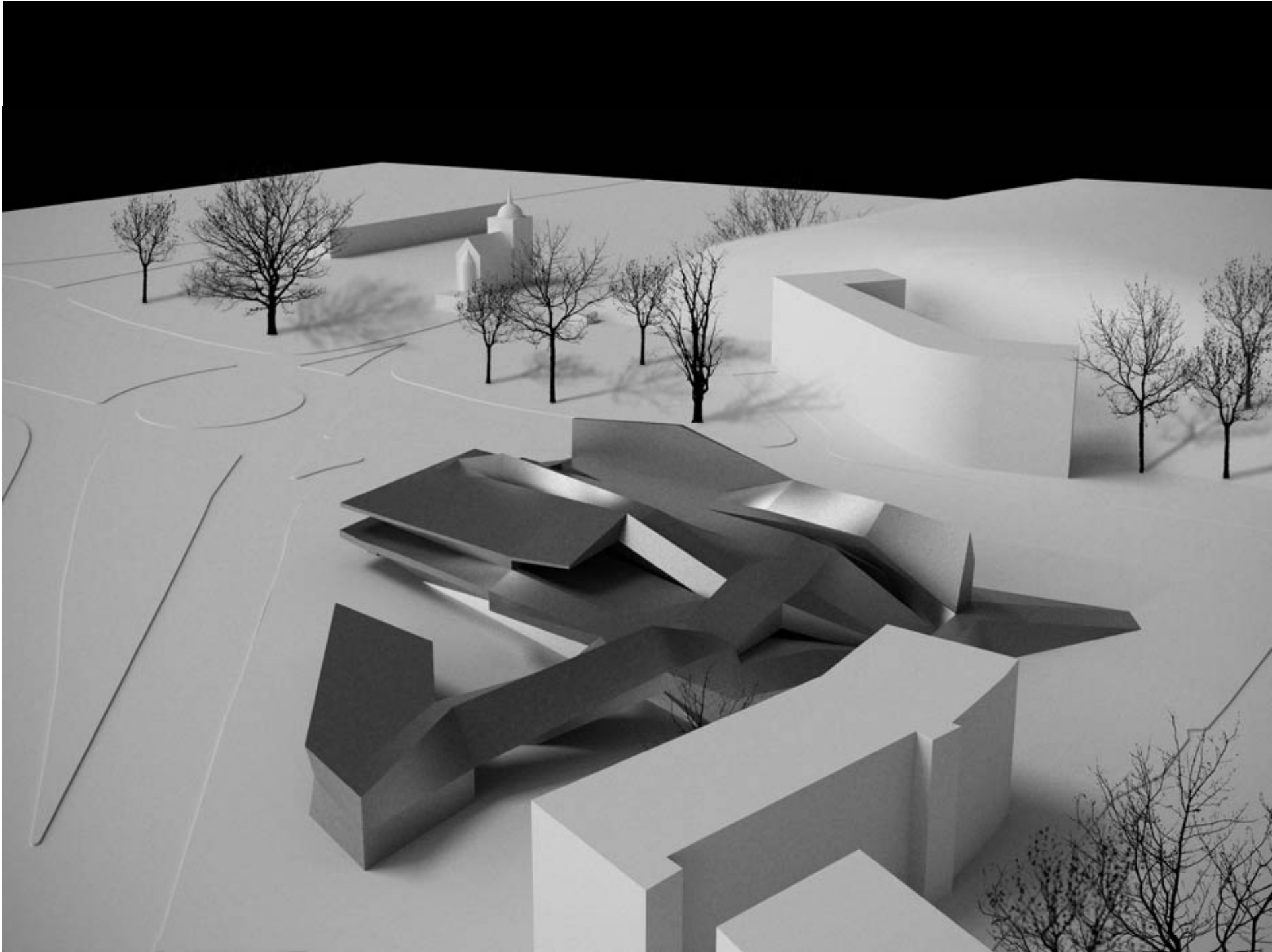

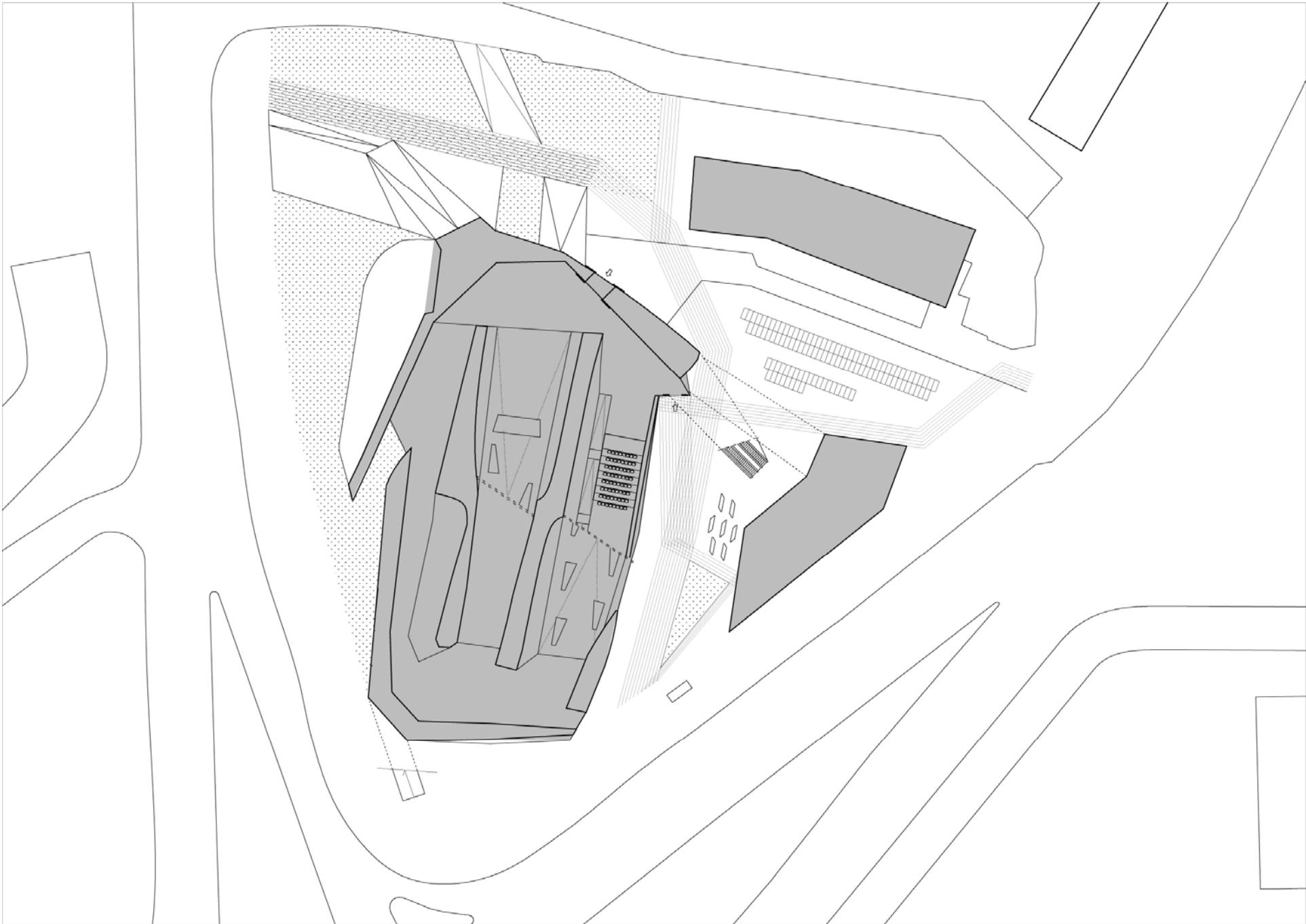

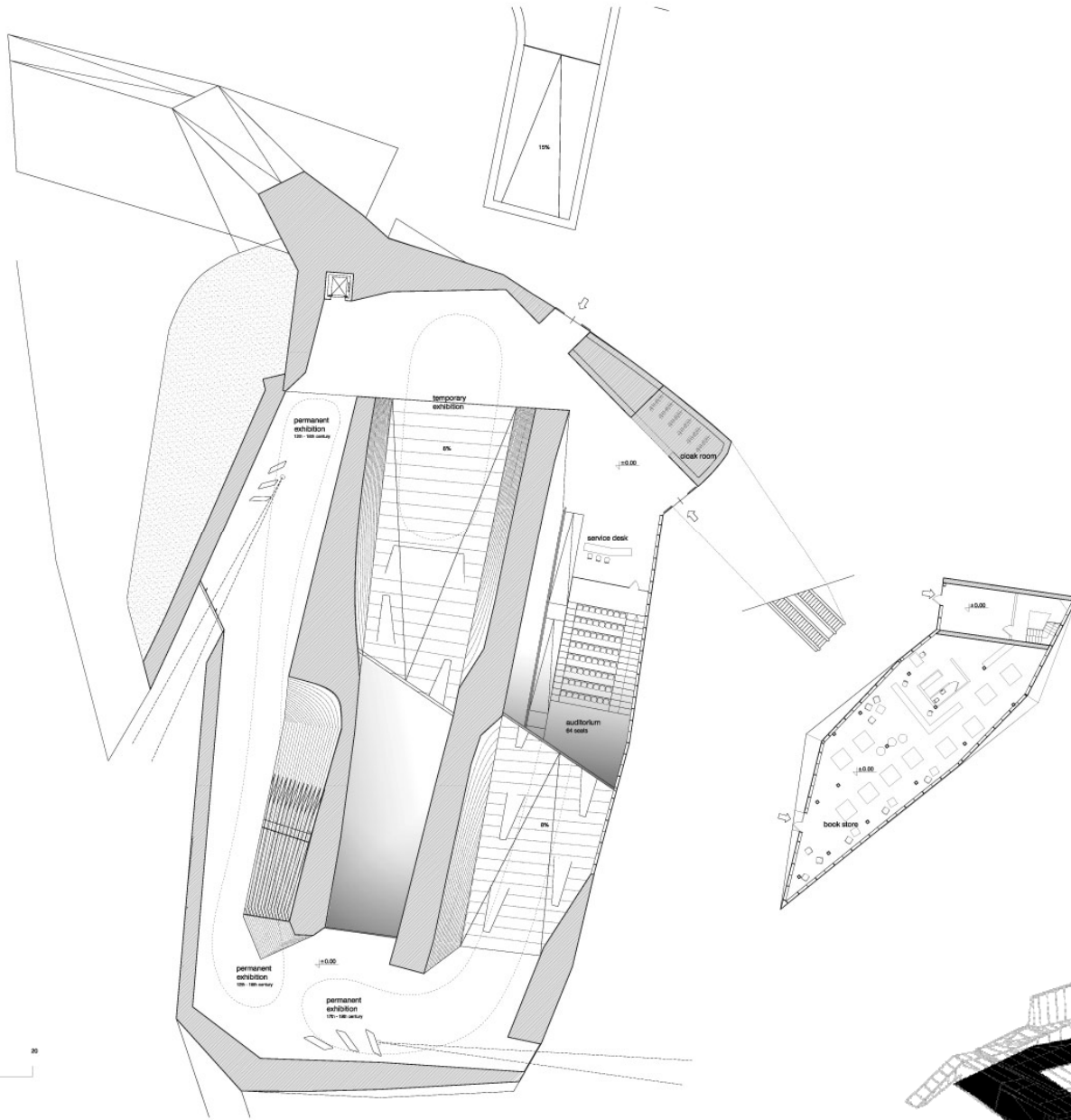

level 0

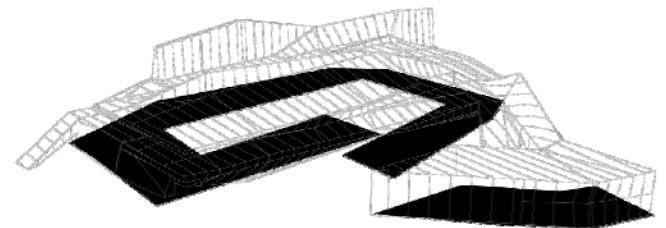
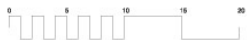

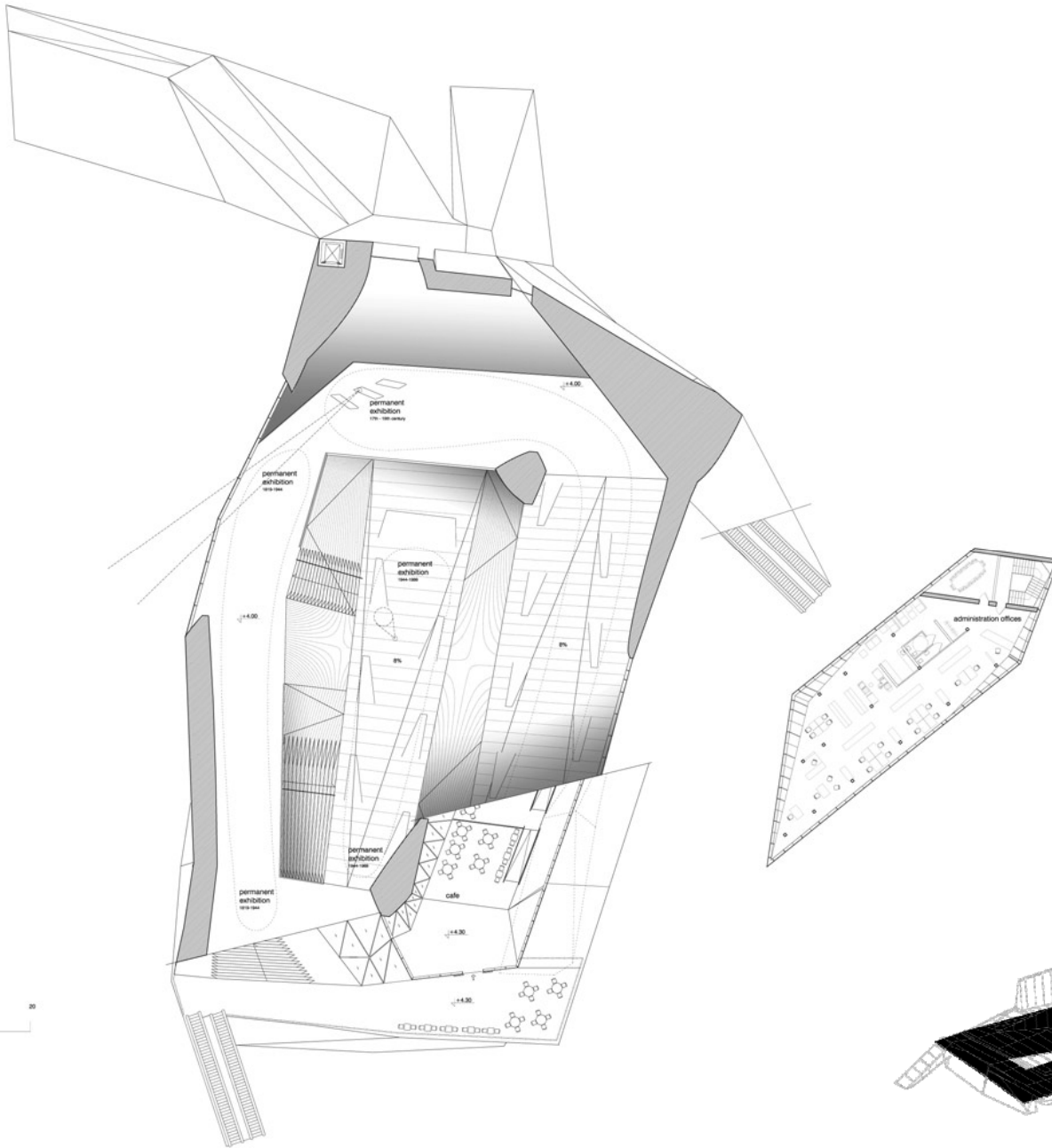

level +1

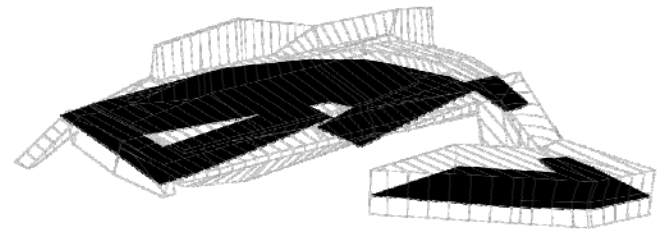

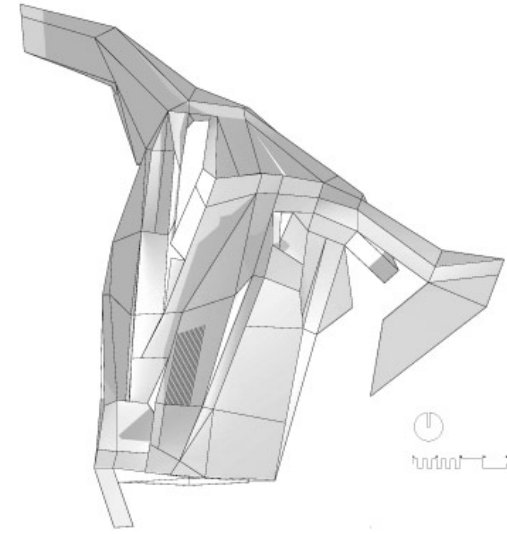
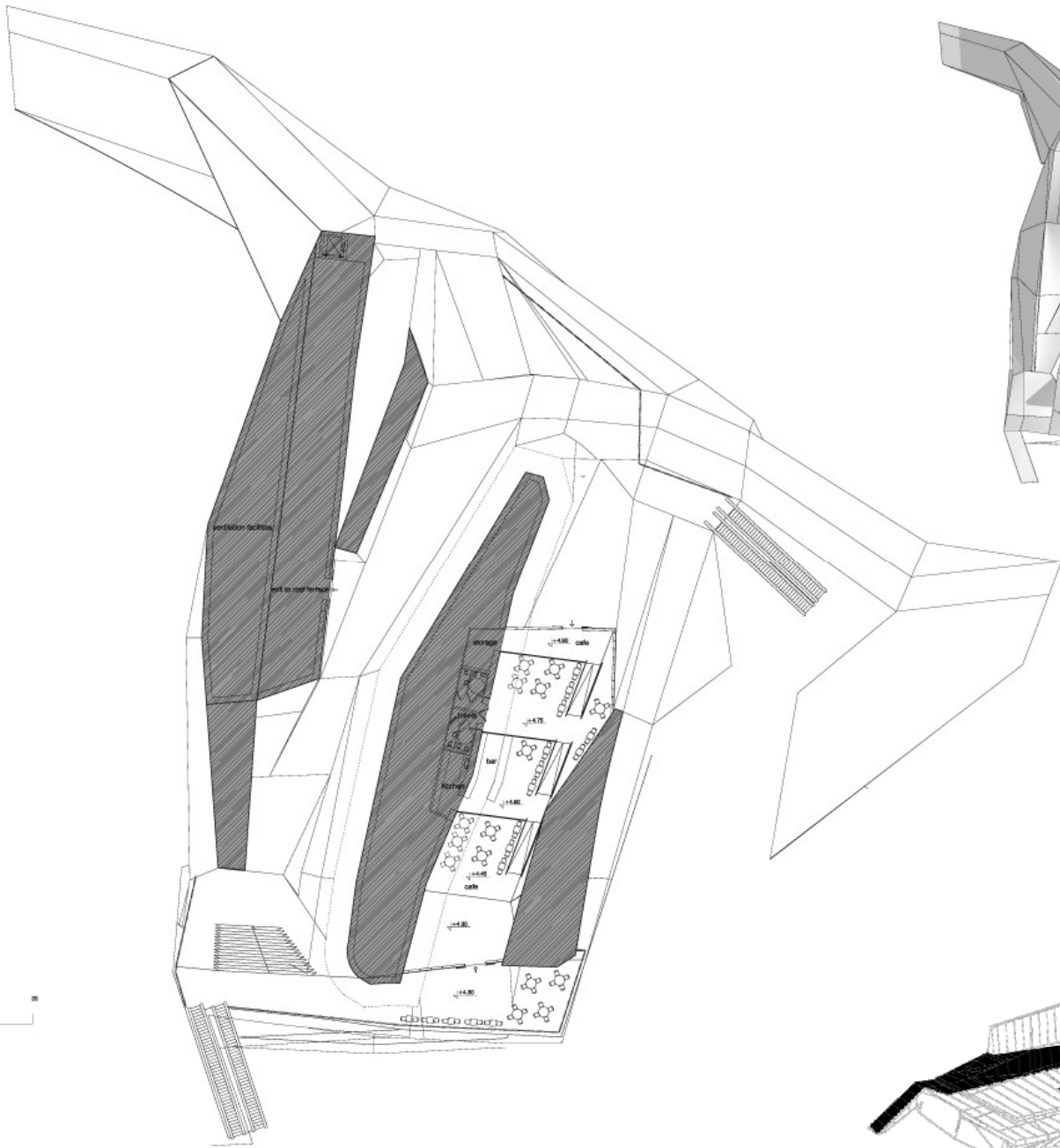

level +2

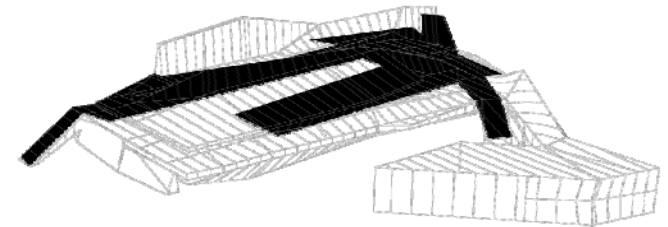

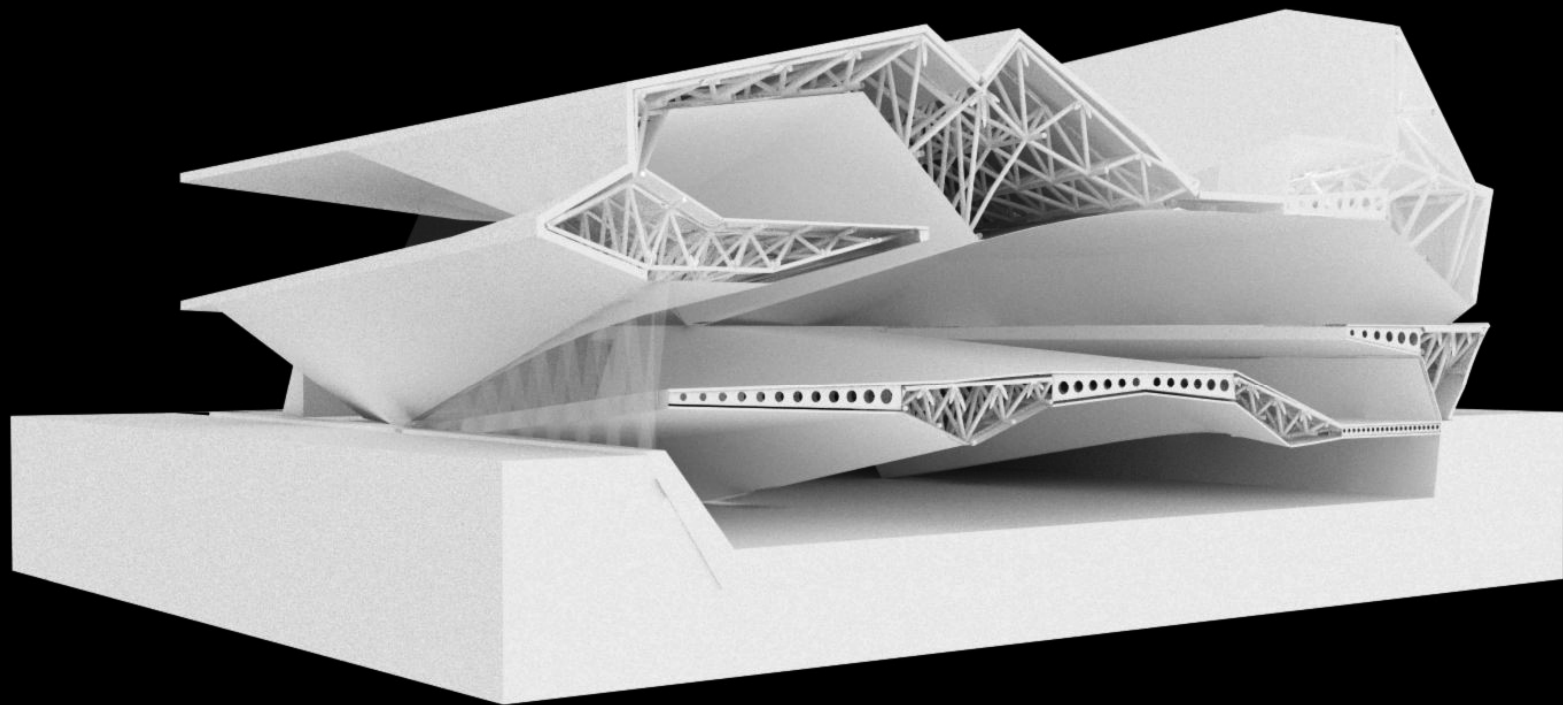

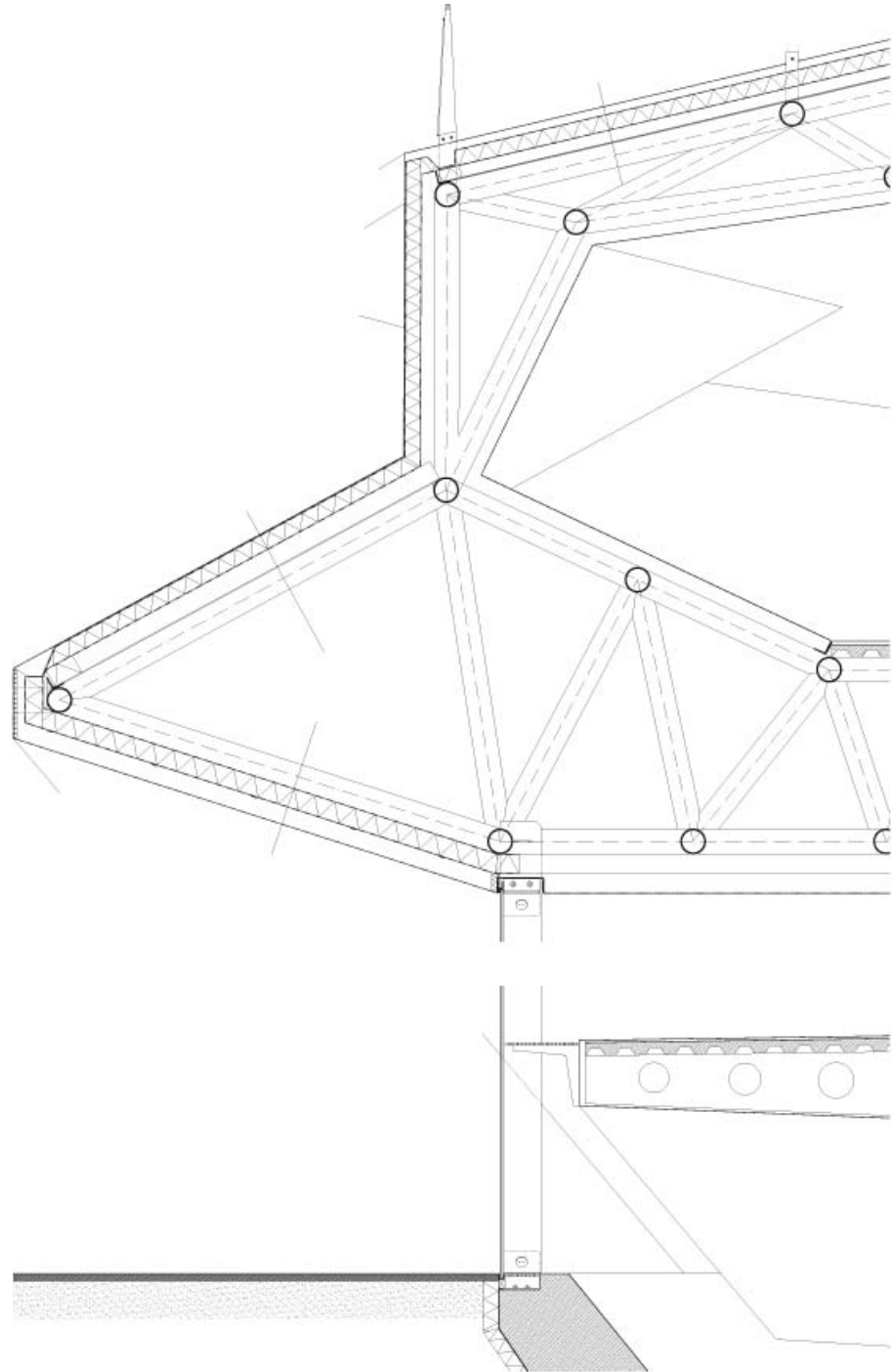
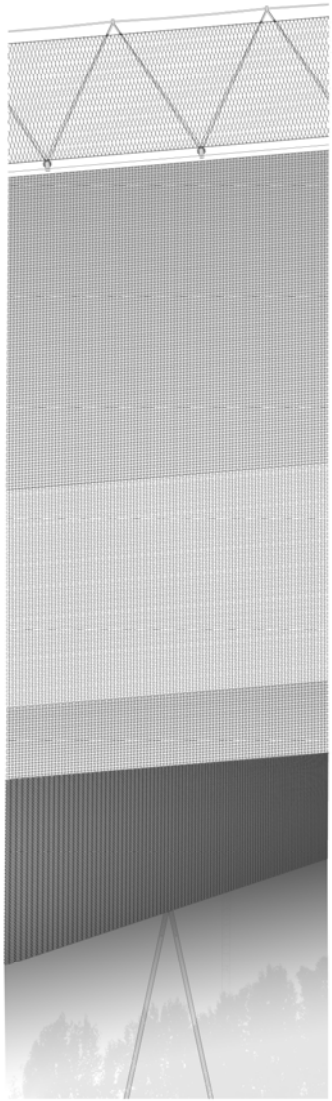

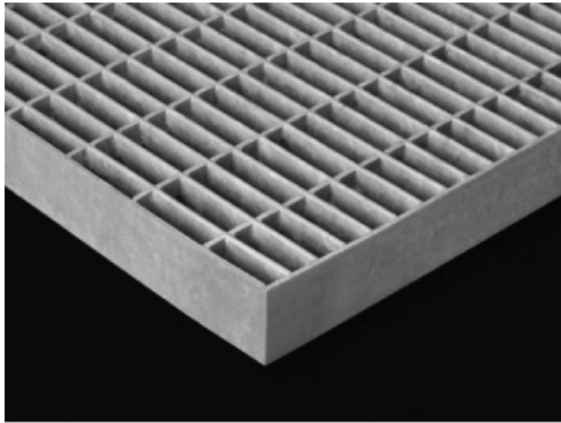

open area - 60 %



0 - 5°

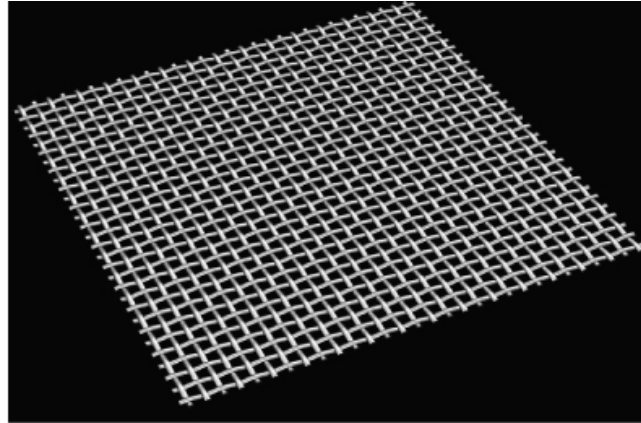

open area - 42 %
flexibility - 2 directions



5 - 45°

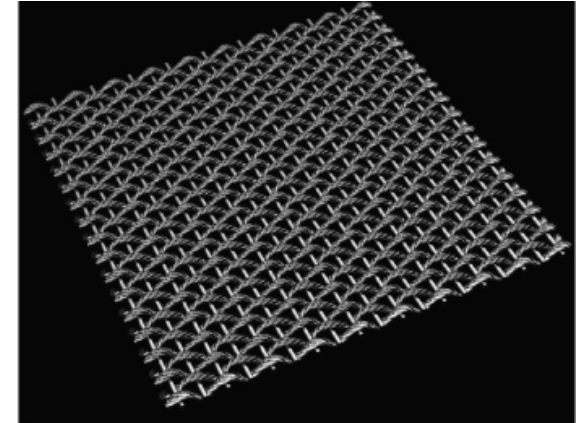

open area - 20 %
flexibility - 2 directions

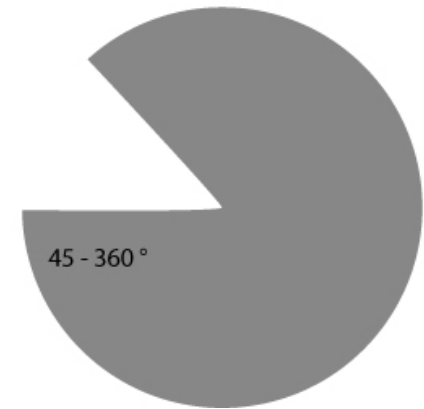

45 - 360°

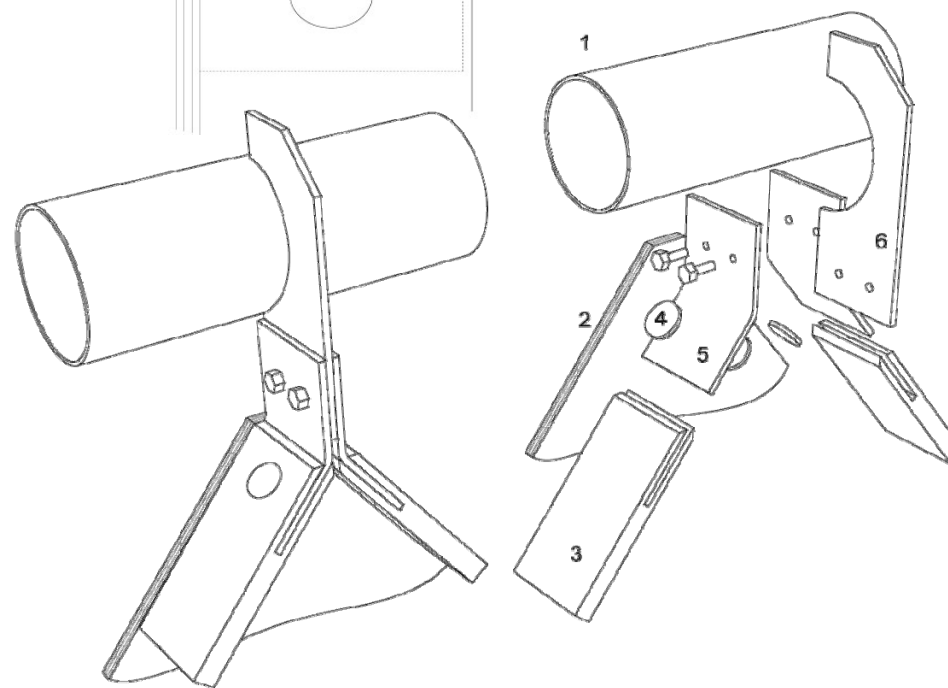
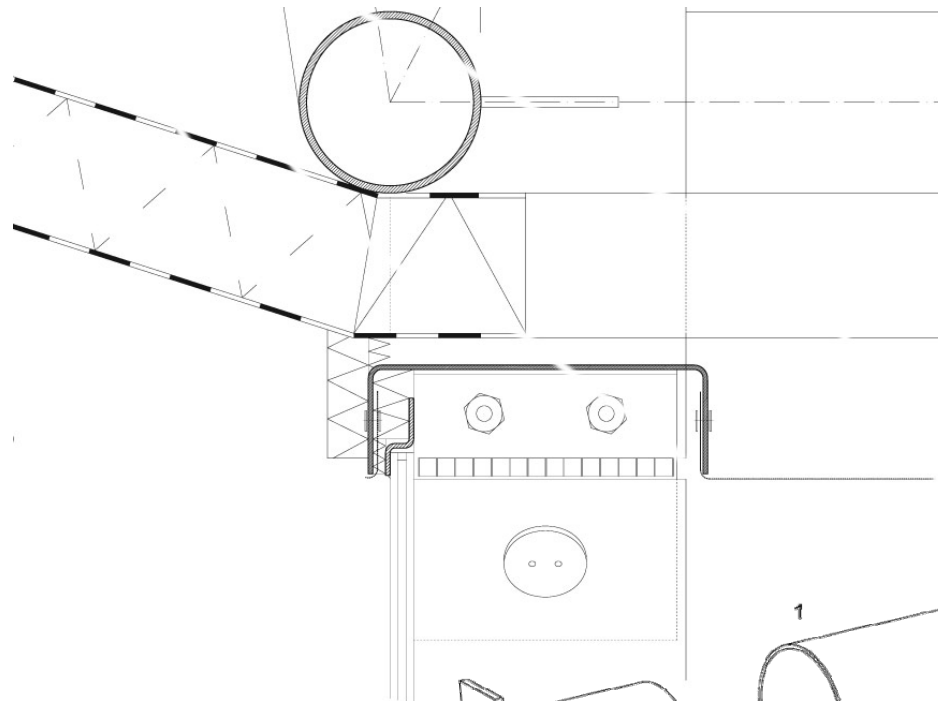
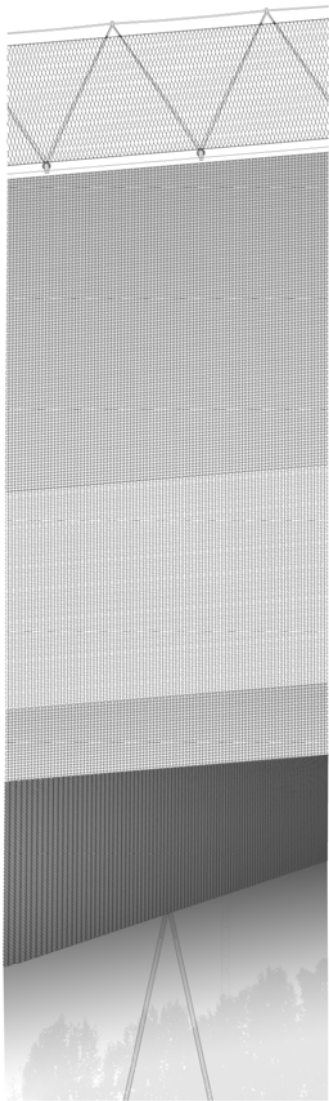

- 1 - space frame
- 2 - double glazing
- 3 - glass mullion
- 4 - aluminum fixing
- 5 - bent steel plate
- 6 - steel plate

the visit

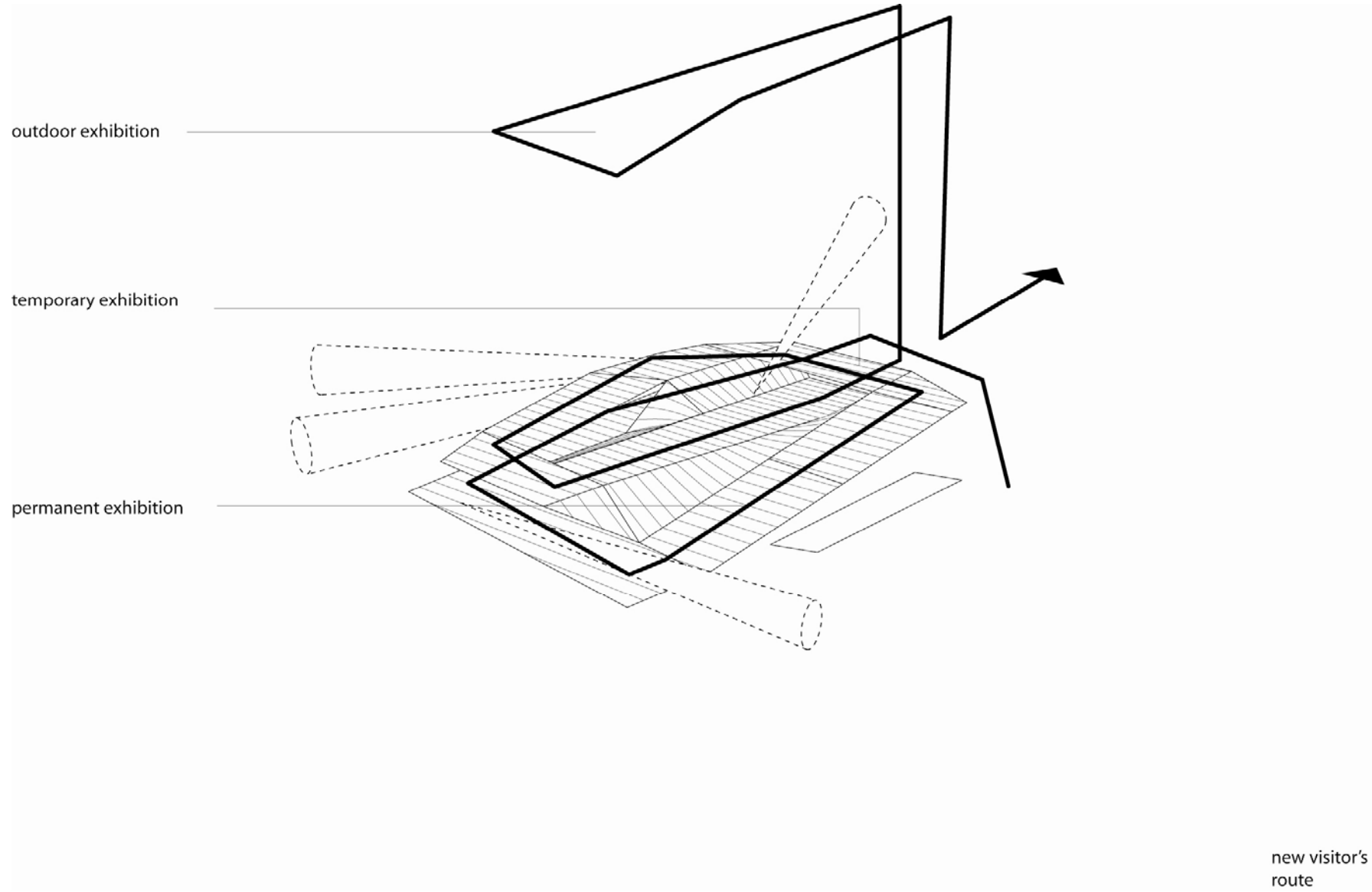



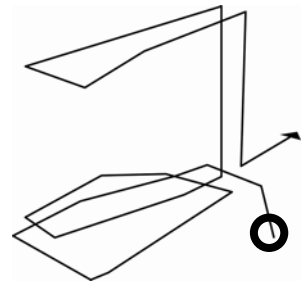
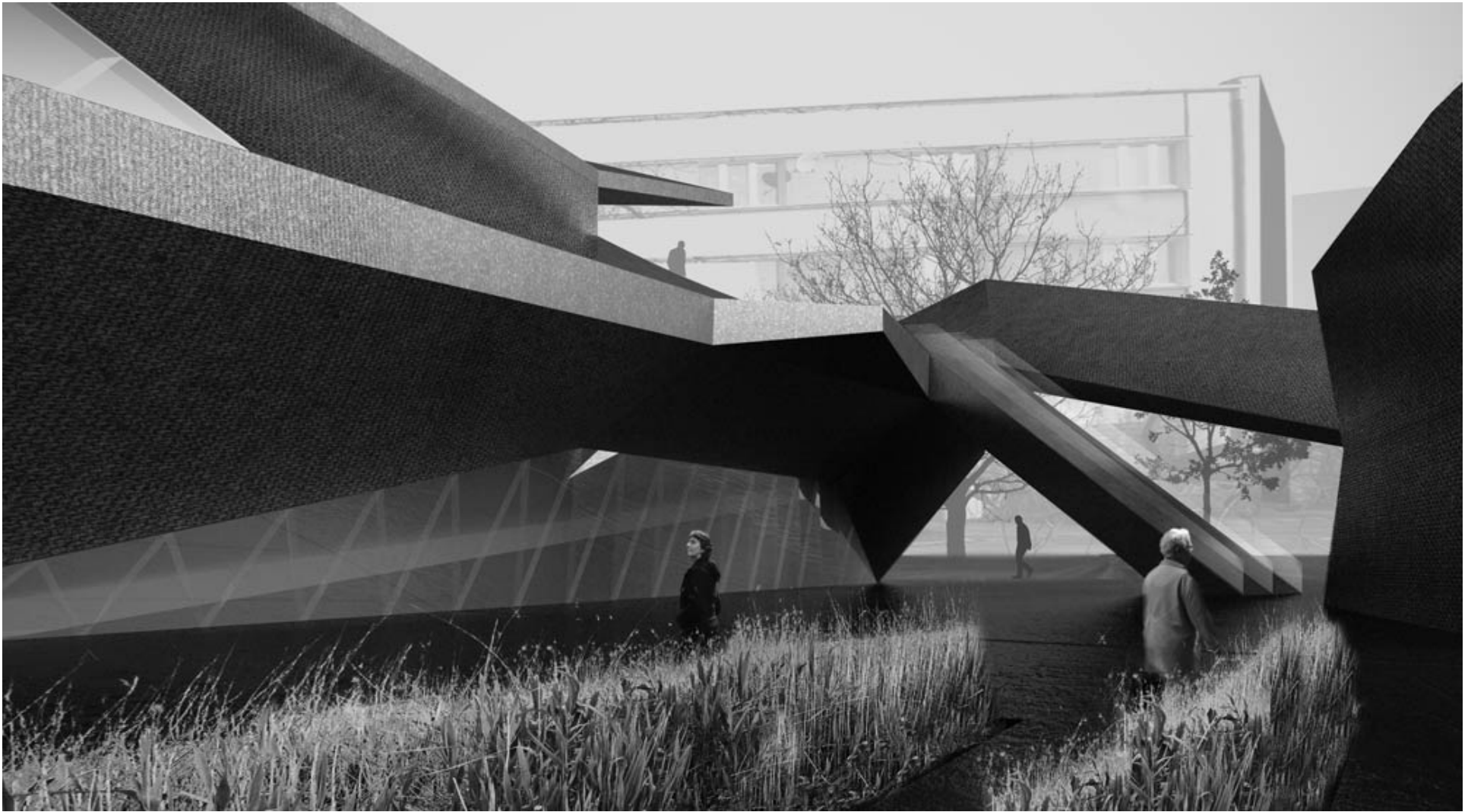

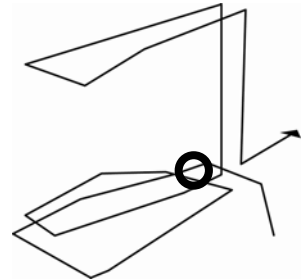
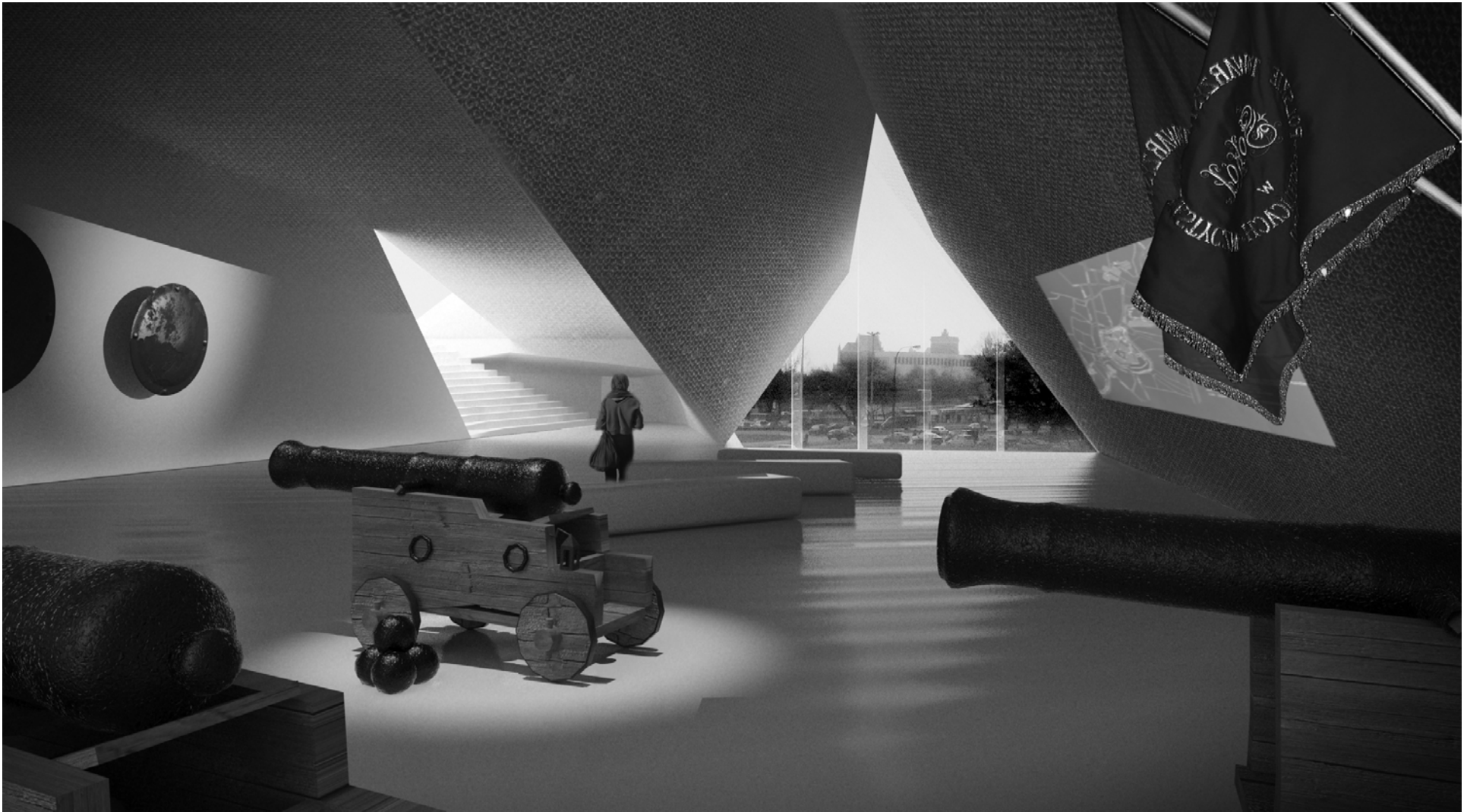

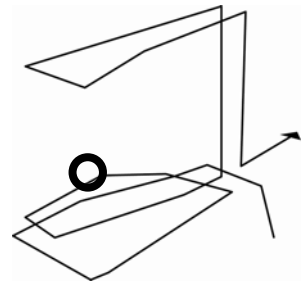

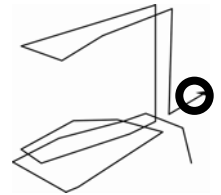

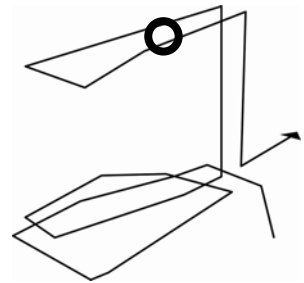
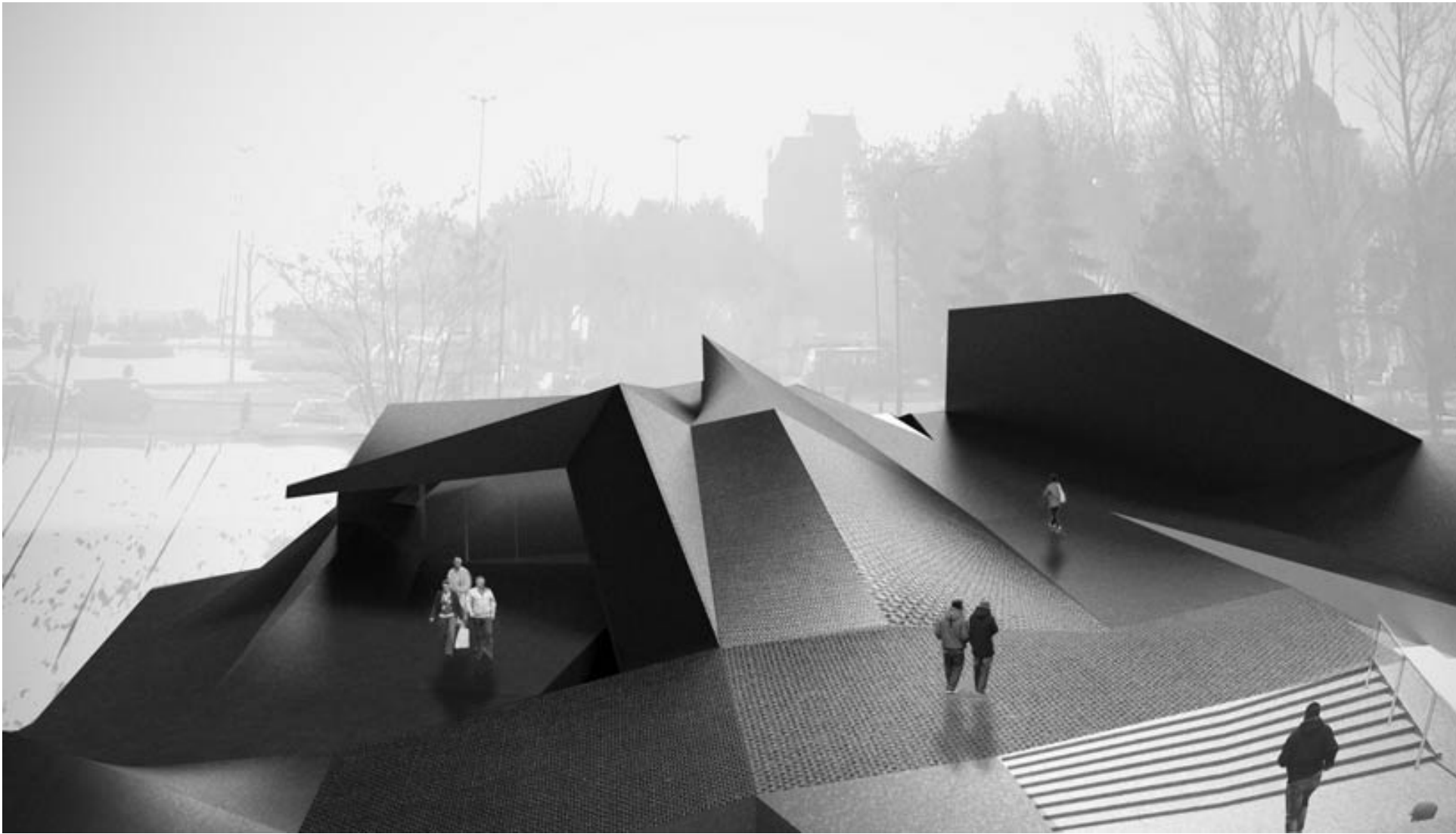

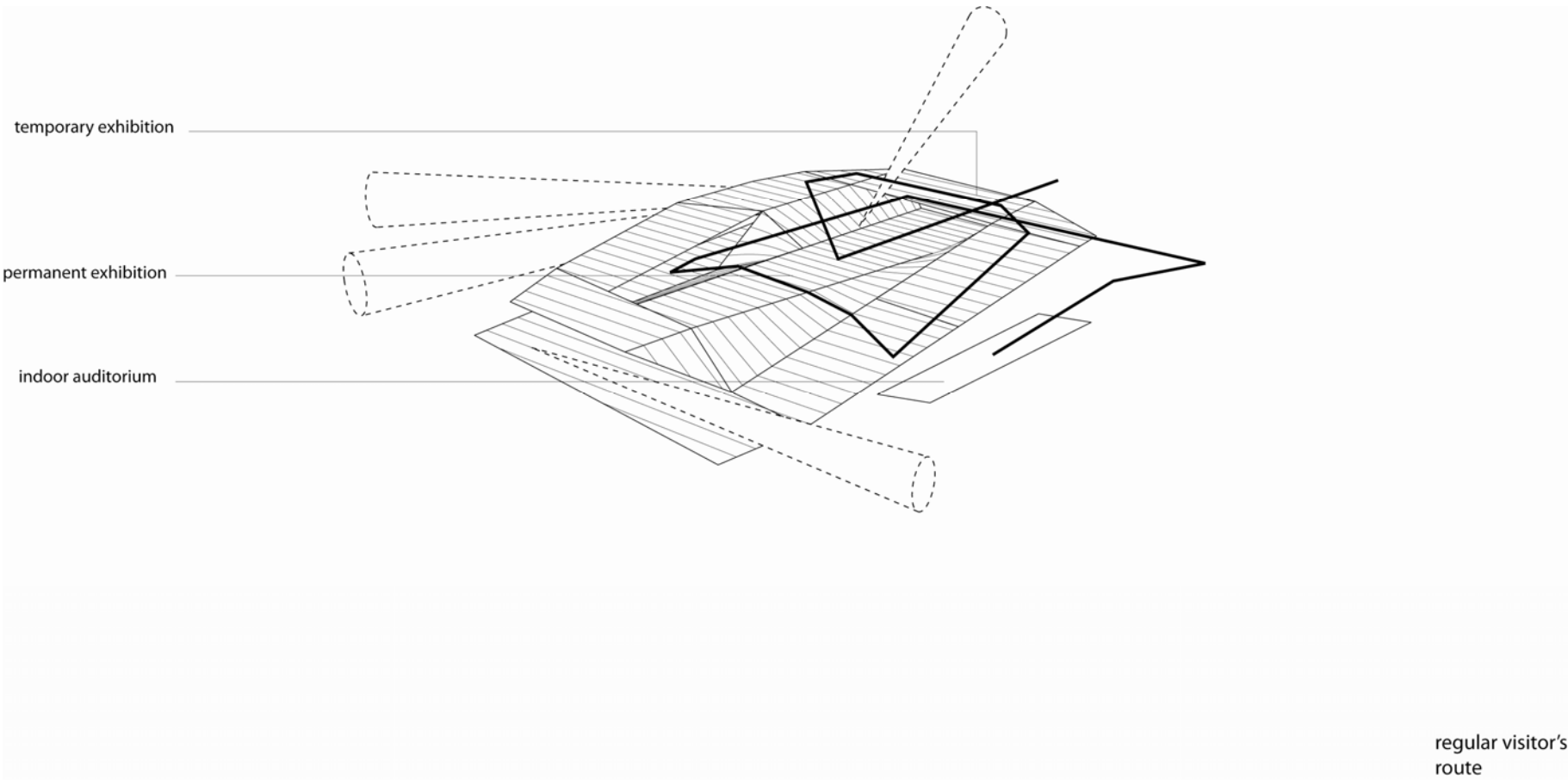

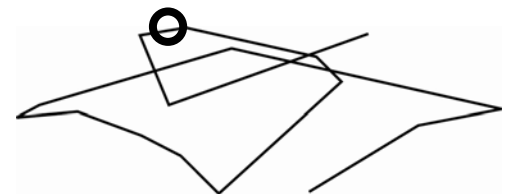
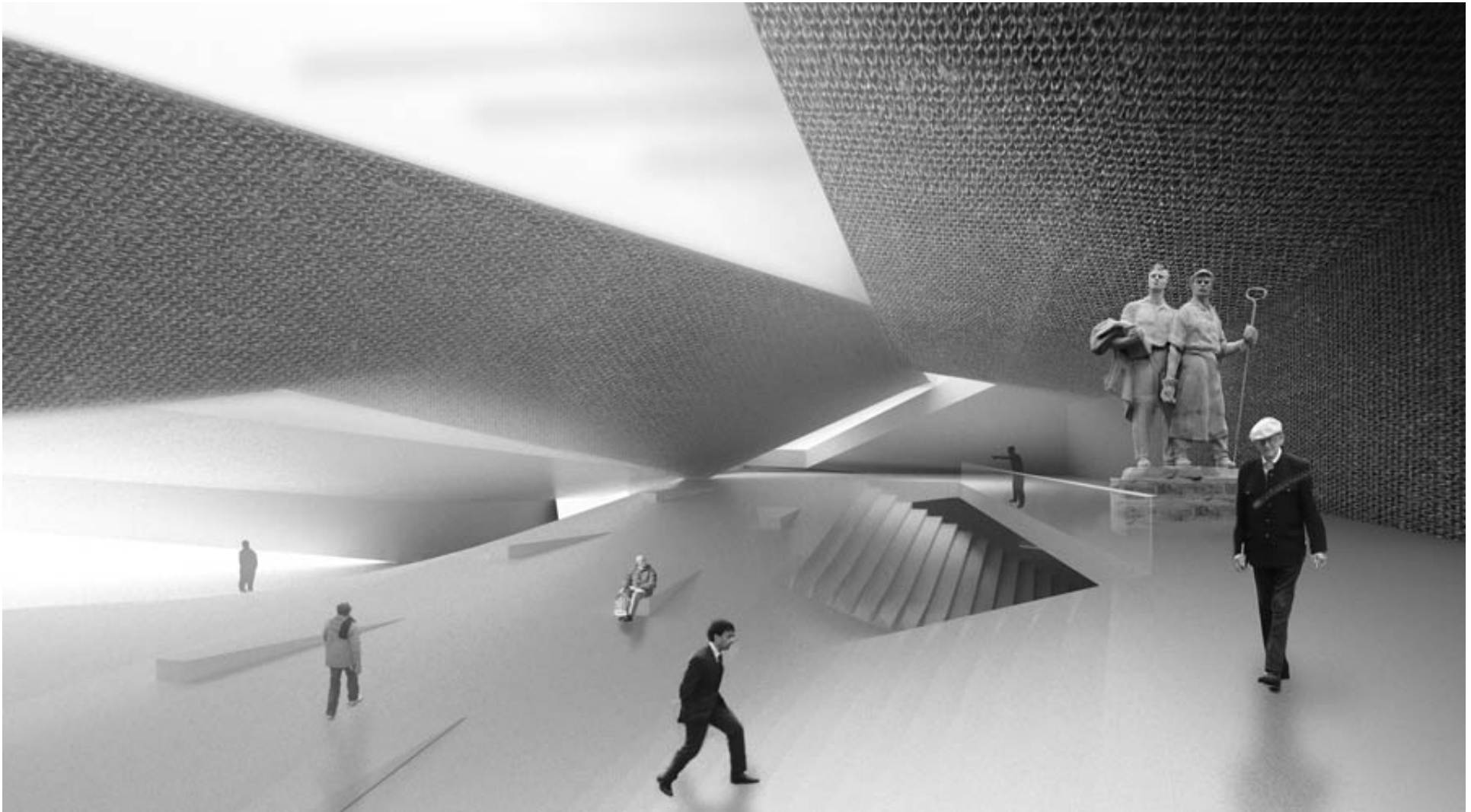

Thank you