

Design and Evaluation of a Visual Interface for an En Route Air Traffic Control Merging Task

Master Thesis
E.S. Bakker

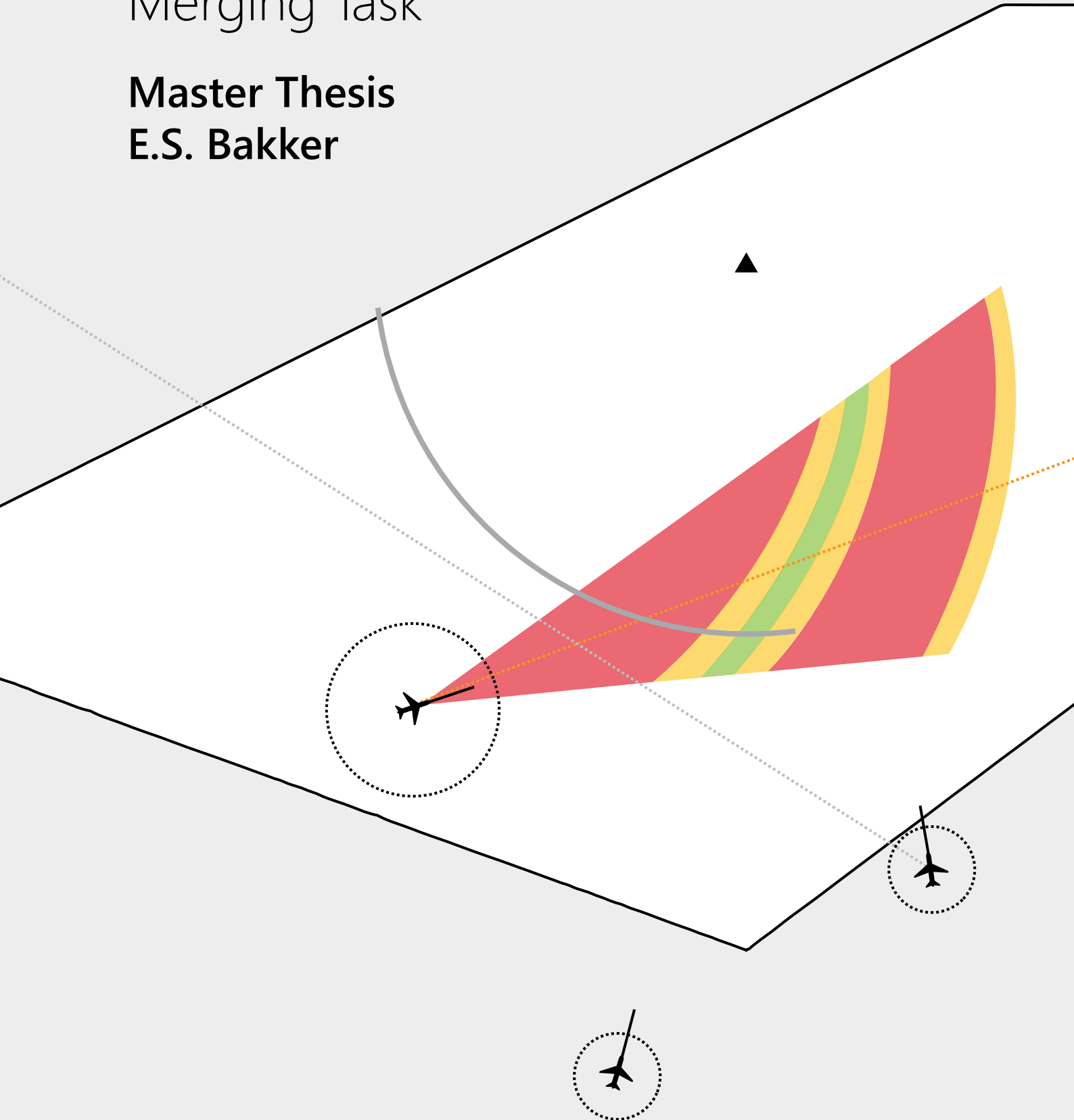

Design and Evaluation of a Visual Interface for an En Route Air Traffic Control Merging Task

Master Thesis

by

E.S. Bakker

to obtain the degree of Master of Science at the Delft
University of Technology,

Student number:	4233816	
Project duration:	Nov 12, 2017 – Oct 30, 2019	
Thesis committee:	Prof. Dr. Ir. M. (Max) Mulder	TU Delft, Supervisor
	Dr. Ir. C. (Clark) Borst,	TU Delft, Supervisor
	F. (Ferdinand) Dijkstra,	LVNL, Supervisor
	Dr. O.A. (Alexei) Sharpans'kykh	TU Delft, External Committee Member

An electronic version of this thesis will be made available at <http://repository.tudelft.nl/>.

Preface

I started this research with three intentions; I wanted to challenge my analytical skills and my creative design skills in a challenging project, I wanted to become an expert on area control, and I wanted to combine academic research with the practical business world in the hope to contribute something to the future of air traffic control. Looking back, I feel like I have achieved most of what I set out to do. I devoted a lot of energy and time to this project and I am proud of the final outcome. I would like to thank all of you who helped me along the way.

First of all, thank you Max Mulder, your high-level perspective has helped me move in the right direction and your criticism has taken my work to a higher level. Thank you, Clark Borst, for helping me with day-to-day problems in the design process and helping me stay motivated. Thank you, René van Paasen, for helping me with programming difficulties. Thank you, Ferdinand Dijkstra, for sharing your knowledge with me and providing me with all the necessary data. Thank you, all of my experiment participants, for your time and useful feedback. Thank you, Jonah Bekkers and Matthijs van den Berg, for taking the time to share your professional insights. And finally, thank you to all for being so understanding throughout this process. When I started this project, I never imagined it to be so complicated. In the past year I have learned so much, and I am thankful that I have been given the space to do so. It was a valuable experience and I am excited of what lies ahead!

Delft, October 14, 2019

Contents

I	Thesis Paper	1
II	Literature Review and Preliminary Research (<i>Graded under AE4020</i>)	23
III	Book of Appendices	91
1	Instruction Manual	93
1.1	Sector	94
1.2	The Radar Screen	94
1.3	The Available Display Elements	95
1.4	The Full Display and the Influence of Wind	101
1.5	Control Task	102
1.6	Workload Measurement.	102
1.7	Training Scenarios	103
1.8	Cheat Sheet	109
2	Pre-Experiment Questions	111
3	Scenario Design	115
4	Code Layout	119
4.1	Sector X Code Structure	119
4.1.1	Initializing the Application.	119
4.1.2	Visualization of the Calculations.	121
4.2	Code Alterations	122
4.2.1	Loading the Data.	122
4.2.2	Adding Wind.	122
4.2.3	Visualization Elements.	122
4.2.4	Data Saved.	124
5	Expert Questionnaires	125
5.1	Pre-Questionnaire	126
5.2	Post-Questionnaire	127
6	Final Situations	131
7	Individual ISA Workload Ratings	141

Part I

Thesis Paper

Design and Evaluation of a Visual Interface for an En Route Air Traffic Control Merging Task

Author: E.S.Bakker*; Supervisors: C. Borst[†], M. Mulder[‡], F. Dijkstra
Delft University of Technology, 2629 Delft, The Netherlands

In the past decades, air traffic growth has resulted in increasingly complex situations. In order to guarantee safety and efficiency is maintained, new automation tools and interfaces must be developed. In collaboration with the Netherlands Air Navigation Service Provider, the Inbound Traffic Support System interface was developed. This display reveals the constraints of a merging task for an area controller within the South Sector of Amsterdam Airport Schiphol. The interface aims to visualize the possible solutions of a merging task, such that the impact of decisions can be foreseen. By showing the affordances of the work domain, the display keeps the Air Traffic Controller as the active decision maker rather than issuing advisories. Two professional area controllers examined the proposed display and expressed interest in the additional elements, but also voiced concerns about display clutter. In an experiment the effects of the Inbound Traffic Support System interface were examined for semi-professional participants. When using the display, participants could better estimate whether an aircraft was going to adhere to the altitude restriction. A decreasing trend in the number of control commands for difficult scenarios was found. Possibly, because participants had a better understanding of the situation, and fewer control adjustments had to be made. Moreover, a difference in performance between the participants was observed. Some participants made use of the tools as was intended, whereas others seemed at times to be rather overwhelmed with the information. It appears that by revealing the solution space, the interface forces the user to think about a control strategy at an earlier stage.

Nomenclature

ACC	= Area Control Center	IAF	= Initial Approach Fix
ATC	= Air Traffic Control	IAS	= Indicated Airspeed
ATCo	= Air Traffic Controller	ICAO	= International Civil Aviation Organisation
ATM	= Air Traffic Management	ISA	= Instantaneous Self-Assessment
CACS	= Current Area Control System	ITSS	= Inbound Traffic Support System
CTA	= Control Area	IV	= Independent Variable
CV	= Control Variable	kts	= Knots
DV	= Dependent Variable	LVNL	= Luchtverkeersleiding Nederland (Dutch ATC)
EID	= Ecological Interface Design	NLR	= Netherlands Aerospace Centre
FL	= Flight Level	NM	= Nautical Miles
GS	= Ground Speed	TAS	= True Airspeed
HMS	= Human Machine System	TMA	= Terminal Control Area

I. Introduction

Within Air Traffic Management (ATM), a controller at the Area Control Center (ACC) is responsible for the safe and efficient conduct of en route flights inside the Control Area (CTA). The primary purpose of an ACC Air Traffic Controller (ATCo) is to ensure safety by maintaining adequate separation. International Civil Aviation Organisation (ICAO) regulations specify that all aircraft must either be vertically separated by more than 1,000 ft or have a minimum horizontal separation of 5.0 NM [1]. Furthermore, an area controller must organize

and expedite the traffic. This entails handling descending, climbing and crossing aircraft around the same levels, organizing inbound and outbound traffic flows and giving route clearances to aircraft entering the surrounding sectors.

Inbound traffic must be merged towards an Initial Approach Fix (IAF). This is a defined space that marks the beginning of the initial segment and the end of the arrival segment, where an approach controller takes over. Handling traffic at varying heights can be difficult. Speed commands are given in Indicated Airspeed (IAS), but the Ground Speed (GS) depends on aircraft altitude and wind conditions. Aircraft flying at a higher altitude are faster relative to the ground. The ATCo must estimate if crossing and merging maneuvers are feasible and check if the situation will evolve as was anticipated.

*MSc Student, Control and Operations Division, Faculty of Aerospace Engineering, Kluyverweg 1; elinesbakker@gmail.com

[†]Assistant Professor, Principal Investigator Control and Operations Division, Faculty of Aerospace Engineering, Kluyverweg 1; C.Borst@tudelft.nl

[‡]Professor, Chairman Control and Operations Division, Faculty of Aerospace Engineering, Kluyverweg 1; m.mulder@tudelft.nl

Hence, the task of a controller is already demanding and will become more difficult in the future, because air traffic is growing. In the past decades, the number of aircraft in Dutch airspace has increased substantially and is expected to continue to grow even further [2]. This growth has led to increasingly complex situations involving more aircraft at the same time. As a result, the profession of an ACC ATCo has become more demanding. At Air Traffic Control the Netherlands (LVNL), the ATCos have reported an increasing workload within recent years. Even though no increase in serious incidents has been observed, the number of irregularities within the Electronic Guard Report has been increasing, especially within the Amsterdam South Sector. Most recorded events of increased workload resulted from aircraft unable to reach the instructed height in time. [3]

In order to assist controllers in their current tasks and to facilitate further growth, new forms of automation are expected. In the distant future, this may result in area control support systems that make use of four-dimensional trajectories [4] [5]. However, it will probably take a long time before a controller can fully rely on a 4D system. Meanwhile, automation systems that match the current work domain are needed. These systems could support the current tasks of an area controller and could bridge the gap between the current operation and the future 4D environment. In order to gain operational acceptance, close attention must be paid to the controller's needs and work preferences in the design of automation. Research has shown that level of acceptance is driven by the extent to which the support system complies with the capabilities and strategies of the user [6]. Furthermore, it has been shown ATCos are more likely to accept automatic systems if they are cognitively engaged in the task [7].

With this in mind, an interface that supports parts of the decision-making process of an area controller is developed. The research focuses on the merging task. Although not the only task of an ATCo, merging is an essential task and major cause for workload. Within the Amsterdam South Sector, in case of a high supply of inbound traffic, two controllers can even divide the control tasks. In that case, the inbound traffic is handled by one controller while the other controller handles all other traffic [3].

The purpose of this research is to provide insight into the challenges of a merging task for an area controller within the Amsterdam South Sector, with the objective of maintaining safety and improving controller performance. The interface must make sure that the impact of decisions can be foreseen. To ensure that the interface and automation tools match the current Air Traffic Control (ATC) operation, the interface is developed in close collaboration with the LVNL. In this paper the proposed Human Machine System (HMS) is presented and evaluated.

The structure of the paper is as follows. First, background information on the Amsterdam South Sector is provided in

Section II. Then, the novel interface concept is explained in detail in Section III. Next, a description of the experimental set-up is given in Section V. The results are presented in Section VI. This is followed by a discussion in Section VII. Finally, the conclusions are given in Section VIII.

II. Problem Background

The Amsterdam South Sector is one of the CTAs in the Netherlands. It spans the area between the border of Belgium and Terminal Control Area (TMA) of Schiphol and it has an adjacent military airspace. Its size is 90 NM horizontally and 50 NM vertically. The area controller is responsible for all traffic within this area between FL 55 and FL 245. This section first explains why the sector is regarded as especially difficult by ATC experts and then discusses how merging tasks are currently handled.

A. Complexities in the Amsterdam South Sector

For several reasons, the Amsterdam South sector is considered to be more difficult than other CTAs in the Netherlands. Primarily, the sector is relatively small. Therefore, there is very limited space to efficiently sequence flights. As a result, decisions have to be made quickly and there is limited space to correct decisions that evolve differently than the controller had expected. When many inbound aircraft arrive at the same time, controllers cannot accommodate for all traffic and make use of a holding pattern.

Secondly, the Amsterdam South Sector has to deal with more crossing traffic. In 2018, there were 67,638 aircraft in the Amsterdam South sector that were not going to or coming from Schiphol. In the Amsterdam East Sector only 34,173 aircraft were not inbound or outbound Schiphol flights [2]. This can be seen as an indication that the complexity of traffic handling in the Amsterdam Sector is greater than in other sectors. Most regional traffic in the Amsterdam South Sector goes to or comes from the surrounding airports Rotterdam Airport, Eindhoven Airport and Brussel Airport. These aircraft strongly influence the solution space available for the inbound traffic and require much focus from the controller. The standard arrival routes from the surrounding airports cross the standard arrival routes for Schiphol. The traffic flows must cross whilst descending or ascending. Situations that involve a change in altitude are complicated and consequently demanding for the controller.

Thirdly, the majority of inbound traffic going to Schiphol arrives from the South. In 2018, the Amsterdam South Sector had 4,241 inbound aircraft more than the Amsterdam East Sector [2], which has the second highest number of inbound aircraft. Also, the volume of inbound traffic in the sector has increased strongly in the past few years. Since 2013, the number of inbound aircraft in the Amsterdam South Sector has increased by 15.8% [2]. Thereby, the complexity of traffic handling has also grown. Hence, the Amsterdam South Sector has to deal with a greater number of inbound aircraft and more additional traffic.

B. The Merging Task within the Amsterdam South Sector

In a merging task, the inbound traffic has to be merged towards an IAF. In this task, the controller must adhere to a specific target time for every aircraft. The inbound traffic comes from standard arrival routes, which are visible in Figure 1. Traffic from the South comes via three arrival routes (DENUT, HELEN and PUTTY). The vast majority of those aircraft comes from DENUT and HELEN. The arrival routes join at Haamstede, from where the arrival route continues towards the IAF RIVER. At RIVER the arrival routes are combined with the arrival route coming from PESER.

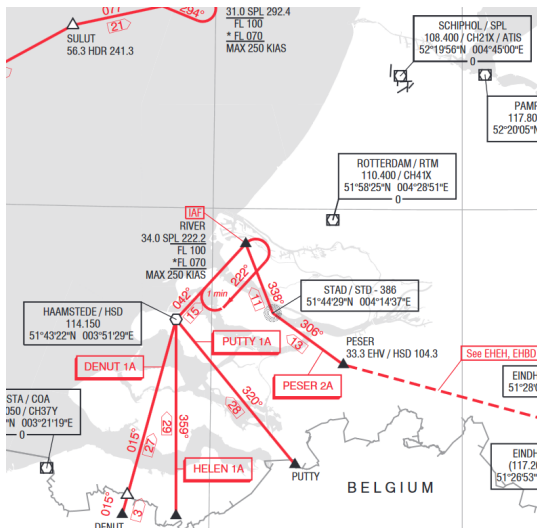

Fig. 1 Standard Arrival Routes for Inbound traffic in the Amsterdam South Sector. [8]

In practice, aircraft do not neatly follow these arrival routes. It is not unusual for an aircraft to fly at considerable offset of the standard arrival route. Figure 2 shows all inbound traffic paths going to Schiphol in the Amsterdam South Sector for one 24 hour period. It can be seen that aircraft do not exactly fly over HELEN or DENUT.

The Area controller must sequence the incoming aircraft. This is currently done by vectoring, as can be seen in Figure 2. By adjusting the length of the path, it is determined which aircraft arrives at the IAF first. Some paths are shortened by commanding the aircraft to go directly towards River, without first going to Haamstede (HSD). Other paths are elongated in the west side of the sector. Another method for extending the flight path is to place the aircraft in a holding pattern at RIVER. Although not optimal, this method is frequently used due to the limited available space within the sector. With support from the designed display, the controller will ideally have to make less use of the holding patterns.

III. Proposed New Concept

The Inbound Traffic Support System (ITSS) described in this section, is a new display that uses visual tools to assist the air traffic controller in a merging task. Section III.A explains

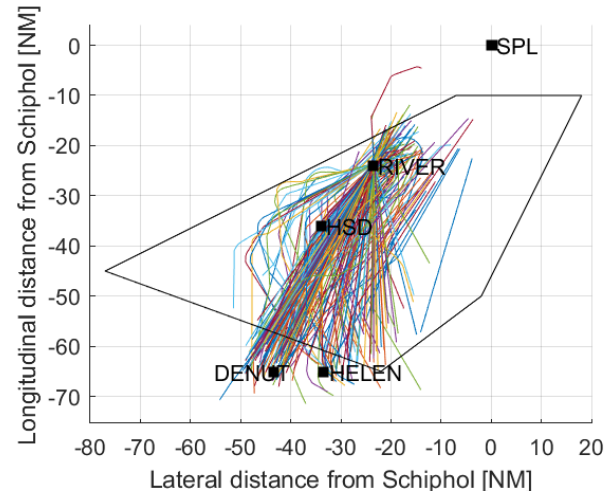

Fig. 2 All inbound traffic paths going to Schiphol in the Amsterdam South Sector for one 24 hour period.

the design requirements. A version of the simulator environment without the visual tools (the Current Area Control System (CACS)) is used as a baseline. This system is inspired by the radar screen currently used at the LVNL and is explained in Section III.B.

The ITTS expands upon the CACS in numerous ways. The visual enhancements for a single aircraft are explained in Section III.C. Then, the subsequent sections describe additions in multiple aircraft situations. Some of the visual elements of the display are always shown, others appear only upon interaction. The colours used in the explanatory figures resemble the colors used in the simulation as much as possible, but were changed in some cases for clarification purposes.

A. Design Requirements

Air Traffic Controllers are in charge of a complex system. In the task of merging aircraft, a controller is not able to fully assess the system; the exact dynamics of descent paths and the effects of wind can be estimated with experience, but never fully calculated. It is here where clever automation, in combination with good interface design, can change the way controllers operate.

Research has shown that a useful interface must help an operator to understand the link between the data and the functional objectives [9]. Therefore, the goal of the interface is to visualize the possible solutions of an area controller's task of merging aircraft towards a restricted waypoint in the current work domain, such that the impact of decisions made can be foreseen and safety is maintained during demanding circumstances arising from an increasing number of aircraft movements. This translates into the following requirements:

1. The display must keep the user as the active decision maker,
2. The support system must support the controller's tasks

- in merging aircraft before approach,
- 3. The display must be implementable inside the current LVNL systems with minor modifications, and
- 4. Display clutter must be minimized.

Because the user must be kept as the active decision maker, the proposed new concept is inspired by Ecological Interface Design (EID) [10][11]. The EID method is meant for well-trained professionals and aims to reveal the affordances of the work domain whilst keeping the user in control. An affordance describes opportunities for action for the goal-relevant properties of a system.

B. The Current Area Control System

Because the design should be comparable to current implementations, a simulation environment based on the radar screen used at the LVNL was developed. In the simulator, the Amsterdam South Sector, its waypoints and the aircraft inside the sector were replicated (Figure 3). All aircraft information that is currently available to the area controllers is shown in the aircraft label, which is enlarged in the figure. For each aircraft, this label shows (left-to-right then top-to-bottom); the callsign, the current flight level, the target flight level, the indicated airspeed, the ground speed, the heading, the aircraft type and the destination waypoint.

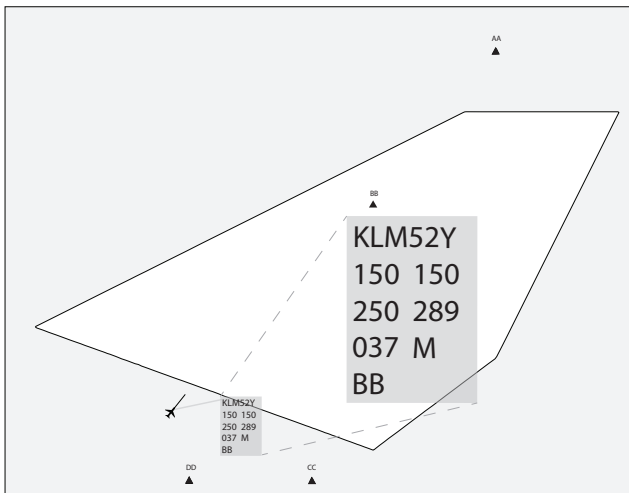

Fig. 3 Replica of the Amsterdam South Sector with enlarged aircraft label

Commands to alter the course of an aircraft are given using the command window depicted in Figure 4. The user can change the target flight level (EFL), change the heading (HDG), proceed directly to the destination waypoint (DCT), change the target indicated airspeed (SPD), hand over the aircraft to the next sector (TOC), clear the commands given (CLR) and execute the given command (EXQ).

Furthermore, the simulator updates the radar screen every 5 seconds. This is in line with the radar update rate used at the LVNL. Also, the simulator is able to take into account

uniform wind conditions. The wind is assumed to be constant throughout time and does not vary with height.

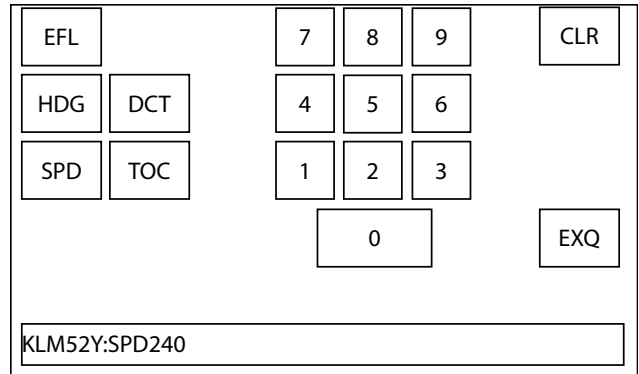

Fig. 4 The command interface used in the simulator

When using the ITSS, additional information is available to the user. Interaction with the radar screen makes the requested visual elements appear. When all optional elements are inactive, the ITSS almost shows the same number of elements as current LVNL controllers are accustomed to.

C. Single Aircraft Visualization Elements

In the ITSS, each aircraft on the radar is circumscribed with a radius of 2.5 NM. As a consequence, the 5 NM separation requirement can be evaluated at a glance; the circles are not allowed to touch or overlap.

When the user selects an aircraft, the radius of the circle is adjusted to the 5 NM separation minimum. The rationale behind this is that the perspective shifts from the overall situation to the interaction of one aircraft with the environment. In addition, the color of the selected aircraft is modified and a circular line segment around the destination waypoint is generated. This arc represents the locations within the sector where a descent maneuver must start at the latest for a direct-to path in order to reach the target flight level, given the aircraft's current height and speed.

Figure 5 shows two scenarios. The arc is visible in both. In Figure 5b, the aircraft has surpassed the arc, and it is no longer able to reach the IAF when flying directly towards the destination. If so, the color of the arc and the current and target flight level change. In case an aircraft is not selected whilst having surpassed the arc, the color in the aircraft label still changes to inform the user that action is required. The situation can be resolved by elongating the aircraft path towards the destination.

D. Relative Track Line

The relative track visualization informs the user whether adequate separation is maintained in the near future and gives an indication of the distance at which the aircraft will cross. This concept can be made clear using Figure 6.

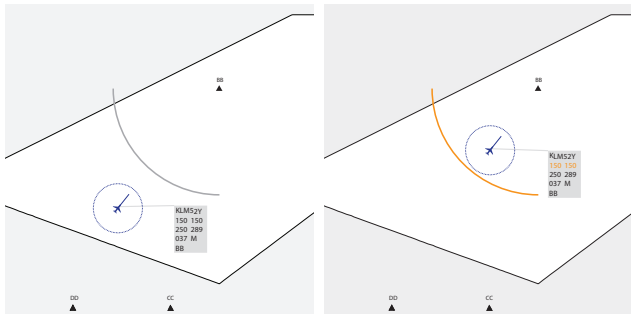

(a) 5 NM circle and the descent arc (b) Descent arc for situation that needs to be addressed

Fig. 5 Single aircraft visualization elements

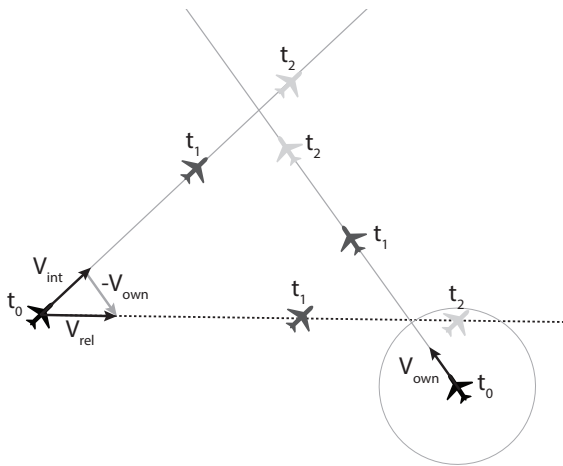
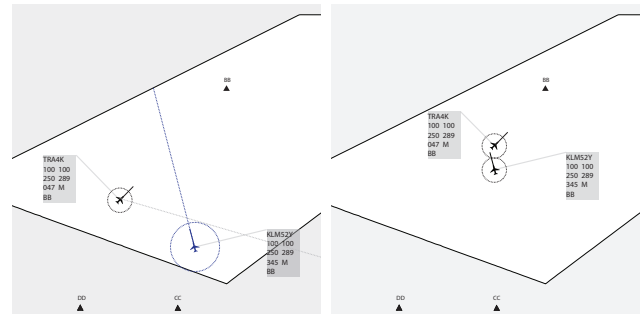

Fig. 6 Relative track line

In this figure, two aircraft are visible at time t_0 along with their speed vectors V_{own} and V_{int} . Assuming that the aircraft states will remain unchanged in the near future, a conflict prediction can be made. The speed vector, V_{own} , is subtracted from the V_{int} vector to obtain the relative speed vector V_{rel} . The line that extends from the relative velocity vector, is the relative track line. This line indicates the path the intruder aircraft follows relative to the selected aircraft. At t_1 the aircraft have gotten closer and at t_2 the aircraft have crossed, but they have done so with insufficient distance between them. This could have been foreseen, using the relative track line. As long as the line does not cross the 5 NM circle around the selected aircraft, the aircraft will retain separation. Furthermore, the orientation of the line illustrates which aircraft will cross in front of the other. In Figure 6, the intruder will cross in front of the selected aircraft.

The relative track line concept works well in separating aircraft at the same level, because the aircraft are vectored. Within the ITSS display, the relative track line is automatically portrayed on the display for a selected aircraft, when either the vertical separation is smaller than 1,000 ft or the aircraft



(a) Tangent relative track line (b) CPA of 5 NM

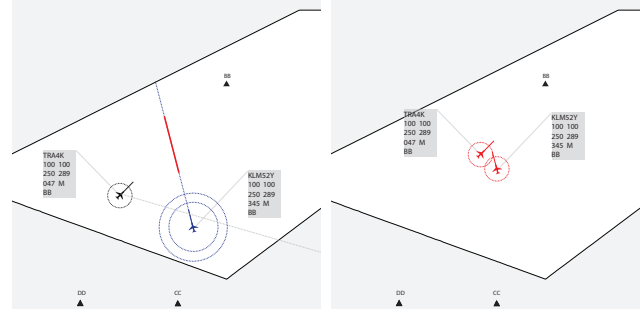

(c) Relative track line crossing (d) Safety violation

Fig. 7 Relative track visualization for two two-aircraft situations and the consequences thereof

have an identical target flight level. When the aircraft have an identical target flight level, the current speed conditions are used in the calculations. In Figure 7a, a two-aircraft situation can be observed where both aircraft fly at the same altitude and with equal speed. The relative track line takes uniform wind conditions into consideration. In the figure, the relative track line is tangent to the 5 NM boundary. Thus, the closest point of approach is exactly 5 NM, as shown in Figure 7b for the same scenario at a later time.

A loss of separation does occur for the situation depicted in Figure 7c if the user does not intervene. The location of the prospective safety violation is visualized along the predicted trajectory using a red line segment. In Figure 7d, it becomes apparent that the line segment indeed corresponds with a separation distance smaller than 5 NM.

Moreover, a second 7 NM circle may be observed. This functionality can be activated by the user. Expert interviews at the LVNL indicated that a slightly larger separation distance is often maintained, as it requires less monitoring. For the 7 NM circle, the tangent line principle works identically.

E. Available flight paths to the IAF

An area controller must organise traffic flows such that each aircraft reaches its respective IAF. To do this more than conflict detection is needed.

The available flight paths to reach the IAF are visualized inside the sector to help the controller organize the traffic

flows. Figure 8 illustrates the concept. At time t_0 two aircraft are visible. Aircraft 1 is on a direct-to path towards the IAF and Aircraft 2 is selected and still needs control commands to reach the destination waypoint. The controller must decide whether the selected aircraft (Aircraft 2) will end up in front or behind the aircraft that is already on a direct-to path (Aircraft 1). To help with this decision, for multiple points in the sector, the time it takes the selected aircraft to fly directly to that point and from there to the destination waypoint is calculated. This is more commonly known as a "dogleg" maneuver.

Point A and Point B illustrate the locations where a direct-to command is given for two "dogleg" paths. The path going to point B and then to the IAF requires a heading change at time t_0 and is longer than the path going to Point A and then to the IAF. For each "dogleg" path it is calculated how long it takes to reach the IAF. The IAS is assumed to be constant in the calculation but the GS is adjusted according to the height in the predicted descent profile and the wind conditions. The same calculation is done for Aircraft 1 and the time difference at the IAF is converted into a relative distance.

The difference in distance can then be displayed within the sector using the colors in Table 1. The information for the "dogleg" flight path is encapsulated in the pixel color at the location where a direct-to command is given. This means that for the potential flight path that first goes to Point A and then to the IAF the relative distance with Aircraft 1 is display at the location of point A. In the figure the consequent separation distances at time t_1 are presented. The path through point A (red) results in a separation of less than 5 NM at the IAF and the path through Point B (transparent) has a separation distance of more than 7 NM at the IAF.

Since not all points within the sector provide realistic "dogleg" flight paths, the calculations are not performed for all points inside the sector. A flight cone is created with its borders at ± 15 degrees from the current course angle. This cone is estimated to cover all realistic flight paths and is based on analysis of control behaviour data provided by the LVNL.

Table 1 Color given based on spatial difference at IAF

Distance at IAF [NM]	category	color
0-5	warning	red
5-7	caution	orange
>7 (in front)	safe	green
>7 (behind)	safe	no color

Since each decision taken by the controller affects the entire solution space, a starting point for the calculation is required. The unselected aircraft included in the calculation must be on their way towards the IAF, because otherwise many degrees of freedom still influence the aircraft's arrival time at the IAF, making it impossible to advise the selected aircraft which path to take. Thus, once one aircraft has been

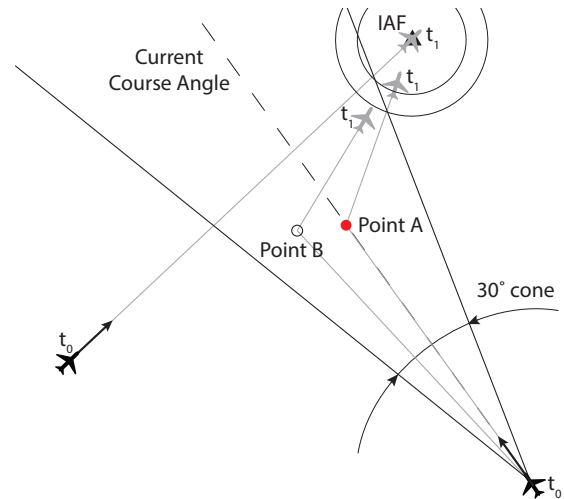

Fig. 8 "Dogleg" paths for selected aircraft

commanded to go towards the IAF, the display allows for the other aircraft to be build around the first one. The color of the aircraft inside the sector changes when on a direct-to path towards the IAF to inform the user which aircraft are included in the calculation. A distinction is made between aircraft on a descent path (green) and those not yet descending (grey).

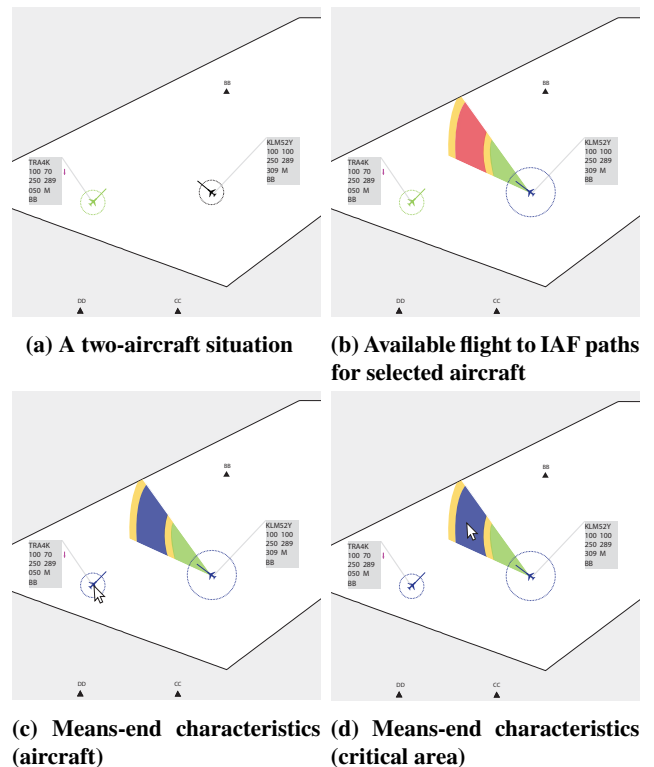

Fig. 9 Visualization of the available flight paths under current flight conditions

Figure 9a shows a scenario for the ITSS display in which an aircraft (green) is on its way towards the destination way-

point. Upon selecting the other aircraft (black), the available flight paths become clear for this aircraft (Figure 9b). The green color of the pixels in the vicinity of the aircraft indicate that if a direct-to command is given at one of those locations the aircraft will arrive *in front* of the other by at least 7 NM. Evidently, when the path length is increased the aircraft will take longer to reach its destination and this will influence the separation between the aircraft. If it continues along its current course and a direct-to command is given in the nearest orange area, the selected aircraft will still end up *ahead* of the other aircraft, but the margins will have become smaller. The red area indicates the locations for which a direct-to command would result in a safety violation at the IAF. The outermost orange area results in separation distance between 5 NM and 7 NM, where the selected aircraft is vectored *behind* the other aircraft. If an aircraft ends up *behind* by more than 7 NM, no color is given. This is done to minimize screen clutter, since there are continuously aircraft (further) ahead in a continuing merging task.

In situations involving more aircraft, the connection between red zones and the aircraft causing them is made evident by highlighting the aircraft when hovering over the red zone and vice versa. Figure 9c and Figure 9d show the means-end connection for a situation where the (enlarged) mouse is hovered over an aircraft that causes a conflict, and a situation where the mouse is hovered over a conflict zone, respectively.

When the aircraft on a direct-to path are not yet descending, this introduces an additional uncertainty. It is known that the aircraft needs to descend, but not where that command will be given. The algorithm assumes that all aircraft on a direct-to path are already descending towards the restricted height. Therefore, the cone visualization is not entirely accurate. However, flying for a longer period of time at a higher altitude will cause the aircraft to fly faster due to difference in True Airspeed (TAS) with height. Thus, a later descend command causes an aircraft to arrive at the IAF faster. So, when vectoring an aircraft behind, this does not influence the safety, since the separation margins can only increase. When an aircraft is commanded to go in front of an aircraft that is not yet descending, this could lead to dangerous situations. However, this is not a very common procedure. Besides, the visualization is recalculated every 5 seconds and will therefore also change over time when the aircraft descends at a later stage.

For multiple aircraft situations, as for instance illustrated in Figure 10, the visualizations are combined and the critical colors are given priority. Two critical areas are depicted. If a direct-to command is given at this moment, i.e. inside the first red zone directly emerging from the selected aircraft, this will result in a loss of separation at the IAF. Should the choice be made to order the aircraft to go straight towards the destination waypoint anyhow, the consequences of that decision can also be seen when no aircraft is selected. The orange color (Figure 10b) warns the user of a future conflict. A possible solution to this merging task is to let the aircraft continue along its

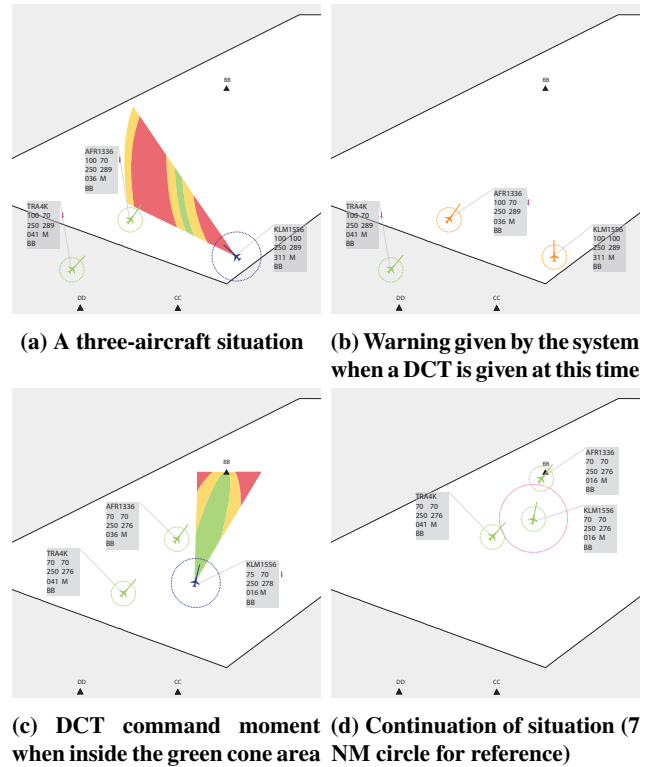

Fig. 10 Possible solution strategy using the available flight paths under current flight conditions

current trajectory until the green flight path region has been reached and to then give a direct-to command (Figure 10c). Figure 10d presents the separation result of that decision. A 7 NM distance is indeed kept with respect to both aircraft, as is illustrated by the 7 NM circle that is added for clarification purposes.

The visualization only takes into account the separation when arriving at the IAF. This means that the information needs to be combined with the previously explained relative track information to ensure separation within the sector.

F. Available flight paths for altered speed

Aside from performing calculations for current speed conditions, the display can also visualize flight paths with alternative speed information. This is done in a distinct display layer that, initiated by the operator, can be superimposed on the present solution. By means of a toggle function, the user can adjust speed used in the calculation inside the new layer with steps of 10 kts. The areas inside the flight cone that do not cause a safety violation are given a transparent grey color. Also, the fictitious aircraft speed is displayed within the aircraft label in a different color to notify the user which speed is now used in the visualization.

Figure 11a shows the available flight paths under the current conditions. The selected aircraft fits in-between the two (green) aircraft already on descent. The effect of changing the

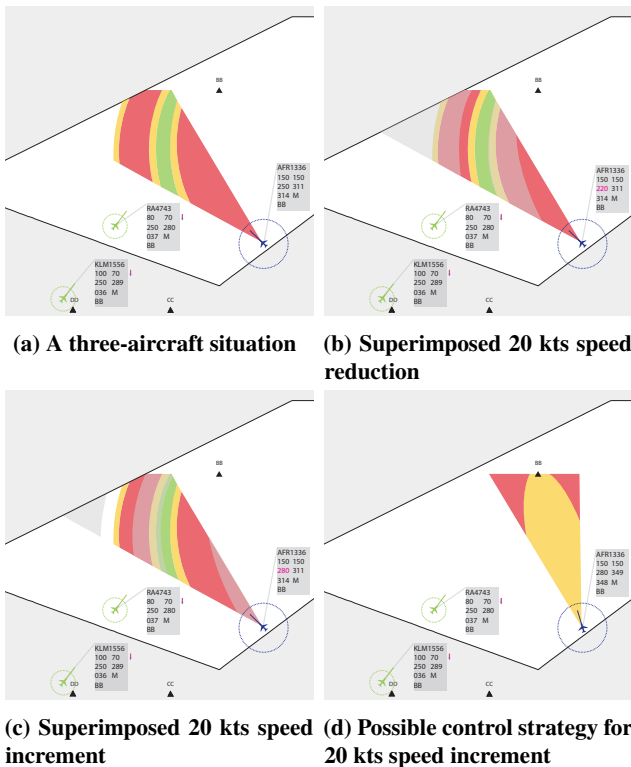

Fig. 11 The available flight paths under current and altered speed conditions

speed becomes apparent in Figure 11b. For reduced speed, the aircraft has to turn towards the destination waypoint earlier.

Alternatively, to increase throughput, the operator can examine if the selected aircraft can reach the IAF first. Figure 11c shows the same situation for increased speed. Since a new highlighted area becomes apparent, the aircraft is able to end up in front of both green aircraft with sufficient distance. The result of this solution is depicted in Figure 11d. The selected aircraft will indeed end up in front by at least 5 NM. If the user wants to extend this to 7 NM, additional measures have to be taken.

G. Combining all elements

Combining all the elements yields the display that is depicted in Figure 12. Aside from presenting the system as a whole, the figure also illustrates how difficult it is to establish what the best solution strategy is. A change in wind circumstances, completely changes the solution space, which underlines the usefulness of support. By showing what the effects are, we do expect the operator to be able to do more with the visualisation elements than just on the basis of his or her internal mental model.

In Figure 12a, a situation for a 25 kts uniform wind coming from the west is presented. According to the available flight paths visualization for current flight conditions, the aircraft is able to end up in-between two other aircraft (green) even

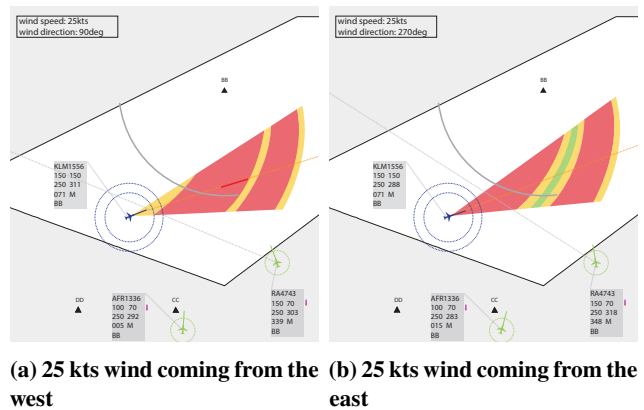

Fig. 12 The full display

though the margins are small. However, the relative track line crosses the 5 NM circle and a loss of separation will occur before reaching the direct-to location. A better solution for the current speed would be command the selected aircraft to go directly towards the IAF at this time. It will reach the IAF first with a separation distance between 5 NM and 7 NM.

Figure 12b shows the same situation for a 25 kts wind coming from the east. Here, the selected aircraft can no longer end up in front for present speed conditions. The relative track line illustrates that the aircraft will cross at more than 7 NM when following their current trajectories. Furthermore, the margins to end up in-between the aircraft have increased, making it a sensible solution.

IV. Professional Opinions

The proposed ITSS display is a first attempt to develop a new interface for handling the air traffic in the Amsterdam South Sector. To investigate the effectiveness of the proposed concept, two area controllers, ATCo A with 3 years of experience and ATCo B with 7 years of experience, were asked to assess the proposed solution. The purpose was to find out whether controllers were interested in the proposed solution and whether they would see themselves using such tools in the future. All of the complementary visual elements were first evaluated separately, and then as a whole, by means of a questionnaire.

Before working with the ITSS, both area controllers were asked whether they foresee a substantial change in their work in the upcoming years, and if they consider a human being a vital asset in a control task. This was done to see what attitude they had towards automation within their work domain. ATCo A indicated that he expected that system support will assist in providing relevant information that can be used to verify planned solutions. They both agreed that in unexpected circumstances human intervention is essential. Furthermore, ATCo A noted that as long as an ATCo legally has the final responsibility, he or she should also be the one making the decisions.

After using the ITSS display, both area controllers agreed that the proposed visualization elements could make the ATC control task easier. ATCo A stated: *"I see most benefit in spending less time checking and checking again if a situation will evolve the way I anticipated"*. ATCo B found that the system gave a *"clear input of when to give certain command"*. When asked if with further research (part of) this solution should be implemented in the future, ATCo A strongly agreed. He commented that specifically the merging and separation guidance would benefit the system currently in place. ATCo B agreed with the statement and noted that *"The circles and IAF separation would make our core task a bit easier"*. However, they also saw downsides. ATCo B wondered whether the benefits would outweigh the negative consequences of screen clutter. ATCo A also recognized screen clutter as an issue and noted that it would be interesting to pay more attention to what is useful in which case. Furthermore, the relative track line was received less positive than the other visual elements. It was described as *"too abstract"* and *"of no added value"*.

Overall, the professional controllers were quite positive. Both would like to see part of the proposed solution implemented, despite a reserved initial attitude. Moreover, they indicated that they wanted more time with the system to fully understand the meaning of all the elements.

In addition to the analysis of professional controller opinions, the effect the proposed interface has on performance was investigated by means of an experiment.

V. Experiment Set-up

The experiment aims to evaluate the effectiveness of the ITSS interface. It investigates how the new display elements affect safety and performance in ATC. Due to the busy schedules of the professionals, the experiment was performed using individuals with an affinity with the work domain.

A. Apparatus

The experiment was performed in a closed room at the Faculty of Aerospace Engineering. The participants used one monitor for the radar screen (Figure 12) on their left-hand side and on for the command window (Figure 4) on their right (both 1920x1080 pixels resolution). Commands were given by first selecting the aircraft on the left monitor and, subsequently, clicking the buttons on the command window on the right monitor.

B. Participants, Instructions and Procedure

Eight subjects participated, all can be considered as ATC domain experts. Most semi-expert participants had previously taken part in an extensive five-day Air Traffic Control course at the Netherlands Aerospace Centre (NLR).

All subjects got identical instructions. First, an instruction manual was read and 10 short training scenarios were carried out. Here, the participants could familiarize themselves with

the simulator. Then, after the training phase, participants had to answer pre-experiment questions to make sure they understood the visualization elements.

Before starting the experiment phase, all participants were told to safely guide the aircraft towards the IAF and hand them over to a (fictitious) approach controller. All aircraft had to arrive the IAF at FL 70. A difference of less than 10 FL was tolerated and was not registered as an violation of procedural compliance. Moreover, the aircraft had to reach the IAF indicated airspeed of 250 kts. Here a speed difference of less than 10 knots was allowed.

Primarily, participants had to prevent conflicts from happening. Besides, they were also instructed to guide traffic as efficient as possible. This implies that the throughput should be maximized to the extent possible, while keeping the workload manageable.

Aside from managing the air traffic, Transfer of Control (TOC) commands had to be given. A TOC command hands an aircraft over to the next sector. For inbound aircraft this means that an approach controller takes over. When a TOC command has been given, it is no longer possible to adjust the trajectory or speed of that aircraft.

C. Scenarios

Each participant conducted eight 12-minute scenarios. The experiment scenarios were created using flight data from the LVNL, such that they resembled reality as good as possible for the merging inbound traffic task. Evidently, air traffic controllers have more responsibilities than just merging incoming traffic. Hence, an inevitable discrepancy with reality was introduced.

Using the LVNL data, the number of inbound aircraft within the Amsterdam South Sector was recorded on a 24 hour time scale. An example of one 24 hour period can be found in Figure 13. These plots helped to create a clear picture of the typical quantity of the inbound traffic at Schiphol. It may be viewed that, for this specific day, there are at most 7 aircraft within the sector and that the area controller's work consists of peak moments. The inbound flight data were further analyzed based on the flight paths, speed and altitude of the traffic and then converted into traffic scenarios. Two complexity levels were distinguished; Medium and Hard. The complexity levels will be further explained in Section V.D. The Medium test scenarios were designed such that 4-5 aircraft are in the sector at the same time. The Hard test scenarios contain 5-6 aircraft simultaneously.

Since the simulator did not support giving commands automatically, the commands given by the previous controller in the LVNL data could not be re-created. Therefore, the aircraft emerged in the South of the sector at the moment they were transferred to the area controller within the data. Because of this, the participants could not see the aircraft approaching

their sector and were not able to include upcoming aircraft in their control strategy.

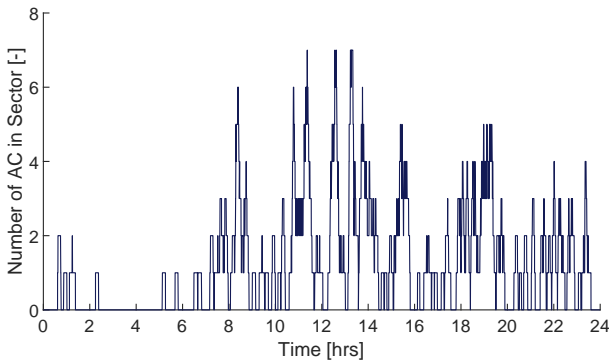

Fig. 13 The number of inbound aircraft in the Amsterdam South Sector at Schiphol in a 24 hour period

Within the designed test scenarios, the aircraft entered the sector between FL 200 and FL 220, with some outliers coming in at a higher or lower flight level. There were two types of aircraft within the scenarios, Medium and Heavy. Most aircraft landing at Schiphol fall into the Medium category. This category contains short- to medium-range airliners such as the B737, A320 and the E190. In the scenarios, Medium type aircraft entered the sector at 260-280 kts IAS. Heavy aircraft, such as the B747 and the A380, generally flew faster when entering the sector (at a speed of 310-320 kts IAS).

D. Independent Variables

Within the experiment two within-subject Independent Variables (IVs) were present that are depicted in Table 2.

Condition	Display Type	Traffic Intensity
1	CACS	Medium: 7 a/c
2	ITSS	Medium: 7 a/c
3	CACS	High: 10 a/c
4	ITSS	High: 10 a/c

Table 2 Independent variables and their conditions

The first IV, display type, has two levels; the Current Area Control System (CACS) and the Inbound Traffic Support System (ITSS). The CACS resembles the current radar display professionals at the LVNL work with. The second condition is the newly designed ITSS. When using this support system, the participant can use the distance circles, sector conflict detection and IAF spacing as additional cues to solve the conflict.

The second IV, traffic intensity, also had two levels; Medium and High. The Medium test scenarios consisted of seven aircraft in total and the Hard test scenarios consisted of ten aircraft in total. Each participant completed two scenarios per condition. Thus, eight scenarios were performed by

every participant. The Latin Square in Figure 14 shows the order of the scenarios per participant. Scenarios A, B, C and D can be distinguished. It can be seen that each participant solved all scenarios twice; once with the CACS display and once with the ITSS display. This way, the results could be better compared. The participants were not informed the scenarios were identical. Because the scenarios with Medium traffic intensity (A and B) were assumed to be easier, all participants performed these experimental conditions first.

		Order of Experiment Scenarios							
		Low Traffic (1-4)				High Traffic (5-8)			
Participant	1	A	B	A	B	C	D	C	D
	2	A	B	A	B	C	D	C	D
	3	A	B	A	B	C	D	C	D
	4	A	B	A	B	C	D	C	D
	5	B	A	B	A	D	C	D	C
	6	B	A	B	A	D	C	D	C
	7	B	A	B	A	D	C	D	C
	8	B	A	B	A	D	C	D	C

Fig. 14 An overview of Latin Square experiment matrix. White: CACS, Grey: ITSS

E. Control Variables

In an attempt to avoid confounds, the following Control Variables (CVs) were kept constant:

1. Apparatus,
2. Instructions,
3. Sector layout,
4. Aircraft performance, and
5. Simulator options.

The aircraft performance characteristics were constant throughout all scenarios. The descent rates and the speed limits were based on aircraft type. In addition, within the simulator, the update rate of the traffic was kept at 5 seconds. The wind conditions were uniform and constant throughout a scenario. Also, the visualization colors used were unaltered.

F. Dependent Variables

The Dependent Variables (DVs) will presumably change in response to the conditions of the IVs. The DVs measured to determine safety are:

1. Number of loss of separations,
2. Number of warning notifications, and
3. Duration of warning notifications.

As a measurement of safety, the loss of separations were logged throughout the experiment. The number of notifications for potential future loss of separations was recorded as well. A warning notification was given for a potential

LOS within 60 seconds. Furthermore, the duration of these notifications is saved.

For determining performance, the following DVs were recorded:

1. Number of Control Instructions,
2. Additional Track Miles,
3. Average Separation at the IAF,
4. Number of aircraft arrived at, and en route to towards approach control,
5. Number of violations of procedural compliance, and
6. Workload.

For each participant the number of control actions was recorded. The type of command was documented together with the location and time of the instruction. The tracks of the aircraft were logged and the number of additional track miles was established. Additional track miles are characterized as the difference between number of flown track miles to reach the IAF and the minimum track miles required for each aircraft to reach the IAF on a direct-to path. For each aircraft that arrived at the IAF, the separation with the preceding aircraft was recorded. This measurement illustrates the balance between safety and throughput. Besides, the number of aircraft en route to approach control was documented.

Due to time limitations, not all aircraft in a scenario reached the IAF before the end of the scenario. The number of aircraft en route to approach control consists of the aircraft that have already reached the IAF and the aircraft that are on a direct-to path towards it. This measure provides an insight into the number of aircraft handled after 12 minutes and, thereby, how efficient the user operated. When a direct-to command results in a safety violation at the target waypoint, this is also documented. When an aircraft reached the IAF, it was checked whether the participant adhered to the control task. If a difference in altitude greater than 10 flight levels with respect to the required value was detected, it was registered as a violation of procedural compliance. Moreover, each subject needed to indicate Instantaneous Self-Assessment (ISA) ratings of their subjective workload once every minute throughout the experiment [12].

The subsequent DVs are used to confirm if the user made use of the additional visual functionalities when using the ITSS display:

1. Number of aircraft clicks,
2. Number of hovers,
3. Number of uses of the speed toggle, and
4. Number of uses of the 7 NM circle.

Throughout the scenarios, the number of aircraft clicks was recorded. Aircraft clicks are required to give commands, but when using the ITSS display, clicks also provide additional visual information for the selected aircraft. Moreover, the

activity of the hover function, the speed toggle, and the 7 NM circle toggle was logged. These options were only available for the ITSS display condition.

G. Hypotheses

The DVs are expected to change in response to the IVs. Concerning the difference between the CACS and the ITSS, the following hypotheses are made.

1. Safety
 - 1.1. Participants can handle traffic safely; no loss of separations occur with both interfaces.
 - 1.2. When using the ITSS interface, the number of warning notifications decreases.
2. Workload
 - 2.1. Use of the ITSS interface results in a reduction of ISA workload ratings for complicated scenarios.
 - 2.2. When using the ITSS interface, the workload is slightly increased for the medium scenarios.
 - 2.3. When using the ITSS interface, the workload shifts to an earlier moment in time.
3. Performance
 - 3.1. The number of control instructions will decrease for the complicated scenarios in the ITSS condition.
 - 3.2. The number of violations of procedural compliance in flight level will decrease when using the ITSS interface.
4. Use of the Interface
 - 4.1. Participants will use the visual assistance tools available in the ITSS display.
 - 4.2. The number of aircraft clicks will increase due to the use of the ITSS display.

VI. Results

Within this section, the experiment results for safety, workload, performance and use of the interface are presented. For each DV, the non-parametric Wilcoxon signed-rank was used to test for statistical significance. To correct for having numerous hypotheses, a Bonferroni correction (significance level of $p = 0.05/2$) was applied.

When the results were analyzed, it became apparent that the two scenarios that were supposed to have the same level of difficulty in the high traffic intensity condition had not. Even though the same number of aircraft were used, one of the scenarios was considered a lot more difficult than the other. Therefore, it was decided to consider each scenario as a different condition in analyzing the results. It is important to note that, by doing so, the Latin Square matrix in Figure 14 is no longer correct. To create a correct experiment for the new conditions at least 16 participants would have been necessary.

A. Safety

In ATC safety is of utmost importance and separation should always be maintained. For the semi-expert participants, the number of loss of separations was recorded and the warning notifications were investigated.

1. Loss of separation

The most crucial safety measure is the number of times a loss of separation occurs. Figure 15 shows that this only happened for the complicated scenarios C and D. Four safety violations were found when using the CACS display. When using the ITSS display, two safety violations were detected. One of those happened when the participant disregarded the information provided by the system and noted that this particular loss of separation was no issue, since it happened close to the IAF and the aircraft would come closer together during final approach anyway. It was hypothesized that no loss of separations would occur. This was not the case; the semi-professional users did not maintain separation at all times. This can probably be attributed to the lack of experience.

When comparing the interfaces, fewer loss of separations happened when using the ITSS display, although a statistical significance could not be proven. The Wilcoxon signed-rank test gave ($Z = -.577$, $p = 0.564$) for Scenario C and ($Z = -1.000$, $p = 0.317$) for Scenario D.

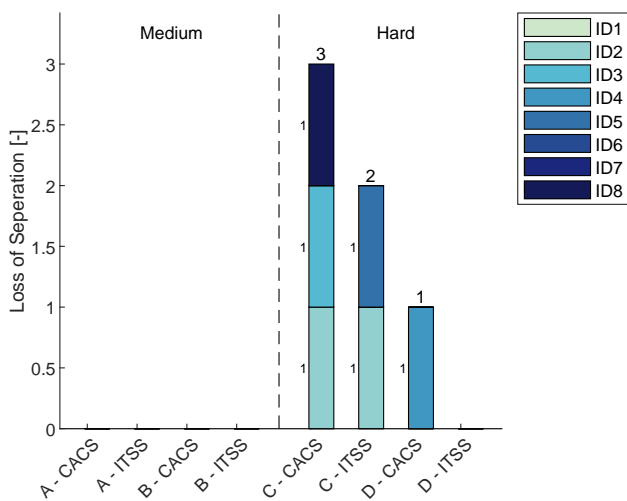

Fig. 15 The number of times a loss of separation occurred, per scenario

2. Number of warning notifications

When a warning notification was given for both the CACS and the ITSS display, the user was informed using red aircraft colors and an aural alert. When no action was taken, such a notification would result in a loss of separation within 60 seconds. Figure 16 shows the number of warning notifications, per scenario for each participant. A first thing that stands out is the five warning notifications in the ITSS Scenario A conditions. Possibly, the participants were still getting used to

the display. Scenario A using the ITSS display was the first condition Participants 2 and 4 tested. Therefore, a learning effect could be the cause of the notifications.

Scenario C contains a lot more warning notifications than Scenario D in both conditions. This difference can be explained by the unintended difference in complexity between the two scenarios. In theory, the user could have foreseen the warnings when using the additional display elements and could therefore have prevented them from happening. For some participants, the sudden appearances of aircraft on the screen led to unforeseen situations that caused them to change their current strategy. This sudden change can account for some of the notifications, that could no longer be prevented.

Furthermore, it is possible that the user did not have the capacity to take full advantage of the functionality when performing under high pressure. The extra information can be overwhelming when you do not have sufficient time to look at it. For other participants the notifications in the ITSS condition were a conscious choice. Because the exact location of loss of separation was evident, some participants were willing to let the aircraft get closer to each other. Participant 1 said: "I can better estimate the moment I need to give commands and that gives me more confidence to do it tighter." Initially, this was not taken into consideration. It is noteworthy that even though the numbers for Scenario D are equal, different participants caused these notifications.

It was hypothesized that the number of warning notifications decreases when using the ITSS interface, but this turned out not to be the case. In the Wilcoxon signed-rank test, there was no significant difference between the display conditions; Scenario A ($Z = -1.890$, $p = 0.059$), Scenario B ($Z = -1.000$, $p = 0.317$), Scenario C ($Z = -0.333$, $p = 0.739$) and Scenario D ($Z = 0.000$, $p = 1.000$).

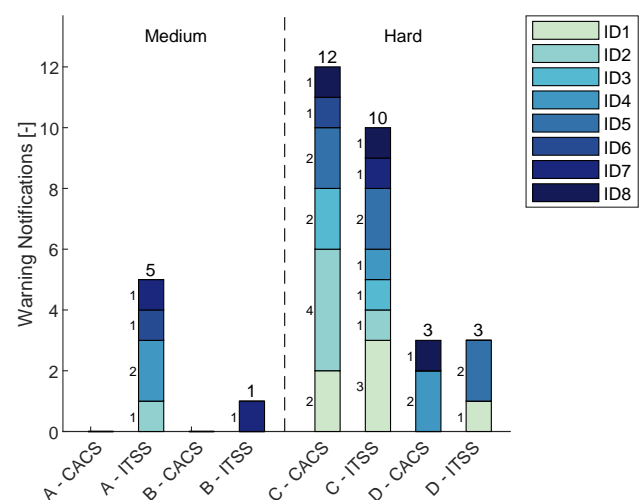

Fig. 16 The number of warning notifications, per scenario

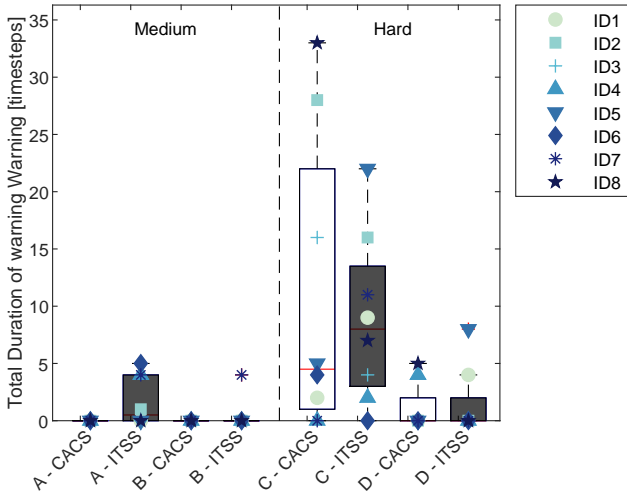

Fig. 17 The total duration of a warning notifications, per scenario

3. Duration of warning notifications

Figure 17 presents the total duration of the warning notifications per participant. Each time step corresponds to 5 seconds, which is the radar update rate. It may be observed that all the notifications given for Scenario A in the ITSS conditions were resolved quickly. Also, the average duration of warning notifications is higher for the ITSS display Scenario C. Again no statistical difference was found. The Wilcoxon signed-rank test found Scenario A ($Z = -1.841$, $p = 0.066$), Scenario B ($Z = -1.000$, $p = 0.317$), Scenario C ($Z = -0.421$, $p = 0.674$) and Scenario D ($Z = -.184$, $p = 0.854$).

B. Normalized ISA workload

In Figure 18, the normalized ISA Workload, as perceived by the controller, is presented. In Scenario A, the ITSS workload has a higher average and a higher standard deviation. For Scenario B, the standard deviation for the ITSS condition is also larger than the CACS condition, whereas the mean is just slightly lower. In the hard scenarios, the mean is higher for Scenario C and lower for Scenario D in the ITSS display condition. When considering all the scenarios, there is no clear trend that shows the effect of using the ITSS display. The Wilcoxon signed-rank results were as follows; Scenario A ($Z = -1.960$, $p = 0.050$), Scenario B ($Z = -0.140$, $p = 0.889$), Scenario C ($Z = -1.260$, $p = 0.208$) and Scenario D ($Z = -0.980$, $p = 0.327$).

For none of the scenarios the CACS display and the ITSS display were found to be significantly different. It was hypothesized that the ITSS display would slightly increase workload for the medium scenarios. An increase in workload can be observed, although statistically non-significant. This could indicate that the additional information provided extra workload, because the user had to monitor more things, whilst gaining more insight into the complexity of the problem. In the relatively simple scenarios the users did not need the additional information to solve the situations at hand. Thus, the visualization elements require attention from the controller

without providing much benefit.

For the complicated scenarios it was hypothesized that the workload would decrease when using the ITSS interface. It was expected that by showing the possible solution strategies, the controller could better anticipate the effects of his or her control decisions. In a more demanding environment this would potentially lead to fewer decisions that had to be adjusted throughout the scenario and a decrease in required monitoring time. Thereby, leaving the controller with more time to think. This turned out not to be the case. For some participants the visualization elements worked as expected, but others did not have sufficient time to make use of the elements. Thus, a large spread between participants is visible in the data. The data also vary per individual. Participant 3 gave the highest score of all participants in the ITSS Scenario A condition and the lowest score in the ITSS Scenario C and ITSS Scenario D condition. This is partly due to a lack of experience for the semi-professional participants. The complexity of a scenario is strongly related to the choices made. If problems are created at the beginning of a scenario, this can be hard to recover from.

Another thing that influenced the workload ratings is that the scenarios were stopped after 12 minutes. The future workload was visible in the ITSS condition due to the visualization elements, but was unclear in the CACS interface. The ISA workload ratings only measure the perceived workload and in some cases participants thought everything was under control even though this was not the case. Their choices would have led to potential safety violations after 12 minutes, but they were not yet aware of this.

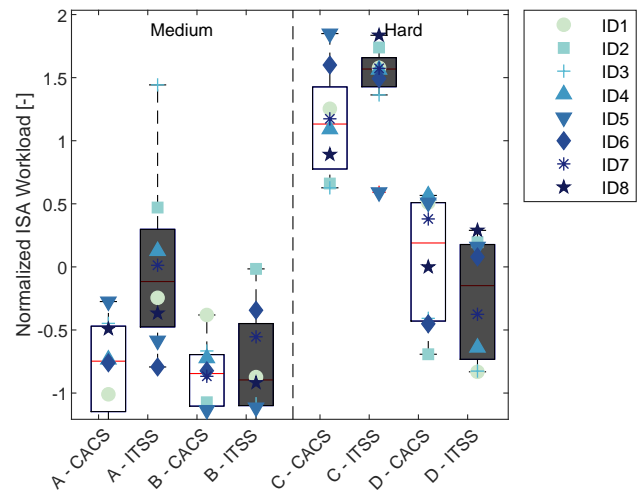

Fig. 18 The normalized ISA Workload, per scenario

C. Performance

The performance of all participants was investigated and will be presented in this section.

1. Number of commands

As a first indication of performance, the number of commands was recorded. Figure 19 shows the total number of commands given. The total number of commands consists of the commands that alter the trajectory of the aircraft and the transfer of control commands. In the Medium scenarios, the values are approximately constant across conditions. Wilcoxon signed-rank gives; Scenario A ($Z = -1.187, p = 0.235$) and Scenario B ($Z = -1.103, p = 0.270$). A difference can be seen between participants. Some use more commands than others.

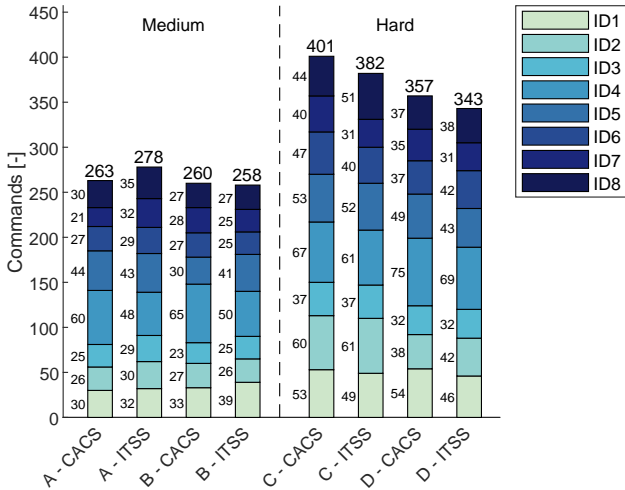

Fig. 19 The number of commands given, per scenario

In the Hard scenarios, a difference between Scenario C and Scenario D can be observed. Furthermore, it is visible that fewer commands are used when using the ITSS display. This is in line with the hypothesis that the number of control instructions will decrease for the complicated scenarios in the ITSS condition. It is possible that, when additional information is provided, previous control commands no longer have to be adjusted.

This notion is further supported by the data in Figure 20. Here, a cumulative plot of the commands over time is presented for Scenario D. The first few minutes the values are approximately the same. But as the scenario progresses the difference becomes larger. Even though a trend is visible the results are statistically non-significant. Wilcoxon's analysis gives; Scenario C ($Z = -1.187, p = 0.235$) and Scenario D ($Z = -1.103, p = 0.270$).

2. Violations of procedural compliance

In the control instructions, the participants were told all aircraft had to arrive at the IAF at FL 70. A difference of more than 10 FLs was considered a violation of procedural compliance. Figure 21 shows the number of times an aircraft reached the IAF at an altitude higher than FL 80. A clear distinction between the CACS display condition and the ITSS display condition is present. The circular arc visualization was clearly helpful for the participants in determining whether

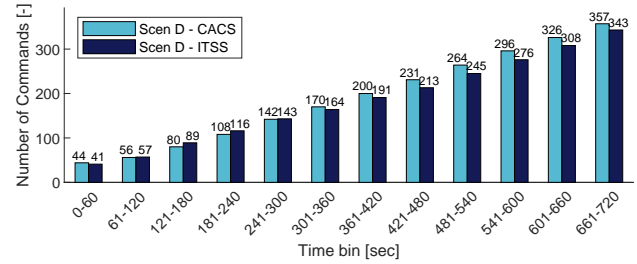

Fig. 20 The cumulative number of commands given over time for Scenario D for the CACS and ITSS condition

an aircraft was still able to lose its energy before reaching the target waypoint. The descent arc element was relatively easy understood, requires no extra training, and provides a clear insight into a problem of the Amsterdam South Sector; there is very little room in the sector and descent commands have to be given early.

As a result of the information from the ITSS condition, the participants knew for the remaining other scenarios that prompt action was important. For Scenario A, the Wilcoxon signed-rank test was found to be significant after applying the Bonferroni correction ($Z = -2.646, p = 0.008$). For Scenario B ($Z = -1.342, p = 0.180$) and Scenario C ($Z = -1.414, p = 0.157$) the trend was apparent but could not be statistically substantiated. The hypothesis that the number of violations of procedural compliance in flight level will decrease for the ITSS condition seems probable, but could not be confirmed for all conditions.

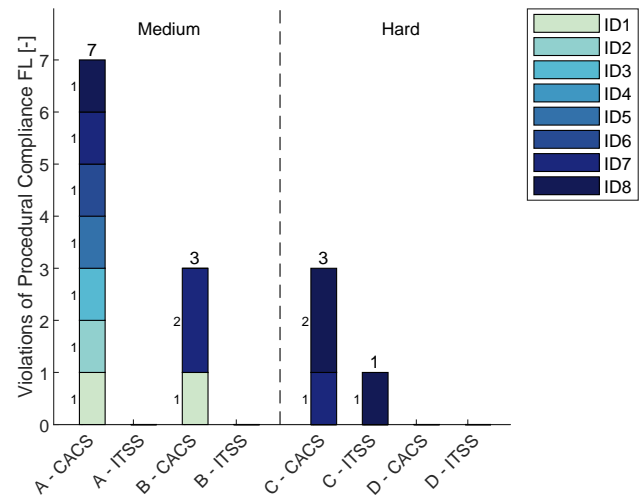

Fig. 21 Number of violations of procedural compliance for FL

3. Additional track miles

Figure 22 depicts the additional track miles, per participant. This is a summation of the difference between the number of flown track miles and the minimum track miles needed to reach the IAF for all aircraft. The values are similar for the

CACS and ITSS condition. It can be observed that in Scenario C, which was considered more difficult, the aircraft travelled a longer path. Besides, it can be seen that the data are widely dispersed between participants. Participants had varying skill levels and different solution strategies. Participant 4 did not take any chances when under pressure and elongated the path of the aircraft by a lot more than other participants. The outlier in the CACS Scenario A condition is due an erroneously given TOC command. Participant 7 gave this command by accident, and because of this, the aircraft kept flying in the direction it had at that time.

No statistical significance was found using the Wilcoxon signed-rank test; Scenario A ($Z = -1.120$, $p = 0.263$), Scenario B ($Z = -0.700$, $p = 0.484$), Scenario C ($Z = -0.840$, $p = 0.401$) and Scenario D ($Z = -0.700$, $p = 0.484$). This is in line with the hypothesis.

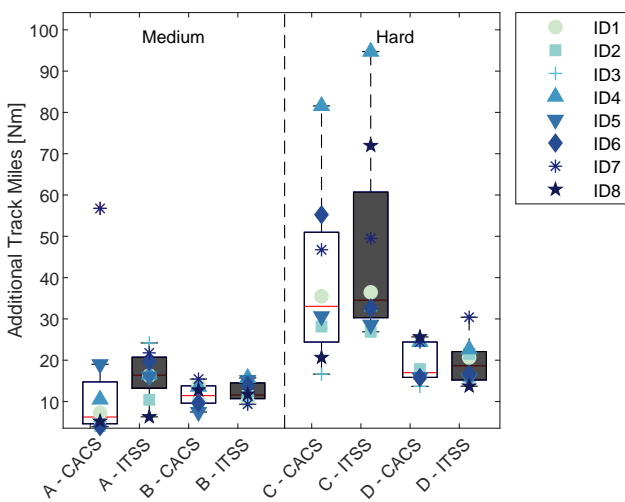

Fig. 22 The number of additional track miles travelled, per scenario

4. Separation at the IAF

As a measure of performance, the separation at the IAF was recorded. For each aircraft that arrived at the IAF the distance with respect to the aircraft in front was logged. Moreover, for the aircraft that had not yet reached the IAF and were on a direct-to path towards it, the separation data were extrapolated. Figure 23 presents the number of aircraft that have reached the IAF or are on a direct-to path towards it. Instead of showing it per participant, the figure shows the "correct" and "incorrect" movements for all participants combined. Incorrect movements are those that would result in a loss of separation at the IAF. The data indicate how many aircraft have been handled by the controller after 12 minutes and therefore illustrates how efficiently the user operated. The figure illustrates that in some cases the aircraft will, under current conditions, experience a loss of separation at the IAF. This does not mean this will be the case, but it *does* imply that future action is required to prevent this from happening. This measurement is therefore closely related to the workload measurement. When no additional information is provided,

the user may have the impression that everything is going all right even though this is not the case. For the Medium scenarios when using the ITSS, an increase in the number of handled aircraft can be observed. Scenario D shows a similar amount of aircraft sent towards the IAF for the CACS and ITSS condition. Within the ITSS display condition, no aircraft need to be adjusted. This means a calmer continuation of the scenario after 12 minutes. However, when considering Scenario C, this is not the case. A lower number of aircraft has been sent towards the destination waypoint and additional commands are still required. This might mean that under high pressure conditions, participants were not able to fully benefit from the additional information provided.

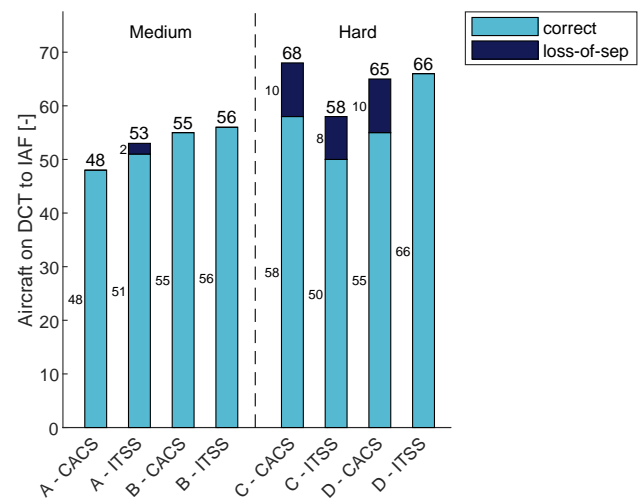

Fig. 23 The number of aircraft on a direct-to path towards the IAF

Figure 24 depicts the mean separation at the IAF. The information is a combination of the actual and the extrapolated data. It can be seen that the mean separation is higher for the Medium scenarios. This makes sense; a controller only wants to decrease the separation between aircraft when it results in increased throughput. Performing the Wilcoxon signed-rank test gave; Scenario A ($Z = -0.840$, $p = 0.401$), Scenario B ($Z = -0.840$, $p = 0.401$), Scenario C ($Z = -1.680$, $p = 0.093$) and Scenario D ($Z = 0.000$, $p = 1.000$). For Scenario D, the sum of negative ranks equaled the sum of positive ranks. Results for the CACS display were found to be not statically different than those obtained with the ITSS display.

5. Performance per scenario

For each scenario, the position of all aircraft after 12 minutes was inspected. The spatial location of the aircraft was visualized and problematic cases were emphasized in red. Thereby, the consequences of the choices made could be easily represented. Figure 25 shows an example of a situation in which the ITSS display proved to be of added value. It depicts the CACS display and ITSS display for Scenario D, as they were when the scenario ended for Participant 2. In the CACS display condition, five aircraft are en route towards the

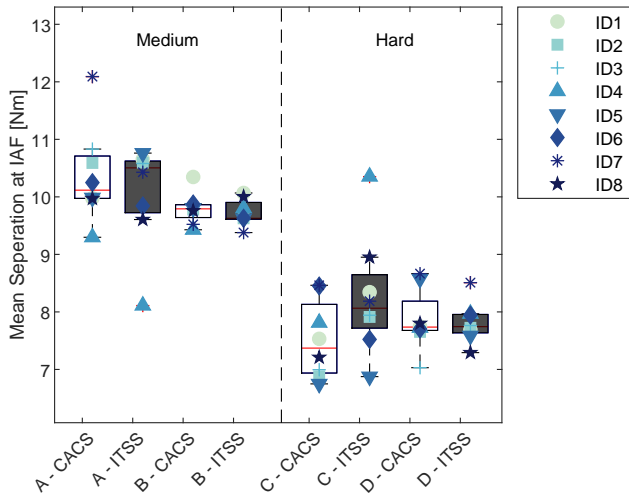

Fig. 24 The average separation at the IAF in NM for extrapolated data, per scenario

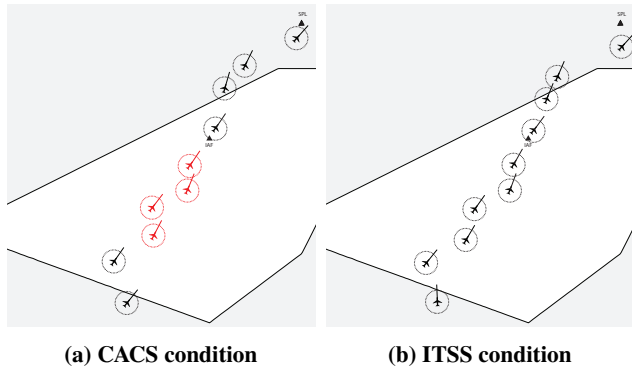
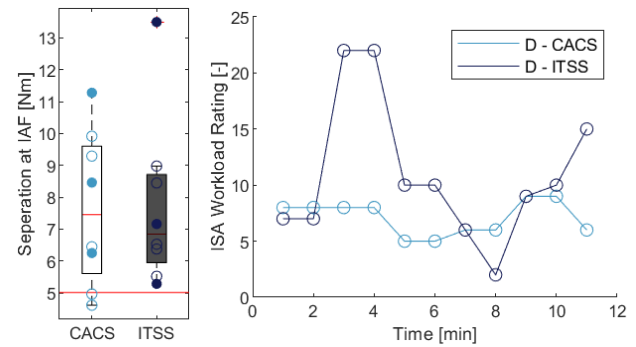

Fig. 25 Final situations for Scenario D and Participant 2

destination waypoint. However, for the situation as it is now, future problems are expected. If the situation is continued, the planes will come too close together and additional control actions will be required. The ITSS condition looks similar, but here the aircraft have been merged successfully and no further control actions are needed. Figure 26a shows the separation values at the IAF for both scenarios. The filled circles represent the aircraft that have not reached the IAF yet, whereas the transparent circles stand for the predicted separation. For the CACS display, two points are indeed below the 5 NM threshold.

In Figure 26b the workload throughout the scenario is displayed. For the proposed new concept, the workload is fluctuating and a lot higher in the initial phase, as was hypothesized. For the CACS condition, the workload ratings are more stable during the 12 minutes. The increased initial workload for the ITSS display could be caused by the visualization elements that make all restrictions immediately apparent. Even though the workload is currently stable in the CACS display, an increased workload is expected at a later stage as a result of potential safety violations. This illustrates that the full effect

of the decisions made is not always present in the data after 12 minutes.



(a) IAF separation **(b) Workload over time**

Fig. 26 Scenario D performance for Participant 2

In Figure 27, a situation is depicted where the ITSS display was not used as was intended. The CACS condition does not show any peculiarities. When using the ITSS display, the participant noticed he was too late to give several descend commands. He tried to solve the problem by elongating the aircraft paths without properly taking the other aircraft into account. Officially, this did not result in a loss or separation within the 12 minutes of the simulation, but a loss of separation could only have been prevented in the subsequent minutes using an altitude command. Figure 28a shows a predicted separation of 5.5 NM, because it only considers the separation when the aircraft reaches the IAF. An increased workload rating for the ITSS condition is present in Figure 28b. More training might help users to understand the elements better and remain calm when confronted with the limited space available in the sector. Potentially, this would make the performance data more consistent.

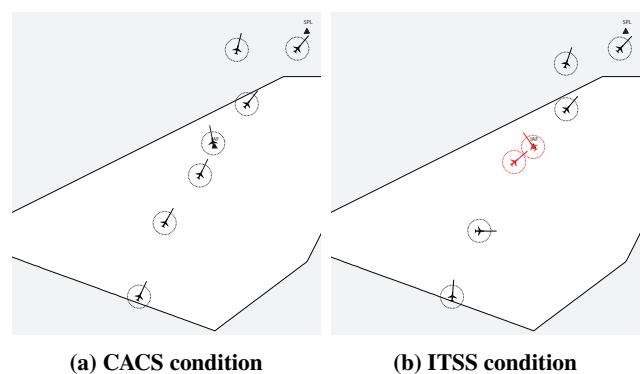

Fig. 27 Final situations for Scenario A and Participant 4

D. Use of the Interface

To verify whether participants used the additional functionalities of the ITSS display, the use of the interface was investigated.

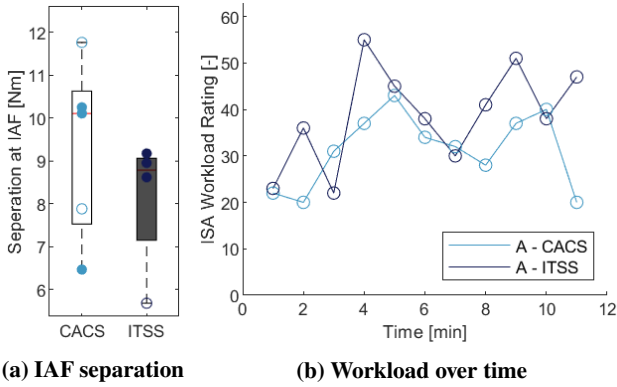

Fig. 28 Scenario A performance for Participant 4

1. Aircraft clicks

Figure 29 depicts the number of times an aircraft was selected. To make use of the visual extensions in the ITSS display, the user had to interact with the display by selecting an aircraft. It may be observed that for each scenario the ITSS display was selected more frequently than the CACS display.

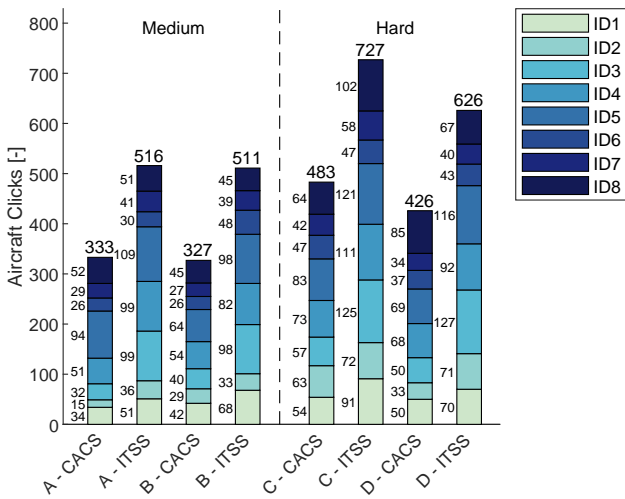

Fig. 29 The number of times an aircraft was selected, per scenario

It was hypothesized that the number of aircraft clicks would increase due to the use of the ITSS display. This indicates that users were indeed gathering additional information to solve the situation at hand. In the Wilcoxon post hoc analysis the difference was significant for Scenario A ($Z = -2.380$, $p = 0.017$), Scenario B ($Z = -2.366$, $p = 0.018$) and Scenario C ($Z = -2.384$, $p = 0.017$). Scenario D ($Z = -2.103$, $p = 0.035$) was not found to be significant after applying the Bonferroni correction.

2. Use of means-end relationship of a safety violation

The number of times the user explored the means-end relationship of a potential safety violation was also monitored. How often the user hovered the cursor over a conflict region, or the aircraft causing the conflict, is depicted in Figure 30 and

Figure 31, respectively. It can be seen that the functionality in both figures was used most in Scenario C. This makes sense, since Scenario C was perceived as more complicated and safety notifications took place more frequently. In the case of more conflicts, the users make more use of the functionality to help them work out a solution to the situation. Besides, a difference between the participants is visible; for example, Participant 3 made use of the cone conflict detector more often than others throughout all scenarios.

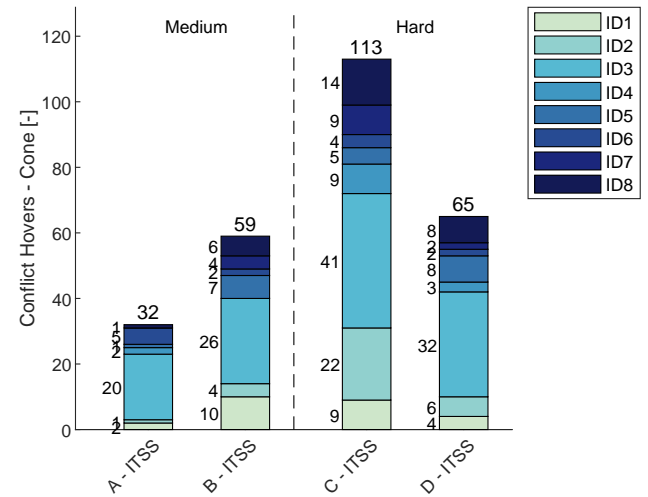

Fig. 30 The number times the conflict hover function was used for a conflict region inside the cone, per ITSS scenario

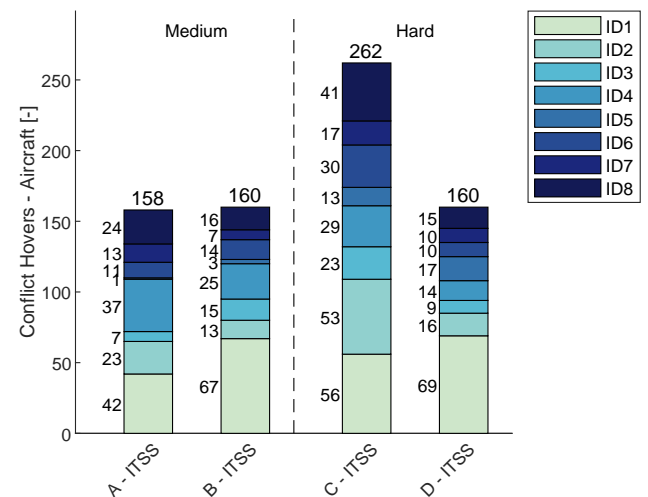

Fig. 31 The number times the conflict hover function was used by hovering over an aircraft, per ITSS scenario

3. Use of speed toggle

In Figure 32, the number of times the speed toggle function was used per ITSS scenario is visible. The speed toggle function was used more frequently in the more complicated scenarios. It could be that if there are fewer aircraft in the

sector it is simpler to resolve the situation without issuing speed changes. Additionally, it could be argued that that users increasingly understood the usefulness of the speed function. This functionality is relatively complicated and the practice in the medium scenarios may have helped to increase understanding. Striking is that only three participants used the speed toggle function in Scenario C. These users made extensive use of this functionality. Other participants did not have time to probe to see the consequences of speed commands, or did not think a speed change was a correct method to resolve the situation, or did not consider it altogether.

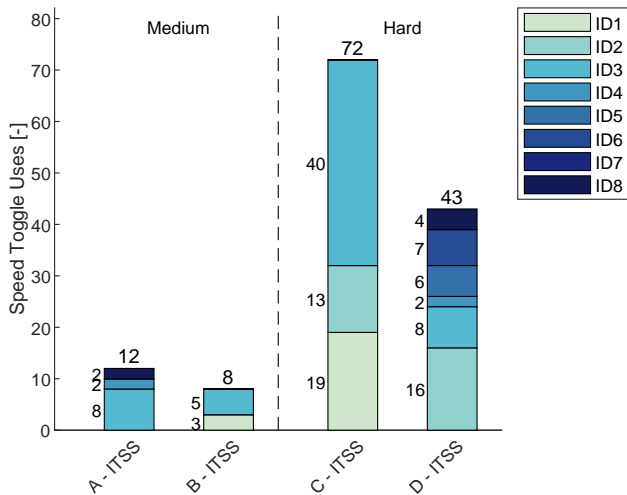

Fig. 32 The number times the speed toggle was used, per ITSS scenario

4. Use of 7 NM circle

The number of times the 7 NM circle toggle was used is shown in Figure 33. In Scenario C, this functionality was only used once by Participant 3. The plot illustrates that participants had no time to focus on things that were not safety-critical when performing under high pressure. Also, it can be noted that not all participants made use of this functionality.

VII. Discussion and Recommendations

The main objective of this research was to investigate whether the radar display of an area controller, within the Amsterdam South Sector, could be enhanced for the purpose of a merging task. The research set out to keep the controller as the active decision maker, to prevent a potential decrease in situation awareness, and to decrease the risk of non-acceptance of the automated tools.

The proposed ITSS display has succeeded in mapping the complexity of the Amsterdam South Sector, while the user retains full control. The display clearly indicates that there is indeed very little room for the descent maneuver due to the size of the sector, and the user is made aware that control strategies have to be made quickly. It was hypothesized that number of violations of procedural compliance in flight level

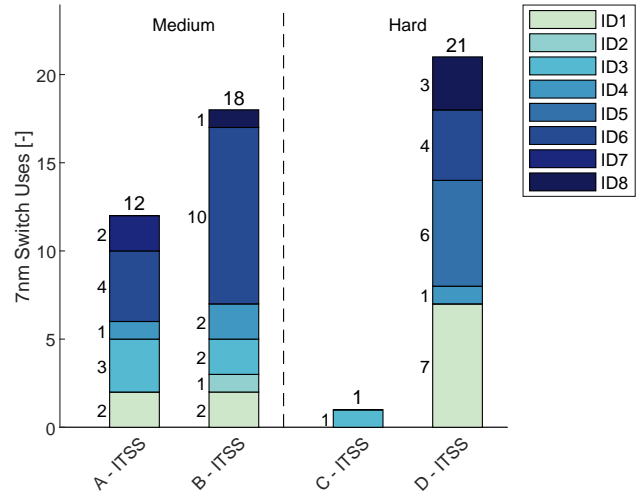

Fig. 33 The number times the 7 NM circle toggle was used, per ITSS scenario

would decrease for the ITSS condition. The results show that this seems probable, but it could not be statistically confirmed for all conditions.

Moreover, it was hypothesized that no loss of separations would occur. This was not the case; the semi-professional users did not maintain separation at all times. This can probably be attributed to the lack of experience. When professional area controller make use of the interface it is still expected that safety violations do not occur.

Also, it was hypothesized that the number of warning notifications would decrease when using the ITSS interface. This did not happen. It could be that the controllers did not have capacity to take full advantage of the functionality when performing under high pressure. Besides, it was found that some participants were willing to let the aircraft get closer to each other when they had the additional information at their disposal. They felt more confident, because the exact location of loss of separation was evident.

Furthermore, the results showed that the additional information did not always lead to a better control strategy. This section discusses the variation in controller behaviour, the limitations in the experiment design and the link between the proposed system and the current systems used at the LVNL.

A. Controller Behaviour

The ITSS display intended to support the controller's tasks in merging aircraft. When using the display, participants were made aware of upcoming safety violations at an earlier stage and were thereby forced to think about solutions sooner. It was hypothesized that the workload would shift to an earlier moment in time. This turned out to be the case for some participants.

It was hypothesized that the ITSS display would slightly increase workload for the medium scenarios, because the op-

erator has to process the additional information. Although the trend was visible no statistical difference was found. For the complicated scenarios it was hypothesized that the workload would decrease when using the ITSS interface. It was expected that by showing the possible solution strategies, the controller could better anticipate the effects of his or her control decisions. However, when examining the data, it became clear that the additional visual elements did not necessarily have the desired effect. Some participants performed differently than expected. They created hazardous situations, possibly because they were at times somewhat overwhelmed by the amount of information. This is supported by the comments users gave. Participant 1 said to be "*overtaken by events*" and Participant 4 said he had "*no time to use the tools*". This confirms the notion that, for a complex work domain, EID-inspired interfaces can have a workload-increasing effect [13].

This difference between participants was also visible for the control commands. It was hypothesized that fewer commands would be used when using the ITSS display in the complicated scenarios. Ideally, when additional information is provided, previous control commands no longer have to be adjusted, because the consequences of the commands are already visible at the moment they are given. Although a decreasing trend was visible, the difference was more evident for some participants than for others. The decreasing trend was supported by the analysis of commands over time. As the scenario progressed, the difference between the CACS interface and the ITSS interface became larger.

Research revealed that interfaces inspired by ecological interfaces are not simple and will not eliminate the need for extensive learning and training [13]. The LVNL professionals indicated they thought the ITSS display would make their task easier. This difference could be attributable to the difference in skill level between the experiment participants and trained professionals.

A difference was also visible in the analysis of the use of the interface. It was hypothesized that the number of aircraft clicks would increase due to the use of the ITSS display. The user had to interact with the display to see the additional information. The hypothesis was confirmed by the data. Furthermore, it was hypothesized that participants would use the visual assistance tools available in the ITSS display. It was observed that the participants indeed made use of the visualization elements and that some participants made more use of the functionalities than others. It was also noticeable that for some elements, such as the speed functionality, the perceived workload influenced whether the elements were used. In demanding conditions some participants made little use of the additional information.

This may change with more training. Perhaps more training sessions will teach the operators how to use the functionalities even under demanding circumstances. This could then also have a positive influence on the performance parameters.

Hence, for future research, it is recommended that more training time is scheduled in order for the participants to fully understand and get used to the additional systems. Perhaps, more time with the system will ensure that full use is made of the functionality and reduce the distribution in the data. Also, it is strongly recommended to do an experiment with professional controllers. It is expected that, when working with professionals, the performance between participants is a much more constant and the effects of the display will be more clear.

B. Experiment Design

The experiment data were found to be non-significant in most cases. The variation in control behavior has influenced this, but in addition, the lack of significance may be attributable to low sample size of only 8 participants. The experiment was performed with limited resources and within limited time. Due to the lack of time, the scenarios had to be stopped after 12 minutes. Therefore, not all the effects of the control decisions were visible in the data. It is recommended that for future research a larger group of participants is used and that the full effect of control decisions is evaluated for a longer time.

Furthermore, in the execution phase of the experiment, it became clear that the scenarios varied in complexity. This is partly due to the appearance of aircraft throughout the scenarios. To make the scenarios as realistic as possible, real LVNL flight data were used for the creation of the scenarios. Since the simulator did not support giving commands automatically, the commands of the previous controller could not be re-created. The choice was made to make the aircraft appear the moment they were transferred to the controller within the data. By doing this, the users could not account for aircraft yet to come in their control strategy. For some participants, this had a substantial impact, because they had to abruptly deviate from their initial plan. For future research, it is recommended to adjust the simulator such that commands within the data issued by a previous controller can be given automatically by the system.

Besides, it has been observed that only the number of aircraft is not a good measure of scenario difficulty. Therefore, it is recommended to take other measures of complexity, such as dynamic density, into account when designing the scenarios [14].

C. Workplace Implementation

One of the requirements was that the display must be implementable inside the current LVNL systems with minor modifications. The ITSS display was designed to correspond as much as possible with current LVNL systems and all calculations are made in real time. However, the designed display was a first concept and consequently there was a gap between simulation and reality. The proposed concept only considered a merging task whereas in reality controllers must also handle outbound and crossing traffic.

Within the simulator, wind was implemented to make the calculations more realistic. However, the wind in the simulator was constant and uniform over height. Wind conditions provided by the Royal Dutch Meteorological Institute (KNMI) could help make the wind conditions more realistic and are already available at the LVNL.

Furthermore, there is a discrepancy between the instantaneous execution of a command in the simulator and the real operation where the controller depends on pilots. Pilots impose a delay on the execution of commands. Therefore, a sensitivity analysis that investigates the effects of delays in commands is needed before potential implementation.

Furthermore, it is recommended that display clutter is reevaluated per use case. The design can be overwhelming, whereas some information might only be useful in specific situations. Should this be the case, then the number of display elements can be decreased and display clutter can be limited. This may have a positive effect on performance.

In addition to the practical objections, there must also be widespread support among Air Traffic Controllers before a solution could be implemented. The Air Traffic Control sector is conservative due to the high-risk safety-critical operation. Two controllers inspected the ITSS display and expressed their positive interest in the concept. Two is too small a group to draw definitive conclusions, but it does show the potential of the proposed concept. The professionals also voiced their concerns about the display clutter. Therefore, future research should investigate whether benefits of additional information outweigh the negative consequences of screen clutter for well-trained professionals.

VIII. Conclusion

This research set out to map the challenges of a merging task within the Amsterdam South Sector. The objective was to develop an interface that visualizes the possible solutions to a merging task, such that the impact of decisions made can be foreseen. Two professional area controllers expressed their interest in the concept, but emphasized the problems screen clutter could cause. In an experiment, the difference between the proposed concept and the operational system was investigated for semi-professional participants. It was found that, when using the proposed interface, the aircraft arrived at the IAF at the required height more frequently. Hence, the controller could better estimate whether an aircraft would adhere to the altitude restriction. Although non-significant, fewer commands were given in difficult scenarios. Time analysis of control commands supported the notion that when additional information is provided, fewer control adjustments had to be made. The aircraft trajectories and separation at the IAF remained unchanged. No clear trend was found for workload. It does seem that proposed interface can at times increase the workload by revealing conflicts earlier. This forces the user to think about control strategies earlier. Furthermore, a difference

was found between the participants when observing individual performance. Some participants made use of the tools as was intended, whereas others were at times overwhelmed by the amount of information. The difference was also present in the use of the interface measurements. Future research should investigate the effects the display has on professional area controllers. The effects of training should be researched and it should be investigated if the benefits of additional information outweigh the negative consequences of screen clutter, especially for ATC professionals.

References

- [1] International, Civil, Aviation, and Organization, "Procedures for Air Navigation Services, Air Traffic Management," , November 2001. Doc 4444.
- [2] LVNL, "Schiphol Traffic Data," , September 2019. Inhouse data.
- [3] Westerveld, E., "Voorstudie Oplossen knelpunten sector 3," , February 2016.
- [4] SESAR, "The Roadmap for Delivering High Performing Aviation for Europe: European ATM Master Plan," , March 2015.
- [5] Klomp, R. E., Riegman, R., Borst, C., Mulder, M., and van Paassen, M. M., "Solution Space Concept: Human-Machine Interface for 4D Trajectory Management," *13th USA/Europe Air Traffic Management Research and Development Seminar*, 2019.
- [6] Westin, C., Borst, C., and Hilburn, B., "Strategic Conformance: Overcoming Acceptance Issues of Decision Aiding Automation?" *IEEE Transactions On Human-Machine Systems*, Vol. 46, No. 1, 2016, pp. 41–52.
- [7] Molesworth, M. R. C., and Williamson, B. R., "Why Air Traffic Controllers Accept or Refuse Automated Technology," in *16th International Symposium on Aviation Psychology*, 2011, pp. 615–620.
- [8] AIS the Netherlands, "Airspace Structure and ATS Airspace Classification," , 2015.
- [9] van Paassen, M. M., Borst, C., Ellerbroek, J., Mulder, M., and Flach, J. M., "Ecological Interface Design for Vehicle Locomotion Control," *IEEE Transactions On Human-Machine Systems*, Vol. 48, No. 5, 2018, pp. 541–555.
- [10] Vicente, K. J., and Rasmussen, J., "Ecological Interface Design: Theoretical Foundations," *IEEE Transactions on Systems, Man, and Cybernetics*, Vol. 22, No. 4, 1992, pp. 589–606.
- [11] Vicente, K. J., and Rasmussen, J., "The Ecology of Human-Machine Systems II Mediating "Direct Perception" in Complex Work Domains," *Ecological Psychology*, Vol. 2, No. 3, 1990, pp. 207–249.
- [12] Tattersall, A. J., and Foord, P. S., "An Experimental Evaluation of Instantaneous Self-Assessment as a Measure of Workload," *Ergonomics*, Vol. 39, No. 5, 1996, pp. 740–748.
- [13] Borst, C., Flach, J. M., and Ellerbroek, J., "Beyond Ecological Interface Design: Lessons from Concerns and Misconceptions," *IEEE Transactions on Human-Machine Systems*, Vol. 45, No. 2, 2015, pp. 164–175.
- [14] Kopardekar, P., and Magyarits, S., "Dynamic density: measuring and predicting sector complexity," 2002, pp. 2C4–1. doi:10.1109/DASC.2002.1067920.

Part II

Literature Review and Preliminary Research (*Graded under AE4020*)

Ecological approach to an en-route Air Traffic Control merging task

MASTER OF SCIENCE PRELIMINARY THESIS

For obtaining the degree of Master of Science in Aerospace Engineering
at Delft University of Technology

E.S.Bakker

Delft, September 13, 2018

Preface

For the past three months, I have worked on the preliminary phase of my thesis. I have learned a lot within the field and I feel like I have made substantial progress in this period. For the most part, I have enjoyed the process of graduating. At times I have found it difficult to find the next step within the design process. Thank you Max Mulder, Clark Borst and René van Paasen for helping move in the right direction and being willing to help me every step of the way. I look forward to the next phase of my thesis, in which I hope to contribute something to the Air Traffic Control sector.

Delft, September 13, 2018

Nomenclature

ACC Area Control Centre
AH Abstraction Hierarchy
APP Approach Control
ATC Air Traffic Control
ATCo Air Traffic Controller
ATM Air Traffic Management
CAS Calibrated Airspeed
CCIS Closed Circuit Information System
CD&R Conflict Detection and Resolution
CPA Closest Point of Approach
CTA Control Area
CTR Control Zone
CWA Cognitive Work Analysis
DCT Direct-to
EAS Equivalent Airspeed
EAT Expected Approach Time
EFL Executive Flight Level
EID Ecological Interface Design
FBZ Forbidden Beam Zone
FIR Flight Information Region
GS Ground Speed
HDG Heading
IAF Initial Approach Fix
IAS Indicated Airspeed
IATA the International Air Transport Association
ICAO International Civil Aviation Organization
KBB Knowledge-Based Behavior
LVNL Luchtverkeersleiding Nederland
MUAC Maastricht Upper Area Control Centre
RBB Rule-Based Behavior

RNAV Area Navigation

RPI Relative Position Indicator

SBB Skill-Based Behavior

SPD Speed

SRK Skills, Rules and Knowledge Taxonomy

SSD Solution Space Diagram

STCA Short Term Conflict Alert System

TAS True Airspeed

TOC Transfer of Control

TSD Time-Space Diagram

TSR Travel Space Representation

TSVD Time-Space and Vertical Display

UTA Upper Airspace

XFL Exit Flight Level

List of Figures

2.1	The Amsterdam Flight Information Region [32]	7
2.2	Schematic representation of the airspace division [11]	7
2.3	Dutch airspace structure and ATS airspace classification [28]	8
2.4	The Amsterdam South sector	9
2.5	Standard arrival chart Schiphol [27]	9
2.6	Work-space of an Area Controller [20]	11
2.7	The sector 3 radar screen used at the LVNL	11
2.8	Label as is visible on a radar screen [36]	11
2.9	Sample label as is visible on a radar screen [36]	11
3.1	Track definitions as defined by ICAO [21]	14
4.1	Levels of abstraction representing the physical implementation and Functional Purpose in varying degrees, as developed by Rasmussen [23]	20
4.2	A portion of an Abstraction Hierarchy for a hypothetical scientific research program in human factors. [37]	21
4.3	Decision Ladder including the Skills-, Rules- and Knowledge-Based behavior domains [5]	22
4.4	The Skills-, Rules-, Knowledge Taxonomy [22]	22
5.1	Vehicle locomotion control as a multi-loop control problem. [34]	25
5.2	Air Traffic Control as a hierarchy of nested control problems at different time scales. [34]	25
5.3	Abstraction Hierarchy for CD&R in ATC [4]	25
5.4	Calculation of CPA in traditional plan view presentation [31]	26
5.5	Possible solutions (numbers 1 to 3) to a conflict situation using an SSD approach. [31]	26
5.6	Solution Space Diagram developed for the Navigation Display in a cockpit [31]	27
5.7	Solution Space Diagram developed for the Air Traffic Control Plan View Display [4]	27
5.8	Conflict types and their visualizations within the SSD. [6]	27
5.9	Implicit means-ends relations between conflict zones and aircraft plots [4]	28
5.10	Experimental display for merging aircraft with the SSD [35]	28
5.11	The SSD used as interface for merging aircraft [35]	29
5.12	The Travel Space Representation (TSR) of a conflict situation. [17]	30
5.13	The Time-Space and Vertical Display [16]	31
5.14	The speed envelope in a Time-Space Diagram [33]	31
5.15	Detection of a forbidden zone in the TSD of aircraft A, caused by aircraft B when both trajectories are in the horizontal plane [33]	32
5.16	Time-space line and typical forbidden zones for aircraft A. The zones are caused by aircraft B and differ in shape, depending on the 3DT of A and the 4DT of B.[33]	32
5.17	Sketches of typical forbidden zones in the VSD of aircraft A, due to aircraft B, for situations in the vertical plan [33]	33
5.18	Conflict resolution through lateral instructions. The first resolution provides a solution without causing a delay and would be preferred. [29]	33
5.19	Detailed sketch of the TSVD when an aircraft is selected [29]	33
5.20	Schematic diagram of the RPI application [19]	34
5.21	RPI display for choosing the traffic flow the aircraft joins [19]	34
5.22	RPI display for identifying the last aircraft before a runway change [19]	35
5.23	RPI display for identifying the first aircraft after a runway change [19]	35
6.1	The created Abstraction Hierarchy for a merging task	39

7.1	The LVNL radar display in the rapid-prototyping environment	43
7.2	The black and white radar display in the rapid-prototyping environment	43
7.3	The command display in the rapid-prototyping environment	43
7.4	Visualization of the last possible descent moment for three situations	45
7.5	Initial indication of waypoint arrival order	45
7.6	Example of a dog-leg procedure	46
7.7	Visualization of the available flight paths under current flight conditions	47
7.8	Visualization of the effects on changing speed	49
7.9	Visualization of the impact of changing the descent point	50
7.10	An example of combining visualizations from multiple aircraft situations	51
7.11	The proposed EID for an Area Controller's merging task	51

List of Tables

3.1	Conflict types for situations involving two aircraft	14
7.1	Rate of descent values used per aircraft type [20]	44
7.2	Color given based on time difference at arrival	46

Contents

Nomenclature	v
List of Figures	vii
List of Tables	viii
1 Introduction	1
1.1 Background	1
1.2 Problem Statement	1
1.3 Research Question	2
1.4 Report Structure	3
I Literature Review	4
2 Present Air Traffic Control Structure	6
2.1 Airspaces	6
2.2 The Amsterdam South Sector	7
2.3 Area Control Tasks and Responsibilities.	10
2.4 Area Control Equipment	10
3 Best Practices	13
3.1 Relevance of ATC Heuristics.	13
3.2 Conflict Definitions	14
3.3 Rules of the Air	14
3.4 Heuristics for Resolving Potential Conflicts	15
3.5 ATC practice in the Amsterdam South Sector	18
4 Principles of Ecological Interface Design	19
4.1 The Abstraction Hierarchy	19
4.2 The Decision Ladder	20
4.3 The Skills-, Rules-, Knowledge Taxonomy	21
4.4 The Relevance of EID in Air Traffic Control	23
5 Air Traffic Control Applications of Interface Design	24
5.1 The Influence of Defining Boundaries	24
5.2 The Solution Space Diagram	25
5.3 The Travel Space Representation	29
5.4 The Time-Space and Vertical Display	30
5.5 The Relative Position Indicator	34
5.6 Implications for the New EID	36
II Part 2: Preliminary Research	37
6 The Preliminary Work Domain Analysis	39
6.1 Abstraction Hierarchy.	39
6.2 Aircraft Performance Constraints	40
7 The Preliminary Display Design	42
7.1 Means Used to Design the Display	42
7.2 Current Assumptions	43
7.3 Visualizing the Last Possible Descent Moment	44
7.4 Visualizing the Available Flight Paths Under Current Flight Conditions	45
7.5 Visualizing Speed Changes	48

7.6 Visualizing Impact of Descent Point.	50
7.7 Visualizing Multiple Aircraft.	50
7.8 Overview of the Preliminary Display	51
8 Concluding Remarks	52
A Airspeeds	53
Bibliography	54



Introduction

1.1. Background

In the past decades, the air traffic industry has increased tremendously. More and more people are traveling by air, both for recreational and business purposes. The International Air Transport Association (IATA) reveals an 80% growth in global passenger numbers since 2005 and expects the total number of passengers to grow further till 7.2 billion passengers in 2035 [12]. This is nearly double the air travelers registered in 2016. In the Netherlands the increasing trend is also present. At Schiphol Airport, the yearly air traffic movements recorded have increased by over 200% since 1992 [24].

Within this increasingly crowded airspace Air Traffic Management (ATM) is responsible for leading the aircraft safely through the air. The increase in air traffic poses new challenges for ATM. In order to facilitate the growth in traffic movements, new ways of approaching air traffic have to be developed. Especially in Air Traffic Control (ATC), the part of ATM that safely separates and guides aircraft whilst they are flying, new developments are expected. Studies have indicated that the workload of an Air Traffic Controller (ATCo) is likely the biggest functional limitation on the capacity of the ATM system [10]. Currently, Air Traffic Controllers are obligated to take a break after 2 hours and 20 minutes due to the demanding nature of their work. A higher traffic density obviously causes a higher workload as more aircraft have to be cleared and guided through the air. Besides this, it also leads to increasingly complex situations involving more aircraft at the same time, which increases workload even further.

Thus, in order to facilitate the future increase in air traffic, new systems have to be developed without compromising safety regulations. Automation is expected to have a large role in the development of new systems. When using automated systems, it is important to ensure the human operator remains part of the control loop. With more automation in a system that still incorporates human control, the role of the human becomes more critical. This is emphasized by the ironies of automation [3]. A system with automation is more complicated than a system without it. However, people tend to assume it is the other way around. Moreover, automation takes away the practice possibilities of a controller and leaves the controller with a monitoring task, which is not something humans are generally good at. So, to create a successful new system, it is crucial to also look at the connection the automated system has with the controller.

1.2. Problem Statement

An Area Controller needs to separate aircraft from each other for safety purposes and at the same time he/she has to efficiently guide the aircraft towards their destination. Aircraft typically arrive from all directions in the sector. Some of these are aircraft are flying through the sector, others have just taken off or are getting ready to land. The increasingly crowded airspace results in a higher workload for an Area Controller. Area Controllers working in the Dutch Air Traffic Control sector are already working at the limits of their capability [30]. Forecasts show that the amount of aircraft flying through the sector is only expected to increase. Therefore, smart systems that assist Air Traffic Controllers are needed.

However, assisting a controller is not straightforward. These people work within a complex work domain and have to make fast decisions. Interviews with Dutch Air Traffic Controllers revealed that control decisions are made within seconds [30]. Assisting tools should therefore make the possible solutions apparent, without requiring a lot of time from the controller. Moreover, the controller has a lot of freedom in deciding what to do. It is possible to alter the ground track, the height along this ground track and the speed of each individual aircraft. This means there are many different solution strategies. Besides, the controller has to work with many different aircraft types. Each of these aircraft types has other performance characteristics. Heavy aircraft fly faster than light aircraft and leave a larger area behind them that has to be kept free. Descent rates vary a great deal between aircraft types. These differences in performance make the task more complicated. Controllers get extensive training to be able to do this, but it remains a very demanding task. The assisting tool should enable the controller to be aware of the full set of possibilities.

One of the tasks of an Area Controller is to merge the aircraft towards an Initial Approach Fix. This task is especially complicated due to the descending flight paths. Aircraft fly faster compared to the ground with the same indicated airspeed. Thus, it is hard to estimate when and at what distance the aircraft will cross paths. Still, the distance between aircraft can not be too large, since this leads to congestion at a later stage. When the Area Controller is assisted in the merging task this could lower his/her workload. Besides, the decisions made in the merging task strongly impact the workload of the Approach Controllers. When the aircraft deviate from their planned arrival time this can lead to issues in the next sector.

Hence, Area Controllers would benefit from support in the merging task. Therefore the main objective is the following;

To assist the Area Controller in the decision making process of a merging task, whilst taking into account the controller's capabilities and current work domain.

In order to accomplish the previously determined objective, a scope has been defined to frame the research conducted. This thesis will focus on solving the objective using the principles of Ecological Interface Design. This design framework that shows the affordances of the system has proven to work well in complex work domains. When the goal-relevant properties and constraints of tasks are identified, controllers can make effective use of their human perception and action capabilities. Previous work using the EID framework has shown good results in the Air Traffic Control sector [31] [16].

The interface will be created for *current* Air Traffic Control support, using the information and technology that is currently available. Furthermore, the Amsterdam South sector is chosen as a starting point for the design. An additional complexity of this sector is its size. The small sector gives the controller less room to maneuver. The display will be created specifically for this sector and can later be extended to match other sectors.

1.3. Research Question

Bearing in mind the background information and the problem statement, three research questions are formulated to guide the research throughout the thesis. All questions are supported by sub-questions.

(1) What information would support the Air Traffic Controllers task of merging aircraft towards a restricted waypoint in an approach maneuver?

- (a) What are good practices in current Air Traffic Control?
- (b) What are the aircraft's performance constraints in aligning aircraft for approach?

(2) How is the supporting information in the task of merging aircraft towards a restricted waypoint best visually presented using the principles of Ecological Interface Design?

- (a) How to make the affordances of good Air Traffic Control practice visible on a screen?

(3) Does the designed Ecological Interface increase the performance of an Air Traffic Controllers task of merging aircraft in an approach maneuver towards a restricted waypoint?

- (a) How to quantify the quality of the operator's decisions?
- (b) How to set up a human-in-the-loop experiment to test performance?

1.4. Report Structure

This report consists of two main phases; the literature survey and the preliminary research. In the literature survey relevant knowledge from previous research is presented. First, the current Air Traffic Control practices are analyzed. Chapter 2 presents the current state Air Traffic Control is in. The most important regulations and goals are presented along with the tools available to achieve these goals. In Chapter 3 the heuristics controllers use to solve conflicts are evaluated. This thesis will try to assist controllers current solution methods using the principles of Ecological Interface Design. Chapter 4 explains the principles of this method. In Chapter 5, examples of this method in the field of Air Traffic Control are explained. Even though the final design does not necessarily have to resemble one of these designs, valuable lessons can be learned from the design process of these interfaces.

The preliminary research starts with an evaluation of the work domain in Chapter 6. In Chapter 7, the current state of the preliminary display is explained. Finally, concluding remarks and the steps that will be taken next can be found in Chapter 8.

Part I

Literature Review

2

Present Air Traffic Control Structure

The current commercial flight industry has been increasing over the past decades and is expected to increase even further in the upcoming years. Within this increasingly crowded airspace, Air Traffic Management (ATM) ensures safe and efficient flight. This chapter will elaborate upon the current rules and procedures within the part of Air Traffic Control (ATC) that is located at the Area Control Center (ACC) and the role an Air Traffic Controller (ATCo) has within ATM.

Firstly, in Section 2.1, the current airspace divisions and associated responsibilities for each division are explained. An more detailed explanation of the Amsterdam South sector is given in Section 2.2. In Section 2.3, the tasks of an Area Controller are explained. The Area Controller has equipment available to perform the tasks described. Section 2.4 gives an overview of the available work material. Rules and regulations for ATC do not define solution strategies, because one straightforward solution is often not present in this complex work domain. A separate chapter (Chapter 3) is devoted to the decision making process and the development of best practices using the equipment at hand.

2.1. Airspaces

The airspace is divided into different regions to ensure save and efficient air travel. The largest division of airspace is the Flight Information Region (FIR). A FIR is defined in all areas where it has been determined that flight information service and alerting service will be provided for aircraft. Around the world the airspace is divided into these regions. In small countries, such as the Netherlands, there is only one FIR. The Dutch Amsterdam FIR can be found in Figure 2.1. Within a FIR three-dimensional segments can be identified. These sections depend on, among other things, flight level and proximity to an airport. Figure 2.2, shows a graphical representation of the Dutch Amsterdam FIR and one airport located within the FIR. The figure shows the controlled airspaces within the FIR. At the highest level there is the Upper Airspace (UTA), defined as the entire airspace with a flight level that exceeds 245. This airspace is mainly used for aircraft flying over the Netherlands and is controlled by Eurocontrol's Maastricht Upper Area Control Centre (MUAC). Below this the Luchtverkeersleiding Nederland (LVNL) is responsible for controlling the airspaces. The Control Area (CTA) is controlled by the ACC. The arriving aircraft are merged to all arrive at the Initial Approach Fix (IAF) within a certain speed range and at a certain flight level. The other way around, departing aircraft are safely guided trough the airspace and handed to other airspace sections to safely reach their destination. From the IAF onward, Approach Control (APP) controls the terminal control area (TMA). The TMA is a designated area of controlled airspace around an airport. The last part of descent and the first part of ascent are handled by the Tower Control; in the Control Zone (CTR) they ensure save landing and take-off at the airport.

Each three-dimensional segment of airspace is assigned a class, that has been defined by The International Civil Aviation Organization (ICAO) [21]. The classes differ in their need to be controlled by ATC, the allowed flight equipment and whether or not a flight plan and radio contact in required. Class A has the strictest regulations and Class G is valid when the least amount of regulations apply. In the Netherlands, a relatively large part of the country is Class A airspace. All CTA's and and the larger TMA's fall within this class. The following rules hold for class A:

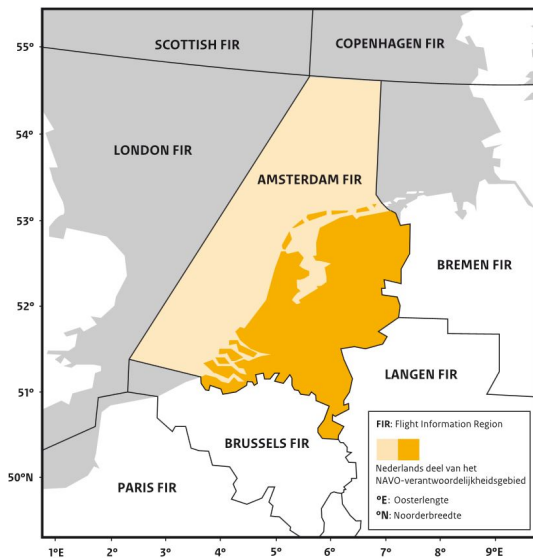

Figure 2.1: The Amsterdam Flight Information Region [32]

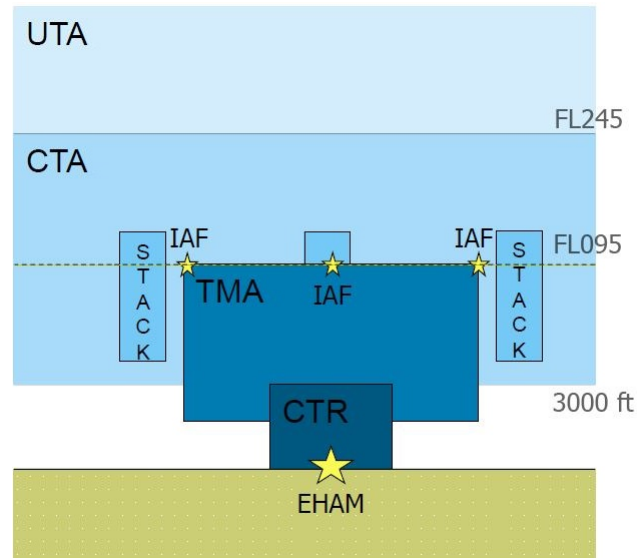

Figure 2.2: Schematic representation of the airspace division [11]

**All aircraft must be controlled and separated from each other by ATC.
Radio contact and ATC clearance are obligated for each aircraft.
Only IFR flights only are permitted.**

A full overview of the Dutch Amsterdam FIR is available in Figure 2.3. It contains the full airspace structure and classification. For each airspace region, with a corresponding class, the associated flight levels and boundary regions are visible. The larger airports have a CTR that falls into class C and the smaller airports have a CTR with class D. The TMA area guarded by an Approach Controller can belong to multiple classes. The TMA areas around Schiphol belong to class A. As an Air Traffic Controller located at the area control centre, all airspaces that can be controlled are Class A. There are six CTA regions defined, as is indicated using the yellow lines in the map. An Area Controller will be responsible for one of these regions and hand over aircraft to another controller when traffic reaches the boundary of the airspace.

2.2. The Amsterdam South Sector

One of the CTA's in the Dutch airspace is called the Amsterdam South sector and is also known as Sector 3. It is for this sector that the assisting display is developed. Figure 2.4 shows the boundaries of this sector. The boundary coordinates are drawn on top of a map to give a clear indication of its size. It spans 90NM horizontally and 50NM vertically, which corresponds to 167km and 93km, respectively. One Area Controller is responsible for all traffic within this area between FL55 and FL195. It can be observed that the region in Figure 2.4 does not fully correspond to the sector in the Dutch airspace structure 2.3. This is because the sector has been changed and the maps have not been updated yet.

The Area Controller has to merge the aircraft that are on their way to a nearby airport towards an IAF. This is a defined space that marks the beginning of the initial segment and the end of the arrival segment. From there an Approach Controller takes over. In Sector 3, the IAF is called RIVER. It is located close to Hoek van Holland. At RIVER every airplane has to be between FL70 en FL100 and at a maximum speed of 250kts. When the flight level is above 70 the must be descending towards FL70 at RIVER. It is the Area Controller's task to make sure this always happens. RIVER has multiple arrival routes. The standard arrival routes are visible in Figure 2.5. The routes from DENUT, HELEN and PUTTY join at Haamstede. At RIVER the traffic from PESER is combined with the traffic form Haamstede. Figure 2.5 also shows the holding pattern at RIVER.

From RIVER onward, the traffic is landed on one of the runways at Schiphol. Usually the traffic uses runway 06, runway 18 center or runway 18 right (Figure 2.5). When an airplane is supposed to land at runway 06 this impacts the required flight level at RIVER. Since the flight path towards runway 06 is remarkably short an aircraft must be at FL70 at the IAF.

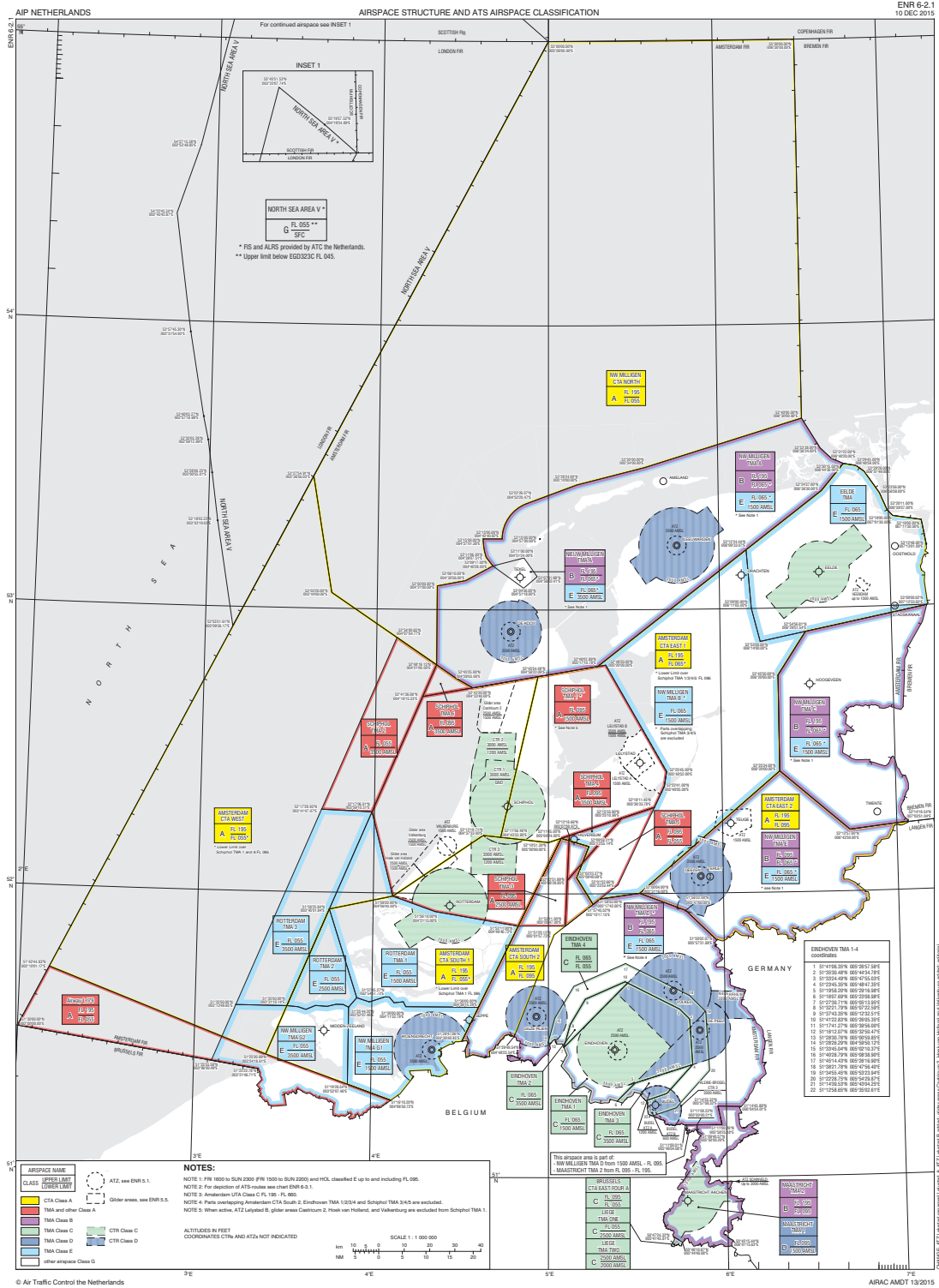

Figure 2.3: Dutch airspace structure and ATS airspace classification [28]



Figure 2.4: The Amsterdam South sector

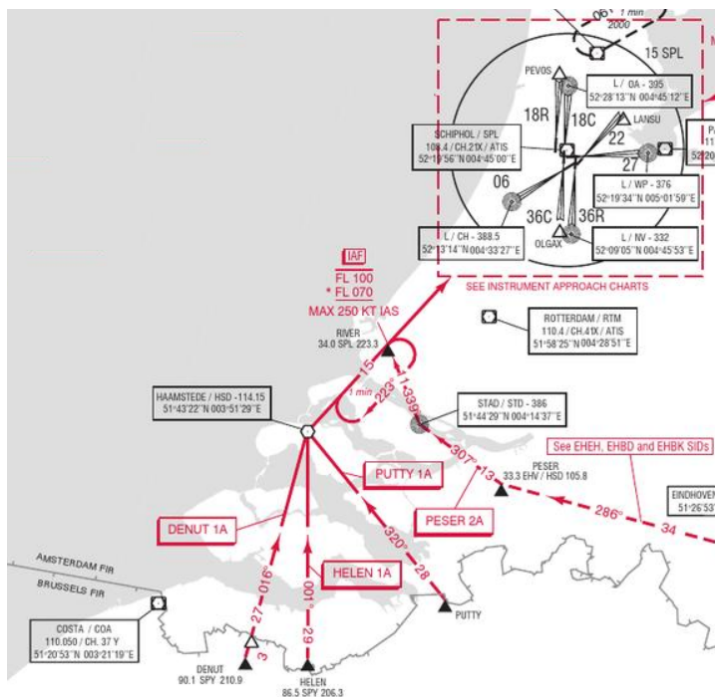

Figure 2.5: Standard arrival chart Schiphol [27]

The Amsterdam South sector is considered to be hard to control because of three reasons. Firstly, because it is relatively small. There is little space for the aircraft to maneuver in and therefore no time to correct misestimates. Secondly, a lot of traffic going to Schiphol arrives from the south. As a consequence, this sector has to deal with a greater number of planes in general. Lastly, the sector has to deal with a lot of different types of traffic. Within the small space there are aircraft ascending from and descending to Schiphol. But, there is also traffic going towards and arriving from the surrounding airports such as Rotterdam Airport, Lelystad Airport and Eindhoven Airport. Moreover, there is traffic passing through in the longitudinal and lateral plane.

The controller must separate all this traffic. The surrounding aircraft also restrict the possibilities the controller has in the merging task. This makes the merging task more complicated than it is in the surrounding sectors. Aircraft typically arrive at the sector in a descent maneuver. In an interview with current Area Controller it was mentioned that in high workload conditions a controller only has a couple of seconds to decide on a strategy [30]. The communication towards the pilot also takes time. The controller has to call the pilot and takes about 10 seconds to inform the pilot of the assignment. The pilot repeats back the message, which takes another 10 seconds. The controller also mentioned that the workload in the Amsterdam South sector is not constant and that traffic generally arrives in peaks.

2.3. Area Control Tasks and Responsibilities

The previous section showed how airspace sections are defined. This section includes the objectives Air Traffic Controllers have to work with and the regulations within the airspace section the controller is responsible for.

According to ICAO rules the controller is obligated prevent collision between aircraft and between aircraft and obstructions. Furthermore clearance between all flights in the airspace has to be given by the controller. This means that for an aircraft to proceed under specified conditions within controlled airspace authorization has to be given. When aircraft move outside the responsibility boundaries they have to be handed over to another Air Traffic Controller. It is important to make sure the controllers located at approach and in the tower can still manage the workload given to them, when aircraft arrive at the IAF. These requirements form the following main objective of the Area Controller's job:

Provide aircraft with advice and information required for the safe and efficient conduct of on-route flights.

This objective translates into main the following tasks:

- Ensure safety by maintaining adequate separation above the minimum defined by ICAO; a vertical separation minimum of 1000 ft (300 m) below FL 290 and a horizontal separation minimum of 5.0 NM (9.3 km) [21]
- Organize traffic flows to reach the IAF at an appropriate time to avoid airport congestion.
- Handle overtaking, descending, climbing and crossing aircraft around same levels.
- Regulate the speed of all aircraft on the same traffic flow.

The first task is undoubtedly the most important. The en-route separation minima should always be respected. When the regulations are violated, it is called a loss of separation; a serious incident which has to be reported to the authorities. In order to prevent this from happening, the suggested minimum operational separation during flight is somewhat higher than 5NM. Controllers typically use 6 or 7NM. In the rest of the tasks, such as avoiding airport congestion and shortening aircraft routes, complying with the objectives is less straight forward. The solution is dependent on many different factors and it is difficult to judge whether a solution is optimal. Controllers can have different ways to solve the same situation. Chapter 3 is devoted to the decision making process and the development of best practices.

2.4. Area Control Equipment

In order to comply with the safety requirements and meet the overall objectives an Area Controller has equipment at his/her disposal. This section will cover this current equipment available and possible future extensions.

The workspace of an Area Controller typically looks as in Figure 2.6. The most important sources of information are the Closed Circuit Information System (CCIS) display, the communication panel, and the radar screen. The CCIS provides the controller with current information on the weather and the status of systems and is indicated by number 4. The COM panel allows the controller to communicate his/her decisions with other Air Traffic Controller and pilots and is represented using number 16.

The radar screen is the most important instrument. Figure 2.7 shows part of the Dutch airspace and an example of what a radar display looks like. Each aircraft is symbolized using a square. The line connected to the square is the prediction line, which shows the predicted direction (and speed) when maintaining current flight conditions. The dots behind each aircraft displays the aircraft's history. One dot corresponds to fifteen minutes in time. The yellow aircraft is at that point selected aircraft. Furthermore, additional information is also displayed for each aircraft.

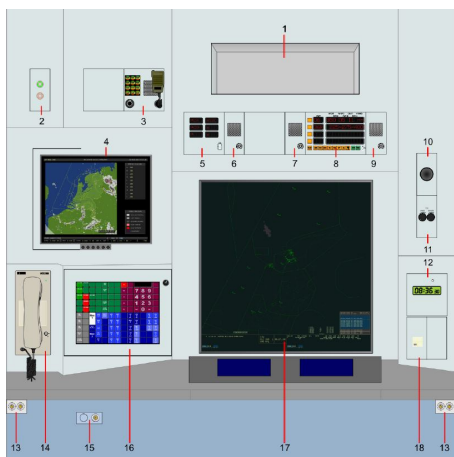

Figure 2.6: Work-space of an Area Controller [20]



Figure 2.7: The sector 3 radar screen used at the LVNL

As is indicated in Figure 2.8, the following data is presented for each aircraft.

- **callsign:** the callsign of aircraft
- **mode C:** the altitude shown in flight levels
- **EFL:** executive flight level; the flight level assigned by the controller
- **XFL:** exit flight level, the flight level where the aircraft transfers to the next sector
- **EAT:** expected approach time at the Initial Approach Fix
- **gnd spd:** the ground speed in knots
- **aspd:** the assigned indicated speed in knots
- **type:** the aircraft type
- **ahdg:** assigned or cleared heading

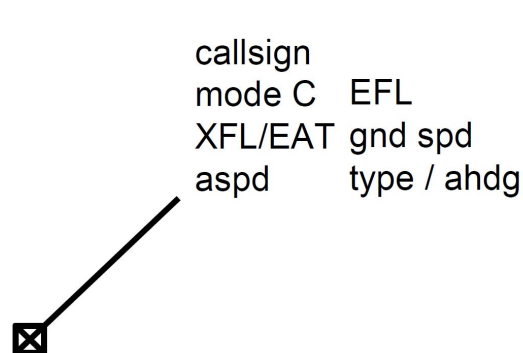

Figure 2.8: Label as is visible on a radar screen [36]

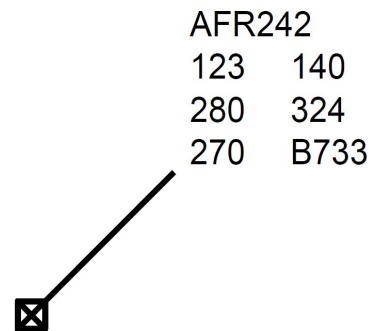

Figure 2.9: Sample label as is visible on a radar screen [36]

The callsign is the code by which an aircraft can be identified. The combination of Mode C and EFL shows the controller whether an aircraft is going to climb or descent. The aircraft type information gives the pilot a sense of the climb and descent profiles. Aircraft can have very different performance characteristics. This also holds for slowing down and speeding up, when a new speed is assigned. The controller uses the radar information in combination with additional resources to organize a safe traffic flow. The information available allows them to create a mental model of the situation.

In addition to this information some other systems are available to ATCo. Wind information is presented in a table. For several flight levels the wind information is given per sector. Also, the controller is provided with a planned arrival time and an estimated arrival time per aircraft. The difference between the planned arrival time and the actual arrival time can at most be 2 minutes. [30]

Besides, there are more advanced systems to support the controller. For example, a Flight Progress system determines what information is shown to which controller on the radar screen and a Short Term Conflict Alert System (STCA) warns for possible violations of the separation minima. The Conflict Alert System is not meant to be used as a primarily tool to maintain the set separation minima, but should be used as a safety net.

3

Best Practices

Chapter 2 contained a description of the job requirements of an Area Controller and the equipment the controllers have at their disposal to meet these requirements. Although the regulations set by the industry are incredibly important, they do not define how the controller actually solves a conflict. This chapter will elaborate on the mental model controllers make when solving conflicts and the heuristics they develop as professionals. The training to become an Air Traffic Controller does not entail specific solution strategies, but research has been done to develop a set of heuristics in order to define if certain Air Traffic Control practices can be considered to be good or bad.

Firstly in Section 3.1, the relevance of Air Traffic Control heuristics is explained. Then a distinction is made between types of conflicts in Section 3.2. The Rules of the Air can be found in Section 3.3. A developed set of heuristics will be explained in Section 3.4. These are developed in multiple studies in which Air Traffic Controllers were interviewed on what they would do in certain situations.

3.1. Relevance of ATC Heuristics

In controlling the environment they work in, controllers tend to create a mental model of the situation [26]. They visualize the aircraft in a particular manner that helps them understand what the problems are and how to solve them. They commonly think ahead and thereby try seeing upcoming events in advance and act upon their findings [26]. Not every controller does this in the same way. Different people create a different mental model of the same situation. In his book *Air Traffic Control* [26], Sanne interviewed multiple Air Traffic Controllers on how they visualize air traffic situations. He found that some people visualized themselves in the center of the conflict, as if they were in an aquarium, whereas others looked at the traffic from below or from the side. And while the recognized patterns are not equal for all controllers Sanne realized the importance of creating a "common orientation".

This is mainly because Air Traffic Control is largely based on teamwork. The controllers in the sectors around an individual have to understand how that controller works and in case of an emergency they have to help out. When controllers have a common understanding of the situation, they are able to monitor each other. Thereby, potential mistakes can be corrected and teachers can evaluate if the candidate has learned what is relevant information in a particular situation. D'Archy & Della Rocco also emphasized the importance of teamwork. In their research [8], they concluded that the controller's situation awareness generally includes knowledge of the skills and preferences of the other controllers.

When a better understanding of Air Traffic Control practices is obtained, these insights could then be used in training to improve the overall quality of Air Traffic Control. Fothergill & Neal performed research into control heuristics and concluded that the obtained results could be incorporated into training programs, rostering decisions and sector design [9]. Besides the safety and training improvements, a better understanding of control heuristics would be very useful in the development of new automation system. Kirwan & Flynn tried to set up a set of general and non-general rules for ATC [15]. They did this as a part of the Conflict Resolution Assistant (CORA2) design. EID inspired designs can also benefit from a better understanding the decisions controllers make. Hence, there are many reasons to develop a set of Air Traffic Control heuristics.

3.2. Conflict Definitions

ICAO defined a set of tracks for the purpose of application of longitudinal separation [21]. In a longitudinal situation aircraft can be on the same track, on reciprocal tracks or on crossing tracks. Each of these tracks can be found in Figure 3.1.

Aircraft are considered to be on the same track when the angular difference between two aircraft is less than 45 degrees or more than 315 degrees, and the protected airspaces overlap. Reciprocal tracks are defined as tracks whose angular difference is more than 135 degrees but less than 225 degrees, and whose protected airspaces overlap. Finally, crossing tracks are tracks that have an angular difference different from the other two possibilities and whose protected airspaces overlap. This means the angles between 45 and 135 degrees and the angles between 225 and 315 degrees.

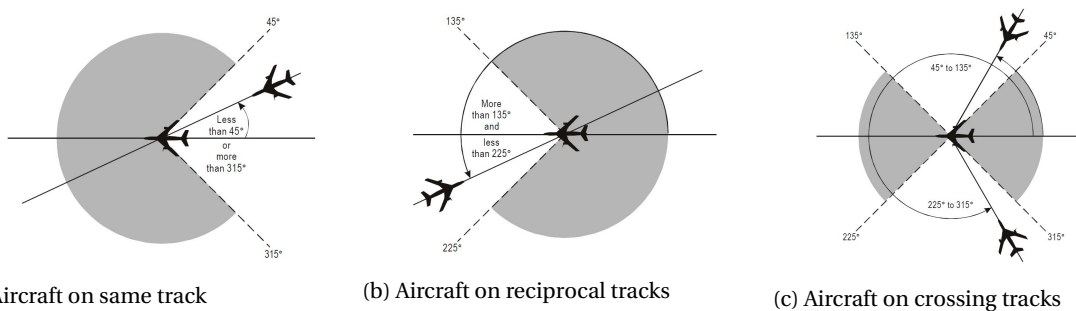

Figure 3.1: Track definitions as defined by ICAO [21]

Next to these track definitions, a range of conflict situations has been established. Each of these conflict types falls into one of the previously described categories. Table 3.1 shows the most common conflict types controllers have to deal with, when considering two aircraft.

Table 3.1: Conflict types for situations involving two aircraft

Conflict situation	heading difference (degrees)
Head on (HON)	170 - 180
Overtake (OVR)	0 - 10
Crossing (CRO)	10 - 170
Crossing + bias (CRB)	10 - 170
Perpendicular (PER)	80 - 100

3.3. Rules of the Air

The International Civil Aviation Organization (ICAO) has developed International Standards for Air traffic [2]. These standards are known as the "Rules of the Air". The first version of these rules was established in 1945 in order to create an international standard. The rules that were then developed are still of importance today. Over the years the rules have evolved to cope with the ever increasing sophistication of aircraft and the increased density of aircraft movement. The current "Rules of the Air" originate from 2005.

Chapter 3 of the "Rules of the Air" document establishes the following standard.

"An aircraft shall not be operated in such proximity to other aircraft as to create a collision hazard."

The document then proceeds to explain the basic rules governing right-of-way. These right-of-way rules apply under Visual Flight Rules. The right-of-way rules have been established and agreed upon internationally to ensure that aircraft in proximity with each other know which aircraft has right-of-way over the other.

and what action must be taken to avoid collision. The most important right-of-way rules are the following;

- 1: "The aircraft that has the right-of-way shall maintain its heading speed."**
- 2: "When two aircraft are approaching head-on and there is danger of collision, each shall alter its heading to the right."**
- 3: "When two aircraft are converging at approximately the same level, the aircraft that has the other on the right shall give way."**
- 4: "An aircraft that is being overtaken has the right-of-way and the overtaking aircraft shall keep out of the way of the other aircraft by altering its heading to the right."**

Aside from the right-of-the-way rules, the document specifies rules for when an aircraft flies under Instrument Flight Rules, as is the case in the controlled Amsterdam South sector. It explains the rules that have to do with Air Traffic Control Service. For example, an Air Traffic Control clearance shall be obtained prior to operating a controlled flight. A clearance can be requested by submitting a flight plan to an ATC unit. It mentions that each aircraft should adhere to the current flight plan and that controlled flight shall report the time and level of passing each designated compulsory reporting point to the appropriate air traffic services unit, as soon as possible.

Also, the document specifies that for flight between FL 290 and FL 410, there is a division in flight level;

"An IFR flight operating in cruising flight in controlled airspace shall be flown at a cruising level, or, if authorized to employ cruise climb techniques, between two levels or above a level, selected from the tables of cruising levels in Appendix 3."

This is known as the semicircular rule. It defines an East/West track split. Airplanes that are eastbound (with a heading angle between 0° and 179°) fly on the odd thousand feet level (FL 250, 270, 290 etc.). West-bound planes (between 180° and 359°) fly on the even thousands (FL 260, 300, etc.).

3.4. Heuristics for Resolving Potential Conflicts

In order to get a better understanding of how Air Traffic Controllers make decisions and what these decisions are, multiple studies have been done. This section includes the ideas and results found by D'Archy & Della Rocco, Kirwan & Flynn, Kallus et al., and Fothergill & Neal.

In 1999, Kallus et al. did research in five different en-route control centres in Europe [14]. They used cognitive interviews and behavioural observations to allow a process description of the en-route controller's tasks. One of their important findings was that the allocation of energy is a core process within en-route control. An increase of attention was observed when the workload increased. They also observed that in low workload conditions, controllers tended to wait and see before taking action. Because of this wait-and-see strategy a more globally optimal resolution can be found. Waiting and meanwhile monitoring the situation does require cognitive resources and therefore this strategy can not always be used. In higher workload conditions, controllers acted immediately and tended to use a more flexible strategy.

D'Archy & Della Rocco did an FAA study involving 100 controllers in 2001 [8]. They found that controllers become more conservative when facing difficulties like high workload, fatigue, aging, and bad weather. In high workload conditions controllers often used the first strategy that came to mind. The more experienced participants were, the more likely they reported formulating backup plans.

In their research Kirwan & Flynn interviewed forty-five controllers from seven countries to determine their best resolutions for a series of statically presented conflict scenarios [15]. They did this as part of the design of the conflict resolution assistant (CORA2) automation system. A set of principles was identified during the conducted interviews. Some of the principles were only cited once, by an individual controller. This suggests that there is a high degree of individuality about these principles. However, many of the found

principles supported each other. The heuristics may provide the opportunity to narrow down the solution space in conflict resolution problem analysis.

The found heuristics were categorized. Some of these applied in all situations and were labeled generic. An example of a very high level generic heuristic is that the controller should keep it simple. More contextual heuristics included that the number of aircraft to move should be minimized and that a controller should look for one key action to resolve the situation. Moreover, the interviews revealed that initial changes should be given early on and fine-tuning should be done later. Controllers also indicated that it was important to narrow down the problem space by checking aircraft and ruling them out. A convenient way to solve conflicts is to address the aircraft in pairs. It was observed that controllers first use a pairwise solution strategy and then check for additional conflicting aircraft. Along the lines of efficiency the additional tracks mile flown should be minimized. Furthermore, resolutions that required less coordination were preferred and controllers should always hand off traffic in a way that is acceptable for the next sector.

A set of heuristics for specific conflict situations was also established. For converging tracks it was noted that a short-cut should be given when it can end the conflict. However, another controller noted that it is considered to be better to put an aircraft behind converging track. Moreover, for crossing conflicts the slower aircraft should be turned behind the other aircraft to minimize extra distance flown.

So, from this research it can be concluded that controllers have a set of heuristics that they have acquired using experience. The choice of the heuristic depends on the complexity of the situation and the environment conditions. Building upon the research done, Fothergill & Neal tried to further identify what the heuristics used by ATCOs are.

In the research fourteen en-route radar ATC operators were presented with static maps of new scenarios. For each scenario they were asked what they would do in the situation. They were asked to explain their thought process step by step and also indicate what they were looking at. Each conflict conversation took up approximately 20 minutes. From these conversations the steps of a participant were broken down. This led to the development of detection and resolution heuristics.

It was found that controllers used three primary conflict detection heuristics. Controllers tend to focus on levels, tracks and headings. Usually the levels were checked first. Only after finding that levels conflict, attention was paid to the direction the aircraft was going. High priority tasks were attended to first. Aircraft that are in close proximity, converging or climbing were considered to belong to this high priority category. It was also detected that key aircraft are prioritized and groups of aircraft with similar characteristics. This simplifies the situation at hand. In terms of conflict resolution, controllers relied on five lateral and eight vertical heuristics. The complexity of the situation appeared to influence the choice of heuristic. This is in line with earlier research. It is important to realize that these heuristics were developed using interviews. It may be that what people say is not necessarily what they would actually do in a situation. The found heuristics are presented below.

1. Point behind other aircraft

In this heuristic a controller vectors one aircraft directly at or just behind a potentially conflicting aircraft. The controller only has to give one heading change instruction. Therefore it is a typical "set and forget" strategy that requires minimal attention. In the experiment it was used by multiple controllers in a crossing track situation where the aircraft were on the same flight level. This heuristic corresponds to the results from Kirwan & Flynn, in which the slower aircraft should be vectored behind the faster one.

2. Direct away from potential conflicts

This second heuristic involves assigning an aircraft a short trajectory deviation from its planned route. The newly assigned vector will make sure that the aircraft does not encounter a loss of separation with a conflicting aircraft. A controller has to issue a heading change. Afterwards, the new trajectory has to be monitored. Just as in the previous heuristic only one instruction is needed. However, such a solution does create future workload, as the new trajectory has to be monitored and the aircraft has to be redirected to its originally planned route.

3. Parallel track

In the parallel track heuristic, a new trajectory is assigned, which is parallel to the original route. This additional track can be used for a short time to ensure aircraft can remain separated from other aircraft in the surroundings. A controller has to issue a heading change, listen for the readback and monitor the new

trajectory. Again the aircraft has to be redirected back to its original route somewhere in the future. This will therefore increase the controller's later workload.

4. Take out for five miles, then put back on track

This heuristic is similar to the previous one. An aircraft is assigned a new trajectory 5NM right or left of its current route. After a short time the aircraft is put back on its original track. This heuristic can be seen as going around an aircraft to ensure separation. It can best be used on same track conflicts in which there is a speed difference. This tactic is also known as the dog-leg procedure.

5. Pass in front

This is undoubtedly the most complicated lateral heuristic. It involves assigning an aircraft a trajectory, which ensures it will pass in front of a conflicting aircraft. The approximate crossing point and time have to be estimated by the controller. This process is very time consuming. When a safe solution has been calculated, a vector is issued. A controller has to wait for the readback and has to monitor the new situation. Finally the aircraft will be put back on its original route. The risks are usually higher with this heuristic since it depends on human perception. The other resolution strategies are therefore safer, but might require more time.

6. Cut off at nearest available level on climb

When an aircraft is climbing, this is a heuristic that can assure separation quickly. The aircraft's cleared flight level is changed to the nearest available level on its climb. This means that when the aircraft is climbing through flight levels of other aircraft, the newly assigned flight level is the first flight level that does not cause problems with lower flying aircraft. In a two aircraft situation this would be the 10 flight levels below the upper aircraft. be the very first flight level. When more aircraft are involved this is a safe solution, because the controller does not have to estimate whether aircraft will get in trouble. It is guaranteed that no loss of separation will occur since the aircraft will cross none of the flight levels belonging to other aircraft. By doing this the newly assigned level will at least be a 1000 feet below the levels of all conflicting aircraft by the crossing point. The solution assures separation quickly and does not require a lot of visual monitoring. However, the aircraft could probably have climbed further. Climbing faster leads to higher speeds at altitude, less noise and it makes sure that the aircraft does not have to climb less later on.

7. Cut off at highest possible level on climb

This heuristic is also meant for climbing aircraft. The aircraft gets a new cleared flight level, which is the highest vacant level the aircraft can reach with the other present aircraft at the crossing point. This means that it is possible to cross other aircraft's flight levels when no loss of separation will occur. The controller must estimate how high the aircraft can climb at the crossing point. The controller uses the current performance of the aircraft to determine if the level is vacant at that point. This method requires more attention and increases the controller's workload, since the controller has to calculate which is the highest level that can be reached.

8. Request nearest level above conflicting aircraft

This next heuristic requests the nearest flight level above conflicting aircraft. That means one of the aircraft can move up to avoid a conflict. This tactic is used when two aircraft are on a converging track. The controller needs to calculate whether the aircraft can sufficiently reach this level in time to avoid a loss of separation. He/she should monitor the climb to the new level.

9. Descend to nearest available level

One possibility in a conflict situation is to assign an aircraft to the nearest available lower level. The controller has to assess if that level is going to be free, but besides that this is not a very complicated heuristic. It ensures separation quickly, the descent time is short and therefore the monitoring time is limited as well. This heuristic does also have a downside. By descending to a lower level the aircraft will use more fuel than it otherwise would have done. Furthermore, it increases the future workload as an aircraft might have to climb back to its original level. Controllers mainly use this heuristic when two converging aircraft are at the same level. It is usually not preferred and only used in high workload situations.

10. Assign the only level available

This heuristic ensures that every aircraft maintains a different level. The aircraft is cleared to the only vacant flight level available. This might not be an efficient solution, as the level may not be near to the aircraft's current altitude. Thus, this solution is typically used only during busy periods. The workload can be lowered drastically with this heuristic.

11. Step climb/descent

In this heuristic the aircraft's cleared flight levels are changed in steps. Separation can be assured quickly using this method. This heuristic is more time consuming than other resolutions, because for each level change the controller has to clear the flight level, listen for readbacks and monitor the climb/descent actions. However, it does allow controllers to keep the aircraft on the planned trajectory without restricting them at certain levels for long periods.

12. Expedite climb/descent

This heuristic involves issuing an instruction to an aircraft to expedite their climb or descent maneuver. This way a cleared level can be reached faster and a conflicting situation can be solved earlier on. This is a good heuristic when margins are small.

13. Report maintaining

This heuristic involves a controller requesting an aircraft to report back to them when a particular level is reached. This heuristic serves as a check for the operator. Thereby, the controller's assumptions on a situation are confirmed, or the controller still has time to resolve the conflict solution.

3.5. ATC practice in the Amsterdam South Sector

The research described in this chapter explains what rules aircraft have to adhere to and what control heuristics controllers use to ensure safe and efficient flight. Research agrees that the complexity of the work situation influences the heuristics used by the controller. And even though the heuristics presented in this chapter do not describe a single "best solution" for every distinct situation, they do provide an insight into the way controllers handle certain situations.

The knowledge from this chapter was confirmed by Air Traffic Controllers that control the Amsterdam South sector [30]. They recognized the found heuristics. When it was asked how one can identify if a controller resolution is a good one, they commented that good Air Traffic Control practice has to be efficient. The definition of efficient is first of all the overall time spent by the controller. Only when the complexity of the task at hand is low, will an aircraft take into account other types of efficiency, such as the time it takes for aircraft to arrive at the airport or the amount of fuel used.

The first research question in this thesis is "What information would support the Air Traffic Controllers task of merging aircraft towards a restricted waypoint in an approach maneuver?"

To support the answer to this question the sub-question "What are good practices in current Air Traffic Control?" was formulated. The heuristics investigated and the information provided by the LVNL controllers give a good indication of what "good" ATC looks like. This information can be used to design systems that assist controllers in their decision making.

4

Principles of Ecological Interface Design

In 1990, Kim J. Vicente and Jens Rasmussen introduced the concept of Ecological Interface Design (EID) [38]. In a society where systems were (and are still) becoming more and more complex, they recognized that the goal-relevant properties of tasks in such complex systems can not be observed directly. The developed theoretical framework has two main goals. Firstly, it should reveal the affordances of the work domain in order to support each of the levels of cognitive control. Secondly, it should not cause controllers to use a higher level of cognitive control than is required for a specific task. When the proposed goals are met, the users of the interfaces can make effective use of their human perception and action capabilities. Also, they are supported by additional information in situations that go beyond procedure. [38][39]

Cognitive Work Analysis (CWA) is a formative framework used for designing interfaces based on an ecological approach [37]. It focuses on identifying requirements and starts by looking at the environment. Only after this, more cognitive factors are taken into account. The requirements and constraints which were identified in the CWA framework, are used to develop interfaces. When designing a new interface using the methods of CWA, first a Work Domain Analysis is done, followed by a control task analysis and a worker competencies analysis. Each of these analyses have their own method to discover constraints.

Section 4.1 describes the concept of the Abstraction Hierarchy. This is a useful method in determining the work domain constraints. In Section 4.2, the Decision Ladder is explained as a means for the control task analysis. The Skills, Rules, Knowledge taxonomy, found in Section 4.3, is a method developed to address the worker competencies. The relevance of the EID method is explained in Section 4.4.

4.1. The Abstraction Hierarchy

In EID the work domain is analyzed using the Abstraction Hierarchy (AH) developed by Rasmussen [23]. In order to effectively set up a AH, first the boundary of the work domain of interest has to be defined. Different boundary choices for the work domain will result in different outcomes. There is no correct way to draw the boundary, since different boundaries are useful for different kinds of analyses. In general, a good way to define a boundary is to make sure that the interaction between the work domain and the environment is relatively weak [37].

The Abstraction Hierarchy consists of 5 levels, which are displayed in Figure 4.1. Rasmussen defined each of the levels in the following manner. The Functional Purpose level contains the purpose for which the system was designed. A work domain usually has more than one purpose and therefore this level consists of multiple components. For example, when considering collision avoidance, the system needs not only be safe, but also productive and efficient [31]. The Abstract Function describes the underlying laws and principles that govern the goals of the system. One of the clear examples of an Abstract Function, when considering the prior example of collision avoidance, is separation. The Generalized Function explains the processes using models. Aircraft motion is a one of the Generalized Functions needed to describe separation. The Physical Function level describes the characteristics of the components and the connections between them (aircraft lift, drag etc.). Finally, the Physical Form level contains the locations and appearances of all the components in the

system (physical aircraft components).

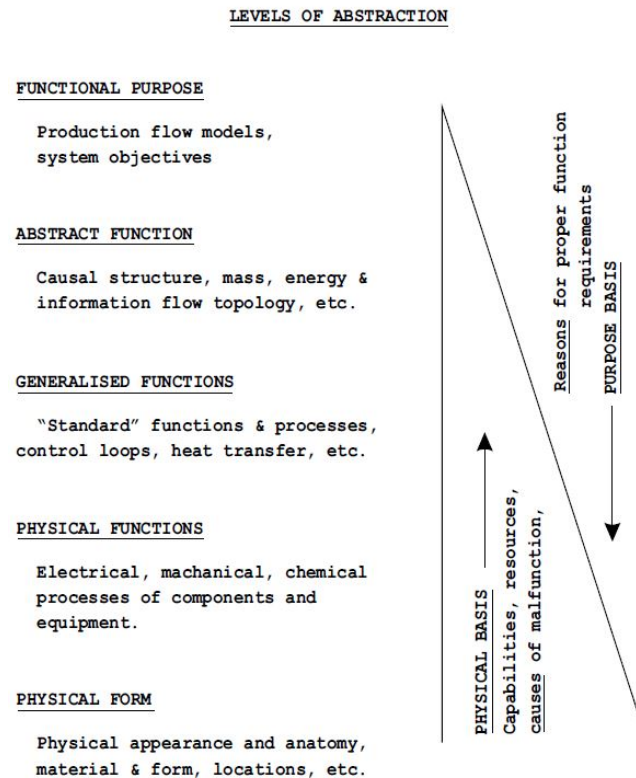

Figure 4.1: Levels of abstraction representing the physical implementation and Functional Purpose in varying degrees, as developed by Rasmussen [23]

These levels are connected by a structural means-end link. This means that a specific level in the AH can be achieved with the nodes under it and will be used to achieve the higher level nodes. This is equivalent to the goal-oriented questions shown in Figure 4.2. The work domain can be observed at any level defined as "What". Given the choice for the "What" level, the level above specifies "Why" that is and the level below specifies "How" it is achieved. The AH can also include a part-whole classification. This is called the Abstraction Decomposition Space. On the horizontal axis the components range from total system to single components.

When a work domain is analyzed and visualized using these abstraction levels, a person is able to focus on the things that are currently relevant by using the information at a certain abstraction level. In EID, for as much as possible, all of the abstraction levels are visualized. Ideally, by doing this the person's required workload can be reduced, whilst providing them with enough information to anticipate in case of unexpected events. It is important to note that, due to the broad range of control possibilities at different levels of abstraction, an EID is definitely not a simple system and is generally meant for well-trained professionals.

4.2. The Decision Ladder

The Work Domain Analysis previously described identifies the field of action and is the first step in designing a successful EID. However, there are additional constraints imposed by the control task. In order to find the control requirements in the system, a control task analysis is done. It is made to describe what needs to be done and not how to do it or who does it. In the CWA framework the control task analysis is addressed using a decision ladder.

A decision ladder is a traditional linear sequence of information processing tasks folded in half, in which it has been recognized that it is not necessary to walk through all the defined activities and states of knowledge to control a system. It tries to find out what conditions have to be satisfied for expert performance.

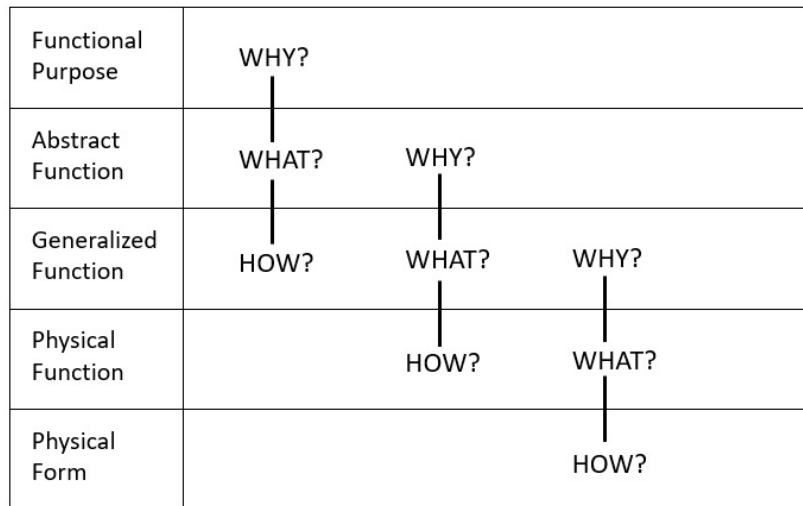

Figure 4.2: A portion of an Abstraction Hierarchy for a hypothetical scientific research program in human factors. [37]

A completely inexperienced controller will probably follow the full traditional sequence, which corresponds with causal reasoning. But with experience comes the ability to take shortcuts with in this process. Figure 4.3 shows the decision ladder and the Skill-, Rule- and Knowledge based domain is explained in Section 4.3. The boxes represent information-processing activities and the circles are states of knowledge. Each information-processing activity leads to a new state of knowledge. The left side of the decision ladder describes the situation analysis, the top represents the goals and the right portrays the planning of the control action. Experienced controllers are able to make a connection between the situation analysis and the planning. When a short-cut is taken from an information-processing activity to a state of knowledge, it is called a shunt. A leap connects two states of knowledge. Leaps are direct associations and therefore they do not require information processing. [13] [37]

Using this ladder, control activities can be analyzed. It not necessary to start a control activity with the activation. For example, when using a schedule for control, it can start at the task state. And when a goal state needs to be achieved it can start at the target state. By analyzing all the cognitive activities the requirements for good control are identified. This knowledge can then be used to design procedures and context-sensitive interfaces. This information acts on the previously described AH and the AH, in its turn, provides the information to the control tasks. [37]

4.3. The Skills-, Rules-, Knowledge Taxonomy

The worker competencies analysis is the last step of the CWA. The Skills, Rules and Knowledge Taxonomy (SRK) is used as a tool to evaluate the controller’s capabilities. Rasmussen developed this process in 1983 to address the need for a worker competency analysis [22].

Rasmussen divided human behavior into 3 separate categories: Skill-based behavior (SBB), Rule-Based behavior (RBB) and Knowledge-Based Behavior (KBB). Each of the categories involves a distinct way of representing constraints and varies in the amount of mental load it requires. Figure 4.4 displays the SRK taxonomy.

SBB uses signal inputs for sensory-motor tasks. A signal is a continuous indicator that has no particular meaning on its own. Because the signals are in continuous time, there is a direct coupling to the environment. Reacting on the perceived signals does not require conscious attention and is therefore not a tiresome activity. In RBB an operator reacts using signs. A sign is a familiar perceptual cue in the environment. This means that the operator has seen the indicator before, recognizes this cue and performs a memorized task, as was defined by procedure, belonging to this cue. This category is typically used when something changes in the environment. Finally, there is the KBB category. Here the operator mainly deals with unanticipated events. Since the operator is not familiar with the situation he or she has to reason about what the best strategy is for this particular situation.

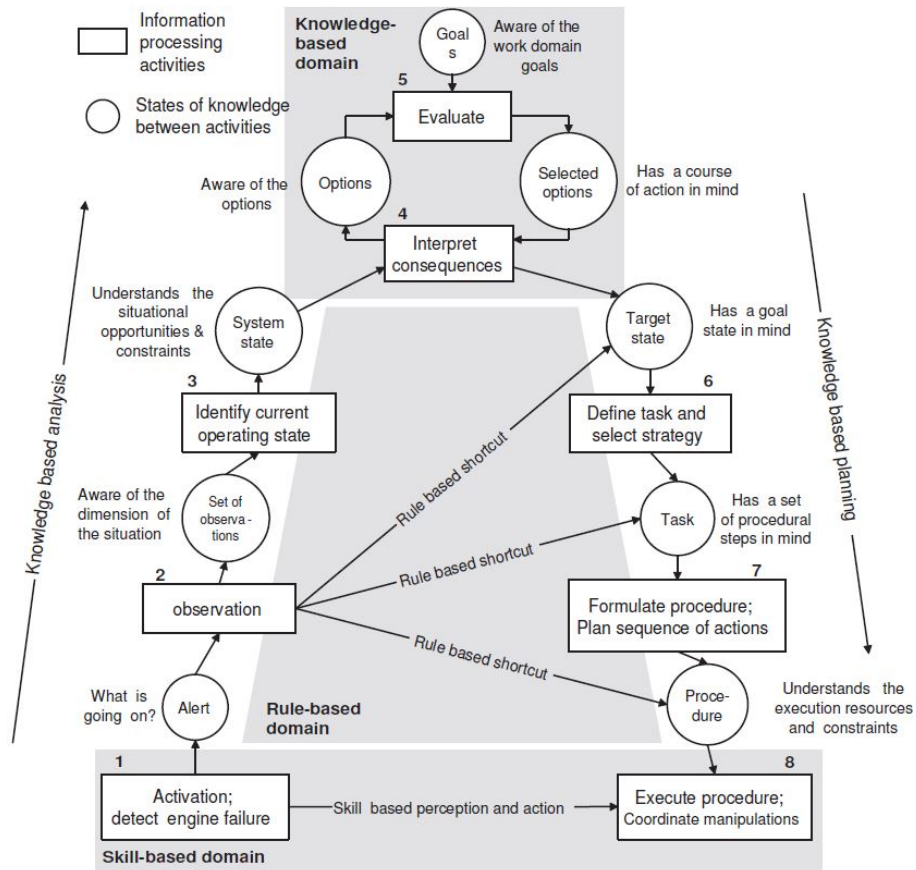

Figure 4.3: Decision Ladder including the Skills-, Rules- and Knowledge-Based behavior domains [5]

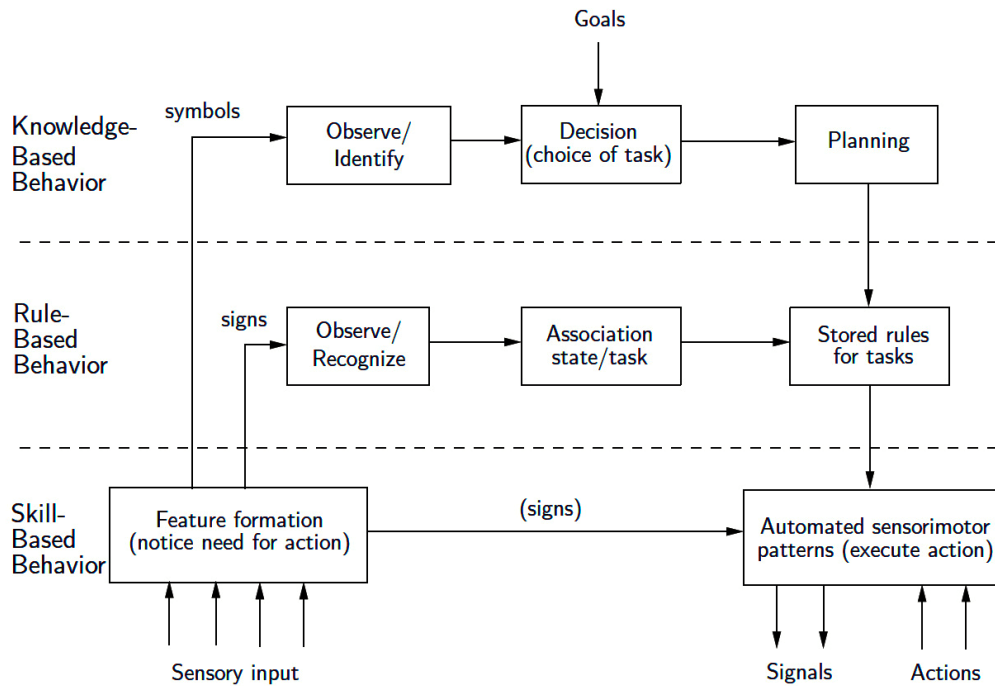

Figure 4.4: The Skills-, Rules-, Knowledge Taxonomy [22]

Figure 4.3 displays each of the categories in the decision ladder. Signals form a connection between activation and procedure execution. A sign is observed and due to the operator's previous experience a goal state, task, or procedure is directly identified. The top of the decision ladder corresponds with this knowledge based domain, where symbols are used to anticipate unfamiliar events.

When creating an interface, the SRK taxonomy is used to take advantage of human perception. It is important to not force operators to use a higher level of cognition than is required. Doing this leads to a higher workload, which causes stress and even potentially dangerous situations. At the same time it is important to provide the operator with the support to still be able to use all levels of the SRK taxonomy and all levels of abstraction. That way operators can use their creativity to react in case of unanticipated events in ways the system's automation is not able to.

4.4. The Relevance of EID in Air Traffic Control

Over the years, EID has proven to be an effective method to design interfaces. When the goal-relevant properties of tasks are identified, an interface can make effective use of their human perception and action capabilities. Previous designs have increased the controller's situation awareness and have supported the controller even in situations that went beyond procedure. [39][5]

When considering the task of merging aircraft traffic for approach, the question remains why one would use Ecological Interface Design instead of other design methods.

The most important answer to this question is; because Air Traffic Controllers are in charge of a complex system. The EID approach adds value when even experienced users do not understand the system completely. When a user does not fully understand all the relationships in a complex work domain, or is not able to foresee these relationships within the given time frame, showing the affordances of the system has the most impact. In the task of merging aircraft a controller is not able to fully understand the system. The exact dynamics of descent paths or the effects of wind can be estimated with experience but never fully calculated. It is here where automation in combination with good interface design can make a big impact. The computer calculations could also be done without using the ecological design method to display them. However, situation awareness is of crucial importance within the Air Traffic Control sector. Mistakes can simply not be tolerated. For this reason the sector has been conservative when it comes to automation. All controllers have to have a full understanding of the situation at all times. Displays that issue advisories could decrease the situation awareness of a controller because he/she no longer has to independently make a decision. With an EID display the controller ideally becomes more aware of the environment due to efficient visualization of the constraints. When the constraints are properly visualized the controller should be able to deal with of unforeseen events, thereby dismissing the main objections the sector has with automation. Also, the methods of EID can identify constraints that the controller was previously unaware of. EID could be a solution in the task of merging aircraft traffic for approach. In other tasks within the Air Traffic Control sector the ecological has already proven effective. Chapter 5 explains some of these successful designs.

5

Air Traffic Control Applications of Interface Design

Chapter 4 explained the principles of EID and why this approach is important. Today, the framework set up in the 1990s is still very relevant and used in the development of new Ecological Interfaces. This chapter focuses on displays that are relevant in the field of Air Traffic Control. Most of the discussed displays are EIDs, because the aim of this thesis is to create an ecological display. However, a non ecological way to merge traffic is also presented. The current state of the art EIDs that are relevant in the field of Air Traffic Control may not resemble the final interface created for merging aircraft, but they provide a good example of how to design an good Ecological Interface. Also, they serve as a source of inspiration. The merging display is a good example of a way a merging task might be resolved.

In Section 5.1 the influence of defining boundaries is elaborated upon. The choice of boundary greatly influences the final design of an Ecological Interface. Section 5.2 will cover the Solution Space Diagram developed to maintain separation. Then in Section 5.3 the Travel Space Representation is presented. The Time-Space and Vertical display is explained in Section 5.4. Section 5.5 includes a non ecological display used in merging aircraft and finally, in Section 5.6, implications for the design of a new display are discussed.

5.1. The Influence of Defining Boundaries

When controlling a moving object, motion and time are coupled. In their work pilots and operators must focus on the immediate response of the system and at the same time plan their work for the future. So, in controlling a process operators organize their work along multiple time spans. Each of these time spans commonly has a closed control loop. In Figure 5.1, different time scale loops are visible. In the short term loop state control is used to control the vehicle dynamics. On a larger time scale different closed control loops allow for path control or even trajectory control. When designing an EID display, ideally, all of these control loops are supported by the interface. In that situation, the operator would be able to switch between the different time spans. However, designing a display that supports all control loops simultaneously is not (yet) possible. Instead a certain time scale is chosen at the beginning of the design process. Choosing another time scale as the defining boundary can result in a completely different Ecological Interface.

Rasmussen already recognized that a different boundary choice will result in a different CWA [37]. Since then, further research and the development of actual interfaces have indeed confirmed this [34]. When a certain time span has been selected by the designer, it is important to match the chosen control span and the capabilities of the operator by selecting the correct input variables. An input must have limited complexity in order to be able to create a meaningful visualization.

In ATC, operators also make decisions over multiple time spans. Figure 5.2 depicts the Air Traffic Control tasks at different time scales. They range from tactical control practices, such as maintaining separation, to strategy control practices, like managing the airspace. Within this thesis the aim is to create an interface that assists controllers in merging aircraft before Approach Control (Chapter 1). Thus, the problem is fairly strate-

gic. The display should avoid conflicts with other aircraft, but also manage part of its mission. The controller determines when the aircraft arrive at the runway and in what order. It does not control its entire mission though, so the time scale for the proposed problem would be located somewhere between avoiding conflicts and managing aircraft missions.

The following sections explain some of the developed Ecological Interfaces in the field of ATC. These designs differ in the time span they were developed for. Some are more towards tactical control, such as the Solution Space Diagram (Section 5.2), whereas others focus more on strategic control.

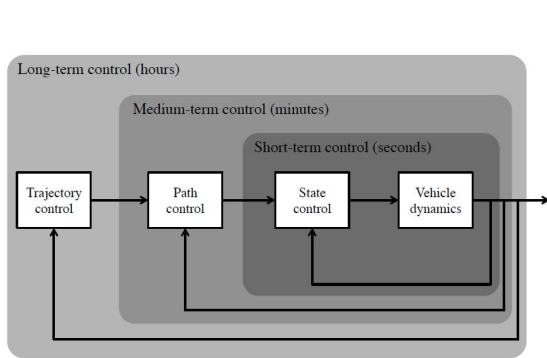

Figure 5.1: Vehicle locomotion control as a multi-loop control problem. [34]

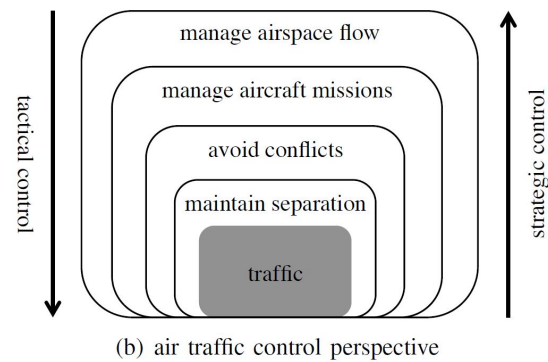

Figure 5.2: Air Traffic Control as a hierarchy of nested control problems at different time scales. [34]

5.2. The Solution Space Diagram

The Solution Space Diagram (SSD) is an Ecological Interface used in aircraft separation. It has been developed for the purpose of self-separation in a cockpit and for the purpose of Air Traffic Control. The following section describes the principles of this interface, the ecological aspects it possesses and what the relevance of this display is in light of the research question.

Chapter 4 explained that the design of every Ecological Interface starts with a Work Domain Analysis. In the task of Conflict Detection and Resolution (CD&R) the Abstraction Hierarchy was developed for the purpose of ATC. This is shown in Figure 5.3. Besides the safety purpose, productivity and efficiency also have to be considered. The means-end links between abstraction levels are visualized using lines.

Functional purpose	Productivity	Efficiency	Safety
Abstract function	Locomotion		Separation
Generalized function	Performance envelope	Coordination	Source(s) / sink(s)
Physical function	Flight plan	Clearance(s)	Airspace
Physical form	Controlled aircraft state (position & speed vector)	Structure (routings, shape, dimensions)	Observed aircraft states (positions & speed vectors)

Figure 5.3: Abstraction Hierarchy for CD&R in ATC [4]

The SSD shows the affordances of short term separation conflicts of an aircraft with the aircraft in the neighbourhood. The Closest Point of Approach (CPA) is calculated as a method to express aircraft separation. The CPA is defined as the smallest spatial separation between two aircraft over a short time horizon. Important to notice is that the conflicts are analyzed in the relative velocity field. When the conflicts are analyzed in traditional plan view presentation, a change in direction does not necessarily lead to a resolution of the conflict. Figure 5.4 shows a conflict in which a change of heading does not solve the conflict, because CPA changes location in the absolute space. Instead of solving the conflict at hand, the minimum absolute dis-

tance between the aircraft becomes smaller. When the relative velocity field is used, the solution space does become apparent. This results in an intruder-centered reference frame. The motion of the selected aircraft is expressed relative to the intruder and the spatial separation can be linked to the aircraft's speed and heading.

Figure 5.5a shows a situation in a such a reference frame involving two aircraft. The velocity of the intruder and the selected aircraft are visualized. The relative velocity can first be calculated using 5.1.

$$\vec{V}_{rel_{own}} = \vec{V}_{own} - \vec{V}_{int} \quad (5.1)$$

The required minimum vertical separation of 5NM is visualized using a 5NM circle around the intruder aircraft, called the protected zone. Two tangent lines can be drawn from the aircraft that is going to be altered to the protected zone of the intruder aircraft. The cone that is created is referred to as the Forbidden Beam Zone (FBZ). As long as the relative velocity vector is within this cone, this means that a loss of separation will occur somewhere in the near future. Figures 5.5b and 5.5c show this forbidden zone and the velocity vectors of the two aircraft. The relative velocity can be altered by changing the own velocity vector. Separation can then be maintained by actions that cause the relative velocity vector to move outside the forbidden beam zone. Multiple actions can be used to do this. Firstly, the speed can be altered, whilst keeping the heading constant. The speed can be increased (or decreased) until the relative velocity vector lies outside the FBZ zone. Obviously, the aircraft stall characteristics and structural limitations have to be taken into account. Number 1 indicates until up to where the velocity has to be increased to guarantee no loss of separation will occur. Secondly, the heading can be changed, whilst keeping the velocity constant. Number 2 and 3 show the minimum required heading change to avoid a conflict. Thirdly, a combination of the two strategies is possible. The arcs in Figure 5.5c, show the heading limitations as a function of speed. [31]

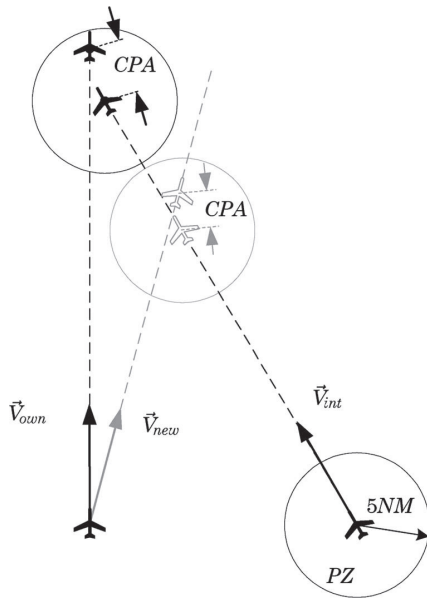

Figure 5.4: Calculation of CPA in traditional plan view presentation [31]

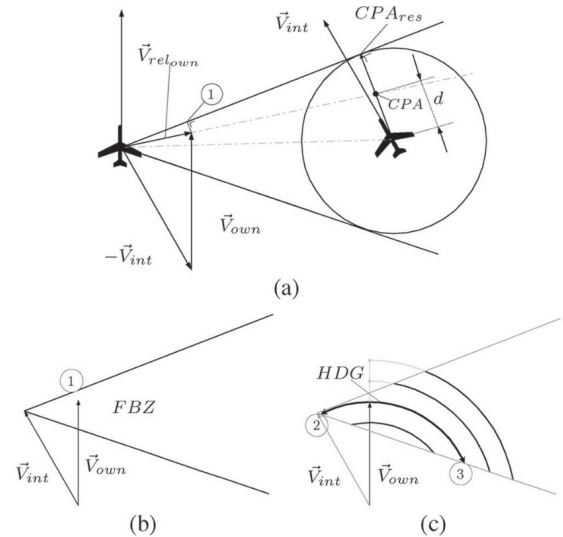

Figure 5.5: Possible solutions (numbers 1 to 3) to a conflict situation using an SSD approach. [31]

To use the acquired relative space knowledge in an absolute visual domain, the conflict zone has to be translated back to absolute space. This is done by translating the cone over the intruder's velocity vector. Doing this results in the Solution Space Diagram (SSD) for a specific aircraft. The developed SSD interfaces for pilots and for Air Traffic Controllers are shown in Figure 5.6 and Figure 5.7, respectively. The Air Traffic Controller is able to switch between aircraft, depending on which trajectory he/she wants to alter.

In both applications the SSD allows the controller to detect conflicts and ensure separation by changing heading and/or speed. This is connected to the safety goal presented in the Abstraction Hierarchy. However, the solution has to be efficient and productive at the same time. A solution is effective when only a small state change is (\vec{V}) required. When considering resolution options 1, 2, and 3 in Figure 5.5, it can easily be seen that the smallest state change is achieved by increasing the speed. Thus, this is the most effective solution. When a heading change is chosen, option 2 is more effective than option 3. Productive flight means guiding the

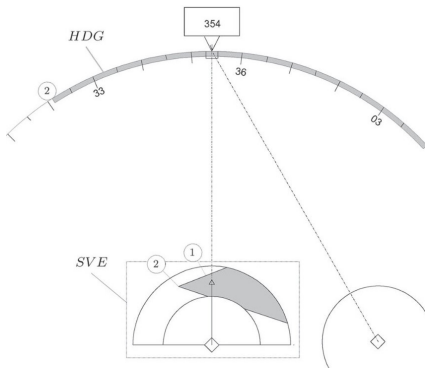

Figure 5.6: Solution Space Diagram developed for the Navigation Display in a cockpit [31]

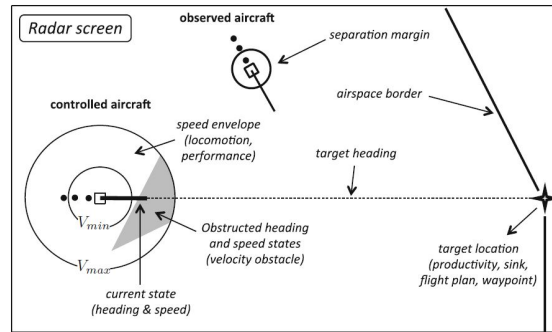

Figure 5.7: Solution Space Diagram developed for the Air Traffic Control Plan View Display [4]

aircraft to a safe area that is closest to its next destination point. A maximum heading change of 90 degrees is implemented to ensure the flight remains productive. [31]

When considering a two aircraft conflict, the goals of safety, efficiency and productivity can be combined to a set of "best practices". Figure 5.8 shows five conflict types and their SSDs. The diagrams provide a straightforward solution for a conflicting pair of aircraft, displayed using the dotted arrow. For example, when considering a crossing conflict, the slower aircraft is vectored behind the faster aircraft, because this maneuver results in the smallest state change. This is also known as the typical "set-and-forget" strategy that minimizes the required monitoring time. This is in line with the research done by Kirwan & Flynn [15] that was presented in Chapter 3. When a distance bias is added to the situation, it becomes easier to maneuver the faster aircraft. The solutions found using the SSD's strategies are in line with the heuristics proposed in Chapter 3. [6]

When more aircraft are introduced the situation becomes more complex. Several FBZs are then shown superimposed on each other. It is not possible to define a best solution that always holds. The third aircraft can either support the proposed best solution or create a conflict with the best solution for two aircraft. When this is the case the controller needs to deviate from his/her two aircraft strategy and use the interface to come up with a new solution.

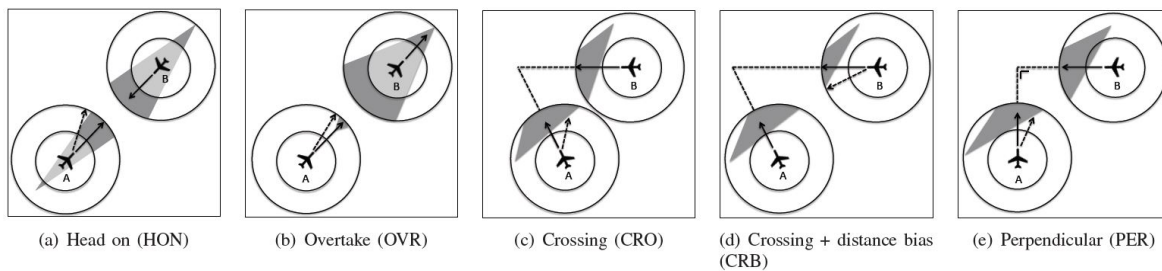

Figure 5.8: Conflict types and their visualizations within the SSD. [6]

So, using the SSD display, a controller (or pilot) is able to ensure productive, efficient and safe flight without having to calculate, among other things, aircraft maneuvering capabilities. Good ATC practice for avoiding conflicts becomes apparent in the design, but it is also possible to deviate from the "best practices". This is in line with the EID philosophy. The controller does not have to reason every move, thereby reducing the workload. The lower levels are implicitly present in the design. The Forbidden Beam Zone triangle reveals information about the surrounding aircraft. The locations, flight directions and proximities of the surrounding aircraft can be deduced with help from the FBZ. Referring to Figure 5.9, the way the lower level information is incorporated in the design is explained. Aircraft that are nearby will cause a wider angle in the FBZ than aircraft further away will do. The absolute location of an aircraft can be approximated using

the direction of the cone. The cone will have a slight offset with respect to the aircraft's actual location, but it does indicate an approximate direction. Furthermore the intruder aircraft's absolute velocity vector can be determined by drawing an imaginary line from the aircraft toward the tip of the triangle. Hence, the orientation of the FBZ comprises the information needed to move from higher-level functional information to lower-level objects. [4]

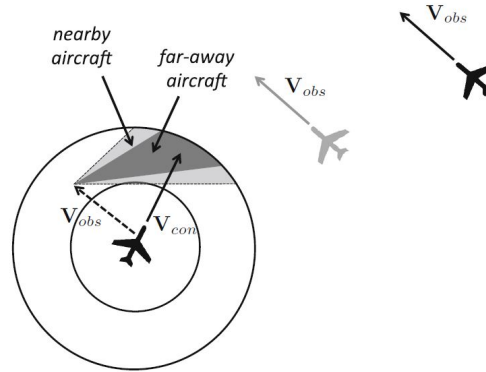

Figure 5.9: Implicit means-ends relations between conflict zones and aircraft plots [4]

Overall, the SSD is an ecological method that provides the pilot or controller with the affordances of a situation in which a conflict has to be avoided. Considering the problem statement and the proposed research question (Chapter 1), it is especially interesting to see the effects a SSD can have in merging aircraft.

The effects of using the SSD on controller workload in a merging task have been investigated. A display was created with the Plan View Display on the left side, and the Solution Space Diagram at the top right (Figure 5.10). This display the SSD is no longer attached to the aircraft symbol. In the SSD speed and heading changes can be performed, as can be seen in Figure 5.11. Some additional features were added to the SSD. Conflict areas are colored differently based on whether they have already established a trajectory, heading lines were added and current velocity vectors are shown. Moreover, a medium size circle representing the exit speed is shown.

The experiment investigated the effect of merging aircraft into a single route in a 2D world. At fixed intervals experiment subjects provided subjective ratings of workload. It was concluded that, especially in high traffic density situations, the Solution Space Diagram can reduce Air Traffic Controller workload [35]. This looks promising, but it is important to realize this result was found in a 2-dimensional situation, and does not guarantee that the same holds for situations including height. Besides, the research problem is a more strategic one; ideally the controller would prevent conflict situations before having to deal with them. Picking a solution based on conflict avoidance might not be the best way to resolve a merge situation.

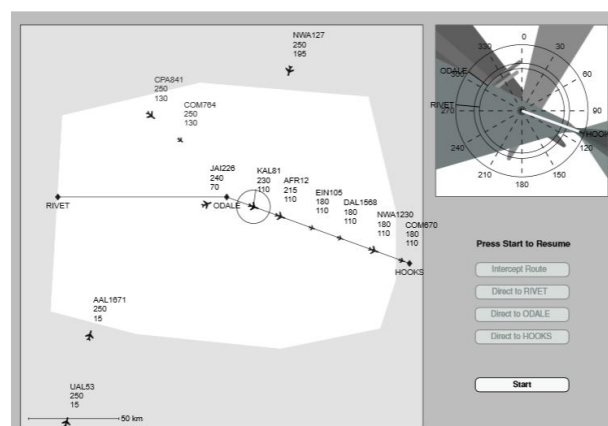

Figure 5.10: Experimental display for merging aircraft with the SSD [35]

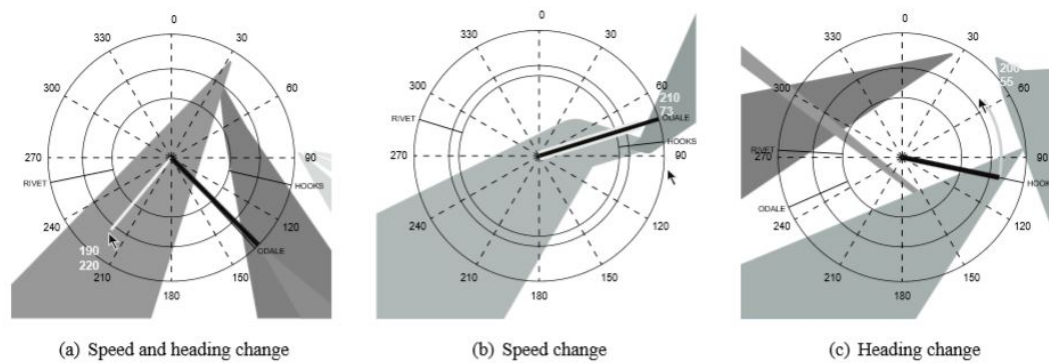

Figure 5.11: The SSD used as interface for merging aircraft [35]

5.3. The Travel Space Representation

In the future Air Traffic Management is expected to change considerably. Advancements in technology will make it possible to use a 4D definition of the aircraft trajectory (4DT). The technology advancement will induce changes for the control practices in all times spans. Due to the predefined four-dimensional trajectories, the plan will initially contain no conflicts. Unforeseen events can cause delays that induce potential conflict situations. Within the SESAR overall operational concept, multiple stages of trajectory planning are foreseen. One of these stages is the tactical monitoring phase. This phase looks at the situation 30 minutes in advance of the flight up to now. In this phase the controller has to redefine the trajectories to ensure safe flight. An Ecological Interface prototype was designed for refinement of these trajectories within the tactical monitoring phase.

The Travel Space Representation (TSR) is a constraint-based decision support tool that visualizes the boundaries of safe control for the task of short-term trajectory based control. It visualizes a set of constraints that bound safe and feasible control actions to reroute a selected aircraft. It does not propose a single trajectory advisory, as is instructed by the principles of EID. The key assumption in this design is that an aircraft is obligated to arrive at its next waypoint according to the 4DT schedule. Arriving at time at this fixed point is a hard constraint. This means it must be met.

Figure 5.12a shows a conflict situation in a future work domain. The aircraft is flying along a predefined trajectory towards its next waypoint. The two aircraft cross tracks and a restricted area is present in the trajectory of the observed aircraft. The observed aircraft has to arrive at the fixed point at the same time as was initially set. This means that the speed has to be increased, because the trajectory will become longer than the initial direct-to path. Figure 5.12b shows the performance envelope of the observed aircraft. The outer boundaries are performed at maximum speed. The aircraft turn characteristics determine the rounded shape of the travel space close to the current aircraft position and the waypoint. The light grey areas symbolize the safe field of travel and the dark grey areas represent the restricted field of travel. If the next waypoint would be placed in this area, that would cause a loss of separation in the near future. A controller can choose a next waypoint somewhere in the safe zone and thereby create a new trajectory. A possible solution to the conflict is found in Figure 5.12c. It is still possible to choose a waypoint outside of the safe field of travel but this will induce a time delay. In a 4DT control environment this is not desirable.

Within the context of Ecological Interface Design, this can be considered a good design. The controller remains the active decision maker and the solution space is clearly visualized. The flight is safe, because the conflict is averted. The flight is more effective when a smaller speed change is used. Also, the flight can always be considered productive, because there are no time delays. However, expert controllers revealed to have a relatively low trust in the interface created. Therefore, constraints associated with current practice will have to be visualized in future versions of this display, if it were to be implemented.

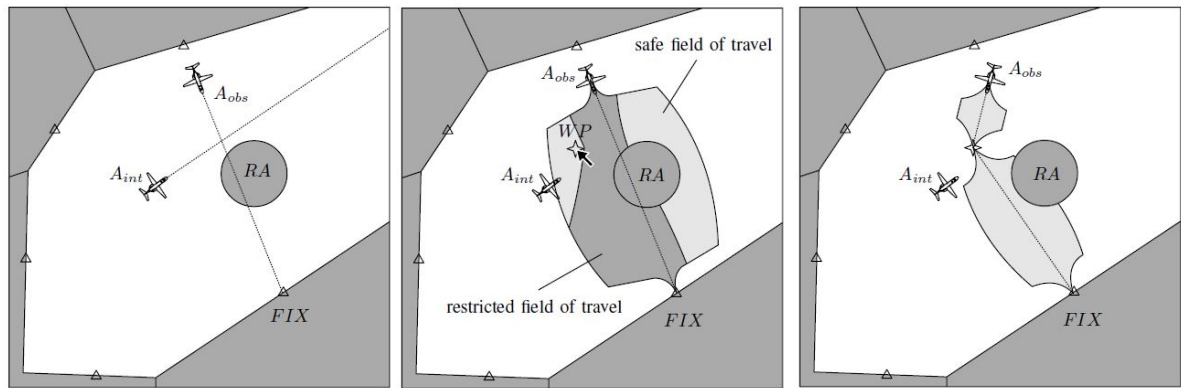

(a) Two conflicting aircraft and a re- (b) The TSR and placement of an inter- (c) Resulting trajectory for the observed
 restricted airspace
 mediate waypoint
 aircraft

Figure 5.12: The Travel Space Representation (TSR) of a conflict situation. [17]

In light of the scope of this thesis, this display is not feasible. Current Air Traffic Control can not yet be based on 4D trajectories. In the future this display might revolutionize the way the Air Traffic Control sector operates, but for now this is not possible. This display is nonetheless a good example of an Ecological Interface Design. It displays the aircraft's constraints in the environment instead of attached to the aircraft. The realization that constraints can be visualized in the background could be useful in developing a new type of display.

5.4. The Time-Space and Vertical Display

Another Ecological Interface Design based on a four-dimensional trajectory, is the Time-Space and Vertical Display (TSVD). This display is meant for long term planning of when an aircraft will arrive at the IAF. That means that boundary of this Ecological Interface Design is more toward strategic control, considering Figure 5.2 in Section 5.1. This long term control strategy requires better communication with the surrounding sectors. The TSVD was designed to manage inbound traffic while coordinating plans with adjacent sectors. This way the human is able remain aware of the situation and is able to take over in case the automation fails.

A study by E.S van Dijk et al. investigated how Air Traffic Controllers should be supported in issuing speed changes in their own and adjacent sectors in future procedures [33]. A Time-Space Diagram (TSD) interface was made. This interface was extended by Klomp et al. [16]. A vertical plane was introduced. This led to the Time-Space and Vertical Display (TSVD). More work was done in quantifying work load and situation awareness. To Assist ATC in monitoring continuous descent approaches, procedures were visualized using the TSVD.

Figure 5.13, shows the Time-Space Diagram for one aircraft. The top of the figure shows the time-space line. This line starts at the current position in space-time and shows the distance still to go to the IAF. This distance is defined along the predicted ground path of the aircraft. This means that when an aircraft does not use the shortest ground route, a direct-to would shorten the distance to go in this visualization. A straight time-space line shows a constant speed. In a descent a pilot usually keeps the indicated airspeed constant. This has an influence on the Ground Speed (or True Airspeed when excluding wind). The ground speed decreases with declining altitude, which induces a curve to the time-space line. A more detailed description of the difference between airspeeds is given in Appendix A. The crossing of the time-space line with the vertical line indicates the arrival time at the IAF. The bottom of the figure shows the vertical profile along the same predicted ground path. It starts at the current altitude and shows the altitude at the IAF. The time at which an aircraft arrives at the IAF can be altered by changing its speed. The speed limits are given by the aircraft's stall speed and its structural limits. Figure 5.14 shows the affordance of an aircraft when adjusting the airspeed. Because altitude influences the ground speed, changing the vertical profile will also alter the arrival time at IAF. The time-space lines will move upwards slightly due to the lower ground speed caused by the lower altitude.

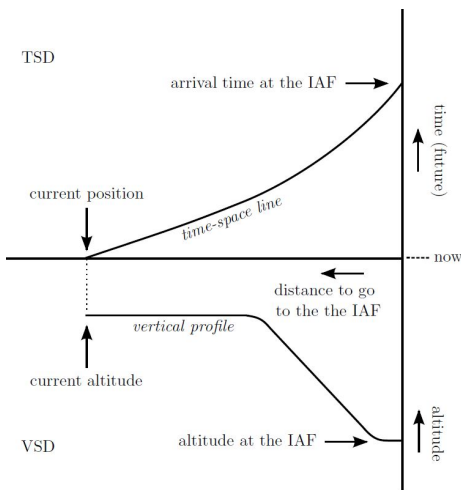

Figure 5.13: The Time-Space and Vertical Display [16]

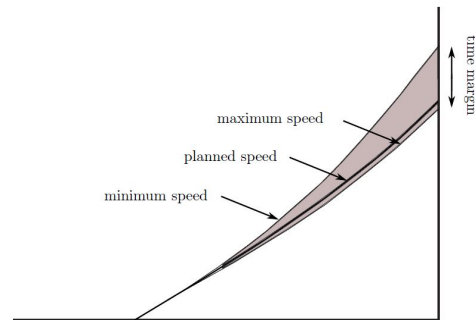

Figure 5.14: The speed envelope in a Time-Space Diagram [33]

When an additional aircraft is added to the situation, a conflict can arise. A distinction is made between aircraft crossing in the horizontal plane and aircraft planes crossing in the vertical plane. Figure 5.16 includes the perpendicular situation for two different speeds of the intruding aircraft, the crossing tracks, an overtake situation and a head on situation. The red-dotted lines show the typical forbidden zones. These are determined using the 1000ft minimum vertical distance and 5NM horizontal distance, defined by ICAO [21]. How such a forbidden zone is created is illustrated in Figure 5.15. The image in the top left shows the initial situation. The plan view of the situation and the Time-Space Diagram are both displayed. At t_1 , the protected zone of aircraft B will cross part of the trajectory of aircraft A. The bold line indicates the crossing between trajectory and protected zone. It can, at that time instant, be drawn in the TSD. At t_2 a larger part of the trajectory and the protected zone overlap and at t_3 the overlap becomes smaller again. When the intersection lines are drawn for small time increments, this creates a protected zone. The bottom left shows a circle for this particular perpendicular conflict. The circular shape will only be present if both aircraft have an identical speed. Figure 5.16 shows the perpendicular situation for an intruding aircraft that is faster than the aircraft that is to be controlled. The protected zone created in this situation is an ellipse with its major axis in line with the slower aircraft. The size of the ellipse decreases with faster speeds. The crossing conflict creates an elliptically shaped forbidden zone, which is tilted at an angle. For the in-trail and head-on conflict, a forbidden "strip" is created. For the in-trail conflict, the conflict can be avoided by slowing down aircraft A and thereby moving the time-space line slight upward. When looking at the head-on conflict it is not possible to avoid the conflict when remaining on the same trajectory. In the vertical situation similar forbidden zones can be detected. Figure 5.17 shows the protected zones in the vertical situation. A typical rhombus shape is found for all situations except the vertical descend. In this (theoretical) case the protected zone has the same shape as the protected area around the aircraft. It display also makes it clear that, when remaining on the fixed trajectories, it is not possible to avoid loss of separation when the two aircraft are in opposite direction.

When two aircraft are on their way to the same destination point, multiple lines can be displayed in the TSVD. This is the case when aircraft are merged before approach. Figure 5.18 shows such a situation. It is important to realize that an intersection of these lines will only lead to a loss of separation when the two planes are on the same the track when the crossing takes place. The dotted line in the figure shows from where on the aircraft are on the same track. The grey area represents the 5NM protected zone behind aircraft 1. The red and the green area show where a loss of separation is and is not the case, respectively. To solve the conflict the speed could be altered, but when the velocity envelope of the aircraft does not allow for a speed resolution other strategies are possible. When a controller gives a direct-to command the to-be-travelled path becomes shorter. This makes the time-space line and associated forbidden area shift to the right if speed is remained constant. Another option is to make aircraft 2 enter a holding pattern. Its time-space line will move up by 4 minutes for each turn.

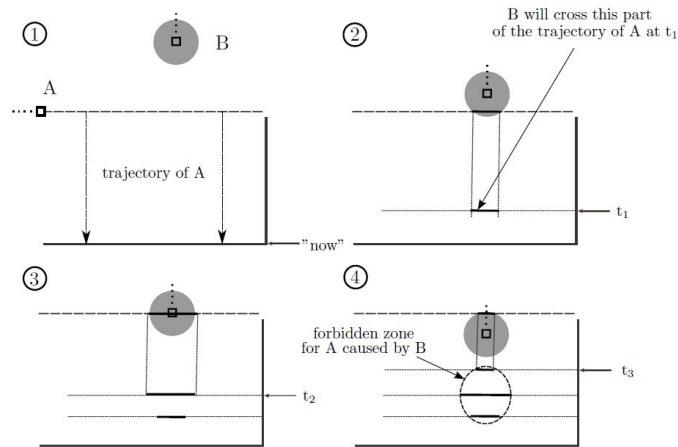

Figure 5.15: Detection of a forbidden zone in the TSD of aircraft A, caused by aircraft B when both trajectories are in the horizontal plane [33]

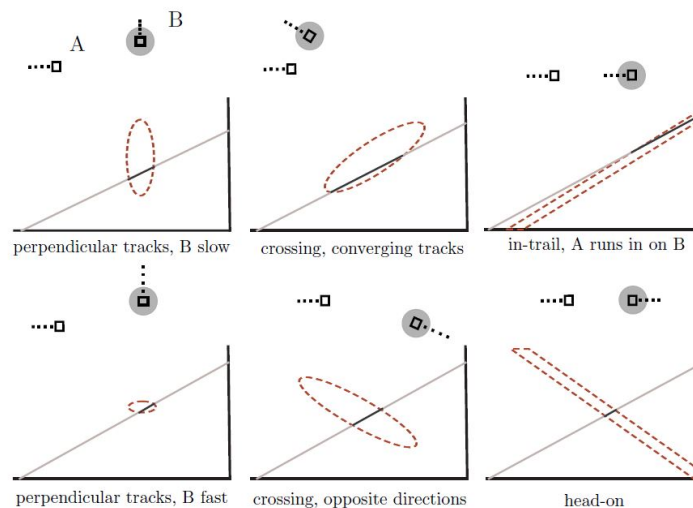

Figure 5.16: Time-space line and typical forbidden zones for aircraft A. The zones are caused by aircraft B and differ in shape, depending on the 3DT of A and the 4DT of B.[33]

The TSVD is an Ecological Interface that reveals the upcoming conflicts in space-time. The speed is implicitly available in the steepness of the curve, but for the exact trajectory the plan view display has to be consulted. The TSVD is meant as an addition to the existing plan view radar display and does not include all aircraft characteristics. However, these characteristics are still available in the combined system. When along a fixed 4D trajectory, the TSVD clearly indicates the upcoming conflicts and what speed changes are needed to resolve this conflict. However, when the trajectory is altered the associated TSVD changes. This means that especially with multiple aircraft it becomes difficult to create a mental model of the situation.

The study by Klomp investigated whether the TSVD can support an ATCo with managing inbound traffic [16]. The created display is present in Figure 5.19. The red areas indicate forbidden zones for the selected aircraft and the blue bars on the right indicate the wake vortex separation on the runway. When this interface was tested a trend towards better situation awareness was found, but the results were not significant. The participants indicated that they did not make use of the vertical part of the display and that they did not make use of the vertical plane to separate aircraft at all. Furthermore, some of the resolution strategies were very small openings in the time-space domain. A real Air Traffic Controller would never use such a small opening because the risk of failure is too high.

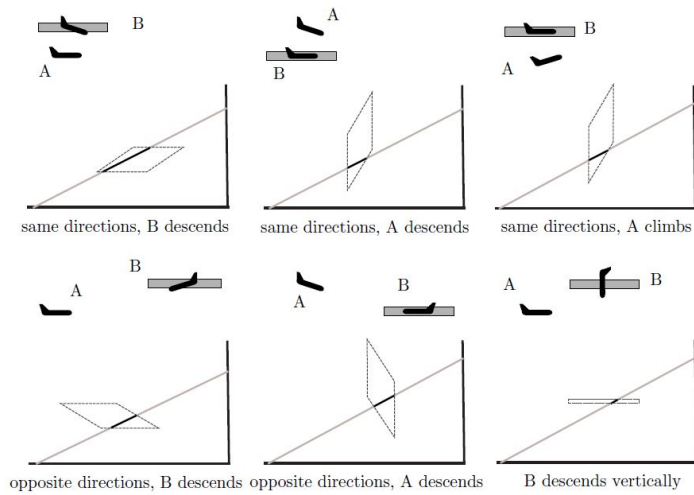

Figure 5.17: Sketches of typical forbidden zones in the VSD of aircraft A, due to aircraft B, for situations in the vertical plan [33]

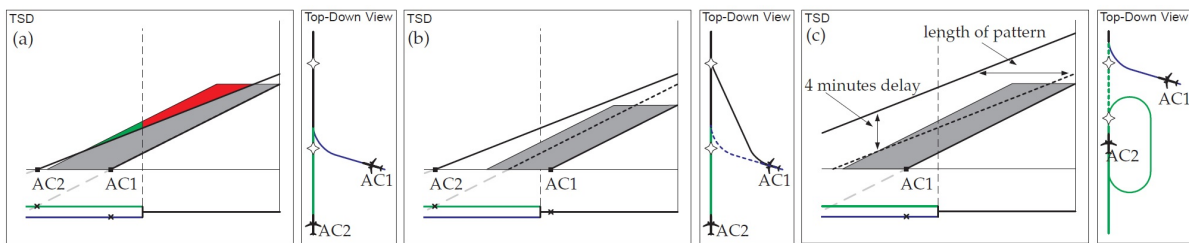

Figure 5.18: Conflict resolution through lateral instructions. The first resolution provides a solution without causing a delay and would be preferred. [29]

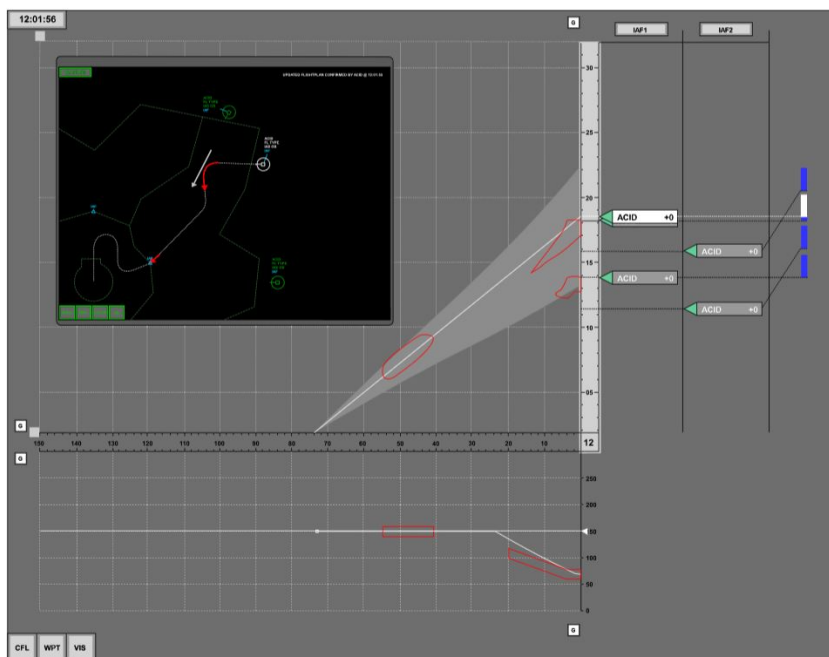

Figure 5.19: Detailed sketch of the TSVD when an aircraft is selected [29]

This display to merge air traffic is based on a 4D trajectory and is not feasible in the scope of the research question in its current form because of this. In the current control situation the exact position in time would have to be estimated, which introduces probability bands. The TSVD has shown that, not only the relative position of aircraft, but also the physical location in time compared to the target location is important. This is a very useful insight. However, the introduction of changes in the path by using for example "dog-legs" will change the display too much with a control command. Therefore it is complicated for the controller to have a full comprehension of the situation. Ideally, the newly designed display would be able to do this within a 3D frame and integrate the information into the plan view display as much as possible.

5.5. The Relative Position Indicator

The Relative Position Indicator (RPI) is a display tool that, unlike the previously described displays, was developed specifically to manage merging traffic. MacWilliams, Smith and Becher developed this display tool to assist Approach Controllers in the task of merging aircraft before landing [19]. It was specifically designed to support the Approach Controllers of the south and west arrival stream and Ronald Reagan Washington National Airport.

Within the display, aircraft along one flow are projected along the path of aircraft they have to be merged with. By doing this, the controller is able to see the relative position of the aircraft that all have to go to the same destination. This goal of the information is to provide early situation awareness and to reduce the total distance flown by the aircraft. Figure 5.20 shows a schematic visualization of the RPI.

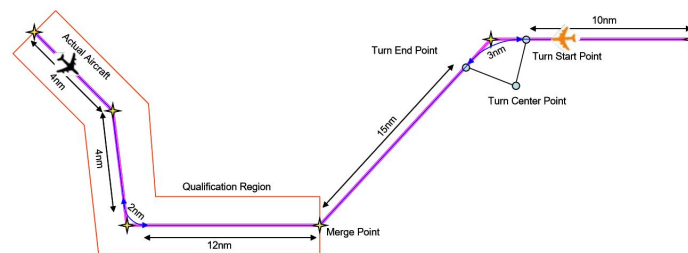

Figure 5.20: Schematic diagram of the RPI application [19]

The projections are useful in two situations. The first of these is displayed in Figure 5.21. In this figure, the controller has to determine which flow the aircraft arriving from the northwest should join. It is straightforward to see that the bottom path is the better option in this case. The other path does not allow for another aircraft in the sequence. With this tool the appropriate flow can be determined earlier and the resulting merge requires less intervention.

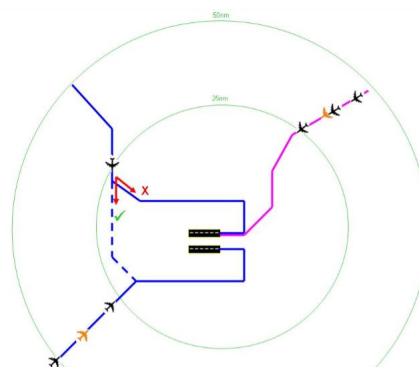

Figure 5.21: RPI display for choosing the traffic flow the aircraft joins [19]

A second application of the RPI is the sequencing of aircraft for changes in the runway configuration. Figure 5.22 and Figure 5.23 display such a situation. In the first figure, all aircraft approach the runway from the east. In this situation, it is assumed that the runway configuration has to be changed. The tool can be used to identify the last aircraft. After doing so, the display will switch to the view presented in Figure 5.23. The aircraft are now projected upon a new path that approaches the runway from the west. The controller continues to oversee all of the aircraft to make sure that sufficient time is kept between the aircraft landing in the new and the old configuration.

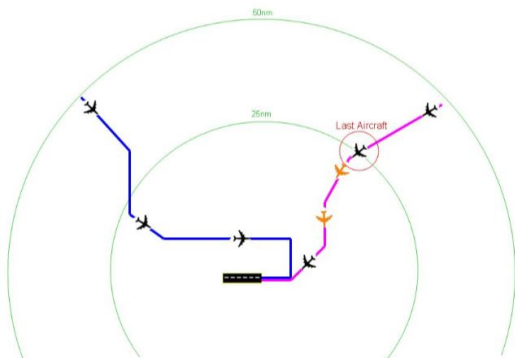

Figure 5.22: RPI display for identifying the last aircraft before a runway change [19]

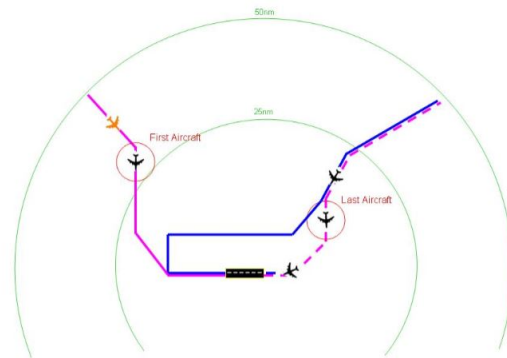

Figure 5.23: RPI display for identifying the first aircraft after a runway change [19]

In order to prevent screen clutter not all aircraft are projected. A qualification region is defined and additional rules such as heading, altitude and runway assignment are used to ensure the controller does not see more projected aircraft than is necessary.

When testing this application in a human-in-the-loop experiment, controllers observed that it was easier to recognize the sequence of aircraft. Using speed command the controllers were able to resolve speed conflicts well before the merge point. This led to a decrease in the use of elongating the final approach routes and delay vectors. The RPI display test data was compared to historical flight data. The researchers found that the flights previously experiencing delay vectoring had an average reduction of flight time of 4.46 minutes [18]. When looking at this data it is tempting to think that the projection strategy is useful in the area control merge task investigated in this thesis.

Yet there are still issues with this technique. First of all, the visual cues of the projected aircraft do not always resemble its real dynamics. The application uses the terminal area RNAV routes in its calculations. When the aircraft to be controlled all have the same characteristics, fly at the same speed and have the same path the projection is relatively simple. The algorithm can just project one aircraft along the path of another aircraft. However, when this is not the case, the projection might not resemble the actual situation and influence the controller with confusing information. For example, when both aircraft stick to their RNAV path and both paths have an equal geometry, but the to be projected aircraft has a higher IAS this poses a problem. Because of the speed difference, the turn radius of the two aircraft will differ. The bigger turn radius of the faster aircraft will still be projected onto the turn radius of the slower aircraft. This means that the projected indicator will travel a smaller distance along the turn than it does on its own path. As a result, the speed of the indicator will increase in the turn. Also, the aircraft will be flying slightly outside the nominal route for a short distance, because of this difference in turn radius. When the to be projected aircraft is flying slower than the other aircraft this is the other way around. The projected aircraft indicator will display a slower displacement while in turn. These differences are relatively small, but when aircraft deviate from their routes the differences become larger. An offset from the defined path and a vectored track will both cause larger speed differences. The accuracy of the projection is thus dependent on how accurately the aircraft follow the set paths. The impact of these cues still has to be investigated.

Also, this application requires the controller to use speed commands to solve the conflicts. When looking at the Amsterdam South sector it can be concluded that controllers do not only use this strategy. Besides, the aircraft in this sector do not follow perfect paths. In Chapter 4, the ecological approach is explained. Within

this approach emphasis is put on showing the affordances of the work space. This way a controller can be fully aware of the situation at hand and make a considered decision. Even though the RPI does not issue advisories, it does not show the full scope of possibilities. Hence, using projected aircraft may not be the best way to solve the merging problem at hand.

5.6. Implications for the New EID

In light of the proposed research objective, it is useful to look at how the discussed displays for ATC can impact the design of the new display.

The Solution Space Diagram has already been tested in a 2-dimensional merging task. In high traffic density situations, the Solution Space Diagram reduced Air Traffic Controller workload. These results are promising and therefore it is important to look at how these cues can be used within the new display. Advantages of the display are that the EID can be integrated into the plan view display and that the constraint information is easy to understand. However, picking a solution based on conflict avoidance might not be the best way to resolve a merge situation. The Air Traffic Control perspective is more strategic in this merging task and therefore an alternative display may be a better solution.

The ideas presented in the Travel Space Representation can not be used directly in the design of the new interface. Current Air Traffic Control can not yet be based on 4D trajectories. The display uses the time the aircraft has to arrive at the next waypoint as most important constraint. This display is nonetheless a good example of an Ecological Interface Design and can be used as an inspiration. It displays the aircraft's constraints in the sector instead of attached directly to the aircraft. In the problem at hand, which has little constraints, this method could be useful in developing a new type of display.

The Time-Space and Vertical Display recognizes that, not only the relative position of aircraft, but also the physical location in time compared to the target location is important when merging aircraft for approach. This insight is a very useful one for the development of a new display. However, the introduction of changes in the path and uncertainties due to the 3D representation will change the display too much with a control command. Some of the ideas can be leveraged for the new design.

The Relative Position Indicator is the only display that is not an EID. It projects an aircraft on the path of another aircraft. The main problem with this display is that a controller can only use one strategy to resolve conflicts; issue speed commands. In Air Traffic Control the controller uses multiple strategies. The RPI does not show the full scope of possibilities and is therefore not a good starting point for the design of the new interface. The idea of showing the relative position of the to be merged aircraft is useful and might be adopted in a different format in the new design.

Thus, the resulting display will probably not closely resemble one of the previously designed interfaces, but in any case a lot can be learned from these interfaces. First of all, the previous created displays can be used as a source of inspiration. They contain smart ways to visualize the constraints of the work domain at different time spans. Some elements of these designs might be useful in the task of merging aircraft for approach.

Secondly, the process in which the EIDs were developed is valuable. Experience has taught us how to handle a new design process. It has been found that awareness of the coordinate systems, in which the constraints of a work domain are expressed, can speed up the design process. When multiple coordinate systems can be used, it helps to try to identify and visualize the individual constraints first and then merge them later on. This way predictable patterns can be recognized. Furthermore, it was discovered that in performing a Work Domain Analysis it is beneficial to play around in simulations. Doing this can trigger a search for simpler representations in a work domain.

Moreover, to make sure that the EID will be used in industry it is important to add the ecological displays to the existing instrumentation of vehicles or to enhance the existing displays to incorporate EID elements. The result usually employs multiple layers. When these layers are properly aligned and scaled, it can provide a good overview of the constraints and affordances of the system. [34]

Part II

Part 2: Preliminary Research

6

The Preliminary Work Domain Analysis

To be able to design a supporting system, a work domain analysis has to be performed. Part of this analysis was done by investigating the current state the Air Traffic Control sector is in. Chapter 2 and Chapter 3 provide a description of the current work domain. Chapter 2 investigated the structure, equipment and regulations in the Amsterdam South sector. In Chapter 3, an attempt was done to defined what good control practice is.

This chapter continues the work domain investigation. An attempt to define the work domain constraints is made. Section 6.1 presents the created Abstraction Hierarchy. In Section 6.2, the physical constraints belonging to an aircraft are investigated. The information in this chapter was used to effectively design the preliminary display design.

6.1. Abstraction Hierarchy

In EID, the first step in analyzing the work domain is the Abstraction Hierarchy. The Abstraction Hierarchy is a method used to determine the work domain constraints. A typical Abstraction Hierarchy consists of the following elements: The Functional Purpose, the Abstract Function, the Generalized Function, the Physical Function and the Physical Form.

Figure 6.1 shows the created Abstraction Hierarchy. The Functional Purpose level contains the purpose of the work domain. Here, the purpose is to ensure safe and efficient air traffic movements. The underlying causal relationships are described by the Abstract Function level. Means-end links (displayed using lines) connect the elements from the levels.

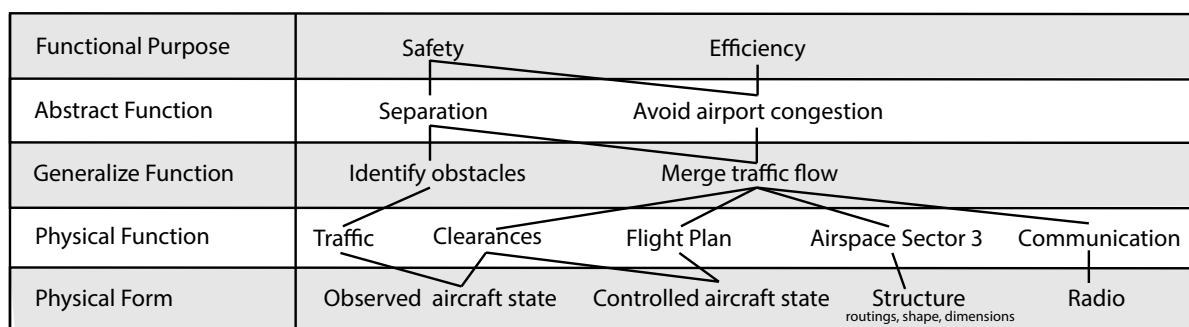

Figure 6.1: The created Abstraction Hierarchy for a merging task

In this case, safety is achieved by means of aircraft separation and by avoiding airport congestion. When airport congestion is avoided this makes the flow of traffic more efficient. The Generalized Function level explains how the Abstract Function can be achieved. Separation can be achieved by identifying potential conflicts and by preventing these conflicts by merging the traffic flow. The latter also ensures (if done properly) that congestion in the Approach Control sector is avoided. The Physical Function level shows the means needed to be able to achieve the Generalized Function elements. The traffic, the clearances, a flight plan,

the sector and means of communication were defined as necessary means to accomplish the General Functions. The Physical Form level typically contains the appearance, condition and location of each component in the system. Within this environment the Physical Form contains the states of the to be controlled and the observed aircraft, the structure of the sector and the radio that communicates the control decisions.

6.2. Aircraft Performance Constraints

Since the controller has a lot of freedom in the control decisions, it is complicated to define work domain constraints. Many different parameters can be changed and each of the parameters influences the solution space. However, the physical constraints of an aircraft can not be changed. Therefore, the aircraft constraints provide a nice starting point for defining the work domain constraints.

From the book "Elements of airplane performance", a set of equations to predict the performance of an airplane was distracted [25]. The extremes of the performance can be predicted using the following equations 6.1 till 6.13.

Minimum Speed

When an airplane flies sufficiently slow, it does not generate enough lift to remain airborne. The speed is know as the stall speed. The stall speed in symmetric flight can be calculated by:

$$V_{TAS,s} = \sqrt{\frac{W}{S} \frac{2}{\rho} \frac{1}{C_{L,max}}} \quad (6.1)$$

It is important to note that in a turn the stall speed increases as a result of the load factor. The load factor changes inversely with the cosine of the bank angle. When taking into account the turn performance, the stall speed becomes:

$$V_{TAS,s} = \sqrt{\frac{W}{S} \frac{2}{\rho} \frac{1}{C_{L,max}}} n = V_{TAS,s} \sqrt{n} \quad (6.2)$$

$$n = \frac{1}{\cos(\phi)} \quad (6.3)$$

Maximum Speed

The maximum achievable speed (in steady, level flight) is reached when the power available is equal to the power required. This is the case when the thrust is equal to the drag. This leads to the following equations, where C_D can be replaced using the lift-drag polar.

$$T = \frac{C_D}{C_L} W \quad (6.4)$$

$$C_D = C_{D,0} + \frac{C_L^2}{\pi A e} \quad (6.5)$$

These equations can be rewritten to:

$$C_{L,Vmax} = \frac{\frac{T}{W} \pm \sqrt{\left(\frac{T}{W}\right)^2 - \frac{4C_{D,0}}{\pi A e}}}{\frac{2}{\pi A e}} \quad (6.6)$$

The result can be plugged into the general speed equation to obtain the maximum flight speed.

Maximum Climb Rate

The maximum climb rates can be determined using the energy equation.

$$\frac{dE_{tot}}{dt} = (T - D)V_{TAS} = mg \frac{dh}{dt} + mV_{TAS} \frac{dV_{TAS}}{dt} \quad (6.7)$$

This can be rewritten to the following equation for rate of climb:

$$RoC = \frac{dh}{dt} = \frac{V_{TAS}}{W} (T - D) \left[1 + \left(\frac{V}{g} \right) \left(\frac{dV_{TAS}}{dt} \right) \right]^{-1} \quad (6.8)$$

When it is assumed the change in airspeed is zero, the equation is simplified to:

$$RoC = \frac{V_{TAS}}{W} (T - D) = \frac{(P_a - P_r)}{W} \quad (6.9)$$

The maximum rate of climb is achieved when the difference between power available and power required ($P_a - P_r$) is maximum.

Maximum Descent Rate

For the rate of descent the same hold as for the rate of climb. The change in total energy per unit of time is given by Equation 6.7. Rewriting this for the rate of descent gives:

$$RoD = -\frac{dh}{dt} = -\frac{V_{TAS}}{W} (T - D) \left[1 + \left(\frac{V}{g} \right) \left(\frac{dV_{TAS}}{dt} \right) \right]^{-1} \quad (6.10)$$

Again assuming the airspeed stays constant this gives. The

$$RoD = -\frac{V_{TAS}}{W} (T - D) = -\frac{(P_a - P_r)}{W} \quad (6.11)$$

The maximum rate of descent can be calculated by taking the most negative $P_a - P_r$.

Decelerating Performance

The largest possible deceleration is present when the drag is maximum, whilst keeping the thrust at a minimum. The maximum obtainable energy dissipation is therefore equal to:

$$(T_{idle} - D)_{min} \quad (6.12)$$

Considering the energy equation (Equation 6.7) and assuming that the deceleration takes place during level flight leads to equation 6.13 for decelerating aircraft.

$$\frac{V_{TAS}}{dt} = \frac{T_{idle} - D}{m} \quad (6.13)$$

7

The Preliminary Display Design

Within this chapter, the preliminary display will be explained. Section 7.1 describes the means used in the display design. The assumptions the design is currently based on are present in Section 7.2. Subsequently, the elements in the display will be explained separately. Section 7.3 includes the visualization of the last possible descent moment. In Section 7.4 the possible level flight paths are visualized. This is extended to also include speed information in Section 7.5. Section 7.6 explains the visualization that shows the impact of the descent moment. When more than two aircraft are present in a control situation the results need to be combined. Section 7.7 gives an explanation hereof. Finally, the full display is shown in Section 7.8.

7.1. Means Used to Design the Display

In order to design a new ecological interface a rapid-prototyping environment is essential. This project is developed in a simulator written in Java. The simulator was created by Clark Borst and Rolf Klomp at the Delft University of Technology and has been used in previous Ecological Interface Design research done by the Control and Simulation department. Realistic air traffic scenarios can be created and in this way the designer can get a feeling for the usefulness of the display. Moreover, the simulator can be used in experiments.

Within the simulator, it is relatively easy to create your own visualization and add it to the work that was already there. In this case, the SSD described in Section 5.2 of the literature review is used as an additional source of information in the display. A new sector or configuration can be easily created to match the project needs. The controllers at the LVNL use radar screens. These screens are mostly black. Figure 7.1 shows a recreation of the Amsterdam South sector created to match the radar screen as well as possible. Within the report the simulator configuration has been adjusted to a lighter mode to clarify the results. The same image in the other configuration is available in Figure 7.2. The triangles within this figure correspond with the waypoints in the Amsterdam South sector such as RIVER, HELEN and DENUT.

The aircraft within the sector can be controlled using the command window (Figure 7.3). Similarly to the real Air Traffic Control environment, the controller can command a change in flight level (EFL), change the heading (HDG), instruct an aircraft to go directly to its target (DCT), alter the speed (SPD) or do a Transfer of Control (TOC).

The simulator is programmed using Java. Java is a class-based and object-oriented programming language. Part of the visualization is created using shaders. Shaders are programs written in the C-like language GLSL that rest on the GPU. Making use of shaders makes the total program more efficient, since it relieves the main processor. Shaders are only able to communicate via their inputs and outputs. An ordered list of vertices can be sent to the pipeline. Then, it is possible to assign a color to every separate pixel, based on the shader calculation without having to loop through each point separately. The pixel colors are returned to the Java environment and can be used to display the visualization. The visualizations presented in the remainder of the chapter make use of this functionality.

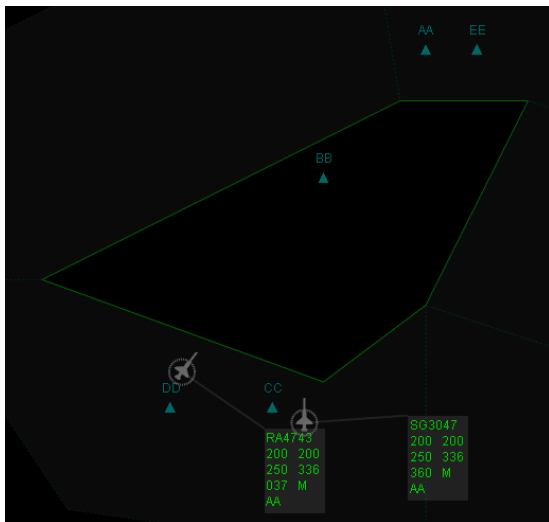

Figure 7.1: The LVNL radar display in the rapid-prototyping environment

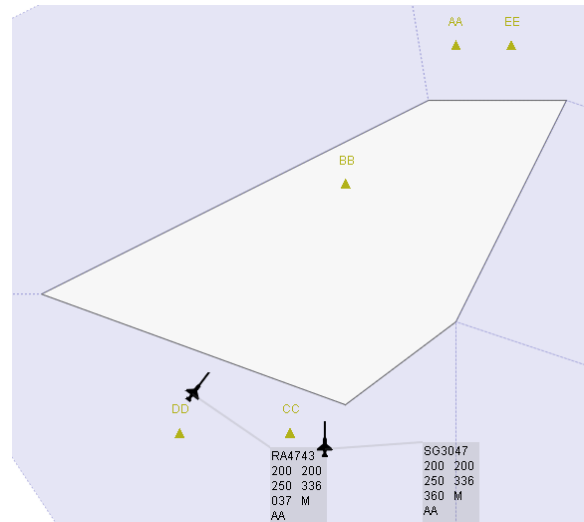

Figure 7.2: The black and white radar display in the rapid-prototyping environment

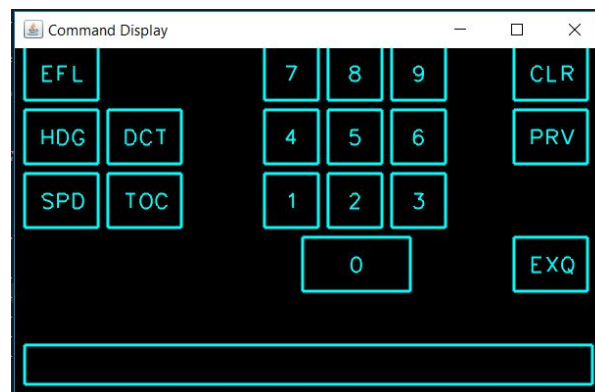

Figure 7.3: The command display in the rapid-prototyping environment

7.2. Current Assumptions

The preliminary version of the display was designed using a simplified version of the problem. Experience from previous EID displays has shown that it can be beneficial to start simple and, later on, eliminate constraints one by one. The current display design presented in the next section is based on the following assumptions.

- Ground Speed is equal to True Airspeed, because wind is assumed to be absent.
- All aircraft in the scenario have to be merged for approach.
- All aircraft fly towards a restricted point in space.
- All aircraft have to be at FL70 at the Initial Approach Fix.
- Air traffic consists of three aircraft types.
- An aircraft follows its current path perfectly, unless a control command is given.
- A command is followed the moment it is issued using the command display.
- An aircraft in a descent maneuver will only stop this maneuver when the target altitude is reached.
- An aircraft not in a descent maneuver that has to go to the Initial Approach Fix will descend as late as possible.

7.3. Visualizing the Last Possible Descent Moment

In the design process of an ecological interface, the first step is to do a work domain analysis to define the constraints of the work domain. The main difficulty of this work domain is that there are very few fixed constraints. The controller is able to change the speed, the heading, the point in which the descent is initiated and the ground track of each aircraft. Most of the constraints come from the surrounding planes, but these can also be altered. Changing one of these parameters for one aircraft influences the maneuvering possibilities of all other aircraft.

The physical constraints belonging to an aircraft (Section 6.2) can not be changed and are therefore a good starting point. When aircraft have to land on a runway, they first have to loose their energy. An aircraft has a lot of kinetic and potential energy whilst in the air. Loosing this energy takes time and thereby distance. The first visual tool focuses on this particular constraint. It is meant to provide insight into whether an aircraft is still able to reach the Initial Approach Fix at the required flight level and speed.

For a controller, estimating the distance needed for descent towards the Initial Approach Fix is a complicated task due to the changing ground airspeed and the varying descent rate. There is a difference between the speed indicated in the aircraft (and on the primary flight display of a controller) and the speed the aircraft has relative to the ground. The speed relative to the ground is called the Ground Speed (GS). When there is no wind (as is assumed in this case) this speed is equal to the True Airspeed (TAS). The TAS varies with height. An aircraft at a higher altitude will go faster with the same Indicated Airspeed (IAS). If an aircraft descends later and keeps all other parameters constant, it will arrive at the waypoint earlier. A more detailed description of why this is and how to convert from one airspeed to the other can be found in Appendix A.

An algorithm uses the airspeed conversion formulas at each time step to calculate the correct Ground Speed. The rate of descent is derived from data. This value is also dependent on height. The values differ per aircraft type and can be found in Table 7.1 [20]. These parameters and the other flight characteristics are combined to calculate the distance that is needed to descend to the required flight level. The flight level at the Initial Approach Fix can be altered, but is set to FL70 by default based on the analysis done for the Amsterdam South sector (Section 2.2).

Table 7.1: Rate of descent values used per aircraft type [20]

Aircraft Type	ROD (FL 0 -100)	ROD (FL 100-200)	ROD (FL 200-300)
Light	2400 fpm	3600 fpm	3285 fpm
Medium	1570 fpm	1985 fpm	2700 fpm
Heavy	1345 fpm	1755 fpm	2205 fpm

In Figure 7.4, the visualization is presented. When an aircraft is clicked, the display indicates the last possible point of descent using a quarter circle. The circle is attached to the destination waypoint and the orientation of the quarter circle depends on the angle between the destination waypoint and the airplane. In subfigure 7.4a, the aircraft is in a descent maneuver (indicated by the purple arrow). When the aircraft continues the descent the part circle will become smaller. Figure 7.4b shows the same aircraft at a later point in time. It can be observed that the distance between the aircraft and the border of the circle remains constant. When the aircraft would stop descending and would fly straight on, the distance between the circle and the aircraft becomes smaller.

The difference between the descent distances of different aircraft types was surprising. Figure 7.4a and Figure 7.4c show two aircraft at the same height. The light aircraft needs much less distance to descend to the waypoint.

It is important to note that it is assumed that the aircraft flies exactly towards the waypoint. In real Air Traffic Control it does not matter if the aircraft has a slight offset. In a future design, the waypoint can be extended to a region. A better estimation can be made to make the last possible descent moment visualization more accurate.

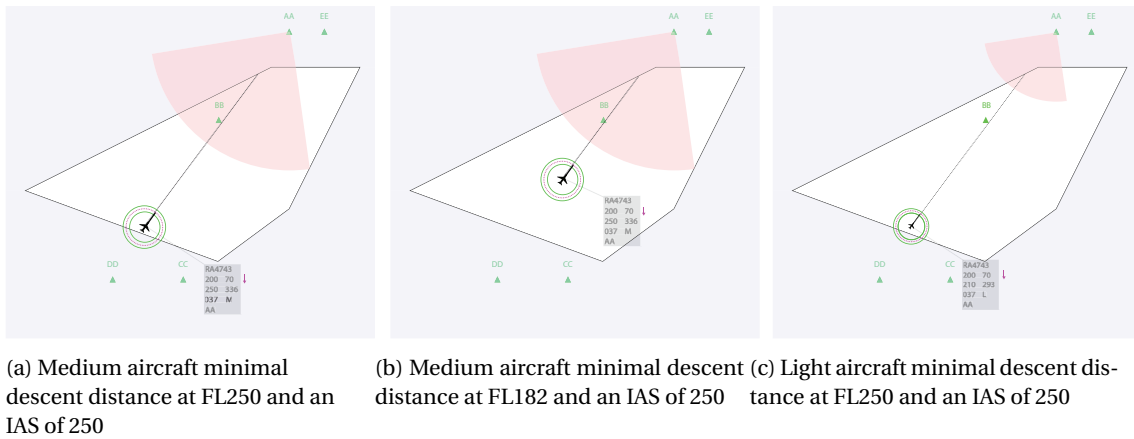

Figure 7.4: Visualization of the last possible descent moment for three situations

7.4. Visualizing the Available Flight Paths Under Current Flight Conditions

When there is more than one airplane in the sector, the Air Traffic Controller’s tasks begin. All aircraft in the sector have to stay separated by at least 5NM, but 6 or 7NM are more common in practice. Some planes are on their way towards the runway, but others have just taken off or only have to travel through the sector. The Air Traffic Controller takes into account the full system when deciding what to do. To do this he/she can issue speed changes, heading changes and direct-to’s.

The necessary calculations for decision making have to be done very fast. This section focuses on visualizing the available flight paths under current flight conditions. Thereby, ideally making the controller’s solution possibilities more apparent. The idea is to give the controller an idea of which flight paths do not cause problems under the current circumstances. It extends the estimated time of arrival information they already have access to.

The visualization only uses aircraft for which the path to the Initial Approach Fix has already been defined. So, in order to create a meaningful visualization, a starting point has to be selected. In the initial stage each of the aircraft can be selected as a starting point. An indication of which aircraft will arrive first at the Initial Approach Fix is given by the relative speed vectors when a aircraft is selected. This does not take into account the difference in descent paths and considers only the current speed. An additional feature is developed to give the user an idea of which aircraft arrives first under the current circumstances. This is depicted in Figure 7.5. The Air Traffic Controller selects a waypoint and will then see what aircraft have that waypoint as destination, because they turn purple. Besides, the controller sees which of these will arrive the earliest under the current circumstances using numbers. In this case the right aircraft (SG3047) will arrive before the left aircraft (RA4743).

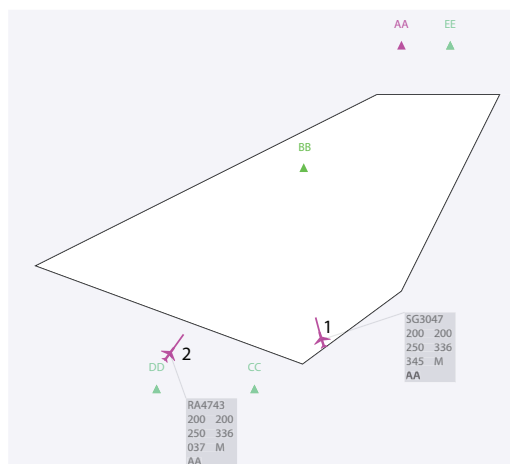

Figure 7.5: Initial indication of waypoint arrival order

When the controller selects a starting point, the other aircraft can be built around it. The difference in arrival time at the Initial Approach Fix has to be approximately two minutes. The 5NM separation always has to be kept to, but the two minute separation is a good indicator for this. The created display makes use of this time based separation. The idea is to display the difference in estimated time of arrival within the sector space. For each point the arrival time is calculated when using a dog-leg maneuver. A schematic example of such a maneuver is depicted in Figure 7.6.

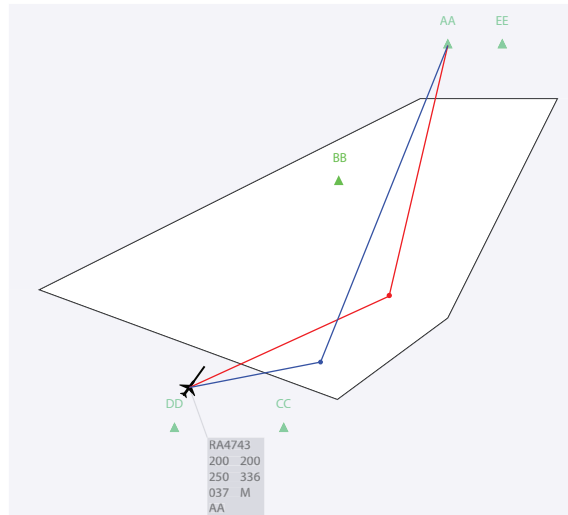

Figure 7.6: Example of a dog-leg procedure

The algorithm calculates the time it takes to fly directly to the selected point and from there to the destination waypoint. The aim is to calculate how far apart in time the two airplanes will arrive at the destination waypoint. Evidently, when the path length is increased the aircraft will take longer to reach its destination. The calculated time is then compared to the time the other aircraft needs to fly its trajectory. This time separation for this dog-leg is divided into one of four categories. In the warning category, the aircraft have less than a 110 second separation. A caution category is for aircraft between 110 and 150 seconds. An available (ahead) region is added for all solutions where the selected will end up in front of the other aircraft by more than 150 seconds. When the aircraft will end up behind by more than 150 seconds, no color is given. Table 7.2 gives an overview of this information.

Table 7.2: Color given based on time difference at arrival

Time difference [sec]	category	color
0-110	warning	red
110-150	caution	orange
>150 (ahead)	available	green
>150 (behind)	available	no color

Figure 7.7 shows the resulting display, using the values from Table 7.2. Figure 7.7a shows two medium type airplanes that both fly with an Indicated Airspeed of 250kts and are within a descent path. In this situation, the aircraft is able to end up in front of the other aircraft when a direct-to command is given. When the controller wants the aircraft to end up behind it he/she can select any dog-leg path that is orange and outside of the red band. The Solution Space Diagram provides the user the conflict information just ahead. It is important to realize the background information only takes into account the arrival time. The controller still has to separate the incoming traffic using extension tools such as the SSD.

Figure 7.7b shows the same situation at a later time. The controller did give the command and at this stage it is no longer possible to end up in front with enough spatial separation using a dog-leg maneuver. In Figure 7.7c and Figure 7.7d, the same situation is presented for different flight speeds. When the aircraft flies

at a speed of 280kts, it will end up ahead of the other aircraft by more than 150 seconds on a direct-to path.

The display described in this section uses one flight speed and one point of descent. Clearly, these parameters can be changed. Section 7.5 and 7.6 are devoted to extending this visualization further to take into account some of the other control possibilities. When more aircraft are in the sector, the calculated points are combined. Section 7.7 explains how this is done.

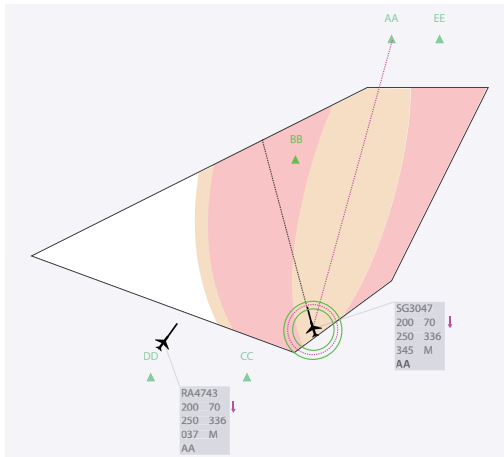

(a) A two-aircraft situation, where the selected aircraft is able to end up in front of the other.

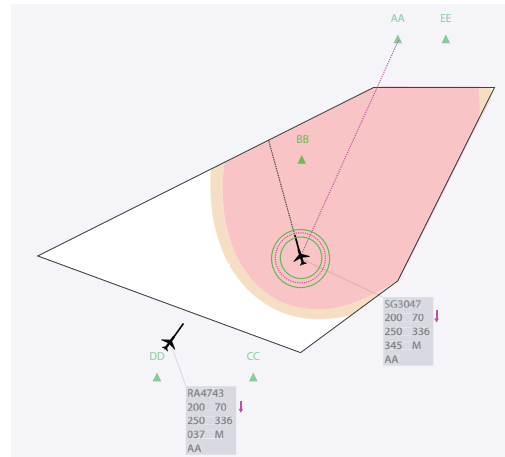

(b) A two-aircraft situation, where the selected aircraft is no longer able to end up in front of the other.

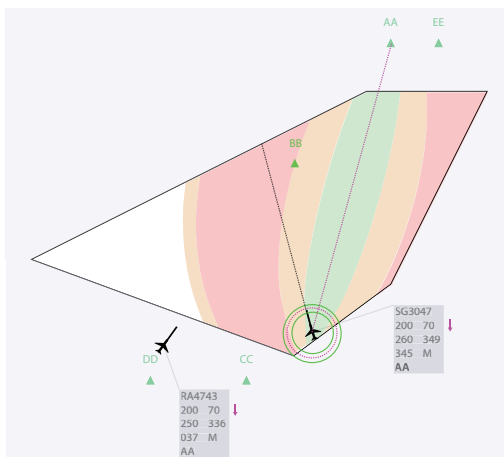

(c) A two-aircraft situation with increased speed, where the selected aircraft is able to end up in front of the other.

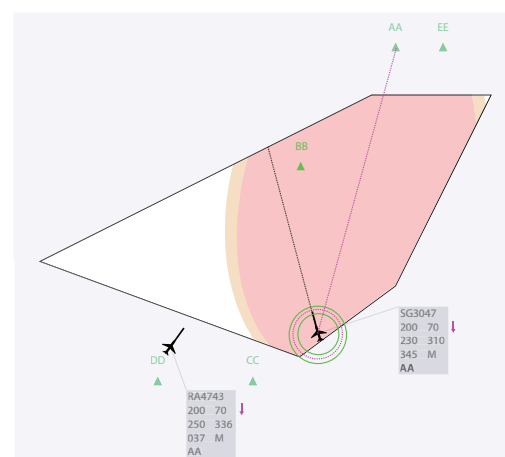

(d) A two-aircraft situation with reduced speed, where the selected aircraft ends up behind the other.

Figure 7.7: Visualization of the available flight paths under current flight conditions

7.5. Visualizing Speed Changes

Research into the current practices in the Amsterdam South sector showed that the Area Controllers use speed commands as one of the possibilities to handle the incoming traffic. All aircraft have to arrive at the IAF within a certain speed range. Airplanes are generally in a descent path when they arrive at the sector. When a great speed change is commanded, speed-brakes are necessary to lose energy. This costs fuel and is not preferred by airline companies. Still, for a controller it is often a solution that consumes little of their time, because of the "set-and-forget" strategy. This means that after doing this the airplane needs little attention. When a different strategy is chosen at a later stage the speed reduction still has to be communicated. So even though it is not energy efficient, it is a good solution strategy for a controller.

Thus, a visualization of the effects of speed changes even during descent maneuvers would be useful. An indication of the effects of slowing down an aircraft are given in this section. At this moment, the solution does not have the capability to show the full impact of a speed change, but with an extension to the ideas presented in Section 7.4, the display does give the user an indication of the impact a speed change has on the complex system.

Figure 7.8a shows a similar display as the one that revealed the available flight paths under current flight conditions. Only now there are additional lines visible in the red-colored area. These lines indicate the border of the red area when slowing down the selected aircraft. Each line corresponds to a 10kts speed reduction. To further clarify this principle, Figure 7.8b, Figure 7.8c and Figure 7.8d are added. Each of these figures shows the situation in Figure 7.8a at a different speed. It can be seen that the line closest to the orange area in Figure 7.8a is indeed the boundary of the red area in Figure 7.8b. The other white line indicates where the warning area border starts for a 20kts speed reduction. Figure 7.8c shows this situation. In the figure the aircraft is still within the "warning" area, but the red area has become much smaller. Therefore, more dog-leg paths have become available. Lastly, in Figure 7.8d the situation for a 30kts speed reduction can be found. In this situation the airplane will be safely behind the other airplane even when a direct-to is commanded.

In summary, Figure 7.8a allows the controller to see the speed reduction needed to arrive behind the other aircraft on a direct-to path, by counting the number of white line plus one. Besides, each line indicates the available flight paths for that speed reduction. When the controller changes the current speed, the display will change according to the new situation.

In theory it would be possible for an aircraft to increase its speed. The current display does not depict such information. However, since these aircraft are on their way to the runway and need to lose energy, making them fly faster is illogical. Keeping in mind not to make the display too complicated, it was decided to not incorporate this information.

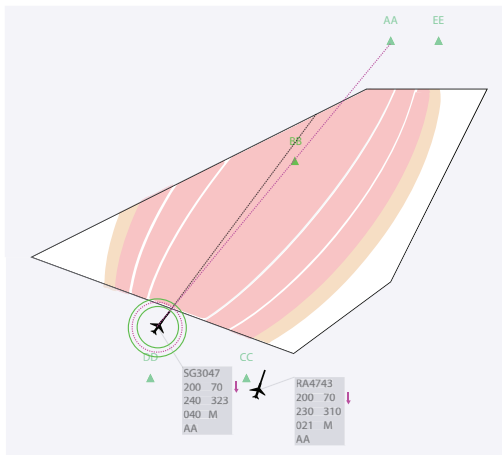

(a) A two-aircraft situation, in which a 30kts speed reduction is required for arriving at a safe distance behind the green aircraft at the IAF

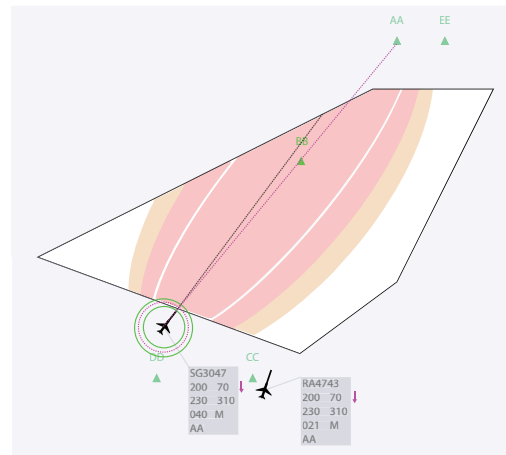

(b) A two-aircraft situation, in which a 20kts speed reduction is required for arriving at a safe distance behind the green aircraft at the IAF

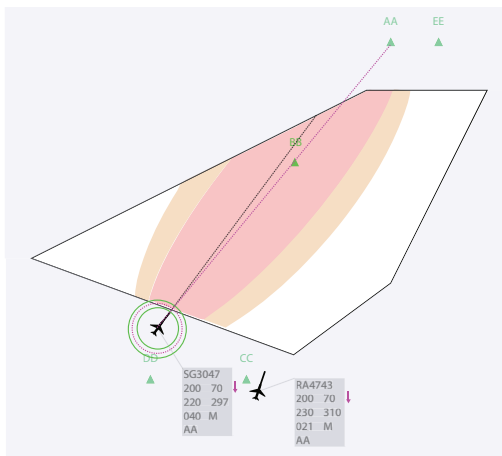

(c) A two-aircraft situation, in which a 10kts speed reduction is required for arriving at a safe distance behind the green aircraft at the IAF

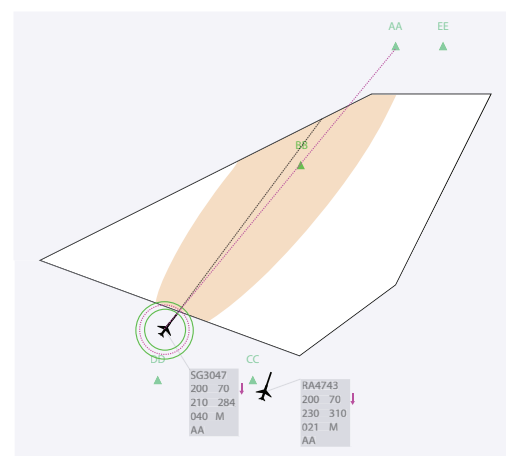

(d) A two-aircraft situation, in which the selected aircraft arrives at the IAF a safe distance behind the green aircraft

Figure 7.8: Visualization of the effects on changing speed

7.6. Visualizing Impact of Descent Point

Aircraft generally arrive at the Amsterdam South sector descending (Section 2.2). Although it is not the most common action, it is possible to stop the descent and continue descending at a later stage. This is known as the step descent heuristic (Chapter 3). Because of the difference in Ground Speed with altitude, the selected airplane will arrive earlier at the Initial Approach Fix and can possibly overtake another aircraft. An added benefit of flying at a higher altitude is that the aircraft will use less fuel and is responsible for less noise perceived on the ground.

For completeness, the option to descend at a later stage is added to the display. In Figure 7.9, the last possible descent moment circle and available flight paths are present. Additionally, along the direct-to path a line is pictured. This line indicates the color the background has at the airplane's position when the plane descends at a specific point along the visualized line. In Figure 7.9a, the plane selected is in a descent maneuver. It is assumed this descent will continue until the aircraft has reached the required flight level at the Initial Approach Fix. In this case it will arrive just before the other aircraft does. The separation can be increased by stopping the descent and starting again later along the path. How much it will change can be seen from the color of the line. When the aircraft stops its descent path now and descends as late as possible (at the border of the quarter circle), it is located in the green area. Thus, the aircraft are at least 150 seconds apart. Figure 7.9b shows the mentioned extreme case. The line itself has not changed but the assumed descent point along it has. In this figure, the aircraft will start its descent at the last possible moment. The space for dog-leg paths has changed substantially without changing the indicated speed of the aircraft.

This functionality can be especially useful for light aircraft, which have more room for adjustments in their path. For medium and heavy aircraft the sector is too small for it to have a big impact.

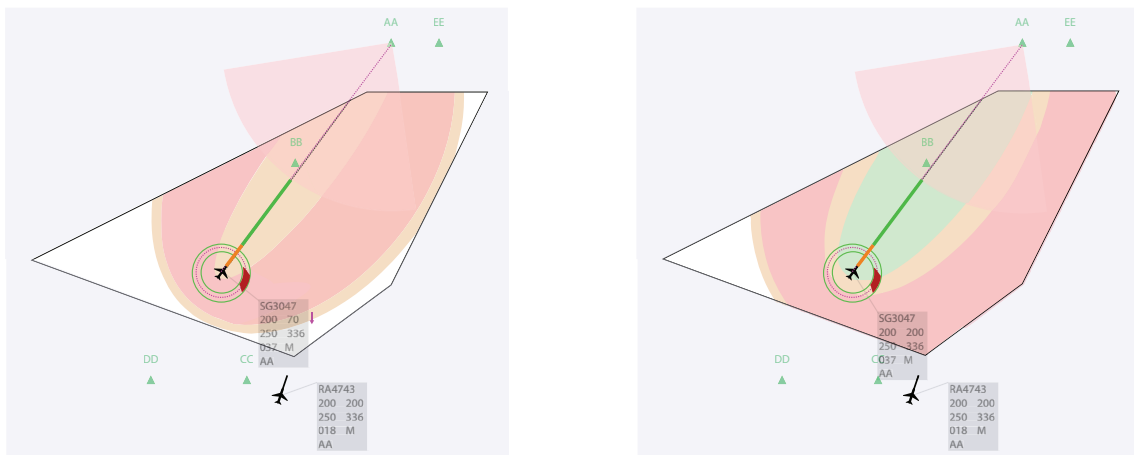

(a) A two-aircraft situation, in which the aircraft descends as early as possible

(b) A two-aircraft situation, in which the aircraft descends as late as possible

Figure 7.9: Visualization of the impact of changing the descent point

7.7. Visualizing Multiple Aircraft

So far, all situations presented consist of two aircraft. In a real Air Traffic Control situation, more aircraft will be present. The previously described visualizations are superimposed. Priority is given to the more critical color. This means that, if a pixel in the background has to be both green and orange, it will become orange. Figure 7.10 shows an example of such a situation. In Figure 7.10a, the selected aircraft will (in the current speed conditions) end up behind the other aircraft. Figure 7.10b shows a similar situation in which the selected aircraft will (on a direct-to path) end up in front of the other aircraft. Figure 7.10c shows the combination of the previous situations. The possible paths are still clearly visible in this situation. The dog-leg paths located in the green areas will make sure the aircraft is located in between the two other aircraft.

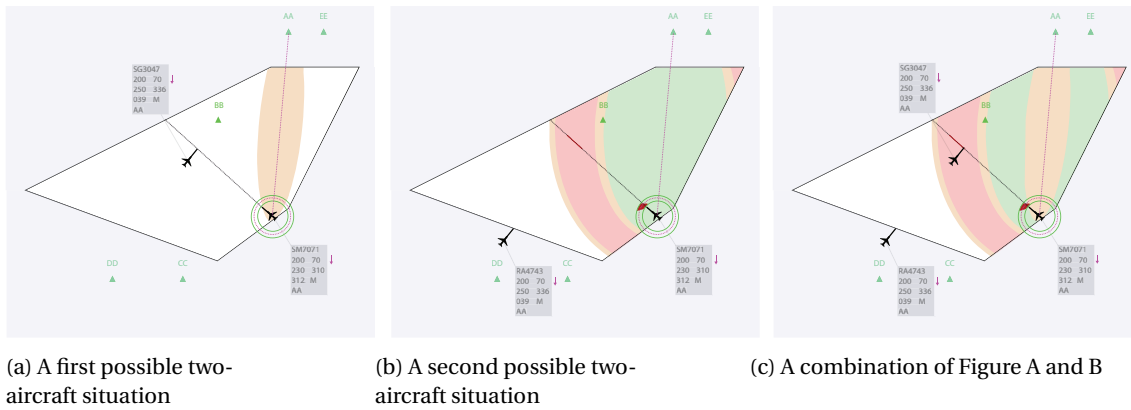

Figure 7.10: An example of combining visualizations from multiple aircraft situations

7.8. Overview of the Preliminary Display

One of the research questions in this thesis is:

How is the supporting information in the task of merging aircraft towards a restricted waypoint best visually presented using the principles of Ecological Interface Design?

In EID, the aim is to show the affordances of the work domain. A display designed for a complex work domain should not issue advisories, because this can be at the expense of situation awareness. Instead, ideally, all possible resolutions are visualized.

An example of the proposed solution with all the designed elements included can be found in Figure 7.11. At this point in the design process, this is considered to be the way to visualize the supporting information for a merging task.

Using the display, the controller can immediately see what paths are possible and what the impact of a speed reduction or a step descent would be. Thus, the user remains aware of the situation and can make decisions individually as is required by the EID methodology.

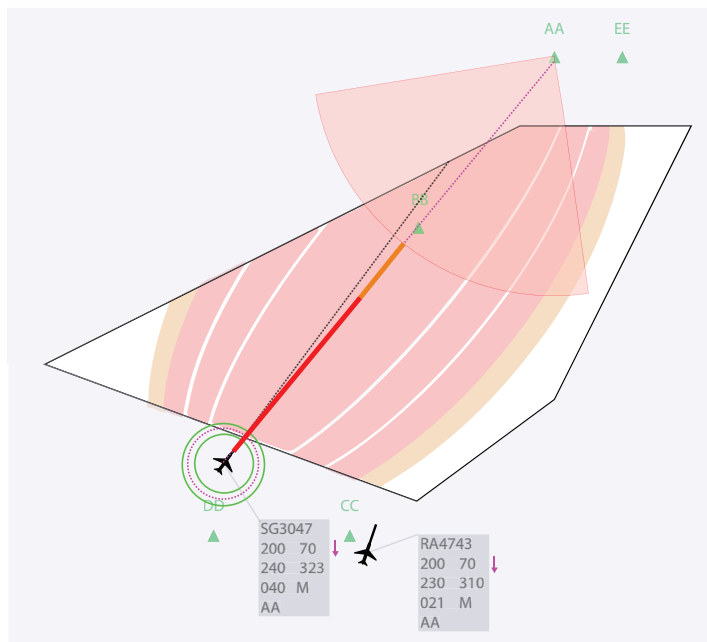
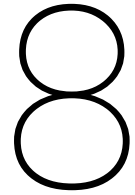

Figure 7.11: The proposed EID for an Area Controller's merging task



Concluding Remarks

The main objective of this thesis is to assist the Area Controller in the decision making process of a merging task, whilst taking into account the controller's capabilities and current work domain. So far, a literature review has been conducted and a preliminary display has been designed. To meet the objective three research questions were proposed. Each question is supported by sub-questions that help answer the question. The research questions can at this point not be fully answered, but the current findings and the steps that will be taken next will be presented.

(1) What information would support the Air Traffic Controllers task of merging aircraft towards a restricted waypoint in an approach maneuver?

In order to answer this research question, two sub-questions were formulated. To answer these, the current good practices were investigated by means of a literature review. It can be concluded that one best strategy can not be defined on paper, but a set of strategies have been identified. Also, research was done into the aircraft's performance constraints. It was found that the minimum descent distance is important information, since the aircraft needs to lose its potential and kinetic energy.

These sub-questions helped identify that information about possible paths and speed is most useful. The path information can be used to see the effects of direct-to commands along the current heading. Speed reduction is a common strategy among controllers and the influences of changing speed are therefore important information when supporting them.

(2) How is the supporting information in the task of merging aircraft towards a restricted waypoint best visually presented using the principles of Ecological Interface Design?

At this moment, the latest descent information is displayed using a circle attached to the IAF. The path information is visualized in the sector. For each point the possibility of a dog-leg procedure through that point is calculated. The speed information is visualized using white lines in the path information. The effects of the chosen descent point are visualized using a line along the direct-to path.

The current methods could change due to the iterative nature of a design process, but at this moment this is considered to be the best way to present the information.

The last research question concerns the increase in performance and will be tested in an experiment in a later stage of this thesis.

From this point on the design process continues. A logical next step would be to include wind in the simulation. Wind is an important parameter in the design process of a controller. If the display is able to support the controller with separate control strategies for different wind conditions, the assistance can have major implications for the Air Traffic Control sector. Subsequently, realistic traffic situations will be investigated to see if the currently proposed display is able to assist in such situations. Data, acquired from the LVNL, will be used to create such traffic situations. The display will be altered in an iterative process to assist the controller as well as possible. Afterwards, a human-in-the-loop experiment will be performed to see the effects of using the display. A computer with a main screen and additional touchscreen, on which the command window is displayed, will be used to test the control decisions in traffic situations with and without the proposed display. Participants will be analyzed based on the quality of their control decisions and their perceived workload. Good control primarily guarantees separation. Additional parameters regarding efficiency will also be taken into account. To analyze the perceived workload questionnaires will be used.

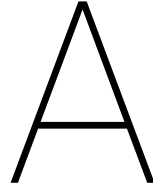

Airspeeds

The definitions in this Appendix are derived from [7] and [1].

Indicated Airspeed (IAS)

Indicated Airspeed is the speed that is visible on the aircraft indicator. It reflects the standard atmosphere adiabatic compressible flow at sea level. The IAS can be measured with a pitot tube. It uses the difference between the total pressure and the static pressure to do this. It can be calculated using A.1.

$$IAS = \sqrt{7 \frac{p_0}{\rho_0} \left[\left(\frac{p_t - p_a}{p_0} + 1 \right)^{\frac{1}{3.5}} - 1 \right]} \quad (A.1)$$

In the formula p_0 and ρ_0 are the pressure and density at sea level conditions. p_a is the ambient pressure at the flight altitude and p_t is the pressure of the free stream. $p_t - p_a$ is known as the impact pressure.

Calibrated Airspeed (CAS)

The Calibrated Airspeed is the Indicated Airspeed corrected for instrument and position errors. Generally, the position and instrument errors are small. It can be reasonably assumed that;

$$CAS \cong IAS \quad (A.2)$$

Equivalent Airspeed (EAS)

The Equivalent Airspeed is equal to the calibrated airspeed corrected for adiabatic compressible flow for a particular altitude. This means that when flying at sea level under international standard atmosphere conditions the Calibrated Airspeed and the Equivalent Airspeed equal. When the position and instrument errors are small the EAS can be calculated using Equation A.3.

$$EAS \cong \sqrt{7 \frac{p_a}{\rho_0} \left[\left(\frac{p_t - p_a}{p_a} + 1 \right)^{\frac{1}{3.5}} - 1 \right]} \quad (A.3)$$

True Airspeed (TAS)

The True Airspeed is the airspeed of an aircraft relative to undisturbed air. It is equal to EAS multiplied by the square root of the relative air density.

$$V_{EAS} = V_{TAS} \sqrt{\left(\frac{\rho}{\rho_0} \right)} \quad (A.4)$$

To get from Indicated Airspeed to True Airspeed (assuming there are no errors in the IAS measurement) the following holds;

$$V_{TAS} = \sqrt{\frac{2\gamma}{\gamma-1} \frac{p}{\rho} \left((1+X)^{\frac{\gamma-1}{\gamma}} - 1 \right)} \quad \text{with} \quad X = \frac{p_0}{p} \left[\left(1 + \frac{\gamma-1}{2\gamma} \frac{p_0}{p_0} V_{IAS}^2 \right)^{\frac{\gamma}{\gamma-1}} - 1 \right] \quad (A.5)$$

Ground Speed (GS)

Ground Speed is the speed the aircraft has relative to the ground. When there is no wind this speed is equal to the True Airspeed. In practice this will never be the case and wind has to be taken into account to accurately calculate the distance with respect to the ground.

Bibliography

- [1] MAE 5420 -Compressible Fluid Flow slides.
- [2] Rules of the Air Annex 2 to the Convention on International Civil Aviation. 2005.
- [3] L Bainbridge. Ironies of Automation. 1982. doi: 10.1016/S1474-6670(17)62897-0.
- [4] C. Borst, V. A. Bijsterbosch, M. M. van Paassen, and M. Mulder. Ecological interface design: supporting fault diagnosis of automated advice in a supervisory air traffic control task. *Cognition, Technology and Work*, pages 1–6, 2017. DOI: 10.1007/s10111-017-0438-y.
- [5] Clark Borst. *Ecological Approach to Pilot Terrain Awareness*. PhD thesis, Delft University of Technology, 2009.
- [6] Clark Borst, Roeland Visser, M M Van Paassen, and Max Mulder. Ecological approach to train air traffic control novices in conflict detection and resolution. 2016.
- [7] Mustafa Cavcar. Airspeed Definitions.
- [8] Jean-François D’Arcy and Pamela S. Della Rocco. Air traffic control specialist decision making and strategic planning – a field survey, March 2001.
- [9] Selina Fothergill and Andrew Neal. Conflict-resolution heuristics for en route air traffic management. In *Proceedings of the Human Factors and Ergonomics Society 57th Annual Meeting*, 2013.
- [10] B. Hilburn. Cognitive complexity in air traffic control - a literature review, March 2004.
- [11] Jacco Hoekstra. Ae4321-15 air traffic management slides: Ais, air traffic services, airspaces, 2016.
- [12] *Fact Sheet, Industry Statistics*. IATA, June 2017. Historic data form ICAO.
- [13] Lars Peter Jensen and P. Koch. An ecological man-machine interface for temporal visualization. In *Intelligent User Interfaces*, page 235–238, 1993.
- [14] Wolfgang K. Kallus, Dominique van Damme, and Andrea Dittmann. Integrated task and job analysis of air traffic controllers - phase 2: Task analysis of en-route controllers, Oktober 1999.
- [15] Barry Kirwan and Mary Flynn. Investigating air traffic controller conflict resolution strategies, March 2002.
- [16] R. E. Klomp, M. Mulder, M. M. van Paassen, and M. I. Roerdink. Re-design of an inbound planning interface for air traffic control. *AIAA Guidance, Navigation, and Control Conference*, pages 1–27, 2011.
- [17] Rolf Klomp, Clark Borst, Rene van Paassen, and Max Mulder. Expertise level, control strategies, and robustness in future air traffic control decision aiding. *IEEE Transactions On Human-Machine Systems*, page 1–12, 2015. doi:10.1109/THMS.2015.2417535.
- [18] Paul Macwilliams and Donald Porter. An assessment of a controller aid for merging and sequencing traffic on performance-based arrival routes.
- [19] Paul V. MacWilliams, Arthur P. Smith, and Thomas A. Becher. RNP RNAV arrival route coordination. In *AIAA/IEEE Digital Avionics Systems Conference - Proceedings*, 2006. ISBN 1424403782. doi: 10.1109/DASC.2006.313682.
- [20] Luchtverkeersleiding Nederland. Operations and instructions manual - amsterdam acc controllers, 2012.

- [21] International Civil Aviation Organization. Procedures for air navigation services, air traffic management, November 2001. Doc 4444.
- [22] Jens Rasmussen. Skills, rules, and knowledge; signals, signs, and symbols, and other distinctions in human performance models. *IEEE Transactions on Systems, Man, and Cybernetics*, 13(3):257–266, 1983.
- [23] Jens Rasmussen. The role of hierarchical knowledge representation in decision making and system management. *IEEE Transactions on Systems, Man, and Cybernetics*, 15(2):234–243, 1985.
- [24] *Monthly Transport and Traffic statistics 1992 - current*. Royal Schiphol Group, August 2017.
- [25] Ger J.J. Ruijgrok. *Elements of airplane performance*. Delft Academic Press, 2009.
- [26] Johan M Sanne. *Creating Safety in Air Traffic Control*. Arkiv forlag, 1999.
- [27] Air Traffic Controllers the Netherlands. Aip netherlands - schiphol standard arrival chart, July 2009.
- [28] AIS the Netherlands. Airspace structure and ats airspace classification, 2015.
- [29] M. Tielrooij, A. C. In 't Veld, M. M. van Paassen, and M. Mulder. *Development of a Time-Space Diagram to Assist ATC in Monitoring Continuous Descent Approaches, Air Traffic Control*. 2010.
- [30] Air traffic controllers from the LVNL. Interview regarding the amsterdam south sector. personal communication, May 2018.
- [31] Stijn B. J. Van Dam, Max Mulder, and M. M. van Paassen. Ecological interface design of a tactical airborne separation assistance tool. *IEEE Transactions on Systems, Man, and Cybernetics*, 38(6):1221–1233, 2008.
- [32] Ministerie van defensie. Verdediging nederlands luchtruim, november 2017. <https://www.defensie.nl/onderwerpen/taken-in-nederland/verdediging-nederlands-luchtruim>.
- [33] E. S. van Dijk, M. Mulder, M. M. van Paassen, and M. I. Roerdink. An interface for inbound traffic management by air traffic control. *AIAA Guidance, Navigation, and Control Conference*, pages 1–23, 2009.
- [34] M. M. van Paassen, C. Borst, J. Ellerbroek, M. Mulder, and J. M. Flach. Ecological interface design for vehicle locomotion control. *IEEE Transactions On Human-Machine Systems*, 10(20):1–13, 2018.
- [35] G A Mercado Velasco, M Mulder, and M M Van Paassen. Analysis of air traffic controller workload reduction based on the solution space for the merging task. In *AIAA Guidance, Navigation, and Control Conference*, pages 1–18, 2010. doi: 10.2514/6.2010-7541.
- [36] T.H. Verhoogt. Syllabus "introduction to air traffic control", January 2015. Course lay-out.
- [37] Kim J. Vicente. *Cognitive Work Analysis, Toward Safe, Productive, and Healthy Computer-Based Work*. Lawrence Erlbaum Associates, 1999.
- [38] Kim J. Vincente and Jens Rasmussen. The ecology of human-machine systems ii mediating "direct perception" in complex work domains. *Ecological Psychology*, 2(3):207–249, 1990.
- [39] Kim J. Vincente and Jens Rasmussen. Interface design Theoretical foundations. *IEEE Transactions on Systems, Man, and Cybernetics*, 22(4):589–606, 1992.

Part III

Book of Appendices



Instruction Manual

Dear participant,

Thank you for taking part in this experiment. As part of a master thesis a new interface was developed to help you (the participant) guide arriving aircraft towards an initial approach fix (IAF).

In this experiment you will start with 10 short training scenarios. Here, it is possible to get familiar with the java model and the new interface elements. Afterwards, 4 different configurations will be tested. You will test the interface with and without visual extensions for moderate and complicated traffic situations. Each of these 4 experiment configurations consists of 2 scenarios that each take approximately 12 minutes.

Throughout the experiment, you will be asked to report your experienced workload using subjective workload ratings. These ratings are crucial in determining the relevance of the new display and should be given as accurately as possible. In this manual a more detailed description of the model and its elements is given.

1.1. Sector

The experiment will be performed in a modelled environment. The sector the experiment is performed in is a simplified version of the Amsterdam South Sector. Figure 1.1 shows the sector as it will be visible on the modelled radar screen. However, to clarify the principles explained, drawings with adjusted colors will be used to explain the display in this manual.

Figure 1.2 shows a drawing of the sector. The sectors spans 95 NM (176 km) laterally and 55 NM (102 km) longitudinally. The initial approach fix RIVER is indicated by BB and SPL is shown using AA. In this experiment all aircraft need to fly 250 kts indicated airspeed at an altitude 7000ft (FL 70) when arriving at the IAF.

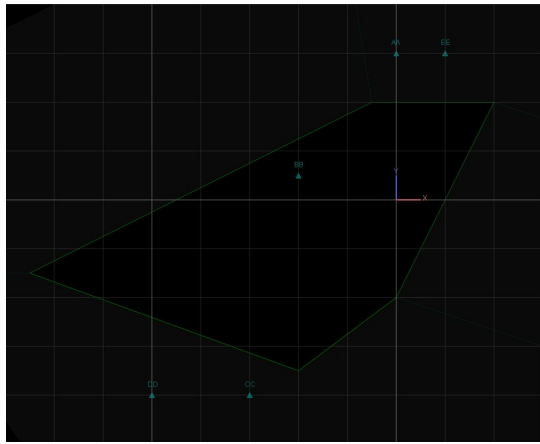

Figure 1.1: Modelled radar screen for the Amsterdam South Sector

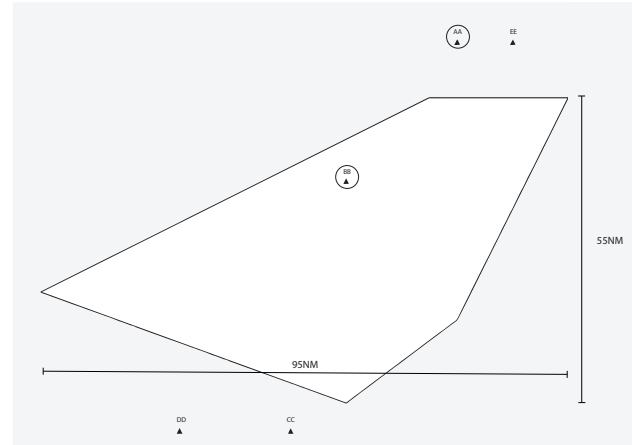

Figure 1.2: Drawing of the modelled radar screen for the Amsterdam South Sector

1.2. The Radar Screen

In Figure 1.3 the sector is displayed along with one aircraft. Some additional information regarding the aircraft is displayed using the aircraft label. For each aircraft this label shows (left-to-right then top-to-bottom); the callsign, the current flight level, the target flight level, the indicated airspeed, the ground speed, the heading, the aircraft type and the destination waypoint. The aircraft characteristics and a support compass rose can be found on the cheat sheet (Section 1.8).

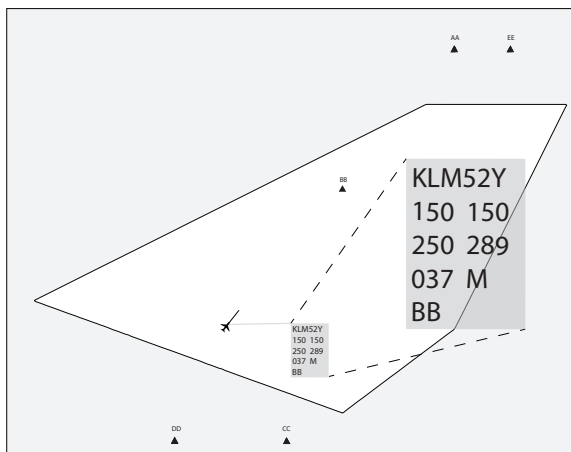

Figure 1.3: Highlighted aircraft label

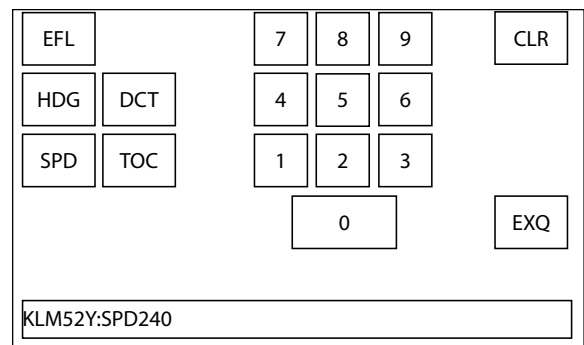

Figure 1.4: Command window

Commands to alter the course of an aircraft are given using the command window. Figure 1.4 shows the command window along with a possible command. The following commands can be given:

- EFL (Executive Flight Level): Change the target flight level
- HDG (Heading): Change the heading to a value between 1 and 360 degrees
- DCT (Direct-to): Proceed directly to the destination waypoint
- SPD (Speed): Change the (target) indicated airspeed within the performance envelope of the aircraft (error message otherwise)
- TOC (Transfer-of-control): Hand over the aircraft to the next sector
- CLR (Clear): Clear the commands given
- EXQ (Execute): Execute the given command

1.3. The Available Display Elements

In the newly designed display, more information is available to the user. Each of the extensions will be explained separately. Firstly, the visualization of the last possible descent moment and the 5 NM separation minimum is presented. Then the relative speed indicator and its use in conflict situations is explained. This is followed by an explanation of the possible flight paths towards the IAF. This is extended to also include speed information. Finally, all elements are combined and the effects of wind are made visible.

Single aircraft visualizations

In the new display each aircraft is circumscribed by a circle with a radius of 2.5 NM. Because of this, it is easier to determine if aircraft are separated by at least 5 NM; the circles are not allowed to touch one another. When an aircraft is selected by clicking on it, additional information will appear. In figure 1.5 such a situation is displayed. After clicking on the aircraft, the aircraft changes color. In the radar screen this is yellow, but within the drawings this is visualized using blue. Also, two circles become apparent. The inner circle represents the 5 NM separation minimum. The outer circle represents 7 NM. This number was extracted from expert interviews as a separation distance that requires less attention in the future. This second circle can be turned on or off using a toggle function.

Besides, a circular line segment can be seen. This arc represents the last possible location for an aircraft to start the descent manoeuvre and still reach the target flight level at the IAF using the current FL and speed. When an aircraft continues flying at its current flight level and crosses the line segment this means that it will no longer be able to reach the required flight level at the IAF when flying directly towards the destination. Figure 1.6 displays such a situation (now without the 7 NM circle). When this happens the color of the line segment and the current and target flight level change to orange. When the aircraft is not selected the color in the aircraft label still changes color to inform the user that action is required. The situation in Figure 1.6 can still be solved using speed brakes or by elongating the flight path. The latter is achieved by not flying directly towards the destination waypoint.

Relative tracks

In order to decide if an aircraft will have potential loss of separation in the near future the relative tracks visualization is used. In Figure 1.7a a two-aircraft situation is visible. The aircraft with ACID KLM52Y is currently selected. Both aircraft fly at the same altitude and with the same speed. The question is whether the selected aircraft is able to fly a safe distance behind the aircraft indicated by TRA4K. The relative track line originating from the non-selected aircraft helps with this task. As long as this line does not cross the 5 NM circle a loss of separation will not occur. To further clarify this principle, Figure 1.7b and 1.7c show the same situation at a later time stage. As can be seen, while the aircraft continue along their trajectories the relative track is still tangent to the 5 NM boundary. In Figure 1.7d, the closest point of approach can be found. And the aircraft indeed cross each other at exactly 5 NM distance.

Almost the same situation can be seen in figure 1.8, but since the relative track line and the 5 NM circle intersect, a loss of separation will occur when the user does not intervene (Figure 1.9). The points where this

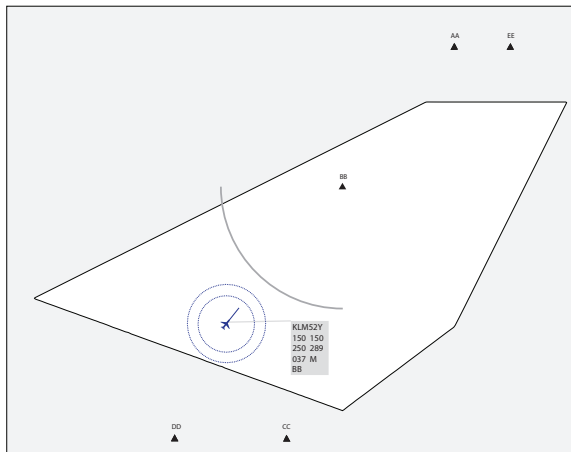

Figure 1.5: Selected aircraft visualization

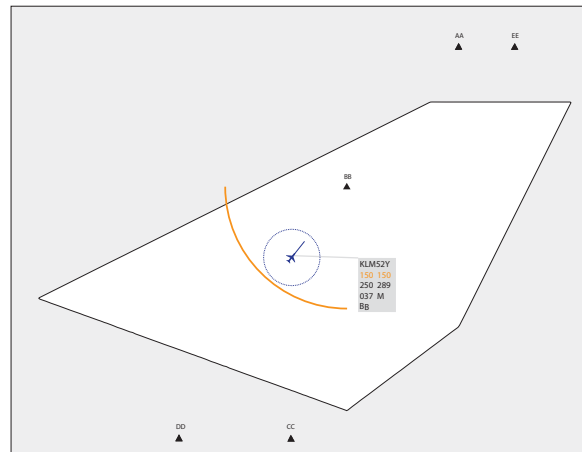
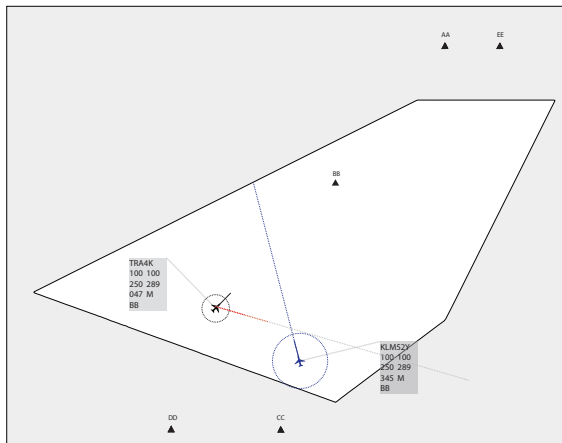
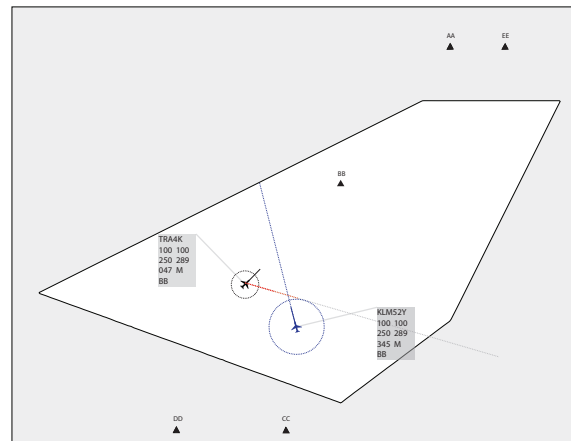

Figure 1.6: Selected aircraft visualization when the last possible descent arc has been passed



(a) Relative track visualization starting point



(b) Relative track visualization at a later stage

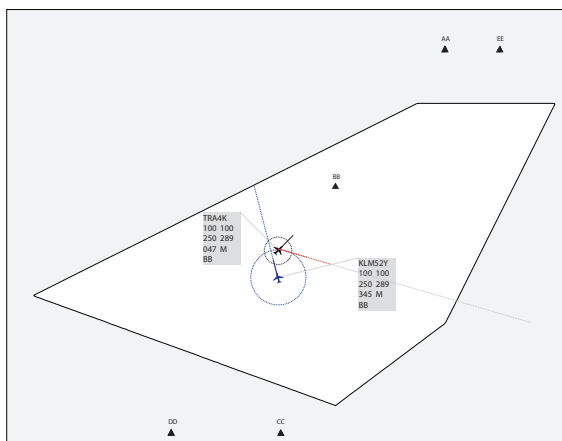

(c) Relative track visualization at a later stage

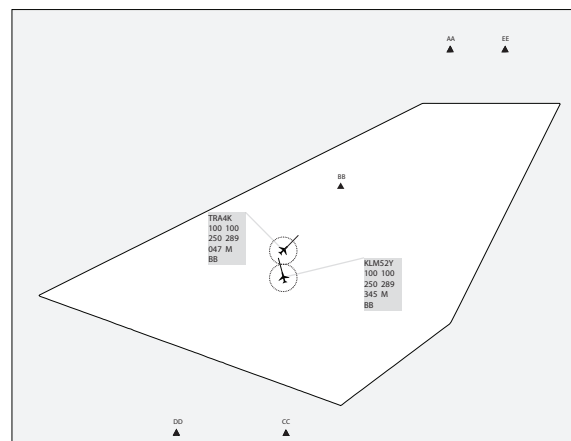

(d) Relative track visualization closest point of approach

Figure 1.7: Relative track visualization in a two-aircraft situation where the selected aircraft flies a safe distance behind the other aircraft

will occur is visualized along the course line using a red line segment.

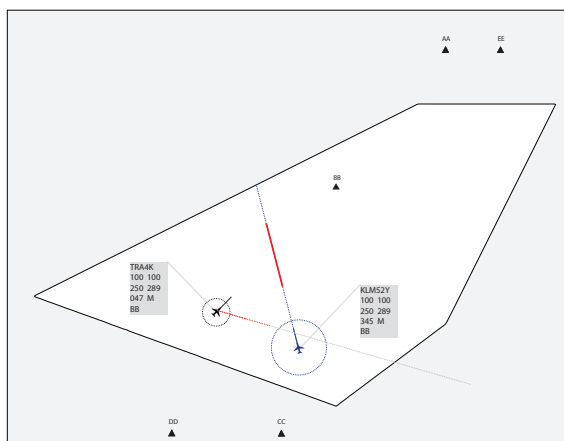

Figure 1.8: Relative track visualization starting point

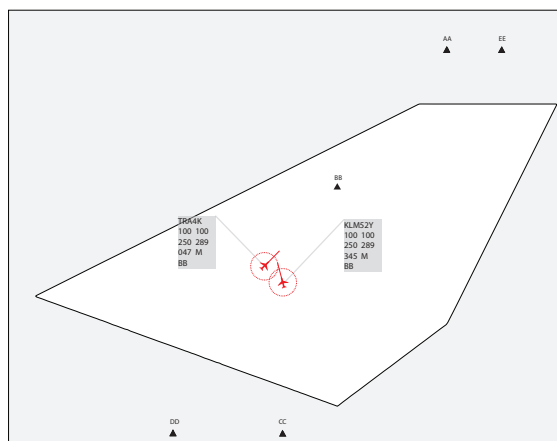

Figure 1.9: Relative track visualization conflict situation

This principle can also be used with the 7 NM circle if the controller wants to ensure a large safety margin.

Available flight paths under current flight conditions

The previous visualization gives inside into whether aircraft will experience a conflict in the future. However, in order to safely guide aircraft towards the destination waypoint more than conflict detection is needed. Therefore, the available flight paths towards the IAF are visualized. For each point on the screen, the time it takes to fly directly to that point and from there to the destination waypoint is calculated. This is also known as a dogleg manoeuvre. Figure 1.10 shows two dogleg paths. The information for the red path will be displayed at the location of the red dot. Similarly, the available flight path information for the blue path is displayed at the location of the blue dot.

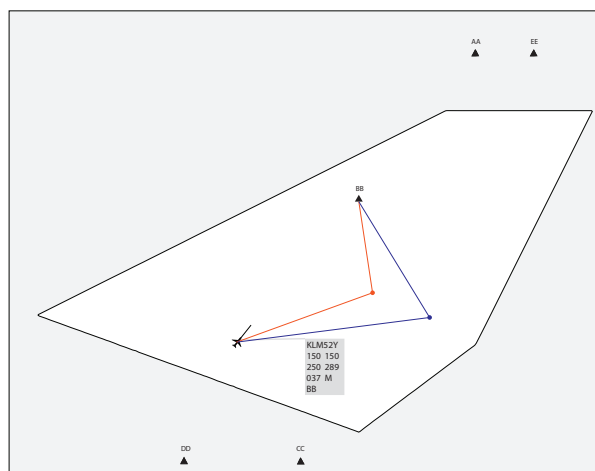

Figure 1.10: Two possible dogleg paths for one aircraft

The aim is to calculate how far apart the two airplanes will be when they arrive at the destination waypoint. Evidently, when the path length is increased the aircraft will take longer to reach its destination and this will influence the separation between the aircraft.

Since each decision taken by the controller influences the entire solution space, a starting point is needed. Once one aircraft has been commanded to go towards the IAF, the other aircraft in the sector can be built around the first one. The user can see which aircraft are on their way towards the IAF (and therefore included in the visualization) because the color of those aircraft changes. When the aircraft is on a direct-to path and descending to FL 70 the color becomes green and when the aircraft is on a direct-to path and not yet descending to FL 70 the color changes to a different shade of grey.

Table 1.1: Color given based on spatial difference at IAF

Distance at IAF [NM]	category	color
0-5	warning	red
5-7	caution	orange
>7 (in front)	safe	green
>7 (behind)	safe	no color

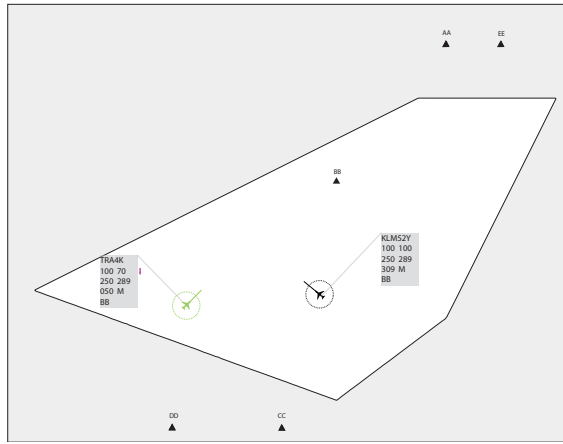

(a) A two-aircraft situation; TRA4K is on its way to BB

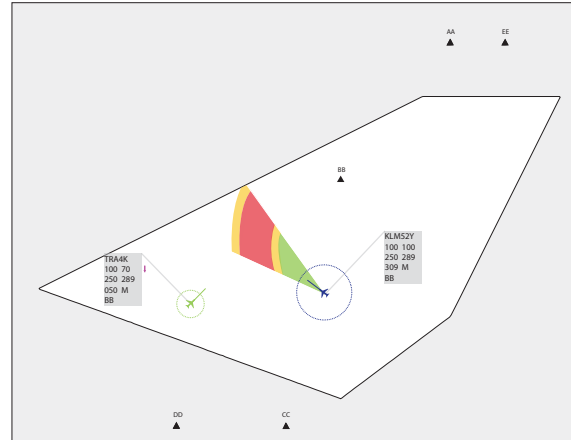

(b) A two-aircraft situation; IAF available flight paths for selected aircraft

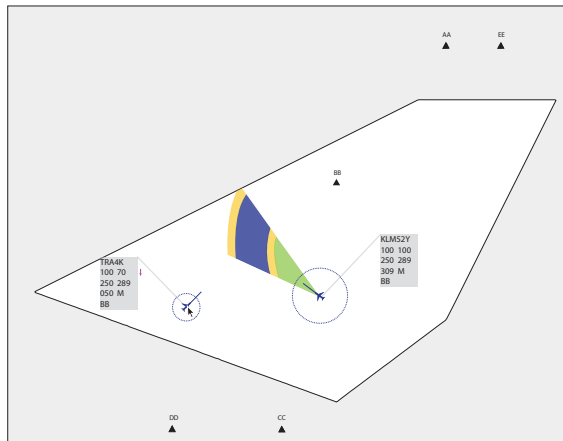

(c) A two-aircraft situation; means-end characteristics (aircraft selected)

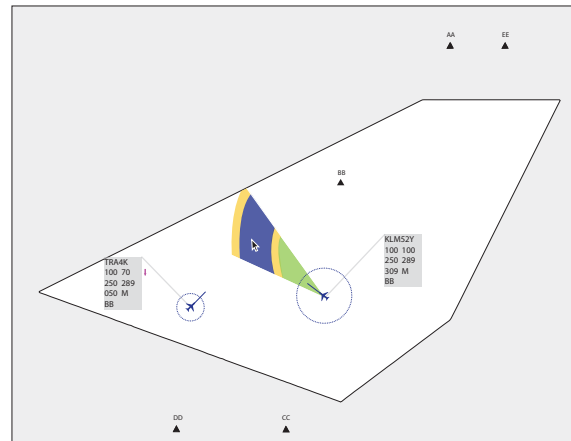

(d) A two-aircraft situation; means-end characteristics (critical area selected)

Figure 1.11: Visualization of the available flight paths under current flight conditions

Figure 1.11a shows a situation in which an aircraft (TRA4K) is on its way towards the destination way-point. When the other aircraft (KLM52Y) is selected (Figure 1.11b) the available flight paths are shown in the background. When KLM52Y is commanded to fly directly towards the IAF it will end up in front of TRA4K by at least 7 NM. If it continues along its current course and a direct-to command is given at a later stage the margin becomes smaller or even critical. If it flies even further towards the non-colored area it will end up a safe distance behind TRA4K. **It is important to realize that this visualization only takes into account the separation when arriving at the IAF. This means that the information needs to be combined with the previously explained relative track information to ensure separation within the sector.**

Moreover, the means-end properties are visible by hovering the cursor over the critical areas. In Figure 1.11c the cursor hovers over TRA4K and both the aircraft and the critical area light up. The same happens when the critical area is "selected" (Figure 1.11d).

When more than two aircraft are involved, the visualizations are superimposed. The critical colors are given priority. Figure 1.12a depicts such a situation. Both AFR1336 and TRA4K create a critical area. When a direct-to command is given at this moment this will create a loss of separation at the IAF. This information is also available to the controller when an aircraft is not selected. The orange color (Figure 1.12b) warns the user of a future conflict. When the controller gives a direct-to command within the green area (Figure 1.12c), a 7 NM distance is indeed kept with respect to both aircraft as can be seen in Figure 1.12d.

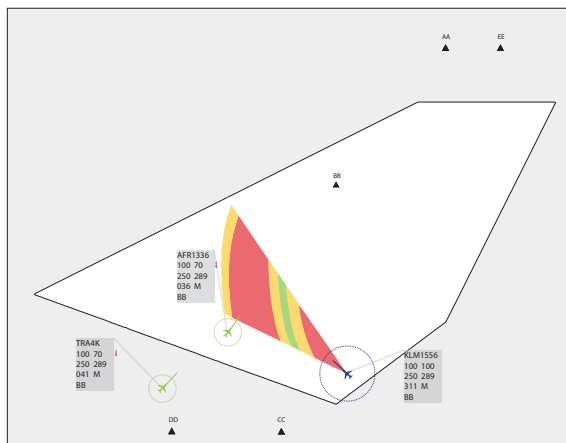

(a) A three-aircraft situation; superimposed visualization areas

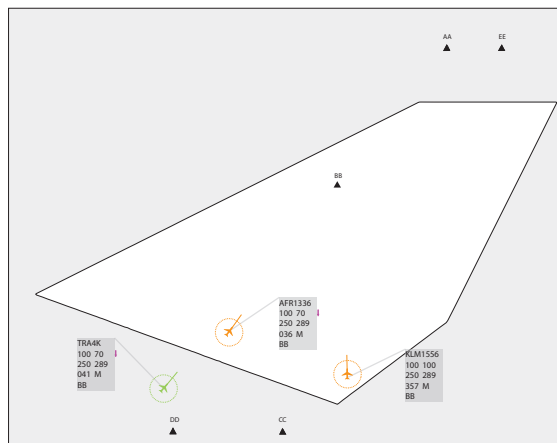

(b) A three-aircraft situation; warning given by the system

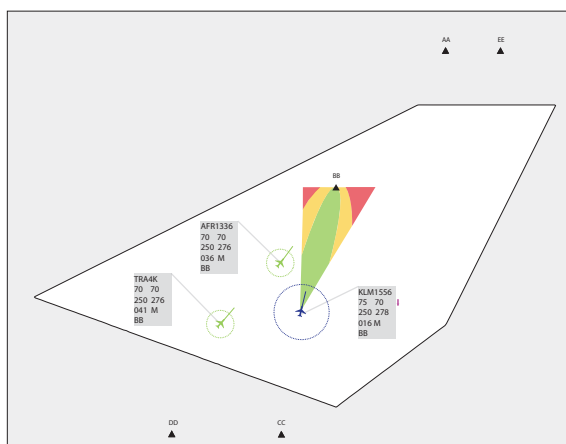

(c) A three-aircraft situation; correct command moment

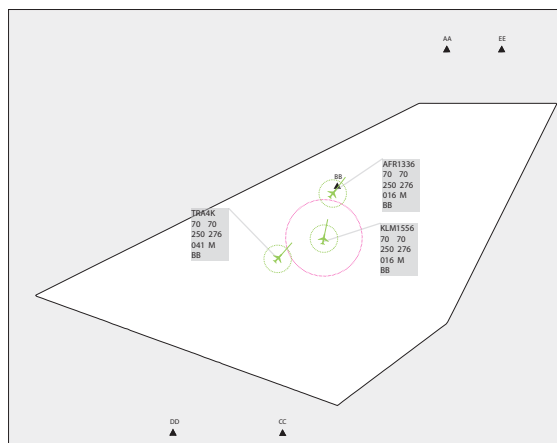

(d) A three-aircraft situation; continuation of situation (7 NM circle for reference)

Figure 1.12: Visualization of the available flight paths under current flight conditions

IAF paths for altered speed

The previous visualization only took into account the current speed conditions. By means of a toggle function, alternative speed information can also be visualized. **The areas that would not be colored red when flying at a different speed are laid over on the current visualization using a new (white) layer.** The IAS in the aircraft label is changed to the "new" speed using a purple color.

Figure 1.13 and Figure 1.14 show two situations in which the speed information can be used to solve a situation. In Figure 1.13a a conflict situation is present. When the speed is lowered to 240 kts (Figure 1.13b) the red area becomes smaller. You can see this because part of the red area has a white layer on top of it. This part will not be red when a speed of 240 kts is commanded. In Figure 1.13c it can be seen that, when the speed is lowered to 230, it is no longer necessary to change the path towards the IAF. After commanding an IAS of 230 kts the new situation will resemble Figure 1.13d. So, it is possible to see whether a path will lead towards

a loss of separation at the IAF for all speeds, but it is not possible to see if the margin will be between 5 and 7 NM or more than 7 NM.

Figure 1.14 shows another situation. It can be seen that the selected aircraft is able to end up in between RA4743 and KLM1556 for the current flight conditions. Changing the speed influences the possible paths. In Figure 1.14b the speed has been reduced by 30 kts to 220 kts. For lowered speed, the aircraft has to turn towards the destination waypoint earlier. In figure 1.14c, the speed toggle function has been increased by 30 kts to 280 kts. In this case a new highlighted area becomes apparent. Thus, for a speed a 280 kts the selected aircraft is able to end up in front of both aircraft with sufficient distance. Figure 1.14d it can be seen that this is indeed the case after a command is given. The selected aircraft will end up in front of RA4743 by at least 5 NM. If the user wants to extend this to 7 NM, additional steps have to be taken.

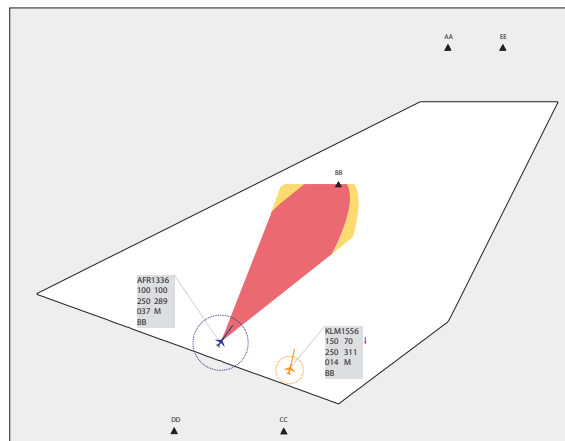

(a) A two-aircraft conflict situation

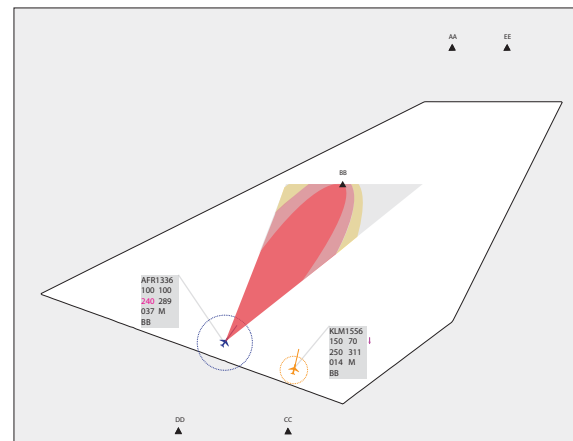

(b) A two-aircraft conflict situation and superimposed 10 kts speed reduction

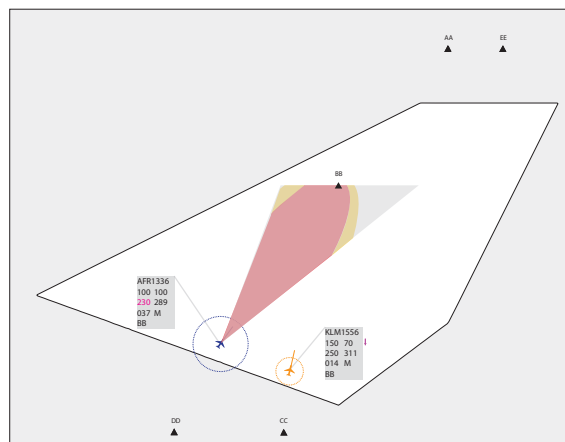

(c) A two-aircraft conflict situation and superimposed 20 kts speed reduction

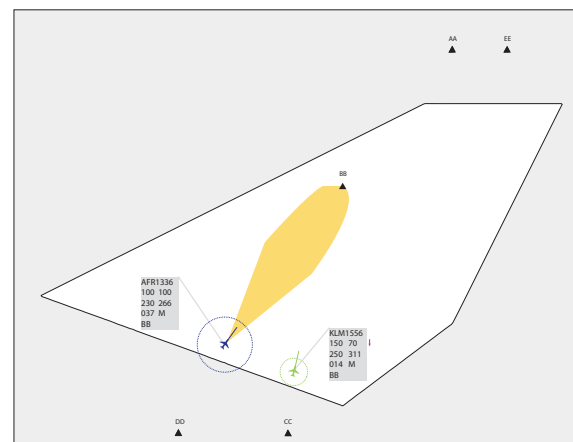

(d) Solution of a two-aircraft conflict situation

Figure 1.13: First visualization of the available flight paths under current and changed speed conditions

IAF paths for direct-to paths without descend command

Until now all aircraft on a direct-to path were also descending towards FL 70. When this is the case it is possible to calculate in detail how long an aircraft will take to reach the IAF. When this is not the case this introduces an extra uncertainty. It is known that the aircraft needs to descend to FL 70, but not where that command will be given. The command has to be given in front of the last possible descent arc. Between the part circle and the current position the command location is uncertain. The algorithm assumes that all aircraft on a direct-to path are already descending towards FL 70. This means that the cone visualization is not entirely accurate. However, flying longer at a higher altitude will cause the aircraft to fly faster. Thus, a later descend command causes an aircraft to arrive at the IAF faster. So, when vectoring an aircraft behind, this

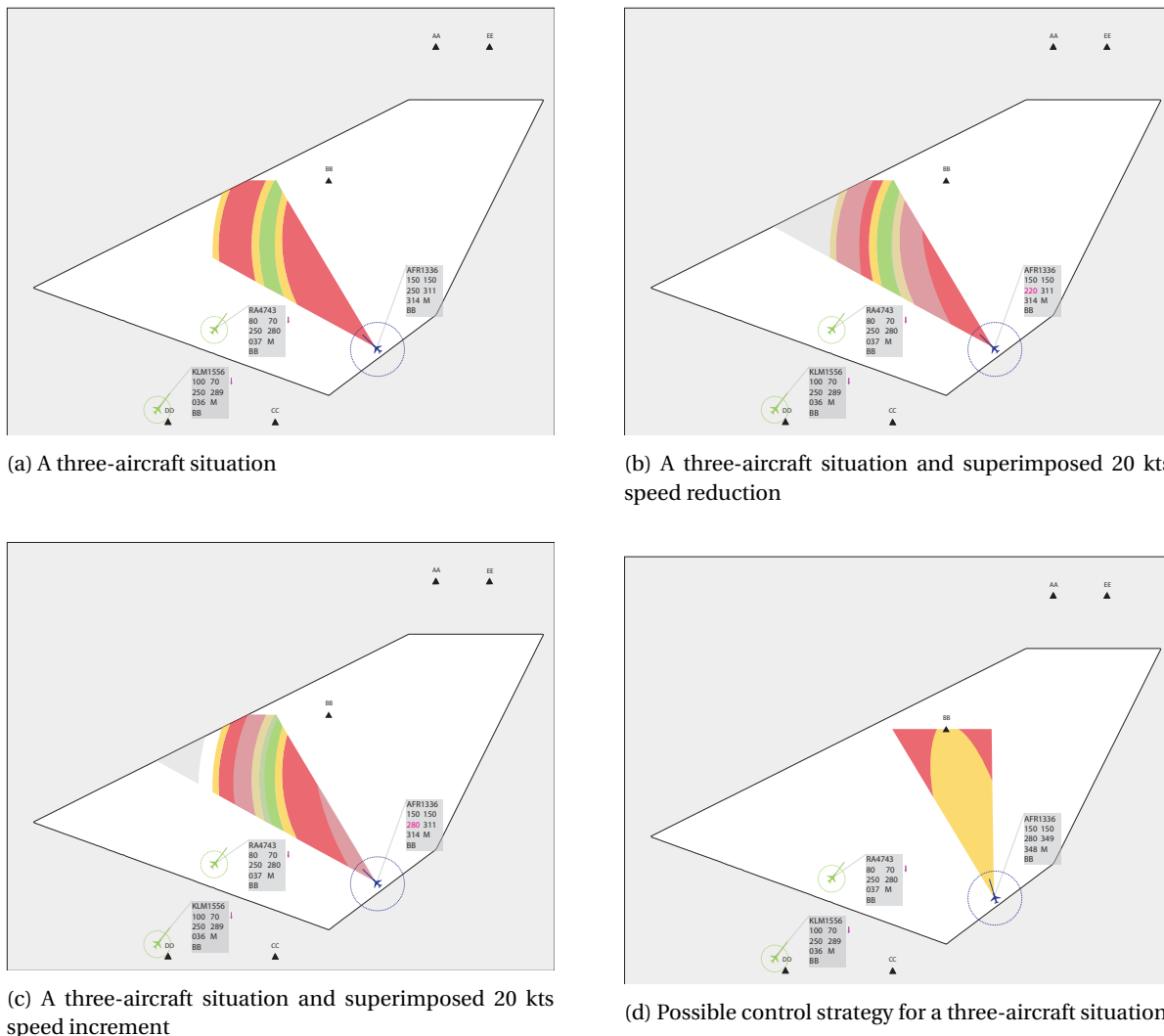

Figure 1.14: Second visualization of the available flight paths under current and changed speed conditions

does not influence the safety, since the separation margins only increase when the descend command is given at a later stage. However, when an aircraft is commanded to go in front of an aircraft that is not yet descending, this could lead to dangerous situations. This is an unlikely scenario that will not occur regularly. Still, you can see that the aircraft is on a direct-to path but not yet descending to FL 70 because of the light grey aircraft color (instead of green). The visualization is recalculated every time step and will therefore also change when the aircraft descends at a later stage. In practice the impact of the descend moment will be small. The aircraft coming into the Amsterdam South Sector fly at high altitude and have little room to descend towards FL 70.

1.4. The Full Display and the Influence of Wind

Combining the information from the previous sections yields the display that you as participant will test. All visualization elements are able to take into account uniform wind conditions. This way scenarios will resemble the reality more closely. Figure 1.15 shows a situation for a 25 kts wind coming from the west. Figure 1.16 shows the same situation for a 25 kts wind coming from the east.

It can be seen that different solution strategies are applicable in the situations. In the first scenario it is still possible for the selected aircraft to end up in front of the other two aircraft. Since the relative track line crosses the 5 NM circle a loss of separation will occur in the near future when no action is taken. In the second situation this is not the case; the selected aircraft is able to fly behind the other. Furthermore, the margins to end up in between the aircraft have increased. In this experiment the wind conditions will be constant. In

the right upper corner a compass rose indicates the direction and speed of the wind. In all training scenarios the wind will com from the south-west and have a speed of 10 kts.

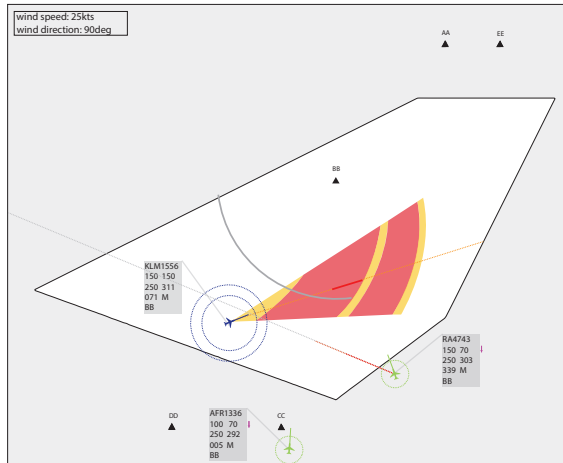

Figure 1.15: The full display for a 25 kts wind coming from the west

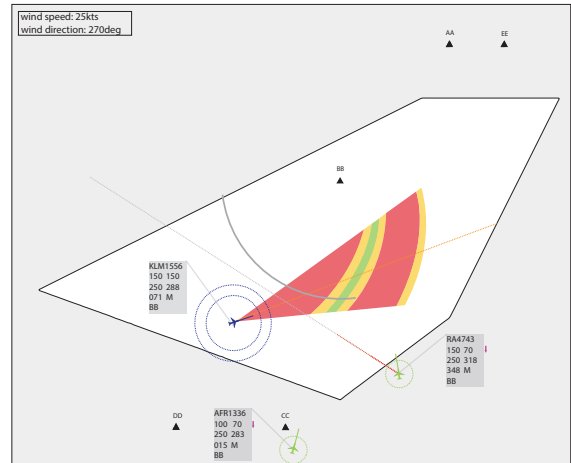

Figure 1.16: The full display for a 25 kts wind coming from the east

1.5. Control Task

Your task as a participant is to safely guide the aircraft towards the IAF and hand them to approach control. All aircraft have to arrive at the IAF (RIVER) at flight level 70 and with a speed of 250 kts. First and foremost, you must separate the aircraft to prevent conflicts from happening. Besides this, you should try to make this process as efficient as possible. So, try to avoid unnecessary detours and try to keep your workload manageable. All aircraft have RIVER as the destination waypoint. They do not follow predefined paths and will continue along the current trajectory unless a control command is given. The commands that can be given are explained in Section 1.2 and all aircraft have to be handed over to the next sector.

1.6. Workload Measurement

The workload will be measured every 30 seconds using a bar that will appear on the left side of the screen. Figure 1.17 shows the modeled radar screen along with the workload bar. Using the cursor, you have to rate your experienced workload on a scale between 0 and 100. Please do this as accurately as possible.

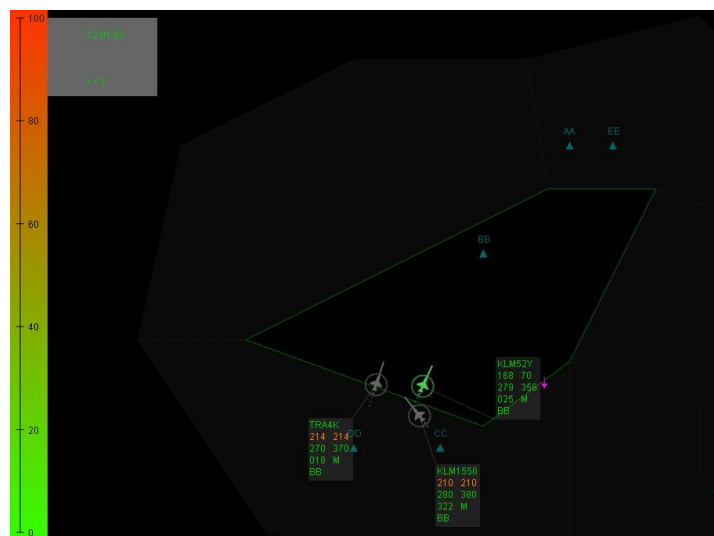

Figure 1.17: Workload bar on the left side of the radar screen

1.7. Training Scenarios

Before participating in the experiment, you will first practice using 13 training scenarios. This way, you will get familiar with the model and the newly added display elements. Before starting a testing scenario first read the tasks you will need to do within the scenario. Scenario 1-12 are based on the newly designed display and the last scenario will be without visual support. Good luck!

Test Scenario 1

- Start the Air Traffic Control simulation module.
- Click Simulator -> Start and type Training.
- Click Load experiment.
- When you are ready click Start experiment.
- On the screen you see the Amsterdam South Sector and one aircraft. Click on the aircraft you see on the screen to select it.
- The color of the aircraft and the aircraft label have changed and the 2.5 NM circle has changed to a 5 NM circle. Deselect by clicking anywhere else.
- Select the aircraft again by clicking the aircraft label.
- Drag the label to a different position on the screen.
- Change the target flight level using the command window. While the aircraft is selected, click EFL and then use the numbers to command it to go to FL 70. The command can be seen on the bottom of the command window. Click EXC to execute.
- Look at the changed aircraft label and the added arrow indicating the aircraft is descending.

Test Scenario 2

- When you are ready click Next scenario.
- Again, there is one aircraft in the sector. Select it.
- Give the aircraft a direct-to command (DCT) using the command window.
- You can see that the aircraft is close to the latest descent border. This part circle visualizes the point an aircraft has to start descending to reach its target at the appropriate height. Deselect the aircraft.
- Wait until the flight level and target flight level field in the aircraft label turn orange. This indicates that whilst flying on a direct-to path it is no longer possible to arrive at RIVER at the required altitude.
- When this happens select the aircraft again. It can be seen that the latest possible descent circle has also changed color.
- Change the speed to 220 IAS using the command window.
- Look at the latest possible descent circle and observe how it becomes smaller as the aircraft decreases speed.
- When the speed reduction is sufficient the orange colors will disappear. Wait until the aircraft has again passed the part circle and the orange colors are present.
- Solve the situation by making the path longer. Command a target flight level (EFL 70) and a heading change (for instance HDG 90).
- See how the circle becomes smaller as the aircraft descends. When the aircraft is outside of the danger zone give a direct-to command (DTC).
- Observe how the circle becomes smaller as the aircraft gets closer to its target.

Test Scenario 3

- When you are ready click Next scenario.
- In the sector you now see 2 aircraft.
- Select the aircraft with ACID RA4743.
- Look at the line that becomes visible on the screen. This is the relative track line. It visualizes the tracks the aircraft will follow with respect to each other. When this line crosses the 5 NM circle a loss of separation will occur in the near future. In this case the line just touches the circle. This means the aircraft will cross with precisely 5 NM between them.
- Deselect by clicking anywhere else.
- Select the aircraft with ACID KLM1556.
- Here the relative track line also just touches the 5 NM line, which makes sense. Wait for a while and observe how the aircraft move in the sector.
- Change the IAS of KLM1556 to 270 kts.
- See how the line now crosses the 5 NM circle. This means that a loss of separation will occur in the near future if no action is taken. This is also indicated using the red line segment along the course line. Along this line segment the aircraft will be spaced by less than 5 NM.
- Change the IAS of KLM1556 to 210 kts.
- If the lines now longer cross this means KLM1556 will fly behind RA4743 by more than 5 NM. Press the 7 on the keyboard.
- Now the 7 NM circle is also present. When the relative track line crosses this circle, this means the closest point of approach will be between 5 and 7 NM. Otherwise the aircraft will cross with more than 7 NM between them.
- Press the 7 button again to turn the 7 NM circle off again.

Test Scenario 4

- When you are ready click Next scenario.
- This scenario contains 3 aircraft.
- Select the aircraft with ACID TRA4K.
- Two relative track lines become visible. The length of the line gives information about how fast the aircraft move with respect to each other. In this case TRA4K and AFR1336 move little with respect to each other. This makes sense because they fly with "almost" the same heading. TRA4K and KLM1556 move faster with respect to each other. Neither AFR1336 nor KLM1556 creates a conflict with TRA4K in the near future.
- While TRA4K is selected, change the heading to 360 degrees.
- Look at the screen and observe how the relative track line change.
- While TRA4K is selected, change the heading to 70 degrees.
- Look at the screen and observe how the relative track line change.

Test Scenario 5

- When you are ready click Next scenario.
- This scenario contains 2 aircraft.
- Select the aircraft with ACID KLM1556.
- The relative track line crosses the 5 NM line so a loss of separation will take place if nothing is done to prevent it. Where this will happen can be seen by the red line segment along the the course line.
- Select the aircraft with ACID RA4743 and note the same conflict.
- Deselect by clicking anywhere else.
- Wait for a bit and let the aircraft get closer to each other. When the loss of separation will happen within 120 seconds both aircraft will turn orange.
- Wait a bit longer. When the loss of separation will happen within 60 seconds the aircraft will turn red and you will hear a warning sound.
- Solve the situation by commanding a heading change before the aircraft are within 5 NM of each other.

Test Scenario 6

- When you are ready click Next scenario.
- This scenario contains 2 aircraft. In this scenario both aircraft have to go to waypoint RIVER. To help do this a visualization has been developed. This visualization needs a starting point.
- Select the aircraft with ACID RA4743 and give it a direct-to (DCT) command. This aircraft now serves as a starting point.
- Select the aircraft with ACID KLM1556.
- In the background a cone appears. This cone presents information about the possible flight paths for the selected aircraft relative to RA4743. Each pixel visualizes for a specific path how far the aircraft will be apart when they arrive at RIVER. So, the color of a pixel represents how far the aircraft will be apart at waypoint RIVER when a direct-to command is given at the pixel location. When the color is green, the selected aircraft (KLM1556) will be in front of the other aircraft (RA4743) by more than 7 NM. For an orange color the aircraft are spaced by at least 5 NM. The red area visualizes paths that cause a loss of separation at the IAF. When no color is visible the selected aircraft will end up behind the other aircraft by more than 7 NM.
- Thus, the red area depicts the points where a direct-to command would lead to a loss of separation. To see which aircraft creates which red area, means-end links have been created. Hover with your mouse over RA4743 while KLM1556 is still selected.
- The conflicting area and the aircraft are highlighted.
- Now hover with your mouse over the conflicting area.
- The conflicting area and the aircraft are again highlighted. This way in situations with more than 2 aircraft it is possible to see which aircraft causes which conflict zone.
- Give a direct-to command while the aircraft is still within the green part of the cone visualization.
- Look at the screen and observe how the IAF visualization changes.
- The pixels between the KLM1556 and RIVER should now be green. Thus, following this path the aircraft will be spaced by more than 7 NM. When you alter the path of the aircraft (make it longer) the aircraft will be closer. Therefore, not all pixels within the cone are necessarily green.
- Select the aircraft with ACID RA4743.

- In this case no visualization is present. The aircraft will already be separated by more than 7 NM. So, changing the path of RA4743 (making it longer) will not lead to dangerous situations in the future.
- Wait while the aircraft move towards RIVER. Hit the 7 button to see that they are indeed more than 7 NM apart.

Test Scenario 7

- When you are ready click Next scenario.
- This scenario contains 3 aircraft of which two (KLM1556 and RA4743) are already on their way towards the IAF (indicated using the green aircraft color).
- Select the aircraft with ACID SM7071.
- The IAF visualizations are now superimposed based on severity. Red colors are more important than orange colors and orange colors are more important than green colors.
- In this case you can see that it is possible to end up in between KLM1556 and RA4743. However, when you want to space the aircraft by at least 7 NM, the margins are really small.
- In the current situation no conflict situations will happen in the near future because the relative track lines do not cross the 5 NM circle. Thus, in this case, it is possible to wait until the aircraft has moved out of the red area and then give a direct-to command.
- To resolve the situation faster, a heading change can be given first. Command a heading change of 320deg (HDG320).
- Wait until the aircraft is out of the red zone (and as close as possible to the green zone) and give a direct-to command (DCT).
- When the pixels between the aircraft and RIVER are now orange this means the aircraft will be separated between 5 and 7 NM. Press 7 and wait to verify this is the case.

Test Scenario 8

- When you are ready click Next scenario.
- This scenario contains 2 aircraft. Select the aircraft with ACID KLM1556.
- You can see that in this case solving the conflict with a changed flight path will be complicated.
- It is possible to solve the problem with speed change. The effects of speed can be seen using a toggle function. Click the minus sign to see the effects of changing the speed to 240 kts.
- In the aircraft label the IAS has changed color and now indicates 240. Also, in the IAF visualization, a new white transparent layer is visible. This layer symbolizes the non-red areas in the visualization for the speed indicated in purple.
- Command a speed of 240 kts and see how the red visualization becomes a bit smaller.
- While KLM1556 is selected, click the minus sign again to see the effects of further decreasing the speed.
- When it is possible to manoeuvre behind RA4743 on a direct-to path (transparent layer between aircraft and RIVER is visible) give a speed command and a direct-to command.
- It is still possible you see an orange visualization area after giving this command. The toggle function only shows the non-red areas and is not able to distinguish between 5 and 7 NM separation. It is made to safely solve conflict situations.
- When you want to separate the aircraft with a minimum of 7 NM you need to decrease the speed even further (on intuition) or change the path the aircraft follows after giving the speed command.
- Wait and observe the aircraft while they move towards RIVER.

Test Scenario 9

- When you are ready click Next scenario.
- This scenario contains 3 aircraft. Select the aircraft with ACID KLM1556.
- Hover over one of the red areas to see which aircraft caused that conflict area.
- In this case it is possible to end up between RA7643 and AFR1336. However, in the current situation a loss of separation will occur before a direct-to command can be given. This can be solved using a heading change, but a speed change can also be given.
- Use the speed toggle to see what happens for increased and decreased speed.
- You should have observed that there are multiple solution strategies. You can increase the speed enough to end up in front of both aircraft, or you can decrease the speed so that the loss of separation in the sector does not happen and give a direct-to command to end-up in between the two other aircraft.
- In both cases you have to realize that the speed has to be changed in the future so that the aircraft flies 250 kts at RIVER.
- Make a control decision and observe how the scenario continues.

Test Scenario 10

- When you are ready click Next scenario.
- This scenario contains 2 aircraft.
- TRA4K is currently descending to FL 150 on a direct-to path. The reason for this is the crossing with KLM52Y (flying at FL 140).
- Select the aircraft with ACID KLM52Y.
- You see the same type of visualization as in previous training scenarios. In this case the algorithm assumes that the aircraft (TRA4K) is descending towards FL 70 even though it is not. This means that the cone visualization you see is not entirely accurate. However, flying at a higher altitude longer will cause the aircraft to fly faster and make the margins at the IAF larger. Thus, when vectoring an aircraft behind, this does not influence the safety. So, only when commanding an aircraft to go in front this could lead to dangerous situations. You can see that the aircraft is on a direct-to path but not yet descending to FL 70 because of the highlighted grey aircraft (instead of green). Each time step the visualization is recalculated.
- Let the aircraft cross and give KLM52Y a direct-to command when this possible.
- Wait a while and command TRA4K to descend to FL 70.
- Wait and observe the aircraft while they move towards RIVER.

Test Scenario 11

- In this scenario you will guide 3 aircraft towards their destination with the new visualization elements.
- Each aircraft has to fly at 250 kts IAS and FL 70 at the destination.
- The aircraft have to be handed over to the next sector using the TOC command.
- When you are ready click Next scenario.

Test Scenario 12

- In this scenario you will guide 4 aircraft towards their destination with the new visualization elements.
- Some of these aircraft will appear on the radar during the scenario.
- Each aircraft has to fly at 250 kts IAS and FL 70 at the destination.
- The aircraft have to be handed over to the next sector using the TOC command.
- When you are ready click Next scenario.

Test Scenario 13

- In this scenario you will guide 5 aircraft towards their destination with the new visualization elements.
- Some of these aircraft will appear on the radar during the scenario.
- Each aircraft has to fly at 250 kts IAS and FL 70 at the destination.
- The aircraft have to be handed over to the next sector using the TOC command.
- When you are ready click Next scenario.

Test Scenario 14

- In this scenario you will guide 4 aircraft towards their destination without the new visualization elements.
- Some of these aircraft will appear on the radar during the scenario.
- Each aircraft has to fly at 250 kts IAS and FL 70 at the destination.
- The aircraft have to be handed over to the next sector using the TOC command.
- When you are ready click Next scenario.

Test Scenario 15

- In this scenario you will guide 5 aircraft towards their destination without the new visualization elements.
- Some of these aircraft will appear on the radar during the scenario.
- Each aircraft has to fly at 250 kts IAS and FL 70 at the destination.
- The aircraft have to be handed over to the next sector using the TOC command.
- When you are ready click Next scenario.

1.8. Cheat Sheet

Heading angles

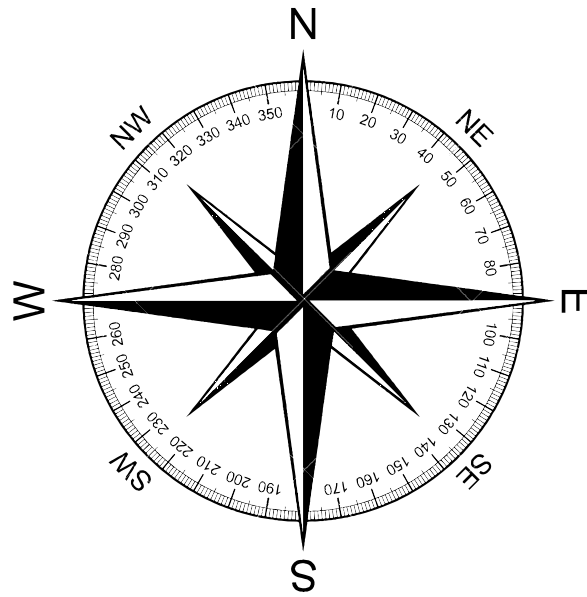

Figure 1.18: Heading directions

Aircraft characteristics

Performance Medium Aircraft (e.g. Boeing 737-400)			
IAS MIN	200 kts	IAS MAX	290 kts
ROC (FL 0-100)	2490 fpm	ROD (FL 0-100)	1570 fpm
ROC (FL 100-200)	2265 fpm	ROD (FL 100-200)	1985 fpm
ROC (FL 200-300)	1530 fpm	ROD (FL 200-300)	2700 fpm

Performance Heavy Aircraft (e.g. Boeing 747-200)			
IAS MIN	230 kts	IAS MAX	350 kts
ROC (FL 0-100)	3160 fpm	ROD (FL 0-100)	1345 fpm
ROC (FL 100-200)	2770 fpm	ROD (FL 100-200)	1755 fpm
ROC (FL 200-300)	2040 fpm	ROD (FL 200-300)	2205 fpm

2

Pre-Experiment Questions

To make sure all participants understand the visualization elements 5 questions were asked to test their knowledge. After answering all questions, in each situation the correct answers were briefly explained.

1. How far apart are these two aircraft at the IAF if the selected is given a direct-to command at this moment?

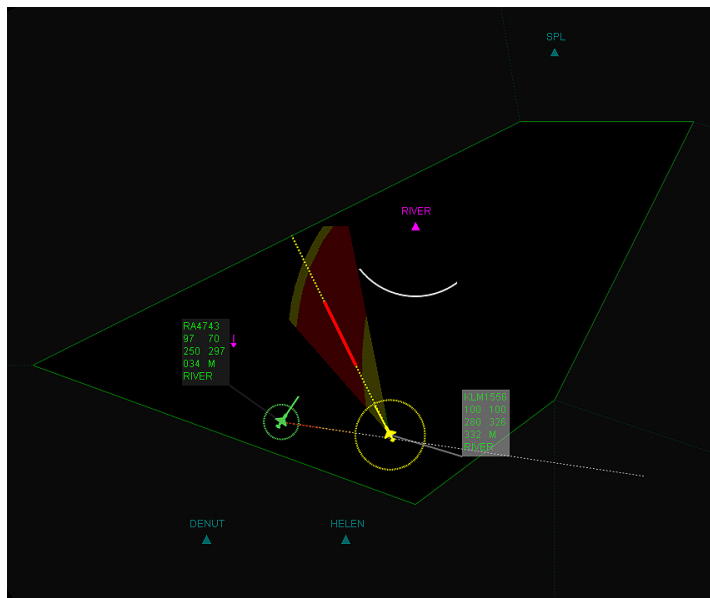

Figure 2.1: Control situation for question 1.

2. How can you make sure the selected aircraft reaches the IAF at flight level 70?

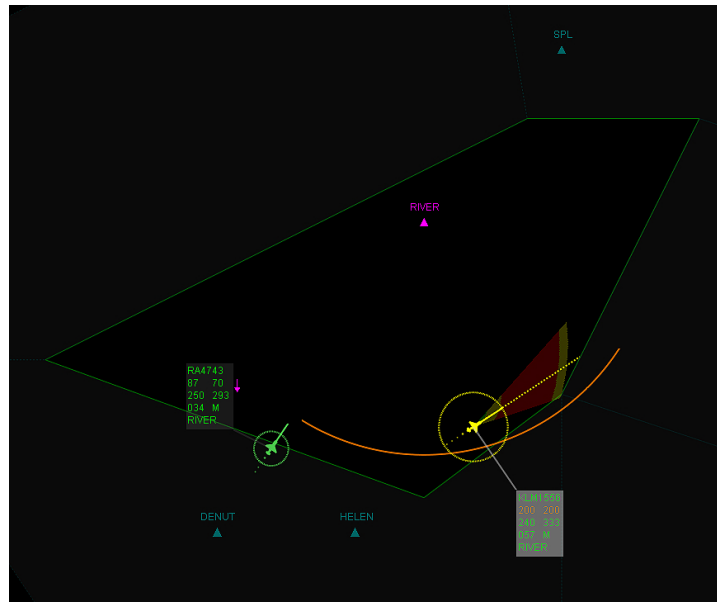

Figure 2.2: Control situation for question 2.

3. If the speed of the selected aircraft is changed to 240 kts IAS and a direct-to command is given, how far are the aircraft apart at RIVER?

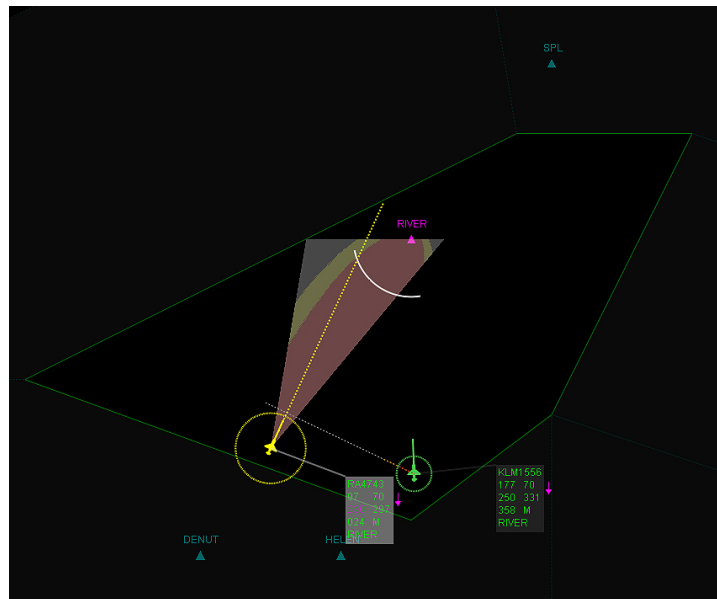

Figure 2.3: Control situation for question 3.

4. Can the selected aircraft end up in between SG3047 and KLM1556 when only using a direct-to command along its current flight path?

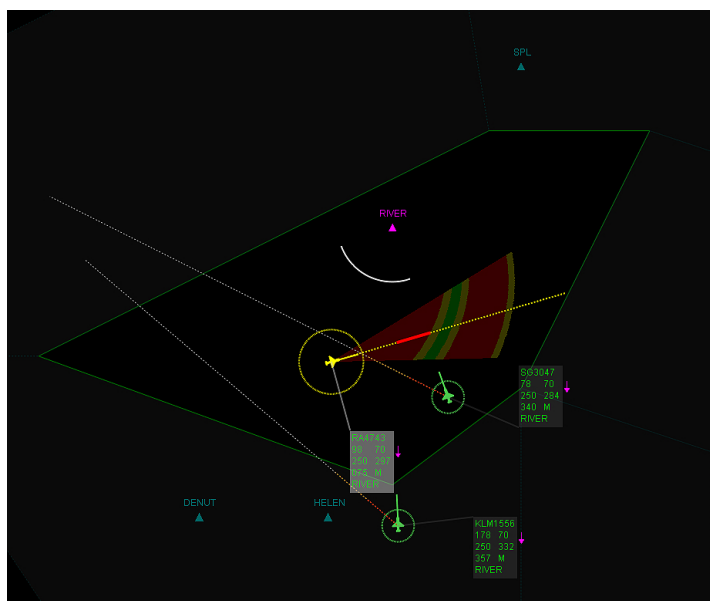

Figure 2.4: Control situation for question 4.

5. Can the selected aircraft move safely in front of KLM1556 if a direct-to command is given at this instance?

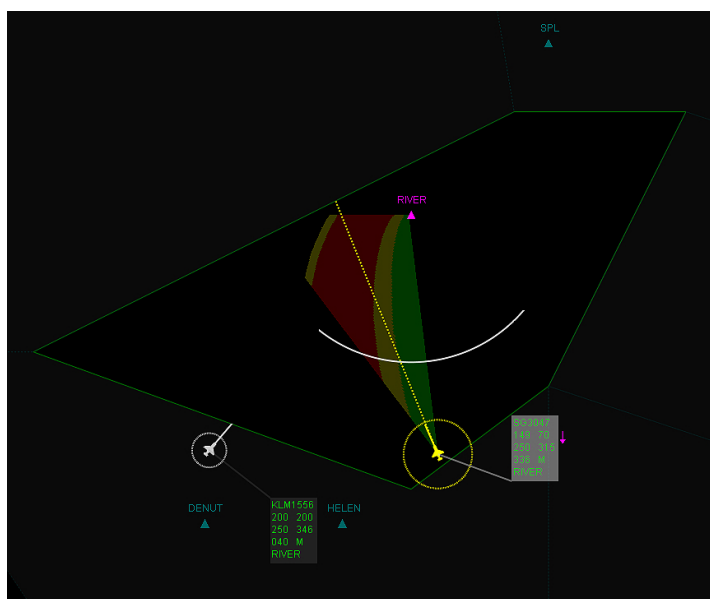

Figure 2.5: Control situation for question 5.

3

Scenario Design

In the experiment each participant performed eight 12-minute scenarios. The experiment scenarios were created using flight data from the LVNL, so that they resembled the reality as well as possible for the merging inbound traffic task.

The traffic data from the LVNL was first analyzed. The data was divided into inbound and outbound traffic. Then, the inbound traffic coming from either HELEN or DENUT was selected. These aircraft all flew through the Amsterdam South Sector before they landed at Schiphol. For multiple days, the number of inbound aircraft within the Amsterdam South Sector was recorded on a 24-hour time scale. When a new aircraft surpassed HELEN OR DENUT the count went up and when an aircraft reached RIVER the count decreased. An example of one 24-hour period can be found in Figure 3.1. These plots helped create a clear picture of the typical quantity of the inbound traffic at Schiphol. In Figure 3.1 may be viewed that, for this specific day, there are at most 7 aircraft within the sector and that the controller's work consists of peak moments.

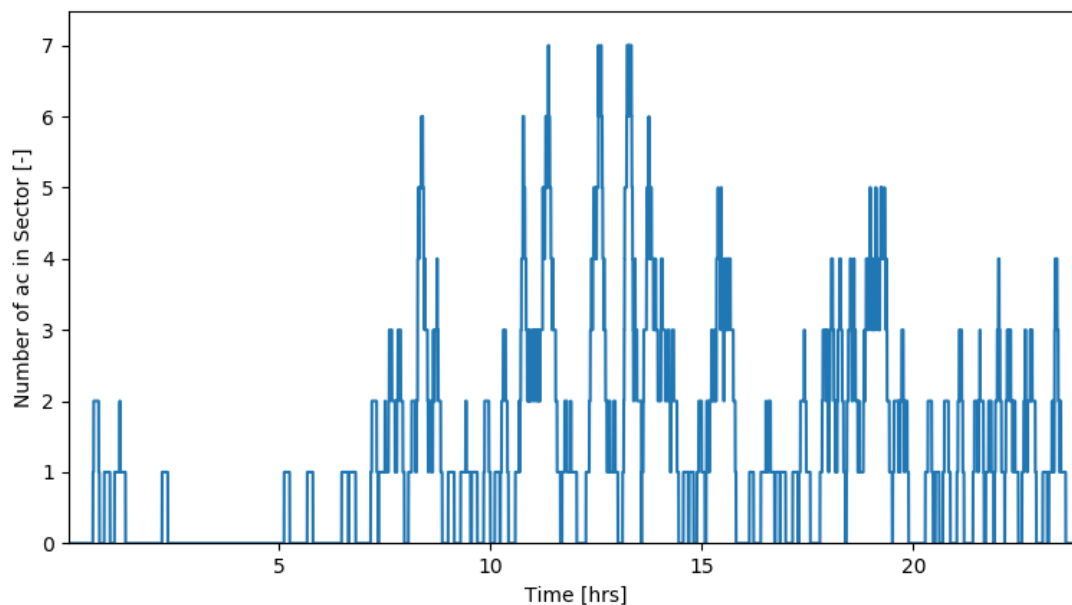

Figure 3.1: Number of aircraft in the Amsterdam South Sector on a typical day at Schiphol

The inbound flight data was further analyzed based on the flight paths, speed and altitude of the traffic. Figure 3.2 displays all flight paths between HELEN/DENUT and RIVER for a 24-hour period. Within this figure, it becomes clear that not all aircraft make use of the default route passing through Haamstede (HSD). Some paths are shortened by commanding the aircraft to go directly towards River, without first going to HSD.

Other paths are elongated in the west side of the sector. Another method for extending the flight path is to place the aircraft in a holding pattern at RIVER.

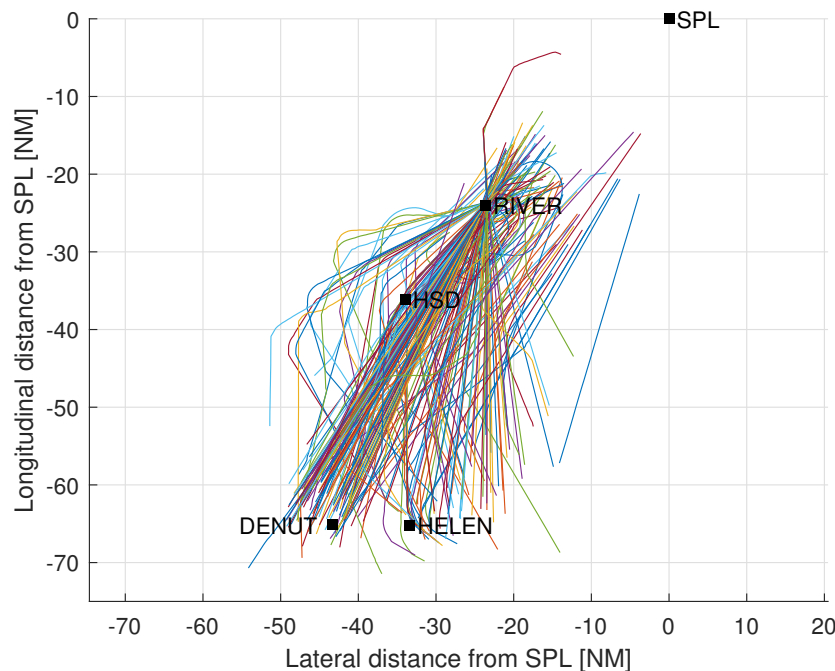

Figure 3.2: Number of aircraft in the Amsterdam South Sector on a typical day at Schiphol

An example of a situation that occurred at Schiphol, can be found in Figure 3.3. It shows a peak moment involving seven inbound aircraft. The figures show the current situation with the Amsterdam South Sector at a specific time during the day. In this case, the plots are 5 minutes apart. All aircraft enter at approximately FL 220. In the plot showing the situation at 13:17, it becomes clear that the path of some aircraft is elongated along the west side of the sector. At 13:22, the aircraft seem merged in sequence. It can be observed that some planes are still at a high flight level when approaching River (FL 70 - FL 100). At 13:27, it becomes clear that 3 aircraft were placed into a holding pattern. Such decisions are costly and influence the possible solution strategies for the incoming traffic. With adequate support, such situations could ideally be prevented.

By analyzing many of such situations, a clear picture of the everyday traffic situation was developed. This was then converted into traffic scenarios that resembled every day practice as well as possible. However, resembling reality proved a complicated task. Evidently, air traffic controllers have more responsibilities than just merging incoming traffic. Outbound traffic increases the workload and can also complicate the merging task, by making some solutions strategies infeasible. Additionally, it was found by testing that the semi-professional participants are not able to handle the (inbound) traffic intensity professional controllers deal with on a daily basis. It is essential that the participants are able to manage the traffic to obtain useful data.

Therefore, an appropriate difficulty level was selected by trial and error. It was decided to base the difficulty of a scenario on the number of aircraft. After playing around within the simulator (Sector X) with multiple scenarios based on LVNL data, two complexity levels were distinguished; Medium and Hard. The medium test scenarios were designed such that 4-5 aircraft were in the sector at the same time. The hard test scenarios contain 5-6 aircraft simultaneously. However, it is up to the participant to make sure that this is indeed the case. When a miscalculated decision is made the number of aircraft can increase quickly, thereby increasing the complexity of the problem at hand.

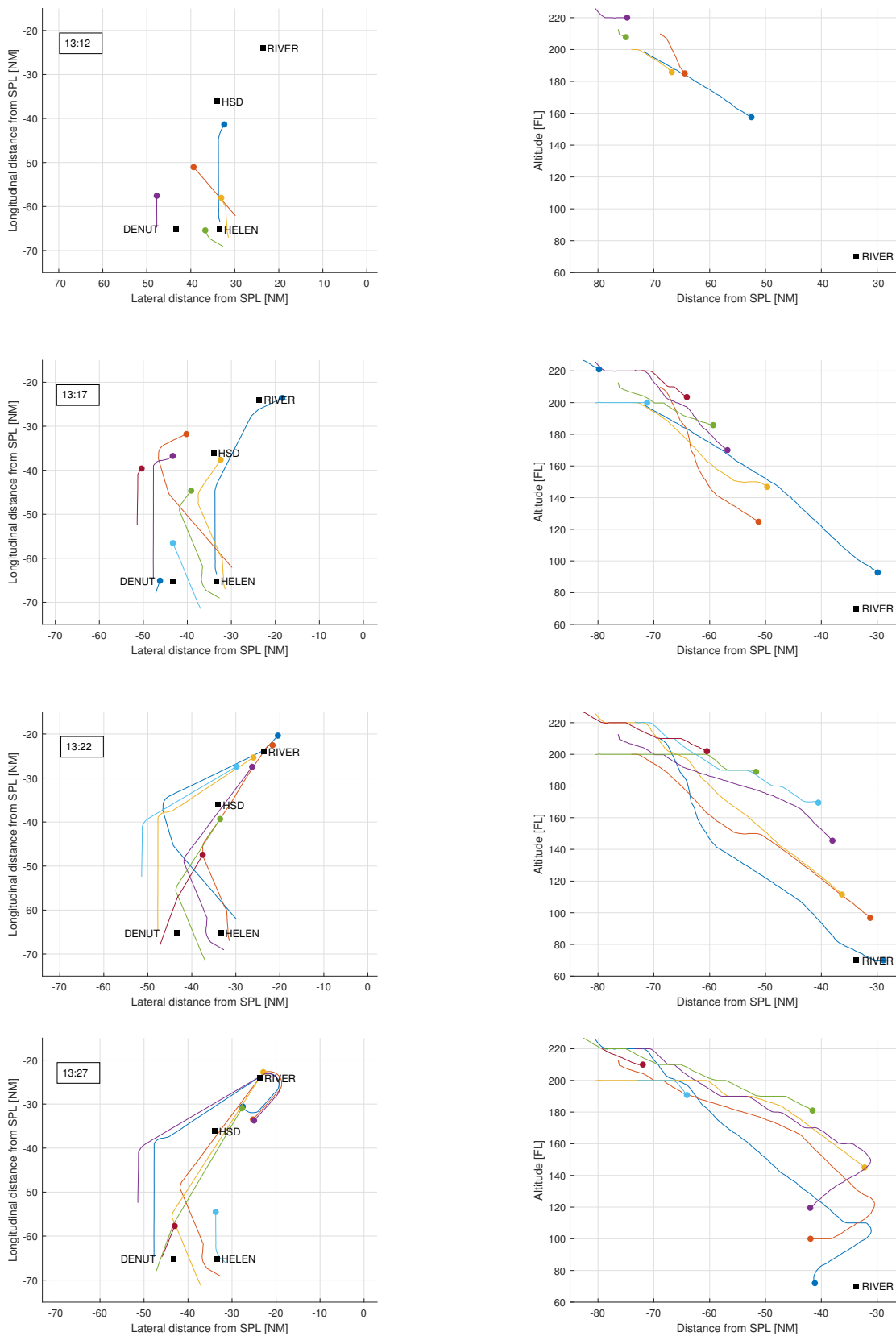

Figure 3.3: Current position and path up to the current position for the aircraft in the sector for a specific time

Another difference between reality and the traffic scenarios created is that the aircraft emerge on the screen when they are transferred to the controller. This simulator did not allow for commands to be given automatically throughout the scenario. Therefore, it was impossible to simulate the commands of the previous controller.

For the designed test scenarios, the aircraft typically entered the sector at a flight level of 200-220, with some outliers coming in at a higher or lower flight level. There were two types of aircraft within the scenarios (medium and heavy). Most aircraft landing at Schiphol fall into the medium category. This category contains short- to medium-range airliners such as the B737, A320 and the E190. In the scenarios medium aircraft typically entered the sector at 270-280 kts IAS. Heavy aircraft, such as the B747 and the A380, generally flew faster when entering the sector (at a speed of 310-320 kts IAS).

4

Code Layout

Within this chapter, an overview of the code layout used to develop the Inbound Traffic Support System interface is given. The code written is an extension to a rapid prototyping environment developed at Delft University of Technology. This framework, called Sector X, is the collaborative effort of, among others, Clark Borst and Rolf Klomp. In Section 4.1, a brief overview of the java program structure is given. The most important classes and their interactions are explained. In Section 4.2, the adjustments made for the development of the Inbound Traffic Support System interface are elaborated upon.

4.1. Sector X Code Structure

This section first explains the initialization of the Sector X framework, followed by a clarification of how the data is visualized. The functioning of the MouseListeners, KeyListeners and EventListeners and their influence on the visuals is explained. The description isn't all-encompassing, due to the size of the framework. Even so, it aims to clarify the process for those unfamiliar with the simulator.

4.1.1. Initializing the Application

The main file in the Sector X simulator is `SSDFrame()`. When this file is run, the application is first initialized. Figure 4.1 shows a flow diagram of the initialization process.

Initially, within the `SSDFrame()` class, the `GLContentFrame()` class is added. This class is an extension of `JFrame` and creates the user panel. It specifies the size and appearance of the user interface. The functions that allow for MouseListeners, KeyListeners and EventListeners (such as `addGLMouseListener()`) are created within this class.

Next, using `GLContent()`, the radar screen content is initialized and added. `GLContent()` contains the initial screen element states and the functions that can later visualize the display layers at 60Hz. Here, the display elements are also specified so that the program can, at a later stage, visualize the underlying data. The `GLContent()` class makes use of many helper functions and is further explained in Subsection 4.1.2. Within `SSDFrame()` class, the `GLContent()` class is added to the listener functions (`GLPanel.addGLEventListener(s_gcontent)`). Because the `GLContent()` class implements the listeners, the radar screen becomes interactive. Initial screen element states within `GLContent()` are saved to the `GLSS()` class. This class is the radar screen state tracker. It stores default preferences and follows the behavior of the user. Many other functions and classes make use the `GLSS()` class to save their current state. Examples of information pieces stored in `GLSS()` are the number of times an aircraft label is clicked, which aircraft is currently selected and a boolean that determines if history dots are shown.

After initializing the panel, the default configuration file is parsed (default specified in `GLSS()`). When another configuration is desired, the user can adjust it using `ActionListener()` functions that are connected to the buttons in the user panel (`GLContentFrame`). The `parseXMLConfig()` class sets, among other things, many parameters in the `GLConfig()` class that are connected to appearance of the visualization.

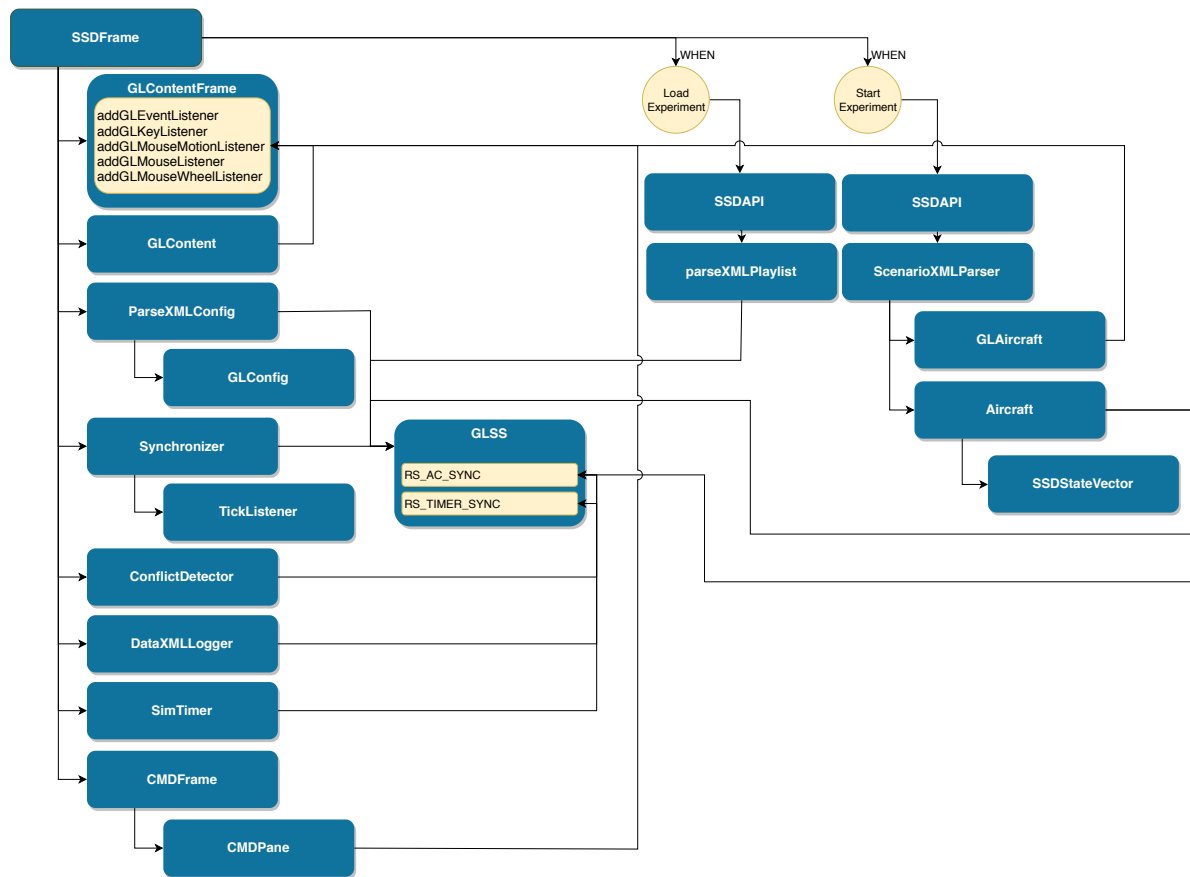

Figure 4.1: Flow Diagram of the Initialization Process of the Sector X Simulator

Subsequently, within SSDFrame, the refresh rates of the radar calculations are specified and saved using the Synchronizer() class. This class makes use of the Ticklistener() class. While alive, it tracks the system current time in milliseconds and, when a set period of time has passed, it calls the tick function. Two separate synchronizers are created. The first one (GLSS.RS_AC_SYNC) updates every 5 seconds. The ConflictDetector() and the DataXMLLogger() class are added to this ticklistener. When a scenario is loaded each individual aircraft is also added to this ticklistener. The ConflictDetector() calculates, once every tick, whether a pair of the aircraft within the GLSS list will face potential conflict and stores this information in the Aircraft() class. This tick function is updated with the same rate as an actual radar screen. The second synchronizer (GLSS.RS_TIMER_SYNC) updates every second. The SimTimer() class contains classes such as the workloadRating() class. These functionalities are independent of the radar screen rate and are reevaluated every second.

With the refresh rates specified, the program still needs to be able to handle air traffic control commands. In order to pass a command, within SSDFrame(), a command pane is created in CMDFrame(). This class make use of the CMDPane() class that implements the GLContentFrame() listener functions.

Next, the jLoadExperimentActionPerformed function in the experiment dialog registers that the user wants to load a playlist. Using the SSDAPI() class, the parseXMLPlaylist() class is called. Here XML data is parsed and stored.

When the jStartExperimentActionPerformed function is called, the first scenario will start. Within the ScenarioXMLParser() class, the sector specifications are saved and each aircraft is connected to an Aircraft() class and corresponding SSDStateVector(). The aircraft class contains the aircraft dynamics calculations and uses other functions that do things such as descent profile calculations and the conversion from indicated airspeed to ground speed. All of the aircraft data is gathered in GLSS.RS_AIRCRAFT_LIST and a list of all

the aircraft pairs is generated. The latter is created using `SSDAPI.createAircraftPairs()` inside `ScenarioXML-Parser()` and is used for later conflict detection. As was previously mentioned, each aircraft class is also added to the `GLSS.RS_AC_SYNC` Ticklistener in this class.

Thus, when the simulator is started, a synchronizer will start calculating the aircraft trajectories and possible conflicts between aircraft every 5 seconds as long as the scenario is not finished. The simulator will react to mouse and key updates and the visualizations have a screen refresh rate of 60Hz.

4.1.2. Visualization of the Calculations

The data that is updated using the tick functions needs to be visualized and should allow for interaction with the user. Figure 4.2 shows the connections between classes that make this possible.

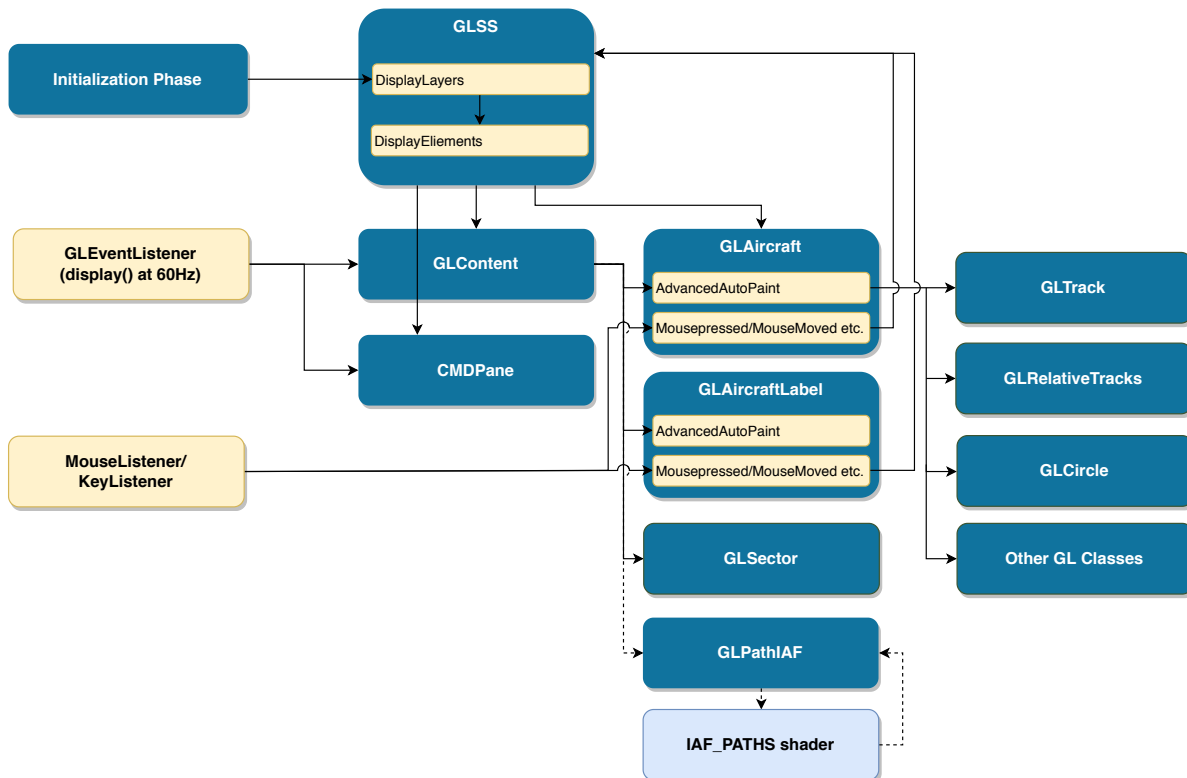

Figure 4.2: Flow Diagram of the Initialization Process of the Sector X Simulator

Within the initialization phase, the display layers and the display elements connected to these layers were already specified. This data is the used by the `GLEventListener()` that updates the screen at 60Hz. The `GLAutoDrawable` is a rendering tool from OpenGL that calls `display()` for all registered `GLEventListeners`. In this case the `GLEventListener()` calls two `display()` functions.

The first one is the `GLContent()` class. The `GLContent()` Class connects to the `GLAircraft()` class. Each `GLAircraft()` within `GLContent()` visualizes one aircraft. To do this, other visualization classes, such as `GLTrack()`, `GLRelativeTracks()` and `GLCircle()`, are used. In a similar manner, the `GLAircraftLabel()` class is connected to the `GLContent()` class. The `GLSector()` class and the `GLPathIAF()` class are updated with the screen refresh rate as well. The `GLPathIAF()` class was added to the existing framework and is further explained in Section 4.2. Its interactions are shown using dashed lines.

The second `display()` function that operates at 60Hz is within the `CMDPane()` class. Here, the command window visualization is updated.

As long a the user does not interact with the interface, the tick functions update the information coming

from the `GLSS()` class and the information is shown in the screen. When the user does interact with the simulation, the `MouseListener()` and `KeyListener()` functions within the `GLAircraft()` and `GLAircraftLabel()` classes are used. These functions update the data stored within `GLSS()`. Because of this, the screen will update the next time frame. Thus, by using these functions, the user can interact with the screen. He or she can select an aircraft or other visualization element that helps the decision-making process in the area control task.

4.2. Code Alterations

This section briefly explains the adjustments made to the Sector X simulator. These alterations make the Inbound Traffic Support System possible.

4.2.1. Loading the Data

Within `parseXMLScenario()`, the aircraft data is loaded for a scenario. A new variable `ACTIVE_TIME` is added to the `SSDStateVector()`. It is populated if the parameter exists in the XML input file. If not, the value is set to zero. This parameter is used in the `Aircraft()` class to check if the aircraft is already active. By doing so, it is possible to make aircraft appear on the screen throughout the scenario.

Moreover, to make the available flight paths visualizations possible, a new display element was added in `parseXMLScenario()`. The `GLSS.addDisplayElement(new GLPATHIAF(myVisSector), GLSS.DISPLAY_LAYER.LAYER_2)` command adds the new visual element to a display layer. Also, the `GLSS.RS_VISIALIZATION_POLYGON` is created in the `parseXMLScenario()` class. This Polygon is used to check if an aircraft is inside the area where path visualizations are created.

4.2.2. Adding Wind

To account for the effects of wind, a `UniformWind()` class was added to the simulator. Within this class, `direction_deg` and `speed_kts` are specified. These values impact the calculation done in the `Aircraft()` class. Three new functions were added to the class.

The `getGroundSpeed_kts(float altitude_ft)` function uses the current altitude in feet and the indicated air-speed. First the true airspeed is calculated using the `IASToTAS` function from the `Atmosphere()` class. A TAS vector and wind vector are created and, using vector calculus, the resulting ground speed is calculated.

The `getCourseAngle_deg(float altitude_ft)` function calculates the course angle. When the wind vector and TAS vector do not have the same direction, the course angle differs from the heading angle. It is calculated using `normalizeHeading((float)Math.toDegrees(Math.atan2(V_g.getX(), V_g.getY()))`, where `V_g` is the ground speed. This function is, for instance, used in the `AutoPaintScaled` function of the `GLCourse()` class. Here a line along current flight direction is constructed. The values are also stored in `STATE.CRS_DEG` with `SSDStateVector()`.

In the `getHeadingFromCourse_deg` function the opposite happens. Here, the required heading angle for a desired course is calculated. This is used when a direct-to command is given. The `directToCOPX()` function uses `calcCOPXDirection_deg()` to calculate the course needed for a direct-to command and `getHeadingFromCourse()` subtracts the wind vector from this vector and normalizes the heading.

The wind also influences the conflict detection method. The `SSDFBZ()` class uses the course angles instead of the heading angles to update the `ConflictDetector()`. This information is then used for alert messages and the relative track visualization.

4.2.3. Visualization Elements

Descent Circle

The Descent Circle is created within the `GLAircraft()` class. Via the `GLContent()` class, the `autoPaintScaled()` function is called 60 times per second for each aircraft. If the aircraft is selected and is on a course angle towards the COPX, the algorithm calculates the current distance towards to the COPX. This distance is compared with the minimum distance needed to descent to the required altitude. This distance is calculated by calling `latest_descent(float delta_speed)` within the corresponding `Aircraft()` class. This function assumes the

current indicated flight speed remains constant and is calculated for a direct-to path. In an iterative manner, the ground speed at a specific height is calculated using Atmosphere.IASToTAS(spд_IAS,height_aircraft). The minimum descent distance is then calculated by integrating the speed.

The distance is visualized using the GLPartCircle() class. It draws a line with a radius equal to the minimum distance around the COPX point. If the minimum needed distance is larger than the current distance towards the COPX, the algorithm changes the color of the GLPartCircle() line. Within the GLAircraftLabel() class, also connected to GLContent(), the color of the current and target altitude is also altered if the late_descent parameter is true.

Relative Tracks

The RelativeTrack() class already existed, but was altered to account for wind conditions. Also, a 7NM circle toggle function was added to give the user an indication of the distance between two aircraft when they pass each other. The 7NM toggle makes use of the KeyPressed function within the GLContent() class. It sets the GLSS.RS_SHOW_7NM_CIRCLE boolean, which is used when drawing the circle in the GLAircraft() class.

Available Flight Paths

The available flight paths are visualized within the sector. Within the ScenarioXMLParser(), the GLPathIAF() class is added to display layer 2. In the display() function of the GLContent() class, the autoPaintScaled() function within the GLPathIAF() class is called. Here, when the aircraft is selected and the B_SHOW_IAF_PATHS boolean is true, visuals are drawn. Since not all points within the sector provide realistic flight paths, a flight cone is created. Visualization_Area(course_angle,aircraft) does this. It outputs an ArrayList<ArrayList<Double>> of the points that define the border of the polygon to be visualized. The function calculates these points by calculating the intersection of the borders of the sector and the two lines originating from the selected aircraft. These lines are at ±15 degrees from the current course angle. In some cases, these lines cross multiple sector boundaries. In that case, the intersection of the borders also has to be included in the arraylist.

When the polygon is defined, the path calculations are done for each point within the polygon separately. To improve speed, this is done using shaders that use the GPU, instead of the CPU, for their calculations. The shader makes use of a GPU rendering pipeline. The pipeline data is specified within the java code and, depending on the outcome of the calculations, the shader adjust the pixel color of each point inside the previously defined polygon. The gl.glUseProgram(GLSS.SHADER_PROGRAM.IAF_PATHS_SHADER.getShaderHandle()) statement initializes the use of the shader. Within the .vert file, the vertex of the location of the pixel is specified using gl_Vertex.xy. The ftransform() statement converts the vertex to the screen position. Within the .frag file the location is specified by vec2 world_loc. The vec2 w_pos = vec2(world_loc.x, world_loc.y) is different for every pixel. The other variables do not change from one shader invocation to the next for a particular rendering call. These uniform variables are global shader variables declared with the "uniform" storage qualifier. The aircraft data of the selected aircraft and all the aircraft on a direct-to path towards the destination waypoint is gathered in a texture (Septex) that can be seen in Figure 4.3. The texture is created in GLAircraftTex2(). Within this class, the aircraft that are not on a direct-to path or go to a different waypoint are first excluded. Then inside GLTex2DRGBA32F(), the texture is binded using gl.glBindTexture(GL2.GL_TEXTURE_2D, super.getHandle()[0]). Within the .frag file, the texture data is stored in the uniform sampler2D variable named data_tex. Because the texture coordinates are normalized between [0,1] in width and height, the size of the texture is needed to extract the data. The w_cnt and h_cnt variables binded in the GLPathIAF() class using loc = gl.glGetUniformLocation(shaderHandle, "w_cnt") and gl.glUniform1i(loc, w_cnt) make sure this happens. The lines coord = vec2(wStep * 1.5, hStep * 1.5) and vec4 pos_con = texture2D(data_tex, coord).xyzw extracts the selected aircraft's position from the texture (for wStep=4 and hStep=5 in Figure 4.3). Using similar shaderHandle commands, the wind parameters and the pixel color possibilities are specified.

First Row	#_obs_ac	#_obs_ac	#_obs_ac	#_obs_ac												
AC_selected	0	0	0	0	Pos_x	Pos_y	Alt	Alt_tar	GS_x	GS_y	Vs	IAS	COPX_x	COPX_y	COPX_alt	AC_type
AC_1	0	0	0	0	Pos_x	Pos_y	Alt	Alt_tar	GS_x	GS_y	Vs	IAS	COPX_x	COPX_y	COPX_alt	AC_type
AC_2	0	0	0	0	Pos_x	Pos_y	Alt	Alt_tar	GS_x	GS_y	Vs	IAS	COPX_x	COPX_y	COPX_alt	AC_type
AC_3 etc.	0	0	0	0	Pos_x	Pos_y	Alt	Alt_tar	GS_x	GS_y	Vs	IAS	COPX_x	COPX_y	COPX_alt	AC_type

Figure 4.3: Septex texture to be send to shader

After initializing the variables in the frag file, the time it takes to travel from the current location to a specific pixel and from that pixel to the COPX point is calculated inside the shader. This time is compared to the time it takes the aircraft on a direct-to path. This time difference is converted to a distance and a pixel color is assigned to the pixel depending on the outcome. The `REQUIRED_HEADING()` function calculates which heading is required to reach a location under the current wind conditions. The `IAStoTAS` function converts the indicated airspeed.

A second shader is used to visualize the effects of changing the speed. The only difference with the other shader program is the input value of the speed (controlled by a toggle function) of the controlled aircraft and RGBA values of the to be colored pixels.

The speed toggle makes use of the `KeyPressed` function within the `GLAircraft()` class. When pressing + or -, the `STATE.IAS_KTS_DIF` parameter in the `SSDStateVector()` of the selected aircraft is adjusted.

To give the user insight into where the conflict zones originate from, means-end relations are added to the IAF path visualizations. The means-end connection works in two ways. The connection can be seen by hovering the mouse over an aircraft that causes a conflict or by hovering over a conflict zone. In case the user has one aircraft selected (the path visualization is visible) and hovers with the mouse over another aircraft, this is registered by a `MouseListener`. The `setHighlighted` parameter is set to true. Within `GLPATHIAF()`, if this is the case, the first variable of the `Septex` texture (Figure 4.3) for that aircraft is set to 1 using `intent[obsAcIdx][(4 * 0) + 0] = 1`. The calculations within the shader do not change, but the boolean in the texture changes the color of the conflict zones. To create the means-end relations the other way around, the program has to check whether the mouse is inside the visualization area, and if so, if it hovers over a conflict area. If `RS_VISIALIZATION_POLYGON2.contains (GLSS.RS_MOUSE_POSITION_MOVED_X_NM, GLSS.RS_MOUSE_POSITION_MOVED_Y_NM)` is true, the `IAFPathsHelper.treatStateArray()` function is called. This code is similar to the code executed in the shader. But instead of doing it for all pixels, it only calculates the path of the current mouse location. If this path predicts a conflict, the `Septex` boolean is set to 1 and the aircraft that causes the conflict is highlighted.

4.2.4. Data Saved

The experiment scenario data has to be stored for data processing. This is accomplished using the `DataXMLLogger()` class. The log file is created when the `loadNextScenario()` function within `SSDAPI()` is called. When creating the file, the `writeHeader()` function inside `DataXMLLogger()` is exercised. This function saves the date and time, the airspace specifications, and the initial traffic situation.

Throughout each experiment scenario, the `GLSS.RS_AC_SYNC` Synchronizer calls the `DataXMLLogger()` tick function once every 5 seconds. This `tick()` calls the `log()` function which writes the current state of each aircraft. The current and target position parameters, speed parameters and heading angles are saved. The conflict detection and selection parameters are also stored every timestep.

The scenario ends when, within `SimTimer()`, `GLSS.R_TIME_SEC` is greater than `GLSS.RS_PLAYLIST.TrainingDurations().get(GLSS.RS_PLAYLIST_TRAINING_ITEM)`. If this is the case, the synchronizer pauses within `SSDAPI()`. After completing the scenario workload questionnaire, the simulation is stopped. The `closeFile()` function is called. In this function the commands given throughout the scenario are added. Also, the accumulative data concerning the use of the interface is added to the data file.

5

Expert Questionnaires

Aside from the official scientific experiment, short experiment scenarios were tested by Dutch air traffic controllers employed by the LVNL and other people within the organization. They got the opportunity to experiment with the new visualization elements and share their opinion. In a pre-questionnaire the participants had to indicate their level of expertise. In a post-questionnaire they could share their insights.

5.1. Pre-Questionnaire

Please indicate how much you agree with the following statements.

Date:

Subject ID:

What kind of experience do you have in air traffic control?

O I am an Area controller with years of experience.

O I have done an ATC course that lasted

O I work within the ATC industry but have no prior experience.

- 1. Automation will change the way controllers operate within the next 10 years.

O Strongly disagree O Disagree O Neither agree nor disagree O Agree O Strongly agree

Please explain.

.....
.....
.....

ATCo A (Agree): More focus on standard/steady handling of traffic. Predictability becomes more important. System support will assist in this matter and leave less room for "controller creativity".

ATCo B (Agree): I expect systems to support the ATCo in making better decisions. The system will show relevant information that can be used verify planned solutions or guide ATCo in coming up with solutions.

- 2. It is important that a person (and not a computer) takes the control decisions.

O Strongly disagree O Disagree O Neither agree nor disagree O Agree O Strongly agree

Please explain.

.....
.....
.....

ATCo A (Neither): Unexpected circumstances (weather, emergencies etc.) will require human intervention. Standard handling will be more and more automated to optimize predictability.

ATCo B (Agree): This is a very principal and theoretical discussion. As long as an ATCo has the final responsibility legally. She or he should also be the one making the decisions. If "society" accepts computers to have the final responsibility things will gradually change.

5.2. Post-Questionnaire

Please indicate how much you agree with the following statements.

Date:

Subject ID:

- 1. The air traffic control simulation resembles the reality.
 Strongly disagree Disagree Neither agree nor disagree Agree Strongly agree
 If no, please explain.

.....
.....
.....

ATCo A: Agree

ATCo B: Agree

- 2. The 2.5NM circle makes it easier to estimate how far apart aircraft are.
 Strongly disagree Disagree Neither agree nor disagree Agree Strongly agree
 Please explain.

.....
.....
.....

ATCo A (Neither): Takes some time to get used to. Will need some more time with this to give good judgement. First impression: probability agree in the future.

ATCo B (Agree): It's weird we don't actually have a reference to 5NM on our screen. This is a relatively clean way to visualize 5NM.

- 3. The last possible descent moment arc helps me to estimate when to give a descend command.
 Strongly disagree Disagree Neither agree nor disagree Agree Strongly agree
 Please explain.

.....
.....
.....

ATCo A (Neither): It only helped me to see when the flight was not going to make the restriction. This was helpful.

ATCo B (Neither): We usually start descending ASAP, so it's not very beneficial to us. However, in the future I do expect we'll be focusing on CDO more.

- 4. The relative track visualization has helped me to estimate the separation margins in crossing situations.
 Strongly disagree Disagree Neither agree nor disagree Agree Strongly agree
 Please explain.

.....
.....
.....

ATCo A (Neither): I will need some more time with the system to fully understand the meaning of the lines/colours Probably more agree in the future.

ATCo B (Disagree): The relative track margin felt a little too abstract. I do see the added value of the calculation but I don't necessarily see the added value of showing it to the ATCo.

- 5. The cone visualizations have helped me to separate aircraft at the IAF.
 Strongly disagree Disagree Neither agree nor disagree Agree Strongly agree
 Please explain.

.....

ATCo A (Neither): See above.

ATCo B (Strongly Agree): It is a better tool for sequencing compared to the CEO-measurement we use now

- 6. The speed toggle function clearly indicates the impact of a speed change.
 Strongly disagree Disagree Neither agree nor disagree Agree Strongly agree
 Please explain.

.....

ATCo A (Neither): Not Used.

ATCo B (Neither): I haven't used this function, but I actually wanted to say a probing function for speed would be useful, so I think the function is a good addition.

- 7. In general, the new visualizations help to foresee the effects of the taken control decisions.
 Strongly disagree Disagree Neither agree nor disagree Agree Strongly agree
 Please explain.

.....

ATCo A (Neither): See above.

ATCo B (Agree): They help visualizing the expected outcome of a plan.

- 8. The new visualization elements clutter the screen.
 Strongly disagree Disagree Neither agree nor disagree Agree Strongly agree
 Please explain.

.....

ATCo A (Agree): The screen is now relatively clean (few lines, no other traffic). In a more realistic setting the lines/colors/cones would be too much (at least initially, maybe you can get used to it).

ATCo B (Agree): It's interesting to pay more attention to what's useful in which case. For example: the conflict detection shows "no conflict" with traffic 25NM in front. I don't need a visualization to know that.

- 9. I solved situations differently than I would usually do.
 Strongly disagree Disagree Neither agree nor disagree Agree Strongly agree
 If yes, please explain.
 Please explain.

.....

ATCo A: Strongly Disagree

ATCo B (Neither): I used the system as a way to verify my solutions. I do see me picking a "new" solution more often as I know I will be backed up by the system.

- 10. The proposed visualization elements could make the ATC control task easier.
 Strongly disagree Disagree Neither agree nor disagree Agree Strongly agree

Please explain.

.....
.....
.....

ATCo A (Agree): Clear input of when to give certain commands. Problem is HMI ("screen clutter")

ATCo B (Agree): I see most benefit in spending less time checking and checking again if a situation will evolve the way I anticipated.

- 11. With further research (part of) this solution should be implemented the future.
 Strongly disagree Disagree Neither agree nor disagree Agree Strongly agree

If yes, please explain and indicate which parts you would like to see implemented.

.....
.....
.....

ATCo A (Agree): The circles and IAF separation make our core task a bit easier. Question is whether the benefits outweigh the negative consequences of screen clutter. Last possible descent arc is great in theory, but in practice (nearly) impossible due to humans in the cockpit.

ATCo B (Strongly Agree): Specifically, the merging and separation guidance.

- 2.5NM circles: ATCo A, ATCo B
- Last possible descent arc
- Relative track lines
- IAF separation visualization: ATCo A, ATCo B
- IAF speed toggle visualization: ATCo B

6

Final Situations

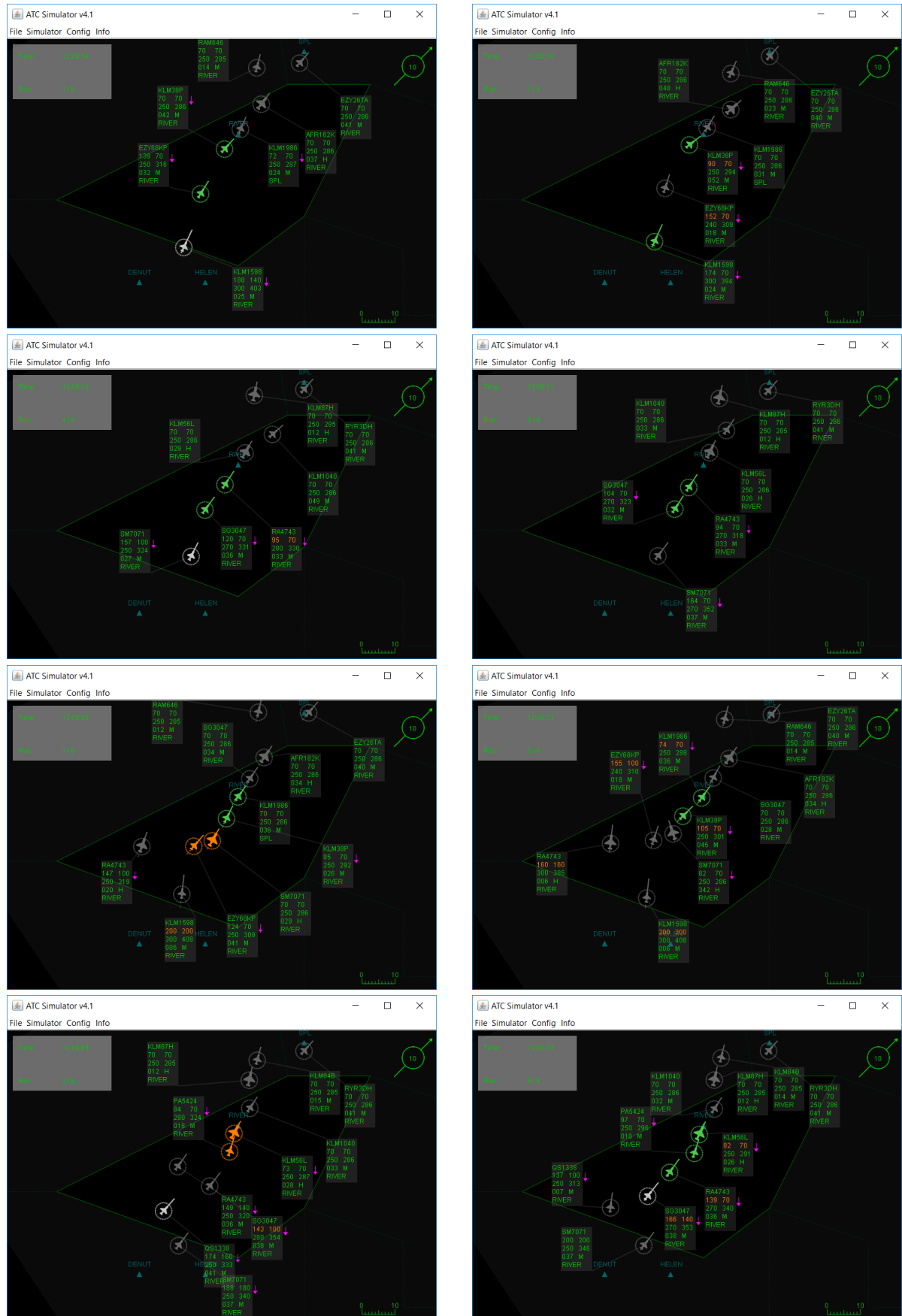

Figure 6.1: Participant 1

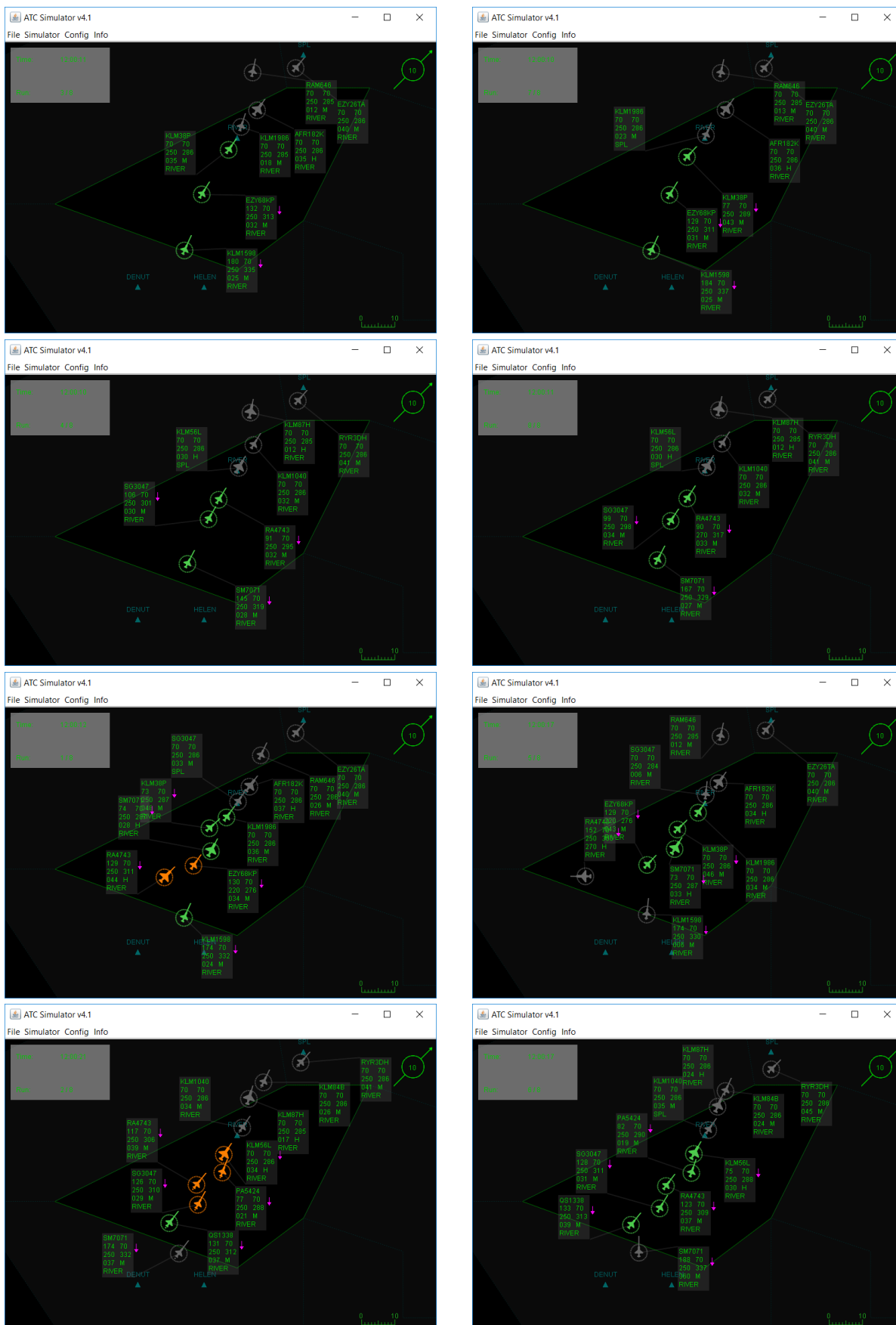

Figure 6.2: Participant 2

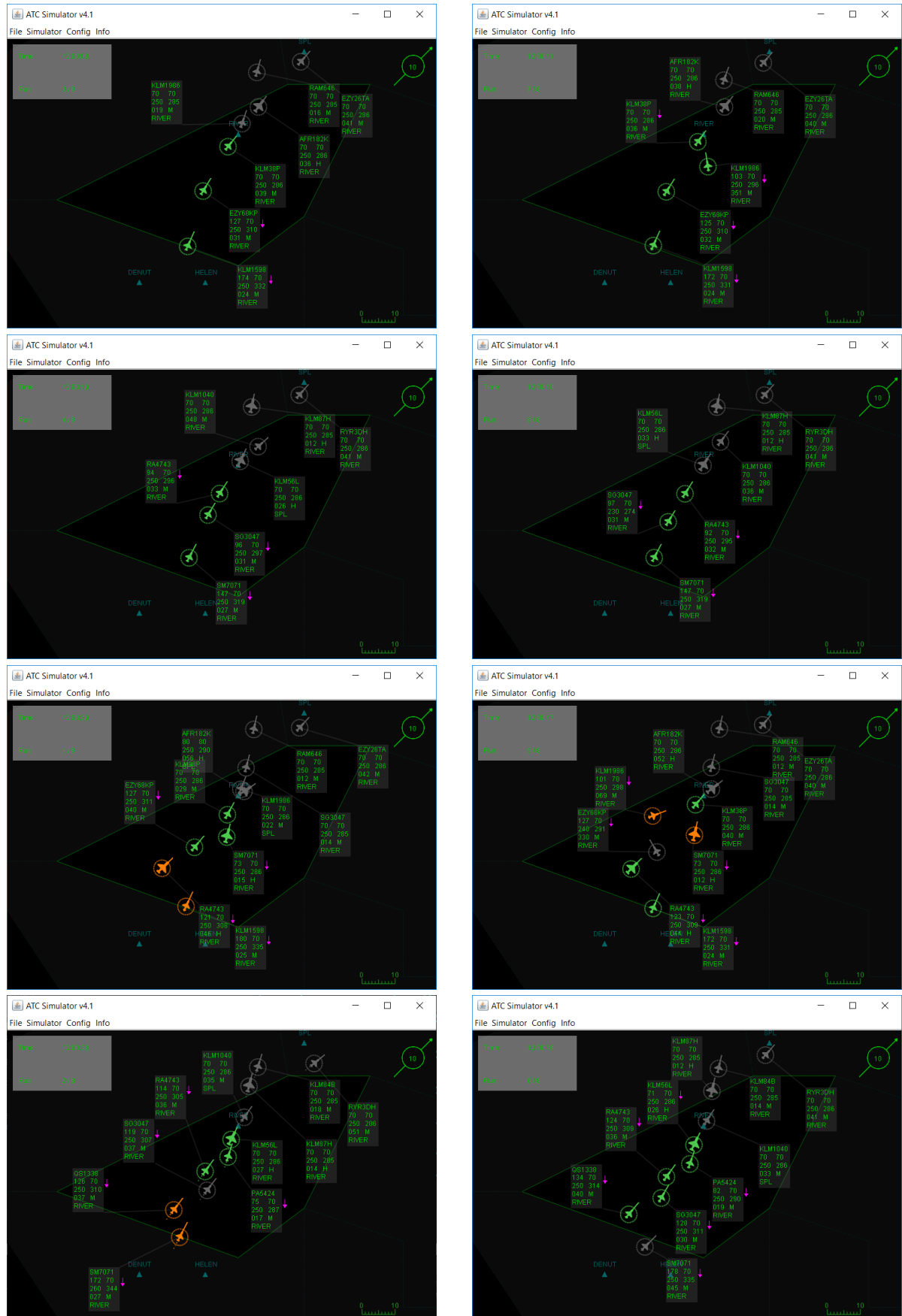

Figure 6.3: Participant 3

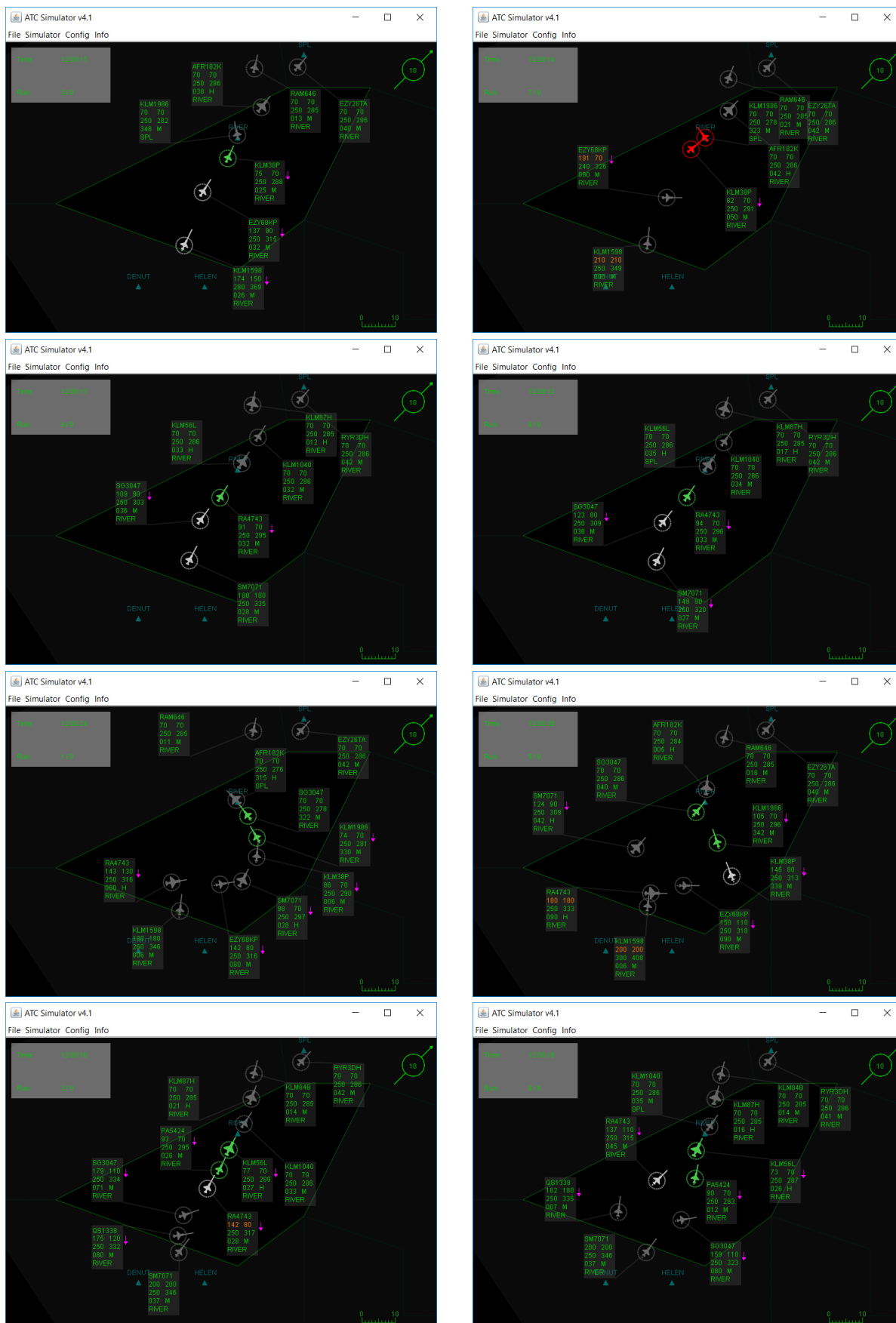

Figure 6.4: Participant 4

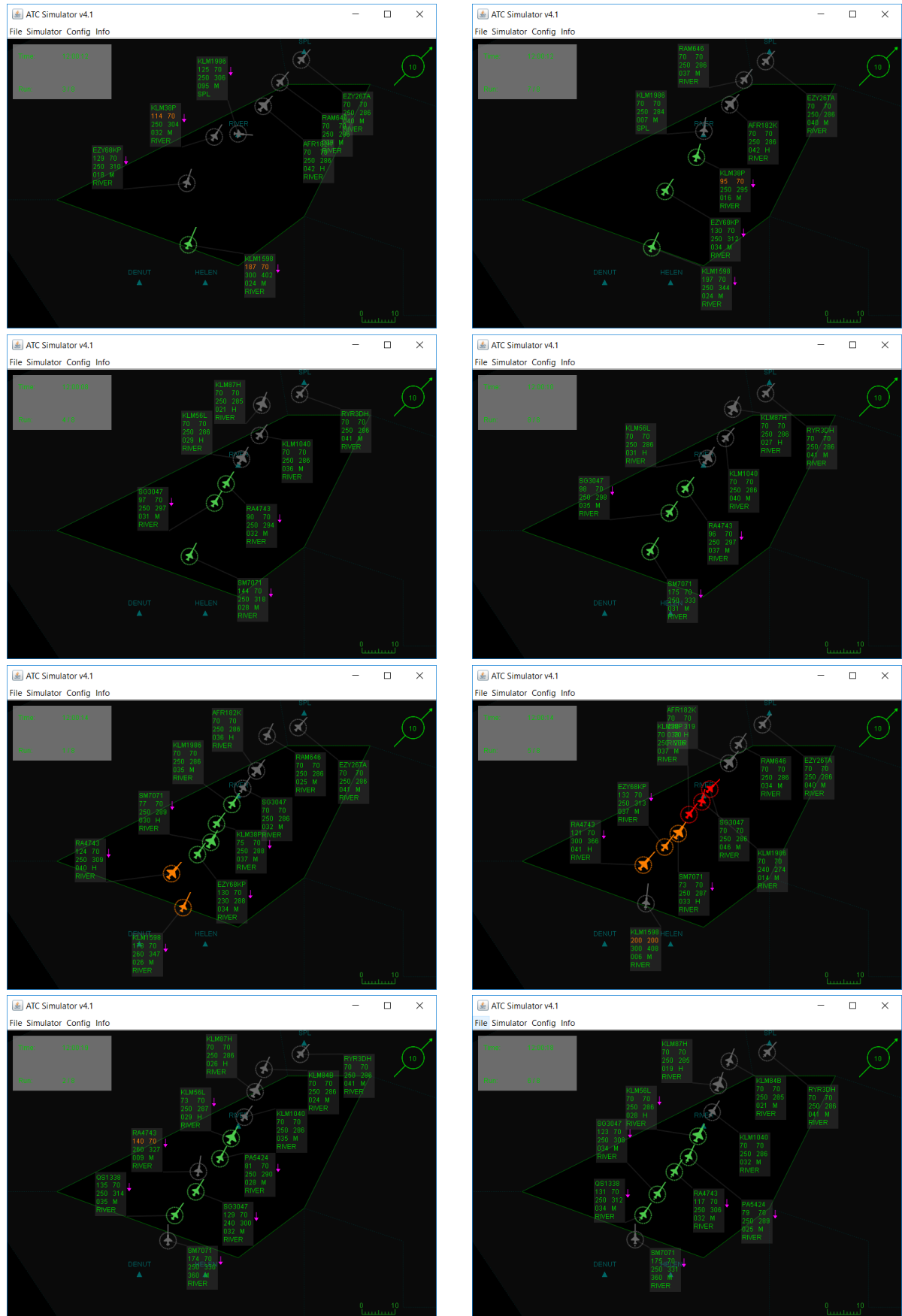

Figure 6.5: Participant 5

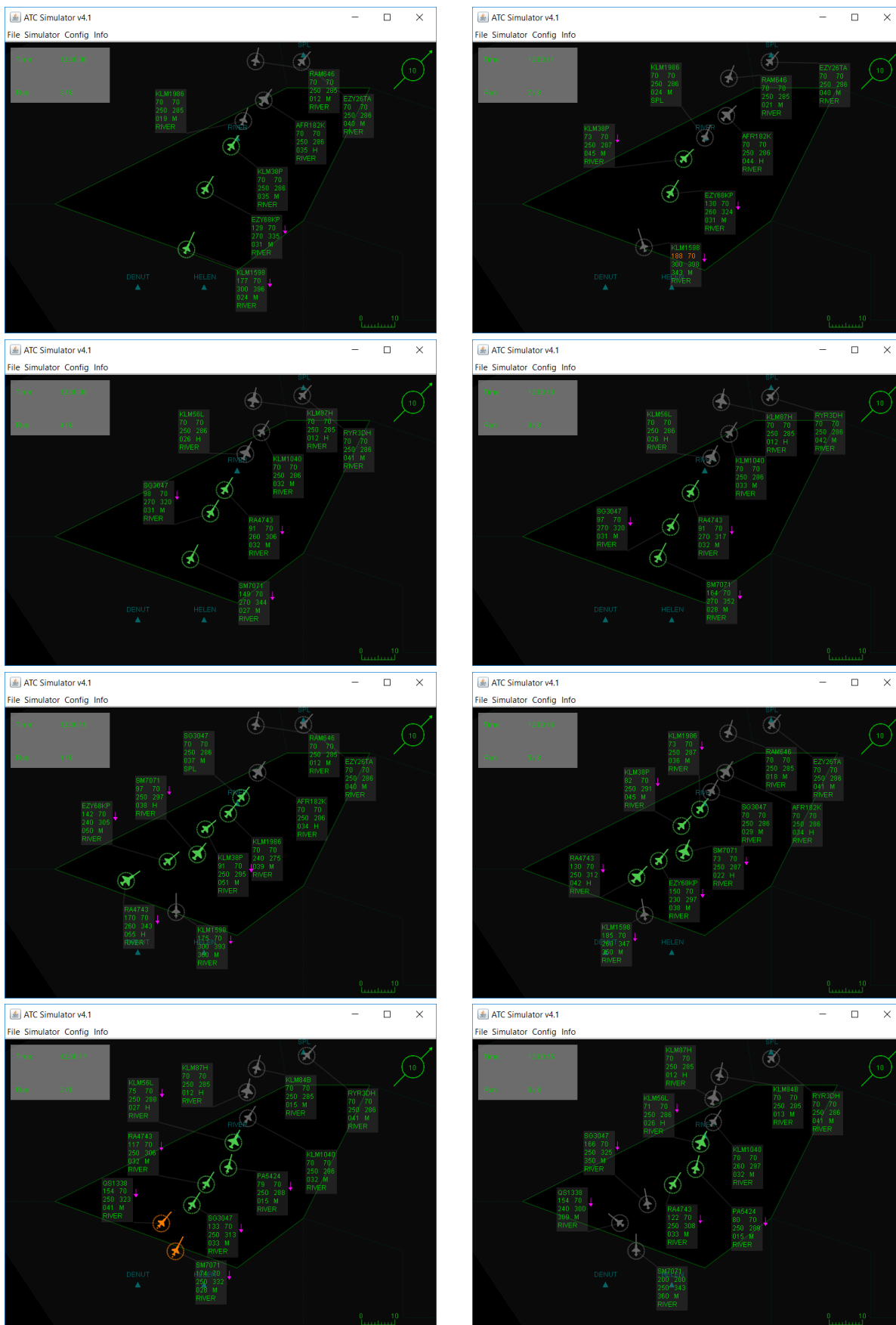

Figure 6.6: Participant 6

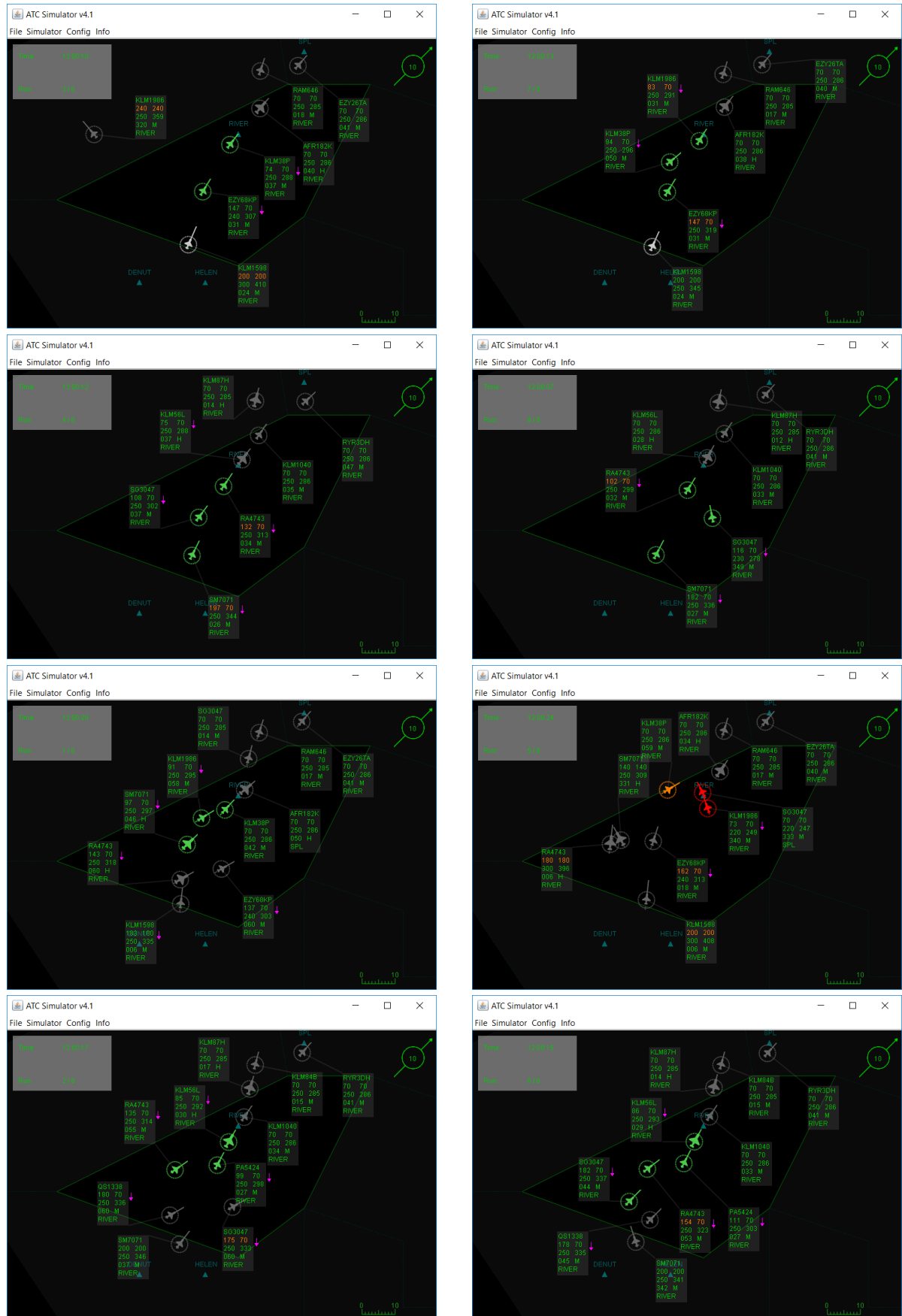

Figure 6.7: Participant 7

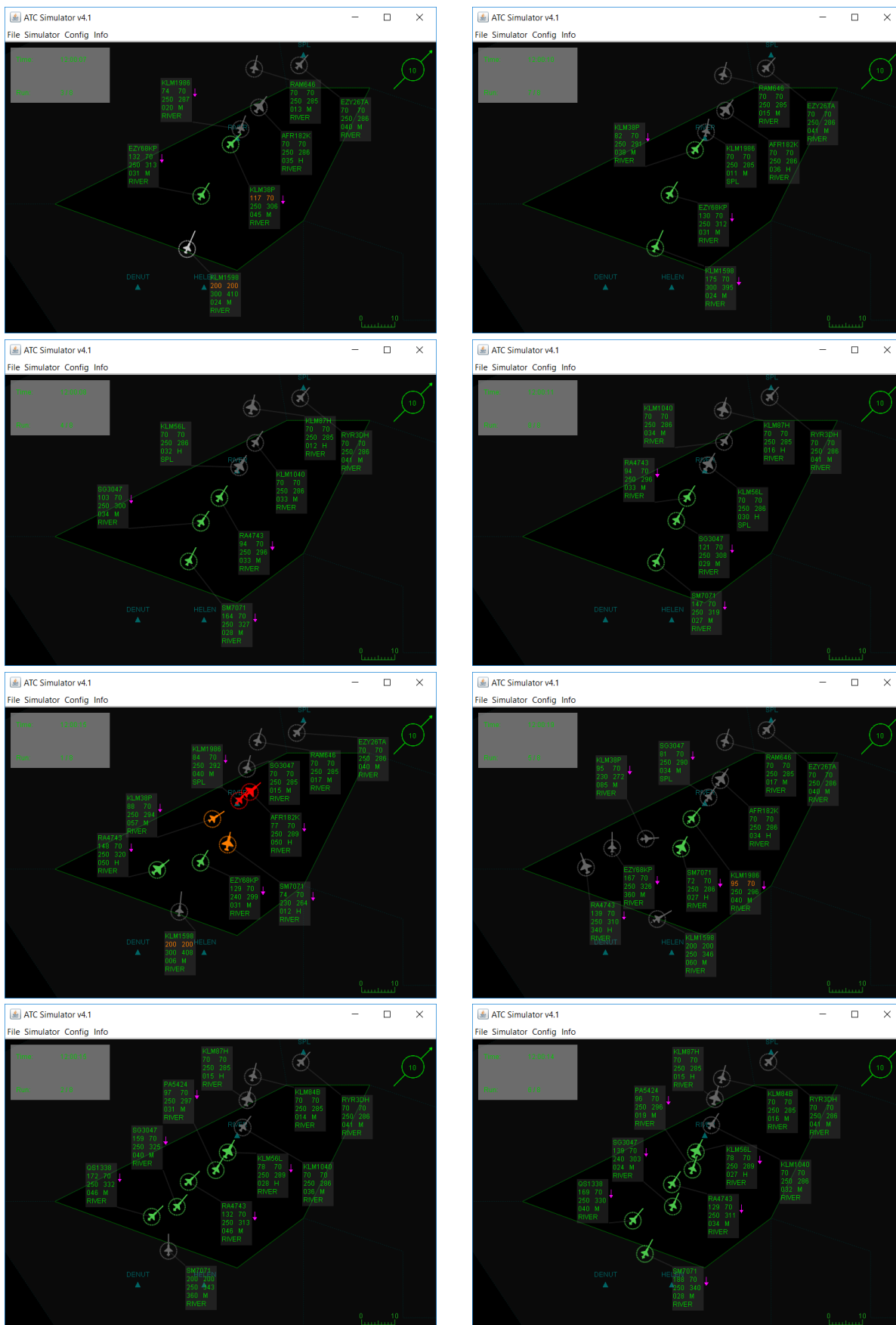

Figure 6.8: Participant 8

Individual ISA Workload Ratings

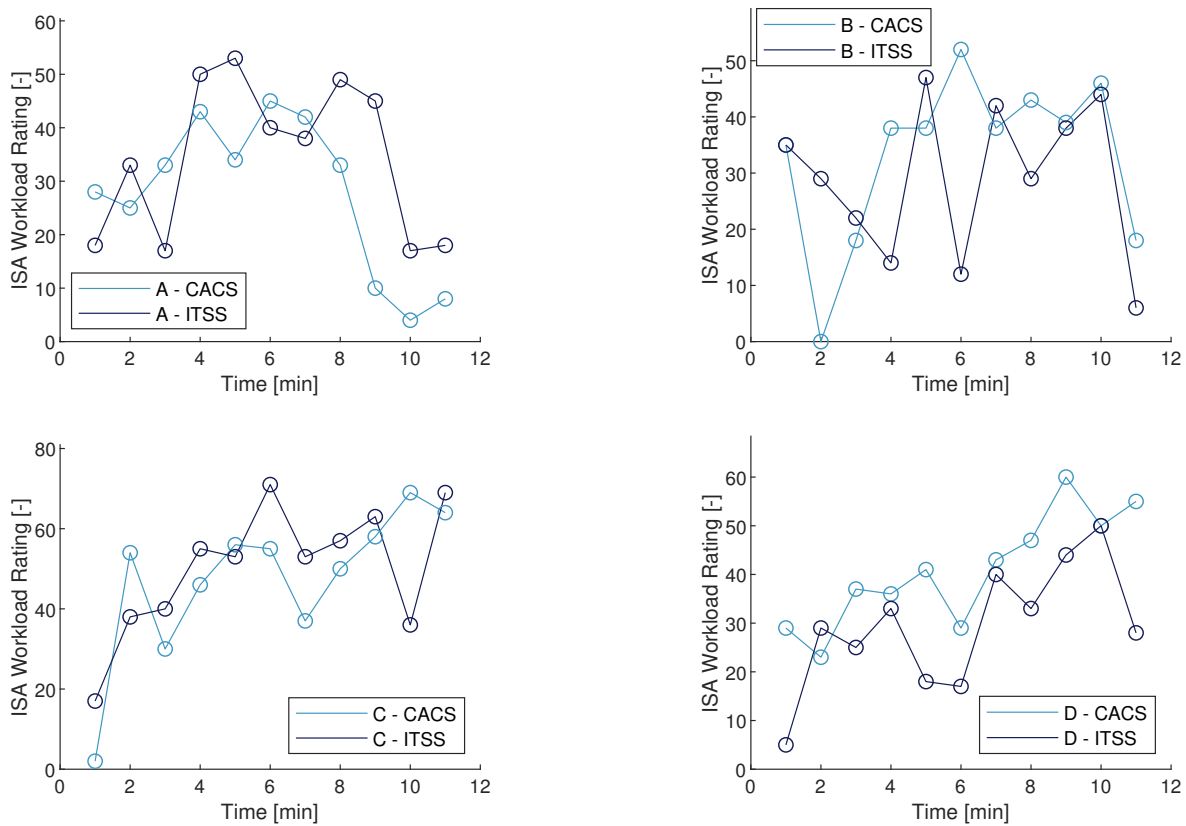

Figure 7.1: ISA workload ratings over time for Participant 1

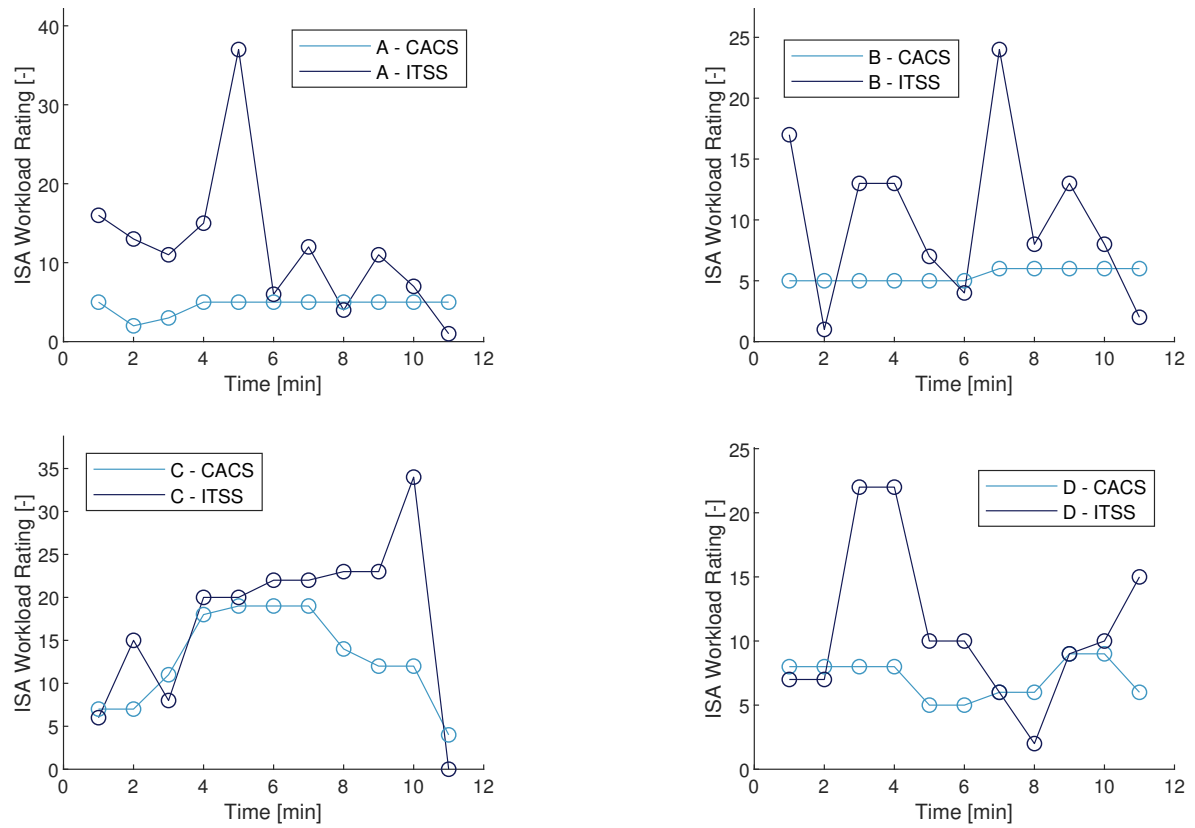

Figure 7.2: ISA workload ratings over time for Participant 2

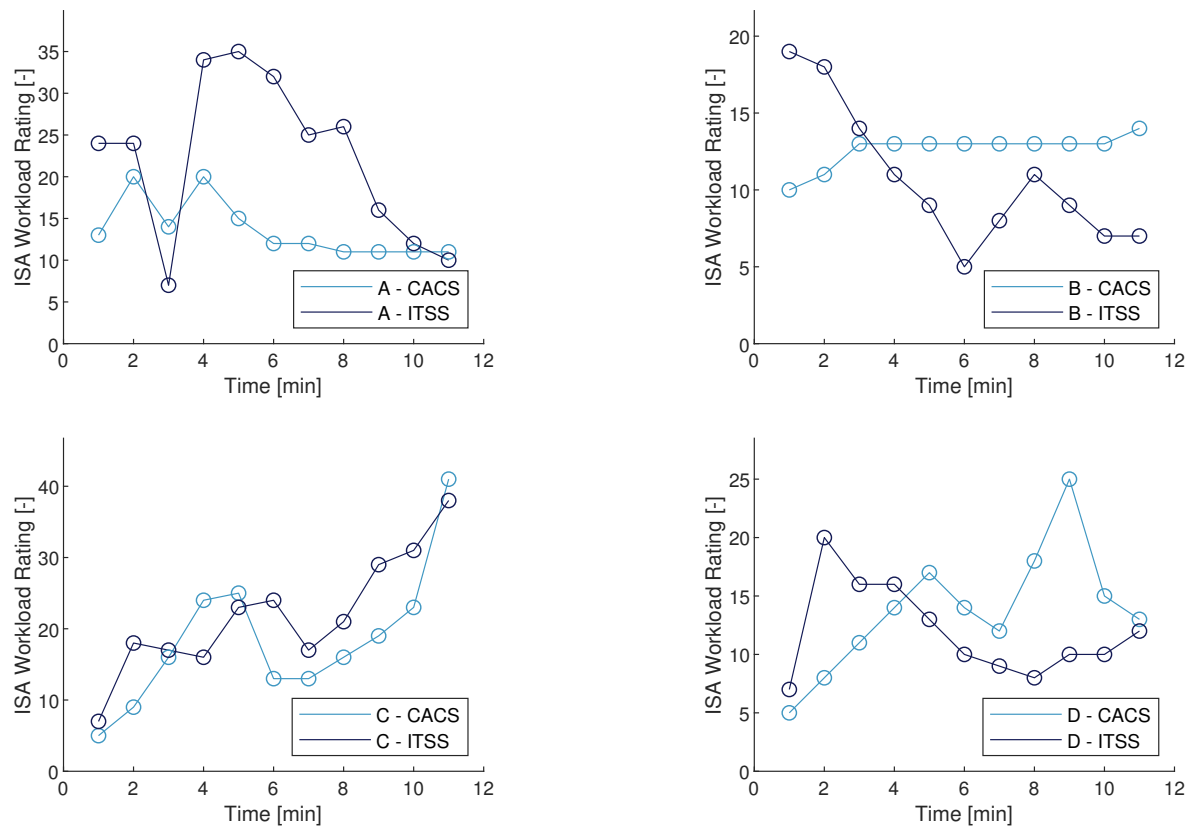

Figure 7.3: ISA workload ratings over time for Participant 3

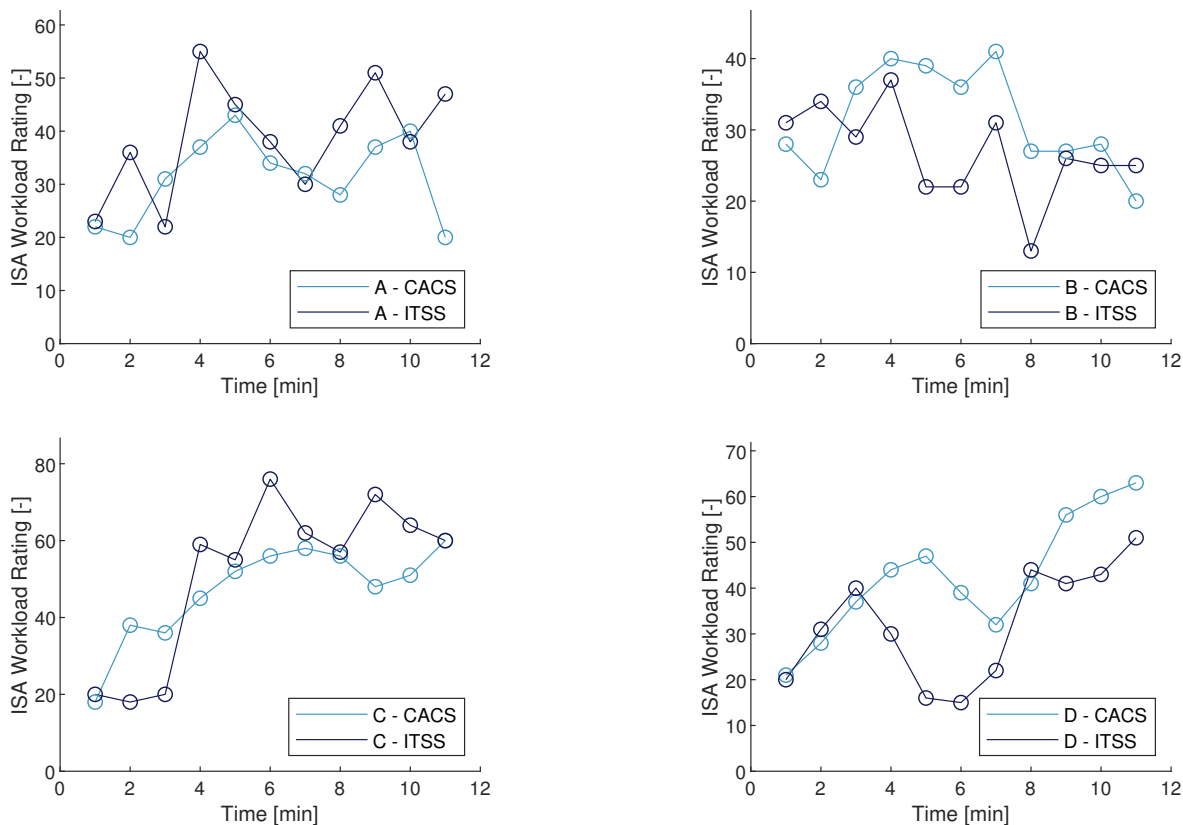

Figure 7.4: ISA workload ratings over time for Participant 4

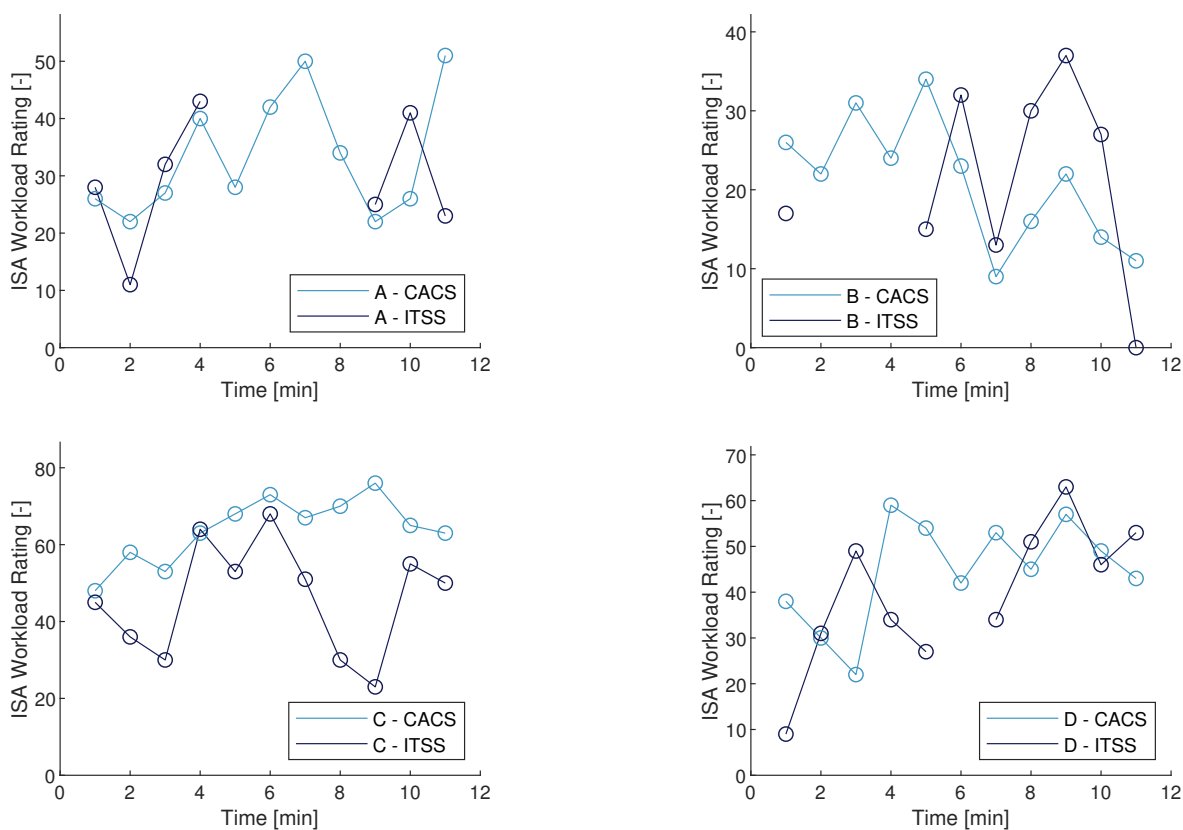

Figure 7.5: ISA workload ratings over time for Participant 5

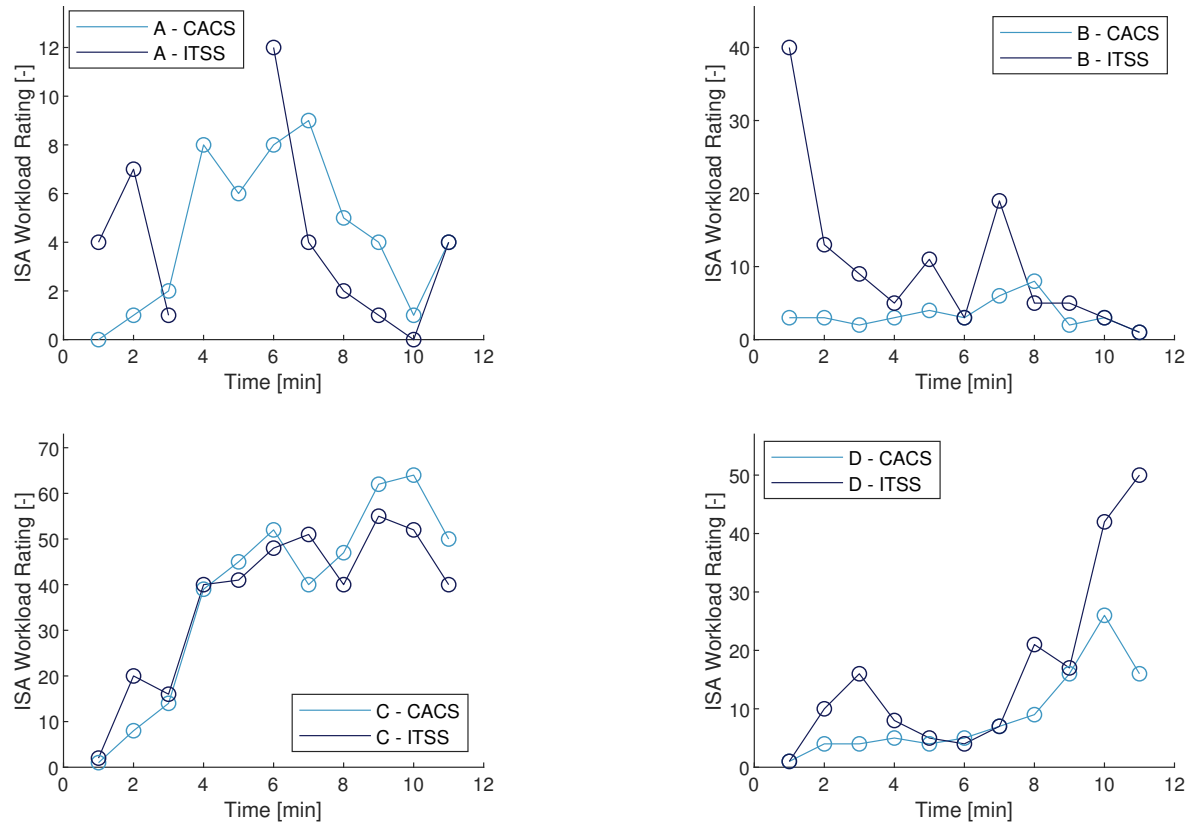

Figure 7.6: ISA workload ratings over time for Participant 6

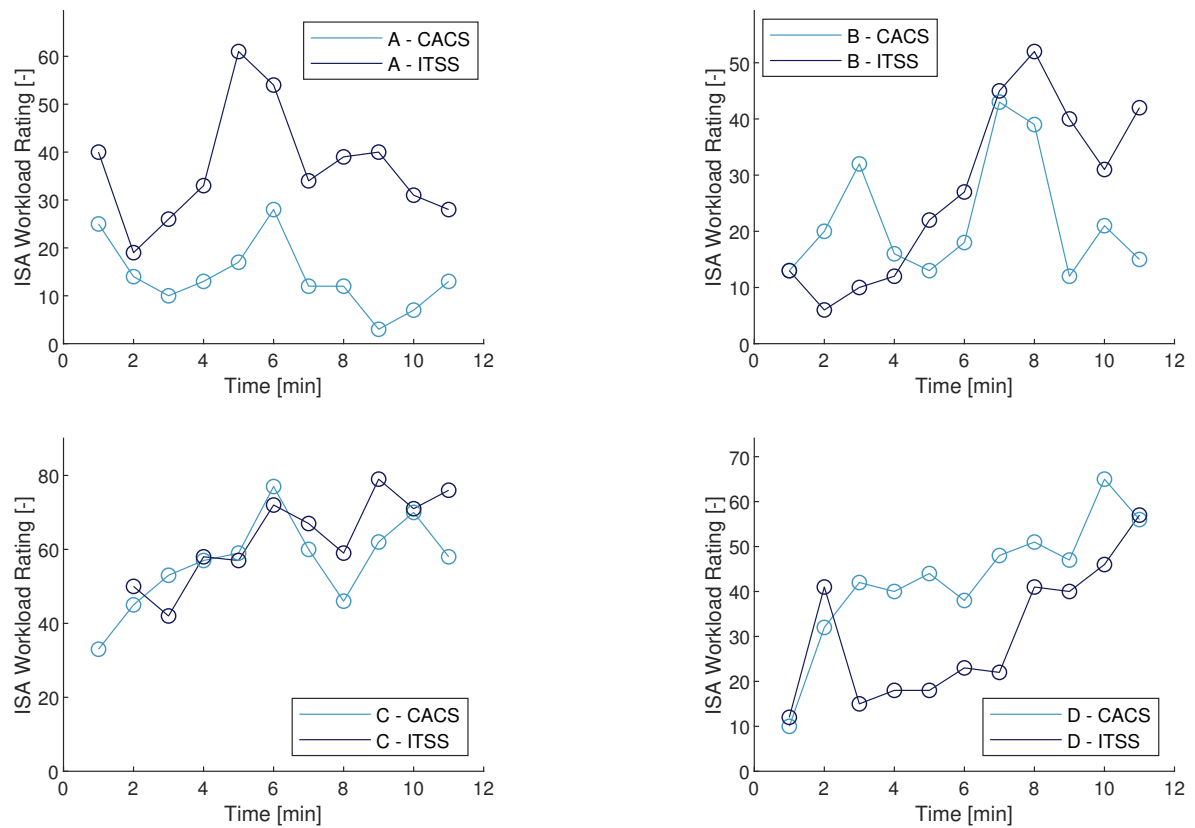

Figure 7.7: ISA workload ratings over time for Participant 7

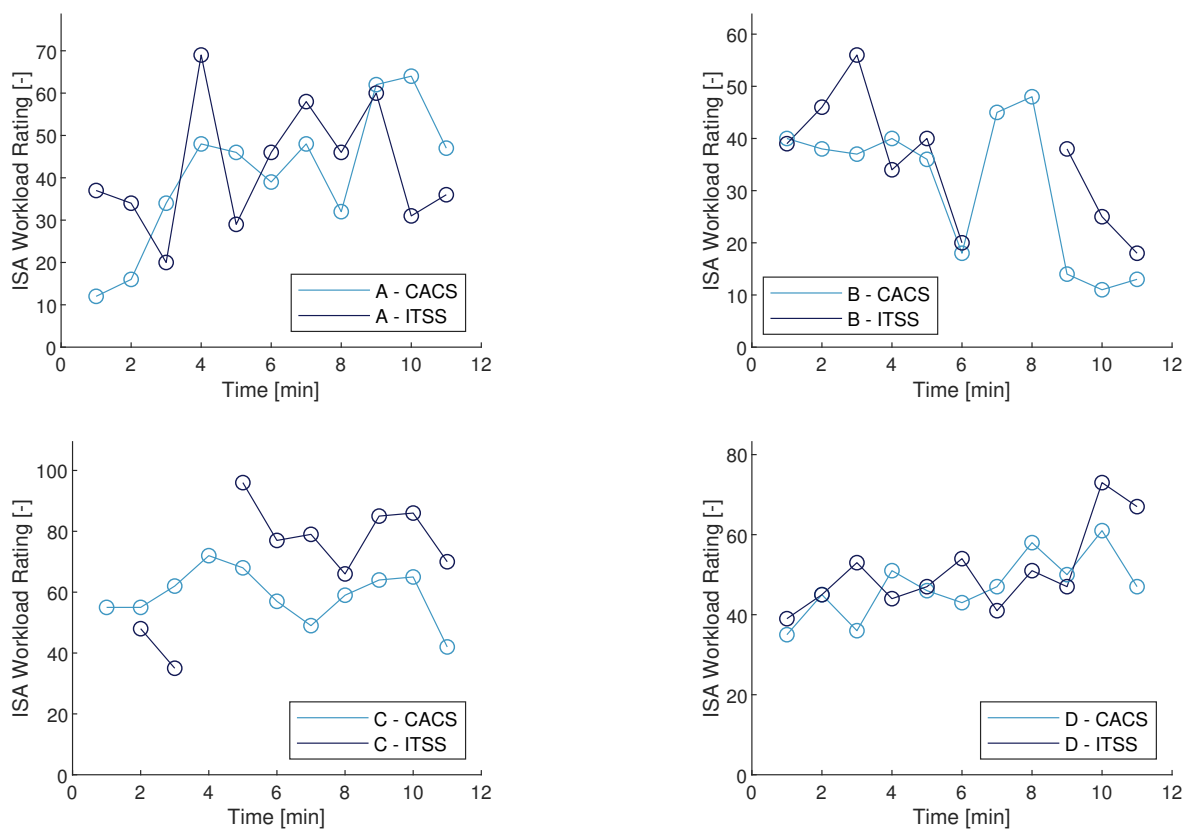

Figure 7.8: ISA workload ratings over time for Participant 8