

**SSC-385**

**Hydrodynamic Impact on  
Displacement Ship Hulls**  
*An Assessment of the State of the Art*



This document has been approved  
for public release and sale; its  
distribution is unlimited

**SHIP STRUCTURE COMMITTEE**

**1995**

### SHIP STRUCTURE COMMITTEE

The SHIP STRUCTURE COMMITTEE is constituted to prosecute a research program to improve the hull structures of ships and other marine structures by an extension of knowledge pertaining to design, materials, and methods of construction.

RADM J. C. Card, USCG (Chairman)  
Chief, Office of Marine Safety, Security  
and Environmental Protection  
U. S. Coast Guard

Mr. Thomas H. Peirce  
Marine Research and Development  
Coordinator  
Transportation Development Center  
Transport Canada

Mr. Edwin B. Schimler  
Associate Administrator for Ship-  
building and Technology Development  
Maritime Administration

Dr. Donald Liu  
Senior Vice President  
American Bureau of Shipping

Mr. Robert McCarthy  
Director, Survivability and Structural  
Integrity Group (SEA O3P)  
Naval Sea Systems Command

Mr. Thomas Connors  
Acting Director of Engineering (N7)  
Military Sealift Command

Dr. Ross Grahm  
Head, Hydronautics Section  
Defence Research Establishment-Atlantic

#### EXECUTIVE DIRECTOR

CDR Stephen E. Sharpe, USCG  
U. S. Coast Guard

#### CONTRACTING OFFICER TECHNICAL REPRESENTATIVE

Mr. William J. Siekierka  
Naval Sea Systems Command

### SHIP STRUCTURE SUBCOMMITTEE

The SHIP STRUCTURE SUBCOMMITTEE acts for the Ship Structure Committee on technical matters by providing technical coordination for determining the goals and objectives of the program and by evaluating and interpreting the results in terms of structural design, construction, and operation.

#### MILITARY SEALIFT COMMAND

Mr. Robert E. Van Jones (Chairman)  
Mr. Rickard A. Anderson  
Mr. Michael W. Touma  
Mr. Jeffrey E. Beach

#### MARITIME ADMINISTRATION

Mr. Frederick Seibold  
Mr. Richard P. Voelker  
Mr. Chao H. Lin  
Dr. Walter M. Maclean

#### U. S. COAST GUARD

CAPT George Wright  
Mr. Walter Lincoln  
Mr. Rubin Sheinberg

#### AMERICAN BUREAU OF SHIPPING

Mr. Glenn Ashe  
Mr. John F. Conlon  
Mr. Phillip G. Rynn  
Mr. William Hanzelek

#### NAVAL SEA SYSTEMS COMMAND

Mr. W. Thomas Packard  
Mr. Charles L. Null  
Mr. Edward Kadala  
Mr. Allen H. Engle

#### TRANSPORT CANADA

Mr. John Grinstead  
Mr. Ian Bayly  
Mr. David L. Stocks  
Mr. Peter Timonin

#### DEFENCE RESEARCH ESTABLISHMENT ATLANTIC

Dr. Neil Pegg  
LCDR Stephen Gibson  
Dr. Roger Hollingshead  
Mr. John Porter

### SHIP STRUCTURE SUBCOMMITTEE LIAISON MEMBERS

SOCIETY OF NAVAL ARCHITECTS AND  
MARINE ENGINEERS  
Dr. William Sandberg

NATIONAL ACADEMY OF SCIENCES -  
MARINE BOARD  
Dr. Robert Sielski

CANADA CENTRE FOR MINERALS AND  
ENERGY TECHNOLOGIES  
Dr. William R. Tyson

NATIONAL ACADEMY OF SCIENCES -  
COMMITTEE ON MARINE STRUCTURES  
Dr. John Landes

U. S. NAVAL ACADEMY  
Dr. Ramswar Bhattacharyya

WELDING RESEARCH COUNCIL  
Dr. Martin Prager

U. S. MERCHANT MARINE ACADEMY  
Dr. C. B. Kim

AMERICAN IRON AND STEEL INSTITUTE  
Mr. Alexander D. Wilson

U. S. COAST GUARD ACADEMY  
LCDR Bruce R. Mustain

OFFICE OF NAVAL RESEARCH  
Dr. Yapa D. S. Rajapaske

U. S. TECHNICAL ADVISORY GROUP TO THE  
INTERNATIONAL STANDARDS ORGANIZATION  
CAPT Charles Piersall

MASSACHUSETTS INSTITUTE OF TECHNOLOGY  
CAPT Alan J. Brown

STUDENT MEMBER  
Mr. Jason Miller  
Massachusetts Institute of Technology

## Member Agencies:

American Bureau of Shipping  
 Defence Research Establishment Atlantic  
 Maritime Administration  
 Military Sealift Command  
 Naval Sea Systems Command  
 Transport Canada  
 United States Coast Guard



## Ship Structure Committee

An Interagency Advisory Committee

SSC-385  
 SR-1342

2 January 1996

## Address Correspondence to:

Executive Director  
 Ship Structure Committee  
 U.S. Coast Guard (G-MMS/SSC)  
 2100 Second Street, S.W.  
 Washington, D.C. 20593-0001  
 Ph:(202) 267-0003  
 Fax:(202) 267-4816

### HYDRODYNAMIC IMPACT ON DISPLACEMENT SHIP HULLS

The ability of the naval architect to optimize the structural design of a ship is limited by both our understanding of, and our ability to predict hydrodynamic loads. In addition to having to account for the random nature of wave induced loads, transient loadings such as slamming, wave slap and frontal impacts must also be addressed. Failure to account for these impulsive loads and how best to combine these loads with ever present slow varying wave induced loads can result in, at best, reduced ship operational time and, at worst, catastrophic failure.

In order to address these concerns, a critical review of the state of the art in predicting hydrodynamic impact forces has been completed. This report identifies numerous theories of hydrodynamic impact loading that have been developed over the years by many researchers. These theories are evaluated to identify which are most applicable for use in design with example calculations presented. Recommendations for future research are given.

J. C. CARD  
 Rear Admiral, U.S. Coast Guard  
 Chairman, Ship Structure Committee

1. Report No. SSC-385	2. Government Accession No. PB96-129101	3. Recipient's Catalog No.	
4. Title and Subtitle HYDRODYNAMIC IMPACT LOADING ON DISPLACEMENT SHIP HULLS - AN ASSESSMENT OF THE STATE OF THE ART -		5. Report Date April 15, 1995	
		6. Performing Organization Code	
7. Author(s) Dr. John C. Daidola and Dr. Victor Mishkevich		8. Performing Organization Report No. SR-1342	
9. Performing Organization Name and Address M. ROSENBLATT & SON, INC. 350 Broadway New York, NY 10013		10. Work Unit No. (TRAIS)	
		11. Contract or Grant No. DTCG23-92-C-E01088	
12. Sponsoring Agency Name and Address SHIP STRUCTURE COMMITTEE U. S. COAST GUARD 2100 Second Street, S.W. Washington, D.C. 20593		13. Type of Report and Period Covered Final Report	
		14. Sponsoring Agency Code G-M	
15. Supplementary Notes Sponsored by the Ship Structure Committee. Jointly funded by its member agencies.			
16. Abstract <p>This report provides a comprehensive assessment of the state of the art of hydrodynamic impact loading on displacement ship hulls. The subject is considered in light of the three distinct phenomena of slamming, wave slap, and frontal impact. Factors leading to hydrodynamic impact are defined in terms of environmental and vessel characteristics. The theories of impact are reviewed in sub-categories of two and three dimensional analytical hydrodynamic models, hydroelastic models, seakeeping theory, model tests, and full scale data. The techniques and procedures identified which lend themselves to analysis and potential design application are identified and described, the characteristics of each summarized, and example calculations relating the techniques and procedures presented. The report concludes with recommendations for future research.</p>			
17. Key Words Hydrodynamic, Frontal Impact, Displacement Ships, Slamming, Hydroelastic, Seakeeping, Impact, Wave Slap, Model Tests, Theory		18. Distribution Statement Distribution Unlimited, Available from: National Technical Information Service U.S. Department of Commerce Springfield, VA 22151	
19. Security Classif. (of this report) Unclassified	20. Security Classif. (of this page) Unclassified	21. No. of Pages 204	22. Price \$36.50 Paper \$17.50 Micro





United States Department of Commerce  
Technology Administration  
National Institute of Standards and Technology  
Metric Program, Gaithersburg, MD 20899

## METRIC CONVERSION CARD

Approximate Conversions to Metric Measures

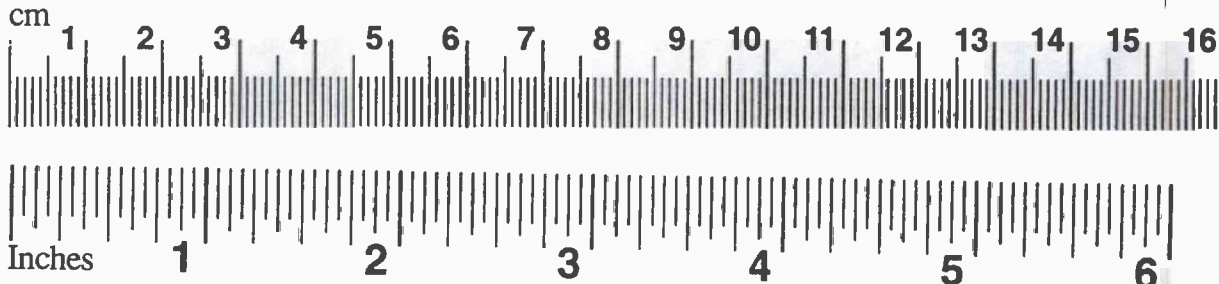
Symbol When You Know Multiply by To Find Symbol

LENGTH			
in	inches	2.5 centimeters	cm
ft	feet	30 centimeters	cm
yd	yards	0.9 meters	m
mi	miles	1.6 kilometers	km
AREA			
in <sup>2</sup>	square inches	6.5 square centimeters	cm <sup>2</sup>
ft <sup>2</sup>	square feet	0.09 square meters	m <sup>2</sup>
yd <sup>2</sup>	square yards	0.8 square meters	m <sup>2</sup>
mi <sup>2</sup>	square miles	2.6 square kilometers	km <sup>2</sup>
	acres	0.4 hectares	ha

MASS (weight)			
oz	ounces	28 grams	g
lb	pounds	0.45 kilograms	kg
	short tons (2000 lb)	0.9 metric ton	t

VOLUME			
tsp	teaspoons	5 milliliters	mL
Tbsp	tablespoons	15 milliliters	mL
in <sup>3</sup>	cubic inches	16 milliliters	mL
fl oz	fluid ounces	30 milliliters	mL
c	cups	0.24 liters	L
pt	pints	0.47 liters	L
qt	quarts	0.95 liters	L
gal	gallons	3.8 liters	L
ft <sup>3</sup>	cubic feet	0.03 cubic meters	m <sup>3</sup>
yd <sup>3</sup>	cubic yards	0.76 cubic meters	m <sup>3</sup>

TEMPERATURE (exact)			
°F	degrees Fahrenheit	subtract 32, multiply by 5/9	degrees Celsius



Approximate Conversions from Metric Measures

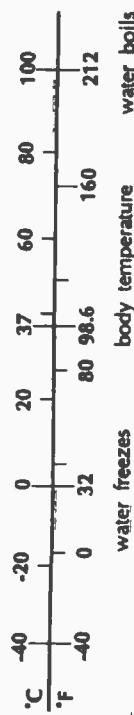
Symbol When You Know Multiply by To Find Symbol

LENGTH			
mm	millimeters	0.04 inches	in
cm	centimeters	0.4 inches	in
m	meters	3.3 feet	ft
m	meters	1.1 yards	yd
km	kilometers	0.6 miles	mi
AREA			
cm <sup>2</sup>	square centimeters	0.16 square inches	in <sup>2</sup>
m <sup>2</sup>	square meters	1.2 square yards	yd <sup>2</sup>
km <sup>2</sup>	square kilometers	0.4 square miles	mi <sup>2</sup>
ha	hectares (10,000 m <sup>2</sup> )	2.5 acres	

MASS (weight)			
g	grams	0.035 ounces	oz
kg	kilograms	2.2 pounds	lb
t	metric ton (1,000 kg)	1.1 short tons	

VOLUME			
mL	milliliters	0.03 fluid ounces	fl oz
mL	milliliters	0.06 cubic inches	in <sup>3</sup>
L	liters	2.1 pints	pt
L	liters	1.06 quarts	qt
L	liters	0.26 gallons	gal
m <sup>3</sup>	cubic meters	35 cubic feet	ft <sup>3</sup>
m <sup>3</sup>	cubic meters	1.3 cubic yards	yd <sup>3</sup>

TEMPERATURE (exact)			
°C	degrees Celsius	multiply by 9/5, add 32	degrees Fahrenheit



## TABLE OF CONTENTS

	<u>Page</u>
List of Illustrations .....	ix
List of Tables .....	xii
Acknowledgement .....	xiii
<b>1. INTRODUCTION .....</b>	<b>1-1</b>
1.1 General .....	1-1
1.2 Description Of Impact Phenomena Experienced By A Ship At Sea ...	1-4
1.2.1 Slamming .....	1-4
1.2.2 Wave Slap .....	1-5
1.2.3 Frontal Impact .....	1-5
1.3 Impact On Small Craft Including Planing and SES Types .....	1-6
1.4 Impact on Aircraft Landing On Water .....	1-6
<b>2. PHENOMENA FOR OCCURRENCE OF HYDRODYNAMIC IMPACT .....</b>	<b>2-1</b>
2.1 General .....	2-1
2.2 Factors Leading to Proper Conditions for Slamming .....	2-1
2.2.1 Sea State .....	2-1
2.2.2 Speed .....	2-3
2.2.3 Heading .....	2-3
2.2.4 Draft .....	2-3
2.2.5 Ship Form .....	2-4
2.3 Factors Leading to Proper Conditions for Wave Slap .....	2-4
2.3.1 Sea State .....	2-4
2.3.2 Speed .....	2-4
2.3.3 Heading .....	2-5
2.3.4 Draft .....	2-5
2.3.5 Ship Form .....	2-5
2.4 Factors Leading to Proper Conditions for Frontal Impact .....	2-5
2.5 Structural Response .....	2-5
<b>3. HYDRODYNAMIC IMPACT .....</b>	<b>3-1</b>
3.1 Introduction .....	3-1

3.1.1	General .....	3-1
3.1.2	Slamming .....	3-1
3.1.3	Wave Slap .....	3-2
3.1.4	Frontal Impact .....	3-4
3.2	Theoretical Approach .....	3-6
3.2.1	Introduction .....	3-6
3.2.2	Two-Dimensional .....	3-7
3.2.3	Three-Dimensional .....	3-24
3.2.4	Hull Response .....	3-33
	3.2.4.1 Response of Structure to Water Impacts .....	3-33
	3.2.4.2 Hull Response Theory .....	3-35
	3.2.4.3 Classification Society Rules .....	3-44
3.2.5	Seakeeping .....	3-45
	3.2.5.1 General .....	3-45
	3.2.5.2 Seakeeping Hydrodynamics .....	3-46
	3.2.5.3 Seakeeping Events .....	3-47
3.3	Experimental Results .....	3-48
3.3.1	Model Tests .....	3-48
	3.3.1.1 Results .....	3-48
	3.3.1.2 Model Scale Effects .....	3-54
3.3.2	Full Scale Data .....	3-57
3.3.3	Empirical Methods Based on Experiment .....	3-62
4.	<b>ANALYSIS TECHNIQUES AND PROCEDURES .....</b>	<b>4-1</b>
4.1	General .....	4-1
4.2	Slamming .....	4-1
4.2.1	Von Karman [32] - Monohulls .....	4-1
4.2.2	Ochi and Motter [28] - Monohulls .....	4-1
4.2.3	Kaplan and Sargent [125] - Monohulls .....	4-8
4.2.4	Kaplan [102] - Multi-hulls .....	4-9
4.2.5	Troesch and Kang [3] - Monohulls .....	4-10
4.2.6	Jasper and Church [119], Chuang [120] .....	4-10
4.2.7	Stavory and Chuang [59] .....	4-11
4.2.8	Slam Pressure Predictions Using Scaled Models [3] .....	4-12
4.2.9	Bishop and Price [29] .....	4-12
4.2.10	U.S. Federal Aviation Administration .....	4-13

4.2.11	Zhao and Faltinson [68]	4-13
4.2.12	Mitsubishi Heavy Industries	4-14
4.2.13	Aksu et al.	4-14
4.3	Wave Slap	4-15
4.3.1	Wave Slap Pressure Predictions Using Scaled Models [3]	4-15
4.3.2	Garcia [168]	4-15
4.3.3	U. S. Navy [210]	4-15
4.4	Frontal Impact	4-16
4.4.1	Troesch and Kang [5] - Monohulls	4-16
4.4.2	Kaplan and Sargent [125] - Monohulls	4-16
4.4.3	Jasper and Church [119], Chuang [120]	4-16
4.4.4	Frontal Impact Pressure Predictions Using Scaled Models [2]	4-16
4.4.5	Gran et al. [64]	4-16
5.	<b>SELECTION OF ANALYSIS TECHNIQUES FOR APPLICATION</b>	5-1
5.1	General	5-1
5.2	Comparative Tabulation	5-1
5.3	Evaluation	5-1
5.3.1	Slamming	5-1
5.3.2	Wave Slap	5-23
5.3.3	Frontal Impact	5-24
6.	<b>EXAMPLE CALCULATIONS</b>	6-1
6.1	General	6-1
6.2	Pressure	6-1
6.2.1	Wedge	6-1
6.2.2	Circle	6-8
6.2.3	Parabola	6-8
6.2.4	Bow Flare Section	6-8
6.2.5	Hull Section	6-8
6.3	Forces	6-9
6.3.1	Wedge	6-9
6.3.2	Circle	6-9
6.3.3	Sphere	6-10
7.	<b>CONCLUSIONS</b>	7-1



8.	<b>RECOMMENDATIONS FOR FUTURE RESEARCH</b> .....	8-1
9.	<b>REFERENCES</b> .....	9-1

## LIST OF FIGURES

		<u>Page</u>
1-1	Number of Publications Covered by Present Review .....	1-3
2-1	Combined Loads on Ship Hull in Waves (from Kaplan and Dalzell [8]) .....	2-2
2-2	SES-600 Hullborne Hull Girder Bending Moments. Slamming occurs at $h_{1/3} = 3m$ [7] .....	2-6
2-3	Calculated Force Applied at Various Stations as a Function of Time; Mariner; Sea State 7; Significant Wave Height 25 ft., Ship Speed 7.4 Knots, Light Draft [28]	2-8
2-4	Time History of Bending Moment at Station $7\frac{1}{2}$ ; Tanker in Ballast [6] .....	2-9
2-5	Time History of Bending Moment at Midships; Containership, $F_n = 0.261$ [6]	2-9
3-1	Overview of the Predictive Approaches for Slamming .....	3-2
3-2	Overview of the Predictive Approaches for Wave Slap .....	3-3
3-3	Overview of the Predictive Approaches for Frontal Impact .....	3-5
3-4	Wedge Entry Into Fluid Medium [32] .....	3-8
3-5	Hull Station Weighting Factor [42] .....	3-10
3-6	Ratio of Apparent Mass to Von Karman Apparent Mass Versus Deadrise Angle [45] .....	3-12
3-7	Experimental and Theoretical Comparison of the Vertical Slam Coefficient for the Flared Body. (Zero degree trim, 61 cm (2.0 ft) drop height) [5] .....	3-14
3-8	Experimental and Theoretical Comparison of the Vertical Slam Coefficient for the Flared Body. (Ten degree trim, 61 cm (2.0 ft) drop height) [5] .....	3-14
3-9	Definitions of Coordinate System and Control Surfaces Used in Numerical Solution of Water Entry of a Wedge by a Boundary Element Method [68] .....	3-16
3-10	Definitions of Parameters Characterizing Slamming Pressure During Water Entry of a Blunt Two-Dimensional Body [68] .....	3-16
3-11	Prediction of the Pressure Distribution and Free Surface Elevations During Water Entry of a Wedge ( $\beta = 4^\circ$ ) With Constant Vertical Velocity .....	3-17
3-12	Predictions of Pressure Distribution During Water Entry of a Wedge with Constant Vertical Velocity $V_0$ By Means of the Similarity Solution [68] .....	3-19
3-13	Prediction of Maximum Pressure Coefficient $C_{p\max}$ During Water Entry of a Wedge with Constant Vertical Velocity $V_0$ by Means of Similarity Solution and Wagner's Jet Flow Solution (Asymptotic Solution) [68] .....	3-20
3-14	Prediction of Pressure Distribution During Water Entry of a Wedge with Constant Vertical Velocity $V_0$ by Means of Asymptotic Method Described by Zhao & Faltinsen [68] .....	3-21
3-15	Maximum Impact Pressures on a Circular Cylinder as a Function of Time After Initial Impact ( $V = 8\text{ms}^{-1}$ , $R = 5\text{m}$ ) (Hagiwara & Yuhara [79]) .....	3-23
3-16	Use of Strip Theory to Calculate Loads on Sections of Ships [4] .....	3-25
3-17	Experimental and Theoretical Comparison of the Vertical Slam Coefficient For a Sphere (Drop height - 61 cm (2.0 ft.)) [5] .....	3-26
3-18	Panel Distributions for the Cylindrical and Flared Bodies .....	3-28

3-19	Experimental and Theoretical Comparison of the Vertical Slam Coefficient for the Cylindrical Body (Zero Degree Trim, 61 cm (2.0 ft.) Drop Height) [5] . . . . .	3-29
3-20	Experimental and Theoretical Comparison of the Vertical Slam Coefficient for the Cylindrical Body (Ten Degree Trim, 61 cm (2.0 ft.) Drop Height) [5] . . . . .	3-29
3-21	Method for Determining Added Mass for Immersion and Emersion . . . . .	3-38
3-22	Cross Sections at 0.1L (1) and Amidship (2) [98] . . . . .	3-42
3-23	The $v$ value as a function of the impact duration $\tau$ [98] . . . . .	3-42
3-24	Longitudinal Distribution of a Coefficient $K_m$ for Bending Moment and $K_n$ for Vertical Force Due to Bow Flare Slamming [98] . . . . .	3-42
3-25	Comparison of Theoretical and Experimental Results for Model of a Tanker "Sofia" [98] . . . . .	3-43
3-26	Theoretical Data for Bending Moments Due to Bottom Slamming (1) and Bow Flare Slamming (2) for the General Cargo Ship "Leninskyi Komsomol" [98] . . . . .	3-43
3-27	Impact Pressure-Velocity Relationship Obtained From Experiments on Models Representing Various Section Shapes [3] . . . . .	3-51
3-28	Comparison of Pressure Velocity Relationships Obtained in Three Different Types of Experiment [156] . . . . .	3-53
3-29	Maximum Shock Pressure Versus Total Energy of Wave in Deep Water [168]	3-55
3-30	Effect of Velocity Time History and Body Geometry on Free-Surface Elevation and Pressure Distribution on the Cross Section With Bow Flare at Final Time of Numerical Simulation	
	(a) Results of simulation	
	(b) Impact velocity time history	
	(c) Cross sections of model used in numerical simulation . . . . .	3-58
3-31	Bow Flare Pressure Pulses on CFAV QUEST [192] . . . . .	3-59
3-32	Full Scale Slamming Pressure Measurements on Reefer Ship "KAMCHATSKIE GORI" [19] . . . . .	3-61
3-33	$K_1$ -Value for Hull Shape Series [28] . . . . .	3-63
3-34	The Distribution of a Normal Pressure $p_n$ Over the Bottom One-Tenth of the Draught at Any Instant (a); and Notation Used in Writing Down That Contribution Made at the $i$ th Element of the Ship's Bottom to the Total Transient Force per Unit Length (b) . . . . .	3-66
3-35	Comparison of $k_1$ Values [[117] . . . . .	3-67
3-36	Idealization of Three-Dimensional Impact Forces on a Ship Section . . . . .	3-67
3-37	Pressure Reduction Coefficients for SES, ACV and SWATH Vessels . . . . .	3-68
4-1	Flow Chart for Prediction of Slamming Characteristics and Hull Responses [28]	4-2
4-2	Explanatory Sketch of Probability Density Function of Extreme Pressure . . .	4-5
4-3	Explanatory Sketch of the Distribution of Extreme Pressure Along the Section Girth . . . . .	4-7
4-4	Impact Force Applied at Various Stations as a Function of Time; Mariner, Sea State 7, Significant Wave Height 25 ft, Ship Speed 7.4 Knots, Light Draft . . . . .	4-7
4-5	Flow Chart for Prediction of Slamming Characteristics and Hull Response [125]	4-9
4-6	Diagram of Structural Seaworthiness Digital Computer Program ROSAS . . .	4-10
4-7	Velocity Diagram for Impact Surface . . . . .	4-12

6-1	Comparison of Maximum Pressure Coefficient for Wedge Shaped Sections as Determined by Various Methods . . . . .	6-3
6-2	Comparison of Maximum Pressure Coefficient for Circular Cylinder Section as Determined by Various Methods . . . . .	6-4
6-3	Comparison of Maximum Pressure Coefficient for Parabolic Section as Determined by Various Methods . . . . .	6-5
6-4	Comparisons Between Numerical and Experimental Pressure Measurements on Bow Flare Section (Faltinsen [183]) . . . . .	6-6
6-5	Comparison of Calculated $K_1$ Values Obtained from Different Model and Full Scale Tests . . . . .	6-7
6-6	Comparison Between Theoretical Values of Slam Force Coefficient of a Wedge Moving with Constant Downward Velocity $V$ . . . . .	6-13
6-7	Comparison Between Experimental Theoretical Values of Slam Force Coefficient During Entry of a Circular Cylinder with Constant Downward Velocity $V$ . . .	6-14
6-8	Experimental and Theoretical Comparison of the Vertical Slam Coefficient for a Sphere . . . . .	6-15
6-9	Experimental and Theoretical Comparison of the Vertical Slam Coefficient for a Cylindrical Body with $L/B=2$ [5] . . . . .	6-16
6-10	Comparison of Theoretical Results for Bending Moments Amidship Due to Bottom Slamming of the Ship WOLVERINE STATE . . . . .	6-17

## LIST OF TABLES

	<u>Page</u>
3-1	Added Mass Coefficients, $C_v$ , for Lewis Two-Parameter [64] ..... 3-13
3-2	Classification Society Rule Features Pertinent to Slamming [3] ..... 3-45
3-3	Models Used in Slamming Impact Study [3,142] ..... 3-50
5-1	Summary of Analysis Technique Characteristics - Slamming ..... 5-2
5-1a	Summary of Analysis Technique Characteristics - Slamming ..... 5-5
5-1b	Summary of Analysis Technique Characteristics - Slamming ..... 5-8
5-2	Summary of Analysis Technique Characteristics - Wave Slap ..... 5-11
5-3	Summary of Analysis Technique Characteristics - Frontal Impact ..... 5-14
6-1	Analysis Techniques - Pressure
6-2	Impact Pressure, Stavovy and Chuang Method [59], Data from Ochi & Motter [28] ..... 6-11
6-3	Analysis Techniques - Forces ..... 6-12



## ACKNOWLEDGEMENT

The authors wish to thank the SSC Project Technical Committee for its guidance during the conduct of this study.

At M. Rosenblatt & Son, Inc., Messrs. Anthony Bromwell and Christopher Reyling contributed to the technical effort. Mrs. Evelyn Goodman painstakingly prepared the text allowing for the authors' indulgences.

Several references and literature sources were provided by Dr. Alfred Tunik, Senior Engineer, American Bureau of Shipping; Dr. Ephraim Suhir, Member of Technical Staff, AT&T Bell Laboratories; Dr. Vladimir Ankudinov, Vice-President, Designers and Planners, Inc.; and Mrs. Leslie Mitchell, Administrative Assistant, Science Applications International Corporation. The authors appreciate helpful suggestions provided by Dr. P. Kaplan, Chairman, Hydromechanics, Inc.; Mr. D. Lavis, Chief Executive Officer, Band, Lavis, and Assoc., Inc.; Prof. Armin Troesch, University of Michigan; and the Survey of Russian/Soviet Studies results and data on hydrodynamic load estimation by Drs. O. Ravinovitch, D. Rostovtsev, and I. Stepanov at the St. Petersburg State Marine Technical University, St. Petersburg, Russia.

# 1. INTRODUCTION

## 1.1 General

The procedures for the estimation of hydrodynamic impact loads have been under development for decades and vary considerably in their approach, required effort for application, and results. The Ship Structure Committee (SSC) has identified the need for accurate impact load estimation techniques. The SSC's first objective is assessing the state-of-the-art in estimating forebody hydrodynamic impact loading, which is the subject of this project.

In the Ship Structure Committee Long-Range Research Plan [1]\* covering the years 1990-2000, the Research and Development (R&D) tasks in slamming and bow flare impact are ranked as having the "greatest value" of structural improvement and as "top value" of importance.

The extreme forces exerted on a ship's hull are the principal drivers of the structural arrangement and scantlings of a vessel. The forces which exert the greatest loads are the results of hydrodynamic impact which has been termed the least understood area of ship structural design [2]. This phenomenon has been defined in terms of three categories of loading which manifest themselves in different ways and at different locations on a ship's hull: Slamming, Wave Slap, and Frontal Impact.

These extreme environmental forces drive structural design in one direction, towards more substantial and heavier structure. The unfortunate consequences to a vessel include the effects of weight addition, reduced payload, increased construction costs, and reduced vessel speed. This is a particularly acute problem in high-speed combatants and patrol craft, which are highly weight critical. Accordingly, a conservative approach to estimating the impact loads can result in an extremely heavy penalty to the vessel under construction where weight is a problem.

A more rigorous design approach involves the complete determination of the loads and responses on the basis of scientific data rather than by use of empirical procedures. The design of the main hull girder has long ago resulted in standard procedures for still water and wave bending loads. These procedures have been able to model the wave bending phenomena as a quasi-static process and the results have proven to be adequately accurate. They have become standard and accepted practices. On the other hand, reliable means for the estimation of hydrodynamic impact loads, which are necessary to design and optimize the hull structure forward, have not been identified. It is only when these impact loads can be estimated with reasonable accuracy that design, maintenance, and repair decisions can be made rationally.

\* Number in brackets indicate references in Section 10, References.

Hydrodynamic impact loading cannot be modeled as a quasi-static phenomenon as wave bending. It is an impulse phenomenon involving extreme pressures acting over a body surface during very short time periods relative to the natural rate of response of the structure. It is the lack of understanding with regard to the chain of events occurring during the impulse time that presents the greatest problem. Furthermore, impulse loading can involve complex mathematics dealing with three-dimensional fluid modeling. The formulas for this type of model at present are only solved by making assumptions about the temporal and spatial distribution of forces, and it is these assumptions that may introduce inaccuracies.

The presence of assumptions in hydrodynamic impact theories is well recognized and traditional approaches to structural design and performance assessment have consequently relied on deterministic and empirical safety factors to account for the possible variabilities. These safety factors vary significantly and are not founded on a uniform rational philosophy. Furthermore, associated with a given nominal safety factor, no matter how conservative it may be, there is invariably some underlying probability of failure which is accentuated by the large loads that accompany hydrodynamic impact. There is, therefore, a dire need to develop accurate prediction methods for hydrodynamic loads in order to reduce the probability of structural failure.

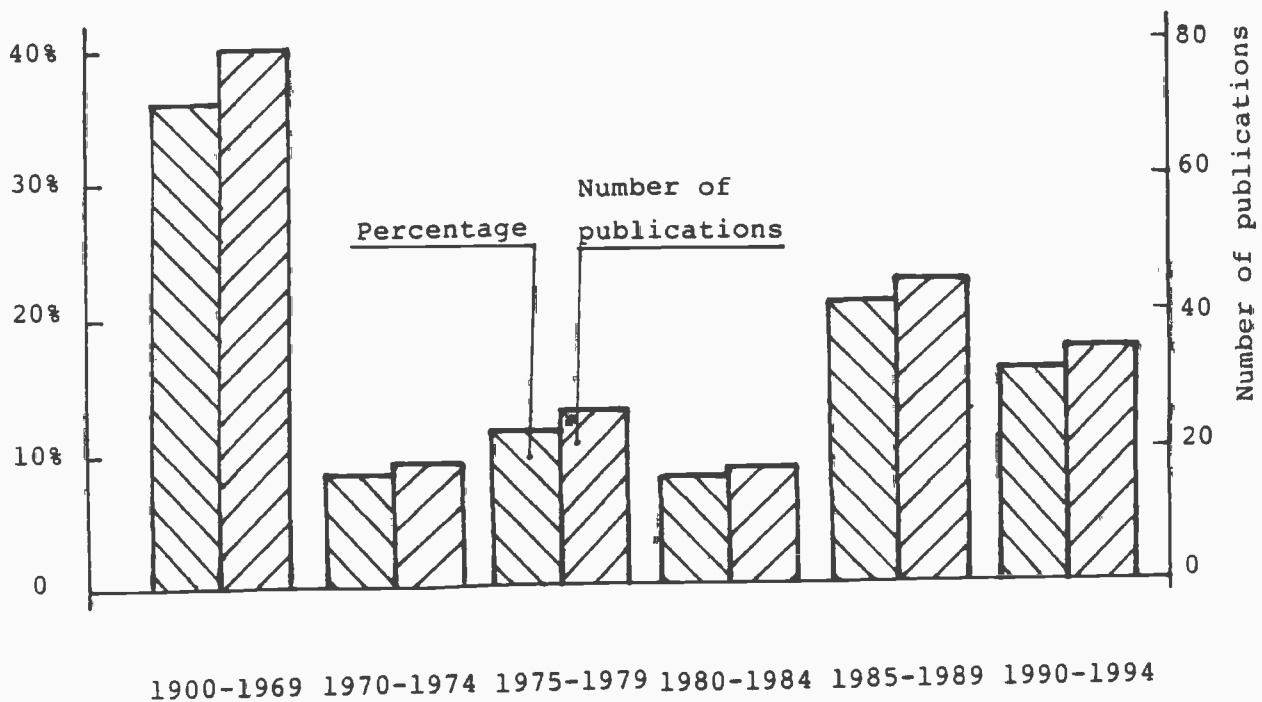
The dynamic response of structure to extreme hydrodynamic loadings is a highly transient and non-linear process. The damage sustained by a vessel due to hydrodynamic impact loading can manifest itself in many forms, from deformed shell plating, to distorted and buckled longitudinals and frames, and to fatigue cracking. For the most part damage is sustained by the vessel's tertiary structure at the location of impact, but the secondary and primary structures are affected as well. The secondary structure can be damaged by the direct action of impulse forces or by the high frequency whipping forces that accompany hydrodynamic impact. The primary structure is usually only affected by the whipping forces.

The safe and economical operation of engineering structures demands that technical capabilities exist for the estimation of hydrodynamic impact loads. This report touches on broad technical areas as the study of hydrodynamic impact loading is a hydro-elastic phenomenon, yet at the same time it will concentrate on the specific aspect of impact load prediction as related to high speed weight critical vessels. First, all types of theories that have been developed over the years are identified. Next, these theories and prediction methods are evaluated to pinpoint the most accurate. In addition, the gaps or assumptions that exist in current technology are addressed. In order to verify the accuracy of these prediction methods, they are applied to two vessels for correlation. In conclusion, possible future research is identified where the gaps and assumptions previously addressed are considered. A total of 222 references were reviewed in the process of preparing this report. The distribution of publications over years is shown in Figure 1-1.

The sections that follow address each type of hydrodynamic impact subject area in more depth. As there are some distinct differences in their interpretation, it is the

purpose here to clearly define each as they have been identified in the literature, and as they will be used in the subsequent sections of this report. Correlation with the recently published Society of Naval Architects and Marine Engineers (SNAME) notes on ship slamming [3] has been emphasized.

The original intent was to publish all numerical data in this report in SI units. However, the great diversity of analyses of previous investigations reported in both British and metric units made this task sufficiently difficult to effect a change in approach. Accordingly, there is a variation of units reported and the reader should be certain of the units currently in use throughout the text.



**Fig. 1-1 Number of Publications Covered by Present Review  
(Total of 222 References)**



## 1.2 Description Of Impact Phenomena Experienced By A Ship At Sea

When a ship navigates in rough seas it frequently experiences various types of impacts from the waves which give rise to a shudder or elastic vibration throughout the hull. The descriptions or definitions of these wave impact and vibration phenomena have been many, but to date, none have gained universal acceptance. For example, the terms "slamming" and "pounding" have been associated with these phenomena, but considerable confusion exists in the literature as to the definition of these terms.

The term "pounding" has been used to mean many different things, such as: (1) a blow applied at the ship's hull; (2) an impact when the ship approaches the water; (3) a rapid or sudden application of a load due to contact with a shoal or rocks; (4) a blow received by the hull of a fast motor craft due to planing action at high speed; or (5) a wave slap resulting in a jarring load which is abrupt but not severe. Quite frequently, the word "pounding" is loosely considered synonymous with "slamming". Yet, the definition of the word "slamming" is no clearer. For example, "slamming" has been used to mean: (1) an impact when the water approaches the ship; (2) an impact at the ship bow; (3) an impact on the bow flare; (4) an impact of the bottom of a large displacement vessel (as contrasted to small craft); or more generally, (5) any impact between any part of the side or bottom of a ship and the water surface which generates a shock-like blow to the ship. The literature has also failed to agree on the prerequisites for slamming. Some investigators believe forefoot emergence is necessary, while others suggest that damage can occur without forefoot emergence [3].

The foregoing should give the reader some idea of the confusion which is prevalent in the interpretation of "wave impact and vibration phenomena." The need for clarification should be apparent. In what follows, the various types of wave impact will be discussed in more detail, and attempts will be made to clearly differentiate between them.

### 1.2.1 Slamming

The term Slamming will be used to describe Forward Bottom Impact [3]. During higher sea states, when a vessel experiences large pitch and heave motions, the forefoot of a vessel can rise above the water surface. As the vessel re-enters the water large impulse pressures are imparted to the hull structure due to the relative motions of the sea and ship. The hull literally slams into the water surface. At this time the vessel experiences heavy impulse pressures to the local forefoot structure and subsequent whipping forces to the entire hull structure [2]. It is these large impulse pressures and whipping forces that cause extensive local damage to and high frequency stresses in the ship's structure.

It is generally reasoned that these loadings are associated with the short time exchange of momentum between the ship and the sea; such exchanges can only take place in the vicinity of the free surface of the fluid. The duration of slamming pressure measured at one position on the structure is in the order of milliseconds [4] and very localized in space. Furthermore, the position where high slamming pressures occur changes with time



and slamming pressures are sensitive to the manner in which the water impacts the structure. The loadings generated, because of their short duration, excite dynamic response of the local structure and hull girder. Damage to the local structure and support structure is the most frequent occurrence but deckhouse connections have been known to rupture and main hull girder strength failures have been initiated [2].

### 1.2.2 Wave Slap

The term Wave Slap will be used to describe any Bow-Side Impact between a wave system and a marine structure. In general wave slap involves the act of a severe wave system imparting its energy to a relatively stationary structure. Although somewhat of an ambiguous definition, wave slap is uncharacteristic of other forms of hydrodynamic impact loading. For example, for wave slap to occur, the large pitch and heave motions associated with both bottom and flare slamming (frontal impact) need not be present. In addition, forefoot emergence and forward speed are not necessarily present. An important factor of wave slap, as similar to other impact forces, is wave severity [2]. Evidence of wave slap damage can be found at or near the operating waterline, and usually affects the lighter structure at the forward end of a vessel. It is usually the least severe of the three forms of hydrodynamic impact.

### 1.2.3 Frontal Impact

Frontal Impact will be used to describe the occurrence of Flare Slamming [3] and/or Shipping of Water (a.k.a. Green Water on Deck). For those two types of hydrodynamic impact mentioned the following descriptions will apply.

The term Flare Slamming will describe the impact forces applied to the bow flare of a vessel. As a result of large ship motions, an impact force is generated on the bow flare as it enters an oncoming wave system. This impact produces not only high forces, but also the intense shudder and high frequency vibrations associated with bottom slamming. While similar to bottom slamming, some major differences exist between bow flare and bottom slamming. One is the speed of impact which is slower with flare slamming than with bottom slamming. This reduces the peak impulse pressure applied to the structure; furthermore, the pressure is spread across the rapidly increasing cross-sectional area of the bow flare, potentially causing larger total forces on the structure. This is the main reason why the prediction methods for bottom slamming tend to inaccurately predict the forces caused by bow flare slamming. The second difference is that forefoot emergence is a characteristic of bottom slamming while it is not for flare slamming [3]. Also, the duration of the impact force is relatively long for the flare impact as compared to that for forward bottom impact.

To fully describe the impact force on the bow flare and the resulting structural response, a number of variables (entrapped air, hydro-elastic interaction, and non-linear free surface mechanics) must be correctly taken into account. In addition, a three-dimensional solution to the fully non-linear boundary value problem has not yet been found. The

complexities of the non-linear free surface and body boundary conditions require that simplifying assumptions be made in order to calculate the impact forces [5].

The term Shipping of Water will be used to describe the following: As a result of large ship motions and forward speed, the bow of a vessel can travel below the surface of an oncoming wave system and plunge into it, causing the water to break over the bulwark and onto the deck of the vessel. Large pressures are applied to the deck structure causing damage. This phenomenon is generally associated with bow flare impact, and is therefore grouped with it [3].

### **1.3 Impact On Dynamically Supported Craft Including Planing and SES Types**

At high speeds, the forward bottom of dynamically supported craft rides clear of the water surface and the hull is mainly supported by planing action of the aft body or lift provided by the air cushion on Surface Effect Ships (SES). When the craft fails to maintain dynamic equilibrium in encountering waves, it plunges onto the water surface and an impact is applied to the bottom. This impact causes a shudder throughout the hull. The sea condition, and pitch and heave motions are not necessarily severe. The location of the impact and structural damage (if any) is on the craft bottom and or cross structure of SES.

### **1.4 Impact On Aircraft Landing On Water**

Aircraft landing on water are usually supported by planing action of the fuselage bottom or pontoons under the wings. The dynamic phenomena are then identical to those for planing craft.

Interestingly, the first efforts in describing and predicting hydrodynamic impact were directed to aircraft and the interest has continued over the years. Consequently, the literature contains numerous references specifically for aircraft but which have been useful for ships and craft.

## 2. PHENOMENA FOR OCCURRENCE OF AND RESULTING FROM HYDRO IMPACT

### 2.1 General

Hydrodynamic impact in displacement ships does not occur in calm water. Rather, the vessel must be travelling in a seaway of some relative magnitude. This combined with inherent and operational characteristics of the vessel can result in a combination of phenomena which will provide the opportunity for hydrodynamic impact loading. Once this occurs the results may be the generation of significant impact forces applied to the hull. These in turn will generate a structural response in the hull. For small craft the effect of impact on heave and pitch is significant enough that the two problems should be coupled [6,7]. The interrelationships are shown in Figure 2-1 [8].

The sections which follow address these phenomena separately for bottom slamming, bow flare impact and frontal impact, respectively.

### 2.2 Factors Leading To Proper Conditions For Slamming

Szebehely [9], and Akita and Ochi [10,11] have found from tests in regular waves that slamming generally occurred when the ship model and the impact surface were nearly parallel. Szebehely showed that three conditions must exist for a slam to occur; (1) bow emergence, (2) a certain magnitude of relative velocity between the bow and wave surface, and (3) unfavorable phase between bow motion and wave motion. A fourth criterion mentioned by Szebehely affecting the severity of slamming was the angle between the wave surface and keel. Ochi [12] examined the condition leading to slamming from tests in irregular waves and found that bow emergence was a prerequisite for bottom slamming. However, bow emergence was not sufficient cause for slamming and it appears that a critical relative velocity exists between bow and wave, below which slamming does not occur. This critical relative velocity equals to  $0.096(g*L)^{0.5}$ , where L is the ship length in meters, and  $g=9.81 \text{ m/sec}^2$  is gravitational acceleration.

Perhaps the most significant factors which govern or influence slamming conditions are the length of ship, sea severity, ship speed, and course angle relative to predominant sea, ship loading condition, overall ship form as it affects ship motion, and also fullness or flatness of bottom forward.

#### 2.2.1 Sea State

Ochi [12] has shown that model test results suggest that slamming severity increases with wave severity, if other conditions remain equal.

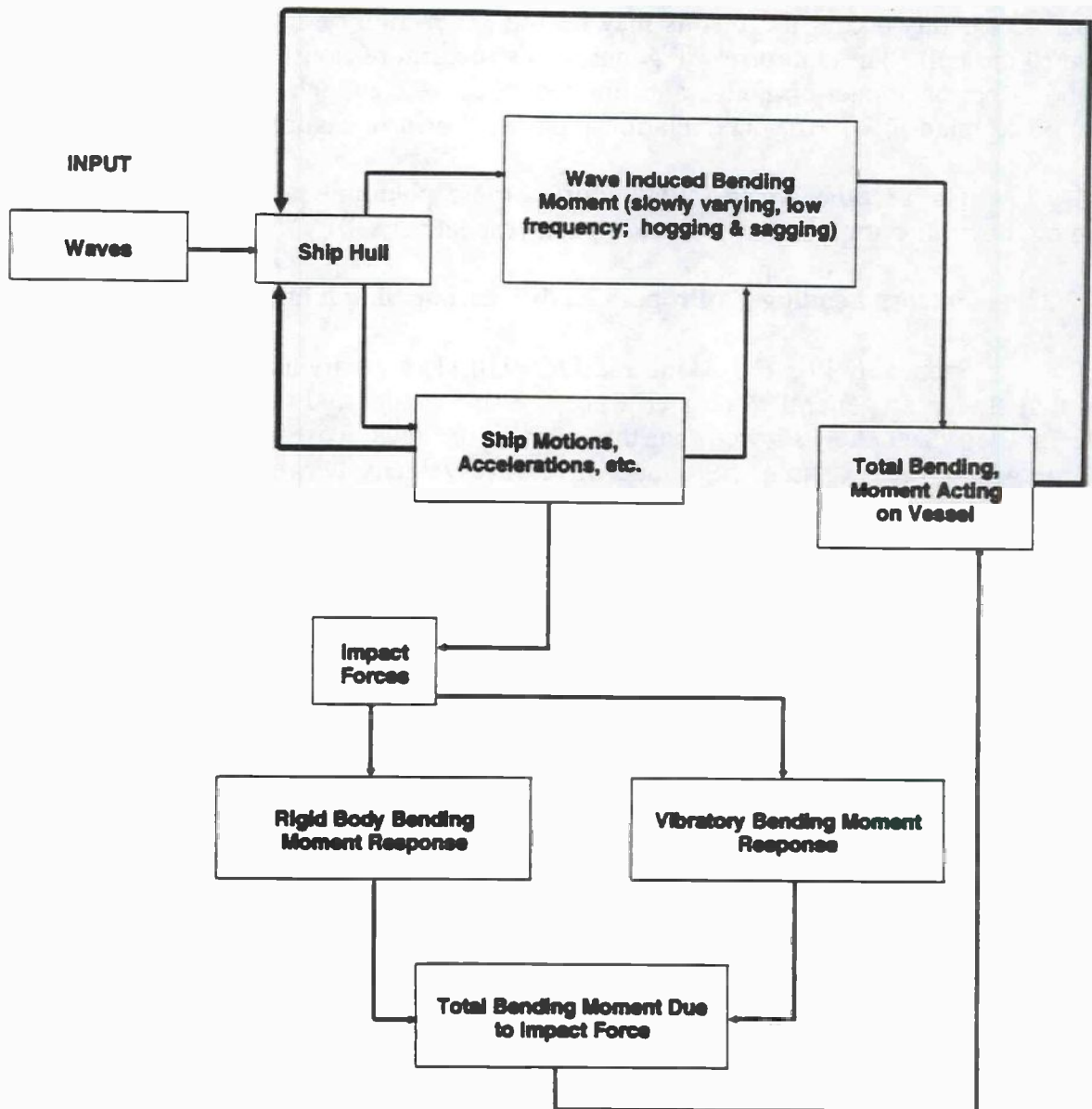


Fig. 2-1. Combined Loads on Ship Hull in Waves (From Kaplan and Dalzell [8])

### 2.2.2 Speed

The forward speed of a vessel has a significant effect upon the severity of slamming [3]. In regular waves the primary effect of speed is to change the period of encounter and, therefore, the tuning factor which has a significant effect on the motions and hence bow emergence and relative velocity. Thus, for a given ship, there are certain dangerous speeds associated with certain waves. Prudent ship masters normally reduce the speed of a ship to avoid slamming. An often used criterion for "voluntary speed reduction" is that a typical ship master reduces the speed if slams occur for more than three out of 100 waves that pass the ship [4]. If slamming occurs in very short waves and low ship speeds, the probability of slamming may be reduced by increasing speed somewhat. In waves of length equal to and greater than ship length, however, a speed reduction is necessary if slamming becomes severe.

The principles of slamming in regular waves may also apply in irregular waves. Ochi [12] has shown that model tests indicate that with increasing speed, the probability of slamming and the pressure magnitude increases, and the location of maximum pressure shifts aft. At very high speeds, the so-called supercritical speed, it can be expected that the impact pressure could be reduced since the ship motions will be reduced above these supercritical speeds.

### 2.2.3 Heading

Ochi [12] has shown from model tests that the most severe condition for slamming occurs when the predominant direction of the oncoming waves is from head-on to about 30 degrees off the bow. This can be attributed to the fact that pitch and heave, the major contributors to the relative motion between wave and ship, are maximum for this range of headings. The severity of slamming decreases significantly for waves with heading angles greater than 30 degrees off the bow, and there is virtually no slamming for waves with heading angles greater than 60 degrees off the bow.

### 2.2.4 Draft

Ochi [12] has shown as well that model tests indicate that increasing the draft of a ship generally decreases the probability of slamming, as well as reduces the pressure magnitudes. Ochi [13] showed that the reduced slamming occurrence for deep draft may be attributed more to the less frequent forefoot emergence than to reduced vertical motion at the bow. The ship motions which have a close relation to slamming are not significantly different for light and heavy draft conditions; however, the reduced draft at the bow for ballast condition results in more frequent bow emergence. These findings are also in agreement with those reported by Lehman in [14] and Society of Naval Architects of Japan [15]. It may therefore be concluded that increasing the ship draft is advantageous in minimizing the amount and extent of slamming pressure, thereby reducing bottom structural damage.



### 2.2.5 Ship Form

Results of model experiments in waves by Dillon and Lewis [16] indicates that substantial changes in transverse section shape, while maintaining forebody design waterline configuration, results in negligible change in pitch amplitude and bow acceleration regardless of the variation in wave height and length. On the other hand, it has been established by Ochi [13] that there is a small increase in the pitch, heave, and bow acceleration amplitudes when the forebody design waterline configuration is increased in beam in way of the forward most stations. However, as a result of improved phase relationship between the motion of the ship bow and the water surface, an overall decrease in the relative bow motion was observed for the ship with the increased forebody waterline configuration. This reduced relative bow motion, and the more "V" shaped underwater bow, which automatically resulted from increasing waterline beam while maintaining sectional area, resulted in less keel slam pressure.

This conclusion is confirmed by Ochi [17], during experiments with two vessels of vastly dissimilar forebody shape, but with quite similar forebody design waterline configuration. One model had modified "U-V" sections and a cutaway forefoot, and the other had extreme "U" shaped sections, a bulb and a vertical stem below the design waterline. Within the possible range of variation for afterbody forms with conventional single and twin screw propulsion, the afterbody form has significantly less influence on the incidence of slamming than the forebody form.

Lacey [18] reported the higher incidents of localized bow structural damage caused by slamming for ARCO tankers with blunter, more stubby entrance. His conclusion was made on the basis of analysis of damages of 10 tankers with different hull fullness serving the same route between Alaska and the lower United States West Coast ports.

## 2.3 Factors Leading to Proper Conditions for Wave Slap

When a ship is navigating in rough oblique seas, waves slap the side plating at the bow and vibration is excited in the hull. Large pitching or heaving motions are not necessarily associated with this phenomenon although rolling may be. The location of impact and any structural damage will be on the bow side plating.

### 2.3.1 Sea State

Sea state (sea severity) is the important factor which governs the wave slap phenomenon [3]. The intensity of wave slap increases with wave severity.

### 2.3.2 Speed

The forward speed of a vessel has no significant effect on severity of wave slap [2].

### **2.3.3 Heading**

The course angle is the important factor for wave slap [3]. For fine bow entrance (near the waterline and above) the most severe condition for wave slam occurs when the predominant direction of the oncoming waves is close to 90 degrees off the bow. For larger entrance angles the critical course angle decreases. For example, the Soviet tanker "Krim" with traditional block coefficient of 0.80 experienced severe wave slaps due to extremely blunt fore lines above the operating waterline [19] while in head seas.

### **2.3.4 Draft**

Ship draft is unrelated to the wave slap and forefoot emergence is not required.

### **2.3.5 Ship Form**

As was mentioned in the Section 2.3.3, the ship fore lines near and above the operating waterline has a significant effect on direction of critical heading angles and intensity of wave slap loads.

## **2.4 Factors Leading to Proper Conditions for Frontal Impact**

The frontal impact phenomenon is very similar to slamming. One can assume the same factors leading to proper conditions as for slamming (see Section 2.2). The significant difference between these two is that the forward bottom impact is always associated with the emergence of the forefoot, while frontal impact (bow flare and green water on deck) is not. The duration of the impact force is relatively long for frontal impact as compared to that for slamming. This phenomenon appears to be serious only for a ship having large bow flare such as an aircraft carrier and other naval combatants or container ships and with increasing speed the seriousness of this problem is intensified (see, for example, Vulovich, Hirayama [20]).

For Sea State, Speed, Heading, Draft, Ship Form conditions see Sections 2.2.1 through 2.2.5.

## **2.5 Structural Response**

There are three main facets to vessel hull strength analysis, namely:

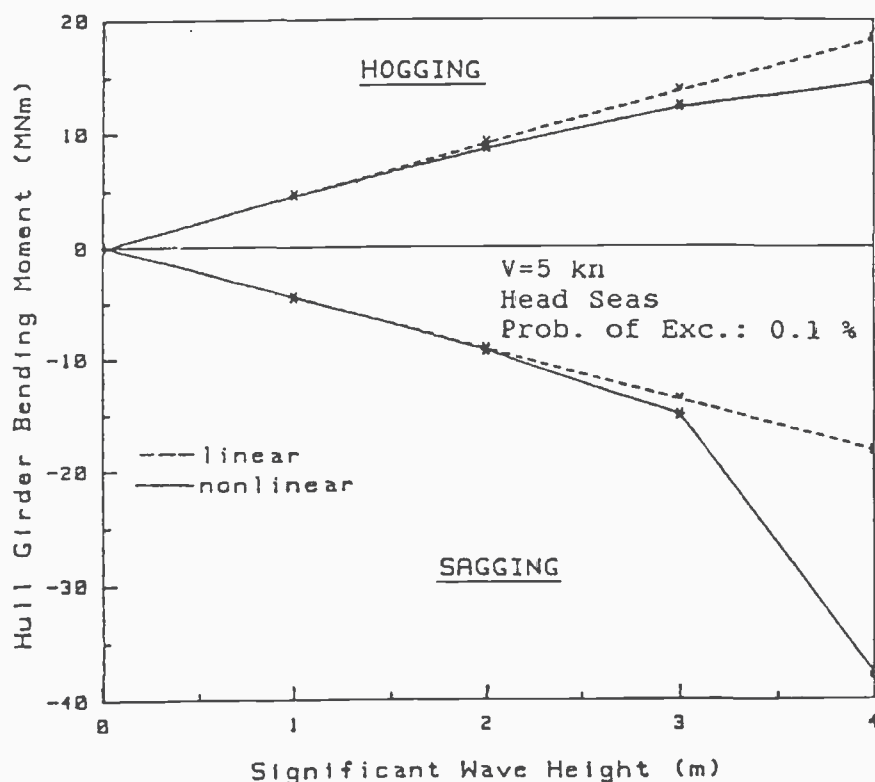
- (1) Determination of the hull loadings;
- (2) Determination of the structural responses resulting from the loads;
- (3) Determination of the ability of the material and structure to withstand the resulting stresses.

Solutions to the first two of these problems have been the primary concern of structural seaworthiness studies. This report on hydrodynamic impact concerns mostly the first one, although there are methods coupling the second.

When a ship is exposed to ocean waves without hydrodynamic impact present, it is subject to three types of hydrodynamic forces:

- hydrostatic force
- inertial and damping forces
- wave excitation forces (the simplified form of which is known as the Froude-Krylov force).

Determination of these forces is sufficient to provide one with predictions of rigid body ship motions, [3], [21]. Ship motions and wave loads can be predicted by linear or nonlinear approaches. Whereas linear theory of wave loads on ships is a very valuable tool for fatigue investigation, it can only give a rough indication of load ranges and of differences between different ships, loading cases and locations in the structure for determining extreme loads during the lifetime of a ship; this is so because nonlinear effects are very important in extreme weather conditions [21,22,23,24,25]. Figure 2-2 (calculated according to [26] gives an indication of growing non-linear effects with increasing wave heights [7].



**Fig. 2-2. SES-600 Hullborne Hull-Girder Bending Moments. Slamming occurs at  $h_{1/3} = 3m$  [7]**

Hydrodynamic impact loads are dynamic impulse loads resulting from slamming or wave impact on the forefoot, bow flare and other parts of the hull structure, including the effects of green water on deck. In response to hydrodynamic impact in heavy or moderate seas, a ship can develop substantial elastic hull stresses. This includes flexural vibration of the hull girder including transient hull vibration that is termed whipping and persists for a large number of cycles, the rate of decay being small, and can be analyzed using a linear elastic model [27]. Local hull response under these same loads may require use of analysis based on an inelastic behavior approach. The effect may be bottom and bow damage above the waterline. The bottom plating may experience fatigue, local damage may be inflicted due to overstressing and equipment, particularly sonar domes, may suffer as a result of the "shock" loading.

The slamming pressure is distributed over an area of the ship bottom in the immediate vicinity of the point of re-entry, and is typically a maximum on the centerline at any instant of time. As the ship forefoot re-enters the water, the point of maximum pressure tends to move toward the bow. The position of maximum pressure is about 15-25% of ship length aft of the forward perpendicular. As a result of the movement of the re-entry location, the pressure pulse moves also, meanwhile maintaining its peak intensity.

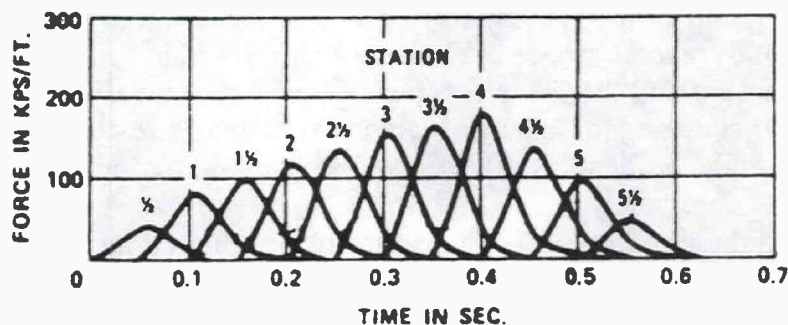
The duration of slamming pressure measured at one place of the structure is of the order of milliseconds, in contrast with wave-induced loads which have significantly higher periods. Due to the movement of the re-entry location, the total duration of the force pulse that the ship experiences will be several times as great as the pulse duration at a single station. This space-time behavior of the force is illustrated in Figure 2-3 from Ochi and Motter [28].

The slam-induced vibration may result in vibratory stress intensities that are equal in magnitude to the wave-induced low frequency bending stresses [6,27,29]. Examples of time history of deck stresses in amidship section are shown in Fig. 2-4 for a tanker in the ballast condition (slamming only) and in Fig. 2-5 for a containership in the full load condition (slamming and bow-flare impact). Dash lines show wave-induced stresses and solid lines correspond to total stresses. These results show that stresses due to slamming have an impulsive nature and the first stress peak coincides, as a rule, with the instant when a hogging moment is changing to sagging. Maximum dynamic stresses in this case are equal to the sum of wave-induced bending stresses and stresses occurring after impact.

The slamming stresses must be carefully evaluated and be suitably combined with the low-frequency wave-induced bending stresses. Attempts to solve the problem of combining the low-frequency wave-induced bending and the high-frequency slamming induced bending moments in ships have so far been based on a Poisson pulse train model for the occurrence of the slamming impacts. A review and revision of this approach was made by Hansen [30].

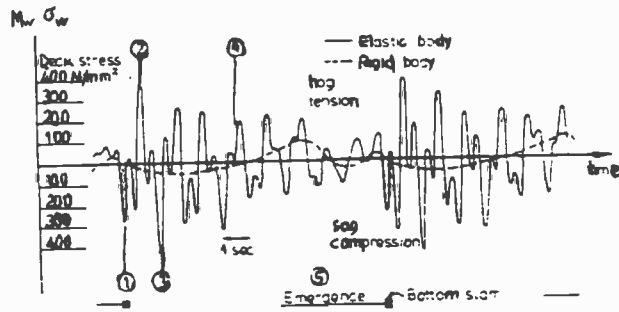
In contrast, the impulsive loads due to the bow flare impact have greater duration and coincide with maximum wave-induced sagging moment. As a result fast ships with substantial bow flare may experience a maximum sagging bending moment which is significantly larger than the maximum hogging moment. Hence, bow flare impact may be more dangerous for these types of vessels [6].

In general, whipping of a ship's hull due to impact loadings can cause large additional hull girder bending moments of a transient nature, as opposed to the more slowly varying bending moment due to buoyancy or wave-induced effects. Additional research is needed to determine how significant whipping stresses are in producing hull failures.

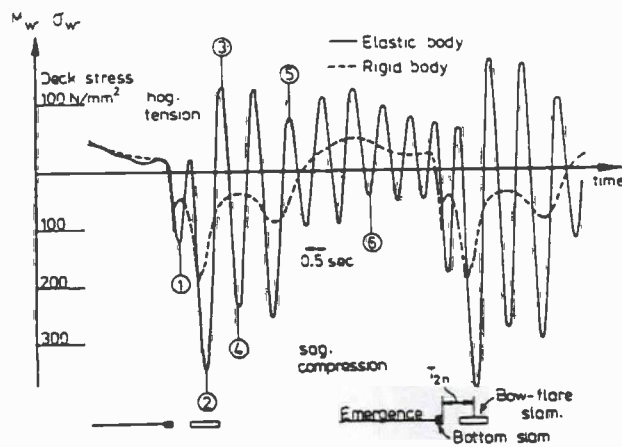


**Fig. 2-3. Calculated Force Applied at Various Stations as a Function of Time; Mariner; Sea State 7, Significant Wave Height 25 ft., Ship Speed 7.4 Knots, Light Draft [28]**





**Fig. 2-4. Time History of Bending Moment at Station 7½; Tanker in Ballast [6]**



**Fig. 2-5. Time History of Bending Moment at Midships; Containership,  $F_n = 0.261$  [6]**

### 3. HYDRODYNAMIC IMPACT

#### 3.1 Introduction

##### 3.1.1 General

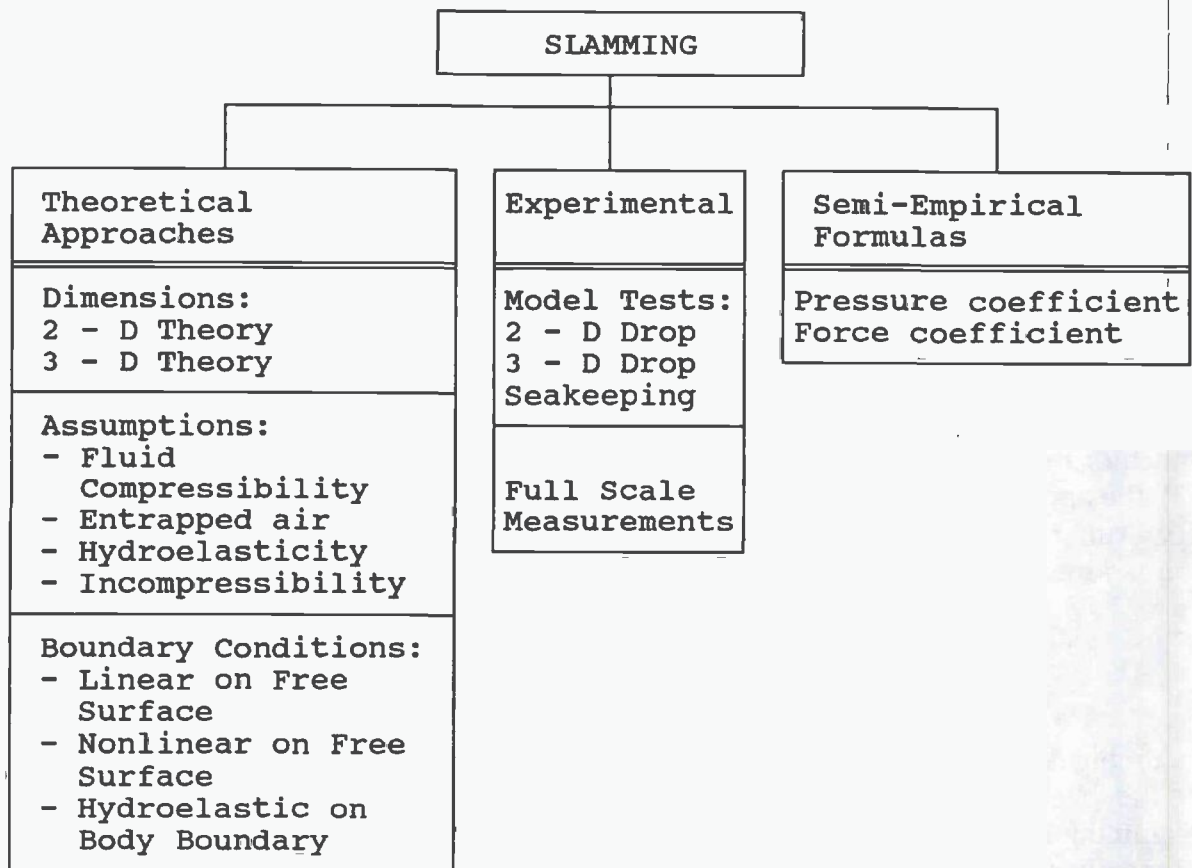
The previous section has provided a description of the phenomena which can lead to the occurrence of hydrodynamic impact. This section addresses the predictive approaches and data which are available to determine the magnitude of the hydrodynamic impact loading under these conditions.

The variety and volume of predictive approaches and data is significant and much of the work builds upon previous efforts. Accordingly and consistent with SNAME [3], the approaches have been categorized broadly in three groups; Theoretical Approaches, Experimental Results and Empirical Formulas. The sub-sections which follow in this report will address each of these.

##### 3.1.2 Slamming

The current prediction methods for bottom slamming rely on a certain level of ambiguity. Slamming impact has in the past been modeled as a quasi-static force applied to the local structure, similar to wave bending moment calculations. More recently, bottom slamming has been predicted using two-dimensional models and slender body theory and currently three-dimensional models are under development. In order to fully describe impact forces and resulting structural response, various phenomenon (entrapped air, hydro-elastic interaction, compressibility effects, and non-linear free surface mechanics) must be correctly modeled [5]. It is the lack of understanding with regard to these phenomenon that presents the largest problem. As a result, marine structures are usually designed and constructed with a considerable degree of indeterminacy or redundancy to help compensate for the complex and uncertain nature of the ocean environment. The formulae for this type of modeling at present are only solved by making assumptions about the temporal and spatial distribution of forces, and it is these assumptions that introduce inaccuracies in impact load prediction and subsequent structural design inefficiencies.

Figure 3-1 provides an overall view of the nature of the predictive approaches for slamming. This is not to imply that every procedure includes all the features noted and in fact, historically, the most work has been accomplished with 2-D theory assuming rigid bodies. The phenomena is described differently by a number of investigators. Some consider the pressures and/or forces at the instant when the hull strikes the free surface of the waves. This type of slam is of short duration and spray, compressibility and air cushioning may be important. Others consider the pressure and force variations as the hull continues to enter the water. Bishop and Price [29] have termed the former "impact slamming" and the latter "momentum slamming" noting that slamming is really a combination of the two, while frontal impact is adequately described only by the latter.



**Fig. 3-1. Overview of the Predictive Approaches for Slamming**

### 3.1.3 Wave Slap

As previously mentioned, wave slap is an impulse phenomenon, although usually the least severe of the three forms considered herein. The impulsive pressures of hydrodynamic loading in part rely on the relative motions of both the sea and the structure. Since the relative motion of the structure during wave slap approaches zero, there is a reduction in the peak impulse pressures. For the most part wave slap has received little attention. Most investigations of hydrodynamic activity have concentrated on bottom slamming and its more serious consequences. Investigations into wave impact water pressures on the hull of a ship are very difficult to address. Researchers have conducted ship model tests to study under what conditions impulsive wave pressure will occur and what part of the hull surface the wave impact will affect. In addition, experiments have been conducted to observe some aspects of water impact to clarify the roles of certain mechanisms.

Furthermore, studies on the phenomenon of breaking waves on a ship's side were performed in a series of model scale experiments in which the time and space variation of impact forces impinging on a flat vertical plate were recorded. These experiments

suggested that the temporal variation of the pressure at a specific point is a pulse that can be idealized by a function that assumes zero time rise and decays exponentially [30a].

Also, investigations of wave pressures and forces on plane vertical walls carried out in coastal design engineering are of great importance. An overview of recent works on wave loads acting on vertical wall (usually a concrete caisson which rests on a rubble-mount base), with annotated bibliography, was published by Green [31].

Finally, design procedures commonly used by naval architects employ standard wave slap pressure loadings in lbs/ft<sup>2</sup> which vary from a maximum at the vessel waterline to lower values at higher vertical elevations.

Figure 3-2 provides an overall view of the nature of predictive approaches for wave slap. This is not to imply that every procedure includes all the features noted and in fact, historically, most work has been accomplished with experiments and semi-empirical formulas.

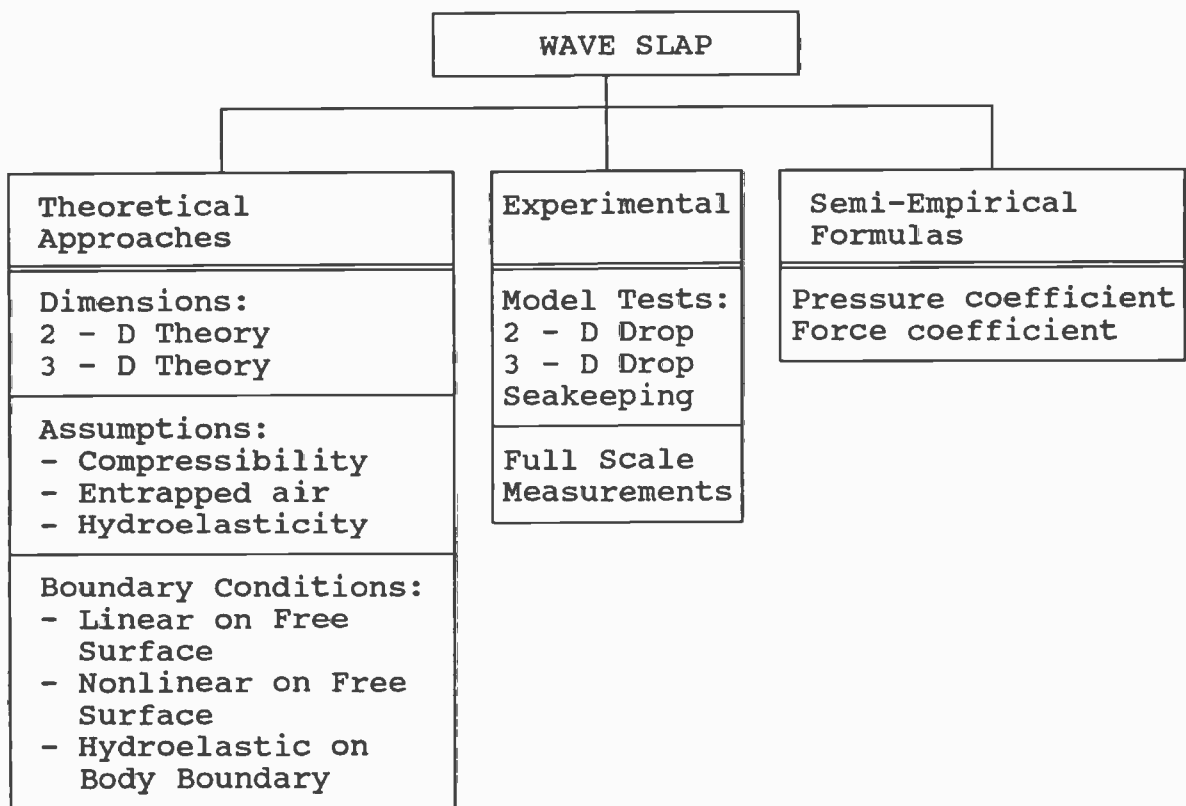


Fig. 3-2. Overview of the Predictive Approaches for Wave Slap

### 3.1.4 Frontal Impact

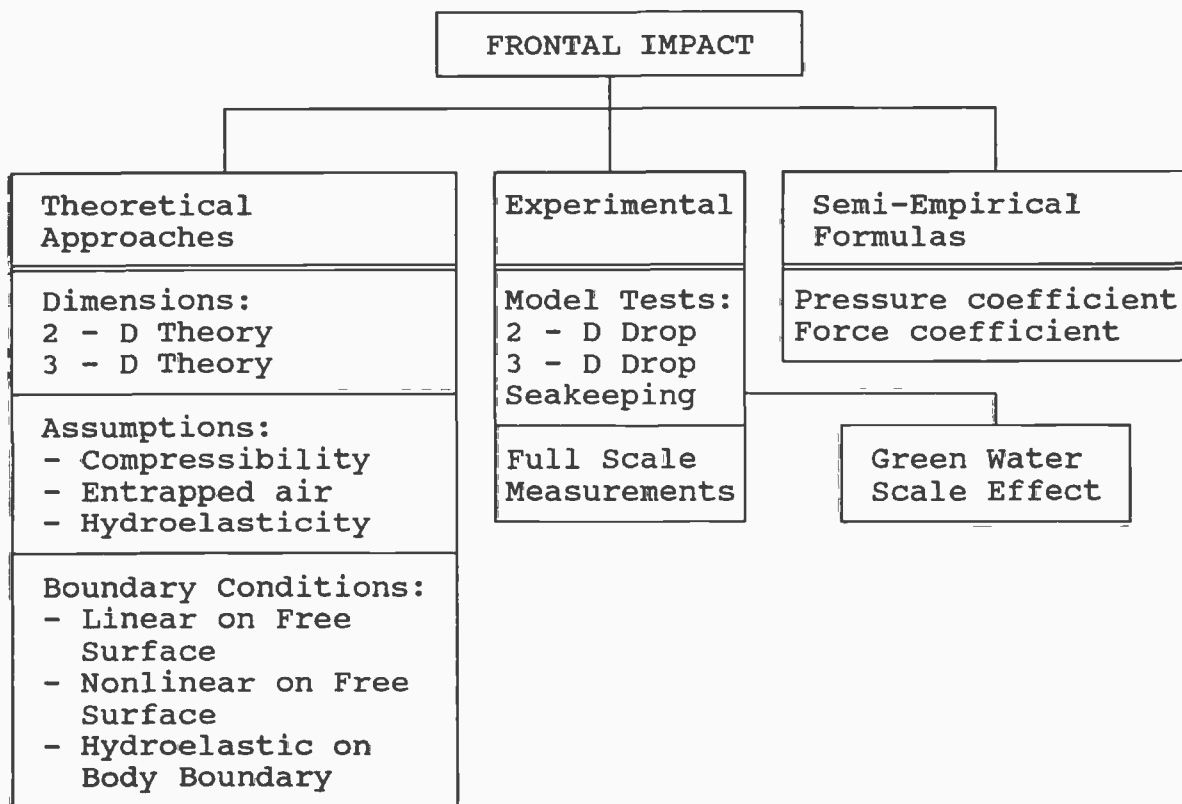
To fully describe the impact force on the bow flare and the resulting structural response, a number of variables (entrapped air, hydro-elastic interaction, and non-linear free surface mechanics) must be correctly taken into account. In addition, a three-dimensional solution to the boundary value problem has not yet been found. The complexities of the non-linear free surface and body boundary conditions require that simplifying assumptions be made in order to calculate the impact forces [5].

Most current prediction methods use two-dimensional calculations coupled with strip-theory assumptions to yield their three-dimensional results. Slender body or strip theory has long been accepted in normal linear seakeeping analysis, however the usual seakeeping quantities of interest are vessel motions and bending moments and shear forces near the middle of the ship. These forces and moments are typically less sensitive to end effects where strip-theory approximations are less valid. Bow flare impact and loads occur in places of high longitudinal curvature and the applicability of strip theory is thus more questionable. In fact there is evidence that strip-theory in these calculations may over predict the impact force by a significant amount [5].



Investigating such a problem requires investigating the relationship between ship's motion and environmental conditions. The impact problem associated with green water conditions are related to bow submergence. However, the relative bow motion depends on the environmental conditions and on the ship's characteristics. Researchers have investigated the impact strength of ships due to shipping green seas. Ship model test experiments were conducted to quantify the amount of peak pressure due to wave impact and their associated duration times. The results classified the generating mechanism of shipping green seas into three categories: dropping of piled up spray; dropping of swelled up waves; and scooping waves after submergence on the foredeck. In addition, conclusions were made that the time variation in the impact force due to shipping green seas results in the highest pressure loading during the dropping of piled up spray and swelled waves [31a]. These pressures were predicted to reach 50 tons/m<sup>2</sup> in the worst conditions.

Figure 3-3 provides an overall view of the nature of predictive approaches for frontal impact. This is not to imply that every procedure includes all the features noted and in fact, historically, the most work has been accomplished with 2-D theory.



**Fig. 3-3. Overview of the Predictive Approaches for Frontal Impact**

## 3.2 Theoretical Approach

### 3.2.1 Introduction

The problem of interaction between a solid body and a liquid with a free surface is a broad subject that includes several significant sections of classical and modern hydrodynamics. In this review the attention will be paid to the analysis of processes characterized by strong unsteadiness in their development and by the existence of a contact line between the free surface of the liquid and the body surface. In the general form such processes can be described in the following manner: At the initial instant of time  $t=0$ , a solid body touches a free surface of liquid. At this moment the position of the body, the domain occupied by the liquid, and the velocity field of the liquid particles are assumed to be known. For  $t>0$ , either the law of body motion or the external forces affecting it are prescribed. The flow field and the character of its action upon the body are to be determined.

The first theories of body impact with water (the penetration theory of von Karman [32] and the impact theory of Wagner [33] and Sedov [34]) were directed at a global description of this process. Many applied problems have since been solved on the basis of these theories. But in some cases, more complete information about the process is required. For instance, it is necessary to take into account the peculiarities of the flow velocity field in order to determine the height and form of a free surface splash during impact. It should be noted that very often the global characteristics can be determined with good accuracy from only rather simplified knowledge of the interaction mechanism, and therefore a detailed description of the process in some problems is unnecessary.

The problem of a blunt body penetrating a liquid that initially occupies a lower half-space and is at rest is a typical problem considered in this Chapter. Even with further simplifications (the fluid is assumed to be ideal and incompressible, its flow to be potential, and the solid body to be rigid) the problem is still very complicated for the following reasons:

- The flow region is not predetermined;
- Division of its boundary into components (wetted part of a body surface and free boundary) is also unknown;
- Singularities can appear on the three-phase contact line.

Quantitative information about the process of interaction, even with the use of idealized models, can be obtained only on the basis of numerical methods. The expanding application of numerical modeling is the modern trend in hydrodynamics. A number of numerical techniques, combined with powerful computers, have been applied in recent years to complex problems in marine hydrodynamics, including ship resistance and propulsion [35], seakeeping and maneuvering [36,37,38]. The "Numerical Tank" approach is commonly used in science and engineering [39].

At the same time, to understand the dynamics of the process and develop an adequate computational algorithm, it is necessary to investigate analytically the qualitative nature of the phenomenon, obtaining simplified and asymptotic solutions for major stages of the process that are difficult and inexpedient to derive by numerical methods.

It should be noted that at the present time there are no mathematically rigorous results of a general character in the theory of nonlinear unsteady hydrodynamic problems with a free boundary and a contact line. Thus the following solutions and asymptotic expansions are of approximate character.

### 3.2.2 Two-Dimensional

Most theoretical studies pertaining to slamming impact which have appeared in the literature to date have treated the impact of a two-dimensional body falling onto calm water. The majority of the studies deal with incompressible fluid and are based on the earlier work of von Karman [32,40]<sup>\*</sup>, and later extended by Wagner [40,41]<sup>\*</sup>. Their work essentially involved a rigid wedge entering a fluid boundary as shown in Figure 3-4. The basic idea of von Karman was that during impact the momentum of the dropping body is imparted to the momentum of an apparent mass of water assumed to be that associated with an imaginary flat plate having the dimensions of the wedge at the intersection of the water surface. Wagner introduced the concept of pile-up water at the side of the wedge during entry, computed the pressure distribution, spray thickness, and gave the equation of a constant-force bottom.

These theories begin with the momentum conservation principle which requires that the system consisting of the body and water preserve its total momentum. Let the momentum at the instant the body touches the water surface be  $M \cdot V_o$ , where  $M$  = mass of the body, and  $V_o$  = velocity at the moment of impact. During penetration the velocity of the body is reduced ( $V < V_o$ ), and its mass is increased due to the inertia of the water moving with it. This apparent increase of mass,  $m_z$ , is called "added mass". If the external forces (such as buoyancy, gravity, and friction) acting on the body are represented by  $F$ , the equation describing the motion of the system may be written as:

$$M\dot{V} + \frac{d}{dt}(m_z V) = F \quad (3-1)$$

where,  $V$  can be obtained from:

$$(M+m_z)V - MV_o = \int_0^t F dt \quad (3-2)$$

<sup>\*</sup>Superscript indicates more detailed evaluation of references in Section 4, 5 and 6.

Then, the impact force at any instant is given by  $d/dt (m_{zz}V)$ . Hence, the impact force for a given  $V$  is determined by the instantaneous value of  $m_{zz}$  and by its derivative  $dm_{zz}/dt$ . Therefore, a correct estimation of the variable added mass is essential.

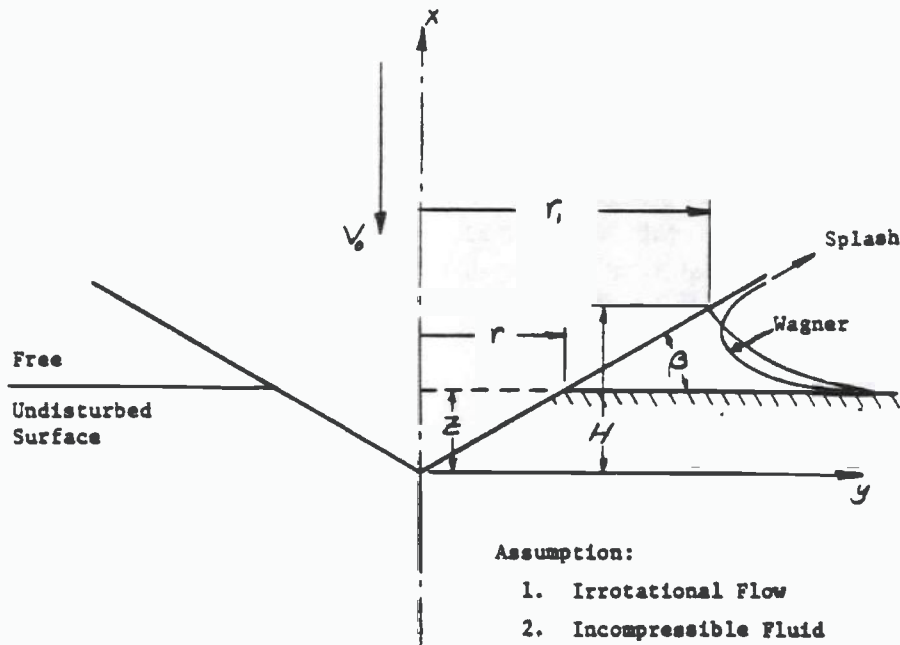


Fig. 3-4 Wedge Entry Into Fluid Medium [32]

If we assume that the viscosity of the fluid is negligible and the fluid is initially at rest, the motion of the fluid during impact may be considered to be irrotational and a velocity potential,  $\phi$ , exists.

The added (or apparent) mass due to an energy transfer of the fluid particles is related to the velocity potential according to [32]:

$$m_{zz} = \frac{\rho}{V^2} \iint \phi \frac{\partial \phi}{\partial n} ds \quad (3-3)$$

If furthermore, the fluid is considered to be incompressible, the velocity potential,  $\phi$ , satisfies the Laplace equation,

$$\nabla^2 \phi = 0 \quad (3-4)$$

If the free surface condition is linearized and approximated by its initial undisturbed position away from the body, then in this region the boundary condition has been termed equipotential, which ignores the piled up water at the body:

$$\phi = 0 \quad (3-5)$$

On the body:

$$\frac{\partial \phi}{\partial n} = V_n \quad (3-6)$$

Von Karman [32]<sup>\*</sup> considered this problem for a wedge with a small wedge angle as shown in Figure 3-4 in the interest of making stress analyses of seaplane floats during landing. He took the added mass for a long plate of width  $2r$  accelerated in a fluid as  $\frac{1}{2} \rho r^2 \pi$  and neglected buoyancy effects (Note that  $\frac{1}{2} \rho r^2 \pi$  is half the added mass in heave of the flat plate in an infinite fluid for infinite frequency. He determined the following impact force for unit length and average pressure:

$$F = \frac{V_o^2 \cot \beta}{\left(1 + \frac{\rho \pi r^2}{2M}\right)^3} \rho \pi r \quad (3-7)$$

$$p = \rho \frac{V_o^2}{2} \frac{\pi \cot \beta}{\left(1 + \frac{\rho \pi r^2}{2M}\right)^3} \quad (3-8)$$

Here  $M$  = mass of the body per unit length. The maximum pressure is equal to:

$$p_{\max}(r=0) = \frac{\rho V_o^2}{2} \pi \cot \beta \quad (3-9)$$

For  $\beta = 0$  the pressure is infinite but for a seaplane with floats having  $\beta = 20^\circ$  the author obtained acceptable results.



The U.S. Federal Aviation Administration [42] has adopted a similar formula for the design pressure to be applied to the hull and main float bottom pressures of seaplanes. Frames and bulkheads, stringers, and bottom plating are considered. As an example, for a bottom without curvature the pressure at the chine is to be 0.75 times the pressure at the keel and the pressures between the keel and chine vary linearly. The pressure at the keel is:

$$p_K = C_2 (K_2 V_{SI}^2 / \tan \beta_K) \quad (3-10)$$

where:

$p_K$  = pressure at the keel, psi

$C_2$  = 0.00213

$K_2$  = hull station weighting factor, Figure 3-5

$V_{SI}$  = speed, knots

$\beta_K$  = angle of dead rise at keel

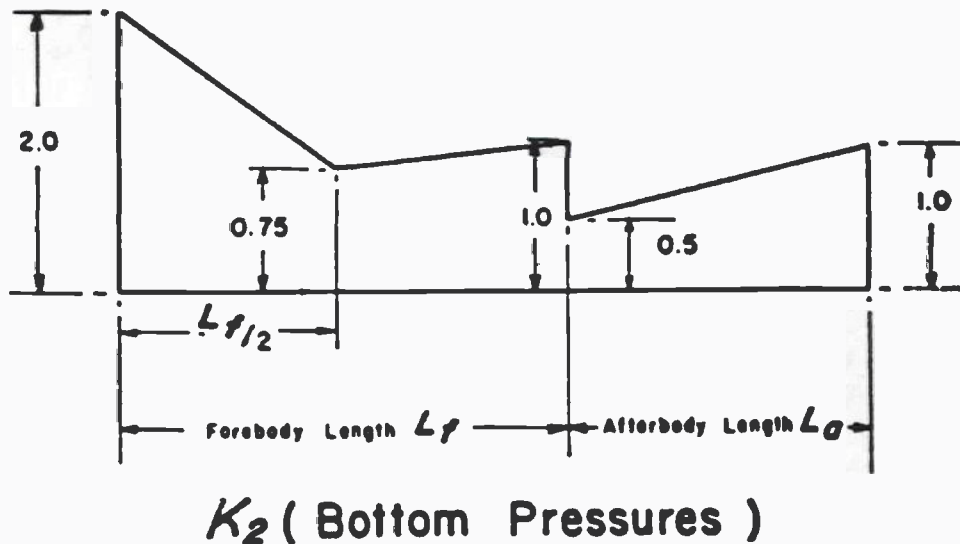


Figure 3-5: Hull Station Weighting Factor [42]

Wagner's linearized theory [33]<sup>\*</sup> considers pile-up of water at the free surface as shown in Figure 3-4. It significantly refines the wetted area and, hence, averaged pressure. In accordance with this solution the impact force per unit length is and maximum pressure are:

$$F = \frac{V_0^2}{\left(1 + \frac{\rho \pi r_1^2}{2M}\right)^3} \rho \pi r_1 \quad (3-11)$$

$$p_{\max} = \frac{\rho V_0^2}{2 \left(1 + \frac{\rho \pi r_1^2}{2M}\right)^2} \frac{1}{u^2} \quad (3-12)$$

where:

$$u = V|dr_1/dt$$

$V$  = The variable speed at which the section enters the water surface.

$V_0$  = Velocity at the moment of impact or the rate of penetration of the body into the wave.

$r_1$  = half-breadth of impact surface to point where spray breaks away.

Wagner shows that  $u$  is of the order of the magnitude of the keel angle  $\beta$ . Consequently, if the deadrise angle is small, Von Karman's Equation (3-7) for the force is identical to Wagner's Equation (3-11). Simultaneously, the pressures are equal to Equation (3-9).

Armand and Cointe [43]\* have shown that Wagner's wetting correction is valid at the instant of impact but additional terms are necessary for later time and larger depths. A number of investigators have since used Wagner's approach of "fitting" and correcting the free surface shape including Hillman [44] and Chu and Abramson [45]. In these so called expanding wedge theories as the wedge dead-rise angle,  $\beta$ , tends towards zero, the pressure becomes infinite [46].

Also, based on these fundamental ideas are the works of Milwitzky [47][48][49], and Mayo [50][51], Bisplinghoff [52][53], and Szebehely [54][55][56]. These studies dealt primarily with the impact of a wedge as applied to seaplane hulls. Szebehely was among the first to apply the idea to the specific problem of ship slamming. Later, Todd [57] and Bledsoe [58] computed pressures for ship-like sections following the work of Szebehely. The hydrodynamic impact problem for bodies other than the wedge has been treated by Schnitzer and Hathaway [59], and Fabula [60][61] on elliptical cylinders, by Fabula and Ruggles [62] on circular cylinders (growing circular arc), by Ochi and Bledsoe [63] on a body of general shape representing the ship bow form.

A review of various fitting techniques used in hydrodynamic impact theory to convert to ship-like bow forms may be found in the work of Chu and Abramson [45]. Figure 3-6 shows the results of utilizing various representations for the 2-D section in the corresponding 2-D theory. In each of these "fitting" techniques the velocity distribution on the free surface zero potential line is taken to be that of the circumscribing flat plate, ellipse, or circle. The authors conclude that fitting methods are adequate for bodies for reasonably large deadrise angle during later stages of the impact process. For bodies of small deadrise angle, more typical of ship bottom structures, more accurate formulations that avoid linearization of the free surface boundary conditions are probably required, but will involve somewhat lengthy numerical procedures. They do acknowledge, as shown in Figure 3-6, that Von Karman's theory is good for low deadrise angles when the body is almost a flat plate.

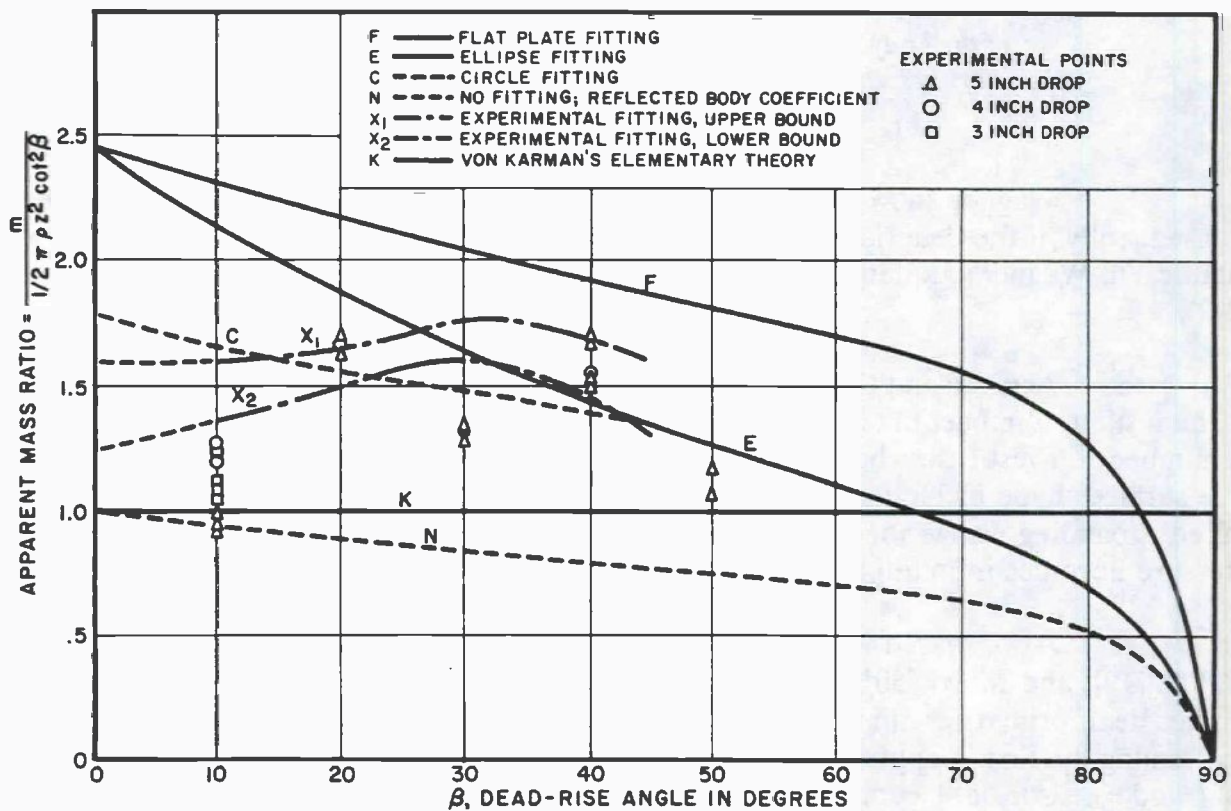


Figure 3-6: Ratio of Apparent Mass to Von Karman Apparent Mass Versus Deadrise Angle [45]

Gran et al [64]\* in considering bow flare hydrodynamic forces conclude that the solutions to Equation (3-3) for the time varying added mass are few but include the circular cylinder which by means of conformal mapping can be extended to a variety of different forms. An expression for the instantaneous impact force is given as:

$$F = \pi \rho r C_v V_o^2 \frac{dr}{dx} \tag{3-13}$$

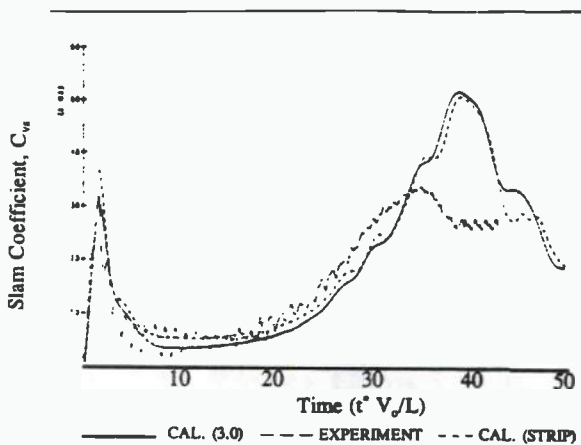
$$M = \frac{\pi}{2} \rho C_v b^2 \tag{3-14}$$

where  $C_v$  is the ratio between hydrodynamic mass of the actual hull form section shape and hydrodynamic mass of a circular cylinder of the same beam.  $C_v$  coefficients are given which are said to include a correction for piled-up spray, Table 3-1.

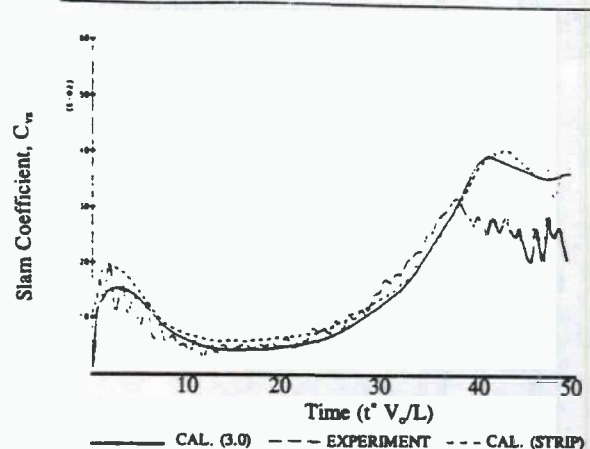
Section Area Coeff: = (SA)/2d B	0.5	0.6	0.7	0.8	0.9
0.2	0.90	0.93	0.97	1.01	1.05
0.4	0.85	0.89	0.94	1.01	1.10
0.6	0.82	0.87	0.93	1.02	1.13
0.8	0.80	0.85	0.92	1.02	1.16
1.	0.78	0.83	0.91	1.02	1.19
1.5	0.76	0.81	0.89	1.02	1.23
2.	0.76	0.80	0.88	1.03	1.26
2.5	0.75	0.79	0.87	1.03	1.26
3.	0.75	0.78	0.87	1.03	1.29
4.	0.75	0.77	0.86	1.03	1.31

Table 3-1: Added Mass Coefficients,  $C_v$ , for Lewis Two-Parameter Forms [64]

The statement of the entire boundary value problem in three dimensions, including non-linear boundary conditions, is given in Section 3.2.2. The two-dimensional cases just discussed had simplified or linearized boundary conditions. Troesch and Kang [5]<sup>x</sup> have developed a computer based three-dimensional integral equation technique satisfying the exact body boundary and the equipotential free surface conditions. They determined that the results compare well with the equivalent two-dimensional strip theory when the beam to draft ratio exceeds 2.0 and that adequate engineering predictions are obtained for slamming but that bow flare slamming was over-predicted by about 30% at peak, Figures 3-7 and 3-8. They ascribe this to the simplified free surface boundary condition which neglects the jet-like behavior of the water above the mean waterline. It should also be noted that in the case of the vertical slam of a sphere they found consistent over-prediction of the force by about 40% by the two-dimensional method compared to the three-dimensional.



**Figure 3-7: Experimental and Theoretical Comparison of the Vertical Slam Coefficient for the Flared Body. (Zero degree trim, 61 cm (2.0 ft) drop height) [5]**



**Figure 3-8: Experimental and Theoretical Comparison of the Vertical Slam Coefficient For the Flared Body. (Ten degree trim, 61 cm (2.0 ft) drop height) [5]**

The rapid increase in computer computational power has resulted in attempts to solve the two-dimensional equivalent of the non-linear boundary value problem. Greenhow [65], Greenhow and Lin [66] and Yim [67] have made use of the Cauchy integral theorem including the rigid body boundary and a mixed Eulerian-Lagrangian description of the free surface. Calculations have shown some agreement for pressure distribution on small to moderate wedge angles below the mean free surface.

A numerical method for studying water entry of a two-dimensional body of arbitrary cross-section was presented by Zhao and Faltinsen [68]. In this solution the exact nonlinear free-surface condition without gravity is satisfied. Important features of the



solution method are how the jet flow occurring at the intersection between the free surface and the body is handled, and how conservation of fluid mass is satisfied in areas of high curvature of the free surface. The method confirms that conservation of mass, momentum and energy are satisfied. It was also verified by comparisons with similarity solution results for wedges with deadrise angles varying from 4 deg. to 81 deg.

In this method water is assumed incompressible and the flow is irrotational. That means that impact velocity is not so high that compressibility effects in the water matter. In practice this is not a severe limitation. Korobkin and Pukhnachov showed that the effects of gravity, viscosity, and capillarity are negligible in the initial stage of impact [69]. It is assumed that no air pocket is created during impact. This means that deadrise angle has to be larger than 2-3 deg.

Under these assumptions the velocity potential satisfies the Laplace equation (3-4) in the fluid domain. The pressure is set equal to a constant atmospheric pressure on the free surface. The kinematic free surface condition is that a fluid particle remains on the free surface. Hence the motion of the free surface may be found by integrating the fluid velocity. The dynamic free surface condition (applied to the exact free surface) can be written as:

$$\frac{D\phi}{Dt} = \frac{1}{2} \left[ \left( \frac{\partial\phi}{\partial x} \right)^2 + \left( \frac{\partial\phi}{\partial y} \right)^2 \right] \quad (3-15)$$

where  $D/Dt$  is the substantial derivative. The body boundary condition on the wetted body surface can be expressed in form of Eq. (3-6).

It is assumed that a jet flow is created at the intersection between the free surface and the body surface as shown in Figure 3-9. The pressure is set equal to atmospheric pressure in the upper part of the jet (lines AB and CD) where fluid motion is assumed to be a one-dimensional.

The unknown velocity potential  $\phi$  for the flow inside the fluid domain is represented by Green's second identity, i.e.

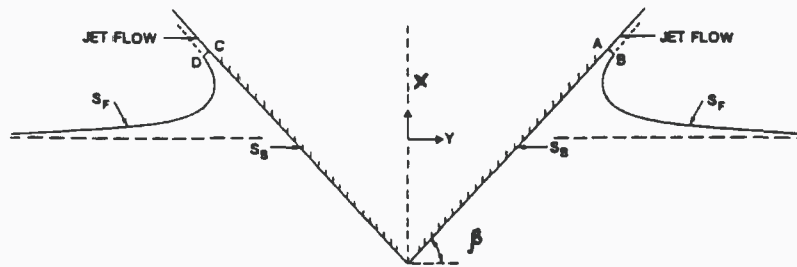
$$2\pi\phi(x,y) = \int_S \left[ \frac{\partial\phi(\xi,\eta)}{\partial n(\xi,\eta)} \log r - \phi(\xi,\zeta) \frac{\partial \log r}{\partial n(\xi,\eta)} \right] ds \quad (3-16)$$

where  $r = [(x-\xi)^2 + (y-\eta)^2]^{1/2}$ . The surface  $S$  consists of AB, CD,  $S_B$ ,  $S_F$  and  $S_\infty$ , where  $S_\infty$  is a control surface far away from the body.

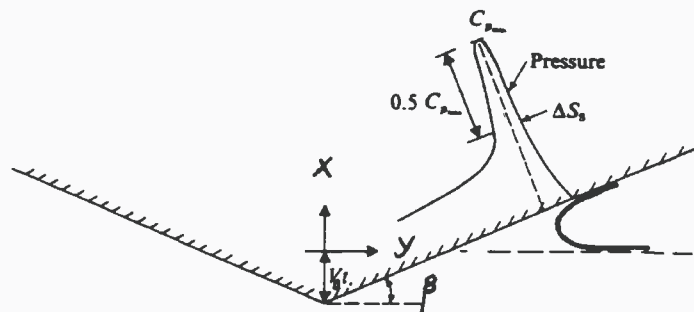
In the numerical evaluation of Equation (16), the free surface  $S_F$  and body surface are divided into a number of straight line segments, on which  $\phi$  and  $\partial\phi/\partial n$  is constant and  $\phi$  has a linear variation over AB and CD.

The integral equation is satisfied at the midpoint of each segment. In the time integration of the free-surface position, it is important to satisfy conservation of fluid mass carefully.

Typical pressure distribution along a body surface is shown in Fig. 3-10. Fig. 3-11 shows numerical predictions of pressure distribution and free-surface elevation around wedges that are forced with constant vertical velocity  $V_0$  through and initially calm free-surface.

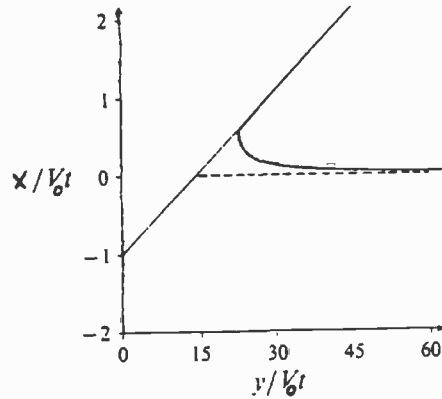
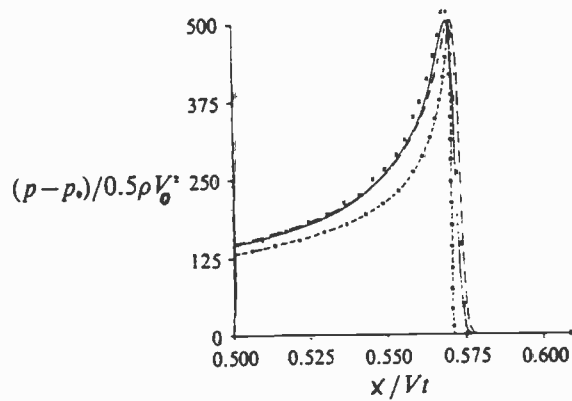


**Fig. 3-9. Definitions of Coordinate System and Control Surfaces Used in Numerical Solution of Water Entry of a Wedge by a Boundary Element Method [68]**



$C_p$  = pressure coefficient.  
 $\Delta S_s$  = spatial extent of the slamming pressure.

**Fig. 3-10. Definitions of Parameters Characterizing Slamming Pressure During Water Entry of a Blunt Two-Dimensional Body [68]**



—————	similarity solution
x x x x	boundary element
- - -	asymptotic solution
- o -	Watanabe [70]

**Fig. 3-11. Prediction of the Pressure Distribution and Free Surface Elevations During Water Entry of a Wedge ( $\beta = 4^\circ$ ) With Constant Vertical Velocity**

The pressure distribution for different deadrise angles of wedges is shown in Fig. 3-12. When the deadrise angle  $\beta$  is larger than about 45 deg., the maximum pressure occurs at the apex of the wedge. Comparison for maximum pressure coefficient  $C_{p \max}$  with Wagner's formula is shown in Fig. 3-13. For very large  $\beta$ -values Wagner's formula underpredicts the maximum pressure. For  $\beta < 45$  deg. agreement with Wagner's formula is excellent.

Another way to obtain a numerical solution to the nonlinear problem with free surface is based on the analysis of so-called similarity solution. Dobrovol'skaya [71] has presented similarity solutions for flow around symmetrical wedges. In the similarity flow the fluid velocity can be written as

$$\nabla\phi = V_o F \left( \frac{x}{V_o t}, \frac{y}{V_o t} \right), \quad (3-17)$$

where F is a function that should be found by solving the special integral equation. Zhao and Faltinsen [68] reviewed the Dobrovol'skaya solution [71] and presented numerical results for different deadrise angles, see Fig.3-12. It is shown that when the deadrise angle of the wedge is larger than about 45 deg., the maximum pressure occurs at the apex of the wedge. In other words, for this values of  $\beta$  the pressure distribution on the body surface does not show the typical slamming behavior of high impulse pressures concentrated over small surface areas.

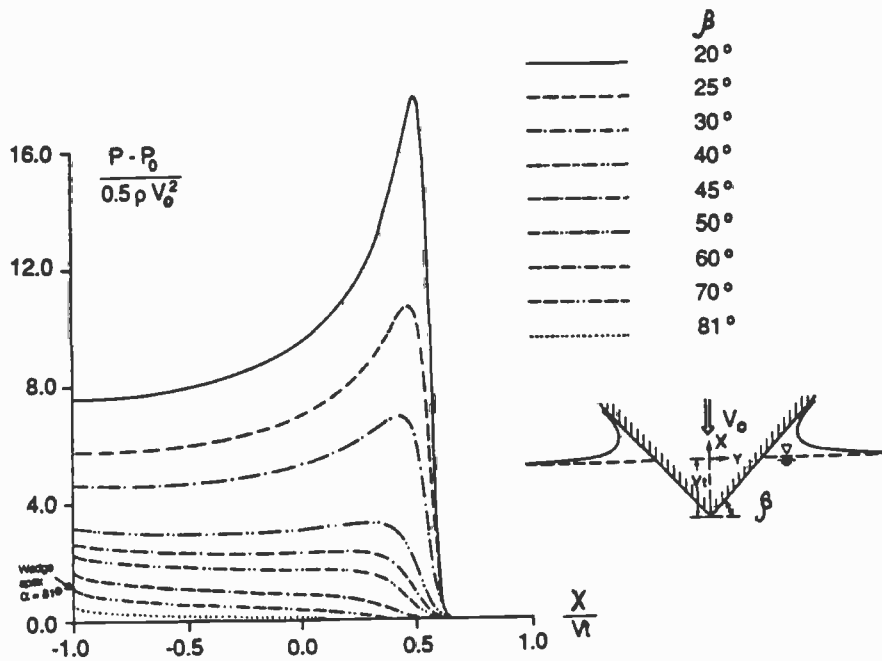
Very good results, close to "exact" numerical solution were derived by Zhao and Faltinsen [68] on the basis of the method using matched asymptotic expansions. The flow is divided into an inner and outer flow domain. In the inner flow the details of the jet flow at the intersection between the free surface and the body surface are studied by means of Wagner local jet flow analysis. In the outer flow the body-surface conditions and the free-surface conditions are transferred to a horizontal line and the body corresponds to a flat plate. The velocity potential is set equal to zero in the free-surface conditions. The inner and outer solutions are matched, which enables one to set up a composite solution for pressure distribution. This technique was shown by Armand and Cointe [43], Cointe [72], and Howison et al [73]. Relationships between inner, outer and composite solutions are shown in Figure 3-14.

According to asymptotic solution the vertical coordinate of maximum pressure is equal to

$$x = \left( \frac{\pi}{2} - 1 \right) V_o t, \quad (3-18)$$

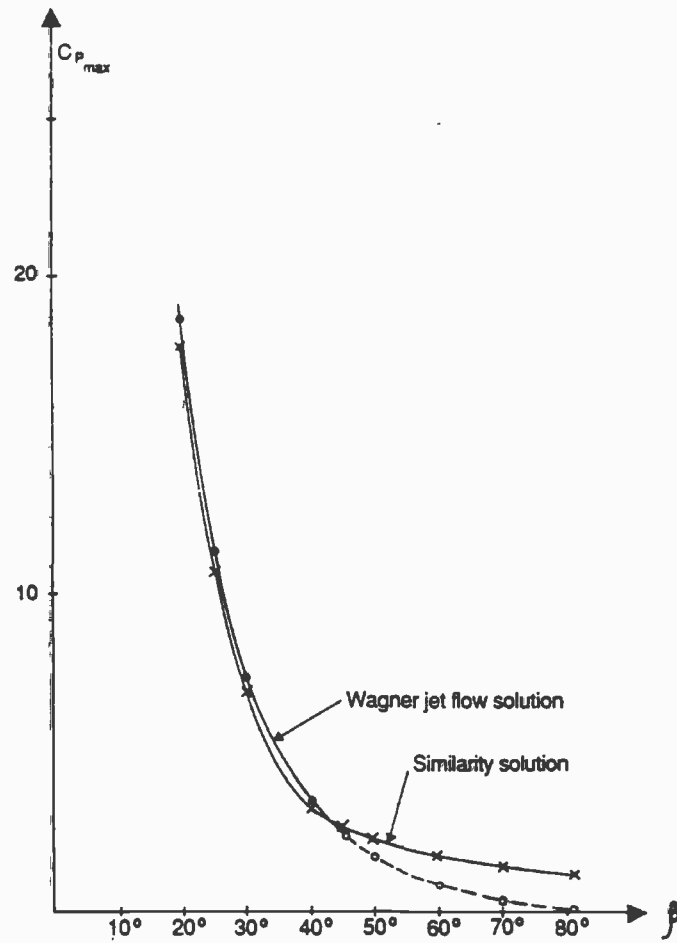
and the maximum pressure (slamming pressure) coefficient is equal to

$$C_{pmax} = \frac{Pmax - P_o}{0.5 \rho V_o^2} = \frac{\pi^2}{4} \cotan^2 \beta \quad (3-19)$$

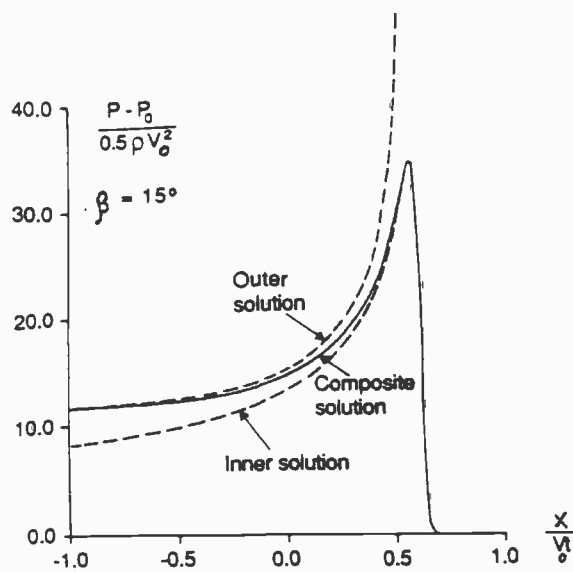


**Fig. 3-12. Predictions of Pressure Distribution During Water Entry of a Wedge With Constant Vertical Velocity  $V_0$ . By Means of the Similarity Solution [68]**





**Fig. 3-13. Prediction of Maximum Pressure Coefficient  $C_{p_{max}}$  During Water Entry of a Wedge with Constant Vertical Velocity  $V_0$  by Means of Similarity Solution and Wagner's Jet Flow Solution (Asymptotic Solution) [68]**



**Fig. 3-14. Prediction of Pressure Distribution During Water Entry of a Wedge with Constant Vertical Velocity  $V_0$  by Means of Asymptotic Method Described by Zhao & Faltinsen (68)**

The jet thickness is

$$\delta = \frac{1}{4} V_0 t \tan \beta \quad (3-20)$$

The asymptotic solution is shown in Figure 3-13. For small and moderate deadrise angles the agreement with the similarity solution is very good.

Watanabe [70] has also provided a solution based on matched asymptotic expansions and local jet flow analysis. However, his analysis of the jet flow, the matching, and the final results are not the same as Zhao and Faltinsen [68].

A two-dimensional potential-flow model was employed to predict the flow fields generated by a wedge penetrating a still fluid at constant velocity [74]. The model includes the full nonlinear free-surface boundary conditions on a boundary-fitted coordinate system. The model equations were solved using a second-order finite-difference technique with a modified Euler method for the time domain and a successive overrelaxation procedure for the spatial domain. The mathematical model gives pressure distributions and force coefficients in excellent agreement with observations and theoretical results.

Hydrodynamic impact pressures, both on the hull bottom and on the wet-deck, are of particular interest in multi-hull and SES hydrodynamics [7]. These pressures can be calculated by using methods well established for the conventional ships. Based on classical hydrodynamics, Toyama [75] developed an improved two-dimensional method for calculating hydrodynamic impact pressures on an arbitrary ship section. The author applied this method to SES hull sections.

In concluding on the analysis of the 2-D incompressible solutions, it should be pointed out that designer must be careful in applying results for wedges to other cross sections. The local deadrise angle is not the only important body parameter. For instance, the local curvature also matters. Further, the assumption of constant body velocity does not account for accelerations that may have importance, in particular for drop test experiments. This will be discussed later.

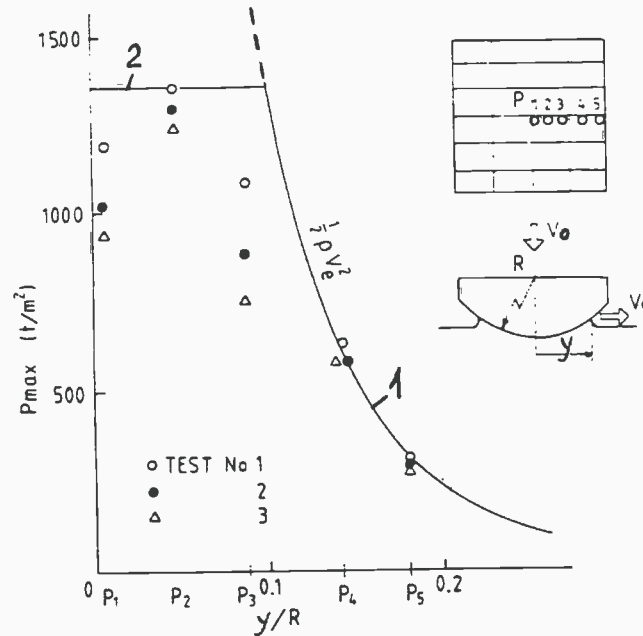
All the above mentioned theories for incompressible fluid, however, are not applicable at the instant of impact. This is due to the fact that the velocity potential instantaneously jumps from zero to a finite value and thereby the magnitude of the impact pressure becomes infinite. This situation can be eliminated if the compressibility of water is included in the theory. For this case, the velocity potential must satisfy the wave equation instead of Equation (3-4). That is:

$$\nabla^2 \phi = \frac{1}{c^2} \frac{\partial^2 \phi}{\partial t^2} \quad (3-21)$$

where:

$c$  = velocity of sound in the fluid.

The effect of compressibility of water on the impact of a flat plate was studied by Von Karman [32], Egorov [76] and Ogilvie [39], and of a wedge by Skalac and Feit [78]. In the latter two studies, supersonic flow theory was applied to the impact problem. That is, if the expansion rate of the area of contact between the water and the body exceeds the sound velocity, then the compressive wave will not propagate outward from the edges of the contact surface and hence the free water surface beyond the contact surface will not be disturbed. An acoustic pressure is applied to the contact surface in this case. Immediately after contact, the expansion rate decreases; then, the acoustic pressure is dissipated and only the hydrodynamic pressure remains. Although these theories give a finite magnitude of pressure at the moment of impact, the magnitude is still very high in comparison with that expected to occur in ship slamming. In addition, the theories on compressibility show that the pressure is linearly proportional to the impact velocity which is contradictory to the results observed in ship slamming which show instead the pressure to be approximately proportional to the square of the velocity. Hence, the notion of compressibility of water may not be appropriate to the slamming problem.



- 1 - Wagner's formula
- 2 - Acoustic pressure  $\rho C V_0$   
( $C_p = 375$ )

**Fig. 3-15. Maximum Impact Pressures on a Circular Cylinder as a Function of Time After Initial Impact ( $V=8\text{ms}^{-1}$ ,  $R=5\text{m}$ ). (Hagiwara & Yuhara, [79])**

The acoustic pressure, or limit for pressure in water under impact, is equal to

$$P_{ac} = \rho C V_0 \tag{3-22}$$

With no air content  $C$  varies typically between 1450 m/s and 1540 m/s. In rough seas, air bubbles will be in the water altering the speed of sound dramatically. The importance of the acoustic pressure is illustrated in Figure 3-15 where pressure results from forcing a vertical cylinder with radius 5 m through the free-surface with velocity  $V_0 = 8$  m/s are presented, Hagiwara and Yuhara [79]. As it is shown from this figure, the acoustic pressure is about 125 times the atmospheric pressure and the maximum pressure occurs close to the centerline of the cylinder. When  $y \geq 0.5$  m the slamming pressure is determined from Wagner's analysis. As pointed out earlier, the slamming pressures are very local in time and space and the maximum slamming pressure does not occur simultaneously around the cylinder surface.

Other considerations in the theoretical treatment of the impact problem are the effect of entrapped air between the body and the water at the moment of impact, and

the effect of body elasticity. Kamel [80] concluded that shock pressures resulting from the impact between a solid and a liquid, as in his specific investigation of waves breaking against coastal structures, can best be described as a water hammer phenomenon where the compressibility of the liquid and the elasticity of the solid are the governing factors. He expects that in most cases the pressure will be reduced due to the presence of some air. The effect of deformation of the hull cross section (plate) on impact was studied by Weing [81], Meyerhoff [82] and Chuang [83]. In Meyerhoff's study, the general formulation of Wagner's theory for a wedge including elasticity was developed. Sellers [84] has developed a solution for maximum impact pressure taking into account structural elasticity and entrapped air:

$$p_{\max} = S_T \rho_s C_w V_o \quad (3-23)$$

where:

$$\begin{aligned} S_T &= \text{a function of the structural impedance} \\ \rho_s, C_w &= \text{mass density and speed of shock wave in water-air mixture} \\ V_o &= \text{relative velocity of impact} \end{aligned}$$

Sellers found that in full scale with high relative velocities the effects of structure can be important and reduce the impact pressure as flexibility of the structure increases. Equation (3-23) results in conservative predictions of full-scale pressure and the effect of air entrapment on the maximum pressure does not appear significant.

### 3.2.3 Three-Dimensional

The application to three-dimensional cases has been less significant to date due to the increased complexity of the mathematical problem. The theories which have been developed predominantly rely on potential flow. The impact pressures and loads are assumed to be due to a rigid body entering otherwise calm water. Viscosity, surface tension, air entrapment, compressibility of air or water and vessel forward speed are ignored. Hydro-elasticity is considered in some cases which are identified in Section 3.2.4.2 herein.

Relatively few attempts have been made to rigorously solve impact problems dealing with three dimensional bodies. Examples are Shiffman and Spencer [85], Chuang [86], and Miloh [87]. Shiffman and Spencer and Chuang developed general expressions for the pressure distributions and slamming forces on a cone. Using similar assumptions, Miloh analytically derived the added mass coefficients for a double spherical bowl. From these coefficients the impact force on a sphere was calculated assuming that the free surface is represented by an equi-potential surface.

Of practical engineering interest are the impact forces in the bow region of a ship. Due to complexities associated with the three-dimensional boundary value problems, it has been common practice to use simplifying assumptions that reduce the calculations of hydrodynamic forces to a two-dimensional strip theory. Examples of this are given by Ochi



and Motter [88], [28], Yamamoto, et al [89], Belik, et al [90], and Oliver [91]. These types of hydrodynamic theories assume that the ship is of sufficient length and cross-sectional uniformity to allow the hull to be divided into segments, each of which is assumed to act independently of any other, Figure 3-16. A number of two-dimensional solutions are then summed to yield the total impact force. Techniques such as these are not precise in the bow region where the assumed two-dimensionality of the flow may not be valid. An illustration of the relative error of the two-dimensional approximation for three-dimensional bow loads can be seen in Figure 3-17. There the nondimensional impact force for a sphere, defined by  $C_s = 2 (\text{impact force}) / \rho \pi R^2 V_0^2$  is calculated using results similar to Miloh [87] for three-dimensional theory and a strip theory based on Kaplan and Silbert's [92] or Sarpkaya and Isaacson's [93] formulas for a circular cylinder. The slam coefficient is plotted as a function of  $z/R$ , the normalized vertical distance. In both cases the free surface is represented by an equipotential surface and the velocity of the body is constant. While the strip theory approximation of the sphere represents an extreme example, it demonstrates the need to exercise caution when applying two-dimensional solutions in areas where three-dimensional effects are large.

The following is the formulation of the three-dimensional potential impact problem with non-linear free surface condition Troesch, Kang [5].

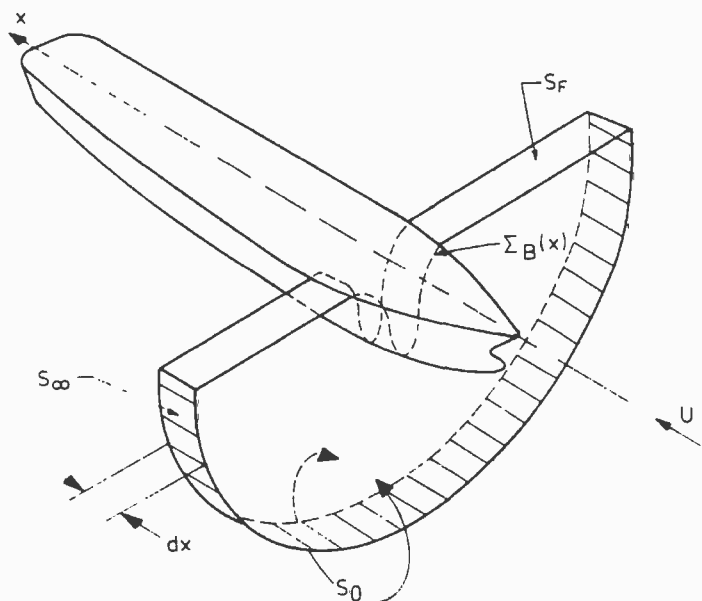
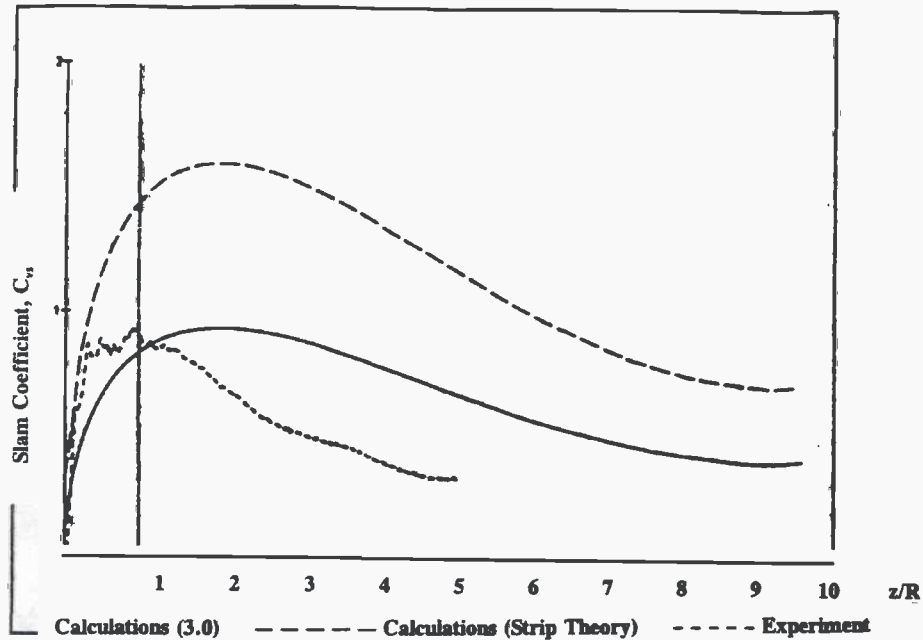


Fig. 3-16. Use of Strip Theory to Calculate Loads on Sections of Ships [4]



**Fig. 3-17. Experimental and Theoretical Comparison of the Vertical Slam Coefficient For a Sphere (Drop height - 61 cm (2.0 ft.))[5]**

Consider an ideal fluid where a rigid body passes through the free surface. The boundary value problem for the three-dimensional case has been described by Troesch and Kang [5]:

The free surface is defined by

$$z = \zeta(x,y,t) \tag{3-24}$$

where  $(x,y,z)$  is a right-handed coordinate system with  $z$  positive upwards and the origin located at the mean free surface. The governing field equation is the 3-D Laplace Equation, Equation (3-4). Newman [94], among others, derived the complete free surface boundary condition, including both kinematic and dynamic considerations as

$$\frac{\partial^2 \phi}{\partial t^2} + g \frac{\partial \phi}{\partial z} + 2 \nabla \phi \cdot \nabla \frac{\partial \phi}{\partial t} + \frac{1}{2} \nabla \phi \cdot \nabla (\nabla \phi \cdot \nabla \phi) = 0 \tag{3-25}$$

which must be satisfied on the surface defined by Equation (3-24). Here  $g$  is the gravitational constant. The body boundary condition, satisfied on the instantaneous body surface, is expressed as

$$\frac{\partial \phi}{\partial n} = \underline{V} \cdot \underline{n} \quad (3-26)$$

where  $\underline{V}$  is the velocity vector of the body and  $\underline{n}$  is the outward unit normal. To complete the statement of this boundary value problem, radiation conditions must be given.

$$\phi = 0 \quad x, y = \infty \quad (3-27)$$

If a velocity potential satisfying the above conditions can be found, then the pressure may be determined from Bernoulli's equation as

$$\frac{p}{\rho} + \frac{\partial \phi}{\partial t} + \frac{1}{2} \nabla \phi \cdot \nabla \phi + gz = \text{constant} \quad (3-28)$$

Once the pressure distribution becomes known, it can be integrated and the force found in a straight-forward manner.

If only vertical motion is considered. The velocity vector,  $\underline{V}$ , used in the body boundary condition is determined from the solution of the equations of motion in the vertical plane shown below:

$$F_z = m\ddot{z} = - \int \int p n_z dS - mg \quad (3-29)$$

The vertical velocity,  $\dot{z}(t)$ , and displacement,  $z(t)$ , are found through the usual integration formulas of:

$$\dot{z}(t) = \int_0^t \ddot{z}(t) dt \quad (3-30)$$

$$z(t) = \int_0^t \dot{z}(t) dt \quad (3-31)$$

A general three-dimensional solution to the boundary value problem posed by Equations (3-24) - (3-27) has not yet been found. The complexities of the non-linear free surface and body boundary conditions have resulted in assumptions being made in order to calculate the impact forces as have been reviewed by Greenhow [65]. Troesch and Kang [5] have noted it is possible to catalogue the various existing theories based upon their

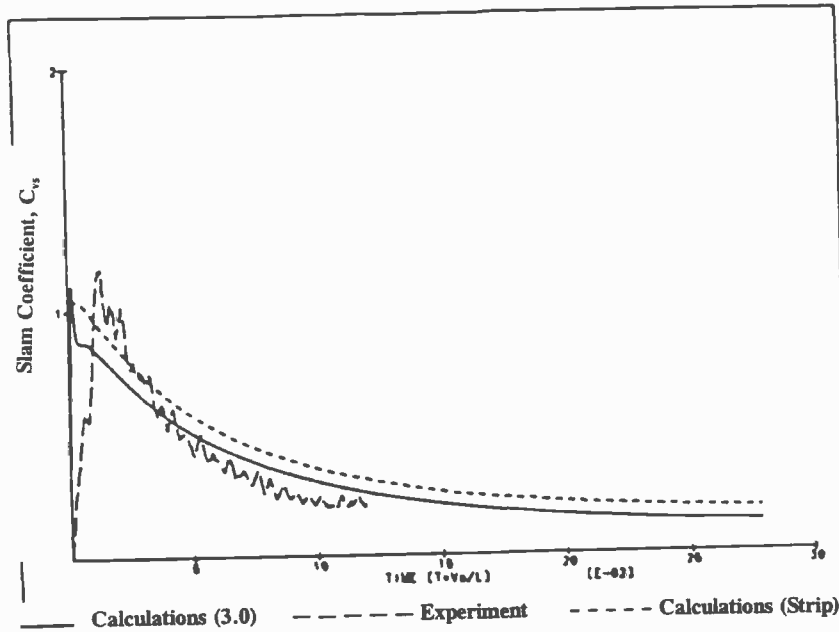
approximations of the boundary conditions and their assumptions regarding rigid body dynamics and there are extensive literature surveys on the subject available as part of the publications of The International Ship Structures Congresses (ISSC) [22,23,24,95]. The simplification of the problem to two-dimensional theory is treated in Section 3.2.1 herein.

Troesch and Kang [5]\* developed both two-dimensional strip and three-dimensional panel methods for the solution of the impact boundary value problem satisfying the body boundary condition and the simplified equipotential free surface condition ( $\phi = 0$ ). In order to investigate the validity of the assumptions listed in the previous paragraphs, the hydrodynamic impact forces acting on two different body shapes were examined [5]. The body shapes are shown in Figure 3-18. One has circular cross sections with a cylindrical parallel midbody. The ends are halves of hemispheres. The other body has a bow flare shape with elliptical water lines. Both shapes have length-to-beam ratios of 2.0. The cylindrical shape has a beam-to-draft ratio of 2.0, while the flared body has a beam-to-draft ratio of 1. Theoretical pressures were calculated by both two- and three-dimensional boundary integral methods. Experimental results were obtained in the Ship Hydrodynamics Laboratory at the University of Michigan. These results were representative of time histories of a series of impact experiments. The bodies shown in Figure 3-18 were dropped from three drop heights, with three different trim angles, 0, 5, and 10 degrees.

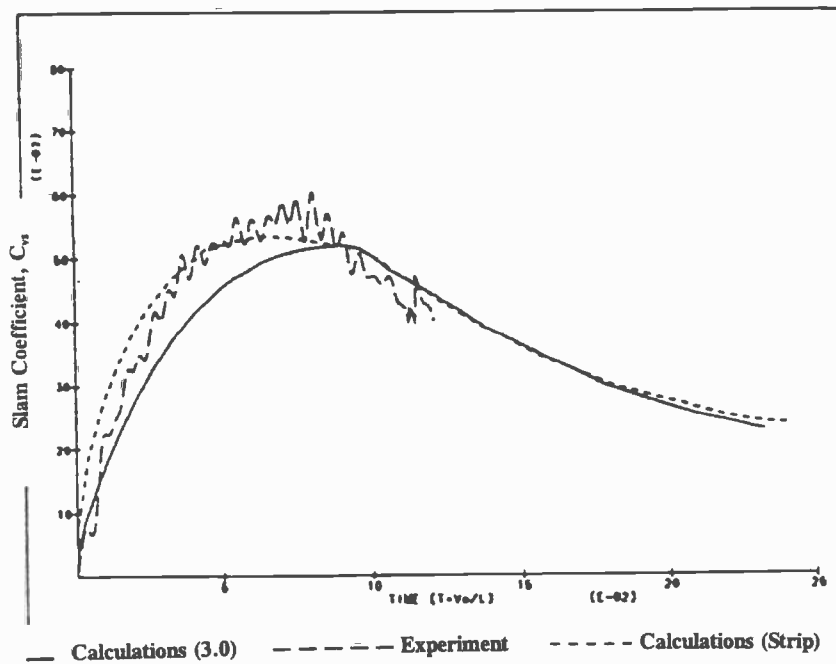
The vertical impact force as function of time for the cylindrical body is shown in Figure 3-19 for zero trim angle and Figure 3-20 for a 10 deg. trim in the form of the vertical slam coefficient,  $C_{vs}$ .



**Fig. 3-18. Panel Distributions for the Cylindrical and Flared Bodies.**



**Fig. 3-19. Experimental and Theoretical Comparison of the Vertical Slam Coefficient for the Cylindrical Body (Zero Degree Trim, 61 cm (2.0 ft.) Drop Height) [5]**



**Fig. 3-20. Experimental and Theoretical Comparison of the Vertical Slam Coefficient for the Cylindrical Body (Ten Degree Trim, 61 cm (2.0 ft.) Drop Height) [5]**



$$C_{vs} = \frac{2m\ddot{z}}{\rho\pi\left(\frac{L}{2}\right)^2V_o^2} \quad (3-32)$$

where:

- m = mass
- $\ddot{z}$  = vertical acceleration
- $\rho$  = water density
- L = representative length (for the sphere L is the diameter, for the cylindrical body or the flared body it is the overall length)
- $V_o$  = is the initial impact velocity

Theoretical calculations based upon the three-dimensional and two-dimensional methods are shown by the solid and short dashed lines respectively. The experimentally measured force is given by the intermediate dashed line. The data for the flared body is shown in Figures 3-7 and 3-8.

Based upon the information displayed in these figures, the following observations may be made:

- The 2-D and 3-D theoretical curves are surprisingly close when compared to the results for the sphere, a body with a beam to draft ratio of 1.0, shown in Figure 3-17. It is interesting that experimental curves for cylindrical body are close to the 2-D solution for the initial phase of impact, while the 3-D theory predicts maximum force coefficient well.
- The slam coefficient for the flared body is characterized by two maxima, one occurring during the initial contact between body and water, and the other when the flared sections pass through the surface. The second maxima due to flare has a value equal to or greater than the first maximum.
- The variation of the trim angle from 0 to 10 degrees produces a significant decrease in the maximum value of slam coefficient for the cylindrical shape and for the first maximum in the flared body curve. Those values decrease by approximately a factor of two over this range of trim. The decrease due to trim angle change in the second maximum for the flared body is not as large. In fact, the experimental value remains essentially equal for trim angles from 0 to 5 degrees and then decreases slightly at 10 degrees.
- The comparison between theory and experiment for the slam coefficient maximum of the cylindrical shape and for the first maximum of the flared body is good. However, the second maximum for the flared body was consistently overpredicted, with the largest error occurring at a trim angle of 0 degrees and the smallest at 10 degrees.

- The nondimensional time coordinates for the slam force coefficient maxima were underpredicted depending upon the body and trim considered.
- These results are applicable to both slamming and bow flare impact.

The solution to the three-dimensional problem of submersion of an object of an arbitrary form in ideal incompressible flow was gained by Stepanov for free-fall life boats [96], [97]. The numerical solution to the boundary value problem with a nonlinear condition on the free surface was performed by using the integral equation method. The general problem was transformed into some sequence of problems for fixed instances in time separated by small intervals. The integral equation was reduced to a system of linear algebraic equations. To determine the vertical resultant force the Lagrangian formula for changing of the kinematic energy of fluid expressed in generalized coordinates was used.

The analysis of the kinematic energy of fluid was also used by Chuvikovsky for evaluation of slam forces acting on a 2-D section of a ship [98], [99]:

$$q(x,t) = m(\zeta,x)\ddot{\zeta} + K\dot{\zeta}^2 \frac{\partial m(\zeta,x)}{\partial \zeta} \quad (3-33)$$

where:  $m$  = added mass of the immersed part of 2-D section;  
 $\zeta$  = relative vertical motion of this section during pitch and heave.

The factor K depends on the section deadrise angle  $\beta$  (degrees):

$$K = 1 - \frac{1}{2} \left( \frac{\beta}{90} \right)^{1.5} \quad (3-34)$$

The kinematic energy approach was commonly used by Russian engineers to calculate dynamic bending moments [96], [98].

Kaplan and Malakhoff [100] have applied the expanding wedge work of von Karman [32] to the bows of SES craft. They utilize a formulation of the 2-D added mass to represent the 3-D added mass of the bow. In carrying out this work for higher speed vessels than displacement hulls, the effect of forward speed is considered in the framework of an analytical model proposed by Smiley [101] using the concept of equivalent planing velocity. They show the resultant slamming pressure as:

$$P_{slam} = \frac{\rho}{2} [u + W_r \cot(\tau + \theta)]^2 \quad (3-35)$$

where  $u$  is forward velocity,  $W_r$  is the vertical velocity,  $\tau$  relates to hull geometry and  $\theta$  is pitch. They conclude that this expression indicates the quadratic variation of slam pressure

with vertical velocity when the forward speed is relatively low, as in the case of a surface ship where the large velocity at the bow influencing impact pressure is the relative vertical velocity between the vessel and the sea surface. For the SES case the expressions indicate both linear and quadratic variation with relative vertical velocity, together with a forward speed effect.

Kaplan [102] has applied a similar approach to predict impacts on the water surface of the flat of bottom of centerbody surfaces of multi-hull vessels such as SWATH and catamarans. Von Karman's technique is applied however in taking the 2-D section in the longitudinal plane rather than the transverse where the flat exists and as a result the singular (i.e., infinite) behavior associated with the time rate of change of the sectional added mass is avoided. As an example, the added mass of the flat wetdeck is taken as:

$$m_s = \rho \frac{\pi}{8} bc^2 \quad (3-36)$$

where  $b$  is the beam of the flat wetdeck and  $c$  is the changing wetted length which has a finite angle with the wetdeck surface. Kaplan reasons that the wetdeck beam is generally large compared to the wetted length and hence Equation (3-36) is a valid expression of the three-dimensional added mass.

Ohtsubo and Fukumura [103] and also Tanizawa [104] applied boundary elements to solve the self-symmetrical problem of a rigid symmetrical wedge entering vertically and with constant speed into initially calm water. Comparison of the pressure distributions with Wagner's expanding plate theory showed good agreement for small deadrise angles, up to about 10 degrees. For larger deadrise angles the comparison with Wagner is not good. However, a comparison with expanding prism results would have been more appropriate. Good agreement is achieved with Hughes' [105] numerical results for a large deadrise.

The problem of oblique wedge entry into initially calm water was investigated by Greenhow [65]. The study allows nonsteady speed, gravity and suction on the "backside". The author shows that for sharp wedges satisfactory results are obtained with deadrise of up to about 30 degrees and fair results for a deadrise angle of 45 degrees.

Arai and Matsunaga [106], [107] applied finite difference methods to solve the problem of a cross section with considerable flare entering into an initially calm water surface at constant speed, and at an angle. The effect of gravity is included. Comparison of computed and measured time histories show remarkable agreement. The authors conclude that the numerical approach is well suited to predict the high pressure region, which extends over a considerable area of the flare when the flare comes into contact with the water.

The water entry of a rigid circular cylinder into a compressible fluid was studied by Radev [108]. Results are presented for a cylinder of 0.15 m diameter and two

entry velocities. Results show that the elevation of the fluid surface tends to reduce the pressure with increasing time.

The cushioning effect of layers of elastomeric material bonded to the undersurface of a flat bottom falling on calm water was investigated by Ando [109]. It was shown that a layers of optimum elasticity could significantly reduce the slamming forces for flat bottoms striking the water vertically. Such layers tended to increase the slamming force for wedge-shaped bottoms. However, the peak impact forces for the wedges were considerably smaller than those for the flat bottom under identical drop conditions.

The effect of the three-dimensionality of the ship hull and the wave was calculated by Watanabe [110], by means of matched asymptotic expansions assuming small immersion and neglecting gravity. The calculated results were compared with experimental results obtained in free-running tests with a bulk-carrier model. Agreement between calculation and experiment was satisfactory only when the measured motion response was used instead of a theoretical prediction.

A theoretical method for the prediction of impact pressures of arbitrary ship-like 2-D forms was presented by Song et al [111]. The flow around the two-dimensional shape immersing at constant speed was approximated by a multi-coefficient conformal transformation technique applied to the instantaneous immersion. Piled-up water during immersion was considered. Two typical sections, a fishing vessel midship section and a containership forebody section were investigated.

Although most theoretical studies involving wave slamming have considered the case of regular waves, Isaacson and Subbiah [112] have recently analyzed the application of a suitable force formulation to the case of random waves impacting on a horizontal cylinder. An expression is developed for the probability distribution of the force maxima, based on the assumption of a narrow-band spectrum.

### **3.2.4 Hull Response**

#### **3.2.4.1 Response of Structure to Water Impacts**

Slamming damages have been a matter of concern for more than 60 years and for the past 30 years, hull structure damages due to heavy weather vessel operations have fairly consistently been 10-12% of vessel claims, about the same as for collisions [24].

The ability to predict forces acting on the ship forebody and stern surfaces and the resulting dynamic hull girder response has been of long standing concern. As ship fatigue life came into question during the sixties, the manner in which slamming induced dynamic hull girder response superimposed on the quasi-static wave load response took on interest that remains today.



In accordance with the general approach (see, for example, Lewis and Gerard [113]) ship structural response to slamming may be grouped into three categories; i.e., localized response, transitional response, and overall response. During and immediately after slamming, there is a period of localized response when the hull-plate panels respond immediately because of direct contact with the slamming load. Since keel, floors, and nearby frame structures function as supports to the hull plating, they also react without delay. This is followed by a period of transition during which momentum imparted to the outer hull in the slamming area is transferred to the nearby outer hull, as well as to interior hull structural members, but the entire ship hull is not yet aware of the slamming load. Finally, there follows a period of overall response. If the exciting force, i.e., the slamming load, has produced sufficient momentum, the hull may vibrate vertically, horizontally, longitudinally, torsionally, or in any combination of these, depending on what portion or locality of the ship hull has been affected. This hull vibration is sometimes referred to as whipping. In addition, impact loads and the dynamic structural response contribute to fatigue.

Only the overall effects can normally be noticed by those aboard the ship. As both the loadings of the local and of the overall structure may well exceed the limits of safe operations, an assessment solely on the basis of the overall response is unsatisfactory. Methods to describe the limits of safe operation of ships with respect to impact loads in severe seas have so far only been developed for the risk of the bottom slamming. For example, Lipis [114] relates sea state to vessel proportions, draft, engine power, and speed. Such an approach seems to be insufficient for ships with fine hull lines and a minimum of flat bottom [115].

When a ship is exposed to ocean waves, it is subjected to three types of hydrodynamic forces. These force components are the hydrostatic force, inertial and damping forces (characterized by added mass and damping coefficients); and wave excitation forces (the simplified form of which is known as the Froude-Krylov force). Determination of these forces are sufficient to provide one with predictions of rigid body ship motions. However, in response to slamming in heavy or moderate seas, a ship can develop hull stresses associated with the flexural vibration (whipping) of the hull girder. This high frequency excitation may be generated when either there is an emersion of the ships keel (at either the bow or stern) followed by a significant impact upon reentry, or for ships with pronounced bow flare when a sudden increase in submerged area results in a rapid increase in added mass with associated increases in local pressure. Kline and Daidola [116] have shown slam-induced and bow flare frontal impact induced vibratory response appears to vary measurably with ship stiffness and the trends are uniform and consistent, i.e., increased stiffness increases response, and decreased stiffness lowers response.

It should be noted that impact loads of high performance vehicles (ACV, SES, SWATH, high-speed catamarans, planing or semiplaning monohulls) are basically of the same nature as on conventional ships and even seaplanes. Stavovy and Chuang [117] gave a procedure to compute slamming impact pressure of high performance vehicles (HPV), in



which they provided an empirical formula based on two- and three-dimensional model test data. Nevertheless, the HPV's have some special features.

Weight is a critical matter of all HPV's, and every precaution must be taken, therefore, to reduce weight to a minimum. This leads to the consideration of alternative materials to steel to minimize structural weight. To achieve a lightweight and safe structure, not only must the structural design loads be as realistic as possible, but also the structural response analysis should be of high reliability and accuracy. However, in the case of aluminum (the material for many HPV structures) even more careful attention must be given to fatigue loads as the allowable fatigue stress in comparison to yield is generally lower than that for steel.

The high hydrodynamic loads due to high speed and the unconventional geometry of means of support cause unusual load distributions. For example, for the case of a catamaran cross deck the two sidewalls tend to seal off the escape of water when contact is made with the free surface. Thus, the cross structure may be more vulnerable to a hydrodynamic impact than the bottom of a ship bow. This also implies that the threshold velocity associated with cross-structure slamming should be somewhat lower than used for normal monohull applications. Hadler, et al [118] assumed a zero value of the threshold velocity for slamming pressure calculations connected with the catamaran USNS HAYES. They found good agreement between calculated values of slamming pressure and measured results.

There are two main approaches to predict the overall structural loading of ships due to hydrodynamic impact:

- Based on estimation of the local pressure distribution;
- Based on the analysis of relative motion and momentum without predicting the local pressure distribution.

The following sections discuss the coupled hydrodynamic and structural techniques developed to address overall or hull response to hydrodynamic impact. As such, they consider theoretical 2-D, 3-D and experimental hydrodynamic impact loading theories as well.

#### 3.2.4.2 Hull Response Theory

In the early 1960s, Jasper [119] developed a theoretical analysis of hull whipping induced by bow-flare type of frontal impact. It utilizes measured or calculated rigid-body motion at each transverse section of a ship to compute the instantaneous waterline as well as the velocity of the section relative to the water and computes the added mass for each section at each waterline. The hydrodynamic force at each section is calculated as the time rate of change of the momentum imparted to the water and is added to the buoyancy and damping forces to give the total force. Finally, it computes response

of the elastic ship, thus giving the desired bending moments and shear forces in the vertical plane for a ship operating in a head sea. The theory was first programmed for analog computers (SAC: Seaworthiness Analog Computer) and later for digital computers (ROSAS: Response of Ship at Sea). As discussed in Section 3.3.2 the comparison with full scale results from the ESSEX was encouraging.

Chuang [120,121,122] expanded ROSAS to ROSAS3 [123] incorporating the effects of both lateral and torsional bending. Due to lateral symmetry in a ship the problem is subdivided into two independent sub-problems. That is, one sub-problem for the vertical motion identical to the two-dimensional analysis and one additional sub-problem for the horizontal motion coupled with the torsional motion. However, while bottom slamming forces are included for the vertical plane they are not taken into account for the coupled horizontal and torsional components.

ROSAS [120]\* accepts the wave data as input in the form of sinusoidal continuous or discrete trains which move without change in form and at constant wave velocity from the bow to the stern of a moving ship. The moving waterline is then considered at each of 21 discretized stations along the ship. The forces generated by the moving wave consist of added mass ( $P_1$ ), buoyancy ( $P_2$ ) including Smith correction, hydrodynamic damping ( $P_3$ ), and bottom slamming ( $P_4$ ). The total force then becomes:

$$P(x,t) = P_1 + P_2 + P_3 + P_4 \quad (3-37)$$

where:

$$P_1 = \frac{d}{dt} (m_v V_r) \quad (3-38)$$

$$P_2 = \rho A \left( g + \frac{dV}{dt} \right) - \rho g A_o \quad (3-39)$$

$$P_3 = C(\omega) V_r \quad (3-40)$$

$$\begin{aligned}
P_4 &= \text{bottom slamming force due to triangular pressure} \\
&\quad \text{distribution computed by Chuang [124]} \\
\omega &= \text{wave frequency} \\
V_r &= \text{relative vertical velocity}
\end{aligned}
\tag{3-41}$$

The added mass  $m_v$  and submerged area  $A$  are repeated into linear and nonlinear terms:

$$m_v = m_o + \overline{m_v} \tag{3-42}$$

$$A = A_o - b_1 Y_r + \overline{A} \tag{3-43}$$

where  $m_o$  is the added mass associated with the still waterline, and  $m_v$  is the time varying portion of the added mass as shown in Figure 3-21, which are computed by the method of Wagner [33].  $A_o$  is the cross sectional area up to the mean waterline (still waterline).

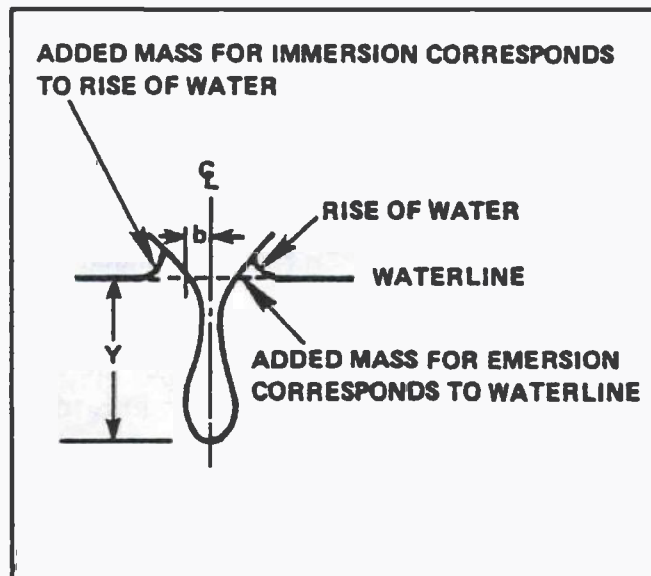
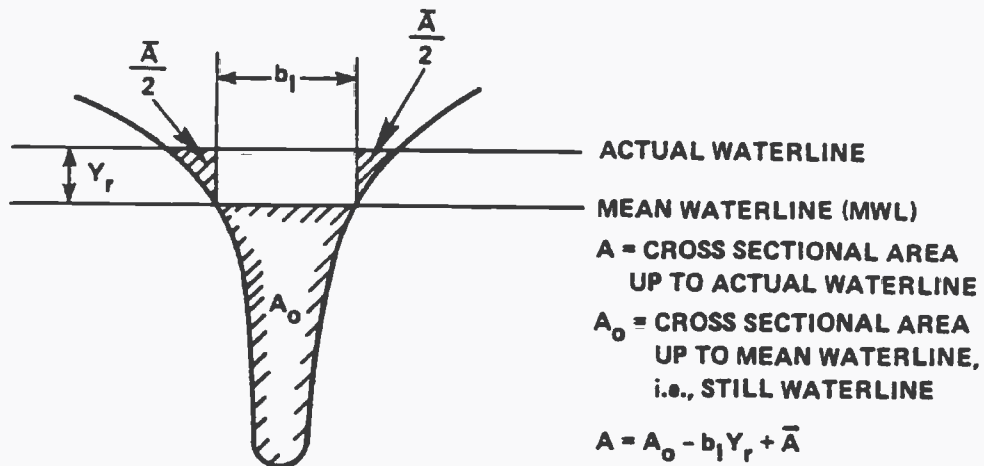
When the force function  $P(x,t)$  acts on the flexible ship the governing equations of ship response for deflection  $Y$  which are solved in the time domain:

$$m \frac{\partial^2 Y}{\partial t^2} + C \frac{\partial Y}{\partial t} + \frac{\partial V}{\partial x} = P \tag{3-44}$$

$$\text{Inertia} + \text{damping} + \text{shearing} = \text{excitation} \tag{3-45}$$

Kaplan and Sargent have developed procedures to perform time domain analysis at relatively high execution speed [125]<sup>x</sup>. The approach utilizes motions through the use of the linear, frequency domain, ship motion theory used, along with fluid momentum analysis techniques, to provide for an initial estimate of impact forces. Once determined, the effects of non-linear buoyancy and momentum changes are estimated similar to Jasper [119] and Chuang [120]. Results are fed back as corrections to the initial estimate. The procedure is repeated until the solution converges. Structural responses are determined by assuming the hull to be a non-uniform Timoshenko beam. However, rather than solving for the governing differential equation a digital filtering technique is used to determine the flexural response of the first elastic mode only. As seakeeping theory is used to determine the impact force, the details of the force prediction technique are discussed in 3.2.4.2 Seakeeping Hydrodynamics.

Bishop, Price, et al [29][90][126][127] have performed extensive work in the area of hydro-elastic response of ships. Initial efforts began with investigations of responses in the vertical plane only and was later expanded to include not only lateral responses but asymmetric hull shapes as well. All these approaches are based on linear strip theory and assume that the ship can be represented as a non-uniform Timoshenko beam. The authors are of the opinion that a rigid body model for the hull girder will not result in the same response forces as when the stiffness and vibratory character of the hull is considered.



**Fig. 3-21. Method for Determining Added Mass for Immersion and Emersion**

The authors consider slamming as a combination of initial impact, for which they use the method of Stavovy and Chuang [117] to calculate pressures and forces, and subsequent momentum slamming as the hull plunges further in the water, for which they use the method of Leibowitz [128][129] for the added mass and buoyancy. They also consider frontal impact (flare slamming) using the latter approach. The time history of the force at each section is estimated by the techniques of Ochi and Motter [28] and Kawakami, Michimoto and Kobayashi [130]. More recently, work [131] has centered on applying a linear finite element approach to describe the elastic hull model and a hydrodynamic model based on translating pulsating sources and sinks and extending their approach to three dimensions [132].

The American Bureau of Shipping [133], [134] predictions for the vertical hull girder bending moments of a flexible ship can be performed by using the computer program ABS/BOWSLAM. The procedure treats the hull girder as a non-uniform Timoshenko beam and a modal analysis approach is used to determine structural responses. Inputs required for this analysis include ship mass, added mass and damping coefficients, relative motion and velocity at ship sections ahead of midships, and the first five or more modal shapes and corresponding natural frequencies. These parameters are determined by the computer programs ABS/SHIPMOTION and ABS EIGEN - V.

Although the procedure which is used is applicable to both regular and irregular waves, the model currently in use is limited to regular waves. Hence predictions of structural response of irregular seas must be represented by an equivalent regular wave system. Calculations can be performed for head seas only.

Mitsubishi Heavy Industries [135]: A time domain non-linear program, MSLAM, for predicting ship response to slamming has been developed by the Nagasaki Experimental Tank of Mitsubishi Heavy Industries [20]. The procedure allows for the prediction of time histories for vertical motion (heave and pitch), shear and bending moments as well as the effects of whipping due to both bow flare and keel slamming.

Strip theory is used to determine hydrodynamic coefficients for added mass, damping and wave exciting force. Non-linear effects are accounted for by calculating the change in added mass at each time step. Structural responses are determined by representing the ships hull as a non-uniform Timoshenko beam. Results can be obtained for either regular or irregular long-crested waves.

Chou, S. K., Chiu, F. C. and Lee, Y. J.: Have performed studies on non-linear motions and wave loads, including whipping of high speed craft [3]. The general approach utilizes a modified strip theory in order to predict sectional hydrodynamic coefficients at each time step and represents the ships hull as either an Euler or Timoshenko beam. Structural responses are determined by either modal superposition or finite element methods.

Most of Russian studies of hull response to the hydrodynamic impact deal with semi-empirical formulas for the dynamic bending moments due to bottom or bow flare slamming [96,98]. According to this approach, the amplitude value of the bending moment amidship due to bottom slamming can be calculated as:

$$M_{\max} = 0.0028 \gamma \frac{h_{3\%}}{\sqrt{C_B \rho m}} (h_{3\%}/L - 2T_2/a_* L) a_*^2 (\bar{b}_2^* \beta_2^{*0.5})^{4/3} \bar{\sigma}_1 \nu(\bar{\tau}) (1+10Fr) (1-\psi L/3T) B^2 L^2 / 10T, \quad (3-46)$$

where

- $\gamma$  = specific weight of water,  $t/m^3$ ;
- $h_{3\%}$  = wave's height with probability 3% that random function  $h$  exceeds  $h_{3\%}$ ,  $m$ ;  $h_{3\%} = 1.33h_{1/3}$ ;
- $L, B, T$  = respectively length, beam, and draught amidship,  $m$ ;
- $T_2$  = the draught at the section  $X_2 = 0.1L$ ,  $m$ ;
- $\psi$  = trim angle, positive if  $T_2 > T$ ,  $rad.$ ;
- $\bar{b}_2^*$  = the relative beam of the section at  $0.1L$  above base line at  $0.1B$ ,  $\bar{b}_2^* = b_2^*/B$ , (Fig. 3-22);
- $\beta_2^*$  = area coefficient for the section at  $0.1L$  between base line and  $0.1B$ ;
- $\bar{\sigma}_1 = \sigma_1 \sqrt{L/g}$ ;
- $\bar{\tau} = \frac{0.1(1-0.8\beta_2^*)\bar{\sigma}_1}{1+2.5Fr}$ ;
- $\sigma_1$  = frequency of the first flexural mode (natural);
- $Fr$  = Froude number;
- $a_*$  = RAO value for vertical motion of section at  $0.1L$ :

$$a_* = K(C_B) (1.3+6.5Fr) (2.4-1.75\alpha) (0.7 + \frac{10T}{L}) (0.3+3\rho_m) \quad (3-47)$$

- $K(C_B) = 1-12(C_B-0.67)^2 m$ , but not less than 0.80 for  $C_B > 0.67$  and 0.9 for  $C_B < 0.67$ ;
- $C_B$  = ship hull block coefficient;
- $\alpha$  = waterplane area coefficient;
- $\rho_m$  = relative radius of inertia.



$$\rho_m = \frac{1}{L} \left[ \frac{\int_0^L x^2 m(x) dx}{\int_0^L m(x) dx} \right]^{0.5};$$

$v(\bar{\tau}) =$  coefficient taking into account the impact impulse duration (Fig. 3-23).  
 $m(x) =$  ship mass distribution including added mass of water

The formula (3-47) is valid for Froude number  $Fr \leq 0.2$  and  $0.6 \leq \alpha \leq 0.9$ .

A similar formula is valid for the dynamic bending moment due to bow flare lamming:

$$M_{\max} = 0.003 \gamma \frac{K_M(\bar{x})}{\sqrt{C_B \rho_m}} \cdot \frac{h_{3\%}^2}{H_f} a_*^2 (1 + 2.5 Fr)_*^2 \quad (3-48)$$

$$\left[ (\bar{b}_f)^{1.5} \sqrt{1 - \left( \frac{1.5 H_f}{h_{3\%} a_*} \right)^2} - (\bar{b}_2^v)^{1.5} (\bar{b}_5^v)^{0.5} \right] B^2 L$$

where

$K_m(\bar{x}) =$  coefficient taking into account distribution of the bending moment (Fig. 3-24);  
 $H_f =$  freeboard at cross section  $0.1L$ , m;  
 $\bar{b}_2^f =$  relative beam of the upper deck at cross section  $0.1L$ ,  $\bar{b}_2^f = b_2^f/B$ ;  
 $\bar{b}_2^v =$  relative hull beam on the waterline at the section  $0.1L$ ;  
 $\bar{b}_5^v =$  the similar value for the cross section  $0.25L$ .

If value in the brackets is negative, the bending moment equals to zero.

The comparison of theoretical results obtained by using of the Equations (3-46) and (3-48) and experimental data is shown in Figures 3-25 and 3-26. The data represented in the form of nondimensional bending moment  $M_{\max} = M_{\max}/(0.5 \gamma h_{3\%} BL^2)$  correspond to the tanker "Sofia". The Figure 3-25 demonstrates the effect of Froude number on bending moment due to the bottom slamming. Figure 3-26 shows the behavior of the nondimensional bending moments for the bottom slamming (curve 1) and for bow flare slamming (curve 2) as a function of bow draught ration for constant Froude number  $Fr = 0.25$ . These data were obtained for the general cargo ship "Leninskyi Komsomol". It should be noted that the bending moment increases considerably with Froude number.

Equations (3-46) and (3-48) are quite informative. They enable the designer to evaluate the effect of ship motions parameters, environmental factors and main dimensions on the magnitude of the bending moments due to bottom and bow flare impact.

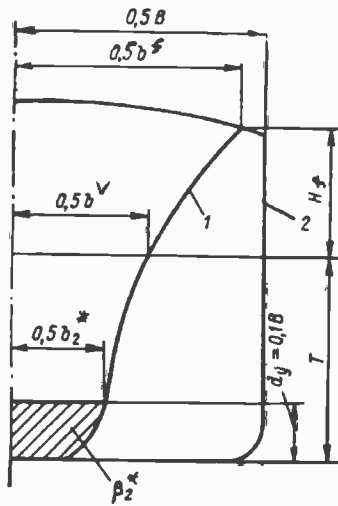


Fig. 3-22. Cross Sections at 0.1L (1) and Amidships (2) [98]

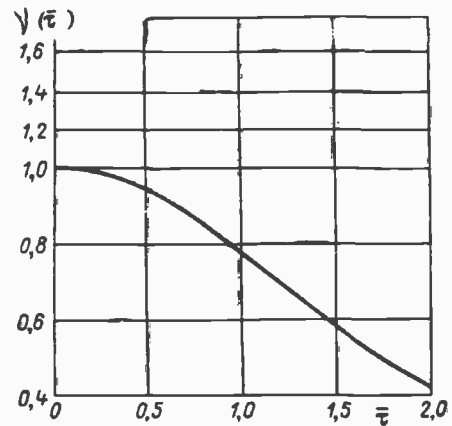


Fig. 3-23. The  $v$  value as a function of the impact duration  $\tau$  [98]

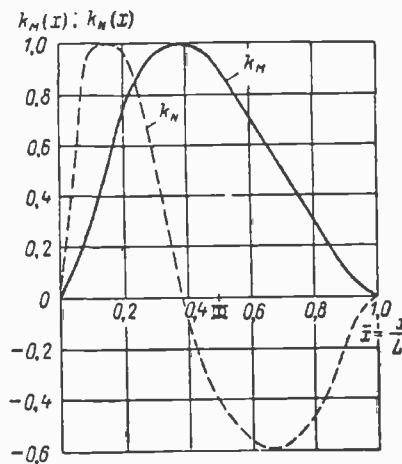
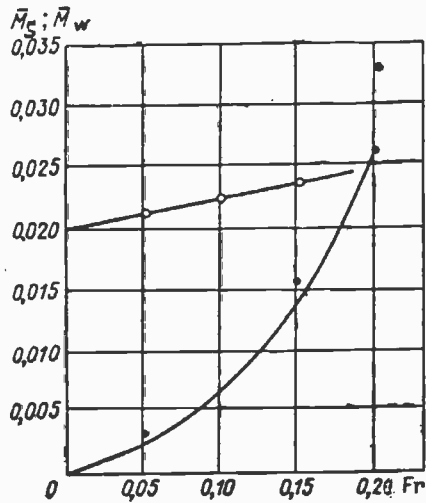
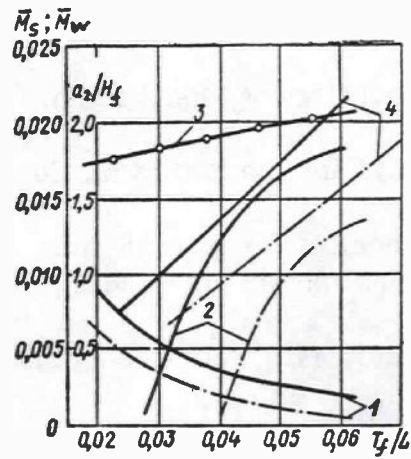


Fig. 3-24. Longitudinal Distribution of a Coefficient  $K_M$  for Bending Moment and  $K_N$  for Vertical Force Due to Bow Flare Slamming [98]



$T_f/L=0.032$ ;  $h_{3\%}/L=1/20$ ;  $\lambda/L=1$ ;  
 — formula (3-46) for maximum bending moment due to bottom slamming  $M_s$ ;  
 -o- wave bending moment  $M_w$ .

**Figure 3-25. Comparison of Theoretical and Experimental Results for Model of a Tanker "Sofia" [98]**



—  $h_{3\%}/L = 1/15$   
 -o-  $h_{3\%}/L = 1/20$   
 3 Wave bending moment  $M_w$   
 4 ratio of wave height at section  $0.1L$  to freeboard.

**Figure 3-26. Theoretical Data for Bending Moments Due to Bottom Slamming (1) and Bow Flare Slamming (2) for the General Cargo Ship "Leninskyi Komsomol" [98]**

In addition to those mentioned here, other computer codes have been developed by Mansour and d'Oliveira [27], Antonides [136], Yamamoto, Fujino and Fukasawa [89], Schlachter [26]. The procedures and programs selected for review above have been based on availability of reference material. Others may also be suitable for mention, but sufficient detail and computer codes are proprietary. A sample list of possible sources of other potential procedures, partly based on a U.S. Navy report [137], can be mentioned:

- David Taylor Model Basin (Generalized Bending Response Code GBRC);
- BMT International, Inc., Columbia, MD (now Designers & Planners, Inc.);
- Kockums Computer System AB, Sweden (program HULLTECH for simulating of ships' motion in frequency and time domains);
- Det Norske Veritas (ship motions programs SWAN-I and SWAN-II);
- Hydromechanics, Inc., Delray Beach, Fl (programs for simulation of wave induced responses and slamming SCORES II SLAM);
- Science Applications International Corporation, Annapolis, MD (Small Amplitude Motion Program SAMP and Large Amplitude Motion Program LAMP);
- Analytical Methods, Inc., Redmond, WA (Wave-Hull Interaction Program WHIP);
- Offshore Technology Research Center, College Station, TX;
- Future Technology, MTG Marin Technik GMBH, Hamburg, Germany;
- MARIN, Wageningen, The Netherlands;
- Advanced Multi-Hull Designs Pty. Ltd., Sidney, Australia

### 3.2.4.3 Classification Society Rules

Classification society rules for hull structure have considered special strengthening requirements pertinent to slamming. These do not explicitly address the loading but instead are generally implemented under the subject of strength of forward structures of the vessel.

In general, all societies require stiffer floors and girders, closely spaced stiffeners and, in some cases, intermediate stiffeners or intercostals. The bottom platings are increased; however, some rules have allowed less increase in plating thickness if certain additional stiffeners are added. A comparison of various rules is shown in Table 3-2 [3].

### 3.2.5 Seakeeping

#### 3.2.5.1 General

The analytical evaluation of seakeeping has long made successful use of slender body and linear two-dimensional strip theory.

Classification Society	Extent of Forward Strengthening	Limits of Forward Draft at FP for Bottom Plating	Ship Speed
American Bureau of Shipping	0.25L if $C_b \leq 0.6$ 0.30L if $C_b \geq 0.8$	Bottom plating strengthening procedure is provided	Subject to special consideration
Bureau Veritas	0.25L	Bottom plating strengthening procedure is provided	
China Corporation Register of Shipping	0.2L if machinery amidships, 0.25L if machinery aft of comparatively broad flat-of-bottom forward	Bottom plating strengthening procedure is provided	Extend strengthening to 0.25L from the fore-end in ship's of relatively high speed
Det Norske Veritas	Depends on forward ballast draft, breadth of bottom, and ship's length	Strengthening method is based on estimating slamming pressure	Embedded in slamming pressure
Germanischer Lloyd's	0.25L if machinery amidships, if machinery aft, 0.3L if $L < 100$ m 0.25L if $L > 150$ m (0.4 - 0.001L) if $100 \text{ m} \leq L \leq 150 \text{ m}$	Bottom plating strengthening procedure is provided. Full strengthening if draft is $< 0.03L$ . No strengthening at all if draft is $> 0.04L$ . L should not be taken more than 200 m.	If speed $> 1.6\sqrt{L}$ kts, strengthening extends aft. If speed $> 10$ kts or $1.2\sqrt{L}$ kts, bottom plate thickness increases by 0.5 mm for each extra knot of speed and not to exceed 2 mm
Korean Register of Shipping	From 0.15L to 0.3L according to $\sqrt{VL}$	Strengthening method is based on estimating slamming pressure	Embedded in slamming pressure
Lloyd's Register of Shipping	0.3L	Strengthening method is based on estimating slamming pressure	
Nippon Kaiji Kyokai	From 0.15L to 0.3L according to $\sqrt{VL}$	Strengthening method is based on estimating slamming pressure	Embedded in slamming pressure
Registro Italiano Navale	Between 0.25L and 0.05L	Bottom plating strengthening procedure is provided	
Register of Shipping USSR/Romanian	0.25L	Bottom plating strengthening procedure is provided	$\sqrt{VL} > 1.25$ bottom strengthening area shall extend aft from the section located at 0.25L from FP by 0.03L for each additional knot, but in any case, the length of strengthening area shall not exceed 0.5L

Table 3-2: Classification Society Rule Features Pertinent to Slamming [3]



The usual seakeeping quantities of interest are global hydrodynamic forces or bending moments and shear forces in the main body of the hull. These forces and moments are typically insensitive to end effects where strip theory approximations are less valid. However, Troesch and Kang [5] have shown that in some cases two-dimensional and three-dimensional bow flare slam theoretical results compare well to each other.

Some approaches to the analysis of slamming substitute the frequency-dependent added mass computed for seakeeping analysis for the infinite fluid added mass resulting from the impact boundary value problem as discussed by Beukelman [137a]. The impact pressure or impact force is determined for the predominant frequency of encounters for the vessel in a seaway. Armand and Cointe [43] have discussed the use of infinite frequency added mass under circumstances of shallow drafts and small time scales. Troesch and Kang [5] indicate concern for the general use of frequency dependent coefficients which are derived from linear frequency domain hydrodynamics which are derived from a different boundary value problem than the impact added mass.

### 3.2.5.2 Seakeeping Hydrodynamics

Kaplan et al [125]\* and [138,139] have developed a procedure for vertical plane motion slamming and bow flare impact utilizing 2-D ship motion theory and impact momentum theory for the prediction of hull girder bending moments and shear forces. Local pressures are not determined. The slam force  $P(x,t)$  is made up of two terms, one of which is of inertial nature considering momentum and the other is due to buoyancy. Both are the result of the continuing submergence of the hull during a slam event.

$$P(x,t) = P_1(x,t) + P_2(x,t) \quad (3-49)$$

$$P_1(x,t) = -\frac{D}{Dt}(m_{nl}w_r) \quad (3-50)$$

where the operator

$$\frac{D}{Dt} = \frac{\partial}{\partial t} - V \frac{\partial}{\partial x} \quad (3-51)$$

$m_{nl}$  is the additional added mass at a 2-D section that is determined from the instantaneous immersion geometry of the ship section. This added mass is frequency dependent. (The authors note a high frequency limit is used to arrive at frequency independence.) The relative velocity  $w_r$  is determined from the 2-D linear seakeeping theory solutions of the rigid body motions.

$$P_2(x,t) = \rho g A_{n2}(Z_r, x) \quad (3-52)$$

Where similar to Jasper [119] and Chuang [120], Equation (3-39),  $A_{n2}$  is the additional cross-sectional area at a section due to the difference between the area corresponding to the instantaneous submerged portion of the ship section and that corresponding to the still waterline, and after eliminating the linear buoyance force terms.

Kaplan [102]<sup>\*</sup> has extended this procedure to predict slamming of twin hull vessels with centerbody or cross structure such as SES, SWATH and catamarans by introducing forces due the cross structure and adding them to the flare effects considered for monohulls. The author's approach to determining the centerbody impact forces are discussed in Section 3.2.3 herein.

### 3.2.5.3 Seakeeping Events

Ochi and Motter's analysis technique is developed through a series of publications spanning a number of years [for example 11,12,28,88,140,141,142]. The culmination appears to be a method taking into account the entire spectrum of phenomena surrounding slamming [28]<sup>\*</sup>. The heart of the method describing the hydrodynamic impact itself is based on the empirical and widely used pressure relation for two-dimensional sections, which is discussed further in Section 3.3.1:

$$p = kV^2 \quad (3-53)$$

Seakeeping events are then considered to identify the frequency of occurrence of slamming and the relative velocity between the ship and the wave at the occurrence. The seakeeping events are assumed to be Raleigh distributed. Since the amplitude of relative velocity follows the Raleigh probability law, it can be shown that the impact pressure has a truncated exponential probability distribution. A comparison between the theoretical probability density function and the histogram of impact pressure obtained from model experiments shows some discrepancy at lower pressures, but overall agreement appears reasonable. From the probability density function, the average and 1/3 highest pressure can be obtained.

It is assumed the magnitude of impact pressure varies randomly from one impact to the next following the truncated exponential probability distribution. The statistical prediction of the extreme values of impact pressure can be achieved by application of order statistics. The desired slamming pressures are obtained for two-dimensional strips of the hull and the results are added to provide an integration along the length of the vessel.

### 3.3 Experimental Results

#### 3.3.1 Model Tests

##### 3.3.1.1 Results

Experimental study on slamming impact is generally divided into two types; one being the two-dimensional drop of a body onto the water surface, the other being the model experiment conducted in either regular or irregular waves generated in the towing tank. In both cases, the common purpose of these studies is to obtain the relationship between the pressure magnitude and the velocity at the instant of impact for a given body. The two-dimensional test results are useful to evaluate qualitatively the effect of hull form on impact or to evaluate the structural response of bottom plate to an impact load if a structural model is employed in the test. This can be seen in Szebehely [143], Ochi [144], Clevenger [145], and Chuang [146][147]. A review of the literature published in various fields on hydrodynamic impact and water entry may be found in the work of Szebehely and Ochi [143] Chuang [148], as well as 11th ISSC [24,115].

Pressure measurements on the bottoms of two types of planning hulls were published by Hirano, et al [149,150]. These measurements were performed on the models of a wedge-form hull and of a prismatic bottom with 13 degrees of deadrise and vertical sides. Tests were performed in calm water and the primary objectives were measurements of lift, drag and moment.

Watanabe, *et al.* [151] observed the bottom impact phenomena on a flat bottomed tanker model by means of high speed video and a transparent model. The model was towed in regular waves and was free to heave and pitch. One camera was set to monitor the impact through the hull, the other camera was used to record the pressure shown by an oscilloscope. Three types of slamming events were observed. They were called, (a) oblique impact, (b) trapped-air impact, and (c) normal impact. The videos showed that the high peak pressure occurs for the trapped air impact when the pick-up is in the region of the trapped air. In the case of "normal" impact the tests confirm that the pressure peak is related to the rapid expansion of the wetted area. The authors conclude that in every case three-dimensionality plays an important role.

The effect of bow flare on wave loads of a container ship was investigated by Watanabe, *et al.* [152]. A model with two types of bow flare shapes was tested in regular and irregular waves. The model was built of synthetic resins simulating the bending stiffness of the ship. Test measurements were analyzed for impact pressures at the bow, frequency of deck wetness and green seas as well as the asymmetry of the vertical wave bending moment.

Chiu, et al [153] had earlier presented a method to predict vertical motions and vertical wave loads on high speed craft which are assumed rigid. The authors determined that as the size of high-speed vessels increases the influence of fluid-structure

interaction needs attention. A rigid and an elastic model for the craft were used, and in addition, tests were carried out to measure vertical motions of two wooden models of different scale ratio. Another test series was carried out to measure the vertical bending moment along ship's length incorporating an elastic "backbone". The conclusion was that the two methods for predicting the vertical loads were satisfactory for practical purposes. The correlation between the maxima of vertical bow acceleration and bending moment was confirmed also for high speed craft of larger size.

Nagai and Hashimoto [154] address the problem of longitudinal stress and local pressure load in the bottom structure subjected to impact loads. Tests carried out comprised drop tests of flat fiber reinforced plastic (FRP) plates horizontally on a water surface and of measurements during sea trials of FRP high speed craft.

Sawada and Watanabe [155] compared two approaches to construct elastic ship models which simulate the elastic response of a ship at model scale, viz: (1) using synthetic resin for the shell; (2) using aluminum bars as the hull "backbone" while urethane foam is utilized for shaping the hull. Three models were built and tested: A container ship and a high speed patrol craft in accordance with method (1); and a bulk carrier following method (2). Comparison with sea trial results is said to show excellent agreement.

The results obtained from experiments on models representing various sectional shapes are compiled in SNAME [3] and information concerning these tests is given in Table 3-3, and the data are plotted in Figure 3-27. The following remarks are provided relative to Figure 3-27:

- Magnitudes of impact pressure are the maximum values during impact.
- All lines showing the relationship between pressure and velocity were drawn such that the impact pressure is proportional to the square of the velocity. Impact pressure is expressed by:

$$p = kV_i^2 \quad (3-54)$$

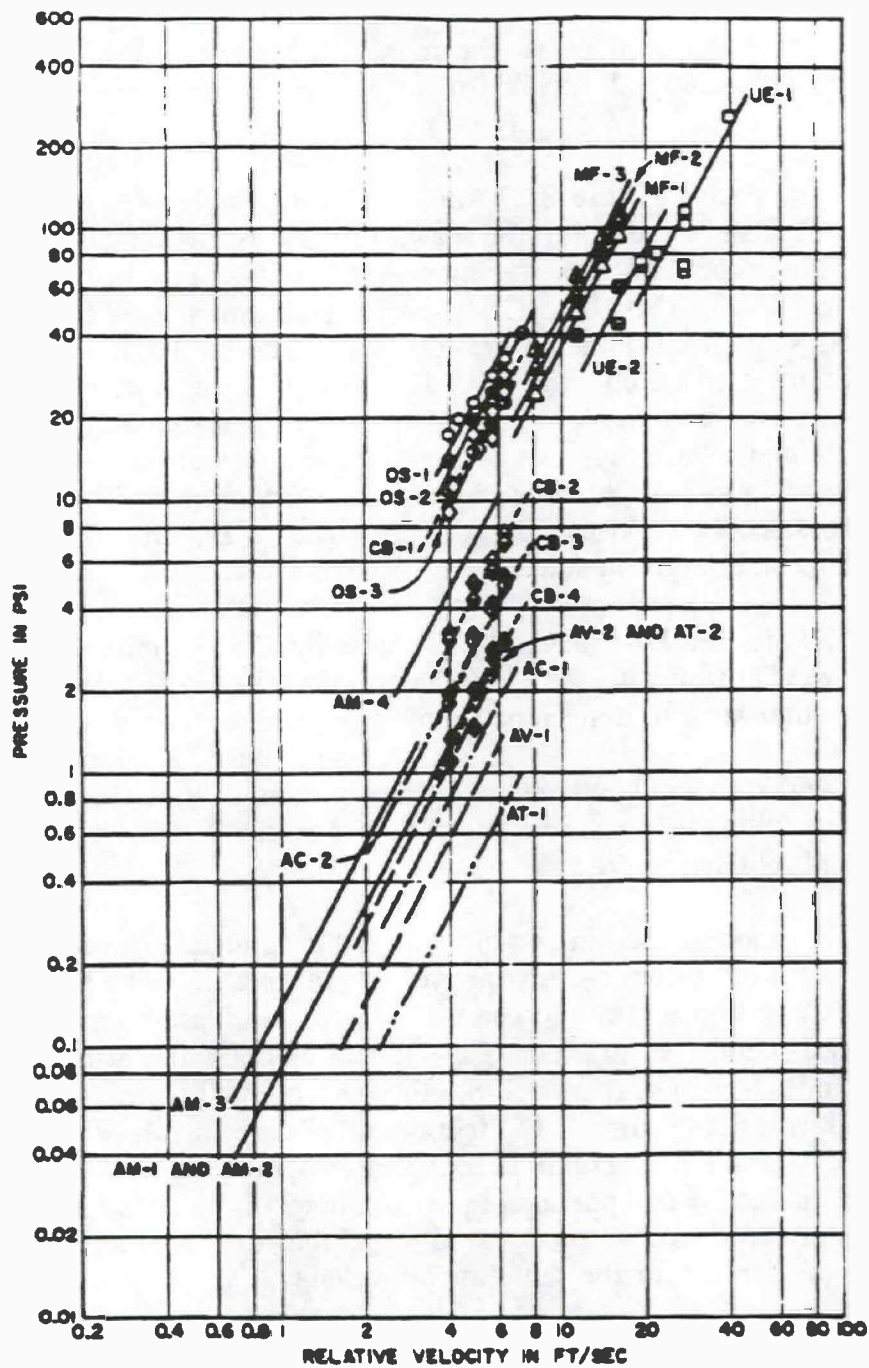
where  $k$  is a constant which depends on the body cross section shape, and  $V_i$  is the velocity at the moment of impact. Van Karman [32,40] and Wagner [33,41] originally used  $2C$  for what later became  $k$ . Here pressure  $p$  is in psi (lbs/sq.in.), and velocity is in ft/sec.

- There is no significant effect of ship speed on the  $k$ -value for low and medium speed ships.
- The  $k$ -value for regular or irregular waves is virtually identical.
- The  $k$ -value is virtually identical for different sea states

Ident.	Test		Model		k-value psi-sec <sup>2</sup> /ft <sup>2</sup>	Reference
	Drop Test	Seaworthiness Test	Two-Dimensional	Ship Form		
AM-1		Irregular waves		12.7-ft. MARINER, Station 2	0.086	74
AM-2		Regular waves		5.5-ft. MARINER, Station 2	0.086	7
AM-3		Regular waves		5.5-ft. MARINER, Station 3 1/2	0.145	
AM-4	Open water			5.5-ft. MARINER, Station 3 1/2	0.305	
AV-1		Regular and irregular waves ↓		17.5-ft. Modified MARINER, Station 2	0.033	73
AV-2				12.7-ft. Modified MARINER, Station 3 1/2	0.077	
AC-1				17.5-ft. CHALLENGER, Station 2	0.053	74
AC-2				17.5-ft. CHALLENGER, Station 3 1/2	0.125	
AT-1				17.5-ft. TOWNSEND, Station 2	0.021	
AT-2				17.5-ft. TOWNSEND, Station 3 1/2	0.077	
MF-1	Test channel (2-dimensional flow) ↓		10.2 x 7.7 ft Flat bottom Structural model (22,500 lbs)		0.365	69
MF-2			↓ (28,800 lbs)		0.420	
MF-3			↓ (39,300 lbs)		0.495	
OS-1			U-form (190 lbs)		0.950	70
OS-2			UV-form (190 lbs)		0.780	
OS-3			V-form (190 lbs)		0.580	
UE-1	Open water ↓		7.5 x 6.6 ft Wedge (10 deg) Structural model		0.150	71
UE-2			7.5 x 6.6 ft Flat bottom Structural model		0.210	41
CB-1	Test channel (2-dimensional flow) ↓		26.5 x 20 in. Flat bottom		0.660	
CB-2			26.5 x 20 in. Wedge ( 6 deg)		0.190	72
CB-3			(10 deg)		0.125	
CB-4			(15 deg)		0.031	

Table 3-3. Models Used in Slamming Impact Study [3,142]





**Fig. 3-27. Slamming Impact Pressure-Velocity Relationship Obtained From Experiments on Models Representing Various Section Shapes [3]**

- The critical portion of the impact process is over when the section is submerged to a depth of 1/10 its calm water draft, or .005 the vessel length.

The generalized form of the impact pressure-velocity relationships for different model tests was published in Principles of Naval Architecture [156] and is presented in Fig. 3-28.

Comparing Figure 3-27 and 3-28 with Table 3-3, it can be seen that all pressure magnitudes obtained from the seaworthiness tests are smaller than those obtained from the two-dimensional tests for the same velocity. It is of particular interest to compare the k-values for AM-3, AM-4, and OS-2 since the section shapes for which the pressure-velocity relationships were obtained are the same, (Station 3-1/2 of the MARINER), but the test conditions are entirely different. That is, AM-3 was obtained from seaworthiness tests in regular waves on a 5.5 foot model at a speed corresponding to 10 knots full scale. AM-4 was obtained from drop tests of the same model onto a calm water surface from various heights and OS-2 was obtained from a drop test of a two-dimensional model having a constant cross section. As can be seen in Figure 3-27, the k-values are significantly different and become larger in sequence of AM-3, AM-4, and OS-2.

Sikora and Disenbacher [157] have carried out model tests of the 3500-ton TAGOS 19 SWATH ship with the model instrumented on the wet deck, the haunch, and the inner and outer strut to determine slam, frontal impact and wave slap pressures.

Wahab, et al [158] report on model tests of the ASR Catamaran in waves. These data, plus full scale measurements obtained on the T-AGOR-16 in the Atlantic, are further analyzed by Giannotti and Fuller [159].

For models used in two-dimensional drop tests, Figure 3-27 also shows some trend on the effect of bottom rigidity on pressure magnitude. The OS-group models have a 2.5 inch thick wood bottom reinforced with 1 inch aluminum bar and appear to have the highest rigidity as compared to Model CB-1 (small model with flat bottom, steel plate 1/2 inch thick). Model MF-1 (large model with flat bottom, steel plate 1/2 inch thick), and UE-2 (large model with flat bottom, HTS steel plate 1/8 inch thick). Pressure magnitudes for the same velocity gradually decrease in sequence following the above listed order. Chuang [147] made an interesting comparison of pressure magnitudes between the two-dimensional rigid and pressurized inflatable model, and found that the latter showed considerably less pressure than the former for the same impact velocity.

The trapped air phenomenon appears to occur in reality for two-dimensional impact of a flat body on the smooth water as evidenced by underwater photographs shown by Chuang [160]. Fujita [161], Lewison and Maclean [162], and Johnson [163] also studied this problem.

Whitman and Pancione presented a "scaling law" for maximum pressure on a flat plate with entrapped air due to hydrodynamic impact [164]. Under the assumption that air compression is polytropic and the inertia terms are small compared with the viscous terms, they found that the maximum pressure varies directly with the leakage of the trapped air. Thus, circular plate of diameter  $\ell$  should experience a maximum pressure only 83

percent of that of a square plate of edge  $\ell$  for the same weight and drop height. They derived a "similarity" parameter scaling impact pressures which consider several variables addressed in experiments performed by Gerlach [165], including air content.

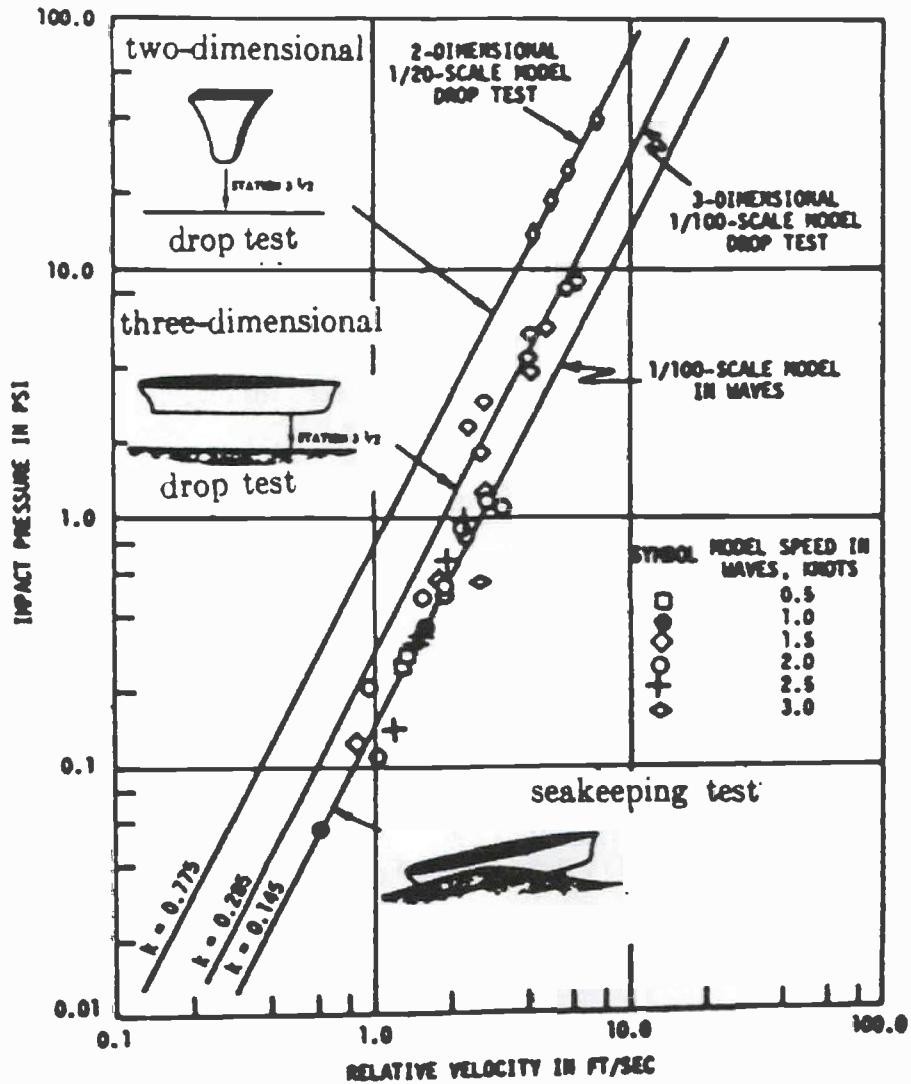


Fig. 3-28. Comparison of Pressure-Velocity Relationships Obtained in Three Different Types of Slamming Experiments [156]

Nott [166] has confirmed by model tests that in general for the non-uniform hydrodynamic pressures on sonar domes, a simulation by multiple static loads and the influence-coefficient method of Lunchick et al [167] leads to stresses equivalent to those resulting from three-dimensionally applied steady state hydrodynamic loads.

Garcia [168] has carried out tests concerning shock pressures created by water waves breaking against vertical barriers. These wave pressures were studied using small-scale oscillatory waves in a flume fitted with a beach slope and test wall. The variation of pressure with both time and position on the wall were determined for several wave heights, wave periods, water depths, and beach slopes. The variation of pressure with time was found to be similar to that reported by previous investigations. The pressure-time variation can be divided into two parts; namely, initial shock pressure which occurs as the wave strikes the wall and a secondary pressure which is associated with the run up of the wave on the wall. The shock pressure is characterized by a very intense pressure peak of short duration as shown in Figure 3-29 which also notes data from the work of Ross [169], Denny [170], DeRouville et al [171], Nagai [172] and Rundgren [173]. This is followed by the much less intense but longer duration secondary pulse. Equations 3-64 through 3-66 define the terminology. The maximum shock pressure that occurred for each wave condition was localized over a small region of the test wall between the still-water level at the wall and the elevation of the crest of the wave striking this wall. Above the region of maximum shock pressure the magnitude of pressure decreases to zero and below to one-tenth of the maximum.

### 3.3.1.2 Model Scale Effects

In any attempt to determine the slamming pressure of a ship by means of model tests, the laws of similitude are of prime importance. These include modelling and scale effects on size, weight, two-dimensional versus three-dimensional models, and drop tests versus tests on waves.

The publications in the literature discussed in the previous section demonstrate the progress achieved in the understanding and modeling of impact phenomena. Nevertheless, the International Ship Structures Congress listed a number of issues which still need clarification [115]. Among these are:

- Scale effect between model tests and full scale for the different forms of hydrodynamic impact; there are indications that there ought to be a scale effect when air entrapment is involved;
- Randomness of impact pressures due to small scale water surface deformations (ripples) and possibly other effects, even for similar relative configurations in the macroscopic sense. In this context, the water surface after ship bottom emersion or in the splash zone is never smooth.

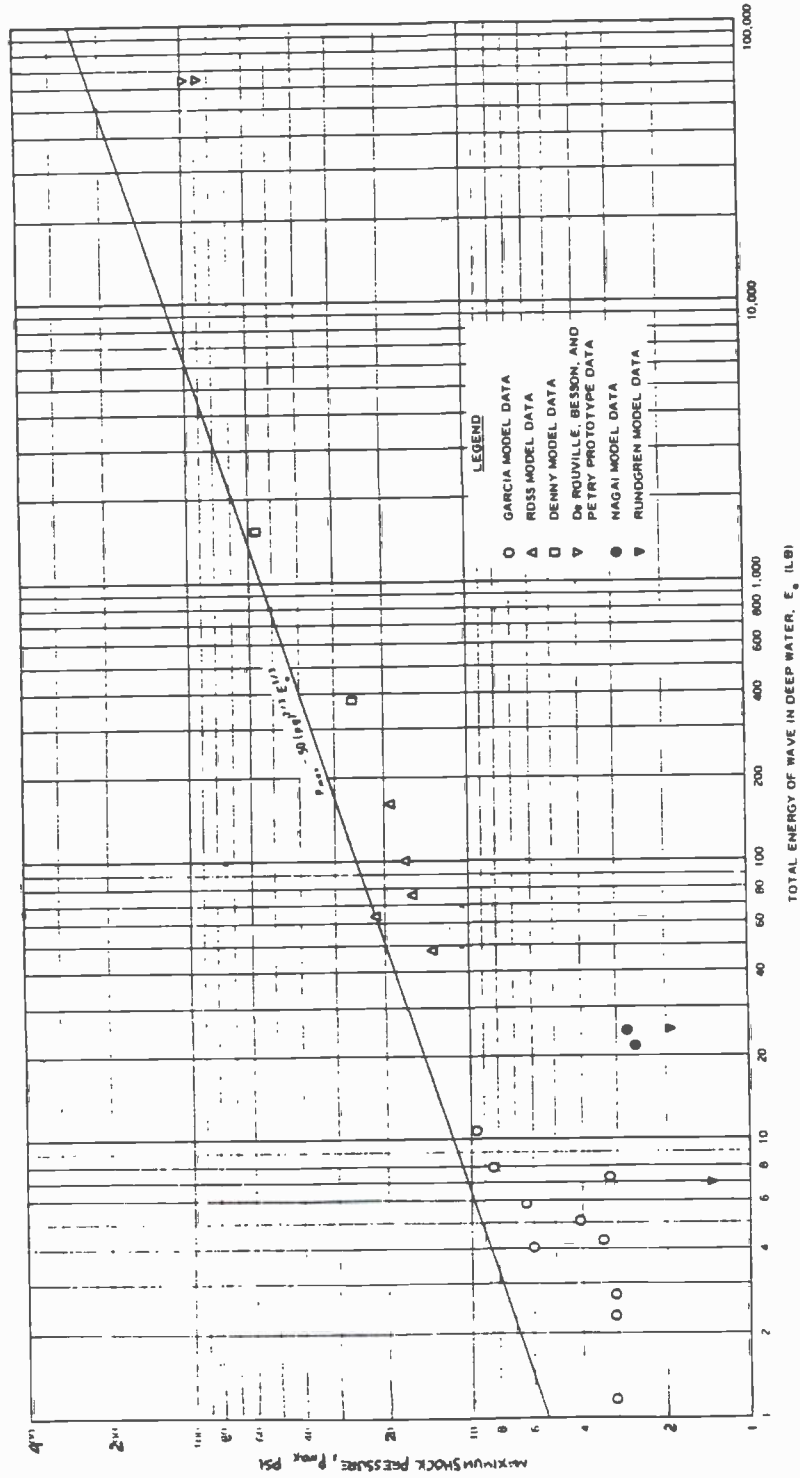


Figure 3-29: Maximum Shock Pressure Versus Total Energy of Wave in Deep Water [168]



A discussion and analysis of modelling scale effects is provided in SNAME [3] and it is concluded that in slamming tests of models, the differences in impact pressure may be caused by the following:

- Froude scaling applies.
- Mass per unit impact area are different between model and full-scale.
- Fluid can flow more easily in three-dimensional flow than in two-dimensional flow.
- Impact of the flat-of-bottom generates the maximum impact pressure at its center with gradually reduced pressure away from the center, and zero pressure at the edges, hence measurements must be comprehensive.
- $p = kV^2$  can be applied to both the model and the ship regardless of their sizes, i.e.,  $k$  depends on body cross sectional shape only.

However, as the phenomena of hydrodynamic impact loads are multi-variable, model tests provide a means to determine these loads taking into account the interrelated effects. SNAME [3]<sup>\*</sup> notes that the model must be fitted with pressure panel sensors whose design is based on Froude scaling and match the structural configuration, scantlings and the corresponding dynamic frequencies to be investigated. Sellars [84] has identified the necessary structural scaling as equivalence of the Cauchy number giving the relative magnitude of inertial forces to elastic forces. The sensors may represent a plate panel or a grillage. It is suggested the model be constructed of polyvinyl chloride (PVC) sheets mounted on a support frame. The panels and grillages should be instrumented with strain gauges to provide a direct means of relating measured structural response to an equivalent uniform impact load. A similar problem was investigated by Band [174]. He found that for the determination of wet-deck slamming loads the local structure in question (plates, stiffeners, etc.) must be modeled with scaled rigidity. Specially constructed panels, that can be calibrated to measure average pressure, must be incorporated in the model. In this case, meaningful pressures, shear forces, bending moments can be obtained from measurements.

Faltinsen [175] investigated the effect of varying velocity during impact (velocity time history) on pressure magnitude and distribution. He pointed out that it is very important to account for the varying velocity - that means the large retardation of the body that occurs at the end of impact. The retardation causes pressure reduction due to the "added-mass" effect. This means that drop tests require accurate velocity measurements of the model. Further, the scaling of drop tests results to full-scale pressure on a vessel is questionable when large retardations of the model occur. Since a vessel will have a smaller retardation than the drop test model, unconservative full-scale predictions for a vessel can occur as a consequence. The effect of the model retardation is illustrated in Fig. 3-30 from

[68]. This figure shows the free-surface elevation and the pressure distribution at the final time of the numerical simulation by the nonlinear boundary element method. Three different cases are presented. One case is with a symmetric body and constant downward velocity of  $V_0 = 4.05$  m/s. The two other cases are with an asymmetric body. The geometry of the body was taken from Yamamoto paper [176]. It can be seen that the variation of velocity is more important than whether the body is symmetric or asymmetric.

The model testing can include collections of wave impact data for a range of sea, heading and speed conditions which correspond to the ship's projected operational environment. A probabilistic analysis can then be performed to determine a maximum lifetime design pressure. If a Weibull analysis is performed, the following results are given:

$$N_p = f(I_n) \quad (3-55)$$

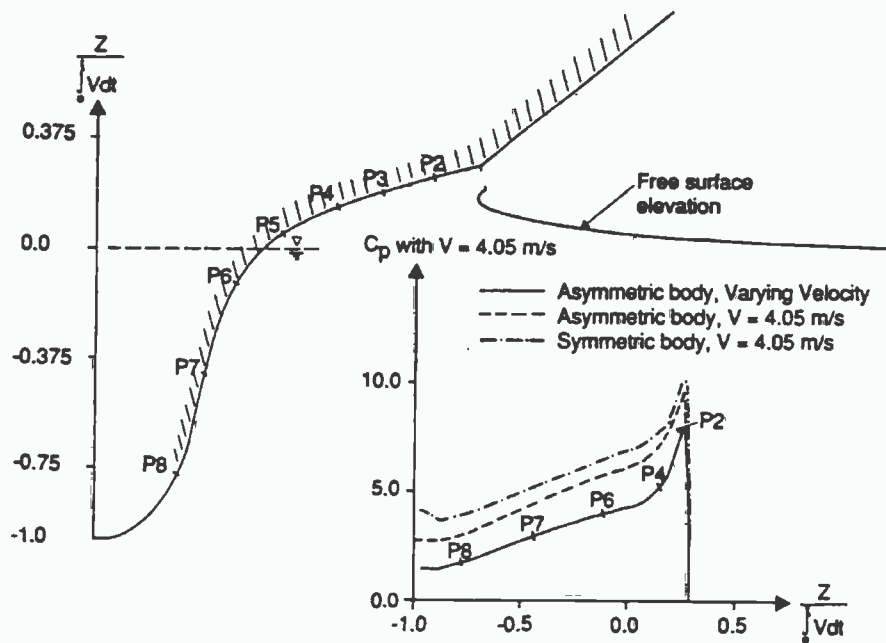
$$p_\alpha = \frac{p_{\max} \left[ \ln \left( \frac{N_p}{\alpha} \right) \right]^{1/M}}{[\ln(N_p)]^{1/M}} \quad (3-56)$$

where:

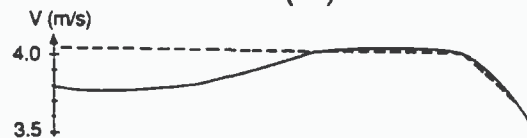
- $N_p$  = The total number of impacts expected over the life of the vessel for the gauged locations and operating conditions;
- $I_n$  = The frequency of impacts as determined from model tests for a specific combination of ship speed, heading and sea state;
- $M, \beta$  = Slope and y intercept of Weibull plot;
- $p_{\max}$  = Pressure with 63.2% probability of being exceeded;
- $\alpha$  = Probability of exceedance;
- $p_\alpha$  = The extreme maximum pressure with a probability of exceedance  $\alpha$ .

### 3.3.2 Full Scale Data

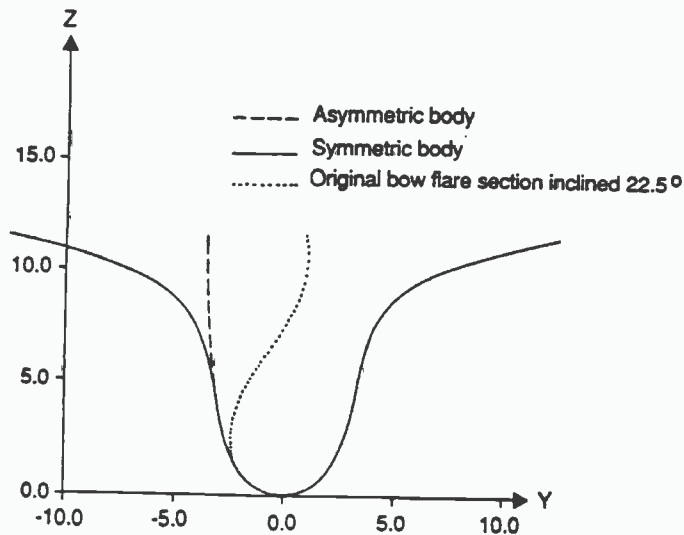
Significant full scale slamming data are available. A list of references is given under "Full Scale Measurements" in [177] and other full scale information is referenced in [178]. More recently Daidola et al [179] have prepared a bibliography supporting this SSC project which includes data for aircraft landings as well.



(a)



(b)



(c)

**Fig. 3-30. Effect of Velocity Time History and Body Geometry on Free-Surface Elevation and Pressure Distribution on the Cross Section With Bow Flare at Final Time of Numerical Simulation**

(a) Results of simulation

(b) Impact velocity time history

(c) Cross sections of model used in numerical simulation

There are two major types of slamming data collected. The first type concerns the local slamming at the bow. This includes local slamming pressure measurements and the local structural response in the slamming areas, such as information obtained from the sea trial of USCGC UNIMAK [180] and Motor Torpedo Boat YP 110 (ex PT 8) [181].

The second type of slamming data collected concerns the hull whipping stress caused either due to the bow flare slamming, such as sea trials of USS ESSEX [182], or bottom slamming, such as the sea trials of USS EDWARD MCDONNELL (DE 1043) [183] and other ships [184][185][186][187][188]. The analyses of sea trial data of USS ESSEX were performed and used to compare with the model test [189], the Seaworthiness Analog Computer [190], and the Structural Seaworthiness Digital Computer Program [120]. Their agreements were considered very good.

Data collections on bottom slamming during ship operations were attempted by several ships. The S/S WOLVERINE STATE is probably one of few where enough information to be reported [191] was obtained.

Pegg *et al.* [192] have carried out finite element predictions of measured bow flare plate stresses under dynamic loading. The analyses are based on pressures measured on the research vessel CFAV QUEST as shown in Figure 3-31.

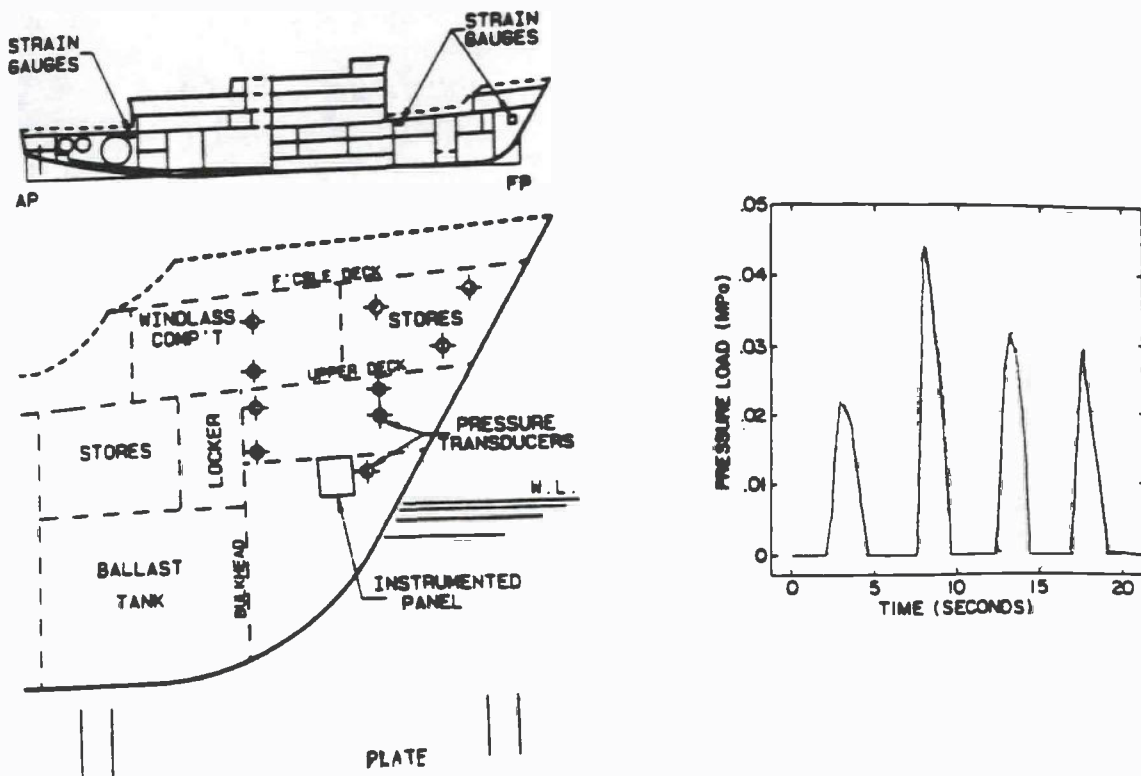


Fig. 3-31. Bow Flare Pressure Pulses on CFAV QUEST [192]

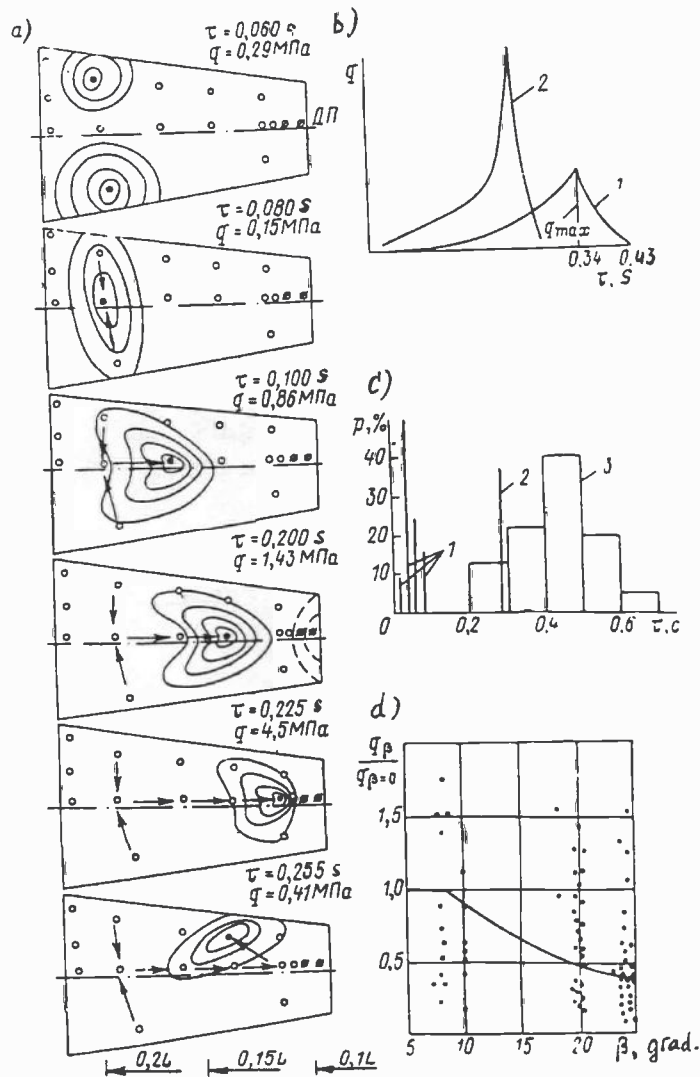
The sea trials of the catamaran USNS HAYES collected a considerable amount of test data on the slamming of cross structure (which bridges the twin hulls of the catamaran) [118].

Takemoto, et al [193] measured wave impact loads and hull response during sea trials with a 1,300 ton patrol vessel in severe seas with variation of heading and ship speed. Some of the results were published earlier. Further analysis showed that: (1) Bow flare slamming induced high bending stresses in the deck; (2) Bow flare slamming induced whipping vibrations; explanations of the excitation mechanism were deduced which also explain the sharp decay of whipping vibration after the strike; (3) Whipping stresses and frequencies are high when compared with normal wave bending; therefore, they can be expected to have an influence on fatigue life.

Purcell, et al [194] published a structural analysis of the forward bottom of a patrol boat. The analysis uses relatively simple assumptions for the impact load. Slamming pressure measurements on a model in irregular waves and the results of sea tests with the full-scale craft, which was driven at high speed into severe seas, causing slamming and some dishing of the plating were reported. Conclusions include recommendations for structural improvements.

Full-scale measurements of impact loads were performed by Barabanov et al [195,96] and by Rask [196]. For a 34 m patrol boat, the latter author compared the measured k-factor in the formula of equation (3-54) for impact pressure. He concluded that the k-factor varied considerably from one impact to another, depending to a great extent on the rolling motion. Analysis of full-scale results for three ships enabled the author [195] to derive a semi-empirical formula for slamming design loadings with parameters depending on ship speed, length and draft. Very strong speed and draft dependences can be identified.

Bugakov [197,198] has reported on his investigations of slamming effects and storm damages and their relations to safe sea speed and performance of hull forward bottom structures. In the case of a reefer vessel KAMCHATSKIYE GORI, damages were reported on the side shell plating after heavy weather operations. Authors of [195] and [197] reported a recorded peak slamming pressure of 4.5 MPa (654 psi) during an experimental cruise, Figure 3-32, more than twice the 2.17 MPa (315 psi) maximum pressure recorded during the sea trials of the USCGC UNIMAK. In studying several ship classes, Bugakov found that slamming damage repairs cost 2.5-3 times that of new construction and a 60-70% increase in plate strength reduces slamming damage expenses by about 75%. He concluded that, giving consideration to lost ship speed, repair and vessel availability costs during repairs, it is best to increase scantlings in the bow flare and foredeck between 0.1 and 0.2L and in the bottom plating from 0.22-0.32L aft of the forward perpendicular. Bugakov recommended use of special storm diagrams as guidance for safe sea speed, constructed to indicate permissible speed for ships being designed, built and operated. They should be included as a part of the ship's seaworthiness and strength certificate. Such diagrams were published by Aertssen [199], Tasaki et al [200], Cruikshank [201], Lipis and Remez [114].



**Fig. 3-32. Full Scale Slamming Pressure Measurements on Reefer Ship "KAMCHATSKIE GORI" [197]**

- (a) Loading process during most strong hit; o pressure gauges;  $\phi$  pressure gauges destroyed during sea trials; — contours of constant pressure.
- (b) Typical pressure time history.
- (c) Natural half of periods of fore bottom structure (1), hull (2) and slamming pressure duration (3).
- (d) Effect of deadrise angle on slamming pressure.



Solomentsev [202] points to poor seaworthiness of twin hull vessel structure mainly due to a serious underestimate of the frequency and severity of cross-structure slamming impacts. Seven passenger, ferry, fishing and research vessels are reviewed and design recommendations were made for seaworthiness improvements that will not result in substantial deterioration in the economic attributes of these vessels, e.g., fuel consumption and structural weight.

### 3.3.3 Empirical Procedures Based on Experiment

#### 3.3.3.1 k-Value Procedures

A number of empirical procedures based on experiment predominantly seek to identify the value of "k" in Equation (3-54).

In his earlier work Ochi [142] develops *k*-values for eight hull transverse section forms through the use of model experiment results. Later, Ochi and Motter [203] developed a technique for calculation of *k* or *k<sub>1</sub>* from an equation with coefficient obtained from a three parameter mapping of a hull section:

$$\begin{aligned} k &= e^{(-3.599 + 2.419a_1 - 0.873a_2 + 9.6241a_3)} \\ k_1 &= k/1/2\rho \end{aligned} \tag{3-57}$$

The authors [28] have attempted to simplify the *k*-value prediction technique by presenting them for a series of section shapes in a graphical format for a total series of 120 different hull form sections with various combinations of beam/draft ratios, sectional area and flat of bottom. Figure 3-33 gives an example of the results where the computed *k<sub>1</sub>* values are presented as a function of width/draft ratio, *b/d*, flat of bottom width ratio, *b\*/b*, and the sectional area coefficient  $C_a = A^*/(2bd)$ . The term *b\** is the half width of the flat-of-bottom and *A\** is the full sectional area below the one-tenth of the design draft, *d*, at the design beam, *b*. The authors conclude that the *k<sub>1</sub>* value appears to be a function of *b\*/b* for any *b/d* value, and independent of the hull shape series A, B or C, and of the sectional area coefficient.

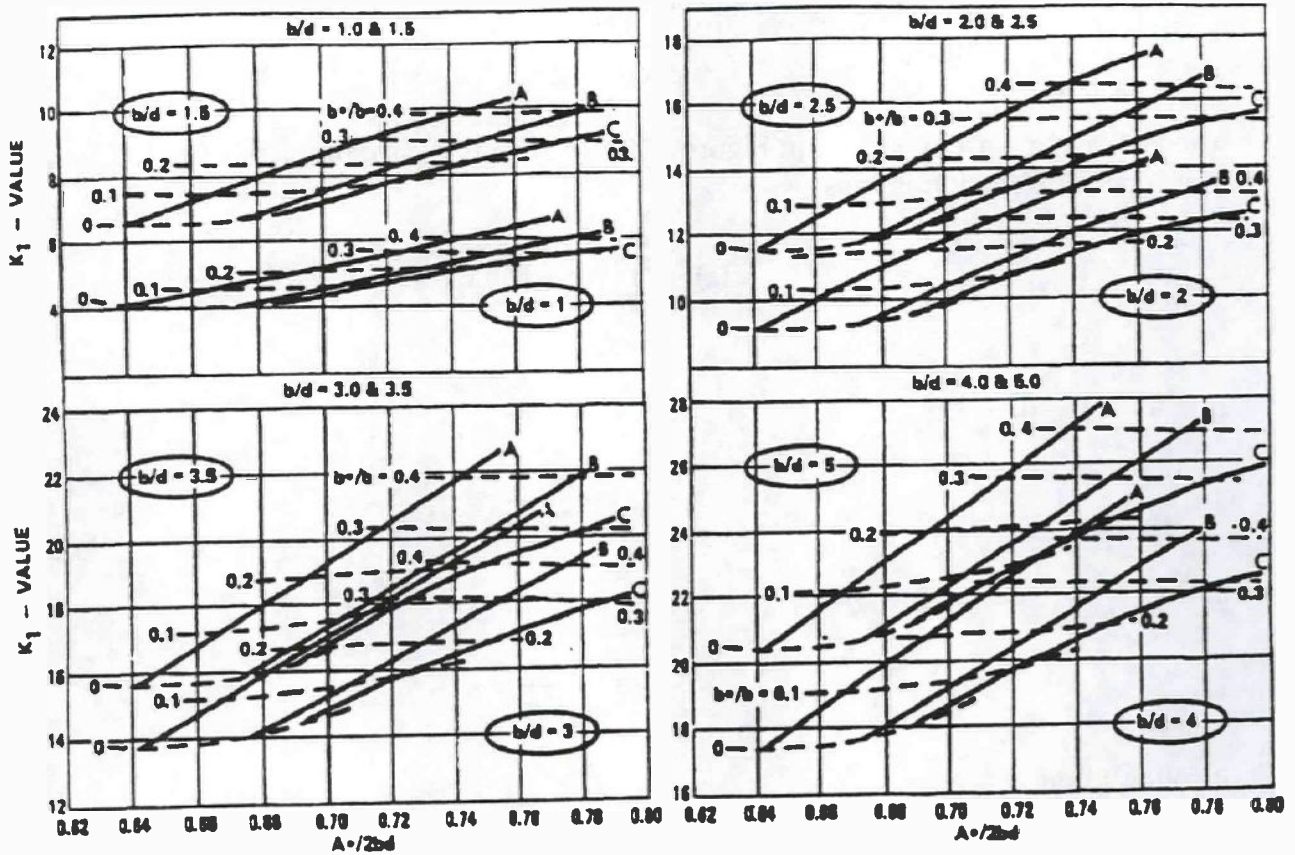


Fig. 3-33.  $K_1$ -Value for Hull Shape Series [28]

In this approach the loading is assumed to act instantaneously over the bottom one-tenth of the draught (i.e., over a dept of  $0.1 T$ ) but the pressure varies over this region, being assumed zero at  $0.1 T$  and a maximum,  $p_{max}$ , at the keel. Figure 3-34(a), taken from the book by Bishop and Price [29], shows the profile of the region of interest. As a simplification, the normal pressure at any angle is assumed to be given by

$$p_n(\phi) = p_{max} \frac{y(\phi)}{d}, \quad (3-58)$$

where  $d = 0.1 T(x)$  and  $p_{max}$  is deduced from equation (3-50).

The next transient force at any section can be evaluated by integrating the vertical component around the section profile. The contribution to the net vertical transient force per unit length along the hull exerted at the  $i$ th element of the section is given by

$$p_i \cos \beta_i \delta s_i$$

where  $\beta_i$  and  $\delta s_i$  are as shown in Figure 3-34(b). The total instantaneous vertical force per unit length on section is thus

$$F(x) = 2 \sum_{i=1}^{n-1} p_i \cos \beta_i \delta s_i$$

But since  $y_1 = d$ ,

$$p_i = p_{\max} \frac{y_{i+1} + y_i}{2y_1}$$

and

$$\cos \beta_i = \frac{x_{i+1} - x_i}{\delta s_i},$$

it follows that

$$F(x) = p_{\max} G(x),$$

where the shape factor

$$G(x) = \frac{1}{y_1} \sum_{i=1}^{n-1} (y_{i+1} + y_i) (x_{i+1} - x_i).$$

Turning now to the temporal variation, we employ an assumption due to Kawakami et al [130]. It is that the transient loading is of the form

$$F(x,t) = \frac{p_{\max}}{T_0} G(x) t e^{(1-t/T_0)}, \quad (3-59)$$

where  $T_0$  is the time that elapses between the instant at which the bottom strikes the wave surface and the instant at which the loading reaches its maximum value.

Chuang [204] has also carried out experiments on models appropriate for high speed vehicles, studied methods for calculating slamming pressures and compared these with actual experiments [205,206]. Stavovy and Chuang [117]\* developed the earlier works of Chuang into a rational method for calculating slamming pressures which they have prepared for high-speed vehicles as well as conventional ships. The method determines the impact pressure in an infinitesimal area of the hull bottom. In that area the deadrise, buttock, trim and heel angles are determined from ship lines, body plan, ship motions and wave profile. The authors consider the sum of the pressures acting normal to the bottom as that due to slamming and planing where this is present:

$$P_t = P_i + P_p \quad (3-60)$$

where:

- $p_t$  = total pressure
- $p_i$  = impact pressure
- $p_p$  = planing pressure which is usually small and insignificant compared with the impact pressure

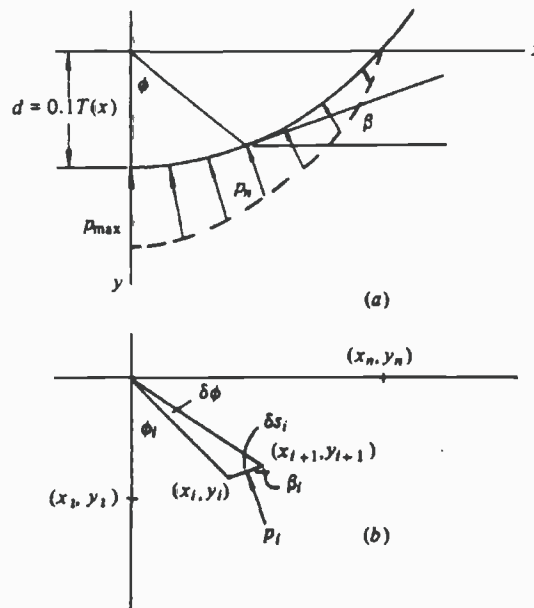
$$P_i = k_1 V_n^2 \quad (3-61)$$

where:

- $V_n$  = relative normal velocity of impact body to wave surface on plane normal to wave surface
- $k_1 = 0.37 \xi / 2.2 + 0.5$  ;  $0 \leq \xi < 2.2$  degrees
- $k_1$  = various other relationships ;  $2.2 \leq \xi$  degrees
- $\xi$  = effective impact angle on plane normal to wave surface and impact surface on hull bottom, measured from wave surface to impact surface of hull bottom

The resulting values for  $k_1$  are shown in Figure 3-35 as a dashed line.

To evaluate the lateral transient force per unit length along the hull a distribution of hydrodynamic panels over the estimated slamming area is used (see, for example, Aksu et al [207]). Thus, by distributing hydrodynamic panels and defining a slam (or slams) due to the relative motion between structure and waves, the slamming pressure forces on each panel can be calculated. Figure 3-36 illustrates the application of this approach in 3-D analysis.



**Fig. 3-34 (a) The Distribution of normal pressure  $p_n$  over the bottom one-tenth of the Draught at Any Instant.**

**(b) Notation Used in Writing Down That Contribution Made at the  $i$ th Element of the Ship's Bottom to the Total Transient Force per Unit Length.**

### 3.3.3.2 Other Procedures

Sikora and Disenbacher [157] have developed a procedure to predict maximum pressures based on model testing of a large SWATH. By instrumenting a model at several locations with pressure transducers, time histories and histograms of pressure magnitudes were developed. Based on these, cumulative probability of exceedance distribution were determined, the pressure magnitude assumed to be directly related to the square of the relative impact velocity and the pressure taken as a Rayleigh distribution for relative velocity. The expression for lifetime expected pressure becomes:

$$p(\max) = \sqrt{E} A \ln(N/\alpha) \quad (3-62)$$

where:

- $p(\max)$  = maximum impact pressure
- $A$  = distribution coefficient
- $\sqrt{E}$  = RMS of the pressure magnitudes
- $N$  = total number of impacts during the life of the vessel
- $\alpha$  = a risk factor

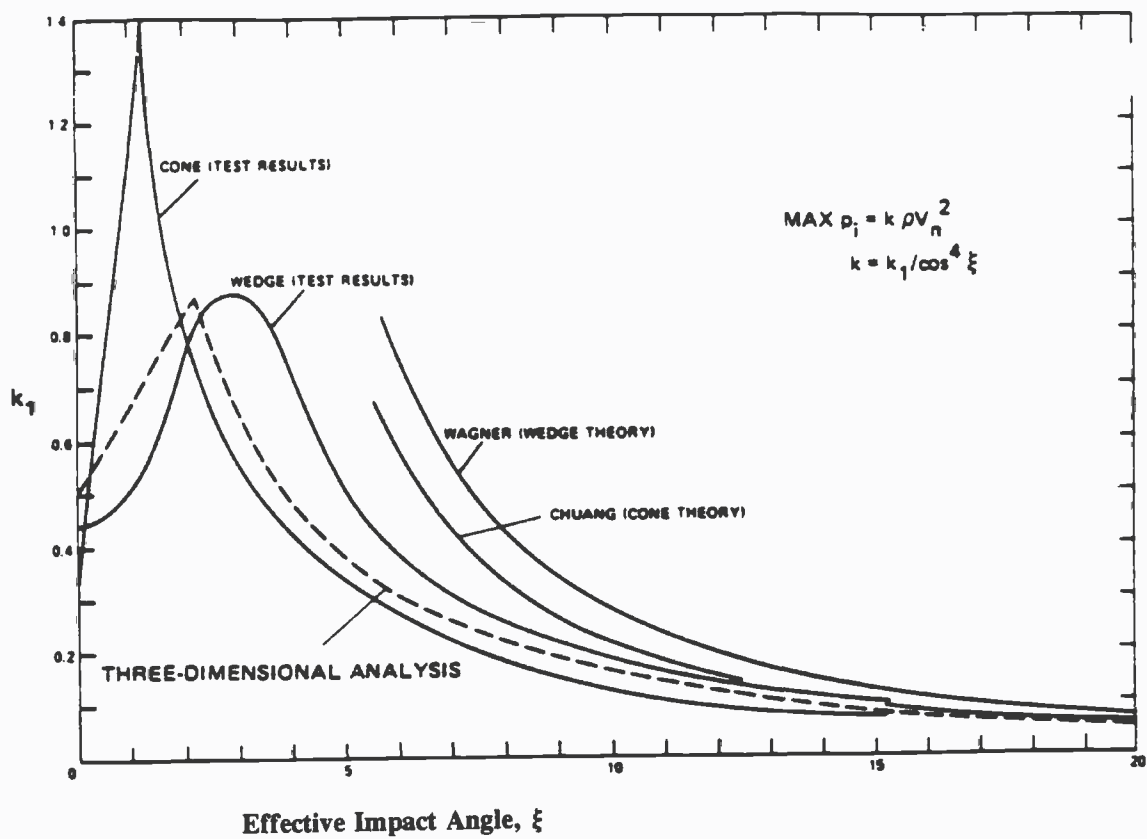


Fig. 3-35. Comparison of  $k_1$  Values [117]

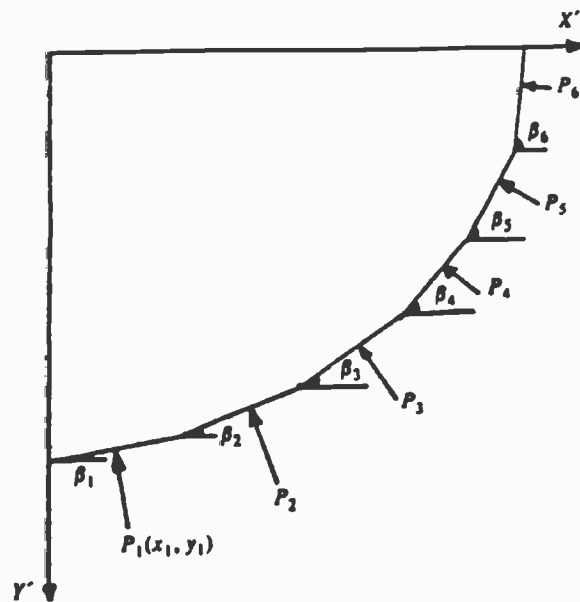


Fig. 3-36. Idealization of Three-Dimensional Impact Forces on a Ship Section



The total number of impacts,  $N$ , is the product of the frequency of impacts as measured in tests times the time the vessel is expected to spend at sea times the probabilities of being in those headings, speeds and wave heights in which slamming is likely to occur. The risk factor is taken as less than 1.0 and hence artificially increases the number of impacts and hence design maximum pressure. In TAGOS 19 a risk factor of 0.37 was assumed for plating, .01 for stiffeners and .0001 for girder design where any type of failure is to be avoided. For the TAGOS 19 the pressures from model tests as expressed by Equation (3-61) were for full scale panel sizes of 2 by 4 ft. The pressure modification according to area used by the authors was taken from Allen and Jones [208], Figure 3-37.

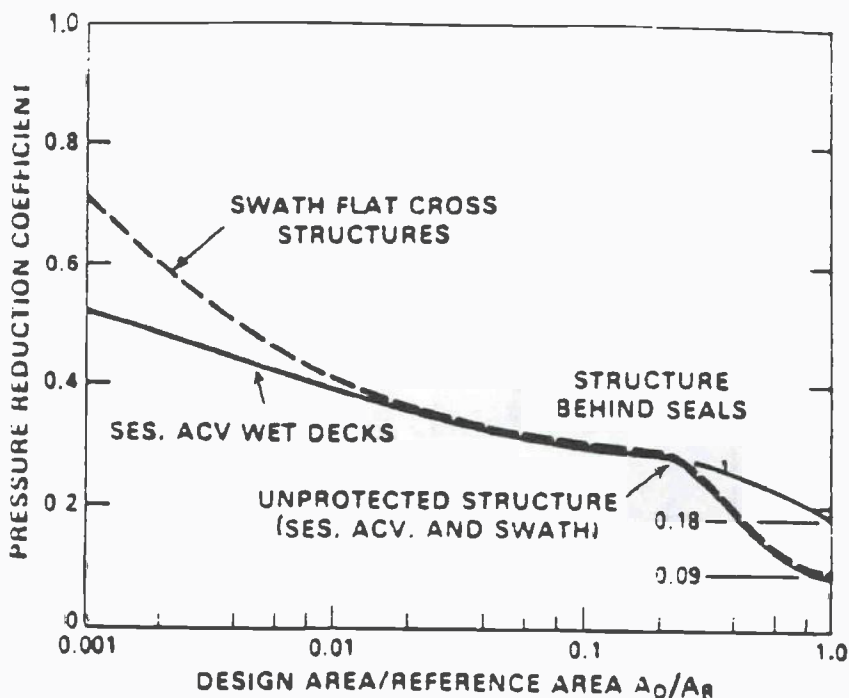


Figure 3-37: Pressure Reduction Coefficients for SES, ACV and SWATH Vessels

Allen and Jones [208] have developed a procedure to predict the structural design limit pressure magnitudes and distributions for slamming in a number of high performance marine vehicles. Methods are presented for planing and hydrofoil hulls, and for SES, ACV wet decks and SWATH flat cross structures. The procedures describe a simple approach to provide a designer with an equivalent uniform static pressure for each hull structural component under localized water impact load. The required input includes:

- Vehicle displacement,  $\Delta$  or  $w_L$
- Vehicle draft in the case of monohulls,  $d$
- Pitch radius of gyration,  $r_x$
- Impact load factor,  $N_z$
- Conceptual layout of internal structure.

These are utilized to express the pressure for planing and hydrofoil hulls as:

$$p_D = 4.44FK_D N_z d \quad (3-63)$$

where:

- $p_D$  = Equivalent uniform static design pressure, psi
- $F$  = Longitudinal pressure distribution as a function of longitudinal location of the structural design area
- $K_D$  = Pressure reduction coefficient as a function of the calculated values of  $A_D/A_R$
- $A_D$  = Structural design area, in.<sup>2</sup>
- $A_R$  = Impact reference area =  $\frac{25\Delta}{d}$  (144), in.<sup>2</sup>
- $\Delta$  = Full load displacement in long tons
- $d$  = Full load static draft in feet

The most difficult and controversial input required in the procedure is the impact load factor,  $N_z$ . The factor  $N_z$  can be found from model tests where it would be that portion of the acceleration at the center of gravity due to impact forces (as apposed to bouyancy forces, or in the case of SES and ACV's, cushion forces). Savitsky and Brown [209] present an analytical method for determining the load factors for planing hulls.

Garcia [168]<sup>x</sup> provides a procedure to determine the impact pressure and distribution for wave slap as a result of his testing of water waves breaking against vertical barriers as discussed in Section 3.3.2. He gives the maximum pressure as:

$$p_{\max} = 50(\rho g)^{1/2} E_o^{1/2} \quad (3-64)$$

where:

$$E_o = \text{wave energy} = \frac{1}{8} \rho g H_o^2 L_o$$

$H_o, L_o$  = wave height and length respectively  
 $y$  = distance above or below point of maximum pressure,  $p_{\max}$

with the shape of the pressure distribution above the point of maximum pressure at  $y = 0$ :  
and below:

$$p = p_{\max} \left( 1 - \frac{2y}{d_w} \right)^2 \quad (3-65)$$

$$p = p_{\max} \left( 1 - \frac{1.5y}{d_w} \right)^2 \quad (3-66)$$

$d_w$  = still-water depth at the wall

The exact location of the point of maximum shock pressure was a function of the still-water depth at the wall, the deep water wave steepness and the slope of the beach in front of the wall. The maximum pressure position approaches the still water level as the beach slope increases and for a beach slope of 1:10 is within 0.9-1.1 of the still-water level.

According to the U.S. Navy Structural Design Manual [210], wave slap loads acting on vertical surfaces, such as the upper shell on most hull forms, are generally assumed as 500 psf minimum. For inclined surfaces, the following assumptions are usually made:

- a. Sponson loads with medium height:  
1600 psf in the forward one-third length  
1000 psf in the after two-thirds length
- b. High sponsons: 500 psf
- c. Bow flare regions: 1600 psf (average)

Koelbel [211] discusses the calculation methods currently in use for predicting the hydrodynamic loads of high speed planing craft, including experimental results. With this discussion he presents the uncertainty inherent in these methods. He then recommends using the much simpler and more certain approach of picking the design vertical acceleration of the craft based on the intended service, and calculating the loads from the acceleration.

## 4. ANALYSIS TECHNIQUES AND PROCEDURES

### 4.1 General

A number of the hydrodynamic predictive approaches and data discussed in the previous sections have been presented by their respective authors in the format of an analysis technique which can be utilized to predict hydrodynamic impact loadings in design. This section addresses specific techniques which have been identified and which appear to exhibit unique features.

### 4.2 Slamming

#### 4.2.1 Von Karman [32] - Monohulls

##### 4.2.1.1 General

Started the analytical analysis of slamming while trying to develop a means for determining impact loads on seaplane floats during landing. The procedure is a force and pressure formula for a 2-D section. Wagner [33] furthered the approach by considering spray during impact.

##### 4.2.1.2 Prerequisite Information

- Section shape of vessel
- Impact velocity

##### 4.2.1.3 Procedure

Force and pressure determination in accordance with Equations (3-7)-(3-9) of Section 3.2.1.

#### 4.2.2 Ochi and Motter [28] - Monohulls

##### 4.2.2.1 General

The overall method developed by Ochi is depicted in Figure 4-1 and includes a number of phenomena related to slamming, among which are:

1. Frequency of Occurrence
2. Limiting Speed (Slamming Tolerable)
3. Time Interval Between Slams
4. Slamming Pressure
5. Time Before Next Slam
6. Extreme Probability Pressure

8. Extreme Pressure for Design
9. Ship Speed Free from Slamming
10. Slam Impact Force
11. Main Hull Girder Response

The hydrodynamic impact theory utilized has been addressed in Section 3. Computer programs representing parts of the method for the overall procedure are available in the literature.

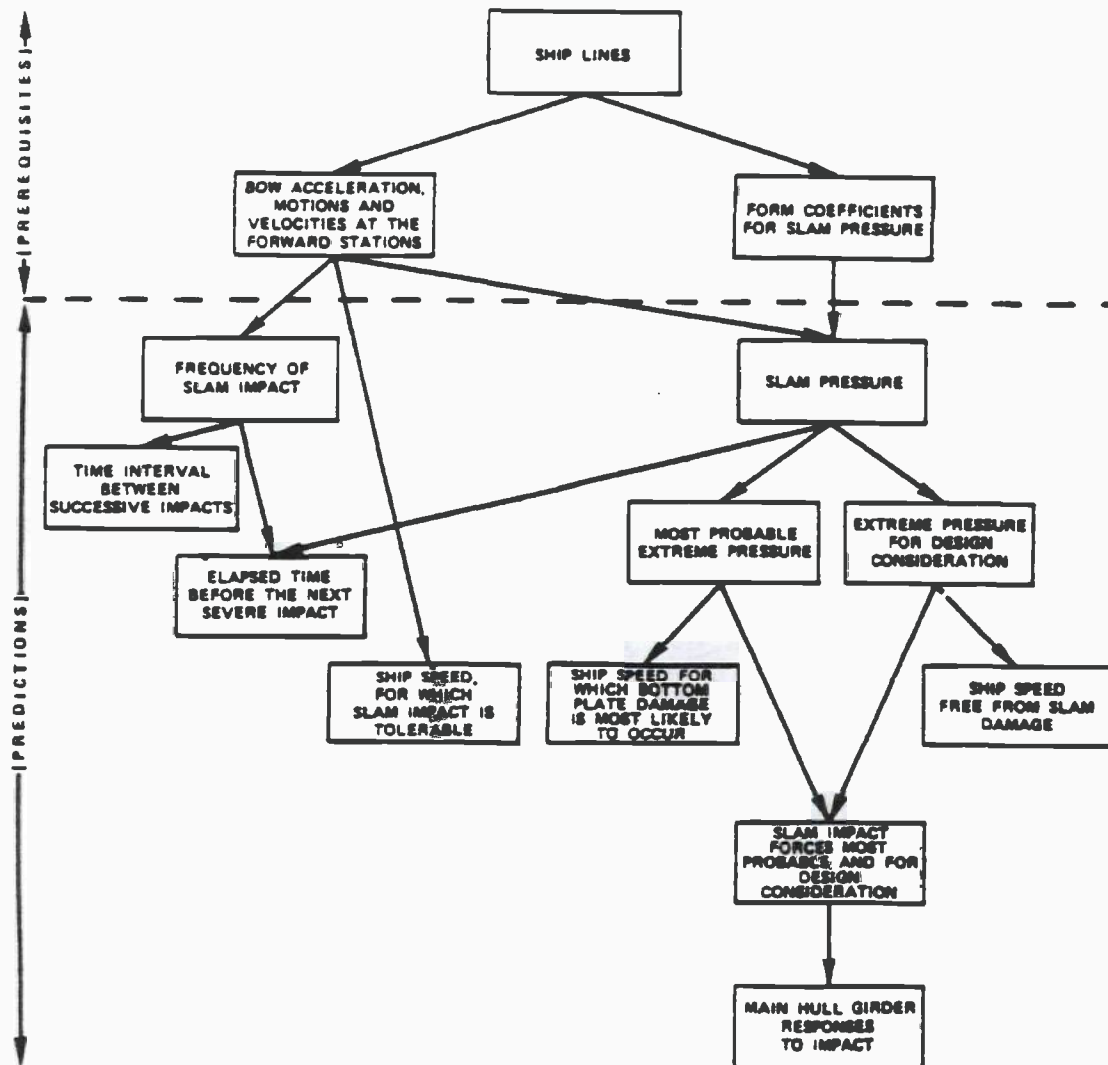


Fig. 4-1 Flow Chart for Prediction of Slamming Characteristics and Hull Responses [28]

#### 4.2.2.2 Prerequisite Information

- Vessel lines plan
- Operational Conditions
  - Draft
  - Trim
  - Speed
  - Environment (sea state)
- Statistical acceleration at bow and motions and velocities relative to waves at several forward locations (from seakeeping computer programs).
- Form coefficient for pressure term

#### 4.2.2.3 Procedure

*Step 1:* Frequency of occurrence of slam impact. This can be obtained from the information on ship motion and velocity relative to waves from a frequency versus time basis.

*Step 2:* Limiting speed for which slamming impact is tolerable. From results obtained in Item 1 as a function of ship speed, the limiting speed for which slam impact is tolerable is estimated as the speed for which either the probability of slam impact at Station 3 reaches a level of 0.03 or the significant amplitude of the vertical bow acceleration reaches a level of 0.4 g.

*Step 3:* Time interval between successive impacts. From results obtained in Item 1, the time interval between successive impacts can be estimated.

*Step 4:* Slamming pressure: The probability function necessary for predicting impact pressure is established utilizing the form coefficient and motion data from which the average and significant values of impact pressure can be predicted.

The average pressure ( $p$ ), average of  $\frac{1}{3}$  highest pressure ( $p_{\frac{1}{3}}$ ) can be obtained by the following:

$$p = k(\dot{r}_*^2 + R\dot{r}') = \frac{1}{2}\rho k_1(\dot{r}_*^2 + R\dot{r}') \quad (4-1)$$

$$p_{\frac{1}{3}} = k(\dot{r}_*^2 + 2.10 R\dot{r}') = \frac{1}{2}\rho k_1(\dot{r}_*^2 + 2.10 R\dot{r}') \quad (4-2)$$



Where:

- $r_*$  = threshold Relative Velocity (Velocity below which no slams occur).
- $Rr'$  = twice Variance of Relative Velocity, equal to area under spectral density function of relative velocity at desired location attainable via ship motion computer programs.
- $k$  = form Coefficient for Slamming Pressure  
=  $\exp(-3.599 + 2.419a_1 - 0.873a_3 + 9.624a_5)$
- $k_1$  = nondimensional form coefficient,  $k_1 = 2k/\rho$ .  
=  $\exp(1.377 + 2.419a_1 - 0.873a_3 + 9.624a_5)$
- $a_1, a_3, a_5$  = constants unique to hull section shape and a function of beam, depth, sectional area and moment of inertia for which a Fortran computer code program is available [84].

The magnitude of threshold relative velocity,  $r_*$ , is defined as 12 feet per second for a 520 ft. vessel, and is said to be obtained empirically through model experiments and the Froude law to apply to ships of different length. In other words, the threshold relative velocity  $r_* = 0.096\sqrt{gL}$ . The source is not stated but the value has not been confirmed through full-scale trials.

*Step 5:* Elapsed time before the next severe impact. The time between one severe impact and the next at a specific location along the ship length can be estimated from the results obtained in Steps 1 and 4.

*Step 6:* Most probable extreme pressure. By applying order statistics, the magnitude of the largest impact pressure most likely to occur in a specified ship operation time in a given sea can be predicted at any location along the ship length from the results obtained in Item 4.

The magnitude of extreme pressure most likely to occur in  $n$ -observations (the most probable value) is equal to

$$\bar{p}_n = \frac{1}{2} \rho k_1 (r_*^2 + Rr' \ln n) \quad (4-3)$$

where:

$n$  = Number of observations.

The magnitude of extreme pressure for which the probability of being exceeded is  $\alpha$ , designated by  $p_n(\alpha)$

The most probable extreme pressure in " $n$ " observations becomes:

$$\hat{p}_n(\alpha) = \frac{1}{2} \rho k_1 [r_*^2 - R_r' \ln(1 - (1 - \alpha)^{1/n})] \quad (4-4)$$

where:

$\alpha$  = pre-assigned small probability specified by the designer.

Fig. 4-2 shows a pictorial sketch of the probability density function of the extreme pressure.

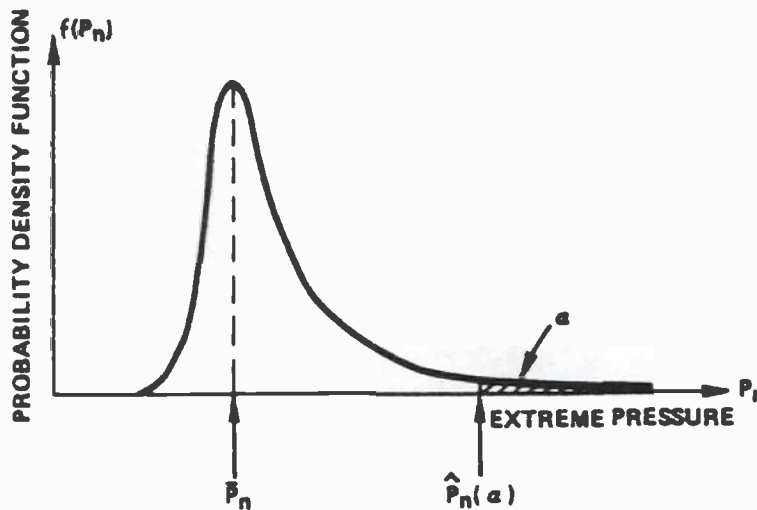


Fig. 4-2. Explanatory Sketch of Probability Density Function of Extreme Pressure

A Fortran Computer code for estimating extreme values of slamming pressure is available [86]. It also computes the probabilities of occurrence of bow emergence, slamming, and deck wetness.

*Step 7:* Ship speed at which bottom plate damage is most likely to occur. By equating the pressure magnitude obtained in Item 6 to that which will cause permanent set of a rectangular plate, the speed is estimated at which bottom plate damage is most likely to occur.

*Step 8:* Extreme pressure for design consideration. The magnitude of extreme pressure for design consideration can be estimated by applying order statistics to the probability function obtained in Item 4. The extreme value is controlled by a pre-assigned small probability of being exceeded that is specified by the designer.

*Step 9:* Ship speed free from slam damage. By equating the pressure magnitude obtained in Item 8 to that which will cause permanent set of a rectangular plate, the attainable (maximum) speed below which no plate damage would occur is estimated. The probability of occurrence of damage is the small number assigned in Item 8.

*Step 10:* Slam impact force. The magnitude of impact force can be estimated from Items 6 or 8, taking spatial distribution and traveling time of the pressure into consideration. The force evaluated using the extreme pressure in Item 8 is used for design consideration.

Since the slam impact pressure usually travels either forward or aft with changing magnitude, the spatial distribution of pressure on the bottom as a function of time is necessary for predicting loads.

**Traveling Time:** Triangular shape; assumed duration of 0.1 second for 520 foot vessel. By Froude's Law, the duration time of pressure  $t_1$  at any point for a ship of length  $L$  in feet, is given by:

$$t_1 = 0.1 \sqrt{\frac{L}{520}} = \frac{4.4}{10^3} \sqrt{L} \quad (4-5)$$

**Velocity of Travel:** The impact pressure travels along the ship length with changing magnitude with the following velocity:

$$V = 260 \sqrt{\frac{L}{520}} = 11.4 \sqrt{L} \quad (4-6)$$

**Hull Domain of Impact Pressure:**

- **Longitudinal:** Can be found by examination of the number of impacts. The number reduces significantly with increasing distance from the F.P. The location where the number of impacts equals 1 will be the extent of longitudinal length.

- Vertical: ( $0.1 H$ ,  $H = \text{draft}$ ) But the pressure traveling velocity differs (in the upwards direction) at each section, due to the difference in the magnitude of relative velocity.

The impact force for a given section can now be evaluated by integrating the pressure along the girth up to a vertical limiting height determined previously. The procedure of evaluating the extreme pressure force is as follows:

- The distance along the girth up to the limiting height for impact force consideration is extended to a straight line.
- The most probable pressure  $p_n$  obtained previously is applied uniformly on the flat bottom.
- The pressure assumed to reduce linearly along the curved section of the hull (i.e., from the outward extent of the flat bottom to  $0.1 H$ ).
- The cosine - component of the angle between the normal angle of the force to hull and the vertical is multiplied by the pressure ( $p_n$ ) in order to obtain the vertical pressure component at each point along the girth, Figure 4-3.
- Taking the pressure duration into account at each point, integration of the magnitude of pressure will then provide the most probable impact force applied to the section as a function of time, Figure 4-4.

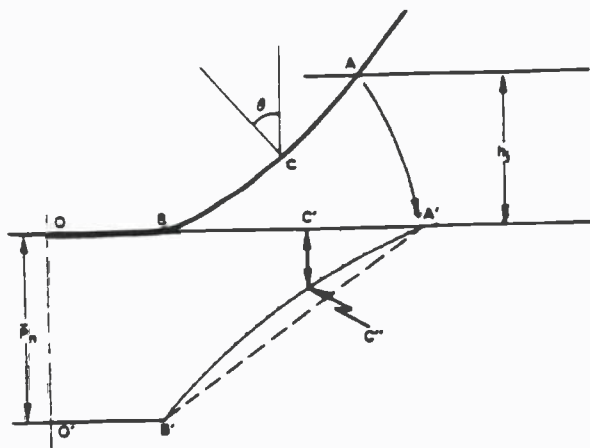


Fig. 4-3 Explanatory Sketch of the Distribution of Extreme Pressure Along the Section Girth

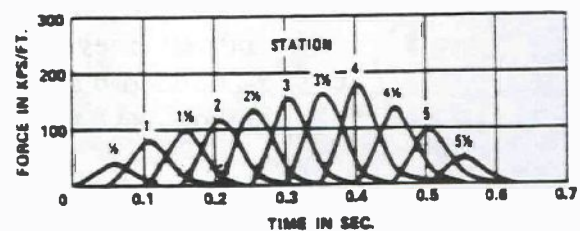


Figure 4-4 Impact Force Applied at Various Stations as a Function of Time; Mariner, Sea State 7, Significant Wave Height 25 ft, Ship Speed 7.4 Knots, Light Draft

*Step 11:* Main hull girder responses to impact. Using the information obtained in Item 10 as an input, the main hull girder responses such as whipping stress and deceleration due to impact are estimated by solving a mathematical model representing the hull structural characteristics. Available computer programs for dynamic response of the hull may be used with necessary alterations.

#### 4.2.3 Kaplan and Sargent [125] - Monohulls

##### 4.2.3.1 General

These authors have developed a computer-based approach to predicting slam forces and the resulting bending moments and shear forces in the hull. Through the use of two-dimensional linear frequency domain, ship motion theory relative motions and frequency dependent added mass is determined. The results are used along with fluid momentum considerations in slamming to provide an initial estimate of impact forces. Then, the effects of non-linear buoyancy due to momentum changes in terms of instantaneous added mass, both due to continuing submergence of the section, are estimated. Results are fed back as corrections to the initial estimates. A time domain format of the program has been adopted as the process is transient and non-stationary. The computer program is not publicly available.

The overall approach is shown in Figure 4-5. The theoretical basis of the procedure is discussed in Section 3. The equation numbers in Figure 4-5 define those in the author's work.

##### 4.2.3.2 Prerequisite Information

- Vessel lines
- Hull weight distribution
- Heave and pitch motion frequency response including absolute motions and velocities relative to the waves in the desired sea conditions.
- 2-D added mass for different levels of immersion of a section. The authors have utilized frequency dependent added mass.

##### 4.2.3.3 Procedure

As depicted in Figure 4-5 with the prerequisite information identified the calculation sequence for the time history simulation can begin. The entire procedure is automatic with the intermediate evaluations noted.

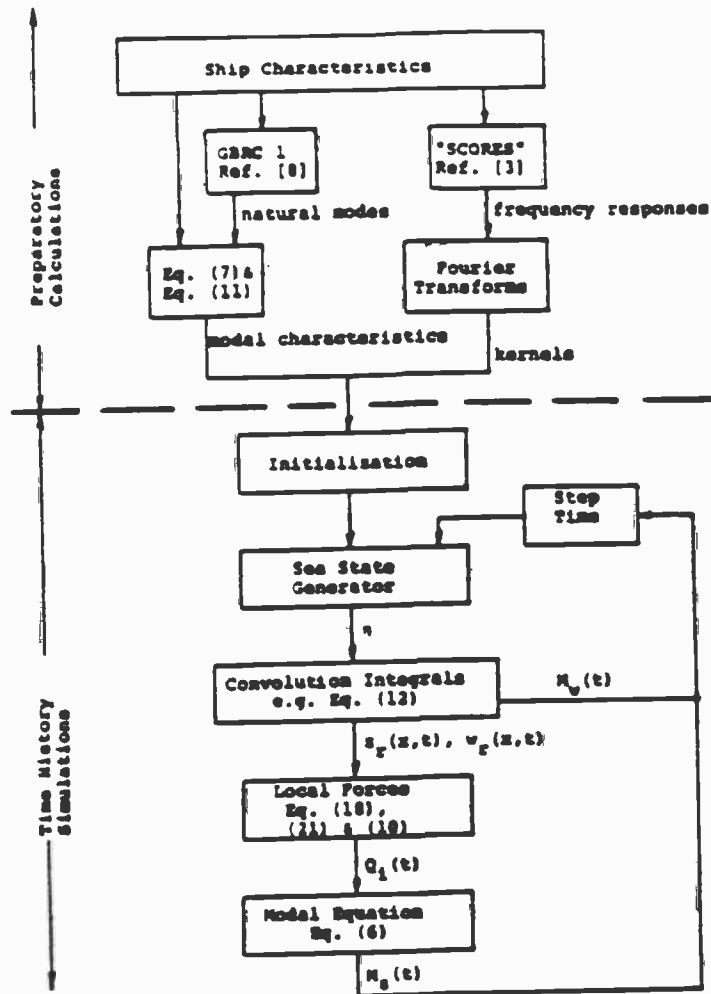


Fig. 4-5. Flow Chart for Prediction of Slamming Characteristics and Hull Response [125]

#### 4.2.4 Kaplan [102] - Multi-hulls

A quasi-three-dimensional fluid momentum analysis has been applied to predict impacts on the water surface of the flat of bottom centerbody surfaces of multi-hulled marine craft such as SES, SWATH and catamarans. The total force developed is treated as the summation of the bow ramp, flat wetdeck between the hulls and the flare of the hulls as:

$$\text{Vertical Slam Force} = Z_{\text{slam}} = Z_{\text{ramp}} + Z_{\text{wetdeck}} + Z_{\text{flare}}$$

The method requires the prediction of the vessel response to waves from which the time and spacial relationships between the hull surface and wave profile can be obtained. The momentum relationships associated with a slam are then evaluated and modified to account for unsteady lift force generation and any buoyancy contributions of the submerging structures.

The entire calculation is carried out by computer program which is proprietary.



By comparison (author's, not shown in reference) to a set of model test results [212] for an SES it is concluded that it is possible for significant differences in the loads to manifest themselves due to small differences in the occurrence time of the vessel motions or the incident wave reference. However, for the case of irregular waves where different aspects of ship orientation and motion magnitudes cover a significant degree of change in an irregular fashion, the results should appear similar. It is suggested by the author that similar results can also be expected for catamaran hulls and SWATH due to the similarity of large flat surfaces and the same type of motion analysis procedure.

This approach is essentially identical to that for monohulls developed by Kaplan and Sargent [125] and presented in 4.2.2 except that the seakeeping analysis pertains to twin hull vessels, the slam forces due to the centerbody have been added, and hull flexure is not considered.

#### 4.2.5 Troesch and Kang [3] - Monohulls

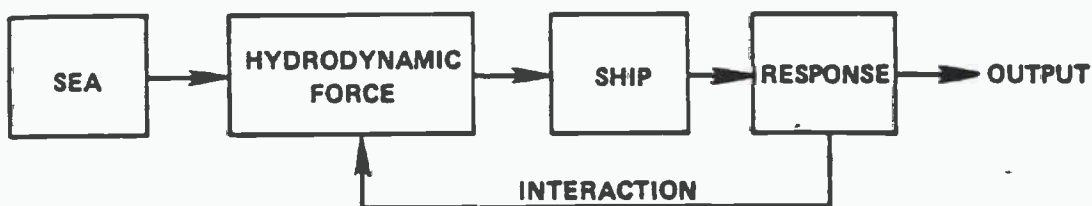
The two-dimensional and three-dimensional techniques developed by these authors appear to be equally applicable to slamming and bow flare impacts. As they were particularly concerned with bow flare impact a summary of their technique is given in Section 4.4.

#### 4.2.6 Jasper and Church [119], Chuang [120]

##### 4.2.6.1 General

Figure 4-6 shows a block diagram of the structural seaworthiness digital computer program ROSAS. The "sea" subroutine is capable of simulating regular sinusoidal waves, a wave train of definite shape or simply a sinusoidal pulse at a prescribed location. The response of the ship feeds back to the hydrodynamic subroutine to produce dynamic interaction between the ship and the hydrodynamic forces. In case bow emergence occurs, a slamming subroutine compares the bottom slamming forces and adds them to the hydrodynamic forces for computing ship responses in terms of forces in the hull girder.

The computer program is available in the literature [120].



**Figure 4-6: Diagram of Structural Seaworthiness Digital Computer Program ROSAS**

#### 4.2.6.2 Prerequisite Information

- Vessel lines plan
- Operational Conditions
  - Draft
  - Trim
  - Speed
  - Simplified wave description

#### 4.2.6.3 Procedure

As depicted in Figure 4-6 with the prerequisite information identified the calculation sequence for the time history simulation due to the moving wave can begin. The entire procedure is automatic with a system of ordinary differential equations representing the equations of motion for the discretized hull and numerically integrated by the Runge-Kutta method.

### 4.2.7 Stavovy and Chuang [117]

#### 4.2.7.1 General

The authors have developed a procedure to determine the impact pressure in an infinitesimal area of the hull bottom at point A in Figure 4-7.

The basis is described in Section 3.3.3 and consists of determining the relative normal velocity of impact of body to wave surface,  $V_n$ , and the effective impact angle,  $\xi$ , on a plane normal to the wave surface and impact surface on the hull bottom. With  $\xi$  known the peak pressure factor,  $k_1$ , can be selected from Figure 3-35. The impact pressure at point A is equal to

$$P_A = k_1 V_n^2$$

The entire calculation can be carried out by computer program which is available in the literature and demonstrated in Table 6-2.

#### 4.2.7.2 Prerequisite Information

- Vessel lines
- Sea conditions
- Vessel forward speed
- Vessel seakeeping motion characteristics

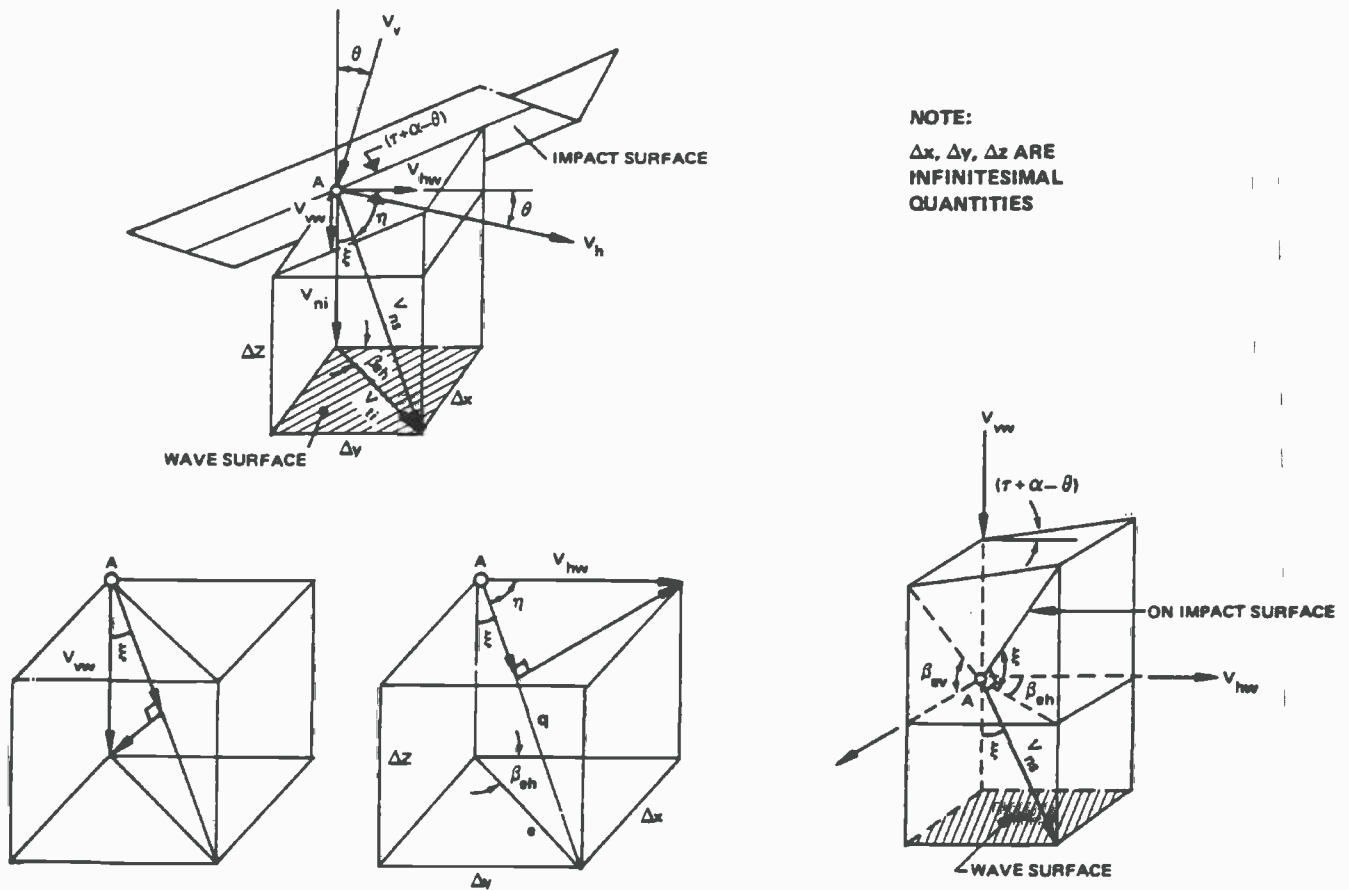


Figure 4-7: Velocity Diagram For Impact Surface

#### 4.2.7.3 Procedure

The procedure involves determining the impact velocity and orientation, and pressure factor for which a computerized procedure is available. The seakeeping motions of the vessel need to be superimposed.

#### 4.2.8 Slam Pressure Predictions Using Scaled Models [3]

The procedure is described in Section 3.3.3. It consists of testing a hydroelastic model of a vessel in irregular waves and measuring the response. A probabilistic Weibull analysis of the results is carried out to derive the lifetime maximum pressures.

#### 4.2.9 Bishop and Price [29]

The unique features of the authors' approach are in the consideration of the hull stiffness and vibratory characteristics and the incorporation of an initial impact slam and

following momentum slam. The procedures for determining the hydrodynamic loads are adopted from others as follows:

- Impact Forces - Stavovy and Chuang [117]
- Momentum Forces - Leibowitz [128]
- Force Time Histories - Ochi and Motter [28] and Kawakami, Michimoto and Kobayaski [130]

A computerized technique is not available in the literature.

#### 4.2.10 U.S. Federal Aviation Administration [42]

In the U.S. Code of Regulations they maintain a procedure for design impact loading of seaplanes during take-off and landing. The procedure itself is directed at seaplanes. The pressure predictions utilize semi-empirical formulas similar to Von Karman [32] and Wagner [33].

#### 4.2.11 Zhao and Faltinsen [68]

##### 4.2.11.1 General

The authors have developed a procedure to determine pressure distributions over a surface of a two-dimensional body of arbitrary cross-section. The water free surface is initially calm and its depth is infinite. The solution is applicable both to slamming and bow flare impact.

The technique is described in Section 3.2.2 and is based on the solution of Laplace's equation with nonlinear free boundary condition. The numerical procedure is applied to the integral equation corresponding to a boundary value problem.

Parametric numerical solution ("similarity" solution) and an asymptotic solution are available for the wedge-like bodies.

##### 4.2.11.2 Prerequisite Information

- Vessel cross-section lines.
- Impact velocity time history.

##### 4.2.11.3 Procedure

The procedure determines the pressure distribution. The seakeeping motions of the vessel need to be superimposed.

#### 4.2.12 Mitsubishi Heavy Industries (Toki et al [135]; Vulovich et al [20])

##### 4.2.12.1 General

The authors developed a time-domain numerical simulation program MSLAM and a model test technique which the authors term the "elastic backbone model" technique. Basic assumptions and theoretical formulation on which the simulation program was based include assumption of constant advance ship speed in regular or long-crested irregular waves, use of strip theory, and a nonuniform Timoshenko beam approach. The method is described in Section 3.2.4.2. The computer program of the procedure is not available in the public domain.

##### 4.2.12.2 Prerequisite Information

- o Vessel lines (Bonjean data)
- o Hull Weight Distribution
- o Bending rigidity distribution
- o Sea conditions
- o Vessel forward speed

##### 4.2.12.3 Procedure

The SLAM program calculates time histories of ship vertical motions (heave and pitch), hull vertical vibration and vertical shearing force and bending moment on the hull girder. It also accounts for the effects of large bow flare, bottom emergence, bottom and bow flare slamming, and a combined effect of ship motions as a rigid body and lower-mode hull girder vibrations.

#### 4.2.13 Aksu et al. [132]

##### 4.2.13.1 General

The authors have developed a time-domain simulation method to determine transient vertical and transverse responses (motion, distortion, bending moment, shear force, twist) in head and oblique waves. Slamming pressure is calculated on the basis of the Stavovy and Chuang method. The seaway is assumed to be irregular and long crested. The technique is described in Section 3.2.4.

The method can be applied to arbitrary shaped, non-beam-like structures, for example, multi-hulls. The computer program is not available in the public domain.

#### 4.2.13.2 Prerequisite Information

- o Vessel lines
- o Hull weight distribution
- o Bending rigidity distribution
- o Sea conditions
- o Vessel forward speed

#### 4.2.13.3 Procedure

The simulation program calculates time histories of ship motions, hull wave and transient vibration, shearing force and bending moment on the hull girder in vertical and horizontal planes.

### 4.3 Wave Slap

#### 4.3.1 Wave Slap Pressure Predictions Using Scaled Models [3]

In principal the type of approach discussed for slamming in Section 4.2.6 should be possible.

#### 4.3.2 Garcia [168]

Garcia developed a procedure for breaking wave pressures, specifically for breakwaters, but which in principal can be considered for wave slap. The procedure predicts a maximum wave impact pressure based on wave characteristics and provides expressions for varying the pressure from the point of maximum impact, which is between 0.9 and 1.1 times the still-water line, herein taken as the vessel draft.

Vessel speed would have to be incorporated in application to ships and perhaps this can be incorporated as an effective wave length.

The expressions for pressure and additional discussions are provided in Sections 3.3.3.2.

#### 4.3.3 U.S. Navy [210]

Pressures for various impact surface positions are presented for design.



## **4.4 Frontal Impact**

### **4.4.1 Troesch and Kang [5] - Monohulls**

The procedure by Troesch and Kang is based on either a two-dimensional strip theory or three-dimensional panel integral equation mathematical basis as discussed in Sections 3.2.2 and 3.2.3. It considers both bow flare and slamming impact.

The reported extent of application of the procedure has been to two ship idealizations as shown in Figure 3-18. Troesch [213] has indicated the 2-D program has been expanded to accept ship forms.

The computer program required to execute the calculations is available at the University of Michigan.

It is surmised that the calculation requires the impact velocity, vessel orientation, and geometry to be input. It is only for calm water.

### **4.4.2 Kaplan and Sargent [125] - Monohulls**

The authors utilize the same procedure used for slamming and discussed in Section 4.2.2 for predicting bow flare impact.

### **4.4.3 Jasper and Church [119], Chuang [120]**

The authors utilize the same method used for slamming and discussed in Section 4.2.6 except that the slam force is replaced by non-linear added mass and buoyancy.

### **4.4.4 Frontal Impact Pressure Predictions Using Scaled Models [2]**

The type of approach is the same as was discussed for slamming in Section 4.2.8.

### **4.4.5 Gran et al [64]**

The authors have developed an expression for the instantaneous impact force as described in Section 3.2.2. They emphasize that the immersion of the solid body will continuously change the added mass distribution, and it is therefore important to understand that their approach is based upon a quasi-stationary assumption, i.e., the water flow at each instant is taken to be identical with steady state flow. The simplified two-dimensional problem in the place of a cross-section and head waves are considered. Stress response evaluation is based on a flexible hull model.

## 5. COMPARISON OF ANALYSIS TECHNIQUES FOR APPLICATION

### 5.1 General

In this section the analysis techniques identified in Section 4. herein will be compared in order to identify those which appear to be most successful in predicting hydrodynamic impact phenomena. These will be compared further with example calculations in Section 6.

The comparison of the analysis techniques has been accomplished in the following fashion:

- Comparative tabulation of the salient characteristics of each theory including method, sea surface conditions, rigidity of impact surface, 2-D or 3-D, hull form characteristics, forward speed; Section 5.2.
- Identification of strengths and weaknesses; Section 5.3.

### 5.2 Comparative Tabulation

Tables 5-1 through 5-3 give a comparative tabulation of the analysis techniques identified in Section 4. Each table consists of three sheets to describe each method.

### 5.3 Evaluation

#### 5.3.1 Slamming

##### 5.3.1.1 Von Karman [32] - Monohulls

###### Strengths:

- Simple.

###### Weaknesses:

- Does not consider waves.

###### Other features:

- Enhanced by subsequent researchers such as Wagner [33].

Method	Type of Ships	Basis Formulation	2-D/3-D	Sea Surface
Von Karman [32]	Monohulls	Hydrodynamic wedge impact theory.	2-D	Calm.
Wagner [33]	Monohulls	Hydrodynamic wedge impact theory.	2-D	Calm.
Armand and Cointe [43]	Pontoon-Like Monohulls	Hydrodynamic cylinder impact theory	2-D	Calm.
Stavovy and Chuang [117]	All	Combination of wedge and cone theories and experimental results including 2-D/3-D.	3-D	Regular wave from any direction.
SNAME [3] Scaled Models	All	Hydro-elastic model tests with probabilistic analysis of results.	3-D	Waves from any direction.
Bishop and Price [29]	Monohulls	Hydro-elastic beam analysis with impact forces by others.	2-D	Head sea waves.

**Table 5-1: Summary of Analysis Technique Characteristics - Slamming**  
**[Continues on 3 Sheets]**

Method	Impact Surface/ Hull Rigidity	Hull Form Characteristics	Forward Speed	Theoretical/Experimental Model Description Boundary Conditions
Von Karman [32]	Rigid/ Rigid	Actual section shape.	Included in impact velocity.	Wedge impact in calm water <u>Linear free surface.</u>
Wagner [33]	Rigid/ Rigid	Actual section shape.	Included in impact velocity	Wedge impact in calm water <u>Linear free surface</u>
Armand and Cointe [43]	Rigid/ Rigid	Circular arc bottom.	May be included in impact velocity.	Small perturbation <u>asymptotic model</u> Body and free surface linear.
Stavovy and Chuang [117]	Rigid/ Rigid	Actual section shape.	Included in impact velocity.	3-D experiment.
SNAME [3] Scaled Models	Elastic/ Elastic	Actual	Yes	Exact model of full scale.
Bishop and Price [29]	NA*/ Elastic	Actual	Yes	Freely floating elastic beam representation of hull with impact forces by Stavovy and Chuang [54] and Leibowitz [60].

\*Not applicable.

Table 5-1: (Continued - Page 2)

Method	Types of Example Calculations	Correlation with Full Scale or Model Experiment	Pressure/ Force Determined	Reference Sections
Von Karman [32]	Seaplane pontoon.	Acceptable agreement with experiments and full scale results.	Yes/ Yes	3.2.2
Wagner [33]	Seaplane pontoon.	Acceptable agreement with experiments and full scale results.	Yes/ Yes	3.2.2
Armand and Cointe [43]	2-D circular cylinder.	Acceptable agreement with model experiment for initial stage of impact	Yes/ Yes	3.2.2
Stavovy and Chuang [117]	Slow to fast monohulls and catamaran cross structure.	Good correlation with monohulls and full scale catamaran results.	Yes/ No	3.3.3.1
SNAME [3] Scaled Models	None.	No comparisons.	Yes/ Yes	3.3.3
Bishop and Price [29]	Destroyer and frigates.	Reasonable agreement with full scale tests	No/ Yes	3.2.4.2

Table 5-1: (Continued - Page 3)



Method	Type of Ships	Basis Formulation	2-D/3-D	Sea Surface
Ochi and Motter [28]	Monohull	Slamming occurrence predicted by statistical seakeeping events and pressure by empirical relationship based on test data.	2-D integrated to product quasi 3-D results.	Irregular sea wave from any direction.
Kaplan and Sargent [125]	Monohull	Slamming occurrence predicted by changes in momentum and buoyancy utilizing 2-D seakeeping theory and response includes hull flexure.	2-D integrated to produce quasi 3-D results.	Irregular head sea waves.
Troesch and Kang [5]	Monohull	Hydrodynamic impact boundary value theory.	2-D and 3-D.	Calm water.
Kaplan [102]	Multi-hulls	Slamming occurrence predicted by seakeeping theory and centerbody slam forces by the Von Karman technique adopted by the author.	3-D for centerbody.	Regular head sea waves.
Jasper and Church [119]  Chuang [120]	Monohull	Slamming occurrence predicted by travelling wave pressure by empirical relationship and response includes hull flexure.	2-D discretization of hull producing quasi 3-D results.	Regular head sea wave.

**Table 5-1a: Summary of Analysis Technique Characteristics - Slamming**  
**[Continues on 3 Sheets]**



Method	Impact Surface/ Hull Rigidity	Hull Form Characteristics	Forward Speed	Theoretical/Experimental Model Description
Ochi and Motter [28]	Rigid/ Rigid	Actual	Considered as part of sea-keeping events but deemed unimportant for pressure to 15 knots.	Not applicable as slam pressure based on tests. Seakeeping model used is based on strip theory, or experiments.
Kaplan and Sargent [125]	Rigid/ Elastic (1st Mode)	Actual	Considered as part of seakeeping events.	Per 2-D seakeeping theory except added mass and buoyancy provided at the actual waterline as opposed to the still waterline.
Troesch and Kang [5]	Rigid/ Rigid	2-D Actual/ 3-D Ideal Cases	Included.	Body boundary and linear free surface.
Kaplan [102]	Rigid/ Rigid	Actual	Considered as part of sinusoidal wave passing hull.	2-D Von Karman impact theory applied to centerbody in 3-D.
Jasper and Church [119]  Chuang [120]	Rigid/ Elastic	Actual	Considered as part of sinusoidal wave passing hull.	Discretized hull sections with 2-D section properties, including impact added mass by Wagner and buoyancy at the actual waterline as opposed to the still waterline.

Table 5-1a: (Continued - Page 2)

Method	Types of Example Calculations	Correlation with Full Scale or Model Experiment	Pressure/ Force Determined	Reference Sections
Ochi and Motter [28]	Application to a 520' LBP MARINER cargo vessel.	Pressure relation has significant correlation but overall method has not been compared to actual results.	Yes/ Yes	3.3.3.1
Kaplan and Sargent [125]	Containership	Containership full scale data indicates bending moment predictions high but velocities are acceptable according to authors.	No/ Yes	3.2.4.2
Troesch and Kang [5]	Two idealized 3-D forms	Good with experiment.	Yes/ Yes	3.2.3
Kaplan [102]	For an SES	Not shown in reference but author states that magnitudes of the loads are in agreement.	No/ Yes	3.2.3
Jasper and Church [119]  Chuang [120]	ESSEX aircraft carrier	Acceptable agreement with full scale experiment.	No/ Yes	3.2.4.2

Table 5-1a (Continued - Page 3)

Method	Type of Ship	Basis Formulation	2-D/3-D	Sea Surface
Zhao and Faltinsen [68]	Monohulls	Hydrodynamic impact theory for arbitrary shape.	2-D	Calm
Mitsubishi Heavy Industries (Toki et al [135])	Monohulls	Time domain simulation of ship motions. Strip theory and nonuniform beam approach.	2-D for slamming force	Regular or irregular long crested waves.
Aksu et al [132]	Multihulls	Time domain simulation of ship motions. Stavovy and Chuang method for slamming pressure.	3-D	Irregular long crested waves.

**Table 5-1b: Summary of Analysis Technique Characteristics - Slamming  
(Continues on Three Sheets)**



Method	Impact Surface/Hull Rigidity	Hull Form Characteristics	Forward Speed	Theoretical/Experimental Model Description Boundary Condition
Zhao and Faltinsen [68]	Rigid/Rigid	Actual section shape.	Included in ship motions prediction method.	2-D hydrodynamic <u>impact</u> . Non-linear boundary conditions.
Mitsubishi Heavy Industries (Toki et al [135])	Rigid/Elastic	Actual section shape.	Included in ship motions prediction method.	2-D slamming model based on momentum <u>law formula</u> . Linear free surface.
Aksu et al [132]	Rigid/Elastic	Actual section shape.	Included in ship motions prediction and impact velocity.	Semi-empirical Stavovy and Chuang model.

Table-5-1b: (Continued - Page 2)

Method	Types of Example Calculations	Correlation With Full Scale or Model Experiment	Pressure/ Force Determination	Reference Sections
Zhao and Falinsen [68]	Wedge impact; bow flare section impact	Good agreement with model experiment (bow flare section) [183].	Yes/Yes	3.2.2
Mitsubishi Heavy Industries (Toki et al [135])	Containership	Considerable underestimation of compressive stress on the foredeck; Slight over estimation of stresses on the mid portion of the deck.	No/Yes	3.2.4.2
Aksu et al [132]	Barge Elastic	No comparisons with experiment.	Yes/Yes	3.2.4

Table 5-1b: (Continued - Page 3)

Method	Type of Ships	Basis Formulation	2-D/3-D	Sea Surface
Garcia [168]	All	Model experiments on breakwaters.	2-D	Waves
U.S. Federal Aviation Administration (FAA) [42]	Seaplanes	Wedge impact, including bow flare sections.	2-D with 3-D corrections	Calm.
U.S. Navy [210]	All	Design pressures for various impact surface positions.	2-D	Waves

**Table 5-2: Summary of Analysis Technique Characteristics - Wave Slap  
[Continues on 3 Sheets]**



Method	Impact Surface/ Hull Rigidity	Hull Form Characteristics	Forward Speed	Theoretical/Experimental Model Description Boundary Conditions
Garcia [168]	Rigid/ Rigid	NA*	Not included but authors wave length can be adjusted to reflect.	Regular wave striking breakwater. Body and free surface complete formulation.
U.S. Federal Aviation Administration [42]	Rigid/ Rigid	Simple shapes (wedge, un-flared and flared bottom).	Yes	Wedge impact in calm water. Linear free surface.
U.S. Navy [210]	Rigid	All ships	Not explicit.	N/A

\*Not applicable.

Table 5-2: (Continued - Page 2)

Method	Types of Example Calculations	Correlation with Full Scale or Experiment	Pressure/ Force Determined	Reference Sections
Garcia [168]	None	Good correlation with model tests.	Yes/ No	3.3.3.2
U.S. Federal Aviation Administration [42]	None	Design loads method is based on semi-empirical formulas. Hence, loads should correlate with full scale experiment corrected by margin of safety factors.	Yes/ Yes	3.2.2
U.S. Navy [210]	Exclusive use in design	Routinely used in design over the years.	Yes/ No	3.3.3.2

Table 5-2: (Continued - Page 3)

Method	Type of Ships	Basis Formulation	2-D/3-D	Sea Surface
Troesch and Kang [5]	Monohull	Bow flare impact; impact boundary value theory.	2-D and 3-D.	Calm water.
Kaplan and Sargent [125]	Monohull	Bow flare impact predicted by changes in momentum and buoyancy utilizing 2-D seakeeping theory and response includes hull flexure.	2-D integrated to produce quasi 3-D results.	Irregular head sea waves.
Jasper and Church [119] Chuang [120]	Monohull	Bow flare impact predicted by changes in momentum and buoyancy utilizing sinusoidal waves and response includes hull flexure.	2-D integrated to produce quasi 3-D results.	Regular head sea waves.
Gran et al [64]	Monohull	Bow flare impact boundary value theory.	2-D	Waves [identified as relative impact velocity].
U.S. Federal Aviation Administration (FAA) [42]	Seaplanes	Wedge impact, including bow flare sections.	2-D with 3-D Corrections	Calm.

**Table 5-3: Summary of Analysis Technique Characteristics - Frontal Impact**

Method	Impact Surface/ Hull Rigidity	Hull Form Characteristics	Forward Speed	Theoretical/Experimental Model Description Boundary Conditions
Troesch and Kang [5]	Rigid/ Rigid	Actual	Not considered.	Potential panel method Body boundary and simplified free surface.
Kaplan and Sargent [125]	Rigid/ Elastic (1st Mode)	Actual	Considered as part of seakeeping events.	Per 2-D seakeeping theory except added mass and buoyancy provided above the still waterline as necessary. Added mass based on infinite oscillation theory.
Jasper and Church [119]  Chuang [120]	Rigid/ Elastic	Actual	Considered as part of seakeeping wave speed passing ships.	Discretized hull sections with added mass and buoyancy provided above and below still waterline as necessary. Added mass is based on impact momentum theory.
Gran et al [64]	Rigid/ Elastic	Actual	Yes	Consistent with 2-D impact boundary value problem with corrections for spray. Simplified wave profile.
U.S. Federal Aviation Administration [42]	Rigid/ Rigid	Simple shapes (wedge, unflated and flatted bottom)	Yes	Wedge impact on calm water. Linear free surface.

Table 5-3: (Continued - Page 2)



Method	Types of Example Calculations	Correlation with Full Scale or Model Experiment	Pressure/ Force Determined
Troesch and Kang [2]	Two idealized 3-D forms	Cylindrical shape: Good agreement with model drop test. Flared body: Good agreement with model drop test for first maxima; overpredicts the magnitude of second maxima.	Yes/ Yes
Kaplan and Sargent [125]	Aircraft carrier	Aircraft carrier model test results are in good agreement	No/ Yes
Jasper and Church [119]  Chuang [120]	ESSEX aircraft carrier	Aircraft carrier model test results are in good agreement.	No/ Yes
Gran et al [64]	Lewis form hull sections.	Reasonable agreement with scale stress measurements (fast cargo ship).	No/Yes
U.S. Federal Aviation Administration (FAA) [42]	None	Design loads method is based on semi-empirical formulas. Hence loads should correlate with full scale experiment corrected by margin of safety factors.	Yes/ Yes

Table 5-3: (Continued - Page 3)

### 5.3.1.2 Wagner [33] - Monohulls

#### Strengths:

- Simple

#### Weaknesses:

- Does not consider waves

#### Other features:

- An enhancement of Von Karman's approach wherein a refinement of the wetted surface area and hence average pressure is obtained by considering the pile-up of water at the free surface during impact.

### 5.3.1.3 Armand and Cointe [43]

#### Strengths:

- Simple asymptotic formula for force valid for initial stage of impact.
- Can serve as a standard for advanced calculations and experiments.

#### Weaknesses:

- Applicable only for simple ship hull with circular shape.
- Actual sea state not considered.
- Utilizes only through strip theory (3-D effects not included).

### 5.3.1.4 Stavovy and Chuang [117] - All

#### Strengths:

- Considers all types of vessels.
- Considers any forward speed, including high speed craft.
- Correlation to a relatively large number of models and full scale measurements.



- Computer code available in literature.
- Considers hull geometry.
- Considers simplified wave definition.
- Computer calculations of a moderate extent.

Weaknesses:

- Only considers infinitesimal area at a single point each time.
- Sea state not statistically described.

**5.3.1.5 SNAME [3] Scaled Models - All**

Strengths:

- Considers all types of vessels.
- Considers vessel speed.
- Considers exact hull geometry.
- Considers exact wave conditions.

Weaknesses:

- Requires scaling to full scale.
- Extensive model testing required.

**5.3.1.6 Bishop and Price [29]**

Strengths:

- Considers overall hull geometry.
- Considers sea conditions.
- Acceptable correlation with experiment.

- Strengths of impact load theories it employs (Ochi and Motter [83] or Liebowitz [60]).

Weaknesses:

- Limited application.
- 2-D approach to impact problem.

Other features:

- Computer code proprietary.

#### 5.3.1.7 Ochi and Motter [28] - Monohulls

Strengths:

- Provides a procedure for determining the occurrence of slamming at sea.
- Statistical description of slamming pressure is provided.
- Utilizes an extensively correlated pressure relationship.
- Considers overall hull geometry.
- Computer codes available

Weaknesses:

- Strip theory; ignores ship rolling and non head sea directions.

#### 5.3.1.8 Kaplan and Sargent [125] - Monohulls

Strengths:

- Considers overall hull geometry.
- Considers sea conditions.

Weaknesses:

- Limited application and correlation to tests; therefore accuracy not known. Did not correlate in one case.
- Local pressure not available.

Other features:

- Proprietary computer code

**5.3.1.9 Troesch and Kang [5] - Monohulls**

Strengths:

- Considers significant aspects of 3-D problem.
- Good correlation to limited experiments.

Weaknesses:

- Limited application to ship hull forms and comparison to tests.
- Most likely significant computation capacity and time required for the 3-D approach.

Other features:

- Proprietary computer code.

**5.3.1.10 Kaplan [102] - Multi-Hulls**

Strengths:

- Appears to be applicable to various multi-hull vessels
- Considers overall hull geometry
- Computer calculations of moderate extent for added force due to cross structure.

Weaknesses:

- Limited comparison to experiment.

Other features:

- Proprietary computer code.

**5.3.1.11 Jasper and Church [119], Chuang [120] - Monohulls**

Strengths:

- Considers overall hull geometry.
- Considers idealized and more simplified sea state definitions.
- Computer code available in the literature.

Weaknesses:

- Limited application and correlation to tests.
- Local pressure not considered.
- Sea state not statistically described.

**5.3.1.12 Zhao and Faltinsen [68]**

Strengths:

- Arbitrary cross-section, including bow-flare forms.
- Simple "similarity" and asymptotic solutions for wedges are available.
- Actual impact velocity time history can be considered.
- Good correlation to limited model experiment and other calculations.

Weaknesses:

- Actual sea state not considered.
- Utilizes only through strip theory (3-D effects not included).

Other features:

- Computer code is proprietary.

#### 5.3.1.13 Mitsubishi Heavy Industries (Toki et al [135])

##### Strengths:

- Arbitrary cross-section of actual ship hull.
- Considers arbitrary sea state and wave directions.
- Effect of ship speed is included.

##### Weaknesses:

- Local pressure not considered.
- Poor correlation with stress measurements in deck.

##### Other features:

- Computer code is proprietary

#### 5.3.1.14 Aksu et al [132]

##### Strengths:

- Arbitrary cross-section of actual ship hull.
- Considers arbitrary sea state and wave directions.
- Effect of ship speed is included.
- 3-D effects are considered in ship motions and slamming pressure predictions.

##### Weaknesses:

- More extensive comparisons with model and full scale are needed.

##### Other features:

- Computer code is proprietary.

## 5.3.2 Wave Slap

### 5.3.2.1 Garcia [168] Breakwater Models - All

#### Strengths:

- Based on significant tests and model test correlation.
- Simple formulas for estimation provided.

#### Weaknesses:

- Developed for breakwaters.
- Does not explicitly consider forward speed.

### 5.3.2.2 U.S. Federal Aviation Administration [42]

#### Strengths:

- An established official procedure
- Simple, engineering-oriented procedure

#### Weaknesses:

- Only for seaplanes.
- Does not consider waves.

#### Other features:

- Design loads method includes margin of safety factors.

### 5.3.2.3 U.S. Navy [210] - All

#### Strengths:

- Extensive historical use in design applications.
- Pressure directly provided.

#### Weaknesses:

- Does not explicitly consider forward speed.



**5.3.2.4 SNAME [3] Scaled Models - All  
See Section 5.3.1.5**

**5.3.3 Frontal Impact**

**5.3.3.1 Troesch and Kang [5] - Monohulls/Bow Flare**

Strengths:

- Considers significant aspects of 3-D problem.

Weaknesses:

- Limited application to ship hull forms and comparison to tests.
- Over-predicts experimental results.
- Does not consider sea conditions or vessel forward speed.
- Most likely significant computation capacity and time required for the 3-D approach.

Other features:

- Computer code is proprietary.

**5.3.3.2 Kaplan and Sargent [125] - Monohulls/Bow Flare**

Strengths:

- Considers overall hull geometry.
- Considers sea conditions.
- Limited but good correlation.

Weaknesses:

- Limited application.
- Local pressure not determined.

Other features:

- Computer code is proprietary.

**5.3.3.3 Jasper and Church [119] and Chuang [120]  
See Section 5.3.1.10**

**5.3.3.4 Gran et al [126]**

**Strengths:**

- Incorporates 2-D boundary value problem.
- Considers hull geometry.
- Sea conditions introduced in relative velocity.
- Simple formulas.

**Weaknesses:**

- Needs to be integrated into a seakeeping simulation for computation of instantaneous force integrated over ship length.
- Computer code proprietary.
- Local pressures not available.

**5.3.3.5 U.S. Federal Aviation Administration [42]**

**Strengths:**

- An established official procedure.
- Simple, engineer-oriented procedure.

**Weaknesses:**

- Only for seaplanes.
- Does not consider waves.

**Other features:**

- Design loads method includes margin of safety factors.

**5.3.3.6 SNAME [3] Scaled Models - All  
See Section 5.3.1.5**

## 6. EXAMPLE CALCULATIONS

### 6.1 General

Sections 4 and 5 of this report have considered several analysis techniques on their own basis. Herein an attempt is made to consider the results of each when applied to specific examples.

As there are a significant number of techniques and some are available only in proprietary and/or lengthy computer based techniques which cannot be exercised as part of this study, a more common basis of comparison is necessary. As a result, for each of the hydrodynamic phenomena considered, a base approach for comparison has been identified. Example calculations are then performed utilizing this base technique for examples cited in other techniques and the results compared.

### 6.2 Pressure

Due to lack of computer codes in the public domain, detailed information about the techniques used, geometry, and impact velocity time history, the results regarding the 2-D and 3-D nonlinear unsteady theories cannot be obtained for cases not analyzed by the authors of these methods. For this reason only examples with simple geometries (wedge, circle, sphere, etc.) and impact calculations performed by the main contributors are discussed in this Section. As a rule, the approaches of von Karman [32], Wagner [33], Stavovy-Chuang [117], Ochi-Motter [28] and Zhao-Faltinsen [68] can be applied to all cases represented. Table 6-1 summarizes the techniques used for comparisons.

A number of investigators have utilized the pressure-velocity relationship with the factor  $k_I$  as a means to evaluate the effects of slamming. As the velocity for impact can be approximated from the description of the slamming event, it has been decided that a comparison on the basis of the  $k_I$  factor may be the most realistic and tangible common denominator. Stavovy and Chuang [117] have already carried out some comparisons as shown in Figure 3-35. The estimated results of others are shown in Figures 6-1 through 6-5 for the maximum pressure coefficient  $C_{pmax}$ :

$$C_{pmax} = p_{max}/0.5\rho V^2$$

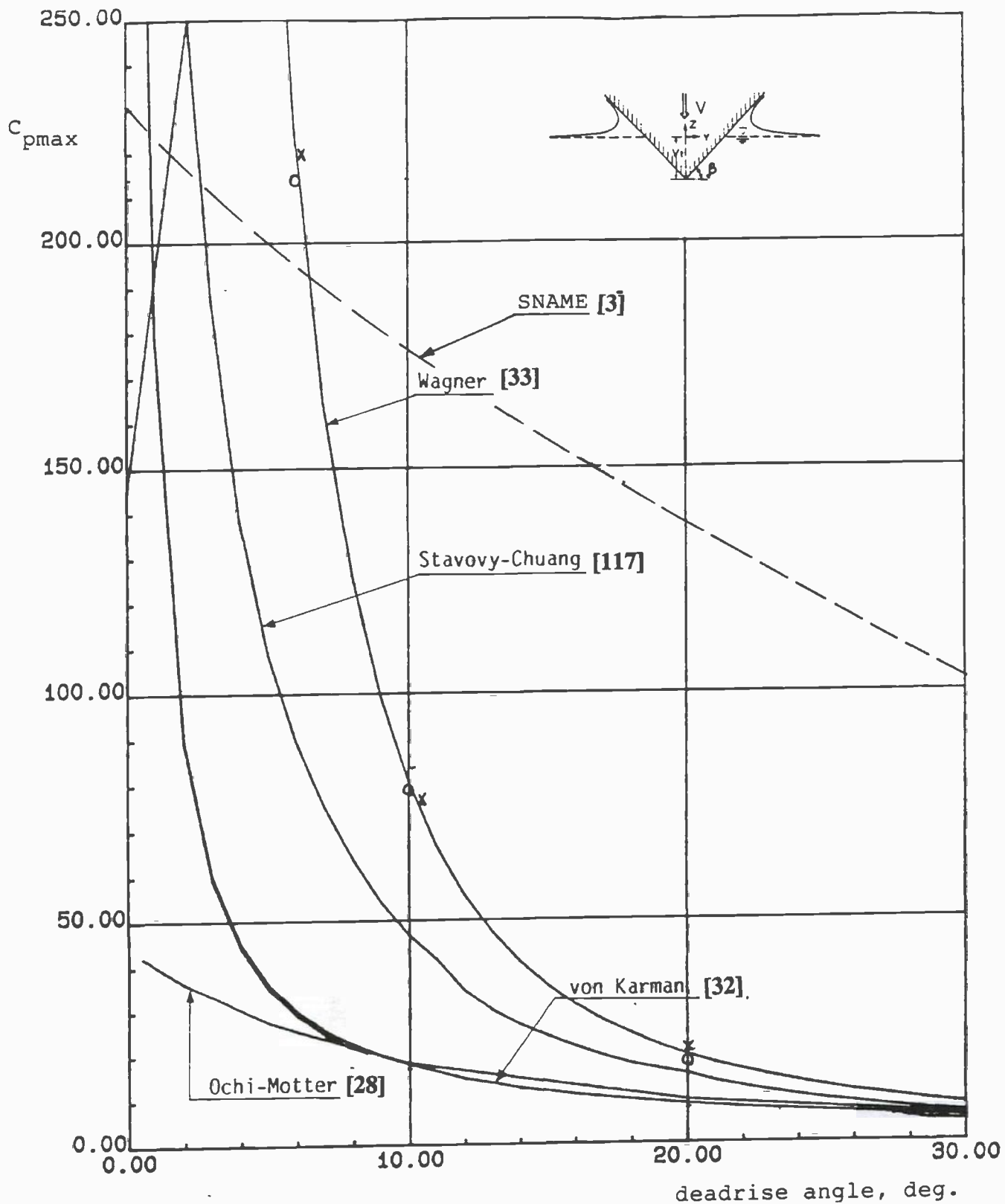
The sections 6.2.1-6.2.4 correspond to calm water, and case 6.2.5 to a seaway.

#### 6.2.1 Wedge

The comparison of maximum pressure coefficient for wedge shaped 2-D sections is shown in Figure 6-1 for different deadrise angles. The classical solutions of von Karman [32] and Wagner [33] are presented along with the "universal" approximation of

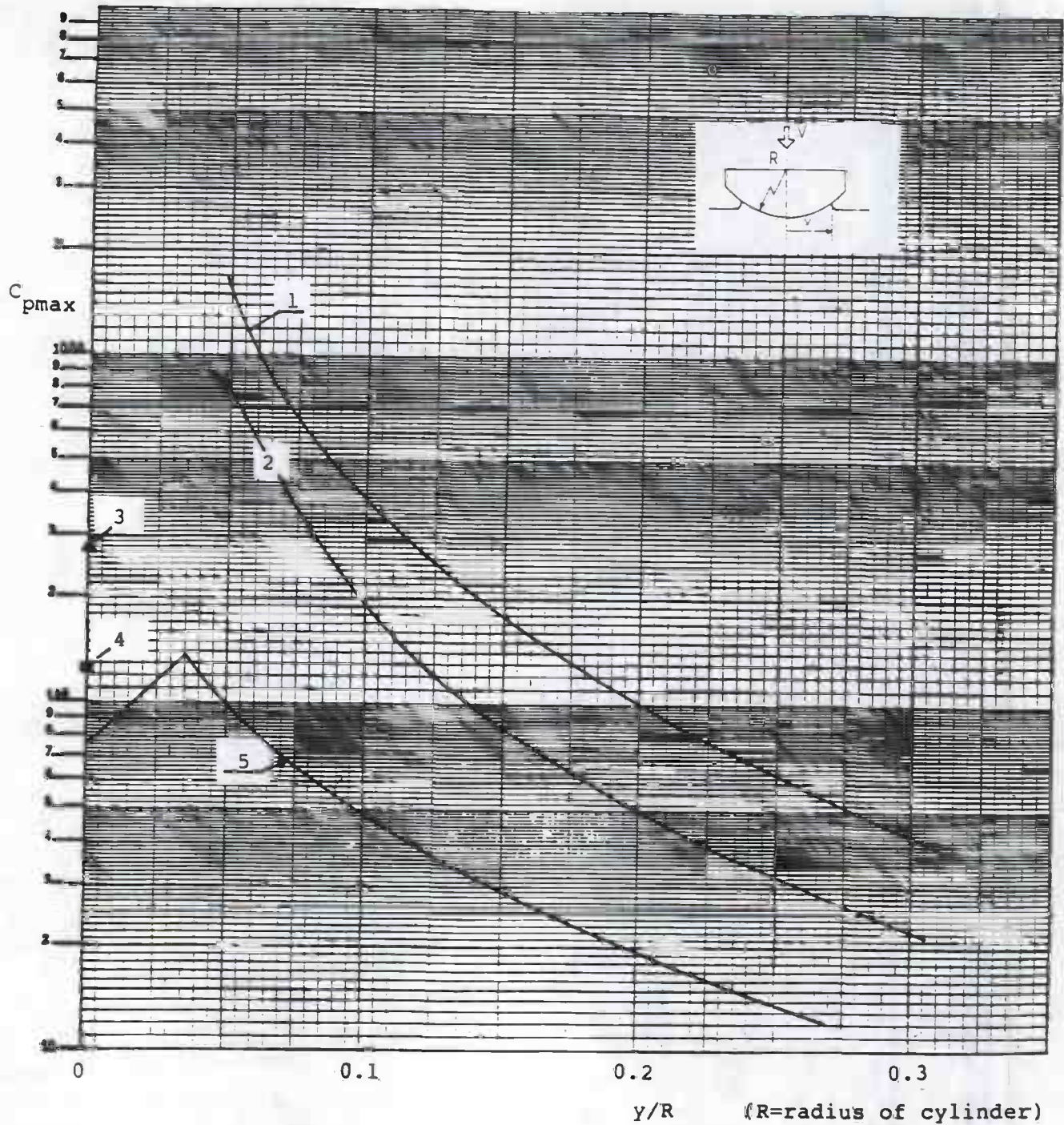
<u>Analysis Technique</u>	<u>Body</u>	<u>Short Solution Description</u>
von Karman [32]	wedge, circle, parabola, bow flare section	2-D theory based on momentum consideration
Wagner [33]	wedge, circle parabola; bow flare section	2-D theory taking into account real wetted area; calm water
Armand and Cointe [43]	circle	2-D theory based on the method of method of asymptotic expansions; calm water
Stavovy and Chuang [117]	wedge, circle, parabola; bow flare section	approximation of pressure-impact velocity relationship valid for 2-D 3-D bodies; calm and wave surface
Ochi and Motter [28]	wedge, circle, parabola; bow flare section; bow section	approximation of pressure-impact velocity relationship valid for ship hulls; calm and wave surface
Zhao and Faltinsen [68]: similarity solution	wedge	numerical nonlinear procedure applied to a wedge with arbitrary deadrise angle
boundary element	wedge; bow flare section	numerical nonlinear unsteady procedure valid for 2-D entry problem
SNAME method [3]	wedge, circle parabola, bow flare section	approximation of pressure-impact relationship, valid for ship hull
Garcia [168]	breakwaters	approximation of pressure-impact relationship on breakwaters based on tests.
U.S. Navy [210]	all ship sections	pressures for wave slap.

**Table 6-1 Analysis Techniques - Pressure**



o Zhao-Faltinsen (Similarity Solution) [68]  
 x Zhao-Faltinsen (Boundary Element Solution) [68]

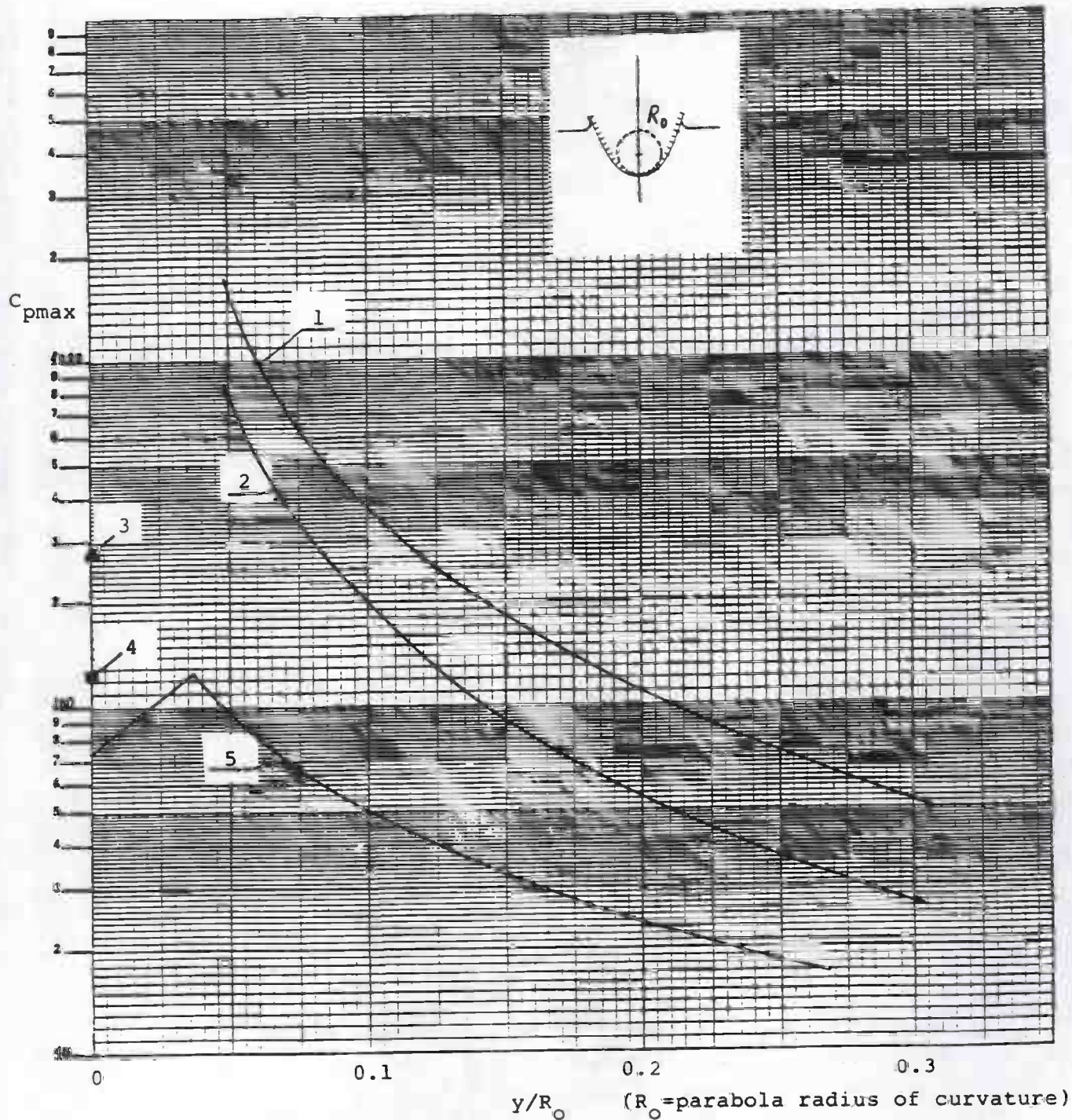
**Fig. 6-1. Comparison of Maximum Pressure Coefficient for Wedge Shaped Sections as Determined by Various Methods**



- |   |                                     |   |                          |
|---|-------------------------------------|---|--------------------------|
| 1 | Wagner [33], Armand and Cointe [43] | 3 | SNAME [3]                |
| 2 | von Karman [32]                     | 4 | Ochi and Motter [29]     |
|   |                                     | 5 | Stavovy and Chuang [117] |

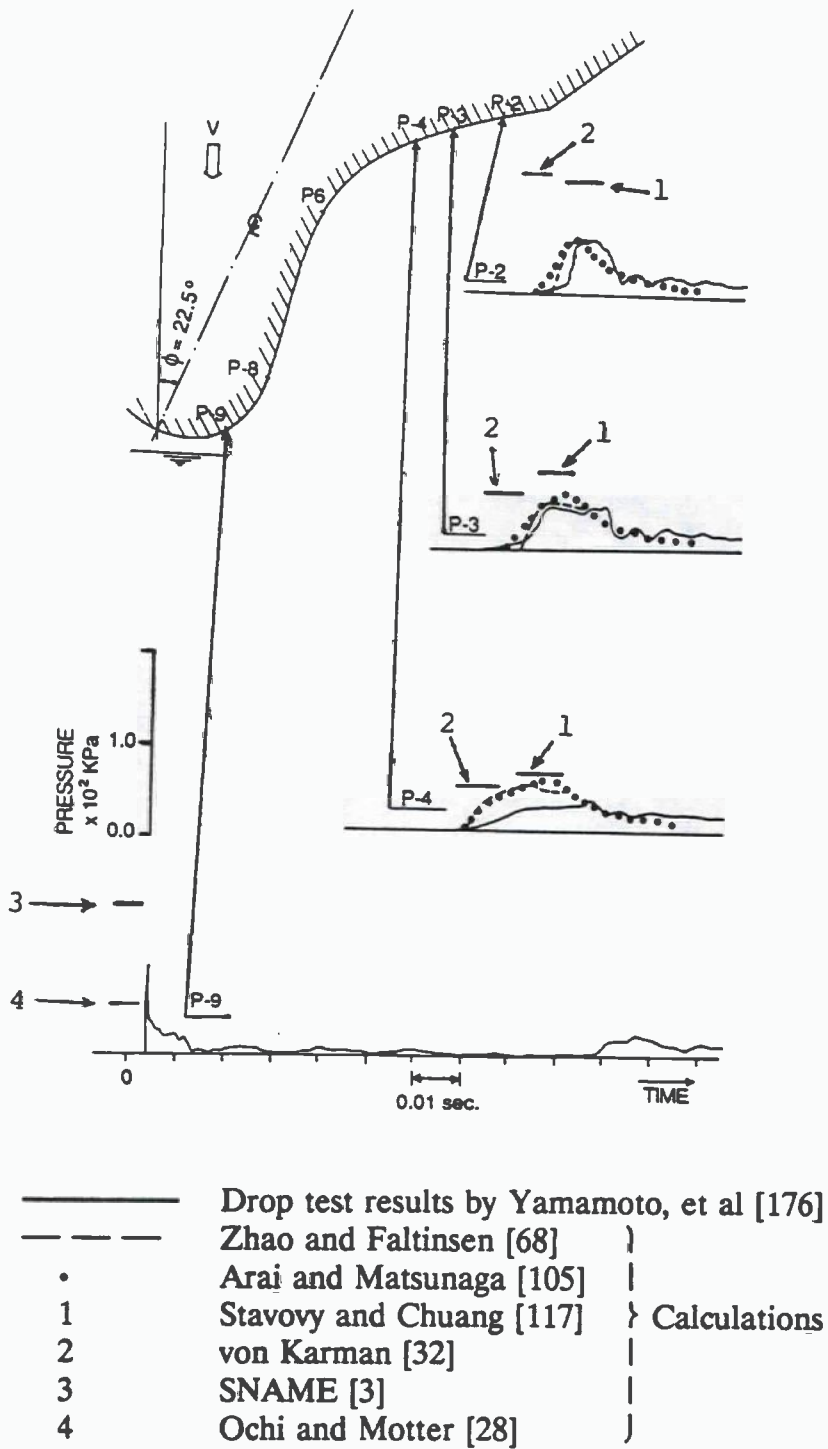
Fig. 6-2. Comparison of Maximum Pressure Coefficient for Circular Cylinder Section as Determined by Various Methods



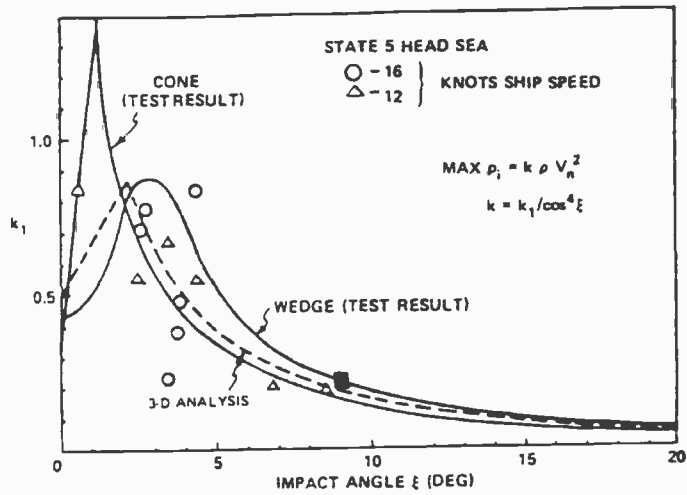


- |   |                 |   |                           |
|---|-----------------|---|---------------------------|
| 1 | Wagner [33]     | 3 | SNAME [3]                 |
| 2 | von Karman [32] | 4 | Ochi and Motter [28]      |
|   |                 | 5 | Stavovey and Chuang [117] |

Fig. 6-3. Comparison of Maximum Pressure Coefficient for Parabolic Section as Determined by Various Methods



**Fig. 6-4. Comparisons Between Numerical and Experimental Pressure Measurements on Bow Flare Section**



Note:  $K_1$  Values Proposed by Stavovy and Chuang [117] (- - -),  
 and Obtained From Ochi and Motter Data (■)

Fig. 6-5. Comparison of Calculated  $K_1$  Values Obtained from  
 Different Model and Full Scale Tests

Stavovy-Chuang [117] and other data. The difference between von Karman's and Wagner's solutions is due to correction on wetted surface length. It is known that the actual waterline width is  $\sqrt{2}$  times larger than the undisturbed waterline used by von Karman. The Zhao-Faltinsen solutions [68] are reasonably close to Wagner's solution, as was indicated earlier (see Fig. 3-13). The SNAME method [3] gives moderate values for small deadrise angles and greater values for large ones.

### 6.2.2 Circle

The widely discussed case of impact of the circular cylinder is analyzed in Figure 6-2. Again the difference between von Karman's and Wagner's solutions is well pronounced. The Stavovy-Chuang method [117] exhibits conservative behavior, as well as the Ochi-Motter and SNAME methods. It should be pointed out that latter two give only maximum pressure for the initial stage of slamming.

### 6.2.3 Parabola

This 2-D form is similar to a U-shaped cross-section of a ship's hull. As a result, the methods of Stavovy-Chuang, Ochi-Motter and SNAME give close values for the maximum pressure coefficient, Figure 6-3. The von Karman and Wagner solutions overpredict the slam pressure coefficient. To allow for an easier comparison with the circle case, independent variable was constructed on the basis of parabola radius of curvature. Indeed, the curves for small  $y/R$  values are almost the same as in Figure 6-2.

### 6.2.4 Bow Flare Section

Zhao and Faltinsen presented the results of numerical modeling of impact of the bow flare 2-D section [68]. The comparison between numerical and experimental pressure measurements are shown in Figure 6-4. Reasonable agreement between test results, numerical data and the Stavovy-Chuang method is evident. The other techniques also give good results. However, a significant overestimation by the SNAME method for slamming pressure is seen (gauge P-9).

### 6.2.5 Hull Section

Consider a comparison of the experimental data presented by Ochi and Motter [28] and the results of prediction by the Stavovy-Chuang technique [117]. This case was chosen because it corresponds to a seaway. The example of "reverse" calculations was performed to determine coefficient  $k_1$  for pressures used in the Stavovy-Chuang method. All steps are summarized in Table 6-2. The calculations use experimental data on pressure pick (identifier PIC) as an input information along with the geometry of ship and her kinematic parameters of motion. The result, coefficient  $k_1$ , is shown in Figure 6-5 (black square). As it can be seen from the last two lines of Table 6-2 and Figure 6-5, the agreement is relatively good.

Pressures due to wave slap can be determined from Garcia [168] and the U.S. Navy [210]. A comparison of allowable pressures specified by the U.S. Navy Structural Design Manual [210] and those predicted by Garcia's method [168] shows that the latter are significantly larger. It is believed the reason is that Equation (3-64) corresponds to total breaking and reflecting of waves on a wall mounted on the sea bottom. In the case of a ship only a portion of the wave is involved and the water particles can also move under the ship hull so wave diffraction and reflection are not complete as in wavebreaking wall.

### 6.3 Forces

There are two general approaches to calculate transient force acting at any section of a ship hull: (1) integrating the corresponding component of impact pressure around the section profile; (2) by using the momentum law. In the first case maximum impact pressure can be evaluated on the basis of data from Section 6.2. The pressure distribution functions for slamming, frontal impact, and for wave slap, are described in Chapter 3.

All techniques with force data available are listed in Table 6-3. Other procedures (Kaplan [102], Kaplan and Sargent [125], Jasper and Church [119], Bishop and Price [29], Federal Aviation Administration [42]) use the momentum approach and hence coincide with von Karman's theory [32] or lie between von Karman's and Wagner's theory. The problems analyzed include the impact of a wedge, Figure 6-6, circle Figure 6-7, a sphere Figure 6-8, and a cylindrical body Figure 6-9. In all examples the water was calm.

#### 6.3.1 Wedge

A comparison between theoretical values of slam force coefficient of a wedge is presented in Figure 6-6. The value of  $Vt$  has been chosen as a dimensional parameter of length. The impact force itself is proportional to the time variable and equal to zero at  $t=0$ . The data gained by Wagner's solution and Zhao-Faltinsen's techniques are sufficiently close. At the same time Gran's theory underestimates most of the data.

#### 6.3.2 Circle

The results of calculations and experiments for the well-known problem of the circle impacting on calm water is shown in Figure 6-7. According to the data presented, the experimental and theoretical results corresponding to the initial stage of impact lie between von Karman's and Wagner's solutions. For  $Vt/R=0.1..0.2$  the experimental results lie between Armand & Cointe's solution and Gran's approach. It should be noted that the experimental slam force coefficient at  $t=0$  equals zero, due to effects not included in the theoretical models. Armand and Cointe's technique based on the matched asymptotic expansions method demonstrates that Wagner's wetting correction is indeed valid at the instant of impact, but additional terms are required for later time and larger depths. The effect of these phenomena are seen in Figure 6-7.



### 6.3.3 Sphere

In addition to the Figure 3-17, Figure 6-8 illustrates the differences between the approaches in the problem of a sphere impact on calm water. Surprisingly good results for the very initial impact stage is provided by the von Karman theory [32], combined with the strip theory technique. Note that strip theory and nonlinear 2-D numerical modeling give worse results. For this comparison the only one value of von Karman's solution for force coefficient was used (@t=0). The numerical 3-D solution obtained by Troesch and Kang [5] is in good agreement with experiment for the range  $0 < z/R < 0.2$  (z=vertical coordinate of the point at a bottom of the sphere).



IMPACT PRESSURE FROM DATA, PIC =	83.09 PSI	
Vh =	7.4 kts	12.50 ft/sec
Vv =		5.97 ft/sec
Sea State		7
WAVE HEIGHT, H =		20 ft
WAVE LENGTH, Lw =		400 ft
WAVE NUMBER, K = 2*pi/Lw		0.016
MAX. WAVE SLOPE, (THETA)max = Kh =		0.157
percent y =		0 %
DEADRISE ANGLE, B =	0 deg =	0 rad
TRIM ANGLE, T =	0 deg =	0 rad
BUTTOCK ANGLE, AL =	0 deg =	0 rad
SLOPE, WS = [360*H/(2*Lw)]*COS(2*@pi*y) =	9 deg =	0.157079 rad
TBEH = TAN(B)/(SIN(T-WS)+TAN(AL)*COS(T-WS)) =		0
TBEV = TAN(B)/(COS(T-WS)-TAN(AL)*SIN(T-WS)) =		0
BehO, BEHO =	0 deg =	0 rad
SIN(T-WS)+TAN(AL)*COS(T-WS) =		-0.156
beh, BEH =	180 deg =	3.142 rad
bev, BEV =	0 deg =	0.000 rad
TXI = COS(BEH)*TAN(T+AL-WS)+SIN(BEH)*TAN(BEV) =		0.158
IMPACT ANGLE, XI =	9 deg =	0.157 rad
Vw, VW - 2.26*SQRT(WL)	45.20 ft/sec	
Von, VON - Vw*sin(WS)	7.07 ft/sec	
Vo - K*H*Vw/2	7.10 ft/sec	
VOT = SQRT(VO 2-VON 2)	0.64 ft/sec	
SIN (2*PI*Y)	0.00	
VOT - VOT, if sin(2pi*Y) < 0	0.64 ft/sec	
VHW = VH*COS(WS)-VV*SIN(WS)-VOT	10.77 ft/sec	
VVW = VH*SIN(WS)+VV*COS(WS)+VON	14.92 ft/sec	
VNS = VHW*COS(BEH)*SIN(XI)+VVW*COS(XI)	13.05 ft/sec	
VN = VNS*COS (XI)	14.74 ft/sec	
VT = VNS*SIN (XI)	2.33 ft/sec	
c = PIC/(1.94*VN 2)	0.23	
c1 = k*(COS(XI)) 4	0.22	
c1 = (from Stavovy-Chuang)	0.20	

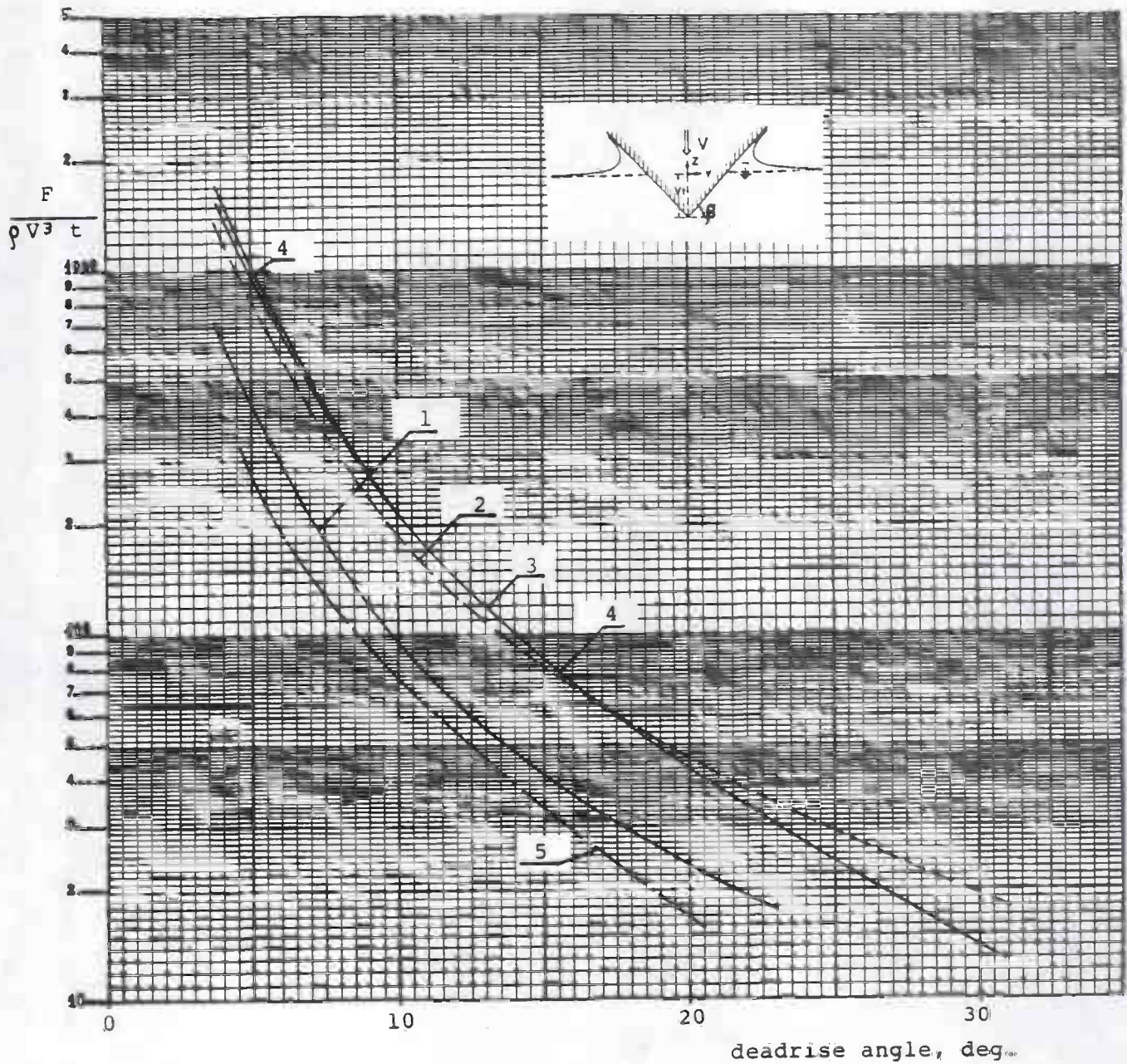
- Notes:
1. For definitions see Figure 4-7.
  2.  $WL = L_w =$  wave length, ft.
  3.  $VW = V_w = (g/K)^{1/2} =$  wave celerity

Table 6-2. Comparison of the pressure coefficient  $k_f$  found from experimental data of Ochi & Motter (Ref. 28) and proposed by Stavovy & Chuang (Ref. 117).

<u>Analysis Technique</u>	<u>Body</u>	<u>Short Solution Description</u>
von Karman [32]	wedge, circle, sphere *, cylindrical body *	2-D theory based on momentum considerations
Wagner [33]	wedge, circle, sphere *, cylindrical body *	2-D theory taking into account account real wetted area; calm water
Armand and Cointe [43]	circle	2-D theory based on the method of asymptotic expansions; calm water
Zhao and Faltinsen [68]: similarity solution	wedge	numerical nonlinear procedure applied to a wedge with arbitrary deadrise angle
boundary element solution	wedge	numerical nonlinear unsteady procedure valid for 2-D entry problem
Troesch and Kang [5]	sphere; cylindrical body	numerical nonlinear unsteady procedure valid for 2-D and 3-D entry problem
Gran, et al [64]	wedge, circle	2-D approach based on quasi-steady consideration of fluid momentum

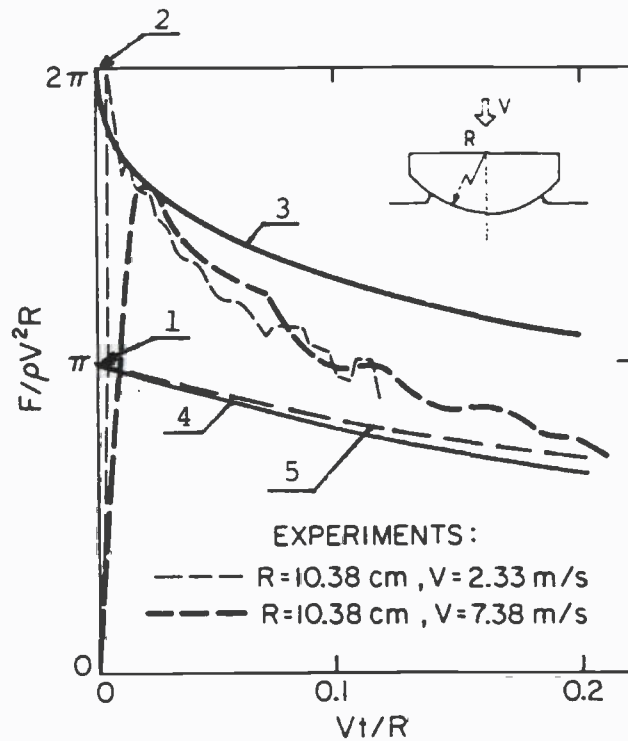
\* 2-D solution applied to 3-D problem through the strip theory.

**Table 6-3. Analysis Techniques - Forces**



- $t =$  time variable with  $t=0$  corresponding to initial time of impact  
 1 von Karman [32]  
 2 Wagner [33]  
 3 Zhao and Faltinsen (similarity solution) [68]  
 4 Zhao and Faltinsen (boundary element solution) [68]  
 5 Gran, et al [64]

**Fig. 6-6. Comparison Between Theoretical Values of Slam Force Coefficient of a Wedge Moving with Constant Downward Velocity  $V$**



$t =$  time variable with  $t=0$  corresponding to initial time of impact

- — experiments [43]
- 1 von Karman [32]
- 2 Wagner [33]
- 3 Armand and Cointe [43]
- 4 Gran [64]
- 5 Faltinsen [4]

**Fig. 6-7. Comparison Between Experimental and Theoretical Values of Slam Force Coefficient During Entry of a Circular Cylinder with Constant Downward Velocity  $V$**

### 6.3.4 Cylindrical Body

The good agreement between experimental data and results of calculations for the cylindrical body with length-width-draft ratio 2:1:0.5 [3] is shown in Figure 6-9. For this ship hull-like body von Karman's solution plus strip theory illustrate excellent results for the maximum slam force coefficient. The force time history is predicted by the theoretical approaches very well. As in the previous case, Wagner's solution applied with strip theory overestimates the slam force coefficient at the instant of impact  $t=0$ . This is due to increased wetted area.

### 6.4 Bending Moment

The comparison between two theories based on the momentum consideration approach to bottom slamming is shown in Figure 6-10 for the ship WOLVERINE STATE in light loading. The first method developed in Russia [157], [159], uses semi-empirical formula described in Section 3.2.4.2 (formula (3-46)). Second one is developed by Kaplan and Sargent [99]. The bending moment in this method is a result of numerical simulation on analogue computer. One can see reasonable agreement with slight overprediction by Russian technique. It should be noted that these methods use different procedures for the prediction of ship motions.

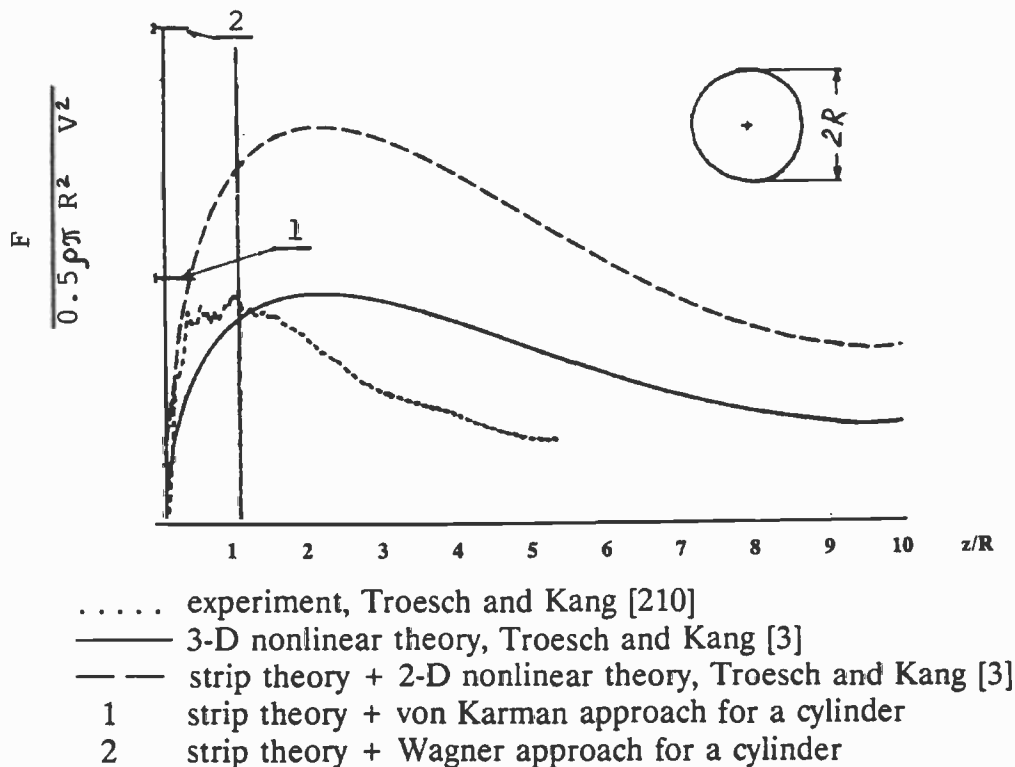
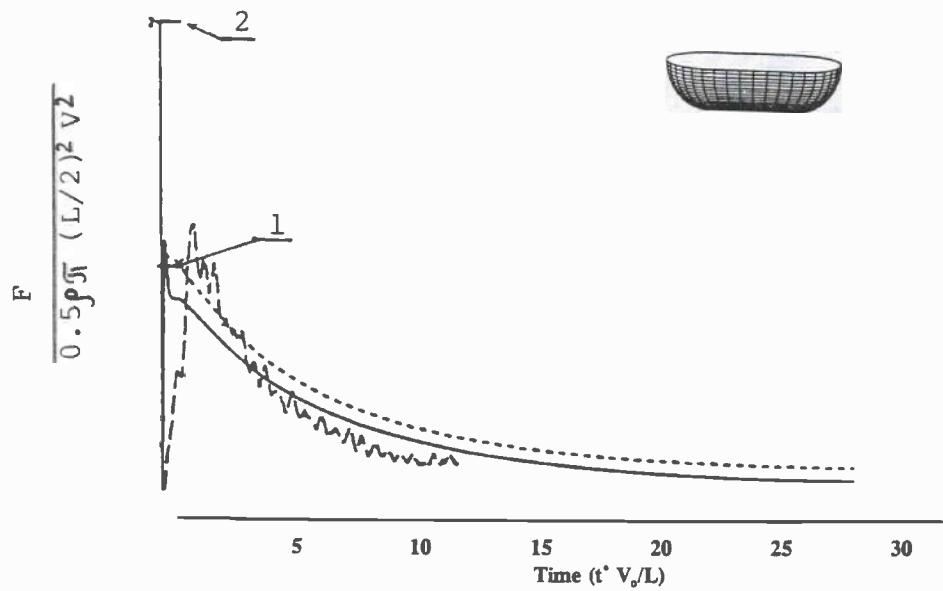


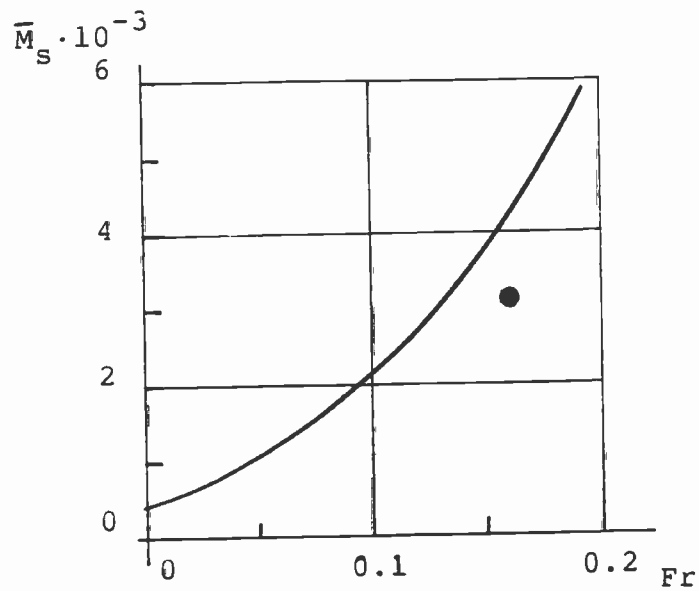
Fig. 6-8. Experimental and Theoretical Comparison of the Vertical Slam Coefficient for a Sphere



- — — experiment, Troesch and Kang [214]
- 3-D nonlinear theory, Troesch and Kang [5]
- - - - strip theory + 2-D nonlinear theory, Troesch and Kang [5]
- 1 strip theory + von Karman approach for a cylinder
- 2 strip theory + Wagner approach for a cylinder

**Fig. 6-9. Experimental and Theoretical Comparison of the Vertical Slam Coefficient for a Cylindrical Body With  $L/B=2$  [5]**





State State = 7,  $h_{1/3} = 39$  ft, Head Seas

———— Boytsov and Paliy [96], [98]

• Kaplan and Sargent [125]

**Fig. 6-10 Comparison of Theoretical Results for Bending Moments Amidship Due to Bottom Slamming of the Ship WOLVERINE STATE**

## 7. CONCLUSIONS

The results of the survey and assessment reported herein suggest the following conclusions:

- The phenomena of hydrodynamic impact are still not completely understood. More design guidance as to how these phenomena should be avoided from an operational perspective, or how their dangerous load effects should properly be repelled or absorbed in the structural design, would be extremely useful.
- In the investigation of structural systems, information on pressure, force and their spatial distribution is necessary.
- Model and full scale test results remain the most reliable source of information on pressures and forces induced by the ship hull impacting on the disturbed sea surface.
- The most accurate theoretical pressure distribution and time history can be obtained by using numerical nonlinear unsteady methods. At this time they are developed only for the case of calm water. Most of them solve the 2-D problems (Zhao and Faltinsen [175], Arai and Matsunaga [106]) and only one "exact" method is available for solution of the 3-D impact problem (Troesch and Kang [58]).
- An engineering approach for predicting impact loads can be based on simpler theories and/or semi-empirical relationships. For example, the maximum impact pressure can be satisfactorily predicted by the Stavovy-Chuang method [117], based on the generalization of 2-D and 3-D solutions, as well as experimental data obtained for ship hulls. The SNAME technique [3] and Ochi-Motter method [28] are also good for this purpose. Stavovy-Chuang's technique is most powerful because of its ability to address a variety of hull forms and sea conditions.
- In spite of rapid development of sophisticated numerical methods and codes used for modeling of the 3-D impact problem, the well known and commonly used strip theory combined with simple 2-D momentum theories (for example, von Karman [32]) remains a good source of reasonable data for impact force prediction, especially in slamming problems. Indeed, the usual quantities of interest are global hydrodynamic forces or bending moments and shear forces near the middle of the hull. These forces and moments are typically insensitive to the end effects where strip theory approximations are less valid. Frontal or bow flare impact and the resulting primary structural loads occur in areas of rapid longitudinal curvature of hull lines. The applicability of strip theory in these calculations is questionable.
- Wave slap can still only be addressed by rules for pressures which may be experienced at various locations of the hull.

- Further improvements of theoretical approaches are needed to reduce discrepancies between numerical techniques and experimental data. Some of them will be discussed in the next Section.
- Hydrodynamic impact theories and numerical fluid dynamics in general are expanding at a rapid rate. Concurrently computer technology is expanding and proliferating as well, allowing ever more complex computations to be realistically carried out. As time moves on it will be important to cross-correlate the approaches on the forefront of technology with requirements of engineering practitioners.
- A number of the potential hydrodynamic models of the future will relate to pressure. It will be important to have available structural models which will transmit the loads throughout the ship to develop proper shear and bending moments.

## 8. RECOMMENDATIONS FOR FUTURE RESEARCH

### 8.1 General

In the design of reliable and cost/weight effective ship structures operating in harsh environments, the prediction of hydrodynamic impact loadings plays an important role. As a result, in one context a structural engineer can feel the need to apply high precision prediction techniques for impact forces. This, of course, requires the availability of advanced numerical and experimental approaches, use of powerful computers, sophisticated algorithms, and software. At the same time, the reliability of complex engineering structures depends on a variety of other loadings and many factors, for example: material properties, margins of safety, and some parameters having a random nature. In this context the structural engineer must consider a myriad of analyses and needs some reasonable trade-off between time-consuming computerized "exact" (nonlinear, unsteady, and so on) solutions and simpler analytical formulas (e.g., von Karman or Wagner for impact) having clear physical meaning but, at the same time, realistic requirements for application within a design spiral. Therefore, the concept of development of an engineering method, consisting of the explicit relationships between governing parameters and proven by extensive analytical, numerical, and experimental studies, can be considered as the most important direction in future research of hydrodynamic impact loadings.

The areas of investigation which will contribute to development of the above-mentioned engineering method can be subdivided into three programs:

- Near-term program which covers years 1-2 of investigation and application of known techniques in design practice;
- Mid-term program which covers years 2-4, dedicated to improvement of existing analytical methods and approaches to make possible their application as design procedures;
- Long-term program covering the period beyond 4 years, consisting of R&D of advanced sophisticated numerical techniques without necessarily an immediate engineering application.

### 8.2 Near-term Program

During the near-term program attempts should be made to choose the most reliable engineering method from all available and applicable techniques and adjust it, as necessary, for the ship design and analysis purposes.

*Slamming:* The most promising approach for estimation of slamming pressures in actual sea conditions can be based on the Stavovy and Chuang method. The technique of Ochi and Motter also provides satisfactory results. An efficient estimate of maximum pressure can be obtained by using the method of Zhao and Falinsen

for arbitrary wedge-like forms with any deadrise angle and the Wagner solution for small angles.

The investigation of these procedures and combination into a self-contained computer code applicable to ships is expected to require 2 person-years.

*Wave Slap:* The U.S. Navy method, providing design pressures for various impact surface positions, is believed to be the most reliable and ready-to-use technique for design practice. It enables one to assume wave slap pressures for different structural members. This method is already available although not generally known.

*Frontal Impact:* The bow flare impact force can be predicted by changes in momentum and buoyancy. The Kaplan and Sargent method can be utilized in combination with seakeeping theory to estimate hull girder forces generated by frontal impact loads. The prediction of pressure due to frontal impact can be based on the Stavovy and Chuang method.

The investigation of these procedures including extensive correlation with experimental and full scale results, and combination into a self-contained computer code applicable to ships, is expected to required 2 person-years.

### 8.3 Mid-term Program

This program will deal with further development of advanced modern techniques which have been developed mostly by R&D Centers and Universities. Two approaches are most promising in this context: the 3-D finite element analysis by Troesch and Kang and 2-D finite difference numerical solution by Zhao and Faltinsen. These methods should be developed to take into account actual ship forms (mono- and multi-hulls) and actual sea surface conditions. To suggest application of these numerical techniques in design practice, extensive experimental and full scale verification will be needed, including seakeeping and drop tests, full-scale pressure measurements with precise probes, and adequate correlation with this data.

The above-mentioned methods should equally be useful for *Slamming, Wave Slap, and Frontal Impact* loadings predictions.

The investigation of these procedures and combination into a self-contained computer code application to ships is expected to required 2 to 4 person-years for each of the methods, depending on their current state of development.

### 8.4 Long-term Program

The long-term program will cover many aspects of research activities in areas of modern Marine Hydrodynamics, Numerical Fluid Dynamics, and Computer Science

(especially in parallel and distributed computing). First this program will result in solutions to theoretical and then to practical design problems. These investigations can start in the near future and emphasize development of 3-D non-linear seakeeping predictions and a Euler solver for simulation of *Slamming and Wave Slap* loadings experienced by a ship in rough seas. Successful prediction of *Bow Flare* loads should be obtainable with the development of a Navier-Stokes equation solver considering viscous flow separation, entrapped air, and compressibility effects.

The investigation of these procedures and combination into a self-contained computer code applicable to ships is expected to be an ongoing process for years to come. A development of the procedures into an engineering approach should be expected to take in the order of 10 person-years, but could be as high as 15 to 20 person-years.

It is also acknowledged that this approach is highly dependent on available computer technology which continues to develop rapidly and will serve to foster these types of analytical procedures.

#### 8.5 General Characteristics of Research

- A new advanced 3-D theory and numerical technique should be developed to improve seakeeping predictions (ship motions), wave loads, and nonlinear forces and moments induced by hydrodynamic impact. In this context, the time domain analysis of coupled seakeeping/impact problems via computer simulation is more promising. The continuous development of increased computer capabilities should make it plausible to achieve this in the future which will result in the ability to perform rapid assessment of hydrodynamic loads on different ships for a range of operational and environmental conditions.
- Most of the recently developed numerical techniques assume that the water surface is calm and the ship does not have roll motions. A rigorous solution of the nonlinear unsteady problem with actual free surface is extremely complex; however, it can provide the researcher/engineer with a deeper understanding of the hydrodynamic impact phenomena.
- Methodologies for conventional monohull vessels which show promise should be investigated for possible extension to advanced marine vehicles, including multi-hulls, SES, SWATH, etc.
- More accurate treatment of the free surface, including jet spray, is needed in numerical analysis of the 3-D impact problems, especially in frontal and bow flare impact. This may attenuate the maximum impact force in flared bodies and reduce any overestimation resulting from existing numerical techniques.



- The nonlinear boundary element method is a useful tool for a broad class of hull forms. However, it is necessary in the future to incorporate the effect of flow separation, for instance entrapped air, and compressibility effects (where needed).
- The numerical simulation of slamming should include the actual impact velocity time history. The "added-mass" effect on the slamming pressure due to large retardation typical of a drop test model can result in optimistic slamming predictions.
- The statistical and/or probabilistic nature of hydrodynamic impact loads can be found from the analysis of time histories obtained from extensive model or full scale tests. Similar results can in principle be gained from the results of a series of computer-based Monte Carlo simulation studies.

9. **REFERENCES**

- 1 MacCutcheon, E.M.; Oakley, O.H.; Stout, R.D.  
Ship Structure Committee Long Range Research Plan -  
Guidelines for Program Development  
SSC Report SSC-316  
1982
- 2 Weirnicki, C.J.  
Damage of Ship Plating Due to Wave Impact Loads  
SNAME, STAR Symp. pp 151  
1986, May
- 3 Notes on Ship Slamming  
Society of Naval Architects and Marine Engineers  
SNAME Technical and Research Bulletin 2-30.  
1993, May
- 4 Faltinsen, O.M.  
Sea Loads on Ships and Offshore Structures  
Cambridge University Press, 328 pp  
1990
- 5 Troesch, A.W.; Kang, C.G.  
Bow Impact Loads Including Effects of Flare  
Final Report  
UM Rpt for MarAd, Rept. No. MA-RD-840-88037, MTIF-03/8451  
1991
- 6 Hughes, O.F.  
Ship Structural Design  
John Wiley and Sons  
1983
- 7 Surface-Effect Ships  
Report of Committee V.4  
12th International Ship and Offshore Structures Congress, Canada  
1994
- 8 Kaplan, P.; Dalzell, J.F.  
Hydrodynamic Loads Prediction (Including Slamming) and Relation  
to Structural Reliability  
Ship Structures Symposium, Arlington  
1993, November

- 9        Szebehely, V.G.; Todd, M.A.  
          Ship Slamming in Head Seas  
          DTMB, Rpt. No. 913  
          1955, February
- 10       Akita, Y.; Ochi, M.K.  
          Investigations on the Strength of Ships Going in Waves  
          By Model Experiments  
          JZK Rpts 1-3, No. 95, 96, 97; or SNAME  
          1965
- 11       Ochi, M.K.  
          Model Experiments on Ship Strength and Slamming  
          in Regular Waves  
          SNAME, Transactions, Vol 66, pp 345-383  
          1958
- 12       Ochi, M.K.  
          Extreme Behavior of a Ship in Rough Seas - Slamming and  
          Shipping Green Water  
          SNAME, Transactions, Vol. 72  
          1964
- 13       Ochi, M.K.  
          Experiments on the Effect of Bow Form on Ship Slamming  
          DTMB, Report 1400  
          1962
- 14       Lehman, G.  
          Bodenschaden in Vorschiff unter die Neuen Vorschriften  
          der Klassifications  
          Schiffahrt und Hafenbau, 37  
          1936, April
- 15       SNAJ  
          Report on the Investigation Committee on Damage of  
          Diesel Ships due to Slamming  
          Society of Naval KArchitects of Japan  
          1936
- 16       Dillon, E.S.; Lewis, E.V.  
          Ships with Bulbous Bows in Smooth Water and in Waves  
          Report S-1, SNAME T&R Symposium  
          1967, October

- 17 Ochi, M.K.  
Performance of Two Hull Forms (U & V) in Irregular Waves  
SNAME, Report S-1, T&R Symposium  
1967
- 18 Lacey, P.; Edwards, R.  
ARCO Tanker Slamming Study  
Marine Technology, Vol. 30, No. 3  
1993, July
- 19 Matveev, G.A.; et al  
Results of Full Scale Tests of the "Krim" Class Tankers  
Krylov Research Institute, Leningrad  
1974
- 20 Vulovich, KR.; Harayama, T.; et al.  
Characteristics of Hull Stresses Measured on a Large  
Containership in Rough Seas  
Transactions of the SNAME, Vol 97, 1989, BMT-90040786  
1989, November
- 21 Beck, R.F.  
Motions in Waves  
Principles of Naval Architecture, 2nd Rev., SNAME, Vol III  
1988
- 22 8th Int. Ship Structures Congress  
1982
- 23 9th Int. Ship Structures Congress  
1985
- 24 11th International Ship and Offshore Structures Congress  
Report of Committee II.2, "Dynamic Load Effects", China  
1991
- 25 Environmental Forces  
Report of Committee of 10th International Ship Structures  
Congress, Denmark  
1988
- 26 Schlachter, G.  
Hull Girder Loads in a Seaway Including Non-Linear Effects  
Marintechnik, GmbH, Hamburg, Germany, Schiffstechnik, Vol. 36  
1989, H.4

- 27      Mansour, A.E.; D'Oliveira, J.M.  
         Hull Bending Moment Due to Ship Bottom Slamming  
         in Regular Waves  
         SNAME, JSR, Vol. 19, No. 2  
         1975, June
- 28      Ochi, M.K.; Motter, L.E.  
         Prediction of Slamming Characteristics and Hull Responses  
         for Ship Design  
         SNAME, Transactions  
         1973
- 29      Bishop, R.E.D.; Price, W.G.  
         Hydroelasticity of Ships  
         U.K. Cambridge University Press  
         1979
- 30      Hansen, P.F.  
         On Combination of Slamming- and Wave-Induced Responses  
         Journal of Ship Research, Vol. 38, N 2  
         1994, June
- 30a     Melville, W.K. and Chan, E.S.  
         Personal Communication, April, 1984,  
         as referenced in [2].
- 31      Green, T.  
         Wave Forces on Vertical Walls. An Overview of Recent Work  
         with Annotated Bibliography  
         University of Wisconsin  
         1989, June
- 31a     Kawakami, M.  
         "On the Impact Strength of Ships Due to Shipping Green Seas-  
         Towing Experiments of a Ship Model in Regular Waves"  
         Selected Papers from the Journal of the Society of Naval  
         Architects of Japan, Vol. 8, pp. 1-16  
         1971
- 32      Von Karman, T.  
         The Impact on Seaplane Floats During Landing  
         NACA, Tech Note 321, SITDL TR 1854  
         1929, October

- 33 Wagner, H.  
Landing of Sea Planes  
NACA Tech. Memo 622, SITDL TR 2101  
1931, May
- 34 Sedov, L.I.  
Two-Dimensional Problems in Hydrodynamics and Aerodynamics  
Interscience  
1965
- 35 Fritts, M.; Comstock, E.; Lin, W.C.; Salvesen, N.  
Hydro-Numeric Design: Performance Prediction and  
Impact on Hull Design  
SNAME Transactions, Vol. 98  
1990
- 36 Hutchinson, B.  
Seakeeping Studies: A Status Report  
Transactions of the SNAME, Vol. 98  
1990
- 37 Wang, X.D.; Huang, Z.J.; Hsiung, C.C.  
Application of the Flux Vector Splitting Method to Capture  
Shock Waves and Calculate Pressure in Ship Slamming  
20th Symposium on Naval Hydrodynamics, Santa Barbara  
1994, August
- 38 Maskew, B.  
A Nonlinear Numerical Method for Transient Wave/Hull Problems  
on Arbitrary Vessels  
SNAME Transactions, Vol. 99  
1991
- 39 Newman, J.N.  
The Numerical Towing Tank - Fact or Fiction?  
Schiffstechnik, Vol. 36, H.4  
1989
- 40 Von Karman, T.  
Calculation of the Pressure Distribution on Airship Hulls  
U.S. Experimental Model Basin (DTMB), SITDL, TR 1856  
1930, March



- 41 Wagner, H.  
Über Stross-und Gleitvorgange an der Oberflasche  
von Flussigkeiten  
ZAMM, Vol. 12, No. 4  
1932
- 42 United States Government  
Code of Federal Regulations, Title 14, Chapter 1, Federal  
Aviation Administration  
CFR 14, Part 25, pp. 263-267, 1980;  
pp. 321-326, 1993
- 43 Armand, J.L.; Cointe, R.  
Hydrodynamic Impact Analysis of a Circular Cylinder  
5th OMAE Symp. Proceedings, Tokyo, Japan  
1986
- 44 Hillman, A.  
Vertical Impact on a Water Surface By a 60 Degree Cone  
Math Tables Project, N.Y. University  
1946
- 45 Chu, W.; Abramson, H.N.  
Hydrodynamic Theories of Ship Slamming - Review and Extension  
SNAME, JSR, Vol. 4, No. 4, PP-9-21, SWRI, San Antonio, Texas  
1961, March
- 46 Henry, Jr.; Bailey, KF.C.  
Slamming of Ships: A Critical Review of the Current  
State of Knowledge  
SSC, Rpt. No. 208, Teledyne Materials Research Co. NTIS-AD-711267  
1970
- 47 Milwitzky, B.  
A Theoretical Investigation of Hydrodynamic Impact Loads on  
Scalloped Bottom Seaplanes and Comparisons with Experient  
NACA, Rpt. No. 867  
1947
- 48 Milwitzky, B.  
Generalized Theoretical and Experimental Investigation of the  
Motions and Hydrodynamic Loads Experienced by V-Bottom Seaplanes  
During Step Landing Impacts  
NACA, Tn-1516  
1948

- 49 Milwitzky, B.  
Generalized Theory for Seaplane Impact  
NACA, TR 1103  
1952
- 50 Mayo, W.L.  
Analysis and Modification of Theory for Impact of Seaplanes on Water  
NACA, TN-1008  
1945
- 51 Mayo, W. L.  
Theoretical and Experimental Dynamic Loads for a Prismatic Float  
Having an Angle of Deadrise of 22-1/2 Degrees  
NACA, Rpt. No. L-5-F-15  
1945
- 52 Bisplinghoff, R.O.; Doherty, C.S.  
A Two Dimensional Study of the Impact of Wedges on a Water Surface  
MIT, Rpt.  
1950
- 53 Bisplinghoff, R.L., Doherty, C.S.  
Some Studies of the Impact of Vee Wedges on a Water Surface  
Franklin Institute, Journal, Vol. 253, No. 6, pp 547-61  
1952
- 54 Szebehely, V.G.; Brooks, S.H.  
Hydrodynamics of Slamming of Ships  
NTMB, Report 823  
1952, July
- 55 Szebehely, V.G.  
Hydrodynamic Approach to the Slamming of Ships  
2nd Midwestern Conference on Fluid Mechanics, Proceedings  
1952
- 56 Szebehely, V.G.; Todd, M.A.; Lum, S.M.Y.  
On Slamming  
DTMB, Rpt. 995, European Shipbuilding, Volumd 3-4  
1956, January
- 57 Todd, M.A.  
Slamming Due to Pure Pitching Motion  
DTMB, Rpt. No. 833  
1955

- 58 Bledsoe, M.D.  
Series Investigation of Slamming Pressures  
DTMB, Rpt. No. 1043  
1956
- 59 Schnitzer, E.; Hathaway, M.E.  
Estimation of Hydrodynamic Impact Loads and Pressure  
Distributions on Board Approximating Elliptical Cylinder  
and Special Reference to Water Landings of Helicopters  
NACA, Report TN 2889  
1953
- 60 Fabula, A.G.  
Some Theoretical Calculations on the Impact of Circular  
Cylinders on Water  
U.S. Naval Ordnance Test Station, China Lake, CA, TRP 111  
1955
- 61 Fabula, A.G.  
Ellipse-Fitting Approximation of Two-Dimensional Normal  
Symmetric Impact of Rigid Bodies on Water  
5th Midwestern Conf on Fluid Mechanics, Proceedings, UOFM  
1957, April
- 62 Fabula, A.G.; Ruggles, I.D.  
Vertical Broadside Water Impact of Circular Cylinder; Growing  
Circular Arc Approximation  
NAVROD Rpt 4947 (NOTS 1268)  
1955
- 63 Ochi, M.K.; Bledsoe, M.D.  
Hydrodynamic Impact with Application to Ship Slamming  
4th ONR Symp on Naval Hydrodynamics, Vol. 3  
1962
- 64 Gran, S.; Olsen, H.; Tellsgard, F.  
Hull Response to Hydrodynamic Forces on Bow Flare  
Det Norske Veritas, Norwegian Maritime Research, No. 3, Vol. 4  
1976
- 65 Greenhow, M.  
Wedge Entry Into Initially Calm Water  
Applied Ocean Research, Vol. 9, No. 4  
1987

- 66 Greenhow, M.; Lin, W.M.  
 Numerical Simulation of Nonlinear Free Surface Flows Generated  
 by Wedge Entry and Wavemaker Motions  
 4th Int'l Conf. Numerical Ship Hydrodynamics, Proceedings,  
 Washington, D.C. NMRC-11-2086-A7 (1991)  
 1985
- 67 Yim, B.  
 Numerical Solution for Two-Dimensional Wedge Slamming with a  
 Nonlinear Free Surface Condition  
 4th Int'l Conf Numerical Ship Hydrodynamics, Proceedings,  
 Washington, D.C., NMRC-11-2086/A8  
 1985
- 68 Zhao, R.; Faltinsen, O.  
 Water Entry of Two-Dimensional Bodies  
 Journal of Fluid Mechanics, Vol. 246  
 1993
- 69 Korobkin, K.A.A.; Puchnachov, V.V.  
 Initial Stage of Water Impact  
 Annual Review on Fluid Mechanics, Vol. 20  
 1988
- 70 Watanabe, T.  
 Analytical Expression of Hydrodynamic Impact Pressure by Matched  
 Asymptotic Expansion Technique  
 Trans. West-Japan Soc. Naval Architect. No. 71  
 1986
- 71 Dobrovol'skaya, Z.N.  
 On Some Problems of Similarity Flow of Fluid With a Free Surface  
 Journal of Fluid Mechanics, Vol. 36  
 1969
- 72 Cointe, R.  
 Free Surface Flows Close to a Surface-Piercing Body  
 In "Mathematical Approaches in Hydrodynamics" (ed. T. Miloh),  
 SIAM, Philadelphia  
 1991
- 73 Howison, S.D.; Ockendon, J.R.; Wilson, S.K.  
 Incompressible Water-Entry Problems at Small Deadrise Angles  
 Journal of Fluid Mechanics, Vol. 222  
 1991

- 74 Venkat, N.K.; Spaulding, M.L.  
Numerical Simulation of Nonlinear Free-Surface Flows  
Generated by a Heaving Body of Arbitrary Cross Section  
Journal of Ship Research, Vol. 34, N 2  
1990, June
- 75 Toyama, Y  
Two-Dimensional Water Impact of Unsymmetrical Bodies  
Journal of the Society of Naval Architects of Japan, Vol. 173  
1993
- 76 Egorov, I.T.  
Udar o Schimaemuiu Zhidkost (Impact of a Compressible Fluid)  
NACA, TM 1413  
1958, February
- 77 Ogilvie, T.F.  
Compressibility Effects on Ship Slamming  
Schiffenstechnik, Volume 10, No. 53, pp 147-154  
1963
- 78 Skalak, R.; Feit, D.  
Impact on the Surface of a Compressible Fluid  
ASME, Paper No. 65-WA/UnT-3, Columbia University Dept. of  
Civil Engineering, Tech. Rpt. 31  
1965, December
- 79 Hagiwara, K.; Yuhara, T.  
Fundamental Study of Wave Impact Loads on Ship Bow  
Selected Papers from the Journal of Soc. Nav. Arch., Japan, Vol. 14  
1976
- 80 Kamel, A.M.  
Shock Pressures Caused by Waves Breaking Against Coastal Structures  
ACOE, Waterways and Experiment Station, MRIS-054189  
1968, September
- 81 Weinig, F.  
Impact of a Vee-Type Seaplane on Water With Reference to Elasticity  
NACA, TM 810  
1936
- 82 Meyerhoff, W.K.  
Die Berechnung Hydroelastischer Stotze  
Schiffstechnik, Volume 12, No. 60, 61  
1965

- 83      Chuang, S.S.  
          Theoretical Investigation of Dynamic Interaction Between  
          Ship Bottom and Fluid During Slamming  
          DTNSRDC Report No. 2403  
          1967, December
- 84      Sellars, F.H.  
          Water Impact Loads  
          SNAME, Chesapeake Section, MRIS-084451 and SNAME Marine  
          Technology  
          1976, January
- 85      Shiffman, M.; Spencer, D.C.  
          The Force of Impact on a Cone Striking a Water Surface  
          Commun. Pure and Applied Math, Vol. 4  
          1951
- 86      Chuang, S.L.  
          Theoretical Investigation of Slamming of Cone-Shaped Bodies  
          SNAME, JSR, Vol. 13, No. 4, MRIS  
          1969, December
- 87      Miloh, T.  
          Wave Slam on a Sphere Penetrating a Free Surface  
          Journal of Engineering Math, Vol. 15, No. 3  
          1981
- 88      Ochi, M.K.; Motter, L.E.  
          Prediction of Extreme Values of Impact Pressures Associated  
          with Ship Slamming  
          SNAME, JSR, Vol. 13, No. 2, MRIS-015291  
          1969
- 89      Yamamoto, Y.; Fujino, M.; Fukasawa, T.  
          Motion and Longitudinal Strength of a Ship in Head Sea and  
          Effects of Non-Linearities (1st, 2nd, 3rd Reports)  
          Journal, Society of Naval Architects of Japan,  
          Vol. 143 (1978), Vol. 144 (1978), Vol. 145 (1979)
- 90      Belik, O.; Bishop, R.E.D.; Price, W.G.  
          A Simulation of Ship Responses due to Slamming  
          in Irregular Head Waves  
          RINA, pp 237-253  
          1982



- 91 Oliver, J.C.  
Advanced Method for Ship Motion and Wave Load Predictions  
Ship Structure Committee Project, SR 1277, Giannotti and Assoc.  
1983
- 92 Kaplan, P.; Silbert, M.N.  
Impact Forces on Platform Horizontal Members in the Splash Zone  
OTC Paper No. 2498, Houston, TX  
1976
- 93 Sarpkaya, T.; Isaacson, M.  
Mechanics of Wave Forces on Offshore Structures  
Van Nostrand Reinhold Co., New York  
1981
- 94 Newman, J. N.  
Marine Hydrodynamics  
The MIT Press, Cambridge, Massachusetts  
1977
- 95 Dynamic Load Effects  
Report of Committee of 10th International Ship Structures  
Congress, Denmark  
1988
- 96 Rabinovitch, O.N.; Rostovtsev, D.M.; Stepanov, I.V.  
A Survey of the Russian/Soviet Studies, Results and Data on  
Hydrodynamic Impact Load Estimation in Marine (and Non-Marine)  
Structure Design Practice  
St. Petersburg State Marine Technical University,  
St. Petersburg, Russia  
1993
- 97 Stepanov, I.V.  
Principles of the Free Fall Life Boats Design  
Ph.D. Thesis, Leningrad Shipbuilding Institute  
1988
- 98 Boytsov, G.V.; Paliy, O.M.  
Hull Strength and Structures for Ships of New Types  
Leningrad, Sudostroenie Publ. House  
1979
- 99 Chuvikovsky, KG.S.  
Hull Dynamic Bending Due to Impact on Head Waves  
Proc. of the Krylov Research Institute, No. 245  
1968

- 100 Kaplan, P.; Malakhoff, A.  
Hard Structure Slamming of SES Craft in Waves  
AIAA/SNAME, Advanced Marine Vehicles Conference,  
San Diego, CA, Paper No. 78-746  
1978, April
- 101 Smiley, R.F.  
A Semi-Empirical Procedure for Computing the Water-Pressure Distribution  
on Flat and V-Bottom Prismatic Surfaces During Impact on Planning  
NACA Tech, Note 2583  
1953, December
- 102 Kaplan, P.  
Analysis and Prediction of Flat Bottom Slamming Impact of  
Advanced Marine Vehicles in Waves  
ISP, Vol 34, No. 391  
1987, March
- 103 Ohtsubo, H.; Fukumura, M.  
Simplified Analysis of Impact Pressure Taking into Account of Splash  
Journal of Soc. of Nav. Arch. of Japan, No. 162  
1987, December
- 104 Tanizawa, K.  
Self-Similar Solution of Wedge Entry Problem by B.E.M.  
Journal of Soc. of Nav. Arch of Japan, No. 160  
1987, December
- 105 Hughes, O.F.  
Solution of the Wedge Entry Problem by Numerical Conformal Mapping  
Journal of Fluid Mechanics, Vol 56  
1972
- 106 Arai, M.; Matsunaga, A.  
A Numerical and Experimental Study of Bow Flare Slamming  
Journal of Soc. of Nav. Arch of Japan, No. 166  
1989, December
- 107 Arai, M.; Matsunaga, K.  
A Numerical Study of Water Entry of Two-Dimensional  
Ship-Shaped Bodies  
PRADS  
1989

- 108 Radev, D.  
Numerical Realization of Problem for Entry of Rigid Circular  
Cylinder in Compressible Fluid  
4th Intern. Congress Int. Marit. As. East Med., Vol. 5  
1987
- 109 Ando, S.  
Cushioning of Slamming Impact by Elastomeric Layers  
Journal of Ship Research, Vol. 33, No. 3  
1989
- 110 Watanabe, T.  
Effects of Three-Dimensionality of Ship Hull on  
Wave Impact Pressure  
Journal of Soc. Nav. Arch. of Japan, No. 162  
1987, December
- 111 Song, J.; Dai, Y.; Li, W.  
The Computation of Oscillatory Pressure and Impact Pressure  
for Two-Dimensional Bodies  
Journal of Harbin Shipb. Engng. Inst., Vol. 9, No. 4  
1988
- 112 Isaacson, M.; Bussiah, K.  
Random Wave Slamming on Cylinders  
Journal of Waterway, Port, Costal and Ocean Engng, No. 2  
1993
- 113 Lewis, E.V.; Gerard, G.  
A Long Range Research Program in Ship Structural Design  
SSC Final Rpt No. SSC-124  
1959, November
- 114 Lipis, V.B.; Remez, Y.V.  
Diagrams for Safe Ship Routing in Rough Seas  
Handbook, Moscow Transport Publ. House  
1982
- 115 11th International Ship and Offshore Structures Congress  
Report of Committee I.2, "Loads", China  
1991
- 116 Kline, R.G.; Daidola, J.C.  
Ship Vibration Prediction Methods and Evaluation of  
Influence of Hull Stiffness Variation on Vibratory Response  
SSC, Rpt. No. 249  
1979

- 117 Stavovy, A.B.; Chuang, S.L.  
Analytical Determination of Slamming Pressures for  
High Speed Vehicles in Waves  
SNAME, JSR, Vol 20, No. 4  
1976, December
- 118 Hadler, J.B.; Lee, C.M.; et al  
Ocean Catamaran Seakeeping Design Based on the  
Experiences of USNS Hayes  
SNAME, Transactions  
1974
- 119 Jasper, N.H.; Church, J.W.  
Structural Seaworthiness Studies  
SNAME, Transactions, Vol. 71  
1963
- 120 Chuang, S.L.; Schroeder, E.A.; Wybraniec, S.  
Numerical Analysis by Digital Computer Program ROSAS of Response  
of Ship-Hull Structure at Sea  
Numerical Analysis of Dynamics of Structures Proceedings of  
EUROMECH Colloquim 122, Ecole Polytechnique, Paris  
1979, September 3-5
- 121 Chuang, S.L.  
General Considerations in the Mathematical Modeling for  
Three-Dimensional Computer Program ROSAS3  
David Taylor Naval Ship Research and Development Center,  
Rpt. 1185  
1981
- 122 Chuang, S.L.  
Numerical Modeling and Computer Programming for Program ROSAS3  
David W. Taylor Naval Ship Research and Development Center,  
Structural Department Report No. 1198  
1958, August
- 123 Chuang, S.L.  
Dynamic Structural Analysis in Time Domain by Digital Computer  
ROSAS3 on Responses of Ship at Sea Proceedings of the International  
Symposium on Marine Structures, Shanghai, China  
1991, Septembaer 13-14
- 124 Chuang, S.L.; Birmingham, J.T.; et al  
Experimental Investigation of Catamaran Cross-Structure Slamming  
SITDL TR 11078, NSRDC Rpt. 4653, pp 55, MRIS-07-127751  
1975, September

- 125 Kaplan, P.; Sargent, T.P.  
Further Studies of Computer Simulation of Slamming and Other  
Wave-Induced Structural Loadings on Ships in Waves  
SSC-231, MRIS-040601, NTIS-AD-752479  
1972, July
- 126 Bishop, R.E.D., Clarke, J.D.; Price, W.G.  
Comparison of Full Scale and Predicted Responses of  
Two Frigates in a Severe Weather Trail  
RINA, Trans. v.126  
1984
- 127 Belik, O.; Bishop, R.E.; Price, W.G.  
Influence of Bottom and Flare Slamming on Structure Response  
RINA, Vol 130, MTIF-02/10482  
1988
- 128 Liebowitz, R.D.  
Method for Predicting Slamming Forces on and Response  
of a Ship Hull  
DTMB, Rpt. 1691  
1963, September
- 129 Leibowitz, R.C.  
Comparison of Theory and Experiment for Slamming of  
a Dutch Destroyer  
DTMB, Rpt. 1511  
1962, June
- 130 Kawakami, M.; Michimoto, J.; Kobayashi, K.  
Prediction of Long Term Whipping Vibration Stress Due to Slamming  
of Large Full Ships in Rough Seas  
ISP, No. 24  
1977
- 131 Bishop, R.E.D.; Price, W.G.; Wu, Y.  
A General Linear Hydroelasticity Theory of Floating  
Structures Moving in a Seaway  
Royal Society of London Transactions, pp 375-426  
1986
- 132 Aksu, S.; Price, W.G.; Temarel, P.  
A Three Dimensional Theory of Ship Slamming in Irregular Oblique  
Seaway Advanced in Marine Structures - 2  
Elsevier Applied Science, pp. 208-229  
1991

- 133 American Bureau of Shipping  
Estimate of Ship Bottom Slamming  
ABS  
1979, December
- 134 Ng, R.C.; Chen, H.H.  
Analytical Study on Bow Flare Impact  
American Bureau of Shipping: Phase I - 1979, July;  
Phase II - 1980, February; Phase III - 1981, May;  
Phase IV - 1982, June
- 135 Toki, N.; Hatakenaka, K.; Takahashi, T.; Fujii, H.  
Experimental and Theoretical Approach to the Estimation of  
Non-Linear Vertical Wave Loads  
Journal of the Soc. Nav. Arch. of Japan  
1983, November
- 136 Antonides, G.P.  
A Computer Program for Structural Response to Ship Slamming (SLAM)  
Naval Ship Research and Development Center  
1975, July
- 137 Comparative Analysis of Analytical Predictions for  
Hydrodynamic Loads in a Seaway  
NAVSEA Technical Note 051-55W-TN-0094  
1992
- 137a Beukelman, W.  
Bottom Impact Pressure Due to Forced Oscillation  
Delft, Netherlands, or ISP, Vol. 27  
1980, May
- 138 Kaplan, P.; Sargent, T.P.; Raff, A.I.  
An Investigation of the Utility of Computer Simulation to Predict  
Ship Structural Response in Waves  
SSC-197, DON, Tech Rpt.  
1969, June
- 139 Kaplan, P.  
Computer Simulation of Ship Structural Loads Due to Waves  
AIAA/ASME, Structural Dynamics and Materials Conference,  
San Antonio, TX, Paper No. 72-342  
1972, April



- 140 Ochi, M.K.; Motter, L.E.  
A Method to Estimate Slamming Characteristics for Ship Design  
SNAME, NY Sec. Mtg.  
1970
- 141 Ochi, M.K.  
On Prediction of Extreme Values  
SNAME, JSR  
1973, March
- 142 Ochi, M.K.  
Ship Slamming-Hydrodynamic Impact Between Waves and  
Ship Bottom Forward  
ASME, Fluid-Solid Interaction Symposium  
1967, November
- 143 Szebehely, V.G.; Ochi, M.K.  
Hydrodynamic Impact and Water Entry  
Applied Mechanics Surveys, Spartan Books  
1966
- 144 Ochi, M.D.; Schwartz, F.M.  
Two Dimensional Experiments on the Effects of Hull Form  
on Hydrodynamic Impact  
DTMB, Rpt. 1994  
1966
- 145 Clevenger, R.L.; Melberg, L.C.  
Slamming of a Ship Structural Model  
M.S. Thesis, MIT  
1963, May
- 146 Chuang, S.L.  
Slamming of Rigid Wedge-Shaped Bodies with Various  
Deadrise Angles  
DTMB, Rpt. No. 2268  
1966, October
- 147 Chuang, S.L.  
Experimental Investigation of Hydrodynamic Impact on  
Inflatable Fabric Ship Sections  
David Taylor Model Basin Report No. 2080  
1965, October

- 148 Chuang, S.L.  
Investigation of Impact of Rigid & Elastic Bodies with Water  
NSRDC  
1970
- 149 Hirano, S.; Yoshikava, S.; Himeno, Y.  
Pressure Measurement on the Bottom of a Wedge-Form Planing Hull  
Kansai Soc. Nav. Arch. of Japan, No. 208  
1988, March
- 150 Hirano, S.; Uchida, S.; Himeno, Y.  
Pressure Measurement on the Bottom of Prismatic Planing Hull  
Kansai Soc. Nav. Arch. of Japan, No. 213  
1990, March
- 151 Watanabe, I.; Tanizawa, K.; Sawada, H.  
An Observation of Bottom Impact Phenomena by Means of  
High Speed Video and Transparent Model  
Journal of Soc. Nav. Arch. of Japan, No. 164  
1988, December
- 152 Watanabe, I.; Ueno, M.; Sawada, H.  
Effects of Bow Flare Shape to the Wave Loads of a Container Ship  
Journal of Soc. Nav. Arch. of Japan, No. 166  
1988, December
- 153 Chui, F.C.; Fujino, M.  
Nonlinear Prediction of Vertical Motions and Wave Loads of  
High-Speed Crafts in Head Seas  
Intern. Shipb. Progress, Vol 36, No. 406  
1989
- 154 Nagai, T.; Hashimoto, T.  
On the Maximum Stress of Bottom Shell and Impulsive  
Water Pressure of FRP High Speed Craft  
West Jap. Soc. Nav. Arch., No. 79  
1990, March
- 155 Sawada, H.; Watanabe, I.; et al  
On an Elastic Model to Simulate Elastic Hull Responses of Ships  
Ship Research Institute, Japan, Vol. 24, No. 2  
1987
- 156 Paulling, R.  
Strength of Ships  
Principles of Naval Architecture, 2nd Rev., SNAME, Vol. I  
1988

- 157 Sikora, J.R.; Dinsenbacher, A.L.  
SWATH Structure: Navy Research and Development Applications  
SNAME, Marine Technology, Vol. 27, No. 4, pp 211-220  
1990, July
- 158 Wahab, R.; Pritchett, C.; Ruths, L.  
On the Behavior of the ASR Catamaran in Waves  
Marine Technology  
1971, July
- 159 Giannotti, J. G.; Fuller, N.R.  
Slamming of High Performance Marine Vehicles  
11th Annual Symp. of the Association of Senior Engineers  
1974, March
- 160 Chuang, S.L.  
Experimental Investigation of Rigid Flat Bottom Body Slamming  
DTMB Rpt 2041, Sept. 1965;  
SNAME, JSR, pp 1-17, 1966, March
- 161 Fujita, A.  
Impact of Circular Plate Falling Upon a Water Surface  
SNAJ, Journal  
1954
- 162 Lewison, G.; MacLean, W.M.  
The Effect of Entrapped Air Upon the Slamming of Ships Bottoms  
University of California, Berkeley, CA, Rpt No. NA-66-5  
1966
- 163 Johnson, R.S.  
The Effect of Air Compressibility on a First Approximation to  
the Ship Slamming Problem  
SNAME, JSR  
1968, March
- 164 Whitman, A.M.; Pancione, M.C.  
Similitude Relation for Flat Plate Hydrodynamic Impact  
Journal of Ship Research  
1973, March
- 165 Gerlach, C.R.  
Investigation of Water Impact of Blunt Rigid Bodies -  
Size Scale Effects  
Technical Report #2, Southwest Research Institute  
1968, November

- 166 Nott, J.A.  
Techniques for Simulating the Hydrodynamic Forces on  
Sonar Domes by Static Loads  
DTMB, Rpt. 1441  
1961, April
- 167 Lunchick, M.E.; Eibling, J.H.; Short, R.D., Jr.  
A Feasibility Study of Methods for Simulating by Static Forces the  
Nonuniform Hydrodynamic Pressures on Sonar Domes  
DTMB, Rpt. 1134  
1957, May
- 168 Garcia, W.J., Jr.  
Experimental Study of Breaking Wave Pressures  
Army Corps of Engrs., Vicksburg, MD  
1968, September
- 169 Rose, C.W.  
Shock Pressure of Breaking Waves  
Fourth Conference on Coastal Engineering, Chicago  
1953
- 170 Denny, D.F.  
Further Experiments on Wave Pressures  
Journal of Institution of Civil Engineers, Vol. 35, No. 4  
1951, February
- 171 DeRouville, A.; Besson, P.; Petry, P.  
Development of International Studies on Wave Force  
Translation, U.S. Army Engineer Waterways Experiment Station  
Research Center, Vicksburg, Miss., TR N 40-13  
1940, May
- 172 Nagai, S.  
Shock Pressures Exerted by Breaking Waves on Breakwaters  
ASCE Journal, Waterways and Harbors Division, Vol. 86, WW2  
1960, June
- 173 Rundgren, L.  
Water Wave Forces: A Theoretical and Laboratory Study  
Transactions of Royal Institute of Technology, Institution of  
Hydraulics, Stockholm, Bulletin 54  
1958

- 174 Band, E.G.U.  
 Predicting the Unpredictable - Development of Rational Design  
 Loads for High Performance Vessels  
 Band, Lavis & Assoc., Inc., High Speed Surface Craft Exhibition  
 and Conference, Sussex, UK  
 1980, June
- 175 Faltinsen, O.M.  
 On Seakeeping of Conventional and High-Speed Vessels  
 Journal of Ship Research, Vol. 37, No. 2  
 1993
- 176 Yamamoto, Y.; Iida, K.; Fukasawa, T.; Mirakami, T.; Arai, M.; Ando, M.  
 Structural Damage Analysis of a Fast Ship Due to Bow Flare Slamming  
 Intern. Shipb. Progress, Vol. 32, No. 369  
 1985
- 177 Giannotti, J.G.  
 Bibliography on Slamming, Impact and Other Transient  
 Related Phenomena  
 Prep. by Giannotti & Assoc., Inc. for SNAME Panel HS-2  
 of the Hull Structure Committee, 114 pp.  
 1985
- 178 Spinelli, L.  
 Theoretical Research and Experiments in Slamming  
 Registro Italiano Navale, Genoa, Italy  
 1967, February
- 179 Daidola, J.C.; Mishkevich, V.G.; Bromwell, A.  
 Bibliographic Summary on Hydrodynamic Impact Loading on  
 Displacement Ship Hulls  
 M. Rosenblatt & Son, Inc., Draft Report for SSC Project SR-1342  
 June 1994
- 180 Greenspon, J.E.  
 Sea Tests of the USCGC UNIMAK; Part 2: Statistical Presentation  
 of the Motions, Hull Bending Moments and Slamming Pressures for  
 Ships of the AVP Type  
 DTMB Report 977  
 1957, April
- 181 Heller, S.R.; Jasper, N.H.  
 On the Structural Design of Planing Craft  
 RINA, Quarterly Transactions  
 1960, July

- 182 Jasper, N.H.; Birmingham, J.T.  
Strains and Motions of USS Essex During Storms Near Capt Horn  
DTMB, Rpt. No. 1216  
1958, August
- 183 Birmingham, J.T.; Palmer, F.W.  
Stresses and Motions of a Destroyer Escort in Random Seas  
NSRDC, Rpt. No. 2610  
1968, March
- 184 Palmer, F.W.; Birmingham, J.T.  
Structural Seaworthiness and Hull Deckhouse Interaction  
of USCG Hamilton (WHEC 715)  
NSRDC, Structures Note 139  
1969, June
- 185 Jasper, N.H.; Andrews, J.N.  
Preliminary Report of Strains and Motions of USS Ranger (CVA 61)  
During a Voyage Around Capt Horn  
DTMB, Report No. 1289  
1959, January
- 186 Birmingham, J.P.; Brooks, R.L.; Jasper, N.H.  
Statistical Presentation of Motions and Hull Bending  
Moments of Destroyers  
DTMB, Rpt. No. 1198  
1960, September
- 187 Bledsoe, M.D.; Bussemaker, O.; Cummins, W.E.  
Seakeeping Trials on Three Dutch Destroyers  
SNAME, Transactions, Vo. 68, pp 37-137, DTMB Rpt. 1559  
1960
- 188 Palmer, F.W.  
Structural Seaworthiness Evaluation of USS Benicia  
NSRDC, Structures Note 290  
1974, October
- 189 Andrews, J.N.; Dinsbacher, A.L.  
Response Amplitude Operators and Whipping Response of  
Carrier Model in Random Waves  
NSRDC, Rpt. No. 2522  
1968, January



- 190 Andrews, J.N.; Chuang, S.L.  
Seaworthiness Analog Computer  
DTMB, Rpt. No. 1829  
1965, August
- 191 Wheaton, J.W.; et al.  
Analysis of Slamming Data from the S.S. Wolverine State  
Teledyne Material Research Co., Rpt. No. E-116(a)  
1969, December
- 192 Pegg, N.G.; Vernon, T.A.; Wegner, L.; et al  
Force Elevation Prediction of Measured Bow Flare Plate  
Stresses Under Dynamic Wave Loading  
RINA, Vol. 133, MTIF-12/12164  
1989
- 193 Takemoto, H.; Hasizume, Y.; et al  
Full-Scale Measurements of Wave Impact Forces and Hull  
Response of a Ship in Waves  
Journal of Soc. Nav. Arch. of Japan, No. 164  
1988, December
- 194 Purcell, E.S.; Allen, S.J.; Walker, R.T.  
Structural Analysis of the U.S. Coast Guard Island Class Patrol Boat  
Trans. SNAME, Vol. 96  
1988
- 195 Barabanov, N.V.; Ivanov, N.A.; Kulesh, V.A.  
External Slamming Loads and Design of Low Bottom Structures  
Sudostroenie, No. 5  
1985
- 196 Rask, I.  
Slamming Pressure in Short-Crested and Oblique Seas  
Chalmers Univ. of Technology, Goteborg  
1986
- 197 Bugakov, V.N.  
Analysing Hull Bottom Structures for Slamming Effects  
Sudostroenie, No. 7  
1986
- 198 Bugakov, V.N.  
Storm Damage and Safe Ship Speed  
Sudostroenie, No. 12  
1988

- 199 Aertssen, G.; van Sluys, M.F.  
Service Performance and Seakeeping Trials on  
a Large Containership  
Trans. of Royal Inst. of Naval Arch., Vol 116  
1974
- 200 Tasaki, R.; Takerawa, S.; Takaishi, Y.  
Collection and Analysis of Full Scale Data  
Report of Seakeeping Committee, 14ITTC, Ottawa  
1975
- 201 Cruikshank, J.M.; Landsburg A.C.  
Guidelines for Operating at IMCO Segregated Ballast Levels  
IMCO, DE XYII, London  
5.1.1977
- 202 Solomentsev, O.I.  
Consideration of the Seaworthiness Requirements on  
Designing Sea-Going Catamarans  
Sudostroenie, No. 4  
1988
- 203 Ochi, M.K.; Motter, L.E.  
A Method to Estimate Slamming Characteristics for Ship Design  
SNAME, Marine Technology  
1971, April
- 204 Chuang, S.L.  
Impact Pressure Distribution on Wedge-Shaped Hull Bottom  
of High-Speed Craft  
DTNSRDC Report No. 2953  
1969, August
- 205 Chuang, S.L.  
Design Criteria for Hydrofoil Hull Bottom Plating  
DTNSRDC, Report No. 3509  
1975, August
- 206 Chuang, S.L.  
Slamming Tests of Three Dimensional Models in Calm Water and Waves  
NSRDC, Rpt. No. 4095, MRIS-050494, NTIS-AD-767021/9  
1973, September
- 207 Intentionally left blank.

- 208 Allen, R.G.; Jones, J.R.  
A Simplified Method for Determining Structural Design Limit  
Pressures on High Performance Marine Vehicles  
AIAA/SNAME Advanced Marine Vehicle Conference  
1978, April
- 209 Savitsky, D.; Brown, P.W.  
Procedures for Hydrodynamic Evaluation of Planning Hulls  
in Smooth and Rough Water  
Marine Technology  
1976, October
- 210 Structural Design Manual for Naval Surface Ships,  
Naval Ship Engineering Center, Dept. of the Navy  
1976, December
- 211 Koelbel, J.  
Comments on the Structural Design of High Speed Craft  
SNAME Chesapeake Section  
1993, November
- 212 Brown, P.O.; Fridsma, G.; Klosinski, W.E.  
Performance and Seakeeping Tests and Analysis of a Structural  
Loads Model of a L/B=6 Ruotant Sidewall SES  
Division Laboratory, Rpt. No. 2137  
2981, March
- 213 Troesch, A.  
Private Communication  
1993, July 13
- 214 Troesch, A.W.; Kang, C.-G.  
Hydrodynamic Impact Loads on Three-Dimensional Bodies  
16th Symposium on Naval Hydrodynamics, Berkeley  
1986
- 215 Ochi, M.K.  
Prediction of Occurrence and Severity of Ship Slamming at Sea  
5th Symp. of Naval Hydrodynamics, ONR  
1964

- 216 Ochi, M.K.; Motter, L.E.  
Prediction of Extreme Ship Responses in Rough Seas  
of the North Atlantic  
Int'l Symp. on the Response of Marine Vehicles and Structures  
in Waves, University College  
1974, April
- 217 Chuang, S.L.  
Experimental Investigation of Hydrodynamic Impact on Inflatable  
Fabric Ship Sections  
Model Basin Report No. 2080  
1965, October
- 218 Kawakami, M.; Tanaka, K.  
On Shipping Impact of Green Seas & Whipping Vibrations  
of a Large Full Ship  
WJSNA, Transactions, No. 50  
1975, August
- 219 Dalzell, J.F.  
A Note on Structural Loads Analysis in the Reliability Context  
David Taylor Research Center, DTRC/SHD-1374-01  
1991, November
- 220 Lin, W.M.; Yue, D.K.P.  
Numerical Solutions for Large-Amplitude Ship Motions  
in the Time Domain  
18th Symposium on Naval Hydrodynamics, Ann Arbor  
1990, August
- 221 Maskew, B.; Troesch, A.; Wang, M.  
Comparison of Calculated and Measured Loads on a Flared Body  
Oscillating in a Free Surface  
20th Symposium on Naval Hydrodynamics, Santa Barbara  
1994, August
- 222 Aksu, K.S.; Price, W.G.; Temarel, P.  
A Comparison of Two-Dimensional and Three-Dimensional  
Hydroelasticity Theories Including the Effect of Slamming  
Proc. of Ins. of Mech. Engrs., vol. 205, N 1  
1991

## PROJECT TECHNICAL COMMITTEE MEMBERS

The following persons were members of the committee that represented the Ship Structure Committee to the Contractor as resident subject matter experts. As such they performed technical review of the initial proposals to select the contractor, advised the contractor in cognizant matters pertaining to the contract of which the agencies were aware, and performed technical review of the work in progress and edited the final report.

Mr. Alan Engle	Naval Sea Systems Command
Dr. Walter Maclean	U.S. Merchant Marine Academy
Mr. James White	U.S. Coast Guard
Mr. Richard Dai	U.S. Coast Guard
Dr. Subrata Chakrabarti	Chicago Bridge and Iron
Mr. Raymond Ng	American Bureau of Shipping
Mr. William Siekierka	Naval Sea Systems Command, Contracting Officer's Technical Representative
Dr. Robert Sielski Mr. Alex Stavavoy	National Academy of Science, Marine Board Liaison
Cdr. Steve Sharpe	U.S. Coast Guard, Executive Director Ship Structure Committee