

Document Version

Final published version

Licence

CC BY-NC-SA

Citation (APA)

van Koningsveld, M., Verheij, H. J., & de Vriend, H. J. (2021). Part III - Ch 1 Waterway transport. In M. V. Koningsveld, H. J. Verheij, P. Taneja, & H. J. de Vriend (Eds.), *Ports and Waterways: Navigating a changing world* (pp. 195-222). TU Delft OPEN Publishing.

Important note

To cite this publication, please use the final published version (if applicable). Please check the document version above.

Copyright

In case the licence states "Dutch Copyright Act (Article 25fa)", this publication was made available Green Open Access via the TU Delft Institutional Repository pursuant to Dutch Copyright Act (Article 25fa, the Taverne amendment). This provision does not affect copyright ownership. Unless copyright is transferred by contract or statute, it remains with the copyright holder.

Sharing and reuse

Other than for strictly personal use, it is not permitted to download, forward or distribute the text or part of it, without the consent of the author(s) and/or copyright holder(s), unless the work is under an open content license such as Creative Commons.

Takedown policy

Please contact us and provide details if you believe this document breaches copyrights. We will remove access to the work immediately and investigate your claim.

1 Waterway transport

Sooner or later waterborne transport ends up in confined waters, be it a port access channel through a shallow coastal zone, the water bodies inside a sea port, or an inland port or waterway. If they form a properly functioning network, such waterways are not only important elements in the supply chain, but also drivers of economic development. They should therefore be designed carefully, so as to enable efficient, smooth and safe navigation. More than in deep open water, this requires insight into how vessels behave when sailing and interacting in confined water, including the pertinent hydrodynamic phenomena.

Part III Waterways focuses on these confined elements of the transport network, with the intention to enable students as well as professionals to perform feasibility studies, develop functional designs and carry out performance analyses.

Apart from the major inter-ocean canals, [Figure 1.1](#) shows all elements of a waterborne transport network: from the port approach channel via the water bodies inside the port, the rivers and canals to the inland ports. All elements are necessary for efficient, reliable and safe transport and should therefore be considered in mutual connection.

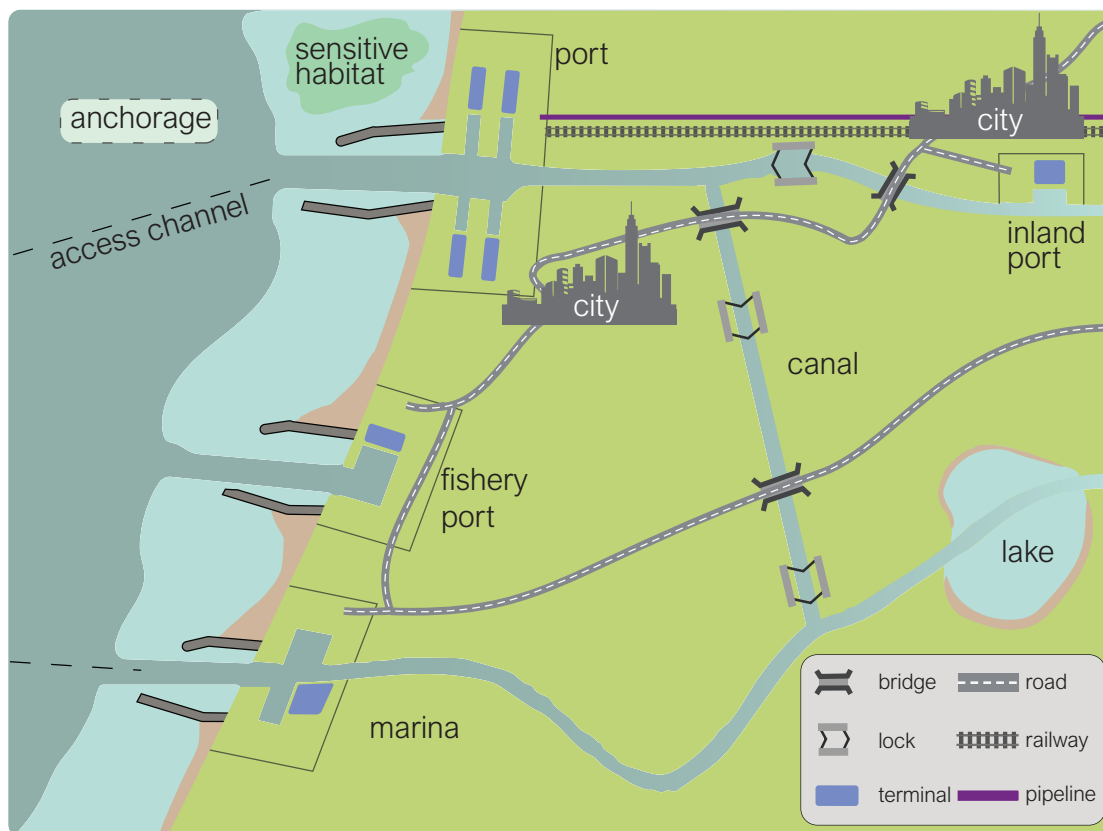

Figure 1.1: Elements of a transport network (by TU Delft – Ports and Waterways is licenced under CC BY-NC-SA 4.0).

Starting point of such an integrated analysis is the supply chain. Considering inland transport as a chain of activities and facilities offers possibilities for analysis, optimisation and adaptation, similar to the supply chain approach for port terminals. [Figure 1.2](#) shows the consecutive steps in the transport of cargo from a seaport terminal to a hinterland terminal. To establish the efficiency and effectiveness of this supply chain we need to understand the functioning of the individual elements and how they interconnect.

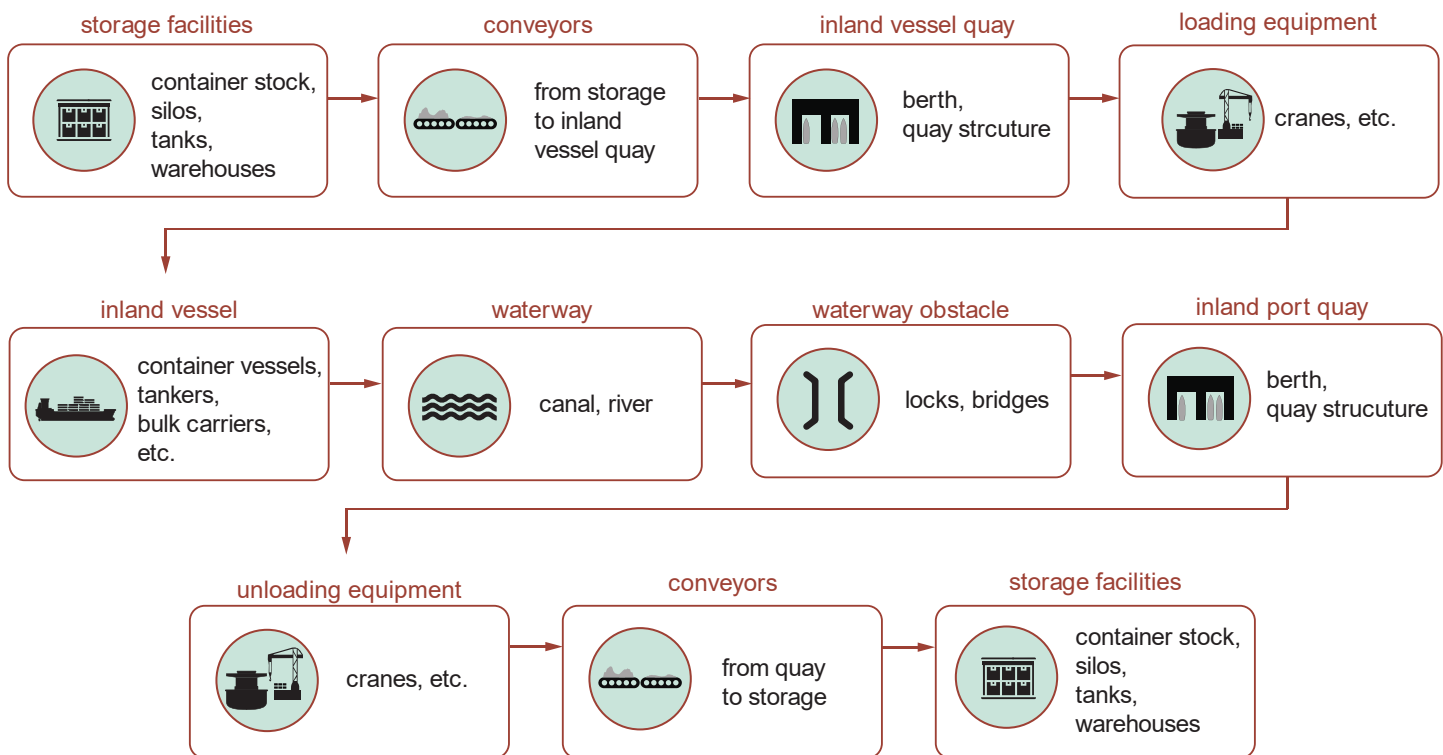

Figure 1.2: Supply chain for inland waterway transport (by TU Delft – Ports and Waterways is licenced under CC BY-NC-SA 4.0).

Taking the supply chain as a starting point raises questions such as:

- What is the transport demand for each type of cargo (containers, dry bulk, liquid bulk, etc.)?
- What type of vessels are involved, considering cargo type (container vessels, tankers, dry bulk vessels, etc.), but also vessel dimensions (length, beam, draught, etc.)?
- What time to consider for mooring/unmooring?
- What time to consider for loading/unloading (type of equipment)?
- How many berths of what length are needed?
- How much loading/unloading equipment is needed to keep waiting times below the allowable maximum?
- How many conveyor belts/cranes are needed to move the cargo?
- How much storage capacity is needed, based on maximum call size and a maximum allowable dwell time?
- How many conveyor belts/cranes are needed to transport the arriving cargo to the hinterland stations?
- What is the length of the route over water?
- How do these vessels behave and interact when sailing in confined water?
- What are the required dimensions of the waterway?
- How do the properties and facilities of the waterway (water depths, currents, locks, bridges, bottlenecks, signs, signals, [Fairways Information Services \(FIS\)](#), [Vessel Traffic Service \(VTS\)](#), etc.) affect transport efficiency?

In [Part II](#) we have already addressed some of these questions, especially those pertaining to ports and terminals. [Part III](#) addresses those that concern waterways and vessel behaviour.

1.1 Importance of waterways

1.1.1 Historical background

Inland waterborne transport has been used already in ancient times to bring goods to and from the hinterland. Ancient Mesopotamia used the rivers Euphrates and Tigris for this purpose, Egypt the river Nile. The possibility of waterborne transport has brought great wealth and power to these civilisations.

Yet, rivers may not always be reliable as transport routes, sometimes even hazardous. In times of drought, the water depth may become too low for navigation, or the variable channel-shoal pattern involves the risk of grounding and accidents. Otherwise, currents can be dangerous and rapids may block further navigation upstream. Therefore, already in ancient times people began digging channels. In Mesopotamia, for instance, these were primarily meant for irrigation, but even then they were also used for navigation. In the 6th century BC the Persian emperor Darius I built the first canal primarily for navigation. It linked the Nile with the Red Sea and was meant to boost the economy of the newly conquered province of Egypt. The Chinese started building canals in the 3rd century BC, culminating in the so-called Grand Canal that connected the Yangtze River and the Yellow River. It was meant to bring agricultural products from the fertile Yangtze area to Xi'an, by the time the centre of power.

In the Netherlands the Romans built the Corbulo Canal, which connected the rivers Rhine (by the time debouching near the city of Leyden) and Maas (Figure 1.3). It was meant for commercial transport, as an alternative for the route via the hazardous coastal waters. The Romans built another system of canals in the area north of the Rhine, the Drusus Canals, but this was meant for military transport.

A canal also requires facilities to control the water level. Initially, this was done by weirs, with a gap in the middle that could be opened to let boats through. Clearly, this so-called flash lock works well in one direction, but not in the other. The Chinese engineer Chiao Wei-yo is said to have invented the pound lock in the 10th AD. The first European lock of this type is probably the one at Vreeswijk, the Netherlands, built in 1373 in a canal from city of Utrecht to the river Lek. Initially, the gates were simple flat structures that were raised and lowered when necessary. The idea of mitred gates, first applied in Milan round the year 1500 and still common in present-day locks, is attributed to Leonardo da Vinci.

From the 12th onwards, canals were built all over Europe, many of them in the Netherlands. The latter were primarily meant for drainage, with navigability as a welcome bonus. The transport network obtained in this way was an integral part of the region's economic development. The same is true for many other regions: economic development goes hand in hand with the availability of a good transport network.

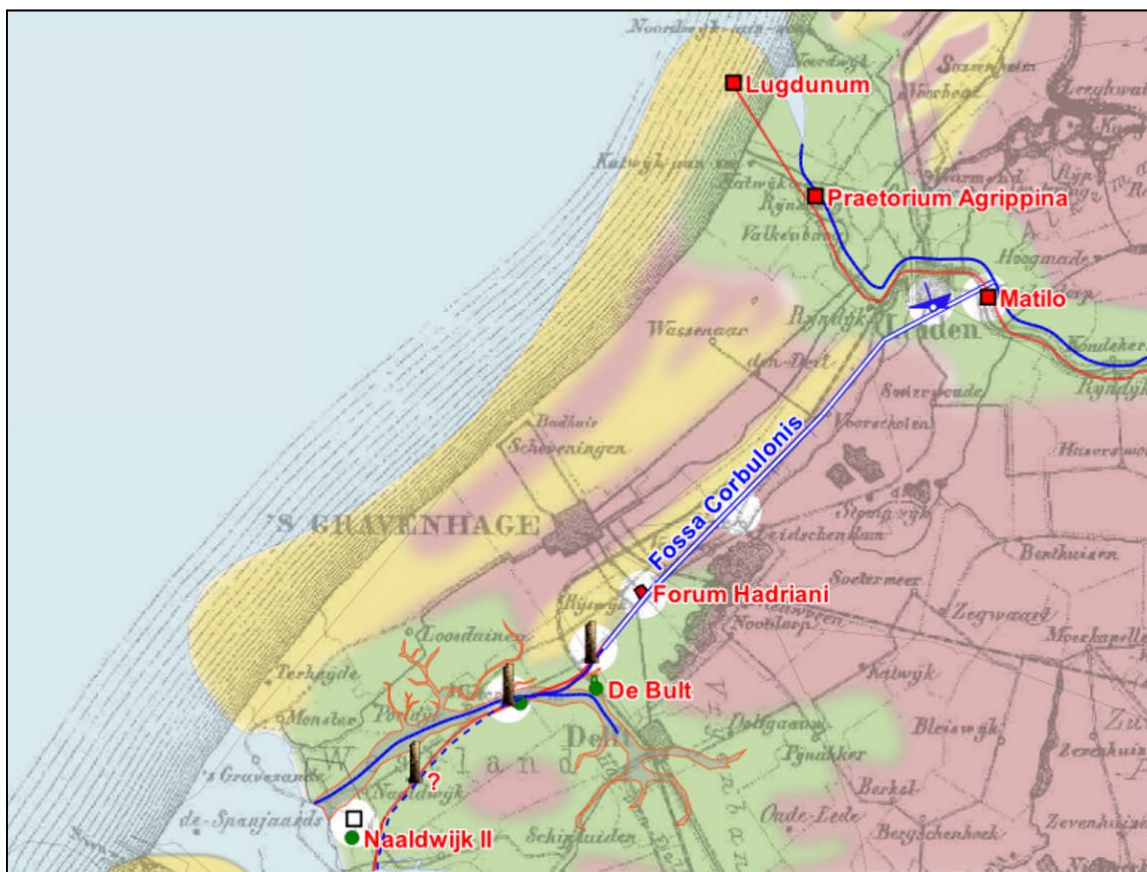

Figure 1.3: The Corbulo Canal built by the Romans and connecting Rhine and Maas (*Fossa Corbulonis* map by Hans Erren is licenced under CC BY 3.0).

1.1.2 Modern waterways

Two modern waterways are of paramount importance to overseas transport routes because they connect two oceans, hence shorten trade routes significantly. The Suez Canal connects the Indian Ocean, via the Red Sea and the Mediterranean, to the Atlantic Ocean, and the Panama Canal forms a shortcut between the Atlantic Ocean and the Pacific.



Figure 1.4: Route between Europe and Asia shortened by the Suez canal (by TU Delft – Ports and Waterways is licenced under CC BY-NC-SA 4.0).

The Suez Canal was constructed by the Suez Canal Company between 1859 and 1869. It was officially opened on November 17th 1869. It meant a radical shortening of the trade routes between Asia and Europe, no longer around Cape of Good Hope. A trip from a port in Western Europe to the Indian Port of Mumbai, for instance, was shortened by approximately 8.500 km from its original 20.000 km (Figure 1.4). The canal has no locks; the main limiting factor for the size of the largest passing vessels (Suezmax-class) is the Suez Canal Bridge. In 2015 the canal was expanded to allow for two-way traffic, which drastically enhanced its capacity. Environmental concerns have been raised, however, about the impact on the local population and the (increased) connection between the Red Sea and the Mediterranean sea, due to exchange of biological material. Moreover, the blockade between 1967 and 1975 forced oil transporting companies to develop **Very Large Crude Carriers (VLCCs)** in order to sail economically around the Cape again. These carriers, which are too large for the Suez Canal, are still in use, at the expense of the revenues from the canal.

After centuries of dreaming, decades of planning, and numerous failed attempts, the Panama Canal was successfully opened on August 15, 1914, with the passage of the cargo ship SS Ancon. It meant a major shortening of the trade routes (no longer around Cape Horn) between the Atlantic and the Pacific basins. The route between New York and San Francisco, for instance, was shortened from 22.500 km to 9.500 km. While this fact benefited many, it also caused a severe drop in traffic along Chilean ports due to shifts in maritime trade routes. The canal was a major engineering effort, with lock systems lifting the ships up to 26 m above sea level and down again (Figure 1.5).



Figure 1.5: The Panama Canal. Top: longitudinal profile; bottom left: the oldest Gatún locks (Atlantic lock system); bottom right: the newest Cocoli locks (Pacific lock system) (source top panel: [Panama Canal Map EN](#) by Thomas Rmer is licenced under CC BY-SA 2.0; source bottom panels: [Panama Canal Gatun Locks opening](#) by Stan Shebs is licenced under CC BY-SA 3.0 and [ACP conceptual view of the Third Set of Locks 02](#) by Autoridad del Canal de Panama is licenced under CC0 1.0).

Note in the bottom right panel the water storage reservoirs next to the lock. Careful water management must prevent drainage of the entire Gatun Lake via the locks. The importance of the Panama canal is illustrated by the fact that its dimensions determined the design of a new class of ships, the Panamax class. Several years ago the Panama locks were upgraded to allow larger vessels to pass and this has led to another new class of ships, the New Panamax or Neopanamax class, which include large container carriers upto 14,500 TEU (366 x 49 x 15.2 m).



Figure 1.6: Network of 17th-century boat-canal in the province of South Holland (image by [Heritage House South Holland](#) can be freely reused for non-commercial purposes, provided attribution is mentioned).

Also in the Netherlands canal building has had a huge economic impact. In the 17th century a network of boat-canal developed (Figure 1.6) which brought trade and wealth to the cities they connected. In that period Amsterdam was the most important commercial centre of the country, node in a thriving network of trade routes. The port was accessed from the North Sea, via the Texel inlet and the shallow Zuyderzee. The port of Amsterdam went on the decline when this tidal bay shoaled, the harbour silted up and vessel sizes increased.

After the French occupation, the newly appointed king decided to build an 80 km canal from Den Helder to Amsterdam, to improve access for seagoing vessels (Figure 1.7, left). This canal, built entirely by manpower, was completed in 1824, but functioned only for some 50 years. When after a few decades it became too narrow for the ever-larger vessels, it was decided to build a larger and much shorter (21 km) canal straight from Amsterdam to the sea, the North Sea Canal (Figure 1.7, right), finished in 1876. From an engineering point of view this was a particular challenge because the dune front had to be cut through and it was unclear what consequences that would have (also see Van de Ven, 2008). The North Sea Canal has allowed Amsterdam to maintain its position as an important port and trade centre. In 2022 a new larger lock will become operational.

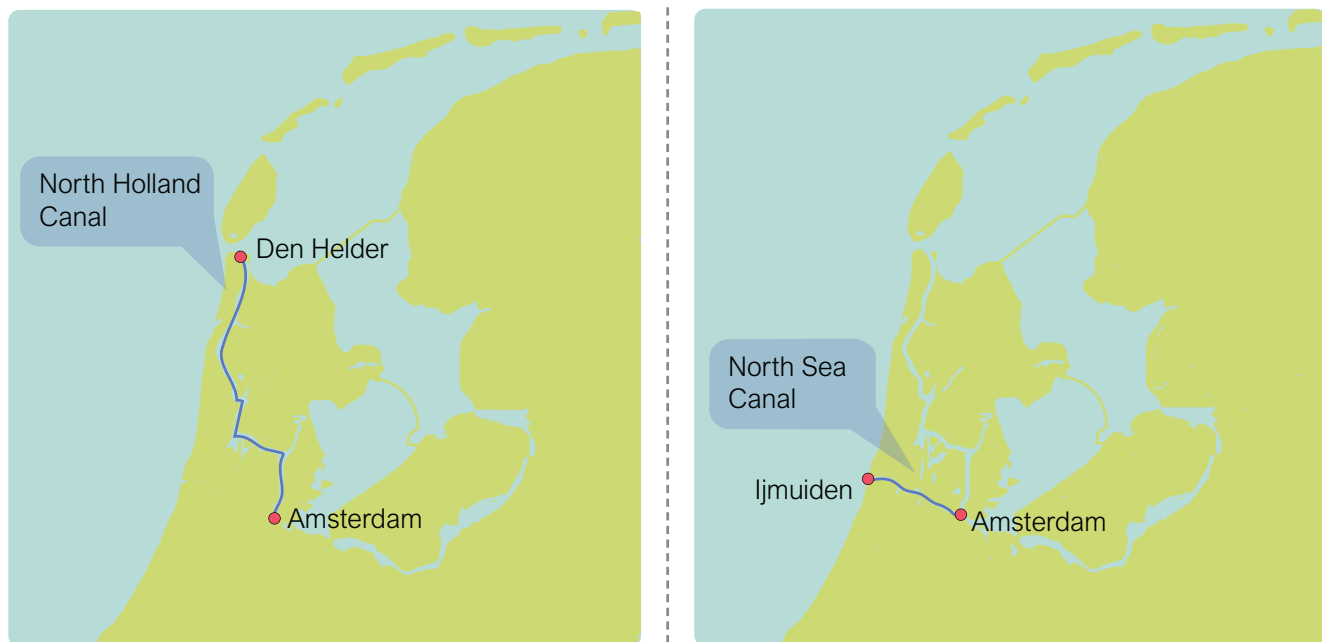

Figure 1.7: Amsterdam's connections with the sea; left: North Holland Canal; right: North Sea Canal (images by TU Delft – Ports and Waterways are licenced under CC BY-NC-SA 4.0).

At about the same time, the access to the port of Rotterdam became problematic. After a long and difficult process of trial, error and political deliberation, the shallow mouth of the river Maas was dammed and the Nieuwe Waterweg (New Waterway) was dug through the dune area. At the time (1865), Rotterdam was already an important port, due to its hinterland connection via the Rhine, but its deteriorating accessibility from the sea meant a disadvantage with respect to its main competitors, Antwerp and Hamburg. The new canal gave Rotterdam (and the economy of the Netherlands) a major boost, with it becoming the world's largest port in the second half of the twentieth century, and still the largest port of Europe at present.

1.1.3 Transport corridors

Another important category of waterways, next to big shortcuts of worldwide trade routes and canals giving access to ports, are those that together constitute Inland Water Transport (IWT)-corridors. Figure 1.8 shows the Northwest European waterway network used for container transport. The density of the terminals shows the importance of the north-south Rhine-Alpine corridor from the Netherlands into Germany and further south to the Alpine area (possibly to be extended to the industrial areas of France and Northern Italy).



Figure 1.8: Northwest European container transport network (by TU Delft – Ports and Waterways is licenced under CC BY-NC-SA 4.0).

Figure 1.9 shows, however, that this north-south corridor remains to be completed, just like several east-west corridors. Also note that Russia has a prominent corridor between Leningrad and the Black Sea, but no inland connection so far with the European network.



Figure 1.9: Major European corridors for waterborne transport (by TU Delft – Ports and Waterways is licenced under CC BY-NC-SA 4.0).

A new canal is under construction in northern France: the Seine Nord Europe Canal, part of a scheme to connect the Seine with the Scheldt, hence Paris with Antwerp and Rotterdam (Figure 1.10). This canal is aimed to be in use in 2022 and enable transport with larger vessels between these ports. Now the maximum load capacity is about 600 ton (European Conference of Ministers of Transport (CEMT) Class II). In the new situation the Seine-Scheldt connection is available for vessels up to 4400 ton and two-barge push-tow units (CEMT Class Vb), with single lane traffic on parts of the waterway. The goal of the new canal (estimated CAPital EXpenditures (CAPEX) 4.5 billion Euro) is to transport 12 to 25% of the current road transport over water. This will save 8 billion Euro (Present Value (PV)) of transport costs and is estimated to have an environmental benefit worth 2 billion Euro (less fuel consumption, fewer emissions, less traffic congestion).



Figure 1.10: Seine-Scheldt corridor (by TU Delft – Ports and Waterways is licenced under CC BY-NC-SA 4.0).

The Seine-Scheldt corridor is part of the so-called Trans-European Transport Network (TEN-T) in the European Union (EU). This is a planned network of roads, railways, airports and water infrastructure covering the EU, as part of a wider system of Trans-European Networks (TENs), including a telecommunications network (eTEN) and a proposed energy network (TEN-E or Ten-Energy). The TEN-T program provides clear policy guidelines for future modifications to transport networks, including those over water. The program makes clear which network connections are foreseen for the future, it provides clear guidance regarding the vessels to be accommodated by specific parts of the network, and provides policy guidance as to where inland ports and (un)loading facilities should be located. For practical reasons, the EU distinguishes a number of main corridors within the TEN-T network.

The Trans-European Networks initiative aims at an integral approach, optimising individual networks within the context of the entire system, all to the benefit of the Community as a whole. In Central and Eastern Europe the EU is presently planning a further extension of the waterway network, expecting it to significantly enhance the regional economy, hence the coherence of the Union.

A main issue for the proper functioning of corridors is that the service levels of the various elements should align. In practice this translates to waterway and infrastructure classification, which means that in a corridor that is supposed to be able to handle vessels up to a given class, each element in that corridor should at least be able to provide that service level. This applies to national corridors, but also to international ones, such as the Rhine Alpine corridor.

These international corridors require alignment of legislation, regulations and design standards. Lengthy bureaucratic border controls can significantly reduce a corridor's capacity, like in the case of the Danube. It is interesting to know that this cross-border alignment is not something that emerged only recently. Already since the 17th century, agreement on trade over the Rhine has been on the political agenda, albeit with varying degrees of success. In 1815 the freedom of international navigation on the Rhine, as well as a [Central Commission for the Navigation of the Rhine \(CCNR\)](#) to enforce that freedom, were established as part of the Final Act of the Congress of Vienna. In 1868 the Convention of Mannheim was signed, an international treaty between Baden, Bavaria, France, Hesse, the Netherlands and Prussia, to regulate vessel traffic on the Rhine.

The principles of the Mannheim Treaty are :

- free shipping;
- equal treatment between states, of sailors as well as fleet;
- exemption from shipping charges;
- simplified customs clearance;
- obligation to maintain the Rhine's banks;
- standardisation of ship safety and ship traffic regulations;
- a single jurisdiction for shipping matters and the establishment of Rhine waterway courts;
- a common procedure of appeal.

International corridors are connected with national networks. The Netherlands maintains eight national corridors. An analysis of supply and demand, and a decision on appropriate service levels, have led to a class definition for each corridor (see also [Figure 1.11](#)). National waterway management aims to ensure that the waterways function at the specified class level, regardless of varying conditions (such as high or low water levels).

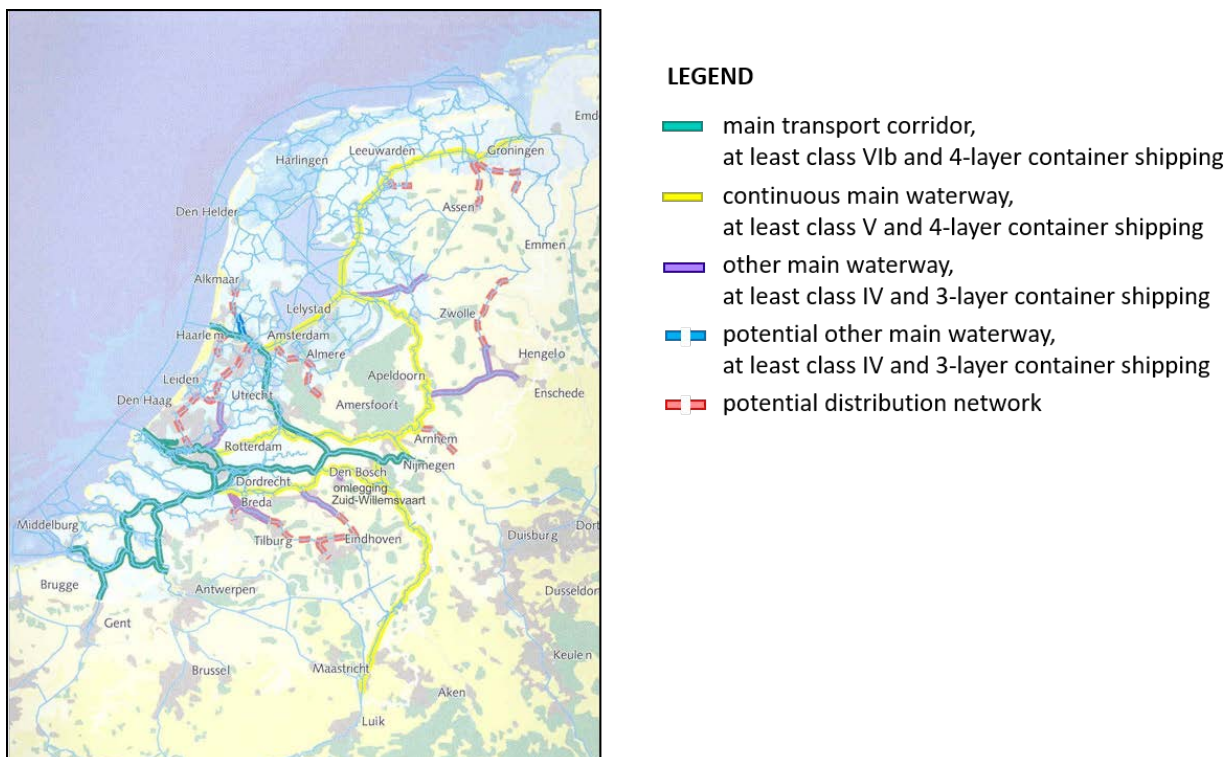

Figure 1.11: Envisage transport corridors in the Netherlands by 2020 (image from [Min V&W, 2004](#), reproduction is allowed provided attribution is mentioned).

All this shows how important a well-functioning inland transport system is to the economic (and social) development of a country or region. A clever design of transport infrastructure, including waterway networks, can make a major difference to that development. Yet, this is not a trivial matter: it involves major investments over long periods of time in a context of large uncertainties. Strategic thinking, adequate information, careful analysis, smart engineering and sufficient adaptability are therefore key ingredients for success. In the following sections and chapters we will further discuss these matters.

1.2 Inland Waterway Transport networks

The previous section clearly illustrates that waterways form networks. An **Inland Water Transport (IWT)** network consists of:

- waterways;
- hydraulic structures, such as locks and bridges (movable and fixed);
- inland ports and **IWT** terminals;
- mooring facilities (quays, guiding structures, bollards and dolphins, et cetera); and
- service facilities, such as bunker stations.

The quality of the waterway infrastructure determines the efficiency and reliability of the supply chain. **IWT** may be compared as follows to the other modalities:

- the waterway dimensions determine the allowable size of the vessels (classification);
- presence of locks and movable bridges influences waiting times;
- available water depth and air draught of fixed bridges affects the load capacity of vessels;
- the presence of inland ports affects the efficiency of using the **IWT** mode compared to other modalities;
- the maintenance condition, equipment (buoys, signs, lights, presence of **VTS**) and the traffic support systems may influence the safety of navigation and the risk of accidents.

1.2.1 Classification of waterways

As indicated in the section on transport corridors, a main issue for the proper functioning of **IWT** networks is that the service levels of the various elements align. A common method to achieve this is to agree on a classification of waterways. A waterway may be attributed a certain ‘class’ when its dimensions allow vessels of a particular class to use them. A standard for classification agreed in Europe is the **CEMT** classification. The decision to what class

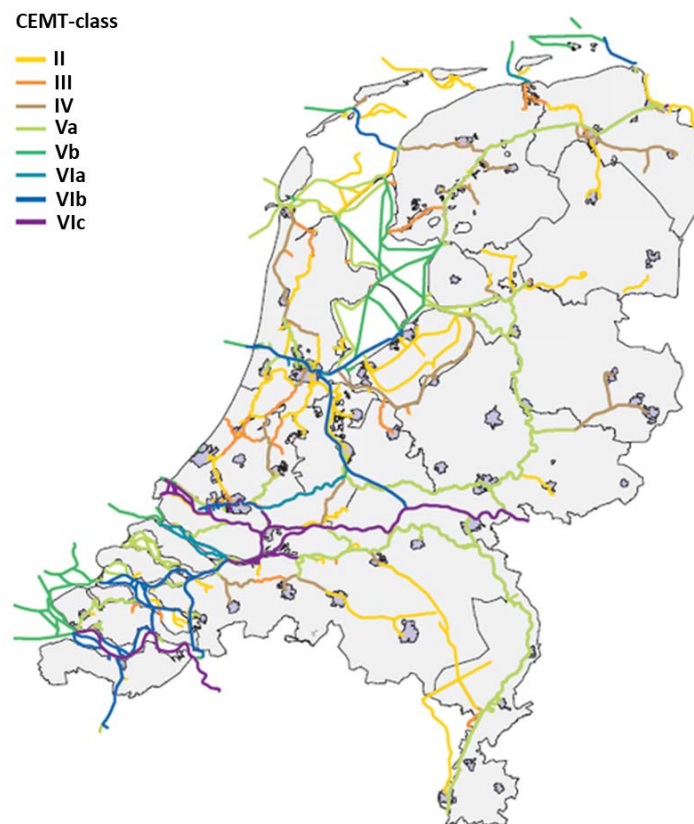

Figure 1.12: **CEMT** classification of inland waterways in the Netherlands (image from *Min V&W (RWS-AVV) and CBS, 2003*, reproduction is allowed provided the attribution is mentioned).

a waterway should be designed is based on the amount of cargo that is potentially transported on a particular route and the type of vessel that is foreseen to be the most appropriate to do this. Figure 1.12 shows the CEMT classification of the Dutch waterways.

1.2.2 Inland ports

Many municipalities have a port where one or more companies use the available quays and facilities. Inland ports have three functions:

1. node in a transport network;
2. location for industry and related services;
3. part of a production network.

Inland ports may have a local, regional or (inter)national function. Figure 1.13 shows the most important inland ports in the Netherlands.



Figure 1.13: Most important inland ports in Netherlands (by TU Delft – Ports and Waterways is licenced under CC BY-NC-SA 4.0).

Table 1.1 gives an overview of the number of inland ports per province in the Netherlands. For more information: Nederlandse Vereniging van Binnenhavens (<http://havens.binnenvaart.nl/home>) and Bureau Voorlichting Binnenvaart (<http://bureauvoorlichting binnenvaart.nl>).

Province	Inland ports		
	Total number of ports	% of total	Number of ports with > 1 mln ton
Drenthe	6	2	1
Flevoland	7	2	0
Friesland	26	7	1
Gelderland	61	16	10
Groningen	21	5	1
Limburg	26	7	11
Noord-Brabant	39	10	9
Noord-Holland	51	13	7
Overijssel	25	6	3
Utrecht	21	5	1
Zeeland	19	5	5
Zuid-Holland	84	22	14
Total	385	100	63

Table 1.1: Number of inland ports per province (Korteweg and Kuipers, 2004).

A strategic position of inland ports with respect to the end destinations of the main cargo flows can mean the difference between *IWT* being the competitive transport mode or not.

1.2.3 Cargo flows

Figure 1.14 presents the inland waterborne cargo flows in Western Europe. It clearly shows that there still are several missing links in the European *IWT* network (also see Section 1.1.3). Filling these is likely to improve trans-European waterborne transport efficiency significantly and cause a change in modal split.

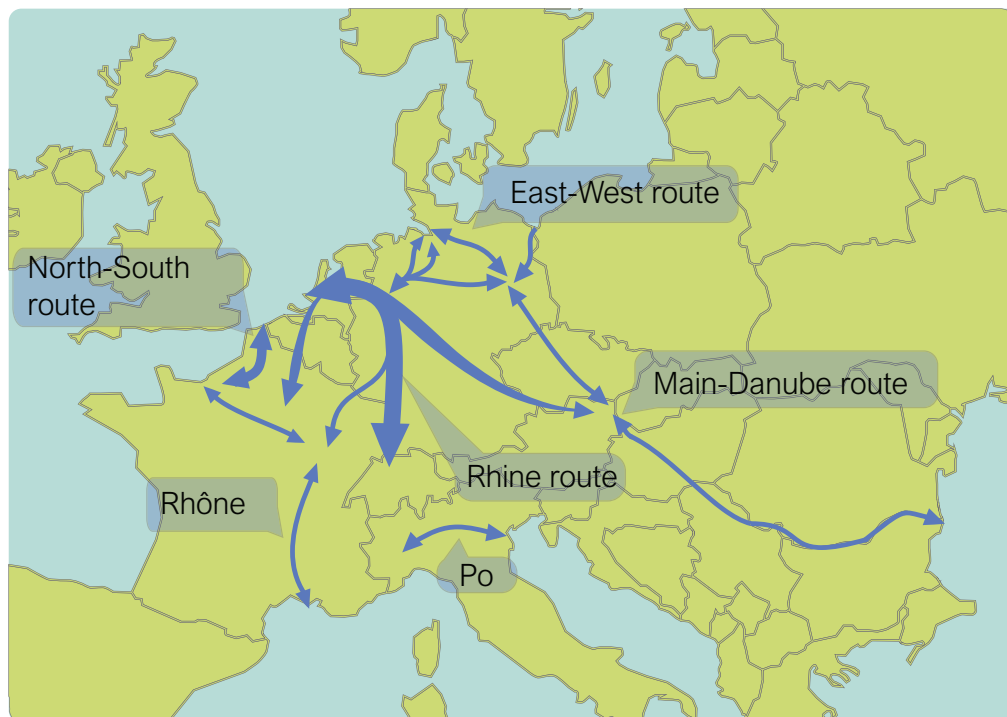

Figure 1.14: Waterborne cargo flows in Western Europe (adapted from Jimenez and Remác, 2016, by TU Delft – Ports and Waterways, licenced under CC BY-NC-SA 4.0).

Furthermore, the capacity of the existing waterway network is not fully used: on some routes 4 to 5 times more cargo could be transported. This could be even more if there were no bottlenecks such as locks and bridges.

Figure 1.15 gives an indication of the cargo flows in the Netherlands, showing that the export volume is dominant over the transit transport and transport inside the country. It also shows that by far the largest part of the cross-border outgoing transport goes to Germany and Belgium.

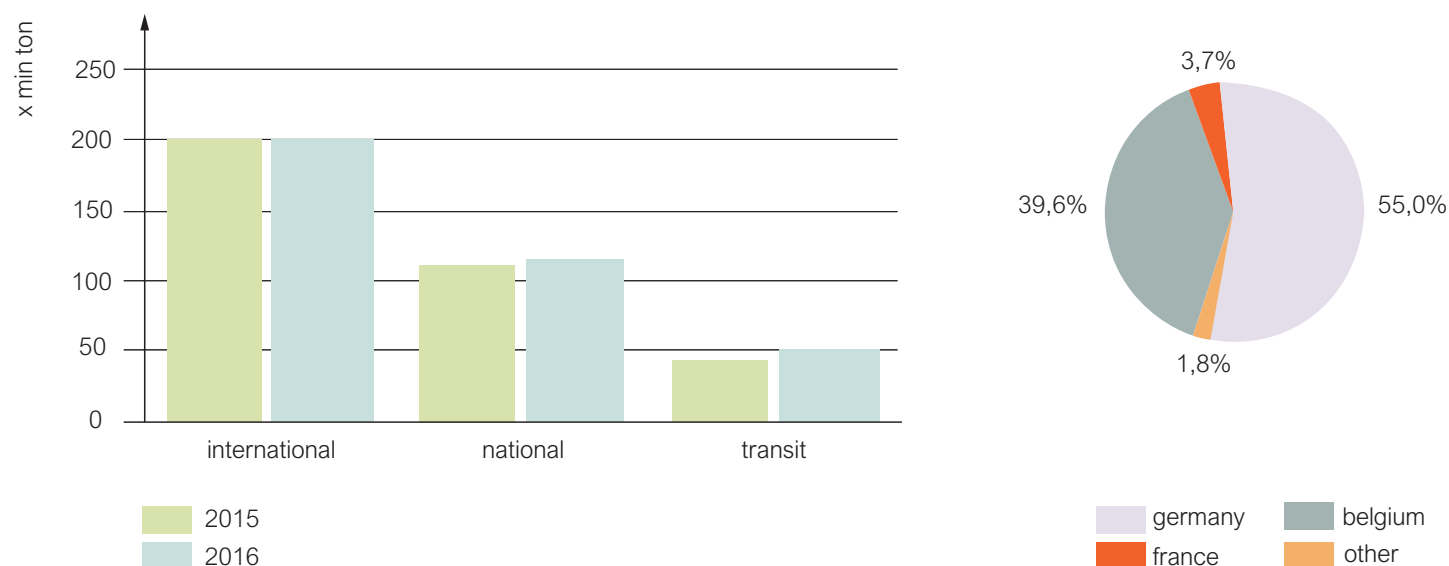

Figure 1.15: Inland shipping cargo flows in the Netherlands, by type (left) and by destination (right) (reworked from CBS 2017 by TU Delft – Ports and Waterways is licenced under CC BY-NC-SA 4.0).

Another relevant piece of information is how much inland shipping contributes to the total flow of goods. Figure 1.16 shows the modal split and the total amounts of cargo transported into, within and out of the Netherlands. The striking difference in the contribution of inland shipping between the incoming and outgoing cross-border cargo flows reflects the importance of the cargo flow from the Port of Rotterdam to the hinterland, especially Germany.

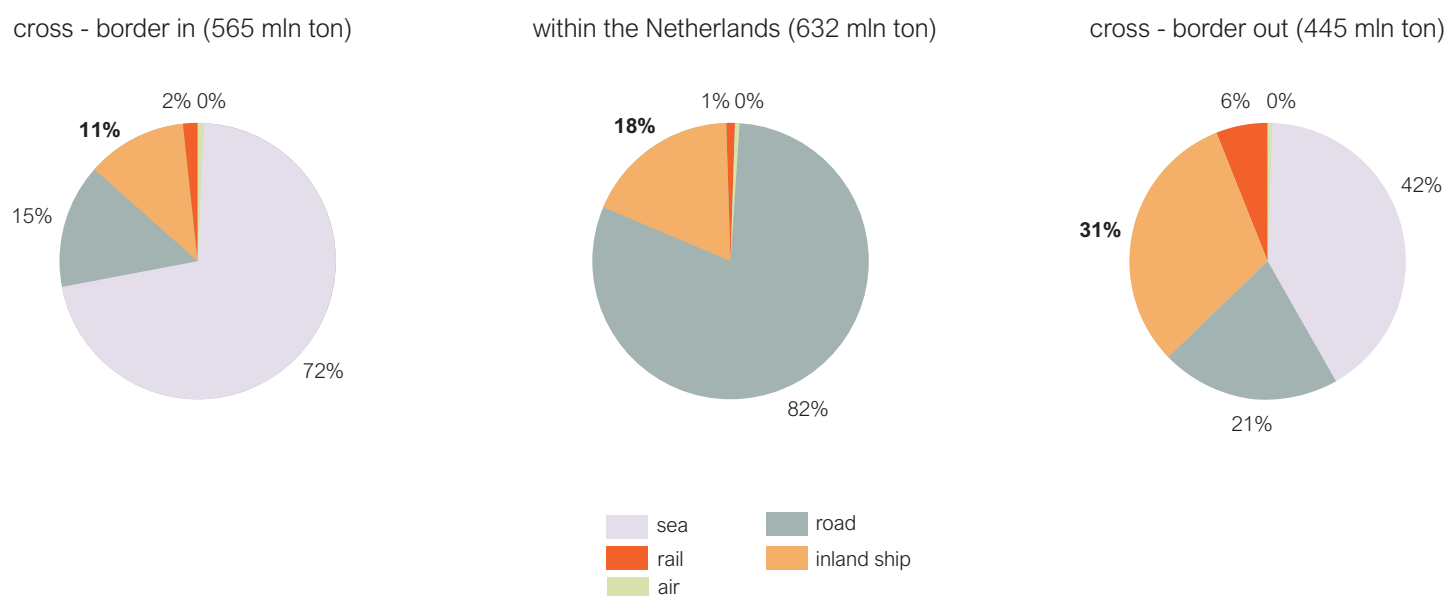

Figure 1.16: Modal split in the Netherlands, 2015 (reworked from www.schuttevaer.nl by TU Delft – Ports and Waterways is licenced under CC BY-NC-SA 4.0).

In the Netherlands a relatively high percentage of the total IWT goes to the hinterland. Nevertheless, also in other countries there are ports with transshipment of cargo to inland vessels, as Table 1.2 and Figure 1.17 show for container transshipment.

Port	Transshipment volume (1000 TEU)			Modal split		
	Total	To hinterland transport	To inland shipping	Inland shipping	Rail	Road
Antwerp	8,176	7,824	2,618	33%	10%	57%
Hamburg	9,890	5,390	92	2%	34%	64%
Hongkong	23,900	unknown	2,700	unknown	unknown	unknown
Le Havre	2,638	1,880	259	9%	5%	86%
New Jersey	5,300	unknown	unknown	< 1%	12%	87%
New Orleans	250	unknown	41	unknown	unknown	unknown
Rotterdam	10,790	8,200	2,500	30%	11%	15%
Shanghai	26,150	unknown	2,500	10%	1%	89%

Table 1.2: Container transshipment per port in 2007 (Kolkman, 2009).

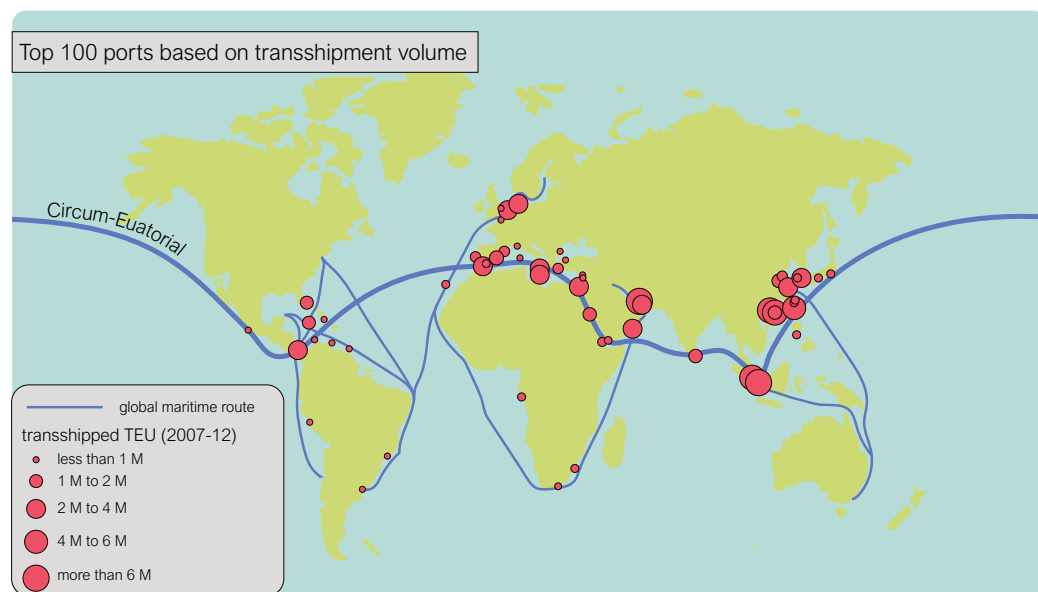

Figure 1.17: Transshipment of containers (reworked from <http://www.porteconomics.eu> by TU Delft – Ports and Waterways is licenced under CC BY-NC-SA 4.0).

1.2.4 Multimodal and synchromodal transport

Much transport is multimodal, i.e. on the way to the destination there is a transfer to other another transport mode. A common form of transshipment follows the so-called hub-and-spoke model (Figure 1.18). It means that

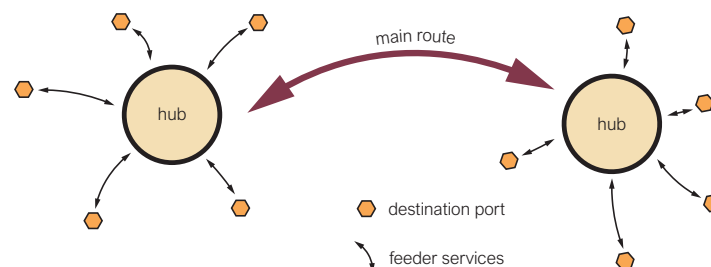

Figure 1.18: Hub-and-spoke model (by TU Delft – Ports and Waterways is licenced under CC BY-NC-SA 4.0).

vessels (or other transportation vehicles) collect their load from various terminals in a sea port (the hub) and bring it to a number of destination ports or end destinations inland, or the other way around (the feeder services).

This is also characteristic of the transport via the Rhine: vessels serve in general only a limited number of terminals, typically between one and five. At these terminals, containers are loaded for various seaport terminals, meaning that relatively many seaport terminals must be visited, on average nine terminals per trip. On the other hand, each seaport terminal is visited by inland vessels of different operators and coming from or heading for different destination ports. As a result, inland vessels spend a lot of time sailing between various terminals of a hub port and waiting to be served there. Figure 1.19, top, depicts this situation for container transport.

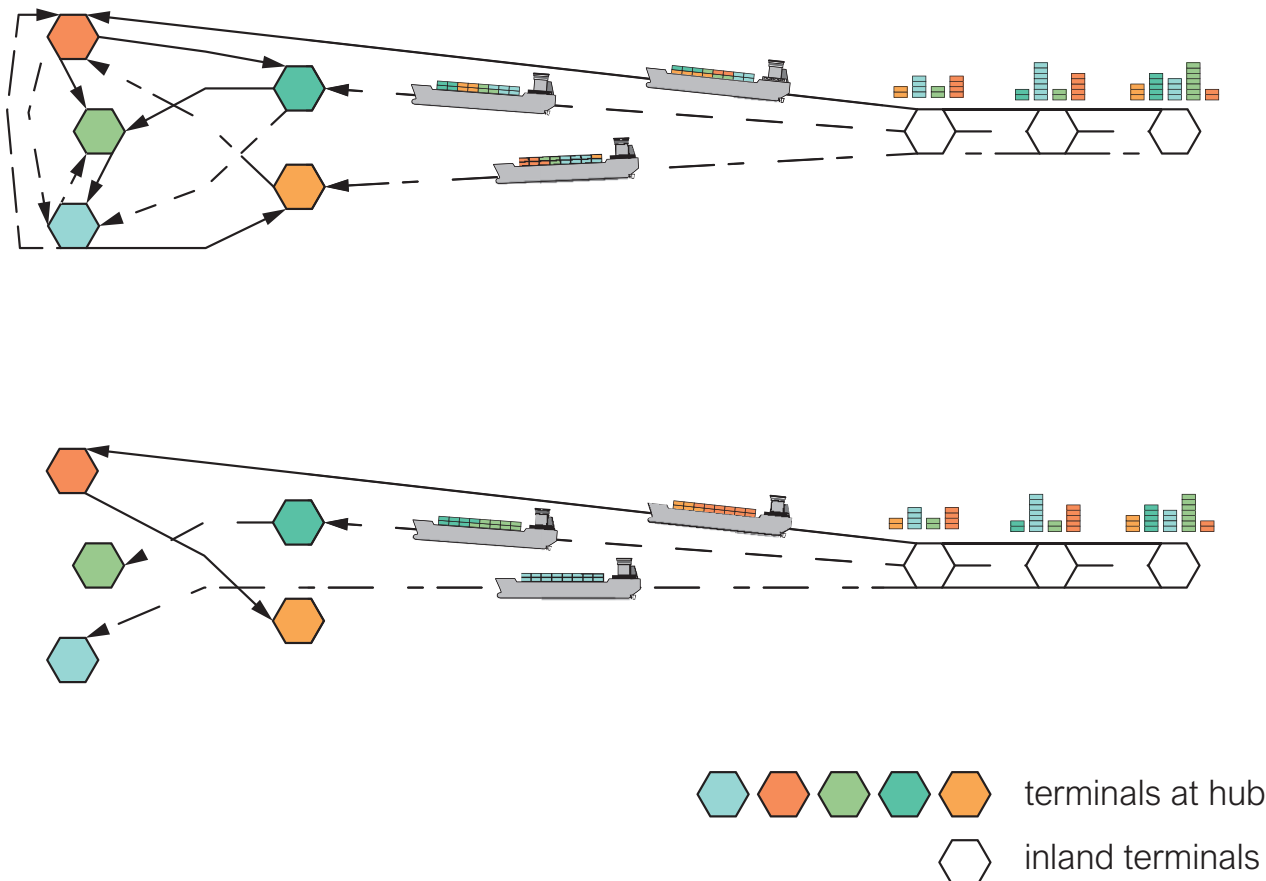

Figure 1.19: Loading- and unloading efficiency: present and desired state (by TU Delft – Ports and Waterways is licenced under CC BY-NC-SA 4.0).

Port authorities recognise that the desired growth of container transport is jeopardised by congestion of inland vessels at seaport terminals. Inland container vessels are often loaded and unloaded at the same quays as sea-going vessels. Unlike sea shipping companies, those operating inland have no binding contract with the seaport or terminal authority. This may explain why, if a terminal is busy, sea-going vessels get priority, even if this leads to a suboptimal situation regarding the supply chain. The remedy may be a better planning of container transshipment in ports. Three aspects are important:

1. *Improved integral planning* – optimised planning of quay, crane and depot availability yields a better use of these facilities.
2. *Call optimisation* – bundling of containers per terminal, destination or vessel, will decrease the number of vessel calls while increasing the call size, thus enhancing the chain efficiency.
3. *Performance measurement* – monitoring of supply chain performance and individual actors, as well as the effect of measures taken, will enable a policy of gradual improvement.

The ultimate alignment of transport modes is called *sychromodality*. Here the transport chain stakeholders actively interact to enable real-time switching between transport modes tailored to make optimal use of available resources. Sychromodal transport is characterised by:

- optimal combination of modalities,
- flexibility to change (part of) cargo to another modality, and
- a virtual network with a supply chain director.

For the first practical experiences in the Port of Rotterdam, see [Van Duin et al. \(2019\)](#).

1.3 Commodities

In [IWT](#) we distinguish dry bulk, liquid bulk and container transport as well as passenger transport ([Figure 1.20](#)). Some characteristics of [IWT](#) in the Netherlands ([Bureau Voorlichting Binnenvaart, 2006](#)):

- It is market leader in international transport with a market share of about 60% of the total transported weight.
- It is market leader in bulk cargo transport, in particular for ore, coal, sand, gravel.
- It is market leader in chemical bulk transport, by lack of competition for this type of cargo.
- Inland navigation is strongly related to seaports. More than 60% of inland transport, mainly transit transport to and from the hinterland, finds its origin or destination in a seaport. For Maasvlakte 2 it has been agreed by contract that maximum 35% of the cargo shall be transport by road and 45% over water. For other ports there is no such agreement, because there it is easier to switch to another modality.
- Inland container transport has grown strongly over the last decennia. Most containers are transported by road but the share of transport over water has grown from about 15% in 1994 to about 33% in 2004 (measured in transported weight).
- [IWT](#) has no position in the transport of base- and end-products, it is rather a niche player in this field. The only exception is short-distance pallet transport, where in-time delivery is critical.

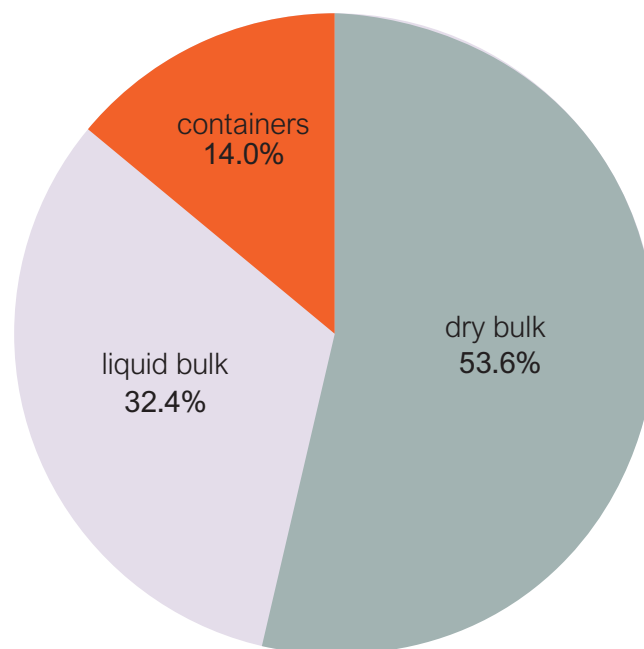

Figure 1.20: Cargo type percentages in the total IWT transport performance in tonkm in the Netherlands in 2019 (source: Eurostat, image by TU Delft – Ports and Waterways is licenced under CC BY-NC-SA 4.0).

1.4 Fleet

The West European inland fleet consists of more than 12,000 vessels ([Table 1.3](#)), of which 45% sails under the Dutch flag. The Dutch fleet sails mainly on the rivers in the Rhine and Maas basins. Unlike the situation in sea-going transport, a large part of the vessels is owned by individuals or families. The more than 250,000 recreational vessels in the Netherlands are not counted among the inland fleet.

Country	Vessel type					
	motor freighter	push barge	tugboat	push boat	motor tanker	tanker barge
Germany	887	758	122	226	366	41
Belgium	1,003	258	10	95	187	6
France	839	372	0	11	37	44
Luxembourg	7	0	3	7	15	1
Netherlands	2,740	998	408	593	839	18
Switzerland	14	2	4	2	50	3
Poland (2010)	71	571	17	192	0	0
Czech Rep.	32	119	83		0	0
Total	5,593	3,078	564	1,209	1,494	113

Table 1.3: West-European inland fleet composition in 2013 (*Bureau Voorlichting Binnenvaart, 2017*).

1.4.1 Inland vessel types

There are many types of inland vessels with a variety of shapes and sizes, mainly determined by the area of operation and the cargo type. The older ship types were named after a specific waterway or sailing area (Table 1.4). They all have their specific dimensions. For example, the Peniche (in Dutch: Spits) sails on the narrow French canals, in the southern part of the Netherlands and in Belgium. The Dortmund is named after the German Dortmund-Ems Canal, the Rhine-Herne Canal vessel after the German Rhine-Herne Canal. The Europe vessel is built especially for the larger European rivers and canals. Nowadays, newly built ships are designed on the basis of operational area and the type of cargo, rather than for a specific waterway. They often have deviating dimensions.



Spits / Peniche vessel CEMT/RWS-class I/M1



Kempenaar CEMT/RWS-class II/M2



Dortmund-Ems Canal CEMT/RWS-class III/M4



Rhine-Herne Canal CEMT/RWS-class IV/M6

Table 1.4 – Continued on next page

Table 1.4 – continued from previous page



Large Rhine vessel CEMT/RWS-class Va/M8



Jowi-class CEMT/RWS-class VIa/M12

Table 1.4: Motor vessels.

In 1954 an international classification system (CEMT classification) was introduced which divides the waterways into five classes depending on the horizontal dimensions. Starting point of the system were the dimensions of five ship types frequently sailing at that moment in Western Europe. The latest classification according to this system is known as CEMT 1992.

In 2002 the Dutch authorities concluded on the basis of an analysis (Min V&W (RWS-AVV), 2002) that the dimensions in the CEMT-table were no longer representative of the West European fleet and did not reflect that ships were made longer while keeping the same standard beam. Obviously, the tonnage increased. Moreover, the loaded draught proved to be larger than given in the CEMT-table. Therefore, a new and more detailed vessel classification was introduced, the AVV-2002 table (Min V&W (RWS-AVV) and CBS, 2003) (Table 1.5 and Table 1.6).

CEMT	AVV-2002	Name	B_s (m)	L_s (m)	D_s loaded (m)	max. load (ton)	air draught (m)
	M0					1-250	
I	M1	Spits / Peniche	5.05	38.5	2.50	251-400	5.25
II	M2	Kempenaar	6.60	50-55	2.60	401-650	6.10
III	M3	Hagenaar	7.20	55-70	2.60	651-800	6.40
	M4	Dortmund-Ems	8.20	67-73	2.70	801-1050	6.60
	M5	Dortmund-Ems elongated	8.20	80-85	2.70	1051-1250	6.40
IVa	M6	Rhine-Herne	9.50	80-85	2.90	1251-1750	7.00
	M7	Rhine-Herne elongated	9.50	105	3.00	1751-2050	7.00
Va	M8	Large Rhine	11.40	110	3.50	2051-3300	9.10
	M9	Large Rhine elongated	11.40	135	3.50	3301-4000	9.10
VIa	M10	Reference vessel	13.50	110	4.00	4001-4300	9.10
	M11	Reference vessel	14.20	135	4.00	4301-5600	9.10
	M12	Rhinemax	17.00	135	4.00	> 5601	9.10

Table 1.5: RWS 2010 for motor vessels (RVW, 2020).













CEMT	AVV-2002	Arrangement	B_s (m)	L_s (m)	D_s max (m)	max. load (ton)	air draught (m)
I	B01		5.20	55	1.90	0-400	5.25
II	B02		6.60	60-70	2.60	401-600	6.10
III	B03		7.50	80	2.60	601-800	6.40
	B04		8.20	85	2.70	801-1250	6.60
IVa	BI		9.50	85-105	3.00	1251-1800	7.00
Va	BII-1		11.40	95-110	3.50	1801-2450	9.10
	BIIa-1		11.40	92-110	4.00	2451-3200	9.10
	BIIL-1		11.40	125-135	4.00	3201-3950	9.10
Vb	BII-2I		11.40	170-190	3.50-4.00	3951-7050	9.10
VIa	BII-2b		22.80	95-145	3.50-4.00	3951-7050	9.10
VIb	BII-4		22.80	185-195	3.50-4.00	7051-12000	9.10
VIc	BII-6I		22.80	270	3.50-4.00	12001-18000	9.10
VIIa	BI-6b		34.20	195	3.50-4.00	12001-18000	9.10

Table 1.6: RWS 2010 classification for pushed convoys and coupled units (RVW, 2020).

Compared to the CEMT-table the classification presents a larger number of subclasses. After additional studies of large ships by MARIN, the AVV-2002 table has been transformed into the RWS 2010 classification, which is included in the Guidelines for Waterways 2020.

For the dimensions of motor vessels, push-tow units and coupled convoys (two coupled motor vessels or a motor vessel coupled with one or more barges, see RVW (2020) for the classification table) the more detailed AVV-2002 is recommended for research, predictions, and statistical interpretations. Table 1.7 shows examples of push-tow units and coupled units.

Besides motor vessels, push-tow units and coupled units, also river cruise vessels, ferries and recreational craft are sailing on the European waterways.



Push boat



Push boat

Table 1.7 – Continued on next page

Table 1.7 – continued from previous page



Barge CEMT-class Va



Coupled unit CEMT-class Vb



4-barge push-tow unit CEMT-class VIb



6-barge push-tow unit CEMT-class VIIa

Table 1.7: Push-towing and coupled units.

1.4.2 Developments of the inland fleet

The inland fleet is continuously developing and renewing itself, but it takes a long time due to the long life-cycle of vessels and engines. Recent developments are:

- changes in steering devices and installed power;
- increase in scale: decreasing number of small vessels (CEMT classes I to III) and increasing number of large vessels, particularly CEMT-class V and higher (new length 135 m; new beam 14.20 and 17 m);
- increasing total load capacity;
- conservation and renewal of smaller vessels which can reach destinations on smaller waterways;
- growing share of double-hull tankers for safety reasons;
- more strict emission requirements;
- on-board [Information and Communication Technologies \(ICT\)](#), such as [River Information Services \(RIS\)](#);
- use of light-weight materials in shipbuilding; lighter vessels are of interest for smaller waterways ([Policy Research, 2007](#));
- new ship types, such as the NeoKemp (a modern type of Kempenaar), the AMS barge, the INBI vessel, and the riversnake push-tow unit;
- diversification of the fleet (fast vs. slow; large vs. small; multipurpose vs. specific cargo), on the one hand; strong specialisation (cargo type and transport relation) due to market segmentation ([CCR, 2002](#)), on the other.

As a consequence, small inland vessels seem to be pushed into a niche market (Buck Consultants International, 2008), larger vessels being cheaper per ton cargo, easier to finance and more attractive for the skipper (as they offer more space for living). These larger vessels, however, cannot reach every destination: about one-third of the 14,000 km long waterway network in the Netherlands, Belgium, Germany and France is only accessible for vessels up to 1,500 ton and 85 m long.

Other consequences are:

- less efficient locking in locks that have not been designed for these large vessels,
- heavier collisions due to extra mass, and
- bridge passages become more critical, due to the larger beam.

River cruise vessels

Renewal is also taking place in the river cruise fleet. Every year a number of new large and very luxurious river cruise vessels appear, especially in the Rhine/Main/Danube region (Figure 1.21). Many of these vessels have been built in the Netherlands.

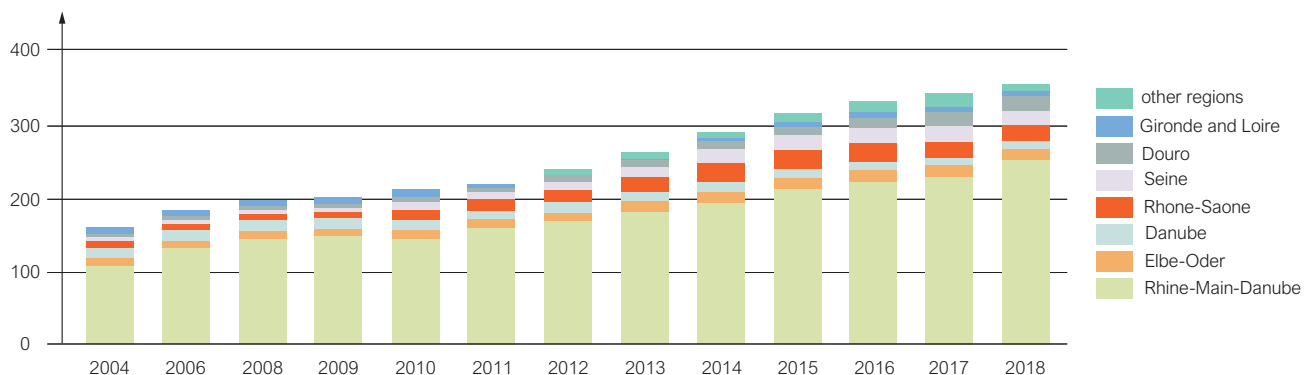

Figure 1.21: River cruise fleet per region (reworked from Hader, 2018, by TU Delft – Ports and Waterways is licenced under CC BY-NC-SA 4.0).

Tankers

The discussion on environmental safety of single-hull tankers has a large impact on this fleet. The reason is a number of environmental disasters with sea-going tankers, such as the “Erika” and “Prestige”. These disasters resulted in world-wide public and political discussions about the use of single-hull tankers. As a consequence, also inland tankers also change to double hulls, although environmental disasters with inland tankers have never occurred. Since big oil companies required transport by double-hull tankers, many large inland tankers (> 5,000 ton) have been built. In the Netherlands they are mainly used in the [Amsterdam-Rotterdam-Antwerp area \(ARA-area\)](#). In 2011 a still larger inland taker was introduced: the Vorstenbosch, with dimensions 147.5 x 22.8 x 5.4 m) and a load capacity of 13,300 ton (source: [Bureau Voorlichting Binnenvaart, 2020](#)). This vessel also operates mainly in the seaports and the [ARA-area](#).

Container vessels

About 40% of the container transport within the Netherlands is carried out by inland vessels. There are over 50 inland container terminals in Northwest Europe and still new ones are being realised. An increasing network of efficiently operating terminals will stimulate the regional distribution of cargo by inland transport. Furthermore, a scale increase in container vessels can be observed. Around 2005, the maximum capacity of inland container vessels was 200 TEU (3500 ton), with vessels dimensions of 110 m length, 11.40 m beam and 3.5 m draught. Since then vessels have been built with capacities up to 500 TEU (4,000-5,000 ton) and dimensions of 135 m length, 14 – 17 m beam and 4 m draught (Figure 1.22).

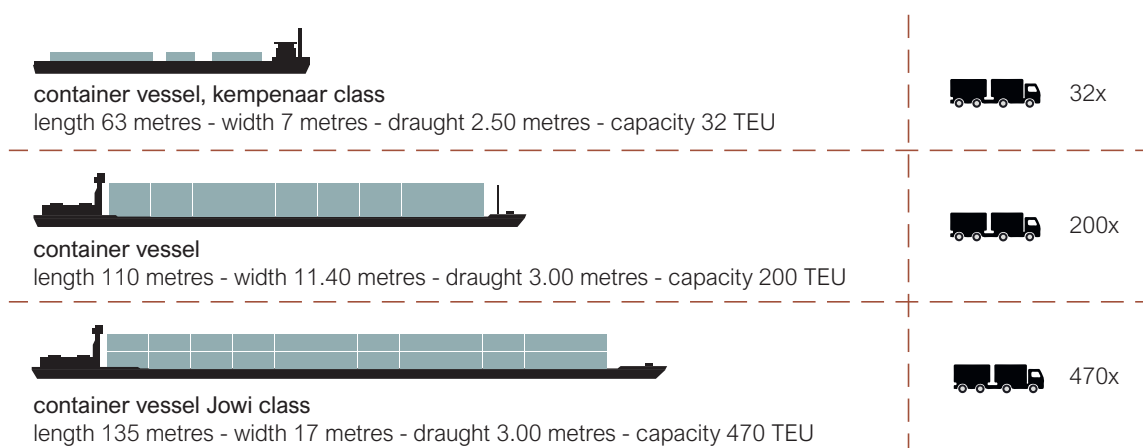

Figure 1.22: Modern inland container vessels (reworked from *Bureau Voorlichting Binnenvaart, 2006*, by TU Delft – *Ports and Waterways* is licenced under CC BY-NC-SA 4.0).

The Neokemp (see [Figure 1.22](#), top panel, for the dimensions and loading capacity) was designed in the year 2000 for small waterways with fixed and low bridges. The steering house, located at the front, can be lowered to pass low bridges and raised to overlook the containers ([Figure 1.23](#)).



Figure 1.23: *Neokemp container vessel* (by S.J. de Waard is licenced under CC-BY-SA-3.0).

In practice, it is very important to develop a good business case before building these new smaller vessels, because there can be a strong competition with older vessels, which are often written off.

Beam of container vessels

Most vessels (80 m long, 9.5 m wide) can have three containers next to each other in stacks of three layers. The standard class Va vessel (110 m long, 11.4 m wide) is often adjusted to four standard containers next to each other and four layers high (200 TEU). There is a demand, however, for a larger width in order to place four pallet-wide containers next to each other. This would require a beam of 12.0 m ([Van Dorsser and Verheij, 2016](#)).

Since the 1990s also coupled units are used (up to 800 TEU). The largest container vessel type nowadays is the Ursa Montana ([Figure 1.24](#)), specially designed for coupled units. Its dimensions are 193 x 17.3 x 4.1 m, its maximum load 5,400 ton. Coupled convoys can be up to 190 m long and 14, 17, 20 or 22 m wide. With a draught up to 4.0 m these vessels can transport 5,000, 7,000 or 9,000 ton, respectively, corresponding to about 300, 500 or 800 TEU. Dry bulk (container) vessels wider than 18m are not active yet, probably because the container or river terminals along the Rhine are not suitable for them.



Figure 1.24: The coupled unit Ursa Montana transports 712 TEU (400 × 40-foot high cube containers) (from binnenvaartkrant.nl, “800 TEU in één keer”, Copyright by Binnenvaartkrant).

Container vessels with on-board crane

The costs of cranes on terminal quays can be avoided if the container vessels can load and unload themselves. An example of a container vessel with an on-board crane is the crane barge, an innovative inland vessel with its own crane that can transport 130 TEU, see [Figure 1.25](#).



Figure 1.25: Crane barge with its own crane (MCKS Mercurius by Mercurius Group is licenced under CC BY-NC-SA 4.0).

Estuarine shipping

Since about 2010 navigation with strengthened inland vessels takes place on a route between the Belgian ports of Oostende and Zeebrugge and the mouth of the Westerschelde, see [Figure 1.26](#).



Figure 1.26: The Deseo on the Westerschelde ([Maassluis 8-6-2019](#) by kees torn is licenced under CC BY-SA 2.0).

This so-called estuarine shipping improves the accessibility of coastal ports. The Flemish sea ports are connected via waterways with the hinterland, but their capacity is insufficient (see, for instance, www.wenz.be). At the moment there is no estuarine shipping by Dutch vessels, but it can become relevant because of the growing transport of oil products between the northern and southern sea ports of the Netherlands. Container transport between Maasvlakte 2 and Antwerp may also be interesting. It requires new regulations for inland vessels adapted for estuarine shipping along the coast. So far, skippers have to observe the [International Convention for the Safety of Life at Sea \(SOLAS\)](#) rules, which are mandatory for all international trips.

1.4.3 Vessel characteristics

This paragraph will discuss some important terms related to ship dimensions, the propulsion system and the rudder system ([Figure 1.27](#)). This is relevant for computations of the ship-induced water motions, ship speed and performance of [IWT](#) regarding emissions, et cetera (see [Part IV](#)).

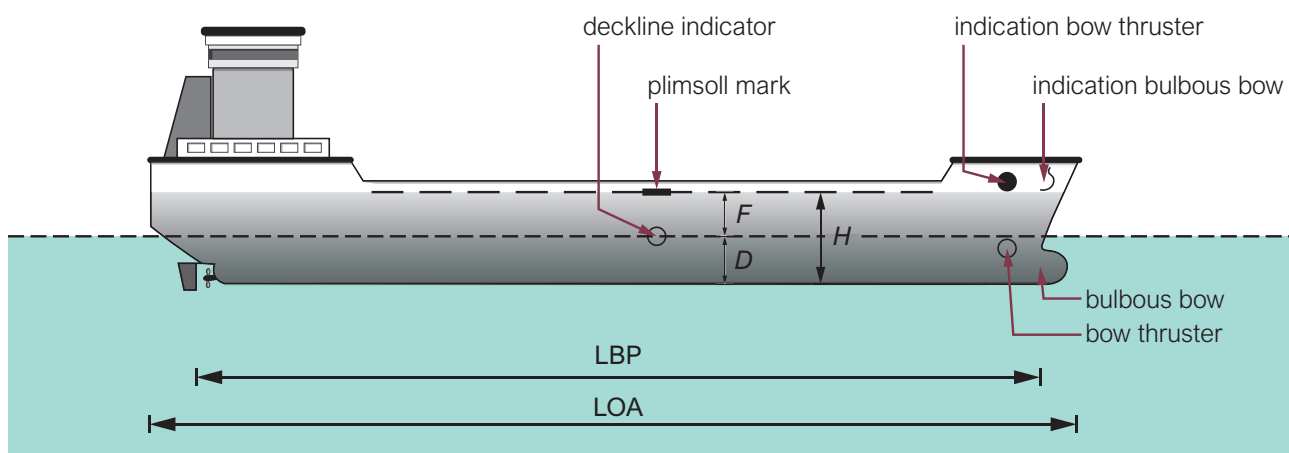

Figure 1.27: Ship characteristics (by TU Delft – Ports and Waterways is licenced under CC BY-NC-SA 4.0).

Ship related terminology

- *carène* – shape of the immersed part of the ship’s hull;
- *displacement* (∇) – displaced water volume, so the volume of the carène. Often expressed as mass of displaced water (Δ);
- *amidship section* – largest cross-section of a ship;
- *waterplane* – intersection between the surface of the water and the hull. The loaded waterline is the waterplane when the ship is loaded;
- *freeboard* (F) – distance from the top of the deck to the waterplane;
- *length between perpendiculars* (L_{BP} or L_{PP}) – the horizontal distance in metres between (1) the point of intersection of the ship’s bow and the waterline when fully loaded, and (2) the vertical line through the axis of the rudder of the ship;
- *length over all* (L_{OA}) – distance between the front point of the bow and the backside of the stern;
- *length at the waterline* (L_{WL}) – distance between the points of intersection of the ship’s bow and the ship’s stern with the waterline when fully loaded
- *beam* (B_s) – maximum width of the ship;
- *draught* (D_s) – distance from waterplane to the bottom of the keel;
- *air Draught* (D_{air}) – distance from waterplane to the highest point above the waterplane;
- *sheer line depth* (H) – vertical distance between the bottom of the freeboard deck and the top of the keel;
- *cargo capacity* – the weight of the cargo;
- *block coefficient* (C_B) – this dimensionless coefficient determines the slenderness of the ship. A low value represents a slender hull shape and a higher value a fuller, more blunt shape.

$$C_B = \frac{\nabla}{L_{BP} \cdot B_s \cdot D_s} \quad (1.1)$$

Shape of the vessel and block coefficient

The design of the bow of the ship in particular is of great influence on the resistance encountered during sailing. A streamlined ship will encounter less resistance than a rectangular barge. On the other hand, a rectangular barge has a larger load capacity. Therefore, depending on the intended route, a compromise will have to be reached between load capacity and navigation speed. The design of ships thus varies from very blunt-shaped vessels (Peniche) to a very streamlined design (Danube pull-tow units).

The block coefficient (Equation 1.1) expresses the relative importance of resistance, viz. the larger the coefficient is, the more resistance the vessel will encounter. Table 1.8 gives the block coefficients for a number of vessel types. For longer ships the block coefficient may approach 1, since the influence of the bow and the stern of the ship decrease correspondingly.

Vessel type	Block coefficient (C_B)
Container vessel	0.65 - 0.70
Bulk carrier	0.70 - 0.80
LNG tanker	0.75 - 0.80
Inland motor vessel	0.80 - 0.95
Barge of a push-tow unit	0.96 - 0.99
Tug	0.45 - 0.50
Tug for sea-going vessels	0.50 - 0.60

Table 1.8: Block coefficients (by TU Delft – Ports and Waterways is licenced under CC BY-NC-SA 4.0).

Propulsion

Most conventional inland vessels have one (main) propulsion system. Larger motor vessels (engine power over 750 kW) are often provided with two propellers. Depending on the installed engine power, modern push boats are provided with two or three propellers, placed in nozzles. The diameter of the propeller is about 2 m. To estimate the required power the following rule of thumb is used: engine power in HP = 1.3 to 2 times the load capacity in tons. The factor 1.3 applies to conventional vessels, the factor 2 to tankers and push barge units. Another rule for cargo vessels says: average power is about 0.5 kW per ton load capacity with a standard deviation of 20 to 30%. Note that part of the installed engine power is used for systems on board, such as heating and lighting (hotelling part). This is relevant for speed and emission computations (see [Part IV – Chapter 5](#)).

Characteristic values of installed engine power in inland vessels are are ([MARIN, 2008](#); [PIANC, 2008a](#)):

- *dry bulk vessels of the Dortmund-Ems Canal type and Rhine-Herne Canal type* – 1 (sometimes 2) propellers of 1.2 to 1.6 m diameter; installed propulsion power 550 to 750 kW; installed bow thruster power about 250 kW (standard deviation 30%);
- *modern, newly built vessels of the Rhine type and Rhinemax type (length 110 to 135m)* – usually 1 and, sometimes 2 propellers in a nozzle of 1.6 to 1.8 m diameter; installed power 900 to 2800 kW; installed bow thruster power up to 700 kW (standard deviation 30%);
- *container vessels (400 TEU; length 135m)* – 2 propellers in a nozzle with a diameter of 1.6 to 1.8 m and an installed power of 2000 to 3400 kW; equipped with 2 bow thrusters;
- *pushers* – 2 or 3 propellers in nozzles with a diameter of 2.7 m and an installed power of 900 to 2800 kW; 1 or 2 bow thrusters or flanking rudders;
- *river cruise vessels* – 2 or 3 propellers in nozzles with a diameter of 1.6 to 1.8 m and an installed power of 800 to 1400 kW; equipped with 2 bow thrusters;
- *tugs* – 2 propellers in nozzles with a diameter of 1.6 to 1.8 m and an installed power of 800 to 1000 kW; equipped with 2 bow thrusters.

Regarding steering devices and installed power, we see that nearly all new vessels are equipped with bow thrusters, and that the installed power is increasing for the main propulsion system as well as the bow thrusters.

Bow thrusters

Most inland vessels are equipped with a bow thrusters nowadays; 95% of motor vessels of the classes IV and higher has such thrusters. The manoeuvrability of a vessel at low ship speeds is improved considerably by bow thrusters, which is important in waiting areas at locks and bridges, and at quays. They also increase safety and manoeuvrability in narrow canals or rivers. Three types of bow thruster systems are used for inland vessels, viz. the transverse jet system with four distinct outflow openings ([Figure 1.28](#)), and the steering roster and compound jet, both with 360° turnable outflow in the ship's keel ([Figure 1.29](#)).

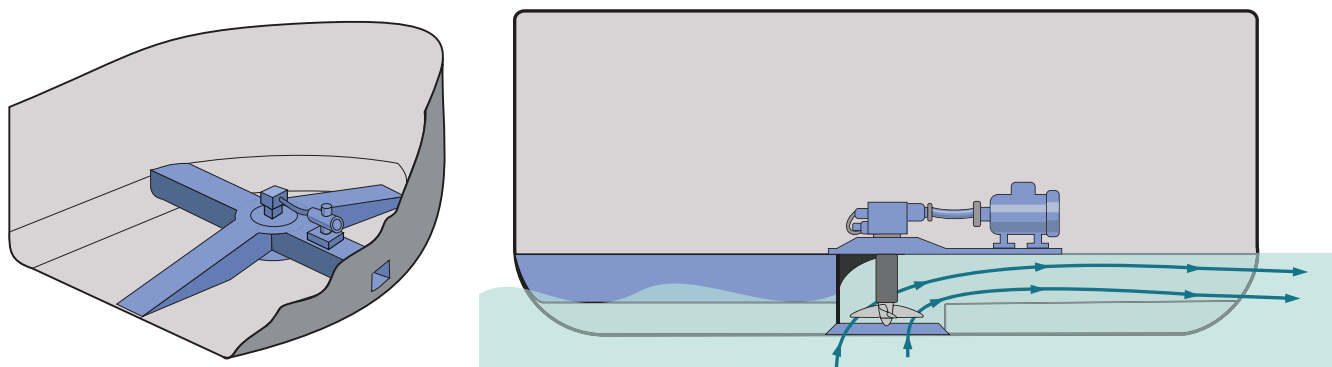

Figure 1.28: Bow thruster, type transverse jet with intake in the vessel's keel (by TU Delft – Ports and Waterways is licenced under CC BY-NC-SA 4.0).

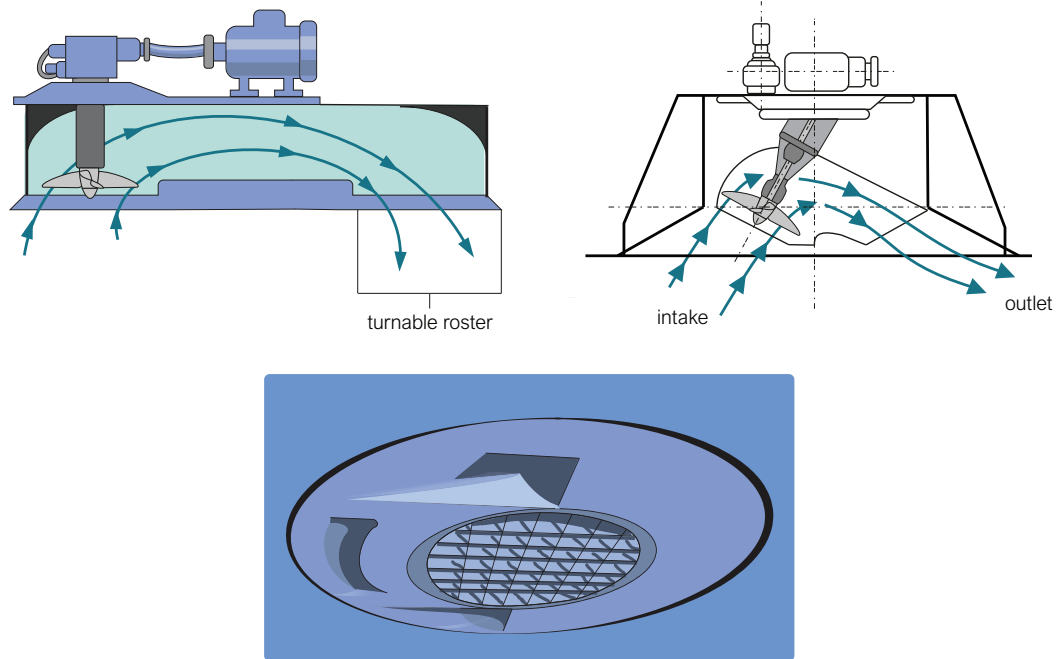

Figure 1.29: Bow thruster, type compound jet (by TU Delft – Ports and Waterways is licenced under CC BY-NC-SA 4.0).

The larger the installed power, however, the more an unprotected berth bottom will scour during mooring and unmooring, or the heavier the bed protection required. In windy stretches of canals and rivers, where bow thrusters are used to keep the ship on course, bank protection may also be necessary. Even protections on top of pipelines and tunnels have to be checked for the higher flow velocities and turbulence levels in the propeller and thruster jets.

Rudder system

The functioning of the rudder can be explained in a somewhat simplified manner as follows (Figure 1.30). A pressure (F_p) exists due to a rotation of the rudder over an angle δ_r and has its point of impact in the pressure point at a distance (e) from the front of the rudder. This force can be resolved into a rudder resistance (F_L) parallel to the ship's axis and a transverse force (F_T) perpendicular to this axis. The transverse force (F_T) will

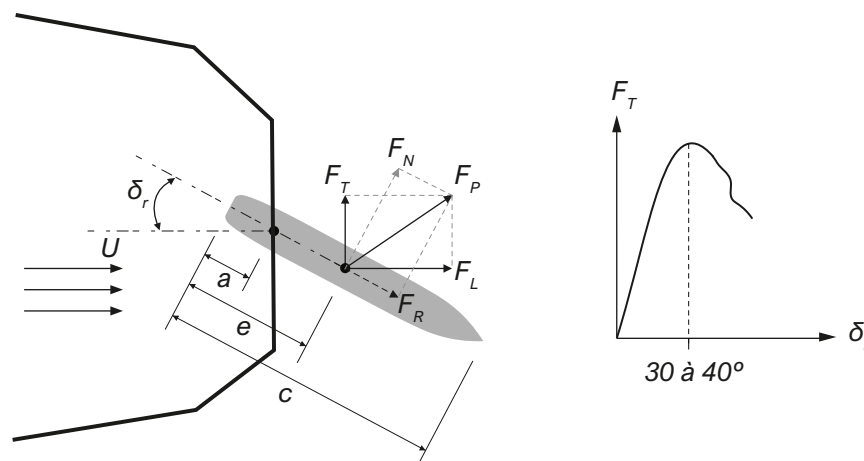

Figure 1.30: Principle of rudder system (by TU Delft – Ports and Waterways is licenced under CC BY-NC-SA 4.0).

push the stern of the ship to the right (starboard), while the bow will steer left (port side). The rudder resistance causes the ship to slow down. The size of these forces depends on the rudder type and the current velocity of the water. The more propulsion power is transferred into transverse force power, the more efficient the rudder is.

The two most familiar rudder systems are the singular rudder and the multiple rudder. For better operation and smaller rudder forces a multiple rudder is used. More information on rudders can be found in maritime manuals (see for example: [Molland and Turnock, 2007](#)).

Head rudder

The modern inland vessels have such large dimensions that one stern rudder system is seldom sufficient. To enhance manoeuvrability a head rudder can be applied ([Figure 1.31](#)). A small rotation of this device causes a considerable moment around the ship's centre of gravity. With head rudders it is easier to stay on course when approaching a lock, to manoeuvre when coupling barges in a current, or to hold the course of an empty vessel in cross-wind. Nowadays, most vessels use bow thrusters instead of a head rudder.

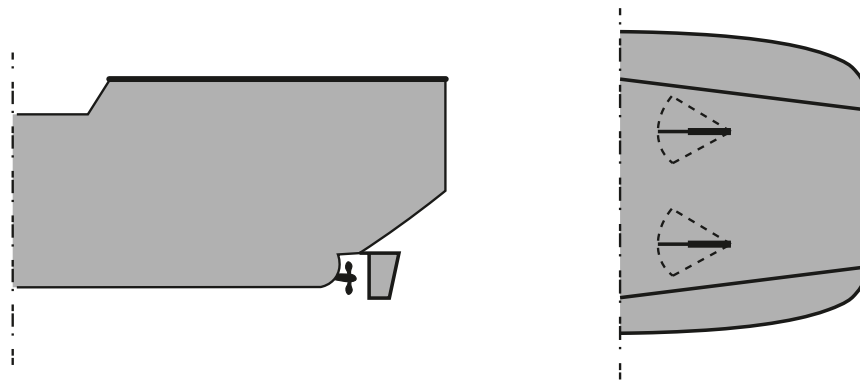

Figure 1.31: Head rudder (by TU Delft – Ports and Waterways is licenced under CC BY-NC-SA 4.0).

Spuds

In inland navigation the use of spuds is increasing. A spud is a vertical vertical pipe that can be pinned into the channel bottom. A clever combination of spuds enables vessels to fix or moor themselves ([Figure 1.32](#)). The use of spuds has the advantage of less CO₂ emission, less time needed for mooring and unmooring in waiting areas at locks and bridges and central control of the vessel from the steering room without interference of the crew. A possible disadvantage of spuds is damage to bed protections and the risk of puncturing the impermeable layer. Spuds cannot be used in areas with a rock bottom, like in the German Rhine.

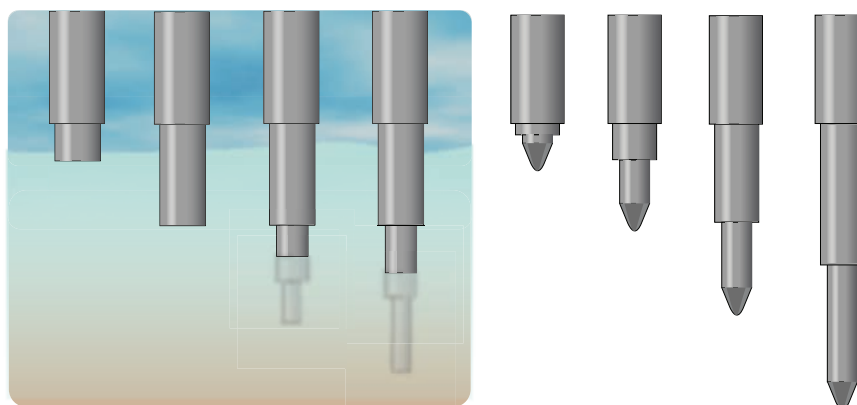

Figure 1.32: Spuds of the telescope type (by TU Delft – Ports and Waterways is licenced under CC BY-NC-SA 4.0).