

HYDRAULIC RAMS

Consumers guide

P. de Jong

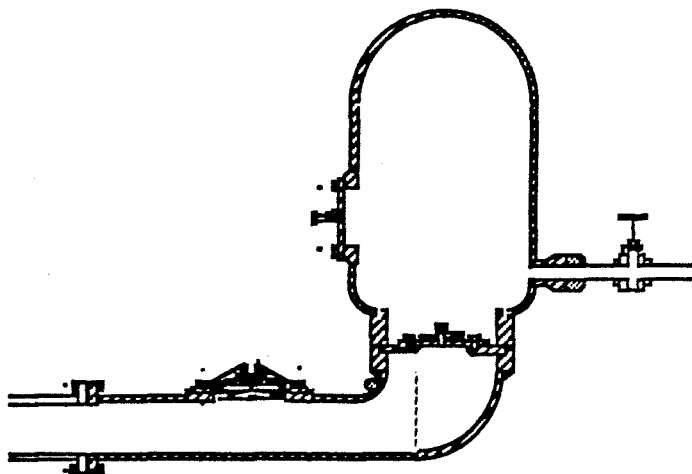

TU Delft

Delft University of Technology

centre for international cooperation
and appropriate technology

consumers guide

HYDRAULIC RAMS

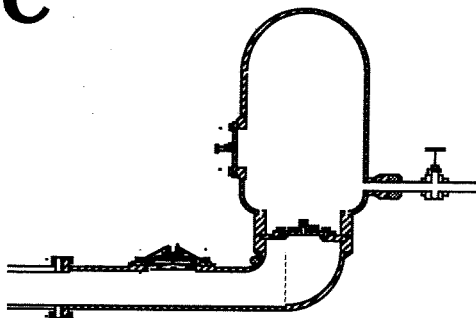

p. de jong

delft university of technology

**centre for international cooperation
and appropriate technology**

	page
1. Introduction	2
2. Appropriate water supply	2
3. Hydraulic rams	3
4. Description of hydraulic rams	3
5. Basic Requirements	4
6. Site selection	5
7. Installation and maintenance	7
8. Prices and costs	8
 Appendices:	
a. Operation of hydraulic rams and characteristics	9
b. Results of the comparative laboratory and field tests	13
c. Calculation example	16
d. Bibliography	17
e. Adresses of hydraulic ram manufacturers	19

1. Introduction

This report is the result of a project, called "comparative tests on commercial and newly designed waterrams", carried out by the Delft University of Technology and the Foundation of Dutch Volunteers in Rwanda.

The aim of this project was twofold:

- to test new, and cheap (i.e. locally constructable and maintainable) types of hydraulic rams,
- to compare several commercial types, in order to make a "consumers guide" for developing countries.

At the Laboratory of Fluid Mechanics of the Delft University of Technology the most essential aspects of the behaviour of commercially available rams were compared. Valve behaviour, delivery head, delivered quantity and efficiency were accentuated.

Samples of the rams, tested in the laboratory were checked in Rwanda on reliability, durability and possibilities for local maintenance.

2. Appropriate water supply

A reliable water supply is one of the basic needs of people. It is a rather disappointing experience to find a dried-up well after several miles of walking, or to get just a few drips of brown water out of an expensive pump. Many people are dealing with this sort of problems, especially in the arid areas of the Third World.

A lot of pumping systems were developed to fulfill this need:

- # hand-driven pumps, using human energy to get water out of the earth or river into a bucket or to lift water to a certain level (into a storage tank) from which it can be distributed.
- # an improvement is found in using animal traction instead of human energy. Transmission is necessary, but outputs are five to ten times greater than that of man.
- # the next step is to use fossil fuels or renewable energy for pumping. Animals can be used for other activities, instead of pumping for many hours, the pump can be used 24 hours per day and delivery of larger quantities of water are possible.

The pump itself, of course, has to be appropriated to its use and to its energy system. A donkey will pull harder than a man, the beats of a diesel pump will effect the pump in a totally different way than the constant rounds of the cattle. The hand pump is a simple design, means less maintenance and is easy to repair. Diesel and electric pumps are more sophisticated, but they require technical know-how and installation, maintenance and repair facilities.

Another disadvantage of diesel and electric pumps, is the dependence on fuel. Disruptions in the fuel supply will stop the pump and the total water installation.

For this reason 'appropriate technologists' have been looking for renewable energy sources: solar, wind and biomass energy and hydropower. Depending on the environmental and economical situation and, again, the available facilities, a choice can be made:

- # solar energy (photovoltaic cells, control device and a electric pump) requires a high level of technical skills and investment. The systems

can only be imported from industrialized countries.

- # wind energy (rotor, power transmission mechanism and a pump or a wind-driven electro-generator and an electric pump) requires also an investment higher than for diesel pumps, but has lower running costs and it can have a longer service life. A suitable wind regime is necessary; the average wind speed has to be higher than 3.5 m/s.
- # biomass can be processed to combustible gasses or liquids, which can be used as fuel for small engines to drive water pumps. Special energy crop production will be necessary most of the time; a trained operator is essential. Due to the minimum size of a biomass plant, such systems will not be adequate under quantities of 150 m³ of delivered water daily.
- # hydro-powered pumping systems, which could be divided into three main types:
 - turbine pumps, a water turbine with a centrifugal pump (flow of river, stream or channel 15 m/s, drive head of at least 0.5 m),
 - river current pumps, a vertical shaft rotor with transmission to a small centrifugal pump on a floating pontoon (e.g. flow of river 1.0 - 1.5 m/s, delivered quantity 100 - 300 l/min to a delivery head of 5 m),
 - hydraulic rams, a good solution if the conditions are favourable.

A more complete overview of the possibilities is given in 'Renewable Energy Sources for Rural Water Supply' (litt. 9).

3. Hydraulic rams

The decision to choose rams could be made after surveying the situation, measuring the available source supply, the obtainable supply head and the required delivery head as well as some additional data.

If the basic requirements could be fulfilled and the possible site meets its criteria (§ 5 and § 6), rams can be considered.

A final aspect of such a decision is the price of the system (§ 8).

In appendix A the operation of the ram is described including some specifications of the normally used characteristics. Furthermore, a comparison of rams in the laboratory and in the field, as well as a calculation example and addresses of manufacturers are given in the appendices.

4. Description of hydraulic rams

The various components from which a typical hydraulic ram installation is constructed are supply reservoir, drive pipe, hydraulic ram, delivery pipe and a storage tank.

The hydraulic ram itself is structurally simple, consisting of a pump chamber fitted with only two moving parts: an impulse valve through which the driving water is wasted (waste valve) and a delivery valve (check valve) through which the pumped water is delivered.

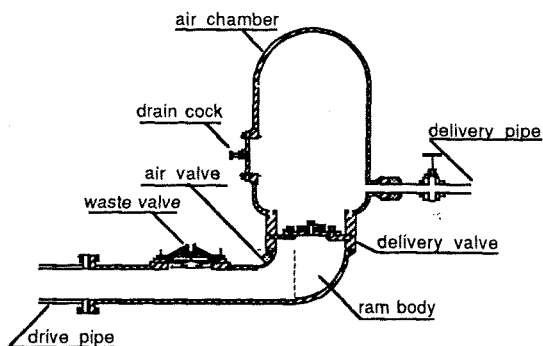

Fig. 1. Nomenclature of a hydraulic ram

In empty condition the waste valve normally falls open by gravity. Some designs of hydraulic ram use spring-activated waste valves. The delivery valve usually is a simple rubber disc covering a ring of holes. Surmounting the delivery valve is the air chamber or surge tank. When the ram operates, this tank is partly filled with water and partly with air. Connected to the air chamber is the delivery pipe, so the pressure in the air chamber is the delivery pressure. An inclined conduit, the so-called drive pipe, connects the ram body with the water supply. This drive pipe is the essential part of the installation in which the potential energy of the supply water is first converted into kinetic energy and subsequently into the potential energy of water delivered.

5. Basic Requirements

The use of a hydraulic ram requires the availability of suitable and reliable supply of water, with a sufficient fall to operate the ram. The supply can be any source of flowing or stagnant water such as a spring, stream, river, lake, dam or even a pond fed by an artesian well. Small size rams require a supply flow of at least 5 to 25 litres per minute, whereas very large rams may need as much as 750 to 1500 l/min. For most hydraulic rams the fall in driving water from the source to the ram must be at least 1 m.

Of course, not every spring, river etc. is suitable. The quality of the water is very important and has to be checked first. Most countries and communities have their own quality standards and methods of control. If the quality is not sufficient, complementary measurements have to be taken.

6. Site selection

When selecting a potential site for the hydraulic ram installation it is essential that provisions can be made both for water input to the ram and for proper drainage of the waste water away from the ram. The waste valve should under no circumstances, flood conditions included,

be submerged, since this will seriously affect its operation.

Before any possible lay-out of the installation can be designed, information must be gathered on the following items:

- 1) Amount of water available to power the ram (source flow) [l/min]
- 2) Minimum quantity of water to be pumped (delivery flow) [l/day]
- 3) Working fall (supply head) which can be obtained [m]
- 4) Distance in which the working fall can be obtained [m]
- 5) Vertical lift from ram site to delivery site [m]
- 6) Length of delivery pipe from ram to delivery site [m]

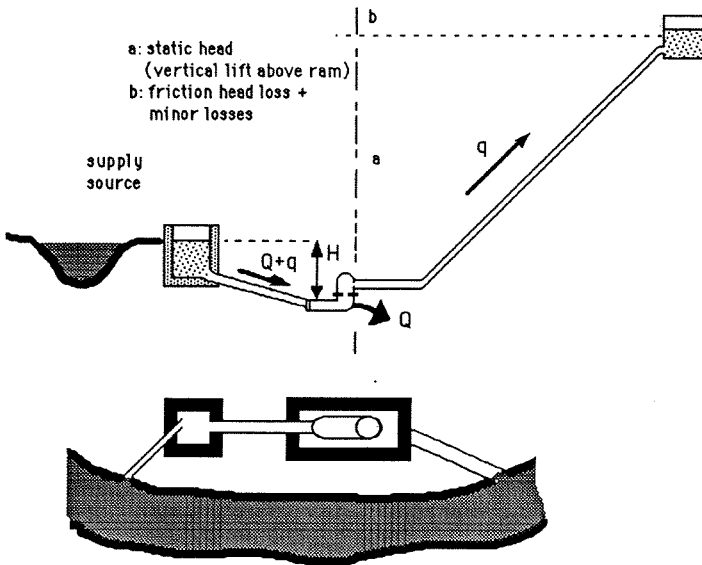

Fig. 2. Site of a hydraulic ram, $h_d = a + b$ (cross-section and top view)

Unless the supply water is obviously more than adequate, the source flow must be measured with reasonable accuracy. The possible change of flow at different times of the year should be established in order to determine the minimum guaranteed flow available.

The total daily volume of water required to be pumped can be calculated according to the purpose of use. For example, if the water is to be used for domestic consumption, the daily demand may be approximated by:

$$\text{Water Demand} = \text{Users} * \text{Per Capita Consumption}$$

A typical per capita consumption could be 40 to 50 litres/person/day. If

live- stock is present, its water use should be included also. Given the fact that the hydraulic ram is capable of operating continuously twenty-four hours per day, the required pumping rate (q) is obtained by dividing the daily water demand by $24 \cdot 60 = 1440$ minutes; in formula:

$$\text{Pumping Rate } q \text{ [l/min]} = \frac{\text{Water Demand [l/day]}}{1440 \text{ [min/day]}}$$

The working fall (supply head H_s) is measured vertically from the supply source level to the output level at the waste valve of the ram. The pumping capacity varies directly with the supply head.

The supply head can be increased by increasing the input level (e.g. by selecting the water input further upstream) and/or by lowering the position of the ram itself (as long as it can be placed on a spot from which the waste water can be easily drained away, e.g. to a suitable discharge point further downstream).

The next question to be answered is what pressure head the hydraulic ram will need in order to lift the water to the storage tank and to overcome all energy losses. In general this will be equal to:

$$\text{Delivery Head } (h_d) = \text{Vertical Lift above Ram} + \left[\frac{f L_d}{d} + \xi_d \right] \frac{v^2}{2g}$$

where

f	= pipe friction factor	[-]	(0.02 - 0.04)
L_d	= length of delivery pipe	[m]	(50 - 2000)
d	= internal diameter of delivery pipe	[m]	(0.02 - 0.05)
ξ_d	= sum of minor loss factors	[-]	(0 - 10)
v	= average velocity in delivery pipe	[ms ⁻¹]	(0.2 - 0.5)
g	= acceleration due to gravity	[ms ⁻²]	(9.8)

Vertical lift must be measured from the location of the ram to the highest possible water surface level (overflow level) in the storage tank.

Minor losses may usually be neglected (or roughly estimated) as compared with vertical lift and friction head loss.

Knowing the available source supply (Q_{source}), the required pumping rate (q), the supply head (H_s) and the delivery head (h_d) the size of the hydraulic ram can be selected with the aid of the appropriate performance tables or, when available, with use of empirically obtained q/Q vs h_d/H_s - curves:

The sum of the waste flow (Q) used by the ram and the pumping rate (q) must be less than the minimum source flow, i.e. $Q + q < Q_{\text{source}}$

Since supply head (H_s) and delivery head (h_d) are more or less fixed by the terrain conditions (topography), the size of the hydraulic ram is mainly determined by the desired pumping rate, or limited by the available source supply to drive the ram.

In cases where the installation has not enough capacity to meet the daily water demand, a battery of several rams may be used. Of course, this requires a source which can supply water at a sufficient rate. Each ram must have its own individual drive pipe, but they may use the same delivery pipe unless they are meant to supply different places.

A battery of hydraulic rams is also very useful in situations where the minimum flow during periods of drought only can power one or two rams and the maximum flow can drive more rams.

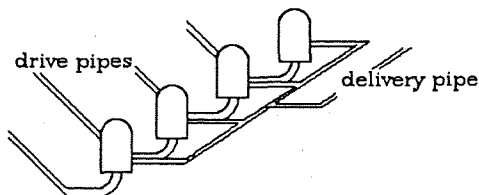

Fig. 3. Battery of a hydraulic rams

In a case where the supply water can power only one hydraulic ram, but the delivery flow does not quite meet the water demand, the waste water from the initial ram could be used to drive another ram.

7. Installation and maintenance

Since the hydraulic ram undergoes savage pounding under operation, it should be firmly bolted to a concrete base.

The drive pipe is by far the most important part of the installation; it carries the water from the supply reservoir to the ram and contains the high pressure surges (waterhammer) during the pumping stage of the operating cycle of the ram. The drive pipe should therefore be made of strong, rigid material, preferably galvanized iron. It should be watertight and rigidly anchored. The length should be approximately 4 to 7 times the supply head H_s .

The inlet to the drive pipe must always be submerged to prevent air from entering the pipe; air bubbles in the drive pipe will dramatically affect the operation of the ram or even lead to complete failure. For this reason the drive pipe should be laid as straight as possible throughout its entire length without any elevated sections which could trap air. A dip to allow the drive pipe to follow the contour of the ground is permissible.

The delivery pipe may be made of any material (e.g. P.V.C. - polyvinyl chloride or HDP - high density polyethylene) provided it can withstand the delivery pressure.

If the delivery head exceeds the pipe's pressure specification, then the lower portion of the delivery pipe must be galvanized iron pipe. In fact it may be advisable always to use an initial length of galvanized iron pipe to ensure a sturdy connection to the ram.

To facilitate operation and maintenance of the hydraulic ram the drive pipe and the delivery pipe should each be connected to the ram with union joints and stop-valves. The stop-valve in the drive pipe should be incorporated in such a manner as to prevent the formation of air pockets; a rotary type of valve (globe valve) is preferable to an ordinary gate valve since the latter may not be strong enough against the severe loads of the waterhammer pressures.

The maintenance required for a hydraulic ram is, compared to most other pumping systems, very little and infrequent. It includes:

- replacement of the valve rubbers when they are worked out
- adjustment of the tuning of the waste valve
- tightening bolts which have worked loose.

Occasionally the hydraulic ram may need dismantling for cleaning. It is essential that as little debris as possible enters the drive pipe. It is therefore necessary to provide a grate at the intake of the supply source as well as a strainer at the inlet side of the drive pipe to hold up floating leaves and debris. The grate and strainer must be checked every now and then and cleaned if necessary to ensure that the water supply is flowing at the maximum rate.

It must be stated that the foregoing remarks on the practical use of the hydraulic ram only highlights some of the main features of the installation. Every situation may vary in detail; specific design and techniques suited to the particular site may be necessary to create the most appropriate hydraulic ram installation.

More detailed information on how to construct, operate and maintain the ram installation is depending on the type of ram and can be found in the appropriate product information. Some manufacturers (e.g. Blake, Jandu, Schlumpf and Vulcan) do supply comprehensive information.

8. Prices and costs

Prices of hydraulic rams vary from US \$ 1000 to US \$ 3500. During the research in Rwanda it became clear that this price is a small part of the total costs of a complete water supply system. A rough breakdown of these costs looks as follows

pipes and accessories	45 %
construction works	30 %
transportation (including transport from Europe to Africa)	15 %
hydraulic rams	10 %

Although rams do not have fuel costs, expenses for spare parts and maintenance are most common. There has to be someone available for regular check-ups and reparations (weekly to monthly). This person should be trained first.

The percentual breakdown of the total costs leads to the conclusion that the price of the ram itself is of less importance. A cheap ram with a low output and a bad performance could throw the whole expensive system idle.

The risk of drop out of the total system is also rather high when other parts of the system, e.g. the drive pipe, were not installed very solidly.

Another lesson which could be learned from the total costs overview is the knowledge on the availability of all materials is essential in order to make a realistic estimation of the total costs.

A.1. Operation of hydraulic rams

The ram operates on a flow of water falling under a head (abbreviated H_s) from the supply reservoir down through the drive pipe into the pump chamber. The water escapes through the opened waste valve into the surrounding area. With the acceleration of the water the hydrodynamic drag and pressure on the waste valve will increase. When the flow of water through the waste valve attains sufficient velocity, the upward force on the valve will exceed its weight and the valve will slam shut. (In a good ram design the valve closure is rapid, almost instantaneous.)

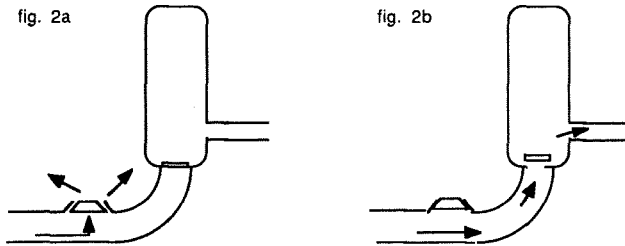

Thus the flow through the waste valve is abruptly stopped, but since the column of water in the drive pipe still has a considerable velocity a high pressure develops in the ram, locally retarding the flow of water.

If the pressure rise is large enough to overcome the pressure in the air chamber the delivery valve will be forced open, which in turn limits the pressure rise in the ram body to slightly above the delivery pressure. The front of this pressure rise expands upstream, partly reducing the flow velocity in successive cross-sections of the drive pipe as it passes. In the meantime the remainder of the flow passes through the opened delivery valve into the air chamber. The 'air cushion' permits water to be stored temporarily in the air chamber with only a comparatively low rise in local pressure, thus preventing the occurrence of waterhammer (shock waves) in the delivery pipe.

With the propagation of successive pressure surges up and down the drive pipe water continues to flow into the air chamber with step-wise decreasing velocity until the momentum of the water column in the drive pipe is exhausted.

The higher pressure which now exists in the air chamber will initiate a reversal flow in the direction of the supply reservoir. This causes the delivery valve to close, preventing the pumped water from flowing back into the ram body. The 'recoil' of water in the drive pipe produces a slight suction in the ram body, thus creating an underpressure near the waste valve. The underpressure makes it possible for the waste valve to reopen, water begins to flow out again, and a new operating cycle is started.

fig. 2c

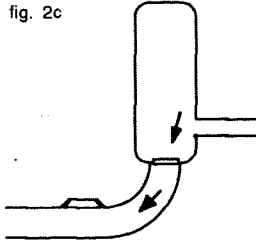
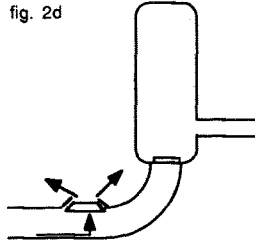

fig. 2d



Meanwhile the water forced into the air chamber, is driven into the delivery pipe to the storage tank at the high level, from which it can be distributed by gravitation as required.

An air valve or snifter valve is mounted into the ram body to allow a small amount of air to be sucked in during the suction part of the ram cycle. This air is carried along with the next surge of water into the air chamber. The air in this chamber is always compressed and needs to be constantly replaced as it becomes mixed with the water and lost to the storage tank. Without a suitable air valve the air chamber would soon be full of water and the hydraulic ram would then cease to function.

Depending on supply head, waste valve adjustment and, to a lesser degree, on drive pipe length and delivery head the cycle is repeated with a frequency of about 30 to 150 times a minute.

Once the adjustment of the waste valve has been set (valve stroke and - if present - tension of the return spring), the hydraulic ram needs almost no attention provided the water flow from the supply source is continuous, at an adequate rate and no foreign matters get into the pump blocking the valves.

A.2. Characteristics

For users of the ram the pumping rate q (output capacity) is the first consideration, since this should meet their demand.

Given an available source supply the pumping rate q of a hydraulic ram is determined by the supply head H_s and the delivery head h_d .

An increase of supply head H_s increases the pumping frequency (more beats per minute) and thereby increases the pumping rate q .

Commercially-made hydraulic rams are available in various sizes, covering a wide range of source supplies. The size of the ram (traditionally given in inches) usually denotes the nominal diameter of the drive pipe. The larger the size of the ram the more water is required to operate the ram and the more water can be delivered to a higher level.

Efficiency requires some special attention since different expressions are obtained in product information as well as in literature.

Some give the Rankine equation considering the installation as a whole and taking the head water level as datum. The useful work done in unit time, i.e. the net amount of potential energy of the water delivered, is given by $\rho g q (h_d - H_s)$. The net amount of energy used by the ram, i.e. the change in potential energy of the driving water is given by $\rho g Q H_s$.

$$\eta_{\text{rnk}} = \frac{\Delta E_{\text{pot}} \text{ water delivered}}{\Delta E_{\text{pot}} \text{ driving water}} = \frac{q * (h_d - H_s)}{Q * H_s}$$

In product information of hydraulic ram manufacturers, as well as in some other publications, efficiency is often simply defined as

$$\eta_{\text{trd}} = \frac{q * h_d}{Q * H_s}$$

The Rankine figure is always the lowest, while the 'trade expression' yields somewhat higher values; especially at low delivery heads the difference is significant.

The efficiency curve is most important when the supply source is limited and waste water must be kept at a minimum. In situations where there is an abundance of supply water the efficiency is a secondary matter. However, efficiency figures give a good indication of the hydraulic performance of the ram. High efficiency machines are hydraulically well-designed, i.e. have fair and smooth waterways and consequently low energy losses.

It should be standard commercial practice that manufacturers of hydraulic rams provide comprehensive and reliable information on the performance characteristics of their rams. Unfortunately this is not always the case.

For example, some ram manufacturers state that the 'output' of their rams can be calculated using the simple formula

$$q = \frac{Q * H_s}{h_d} * 0.6$$

The formula is based merely on the rule of thumb which means that the efficiency of a hydraulic ram is around 60 %. Apart from the fact whether the specific ram is capable of attaining this efficiency, it is unlikely that the use of the formula is correct for all arrangements of supply and delivery heads, since it has been found from experiments that efficiency eventually diminishes as head ratio h_d/H_s increases.

A more realistic approach is followed by manufacturers recommending the formula

$$q = \frac{Q * H_s}{h_d} * \eta$$

where numerical values of η are given in relation to head ratio h_d/H_s .

Only a few manufacturers provide empirically obtained operating tables.

B. Results of the comparative laboratory and field tests

In the Laboratory at Delft 12 types of hydraulic rams of 6 manufacturers were tested. An important result of this investigation was a sound theoretical description of what is happening inside the ram (litt. #1). This was the basis of this guide and will be a valuable point of departure for further research.

The results are given in the table on the next two pages. Specific remarks and assessments (field tests) are given at the end of this appendix. Figures for efficiency and pumping capacity, are placed next to the price per type.

In the field tests in Rwanda it became clear that hydraulic rams are sensitive to damage and obstruction, and depend strongly on the functioning of the rest of the system (drive and delivery pipe). Maintenance and repair played an important role.

It has to be kept in mind that the rather negative picture has been caused by the field testing procedure. While testing, the output should be watched continuously. In Rwanda however, weekly to monthly checks were carried out and there was not enough time to solve occurring problems immediately. A delay of some weeks in maintenance or repair of a ram is not a characteristic of that particular ram.

Another disadvantage of the procedure followed during the field tests as well as in the laboratory is the use of just one prototype of every model. Yet it is possible that just a good or worse prototype is used. There seems to be no direct relation between price and efficiency as can be seen in the table on the following pages. Keeping in mind the earlier statements on the total costs of a water supply system and the importance of efficiency, hydraulic rams with an efficiency less than about 55 % are disproportionately expensive.

The schedule on the testing program prevented the investigation of the newly designed rams Mbaraga I and II. These rams were designed after the unsatisfactory experiences (maintenance) in the field test after finishing the laboratory tests.

The locally designed and constructed hydraulic rams (Mbaraga I and II, as well as the ITDG-ram) are, compared to the commercially available rams, still in a too experimental stage to judge their value. Justification for the use of this types could be caused by the specific local situation (availability of other rams and materials, transport problems, construction capacity etc.).

Hydraulic ram	Supply Head Hs	Waste Flow Q (a)	Period Time T (a)	Delivery Head hd [m]	
	[m]	[l/min]	[s]	from	to
Blake Hydram No. 2 (1,5")	1.35	40	1.600	12	112
	2.00	39	1.000	11	130
	3.00	38	0.700	11	140
Blake Hydram No. 3,5 (2,5")	1.35	110	1.600	8	112
	2.00	100	1.000	8	120
	3.00	95	0.700	12	133
Alto J 26-80-8 (1")	1.00	14	1.300	6	19
	2.00	14	0.700	9	33
	3.00	15	0.550	12	42
Alto CH 50-110-18 (2")	1.00	33	1.000	6	40
	2.00	36	0.600	7	60
	3.00	39	0.450	10	66
Vulcan 1" (1")	1.00	15	1.550	4	75
	2.00	17	0.950	8	117
	3.00	16	0.650	13	134
Vulcan 2" (2")	1.00	35	1.150	6	68
	2.00	33	0.600	12	80
	3.00	34	0.450	18	88
SANO No.1-25 mm (1")	1.00	10	1.100	4	67
	2.00	10	0.550	9	81
	3.00	10	0.400	11	93
SANO No.4-50 mm (2")	1.00	60	1.900	4	102
	2.00	55	0.900	8	120
	3.00	60	0.650	12	138
Davey No. 3 (1")	1.00	13	1.900	2	28
	2.00	13	1.000	4	44
	3.00	12	0.750	6	54
Rife 20 HDU (2")	1.25	85	2.500	4	112
	2.00	80	1.300	4	133
	3.00	80	0.900	6	154
Schlumpf 4A5 (1,5")	1.00	25	1.500	4	32
	2.00	32	1.400	6	29
	3.00	30	1.000	9	27
Schlumpf 4A23 (1,5")	1.00	25	1.900	4	40
	2.00	45	1.600	8	78
	3.00	36	1.100	9	73

(a) approx. average value for the whole range of operation

Hydraulic ram	Pumping Rate q [l/min]		Efficiency	Price	Maintenance Durability Reliability (d)
	from	to	% (b)	(c)	
Blake Hydram No. 2 (1.5")	2.00	0	44/42/37	£ 250	
	4.75	0	62/64/60		
	7.70	0	67/70/67		
Blake Hydram No. 3,5 (2.5")	9.95	0	51/51/45	£ 450	-
	17.15	0	65/64/57		-
	20.30	0	70/73/68		+
Alto J 26-80-8 (1")	1.10	0	- / - / -	Frs 3550	
	1.75	0	45/ 8/ -		
	2.20	0	38/ - / -		
Alto CH 50-110-18 (2")	1.25	0	37/ - / -	Frs 6950	-
	3.05	0	40/36/ 1		+
	4.45	0	38/41/22		++
Vulcan 1" (1")	1.00	0	36/34/18	£ 165	
	1.00	0	48/52/51		
	2.25	0	52/58/57		
Vulcan 2" (2")	4.25	0	70/63/31	£ 365	
	5.05	0	75/68/54		
	5.40	0	76/71/56		
SANO No.1-25 mm (1")	1.05	0	45/35/11	DM 700	
	1.50	0	60/59/44		
	2.05	0	61/64/54		
SANO No.4-50 mm (2")	4.70	0	38/32/27	DM 1350	-
	8.40	0	63/63/62		-
	10.25	0	65/68/66		-
Davey No. 3 (1")	2.67	0	26/ - / -	£ 250	
	3.77	0	51/16/ -		
	4.80	0	59/47/ -		
Rife 20 HDU (2")	3.90	0	26/28/27	\$ 800	-
	8.90	0	42/54/45		--
	12.90	0	45/47/48		-
Schlumpf 4A5 (1.5")	3.85	0	- / - / -	SFr 2000	
	9.30	0	22/ - / -		
	10.30	0	38/ - / -		
Schlumpf 4A23 (1.5")	3.70	0	37/ 2/ -	SFr 3000	-
	7.65	0	44/33/ 8		-
	11.70	0	53/35/16		-

(b) for resp. h = 20 m, 40 m and 60 m

(d) according to field tests

(c) global prices 1980/1981

Remarks and assessments per ram (field tests)

Blake 3 1/2"

During the 11/2- year testing-period of this ram it has been standing still during most of the time due to external influences (drive and delivery pipes and a flexible joint). The joint between drive pipe and ram body seemed to cause heavy trouble for local maintenance.

SANO 4

With the Sano-ram also external influences played an important role. The delivery valve caused trouble time and again.

Schlumpf No. 4A23

Again external factors were of great influence. After a few days the delivery valve had to be modified fundamentally.

Vulcan 21/2"

After some starting problems this ram worked reasonably although a lot of time was lost due to external factors. Repairing was necessary twice; a new gasket and two rubber delivery valve clacks.

Vulcan 2"

Misjudgement during the installation (wrong interpretation of the pump behaviour due to a leaking drive pipe) of this Vulcan caused its premature removal. So classification is not possible.

Rife # 20 HDU

The Rife could not function under the given conditions, although according to the description of the manufacturer, it should have been possible.

Alto CH No. 50-110-18

With the Alto the installation problems already appearing by the Vulcan 2", showed up again. After repairing the drive pipe and slowing down the waste valve by some modifications, there were no internal break-downs, but the drive pipe broke again, combined with a period with lack of water. After a working period of 16 months the Alto ram was extremely worn down, also as a result of aggressive-water.

Mbaraga I & II

Mbaraga I & II are designed locally and constructed hydraulic rams. This was done because of the poor results of the commercially available rams. These rams were not tested in Delft but nevertheless a, not surprising, result can be given: reliability and durability were very poor and access of local maintenance was good

C. Calculation example

Given: a community of 60 persons and some cattle (30)

Water Demand = Population * Capita Consumption

The capita consumption depends on geographic, social and cultural aspects, but most of all on the availability of water. The domestic consumption could be 2 - 5 liters daily, with a population living 15 km from a water source. Having a watertap, shower and adjusted toilet, it could be 60 - 80 litres per day per person.

For this example is calculated with 50 litres daily and 20 litres for the local cattle per animal. So,

Water Demand = $60 * 50 + 30 * 20 = 3600$ l/day

The pumping rate (continuously pumping) will be

$$\text{Pumping Rate} = \frac{3600}{1440} = 2.5 \text{ l/min}$$

The next figure needed is the delivery head. Herefore is given:

$f = 0.04$ (estimation, depending on the pipes available)

$L_d = 1000$ m (to be measured in the field)

$d = 0.02$ m (a suitable diameter for this pumping rate? Has to be checked.)

$\xi_d = 10$ (estimation for a long and difficult track)

$v = 0.3 \text{ ms}^{-1}$ (estimation, has to be checked)

$g = 9.8 \text{ ms}^{-2}$

Vertical lift = 40 m (to be measured in the field)

$$h_d = 40 + \left[\frac{0.04 * 1000}{0.02} + 10 \right] \frac{0.3^2}{2 * 9.8} = 49 \text{ m}$$

As shown in the table on page 13 and 14 such a supply could be created with e.g. a Blake Hydram no. 2 or some others, using a supply head of 3.00 m at least and a supply flow around 60 l/min. With a given efficiency of 70 % this will result in

$$q = \frac{60 * 3.00}{49} * 0.70 = 2.57 \text{ l/min}$$

D. Bibliography

- # 1 Hydraulic rams, a comparative investigation, 112 pp. + 143 pp. appendices, 1987
J.H.P.M. Tacke, Laboratory of Fluid Mechanics, DUT
Centre for International Cooperation and Appropriate Technology,
Delft University of Technology, P.O. Box 2600 GA Delft, The
Netherlands
- # 2 A manual on the hydraulic ram for pumping water, 40 pp., 1978
S.B. Watt
Intermediate Technology Development Group, 9 King Street,
London WC2E 8HW, United Kingdom
- # 3 De waterram - een theoretische beschouwing n.a.v. een a.t.
ontwerp, 70 pp., (Nederlands), 1976
K. Kempenaar and H. Wesseling, DUT
Centre for International Cooperation and Appropriate Technology
- # 4 Field tests on hydraulic rams in Rwanda, 1987
E. Hamel, SNV
Foundation of Dutch Volunteers, Bezuidenhoutseweg 161, 2594
AG, The Hague, The Netherlands
- # 5 Drawings of hydraulic rams, 42 pp., (Duits/Engels), 1979
German Appropriate Technology Exchange, Postfach 5180,
D-6236 Eschborn, Germany
- # 6 Proceedings of a workshop on hydraulic ram pump (hydram)
technology, Arusha, Tanzania, 121 pp., 1984
E.J. Schiller, ITDG
Intermediate Technology Development Group
- # 7 The construction of a hydraulic ram pump, 36 pp.
A.R. Inversin
South Pacific Appropriate Technology Foundation, P.O. Box 6937,
Boroko, Papua New Guinea
- # 8 Ontwerp en bouw van een waterram proefinstallatie, ontwikkeling
waterramimpulsklep simulatiemodel, 51 pp. + bijlagen,
(Dutch), 1986
H.M. Zilvold, HTS Zwolle, The Netherlands
- # 9 Renewable Energy Sources for Rural Water Supply, 133 pp. +
appendixes, 1986
International Reference Centre, P.O. Box 93190, 2509 AD, The
Hague, The Netherlands
- # 10 A handbook of gravity-flow water systems, 186 pp. + appendixes,
1980
Intermediate Technology Development Group

E. Adresses of hydraulic ram manufacturers

Alta Cabeza "Gaviotas"	Centro Las Gaviotas, Paseo Bolivar no. 20 - 90, Bogota, Columbia
Auto-Lift Pump	Godbole & Sons, New Ramdaspath, Kachipura, Nagpur - 1, India
Bélier ALTO	J.M. Desclaud, 57, Rue Bertrand-de-Goth, 33800 Bordeaux, France
Billabong	John Danks & Son. Pty Ltd, Doody Street, Alexandria, Sydney, New South Wales, Australia
Blake Hydram	John Blake Ltd, P.O. Box 43, Accrington, Lancashire BB5 5LP, UK
Bomba Hidraulicas Rochfer	Industrias Mecanicas Rochfer Ltda. Avenida Jose de Silva 3765, Jardin Moria Rosa, Caixa Postal 194, Sao Paulo, CEP 14400, Brazil
Briau Hydram	Briau S.A., B.P. 43, 37009 Tours, France
BZH Hydraliska	Ab Bruzaholms Bruk, 570 34 Bruzaholm, Sweden
CeCoCo Hydro-HI-Lift Pump	CeCoCo, P.O. Box 8, Ibaraka City, Osaka 567, Japan
Chandra Hydram	Singh Metal Casting Works, 110-D Nirala Nagar, Lucknow, India
Fleming Pump	C.W. Pipe Inc., P.O. Box 678, Amherst, Virginia 24521, USA
Jandu's Hydram	Jandu Plumbers Ltd, P.O. Box 409, Uhuru Road, Arusha, Tanzania
Pompe Pilter	Pilter, 22, Rue Florian, 75020 Paris, France
Premier Hydram	Premier Irrigation Equipment Ltd, 17/1C Alipore Road, Calcutta 700.027, India
Rife Ram Pump	Rife Hydraulic Engine Manufacturing Co., 316 W. Poplar Street, P.O. Box 790, Norristown, PA 19401, USA
SANO Ram Pump	Pfister & Langhanss, Sandstraße 2-8, Postfach 3555, 8500 Nürnberg 1, Federal Republic of Germany

Schlumpf Pump

Schlumpf AG, CH-6312 Steinhausen,
Kanton Zug, Switzerland

Vulcan Hydram

Green & Carter Ltd, Ashbrittle, Near
Wellington, Somerset, TA21 0LQ UK

Wama Pump

WAMA Maschinenbau, Bergstraße 8,
8018 Grafing bei München, Federal
Republic of Germany

DISCLAIMER

This publication was prepared by the Delft University of Technology - Centre for International Cooperation and Appropriate Technology (CICAT), as part of a project financed by the Netherlands Ministry of Foreign Affairs - Directorate General for Development Cooperation (Bureau for Research and Technology).

The views expressed in this publication do not necessarily reflect those of the Netherlands Ministry of Foreign Affairs or of the Delft University of Technology.

Neither the Ministry nor the University makes any warranty, expressed or implied, or assumes any legal liability for the completeness of the information presented.

The mention of specific companies or certain manufacturers products does not imply that these are endorsed or recommended in preference to others of a similar nature that are not mentioned.