

Drag reduction through a streamlined aerodynamic design process

M. Peeters

Delft University of Technology

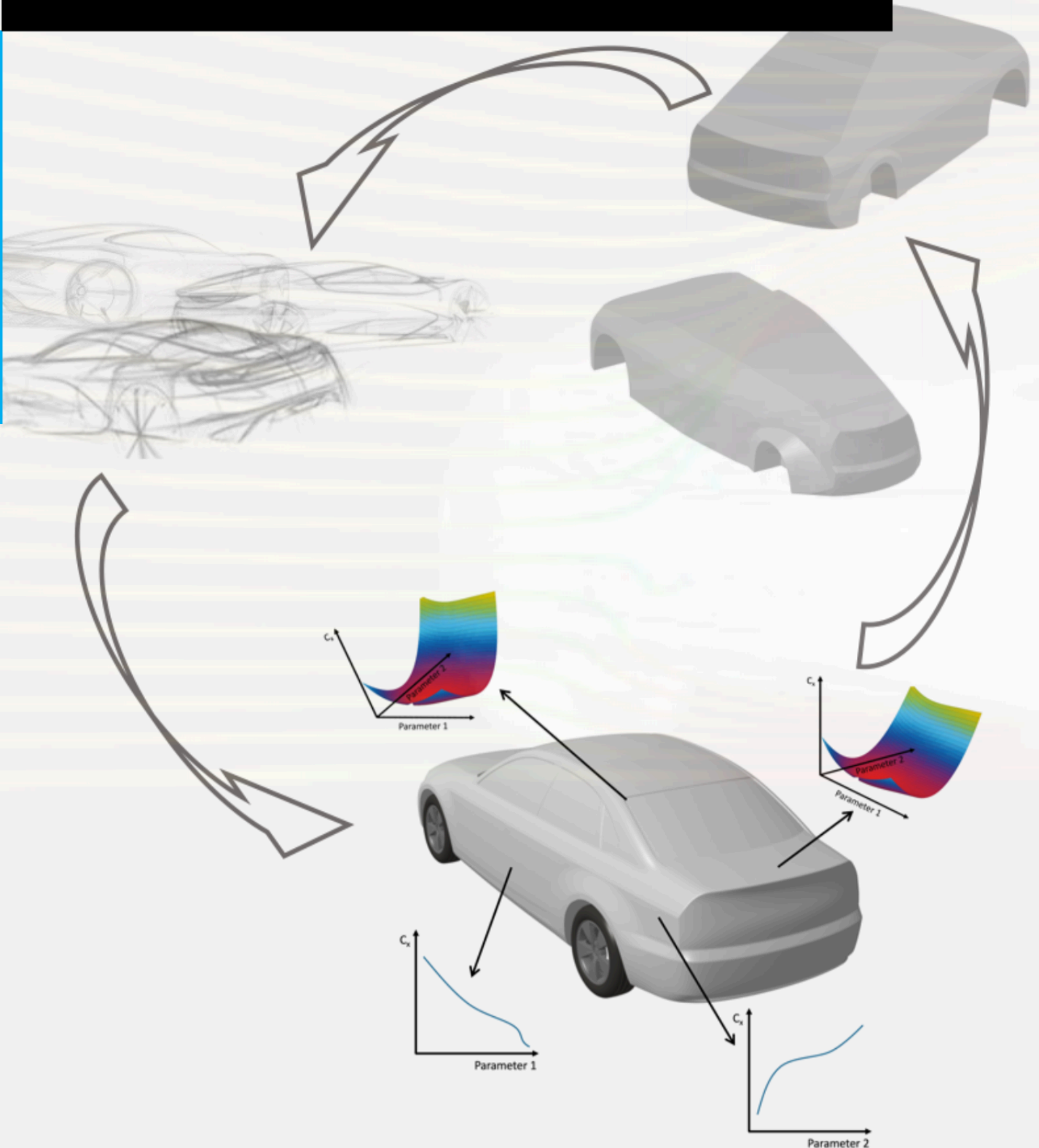

Drag reduction through a streamlined aerodynamic design process

Development and implementation of a methodology to accelerate the aerodynamic design process in the preliminary phase of car design

By

M. Peeters

in partial fulfilment of the requirements for the degree of

Master of Science
in Aerospace Engineering

at the Delft University of Technology,
to be defended publicly on Thursday February 11, 2016 at 01:30 PM.

Supervisor:	Ir. M.F.M. Hoogreef	TU Delft
	Dr. ir. G. La Rocca	TU Delft
Thesis committee:	Prof. dr. ir. L.L.M. Veldhuis,	TU Delft
	Dr. ir. F.F.J. Schrijer,	TU Delft

This thesis is confidential and cannot be made public until February 10, 2016.

An electronic version of this thesis is available at <http://repository.tudelft.nl/>.





Copyright © M. Peeters
All rights reserved

Summary

Continuous innovation is very important to stay competitive in today's world. Automotive manufacturers are an excellent example of this evolution when looking to new vehicle concepts. But also behind the scene, they have to be innovative in order to be able to keep up this progression. Aerodynamics has a large influence on the total performance of the car, and therefore fulfils a very important role in this innovation story. Aerodynamics is absolutely not straightforward which makes it on the one hand difficult to deal with and to estimate its influences, but on the other hand, this creates an improvement potential. Today's passenger cars are already aerodynamically optimised to a fairly large extent, meaning improvements become rather marginal. To be able to keep this tendency of improving in the future, the aerodynamic design process has to be adapted.

The focus of this work will be on the reduction of the air resistance of cars, which has a large influence on its top speed and fuel consumption. Especially the latter is very important today and will even gain more importance for future cars. Earlier research has shown that 70% of the reduction of the air resistance and the corresponding C_x value is done during the preliminary aerodynamic design phase. This phase is characterised by a high design freedom and a low level of detail of the corresponding design. Due to this, this early phase invites for shape optimisation of the basic aerodynamic shape having much more potential to achieve a lower C_x value. At the end of this phase, all fundamental parameters, dimensions etc. that define the final car will be fixed in order to begin the further detailed design during which detail optimisation is only possible anymore. This fundamental difference between the early phase and subsequent detailed design is responsible for their difference in influence on the final achieved C_x value and reduction. In order to achieve a successful aerodynamic design in terms of air resistance, the importance of that early design phase cannot be underestimated.

To prevent aerodynamic improvements from stagnating, this preliminary design phase has to be fully exploited. Those preliminary phase can be split into three specific sub phases, namely the initial phase, preliminary studies and concept phase. In the first, the high level targets of the car design will be determined, which the final design should comply with. After this, as much as possible information and knowledge about the design has to be gathered during the so called preliminary studies. This knowledge will be used to formulate thoughtful concepts for the subsequent concept phase where they will be assessed and developed further until one final design concept remains which should comply with all the earlier defined high level targets. The quality of the information and knowledge gathered during those preliminary studies is therefore critical for a comprehensive final design. This is valid for the whole aerodynamic design and by extension also the total car design. But as already said, this work focuses on the design of the car exterior in terms of C_x value.

It was observed in this work that the current situation has potential for improvement. More specifically, it was noticed that the aerodynamic department is occupied mainly with detail optimisation instead of the more favourable shape optimisation during those preliminary studies. The reason for this is due to a combination of their minor influence on the car exterior design compared to the aesthetics department and the current process flow during those studies. This current process flow is very inefficient and contains too much time-consuming and repetitive manual work. This combined with the short timespan of those preliminary studies lead to a limitation of the gathered knowledge of the car exterior design that is investigated. This is the main reason why the aerodynamicists are currently doing mainly detail instead of shape optimisation. For the latter, more investigations of higher quality (higher order) are required, which

the current inefficient process flow does not allow for. Therefore, the aerodynamicists are limited to detail optimisation because of this, which is explained more into detail in this work.

Thus, adapting the current process flow to allow the aerodynamic department to do shape instead of detail optimisation was found to be the main solution to improve and further reduce the C_x value and prevent it from stagnating in the future. The current process flow of those preliminary studies was analysed in this work and a suggested methodology that could accomplish those improvements was formulated based on this. The main difference of this methodology compared to the current situation is the implemented closed-loop instead of the open-loop modelling of the aerodynamic behaviour during those preliminary studies. This requires a fully automated process flow, which is missing in the current situation. In order to be able to also work out this suggested methodology to a fully working process flow, an automated generation of the geometric variants have to be provided. This was achieved by developing a parametric geometry model capable of instantly delivering the required geometric variant without human interaction. The parametric model is an approximation of the real car exterior geometry, but its accuracy was proved with relevant CFD simulations. The closed-loop surrogate modelling is realised by using a MATLAB-based toolbox, called SuMo-toolbox, which is implemented in the software framework of the developed methodology. A secure shell connection between this software framework in MATLAB and the Linux machine, on which the simulations are done, assures a stable and fully automated process flow. After this working out of the presented methodology, a reality-based use-case was done to estimate its potential for improvements compared to the current situation. Promising results were already obtained which also confirm the promised theoretical improvements in praxis. Also conclusions and recommendations for future work or alternative implementations and extensions of this methodology are formulated in this work.

This work was meant as an initial step and incentive to apply this methodology in the current industry. Before this could be possible, further research and work has to be done to make it practically implementable. This new process flow means a drastic change of the current one. It is typical for large companies to be unwilling to take this step. But if this methodology could be further developed so that it could fulfil its supposed role, namely improving and further reducing the C_x value of cars, it will become an important tool in the (near) future for manufacturers to become or stay ahead of their competitors. Certainly in today's world of increasingly strict economics, its role cannot be underestimated.

Acknowledgements

With this thesis, I complete my graduation at the Faculty of Aerospace Engineering of the Technical University of Delft. Besides graduating and saying goodbye to my life as a student, a new period in my life will begin also. Although this was not the easiest period, it will certainly be one of the most important ones in my life. By going through ups and downs I met up with my boundaries which was sometimes certainly not easy to deal with. But getting to know them by hard has allowed me also to push them and be able to develop my personality and skills. I am very proud on this personal evolution and that I came much stronger out of this period which I will positively remember for the rest of my life. Of course, I am sure that I would not have made it without the support and help of some people I would hereby like to thank.

First, I would like to thank my supervisors, Ir. Maurice Hoogreef and Dr. Ir. Gianfranco La Rocca for their support and insights they gave me during my thesis. I want to say a special thank you to Maurice, who was very important for me because of his qualitative support and dedication. Without him, I would not be able to finish this thesis successfully.

I also want to thank my chefs and colleagues at HABO Engineering for their support to successfully combine this thesis with my professional life.

Last but certainly not least, I want to say a huge thank you to my parents, girlfriend, brother, sister and family for their unlimited support, patience and believe in me. Without them, I would not have been able to finish or even start this thesis.

Delft, The Netherlands
11 February 2016

Matthias Peeters

Contents

Summary.....	v
Acknowledgements.....	vii
Contents.....	ix
List of Figures	xi
List of Tables	xv
Nomenclature	xvii
Chapter 1 Introduction	1
1.1 Background	1
1.2 Goal	2
1.3 Current state and problem description	2
1.4 Solution strategy	3
1.5 Overview and report structure	3
Chapter 2 Background information.....	5
2.1 Aerodynamics	5
2.1.1 Aerodynamics of a passenger car.....	5
2.2 Aerodynamic design in the automotive industry	15
2.2.1 Engineering design process	15
2.2.2 Aerodynamic design in the automotive industry	17
2.2.3 Aerodynamic vs. aesthetic design: observation summary	29
2.2.4 Conclusion	30
2.3 Surrogate modelling.....	31
2.3.1 What is it?.....	31
2.3.2 Use.....	32
Chapter 3 Approach	35
3.1 Overview.....	35
3.2 Analysis of the actual situation.....	36
3.2.1 Overview and link to Chapter 2	36
3.2.2 Preliminary studies	37
3.2.3 Looking for solutions	41
3.3 Suggested solution: concept definition	49
3.4 Geometry generator.....	51
3.4.1 Functional analysis	51
3.4.2 Development approach.....	52
3.4.3 Development of the parametric geometry model	55
Chapter 4 Results	69
4.1 Introduction	69
4.2 Use-case.....	69

4.2.1 Use-case definition	69
4.2.2 Reference model	70
4.2.3 OpenFOAM settings	71
4.2.4 Surrogate modelling settings	76
4.2.5 Specifications of the used machines	76
4.3 Results of use-case	76
4.3.1 Experiment 1	77
4.3.2 Experiment 2	80
4.3.3 Experiment 3	83
4.4 Discussion of the results	89
4.4.1 Overview	89
4.4.2 Importance of the new geometry generator	89
4.4.3 Surrogate modelling: open-loop vs. closed-loop	90
4.4.4 Summary	91
4.5 Generalisation of the suggested methodology.....	91
4.5.1 Generalisation concept	92
4.5.2 General aerodynamic design	92
4.5.3 Other fields of application	93
4.5.4 Generalisation: conclusion	93
Chapter 5 Conclusions & Recommendations.....	95
5.1 Conclusions	95
5.2 Recommendations for future work.....	100
5.2.1 Geometry generator.....	100
5.2.2 Overall methodology.....	101
References	103
A Blueprints final parametric model	105
B Software implementation.....	109

List of Figures

FIGURE 1-1: HISTORICAL EVOLUTION OF THE DRAG COEFFICIENT OF PASSENGER CARS (HUCHO, AERODYNAMICS OF ROAD VEHICLES, 1993)	1
FIGURE 1-3: MAIN APPROACH, OVERVIEW	2
FIGURE 2-1: CAR SHAPE TYPES	6
FIGURE 2-2: BREAKDOWN STRUCTURE OF THE INFLUENCES ON THE AIR RESISTANCE OF A CAR	6
FIGURE 2-3: SIDE VIEW OF THE TYPICAL FLOW AROUND A CAR (HUCHO, AERODYNAMICS OF ROAD VEHICLES, 1993)	7
FIGURE 2-4: INFLUENCE OF THE RELATIVE VELOCITY (TOP: $V_{REL} = 0$, BOTTOM: $V_{REL} \neq 0$) BETWEEN A BLUNT BODY AND THE GROUND ON THE FLOW BETWEEN BOTH	7
FIGURE 2-5: BOUNDARY LAYER FORMATION UNDER A CAR WITH NO AMBIENT WIND (GENTA & MORELLO, 2009)	8
FIGURE 2-6: INFLUENCE OF THE FLOW AND BOUNDARY LAYER FORMATION UNDER THE CAR ON THE WAKE AT THE REAR (GENTA & MORELLO, 2009)	8
FIGURE 2-7: SCHEMATIC VIEW OF THE FLOW BETWEEN A CAR AND THE GROUND (HUCHO, AERODYNAMIK DES AUTOMOBILS, 2008)	9
FIGURE 2-8: CAR-GROUND REFERENCE FRAME, XY-PLANE PARALLEL TO THE GROUND	9
FIGURE 2-9: LONGITUDINAL FORCE EQUILIBRIUM OF A CAR WITHOUT AMBIENT WIND	10
FIGURE 2-10: LONGITUDINAL FORCE EQUILIBRIUM OF A CAR WITH NO AMBIENT WIND AND RELEVANT DECOMPOSITION IN COMPONENTS	10
FIGURE 2-11: EXTERNAL FORCES WORKING ON A CAR WITH AMBIENT WIND	11
FIGURE 2-12: COMMON USED REFERENCE FRAME FOR THE TECHNICAL DESIGN OF A CAR	12
FIGURE 2-13: DIVISION OF THE SEPARATE DRAG SHARES OF A CAR ACCORDING TO (SCHÜTZ, 2013)	12
FIGURE 2-14: MAJOR LOCATIONS OF FLOW SEPARATION AROUND A CAR (SCHÜTZ, 2013)	13
FIGURE 2-15: SCHEMATIC OVERVIEW OF THE FLOW BEHIND A CAR FOR THE THREE MAIN TYPES SQUAREBACK, FASTBACK AND NOTCHBACK (SCHÜTZ, 2013)	14
FIGURE 2-16: THREE MAIN DESIGN PROCESS PHASES IN THE AUTOMOTIVE INDUSTRY	15
FIGURE 2-17: EXAMPLE OF THE INFLUENCING FACTORS IN THE INITIAL AND CONCEPT PHASE OF A NEW CAR MODEL (HIRZ, STADLER, PRENNER, & MAYR, 2012)	16
FIGURE 2-18: DESIGN PROCESS INCLUDING SUB-PHASES AND CONCEPT ELIMINATION	17
FIGURE 2-19: VARIATION OF THE KNOWLEDGE, DESIGN FREEDOM AND DETERMINED COST WITH THE PROJECT AGE	17
FIGURE 2-20: AERODYNAMIC DESIGN STRATEGIES (HUCHO, AERODYNAMIK DES AUTOMOBILS, 2008)	20
FIGURE 2-21: CONTRIBUTION TO THE REDUCTION OF C_x OF EVERY DESIGN PHASE OF THE BMW X5 (LIEBL, KERSCHBAUM, & PFANNKUCHEN, 2008)	20
FIGURE 2-22: AERODYNAMIC DEVELOPMENT TOOLS DURING THE DESIGN PROCESS	21
FIGURE 2-23: INFLUENCE OF THE AMBIENT WIND, V_w , ON THE YAW ANGLE Γ	21
FIGURE 2-24: GENERAL OVERVIEW OF THE AERODYNAMIC DESIGN PROCESS AT AUDI AG (WURZEL, 2008)	22
FIGURE 2-25: GENERAL OVERVIEW OF THE AERODYNAMIC DESIGN PROCESS AT DAIMLER AG (JEHLE-GRAF, 2011)	22
FIGURE 2-26: CENTRALISED DATABASE MANAGEMENT SYSTEM (HIRZ, STADLER, PRENNER, & MAYR, 2012)	24
FIGURE 2-27: VISUALISATION OF THE TERM VIRTUAL CONCEPT CAR (HIRZ, STADLER, PRENNER, & MAYR, 2012)	24
FIGURE 2-28: INTEGRATION OF AERODYNAMICS, STYLING AND OTHER INFLUENCES ON THE C_x DESIGN VISUALISED AS MODULES OF A VIRTUAL CONCEPT CAR (HIRZ, STADLER, PRENNER, & MAYR, 2012)	25
FIGURE 2-29: MAJOR CAR EXTERIOR DESIGN PARAMETERS FOR THE FRONT OF A CAR (SCHÜTZ, 2013)	26
FIGURE 2-30: MAJOR CAR EXTERIOR PARAMETERS OF A SIMPLIFIED NOTCHBACK REAR GEOMETRY (SCHÜTZ, 2013)	26
FIGURE 2-31: TYPICAL REPEATED WORK FLOW FOR C_x DESIGN IN THE AERODYNAMICS DEPARTMENT, MANUAL STEPS IN YELLOW	27
FIGURE 2-32: EXAMPLE OF A POLYNOMIAL SURFACE INCLUDING ITS CONTROL GRID	28
FIGURE 2-33: GENERAL INTERACTION BETWEEN AESTHETIC AND AERODYNAMIC DESIGN CONCERNING THE CAR EXTERIOR DEVELOPMENT	29
FIGURE 2-34: INTERACTION BETWEEN THE AESTHETIC AND AERODYNAMIC DEPARTMENT DURING THE PRELIMINARY STUDIES OF THE CAR EXTERIOR DESIGN	30
FIGURE 2-35: REAL WORLD SYSTEM (A), SIMULATION MODEL (B), SURROGATE MODEL (C) (SURROGATE MODELING LAB, 2015)	31
FIGURE 2-36: SIMULATION MODEL (SURROGATE MODELING LAB, 2015)	32

FIGURE 2-37: SURROGATE MODEL (SURROGATE MODELING LAB, 2015)	32
FIGURE 3-1: OVERVIEW OF THE APPROACH TO IMPROVE THE AERODYNAMIC DESIGN IN THE AUTOMOTIVE INDUSTRY	36
FIGURE 3-2: MAIN PROBLEM AND SUGGESTED SOLUTION OVERVIEW, BASED ON THE CURRENT SITUATION OBSERVATION	36
FIGURE 3-3: GENERAL REPRESENTATION OF THE PRELIMINARY STUDIES FOR C_x DESIGN	38
FIGURE 3-4: MAIN BUILDING BLOCK OF THE PRELIMINARY STUDIES	38
FIGURE 3-5: MAIN BUILDING BLOCK VISUALISATION OF THE PRELIMINARY AERODYNAMIC STUDIES OF THE CURRENT SITUATION	38
FIGURE 3-6: C_x RESPONSE OF THE CAR EXTERIOR GEOMETRY FOR A CHOSEN SPECIFIC PARAMETER RANGE	39
FIGURE 3-7: FORMAT OF THE AERODYNAMIC INVESTIGATIONS ON THE DESIGN PROPOSAL GEOMETRY	39
FIGURE 3-8: COMBINING THE RESULTING SURROGATE MODEL OF INDEPENDENTLY INVESTIGATED PARAMETERS	39
FIGURE 3-9: SURROGATE MODELLING OF THE DISCRETE SAMPLE EVALUATION POINTS	40
FIGURE 3-10: CURRENT GENERAL STRUCTURE OF THE C_x INVESTIGATIONS OF THE CAR EXTERIOR DURING THE PRELIMINARY STUDIES.....	40
FIGURE 3-11: BREAKDOWN OF THE MAIN OBSERVATIONS OF THE CURRENT SITUATION, PROBLEM IDENTIFICATION AND SUGGESTED SOLUTION	41
FIGURE 3-12: A) OPTIMAL (GREEN) AND UNDERSAMPLING (RED), B) OVERSAMPLING.....	43
FIGURE 3-13: OVERVIEW OF THE THREE MAIN STEPS OF SURROGATE MODELLING	44
FIGURE 3-14: SURROGATE MODELLING, OPEN-LOOP (A) AND CLOSED-LOOP (B) CONTROL (SURROGATE MODELING LAB, 2015).....	45
FIGURE 3-15: PRACTICALLY ORIENTED VISUALISATION OF CONTROLLED SURROGATE MODELLING (SURROGATE MODELING LAB, 2015) ..	46
FIGURE 3-16: COMPARISON OF THE OPEN (TOP) AND CLOSED-LOOP (BOTTOM) SURROGATE MODELLING PROCESS FLOW DURING THE PRELIMINARY STUDIES.....	49
FIGURE 3-17: SURROGATE MODEL GENERATOR FOR C_x DESIGN, GENERAL CONCEPT	49
FIGURE 3-18: SIMULATOR BLACK BOX.....	50
FIGURE 3-19: SIMULATOR WITH VISUALISATION OF THE CURRENT INTERNAL PROCESS FLOW	50
FIGURE 3-20: SIMULATOR FLOWCHART FOR A SINGLE AERODYNAMIC SIMULATION	50
FIGURE 3-21: PROCESS OVERVIEW OF THE SUGGESTED METHODOLOGY	50
FIGURE 3-22: GEOMETRY GENERATOR, I/O OVERVIEW	51
FIGURE 3-23: 3D-VIEW OF THE DRIVAER SEDAN.....	52
FIGURE 3-24: FRONT, RIGHT AND TOP VIEW OF THE DRIVAER SEDAN	52
FIGURE 3-25: PARAMETRIC GEOMETRY MODEL, DEVELOPMENT APPROACH	53
FIGURE 3-26: GEOMETRIC PARAMETERS CHOSEN FOR THE ASSESSMENT OF THE GEOMETRIC MODEL.....	54
FIGURE 3-27: SIGNIFICANCE OF Δ 'S AND TENDENCIES	55
FIGURE 3-28: EXAMPLES OF SIMILAR C_x RESPONSES BETWEEN THE REAL AND APPROXIMATING GEOMETRY	55
FIGURE 3-29: VISUALISATION OF THE PARAMETRIC MODEL TOPOLOGY, PROFILE VIEW	56
FIGURE 3-30: VISUALISATION OF THE PARAMETRIC MODEL TOPOLOGY, 3D-VIEW	56
FIGURE 3-31: 3D-VIEW OF THE PARAMETRIC MODEL VERSION 1	57
FIGURE 3-32: FRONT, RIGHT AND TOP VIEW OF THE PARAMETRIC MODEL VERSION 1.....	57
FIGURE 3-33: SCALE FOR THE PRESSURE (LEFT) AND VELOCITY (RIGHT) FIELD RESULTS VISUALISATIONS.....	57
FIGURE 3-34: PRESSURE FIELD PARAMETRIC MODEL V2 (LEFT) AND THE REFERENCE MODEL (RIGHT)	58
FIGURE 3-35: REFERENCE MODEL (BOTTOM), PARAMETRIC MODEL V1 (TOP), LEFT VIEW OF THE VELOCITY FIELD AND STREAMLINES OF THE SYMMETRY PLANE	58
FIGURE 3-36: DETAILED VIEW OF THE FLOW AROUND THE CAR EXTERIOR OF THE REFERENCE MODEL (BOTTOM) AND THE PARAMETRIC MODEL V1 (TOP) IN THE SYMMETRY PLANE.....	59
FIGURE 3-37: REFERENCE MODEL (BOTTOM), PARAMETRIC MODEL V1 (TOP), TOP VIEW OF THE VELOCITY FIELD	59
FIGURE 3-38: REFERENCE MODEL (BOTTOM), PARAMETRIC MODEL V1 (TOP), TOP VIEW OF THE VELOCITY FIELD WITH STREAMLINES.....	59
FIGURE 3-39: REFERENCE MODEL (BOTTOM), PARAMETRIC MODEL V1 (TOP) OVERVIEW OF THE VELOCITY FIELD WITH STREAMLINES.....	60
FIGURE 3-40: DEFINITION OF THE B-SPLINE-BASED OBJECT USED IN THE PARAMETRIC MODEL V2.....	61
FIGURE 3-41: 3D-VIEW OF THE PARAMETRIC MODEL VERSION 2	61
FIGURE 3-42: FRONT, RIGHT AND TOP VIEW OF THE PARAMETRIC MODEL VERSION 2.....	61
FIGURE 3-43: PRESSURE FIELD PARAMETRIC MODEL VERSION 2 (LEFT) AND THE REFERENCE MODEL (RIGHT)	62

FIGURE 3-44: REFERENCE MODEL (BOTTOM), PARAMETRIC MODEL V2 (TOP), LEFT VIEW OF THE VELOCITY FIELD AND STREAMLINES OF THE SYMMETRY PLANE	62
FIGURE 3-45: DETAILED VIEW OF THE FLOW AROUND THE CAR EXTERIOR OF THE REFERENCE MODEL (BOTTOM) AND THE PARAMETRIC MODEL V2 (TOP) IN THE SYMMETRY PLANE	63
FIGURE 3-46: REFERENCE MODEL (BOTTOM), PARAMETRIC MODEL V2 (TOP), TOP VIEW OF THE VELOCITY FIELD	63
FIGURE 3-47: REFERENCE MODEL (BOTTOM), PARAMETRIC MODEL V2 (TOP) TOP VIEW OF THE VELOCITY FIELD WITH STREAMLINES.....	63
FIGURE 3-48: REFERENCE MODEL (BOTTOM), PARAMETRIC MODEL V2 (TOP) OVERVIEW OF THE VELOCITY FIELD WITH STREAMLINES.....	64
FIGURE 3-49: COMPARISON OF THE C_x RESPONSE OF THE CAR EXTERIOR GEOMETRY OF THE REAL AND PARAMETRIC MODEL FOR THE TRUNK EXTREMUM VARIATION	65
FIGURE 3-50: COMPARISON OF THE C_x RESPONSE OF THE CAR EXTERIOR GEOMETRY OF THE REAL AND PARAMETRIC MODEL FOR THE REAR WINDSHIELD ROOT VARIATION.....	65
FIGURE 3-51: PARAMETRIC GEOMETRY MODEL EVOLUTION.....	66
FIGURE 3-52: GEOMETRY GENERATOR, FIRST EXAMPLE OF EXTREME GEOMETRY.....	66
FIGURE 3-53: GEOMETRY GENERATOR, SECOND EXAMPLE OF EXTREME GEOMETRY	66
FIGURE 3-54: COMPARISON OF BOTH EXAMPLES OF EXTREME GEOMETRY	67
FIGURE 4-1: EXPERIMENT 1, MAX, MIN AND NEUTRAL GEOMETRY VARIATION OF THE CAR EXTERIOR IN THE SYMMETRY PLANE.....	70
FIGURE 4-2: EXPERIMENT 2, MAX, MIN AND NEUTRAL GEOMETRY VARIATION OF THE CAR EXTERIOR IN THE SYMMETRY PLANE.....	70
FIGURE 4-3: 3D-VIEW OF THE NEUTRAL PARAMETRIC MODEL BASED ON THE DRIVAER SEDAN	71
FIGURE 4-4: FRONT, RIGHT AND TOP VIEW OF THE NEUTRAL PARAMETRIC MODEL BASED ON THE DRIVAER SEDAN	71
FIGURE 4-5: OPENFOAM PROCESS SEQUENCE.....	72
FIGURE 4-6: MESH PATCHES	72
FIGURE 4-7: MESH DIMENSIONS, LEFT VIEW.....	73
FIGURE 4-8: MESH DIMENSIONS, TOP VIEW	73
FIGURE 4-9: MESH DIMENSIONS, FRONT VIEW.....	73
FIGURE 4-10: MESH SETUP, 3D-VISUALISATION	74
FIGURE 4-11: MESH RESULT, LEFT VIEW	74
FIGURE 4-12: MESH RESULT, TOP VIEW	74
FIGURE 4-13: EXPERIMENT 1, EVOLUTION OF THE RMSE OF THE FITTED MODEL AS A FUNCTION OF THE NUMBER OF SAMPLES	77
FIGURE 4-14: EXPERIMENT 1, COMPARISON OF THE 4 TH AND 5 TH DEGREE POLYNOMIAL FITTED MODEL FOR 14 SAMPLES	78
FIGURE 4-15: EXPERIMENT 1, COMPARISON OF THE 4 TH AND 5 TH DEGREE POLYNOMIAL FITTED MODEL FOR 25 SAMPLES	78
FIGURE 4-16: EXPERIMENT 1, COMPARISON OF THE 4 TH DEGREE POLYNOMIAL FITTED MODEL FOR 8, 14 & 25 SAMPLES	79
FIGURE 4-17: EXPERIMENT 1, COMPARISON OF THE 5 TH DEGREE POLYNOMIAL FITTED MODEL FOR 8, 14 & 25 SAMPLES.....	79
FIGURE 4-18: EXPERIMENT 2, EVOLUTION OF THE RMSE OF THE FITTED MODEL AS A FUNCTION OF THE NUMBER OF SAMPLES	80
FIGURE 4-19: EXPERIMENT 2, COMPARISON OF THE 4 TH AND 5 TH DEGREE POLYNOMIAL FITTED MODEL FOR 14 SAMPLES	80
FIGURE 4-20: EXPERIMENT 2, COMPARISON OF THE 4 TH AND 5 TH DEGREE POLYNOMIAL FITTED MODEL FOR 28 SAMPLES	81
FIGURE 4-21: EXPERIMENT 2, COMPARISON OF THE 4 TH DEGREE POLYNOMIAL FITTED MODEL FOR 8, 14 & 28 SAMPLES.....	82
FIGURE 4-22: EXPERIMENT 2, COMPARISON OF THE 5 TH DEGREE POLYNOMIAL FITTED MODEL FOR 8, 14 & 28 SAMPLES.....	82
FIGURE 4-23: EXPERIMENT 3, EVOLUTION OF THE RMSE OF THE FITTED MODEL AS A FUNCTION OF THE NUMBER OF SAMPLES	84
FIGURE 4-24: EXPERIMENT 3, 4 TH DEGREE POLYNOMIAL SURFACE FOR 24 SAMPLES	85
FIGURE 4-25: EXPERIMENT 3, 5 TH DEGREE POLYNOMIAL SURFACE FOR 24 SAMPLES	85
FIGURE 4-26: EXPERIMENT 3, 4 TH DEGREE POLYNOMIAL SURFACE FOR 31 SAMPLES	86
FIGURE 4-27: EXPERIMENT 3, 5 TH DEGREE POLYNOMIAL SURFACE FOR 31 SAMPLES	86
FIGURE 4-28: EXPERIMENT 3, 4 TH DEGREE POLYNOMIAL SURFACE FOR 36 SAMPLES	87
FIGURE 4-29: EXPERIMENT 3, 5 TH DEGREE POLYNOMIAL SURFACE FOR 36 SAMPLES	87
FIGURE 4-30: EXPERIMENT 3, 4 TH DEGREE POLYNOMIAL SURFACE FOR 44 SAMPLES	88
FIGURE 4-31: EXPERIMENT 3, 5 TH DEGREE POLYNOMIAL SURFACE FOR 44 SAMPLES	88
FIGURE 4-32: OVERVIEW OF THE FINDINGS OF THE DISCUSSION OF THE RESULTS	91
FIGURE 4-33: CLOSED-LOOP SURROGATE MODELLING, PROCESS FLOW	92

FIGURE 4-34: PROCESS FLOW OF THE SIMULATOR SPECIFIC FOR THE C_x -VALUE DESIGN OF THE CAR EXTERIOR DURING THE PRELIMINARY STUDIES	92
FIGURE 4-35: GENERAL PROCESS FLOW DURING THE AERODYNAMIC DESIGN.....	92
FIGURE 4-36: GENERAL PROCESS FLOW OF THE SIMULATOR	93
FIGURE 4-37: GENERAL PROCESS FLOW OF THE SIMULATOR EXTENDED WITH MULTIPLE SIMULATIONS COMBINED	93
FIGURE 5-1: CURRENT INTERACTION OF AERODYNAMICS AND AESTHETICS DURING THE PRELIMINARY PHASES FOR THE CAR EXTERIOR DESIGN	95
FIGURE 5-2: USEFULNESS OF INVESTIGATIONS WITH AN INCREASED PARAMETER RANGE.....	98
FIGURE 5-3: COMBINING THE RESULTING SURROGATE MODEL OF INDEPENDENTLY INVESTIGATED PARAMETERS	98
FIGURE 5-4: HIGHER ORDER INVESTIGATIONS OF THE CAR EXTERIOR GEOMETRY	99
FIGURE 5-5: TARGET INTERACTION OF AERODYNAMICS AND AESTHETICS DURING THE PRELIMINARY PHASES FOR THE CAR EXTERIOR DESIGN	99
FIGURE A-1: PARAMETER DEFINITIONS, FRONT VIEW AND WHEEL CASE PARAMETERS.....	105
FIGURE A-2: PARAMETER DEFINITIONS, LEFT VIEW 1.....	106
FIGURE A-3: PARAMETER DEFINITIONS, LEFT VIEW 2.....	107
FIGURE A-4: PARAMETER DEFINITIONS, TOP VIEW	108
FIGURE B-1: SOFTWARE FRAMEWORK, EXTERNAL STAKEHOLDERS.....	109
FIGURE B-2: LOW EXPERIENCE USER REQUIREMENTS.....	110
FIGURE B-3: HIGH EXPERIENCED USER REQUIREMENTS	111
FIGURE B-4: SOFTWARE FRAMEWORK, HIGH LEVEL REPRESENTATION OF THE INTERNAL STRUCTURE	111
FIGURE B-5: FOLDERS AND FILES OVERVIEW ON THE WINDOWS MACHINE.....	114
FIGURE B-6: FOLDERS AND FILES OVERVIEW ON THE LINUX MACHINE AND IN THE OPENFOAM CASE DIRECTORS	114
FIGURE B-7: SCHEMATIC OVERVIEW OF THE SOFTWARE FRAMEWORK.....	115
FIGURE B-8: SCHEMATIC OVERVIEW OF THE SIMULATOR	116

List of Tables

TABLE 2-1: OVERVIEW OF USED SOFTWARE BY LARGE CAR MANUFACTURERS	29
TABLE 4-1: OVERVIEW OF THE THREE EXPERIMENTS OF THE USE-CASE	70
TABLE 4-2: INITIAL CONDITIONS OF THE INCOMING AIR FLOW	75
TABLE 4-3: MAIN GEOMETRIC CHARACTERISTICS OF THE CAR EXTERIOR FOR CALCULATING C_x AND THE REYNOLDS AND MACH NUMBER OF THE FLOW	75
TABLE 4-4: REALIZABLE K- ϵ TURBULENCE MODEL, USED COEFFICIENTS VALUES	76
TABLE 4-5: RELEVANT SPECIFICATIONS OF THE USED MACHINES DURING THE USE-CASE	76
TABLE 4-6: OVERVIEW OF THE INFLUENCE OF THE MESH AND STL-GEOMETRY ACCURACY ON THE SIMULATION CONVERGENCE	90

Nomenclature

Latin Symbols

a	Acceleration	$[\text{m/s}^2]$
A	Area	$[\text{m}^2]$
C_D	Aerodynamic drag coefficient	$[-]$
C_L	Aerodynamic lift coefficient	$[-]$
C_M	Aerodynamic moment coefficient	$[-]$
C_p	Pressure coefficient	$[-]$
C_x	Aerodynamic drag coefficient (preferred notation in the automotive industry)	$[-]$
D	Aerodynamic drag	$[\text{N}]$
F	Force	$[\text{N}]$
k	Kinetic energy	$[\text{J/kg}]$
L	Aerodynamic lift	$[-]$
m	Mass	$[\text{kg}]$
Ma	Mach number	$[-]$
M	Moment	$[\text{Nm}]$
N	Normal force	$[\text{N}]$
p	Pressure	$[\text{Pa}]$
Re	Reynolds number	$[-]$
S	Aerodynamic side force	$[\text{N}]$
t	Time	$[\text{s}]$
T	Thrust or propulsive force, temperature	$[\text{N}], [\text{K}]$
V	Velocity, speed	$[\text{m/s}]$
W	Gravitational weight	$[\text{N}]$

Greek symbols

α	Incidence angle of the free stream	$[\text{°}]$
β	Yaw angle of the free stream flow	$[\text{°}]$
γ	Yaw angle of the ambient wind	$[\text{°}]$
ε	Turbulence dissipation rate	$[\text{J}/(\text{kg}\cdot\text{s})]$
μ	Dynamic viscosity	$[\text{Pa}\cdot\text{s}]$
ν	Kinematic viscosity	$[\text{m}^2/\text{s}]$
ρ	Density	$[\text{kg}/\text{m}^3]$

Subscripts

f	Front friction
l	Left
r	Right, rear, rolling resistance
ref	Reference
w	Ambient wind
∞	Free stream

Abbreviations

CAD	Computer-aided design
CAS	Computer-aided styling
CFD	Computational fluid dynamics
CoG	Center of gravity
CoP	Center of pressure
CPU	Central processing unit
GHz	Gigahertz
I/O	Input/Output
NURBS	Non-uniform rational basis spline
RAM	Random-access-memory
SOP	Start of production

Chapter 1

Introduction

1.1 Background

Continuous innovation is very important to stay competitive in today's world. Automotive manufacturers are an excellent example of this evolution when looking to new vehicle concepts. But also behind the scene, they have to be innovative in order to be able to keep up this progression. Aerodynamics has a large influence on the total performance of the car, and therefore fulfils a very important role in this innovation story. Aerodynamics is absolutely not straightforward which makes it on the one hand difficult to deal with and to estimate its influences, but on the other hand, this creates an improvement potential. Today's passenger cars are already aerodynamically optimised to a fairly large extent, meaning improvements become rather marginal as is shown for the C_x value in Figure 1-1. To be able to keep this tendency of improving in the future, the aerodynamic design process has to be adapted.

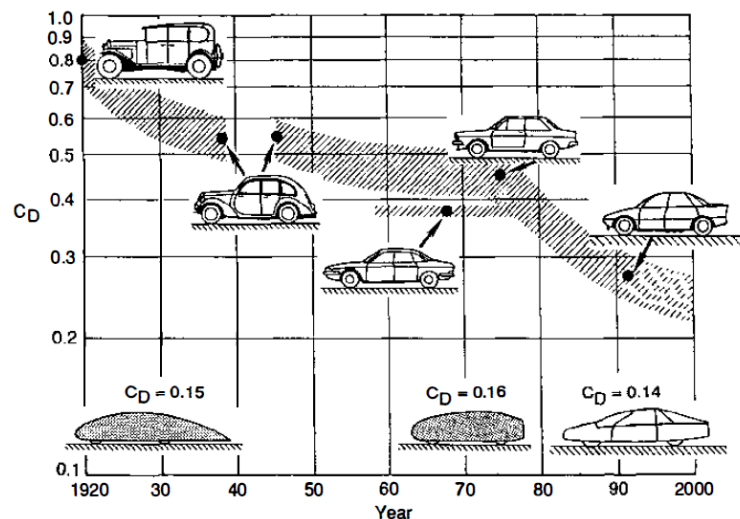

Figure 1-1: Historical evolution of the drag coefficient of passenger cars (Hucho, Aerodynamics of road vehicles, 1993)

The focus of this work will be on the reduction of the air resistance of cars, which has a large influence on its top speed and fuel consumption. Especially the latter is very important today and will even gain more importance for future cars. Earlier research has shown that 70% of the reduction of the air resistance and the corresponding C_x value is done during the preliminary aerodynamic design phase (Hirz, Stadler, Prenner, & Mayr, 2012). This phase is characterised by a high design freedom and a low level of detail of the corresponding design. Due to this, this early phase invites for shape optimisation of the basic aerodynamic shape having much more potential to achieve a lower C_x value. At the end of this phase, all fundamental parameters, dimensions etc. that define the final car will be fixed in order to begin the further

detailed design during which detail optimisation is only possible anymore. This fundamental difference between the early phase and subsequent detailed design is responsible for their difference in influence on the final achieved C_x value and reduction. In order to achieve a successful aerodynamic design in terms of air resistance, the importance of that early design phase cannot be underestimated.

To prevent aerodynamic improvements from stagnating, this preliminary design phase has to be fully exploited. That preliminary phase can be split into three specific sub phases, namely the initial phase, preliminary studies and concept phase. In the first, the high level targets of the car design will be determined, which the final design should comply with. After this, as much as possible information and knowledge about the design has to be gathered during the so called preliminary studies. This knowledge will be used to formulate thoughtful concepts for the subsequent concept phase where they will be assessed and developed further until one final design concept remains which should comply with all the earlier defined high level targets. The quality of the information and knowledge gathered during those preliminary studies is therefore critical for a comprehensive final design. This is valid for the whole aerodynamic design and by extension also the total car design. But as already said, this work focuses on the design of the car exterior in terms of C_x value.

1.2 Goal

The main goal of this thesis is to look for a method to improve the aerodynamic design of cars, but focused on the C_x of the car exterior. This is done by analysing the actual situation in terms of processes, process structure and the role of the aerodynamic department in the whole development process. The results and observation of this analysis will be used to identify problems, deficiencies and potential improvements. After this, a methodology will be formulated that could improve the actual situation and by extension the aerodynamic C_x design of cars. Then, this suggested methodology will also be worked out to a fully working process flow so that a reality-based use-case can be done to estimate its potential for improvements compared to the current situation. An overview of the main parts of the approach that will be followed in this work to achieve its main goal, namely improving the aerodynamic C_x design of cars, is shown in Figure 1-2.

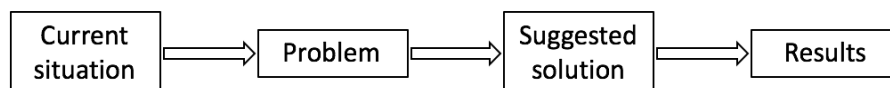

Figure 1-2: Main approach, overview

1.3 Current state and problem description

The main intension of this work is to find a method to improve the C_x design of cars. The current situation will be the starting point for this. In Chapter 2, it will be explained that the aerodynamic department has a minor role and influence compared to the aesthetic design during the development of the car exterior. This leads to a final design that is mainly focused on aesthetics and which does not exploit its aerodynamic potential. The reason for this is that aesthetics are more important for the customer than aerodynamics. The aerodynamics could be more exploited if the role and influence of the aerodynamic department could be increased compared to the aesthetic design. Although this dominant role of the aesthetic department, the

aerodynamicists are allowed to increase their influence. Unfortunately, this is currently obstructed due to a combination of the organisation and structure of the cooperation between both departments and the inefficient process flow of the aerodynamic processes during the early phases. A detailed analysis will clearly identify the problems, deficiencies and potential improvements of the current situation. All this will be clearly explained in Chapter 2 and 3.

This is done by analysing the actual situation in terms of processes, process structure and the role of the aerodynamic department in the whole development process. The results and observation of this analysis will be used to identify problems, deficiencies and potential improvements

1.4 Solution strategy

Based on the current situation of the aerodynamic C_x design in the automotive industry, a methodology will be formulated that could accomplish the suggested improvements. This suggested methodology will also be worked out to a fully operating process flow. A reality-based use-case will also be done to estimate its potential for improvements compared to the current situation. The main achievement that is tried to obtain with this work, to estimate the potential of such a methodology by describing it in theory, developing it in praxis and obtain compare its use-case with the current situation. Conclusions and recommendations will be formulated based on all of this. This work can be considered as and is intended to be the initial step or push to realise this and to further reduce the air resistance of cars in the future.

1.5 Overview and report structure

Chapter 2 will be devoted to the background information required in order to be able to follow and understand this report and is composed of three parts. The first part covers a brief introduction of car aerodynamics and some specific terms used in the automotive industry. The second part contains all the relevant information about the current aerodynamic design process of cars. To provide a total picture, this part will first start with an overview of the relevant aspects of the whole process of car design before focusing on the aerodynamic design. The third part will introduce surrogate modelling, which will be important for this work.

In Chapter 3, the analysis of the current situation, described in Chapter 2, will be done first. After this, the formulation of the suggested methodology and development of the needed geometry generator, required to achieve this, will be done.

Chapter 4 covers the use-case of the developed methodology. After defining this use-case, the obtained results will be presented including the formulation and description of the observations. Then, these results will be discussed including the performance of this methodology compared to the current situation from a rather qualitative point of view. This chapter will end with a brief discussion about the usefulness of such a methodology for the design of other aerodynamic aspects and even in other fields of application.

Chapter 5 will be the last chapter and contains the conclusions and recommendations of this work.

Chapter 2

Background information

2.1 Aerodynamics

The aerodynamic fundamentals will not be treated in this chapter, but can be found in specialised literature like (Anderson Jr., 2007). It is recommended for readers who are less familiar with aerodynamics to go through these basics because it will help to understand the aerodynamic part of this report.

2.1.1 Aerodynamics of a passenger car

Cars are blunt bodies with a very detailed and complex geometry which move through the air in very close proximity to the ground. They have rotating wheels, wheel wells working as cavities, internal flows, etc., all contributing to the complex aerodynamic behaviour of a car. The flow is highly three-dimensional with (mainly) turbulent boundary layers and characterised by a large amount of separation. This separation may be followed by reattachment and otherwise it will result in disturbing vortices and wakes. At the rear of the car, separation results in large turbulent wakes which could contain longitudinal trailing vortices. As for all blunt bodies, its drag is mainly pressure drag and because of the three-dimensional flow it is difficult to predict. This section is mainly meant to give an overview of some terms and to introduce some effects that have to be considered when dealing with car aerodynamics (e.g. ground effect and boundary layer) because of their influence on the occurring aerodynamic forces.

This section will start with an overview of the typical shape types of a car followed by the identification of the different parts of the flow. After this, the car's reference frame and external forces will be defined. To finish this section, a general overview of the drag of a car is given together with its causes related to the car exterior geometry.

2.1.1.1 Car shapes

In general, all normal passenger car models can be subdivided into three general shapes, namely notchback, squareback and fastback, which are shown in Figure 2-1. The first two are better known under the name sedan and station wagon respectively. Their only principal difference is the rear geometry.

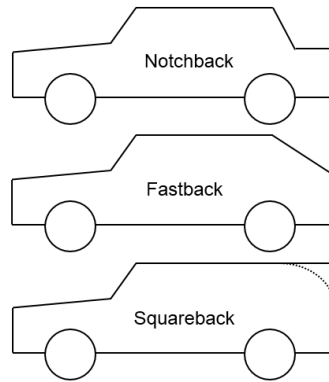

Figure 2-1: Car shape types

2.1.1.2 Identification of the flow

The total air flow around a car will determine its air resistance and can be subdivided into different contributions. A representation of all the aspects that contribute to the air resistance is shown in Figure 2-2.

The main focus will be on the flow around the main body (as indicated in green in Figure 2-2), but the internal flows through the car (orange) cannot be neglected because they will also influence the outer aerodynamics of the car. These flows will not be discussed for their cooling (engine and components) and ventilation (passenger compartment) capacities, but as part of the total flow behaviour around the car. This is done for completeness in this section, but as it will become clear later in this report, the focus will be on the air resistance of the car exterior only due to the external flow.

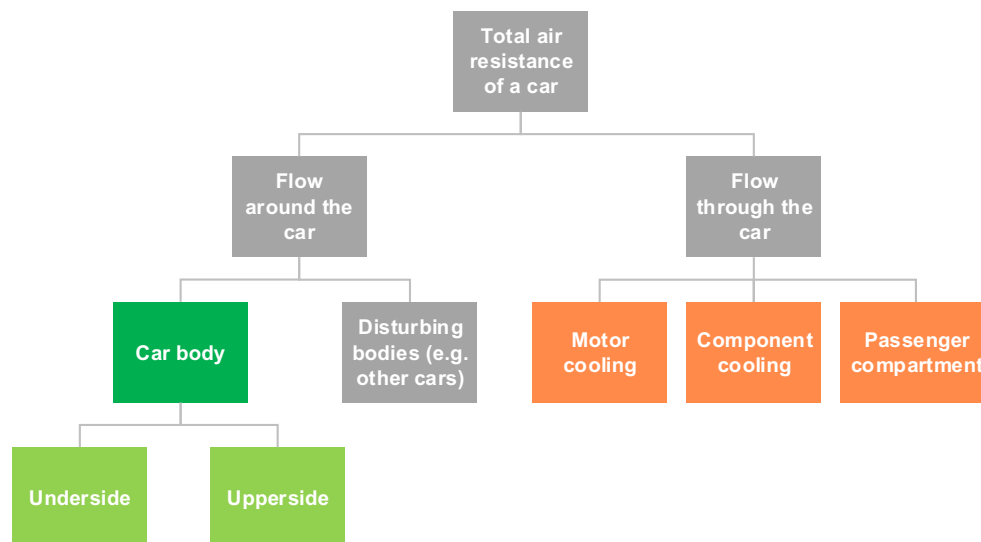

Figure 2-2: Breakdown structure of the influences on the air resistance of a car

Flow around the car

In Figure 2-3, a side view of the typical flow around a car is given. The Reynolds number is usually calculated with the air properties of the free stream and the length of the car. It can be seen that the flow is plagued by separation (reverse flow). How this separation behaves will be discussed in more detail later in this section.

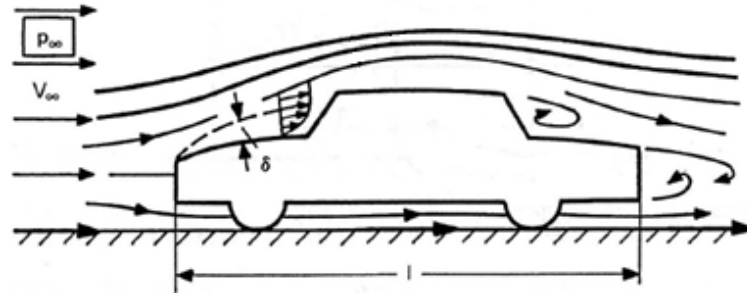

Figure 2-3: Side view of the typical flow around a car (Hucho, *Aerodynamics of road vehicles*, 1993)

Typically, most attention goes to the flow on the upper side of the car, but the flow at the underside is also very important for the aerodynamics of the car. The effect of a relative velocity between the ground and the car can be introduced by looking to the flow around a blunt body which is close to the ground (Figure 2-4). Between the blunt body and the ground, a boundary layer profile comparable to that formed in a fluid flow through a duct is formed when the relative velocity is zero. This is illustrated in Figure 2-4 top, in which the local velocities are represented in the reference frame of the body. When the body moves relative to the ground (like a car does), a different situation is created. The ground moves backwards in the reference frame of the body and pulls the air (between the body and the ground) to move faster. This enhances the Bernoulli effect under the body so that the downforce is increased (or the lift decreased). The development of the boundary layer profile between the body and the ground is shown in Figure 2-4, bottom. This boundary layer profile will only be valid when the flow under the body is not accelerated over a longer distance (so if the blunt body is not very large in absolute dimension). Otherwise, the air between the body and the ground will not be at rest anymore with respect to the ground, and a boundary layer will be formed.

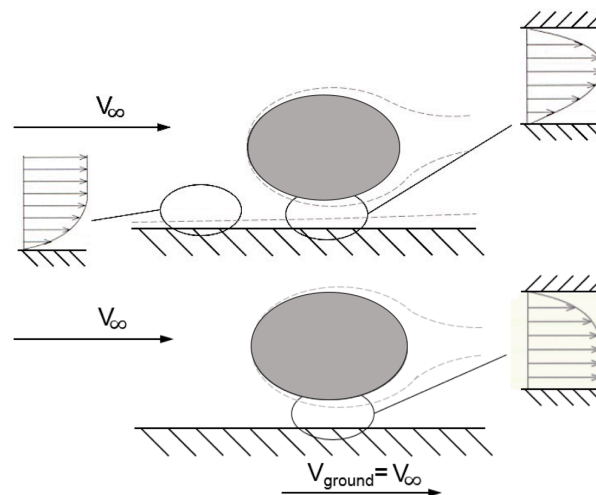

Figure 2-4: Influence of the relative velocity (Top: $V_{rel} = 0$, bottom: $V_{rel} \neq 0$) between a blunt body and the ground on the flow between both

In practice, this situation of the blunt body in Figure 2-4 will not occur for the flow under a car. Not only on the underbody of the car, but also on the ground, a boundary layer will be formed. This is shown in Figure 2-5, for the situation without ambient wind. Starting from point A, the boundary layer thickens and usually, the flow velocity outside this boundary will be different from that of the free stream, meaning that the flow is not at rest anymore with respect to the ground. Therefore, a boundary layer will appear on the ground as well. Depending on the ground clearance of the car and the roughness of both surfaces (ground and underbody), these two boundary layers can remain separated or meet each other (as in point H) (Genta

& Morello, 2009). When they meet, the flow under the car is blocked and tends to move with the car causing another boundary layer to start developing and a vortex may be formed between H and L.

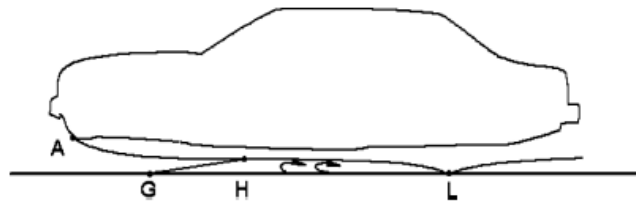

Figure 2-5: Boundary layer formation under a car with no ambient wind (Genta & Morello, 2009)

In Figure 2-6, the influence of both described situations on the wake behind the car is shown. The lower situation b, where both boundary layers remain separated, is much more favourable because of the lower generated drag and lift. The flow velocities under the car are higher and the wake is smaller compared to the situation where the flow is blocked. Also the pressure in the wake is increased due to the flow under the car. These higher velocities (and thus lower static pressure) under the car result in a lower upward lift and the smaller wake with increased pressure reduces the drag.

As was already discussed, the boundary layer will thicken faster when the surface is rougher. Thus when the underbody of the car is rougher, it is more likely that the two boundary layers will meet. A smaller ground clearance will have the same consequence as a high roughness. So a smooth underbody and large ground clearance would be beneficial for low drag and lift. But on the other hand, a smaller ground clearance will reduce the drag because the total height and thus frontal area of the car is decreased. This effect will be more profound at higher speeds ($\sim V^2$).

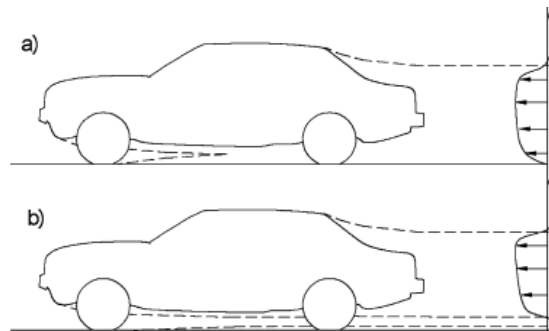

Figure 2-6: Influence of the flow and boundary layer formation under the car on the wake at the rear (Genta & Morello, 2009)

Moreover, it is beneficial for the dynamic driving behaviour to have a low centre of gravity (CoG), therefore a ground clearance as small as possible would be beneficial. These considerations are preferable over aerodynamic considerations. The minimal ground clearance is usually determined by the typical road surface it has to drive on (e.g. city, safety islands, underground parking exits, off-road) for the highest load case (all passengers and luggage in the car). For the smoothness of the underbody, a balance between aerodynamics and cooling of the components (exhaust, brakes, etc.) has to be found. This shows already that the aerodynamic design is dependent on many external factors and a good balance has to be found.

The flow under the car is also dependent on the cooling flow mainly coming from the engine and the front wheel brakes. A schematic view of the underbody flow is shown in Figure 2-7 and it can be seen that it has

a diverging flowing character. It is favourable for the predictability of the total flow and the aerodynamic performance of the car to prevent this divergent flowing.

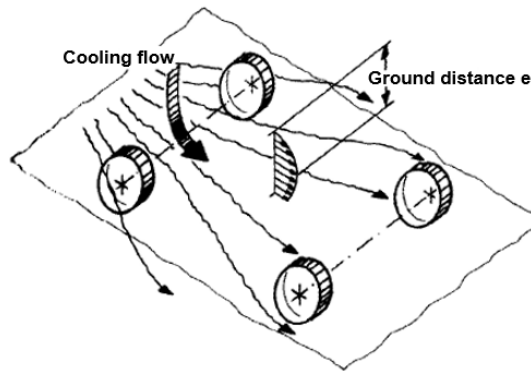

Figure 2-7: Schematic view of the flow between a car and the ground (Hucho, *Aerodynamik des Automobils*, 2008)

Flow through the car

The flows through the car are called the internal flows and are used for cooling of e.g. the engine, brakes and for the ventilation of the passenger compartment. From these flows, the one for the engine cooling has the largest influence on the flow around the car. As can be seen in Figure 2-7, this cooling flow will (mainly) merge into the underbody flow after leaving the heat exchanger (ventilator). This engine cooling configuration is the most commonly used for passenger cars, other possibilities are not discussed here.

2.1.1.3 Reference frame and external forces and moments

The choice of an appropriate reference frame is very important for unambiguity. There are different, commonly used reference frames which all have their specific practical utility. For the technical design, a reference frame fixed to the body and a clearly defined origin would be preferable. For inner wheel design, a non-rotating reference frame fixed with an origin lying on the wheel axle would be an appropriate choice. These are a few examples, important to know is that they have to be clearly defined.

The most commonly used reference frame to express the external forces that work on the car is a right-handed coordinate system with its CoG as the origin and the orientation of the axes as in Figure 2-8. Its xy -plane stays parallel to the road which allows for a more simple representation of the longitudinal and lateral force balance, as will become clear immediately.

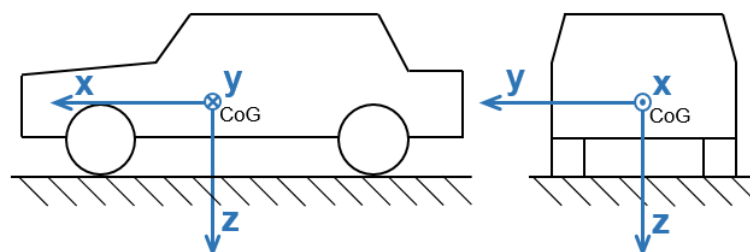

Figure 2-8: Car-ground reference frame, xy -plane parallel to the ground

A distinction has to be made between the situation with and without the presence of a (lateral) ambient wind. In both situations, the car is supposed to drive in a straight line with a constant speed so no lateral and longitudinal forces occur due to acceleration.

Without ambient wind, the air velocity will be exactly the opposite of the car's velocity. Therefore, the flow is symmetrical and the generated aerodynamic force will lie in the car's plain of symmetry and will have no lateral component. Only a longitudinal force equilibrium is of importance, which is shown in Figure 2-9. It is preferred to decompose this aerodynamic force into one component perpendicular to and one parallel to the road (and car speed), respectively the lift and drag. This is the most convenient representation because it is the component of the aerodynamic force in the direction of the car motion that has to be overcome by the thrust and not the one in the direction of the air speed. In this situation, both directions are equal, but this will not be true when an ambient wind is present. Moreover, it is also common to express this lift and drag with respect to the CoG. This movement of forces implies an additional aerodynamic pitching moment around the y-axis. In Figure 2-10, the most commonly used representation of the force equilibrium is shown.

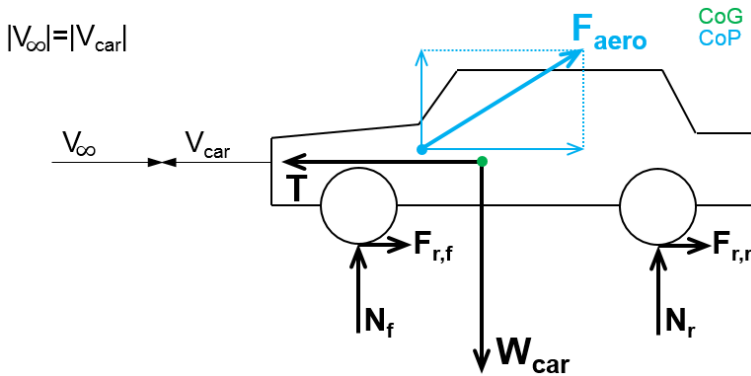

Figure 2-9: Longitudinal force equilibrium of a car without ambient wind

Thus the air resistance or aerodynamic drag of a car is expressed parallel to the motion or speed of the car. Therefore, in the automotive industry it is convenient to use the notation C_x instead of C_D for the dimensionless drag coefficient, so that the equation for the drag force, D , can be written as:

$$D = C_x \cdot \frac{1}{2} \cdot \rho_\infty \cdot V_\infty^2 \cdot A_f \quad (2.1)$$

In which ρ_∞ and V_∞ are respectively the density and velocity of the free stream and A_f the frontal area of the car.

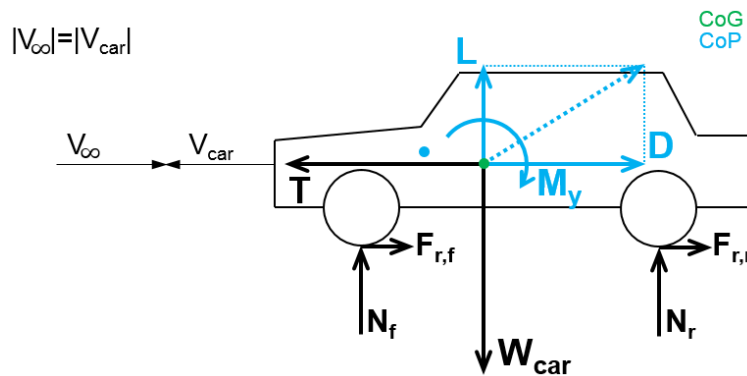

Figure 2-10: Longitudinal force equilibrium of a car with no ambient wind and relevant decomposition in components

In reality, there will always be ambient wind with a non-uniform velocity profile because of the local topography and the Earth boundary layer. Both its magnitude and direction will fluctuate, meaning that in general, a situation without ambient wind is never the case. Because of this ambient (lateral) wind, the flow

will be asymmetrical and the aerodynamic force will also have a lateral component now. Now the lateral force equilibrium is also of importance. The aerodynamic components in all the six degrees of freedom can be different from zero now and are shown in Figure 2-11 for a car driving in a straight line. These aerodynamic components are the rolling, pitching and yawing moment and the drag, lift and side force, respectively noted as M_x, M_y, M_z, L, D and S . Also in Figure 2-11, the other external forces working on the car are shown, namely the friction and normal forces between the tires and the road weight of the car. Due to this friction, the thrust can be transferred to the road (tractive forces are represented by the total thrust T). Moreover, this friction is needed for reaching a lateral force equilibrium but it also causes longitudinal friction losses due to the rolling resistance of the tires. This will not be further discussed because this work will focus on the drag resistance of the car limited to the case without ambient wind (Figure 2-10).

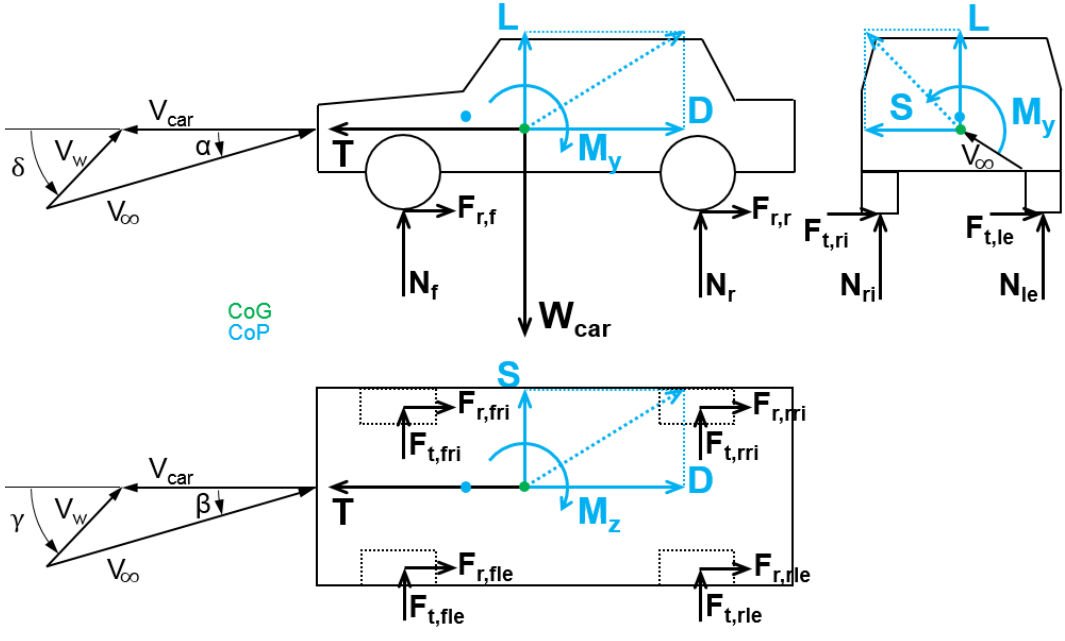

Figure 2-11: External forces working on a car with ambient wind

For the technical design, a common used reference frame is one that coincides with the front axle (Figure 2-12).

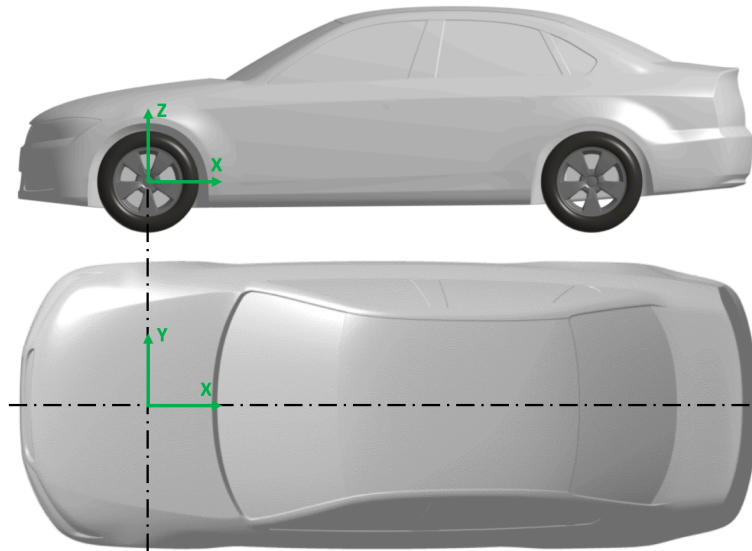

Figure 2-12: Common used reference frame for the technical design of a car

2.1.1.4 Drag

The focus will now be on the drag of the car. As can be seen in equation (2.1), the only geometrical parameter to reduce the drag is the effective frontal area, $C_x \cdot A_f$. The frontal area, A_f , is highly related to the internal sense of space of the car and therefore it will be determined by the required size of the car model meaning that a decrease is difficult to achieve. Even an increase of A_f is more likely because customers do not like a car with a smaller sense of space than its predecessor. Thus the only way to reduce the drag of a car is by reducing its C_x such that it compensates for a possible increase of A_f and results in a net decrease of the effective frontal area.

According to (Schütz, 2013), the contributions to the total air resistance of a car can be assumed as in Figure 2-13.

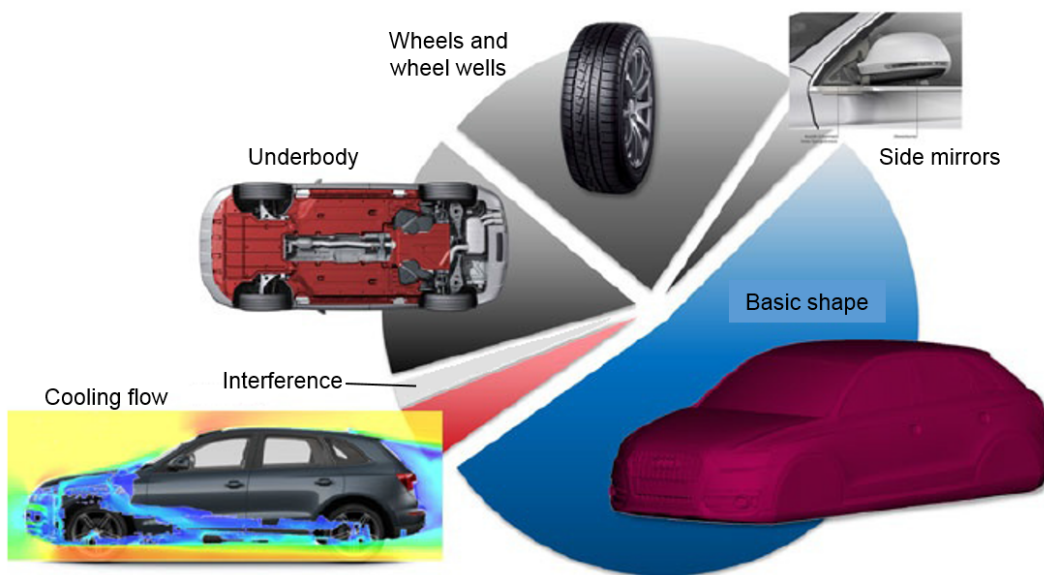

Figure 2-13: Division of the separate drag shares of a car according to (Schütz, 2013)

The drag of a car is mainly pressure drag, but also interference drag, friction drag and induced drag will have a share. Because the pressure drag is the main part of the total drag, this subsection will briefly introduce the most important occurring flow separation of the external flow around the car exterior and the influence of its basic shape on its drag.

Identification of the separation around a car

The flow around a car is characterised by separation. Therefore, it is important to identify the major locations around a car where separation will occur, but also to determine its typical behaviour at each location. In Figure 2-14, an overview of the major locations around a car where separation will occur is given. At some locations, reattachment is likely to occur.

Two main types of separation can be distinguished, namely dead water and vortices. Dead water can be assumed as being quasi two-dimensional while vortices are highly three-dimensional. It is difficult to assign exactly one of these two types to each location of Figure 2-14. At the hood-windshield junction and front end, a dead water region will most likely occur while at the windshield-side-window junction a vortex will clearly be the case. For the other regions, a combination of both will arise.

The hood-wind junction is a commonly used location for the inlet of the ventilation of the passenger compartment of the higher static pressure. For this inlet, it is important that the local flow conditions are independent of the air velocity, which is not always the case. Also, this inlet can be used to avoid separation in the junction. In this work, more attention to this subject will not be given. The windshield-side-window junction plays an important role for the side force (as already discussed in the previous section) and also for the drag of the car. The side windows are mainly important for the drag. The lower front-bumper region and front corners are important for the inflow of the wheels and wheel wells which will be discussed later in this section.

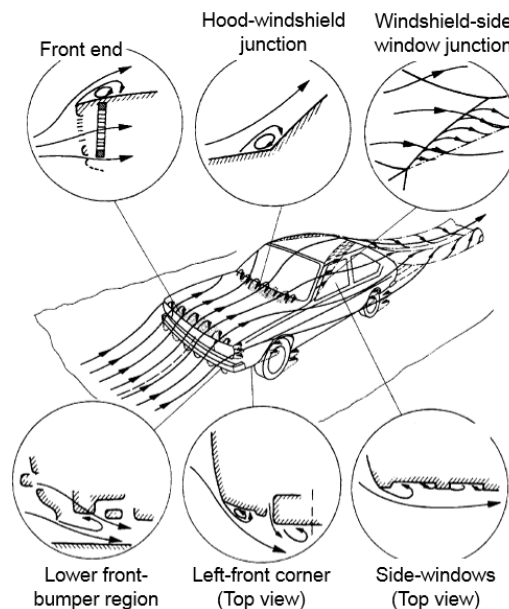

Figure 2-14: Major locations of flow separation around a car (Schütz, 2013)

The largest and most important amount of separation will occur behind the car and is given schematically in Figure 2-15. It can be seen that not only the size, but also the behaviour and structure of the separated flow will be different for the three main types of the rear geometry. For all three types, the wake behind the car will in general be a combination of a dead water zone and longitudinal trailing vortices.

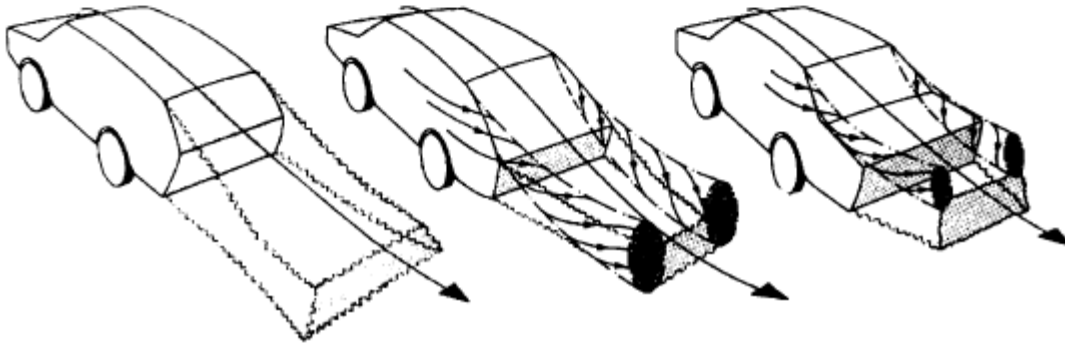

Figure 2-15: Schematic overview of the flow behind a car for the three main types squareback, fastback and notchback (Schütz, 2013)

Because of its size, the wake behind the car has the largest influence on the drag and thus on the C_x value. Nevertheless, the influences of the other ‘smaller’ vortices around the car may not be underestimated.

In general, the primary concern is to obtain a smooth and attached flow for as long as possible and to avoid separation as much as possible. If the flow would already be separated and scattered starting from the front of the car, it will be impossible to achieve its imposed aerodynamic performance. In general, it is essential to keep the flow smooth and attached to the car for as long as possible. This is applicable to all parts of the car although separation will be unavoidable, certainly at the back due to its blunt shape.

Influence of the basic shape

The basic shape of a car has the largest contribution to the total drag as was shown in Figure 2-13. Although in practice all its parts cannot be designed and optimised independently from each other, three main contributions can be distinguished (Hucho, Aerodynamics of road vehicles, 1993):

The **forebody drag** is caused by the overpressure at the front of the car which tends to push against the car (in the direction of the drag force). It could be decreased by reducing the zone of stagnating flow at the front (e.g. slanting the front geometry), accelerating the flow over the front of the car and rounding edges (smoothing the geometry).

The **base drag** is caused by the insufficient pressure recovery at the rear of the car due to the occurring large separation wake typical for blunt shapes (Figure 2-15). This under pressure will tend to suck the car against its driving direction and thus working in favour of the drag. Decreasing this under pressure, or the geometric area it acts on will reduce this drag force contribution. This could be done by e.g. slanting the rear geometry (so called boat-tailing), rounding edges or enhancing the flow in this wake.

The last one is the drag due to the **side wall, roof and underbody**, which can rather be seen as friction forces working in favour of the drag force. Those forces are negligible compared to the two above, but these should be designed to not advance separation due to roughness by making them as smooth as possible. Also, they have an influence on the total external flow of the car. For example making the underbody smooth will result in a good flow under the car enhancing and increasing the flow velocity in the wake and thus a smaller under pressure there.

2.2 Aerodynamic design in the automotive industry

The aerodynamic design in the automotive industry contains more subject areas than only the air resistance. Noise reduction, other aerodynamic forces like the lift, side wind design and cooling flows are also important ones. Because their design approaches differ from each other, it is impossible to discuss and address them all in this thesis. The focus will be on the reduction of the air resistance.

In this section, the aerodynamic design during the early design phases in the automotive industry will be discussed. The discussion will start with a general overview of the main process phases of the complete design process. After this, the role and general overview of the aerodynamic design through this complete design process will be discussed. This will be done by making a brief comparison of the main differences between the role of aerodynamic design during the development of commercial aircraft and passenger cars first. Then the specific case for passenger cars is described. After this general overview, a more detailed discussion about the aerodynamic design in the preliminary design phase is provided.

This section will end with a summary of the cooperation of the aerodynamic and aesthetic department with respect to the C_x design of the car exterior, based on what was explained in the other subsections.

2.2.1 Engineering design process

The goal of a manufacturer is to build a product with a specified performance requirement. In order to achieve this, a plan of action is needed which can be formulated in the shape of an engineering design process. This is a multi-step process including research, problem identification, requirements specification, feasibility assessment, preliminary and detailed design, tool design, prototyping, maintenance planning, system integration, production planning, etc. All those tasks are not necessarily sequential steps, some are also completed simultaneously. A discussion of all the process aspects is beyond the scope of this thesis. Therefore, only relevant aspects with respect to aerodynamic design will be discussed from a point of view of how they appear and how they are used in the automotive industry.

A typical engineering design process to develop a car model is characterised by three main chronological phases (the initial, the concept and the series development phase) and two critical process stages (the design freeze and the start of production or SOP). This is illustrated in Figure 2-16. The design freeze can be at the end of the concept phase or already in the series development phase. The choice on where it will be placed officially, has a rather subjective character.



Figure 2-16: Three main design process phases in the automotive industry

The initial phase includes all the work that has to be done in order to be able to produce useable concepts in a consistent, structured and fast manner during the concept phase. This initial phase can be subdivided in a non-technical and technical part. During the former, the top level requirements will be determined using a detailed analysis of e.g. the competitors, market, customer, legislative regulations, etc. In order to use them as design objectives and guidance during the technical design, they have to be translated into useable or measurable requirements like e.g. guiding rules, design values and constraints. This can be considered as the start of the technical part of the initial phase. During this part, all kinds of studies are done

about how these imposed requirements can be practically realised. Because of the high interdisciplinary character a (complex) product entails, these studies are not straightforward and their quality is highly dependent on the mutual cooperation of the involved departments. The quality of the results will have a large influence on the further concept and detailed design and on the performance of the end product.

In the concept phase, the high-level design concept of the car is created. A certain amount of hopefully favourable concepts is created by using the obtained results and knowledge of the studies during the initial phase. This is not a simple task because there are so many different (and conflicting) design aspects or disciplines that have to be satisfied, as is illustrated in Figure 2-17 for a car model. In this regard, the used concurrent engineering working methodology also creates additional complexity. As can be also seen in Figure 2-17, exterior surfaces design is just one of the many design aspects of a car. Aerodynamics and aesthetic design are the two main parts for this design step and will be essential for this thesis. This illustrates the complexity of what all has to be taken into account.

After the creation of these different concepts, some sort of elimination competition is held between them until one remains. During different rounds, all these concepts are analysed and rated in terms of the imposed requirements. After every round, one or more concepts are eliminated until at the end, one remains. This elimination is done in order to save cost and time, because concepts already appearing to be less favourable as others no longer consume resources. The level of detail of the analysis and testing of the remaining concepts increases with every round. Additional research and testing can be done on the final concept, leading to final design adjustments. After this, a design freeze will follow, meaning the official start of the detailed design has arrived. This design freeze can be situated at the end of the concept phase or as part of the series development phase. This is dependent on whether these final adjustments are considered as part of the concept phase or already as part of the detailed design, which is dependent on the preference of the product developers.

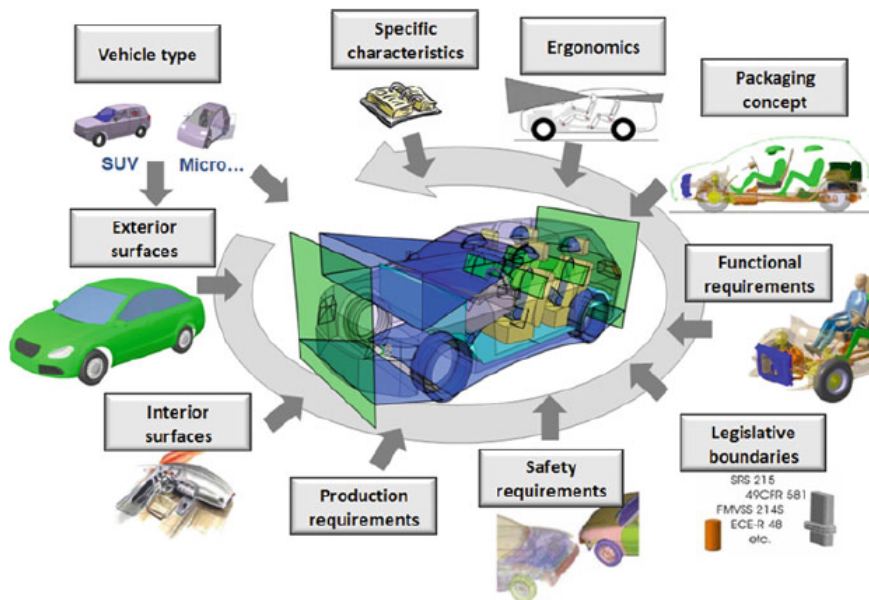

Figure 2-17: Example of the influencing factors in the initial and concept phase of a new car model (Hirz, Stadler, Prenner, & Mayr, 2012)

After the design freeze, the actual detailed design starts. This phase is called the series development phase and includes all the remaining steps in order to be able to start production, like detailed design, production planning, testing, tool design, etc. The SOP due date will then also mean the end of this third and last design

process phase. Figure 2-18 gives a visualisation of the design process including the main sub-phases and concept elimination. Also in this figure, the design freeze is chosen to lie in the last phase.

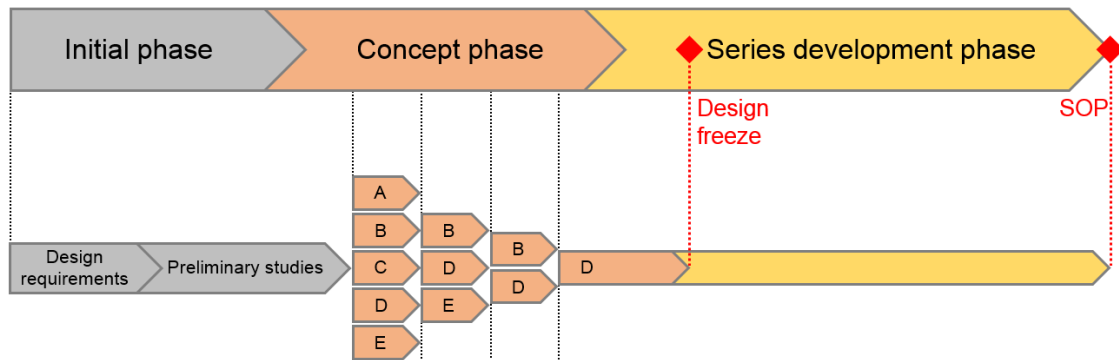

Figure 2-18: Design process including sub-phases and concept elimination

The objective of these different design phases is to create a product design that will completely and properly implement all the requirements and will lead to a successful product. This can only be achieved when every phase is executed in a thoughtful and comprehensive manner. Namely, without a high quality of the initial phase, the concept phase will be negatively affected. This will lead to adjustments of the project in a later phase which will increase the development costs and can even delay the start of the production and sale, resulting in even higher costs. As can be seen in Figure 2-19, the determined or life-cycle costs are already largely defined in the early phases. Therefore, adjustments costs also increase steep with the elapsed project time, while the design freedom has the opposite trend. So it can be said that the amount of success of the product is mainly determined by the initial and concept phase.

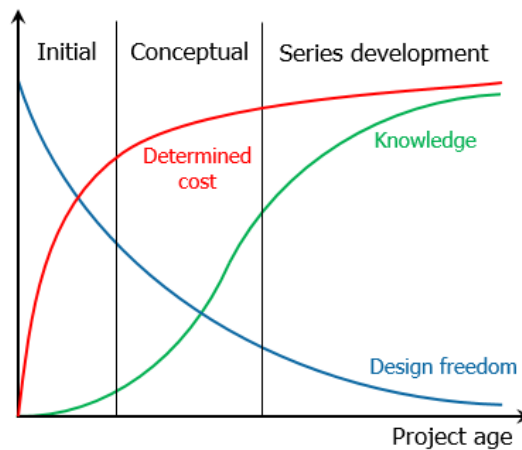

Figure 2-19: Variation of the knowledge, design freedom and determined cost with the project age

2.2.2 Aerodynamic design in the automotive industry

This subsection will cover the current aerodynamic design in the automotive industry. First an introductory example about the role of aerodynamic design compared to the aesthetic design is given. After this, the aerodynamic design during the whole car development process as presented in the previous subsection will be explained. Then, the current structure and organisation of the preliminary studies of the C_x design of the car exterior will be treated in more detail. It has to be said that everything in this subsection is based on observations of how it is currently done in the automotive industry only. This subsection forms a very important base for the next chapter.

2.2.2.1 Position of the aerodynamic design

The role and importance of aerodynamic design during the entire design process forms a ground for discussion. In this context, it has to be mentioned first that no opinion will be considered as the right one. The following is used to show that there is a ground for discussion about the role of aerodynamic design and that it depends on the final product. Therefore, it is very important to clearly define its role and influence for every aspect of the process. When not done properly, this will lead to misunderstanding resulting in e.g. delay, problems and extra costs. This is illustrated with a comparison between passenger cars and commercial airplanes in terms of aerodynamic design and its role of importance.

The main difference of both vehicles are their operating velocities and both also have a different dependence on their aerodynamics. Both can be seen as reasons for a potential conflict of opinions concerning the importance of the aerodynamic their aerodynamic design compared to other design aspects:

(1) The fundamental working principle of an airplane is based on its aerodynamic performance. So without a descent aerodynamic performance, it will not be able to fly and fulfil its main functionality, namely transporting passengers or cargo. On the contrary, the aerodynamic performance of a car is a consequence of its main functionality. Strictly speaking, a car can still fulfil its main functionality without having a descent aerodynamic performance, but this does not mean that aerodynamics has no influence on how it performs. This already shows the difficulty of this discussion. Although a car with a bad aerodynamic performance can still drive, questions about e.g. the car's handling performance or comfort can be asked. High speed stability has an influence on the former while aerodynamic noise on the latter. These are just a few of the many possible examples, but they bring already an important question that could rise in such a discussion; Does the aerodynamic performance have to be seen as an unpleasant consequence of using a car (caused by moving through air) or as an important design objective on its own? Obviously, the latter sounds as the right one, but then the question about its relative importance arises.

(2) The three main car shape types are the notch-, fast- and squareback. Apart from that, the generic shape or topology of the average passenger car can be considered rather general. Yet, car manufacturers all have their own peculiar and characteristic aesthetics which distinguishes their cars from those of their competitors. Also e.g. company image, car performance (e.g. sportiness), etc. are distinguishing factors, but are disregarded here.

Thus the aesthetics can be seen as a distinguishing factor that can influence customers for buying the car or not. Therefore an important part of the design and development of a car is aesthetics, which actually be driving the aerodynamic design.

Commercial airplanes also have the same generic shape, but are less distinguishable between different manufacturers when it comes to aesthetics (which fanatics might disagree on this, so again a point of discussion). Commercial airplanes are, as their name suggests, for commercial use. Therefore, requirements concerning e.g. fuel costs are important for the (financial) success of the airline companies. When they have to choose between an aesthetically beautiful, but economically unfavourable airplane or the opposite, their choice is obvious.

It is not said here that fuel costs are not considered important for buyers of passenger cars. This is rather to show that it is not an easy decision assigning the right importance to each factor used in the design process. The difference between passenger cars and commercial airplanes in this point of view can be seen as follows:

the decisions of passenger car buyers are in general led by factors which can have a larger variety and are also related to emotion (e.g. cost, fuel economy, performance, image, luxury) while those for commercial airplane buyers have a smaller variety and are generally rational (e.g. cost, fuel economy, performance).

(3) The (exterior) design of a commercial airplane can be decomposed in three main parts, namely the fuselage, wing and tail section. Although there are interference effects between them, they can be seen, to a large extent, as independent aerodynamically defined parts. This allows an optimisation of the aerodynamic performance of each main part with specific constraints and main functional purpose. This 'individual' approach is only valid to a limited extent and for when considering only one design discipline (aerodynamics in this case). For a passenger car, such a subdivision to that extent is not possible. Different parts of the blunt body can be identified, but they cannot be treated as aerodynamically independent.

(4) The design constraints and requirements are very different for passenger cars and commercial airplanes. These can be legislative regulations, safety standards, packaging, etc. Such differences will have influences on the determination of design constraints and the assignment of importance of the different design disciplines.

Finally, it can be said that those differences could be a ground for discussion about the determination of the design constraints and assignment of importance of the different design disciplines. The purpose of this part is to show that for a successful and thoughtful design of a product, it is essential to clearly define and fix all the constraints and importance, decisive constraints etc. This will ensure that everyone, involved during the development, is on the same page and will avoid unexpected and undesirable events from happening.

2.2.2.2 Aerodynamic design process

The final design of a product is the result of the integration of many specific design aspects or disciplines. The responsibilities for these disciplines are decentralised in specific departments. In the automotive industry, the aerodynamic department is one of them and is responsible for the complete aerodynamic design covering e.g. aerodynamic forces, aerodynamic noise, cooling flow, etc. The main focus lies on the behaviour of the lift (which influences the driving stability, side wind stability and behaviour), cooling flow and air resistance.

The outline of the aerodynamic design through the whole design process, from initial phase till SOP, will be sketched briefly. This outline will be based on how the reduction of the air resistance is practically done and organised throughout this process. The most important parameter for reducing the air resistance is the C_x value, which was already treated in the previous section of this chapter.

The target value of C_x is determined in the initial phase and has to be met by the end design. In principle, there are two general strategies to achieve a low air resistance, namely shape optimisation and detail optimisation, which are illustrated in Figure 2-20. The latter starts from a given shape, the preferred aesthetic car shape, and tries to reduce its C_x value by optimising the form details. This will almost have no changes on the aesthetic design of the car, but the achieved C_x reduction is also relatively limited. On the contrary, shape optimisation focuses on obtaining a basic car shape with a small C_x value on which the further design will be based. This has more potential for achieving a much lower C_x value of the end design, but will also have a large influence on the aesthetic look of the car. Therefore, a close cooperation between the aesthetic and aerodynamic department is necessary and essential in order to achieve the objectives of both sides. In general, the aesthetic department will have the final say.

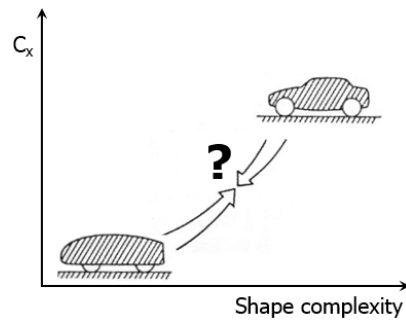

Figure 2-20: Aerodynamic design strategies (Hucho, Aerodynamik des Automobils, 2008)

Nowadays automotive aerodynamic design contains both design strategies. While the initial and concept phase are based on shape optimisation, the detailed design phase uses the other variant to contribute to C_x reduction. This also explains why the largest part of the achieved C_x reduction is determined during those preliminary design phases, showing once more the importance of these early phases for the success of a product, as well as for the achievable reduction in C_x (Figure 2-21).

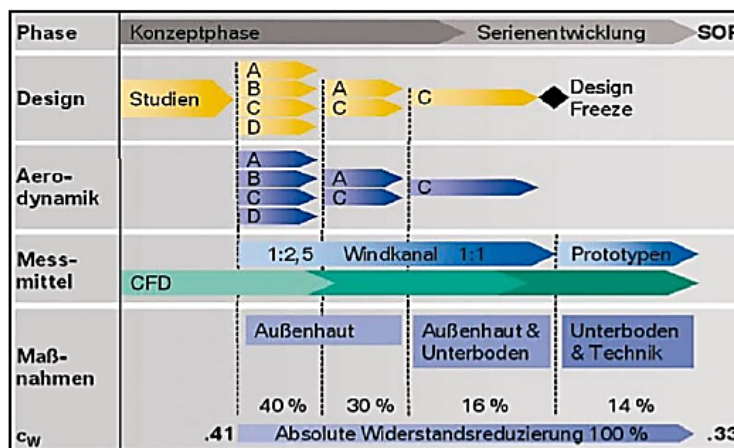

Figure 2-21: Contribution to the reduction of C_x of every design phase of the BMW X5 (Liebl, Kerschbaum, & Pfannkuchen, 2008)

In the initial phase, model simulations, technical and non-technical analyses, etc. are done in order to determine the top-level requirements. In case of the technical requirements, their target values have to be a balance between ambition and feasibility. These are mainly determined with the help of simulations and analyses. The desired fuel economy and top speed are examples of parameters which have a large influence on C_x . It can also be that the target value is chosen to be simply lower than the C_x of its predecessor. This is mainly the case when not enough resources are available to support a better-founded target choice.

When the top-level requirements are known, the preliminary studies can start during which clay models and CFD (Computational Fluid Dynamics) simulations are used, as can be seen in Figure 2-22. These clay models are used for wind tunnel testing and are typically 1:2.5 or 1:4 scaled. They can be modified quickly so that as many variants as possible can be tested in the available time period. Numerical CFD simulations are done in parallel. The use of both is very important because of their complementary characteristics so that they can support each other in order to obtain a comprehensive design. With the results obtained from the wind tunnel testing of the clay models and the CFD simulations, aerodynamic concepts are now created in close collaboration with the aesthetic design department. These concepts are limited to the outer car shape with a rather standard underbody, but without internal flow and sometimes also without the wheels,

depending on the manufacturer. The aerodynamic assessment of these so called ‘closed front’ models during the elimination rounds is done by using both wind tunnel testing of the clay models and CFD simulations. As the detail and extent of the testing and calculations increases, less concepts remain. When the final concept is chosen, a 1:1 model will be made so that a detailed analysis of the flow field can be done. This full-size model is also called an ‘open front’ model because now the cooling flow and flow for the passenger compartment is investigated, together with the influence of the underbody, wheel covers and wheels itself. When the final adjustments based on the obtained results from wind tunnel testing and CFD calculations on this open front model are done, the design is frozen.

After this design freeze, full-size model investigation still occurs until very detailed prototypes can be built. These prototypes will then be used for detailed investigations and testing in the wind tunnel as well as on the road. During this phase, CFD is still used to support the whole process. As soon as the design is frozen, only detailed adjustments can be done, meaning that detailed optimisation is now the leading design strategy for the C_x design. The whole design process, together with the available aerodynamic development tools and their usability, is shown in Figure 2-22.

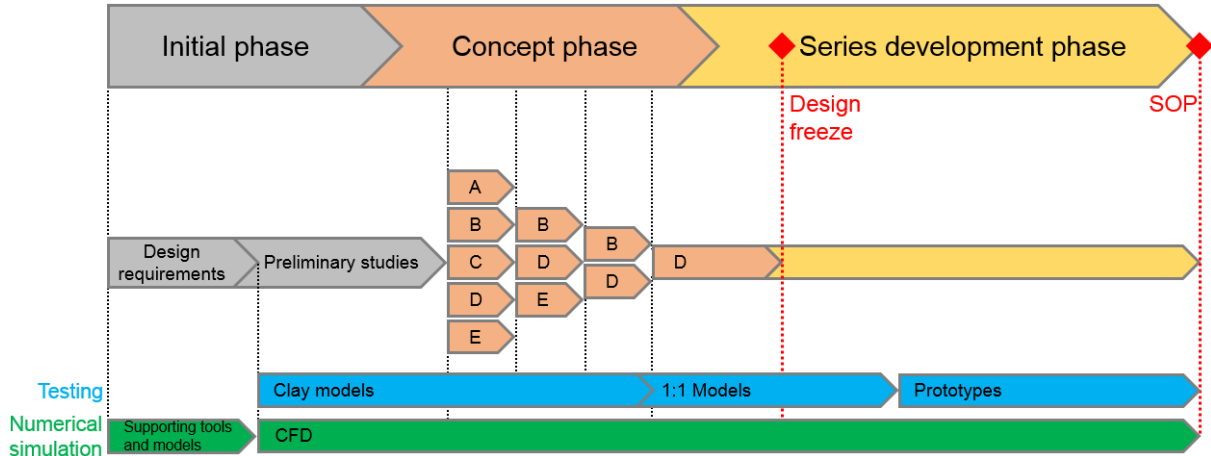

Figure 2-22: Aerodynamic development tools during the design process

CFD calculations and experimental wind tunnel tests without an ambient wind velocity form the most important part of C_x design. In reality, there will always be ambient wind resulting in a yaw angle between the free stream air flow and the car’s driving direction, as is shown in Figure 2-23. This side wind causes in general a larger C_x value. Therefore, not only the value of C_x without ambient wind is important, but also the gradient of C_x with the yaw angle. This gradient can only be determined accurately by performing side wind calculations and wind tunnel tests, which will therefore be also used during the C_x design. But it has to be said that the no-ambient wind calculations and tests remain the main ones. This is partly due to the fact that C_x determined without ambient wind is used for comparison of different cars with each other.

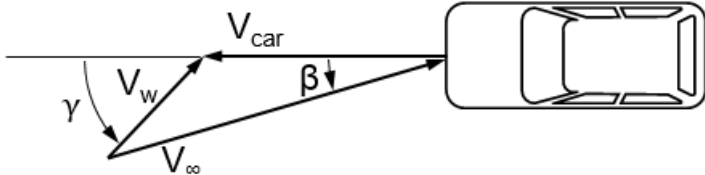

Figure 2-23: Influence of the ambient wind, V_w , on the yaw angle γ

It can be concluded that both the initial and concept phase play an essential role for the success of the end product. The better these two early phases are structured, the more effectively and efficiently the available resources are used. This can be beneficial in three ways. The first is that a higher reduction of C_x will be possible so that its target value can be set more ambitious. The second is that this specific C_x reducing design approach can be applied on more car models than before because of the more effective use of the same amount of resources. Both ways contribute to the achievement of reducing the C_x of modern cars. A third way these freed up resources can be used for, is for the design and analysis of other aerodynamic aspects like e.g. the crosswind sensitivity. This will contribute to a more comprehensive aerodynamic design of the car in all its (aerodynamic) aspects.

To end this section, an overview of the general structure of the aerodynamic design process at Audi AG and Daimler AG is given by way of example in Figure 2-24 and Figure 2-25. Those from BMW AG were already given in Figure 2-21. In all three figures, the structure of Figure 2-22 can be recognised.

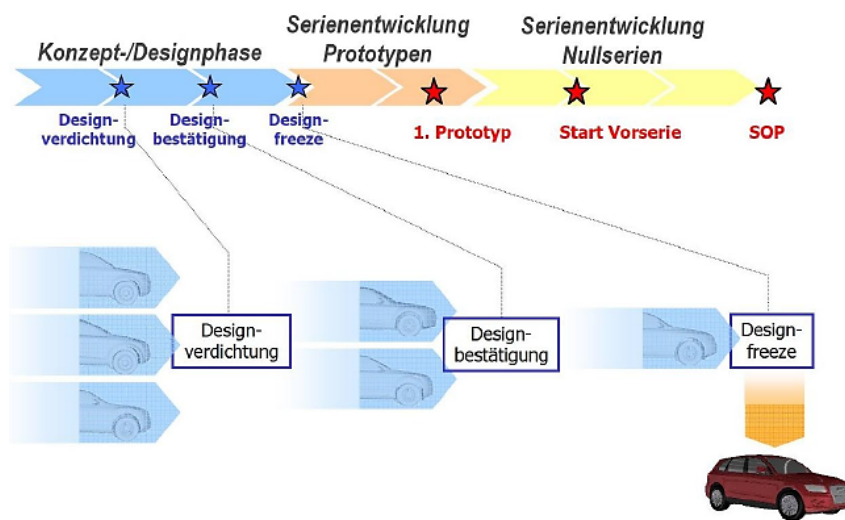

Figure 2-24: General overview of the aerodynamic design process at Audi AG (Wurzel, 2008)

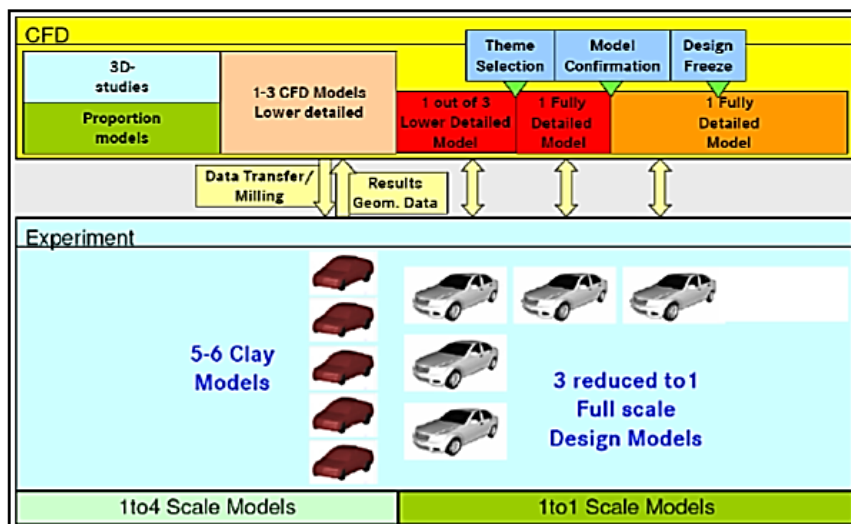

Figure 2-25: General overview of the aerodynamic design process at Daimler AG (Jehle-Graf, 2011)

2.2.2.3 Preliminary studies during aerodynamic design

The focus of this work will be on the preliminary studies concerning C_x reduction. As already explained, these are carried out during both the initial and concept phase before actual concepts are created. Their target is to provide the needed information in order to create the best possible concepts that hopefully already comply with all the aerodynamic, packaging, legislative etc. requirements. This is not a straightforward task, because a compromise between all the departments involved has to be found. The specific studies on every corresponding aspect have to be performed by the involved departments. In case of air resistance and thus C_x , the main involved parties are the aerodynamic and aesthetic design departments. Their study on the reduction of C_x during the preliminary design phase will now be discussed in more detail.

The first step is a design proposal of the outer body shape, so that the raw intention of the outer design of the model is directly made clear. The reason why the proposal is coming from the aesthetic design department and not from the aerodynamic one is because aesthetic design is considered more important and makes the final design decision. This model is based on what the aesthetic design wants the exterior of the car to look like and is given to the aerodynamics department. They will analyse and investigate it so that they can propose adjustments in favour of C_x targets. These adjustment proposals follow from CFD simulations on the outer body shape and are formulated with respect to the original basic model coming from design, in terms of how much it positively or negatively influences the C_x value. For the next design proposal, the design department tries to take them into account. It has to be mentioned that also the requirements of other involved departments count, which makes the task even more complex.

This iterative process is repeated until the end of the available time period and will lead to concepts that hopefully comply with the targets of all the involved departments. Therefore, it is very important that these studies can be performed in the most optimal way, so that indeed the requirements of all departments can be fulfilled as good as possible. The process structure of these preliminary studies concerning the design of a passenger car's air resistance will be the subject of this work.

During these preliminary studies (and phases), it is very important that the work of every department is based on the same model data. Therefore, an integrated database structure that can organize and maintain all the work of the different departments is essential. Such a centralized database supports interdepartmental studies and also avoids inconsistent data flows. A visualisation is given in Figure 2-26, which represents the database structure as a supporting concept tool of the whole initial and concept phase.

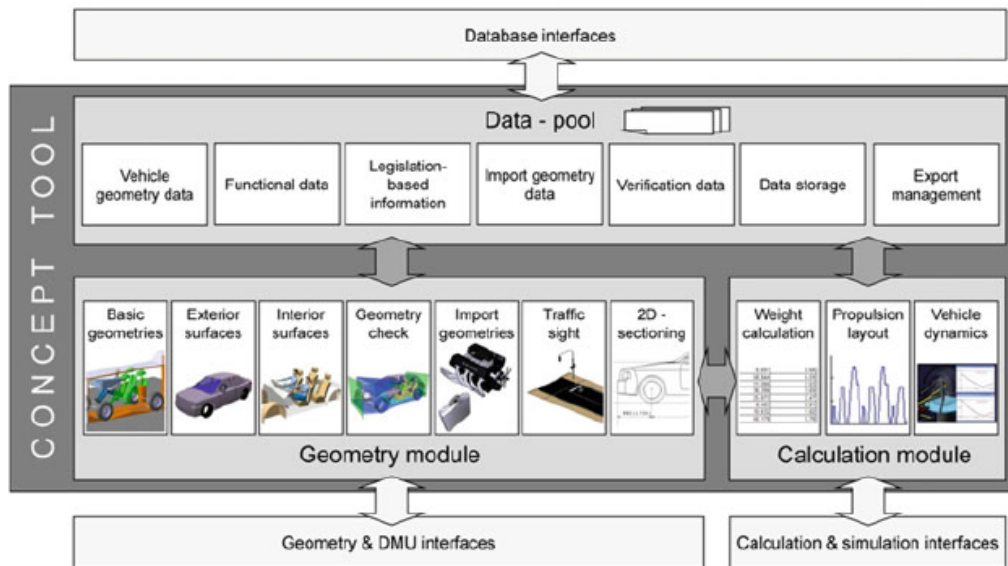

Figure 2-26: Centralised database management system (Hirz, Stadler, Prenner, & Mayr, 2012)

The collection of all the performed studies and created concepts by all the departments can be seen as a virtual concept car, which is saved in the central database. This concept is illustrated in Figure 2-27 in which aerodynamics is assumed to be part of the styling group. All departments have their own predefined contribution and responsibilities, which are mainly mutually shared. Therefore, it is important to clearly define which departments have to cooperate for which design contribution and in what way. The exact procedure and the mutual role distribution has to be defined in advance. The involved parties for the C_x design are shown in Figure 2-28.

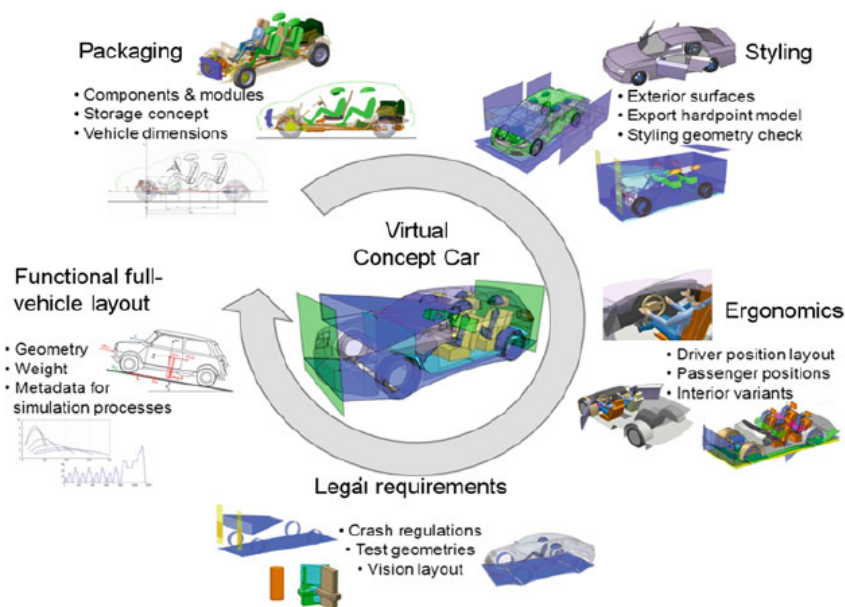

Figure 2-27: Visualisation of the term virtual concept car (Hirz, Stadler, Prenner, & Mayr, 2012)

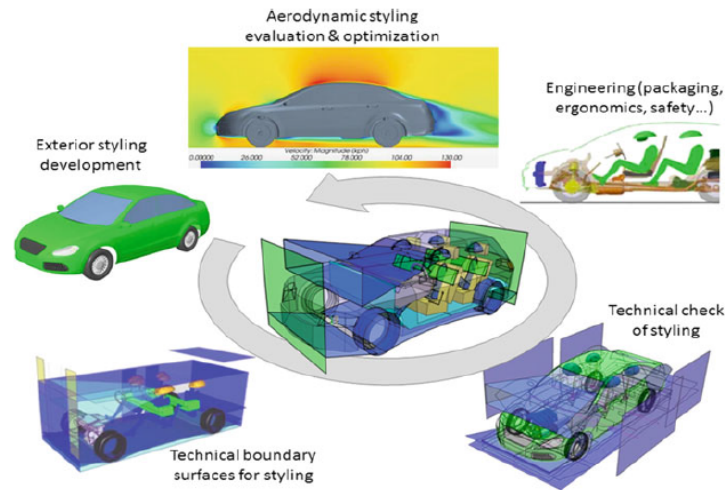

Figure 2-28: Integration of aerodynamics, styling and other influences on the C_x design visualised as modules of a virtual concept car (Hirz, Stadler, Prenner, & Mayr, 2012)

Before going further, it is important to mention that it is essential to define the characteristics of the communal car model in a unified way. Otherwise this virtual concept car model becomes useless because variant investigations performed or changes proposed by one involved department could not be used to make statements about the car concept in another department. Therefore, it is essential to agree upon some kind of parameterisation of the car concept characteristics between the involved departments for that specific design aspect. For the design of the car exterior, a parametric format of the car exterior is defined between the aesthetic and aerodynamic department which they both use to communicate with each other. This definition is company dependent and is confidential information. It is often referred to as the geometric proportions of the car exterior, defined in such a way that they could be used in a practical way in both the aerodynamic and aesthetic department. They have to be capable to clearly capture and define the investigations of geometric variants, so that these are reproducible and traceable, which determines the success of the preliminary studies as will become clear later. Some examples are shown in Figure 2-29 and Figure 2-30.

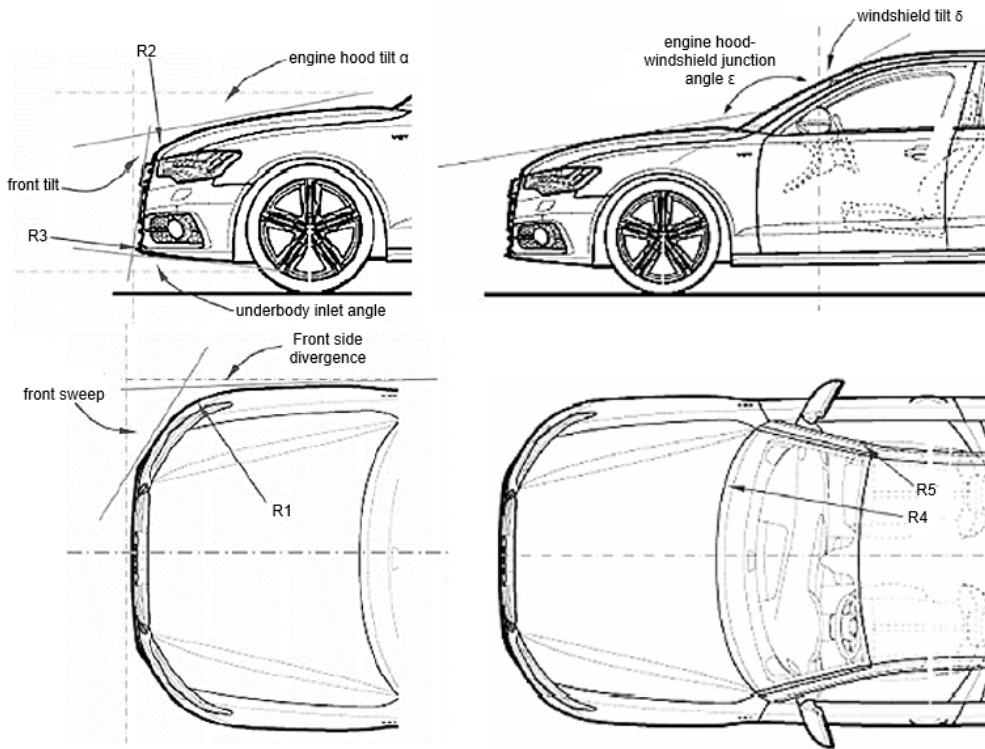

Figure 2-29: Major car exterior design parameters for the front of a car (Schütz, 2013)

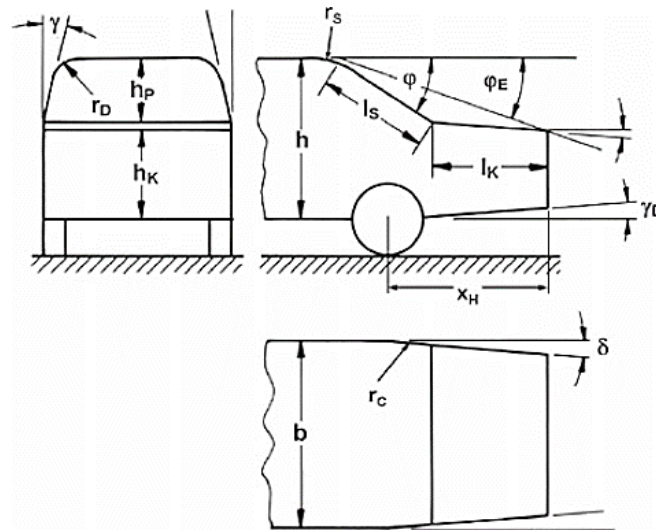

Figure 2-30: Major car exterior parameters of a simplified notchback rear geometry (Schütz, 2013)

Nowadays, the styling propositions are mainly created in computational styling software, also called CAS (Computer-aided styling). This software is developed for aesthetic design, but does not meet the needs for technical design. Therefore, the outer body data has to be converted to the CAD (Computer-aided Design) software, where the technical investigation and design can be done. Different variants of the exterior outer surface they want to investigate, have to be created. The geometric variance of each such variant is described uniquely by using the above mentioned parameters. Each variant has to be turned into a useable model for CFD simulation by adding the underbody, making the surface closed, etc. Only now, each variant model can be transferred to the CFD software. The complete CAD-model will be converted first after which

the required preparations for the simulations can be done (pre-processing).

The creation of each exterior surface variant and the subsequent editing into a useable model for CFD is done **manually** because there is no uniform way available yet to automate this. This is non-creative, repetitive and very time-consuming work which therefore shows potential for improvement by automation. After conversion of these models to the CFD software, the pre-processing (boundary conditions definition, meshing and setting definition), solving and post-processing can be done. The obtained results are analysed, interpreted and reported. The aerodynamic department now can use this results to reinforce and defend their demands towards the aesthetic department. The transferring or communication of those demands to the aesthetic design department is done by using again those defined parameters so that no unambiguity can sneak in. The latter will then come with a new design that will go through the whole cycle again. It has to be mentioned that this new design is not only dependent on the needs of the aerodynamics department, but on all the needs of the involved departments. A summary of the just described workflow, relevant for the C_x design is shown in Figure 2-31, in which the manual process steps are coloured yellow. For this thesis, it will become clear in the next chapter that the most important manual step is the one to create the car exterior geometry variants. This step is very time-consuming (about at least one hour per variant) and stands in the way of an automated process flow.

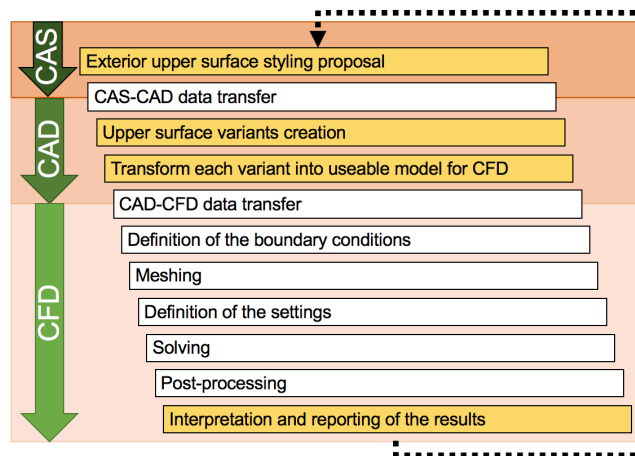

Figure 2-31: Typical repeated work flow for C_x design in the aerodynamics department, manual steps in yellow

The required boundary conditions, meshing and settings during the pre-processing for the CFD simulation, as well as the post-processing can be done in a uniform and highly automated way for each variant model. The time it takes is determined by the available computer power and does not require any further supervision. The exact boundary conditions, settings, etc. can be exactly defined in advance so that no further knowledge is required during the execution of these steps. On the other hand, for the manual results interpretation and reporting, specific expertise is necessary. As already said, the manual creation of the variants and models is non-creative, repetitive and time-consuming work. The outer surface has to be adapted for creating those variants and this can be done in two main ways using the current CAD software, namely with freeform surface modelling or geometry morphing.

Freeform surface modelling uses polynomial surfaces (Figure 2-32) and is very useful for rapidly creating a surface. It is often used for out-of-the-box creatively creating surface or adapting existing geometries. The usual way in which the geometry is defined and available in CAD-software for operating on it is based on NURBS (Non-uniform rational basis spline). This means that for free modelling, a correct conversion to a polynomial representation has to be done first. Also, such polynomial geometries are controlled by a 'dead' grid (Figure 2-32). The points of the surface itself have a specific position in space, but these control points of the grid do not. Therefore, the surface can be reformed by using operations on this grid, but these

operations are not exactly reproducible. This means no variants can be created in a consequent manner, so that automation is excluded for now and it still has to be done manually. Linking this grid with a basic parametric geometry that can be controlled could be a solution, but such parameterisation is limited to local use only and therefore not very useful. The effects of a geometry change in a certain zone of the surface on the rest of the surface can still not be compensated for in a reproducible manner. The implementation of a knowledge based system could be a solution to tackle this problem. Also only the outer upper body is adapted for each variant. The added underbody needed to transform it into a useable model, is a standard model and is not flexible for creating variants. Making it flexible and capable for creating variants could be also an interesting thing to look into. The same approach as for the outer body could be probably used, namely implementation of knowledge based systems. Then both the upper exterior surface as the underbody are flexible resulting in a more comprehensive investigation resulting in hopefully a lower C_x value of the end product.

The second way, morphing of the NURBS geometry, has not such a large freedom factor as the previous method, but has more potential to control the geometric changes in a reproducible and consequent way. Unfortunately, an additional geometry which could control this morphing in an automatic way is not yet available in the current CAD-software so that an automatic generation of this geometric variants is not yet possible.

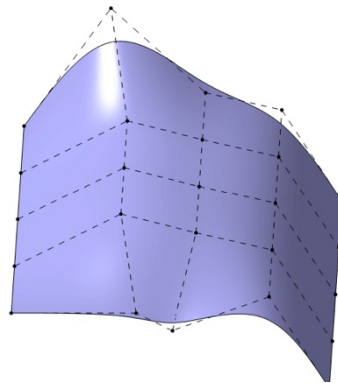

Figure 2-32: Example of a polynomial surface including its control grid

In general, three main types of software are necessary, namely CAS, CAD and CFD. The latter can be divided again in software for pre-processing, solving and post-processing. In general, all the manufacturers have their own in-house developed tools. These tools are developed to improve the process by making it faster, more automated, easier to handle i.e. to reduce the process time so that more analysing can be done in the same amount of time. They are mainly automated routines for the communication and conversion between different software, automatic pre-, post-processing and solving, etc. Specific names and functionalities of those tools are confidential information and very difficult to find. Therefore, they are not further mentioned in this work. Also commonly used are standard software which is customised by the developing company to the needs of the manufacturer. In Table 2-1: Overview of used software by large car manufacturers, an overview is given of the used software at relevant manufacturers.

	Mercedes-Benz	Audi/VW	BMW	Volvo
CAS	Unknown	Unknown	Maya Cinema 3D	Unknown
CAD	Catia V5	Catia V5	Catia V5	Catia V5
CFD Pre-processing	StarCD StarCCM+	Unknown	PowerCase PowerDelta	ANSA Harpoon Tgrid (FLUENT)
CFD Solver	StarCD StarCCM+	OpenFoam	Powerflow	FLUENT Radtherm
CFD Post-processing	StarCD StarCCM+	Unknown	PowerViz	Ensignt, MATLAB FLUENT (Cfd-post)

Table 2-1: Overview of used software by large car manufacturers

2.2.3 Aerodynamic vs. aesthetic design: observation summary

It is important for this work to briefly clarify the general structure of how the aerodynamic and aesthetic design currently work together to design the car exterior. This will be done in this subsection by giving a brief summary and overview based on what was already said, supplemented with some additional supporting information.

For the car exterior design, the aesthetics are considered to be more important than the aerodynamics. This is due the customer, who bases his choice much more on aesthetics than on aerodynamics. This does not mean that aerodynamic features could not enhance the car's aesthetics or that an improved fuel consumption could also play a role for his choice. It is already clear that there are a lot of influences. In general, it can be said that currently during the aerodynamic design of the car exterior, the aesthetic design has the highest and last word. This can be seen in the actual structure of the preliminary phases and studies where the aesthetic department proposes a car exterior by giving it to the aerodynamic department which can then investigate it and propose their wished demands for the next repeated cycle. Of course, to come to a comprehensive design of the car exterior, a first proposal has to be the starting point. But because this way of working is repeated, the minor role of aerodynamics can be noticed already in this structure. One cycle could be visualised as in Figure 2-33.

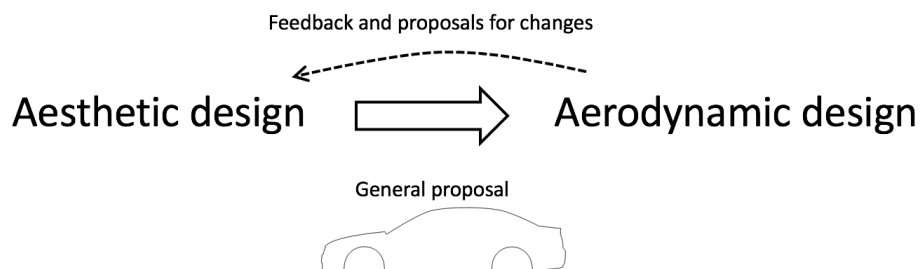

Figure 2-33: General interaction between aesthetic and aerodynamic design concerning the car exterior development

The proposal of aesthetics to the aerodynamic department is done with a car exterior surface given in a compatible format of the used CAD-software. On the other side, the feedback and proposals of the aerodynamicists are done in the form of some report which contains the desired geometry changes in the form of parameter values (or ranges of values). Those parameter definition and their importance were already explained previously with some examples in Figure 2-29 and Figure 2-30.

It could be observed that those proposals of the aerodynamic design are mainly limited to minor changes resulting in only little influence of the design cycle organisation of Figure 2-33. It can be said that they are rather doing detail optimisation on the proposals of the aesthetic design than doing shape optimisation (Figure 2-20). Due to this, Figure 2-33 can be updated to Figure 2-34. As already said, it is only in these preliminary phases that shape designing and optimising is possible because after these phases, the design will be frozen and only detail optimisation will be further possible. This means that in order to exploit the aerodynamic potential that shelters in those early phases, it is important for the aerodynamic department to optimise the shape and not the details as is now rather the case. The global shape is now coming from the aesthetic design and is not based on aerodynamic characteristics.

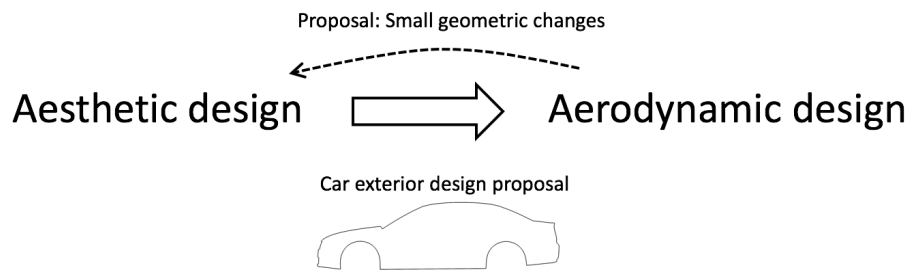

Figure 2-34: Interaction between the aesthetic and aerodynamic department during the preliminary studies of the car exterior design

It is very important to say that the aerodynamic department is allowed to do larger proposals and impose more drastic demands, but it seems like they do not achieve this due to lack of time and an abundance of manual and time consuming tasks. If this could be dealt with, they could influence the global shape of the car exterior and instead of only influencing the details resulting in a final design shape where a compromise of aerodynamics and aesthetics can be found. This does not mean that the aesthetic department will lose its dominant position, but that the influence of the aerodynamicists on the final design will increase. This is very important for the next chapter and the remainder of this work.

2.2.4 Conclusion

In this section, the current state of the aerodynamic design was presented and explained, which belongs to the **current situation** block of Figure 1-2. Also, the first definition of the **problem** that has to be dealt with in order to be able to improve the aerodynamic design of cars, can be given now:

The main problem is the minor role and influence of the aerodynamic design compared to the aesthetic design. To be able to change this for the C_x design of the car exterior, it appears that the corresponding preliminary studies have an essential role and have to be focused on because the aerodynamic department is allowed to propose more drastic and global changes, but it seems they do not accomplish this.

In Chapter 3, the current situation and more specifically, the preliminary studies devoted to the C_x design of the car exterior, will be looked and analysed more into detail. After this, the problem definition can be extended such that possible solutions can be looked for. The suggested methodology to address the problem will then be worked out in the remainder of that chapter. Chapter 4 will then cover the use-case for validation of the methodology and the results.

Before going to Chapter 3, it is important to first briefly introduce surrogate modelling because this is essential for a good understanding of the remainder of this report.

2.3 Surrogate modelling

2.3.1 What is it?

It is important for the next section and the remainder of this report to introduce the term surrogate model. Only the essential aspects and characteristics of surrogate models, which are significant for this work, will be treated briefly here.

A surrogate model can be seen as an important tool to efficiently gather data and to explore and analyse this data to process it into knowledge. Efficient use of simulation time and resources are important for the quality of the analyses of the gathered data and thus the resulting knowledge. A discussion about surrogate models continues on what has been said about the latest science paradigm/era in the previous section. To start with, first the differences and cohesion between a real world system, a simulation model and a surrogate model have to be made clear.

A real world system is, as its name implies, the real system how it occurs and behaves in the real world. Those systems or real world phenomena are the ones which are investigated and tried to be understood by people. They can be seen as Input/Output (I/O) systems (Figure 2-35) and are investigated by measuring the response of the output corresponding to a specific variation of input variables. Not every real world system is suitable to be investigated in this way due to its possible complex, non-amenable and uncontrollable behaviour. Also, a relevant experimental setup is not possible for every system. This calls for the need of a simulation model.

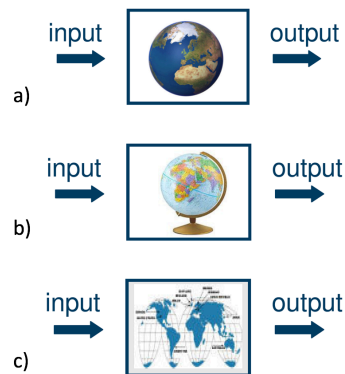

Figure 2-35: Real world system (a), simulation model (b), surrogate model (c) (Surrogate Modeling Lab, 2015)

A simulation is literally a virtual experiment, while a model is an abstraction of a (real) system (going from a real world system to even another model). A simulation model can be seen as a digital prototype of a physical real world system by containing a numerical model with a fidelity that can go from low till high. The level of fidelity is dependent on the modelled system and computer power, which go hand in hand inversely. In general, high fidelity needs higher computing power and time and for some systems, therefore no high fidelity modelling is possible or realistic (e.g. aerodynamic drag). By simulating this simulation model's behaviour (using virtual experiments), the behaviour of the real system (or performance) in the real world is tried to be predicted. So a simulation tries to capture the behaviour of a real system by discretising and approximating it. They are widely used in engineering design and are therefore very important today, but like everything else, they have their (dis)advantages which are not further discussed here. A simulation model can also be seen as a I/O system, but then in the virtual world (Figure 2-35b). Although simulation models can be very accurate and are domain-specific, they have a big

disadvantage in terms of manageability; a new simulation evaluation is needed for every new sample of the design space that needs to be investigated (Figure 2-36). In addition, simulation models can be time consuming to run, complex, etc. It is clear that they are not very manageable to work with and usable for i.a. design optimisation or sensitivity analysis. This calls the need for surrogate models.

A surrogate model is an approximation model of a simulation model which is much more manageable to work with than working with the simulation itself, especially when one simulation run is time-consuming. This is due to the fact that a surrogate model is a mathematical approximation of the behaviour of the simulation model, meaning it can be seen as a fast-running approximation of a time-consuming and complex simulation model. A simulation model can be seen as a black box with a specific output response for every corresponding input, without knowing the behaviour of the black box itself (Figure 2-36). With this approach, a surrogate model is constructed by so called behavioural or black box modelling. This means, it is not needed to know or understand the exact working of the inner simulation code. Only the input-output behaviour is needed and used to construct the surrogate model. Thus a surrogate model mimics the behaviour of the underlying simulation model and is constructed by analysing its input-output behaviour without knowing its inner code (black box modelling). In fact, it can be said that a surrogate model is a model of a model of which the latter is the simulation model. The approach of trying to catch the behaviour of a simulation model with only knowing its input-output response is therefore said to be data-driven and bottom up.



Figure 2-36: Simulation model (Surrogate Modeling Lab, 2015)

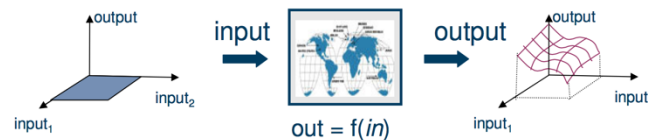

Figure 2-37: Surrogate model (Surrogate Modeling Lab, 2015)

2.3.2 Use

In the previous subsection, it was made clear that the purpose of a surrogate model is to eliminate the most important disadvantage of a simulation model, namely that for every new sample a new time consuming simulation run is needed. When sticking to the black box representation, a surrogate model can be seen as a black box of which its behaviour is described with an analytical model, based on the underlying simulation model. This allows an instant evaluation for every new sample of the design space that needs to be investigated. This is where its true power lies.

The application range of surrogate models can be divided into two main categories:

- Design optimisation
- Design space approximation (emulation)

Due to its manageability, the surrogate model is now very suitable to be used for design optimisation, sensitivity analyses, design space exploration, etc. It can be very useful to gain insight into the global behaviour of the real world system (via the simulation model as an interim or not) also and is frequently used in the aerodynamic design of cars as will become clear in the next chapter.

So a surrogate model is a one-time investment after which its instant evaluation asset can be used. Of course, it can be updated, but after the first investment, it can already be used for this. During its generation, simulation runs have to be performed meaning that the needed time for this generation is dependent on the amount of samples and the average time needed for such a simulation run. To be complete, it has to be said that the use of computing clusters and computer power have been disregarded in this discussion. Also, the accuracy of the surrogate model is very important because further analyses, optimisations, operations, conclusions, etc. will be based on it.

It can be said that the challenge of the generation of a surrogate model lies in its accuracy and speed for which an adequate balance has to be found. In general, it comprises the following three major steps:

- Sample selection
- Building of the model by optimising its parameters (model tuning or training)
- Assessment of the model, appraisal of its accuracy

Thus the term surrogate model is used as general designation for analytical models generated and used with this purpose. The analytical model itself can be of different types. Some examples of such model types are a response surface model (RSM), Kriging model or artificial neural networks. The type of model used is dependent on the behaviour of the data set and thus system characteristics. Every model type has its own characteristics, strengths and weaknesses and is therefore not equally suitable for every set of data or system behaviour. Also their accuracy and speed are not equal so that depending on the specific situation, some types are more appropriate to use than others. So together with the settings, the choice of model type is very important for the quality and speed of the resulting surrogate.

To end this section, look back to Figure 2-35 one last time. All three systems can be represented as I/O systems. They are all linked to each other with the real world as an (in)direct starting point. Their most important differences lie in their manageability of sample data for which the surrogate model represents a very important tool in the latest science era that reigns today and can help the automotive industry. The use and importance of surrogate modelling for this work will be explained in the next chapter.

Chapter 3

Approach

3.1 Overview

This chapter is the core of this work and will build further on the previous chapters. To start, an overview of the approach to achieve the desired improvements of the actual situation that builds further on Chapter 1, will be given. The overview given there was about the whole work while the one here goes further into detail about the analysis and realisation part.

As already said in the introduction, the main intent of this thesis is to look for possible improvements for the organisation of the aerodynamic processes in the early phase of development in the automotive industry. A possible methodology will be worked out to that extent so that its potential could be estimated and could be used. Also possible pitfalls and recommendations for future work will be formulated to provide an initial push. The way in which this worked out methodology and recommendation were done, will be clarified in this chapter.

In Chapter 2, it was already clarified that to improve the aerodynamic design of the car, the influence of the aerodynamics department has to be increased and their role enhanced compared to the aesthetic design. More specifically, the aerodynamic department has to become able to contribute to the shape optimisation of the car exterior instead of the detailed optimisation they are sentenced to currently. Why it is currently not possible and how this could be achieved will be subject of this chapter. Also, it came out that the preliminary studies during those design phases are essential for the subsequent concept development and assessment phase in order to be able to exploit the aerodynamic potential contained in these early phases. The focus of this work lies on the drag coefficient, C_x , of the car exterior due to only the external flow.

To clarify the structure of this chapter, Figure 1-2 is used again and repeated in Figure 3-1. The current situation described in Chapter 2 will be used to analyse the preliminary studies of the C_x value design of the car exterior further into detail and to look into the process flow and structure of those preliminary studies. They will be analysed so that deficiencies and potential improvements could be identified. Based on this, possible solutions will be looked for and formulated. After this, a suggested methodology which could offer a solution of the main defined problem (above) will be chosen, worked out and validated with real results. Those results, the findings and pitfalls will later be used in the conclusions and recommendations of Chapter 5, the validation is done in Chapter 4.

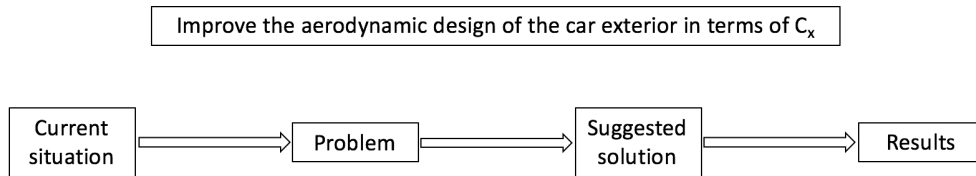

Figure 3-1: Overview of the approach to improve the aerodynamic design in the automotive industry

For understanding this chapter, it is important to be familiar with what was already told in Chapter 2. This chapter will start with an analysis of the actual situation, more specifically of the preliminary studies. Then, the concept of the proposed methodology will be defined. After this, the development of the needed geometry generator will be explained.

3.2 Analysis of the actual situation

3.2.1 Overview and link to Chapter 2

The main purpose of this work is to find a method to improve the aerodynamic design process in the automotive industry by focusing on the early phases. In Chapter 2, it was observed that the aerodynamic efforts for the car exterior design are rather comparable with detail optimisation instead of shape optimisation. The latter would be preferred because in the early phase, the needed design freedom is still there (Figure 2-19) and it was already said in in Chapter 2 that this shape optimisation is more appropriate to achieve a low C_x value of the car exterior (Figure 2-20). Thus to improve the aerodynamic design (here C_x) of the car exterior, the aerodynamic department should shift its focus from detail to shape optimisation in those early phases. This can be summarised by extending Figure 3-1 to Figure 3-2 with the main problem and suggested solution based on the observation of the current solution of Chapter 2.

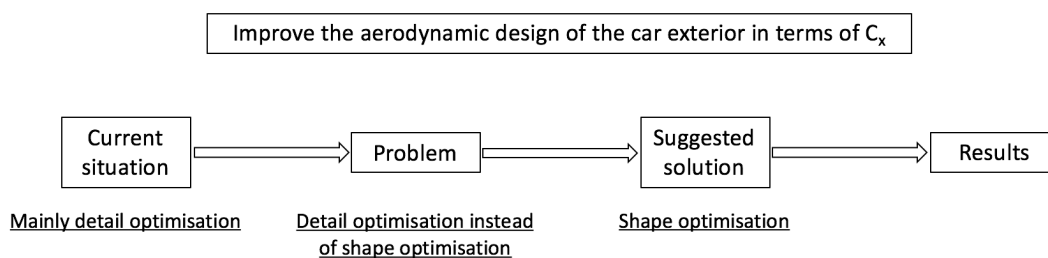

Figure 3-2: Main problem and suggested solution overview, based on the current situation observation

It was already mentioned that the aerodynamicists are not forbidden to do shape instead of detail optimisation and it would be unrealistic to say that they would not already know this would lead to a lower C_x value. Therefore, there should be another reason why they do not apply shape optimisation already. The most obvious reason for this would be that the current processes of these preliminary studies are not appropriate for them to formulate such comprehensive demands on the car exterior proposal they receive from the aesthetic design (Figure 2-33).

In this section, the current situation will be further analysed by focusing on the preliminary studies of the C_x design of the car exterior. A top-down analysis approach of the relevant processes during those

preliminary studies will be done in order to be able to identify problems, deficiencies and potential improvements.

3.2.2 Preliminary studies

3.2.2.1 High level purpose

The positioning of the preliminary studies in the complete aerodynamic design process was already given in Chapter 2. With that in mind, it can be said that the most important purpose of the preliminary studies is to gather as much useful information and knowledge as possible in order to be able to formulate realistic and useful concepts for the subsequent concept phase (Figure 2-18). Therefore, the following can be said concerning the preliminary studies:

“In order to be able for the aerodynamic department to go from detail to shape optimisation, the amount of gathered information during the preliminary studies has to be increased. In this way the influence of the aerodynamic department on the car exterior design in terms of C_x is strengthened and the aerodynamic potential could be exploited resulting in an improved final design in terms of C_x value (air resistance).”

Before going further, the difference between data and knowledge has to be briefly clarified. It is very important to understand they are not the same, but it is not easy to explain this transparently:

Gathering useful data and processing it in such a way that useful conclusions can be drawn by seeing trends will lead to an increase of the understanding of the design the data is based on. This means that an increase of the knowledge about that design is achieved that could be used to optimise it (lowest C_x while satisfying the wishes of all other departments too).

So without the appropriate structure and organisation (plan) to process and handle this data, massive amounts of data will be useless because these do not contribute to the increase of knowledge. Data has to be explored and analysed in order to be converted to knowledge. It is very important to understand that (additional) gathered data that cannot be converted into knowledge is a waste of time and resources. Therefore, also the focus on how to process this gathered data into useful knowledge is at least as important. It is this knowledge that will be essential in order to be able to generate realistic and useful concepts (Figure ?? in Chapter 2). Also the quality of the gathered data itself and its organisation is crucial for the reliability and accuracy of the derived conclusions and knowledge.

“Focusing on how to convert the gathered data into knowledge is at least as important as increasing the amount of gathered data. The quality and organisation of the gathered data is crucial for the reliability and accuracy of the corresponding derived knowledge”

3.2.2.2 Top-down approach: General structure and organisation

After the formulation of the high level purpose of those preliminary studies, it is time to analyse them more in detail. This will be done with a top-down approach. Figure 3-3 is a visualisation of the principal functioning of those studies in which the black box representation is the process used for gathering the data and knowledge.



Figure 3-3: General representation of the preliminary studies for C_x design

The most important building block of those studies is presented in Figure 3-4 and is represented as a black box with specified I/O characteristics. It is the process needed to become the response of one design space input sample, so the C_x value for a specific car exterior configuration. For the aerodynamic preliminary studies, the structure of this process has already been discussed in Chapter 2. The three general steps were, (1) geometry generation, (2) meshing and setting up the experiment and (3) running the simulation. So it is clear that this process consists of a simulation model of the reality, which is the aerodynamic behaviour of the car exterior in terms of C_x . This is very important to know to go further.

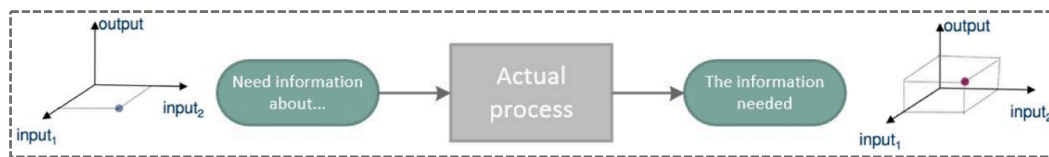

Figure 3-4: Main building block of the preliminary studies

Figure 3-5 is an extension of Figure 3-4 including a corresponding simulation time, Δt , which is the time needed to perform all the tasks of Figure 2-31 to get the C_x value for the corresponding wanted car exterior geometry.

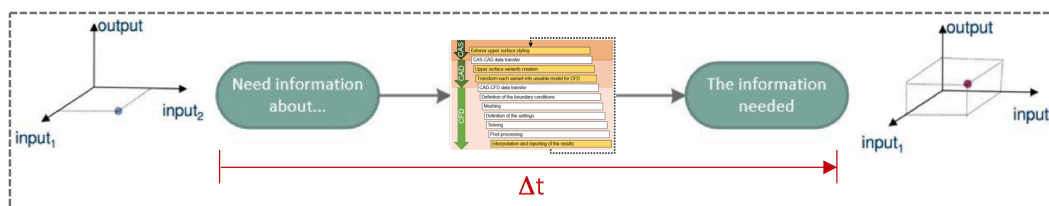

Figure 3-5: Main building block visualisation of the preliminary aerodynamic studies of the current situation

In order to get an idea of the behaviour of this simulation model, discrete information is not sufficient. Every sample represents the C_x value of the specific simulated car exterior geometry. The design space consists of the desired parameter ranges which unambiguously describe and define a specific car exterior geometry as explained in 2.2.3. The choice of those ranges are left to the aerodynamic department and are the parameter and thus geometry variations that are planned to be investigated. They are chosen such that the corresponding parameter value of the design proposal geometry is captured to be able to make a comparison. The results of those investigations are in the form of the C_x response as a function the variation of the exterior geometry expressed as parameter variations of which an example is shown in Figure 3-6. The results of multiple parameters investigations will then be combined like in Figure 3-7 and are used to gain insight in the car exterior design so that thoughtful aerodynamic demands can be formulated and proposed to the aesthetic design. Investigating multiple parameters at the same time to map their combined influence on the C_x value could also be done. Currently, the single investigations are combined afterwards as in Figure 3-8. Combining them already during the simulations would be beneficial because then,

influences on C_x caused by a combination of those parameters could be captured as well. Such cross-relating phenomena cannot be found if the parameter variations are simulated and investigated independently from each other.

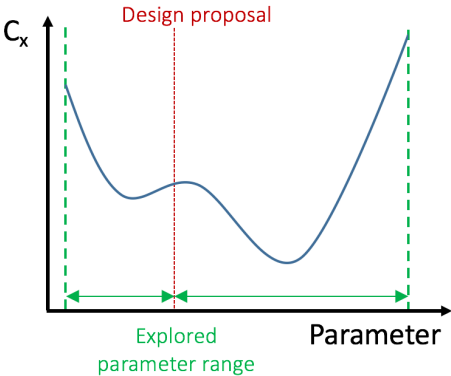

Figure 3-6: C_x response of the car exterior geometry for a chosen specific parameter range

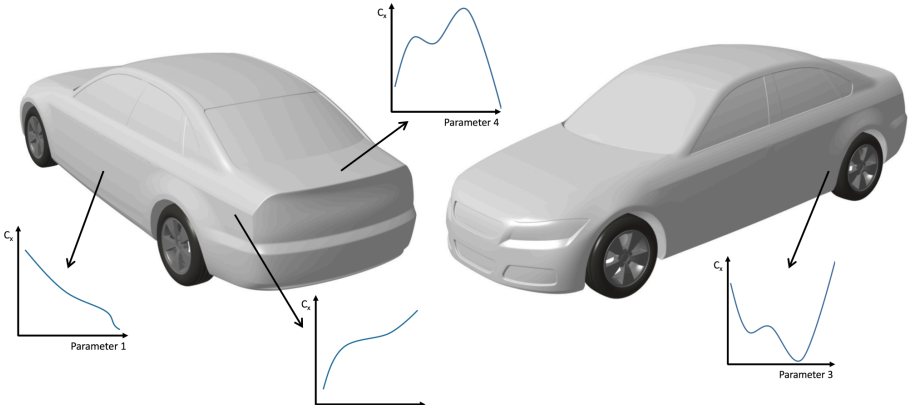

Figure 3-7: Format of the aerodynamic investigations on the design proposal geometry

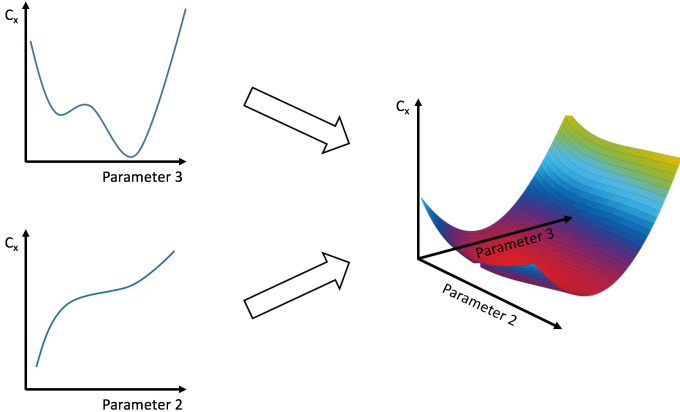

Figure 3-8: Combining the resulting surrogate model of independently investigated parameters

In order to get results in the form shown in Figure 3-6, discrete sample evaluations obtained by the simulation process flow (Figure 3-5) have to be converted to continuous information like in Figure 3-6. For this, surrogate modelling which was introduced in chapter 2, is used. Currently, certain amount of samples equally divided over the corresponding parameter range will be simulated and used to generate a surrogate model as is shown in Figure 3-9. Actually this can be seen as a Design of Experiments (DOE) with an initial sample collection, resulting in a corresponding surrogate model. With this information, the current structure of those parameters response investigations can be visualised as in Figure 3-10.

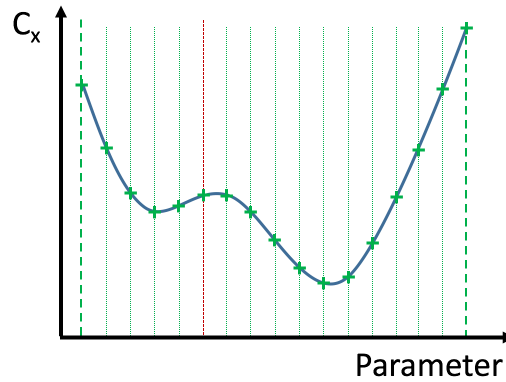

Figure 3-9: Surrogate modelling of the discrete sample evaluation points

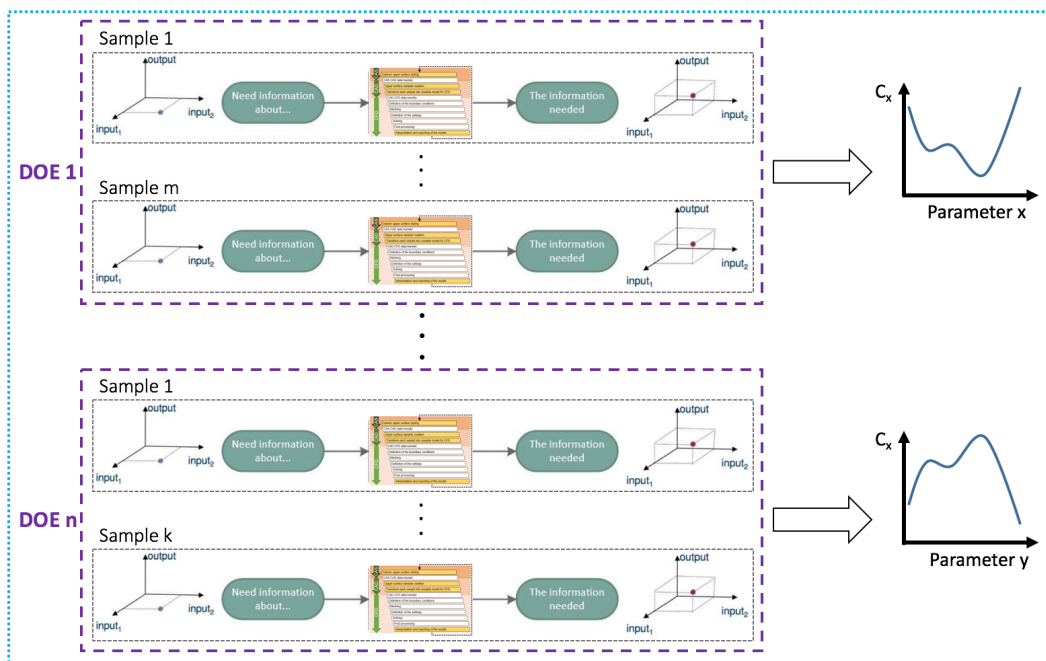

Figure 3-10: Current general structure of the C_x investigations of the car exterior during the preliminary studies

It is important that the created surrogate models are representative for the real behaviour or in other words the real C_x response as a function of that specific geometric parameter. This is highly dependent on the amount of samples that are used and a more appropriate quantity for this would be the density of this sample collection. Without a high density of sample points, it is impossible to know and control whether the surrogate model is a correct representative. This is very important to know, because further conclusions and the final demands intended for the aesthetic design are based on this created surrogate models. On the

other side, a low density will use less resources so that more investigations could be done. This will be covered later into more detail.

Also, it was already said that investigations with multiple parameters at the same time could also be done and be very useful to find cross-influencing phenomena. The major drawback for this is that the amount of needed samples to achieve an acceptable density of the sample collection increases exponentially with the amount of involved geometric parameters. This is probably the reason why currently this is not done, indicating that the actual process flow is too inefficient or too slow to achieve this during the current timespan of the preliminary studies available.

3.2.2.3 Problem identification and definition

The first definition of the main problem was already done in Chapter 2:

(1) The main problem is the minor role and influence of the aerodynamic design compared to the aesthetic design. To be able to change this for the C_x design of the car exterior, it appears that the corresponding preliminary studies have an essential role and have to be focused on because the aerodynamic department is allowed to propose more drastic and global changes, but it seems they do not accomplish this.

Now it is possible to extend this definition of the already identified problem with:

(2) The problem of the preliminary studies is that they do not gather the required amount of data and information to change this situation of minor role and influence. Therefore, their processes and process flow have to be improved and adapted so that they do allow an increase of gathered data and knowledge about the existing design.

Extending Figure 3-2 with this information results in Figure 3-11.

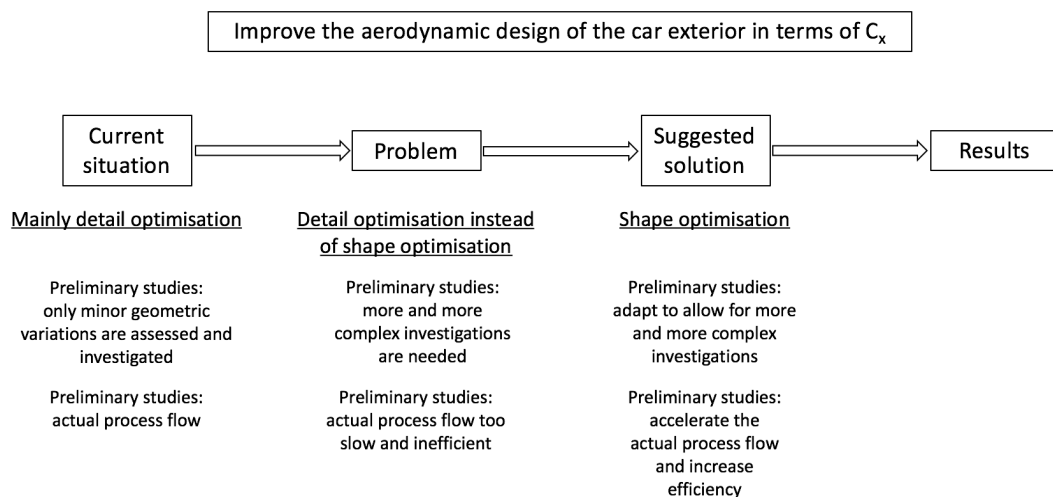

Figure 3-11: Breakdown of the main observations of the current situation, problem identification and suggested solution

3.2.3 Looking for solutions

Now it is time to look for useable concepts to achieve the suggested solution statements of Figure 3-11. A concept definition of the methodology that will be worked out, will be given in Section 3.

The timespan of the preliminary studies will not change, so it is clear that to increase the amount of gathered data, information and knowledge, more DOE's should be done in the same amount of time. There are two possible ways for this:

1. *Increase the amount of engineers and/or computing power/resources depending on which of the two is the actual bottleneck.*
2. *Decrease the needed time to complete/perform a DOE.*

Those two ways have to be complemented by a third one, because they only consider the quantity of the gathered data/information knowledge and not the quality. To increase that quality, the accuracy of the generated surrogate models has to be improved, therefore:

3. *Increase the accuracy of the obtained surrogate models.*

The first way is not representative for this thesis, so that the second, more sustainable, and third option will be further worked with. Both ways have contradicting influences and will be treated separately first, before making further intermediate conclusions.

3.2.3.1 Decrease the needed time to complete/perform a DOE

Not every DOE needs the same amount of time to complete. Its duration is dependent on the number of runs it needs, so on the chosen initial sample collection. Also, the quality of the surrogate model resulting from a DOE is very dependent on the choice of its samples. Therefore, this will be discussed together with the analysis on how to increase the quality of surrogate models in the next paragraph.

If the Δt that comes with every simulation run (Figure 2-31) can be decreased, this will directly decrease the total duration. In section ... in Chapter II, it was made clear that the step where the geometry variants are created is the one with the most potential for time savings. This is due to its time consuming, non-creative and repetitive character. Moreover, automation of this step will be required to work out the suggested solution as will become clear later.

“The time needed to complete/perform a DOE can be decreased by:

1. *Automating the process steps (eliminating time-consuming, repetitive, manual work).*
2. *Limiting the amount of samples to a minimum, meaning a low density of sample points.”*

For the specific aerodynamic preliminary studies for the car exterior surface drag, the first point can be more specific and therefore replaced by:

1. *Making the generation of the variants automatic. (This is also needed to change the process structure, as will become clear later.)*

3.2.3.2 Increase the accuracy of the obtained surrogate models.

As was already said, the quality of the surrogate model resulting from a DOE is very dependent on the choice of its (initial) samples. The denser they are, the higher the chance that the surrogate model approximates the real behaviour of the simulation model and so the real system. This is due to the fact that a higher density of samples increases the chance of finding the surrogate model that corresponds to that behaviour. This is because the data collection contains more information about the simulation model's behaviour, so that the (mathematical) approximation model has to 'guess' less and can be better founded. In this view, three types of sampling can be distinguished: undersampling, oversampling and optimal sampling (Figure 3-12). The first one results in wrong approximation models because too little information

of the real system behaviour is known as is shown in Figure 3-12a. The result is an inaccurate model of the real system's behaviour which is unreliable and can lead to wrong conclusions about that system, making it useless and unreliable. In the opposite case, oversampling Figure 3-12b, the real system's behaviour is very precisely approximated, but with an overuse of resources and simulation time due to the too many sample points. This can also be disadvantageous if the simulation time is high for each sample point. Just enough points to reach a high accuracy of the approximation model is the optimal case. This is very difficult to achieve with only an initial sample collection and calls for adaptive sampling which is explained later in this section.

Not only is the choice of sample collection crucial for the resulting surrogate model, also the type of model that will be used as surrogate model. The characteristics of the data set like e.g. smoothness, linearity, peak sharpness have an influence on the choice of model type. This is because every model type also has its own method and thus characteristics including specific strengths and weaknesses meaning not every model would suit every data set optimally. This is due to the mathematical base and building. So a match between data set and model type also has to be found besides the sample collection although the former is rather a condition for optimal accuracy while the latter is a prerequisite.

Keeping this in mind, it can be said that:

“The accuracy of the obtained surrogate models can be increased by:

1. *Choosing for a high density of sample points.*
2. *Choosing a model type that matches the data set.*

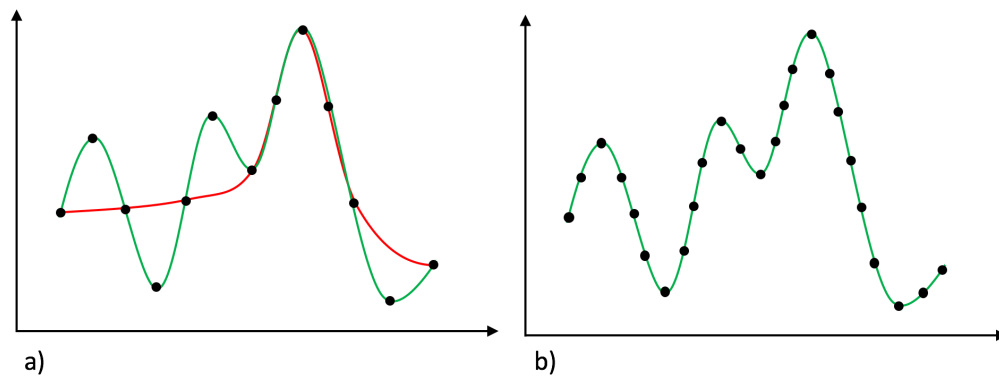

Figure 3-12: a) Optimal (green) and undersampling (red), b) oversampling

3.2.3.3 Combining them

It is clear that there is a contradiction concerning the density of the sample points so that a balance will have to be found. The goal is to maximise the accuracy and to minimise the amount of sample points needed for this. Practically, this means a surrogate model that satisfies the imposed accuracy with a minimum amount of samples. Oversampling corresponds to wasting resources decreasing the time efficiency, while undersampling leads to missing out information which is detrimental to the accuracy of the surrogate model and its usefulness to draw conclusions for collecting knowledge about the design. It is clear that the sample collection plays an essential role in order to achieve both a decrease of the duration time and an increase of the accuracy.

- *The size of the sample collection directly determines the duration time of the DOE (about $\#samples * \Delta t$) and the density (and thus quality).*

- *The choice of the samples in the design space determines the quality of the surrogate.*

To be complete, it has to be said that when using a cluster of resources, the total amount of absolute time needed for the DOE could reduce to the longest simulation run (if all samples could be run in parallel).

3.2.3.4 Domain experts

When looking back to the three major steps during the generation of a surrogate model, which were listed in the last section of Chapter 2, both the choice of sample collection and its size can be categorised as aspects of the sample selection. The other two steps were model building, tuning and model assessment. For the former, the selection of the model type is not a straightforward choice because of its dependency on the data set characteristics, and thus on the problem (system to approximate) requirements. This could be solved by fitting different model types on the sample set and make the final choice dependent on the model assessment of each model. This causes another obstacle to be overcome:

- What is a good model?
- Is the assessment type-specific or not? And thus, is it possible to compare different model types with each other or not?

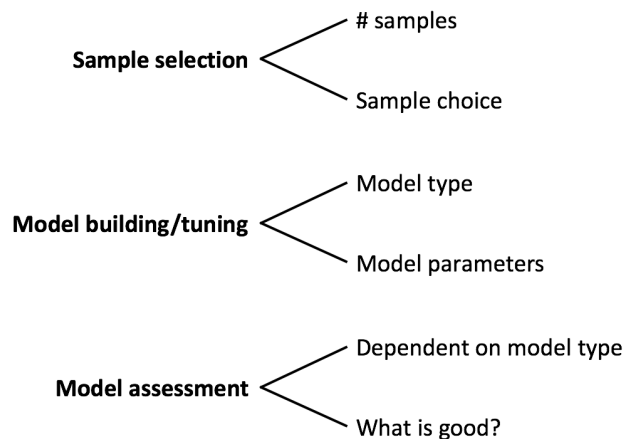

Figure 3-13: Overview of the three main steps of surrogate modelling

This calls for the help of so called surrogate modelling experts which would perform the generation of those surrogate models for each DOE. This would impose even more demands on the required recourses during those preliminary studies. Therefore, each model is generated with the same technique, mostly a response surface model to obtain an optimal response, which could be e.g. an n-degree polynomial model. Using a good allround model requires none or less specific background knowledge and delivers satisfying results. Moreover, the dimensions of the samples are for the moment during the preliminary aerodynamic studies limited to a maximum of two input parameters, resulting in a regression curve or surface. Increasing the dimension of the input combination would lead to more possibilities concerning parameter correlation analyses. But without further adaptations of the actual process, this will be unrealistic in practice because the size of the initial sample collection would increase exponentially with the dimensions of the amount of input parameters.

Furthermore, it was said also, that how well these three major steps are executed, implemented, set up and attuned on each other, determines the accuracy of the surrogate and the time efficiency of its generation that can be achieved. Although, this is another reason in favour for the use of domain experts, this still remains unrealistic. When focusing on the sample selection, a step forward could be to replace the

sequential (one time) sampling into smaller sample collections. The choice of the next one could then be dependent on an analysis of the previous one(s). So the sampling would evaluate from an open to a closed control loop. This is called adaptive sampling because after the initial sampling, the additional samples are dependent on the already generated model and the behaviour of the previous samples (input-response analysis). This could lead to more efficient sampling which focuses on the behaviour of the simulation model (that has to be approximated, mimicked). This means more manual work and it is not clear whether the saved time due to the (hopefully) less sample evaluations (and thus simulation runs) would compensate for the additional manual work. Moreover, it is preferred that the sample selection is done by those modelling or domain experts because of their experience. A summary of the main tasks of such desired experts can be done now:

- Initial sample collection determination
- Adaptive sampling management
- Model selection, assessment and tuning in an iterative way

With the exception of the first task, all tasks should be done iteratively resulting in the following process flow:

- Start with a small set of initial simulations
- Build a surrogate model (determine accuracy)
- Determine the locations in the design space for additional simulations
- Repeat these steps till the achieve accuracy is high enough

A comparison of the flow chart of the existing process and the process with adaptive sampling is shown in Figure 3-14

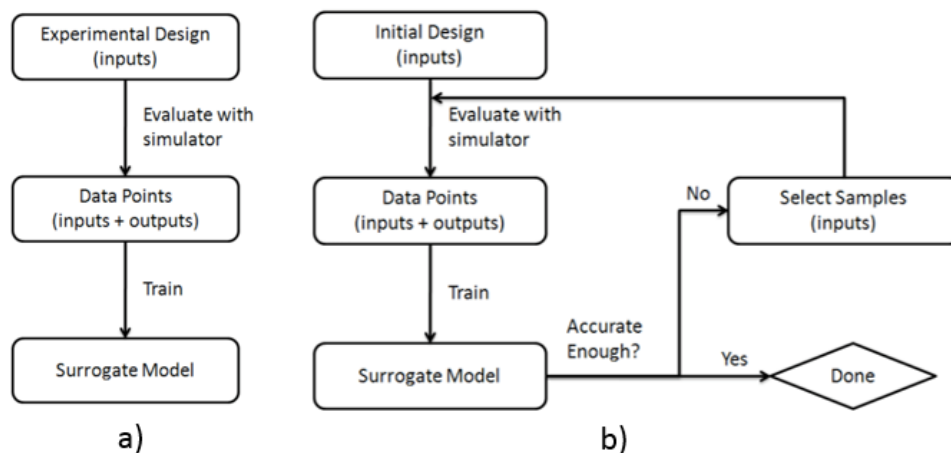

Figure 3-14: Surrogate modelling, open-loop (a) and closed-loop (b) control (Surrogate Modeling Lab, 2015)

Figure 3-15 shows a more practical visualisation of surrogate modelling with a closed-loop control.

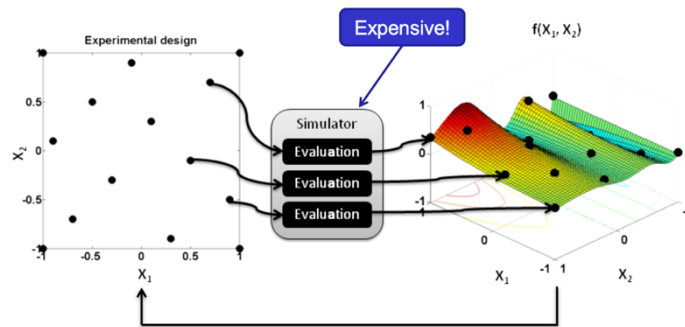

Figure 3-15: Practically oriented visualisation of controlled surrogate modelling (Surrogate Modeling Lab, 2015)

Concerning adaptive or closed-loop controlled sampling, the following can be said:

“Adaptive sampling (or closed-loop controlled sampling) is essential to achieve a good balance between time efficiency and accuracy of surrogate models. Therefore, the process philosophy has to be changed from sequential to adaptive surrogate model generation.”

Now that this is clear, the use of domain experts can be further explained. It is clear that the resulting surrogate model is only as good as the domain expert (and of course also the data and thus simulation model). This is a major drawback because it is not possible to make use of a domain expert in every situation and moreover, it is practically very difficult to only rely on him. More specific, the achieved accuracy and quality are too dependent on the qualification and experiences of the domain expert and are difficult to quantify and controlled objectively. Some more practical drawbacks that come to mind concerning the use of a domain expert are:

- Difficult to replace
- Repetitive? (Interesting job?)
- Traceability?
- Measurable accuracy?
- Time needed?

Beside these thoughts, also the responsibility of all those above mentioned tasks do not speak in favour of a domain expert. Furthermore, it is unknown how much domain experts are needed to perform the required amount of DOE's as in Figure 3-10 and it is very difficult to find or educate the needed amount of domain expert for a very specific field of application and above all unrealistic to successfully implement this in practice. Therefore, a software solution which could perform these tasks in an automated and reliable way would be welcome.

“A software solution which could replace a domain expert and take over all his tasks to generate surrogate models in a fully-automated way would be welcome/make it practically possible to implement closed-loop surrogate modelling.”

3.2.3.5 Software solution

The most important requirements for such a software tool would be:

- Support for the most important mathematical models
- Selectable/settable (objective) accuracy
- Independent of field of application, settings used for the specificity

- Automatic assessment
- Trade-off dependent on data-set (choice of the best model)
- Fully automated, bash run capabilities (without manually input during model generation)
- Robust
- Flexible implementable
- Easy to use by non-domain expert, meaning without expert knowledge about its internal functioning
- Support for grid-use, to make use of the computer resources if available

The use of such a software tool also imposes some demands on the environment it should be implemented in and which have to be met:

- Implementable in the available software environment
- Sample evaluation process has to be fully-automated, simulation run process has to be automated

For the case of the actual aerodynamic preliminary studies of the car exterior drag, the second requirement is not fulfilled. How this is tackled, will become clear in the next section (concept definition) and later in this chapter.

3.2.3.6 Summary

To end this section, a summary of the intermediate conclusions is made and discussed briefly before going to the next section where a suggested solution will be defined based on the findings here.

“The main problem is the minor role and influence of the aerodynamic design compared to the aesthetic design. To be able to change this for the C_x design of the car exterior, it appears that the corresponding preliminary studies have an essential role and have to be focused on because the aerodynamic department is allowed to propose more drastic and global changes, but it seems they do not accomplish this.”

“Focusing on how to convert the gathered data into knowledge is at least as important as increasing the amount of gathered data. The quality and organisation of the gathered data is crucial for the reliability and accuracy of the corresponding gathered knowledge”

To increase the amount of gathered data, information and knowledge, more DOE's should be done/executed in the same amount of time. To increase the amount and improve the quality of the generated surrogate models, the following things can be done:

1. *Increase the amount of engineers and/or computing power/resources depending on which of the two is the actual bottleneck.*
2. *Decrease the needed time to complete/perform a DOE.*
3. *Increase the accuracy of the obtained surrogate models.*

The time needed to complete/perform a DOE can be decreased by:

1. *Automating the process steps (eliminating time-consuming repetitive work).*
2. *Limiting the amount of samples to a minimum, meaning a low density of sample points.*

The accuracy of the obtained surrogate models can be increased by:

1. *Choosing for a high density of sample points.*

2. Model type matching the data set.

The sample collection plays an essential role in order to achieve both a decrease of the duration time and an increase of the accuracy.

- *The size of the sample collection directly determines the duration time (about size* Δt) and the density, thus quality.*
- *The choice of the samples in the design space determines the quality of the surrogate.*

“Adaptive sampling is essential to achieve a balance between time efficiency and accuracy of surrogate models. Therefore, the process philosophy has to be changed from sequential to adaptive surrogate model generation.”

“A software solution which could replace a domain expert and take over all his tasks to generate surrogate models in a fully-automated way would be welcome/ make it practically possible to implement this idea.”

The most essential conclusion is that the process structure of the preliminary studies should be changed in order to get more accurate and reliable surrogate models in a shorter time. Only this could lead to a process flow which allows for more and more complex investigations. Due to this, shape optimization and more comprehensive and extensive demands towards the aesthetic design will become possible which will enhance the position and influence of the aerodynamics department on the car exterior design.

Instead of generating the surrogate model as some sort of fitting after all the sample evaluations are done, the sampling and model tuning have to be done in parallel and dependent on each other in a controlled loop. If such a control loop with feedback is properly attuned, this will create the possibility to control the sampling and model during its generation (so-called adaptive modelling and adaptive sampling) which allows to really find a balance between time efficiency and model accuracy and thus optimal sampling. Moreover, the model accuracy can now be assured effectively because the evolution of the surrogate model can be measured as a function of the number of used samples. The current post-process generation of the surrogate model did not allow for this optimal sampling and it could also not guarantee whether the model is a good approximation of the real behaviour or not.

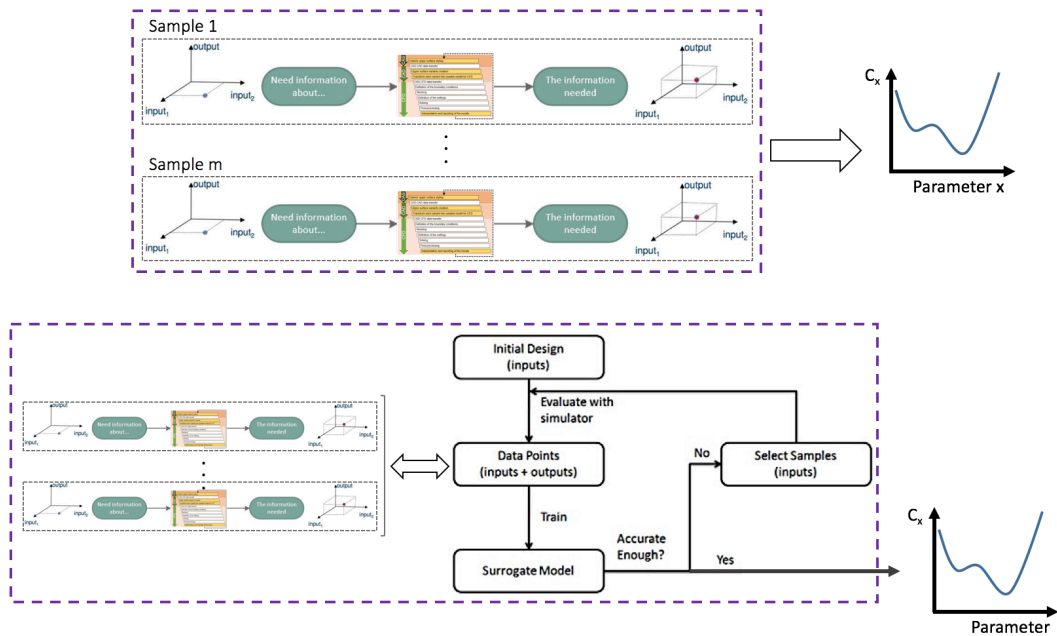

Figure 3-16: Comparison of the open (top) and closed-loop (bottom) surrogate modelling process flow during the preliminary studies

3.3 Suggested solution: concept definition

The **current situation** as well as the **problem** identification and definition have already been covered. Also an analysis of the current situation to look for possible solutions has already been addressed in the previous subsection. Based on this, now it is time to define a **suggested solution** or better said methodology (Figure 1-2).

The internal working of the surrogate model generator during the preliminary aerodynamic studies for the C_x design of the car exterior will have to be adapted. In other words, it has to be changed from open-loop to closed-loop surrogate modelling as in Figure 3-14. In Figure 3-17, the high-level presentation of the surrogate model generator is given.

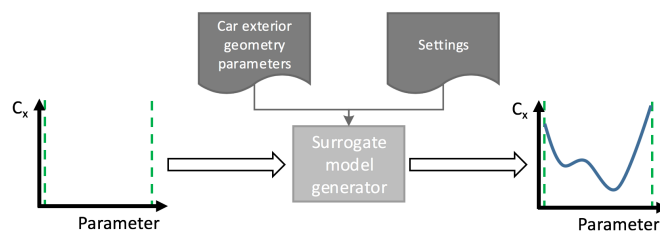

Figure 3-17: Surrogate model generator for C_x design, general concept

The closed-loop surrogate modelling was already given in Figure 3-14b, in which the process flow for the sample evaluation is missing. This can be regarded as a simulator with a general presentation as in Figure 3-18.

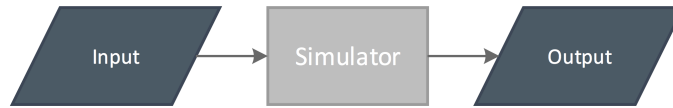

Figure 3-18: Simulator black box

The current internal process flow of the simulator was already explained in Chapter 2. Therefore, Figure 3-18 can be extended with Figure 3-5, resulting in Figure 3-19.

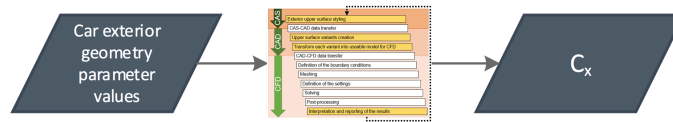

Figure 3-19: Simulator with visualisation of the current internal process flow

As was already explained in Chapter 2, the process flow is not completely automated, meaning a batch process is not possible. This is due to the manual generation of the geometry variants as described there as well. This has to be solved in order to achieve closed-loop surrogate modelling without the interaction of the above discussed domain experts. This will be done by using a parametric model that can be controlled automatically and will be covered in the next section. With this known, Figure 3-19 can be updated to Figure 3-20 which shows the conceptual scheme of the simulator needed for the methodology developed in this work. Applying Figure 3-14b leads to the general process flow of this methodology shown in Figure 3-21.

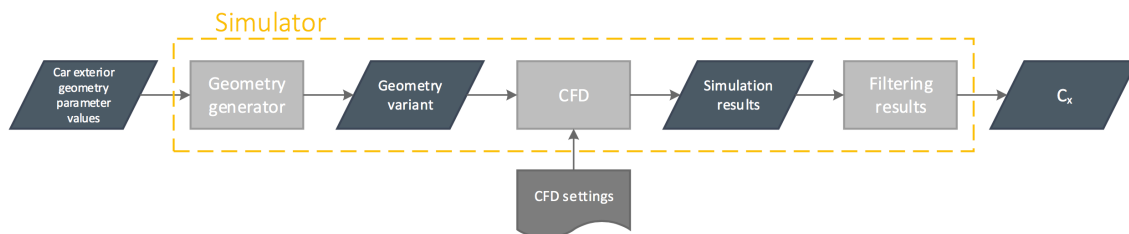

Figure 3-20: Simulator flowchart for a single aerodynamic simulation

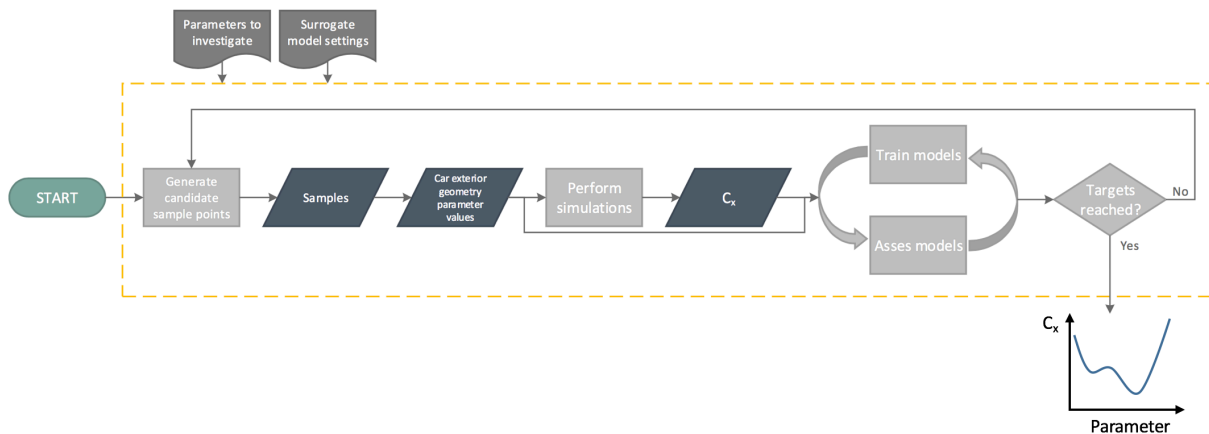

Figure 3-21: Process overview of the suggested methodology

3.4 Geometry generator

The whole development of the geometry generator needed to be able to work out the above suggested and defined methodology will be explained in this section. Not only is an automatic geometry generator essential to work out the suggested solution (bash process possible) of a closed-control surrogate modelling process, it will also directly remove the time needed to create geometry variants by taking over the manual work (Figure 2-31).

This section will start with the determination of the functionalities of this geometry generator. After this, an overview of and the actual development of the parametric model will be covered.

3.4.1 Functional analysis

The geometry generator is actually a parametric model which should be able to generate on command a desired output geometry of the car exterior based on a set of parameter values it receives as input. In Figure 3-20, it can be seen that it is situated at the beginning of the simulator process and has to feed the required geometry to the aerodynamic simulation. This aerodynamic simulation will be done using OpenFOAM and will be covered later in this chapter. The I/O overview of the geometry generator is presented in Figure 3-22.

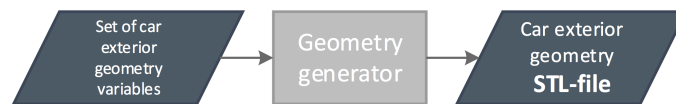

Figure 3-22: Geometry generator, I/O overview

The geometry generator gets a set of parameter values as input and will create the corresponding car exterior geometry which it gives as output in the form of a STL-file (STereoLithography). This is because the used automatic meshing utility in the OpenFOAM-mesher needs a geometry in STL-format.

The software framework of the complete tool and of the internal simulator will be programmed in MATLAB. This means that the geometry generator should be able to communicate with MATLAB. It should be possible that MATLAB gives a certain input-set and command to get the corresponding STL-file which will then have to be send to OpenFOAM.

When looking back to Chapter 2, where the process steps were listed and clarified which are needed for one sample evaluation, it was said that the generation of the car exterior surface variants are very repetitive, non-creative and time-consuming work. The geometry generator should take over this work resulting in an automatic process flow. The reason why this was not already automated was also explained there. Due to this, it was chosen to develop a parametric model of the car exterior geometry which is controllable enough, but at the same time also realistic enough. How this is done exactly, will be explained in the next subsection. Of course, this model stays an approximation, so a controllable and reliable automatic morphing of the realistic geometry would be even one more step forward.

Now, the basic functionalities the geometry generator should at least have, are the following:

- Communication with MATLAB
- Able to generate STL-geometry
- Extendable, adaptable parametric geometric model (Genworks International, 2015)

It was chosen to develop the geometry generator with a software called GDL, because due to the above listed functionalities, a KBE (knowledge based engineering) platform is needed. For more information on this software is referred to (Genworks International, 2015).

3.4.2 Development approach

In this subsection, the realist car model that will be used as reference geometry will be introduced first. Then, the practical development approach of the parametric model will be clarified. After this, it is also mentioned how the geometry generator is controlled by the software framework in MATLAB.

3.4.2.1 DrivAer

The DrivAer is developed as a cooperation between the BMW Group, Audi AG and the Technical University of Munich. It is a realistic generic car shape to perform fundamental research on that is shared between the involved partners. For more information is referred to (Heft, Indinger, & Adams, 2012).

The DrivAer sedan will be used as the realistic reference model in this work. Its main dimensions can be found in (Heft, Indinger, & Adams, 2012). The car is comparable to a small middle class car like the BMW3 series, AUDI A4, Mercedes C-Class or the VW Passat. The sedan version is used because it is the most relevant to the automotive industry. There, the sedan version of a specific car model is considered as the basic model of which the corresponding derivatives are based like e.g. the station wagon. Figure 3-23 and Figure 3-24 contain the relevant views of the DrivAer sedan.



Figure 3-23: 3D-view of the DrivAer sedan

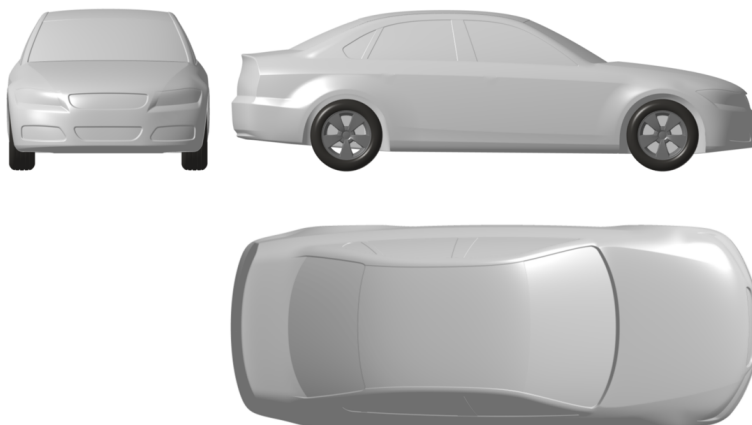

Figure 3-24: Front, right and top view of the DrivAer sedan

3.4.2.2 Parametric geometry model development

It was already said that the parametric model has to be controllable and realistic enough at the same time. In practice, this means that a balance has to be found between its amount of parameters and the relevance of its C_x response compared to those of the realistic car exterior. Therefore, the development of the parametric geometry model will be done in different steps. The evolution of the model will evolve hand in hand with its complexity and the corresponding amount of required parameters.

First, a geometry model with a minimum amount of parameters will be made after which its aerodynamic behaviour is assessed and compared to the real (and detailed) car exterior geometry. The recommendations coming from this aerodynamic analysis will be used to develop a next version of the parametric model. This will be done iteratively until the parametric model's behaviour is realistic enough compared to the real one. Figure 3-25 gives a visualisation of this development process.

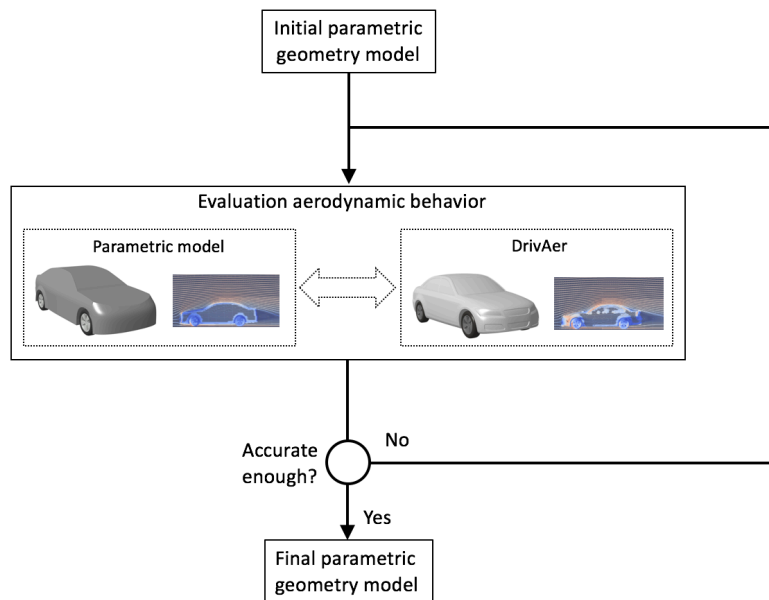

Figure 3-25: Parametric geometry model, development approach

The question that has to be asked now, is how this aerodynamic assessment will be done. The first step is to measure all the defining parameters of the parametric model on the real geometry of the DrivAer assuring that the former is a correct approximation of the latter. Then, relevant geometry variants will be generated for both of them. The chosen parameters to assess the geometric model with the realistic car exterior of the DrivAer will be (Figure 3-26):

- Parameter 1: Trunk extremum, “Trunk_corner_delta_z” (Appendix A)
- Parameter 2: Rear windshield root, “Trunk_windshield_junction_x” (Appendix A)

For each of those parameters, a range of variants will be created:

- Parameter 1: -100 mm - 100 mm in steps of 10 mm, meaning 21 samples
- Parameter 2: -100 mm - 20 mm in steps of 6 mm, meaning 21 samples

More parameters could be chosen to validate the parametric model more extensively.

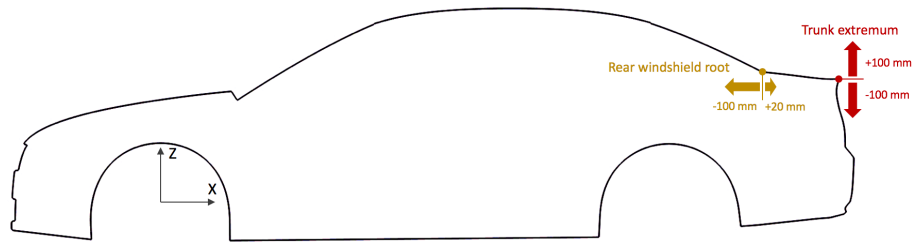

Figure 3-26: Geometric parameters chosen for the assessment of the geometric model

Those variants can be easily generated for the parametric geometry model, but not for the real geometry. The creation of those realistic variants will be done manually by using morphing techniques in Catia V5 and will take up at least a couple of hours in total for each separate parameter shown in Figure 3-26. This is very time-consuming compared to the instant generation of the geometry generator. After all this is done for each variant, each of them will be simulated in OpenFOAM under the same conditions and case and simulation settings. Then, the following comparisons will be made:

- Global comparisons of the course of the streamlines between the parametric model and real geometry.
- Comparison of the C_x response, tendencies and ΔC_x of the range of variants for each chosen parameter between the parametric and real geometry.

Those comparisons could be repeated for different free stream velocities or a variation of other initial case settings. In this work, these comparisons are only done for the case and simulation settings used for the surrogate modelling which are given in Chapter 4.

The reason why the tendencies and deltas (ΔC_x) of the C_x response are used, is because they are much more relevant to compare the real geometry and the parametric model than its absolute values. As can be seen in Figure 3-27, the difference between curve 1 and 2 can be reduced to a constant offset for which can easily be corrected. The difference with curve 3 is much more complex and although the overall trend of all curves is in the same direction (namely increasing), the behaviour of the C_x response as a function of the corresponding parameter variation is not similar. After all, the parametric geometry model remains an approximation of the real geometry, so it would be ideal to create a model which approximates its behaviour without an offset. This can probably be achieved by implementing all the details, but then is the question how many parameters will be needed for this, and how controllable and reliable will the model still be. Therefore it was decided for this work that the parametric geometry model will be considered realistic enough if the C_x response as a function of the corresponding parameter variations each have the same tendencies and ΔC_x as the compared to those of the real geometry. This is necessary in order to have reliable results of the surrogate modelling experiments executed with this methodology further in this work. Figure 3-28 shows some examples of C_x response which would be approved.

Also it has to be noted that a simulation model is not the truth, therefore when simulations are concerned, it is preferred to work with Δ 's and tendencies.

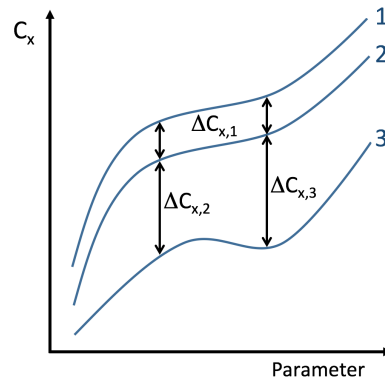

Figure 3-27: Significance of Δ 's and tendencies

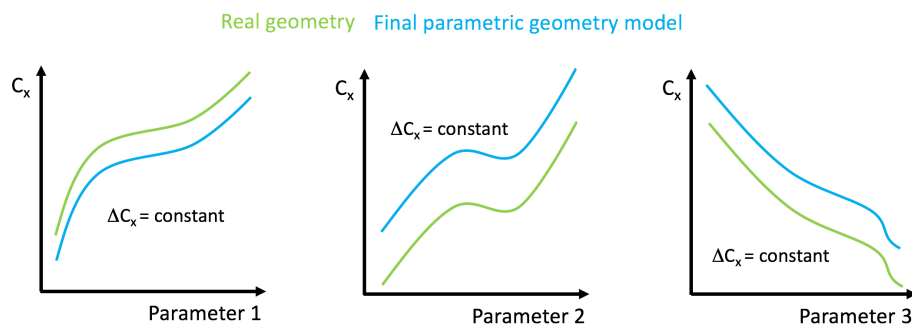

Figure 3-28: Examples of similar C_x responses between the real and approximating geometry

The actual development of the parametric geometry model will be done in this way and will be explained further in this section.

3.4.2.3 Control of the geometry generator

Before going to the practical development of the parametric model in the next subsection, one thing has to be discussed first. The communication with and the control by the software framework in MATLAB is also very important because the geometry generator would be useless without this working.

A client-server communication, based on the http-protocol, between the geometry generator and the software framework in MATLAB will be set up. In this way, the software framework can control the geometry generator and ask for a specific geometry when needed. How this is exactly done, can be found in Appendix B.

3.4.3 Development of the parametric geometry model

3.4.3.1 Assumptions

The car exterior will be provided with rotating wheels and a moving ground based on the free stream velocity of the incoming air. To reduce the complexity of the geometry generator, these rotating wheels will be fixed in dimensions and positioning. This means, the wheel base length and both track widths of the car cannot be used as a variable for the surrogate modelling. Also, the door handles and outside mirrors are left out like in the reference model. This can be justified because in the early aerodynamic phases where the proportions of the car exterior are investigated, such add-ons are not focused on and will be added later.

The parametric model is built up from objects based on the typical topology of current cars. The main classes required for this typical topology are for this model shown in Figure 3-29 and Figure 3-30.

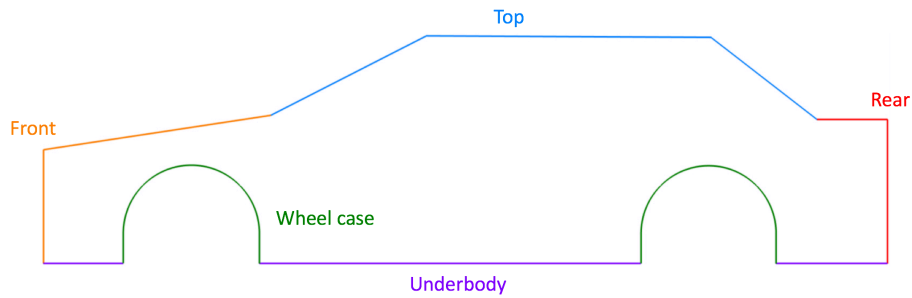

Figure 3-29: Visualisation of the parametric model topology, profile view

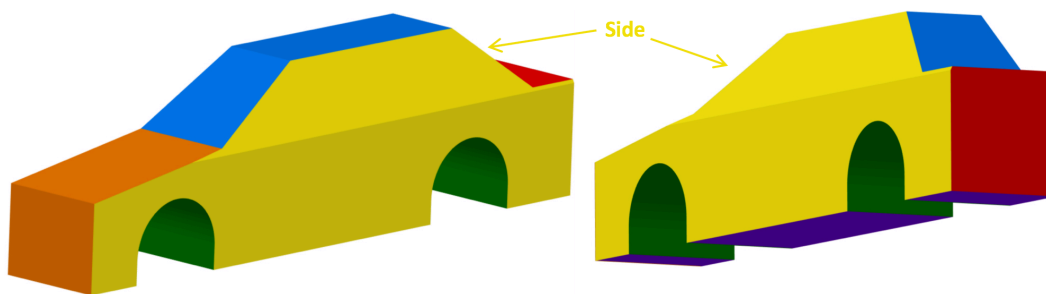

Figure 3-30: Visualisation of the parametric model topology, 3D-view

In this work, a sedan will be used which consist of the following objects:

- Sedan Front (class Front)
- Sedan Rear (class Rear)
- Sedan Top (class Top)
- Sedan Underbody (class Underbody)
- Wheel case front (class Wheel case)
- Wheel case rear (class Wheel case)
- Sedan Side (class Car Side)

3.4.3.2 Version 1

The resulting geometry generated with this model version based on the realistic geometry of the DrivAer sedan is shown in Figure 3-31 and Figure 3-32.

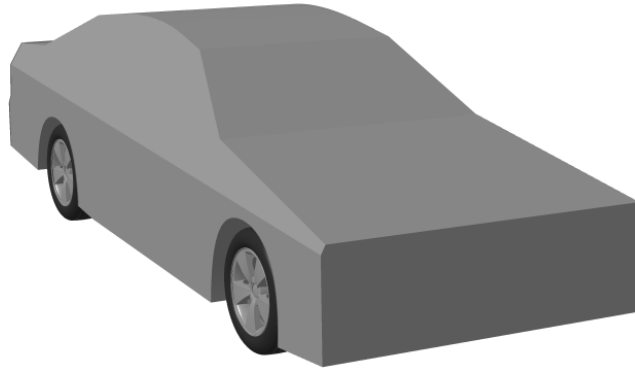

Figure 3-31: 3D-view of the parametric model version 1

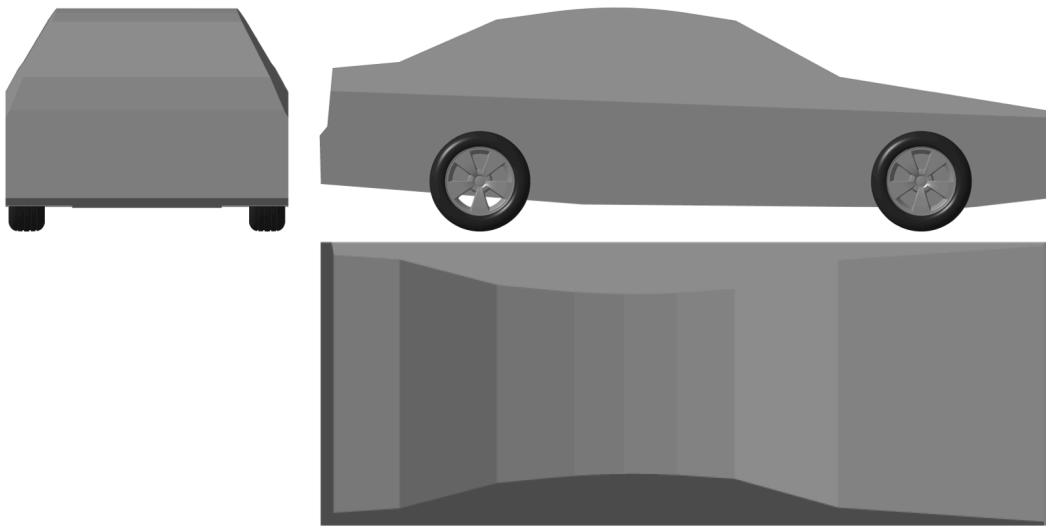

Figure 3-32: Front, right and top view of the parametric model version 1

Now, the aerodynamic behaviour of this generated geometry has to be compared with that of the realistic DrivAer. As already said, this will be done by using OpenFOAM. The visualisation of the resulting pressure and velocity fields of the air flow obtained by the OpenFOAM simulations will all have the same color scale throughout this whole report (Figure 3-33).

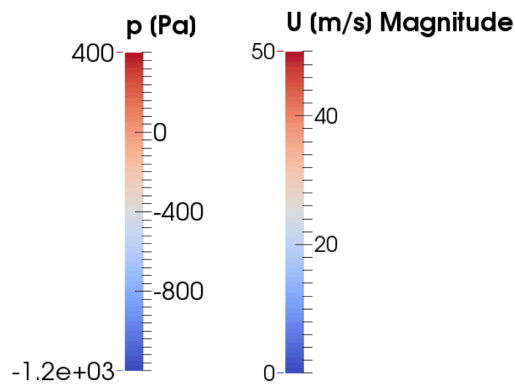

Figure 3-33: Scale for the pressure (left) and velocity (right) field results visualisations

In Figure 2-32, the pressure distribution working on the exterior geometry of both models is given. The overall picture of this pressure distribution looks similar but the pressure transition due to the rude shape of the frontal area is very sharp and not a good approximation of the smoother transition of the real geometry.

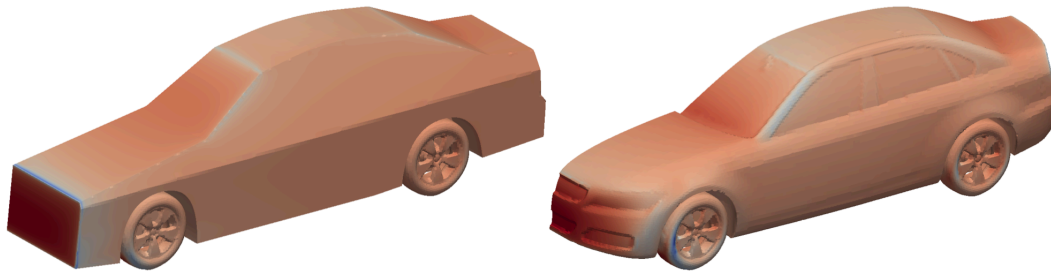

Figure 3-34: Pressure field parametric model V2 (left) and the reference model (right)

Figure 3-35 shows a left view of the velocity field of the flow including streamlines in the symmetry-plane of the car. The overall picture looks similar for both models when looking to the presence of the stagnation zone at the front and depression zone and wake at the rear and the raw course of the streamlines. But around the approximation model, some early separation can be identified at the front of the car. More specifically, due to the sharp edges and transition of the frontal area, the flow is separated at the motor hood and reattaches again somewhere at the height of the front windshield. This separation is indicated by the low velocity (blue) streamlines which can be seen more clearly when zooming in on this as in Figure 3-36. Also in this figure, it can be noticed that the overall velocity close to the exterior geometry is lower for the approximating model as it is for the real one. This is confirmed by Figure 3-37 which shows the top view of the pressure field. This lower overall velocity field close to the car exterior could indicate early and extensive separations of the flow.

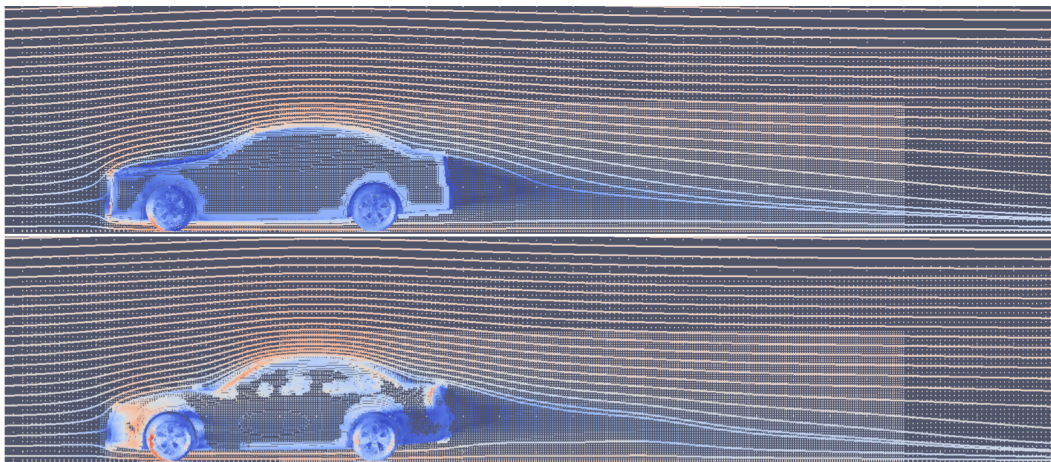

Figure 3-35: Reference model (bottom), parametric model V1 (top), left view of the velocity field and streamlines of the symmetry plane

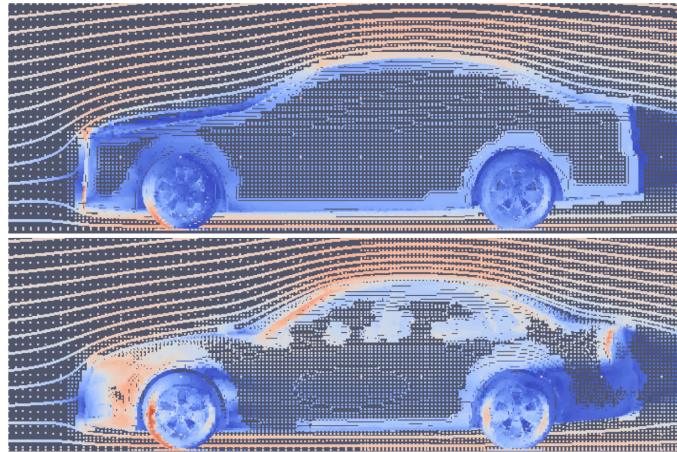

Figure 3-36: Detailed view of the flow around the car exterior of the reference model (bottom) and the parametric model V1 (top) in the symmetry plane

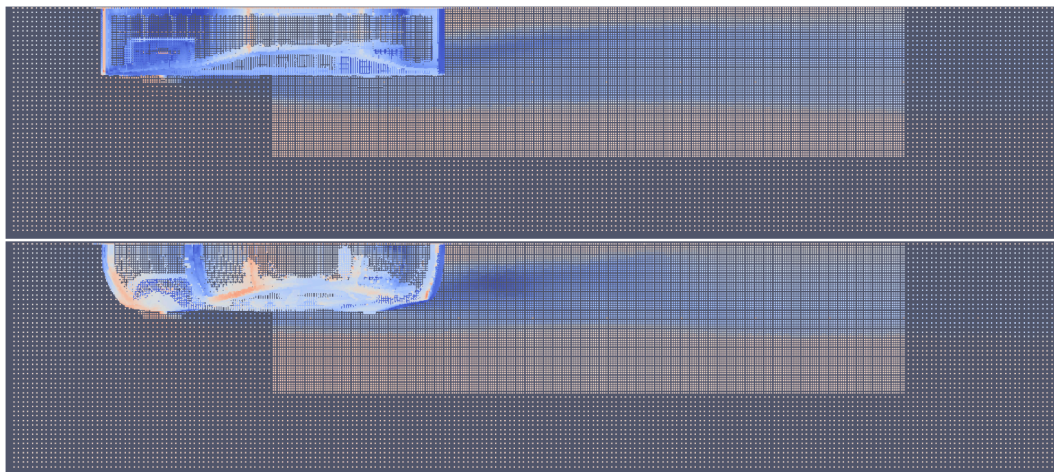

Figure 3-37: Reference model (bottom), parametric model V1 (top), top view of the velocity field

What was observed in the left view of the velocity field of the flow (Figure 3-35 and Figure 3-36), is confirmed by looking to Figure 3-37 and Figure 3-38. In the latter, also early separation can be found of the flow coming from the frontal area to the side of the car, similar as what happened at the motor hood.

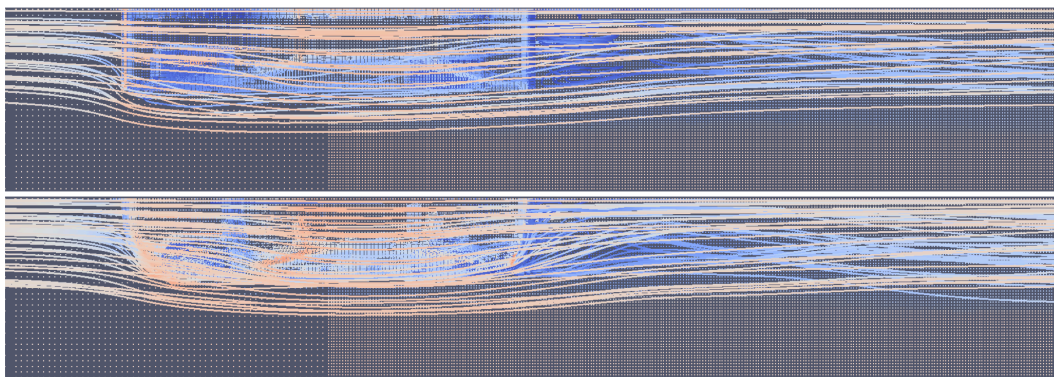

Figure 3-38: Reference model (bottom), parametric model V1 (top), top view of the velocity field with streamlines

In general, the overall flow pattern of the approximating model is similar to that of the realistic geometry. But the early separations which were found and can be related to the sharp transitions in the pressure and velocity fields are remarkable and cannot be neglected. Figure 3-39 confirms the smoother flow around the real geometry compared to the approximation and is caused by the many sharp edges and geometry transitions of the latter. The C_x value of both valid for the simulation settings given in Chapter 4 lies around 0.5 and 0.353 for the approximation and realistic model respectively. The C_x response for varying geometry is not done here because it is already concluded that the model is not refined enough.

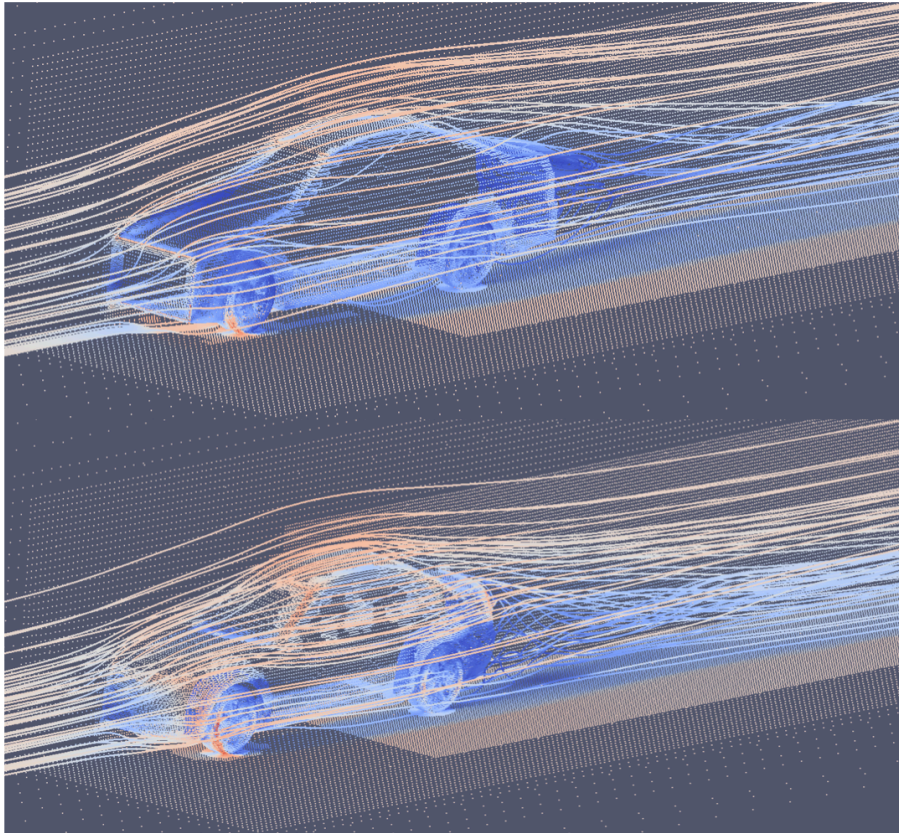

Figure 3-39: Reference model (bottom), parametric model V1 (top) overview of the velocity field with streamlines

3.4.3.3 Version 2

Due to the early separation of the sharp edges and non-smooth profile and transitions of the peaked first model version, these have to be made much smoother. For this, a geometry object based on a b-spline curve is created and used for the programming of this version of the parametric model in GDL. The result of this is a geometry object constructed of a third degree b-spline with four control-points, but alternative inputs which are more practical to work with for approximating a car exterior geometry. In the parametric model, this object is only used for creating b-spline curves in a plane, but 3D-splines should also be possible. The definition of this object is given in Figure 3-40 and it required inputs are:

- Start point coordinates
- End point coordinates
- Tangent at the start point (direction-vector of the tangential)
- Tangent at the end point (direction-vector of the tangential)
- Tension at the start point (real number going from 0 till 1)
- Tension at the end point (real number going from 0 till 1)

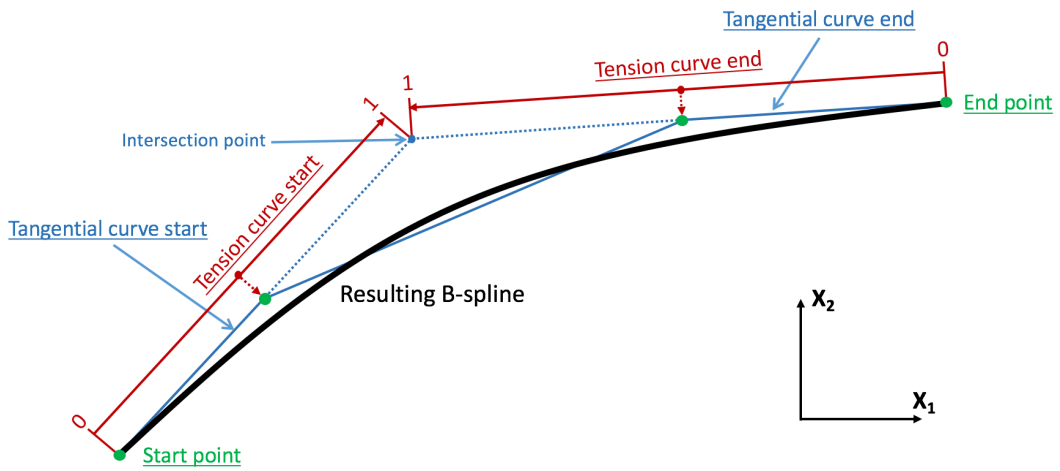

Figure 3-40: Definition of the b-spline-based object used in the parametric model V2

The blueprints including parameter names and their sign conventions of this second version of the parametric model can be found in Appendix A. The resulting geometry generated with this second model version based on the realistic geometry of the DrivAer sedan is shown in Figure 3-41 and Figure 3-42.

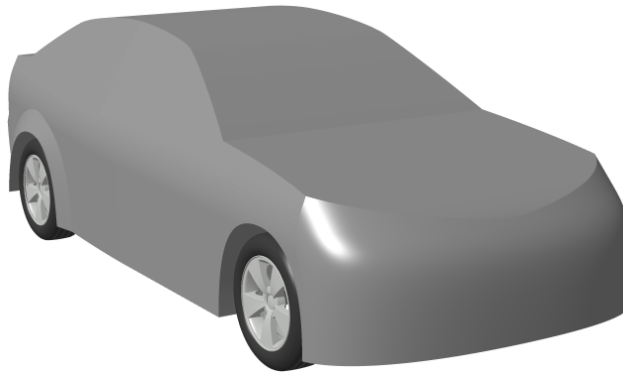

Figure 3-41: 3D-view of the parametric model version 2

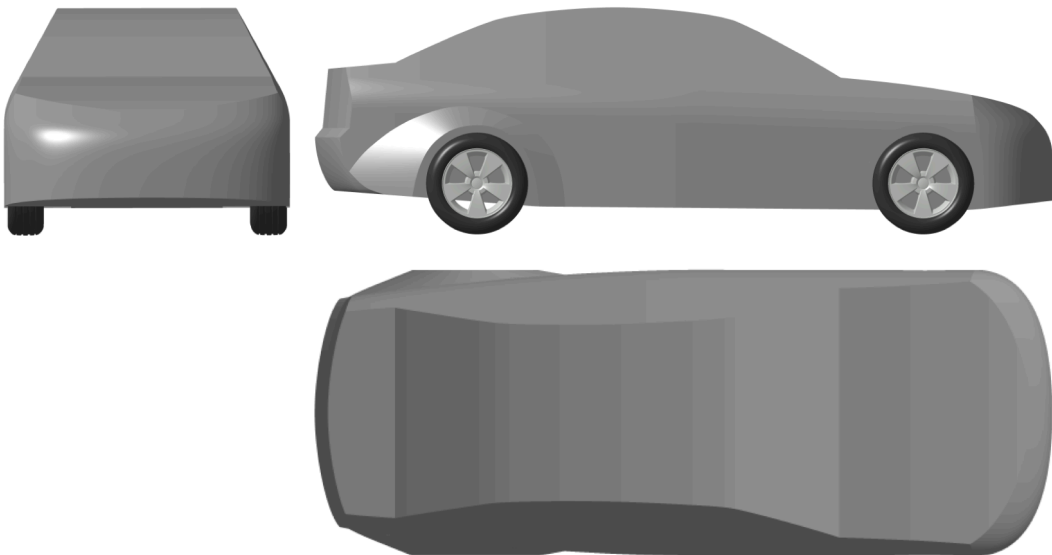

Figure 3-42: Front, right and top view of the parametric model version 2

Figure 3-43 shows the pressure distribution around the car exterior of the approximating and real model. It can be noticed that the transitions and variation of this pressure distribution is much smoother compared to its previous version. It can also be noticed that the parametric model contains some sharp edges resulting in a small difference of the pressure distribution around the front wheel. This is because the smoothing of edges is limited in the GDL software because it is not possible to select the appropriate edges parametrically. This limitation had no further consequences for this work.

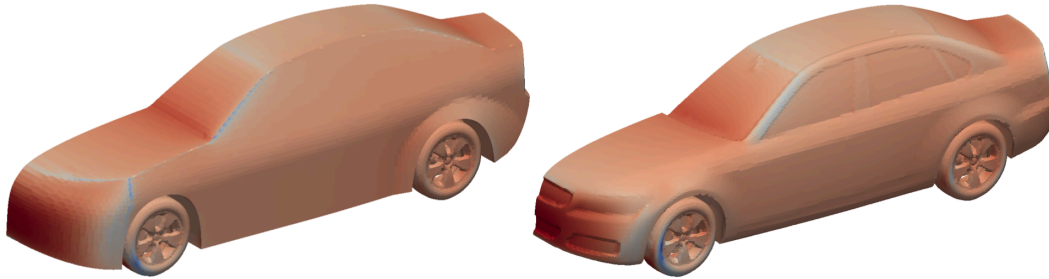

Figure 3-43: Pressure field parametric model version 2 (left) and the reference model (right)

Also the velocity field and streamlines shown Figure 3-44-Figure 3-48 lean much more towards those of the real model. Also the picture of the overall velocity around and close to the exterior is very similar between both. This is confirmed by the absence of early and extensive separation which was found in the previous version of the approximating model.

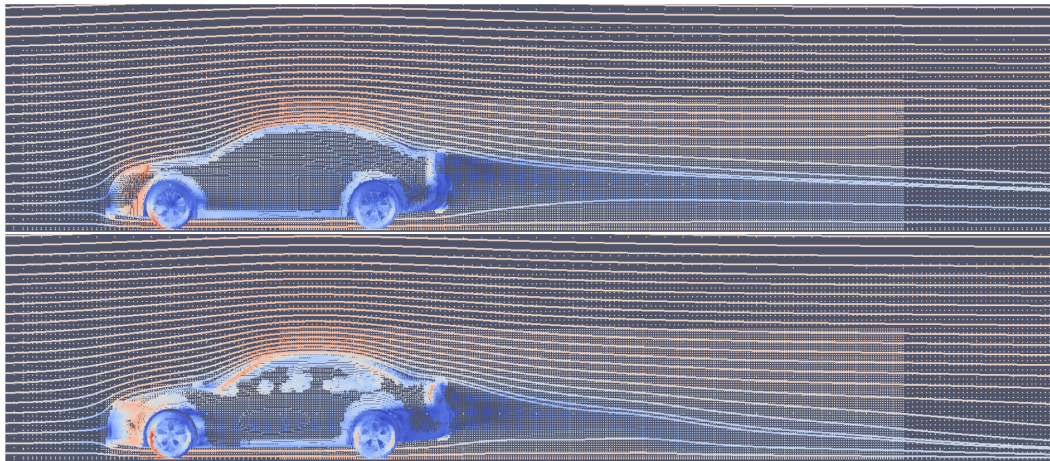

Figure 3-44: Reference model (bottom), parametric model V2 (top), left view of the velocity field and streamlines of the symmetry plane

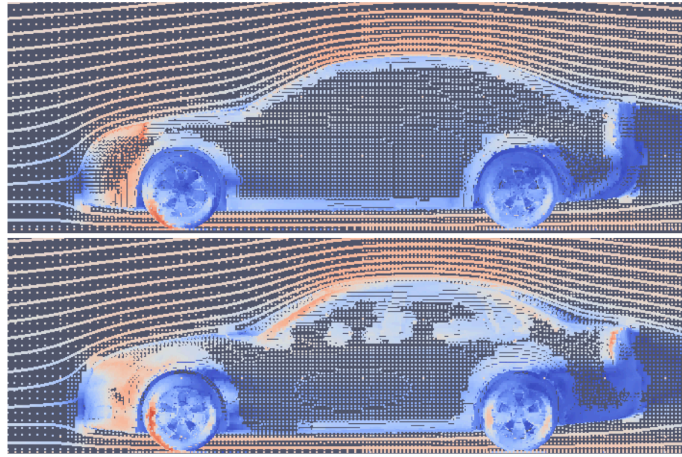

Figure 3-45: Detailed view of the flow around the car exterior of the reference model (bottom) and the parametric model V2 (top) in the symmetry plane

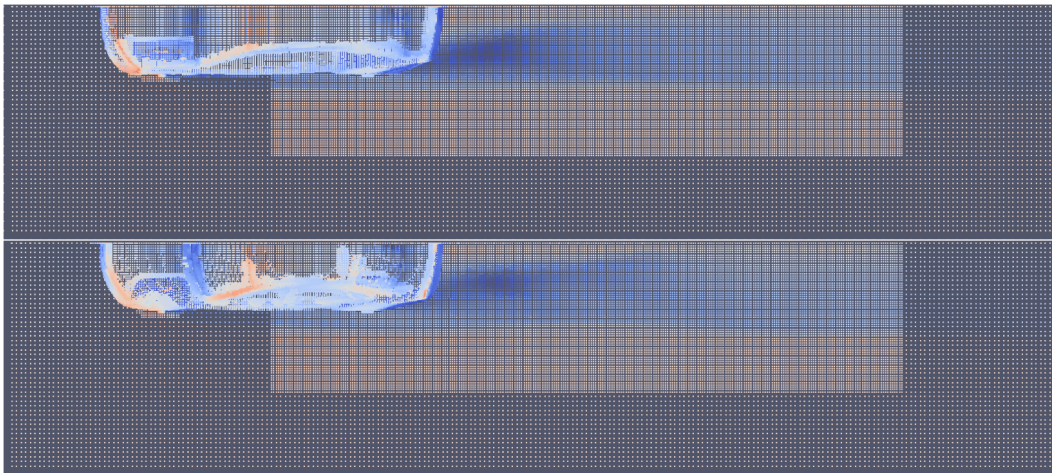

Figure 3-46: Reference model (bottom), parametric model V2 (top), top view of the velocity field

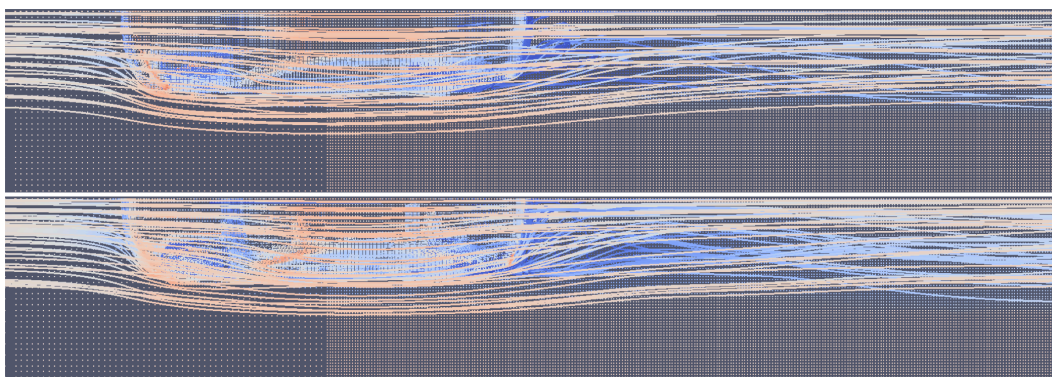

Figure 3-47: Reference model (bottom), parametric model V2 (top) top view of the velocity field with streamlines

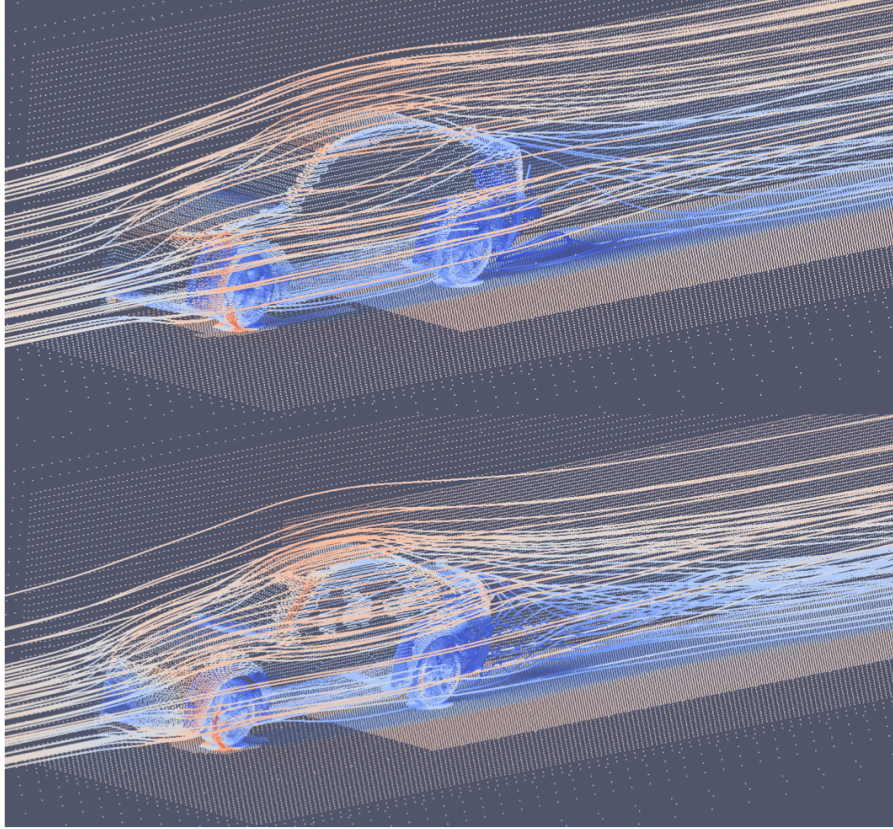

Figure 3-48: Reference model (bottom), parametric model V2 (top) overview of the velocity field with streamlines

In general, the overall flow pattern of the approximating model is very similar to that of real geometry and early separations of the flow in close proximity of the exterior is also eliminated compared to its previous version. This smoother and much more realistic flow is confirmed by Figure 3-48. After this approval of the overall pressure and velocity fields of the flows, it is time to compare its C_x response due to geometric variations with the response of the real geometry.

When looking to Figure 3-49 and Figure 3-50 (where C_x is expressed with a factor of 1000), it can be said that the parametric model of the car geometry is an accurate approximation of the real car in terms of C_x for both geometric parameters because it complies with the assessment conditions described previously in this section. Both parameters will therefore be usable for the use-case of Chapter 4 from which the response curve of C_x of the parametric model in Figure 3-49 and Figure 3-50 are coming. The obtained C_x value of the neutral parametric and realistic model are respectively 0.353 and 0.348.

Together with what was already said about the pressure and velocity fields of this parametric model compared to the realistic geometry, it can be concluded that it is a good substitute for the realistic geometry and can be used as geometry generator for this thesis.

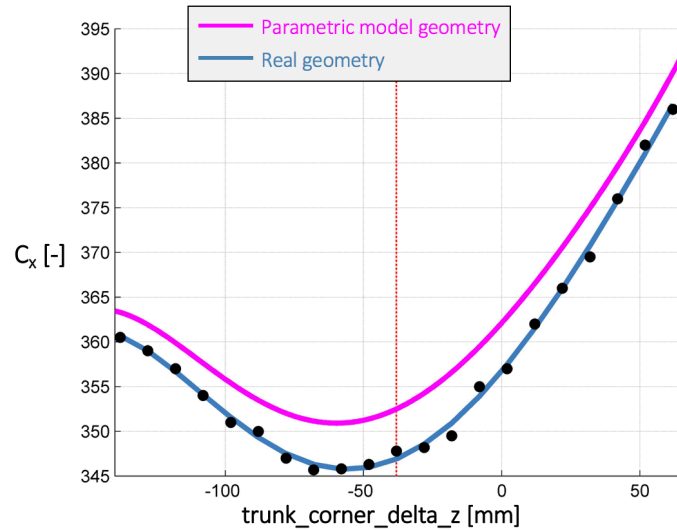

Figure 3-49: Comparison of the C_x response of the car exterior geometry of the real and parametric model for the trunk extremum variation

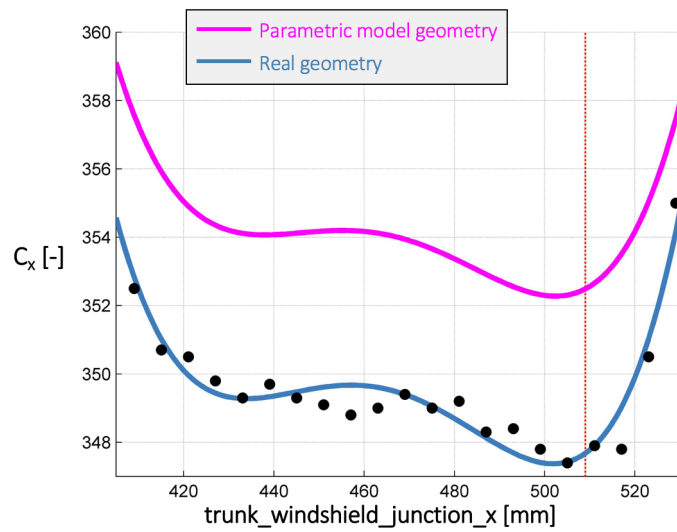

Figure 3-50: Comparison of the C_x response of the car exterior geometry of the real and parametric model for the rear windshield root variation

3.4.3.4 Summary

An overview of the geometric comparison of the first and final version of the approximating geometric model is shown in Figure 3-51. The geometry generator is also stable enough to generate the extreme geometries of large parameter ranges that will be beneficial for a large exploration of the design space. Some examples of such extreme geometries are shown in Figure 3-52-Figure 3-54.

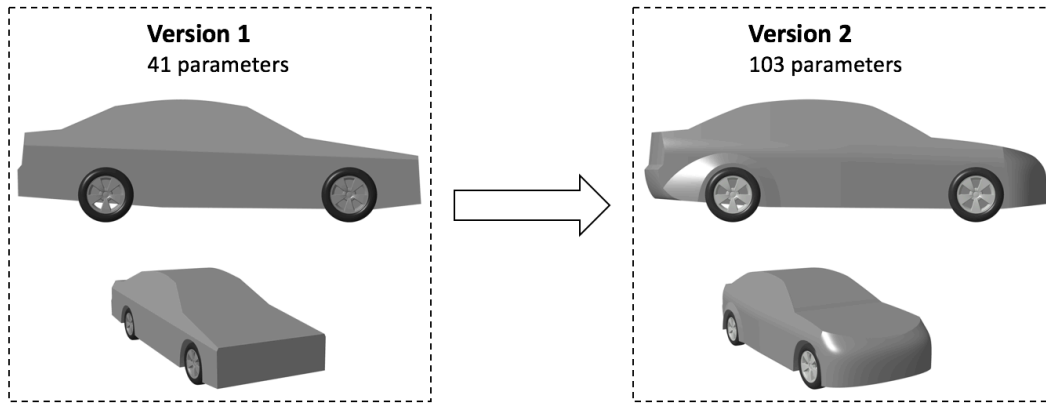

Figure 3-51: Parametric geometry model evolution

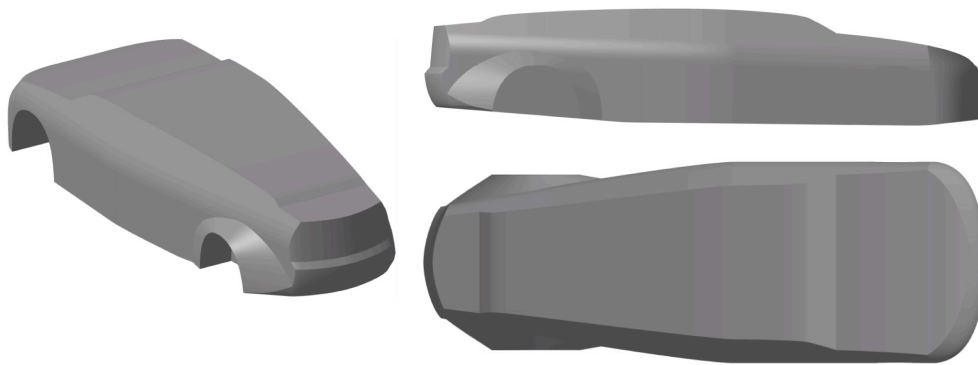

Figure 3-52: Geometry generator, first example of extreme geometry

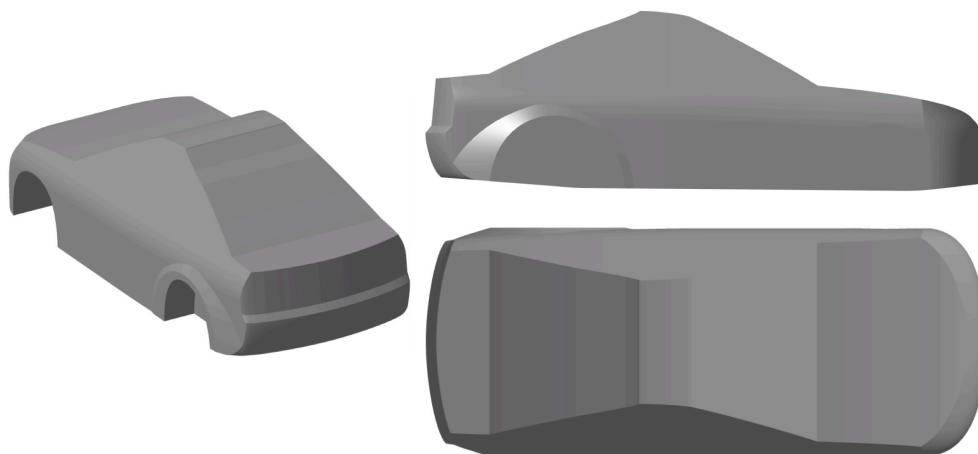

Figure 3-53: Geometry generator, second example of extreme geometry

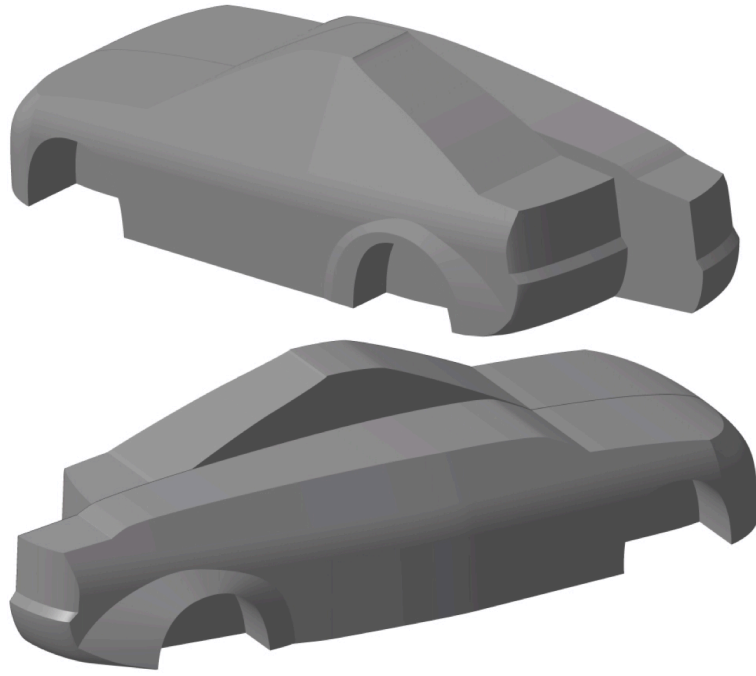

Figure 3-54: Comparison of both examples of extreme geometry

Chapter 4

Results

4.1 Introduction

In this chapter, the results and detailed specifications of the use-case of the suggested methodology presented in Chapter 3 will be described. After this introduction, first the use-case will be defined including all the used settings, geometries, etc. so that the results could be reproduced afterwards and also the validity of the results is known. In the next section, the obtained results which will be presented. Those results will be discussed in the subsequent section, resulting in conclusions and statements about the potential of such methodology for improving the aerodynamic design of the C_x value of the car exterior design. This results section will be important for Chapter 5 where the conclusions and recommendations of this whole thesis will be given. This chapter will end with some thoughts about the generalisation of the presented methodology for use in other fields of application.

4.2 Use-case

In this section, the detailed specifications of the used settings, models, etc. for the use-case will be given. In other words, everything that is needed to reproduce this. First the use-case will be generally defined. After this, the used reference model and its corresponding approximation model for the geometry generator, OpenFOAM settings, surrogate modelling settings and the specifications of the used computers will be given.

4.2.1 Use-case definition

The purpose of this use-case is to test the performance and usefulness of the process flow of the methodology developed in Chapter 3. The purpose of this methodology was to improve the aerodynamic design process of the car exterior in terms of C_x (air resistance). This was defined and covered in Chapter 2 and 3. The new process flow will be demonstrated with a test-case representative for the current situation of aerodynamic design in the industry, based on real data so that the potential of this methodology could be estimated. Also, its usefulness and why it could improve the current aerodynamic design process will be covered and derived using the obtained results. Those conclusions will be used to be combined with the thoughts, which came up during the development described in Chapter 3, to come to communal conclusions and recommendations in Chapter 5.

Three surrogate models will be created, each during one experiment. The first two will have one input parameter to investigate its C_x response of the car exterior and will therefore be a two-dimensional problem. The third one will have those two previous parameters combined as input, meaning a three-dimensional

problem. Those parameters both belong to the geometrical parameters set of the geometry generator model. They were already used for the assessment of that parametric model in Chapter 3 and their names and definitions can be found in Appendix B. An overview of those three experiments of the use-case is given in Table 4-1. It can be seen that the first and second experiment investigate a parameter range of respectively $[-100 \text{ mm}, +100 \text{ mm}]$ and $[-100 \text{ mm}, +20 \text{ mm}]$ around the corresponding value of the neutral geometry, in this case the DrivAer sedan. Figure 4-1 and Figure 4-2 give a visualisation of the neutral geometry and its corresponding lower and upper variations for both experiments.

	Experiment 1	Experiment 2	Experiment 3
Parameter name(s)	Trunk_corner_delta_z	Trunk_windshield_junction_x	Trunk_corner_delta_z Trunk_windshield_junction_x
Value of the neutral geometry	-38.07 mm	509.04 mm	-38.07 509.04
Investigated range [mm]	$[-138.07, 61.93]$	$[409.04, 529.04]$	$[-138.07, 61.93]$ $[409.04, 529.04]$
Output	$C_x * 1000$		

Table 4-1: Overview of the three experiments of the use-case

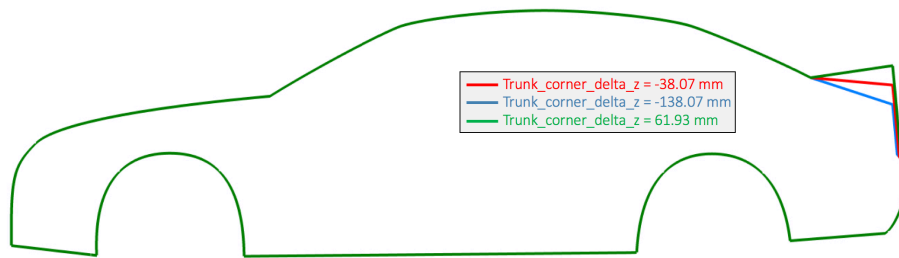

Figure 4-1: Experiment 1, max, min and neutral geometry variation of the car exterior in the symmetry plane

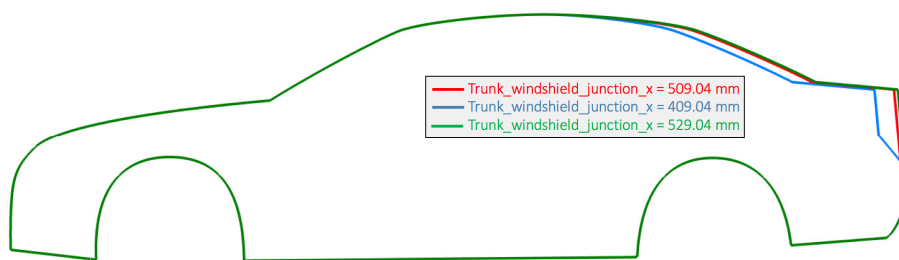

Figure 4-2: Experiment 2, max, min and neutral geometry variation of the car exterior in the symmetry plane

4.2.2 Reference model

4.2.2.1 DrivAer

The DrivAer sedan will be used as the reference model and was already presented in Chapter 3.

4.2.2.2 Parametric base model of the geometry generator

Before the geometry generator can be used for a new car model geometry, it first has to be set up by configuring the base or neutral model of the geometry. This comes down to giving every geometric

parameter a value based on the reference model, in this case the DrivAer sedan. This has to be done manually by measuring the DrivAer geometry in Catia V5 and extracting the corresponding parameter values. During this, it is important to correctly apply the definitions and sign conventions of the whole parameter set (Appendix A). In Chapter 5, some recommendations and alternatives for this manual measuring method will be given.

A more appropriate name for this so called base model, is the neutral geometric variant. The latter naming will be maintained during the remainder of this chapter. Figure 4-3 and Figure 4-4 show this neutral version and can be compared with Figure 3-23 and Figure 3-24.

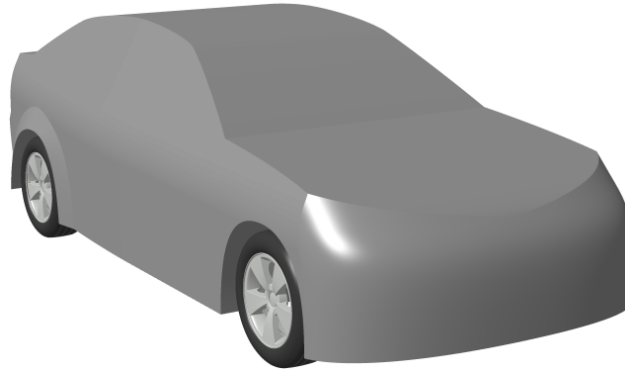

Figure 4-3: 3D-view of the neutral parametric model based on the DrivAer sedan

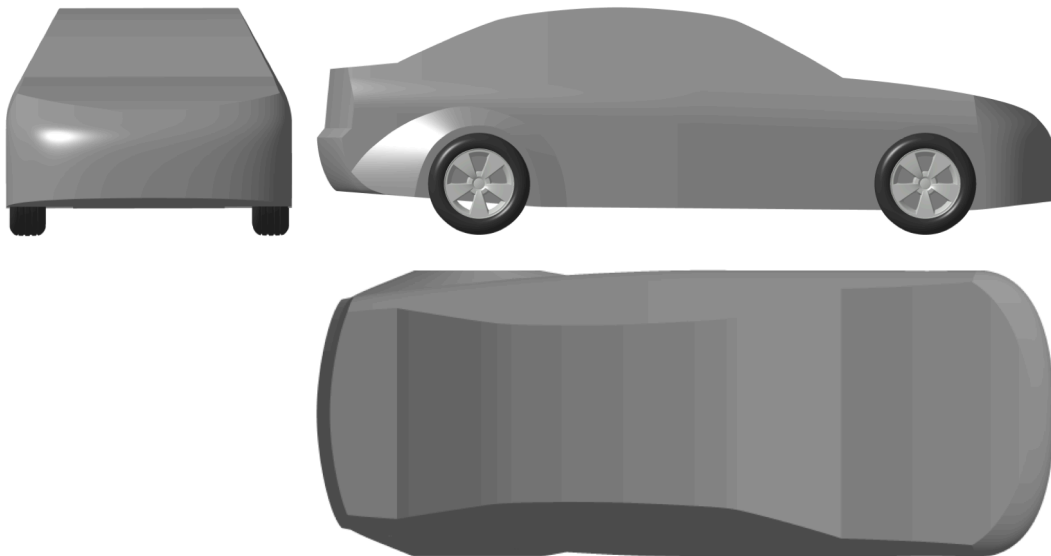

Figure 4-4: Front, right and top view of the neutral parametric model based on the DrivAer sedan

4.2.3 OpenFOAM settings

In this subsection, the used meshing tool and its settings, solvers and case settings are given because they are important for the reproducibility and traceability of this work. This section is used to give an overview of the used OpenFOAM settings, for the specific details is referred to the OpenFOAM case files on the CD accompanying this work. Also, not all the terms and settings mentioned in this section will be clarified or explained. For this is referred to the OpenFOAM userguide (OpenFOAM Foundation, 2015).

4.2.3.1 Process overview

OpenFOAM version 2.3.1 is used for this use-case. The overview of the process steps is given in Figure 4-5.



Figure 4-5: OpenFOAM process sequence

4.2.3.2 Parallel computing

The meshing and solving are done using parallel computing on 12 threads, which is the maximum allowed by the used Linux machine.

4.2.3.3 Meshing

For generating the mesh, the snappyHexMesh utility is used, which is supplied with OpenFOAM. From a triangulated surface geometry (STL-format), it generates a three-dimensional mesh which contains hexahedral and split-hexahedral cells. A starting mesh is refined iteratively after which the resulting split-hex mesh is morphed to the surface resulting in a mesh approximating surface. The accuracy can be set as desired. This process is fully-automated, but needs a correct setup. There are many settings for each process step so that their execution and quality of the outcome can be fully controlled and pre-specified. Those settings are very extensive and are collected in one so-called dictionary file which has to be correct. Going further into the details will not be done in this work, but the used snappyHexMesh dictionary-file will be provided on the CD-Rom for archival of this work. For more detailed information is referred to the OpenFOAM user guide which can be found on (OpenFOAM Foundation, 2015).

The dimensions of the base mesh and the two refinement zones, as well as the boundary types are given in Figure 4-6-Figure 4-10.

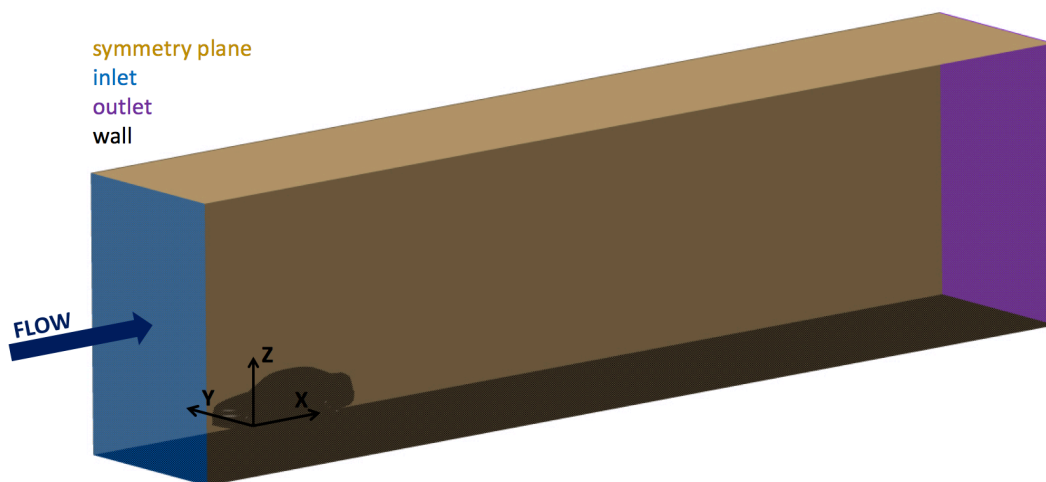

Figure 4-6: Mesh patches

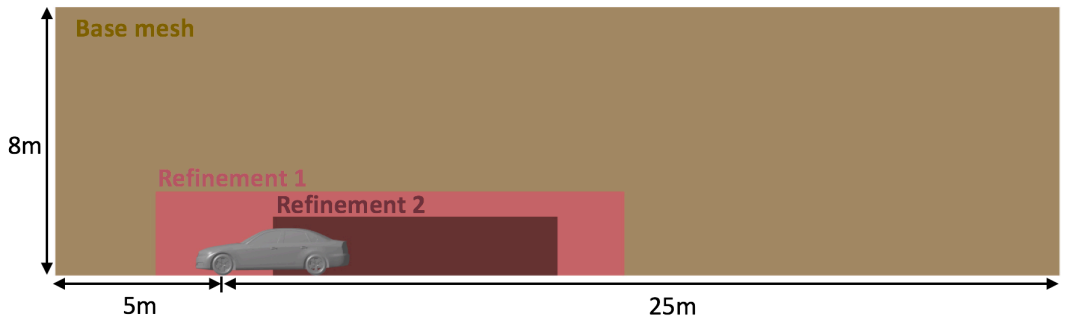

Figure 4-7: Mesh dimensions, left view

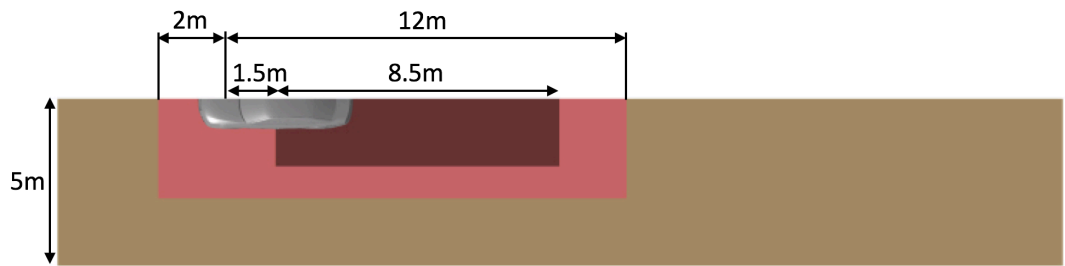

Figure 4-8: Mesh dimensions, top view

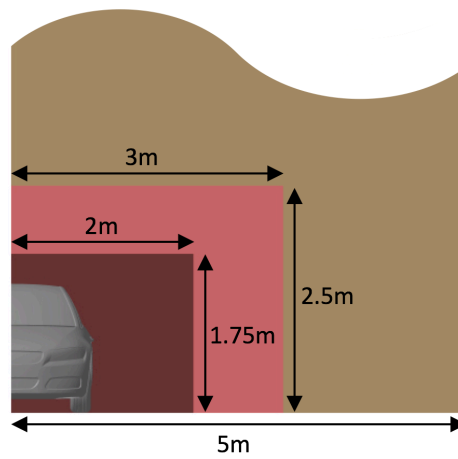

Figure 4-9: Mesh dimensions, front view

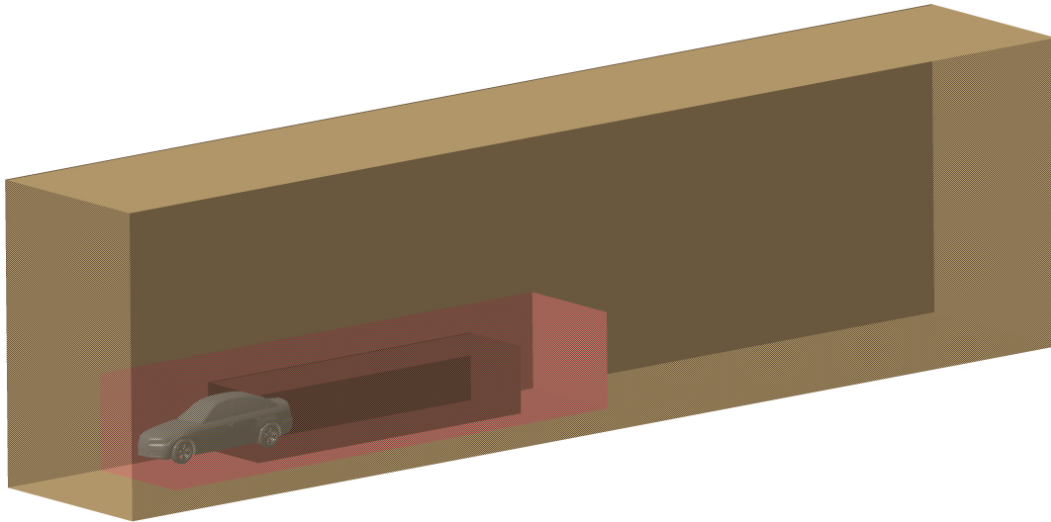

Figure 4-10: Mesh setup, 3D-visualisation

Figure 4-11 and Figure 4-12 show the resulting hexahedral mesh in OpenFOAM, which contains about 1.4×10^6 cells.

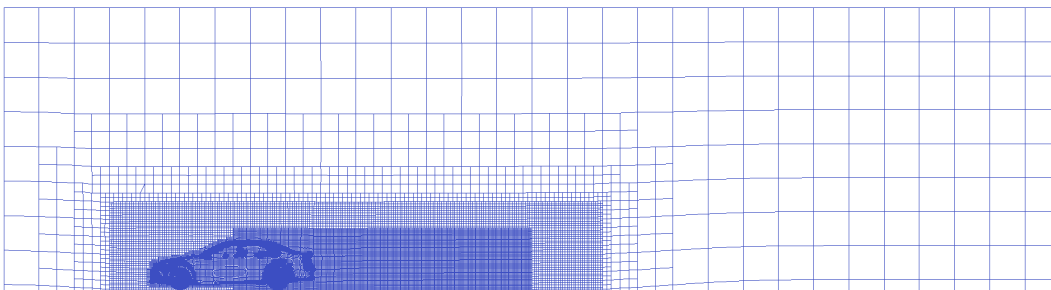

Figure 4-11: Mesh result, left view

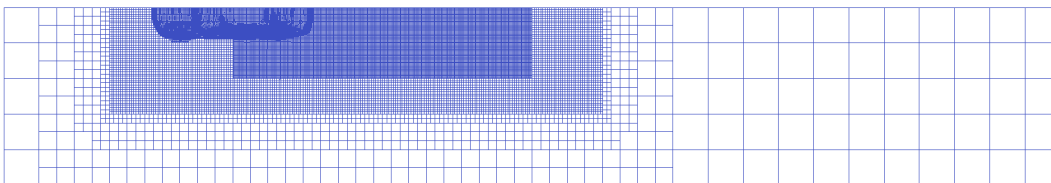

Figure 4-12: Mesh result, top view

4.2.3.4 Case setup

An overview of the main quantities and settings is given here.

Initial conditions

The initial flow conditions are given in Table 4-2.

Velocity [m/s]	27.78
Kinetic energy, k [J/kg]	0.001157
Turbulence dissipation rate, ϵ [J/(kg.s)]	3.3398×10^{-5}

Static pressure, p [Pa]	0
Air density, ρ [kg/m ³]	1.225
Kinematic viscosity, ν [m ² /s]	1.46×10^{-5}
Temperature, T [K]	288.15

Table 4-2: Initial conditions of the incoming air flow

The static pressure of the incoming flow is chosen to be 0 Pa, so that pressure variations can be more easily distinguished on the visualisation of the resulting flow. This choice has no influence on the obtained results and velocity field of the resulting flow.

To calculate the drag force and corresponding C_x of the car exterior, the frontal area is needed. Also, the wheelbase is required to calculate the corresponding Reynolds (Re) and Mach (Ma) number of the flow. By using the wheelbase as characteristic length, Re is about 5.3×10^6 . Ma is about 0.081 allowing to assume that the flow is incompressible.

A_{ref} [m ²]	1.066
Wheelbase [m]	2.786

Table 4-3: Main geometric characteristics of the car exterior for calculating C_x and the Reynolds and Mach number of the flow

The air flow over the ground and car exterior is considered to be without slip. The ground is given a velocity condition equal to the incoming flow while the wheels are rotating with the corresponding rotational velocity. Both are done to simulate a car driving over a road at a constant speed of 27.78 m/s (100 km/h).

General settings

The simulation runs for 1200 iterations. This value is chosen based on experiences and observations of the simulation convergence of the C_x value. For 1200, the last 300 points have a minimum and maximum value which differ about 0.0003 at maximum in C_x value. From these last 300 points, the mean is calculated and used as the final C_x value coming out of the simulation and used for the surrogate modelling.

Solver

The used solver is called simpleFoam which is a steady state solver for incompressible, turbulent flow.

Discretisation schemes

For an overview of the used discretisation schemes during the simulation is referred to the case files on the CD accompanied by this work.

Turbulence model

The realisable k- ϵ turbulence models is used because:

- The mean flow of complex structures is captured very well.
- The model has a good performance for swirling, rotating and separated flows.
- It is the main model used for the simulation of the flow around a car body.

The used coefficients determining the realisable k- ϵ model are given in Table 4-4. For more information why a turbulence model is needed and how the realisable k- ϵ model is built up, is referred to specialised lecture as for example (Wilcox, 2006).

C_{μ} [-]	0.09
A_0 [-]	4.04
C_2 [-]	1.92
α_k or σ_k [-]	1.0
α_ε or σ_ε [-]	0.76923
α_h or σ_h [-]	1.0

Table 4-4: Realizable k - ε turbulence model, used coefficients values

4.2.4 Surrogate modelling settings

In this section, the needed information for each performed experiment of the use-case concerning the surrogate modelling is given. For more information about the used specific algorithms and methods is referred to (Surrogate Modeling Lab, 2015).

Experiment 1 & 2

- *Model type:* 4th & 5th degree polynomial
- *Assessment method:* Cross-validation with the RMSE (Root mean squared error) used as the error function
- *Initial sampling:* Latin hypercube with 8 sample points
- *Adaptive sampling:* combination of two algorithms, namely lola-voronoi (weight 0.7) & error (weight 0.3)

Experiment 3

- *Model type:* Polynomial surface, 5th degree in both directions
- *Assessment method:* Cross-validation with the RMSE (Root mean squared error) used as the error function
- *Initial sampling:* Latin hypercube with 12 sample points
- *Adaptive sampling:* combination of two algorithms, namely lola-voronoi (weight 0.7) & error (weight 0.3)

4.2.5 Specifications of the used machines

Windows machine (hp Elitebook 8540w)	Linux machine (Dell Precision T5500)
Windows 7	Ubuntu 14.04 LTS
Intel Core i7 CPU Q720 1.60GHz	Intel Xeon CPU E5645 2.40 GHz (12 threads)
4 Gb of RAM	48 Gb of RAM
MATLAB R2014a	

Table 4-5: Relevant specifications of the used machines during the use-case

4.3 Results of use-case

In each experiment, the developed methodology is applied and the surrogate modelling is done without setting a target for the model accuracy. In this way, the evolution of the resulting models and the

corresponding measured accuracy could be observed. The measured accuracy is done with the RMSE of the fitted model, but can be also more advanced existing methods. Also the evolution of both 4th and 5th degree polynomials will be observed both separately as well as in comparison to each other.

4.3.1 Experiment 1

In Figure 4-13, the RMSE of the fitted 4th and 5th degree polynomial model is shown as a function of the amount of samples. The RMSE can be seen as the model score and should be as low as possible. Its dimensions are the same as that of the output of the simulator, namely $C_x \cdot 1000$, so that it can be seen as some sort of mean deviation or accuracy of the obtained model. The general trend is not a model score that converges to zero, but rather to a higher value. Although Figure 4-13 seems to keep increasing for more number of samples, it is rather expected that the RMSE will stabilise around a specific value not much higher as shown there. Unfortunately, running more samples was practically not possible.

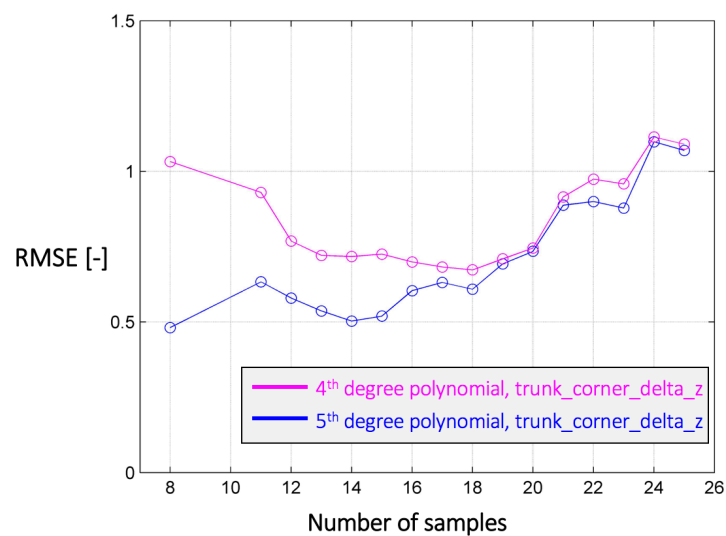

Figure 4-13: Experiment 1, evolution of the RMSE of the fitted model as a function of the number of samples

When excluding the initial model, it can be noticed that first a minimum of the RMSE is achieved after which it increases again. This minimum is 14 for the 5th degree polynomial and 18 for the 4th degree. The RMSE of the latter is constant by approximation between 13 and 20 samples. Therefore, the communal amount of samples of both polynomial model for which the RMSE is minimum, is considered to be 14. It looks like it is more difficult to decrease the model error as the number of samples increases. A reason for this could be the accuracy and consistency of the CFD simulation in the simulator which could be solved by optimising the mesh and case settings. In general, making a CFD simulation more accurate goes hand in hand with more computing power which was unfortunately not possible for this work due to the limited computing power available. On this accuracy and consistence of the CFD simulation will be reflected later in this chapter.

Knowing this, it seems appropriate to compare the resulting models with each other for 8, 14 and 25 samples. But first both the 4th and 5th degree models for 14 and 25 samples are shown Figure 4-14 and Figure 4-15 respectively in which the neutral geometry is indicated by the red dashed line.

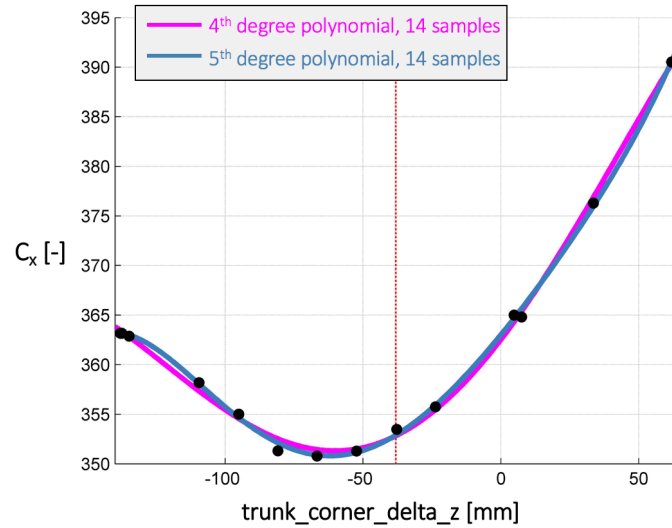

Figure 4-14: Experiment 1, comparison of the 4th and 5th degree polynomial fitted model for 14 samples

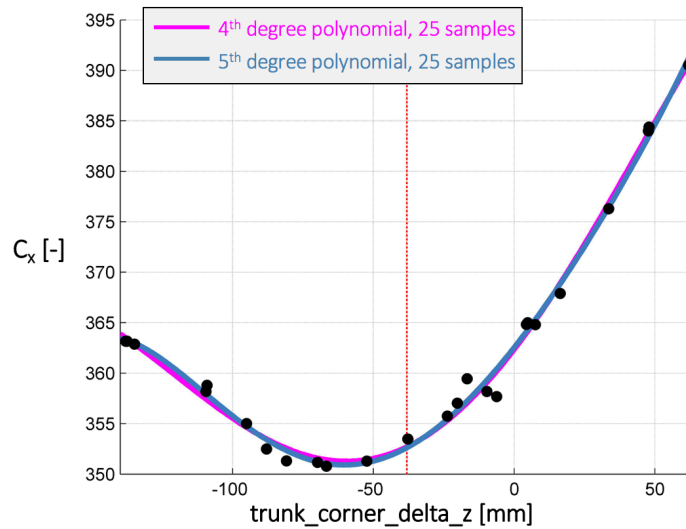

Figure 4-15: Experiment 1, comparison of the 4th and 5th degree polynomial fitted model for 25 samples

The presence of the adaptive modelling can clearly be seen in both figures. The underlying algorithm that is used here (combination of an error and the lola-voronoi algorithm as mentioned previously) searches for regions with a higher estimated error and non-linearity to sample. Also globally seen, both polynomial models can be assumed to be good representatives for each other and even seem to converge to each other for a higher amount of samples.

When looking to Figure 4-16 and Figure 4-17, the evolution of both 4th and 5th degree polynomial models only seem to change marginally for an increasing amount of samples. For this experiment, the initial 8 samples would already suffice and it could be said that the additional sampling and thus use of resources do not pay off. This is not always the case as will become clear when looking to the second experiment.

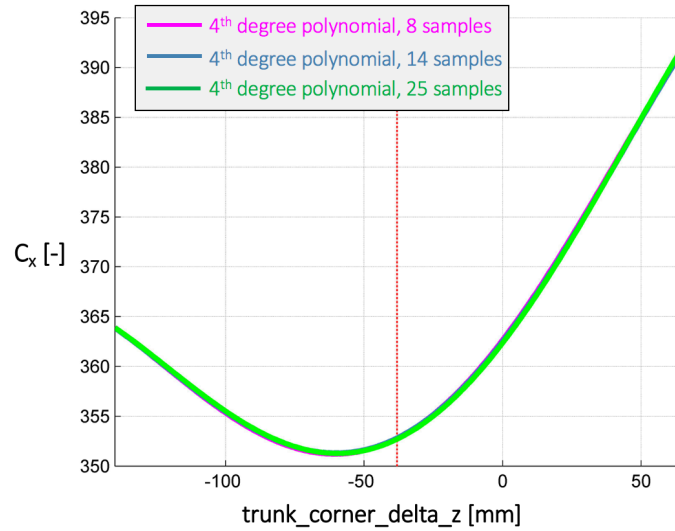

Figure 4-16: Experiment 1, comparison of the 4th degree polynomial fitted model for 8, 14 & 25 samples

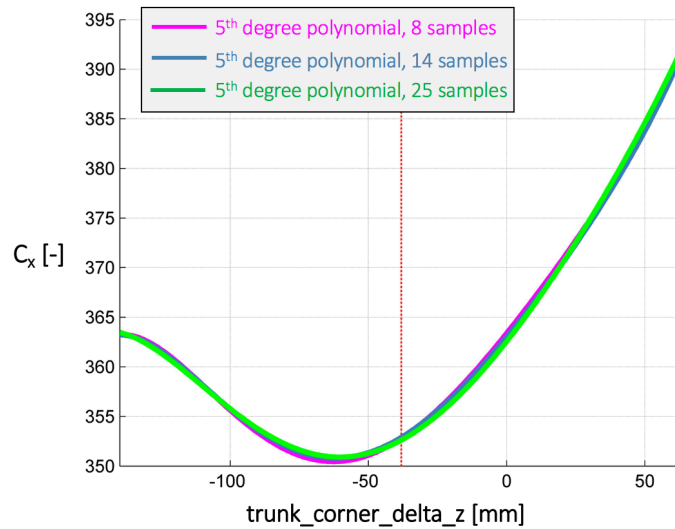

Figure 4-17: Experiment 1, comparison of the 5th degree polynomial fitted model for 8, 14 & 25 samples

Instead of assessing the surrogate model on its RMSE, it would be more useful to compare the sequential created models with each other. In this way, a convergence of those subsequent models can be assessed and used to decide whether the actual model for the corresponding required amount of samples is accurate enough. This is more representative than using the RMSE because it seems like this is not a useful representation of the model's convergence.

For the current situation of the aerodynamic preliminary studies where a fixed amount of samples is simulated and used for the generation of the surrogate model, it was already said that it is impossible to control whether the resulting model is an accurate representative of the real behaviour or not. To assure this accuracy, a higher sampling density is preferred resulting mostly in oversampling and thus consuming a lot of resources. The opposite, under sampling, would not waste resources, but results in bad accuracy. This was already explained in Chapter 3, but the experiment results here prove that by using such a convergence check would assure an optimal use of resources because the required accuracy can be achieved with a minimum amount of samples. This observation will be further treated during the discussion of the results, later in this chapter.

4.3.2 Experiment 2

In Figure 4-18, the evolution of the RMSE for this experiment is shown. The same trends as in the previous experiment can be noticed. The amount of samples for which the RMSE achieves a minimum is for both 4th and 5th degree polynomial models the same, namely 14.

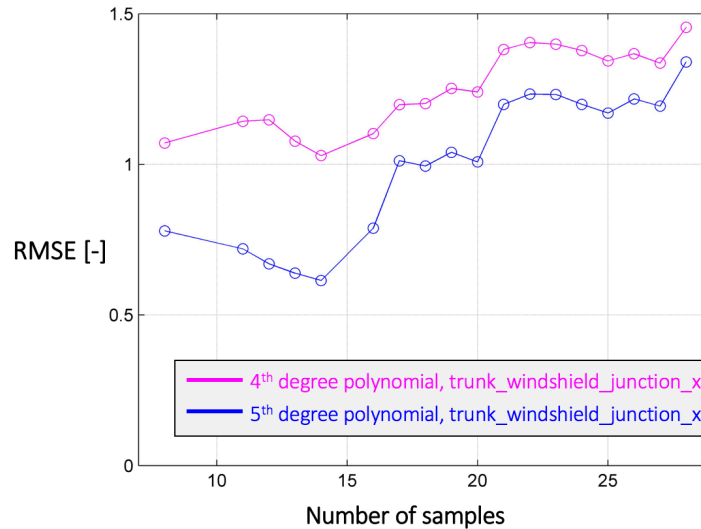

Figure 4-18: Experiment 2, evolution of the RMSE of the fitted model as a function of the number of samples

Respectively Figure 4-19 and Figure 4-20 contain the polynomials for 14 and 28 samples. It can be noticed that the 4th and 5th degree polynomials differ remarkably which was not the case in the previous experiment. Therefore, it is difficult to decide which one is considered as the better representative for the real and unknown C_x response. The difference between those two approximations is the most pronounced at the lower boundary of the investigated parameter range. There, the 4th degree polynomial designates an increase while the other one seems to decrease again. When looking to Figure 4-2, it is plausible that the pressure recovery and wake is influenced negatively by the decreasing parameter value, which is confirmed by Figure 4-19 and Figure 4-20. For an even more decreasing trunk_windshield_junction_x parameter value, this phenomenon would probably not be inverted so that the 4th degree polynomial seems to be the more logical representative of the real aerodynamic behaviour.

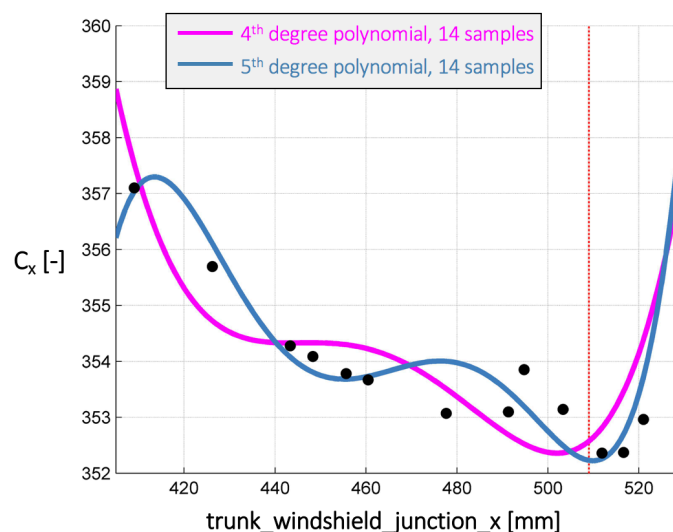

Figure 4-19: Experiment 2, comparison of the 4th and 5th degree polynomial fitted model for 14 samples

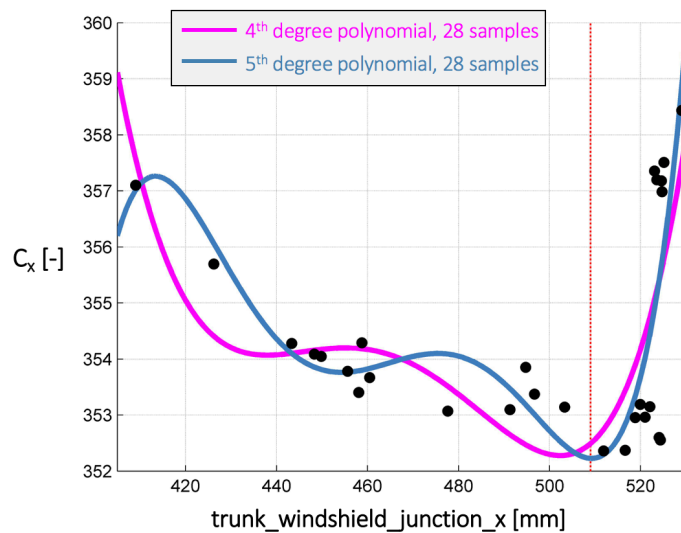

Figure 4-20: Experiment 2, comparison of the 4th and 5th degree polynomial fitted model for 28 samples

When looking to Figure 4-19 and Figure 4-20, it can be said that multiple regions with a low inconsistency of the sample data can be distinguished. This ‘randomness’ causes difficulties for the fitting of the models resulting in a higher amount of samples needed for the models to show convergence. Comparing Figure 4-21 and Figure 4-22 with Figure 4-16 and Figure 4-17 confirms this. Moreover, it can also be said that the usefulness of such a convergence criterion of the fitting models, as mentioned during the previous experiment discussion, is also confirmed with this because both 4th and 5th degree models seem to converge. If such convergence criterion would be used to control the surrogate modelling, experiment 1 would need much less samples than experiment 2 resulting in less use of resources while still achieving the required accuracy compared to the real aerodynamic behaviour. When comparing this to the current situation, where .g. an amount of 16 samples per experiment is chosen to be needed, the following can be said:

- Experiment 1: Applying closed-loop surrogate modelling with a model convergence criterion to finish the modelling would save 8 sample evaluations meaning 50 % of the used resources is saved.
- Experiment 2: Applying closed-loop surrogate modelling with a model convergence criterion to finish would result in more sample evaluations (how much more is dependent on the required convergence level), but the accuracy of the final model is assured. This assured accuracy cannot be underestimated because this means that the model is a reliable approximation of the real aerodynamic behaviour and will be used to assess the car’s exterior design. If the accuracy and thus reliability is unknown (as in the current situation), conclusions are based on this and could not be ensured to be correct. This could lead to unexpected behaviour of the car exterior design which is unwanted.

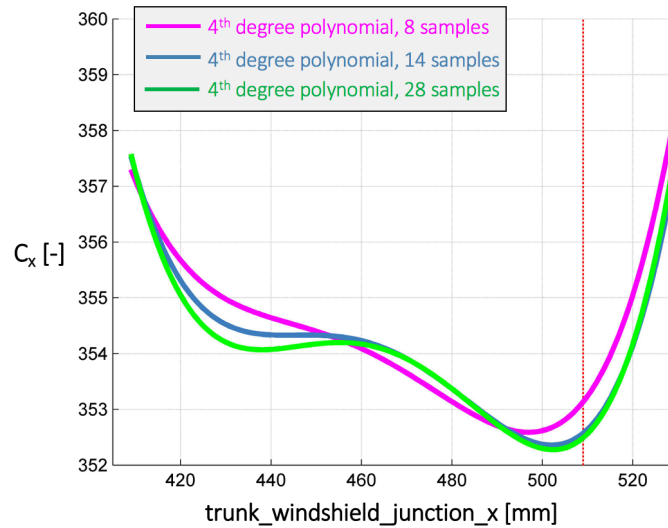

Figure 4-21: Experiment 2, comparison of the 4th degree polynomial fitted model for 8, 14 & 28 samples

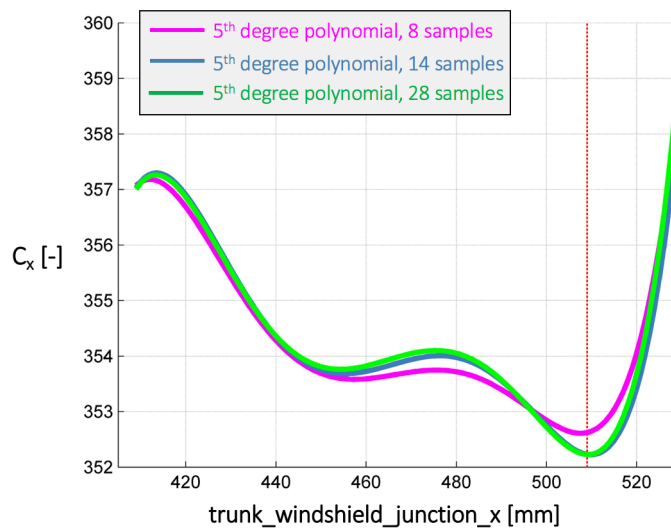

Figure 4-22: Experiment 2, comparison of the 5th degree polynomial fitted model for 8, 14 & 28 samples

It can be said that there are similarities (e.g. convergence of the models), but also differences between what was observed in the results of both experiments. While both 4th and 5th degree polynomial models converged already for a small amount of samples in the first experiment, this was not the case for the second one. Moreover, for the latter there was also a remarkable difference between the 4th and 5th degree models. Those problems seem to be caused by the different characteristics of the data set of both experiments. The main characteristics that seem to be responsible for this are:

- The range of the C_x response for the associated geometric parameter range (about 39 C_x counts for the first and 6 for the second experiment).
- Inexplicable regions with low accuracy of the sample responses

The main reason seems to be the first one, because the inaccuracy of the CFD simulation results in an inconsistency of the sample results that can be expressed as an error in terms of C_x counts. How much this would be is not only dependent on the simulation settings (mesh accuracy, solver settings, etc.) but also on the simulated geometric parameters. This is because it is plausible that for the variation of some parameters,

the flow could become more or more rapidly unstable due to e.g. occurring separation. This dependency could probably be decreased by adapting or increasing the simulation settings.

For a smaller range of C_x response (experiment 1), this simulation error will become larger relatively seen as for a larger range (experiment 2). This causes the difficulties and slower convergence of the surrogate models observed by comparing both experiments.

In the results of both experiments, the presence of inexplicable regions with a lower accuracy was observed. Although they seem to be small in experiment 1 (Figure 4-15 around [-20,-10]), their size is comparable with and probably even larger than the deviations noticed over the whole investigated parameter range in experiment 2 (Figure 4-20). Therefore, it can be said that the main reason for these problems is the size of the range of the C_x response about which the following can be said.

The range of the C_x response has to be sufficiently large compared to the inaccuracy of the sample results due to the CFD simulation. How much larger this should be is dependent on the accuracy of those CFD simulations and could therefore be influenced by increasing the CFD settings and computing power.

Also, the investigated range of the parameter variation could be increased. This does not guarantee a larger range of the C_x response, but could lead to a more global investigation of the aerodynamic behaviour where the difficulties cause by those ‘randomness’ could be damped out.

4.3.3 Experiment 3

This experiment combines the two parameters of the previous two experiments to investigate them together resulting in a surface fitting surrogate model. The two model types that will be applied are a 4th and 5th degree polynomial surface with the same degree in both directions. Because it is difficult to do a similar comparison as in the previous experiments for a surface model in a clear way, this will not be done in such detail as before.

Figure 4-23, which shows the evolution of the RMSE of both surface models, is similar to those of the first two experiments (Figure 4-13 and Figure 4-18). For the 4th order surface, a minimum amount of 17 samples is needed to become a first relevant model. For the other, 24 samples are needed. The resulting surface models are shown in Figure 4-24-Figure 4-31 for 24, 31, 34 and 44 samples. In those figures, the larger range of the C_x response for the trunk variants compared to the windshield variants of respectively the first and second experiment can be distinguished.

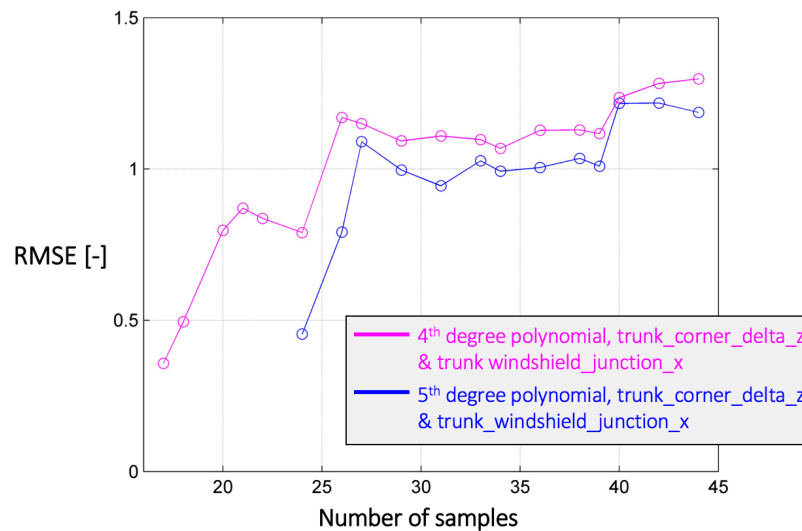

Figure 4-23: Experiment 3, evolution of the RMSE of the fitted model as a function of the number of samples

By looking to the evolution of both 4th and 5th degree polynomial surfaces as a function of their number of samples in Figure 4-24-Figure 4-31, the usefulness of the adaptive modelling can be noticed. Its sample selection in areas of higher uncertainty and error can be seen. Although it is less practical for a surface model to make qualitative conclusions about its convergence, this was observed during this third experiment as it was also for the first two. More samples should have been done during this experiment to achieve a clear convergence. But it can be concluded with the results of this third experiment that higher order investigations by using closed-loop surrogate modelling will need much less samples. This directly results in a decreased use of resources allowing those complex investigations to be actually done. This is a very important advantage compared to the current situation, which will be used later in this chapter and in the next one.

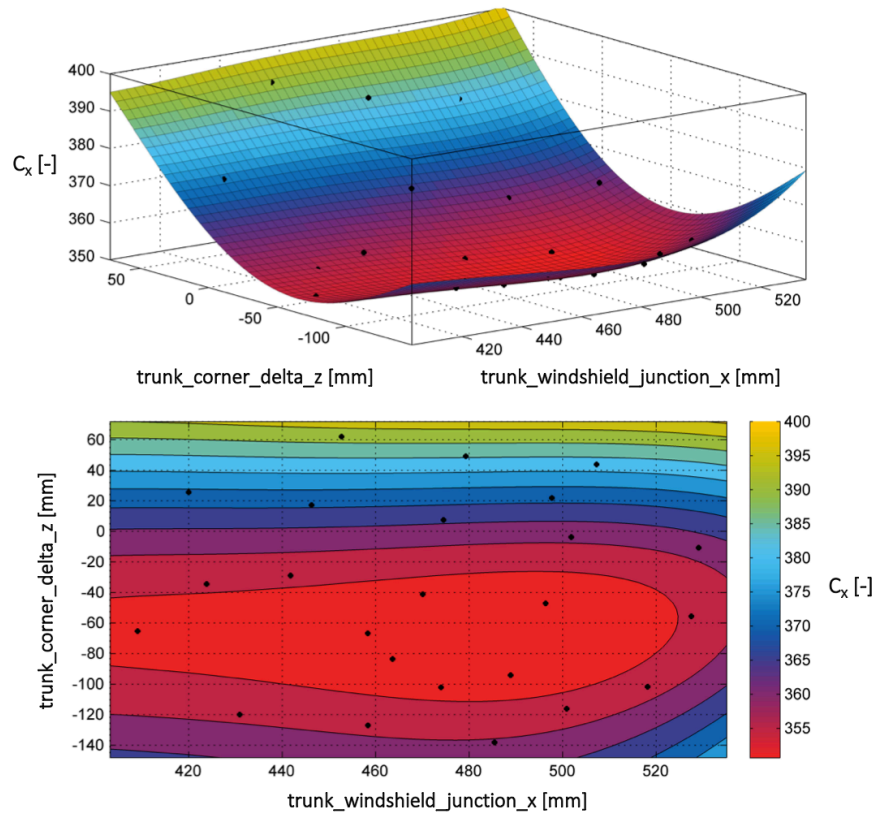

Figure 4-24: Experiment 3, 4th degree polynomial surface for 24 samples

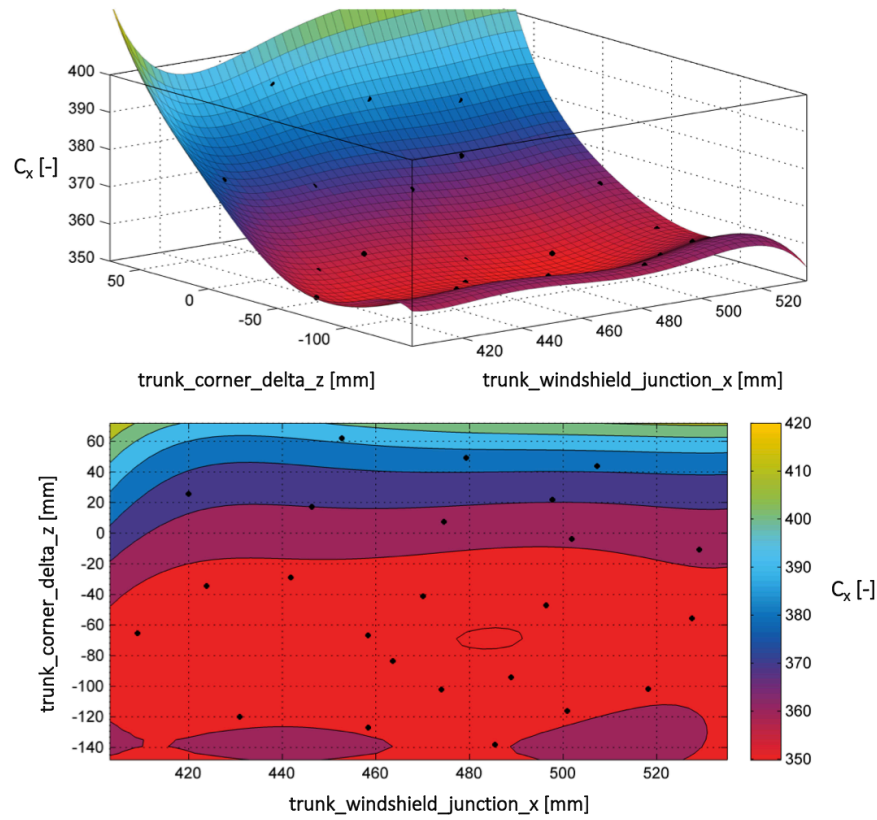

Figure 4-25: Experiment 3, 5th degree polynomial surface for 24 samples

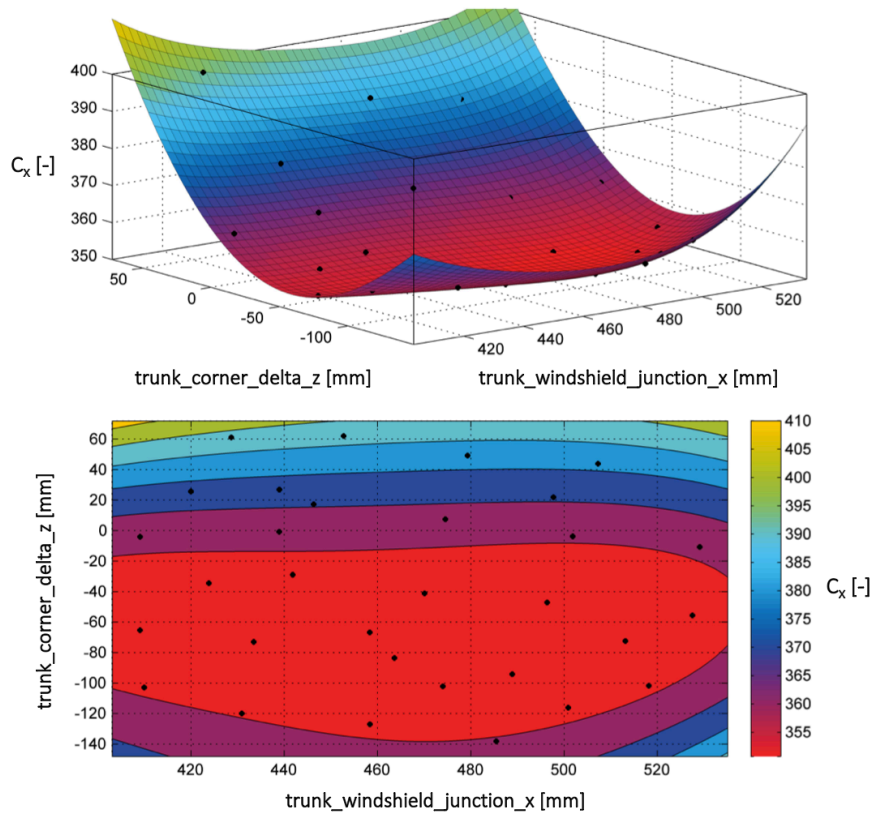

Figure 4-26: Experiment 3, 4th degree polynomial surface for 31 samples

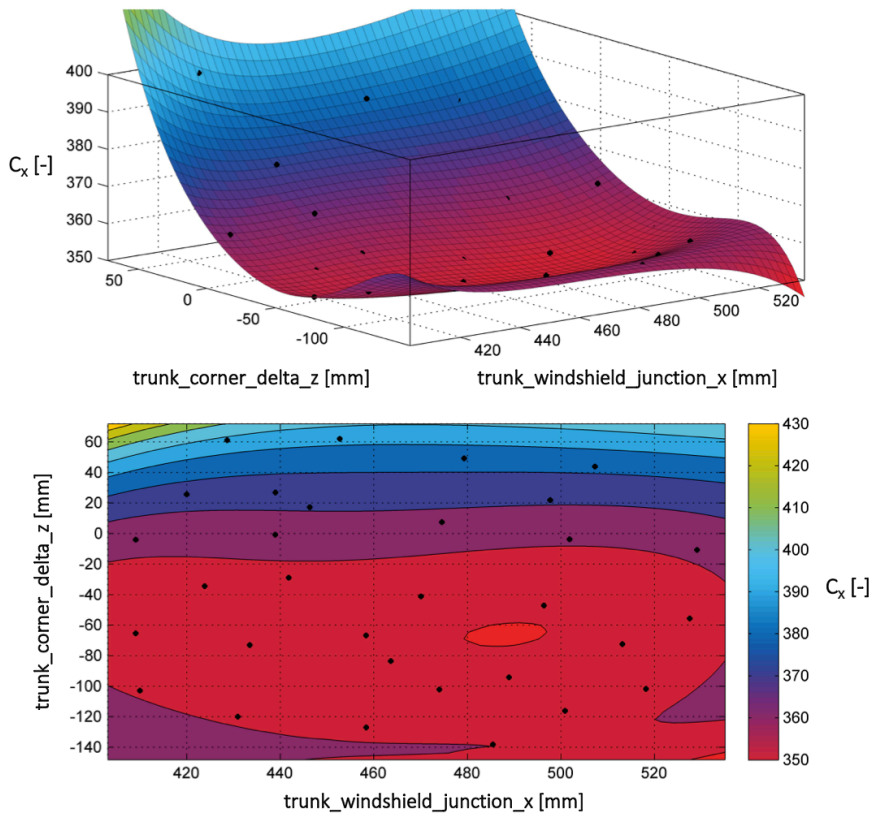

Figure 4-27: Experiment 3, 5th degree polynomial surface for 31 samples

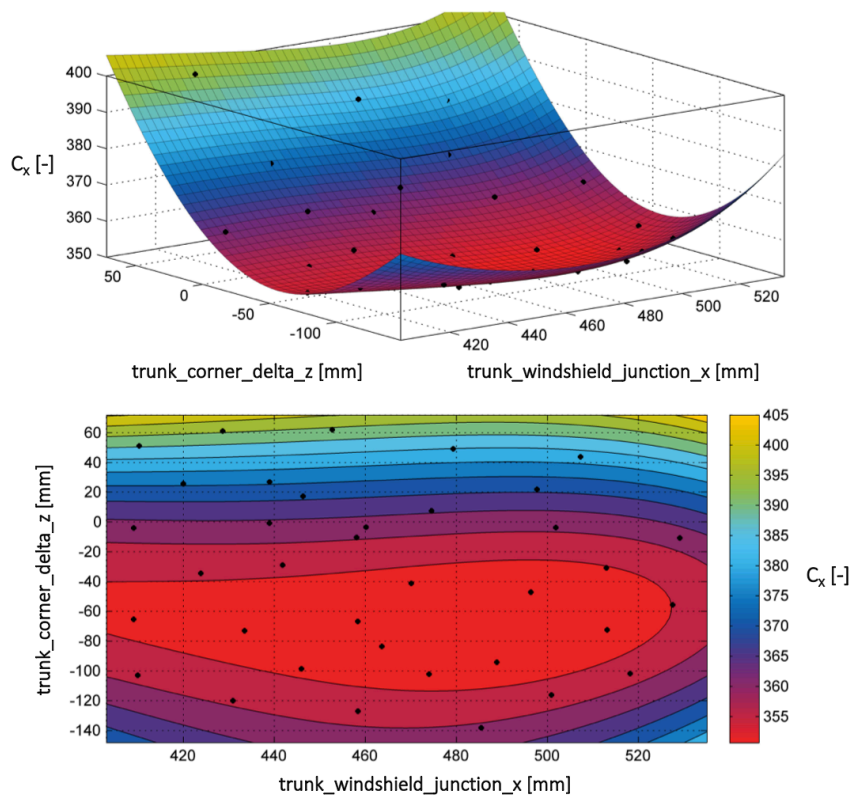

Figure 4-28: Experiment 3, 4th degree polynomial surface for 36 samples

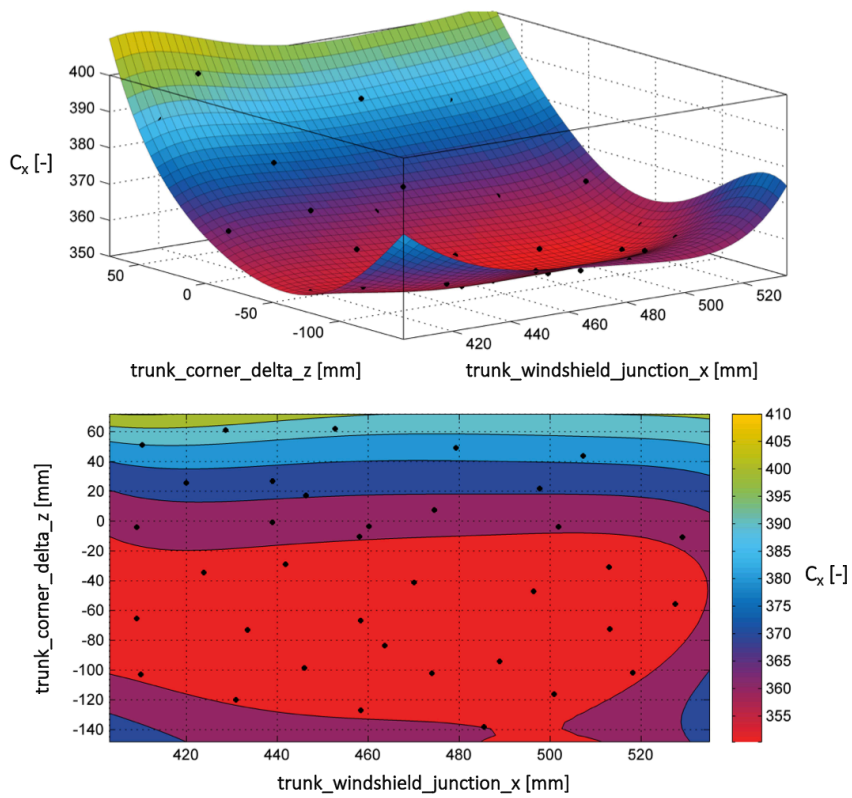

Figure 4-29: Experiment 3, 5th degree polynomial surface for 36 samples

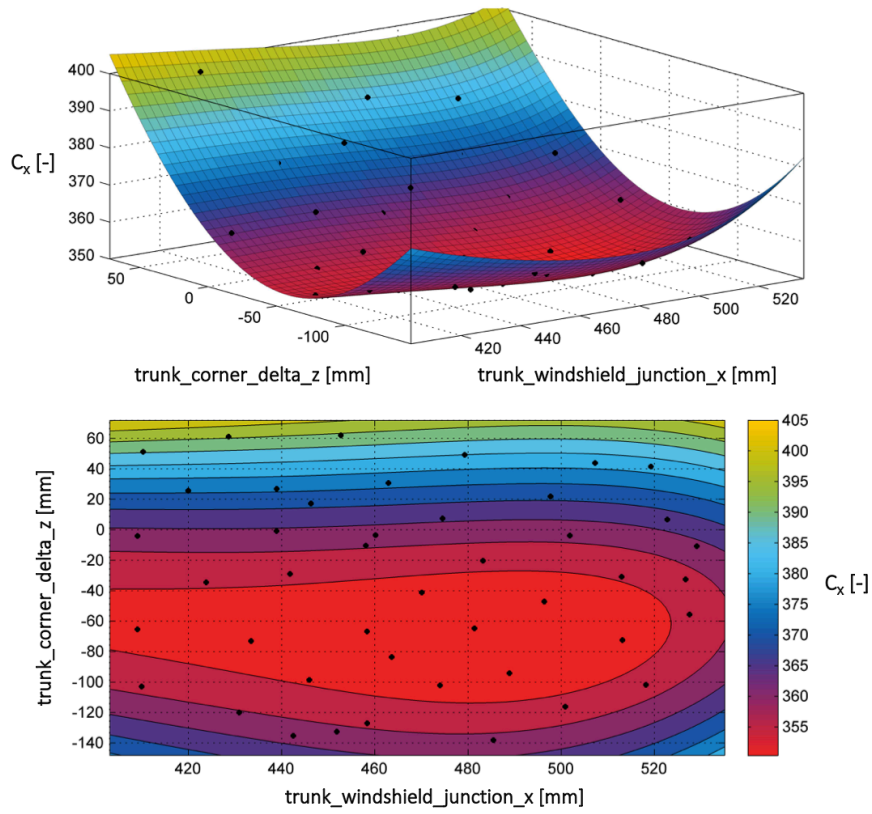

Figure 4-30: Experiment 3, 4th degree polynomial surface for 44 samples

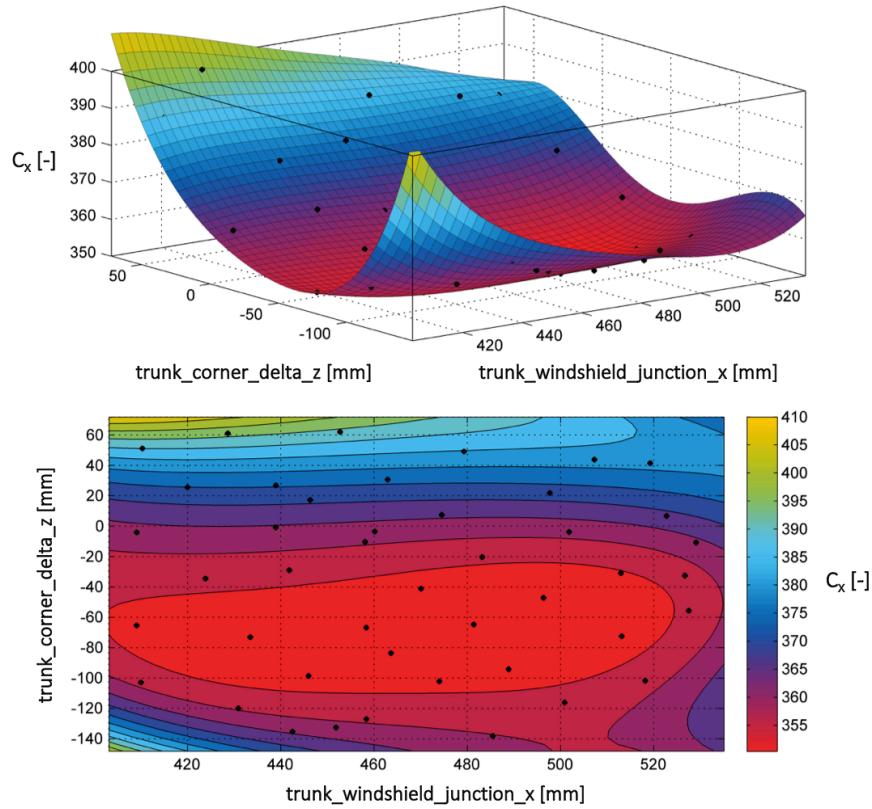

Figure 4-31: Experiment 3, 5th degree polynomial surface for 44 samples

4.4 Discussion of the results

4.4.1 Overview

For clarity, the discussion of the results of the use-case will be divided into multiple parts. First, the influence of the implementation of the geometry generator will be assessed. Also, some things noticed during its development and implementation concerning its influence on the sample results (e.g. accuracy) will be covered. After this, the process flow of the current situation and the methodology presented in this thesis will be compared. In other words, open-loop compared to closed-loop surrogate modelling will be compared based on what was said ‘in theory’ in Chapter 3 and what was observed in this chapter. This section will end with a short summary of the most important conclusions made.

4.4.2 Importance of the new geometry generator

In Chapter 3, it was already said that the development of the automatic geometry generator had two main goals:

1. Decrease the Δt of the process flow in Figure 2-31 decreases, resulting in more DOE’s that can be done in the same amount of time.
2. Closed-loop controlled surrogate modelling could be realised in practice.

The former has led to the elimination of the main bottleneck of the process flow in Figure 2-31, namely the manual geometry generation which was very time-consuming and repetitive work. This work and the extensive time consuming can now be saved due to the parametric approximation model serving as the new geometry and allowing this to automate this geometry generation. Moreover, each geometry variant is created almost instantaneously (less than a second). The only thing that has to be done before, is converting the real car exterior, that has to be approximated, to the parametric model by measuring all the defined parameter values according to Appendix A. This takes less than one hour and in modern CAD-software programs like Catia, this could even be automated by using macro programming.

A distinction has to be made between two consequences of the time saving due to the automated geometry generator. First, more samples and thus DOE’s can be done in the same amount of time and thus during those preliminary studies. Secondly, the engineers which had to do this manual work can now use their time for more qualitative work like interpreting results and formulating more comprehensive and thoughtful conclusions concerning the car exterior design.

The output of the geometry generator has a direct influence on the mesh and therefore also on the results coming out of the CFD simulation in OpenFOAM. More specifically, it was noticed that the quality of the STL-geometry had a significant influence on the convergence and accuracy of the simulation. The tessellation parameters of the geometry model which define the accuracy of the conversion to the STL-geometry had an influence whether the aerodynamic forces (and thus the C_x value) converged or not and also on the accuracy of the resulting C_x value itself. Moreover, those tessellation values were also depending on the meshing accuracy and vice-versa. A balance between both had to be found because a certain accuracy or consistency of the resulting C_x value is essential for the surrogate modelling as was already noticed in the results section. This C_x value consistency can be seen as the relative accuracy of ΔC_x for a Δ input. The absolute accuracy is not relevant, because no simulations are correct, but they are useful in identifying trends and responses. In Table 4-6, an overview of the influence of the STL and mesh accuracy on the

convergence of the simulation results is given. A high, middle and low mesh accuracy corresponds to more than 2×10^6 cells, $1.3-1.4 \times 10^6$ and less than 1×10^6 cells respectively.

STL accuracy	Mesh accuracy	C_x accuracy/consistency	Convergence
High	High	Bad	None
	Middle	Bad	None or oscillating
	Low	Bad	None or oscillating
Middle	High	Bad	None or oscillating
	Middle	Good	Yes and stable
	Low	Bad	Yes or oscillating
Low	High	Bad	Yes or oscillating
	Middle	Bad	Yes or oscillating
	Low	Bad	None or oscillating

Table 4-6: Overview of the influence of the mesh and STL-geometry accuracy on the simulation convergence

The length of the refinement zones behind the car (Figure 4-7-Figure 4-9) were noticed to be critical for the simulation to be convergent or not. Thus a good choice of mesh and STL accuracy is important and can also be confirmed with what was observed in the previous section. There it was said that the range of the C_x response have to be significantly larger than the simulation inconsistency. In order to achieve this, minimising this simulation inconsistency will be beneficial.

Of course, the geometry generator remains an approximation, so automatic morphing of the real car exterior would be one step further and better. Unfortunately, this is not realisable yet. But, the parametric model has proven to be very useful to validate such a closed-loop surrogate modelling process and to be able to estimate the potential of such a methodology. Also, it is very useful to make an estimation of the design space during the preliminary phases because as was shown in Chapter 3, C_x varies with the same trends for the real and approximated car exterior.

4.4.3 Surrogate modelling: open-loop vs. closed-loop

In the previous section, the results of the performed experiments were given and already briefly discussed. Based on this, it can be said that closed-loop surrogate modelling pays off. It was already said in Chapter 3 that with closed-loop surrogate modelling, a controlled and assured accuracy could be achieved for a minimal amount of samples. The results in this chapter confirm this also. It is very important that this is demonstrated because it is a huge improvement compared to the actual situation of open-loop surrogate modelling where the model accuracy (model convergence) cannot be controlled and assured. Moreover, the amount of samples is a more or less well-considered guess and could lead to extensive use of resources on one side (oversampling) or inaccuracy and unreliability of the surrogate model on the other side.

This optimal sampling of the improved process flow leads to a next very important advantage compared to the current situation. Higher dimension surrogate models could be very useful to identify and quantify phenomena due to the cross-influence of specific parameter combinations of the car exterior geometry as was already mentioned in Chapter 2. But it was also already said there that the amount of needed samples to assure a preferred accuracy (oversampling to certainly ‘capture’ the correct behaviour) increases exponentially with the amount of parameters to be investigated together. This combined with the current inefficient process flow led to the avoidance of such higher order investigations. The improved process flow based on the closed-surrogate modelling could reduce the amount of needed samples for this higher order investigations drastically by its adaptive sampling and monitoring of the model convergence for every

sampling step. The reduction of needed samples is of course dependent on the data set characteristics (C_x response range vs. simulation inconsistency), but will increase even more for higher orders. This optimal sampling will assure a certain achieved accuracy and an optimal use of the available resources. This will lead to the potential to actually generate such higher order surrogate models with all their related advantages (more insight in the car exterior design, much more comprehensive design, allowing for well founded shape optimisation and finally improved aerodynamic design thus lower C_x value).

4.4.4 Summary

Combining the findings in this chapter leads to the overview in Figure 4-32.

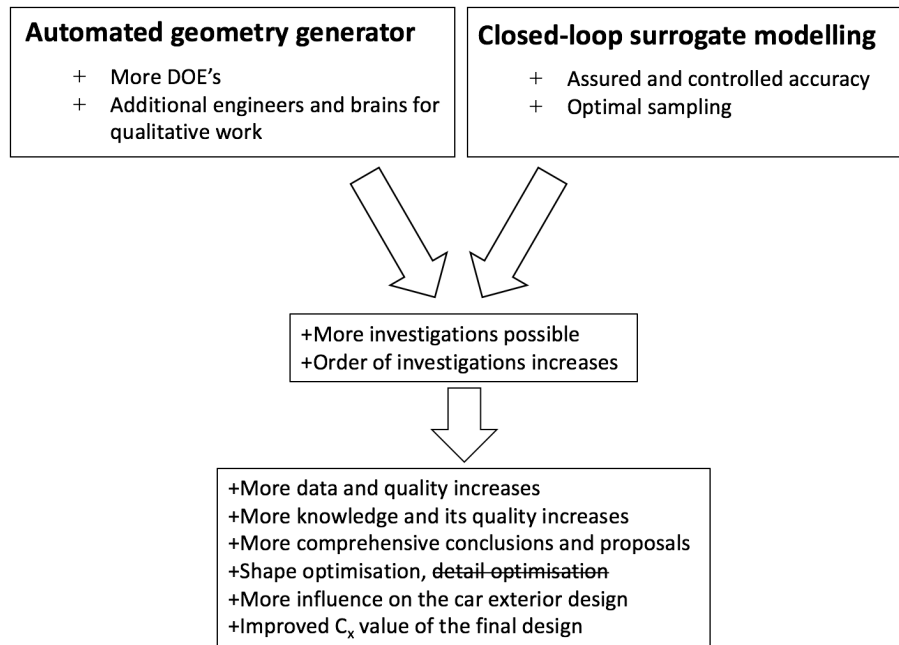

Figure 4-32: Overview of the findings of the discussion of the results

4.5 Generalisation of the suggested methodology

The suggested methodology to solve the problem of the minor role and influence of the aerodynamic department on the car exterior design in terms of C_x value was done specifically for this case. This process of closed-loop surrogate modelling could be generalised to other aspects of the aerodynamic design during the early or even later design phases. Moreover, the power of this methodology also lies in its flexibility to fit in different software environments and even other fields of application. This is realised by its framework, which controls the communication and information flow between the different components. For example, changing the CFD software package or focusing on other geometry types by changing the code of the geometry generator should be theoretically and practically possible. One step further, the topology of this tool can even be seen as a generic tool which can be adapted to everyone's needs. Combining CFD and stress analysis for the development of a specific component in the automotive or aerospace industry could be a possible specific application. Why and how this could be done, will be covered briefly in this section.

4.5.1 Generalisation concept

In Figure 4-33, Figure 3-21 is repeated in which the process flow of a closed-loop surrogate model generator was shown. It can be noticed that only the simulator is dependent on the field of application. Repeating also Figure 3-20 in Figure 3-34 and generalising it first to overall aerodynamic design first and then even more, to other fields of application will be done in the next subsections.

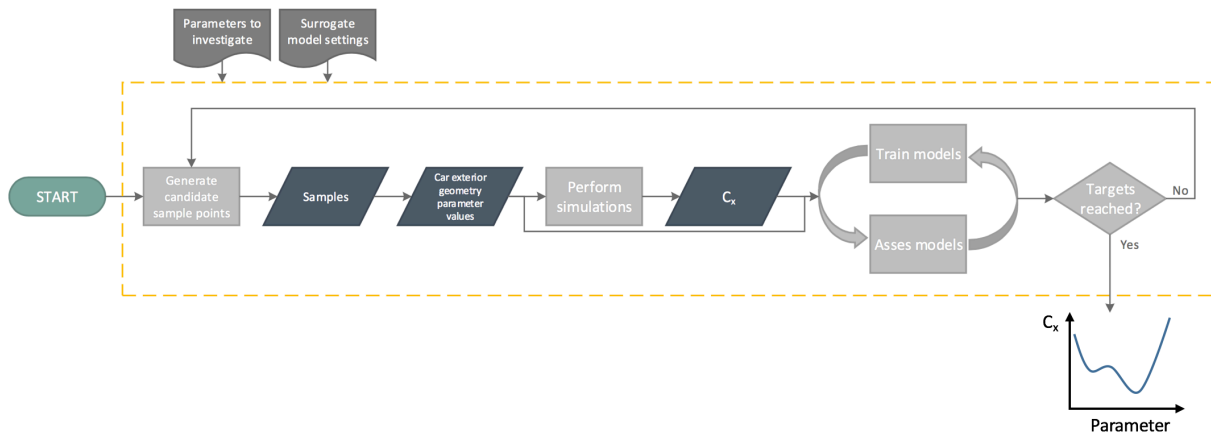

Figure 4-33: Closed-loop surrogate modelling, process flow

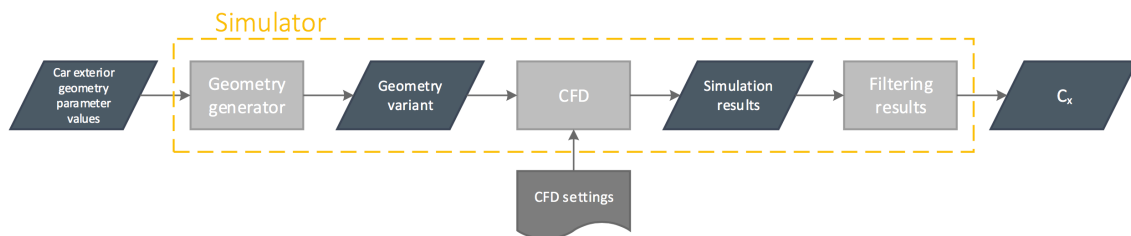

Figure 4-34: Process flow of the simulator specific for the C_x -value design of the car exterior during the preliminary studies

4.5.2 General aerodynamic design

Generalising Figure 4-34 for application of the whole car aerodynamic car exterior design results in Figure 4-35.

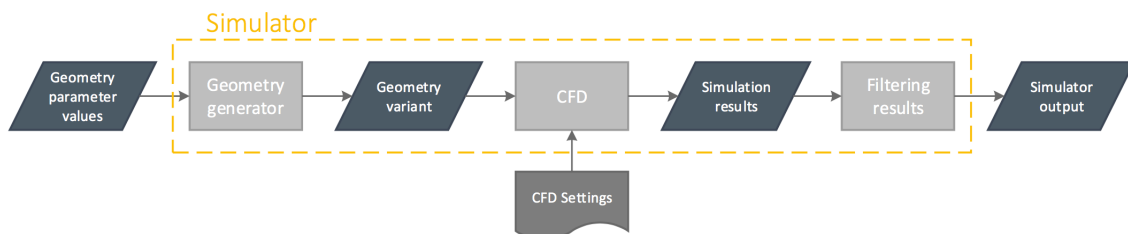

Figure 4-35: General process flow during the aerodynamic design

The advantage to also use this process flow during the preliminary studies of other aerodynamic characteristics of the car exterior (like the lift) are the same as for the design of the C_x value the car exterior listed in this work. Moreover, by using it for different characteristics, they could be combined in the same surrogate model to increase the quality of the aerodynamic design and even more aerodynamic potential hidden in the early phases could be exploited.

The above shown process flow could also be used for other aerodynamic design which is not focused on the car exterior if a suitable automatic geometry generator could be used. In case such a generator does not already exist like in this work, the same concept of a parametric model could be applied for that specific case. This is a huge power lying in this concept of a geometry generator, because also a tool like GDL is able to capture KBE knowledge in this model which could be very useful. As before, the same advantages as in the previous case and in this thesis are valid and also different aspects of the total aerodynamic design (different parts of the car) could be combined and optimised together. This could be done not only for the early aerodynamic design phases, but also for the following detailed design phases.

4.5.3 Other fields of application

Generalising Figure 4-35 even more results in Figure 4-36. Also extending the simulator to a combination of specific simulations could be done for which an example is shown in Figure 4-37. The geometry then has to be able to provide the geometry in the format required for every simulation software. An example could be to combine a CFD and stress simulation of the car body to optimise the car exterior for strength, lightweight and air resistance.

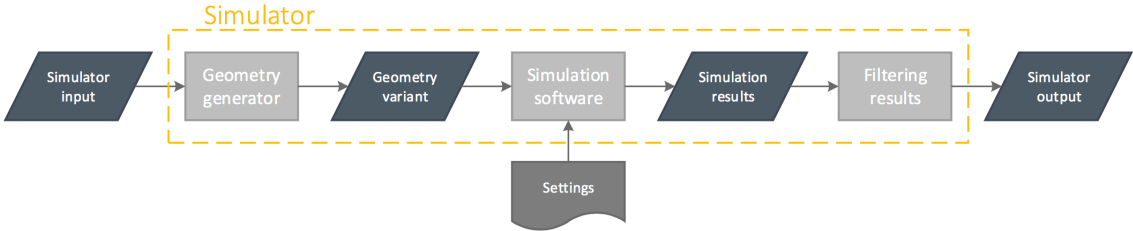

Figure 4-36: General process flow of the simulator

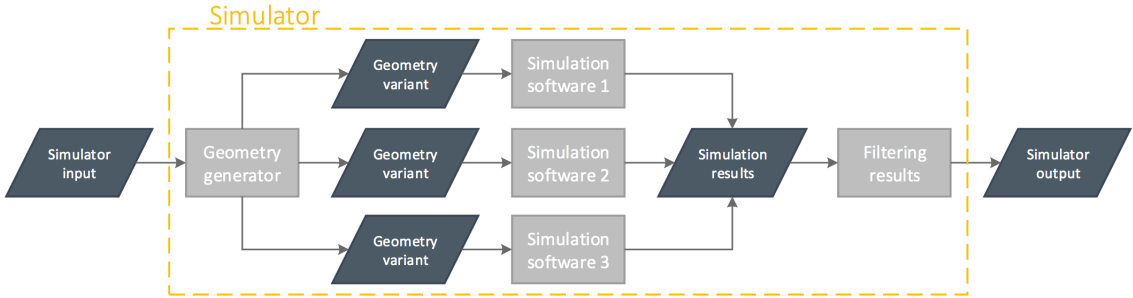

Figure 4-37: General process flow of the simulator extended with multiple simulations combined

Here can also be said that if an automatic geometry generator is not already available, it could be developed specifically to the requirements needed. Again the same advantages are valid. Combining such surrogate modelling of different field of applications with each other could lead to an even more thoughtful complete product design as would be possible before. For example, in the automotive industry, aerodynamic and stress simulations could be combined to design a light but aerodynamic product that fulfils all external legislation etc. It is only a matter of creatively customising the simulator process flow.

4.5.4 Generalisation: conclusion

It is clear from the previous sections that a generalisation of the suggested and worked out solution in this work could be generalised for use in other aerodynamic design processes, even in other phases than the early ones and even other fields of applications. This means the process philosophy hidden in closed-loop

surrogate modelling is very powerful. It is a matter of creatively customising the simulator process flow and geometry generator to the specific needs. This work can be seen as a prove that this is not impossible and could also be used as some sort of guidance or practical successful example.

Chapter 5

Conclusions & Recommendations

5.1 Conclusions

It can be concluded that the main problem which prevents exploiting the aerodynamic potential hidden in the early phases (initial and concept phases) was the minor role and influence of the aerodynamic design compared to the aesthetic design. Both are the main contributors for the car exterior shape, but aesthetics is dominant due their importance for the customer and brand identity. Because of this dominant role, the aesthetics department comes up with a proposal for the car exterior design that will be given to the aerodynamicists which have to investigate it and propose demands for changes to meet requirements on the C_x value that will be reported back to the aesthetics. This was explained in Chapter 2 and the visualisation for this cooperation recurring until the preliminary studies are over, is repeated here in Figure 5-1. It was also concluded there that the current proposals of the aerodynamicists were rather limited to small geometric changes indicating detail optimisation instead of the more favourable shape optimisation. It was concluded that this was due to the current processes and process flow which do not allow for the more extensive investigations of the influence of the car exterior geometry on the C_x value. So in order to be able to change this, the process flow of those preliminary studies should be improved. The role of the aerodynamic design cannot be changed because this is fixed, but its influence on the car exterior design can be increased.

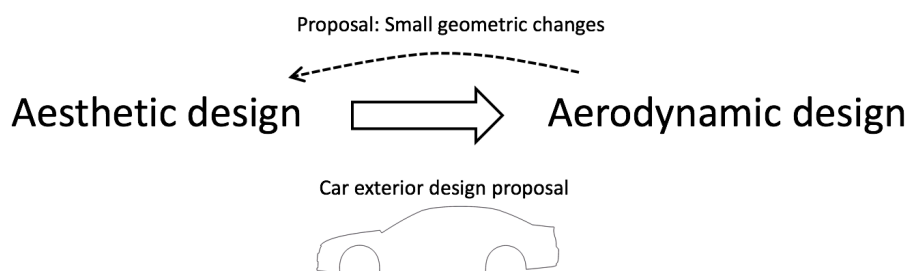

Figure 5-1: Current interaction of aerodynamics and aesthetics during the preliminary phases for the car exterior design

The main problem during these preliminary studies was found to be their inefficient and time-consuming process flow. This is mainly due to the time-consuming and repetitive manual work to create the geometry variants needed for the simulation and investigation of the C_x response due to the geometry variations as described in Chapter 2. Also, the process to convert the gathered data into knowledge was found to have a low accuracy, time-efficiency and inefficient use of resources, resulting in low and non-controllable quality of the surrogate models and thus a low value of the performed investigations leading to a very limited acquired knowledge. The suggested solution for this was to change the open-loop surrogate modelling to closed-loop. To be able to do this, an automatic generation of geometries had to be found first. Due to its

unavailability in the automotive industry, it was decided to approximate the car exterior of the corresponding car model with a parametric geometry model, which could be generated automatically. This model had to be controllable enough, but at the same time also realistic enough because otherwise it had no value. This was realised and the closed-loop surrogate modelling methodology was developed and worked out in Chapter 3.

The reality-based use-case, which was defined in Chapter 4, was done in order to estimate the potential improvement such a suggested methodology could accomplish compared to the current situation. The obtained results with this use-case are promising. The proclaimed improvements of such a methodology based on closed-loop surrogate modelling compared to the current situation formulated in Chapter 3, were confirmed to be also valid in praxis. The suggested and developed methodology has two main difference compared to the current situation:

- Closed-loop versus open-loop surrogate modelling currently
- Automated geometry generator versus manual geometry generation

The (dis)advantages of both the closed-loop surrogate modelling and the automated geometry generator that could be derived from this work, are:

Closed-loop surrogate modelling

- + Optimal sampling
- + Accuracy of the surrogate model can be assured and controlled
- + Allows for surrogate model with higher dimensions

- The current process flow in the industry has to be changed. Most large companies are very static and therefore rather unwilling to do this. So this is a challenge.

Automatic geometry generator

- + Realisation of closed-loop surrogate modelling
- + Eliminating the time-consuming, repetitive and manual geometry generation. At of the sample evaluation process flow is reduced to only the simulation time. Resources and engineers are released

- Remains an approximation of the car exterior

The reduction of the needed time to evaluate one sample directly results in a higher amount of samples that can be done in the same amount of time. The optimal sampling (controlled by the convergence of the surrogate model as discussed in Chapter 4) guarantees an efficient use of the simulation resources. So less samples are needed, reducing the total amount of needed resources. Moreover, each sample evaluation consumes less resources. In other words, more can be done with less resources.

The resources saved due to the elimination of the manual work is the time of the engineers that had to do this work before. Their competences can now be exploited for what they are intended for, namely qualitative instead of quantitative work. They now can be used to analyse the obtained investigations results (surrogate models) and draw conclusions to be processed to the proposals of Figure 5-1. This will increase the quality of those proposals and this additional manpower will also be needed in order to be able to process the increased amount of investigation results due to this improved situation.

The resources saved by the decreased amount of required samples is freed up computing time which can be directly used to perform additional samples. Removing the manual geometry generation step also makes those sample evaluations independent of manual interaction. This results in a more efficient use of those computing resources by avoiding periods where there are only sample evaluations waiting for this manual interaction.

This optimal sampling is controlled by the surrogate modelling convergence resulting in a minimum amount of needed samples to achieve the desired accuracy. In the current situation, this accuracy was unknown because only the resulting surrogate model of the initial sampling was available. Therefore, no information about model convergence is available. In the case of optimal sampling, the needed amount of samples is thus dependent on the accuracy and this convergence. This will lead to the avoidance of under sampling (leading to an incorrect approximation of the aerodynamic C_x response) and oversampling (leading to a waste of resources, but the accuracy is achieved). This accuracy is essential because without it being assured, the subsequent analyses and conclusions are based on unreliable information. This could lead to wrong design proposals or decision resulting in possible unexpected and unwanted surprises or and in the worst case a final design that do not comply with its targets like e.g. a C_x value that is too high. This is confirmed by the difference between the first two experiments done in Chapter 4. If in the current situation, the sample amount would be chosen to be 12, this would lead to oversampling and under sampling in respectively the first and second experiment. Which situation is applicable is unknown before the investigation. Therefore, to avoid such situations, optimal sampling has proven its usefulness.

In general, it can be said that all the discussed advantages lead to the following main improvements of the current situation:

- More sample evaluations can be done in the same amount of time
- Less samples are needed for each investigation or surrogate modelling of which its accuracy can be assured.

Both improvements are not directly convertible to an increased knowledge about the car exterior design. Also, this improvements have to be converted into better and more comprehensive proposals to be fed back to the aesthetic design (Figure 5-1) in order to increase the influence of the aerodynamics on the car exterior design. Thinking further and having the results of the use-case of Chapter 4 in mind, leads to a conversion of the above listed improvements. Having the possibility to do more sample evaluations in the same amount of time and needing less samples for each investigation leads to the ability to do:

- Investigations over a larger parameter range
- Higher order investigations, meaning increasing the amount of parameters that can be investigated at the same time

It was already said that shape optimisation of the basic shape requires more complex and extensive investigations of the car exterior geometry on the C_x value. Investigations over a larger parameter range and/or with a higher order comply with those higher demands and could realise shape optimisation.

The advantage of such an increased parameter range that can be investigated is shown in Figure 5-2 for a single parameter. A so called global minimum of the C_x value can be found instead of the local minimum that was considered as the lowest possible value before. This situation can also be generalised for multiple parameters.

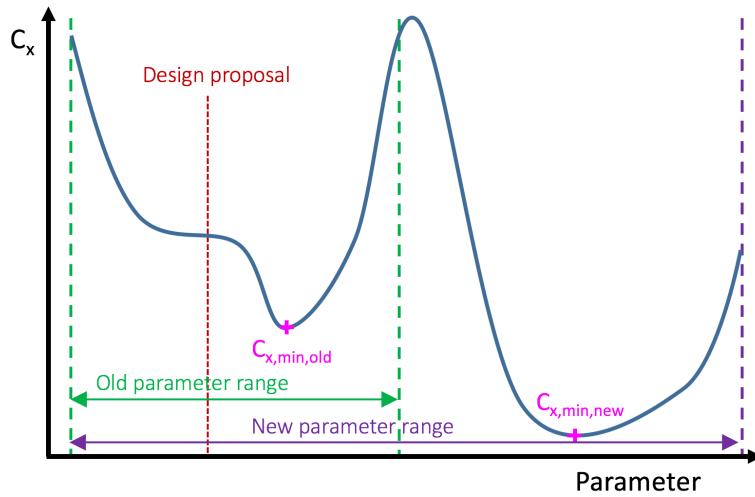

Figure 5-2: Usefulness of investigations with an increased parameter range

Higher order investigations have the advantage to include the influence of multiple geometry parameters on the C_x value at the same time. Currently, the results of multiple investigations of a single parameter are combined into one (Figure 5-3). The combination of independently investigated parameters to draw conclusions about their communal influence or C_x could be useful for e.g. a first estimation. Compared to this, higher order investigations have the advantage to be able to capture phenomena due to some sort of cross-influence between those parameters. A method as in Figure 5-3 is not able to do this resulting in the missing out of information. Such higher order investigations as shown in Figure 5-4 will therefore lead to a better of understanding of the influence of the car exterior geometry on its C_x value. This will result in more comprehensive proposals (compared to Figure 5-1) and a larger influence of the aerodynamics on the final car exterior leading to a more comprehensive design from an aerodynamic point of view.

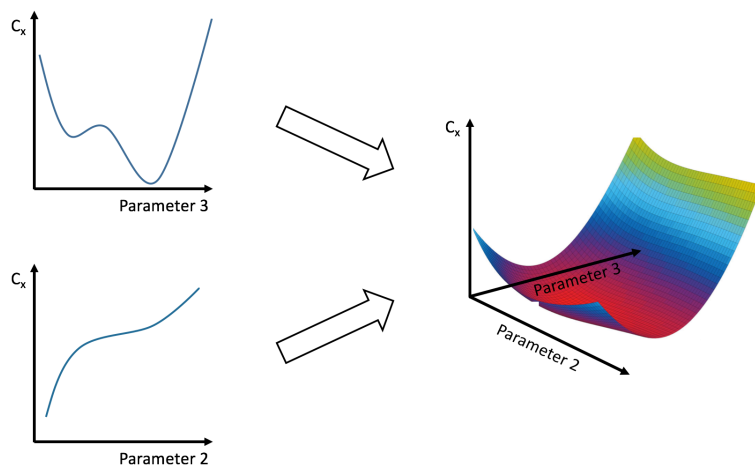

Figure 5-3: Combining the resulting surrogate model of independently investigated parameters

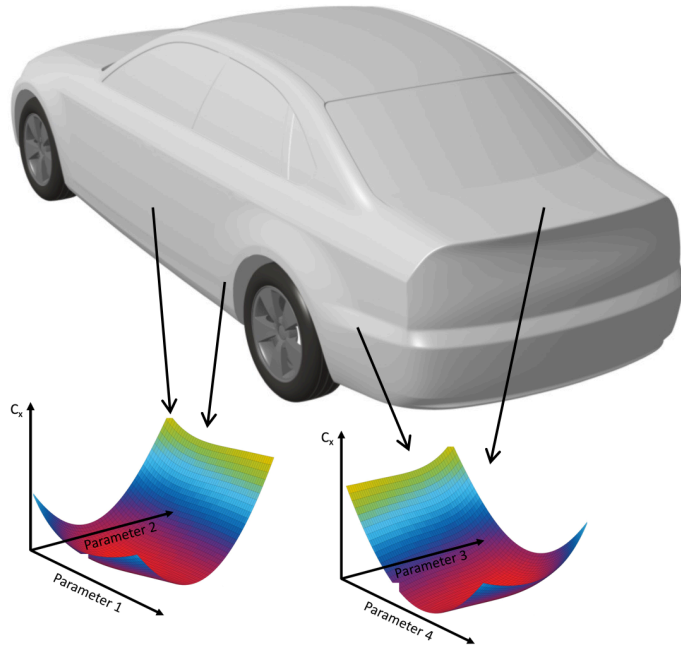

Figure 5-4: Higher order investigations of the car exterior geometry

As a final conclusion, it can be said that the closed-loop surrogate modelling has a high potential and could solve the existing problem of minor influence of the aerodynamics compared to the aesthetics. Instead of proposing minor car exterior changes to reach the C_x target, the aerodynamic department could propose complete car exterior proportions of the whole car or components, like the back of the car as in Figure 5-5. Based on the gathered surrogate models, multiple car exteriors with different proportions but the same C_x value could be proposed. This would lead to an evolution of Figure 5-1 to Figure 5-5. It has been mentioned that the sequence of the proposals remains unchanged, namely aesthetics having the dominant role and first and last word, but the influence of the aerodynamics is increased. If the situation as shown in Figure 5-5 could be realised, the potential of the aerodynamic design (as said before to be 70%) during the preliminary phases could be finally exploited resulting in lower C_x values and fuel efficiency, which will be very important in the future.

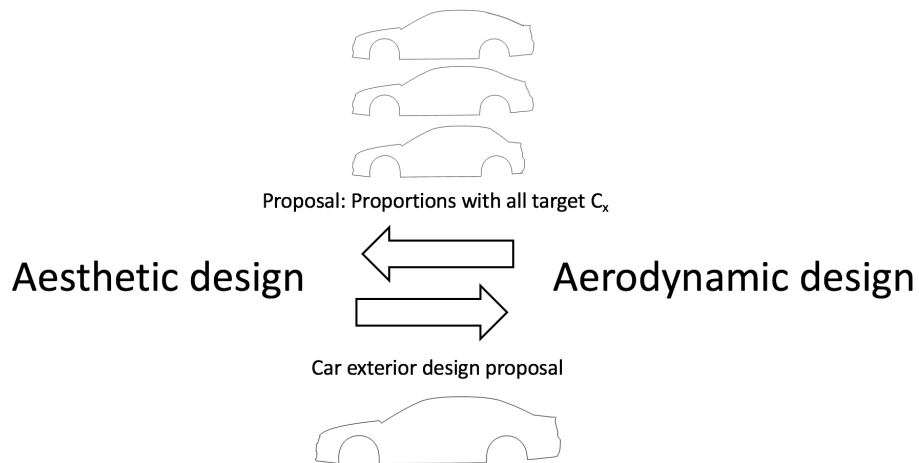

Figure 5-5: Target interaction of aerodynamics and aesthetics during the preliminary phases for the car exterior design

5.2 Recommendations for future work

5.2.1 Geometry generator

An alternative for the actual geometry generator could be to create the geometry variants directly on the mesh. Currently, every geometry variant is meshed from scratch before the CFD simulation is started. If the mesh of the previous variants could be reused and adapted based on its geometric difference compared to its predecessor, the time needed for the meshing could be drastically reduced. Also the time needed to generate the STL-geometry could be saved, but this can be neglected compared to the meshing time. Such a method would be more appropriate for the current situation because the geometric variation between two successive variants will be smaller as it would be in case of adaptive sampling. In the former case, the samples are mainly equally divided over the investigated parameter range and will also be simulated in regular sequence of increasing or decreasing parameter value. In this way, the changes of the mesh will remain rather small and predictable such that such a method should be useful and could drastically reduce the meshing time. In case of adaptive sampling, the difference between successive geometry variants can be much larger. Moreover, the size of the parameter range can be much larger as it is for the current situation (as was mentioned in the previous conclusions) leading to even larger possible variations of the geometry and mesh. Therefore, the time that could be saved by reusing the mesh is less in case of adaptive sampling. A possible solution for this would be to use a hybrid method which could reuse the mesh in case of a small geometry variation and mesh from scratch in case of the opposite. In this way, meshing time could be saved in case of adaptive sampling.

To use the geometry generator for a new car model, it first has to be set up by measuring the corresponding parameter values on this reference model. This could be done automatically with the help of a regular CAD software by using macro programming. Another method would be to do an automatic optimisation of those parameter values based on the difference of the geometry of the parametric and reference model. This difference could be measured using the absolute or relative error or the RMSE at specific discretised places on the geometry.

Although it is an approximation, the choice to make such a parametric geometry model serving as the needed geometry generator has an advantage for the relevance of this thesis. Namely, it is shown that such a parametric model could be developed to specific needs. Thinking of a parametric spoiler or wing used for the detailed design in motorsport. Also applications in other fields than automotive aerodynamics can be thought of. In general, such an approximating parametric model could be used to estimate the design space in order to more strategically perform more time-intensive simulations resulting in a more efficient use of the resources. This is only appropriate if the geometry generation could not be done automatically yet.

It would be beneficial to have an automated geometry generator which is able to morph the real car exterior geometry in a controllable, reproducible and reliable way. Although the parametric model can be made accurate, it remains an approximation of the real car model exterior. Also, the development of a parametric model would be saved in case such a real geometry generator would be already available, decreasing the time needed to practically implement the methodology developed in this work. This is something which will probably be possible in the near future, but for the moment, the actual CAD software packages are not yet mature enough for this.

In the actual geometry generator, the underbody is flat and has no details. This was not included because it is not relevant for the scope of this work that was focused on the development of such a methodology and

to estimate its potential. For implementation in the industry, these underbody details should be certainly included because they have an influence on the flow that cannot be neglected.

Including the dimensions and positioning of the rotating wheels in the geometry generator could be useful. In this way, their influence and that of the wheel base length and both track widths can also be used as a variable that can be investigated. Also a more realistic contact patch of the tire could be useful.

The actual geometry generator has a fixed topology as defined in Figure 3-29 and Figure 3-30. In this way, innovating new design concepts with a different topology cannot be generated. This could be implemented by providing a flexible topology in the parametric model for which a KBE (Knowledge Based Engineering) platform is needed. This is integrated in the used GDL-software in which the geometry generator was developed. The same concept of flexible topology is needed to be implemented in order to generate the car exterior geometry of a station wagon or fastback.

5.2.2 Overall methodology

Instead of investigating the C_x response due to variations of the car exterior geometry, the geometric parameters values corresponding to a specific (target C_x) or minimal possible value of C_x could be looked for. Such an optimisation could be done for the whole car exterior at once, some specific area or just one parameter. This could lead to even more drastic proportions corresponding to a specific value of C_x as would be found with the suggested methodology. Due to its possible out-of-the-box results, such investigations could result in new insights which will only be beneficial for a final comprehensive aerodynamic design.

Robustness is very important and because the whole surrogate modelling process is dependent on the simulation results, the success and realisation potential of such a methodology is dependent on the accuracy and the consistency of those results. This consistency is a problem for aerodynamic simulations as was also noticed in this work. This could be improved by more accurate meshing and solving requiring higher computing power. By extension, for realisation in the (automotive) industry, every component has to be designed or set by an expert and conform to the internal rules and protocols of the company (e.g. CFD setup, surrogate model accuracy, model types and assessment settings). This is essential to get the maximum out of it. Also, it would be beneficial to provide multiple types of setting levels so that the preferred one for a specific situation could be chosen. For a global estimation of the design space for example, a lower CFD and surrogate model accuracy could be chosen to get results rapidly. For a detailed and focused investigation, a higher accuracy would be preferred to get the desired detailed results.

In this work, the simulations were done on one machine so that the needed time is the sum of all of them. It would be a step forward to perform them in parallel on a cluster. This would make this concept more attractable because in the industry they want direct results without a long waiting time. Mostly, large companies have already the required computing resources and infrastructure to achieve this.

In general, large companies are very static due to their embedded vertical hierarchy. Although they could admit that such an improved structure would be beneficial, it is not uncommon that they would be rather unwilling to also effectively implement this. This is probably because of their static character and also because spending money without direct results is not typical for them. They would prefer a ready made methodology that could be implemented relatively and that does not show bugs. To achieve this, further research and work has to be done first for which this work could be an initial step or guidance.

A database could be built consisting of all the gathered data, surrogate models and knowledge. In this way, correlations between different car exterior parameters of the same car model, but even between different

car models could be made. This would lead to so called 'experience' values which could be instantly used for new designs resulting in an even more comprehensive and efficient aerodynamic design.

In Chapter 4, it was also said and explained briefly that this developed method could be generalised to the design of other aerodynamic aspects, even during the detailed design phases and to other fields of applications. If this could be realised in praxis, the whole car design could be more comprehensive. This is also valid for other products. But before this could be achieved, still a lot of work and research has to be done focused on whether this would also be possible in praxis and how. This work could already be an initial step or guidance to start.

References

- Anderson Jr., J. D. (2007). *Fundamentals of Aerodynamics (International edition)* (4th ed.). New York: McGraw-Hill.
- Genta, G., & Morello, L. (2009). *The Automotive Chassis; Volume 2: System Design* (1st ed.). Dordrecht: Springer Netherlands.
- Genworks International. (2015). *Genworks International Documentation*. Retrieved from Genworks Homepage: <http://genworks.com/sessions/25eda522c78/index.html>
- Gorissen, D., Crombecq, K., Couckuyt, I., Dhaene, T., & Demeester, P. (2010, July). A Surrogate Modeling and Adaptive Sampling Toolbox for Computer Based Design. *Journal of Machine Learning Research, 11*, 2051-2055.
- Heft, A. I., Indinger, T., & Adams, N. A. (2012, April 16). Introduction of a New Realistic Generic Car Model for Aerodynamic Investigations. *SAE 2012 World Congress & Exhibition* (p. 14). Detroit, Michigan, USA: SAE International.
- Hirz, M., Stadler, S., Prenner, M., & Mayr, J. (2012). Proceedings of the FISITA 2012 World Automotive Congress, Volume 7: Vehicle Design and Testing. In F. SAE-China, & SAE-China & FISITA (Ed.). (pp. 787-799). Beijing: Springer.
- Hucho, W.-H. (1993). Aerodynamics of road vehicles. *Annual Reviews Fluid Mechanics*, 485-537.
- Hucho, W.-H. (2008). *Aerodynamik des Automobils* (5th ed.). Wiesbaden: Vieweg+Teubner | GWV Fachverlage GmbH.
- Jehle-Graf, E. (2011). *Digital Car Aerodynamics at Mercedes-Benz with STAR -Features and Highlights-*. Retrieved 12 11, 2013, from <http://www.daimler.com>: http://www.daimler.com/Projects/c2c/channel/files/353051_02_C400_14_A_Aerodynamk.pdf
- Kenichi, A., Akio, T., & Saito, I. (2010). Automotive Aerodynamic Design Exploration Employing New Optimization Methodology Based on CFD. *SAE 2010 World Congress & Exhibition* (p. 9). Detroit, Michigan, USA: SAE International.
- Liebl, J., Kerschbaum, H., & Pfannkuchen, E. (2008, April). Die Aerodynamik des neuen BMW X5. *ATZ*, pp. 302-311.
- OpenFOAM Foundation. (2015). *OpenFOAM Documents*. Retrieved from OpenFOAM Homepage: <http://www.openfoam.org/docs/>
- Schütz, T. (2013). *Hucho - Aerodynamik des Automobils (ATZ-MTZ-Fachbuch)* (6th ed.). Wiesbaden: Springer Vieweg.
- Stone, R., & Ball, J. K. (2004). Vehicle Aerodynamics. In *Automotive Engineering Fundamentals* (pp. 435-472). Warrendale, Pa.: SAE International.
- Surrogate Modeling Lab. (2015). *SURrogate MOdelling*. Retrieved from SUMO Lab: <http://www.sumo.intec.ugent.be>

White, F. (2005). *Viscous Fluid Flow (International Edition)* (3th ed.). New York: McGraw-Hill.

Wilcox, D. C. (2006). *Turbulence modeling for CFD*. La Canada, California: DCW Industries, Inc.

Wurzel, F. (2008). Die Rolle der Strakentwicklung im Fahrzeugentstehungsprozess. *Karosseriebautage Hamburg 2008* (pp. 235-245). Wiesbaden: Vieweg+Teubner.

A Blueprints final parametric model

In the following figures, the parameters of the final version of the parametric model of the developed geometry generator are shown. It has to be said that for clarity, not all parameters are included. Those missing are the tension and tangent parameters of each point indicated and named in green. The sign convention of the tangents is always based on the right-hand rule corresponding to the indicated reference frame. Their naming is self explanatory and is clearly structured in the files which can be found on the CD-ROM for archival of this work.

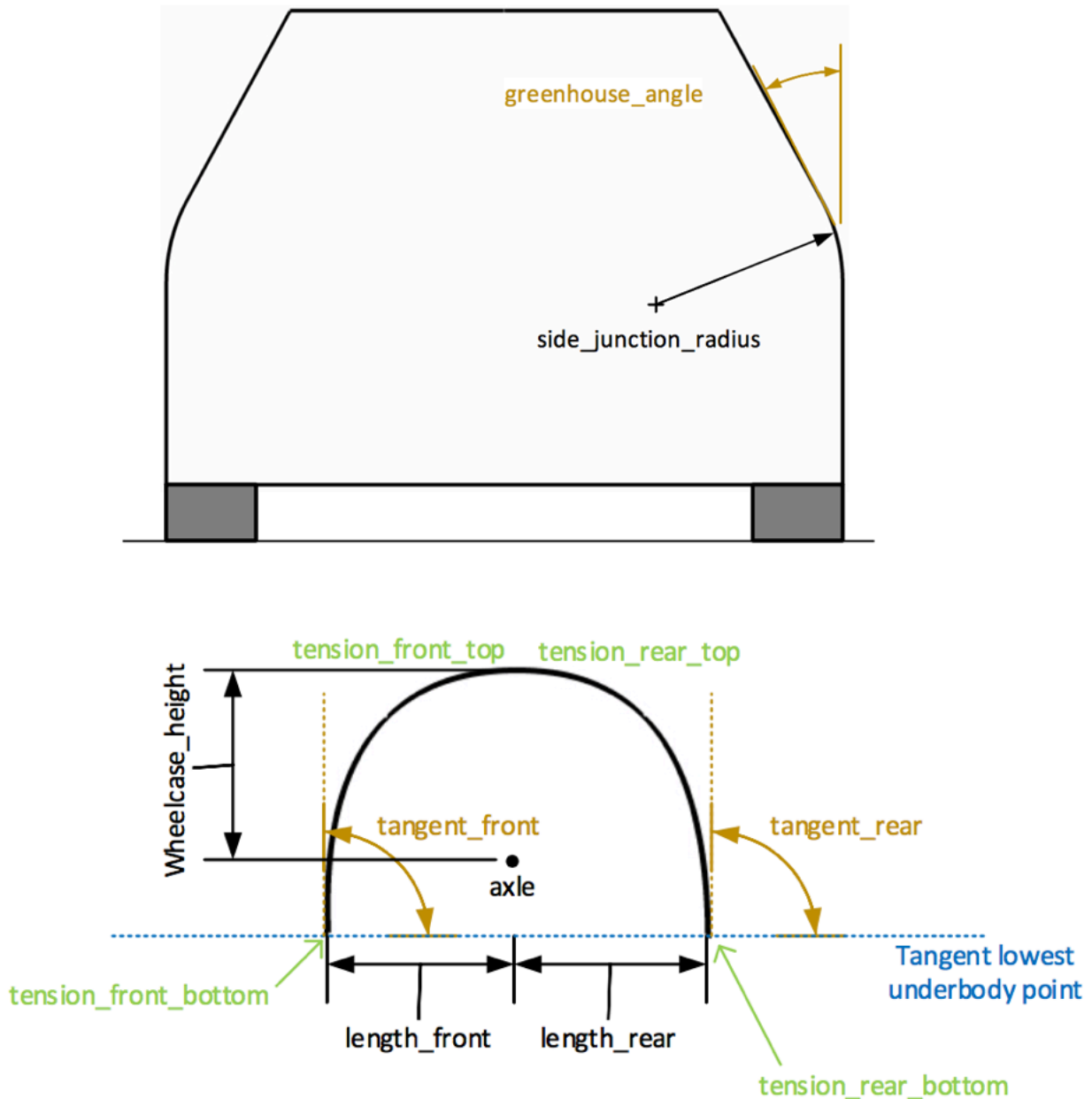

Figure A-1: Parameter definitions, front view and wheel case parameters

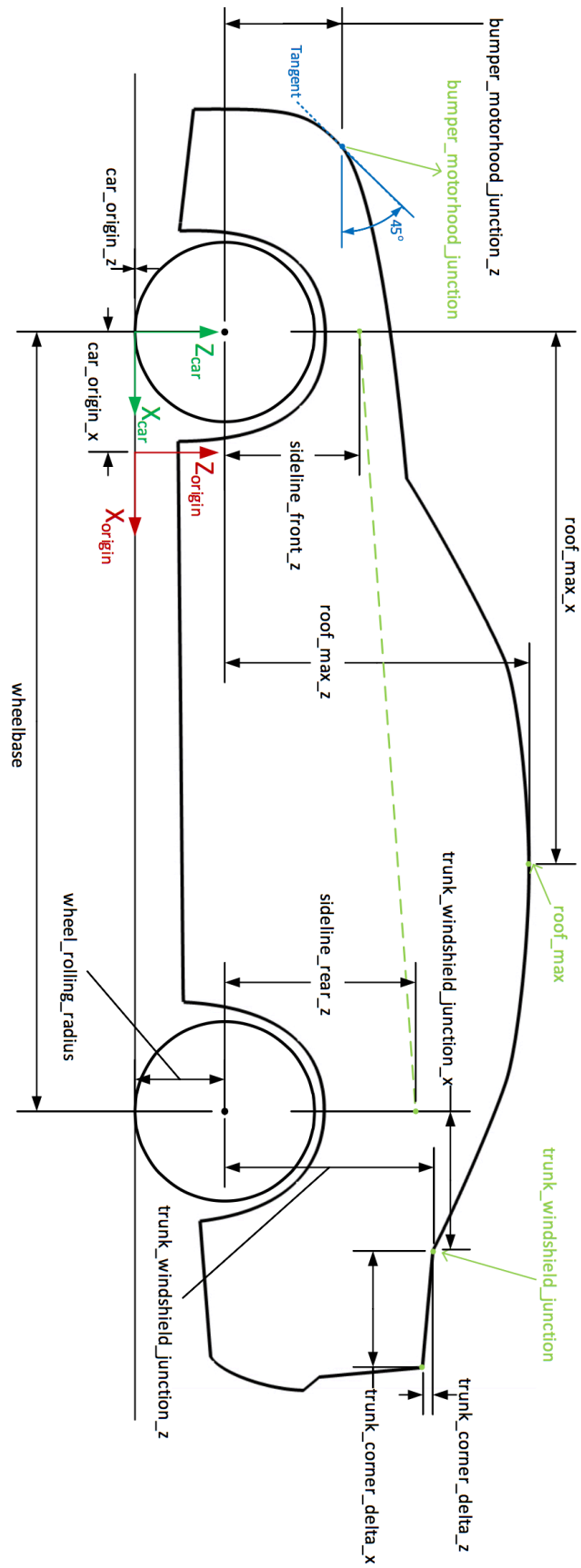

Figure A-2: Parameter definitions, left view 1

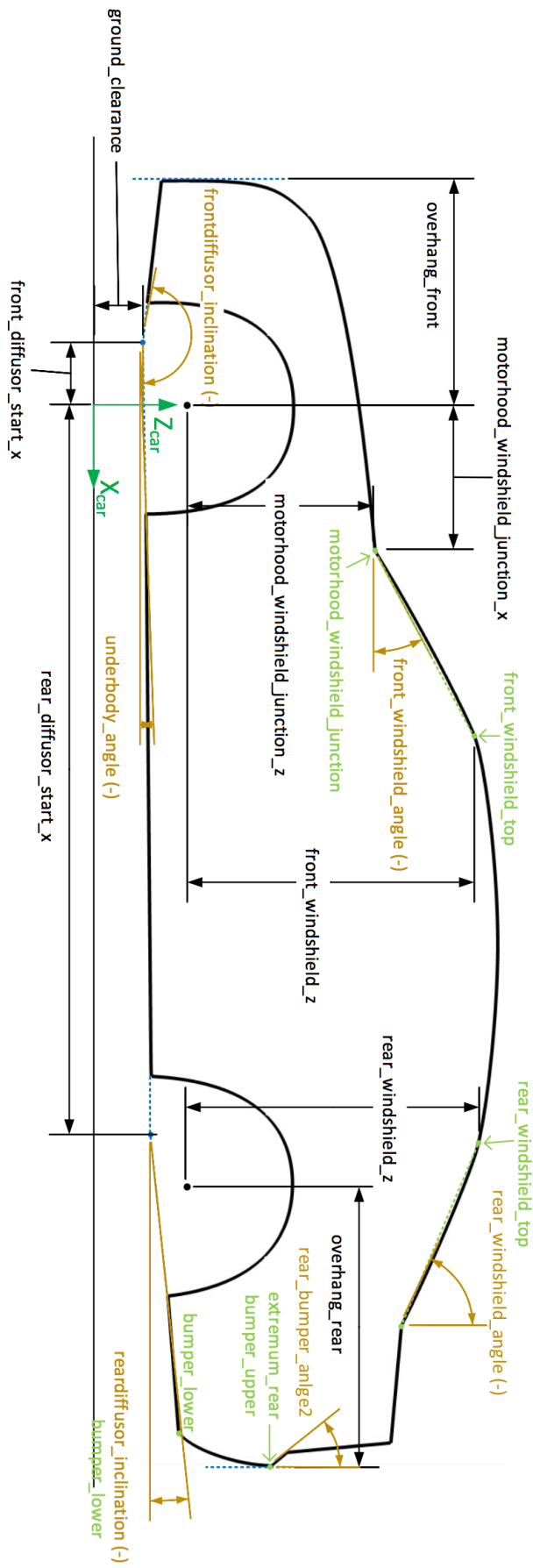

Figure A-3: Parameter definitions, left view 2

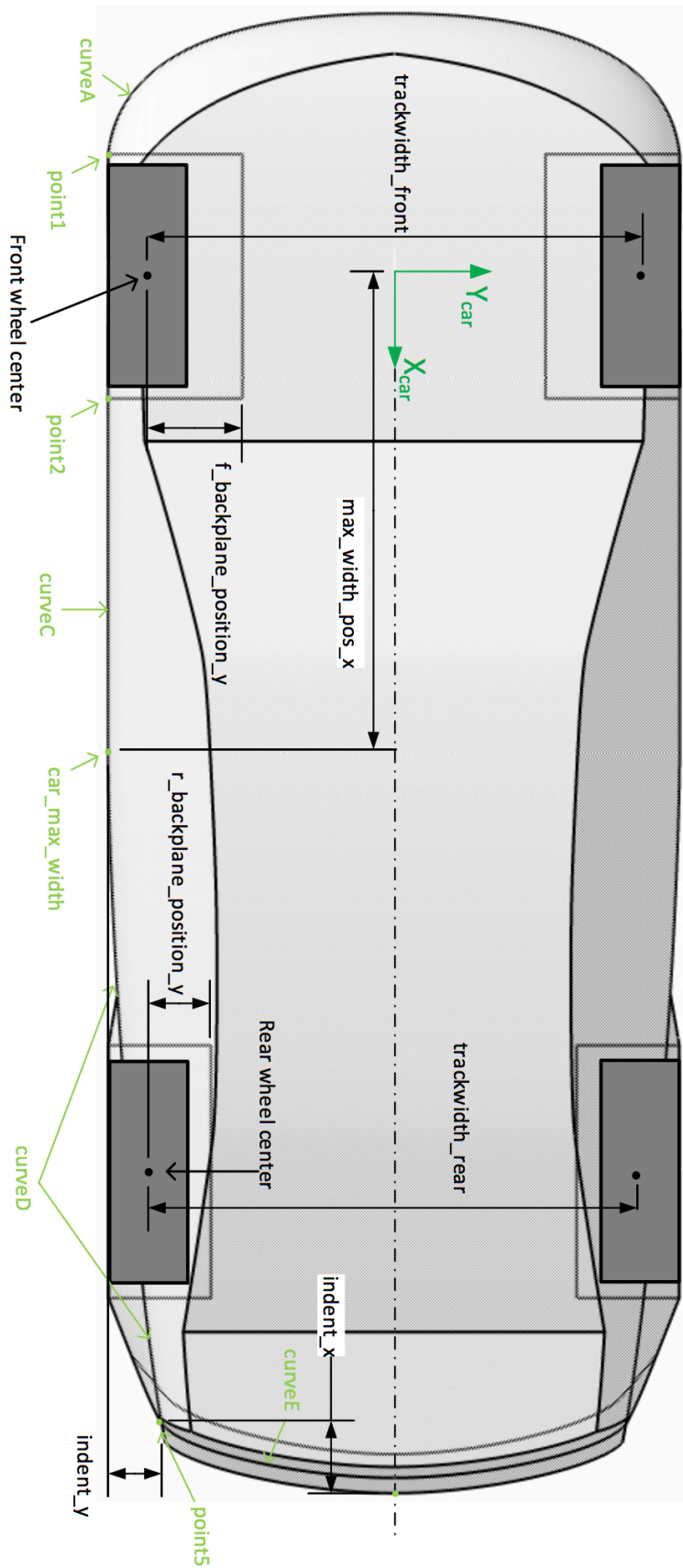

Figure A-4: Parameter definitions, top view

B Software implementation

This Appendix is meant to give some more detailed information about the technical side of the realisation of the methodology presented in this thesis.

B.1 Software framework

The software framework can be seen as the backbone of a software tool, which organises its internal structure as well as the cooperation and implementation with its external surrounding and stakeholders. It is important for the implementation of the suggested methodology in this work and will therefore be considered. First, the functionalities concerning external stakeholders will be covered, after which the ones for the internal structure are addressed. Both will be discussed separately to formulate the high level requirements imposed on the software framework. Based on this, the choice of the specific software package which could fulfil these requirements will be done afterwards. How the developed tool in practice can be operated and interacted with in practice, will be clarified at the end of this Appendix.

B.1.1 External stakeholders

The software tool has to be compatible with the actual available software environment and it has to provide the communication with its stakeholders (cooperation) and the other available processes (if required). Three external stakeholders can be distinguished (Figure B-1):

- User, end-user and administrator
- Software environment it has to be implemented in
- External process it has to cooperate or communicate with

Users

The first one can be further divided into novice or advanced experienced users, which makes a difference of the required interface between them and the tool. The needs of both users are very different and it is important that the tool covers that whole range.

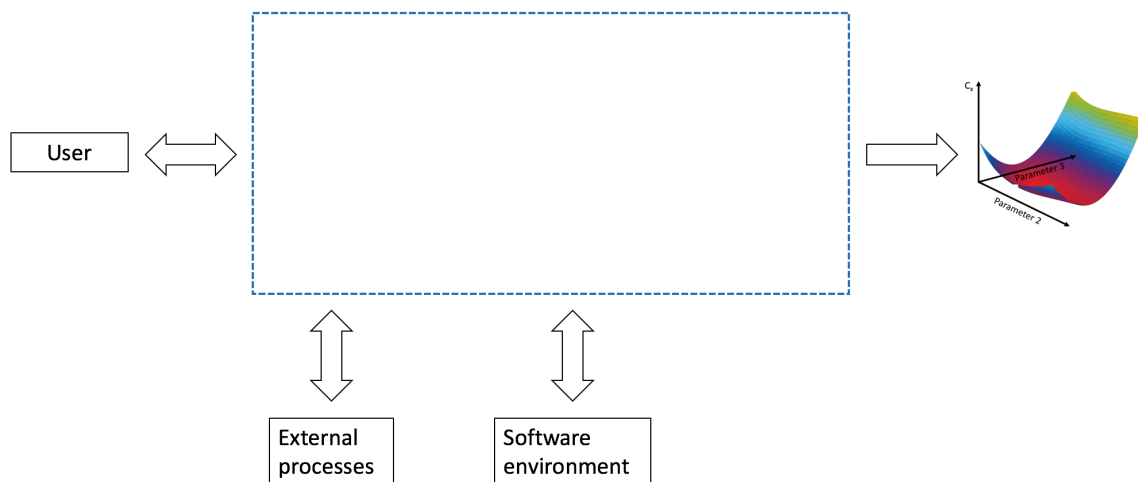

Figure B-1: Software framework, external stakeholders

A novice user requires a tool which is (1) easy-to-use and start and (2) only needs a minimal setup. It is important for a low experienced user that the tool only needs a minimal setup in order to give already useful results. This could be realised by providing a reliable and good balanced set of default settings which provide useful results. This is realistic, because the SuMo-toolbox can take multiple model types into consideration between it makes a trade-off based on their individual performance (and other settings) during that experiment (as was already discussed in the previous chapter). Also, a collection of settings sets could be provided from which a novice user could make his choice based on a high level and understandable description. This would certainly increase the usability, but is not further worked out in this work. Thus with a good set or collection of default settings, the only input that has to be done is that of the input variables specifications because the output has already been fixed to the C_x value.

The choice of settings and variable specifications given as an input by the user should respectively result in the correct toolbox and simulator configuration xml-file as is prescribed by the SuMo-tool documentation. For a low experienced user, the software framework should provide an appropriate interface for the input of which variables to investigate and their specifications and the choice of default settings. Further in this Appendix, it is clarified how this is worked out.

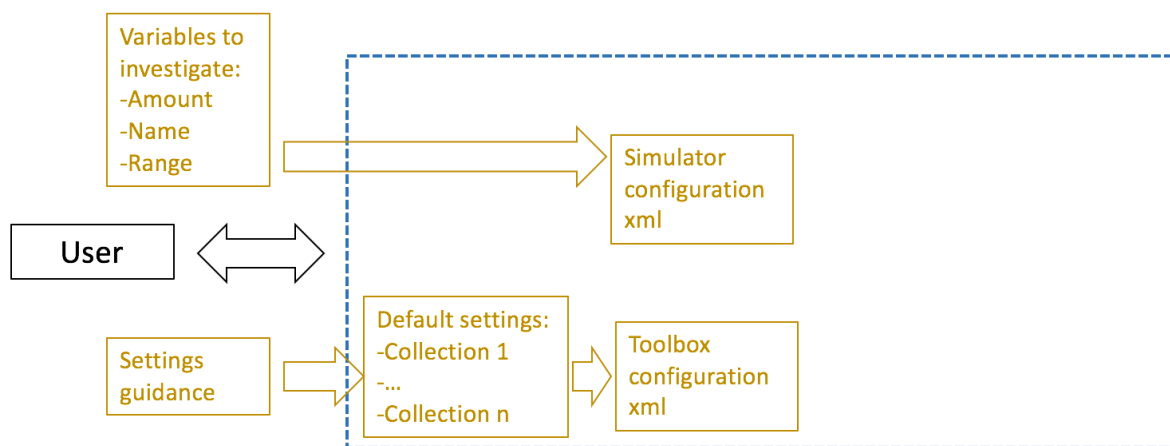

Figure B-2: Low experience user requirements

On the other hand, the advanced user needs a tool with a (1) transparent and (2) flexible, modular and extendable structure. This allows him to tailor the settings and working of the tool to his specific needs. This results in a very extended exploitation of the tool's potential and a powerful use of its possibilities. Therefore, the tasks of the advanced user will be more focused on the exploitation of the tool, than on the application of it. The latter is more a task of the novice user, so that the time of the experienced user can be used for doing what others cannot do. He can be seen as the administrator who provides the required configurations to the lower experienced ones. By organising it like this, the most can be extracted from the tool in terms of accuracy and time-efficiency. It is the task of the administrator to provide the means for a full exploitation.

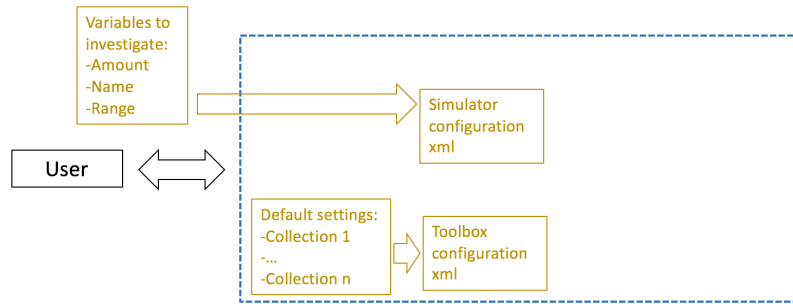

Figure B-3: High experienced user requirements

The requirements of the software framework in terms of users can be summarised as:

- Easy-to-use and start
- Minimal setup needed
- High transparency
- Flexible, modular and extendable structure

Software environment & external processes

The software framework has to be compatible with the software environment it has to be implemented in. This is not only dependent on the available operating system(s), but also on the actual process structure and framework. Therefore, some exotic software package with low-compatibility would not be preferred. This is important for both the implementation in the actual process environment as well as the further usage of the resulting surrogate models. For example, it would be desired to automatically subject the resulting surrogate model for further analyses (sensitivity, what-if, etc.) to directly process them into knowledge about the product which could be used for the determination of subsequent experiments or for capturing in a knowledge database.

B.1.2 Internal structure & organisation

Internally, the software framework has to provide the organisation of and communication between its components. The only external variables for the simulator are the choice and specifications of the parameters of the car exterior geometry, which have to be used as the design variables for the surrogate modelling. Therefore, the only thing that is left, is the structure and organisation, or in other words the framework of the simulator. It would be advantageous in terms of complexity if this could be done also in MATLAB.

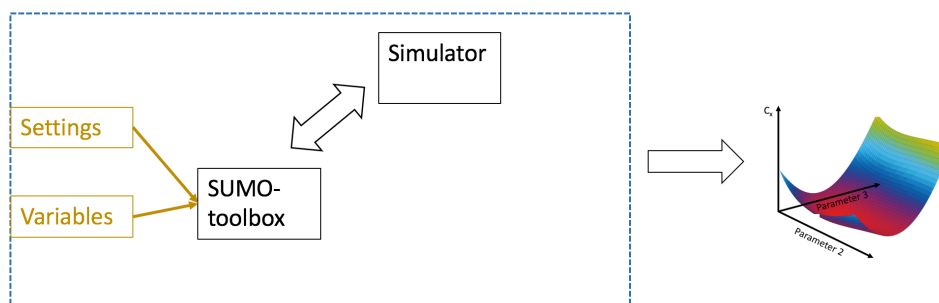

Figure B-4: Software framework, high level representation of the internal structure

B.1.3 Choice

The choice has been made to use MATLAB for the creation of the software framework. This is due to its following features and characteristics which comply with the imposed software-specific demands:

- SuMo-toolbox is in MATLAB
- High compatibility with operating systems and other software packages
- Object-oriented interface
- Highly programmable and customisable software environment
- Widely used and widespread
- Excellent online support

MATLAB is compatible with the most important operating systems (Windows, Linux & OS X) and due to its highly programmable character, it is possible to create all kinds of connections and communication with other software programs and operating systems. Due to this and the fact that to use the SUMO-toolbox, a MATLAB license is already required, the choice for MATLAB is obvious. Moreover, it is already widely spread in the industry and educational world, so the chance that there is already license available, is very high.

B.2 CFD software

B.2.1 Requirements

For the aerodynamic simulation of the flow around the car exterior a CFD-software has to be found. Not only the available solver(s), also its pre- and post-processing capabilities (whether or not included or provided by compatible software) are important for the final choice. Many requirements concerning CFD-software could be formulated. Basically, based on the major part of these requirements, the most common used and well known CFD-software solutions do not differ much from each other. On the other hand, on some of those requirements they do differ clearly:

- License costs
- Extendibility
- Customisability, flexibility

B.2.2 Choice

The above listed requirements were decisive in the choice to go for OpenFOAM (Open source Field Operation And Manipulation). OpenFOAM is a C⁺⁺ toolbox which can be used to develop numerical solver and all kinds of pre- and post-processing utilities for solving continuum mechanics problems (OpenFOAM Foundation, 2015). This means, also CFD problems can be dealt with. Many (standard) solvers and utilities of different types and complexity are already included. But due to its syntax, it allows for the creation of new or the customization of existing solvers. Also, utilities can be adapted or created as desired. This give OpenFOAM a very high level of extendibility and customizability, which can be used to design the simulator component as desired. Moreover, OpenFOAM has no license costs because it is open source software.

Another important feature of OpenFOAM is its parallel processing utility. It provides tools to decompose, reconstruct and redistribute the computational case so that parallel calculations can be performed (source OpenFOAM userguide). This is used in this work in order to fully exploit the available processor cores of the used machine.

It is important to note that OpenFOAM only works on Linux, which will make it more complex because all the other software will be executed on Windows. How this is dealt with can be found into detail in the last part of this Appendix.

B.2.3 Further recommendations

A recommendation for future work could be to make the case setup of the aerodynamic simulation settable by the user through an interface provided by the software framework of the tool. This could be used to make correlations of multiple surrogate modelling experiments which are all set up the same, except for the case set up. An example could be to investigate the influence of the free stream air velocity on the behaviour of the C_x value for specific parameters of the car exterior geometry. Or for the turbulence level of the free stream, or whatever which combination of variable(s) could be interesting.

A second variant on this could be to make the settings of the meshing process, solver, discretisation schemes settable by the user, which will lead to a variance in accuracy and duration time. This could be useful when for example a first estimation or exploration of the design space has to be done, in which case the settings could be downshifted in terms of accuracy but the experiment(s) will be completed much faster. The obtained results could be used to decide whether or not further investigation would be necessary and if so, further experiments could be chosen strategically and with upshifted settings for more accuracy. It has to be noticed that when executing such a surrogate modelling experiment, the simulator is a black box, so no control of the aerodynamic simulation will be done. This is a tricky situation if the case and simulation settings are freely settable because the correctness of results is not traceable and controllable. Therefore, only a user which has lots of experiences should perform. A solution could be that such an expert user could create a collection of settings together with high level prescriptions of their operating range, so that the less experienced user can make his choice. The sets contained in that collection have to be already investigated comprehensively so that they (almost) certainly deliver the desired results.

B.3 SuMo-Toolbox

Before presenting the worked out suggested methodology as a whole, one used software tool has to be mentioned first. This is the SuMo-toolbox and will perform the adaptive modelling and model training tasks needed to achieve a working software architecture for the proposed suggested methodology.

The SuMo-toolbox works in MATLAB and is developed at the SUMO (SURrogate MOdelling) Lab, which is part of the IBCN (Internet Based Communication Networks and Services) research group of the Department of Information Technology (INTEC) of the University of Ghent in Belgium. For more extensive information is referred to (Surrogate Modeling Lab, 2015).

B.4 Overview of the developed software solution

Here, an overview of how the methodology, developed in this thesis, is worked out practically. First, the folders and files structure will be given as well as which files are important for the user to use the tool. After this, a detailed overview of how all components communicate and work together will be given.

B.4.1 Folders and files structure/organisation

Figure B-5 gives an overview of the folder structure and files on the Windows machine. The main information to use the software tool is described in the specific readme files located in the corresponding folders. The same is given for the Linux machine and OpenFOAM case folders in Figure B-6.

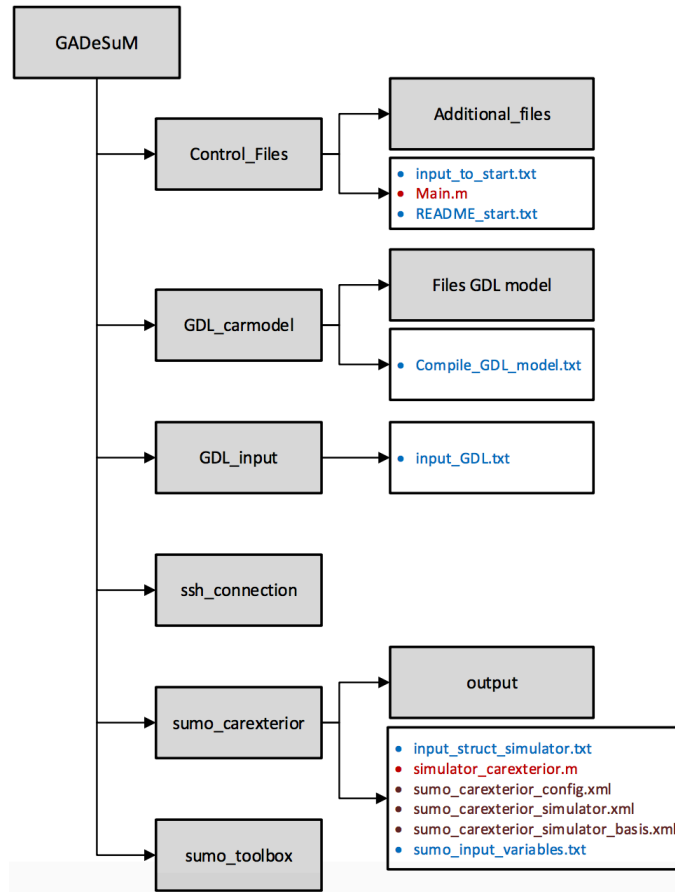

Figure B-5: Folders and files overview on the Windows machine

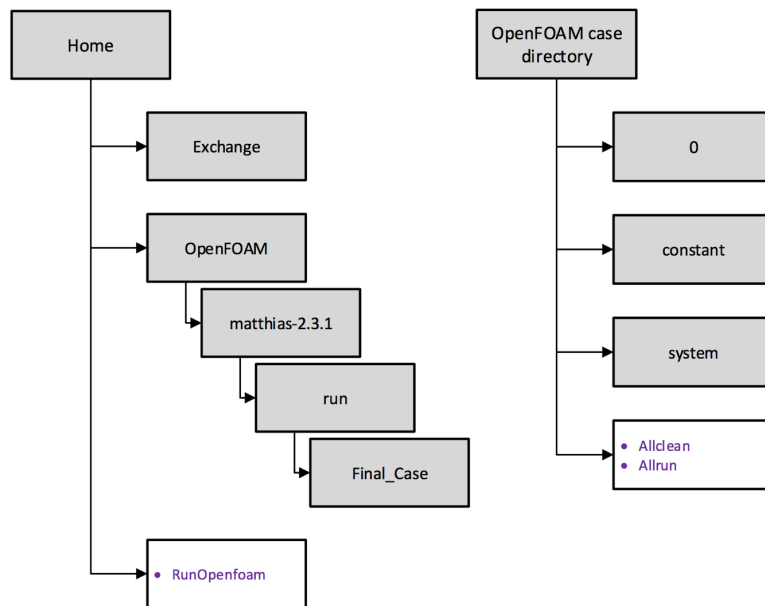

Figure B-6: Folders and files overview on the Linux machine and in the OpenFOAM case directors

B.4.2 Detailed overview

In respectively Figure B-7 and Figure B-8, a schematic overview of the software framework and the simulator is given.

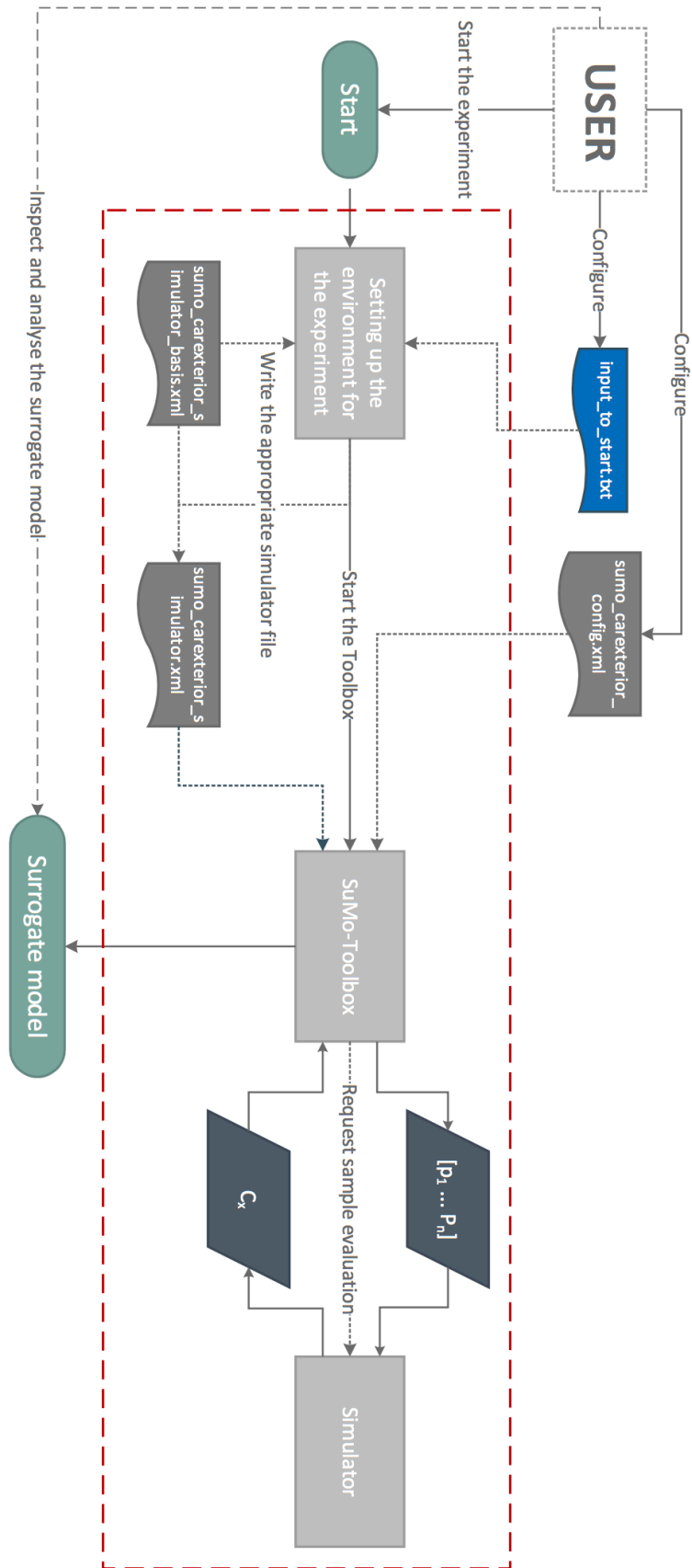

Figure B-7: Schematic overview of the software framework

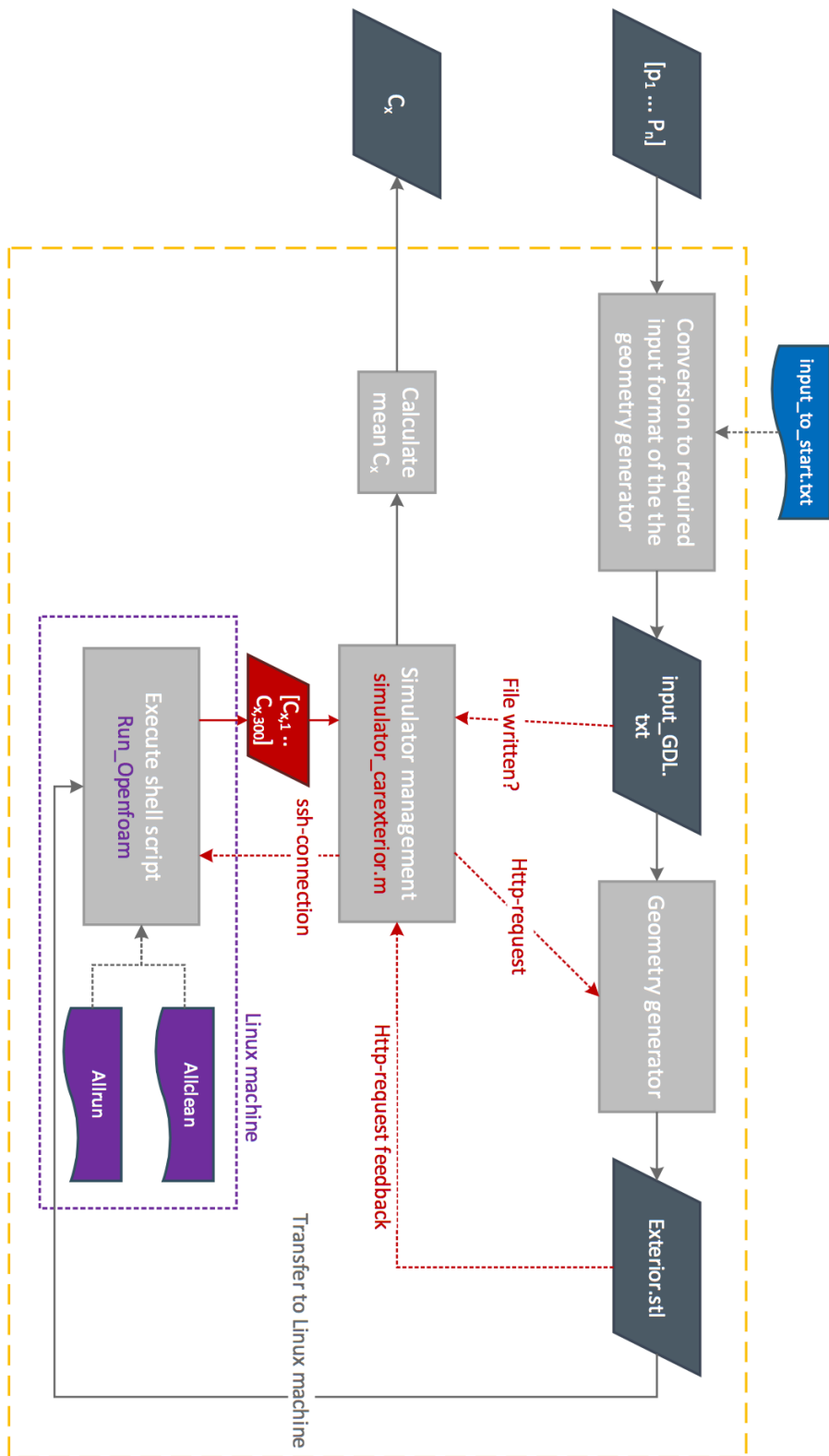

Figure B-8: Schematic overview of the simulator