

# Reflex Modu- lation

Design of an experimental protocol to test voluntary reflex modulation in the wrist flexor

Babette Mulder

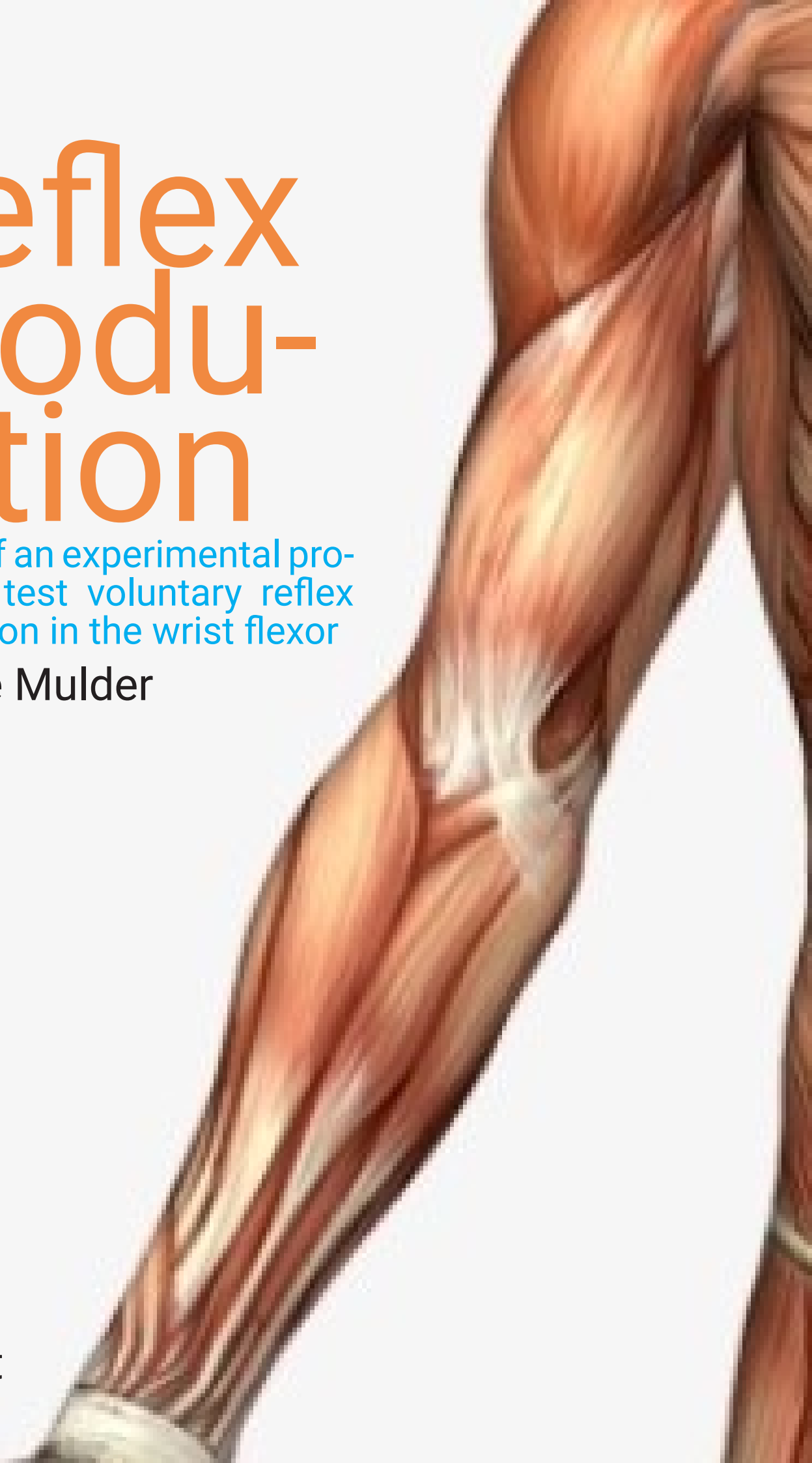



# Reflex Modulation

Design of an experimental protocol to test  
voluntary reflex modulation in the wrist flexor

by

**Babette Mulder**

to obtain the degree of Master of Science in Biomedical Engineering  
at the Delft University of Technology,  
to be defended publicly on Tuesday 12 October 2021, at 15:00.

Student number      5000823  
Project duration:    13 April 2021 – 12 October 2021  
Thesis committee:  Dr. ir. Mark van de Ruit,    TU Delft, supervisor  
                          Dr. ir. Alfred Schouten,    TU Delft, supervisor  
                          Dr. ir. René van Paassen,   TU Delft, committee external member

An electronic version of this thesis is available at <http://repository.tudelft.nl/>.



# Preface

The past year and a half have proven difficult for research. The initial plan for this thesis had to be altered as a consequence of COVID limitations, as no experiments with patients could be conducted at the time of data collection. Regardless, I am proud to present this thesis.

This thesis represents one of two areas in biomedical engineering I was keen to explore the use of haptic robotics to neuromuscular applications. Luckily, I was able to explore the other area through my master internship, where I worked as a clinical engineer on a rehabilitative hand exoskeleton conducting experiments with patients suffering from motor disorders impacting their use of their hand. Both areas are linked in my passion for working on rehabilitative technologies.

This work attempts to make another step towards improved rehabilitative programs through understanding the underlying mechanisms that govern motor disorders, reflexes. In particular, reflex modulation is considered. This thesis implements the design of an experimental protocol that, hopefully, provides an effective answer to examining natural reflex modulation as a consequence of a goal-directed movement. The expectation is that this protocol can then be used to distinguish how this reflex modulation differs between healthy subjects and those suffering from motor disorders. This information could then be used to define rehabilitative programs, and potentially as a measurement tool to monitor progress. Notwithstanding, more research is required in order to effectively integrate this thesis for such purposes.

*Babette Mulder*  
*Delft*  
*October 4, 2021*



# Acknowledgements

Throughout the duration of my project, I have received support from many people and I would like to take the time to thank some of them in particular.

Firstly, I would like to thank my supervisors, Mark and Alfred for their wise counsel and help during the project. To Mark, who guided me through endless PoPe/dSpace problems and always helped me to better understand ControlDesk. To Alfred, who provided advice, feedback and designed the robot I used, the PoPe. In addition, the NMClab meetings for building cooperation and helping each other find solutions.

Secondly, I would like to thank all of my friends who have helped me throughout the degree. To Celine for being a great study buddy and assignment partner. In particular, Olek, Natasha, Francisco, Tomás, and Irene for their help with this project. Furthermore, with the COVID situation, as well as doing trials in summer, it was difficult to find people who were willing to come to university to complete an experiment for 2 hours. I am, therefore, eternally grateful to all of those who participated.

Thirdly, I would like to thank my family for their support. My parents who have supported me in pursuing my goals from a young age, and have helped me throughout my academic career. My father for helping with endless homework and always being there for a hug. My mother who taught me how to be strong and independent. My brother who makes me feel like a good older sister when he asks me for advice, and of whom I am so proud of all that he has achieved.

Finally, I would like to thank Gonçalo for the motivation he has given me, all of his help with the project, the support he has provided throughout the whole degree and the love he has shown me.





# Contents

1	Scientific Article	5
1	Introduction	5
2	Methods and Design Process	6
2.1	Participants	6
2.2	Experimental Setup	6
2.3	Measurement Protocol	7
2.4	Data Processing and Analysis	8
2.5	Statistical Analysis	9
3	Experiments	9
4	Experiment 1	9
4.1	Methods	9
4.2	Results	9
4.3	Discussion	10
5	Experiment 2	10
5.1	Methods	10
5.2	Results	11
5.3	Discussion	12
6	Experiment 3	13
6.1	Methods	13
6.2	Results	13
6.3	Discussion	13
7	Experiment 4	13
7.1	Methods	13
7.2	Results	14
7.3	Discussion	15
8	Experiment 5	16
8.1	Methods	16
8.2	Results	17
8.3	Discussion	18
9	General Discussion	18
9.1	Limitations	19
9.2	Improvements and Future Work	19
10	Conclusion	20
	References	21
	Appendices	23



# List of Abbreviations

ADL	Activities of Daily Living
$A_{M1}$	Area of M1 response
$A_{M2}$	Area of M2 response
ECR	Extensor Carpi Radialis Brevis
EMG	Electromyography
FCR	Flexor Carpi Radialis
GUI	Graphical User Interface
M1	First component of the stretch reflex
M2	Second component of the stretch reflex
MVC	Maximum Voluntary Contraction
PoPe	Pols Perturbator (Wrist Manipulator)
PRBS	Pseudo-random Binary Signals
R&H	Ramp-and-Hold signal
RM-ANOVA	Repeated Measures Analysis of Variance
SNR	Signal-to-Noise Ratio



## Scientific Article

# Design of an experimental protocol to test voluntary reflex modulation in the wrist flexor

Babette Mulder, Delft University of Technology, Netherlands

---

### Abstract

**Background:** Determining how the reflex voluntarily modulates while performing activities of daily living (ADL), and understanding how this modulation might differ between healthy subjects and patients with motor disorders, can aid in developing a rehabilitative program to improve the functional performance of the wrist. The current study designs an ideal experimental protocol that would test reflex modulation as a response to perturbations during a goal-directed movement. **Methods:** A total of twelve participants participated in the five experiments (mean age  $25.99 \pm 3.6$  years in the range 22 - 34, seven men and five women, all right-handed and with no history of neuromuscular impairment). The TU Delft Human Research Ethics Committee gave approval for the current study. The experimental protocol is separated into three pilot experiments, one main experiment and an addendum experiment after proven effectiveness of the protocol. The main experiment is conducted with ten subjects. The design process was iterative. The experiments were tested, designed and implemented on a wrist manipulator (PoPe). The transient perturbations are designed to be Ramp-and-Hold (R&H) perturbations of amplitude  $0.08\text{rad}$ ,  $2\text{rad/s}$  with a  $180\text{ms}$  hold, causing a stretch reflex response in the flexor carpi radialis (FCR). **Results:** The main experiment showed that the short-latency (M1) and long-latency (M2) areas in the FCR significantly differ with respect to the posture at which a perturbation is elicited. Upon showing the effectiveness, the experiment is further improved with the implementation of continuous pseudo-random binary signal (PRBS) perturbations to allow for continuous measuring of the stretch reflex, and thereby increasing protocol efficiency. **Conclusions:** The designed experimental protocol is, therefore, effective in observing reflex modulation during a goal-directed movement performed by the wrist.

*Keywords: Stretch Reflex, Experimental Protocol, Wrist*

---

## 1 Introduction

Motor disorders, where patients can suffer from spasticity and reflex impairments, affect around 200,000 people in the Netherlands alone [1]. With over 600 possible motor disorders [1] - such as Parkinson's, SCI, Complex Regional Pain Syndrome, cerebral palsy - understanding the role of reflexes in motor disorders

can be a powerful tool for improving patient's lives. Increased muscle tone (rigidity) is characteristic to patients with Parkinson's disease, such that flexion and extension of the joint is resisted during stretching [2]. Additionally, poor control of muscle response to signals from peripheral receptors and an atypical increase of reflexes to muscle stretch are two characteristics of spasticity [3]. Spasticity is often

a symptom of Spinal Cord Injury (SCI) and stroke. Rigidity and spasticity are categorized as too low (hyporeflexia) or too high (hyperreflexia) reflex activity, respectively [4]. When the reflex functions abnormally as a result of neurological damage, the role of reflexes is seen through the effects this damage can have on the execution of activities of daily living (ADL).

Reflexes are generally viewed as involuntary responses, originating through spinal pathways. Nonetheless, reflex modulation is possible, without interference from intrinsic stiffness and torque [8]. Reflex responses have also been shown to be adaptable dependent on the goal of the motor task, position, joint angle, environmental conditions and the human intent, supporting the idea of reflex modulation as a result of task dependency [9–16]. For instance, the reflex gain was lowered during a position task compared to a force task while receiving perturbations, indicating task dependent reflex modulation [10, 11]. In addition, less predictable mechanical perturbations showed an increased reflex response than perturbations that were elicited shortly after a warning signal, indicating that reflex modulation is dependent on predictability of the perturbation and the reaction time [12]; which suggests that cortical involvement is present in some aspects of reflexive control, and hence, can alter the reflexive response voluntarily [12, 13].

In a dynamic experiment, Johnson et al. [17] had subjects track a sinusoidal movement, measuring the amplitude of the reflex response when perturbations were elicited at various degrees in the cycle. Notably, the maximum flexor response was seen when the wrist was moving in the flexion direction [17]. Similarly, the maximum extensor response was seen when the wrist was moving in the extension direction [17]. Furthermore, the movement was a sinusoidal movement, and not goal-directed. A goal-directed movement is a movement typically from a starting position to an end position, rather than a cyclical movement. The difference in reflex responses during a goal-directed and cyclical movement is not yet fully understood. As task-dependency was shown to modulate reflexes [9–16], the contrast in intent behind a cyclical movement and a goal-directed movement could have an effect on the reflex modulation observed. Furthermore, goal-directed movements are important to investigate due to their direct application to ADLs.

The motivation to study reflexes arises from the desire to determine how task-specific changes can lead to their modulation during a dynamic motor task. Impaired reflex modulation of the stretch reflex was seen in patients with moderate to severe stroke [5], thus, determining when and under what

conditions natural voluntary reflex modulation occurs aids in the understanding of associated impairments. During the goal-directed movement, the reflex is studied through invoking a sudden stretch reflex. The stretch reflex typically results in the observation of the short latency, M1, and the long latency, M2, components [9]. Reflex modulation is typically observed at the supraspinal level in the M2 component of the reflex, as the M1 component acts as an automated response through the spinal pathways [18]. The M1 response is mediated by group Ia afferents, and characterized as monosynaptic whereas the pathway mediating the M2 response is still debated [9]. Determining how the stretch reflex modulates while performing a goal-directed movement and understanding how this modulation might differ between healthy subjects and patients with motor disorders, helps in the development of a training and/or rehabilitative program to improve the functional performance of the upper limb. An experimental protocol needs to be designed and validated with which such an understanding of reflex modulation can be achieved.

The goal of this study is, therefore, to iteratively design an ideal experimental protocol that would allow for posture-dependent reflex responses to be measured during a goal-directed movement using a robotic wrist manipulator (Pols Perturbator - PoPe).

## 2 Methods and Design Process

### 2.1 Participants

A total of twelve participants volunteered for the five experiments (mean age  $25.99 \pm 3.6$  years in the range 22 - 34, seven men and five women, all right-handed and with no history of neuromuscular impairment). Prior to partaking in the study, participants were provided with an information form, had the opportunity to ask questions and were asked to sign an informed consent form if they agreed to participate (see Appendix D). The TU Delft Human Research Ethics Committee gave approval for the current study.

### 2.2 Experimental Setup

The wrist manipulator (Pols Perturbator, PoPe) [7] used is shown in a schematic in Figure 1. A force transducer mounted in the handle of the PoPe was used to measure the torque exerted by the participant through the wrist. The real-time position of the handle was displayed on the participant screen. The position cursor only moved in the horizontal direction. The setup also consisted of two 15 inch computer screens, one on which to display the visual environment and the other for the researcher to control the graphical user interface (GUI). The participant screen was at an approximate distance of 50 cm

in the participant's direct line of sight.

MATLAB (Release 2021a, The MathWorks Inc., Natick, MA) [19] was used to code the necessary software implemented during the experiment. The controller was governed by a model compiled using MATLAB's Simulink. The Simulink model had to be adapted during the design process. The model was connected to a dSPACE I/O board (DS1104,  $f_s = 2.5kHz$  with 16 bit resolution).

Electromyography (EMG) signals were measured and recorded through the use of the Delsys Bagnoli system (electrode size  $10 \times 10mm$ ) for the flexor carpi radialis (FCR) and extensor carpi radialis (ECR). Prior to sampling, the signals were band-pass filtered from  $20Hz$  to  $450Hz$ . In addition, torque of the wrist, position and velocity of the handle were measured and recorded through the software.

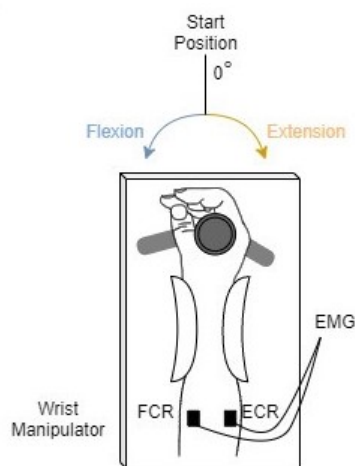

Figure 1: Schematic of the wrist manipulator (PoPe) set up for a right-handed participant. The manipulator is able to cause flexion and extension of the wrist. The torque exerted by the user was read. Perturbations in the extension direction were designed in order to stretch the FCR muscle. A bias force ( $1.2Nm$ ) was implemented on the handle to cause an isometric contraction in the flexion direction.

### 2.3 Measurement Protocol

The participants were seated in a height-adjustable chair. The right arm was placed inside the restraints and held onto the handle of the manipulator. The use of restraints was to align the rotation axis of the manipulator with the flexion-extension axis of the wrist, and to ensure no other joints were involved during the trial.

The iterative design process is separated into five experimental phases: Experiment 1, Experiment 2, Experiment 3, Experiment 4 and Experiment 5. With each phase, potential improvements were discussed and implemented. In order to determine the effectiveness of the implemented changes, for each experimental phase, trials were conducted. Experiments 1 and 2 were pilot experiments, conducted with few

subjects, to develop the protocol. Experiment 3 was developed to test the chosen perturbation parameters with five subjects. The main experiment, conducted with ten subjects to validate the protocol, is Experiment 4. Experiment 5 is an addendum to Experiment 4, where the perturbation type was altered to increase the efficiency of the protocol. The following section describes the general protocol applicable to all experiments; details pertaining to individual experimental phases are given in their respective section. From the beginning of the design process, it was determined that the movement to be measured should be a goal-directed flexion of the wrist.

Initially, the experimental design involved using transient perturbations, which would later change to continuous perturbations for the final experiment. The transient perturbation was a Ramp-and-Hold (R&H) perturbation. The  $40ms$  ramp was given at a velocity of  $2rad/s$  reaching an amplitude of  $0.08rad$  in the extension direction. As a result, the FCR muscle was stretched. The continuous perturbations were designed to be pseudo-random binary signals (PRBS) perturbations with a  $150ms$  switching rate.

The controller used a velocity mode which is a derivation of position mode. The users were able to apply a force to the handle in order to move the wrist in an extension and flexion direction. Figure 2 shows the final visual feedback that the participant was given. The objective was to move the position cursor of the handle from circle A to circle B (causing flexion of the wrist) thereby performing a goal-directed movement. The preparation phase gave the subject time to move to the start position (circle A). The hold periods were held within each of the circles, so that first the participants held the position of the handle constant for  $5s$  in circle A, then performed the movement, and finally held again for  $5s$  in circle B.



Figure 2: Final design of the visual environment used. The participant was instructed to move from circle A to B before and after a hold period of  $5s$ . A cursor is currently placed in circle B, which represents the position of the handle and moves with user input. The position cursor only moved in the horizontal direction visualizing the flexion and extension of the wrist.

Timers were implemented to let the subject know how long the movement and hold periods should take. Training was used to ensure that the subjects always performed the trial in the same manner. If the participant was shown to move too slowly or too quickly, the trial might need to be repeated. Criteria for repetition of a trial is later discussed per experimental phase. In order to motivate the participants to complete the trials with the desired velocity, a scoring system was implemented. Participants could choose to use the scoring system if they felt that it would motivate them. The subject received a score of 1 for each trial completed correctly the first time, 0.5 for a second try and 0 for any subsequent tries. The aim was to get the highest score.

The trials consisted of six conditions (see Table 1), where R&H perturbations were given at five different handle positions, and one condition with no perturbation (none). The five positions included: circle A during the first hold period (hold 1), beginning of the movement at  $0.07\text{rad}$  from the start position (beginning), middle of the movement at  $0.16\text{rad}$  from the start position (middle), end of the movement at  $0.25\text{rad}$  from the start position (end) and circle B during the second hold period (hold 2). Furthermore, the perturbation elicited during a  $5\text{s}$  hold period was given at a random time each trial. Each condition was repeated twenty times, leading to 120 trials. The order of the trials was randomized.

Table 1: Conditions used in the experiment, with their location and their shortened name (Also Known As - AKA).

CONDITION	PERTURBATION POSITION	AKA
1	Random during hold 1	Hold 1
2	Beginning of movement	Beginning
3	Middle of movement	Middle
4	End of movement	End
5	No perturbation	None
6	Random during hold 2	Hold 2

## Force Field

A constant force field was needed to elicit a minimum contraction level in the flexors to allow for more observable reflexes [20–22]. This force field was implemented in the Simulink model, where there was a passive torque value that could be altered. The torque was set to  $1.2\text{Nm}$  [9, 23] to act in opposition to flexion. The force field potentially had a slight position-dependent nature, whereby it increased in difficulty farther from the maximum extension point. This is analyzed in Experiment 4. The stiffness, damping and inertia were set to  $0.5\text{Nm/rad}$ ,  $0.1\text{Nms/rad}$ , and  $0.0016\text{Nms}^2/\text{rad}$ , respectively.

## 2.4 Data Processing and Analysis

MATLAB [19] was used to process and analyze data. For the experiments with transient perturbations, the EMG data was processed through subtracting the mean, rectifying and applying a 3rd order Butterworth filter, with a cut-off frequency of  $80\text{Hz}$ . The reflex window was cut to be an EMG window  $0.2\text{s}$  before and after the elicited perturbation. If no perturbation was elicited, the window was cut to the middle of the trial to show control EMG data. The background EMG values were calculated and used to normalize the EMG data within the cut reflex window. Both the ECR and FCR EMG data underwent the processing, however, the elicited reflexive response was observed in the FCR. The data was then plotted. The mean was taken of all the trials (per condition) in order to determine the mean curve. Typically the M1 response can be seen  $20$  to  $50\text{ms}$  after the perturbation and the M2 response  $50$  to  $100\text{ms}$  after the perturbation. Hence, to calculate the M1 and M2 response area ( $A_{M1}, A_{M2}$ ), the area under the mean curve of the trials was calculated. Figure 3 shows a typical M1 and M2 response in the FCR upon receiving a perturbation, the thicker black line is used to denote the mean curve of the trials. This is the case for all similar figures in this report. The EMG data for Experiment 5 was, however, not cut into a perturbation window, but instead cut to have each movement in one window, due to the continuous perturbations.

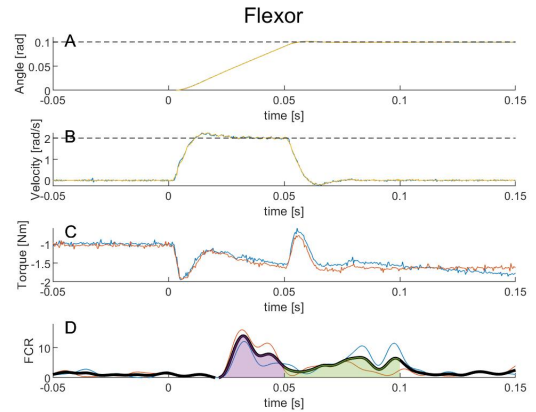

Figure 3: A and B show the Ramp-and-Hold perturbations triggered (position and velocity respectively). C shows the torque on the handle as a consequence of the perturbation. D shows the FCR response. The area used to calculate the M1 response is shown in purple, and the area used to calculate the M2 response is shown in green.

It is important to note that the data analysis varied per experimental phase. The early experiments were primarily used to verify the changes and look for improvements, so the data analysis was limited. All experiments involved EMG data analysis. Position



and velocity data were sorted to reflect the experimental protocol changes. As the design progressed to a final experiment, the data analysis increased in order to better examine the details.

## 2.5 Statistical Analysis

The effect of posture on the response amplitudes ( $A_{M1}$  and  $A_{M2}$ ) was tested through a one-way repeated measures analysis of variance (RM-ANOVA). The effect of the background EMG was also tested through a one-way RM-ANOVA. In the case that sphericity is violated, the Greenhouse-Geisser correction was automatically applied through R (RStudio Version 1.4.1717, Boston, MA) [24]. The statistical analysis was carried out for Experiment 4, which is considered the most developed experiment with six transient perturbations conditions wherein ten subjects were tested. A significance level of 0.05 was used. If the data was found to be significant, a post hoc pairwise t-test was conducted, where p-values were adjusted using the False Discovery Rate multiple testing correction method through R [24].

## 3 Experiments

The next sections discuss changes made to the PoPe software to create the protocol. The data collected from these experiments, with associated figures, can be found in the appendices. Extensive debugging and optimization with regards to safety boundaries, sampling frequencies and Simulink connections was performed throughout the five experiments, specifics can be found in Appendix E.3.

## 4 Experiment 1

This is the first experimental phase wherein the preliminary set-up was created. The goal was to create the visual feedback, test the force field and determine the usability of time-dependent perturbation. Additional information and data collected from this experiment can be found in Appendix A.

### 4.1 Methods

Two participants volunteered for this experiment (one female, one male).

The duration of the movement from circle A to circle B had been set to 1s, for a movement from full extension to full flexion. The initial idea was to have time-dependent perturbations, which with training, would result in a perturbation at the same/similar handle position each time. Therefore, the perturbations during the movement were set to occur at 5s, 5.9s and 6.8s for the beginning, middle and end conditions respectively, and randomly during the hold periods (i.e. first 5s or last 5s of each trial). The training protocol was limited to informing subjects how fast to complete the movement verbally ahead of the trials and to follow the instructions on the screen, but no feedback was given regarding how fast or slow the movement was during the trials.

### 4.2 Results

Reflexes could be seen in the FCR for Subject 2 (see Figure 4), giving an early indication that the chosen protocol can be effective. Primarily a response in the M1 was seen. The M2 response was not as evident. Subject 1 (red) showed less clear responses in the FCR than Subject 2 (black).

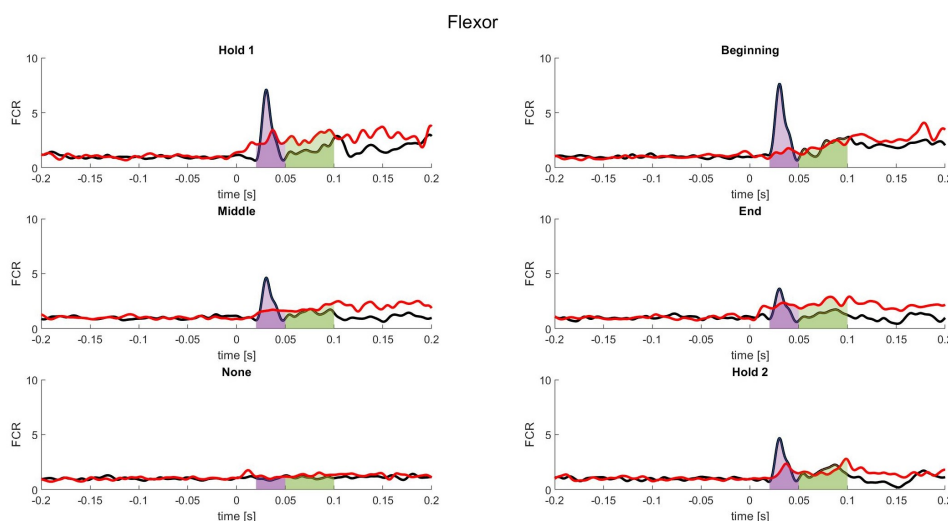

Figure 4: The figure depicts the FCR response for each trial, separated per condition (Subject 1 = red; Subject 2 = black). The black and red lines represents the mean of all the trials per subject. A reflex response is seen for all perturbations conditions indicating early effectiveness of the protocol for Subject 2. Subject 1 shows less evident reflex responses.

It was observed that the long duration of the movement allowed subjects to experience feedback during the movement, which altered their trajectory – subjects would slow down before reaching circle B.

Furthermore, the perturbation amplitude was not consistent, and smaller than the intended  $0.08\text{rad}$ . This was most significantly seen during the movement. An example is shown in Figure 5.

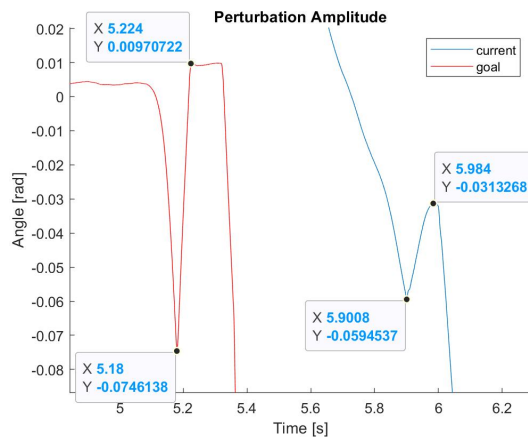

Figure 5: A zoomed in figure of a movement perturbation given during experiment 1 (blue) compared to a sample goal perturbation given (red). The perturbation amplitude can be seen to be around  $0.028\text{rad}$ , which is considerably smaller than the intended  $0.08\text{rad}$ .

Upon plotting the position at time of perturbation onset (see example given in Figure 6), it was evident that the position was not consistent.

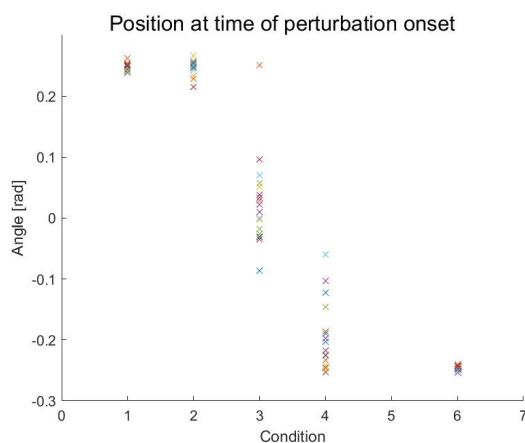

Figure 6: An example figure (Subject 2) demonstrating the handle position when each perturbation was triggered. Particularly the movement conditions show a large variability with the position at time of perturbation onset.

### 4.3 Discussion

This experimental phase had a primary focus to develop the visual feedback, test the force field and

determine the usability of time-dependent perturbations with a training protocol. The results show that the visual feedback was not sufficient to help subjects perform the movement as desired, and that time-dependent perturbations with a training protocol were not able to effectively create position-dependent perturbations.

One particular factor that emphasized the difficulty with using timed perturbations, was the reaction time variation between subjects. Depending on when the subject would start the movement, even if they had the desired movement velocity, the position at time of perturbation onset would still be different than other trials from the same subject and/or other subjects. Therefore, the time-dependent perturbations with training were not an effective solution to creating position-dependent perturbations.

It was evident that the perturbations were altering in amplitude depending on how much velocity and torque the subject was exerting. Particularly during the movement conditions, when the subject would be pushing harder against the handle to complete the movement, the amplitude of the perturbations would be drastically smaller than intended, refer to Figure 5.

Subjects were also experiencing feedback from themselves, as they were slowing down before reaching circle B, thereby, not maintaining a consistent movement velocity. More training and verbal feedback from the examiner would help to improve the movement consistency. One potential improvement could be to perform a direct analysis of each recent trial.

Reflexes were primarily observed for Subject 2 but less present for Subject 1, giving an early indication that the stretch reflex can be triggered with an improved protocol. Currently, the M1 response was observed as a result of the perturbation, but the M2 response is necessary to observe if any reflex modulation is possible. In order to improve the reflexes in all subjects, the protocol must be modified to ensure the perturbations are elicited at consistent handle positions and that the perturbation amplitude does not vary based on user-input.

## 5 Experiment 2

The goal of Experiment 2 was to implement position-dependent perturbations for the movement conditions and to improve the manner of giving feedback to ensure better movement velocity. Additional information and data collected during this experiment can be found in Appendix B.

### 5.1 Methods

Three participants volunteered for this experiment (two female, one male).

Previously, the subjects were not following the desired movement trajectory, starting fast and ending slowly when reaching point B. Therefore, the "GO!" signal was modified to "Start the movement" as it is less aggressive. In order to give additional feedback to the participant during the trials, generated figures with the angle, angular velocity and EMG signals of the most recent trial were used. The examiner was able to judge the movement velocity accuracy through the use of a reference line that stipulated the desired movement velocity. Furthermore, user feedback needed to be removed, such that have users only perform the movement with feedforward mechanisms. In addition, movement range was also shortened: from extension - flexion, to start position - flexion. As a consequence, the movement duration was shortened further, to 200ms.

Position-dependent perturbations had to be implemented in the Simulink model, such that once the handle reached a position, the perturbation would be triggered. This was only implemented for the three movement conditions: beginning, middle and end, where the perturbation position varied the most in the previous experiment (Figure 6).

Due to the varying perturbation amplitude (Figure 5), it was additionally decided to implement a mechanism in the model which would disallow velocity and torque input from the user while the perturbation was occurring, to maintain a consistent perturbation amplitude. To achieve this, the velocity was switched from user input to a reference value, achieving a velocity-hold.

Direct analysis of the most recent trial was done to inform subjects about their movement velocity, during the experiment and whilst training, and to determine if a trial needed to be repeated when a subject performed a poor movement.

## 5.2 Results

In Figure 7, it is possible to see the handle position at the time of perturbation onset. Especially during the movement conditions, the position is kept constant.

Furthermore, Figure 8 indicates that the velocity necessary to reach the perturbations was not equal amongst the conditions. The hold conditions required more than  $2\text{rad/s}$  and the movement conditions only required  $1\text{rad/s}$ . The results also showed that the hold aspect of the R&H perturbation was accidentally removed in the switch over from time-dependent perturbations to position-dependent perturbations, such that the perturbation only consisted of the ramp.

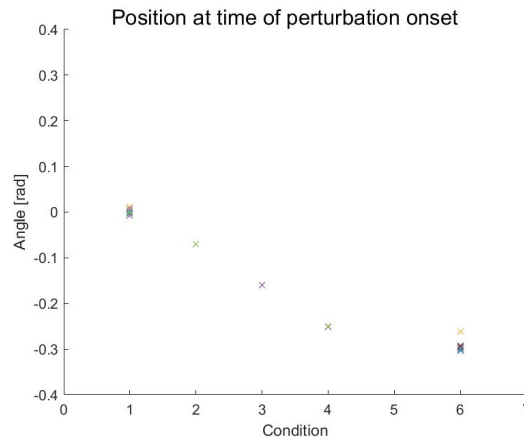

Figure 7: An example figure (Subject 2) demonstrating the handle position at time of perturbation onset. It is possible to see the improved consistency in the perturbation position elicited during the movement conditions as a result of the new position-dependent perturbation design.

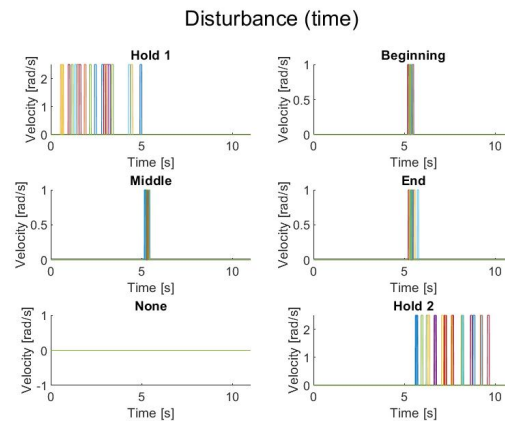

Figure 8: Figure containing all the perturbations elicited during the 120 trials. The movement perturbations used a velocity of  $1\text{rad/s}$  in order to achieve the perturbations whereas the hold perturbations used a velocity of  $2.3\text{rad/s}$ . The velocity of the perturbation is, therefore, not consistent.

The amplitude of the hold 1 and hold 2 perturbations remained inconsistent, while the movement perturbations with the new velocity-hold design had a consistent amplitude for all trials, see Figure 9 for a single trial example (figures showing all trials can be found per subject in Appendix B.2).

Subjects 1 and 3 did not show significant reflex responses in the FCR (see Figure 10, red and black lines respectively). Subject 2 showed a clear M1 response, but not a clear M2 response (blue line in Figure 10).

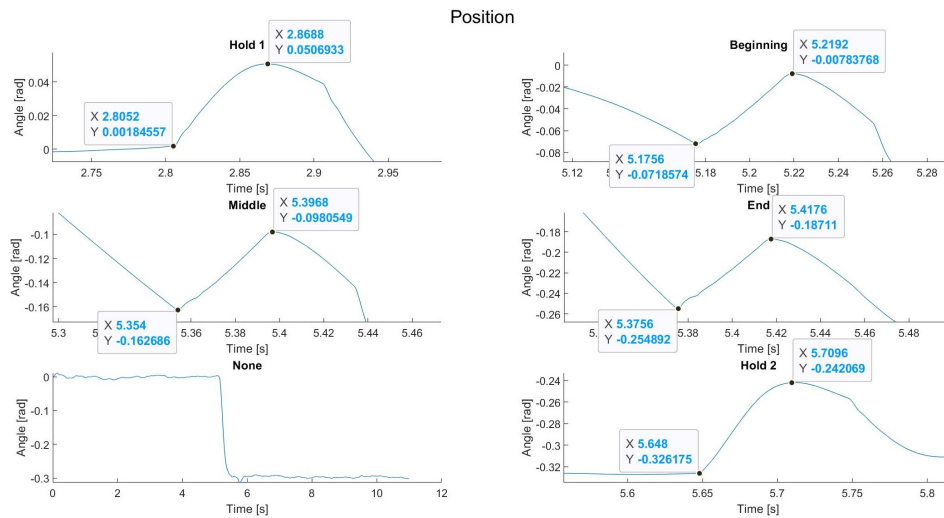

Figure 9: A zoomed in figure of a perturbation given for every condition. The perturbation amplitude can be seen to be around  $0.048rad$  for hold 1 and  $0.084rad$  for hold 2 while the movement conditions have  $0.063rad$  for beginning,  $0.064rad$  for middle, and  $0.063rad$  for end. The figure highlights the effectiveness of the velocity-hold perturbations and the need to apply it to the hold conditions.

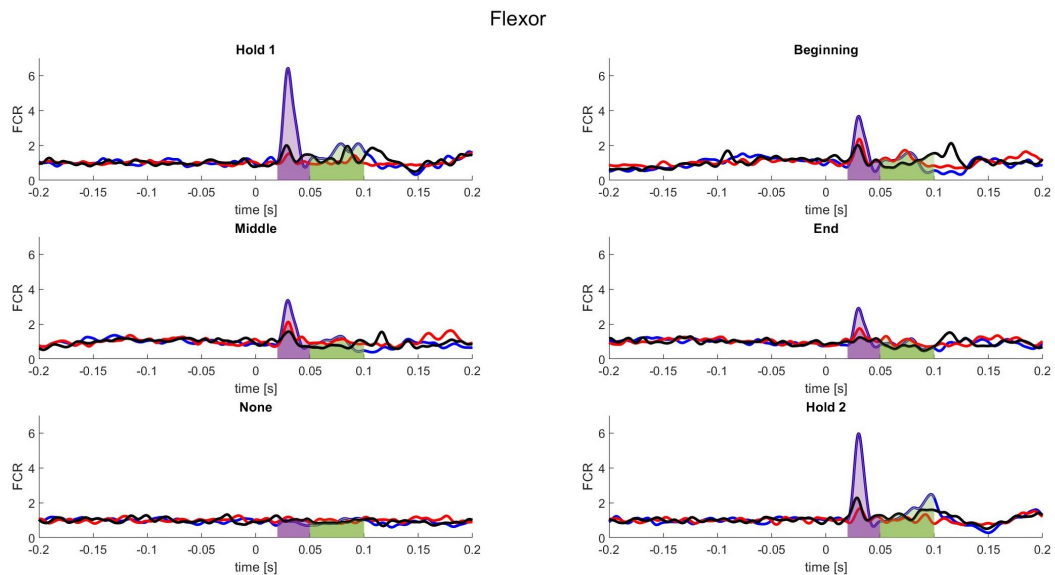

Figure 10: Mean FCR response for each subject, separated per condition (red = Subject 1; blue = Subject 2; black = Subject 3). It is possible to see the larger  $A_{M1}$  for Subject 2 in comparison to Subjects 1 and 3.

### 5.3 Discussion

The goal of the experiment was to implement position-dependent perturbations for the movement conditions and to improve the feedback given to the subjects. It can be said that the new perturbation design worked effectively, and that subject understanding of the velocity movement requirements also ameliorated due to the new training and feedback mechanisms.

The perturbations were consistent in the handle position at perturbation onset, demonstrating effective refined position-dependent perturbation design.

In order to increase the the  $A_{M2}$ , a larger hold for the R&H perturbation is necessary, as it was accidentally removed. In Experiment 1, the hold was  $100ms$ . The hold is important in order to elicit the M2 response [9].

The  $0.06rad$  amplitude with  $1rad/s$  velocity perturbations for the movement conditions indicate that the new perturbation design was effective in maintaining perturbation amplitude consistency, however, the amplitude nor velocity reached the intended parameters. This would explain the lack of significant reflex responses seen in the FCR for subjects 1 and 3

(Figure 10). The gains of the theta controller (Figure 234 in appendix E.3) need to be adjusted in order to achieve the desired amplitude of  $0.08rad$  with a velocity of  $2rad/s$ . In addition, validation of the chosen parameters would be beneficial to ensure that they are able to elicit clear M1 and M2 responses. Moreover, the inconsistent amplitude of the hold condition perturbations imply that the PoPe handle was not executing these perturbations as intended, likely due to user input. Furthermore, the difference in perturbation velocity between the hold and movement conditions is undesirable, as it can impact the data analysis of the observed reflex modulation by no longer being a controlled variable.

The feedback given to the user regarding the movement velocity showed to be very useful. It was better to correct the movement velocity before and/or during the experiment and hence take more time training, than to realize afterwards that a lot of the trials were inconsistent.

## 6 Experiment 3

This experiment was created in order to test perturbation parameters. The goal was to validate that the chosen perturbation amplitude and velocity was sufficient enough to elicit reflexes. It is dissimilar to previous experiments, as explained in the methods section. Additional information and data collected during this experiment can be found in Appendix C.

### 6.1 Methods

Five participants volunteered for this experiment (three female, two male).

The control task consisted of five trials of 30 seconds with ten R&H perturbations in each trial. The trials were conducted using position-mode, which signifies that the handle was locked in position and the user saw the user-input torque displayed on the screen. The subjects were instructed to try and keep the cursor in a green circle in the center of the display while perturbations were given. The circle was placed at the neutral position (Figure 1 at  $0^\circ$ ) of the wrist and looked similar to the circles used for the main experiment. The tested amplitudes were:  $[0.02, 0.06, 0.10, 0.14, 0.18]rad$ , which were based off of Schuurmans [9]. Each amplitude occurred twice within a trial, which resulted in ten perturbations given at each amplitude after completion of the five trials. The time between each perturbation was randomly assigned in a range of  $2.5 - 4.5s$ . The velocity of each perturbation remained at  $2rad/s$ . The hold period of the perturbations was  $100ms$ .

## 6.2 Results

The results showed that all amplitudes were able to elicit reflexes with a velocity of  $2rad/s$ . Figure 3 is an sample figure illustrating a typical response for  $0.1rad$ . Figure 11 shows the  $A_{M1}$  and  $A_{M2}$  averaged over the ten perturbation occurrences plotted against the R&H perturbation amplitude.

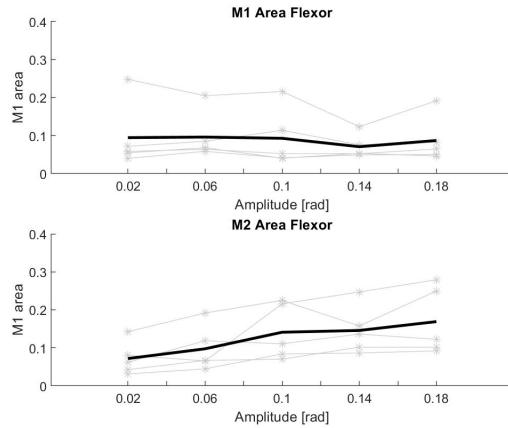

Figure 11: Average  $A_{M1}$  and  $A_{M2}$  per amplitude (FCR). The  $A_{M1}$  is shown to be consistent across all amplitudes. The  $A_{M2}$  increases with amplitude, indicating that saturation of the response was not yet achieved.

### 6.3 Discussion

The experiment validated the desired perturbation amplitude of  $0.08rad$  with velocity  $2rad/s$ . The elicited reflex response could still increase and decrease with respect to other parameters (i.e. perturbation position), as the  $A_{M2}$  increased with the perturbation amplitude, such that saturation of the response was avoided.

## 7 Experiment 4

The goal of this experiment was to implement any further necessary changes, such as position-dependent perturbations with a timer for the hold conditions, as well as to perform the experiment with ten subjects to allow for data and statistical analysis to verify the objectives of the experimental protocol. This experiment is seen as the main experiment. Additional information and data collected from this experiment can be found in Appendices D and E.

### 7.1 Methods

Ten participants volunteered for this experiment (six male, four female).

The hold present during the R&H perturbation needed to be reinstated and lengthened in order to better observe an M2 response. The new hold time is  $180ms$ , longer than the previous  $100ms$  in an attempt to establish more discernible  $A_{M2}$ .

Position-dependent perturbations with velocity-hold were implemented together with an additional loop for time-dependency for the hold conditions, as Experiment 2 showed that the perturbation amplitude was not consistent (Figure 9).

Experiment 3 was modified to be one trial of 30 seconds with ten perturbations of  $0.08\text{rad}$  in order to verify proper EMG placement, and that reflexes could be seen for the individual ahead of completing the main experiment. If no reflexes could be seen, the EMG placements would be checked and if the individual still did not display satisfactory reflexes, the individual would not be assessed for the main experiment. The data for this modified pre-main experiment control trial can be found in Appendix D.2.

During the main experiment subjects were asked to complete at least five training trials. After each trial the participant was given feedback about their movement velocity. If the trial was unsatisfactory, a decision was taken on whether the trial needed to be repeated. If the perturbation occurred during the movement, then an unsatisfactory trial was repeated at a later time, without the subject knowing. If the perturbation occurred during a hold period or no perturbation occurred, then the movement velocity was not as important, so the trial had no need to be repeated. If the subject was consistently incorrectly performing the desired movement velocity, more training trials were done. Subjects were asked to perform the movement with an open and

relaxed hand, pushing primarily with their palm and not using their fingers. Every twenty trials a break was scheduled, but subjects were informed that they could ask for a break at any time. The duration of the break was up to the subject, but generally no more than the allotted two minutes. Using data from the previous experiments, it was observed that the results were the same for 120 trials (twenty per condition) as 60 trials (ten per condition). Hence, the number of trials was reduced to 90 trials (fifteen per condition) to allow for outliers to be removed, thereby also improving the efficiency of the protocol.

## 7.2 Results

Many subjects required more than five training trials in order to master the desired movement velocity, see Subject Comments in Appendix E.4. Typically once the desired velocity had been repeated a few times pre-recording of the data, the subject was able to maintain the same velocity. Feedback was still given after each trial to ensure the velocity is maintained. Some were better than others at maintaining the desired velocity throughout the experiment, others needed to do a few training trials again after each break. Everyone had to repeat trials due to not paying attention or mistakes in the velocity of the movement.

Figure 12 shows the  $A_{M1}$  and  $A_{M2}$  per subject as well as the average for the ECR and FCR respectively.

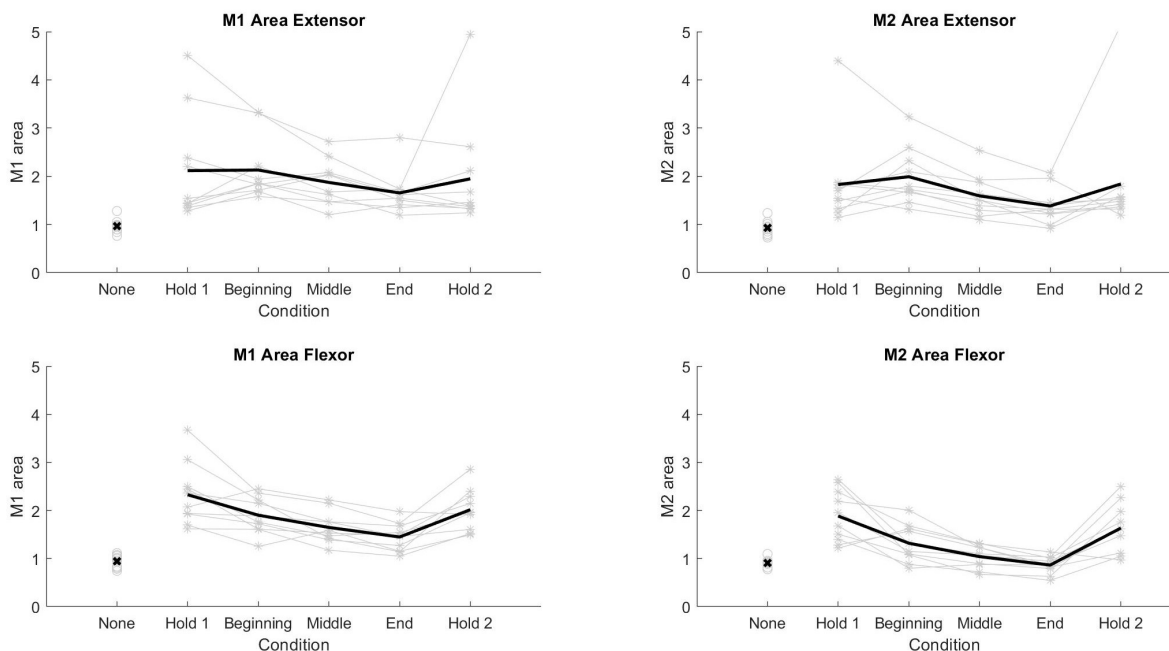

Figure 12: Average  $A_{M1}$  and  $A_{M2}$  per subject (ECR and FCR). The subject lines are shown in light grey. The average of all the subjects is shown in black. It is possible to see the "none" condition as a reference value to illustrate the increase in EMG activity as a result of the perturbation.

Figure 13 shows the position profile of each movement. The amplitude of the perturbation and the velocity used to reach the desired amplitude was very consistent,  $0.08\text{rad}$  and  $2\text{rad/s}$  respectively.

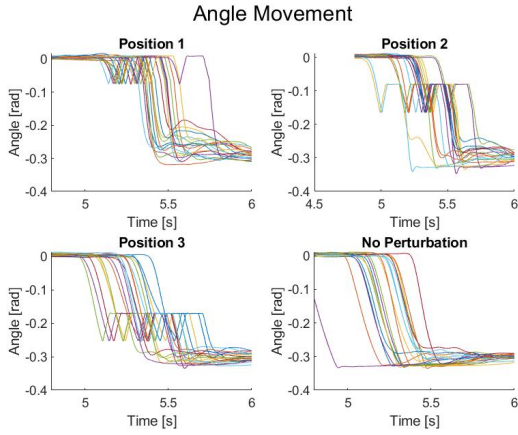

Figure 13: Position profile for each movement (Position 1 =  $0.07\text{rad}$  = Condition 2; Position 2 =  $0.16\text{rad}$  = Condition 3; Position 4 =  $0.25\text{rad}$  = Condition 4 and No perturbation = Condition 5). The figure illustrates the efficacy of the velocity-hold which switched from user-input to disallowing user-input, during execution of the perturbation. Furthermore, the position at which the perturbation was elicited is shown to be consistent. (Subject 1)

A one-way RM-ANOVA test was conducted to determine the significance of the data with respect to each perturbation condition. The calculated values for the F-statistic, p-values and degrees of freedom are shown in Table 2. The results showed that the  $A_{M1}$  and  $A_{M2}$  for the ECR were not significantly different (M1  $F(4,36) = 1.631$ ,  $p = .232$ ; M2  $F(4,36) = 2.669$ ,  $p = .127$ ). The  $A_{M1}$  and  $A_{M2}$  for the FCR were both significantly different (M1  $F(4,36) = 13.460$ ,  $p < 0.01$ ; M2  $F(4,36) = 15.837$ ,  $p < 0.01$ ). A post hoc pairwise t-test conducted for the  $A_{M1}$  FCR showed that all conditions differed significantly from each other, except for Beginning and Hold 2. A post hoc pairwise t-test conducted for the  $A_{M2}$  FCR showed that all conditions again differed significantly from each other, except for Beginning and Hold 2.

Table 2: Summary of one-way RM-ANOVA test to determine the effect of posture on the  $A_{M1}$  and  $A_{M2}$  in the ECR and FCR. The degrees of freedom were used to determine the critical value of 3.828. The significance level is 0.05.

	$df$	$F$	$p$
<b>M1 ECR</b>	4, 36	1.631	0.232
<b>M2 ECR</b>	4, 36	2.669	0.127
<b>M1 FCR</b>	4, 36	13.460	9.60E-4
<b>M2 FCR</b>	4, 36	15.837	5.74E-4

The background EMG is shown to be much smaller for the ECR than the FCR (Figure 14). The average background EMG for the ECR varied between

0.065 and 0.1, whereas the FCR ranged from 0.63 to 1.24. Thereby, indicating the contraction present in the FCR in response to the force field.

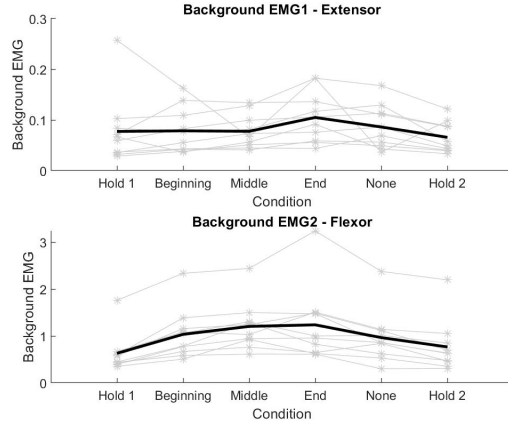

Figure 14: Average Background EMG per subject (ECR and FCR). The subject lines are shown in light grey. The average of all the subjects is shown in black. The background EMG for the FCR was larger than the ECR which is representative of the force field.

A one-way RM-ANOVA test was also conducted to determine the effect of the force field on the background EMG. The calculated values for the F-statistic, degrees of freedom and p-values are shown in Table 3. The results show that the effect was not significantly different for the background EMG of the ECR at a 99% confidence interval ( $F(5,45) = 1.653$ ,  $p = .223$ ). The background EMG of the FCR is shown to be affected by the force field ( $F(5,45) = 16.565$ ,  $p < 0.01$ ), showing significant differences. A post hoc pairwise t-test for the FCR showed that all conditions differed significantly from each other, except for Beginning - End, Beginning - None and Middle - End.

Table 3: Summary of one-way RM-ANOVA test to determine the effect of the force field on the background EMG of the ECR and FCR. The degrees of freedom were used to determine the critical value of 3.5138. The significance level is 0.05.

	$df$	$F$	$p$
<b>BKG ECR</b>	5, 45	1.653	0.223
<b>BKG FCR</b>	5, 45	16.565	2.95E-9

### 7.3 Discussion

The goal of this experiment was to validate that all the implemented changes were effective and that the experiment was able to elicit reflexes in ten subjects. The results show the implemented changes performed well. The statistical analysis shows that the FCR reflex modulated with respect to wrist joint posture.

The feedback and training proved effective. Already in Experiment 2, the feedback and training were shown to aid the consistency of the movement.

In the current experiment, subjects commented on how the visuals helped them to understand how they were performing the movement, for example, starting too fast and ending slowly, and clear improvements were seen after the feedback was given. Furthermore, it was advantageous to complete as many training trials as necessary before starting measuring as it limited the number of repetitions for incorrectly performed trials later. Subjects also appreciated the ability to take breaks and perform some additional training trials before continuing with the experiment, whenever they felt it was necessary to practice the movement.

The perturbation design greatly improved, all perturbations were position-dependent with fixed amplitudes, thereby ensuring that the data is representative of the  $A_{M1}$  and  $A_{M2}$  as a result of the consistent handle positions per condition; rather than other factors, such as perturbation amplitude or varying perturbation velocity. The handle switched between user-input and a velocity-hold seamlessly, as the perturbation amplitude was able to reach  $0.08rad$  without interference. No subjects commented that the mode switching bothered them, or that they even noticed. The velocity of the perturbation was consistently  $2rad/s$ , and the hold period of the R&H perturbation was also consistently  $180ms$ . Designing the perturbations in this manner takes into account reaction delays between the moment the subject is told to move and the moment the subject actually moves. As a result, the training was better focused on performing with a consistent movement velocity, rather than the exact timing of every aspect of the trial.

Experiment 4 was conducted with ten subjects to validate that M1 and M2 responses can be seen in the FCR, and that  $A_{M2}$  modulates dependent upon the conditions present (Figure 12). The experiment demonstrated that the reflex response in the FCR voluntarily modulated as a natural response to the posture at which the perturbation is elicited (all five perturbation conditions were at a different handle position). The statistical analysis performed confirms these findings, post hoc tests showed that almost all of the conditions differed significantly from the others for the  $A_{M2}$  FCR response. The  $A_{M1}$  does not typically modulate due to it being a spinal reflex, but still showed statistically significant modulation for the same condition comparisons. In the ECR, no statistically significant difference was seen between conditions for neither the  $A_{M1}$  nor the  $A_{M2}$ , indicating that although an increased EMG response is present, it is not posture-dependent and likely a result of the perturbation in general.

The background EMG was also plotted for each subject (see Figure 14) in order to determine the ef-

fect of the passive torque on the subjects movements. The figures show that the background EMG between the two channels was not similar in magnitude, reflecting the expected, increased contraction in the FCR compared to the ECR. The statistical analysis demonstrates that the effect was not statistically significant in the ECR. The effect was statistically significant in the FCR, for most conditions. This effect could be the result of the slight position-dependent nature of the force field, although this can not be decisively concluded as it would not explain why Beginning - End, Beginning - None and Middle - End did not show a significant difference. Especially, considering Beginning and End are two conditions quite far away in the movement, it would be expected for those to be significantly different.

Another possible explanation for the significant results in the FCR is that the passive torque was set to the same value of  $1.2Nm$  for all subjects. For some subjects, this torque proved to be quite tiring, requiring many breaks and visible signs of fatigue were apparent. However, for others this torque did not cause any difficulty when performing the trials. It would be interesting to test if the results are still significant if the force field was adapted to be a percentage of the maximum voluntary contraction (MVC) that the subject could perform. Other studies, such as [15, 16, 25], have used this method of eliciting isometric contractions. Cathers et al.[25] instructed subjects to maintain a contraction at 25% of MVC level, as this level is low enough to avoid fatigue while still allowing for a suitable signal-to-noise ratio (SNR) in the EMG.

## 8 Experiment 5

Experiment 4 was seen as the final experimental phase before the continuous PRBS perturbations were implemented. Due to Experiment 4 validating posture-dependent reflex modulation with a significant amount of participants, Experiment 5 only had 2 participants to demonstrate the validity of the PRBS perturbations, and to determine if the experiment time can be decreased while acquiring more relevant data. The data collected from this experiment, with associated figures, can be found in Appendix F.2.

### 8.1 Methods

Two participants volunteered for this experiment (1 female, 1 male).

Each trial was designed to have the subject complete multiple flexion movements within a single trial, after one movement from A to B, the subject moves back to A to start another movement. Previously one movement resulted in one trial, with this experiment, the number of movements completed in a single trial could be easily altered. After some pilot



tests, it was decided that five flexion movements per trial was optimal due to subject fatigue. 40 trials were conducted, such that 200 movements were observed per subject. Furthermore, the hold periods were shortened to a 2s hold. The movement time for previous experiment phases was 200ms, however, due to the PRBS perturbation switching rate of 150ms, perturbations could be easily avoided during the movement. Hence, the movement time was increased to 500ms. A longer movement time also allowed for more PRBS perturbations to be observed during the movement.

The visuals were implemented into a loop such that each movement had the same set of instructions (move to position, hold period 1, movement, hold period 2).

The perturbations for this experiment were changed to continuous PRBS perturbations throughout the trial, even during the extension movement back to circle A. The move back extension was set to 500ms, equivalent to the flexion movement, such that the subject perceived the two movements as equally important and remained concentrated for the duration of the trial. Training was still given before the trials in order to adjust to the new movement velocity and perturbations, as both subjects had previously participated in Experiment 4. The feedback was given per trial, so that after five movements, the subjects received feedback. Trial repetition was determined based on the consistency of more than three movements.

## 8.2 Results

The continuous perturbations with a shorter trial duration allowed for more than double the amount of observable flexion movements taken in less time than Experiment 4 typically took to complete, 200 movements versus 90 movements respectively. The time taken to give feedback and start a new trial was consistent with Experiment 4, but was no longer necessary after every movement, reducing total experiment time as well. In general most of the movements were consistently within the desired velocity range. Subjects also commented that this experiment was more enjoyable than the previous one as it was more engaging and they had more actions to perform per trial.

Figures 15 and 16 show the movements for two trials and all trials, respectively (Subject 1). Subject 2 shows similar results (appendix F). Perturbations were observed during the movement, as well as the hold periods (Figure 15). The movement speed was kept fairly consistent, even if there is a delay in the exact timing of the start of the movement (Figure 16).

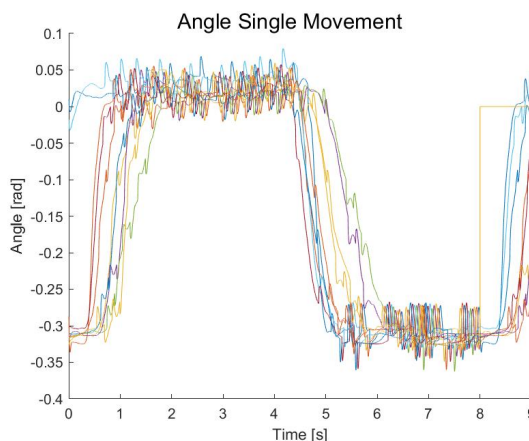

Figure 15: The figure shows the position profile for each movement for two trials. A movement is defined as a flexion movement from point A to point B. The PRBS perturbations are shown during all parts of the movement, as now the switching rate is kept at 150ms but the movement duration is increased to 500ms.

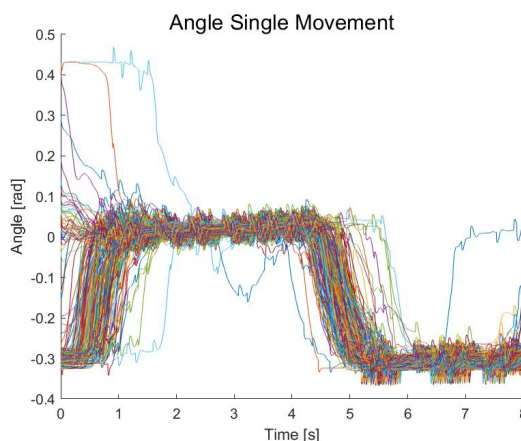

Figure 16: The figure shows the position profile of each movement from A to B (Subject 1) for all trials. During the movement as well as the hold perturbations can be observed. A delay in the exact timing of the movement can be seen, though this does not impact the trial efficacy.

During the trials, very little feedback needed to be given about improving the movement velocity, as usually one or two movements didn't follow the correct movement velocity approximately every three trials. Training took less time than before due to the subjects being familiar with the previous experiments, the main focus was adjusting to the new movement velocity.

Figure 17 shows that the FCR had peaks in the mean response, indicating reflexes were generally observed. These graphs have not been cut to only show the time of the elicited perturbation, as per previous experiments, due to the different and continuous nature of the perturbations.

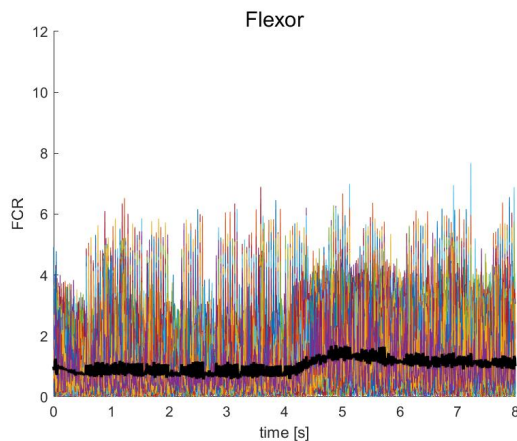

Figure 17: The figure shows the FCR response for all trials (Subject 1). Small peaks can be observed in the normalized mean (black line) indicating increased EMG activity, likely due to a perturbation. It is difficult to fully ascertain due to the nature of the continuous perturbations and no reflex window has been cut like previous trials.

### 8.3 Discussion

Due to the increased number of movements in the same experiment time, there was more leniency towards repetition of trials. The inconsistent movements were removed and considered outliers. Despite removing the outliers, it was still difficult to find an ideal alignment of the movement. An ideal alignment of the movement is important for system identification, as slight variations can alter the estimated parameters. The subjects did show consistency with executing the movement, however, the consistency was not enough to create the ideal alignment.

The continuous PRBS functioned well, eliciting perturbations during the hold and movement periods. The new movement velocity completed the movement in more time than the previous experiments, but the subjects still seemed to be relying mostly on feedforward mechanisms to execute the movement. A benefit to this experiment was that the subject was more autonomous in the trial, the examiner no longer needed to load the next trial after just a single movement. This helped to speed up the process and kept the subjects engaged during the experiment.

Any further data processing is not relevant for the goal of this experiment, as Experiment 4 is considered the main experiment where a large number of subjects were tested for reflex modulation. Due to the movement of the experiment not changing in regards to start position and end position, it can be assumed that Experiment 5 would also elicit reflexes when the FCR is subjected to PRBS perturbations. The goal of Experiment 5 was to convert the already functioning Experiment 4 into a faster experiment, with continuous perturbations, wherein more movements can be

observed in a similar amount of time. This goal was achieved.

## 9 General Discussion

The goal of the current study was to iteratively design an ideal experimental protocol that would test for voluntary reflex modulation as a result of wrist posture during a goal-directed movement. The current study highlights five experimental phases. The first two experiments were conducted with few subjects and transient R&H perturbations to develop the protocol. A control experiment was then conducted to test the perturbation parameters. Once the protocol was almost finalized, Experiment 4 acted as the main experiment, bringing all the changes together and testing ten subjects. Experiment 5 is an addendum to Experiment 4, where the efficiency of the protocol was ameliorated with the implementation of continuous PRBS perturbations. The main experiment demonstrated the ability for the protocol to elicit voluntary reflex modulation as a natural response to the posture-dependent independent variable. The  $A_{M1}$  and  $A_{M2}$  in the FCR were shown to be statistically different as a result of the 6 conditions tested. It can be said that the current study is successful in achieving its goal.

The transient R&H perturbations in the current study were designed to elicit stretch reflex responses in the FCR through incurring a stretch, with an amplitude of  $0.08rad$ , a ramp velocity of  $2rad/s$  and a  $180ms$  hold. A goal-directed movement was implemented to test the effect of the posture at which the reflex was elicited on the stretch reflex responses. Factors such as velocity, amplitude and duration of the perturbation also affect the  $A_{M1}$  and  $A_{M2}$  [9]. Schuurmans et al.[9] hypothesized that stretching the muscle results in an initial burst of Ia afferent input, triggering an action potential in a short time frame, which synchronized the motoneuron pool, often called the M1 response. If the excitation by the Ia afferents lasts long enough, a second spike could be fired by the synchronized neurons, often called the M2 response [9]. Hence, the chosen perturbation amplitude, velocity and duration was shown to be effective in eliciting an M2 response. The importance of the  $A_{M2}$  is shown with respect to testing reflex modulation parameters.

Reflex modulation is typically observed in the M2 component of the reflex, as the M1 component acts as an automated response through the spinal pathways [18]. Task dependency has been shown to instigate modulation of the  $A_{M2}$  [10–16], indicating modulation at the supraspinal level [9]. The M1 response is mediated by group Ia afferents, and characterized as monosynaptic whereas the pathway mediating the M2 response is still debated [9]. The current study

has shown that stretch reflex responses are elicited for both the short latency, M1, and long latency, M2, components of the FCR. The results also show that the  $A_{M1}$  and  $A_{M2}$  of the FCR both significantly differ with respect to the conditions tested. The designed experimental protocol is, therefore, shown to be effective in testing posture-dependent reflex modulation.

Posture-dependency of the M1 and M2 stretch reflexes was primarily assessed in the current study. With varying position, the velocity at which the PoPe handle, and subsequently the wrist, was moving also varied. The  $A_{M1}$  has been shown to be dependent on acceleration, while the  $A_{M2}$  has been shown to be dependent on velocity and acceleration [26]. Nonetheless, it is not relevant to do a separate analysis for velocity-dependent reflex modulation due to velocity of the PoPe handle being a dependent variable of the handle position, and subsequently the wrist joint posture, during the goal-directed movement. Furthermore, the velocity of the perturbation itself is kept constant, at  $2\text{rad/s}$ .

The background EMG of the FCR and ECR are discussed in the results and discussion of Experiment 4, with respect to the effect of the passive torque. In the ECR, the effect was not shown to be significant, whereas in the FCR it was significant as per the one way RM-ANOVA test and post hoc test results. It is unclear whether the significant difference is a result of the slight position-dependent nature of the force field, as certain conditions quite far apart in position did not show a significant difference. The contraction level of the muscle is an important factor to consider when measuring reflex response amplitudes, as an increased contraction results in increased responses [20–22, 27]. If the position-dependency of the force field is noticeable, then the  $A_{M1}$  and  $A_{M2}$  of the FCR should increase with conditions further along the movement (i.e. End, Hold 2). However, this pattern is not seen in Figure 12. Bock et al.[20] explain the occurrence of increased responses being due to "a greater percentage of motoneurons excited close to their threshold activation". More motoneurons are activated by stretch resulting in automatic gain control. Similarly, Stein and Kearney[27] clarify that "increasing voluntary activity increases the fraction of motoneurons that are close enough to threshold to be activated by the stretch". A low level of contraction is already enough to increase the reflex response, as no significant difference was found between high and low contraction levels [21]. Furthermore, maintaining a contraction during the perturbations allows for an increase in reflex activity which follows the same pattern as without the contraction [28], indicating that the contraction does not interfere with the observed reflex modulation. In the wrist,

similar patterns of reflex modulation with higher or lower amplitudes was seen for the active and passive tasks, respectively [17].

Furthermore, the subject comments for Experiment 4 also reflect upon the tiredness of the subjects when performing the experiment, with some subjects not feeling the effects of fatigue, while the other ones do. Further investigation into the nature of the force field must be conducted to determine the reason for the significant difference. Additional investigation would also benefit from understanding if the observed reflex modulation effect changes if the passive torque is set to a percentage of the MVC, to rule out fatigue.

### 9.1 Limitations

A significant limitation to determining protocol efficacy is that the protocol was not tested with persons suffering from motor disorders. Therefore, it cannot be proven that the protocol will be effective, safe and/or suitable for these kinds of subjects.

The data collection is reliant on the completion of the full trial in order to save properly. If a trial is stopped mid-way or triggers an error condition in the GUI, then the data cannot be saved, and the trial would have to be repeated. For single movement trials this is not as impactful, however, when using Experiment 5, it can cause data from multiple movements to be lost.

### 9.2 Improvements and Future Work

One improvement could be to apply the force field taking into account each subject's strength, for instance by using a pre-determined percentage of their respective MVC. This would help to tailor the protocol to each subject's abilities, without risk of early fatigue or triggering safety boundaries. Similarly, the significant differences observed in the background EMG of the FCR should be investigated through various force field implementations and strengths.

The final goal of this protocol is for it to be used with patients with motor disorders, therefore, improving efficiency and accuracy of data can aid with ensuring that the comfort of the patients is maintained. In addition, allowing for the experiment to stop at any movement, without losing data, would also benefit the protocol. Presently, each trial consisted of 5 movements, which semi-automated the process of completing the movements as the examiner does not need to start each movement separately. However, if those five movements were not completed, the data was not saved. Therefore, it would be beneficial to have every movement be seen as a separate trial, and saved as such, while also eliminating the need for the examiner to start each trial.

Efficiency in the protocol could be further im-

proved by implementing a method to automatically detect the movement velocity of the movement and determine if the trial needed to be repeated. If yes, then to repeat the trial, or add it to the back of the protocol to be repeated at the end. With the continuous perturbations, it is easier to repeat trials since the subject will not be affected by the knowledge of when the perturbation would occur, in opposition to the transient perturbation trials. If the velocity is deemed appropriate, then the PoPe should automatically move to the next trial and let the subject know the trial was performed well.

Another factor to implement with the continuous perturbations would be to test for ideal alignment of the movement. Currently, ideal alignment is tested for at the end of the experiment, but checking for alignment during the experiment could reduce the number of outliers. If both velocity and alignment of movement are checked for during the experiment, then the experiment could be shortened due to having to complete less trials. A limit could be implemented for the number of repetitions for every bad trial to avoid the subjects performing the experiment

for too long. Currently, the experimental protocol consists of 200 movements with the idea that there will be outliers, if these outliers are already filtered out during the experimental process, then it is not necessary to perform 200 movements.

## 10 Conclusion

The current study aimed to design an experimental protocol that would allow for analysis of reflex modulation as a result of posture-dependent perturbations while performing a goal-directed movement. The design process started with transient Ramp-and-Hold perturbations, testing the posture-dependency at five different locations within the flexion movement. The results show that the M1 and M2 area in the FCR both differ significantly dependent on the wrist posture. The experimental protocol can, therefore, be said to be effective in testing posture-dependent properties of reflexes in the wrist. Continuous PRBS perturbations were implemented to improve the protocol efficiency and allow for continuous analysis of reflex modulation during the execution of a goal-directed movement.

# References

- [1] Prinses Beatrix Spierfonds. Spierziekten (algemeen) - Prinses Beatrix Spierfonds - <https://www.prinsesbeatrixspierfonds.nl/spierziekten/spierziekten-algemeen/>, 2012. URL
- [2] J. P. Hammerstad, "Chapter 15 - Strength and Reflexes," C. G. B. T.-T. of C. N. (Third E. Goetz, Ed. Philadelphia: W.B. Saunders, 2007, pp. 243–287.
- [3] M. L. Latash and V.M. Zatsiorsky, "6 - Reflexes," in *Biomechanics and Motor Control*, M. L. Latash and V.M. Zatsiorsky, Eds. San Diego: Academic Press, 2016, pp. 99–120.
- [4] H.K. Walker, "Deep Tendon Reflexes," in *Clinical Methods: The History, Physical, and Laboratory Examinations*, 3rd edition, Boston: Butterworths, 1990, Chapter 72.
- [5] D. Piscitelli, N. A. Turpin, S. K. Subramanian, A. G. Feldman, and M. F. Levin, "Deficits in corticospinal control of stretch reflex thresholds in stroke: Implications for motor impairment.," *Clin. Neurophysiol. Off. J. Int. Fed. Clin. Neurophysiol.*, vol. 131, no. 9, pp. 2067–2078, Sep. 2020, doi: 10.1016/j.clinph.2020.05.030.
- [6] N. K. Musampa, P. A. Mathieu, and M. F. Levin, "Relationship between stretch reflex thresholds and voluntary arm muscle activation in patients with spasticity.," *Exp. brain Res.*, vol. 181, no. 4, pp. 579–593, Aug. 2007, doi: 10.1007/s00221-007-0956-6.
- [7] A. C. Schouten, E. de Vlugt, J. J. B. van Hilten, and F. C. T. van der Helm, "Design of a torque-controlled manipulator to analyse the admittance of the wrist joint.," *J. Neurosci. Methods*, vol. 154, no. 1–2, pp. 134–141, Jun. 2006, doi: 10.1016/j.jneumeth.2005.12.001.
- [8] D. Ludvig, I. Cathers, and R. E. Kearney, "Voluntary modulation of human stretch reflexes.," *Exp. brain Res.*, vol. 183, no. 2, pp. 201–213, Nov. 2007, doi: 10.1007/s00221-007-1030-0.
- [9] J. Schuurmans, E. de Vlugt, A. C. Schouten, C. G. M. Meskers, J. H. de Groot, and F. C. T. van der Helm, "The monosynaptic Ia afferent pathway can largely explain the stretch duration effect of the long latency M2 response," *Exp. Brain Res.*, vol. 193, no. 4, pp. 491–500, 2009, doi: 10.1007/s00221-008-1647-7.
- [10] F. Doemges and P. M. Rack, "Task-dependent changes in the response of human wrist joints to mechanical disturbance," *J. Physiol.*, vol. 447, pp. 575–585, Feb. 1992, doi: 10.1113/jphysiol.1992.sp019019.
- [11] F. Doemges and P. M. Rack, "Changes in the stretch reflex of the human first dorsal interosseous muscle during different tasks.," *J. Physiol.*, vol. 447, pp. 563–573, Feb. 1992, doi: 10.1113/jphysiol.1992.sp019018.
- [12] C. J. Forgaard, I. M. Franks, D. Maslovat, and R. Chua, "Perturbation Predictability Can Influence the Long-Latency Stretch Response.," *PLoS One*, vol. 11, no. 10, p. e0163854, 2016, doi: 10.1371/journal.pone.0163854.
- [13] T. Kizuka, T. Asami, and K. Tanii, "Relationship between the degree of inhibited stretch reflex activities of the wrist flexor and reaction time during quick extension movements.," *Electroencephalogr. Clin. Neurophysiol.*, vol. 105, no. 4, pp. 302–308, Aug. 1997, doi: 10.1016/s0921-884x(97)00026-x.
- [14] M. Dimitriou, "Task-dependent modulation of spinal and transcortical stretch reflexes linked to motor learning rate.," *Behav. Neurosci.*, vol. 132, no. 3, pp. 194–209, Jun. 2018, doi: 10.1037/bne0000241.
- [15] V. Dietz, M. Discher, and M. Trippel, "Task-dependent modulation of short- and long-latency electromyographic responses in upper limb muscles.," *Electroencephalogr. Clin. Neurophysiol.*, vol. 93, no. 1, pp. 49–56, Feb. 1994, doi: 10.1016/0168-5597(94)90091-4.
- [16] K. Nakazawa, S. I. Yamamoto, and H. Yano, "Short- and long-latency reflex responses during different motor tasks in elbow flexor muscles.," *Exp. brain Res.*, vol. 116, no. 1, pp. 20–28, Aug. 1997, doi: 10.1007/pl00005740.
- [17] M. T. Johnson, A. N. Kipnis, M. C. Lee, and T. J. Ebner, "Independent control of reflex and volitional EMG modulation during sinusoidal pursuit tracking in humans.," *Exp. brain Res.*, vol. 96, no. 2, pp. 347–362, 1993, doi: 10.1007/BF00227114.
- [18] J. A. Pruszynski, I. Kurtzer, and S. H. Scott, "Rapid motor responses are appropriately tuned to the metrics of a visuospatial task.," *J. Neurophysiol.*, vol. 100, no. 1, pp. 224–238, Jul. 2008, doi: 10.1152/jn.90262.2008.

- [19] MATLAB, 2021, The MathWorks Inc., Natick, MA, URL [https://nl.mathworks.com/products/get-matlab.html?s\\_tid=gn\\_getml](https://nl.mathworks.com/products/get-matlab.html?s_tid=gn_getml).
- [20] P. J. Bock, R. E. Kearney, S. M. Forster, and R. Wagner, "Modulation of stretch reflex excitability during quiet human standing,," *Conf. Proc. ... Annu. Int. Conf. IEEE Eng. Med. Biol. Soc. IEEE Eng. Med. Biol. Soc. Annu. Conf.*, vol. 2004, pp. 4684–4687, 2004, doi: 10.1109/IEMBS.2004.1404297.
- [21] M. M. Mirbagheri, H. Barbeau, and R. E. Kearney, "Intrinsic and reflex contributions to human ankle stiffness: variation with activation level and position,," *Exp. brain Res.*, vol. 135, no. 4, pp. 423–436, Dec. 2000, doi: 10.1007/s002210000534.
- [22] C. M. Evans, S. J. Fellows, P. M. Rack, H. F. Ross, and D. K. Walters, "Response of the normal human ankle joint to imposed sinusoidal movements,," *J. Physiol.*, vol. 344, pp. 483–502, Nov. 1983, doi: 10.1113/jphysiol.1983.sp014953.
- [23] K. E. Rodriguez, W. Mugge, and A. C. Schouten, "Expectancy modulates the stretch reflex,," TU Delft Master Thesis, Oct. 2016, url: <http://resolver.tudelft.nl/uuid:223e6fab-d66b-4114-8162-02105309ff51>.
- [24] R Core Team, 2021, R: A language and environment for statistical computing, R Foundation for Statistical Computing, Vienna, Austria, URL <https://www.R-project.org/>.
- [25] I. Cathers, N. O'Dwyer, and P. Neilson, "Dependence of stretch reflexes on amplitude and bandwidth of stretch in human wrist muscle," *Exp. Brain Res.*, vol. 129, no. 2, pp. 278–287, 1999, doi: 10.1007/s002210050898.
- [26] R. C. van 't Veld, E. H. F. van Asseldonk, H. van der Kooij, and A. C. Schouten, "Disentangling acceleration-, velocity- and duration-dependency of the short- and medium-latency stretch reflexes in the ankle plantarflexors," *J. Neurophysiol.*, Aug. 2021, doi: 10.1152/jn.00704.2020.
- [27] R. B. Stein and R. E. Kearney, "Nonlinear behavior of muscle reflexes at the human ankle joint,," *J. Neurophysiol.*, vol. 73, no. 1, pp. 65–72, Jan. 1995, doi: 10.1152/jn.1995.73.1.65.
- [28] K. Fujio, H. Obata, N. Kawashima, and K. Nakazawa, "The Effects of Temporal and Spatial Predictions on Stretch Reflexes of Ankle Flexor and Extensor Muscles While Standing,," *PLoS One*, vol. 11, no. 7, p. e0158721, 2016, doi: 10.1371/journal.pone.0158721.

# Appendices





## Appendix A: Experiment 1

### A.1: Additional Information

The PoPe setup in real life can be seen in 18.



Figure 18: The PoPe setup in real life. During the experiments, the subjects were instructed to keep the hand relaxed and open.

Multiple visual modes are possible using the PoPe. A new visual mode was created that allowed for a position cursor representative of the handle to be plotted moving from left to right and back in line with the flexion and extension movements of the manipulator. With the new visual mode, the visuals could be improved such that the vertical direction was kept constant, and the cursor only moves in the horizontal direction simulating a flexion and extension movement.

The final visual can be seen in Figure 2. Visual text instructions were given on the screen to inform the participant of the next steps. In Figure 2, the instructions are shown for the completion of the trial, to illustrate their placement. There are 4 sets of instructions: before the start of the trial ("Move to position", "Start in 2...", "Start in 1..."), during the hold period ("Hold for [5,4,3,2,1]..."), during the movement ("GO!", "Finish") and at the end of the trial ("Trial Completed!"). The instructions and circles were color coded to help the participant with understanding. Before the start and at the end of the trial, the text was blue and the circles were red. During the hold period, the text and the circles were both red indicating a *do not move* condition. During the movement, the text and the circles were green, indicating it was time to move. The circles and text turned back to red for the second hold period. Timers were implemented to let the subject know how long the movement should take, which were also used to aid in training. The timers instructed the subject to hold, move and hold again. All the timers were new and designed in specific for this experimental protocol.

The GUI read in an established disturbance file that had to be made prior to starting the experiment. Each new trial was named as a new condition rather than using 6 conditions. As a consequence, the name for each disturbance file was  $VX\_a.mat$ , where X is the trial number (ranging from 1 - 120). Hence, a separate disturbance file was created for each trial, and the condition applied to each file was kept track of using a Microsoft Excel spreadsheet. The results from Experiment 1 showed issues related to the method of naming and creating the disturbance files (appendix A.2). For instance, a file was categorized to be one condition (i.e. middle) but in fact occurred during hold 1. Other issues include: one of the beginning perturbations was created to occur at 5.05s rather than 5s and, one of the no-perturbation files did have a perturbation present. The disturbance file organization ensured that if anything changed with regards to protocol, 120 files would have to be altered as well, and that any experiment must always have 120 trials in order to guarantee that each condition occurred the same amount of times as all the other conditions. This method of creating disturbance files was not sustainable.

## A.2: Results per Subject

### Subject 1

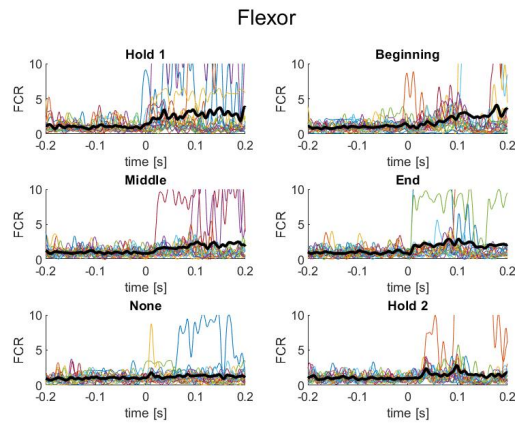

Figure 19: FCR response for each trial, separated per condition.

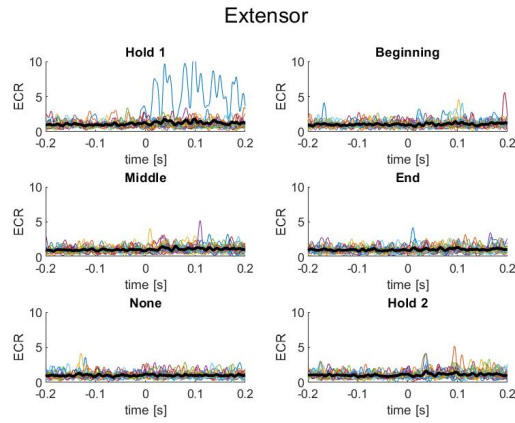

Figure 20: ECR response for each trial, separated per condition.

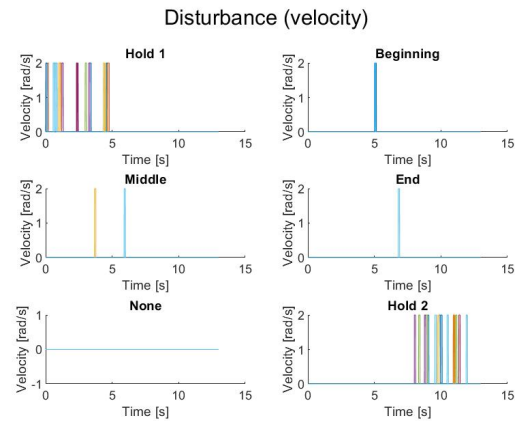

Figure 21: All the perturbations elicited during the 120 trials.

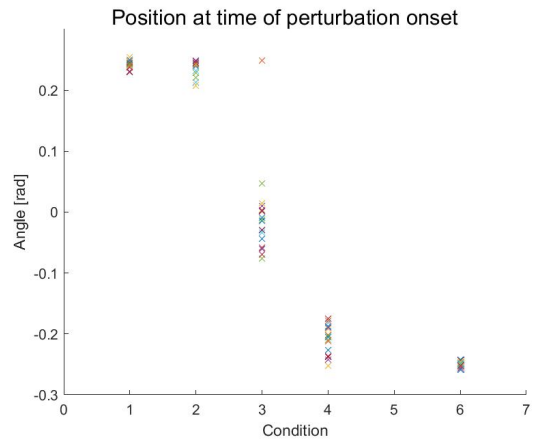

Figure 22: Position of the handle when each perturbation was triggered.

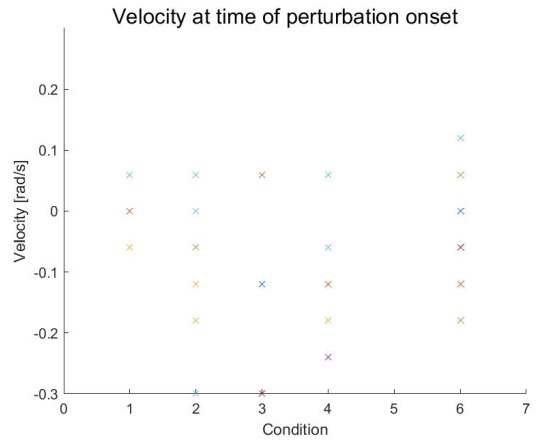

Figure 23: Velocity of the handle when each perturbation was triggered.

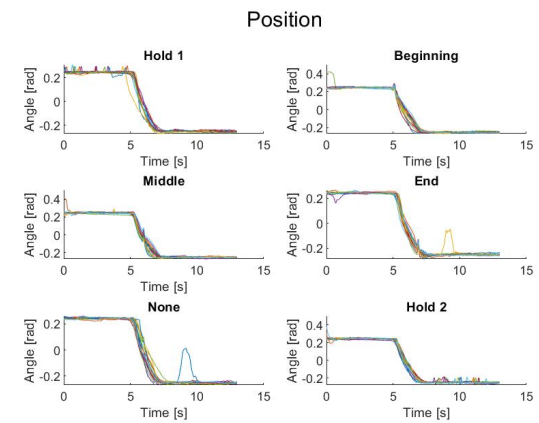

Figure 24: Position profile for each trial, separated per condition.

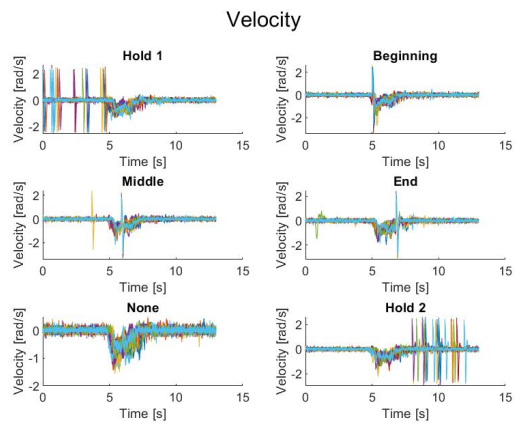

Figure 25: Velocity profile for each trial, separated per condition.

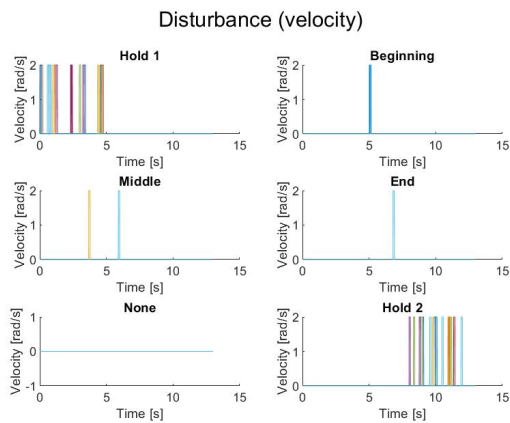

Figure 28: All the perturbations elicited during the 120 trials.

**Subject 2**

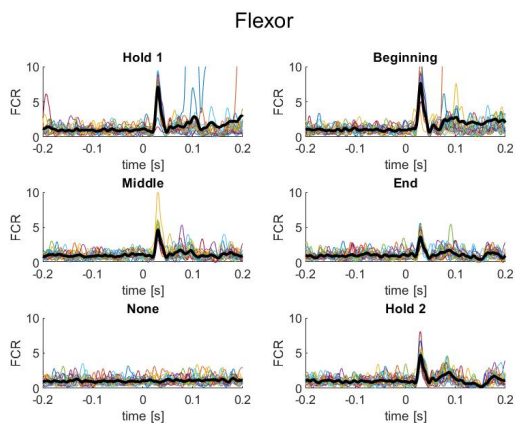

Figure 26: FCR response for each trial, separated per condition.

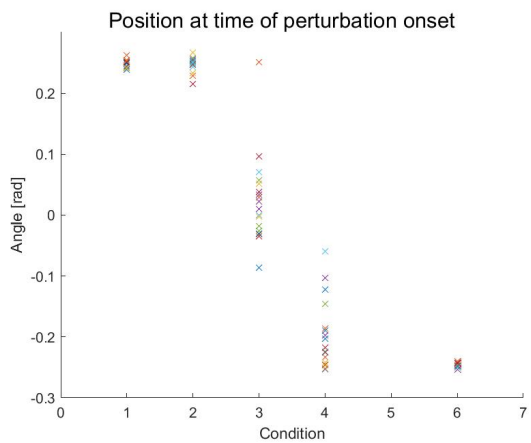

Figure 29: Position of the handle when each perturbation was triggered.

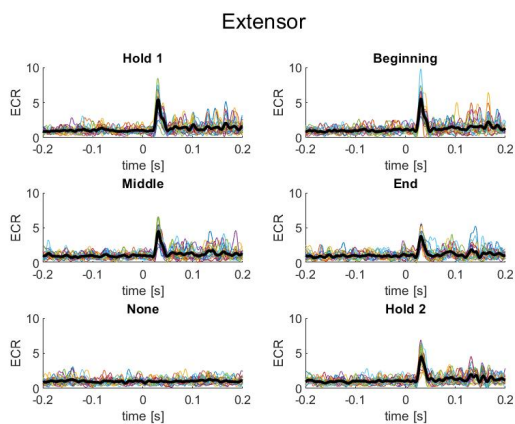

Figure 27: ECR response for each trial, separated per condition.

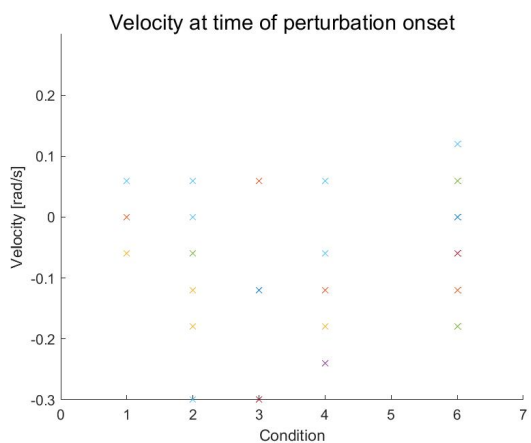

Figure 30: Velocity of the handle when each perturbation was triggered.

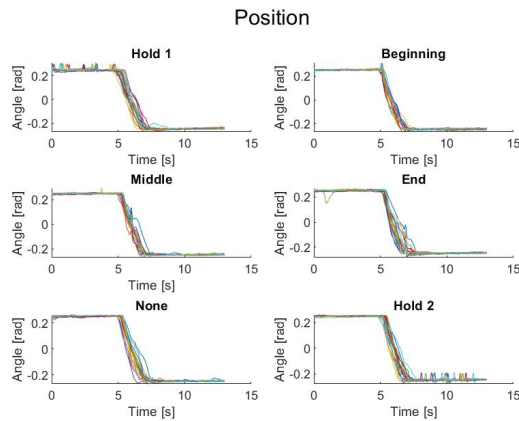

Figure 31: Position profile for each trial, separated per condition.

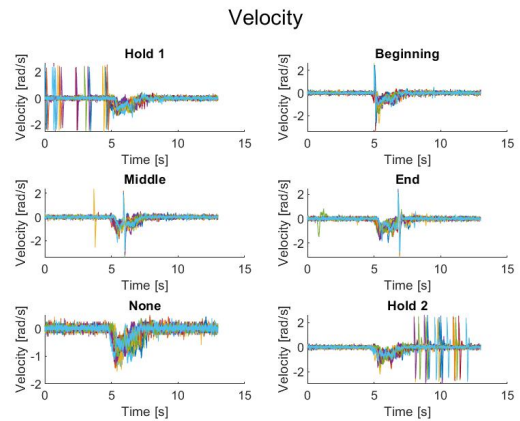

Figure 32: Velocity profile for each trial, separated per condition.

## Appendix B: Experiment 2

### B.1: Additional Information

In order to randomize the timing of the perturbation in the hold periods, the disturbance files for these conditions were scripted to be made and saved upon clicking *Activate Trial Settings* in the GUI. In addition, previously, the filenames were  $VX_a.mat$  where  $X$  is a number from 1-120, so it was not known where the perturbation occurs without looking the filename up in the excel spreadsheet. Designing the protocol to have 6 conditions allowed for the filenames to reflect each condition. For instance,  $V1_x.mat$  was a perturbation in hold 1,  $V2_x.mat$  was a perturbation at the beginning (of the movement),  $V3_x.mat$  was a perturbation in the middle,  $V4_x.mat$  was a perturbation at the end,  $V5_x.mat$  was no perturbation and  $V6_x.mat$  was a perturbation in hold 2; where  $x$  was a letter representing the first 20 letters of the alphabet to reflect 120 trials. To only have six disturbance files, also allowed for the trial order to be truly randomized per subject and to alter the number of trials easily, while still ensuring an equal number of trials per condition. Furthermore, it was easy to split the files per condition, to allow for data analysis per perturbation position.

The perturbation was triggered through reading the position at any given time until the desired angle was reached. The implementation in the Simulink model consisted of creating a new subsystem and loop through which the theta input traveled. The position at which the perturbation occurred could be altered using the operators settings file that was loaded into the GUI.

The amplitude of the perturbation was not consistent as the participant was able to apply their own force against the perturbation. It was important to keep the amplitude consistent as perturbation amplitude was shown to have a significant effect on the observed M1 and M2 areas. In order to ensure consistent amplitude, the Simulink model of the PoPe had to be changed as well.

To combine both the velocity hold and position-dependent perturbations, the Simulink model was altered to include additional pathways, where the model would read the position of the handle in real time, and depending on the condition, would compare it to the desired value to determine if a perturbation should be elicited. If a perturbation was elicited, the Boolean output switches from 0 to 1, thereby enabling the theta controller block (see figure 234) that contains the perturbation description and enabling the velocity-hold. The comparison value was altered with each condition to reflect the position of the perturbation.

The velocity-hold was originally attempted to include torque, instead of the reference velocity, so that the torque attempted by the user was disregarded. However, this was changed to a velocity-hold, because setting the torque to 0 or another constant value affected the manner in which the perturbation was given, as it very often resulted in "torque limit reached" errors. By setting the user velocity to 0, the perturbation could still occur using the pre-defined parameters in the theta controller (see Figure 234 in Appendix XX) and lookup table. The lookup table told the handle to move from 0 to  $0.08rad$  with a velocity of  $2rad/s$ , then moves from  $0.08$  to  $0rad$  with a velocity of  $2rad/s$  signifying the ramp on and ramp off of the perturbation. If the handle was not re-directed back to the original perturbation position, there was a "maximum dtheta" or "maximum torque" error as the user tried to override the perturbation. Furthermore, when the position that triggers the perturbation was passed, the handle was not at  $0rad$  (the neutral/hold 1 position), so the same error occurs as the handle tries to move too quickly back to 0 in order to attempt the 0 to  $0.08rad$  movement. Therefore, the position of the handle at which the perturbation was triggered had to be taken into account so that the handle does a  $0.08rad$  perturbation, starting at the current position.

## B.2: Results per Subject

### Subject 1

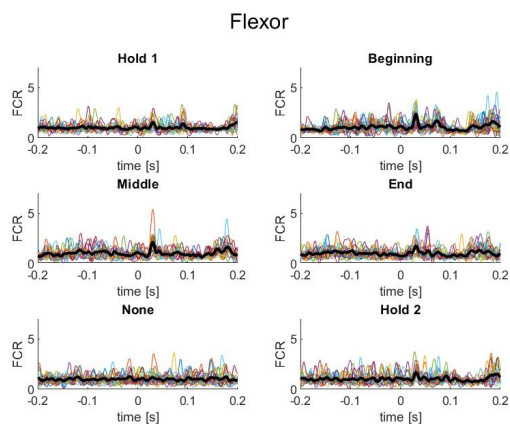

Figure 33: FCR response for each trial, separated per condition.

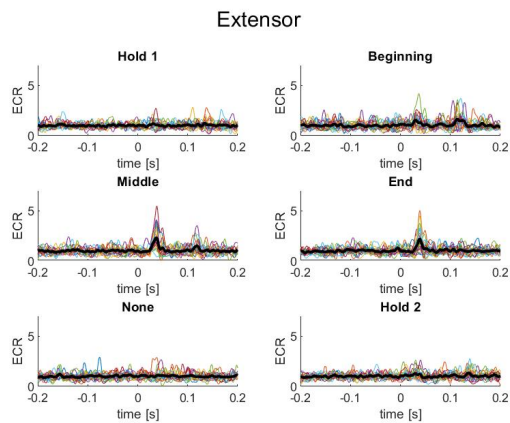

Figure 34: ECR response for each trial, separated per condition.

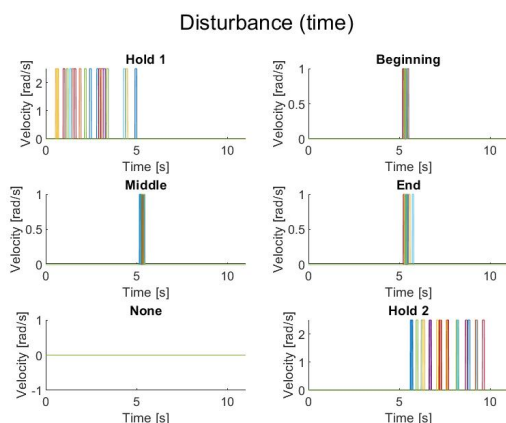

Figure 35: All the perturbations elicited during the 120 trials.

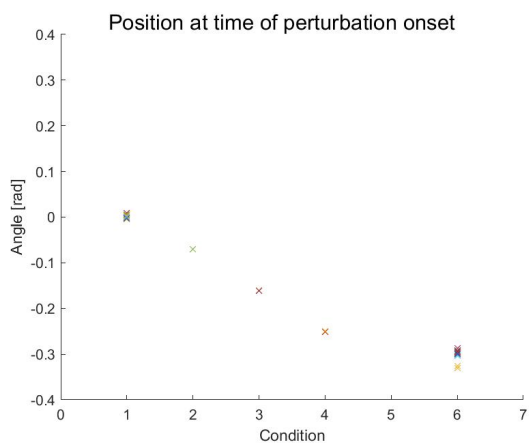

Figure 36: Position of the handle when each perturbation was triggered.

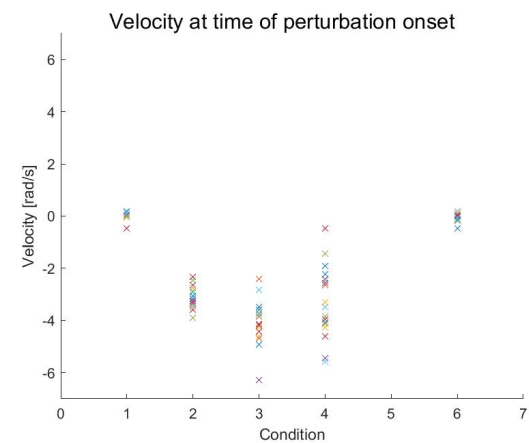

Figure 37: Velocity of the handle when each perturbation was triggered.

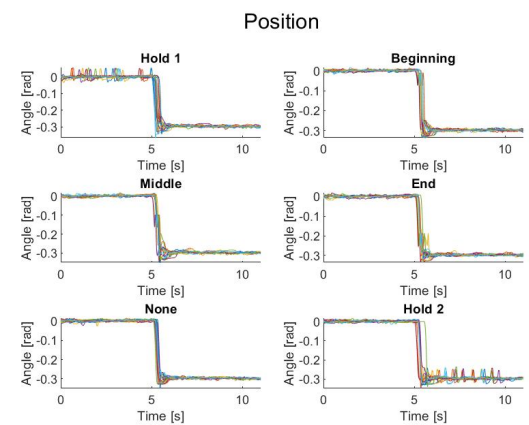

Figure 38: Position profile for each trial, separated per condition.

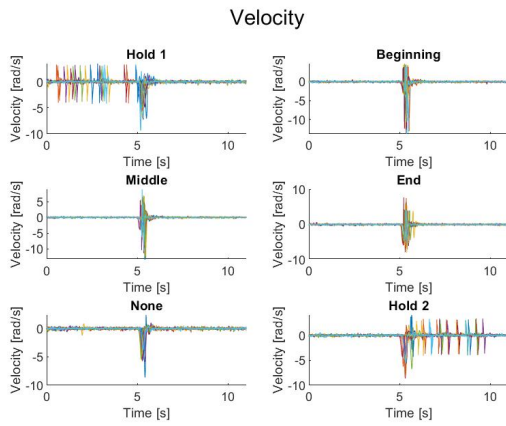

Figure 39: Velocity profile for each trial, separated per condition.

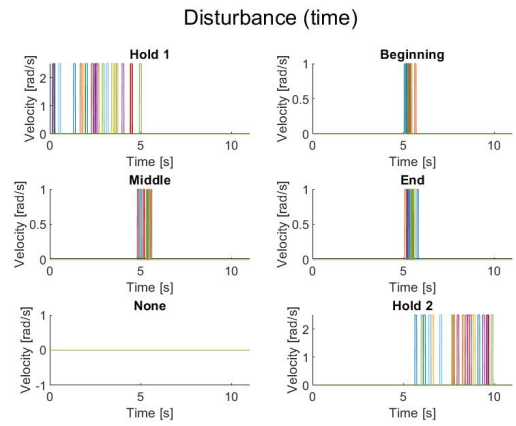

Figure 42: All the perturbations elicited during the 120 trials.

**Subject 2**

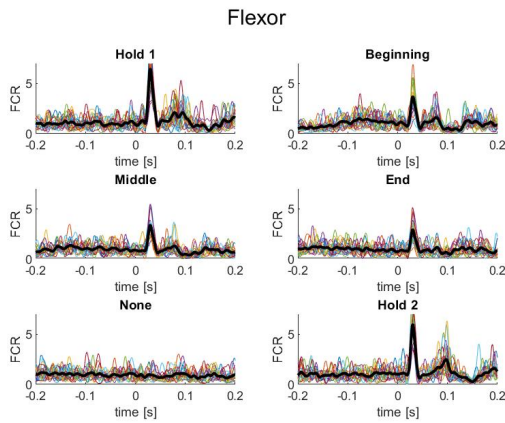

Figure 40: FCR response for each trial, separated per condition.

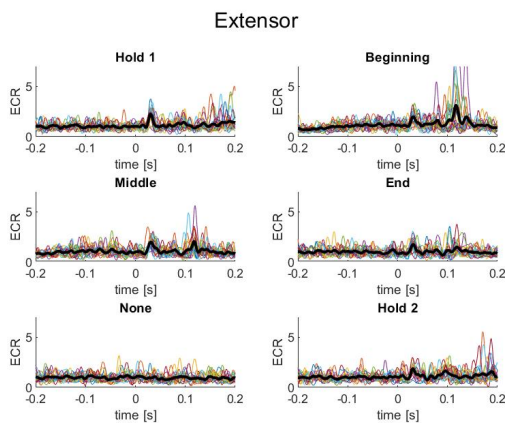

Figure 41: ECR response for each trial, separated per condition.

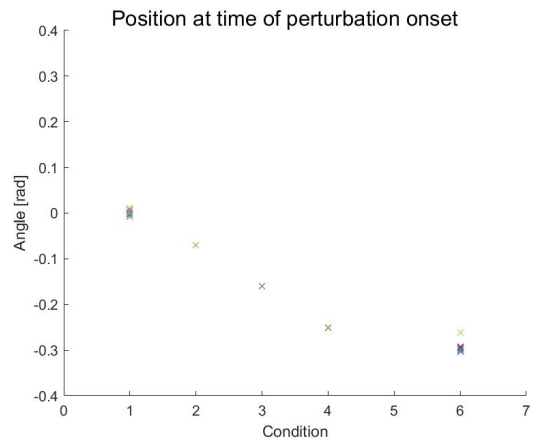

Figure 43: Position of the handle when each perturbation was triggered.

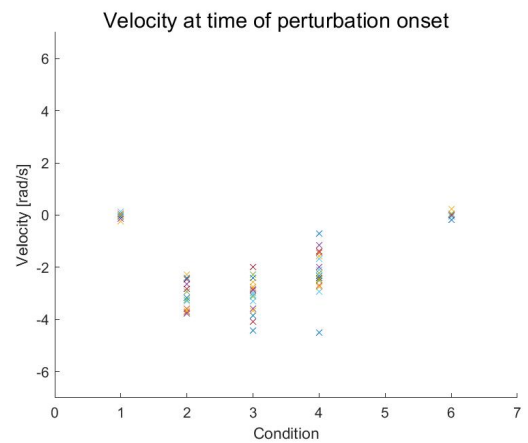

Figure 44: Velocity of the handle when each perturbation was triggered.

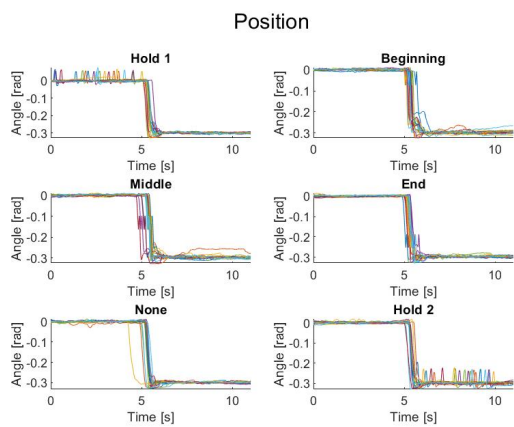

Figure 45: Position profile for each trial, separated per condition.

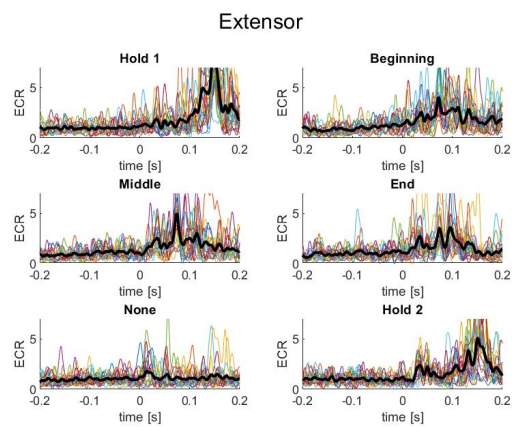

Figure 48: ECR response for each trial, separated per condition.

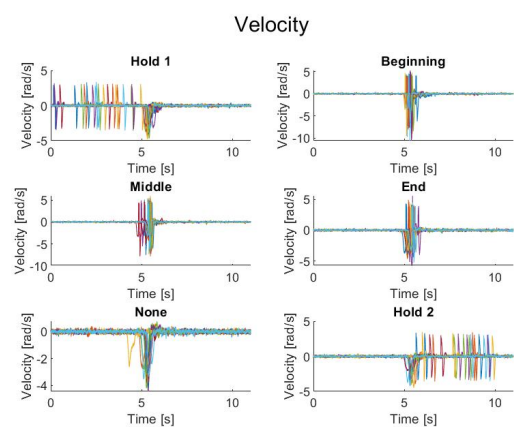

Figure 46: Velocity profile for each trial, separated per condition.

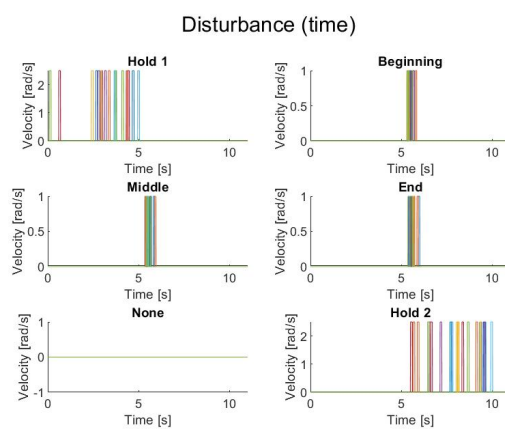

Figure 49: All the perturbations elicited during the 120 trials.

**Subject 3**

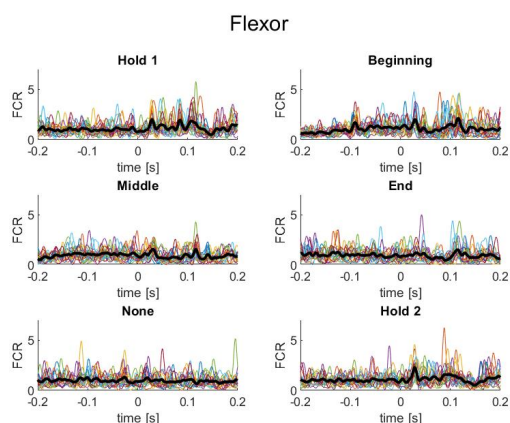

Figure 47: FCR response for each trial, separated per condition.

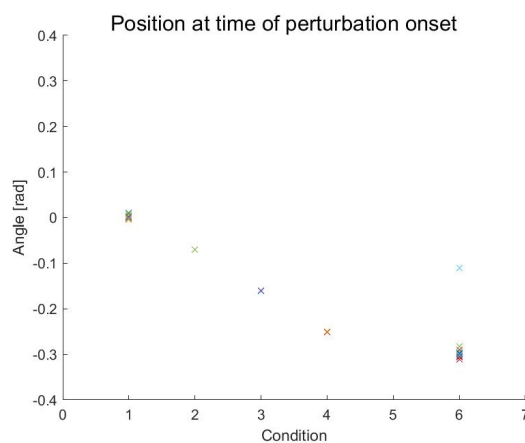

Figure 50: Position of the handle when each perturbation was triggered.

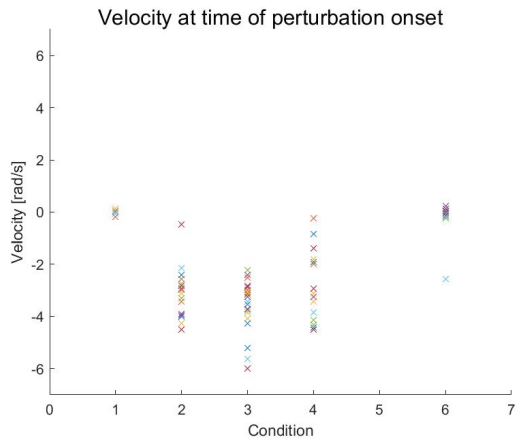

Figure 51: Velocity of the handle when each perturbation was triggered.

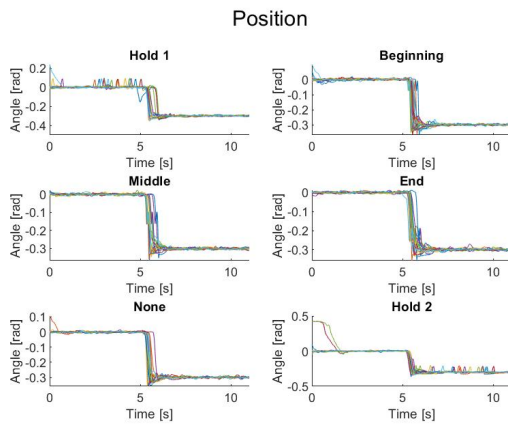

Figure 52: Position profile for each trial, separated per condition.

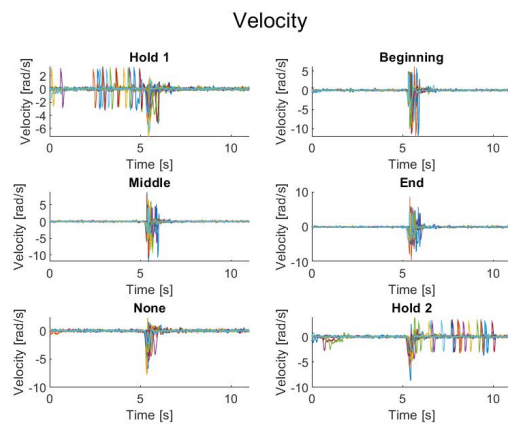

Figure 53: Velocity profile for each trial, separated per condition.



## Appendix C: Experiment 3 Results per Subject

### Subject 1

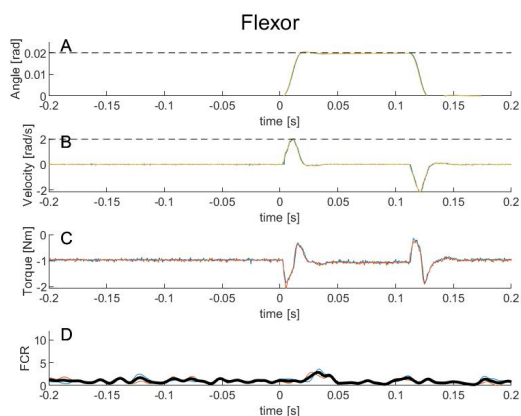

Figure 54: A and B show the Ramp and Hold perturbations triggered (position and velocity respectively). C shows the torque on the handle as a consequence of the perturbation. D shows the FCR response.

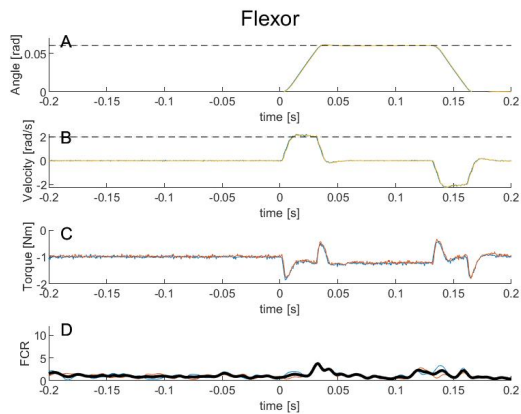

Figure 55: A and B show the Ramp and Hold perturbations triggered (position and velocity respectively). C shows the torque on the handle as a consequence of the perturbation. D shows the FCR response.

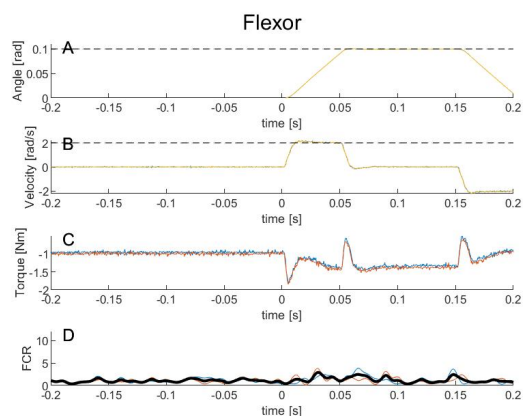

Figure 56: A and B show the Ramp and Hold perturbations triggered (position and velocity respectively). C shows the torque on the handle as a consequence of the perturbation. D shows the FCR response.

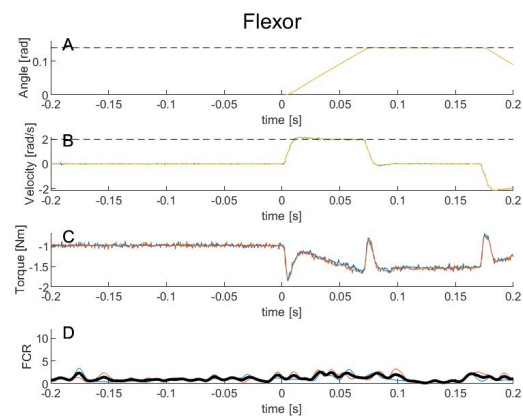

Figure 57: A and B show the Ramp and Hold perturbations triggered (position and velocity respectively). C shows the torque on the handle as a consequence of the perturbation. D shows the FCR response.

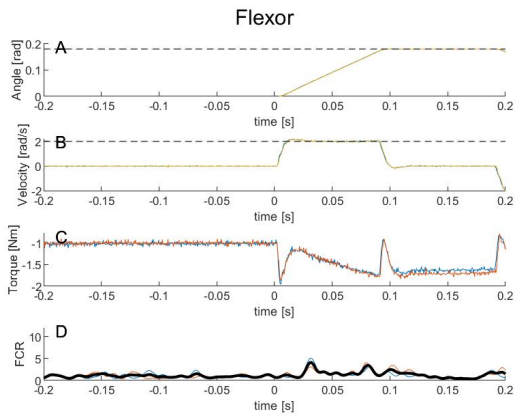

Figure 58: A and B show the Ramp and Hold perturbations triggered (position and velocity respectively). C shows the torque on the handle as a consequence of the perturbation. D shows the FCR response.

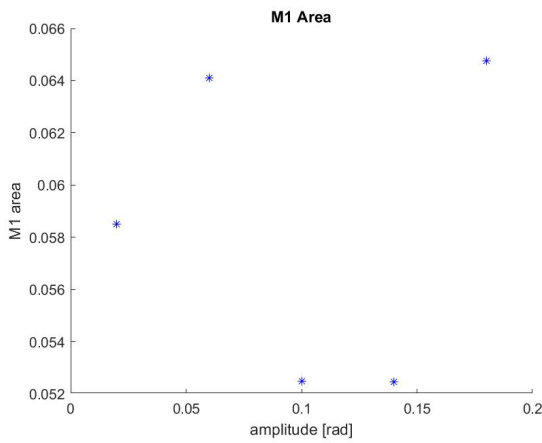

Figure 59: Average M1 area per amplitude.

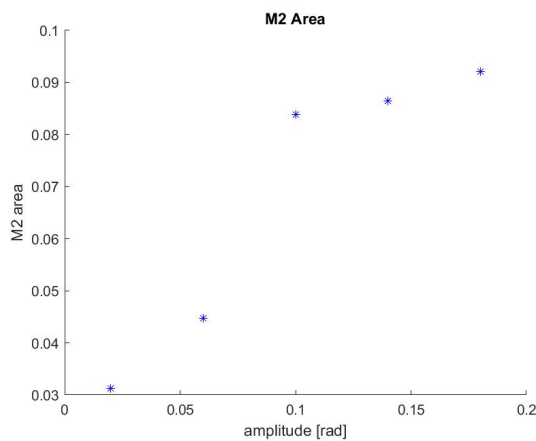

Figure 60: Average M2 area per amplitude.

Subject 2

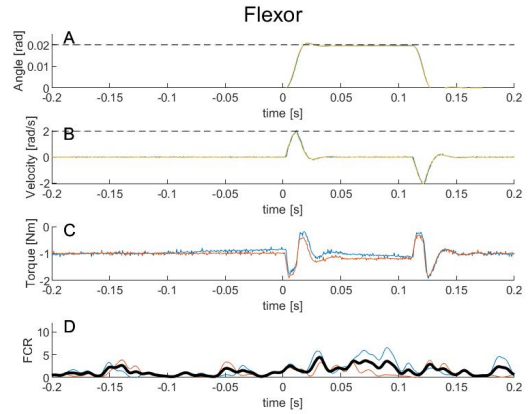

Figure 61: A and B show the Ramp and Hold perturbations triggered (position and velocity respectively). C shows the torque on the handle as a consequence of the perturbation. D shows the FCR response.

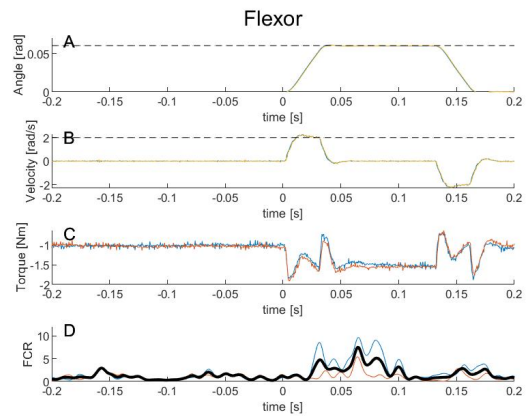

Figure 62: A and B show the Ramp and Hold perturbations triggered (position and velocity respectively). C shows the torque on the handle as a consequence of the perturbation. D shows the FCR response.

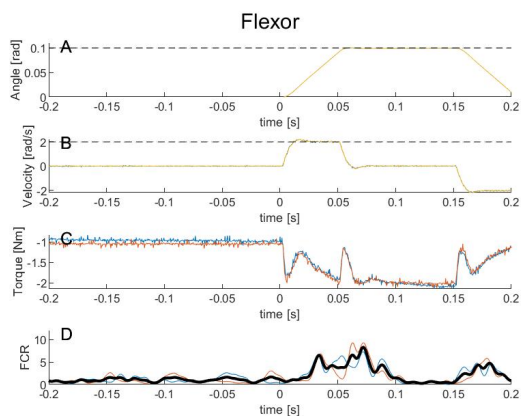

Figure 63: A and B show the Ramp and Hold perturbations triggered (position and velocity respectively). C shows the torque on the handle as a consequence of the perturbation. D shows the FCR response.

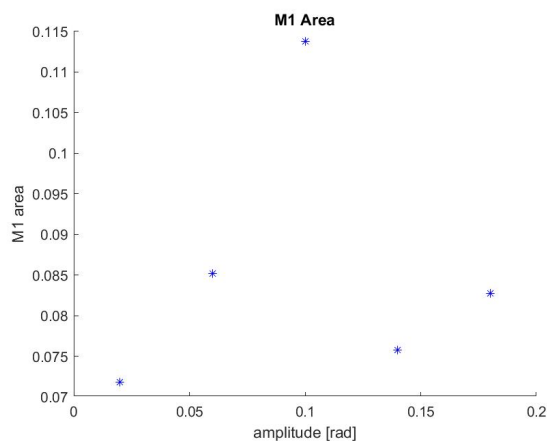

Figure 66: Average M1 area per amplitude.

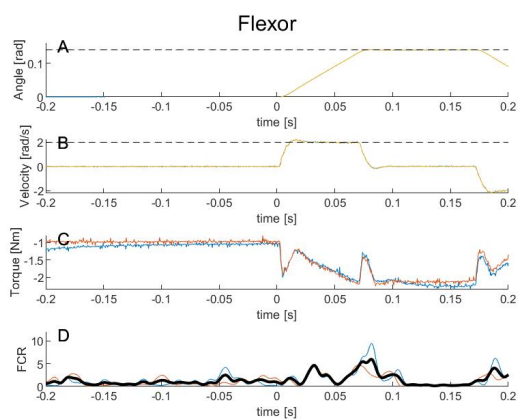

Figure 64: A and B show the Ramp and Hold perturbations triggered (position and velocity respectively). C shows the torque on the handle as a consequence of the perturbation. D shows the FCR response.

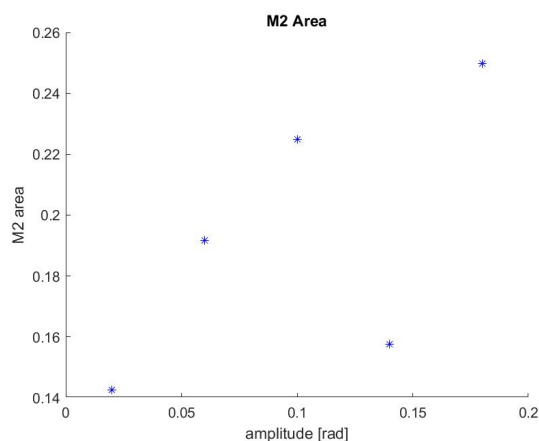

Figure 67: Average M2 area per amplitude.

### Subject 3

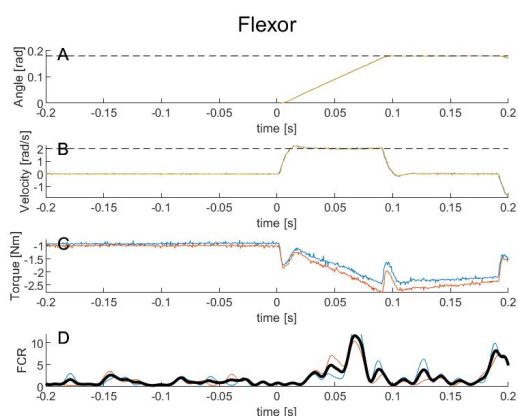

Figure 65: A and B show the Ramp and Hold perturbations triggered (position and velocity respectively). C shows the torque on the handle as a consequence of the perturbation. D shows the FCR response.

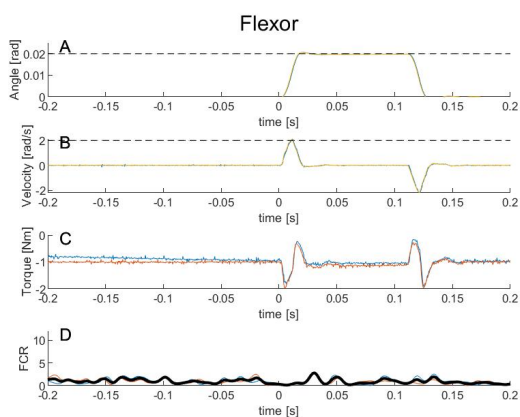

Figure 68: A and B show the Ramp and Hold perturbations triggered (position and velocity respectively). C shows the torque on the handle as a consequence of the perturbation. D shows the FCR response.

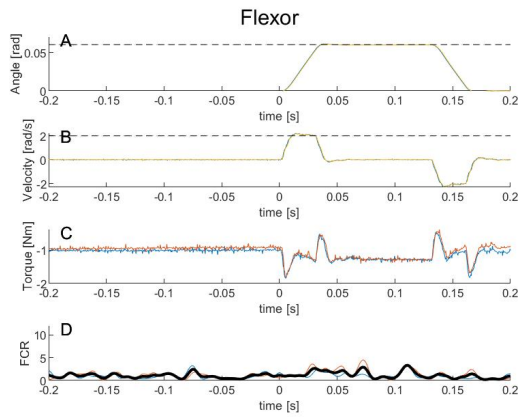

Figure 69: A and B show the Ramp and Hold perturbations triggered (position and velocity respectively). C shows the torque on the handle as a consequence of the perturbation. D shows the FCR response.

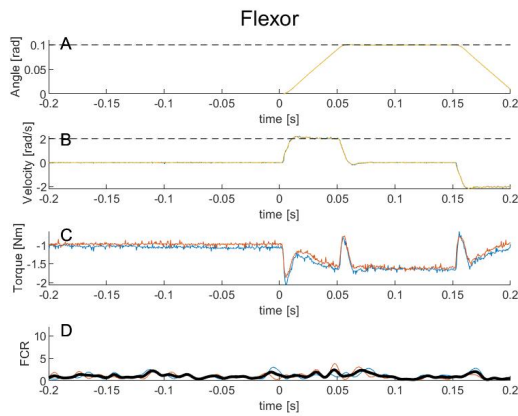

Figure 70: A and B show the Ramp and Hold perturbations triggered (position and velocity respectively). C shows the torque on the handle as a consequence of the perturbation. D shows the FCR response.

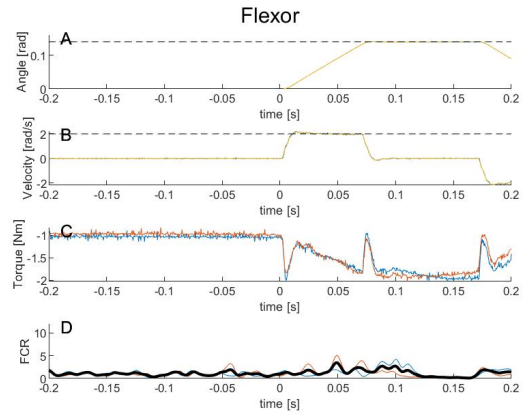

Figure 71: A and B show the Ramp and Hold perturbations triggered (position and velocity respectively). C shows the torque on the handle as a consequence of the perturbation. D shows the FCR response.

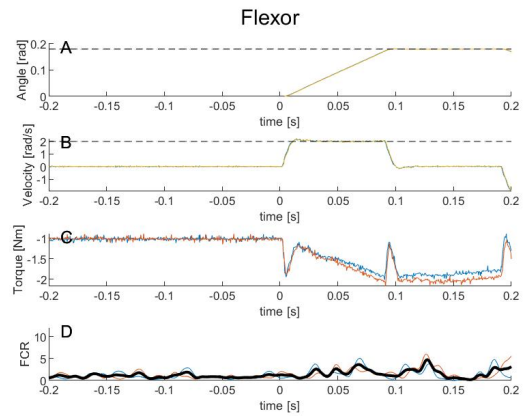

Figure 72: A and B show the Ramp and Hold perturbations triggered (position and velocity respectively). C shows the torque on the handle as a consequence of the perturbation. D shows the FCR response.

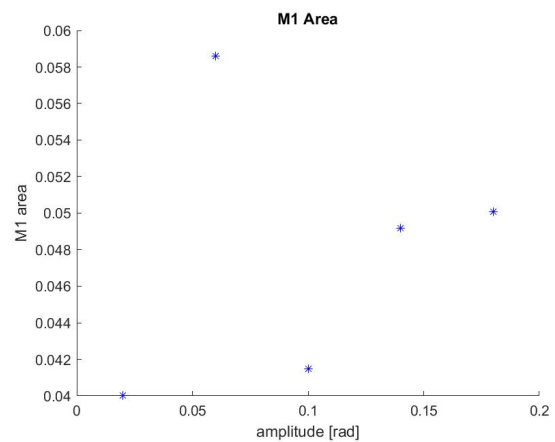

Figure 73: Average M1 area per amplitude.

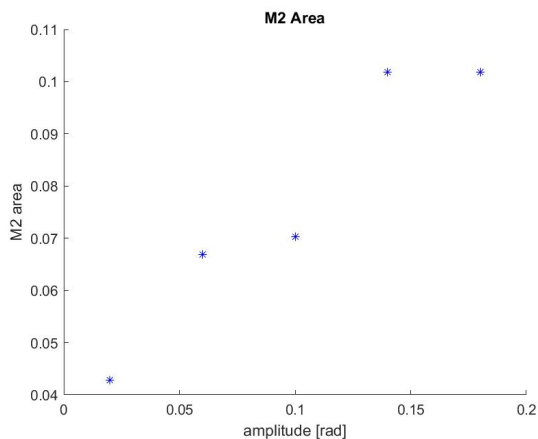

Figure 74: Average M2 area per amplitude.

**Subject 4**

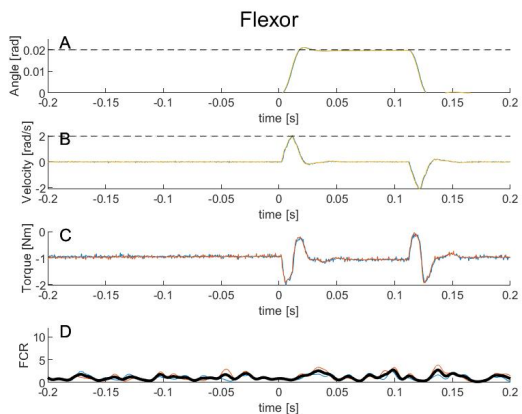

Figure 75: A and B show the Ramp and Hold perturbations triggered (position and velocity respectively). C shows the torque on the handle as a consequence of the perturbation. D shows the FCR response.

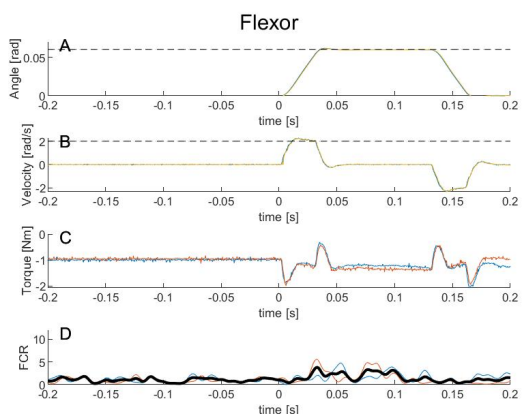

Figure 76: A and B show the Ramp and Hold perturbations triggered (position and velocity respectively). C shows the torque on the handle as a consequence of the perturbation. D shows the FCR response.

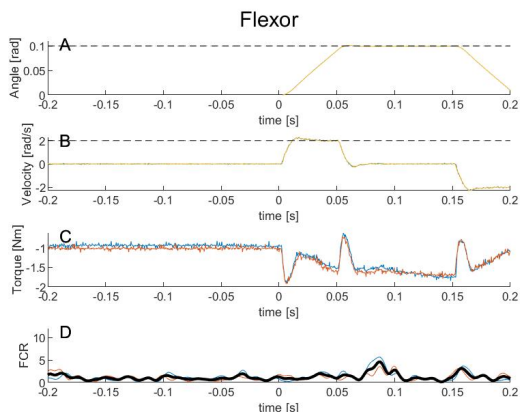

Figure 77: A and B show the Ramp and Hold perturbations triggered (position and velocity respectively). C shows the torque on the handle as a consequence of the perturbation. D shows the FCR response.

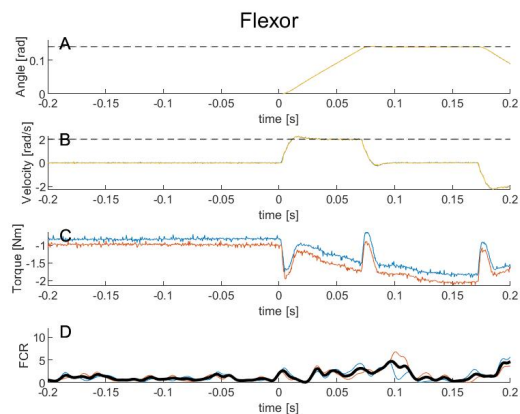

Figure 78: A and B show the Ramp and Hold perturbations triggered (position and velocity respectively). C shows the torque on the handle as a consequence of the perturbation. D shows the FCR response.

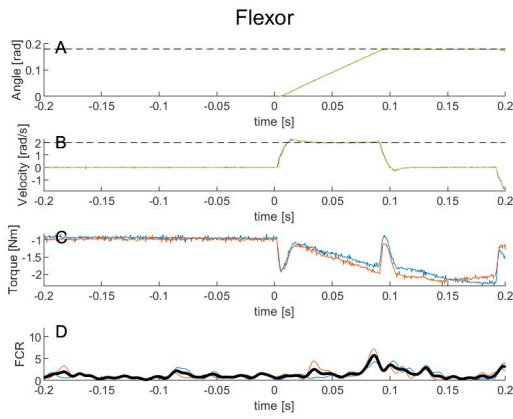

Figure 79: A and B show the Ramp and Hold perturbations triggered (position and velocity respectively). C shows the torque on the handle as a consequence of the perturbation. D shows the FCR response.

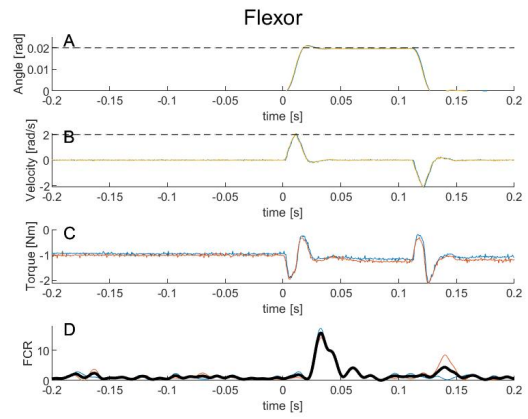

Figure 82: A and B show the Ramp and Hold perturbations triggered (position and velocity respectively). C shows the torque on the handle as a consequence of the perturbation. D shows the FCR response.

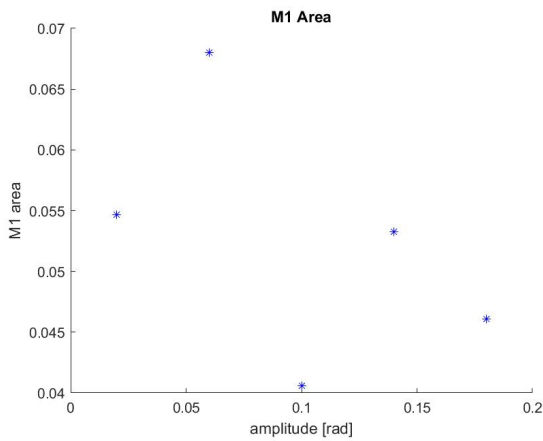

Figure 80: Average M1 area per amplitude.

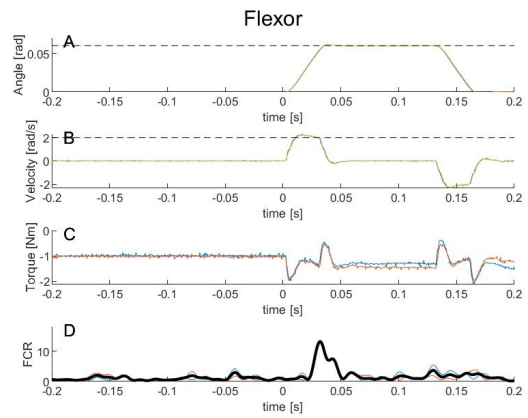

Figure 83: A and B show the Ramp and Hold perturbations triggered (position and velocity respectively). C shows the torque on the handle as a consequence of the perturbation. D shows the FCR response.

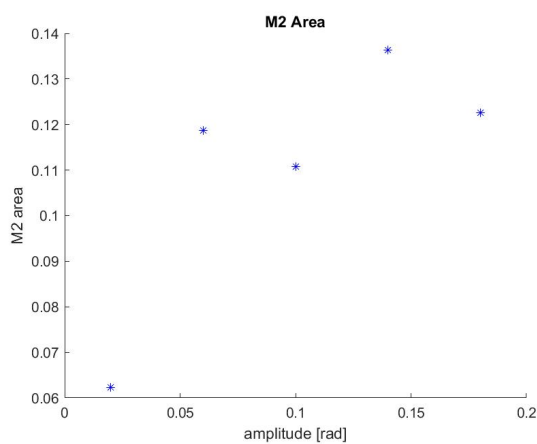

Figure 81: Average M2 area per amplitude.

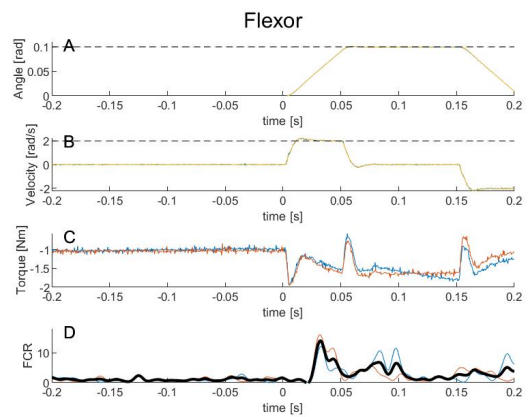

Figure 84: A and B show the Ramp and Hold perturbations triggered (position and velocity respectively). C shows the torque on the handle as a consequence of the perturbation. D shows the FCR response.

**Subject 5**

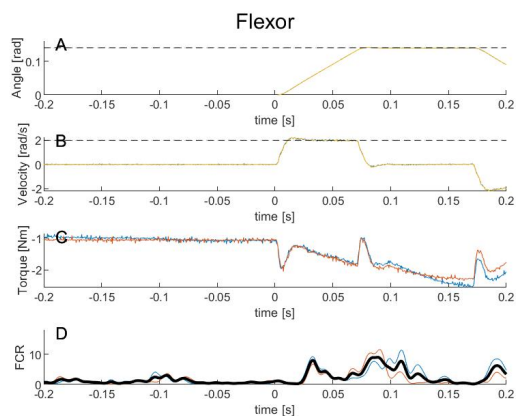

Figure 85: A and B show the Ramp and Hold perturbations triggered (position and velocity respectively). C shows the torque on the handle as a consequence of the perturbation. D shows the FCR response.

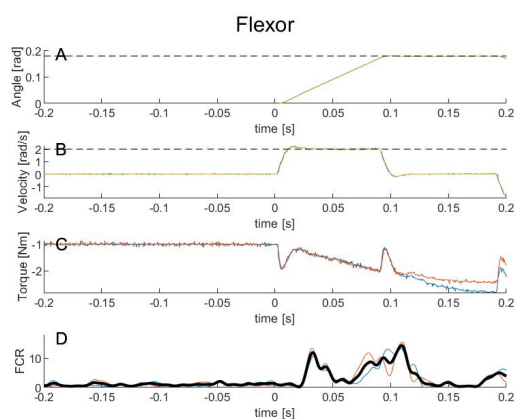

Figure 86: A and B show the Ramp and Hold perturbations triggered (position and velocity respectively). C shows the torque on the handle as a consequence of the perturbation. D shows the FCR response.

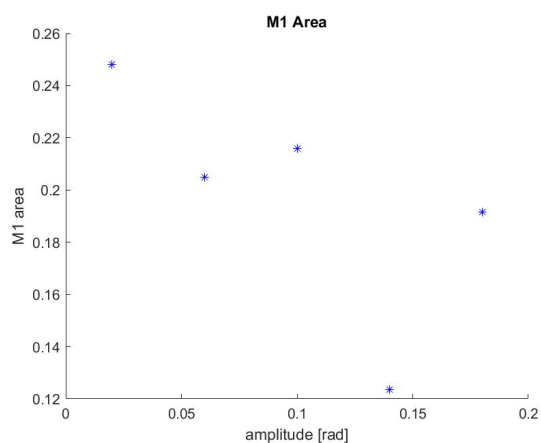

Figure 87: Average M1 area per amplitude.

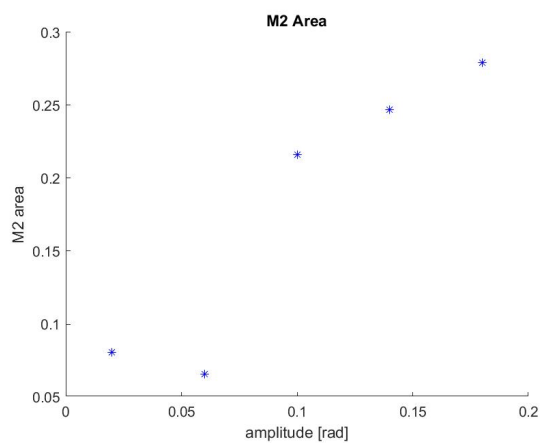

Figure 88: Average M2 area per amplitude.

## Appendix D: Informed Consent Forms and Participant Information for Experiment 4

Neuromechanics & Motor Control Laboratory



### PARTICIPANT INFORMATION LETTER

Concerning the research on intrinsic and reflexive contributions to joint stiffness

Date 21-06-2021, Version 1.1

Dear Sir / Madam,

You have been asked to participate in a study on measuring position contributions to reflex modulation during movement. In this letter you will find information about the research. If you have any questions, please contact the persons listed at the bottom of this letter.

#### **Background of the research**

In the Netherlands alone, an estimated 200,000 people suffer from one or more neuromuscular disorders and about 600 different disorders have been identified. These neuromuscular disorders range from minor discomforts to degenerative diseases where patients gradually lose muscle functionality. It is difficult to accurately diagnose what disorders a patient is suffering from, because many disorders have similar symptoms in the early stages and many patients suffer from multiple disorders at the same time. Reflexes play a crucial role in controlling movement and many of these neuromuscular disorders are linked to improper reflexes.

#### **Goal of the research**

The goal of this project is to design an experimental protocol that elicits reflexes in order to cause modulation of the reflexes. This protocol can then be used on people suffering from neuromuscular disorders to test how their reflexes differ from healthy subjects and to aim to develop an understanding of the underlying mechanisms.

#### **What does participation in the research involve?**

This research is carried out with a 1-degree-of-freedom wrist manipulator (see Figure). This device is actuated by a motor and is connected to a computer that controls the movement of the handle and the forces experienced when holding the handle. During the experiment, you have to hold the handle and perform movements while your lower arm is constrained with soft pads. During the experiment, you will feel a force field trying to pull your wrist clockwise.

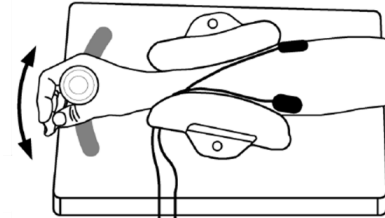

**Figure 1: Wrist manipulator: The arm is constrained by the manipulator by soft pads on both sides. The handle can move freely along 1 degree of freedom. EMG electrodes are attached to the arm.**

The experiment will consist of two phases: A preparation phase and a training and recording phase.

1. **Preparation phase:** To measure the muscle activity in the wrist, EMG electrodes are placed on the skin on the lower arm (see Figure 1). To make the EMG signal as clear as possible, the skin below the electrodes will be cleaned with alcohol, before placing the electrodes. For some participants, EEG measurements will be performed additionally. The chair will be adjusted to your height so that your arm is aligned with that of the manipulator, while your lower arm will be constrained in the manipulator with soft pads. Before starting the experiment, we will do a control experiment to ensure that reflexes can be elicited with the chosen perturbation amplitude.
2. **Training and recording phase:** During these phases you are instructed to hold within and move between circles that are displayed on screen. During the experiment, small perturbations will be applied by the manipulator to evoke reflexes.
  - a. **Training phase:** This phase is for you to get acquainted with the manipulator and the task, without recording your measurements.



## Neuromechanics & Motor Control Laboratory



- b. Recording phase: Measurements will be recorded.

The training phase consists of 5 trials and the recording phase consists of 120 trials, each lasting 11 seconds. After every 20 trials, a 2-minute break is scheduled. You can ask for more rest in between trials if you like. The full experiment will take around 2 hours in total. The experiment will take place in the Neuromechanics & Motor Control Laboratory of the Biomechanical Engineering department at TU Delft (3mE, Room 34-F-1-180).

### **Risks**

The risks of the measurements are minimal. The perturbator is protected against excessive movements and excessive forces. EMG will be measured using clinically approved measurement devices. Before participating in the experiment, the researcher will instruct you about safety procedures and make an assessment of whether you are able to complete the experiment.

### **Voluntary participation**

Your cooperation in this research is voluntary. If you give your consent to this research, you have the freedom at all times to come back on this decision (also during the experiment). You do not have to give an explanation for your decision.

### **Confidentiality of data**

This investigation requires that the following personal data are collected and used: your dominant arm, age, gender, height and weight. To safeguard and maintain confidentiality of your personal information, necessary security steps will be taken. Your data will be stored in a secure storage environment at TU Delft. All data will be processed confidentially and stored using a participant number only. Data will only be accessible for Neuromechanics & Motor Control Laboratory staff members.

Your name will be linked to a participant number only on the informed consent form. The informed consent form will be stored on paper in a separate and secure location. In this way all your details remain confidential. Only the Neuromechanics & Motor Control Laboratory staff members can know which participant number you have. Your participant number will never be shared on publications (master thesis report, scientific publications, reports, ...) about the research.

The results will be published in a master thesis report and possible future scientific publications.

### **Contact Information**

If you have any complaints regarding confidentiality of your data, you can contact the TU Delft Data Protection Officer (Erik van Leeuwen) via [privacy-tud@tudelft.nl](mailto:privacy-tud@tudelft.nl).

On behalf of the researcher(s), thank you in advance for your possible cooperation.

Babette Mulder, Master student  
Alfred C. Schouten, Associate Professor  
Mark van de Ruit, Post-doc Researcher

[B.Mulder-3@student.tudelft.nl](mailto:B.Mulder-3@student.tudelft.nl)  
[A.C.Schouten@tudelft.nl](mailto:A.C.Schouten@tudelft.nl)  
[M.L.vandeRuit-1@tudelft.nl](mailto:M.L.vandeRuit-1@tudelft.nl)

**Consent Form**  
**Measuring Intrinsic and Reflexive Contributions to Joint Stiffness During**  
**Voluntary Movement**

Participant number: \_\_\_\_\_

*Please tick the appropriate boxes*

**Yes No**

**Taking part in the study**

I have read and understood the participant information letter dated 21-06-2021 or it has been read to me. I have been able to ask questions about the study and my questions have been answered to my satisfaction.

I consent voluntarily to be a participant in this study and understand that I can refuse to answer questions and I can withdraw from the study at any time, without having to give a reason.

**Use of the data in the study**

I understand that data I provide will be used for a master thesis report and possible future scientific publications.

I understand that personal information collected about me that can identify me, i.e. dominant arm, age, gender, height and weight, will only be reported in an anonymous form.

**Future use and reuse of the data by others**

I give permission for the measured data and information on the dominant arm, age, gender, height and weight to be archived in TU Delft project storage so it can be used for future research and education. All data will be processed confidentially. Data will only be accessible for Neuromechanics & Motor Control Laboratory staff members.

**Signatures**

\_\_\_\_\_  
Name of participant

\_\_\_\_\_  
Signature

\_\_\_\_\_  
Date

I have accurately read out the information sheet to the potential participant and, to the best of my ability, ensured that the participant understands to what they are freely consenting.

\_\_\_\_\_  
Babette Mulder

Researcher name

\_\_\_\_\_  
Signature

\_\_\_\_\_  
Date

Study contact details for further information:

B. (Babette) Mulder

E: [b.mulder-3@student.tudelft.nl](mailto:b.mulder-3@student.tudelft.nl)

T: +31 6 516 03 41

## D.1: Participant Information

Subject	Age	Gender	Height (cm)	Weight (kg)	Dominant Hand
1	23	F	178	65	Right
2	22	F	169	60	Right
3	23	M	180.5	72	Right
4	25	M	186	83	Right
5	22	M	170	68	Right
6	27	F	166	60	Right
7	31	M	185	73	Right
8	28	F	161	55	Right
9	24	M	183	82	Right
10	34	M	196	82	Right

## D.2: Control Experiment prior to Experiment 4 (Main Experiment)

### Subject 1

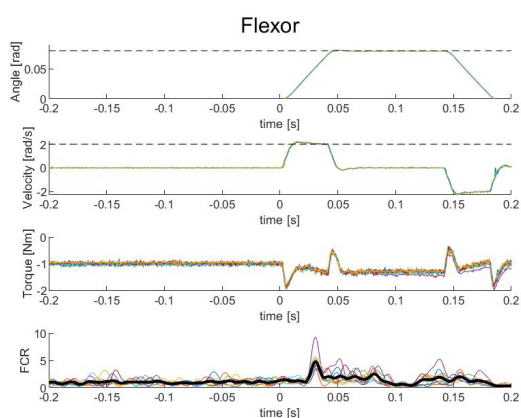

Figure 89: FCR response for the the control experiment, 1 trial with ten  $0.08rad$  perturbations.

### Subject 3

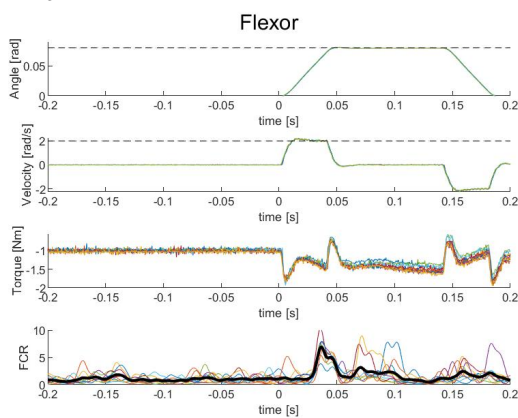

Figure 91: FCR response for the control experiment, 1 trial with ten  $0.08rad$  perturbations.

### Subject 2

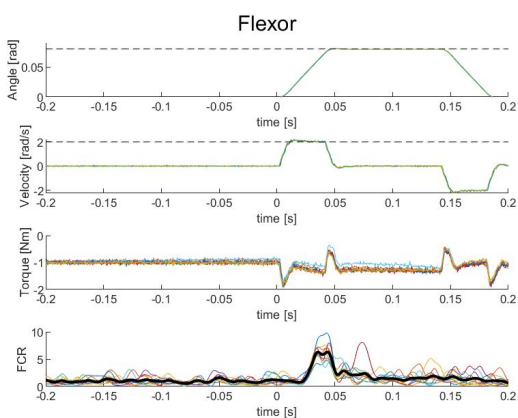

Figure 90: FCR response for the control experiment, 1 trial with ten  $0.08rad$  perturbations.

### Subject 4

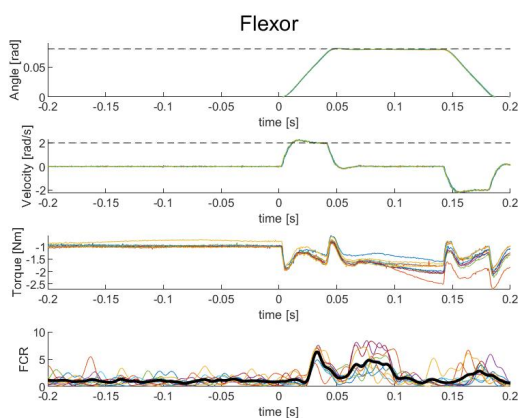

Figure 92: FCR response for the control experiment, 1 trial with ten  $0.08rad$  perturbations.

**Subject 5**

Figure 93: FCR response for the control experiment, 1 trial with ten  $0.08rad$  perturbations.

**Subject 6**

Figure 94: FCR response for the control experiment, 1 trial with ten  $0.08rad$  perturbations.

**Subject 7**

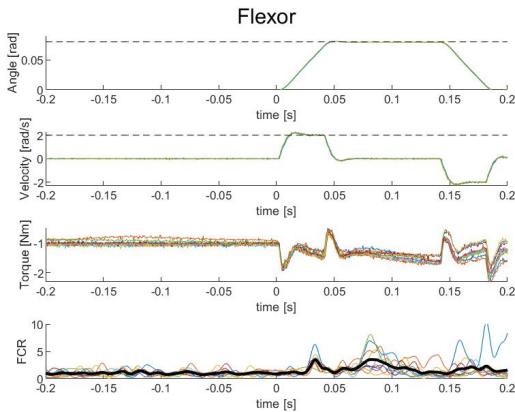
Figure 95: FCR response for the control experiment, 1 trial with ten  $0.08rad$  perturbations.

**Subject 8**

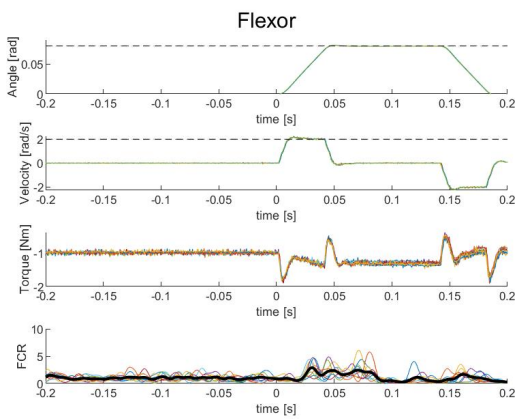
For Subject 8, the control experiment was not functioning properly so we went ahead with the main experiment and checked proper EMG placement and elicited reflexes through the training trials. The subject was shown to have significant reflex responses.

**Subject 9**

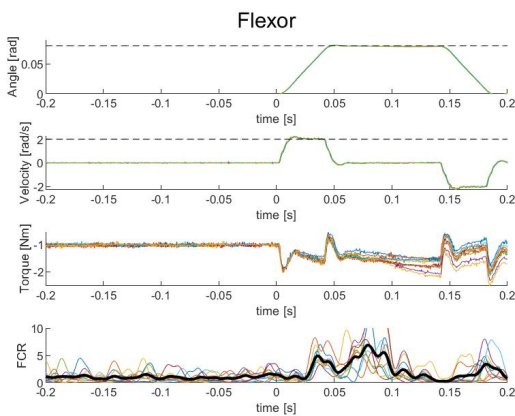
Figure 96: FCR response for the control experiment, 1 trial with ten  $0.08rad$  perturbations.

**Subject 10**

Figure 97: FCR response for the control experiment, 1 trial with ten  $0.08rad$  perturbations.

## Appendix E: Experiment 4

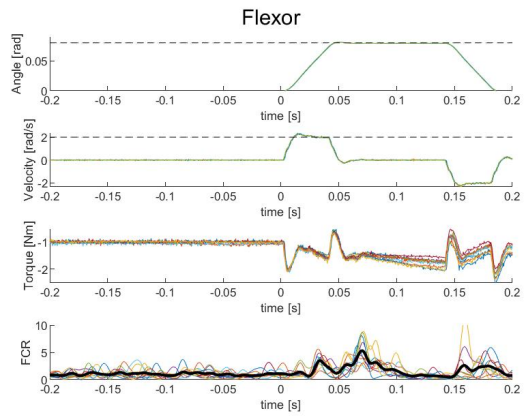
### E.1: Additional Information

The hold perturbations operated in the same way as the movement ones, with the same idea that user input was ignored while the perturbation took place. A timer was added to randomize the time at which the perturbation took place. In addition, a supplementary loop was created wherein the condition of the trial was read in order to identify the correct loop. In previous experiments, each condition went through the position-dependent perturbation loop, but the position comparison value for conditions 1, 5, and 6 were set out of the handle range so as to not trigger the loop. In this experiment, the condition was read which activated the appropriate loops, separated by conditions 2, 3, and 4 for position-dependent perturbations and conditions 1 and 6 for time- and position-dependent perturbations.

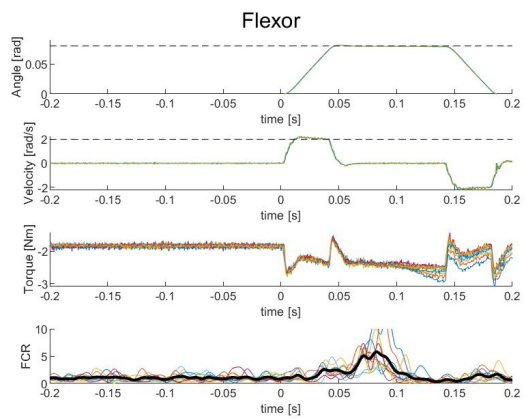
### E.2: Results per Subject

#### Subject 1

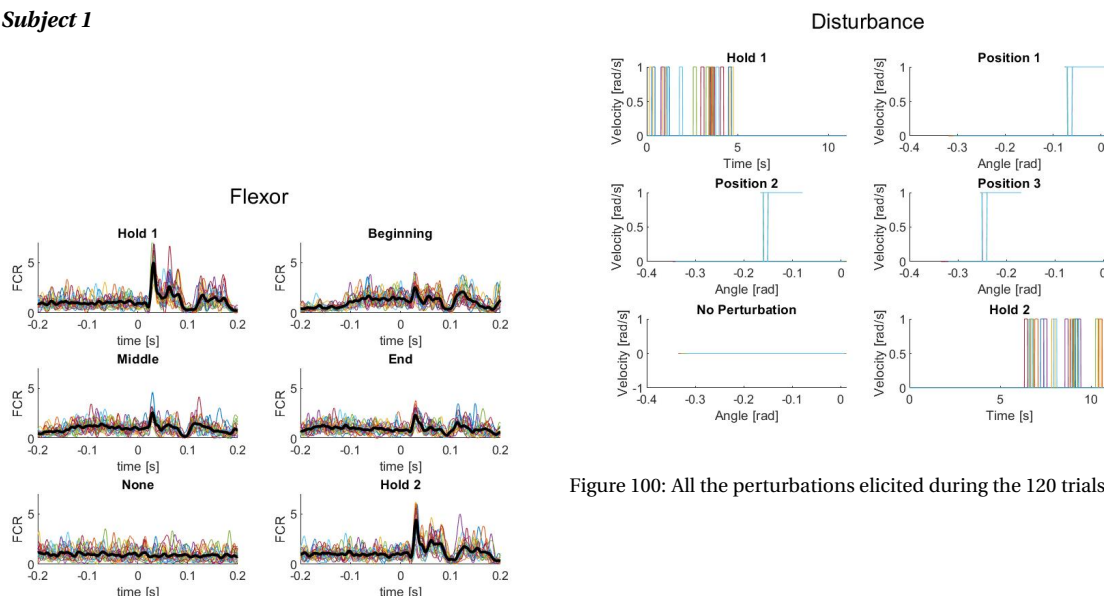

Figure 100: All the perturbations elicited during the 120 trials.

Figure 98: FCR response for each trial, separated per condition.

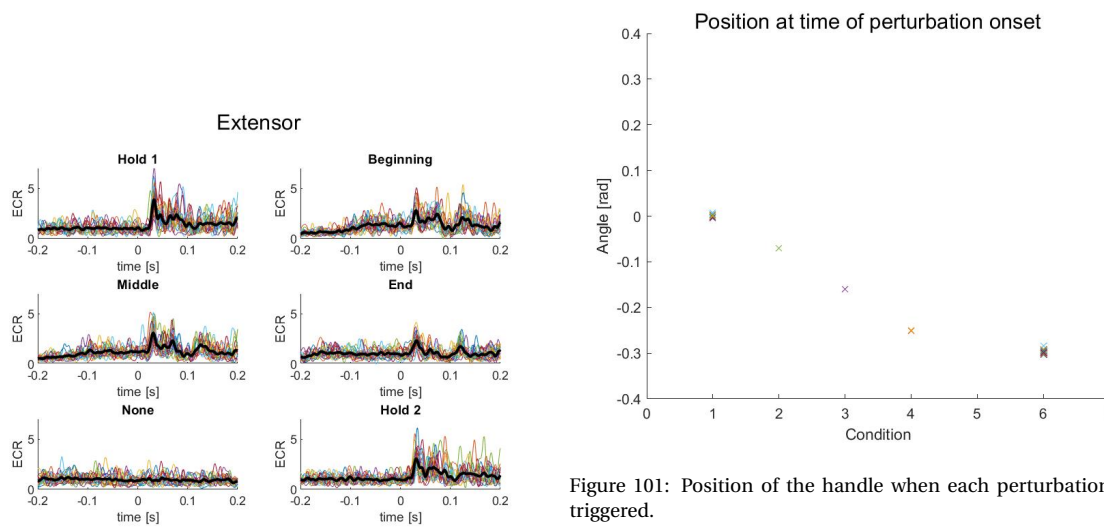

Figure 99: ECR response for each trial, separated per condition.

Figure 101: Position of the handle when each perturbation was triggered.

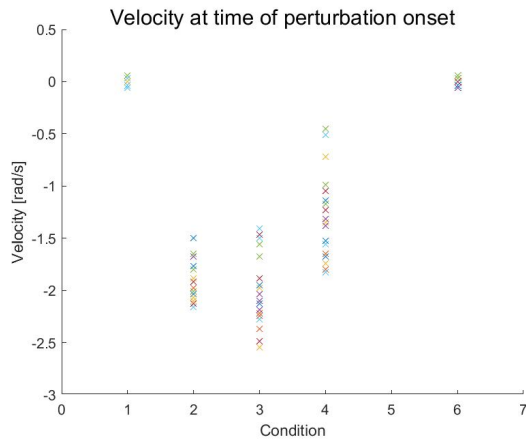

Figure 102: Velocity of the handle when each perturbation was triggered.

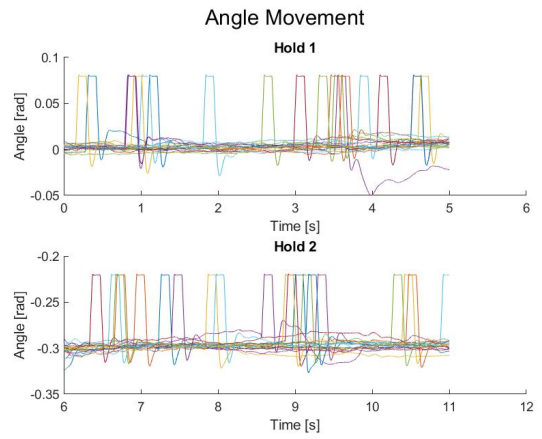

Figure 105: Position profile for each hold - for conditions: 1, 6.

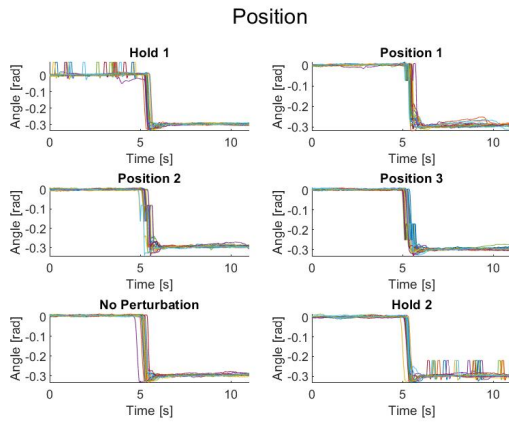

Figure 103: Position profile for each trial, separated per condition.

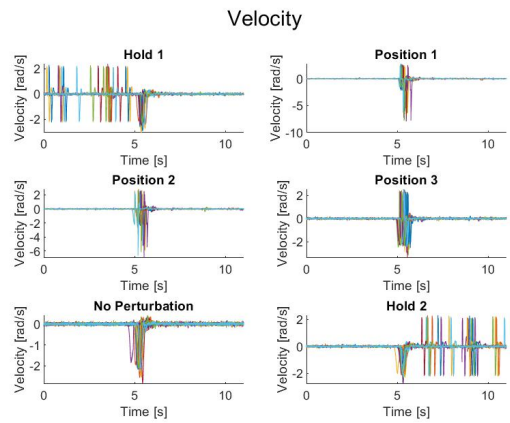

Figure 106: Velocity profile for each trial, separated per condition.

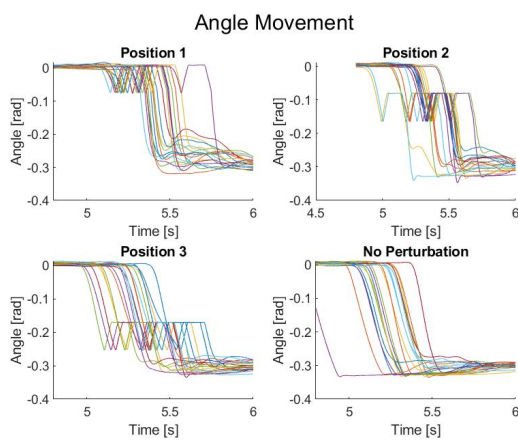

Figure 104: Position profile for each movement - for conditions: 2, 3, 4, 5.

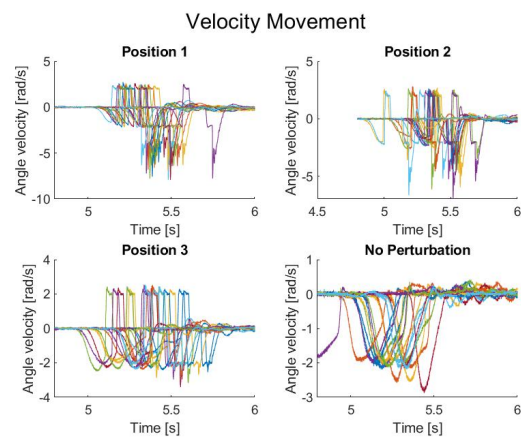

Figure 107: Velocity profile for each movement - for conditions: 2, 3, 4, 5.

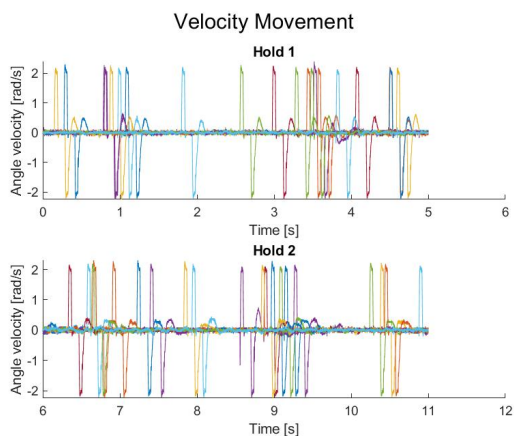

Figure 108: Velocity profile for each hold - for conditions: 1, 6.

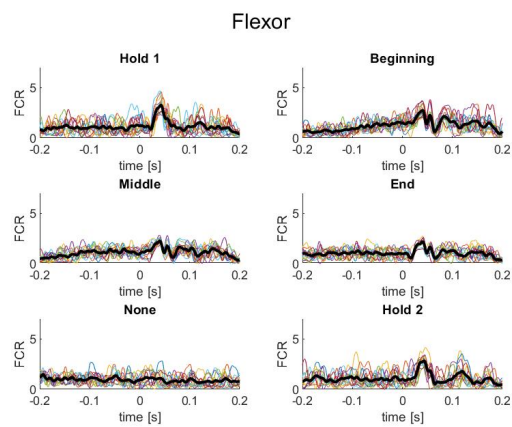

Figure 111: FCR response for each trial, separated per condition.

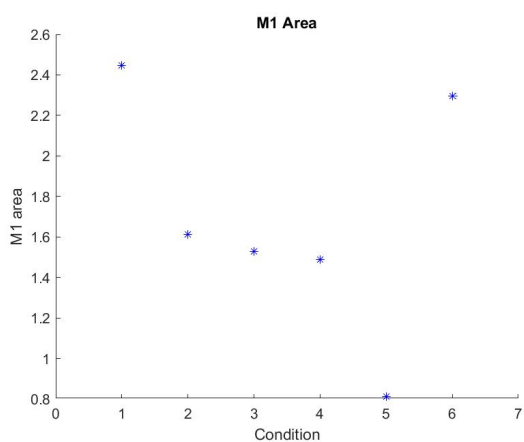

Figure 109: Average M1 area per condition.

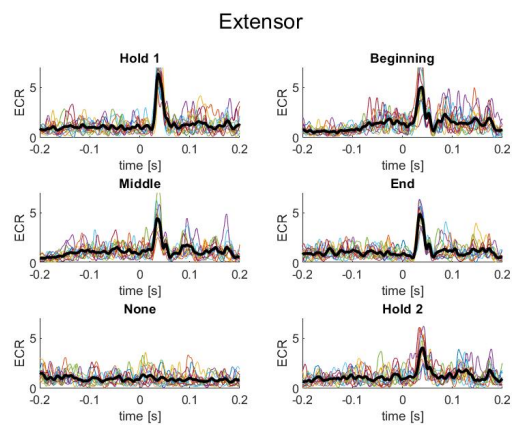

Figure 112: ECR response for each trial, separated per condition.

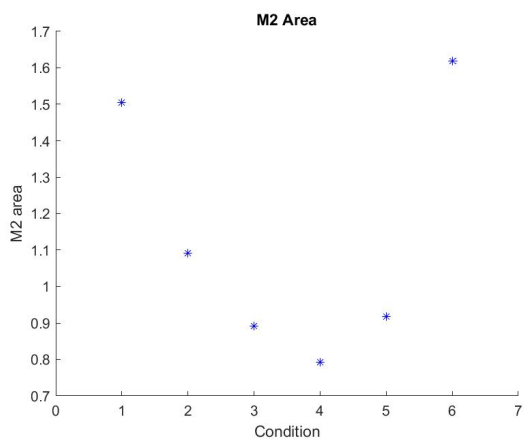

Figure 110: Average M2 area per condition.

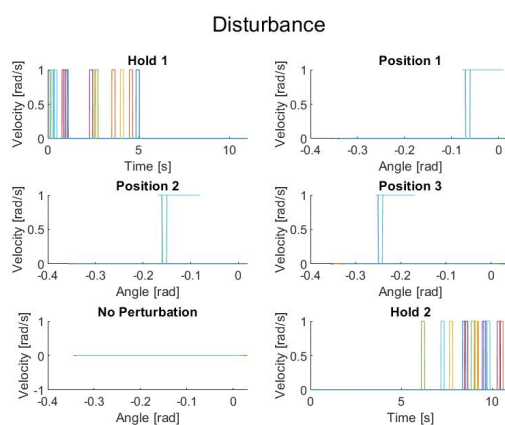

Figure 113: All the perturbations elicited during the 120 trials.

**Subject 2**

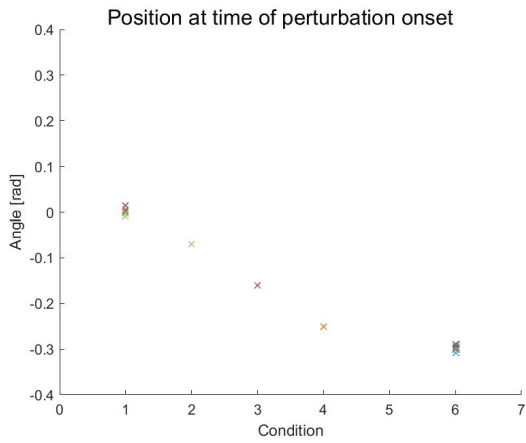

Figure 114: Position of the handle when each perturbation was triggered.

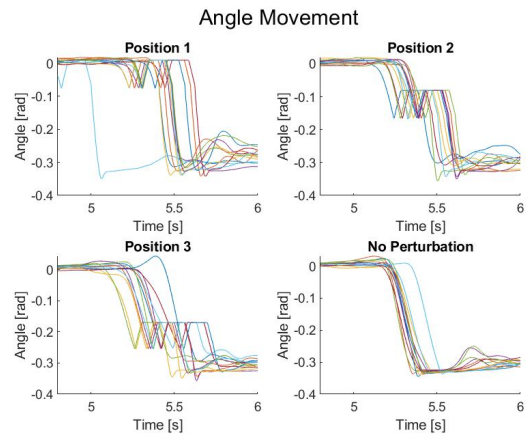

Figure 117: Position profile for each movement - for conditions: 2, 3, 4, 5.

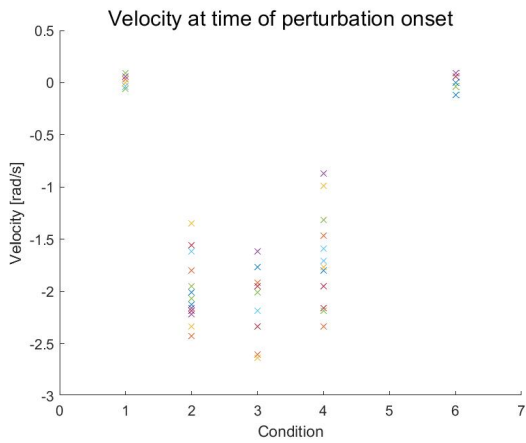

Figure 115: Velocity of the handle when each perturbation was triggered.

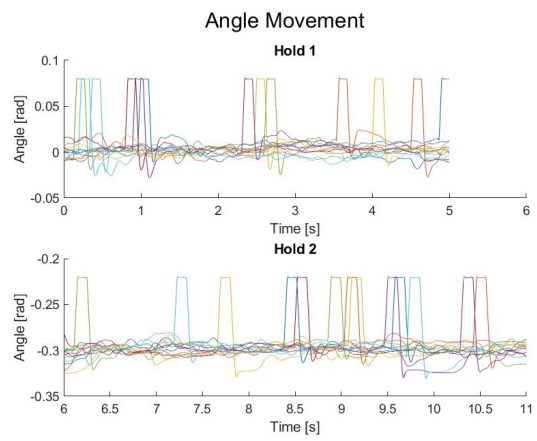

Figure 118: Position profile for each hold - for conditions: 1, 6.

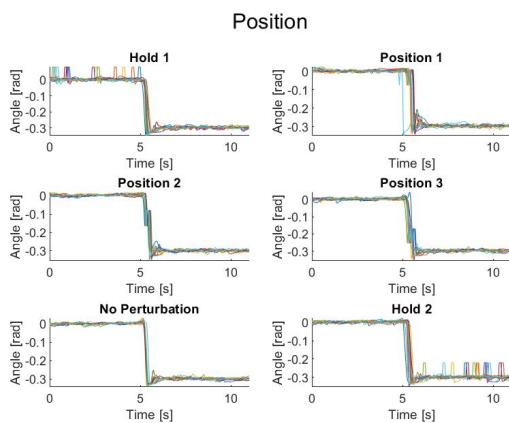

Figure 116: Position profile for each trial, separated per condition.

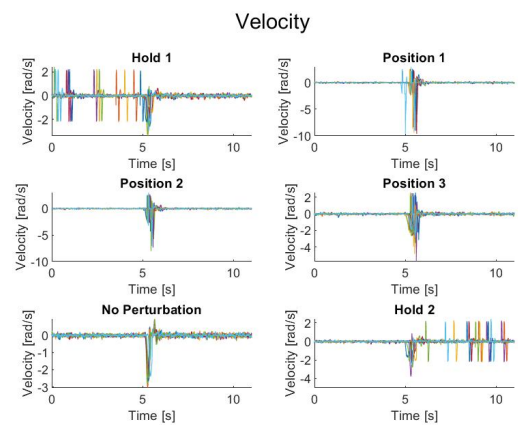

Figure 119: Velocity profile for each trial, separated per condition.



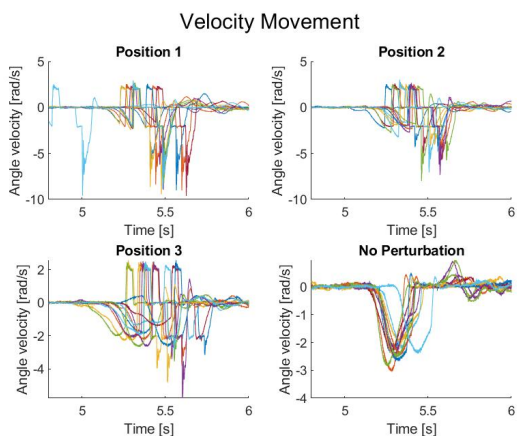

Figure 120: Velocity profile for each movement - for conditions: 2, 3, 4, 5.

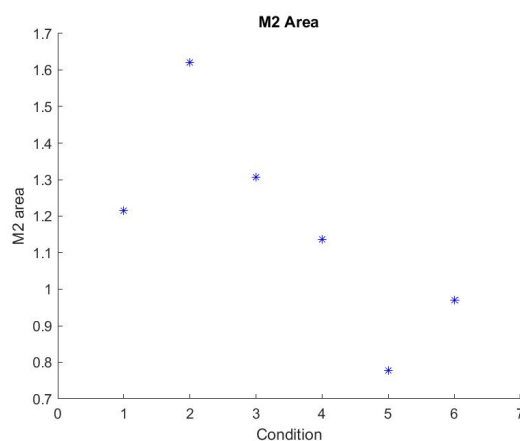

Figure 123: Average M2 area per condition.

**Subject 3**

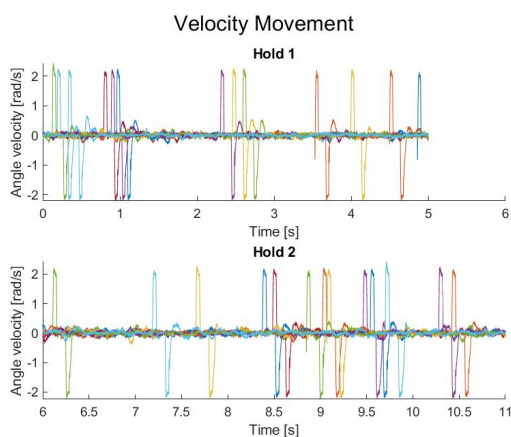

Figure 121: Velocity profile for each hold - for conditions: 1, 6.

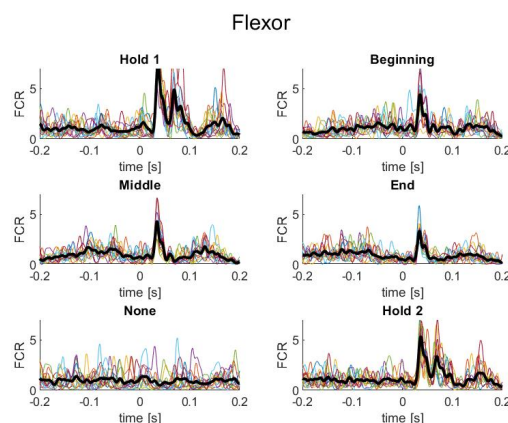

Figure 124: FCR response for each trial, separated per condition.

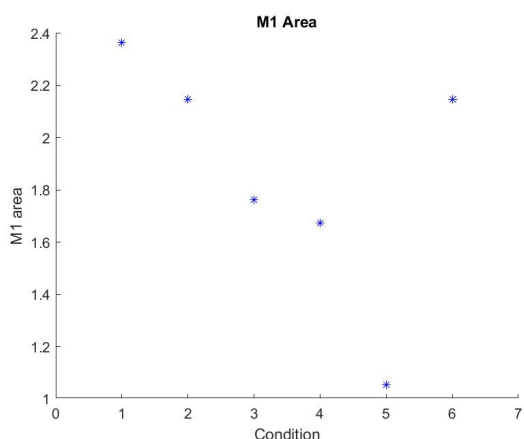

Figure 122: Average M1 area per condition.

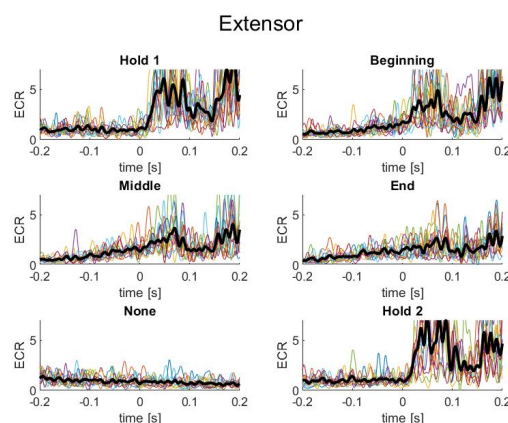

Figure 125: ECR response for each trial, separated per condition.

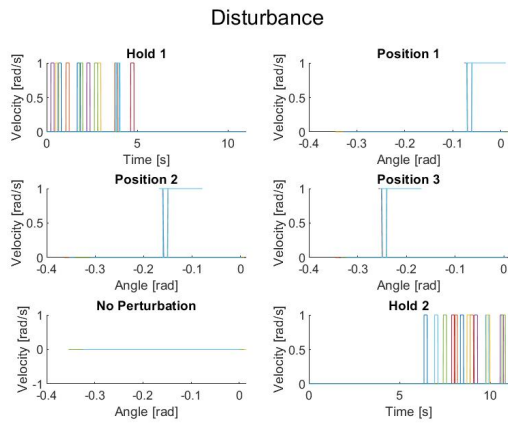

Figure 126: All the perturbations elicited during the 120 trials.

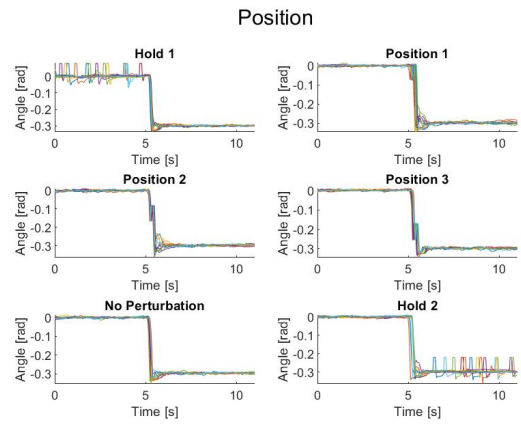

Figure 129: Position profile for each trial, separated per condition.

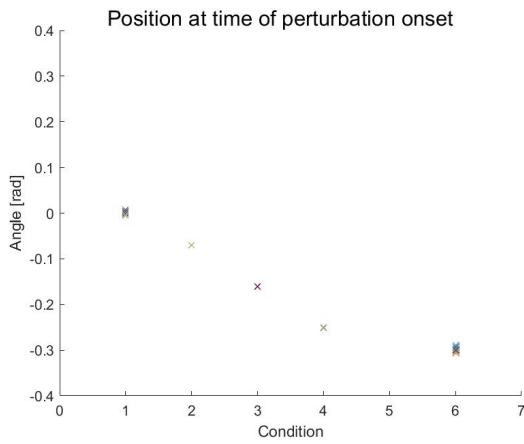

Figure 127: Position of the handle when each perturbation was triggered.

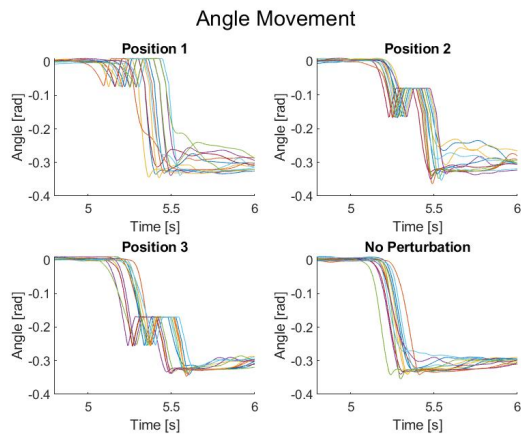

Figure 130: Position profile for each movement - for conditions: 2, 3, 4, 5.

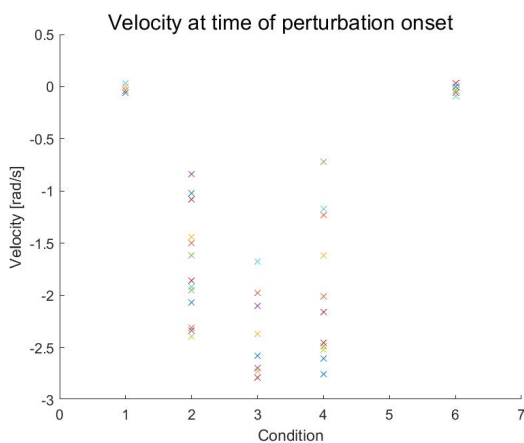

Figure 128: Velocity of the handle when each perturbation was triggered.

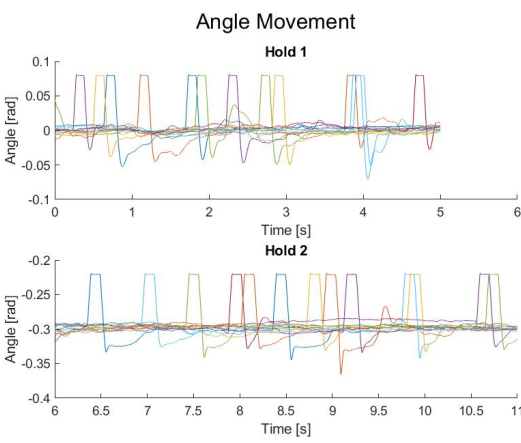

Figure 131: Position profile for each hold - for conditions: 1, 6.

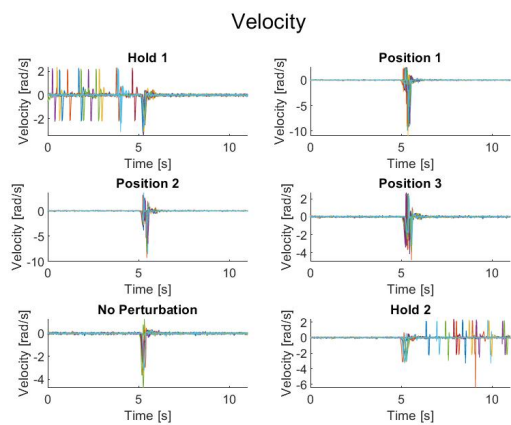

Figure 132: Velocity profile for each trial, separated per condition.

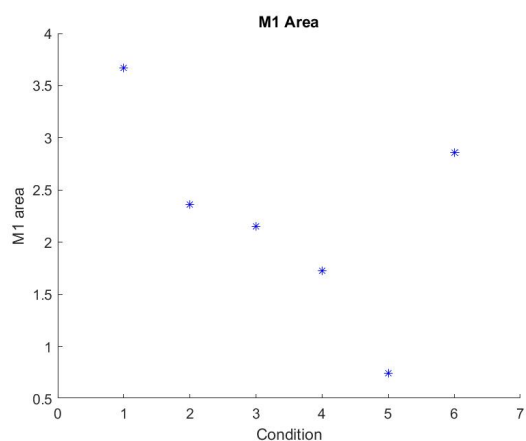

Figure 135: Average M1 area per condition.

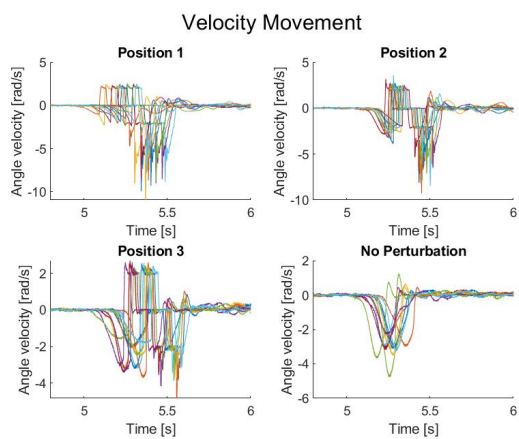

Figure 133: Velocity profile for each movement - for conditions: 2, 3, 4, 5.

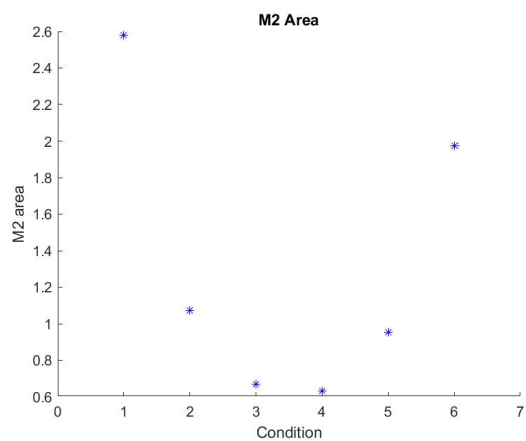

Figure 136: Average M2 area per condition.

**Subject 4**

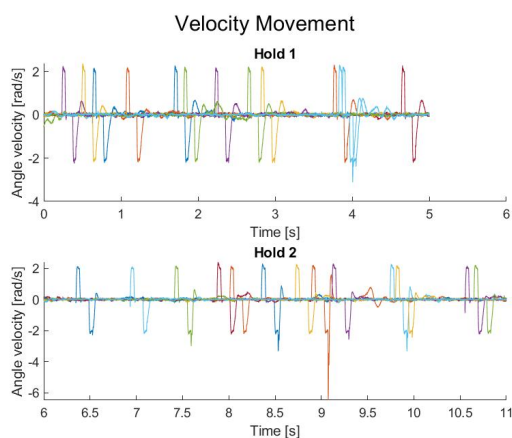

Figure 134: Velocity profile for each hold - for conditions: 1, 6.

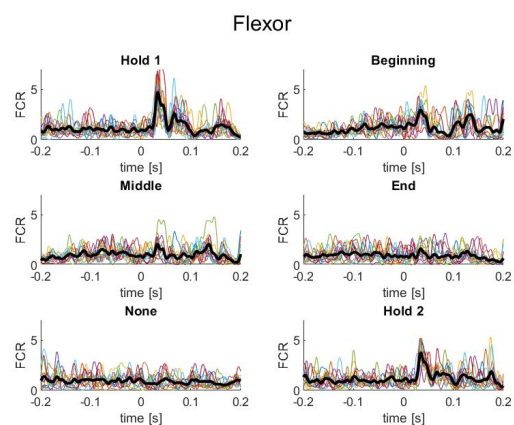

Figure 137: FCR response for each trial, separated per condition.

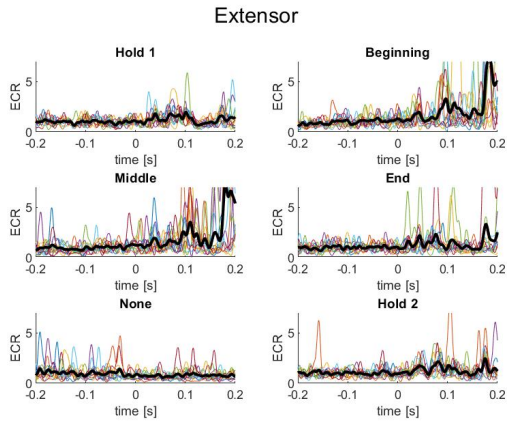

Figure 138: ECR response for each trial, separated per condition.

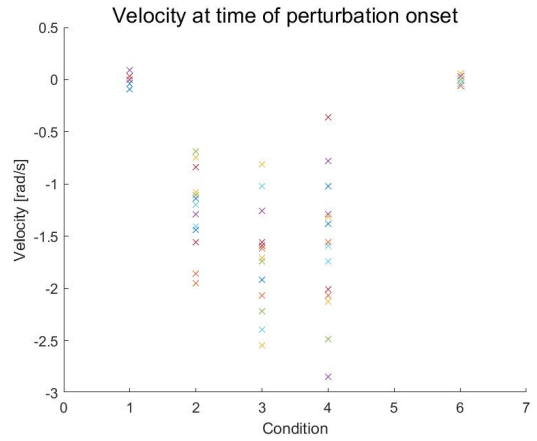

Figure 141: Velocity of the handle when each perturbation was triggered.

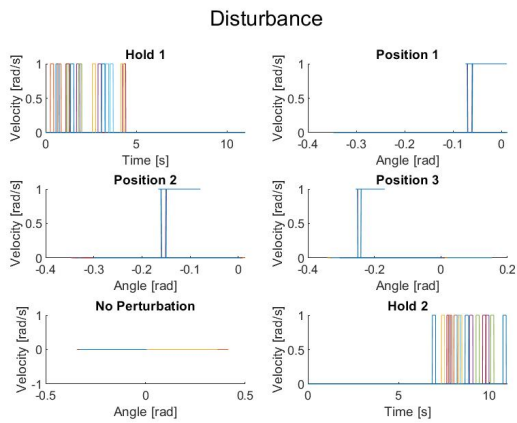

Figure 139: All the perturbations elicited during the 120 trials.

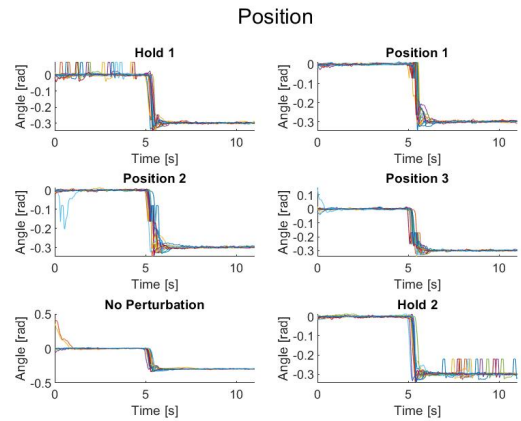

Figure 142: Position profile for each trial, separated per condition.

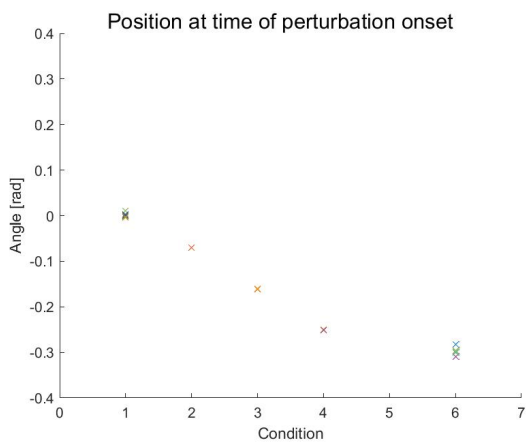

Figure 140: Position of the handle when each perturbation was triggered.

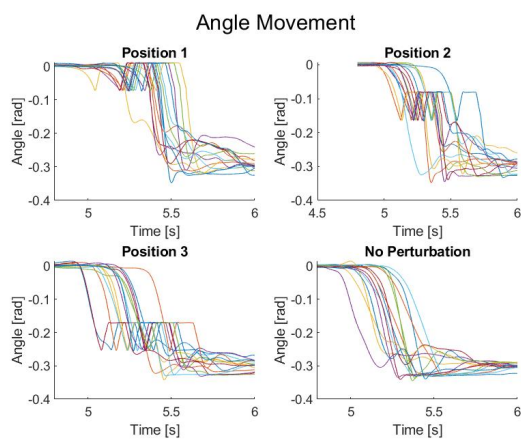

Figure 143: Position profile for each movement - for conditions: 2, 3, 4, 5.

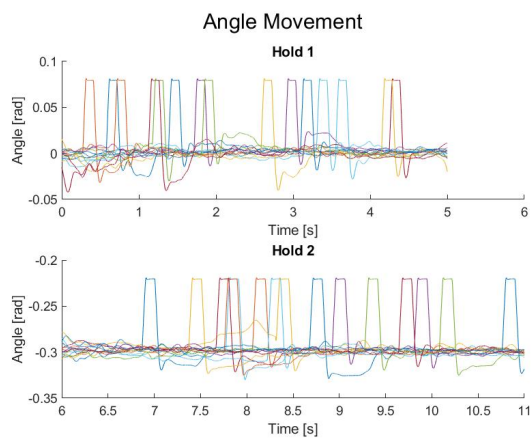

Figure 144: Position profile for each hold - for conditions: 1, 6.

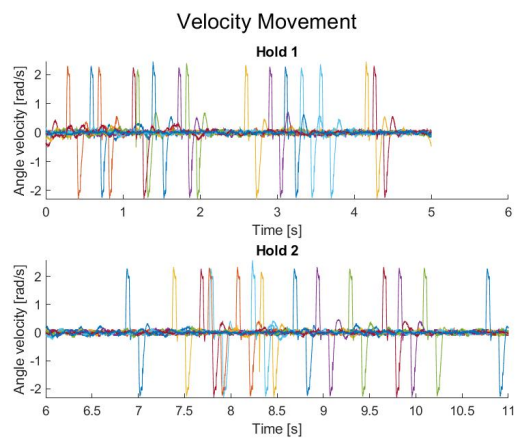

Figure 147: Velocity profile for each hold - for conditions: 1, 6.

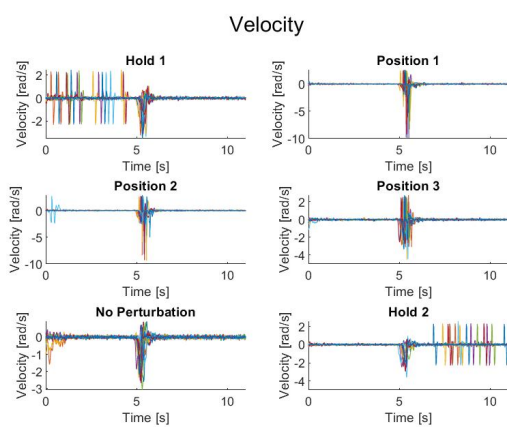

Figure 145: Velocity profile for each trial, separated per condition.

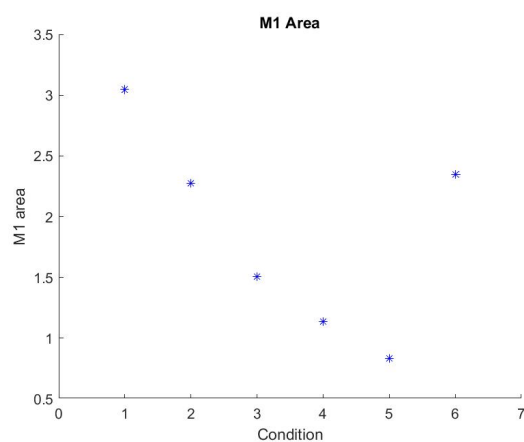

Figure 148: Average M1 area per condition.

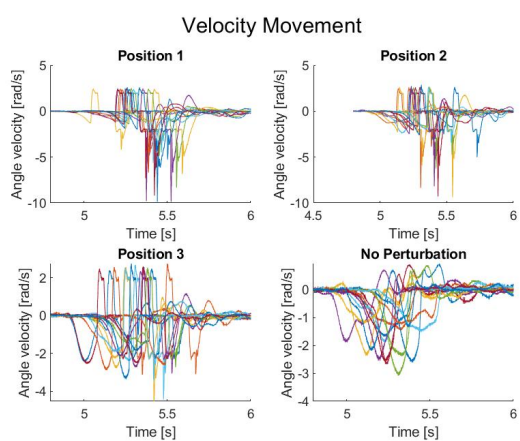

Figure 146: Velocity profile for each movement - for conditions: 2, 3, 4, 5.

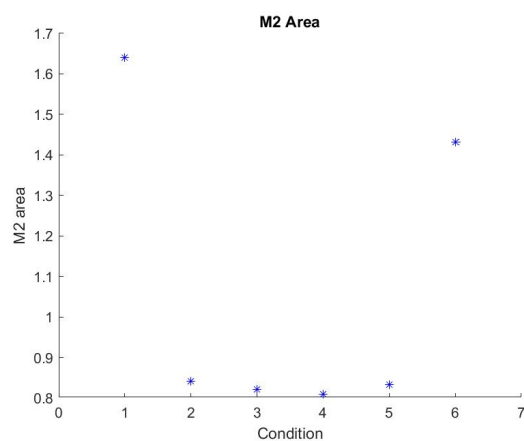

Figure 149: Average M2 area per condition.

---

**Subject 5**

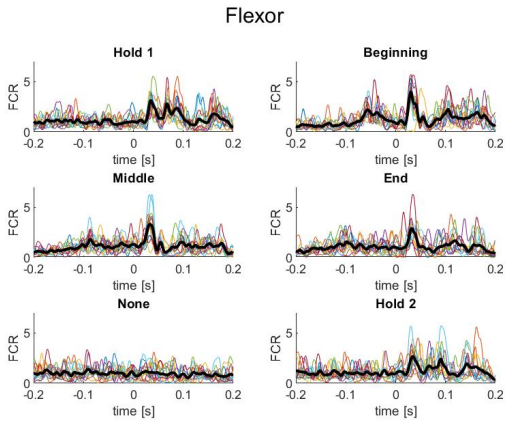

Figure 150: FCR response for each trial, separated per condition.

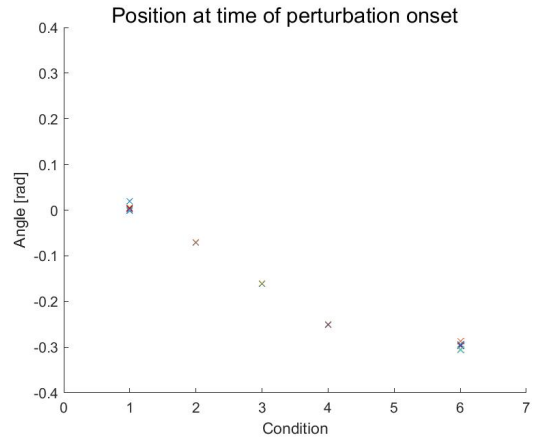

Figure 153: Position of the handle when each perturbation was triggered.

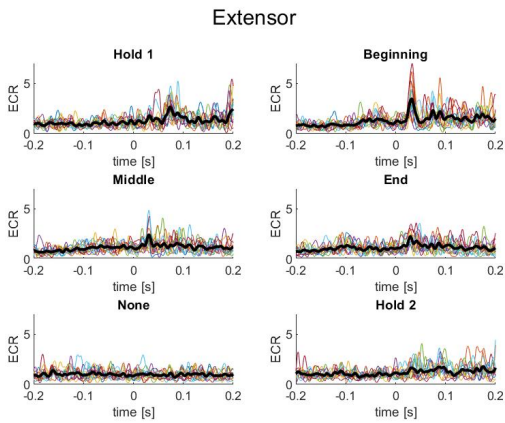

Figure 151: ECR response for each trial, separated per condition.

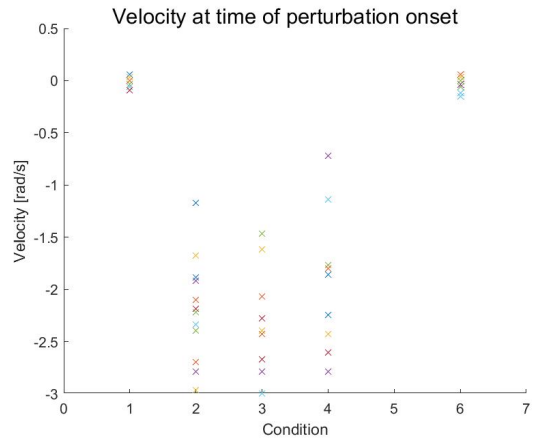

Figure 154: Velocity of the handle when each perturbation was triggered.

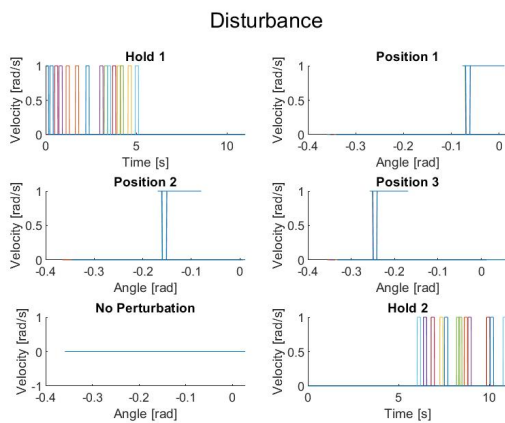

Figure 152: All the perturbations elicited during the 120 trials.

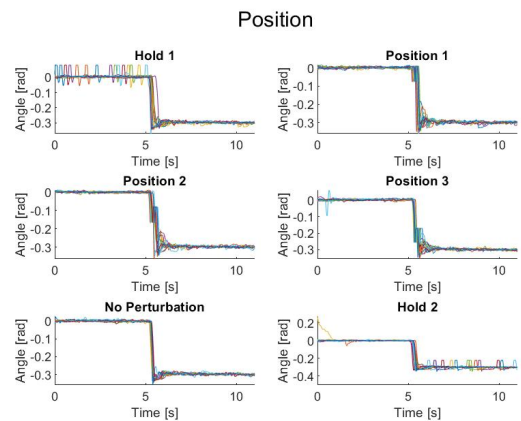

Figure 155: Position profile for each trial, separated per condition.

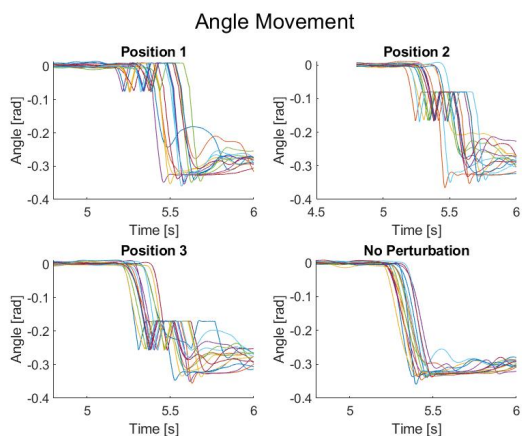

Figure 156: Position profile for each movement - for conditions: 2, 3, 4, 5.

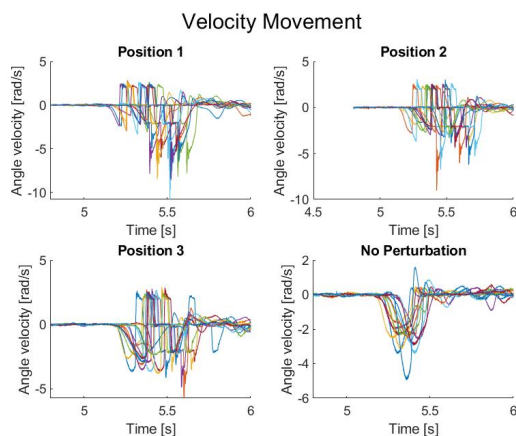

Figure 159: Velocity profile for each movement - for conditions: 2, 3, 4, 5.

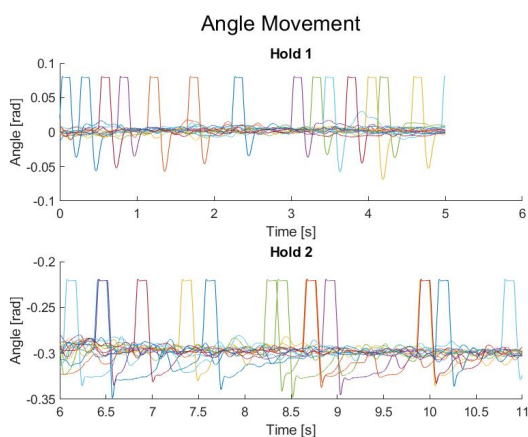

Figure 157: Position profile for each hold - for conditions: 1, 6.

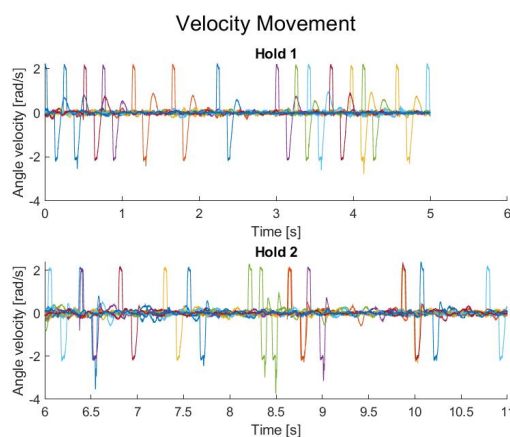

Figure 160: Velocity profile for each hold - for conditions: 1, 6.

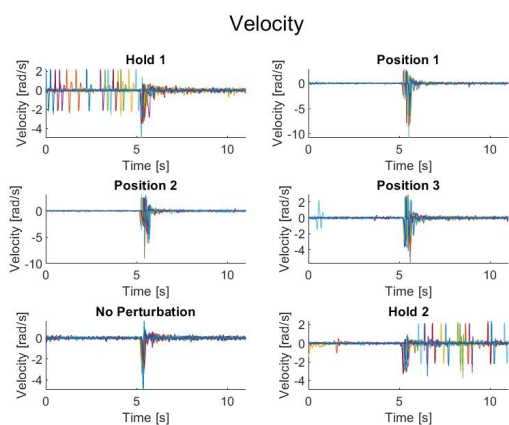

Figure 158: Velocity profile for each trial, separated per condition.

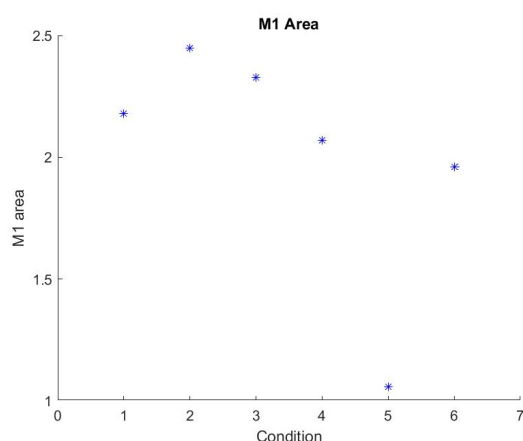

Figure 161: Average M1 area per condition.

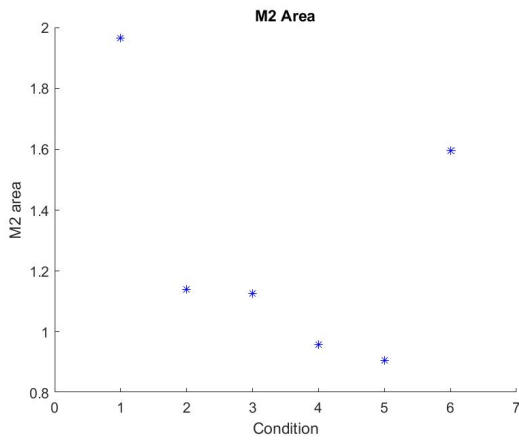

Figure 162: Average M2 area per condition.

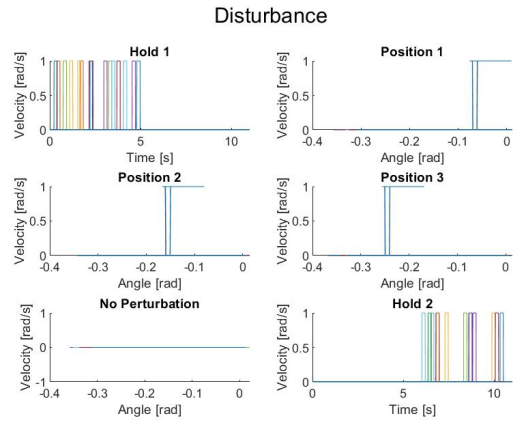

Figure 165: All the perturbations elicited during the 120 trials.

**Subject 6**

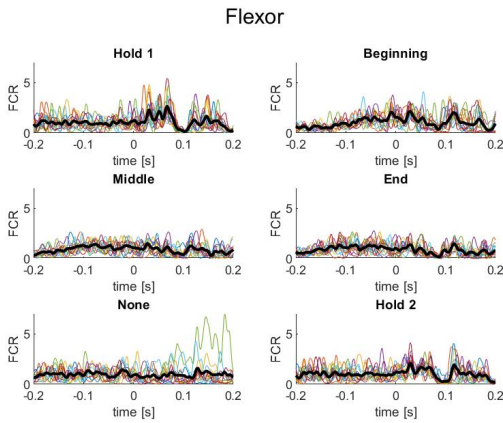

Figure 163: FCR response for each trial, separated per condition.

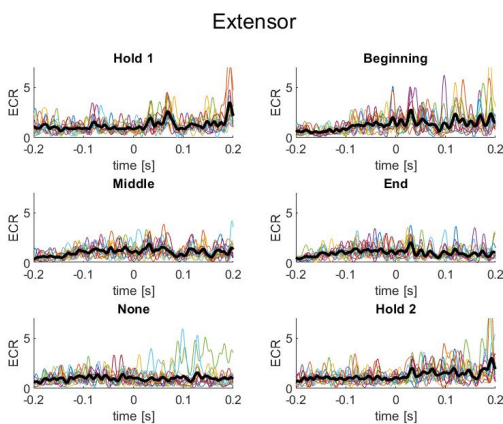

Figure 164: ECR response for each trial, separated per condition.

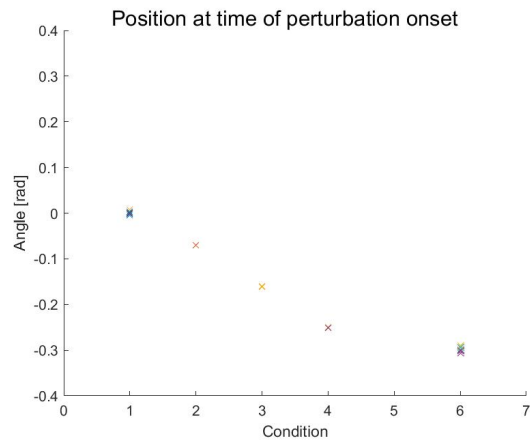

Figure 166: Position of the handle when each perturbation was triggered.

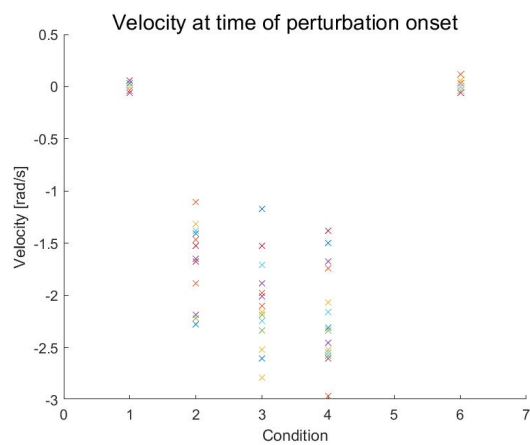

Figure 167: Velocity of the handle when each perturbation was triggered.



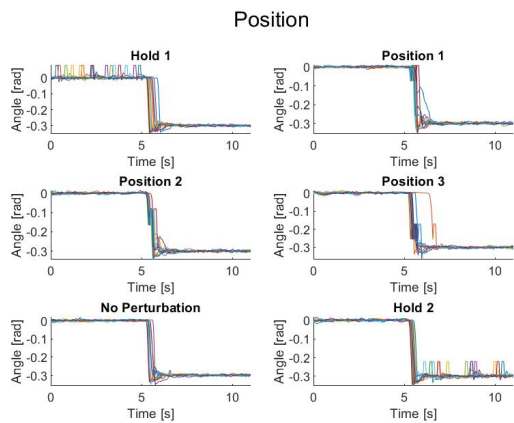

Figure 168: Position profile for each trial, separated per condition.

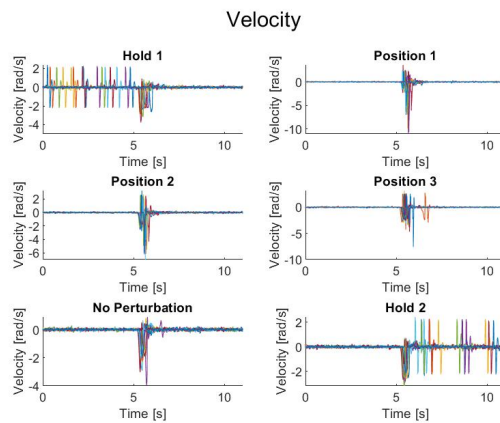

Figure 171: Velocity profile for each trial, separated per condition.

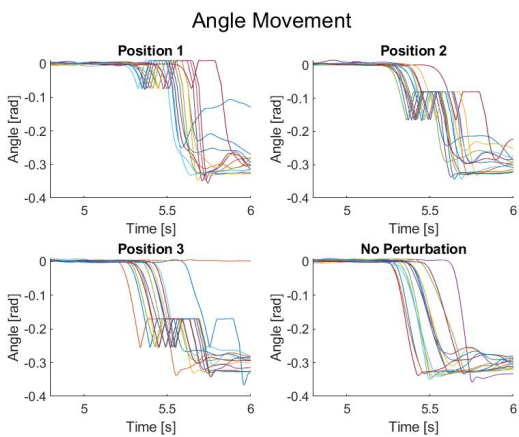

Figure 169: Position profile for each movement - for conditions: 2, 3, 4, 5.

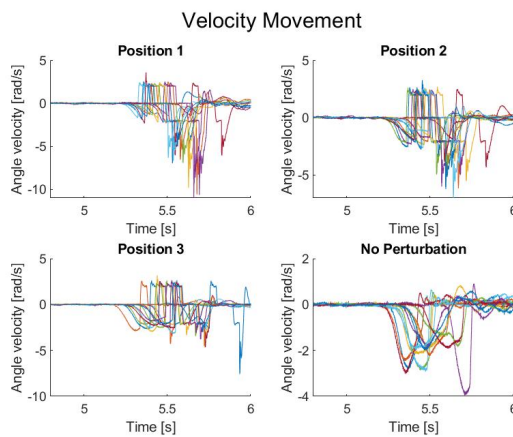

Figure 172: Velocity profile for each movement - for conditions: 2, 3, 4, 5.

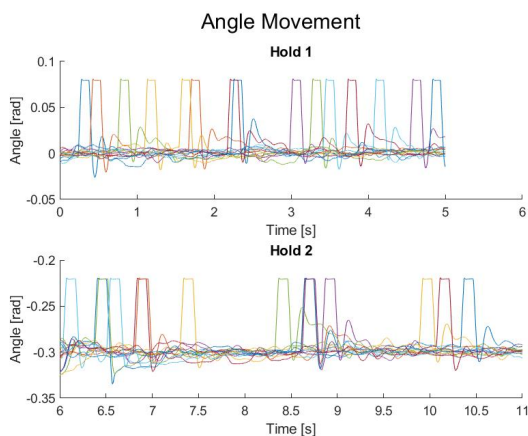

Figure 170: Position profile for each hold - for conditions: 1, 6.

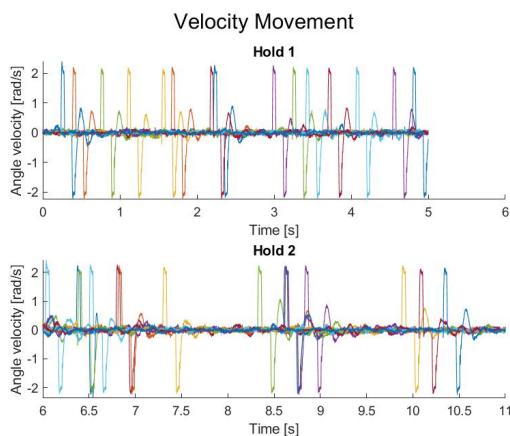

Figure 173: Velocity profile for each hold - for conditions: 1, 6.

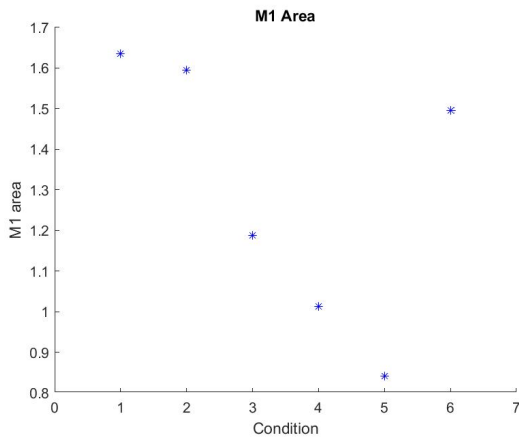

Figure 174: Average M1 area per condition.

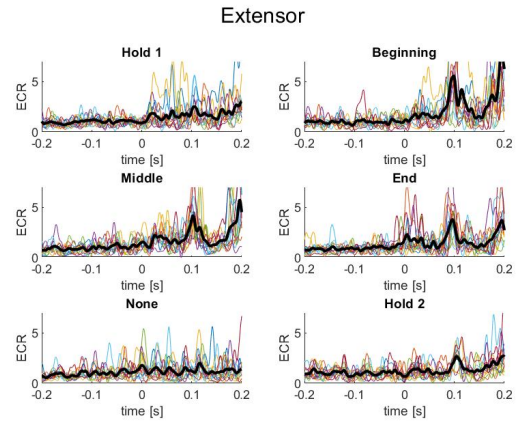

Figure 177: ECR response for each trial, separated per condition.

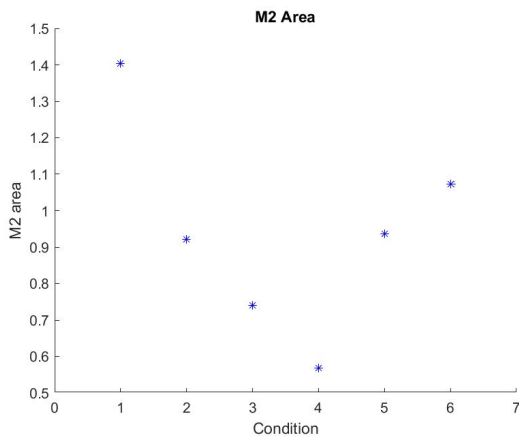

Figure 175: Average M2 area per condition.

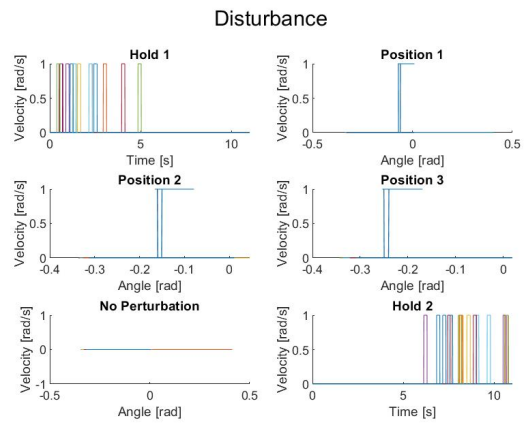

Figure 178: All the perturbations elicited during the 120 trials.

**Subject 7**

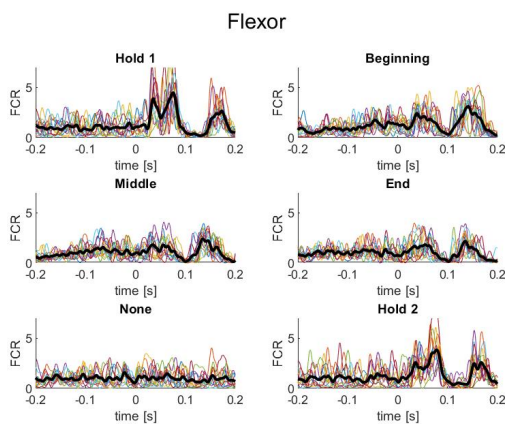

Figure 176: FCR response for each trial, separated per condition.

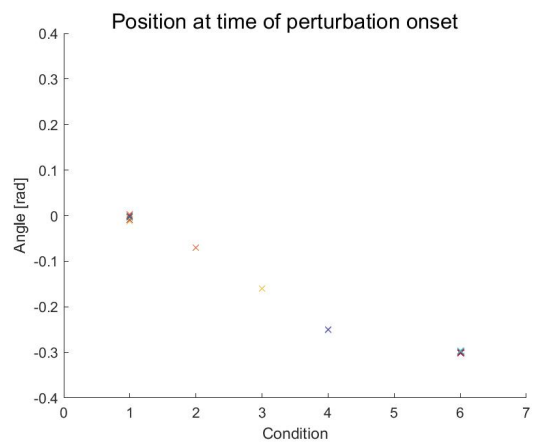

Figure 179: Position of the handle when each perturbation was triggered.

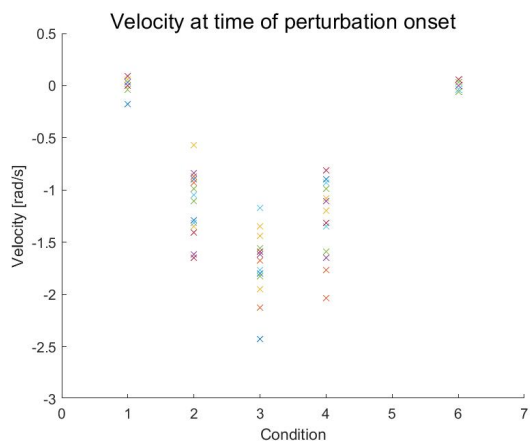

Figure 180: Velocity of the handle when each perturbation was triggered.

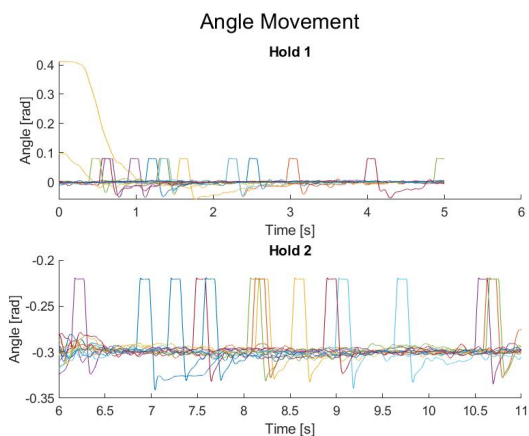

Figure 183: Position profile for each hold - for conditions: 1, 6.

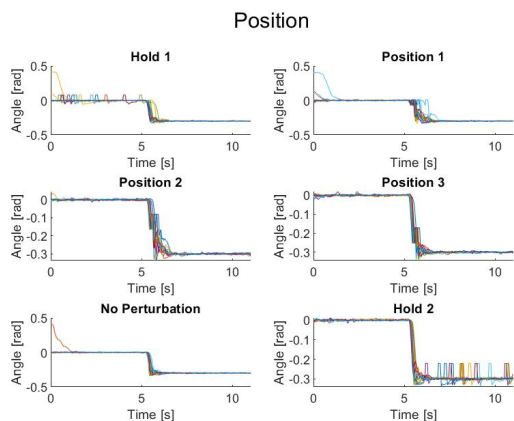

Figure 181: Position profile for each trial, separated per condition.

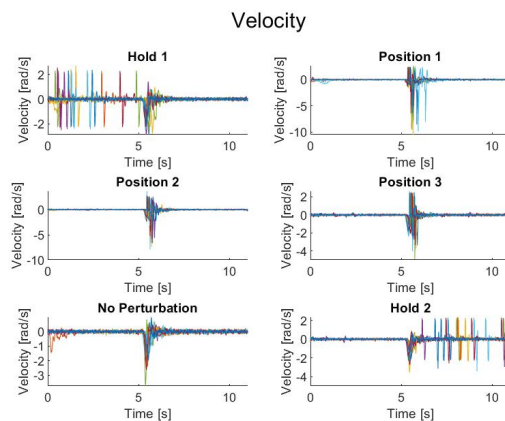

Figure 184: Velocity profile for each trial, separated per condition.

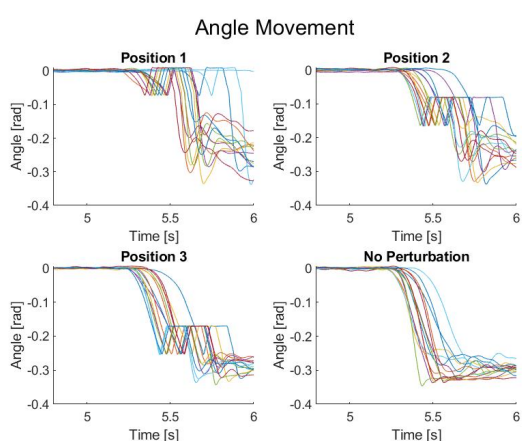

Figure 182: Position profile for each movement - for conditions: 2, 3, 4, 5.

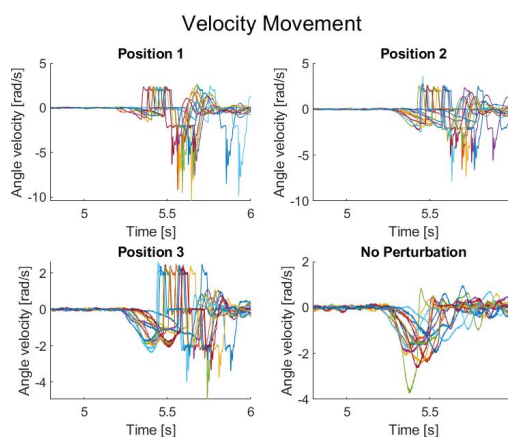

Figure 185: Velocity profile for each movement - for conditions: 2, 3, 4, 5.

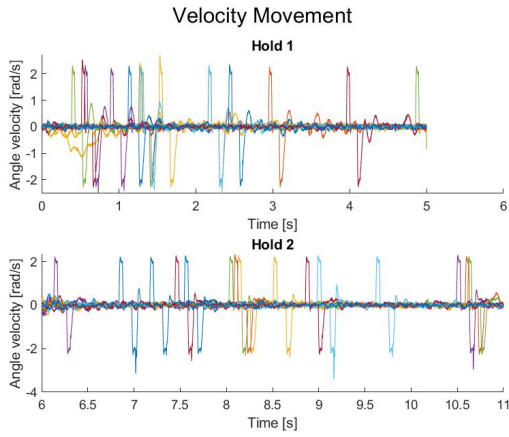

Figure 186: Velocity profile for each hold - for conditions: 1, 6.

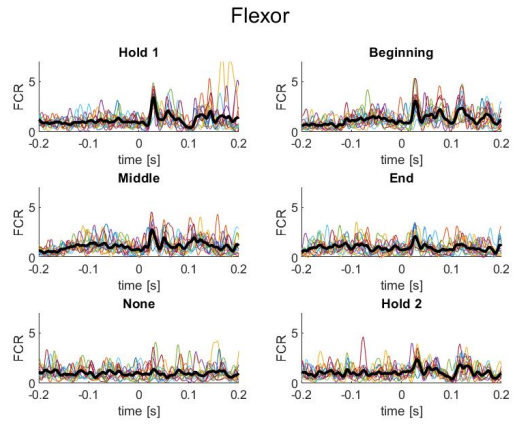

Figure 189: FCR response for each trial, separated per condition.

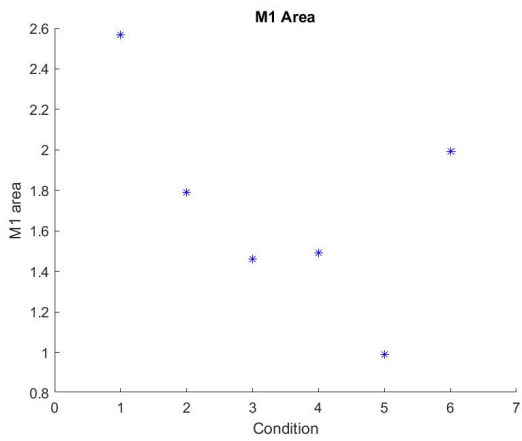

Figure 187: Average M1 area per condition.

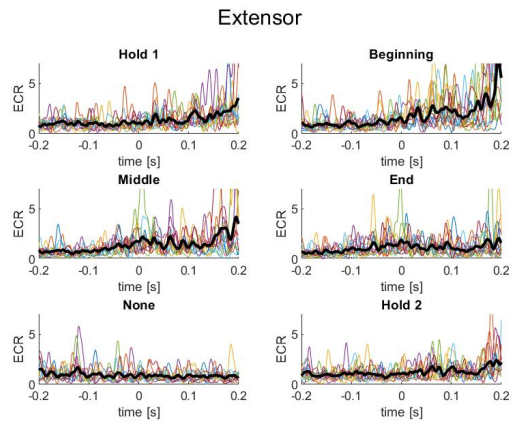

Figure 190: ECR response for each trial, separated per condition.

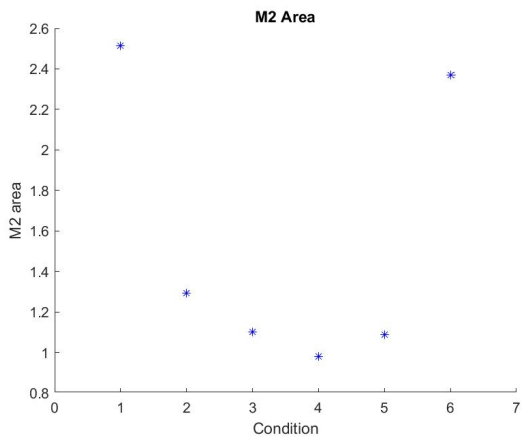

Figure 188: Average M2 area per condition.

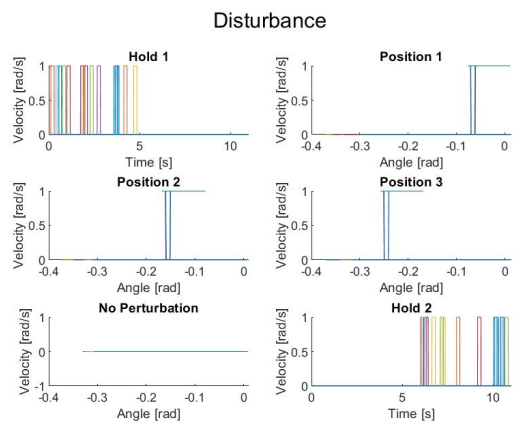

Figure 191: All the perturbations elicited during the 120 trials.

**Subject 8**

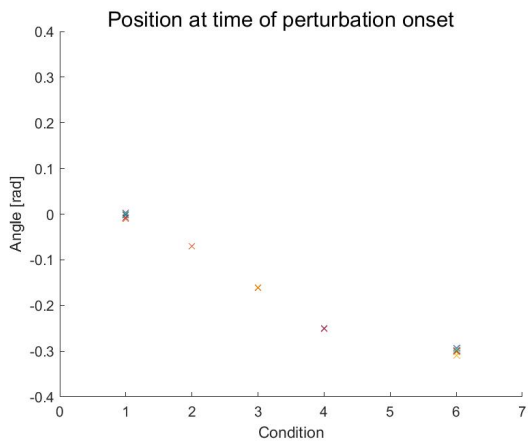

Figure 192: Position of the handle when each perturbation was triggered.

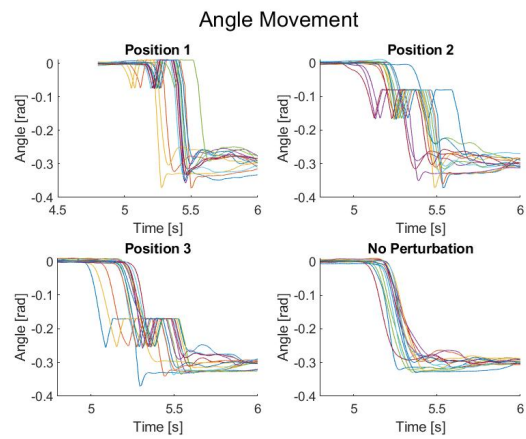

Figure 195: Position profile for each movement - for conditions: 2, 3, 4, 5.

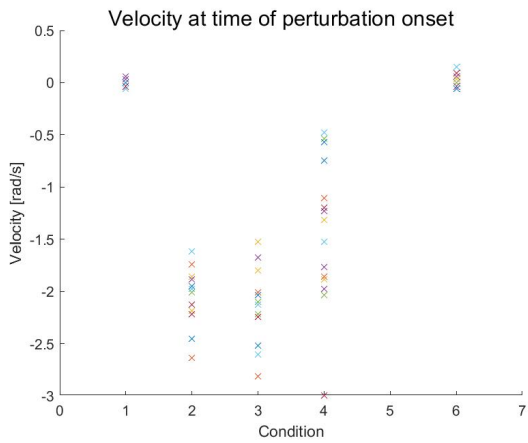

Figure 193: Velocity of the handle when each perturbation was triggered.

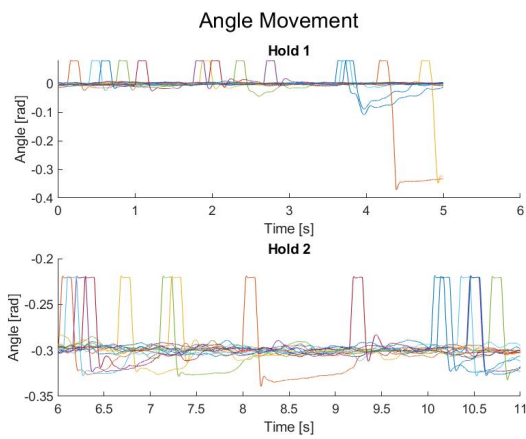

Figure 196: Position profile for each hold - for conditions: 1, 6.

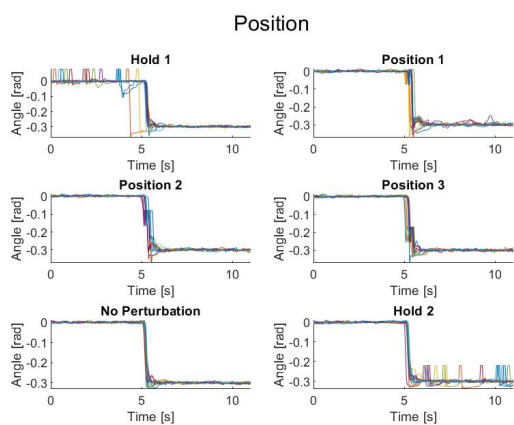

Figure 194: Position profile for each trial, separated per condition.

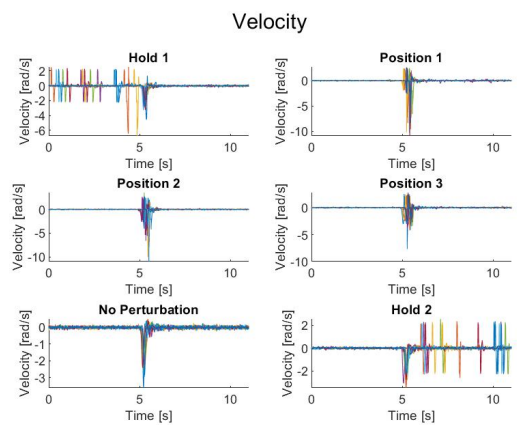

Figure 197: Velocity profile for each trial, separated per condition.

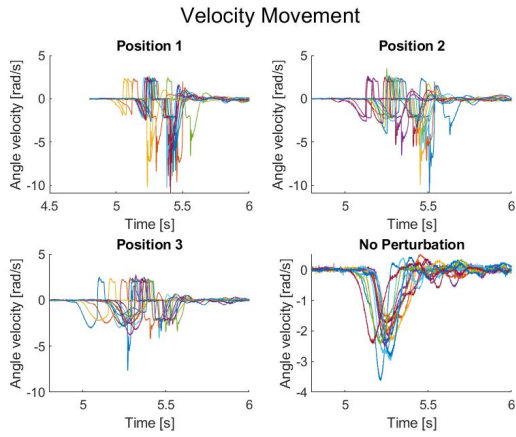

Figure 198: Velocity profile for each movement - for conditions: 2, 3, 4, 5.

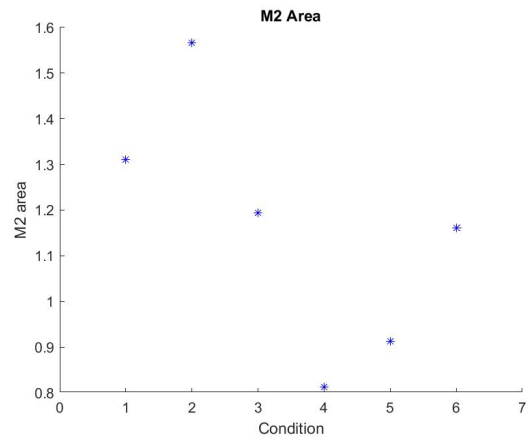

Figure 201: Average M2 area per condition.

**Subject 9**

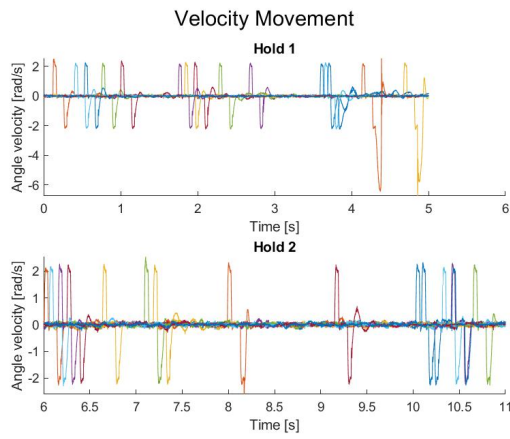

Figure 199: Velocity profile for each hold - for conditions: 1, 6.

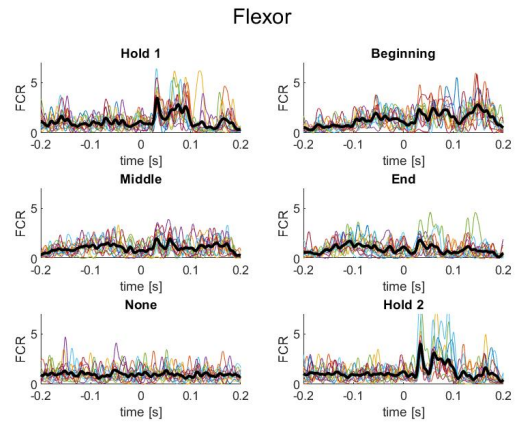

Figure 202: FCR response for each trial, separated per condition.

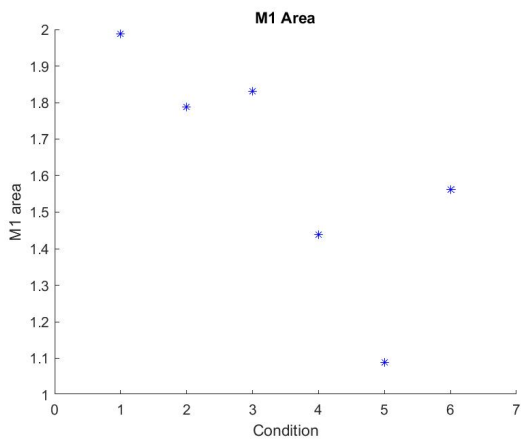

Figure 200: Average M1 area per condition.

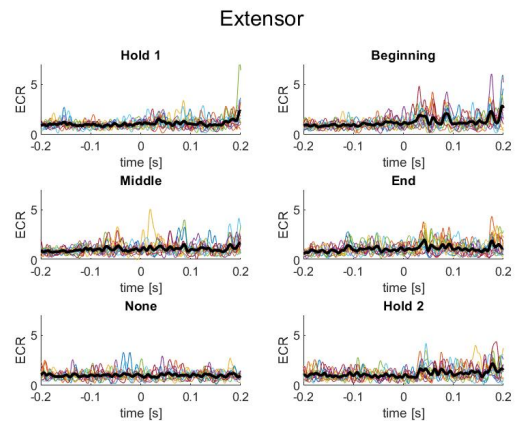

Figure 203: ECR response for each trial, separated per condition.

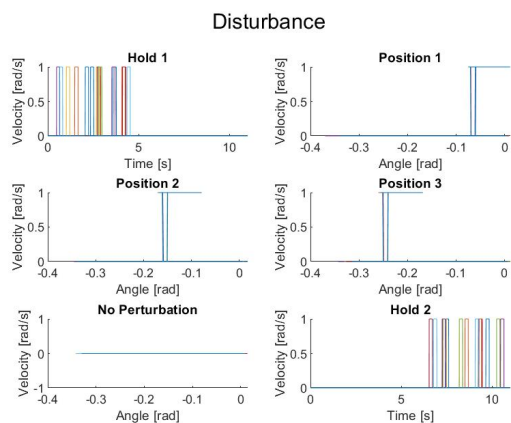

Figure 204: All the perturbations elicited during the 120 trials.

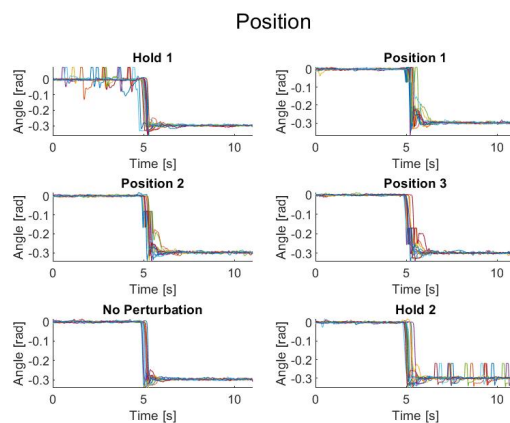

Figure 207: Position profile for each trial, separated per condition.

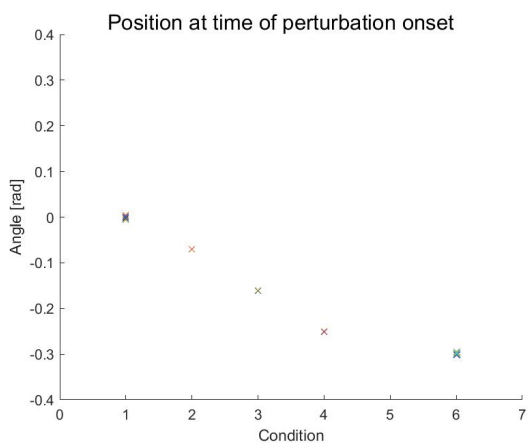

Figure 205: Position of the handle when each perturbation was triggered.

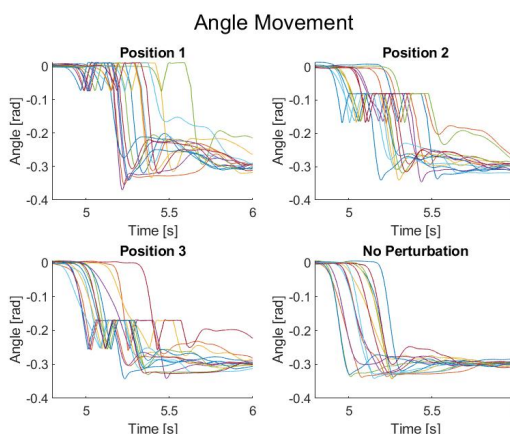

Figure 208: Position profile for each movement - for conditions: 2, 3, 4, 5.

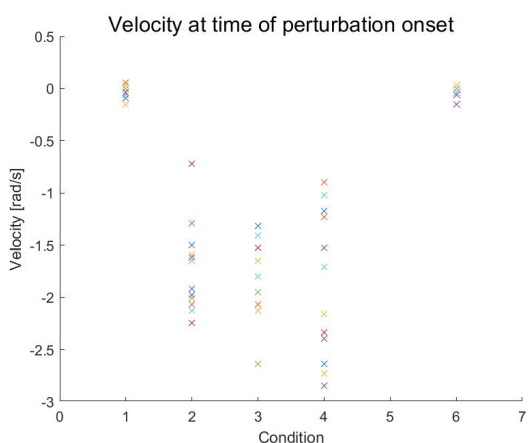

Figure 206: Velocity of the handle when each perturbation was triggered.

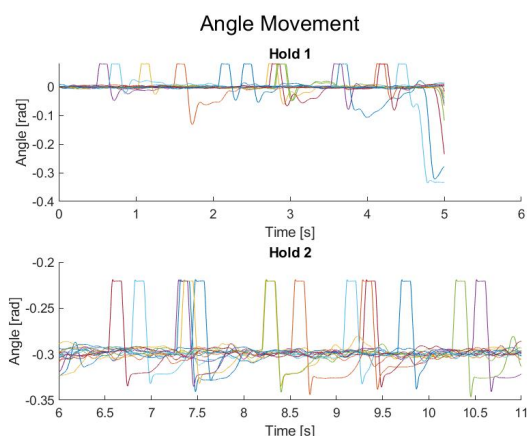

Figure 209: Position profile for each hold - for conditions: 1, 6.

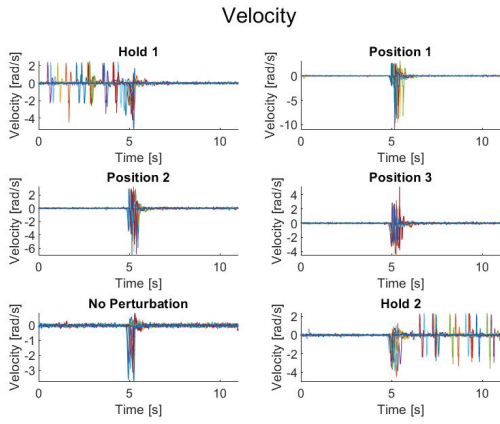

Figure 210: Velocity profile for each trial, separated per condition.

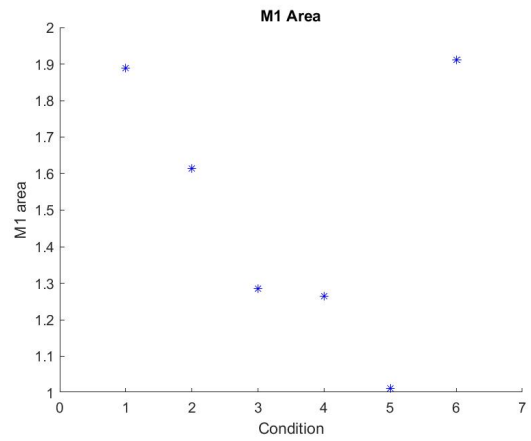

Figure 213: Average M1 area per condition.

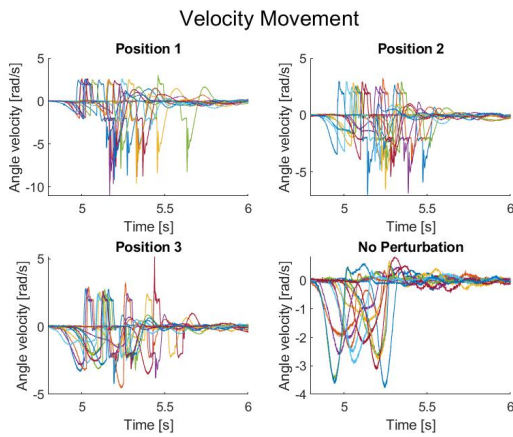

Figure 211: Velocity profile for each movement - for conditions: 2, 3, 4, 5.

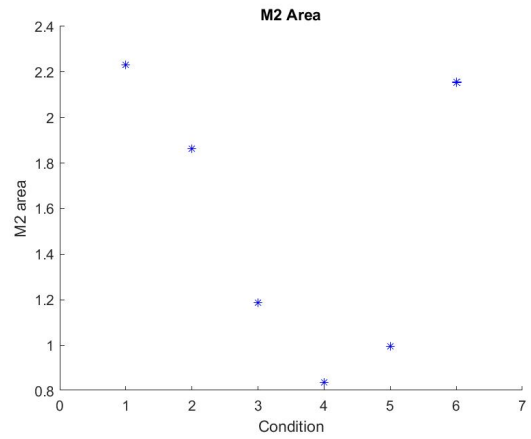

Figure 214: Average M2 area per condition.

**Subject 10**

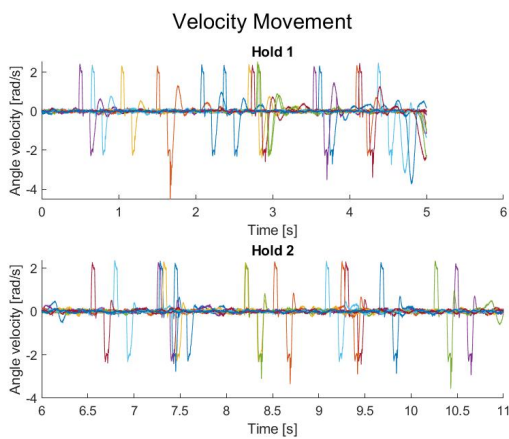

Figure 212: Velocity profile for each hold - for conditions: 1, 6.

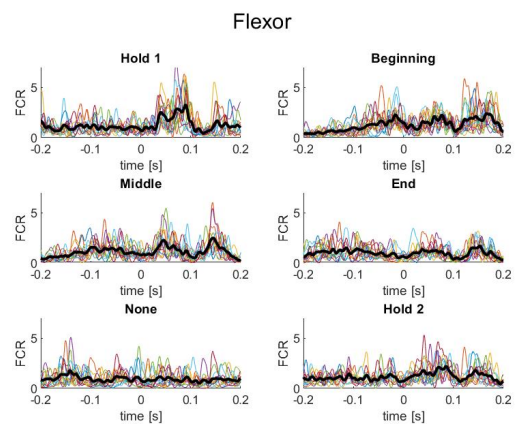

Figure 215: FCR response for each trial, separated per condition.



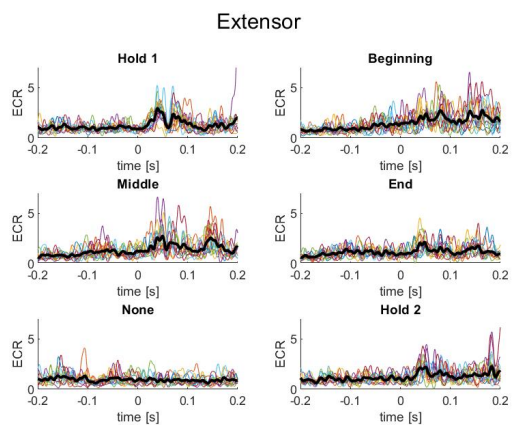

Figure 216: ECR response for each trial, separated per condition.

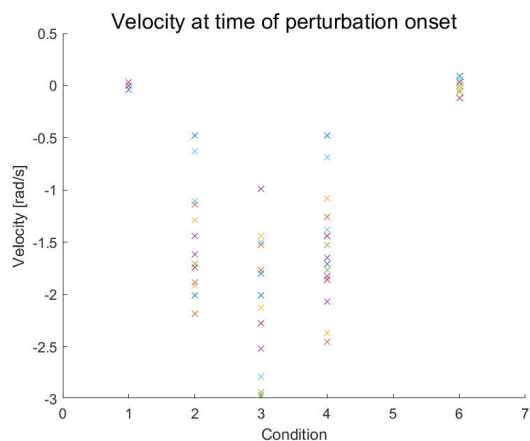

Figure 219: Velocity of the handle when each perturbation was triggered.

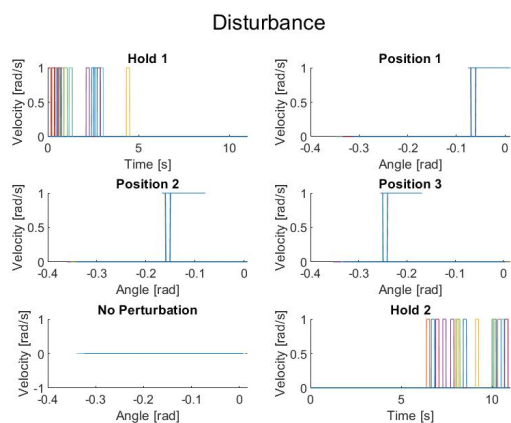

Figure 217: All the perturbations elicited during the 120 trials.

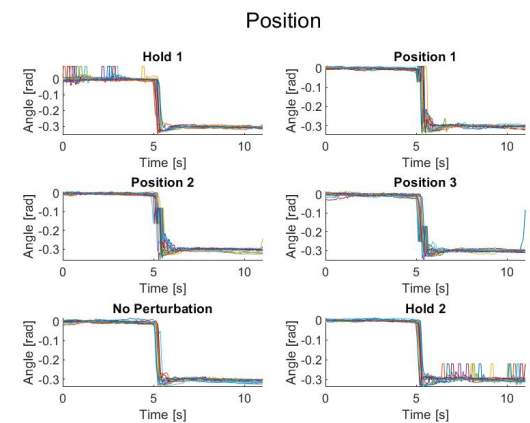

Figure 220: Position profile for each trial, separated per condition.

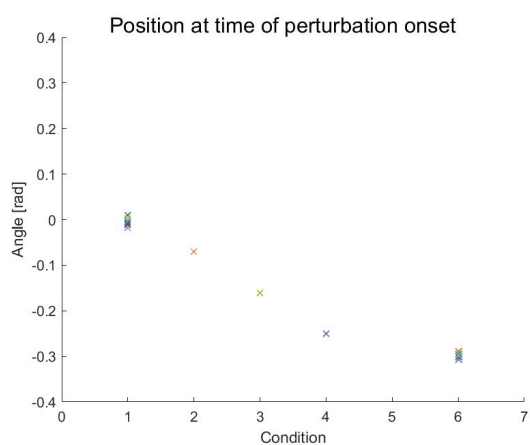

Figure 218: Position of the handle when each perturbation was triggered.

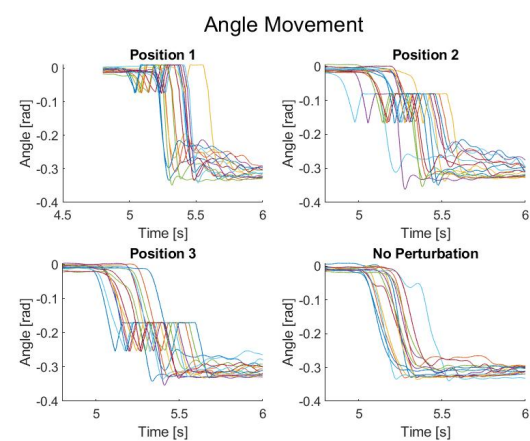

Figure 221: Position profile for each movement - for conditions: 2, 3, 4, 5.

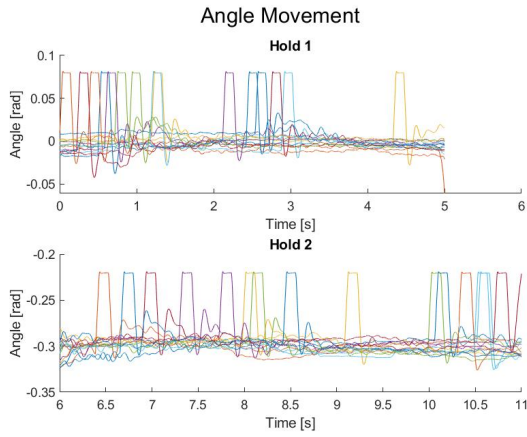

Figure 222: Position profile for each hold - for conditions: 1, 6.

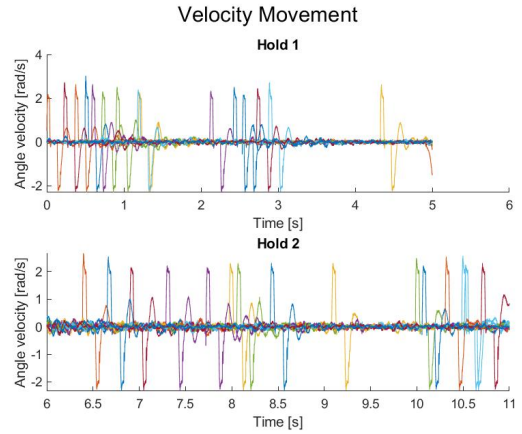

Figure 225: Velocity profile for each hold - for conditions: 1, 6.

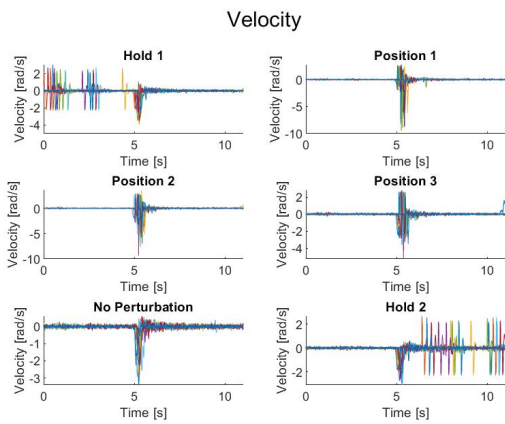

Figure 223: Velocity profile for each trial, separated per condition.

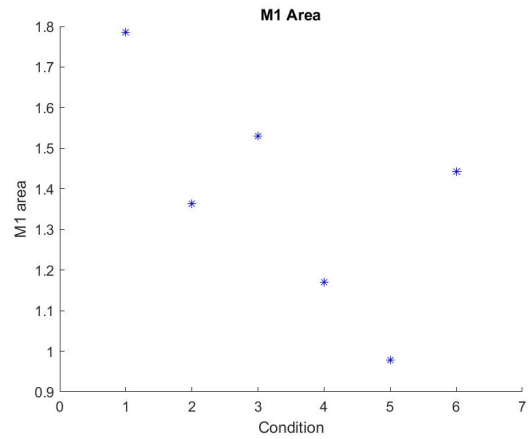

Figure 226: Average M1 area per condition

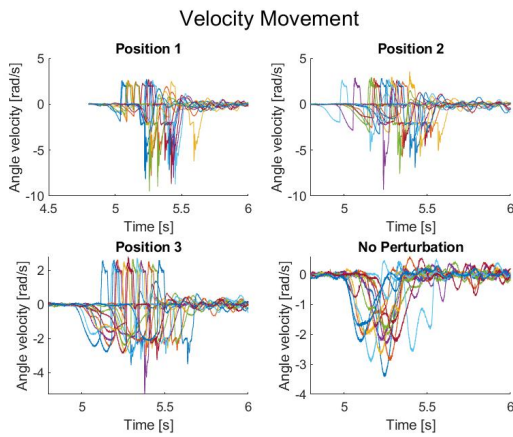

Figure 224: Velocity profile for each movement - for conditions: 2, 3, 4, 5.

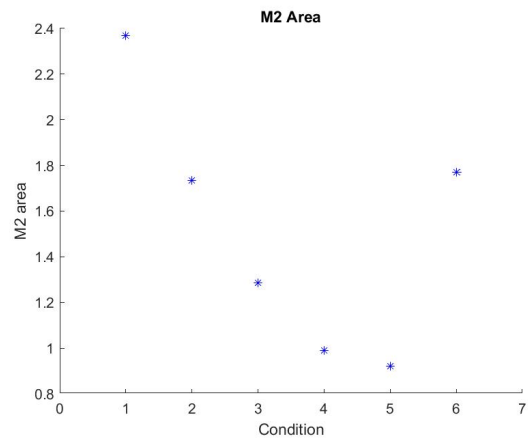

Figure 227: Average M2 area per condition.

### E.3: All Subject Graphs

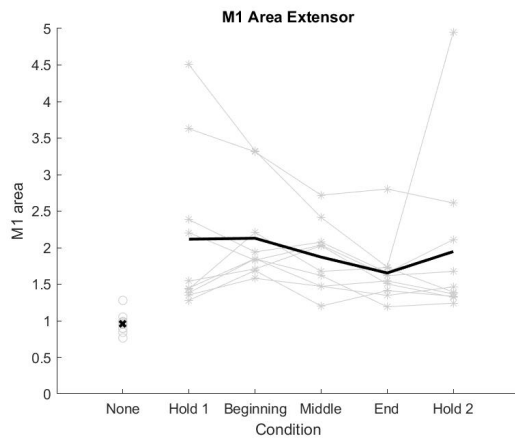

Figure 228: Average M1 area per subject (ECR).

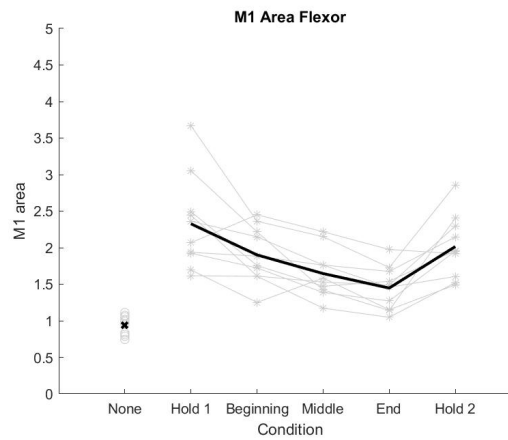

Figure 231: Average M1 area per subject (FCR).

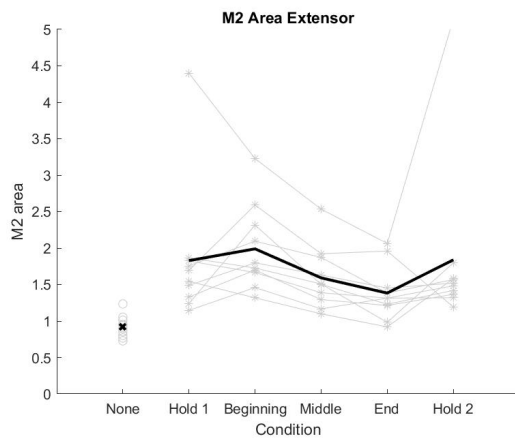

Figure 229: Average M2 area per subject (ECR).

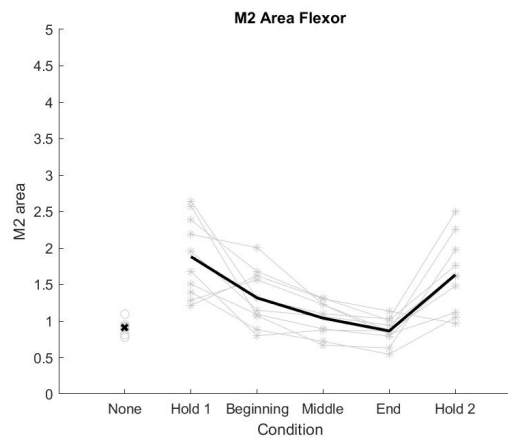

Figure 232: Average M2 area per subject (FCR).

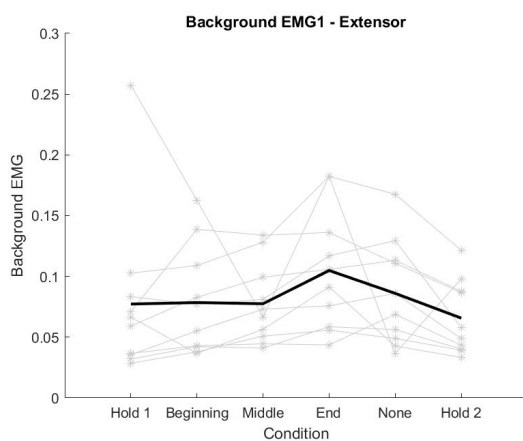

Figure 230: Average Background EMG per subject (ECR).

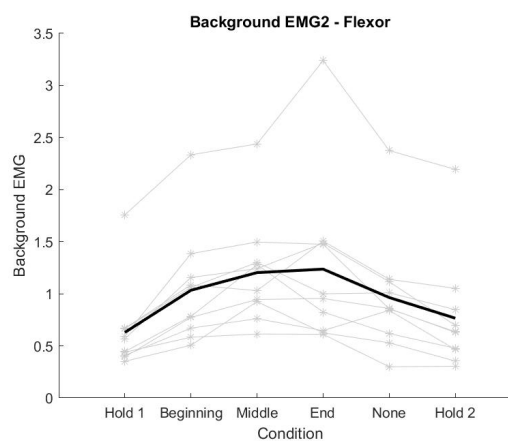

Figure 233: Average Background EMG per subject (FCR).

## E.4: Subject Comments

# Subject Comments

## Experiment 3 (Main)

All Subjects Main experiment
<p><b>Set up</b></p> <p>Channel 1: Extensor (top of arm) Channel 2: Flexor (bottom of arm)</p> <p>Checklist:</p> <ol style="list-style-type: none"> <li>1. Informed consent forms</li> <li>2. Control Trial + analyze data</li> <li>3. Main experiment               <ol style="list-style-type: none"> <li>a. break every 20 trials (or when the subjects request a break)</li> <li>b. check EMG throughout the trials</li> <li>c. at least 5 trials training with no perturbation</li> <li>d. open hand</li> </ol> </li> </ol> <p><b>Note:</b> in the beginning of the experiment, trials were repeated in order to enforce the correct velocity (when there was an incorrect velocity). However towards the end, if the perturbation didn't occur during the movement phase, then sometimes the experimenter would not ask the subject to repeat the trial as it was not relevant for those conditions (V1, V5, V6). Feedback was still given to the subject to inform them that the velocity was too slow/fast, and the next trial was used to determine if the velocity inaccuracy was consistent or just the one trial. If the velocity inaccuracy happened again, both trials would be repeated to enforce the correct velocity, otherwise the trials remained as they were initially recorded. When a trial needed to be repeated, the trial would be repeated at a time that the subject was not aware of in order to avoid knowing when the perturbation would occur (unless the perturbation hadn't occurred yet).</p>
<p><b>Subject 1</b></p> <ul style="list-style-type: none"> <li>- Open hand/relaxed hand</li> <li>- 20 trials per condition (120 total)</li> <li>- Used this data to show that 60 trials results in the same mean as 120 trials (mean is the feature used for data analysis so the most relevant part to keep consistent)</li> <li>- 5 training trials (trials without a perturbation)</li> <li>- No V2 error</li> </ul>
<p><b>Subject 2</b></p> <ul style="list-style-type: none"> <li>- Performed the experiment twice, with open and closed hand to determine the effect of co-contraction in the extensor</li> <li>- Data used is with : Open hand/relaxed hand</li> <li>- Performed 12 trials per condition closed hand and 13 trials per condition closed hand (due to time constraints)</li> <li>- 10-15 trials showed the same results: did 10 with a few extra for outliers</li> <li>- Had to repeat 4 trials due to velocity inaccuracies (8, 11, 28, 52)</li> <li>- 5+ training trials</li> <li>- No V2 error</li> </ul>

**Subject 3**

- Open/relaxed hand
- 13 trials per conditions (10 + 3 outliers) (78 total)
- Velocity of movement took more than 5 trials to get right
- V2 dtheta/torque error occurred multiple times throughout the experiment, the GUI shut off in the middle of the experiment due to one of the errors causing it to no longer respond -> had to start a new experiment and perform only the remaining conditions
- Had to repeat the trials that caused the error (condition 2)

**Subject 4**

- Open/relaxed hand
- 15 trials per condition (90 total) (changed due to better number)
- Velocity of movement took more than 5 trials to get right
- Had to repeat multiple trials due to velocity inaccuracies in the beginning
- V2 dtheta/torque error occurred multiple times throughout the experiment, the GUI shut off in the middle of the experiment due to one of the errors causing it to no longer respond -> had to start a new experiment and perform only the remaining conditions
- Had to repeat the trials that caused the error (condition 2)
- Initially had problems with EMG but that was due to broken ground cable which was fixed before the experiment commenced
- After some trials, the subject mentioned a numbing feeling in their arm -> had to shake out the arm to regain some feeling

**Subject 5**

- Open/relaxed hand
- 15 trials per conditions (90 total)
- The training to get the correct velocity took 20 trials (had to take a break before starting the experiment)
- After each break the subject had to re-train the velocity profile
- After some trials, the subject mentioned a numbing feeling in their arm -> had to shake out the arm to regain some feeling
- No V2 error

**Subject 6**

- Open/relaxed hand
- 15 trials per conditions (90 total)
- Very quick to get the correct velocity profile due to previous experience testing the other experiments (less than 5 training trials, but the 5 training trials were still completed)
- Outlier: V2f.mat didn't have a perturbation while it was supposed to have. Likely was triggered in the move to position phase. This was re-named to V2z.mat so that it would not be plotted for V2. Another trial was taken to replace it.
- V2 error occurred for 1 trial.

**Subject 7**

- Open/relaxed hand
- 15 trials per conditions (90 total)
- V2 error due to too fast velocity from the participant. This participant in particular was very anxious to start the movement as fast as possible and would slow down towards the end. Had to repeat many trials due to this tendency. Did not cause the experiment to break.

<ul style="list-style-type: none"><li>- Velocity took more than 5 trials to get accurate, with persistent difficulty throughout the experiment</li></ul>
<b>Subject 8</b>
<ul style="list-style-type: none"><li>- Open/relaxed hand</li><li>- 15 trials per conditions (90 total)</li><li>- Took more than 5 trials to get the accurate velocity, but once they got it right after the training, there were very little velocity inaccuracies. Every trial was very consistent in the velocity.</li><li>- Also realized themselves when she was performing an incorrect velocity and would ask to repeat the trial</li><li>- Some trials had to be repeated due to not paying attention and not realizing the movement was starting</li><li>- The subject was sitting in a very strained position and had to hold onto the table due to her short height, she could not touch the ground to resist her sliding away in the chair</li><li>- V2 error occurred a couple of times but the experiment was able to continue.</li><li>- No control experiment was done for this participant due to MAPort Error that was not fixed after trying multiple things. The subject had limited time so proceeded with the experiment while checking EMG during the main experiment.</li></ul>
<b>Subject 9</b>
<ul style="list-style-type: none"><li>- Open/relaxed hand</li><li>- 15 trials per conditions (90 total)</li><li>- V2, V3 and V4 error, experiment was able to continue. This subject had a muscular build so the V2/V3/V4 error was triggered due to torque i.e. not because the movement was too fast but that the subject used too much force to perform the movement.</li><li>- Velocity was not consistent, some trials were repeated.</li></ul>
<b>Subject 10</b>
<ul style="list-style-type: none"><li>- Open/relaxed hand</li><li>- 15 trials per conditions (90 total)</li><li>- Small reflexes in the control trial so put in more force in the 2<sup>nd</sup> control trial (moved the desired position to the left of the circle to increase the passive torque)</li><li>- Training to get the velocity profile took more than 5 trials</li><li>- Some trials showed velocity inaccuracies -&gt; repeated at another time to avoid the subject knowing when the perturbation occurred or if the perturbation was in the hold/none trials then it was not repeated (as explained above)</li><li>- No V2 error</li></ul>

## Appendix E.5: Theta Controller and Gains

The robot often times had hidden issues with regards to safety boundaries, mismatch of sampling frequencies, Simulink connections etc. Throughout the process, if a desired idea did not work according to plan, de-bugging had to be done to verify that the robot is attempting to execute the desired plan. Sometimes this showed that there was a mismatch between signals in Simulink, such that incorrect gains were applied or connections were wrongfully attached. ControlDesk is a program that allowed for real-time observation of the Simulink signals on the dSPACE platform, which often helped to identify the cause of such problems.

Furthermore, it was discovered that the sampling frequency written in the Simulink model and the associated MATLAB code were not consistent. This was causing problems with the operation of the robot, and rendered some previous experiments incorrect. For the design process it did not have an effect, as improvements to the design could still be made, but it does mean that any previous data collected with the PoPe could be inaccurate.

It was necessary to solve a problem associated to the gains/parameters involved in the theta controller block. This part of the design process took some time, as gains used in previous papers ([23]) were not yielding the same results. The handle was not fully reaching the desired  $0.08rad$  amplitude, but rather reaching a lower amplitude at  $2rad/s$  before slowing down to finally reach  $0.08rad$ . It was eventually discovered that the mismatch was due to a problem with the sampling frequency hard-coded in the model and the sampling frequency instructed through the scripts. The problem was identified prior to starting Experiment 4. As a consequence, previous experiments may have unreliable data with respect to position and velocity, nonetheless, the improvements made are not affected.

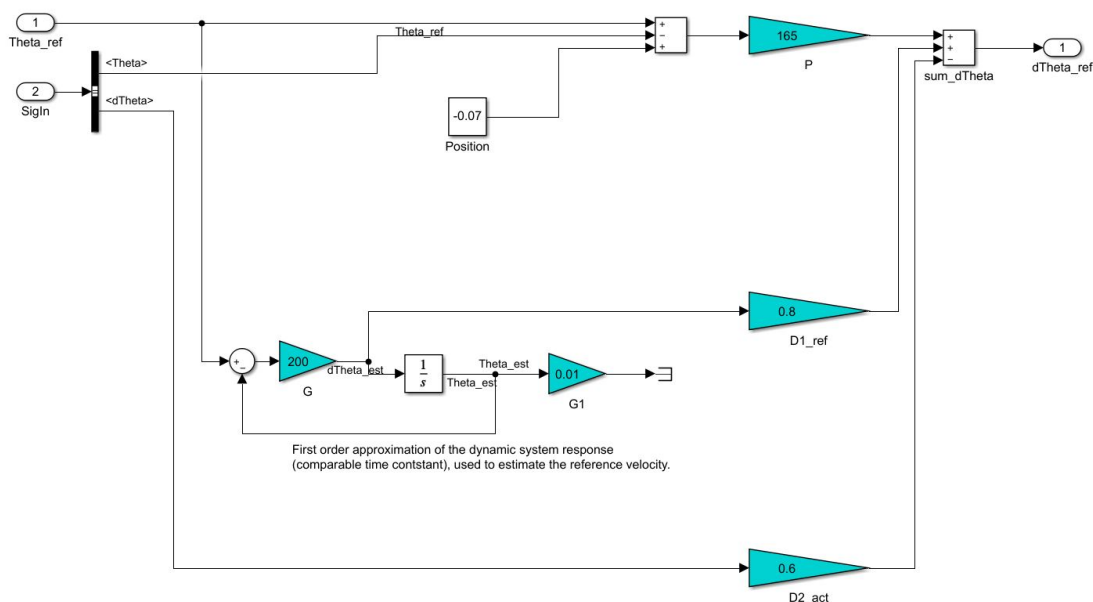

Figure 234: The theta controller is a controller taken from position mode. Essentially the robot switches between modes when the perturbation is triggered. This theta controller had to be altered such that the position at which the perturbation should be triggered is taken into consideration, as in position mode the handle does not move through user input.

## Appendix F: Experiment 5

### F.1: Additional Information

For the pilot test consisting of a  $200\text{ms}$  movement, the PRBS perturbations were switched off as the subject moved back to Circle A. However, there was a delay between the timer associated to producing the visuals, which meant that after 2 movements, the delay would be so large that it was noticeable when the PRBS perturbations and the instructions on the screen did not match up. Hence, only 2 movements were used. Then, it was decided to use a  $500\text{ms}$  movement, and as this change was being implemented, it seemed logical to alter the way the trial was conducted. Rather than having a rest period of 3s with no PRBS perturbations, it was decided to have the move back movement be of the same duration as the flexion movement, and to not turn off the PRBS perturbations at all. As a result, the trial was essentially the same procedure back and forth, which allowed the subject to be less confused about the different settings regarding the duration of the movement, enforced more concentration about staying between the circles, allowed for more movements per trial and avoided the visual delays with regards to the PRBS perturbations. Subject feedback also observed that with this trial composition, the trial was more engaging, as the subject was constantly required to focus, as opposed to focus for just a  $200\text{ms}$  movement before a 3s rest that felt too long and unnecessary for just 2 movements. Furthermore, subjects commented that they preferred to keep the PRBS perturbations active throughout the whole trial as it helped to keep the focus and did not startle the subject once the PRBS perturbations would start up again.

### F.2: Results per Subject

#### Subject 1

##### All Trials - 500ms Movement

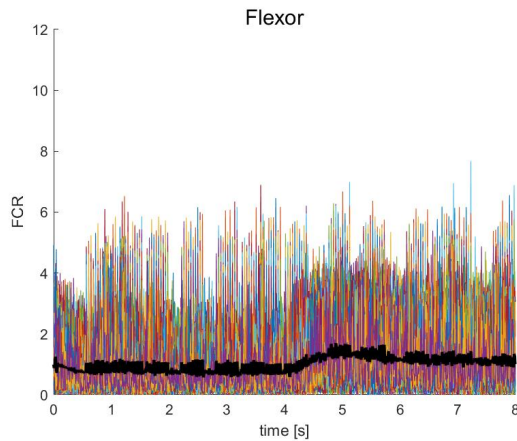

Figure 235: FCR response for each trial.

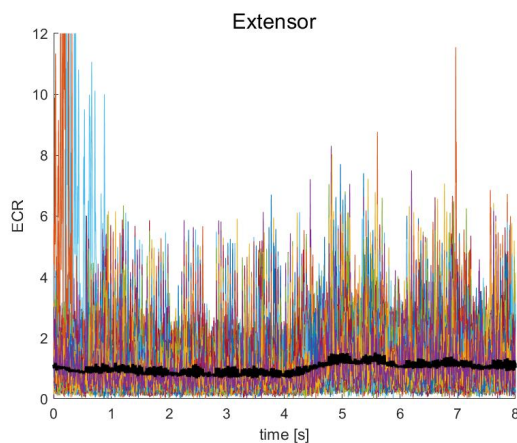

Figure 236: ECR response for each trial.

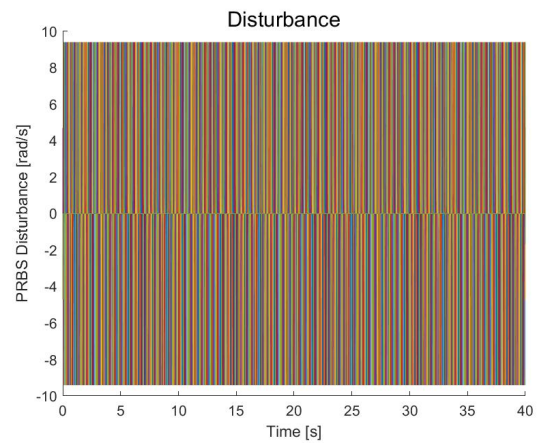

Figure 237: All the perturbations elicited during the 40 trials.

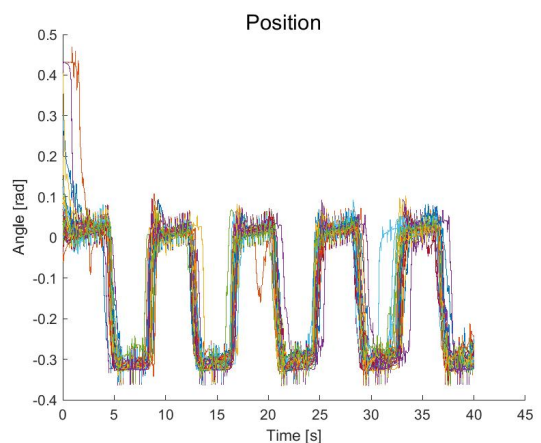

Figure 238: Position profile for each trial.



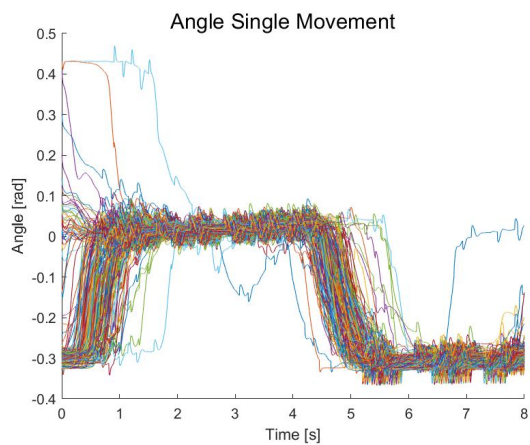

Figure 239: Position profile for each movement.

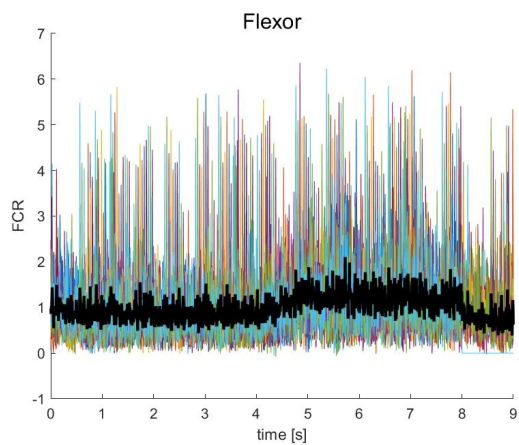

Figure 242: FCR response for each trial.

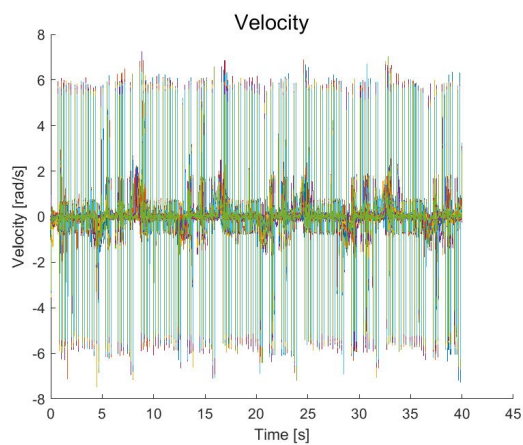

Figure 240: Velocity profile for each trial.

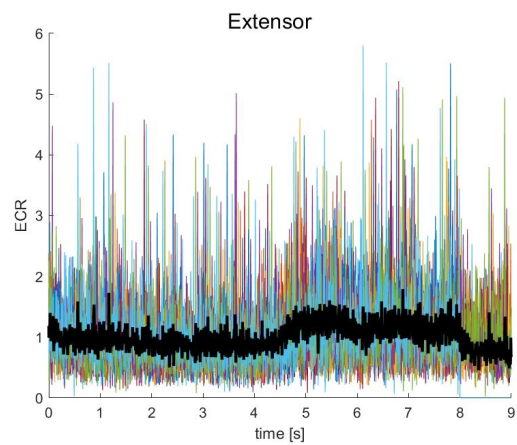

Figure 243: ECR response for each trial.

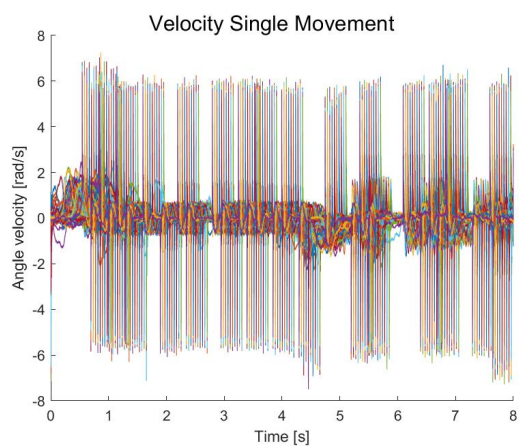

Figure 241: Velocity profile for each movement.

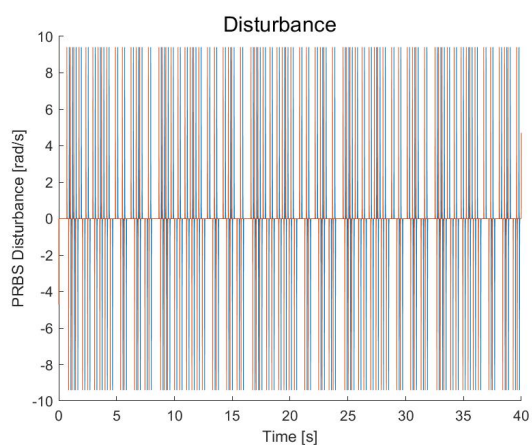

Figure 244: All the perturbations elicited during the 40 trials.

*2 Trials - 500ms Movement*

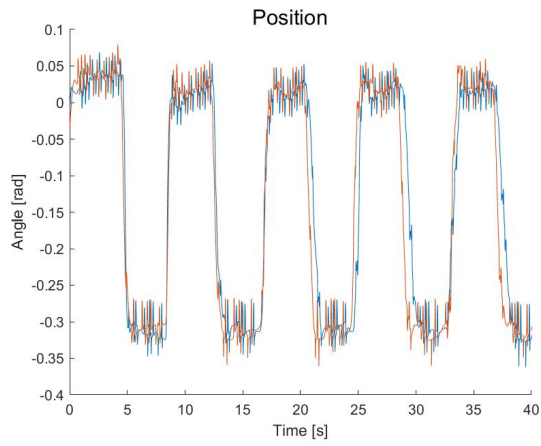

Figure 245: Position profile for each trial.

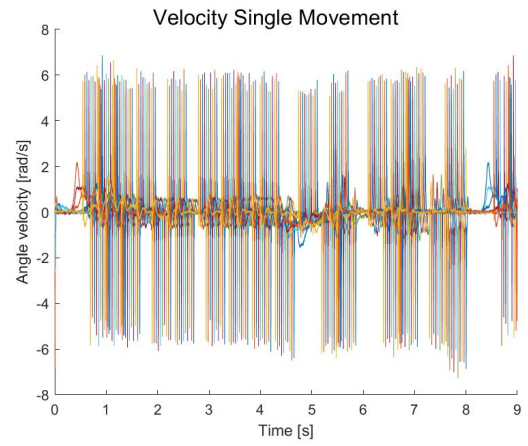

Figure 248: Velocity profile for each movement.

*All Trials - 200ms Movement (Pilot)*

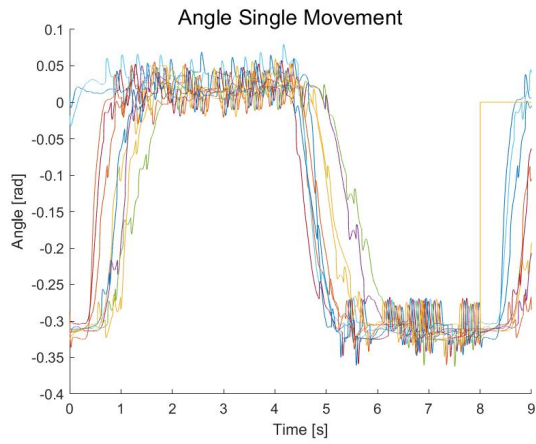

Figure 246: Position profile for each movement.

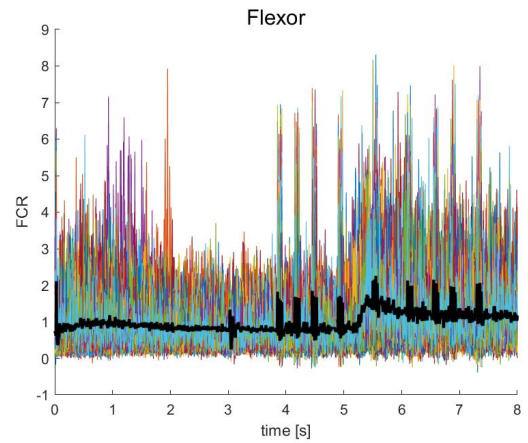

Figure 249: FCR response for each trial.

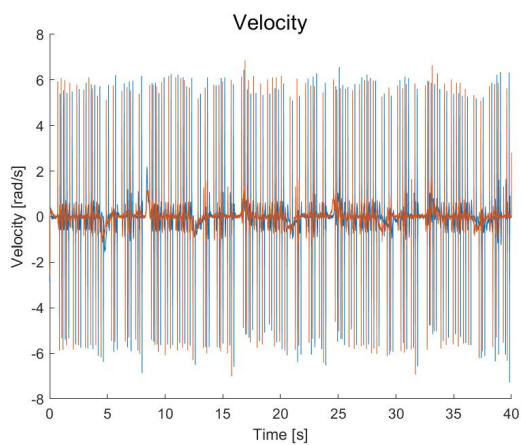

Figure 247: Velocity profile for each trial.

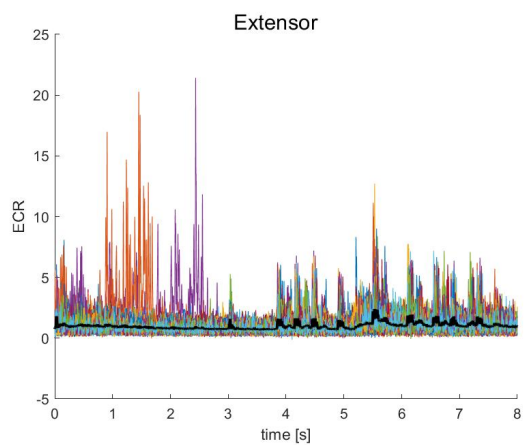

Figure 250: ECR response for each trial.

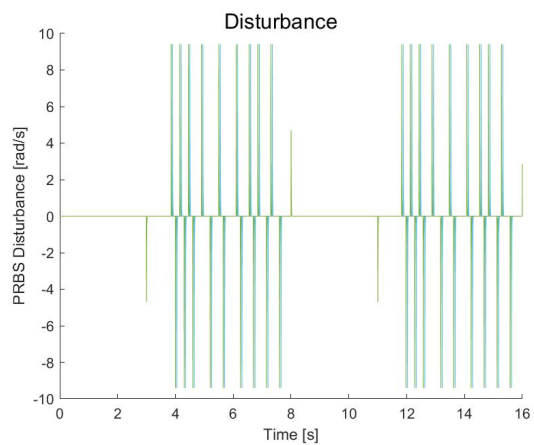

Figure 251: All the perturbations elicited during the 40 trials.

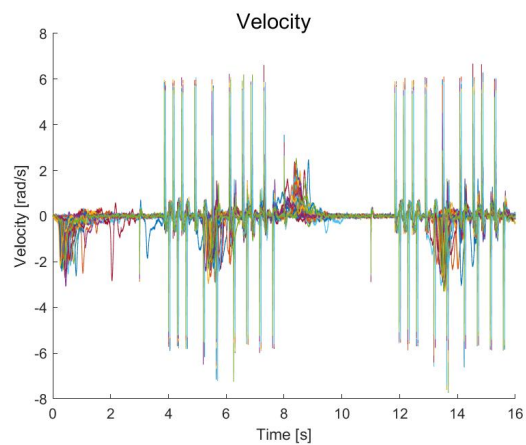

Figure 254: Velocity profile for each trial.

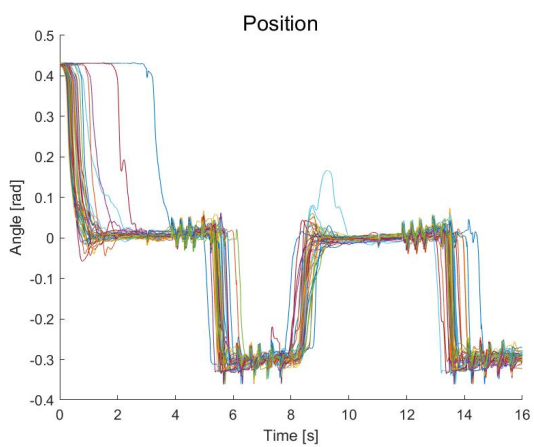

Figure 252: Position profile for each trial.

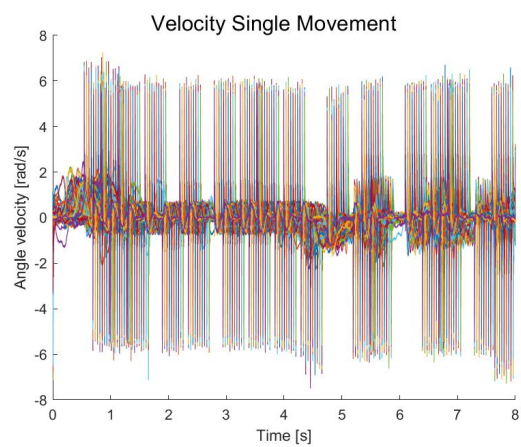

Figure 255: Velocity profile for each movement.

### 2 Trials - 200ms Movement (Pilot)

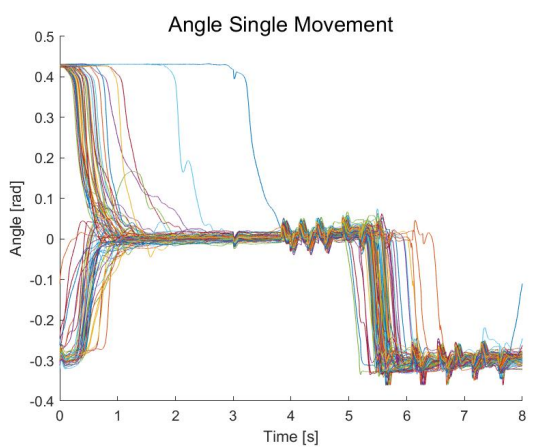

Figure 253: Position profile for each movement.

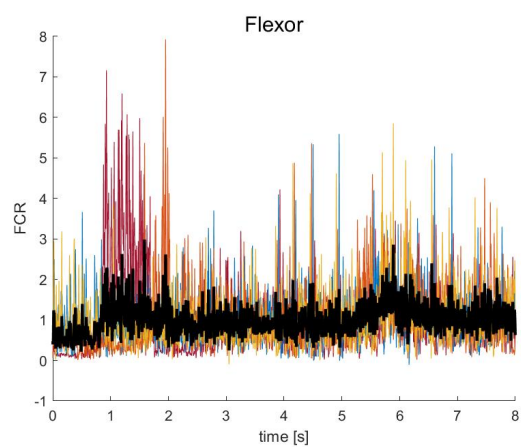

Figure 256: FCR response for each trial.

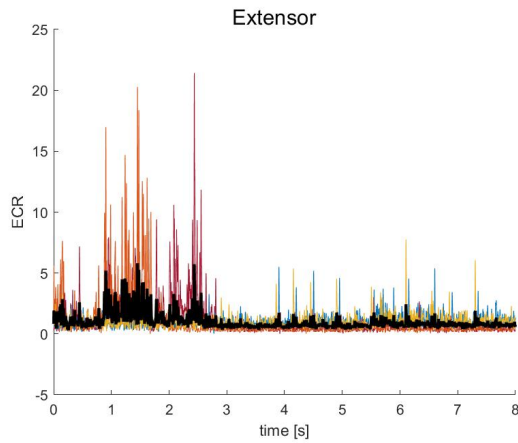

Figure 257: ECR response for each trial.

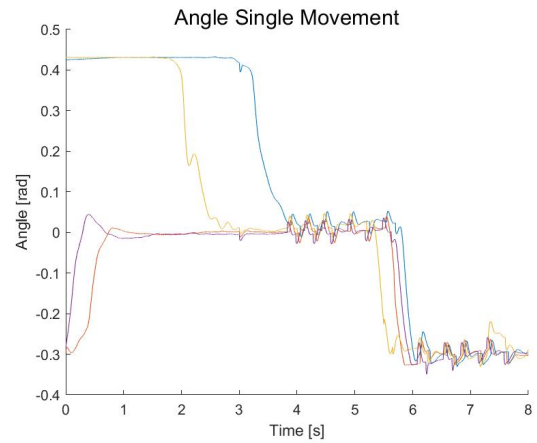

Figure 260: Position profile for each movement.

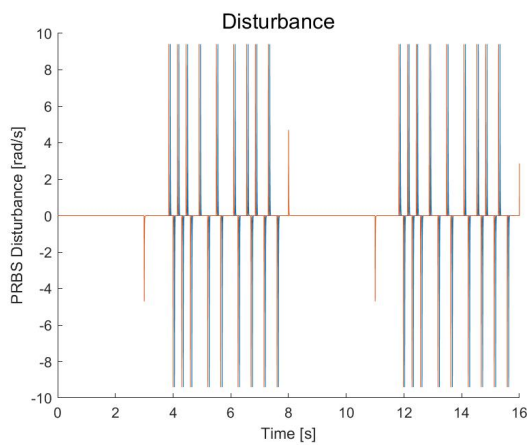

Figure 258: All the perturbations elicited during the 40 trials.

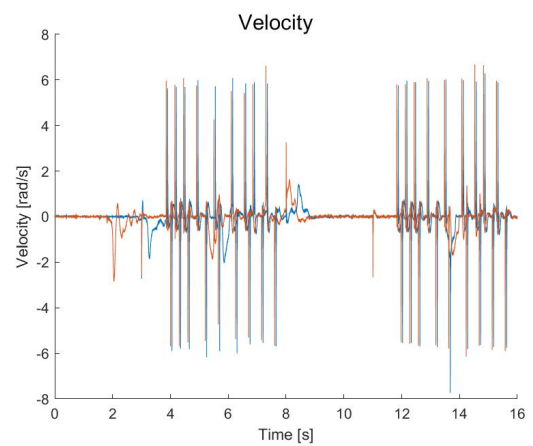

Figure 261: Velocity profile for each trial.

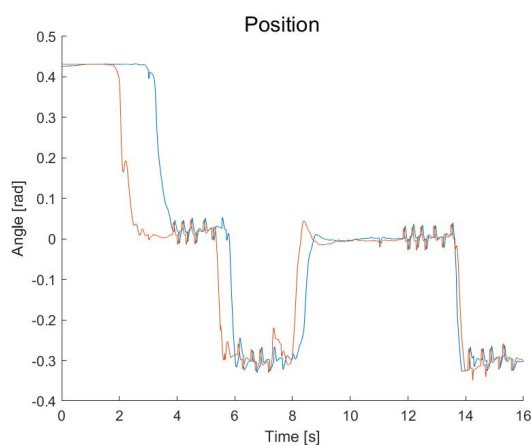

Figure 259: Position profile for each trial.

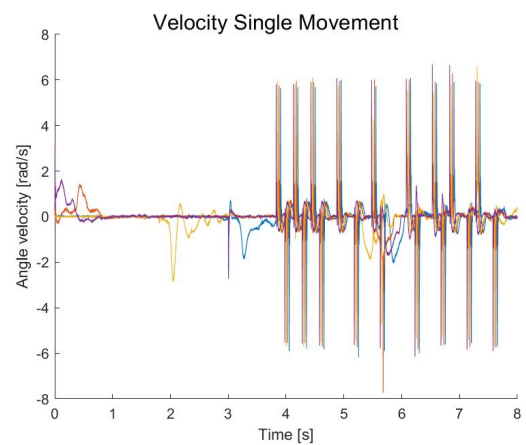

Figure 262: Velocity profile for each movement.

---

### **Subject 2**

*All Trials - 500ms Movement*

---

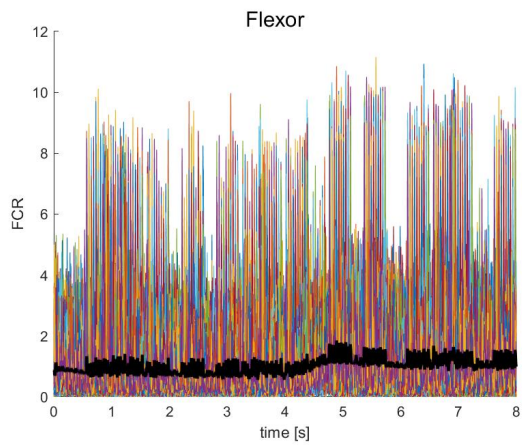

Figure 263: FCR response for each trial.

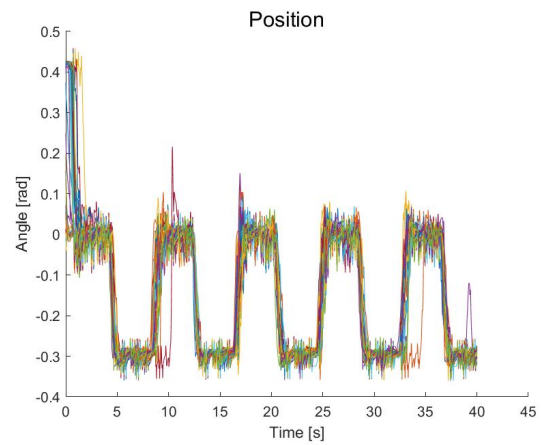

Figure 266: Position profile for each trial.

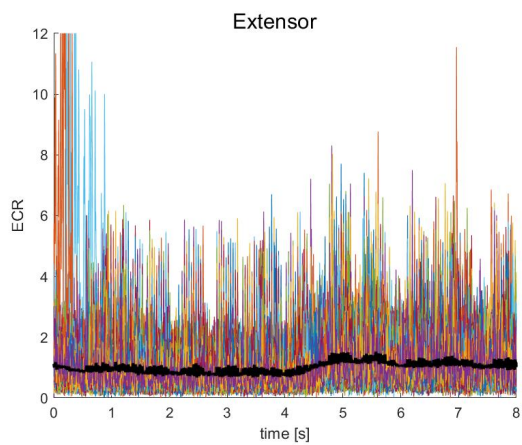

Figure 264: ECR response for each trial.

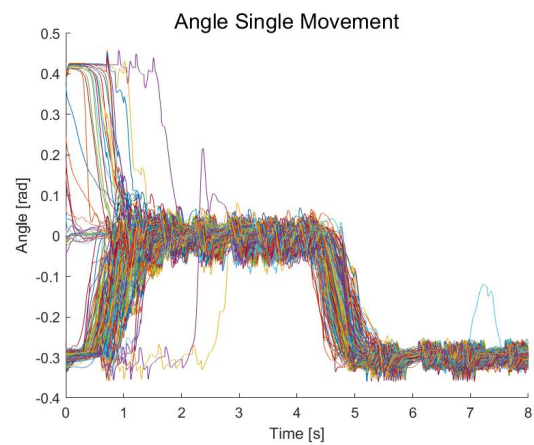

Figure 267: Position profile for each movement.

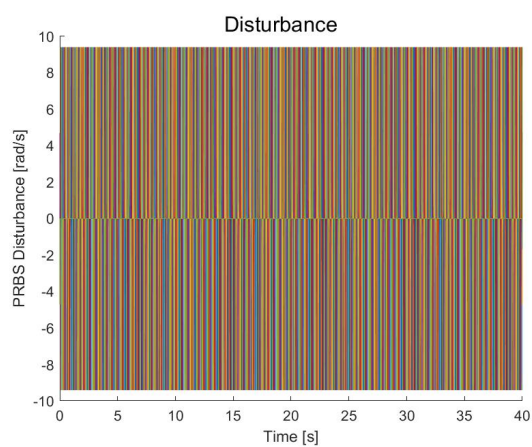

Figure 265: All the perturbations elicited during the 40 trials.

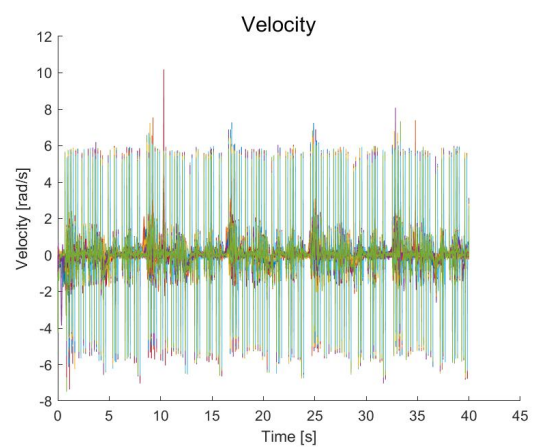

Figure 268: Velocity profile for each trial.

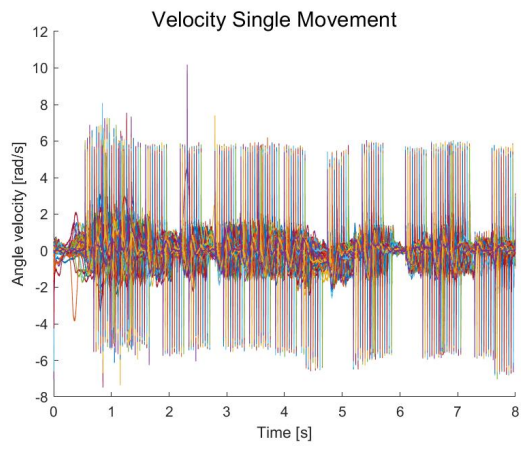

Figure 269: Velocity profile for each movement.