

Improving the consistency of aerodynamic models and thermospheric density and wind data (PP)

Visser, Tim; March, Gunther

Publication date

2018

Document Version

Final published version

Citation (APA)

Visser, T., & March, G. (2018). *Improving the consistency of aerodynamic models and thermospheric density and wind data (PP)*. SPP 1788 DynamicEarth Winter School, Kühlungsborn, Germany.

Important note

To cite this publication, please use the final published version (if applicable). Please check the document version above.

Copyright

Other than for strictly personal use, it is not permitted to download, forward or distribute the text or part of it, without the consent of the author(s) and/or copyright holder(s), unless the work is under an open content license such as Creative Commons.

Takedown policy

Please contact us and provide details if you believe this document breaches copyrights. We will remove access to the work immediately and investigate your claim.

Thermospheric wind measurements from GOCE angular accelerations

T. Visser; Delft University of Technology

SPP1788 DynamicEarth Winter School, Kühlungsborn, Germany

29 January 2018

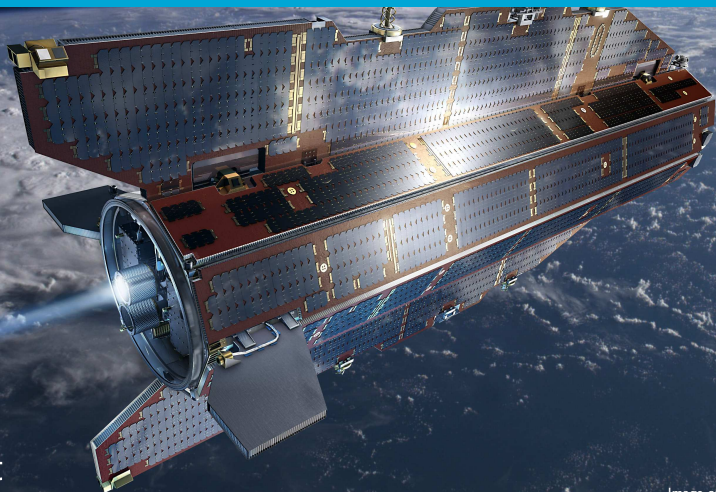

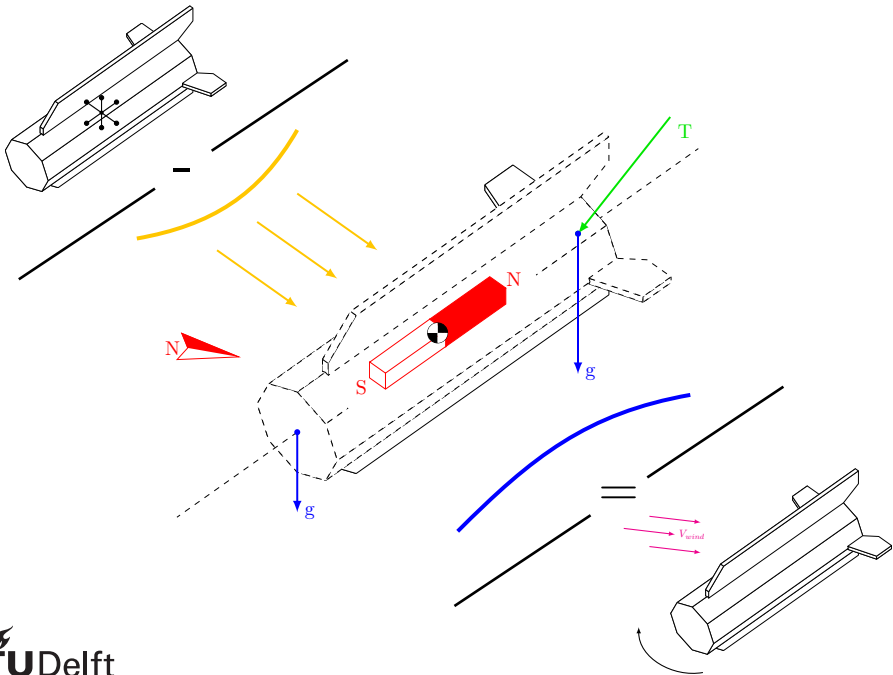

Measured torque

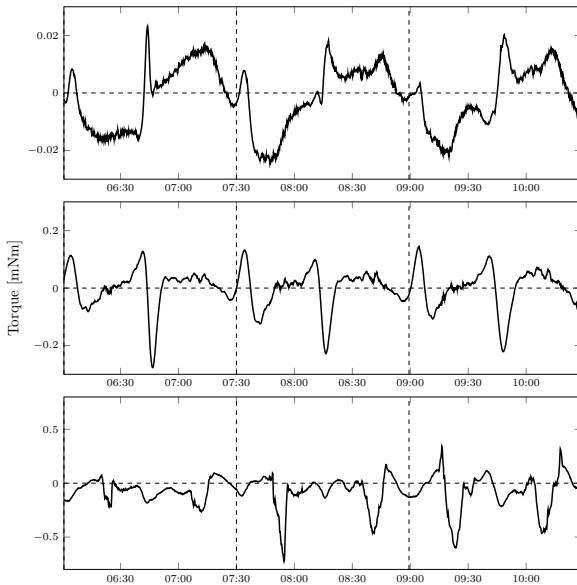

Measured torque

- Magnetic

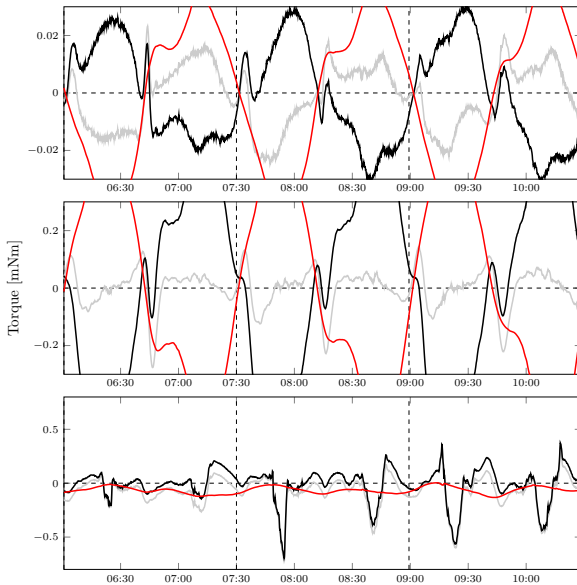

Measured torque

- Magnetic

- Control

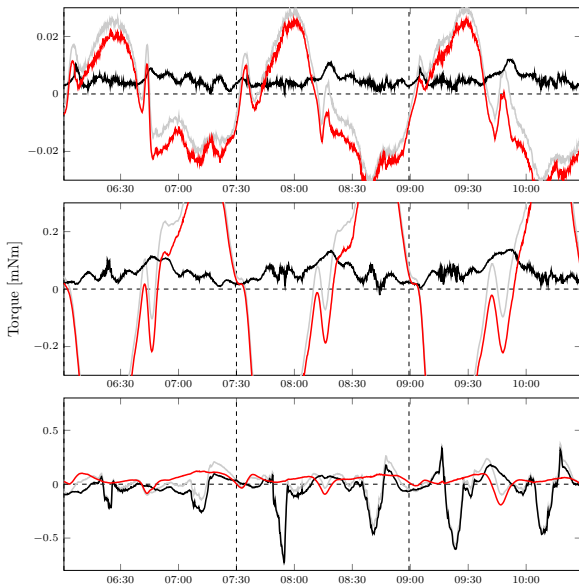

Measured torque

- Magnetic
- Control
- Thruster

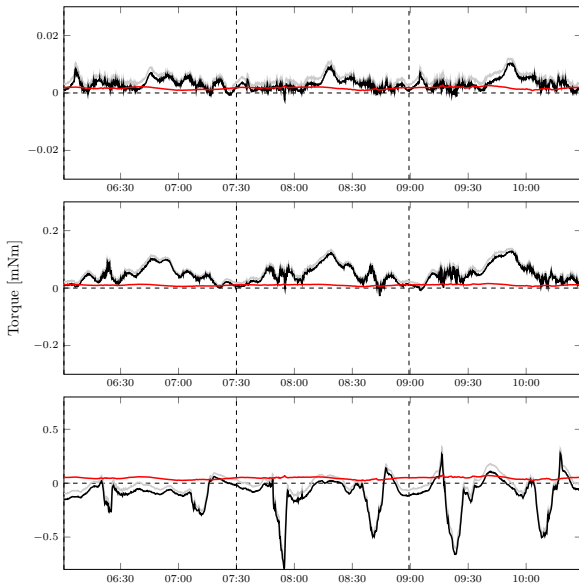

Measured torque

- Magnetic
- Control
- Thruster
- Gravity

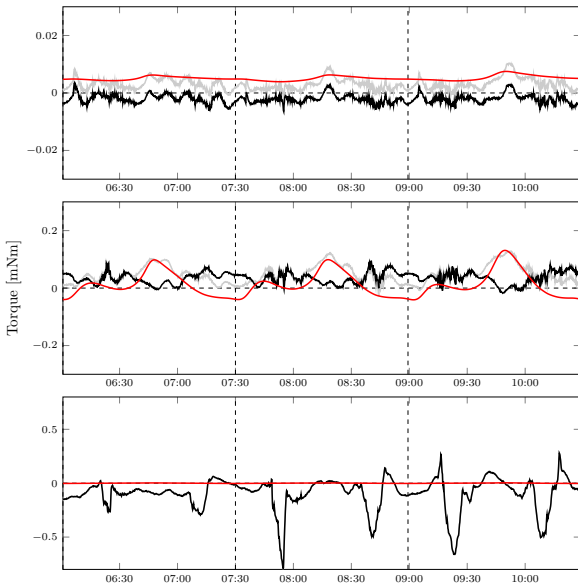

Measured torque

- Magnetic
- Control
- Thruster
- Gravity
- Solar radiation

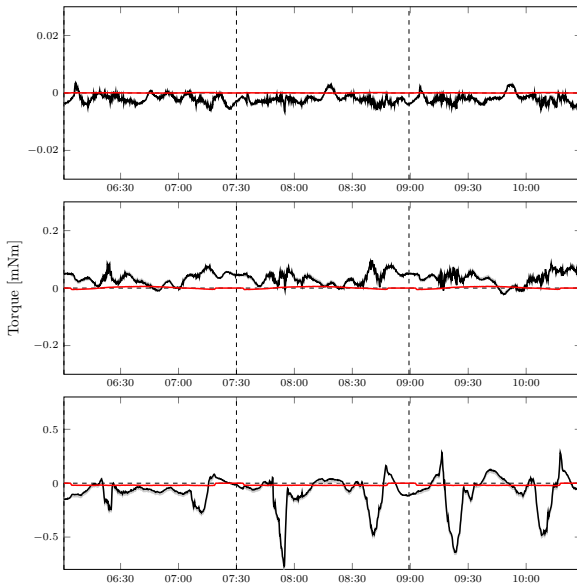

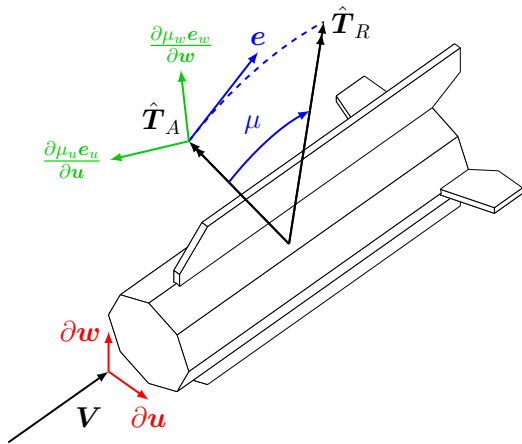

Wind (North-East-Down)

- From forces
- From torques

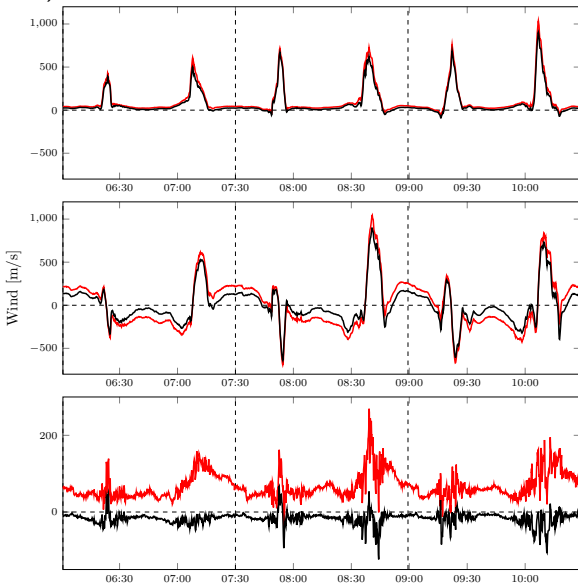

Wind (North-East-Down)

- From forces

- From torques

Filtered ($f \geq 3f_{orbit}$)

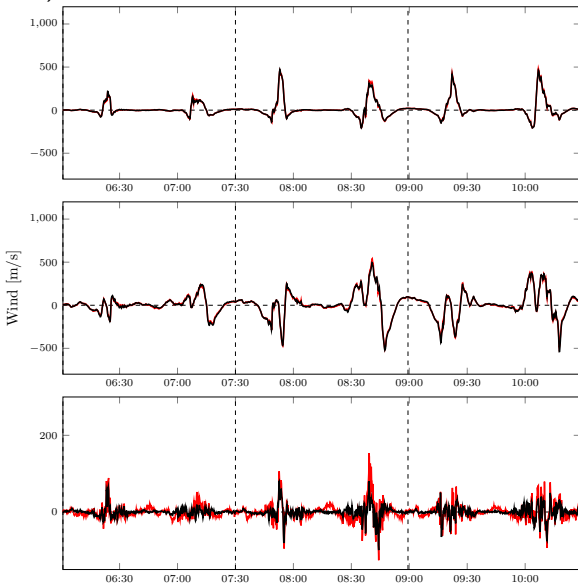



Improving the consistency of aerodynamic models and thermospheric density and wind data

Geometry and aerodynamic model improvement for thermospheric densities

Günther March
Ph.D. Candidate at TU Delft
g.march@tudelft.nl

Current panel models

Swarm Astrium Macro Model

PANEL	0	1	1	1000101	0.0	0.0	1.0
PANEL	0	1	2	1000101	1.540		
PANEL	0	1	3	1000101	0.03	0.0	0.01
PANEL	0	1	4	1000101	0.79	0.0	0.31
PANEL	0	1	5	1000101	0.68		
PANEL	0	2	1	1000101	-0.19766	0.0	0.98027
PANEL	0	2	2	1000101	1.400		
PANEL	0	2	3	1000101	0.06	0.0	0.02
PANEL	0	2	4	1000101	0.17	0.0	0.20
PANEL	0	2	5	1000101	0.78		

... for a total of (only) 15 panels

Current panel models

Swarm Astrium Macro Model

PANEL	0	1	1	1000101	0.0	0.0	1.0
PANEL	0	1	2	1000101	1.540		
PANEL	0	1	3	1000101	0.03	0.0	0.01
PANEL	0	1	4	1000101	0.79	0.0	0.31
PANEL	0	1	5	1000101	0.68		
PANEL	0	2	1	1000101	-0.19766	0.0	0.98027
PANEL	0	2	2	1000101	1.400		
PANEL	0	2	3	1000101	0.06	0.0	0.02
PANEL	0	2	4	1000101	0.17	0.0	0.20
PANEL	0	2	5	1000101	0.78		

... for a total of (only) 15 panels

Current panel models

Swarm Astrium Macro Model

Normal vector components

PANEL	0	1	1	1000101	0.0	0.0	1.0
PANEL	0	1	2	1000101	1.540		
PANEL	0	1	3	1000101	0.03	0.0	0.01
PANEL	0	1	4	1000101	0.79	0.0	0.31
PANEL	0	1	5	1000101	0.68		
PANEL	0	2	1	1000101	-0.19766	0.0	0.98027
PANEL	0	2	2	1000101	1.400		
PANEL	0	2	3	1000101	0.06	0.0	0.02
PANEL	0	2	4	1000101	0.17	0.0	0.20
PANEL	0	2	5	1000101	0.78		

... for a total of (only) 15 panels

Current panel models

Swarm Astrium Macro Model

Normal vector components

PANEL	0	1	1	1000101		0.0	0.0	1.0
PANEL	0	1	2	1000101	<u>Area</u>	1.540		
PANEL	0	1	3	1000101		0.03	0.0	0.01
PANEL	0	1	4	1000101		0.79	0.0	0.31
PANEL	0	1	5	1000101		0.68		
PANEL	0	2	1	1000101		-0.19766	0.0	0.98027
PANEL	0	2	2	1000101		1.400		
PANEL	0	2	3	1000101		0.06	0.0	0.02
PANEL	0	2	4	1000101		0.17	0.0	0.20
PANEL	0	2	5	1000101		0.78		

... for a total of (only) 15 panels

Current panel models

Swarm Astrium Macro Model

				<u>Normal vector components</u>			
PANEL	0	1	1	1000101	0.0	0.0	1.0
PANEL	0	1	2	1000101	<u>1.540</u>		
PANEL	0	1	3	1000101	0.03	0.0	0.01
PANEL	0	1	4	1000101	0.79	0.0	0.31
PANEL	0	1	5	1000101	0.68		
PANEL	0	2	1	1000101	-0.19766	0.0	0.98027
PANEL	0	2	2	1000101	1.400		
PANEL	0	2	3	1000101	0.06	0.0	0.02
PANEL	0	2	4	1000101	0.17	0.0	0.20
PANEL	0	2	5	1000101	0.78		

Area

Optical
properties

... for a total of (only) 15 panels

Improved geometry & aerodynamic model

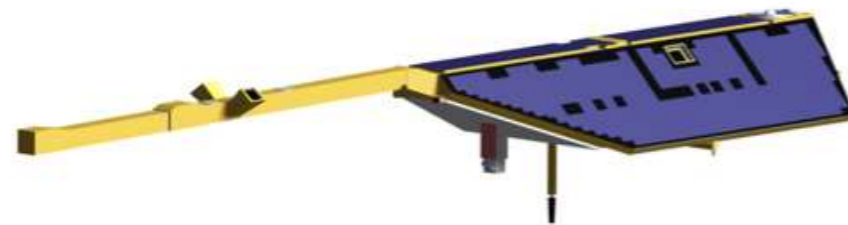

CHAMP

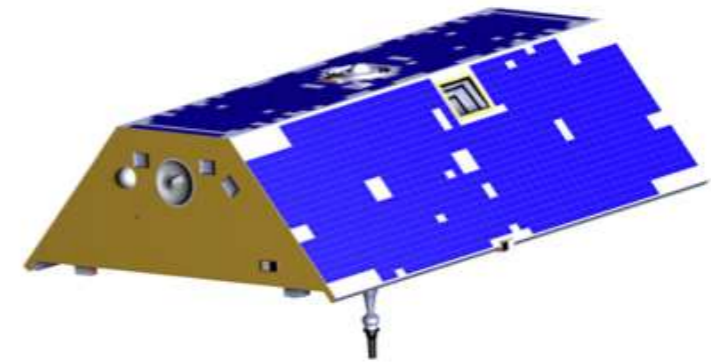

GRACE

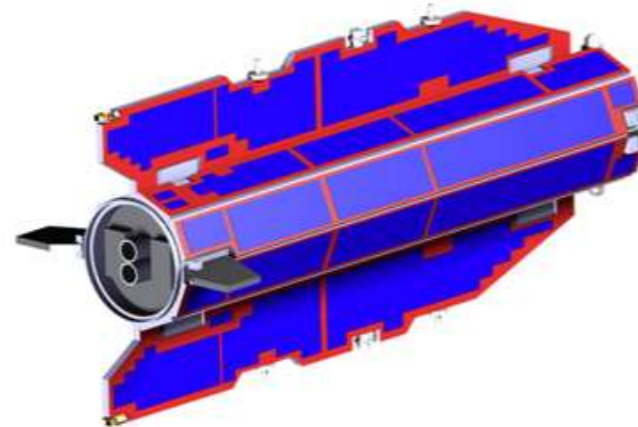

GOCE



Swarm

Computational method for Rarefied flows

SPARTA DSMC Simulator

Stochastic **PA**rallel **R**arefied-gas **T**ime-accurate **A**nalyzer

<http://sparta.sandia.gov>

Statistical comparison

Swarm C density data for the period 19/07/2014 - 30/09/2016 with equivalent **NRLMSISE-00** model output.

Panels method densities (left) are compared with SPARTA results (right).

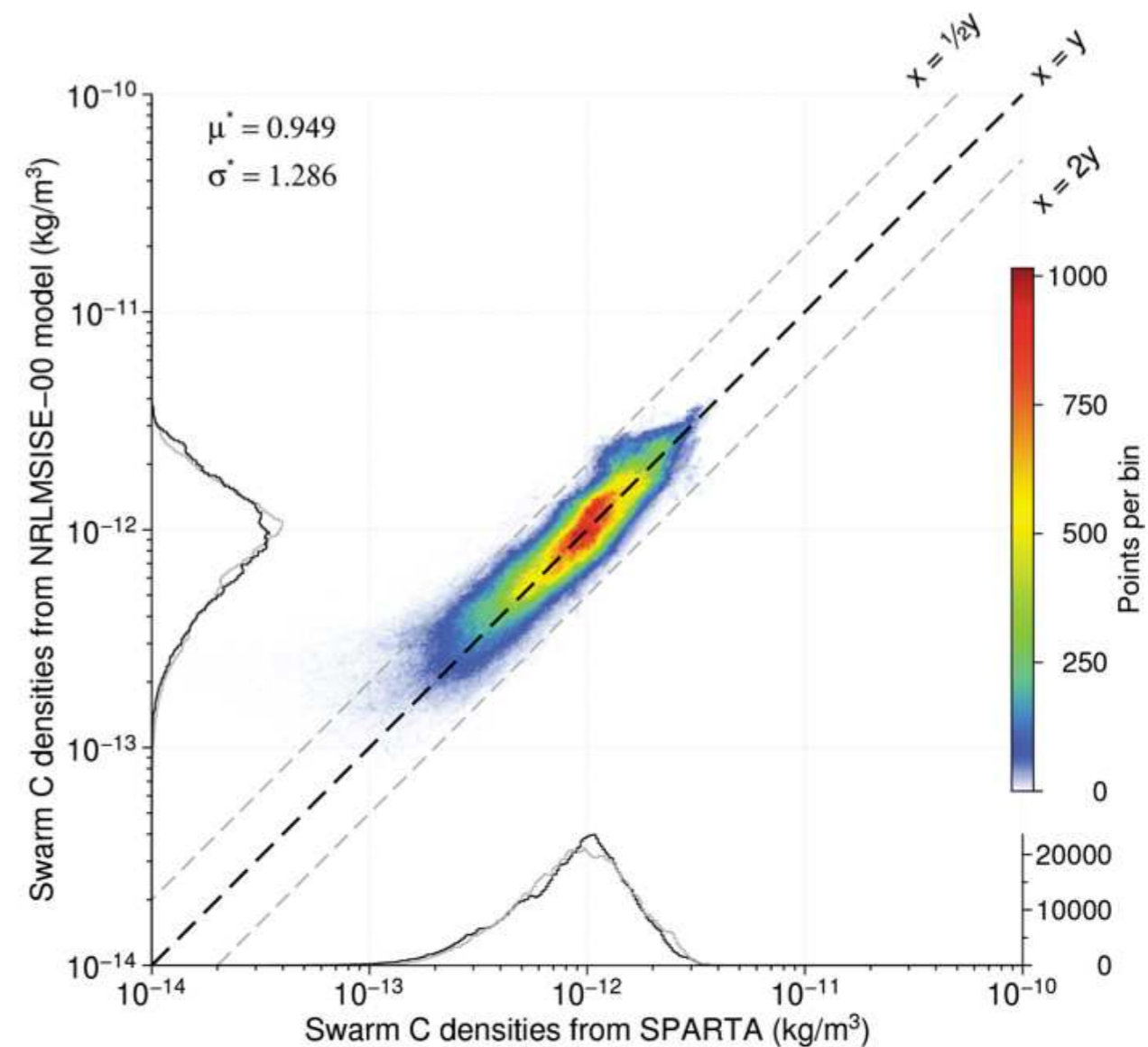
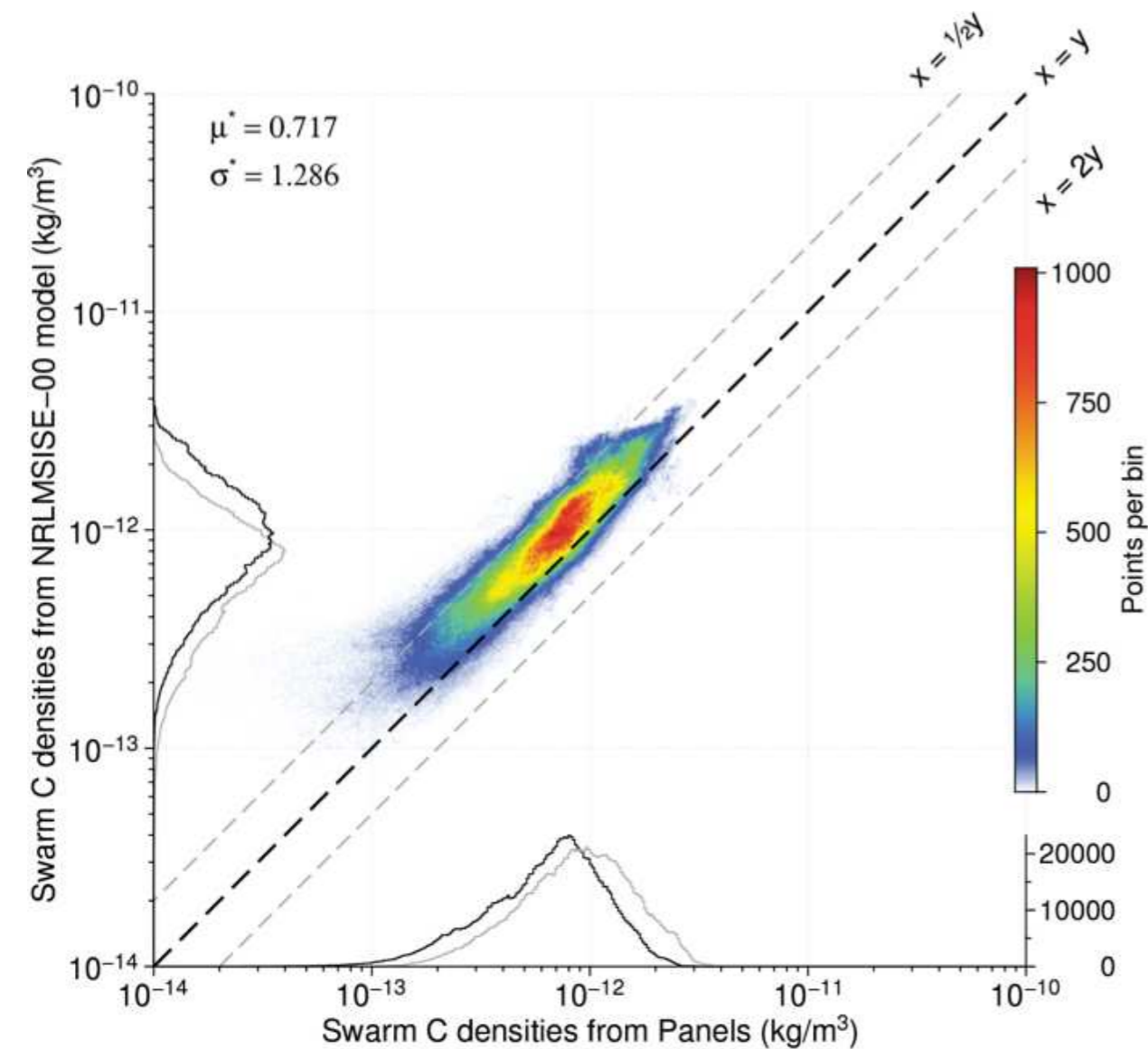

Consistency with other satellites

New densities turned out to be higher reaching a mean **+11%** for CHAMP, **+5%** for GRACE, **+9%** for GOCE and **+32%** for Swarm.

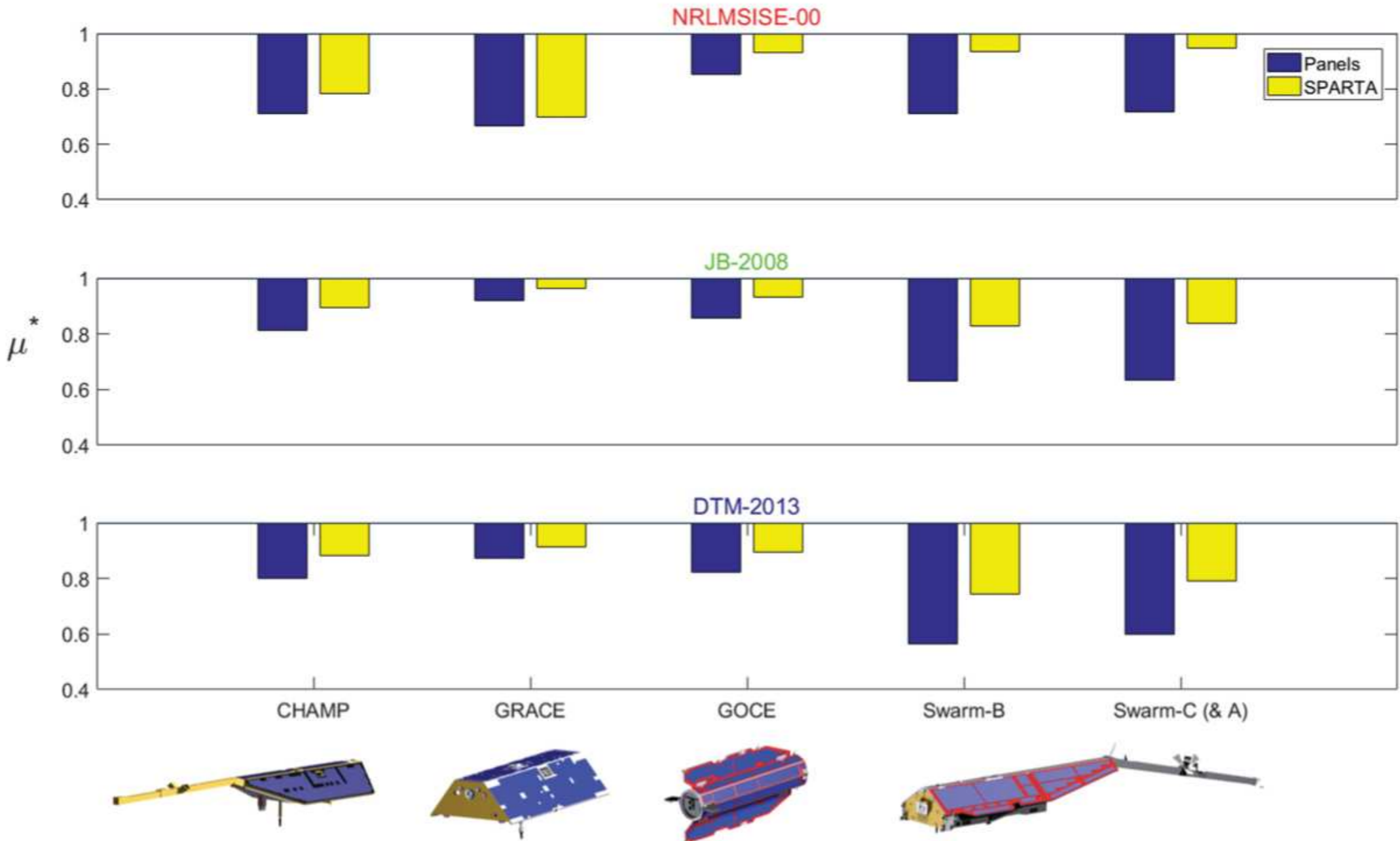

Attitude manoeuvre Comparison

(90° Yaw man.)
13/05/2014

X-Y-Z Accelerations
&
Density comparison with 3
atmospheric models

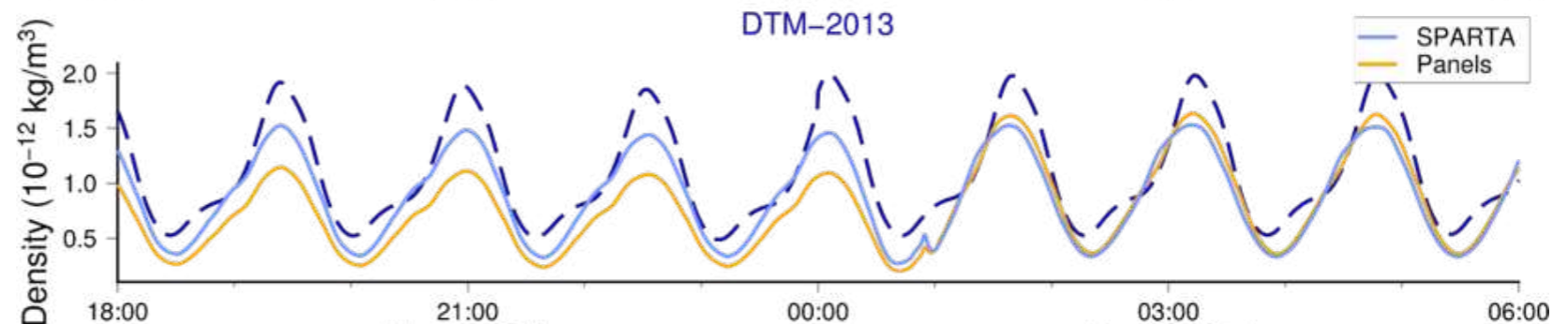
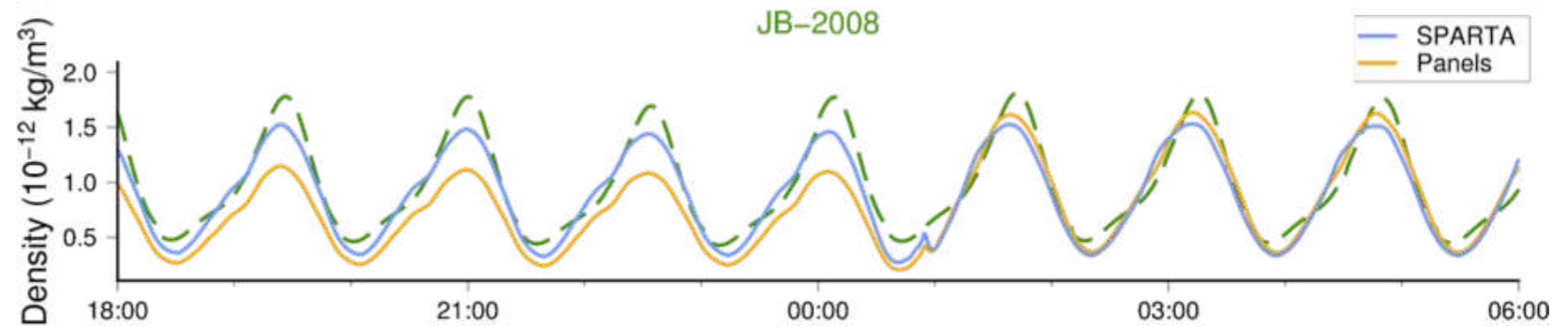
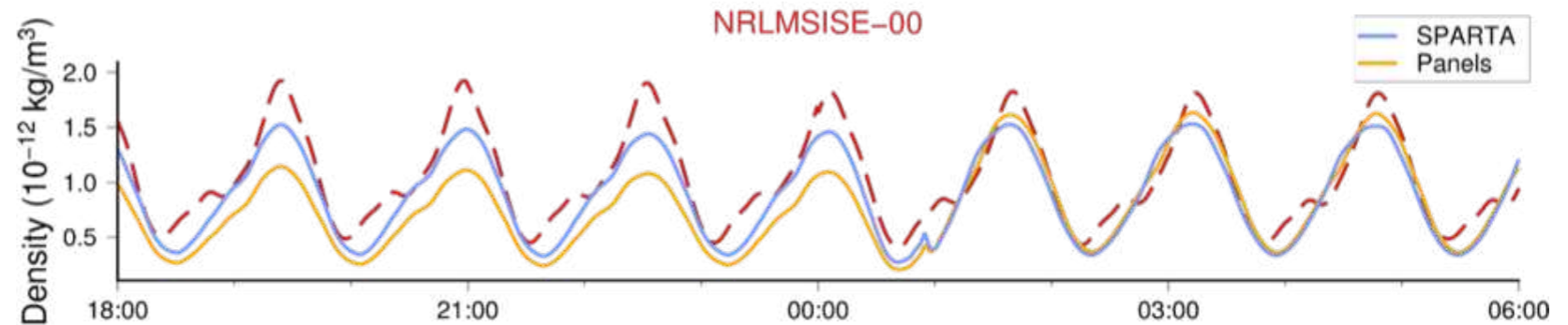
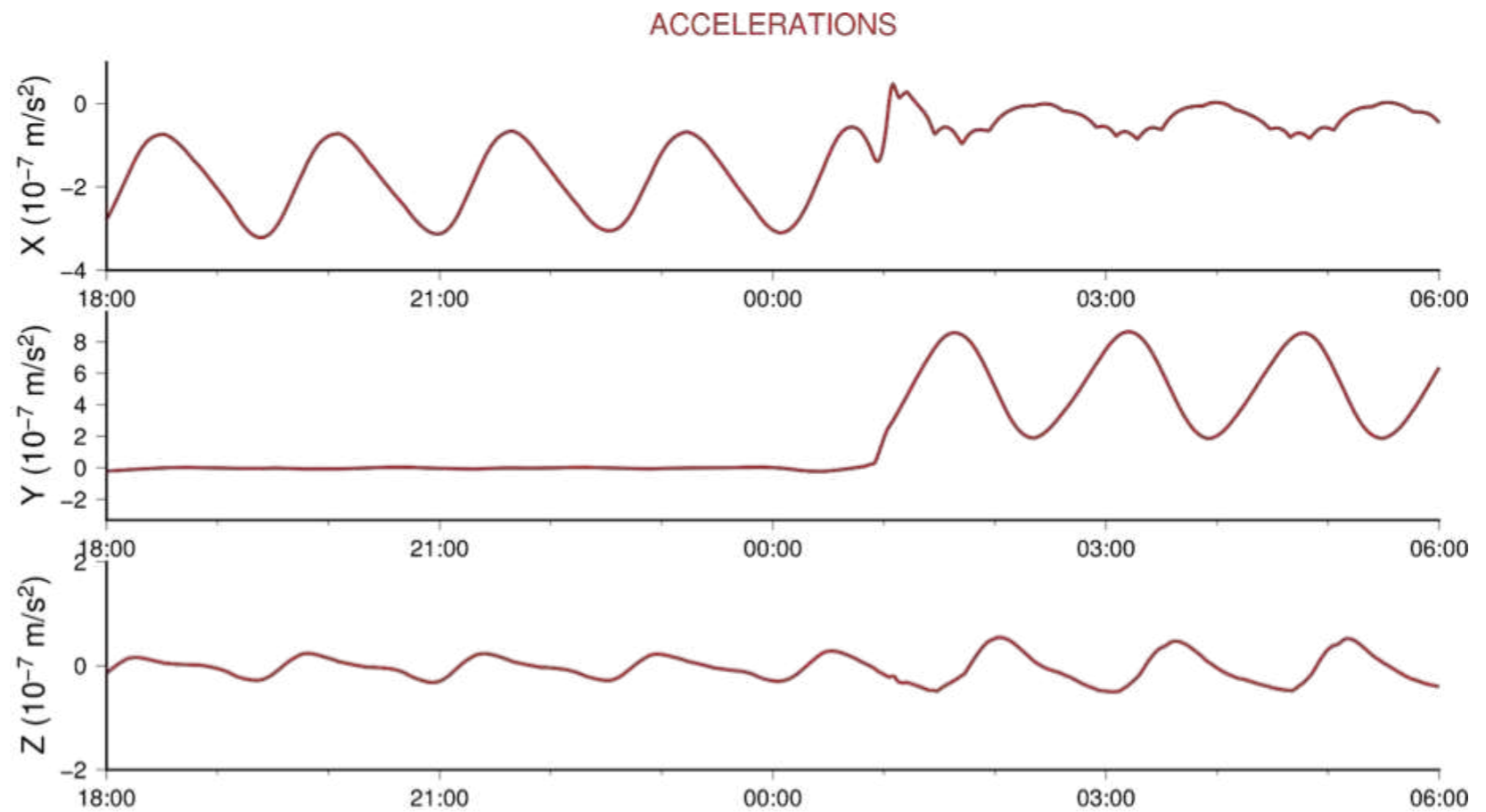

Attitude manoeuvre Comparison

(90° Yaw man.)
13/05/2014

Euler Angles
&
Density comparison with 3
atmospheric models

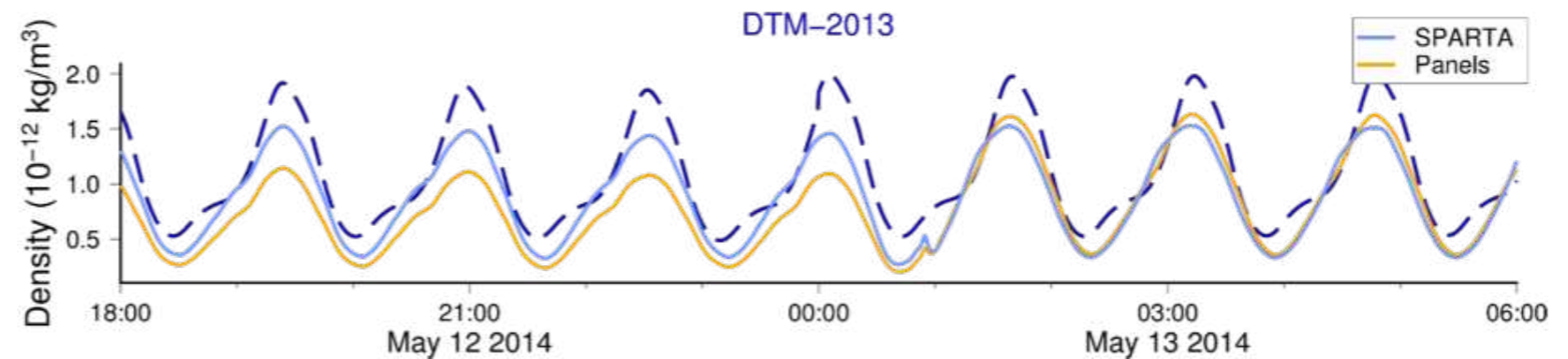
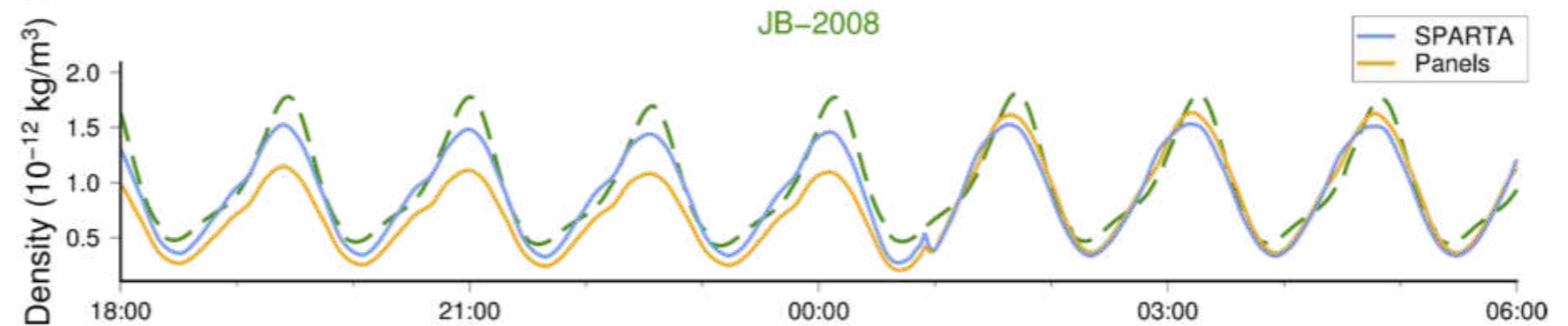
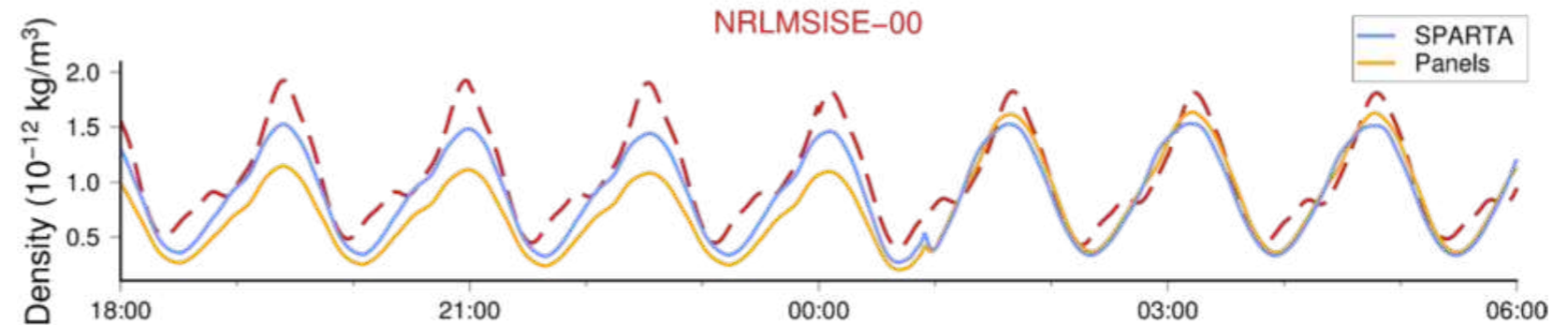
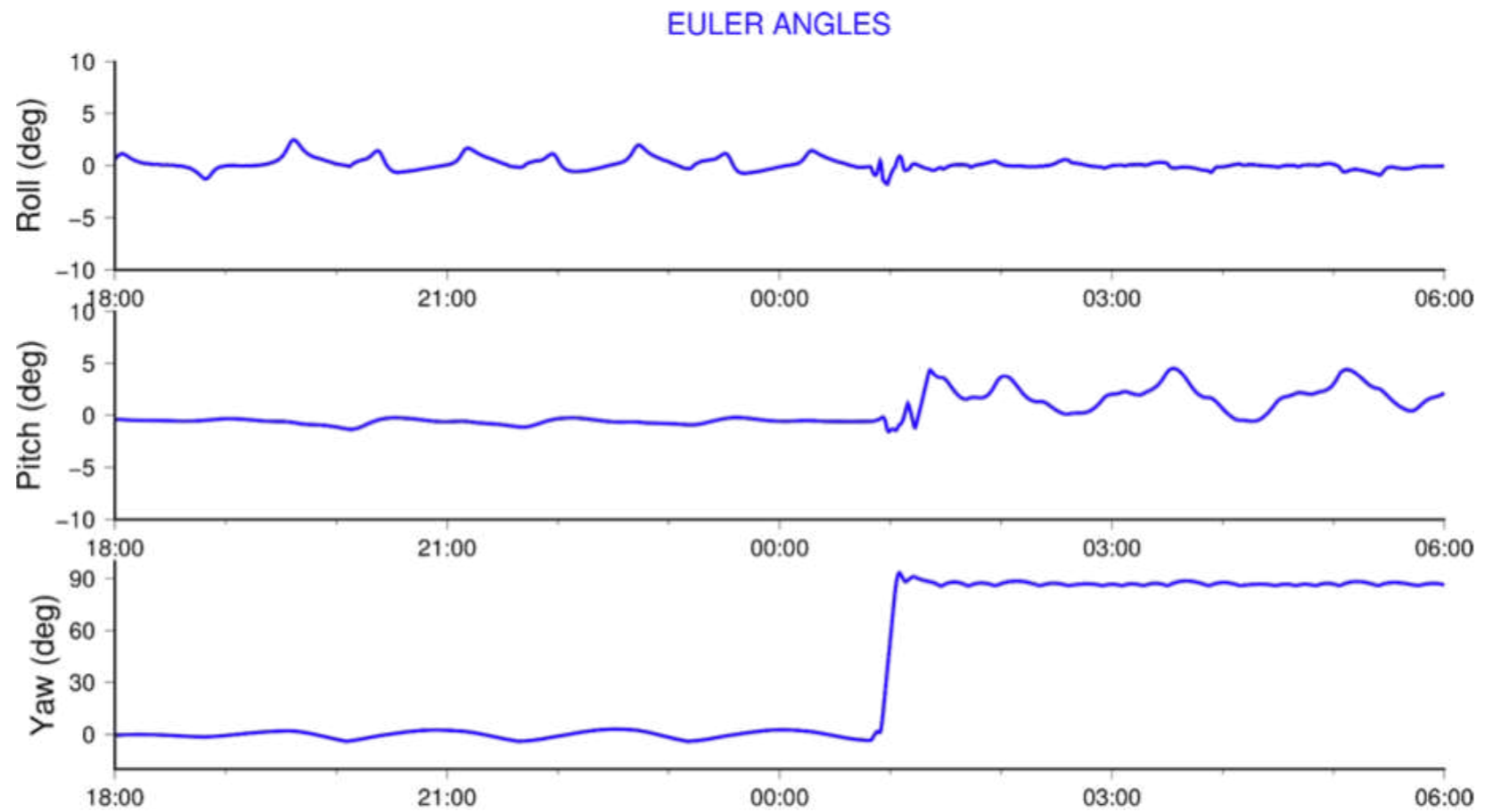

Attitude manoeuvre comparison (90° Yaw)

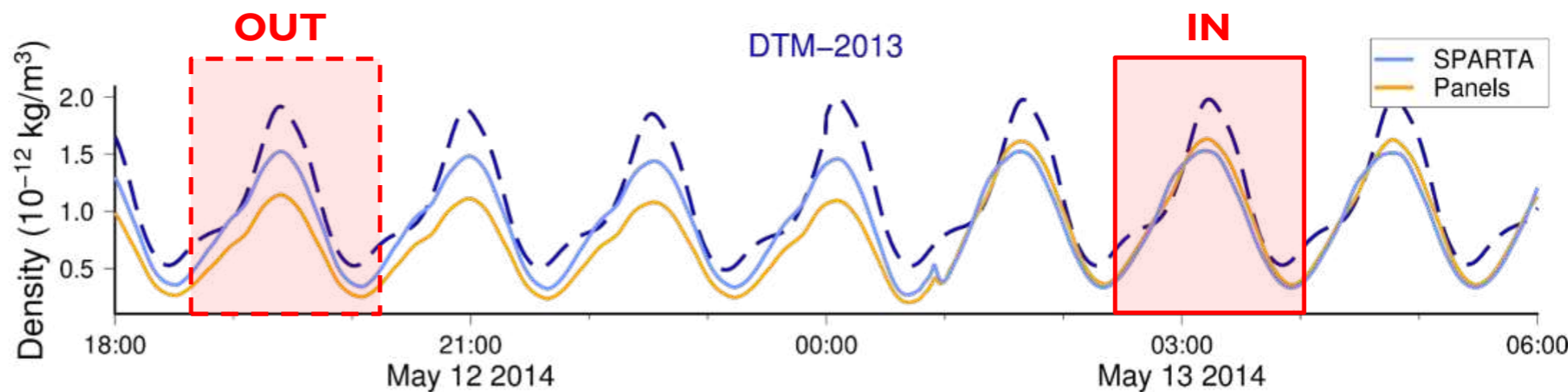
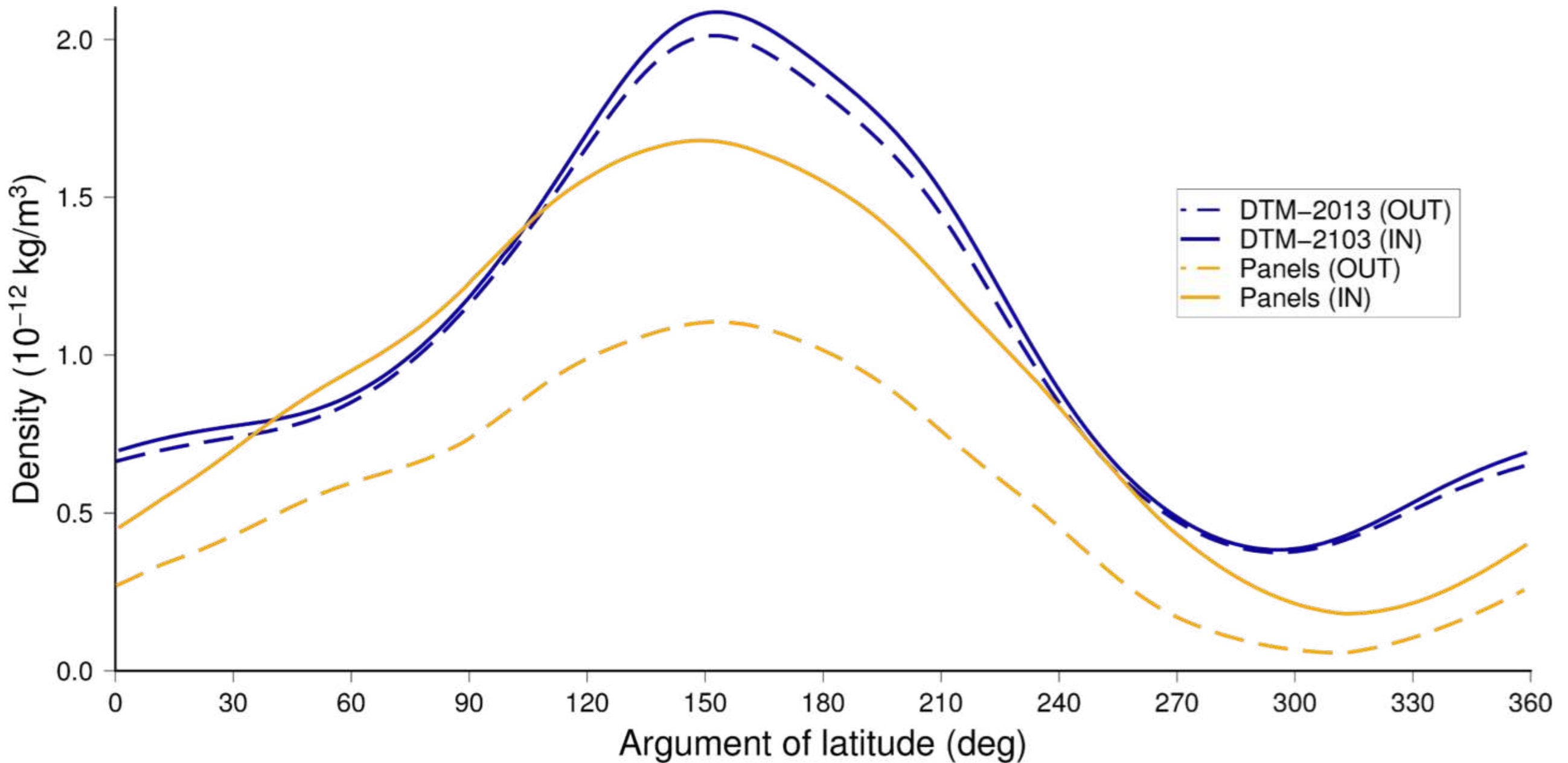

Attitude manoeuvre comparison (90° Yaw)

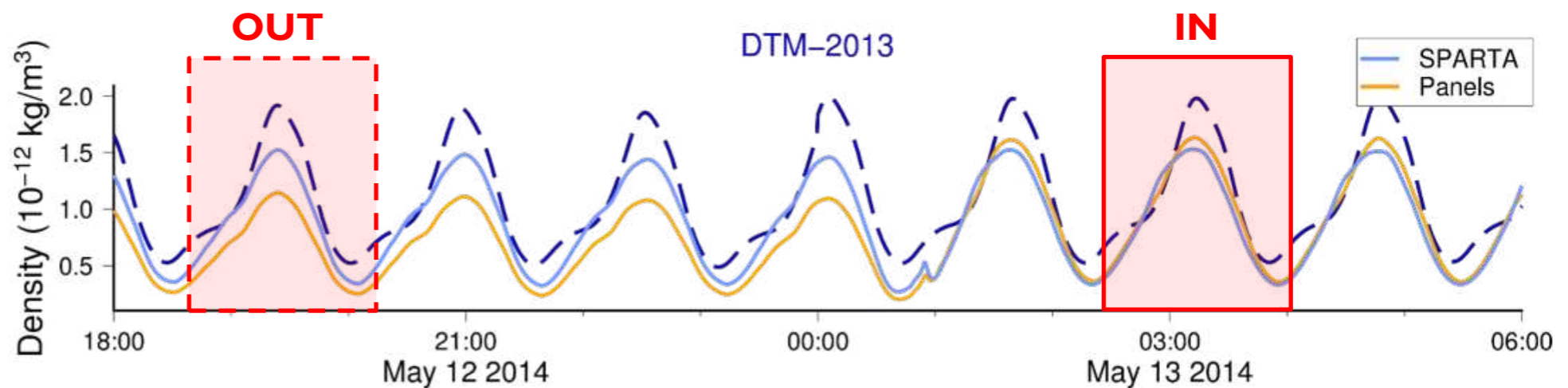
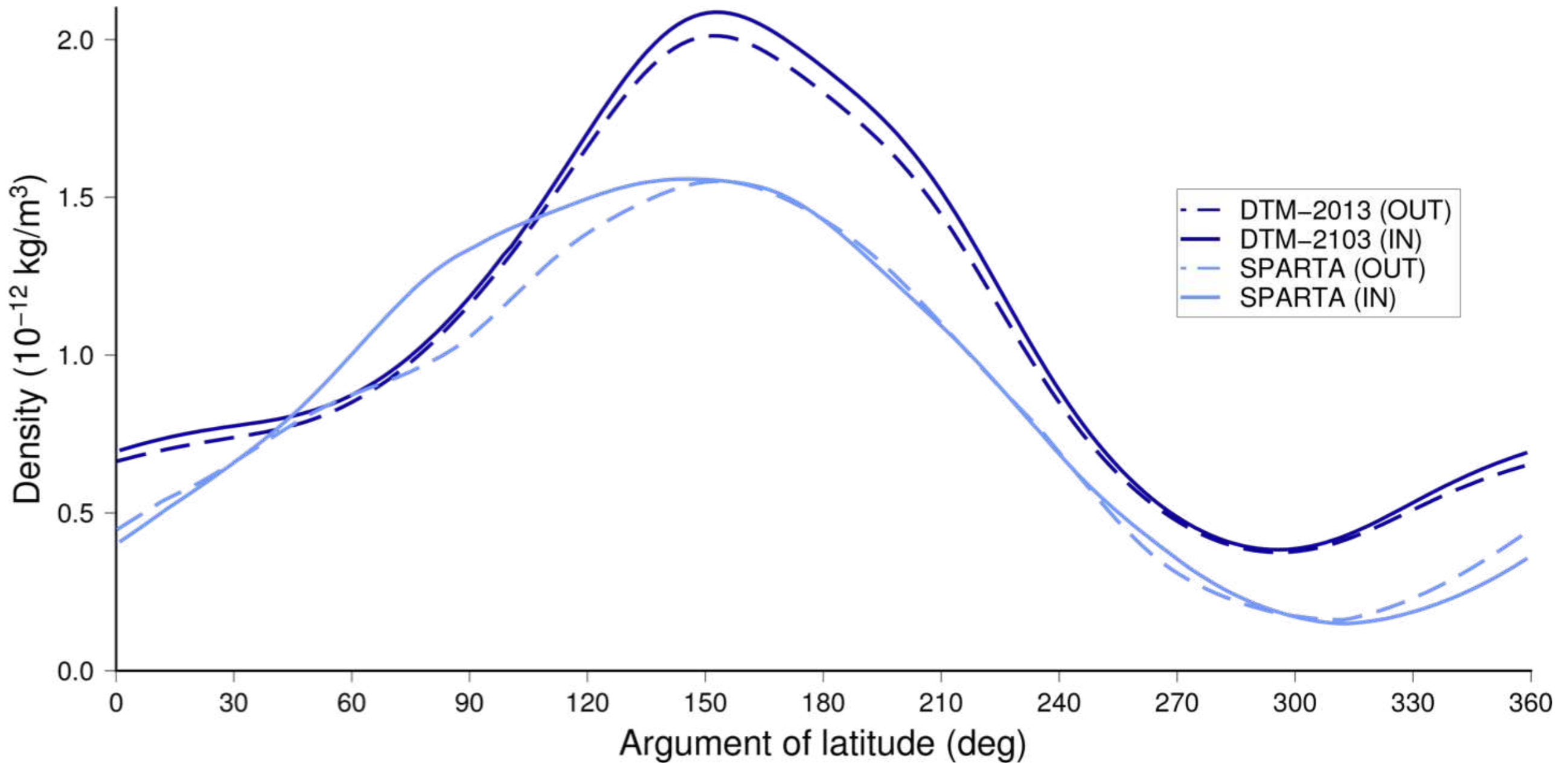

Summary & Outlook

SPARTA data set is currently adopted for L2 DNS-POD product

Gas-Surface Interactions

Specular reflection

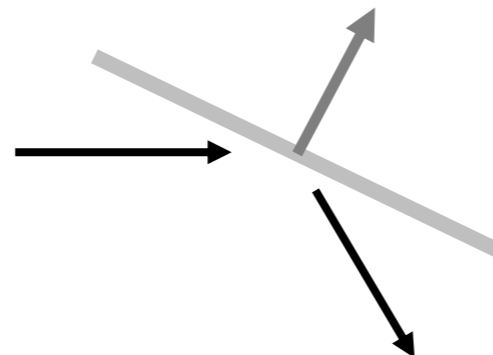

Diffuse reflection

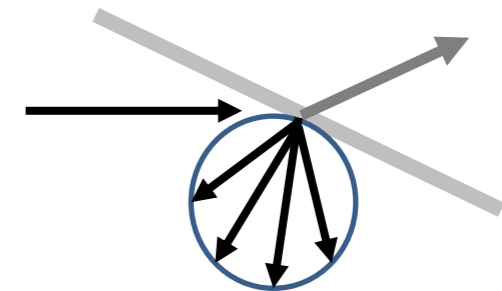

Solar radiation pressure modelling