

plan . ibn tachfine
1:100

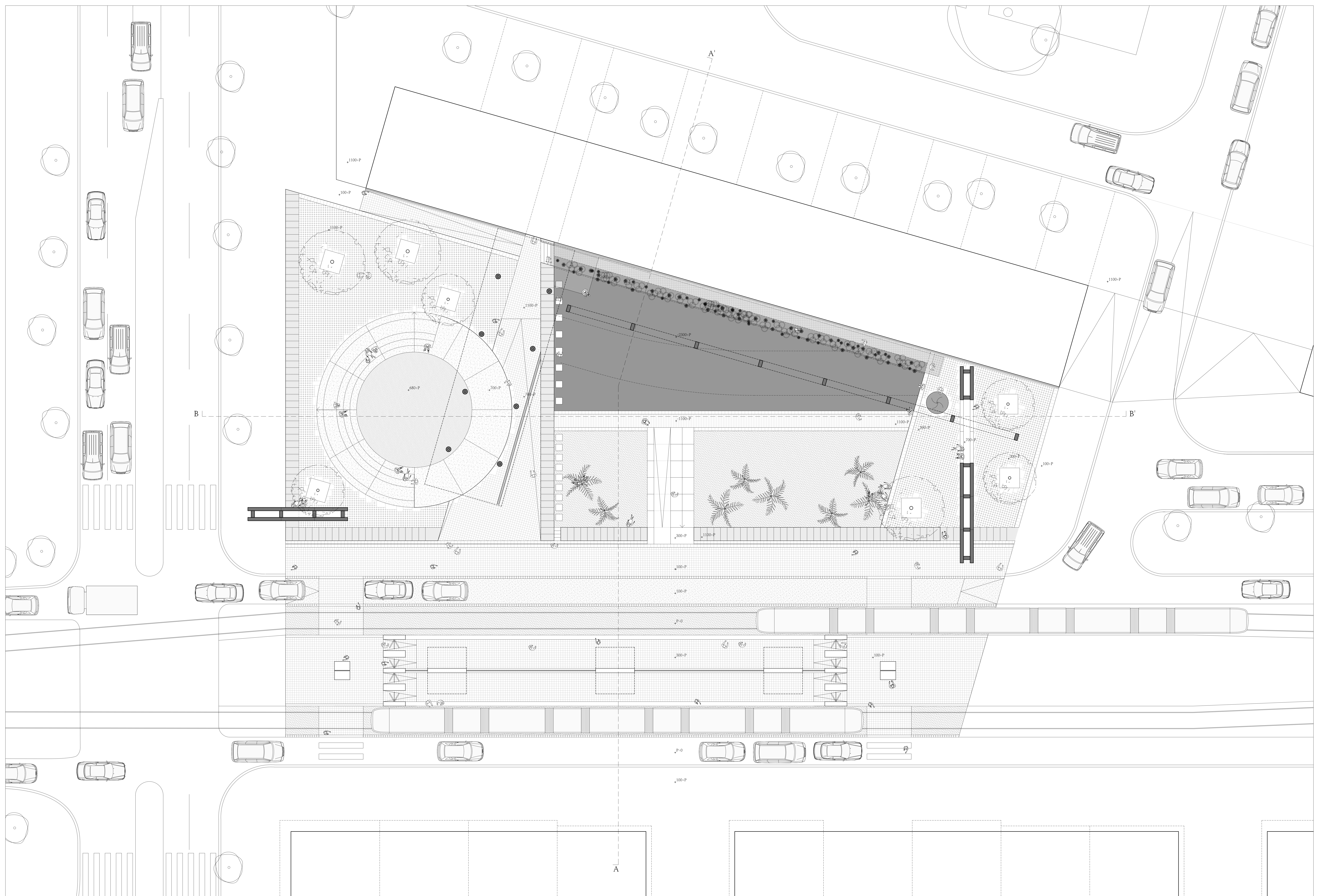

plan . hay mohammadi
1:100

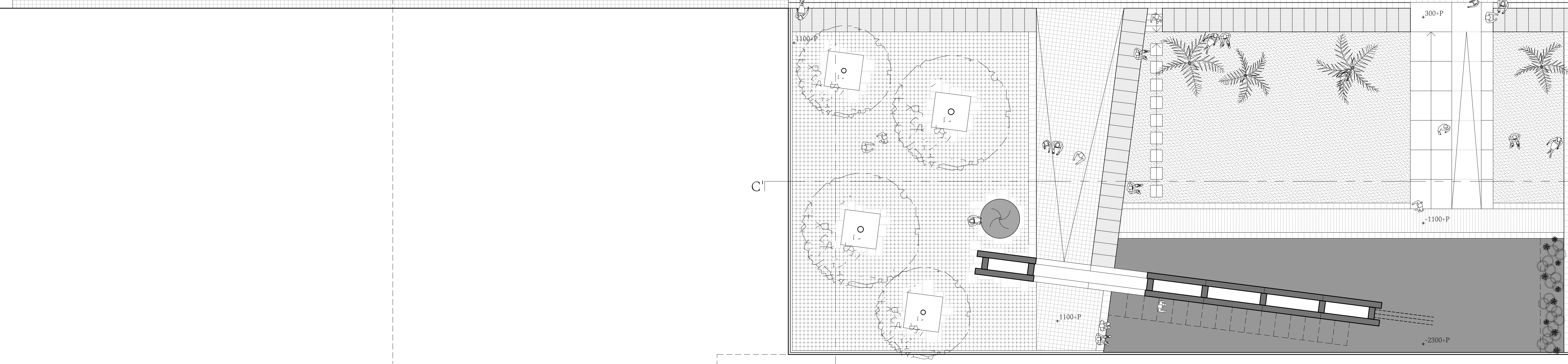
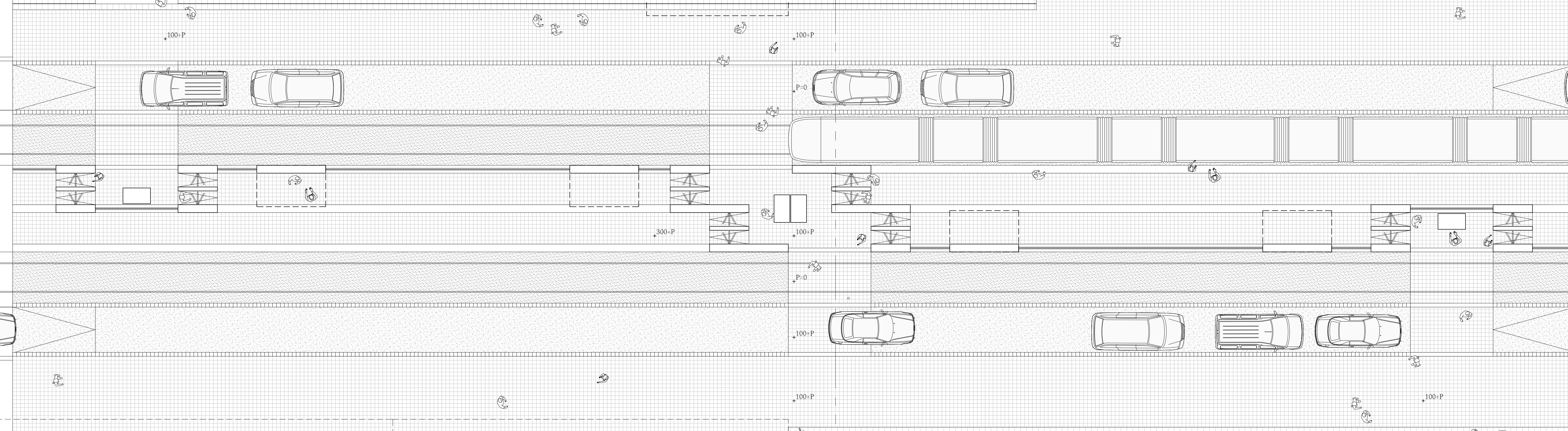
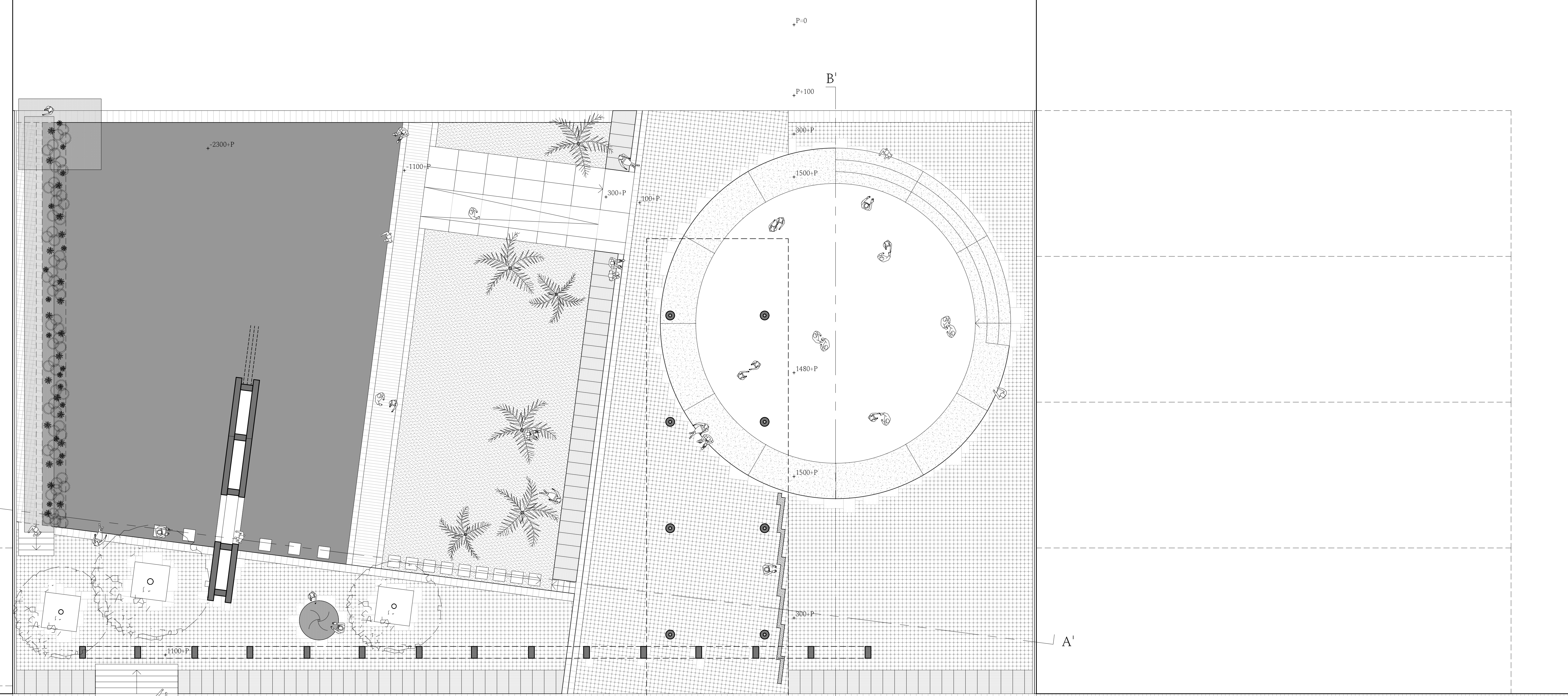

plan . abbatoirs
1:100

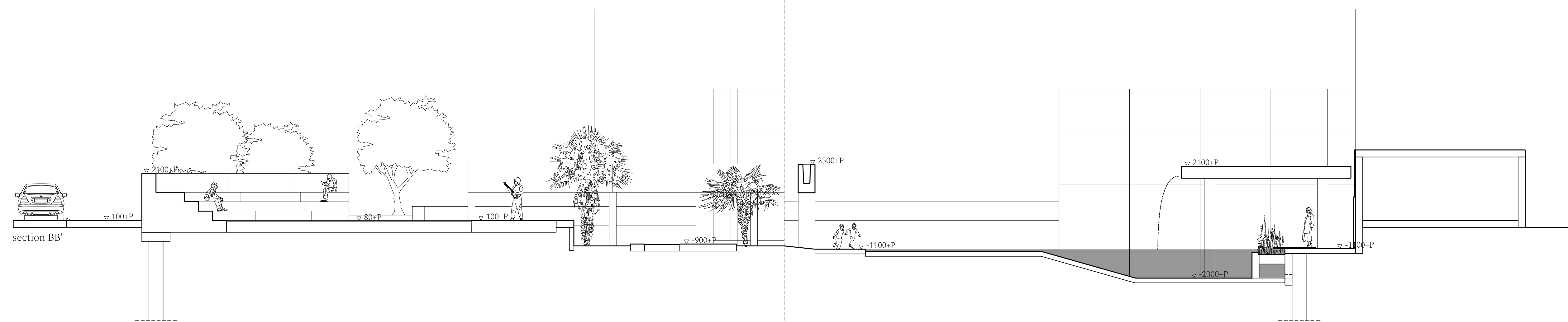
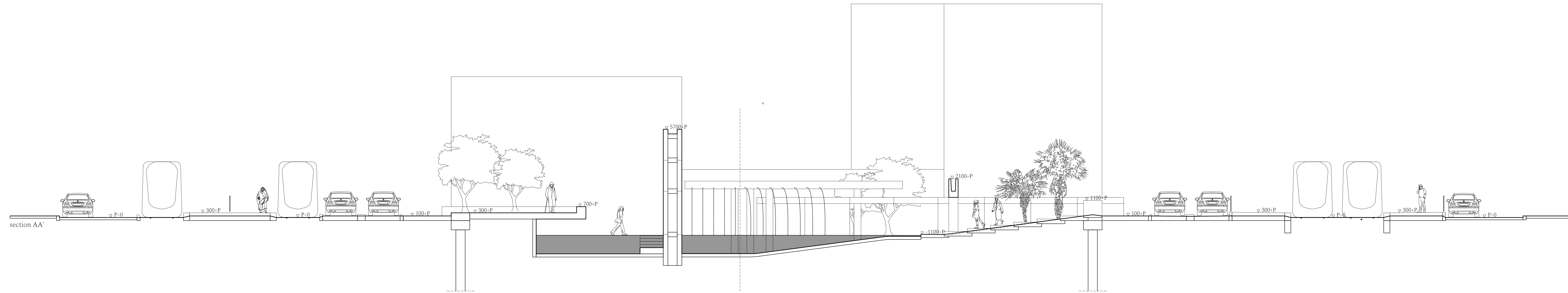

sections . ibn tachfine
1:100

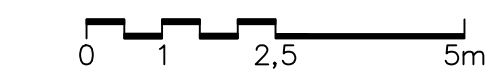

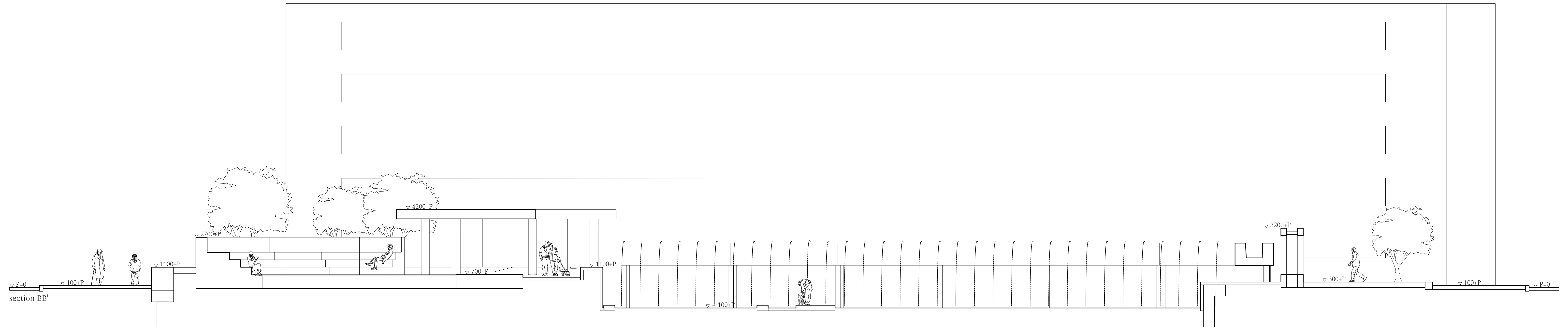
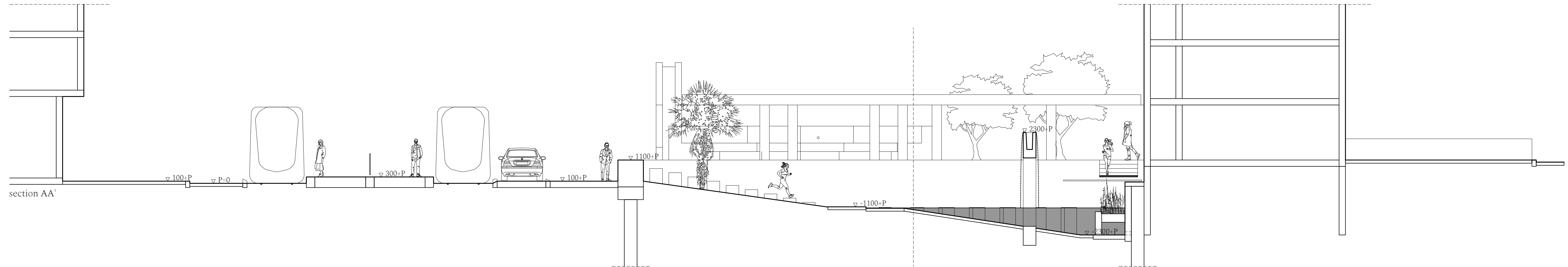

sections . hay mohammadi
1:100

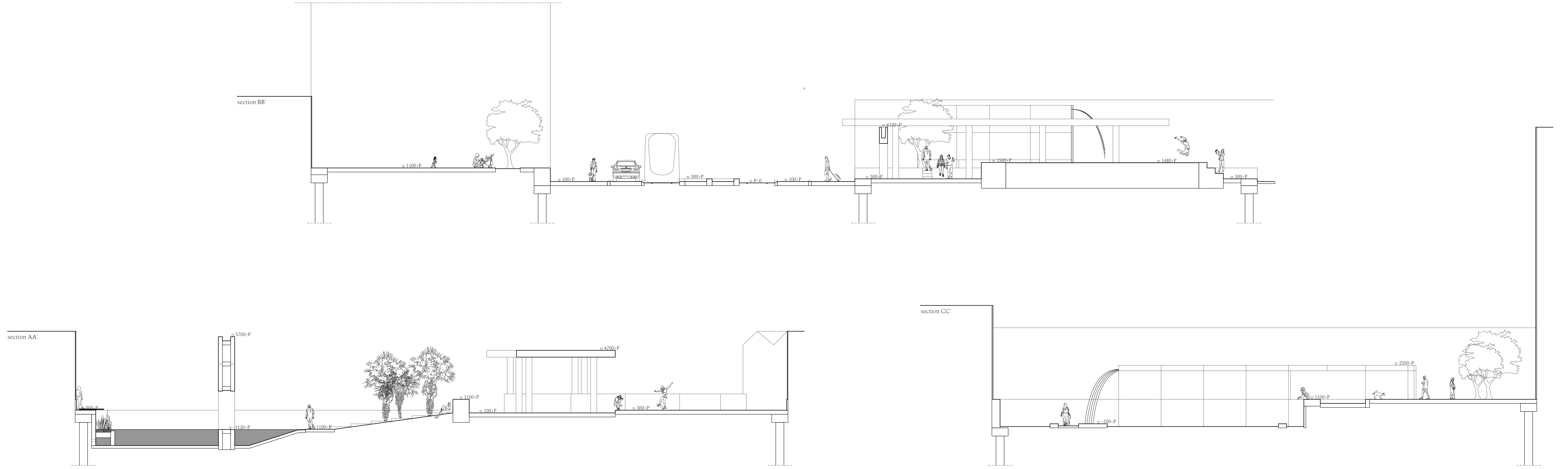

sections . abbatoirs
1:100

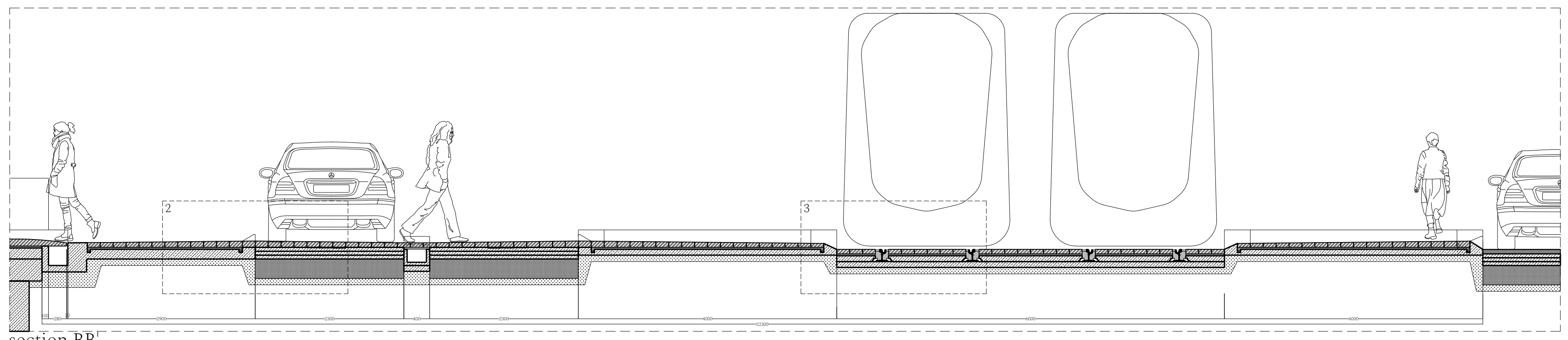
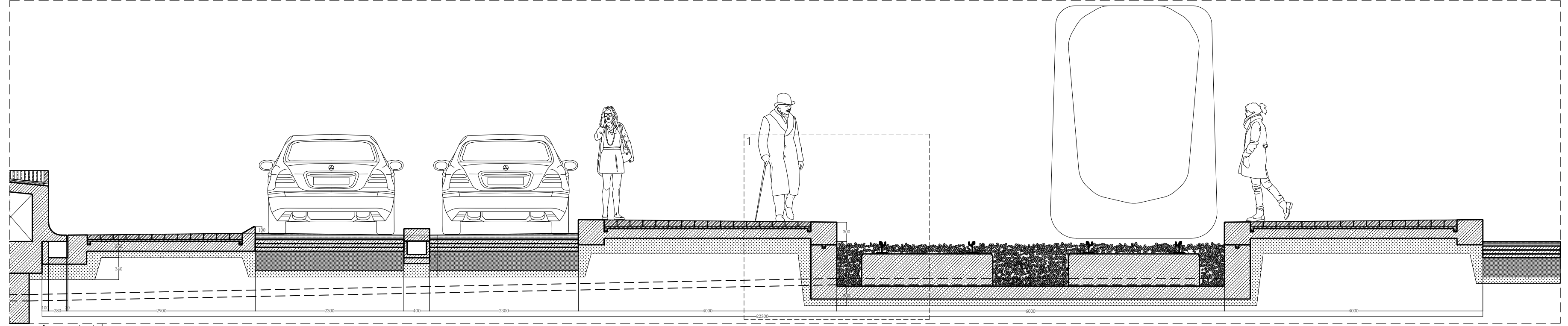
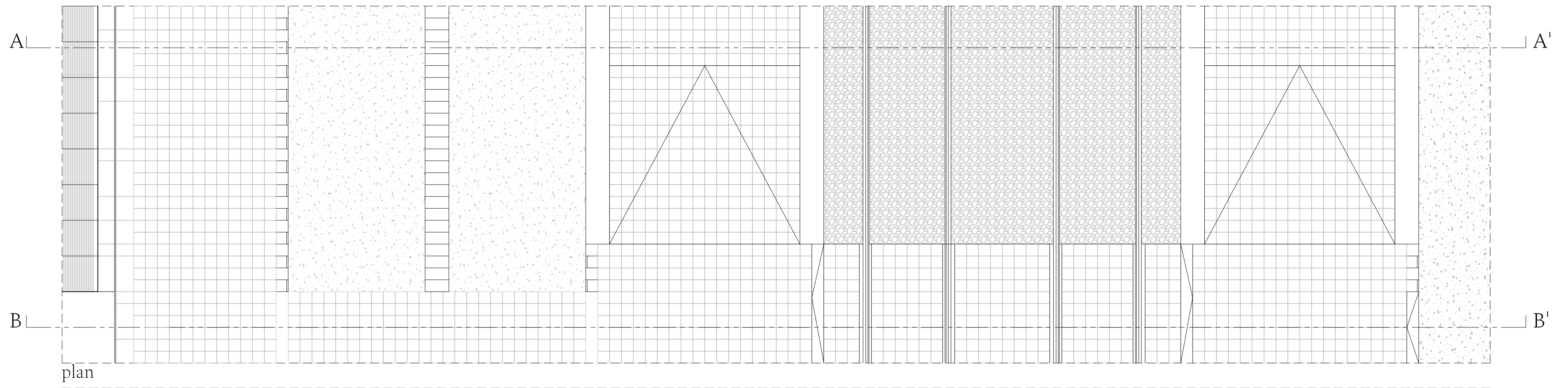

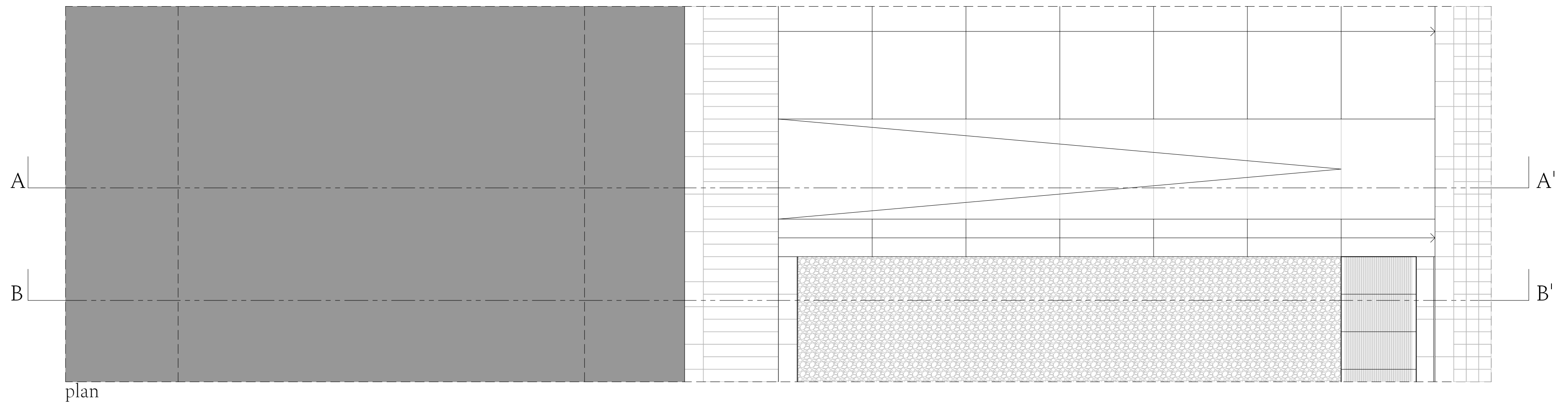

plan

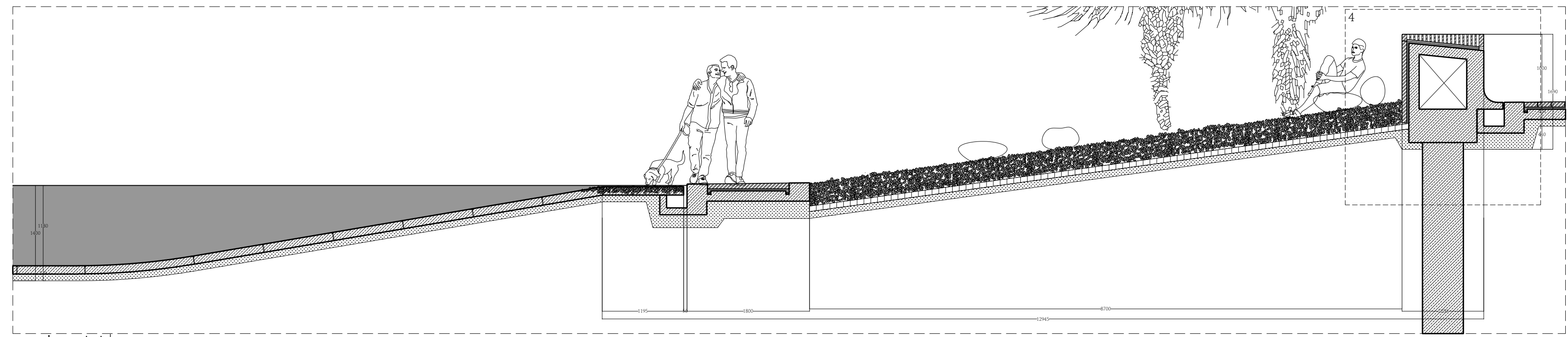

section AA

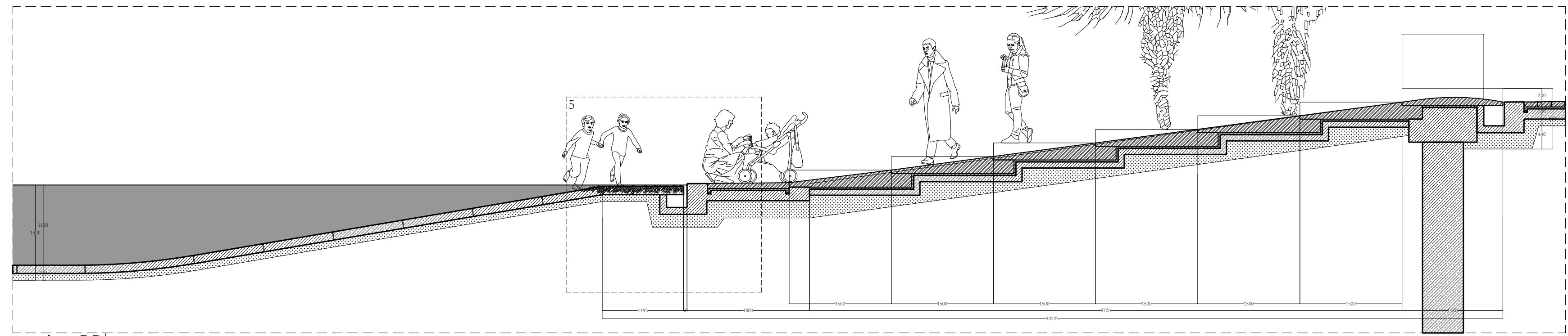

section BB

fragment . surface . slope
1:50

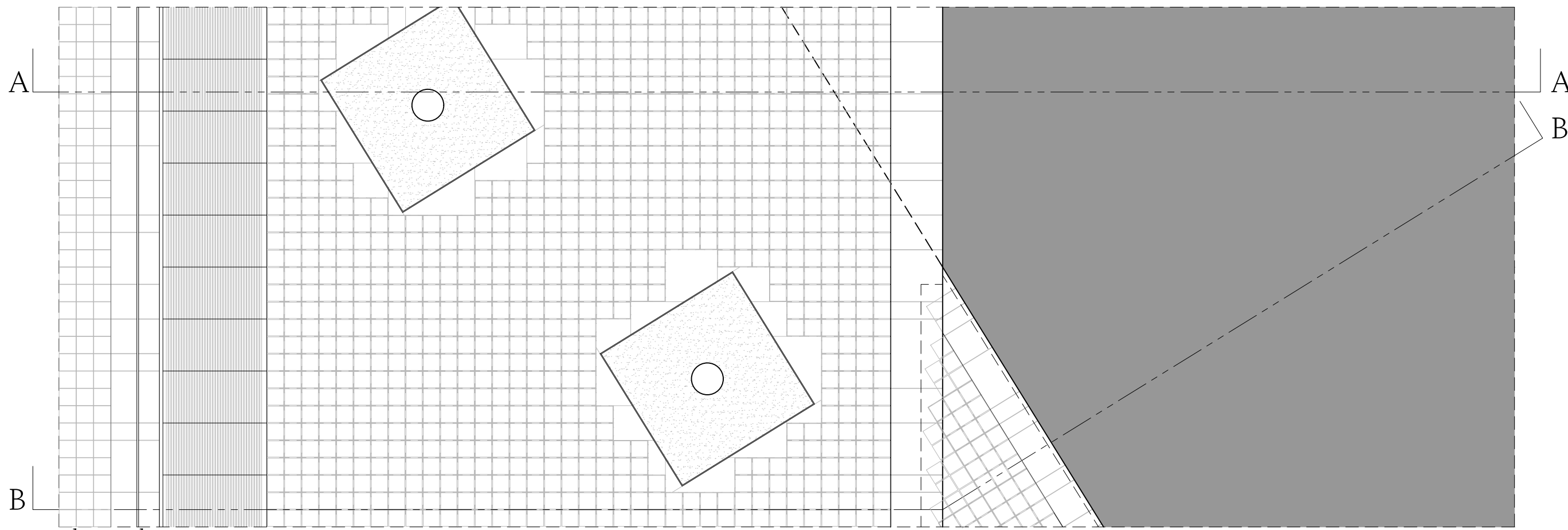

plan . plaza

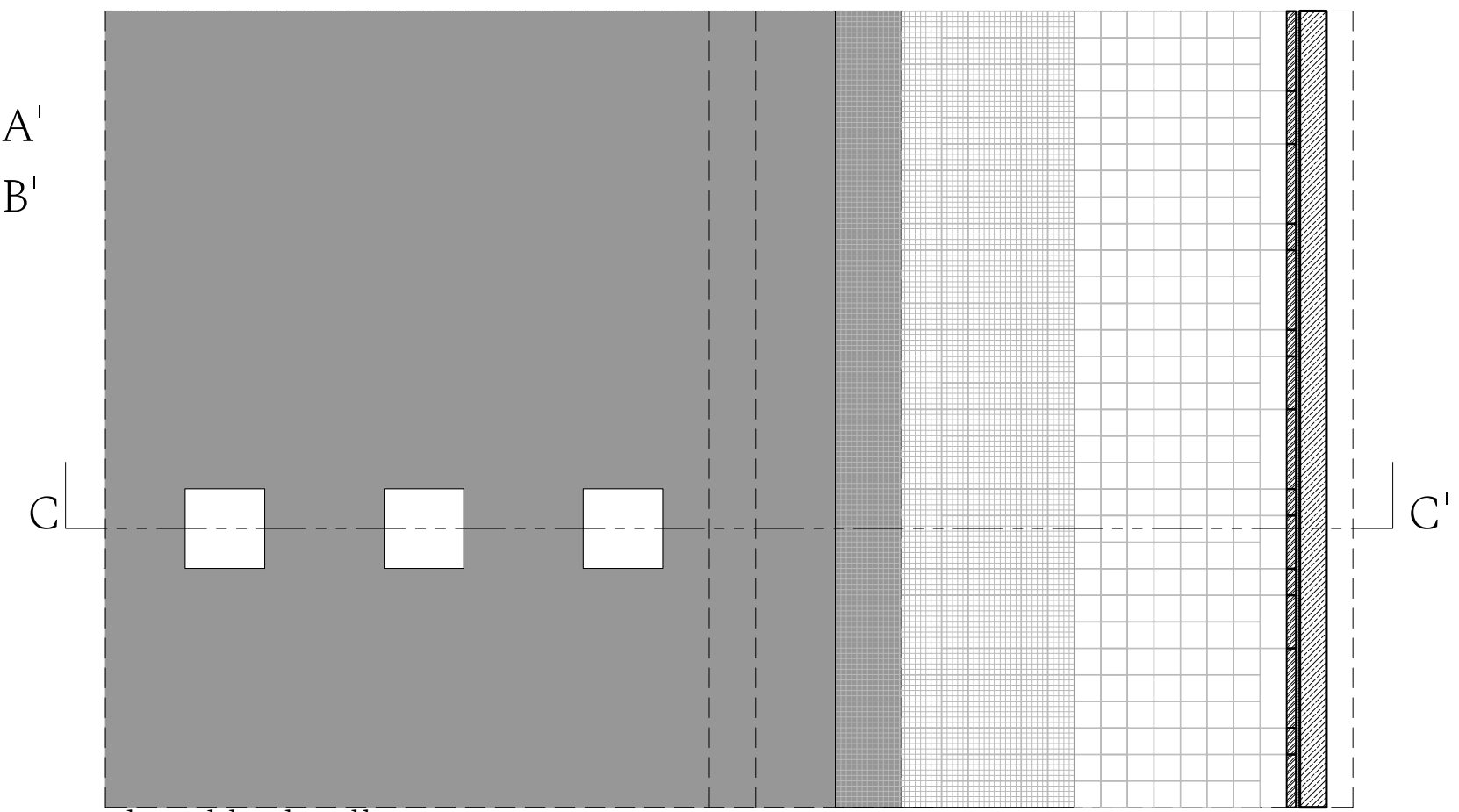

plan . blind wall

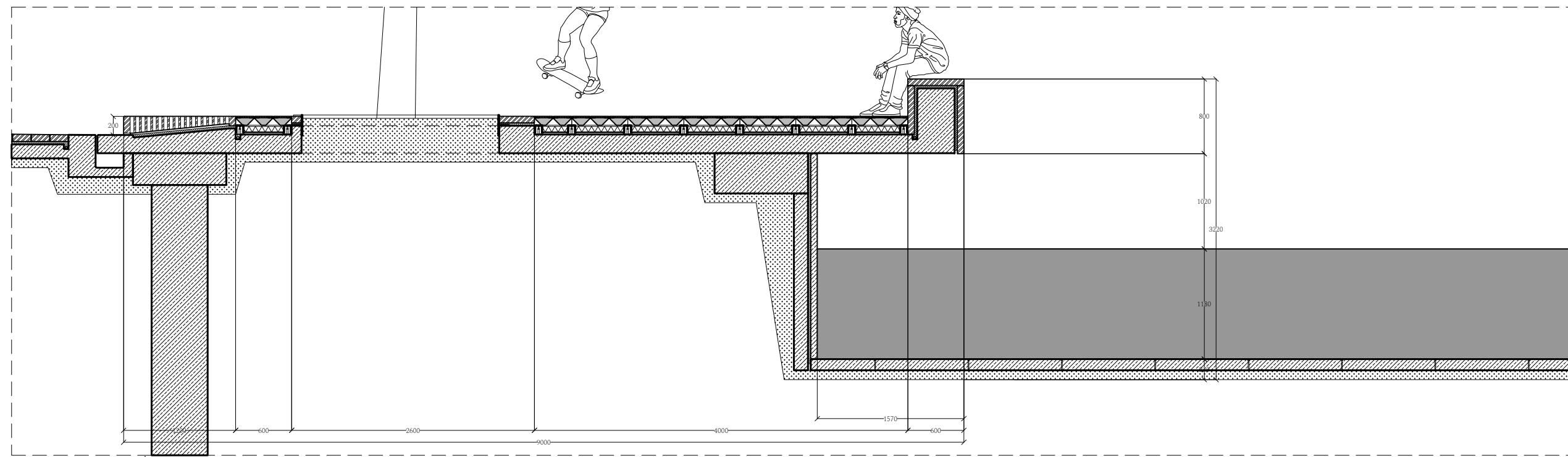

section AA'

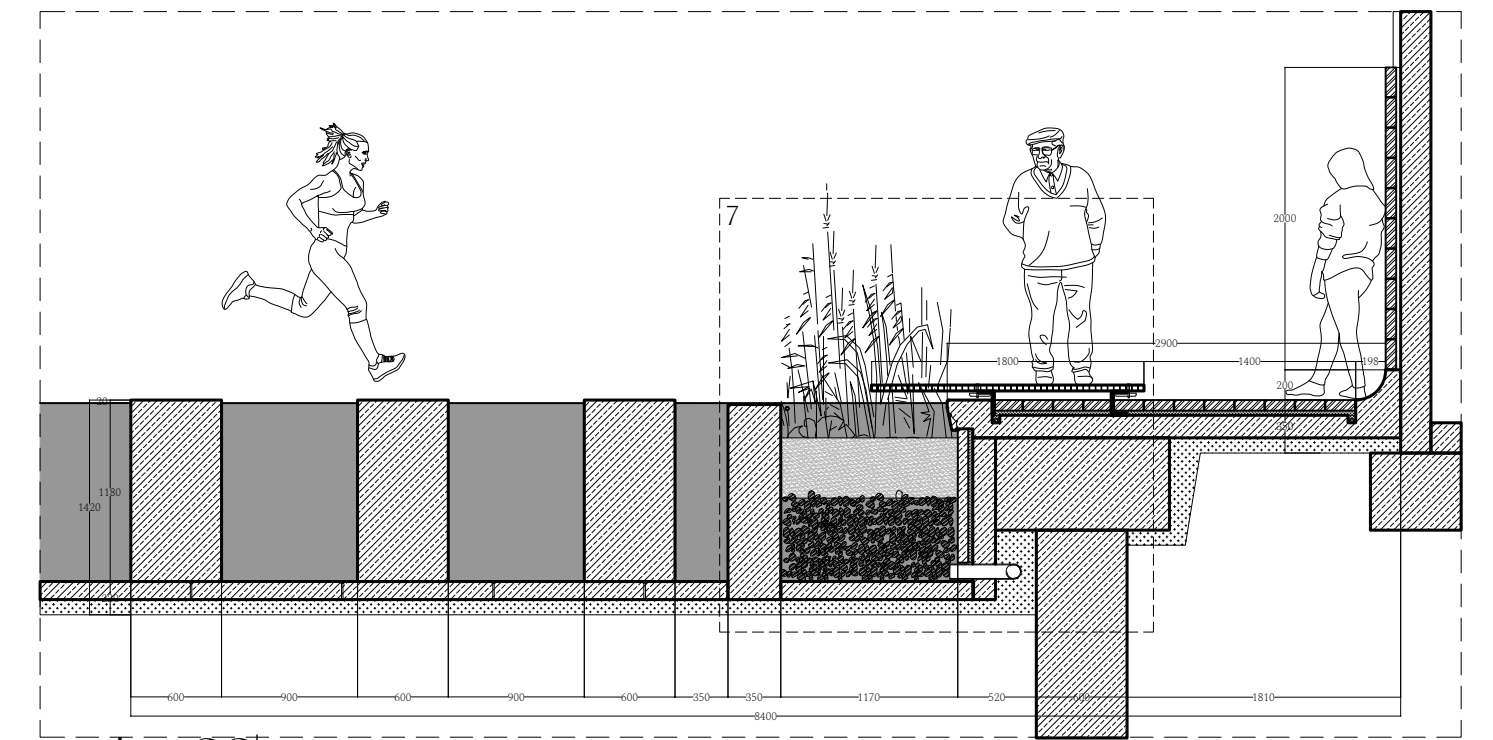

section CC'

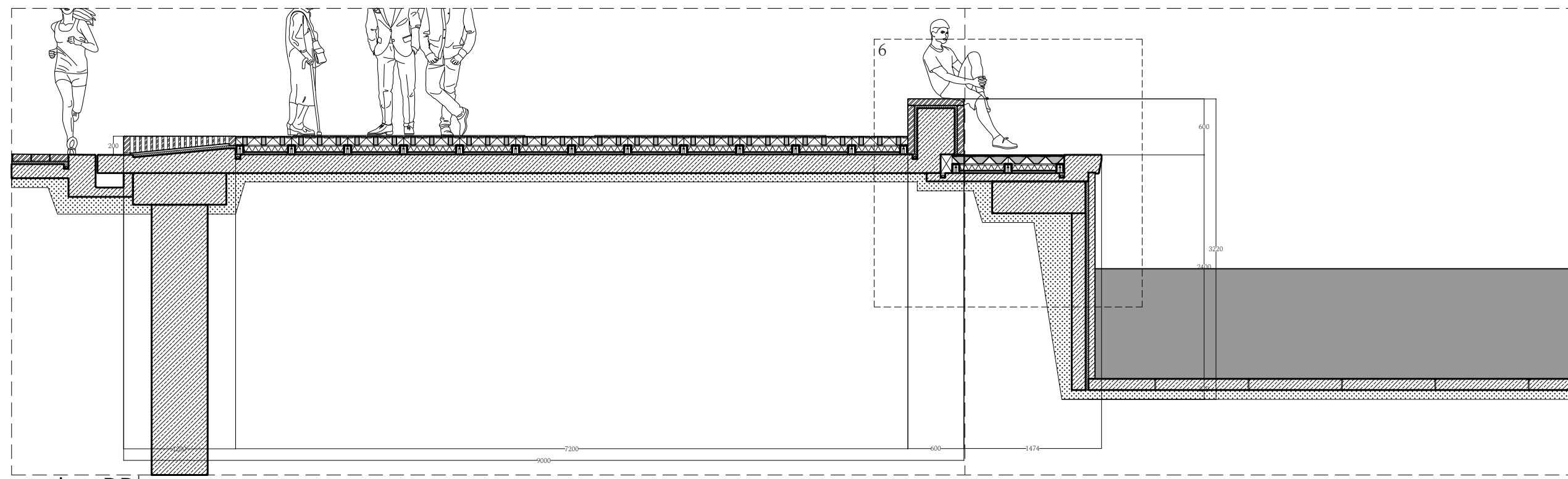

section BB'

fragment . surface . plaza
1:50

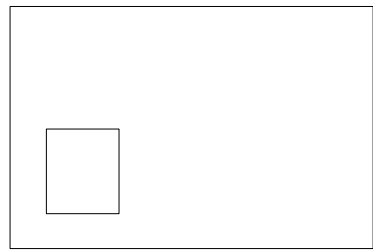

configuration options

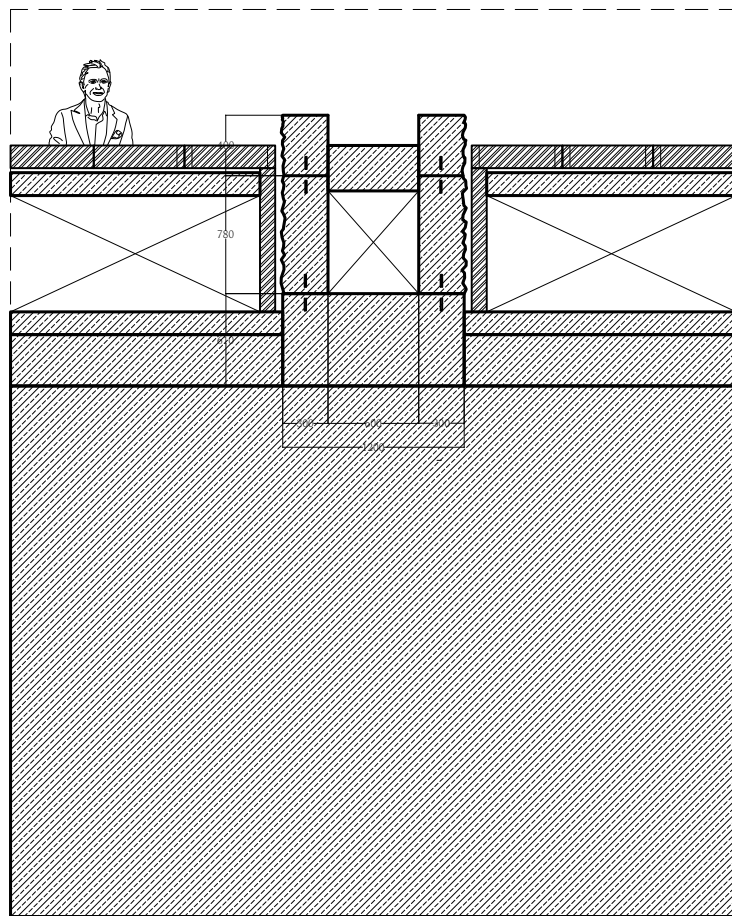

section BB'

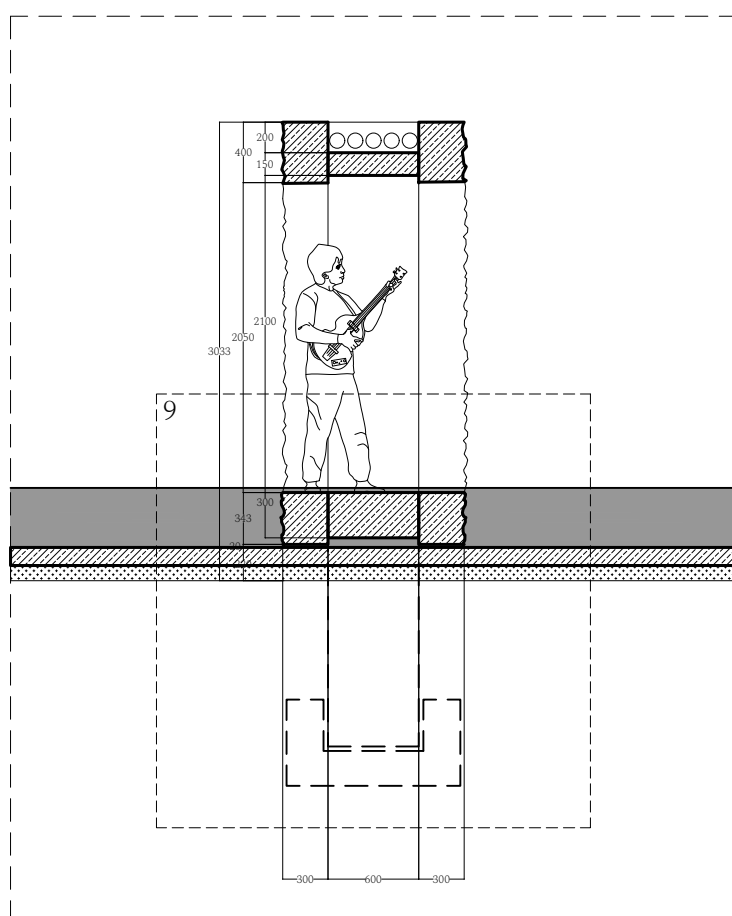

section CC'

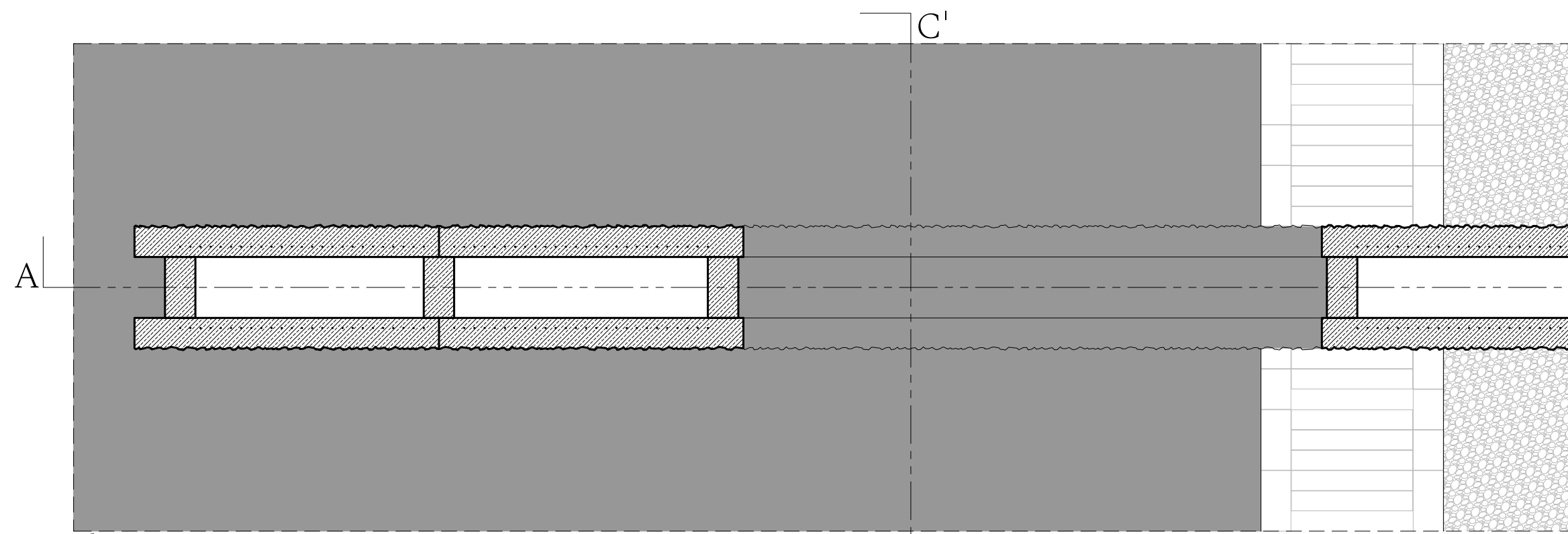

plan

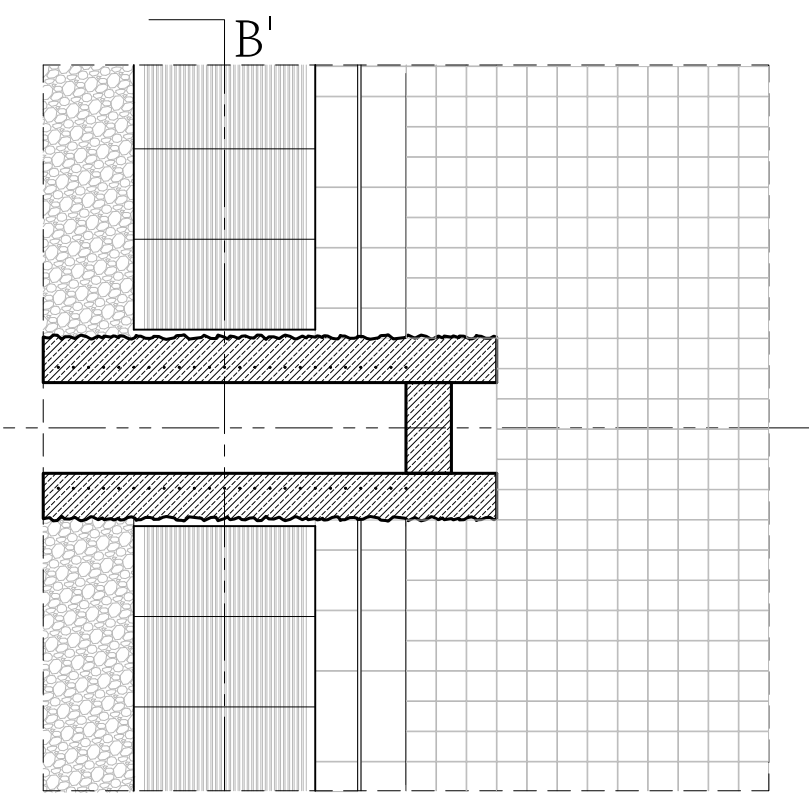

A'

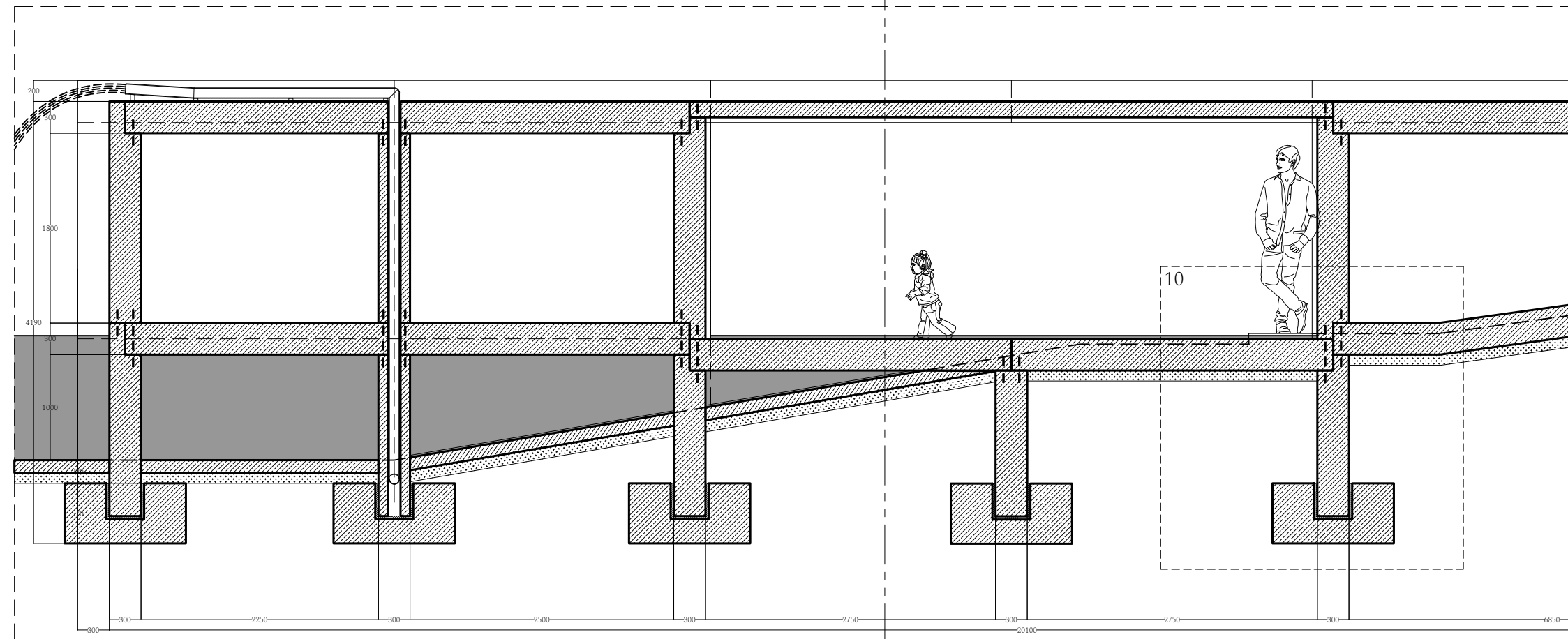

section AA'

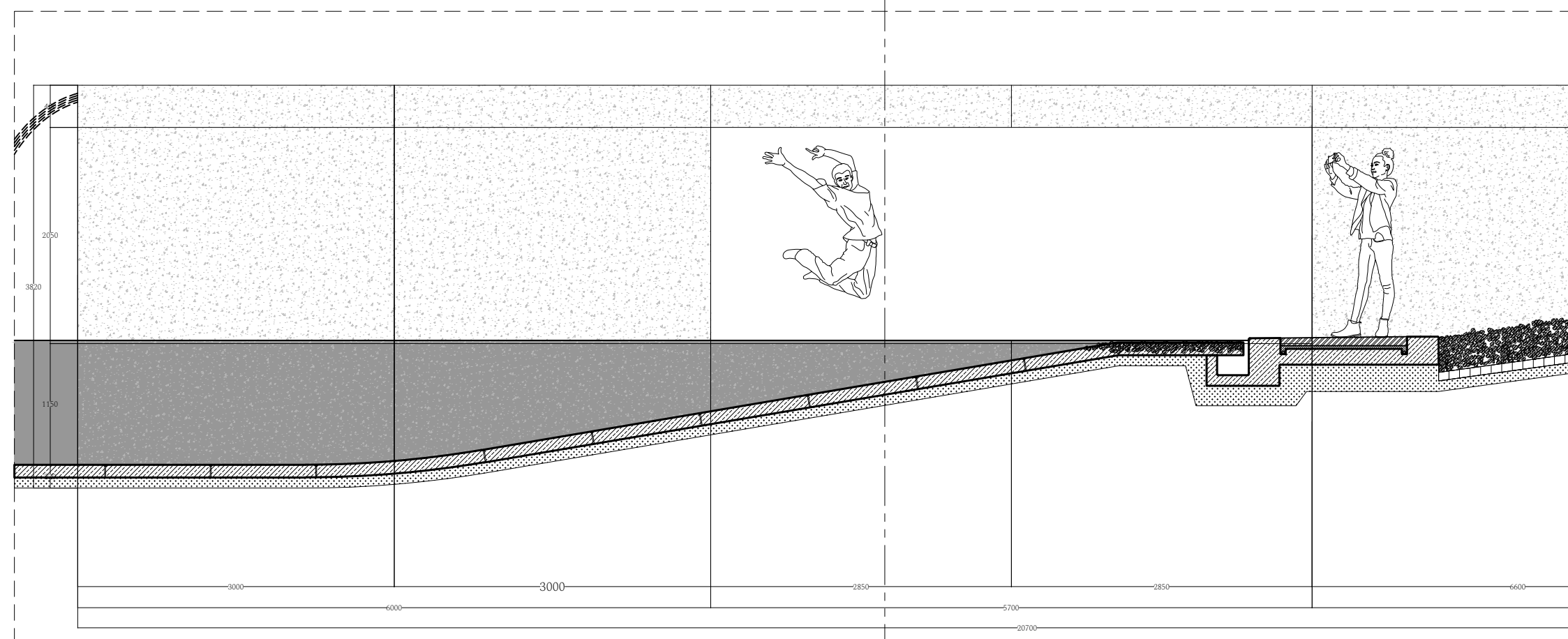
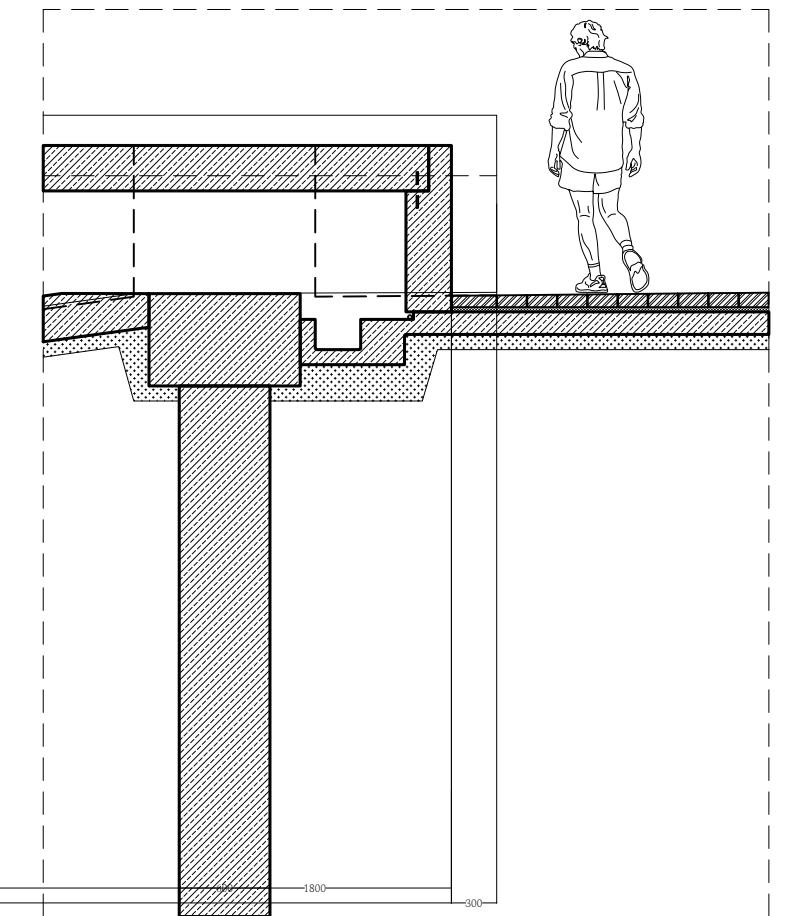

elevation

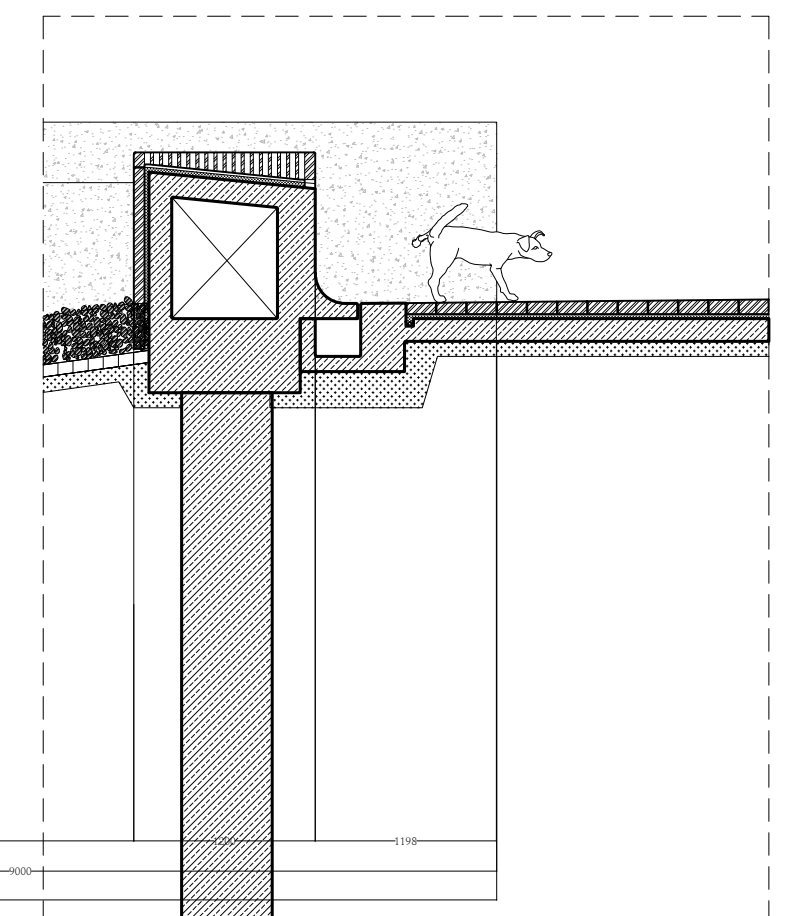

B

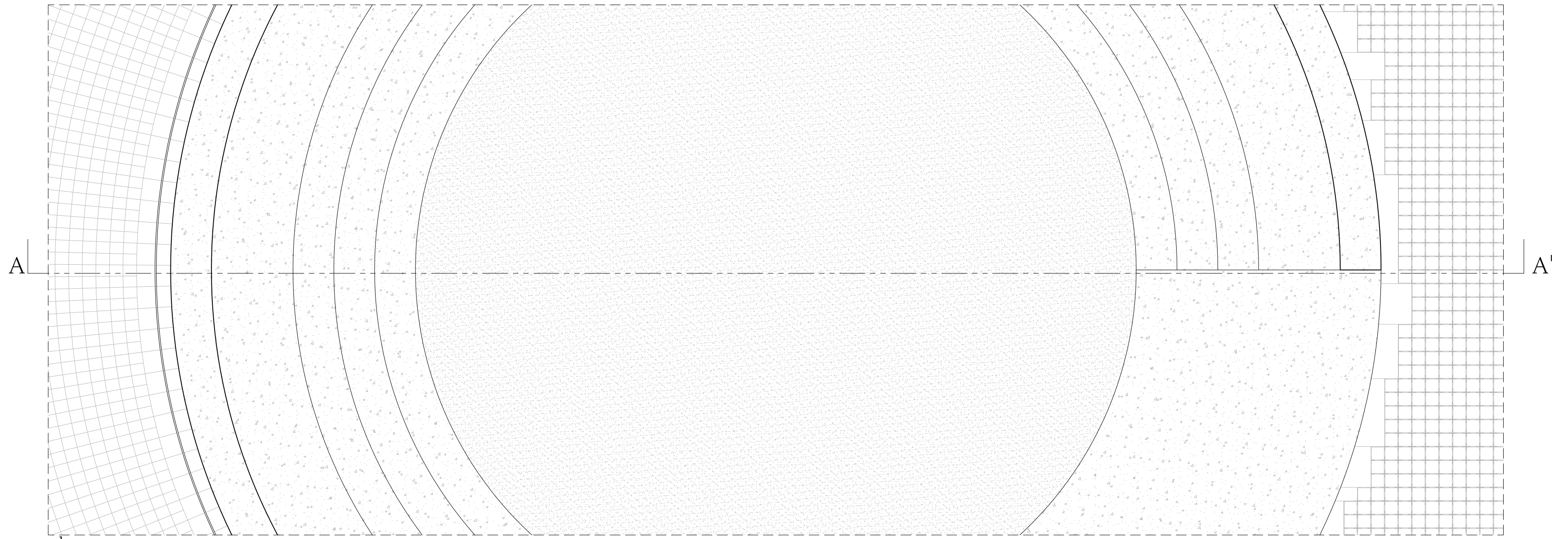

plan

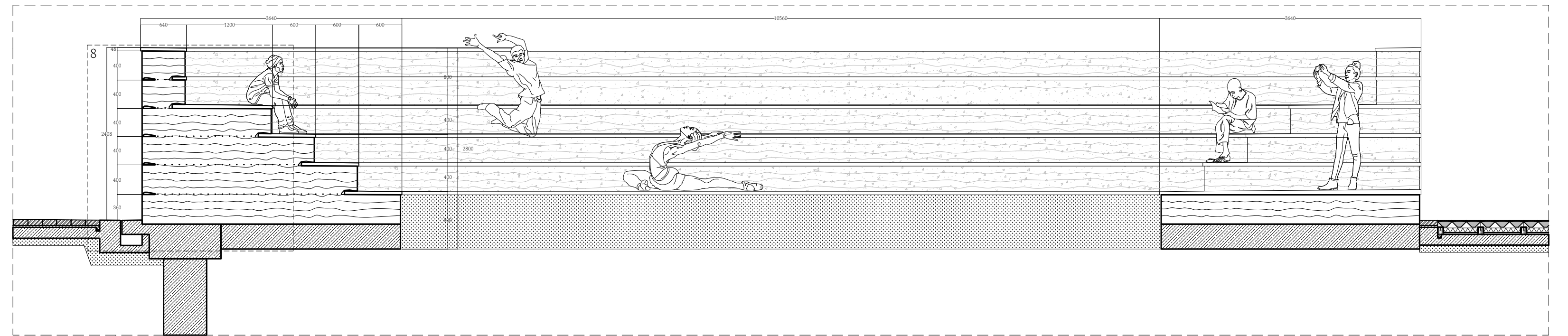

section AA'

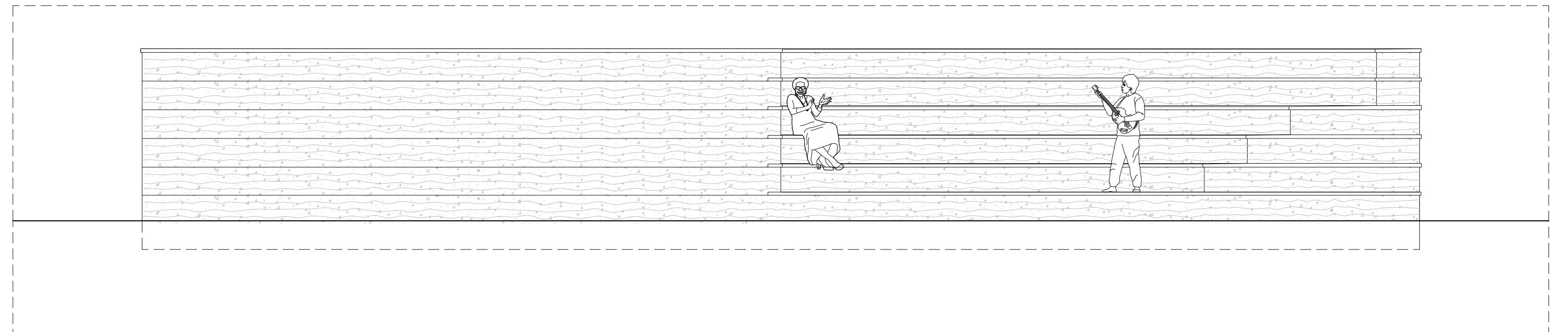

elevation

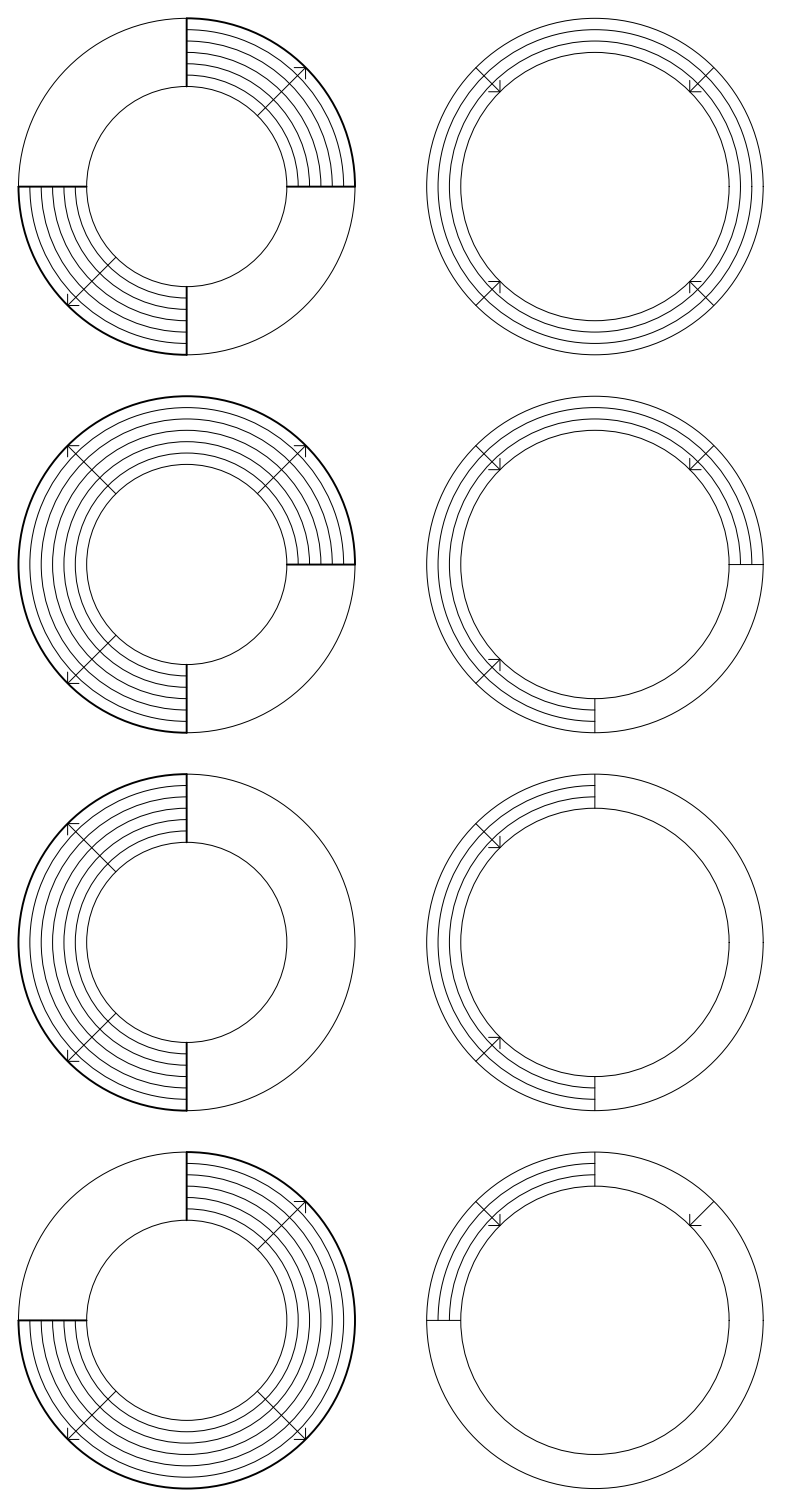

configuration options

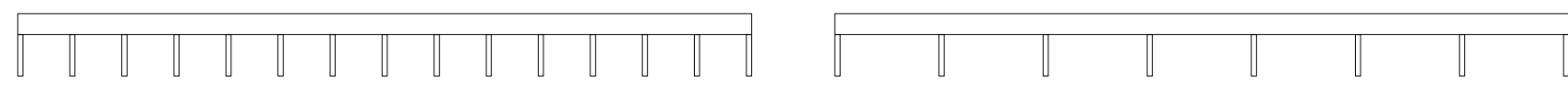
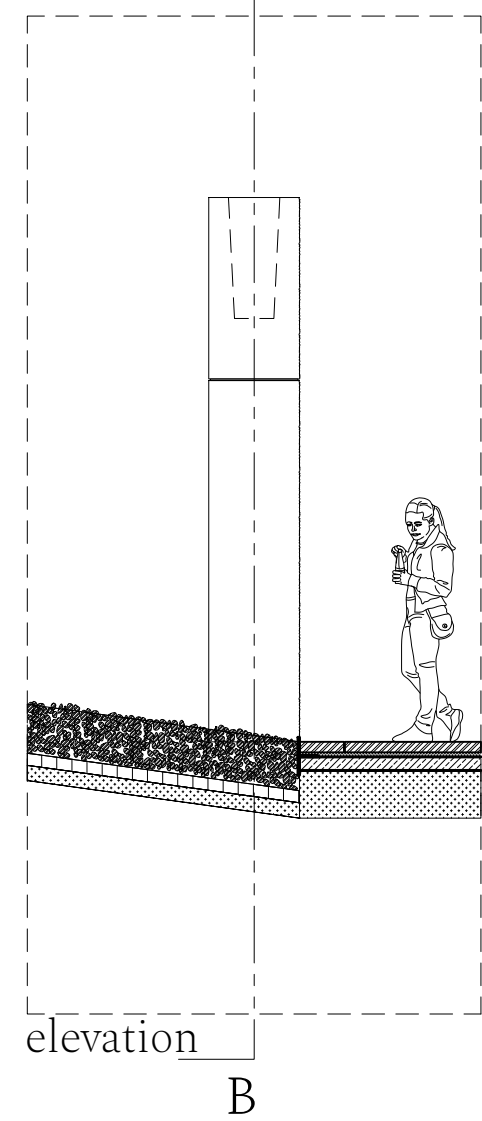
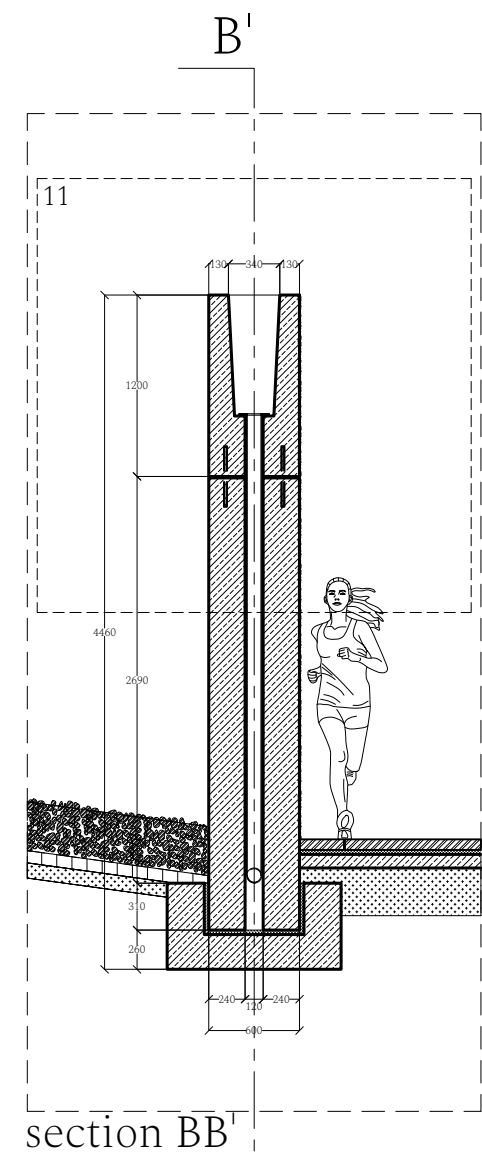

configuration options

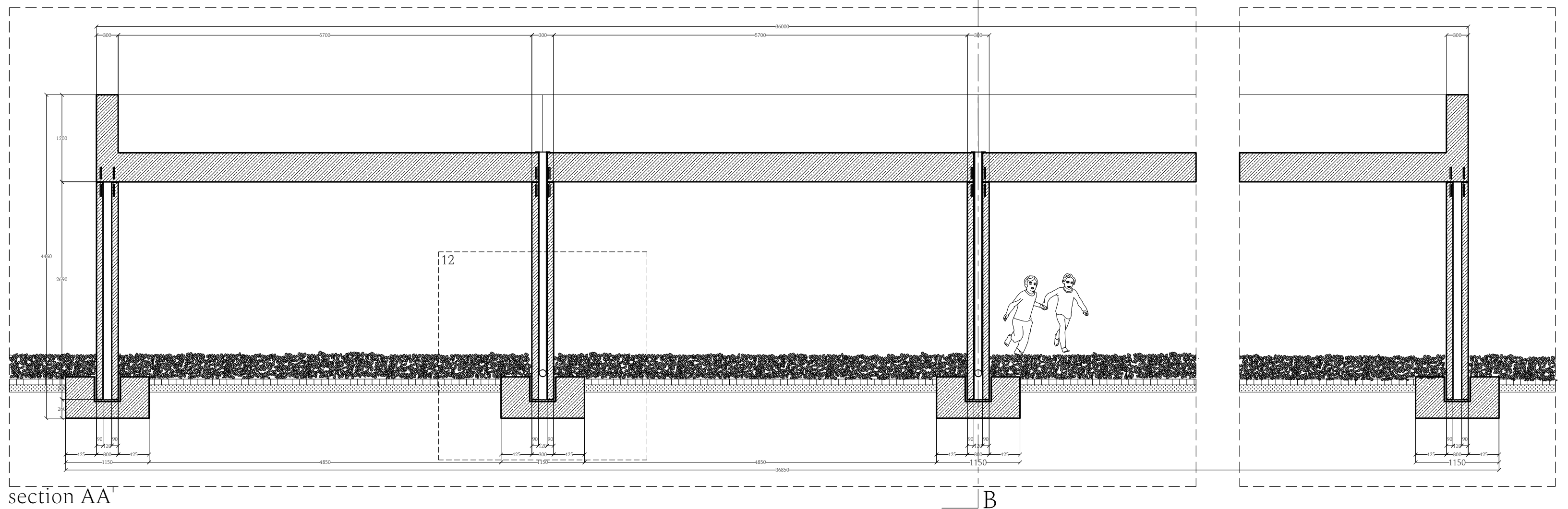
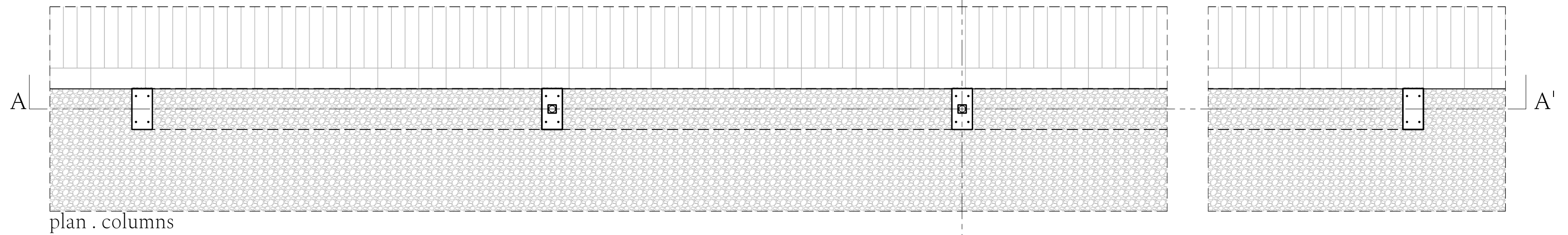
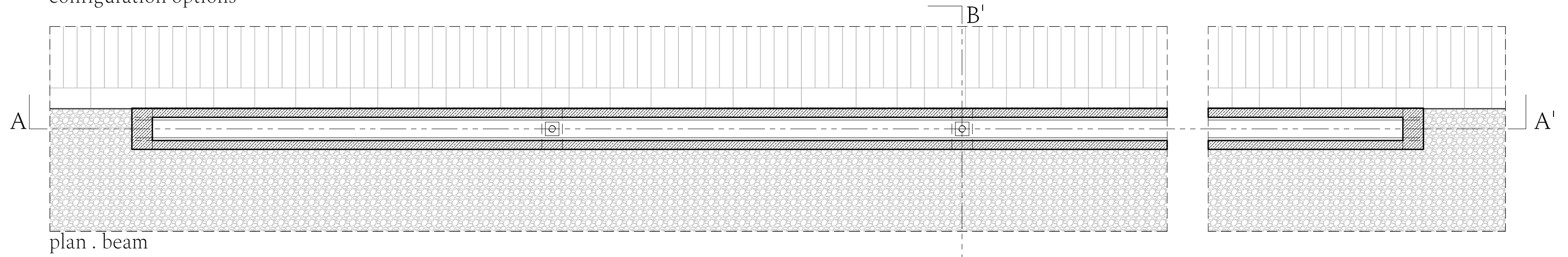

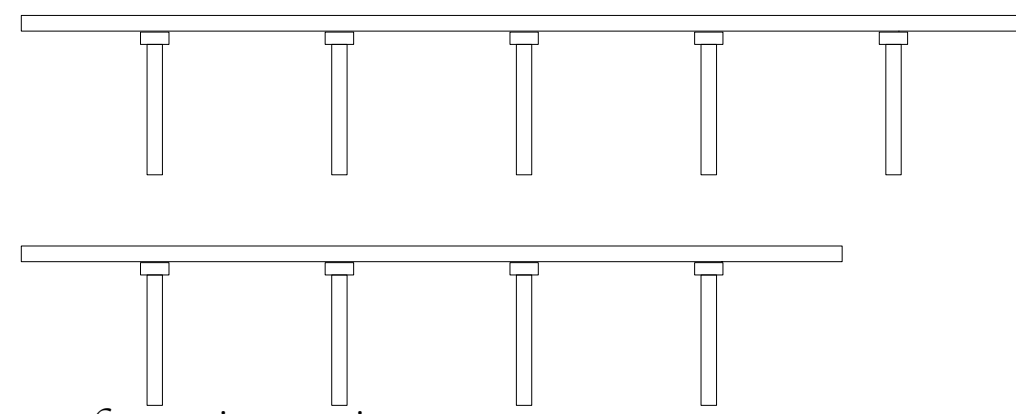

configuration options

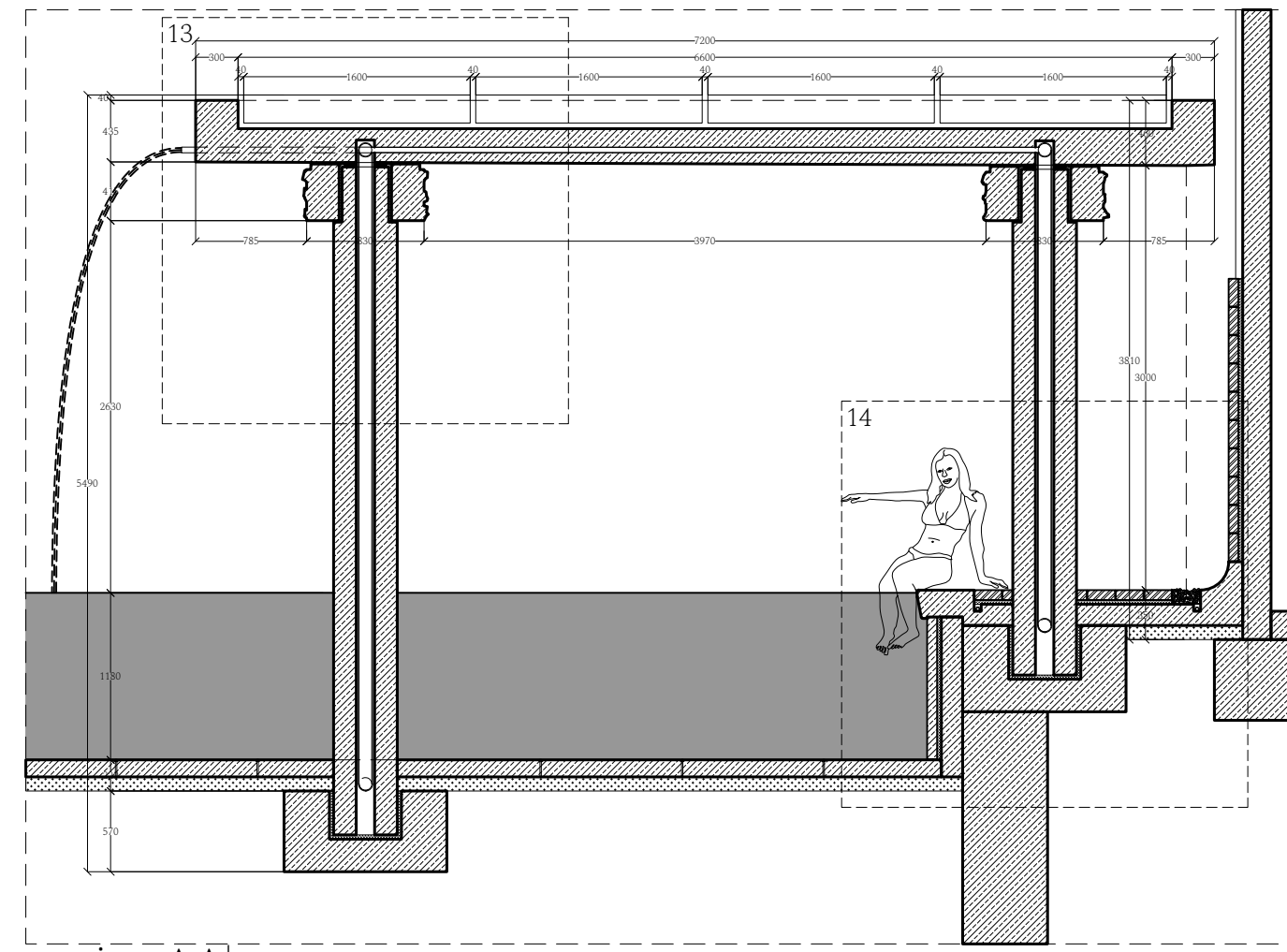

section AA

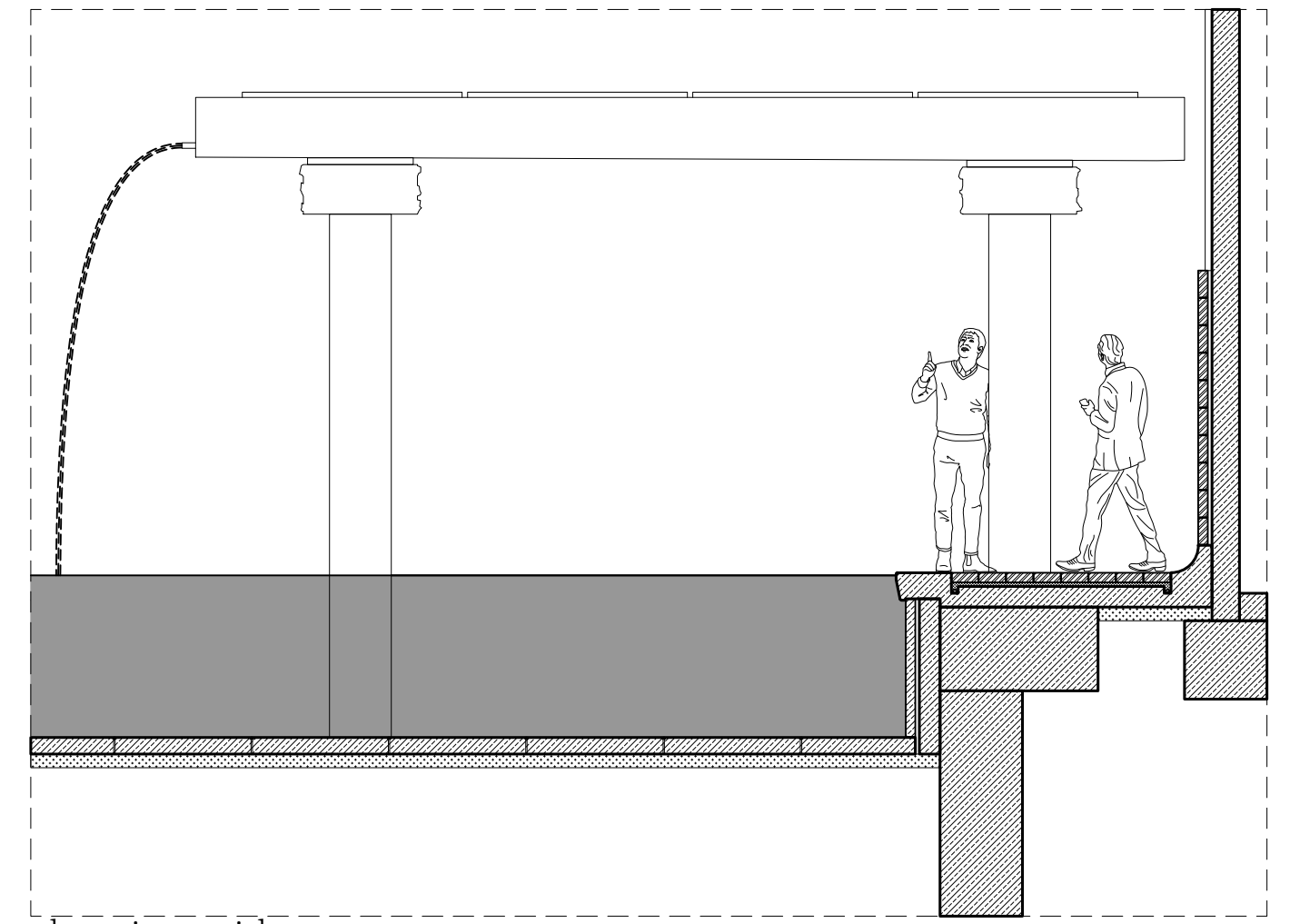

elevation . side

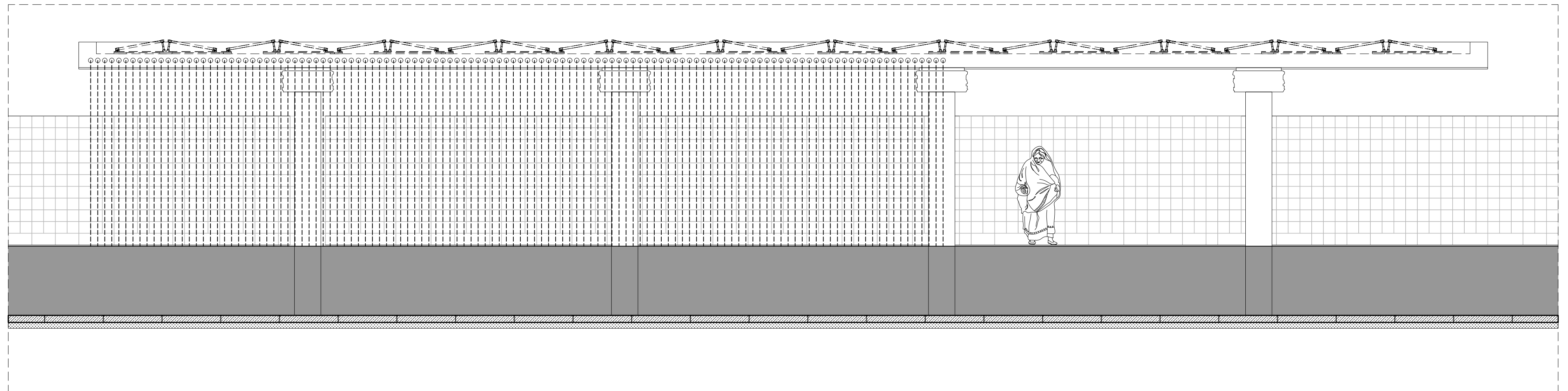

elevation . longitudinal

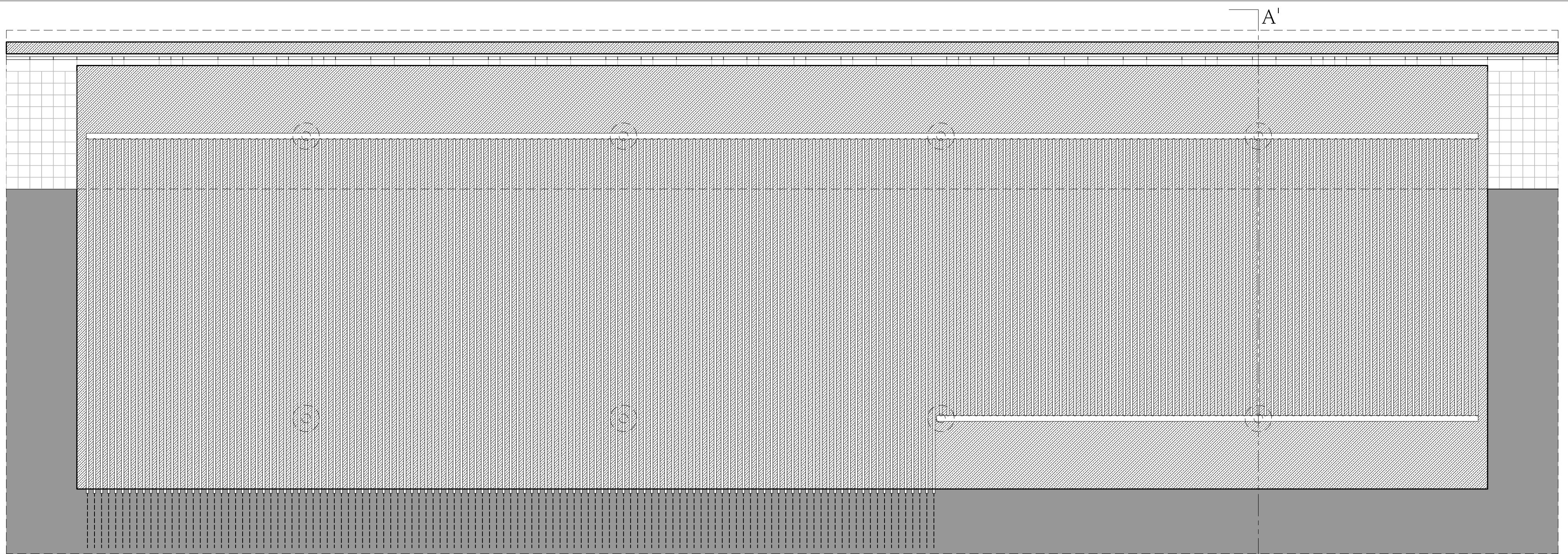

plan . roof

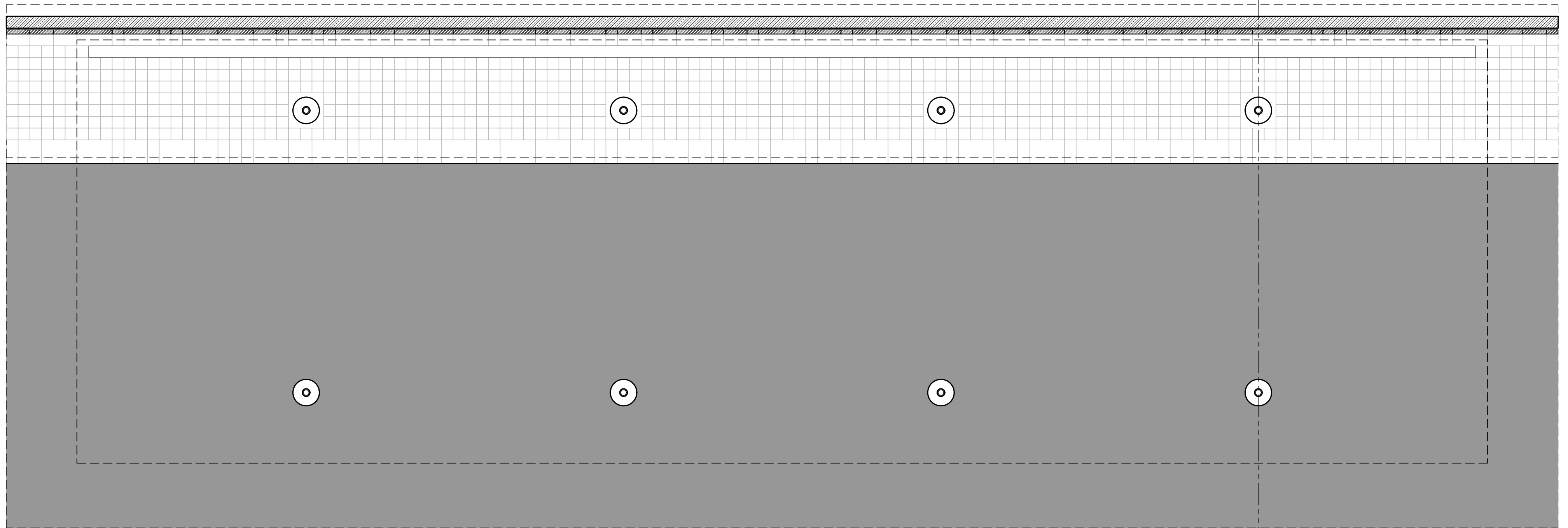

plan . columns

fragment . element . pavilion . plans
1:50