

Delfi-PQ: The first pocketqube of Delft University of Technology

Radu, Silvana; Uludag, Sevket; Speretta, Stefano; Bouwmeester, Jasper; Gill, Eberhard; Chronas Foteinakis, Nikitas

Publication date

2018

Document Version

Accepted author manuscript

Published in

Proceedings of 69th International Astronautical Congress

Citation (APA)

Radu, S., Uludag, S., Speretta, S., Bouwmeester, J., Gill, E., & Chronas Foteinakis, N. (2018). Delfi-PQ: The first pocketqube of Delft University of Technology. In *Proceedings of 69th International Astronautical Congress: Bremen, Germany* Article IAC-18-B4.6B. 5 International Astronautical Federation, IAF.

Important note

To cite this publication, please use the final published version (if applicable).
Please check the document version above.

Copyright

Other than for strictly personal use, it is not permitted to download, forward or distribute the text or part of it, without the consent of the author(s) and/or copyright holder(s), unless the work is under an open content license such as Creative Commons.

Takedown policy

Please contact us and provide details if you believe this document breaches copyrights.
We will remove access to the work immediately and investigate your claim.

IAC-18-B4.6B. 5

DELFI-PQ: THE FIRST POCKETQUBE OF DELFT UNIVERSITY OF TECHNOLOGY

Silvana Radu,

Mehmet Sevket Uludag, Stefano Speretta, Jasper Bouwmeester, Eberhard Gill, Nikitas Foteinakis

Abstract

Delft University of Technology has embarked on PocketQubes to showcase as the next class of miniaturized satellites. In the past decade, CubeSats have grown towards a successful business with mature capabilities. PocketQubes, however, are still in their infancy. The small size of the PocketQubes will trigger innovations in miniaturization and will force one to think differently about space technology. It is not sufficient to simply down-scale existing concepts used in CubeSats, there is a necessity to develop and qualify completely new components through which new applications can be enabled in the future.

The new satellite platform, called Delfi-PQ, inspired by the success of previous Delfi satellite projects is seen as an opportunity for innovation and offers research challenges in the miniaturization field of systems and components. The focus of this paper is to highlight those innovations and challenges, and to communicate the progress that has been made with respect to building a core platform and standardized bus.

The mission of Delfi-PQ is to demonstrate a reliable core bus and outer structure for a three unit PocketQube that shall be tested in flight as a first iteration of a series of PocketQubes to be developed by Delft University of Technology. The core bus shall fit in one unit - 1P (50x50x50mm), having as aim that after further miniaturization and optimization, the second unit shall contain an advanced subsystem (e.g. advanced Attitude Determination and Control System - ADCS) and the third unit shall consist of a scientific payload (e.g. micro-propulsion, lensless camera). For Delfi-PQ, the focus was on the miniaturization process and on the structure of the PocketQube. The core platform of the first Delfi-PQ consists of the Electrical Power System (including two 3.7V batteries and solar panels with two cells/each X-Y face), On-board Computer, Communications System, ADCS (including two magnetorquers and three magnetometers), as well as: temperature sensors and two different sensors for assessing the rotational speed of the PocketQube.

I. INTRODUCTION

The overall technological advance that has been occurring in the past decades in all fields of science is exponentially growing and advancing in the direction of miniaturization. Particularly, in space domain, the rapid and spectacular evolution started in 1957 when the first artificial satellite was launched. The rapid decrease in size and advancement in components and products specifications was possible due to the miniaturization in electronics. Nowadays, the accurate and performant existing on-board instruments that can operate at high capacity can make spacecraft fully autonomous. In the past fifteen years, a new miniaturized satellite of a reduced form factor became popular through strict standardization, emerging into a flourishing business of space industry: CubeSats. They represent satellites of roughly 100x100x100 mm and several combinations of these cubes can be emerged into a bigger satellite if needed. TU Delft was one of the pioneers in designing, developing, manufacturing and launching a 3U CubeSat called DelfiC3. However, because this form factor is fully standardized and after so many years, this side of space industry is still experiencing a growing business, TU Delft oriented towards a new miniaturized version of the CubeSats, the PocketQube. This type of satellite represents a platform of approximately 50x50x50 mm per unit and at the time when TU Delft started the Phase A of the project, no standardization existed. In the meantime, TU Delft along with other partners interested in the same form factor published a first revision of the PocketQube Standard [1] that will be also presented in section II of this paper.

Within section III a detailed description of the mission and the afferent challenges in designing the satellite will be described. Due to the fact that Delfi-PQ (Figure 1) represents the first PocketQube developed by TU Delft, the aim is to set a mechanical standard for this type of satellite and flight test the structure as well as validating in flight the designed and developed core bus. At the moment it is foreseen that a thermal payload provided by an external partner will be integrated, however this depends on the launch date and timeline compatibility.

Section IV will contain a description of the implemented operational modes and the desired FDIR (Fault Detection Isolation and Recovery) which will be designed based on the OBC (On-board Computer Modes) modes. Since the complexity of the PocketQube is not high, the FDIR will be a simple system that makes sure the boot loop is respected and safe mode, as well resets, are applied accordingly with every failure. In theory, the FDIR can be very complicated even for a simplistic system. The most pressing problem encountered depends

directly on actuators and sensors and on assuring that the designed FDIR is robust enough in order to differentiate the output disturbances from the actual failures. For the first iteration of Delfi-PQ, this does not represent an issue, however it is expected to be needed in the future as for the next versions, an advanced ADCS will be added to the core system.

Section V will consist of the testing and launch planning. Challenges with respect to finding a launch and a deployer for this form factor will also be addressed in this section.

Section VI will comprise of conclusions and future work plans with respect to the development of PocketQubes.

The long-term goal of Delfi-PQ is to develop a core platform which secures basic functionalities and shall iteratively evolve over time. Given the fact that TU Delft is a university, it is desired that as many students as possible work on the developed satellite. All Delfi missions had a clear objective for education, technology demonstration and innovation. It is intended that once the first iteration of the satellite is validated, there will always be a launch-worthy satellite in the cleanroom. This can provide hands-on experience to students based on the previous settled baseline gained through the launch of the first PocketQube of TU Delft.



Figure 1 Delfi-PQ

II. POCKETQUBE STANDARD

The idea of this new form factor was first presented and proposed in 2009 by Prof. Robert J. Twiggs in collaboration with Morehead State University (MSU) and Kentucky Space [2,3]. As first showcased, the so called PocketQubes represent a cube-shaped platform of 50x50 mm with an approximated mass of 250 g. The first launched PocketQube was through UniSat5 mission [2,3].

The first revision of the new standard published in July 2018 comprises of an alignment in dimensions between the main players within the PocketQube Community: TU Delft, Alba Orbital and Gauss Srl. The aim of the published document is to manage to converge towards common numbers and interfaces for a PocketQube platform. Due to the lack of such standard, uncertainties with respect to exterior dimensions were disputed, which blocked the PocketQube Community from growing.

The overall long-term goal is to continue the standard with additional revisions that comprise of electrical, testing and operational requirements in order to help in fully defining this form factor: the PocketQube.

The difference between the CubeSat and the PocketQube, is highlighted in the structure and ejection logic. The approximated size per unit (1P) is of a cube of 50x50x50 mm, however, unlike the CubeSat which is deployed along its four edges, the PocketQube uses a sliding backplate in order to be ejected from the deployer. Therefore, one of the sides, has slightly different dimensions that are outlined in Figure 2 [1].

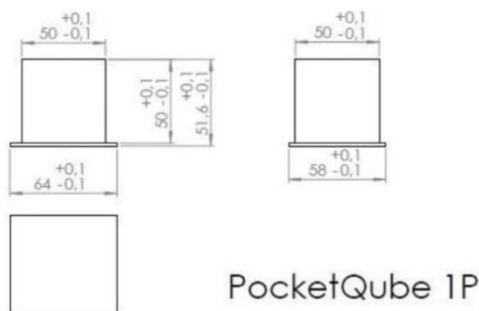

Figure 2 PocketQube dimensions in [mm]

As explained, external dimensions and sliding backplate are different, therefore when combining multiple units, the numbers are as resented in Table 1 which is extracted from the PocketQube Standard [1].

Table 1 PocketQube external dimensions:

Number of Units (P)	External dimensions w/o backplate (mm)	Sliding backplate dimensions (mm)
1P	50x50x50	58x64x1.6
2P	50x50x114	58x128x1.6
3P	50x50x178	58x192x1.6

For more clarification on how the plate slides out of the deployer, see Figure 3.

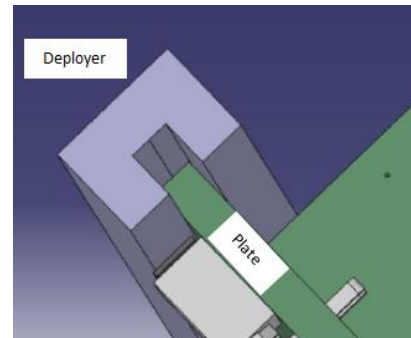

Figure 3 Sliding backplate clamping

The first revision of the published standard [1] presents the mechanical requirements which were the most pressing issues of the development of this type of satellite. Among the dimensions of both the cube and the sliding backplate, other important aspects were clarified in the standard such as: rail clamping dimensions, maximum allowable envelope, kill switches locations and minimum contact surface required.

III. MISSION DESCRIPTION

The overall goal of Delfi-PQ is based on the previous Delfi satellite projects. Previous Delfi mission had clear objectives for education, technology demonstration and innovation. Since TU Delft is a university, the primary goal remains contributing to education in space engineering, however, pioneering this new form factor represents another challenge that TU Delft has embarked on. The plan with respect to PocketQubes is to develop a reliable baseline that will be demonstrated in orbit. From there onwards, advancements to the platform will be made iteratively, trying to find innovative payloads and applications that can fit into the developed platform. Technology demonstration of advanced subsystems is foreseen in the near future, such as micro-propulsion [4], thermal payload, lensless camera, etc. The long term overall goal is to develop 3P PocketQubes and to manage through miniaturization to fit the core bus in 1P, both micro-propulsion and ADCS in 1P and an innovative payload within the remaining 1P.

Well-known Delfi program mission objectives align with the development of the first PocketQube of TU Delft through the following main directions:

1. Education:

As a university, one of the main goals is to pass know-how to students in space engineering field. The idea of having a satellite in the cleanroom on which the students can work and gain hands on experience is meant to teach them (through a Master thesis) as much as possible of what the development of a

satellite means. The long-term goal is to have students experiencing a complete iteration of a satellite, while being responsible for the end-to-end development of a component or subsystem. This aims to prepare them for both the space industry and overall working environment.

2. *Technology demonstration:*

The purpose of this new form factor, apart from testing the applicability and reliability of such a small platform is to demonstrate payloads either that are developed by the teams within the faculty or other made by potential partners. Several payloads that need in orbit demonstration are foreseen at the moment for Delfi-PQ and/or its successor:

- The micro-propulsion team is developing a dual thruster system based on: VML (Vaporizing Liquid Micro-resistojet) and LPM (Low-Pressure Micro-resistojet)[4]. This payload might be integrated to the first Delfi-PQ, however it can be used also for other form factors;
- GPS payload will be integrated on the first launch of Delfi-PQ;
- Thermal payload made by one partner that aims at demonstrating innovative thermal components. This payload will potentially be integrated if the timelines of readiness of payload and planned integration are compatible;
- Radio experiments – as future applications;
- Optical reflector - as future applications;
- Radar calibration experiment – as future applications;

All these are currently potential applications and technologies that can fly this form factor. Depending on the launch date and on the mass & volume budget, more or less payloads than the ones marked as ready can fly on the first Delfi-PQ.

3. *Innovation:*

Given the fact that a PocketQubes is 8 times smaller in volume when compared to a CubeSat, a constellation of 100 or even more PocketQubes launched at once can enable interesting applications (such as optical reflectors, radio and radar experiments) provided there is a frequent launch available. At the moment, Alba Orbital is developing a 96P deployer [5] that is meant to be the size of a 12U CubeSat deployer and being interchangeable.

The **main target** of the first launch of Delfi-PQ is to have a reliable core bus platform that can fit in 1P and to test the overall integrity of the designed structure for this form factor.

i. Structure overview

Delfi-PQ structure fully respects the PocketQube Standard [1] exterior dimensions. The investigations with respect to the inner dimensions and structure were more complicated in terms of optimizing the

utilized space. Research has been conducted whether a 1-stack or 3-stack (Figure 4) of PCBs approach is best.

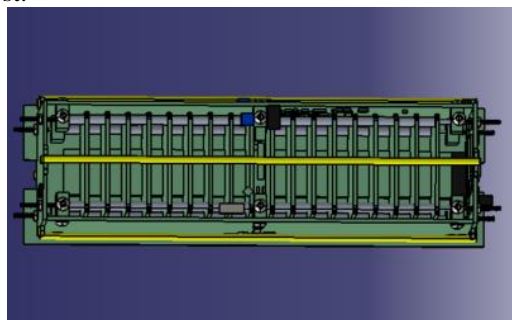

Figure 4 1-stack

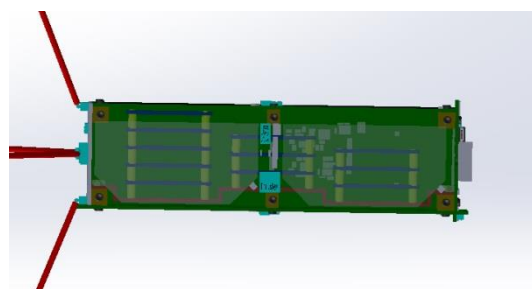

Figure 5 3-stack

After a thorough analysis, the 3 stack approach was discarded for now because of the amount of space lost due to the lower bar (red see Figure 5 3-stack). Therefore, for the first version of the satellite, a 1-stack approach was selected.

The placement of the deployment switches (Figure 6) respect the standard and are in accordance with AlbaPOD which represents the selected deployer for this launch.

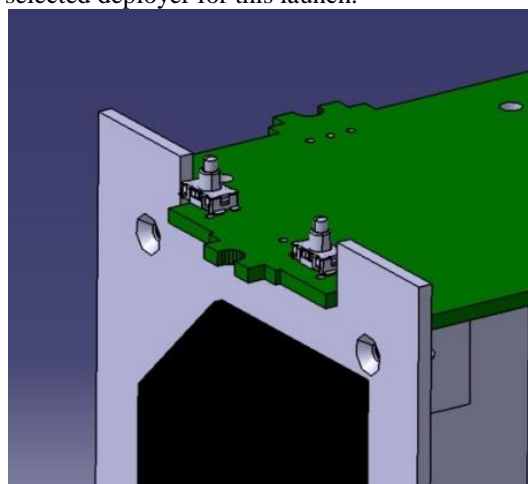

Figure 6 Deployment switches

ii. Core BUS

Antenna – The antenna is planned to operate in UHF and VHF (downlink / uplink) to guarantee

compatibility with the existing equipment at the university and it was selected to have an omnidirectional radiation pattern for ease of operations. The configuration is a dipole with linear polarization realised with two deployable elements (Figure 7 and Figure 8). Due to the fixed length of the antenna (due to the release mechanism), matching is performed electrically, simplifying the design of a multi-band antenna. The deployment system consists of six components which are manufactured and assembled in house.

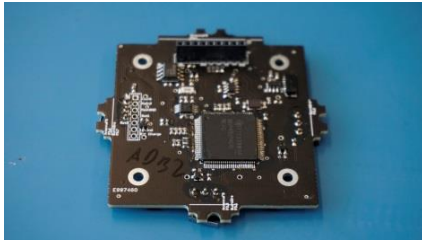

Figure 7 Antenna Board

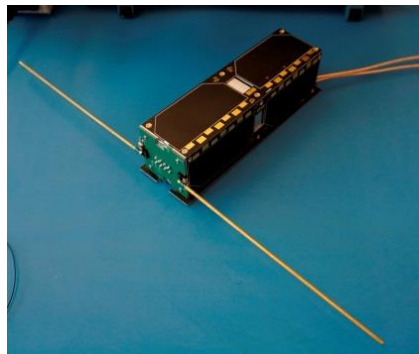

Figure 8 Deployed antennas

Radio – Consists of two sub-components: main board, hosting all the modulation- and demodulation-related components at intermediate frequency, and an RF front-end, hosting the power amplifier and the low-noise amplifier. The current approach has been selected also to allow extending the system to operate in different bands, by keeping a standard intermediate-frequency modem board and extending it with a different RF front-end. The radio can operate in full-duplex over two separate bands (currently UHF for downlink and VHF for uplink).



Figure 9 Radio board

Electrical Power System (EPS) – consists of the battery board (two batteries of 3.7V), main EPS

board (Figure 10) and solar panels (Figure 11). Due to the limited space on the main EPS board, MPPTs have been placed on every solar panel individually. With its dedicated memory, parametric software development and data storage, capabilities have increased [6].

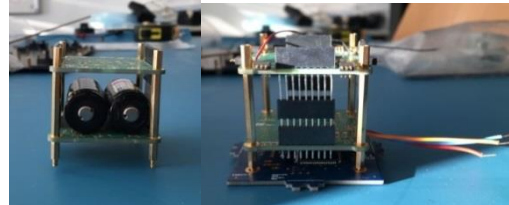

Figure 10 Battery board and EPS board

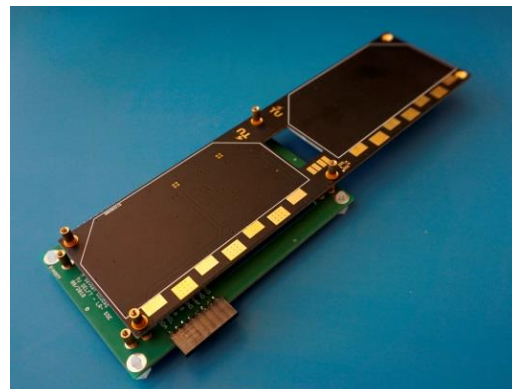
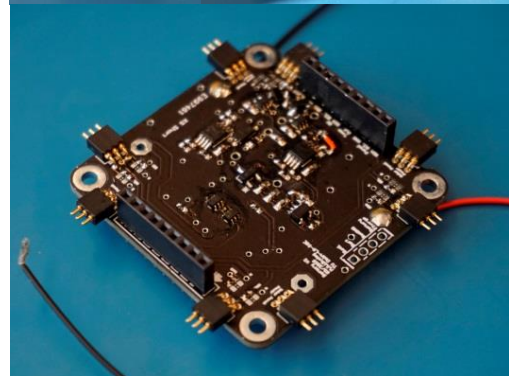

Figure 11 Solar Panels

On-Board Computer (OBC) – has a MSP432 microcontroller and the subsystem (Figure 12) acts as a master for the satellite, implementing all the control logic, described in section IV.



Figure 12 On Board Computer

Attitude Determination and Control System (ADCS) – consists of three magnetorquers (Figure 14) and two IMU. The ADCS (Figure 13) is advanced enough to stabilize the satellite from a maximum rotational speed of 180 degrees/second [12]. The high number comes from previous missions that experienced such a big rotational speed at ejection due to various problems. Indeed, the probability of achieving such rotational speed is low, however additional contingency is welcomed especially at the first launch of a new type of platform. The de-tumbling should stop when the rotational speed reaches 5 degrees/second. For this version of the PocketQube, no Sun sensors are foreseen, however eventually Sun sensors might be added for the next versions.

The integrated magnetometer within the IMU is used for the de-tumbling, taking advantage of the new developments in miniaturized devices for mobile phones.



Figure 13 ADCS

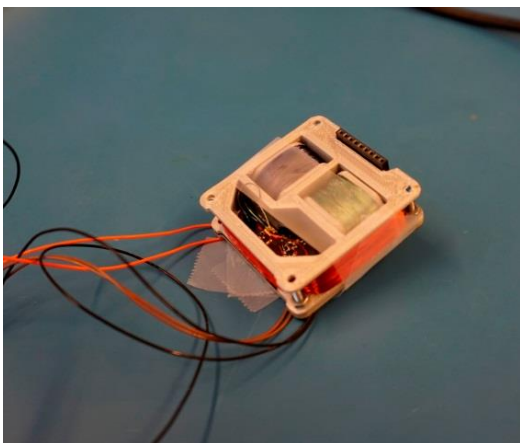

Figure 14 Magnetorquers

iii. Payloads

The most probable payloads to be integrated in the first iteration are:

Thermal Payload - For the first launch of Delfi-PQ, the first payload will be a thermal board designed and manufactured by one of our partners. Provided that the timeframes of launch and delivery for integration are compatible, the thermal payload will be part of Delfi-PQ. The thermal experiment with an innovative

highly conductive link is very flexible. The experiment board will contain a heat source and the power is sunk to another component with sufficient heat capacity. Temperatures are measured in various locations to determine the effective heat flow. Because of the high temporary electrical power demands, an additional battery board might be added. The design of the board respects the PQ9 [7,8] standard and the PocketQube Standard [1].

Micro-propulsion (demonstration payload) – this is the second selected payload that shall be tested on Delfi-PQ because of its current maturity level. Advanced techniques are implemented for propellant storage and acceleration. The main requirements for the demonstration platform are with respect to power consumption, volume and mass: the peak power consumption shall be of maximum 4 W in full thrust, the total wet mass shall be of less than 75 g and the volume including the components shall be within 42x42x30 mm. The micro-resistojet is an ideal candidate for extremely miniaturized satellite platforms, as a consequence of some of its peculiar features, such as: high thrust-to-power ratio, low system mass and versatility when choosing a propellant. The micro-propulsion team intends to use two different resistojet technologies: one based on vaporization of pressurized liquid water and the second based on free molecular acceleration of propellant molecules stored at low pressure. The two different technologies will be implemented on the same PCB [4]. The difference between adapting this payload for PocketQube or for CubeSat consists in the sizing of the tank.

GPS – Considering the recent public attention to pico satellites potential tracking issues [9], a miniaturized GPS receiver based on commercial dual-frequency hardware with modified firmware has been selected. This receiver will allow us to compare the expected satellite position based on TLEs with the actual GPS position to better estimate the “small objects tracking issue”. It should be noted that all the pico-satellites mentioned before are all currently and routinely tracked by NORAD/JSPOC and we expect Delfi-PQ will also be tracked, given the current hardware capabilities of the radar system.

Radio experiment – this experiment takes advantage of the flexibility of the radio system, which allows to select dynamically different modulation schemes and monitor the receiver channel. This experiment will allow to test protocols and schemes not designed for satellite use and better estimate their performances in flight.

The stack configuration for Delfi-PQ is shown in Figure 15:

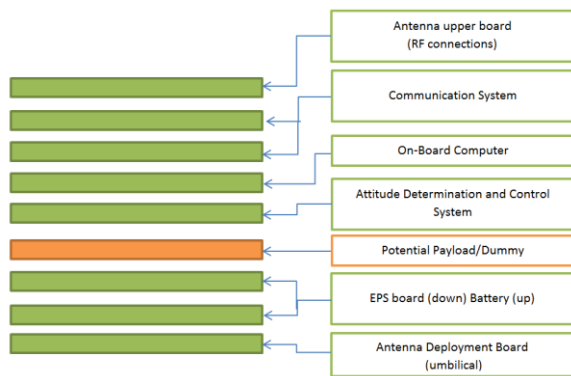

Figure 15 Satellite configuration

Delfi-PQ uses four powerlines (see Table 2) at system level. The main EPS unit powers up/down these lines which means there are only four power consuming switches present, however not all subsystems and payloads can be individually turned off.

Table 2 Powerlines

Power Line	Subsystem/Payload
Main	EPS
V1	On Board Computer, Communication System, MechS
V2	ADCS
V3	Micro-propulsion Payload
V4	Kept for further scientific payloads (e.g. Airbus payload)

The *Antenna Boards* (upper and bottom) form the two extremes of the stack; the former is attached to the antennas and the latter needs to activate the thermal knives upon release of the satellite in space; the boards need to be placed at the extremes because currently the selected antennas are rigid and have approximately the same length as the longitudinal dimension of the satellite.

The *Communication System* needs to be near the *Antenna Support Board (upper)*, to allow a connection between the two systems.

The On-board Computer PCB contains the overall software of the satellite including the FDIR.

The ADCS for now does b-dot, however in the next iterations it is expected to emerge to a subsystem that does also attitude determination and passive control.

Between EPS and ADCS or ADCS and OBC or OBC and Communication system, a payload board can be integrated depending on the TLR of the above-mentioned payloads at the time of launch. If there are no sufficient payloads ready, and depending on the integration process and the deviation of the centre of gravity from centre of mass, dummy boards might be needed in the respective indicated locations.

The *Battery Board* needs to be near the *Electrical Power System*, to allow a connection between the two systems.

iv. Challenges

During mission design and prototyping of main subsystems, several challenges were encountered. Among them, the most important are:

- With respect to miniaturization – for example: stacking options, inner dimensions, rails and spacers, stack height and connector selection, etc.
- With respect to mechanical design – for example: release mechanism of antennas, kill switches placement, inner configuration.
- With respect to standardization – for example: converging to external dimensions with our partners, converging towards the same envelope limit, kill switches placement and minimum contact surface.
- With respect to launch service provider and launch – difficulties in finding a launch service provider. Alba Orbital is currently developing their first PocketQube deployer, therefore TU Delft will be using the AlbaPOD [5] for the first launch.

IV. OPERATIONAL MODES

Because this is the first PocketQube built by the University, it was decided to keep the functionality of the satellite as simple as possible. The operational modes have simple and intuitive loops of functionality and the subsystems have a low number of tasks. The FDIR will be designed in order to be integrated within the modes.

The following operational modes were defined:

OFF Mode:

Technically not an operational mode. The satellite is simply turned off, until the mechanical switch (kill switch) gets unpressed and the satellite gets powered. The analogue protection system can also turn OFF the satellite in case the voltage drops below 2.8 V.

Activation Mode:

The purpose of the Activation Mode is to activate the satellite. Besides the limited amount of subsystems turned on (EPS, OBC and COMMs), the purpose during this mode is to determine whether it is the first time the satellite activates after launch or not.

Deployment Mode:

The purpose of the Deployment mode is to first determine if deployment of antennas occurred and if not, to proceed with deployment.

Safe Mode:

The satellite will automatically switch from almost any mode to Safe mode when certain trigger parameters flag the system to change state. The flags can come under the form of drop in voltage parameters or under the form of failures.

ADCS Mode:

Represents the only mode in which the ADCS is active. A health check of ADCS is performed every time this mode is entered. The purpose is to actuate the magnetorquers in order to reduce the rotational speed of the satellite up to 5 degrees/s on all three axes.

Nominal Mode

Once the activation of the satellite has occurred and the satellite has gone through the ADCS mode accordingly and has established the health status of the subsystems, Nominal Mode is entered. The core subsystems will be turned to their states according to Table 3. Initially the subsystems are duty cycled based on the Power Budget. At later stages, if it turns out that from the housekeeping data the satellite consumes more/less power than expected, the initially indicated duty cycles can be adapted. The nominal mode is the only mode in which the payload will be switched on.

The following tasks are foreseen now for the OBC during nominal mode:

- Check and execute commands one by one;
- Collect telemetry every 10 s and store telemetry;
- Send telemetry;
- ADCS sensing
- Payload loop;

Boot Sequence

The boot sequence (Figure 16) explains the modes through which the satellites needs to pass before reaching nominal mode, after a general reset was performed.

The boot sequence starts with the health check and continues with passing through activation mode in order to determine that the timer of 30 minutes (after ejection) was consumed. During the boot sequence, the deployment mode is entered to determine if deployment was done (successfully or unsuccessfully), thus entering further in safe mode. The two conditions of exiting safe mode that need to be satisfied are not having an active failure flag on board (can be by-passed by ground intervention) and voltage parameters need to be above the given threshold. ADCS mode is entered next and first step is to determine if the ADCS was or not disabled. If the ADCS is still enabled, the rotational speed is assessed and it is determined if de-tumbling should be activated or not. De-tumbling is stopped either

because the desired rotational speed is reached, FDIR flagged an error, or the ground turns off de-tumbling through ground station intervention. After all these modes are passed and exit conditions are satisfied, nominal mode can be entered.

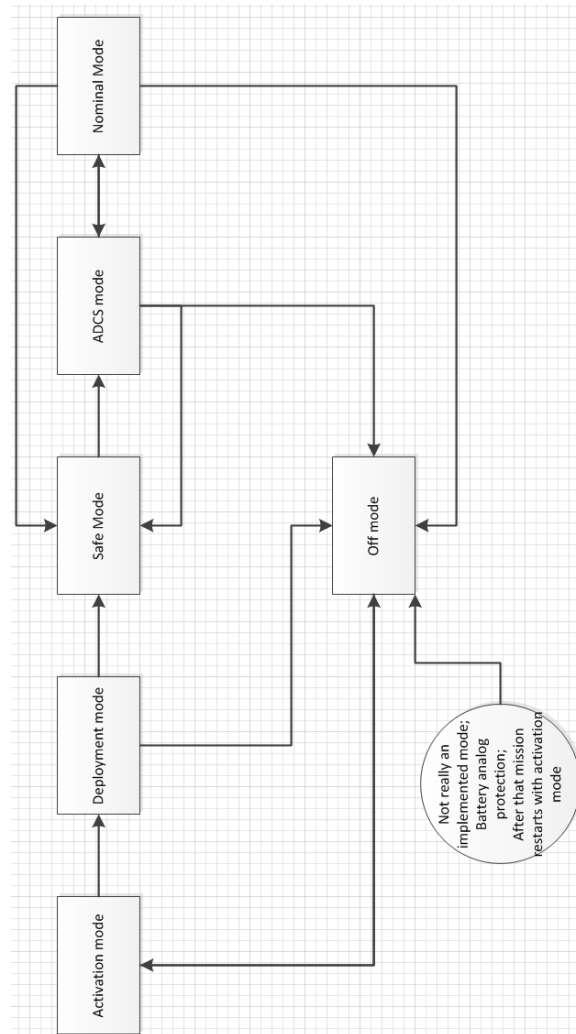

Figure 16 Modes sequence

Table 3 Subsystem status per each mode:

	OFF	Activation	Deployment	Safe	ADCS	Nominal
EPS	Off	On	On	On	On	On
OBC	Off	On	On	On	On	On
COMMS	Off	Receive	Receive	Receive transceiver	Receive transceiver	Receive transceiver
MechS	Off	Idle	Deployment	Idle	Idle	Idle
ADCS	Off	Off	Off	Off	On	Sensing

The FDIR system is a core satellite systems engineering activity that starts at mission design and ends with decommissioning. In this particular case and given the low complexity of the mission, the FDIR will be simple and deterministic. It will be based on overpassing thresholds for various components and subsystems. These thresholds can depend not only on the component technical specification but also on the current operational mode. It is desired that the created FDIR is integrated in the operational modes loops in order to add simplicity to the system. In the future it is expected that the complexity of this system will increase because of the added sophisticated payloads and subsystems. Therefore, it is anticipated that in the future the FDIR will need a total redesign in order to assure its robustness and limited opportunities of transferable errors between components/subsystems.

V. TESTING AND LAUNCHING

FlatSat testing

The purpose of the FlatSat (Figure 17) is to check all electrical connections, all communications between components and the overall systems before the final integration. The aim is to prove that all subsystems are fully-functional by using the created electronic workbench and end-to-end test communications between all boards.



Figure 17 Delfi-PQ FlatSat

The launch is expected to occur in 2019 with a Vector-R rocket [10] as the first orbital launch of the newly formed company.

The opportunity came sooner than the planned launch of Delfi-PQ (Q1 2020), therefore a lot of potential payloads and advanced subsystems had to be dropped in order to be able to take advantage of this opportunity. Due to the time constraint of the Vector launch, it is desired that at first the engineering model of Delfi-PQ to be tested for Random Vibration, Sinusoidal Vibration, Thermal Vacuum Cycling or Steady state testing (hot and cold case) and Thermal Vacuum Bake-Out (in TU Delft’s own facilities). Vibration tests will be performed for both the Dispenser (Alba Orbital) and PocketQubes. Moreover, a duration test of Delfi-PQ shall be done (e.g. 1 week duration test).

The following table provides the information with respect to what tests shall be done as recommended in general for CubeSats:

Table 4 Environmental Tests

Type of Test	Qualification	Acceptance
Random vibration	Required	Required
Sinusoidal vibration	Required for contents that were not covered by random vibration	Required for contents that were not covered by random vibration
Shock	Not required	Not required
Thermal vacuum Cycle	Recommended	Recommended
Thermal vacuum Bake-out	Not required – unless it is demanded prior to vacuum	Required
Duration test	Not required, but recommended	Not required, but recommended

Given the fact that Vector will be at its first launch, previously used parameters [11] were considered as a reference until the launch requirements are provided.

Random Vibration:

	Range	Qualification	Acceptance
Axis		X,Y,Z	X,Y,Z
Profile	Frequency range [Hz]	Amplitude [g ² /Hz]	Amplitude [g ² /Hz]
	20-40	0.007	0.004
	40-80	0.007	0.004
	80-160	0.007-0.022	0.004-0.014
	160-320	0.022-0.035	0.014-0.022
	320-640	0.035	0.022
	640-1280	0.035-0.017	0.022-0.011
	1280-2000	0.017-0.005	0.011-0.003
Acceleration		6.5[g]	5.2[g]
Time		35[seconds/axis]	35[seconds/axis]

Sine Vibration:

	Range	Qualification	Acceptance
Axis		X,Y,Z	X,Y,Z
Profile	Frequency range [Hz]	Amplitude [g]	Amplitude [g]
	5-10	0.5	0.4
	10-15	1.0	0.8
	15-20	0.5	0.4
Sweep rate		2[oct/min]	2[oct/min]

During all vibration tests, it is desired that the PocketQubes are the internal components of the dispenser assembly. Since the dispenser is a 6P deployer and the two PocketQubes that will fly within the dispenser are of 3P each, it is desired to have dummy masses that can replace the satellites. When the vibration tests are performed, inside the deployer shall always be one satellite with one dummy mass of the respective dimensions volume and mass of the other satellite. This action is preferred in order to minimize the damage that could be made to one satellite due to the other.

Before and after each type of vibration test, a functional test will be perform in order to

demonstrate the integrity of the system. Vibration test is scheduled for end of January.

Thermal Bake-Out:

	Qualification	Acceptance
Temperature	-	+50 C
Vacuum level	-	10 ⁻⁵ [mbar]
duration	-	24h

Thermal Vacuum Cycling:

	Qualification	Acceptance
TVac test	Required	Recommended
Min. temp	-20 ± 2°C	
Max. Temp	+50 ± 2°C	
Temp variation rate	≥1°C/min	
Dwell time	1h at extreme temp	
Vacuum	10 ⁻⁵ mBar	
cycles	4	

As previously mentioned, the first launch of Delfi-PQ is offered by Vector – a newly formed company that intends to develop a family of small launchers in order to assure frequent launching opportunities for payloads of up to 65 kg mass [10]. Delfi-PQ will be integrated on-board Vector-R. According to the Vector-R Specifications and user guide, the intention is to assure long-term frequent launches in LEO Sun Synchronous Orbit at altitudes of up to 1000km depending upon payload and inclination. For the first launch, an altitude of 350 km is desired. This would imply an orbit lifetime of approximately 150 days for Delfi-PQ.

VI. CONCLUSIONS

This paper has showcased a new miniaturized satellite designed and developed by TU Delft, based on the created PocketQube Standard. The main aim of this paper was to present the overview of the first PocketQube of TU Delft and the current stage of the mission. Our recent collaboration with Alba Orbital, provided TU Delft with a potential deployer to be used for the first launch. In order to avoid mismatches between the exterior dimensions of the PocketQube and the inner dimensions of the provided deployer, a standard was published as a joint collaboration between TU Delft, Alba Orbital and GAUSS Srl., the three main European players in the PocketQube community in order to facilitate further developments and applications based on PocketQubes.

Acknowledgement:

The authors would like to thank to Michael van den Bos for the work done in magnetorquer calculations and winding which helped the overall ADCS subsystem development.

REFERENCES

- [1] "The PocketQube Standard", TU Delft, Alba Orbital, GAUSS Srl., July 2018; <https://hdl.handle.net/10411/L00Q5S> <https://dataverse.nl/api/access/datafile/11680>;
- [2] Cappelletti, Chantal and Battistini, Simone and Graziani, Filippo; Advances in Space Research- "Small Launch Platforms for Microsatellites";
- [3] Cappelletti, C., 2018. "Femto, pico, nano: overview of new satellite standards and applications." In: Advances in Astronautical Sciences, Proceedings of the 4th IAA Conference on University Satellite Missions and CubeSat Workshop, vol. 163, pp. 503–510;
- [4] V. Pallichadath, L. Turmaine, M. de Athayde Costa e Silva, D.C. Guerrieri, D. Maxence, M.S. Uludag, B. Zandbergen, A. Cervone, "IN-ORBIT MICRO-PROPULSION DEMONSTRATOR FOR PICO-SATELLITE APPLICATIONS", IAF 69th International Astronautical Congress, Bremen, Germany, October 2018;
- [5] Alba Orbital Deployers: <http://www.albaorbital.com/deployers/>
- [6] M.S. Uludag, S. Spretta, j. Bouwmeester, E. Gill, T. PerezSriano - "A New Electrical Power System Architecture for Delfi-PQ" - IAA-AAS-CU-17-07-03;
- [7] "PQ9 and CS14 Electrical and Mechanical Subsystem Interface Standard for PocketQubes and CubeSats", Version 1.0: <https://hdl.handle.net/10411/3V8RUE>;
- [8] J. Bouwmeester, S.P. van der Linden, A. Povalac, E.K.A. Gill – "Towards an innovative electrical interface standard for PocketQubes and CubeSats", Advances in Space Research, April 2018;
- [9] Mark Harris – "FCC Accuses Stealthy Startup of Launching Rouge Satellites" – IEEE Spectrum: <https://spectrum.ieee.org/tech-talk/aerospace/satellites/fcc-accuses-stealthy-startup-of-launching-rouge-satellites> ;
- [10] Vector Company: <https://vector-launch.com/> ;
- [11] QB50 Systems Requirements and Recommendations, Issue 7, 13th of February 2015.
- [12] R. Fonod, E.K.A. Gill, "Magnetic De-tumbling of Fast-tumbling Picosatellites", 69th International Astronautical Congress, Bremen, Germany, October 2018;