

Impact of primary sedimentation on granulation and treatment performance of municipal wastewater by aerobic granular sludge process

Kosar, Sadiye; Isik, Onur; Cicekalan, Busra; Gulhan, Hazal; Sagir Kurt, Ece; Atli, Ezgi; Basa, Safak; Ozgun, Hale; van Loosdrecht, Mark C.M.; More Authors

DOI

[10.1016/j.jenvman.2022.115191](https://doi.org/10.1016/j.jenvman.2022.115191)

Publication date

2022

Document Version

Final published version

Published in

Journal of Environmental Management

Citation (APA)

Kosar, S., Isik, O., Cicekalan, B., Gulhan, H., Sagir Kurt, E., Atli, E., Basa, S., Ozgun, H., van Loosdrecht, M. C. M., & More Authors (2022). Impact of primary sedimentation on granulation and treatment performance of municipal wastewater by aerobic granular sludge process. *Journal of Environmental Management*, 315, Article 115191. <https://doi.org/10.1016/j.jenvman.2022.115191>

Important note

To cite this publication, please use the final published version (if applicable).
Please check the document version above.

Copyright

Other than for strictly personal use, it is not permitted to download, forward or distribute the text or part of it, without the consent of the author(s) and/or copyright holder(s), unless the work is under an open content license such as Creative Commons.

Takedown policy

Please contact us and provide details if you believe this document breaches copyrights.
We will remove access to the work immediately and investigate your claim.

Green Open Access added to TU Delft Institutional Repository

'You share, we take care!' - Taverne project

<https://www.openaccess.nl/en/you-share-we-take-care>

Otherwise as indicated in the copyright section: the publisher is the copyright holder of this work and the author uses the Dutch legislation to make this work public.

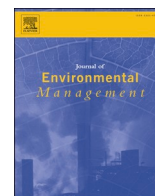

Research article

Impact of primary sedimentation on granulation and treatment performance of municipal wastewater by aerobic granular sludge process

Sadiye Kosar^{a,*}, Onur Isik^{a,b}, Busra Cicekalan^a, Hazal Gulhan^a, Ece Sagir Kurt^c, Ezgi Atli^c, Safak Basa^c, Hale Ozgun^{a,b}, Ismail Koyuncu^{a,b}, Mark C.M. van Loosdrecht^d, Mustafa Evren Ersahin^{a,b}

^a Istanbul Technical University, Civil Engineering Faculty, Environmental Engineering Department, Ayazaga Campus, Maslak, 34469, Istanbul, Turkey

^b National Research Center on Membrane Technologies, Istanbul Technical University, 34469, Maslak, Istanbul, Turkey

^c ISKI, Istanbul Water and Sewerage Administration, Eyup, 34060, Istanbul, Turkey

^d Delft University of Technology, Department of Biotechnology, van der Maasweg 9, 2629 HZ, Delft, the Netherlands



ARTICLE INFO

Keywords:

Aerobic granular sludge
Granulation
Municipal wastewater
Primary sedimentation
Wastewater treatment

ABSTRACT

Aerobic granules contain microorganisms that are responsible for carbon, nitrogen, and phosphorus removal in aerobic granular sludge (AGS) process in which aerobic/anoxic/anaerobic layers (from surface to core) occur in a single granule. Optimizing the aerobic granular sludge (AGS) process for granulation and efficient nutrient removal can be challenging. The aim of this study was to examine the impact of settling prior to AGS process on granulation and treatment performance of the process. For this purpose, synthetic wastewater mimicking municipal wastewater was fed directly (Stage 1), and after primary sedimentation (Stage 2) to a laboratory-scale AGS system. In full-scale wastewater treatment plants, primary sedimentation is used to remove particulate organic matter and produce primary sludge which is sent to anaerobic digesters to produce biogas. Performances obtained in both stages were compared in terms of treatment efficiency, granule settling behavior, and granule morphology. Granulation was achieved in both stages with more than 92% chemical oxygen demand (COD) removal efficiencies in each stage. High nutrient removal was obtained in Stage 1 since anaerobic phase was long enough (i.e., 50 min) to hydrolyze particulate matter to become available for PAOs. Primary sedimentation caused a decrease in influent organic load and COD/N ratio, as a result, low nitrogen and phosphorus removal efficiencies were observed in Stage 2 compared to Stage 1. With this study, the effect of the primary sedimentation on the biological removal performance of AGS process was revealed. COD requirement for nutrient removal in AGS systems should be assessed by considering energy generation via biogas production from primary sedimentation sludge.

1. Introduction

The use of aerobic granular sludge (AGS) technology, that employs both autotrophic and heterotrophic microorganisms for the removal of chemical oxygen demand (COD), nitrogen (N) and phosphorus (P), is rapidly expanding (Winkler et al., 2015). With proper operation conditions applied in the AGS process, microorganisms come together, and layered granules are formed. Generally, sequencing batch reactors (SBRs) are used in AGS systems (Bengtsson et al., 2018; Sengar et al., 2018). SBRs are operated in a cyclic mode, that comprises different phases such as anaerobic filling, aeration, settling, and discharge, often supplemented with an idle phase. With the help of discontinuous

operation in SBRs, microorganisms are exposed to high substrate concentration in the feeding phase and thus substrate can diffuse into inner layers of granules. It was shown that substrate cannot diffuse in deeper layers in continuously fed reactors (Beun et al., 2002). To achieve appropriate N removal, dissolved oxygen (DO) concentration in the aeration phase is controlled to allow denitrification taking place in the inner layers (de Kreuk et al., 2005). When the AGS reactor is fed under anaerobic conditions, polyphosphate-accumulating organisms (PAOs) form the core microbial group in the granules and enhanced biological P removal (EBPR) can be achieved in AGS process (Coma et al., 2012). Moreover, biologically induced precipitation of calcium and magnesium phosphate plays a role in P removal in AGS systems (de Kreuk et al.,

* Corresponding author.

E-mail address: sadiye.kosar@outlook.com (S. Kosar).

<https://doi.org/10.1016/j.jenvman.2022.115191>

Received 22 December 2021; Received in revised form 8 April 2022; Accepted 25 April 2022

Available online 5 May 2022

0301-4797/© 2022 Elsevier Ltd. All rights reserved.

2005).

Since N and P removal strongly depends on the microbial composition of the granules, optimization of the system to promote nitrifiers, denitrifiers, and PAOs is required, which is quite challenging. PAOs are in competition with denitrifiers (Lochmatter et al., 2014) and with glycogen-accumulating organisms (GAOs) for available organic matter (de Kreuk et al., 2005). Some factors that affect nutrient removal in AGS systems are organic loading rate (OLR), availability of readily biodegradable organics in the substrate, the presence of oxygen in the feed period, and the duration of the anaerobic period. The OLR should be high enough for denitrifiers and PAOs (Liu and Tay, 2015). However, the anaerobic phase should be long enough to consume all of the readily biodegradable substrates (Bengtsson et al., 2018). Otherwise, the presence of readily biodegradable substrate in the aerobic phase leads to the domination of ordinary heterotrophs over PAOs (Haaksman et al., 2020). Derlon et al. (2016) achieved high $\text{NH}_4^+\text{-N}$ and P removal efficiencies in the AGS system with low-strength wastewater. Nevertheless, they pointed out that the lack of available carbon caused a lack of sufficient anoxic volume in granules and thus resulted in partial denitrification. The size of organic matter in the substrate also affects the performance of AGS systems. Dissolved organic matter removal efficiency (80%) was reported to be much higher than particulate organic matter (particle diameter $>50\ \mu\text{m}$) in AGS systems (43%) (Schwarzenbeck et al., 2004). Particulate organic matter present in the substrate is important because particulate matter is hydrolyzed on the surface of the granules in anaerobically fed AGS systems. Then, readily biodegradable organics, that are available to be uptaken by PAOs, are released via hydrolysis and can reach the inner parts of the granules. de Kreuk et al. (2010) showed that, if anaerobic phase was kept short, non-hydrolyzed material became available to aerobic heterotrophic and filamentous microorganisms that existed at the surface of granules. This situation caused a decrease of 40% and 46% in N and P removal in AGS process, respectively. In the same study, when the system is fed with wastewater with particulate matter in it, there was a decrease in PAOs accumulation since particulate matters are too big to diffuse into the inner parts of the granules, where PAOs are more likely to be found and thus resulted in a decrease in P removal in the system. Layer et al. (2019) reported, similar to the findings of de Kreuk et al. (2010), an adverse effect of particulate matter in raw wastewater on granulation and treatment performance of AGS. They mentioned that 1–2 h of anaerobic phase was not long enough. Thus, remaining particulate matter was hydrolyzed in aerobic phase and became available for ordinary heterotrophic organisms, which has slowed down granulation (Layer et al., 2019).

Treatment of raw municipal wastewater with AGS process can be much tricky because of the particulate matter fraction presented in the influent. To overcome the downside of particulate matter presence in the influent, anaerobic filling time can be increased in plug-flow reactors to accomplish hydrolysis of particulate matter into readily biodegradable matter and achieve stable granules (de Kreuk et al., 2005; Wagner et al., 2015). Besides, applying simultaneous fill-draw mode in the operation of AGS systems with decreasing effluent withdraw rate to reduce selection pressure was suggested (Wagner et al., 2015). Decreasing the total cycle time, and thus increasing the OLR would be beneficial for nutrient removal (Yu et al., 2021). Another way to decrease the adverse effect of particulate matter on granulation may be the removal of particulate matter from raw wastewater via primary sedimentation. Since particulate matter in the raw wastewater would be removed through primary sedimentation, ordinary heterotrophic and filamentous growth on the surface of aerobic granules would be hindered. Therefore, organic matter can reach to the core of the granules. Additional benefit of using primary sedimentation would be the energy recovery via anaerobic digestion of primary sludge. However, organic load loss with removed particulate matter in primary sedimentation can cause low denitrification or P removal, since it would promote the competition for carbon between denitrifiers and PAOs under anaerobic conditions in the inner part of the granules.

Table 1

Characterization of the synthetic municipal wastewater in Stage 1 and Stage 2.

Parameter	Unit	Concentration	
		Stage 1 (Average \pm SD)	Stage 2 (Average \pm SD)
COD	mg/L	512 \pm 6	393 \pm 3
pCOD	mg/L	205 \pm 5	79 \pm 6
TSS	mg/L	231 \pm 9.9	31.6 \pm 1.7
Total nitrogen (TN)	mg/L	49.0 \pm 1.0	48.0 \pm 2.6
$\text{NH}_4\text{-N}$	mg/L	9.6 \pm 0.6	10.4 \pm 0.6
Total Phosphorus (TP)	mg/L	9.1 \pm 0.2	4.0 \pm 0.2
Turbidity	NTU	108.3 \pm 1.8	11.2 \pm 0.3
pH	–	8.5 \pm 0.05	8.4 \pm 0.07
COD/TN	–	10.5 \pm 0.2	8.2 \pm 0.5

SD: Standard deviation.

The aim of this study was to examine the impact of settling prior to AGS process on the granulation and treatment performance of the process. To evaluate the sole effect of primary sedimentation, synthetic wastewater mimicking municipal wastewater was fed to AGS system directly and after pre-sedimentation. The treatment efficiency, settling behavior of the granules, and granule morphology were evaluated. The results obtained from this study will provide significant information to both process designers and decision makers about the design and operation of AGS processes.

2. Material and methods

2.1. Wastewater and seed sludge characteristics

Two stages have been applied in this study. In Stage 1, synthetic municipal wastewater was directly fed to the AGS reactor, whereas pre-settled synthetic municipal wastewater was fed to the reactor in Stage 2. Synthetic wastewater that represented medium-strength municipal wastewater was prepared on daily basis. Starch was used to mimic particulate matter in synthetic wastewater. The composition of the synthetic wastewater can be found in our previous study (Isik et al., 2019). In Stage 2, synthetic wastewater settled for 30 min and the supernatant taken from the sampling port was directly fed to the AGS reactor. Influent characterization of Stage 1 and Stage 2 are given in

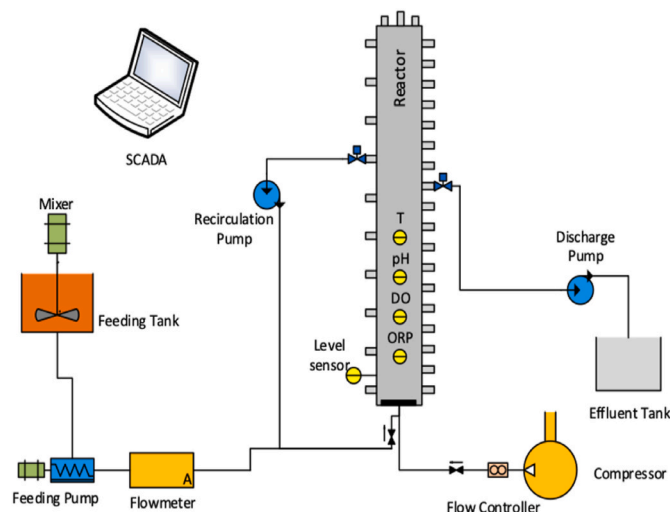

Fig. 1. Experimental setup.

Table 1. Particulate COD (pCOD) concentration of the wastewater decreased from 205 ± 5 mg/L to 79 ± 6 mg/L after sedimentation.

Seed sludge was obtained from the return activated sludge line of a full-scale municipal wastewater treatment plant. Total suspended solids (TSS) concentration of the seed sludge was $10,800 \pm 339$ mg/L and volatile suspended solids (VSS) concentration was 7572 ± 234 mg/L. Seed sludge's COD concentration was $14,029 \pm 471$ mg/L and sCOD/COD ratio was $1 \pm 0.02\%$. Median particle size (d_{50}) of the seed sludge was 44 ± 9.9 μm . Sludge volume index₅ (SVI₅) and SVI₃₀ values of seed sludge were 142 ± 8 mL/g and 69 ± 1 mL/g, respectively. Capillary suction time (CST) of seed sludge was measured as 17 ± 1.3 s and normalized CST was calculated as 1.6 ± 0.1 s/g TSS/L.

2.2. Experimental setup

The experimental setup (Fig. 1) consisted of a plexi-glass reactor with a height of 180 cm and a diameter of 10 cm. Influent was fed to the reactor from the bottom via mono pump (Seepex, Germany), and flowrate was measured via flowmeter (IFM, Germany). Effluent was collected from the discharge valve via peristaltic pump (Lead Fluid, China). Another peristaltic pump (Lead Fluid, China) was used to for recirculation during anaerobic phase. Air was fed to the reactor via a custom-made rubber diffuser. The system consisted of online sensors including temperature (Meter, Turkey), pH (Kuntze Instrument, Germany), DO (Aqualabo, France), oxidation reduction potential (ORP) (Kuntze Instrument, Germany), and level sensors (IFM, Germany). The whole system was equipped with a supervisory control and data acquisition (SCADA) system. Additionally, energy consumption of pumps, aeration system and automation system are monitored via energy analyzers (Novus, Brazil). A tank with 150 L volume was used to settle particulate matter in Stage 2.

2.3. Operational conditions

The reactor was filled with seed sludge prior to each operational condition. Similar operation strategy was applied for each stage. The AGS reactor was operated as a SBR with simultaneous fill/draw. Water level in the reactor was kept at 150 cm (height to diameter (H/D) ratio was 15) and volume exchange ratio (VER) of the system was kept at 50%. Total SBR cycle time was 240 min with 30 min of feed/decant (30 min fill/10 min decant) phase, 50 min of anaerobic phase, 128 min of aerobic phase, 30 min of settling phase, and 2 min of idle phase. OLR in Stage 1 and Stage 2 was 1.54 ± 0.02 kg COD/m³ day and 1.18 ± 0.01 kg COD/m³ day, respectively.

For the application of sedimentation in Stage 2, synthetic municipal wastewater was filled into the settling tank and mixed to have homogeneity. After the mixer was turned off, wastewater settled for 30 min, and the supernatant was collected to be fed to the AGS process. The surface loading rate of the sedimentation process was 1.47 m³/m² h.

2.4. Analytical methods

2.4.1. Experimental methods applied to influent and effluent samples

TSS, VSS, COD, TN, NH₄-N and TP parameters were measured according to Standard Methods (APHA, 2017). To measure sCOD, sample was filtered through 0.45 μm filter (Sartorius, Germany) prior to measurement. pCOD concentration was calculated via subtracting sCOD from total COD concentration. A turbidimeter (Hach 2100P, USA) was used for turbidity measurement. Nitrite and nitrate concentrations were measured by using ion chromatography system (Dionex ICS-300, USA). Particle size distribution (PSD) of sludge samples were measured by Mastersizer 2000 (Malvern Instruments, Hydro 2000 MU, UK).

2.4.2. Experimental methods applied to sludge samples

2.4.2.1. Sludge characteristics. Extracellular polymeric substances (EPS) were extracted according to high temperature-sodium carbonate (Na₂CO₃) extraction method given by Felz et al. (2016). After the extraction, the supernatant was collected to measure protein and carbohydrate concentrations. The method described in Dubois et al. (1956) was applied to measure carbohydrate and glucose (D-glucose monohydrate) was used as standard. Modified Lowry method (Frolund et al., 1995) was applied to measure protein and bovine serum albumin (BSA) was used as standard in measurements.

The integrity coefficient (IC) of aerobic granules was measured using the method described in the study of Ghangrekar et al. (1996). IC is an indicator of granule strength and expressed as the ratio of solids in supernatant to the total weight of the granular sludge (Ghangrekar et al., 1996). Higher IC value shows that strength of granules is lower.

Specific granule density was measured with a pycnometer (van Loosdrecht et al., 2016). In order to determine the diameter of the granules, stereomicroscope (S8AP0, Leica Microsystems, Germany) was used. Before microscopic examination, sludge was sieved through three different mesh sized sieves (from top to bottom: 2 mm, 1 mm and 0.5 mm) (van Loosdrecht et al., 2016) and washed with tap water to remove floccular sludge. Granules were divided into three groups based on their diameters: 0.5–1 mm, 1–2 mm, and >2 mm. To determine the actual diameter of the granules, five granules were selected randomly from each group and examined under light microscopy. PSD of the sludge was measured by Mastersizer 2000 (Malvern Instruments, Hydro 2000 MU, UK). To measure capillary suction time of sludge, a CST analyzer with 18 mm funnel (Triton Electronics, Type 304 M, UK) was used. To minimize the effect of suspended solids concentration on CST, normalized CST value was calculated by dividing CST to TSS concentration of sludge (Khan et al., 2008; Ersahin et al., 2014).

The surface morphology of granules was captured by an environmental scanning electron microscopy (ESEM) (Thermo Fisher Scientific, FEI Quanta FEG 250, USA). Samples were coated with palladium and gold (Pd-Au) by using a vacuum evaporator (Quorum SC7620, UK) to increase the conductivity. ESEM was coupled with an energy dispersive X-ray (EDX) spectroscopy (Ametek Edax Apollo X, USA), that was used to identify the major elements on the surface of the granules. Fourier transform infrared spectroscopy (FTIR) (PerkinElmer, Spectrum 100, USA) was used to identify organic materials on the surface of granules. FTIR spectra were recorded in the range of 400–4000 cm⁻¹. Confocal laser scanning microscopy (CLSM) (Nikon, Japan) was used to identify living/dead organisms on the surface of granules. Granules were stained with Live/Dead BacLight™ Bacterial viability kit (ThermoFisher Scientific, USA) prior to CLSM analysis. The visualization was performed by using the NIS-Elements AR 4.10.01 software (Nikon, Japan). The staining solution was prepared according to the recipe given by Isik et al. (2019). Samples were dried prior to ESEM, FTIR and CLSM analysis.

2.4.2.2. Settling analysis. SVI₃₀ measurement was conducted according to Standard Methods (APHA, 2017). SVI₅ and SVI₁₀ were determined by recording height of the settled sludge after 5 and 10 min of settling, respectively (van Loosdrecht et al., 2016). To determine the settling velocities of aerobic granules, a glass settling column with 6.5 cm diameter and 50 cm height was filled with tap water prior to each settling velocity analysis. The time for an individual granule to settle completely was recorded. Batch settling curves of the granules were created using the method described by van Loosdrecht et al. (2016). In this method, sludge sample was filled into a graduated cylinder and sludge blanket height was recorded at different time intervals.

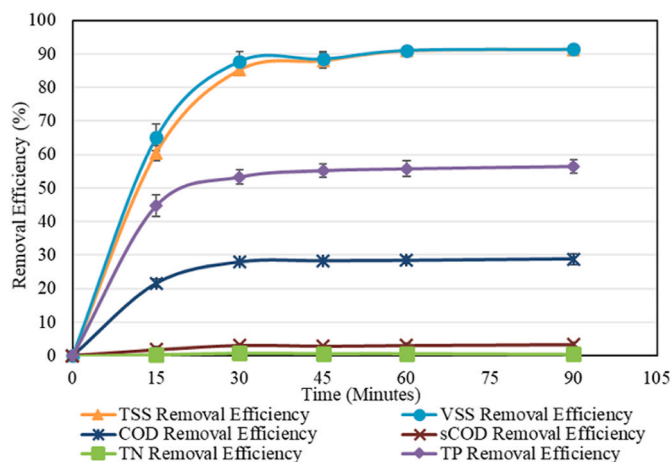

Fig. 2. Removal efficiencies of different parameters during pre-settling experiments.

3. Results and discussion

3.1. Pre-settling experiments

Pre-settling experiments were conducted to determine the optimum settling time for TSS, VSS, COD, sCOD, TN, and TP removal efficiencies (Fig. 2). Primary sedimentation caused less than 4% sCOD and less than 1% TN removal efficiencies as expected. TSS, VSS, COD, and TP removal efficiencies during primary sedimentation did not change significantly after 30 min. COD removal efficiency of primary sedimentation was 22% at 15 min and it increased to 28% at 30 min, while TP removal efficiency was 45% at 15 min and increased to 53% at 30 min. TSS and VSS removal efficiencies after 15 min of settling were 60% and 65%, respectively. Significant increases to 85% and 88% were observed after 30 min of settling in TSS and VSS removal efficiencies, respectively. According to the results in Fig. 2, 30 min of settling was selected as the

optimum time. Primary sedimentation decreased COD/TN ratio from 10.5 ± 0.3 to 8.3 ± 0.5 .

3.2. Effect of pre-settling on treatment performance

Treatment performances of the AGS process for different parameters obtained in each stage are provided in Fig. 3. AGS system was fed with synthetic municipal wastewater directly in Stage 1, and the system reached to steady state conditions at 91st day and 61st day of the operation period in Stage 1 and Stage 2, respectively. After reaching steady state conditions, average COD removal efficiencies were over 92% in both stages (Fig. 3 (a)). Average TN removal efficiency was $81.2 \pm 1.8\%$ in Stage 1, while it was only $38.7 \pm 6.0\%$ in Stage 2. Since $\text{NH}_4\text{-N}$ removal efficiency in each stage was over 89% (Fig. 3 (d)), it can be confirmed that nitrification was not influenced by pre-settling. However, denitrification was severely hampered when pre-settled influent was used. Nitrite concentrations in the influent and effluent were $<0.06 \text{ mg NO}_2\text{-N/L}$ in each stage, indicating full nitrification. Average nitrate concentrations of the effluent in Stage 1 and Stage 2 were $6.3 \pm 1.1 \text{ mg NO}_3\text{-N/L}$ and $23.3 \pm 1.8 \text{ mg NO}_3\text{-N/L}$, respectively. A study on AGS process fed with low-strength domestic wastewater reported that 90% of COD and ~95% of $\text{NH}_4\text{-N}$ removal efficiencies could be achieved (Ni et al., 2009), which is consistent with the results obtained in this study. While average effluent TP concentration obtained in Stage 1 was $0.94 \pm 0.44 \text{ mg/L}$, it was $2.70 \pm 0.24 \text{ mg/L}$ in Stage 2. AGS processes treating wastewaters including particulate matter requires long anaerobic period to provide enough time for hydrolysis of particulates to soluble forms, that is available for anaerobic microorganisms inside the granules (Wagner et al., 2015). In this way, in aerobic phase, attached remaining particulate matter on granule surface is minimized, thus growth of ordinary heterotrophic microorganisms that promote degranulation and filamentous growth can be avoided. Anaerobic period of 50 min applied in this study was found to be enough to hydrolyze particulate matter in Stage 1. On the other hand, when particulate matter in the influent was removed by primary sedimentation, COD/TN ratio was decreased by 22%, thus there was less carbon in anaerobic

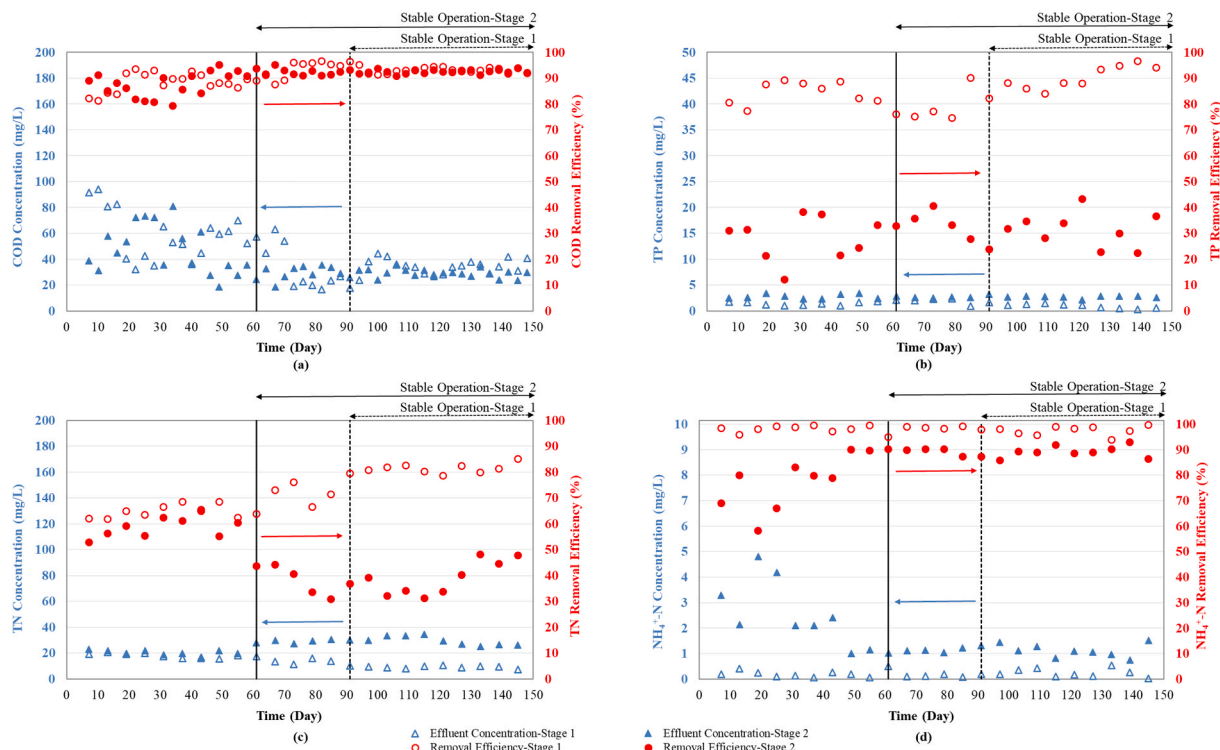

Fig. 3. AGS treatment performance in each stage: (a) COD, (b) TP, (c) TN, (d) $\text{NH}_4\text{-N}$.

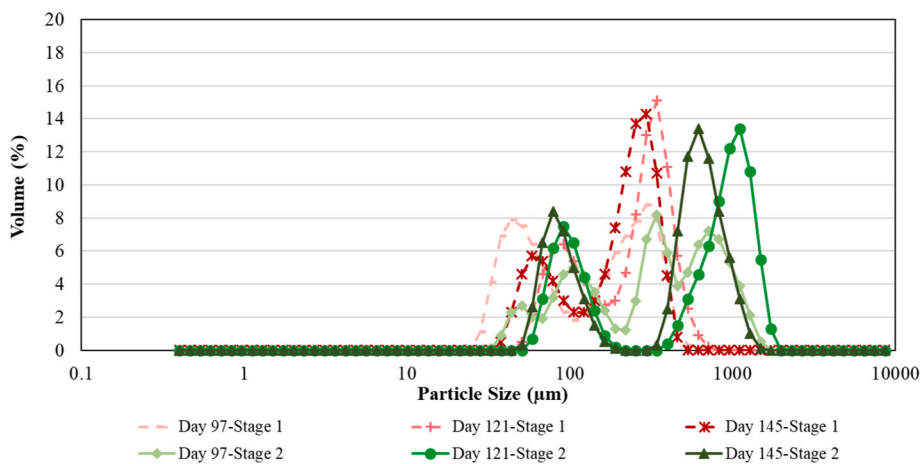

Fig. 4. Particle size distribution of the granular sludge effluent in both stages.

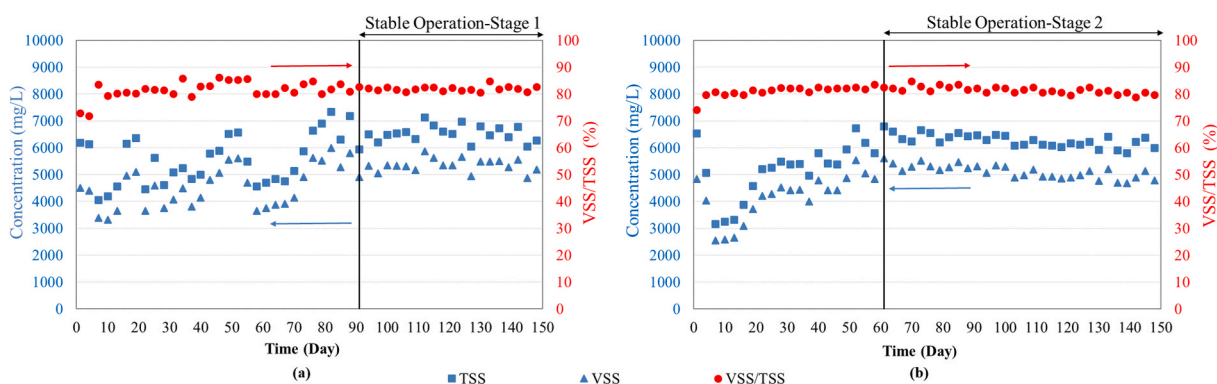

Fig. 5. Biomass concentrations in the AGS process: (a) Stage 1, (b) Stage 2.

phase, anoxic/anaerobic microorganisms' growth was limited. The insufficient carbon for PAOs and anoxic denitrifiers might be the reason behind the low TP and TN removal efficiencies obtained in Stage 2 (Fig. 3(b and c)). Furthermore, high nitrate concentration measured at the end of the aerobic phase most probably hampered formation of anaerobic conditions in the feeding phase of the following cycle in Stage 2, thus ordinary heterotrophic microorganisms (e.g. filamentous ones abundant in Stage 2) might use the nitrate as an electron acceptor instead of converting readily biodegradable substrate to short-chain fatty acids that were available for PAOs (Wentzel et al., 1992).

Average influent TSS and VSS concentrations were 231 ± 9.9 mg/L and 214 ± 8.9 mg/L, while average effluent TSS and VSS concentrations were 8.6 mg/L and 4.9 ± 3.1 mg/L, respectively in Stage 1 resulting in an average TSS removal efficiency of $96.3 \pm 2.0\%$. Average turbidity of influent was determined as 108.3 ± 1.8 NTU, while it was 2.4 ± 1.0 NTU in the effluent of Stage 1. In Stage 2, after primary sedimentation, average influent TSS concentration decreased to 31.6 ± 1.7 mg/L and average effluent TSS concentration was 15.4 ± 2.3 mg/L resulting in an average TSS removal efficiency of $51.3 \pm 8.5\%$. Average influent and effluent VSS concentrations were 26.5 ± 1.4 mg/L and 12.0 ± 2.2 mg/L, respectively in Stage 2. Turbidity of the influent was 11.2 ± 0.3 NTU, and it decreased to 4.7 ± 0.6 NTU in the effluent in Stage 2. Stage 1 provided slightly better effluent quality in terms of suspended solids and turbidity parameters compared to Stage 2. Considering particle size distribution, d_{50} of the influent by volume was 4804 ± 114.0 nm in Stage 1, while it was 2610 ± 31.5 nm in Stage 2. Along with the operation, d_{50} in the effluent decreased to 291.7 ± 15.7 nm and 630.4 ± 82.2 nm at the end of the operation in Stage 1 and Stage 2, respectively (Fig. 4).

Table 2

Characteristics of the sludge in both stages.

Parameter	Unit	Stage 1 (Average \pm SD)	Stage 2 (Average \pm SD)
SVI ₅	mL/g	67 ± 2	55 ± 7
SVI ₁₀	mL/g	55 ± 4	39 ± 4
SVI ₃₀	mL/g	44 ± 5	33 ± 4
SVI ₃₀ /SVI ₁₀	-	0.79 ± 0.04	0.84 ± 0.03
SVI ₃₀ /SVI ₅	-	0.66 ± 0.09	0.61 ± 0.01
CST	s	7.6 ± 0.8	6.3 ± 0.4
Normalized CST	s/g TSS/L	1.22 ± 0.34	0.98 ± 0.03
PSD, d_{50}	μ m	112 ± 2	119 ± 10

3.3. Effect of pre-settling on granule formation and structure

TSS and VSS concentrations of the sludge in both stages are given in Fig. 5. After steady state conditions were achieved, average TSS concentrations were 6505 ± 311 mg/L and 6273 ± 240 mg/L in Stage 1 and Stage 2, respectively. VSS/TSS ratios were 82% in Stage 1 and 81% in Stage 2. Similar TS and VS concentrations were obtained in both stages. Average total COD concentrations were 7015 ± 231 mg/L and 7535 ± 125 mg/L, while average sCOD concentrations were 28.8 ± 9.5 mg/L and 58.2 ± 6.8 mg/L inside the reactor in Stage 1 and Stage 2, respectively. Both stages showed similar pH values in the range of 7.47–7.64.

Sludge characteristics obtained in Stage 1 and Stage 2 are given in Table 2. In Stage 1, SVI₅, SVI₁₀ and SVI₃₀ values were 67 ± 2 mL/g, 55 ± 4 mL/g and 44 ± 5 mL/g, respectively, while they were measured as 55 ± 7 mL/g, 39 ± 4 mL/g and 33 ± 4 mL/g, respectively in Stage 2. Based on these results, a decrease in SVI of granular sludge compared to SVI of seed sludge was remarkable in both stages. SVI₃₀/SVI₁₀ or SVI₃₀/

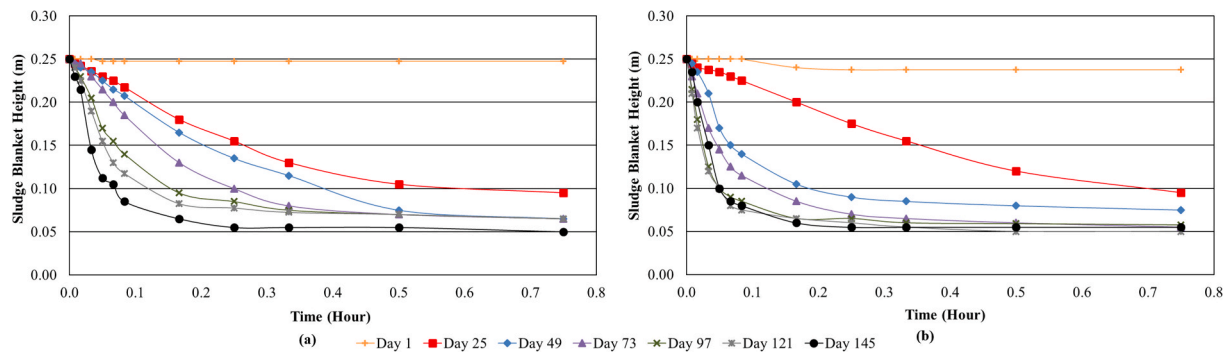

Fig. 6. Batch settling curves of the granular sludge: (a) Stage 1, (b) Stage 2.

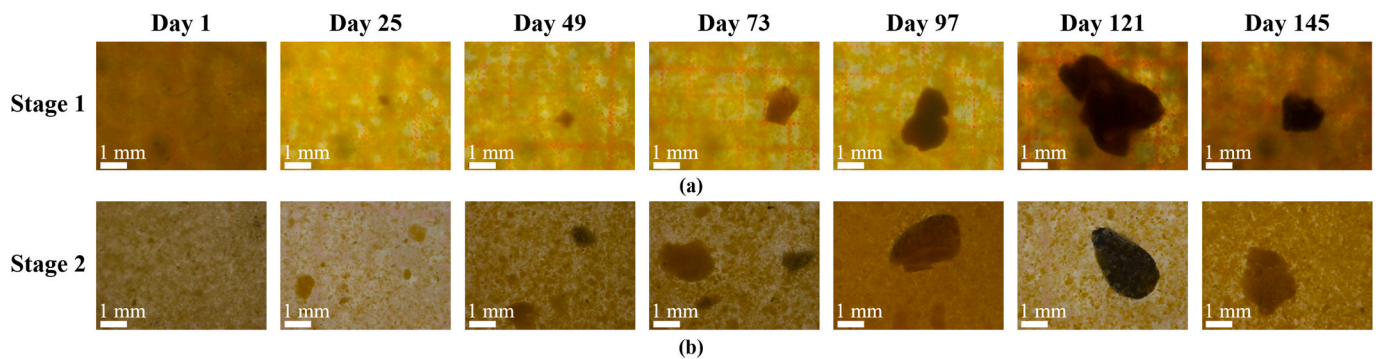

Fig. 7. Evolution of the granular sludge structure: (a) Stage 1, (b) Stage 2.

SVI₅ values are important to express granule formation (de Kreuk et al., 2007). SVI₃₀/SVI₁₀ ratios were obtained as 0.79 ± 0.04 and 0.84 ± 0.05 in Stage 1 and Stage 2, respectively. In a study on AGS process treating low-strength wastewater, SVI₃₀/SVI₁₀ was reported as 0.85 (Derlon et al., 2016), which is comparable with the results our study. Similar to SVI₃₀/SVI₁₀ ratio, SVI₃₀/SVI₅ ratio was found higher for the AGS than that was found for the seed sludge in both stages with an increase from 0.51 ± 0.01 to 0.66 ± 0.09 in Stage 1, and from 0.47 ± 0.02 to 0.61 ± 0.01 in Stage 2. An increase in SVI₃₀/SVI₁₀ and/or SVI₃₀/SVI₅ is an indication for granulation of floccular seed sludge through operation period.

Normalized capillary suction time decreased from 1.59 ± 0.08 s/g TSS/L to 1.22 ± 0.34 s/g TSS/L in Stage 1, and from 1.55 ± 0.16 s/g TSS/L to 0.98 ± 0.03 s/g TSS/L in Stage 2 (Table 2). It can be inferred from low CST values that dewaterability and filterability characteristics of the granular sludge was better than floccular sludge used as seed sludge. Particle size distribution (d_{50}) values of the granular sludge are given as d_{50} values in Table 2. During steady state operation, the average d_{50} values were $112 \pm 2 \mu\text{m}$ and $119 \pm 10 \mu\text{m}$ in the AGS reactor in Stage 1 and Stage 2, respectively. There was no significant difference in terms of d_{50} values of the sludge between stages. However, remarkable increase in d_{50} value of sludge in comparison with seed sludge confirmed the presence and dominance of granules in the reactor.

Batch settling curves obtained in both stages are given in Fig. 6. Sludge blanket height did not show any difference through 0.8 h at the 1st day of the operation. On the other hand, sludge blanket height dropped from 0.25 m to 0.1 m in 0.5 h on day 25, while it took less than 0.1 h on day 145 in Stage 1. In Stage 2, sludge blanket height decreases from 0.25 m to 0.1 m took 0.7 h on day 25, which was slower compared to one achieved in Stage 1. It took less than 0.1 h on day 145 in Stage 2, which was similar to Stage 1.

Fig. 7 shows the change in the morphology of sludge and evolution of granular sludge structure throughout the whole study period. Only floccular sludge with yellow fluffy structure could be seen on day 1 in

Table 3
Physical characteristics of granular sludge.

Size Range →		0.5-1 mm	1-2 mm	>2 mm	0.1-1 mm	1-2 mm	>2 mm
Parameter →	Unit ↓	Stage 1 (Average ± SD)			Stage 2 (Average ± SD)		
IC	%	3.89 ± 0.89			2.38 ± 0.16		
Settling Velocity	m/h	10.31 ± 2.22	26.34 ± 7.85	31.61 ± 6.47	13.00 ± 2.42	26.32 ± 5.18	40.20 ± 5.50
Density	g/L	1005 ± 2	1016 ± 1	1020 ± 4	1008 ± 1	1012 ± 1	1022 ± 6

Fig. 7 (a and b). The first formation of granules with a weak structure could be observed on day 25. The biggest granules have been captured on day 121 with around 4 mm in size in Stage 1. From Fig. 7, it can be seen that particulate matter content in the influent made granules amorphous in Stage 1. Floccular sludge around granules could still be seen after granule formation. The remaining COD at the end of the anaerobic phase can cause floc formation in the aeration period (Pronk et al., 2015a).

Physical characteristics of the aerobic granules are summarized in Table 3. In this study, the integrity coefficient of $3.89 \pm 0.89\%$ and $2.38 \pm 0.16\%$ were obtained for granules in Stage 1 and Stage 2, respectively. It has been shown that strength of granules increased with an increase in applied shear force in terms of superficial air velocity (SUAV) (We et al., 2020). Ibrahim et al. (2010) reported an IC value of 3.7% for AGS system operated with SUAV of 2.33 cm/s. In this study, SUAV was applied as 3.83 cm/s in each stage and IC values are comparable with the results of Ibrahim et al. (2010)'s study. Settling velocities of 10.31–13.00 cm/s, 26.32–26.34 cm/s and 31.61–40.20 cm/s were measured for granules that were in the size range of 0.5–1 mm, 1–2 mm and >2 mm, respectively. Ni et al. (2009) reported 18–40 m/h of settling velocity for aerobic granules in a system that was fed with low-strength wastewater,

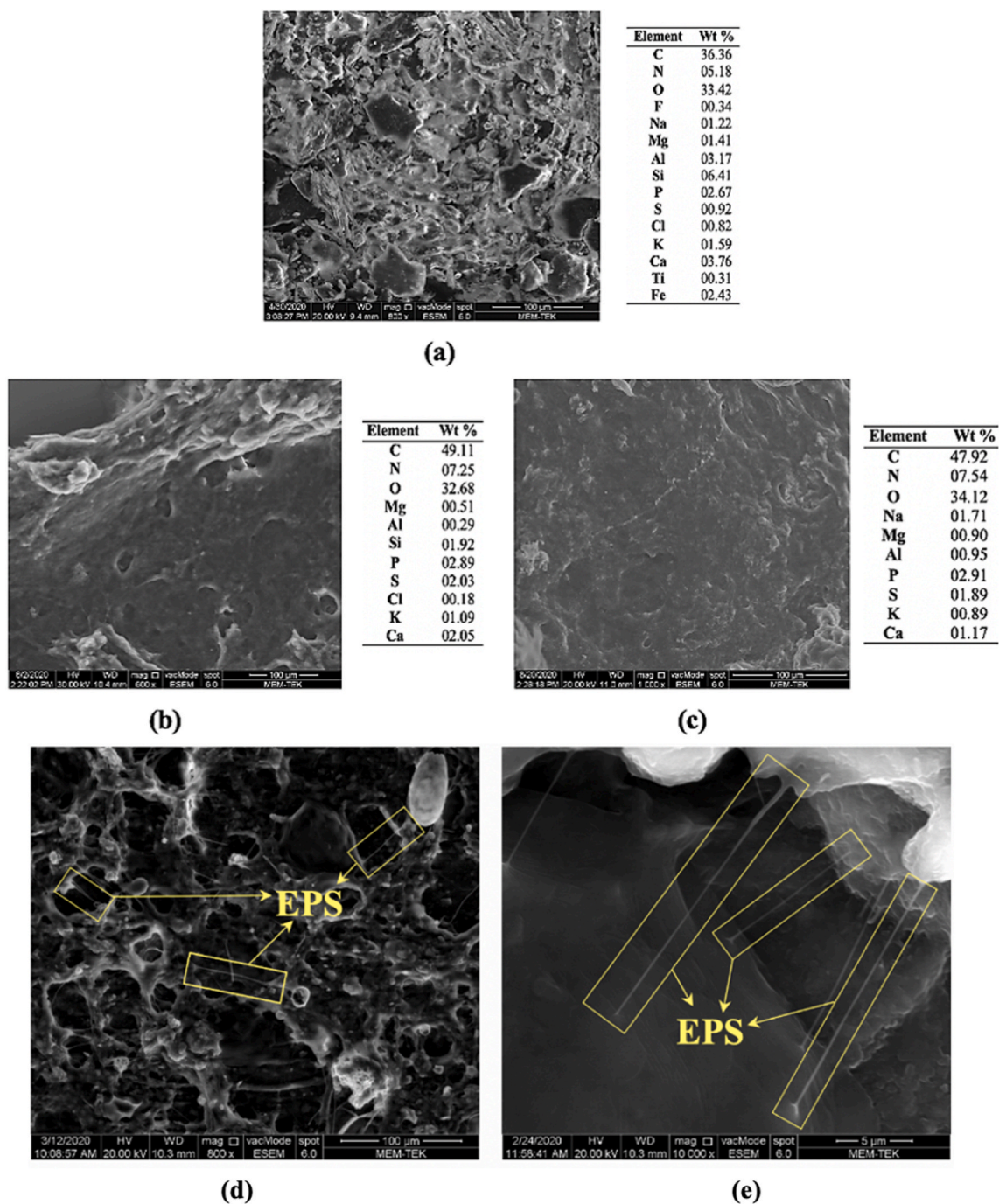

Fig. 8. ESEM images of the seed sludge, granular sludge, and EPS matrix: (a) Seed sludge, (b) granular sludge in Stage 1, (c) granular sludge in Stage 2, (d) magnification: 800 \times , (e) magnification: 10,000 \times .

which is comparable with the findings of this study. Similar granule densities were determined in each stage. Type of microorganism in the granule affects granule density. For instance, PAOs have higher density because of stored polyphosphate inside them (Winkler et al., 2013).

Results of ESEM/EDX analyses of seed sludge and aerobic granules in Stage 1 and Stage 2 are given in Fig. 8 (a–c). Crystal-like structures could be seen in ESEM image of the seed sludge, which was not present in ESEM image of the granular sludge. Aerobic granules had smooth and dense surface structure. EDX analysis showed that the major elemental composition of the seed sludge was 36.36% C, 33.42% O, and 5.18% N. Besides these major elements, it consisted of F, Na, Mg, Al, Si, P, S, Cl, K, Ca, Ti, and Fe. On the other hand, aerobic granules obtained in both stages had higher percentage of C (Stage 1: 49.11%; Stage 2: 47.92%)

and N (Stage 1: 7.25%; Stage 2: 7.54%), indicating higher organic content of the granular sludge compared to the seed sludge.

The surface of aerobic granules was identified by FTIR spectra in Stage 1 and Stage 2 (Fig. 9). Similar peaks in the spectrum were observed in both stages. The peaks at 3276 cm^{-1} indicated the structure of polysaccharides (stretching of the O–H bonds), while the peaks at 2925 cm^{-1} corresponded to aliphatic C–H stretching (Isik et al., 2019; Felz et al., 2020). Amide I (stretching of the C=O bond and C=N bonds) bonds corresponded to the peaks at 1636 cm^{-1} (Li et al. 2015; Wei et al., 2016). The existence of structure of Amides II (deformation of N–H and C=N bonds) was indicated from the peaks at 1541 cm^{-1} . These two amide groups represented protein structure on aerobic granule surfaces. Based on the FTIR spectra results, it was concluded that protein- and

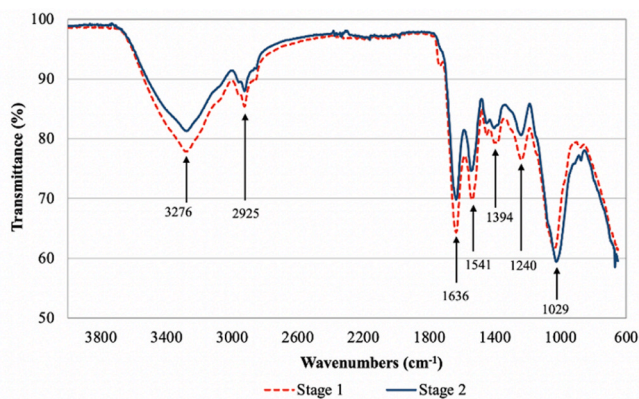

Fig. 9. FTIR spectrum of the granular sludge.

polysaccharide-like substances were present on the surface of aerobic granules.

According to the results of protein EPS (pEPS) and carbohydrate EPS (cEPS) measurements, EPS contents of the granular sludge were 53 ± 1.1 mg pEPS/g VSS and 25 ± 1.1 mg cEPS/g VSS in Stage 1; 47 ± 1.7 mg

pEPS/g VSS and 20 ± 0.1 mg cEPS/g VSS in Stage 2. Ratio of pEPS to cEPS were observed as 2.2 ± 0.1 and 2.4 ± 0.1 in Stage 1 and Stage 2, respectively. EPS analysis showed similar EPS concentrations for each stage. Fig. 8 (d and e) shows SEM images of EPS matrix on the surface of aerobic granules. EPS acts as glue that helps microorganisms come together to form granules, which is significant for granule stabilization (Liu et al., 2004). EPS filaments shown in Fig. 8 (d and e) had adhering effect and were acting like a glue to maintain cells together (Liu and Fang, 2003).

Fig. 10 shows stereomicroscope and CLSM images of the granular sludge. Aerobic granules had smooth surface and no filaments in Stage 1 (Fig. 10 (a)). On the other hand, aerobic granules had filamentous structures in Stage 2 (Fig. 10 (c)). Filamentous growth is a common problem in AGS systems (Liu and Liu, 2006), which causes instability and eventually granule loss. Depending on the anaerobic hydrolysis rate of particulate substrates such as starch or proteins, filamentous growth can be promoted in anaerobically fed AGS systems (We et al., 2020). It was expected that particulate matter in the influent would cause filamentous growth in Stage 1. However, filamentous growth did not occur in Stage 1. This showed that when system is fed with wastewaters including particulate matter content, and anaerobic phase is long enough, filamentous growth on the surface of aerobic granules could be

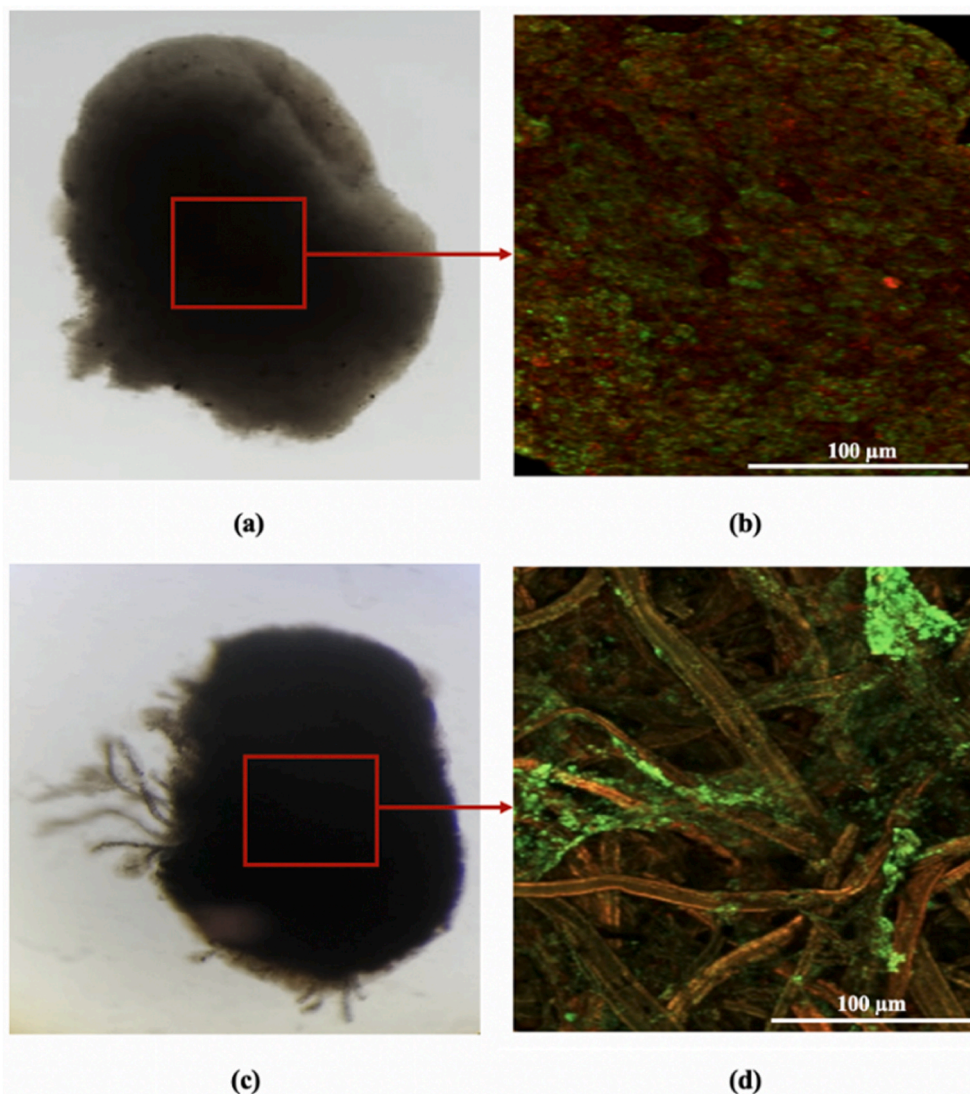

Fig. 10. Stereomicroscope and CLSM images of the granular sludge: (a) Stereomicroscope image (Stage 1), (b) CLSM image (Stage 1), (c) Stereomicroscope image (Stage 2), (d) CLSM image (Stage 2).

prevented. Similarly, Wagner et al. (2015) showed that aerobic granules became more regular when anaerobic phase of AGS system fed with wastewater with particulate matter in it was extended. Another factor that stimulates the growth of filamentous microorganisms in AGS systems is the low organic matter load to which microorganisms are exposed (Liu and Liu, 2006). Wagner and da Costa (2013) observed filamentous growth on the surface of aerobic granules in an AGS system fed with raw domestic wastewater when OLR was decreased from 1.4 kg COD/m³ d to 1 kg COD/m³ d. Thus, the reason of filamentous growth determined in Stage 2 might be low substrate availability. In Stage 2, available organic matter consumption by these filamentous microorganisms on the surface of granules might be the reason that microorganisms in the inner part of the granules suffered from substrate and this situation might increase the competition for substrate between PAOs and denitrifiers. CLSM was performed to visualize living/dead microorganisms on the surface of aerobic granules of each stage. CLSM showed living cells on the aerobic granules surface in green color, while dead microorganisms were shown in red color. Both living and dead microorganisms were observed on the surface of aerobic granules in Stage 1 (Fig. 10 (b)) and Stage 2 (Fig. 10 (d)).

3.4. Energy consumption

In this study, energy consumption of the system was measured and classified as follows: pumping, aeration, and automation. Both stages were operated in the same conditions, thus energy consumptions in Stage 1 and Stage 2 did not differentiate from each other. Pumping energy consumption, that included the energy consumption of feeding pump, recirculation pump, and discharge pump was responsible for 46% of total energy consumption of the system. In full-scale AGS plants, recirculation and discharge pumps are not present, thus pumping energy consumption is expected to be lower than this value (Pronk et al., 2015b). In our study, automation and aeration consumption constituted 32% and 22% of total energy consumption, respectively. Although parameters such as plant size, pollution load, control systems, climate etc. affects energy consumption, most of the energy consumption is caused by aeration in activated sludge systems. A study on energy consumption of a full-scale AGS system showed that conventional activated sludge plants consumed ~60% more energy compared to AGS plants Pronk et al. (2015b) because no mixer, sludge recirculation pump, separate sedimentation tank has been used in AGS systems. In full-scale wastewater treatment plants, it is very important that the number of pumps and their capacities should not be selected more than necessary in order to minimize the energy consumption of the facility (Foladori et al., 2015). On the other hand, in lab-scale studies, the capacities of the pumps are generally chosen to have a wide range enabling to test different operating conditions. This situation should be considered during the assessment of the lab-scale energy consumption data.

4. Conclusions

In this study, performances of AGS systems fed with synthetic municipal wastewater (Stage 1) and with pre-settled synthetic municipal wastewater (Stage 2) were comparatively evaluated at the same operational conditions. The main conclusions that can be drawn from this study are given below:

- Steady-state conditions were reached 30 days earlier in the AGS system fed with pre-settled wastewater.
- With pre-settling, the lower COD/TN ratio of the influent led to reduced denitrification which caused higher nitrate concentration (Stage 1: 6.3 ± 1.1 mg/L, Stage 2: 23.3 ± 1.8 mg/L) in the effluent.
- The reason of filamentous growth at the system with pre-settled wastewater might be the decrease of COD loading rate by 20%, which lowered organic matter availability for microorganisms.

- In the laboratory-scale experimental AGS set-up, pumping, automation, and aeration were responsible for 46%, 32% and 22% of total energy consumption of the system, respectively.

This study showed that a decrease in organic matter concentration due to the application of pre-settling negatively affected the activities of denitrifying and phosphorus-removing microorganisms, and thus caused the overgrowth of filamentous microorganisms on the surface of aerobic granules. Therefore, effluent quality was deteriorated. In case of applying primary sedimentation before AGS process, effluent quality may be improved by modifying operational conditions. Hydrolysable substrate is available for granule formation. Hydrolysis products are stored as PHA and can be used for denitrification processes. Thus, the use of primary sedimentation for energy generation by biogas production should be balanced with COD requirement for nutrient removal.

Sample CRediT author statement

Sadiye Kosar: Conceptualization, Methodology, Investigation, Writing - Review & Editing.

Onur Isik: Conceptualization, Investigation, Validation, Writing - Original Draft, Writing - Review & Editing.

Busra Cicekalan: Investigation.

Hazal Gulhan: Conceptualization, Methodology, Writing - Original Draft, Writing - Review & Editing.

Ece Sagir Kurt: Project administration, Funding acquisition.

Ezgi Atli: Project administration, Funding acquisition.

Safak Basa: Project administration, Funding acquisition.

Hale Ozgun: Conceptualization, Supervision, Validation, Writing - Original Draft, Writing - Review & Editing, Project administration.

Ismail Koyuncu: Writing - Review & Editing, Resources.

Mark C. M. van Loosdrecht: Writing - Review & Editing.

Mustafa Evren Ersahin: Conceptualization, Supervision, Writing - Review & Editing, Project administration.

Declaration of competing interest

The authors declare that they have no known competing financial interests or personal relationships that could have appeared to influence the work reported in this paper.

Acknowledgement

The authors would like to express their gratitude for the PhD Fellowship provided by YOK 100/2000 Scholarship Programme to Sadiye Kosar, by the Council of Higher Education of Turkey. This study was supported by Scientific Research Projects Department of Istanbul Technical University (Project No: MDK-2019-42173). This research was funded by Istanbul Water and Sewerage Administration (ISKI) with the project titled as "Treatment of Wastewaters from ISKI Baltaliman Wastewater Treatment Plant by Aerobic Granular Sludge System in Low Cost and Low Footprint".

References

- APHA, 2017. *Standard Methods for Examination of Water and Wastewater*, 23rd edition. American Public Health Association, Washington.
- Bengtsson, S., de Blois, M., Wilen, B.M., Gustavsson, D., 2018. Treatment of municipal wastewater with aerobic granular sludge. *Crit. Rev. Environ. Sci. Technol.* 48 (2), 119–166. <https://doi.org/10.1080/10643389.2018.1439653>.
- Beun, J., van Loosdrecht, M.C.M., Heijnen, J.J., 2002. Aerobic granulation in a sequencing batch airlift reactor. *Water Res.* 36, 702–712. <https://doi.org/10.1016/j.biortech.2015.02.029>.
- Coma, M., Verawaty, M., Pijuan, M., Yuan, Z., Bond, P.L., 2012. Enhancing aerobic granulation for biological nutrient removal from domestic wastewater. *Bioresour. Technol.* 103 (1), 101–108. <https://doi.org/10.1016/j.biortech.2011.10.014>.
- de Kreuk, M.K., Heijnen, J.J., van Loosdrecht, M.C.M., 2005. Simultaneous COD, nitrogen, and phosphate removal by aerobic granular sludge. *Biotechnol. Bioeng.* 90, 761–769. <https://doi.org/10.1002/bit.20470>.

- de Kreuk, M.K., Kishida, N., Tsuneda, S., van Loosdrecht, M.C.M., 2010. Behavior of polymeric substrates in an aerobic granular sludge system. *Water Res.* 44 (20), 5929–5938. <https://doi.org/10.1016/j.watres.2010.07.033>.
- de Kreuk, M.K., Kishida, N., van Loosdrecht, M.C.M., 2007. Aerobic granular sludge – state of the art. *Water Sci. Technol.* 55 (8–9), 75–81. [https://doi.org/10.1061/\(ASCE\)0733-9372\(2006\)132:6\(694\)](https://doi.org/10.1061/(ASCE)0733-9372(2006)132:6(694)).
- Derlon, N., Wagner, J., da Costa, R.H.R., 2016. Formation of aerobic granules for the treatment of real and low-strength municipal wastewater using a sequencing batch reactor operated at constant volume. *Water Res.* 105, 341–350. <https://doi.org/10.1016/j.watres.2016.09.007>.
- Dubois, M., Gilles, K.A., Hamilton, J.K., Rebers, P.A., Smith, F., 1956. Colorimetric method for determination of sugars and related substances. *Anal. Chem.* 28, 350–356.
- Ersahin, M.E., Ozgun, H., Tao, Y., van Lier, J.B., 2014. Applicability of dynamic membrane technology in anaerobic membrane bioreactors. *Water Res.* 48, 420–429. <https://doi.org/10.1016/j.watres.2013.09.054>.
- Felz, S., Al-Zuhairy, S., Aarstad, O.A., van Loosdrecht, M.C.M., Lin, Y.M., 2016. Extraction of structural extracellular polymeric substances from aerobic granular sludge. *JoVE* (115), e54534. <https://doi.org/10.3791/54534>.
- Felz, S., Neu, T.R., van Loosdrecht, M.C.M., Lin, Y., 2020. Aerobic granular sludge contains Hyaluronic acid-like and sulfated glycosaminoglycans-like polymers. *Water Res.* 169, 115291. <https://doi.org/10.1016/j.watres.2019.115291>.
- Foladori, P., Vaccari, M., Vitali, F., 2015. Energy audit in small wastewater treatment plants: methodology, energy consumption indicators, and lessons learned. *Water Sci. Technol.* 72 (6), 1007–1015.
- Frolund, B., Griebe, T., Nielsen, P.H., 1995. Enzymatic activity in the activated sludge floc matrix. *Appl. Microbiol. Biotechnol.* 43, 755–761. <https://doi.org/10.1007/BF00164784>.
- Ghangrekar, M., Asolekar, S.R., Ranganathan, K.R., Joshi, S.G., 1996. Experience with uasb reactor start-up under different operating conditions. *Water Sci. Technol.* 34 (5–6), 421–428. [https://doi.org/10.1016/0273-1223\(96\)00674-9](https://doi.org/10.1016/0273-1223(96)00674-9).
- Haaksman, V.A., Mirghorayshi, M., van Loosdrecht, M.C.M., Pronk, M., 2020. Impact of aerobic availability of readily biodegradable COD on morphological stability of aerobic granular sludge. *Water Res.* 187, 116402.
- Ibrahim, Z., Amin, M.F.M., Yahya, A., Aris, A., Muda, K., 2010. Characteristics of developed granules containing selected decolourising bacteria for the degradation of textile wastewater. *Water Sci. Technol.* 61 (5), 1279–1288. <https://doi.org/10.2166/wst.2010.021>.
- Isik, O., Abdelrahman, A.M., Ozgun, H., Ersahin, M.E., Demir, I., Koyuncu, I., 2019. Comparative evaluation of ultrafiltration and dynamic membranes in an aerobic membrane bioreactor for municipal wastewater treatment. *Environ. Sci. Pollut. Control Ser.* 26, 32723–32733. <https://doi.org/10.1007/s11356-019-04409-6>.
- Khan, S.J., Visvanathan, C., Jegatheesan, V., BenAim, R., 2008. Influence of mechanical mixing rates on sludge characteristics and membrane fouling in MBRs. *Separ. Sci. Technol.* 43 (7), 1826–1838. <https://doi.org/10.1080/01496390801974647>.
- Layer, M., Adler, A., Reynaert, E., Hernandez, A., Pagni, M., Morgenroth, E., Holliger, C., Derlon, N., 2019. Organic substrate diffusibility governs microbial community composition, nutrient removal performance and kinetics of granulation of aerobic granular sludge. *Water Res.* X 4, 100033. <https://doi.org/10.1016/j.wroa.2019.100033>.
- Li, K., Wei, D., Zhang, G., Li, S., Wang, Y., Wang, B., Ang, X., Du, B., Wei, Q., 2015. Toxicity of bisphenol A to aerobic granular sludge in sequencing batch reactors. *J. Mol. Liq.* 209, 284–288. <https://doi.org/10.1016/j.molliq.2015.05.046>.
- Liu, Y., Fang, H.H., 2003. Influences of Extracellular Polymeric Substances (EPS) on Flocculation, Settling, and Dewatering of Activated Sludge.
- Liu, Y., Liu, Q., 2006. Causes and control of filamentous growth in aerobic granular sludge sequencing batch reactors. *Biotechnol. Adv.* 24, 115–127. <https://doi.org/10.1016/j.biotechadv.2005.08.001>.
- Liu, Y., Liu, Y., Tay, J., 2004. The effects of extracellular polymeric substances on the formation and stability of biogranules. *Appl. Microbiol. Biotechnol.* 65, 143–148. <https://doi.org/10.1007/s00253-004-1657-8>.
- Liu, Y.Q., Tay, J.H., 2015. Fast formation of aerobic granules by combining strong hydraulic selection pressure with overstressed organic loading rate. *Water Res.* 80, 256–266.
- Lochmatter, S., Maillard, J., Holliger, C., 2014. Nitrogen removal over nitrite by aeration control in aerobic granular sludge sequencing batch reactors. *Int. J. Environ. Res. Publ. Health* 11, 6955–6978. <https://doi.org/10.3390/ijerph110706955>.
- Ni, B.J., Xie, W.M., Liu, S.G., Yu, H.Q., Wang, Y.Z., Wand, G., Dai, X.L., 2009. Granulation of activated sludge in a pilot-scale sequencing batch reactor for the treatment of low-strength municipal wastewater. *Water Res.* 43, 751–761. <https://doi.org/10.1016/j.watres.2008.11.009>.
- Pronk, M., Abbas, B., Al-zuhairy, S.H., Kraan, R., Kleerebezem, R., van Loosdrecht, M.C.M., 2015a. Effect and behaviour of different substrates in relation to the formation of aerobic granular sludge. *Appl. Microbiol. Biotechnol.* 99, 5257–5268. <https://doi.org/10.1007/s00253-014-6358-3>.
- Pronk, M., de Kreuk, M.K., de Bruin, B., Kamminga, P., Kleerebezem, R., van Loosdrecht, M.C.M., 2015b. Full scale performance of the aerobic granular sludge process for sewage treatment. *Water Res.* 84, 207–217. <https://doi.org/10.1016/j.watres.2015.07.011>.
- Schwarzenbeck, N., Erley, R., Wilderer, P.A., 2004. Aerobic granular sludge in an SBR-system treating wastewater rich in particulate matter. *Water Sci. Technol.* 49 (11–12), 41–46. <https://doi.org/10.2166/wst.2004.0799>.
- Sengar, A., Basheer, F., Aziz, A., Farooqi, I.H., 2018. Aerobic granulation technology: laboratory studies to full scale practices. *J. Clean. Prod.* 197, 616–632. <https://doi.org/10.1016/j.jclepro.2018.06.167>.
- van Loosdrecht, M.C.M., Nielsen, P.H., Lopez-Vazquez, C.M., Brdjaanovic, D., 2016. *Experimental Methods in Wastewater Treatment*. IWA Publishing.
- Wagner, J., Weissbrodt, D.G., Manguin, V., da Costa, R.H., Morgenroth, E., Derlon, N., 2015. Effect of particulate organic substrate on aerobic granulation and operating conditions of sequencing batch reactors. *Water Res.* 85, 158–166. <https://doi.org/10.1016/j.watres.2015.08.030>.
- Wagner, J., da Costa, R.H.R., 2013. Aerobic granulation in a sequencing batch reactor using real domestic wastewater. *J. Environ. Eng.* 139 (11), 1391–1396.
- We, A.C.E., Aris, A., Zain, N.A.M., 2020. A review of the treatment of low-medium strength domestic wastewater using aerobic granulation technology. *Environ. Sci. Water Res. Technol.* 6, 464. <https://doi.org/10.1039/C9EW00606K>.
- Wei, D., Li, M., Wang, X., Han, F., Li, L., Guo, L., Ai, L., Fang, L., Liu, L., Du, B., Wei, Q., 2016. Extracellular polymeric substances for Zn (II) binding during its sorption process onto aerobic granular sludge. *J. Hazard Mater.* 301, 407–415. <https://doi.org/10.1016/j.jhazmat.2015.09.018>.
- Wentzel, M.C., Ekama, G.A., Marais, G.v.R., 1992. Processes and modelling of nitrification denitrification biological excess phosphorus removal systems – a review. *Water Sci. Technol.* 25, 6–59.
- Winkler, M.K.H., Le, Q.H., Volcke, E.I.P., 2015. Influence of partial denitrification and mixotrophic growth of NOB on microbial distribution in aerobic granular sludge. *Environ. Sci. Technol.* 49 (18), 11003–11010. <https://doi.org/10.1021/acs.est.5b01952>.
- Winkler, M.K.H., Kleerebezem, R., Strous, M., Chadran, K., van loosdrecht, M.C.M., 2013. Factors influencing the density of aerobic granular sludge. *Environ. Biotechnol.* 97, 7459–7468. <https://doi.org/10.1007/s00253-012-4459-4>.
- Yu, C., Wnag, K., Tian, C., Yuan, Q., 2021. Aerobic Granular Sludge Treating Low-Strength Municipal Wastewater: Efficient Carbon, Nitrogen and Phosphorus Removal with Hydrolysis-Acidification Pretreatment. *Science of Total Environment*, 148297.