

REDUCING PIPE PENETRATION COSTS IN SHIPBUILDING

A new engineering & production approach to eliminate manual cutting by use of large predetermined openings

R.A.M. VAN DEN HADELKAMP

Student number: 4155580

Report number: SDPO.17.034.m.



Reducing pipe penetration costs in shipbuilding

A new engineering & production approach to eliminate manual
cutting by use of large predetermined openings

By

R.A.M. van den Hadelkamp

4155580

in partial fulfilment of the requirements for the degree of

Master of Science

in Marine Technology

in the specialization Design, Production and Operation

Faculty of Mechanical, Maritime and Materials Engineering

at the Delft University of Technology,

to be defended publicly on Wednesday November 22, 2017 at 3:00 PM.

Chairman:

Prof.ir J.J. Hopman

Section SDPO

Supervisor:

Dr.ir. J.M.G. Coenen

Section SDPO

First external supervisor:

J.J. Meijer MSc

Royal IHC

An electronic version of this thesis is available at <http://repository.tudelft.nl/>.

PREFACE

This research has been executed to complete the master Marine Engineering at the Technical University of Delft, faculty Mechanical, Maritime and Materials Engineering. It contains the process and results of the 9 months graduation project.

In order to conduct this research thoroughly, a lot of inside information from a lot of different departments was required. I would like to thank all people that have shared their information, knowledge and experience with me during my graduation. This include especially all the interviewed people mentioned in Appendix XI: Interviews. All of them were very interested, helpful and participating with the subject.

I would like to personally thank my supervisors. During the project Joost Meijer acted as my daily supervisor at Royal IHC. By means of a weekly meeting, supplemented by some intermediate conversations, all issues were discussed and new insights were obtained. Besides I would like to thank Dr.ir. J.M.G. Coenen, supervisor from the university, who despite a busy schedule with lots of graduates, always took time for meetings and questions. I also would like to thank Prof.ir J.J. Hopman as chair of my committee for his participation in my graduation.

Finally, I would like to thank the company Royal IHC for giving me all needed sources during the project. A big advantage of a large company is the large variety of people with their experience and knowledge.

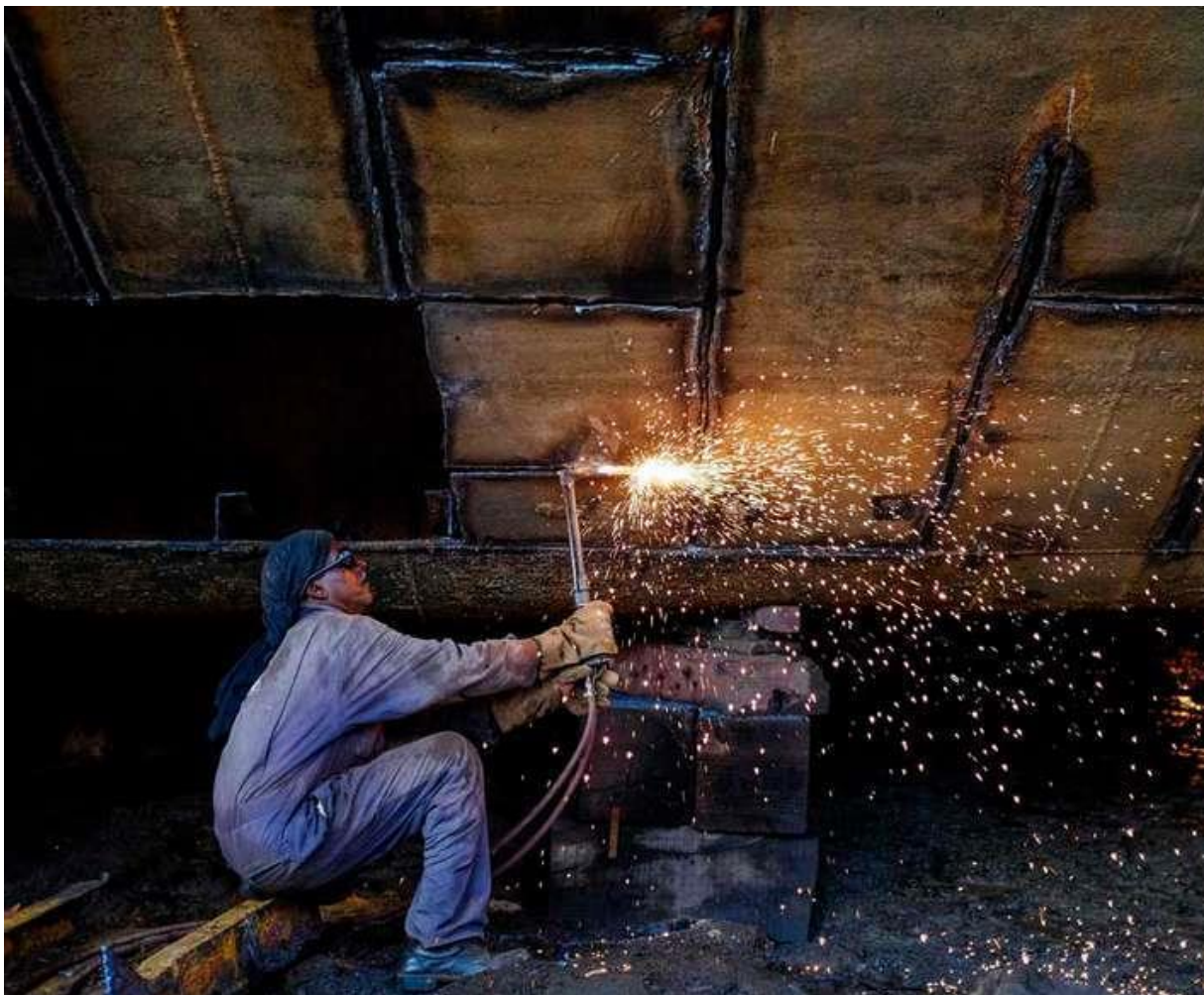

Figure 1 – Manually cutting in shipbuilding (Ellmer)

CONTENTS

Preface	5
Abstract	11
Abbreviations	13
Glossary	13
List of figures	15
List of tables	16
1 Introduction	17
1.1 Piping in ship design	17
1.2 Problem statement	18
1.3 Assignment	21
1.4 Scope	21
1.4.1 General	21
1.4.2 Structural	21
1.4.3 Disciplines	21
1.4.4 Ship types	22
1.4.5 Ship locations	22
1.5 Research questions	22
1.5.1 Main research questions	22
1.5.2 Sub-questions	22
1.6 Research objective	23
1.7 Report organization	25
2 Shipbuilding process	26
2.1 Process description	26
2.2 Concurrent engineering	29
2.3 IHC 2020	30
3 Pipe routing	31
3.1 Piping process	31
3.1.1 Literature piping process	31
3.1.2 Royal IHC piping process	33
3.2 Other industries	35
3.3 Routing algorithm	36
3.3.1 Constraints	36
3.3.2 Fitness function	37
3.3.3 Relevance for this research	38
4 Rules & regulations	40
4.1 Classification	40
4.1.1 Penetrations	40

4.1.2	Pipe routing	43
4.2	IHC rules & standards.....	46
4.2.1	Penetrations	46
4.2.2	Pipe routing	51
4.3	Conclusion Rules & Regulations.....	56
4.3.1	Penetrations	56
4.3.2	Pipe routing	56
5	Manufacturing	58
5.1	Plate cutting	58
5.1.1	Cutting processes.....	58
5.1.2	Plate cutting costs.....	61
5.2	Pipe spool manufacturing	64
6	Systems & locations	65
6.1	General.....	65
6.1.1	Systems.....	65
6.1.2	System locations	66
6.1.3	Problem locations	67
6.2	Accommodation	71
6.2.1	Rooms	71
6.2.2	Systems.....	71
6.2.3	Fire resistance	73
6.2.4	Problem locations	74
7	Design	76
7.1	Opening methods.....	76
7.1.1	Large opening with insert	77
7.1.2	Opening procedure.....	77
7.2	Closing methods.....	79
7.2.1	Steel welded plate	80
7.2.2	Steel bolted plate.....	80
7.2.3	Synthetic bolted plate.....	80
7.2.4	Synthetic glued plate	81
7.2.5	NOFIRNO®	81
7.2.6	Closing method Comparison.....	83
7.3	Estimation method.....	85
7.3.1	Optimal opening estimation algorithm	87
7.3.2	Filling algorithm	90
7.3.3	Conclusion.....	92
7.4	Final concept	93
7.4.1	Opening methods	93

7.4.2	Closing methods	93
8	Validation	94
9	Evaluation	98
9.1	Transit costs	98
9.1.1	Work & material costs	99
9.2	Total Trunk transit costs.....	101
10	Conclusion.....	103
10.1	Conclusion.....	103
10.1.1	Sub-questions.....	103
10.1.2	Main questions.....	104
10.2	Expansion	106
10.2.1	Other ship types	106
10.2.2	Other locations.....	106
10.3	Recommendations	108
10.4	Future outlook	111
	Bibliography	114
	Appendix I: Machinery and piping flow diagram.....	117
	Appendix II: Piping- & penetration standards	118
	Appendix III: Piping- & penetration sizes	119
	Appendix IV: Classification articles holes	122
	Appendix V: Classification articles pipe routing	130
	Appendix VI: Hole costs	141
	Appendix VII: System locations.....	142
	Appendix VIII: Ship systems	144
	Appendix IX: Rooms in sections	145
	Appendix X: Results	147
	Appendix XI: Interviews	157
	Appendix XII: Matlab code.....	177
	Appendix XIII: Scientific paper	191

ABSTRACT

This report describes an actual problem and a possible solution. This problem is the high cutting and repair costs for pipe penetrations if they have to be cut manually during section- or slipway building. The possible solution is a new engineering & production approach to eliminate manual cutting by use of large predetermined openings.

An essential part of ship building is the piping & machinery. A vessel contains an enormous amount of pipes that have to be routed to connect the equipment to each other. Most of these pipes are routed through structural elements like decks, bulkheads and profiles. These passages then need penetrations. If the penetrations are known on time, they can directly be cut with the CNC plasma machine, which is very cheap.

If the positions of the penetrations are not known on time and thereby not present on the **V2 drawing**, they have to be cut manually which can cost up to 1000 euros per **hole**. This is the case if equipment information is not available on time, mainly due to mutual dependencies and deteriorating communication. This information includes 3D models with the size and position of connections. If this information is not available, the piping cannot be routed in detail and the exact locations of penetrations are not known. Therefore the main research question of this report is: What is a method by which pipe penetrations in TSHDs can be sized and located before the detailed pipe routing is known? The corresponding research objective to achieve is:

Minimize

$$C = C_E + C_{PM} + C_O + C_{HC}$$

C = total piping and hole cutting costs

C_O = outfitting costs

C_E = total engineering costs

C_{HC} = hole cutting and closing costs

C_{PM} = piping manufacturing costs

In recently built vessel by Royal IHC, the described problem occurs with custom-built ships at almost any location in the ship. Remarkable is that it occurs in the relatively simple accommodation as well. If a further look is taken into this accommodation, penetrations from the **trunk** to the decks are causing a lot of problems.

It turned out to be too difficult to pre-determine the exact holes for **penetrations** in the trunk on beforehand, which means before the steel plates are cut. This is due to the high density of pipes inside the trunk, which causes problems if e.g. two pipes have to be swapped afterwards. Then the penetrations are already defined and the pipes could block each other. Therefore another approach is required. The idea is to create vertical **openings** between the trunk and decks, which later can be closed when all exact penetration locations are known. This leaves freedom for the pipe routing engineer without imposing a constraint of an exactly pre-determined hole. All possible openings can be determined directly after the **construction plan** is made. Then it can be determined which of the possible openings really need to be opened and with which method they can then be closed. It is possible to just open all openings and estimate which ones could remain closed. Amongst others, for the closing a weld-in steel plate or a new solution on the market called **NOFIRNO®** can be used.

In general, all custom-built vessels from Royal IHC contain the same accommodation systems. This includes water systems, **HVAC** systems and electricity. From these systems, a lot information is available at an early stage. For example, for the water systems the position of components like toilets, showers and washing machines are known. These locations are then used as input for an algorithm. The algorithm first estimates which opening is the optimal one for a certain penetration. Then it checks whether this penetration really fits inside this opening. At the end a layout with the locations of all penetrations is created. This composition is compared to the actual produced ship. With this results, the costs of the new approach, for several opening and closing concepts, are calculated.

For all proposed variants, using a steel insert plate for the closure successfully reduces the costs. With the implementation of the new approach, the following changes will be achieved:

$$C_{E,CS} > C_{E,FS}$$

$$C_{PM,CS} \sim C_{PM,FS}$$

$$C_{O,CS} \sim C_{O,FS}$$

$$C_{HC,CS} > C_{HC,FS}$$

Then:

$$C_{E,CS} + C_{PM,CS} + C_{O,CS} + C_{HC,CS} > C_{E,FS} + C_{PM,FS} + C_{O,FS} + C_{HC,FS}$$

$$C_{CS} > C_{FS}$$

CS = current state

FS = future state

If the new approach is proven in reality for the accommodation trunk, it can easily be expanded to other ship types and –locations.

ABBREVIATIONS

CPE	Central production engineering (work preparation)
CSD	Cutting suction dredger
DN	Diameter Nominal. Refers to the internal diameter of a pipe.
PLV	Pipe laying vessel
TSHD	Trailing suction hopper dredger

GLOSSARY

1.5D elbow	90° welding elbow with a bending radius at the centerline of 1.5x the outside pipe diameter.
1D elbow	90° welding elbow with a bending radius at the centerline of 1x the outside pipe diameter.
Accommodation	Total of rooms that are meant to accommodate the crew, including wheelhouse, bedrooms, offices, sanitary, galley, mess room, hospital, stores and also AC-room and converter room.
Accommodation space	Bedrooms, sanitary rooms, offices, mess room and other rooms without the storage of flammable liquids, excluded control stations and service spaces.
Beaver	Standardized not self-sailing CSD built by Royal IHC
Black water	Water contaminated with feces and other bodily wastes.
Carling	Reinforcement of the structure around heavy equipment.
Construction plan	Royal IHC specific designation of a structural plan.
Control station	Place on the installation from which personnel can monitor the status of the installation, initiate appropriate shutdown actions and undertake emergency communication. (for example wheelhouse)
Deadweight	Weight of cargo plus necessary supplies as fuel, oil, crew and life support.
Dry bulb temperature	Ambient air temperature
Grey water	Water that comes from laundry, bathing and dishwashing, among others.
Hole	Opening cut in the structure for all kind of purposes like penetrations, aerating, lighting and crawling.
HVAC	Heating, ventilation and air conditioning.
Lightship weight	Weight of ship structure, machinery and outfitting.
NOFIRNO®	Fire- and water resistant transit solution by Beele Engineering B.V. using rubber sleeves and a sealant.
Novec	Fire protection fluid.
Opening	Opening in the structure larger than just one penetration.
Orthogonal	With right angle, or perpendicular.
Outfitting	Placement of piping and equipment on a vessel.

Penetration	Transit in the structure for the passage of piping/ cabling.
Pipe spool	Pre-fabricated component of a piping system.
Pre-outfitting	Placement of piping and equipment on a vessel during block section building, before the block sections are transported to the slipway and welded together.
Primary member	Main load-carrying member of a structure.
Service space (high risk)	Galleys, pantries and other rooms with storage of flammable liquids.
Service space (low risk)	Lockers and store rooms not having provisions for the storage of flammable liquids
SLIPSIL®	Fire- and water resistant transit solution by Beele Engineering B.V. using plugs.
Trunk	Shaft over multiple decks for the transportation of ladders, pipes, cables and other piping.
V2 drawing	Version of a technical drawing that is used for the steel cutting among others.
Wet bulb temperature	Temperature that a parcel of air would have if it were cooled to saturation by the evaporation of water.

LIST OF FIGURES

Figure 1 – Manually cutting in shipbuilding (Ellmer)	5
Figure 2 – Piping of a recently built cutting suction dredger by Royal IHC.....	17
Figure 3 – Cause elaboration of the problem	18
Figure 4 – Shortest orthogonal route (left), routing via predetermined hole (right).....	19
Figure 5 – Relations between hull- and mechanical engineering.....	20
Figure 6 – Task division in shipbuilding at royal IHC.....	26
Figure 7 – Iterative process (Evans, 1959)	27
Figure 8 – Ship building process comparison	27
Figure 9 – Sequential vs. concurrent engineering (Wiener, 1988)	29
Figure 10 – Organizational process.....	33
Figure 11 – Pipe routing process	33
Figure 12 – Legend.....	34
Figure 13 – Parallel pair of grids (Dong & Lin, 2016)	38
Figure 14 – Direction constraint including via point.....	39
Figure 15 – Classification societies	40
Figure 16 – Hole in single skin section web	41
Figure 17 – Holes around hatchways (BV)	41
Figure 18 – Deduction criteria breadth (BV).....	42
Figure 19 – <u>Left</u> : hole near profile cutout <u>Right</u> : hole height	46
Figure 20 – Axial preferred hole location	47
Figure 21 – Cable tray penetration.....	48
Figure 22 – Basic rules	51
Figure 23 – Manufacturing rules	52
Figure 24 – <u>Left</u> : Pipe spool with bend and welded elbow.....	52
Figure 25 – <u>Right</u> : Coated pipes sorted in racks for transportation.....	52
Figure 26 – Plasma cutting (TWI).....	59
Figure 27 – Oxy-fuel cutting (Oxyfuel cutting - process and fuel gases, 2017).....	59
Figure 28 – Hole costs.....	61
Figure 29 – Cost per perimeter.....	62
Figure 30 – Cost per hole.....	62
Figure 31 – Cost per hole (simplified).....	63
Figure 32 – Man-hours per section for adding holes at ship 1	68
Figure 33 – Man-hours per section for adding holes at ship 2	68
Figure 34 – Man-hours per section overview for ship 1.....	69
Figure 35 – Man-hours per section overview for ship 2.....	70
Figure 36 – Accommodation decks.....	71
Figure 37 – Example of area types in the accommodation	73
Figure 38 – Added holes per system in accommodation.....	75
Figure 39 – Trunk in accommodation; 3D view with decks (left), top view (right).....	76
Figure 40 – Insert plate with penetrations	77
Figure 41 – Trunk opening constraints	78
Figure 42 – Opening concepts	79
Figure 43 – Closing solutions	80
Figure 44 - NOFIRNO® transit method (self-made pictures during a demonstration at the Beele Engineering research lab)	82
Figure 45 – Two sides of NOFIRNO® transit after a fire.....	82
Figure 46 – Lateral- (left) and axial (middle) movement (Beele Engineering BV, 2017).....	84
Figure 47 – Adding hole to NOFIRNO® transit (right)	84
Figure 48 – Algorithm flow diagram	86
Figure 49 – Bundling of water system pipes.....	88
Figure 50 – Optimal opening estimation algorithms	89

Figure 51 – Pressure drops in HVAC line	90
Figure 52 – Filling algorithm starting screen	91
Figure 53 – Filling sequence	91
Figure 54 – Optimal opening determination algorithm for water systems (left) and HVAC systems (right)	94
Figure 55 – Filling algorithm composition of a deck	94
Figure 56 – 1 opening difference is acceptable	95
Figure 57 – Difference between real and estimated optimal openings for the penetrations	96
Figure 58 – Difference between real and estimated opening that are opened	96
Figure 59 – (left) Normal and added transit for calculation	98
Figure 60 – (right) Closed transit for calculation	98
Figure 61 – Trunk transit costs comparison	102
Figure 62 – Effort-Benefit analysis	102
Figure 63 – Process flow of new approach	110
Figure 64 – Pentamaran concept (Matutis)	111
Figure 65 – <u>Left</u> : Solar powered catamaran (EcoMarinePower)	112
Figure 66 – <u>Right</u> : Pentamaran LNG/ wind power cruise vessel (Ecorizon)	112
Figure 67 – Ballast free ship design (e-MarineEducation)	112
Figure 68 – 3D laser scanning of a ship (Wang)	113

LIST OF TABLES

Table 1 – Design phases	28
Table 2 – Area types (Asmara, 2013)	31
Table 3 – Stakeholders, tools and information	32
Table 4 – Other industries	35
Table 5 – Pipe routing algorithm constraints	37
Table 6 – Constraint functions	37
Table 7 – Weld-in penetrations	48
Table 8 – Penetration standards	49
Table 9 – Special penetrations	50
Table 10 – Indication of system positions (Asmara, 2013)	55
Table 11 – Method comparison (Hussary & Pryor, 2013) (What is the best value, 2013)	60
Table 12 – Hole costs per meter	63
Table 13 – System functions	65
Table 14 – Equipment locations	66
Table 15 – Man-hours for adding holes per area type	67
Table 16 – Accommodation systems	72
Table 17 – Accommodation systems routing	72
Table 18 – Fire integrity of Bulkheads (Bureau Veritas - Steelships, Pt C, Ch 4, Sec. 5, 1.3.7)	74
Table 19 – Fire integrity of decks (Bureau Veritas - Steelships, Pt C, Ch 4, Sec. 5, 1.3.7)	74
Table 20 – Penetration comparison	77
Table 21 – Estimation methods	87
Table 22 – Difference between the algorithm and the real built vessel	95
Table 23 – Number of openings	97
Table 24 – Solution matrix	98
Table 25 – Work costs	99
Table 26 – Transit costs	100
Table 27 – Total trunk transit costs comparison	101
Table 28 – Other possible locations	106
Table 29 – Sections per area type	106

1 INTRODUCTION

In this chapter, an introduction to the research project is given. First, the essence of pipe routing in ship design is discussed. Then the actual problematic situation that occurs is described in detail. Also some important project boundaries are stated. On the basis of this, the research questions for this master thesis are defined.

1.1 PIPING IN SHIP DESIGN

Building a ship is a complex process. There are many sub-processes involved like project management, naval engineering, mechanical engineering and production. In the education program of maritime engineering, a lot of effort is put into subjects like strength, materials, resistance, propulsion, stability and regulations. A topic that is barely addressed is piping in ships. This seems to be remarkable as it may be up to as much as 50% of the whole ship engineering process. For a medium size, complex ship, this comes down to 30.000-40.000 man hours. (Asmara, 2013) Pipes and hoses are required to transport liquids and gases between different systems. A ship requires a large number of systems which then entails a large number of pipes. This can add up to more than 10.000 pipe parts.

Piping and machinery wasn't always an issue in shipbuilding. Piping is related to machinery. The first boats made didn't have any machinery because it was simply not invented yet. Propulsion by sails or paddles does not require any engines, and no engine means also no fuel-, cooling- or lubrication system. 40.000 years B.C., these first boats were using paddles as propulsion and they did this for the next 37.000 years. At 3.000 B.C., finally the sail was discovered in Egypt. In the year 1770, James Watt invented the steam engine. (Roder, 2008) That was the moment when piping and penetrations became important. Since this invention, the number of ship systems increased very rapidly. New techniques like air conditioning, fire-fighting and bow thrusters did also mean more systems and more piping. An interesting question is till what moment this amount of piping will keep increasing. Maybe new propulsion innovations does not need (that much) piping anymore or perhaps we go totally back to basic with sails.

For western shipyards, the pipe routing process is of a great importance. Because of the low labor costs in eastern countries, large steel structure vessels like bulk carriers and container ships can be built much cheaper in this area. Western countries have to distinguish themselves by producing complex, high-tech and custom built vessels. Especially for these vessels, the pipe routing process is crucial because of the large amount and high complexity. (Rose, 2017) If the pipe routing is not engineered in detail or on time, it involves high repair costs. Obviously this should be avoided as much as possible.

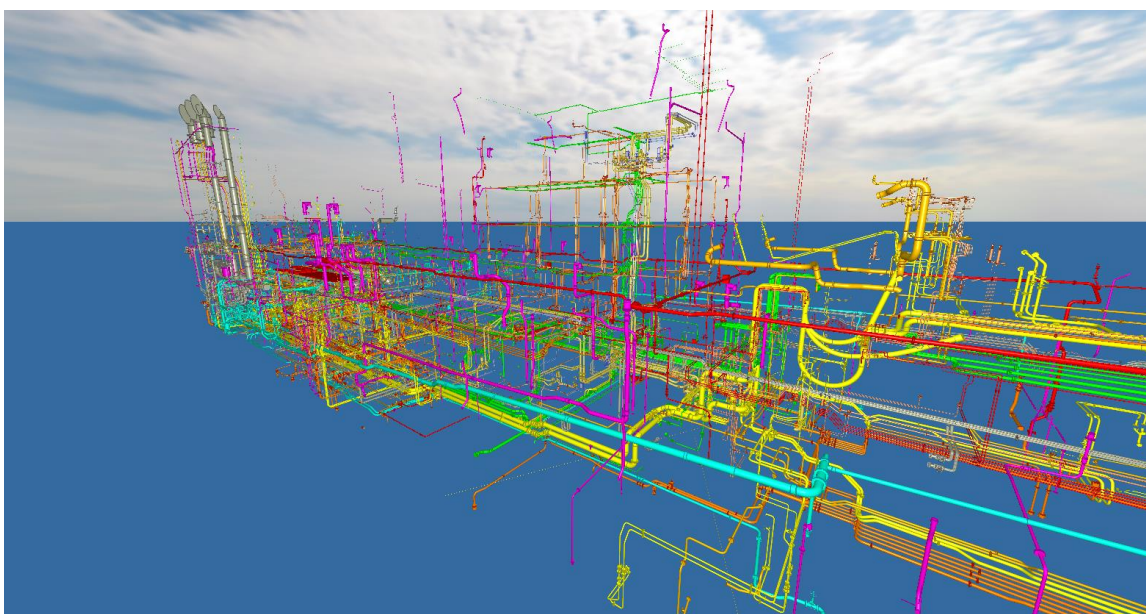

Figure 2 – Piping of a recently built cutting suction dredger by Royal IHC

1.2 PROBLEM STATEMENT

When a new vessel is designed at Royal IHC, the shipbuilding engineering team creates a **construction plan**. Thereafter the ship is divided into sections. Based on the **construction plan**, detailed drawings of each section are made. At IHC, these first drawings are called the V1 drawings. With these drawings, steel can be ordered. The steel plates should be ordered as early as possible in order to manage the promised delivery time. Besides, the V1 drawing is sent to the class inspector who will give his/ her comments. After this, a V2 drawing is created, with all the penetrations, **carling** and marks for foundations. With this drawing, all steel plates can be cut by the CNC plasma cutting machine. If holes are known in the V2 drawing, they can directly be cut at negligible costs.

The **construction plan** is also used by the mechanical engineering department. This department creates diagrams of all systems, containing equipment and connections between, that are required in the vessel. If the geometry and the exact location of it is known, the shipbuilding engineers are able to place the foundations and **carling** underneath it. The size and position of these foundations are required to know, before pipes can be routed. The piping engineer now can route the pipes between start- and endpoint, taking into account the structures and rules & regulations. Many pipes have to be routed through steel surfaces such as webs, floors and bulkheads, which require holes. If the determination of those transits is not performed on time, they are not present on the V2 drawing. This means that they are not cut by the automatic plasma cutting machine and workers have to measure and cut out a lot by hand. Since this could occur at the time that the structure has already been painted, it often causes extra painting work as well. The initial layer of the surrounding area is affected by the additional cutting and finishing processes. Besides the extra costs of this repair work, it also delays the ship building process.

In short, the problems are the higher costs and the delay of time for the ship building, caused by the repair work/ additional work in the field of penetrations. The lack of information resulting in this repair work can be elaborated somewhat further. The specific cause of the problem is elaborated in Figure 3. As can be seen, the unknown location of piping is due to the unknown location of the equipment and the foundations. Then the main reasons for this are the unknown equipment type, unknown equipment location and unavailable 3D CAD model.

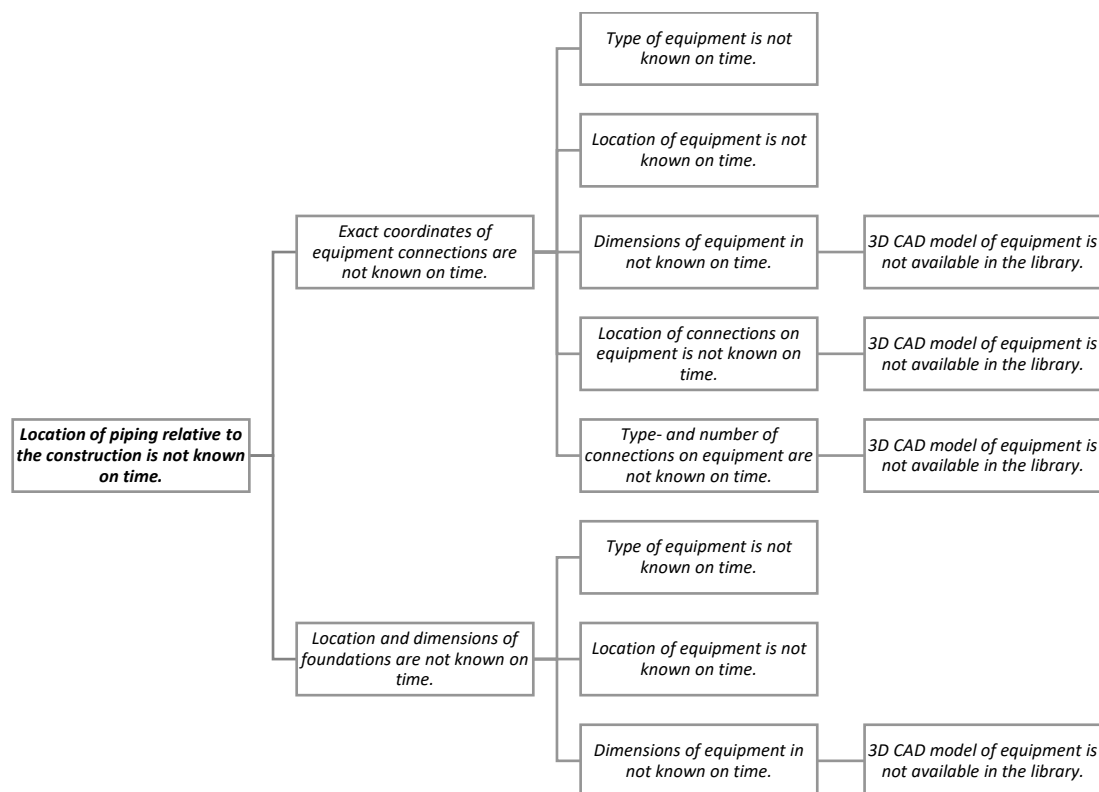

Figure 3 – Cause elaboration of the problem

There are several approaches to deal with this problem, for example:

1. An improved process in which all machinery locations and dimensions are known on time.
2. A different engineering approach in which the piping is routed towards predetermined holes, instead of holes that are cut around the piping. (Figure 4)
3. A different planning where the production only starts when all required holes are defined.

In Figure 5, the real problem is visualized. The blue bars indicate the naval engineering and the red bars the mechanical engineering. Some important predecessors and successors can be seen from this overview. The green arrows show the relations between these two disciplines. If only taking into account the red and blue bars, this represents how it should be. All holes for penetrations are present on the V2 drawing and can therefore be cut by torch cutting machine. The orange bars indicate the occurring problem in practice. If the equipment specifications are not available on time, the exact model of the equipment is also delayed. This again delays the foundations engineering and then the detailed pipe routing. At the end, this causes that the penetrations are not present on the V2 drawing and therefore not cut by torch cutting machine.

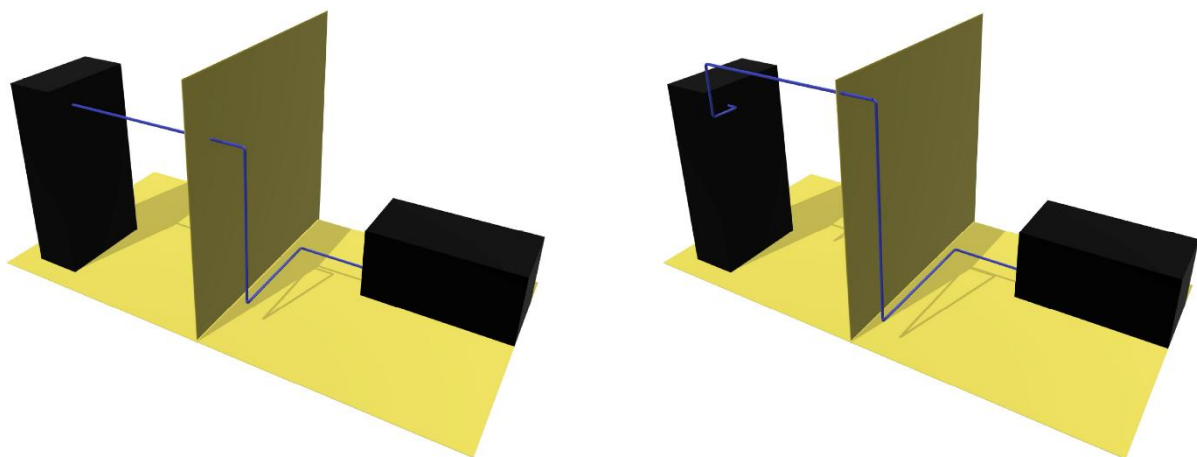

Figure 4 – Shortest **orthogonal** route (left), routing via predetermined hole (right)

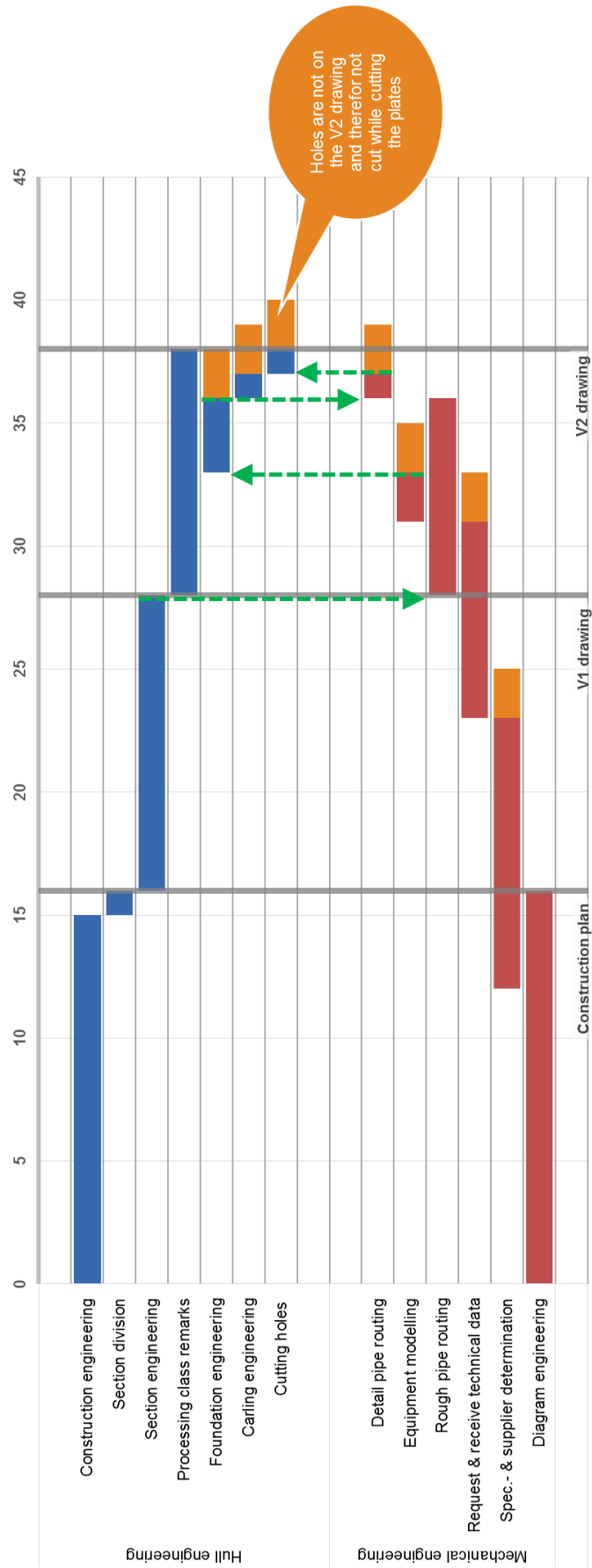

Figure 5 – Relations between hull- and mechanical engineering

1.3 ASSIGNMENT

The assignment is formulated by Royal IHC as follows:

Define an alternative process, by which most of the penetrations can be cut while the plates are being cut. Set up a business case that establishes whether this method is more efficient.

However, as mentioned before, the result does not need to be a process but can be an engineering approach or instruction as well.

1.4 SCOPE

It is important to define a suitable research scope in advance, with the right size regarding to the available resources and time. The project is scoped on different areas: general, disciplines, ship types and ship locations.

1.4.1 GENERAL

If the three possible solution directions from chapter 1.2 are considered, the conclusion is that only the second approach is feasible. The first approach is about improving the process. Therefore especially the communication between departments must be improved and accelerated. Due to more and more outsourcing abroad, this will be very difficult in the future. The third approach is about a different planning. However, a longer lead time is not an option for Royal IHC due to its unique selling point of fast delivery. Besides, there will be not enough time and resources available to test a totally new planning approach. The second approach, a new engineering approach, can be well investigated and evaluated during the research, due to the availability of required resources as stakeholders and registered data.

1.4.2 STRUCTURAL

Some boundaries about the structure and penetrations are listed below. These boundaries are mainly set to keep the case study acceptable regarding the available time and resources. Also to be able to compare the initial situation to the new situation, it is useful to have an unambiguous situation for the case of this research.

- Only penetrations between rooms
- Only penetrations for piping
 - No hatches
 - No manholes
 - No stairways
 - No other openings, like anchor line holes
- Only penetrations for piping that currently is routed in the 3D model
 - No pipes <DN25 and no individual cabling
- No appendages / instruments are taken into account
- No foundations, **carling** and marks for foundations are taken into account

1.4.3 DISCIPLINES

Other important boundaries of the assignment are the different disciplines that are involved in the ship engineering process at Royal IHC. The ones that are listed below are relevant and within the boundary of this research. A broader representation of IHCs disciplines will be shown in chapter 2.1.

- Shipbuilding
 - Engineering
 - Naval
 - Structural
 - Outfit
 - Piping & Machinery
 - Systems
 - Diagrams
 - Routing
 - Life support

- Work preparation (**CPE**)
- Production

It's important that at the end each of these disciplines is satisfied with the result. However, it may be possible that a certain discipline experiences a new method as a deterioration while it could be an improvement for the overall process. Results from conversations with people working within these disciplines can be found in Appendix XI: Interviews. Some major departments that are not taken into account during this research are sales and purchasing. Within the engineering department, the disciplines hydrodynamics and mission equipment are not within the scope of this project, because these engineers do not have much to do with pipe routing between equipment.

1.4.4 SHIP TYPES

The third boundary is the type of ships that are taken into account. The research is carried out at Royal IHC, so it seems to be obvious that the ship types within the scope are the main ones that are built by the yard in the last years. These types contain pipe-laying vessels (**PLV**), trailing suction hopper dredgers (**TSHD**) and cutting suction dredgers (**CSD**). In addition, the focus is on the custom-built vessels. Royal IHC also produces standardized dredgers, like the '**Beaver**' series. These vessels do not have to deal with the problem, because the engineering is a lot more optimized during the years. If there was a modification during building, this was communicated to the engineering department and therefore was not an issue for the next copy ship to build.

Only recently, modifications made to designs during production are systematically being registered by Royal IHC. Because most of the recent built IHC vessels are TSHDs, only for these vessels is sufficient information available. Therefore this will be the main ship type for this research. However, an expansion to the other custom-built vessels can easily be done afterwards.

1.4.5 SHIP LOCATIONS

A final important boundary is the location/ part of the ship. This research is relevant for all locations in the ship that have a high density of piping and mechanical equipment. Different locations which can be thought of are the total hull, the engine room or the accommodation. Initially, the intention is not to exclude anything yet. Later in this research, the final ship location for the case of this research will be appointed.

1.5 RESEARCH QUESTIONS

The research questions of this graduation assignment are the result of the described problem and defined scope. There are two main research questions. To answer these questions substantiated, first the answers to six sub-questions have to be found. The sub-questions are categorized in Literature, Manufacturing, Systems and Design.

1.5.1 MAIN RESEARCH QUESTIONS

- Q1** What is a method by which pipe penetrations in TSHDs can be sized and located before the detailed pipe routing is known?
- Q2** Is the new method more cost efficient than the current situation?

1.5.2 SUB-QUESTIONS

LITERATURE ANALYSIS

- Q3** Which rules and regulations must be taken into account when locating, sizing and cutting the penetrations?
- Q4** Which rules and regulations must be taken into account when routing the pipes?

MANUFACTURING ANALYSIS

- Q5**
 - a. How much does it cost to cut a hole manually afterwards?
 - b. How much does it cost to cut a hole by CNC automatic plasma cutting (Metalix)?
 - c. What are the determining costs for the manufacturing of **pipe spools**?

SYSTEMS ANALYSIS

- Q6** What is the most common location in the ship for each system?
Q7 Which connections does each kind of equipment contain and what is their size range?

DESIGN

- Q8** How can pipes be routed via penetrations?

1.6 RESEARCH OBJECTIVE

In this chapter, the objective of this research is scientifically described.

The aim is to minimize the combination of piping- and penetrations costs.

Minimize

$$C = C_E + C_{PM} + C_O + C_{HC} \quad \{1\}$$

C = total piping and hole cutting costs

C_E = total engineering costs

C_{PM} = piping manufacturing costs

C_O = outfitting costs

C_{HC} = hole cutting and closing costs

The total engineering costs can be defined as:

$$C_E = f(\text{size, complexity, expertise}) \quad \{2\}$$
$$= c_{eng} t_{eng}$$

c_{eng} = costs per hour of engineering (wages)

t_{eng} = engineering hours

The wage is considered to be a constant. The engineering time is highly dependent on size and complexity of the vessel, and the expertise of the pipe engineer.

The pipe manufacturing costs are dependent on pipe length, number of pipe bends, number of welds, purchase parts costs (like flanges) and finishing costs. The function can be defined as:

$$C_{PM} = \sum_{ps} \left(\sum_p (c_p L_p + c_B B) + c_W L_W + \sum_{pp} P_i + F \right) \quad \{3\}$$

(ps =pipe spools, p =pipes, pp =purchase parts)

c_p = pipe costs per rm

c_B = Costs per bend

c_W = welding costs per rm

L_p = pipe length

$B = \text{number of bends}$

$L_W = \text{welding length}$

$P = \text{purchase part costs}$

$F = \text{finishing costs}$

The piping costs per rm is dependent on the pipe specifications. For a specific pipe, this value c_p is considered to be constant. The bending costs are dependent on the wage and the bending time. Both are considered to be constant (bending time constant per bend) so c_B is a constant as well. The welding costs are dependent on wage and welding time (and material). When we take an average workman, c_W can be considered to be constant.

The welding length is dependent on the diameter and number of welds. The purchase part cost is a different value for each different part, but can easily be determined from a library. The finishing costs can differ for each specific pipe. (e.g. galvanized, painted)

The **outfitting** costs are dependent on the size and complexity of the pipe spools, and whether it is executed during **pre-outfitting** or outfitting.

The hole cutting costs are relatively low when it is done by the torch cutting robot. If the size and location is not known one time, it has to be performed by hand. Then the cutting costs per running meter (c_C) will be higher, caused by the less efficient cutting and additional measuring and finishing time. It also contains extra painting costs of parts damages by the cutting and welding. If the robot has cut the holes before painting, this A_{paint} is considered to be zero.

$$C_{HC}(t) = c_C \sum L_H + c_{\text{paint}} A_{\text{paint}} \quad \{4\}$$

$c_C = \text{cutting costs per rm}$

$c_{\text{paint}} = \text{painting costs per } m^2$

$L_H = \text{circumferential length of hole}$

$A_{\text{paint}} = \text{additional painting surface}$

It's also a possibility to route the pipes towards predefined holes and openings. They can then be cut by robot instead of afterwards by hand. Some parameters in the functions will change. First, the *complexity* for the pipe engineer will become higher. This causes a higher C_E . Besides the pipe length (L_P) and number of bends (B) will increase. This causes a higher C_{PM} . However, c_C and A_{paint} will reduce which causes a lower C_{HC} .

New situation:

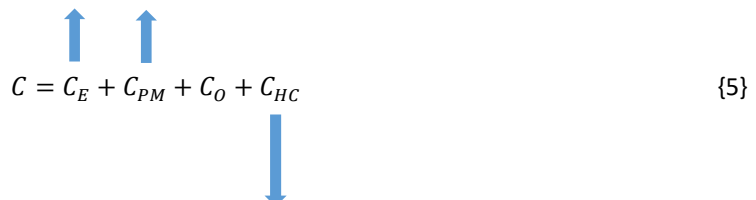
$$C = C_E + C_{PM} + C_O + C_{HC} \quad \{5\}$$

The complete function as described before is:

$$C = C_E + C_{PM} + C_O + C_{HC} \quad \{5\}$$

$$= c_E t_{eng} + \sum_{ps} \left(\sum_p (c_P L_P + c_B B) + c_W L_W + \sum_{pp} (P_i + F) \right) + C_O + c_c \sum L_H + c_{paint} A_{paint} \quad \{6\}$$

Now we can compare the old situation to the new situation. The black variables are the same for both situations, so they cancel each other out. It is considered that the number of pipe spools (divisions) will be the same. Therefore the welding length and the purchase parts are considered to be unchanged. It's also considered that there is no additional cutting and painting.

$$\begin{aligned} & C_{initial} - C_{route\ towards\ holes} \\ &= c_{eng} t_{eng,i} + \sum_{ps} (\sum_p (c_P L_{P,i} + c_B B_i)) + c_{c,i} \sum L_H + c_{paint} A_{paint} - c_{eng} t_{eng,r} - \\ & \quad \sum_{ps} (\sum_p (c_P L_{P,r} + c_B B_r)) - c_{c,r} \sum L_H \\ &= (t_{eng,i} - t_{eng,r}) c_{eng} \\ & \quad + \sum_{ps} \left(\sum_p (L_{P,i} - L_{P,r}) c_P + (B_i - B_r) c_B \right) + (c_{c,i} - c_{c,r}) \sum L_H + c_{paint} A_{paint} \end{aligned} \quad \{7\}$$

Now it can be easily seen that the important variables to measure are the difference in:

- Engineering time
- Pipe length
- Number of bends
- Cutting costs
- Painting costs

At the end, these variables will be the criteria for a viable solution. None of these variables are allowed to increase too much, because that will result in higher costs.

1.7 REPORT ORGANIZATION

This report is made up of three main parts: the analysis, the design and the evaluation.

The analysis includes chapter 2 till chapter 6. In this part first the shipbuilding process is described. Then a further look is taken into the pipe routing process in shipbuilding. The constraints for the design are set in the rules and regulations chapter. In the manufacturing chapter, the real problem is quantified by numbers. Then the systems and locations at which this problem occurs most frequently are identified.

In the design part the problem stated in the introduction, supported by all information from the analysis, is converted into different concepts. All of these concepts are broadly discussed and compared with all advantages and disadvantages. The usability of the design is then tested and examined in the results chapter.

At the end, in the evaluation part, the results are combined with actual costs to get a good comparison between all concepts. In the conclusion chapter, a choice for the best concept(s) is made.

A lot of data and information used for this research can be found in the appendices at the very end of this report.

2 SHIPBUILDING PROCESS

In this chapter, the shipbuilding process is discussed. A comparison is made between the process at Royal IHC, the ship building process as it is defined in literature and the process in comparable industries.

2.1 PROCESS DESCRIPTION

Building a ship is a highly complex task. No engineer or even no yard or subcontractor is able to build a large vessel on his own. Besides, nobody can excel on all different fronts, although it would be beneficial if everybody at least have some inside about other areas. This will be discussed further in chapter 2.2.

In order to make it feasible to build a vessel, the work has to be divided in smaller parts. This means a division of disciplines (e.g. naval, mechanical) and a physical division of section blocks, sections, rooms and systems.

First, there is a division of departments. At Royal IHC, the project management department has an assistant role. It has to define and control the overall project process. Then a distinction is made between sales, purchasing, engineering, work preparation and production. The work preparation department forms the link between engineering and production. When we look further into the engineering department other distinctions are made. There is the naval engineering department which is responsible for the engineering of the vessel itself, the piping & machinery department responsible for the required systems (mechanical engineering). Another department engineers the equipment particular for the mission. At IHC these are mainly dredging, mining or offshore missions. The life support department is responsible for the accommodation. These departments are again divided in different categories. A rough overview is shown in Figure 6. The outlined blocks are most relevant for this research.

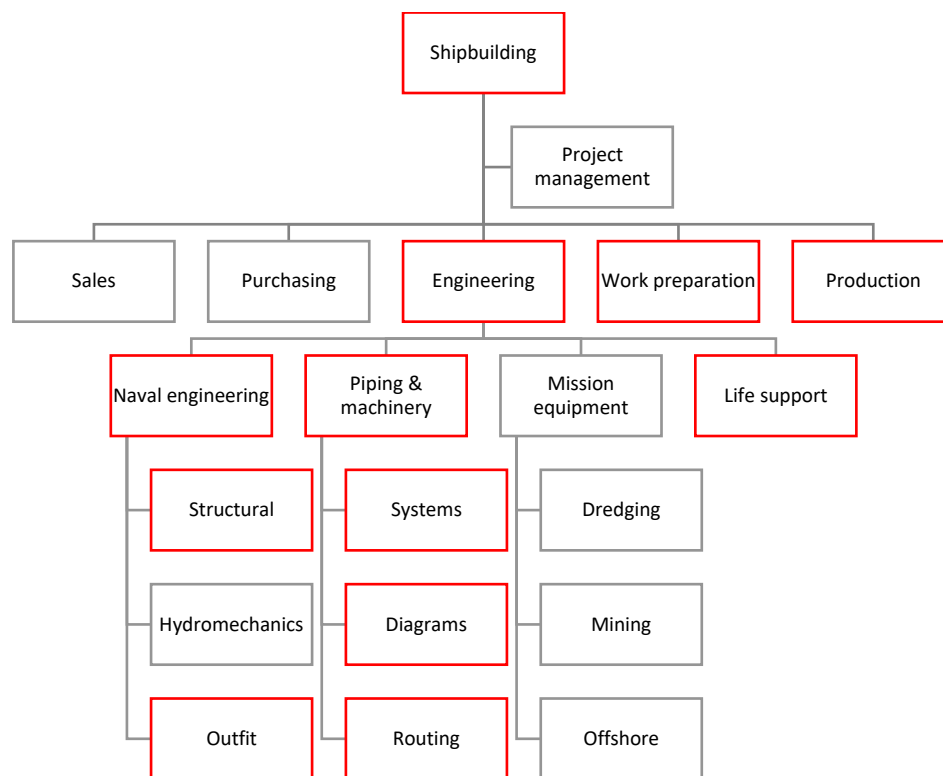

Figure 6 – Task division in shipbuilding at royal IHC

This figure could be extended much further. For example, for the naval structural engineering the ship is first divided in block sections and these block section are then divided in even smaller sections. An engineer is mainly working on one of these sections at a time.

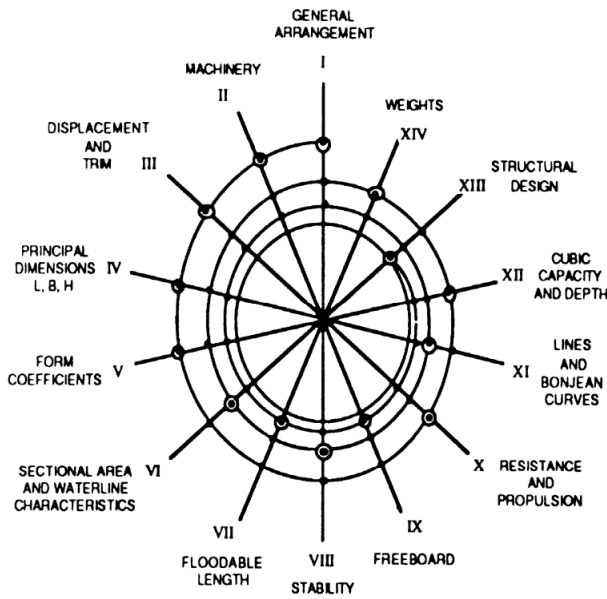

Figure 7 – Iterative process (Evans, 1959)

Ship design is an iterative process. (Figure 7) In practice, the disciplines do not act just as a predecessor or successor. Naval- and mechanical engineers are working simultaneously and are dependent on each other. In the literature, mostly 4-5 different cycles are mentioned. (Miinala, 2017) (Design spiral, 2012) The process starts with the owner requirements. After this, a concept design is performed with the basic specifications like dimensions, layouts, equipment and capabilities. The chosen concept is elaborated further in the preliminary design phase. In the contract design, all hull lines are finalized and the costs are summarized in a contract. Finally, in the detailed design, everything is engineered on a precise level and all drawings for each part or component of the ship are created.

These cycles can be compared with the design stages at royal IHC. As can be seen in Figure 8, the process is broadly equal for most ship building companies.

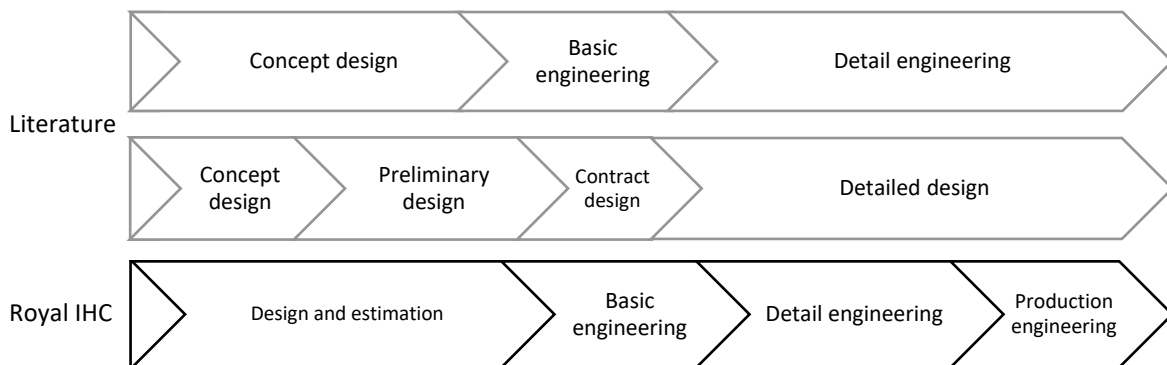

Figure 8 – Ship building process comparison

Each of this design phases contains again a lot of stages which could be in progress simultaneously. The different tasks which are present in almost every ship building project are listed below. (Table 1) A comparison of the separation is made between the literature (Storch, 1995) and Royal IHC.

Table 1 – Design phases

Literature	IHC	Document	
Concept Design	Design and estimation	Definition of the ship type	
		Definition of deadweight	
		Definition of type of propulsion	
		Definition of service speed	
Preliminary Design		Sketch of the General Arrangement, defining the compartment configuration	
		Preliminary body Plan, sufficient to allow the evaluation of the stability and of the cargo capacities	
		Estimative of the propulsive power	
		Estimative of the lightship weight	
		Estimative of ship cost	
Contract Design		Ship Specification	
		General Arrangement	
		Body Plan, with enough detail to allow the manufacture of scaled models for testing in hydrodynamic towing tanks	
		Basic engineering	Classification drawings of the structures (midship section, typical bulkheads, shell expansion, bow and stern structures)
			Stability and longitudinal resistance computations
Diagrams of the main piping systems (cargo, ballast, bilge, firefighting, etc.)			
Material specifications			
Detail design	Detail engineering	Total of the body plan, defining all the structural frames, decks, seams and butts of the shell plates	
		Production drawings of the structures detailed to the block level	
		Pipe routing in 3D model	
		Arrangement of the piping systems (for assembly)	
	Production engineering	Isometric drawings of the piping systems (for manufacture)	
		Information for cutting, bending and assembly of piping systems	
		Information for cutting, bending and assembly of plates and stiffeners (drawings, cutting tapes or files, molds, pin-jigs, etc.)	

The duration of several parts in the design process is highly dependent on the type of the project. Shipbuilding projects can be divided in three types:

- Routine project (shortest cycle):
Ship that is substantially similar to a previous one.
- Creative project:
Ship with substantial differences but the same basics.
- Innovative projects (longest cycle):
Ship with substantial differences and a design which is generally not used.

Royal IHC deals with each of this types of projects. For that reason, the share of each part of the design process differs per ship. Besides, the total duration of the design process is largely dependent on the size and complexity of the vessel. Also the experience know-how of the engineer plays a large role.

2.2 CONCURRENT ENGINEERING

In literature, mainly two well-known design methodologies are mentioned in the field of ship design: Sequential engineering and concurrent engineering. With sequential engineering, a certain department is doing tasks for his own discipline and he delivers it to the other departments. It is an iterative process where everybody continuously has to adjust his designs, dependent on the other disciplines. With concurrent engineering, it is intended that from the beginning, each designer takes into consideration all the elements of the cycle. (Figure 9) The objective is to reduce the number of iterations, shorten the development process and reduce the costs. In 1959, Evans introduced the sequential iterative process as a cycle. (Figure 7)

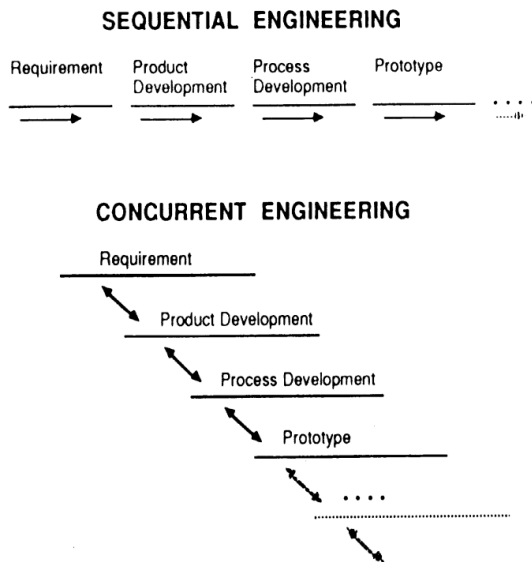

Figure 9 – Sequential vs. concurrent engineering (Wiener, 1988)

There are some main elements which indicate a concurrent engineering process. An important one is the cross functional team. This implies that a team consists of people from multiple disciplines. Because of the close relations, it increases the knowledge of each person about other disciplines. Another element is the concurrent product realization, which means that several things are engineered simultaneously. For example, in shipbuilding, system diagrams are engineered while the hull structure is being defined as well. To ensure that this concurrent engineering runs smoothly, a third element is required. Incremental information sharing is needed to prevent unnecessary iterations. When information is received by a team member, it should be directly shared with the rest of the team. The last main element is integrated project management. This means that engineers are responsible for the entire project, not only for his own specific part. This requires people to think intensively about other disciplines and subjects as well. An important requirement for concurrent engineering is that an engineer must have access to a common (software) model. (Kusiak, 1993)

At Royal IHC, concurrent engineering is obviously applicable. As stated in chapter 2.1, many disciplines are closely related to and dependent on each other and the processes are running simultaneously. In Figure 5, it is clearly shown that the hull engineering and mechanical engineering can start at the same time. The common used software is accessible for each project member. By means thereof, proceedings can be consulted and if an adjustment is made by a certain engineer, it is directly shared to others. In addition, very remarkable and maybe unique for the shipbuilding industry, even production starts while engineering hasn't finished. For IHC this is one of the unique selling points in order to keep the lead time relatively short.

Shipbuilding isn't the only industry in which concurrent engineering is applied. Nowadays Toyota Motor Corporation is the industry leader in product development lead time while using fewer engineers than its competitors. Toyota is seen as the founder of concurrent engineering as well as lean manufacturing in the automobile industry. It found out that sequential engineering involves shortcomings due to the delayed feedback loop. (Sobek II, Ward, & Liker, 1999) Other automobile companies like Honda and General Motors have followed. Just as with ship building, there is even a small part of production which is already started

before the end of engineering. The production of dies starts when the approximate size and number of panels is known. Then the steel blocks can be ordered, which takes a substantial share of the lead time. Also a start can be made with the die formation. The detailing is executed when all detail are fully known. Some other industries where concurrent engineering is being applied are aircrafts, trains, electronics (cameras, printers) and pharmaceuticals. (Stark , 1998) (Juarez, Peydro, Mengual, & Ferrandiz, 2015)

2.3 IHC 2020

Concurrent engineering is closely related to lean manufacturing. For both, the aim is to reduce the lead time and costs. With lean manufacturing, this is reached by eliminating the waste in production. In shipbuilding, this waste can be for example:

- Corrections/ defects
- transportation
- overproduction
- over-processing
- motion
- waiting
- inventory

If Royal IHC wants to be competitive and viable on the market in the coming years, they have to become more lean. In the strategy IHC2020 Royal IHC has decided that the lead time has to be reduced, both for engineering and production. (IHC, 2014) This can be reached by a more efficient shipyard layout, which reduces the transportation, motion and waiting time. (Lang, 2001) Especially relevant for this report is the elimination of corrections. The aim for this research is to eliminate the manual cutting or closing of holes (repair work) which fits very well within the announced IHC2020 strategy.

In other industries like the automobile- and electronics industry, the lean manufacturing invented by Toyota, is very much further developed and implemented. These industries contain a lot of standardizations and large series production. This is much more difficult for the ship building industry. Especially for a company like Royal IHC, each project is on the basis of engineering-to-order. (Coenen, 2008) A ship is rarely the same as a previous one. However, also in this business major steps could be taken.

3 PIPE ROUTING

Pipe routing is one of the most complex tasks of ship building. Many aspects have to be taken into account like equipment, structures, rules and regulations. In this chapter, first the piping process at Royal IHC is discussed. Then an overview is given of pipe routing in other industries. Finally a pipe routing approach for shipbuilding using an algorithm is discussed.

There are three aspects that are of importance during pipe routing; functionality, rules & regulations and engineer experience. (Asmara, 2013) First the pipe must fulfill its function. This is highly dependent on the machinery. The capacity and medium determine the diameter, material, surface treatment and even angle and slope. (the angle can be restricted by the required flow) The way how to route is also dependent on the number of pipes. In a crowded area, you have to take into account other systems which may be designed by colleagues. Often there is also a technical placement requirement related to a system. For example, a sprinkler system has to be placed above fire hazardous equipment. Finally, the manufacturing-, installation- and maintenance costs should be kept as low as possible, without losing the functionality. The second important constraint for the engineer are the rules and regulations regarding efficient engineering and safety. This is explained in detail in 'Rules & regulations'. The third aspect is the value of the piping engineer. Because of the large amount of necessary knowledge and the lack of detailed educations in pipe design, the value of the engineer is extremely dependent on the experience and gathered knowledge.

It is very beneficial when the pipe routing is fully engineered in 3D on a high level of detail. Due to this, a lot of errors like collisions can be identified and solved before production starts. Subsequent adjustments or eliminations of pipes can significantly affect the surrounding pipe systems. Often these pipes have to be adjusted as well. In addition to that, it often happens that whole systems have to be transferred to another room which involves even higher consequences.

There is a large number of piping systems inside a ship. These systems are generally placed in the same type of area. In a working vessel, three main areas can be distinguished. First there is the machinery area. This area has the highest density in number of pipes per cubic meter. In such a room, one pipe can follow many different paths. The second type of area is the accommodation. Here the space is limited as well. and most pipes must be hidden. An additional difficulty is that **grey water** pipes need a slope in order to be drainable. However, the amount of systems and pipes is much less. The last type are the technical areas. These areas are less difficult in terms of finding the path due to relatively more space. However, it needs deep knowledge about the technical system itself. The division of areas is shown in Table 2.

Table 2 – Area types (Asmara, 2013)

Machinery type area	Accommodation type area	Technical type area
Main engine room Auxiliary engine room Pump room	Accommodation spaces Control rooms	Areas where all other systems are placed E.q. dredge pipe area

3.1 PIPING PROCESS

In this chapter, the piping process is discussed. Both the process described in literature and the process at Royal IHC are being illustrated. The piping process for large vessels is not very similar to piping in other industries, because of some unique constraints which will be discussed later. Because of the high complexity, the large amount of systems and the high dependency of engineers on each other, the process must be well organized within a company.

3.1.1 LITERATURE PIPING PROCESS

As discussed in chapter 2, there are generally four phases. This applies to both the naval engineering and for the mechanical engineering. Also the piping, which is a part of mechanical engineering, can be divided in these phases. First, during concept design, a list of requirements arises based on the ship specifications. In this phase the piping discipline can already estimate which systems are needed for the project and where the difficulties

could be. Then in the preliminary design, the major piping systems are selected and arranged on the ship. Location of equipment and connections between them are defined. Subsequently, in the contract design, these schematic overview of systems is elaborated further and additional details and specifications are developed. Also required valves and branches are added. In the last phase, the detailed design, the piping is fully defined and three-dimensionally routed inside the ship model created by the naval engineers. In this phase, all details like supports, reinforcements and separations are included.

Within the piping process, some basic attributes are involved. A division can be made between the people (stakeholders), the tools (software) and the information (files) that are needed. A comparison is made between literature (Asmara, 2013) and Royal IHC. This is shown in Table 3. In the right column the function of each stakeholder, tool and information is described.

Table 3 – Stakeholders, tools and information

(Asmara, 2013)	IHC nomination	Function
Stakeholders		
Project engineering manager	Team leader engineering	Responsible for all engineering activities
(not mentioned)	Lead engineer mechanical	Responsible for all machinery & piping
Pipe group leader	Lead engineer detail mechanical	Lead the group of pipe engineers
Pipe engineer	Engineer detail mechanical	Route the pipes
Cad software administrator	Cad software administrator	Maintenance of CAD software
Marine engineer	Marine engineer	Translation of system to functional requirements and diagrams
P&I diagram engineer	Diagrams engineer	Translation of functional diagram to P&I diagram
Naval architect	Naval architect	Hydrostatics, hydrodynamics, structure, arrangement and constructions
Section designer	Structural/ hull engineer	Render construction plan into 3D section model
3D model builder	Detail engineering modelling	Create new models of components
Ship owner	Customer	Change specifications during process
Marine classification society	Marine classification society	Define rules and standards
Tools		
3D CAD software – outfitting	NUPAS Cadmatic	Route piping in 3D
3D CAD software – diagram	NUPAS Cadmatic	Create P&I diagram
Information		
Functional diagram	System diagram	Illustrate process and flow
P&I diagram	P&I diagram	Functional diagram including locations
Construction plan	Construction plan	Show basic construction of the ship
Section drawing	Section drawing	Show detailed construction of ship section
Pipe specification	Pipe specification	Define pipes (by classification/ ship owner)
Basic design information	General arrangements	Arrangements and specifications
Component 3D model	Component 3D model	Get a full impression of ship section

The theory distinguishes multiple processes within the piping process. (Storch, 1995) (Asmara, 2013) First there is the organizational process. The inputs are the general arrangements and technical specifications. This process output contains the division of tasks over the piping engineer and the determination of a comprehensive planning. This process is executed by the pipe group leader/ lead engineer detail mechanical. (Figure 10)

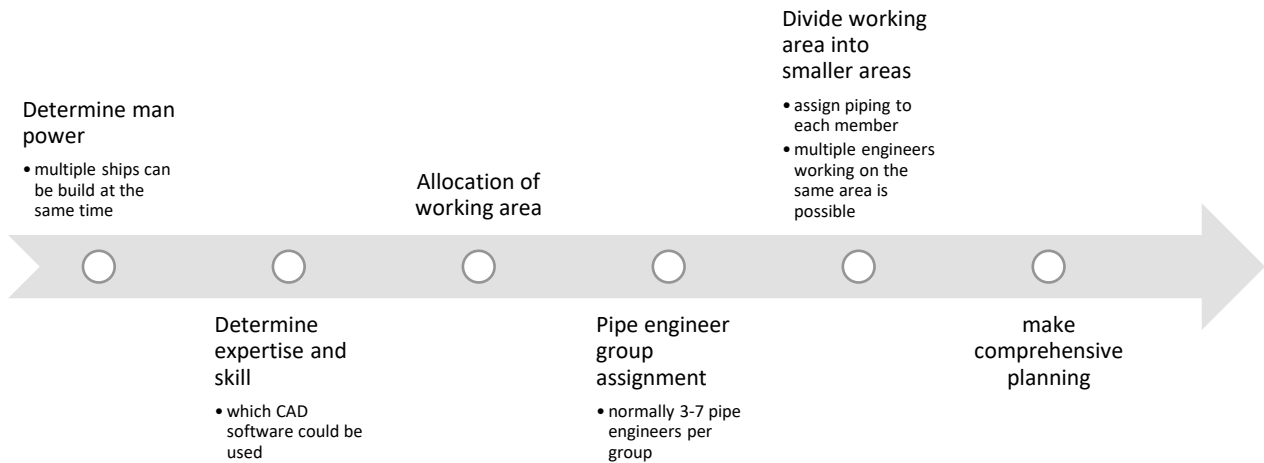

Figure 10 – Organizational process

The next process is the pipe routing process. This process is executed by the pipe routing- and diagram engineers and starts with the assignment following from the previous process. During this process the pipe engineer has to perform a working area assessment. He needs to collect all required information and tools that are involved to create a diagram of each system. On the basis of P&I diagrams, the pipes can be routed in the end. (Figure 11)

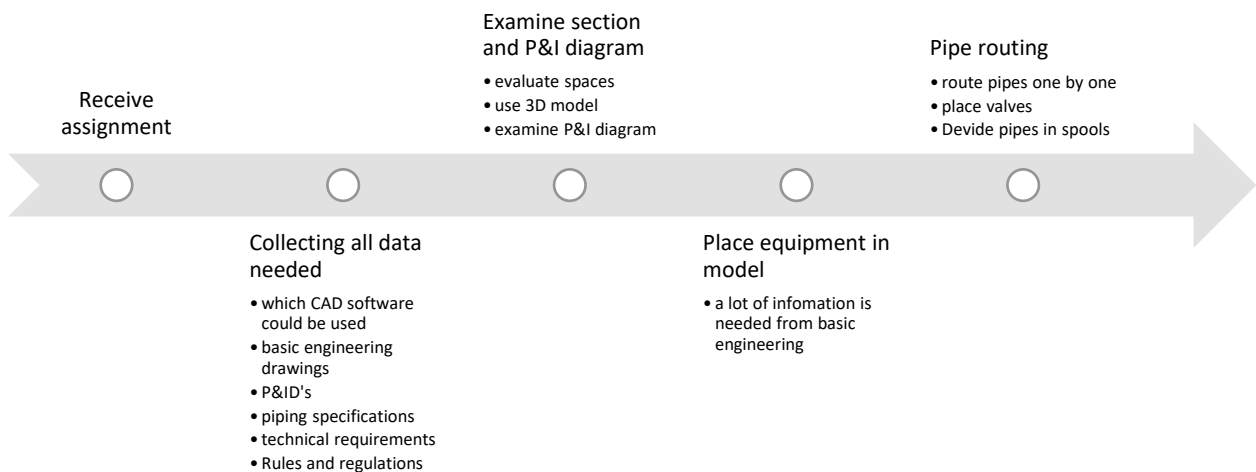

Figure 11 – Pipe routing process

3.1.2 ROYAL IHC PIPING PROCESS

Now we can elaborate somewhat further into this process and how it is executed at Royal IHC. There are basically five phases that are involved in the engineering, production and implementation of a pipe system. The inputs like the **construction plan** and the general arrangement are obtained from the naval engineering department and are then used as a starting point for the mechanical basic engineers. The five phases or departments can be described as follows:

- Basic engineering – define specifications and create P&I diagrams
- Detail engineering – Routes the piping
- Work preparation (CPE) – Creates production drawings and machining files
- Production – Produces the pipe spools
- Outfitting – Places pipe system on vessel

In appendix I, an extensive overview of the piping and machinery process is defined in a flow diagram. It is the full cycle from specifications to a produced pipe spool. A few remarks regarding the interpretation of this scheme have to be made. The meaning of the different shapes and colors are defined in Figure 12.



Figure 12 – Legend

In the left column of the diagram, the four phases are stated. The last phase, outfitting, is left out of consideration because it is not very relevant and too time-consuming for this research. If a transition is to be made from pipe routing towards pre-defined holes, it contains a change in engineering (e.g. more complex, other approach), CPE (e.g. other/ less production drawings) and production (e.g. more bends in pipes,). The outfitting does not change a lot, because the pipes and equipment have to be placed on the ship anyway. However, a large change could be made in the intermediate step before outfitting, in which the holes are cut manually. This is a task of the shipbuilding process and therefore not included here.

In the piping & machinery flow diagram there is made use of several software applications. The most prominent are:

- Cadmatic – Software to model the pipe routing in the 3D vessel. Pipe specifications are imported in a Cadmatic library by the basic engineers. The detail engineers use this library to route the pipes.
- E-browser – Sharing extension of Cadmatic which make it possible for different users to visualize the progress.
- IHC Reporter – Database with modifications and quality issues during production.
- Extended – Software that makes a production planning and divides the pipes into delivery units.
- 3R – Software that creates machining files for the bending and cutting of pipes.

3.2 OTHER INDUSTRIES

Piping in ships is very complex because of the large amount of systems and the limited space. Other industries that have to deal with a lot of systems and pipes are the automobile-, aircraft-, train- and oil- industry. For example, a Boeing 737 contains 530km of cabling, 100,000 wire pieces and 40,300 connectors. (Rocca & Tooren, 2016)

A first large difference is that in these industries, the piping and cabling needs to be hidden when it is designed for passenger transportation. In contrast, there are less difficult penetrations required, for example watertight passages. Besides, these systems mainly need electrical connections (cabling) which are flexible and often does not need to be routed on the exact millimeter for the hole length. The engineering budget and time available for trains, aircrafts, cars and refineries is generally a lot higher than for ships. Especially at IHC, nearly all ships are custom-built and have to be delivered in a limited time frame. Due to this, the production often has to start while engineering is not finished yet. Therefore the pipe routing is less optimized than in comparable industries. (Table 4)

Table 4 – Other industries

Constraint	Ship	Aircraft	Car	Train	Refinery
Large amount of systems	++	++	++	++	++
Limited space	+	++	++	+	-
Tight schedule (due to custom-built products)	++	-	-	-	+
Large bending radii	++	--	--	-	++
Orthogonal routing	++	-	-	++	++
Routing along structure	+	+	+	+	+
Many divisions in lines	++	-	-	++	+
Preferred location of equipment	+	+	+	+	+
Hidden systems	--	++	++	++	--
Lot of watertight penetrations	++	-	-	-	-
Hazardous media	+	+	+	+	+
Rules and regulations (strength and safety)	+	+	+	+	+

3.3 ROUTING ALGORITHM

Nowadays, pipe routing by hand is resulting in high quality systems but it is also very time consuming. Therefore several research is carried out with the aim of optimizing ship pipe routing design using computers. (Dong & Lin, 2016) (Asmara, 2013) Most of this research is based on the particle swarm optimization (PSO).¹ On the basis of a set of constraints this method is searching for the optimal solution, which is the shortest path without violating this constraints. In this chapter, this method is generally described without going into too much detail.

The algorithm consists of a number of elements. The general function which performs velocity and position updates at each iteration is defined as (Dong & Lin, 2016):

$$v_i^k(t+1) = c0 \times v_i^k(t) + c1 \times rand() \times (p_i^k(t) - x_i^k(t)) + c2 \times rand() \times (p_i^g(t) - x_i^k(t)) \quad \{8\}$$

$$x_i^k(t+1) = x_i^k(t) + v_i^k(t+1) \quad \{9\}$$

v = velocity component

x = position component

p = personal best position

p^g = global best position of swarm

c = constant

t = time

The general function consists of the following components:

$$c0 \times v_i^k(t)$$

Inertia component: It represents the contribution of the previous velocity over the current velocity.

$$c1 \times rand() \times (p_i^k(t) - x_i^k(t))$$

Cognitive component: Causes the particle to move to the regions in which it has experienced good individual fitness.

$$c2 \times rand() \times (p_i^g(t) - x_i^k(t))$$

Social component: causes the particle to move to the best region that the swarm has found so far. rand() causes the components to have a stochastic influence on the velocity update.

Summarizing, the position (t+1) is dependent on the initial position (t) plus the velocity component (t). This velocity component is the sum of the inertia component (t), the cognitive component (t) and the social component (t).

3.3.1 CONSTRAINTS

The pipe routing algorithm should not just find the shortest path from start point A to endpoint B. There are some constraints involved which can be divided in three categories. (Table 5)

¹ A set of particles (swarm) flies towards an optimal solution where each particle represents a potential solution to the optimization problem, and reaches the global optimum over a series of iterations.

Table 5 – Pipe routing algorithm constraints

	Constraint
Physical	1. Connect pipe interfaces (startpoint to endpoint)
	2. Avoid obstacles
	3. Arrange pipes orthogonally
	4. Avoid hazardous areas
Economic	5. Minimize length of pipe
	6. Minimize number of pipe bends/ corners
	7. Route pipe close to walls or devices for better supporting
	8. Share pipe rack if possible to reduce installation costs
Aesthetic	9. Arrange pipes to have the same height (in a layer) if possible

The feasible paths are restricted by the physical constraints. Then the optimized path can be found by quantifying the economic and aesthetic constraints.

The physical constraints have the highest priority. They are absolute constraints. Then the installation costs (7,8) are next priority because they are usually higher than the material costs (5-6).

The workspace can be simplified to a 3D cubic box which is decomposed into grids. The grid is dependent on the pipe diameter and the minimum chosen interval distance. A path consists of a group of grids.

Constraints 2,4,5,6,7 and 8 are the objectives of the optimization. 1,3 and 9 are restricted in the algorithm. Of course, constraints 2 and 4 can't be neglected, but it is hard to restrict them directly. On the hand of a large penalty, a path which violates constraint 2 or 4 will never end up as the best result. The following functions are used in the algorithm. (Table 6)

Table 6 – Constraint functions

Constraint	Function	Remarks
1,3,9	Restricted	
2,4	Penalty function f_P	Count number of grids intersected with obstacles on a path
5	Length function f_L	Accumulate number of grids on a path
6	Bend function f_B	Accumulate number of bends on a path
7	Energy function f_E	Grids located close to the walls and devices have lower energy
8	Bonus function f_B	Gives a bonus when pipes are arranged as a group

3.3.2 FITNESS FUNCTION

Based on the function in Table 6, the fitness function of single pipe routing can be defined.

Minimize

$$f_{single}(path) = w_1 f_L(path) + w_2 f_B(path) + w_3 f_E(path) + w_4 f_P(path) \quad \{10\}$$

The overlapping among different pipes is not yet expected in this function, so a penalty of collision is introduced.

$$f_{CP}(path_1 \dots path_k) = Collisionpenalty \times \sum f_{Collision} \quad \{11\}$$

The function contains a (large) constant penalty factor multiplied by the number of collisions between pipes. Also the installation bonus is not yet implemented in f_{single} . In contains a big constant value divided by $(1+)$ the number of parallel pair of grids on two paths. (Figure 13)

$$f_{IB}(path_1 \dots path_k) = \frac{Installationbonus}{1 + \sum f_{Installation}} \quad \{12\}$$

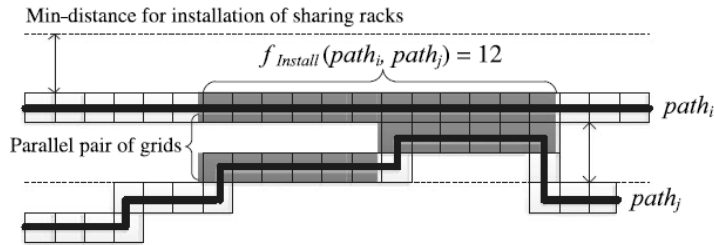

Figure 13 – Parallel pair of grids (Dong & Lin, 2016)

The resulting function for multiple pipes is the summation of the three function mentioned before.

Minimize

$$f_{multiple}(path_1 \dots path_k) = \sum f_{single} + f_{CP} + f_{IB} \quad \{13\}$$

For the branch pipe routing the same approach can be used. The purpose is to minimize the total length of all branches. The overlapping between branches is allowable, because branches can use the same pipe to get somewhere. A bonus function is introduced to induce the overlapping of branches.

$$f_{OB}(path_1 \dots path_k) = \frac{Overlapbonus}{\sum f_{overlap}} \quad \{14\}$$

Then the fitness function of branch pipe routing is defined.

Minimize

$$f_{branch}(path_1 \dots path_k) = \sum f_{single} + f_{OB} \quad \{15\}$$

3.3.3 RELEVANCE FOR THIS RESEARCH

The algorithms described by Asmara and Dong & Lin find the shortest path between start- and endpoint, taking into account the set of constraints. However, this report is about routing pipes towards penetrations instead of finding the shortest path. In other words, it is like a route planner including a 'via' point. The new algorithm will contain a start point, endpoint and in-between point. The set of constraints in Table 5 is still valid, but two constraints have to be added. By implementing these two constraints, the routing algorithms may be applicable for this research as well.

10. The pipe must go through a preset via point.
11. The pipe direction has to be perpendicular to the structure surface at the location of the via point. This already applies for the connections as well.

Constraint 10 can also be reached by the sum of two algorithm runs. The first one from starting point to via point, and the second one from via point to endpoint.

Constraint 11 already applies to the connection at start- and endpoint as well. In this areas it is achieved by defining the direction of the first grid. In the via point, this can be carried out in the same way. De direction of the via point must be restricted. If we then run the algorithm from starting point to via point and from via point to endpoint, constraint 10 and 11 are both satisfied. (Figure 14)

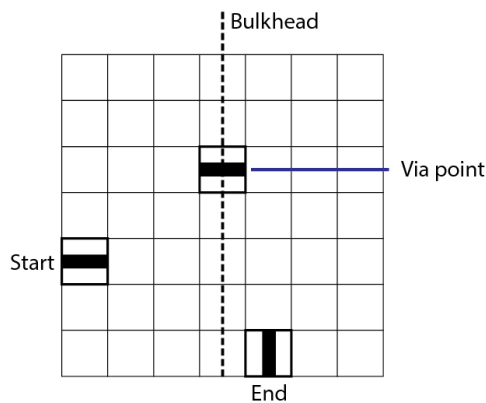

Figure 14 – Direction constraint including via point

If all pipes could be routed automatically, the problem described in 1.2 will not arise. However, automatic routing of all piping in a vessel at an early stage is not very realistic at the moment. For the usage of this algorithm, all constraints like structural members and connection locations must be known on time. But that is exactly the problem, this is often not known. A possible solution at the end should therefore require less input as an precise algorithm described in this chapter.

4 RULES & REGULATIONS

In this chapter most rules and regulations that are relevant for this research are mentioned and discussed. The two subjects that are of interest are penetrations and pipe routing. Penetrations can have a large impact on the strength of the structure and therefore the regulations have to be followed. Specifically for piping, there are some rules and regulations as well, concerning efficient routing and avoiding dangerous situations.

For both penetrations and pipe routing, a division is made between regulations from the classification society, and general rules and standards used by engineers defined by Royal IHC. Some of these will overlap and are not mentioned multiple times.

4.1 CLASSIFICATION

A classification society is a non-governmental organization that establishes technical standards for the construction and operation of marine vessels and offshore structures. (Classification society and IACS, 2016) The main task is to classify and validate the construction and determine whether the structure is safe. The thirteen largest class societies in the world are united as the International Association of Classification Societies (IACS). This collaboration is to ensure as much uniformity as possible throughout the world. For a shipyard, it is important to build according to these classifications, in order to guarantee a reliable and safe vessel for clients. The classification societies that are relevant for Royal IHC are Bureau Veritas (BV), China Classification Society (CCS) and Lloyd's Register (LR). (Figure 15) At least according to one of these is generally built, dependent on the request of the IHC client.

This chapter will first focus on the class rules regarding penetrations, and then regarding pipe routing. All rules from the three classification societies considering the same subject are merged. The exact articles from each society can be found in 'Appendix IV: Classification articles holes' and 'Appendix V: Classification articles pipe routing'.



Figure 15 – Classification societies

4.1.1 PENETRATIONS

Rules concerning penetrations are dependent on rules about holes as well. If a hole cannot be cut on a certain location, a penetration of a pipe is not possible either. First some general rules will be discussed which concern the all piping systems or the whole ship. Then a distinction is made between the direction of the penetration, vertical (deck), longitudinal (bulkhead) and transversal (bulkhead). At the end the rules about shell penetrations are included.

4.1.1.1 GENERAL

A very general rule is that manholes, lightening holes and all other openings on structural members are to be kept clear of areas of stress concentration. If this is impracticable, compensation reinforcement is to be made. Also all corners and openings are to be well rounded to, again to reduce stress concentration. Some examples of high stress areas which must be avoided are:

- Vertical or horizontal diaphragm plates in narrow cofferdams/double plate bulkheads within one-sixth of their length from either end.
- Floors or double bottom girders close to their span ends.
- Primary supporting member webs in way of end bracket toes.
- Above the heads and below the heels of pillars.

Holes in **primary members** are generally not preferred. However, in any case it is needed for lightening. The depth of the hole/opening in single skin sections may not exceed 25% of the web depth. In addition, the distance between the edge of the hole and face plate is not to be less than 40% of the web depth. This distance is in general to be kept from the edge of the hole to the corner of notches (for the passage of frames) as well. For openings cut in single skin sections, the length of opening is not to be greater than the web depth or 60% of the stiffener spacing, whichever is greater. (Figure 16) In double skin section, the depth may not exceed 50% of the web depth and it should be located that the edges are well clear of cut outs. (Figure 19) Holes that do not comply with this requirement are to be reinforced.

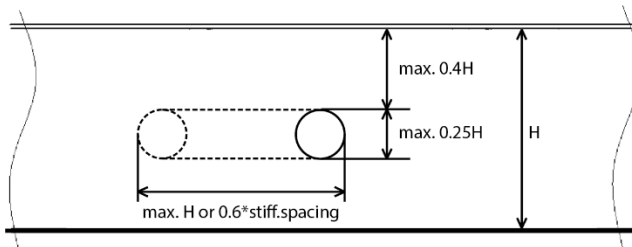

Figure 16 – Hole in single skin section web

4.1.1.2 VERTICAL

The vertical holes and penetrations are passing through the tanktop and decks. Very critical is the strength deck, because of the large forces and moment in this area. Holes in the strength deck are to be kept minimal. They must be spaced as far as practicable from one another and from the ends of superstructures, side shell plating, hatchways corners, or hatch side coamings. Also holes between midship bridge or deckhouse and bulkheads and hatches are to be avoided as far as possible. Around hatchway corners, holes are to be cut outside the hatched areas in Figure 17. The exact calculation of the dimensions in this figure can be found in the appendix.

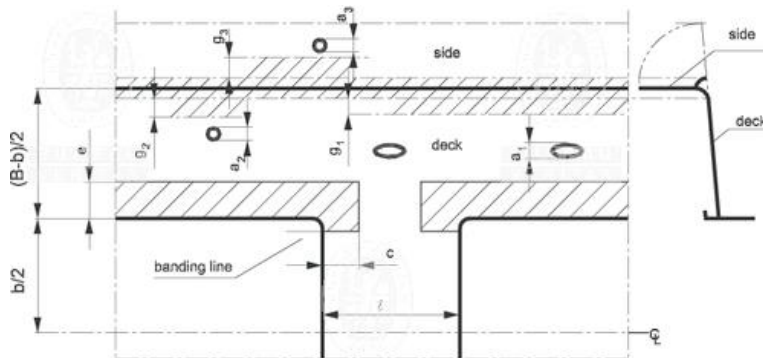

Figure 17 – Holes around hatchways (BV)

Large openings in the strength deck always have to be deducted from the sectional area in the strength calculation. Therefore these large openings are to be avoided as much as possible. Large openings are:

- Elliptical openings exceeding 2,5 m or 0.1B in length
- Elliptical openings exceeding 1,2 m or 0.04B in breadth
- Circular openings exceeding 0,9 m in diameter.

Small vertical holes do not have to be deducted if they meet the following criteria:

$$\sum b_s \leq 0.06(B - \sum b)$$

$\sum b_s$ =Total breadth of small openings, in m, in the strength deck or bottom area at the transverse section considered, determined as indicated in Figure 18.

Σb = Total breadth of large openings, in m, at the transverse section considered, determined as indicated in Figure 18.

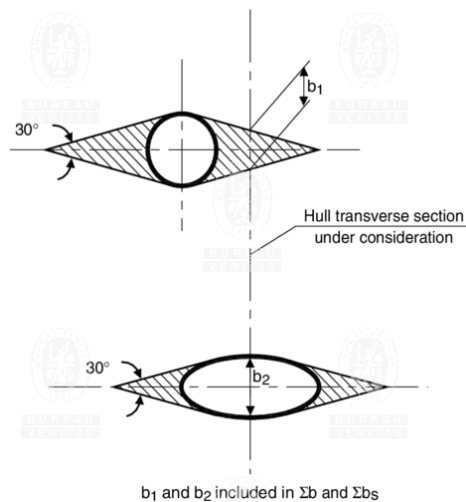

Figure 18 – Deduction criteria breadth (BV)

4.1.1.3 LONGITUDINAL

For longitudinal bulkheads and girders, the same regulations are used as shown in Figure 16. In addition, the maximum web depth is 75mm and no holes are to be cut on the girder web within 200mm from the toe of girder brackets.

4.1.1.4 TRANSVERSAL

Similar to the rule for longitudinal webs, the hole depth may not exceed 25% of the web depth and the width may not exceed 60% of the spacing of deck longitudinals or the web depth, whichever is greater. (Figure 16) Also the maximum depth of 75mm and the minimum distance of 200mm from the toe is similar.

For the collision bulkhead, some specific rules are involved. First, no doors, manholes, access openings, ventilation ducts or any other openings shall be fitted in the collision bulkhead below the bulkhead deck. However, the penetrations of not more than one pipe are allowed for dealing with fluid in the forepeak tank. If the forepeak is divided to hold two different kinds of liquids, the society may allow the collision bulkhead to be pierced below the bulkhead by two pipes. This is only the case if there is no alternative available. The number of openings in the extension of the collision bulkhead above the freeboard deck shall be restricted to the minimum compatible with the design and normal operation of the ship. In addition to this, all such openings must be capable of being closed weathertight.

For watertight bulkheads, the number of holes and penetrations must be reduced to the minimum compatible with the design and proper working of the ship. In double plate bulkheads, holes are not to be cut within one-third of their length from either end.

4.1.1.5 SHELL

For shell openings, the valves are very important in order to avoid water running in when it is not intended. However, the valve within pipe systems are not really relevant for this research.

Generally, the number of openings in the shell plating is to be reduced to the minimum compatible with the design and proper working of the ship. They must not be located at a vertical distance from the decks not less than:

- two times the opening diameter, in case of circular opening
- the opening minor axis, in case of elliptical openings.

Holes and openings should not be cut in or near to the bilge radius and the sheerstrake for strength issues. However for the sheerstrake, if it cannot be avoided, holes that are less than 20% of the depth of the sheerstrake may be accepted. Opening greater than 20% require special consideration.

4.1.2 PIPE ROUTING

Now the rules and regulations concerning pipe routing will be addressed. First some general standard valid for most piping will be discussed. Then relevant rules are described for the most common ship systems.

4.1.2.1 GENERAL

For piping systems in ships, some subjects are defined in the class regulations like bending radii, fixation and isolation. There are also regulations for piping through tanks, holds, bulkheads and hazardous areas.

Radius

At all times, unless otherwise justified, the bending radius measured on the centerline of the pipe is not to be less than:

- twice the external diameter for copper and copper alloy pipes. (2D)
- three times the external diameter for cold bent steel pipes. (3D)

However, it is often determined that bending radii of twice the diameter (2D) for steel pipes are allowed as well. In practice, this is used most at the Royal IHC pipe shop.

Fixation and expansion

The fixation of pipes can be rather complex. Pipes have to be positioned near the structure. Unless otherwise specified, the pipes have to be mounted to the ship structure by collars or similar devices. The shipyard has to take care that:

1. The arrangement of supports and collars is to be such that pipes and flanges are not subjected to abnormal bending stresses, taking into account their own mass, the metal they are made of, and the nature and characteristics of the fluid they convey, as well as the contractions and expansions to which they are subjected.
2. Heavy components in the piping system, such as valves, are to be independently supported.

Besides, pipes are to be so designed and fixed that relative movement between pipes and structures is possible, having due regard to the temperature of the fluid conveyed, the coefficient of thermal expansion and the deformation of the ship hull. All pipes subject to thermal expansion and those which, due to their length, may be affected by deformation of the hull, are to be fitted with expansion pieces or loops.

Insulation

Pipes that are routed in refrigerated rooms or pass rooms intended for temperatures of 0°C or below, are to be insulated from the steel structure, except in positions where the temperature of the structure is mainly controlled by the external temperature and will normally be above freezing point. In addition, all pipes and other components where the temperature may exceed 220°C are to be efficiently insulated. Where necessary, precautions are to be taken to protect the insulation from being impregnated with flammable oils.

Because of this required actions, it is preferred to avoid these temperatures as much as possible.

Passage

There are several spaces in a ship where the passage of piping is to be avoided. If not, it will involve extra costs due to material finish, thickness and reinforcements. The passage of pipes through tanks require special arrangements, in particular for:

- bilge pipes
- ballast pipes

- scuppers and sanitary discharges
- air, sounding and overflow pipes
- fuel oil pipes.

In addition, fresh water may not be too close to oil. Therefore, fresh water pipes are not to be led through oil tanks, and oil pipes not through water tanks. If it is impracticable to do so, the pipes are to be led inside an oil-tight pipe tunnel.

Penetrations through watertight and/or fireproof bulkheads or deck must be minimized. However, if necessary, arrangement are to be made to maintain the watertight fireproof integrity. Pipes passing through cargo holds or tween decks have to be protected against shocks by means of casings. Wash deck pipes and discharge pipes from the pumps to domestic water tanks are not to be led through cargo holds.

Hazardous areas

Liquids and electronics are generally not a nice combination. Therefore, pipes and tanks must not be placed near switchboards or other electrical appliances. If this requirement is impossible to satisfy, gutterways or masks are to be provided. In addition, oil pipes are not to be directly placed above boilers, uptakes, steam pipes, exhaust gas pipes and silencers.

4.1.2.2 SYSTEMS

Now some specific rules per system will be discussed. There are a lot more standards and rules for each system, but in the report only the relevant ones regarding the routing are defined.

Bilge

Bilge pipes have to be arranged in such a way, that any water within any compartment of the ship, or any watertight section of any compartment, can be pumped out through at least one suction pipe (the rise of floor needs to be at least 5°, otherwise more suction pipes). The parts of bilge pipes passing through deep tanks intended to contain water ballast, fresh water, liquid cargo or fuel oil are normally to be contained within pipe tunnels. Bilge suction pipes are preferably no to be led through double bottom tanks. If the bilge system consists one main bilge line, it has to be placed as high as possible in the pipe tunnel. In the case of two main bilge lines, each cargo hold is provided with a branch bilge suction connected to each main bilge line respectively. The bilge main is to be so arranged that no part is situated nearer to the side of the ship than B/5.

Ballast

Ballast pipes are required in all ballast tanks, including aft and fore peak. Ballast pipes are preferable to be led through pipe tunnels. If this is impracticable, and they have to be led through tanks intended for fresh water, fuel oil or liquid cargo, the following is required:

- Reinforced thickness
- Minimal number of joints in these lines
- Expansion bends in these lines within the tank
- No slip joints.

Scupper and sanitary

Scuppers are needed for the drainage of water in areas where water is likely to accumulate, which is not in the ship's bottom. Scupper and sanitary discharge pipes are not to pass through fuel oil-, fresh water- and drinking water tanks.

Air, overflow and sounding

Both air- overflow- and sounding pipes for fuel oil tanks are not to be led through accommodation type rooms.

Air pipes have to be fitted at the highest point of a tank or compartment, opposite to the filling pipes. Generally two air pipes are fitted for each compartment. If only one air pipe is provided, it is not to be used as

a filling pipe. Air pipes of double bottom compartments, tunnels, deep tanks and tanks intended to be pumped up are to be led to the open above bulkhead deck. Air pipes other than those of flammable oil tanks may be led to enclosed cargo spaces above the freeboard deck. Air pipes from storage tanks containing lubricating or hydraulic oil may terminate in the machinery space, provided that the open ends are so situated that issuing oil cannot come into contact with electrical equipment or heated surfaces. Air pipes from heated lubricating oil tanks are to be led to the open.

All tanks which can be filled by a pump require an overflow pipe. The total cross-sectional area of the pipe is defined in the class. The overflow pipe of fuel oil or lubrication oil tanks is to be led to an overflow tank having space reserved for overflow purposes. The pipes are to be self-draining under normal trim.

Sounding pipes are required on tanks intended to contain liquids as well as to compartments which are not readily accessible at all times. They are located as close as possible to the suction pipe and they are to end above the bulkhead deck of freeboard deck. In machinery spaces and tunnels, short sounding pipes led to readily accessible positions above the floor are fitted. Sounding pipes are normally to be straight.

Fuel oil

Fuel oil piping must be separated from piping intended for lubricating oil systems to prevent contamination. They are not to be located near units of high temperature, including boilers, steam pipelines exhaust manifolds and silencers. Pipes conveying oil under pressure are to be of seamless steel or from other approved material having flanged or welded joints, and are to be placed in sight above the platform in well lighted and readily accessible parts of the machinery spaces.

Thermal oil

Thermal oil pipes are not to be led through accommodation type spaces. Heat transfer oil pipes are also not allowed in main and auxiliary spaces, unless they are located in tight manifolds, provided with appropriate means of internal inspection and with drip trays.

Lubrication- and hydraulic oil

Just like with fuel oil, lubrication- and hydraulic oil pipes must be separated entirely from other piping systems and if under pressure, are to be seamless or from other approved material. They must also not be positioned above high-temperature equipment.

Steam line

Steam lines must not be routed through accommodation type spaces, unless they are intended for heating purposes. They are also not preferred in spaces which may be used for cargo. The pipes are to be efficiently secured and insulated, and well protected from mechanical damage. If steam pipes are led through tunnels or duct keels, they are to be secured and insulated as well.

Feed water

Feed water pipes are not allowed to be routed through fuel oil or lubricating oil tanks. Two feed water systems are to be provided for main and auxiliary boilers for essential services, including feed pumps. Feed water may not be contaminated by oil or oily water.

Cooling water

Seawater cooling water systems need sea inlets. Not less than two inlets, fitted on both sides of the ship are to be provided. They are to be low inlets, so designed as to remain submerged under all normal navigating conditions. One of the sea inlets may be that of the ballast pump or of the general service pump.

Compressed air

Air compressors need an area that is provided with sufficient ventilation. All discharge pipes from starting air compressors are to be lead directly to the starting air receivers, and all starting pipes from the air receivers to main or auxiliary engines are to be entirely separate from the compressor discharge pipe system.

4.2 IHC RULES & STANDARDS

In order to create uniformity within the company and a clear overview of defined engineering rules, Royal IHC has created its own rules and standards. The aim is that each engineer makes the best and unambiguous decision for every engineering issue. Some of these are very relevant for this research.

On the one hand there are the rules and agreements set for the company. This contains important aspects that must be taken into account during engineering and also a guidance where to start. On the other hand there is a database of standards with detailed technical information about the construction, sizing and welding of several components and systems in a ship.

4.2.1 PENETRATIONS

A ship can't be built just out of solid plates and stiffeners. A lot of holes are required for several purposes like aeration, lighting, crawling and piping. As mentioned in 1.4, this research is about the penetration of piping through structure members like bulkheads and decks. This can be attained in different ways. The main difference is between rigid and free penetrations, depending on the fire resistance, water tightness and strength of a member.

4.2.1.1 HOLES

Holes in the structure are for the passage of a medium (air, fluid, light, men) or for weight savings. There are strength and stiffness rules regarding holes which have to be taken into account. The ones that are relevant for the passage of systems are discussed.

First, holes must never be too close to a profile cutout. The distance between the hole and the profile cutout has to be at least the height of the cutout. Besides, a hole may never be larger than half the bearer height and it should preferably be placed on the neutral line of the bearer. (Figure 19) In chapter 4.1, holes in primary members are discussed further.

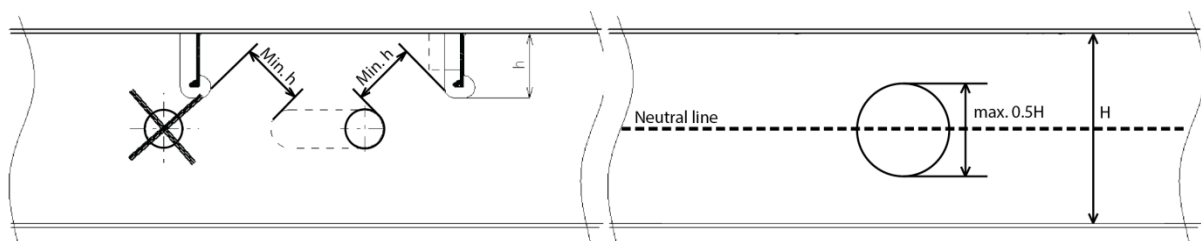

Figure 19 – Left: hole near profile cutout Right: hole height

In the axial direction of the bearer, there is also a preferred position that can be defined. On the location of the turning point there is no moment in the bearer, because the parts around cancel each other out. (Figure 20) This is the best location for a hole. Holes are permitted in the region of $0.7L$ and preferably there are no holes in the $0.15L$ region.

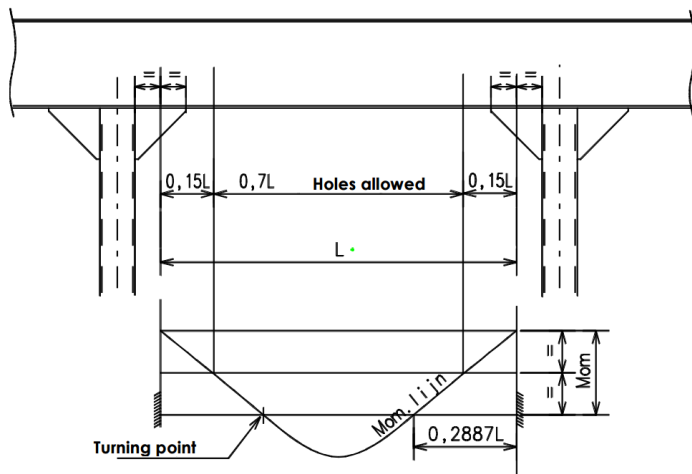

Figure 20 – Axial preferred hole location

It is always preferred to make use of the existing holes in the structure for the pipe penetrations. However, the crawl routes and accessibility of difficult locations have to be taken into account. In this research is dealt with working vessels. Unlike passenger vessels like cruise ships and yachts, not all piping needs to be hidden behind the structure. Therefore it is preferred to route as much as possible underneath and along bearers and webs if there is sufficient deck height and openings present.

Finally, there are some locations where holes are not allowed. This is because of strength issues and safety. These locations contain:

- Through toes (ends) of knees or profile joints.
- Through thick reinforcement plates.
- Close to the corners of large door openings at the location of, for example, the hopper.
- At block, winch and crane supports.
- In the extensions of longitudinal bulkheads and/or frames (e.g. hopper and/or keelson).
- At large transitions in the constructions (e.g. trunk deck to coaming deck hopper).
- At weld joints, section butts and lands in plate fields (engineering costs).
- In integrated engine and pump foundations.
- In plate construction at the shaft bracket for the propeller shaft.
- In plates that are made to be extra thick in relation to their surroundings (difference in thickness more than 3mm).
- Along plate edges of holes or contours, keep at least 100mm free from edge of the plate to the edge of the hole.
- Along weld joints, stay at least 150mm away from them.
- In areas intended for a life boat, gangway or pilot ladder, and not through a fender or at a section cut.

4.2.1.2 PENETRATIONS

Penetrations are the transits that are used for the passage of piping. Penetrations can be free or welded in. Welded penetrations occur in different standardized designs, dependent on the location of the penetration and the size, material, finishing, medium and function of the pipe system.

If a bulkhead or deck needs to be watertight and fire resistant, a free penetrations is not possible. In addition, sometimes the ship's construction does not allow free penetrations in critical decks/bulkheads because of strength reasons. In these cases a choice has to be made between a penetration plate, a welding sleeve or a double welding sleeve. (Table 7) A penetration plate may be needed if during outfitting a flange must be pushed through the hole. It is also used if during production the hole appears to be too large for the required pipe diameter. For most pipes, a single welding sleeve can be used. However, for galvanized pipes like scupper pipes a double welding sleeve is required. This is to avoid the contact between the galvanized pipe and the

structure plate. Other pipes which are generally galvanized are pipes for seawater, sanitary and sounding purposes. This include:

- Bilge
- Ballast
- Fire fighting
- Cooling (seawater)
- Scuppers
- Sanitary
- Water tank sounding
- Oil tank sounding

Table 7 – Weld-in penetrations

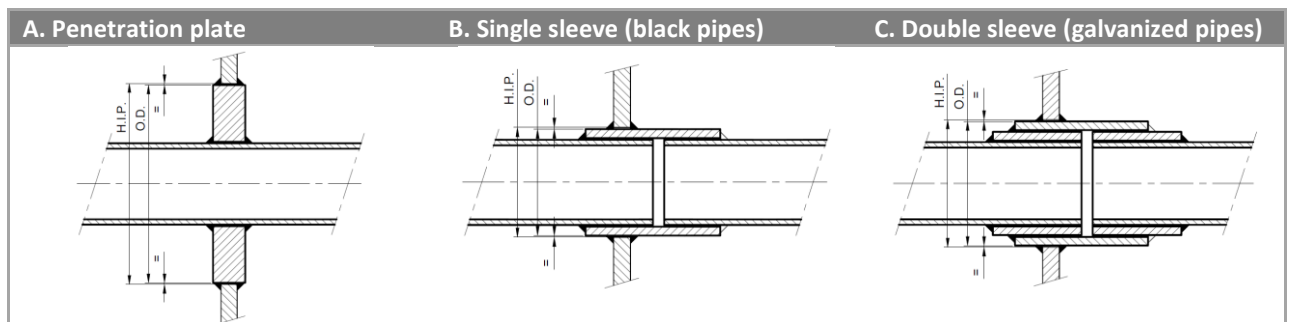

In general, a sleeve is cheaper than a penetration plate and therefore preferred. In tanks, sleeves always will be used unless stated otherwise. For cable tray penetrations, a specific standard is defined by IHC. For non-watertight decks and/ or bearers, a stiffener is needed because of the large width. Two options are shown in Figure 21.

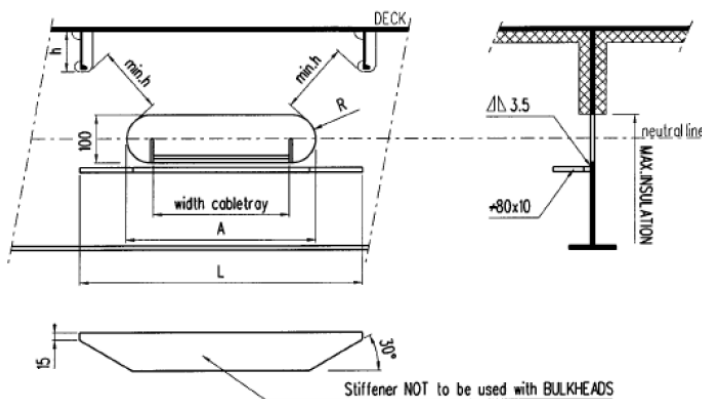

Figure 21 – Cable tray penetration

There are some special penetration designs which are not just a standard penetration plate or sleeve. The most common ‘specials’ used by Royal IHC are shown in Table 9.

4.2.1.3 SIZE

For this research, the pipe diameter isn't the parameter that is ultimately the objective. The size of the hole that has to be cut is of interest. However, when the size of the pipe is determined, the size of the penetration plate or sleeve can also be determined. The sleeve- or penetration plate diameter which has to be used by the engineer for a certain pipe diameter is standardized for some specific piping systems. In Appendix II: Piping- &

penetration standards, the pipes and standards used by Royal IHC are shown for most of the systems. A lot of standards in this table are used several times. Therefore this division can be summarized as shown in Table 8. All standards within the same row have the same penetration size. Then only ca. 16 different penetration types are possible. Each of these 16 types has a standardized penetration size in respect to the pipe diameter. These sizes can be found in Appendix III: Piping- & penetration sizes.

Table 8 – Penetration standards

		Flange 30mm	Flange 40mm	Penetration plate 30mm	Tank connection	Tank connection with routing	Cunifer plate	
Bulkhead flange	<i>PN10</i>	C210P30-ST52	C210P40-ST52	C270P-ST52	C210T-ST52	C210TC-ST52	C598P-ST52	
	<i>PN16</i>	C216P30-ST52	C216P40-ST52					
	<i>PN25</i>	C225P30-ST52	C225P40-ST52					
	<i>PN40</i>	C240P30-ST52	C240P40-ST52					
		Normal	Long version	Section border	Tank connection	Deck penetration	Inner sleeve	Other
Single sleeve	<i>Normal</i>	C300NL-ST52	C300NLL-ST52	C300NS-ST52		C300NDP-ST52		C321NL-ST52 C321NLL-ST52
	<i>Heavy</i>	C301HL-ST52	C301HLL-ST52	C301HS-ST52	C301HTP-ST52			C322HL-ST52 C322HLL-ST52
	<i>Extra heavy</i>	C302EL-ST52	C302ELL-ST52	C302ES-ST52				C323EL-ST52 C323ELL-ST52
	<i>Extra extra heavy</i>	C303EEL-ST52	C303EELL-ST52					C324EEL-ST52 C324EELL-ST52
Double sleeve	<i>Normal</i>	C313NP-ST52		C313NS-ST52			C313N-ST52 C314N-ST52	C314NP-ST52
	<i>Heavy</i>	C315HP-ST52		C315HS-ST52			C315H-ST52 C316H-ST52	C316HP-ST52
	<i>Extra heavy</i>	C317EP-ST52		C317ES-ST52			C317E-ST52 C318E-ST52	C318EP-ST52
Special connections								
Non-ferro metric		C325-200	C325-300					
Metric pipe coupling		C379	C379HTO	C379SS				
Cunifer sleeve		C598L-ST52						
Non-ferro fire/water resistant		C631FM	C631WM1					
G-penetration		A138						

Then, when the size of the penetration is determined, the size of the hole can be calculated with a simple formula. For the hole for a sleeve or for a flange/ penetration plate the formulas are:

$$D_{hole,sleeve} = \begin{cases} D_{sleeve} + 3\text{mm}, & D_{sleeve} \leq 273 \\ D_{sleeve} + 5\text{mm}, & D_{sleeve} > 273 \end{cases} \quad \{16\}$$

$$D_{hole,flange} = D_{flange} + 3\text{mm} \quad \{17\}$$

4.2.2 PIPE ROUTING

There are many base rules which the piping engineer must keep in mind during the determining and routing process. First, the piping must be kept as simple and clear as possible. This is especially of importance in crowded areas like the engine room. To keep a clear overview, there has to be applied as much symmetry as possible relative to the heart of the ship, by mirroring as much as possible similar pipelines. Besides, it is convenient to maintain layers of pipes with the same direction at the same elevation. (Longitudinal, transversal, vertical) It is recommended to keep these pipes grouped and orthogonal which also enables efficient penetrations. If orthogonal (90°) routing is not possible, standard angles of 30° and 45° should be used.

In order to save space and costs, it is important to keep piping as straight and short as possible. Sometimes there are additional constraints regarding the bends in a pipe, for example for a drain or aeration pipe. Between two fixed points, it is often required to create an expansion loop, to avoid undesired stresses in the pipe. An angle in a pipe can be created by bending the pipe or by welding an elbow between two pipes. Using elbows should be avoided as much as possible. It contains a lot of extra welding time and costs. If an elbow is inevitable, a **1.5D elbow** has priority over a **1D elbow**, due to the high costs involved with 1D elbows.

The location of piping in a room is dependent on several aspects. It is obvious that it is preferred that the pipes are not crossing gangways or be located at other disturbing places, but on the other hand valves must be operable by the technicians. Generally, pipes must be located near the structure (deck, bulkhead, tanktop) to enable for supports. Besides, piping must not be positioned too close to machinery, structure and other piping. A minimal distance of 25mm is set as a base rule. (Figure 22)

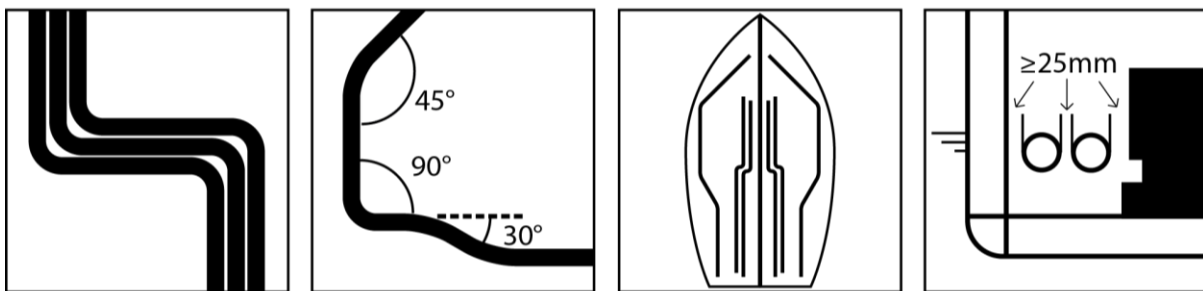

Figure 22 – Basic rules

4.2.2.1 PRIORITIES

Because of the large amount of piping systems within a ship, it is hard to determine where to start. However, some priorities which often are applicable can be defined. The sequence stated below is an indication which can help the engineer. However, the exact order is not always valid. After all, the extent to which the routing is carried out efficiently, is highly dependent on the experience of the engineer.

- Limited space areas
- Large diameter pipes (bilge, ballast, sea cooling water, sounding)
- Sloped pipes
- Ventilation pipes (always at the highest point)
- Fixed pipes (tank coils, tank penetrations)
- Main cable trays

Especially the large diameter pipes are routed first, because they take up most of the space. Sloped and fixed pipes must be located soon as well, because they are highly constraint.

4.2.2.2 MANUFACTURING

It is very important to take into account the manufacturing constraints during engineering. If during production, a pipe spool appears to be not producible, this will involve high adjusting and repair costs, and finally a pipe routing far from optimal will come out. The main issues to deal with are the pipe diameter, bending radius and straight length which is needed for the bending and welding machines. A general used rule of thumb by the pipe shop for the minimal bending radius is two times the diameter. However, due to the flow in the pipe, the class often requires a radius of three times the diameter.

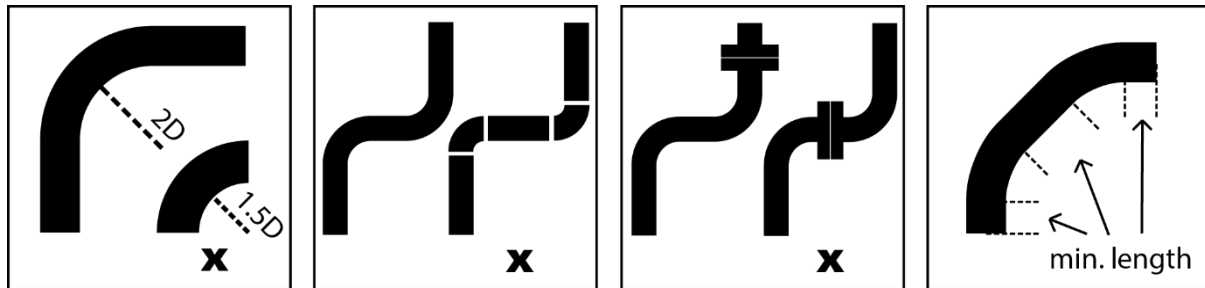

Figure 23 – Manufacturing rules

One pipe spool with more than one bend must be placed on the bending machine only once. This has to be remembered while dividing a pipeline. So it is better to have one pipe with two bends instead of two pipes with one bend each. (Figure 23) There is one exception: If two bended pipes must be welded together it is a lot of work to prepare the welds. Pipe ends must be made square and a beveled end must be grinded for each butt weld. In this situation welding elbows are preferred above bending. In Figure 24, a pipe spool is shown with both a bend and a welded elbow. Figure 25 shows several pipe spool sorted per section ready for transport.



Figure 24 – Left: Pipe spool with bend and welded elbow

Figure 25 – Right: Coated pipes sorted in racks for transportation

4.2.2.3 DIVISION

Another task of the piping engineer is to divide the routed piping into pipe spools. This is necessary, because the purchased pipes have a standard length and the pipe spools must be able to be outfitted. The maximum length of pipe spools depends on the situation. A pipe that will be put in during pre-outfit can often be longer than pipes put in during outfit. In case of any doubt a shorter pipe will be the best option. The maximum length will be 6 meter. (Metric copper pipe 5 meter) Besides, it is advantageous that just a part of the pipe system has to be exchanged if something is broken.

In technical spaces or on every unit, every pipe must be removable by use of flanges. On other parts of the ship, pipes may be welded in. In electrical spaces, this is a must. In addition, flanges are never allowed above electrical equipment. Another thing to take into account is the fact that pipes with flanges or sleeves are easy to weld using a manipulator at the pipe shop. This is a reason to avoid pipe-pipe divisions.

The location of a division has to be chosen deliberately. If for example a reducer is required, it is better to divide the pipe at the small diameter size of the reducer. Because of this, a cheaper and less space consuming flange can be used. If an elbow has to be used, it can be smart to weld the flange directly on to it. This limits the number of welds.

Finally, some practical issues have to be considered. Rounded dimensions makes the check work easier and pipes must be easy to handle. Pipe spools that cannot be placed through holes of 2x2 meter are not desired.

4.2.2.4 SYSTEMS

Besides the general rules which are valid for all piping, there are some specific agreements for each system. The ones that are relevant for this research are listed below.

Bilge and ballast

- The bilge valve is located in the forepeak.
- Bilge suction pipes are, as far as practicable, not to be carried through double bottom tanks.
- Suction filters are placed just under the floor.
- The number of bilge and ballast pipes through tanks must be limited.
- Pipe through tanks must have limited joints and bends. Expansion loops have to be placed if required.

Air and sounding

- The aeration pipes of tanks must be located at the highest point towards the fore ship. They have to lead to an outside deck.
- Aeration pipes should be placed in the shadow of a web frame, bulkhead or construction part.
- Aeration pipe must be routed only upwards to an outside deck.
- Preferably, aeration pipes are not located along the railing or bulwark, but against the deck house wall or hopper coaming.
- The sounding pipes must be located as close as possible to the suction pipe as deep as possible in the compartment.
- The sounding pipe should be vertical without bends.
- Sounding pipes for combustible fluids, with the exception of lubrication / fuel leak oil systems, must end on the outside decks, at locations where there is no risk of ignition.

Firefighting and deck wash

- The main fire-fighting pipeline in the engine room must be as short as possible.
- The isolation valve in the main fire-fighting pipeline must be operated from a location that is always accessible, but should never be operated from a compartment that is connected to the engine room.
- After this valve, the main fire-fighting pipe may no longer be routed through the engine room, or through a compartment that is connected to the engine room.

Scuppers

- Route scuppers as straight as possible without sags in the pipe.
- Place the scuppers as far as possible against the outside wall of the deck house.

Thermal oil

- Thermal oil pipes are only welded in when they pass a water-, gas- or oil-tight deck or bulkhead. In all other situations, the thermal oil pipes are freely routed through the construction.
- The thermal oil pipes may not be routed through the accommodation and control rooms.
- The pipes should be routed in such a way that it is easy to apply the insulation.
- Almost all pipes are insulated, with the exception of the heating coils in the tanks and the pipes designated “NI” and “NIP” on the diagram.
- Thermal oil pipes should not be placed too close to cable trays (min. 200mm).
- The pipes must be provided with expansion loops.

Starting air

- Expensive piping so must be kept short.
- Sags are not allowed in the pipeline.
- The water drain is routed just below the floor.
- The blow-out filter must be placed under the first deck or within a short distance above the bilge.

Working air

- All working air connections should be placed approximately one meter above the floor.
- Work air connections above the “weather deck” should be placed approximately 0.5 meters above the floor.
- The blow-out of the equipment listed below should end as low as possible above the bilge:
 - Working air compressors.
 - Working air dryers.
 - Working air vessels.

Fuel oil

- The fuel oil pipelines are as far as possible at locations that can be easily reached and seen and not close to hot surfaces or electrical equipment.
- Operating valves are located above the floor.
- The fuel oil pipe should not be routed above the engine and exhaust pipe.
- Route overflow pipes with a minimum angle of 2° and avoid sags.

Exhaust gas

- Exhaust gas pipes must be as straight as possible.
- The hole in the deck/ bulkhead should be large enough for a sleeve or flange joint to be placed through it.

Ventilation

- Preferably, ventilation pipes are placed against the accommodation wall or hopper coaming.
- Ventilation ducts must run underneath the bearers with sufficient room for pipelines and cable trays.
- The bottom side of the ventilation duct is at least 2100mm above the floor surface, and higher if possible.
- Route the pipe approximately 20mm below the insulation in order to be able to make further connections and system corrections without any problem.

Sanitary

- The penetrations through a deck are utilized according the IHC standard shown in Table 9-P.
- Penetrations through fire resistant and watertight bulkheads/ decks are placed in accordance with the IHC standard shown in Table 9-L.

Cable trays

- Cable trays should be routed above ventilation ducts as much as possible
- The internal bend radius that has to be taken into account is 300mm.
- Cable trays preferably make angles of 30°, 45° or 90°.

For some of these system it is known in advance whether it must be routed as low as possible or at least below the floor of a room. (Table 10)

Table 10 – Indication of system positions (Asmara, 2013)

System name	Lowest	Below	Above
Fuel oil		X	
Lubrication oil		X	
Dirty oil and sludge		X	
Sea cooling water	X		
Fresh cooling water		X	
Bilge	X		
Ballast	X		
Ventilation			X
CO ₂ , Novec, watermist			X

In addition to these rules, for some specific piping systems, the normally used sizes are defined by the company. Also the sizes that have the possibility of bending at the pipe shop, including the bending radii are indicated. Besides, it is defined whether the welding robot is able to weld flanges on a particular size.

Also for elbows there are some standardized dimensions. As stated before, the usage of welding elbows should be avoided as much as possible, especially for the 1D bends. Small and large **1D elbows** are basically never used. All of this can be seen in Appendix III: Piping- & penetration sizes.

4.3 CONCLUSION RULES & REGULATIONS

In this chapter, the rules and regulations, both defined by royal IHC and the class are summarized.

4.3.1 PENETRATIONS

1. Holes are not allowed on locations of stress concentration. (examples in 4.2.1.2) All openings are to be rounded well.
2. Holes in primary members are not preferred. (if impracticable, follow class rules)
3. The distance between a hole and the profile cutout has to be at least the height of the cutout.
4. A hole may never be larger than half the bearer height.
5. A hole should preferably be placed on the neutral line of the bearer.
6. In axial direction of the bearer, holes are preferred on the turning point and not within the 0.15L region.
7. If possible, use existing holes in the structure for penetrations, or route underneath and along bearers and webs.
8. Watertight and fire resistant penetrations need to be welded in.
9. A single welding sleeve is generally preferred.
10. Use a penetration plate if a flange have to be put through the hole during outfitting.
11. Use a double welding sleeve for galvanized pipes.
12. Special penetrations are shown in Figure 21 and Table 9.
13. The hole diameter is
 - a. Sleeve diameter $\leq 273\text{mm}$; +3mm
 - b. Sleeve diameter $> 273\text{mm}$; +5mm
 - c. Penetration plate ; +3mm
14. Holes in the strength deck are to be kept minimal and must be spaced as far as practicable from one another and from the ends of superstructures, side shell plating, hatchways corners, or hatch side coamings.
15. Large openings in the strength deck always have to be deducted from the sectional area in the strength calculation.
16. No free opening is allowed in the collision bulkhead below the bulkhead deck. One or two pipe penetrations are allowed.
17. In the shell, watertight bulkheads and in the extension of the collision bulkhead above the freeboard deck, the number of openings shall be restricted to the minimum compatible with the design and normal operation of the ship.
18. Holes and openings should not to be cut in or near to the bilge radius and the sheerstrake.
19. In double plate bulkheads, holes are not to be cut within one-third of their length from either end.

4.3.2 PIPE ROUTING

1. Keep the piping clear and simple by keeping it straight and short, limit the number of pipes and use symmetry.
2. Group pipes and maintain layers with the same direction and elevation.
3. Route orthogonal, or with angles of 30° and 45° if this is impracticable.
4. A bending radius of 3D is preferred, 2D is possible.
5. Avoid elbows, use **1.5D elbow** (not 1D) if this is impracticable.
6. One pipe with two bends is better than two pipes with one bend.
7. Take into account the minimum required straight length for bending and welding.
8. Do not locate pipes at disturbing places. (e.g. gangways)
9. Avoid pipes routed through tanks.
10. Pipes and tanks must not be placed near switchboards or other electrical appliances.
11. Locate pipes near the structure.
12. Keep at least 25mm between pipes and structure, equipment and other pipes.
13. All pipes subject to thermal expansion and those which, due to their length, may be affected by deformation of the hull, are to be fitted with expansion pieces or loops.
14. Avoid cold (below 0°C) and hot (above 220°C) areas for piping.

15. Start routing with the large diameter-, sloped- and fixed pipes.
16. Steel pipes have a maximum length of 6 meter, but also the outfit possibility has to be taken into account.
17. In technical spaces, every pipe must be removable by the use of flanges. In electrical spaces, pipes must be welded in.
18. Avoid pipe-pipe divisions.
19. Choose the division location wisely and reduce the space intake and number of welds. (flanges on elbows, flanges on small end of reducer)
20. There are several rules per system can be found in 4.2.2.4 and 4.1.2.2.

5 MANUFACTURING

In the previous chapters, the process for ship design and specifically for pipe routing are discussed. Also the relevant rules and regulations which have to be taken into account during this process are described. In this chapter, the practical part of piping and penetrations is discussed. In order to quantitatively prove the problem stated in the first chapter, the manufacturing costs have to be determined and compared. This chapter consists of two important parts, the manufacturing methods and costs of the holes and the manufacturing of the pipe spools.

5.1 PLATE CUTTING

The holes can be cut by robot or by hand. The aim of this research is to minimize the manual cut holes in a ship, because of the higher costs. In addition, manually cut holes involve a higher failure risk, because it has to be measured and marked by hand. First the cutting processes used by Royal IHC are explained. Then the costs of robotically and manually cut holes are calculated and compared. At the end, a conclusion supplemented by some remarks is stated.

5.1.1 CUTTING PROCESSES

At Royal IHC, there is made use of two cutting methods. The automated holes are cut by plasma cutting and the manual holes are cut by oxy-fuel cutting. A third well-known cutting method in the steel industry, laser cutting, is not used by IHC which will be explained later.

5.1.1.1 PLASMA CUTTING

The cutting robot automatically cuts the plates using a plasma cutting machine. It is a very simple and fast process that starts with a machining file obtained from the work preparation department. The plate parts are then automatically cut and coded. If holes are to be kept 'free', so without another part welded in, some manual finishing like deburring is required.

Plasma is the fourth state of matter, besides solid, liquid and gas. The plasma phase is reached if a gas is heated up further till it is ionized and electrically conductive. Plasma cutting is a technique by which plates and beams made of steel, stainless steel and aluminum can be cut. It makes use of an electric arc between the electrode of the torch and the cutting object. The performed cut is beveled by the process and it contains rounded edges. If this is not desired, further finishing is required. The plasma cutting technique can be used in manual cutting torches, or in combination with an automated CNC machine.

The plasma cutting machine consists of a power supply with wire, an earth cable, a nozzle and a pressure line. Via the pressure line, an inert gas is passed through the nozzle with a high speed. At the same time, a flame arc in the gas is excited between the wolfram electrode and the work piece. Then a part of the gas is transitioned into plasma. The extremely hot plasma of about 30.000 °C melts the metal while the high speed gas blows the melted metal away. (How a plasma cutter works, 2014)

The power supply must have a high voltage. The operating voltage which is required to sustain the plasma phase is about 50 Volts, but the open circuit voltage which is needed to initiate the arc can be up to 400 Volts. The plasma flow during cutting is critical for the cut quality and must be set according to the current level and nozzle bore diameter. If the current is too high for the bore diameter, or the flow is too low for the current, it usually result in a melted nozzle which is catastrophic for the machine. (Lucas, 2017)

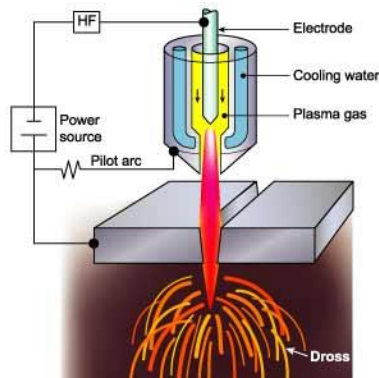

Figure 26 – Plasma cutting (TWI)

5.1.1.2 OXY-FUEL CUTTING

Torch cutting, also known as oxy-fuel cutting or flame cutting, is a widely used method for cutting plates and beams. Oxy-fuel cutting allows for larger thicknesses than plasma cutting. Besides, larger angles of 70° are possible in comparison to 45° using plasma cutting. In addition, there is an economic advantage. Both the initial investment costs, consumables and operating costs are lower than for plasma cutting. (The basics of oxy fuel cutting, 2017) Just as for plasma cutting, the system can be implemented in a CNC machine which results in a fully automated cutting robot. The process contains three essential steps: Preheating, piercing and cutting. (What is oxy-fuel cutting, 2013)

First, the steel material has to be preheated to its kindling temperature (about 960°C) in order to enable cutting. The kindling temperature is the lowest temperature at which the material spontaneously ignites in normal atmosphere without an external source of ignition, such as a flame or spark. (Autoignition temperature, 2016) This heat is provided by an oxy-fuel torch. As the name already reveals, inside this torch a highly gas flammable mixture is created of oxygen and a fuel gas. Commonly used fuel gases are acetylene, propane and natural gas.

The next step is piercing. Once the surface to be cut is fully heated to its kindling temperature, a jet of pure oxygen is turned on to begin piercing through the plate. If the oxygen hits the heated steel, a very fast oxidation process starts. It is an exothermic reaction. This means it generates more heat than it takes to start. Depending on the thickness of the material, this piercing can take a fraction of a second up to several seconds.

The last step is cutting. Once the oxygen stream has pierced the material on one position, the torch can be moved at a constant speed to form a cut. The cutting time of the process is highly dependent on the thickness of the material. The shortest distance is perpendicular to the sheet. Therefore angled cuts (for beveling) are more time consuming. During the cutting, the steel constantly has to be heated. By using a CNC machine, the desired outline can now be formed. Only metals whose oxides have a lower melting point than the base material itself can be cut with this process.

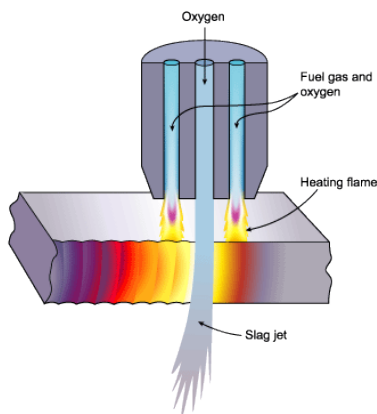

Figure 27 – Oxy-fuel cutting (Oxyfuel cutting - process and fuel gases, 2017)

5.1.1.3 COMPARISON

Laser cutting is another cutting method with very high performances but also high costs. The precision and quality that can be reached with this process isn't necessary for the shipbuilding industry. For the most common plate thicknesses in ships (4-30mm), plasma cutting is the most efficient regarding speed and quality. A broad comparison can be found in Table 11. Values in this table are approximations and can only be used for comparison.

Table 11 – Method comparison (Hussary & Pryor, 2013) (What is the best value, 2013)

	Oxy-fuel cutting	Plasma cutting	Laser cutting	Waterjet cutting
Capital costs	Low (€ 50.000)	High (€ 90.000)	Very high (€ 500.000)	High (€ 90.000)
Operating costs	Low (€15/h)	Low (€15/h)	Moderate (€20/h)	High (€25/h)
Consumable costs	Low	Low	High	High
Cutting speed < 6 mm	Slow	Very fast	Very fast	Slow
Cutting speed < 40 mm	Slow	Very fast	Slow	Very slow
Cutting speed > 40 mm	Slow	Slow	Slow	Very slow
Pierce time	Slow	Very fast	Very fast	Slow
Thicknesses	< 150mm	< 80mm	< 25mm	<100mm
Tolerances	0.75 mm	0.38 mm	0.25 mm	0.20mm
Cut quality	Good	Very good	Excellent	Excellent
Torch configuration	Usually 1 for plate cutting Up to 8 per gantry for beam cutting	Usually 1	Usually 1	Usually 1 for plate cutting Up to 8 per gantry for beam cutting

It is possible that other shipyards, that experience the same problems as stated in this research, make use of other cutting methods as Royal IHC. However, the problems remain because it is about the input that is required on time for the cutting machines.

5.1.2 PLATE CUTTING COSTS

Now the total costs of an automatically cut hole using plasma cutting and of a manually cut hole using oxy-fuel cutting can be determined. In Figure 28, the influencing parts that determine the costs of a hole are elaborated. Categories like engineering costs and cutting costs are directly related to the parameters of equation 1. The figure includes the engineering costs, cutting costs and additional costs that arise when the penetrations are not known on time. The bold parts are only applicable for manually cut holes. The italic parts are different for both methods.

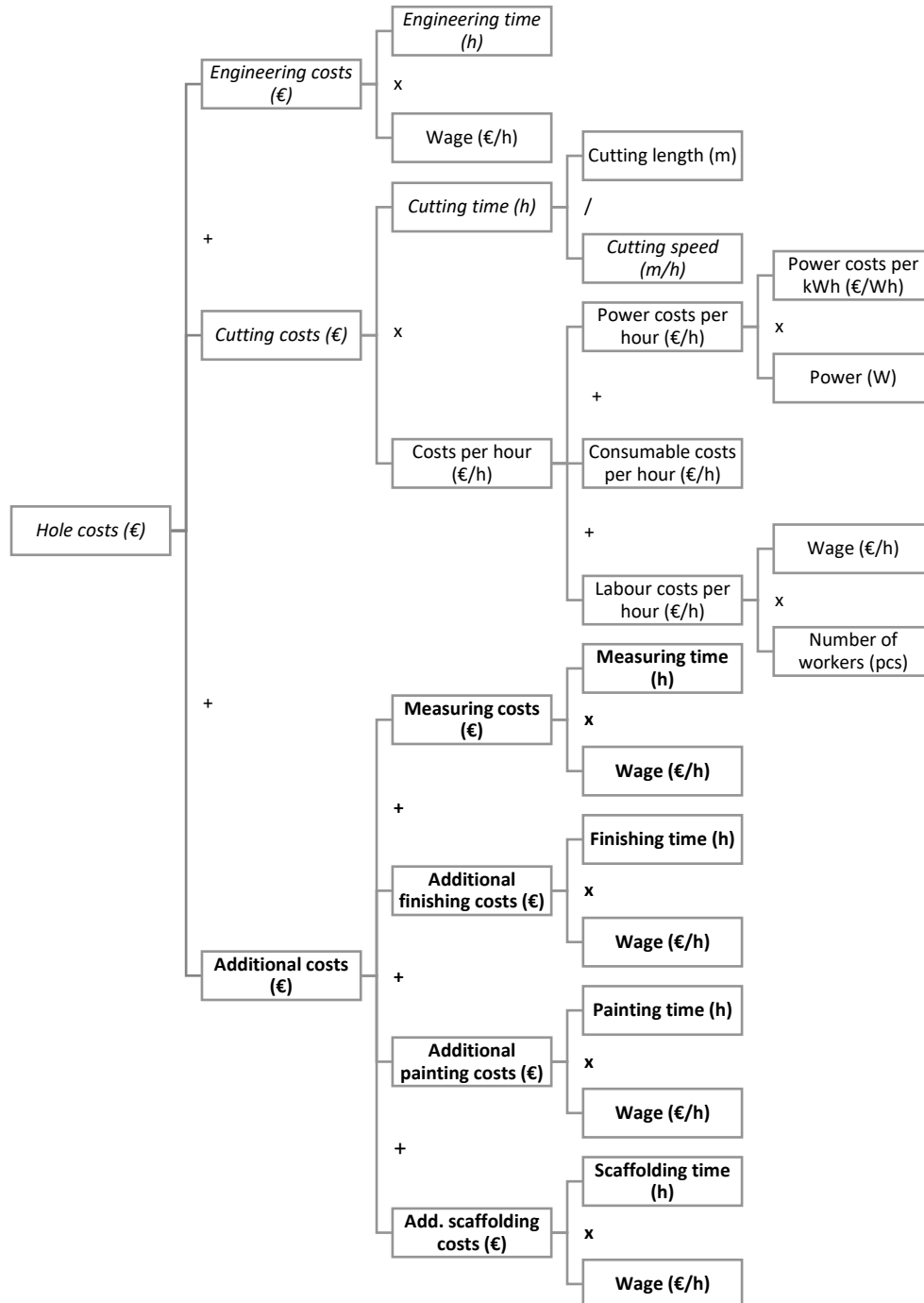

Figure 28 – Hole costs²

The other parameters are considered to be equal for both methods. The consumables for plasma cutting are slightly more expensive but due to the higher speed, it costs approximately the same per hour. The additional

² The hole costs are the total costs that are involved in the creation of a hole, including engineering, cutting and additional costs.

engineering costs due to manual holes are very low. The production drawing is performed anyway, it only has to be printed and handed out. (Smit, 2017)

The hole costs for the automated cutting is determined by the cutting speed, the machine hourly rate (which includes the power- and consumable costs) and the man-hour costs. The man-hour costs are €56 per hour. One single worker can operate 4 plasma cutting machines at a time.

The manually cut hole costs are determined empirically. From a ship built by IHC, the repair man-hours required for adding holes at a location, related to the perimeter/ diameter of that holes and the number of holes are researched. Then the cost per perimeter and cost per hole are determined. (Figure 29 and Figure 30) This contains the total man-hours cost related to the hole. It includes for example:

- Work division
- Drawing printing
- Set up of equipment
- Building of scaffolding
- Measuring and marking
- Finishing
- Additional painting

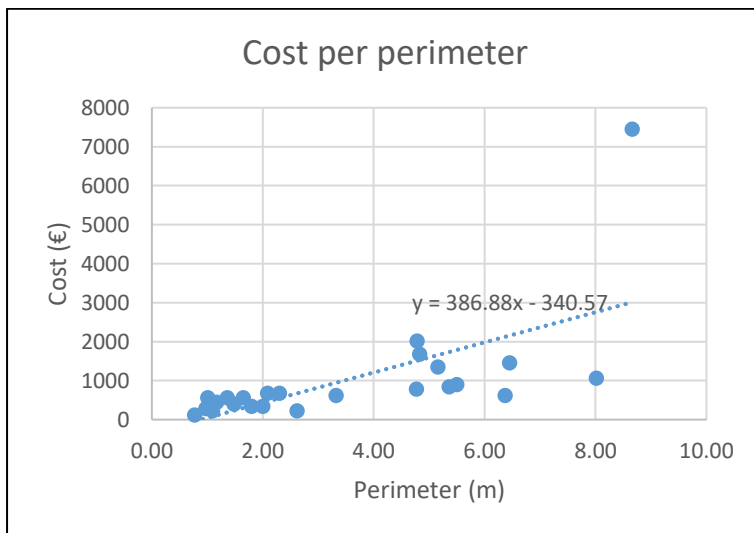

Figure 29 – Cost per perimeter

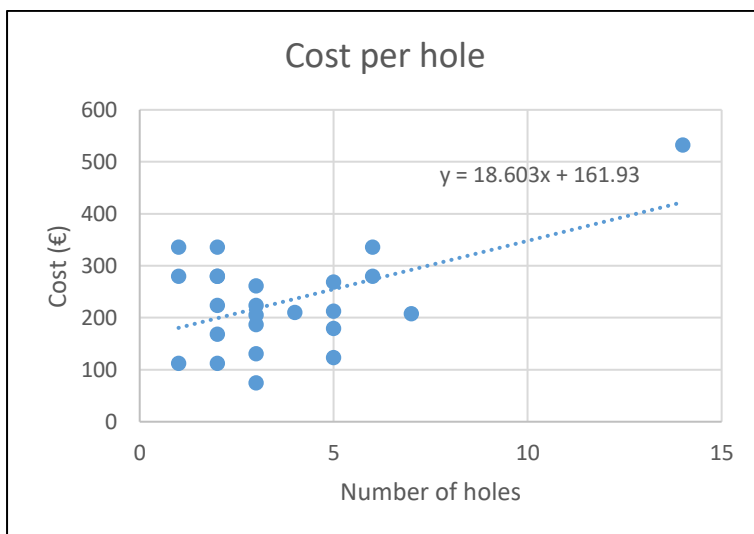

Figure 30 – Cost per hole

The used man-hours and cutting length can be found in Appendix VI: Hole costs.

The cost per hole is just an estimation and can therefore be simplified as shown in Figure 31. It can be seen from this graph that a single hole cost around 180 euros, but every next hole only cost 20 euros. An important conclusion from this is that the cost is mainly caused by side issues like preparing the worksite and guaranteeing the safety. Additional number of holes at the same worksite does not influence the total cost a lot.

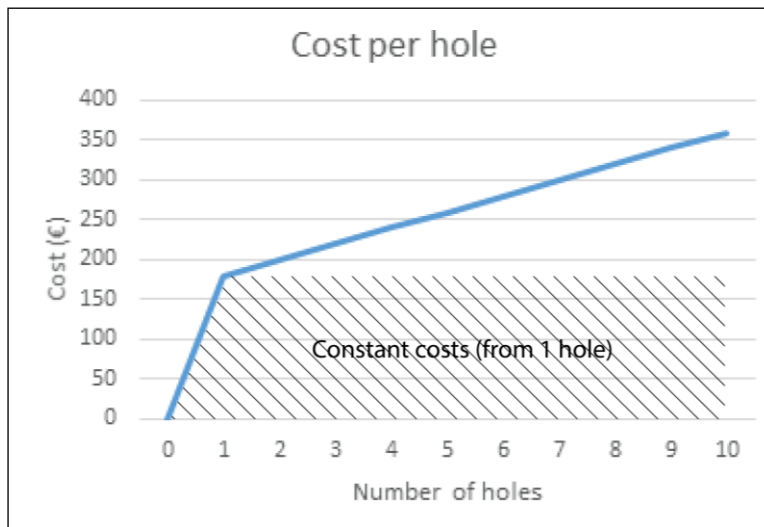

Figure 31 – Cost per hole (simplified)

In Table 12, the comparison is made between a hole cut by plasma robot and by hand. With the plasma cutting machine, the hole cost is dependent on the size and cutting length of the hole. In this calculation, a normal occurring hole diameter of 300 mm is used. As stated before, for manual cutting the cost is not that dependent on the cutting length, but on the total activities involved by cutting a hole. Now the cost of a hole by plasma cutting robot is about 1 euro, and by hand 180 euros. (Table 12)

Table 12 – Hole costs per meter

Metal worker		Plasma cutting machine		Manual cutting	
Man-hour costs	€ 56,00	Cutting speed (m/min)	2	Costs formula	160+20X
Workers per machine	0,25	Machine hourly rate	€ 110,00		
		Hole costs			
		Hole diameter (mm)	300	Number of holes	1
		Cutting time (min)	0,47	Manual cutting costs	€ 180,00
		Machine costs	€ 0,86		
		Wage costs	€ 0,11		
		Total hole costs	€ 0,97		€ 180,00

The calculated values are not very surprising, taking into account the estimations of Hans Smit, general manager of manufacturing departments at Royal IHC. The different costs of a hole he learned out of experience are as follows:

- By CNC plasma cutting machine € <5
- During section building € 150
- On the slipway € 500-1000

There is a large difference in costs between robotically cutting in the beginning and manually cutting during section building or hull assembly. Besides, the risk of errors at the manual cutting is a lot higher. First everything has to be measured by hand and then the cutting torch has to be positioned very precisely. In addition, there is a safety risk involved by the manual cutting when a worker has to climb in the section. Due to small and crowded areas, the change of accidents and injuries is increased. Also, in enclosed spaces there is a risk of gas formation that could be dangerous. Altogether, it is obvious that the manually cutting of holes during section or slipway building should be avoided as much as possible, both for cost and safety issues.

5.2 PIPE SPOOL MANUFACTURING

All the pipe spools for IHC built vessels are produced at IHC piping B.V. located in Sliedrecht. The exact process can be found in the flow diagram in Appendix I: Machinery and piping flow diagram. Mainly, the production of pipe spools consists of cutting, bending, welding and coating. Most of this is done fully automated. The workers only have to transport the pipes between the machines and in the end into the right crate.

If the pipe routing engineer does have some background information about the production process, he is able to lower its costs. Some basic rules that the engineer always has to keep in mind are:

1. One pipe with multiple bends is better than multiple pipes with one bend. Then the worker has to put the pipe into the bending machine just once. Therefore there has to be enough distance between two bends, otherwise it has to be made out of two parts.
2. The bending diameter must be 2 times the diameter maximum (preferable 3x diameter). Smaller bending radii are very expensive.
3. If a reducer is used in a pipe spool, the separation is preferred at the smaller side of the reducer. Then smaller flanges can be used which are cheaper.
4. If flat flanges are allowed, they are preferred. Flat flanges are cheaper than welding neck flanges.

These relatively simple rules result in large cost savings. Important to know for this research is that, if the pipe is already in the bending machine, some extra bends do not involve high costs. Therefore it could be cheap to route a pipe slightly different. For example, if it has to go through a predetermined opening. In chapter 4.2.2, all other issues regarding piping are already mentioned.

6 SYSTEMS & LOCATIONS

A ship cannot sail without its systems. The nature of these systems is continuously changing over time. From oars and sails in ancient times to innovative electric- and LNG systems nowadays. Due to increasing requirements and demands, the amount and complexity increases as well. In this chapter, the most important ship systems and their most common locations on IHC built ships are discussed. Also the used standards for pipes and penetrations per system are mentioned. Then it is researched which systems cause the most problems regarding required penetrations during section- or slipway building. Finally it is chosen at which part of the ship an improvement is best possible.

6.1 GENERAL

It is essential to have a good overview of the whole ship and all of its systems, before an improvement could be made. In this section the main important systems for Royal IHC are discussed. Then the locations of them are determined and finally the locations of the added hole are discussed.

6.1.1 SYSTEMS

Nowadays a complex vessel can have over a hundred systems. At royal IHC, an amount of 62 frequently applied systems are distinguished. A lot of these systems are related and or connected to each other. A broad distinction can be made between prime mover systems, bilge/ballast and dredge systems, accommodation systems and auxiliary systems. However, there are also some relations between systems from different categories. In Table 13, a concise description is given from the largest and/ or most important systems for IHC ships.

Table 13 – System functions

System	Function
Ballast	Fill and empty ballast tanks for ship stability.
Bilge	Pump out fresh water, sea water, oil, sludge, chemical and other fluid from the lower parts of the ship (bilge wells).
Black water	Transport of wastewater containing feces, urine and flush water from toilets.
Central heating	Transport of heated water to radiators for heating.
Chilled water	Chilled water circulation used for HVAC system.
CO ²	CO ² release system for firefighting.
Control air	Air supply for main engine, auxiliary machinery, doors and valves.
Deaeration & sounding	Piping for deaeration and sounding of tanks.
Degassing	Eliminate gas bubbles out of dredged sand/ silt.
Dredging	Pump sand/ silt from seabed and discharge it in the hopper or overboard.
Drip tray and drains	Drain dirty water and oil from drip trays to tank.
Electric installation	Transport of electric cables from generators to electrical equipment.
Exhaust gas	Release exhaust gas from engines to open air.
Firefighting & deck wash	Water supply for fire or deck wash.
Fresh cooling water	Cool main engines and auxiliary machines with water from fresh water tank.
Fuel oil	Supply fuel oil to main engines.
Gland and flushing	Water supply for dredge pump and gate valves used for flushing and pressurizing.
Grey water	Transport of wastewater from showers, sinks, washing food, clothes and dishware.
Hvac	Ventilating, heating, cooling and conditioning of air in rooms.
Hydraulic oil	Transport of oil used for doors, valves, steering gear, winches and CPP.
Jet water	Water used for flushing the hopper, loosening sand from seabed and degassing sand/ silt from dredge system.
Lubricating oil	Transport of oil to main engine and auxiliary machines and gearboxes for lubrication.
Potable fresh water	Supply of hot and cold water for accommodation systems like sanitary and kitchens.
Scuppers	Drainage of water on outside decks to the sea.
Sea cooling water	Transport of seawater to machinery for cooling purposes.

Starting air	Air supply for the starting of the main engine and (auxiliary) generators.
Technical water	Supply of water for several machines in e.g. ballast, bilge, cooling and oil systems.
Thermal oil	Transport of heated oil through systems and tanks.
Watermist or high fog	Watermist release system for firefighting.
Working air	Air supply for air connections.

All of these systems are elaborated further in Appendix VIII: Ship systems. In this overview the main equipment, tanks, components and its connections are shown.

6.1.2 SYSTEM LOCATIONS

Now the function of the systems is discussed, we can take a look at the most common location in the ship for each equipment within the systems. For this, 8 recently custom build ships from IHC are researched. A lot of machines have a standardized room in the ship. However, as a result of specific requirement or issues with a project, the exact room could be changed. In Table 14, an example of the most common location(s) of the equipment is shown with the corresponding system. The total table can be found in Appendix VII: System locations.

Table 14 – Equipment locations

System	Equipment	Room
Ballast	Aux. ballast pump	Engine room/ pump room
	Ballast water treatment unit	Bow thruster room
	Ejector pump	Engine room
Bilge	Bilge ejector dredge pump well	Pump room
	Bilge oily water separator	Engine room
	Emer. Bilge pump bilge well	Engine room
	Emer. Bilge pump tech. space	Technical space
	Oily bilge water pump	Engine room
Bilge/ ballast/ firefighting & deck wash/ gland & flushing	Bilge/ballast/FiFi pump	Engine room
Black water/ grey water	Sewage collecting tank	Engine room
	Sewage discharge pump	Technical space/ engine room
	Sewage pump	Technical space/ engine room
	Sewage treatment unit	Technical space/ engine room

6.1.3 PROBLEM LOCATIONS

In previous chapters, the problem of holes that have to be cut during section- or slipway building is extensively discussed. In this chapter it is tried to find out at what locations of a ship the problem mainly occurs. Therefore two ships of Royal IHC, one already finished and one still in production, are researched. Unfortunately at Royal IHC, systematic registration of 'added holes' is only available since 2016 and only two of these ships are registered precisely enough for the analysis.

For the two ships, say ship 1 and ship 2, both TSHDs, the total man-hours per section used for adding holes during section- or slipway building are examined. Besides, the rooms that are located in these section are determined. This can be seen in Appendix IX: Rooms in sections. In Figure 32 and Figure 33, the man-hours of repair work regarding added holes are shown. Then for both ships a range has been made with colors. In Figure 34 and Figure 35 the man-hours are projected on the ship. Green and red indicate the least and most added holes respectively. Ship 1 and 2 refer to IHC building numbers 1283 and 1289 respectively.

There are some similarities recognizable between the two ships. Red, orange and yellow parts can be seen especially around the engine room, pump room and accommodation. There is also a red part at the aft deck house of ship 1, but this is not visible at all on ship 2.

In chapter 3, a distinction was made between machinery-, accommodation- and technical type areas. The rooms from the ships that are examined in this chapter can be divided in these categories as well. In Table 15, the man-hours that were required for adding holes are shown per area type.

Table 15 – Man-hours for adding holes per area type

	Machinery type area		Accommodation type area		Technical type area		Total
Ship 1	1093	19%	993	17%	3632	64%	5718
Ship 2	125	24%	44,5	9%	351,5	67%	521

As can be seen, for both ships the technical type areas contain the most man-hours. However, these are many areas distributed over the whole ship, from tanks to pump room to aft deck house. The man-hours for machinery type areas are slightly higher. This was to be expected, due to the high complexity and high amount of systems in these rooms. It is remarkable that for ship 1, the accommodation type areas did require almost the same amount as the machinery type areas, while **accommodation spaces** are used to be a lot less complex and occupied. For ship 2, the man-hours are still a bit lower for accommodation type spaces. This can be explained by the fact that the vessel is still under construction, and the accommodation block section is usually built at the end of the process.

In the conclusion of this research, it is important to take into account that because of the lack of data only 2 ships are investigated, and that it is not completely sure that these examples are representative.

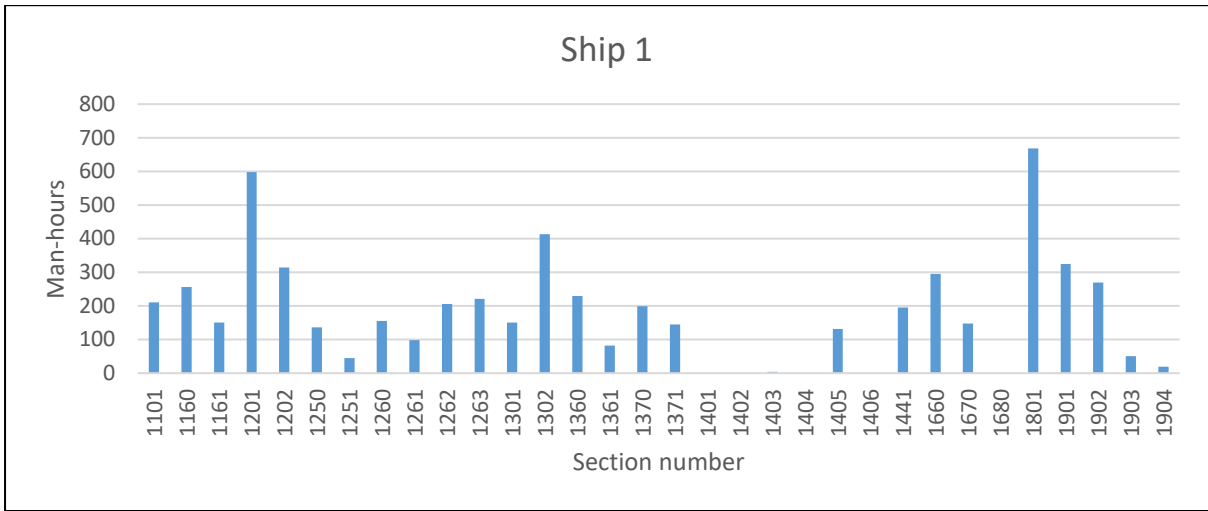

Figure 32 – Man-hours per section for adding holes at ship 1

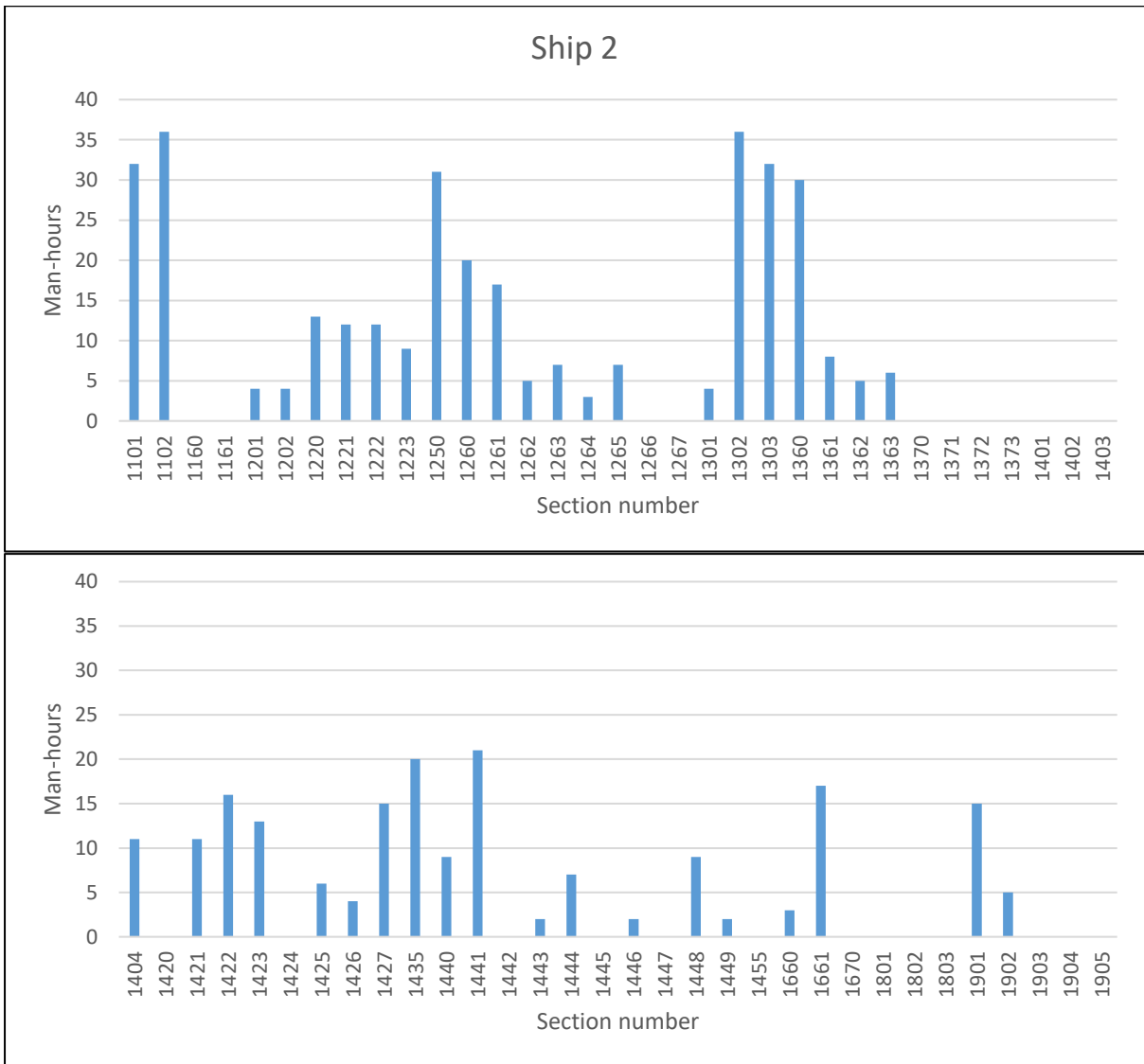

Figure 33 – Man-hours per section for adding holes at ship 2

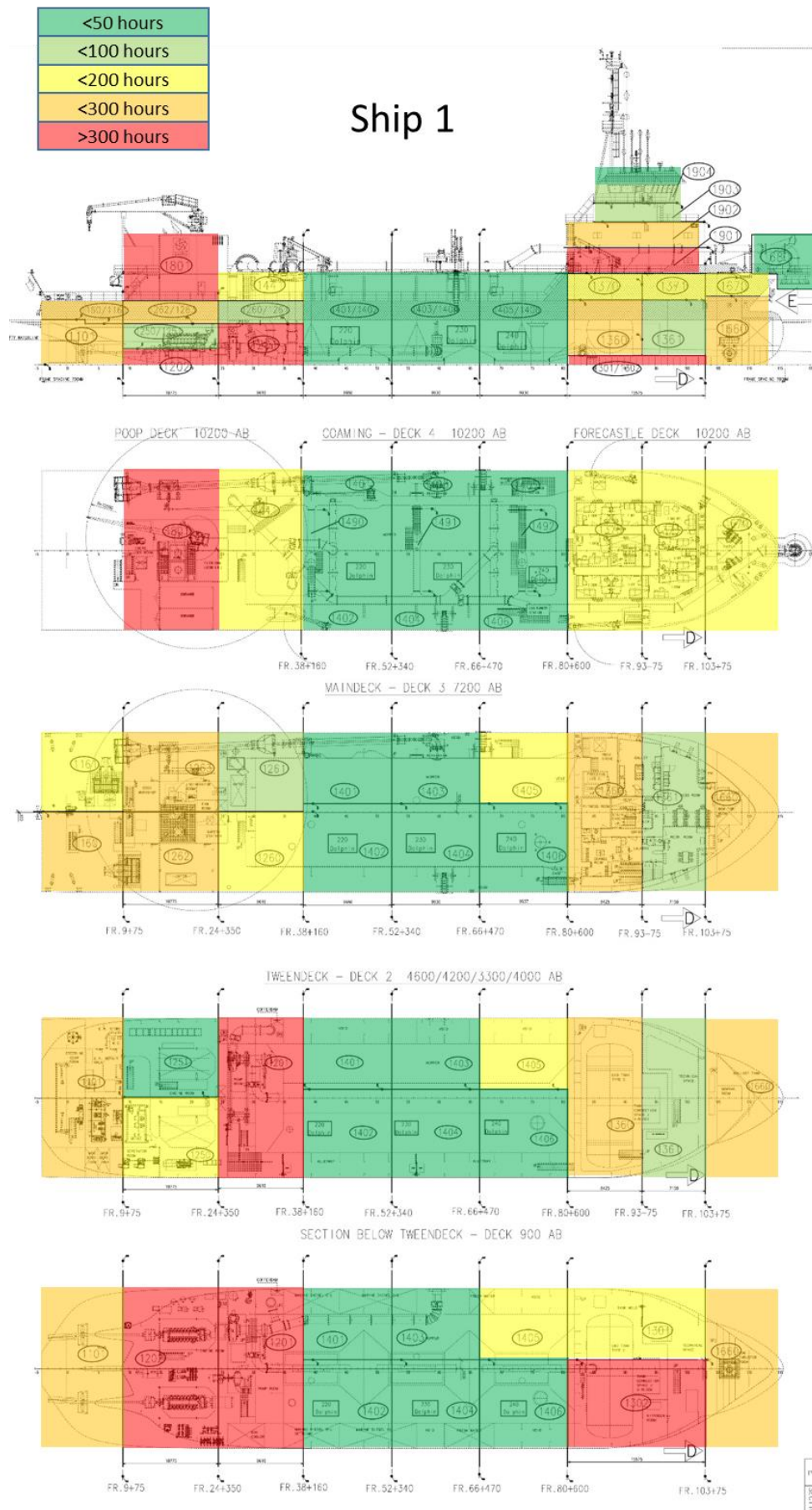
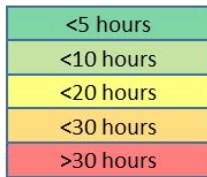

Figure 34 – Man-hours per section overview for ship 1



Ship 2

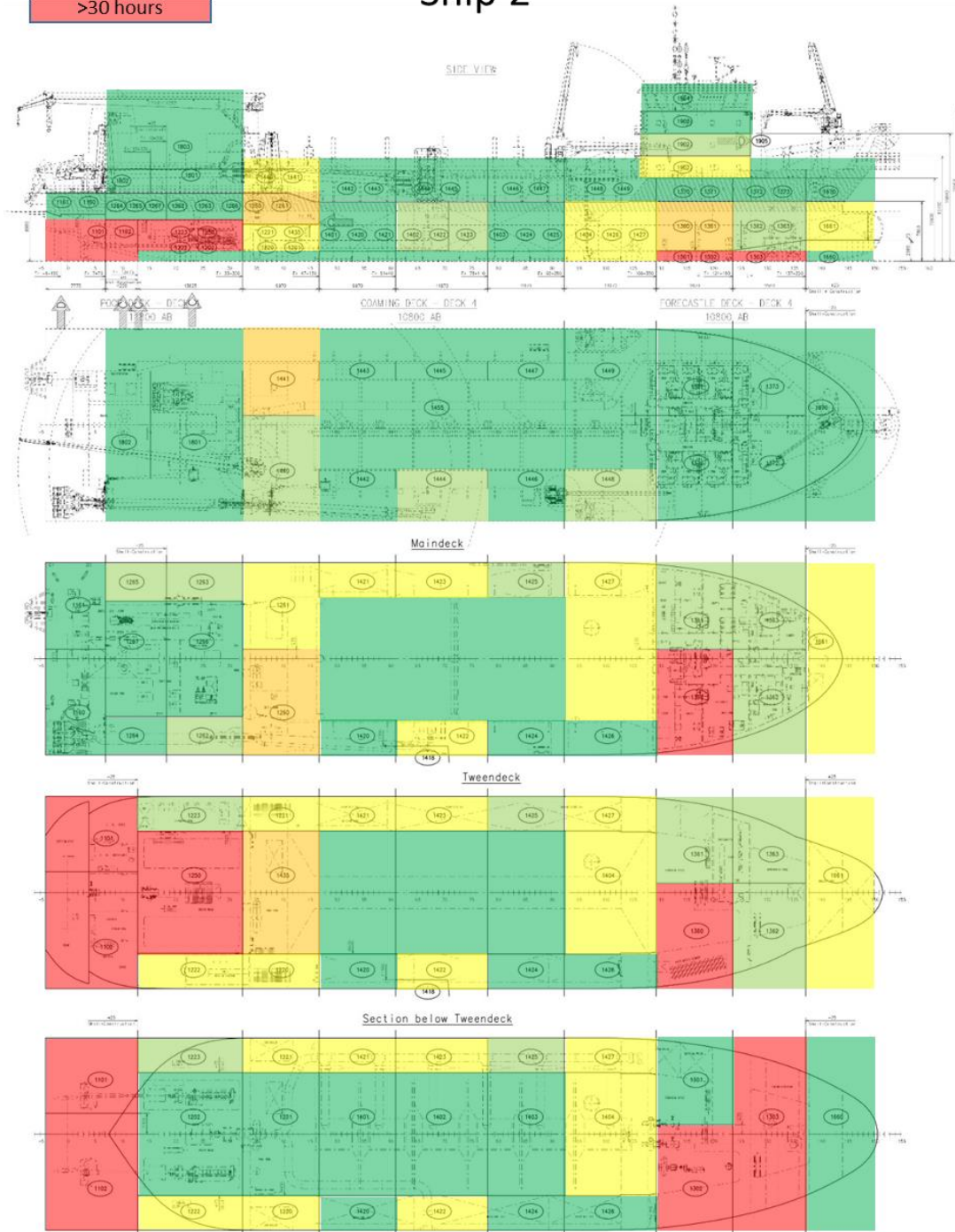

Figure 35 – Man-hours per section overview for ship 2

6.2 ACCOMMODATION

Now, the accommodation area of a ship is considered in more detail. First a general division of decks and rooms is given and then the accommodation systems are discussed. Finally the specific problem areas for the accommodation are located.

6.2.1 ROOMS

The accommodation of a ship has a crucial function for the operators of the vessel. Most of the decisions and actions are taken in this area and are then communicated to other parts of the vessel. For example, the captain can control the ship speed and direction, but also the operation of the cutter ladder, suction tube or pipe lay tower from the navigation bridge. Besides, the accommodation is intended to accommodate the crew. The exact types of rooms is quite deviating for different ships. Most of the IHC custom built vessels do have approximately the same types of rooms at approximately the same location. To get a general overview, six IHC built ships are compared, including TSHDs, CSDs and PLVs.

Generally, at the top of the accommodation on the outside is the top deck. Underneath this the navigation bridge deck is located. Then, in most cases, on the A-deck the converter room and AC-room are located. The other decks are for accommodation purposes. This include bedrooms, offices, sanitary, galley, mess room, hospital and storages. Through all decks there is a staircase and one or more trunks meant for pipes and cabling. These are mostly positioned somewhere in the middle of the deck. The number of decks is strongly dependent on the ship type and number of crew members. An example is shown in Figure 36.

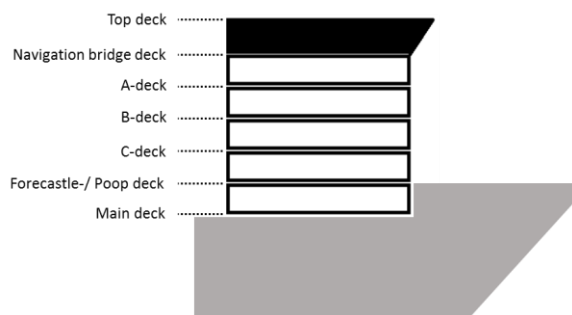

Figure 36 – Accommodation decks

6.2.2 SYSTEMS

Just like the rest of the vessel, the accommodation contains equipment that needs to be connected by pipes, hoses and wires to create a system. Accommodation systems have two main purposes: Control of other systems and life support. Besides, there are some additional systems which are very important as well. (Table 16)

The control of systems mostly require electric wires which are transported via cable pipes and –ladders. Amongst other things, these cables lead between generators, switchboards, sensors, engines and other machinery to the accommodation.

Life support systems on a vessel consist of two main categories: accommodation water and HVAC. Accommodation water system provide the supply and discharge of fresh- and waste water to toilets, showers, sinks, laundry machines, galley etc. All supply water is provided by the 'hot and cold potable water' system. This uses water from a fresh water tank. For discharge there are two different lines. The **black water** lines transport water containing feces, urine and flush water from toilets. The **grey water** lines are for the other accommodation water discharges.

HVAC is an abbreviation for Heating, Ventilation and Air Conditioning. The climate control systems takes care of all three. It consists of supply lines, recirculation lines and exhaust lines. Besides, there is a chilled water system which is used by the air handling unit to cool the air. All berthing, messing, medical, electronics, and necessary control spaces are to be air conditioned to maintain a maximum of 27°C dry bulb and 17°C wet bulb under external ambient conditions up to 32°C (**db**) and 27°C (**wb**) and sea water temperatures of 29°C, with personnel on board and normal machinery operating (Opnavinst, 1996).

Table 16 – Accommodation systems

Life support		Control		Other
Water	HVAC	Electric		
- Hot and cold potable water lines - Grey water lines - Black water lines	- Climate control pipes - Chilled water lines	All electric wires and cables, transported by cable pipes, -trays or -ladders		- Firefighting and deck wash system - Scupper pipes - Ship ventilation pipes

Besides the life support and control systems, there are some other systems which are always required in or on the accommodation. First the 'firefighting system' is essential, especially for accommodated spaces. Next to the water and/or CO² supply, this system often contains fire retardant bulkheads, -doors, and -dampers. Then there are also 'scupper pipes' from all outside decks of the accommodation towards the main deck. Sometimes, these pipes are forced to be routed through the accommodation rooms. Finally, there are 'ship ventilation pipes' which are simple pipes directly to the outside, for ventilation purposes. In Table 17, the most common routing for the most important systems is shown.

Table 17 – Accommodation systems routing

System	From	Via	Via	To	Remark
HVAC - Supply cold	AC room	Trunk	Above ceiling	Several rooms that require AC supply	1 or more pipes downwards with branches to several rooms
HVAC - Recirculation	Corridors	Above ceiling	Trunk	AC room	1 or more pipes upwards with branches to corridors
HVAC - Exhaust	Several rooms with exhaust like toilets	Above ceiling	Trunk	Outside	1 or more pipes upwards with branches from several rooms (see table)
Hot potable water	Fresh water tank	Trunk	Below floor	Each bathroom Wash places Laundry Galley Change room Hospital Each other room with sink	1 pipe upwards and 1 pipe downwards with branches on each deck to mentioned rooms
Cold potable water	Fresh water tank	Trunk	AC room Below floor	Ceiling above nav. Bridge Each outside deck Each bathroom Each toilet room Each wash place Laundry Galley Change room Hospital Each other room with sink	1 pipe upwards and 1 pipe downwards with branches on each deck to mentioned rooms
Black water lines	Each room with toilet	Above ceiling	Trunk	Below accommodation	1 pipe downwards with branches to each deck with toilet(s)
Grey water lines	AC units Fan coils Each room with toilet, shower, and/or sink	Below floor	Trunk	Below accommodation	1 pipe downwards with branches to decks with toilet/shower/sink, ac unit or fan coil
Chilled water supply	Below accommodation	Trunk		AC room	1 pipe upwards to ac room deck
Chilled water return	AC room	Trunk		Under accommodation	1 pipe downwards from ac room deck
Cable tray	Below accommodation	Trunk		Each deck	Multiple trays with branches to each deck

6.2.3 FIRE RESISTANCE

A lot of walls and decks in the accommodation have to be fire resistant. “ships of all types shall be subdivided into spaces by thermal and structural divisions having regard to fire risk of the space” (Bureau Veritas - Steelships, Pt C, Ch 4, Sec. 5, 1.2.1). This is relevant because then other penetration types are involved. There are several types of spaces in the accommodation or adjacent to it. For definitions, see the Glossary. There are different classes of fire resistance. Bulkheads and decks shall be classed as A, B or C.

A-class decks and bulkheads are ‘the most fire resistant’. It shall be made of steel or another equivalent metal and it must be made intact with the main structure of the vessel. When it is subjected to a fire test, it has to be capable of preventing against smoke and flames for 1 hour. In addition, it has to be insulated so that the average temperature on the unexposed side would not rise more than 120°C. Any other point, including joints, may not rise more than 163°C in the amount of minutes indicated by the class code. (A60, A30, A15, or A0)

B-class structures shall be constructed with incombustible materials and be made intact from deck to deck. It has to prevent against flames for half an hour. The average temperature of the unexposed side shall not rise more than 120°C, and any other point shall not rise more than 207° within the time indicated by the class code (B15, B0)

C-class bulkheads or decks shall be constructed of incombustible materials, but do not need any requirements regarding the passage of flames and the rise of temperature.

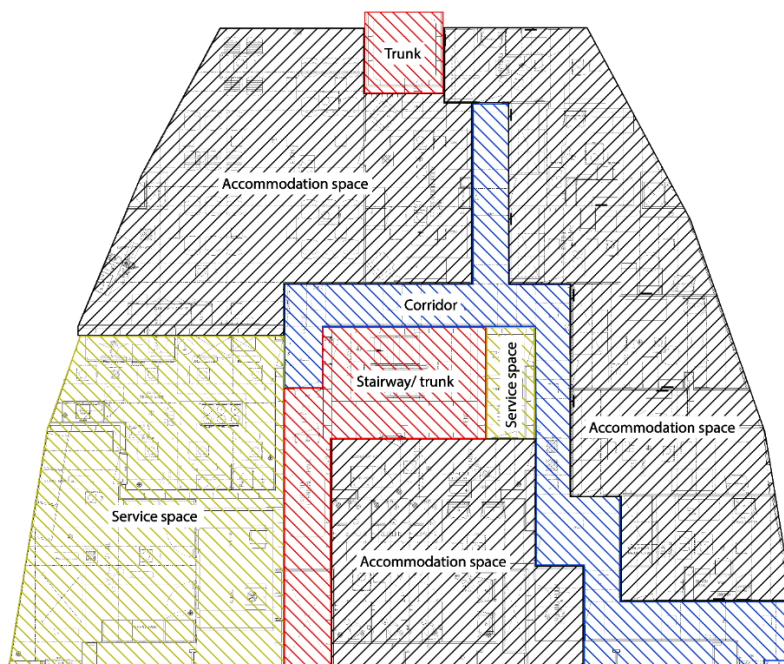

Figure 37 – Example of area types in the accommodation

In Figure 37, an example of a deck with different area types is shown. In Table 18 and Table 19, the requirements between different types of space are shown.

Table 18 – Fire integrity of Bulkheads (Bureau Veritas - Steelships, Pt C, Ch 4, Sec. 5, 1.3.7)

Bulkheads									
		1	2	3	4	5	6	7	8
Control stations	1	A0	A0	A60	A0	A15	A60	A60	-
Corridors	2		C	B0	B0	A0	A60	A0	-
Accommodation spaces	3			C	B0	A0	A60	A0	-
Stairways/ trunks	4				A0	A0	A60	A0	-
Service spaces (low risk)	5					C	A60	A0	-
Machinery type spaces	6						-	A60	-
Service spaces (high risk)	7							A0	-
Outside/ open decks	8								-

Table 19 – Fire integrity of decks (Bureau Veritas - Steelships, Pt C, Ch 4, Sec. 5, 1.3.7)

Decks									
		Space above							
Space below		1	2	3	4	5	6	7	8
Control stations	1	A0	A0	A0	A0	A0	A60	A0	-
Corridors	2	A0	-	-	A0	-	A60	A0	-
Accommodation type spaces	3	A60	A0	-	A0	-	A60	A0	-
Stairways/ trunks	4	A0	A0	A0	-	A0	A60	A0	-
Service spaces (low risk)	5	A15	A0	A0	A0	-	A60	A0	-
Machinery type spaces	6	A60	A60	A60	A60	A60	-	A60	-
Service spaces (high risk)	7	A60	A0	A0	A0	A0	A60	A0	-
Outside/ open decks	8	-	-	-	-	-	-	-	-

6.2.4 PROBLEM LOCATIONS

In the previous sections, the rooms and systems that located in the accommodation are discussed. Now it can be investigated which systems in this area cause the most problems regarding manual cut holes.

Unfortunately, at Royal IHC this 'repair work' is currently administrated for only a short period. Therefore there are just two ship projects which can be used, both trailing suction hopper dredgers. For these ships, the added holes are looked up on the drawings and then related to the system that uses this hole. In Figure 38, the relative amount of added holes between systems is shown. Other water indicates firefighting and scupper systems, other air includes starting air, working air and air & sounding systems. These systems were routed coincidentally through the accommodation, while it is not common.

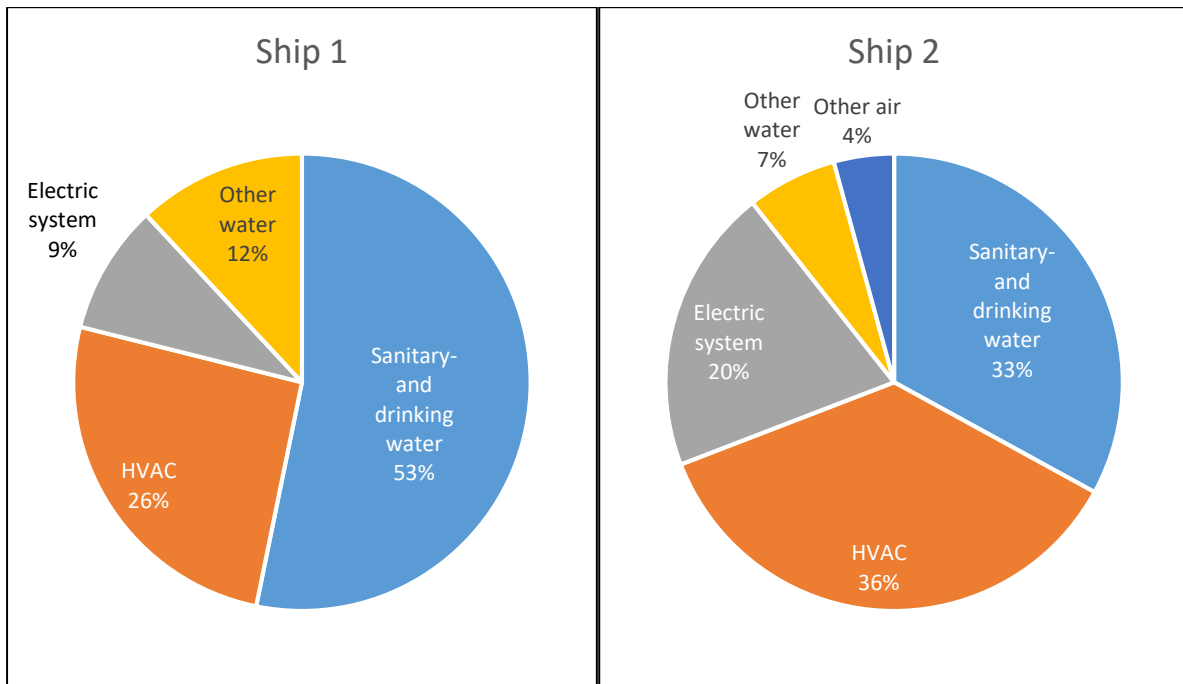

Figure 38 – Added holes per system in accommodation

It can be seen from the graph that added holes for the water (sanitary and drinking) and HVAC systems are prominently present in the accommodation. For both ships it contains about 75% of all holes. It is remarkable that these systems, added by the electric system, are mostly the systems that are routed through the trunk.

7 DESIGN

In the previous chapter, the most common problem locations were discussed. In this chapter, a new engineering approach will be introduced. There are mainly two possible approaches:

- To estimate the exact location of a certain penetration.
- To estimate the approximate location of all penetrations and estimate large openings.

For the case study, a suitable ship location is chosen as well. If this new approach is proven for this location, it could be extended to other ship locations.

The most remarkable location in 6.2.4, where probably the most benefit can be achieved, is the accommodation. When a further look is taken into the accommodation, it can be seen that especially the holes from the trunk to the decks are causing lots of problems. For the recent IHC projects 1276, 1278, 1282, 1285 and 1286, between 95 and 100% of the holes in the trunk were not present on the V2 drawing and therefore not cut by the CNC plasma cutting machine. For this reason the converged case study of this project is about:

Penetrations in the trunk or vent in the accommodation used for the transportation of ladders, pipes and cables.

The trunk is a representative location for the possible future expansion, due to the high density and variety of systems. In Figure 39, a cut out of a typical trunk is shown. It contains a lot of vertical pipes from several systems which penetrate the trunk between deck and ceiling.

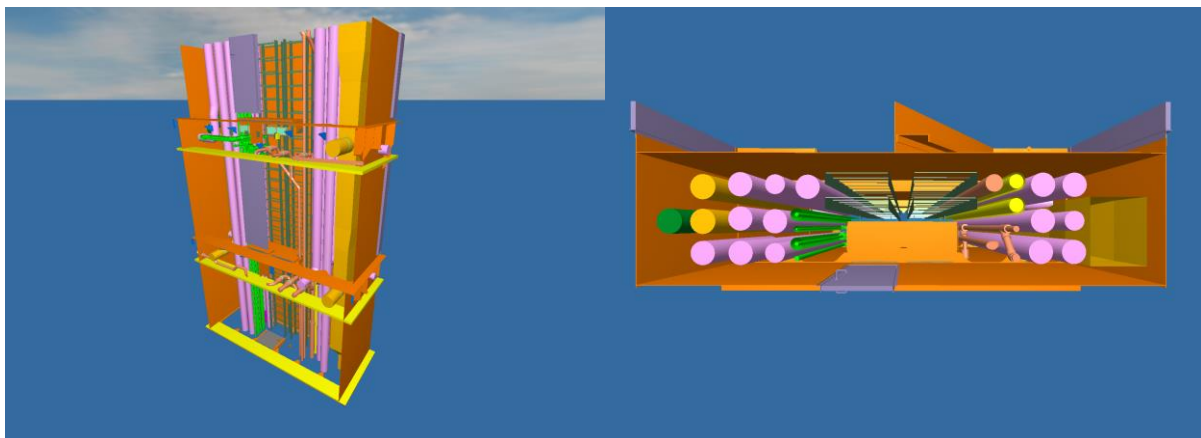

Figure 39 – Trunk in accommodation; 3D view with decks (left), top view (right)

7.1 OPENING METHODS

In the ideal situation, all the penetration locations are known when needed and the holes are cut by the cutting robot. However, in practice this is not always the case. IHC wants to distinguish itself by a short throughput time and by building complex ships. It also has to stay competitive on the price aspect and therefore more and more engineering and production parts are outsourced abroad. This results in slower communication which makes it even more difficult to deliver on time. In the future, there could be even more time pressure due to higher expectations and more outsourcing. Therefore, there may be a need for an emergency solution that is beneficial if the ideal situation cannot be performed.

It would be very beneficial if the exact penetration locations can be estimated before the total routing is finished. However, especially for high density location as the trunk this will be very difficult due to the high density of pipes and small possibility for adjustments. If for example in the end two penetrations need to be swapped, it can cause large problems if they cannot pass each other inside the trunk.

7.1.1 LARGE OPENING WITH INSERT

Because the exact locations and size are too difficult to estimate beforehand, another method is needed. It is possible to make large openings in the trunk initially, so that the cutting and building can start, and later fill these openings with an insert when the exact penetrations are known. If these inserts are made of steel, they can then be cut by the plasma robot as well. This will result in high precision. It will give the routing engineer a lot more time to determine the exact position and size of the penetrations. Currently, these insert plates are sometimes used for repair work, when some holes need to be closed, opened or changed. In Figure 40, an example is shown.

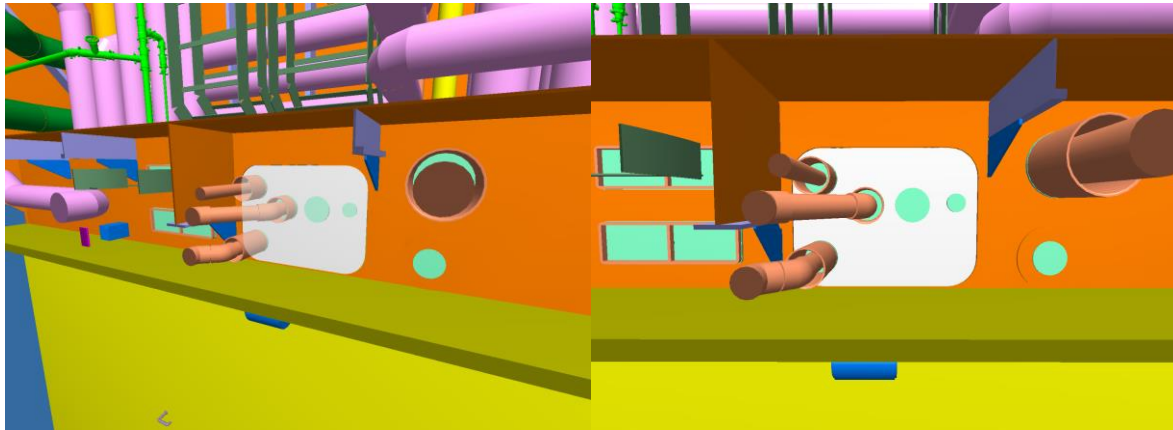

Figure 40 – Insert plate with penetrations

Using an insert has some advantages and disadvantages compared to the automatic plasma cutting and manually cutting. The main advantage is the extra engineering time available and the cheap opening cost due to the plasma robot. The main disadvantage if a steel insert is used is the weld around the plate, but the welding equipment will be already in place, because it is required for the penetrations as well. (Table 20) However, if a metal insert plate is used, it has to be implemented before the end of section building. On the slipway, it is not preferred to use large parts and add a lot of heat, so then the main advantages are gone. In addition, the insert plate should not be too heavy (<23 kg) for lifting, because the usage of cranes will be another disadvantage.

Table 20 – Penetration comparison

	Opening with insert plate	Automatically cut	Manually cut
Opening	Cheap	Cheap	Expensive
Closing	Extra weld around	Only penetration welds	Only penetration welds
Adjustments	Possibility for adjustments	Very expensive adjustment (due to closing)	Possibility for adjustments
Precision	High	High	Low
Pre-outfitting possible	Yes (with plate separation)	Yes	No

7.1.2 OPENING PROCEDURE

The idea as described in 7.1.1 is to make large openings which later can be closed with insert plates. To maintain the most freedom of routing, these openings are to be kept as large as possible. The extra welding length that this entails will probably result in seconds of extra welding time. However, there are some constraints that determine the size and position of the opening. As can be seen in Figure 41, a common trunk consists of plates with vertical profiles with a general distance in between of around 700mm. There are horizontal plates for each deck with a ceiling beneath. The openings are possible between these profiles, deck and ceiling. The lower constraint is the ceiling with a distance of 0. Between the profiles and deck a general distance of 100mm is taken, determined in consultation with the structural engineer. To avoid stress concentrations, the corners are rounded-off with a radius of 100mm as well. Because the trunk dimensions, profiles distances, deck height and ceiling heights are already known on the **construction plan**, these openings can be determined in a very early stage.

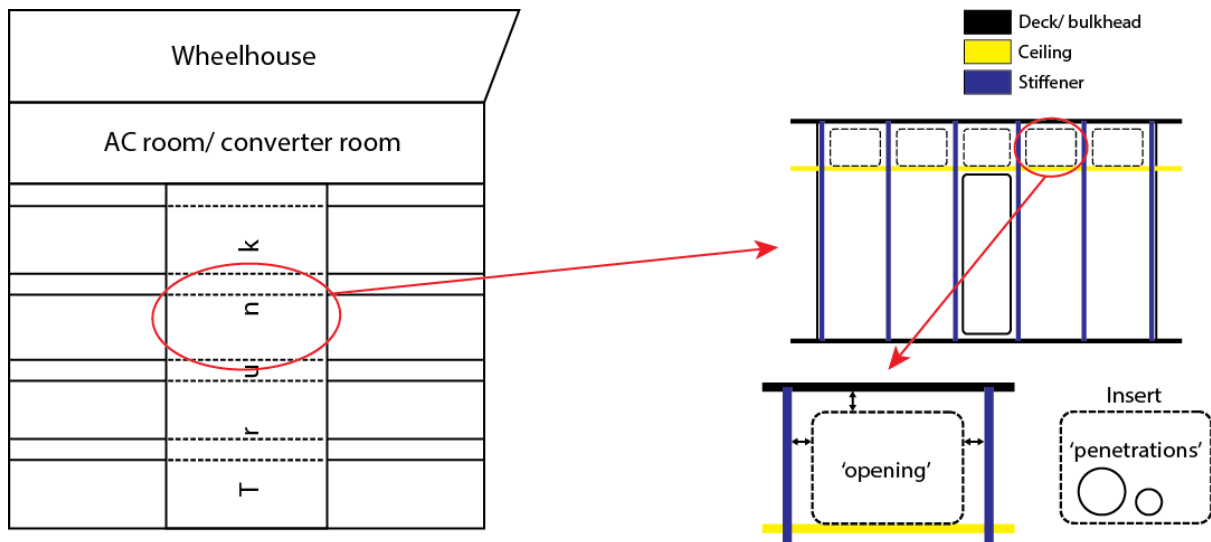

Figure 41 – Trunk opening constraints

There are not many strength issues in the trunk plating, because most of the loads are carried by the profiles and on the outside accommodation structure. However, if there are many openings next to each other, it will be wise to do an additional strength calculation to be totally sure. In most cases, any strength issues can be solved with additional brackets and bars around the opening.

Now it is clear where the openings can be placed and of which size, it has to be determined which openings should really be opened. In general, three different concepts can be distinguished (Figure 42):

1. **Open all the openings** and later close them all with inserts. This implies there probably will be openings without any penetration and they just have to be closed with closing inserts.
2. Estimate where the penetrations will be and **open the openings with expected penetrations**. This implies that there may be wrong estimations and penetrations turn out to be at a position where no opening is. Then still a hole has to be cut manually. It is also possible that openings were estimated incorrect and need to be closed with inserts.
3. Estimate where the penetrations will be and **open the openings with expected penetrations**. If a penetrations is assumed to be sure, and there are no other unsure penetrations in this opening, cut this hole exactly. These penetrations is then fixed and assumption/ exchanges are barely possible. It is also possible that an opening is estimated incorrect and needs to be closed with an insert.

The first method implies a lot of closing work for the closing of unused openings. However, the engineering time till the plates can be cut is very short, because no estimation or routing of the piping is required. There is also lot of freedom for changes in the routing until the end of section building (or maybe even later).

The second method reduces the closing work, at least as the estimation is performed well enough. It highly depends on the correctness and duration of the estimation and the possibility of changing some pipes towards a chosen opening. If this is the case, it will be a cheaper method than the first one.

The last method can be seen as an improvement of the second one. It is not convenient to open the whole large opening if there are only completely certain penetrations in this opening. These penetrations have to be known for sure, because changing is even more expensive than adding.

The third method seems to be the most advanced and beneficial one, because of the least closing work and still large freedom of routing. However, it is dependent on the estimation usability whether this method can really work. If the estimation is really accurate to the current situation, this method will work. If this is not the case, it will involve even more problems due to adjust- and repair work.

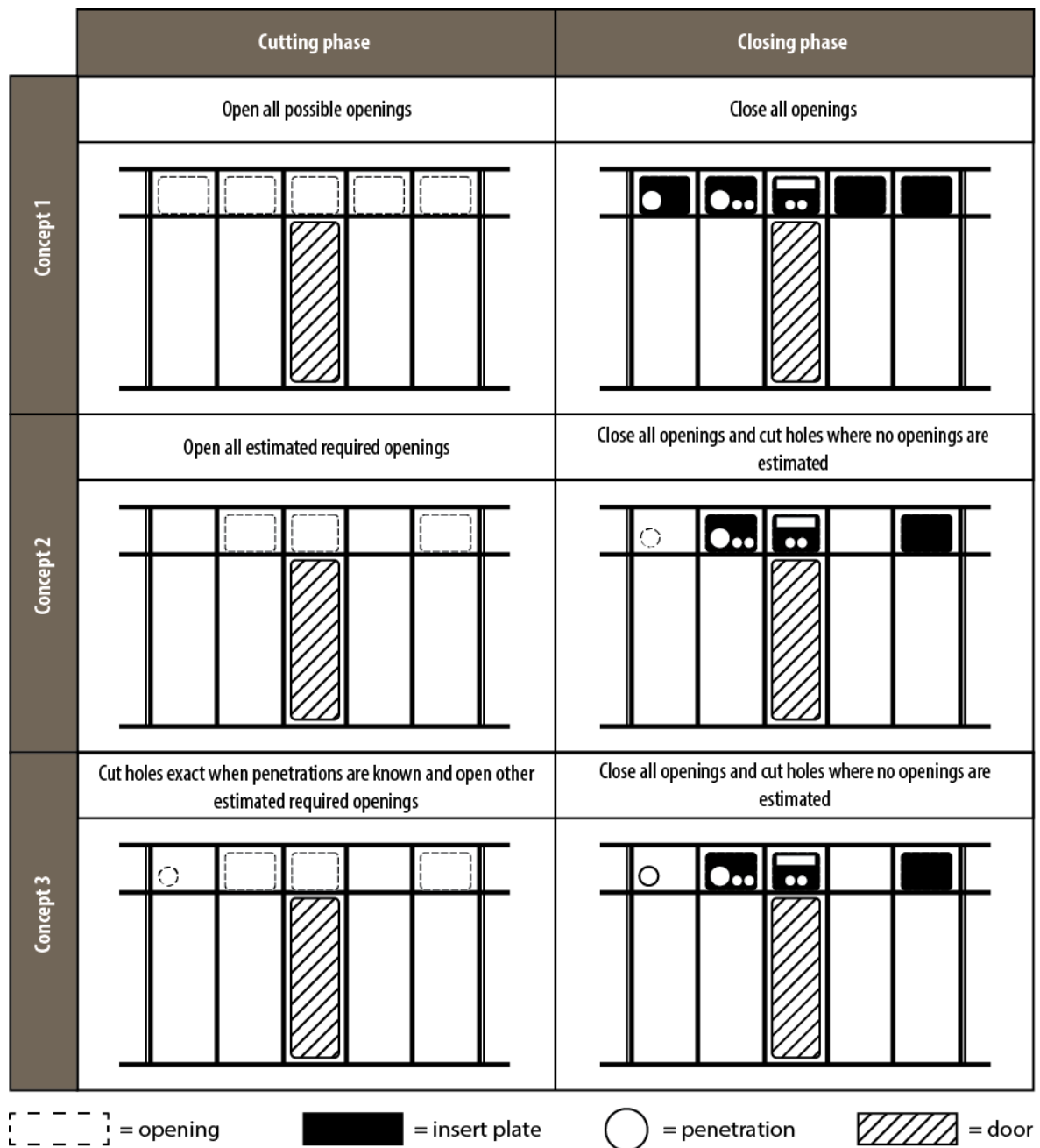

Figure 42 – Opening concepts

7.2 CLOSING METHODS

In the previous section, several methods regarding the openings were discussed. For the closing of the openings there are some different options as well. In this section, the advantages and disadvantages of 5 possible solutions are described and discussed.

The 5 solutions are shown in Figure 43. The differences are mainly the materials and attaching methods. The following options are discussed:

1. Steel plate cut by CNC cutting machine and manually welded in the structure.
2. Steel plate cut by CNC cutting machine and manually bolted to the structure.
3. Synthetic (fireproof) plate supplied by external company bolted to the structure.
4. Synthetic (fireproof) plate supplied by external company glued to the structure.
5. NOFIRNO® solution by Beele Engineering BV.

In Figure 43, all characteristics are organized and will be discussed later. For each one, the underlined column can be seen as the best one for that specific characteristic.

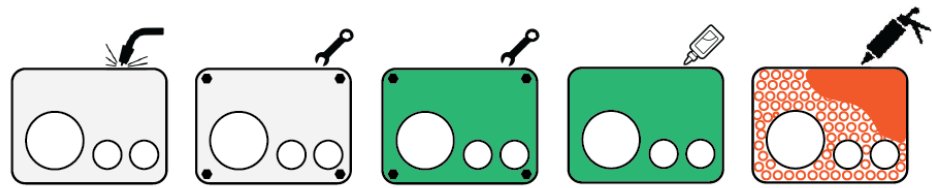

Method	Welding	Bolting	Bolting	Glueing	NOFIRNO® mounting glueing
Material	Steel	Steel	Synthetic	Synthetic	NOFIRNO®
1. Fire protection	<u>Yes</u>	Expensive sealing	Expensive sealing	Expensive glue	<u>Yes</u>
2. Watertight	<u>Yes</u>	<u>Yes</u>	<u>Yes</u>	<u>Yes</u>	<u>Yes</u>
3. Corrosion resistant	No	No	<u>Yes</u>	<u>Yes</u>	<u>Yes</u>
4. Mounting duration	Long	<u>Short</u>	<u>Short</u>	<u>Short</u>	Moderate
5. Absorption of motion	No	No	No	No	<u>Yes</u>
6. Tolerance	Moderate	Low	Low	Moderate	<u>High</u>
7. Heat involved	Yes	<u>No</u>	<u>No</u>	<u>No</u>	<u>No</u>
8. Lifting weight	High	High	Moderate	Moderate	<u>Low</u>
9. Insert cost	<u>Low</u>	<u>Low</u>	Moderate	Moderate	High
10. Penetration required	Yes	Yes	Yes	Yes	<u>No</u>
11. Restricting building phase	Section building	<u>Section building/ slipway</u>	<u>Section building/ slipway</u>	<u>Section building/ slipway</u>	Sec. building/ slipway/ quay
12. Pre-outfitting possible	Seperation required	Seperation required	Seperation required	Seperation required	<u>Yes</u>
13. Adding penetrations cost	High	High	High	High	<u>Low</u>
14. Maintenance	<u>Low</u>	High	High	Moderate	<u>Low</u>
15. Experience/ knowledge available	<u>Yes</u>	<u>Yes</u>	Moderate	Moderate	No
16. Supporting strength	<u>High</u>	<u>High</u>	Moderate	Moderate	Low
17. Structure strength	<u>High</u>	Moderate	Low	Low	Moderate (due to horiz. bar)

Figure 43 – Closing solutions

For the bolted plates, special sealing for water tightness and fire resistance is required. If synthetic/plastic plates are used, a fire resistant/ redundant material has to be applied. NOFIRNO® is a pretty new solution on the market. To be able to create a good comparison, a further look is taken into the methods first.

7.2.1 STEEL WELDED PLATE

Using a steel welded plate would be the most obvious choice, because it is currently applied multiple times at Royal IHC. All the required resources like material, techniques and knowledge is already available by the company. The steel plate can be cut by the automatic CNC plasma machine which is very cheap, fast and accurate. Then the complete insert plate can be welded in the construction. If other welding is required at the same location at about the same moment, this additional welding does not take a lot of effort.

7.2.2 STEEL BOLTED PLATE

Except the bolting holes, the production for the bolted steel plate is the same as for the welded steel plate. However, for the attachment there are threaded holes, blind holes or additional stud bolts required which need a precise alignment. For the fire resistance, an additional sealing or gasket will be necessary. The bolt tightening must be checked very carefully to guarantee the safety.

7.2.3 SYNTHETIC BOLTED PLATE

For the attachment of a synthetic bolted plate, the same requirements are valid as stated in 7.2.2. First a material has to be found which meets the requirements for fire resistance and preferably water tightness. The production will be somewhat different, because the material cannot be cut by the CNC plasma machine. It can be assumed that initially the plates will be ordered externally. The material could be more expensive than steel, because of the special characteristics.

7.2.4 SYNTHETIC GLUED PLATE

For the synthetic glued plate, the production of the insert plate will be the same as discussed in 7.2.3. Now the attachment is different. No bolt holes, bolts or sealing will be required but there must be a good selection for the glue to be used. Besides the fact that it has to be resistant against fire and water, it must provide a strong attachment between steel and plastic. After attaching the plate, it probably must be checked by the class.

7.2.5 NOFIRNO®

NOFIRNO® is one of the transit solutions by Beele Engineering, located in Aalten, the Netherlands. It is designed especially for watertight and fire resistant penetrations.

The product is specially made for multi pipe/ cable penetrations of any size. Initially, there is an opening with a horizontal bar welded in. In Figure 44, this flat bar is represented by the metal pipe.

The following steps have to be done to make this penetration. First the system pipe or cable is put into place and the flexible tubes are put around it. Then it is already impossible to move the pipe in axial direction. If the clearance from the tubes to the end of the outer pipe is equally set to a certain value, the NOFIRNO® mounting glue can be added. Then with a wet wipe it can be flattened and equalized, with a slope if that is desired. This whole process for the specific penetration shown in Figure 44, does take less than 5 minutes.

Because of the high viscosity of the NOFIRNO® compound, it is also possible to fill the penetrations in vertical and even upside down orientations.

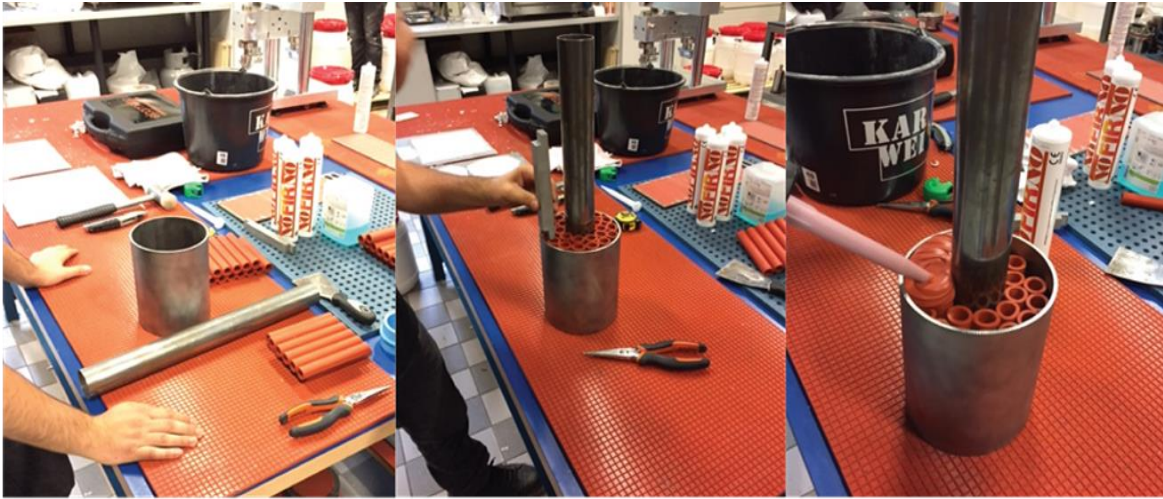

1. All required components and tools are organized 2. The opening is filled with the rubber sleeves, an equal clearance of 20mm till the edge is created 3. The clearance is filled with the NOFIRNO compound

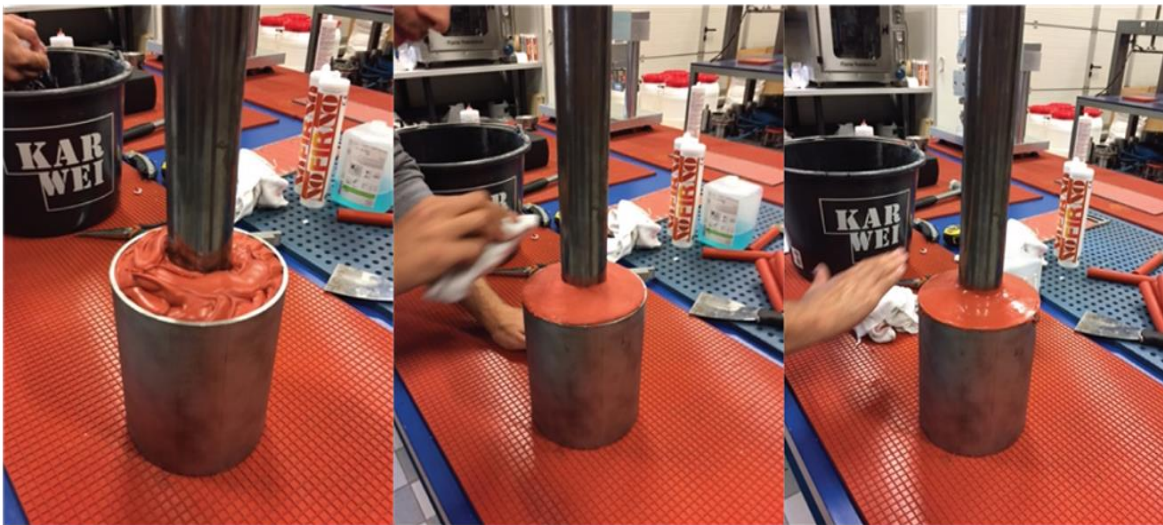

4. There is an abundance of compound, so that it can be pushed between the sleeves, which results in a better bonding 5. With a wet wipe the hydrofobic compound can be equalized, with a slope if that is desired. 6. For the neat appearance, the transit can be finished with an alcoholic based fluid

Figure 44 - NOFIRNO® transit method (self-made pictures during a demonstration at the Beele Engineering research lab)

If a fire rages on one side of the penetrations, the mounting glue turns into ceramic. The flexible tubes stay almost unharmed. On the other side of the penetrations, there is no damage at all as a result of the fire. (Figure 45)



Figure 45 – Two sides of NOFIRNO® transit after a fire

If NOFIRNO® is used to close the openings from the previous chapter, the exact locations of the penetrations are not necessary. It is also possible to put metal, plastic and/or ceramic pipes and cables from all sizes in the same NOFIRNO® transit. It is a relatively new product, but it has gradually been accepted by the large players in the world like the US Navy, the Royal Navy and Hyundai. (Beele, 2017)

7.2.6 CLOSING METHOD COMPARISON.

The five mentioned solutions can be compared on several levels. In Figure 43, a subjective assessment is done for 17 different characteristics. These characteristics will now be discussed shortly.

1. *Fire protection*

The penetrations have to be fire resistant, because of the A0 walls of the trunk. For the first 4 solutions additional fire proof penetrations is required. The bolted plates require expensive sealing/gaskets which do not melt and this also applies to the glue.

2. *Watertight*

All five methods can be made watertight. However, the transits have to be checked very carefully. For bolted plates the bolts and sealing must be checked very carefully. In the accommodation, the water tightness is not of that much importance, but with a view to expansion to other ships sections, it is beneficial.

3. *Corrosion resistant*

Corrosion of the pipes and structure should be avoided as much as possible. Therefore it is important that the openings are fully closed. Also the avoidance of metal parts is very beneficial.

4. *Mounting duration*

The mounting duration is the longest for the welded plate. Welding involves preparation time to put the machinery in place. A NOFIRNO® transit can be finished really fast, but it has to be prepared with a welded horizontal flat bar. The other methods are less time consuming.

5. *Absorption of motion*

A ship structure is constantly moving. To avoid fatigue cracks, it is recommended that the piping have a reasonable freedom of movement. This is possible with the NOFIRNO® solution, both in axial and lateral direction. (Figure 46) Besides, the noise due to vibrations will be highly reduced because of the absorbing sealant.

6. *Tolerance*

If the metal or plastic plates are cut with exact penetration dimensions, the size and position of the penetration holes have to be very accurate. If working with NOFIRNO®, the exact dimension does not matter that much. If necessary, it can even be changed on site.

7. *Heat involved*

Only with the welded plate, there is a lot of heat involved. This has disadvantages like safety reduction and paint damage.

8. *Lifting weight*

The lifting weight must be kept below 23 Kg (according the Dutch OHSAS law). If the weight is higher, lifting pulleys or cranes must be used which then result in a longer mounting time. The lifting weight for NOFIRNO® is only a few grams for the rubber sleeves. For the plastic plates, the weight will probably be much less than for the metal plates.

9. *Material cost*

The material costs for metal plates will be the least. They can easily be made by currently used CNC machines. The plastic plates will cost somewhat more, also because it has to be bought externally. This also applies for the NOFIRNO® material. For the plastic plates, standardized dimensions will reduce the costs, because then a large amount can be ordered at once.

10. *Penetration required*

The first 4 solution do all require an additional fire proof penetration. NOFIRNO® does not need this and also insulation is not required. It could be possible that a particular glue does not need additional penetrations as well.

11. *Restricting building phase*

Because of the heat involved with welding, this can be done until the section building is finished. If necessary, the bolted and glued plates can be inserted during slipway building. If there are already

pipes implemented, it will be more difficult. With NOFIRNO® it does not matter if there are already pipes outfitted. Therefore this could be used when the ship is at the quay as well.

12. *Pre-outfitting possible*

As mentioned above, with NOFIRNO® pre-outfitting is possible. For the other solutions, pre-outfitting requires a separation in the plate, otherwise it cannot be placed.

13. *Adding penetrations cost*

If at a later moment a penetration has to be added to an opening, a hole has to be cut manually for the metal and plastic plates. This involves relatively high costs due to the preparation and damages due to heat. With a NOFIRNO® transit, a penetration can be added easily by cutting a hole with a sharp object like a knife or specially made tool and then fill it with the penetrations and some mounting glue. (Figure 47)

14. *Maintenance*

The bolted plates require the most maintenance. It has to be checked whether the sealing is still sufficient in case of a fire. Also the glue may be checked. The welded plate and NOFIRNO® do not need that much maintenance.

15. *Experience/ knowledge available*

Nowadays the most penetrations are welded in. For the synthetic and NOFIRNO® transits there is not much experience available. However, Beele Engineering BV offers free trainings on site to work with the NOFIRNO® transits.

16. *Supporting strength*

The supporting strength for the piping is the highest with metal plates. With NOFIRNO®, this strength will be less.

17. *Structure strength*

The structural strength of the trunk remains the highest with the metal plates. For the NOFIRNO® transit, a horizontal metal bar is required, which also increases the strength.

This comparison shows whether the concepts are feasible for the intended purpose. In general, all these concepts could be feasible. However, some of them will require more research in the field of materials and production for a valid comparison. This is described further in 7.4.

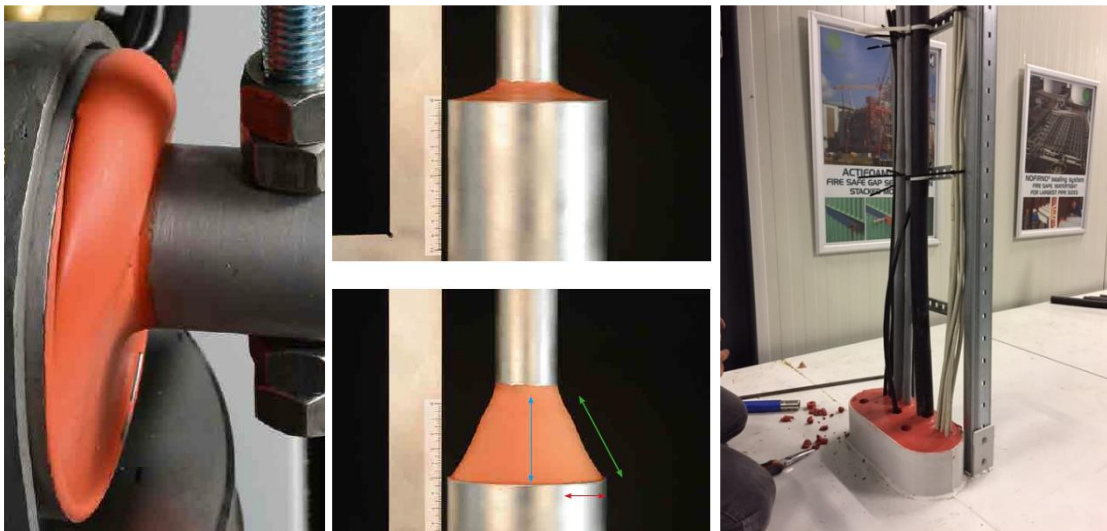

Figure 46 – Lateral- (left) and axial (middle) movement (Beele Engineering BV, 2017)

Figure 47 – Adding hole to NOFIRNO® transit (right)

7.3 ESTIMATION METHOD

In the previous section, the concepts for opening and closing are described. As was argued in this section, for the concept of inserts to work well, it is important that there is logic available to pick 'the right openings', as this will highly contribute to the success of the method. To make sure that the right openings are opened as much as possible, an estimation method with the right functional requirements has to be established. First the overall flow for the estimation is discussed. Then the two algorithms that are used for this estimation are elaborated.

In Figure 48, the total flow diagram is shown that can be used if the approach with using inserts is applied. This diagram can be described in the following 7 steps:

1. *Determine trunk dimensions*
First the dimensions of the trunk are received from the **construction plan**. This is the starting point of the flow.
2. *Determine where openings are possible*
With the dimensions of the trunk, the deck and ceiling heights and the other positions of obstacles like profiles and doors, are known. (See also 7.1.2)
3. *Estimate where systems will penetrate the trunk*
On the basis of arrangements and the equipment on system diagrams, an estimation is done using an algorithm, which will be discussed later.
4. *Choose next optimal opening*
If the penetrations does not fit in the estimated opening, the next best opening will be chosen. To check whether the penetrations fit, another algorithm is used.
5. *Determine which openings need to be opened*
If all penetrations are estimated and appointed to a certain opening, it can easily be seen which openings should be opened and which ones can remain closed.
6. *Cut out only hole for penetrations in these openings*
If an opening contains only 100% sure penetrations, just the penetrations should be cut out, and not the whole opening.
7. *Cut out whole opening*
If there is at least one unsure penetrations, the whole opening has to be cut out.

Now all the construction plates can be cut and the section building can start.

In the diagram, two yellow flag boxes with red outline are indicating the two algorithms that are used for the estimation. First there is the algorithm to estimate which opening is preferred for each penetration. Then there is an algorithm to check whether these penetrations fits in this opening, together with previous appointed ones. These algorithms will be explained in next sections.

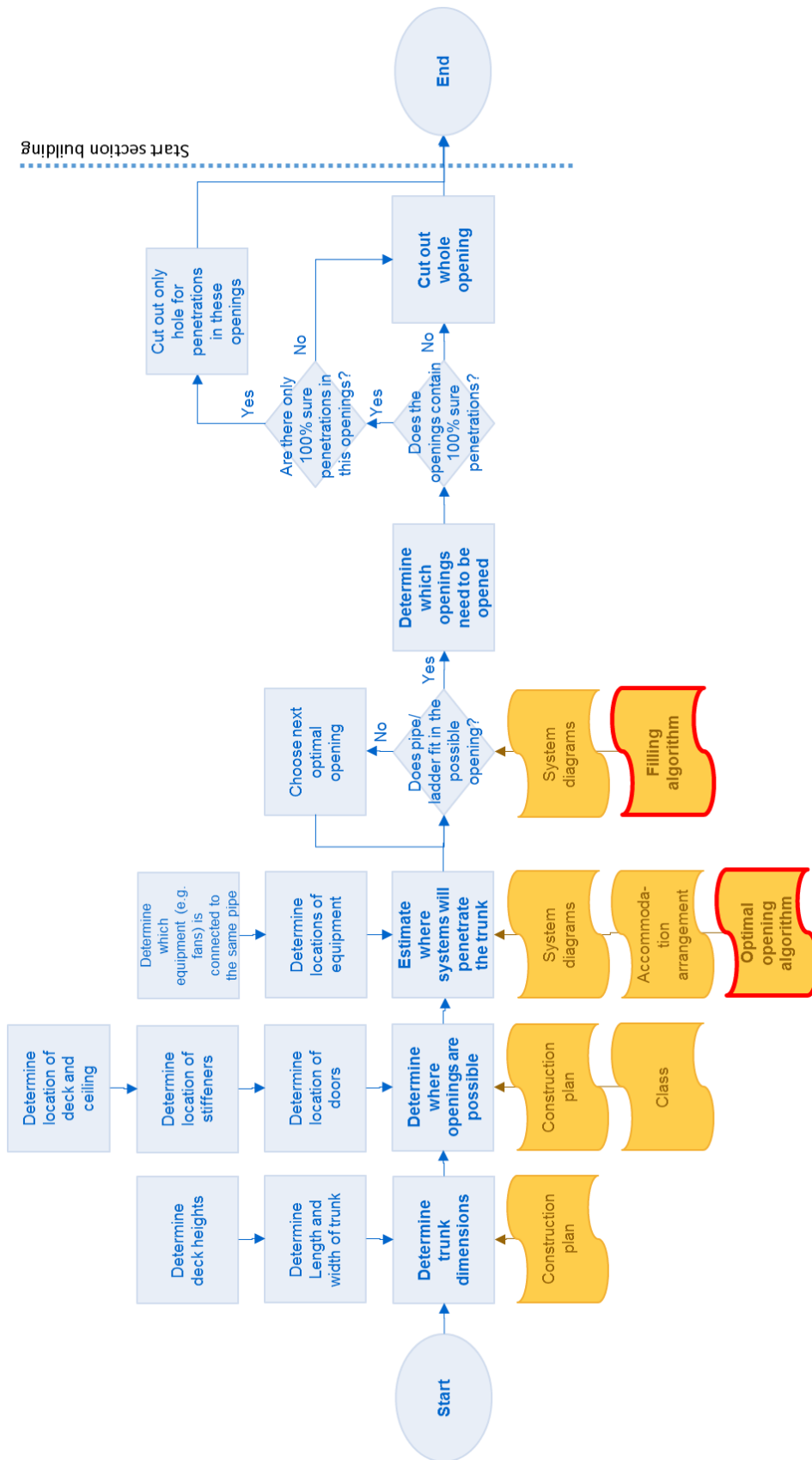

Figure 48 – Algorithm flow diagram

7.3.1 OPTIMAL OPENING ESTIMATION ALGORITHM

The optimal opening estimation algorithm chooses the best opening of the earlier defined possible openings in the trunk. It does not define an exact location inside this opening, to keep the freedom as large as possible for the router. The estimation method for the location of penetrations is not equal for all systems in the trunk. A division is made between cabling, water (grey, black, potable) and HVAC (supply, exhaust, recirculation). In Table 21, the estimation methods for all these systems are described in short. The sequence shown in the left column is also the sequence in which the systems are actually routed in practice and the sequence the filling algorithm will use. This filling algorithm is discussed in the next chapter.

Table 21 – Estimation methods

System	Characteristics	Functional algorithm requirements	Remarks
1. Cabling	<ul style="list-style-type: none"> - Highest position penetrations due to the requirement of 'not having water above cables'. - Penetration positions dependent on locations of vertical cable ladders in the trunk. - Trunk location dependent on converter room arrangement. 	<p>No algorithm used.</p> <p>Vertical cable ladder position considered to be known at the start. Penetration position chosen dependent on ladder position, bending radius, etc.</p>	The trunk location of the vertical cable ladders is very subjective. A well-chosen position is highly dependent on the experience of the engineer.
2. Grey water	<ul style="list-style-type: none"> - Low penetrations due to descending pipes. - Piping from all equipment (toilets, sinks, showers, etc.) of <u>all</u> decks must be routed to the same central pipe(s) in the trunk. - Therefore in many cases 'centralized' position in trunk. 	<ol style="list-style-type: none"> 1. All equipment of a certain penetration must be connected to the same pipe in the trunk with the shortest path. 2. The maximum distance between opening and equipment must be minimized by choosing the right opening. <p>(Figure 50)</p>	This method gives the opening that results in the lowest extreme values for the distance between equipment and main pipe. This is important due to descending pipes.
3. Black water	<ul style="list-style-type: none"> - Pipes are not descending, but vacuum pressurized. - Piping from all equipment (toilets) of <u>each</u> deck must be routed to the same central pipe in the trunk. - Often 1 vertical pipe in the trunk per deck. It is preferred to bundle these pipes. - Therefore in many cases 'centralized' position in trunk. 	<ol style="list-style-type: none"> 1. All equipment of a certain penetration must be connected to the same pipe in the trunk with the shortest path. 2. The maximum distance between opening and equipment must be minimized by choosing the right opening. <p>(Figure 50)</p>	This method gives the opening that results in the lowest extreme values for the distance between equipment and main pipe.
4. HVAC	<ul style="list-style-type: none"> - Air should be conveyed as directly as possible to save space, power and material. - Air velocities should be within permissible limits to reduce noise and vibration. - The index run should be kept as low as possible. 	<ol style="list-style-type: none"> 1. All equipment of a certain penetration must be connected with the minimum spanning tree. 2. The point (COM) on the path with the lowest variance of distances between this point and the equipment must be found. 3. Then the opening with the shortest path between the opening and the COM must be determined. <p>(Figure 50)</p>	This method gives the opening that results in the lowest index run.
5. Hot- & cold potable water	<ul style="list-style-type: none"> - Mostly 4 penetrations on a deck: hot and cold, both in and out. - Each hot- & cold water 'loop' serves both the deck above and below. - So 1 'loop' between each 2 decks which require 4 penetrations. 	<ol style="list-style-type: none"> 1. All equipment of a certain penetration must be connected to the same pipe in the trunk with the shortest path. 2. The maximum distance between opening and equipment must be minimized by choosing the right opening. <p>(Figure 50)</p>	Because the pipes are relatively small, and the system is a pressurized closed loop, it is not really a big problem if the pipes have to take a detour.

7.3.1.1 CABLING

For the determination of the cabling penetrations, no algorithm is used. In general, cabling penetrations are not very suitable for automatic routing and penetration estimation. However, this does not have to be a problem. The sizes and number of penetrations per deck is known on a very early stage. The first thing to do for accommodation routing engineers is the placement of the vertical cable ladders inside the trunk. Sometimes cable ladders are placed in a separate cabling trunk. If this is not the case, the position is dependent on the arrangement of the converter room and the way from trunk to this room, because almost any cable ends in this area. However, this location is very subjective and experience dependent. "5 different routers can choose 5 different locations". There can be hardly found any relation between ships that determines this position. On the basis of these vertical ladders the penetrations to the deck are chosen. The location of this penetration is mostly equal for each deck.

Because of the very early stage the cabling penetrations are determined, and the lack of consistency between different ships, these penetrations are considered to be known in the estimation model. Therefore the cabling penetrations are placed at the start in the known opening at the highest point, because cabling always must be routed as high as possible (Appendix IV: Classification articles holes). As argued, cabling is not very suitable for automatic routing due to the lack of consistent inputs like locations. However, in the future it is possible that the company standardizes the location of the cable ladders by rules, to provide more equality between vessels.

7.3.1.2 WATER

After the cabling penetrations are placed, the estimation for the grey and black water is performed. Especially the grey water penetrations have to be placed as low as possible, due to the descending pipes. To do the estimation, first some data have to be gathered. Grey water is connected to all sanitary-, galley- and laundry equipment. All these locations that have to be reached in a system will be called 'equipment' from now.

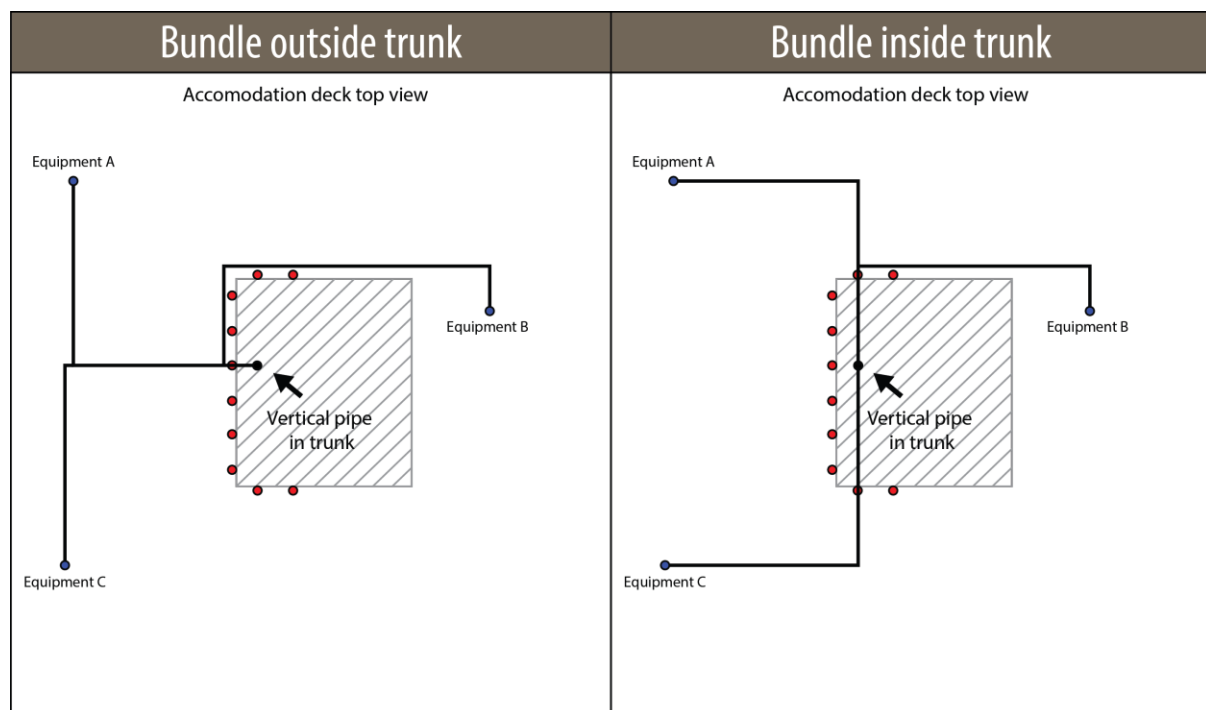

Figure 49 – Bundling of water system pipes

Another choice that has to be made at the start, is whether the pipes will be bundled inside or outside the trunk. (Figure 49) The red dots refer to possible trunk openings, the blue dots to equipment locations. This choice of bundling influences the choice of openings very much. Bundling inside the trunk can minimize the required pipe length, but if the trunk is too crowded, this is mostly not possible.

In the left part of Figure 50, the algorithm used for water lines is shown. The equipment dots represent toilets, shower, sinks etc. The red dots are possible openings. In the center is the trunk and staircase which may not be passed. The algorithm calculates all distances between each red dot and all the equipment of one system. Therefore a “A* shortest path algorithm with avoiding obstacles” is used. (Pathfinding using A*, 2017) Then the red dot with the lowest maximum value of distances to the equipment is chosen as best. Because the maximum distance is the lowest, the extreme values are as small as possible. This is a good characteristic for especially the grey water system, because the descending lines cannot be too long. Because for grey and black water all individual penetrations have to be bundled inside the trunk, the algorithm is run a single time with all the equipment coordinates of all decks. For hot and cold water lines, this is not necessary. These lines are relatively small and are able to pass other piping inside the trunk more easily. For that system, the algorithm runs separately for each deck.

If it is stated that the pipes can be bundled inside the trunk, the system is divided into multiple systems (1 system per penetration). Then the described algorithm is run for each sub-system.

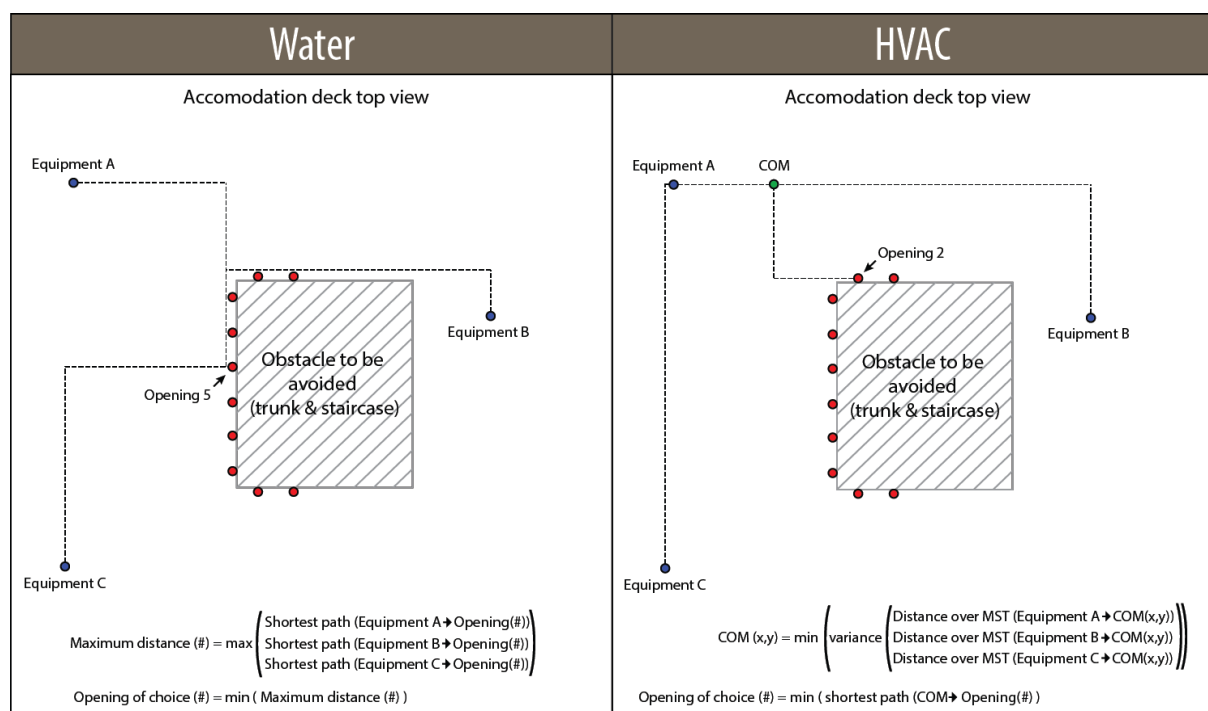

Figure 50 – Optimal opening estimation algorithms

7.3.1.3 HVAC

For the HVAC optimal opening estimation, another method has to be used. Water has simply other characteristics than air. Because of pressure drops, air pipes should not be made too long. Besides, a good distribution over the equipment (for example AC units) is required.

First the algorithm connects all equipment with the “minimum spanning tree algorithm” by Prim. (Prim's Algorithm, 2017) Then the point on this line with the shortest *index run* has to be found. The index run is the run from the fan to the unit with the highest pressure drop. (Figure 51) If the pressure drop is known for the index run, the remaining pressure is supplied to the unit (unit 3 in this case). This pressure X has to be equal for all units. This is done by use of air dampers. (Kharagpur, 2014) The aim is to keep this index run as short as possible. In Figure 51 exactly the same length of duct is used. Nevertheless, the right position of the fan results in a shorter index run. With the algorithm the shortest index run is calculated. That can be reached by calculating the point that has the lowest variance of the distances between this point and all the equipment. (See Figure 50 for the formula) This is now called the “center of mass” (COM). The last step is to find the minimum shortest path between COM and the red dots. The result will be the “opening of choice”.

In Figure 50 it is clearly illustrated that the two different algorithms result in another “opening of choice”. For HVAC the short pipes and good air distribution is very important, while for the water lines only the smallest extreme value is the desired goal.

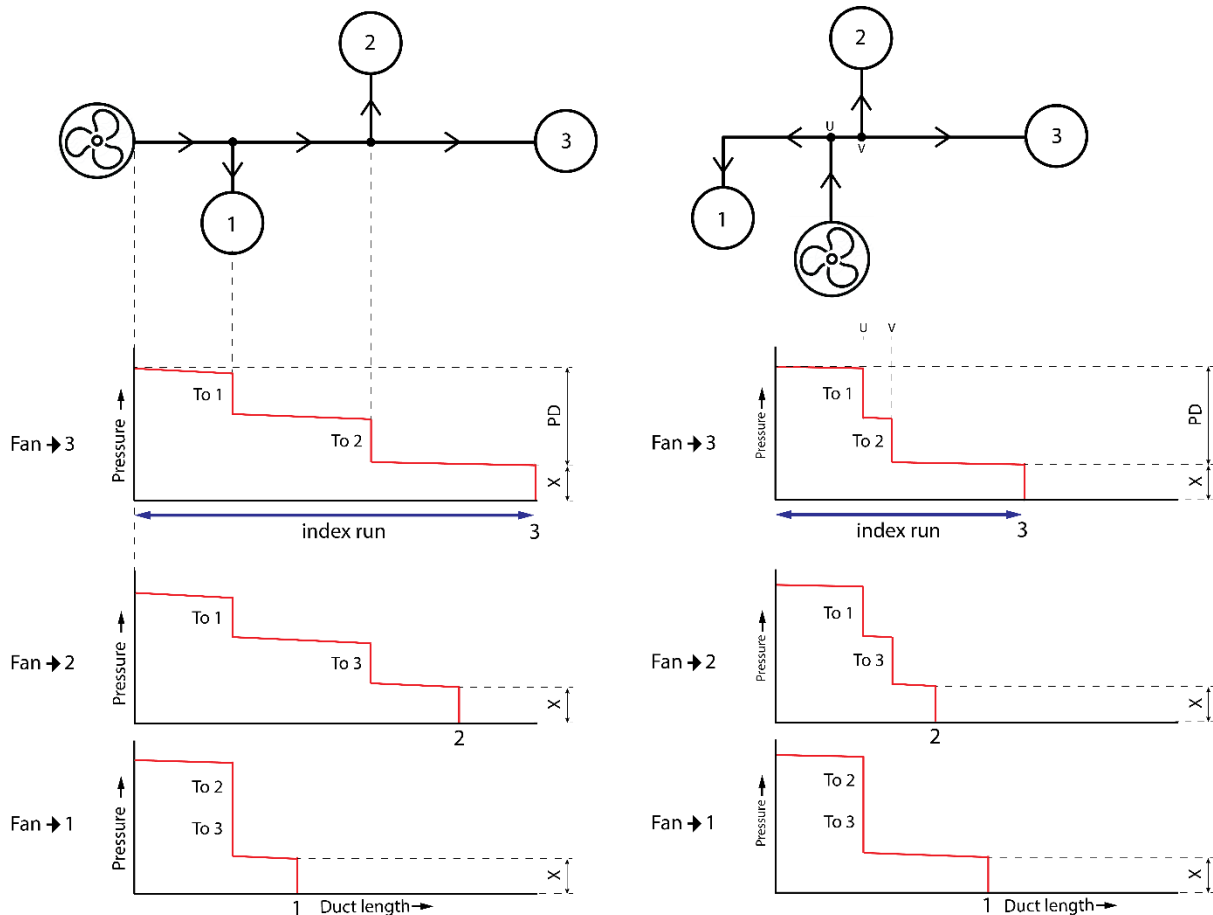

Figure 51 – Pressure drops in HVAC line

7.3.2 FILLING ALGORITHM

If for a certain system the estimation is done for the optimal opening, it has to be checked whether this penetration fits. This is done by a second algorithm. The functional aspect of this algorithm is to check whether the penetration fits in the opening, regarding the size of the opening and the other penetrations. The technical way to check this, is to fill up a rectangle (the opening) with blocks (penetrations) and check whether these blocks fit within the rectangle without overlapping each other.

The starting point of this algorithm is an overview of all the possible openings of the trunk. For these openings a clearance of 100mm to the profiles and deck is included. The corners are rounded off with a radius of 100mm. Then a square area is made which can be used for filling with penetrations. (Figure 52)

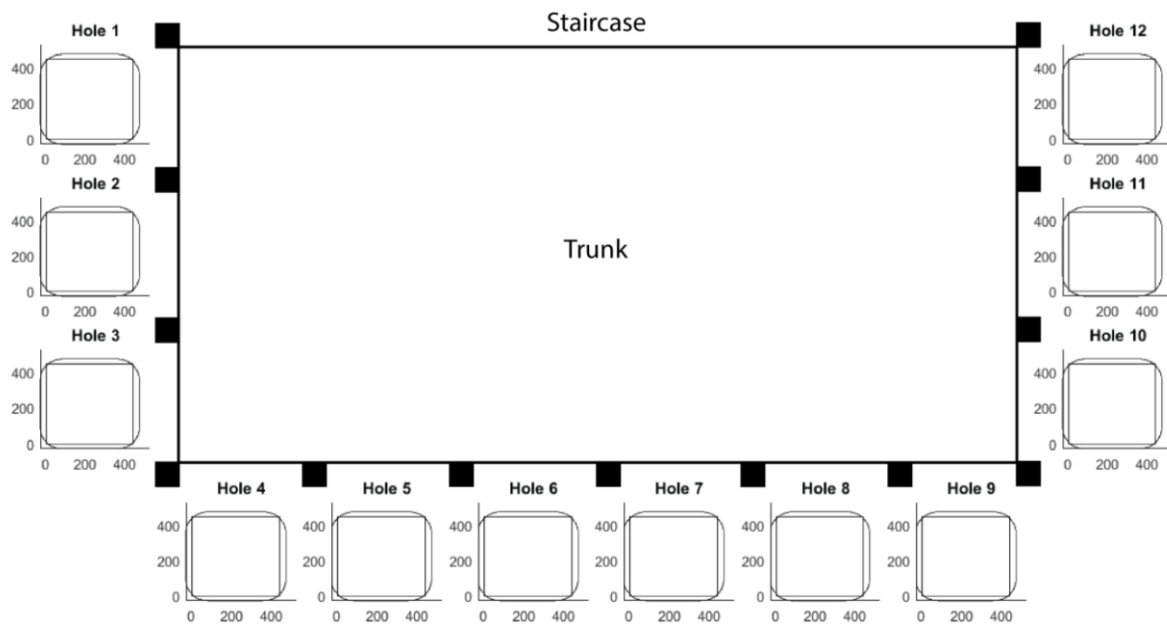

Figure 52 – Filling algorithm starting screen

The input for the overall model are the equipment locations and the penetration size. This size is known from the system diagrams, created by the diagram engineers. The penetrations are simplified to only rectangles instead of circles. For example, a pipe of $\varnothing 150$ is imported as a rectangle of 150x150. This directly gives a margin between the penetrations.

The holes are filled with the sequence as it is routed. (Figure 53) The cable ladders are filled from the top left corner. All electricity is preferred to be routed above other (water) systems. All the other systems are filled from the bottom left corner, always in the right sequence. This keeps the grey water penetration as low as possible.

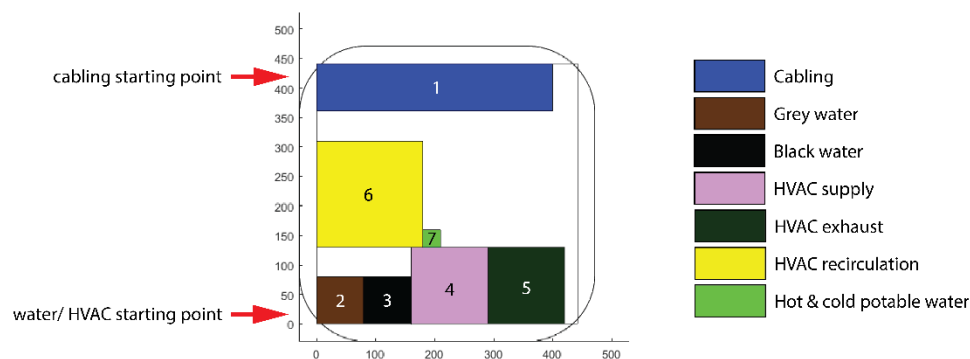

Figure 53 – Filling sequence

The filling works first horizontally. If another penetrations does not fit on the same row, it shifts to the next row. As can be seen in Figure 53, the row is “as high as the highest rectangle”. This has as a positive consequence that at the end all penetrations of a row are allowed to be shifted mutually.

If at a point a next penetration does not fit in the estimated opening, the software displays an error message. Now the algorithm is able to search for the second best opening. However, this is finally not implemented in the program. It turned out to be better to give the user the choice whether he wants to shifts the penetration one opening to the left or one opening to the right. This is because the user has engineering experience and he can apply his knowledge to his decision. For example, he can see whether there is another penetration of the same system in a nearby opening so that they can be bundled. He can also prefer to put it in an opening where already other penetrations are present so that others can remain closed. In short, the software will give an

error message that says another opening has to be picked. Then the user manually chooses another opening. The program then checks whether the penetration fits in this opening of choice.

Recapitulating, the first algorithm estimates the optimal opening for a penetration. The second algorithm checks whether this fits. If this is not the case, the second best opening is chosen. Then, in the end an overview of the openings with penetrations is created and it can be seen which openings must be opened. As mentioned before, not the exact position of the penetration is estimated, only the opening where it should go through.

7.3.3 CONCLUSION

In chapter 7.3, two algorithms are described. The first algorithm consists of two separate parts. They determine the optimal opening for a water and HVAC system penetration respectively. The second algorithm determines whether this penetration fits in the estimated opening, together with other penetrations. All of these algorithms are summarized below.

Optimal opening estimation algorithm → water

1. Find lengths of orthogonal shortest paths between all equipment (A,B,...N) and all openings (1,2,...N).
2. Determine extreme value of the lengths from step 1 for each opening.
3. Determine opening with the lowest extreme value of the length.
4. This opening is the optimal opening.

Optimal opening estimation algorithm → HVAC

1. Find orthogonal minimum spanning tree between all equipment (A,B,...N) with Prim's MST algorithm.
2. Determine lengths between each point on the MST and the all equipment (A,B,...N), measured over the MST path.
3. Determine point on the MST path with the lowest variance of lengths from step 2.
4. Determine orthogonal shortest path between the point from step 3 and all openings (1,2,...N).
5. Determine the opening with the lowest orthogonal shortest path from step 4.
6. This opening is the optimal opening.

Filling algorithm

1. Plot trunk lay-out with all possible openings (1,2,...N).
2. Plot penetration with given dimensions as a rectangle inside the opening followed from the estimation algorithm. (Fill cabling from the left top corner, others from the left bottom corner. The sequence is described in 7.3.2)
3. Determine whether the rectangle fits inside the opening, without overlapping the borders or other penetration rectangles.
4. If yes, plot the rectangle inside the opening.
5. If no, plot the rectangle on the next row and go back to step 3.
6. If the rectangle keeps overlapping the border or other rectangles, ask the user for a new optimal opening. (preferably optimal+1 or optimal-1)

The algorithms were performed successfully with MATLAB R2016a on a laptop with the following features:

- Dell Inspiron 5521
- Windows 10 Home
- Intel® Core™ i7-3537U CPU @ 2.00GHz 2.50 GHz
- RAM-memory 8.00GB
- 64-bits

A full run for one penetrations, including estimation and fitting, takes between 15 and 60 seconds, mainly dependent on the number of equipment. The MATLAB codes can be found in Appendix XII: Matlab code.

7.4 FINAL CONCEPT

In chapter 7.1 and 7.2, three different opening- and five different closing concepts are described. In the next chapters, some of these concepts will be tested and compared to each other, to ultimately make the best choice.

7.4.1 OPENING METHODS

In short, the three opening concepts are:

1. open all openings
2. open all estimated openings
3. open all holes that are sure and all other estimated openings.

The choice whether which method will work best is highly dependent on the effectiveness and correctness of the estimation algorithm. If the results of the estimation are very close to the real outcome, concept 2 or 3 will be more efficient than 1, because there will be not many openings that have to be opened or closed afterwards. If the estimation is not very accurate, concept 1 could still be the best solution. Then it does not matter where the penetrations will be located, and no openings have to be opened afterwards. However, in most cases some openings have to be completely closed. In the next chapter, both concept 1, 2 and 3 will be compared. For concept 3, it will be presumed that 10% of the penetration locations is known for sure.

7.4.2 CLOSING METHODS

In chapter 7.2, five closing method are discussed and compared. For the “steel welded plate” and the “NOFIRNO®” transit, all required knowledge and information is available or can be within a short time. For the other solutions, further research has to be done. For the bolted plates, suitable gaskets or sealing must be found which are water- and fire proof. Also if glue is used, this compound has to meet all the requirements. Besides, there is too little known about the synthetic plates and possible material characteristics. Several tests have to show whether a material is indeed fire- and water resistant, without for example the diffusion of toxic gases. All this additional research is not within the scope of this thesis. Therefore, in the next chapters only the “steel welded plate” and the “NOFIRNO®” transit will be compared to the current situation.

8 VALIDATION

In the previous chapter, the several concepts for opening and closing the openings in the trunk are discussed. Besides, the algorithm is described which will determine which openings should be opened. In this chapter, the accuracy and usability of the algorithms are determined.

For 4 recently built IHC vessels (building numbers 1278, 1283, 1285 and 1289), the algorithms have estimated which trunk openings should be opened and which ones could remain closed. These results are then compared to the actually built vessels. In the next chapter, it will be investigated whether the usage of the algorithm in combination with the new opening and closing concepts could result in an overall cost reduction.

In Figure 54, an example is shown of an algorithm run which determines the optimal opening for a system. This algorithm has been run for all systems at each ship considered.

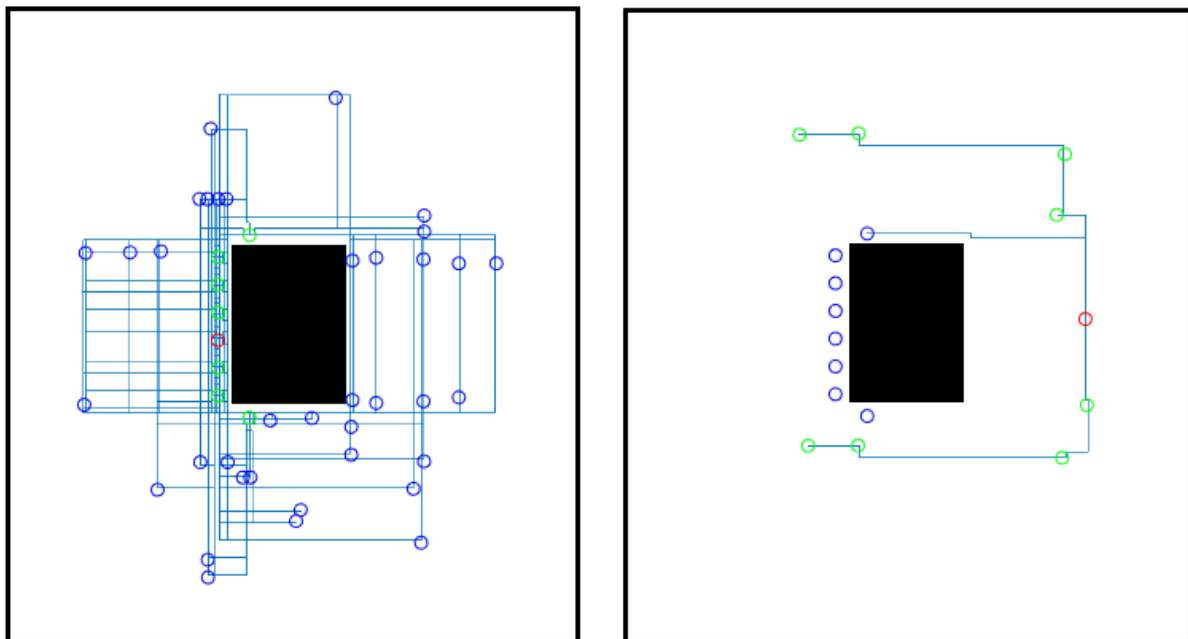

Figure 54 – Optimal opening determination algorithm for water systems (left) and HVAC systems (right)

Then the second algorithm places the system penetrations in the estimated opening and checks whether the penetration fits. At the end, for each ship an overview is created which shows the penetration composition for all openings on each deck. This is done for the estimated penetration locations and for the actually built locations, to get a good comparison. (Appendix X: Results) An example of one deck of a particular vessel is shown in Figure 55. All the penetration dimensions are multiplied by 1.25, because IHC prefers to remain a minimum of 0.5 times the diameter between two penetrations.

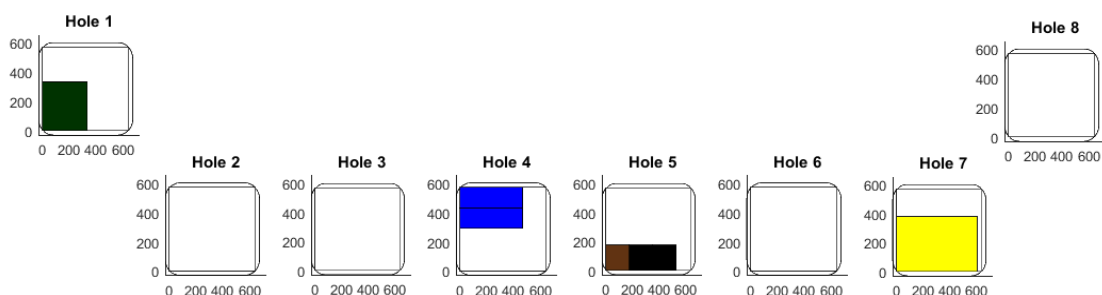

Figure 55 – Filling algorithm composition of a deck

The result at the end contains the estimated opening for all penetrations. With this information, several comparisons can be performed. First for each separate penetration, the difference is determined between the opening that is estimated by the algorithm and the opening that is actually used in the real built ship. If for example the algorithm gives ‘opening 4’ as an optimal and the pipe is actually routed through ‘opening 3’, the difference is 1. This can be summed for all decks of a ship. In addition, these differences between the real used opening and the estimated opening can be taken separately for each system. Then a clear overview of the best and worst matching system is created.

Another comparison that is investigated, is the difference between the openings that are used in real and the openings that should be opened according the algorithm. This gives for example the result that opening 1-2-4-5-8 are used in real and opening 1-3-4-5-7 are opened according the algorithm. This can then be further elaborated for each deck. All the graphs for each vessel can be found in Appendix X: Results. If the estimated opening is not equal to the real opening, in most cases it differs only by 1. It is decided that a difference of only 1 is still acceptable. When a very close look is taken into the 3d model of the built ship, it is found that in almost all cases, the opening next to the used one could be taken as well without any problems. In Figure 56, it can be seen that opening 5 is used in real, but that the estimated opening 4 could have been used as well. If in reality it turns out to be impossible to use the adjacent opening, there will be extra cutting costs, as will be calculated in 9.1.

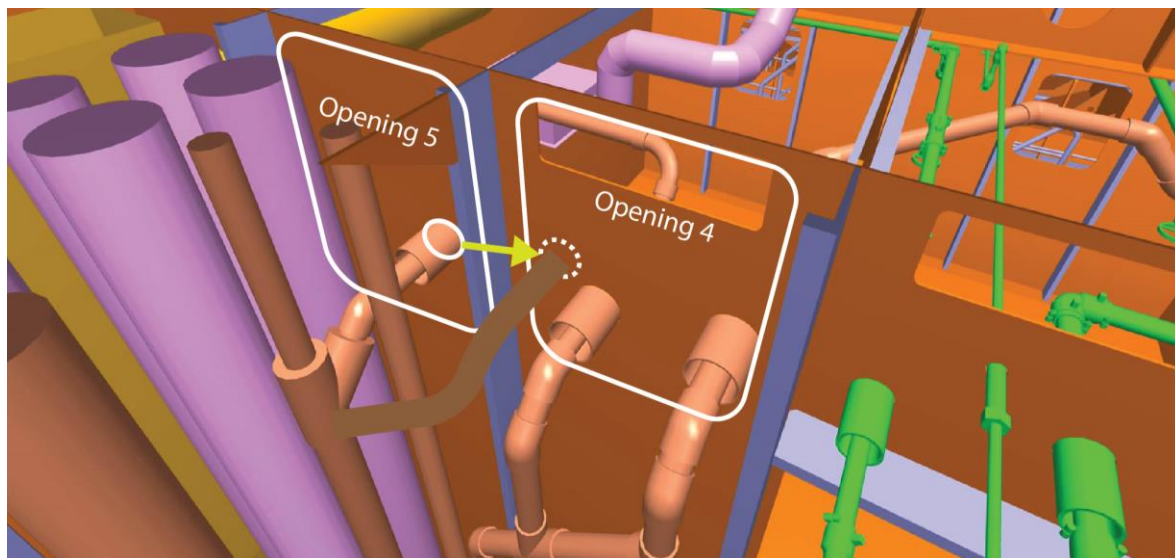

Figure 56 – 1 opening difference is acceptable

If a difference between the algorithm and reality of 0 and 1 is acceptable, these values can be put together in a graph.

Figure 57 gives a general impression about the correctness of the algorithm. It shows the difference between the estimated optimal opening and the real used opening for each penetration. However, it will be more interesting to know the correctness of the opened openings. If there is an opening too little or too many, an opening has to be added or closed respectively. A clear overview of these percentages is shown in a pie chart as well (Figure 58). The values of all charts are also summarized in Table 22. The lower three rows does say more about the actual impact, because that values are about the estimated and real opened openings. Then it does not matter that much which penetration is passing through a certain opening.

Table 22 – Difference between the algorithm and the real built vessel

	1278	1283	1285	1289	Average	Min.	Max.
Correctly estimated opening	88%	88%	97%	81%	89%	81%	97%
Opened opening	79%	81%	82%	82%	81%	79%	82%
Opening to be added	11%	19%	9%	14%	13%	9%	19%
Opening to be closed	10%	0%	9%	4%	6%	0%	10%

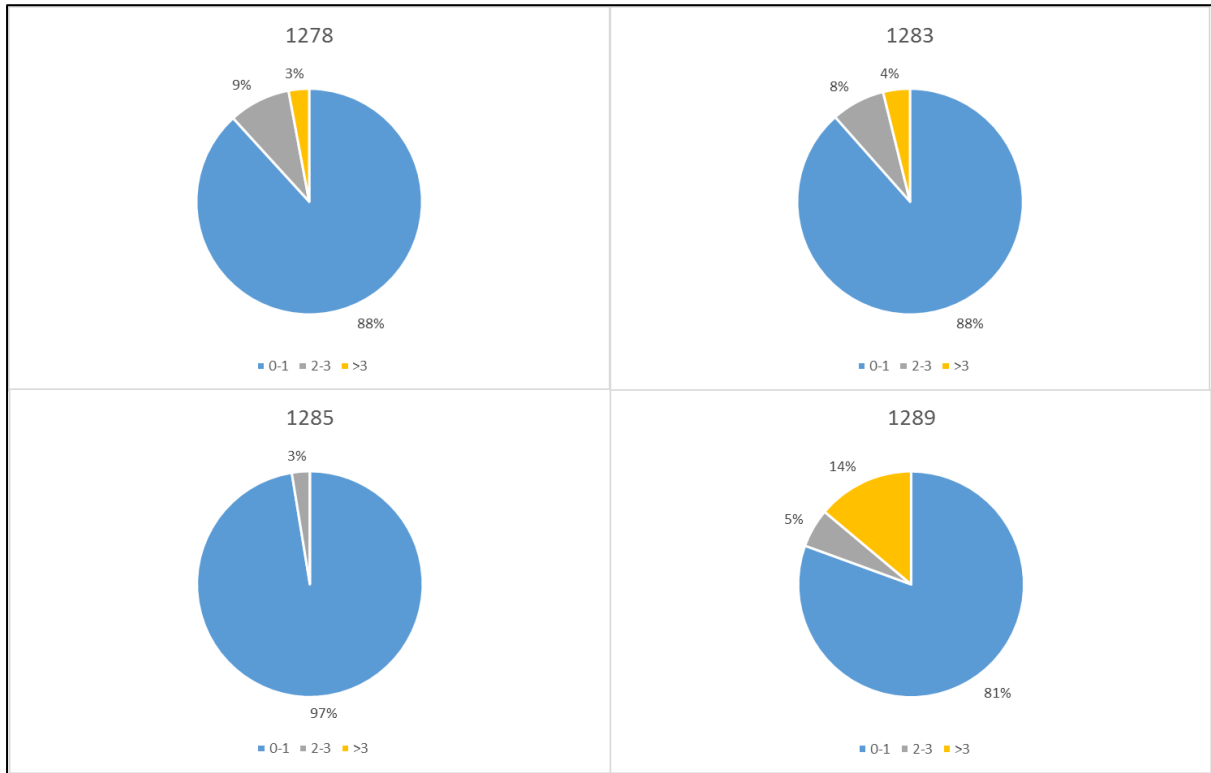

Figure 57 – Difference between real and estimated optimal openings for the penetrations

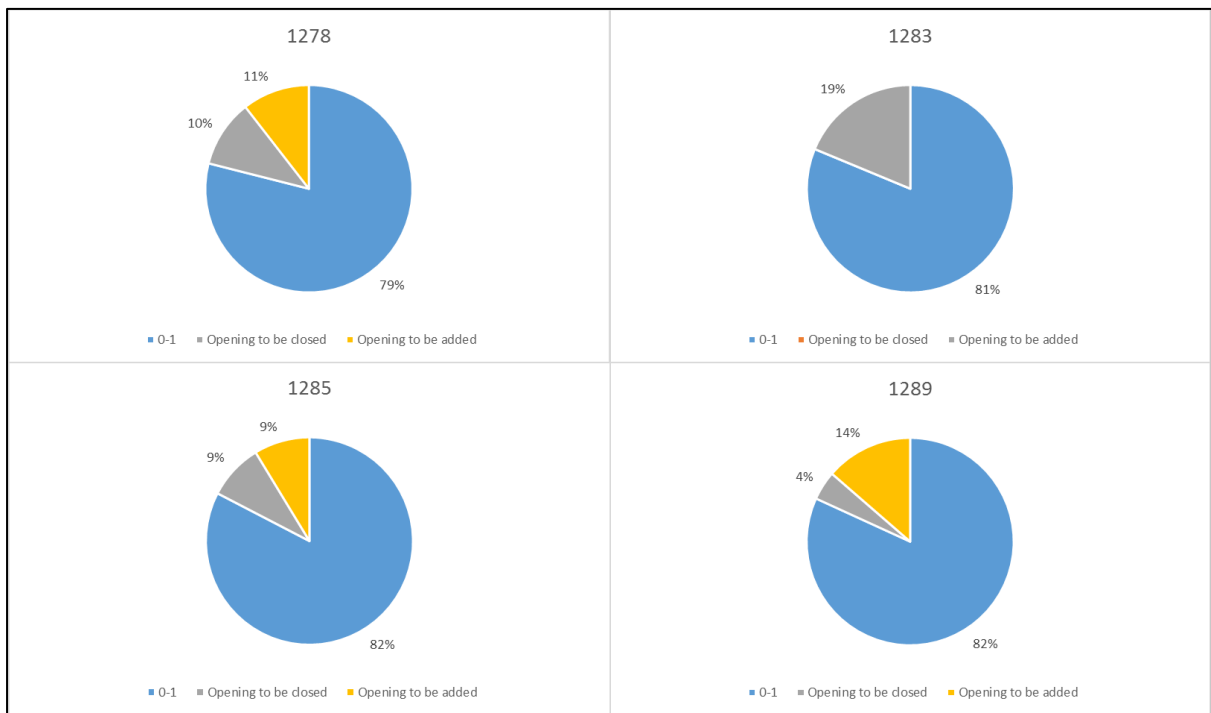

Figure 58 – Difference between real and estimated opening that are opened

The values above give a clear representation of the accuracy of the algorithm. With an average of 88.5% for the penetrations that are estimated right, the algorithm seems useful. Further improvements by using more constraints could even raise this value. For the comparison between different closing methods, other values are important. Therefore for each vessel the total number of correct opened openings, to be added openings and to be closed openings are counted. (Table 23) In addition, the total possible openings of all decks are separated into the final opened- and still closed ones. These values can then be used to calculate the costs of “opening all openings”. The full comparison will be discussed in next chapter.

Table 23 – Number of openings

	1278	1283	1285	1289	Average
0-1 difference (acceptable)	15	13	19	18	16
Opening to be added	2	3	2	3	3
Opening to be closed	2	0	2	1	1
Total openings	30	33	32	33	32
Total opened	17	16	21	21	19
Total closed	13	17	11	12	13

9 EVALUATION

As stated in chapter 7.4, three different opening methods will be compared to the current situation at Royal IHC, for the two different closing methods. (Table 24) Therefore first the costs of several possible transits are calculated. Then with the values of Table 23, the total transit costs of an accommodation trunk in a ship can be calculated.

Table 24 – Solution matrix

	Current state	Open all openings	Open estimated openings	10% sure, others estimated
Manual cutting	X			
Steel insert plate		X	X	X
NOFIRNO®		X	X	X

9.1 TRANSIT COSTS³

In total there are three transit methods that are compared:

- Manual cutting: Manually cut the exact holes for the penetrations if the dimensions are known.
- Welded steel plate: Automatically cut the large openings and fill them with the steel plates.
- NOFIRNO®: Automatically cut the large openings and fill them with the NOFIRNO® sleeves and sealant.

For these three transit methods it is calculated how much a normal transit with penetrations, an added transit with penetrations and a closed transit will cost approximately. For the normal- and added transit, an example transit is used which is shown in Figure 59. The outer dimensions are 500x500 mm with a corner radius of 100mm. It contains one HVAC penetration of 219 mm and two water penetrations of 114 mm. For the closed transit, the same outer dimensions are used, but without any penetrations. (Figure 60)

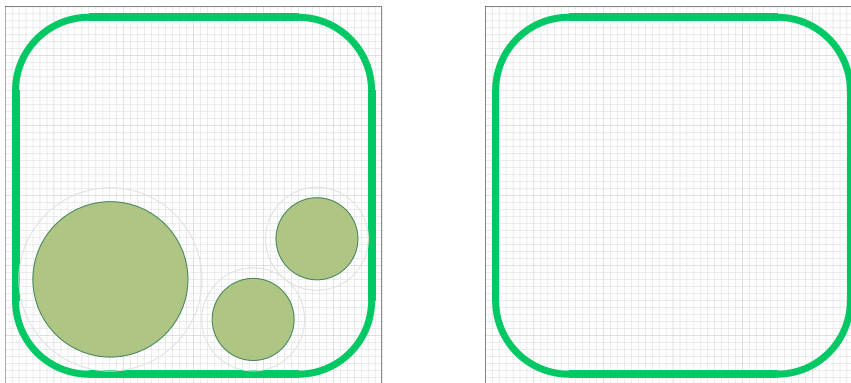

Figure 59 – (left) Normal and added⁴ transit for calculation

Figure 60 – (right) Closed transit for calculation

The costs calculation is divided in two categories: Work and material. Work consists of tasks like welding and cutting, material contains the plugs, plates, pipes, sleeves etcetera. Each transit has a different set of work and material. First the individual costs of these work and material are determined, then they are summed to get a total transit cost.

³ The transit costs are the costs for the opening and closing (with or without penetrations) of an opening.

⁴ A normal transit refers to a transit with penetrations as in the left part of Figure 59. An added transit refers to the same transit, but then including the fact that this opening was not cut by the plasma cutting robot and has to be cut manually.

9.1.1 WORK & MATERIAL COSTS

As said, a normal transit is considered to have three penetrations. In chapter 5.1.2, the hole costs have already been determined. In this case, for 3 holes the total cost is 220 euro. To get the costs for other actions, this price can be divided in sub-actions. Then a percentage can be assigned to each sub-action. With this, some other action costs can be estimated. (Table 25)

There are some remarks regarding this table:

- “Coordinate” consists of all extra actions resulting from repair work, like communicating, explaining, discussing etc.
- “Set up” includes the positioning of tools and equipment. This only counts if it was not already there. For example, the flat bar is welded in directly with the rest of the section, so there is no set up time.
- The welding time for the pipes into the plate is less, because the welds are shorter, and the plate is not already placed in the section.

Table 25 – Work costs

<i>Cutting holes manually</i>			<i>Welding plate</i>			<i>Welding flat bar</i>			<i>Welding pipe in plate</i>		
	%	Cost		%	Cost		%	Cost		%	Cost
Coordinate	25	55									
Set up	20	44	Set up	20	44						
Measure	22.5	49.5									
						Bending	2.5	5.5			
			Welding	22.5	49.5	Welding	22.5	49.5	Welding	5	11
Cutting	22.5	49.5									
Finishing	10	22									
Total	100%	€220		42.5%	€93.5		25%	€55		5%	€11

For the creation of the NOFIRNO® transit, a duration of 1 hour is estimated. The demonstrated transit was performed is less than 5 minutes. Now the transit is about 3 times as big and both sides have to be done: 6x5= 30 minutes. This duration is doubled to get everything in place. It results in a total cost of 56 euro.

Then also the material costs are required for the calculation. For the steel, the area is calculated and multiplied by the price per square meter. The cutting costs calculated in chapter 5.1.2 are added as well. Also the costs of pipes, SLIPSIL® plugs, HVAC connectors and NOFIRNO® sleeves and sealant are included. The exact purchase prices will not be mentioned in this report, but the outcomes are put in Table 26.

There are some remarks regarding this table:

- For NOFIRNO® transits, no additional SLIPSIL® or G-penetration is needed.
- If holes are manually cut, it is considered that there are no added and closed openings, because they are already cut in the final phase.
- If with the steel insert plate method an opening has to be added, it is considered that just the hole for the penetration is cut and not the whole square opening.
- For the closing with NOFIRNO®, the opening has to be filled completely with sleeves and sealant. For the steel plate, just a closing plate has to be welded in.

Now these transit costs can be combined with the values of Table 23. Then the total costs can be calculated, compared and discussed.

Table 26 – Transit costs

	Manual cutting	Welded steel plate	NOFIRNO	Cost	
Normal penetration	<i>Work</i>	Manual cutting	Welding flat bar	€ 55,00	
		Welding Slipsil pipe	Creating NOFIRNO transit	€ 56,00	
		Welding G-pen. pipe			
	<i>Material</i>	Slipsil plug	Steel plate	Flat bar	€ 15,93
		Slipsil pipe	Slipsil plug	NOFIRNO sleeves	€ 564,80
		G-penetration pipe	G-penetration pipe	NOFIRNO sealant	€ 388,50
		G-penetration connecto	G-penetration connectors		
Total	€ 466,81	€ 352,33	€ 1.080,23		
Adding opening	<i>Work</i>	Manual cutting	Manual cutting	€ 180,00	
			Welding Slipsil pipe	€ 22,00	
			Welding G-pen. pipe	€ 11,00	
	<i>Material</i>		Slipsil plug	Flat bar	€ 15,93
			Slipsil pipe	NOFIRNO sleeves	€ 564,80
			G-penetration pipe	NOFIRNO sealant	€ 388,50
			G-penetration connectors		
Total	€ 426,81	€ 426,81	€ 1.260,23		
Closing opening	<i>Work</i>	Welding plate	Welding flat bar	€ 55,00	
			Creating NOFIRNO transit	€ 56,00	
			Flat bar	€ 15,93	
	<i>Material</i>		Steel plate	NOFIRNO sleeves	€ 753,60
				NOFIRNO sealant	€ 514,50
Total	€ 105,51	€ 105,51	€ 1.395,03		

9.2 TOTAL TRUNK TRANSIT COSTS

In the previous parts, all the input for the costs comparison is calculated and described. In Table 27 the total estimated costs are calculated, for all transits in an average trunk of a vessel. This is done separately per opening concept, for both the welded steel plate and the NOFIRNO® transit.

Table 27 – Total trunk transit costs comparison

	Current state	Concept 1 Open all openings		Concept 2 Open estimated openings		Concept 3 10% sure, others estimated		
	Manual cutting	Welded steel plate	NOFIRNO®	Welded steel plate	NOFIRNO®	Manual cutting	Welded steel plate	NOFIRNO®
Normal penetration	€ 8.869,45	€ 6.694,20	€ 20.524,41	€ 5.637,22	€ 17.283,72	€ 7.982,50	€ 5.073,50	€ 15.555,35
Adding opening	-	-	-	€ 1.280,43	€ 3.780,69	-	€ 1152,39	€ 3.402,62
Closing opening	-	€ 1.371,67	€ 18.135,42	€ 105,51	€ 1.395,03	-	€ 94,96	€ 1255,53
Total	€ 8.9K	€ 8.1K	€ 38.7K	€ 7.0K	€ 22.5K	€ 8.0K	€ 6.3K	€ 20.3K
Percentage*	100%	91%	436%	79%	253%	100%	79%	253%

* These values do not include engineering costs and thereby cannot be compared directly.

For the initial manual cutting costs, the price of a manual cut transit is multiplied by the average number of used openings. (Which is “19” from Table 23) This value follows from the registered repair hours and is therefore dependent on the registration consistency of the workers.

For concept 1, the “normal penetrations” costs from Table 26 are multiplied by the average number of used openings as well. Then the “closing opening” costs times the average number of closed openings are added.

For concept 2, the “normal penetration”, “added opening” and “closed opening” costs from Table 26 are used. These values are multiplied by the average number of openings for “0-1 difference” (Which is “16” from Table 23), “opening to be added” (Which is “3”) and “opening to be closed” (Which is “1”) respectively.

Finally for concept 3, it is considered that 10% of the penetrations is known for sure. These holes are already cut directly with the primary steel for the sections. Then the total number of required penetrations/ openings is reduced by 10%. This will result in lower trunk transit costs. However, the percentage in relation to each other will remain equal. For the right comparison, the manual cutting is set to 100% again.

Now there is a clear overview of the purchase- and production costs for several transit methods. If all possible openings are opened and then closed, the welded steel method will give a cost reduction of 9%. This seems to be a small number, but it also can make the engineering process a lot less complex. At the moment it is not possible to put a quantitative value to the decreasing engineering costs. Less work and communication is required, because the structural engineer can place all openings without input from the routing engineer. The NOFIRNO® method will cost much more. However, this comparison is based on purchase and production costs. As stated before, NOFIRNO® has some big advantages in the field of lifespan, safety and adaptability. This could reduce the engineering- and operational costs of the vessel. The exact reduction is hard to calculate and should be experienced with a real built ship. If only the estimated openings are opened and then closed with a steel welded plate, there will be a cost reduction of 21%. However, the implementation of and working with the algorithm will involve more complexity for the engineering department. This increasing or reducing engineering complexity is qualitatively shown in Figure 61. The green and red blocks indicate probable decreasing and increasing engineering costs respectively.

The advantages and disadvantages of all concepts are broadly discussed. This can be converted to “benefits”. However, not all concepts are as easy to implement in the existing process. In Figure 62, the four main concepts are qualitatively visualized in an Effort-Benefit matrix. Especially the mutual relation between the circles are of interest, not the exact position. As can be seen, a steel welded plate involves less effort as the implementation of a new product, NOFIRNO®. Besides, using an algorithm entails even higher effort due to the development, examination and training regarding the software.

The implementation of an algorithm will involve work on the IT department, first for implementation and later for support. Also the work for the routing engineers changes, but if the software is programmed and designed

on a high level, this does not need to result in a lot of difficulties. It must be ensured that the routing engineer remain responsible for the routing and not the algorithm or IT engineer, which demands strict control. If NOFIRNO® is introduced, the work for the routing and structural engineers will become less complex and time pressurized, due to high dimension tolerance and late possible building phases. For the welders and outfitters, the work will change. Workers have to follow a training in the field of NOFIRNO® transits. However, the welding work and the transit production time are probably reduced.

In chapter 10, a judgment will be made about which concept(s) will be most convenient for the future.

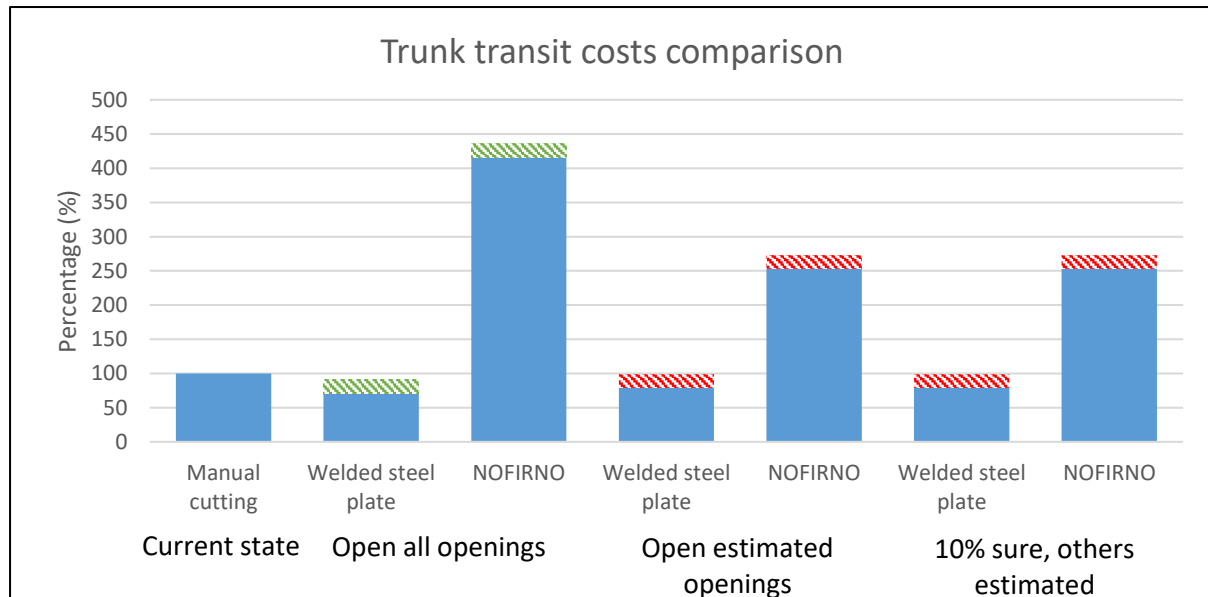

Figure 61 – Trunk transit costs comparison

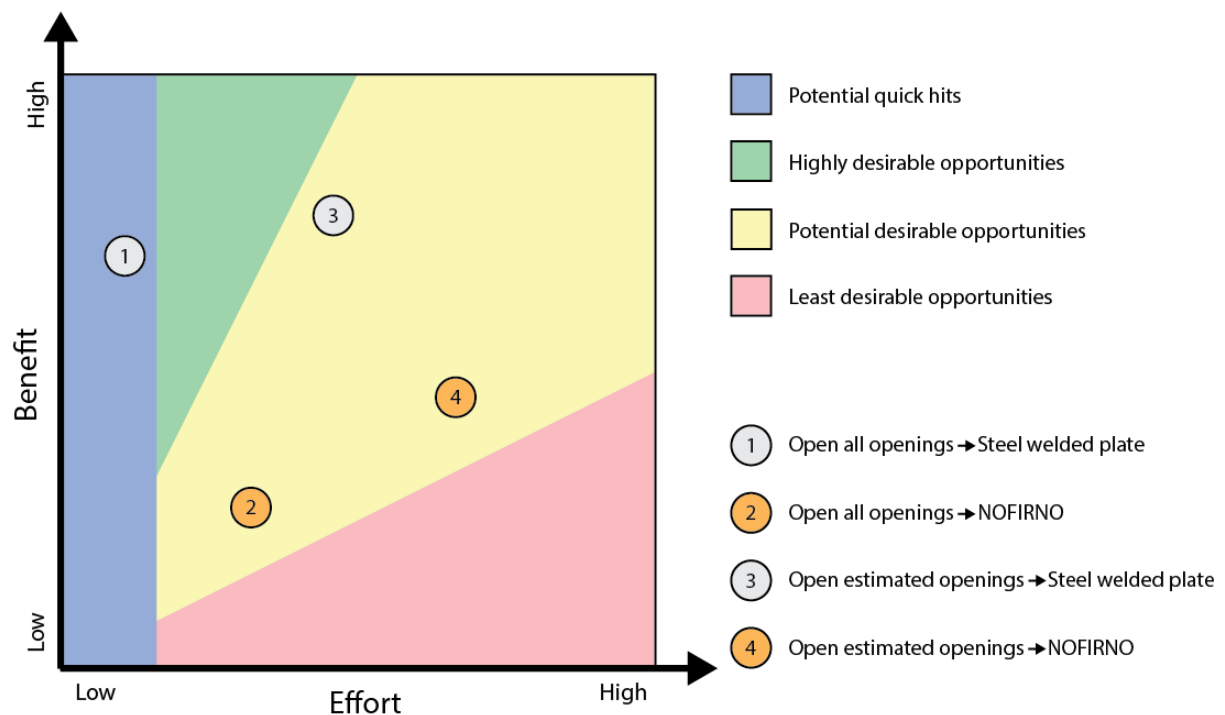

Figure 62 – Effort-Benefit analysis

10 CONCLUSION

In this chapter, first a conclusion is drawn about the optimal concept(s) for different situations. Then a further look is taken into the suitability of the concept in other ship- types and areas. Also some recommendation are made concerning the future for Royal IHC. In the last part, this future outlook is elaborated further, in order to place the result in the right perspective.

10.1 CONCLUSION

In the first part of this report, the problem is broadly described and substantiated. Manually cutting holes in ship constructions during section building or slipway building is very expensive and should be avoided as much as possible. Therefore, the main research questions as stated before are:

- Q1** What is a method by which pipe penetrations in TSHDs can be sized and located before the detailed pipe routing is known?
- Q2** Is the new method more cost efficient than the current situation?

10.1.1 SUB-QUESTIONS

To give a comprehensive answer to the main questions, first the sub-questions had to be answered.

- Q3** Which rules and regulations must be taken into account when locating, sizing and cutting the penetrations?
- Q4** Which rules and regulations must be taken into account when routing the pipes?

Important rules and regulations for this research are about holes/ openings/ penetrations and pipe routings. The sources for these rules and regulations are Royal IHC and the Classification societies. IHC has created its own engineering manuals and component standards. The most common classification societies for Royal IHC are Bureau Veritas, Lloyd's Register and CCS. All related and possibly required rules and regulations for this research are summarized in chapter 4.

- Q5**
 - a. How much does it cost to cut a hole manually afterwards?
 - b. How much does it cost to cut a hole by CNC automatic plasma cutting (Metalix)?
 - c. What are the determining costs for the manufacturing of pipe spools?

The costs of cutting a hole manually are dependent on the building stage.

During section building:

$$C = 160 + 20 X$$

C = Hole costs in euros

X = Number of holes at same location

During slipway building:

$$500 \leq C \leq 1000$$

C = Hole costs in euros

By CNC automatic plasma cutting:

$$C = 1.03 P$$

C = Hole costs in euros

P = Total perimeter of holes in meters

For the costs of a pipe spool, there is no unilateral formula. It is dependent on several aspects. The most important ones, that are influential by the routing engineer, are:

- Usage of bends over elbows.
- Smart choice of separations.
- Usage of 2D or 3D elbows.
- Usage of common components and sizes.
- Take into account the over length for bending and welding.

Q6 What is the most common location in the ship for each system?

Q7 Which connections does each kind of equipment contain and what is their size range?

A distinction of three main area types in ships can be made:

- Machinery type area: main engine room, aux. engine room, pump room
- Accommodation type area: accommodation spaces, control rooms
- Technical type area: all other areas with equipment

Most systems are located in the same area type on every ship. Just as for the locations, also the systems can be divided in categories. The main 4 categories are:

- Prime mover systems
- Bilge/ballast and dredge systems
- Accommodation systems
- Auxiliary systems

All these systems and its connections can be found in Appendix VIII: Ship systems. In the researched vessels, the most repair work for holes was required in the engine room, pump room and accommodation spaces. In the accommodation spaces, problems occur in decks and walls of the trunk and sanitary spaces.

Q8 How can pipes be routed via penetrations?

If pipes are to be routed via penetrations, it is very likely that the pipe routing is not optimal in the area of “shortest length”, “least bends” or “lowest costs”. However, the reduced penetration costs may outweigh this. Therefore, especially the complexity for the pipe routing must not become too high. In a busy and occupied locations as a pipe trunk, it turned out to be too difficult to pre-determine an exact penetration location, without raising the complexity level to an unacceptable level. Therefore, another approach had to be used as was explained in 7.1.1.

To keep the complexity low, and the freedom in space high, large openings are cut before section building. These openings are to be closed when the exact pipe routing is finished.

10.1.2 MAIN QUESTIONS

In chapter 9, the different openings and closings concepts are compared to each other. It is clearly shown that for all proposed variants, using a steel insert plate for the closure successfully reduces the costs. However, it is important to keep in mind that for the problem location definition of this case study only two ships could be investigated, and for the algorithm validation only four ships.

Besides, it is shown that the NOFIRNO® transit will result in (much) higher costs. However, this comparison is about the purchase and production costs. In other words, it does not tell a lot about the costs during operation and possible cost reductions in other areas. For example, the “absorption of motion” quality of NOFIRNO® could result in less costs for noise reduction or less maintenance to the piping due to less vibrations (fatigue) and less corrosion. The exact cost reduction due to these “side effects” is very hard to tell, especially for a new product with little experience and data available. Besides, the comparison is carried out for the costs during section building. If the penetrations are not known until slipway building, the manually cutting and welding costs will increase rapidly. This applies mainly to the manually cutting and “steel insert plate” concepts. For

NOFIRNO®, this costs will not increase a lot, due to the possibility to pre-outfit and the fact that there will be no heat involved.

If the “steel insert plate” concept is used, there is a cost reduction of 9% if all openings will be opened, and 21% if the algorithm is used. If all openings are opened, there is a large reduction of complexity. The engineer does not have to work with an algorithm and can just create the openings at a very early stage. There is very little information from other departments required. A lot of organizational activities will erase. (Figure 61) If the algorithm is used, the cost reduction for purchasing and production is higher. However, then the algorithm has to be further developed in the field of usability and performance testing. This will entail costs in the initial phase.

The research objective for this research was stated as follows in chapter 1.6:

Minimize

$$C = C_E + C_{PM} + C_O + C_{HC} \quad \{1\}$$

C = total piping and hole cutting costs

C_E = total engineering costs

C_{PM} = piping manufacturing costs

C_O = outfitting costs

C_{HC} = hole cutting and closing costs

With the implementation of the new approach, using steel insert plates, these total piping and hole cutting costs will change. First of all the hole cutting costs (C_{HC}) will decrease, because the expensive manual cutting is reduced. Besides, the total engineering costs (C_E) will decrease as well. Pipe routing engineers know where the large openings are and can route the pipe through, without communicating and checking new required holes. The piping manufacturing costs (C_{PM}) will not differ a lot. The routing engineers are somewhat bound to the predetermined openings, but due to the extended time available for adjustments, the routing could even be more optimized regarding cost efficiency. Finally the outfitting costs (C_O) probably will not change. Just as with the manual cutting, the holes are not known very early and therefore pre-outfitting will be difficult. However, due to the large openings it is possible to already put the pipe spools approximately in the right area. Summarizing, the following changes for the new approach will be achieved:

$$C_{E,CS} > C_{E,FS}$$

$$C_{PM,CS} \sim C_{PM,FS}$$

$$C_{O,CS} \sim C_{O,FS}$$

$$C_{HC,CS} > C_{HC,FS}$$

Then:

$$C_{E,CS} + C_{PM,CS} + C_{O,CS} + C_{HC,CS} > C_{E,FS} + C_{PM,FS} + C_{O,FS} + C_{HC,FS}$$

$$C_{CS} > C_{FS}$$

CS = current state

FS = future state

10.2 EXPANSION

As follows from the calculations and estimations, the new approach will result in lower production and purchasing costs. In addition, the complexity for engineers and the required communication will decrease as well. However, it has to be proven in reality. It will be recommended to first test the approach for the researched location in this thesis. Then if the costs of the trunk actually decrease, the approach can be extended to other ship types and areas. Therefore the benefits of this approach should also apply for these extended types and areas.

10.2.1 OTHER SHIP TYPES

This research is focused on TSHDs. This is because the required information and data is available for some recently built vessels of this type. Other commonly built ship types at Royal IHC are CSDs and PLVs. Extending the approach to these ship types is very well possible, because many parts of the vessels are comparable. Especially the design method for the accommodation is similar, because it has the same function for all types. Every seagoing ship needs an accommodation and in most cases a trunk is included. Also areas like engine rooms, tanks and pump rooms (TSHD and CSD) have to accomplish the same function.

The problem that has to be dealt with in this research mainly occurs in custom-built vessels. Therefore the approach shouldn't be extended to the standardized types like **Beavers**. For these vessels, there is enough time and revision possibility available to optimize the design as much as possible.

10.2.2 OTHER LOCATIONS

The approach can be interesting for other areas in the ship than the trunk as well. Therefore, it has to be examined whether the benefits are valuable for these areas too. The main advantages of the new approach are the extra routing time available in combination with the engineering freedom for the routing engineer. The solution is mainly beneficial for fire resistant and watertight transits with multiple pipes/ cables. If NOFIRNO® is used, areas with a lot of vibrations can benefit as well. Meanwhile, areas with high strength limitations are not preferred, due to the large openings. Strength members of the structure will need a further strength examination. A qualitative analysis of this characteristics is carried out in Table 28.

Table 28 – Other possible locations

	Engine room	Pump room	Technical space	Switchboard room
Not all penetrations known on time	+	+	++	+
Lots of equipment	++	+	+	+
Many pipes/ cables bundled	++	+	+	++
Fire resistant	+	+	+	+
Watertight	+	+	+	+
Vibrations	++	+	+	-
Low strength limitations	-	-	-	-

In chapter 6.1.3, the “technical type area” turned out to be the location with the most repair work. This is especially because there are a lot of technical type areas. For example, in IHC ship number 1283 (ship 1) and 1289 (ship 2), the number of sections for each ship type area were as shown in Table 29.

Table 29 – Sections per area type

	Machinery type area		Accommodation type area		Technical type area		Total
Ship 1	4	12.5%	4	12.5%	24	75%	32
Ship 2	9	14%	9	14%	47	72%	65

The technical type areas contain a lot of different rooms. The new approach particularly fits well for a lot of uncertainties and deviations. Therefore the approach could be applied to a large part of all ship rooms.

Summarizing, if the approach is proven for the accommodation trunk, an expansion can be made towards other custom built ship types. Then, if the strength allows, it can be used in other watertight and/ or fire proof ship areas with a lot of uncertain piping and cabling.

10.3 RECOMMENDATIONS

This research has shown that an intermediate solution, between the ideal all-known situation and the manually cutting situation, can be beneficial. In the ideal situation, all penetrations are known on time and no repair work is required. However, this ideal situation is not realistic mainly due to time pressure. Western shipyards like Royal IHC are experiencing great pressure to keep the price low in order to stay competitive to competitors and attractive to customers. For them it is not possible to offer the cheapest and largest vessels, so the focus must be somewhere else. For Royal IHC, it is about complex vessels within a short delivery time. Outsourcing engineering and production, which currently happens a lot, involves an even higher time pressure, due to the slower communication and additional transports. Therefore, the problem stated in this report may be even greater in the future.

According to the results from this research, Royal IHC should implement the new approach for the cases that penetrations are not known for sure on time. However, it is important to keep in mind that due to lack of information the calculated repair costs are only based on two ships, and the algorithm results on only 4 ships. For a more convincing result, during the coming year(s), the approach including algorithm can be examined for the new built ships as well. This will not require a lot of effort, due to the improving tracking and registration of data.

First a trial can be done for a small part of the vessel. This will not be of a large impact, because all the required knowledge and resources concerning the new approach are already available. If this is successful, it can easily be extended. Then, if the stakeholders are convinced, a further look could be taken into the algorithm. It can be optimized by adding more constraints like the bundling of pipes and a certain descending characteristic. Also the interface and user friendliness have to be improved in order to keep it clear and easy for the engineers. In addition, the experienced routers and structural engineer have to give their opinion about the results of the algorithm and which aspect can be improved.

Because of custom-built shipbuilding, the exact situation is not always the same. Therefore, there is no unambiguous recommendation for all situations. A division is made between three situations:

- Ideal situation: Cut all holes by CNC plasma machine if they are sure.
- During section building: First open all openings and close with steel insert plate, later use estimation.
- During slipway building: First open all openings and close used openings with NOFIRNO® and unused openings with steel insert plate if possible, later use estimation.

If penetrations are known for sure, it is always best to cut them exactly by the CNC cutting machine. If a penetration is not known for sure, another approach is required. In the first instance, all possible openings will be opened. During section building, these openings should be closed with steel insert plates. This method can easily be tested without large adjustments or investments. All the material, techniques and other resources are already available within the company. During slipway building, these openings should be closed with NOFIRNO®. It is important to keep in mind that just before the end of section building, if the penetrations are still not known for sure, the horizontal bar is welded in the opening for the NOFIRNO® transit. During section building, the costs for all closing concepts will not differ that much anymore. Then the additional advantages when using NOFIRNO® as discussed before makes the decision.⁵ The steel insert plate with the SLIPSIL® plugs and NOFINRO are both fire resistant and watertight. The main advantages for NOFIRNO® are then the possibility of adding penetrations without heat, no centering required and the possibility of pre-outfitting. By using NOFRINO both C_O and C_E will decrease, but it C_{HC} will increase. Then it has to be determined whether $\Delta C_{HC} < \Delta C_O + \Delta C_E$.

If an expansion for this approach is made to other ship areas, the software will be more complex. Then it has to be assessed whether this outweighs the cost reduction. In Figure 63, the process that describes the decisions regarding the new approach is shown.

⁵ Beele Engineering B.V. advises SLIPSIL plugs for small individual pipes, and NOFIRNO for multiple pipes and pipe larger than 4". Also for off-center and descending pipes NOFIRNO is highly recommended.

In this case study, the cabling penetrations were considered to be known. The cabling penetrations are dependent on the placement of the vertical cable ladders, and that is dependent on the arrangement of the converter room. Because of the high variety of this converter room arrangements and possible design solution, cabling does not fit very well for an automatic algorithm. However, it is remarkable that different engineers will choose different design solutions, because cabling has the priority and therefore not much constraints. In the future it is recommended to create a standard or design rule regarding these cable ladders, in order to create more consistency.

In this research, a lot of innovative advantages of the NOFIRNO® transit are described. Despite the higher purchasing costs, it seems to be a very good solution for the future. Currently the inventor of NOFIRNO®, Beele Engineering B.V., tries to prove that most of contemporary transits are not as fire proof as it is said. Some large players like Hyundai, the Royal Navy and the US Navy are already convinced of the product. Especially for Navies, the increase in performances and safety has higher priority than the costs. Because of the novelty of the product, there is not much known about the costs on the long term. In a few years, more information and proof might be available. Then it could be a really interesting solution for IHC. It will take away a lot complexity to the watertight and fire proof transits. Repair work for the addition of holes will be reduced greatly. Therefore it is highly recommended for Royal IHC, to enter the conversation with Beele Engineering about turning into the new direction.

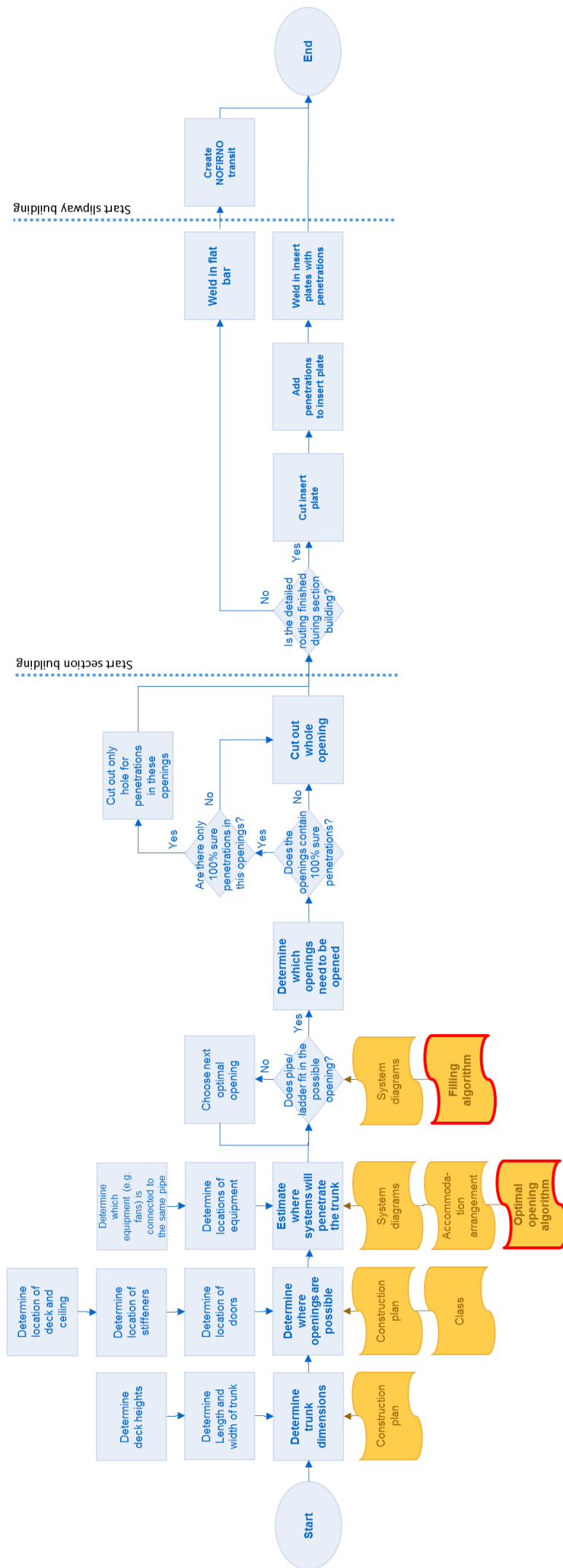

Figure 63 – Process flow of new approach

10.4 FUTURE OUTLOOK

The world is continuously changing. This also holds for the shipping industry. Nowadays the most common ships are industrial vessels (e.g. fishing boats, drilling rigs), cargo carriers (e.g. tankers, container ships), passenger carriers (e.g. ferries, cruise ships) and service vessels (e.g. tugs, towing boats). (Woodward, 2015) The dredging, mining and offshore types of ships built by Royal IHC are industrial vessels. Due to the experience and distinctiveness in complex ships, IHC probably wants to stay in this sector.

At the moment, dredging is the most important and valuable industry for IHC. Dredging will be a viable business in the future as well. Technical progress makes it more and more possible to increase the ship sizes for economic reasons. This is clearly noticeable on for example container- and cruise ships. These mega structures require deep fairways excavated by dredgers. Also for harbors it is really important to have a suitable depth to receive these ships in order to stay competitive. Besides, the world population is continuously growing and in (economically) popular areas more land is desired. Contemporary examples are the artificial peninsulas in Dubai and the 2nd 'Maasvlakte' which increased the port of Rotterdam by 20%. (Nieuw land in zee, 2017) The world population will grow to 12 billion in the year 2100 (Rijnvis, 2014), so new land seems to be a persistent desire.

In 1870, Jules Verne already described men mining the ocean floor, but the real industry emerged nearly 150 years later. (Writer, 2016) Because of the really early stage, there are definitely future perspectives in this industry, especially due to the complexity and uniqueness of these vessels and systems.

The offshore industry can be seen rather broadly. Examples are oil exploration and drilling vessels, support vessels, production vessels and construction vessels. These vessels are mainly intended for the production and transportation of energy raw materials like oil and wind. IHC has recently build a series of pipe laying vessels for the transportation of oil. In about 40 years all (known) oilfields, which currently contain only 1.3 million barrels of oil, will be depleted. (Fox, 2013) Therefore the oil business does not seem very sustainable. The focus must be on renewable energy sources like wind and wave motion. Windmills are mainly built at sea due to advantages regarding wind power and direction. The construction of these farms needs vessels for the placement of the mills and cables. IHC already has experience with piling at sea (IHC Hydrohammer) and heavy lifting, and this will probably expand more and more in the future.

If shipyards want to stay competitive to others the transition towards green shipbuilding has to be made. This transition to renewable energies and environmental friendly operations applies mainly to the resistance and propulsion of future ships. Hull forms will be more optimized in order to reduce the resistance and fuel consumption. Futuristic hull types like hydrofoils, trimarans and pentamarans are researched nowadays. All of these shapes seem to be very difficult to use for e.g. dredgers. Besides, these optimized hull shapes could make the pipe routing even more difficult, because of the complex geometries and the lack of experience in this field. Another way to reduce fuel consumption is to make the ship lighter. A new material, called 'buckypaper' could be the solution for this. It weighs 10 times less than steel and is 500 times stronger in strength. It is also 2 times harder than diamond. It is already widely investigated in the aircraft industry, thus the shipping industry will follow very likely. (Kumar, 2015)



Figure 64 – Pentamaran concept (Matutis)

However, a reduced fuel consumption is not enough when oil is depleted either way. Therefore the propulsion method has to be changed. Currently, LNG powered vessels are very popular and IHC recently launched its first LNG powered dredger. This is also because new generation engines are strongly required in order to comply with the TIER 3 restrictions of 2016 by IMO. (Kumar, 2015) However, also gas is depleting and LNG piping needs to be double-walled and well insulated. This increases the complexity and costs of the system. Alternatives are solar- and wind powered ships. (Figure 65, Figure 66) Sailing ships as used in the past will not return, but wind energy is very interesting to research more extensively. These technologies nowadays do not deliver enough power to propel a large vessel independent on other propulsion systems and it is not commercial viable as well.



Figure 65 – Left: Solar powered catamaran (EcoMarinePower)

Figure 66 – Right: Pentamaran LNG/ wind power cruise vessel (Ecorizon)

These innovations can change a lot about the required systems on board, which is very relevant for this research. For example, sails does not need any prime mover piping and for solar energy (smaller, flexible) more cables could be suitable. Another future innovation that is discussed all over the world is the autonomous vessel. Current technologies are able to control a ship of about 10 meters long. The hardest constraint for this subject are the regulations. (McKeivitt, 2017) These ships will need specific systems to sail autonomous but on the other hand, a lot of accommodation systems are not required anymore. Even the ballast tanks might not be needed anymore in the future, which involves a significant reduction in pipes. A concept is made of a ‘ballast free ship design’, which also mitigates the problem of ballast water disposal. The design includes a constantly flowing system through the hull of the ship. This prevents the transfer of one ecosystem to another. (Figure 67)

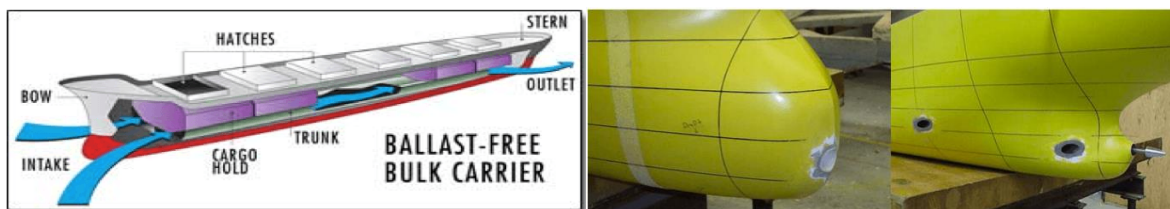

Figure 67 – Ballast free ship design (e-MarineEducation)

Next to the future changes in ship types, -propulsion and –systems, also the manufacturing probably will change. A very promising industrial concerning all industrial sectors is 3D-printing. With this method, complex geometries like a bulbous bow could be built easily. 3D-printers are currently suitable for small products and therefore could be used for ship parts. If something is broken and has to be replaced, the exact geometry then can be built in a short amount of time. Also prototypes for testing and visualizing can be made very fast using this technology. (Kumar, 2015) The final innovations that are discussed are augmented reality and 3D laser scanning. (Morais, 2016) Augmented reality is a live view of reality (by use of a camera) with added element. If for example a worker has to cut a hole on a specific position, he can see this exact position on his screen without measuring. This can save a lot of time. With 3D laser scanning, a particular ship room can be scanned

very accurate. That could be very beneficial if constructing the outfitting. Because of the high accuracy, less repair work is required. It will also be possible to make a 3D as-built model which can be used for a copy order. (Figure 68)

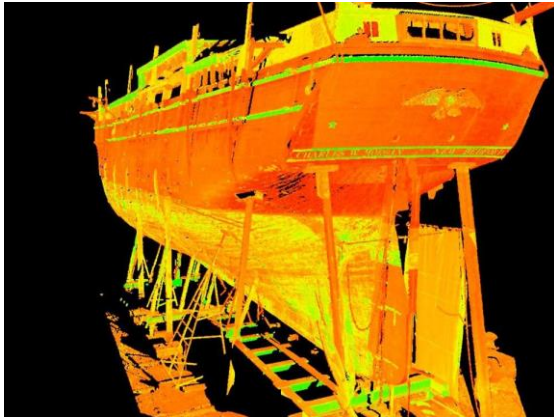

Figure 68 – 3D laser scanning of a ship (Wang)

Summarizing, future customers want commercial attractive, environmental friendly vessels with even shorter delivery cycles. In order to reach this, the concurrent engineering discussed in 2.2, has to be optimized further with more interconnections between all disciplines. Therefore also the common used software must be optimized and automated further.

BIBLIOGRAPHY

- Asmara, A. (2013). *Pipe routing framework for detailed ship design*. PhD Thesis, Technische Universiteit Delft, Automation and robotics, Delft.
- Autoignition temperature*. (2016, June 23). Retrieved from Wikipedia: https://en.wikipedia.org/wiki/Autoignition_temperature
- Beele Engineering BV. (2017). *Axial and radial movement*. Aalten.
- Beele, H. (2017, August 10). Beele Engineering B.V. (R. v. Hadelkamp, Interviewer) (n.d.). *Bureau Veritas - Steelships, Pt C, Ch 4, Sec. 5, 1.2.1*.
- Bureau Veritas - Steelships, Pt C, Ch 4, Sec. 5, 1.3.7. (n.d.).
- Classification society and IACS*. (2016). Retrieved from Maritime connectoir: <http://maritime-connector.com/wiki/classification-society/>
- Coenen, J. (2008). *Controlling engineering to order processes in shipbuilding*. PhD Thesis, Technische Universiteit Delft, Delft.
- Design spiral*. (2012, November 20). Retrieved from Neely Chaulk: http://www.neely-chaulk.com/narciki/Design_spiral
- Dong, Z.-r., & Lin, Y. (2016). *A particle swarm optimization based approach for ship pipe route design*. Dalian University of Technology, Dalian.
- EcoMarinePower. (n.d.). *Solar powered catamaran*. Eco marine Power and Planet Solar.
- Ecorizon. (n.d.). *Eoseas*. Eoseas. STX.
- Ellmer. (n.d.). *Ship repair*. Nautilusmaker, Germany.
- e-MarineEducation. (n.d.). *Ballast free ship concept*. Istanbul.
- Evans, J. (1959). *Basic design concepts*. Naval engineering journal.
- Fox, T. (2013). *Wat als ... de olie opraakt?* Retrieved from Scientias: <https://www.scientias.nl/wat-als-de-olie-opraakt/>
- How a plasma cutter works*. (2014). Retrieved from Lincoln Electric: <http://www.lincolnelectric.com/en-us/equipment/plasma-cutters/process-and-theory/Pages/how-a-plasma-cutter-works.aspx>
- Hussary, N., & Pryor, D. (2013, June 3). *Plasma or oxyfuel?* Retrieved from the fabricator: <http://www.thefabricator.com/article/oxyfuelcutting/plasma-or-oxyfuelr>
- IHC, m. R. (2014). *IHC2020*. Retrieved from Royal IHC intern.
- Juarez, D., Peydro, M., Mengual, A., & Ferrandiz, S. (2015). *A review of concurrent engineering*. University of Valencia, Mechanical and material engineering, Valencia.
- Kharagpur. (2014, December 15). *Design of air conditioning ducts*. Retrieved from Slideshare: <https://www.slideshare.net/sappy2shail/hvac-42706411>
- Kumar, S. (2015, December 23). *7 Technologies That Can Change The Future of Shipbuilding*. Retrieved from Marine insight: <http://www.marineinsight.com/future-shipping/shipbuilding-technologies/>
- Kusiak, A. (1993). *Concurrent engineering*. Iowa: Wiley-interscience.
- Lang, S. (2001). *Shipbuilding and lean manufacturing*. Case study, The society of naval architects and marine engineers, Ypsilanti, Michigan.

- Lucas, B. (2017). *Cutting processes - plasma arc cutting - process and equipment considerations*. Retrieved from TWI: <http://www.twi-global.com/technical-knowledge/job-knowledge/cutting-processes-plasma-arc-cutting-process-and-equipment-considerations-051/>
- Matutis, V. (n.d.). Pentamاران. *Conceptual pentamاران cargo ships can soon become a reality*. Maritimejournal.com.
- McKevitt, J. (2017, April 3). *Will autonomous ships ever set sail, or will regulations keep them docked?* Retrieved from Supplychaindive: <http://www.supplychaindive.com/news/autonomous-remote-shipping-regulations-insurance/439541/>
- Miinala, M. (2017). *Design process*. Retrieved from DeltaMarin: <https://www.deltamarin.com/shipdesign/design-process/>
- Morais, D. (2016, July 26). *Future of Shipbuilding (15+ years)*. Retrieved from Waveform: <http://blogs.ssi-corporate.com/waveform/2016/general/future-of-shipbuilding-15-years/>
- Nieuw land in zee*. (2017). Retrieved from Maasvlakte 2: <https://www.maasvlakte2.com/nl/index/show/id/23/project>
- Opnavinst. (1996). *Shipboard Habitability Program*. Washington, DC: Department of the navy.
- Oxyfuel cutting - process and fuel gases*. (2017). Retrieved from TWI: <http://www.twi-global.com/technical-knowledge/job-knowledge/oxyfuel-cutting-process-and-fuel-gases-049/>
- Pathfinding using A**. (2017). Retrieved from MIT: [http://web.mit.edu/eranki/www/tutorials/search/Prim's Algorithm](http://web.mit.edu/eranki/www/tutorials/search/Prim's%20Algorithm). (2017). Retrieved from Programiz: <https://www.programiz.com/dsa/prim-algorithm>
- Rijnvis, D. (2014, September 18). 'Wereldbevolking zal groeien naar 12 miljard' . *Nu.nl*.
- Rocca, G. I., & Tooren, M. v. (2016). *Automatic 3D Routing for the Physical Design of Electrical Wiring Interconnection Systems for Aircraft*. Delft: Technical University Delft.
- Roder, B. (2008). The Propulsion of Sea Ships. *Verein Hanseatischer Transportversicherer e.V.*, (pp. 1-5). Hamburg.
- Rose, C. (2017). *Automatic production planning for the construction of complex ships*. PhD Thesis, Technische Universiteit Delft, Delft.
- Smit, H. (2017, April). (R. v. Hadelkamp, Interviewer)
- Sobek II, D. K., Ward, A. C., & Liker, J. K. (1999, January 15). Toyota's Principles of Set-Based Concurrent Engineering. *MIT Sloan*.
- Stark, J. (1998). *a few words about concurrent engineering*. Retrieved from JohnStark: <http://www.johnstark.com/fwce.html>
- Storch, R. L. (1995). *Ship production*. Retrieved from Centro de Engenharia e Tecnologia Naval e Oceânica: <http://www.centec.tecnico.ulisboa.pt/en/centec/publications.aspx>
- The basics of oxy fuel cutting*. (2017). Retrieved from HGG: <http://www.hgg-group.com/nl/knowledge-base/oxy-fuel-cutting-oxy-fuel-cutting-basics/>
- TWI. (n.d.). the plasma arc cutting process. *Cutting processes*. TWI, Cambridge.
- Wang. (n.d.). 3D laser scan. *ENHANCING PRODUCTIVITY OF SHIP BUILDING, MAINTENANCE AND REPAIRING THROUGH 3D LASER MEASUREMENT*. Wang & EF Tan Associates, Singapore.
- What is oxy-fuel cutting*. (2013, February 18). Retrieved from ESAB: <http://www.esab.ca/ca/en/education/blog/what-is-oxy-fuel-cutting.cfm>

- What is the best value.* (2013, April 1). Retrieved from ESAB:
<http://www.esabna.com/us/en/education/blog/what-is-the-best-value-plasma-laser-or-waterjet.cfm>
- Wiener, R. A. (1988). *The role of concurrent engineering in Weapon System Acquisition*. Alexandria: Institute for defence analysis.
- Woodward, J. B. (2015, January 23). *Types of ships*. Retrieved from Britannica:
<https://www.britannica.com/technology/ship/Types-of-ships>
- Writer, J. S. (2016, June 14). *Deep Sea Mining: Is the Future 20,000 Leagues Under the Sea?* Retrieved from IQ:
<https://iq.intel.com/deep-sea-mining-is-the-future-20000-leagues-under-the-sea/>

APPENDIX I: MACHINERY AND PIPING FLOW DIAGRAM

This appendix contains the flow diagram of machinery and piping, including Basic Engineering, Detail Engineering, CPE and Production. An enlarged version is attached separately to this report.

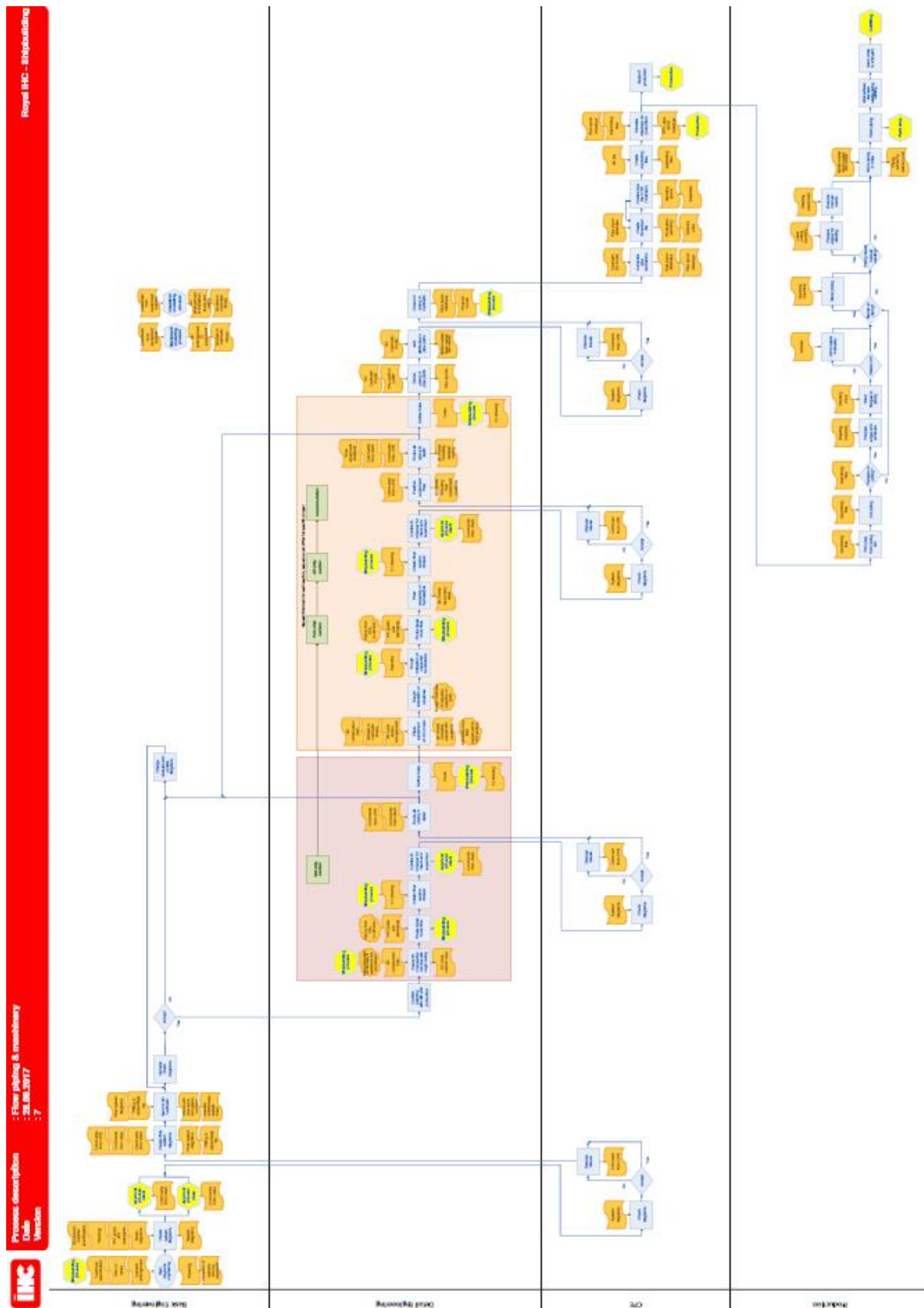

APPENDIX III: PIPING- & PENETRATION SIZES

In this appendix, the standard used pipes, elbows and penetrations including the characteristics are listed.

Piping sizes

Available pipe sizes, bending radii and flanges possibilities

Inch	DN	O.D.	W.T.	W.T. Heavy	Bending radius	Flange automatically welded
3/8"	10	17,2	4,5			
1/2"	15	21,3	3,2	3,2	77	
3/4"	20	26,9	3,2	3,2	80	
1"	25	33,7	3,6	3,6	80	Yes
1 1/4"	32	42,4	2,6	5	77	Yes
1 1/2"	40	48,3	2,6	5	80	Yes
2"	50	60,3	2,9	5	104	Yes
2 1/2"	65	76,1	2,9	5	173	Yes
3"	80	88,9	3,2	5	140	Yes
4"	100	114,3	3,6	5	170	Yes
5"	125	139,7	4	5,6	222	Yes
6"	150	168,3	4,5	5,6	252	Yes
8"	200	219,1	6,3	6,3	354	Yes
10"	250	273	6,3	6,3		
12"	300	323,9	7,1	7,1		
14"	350	355,6	7,9	7,9		
16"	400	406,4	7,9	7,9		
18"	450	457	7,9	7,9		
20"	500	508	9,5	9,5		
22"	(550)	559	9,5	9,5		
24"	600	610	9,5	9,5		
26"	(650)	660	9,5	9,5		
28"	700	711	9,5	9,5		
30"	(750)	762	9,5	9,5		
32"	800	813	9,5	9,5		
34"	(850)	863,6	9,53	9,53		
36"	900	914	9,5	9,5		
38"	(950)	965,2	9,53	9,53		
40"	1000	1016	9,5	9,5		
42"	(1050)	1067	9,5	9,5		
44"	1100	1117,3	9,53	9,53		
46"	(1150)	1168,4	9,53	9,53		
48"	1200	1219	9,5	9,5		

Welding elbow dimensions with bending radii

Inch	DN	O.D.	W.T.	R (1.5D)	R (1D)	Inch	DN	O.D.	W.T.	R (1.5D)	R (1D)
1/2"	15	21,3	3,7	38,1		18"	450	457,2	7,9	585,8	457,2
3/4"	20	26,7	3,9	38,1		20"	500	508	9,5	762	508
1"	25	33,4	3,4	38,1	25,4	22"	550	558,8	9,52	838,2	558,8
1 1/4"	32	42,4	2,6	48	31,8	24"	600	609,6	9,5	914,4	609,6
1 1/2"	40	48,3	2,6	57	38,1	26"	650	660,4	9,52	990,3	
2"	50	60,3	2,9	76	50,8	28"	700	711,2	9,52	1067	
2 1/2"	65	76,1	2,9	95	63,5	30"	750	762	9,52	1143	
3"	80	88,9	3,2	114	76,2	32"	800	812,8	9,52	1219	
4"	100	114,3	3,6	152	101,6	34"	850	863,6	9,52	1295,4	
5"	125	139,7	4	190	127	36"	900	914,4	9,52	1372	
6"	150	168,3	4,5	229	152,4	38"	950	965,2	9,52	1447,6	
8"	200	219,1	6,3	305	203,2	40"	1000	1016	9,52	1524	
10"	250	273	6,3	381	254	42"	1050	1068,8	9,52	1600,2	
12"	300	323,9	7,1	457	304,8	44"	1100	1117,6	9,52	1676,4	
14"	350	355,6	8	533	355,6	46"	1150	1168,4	9,52	1752,6	
16"	400	406,4	7,9	609,6	406,4	48"	1200	1219,2	9,52	1828,6	

Penetration sizes

Inch pipes

Inch	DN	O.D.	Penetration plate diameter				Single sleeve				Double sleeve			Watertight
			PN10	PN16	PN25	PN40	Normal	Heavy	Ex. heavy	Ex.ex. heavy	Normal	Heavy	Ex. heavy	
3/8"	10	17												
1/2"	15	21	100,0	100,0	100,0	100,0	33,7	33,7	33,7		48,3	48,3	48,3	60,3
3/4"	20	27	110,0	110,0	110,0	110,0	38,0	38,0	38,0		54,0	54,0	54,0	60,3
1"	25	34	120,0	120,0	120,0	120,0	48,3	48,3	48,3		60,3	60,3	60,3	76,1
1 1/4"	32	42	145,0	145,0	145,0	145,0	57,0	63,5	70,0		73,0	82,5	95,0	114,3
1 1/2"	40	48	155,0	155,0	155,0	155,0	60,3	70,0	73,0	73,0	76,1	88,9	101,6	114,3
2"	50	60	170,0	170,0	170,0	170,0	76,1	76,1	88,9	88,9	88,9	95,0	114,3	114,3
2 1/2"	65	76	190,0	190,0	190,0	190,0	88,9	95,0	108,0	108,0	108,0	114,3	139,7	139,7
3"	80	89	205,0	205,0	205,0	205,0	101,6	108,0	114,3	114,3	121,0	127,0	139,7	139,7
4"	100	114	225,0	225,0	240,0	240,0	127,0	133,0	146,0	146,0	146,0	152,4	177,8	168,3
5"	125	140	255,0	255,0	275,0	275,0	159,0	159,0	168,3	168,3	177,8	177,8	203,0	219,1
6"	150	168	290,0	290,0	305,0	305,0	193,7	193,7	203,0	203,0	219,1	219,1	244,5	219,1
8"	200	219	345,0	345,0			244,5	244,5	254,0	267,0	273,0	273,0		273
10"	250	273	400,0	410,0			298,5	298,5	305,0	323,9	323,9	323,9		355,3
12"	300	324	450,0	465,0			355,6	355,6	355,6	368,0	394,0	394,0		
14"	350	356	510,0	525,0			394,0	394,0	392,0	406,4	419,0	419,0		
16"	400	406	570,0	585,0			432,0	432,0	442,0	453,0	458,0	458,0		
18"	450	457	620,0	645,0			483,0	483,0	493,0	503,0	509,0	509,0		
20"	500	508	675,0	720,0			534,0	534,0	544,0	554,0				
22"	550	559	735,0				585,0	585,0	595,0	605,0				
24"	600	610	785,0	845,0			636,0	636,0	646,0	656,0				
26"	650	660												
28"	700	711	900,0	915,0										
30"	750	762	970,0	975,0										
32"	800	813	1020,0	1030,0										
34"	850	864												
36"	900	914	1120,0	1130,0										
38"	950	965,2												
40"	1000	1016	1235,0	1260,0										
42"	1050	1067												
44"	1100	1117,3	1345,0	1360,0										
46"	1150	1168,4												
48"	1200	1219	1460,0	1490,0										

G-penetration (HVAC)

O.D.	Uninsulated pipe	Insulated pipe	H.I.P.
114,3	R10	PR10	117
139,7	R12	PR12	143
177,8	R16	PR16	181
219,1	R20	PR20	222
244,5	R22	PR22	248
267	R25	PR25	270
323,9	R31	PR31	327

Metric/ special pipes

O.D.	Non-ferro pipe penetration	Metric pipe coupling	Cunifer sleeve	Non-ferro metric fire resistant/ watertight
6	13,7	20		60,3
8	17,1	22		60,3
10	17,1	25		60,3
12	21,3	28		60,3
14	26,9	28		60,3
15	26,9	35		60,3
16	26,9	32		60,3
20	33,7	38	26,9	60,3
22	33,7	36		60,3
25	42,4	45	33,7	60,3
28	42,4	40		60,3
30	48,3	50	42,4	76,1
35	48,3	50		76,1
38	60,3	60	48,3	
40				76,1
42	60,3	60		114,3
44,5	60,3		60,3	
50				114,3
54				114,3
57			76,1	
63				114,3
75				139,7
76			88,9	
89			101,6	
90				139,7
108			139,7	
110				168,3
125				219,1
133			152,4	
140				219,1
159			168,3	
160				273
219			254	
267			298,5	
324			355,6	

APPENDIX IV: CLASSIFICATION ARTICLES HOLES

In this appendix, all relevant class rules regarding holes and penetrations are listed.

Bureau VERITAS

Part	Chapte	Section	Article
------	--------	---------	---------

General

B	4	3	1.1.5	Openings are to be avoided, as far as practicable, in way of highly stressed areas.
---	---	---	-------	---

Where necessary, the shape of openings is to be specially designed to reduce the stress concentration factors.

Openings are to be generally well rounded with smooth edges.

Vertical

B	4	6	6.1.4	Openings in the strength deck are to be kept to a minimum and spaced as far apart from one another and from breaks of effective superstructures as practicable. Openings are generally to be cut outside the hatched areas; in particular, they are to be cut as far as practicable from hatchway corners.
---	---	---	-------	--

The dashed areas in Fig 1 are those where openings are generally to be avoided. The meaning of the symbols in Fig 1 is as follows:

$$c = 0,07 \ell + 0,10 b \text{ without being less than } 0,25 b$$

$$e = 0,25 (B - b)$$

in the case of circular openings:

$$g = 2 a$$

in the case of elliptical openings:

$$g = a$$

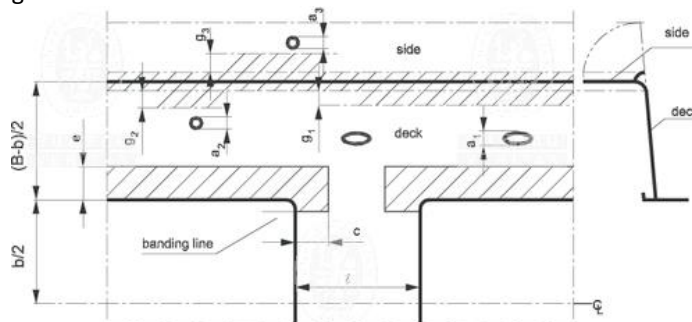

B	6	1	2.1.7	<p>large openings are</p> <ul style="list-style-type: none"> • elliptical openings exceeding 2,5 m in length or 1,2 m in breadth • circular openings exceeding 0,9 m in diameter. <p>Large openings and scallops, where scallop welding is applied, are always to be deducted from the sectional areas included in the hull girder transverse sections.</p>
---	---	---	-------	---

- B 6 1 2.1.8 Smaller openings than those in [2.1.7] in one transverse section in the strength deck or bottom area need not be deducted from the sectional areas included in the hull girder transverse sections, provided that:
 $\Sigma bS \leq 0,06 (B - \Sigma b)$

where:

ΣbS : Total breadth of small openings, in m, in the strength deck or bottom area at the transverse section considered, determined as indicated in Fig. 2

Σb : Total breadth of large openings, in m, at the transverse section considered, determined as indicated in Fig 2

Where the total breadth of small openings ΣbS does not fulfil the above criteria, only the excess of breadth is to be deducted from the sectional areas included in the hull girder transverse sections.

Additionally, individual small openings which do not comply with the arrangement requirements given in Ch 4, Sec 6, [6.1], are to be deducted from the sectional areas included in the hull girder transverse sections.

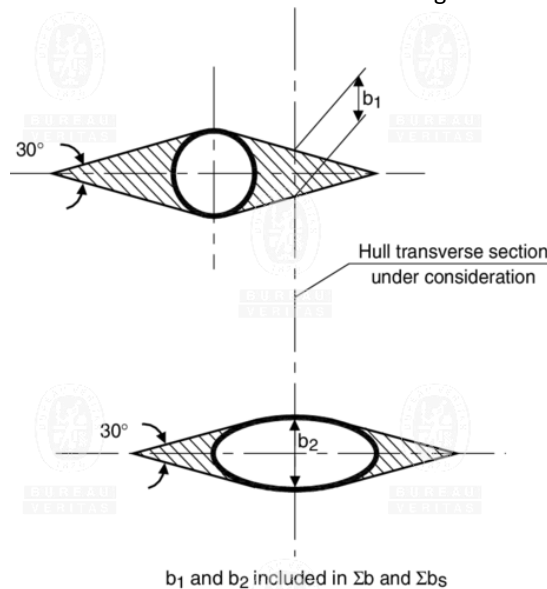

Longitudinal

- B 6 1 2.1.9 Lightening holes, draining holes and single scallops in longitudinals need not be deducted if their height is less than 0,25 hW, without being greater than 75 mm, where hW is the web height, in mm, defined in Ch 4, Sec 3.

Transversal

- B 4 7 1.4.1 Openings may not be cut in the collision bulkhead below the freeboard deck.

The number of openings in the collision bulkhead above the freeboard deck is to be kept to the minimum compatible with the design and proper working of the ship.

All such openings are to be fitted with means of closing to weathertight standards.

- C 1 1 5.3.3 a. Except as provided in b) the collision bulkhead may be pierced below the bulkhead deck by not more than one pipe for dealing with fluid in the forepeak tank, provided that the pipe is fitted with a screw-down

valve capable of being operated from above the bulkhead deck, the valve chest being secured inside the forepeak to the collision bulkhead. the Society may, however, authorize the fitting of this valve on the after side of the collision bulkhead provided that the valve is readily accessible under all service conditions and the space in which it is located is not a cargo space. All valves shall be of steel, bronze or other approved ductile material. Valves of ordinary cast iron or similar material are not acceptable.

- b. If the forepeak is divided to hold two different kinds of liquids the Society may allow the collision bulkhead to be pierced below the bulkhead by two pipes, each of which is fitted as required by a), provided the Society is satisfied that there is no practical alternative to the fitting of such a second pipe and that, having regard to the additional subdivision provided in the forepeak, the safety of the ship is maintained

Shell

B 4 5 7.1.1 Openings in the shell plating are to be located at a vertical distance from the decks at side not less than:

- two times the opening diameter, in case of circular opening
- the opening minor axis, in case of elliptical openings.

Volume

Article

General

2 1.2.5.5 All openings on structural members are to be kept clear of areas of stress concentration and where this is impracticable, corresponding compensation is to be made. All corners and openings are to be well rounded.

2 5.12.2.2 The diameter of lightening holes of primary members is not to be greater than 20% of the web height. The distance between the edge of the hole and face plate is not to be less than 40% of the web height, and an equal distance is in general to be kept from the edge of the hole to the corner of notches for the passage of frames.

Openings with a diameter larger, are subject to check by direct calculation.

Lightening holes are not to be provided on webs of primary members in way of cross ties and their end connections.

Vertical

2 2.4.4.3 Openings in the strength deck outside the line of hatchways are to be kept to a minimum and are to be arranged clear of hatch corners. The corners of all openings are to be well rounded and with the edges smoothed. Openings in the strength deck between midship bridge or deckhouse and bulkheads and hatches are to be avoided so far as possible.

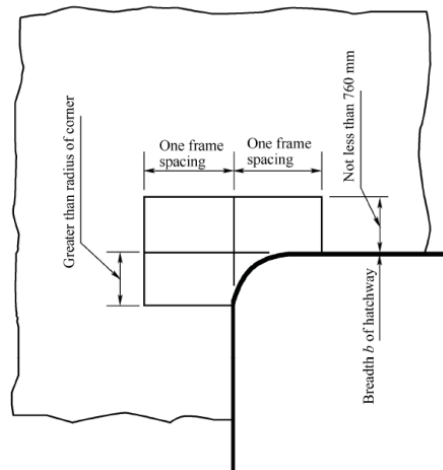

2 2.2.4.6 Deck openings having a length in the fore-and-aft direction exceeding 2.5 m or a breadth exceeding 1.2 m or 0.04B are to be deducted from the sectional areas used in the calculation of the hull girder section modulus.

2 2.2.4.7 Deck openings which are smaller need not be deducted from sectional areas used in the calculation of the hull girder section modulus, provided that the sum b_c of their breadths or shadow area breadths in one transverse section complies with the following:
 $b_c \leq 0.06(B - \sum b)$

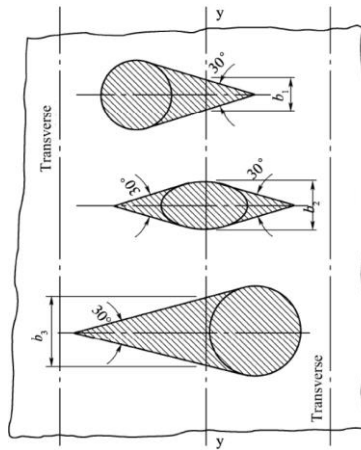

Longitudinal

- | | | |
|---|---------|--|
| 2 | 2.8.3.7 | Holes cut for the passage of pipes or cables in the web of deck girders are to have a depth not greater than 25% of that of the web and a width not exceeding 60% of the spacing of beams or the web depth, whichever is greater, otherwise compensation is required. The edges of holes are not to be less than 40% of the web depth from the face plate of girders. No holes are to be cut on the girder web within 200mm from the toe of girder brackets. |
| 2 | 2.2.4.8 | Openings in longitudinals or longitudinal girders need not to be deducted from the sectional areas used in the calculation of the hull girder section modulus, if their depth does not exceed 25% of the web depth (with a max. depth of 75 mm). |

Transversal

- | | | |
|---|----------|---|
| 2 | 2.8.7.8 | Holes cut for the passage of pipes or cables in the web of deck transverses are to have a depth not greater than 25% of that of the web and a width not exceeding 60% of the spacing of deck longitudinals or the web depth, whichever is greater, otherwise compensation is required. The edges of holes are not to be less than 40% of the web depth from the face plate of deck transverses. No holes are to be cut on the girder web within 200mm from the bracket toe of deck transverses. |
| 2 | 1.12.3.6 | The number of openings in the extension of the collision bulkhead above the freeboard deck is to be restricted to the minimum compatible with the design and normal operation of the ship. All such openings are to be capable of being closed weathertight. |
| 2 | 1.12.5.4 | No doors, manholes, ventilation ducts or any other openings are to be fitted in the collision bulkhead below the bulkhead deck except the pipes, provided that the relevant requirements are complied with. |
| 2 | 1.12.5.1 | The number of opening in watertight bulkheads is to be reduced to the minimum compatible with the design and proper working of the ship. |
| 2 | 2.12.6.3 | Manholes or similar openings are not to be cut in the webs of double plate bulkheads within one-third of their length from either end. |

Shell

- | | | |
|---|----------|--|
| 2 | 1.12.6.1 | The number of openings in the shell plating is to be reduced to the minimum compatible with the design and proper working of the ship. |
|---|----------|--|

Lloyd's register

RRCS = Rules and regulations for the classification of ships

RRCNS = Rules and regulations for the classification of naval ships

RRCOU = Rules and regulations for the classification of offshore units

CSRBO = Common structural rules for bulk carriers and oil tankers

Edition	Part	Chapter	Article
---------	------	---------	---------

General

CSRBO	1	3	6.2.1	Manholes, lightening holes and other similar openings are to be avoided in way of concentrated loads and areas of high shear. In particular, manholes and similar openings are to be avoided in high stress areas unless the stresses in the plating and the panel buckling characteristics have been calculated and found satisfactory.
-------	---	---	-------	--

Examples of high stress areas include:

- Vertical or horizontal diaphragm plates in narrow cofferdams/double plate bulkheads within one-sixth of their length from either end.
- Floors or double bottom girders close to their span ends.
- Primary supporting member webs in way of end bracket toes.
- Above the heads and below the heels of pillars.
- Where openings are arranged, the shape of openings is to be such that the stress concentration remains within acceptable limits.

Openings are to be well rounded with smooth edges.

CSRBO	1	3	6.2.2	Web openings as indicated below do not require reinforcement <ul style="list-style-type: none">• In single skin sections, having depth not exceeding 25% of the web depth and located so that the edges are not less than 40% of the web depth from the faceplate.• In double skin sections, having depth not exceeding 50% of the web depth and located so that the edges are well clear of cut outs for the passage of stiffeners.
-------	---	---	-------	---

The length of openings is not to be greater than:

- At the mid-span of primary supporting members: the distance between adjacent openings.
- At the ends of the span: 25% of the distance between adjacent openings.

For openings cut in single skin sections, the length of opening is not to be greater than the web depth or 60% of the stiffener spacing, whichever is greater. The ends of the openings are to be equidistant from the cut outs for stiffeners.

Where lightening holes are cut in the brackets, the distance from the circumference of the hole to the free flange of brackets is not to be less than the diameter of the lightening hole. Openings not complying with this requirement are to be reinforced according to [6.2.3].

Vertical

- | | | | | |
|-------|---|---|-------|--|
| CSRBO | 1 | 3 | 6.3.1 | Openings in the strength deck are to be kept to a minimum and spaced as far as practicable from one another and from the ends of superstructures. Openings are to be located as far as practicable from high stress regions such as side shell plating, hatchway corners, or hatch side coamings. |
| RRCS | 3 | 3 | 3.4.3 | Openings having a length in the fore and aft directions exceeding 2,5 m or 0,1B m or a breadth exceeding 1,2 m or 0,04B m, whichever is the lesser, are always to be deducted from the sectional areas used in the section modulus calculation. |
| RRCS | 3 | 3 | 3.4.4 | Smaller openings (including manholes, lightening holes, single scallops in way of seams, etc.) need not be deducted provided they are isolated and the sum of their breadths or shadow area breadths (see Pt 3, Ch 3, 3.4 Calculation of hull section modulus 3.4.7), in one transverse section does not reduce the section modulus at deck or bottom by more than 3 per cent. |
| RRCS | 3 | 3 | 3.4.5 | Where B equals the breadth of the ship at the section considered and Σb equals the sum of breadths of deductible openings, the expression $0,06 (B - \Sigma b)$ may be used for deck openings in lieu of the 3 per cent limitation of reduction of section modulus in Pt 3, Ch 3, 3.4 Calculation of hull section modulus 3.4.4. |
| RRCS | 3 | 3 | 3.4.6 | Where a large number of openings are proposed in any transverse space, special consideration will be required. |
| RRCS | 3 | 3 | 3.4.7 | When calculating deduction-free openings, the openings are assumed to have longitudinal extensions as shown by the shaded areas in Figure 3.3.5 Deduction free openings shadow areas. The shadow area is obtained by drawing two tangent lines to an opening angle of 30° . The section to be considered should be perpendicular to the centerline of the ship and should result in the maximum deduction in each transverse space. |

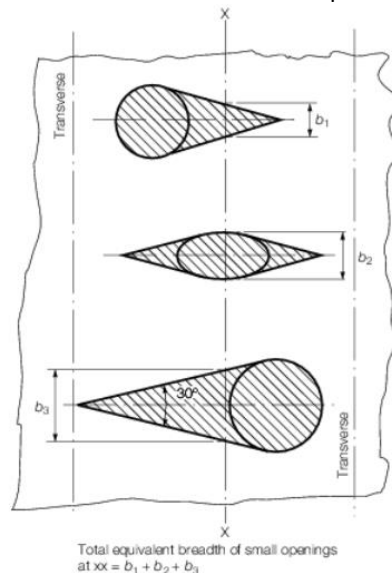

Longitudinal

- | | | | | |
|------|---|---|-------|--|
| RRCS | 3 | 3 | 3.4.8 | Isolated openings in longitudinals or longitudinal girders need not to be deducted if their depth does not exceed 25% of the web depth with a maximum of 75mm. |
|------|---|---|-------|--|

Transversal

- | | | | | |
|------|---|---|-------|---|
| RRCS | 3 | 3 | 4.2.3 | No doors, manholes, access openings, ventilation ducts or any other openings shall be fitted in the collision bulkhead below the bulkhead deck. |
| RRCS | 3 | 3 | 4.5.4 | The number of openings in the extension of the collision bulkhead above the freeboard deck shall be restricted to the minimum compatible with the design and normal operation of the ship. All such openings shall be capable of being closed weathertight. |

Shell

- | | | | | |
|-------|---|---|--------|--|
| RRCOU | 4 | 6 | 3.1.15 | Sea inlets, or other openings, are to have well rounded corners and, so far as possible, are to be kept clear of the bilge radius. Openings on, or near to, the bilge radius are to be elliptical. The thickness of sea inlet box plating is to be the same as the adjacent shell, but not less than 12,5 mm. The ends of stiffeners should in general be bracketed and alternative proposals may be considered. |
| RRCNS | 3 | 2 | 3.3.3 | In general, openings are not to be cut in the sheerstrake; however, if operational requirements dictate, openings that are less than 20 per cent of the depth of the sheerstrake may be accepted. Openings greater than 20 per cent of the depth of the sheerstrake will require special consideration. |

APPENDIX V: CLASSIFICATION ARTICLES PIPE ROUTING

In this appendix, all relevant class rules regarding pipe routing are listed.

Bureau VERITAS

Part	Chapte	Section	Article	
				General
C	1	10	4.4.2	Unless otherwise justified, the bending radius measured on the centreline of the pipe is not to be less than: <ul style="list-style-type: none">• twice the external diameter for copper and copper alloy pipes,• 3 times the external diameter for cold bent steel pipes.
C	1	10	5.2.3	The passage of pipes through tanks, when permitted, normally requires special arrangements such as reinforced thickness or tunnels, in particular for: <ul style="list-style-type: none">• bilge pipes• ballast pipes• scuppers and sanitary discharges• air, sounding and overflow pipes• fuel oil pipes.
C	1	10	5.2.5	As far as possible, pipes are not to pass near switchboards or other electrical apparatus. If this requirement is impossible to satisfy, gutterways or masks are to be provided wherever deemed necessary to prevent projections of liquid or steam on live parts
C	1	10	5.3.2	Where penetrations of watertight bulkheads or decks and fire divisions are necessary for piping and ventilation, arrangements are to be made to maintain the watertight integrity and fire integrity. See also Ch 4, Sec 5, [2].
C	1	10	5.6.1	Piping systems are to be so designed and pipes so fixed as to allow for relative movement between pipes and the ship's structure, having due regard to the: <ul style="list-style-type: none">• temperature of the fluid conveyed• coefficient of thermal expansion of the pipes material• deformation of the ship's hull.
C	1	10	5.6.2	All pipes subject to thermal expansion and those which, due to their length, may be affected by deformation of the hull, are to be fitted with expansion pieces or loops.
C	1	10	5.7.1	Unless otherwise specified, the fluid lines referred to in this Section are to consist of pipes connected to the ship's structure by means of collars or similar devices.
C	1	10	5.7.2	Shipyards are to take care that: <ol style="list-style-type: none">3. The arrangement of supports and collars is to be such that pipes and flanges are not subjected to abnormal bending stresses, taking into account their own mass, the metal they are made of, and the nature and characteristics of the fluid they convey, as well as the contractions and expansions to which they are subjected.

4. Heavy components in the piping system, such as valves, are to be independently supported.

C	1	10	5.8.1	Pipes passing through cargo holds and tweendecks are to be protected against shocks by means of strong casings.
C	1	10	5.8.3	Pipes are to be adequately insulated against cold wherever deemed necessary to prevent frost.
C	1	10	5.8.4	All pipes and other components where the temperature may exceed 220°C are to be efficiently insulated. Where necessary, precautions are to be taken to protect the insulation from being impregnated with flammable oils.

Bilge

C	1	10	6.11.1	Bilge pipes are not to pass through double bottom compartments. If such arrangement is unavoidable, the parts of bilge pipes passing through double bottom compartments are to have reinforced thickness, as per Tab 6 for steel pipes.
C	1	10	6.11.2	The parts of bilge pipes passing through deep tanks intended to contain water ballast, fresh water, liquid cargo or fuel oil are normally to be contained within pipe tunnels. Alternatively, such parts are to have reinforced thickness, as per Tab 6 for steel pipes, and are to be made either of one piece or several pieces assembled by welding, by reinforced flanges or by devices deemed equivalent for the application considered; the number of joints is to be as small as possible. These pipes are to be provided at their ends in the holds with non-return valves.

Ballast

C	1	10	7.2.1	All tanks including aft and fore peak and double bottom tanks intended for ballast water are to be provided with suitable filling and suction pipes connected to special power driven pumps of adequate capacity.
C	1	10	7.2.3	If not contained in pipe tunnels, the ballast steel pipes passing through tanks intended to contain fresh water, fuel oil or liquid cargo are: <ul style="list-style-type: none">• to have reinforced thickness• to consist either of a single piece or of several pieces assembled by welding, by reinforced flanges or by devices deemed equivalent for the application considered• to have a minimal number of joints in these lines• to have expansion bends in these lines within the tank, where needed• not to have slip joints.

Scuppers and sanitary discharge

C	1	10	8.2.1	Scuppers, sufficient in number and suitable in size, are to be provided to permit the drainage of water likely to accumulate in the spaces which are not located in the ship's bottom.
C	1	10	8.12.3	<ol style="list-style-type: none">As a rule, scupper and sanitary discharge pipes are not to pass through fuel oil tanks.Where scupper and discharge pipes pass unavoidably through fuel oil tanks and are led through the shell within the tanks, the thickness of the piping is not to be less than that given in Tab 26, column 1 (substantial thickness). It need not, however, exceed the thickness of the adjacent Rule shell plating.

- c. Scupper and sanitary discharge pipes are normally not to pass through fresh and drinking water tanks.
- d. For passage through cargo oil tanks, see Pt D, Ch 7, Sec 4.

Air, sounding and overflow

- | | | | | |
|---|---|----|-------|--|
| C | 1 | 10 | 9.1.2 | <ul style="list-style-type: none"> a. Air pipes are to be so arranged and the upper part of compartments so designed that air or gas likely to accumulate at any point in the compartments can freely evacuate. b. Air pipes are to be fitted opposite the filling pipes and/or at the highest parts of the compartments, the ship being assumed to be on an even keel. c. In general, two air pipes are to be fitted for each compartment, except in small compartments, where only one air pipe may be accepted. When the top of the compartment is of irregular form, the position of air pipes will be given special consideration by the Society. d. Where only one air pipe is provided, it is not to be used as a filling pipe. |
| C | 1 | 10 | 9.1.3 | <ul style="list-style-type: none"> a. Air pipes of double bottom compartments, tunnels, deep tanks and other compartments which can come into contact with the sea or be flooded in the event of hull damage are to be led to above the bulkhead deck or the freeboard deck. b. Air pipes of tanks intended to be pumped up are to be led to the open above the bulkhead deck or the freeboard deck. c. Air pipes other than those of flammable oil tanks may be led to enclosed cargo spaces situated above the freeboard deck. The air pipe of the scupper tank is to be led to above freeboard deck. |
| C | 1 | 10 | 9.2.1 | Sounding devices are to be fitted to tanks intended to contain liquids as well as to all compartments which are not readily accessible at all times. |
| C | 1 | 10 | 9.2.2 | Sounding pipes are to be located as close as possible to suction pipes. |
| C | 1 | 10 | 9.2.3 | <ul style="list-style-type: none"> a. As a general rule, sounding pipes are to end above the bulkhead deck or the freeboard deck in easily accessible places and are to be fitted with efficient, permanently attached, metallic closing appliances. b. In machinery spaces and tunnels, where the provisions of item a) cannot be satisfied, short sounding pipes led to readily accessible positions above the floor and fitted with efficient closing appliances may be accepted. In ships required to be fitted with a double bottom, such closing appliances are to be of the self-closing type. |
| C | 1 | 10 | 9.2.6 | Sounding pipes are normally to be straight. If it is necessary to provide bends in such pipes, the curvature is to be as small as possible to permit the ready passage of the sounding apparatus. |
| C | 1 | 10 | 9.3.1 | <p>Overflow pipes are to be fitted to tanks:</p> <ul style="list-style-type: none"> • which can be filled by pumping and are designed for a hydrostatic pressure lower than that corresponding to the height of the air pipe, or • where the cross-sectional area of air pipes is less than that prescribed in [9.1.8], item d). |
| C | 1 | 10 | 9.3.2 | <p>Overflow pipes are to be led:</p> <ul style="list-style-type: none"> • either outside, or • in the case of fuel oil or lubricating oil, to an overflow tank of adequate capacity or to a storage tank having a space reserved for overflow purposes. |

Cooling water

- | | | | | |
|---|---|----|--------|--|
| C | 1 | 10 | 10.7.1 | <ul style="list-style-type: none">a. At least two sea inlets complying with [2.8] are to be provided for the cooling system.b. The sea inlets are to be low inlets, so designed as to remain submerged under all normal navigating conditions. In general, one sea inlet is to be arranged on each side of the ship.c. One of the sea inlets may be that of the ballast pump or of the general service pump. |
|---|---|----|--------|--|

Thermal oil

- | | | | | |
|---|---|----|--------|---|
| C | 1 | 10 | 13.9.1 | <ul style="list-style-type: none">a. Thermal oil pipes are not to pass through accommodation or public spaces or control stations.b. Unless they are located in tight manifolds, provided with appropriate means of internal inspection and with a leak collecting system, heat transfer oil pipes are not allowed in main and auxiliary machinery spaces specified in Ch 1, Sec 1, [3.7.3]. |
|---|---|----|--------|---|

Steam lines

- | | | | | |
|---|---|----|--------|--|
| C | 1 | 10 | 15.3.7 | Steam lines are not to pass through accommodation spaces, unless they are intended for heating purposes. |
|---|---|----|--------|--|

Feed water

- | | | | | |
|---|---|----|--------|---|
| C | 1 | 10 | 16.6.1 | Feed water pipes are not to pass through fuel oil or lubricating oil tanks. |
|---|---|----|--------|---|

Compressed air

- | | | | | |
|---|---|----|--------|--|
| C | 1 | 10 | 17.8.2 | Air compressors are to be located in spaces provided with sufficient ventilation. |
| C | 1 | 10 | 17.8.4 | All discharge pipes from starting air compressors are to be lead directly to the starting air receivers, and all starting pipes from the air receivers to main or auxiliary engines are to be entirely separate from the compressor discharge pipe system. |

Oxyacetylene welding systems

- | | | | | |
|---|---|----|--------|---|
| C | 1 | 10 | 19.4.3 | <ul style="list-style-type: none">a. Piping is not to be led through accommodation or service spaces.b. Piping is to be protected against any possible mechanical damage.c. In way of deck or bulkhead penetrations, piping is to be suitably enclosed in sleeves so arranged as to prevent any fretting of the pipe with the sleeve. |
|---|---|----|--------|---|

China Classification society

Volume	Article	
		General
3	2.2.2.3	In general, the radius of curvature of a pipe bend at the centerline of the pipe is not to be less than 3 D.
3	2.8.1.1	All pipes are to be properly secured, and provision is to be made to avoid excessive stresses caused by thermal expansion in pipes or due to deflection of ship structure.
3	2.8.1.6	Fresh water pipes are not to be led through oil tanks, nor oil pipes through fresh water tanks. When it is impracticable to do so, the pipes are to be led inside an oil-tight pipe tunnel.
3	2.8.4.2	All steam, oil and water pipes as well as oil and other liquid tanks are not to be placed above or behind the switchboard. If this is not practicable, suitable protective means are to be provided. In addition, oil pipes are not to be directly placed above boilers, uptakes, steam pipes, exhaust gas pipes and silencers.
3	2.8.6.3	Where the pipes pass through chambers intended for temperatures of 0°C or below, they are in general to be insulated from the steel structure of these chambers.
3	2.8.7.1	Suitable provision for compensation is to be made for all pipes subjected to expansion, contraction or other strain, such as bends, loops, or expansion joints as required
		Bilge
3	3.4.7.1	In way of deep tanks, bilge pipes are preferably to be led through pipe tunnels.
3	3.4.7.3	Bilge suction pipes are not to be led through double bottom tanks as far as practicable.
3	3.9.1.1	If a main bilge line outside engine room is provided, its arrangement is to satisfy either of the following requirements: <ol style="list-style-type: none">1. If there is only one main bilge line, it is to be placed in a pipe tunnel, and as high as possible in the pipe tunnel.2. If there are two main bilge lines, each cargo hold is provided with a branch bilge suction connected to each main bilge line respectively.3.
		Ballast
3	3.8.1.4	Ballast water pipes are not to pass through drinking water, feed water or lubricating oil tanks.
		Air, sounding and overflow
3	2.8.4.1	Air, overflow and sounding pipes for fuel oil tanks are not to be led through living quarters. Where this is not practicable, no detachable pipe joint is permissible in these spaces.

- 3 3.10.2.1 Air pipes are to be provided for tanks intended to carry water, oil fuel and lubricating oil, and also for cofferdams and pipe tunnels. Air pipes to be fitted at the highest part of the tanks and far apart from the filling pipes.
- 3 3.10.3.1 Air pipes to the followings tanks and cofferdams are led to the open above the freeboard deck:
1. Fuel oil tanks
 2. Cargo tanks
 3. Heated lubrication oil tanks and hydraulic oil tanks
 4. Tanks, situated outside machinery spaces
 5. Cofferdams adjacent to fuel or cargo tanks
- Air pipes to the following tanks are to be led to above the bulkhead deck:
1. Double bottom tanks
 2. Deep tanks extending to shell plating
 3. Tanks which can be directly flooded from the outboard and seawater case
 4. Other cofferdams
- 3 3.10.5.1 All tanks which can be pumped up are to be fitted with overflow pipes.
- 3 3.10.5.2 In the case of oil fuel and lubricating oil tanks, the overflow pipe is to be led to an overflow tank.
- 3 3.10.8.1 Sounding pipes are to be provided for all tanks, cofferdams and pipe tunnels as well as bilges or bilge wells which are not at all times readily accessible. All sounding pipes are to be led to positions above the bulkhead deck which are at all times accessible. The sounding pipes are to be fitted as near the suctions as practicable.

Fuel oil

- 3 4.2.4.1 Oil fuel piping is to be separate from other piping systems.
- 3 4.2.4.4 Oil fuel lines are not to be located immediately above or near units of high temperature, including boilers, steam pipelines, exhaust manifolds and silencers.

Steam lines

- 3 4.3.1.1 In general, steam pipes are not to be led through lamp rooms, paint lockers and cargo spaces.

Feed water

- 3 4.4.2.1 Two feed water systems are to be provided for main and auxiliary boilers for essential services, including feed pumps. Feed water systems are to be so arranged that the feed water cannot be contaminated by oil or oily water.

Cooling water

- 4.5.2.3 Not less than two sea inlets, which are to be fitted on both sides of the ship as far as practicable, are to be provided for the cooling water pumps.

Lubrication oil

- 3 4.6.2.1 Lubricating oil piping is to be entirely separate from other piping systems.

Thermal oil

3

4.8.4.7

Thermal oil pipes are not to pass through accommodation spaces nor control stations. Thermal oil piping passing through main and auxiliary machinery spaces is to be restricted as far as possible.

Lloyd's register

RRCS = Rules and regulations for the classification of ships

RRCNS = Rules and regulations for the classification of naval ships

RRCOU = Rules and regulations for the classification of offshore units

CSRBO = Common structural rules for bulk carriers and oil tankers

Edition	Part	Chapter	Article	
				General
RRCS	5	13	2.8.1	All pipes, including scupper pipes, air pipes and sounding pipes which pass through chambers intended for the carriage or storage of refrigerated produce are to be well insulated.
RRCS	5	13	2.8.2	Where the pipes referred to in <u>Pt 5, Ch 13, 2.8 Piping in way of refrigerated chambers 2.8.1</u> pass through chambers intended for temperatures of 0°C or below, they are also to be insulated from the steel structure, except in positions where the temperature of the structure is mainly controlled by the external temperature and will normally be above freezing point. Pipes passing through a deckplate within the ship side insulation, where the deck is fully insulated below and has an insulation ribband on top, are to be attached to the deck plating. In the case of pipes adjacent to the shell plating, metallic contact between the pipes and the shell plating or frames is to be arranged so far as practicable.
RRCS	5	13	2.9.2	Wash deck pipes and discharge pipes from the pumps to domestic water tanks are not to be led through cargo holds. Any proposed departure from this requirement is to be submitted for consideration.
RRCS	5	13	2.9.3	So far as practicable, pipelines, including exhaust pipes from oil engines, are not to be led in the vicinity of switchboards or other electrical appliances in positions where the drip or escape of liquid, gas or steam from joints or fittings could cause damage to the electrical installation. Where it is not practicable to comply with these requirements, drip trays or shields are to be provided as found necessary. Short sounding pipes to tanks are not to terminate near electrical appliances, see <u>Pt 5, Ch 13, 12.13 Short sounding pipes 12.13.2</u> .
				Bilge
RRCS	5	13	3.1.1	All ships are to be provided with efficient pumping plant having the suctions and means for drainage so arranged that any water within any compartment of the ship, or any watertight section of any compartment, can be pumped out through at least one suction when the ship is on an even keel and is either upright or has a list of not more than 5°. For this purpose, wing suctions will generally be necessary, except in short, narrow compartments where one suction can provide effective drainage under the above conditions.
RRCS	5	13	3.4.1	All tanks (including double bottom tanks), whether used for water ballast, fuel oil or liquid cargoes, are to be provided with suction pipes, led to suitable power pumps, from the after end of each tank.
RRCS	5	13	4.2.1	Where the double bottom extends the full length of the machinery space and forms bilges at the wings, it will be necessary to provide one branch and one direct bilge suction at each side.

RRCS	5	13	4.2.2	Where the double bottom plating extends the full length and breadth of the compartment, one branch bilge suction and one direct bilge suction are to be led to each of two bilge wells, situated one at each side.
RRCS	5	13	4.3.1	Where there is no double bottom and the rise of floor is not less than 5°, one branch and one direct bilge suction are to be led to accessible positions as near the centreline as practicable.
RRCS	5	13	7.9.1	Bilge suction pipes are not to be led through double bottom tanks if it is possible to avoid doing so.
RRCS	5	13	7.10.1	In way of deep tanks, bilge pipes should preferably be led through pipe tunnels.
RRCS	5	13	8.1.3	The bilge main is to be so arranged that no part is situated nearer the side of the ship than $B/5$, measured at right angles to the centreline at the level of the deepest sub-division load line, where B is the breadth of the ship.

Air, sounding and overflow

RRCS	5	13	12.4.1	Air pipes are to be fitted to all tanks, cofferdams, tunnels and other compartments which are not fitted with alternative ventilation arrangements.
RRCS	5	13	12.4.2	The air pipes are to be fitted at the opposite end of the tank to that which the filling pipes are placed and/or at the highest part of the tank. Where the tank top is of unusual or irregular profile, special consideration will be given to the number and position of the air pipes.
RRCS	5	13	12.5.1	Air pipes to double bottom tanks, deep tanks extending to the shell plating, or tanks which can be run up from the sea are to be led to above the bulkhead deck. Air pipes to fuel oil and cargo oil tanks, cofferdams and all tanks which can be pumped up are to be led to the open.
RRCS	5	13	12.5.2	Air pipes from storage tanks containing lubricating or hydraulic oil may terminate in the machinery space, provided that the open ends are so situated that issuing oil cannot come into contact with electrical equipment or heated surfaces. Air pipes from heated lubricating oil tanks are to be led to the open.
RRCS	5	13	12.9.1	For all tanks which can be filled by the ship's pumps or by shore pumps, overflow pipes are to be fitted where: <ul style="list-style-type: none"> a. The total cross-sectional area of the air pipe is less than that required by Pt 5, Ch 13, 12.8 Size of air pipes. b. The pressure head corresponding to the height of the air pipe is greater than that for which the tank is designed.
RRCS	5	13	12.9.2	In the case of fuel oil and lubricating oil tanks, the overflow pipe is to be led to an overflow tank of adequate capacity or to a storage tank having a space reserved for overflow purposes. Suitable means are to be provided to indicate when overflow is occurring, or when the contents reach a predetermined level in the tanks.
RRCS	5	13	12.9.3	Overflow pipes are to be self-draining under normal conditions of trim.

RRCS 5 13 12.11.1 Provision is to be made for sounding all tanks and the bilges of those compartments which are not at all times readily accessible. The soundings are to be taken as near the suction pipes as practicable.

RRCS 5 13 12.11.3 Where fitted, sounding pipes are to be as straight as practicable, and if curved to suit the structure of the ship, the curvature must be sufficiently easy to permit the ready passage of the sounding rod or chain.

Fuel oil

RRCS 5 14 2.9.2 Fuel oil pipes are not to be installed above or near high temperature equipment.

RRCS 5 14 2.10.3 The piping arrangements for fuel oil are to be separate and distinct from those intended for lubricating oil systems to prevent contamination of fuel oil by lubricating oil.

RRCS 5 14 4.5.1 Pipes conveying oil under pressure are to be of seamless steel or other approved material having flanged or welded joints, and are to be placed in sight above the platform in well lighted and readily accessible parts of the machinery spaces.

Steam lines

RRCS 5 14 5.4.1 In general, steam pipes are not to be led through spaces which may be used for cargo, but where it is impracticable to avoid this arrangement, plans are to be submitted for consideration. The pipes are to be efficiently secured and insulated, and well protected from mechanical damage. Pipe joints are to be as few as practicable and preferably butt welded.

RRCS 5 14 5.4.2 If these pipes are led through shaft tunnels, pipe tunnels in way of cargo holds or through duct keels, they are to be efficiently secured and insulated.

Feed water

RRCS 5 14 7.1.1 Two separate means of feed are to be provided for all main and auxiliary boilers which are required for essential services. In the case of steam/steam generators, one means of feed will be accepted provided steam for essential services is available simultaneously from another source.

Cooling water

RRCS 5 14 7.5.1 Not less than two sea inlets are to be provided for the pumps supplying the sea-water cooling system, one for the main pump and one for the standby pump. Alternatively, the sea inlets may be connected to a suction line available to main and standby pumps.

RRCS 5 14 7.5.3 Cooling water pump sea inlets are to be low inlets and one of them may be the ballast pump or general service pump sea inlet.

RRCS 5 14 7.5.4 The auxiliary cooling water sea inlets are preferably to be located one on each side of the ship.

Lubrication oil

RRCS 5 14 8.10.1 Pipes conveying lubricating oil under pressure are to be of seamless steel or other approved material having flanged or welded joints, and are to be placed in sight above the platform in well-lit and readily accessible parts of the machinery spaces.

RRCS 5 14 8.15.2 Lubricating oil pipes are not to be installed above or near high-temperature equipment.

Hydraulic oil

RRCS 5 14 9.4.1 Pipes conveying hydraulic oil under pressure are to be of seamless steel or other approved material having flanged or welded joints, and are to be placed in sight above the platform in well lit and readily accessible parts of the machinery spaces.

RRCS 5 14 9.7.1 Hydraulic oil pipes are not to be installed above or near high-temperature equipment.

APPENDIX VI: HOLE COSTS

This table contains cutting lengths and man-hours of repair work, which is used for the cutting cost calculation.

Ship #	Repair #	Hours	Hole diameters (mm)										Extra	Holes	Total per Cost	Cost/hole	
1283	1400wz6	12	276	276	180									3	2,30	672	224
	1250wz3	12	605	60										2	2,09	672	336
	1302wz3	15	403	403	450									4	5,36	840	210
	1160wz3	14	600	600								1000		3	4,77	784,00	261,33
	1161wz3	10	206	114										2	1,01	560	280
	1201wz10	19	350	350	450								4400	5	8,01	1064	212,8
	1250wz2	16											5500	5	5,50	896	179,2
	1251wz3	4	60	60									2240	3	2,62	224	74,67
	1261wz3	133	37	51	51	200	222	160	51	222	51	60	5190	14	8,66	7448	532
	1261wz2	36	130	437	403	286	73	193						6	4,78	2016	336
	1262wz4	2												1	0,77	112	112
	1262wz5	11											770	3	3,32	616	205,33
	1360wz3	7	328	92	52								3324	3	1,48	392	130,67
	1360wz5	6	286	286										2	1,80	336	168
	1361wz3	26	225	328	111	328	405					2060		7	6,45	1456	208
	1361wz5	30	185	117	117	163						3000		6	4,83	1680	280
	1370wz6	5	309											1	0,97	280,00	280
	1371wz3	10											1360	3	1,36	560,00	186,67
	1801wz10	8	136										740	2	1,17	448	224
1801wz13	10	51	51	51	51	25						930	2	1,65	560,00	280	
1901wz6	24	206	309	171								3000	5	5,16	1344	268,8	
1289	1403wz1	6											2000	1	2,00	336	336
	1404wz1	11	117									6000	5	6,37	616	123,2	
	1426wz1	4	156	193										2	1,10	224	112

APPENDIX VII: SYSTEM LOCATIONS

This appendix contains the location of equipment for several ship numbers.

Equipment	Ship number												
	1282	1283	1285	1286	1288	1289	1290	1292					
Aux. bilge/ballast pump	Engine room/ pump room												
Aux. generator	Aux. engine room/ engine room	E.R. store	Engine room	Engine room	Aux. engine room	Engine room	Engine room	Engine room	Engine room	Engine room	Engine room	Engine room	Engine room
Ballast water treatment unit	Bow thruster room	Pump room	Pump room	Pump room	Bow thruster room	Bow thruster room	Bow thruster room	Bow thruster room	Bow thruster room	Bow thruster room	Bow thruster room	Bow thruster room	Bow thruster room
Bilge ejector dredge pump well	Pump room	Pump room	Pump room	Pump room	Pump room	Pump room	Pump room	Pump room	Pump room	Pump room	Pump room	Pump room	Pump room
Bilge/oily water separator	Engine room	Engine room	Engine room	Engine room	Engine room	Engine room	Engine room	Engine room	Engine room	Engine room	Engine room	Engine room	Engine room
Bilge/ballast/FIFI pump	Engine room	Engine room	Engine room	Engine room	Engine room	Engine room	Engine room	Engine room	Engine room	Engine room	Engine room	Engine room	Engine room
Bow thruster	Bow thruster room	Bow thruster room	Bow thruster room	Bow thruster room	Bow thruster room	Bow thruster room	Bow thruster room	Bow thruster room	Bow thruster room	Bow thruster room	Bow thruster room	Bow thruster room	Bow thruster room
Boxcooler	Pump room	Pump room	Pump room	Pump room	Pump room	Pump room	Pump room	Pump room	Pump room	Pump room	Pump room	Pump room	Pump room
BWTU pump	Bow thruster room	Pump room	Pump room	Pump room	Bow thruster room	Bow thruster room	Bow thruster room	Bow thruster room	Bow thruster room	Bow thruster room	Bow thruster room	Bow thruster room	Bow thruster room
Calorifier	Technical space	Technical space	Technical space	Technical space	Technical space	Technical space	Technical space	Technical space	Technical space	Technical space	Technical space	Technical space	Technical space
Chilled water unit	Technical space/ engine room	Technical space	Technical space	Technical space	Technical space	Technical space	Technical space	Technical space	Technical space	Technical space	Technical space	Technical space	Technical space
Chilled water pump	Technical space/ engine room	Technical space	Technical space	Technical space	Technical space	Technical space	Technical space	Technical space	Technical space	Technical space	Technical space	Technical space	Technical space
CO2 bottles	CO2 room	Funnel	Funnel	Funnel	Funnel	Funnel	Funnel	Funnel	Funnel	Funnel	Funnel	Funnel	Funnel
Control air dryer	Engine room/ compressor room	Engine room	Engine room	Engine room	Engine room	Engine room	Engine room	Engine room	Engine room	Engine room	Engine room	Engine room	Engine room
Control air receiver	Engine room/ compressor room	Engine room	Engine room	Engine room	Engine room	Engine room	Engine room	Engine room	Engine room	Engine room	Engine room	Engine room	Engine room
CPP	Engine room	Engine room	Engine room	Engine room	Engine room	Engine room	Engine room	Engine room	Engine room	Engine room	Engine room	Engine room	Engine room
CW buffer tank	Technical space/ engine room	Technical space	Technical space	Technical space	Technical space	Technical space	Technical space	Technical space	Technical space	Technical space	Technical space	Technical space	Technical space
CW expansion vessel	Technical space/ engine room	Technical space	Technical space	Technical space	Technical space	Technical space	Technical space	Technical space	Technical space	Technical space	Technical space	Technical space	Technical space
Degassing unit	Pump room	Pump room	Pump room	Pump room	Pump room	Pump room	Pump room	Pump room	Pump room	Pump room	Pump room	Pump room	Pump room
Dredge pump	Pump room	Pump room	Pump room	Pump room	Pump room	Pump room	Pump room	Pump room	Pump room	Pump room	Pump room	Pump room	Pump room
Dredge pump gearbox	Engine room	Engine room	Engine room	Engine room	Engine room	Engine room	Engine room	Engine room	Engine room	Engine room	Engine room	Engine room	Engine room
Ejector pump	Engine room	Boiler room	Boiler room	Boiler room	Boiler room	Boiler room	Boiler room	Boiler room	Boiler room	Boiler room	Boiler room	Boiler room	Boiler room
Emer. Bilge pump bilge well	Engine room	Engine room	Engine room	Engine room	Engine room	Engine room	Engine room	Engine room	Engine room	Engine room	Engine room	Engine room	Engine room
Emer. Bilge pump tech. space	Technical space	Technical space	Technical space	Technical space	Technical space	Technical space	Technical space	Technical space	Technical space	Technical space	Technical space	Technical space	Technical space
Emer. FIFI pump	Technical space	Technical space	Technical space	Technical space	Technical space	Technical space	Technical space	Technical space	Technical space	Technical space	Technical space	Technical space	Technical space
Emer. Generator	Emerg. Gen. room	Emerg. gen. room	Emerg. engine room	Emerg. gen. room	Emerg. gen. room	Emerg. gen. room	Emerg. gen. room	Emerg. gen. room	Emerg. gen. room	Emerg. gen. room	Emerg. gen. room	Emerg. gen. room	Emerg. gen. room
Emer. Starting air compressor	Emerg. Gen. room	Emerg. Gen. room	Emerg. engine room	Emerg. gen. room	Emerg. engine room	Emerg. gen. room	Emerg. gen. room	Emerg. gen. room	Emerg. gen. room	Emerg. gen. room	Emerg. gen. room	Emerg. gen. room	Emerg. gen. room
Emerg. Air receiver	Emerg. Gen. room	Emerg. gen. room	Emerg. gen. room	Emerg. gen. room	Emerg. gen. room	Emerg. gen. room	Emerg. gen. room	Emerg. gen. room	Emerg. gen. room	Emerg. gen. room	Emerg. gen. room	Emerg. gen. room	Emerg. gen. room
Emerg. Manual compressor	Deck workshop/ safety station	Deck workshop	Deck workshop	Deck workshop	Deck workshop	Deck workshop	Deck workshop	Deck workshop	Deck workshop	Deck workshop	Deck workshop	Deck workshop	Deck workshop
Exhaust gas silencer	Funnel	Funnel	Funnel	Funnel	Funnel	Funnel	Funnel	Funnel	Funnel	Funnel	Funnel	Funnel	Funnel
Flushing pump gate valves	Pump room	Pump room	Pump room	Pump room	Pump room	Pump room	Pump room	Pump room	Pump room	Pump room	Pump room	Pump room	Pump room
FO water separator aux. gen.	Aux. engine room	Engine room	Engine room	Engine room	Engine room	Engine room	Engine room	Engine room	Engine room	Engine room	Engine room	Engine room	Engine room
FO water separator emer. gen.	Emerg. Gen. room	Emerg. Gen. room	Emerg. Gen. room	Emerg. Gen. room	Emerg. Gen. room	Emerg. Gen. room	Emerg. Gen. room	Emerg. Gen. room	Emerg. Gen. room	Emerg. Gen. room	Emerg. Gen. room	Emerg. Gen. room	Emerg. Gen. room
Fresh CW pump aux.	Engine room	Engine room	Engine room	Engine room	Engine room	Engine room	Engine room	Engine room	Engine room	Engine room	Engine room	Engine room	Engine room
Fresh CW transfer pump	Engine room	Engine room	Engine room	Engine room	Engine room	Engine room	Engine room	Engine room	Engine room	Engine room	Engine room	Engine room	Engine room
Fresh water generator	Engine room/ technical space	Technical space	Technical space	Technical space	Technical space	Technical space	Technical space	Technical space	Technical space	Technical space	Technical space	Technical space	Technical space
Fuel oil booster pump	Separator room/ engine room	Separator room	Separator room	Separator room	Separator room	Separator room	Separator room	Separator room	Separator room	Separator room	Separator room	Separator room	Separator room
Fuel oil pump	Engine room	Engine room	Engine room	Engine room	Engine room	Engine room	Engine room	Engine room	Engine room	Engine room	Engine room	Engine room	Engine room
Fuel oil separator feed pump	Engine room	Engine room	Engine room	Engine room	Engine room	Engine room	Engine room	Engine room	Engine room	Engine room	Engine room	Engine room	Engine room
Fuel oil separator unit	Separator room	Separator room	Separator room	Separator room	Separator room	Separator room	Separator room	Separator room	Separator room	Separator room	Separator room	Separator room	Separator room

APPENDIX IX: ROOMS IN SECTIONS

This appendix contains the different rooms, tanks and decks in a certain section for ship 1 (1283) and ship 2 (1289).

Ship 1				
Section	Room, tanks and decks in section			
1101	Steering gear room	E.R. store	E.R. repair area	Tanks
1160	Deck store aft			
1161	Deck store aft			
1201	Pump room			
1202	Engine room			
1250	Engine room			
1251	Engine room	Separator room		
1260	Main deck	Hopper		
1261	Main deck	Hopper		
1262	Main deck	Deck workshop	Incinerator room	Fan room
1263	Main deck	Deck workshop	Safety station	Fan room
1301	Technical space	Tanks		
1302	Technical space	Tanks		
1360	LNG tank	Tanks	Accommodation	
1361	Technical space	Accommodation		
1370	Forecastle deck	Accommodation		
1371	Forecastle deck	Accommodation		
1401	Hopper	Tanks	Alleyway	
1402	Hopper	Tanks	Alleyway	
1403	Hopper	Tanks	Alleyway	
1404	Hopper	Tanks	Alleyway	
1405	Hopper	Tanks	Alleyway	
1406	Hopper	Tanks	Alleyway	
1441	Coaming deck aft			
1660	Bow thruster room	Ballast tank		
1670	Forepeak below coaming deck			
1680	Suction outlet			
1801	Deckhouse aft			
1901	Accommodation			
1902	Accommodation			
1903	Accommodation			
1904	Wheelhouse			

Ship 2				
Section	Room, tanks and decks in section			
1101	Steering gear room	E.R. store	E.R. repair area	Tanks
1102	Steering gear room	Electric store	Electric repair area	
1160	Deck store aft			
1161	Deck store aft	Paint store	Emerg. Gen. room	
1201	Pump room	Hopper	Tanks	
1202	Engine room			
1220	Pump room			
1221	Pump room			
1222	Engine room	E.C.R.		
1223	Engine room	Separator room		

1250	Engine room					
1260	Pump room	Fan room	Hopper			
1261	CO2 room	Fan room	Hopper			
1262	Main deck					
1263	Main deck					
1264	Main deck					
1265	Main deck					
1266	Switchboard room	Funnel	Emerg. Gen. room	Trafo room	Safety station	Hydraulic room
1267	Boiler room	Funnel	Emerg. Gen. room	Trafo room		
1301	Technical space					
1302	Technical space					
1303	Technical space	Bow thruster room				
1360	Technical space	Accommodation				
1361	Technical space	Switchboard room	Accommodation			
1362	Technical space	Bow thruster room	Accommodation			
1363	Technical space	Bow thruster room	Accommodation			
1370	Forecastle deck	Accommodation				
1371	Forecastle deck	Accommodation				
1372	Forecastle deck	Accommodation				
1373	Forecastle deck	Accommodation				
1401	Hopper					
1402	Hopper					
1403	Hopper					
1404	Hopper					
1420	Tanks	Alleyway				
1421	Tanks	Alleyway				
1422	Tanks	Alleyway				
1423	Tanks	Alleyway				
1424	Tanks	Alleyway				
1425	Tanks	Alleyway				
1426	Tanks	Alleyway				
1427	Tanks	Alleyway				
1435	Pump room	Hopper	Tanks			
1440	Coaming deck					
1441	Coaming deck					
1442	Coaming deck					
1443	Coaming deck					
1444	Coaming deck					
1445	Coaming deck					
1446	Coaming deck					
1447	Coaming deck					
1448	Coaming deck					
1449	Coaming deck					
1455	Hopper					
1660	Ballast tank					
1661	Ballast tank					
1670	Forepeak below coaming deck					
1801	Deckhouse aft					
1802	Deckhouse aft					
1803	Deckhouse aft					
1901	Deckhouse	Accommodation				
1902	Deckhouse	Accommodation				
1903	Deckhouse	Accommodation				
1904	Deckhouse	Accommodation				
1905	Deckhouse	Accommodation				

APPENDIX X: RESULTS

This appendix contains the results of the algorithm regarding the trunk composition. The left side indicates the real trunk as it is routed. The right side followed from the estimation algorithm. Vertically, the decks are represented.

Ship number 1278:

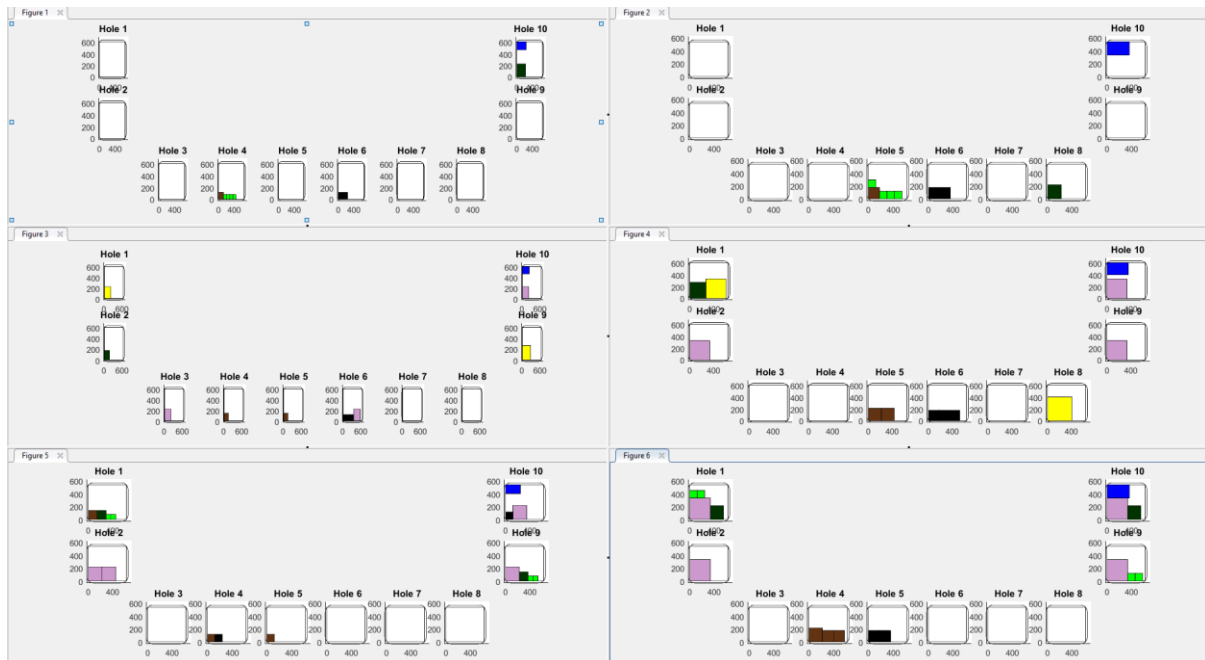

Ship number 1283:



Ship number 1285:

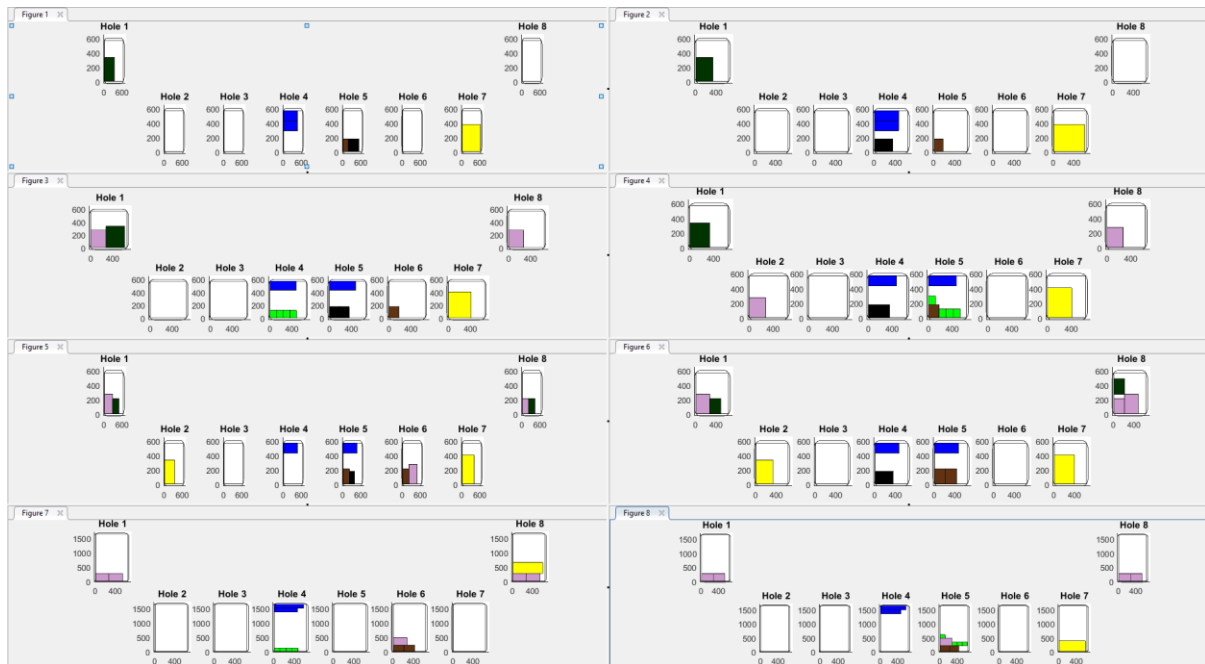

Ship number 1289:

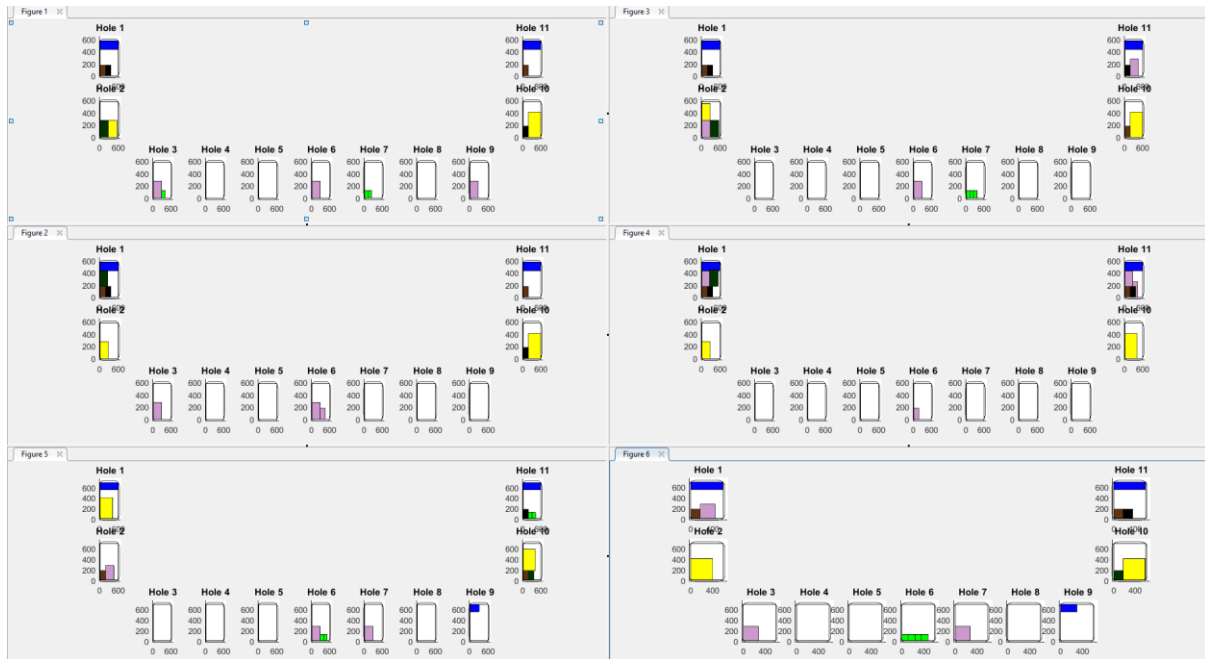

With the results from the algorithm, in combination with the results obtained from the trunk compositions, the following charts are created.

Ship number 1278:

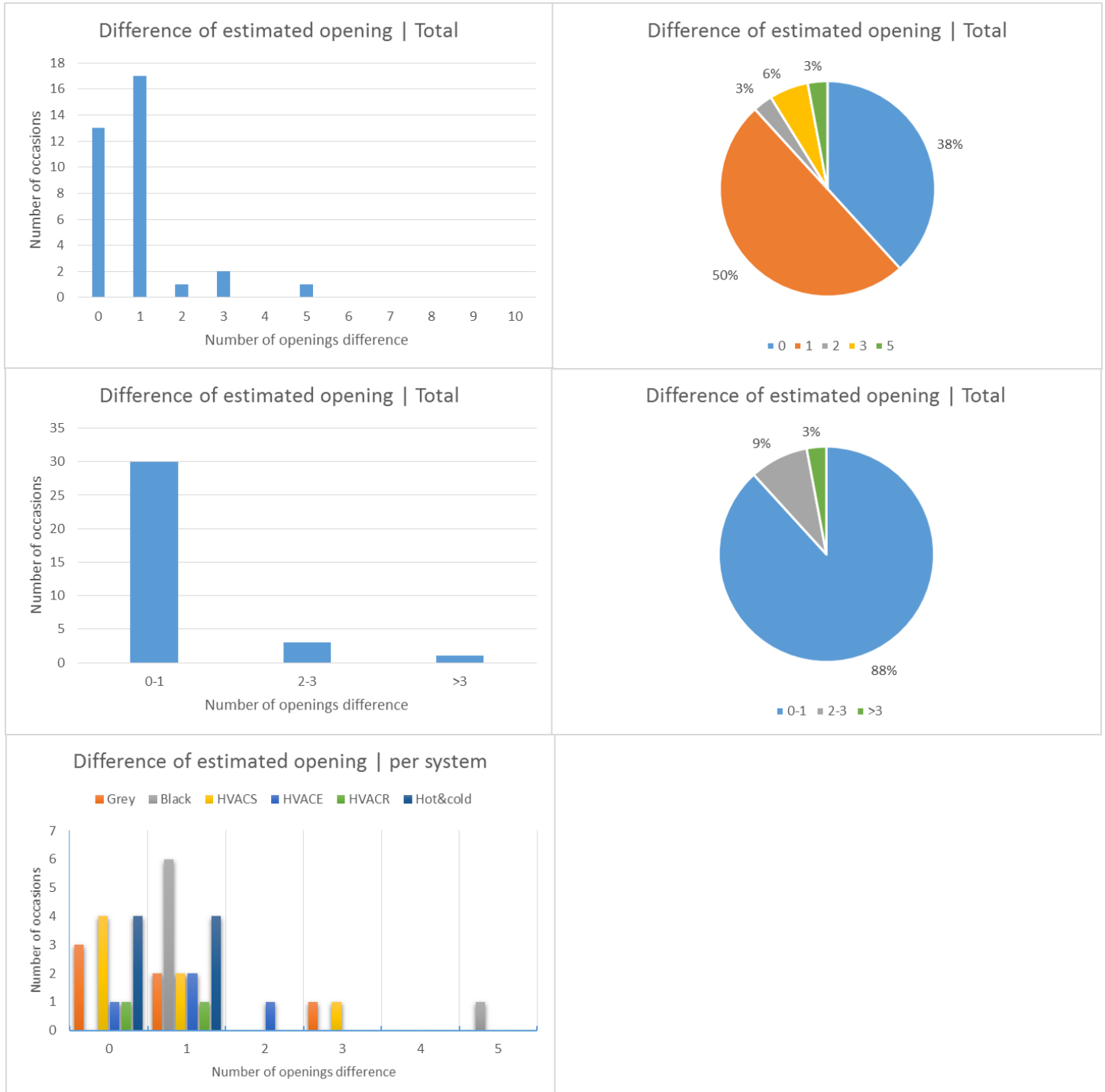

Difference of opened openings | Total

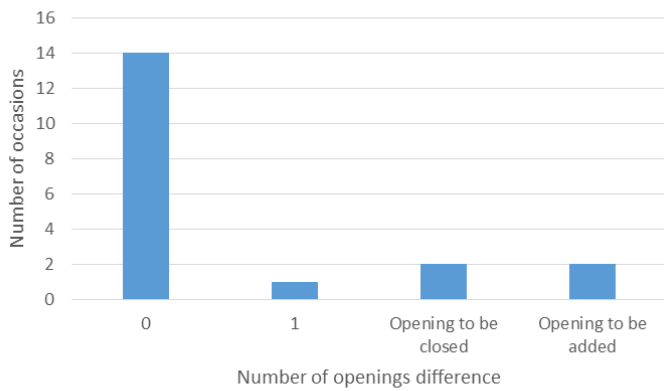

Difference of opened openings | Total

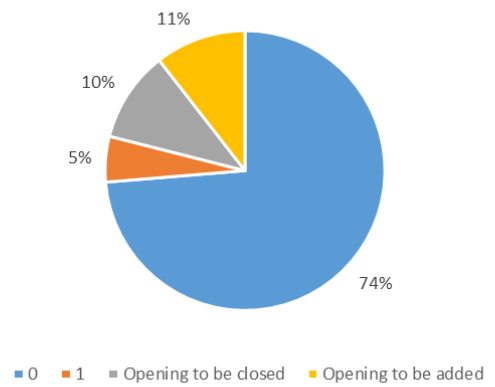

Difference of opened openings | Total

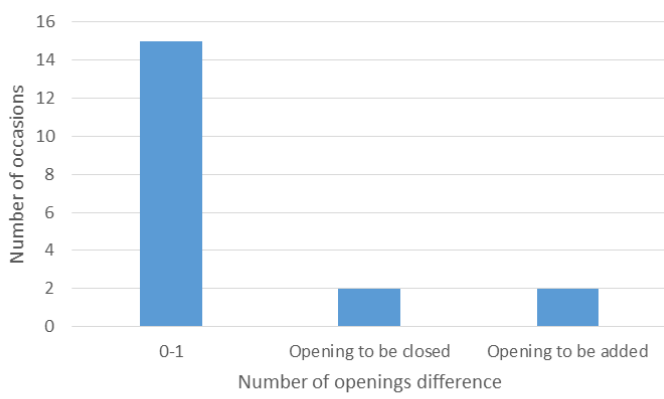

Difference of opened openings | Total

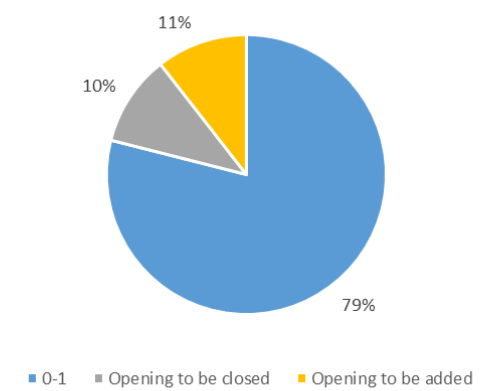

Difference of opened openings | Deck 1

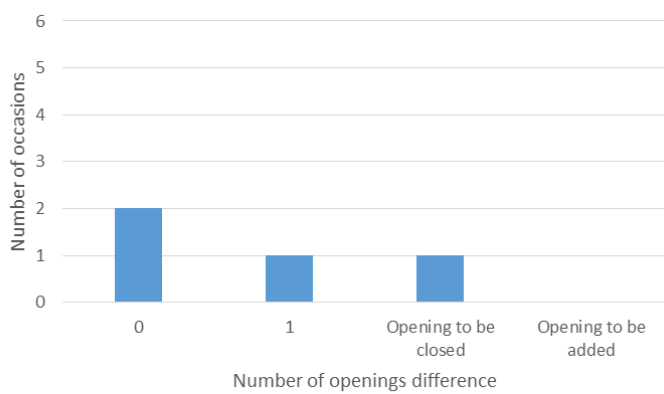

Difference of opened openings | Deck 2

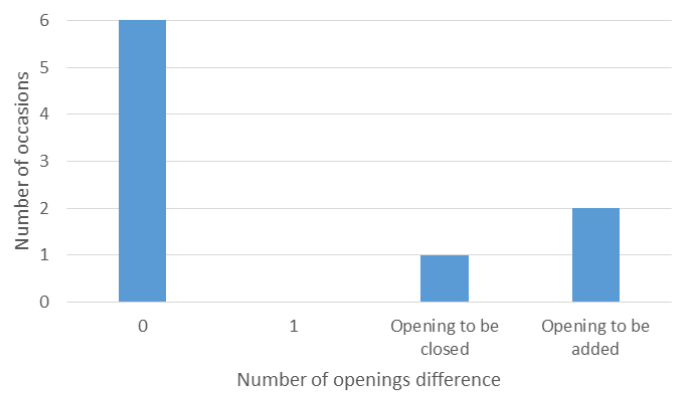

Difference of opened openings | Deck 3

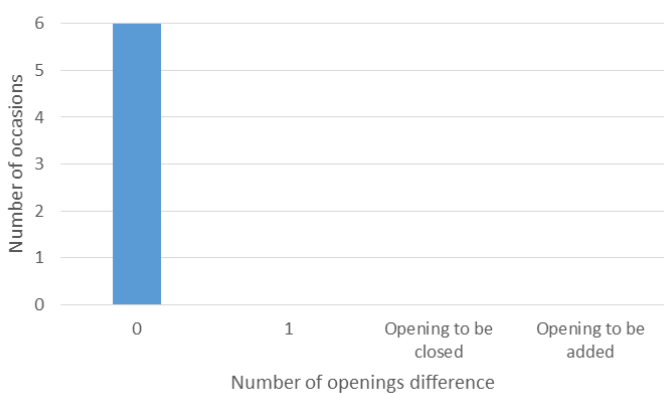

Ship number 1283:

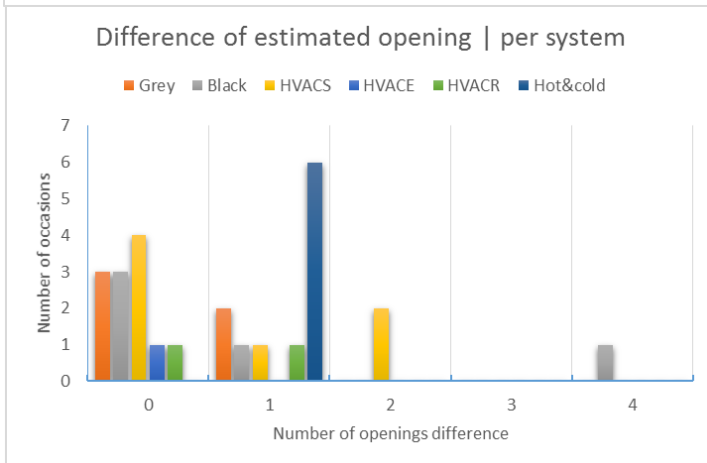
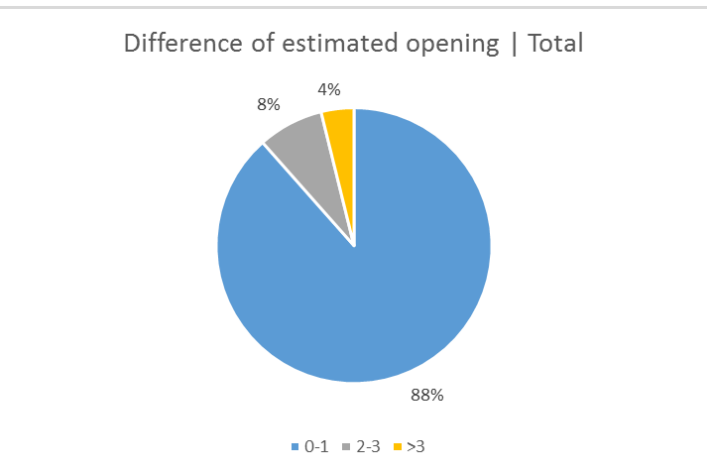
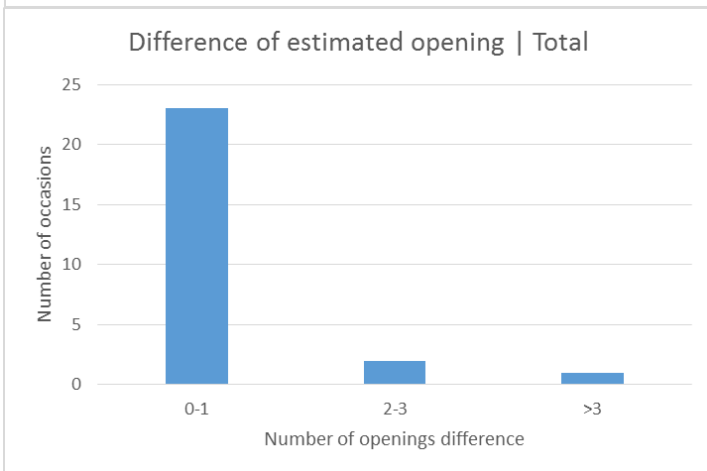
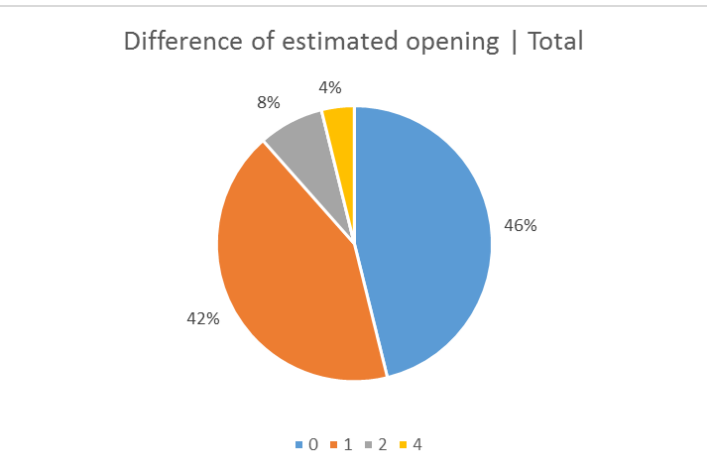
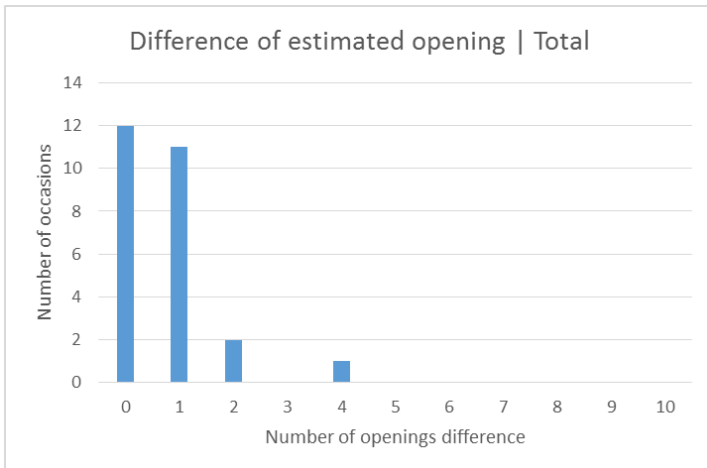

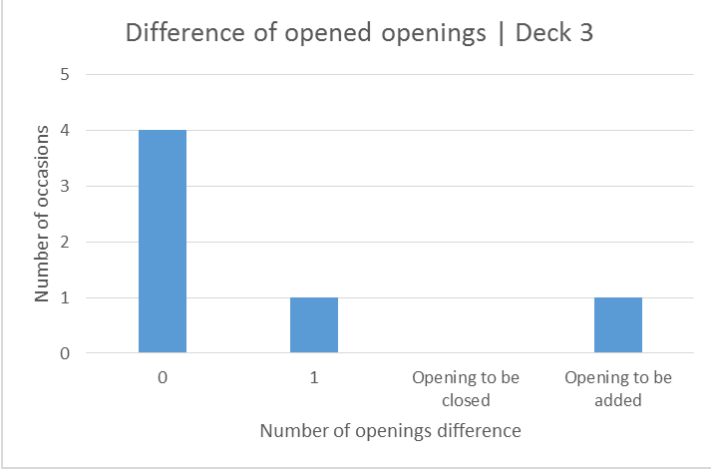
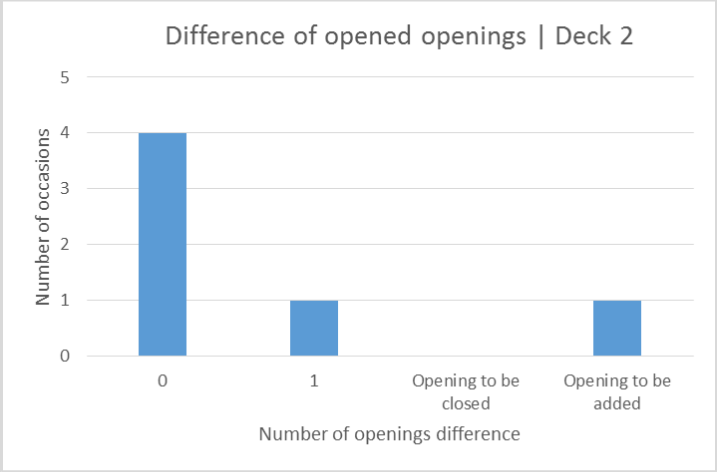
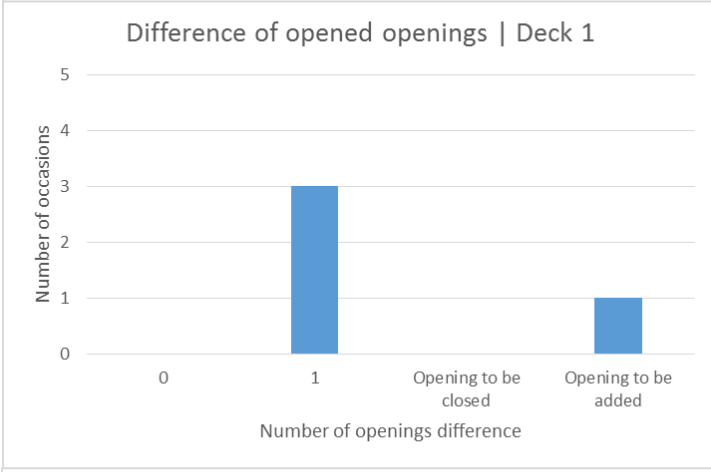
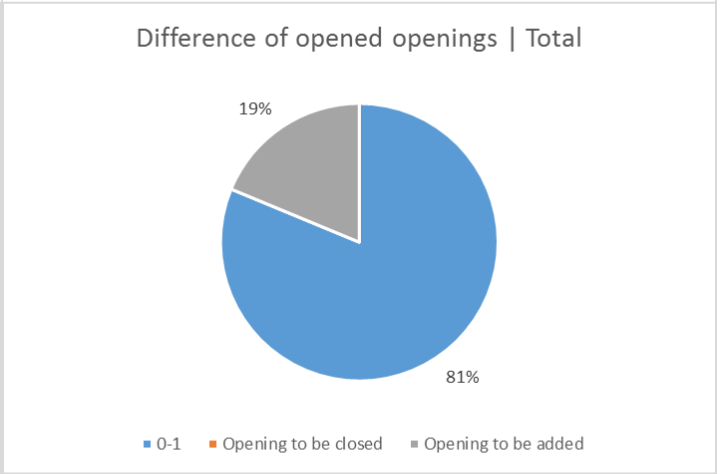
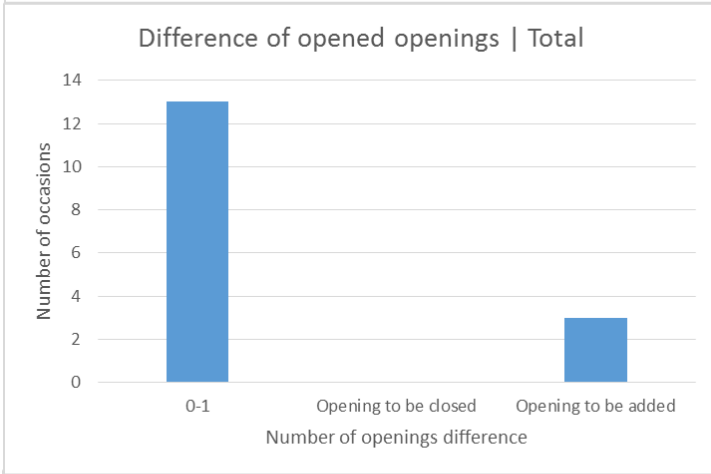
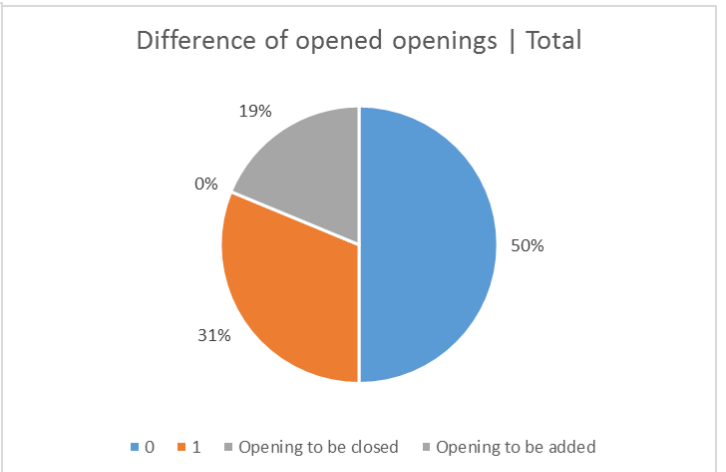
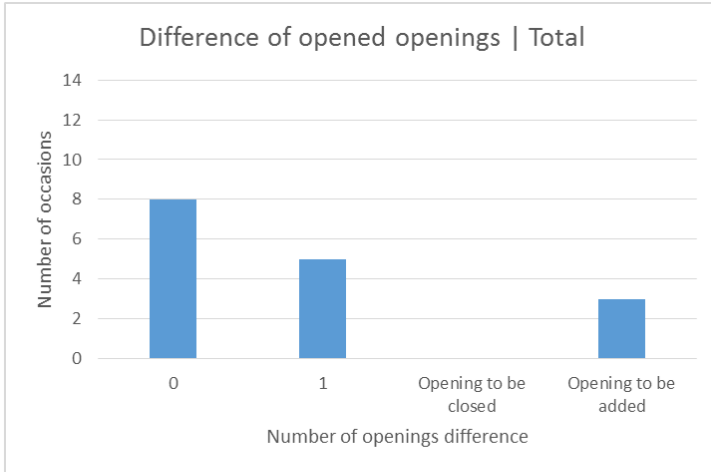

Ship number 1285:

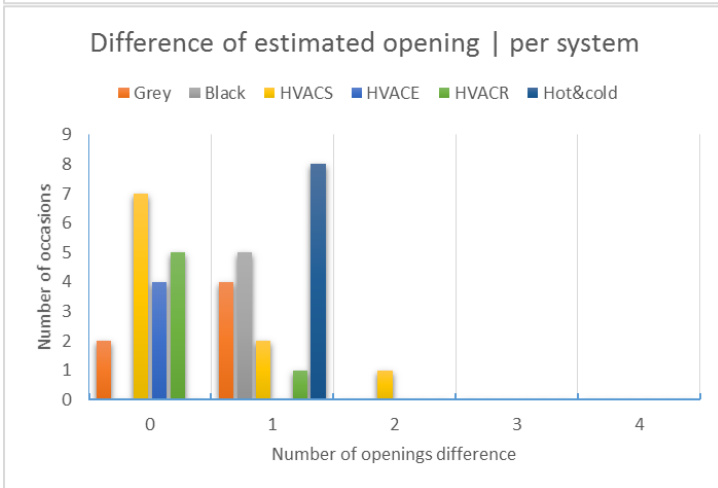
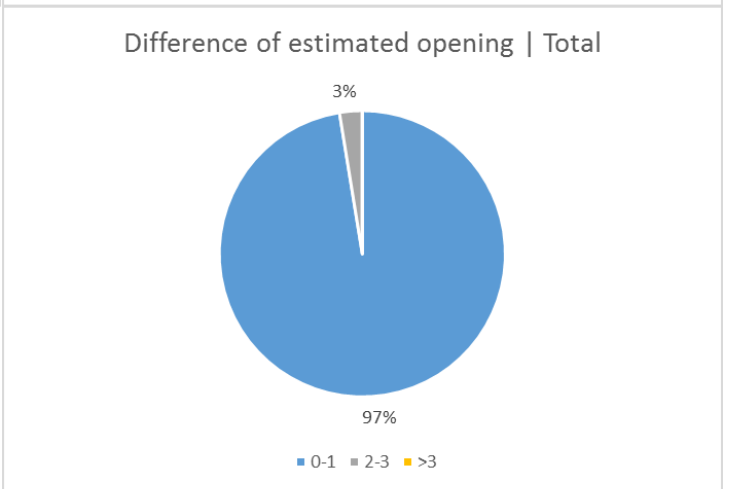
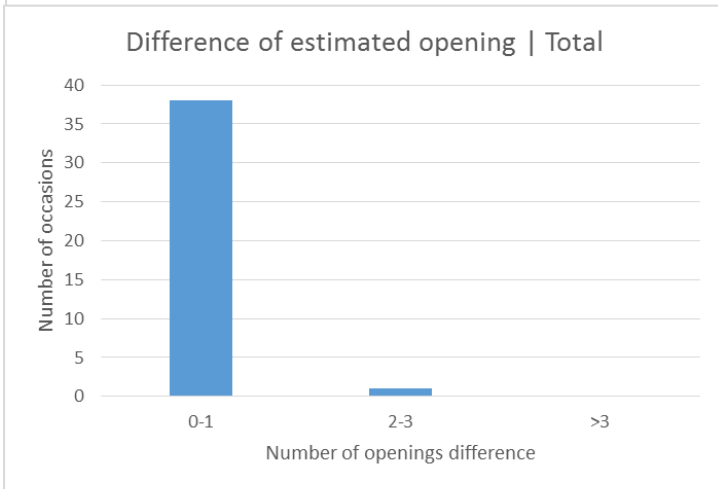
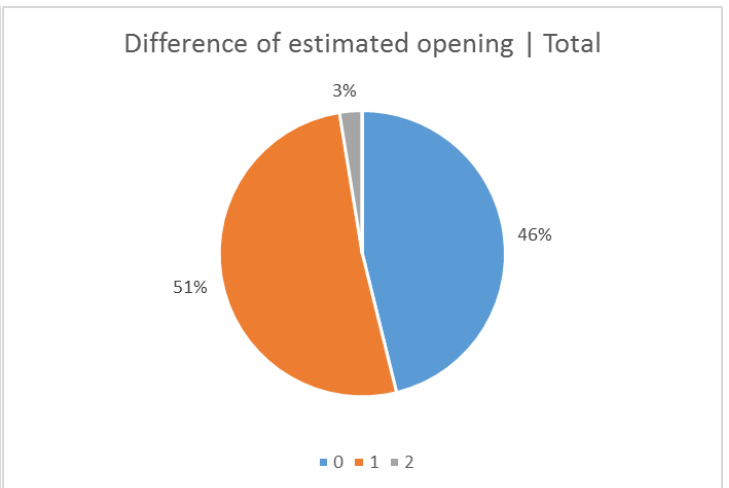
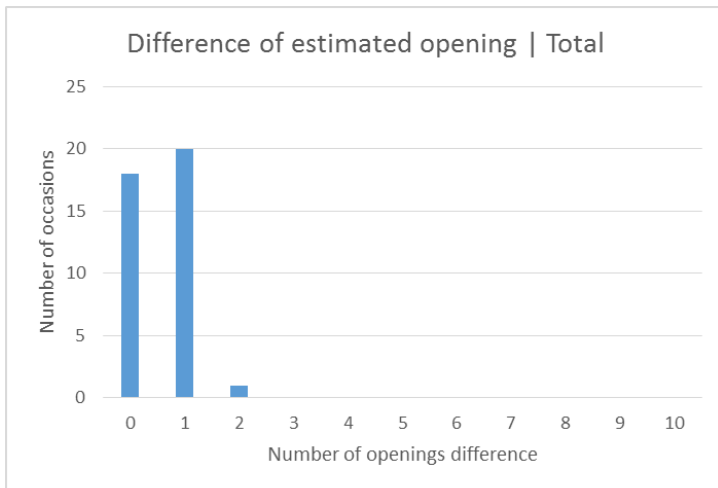

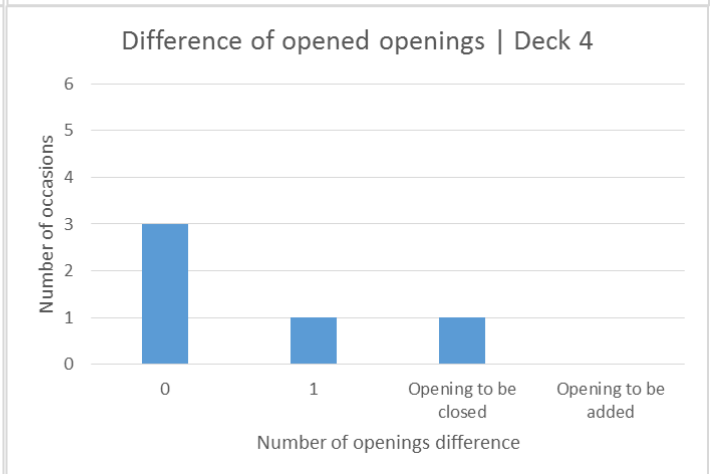
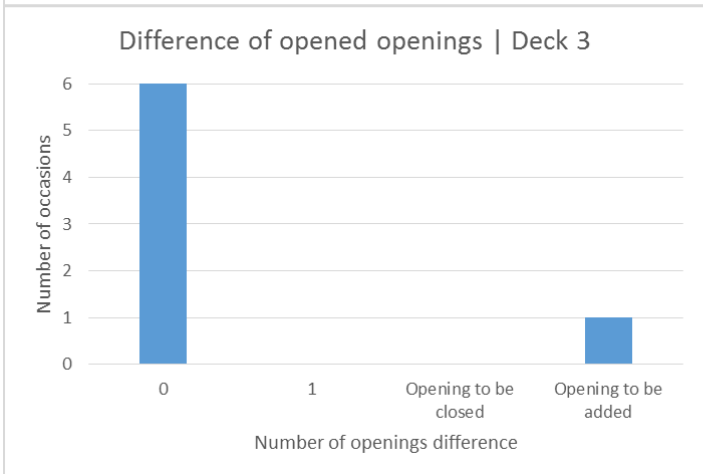
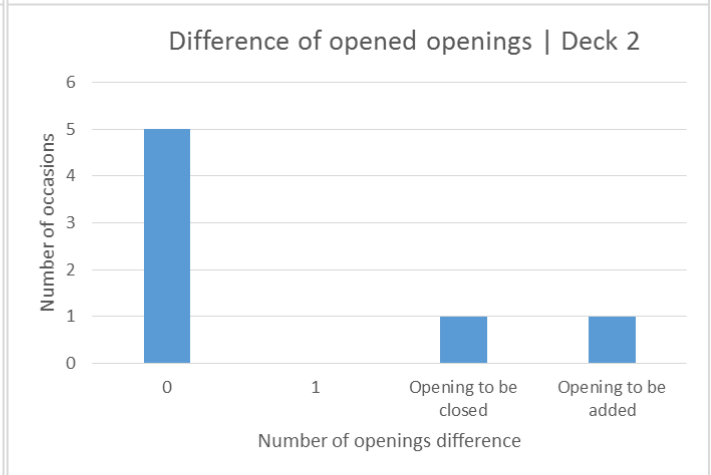
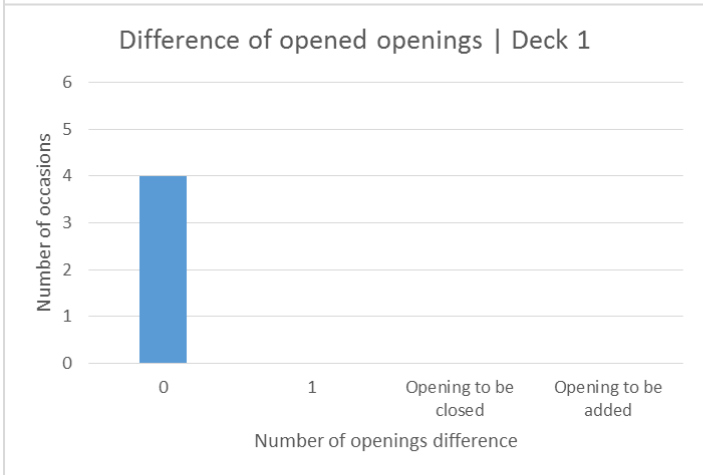
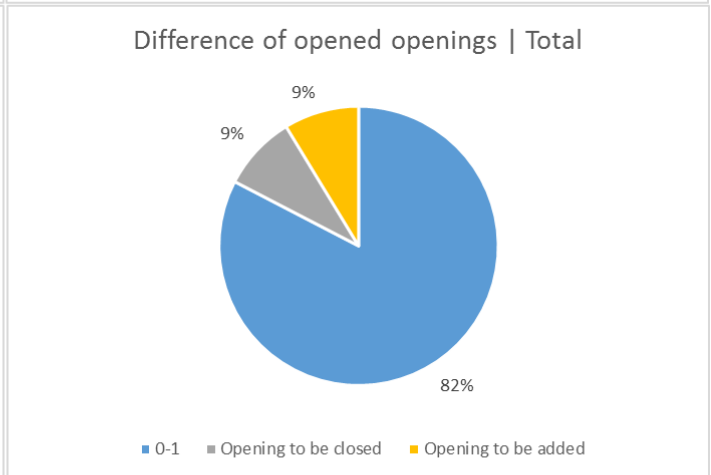
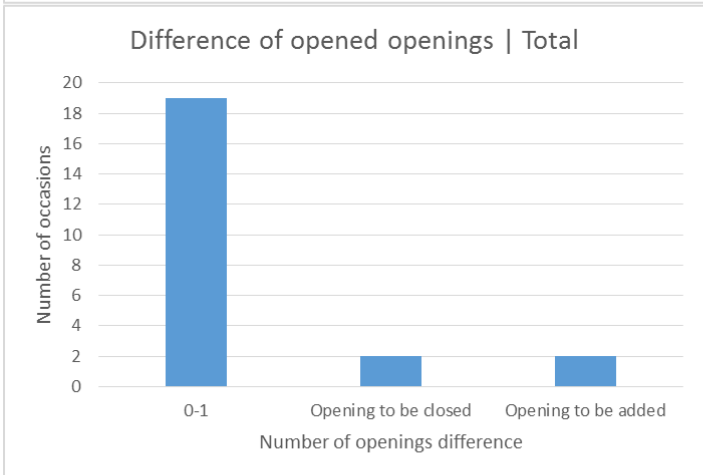
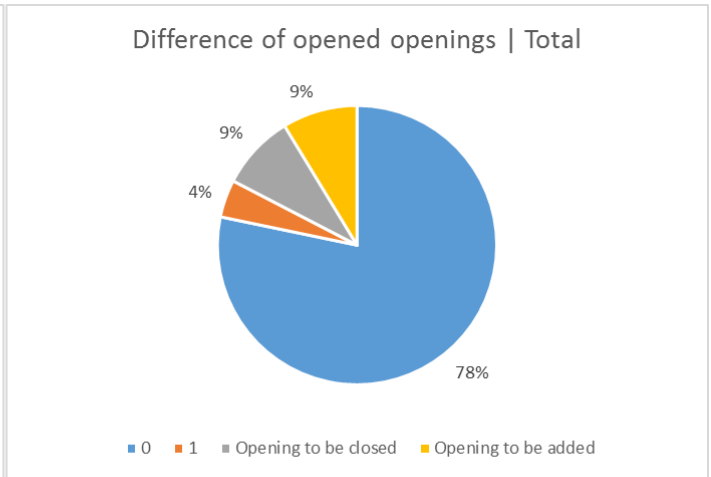
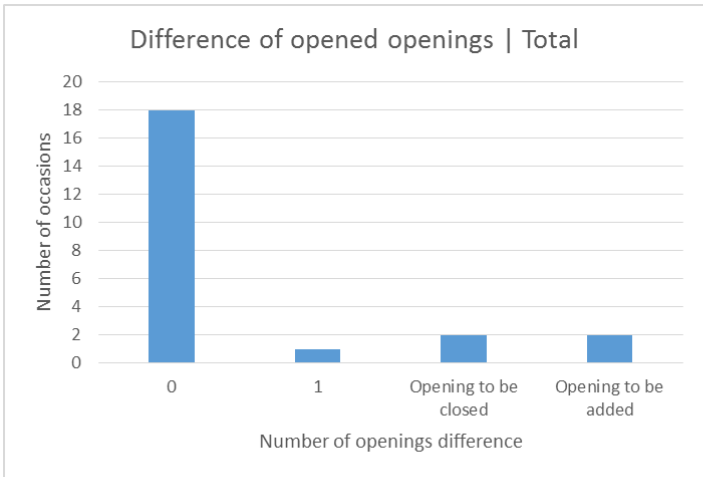

Ship number 1289:

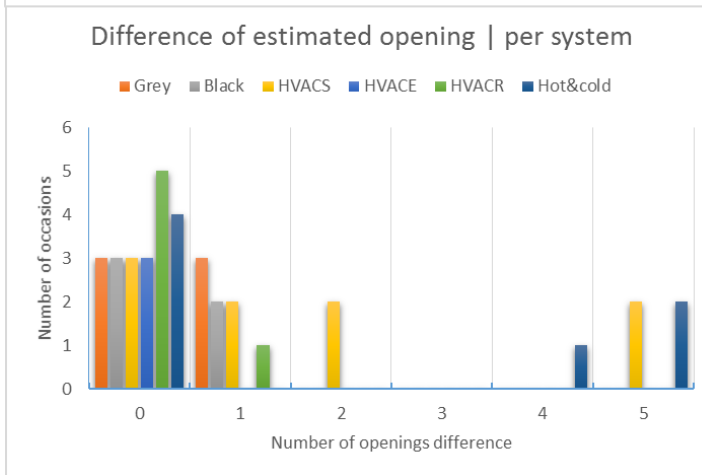
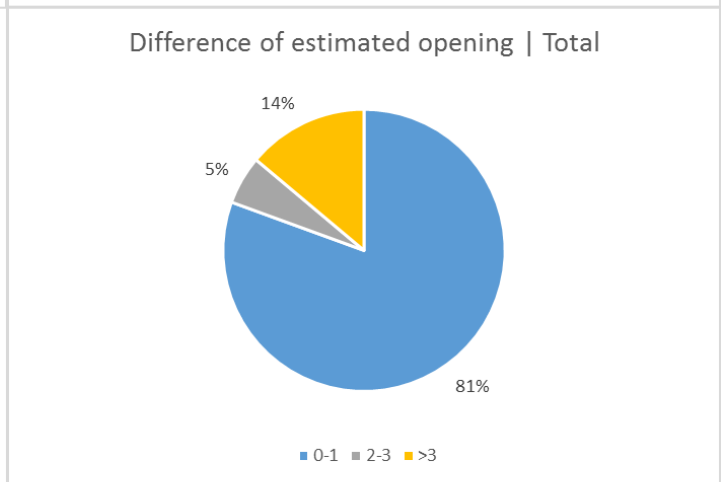
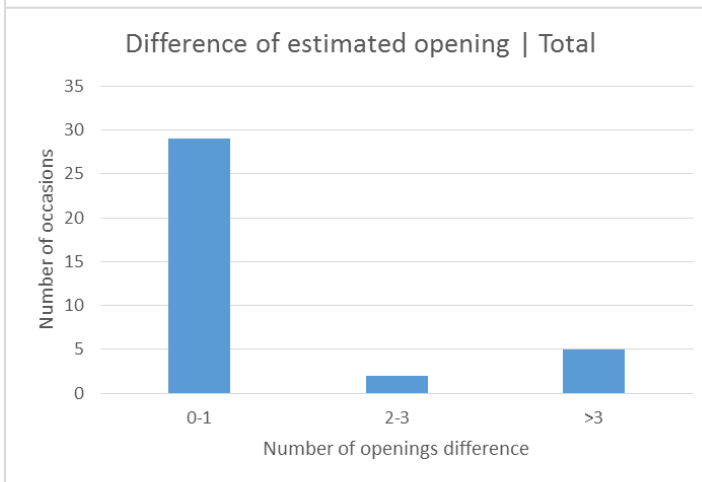
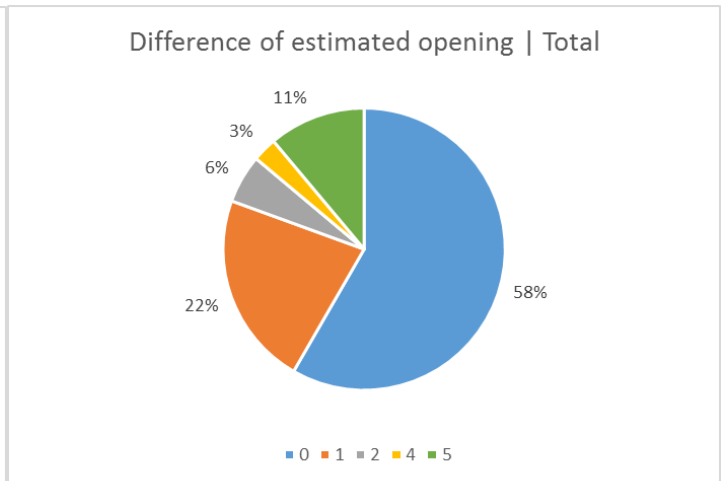
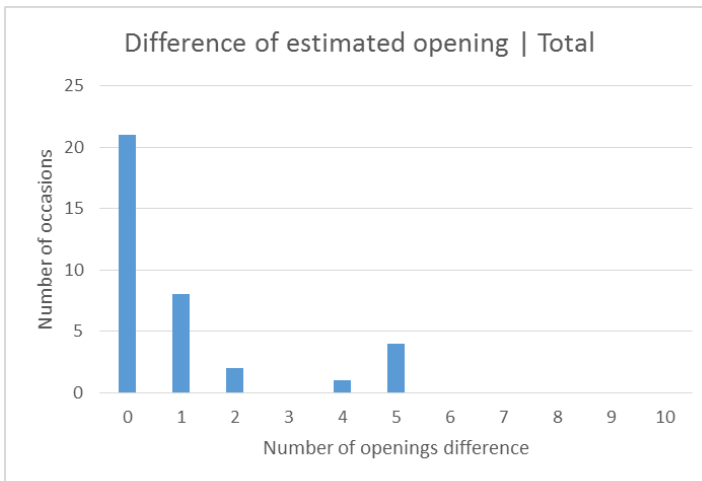

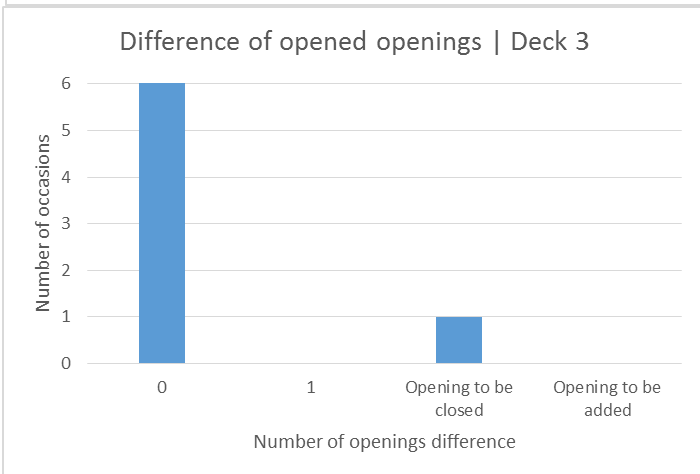
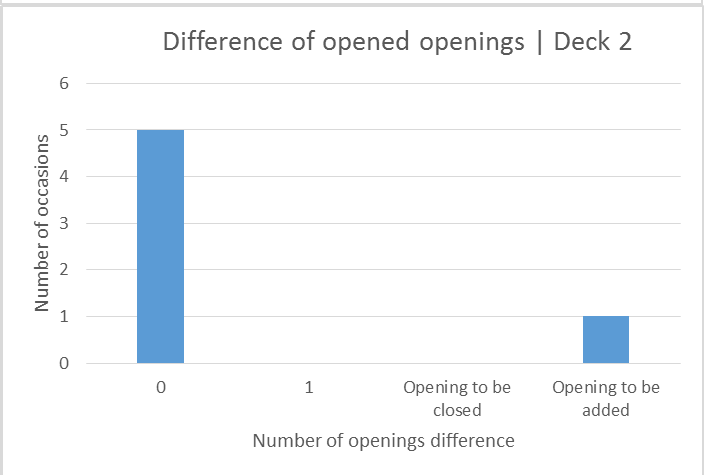
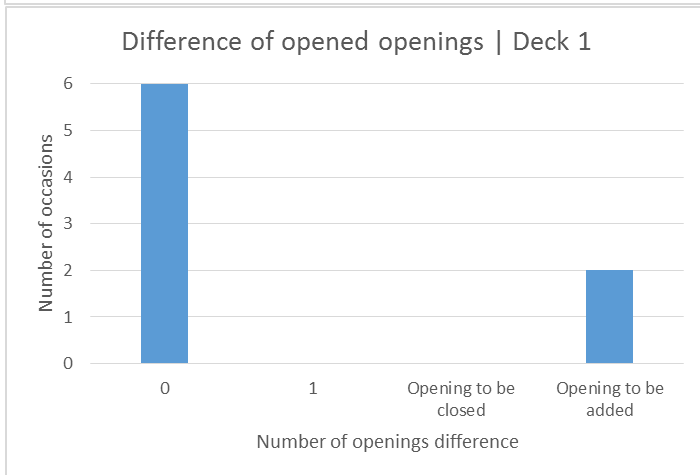
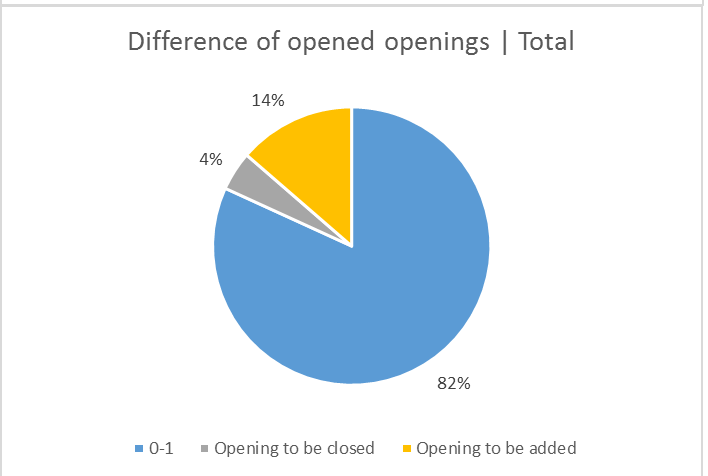
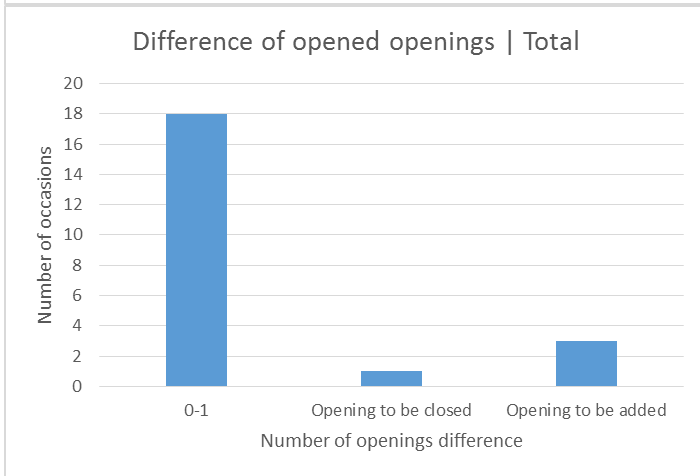
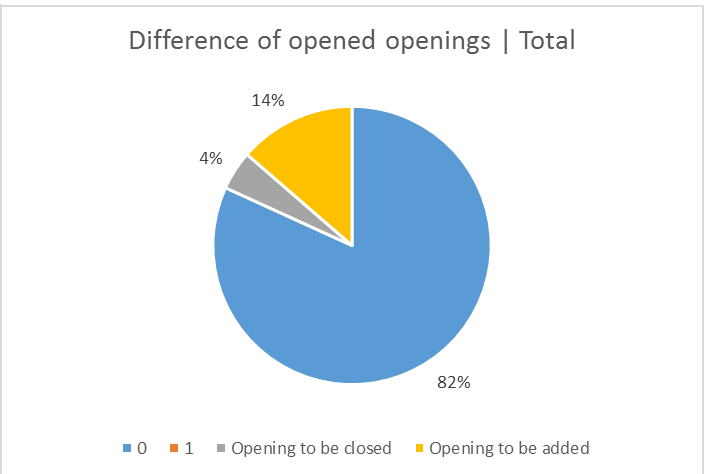
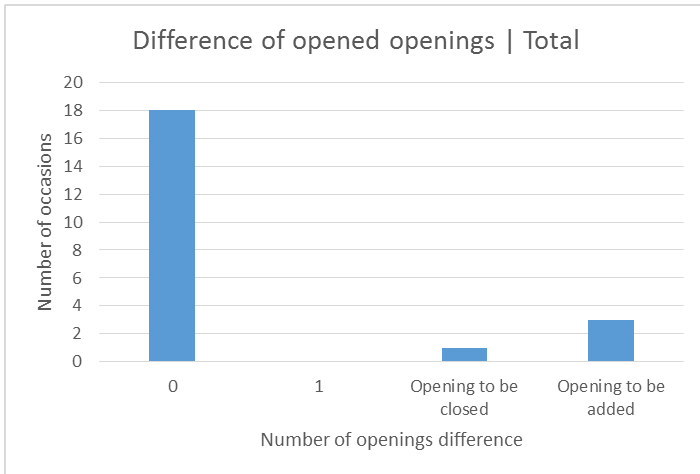

APPENDIX XI: INTERVIEWS

In this appendix, several interview questions and answers from people of multiple disciplines are administrated.

Frank van den Heuvel

Lead engineer detail mechanical

1. Is het punt waarop de mechanical engineering start te vervroegen? Of start dit nu al zo snel mogelijk?

Ik denk dat dit lastig te vervroegen is.

2. Welke openingen e.d. zijn wel al gedefinieerd in de V1 drawing? (manholes, trapgaten, zuigbuisopening)

Mangaten en trapgaten zijn op het construction plan in principe al gedefinieerd.

3. Welke openingen zijn over het algemeen wel altijd gedefinieerd in de V2 drawing en welke vaak niet? (mission equipment, mid section, tanks, accommodatie, waterdichte schotten niet?)

Voorheen waren gewoon alle gaten op V2 gedefinieerd. Nu zijn het vooral wijzigingen die een rol spelen.

4. Zijn er bepaalde systemen die vaak problemen opleveren?

Kleine doorvoeringen voor elektra worden vaak pas heel laat of in het werk zelf gedefinieerd.

5. Zijn er systemen waarbij een kleine omweg (extra lengte, bochten) bij voorbaat al niet mogelijk is? (lucht)

Sommige systemen zoals overflow pijpen moeten een bepaald afschot hebben. Brandstof leidingen wil je graag zo kort mogelijk houden.

6. Waardoor moet meestal de routing achteraf gewijzigd worden?
 - i. Coördinaten van equipment? *Ja*
 - ii. Toegevoegd equipment?
 - iii. Gebrek aan detaillering van piping in P&I diagram?
 - iv.
7. Wordt het routen onderverdeeld onder de pipe engineers per pijp systeem of per ruimte/ sectie in het schip?

Meestal per ruimte.

8. Zijn bij het inladen van het P&I diagram in Cadmatic de begin- en eind coördinaten in 3D bekend? Hoe bepaald je het start en eindpunt?

Nee niet precies. Op het diagram is te zien waar de leiding ongeveer uit moet komen. Er moet zelf nog bepaald worden waar hij bijvoorbeeld een tank in loopt. Als het equipment bekend is kan de aansluiting van de leiding daar wel bekend zijn.

9. Gebruikt Cadmatic op dit moment een algoritme om automatisch te routen?

Niet alle functies worden door IHC gebruikt, maar er zijn zeker wat handige automatische functies.

- a. Wat gebeurt hierbij automatisch?
 - i. Ontwijken obstakels? *Nee.*
 - ii. Kortste route? *Kan ingesteld worden.*
 - iii. Orthogonaal? *Ja.*
 - iv. Buigradii? *Ja.*
 - v. Buighoeken? *Kan ingesteld worden.*
 - vi. Overlengtes? *Ja.*
- b. Wat heeft Cadmatic hiervoor nodig?
 - i. Coördinaten van equipment? *Ja*
 - ii. Pipe spool numbers? *Ja*
 - iii. System numbers? *Ja*

10. Zijn er disciplines die prioriteit hebben boven andere disciplines? (Scheepsbouw, werktuigbouw, CPE, cabling)

De constructie moet altijd sterk genoeg zijn. Er wordt nauw samengewerkt via Cadmatic.

11. Hoe wordt de diameter van het gat bepaald? Vaste tolerantie? Zijn er penetraties die afgesloten worden terwijl dit niet nodig is? (waterdicht niet nodig)

Ja, er is een standaard gesteld voor de tolerantie. Penetraties worden in principe alleen gesloten als die nodige is voor een waterdicht of brandveilig schot.

12. Worden later gemaakte gaten meegenomen in een nieuwe sterkteberekening?

De gaten worden opgegeven via Cadmatic en vervolgens beoordeeld door scheepsbouw. Die koppelt terug naar de router of het goed is of gewijzigd dient te worden.

13. Wat is een G-penetration?

Een penetratie voor HVAC.

14. In de klasse wordt veel gezegd over gaten in primary members. Kunnen gaten in overige platen vrij gekozen worden? Waar kan je zien wat de primary members zijn?

In principe kunnen deze vrij gekozen worden, bij hele grote gaten is een controle wel gewenst.

15. Kun je een inschatting maken van de extra engineeringstijd wanneer een pijp per se door een 'via punt' heen gerout moet worden? (Dus van punt A naar punt B, en van punt B naar punt C)

Dit is sterk afhankelijk van de complexiteit van de ruimte.

16. Is er ergens iets te vinden over de 'vaste' locatie en leidingen van elk systeem of is dit vooral heel veel tekeningen bekijken? (en diameters+aantal aansluitingen?)

In de guide.

17. Zijn de gaten die je ziet in de e-browser alleen de toegevoegde gaten?

Nee dit zijn de meeste gaten die aangevraagd zijn door de router.

18. Is het soms mogelijk om penetraties te voorkomen d.m.v. om een verstijver heen routen?



In de afbeelding is het gedaan om het netjes achter de muur te houden en zodat er gelijk een fixatiepunt is.

19. Zijn het vaak de leidingen die het laatst gerout worden die veel penetraties nodig hebben? (door beperkingen)

Ja, maar ook leidingen die vroeg gerout zijn kunnen later weer aangepast worden.

20. Is de engine room te complex om naar gaten te kunnen routen?

Het is hier inderdaad heel lastig om een precies gat van tevoren te definiëren. Naar gaten toe routen zal het een complexe opdracht maken.

21. Hoe ziet de ruimte eruit als je begint met routen?

Het is een 3D model waar alle routers tegelijk in kunnen werken.

Herik Bosch

Lead engineer detail mechanical

1. Welke openingen zijn over het algemeen wel altijd gedefinieerd in de V2 drawing en welke vaak niet? (mission equipment, mid section, tanks, accommodatie, waterdichte schotten niet?)

De hoofd-zuigleiding is over het algemeen weg gedefinieerd. Op een gegeven moment kunnen de voornaamste systemen echt niet meer wijzigen en zullen de kleinere systemen aangepast moeten worden. Pompsystemen zijn moeilijk aan te passen omdat deze vaak onder een bepaalde waterlijn moeten liggen.

2. Zijn er bepaalde systemen die vaak problemen opleveren?

HVAC geeft regelmatig problemen. Het zijn veel leidingen en ze zijn vaak erg groot. Een voordeel is wel dat ze vaak enigszins flexibel zijn waardoor ze soms wat 'ingedrukt' kunnen worden of een aantal millimeter omgezet.

3. Waardoor moet meestal de routing achteraf gewijzigd worden?
 - i. Coördinaten van equipment?

Ja, dit gebeurt regelmatig. Als bijvoorbeeld een rechtsdraaiende pomp linksdraaiend blijkt te zijn kan het dat hij naar de andere kant van het schip geplaatst moet worden.

- ii. Toegevoegd equipment?

Ja, soms is het hele model nog niet bekend en worden de leidingen er ongeveer heen gerout. De exacte positie van aansluitingen is dan nog niet bekend.

- iii. Gebrek aan detaillering van piping in P&I diagram?

Er wordt geprobeerd om de diagrammen en arrangementen al zo gedetailleerd mogelijk te maken. Echter komt het alsnog voor dat er bijvoorbeeld een extra systeem op een leidingen wordt aangesloten, waardoor de capaciteit en vervolgens de diameter omhoog moet.

4. In de klasse wordt veel gezegd over gaten in primary members. Kunnen gaten in overige platen vrij gekozen worden? Waar kan je zien wat de primary members zijn?

De meeste constructiedelen zijn primary members. Extra brackets zijn bijvoorbeeld secondary members, maar die worden toegevoegd omdat de sterkte dit vereist. Het is dan dus niet handig om er gaten in te maken. Wanden en dekken in accommodatie zijn vaak primary members. Ze moeten daarnaast vaak waterdicht en/of brandwerend zijn. Gaten die geprikt worden, worden bekeken door iemand van constructie, zeker als het grote gaten betreft.

5. Is er ergens iets te vinden over de 'vaste' locatie en leidingen van elk systeem of is dit vooral heel veel tekeningen bekijken? (en diameters+aantal aansluitingen?)

Dit is meestal gebaseerd op ervaring. Diameters komen van basic engineering/ diagram engineering.

6. Is de engine room te complex om naar gaten te kunnen routen?

De engine room is erg complex. Er lopen vooral veel leidingen tussen de systemen in de engine room onderling. Het arrangement van de engine room is tamelijk verschillend per project. Daardoor zal het lastig zijn om standards locaties voor gaten te bepalen. Wel kan dit mogelijk zijn in het tweendeck van de engine room, omdat deze penetraties meestal niet waterdicht hoeven te zijn. Daardoor kunnen er extra grote gaten gemaakt worden waar de leidingen in ieder geval doorheen passen.

7. Welke deel van het routen wordt nu nadat de fundatie bekend is nog gedaan? Alleen in de room waar het equipment staat, of ook in rooms waar de leiding alleen doorheen loopt?

Meestal alleen het laatste deel. In het arrangement worden de leidingen vaak al enigszins naar het 'virtuele' equipment toe gebracht. Voor bijvoorbeeld electrakasten waarvan de specificaties nog helemaal niet bekend zijn wordt vaak een blokje ingetekend, zodat er in ieder geval niet vergeten wordt dat er zaken als kabelgoten naar gerout moeten worden.

8. In hoeverre is de locatie van het equipment wel bekend? Scheelt het meters of centimeters?

De locatie wordt bij de arrangement al wel gekozen, hoewel dit nog wel kan wijzigen. (bijvoorbeeld als een machine niet vervangen kan worden, omdat hij niet bij het luik gebracht kan worden) Meestal scheelt de uiteindelijke locatie niet zo veel, het gaat vooral om de aansluiting t.o.v. de machine.

9. Is 'sanitair' in de E-browser hetzelfde als black water?

Ja.

10. Wordt er altijd 1 doorvoering naar een badkamer gemaakt met vervolgens aftakkingen naar toilet, douche, wastafel of worden er meerdere doorvoeringen gemaakt?

In de hoek van een sanitair unit komen vaak de leidingen omhoog. Vanaf hier kunnen ze dan door de panelen gerout worden.

11. Hoe zit het met de vloeren en plafonds in een dekhuis. Worden doorvoeringen hierin sowieso altijd pas in het werk bepaald?

Ik denk het wel. Dit kan je beter aan iemand van interieurbouw vragen.

12. Hoe wordt het aantal cable trays bepaald?

Door mensen van D&A

Rein Ooms

Diagram engineer

1. Wat is de input voor de diagrams engineer? (welke documenten)

Bestek, class, equipment van leverancier, ihc standaarden, algemeen plan, tank plan

2. Op welke momenten is er contact / overleg met de casco engineering?

Nauwelijks

3. Op welke momenten is er contact / overleg met de detail engineering?

Als er bepaalde zaken bedacht worden, die niet vergeten moeten worden in de detail engineering. (er wordt aangegeven als er dingen opvallend zijn)

Als een pijp bijvoorbeeld door een tank loopt zal de afwerking en dikte aangepast moeten worden.

4. Worden wijzigingen van detail engineering ook doorgevoerd in de diagrams?

In principe is dit wel de bedoeling. Echter komt er vaak bij productie pas naar boven en die koppelen het terug naar diagrams.

5. In hoeverre is de locatie per systeem bekend tijdens diagram engineering?

Ruimte is bekend. Precieze plek niet.

6. In hoeverre is de diameter per systeem bekend tijdens diagram engineering?

Deze wordt door de diagrams engineer bedacht en zou in de regel aan het einde van diagrams engineering vast moeten staan.

7. Wordt in het diagram al bepaald waar leidingen ongeveer lopen? (boven, onder)

Voor bepaalde dingen wordt zeker meegedacht (pre-routen). Sommige pijpen mogen bijv. niet door bepaalde schotten heen en zaken als fire-fighting moeten op een bepaalde plaats zitten. Dit wordt voor de router als zeer prettig ervaren.

8. Waarom worden sommige diagrammen visueel in het schip geplaatst en anderen niet?

Heel afhankelijk van het systeem en of het iets toevoegt. Een systeem dat bijvoorbeeld alleen in de machine kamer loopt hoeft niet op een lay-out getekend te worden.

9. Zijn er gevolgen voor de diagrams engineering wanneer de piping naar de gaten toe gerout moet worden?

In principe niet

10. Van wie krijgt de diagrams engineer verder nog terugkoppeling?

Class en owner

11. Wordt er per systeem of per room getekend?

Per systeem

12. Welke systemen hebben prioriteit

Grote systemen. Grote diameters en over gehele schip verdeeld. Er is geen standaard volgorde.

Mario van den Berg

Production engineer piping

1. Wat is de input voor CPE? (Cadmatic bestand?)

De pipe module van Cadmatic, hiermee kunnen pijpschetsen gegenereerd worden.

2. Op welk moment wordt er materiaal besteld? Is dit anders voor materiaal met lange levertijd?

Nadat het in Vietnam geweest is, dan zijn de orderbehoefte gereed.

3. Hoe/ waarmee wordt de productieplanning bepaald? (diameter, of komt er planning van routing)

Met Extended, op basis van diameters, materialen en lengtes.

4. Op welk moment worden de leidingen ingedeeld in pipe spools?

In principe gebeurt dit al bij de routing, wijzigingen worden doorgevoerd aan de hand van 3R, maar dit zou niet nodig moeten zijn.

5. Op welk moment (in het flow schema) kan er niks meer gewijzigd worden aan de piping?

Vrijwel aan het einde. Wijzigingen in routing moeten echter soms wel weer opnieuw naar Vietnam.

6. Op welke momenten is er communicatie met de pipe router?

Vrijwel over het hele proces, vanaf bestek en diagrams.

- a. Wat wordt er dan gecontroleerd/ verbeterd? Komen grote wijzigingen voor?

Speciale onderdelen die opvallen, eisen die voor productie van belang zijn (zouden bekend moeten zijn bij routers)

- b. In welke software gebeurt dit?

Cadmatic

- c. Zou er meer communicatie moeten zijn?

Is lastig met buitenland, er zit altijd een supervisor tussen wat het minder direct maakt.

7. Op welke momenten is er communicatie met productie?

Veel communicatie (is het gebouw ernaast)

- a. Worden alle pipe spool tekeningen as built gemaakt?

Nee, dit is niet nodig, er veranderd over het algemeen niks.

- b. Wordt dit teruggekoppeld naar de router/ diagram engineer?

Er is weinig afwijking maar als het gebeurt wordt niet dit teruggekoppeld.

8. Waar eindigt de taak van CPE? Is er nog veel support tijdens productie?

Ook bij de montage wordt er regelmatig meegekeken.

9. Wat zijn de gevolgen voor CPE als penetraties niet zijn mee gesneden? Merk CPE daar überhaupt iets van?

In principe veranderd dit niks aan de werkzaamheden van CPE.

10. Wat zijn de gevolgen van extra buigingen in een pipe spool?

Gaat ten koste van de kwaliteit.

a. Kritieke punten qua kosten/ tijd bij engineering

Engineering bij CPE wordt niet erg verlengt, tenzij er meer kritieke punten komen die nader bekeken moeten worden.

b. Kritieke punten qua kosten/ tijd bij fabricage

Nauwelijks extra kosten, nauwelijks extra tijd.

i. Wordt er veel handmatig gelast?

Er wordt weinig handmatig gelast, echter worden er nog wel veel overige handelingen handmatig verricht.

ii. Welke handelingen gebeuren met een robot?

Het lassen van de flenzen aan de pijpstukken en vervolgens het buigen.

iii. Als een pipe spool toch al gebogen moet worden, is een extra buigpunt dan nog kostbaar?

Kost nauwelijks extra.

iv. Vanaf welke diameter wordt buigen erg lastig/ onmogelijk?

Vanaf 1" tot 8" kan met de robot. Kleiner kan ook prima zonder robot.

11. Wat is de pipe spool database precies en hoe wordt hij gebruikt?

Het is een database met alle spool nummers van een project. Aan deze spool nummer hangt vervolgens een aantal specificaties als diameter, wanddikte, materiaal en afwerking.

12. Vind je dat er bij de routing genoeg over productie nagedacht wordt? Moeten zij meer weten of moet dit d.m.v. communicatie met jullie gebeuren?

Routers zouden meer kennis moeten hebben m.b.t. "production engineering". Dit zou veel wijzigingen door CPE schelen.

13. Heb je het gevoel dat het routen naar penetraties toe duurder kan zijn dan het achteraf uitslijpen van gaten?

Ja, absoluut. Het routen wordt veel complexer als er meer kruispunten e.d. komen. Echter, voor iets als accommodatie zijn er zeker wel mogelijkheden.

Anton de Zeeuw

Manager CPE

1. Ziet u de handmatig gesneden gaten al een probleem?

Ja. Het probleem zijn vooral de wijzigingen en extra verstevigingen die gemaakt moeten worden. De vraag is of het verstandig is om gaten de prikken als ze nog niet 100% zeker zijn.

2. Hoe ziet u het routen naar gaten toen in plaats van het achteraf snijden? Kan de kostenbesparing in het maken van gaten opwegen tegen de extra pijpkosten?

Ik denk dat het zeker waard is om te onderzoeken of dit opweegt. Nu wordt door bepaalde vakgebieden weinig gedacht aan de gevolgen voor andere gebieden.

3. Zijn er locaties waar gaten vaak niet op tijd bekend zijn of locaties waar het meestal wel al gesneden is?

Dit is meestal in complexe en volle gebieden, maar als er te weinig tijd is voor de engineering zijn er overal in het schip problemen.

4. Heeft u een idee in welk soort ruimte of type schip de standaardisatie van de gaten het best mogelijk is of het meeste voordeel oplevert?

Vooral in de accommodatie lijkt het me goed mogelijk om te standaardiseren.

5. Hoeveel extra engineering tijd kost het als een gat met de hand gesneden moet worden? (werktekeningen)

Dit valt op zich wel mee. De tekeningen worden sowieso al gemaakt.

6. Wordt het schip opnieuw op sterkte berekend als er later gaten bijkomen? Wanneer wel/niet? Hoeveel kost dit?.

Dit zou wel moeten maar gebeurt niet altijd, voornamelijk door de extra tijd die het kost.

7. Worden alle wanden ook meegenomen in de sterkteberekening?

Dit ligt eraan of het sterkte wanden zijn.

8. In hoeverre kunnen er standaard openingen in liggers gemaakt worden? Is er nu een grote sterktemarge?

Daar zijn standaard richtlijnen voor. Voor grote gaten wordt het wel lastig. Dan wordt de verstijver wel erg groot.

9. Zijn er penetraties die afgesloten worden terwijl dit niet nodig is? (waterdicht niet nodig) Moeten ze dan wel versterkt worden?

Meestal heeft dit als reden dat het waterdicht of brandwerend moet zijn.

10. Waar kan ik zien wat precies de primary members zijn en wat secondary?

In het constructieplan.

11. Zijn de penetraties vooral nodig tussen ruimtes of binnen een ruimte in een verstijver/knie?

Tussen ruimtes.

12. Hoe ziet u het probleem? Moet de engineering geoptimaliseerd worden of moet er gewoon meer tijd genomen worden?

Als je binnen ene beperkte tijd iets voor elkaar wil krijgen, zal het inderdaad geoptimaliseerd worden.

Hans Smit

General manager CPE/Piping/Metalix

1. Welke stappen/ handelingen worden genomen bij het gaten snijden met de cnc machine?
 - *Er komt een machining file binnen.*
 - *De robot snijdt automatische de platen*
 - *Afwerking voor lasdelen niet nodig*
 - *Afwerking alleen nodig voor 'open' gaten als mangaten*
2. Welke (extra) stappen/ handelingen worden genomen bij het gaten snijden met de hand?
 - *Werk moet verdeeld/ uitgedeeld worden*
 - *De tekening moet uitgedraaid worden*
 - *De snijmachines inclusief gasflessen moeten klaargezet worden*
 - *Als de plaat al in het sectieblok zit, moet er een stelling gebouwd worden, of de persoon moet er in klimmen*
 - *Meten/ aftekenen*
 - *Afwerking voor lasdelen soms nodig (schuine kant)*
 - *Afwerking nodig voor 'open' gaten als mangaten*
 - *Geen extra schilderwerk, tenzij het echt helemaal aan het eind van de bouw gebeurt*
3. Is er een verschil in efficiency en kosten tussen cnc-plasma en oxy-fuel?

Plasma is sneller dan oxy-fuel, maar kan door mindere grote diktes heen. Voor IHC is dit voldoende en dus de beste optie.

4. Is er genoeg capaciteit van de snijbrandmachines, of moet er soms gewacht worden op platen?

De plasmamachines zijn in principe constant bezig, maar het is niet de bottleneck van het proces en meer werk voor de plasmamachines zou geen problemen opleveren.

5. Hoe groot is het deel van de handmatig gesneden gaten voor penetraties in relatie tot alle penetratiegaten voor piping?

Dit verschilt tussen ongeveer 10-60%. De 8283 was een project waar veel routing te laat was en waar dus erg veel achteraf handmatig uitgesneden moest worden.

6. Wat zijn de extra veiligheidsrisico's bij het handmatig uitsnijden?

Er zijn veiligheidsregels omtrent beschermende kleding/attributen er mag niet op een bepaalde hoogte met een trap worden gewerkt. Hiervoor moet er dus een stelling gebouwd worden wat weer extra tijd kost. Wanneer het schip al op de helling ligt komen er meer risico's en regels bij kijken. Zo moeten er bijvoorbeeld gasmetingen gedaan worden als er in een afgesloten ruimte gewerkt wordt en de kant op ongelukken in kleine ruimtes is groter.

7. Moet een plasmamachine tijdens het snijden bediend worden door een persoon, of kan hij/zij in de tussentijd andere handelingen verrichten?

1 persoon kan tegelijkertijd 4 machines bedienen.

8. Hoeveel extra tijd kost het in engineering als een gat met de hand gesneden moet worden? (werktekening ipv machining file)

Geen verschil. De tekening is er toch al. Deze moet alleen geprint worden.

9. Is er een wezenlijk verschil tussen het gebruik van consumables (lastorches e.d.) tussen de robot en handmatig?

Dit is verwaarloosbaar. Consumables van plasmamachines zijn wat duurder per tijdseenheid, maar ze snijden ook sneller.

10. Worden er bij handmatig snijden meer fouten gemaakt (locatie en grootte) dan bij automatisch snijden of is dit verwaarloosbaar?

Ja, er worden meer fouten gemaakt, omdat alles handmatig gemeten en afgetekend moet worden. Vervolgens is er in detail altijd afwijking omdat er bijvoorbeeld op de lijn of naast de lijn gesneden kan worden.

11. Zijn er locaties waar gaten vaak niet op tijd bekend zijn of locaties waar het meestal wel al gesneden is?

Een specifieke ruimte is niet te noemen. Als er te laat begonnen wordt met routen heeft dit impact op alle locaties, wat overigens niet nodig lijkt. De ruimte tussen de start- en eind ruimte van een leiding zouden al veel eerder gedefinieerd moeten/kunnen worden.

12. Heeft u een idee in welk soort ruimte of type schip de standaardisatie van de gaten het best mogelijk is of het meeste voordeel oplevert?

Ver gestandaardiseerde en uitgeengineerde schepen zoals beavers hebben minder last van het probleem. Het is goed om naar custom built schepen te kijken.

13. Kunnen vooraf gesneden gaten ook nadelen hebben? (dat bijvoorbeeld bijna gelijke platen of de verkeerde plek geplaatst worden)

Het kan zijn dat gaten later weer dichtgemaakt moeten worden, als ze bijvoorbeeld in een waterdicht schot zitten.

14. Hoe ziet u het routen naar gaten toen in plaats van het achteraf snijden? Kan de kostenbesparing in het maken van gaten opwegen tegen de extra pijpkosten?

Het is beter om te kijken naar hoeveel tijd er extra nodig is in de engineering om de routing helemaal goed te krijgen voordat de gaten gesneden worden. Een pijp met extra bochten kan onnodig veel complexiteit en kosten met zich meebrengen, omdat er bijvoorbeeld extra delingen en flenzen bijkomen. Daarentegen kunnen te veel (mogelijk onnodige) gaten in delen die toch niet waterdicht hoeven te zijn geen kwaad.

15. Overige info:

Tijdsduur Metalix

- *Werkvoorbereiding: 2-3 weken*
- *Materiaal inkopen: 1-2 weken*
- *Totaal: 5 weken*

Gemiddelde kosten per gat

- *Met CNC plasmasnijder € 10 (minder dan een minuut werk)*
- *In de sectiebouw: € 150*
- *Op de helling: € 500-1000*

Tom Roos

Supervisor planning & control

1. Heeft u bij de afgelopen bouwnummers veel vertraging in de planning gezien door het achteraf uitsnijden van gaten?

Ja, dit gebeurt altijd. Het komt niet alleen door het snijden maar door het gehele repair werk. Zo worden ook vaak constructies e.d. gewijzigd.

2. Waar kan ik de kosten/ tijdsduren vinden van achteraf gesneden gaten?

Is opgestuurd.

3. Welke handelingen zijn hierin inbegrepen? (meten/ afwerken/ schilderen)

Alle handelingen die er extra bijkomen door het extra/ gewijzigde gat. Dit bevat ook stellingen bouwen, meter, aftekenen, snijden, spullen neerzetten etc.

4. Hoe vaak komt het voor dat gaten achteraf gesneden moeten worden? Is hier een trend in te vinden?

Dit verschilt heel erg per project. Hoe complexer het schip en hoe meer custom built, hoe meer tijd de engineering nodig heeft (die er niet is).

5. Op welke plekken zijn penetraties vooral te laat bekend? In verstijvers of door schotten?

Gebeurt zowel in schotten als verstijvers. Spaargaten worden vaak niet toegepast in verstijvers. De reden hiervan is niet bekend. In waterdichte schotten is de kans op een handmatig te snijden gat groter, omdat de exacte locatie hier van belang is.

6. Hoe groot is het deel qua vertraging en extra kosten door later gesneden gaten t.o.v. andere repair kosten?

Het is een belangrijk onderdeel van de totale repair kosten. Niet per se het grootste aandeel.

7. Hoe ziet u het probleem? Moet de engineering geoptimaliseerd worden of moet er gewoon meer tijd genomen worden?

Dat is inderdaad de keuze die gemaakt moet worden. Een langere doorlooptijd lijkt geen optie. Hierom zal de engineering verbeterd moeten worden, of de langere engineering tijd moet opwegen tegen de verminderde repaartijd.

Extra: Manuur kost 56 euro

Rosa Tain Rodriguez

HVAC engineer

1. Welk deel van de HVAC wordt extern bepaald en welk deel intern? (capaciteit bepalen, equipment bepalen, locatie bepalen, routen)

Alle berekeningen en schema's worden aangeleverd door de leverancier en vervolgens intern gecontroleerd. IHC gaat dan routen aan de hand van deze schema's. (Het is niet ideaal dat HVAC als enige discipline extern wordt gedaan)

2. Welke stappen neem je als je begint met routen van HVAC in accommodatie? Welke leidingen eerst? Zit er een vast systeem/ volgorde in?

Er is geen vaste volgorde. Alles komt tegelijk, of hetgeen waarvan de informatie als eerste beschikbaar is komt eerst.

3. Moet er ook nog een afzuiging zijn als er een ventilatiepijp naar buiten mogelijk is?

Ventilatiepijpen naar buiten zijn voor overdruk.

4. Is de HVAC routing te standaardiseren, denk je?

Het is heel moeilijk, omdat nooit de situatie hetzelfde is. Daarom moet er altijd een soort vrijheid voor de engineer blijven.

5. Is de plek waar HVAC door wanden heen gaat te standaardiseren, denk je?

Routers willen altijd de optimale oplossing, en ik denk dat dit niet is te standaardiseren.

6. Mogen hete lucht en koude lucht leidingen niet tegen elkaar lopen?

Er wordt over het algemeen maar 1 leiding gebruikt voor zowel warme als koude lucht.

7. Hoe wordt bepaald waar de recirculation nodig is?

De cabin units (toevoer) gaat naar de ruimtes, dan is er een rooster (transfer) naar de corridor en vanuit hier is er een recirculation naar de AC unit. Recirculation is niet mogelijk op plaatsen waar lucht vervuild is, zoals toilet en kombuis.

8. Wie bepaald de grootte en locatie van de trunk/vent?

Degene die de accommodatie maakt.

9. Is de trunk/vent al helemaal gedefinieerd als je begint met routen van HVAC?

Ja

10. Klopt het dat de AC units nagenoeg altijd onder het navigation deck staan?

Ja

11. Zijn er meestal 2 AC units in de accommodatie? Heeft dit alleen met capaciteit te maken?

Ja, er zijn er meestal 2. Dit heeft niet met de capaciteit te maken maar met de regelgeving voor brandwerendheid. De galley moet altijd een aparte unit hebben, omdat hier de kans op brand over het algemeen groter is.

12. Komen central heating lines (radiators) nog vaak voor in plaats van heating via HVAC?

Het komt wel voor, het ligt aan de klant.

13. Hoe flexibel zijn de HVAC leidingen?

Niet flexibel bij de trunk. Alleen de allerlaatste stukken tot apparatuur wordt vaak flexibel gehouden.

14. Hoe weet je hoeveel branches je aan een leiding kunt doen?

Dit heeft te maken met de pressure drop die berekend wordt. Wel is het mogelijk dat verschillende engineers met enigszins verschillende uitkomsten komen.

15. Hoe belangrijk is het dat de leidingen kort blijven? Hoeveel verlies?

Altijd zo kort mogelijk. Echter, de water (afvoer) leidingen zijn meer beperkt en kunnen in geval van nood dus prioriteit hebben.

16. Hoe wordt de exacte locatie van de cabin units bepaald?

Deze wil je altijd zo centraal mogelijk in een ruimte of boven een bepaald apparaat, maar er moet altijd bekeken worden wat mogelijk is in combinatie met andere systemen en constructies.

17. Zijn de diameters van HVAC leidingen vaak hetzelfde? Of binnen een bepaalde range?

Je wilt altijd zo klein mogelijke leidingen. Bij de leverancier (Luka) zijn bepaalde standaardmaten aangegeven.

18. Wanneer zijn HVAC leidingen geïsoleerd? Alleen voor geluid?

In de eerste plaats voor thermische isolatie. Maar ook vaak voor geluid.

19. Wanneer gebruik je een ronde of rechthoekige leiding?

Een ronde leiding is goedkoper en beter voor de flow. Als er te weinig ruimte is wordt een rechthoekige leiding gekozen.

Opmerkingen:

- *De galley zit altijd onderin.*
- *Misschien kan de afmeting per verdieping bepaald worden door de totale inhoud van het dekhuis te delen door het aantal dekken.*

Geert van Gils

Technical manager life support systems

1. Hoe wordt een trunk ontworpen en hoe wordt de routing erdoorheen vervolgens gedaan?

De trunk wordt door construction engineers ontworpen. Vervolgens worden kabelladders, HVAC en sanitair leidingen er in samenspraak doorheen gerout.

2. Welke systemen lopen er altijd door de trunk?

Er niet altijd een trunk en hij zit niet altijd in het midden. Als de trunk er is worden zoveel mogelijk leidingen erdoorheen gerout. Dit is in ieder geval kabelladders, HVAC en sanitair

3. Hoe wordt de indeling van ruimtes in de accommodatie bepaald?

Door design in samenspraak met de klant.

4. Hoe worden doorvoeringen in vloeren en wanden gemaakt (niet staal)?

Dit zijn beton vloeren die pas gestort worden als alle leidingen erdoorheen gerout zijn. Voor natte ruimtes worden epoxyvloeren gebruikt, voor andere vloeren vinyl. Wand naar buiten worden er vervolgens opgezet. Wand naar buiten zijn 20mm dik, tussenwanden 50mm. Als een wand brandwerend of geluiddempend moet zijn worden een spouwmuur gezet.

5. Wordt er altijd 1 doorvoering naar een badkamer gemaakt met vervolgens aftakkingen naar toilet, douche, wastafel of worden er meerdere doorvoeringen gemaakt?

Ja, er wordt per soort leiding 1 doorvoering gemaakt. Als het uit het plafond komt hoeft er helemaal geen doorvoering gemaakt worden. De aftakkingen worden vervolgens in de vrije ruimte in de hoek van de wet-unit gemaakt. Wanneer bijvoorbeeld een wastafel niet in een wet-unit staat zitten de leidingen wel in het zicht.

6. Wordt er nagenoeg altijd dezelfde sanitair unit gebruikt? Wanneer wel/niet?

Ja, er is voor elke vraag een bepaald type, zoals: kleine wastafel, grote wastafel e.d..

7. Voor welke systemen is de kortste route meer van belang? (water of HVAC?)

Dit zou je aan Rein Ooms moeten vragen. Volgens mij doet elke router het anders. "5 verschillende routers maken 5 verschillende routes".

8. Zijn de aansluitingen (aantal en diameter) voor badkamer units altijd gelijk?

Ja, er is alleen verschil qua doorvoeringen als het een waterdicht/ brandwerend schot betreft.

9. Wanneer is bekend waar overige water (keukenblok e.d.) aansluitingen moeten komen?

In ieder geval voor de V2 tekening.

10. Loopt zwart water altijd naar boven (plafond) en grijs en potable water naar beneden (vloer)?

Zwart water kan in principe naar boven en naar beneden, maar boven is geen doorvoering nodig. Potable water kan ook zowel naar boven als naar beneden. Mijn voorkeur heeft hier ook naar boven, omdat dit (soms dure brandwerende) doorvoering bespaard.

Opmerkingen:

Er wordt op dit moment gewerkt aan standaard units met modellen, zodat de exacte locatie van doorvoeringen in principe altijd bekend is. De vraag is dan nog waar de ringleiding moet komen te zitten en of elk dek zijn eigen ringleiding moet krijgen in plaats van een ringleiding met aftakkingen naar boven en beneden. Voordeel van een ringleiding per dek, is de reductie van het aantal doorvoeringen en het feit dat een dek bij lekkage individueel afgesloten kan worden.

Patrick van der Horst

Lead engineer detail hull

1. Hoe groot kunnen gaten zijn?

Gaten kunnen vrijwel net zo groot zijn als de ruimte die er is. Er moet natuurlijk wel wat afstand tot de lassen gehouden worden, maar gaten over de hele breedte zijn in principe gewoon mogelijk.

2. Is er naast een inlasplaat nog extra versteviging nodig?

In theorie kan de ingelaste plaat net zo sterk worden als de originele constructie.

3. Is de hoogte tussen dekken altijd gelijk? Hoe wordt deze bepaald?

Nee, deze wijkt wel eens af. Het is wel al vrij vroeg in het proces bekend.

4. Er wordt in de klasse veel gezegd over gaten in webs. Is dit gelijk voor gaten in grotere platen?

In de meeste platen kunnen in theorie overal platen geprikt worden. Als er twijfel is zal het overlegd en/of berekend moeten worden.

5. Is de afstand tussen verstijvers altijd gelijk?

Nee.

6. Waar kan ik zien wat sterkteschotten zijn?

In de accommodatie zijn dat vooral de buitenwanden. Soms worden binnenwanden meegerekend in de sterkteberekening.

Opmerkingen:

Richt je vooral op sectiebouw. Op de helling is het grootste voordeel weg, omdat het dan alsnog duur kan worden, omdat je er bijvoorbeeld lastig bij kan.

Een ander voordeel is dat het wijzigingsproces verdwijnt. Dit kan vaak veel tijd innemen omdat er veel stappen door verschillende afdelingen/ personen genomen moeten worden.

De hoeveelheid kabels wordt alleen maar meer in de toekomst, omdat er meer apparaten komen. Dit vraagt om meer gaten/ doorvoeringen.

Het probleem met wijzigingen binnen IHC wordt naar mijn idee eerder groter dan kleiner in de toekomst. Alles moet steeds sneller, en het uitbesteden aan het buitenland zal ook niet snel teruggedraaid worden.

Pieter van den Herik

Supervisor CPE

1. Is het mogelijk om een insert plaat na het transport (vanaf externe sectiebouwers) nog in te lassen?

Ja, zo lang het maar voor het conserveren is.

2. Kan de plaat ook nog ingelast worden op de slipway?

Kunststof wel, metaal liever niet door de warmte die erbij komt kijken.

3. Hoe dik zijn de platen van de trunk meestal?

Meestal 6 mm. Soms ook 8-10 mm.

4. Liggen de accommodatie secties langer naast de slipway dan andere secties?

Deze secties worden wel vaak het laatst geplaatst, ze liggen niet per se langer naast de slipway.

5. Welke afstand tot verstijvers/ dekken moet gehouden worden voor de openingen?

Ik zou zo'n 50 mm aanhouden. De hoeken zal ik een radius van 100 mm geven.

Opmerkingen:

- *Moeten de insertplaten wel van staal? Waarom niet kunststof?*
- *Denk aan de delingen die nodig zijn als een pijp niet gepre-outfit kunnen worden.*

Hans Beele

Directeur Beele Engineering BV

1. Wat zijn de belangrijkste voordelen van NOFIRNO®?

- *Het absorbeert bewegingen*
- *Het is zeewaterbestendig*
- *Brandwerend en waterbestendig*
- *Het verouderd nauwelijks, minimaal 20 jaar service life*
- *Geen corrosie*
- *KIWA geeft gratis opleidingen voor de implementatie van NOFIRNO®*

2. Waarom is NOFIRNO® beter dan andere oplossingen?

Over de MCT doorvoeringen voor kabels ontstaat momenteel twijfel over de brandwerendheid. Dit wordt nu nader onderzocht in Noorwegen. Daarnaast is er voor andere doorvoeringen isolatie nodig en voor NOFIRNO® niet. Het absorberen van bewegingen is ook een goede eigenschap in schepen.

3. Hoelang duurt het om een NOFIRNO® doorvoer te maken?

Tijdens een demonstratie is een buis van 60 mm is een doorvoer van 150 mm gemaakt. Dit duurde zo'n 5 minuten.

4. Is NOFIRNO® onderhoudsvriendelijk?

Ja, er is nauwelijks onderhoud nodig, naast het reguliere schoonmaak werk Het oppervlak is daarnaast glad en hydrofoob, waardoor het geen vuil aantrekt.

5. Zijn er referenties die NOFIRNO® reeds hebben toegepast?

- *Maersk oil and gas platforms*
- *IT rooms of a plywood factory in Chile*
- *Passengers terminal at Dubrovnik airport*
- *Songas power plant Tanzania*
- *Hydro company Croatia*
- *Aircraft carrier Royal Navy*

6. Is er een training nodig om met NOFIRNO® te werken?

In het begin is er een korte training nodig die gratis gegeven wordt bij Beele of op locatie.

7. Bied NOFIRNO® ook voordelen wanneer het een niet brandwerende plaat betreft?

Ja, het is dan alsnog een waterdichte doorvoer die bewegingen kan absorberen.

8. Wat kost NOFIRNO® in vergelijking met bijvoorbeeld SLIPSIL®?

De prijzen zijn opgestuurd

APPENDIX XII: MATLAB CODE

This appendix contains most of the used Matlab codes. First there is a starting code to set up the environment. Then there are different codes for the water system estimation, the HVAC system estimation (including Prim's algorithm and COM algorithm) and the filling algorithm.

Starting program

```
%Defining plot and read variables from excel
clear all

mapOriginal=im2bw(imread('1283.bmp')); % input map read from a bmp file. for new maps write
the file name here
figure(1)
imshow(mapOriginal);
set(gca,'YDir','normal');

resolutionX=114;
resolutionY=142;

filename='Mainprogramsheets_1283.xlsx';
sheet=1;
xlRange='I3:J14';
TRUNK=xlsread(filename,sheet,xlRange);
hold on
plot(TRUNK(:,1),TRUNK(:,2),'bo')

%clear variables

Cable{size(TRUNK,1)}=[];
Grey{size(TRUNK,1)}=[];
Black{size(TRUNK,1)}=[];
HVACS{size(TRUNK,1)}=[];
HVACE{size(TRUNK,1)}=[];
HVACR{size(TRUNK,1)}=[];
POT{size(TRUNK,1)}=[];

HPG=0;HPB=0;HPHS=0;HPHE=0;HPCR=0;HPPOT=0;
```

Hole selection water

```
WRange{1}='C21:D101';
WRange{2}='E21:F101';
WRange{3}='M21:N101';

POSW=xlsread(filename,sheet,WRange{W});

%% Shortest path from water points to holes in trunk

jj=0;
while jj<size(POSW,1)
    ii=0;
    while ii<size(TRUNK,1)
        source=[POSW(jj+1,2) POSW(jj+1,1)]; % source position in Y, X format
        goal=[TRUNK(ii+1,2) TRUNK(ii+1,1)]; % goal position in Y, X format

        conn=[0 1 0; % robot (marked as 2) can move up, left, right and down (all 1s), but not
              1 2 1; % diagonally (all 0). you can increase/decrease the size of the matrix
              0 1 0];

        display=false; % display processing of nodes

        %%%% parameters end here %%%%

        mapResized=imresize(mapOriginal,[resolutionY resolutionX]);
        map=mapResized; % grow boundary by a unit pixel

        for i=1:size(mapResized,1)
            for j=1:size(mapResized,2)
                if mapResized(i,j)==0
                    if i-1>=1, map(i-1,j)=0; end
                    if j-1>=1, map(i,j-1)=0; end
```



```

        if i+1<=size(map,1), map(i+1,j)=0; end
        if j+1<=size(map,2), map(i,j+1)=0; end
        if i-1>=1 && j-1>=1, map(i-1,j-1)=0; end
        if i-1>=1 && j+1<=size(map,2), map(i-1,j+1)=0; end
        if i+1<=size(map,1) && j-1>=1, map(i+1,j-1)=0; end
        if i+1<=size(map,1) && j+1<=size(map,2), map(i+1,j+1)=0; end
    end
end
end
source=double(int32((source.*[resolutionY resolutionX])./size(mapOriginal)));
goal=double(int32((goal.*[resolutionY resolutionX])./size(mapOriginal)));

if ~feasiblePoint(source,map), error('source lies on an obstacle or outside map'); end
if ~feasiblePoint(goal,map), error('goal lies on an obstacle or outside map'); end
if length(find(conn==2))~=1, error('no robot specified in connection matrix'); end

%structure of a node is taken as positionY, positionX, historic cost, heuristic cost,
total cost, parent index in closed list (-1 for source)
Q=[source 0 heuristic(source,goal) 0+heuristic(source,goal) -1]; % the processing
queue of A* algorithm, open list
closed=ones(size(map)); % the closed list taken as a hash map. 1=not visited,
0=visited
closedList=[]; % the closed list taken as a list
pathFound=false;
tic;
counter=0;
colormap(gray(256));
while size(Q,1)>0
    [A, I]=min(Q, [],1);
    n=Q(I(5),:); % smallest cost element to process
    Q=[Q(1:I(5)-1,:);Q(I(5)+1:end,:)]; % delete element under processing
    if n(1)==goal(1) && n(2)==goal(2) % goal test
        pathFound=true;break;
    end
    [rx,ry,rv]=find(conn==2); % robot position at the connection matrix
    [mx,my,mv]=find(conn==1); % array of possible moves
    for mxi=1:size(mx,1) %iterate through all moves
        newPos=[n(1)+mx(mxi)-rx n(2)+my(mxi)-ry]; % possible new node
        if checkPath(n(1:2),newPos,map) %if path from n to newPos is collision-free
            if closed(newPos(1),newPos(2))~=0 % not already in closed
                historicCost=n(3)+historic(n(1:2),newPos);
                heuristicCost=heuristic(newPos,goal);
                totalCost=historicCost+heuristicCost;
                add=true; % not already in queue with better cost
                if length(find((Q(:,1)==newPos(1)) .* (Q(:,2)==newPos(2))))>=1
                    I=find((Q(:,1)==newPos(1)) .* (Q(:,2)==newPos(2)));
                    if Q(I,5)<totalCost, add=false;
                    else Q=[Q(1:I-1,:);Q(I+1:end,:)];add=true;
                    end
                end
                if add
                    Q=[Q;newPos historicCost heuristicCost totalCost
size(closedList,1)+1]; % add new nodes in queue
                    end
                end
            end
        end
        closed(n(1),n(2))=0;closedList=[closedList;n]; % update closed lists
        if display
            image((map==0).*0 + ((closed==0).*(map==1)).*125 +
((closed==1).*(map==1)).*255);
            counter=counter+1;
            M(counter)=getframe;
        end
    end
    if ~pathFound
        error('no path found')
    end
    if display
        disp('click/press any key');
        waitforbuttonpress;
    end

    pathtohole=[n(1:2)]; %retrieve path from parent information
    prev=n(6);
    while prev>0
        pathtohole=[closedList(prev,1:2);pathtohole];
    end
end

```

```

        prev=closedList(prev,6);
    end
    pathtohole=[(patthohole(:,1)*size(mapOriginal,1))/resolutionY
(patthohole(:,2)*size(mapOriginal,2))/resolutionX];
    pathLength=0;
    for i=1:length(patthohole)-1,
pathLength=pathLength+historic(patthohole(i,:),patthohole(i+1,:)); end
    line(patthohole(:,2),patthohole(:,1));
    PTH(jj+1,ii+1)=pathLength;
    ii=ii+1;
    end
    jj=jj+1;
end

EXTVAL=max(PTH);
[M,I]=min(EXTVAL)
%M,I]=min(var(PTH))

figHandle=figure(1);
plot(POSW(:,1),POSW(:,2),'bo')
plot(TRUNK(:,1),TRUNK(:,2),'go')
plot(TRUNK(I,1),TRUNK(I,2),'ro')

```

Hole selection HVAC

```

HRange{1}='G21:H31';
HRange{2}='I21:J31';
HRange{3}='K21:L31';

Pos=xlsread(filename,sheet,HRange{H});
%% shortest distances between all points

jj=1;
while jj<size(Pos,1)
    ii=jj+1;
    while ii-1<size(Pos,1)
        source=[Pos(jj,2) Pos(jj,1)]; % source position in Y, X format
        goal=[Pos(ii,2) Pos(ii,1)]; % goal position in Y, X format

        conn=[0 1 0; % robot (marked as 2) can move up, left, right and down (all 1s), but not
diagonally (all 0). you can increase/decrease the size of the matrix
            1 2 1;
            0 1 0];

        display=false; % display processing of nodes

        %%%% parameters end here %%%%

        mapResized=imresize(mapOriginal,[resolutionY resolutionX]);
        map=mapResized; % grow boundary by a unit pixel

        for i=1:size(mapResized,1)
            for j=1:size(mapResized,2)
                if mapResized(i,j)==0
                    if i-1>=1, map(i-1,j)=0; end
                    if j-1>=1, map(i,j-1)=0; end
                    if i+1<=size(map,1), map(i+1,j)=0; end
                    if j+1<=size(map,2), map(i,j+1)=0; end
                    if i-1>=1 && j-1>=1, map(i-1,j-1)=0; end
                    if i-1>=1 && j+1<=size(map,2), map(i-1,j+1)=0; end
                    if i+1<=size(map,1) && j-1>=1, map(i+1,j-1)=0; end
                    if i+1<=size(map,1) && j+1<=size(map,2), map(i+1,j+1)=0; end
                end
            end
        end
        source=double(int32((source.*[resolutionY resolutionX])./size(mapOriginal)));
        goal=double(int32((goal.*[resolutionY resolutionX])./size(mapOriginal)));

        if ~feasiblePoint(source,map), error('source lies on an obstacle or outside map'); end
        if ~feasiblePoint(goal,map), error('goal lies on an obstacle or outside map'); end
        if length(find(conn==2))~=1, error('no robot specified in connection matrix'); end

        %structure of a node is taken as positionY, positionX, historic cost, heuristic cost,
total cost, parent index in closed list (-1 for source)
        Q=[source 0 heuristic(source,goal) 0+heuristic(source,goal) -1]; % the processing
queue of A* algorithm, open list

```

```

        closed=ones(size(map)); % the closed list taken as a hash map. 1=not visited,
0=visited
        closedList=[]; % the closed list taken as a list
        pathFound=false;
        tic;
        counter=0;
        colormap(gray(256));
        while size(Q,1)>0
            [A, I]=min(Q,[],1);
            n=Q(I(5),:); % smallest cost element to process
            Q=[Q(1:I(5)-1,:);Q(I(5)+1:end,:)]; % delete element under processing
            if n(1)==goal(1) && n(2)==goal(2) % goal test
                pathFound=true;break;
            end
            [rx,ry,rv]=find(conn==2); % robot position at the connection matrix
            [mx,my,mv]=find(conn==1); % array of possible moves
            for mxi=1:size(mx,1) %iterate through all moves
                newPos=[n(1)+mx(mxi)-rx n(2)+my(mxi)-ry]; % possible new node
                if checkPath(n(1:2),newPos,map) %if path from n to newPos is collision-free
                    if closed(newPos(1),newPos(2))~=0 % not already in closed
                        historicCost=n(3)+historic(n(1:2),newPos);
                        heuristicCost=heuristic(newPos,goal);
                        totalCost=historicCost+heuristicCost;
                        add=true; % not already in queue with better cost
                        if length(find((Q(:,1)==newPos(1)) .* (Q(:,2)==newPos(2))))>=1
                            I=find((Q(:,1)==newPos(1)) .* (Q(:,2)==newPos(2)));
                            if Q(I,5)<totalCost, add=false;
                            else Q=[Q(1:I-1,:);Q(I+1:end,:)];add=true;
                            end
                        end
                    end
                    if add
                        Q=[Q;newPos historicCost heuristicCost totalCost
size(closedList,1)+1]; % add new nodes in queue
                    end
                end
            end
            closed(n(1),n(2))=0;closedList=[closedList;n]; % update closed lists
            if display
                image((map==0).*0 + ((closed==0).*(map==1)).*125 +
((closed==1).*(map==1)).*255);
                counter=counter+1;
                M(counter)=getframe;
            end
        end
        if ~pathFound
            error('no path found')
        end
        if display
            disp('click/press any key');
            waitforbuttonpress;
        end

        path=[n(1:2)]; %retrieve path from parent information
        prev=n(6);
        while prev>0
            path=[closedList(prev,1:2);path];
            prev=closedList(prev,6);
        end
        path=[(path(:,1)*size(mapOriginal,1))/resolutionY
(path(:,2)*size(mapOriginal,2))/resolutionX];
        pathLength=0;
        for i=1:length(path)-1, pathLength=pathLength+historic(path(i,:),path(i+1,:)); end
        %fprintf('processing time=%d \nPath Length=%d \n\n', toc,pathLength);
        %line(path(:,2),path(:,1));
        PATH{jj,ii}=path;
        SP{jj,ii}=pathLength;
        ii=ii+1;
    end
    jj=jj+1;
end
%%
run PrimsShortestPath
run COM
run Pathtotrunkhvac

```

PrimsShortestPath

```
%making matrices
s=[];
t=[];
weights=[];
MSTTEMP=[];
i=1;
while i<size(Pos,1)
    j=i+1;
    while j<=size(Pos,1)
        s=[s,i];
        t=[t,j];
        weights=[weights,SP(i,j)];
        j=j+1;
    end
    MSTTEMP=[MSTTEMP,i];
    i=i+1;
end
MSTTEMP=[MSTTEMP,size(Pos,1)];

G = graph(s,t,weights);

[T,pred] = minspantree(G);

MST=transpose([MSTTEMP;pred]);
%% Calculating shortest path

jjj=1;
while jjj<size(Pos,1)
    iii=jjj+1;
    while iii-1<size(Pos,1)
        want = [jjj iii]; szA = size(MST,1); idx = false(szA,1);
        for ii = 1:szA
            idx(ii) = all(ismember(want,MST(ii,:)));
        end
        if find(idx)>0
            con(jjj,iii)=1;
        else con(jjj,iii)=0;
        end
        iii=iii+1;
    end
    jjj=jjj+1;
end
```

COM

```
clear SPNEW conNEW

SPnew=SP;
connew=con;

SPnew(end+1,:)=0;
SPnew=SPnew+transpose(SPnew);

connew(end+1,:)=0;
connew=connew+transpose(connew);

MST(any(MST==0,2),:)=[];

s = [transpose(MST(:,1))];
t = [transpose(MST(:,2))];
weights = ones(1,size(MST,1));
G = graph(s,t,weights);
%plot(G,'EdgeLabel',G.Edges.Weight)

%calculating distances from COM to points
i=1;
while i<size(Pos,1)
    j=i+1;
    while j<=size(Pos,1)
        ii=0;
        while ii<size(PATH{i,j},1)

            %to lower point
            PATH{i,j}(ii+1,3)=ii;
        end
    end
end
```

```

%to higher point
PATH{i,j}(ii+1,4)=SPnew(i,j)-ii;

%to other points
m=1;
n=5;
while m<=size(Pos,1)
    if m~=i
        if m~=j
            [P] = shortestpath(G,i,m);
            [K] = shortestpath(G,j,m);

            if size(P,2)<size(K,2)
                TOTAL=0;
                c=1;
                while c<size(P,2)
                    TOTAL=TOTAL+SPnew(P(c),P(c+1));
                    c=c+1;
                end
                PATH{i,j}(ii+1,n)=TOTAL+ii;
                n=n+1;
            else
                TOTAL=0;
                c=1;
                while c<size(K,2)
                    TOTAL=TOTAL+SPnew(K(c),K(c+1));
                    c=c+1;
                end
                PATH{i,j}(ii+1,n)=TOTAL+SPnew(i,j)-ii;
                n=n+1;
            end
        end
    end
    m=m+1;
end
ii=ii+1;

end
j=j+1;
end
i=i+1;
end

%Adding to 1 matrix
Alldis1=[];
i=1;
while i<size(Pos,1)
    j=i+1;
    while j<=size(Pos,1)
        Alldis1=[Alldis1;con(i,j)*PATH{i,j}];
        j=j+1;
    end
    i=i+1;
end

Alldis1(all(Alldis1==0,2),:)=[];

Alldis=Alldis1;
Alldis(:,1)=[];
Alldis(:,1)=[];

%Calculating COM
VarAlldis=var(Alldis,0,2);
[M,I]=min(VarAlldis);
COM1=Alldis1(I,:);

COM2=[Alldis1(I,1),Alldis1(I,2)];

Pathtotrunkhvac

%% Find shortest path from COM to all holes in trunk
clear PTH

iii=0;
while iii<size(TRUNK,1)
    source=[COM2(1,1) COM2(1,2)]; % source position in Y, X format

```

```

goal=[TRUNK(iii+1,2) TRUNK(iii+1,1)]; % goal position in Y, X format

conn=[0 1 0; % robot (marked as 2) can move up, left, right and down (all 1s), but not
diagonally (all 0). you can increase/decrease the size of the matrix
      1 2 1;
      0 1 0];

display=false; % display processing of nodes

%%%% parameters end here %%%%

mapResized=imresize(mapOriginal,[resolutionY resolutionX]);
map=mapResized; % grow boundary by a unit pixel

for i=1:size(mapResized,1)
    for j=1:size(mapResized,2)
        if mapResized(i,j)==0
            if i-1>=1, map(i-1,j)=0; end
            if j-1>=1, map(i,j-1)=0; end
            if i+1<=size(map,1), map(i+1,j)=0; end
            if j+1<=size(map,2), map(i,j+1)=0; end
            if i-1>=1 && j-1>=1, map(i-1,j-1)=0; end
            if i-1>=1 && j+1<=size(map,2), map(i-1,j+1)=0; end
            if i+1<=size(map,1) && j-1>=1, map(i+1,j-1)=0; end
            if i+1<=size(map,1) && j+1<=size(map,2), map(i+1,j+1)=0; end
        end
    end
end

source=double(int32((source.*[resolutionY resolutionX])./size(mapOriginal)));
goal=double(int32((goal.*[resolutionY resolutionX])./size(mapOriginal)));

if ~feasiblePoint(source,map), error('source lies on an obstacle or outside map'); end
if ~feasiblePoint(goal,map), error('goal lies on an obstacle or outside map'); end
if length(find(conn==2))~=1, error('no robot specified in connection matrix'); end

%structure of a node is taken as positionY, positionX, historic cost, heuristic cost,
total cost, parent index in closed list (-1 for source)
Q=[source 0 heuristic(source,goal) 0+heuristic(source,goal) -1]; % the processing queue of
A* algorithm, open list
closed=ones(size(map)); % the closed list taken as a hash map. 1=not visited, 0=visited
closedList=[]; % the closed list taken as a list
pathFound=false;
tic;
counter=0;
colormap(gray(256));
while size(Q,1)>0
    [A, I]=min(Q,[],1);
    n=Q(I(5),:); % smallest cost element to process
    Q=[Q(1:I(5)-1,:);Q(I(5)+1:end,:)]; % delete element under processing
    if n(1)==goal(1) && n(2)==goal(2) % goal test
        pathFound=true;break;
    end
    [rx,ry,rv]=find(conn==2); % robot position at the connection matrix
    [mx,my,mv]=find(conn==1); % array of possible moves
    for mxi=1:size(mx,1) %iterate through all moves
        newPos=[n(1)+mx(mxi)-rx n(2)+my(mxi)-ry]; % possible new node
        if checkPath(n(1:2),newPos,map) %if path from n to newPos is collision-free
            if closed(newPos(1),newPos(2))~=0 % not already in closed
                historicCost=n(3)+historic(n(1:2),newPos);
                heuristicCost=heuristic(newPos,goal);
                totalCost=historicCost+heuristicCost;
                add=true; % not already in queue with better cost
                if length(find((Q(:,1)==newPos(1)) .* (Q(:,2)==newPos(2))))>=1
                    I=find((Q(:,1)==newPos(1)) .* (Q(:,2)==newPos(2)));
                    if Q(I,5)<totalCost, add=false;
                    else Q=[Q(1:I-1,:);Q(I+1:end,:)];add=true;
                end
            end
            if add
                Q=[Q;newPos historicCost heuristicCost totalCost
size(closedList,1)+1]; % add new nodes in queue
            end
        end
    end
    closed(n(1),n(2))=0;closedList=[closedList;n]; % update closed lists
    if display

```

```

        image((map==0).*0 + ((closed==0).*(map==1)).*125 + ((closed==1).*(map==1)).*255);
        counter=counter+1;
        M(counter)=getframe;
    end
end
if ~pathFound
    error('no path found')
end
if display
    disp('click/press any key');
    waitforbuttonpress;
end

paththohole=[n(1:2)]; %retrieve path from parent information
prev=n(6);
while prev>0
    paththohole=[closedList(prev,1:2);paththohole];
    prev=closedList(prev,6);
end
paththohole=[(paththohole(:,1)*size(mapOriginal,1))/resolutionY
(paththohole(:,2)*size(mapOriginal,2))/resolutionX];
pathLength=0;
for i=1:length(paththohole)-1,
pathLength=pathLength+historic(paththohole(i,:),paththohole(i+1,:)); end
PTH(iii+1,1)=pathLength;
iii=iii+1;
end

[M,I]=min(PTH);
%% Find shortest path from COM shortest hole

source=[COM2(1,1) COM2(1,2)]; % source position in Y, X format
goal=[TRUNK(I,2) TRUNK(I,1)]; % goal position in Y, X format

conn=[0 1 0; % robot (marked as 2) can move up, left, right and down (all 1s), but not
diagonally (all 0). you can increase/decrease the size of the matrix
1 2 1;
0 1 0];

display=false; % display processing of nodes

%%%% parameters end here %%%%

mapResized=imresize(mapOriginal,[resolutionY resolutionX]);
map=mapResized; % grow boundary by a unit pixel

for i=1:size(mapResized,1)
    for j=1:size(mapResized,2)
        if mapResized(i,j)==0
            if i-1>=1, map(i-1,j)=0; end
            if j-1>=1, map(i,j-1)=0; end
            if i+1<=size(map,1), map(i+1,j)=0; end
            if j+1<=size(map,2), map(i,j+1)=0; end
            if i-1>=1 && j-1>=1, map(i-1,j-1)=0; end
            if i-1>=1 && j+1<=size(map,2), map(i-1,j+1)=0; end
            if i+1<=size(map,1) && j-1>=1, map(i+1,j-1)=0; end
            if i+1<=size(map,1) && j+1<=size(map,2), map(i+1,j+1)=0; end
        end
    end
end
source=double(int32((source.*[resolutionY resolutionX])./size(mapOriginal)));
goal=double(int32((goal.*[resolutionY resolutionX])./size(mapOriginal)));

if ~feasiblePoint(source,map), error('source lies on an obstacle or outside map'); end
if ~feasiblePoint(goal,map), error('goal lies on an obstacle or outside map'); end
if length(find(conn==2))~=1, error('no robot specified in connection matrix'); end

%structure of a node is taken as positionY, positionX, historic cost, heuristic cost,
total cost, parent index in closed list (-1 for source)
Q=[source 0 heuristic(source,goal) 0+heuristic(source,goal) -1]; % the processing queue of
A* algorithm, open list
closed=ones(size(map)); % the closed list taken as a hash map. 1=not visited, 0=visited
closedList=[]; % the closed list taken as a list
pathFound=false;
tic;
counter=0;
colormap(gray(256));

```

```

while size(Q,1)>0
    [A, I]=min(Q,[],1);
    n=Q(I(5),:); % smallest cost element to process
    Q=[Q(1:I(5)-1,:);Q(I(5)+1:end,:)]; % delete element under processing
    if n(1)==goal(1) && n(2)==goal(2) % goal test
        pathFound=true;break;
    end
    [rx,ry,rv]=find(conn==2); % robot position at the connection matrix
    [mx,my,mv]=find(conn==1); % array of possible moves
    for mxi=1:size(mx,1) %iterate through all moves
        newPos=[n(1)+mx(mxi)-rx n(2)+my(mxi)-ry]; % possible new node
        if checkPath(n(1:2),newPos,map) %if path from n to newPos is collision-free
            if closed(newPos(1),newPos(2))~=0 % not already in closed
                historicCost=n(3)+historic(n(1:2),newPos);
                heuristicCost=heuristic(newPos,goal);
                totalCost=historicCost+heuristicCost;
                add=true; % not already in queue with better cost
                if length(find((Q(:,1)==newPos(1)) .* (Q(:,2)==newPos(2))))>=1
                    I=find((Q(:,1)==newPos(1)) .* (Q(:,2)==newPos(2)));
                    if Q(I,5)<totalCost, add=false;
                    else Q=[Q(1:I-1,:);Q(I+1:end,:)];add=true;
                    end
                end
            end
            if add
                Q=[Q;newPos historicCost heuristicCost totalCost
size(closedList,1)+1]; % add new nodes in queue
            end
        end
    end
    end
    closed(n(1),n(2))=0;closedList=[closedList;n]; % update closed lists
    if display
        image((map==0).*0 + ((closed==0).*(map==1)).*125 + ((closed==1).*(map==1)).*255);
        counter=counter+1;
        M(counter)=getframe;
    end
end
if ~pathFound
    error('no path found')
end
if display
    disp('click/press any key');
    waitforbuttonpress;
end

    pathtohole=[n(1:2)]; %retrieve path from parent information
    prev=n(6);
    while prev>0
        pathtohole=[closedList(prev,1:2);pathtohole];
        prev=closedList(prev,6);
    end
    pathtohole=[(pathtohole(:,1)*size(mapOriginal,1))/resolutionY
(pathtohole(:,2)*size(mapOriginal,2))/resolutionX];
    pathLength=0;
    for i=1:length(pathtohole)-1,
        pathLength=pathLength+historic(pathtohole(i,:),pathtohole(i+1,:)); end
    line(pathtohole(:,2),pathtohole(:,1));

%% Show only shortest path lines

i=1;
while i<size(Pos,1)
    j=i+1;
    while j<=size(Pos,1)
        if con(i,j)==1,line(PATH{i,j}(:,2),PATH{i,j}(:,1));end
        j=j+1;
    end
    i=i+1;
end

figHandle = figure(1);
plot(Pos(:,1),Pos(:,2),'go')
plot(COM2(1,2),COM2(1,1),'ro')
plot(TRUNK(:,1),TRUNK(:,2),'bo')

[M,I]=min(PTH)

```

Fitting algorithm

```
%define rectangle for plot
Xout=500;
Yout=900;
r=100;

Edge=r-cosd(45)*r;
X=Xout-2*Edge;
Y=Yout-2*Edge;

%make plot
HY=2;
HX=7;

n=1;

figHandle = figure(2);
hold on
for k=0:HY-1
    Hole(n)=k*(HX+2)+1;
    subplot(HY+1,HX+2,Hole(n));
    axis([-Edge Xout+Edge -Edge Yout+Edge])
    rectangle('Position',[0 0 X Y])
    rectangle('Position',[-Edge -Edge Xout Yout],'Curvature',[ (2*r/X) (2*r/Y)])
    title(['Hole ' num2str(n)])
    n=n+1;
end

for k=(HY*(HX+2))+2:((HY+1)*(HX+2))-1
    Hole(n)=k;
    subplot(HY+1,HX+2,k);
    axis([-Edge Xout+Edge -Edge Yout+Edge])
    rectangle('Position',[0 0 X Y])
    rectangle('Position',[-Edge -Edge Xout Yout],'Curvature',[ (2*r/X) (2*r/Y)])
    title(['Hole ' num2str(n)])
    n=n+1;
end

for k=HY:-1:1
    Hole(n)=k*(HX+2);
    subplot(HY+1,HX+2,Hole(n));
    axis([-Edge Xout+Edge -Edge Yout+Edge])
    rectangle('Position',[0 0 X Y])
    rectangle('Position',[-Edge -Edge Xout Yout],'Curvature',[ (2*r/X) (2*r/Y)])
    title(['Hole ' num2str(n)])
    n=n+1;
end

sheet=1;
Range1='A19:B19';Range2='C19:D19';Range3='E19:F19';Range4='G19:H19';Range5='I19:J19';Range6='K
19:L19';Range7='M19:N19';

%fill matrices
Cable{I}=[Cable{I}(1:end-1,:);xlsread(filename,sheet,Range1);0 0];
Grey{I}=[Grey{I}(1:end-1,:);xlsread(filename,sheet,Range2);0 0];
Black{I}=[Black{I}(1:end-1,:);xlsread(filename,sheet,Range3);0 0];
HVACS{I}=[HVACS{I}(1:end-1,:);xlsread(filename,sheet,Range4);0 0];
HVACE{I}=[HVACE{I}(1:end-1,:);xlsread(filename,sheet,Range5);0 0];
HVACR{I}=[HVACR{I}(1:end-1,:);xlsread(filename,sheet,Range6);0 0];
POT{I}=[POT{I}(1:end-1,:);xlsread(filename,sheet,Range7);0 0];

A=rectangle('Position',[0 Y-Cable{I}(1,2) 0 0]);
B=rectangle('Position',[0 0 0 0]);

%% Plotting all defined rectangles in figure.

%% Cable ladders

figure(figHandle);
subplot(HY+1,HX+2,Hole(I));

XC(1,1)=0;
YC(1,1)=Y-Cable{I}(1,2);
```

```

if any(Cable{I}>0)

for i=1:size(Cable{I},1)-1
    if Cable{I}(i,1)<=X
        if Cable{I}(i,2)<=Y
            if Cable{I}(i,1)<=(X-XC(i,1))
                A=rectangle('Position',[XC(i,1) YC(i,1) Cable{I}(i,1)
Cable{I}(i,2)], 'FaceColor','Blue');
                XC(i+1,1)=XC(i,1)+Cable{I}(i,1);
                YC(i+1,1)=YC(i,1)-(Cable{I}(i,2)-Cable{I}(i+1,2));
            elseif Cable{I}(i,2)<=min(YC(1:i,1))
                XC(i,1)=0;
                YC(i,1)=min(YC(1:i-1,1))-Cable{I}(i,2);
                A=rectangle('Position',[XC(i,1) YC(i,1) Cable{I}(i,1)
Cable{I}(i,2)], 'FaceColor','Blue');
                XC(i+1,1)=XC(i,1)+Cable{I}(i,1);
                YC(i+1,1)=YC(i,1)+(Cable{I}(i,2)-Cable{I}(i+1,2));
            else
                disp(['Does not fit for hole ' num2str(I)])
                Cable{I}(end-1,:)=[]
                I=I+1
                run Holecheck
                break
            end
        end
    end
else disp(['Does not fit for hole ' num2str(I)])
end
end
YC(end,:)=[];
end
%% Grey water lines

figure(figHandle);
subplot(HY+1,HX+2,Hole(I));

XG=0;
YG=0;
HPG=0;

for i=1:size(Grey{I},1)-1
    if Grey{I}(i,1)<=X
        if Grey{I}(i,2)<=Y
            if Grey{I}(i,1)<=(X-XG(i,1))
                B=rectangle('Position',[XG(i,1) YG(i,1) Grey{I}(i,1)
Grey{I}(i,2)], 'FaceColor',[0.38 0.20 0.07]);
                XG(i+1,1)=XG(i,1)+Grey{I}(i,1);
                YG(i+1,1)=YG(i,1);
                HPG(i,1)=YG(i,1)+Grey{I}(i,2);
            elseif Grey{I}(i,2)<=min(YC)-max(HPG(1:end-1,1))
                XG(i,1)=0;
                YG(i,1)=max(HPG(1:end-1,1));
                B=rectangle('Position',[XG(i,1) YG(i,1) Grey{I}(i,1)
Grey{I}(i,2)], 'FaceColor',[0.38 0.20 0.07]);
                XG(i+1,1)=XG(i,1)+Grey{I}(i,1);
                YG(i+1,1)=YG(i,1);
                HPG(i,1)=YG(i,1)+Grey{I}(i,2);
            else
                stop=0 %dit stuk is afwijkend en werkt niet, omdat het geen function is?? In
debugging mode doet hij het wel....
                Grey{I}(end-1,:)=[]
                while stop==0
                    Doesnotfit
                end
                if stop==1
                    continue
                end
                break
            end
        end
    end
else disp(['Does not fit for hole ' num2str(I)])
end
end
%% Black water lines

figure(figHandle);

```

```

subplot(HY+1,HX+2,Hole(I));

XB=0+XG(end,1);
YB=0+YG(end,1);
HPB=0+max(HPG);

for i=1:size(Black{I},1)-1
    if Black{I}(i,1)<=X
        if Black{I}(i,2)<=Y
            if Black{I}(i,1)<=(X-XB(i,1))
                B=rectangle('Position',[XB(i,1) YB(i,1) Black{I}(i,1)
Black{I}(i,2)], 'FaceColor','Black');
                XB(i+1,1)=XB(i,1)+Black{I}(i,1);
                YB(i+1,1)=YB(i,1);
                HPB(end+1,1)=YB(i,1)+Black{I}(i,2);
            elseif Black{I}(i,2)<=min(YC)-max(HPB)
                XB(i,1)=0;
                YB(i,1)=max(HPB);
                B=rectangle('Position',[XB(i,1) YB(i,1) Black{I}(i,1)
Black{I}(i,2)], 'FaceColor','Black');
                XB(i+1,1)=XB(i,1)+Black{I}(i,1);
                YB(i+1,1)=YB(i,1);
                HPB(end+1,1)=YB(i,1)+Black{I}(i,2);
            else
                disp(['Does not fit for hole ' num2str(I)])
                Black{I}(end-1,:)=[]
                I=I+1
                run Holecheck
                break
            end
        end
    else
        disp(['Does not fit for hole ' num2str(I)])
    end
end
%% HVAC supply

figure(figHandle);
subplot(HY+1,HX+2,Hole(I));

XHS=0+XB(end,1);
YHS=0+YB(end,1);
HPHS=0+max(max(HPG),max(HPB));

for i=1:size(HVACS{I},1)-1
    if HVACS{I}(i,1)<=X
        if HVACS{I}(i,2)<=Y
            if HVACS{I}(i,1)<=(X-XHS(i,1))
                B=rectangle('Position',[XHS(i,1) YHS(i,1) HVACS{I}(i,1)
HVACS{I}(i,2)], 'FaceColor',[0.80 0.60 0.80]);
                XHS(i+1,1)=XHS(i,1)+HVACS{I}(i,1);
                YHS(i+1,1)=YHS(i,1);
                HPHS(end+1,1)=YHS(i,1)+HVACS{I}(i,2);
            elseif HVACS{I}(i,2)<=min(YC(:,1))-max(HPHS)
                XHS(i,1)=0;
                YHS(i,1)=max(HPHS);
                B=rectangle('Position',[XHS(i,1) YHS(i,1) HVACS{I}(i,1)
HVACS{I}(i,2)], 'FaceColor',[0.80 0.60 0.80]);
                XHS(i+1,1)=XHS(i,1)+HVACS{I}(i,1);
                YHS(i+1,1)=YHS(i,1);
                HPHS(end+1,1)=YHS(i,1)+HVACS{I}(i,2);
            else
                disp(['Does not fit for hole ' num2str(I)])
                HVACS{I}(end-1,:)=[]
                I=I+1
                run Holecheck
                break
            end
        end
    else
        disp(['Does not fit for hole ' num2str(I)])
    end
end
%% HVAC exhaust

figure(figHandle);
subplot(HY+1,HX+2,Hole(I));

XHE=0+XHS(end,1);

```

```

YHE=0+YHS(end,1);
HPHE=0+max(max(max(HPG),max(HPB)),max(HPHS));

for i=1:size(HVACE{I},1)-1
    if HVACE{I}(i,1)<=X
        if HVACE{I}(i,2)<=Y
            if HVACE{I}(i,1)<=(X-XHE(i,1))
                B=rectangle('Position',[XHE(i,1) YHE(i,1) HVACE{I}(i,1)
HVACE{I}(i,2)], 'FaceColor',[0 0.20 0]);
                XHE(i+1,1)=XHE(i,1)+HVACE{I}(i,1);
                YHE(i+1,1)=YHE(i,1);
                HPHE(end+1,1)=YHE(i,1)+HVACE{I}(i,2);
            elseif HVACE{I}(i,2)<=min(YC(:,1))-max(HPHE)
                XHE(i,1)=0;
                YHE(i,1)=max(HPHE);
                B=rectangle('Position',[XHE(i,1) YHE(i,1) HVACE{I}(i,1)
HVACE{I}(i,2)], 'FaceColor',[0 0.20 0]);
                XHE(i+1,1)=XHE(i,1)+HVACE{I}(i,1);
                YHE(i+1,1)=YHE(i,1);
                HPHE(end+1,1)=YHE(i,1)+HVACE{I}(i,2);
            else
                disp(['Does not fit for hole ' num2str(I)])
                HVACE{I}(end-1,:)=[]
                I=I+1
                run Holecheck
                break
            end
        end
    else disp(['Does not fit for hole ' num2str(I)])
    end
end
%% HVAC recirculation

figure(figHandle);
subplot(HY+1,HX+2,Hole(I));

XHR=0+XHE(end,1);
YHR=0+YHE(end,1);
HPHR=0+max(max(max(HPG),max(HPB)),max(max(HPHS),max(HPHE)));

for i=1:size(HVACR{I},1)-1
    if HVACR{I}(i,1)<=X
        if HVACR{I}(i,2)<=Y
            if HVACR{I}(i,1)<=(X-XHR(i,1))
                B=rectangle('Position',[XHR(i,1) YHR(i,1) HVACR{I}(i,1)
HVACR{I}(i,2)], 'FaceColor','yellow');
                XHR(i+1,1)=XHR(i,1)+HVACR{I}(i,1);
                YHR(i+1,1)=YHR(i,1);
                HPHR(end+1,1)=YHR(i,1)+HVACR{I}(i,2);
            elseif HVACR{I}(i,2)<=min(YC(:,1))-max(HPHR)
                XHR(i,1)=0;
                YHR(i,1)=max(HPHR);
                B=rectangle('Position',[XHR(i,1) YHR(i,1) HVACR{I}(i,1)
HVACR{I}(i,2)], 'FaceColor','yellow');
                XHR(i+1,1)=XHR(i,1)+HVACR{I}(i,1);
                YHR(i+1,1)=YHR(i,1);
                HPHR(end+1,1)=YHR(i,1)+HVACR{I}(i,2);
            else
                disp(['Does not fit for hole ' num2str(I)])
                HVACR{I}(end-1,:)=[]
                I=I+1
                run Holecheck
                break
            end
        end
    else disp(['Does not fit for hole ' num2str(I)])
    end
end
%% Hot and cold potable water

figure(figHandle);
subplot(HY+1,HX+2,Hole(I));

XPOT=0+XHR(end,1);
YPOT=0+YHR(end,1);
HPPOT=0+max(max(max(HPG),max(HPB)),max(max(HPHS),max(HPHE)),max(HPHR));

```

```

for i=1:size(POT{I},1)-1
    if POT{I}(i,1)<=X
        if POT{I}(i,2)<=Y
            if POT{I}(i,1)<=(X-XPOT(i,1))
                B=rectangle('Position',[XPOT(i,1) YPOT(i,1) POT{I}(i,1)
POT{I}(i,2)],'FaceColor','green');
                XPOT(i+1,1)=XPOT(i,1)+POT{I}(i,1);
                YPOT(i+1,1)=YPOT(i,1);
                HPPOT(end+1,1)=YPOT(i,1)+POT{I}(i,2);
            elseif POT{I}(i,2)<=min(YC(:,1))-max(HPPOT
                XPOT(i,1)=0;
                YPOT(i,1)=max(HPPOT);
                B=rectangle('Position',[XPOT(i,1) YPOT(i,1) POT{I}(i,1)
POT{I}(i,2)],'FaceColor','green');
                XPOT(i+1,1)=XPOT(i,1)+POT{I}(i,1);
                YPOT(i+1,1)=YPOT(i,1);
                HPPOT(end+1,1)=YPOT(i,1)+POT{I}(i,2);
            else
                disp(['Does not fit for hole ' num2str(I)])
                POT{I}(end-1,:)=[]
                I=I+1
                run Holecheck
                break
            end
        end
    end
    else disp(['Does not fit for hole ' num2str(I)])
    end
end
%% Determine overlapping of rectangles

l = max(A.Position(1),B.Position(1));
r = min(A.Position(1)+A.Position(3),B.Position(1)+B.Position(3));
b = max(A.Position(2),A.Position(2));
t = min(A.Position(2)+A.Position(4),B.Position(2)+B.Position(4));
r3 = [l b r-l t-b];
if r3(3)>0
    if r3(4)>0
        disp(['Does not fit for hole ' num2str(I)])
    end
end
end

```

APPENDIX XIII: SCIENTIFIC PAPER

This appendix contains the scientific paper, based on this report.