

ShoreScape

A landscape approach to the natural adaptation of urbanized sandy shores

van Bergen, J.

DOI

[10.7480/abe.2023.09](https://doi.org/10.7480/abe.2023.09)

Publication date

2023

Document Version

Final published version

Citation (APA)

van Bergen, J. (2023). *ShoreScape: A landscape approach to the natural adaptation of urbanized sandy shores*. [Dissertation (TU Delft), Delft University of Technology]. A+BE | Architecture and the Built Environment. <https://doi.org/10.7480/abe.2023.09>

Important note

To cite this publication, please use the final published version (if applicable). Please check the document version above.

Copyright

Other than for strictly personal use, it is not permitted to download, forward or distribute the text or part of it, without the consent of the author(s) and/or copyright holder(s), unless the work is under an open content license such as Creative Commons.

Takedown policy

Please contact us and provide details if you believe this document breaches copyrights. We will remove access to the work immediately and investigate your claim.



ShoreScape

A landscape approach to the natural
adaptation of urbanized sandy shores

Janneke van Bergen

ShoreScape

A landscape approach to the natural adaptation of urbanized sandy shores

Janneke van Bergen



23#09

Design | Sirene Ontwerpers, Véro Crickx

Cover photo | Overview of the Aeolis Project, Oerol 2019. Image by the author.

Keywords | Building with Nature, landscape approach, nourishments, dune formation, urban coastal adaptation, design principles

ISBN 978-94-6366-696-1

ISSN 2212-3202

© 2023 Janneke van Bergen

This dissertation is open access at <https://doi.org/10.7480/abe.2023.09>

Attribution 4.0 International (CC BY 4.0)

This is a human-readable summary of (and not a substitute for) the license that you'll find at:
<https://creativecommons.org/licenses/by/4.0/>

You are free to:

Share — copy and redistribute the material in any medium or format

Adapt — remix, transform, and build upon the material

for any purpose, even commercially.

This license is acceptable for Free Cultural Works.

The licensor cannot revoke these freedoms as long as you follow the license terms.

Under the following terms:

Attribution — You must give appropriate credit, provide a link to the license, and indicate if changes were made. You may do so in any reasonable manner, but not in any way that suggests the licensor endorses you or your use.

Unless otherwise specified, all the photographs in this thesis were taken by the author. For the use of illustrations effort has been made to ask permission for the legal owners as far as possible. We apologize for those cases in which we did not succeed. These legal owners are kindly requested to contact the author.

ShoreScape

A landscape approach to the natural adaptation of urbanized sandy shores

Dissertation

for the purpose of obtaining the degree of doctor
at Delft University of Technology
by the authority of the Rector Magnificus, prof.dr.ir. T.H.J.J. van der Hagen
chair of the Board for Doctorates
to be defended publicly on
Friday 16 June 2023 at 10:00 o'clock

by

Janneke van BERGEN
Master of Science in Architecture,
Delft University of Technology, the Netherlands
born in Vierlingsbeek, the Netherlands

This dissertation has been approved by the promotor.

Composition of the doctoral committee:

Rector Magnificus,
Prof.dr.ing. S. Nijhuis
Prof.ir. E.A.J. Luiten

chairperson
Delft University of Technology, promotor
Delft University of Technology, promotor

Independent members:

Prof.dr.ir. C. Zevenbergen
Prof.dr. E. Braae
Dr.ir. S. de Vries
Prof.dr.ir. K.M. Havik
Prof.dr. K.M. Wijnberg

Delft University of Technology
University of Copenhagen, Denmark
Delft University of Technology
Delft University of Technology
University of Twente

This publication is part of the research programme ShoreScape (ALWTW.2016.038), which is (partly) financed by the Dutch Research Council (NWO).



Wisdom begins in wonder

Socrates

Contents

Abstract	12
Samenvatting	16

1 Introduction 21

1.1	Context: urbanizing coasts under the threat of sea level rise	21
1.2	Building with Nature as an adaptive coastal strategy	28
1.3	Problem statement	33
1.4	Research aim and questions	35
1.5	Research methodology	36
1.6	Research framework	44
1.7	Scope, relevance and limitations	48
1.8	Thesis outline	51

2 Building with Nature as a landscape approach 57

2.1	Introduction	57
2.2	Building with Nature as an adaptive strategy for sandy shores	59
2.3	Building with Nature as a systems approach	73
2.4	Building with Nature as a landscape approach	94
2.5	Building with Nature as a design approach to integrated coastal adaptation	107

3 Landscape design principles for natural coastal adaptation 119

3.1	Introduction: design approach and principles	119
3.2	Intervention: types and design of sandy solutions	122
3.3	Succession: natural processes enhancing dune formation	132
3.4	Limitations: the effects of beach urbanization on dune formation	139
3.5	Landscape design methodology integrating BwN dynamics	150
3.5.1	Morphogenesis: contextual study of coastal dynamics	152
3.5.2	Dynamic profiling: transferring BwN dynamics to coastal design	155
3.5.3	Aeolian design principles: directing sediment transport for dune formation	158

- 3.6 **Design principles for dune widening** 161
- 3.7 **Design principles for dune heightening** 180
- 3.8 **Harvesting and temporal design** 193
- 3.9 **Conclusions regarding BwN as a landscape design approach: towards a dynamic, adaptive and multifunctional coastal landscape** 199

4 **Application: case studies** 207

Design approach and principles tested in site-specific contexts

- 4.1 **Introduction** 207
- 4.2 **Noordwijk: BwN-based adaptation of a highly urbanized waterfront** 210
- 4.3 **Walcheren: coastal landscape regeneration via BwN nourishment** 222
- 4.4 **Petten: BwN prospects after sandy reinforcement** 233
- 4.5 **Sand Motor: optimizing dune dynamics for coastal safety and recreation** 257
- 4.6 **Conclusions case studies** 269

5 **Synthesis** 279

Conclusions and reflection on the design method and principles for integrated coastal adaptation

- 5.1 **Introduction** 279
- 5.2 **Response to the research questions** 281
 - 5.2.1 BwN as a landscape approach 281
 - 5.2.2 BwN design principles for integrated coastal landscapes 283
 - 5.2.3 Application: contextualisation and integration of the design approach and principles in case studies 291
- 5.3 **Conclusion: reflection on the research aim** 298
- 5.4 **Reflection: BwN as an interdisciplinary approach** 300
- 5.5 **Recommendations** 302

- Appendix 308
- Acknowledgments 327
- References 329
- List of Figures 339
- Biography 350
- List of publications 351



Waterfront urbanization along the Belgian coast, diminishing the dunes as a line of defence.
Image by the author.



Abstract

ShoreScape: A landscape approach to the natural adaptation of urbanized sandy shores

Sandy shores around the world suffer from coastal erosion due to land subsidence, a lack of sediment input and sea level rise. This often leads to the construction of hard structures, such as sea walls and breakwaters, that consolidate the coastal zone but disrupt the dynamic system of coastal deltas. To compensate for coastal erosion in a more natural and systemic way, sand nourishments are now increasingly executed. This so-called ‘Building with Nature’ (BwN) technique uses natural resources and dynamics to restore sediment balance within coastal zones and promote coastal regeneration and dune formation. These dynamic nourishment techniques are still in development, placing new demands on coastal spatial planning. How can we position and tune these nourishment dynamics for land formation; not only to optimize coastal safety but also to integrate these dynamics with the ecological and urban functions of the coastal landscape? An integrated design approach is necessary to guide both land-shaping processes and adaptive urban and ecological configurations to support BwN-based dune-formation following nourishment and boost the buffer capacity of coastal zones.

This research aims to develop design principles for integral coastal landscapes that connect geomorphological processes, ecology and adaptive urban design to exploit their potential for the spatial development of multi-functional coastal landscapes—shore-scapes. It focuses on coastal configurations featuring pro-active sediment management through aeolian BwN techniques to build up the coastal buffer in a natural and multifunctional way.

The first step was to reframe BwN nourishment design as a landscape approach, employing natural onshore dynamics to sustain the coastal buffer and increase the multiplicity of the coastal landscape. The coastal landscape can be regarded as the result of the interaction between the geomorphological, ecological and urban system, in response to sea level rise. The mapping of their interactions (via literature review, fieldwork, GIS and CFD-modelling), identified three potential spatial mechanisms to support nature-based dune formation following nourishment: natural succession, dune farming and urban harvesting. To activate these processes for coastal reinforcement and landscaping, and bridge the spatial and time scales involved, three subsequent tools for dynamic design were defined: morphogenesis, dynamic profiling and aeolian design principles.

In the second half of the research, the BwN landscape approach and principles were contextualized and tested across four case studies, which revealed how coastal system's characteristics and nourishment strategy affect dune formation. Responding to various nourishment and urban conditions, spatial arrangements were composed that enhance the aeolian build-up of coastal profiles and landscapes over time, supporting dune reinforcement, multifunctionality and landscape differentiation.

The outcome of this research is threefold. First, BwN was redefined as a landscape approach that employs intersystemic land-shaping processes to support coastal safety, multifunctionality and spatial quality. Second, a set of validated design principles was developed for natural aeolian coastal adaptation following nourishment. Third, spatial arrangements were composed to illustrate how BwN processes ashore can be guided in space and time across various nourishment and urban contexts.

KEYWORDS Building with Nature, landscape approach, nourishments, dune formation, urban coastal adaptation, design principles



Aerial view of the damage caused by Hurricane Sandy to the sandy urbanized New Jersey coast (October 2012).
Source: National Guard of the United States.



Samenvatting

ShoreScape: Een landschapsbenadering voor de natuurlijke adaptatie van stedelijke kustgebieden

Wereldwijd lijden zandige kusten onder kusterosie door zeespiegelstijging en tekort aan sediment. Als antwoord hierop worden zandsuppleties uitgevoerd volgens de 'Building with Nature' (BwN) techniek, waarin natuurlijke bronnen en dynamieken worden aangewend om de zandbalans in het kustfundament te herstellen en duinen te versterken. Deze BwN technieken zijn nog steeds in ontwikkeling en brengen nieuwe vraagstukken met zich mee voor de ruimtelijke inrichting van de kust. Hoe kunnen deze dynamische suppleties gepositioneerd en gefaseerd worden voor landvormende processen, niet alleen om ze te optimaliseren voor kustveiligheid, maar ook om ze aan te laten sluiten bij ecologische en stedelijke ontwikkelingen binnen het kustlandschap? Hiervoor is een nieuwe ontwerpbenadering nodig, voor zowel de landschapsvormende processen die de suppleties teweeg brengen, als wel voor de inpassing van ecologische en stedelijke configuraties. Hiermee kan BwN duinvorming na suppletie de ruimte worden gegeven om daarmee de duinen als storm erosie buffer te versterken.

Doel van dit project is om ontwerpprincipes te ontwikkelen voor integrale landschapsbouw, waarin geomorfologische processen, ecologie en adaptieve stedenbouw worden verbonden, voor de ruimtelijke ontwikkeling van veilige en multifunctionele kustgebieden: 'Shore-Scapes'. Het onderzoek focust op ruimtelijke kustconfiguraties die proactief duinformatie bevorderen volgens de 'Building-with-Nature'(BwN) techniek, teneinde de duinen op een natuurlijke en multifunctionele manier te versterken.

In het eerste deel wordt BwN geherdefinieerd als landschapsbenadering, waarin het BwN potentieel voor dynamische duinversterking en vermogen om de multifunctionaliteit van het landschap te vergroten, worden samengebracht. Het kustlandschap vormt zich door de interacties tussen het geomorfologische, ecologische en urbane systeem, in wisselwerking met de zeespiegelstijging. Middels studie van deze interacties (via literatuuronderzoek, veldwerk, GIS-analyse en CFD-modellering) zijn ruimtelijke mechanismen afgeleid om BwN duinvorming te stimuleren. Om deze scheppende processen voor kustversterking en landschapsbouw te activeren en te verbinden in ruimte en tijd, zijn drie ontwerpfasen gedefinieerd: morfogenese, dynamische profilering en aeolische ontwerpprincipes.

In het tweede deel van het onderzoek is deze BwN landschapsbenadering toegepast en gecontextualiseerd in vier case studies, waarin de ontvankelijkheid voor BwN binnen verschillende suppletie strategieën en kustprofielen is vergeleken. Eerst is geanalyseerd hoe duinvorming binnen de huidige systeemkarakteristieken en de suppletie strategie heeft plaatsgevonden. Vervolgens zijn in een aanvullende ontwerpstudie ruimtelijke en temporale optimalisaties aangebracht om het integrale BwN proces te faciliteren. Via BwN profiel-manipulatie en aeolische principes kan na suppletie de duinvorming voor veiligheid worden gemaximaliseerd en de multifunctionaliteit en diversiteit van het landschap worden vergroot.

De uitkomst van het onderzoek is drieledig: allereerst is BwN geherdefinieerd als landschapsbenadering, waarmee intersystemische landschapsvormende processen worden geactiveerd om de veiligheid, multifunctionaliteit en diversiteit van de kust te vergroten. Ten tweede zijn er een aantal aeolische ontwerpprincipes gedefinieerd en gevalideerd voor natuurlijke duin aangroei na suppletie. Tot slot zijn deze gecombineerd tot een aantal ruimtelijke arrangementen die het BwN duinvormingsproces bevorderen voor een specifieke kustprofilering en landschapsbouw binnen variërende suppletie,- en stedelijke contexten.

KERNWOORDEN Building with Nature, landschapsbenadering, suppleties, duin formatie, adaptieve kustverstedelijking, ontwerpprincipes



Coastal erosion at Surfers Paradise, Australia.
Source: Sheba_Also 43,000 photos, licensed under CC BY-SA 2.0.



HI SURF

1 Introduction

1.1 Context: urbanizing coasts under the threat of sea level rise

Climate change is accelerating sea level rise and coastal erosion, creating a rise in global demand for coastal protection. At the same time, coastal zones around the world continue to urbanize due to their attractive landscape and economic vitality (Hall, 2001; Schlacher et al., 2008; Hallegatte et al., 2011; Malavasi et al., 2013; Hoonhout & Waagmeester, 2014). A quarter of the world's population now lives within 100 km of a coastline, while 600 million people live less than 10 m above sea level. The world's 20 largest metropolises are positioned on a coast, including 13 that would face a high risk of flooding if the sea level were to rise by +1 m (Globalgreen.org, 2013). IPCC (2007) asserts that the warming of the climate system is undeniable and inevitable, noting that droughts and desertification (i.a.) constitute a major reason for concern. These processes will cause communities to move to more humid areas, increasing pressure on coastal zones. This resultant combination of urbanization and erosion leads to a 'coastal squeeze': more urban pressure on an eroding coastal zone.

Without reinforcement, global land loss due to sea level rise could amount to 6,000–17,000 km² by the end of the 21st century, resulting in 1–5 million people being forced to migrate, costing the global economy 300–1,000 billion USD (Hinkel et al., 2013). This future already arises. Jakarta, for example, home to 10 million residents, recently decided to move its political centre inland as a result of sea level rise, land subsidence and limitations on means of adaptation (CNN, 2022).

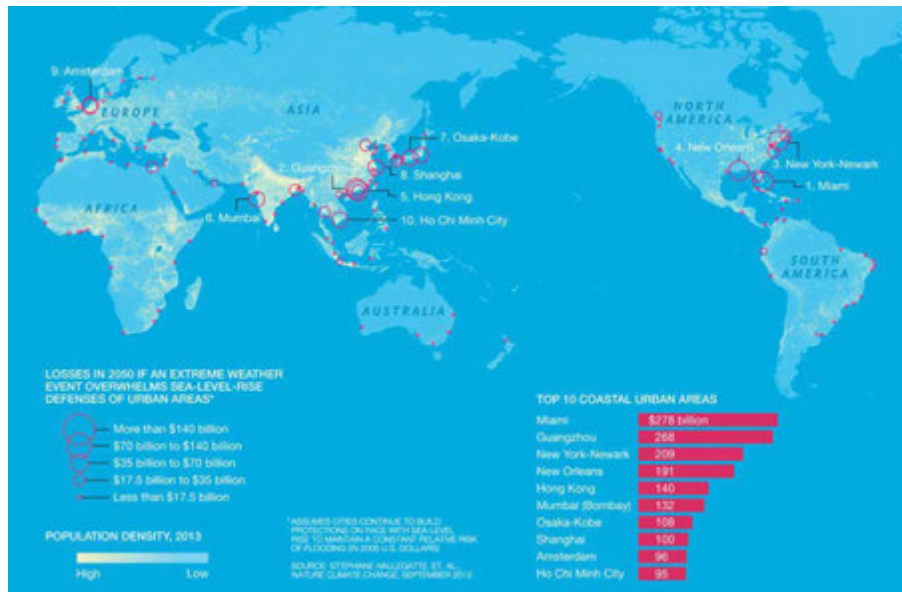

FIG. 1.1 Overview of urban deltas around the world and economic loss estimates if the flood defence structures surrounding these deltas were to fail amid extreme weather conditions in 2050. Source: S. Hallegatte et al., 2013.

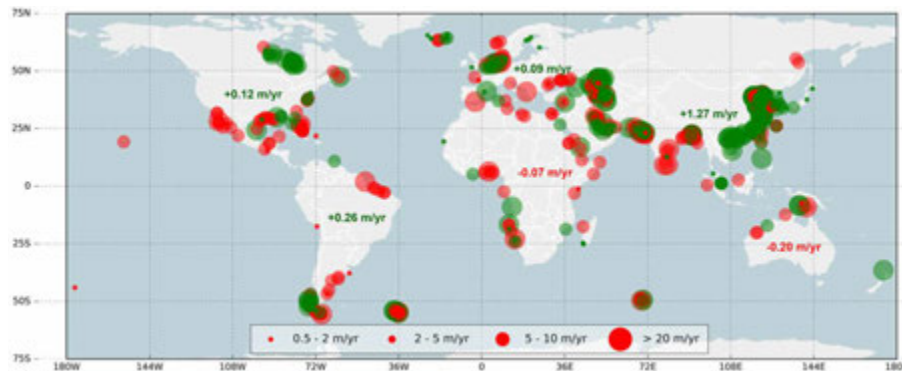

FIG. 1.2 Global map of sandy shores and their rates of erosion (red) and accretion (green). On average, current rates of erosion are still moderate. However, accelerated sea level rise can increase these erosion rates up to 10–20m a year, as is already the case for some shores, such as those in Ghana and India. Source: Luijendijk et al., 2018.

The need for coastal adaptation

About 20% of coastline around the world is sandy (Bird, 1985) and, in turn, vulnerable to coastal erosion by storms, land subsidence, sea currents and offshore sediment transport. Depending on the balance between relative sea level rise and sediment supply, the rate of coastal retreat ranges from one to tens of metres per year (Luijendijk et al., 2018; see Figure 1.2). Coastal erosion is not limited to the developing world but also occurs in developed countries, including the US, Australia, Japan and the Netherlands (Hinkel et al., 2013). Aside from geomorphology, erosion also affects (a)biotic and anthropogenic processes in the coastal zone (e.g., by flooding and salt intrusion), causing the loss of habitats and settlements.

Recent insights into the melting of polar ice caps indicate scenarios of accelerated sea level rise up to +1–2m in the second half of the 21st century (Haasnoot et al., 2018; IPCC 2021), increasing the rate of coastal erosion. Such scenarios increase the urgency of sustainable long-term coastal protection measures, especially in cases where sea level rise coincides with land subsidence in the inner deltas (= relative sea level rise). Therefore, it is vital for all coastal regions to adapt and grow along sea level rise, especially sandy and urbanized shores due to their vulnerability to erosion. The establishment of a buffer against storm erosion, such as a dune system, is critical to withstand the effects of accelerated sea level rise, coastal erosion and increased flooding. This buffer will put greater demands on the adaptive capacity of urban coastal zones. Due to ongoing coastal urbanization, space and time to adapt have become both sparse and costly. Without anticipation it may eventually lead to the construction of large-scale hard infrastructure or monoscapes: assets engineered as a last resort against sea level rise, but disrupting the natural coastal system and detaching coastal cities from their original setting (Figure 1.3).



FIG. 1.3 The seawall at Den Helder in 1900 (left), 1970 (middle) and 2015 (right). Due to coastal reinforcement, the seaside setting of the fishing village was disrupted over time, cutting the town off from the sea with a 12m-high sea wall. Sources: E. de Jong (middle) and Rijkswaterstaat / Simon Warner (right).

Coastal protection: from hard interventions to system-based nourishments

Traditionally, coastal protection has been organized by the construction of large-scale hard structures, such as groynes and seawalls. However, these techniques have negative side effects. They are expensive and disrupt the natural coastal system, causing erosion elsewhere. Additionally, once a seawall is broken, loss is inevitable. Most importantly, hard structures do not address the fundamental cause of coastal retreat: a sediment deficit stemming from relative sea level rise. These insights have led to a paradigm shift in coastal engineering: from the use of hard defence structures to system-based sand nourishments as coasts' prime defence strategy (e.g., Rijkswaterstaat, 1988; US Army Corps, 2018). This new approach is cheaper, more sustainable and offers higher resistance against storms. It uses sand as system-based material and natural dynamics for coastal reinforcement through an approach known as 'Building with Nature' (see also Section 1.2).

In the long term, optimal shore and beach nourishment could compensate for losses caused by coastal erosion and, in turn, mitigate forced migration. However, reducing forced migration by half would require the current global nourishment programme to be quadrupled from 4% of shores nourished in 2000 to 18–33% in 2100 (Hinkel et al., 2013). To make investment in nourishment programmes more efficient, further optimization is necessary. Such optimization could be achieved through a better understanding of land-shaping processes and their interactions with the built environment.

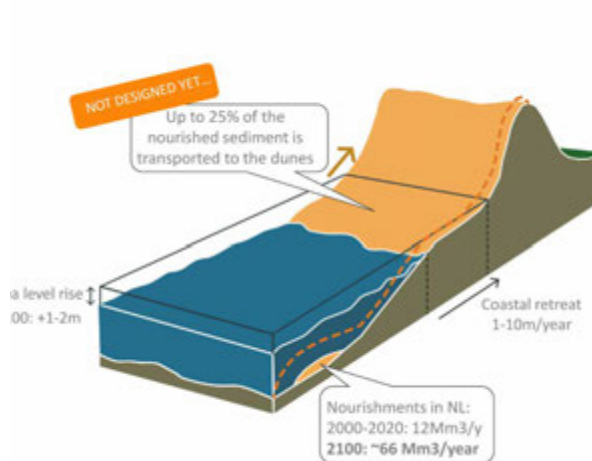

FIG. 1.4 3D section of a Dutch sandy shore, showing sea level rise leading to coastal retreat (1–10m/y) and the need to compensate for this sediment deficit by nourishing the coastal foundation in pace with sea level rise. Image by the author.

Dutch case studies (e.g., Van der Wal, 1999) indicate that up to 25% of nourished volume is capable of landing ashore to reinforce dunes as a natural barrier against storms. However, more knowledge is needed on the resulting dune formation, especially along urbanized shores.

Coastal urbanization: a lack of spatial coherence and adaptivity

At the same time, economic pressures on coastal zones are continually increasing. The Dutch coast, for example, receives almost 50 million day visits and 20 million overnight stays per year with an annual turnover of nearly 3 billion euros (Panteia, 2012), illustrating the social and economic importance of the coastal zone. The Dutch Environmental Assessment Agency (Van Duinen et al., 2016) asserts that a scenario of one million new homes inland till 2040 can become realistic, increasing the urban and recreational pressure on the coastal zone. The stabilization of the Dutch coastline via nourishments has caused a twenty-fold increase in beach housing over the last decade (Broer et al., 2011; Panteia, 2012; Armstrong et al., 2016; Buth, 2016). This increase has led to social protests against the privatization of the coastline and the destruction of the landscape (e.g., the 'Protect the Coast' campaign; Natuurmonumenten, 2016), convincing policymakers to maintain building restrictions in the coastal zone (Kustpact, Ministry of Infrastructure & Environment, 2017)

Beach housing and other speculative forms of waterfront development lead to densification and fragmented planning along coastlines, without the investments to safeguard or improve the coastal landscape as a whole. One example is the Belgian coast, where housing speculation in the past century has led to the dense urbanization of the waterfront, diminishing the dune system as a natural coastal buffer. This trend is also evident in other countries, including the US and Australia.

Most coastal cities around the world are permanently built and therefore not prepared for coastal erosion or retreat strategies. Furthermore, most common seaside typologies, such as high-rise waterfronts, sand ridge settlements and beach resorts, are not equipped to anticipate to dynamic nourishment-, or dune formation processes and related sediment transport. Existing means of adaptive planning are limited. Sea level rise has already eroded many coastlines' natural buffers. This puts significant pressure on the spatial capacity of urban coastal zones to adapt to future sea level rise.



FIG. 1.5 Speculative real estate development in Belgium, diminishing dunes as coastal buffer. Image by the author.

Delta paradox

The combination of coastal erosion and urbanisation, or 'coastal squeeze', illustrates that interactions between coastal functions do not always run smoothly and often limit the development of a more resilient coastal defence zone. Therefore, a more integral approach is necessary (Hallegate, 2010) that combines multiple coastal functions (e.g., safety, ecology, urban use) to facilitate sustainable adaptation to sea level rise. This requires a double adaptation: on the one hand, a new generation of sustainable engineering solutions to keep up with sea level rise; on the other hand, new urban solutions that can incorporate these dynamics, for the Delta metropolis to evolve. Frits Palmboom (2014) refers to these challenges as 'The Delta paradox: the necessity of finding a new balance between regulating and letting go, a new vision on the compartments, edges and defence lines [...], not only concerning the water system and the ecology, but basically applying to the entire spatial—and social—planning'.

Towards multifunctional coastal adaptation

To deal with the effects of sea level rise, a new match has to be made between coastal defence techniques and adaptive spatial design, but a lack of space makes it difficult to negotiate. Existing solutions are often sectoral in nature, leaving the (negative) interactions between coastal functions unaddressed. To adapt to future sea level rise and prevent further erosion, rehabilitation of the coastal buffer capacity is needed, not in a sectoral, but in a multifunctional way to allow for optimal use of the coastal zone.

Interdisciplinary research and collaboration offer chances to develop new adaptive concepts, anticipating to sea level rise and linking flood safety, multifunctionality and spatial quality. In recent years, first concepts of adaptive coastal landscapes or buffer zones have been explored, such as the RAR (Robust Adaptive Framework - Meyer et al., 2015) and 'Rebuild by Design' proposals (Bisker et al., 2016). The recent BwN approach in coastal engineering offers opportunities for the redesign of coastal zones to create greater coherence between sectoral developments. The Dutch studio Coastal Quality (2011–2013; Hoekstra, van Bergen et al., 2013), for example, illustrated how future nourishments can support the multifunctional development of coastal landscapes, indicating the need and opportunities for integrated coastal design. However, current nourishment programs in the Netherlands still lack the urban link to make these dynamics vital parts of coastal cities. Therefore, interdisciplinary research and design are necessary to integrate the aspects of flood safety, morphology, multifunctionality and spatial quality within the coastal zone. Aim is to develop design concepts that integrate coastal dynamics and adaptive coastal planning, in pursuit of coastal zones that are not only safe and dynamic, but also conducive to more inclusive, high-quality landscapes.

ShoreScape: An integrated approach to coastal zones

This research takes BwN as central motive for sustainable coastal development, approached from a landscape perspective. It pursues the employment onshore sediment dynamics to sustain the coastal buffer while strengthening the multifunctionality and spatial quality of the coastal landscape. The research is part of the ShoreScape project (2017–2022), an interdisciplinary collaboration between Delft University of Technology and the University of Twente. This part of the research (sub-project B) aims to develop design principles for integral coastal landscapes that connect geomorphological processes, ecology and adaptive urban design to leverage their potential for the spatial development of multi-functional coastal landscapes—shore-scapes. It focuses on coastal configurations that employ proactive aeolian sediment management as Building with Nature technique to construct sustainable coastal buffer zones in a nature-based and integrated way.

1.2 Building with Nature as an adaptive coastal strategy

Sand nourishments as an emerging coastal defence technique

Sandy shores depend on coastal reinforcement to counter coastal erosion and maintain flood safety, especially in the face of future sea level rise. They need a critical mass of sediment—or the coastal foundation—to retain their function as a protective barrier for the hinterland. The sediment balance can be restored via sand nourishments, which enable the coastal foundation to grow at pace with sea level rise. These nourishments employ the principles of Building with Nature (BwN), in which the sand balance is amplified, and natural dynamics are instrumental in the redistribution of sand along and across the coast. This Section summarizes current nourishment strategies related to dune formation, urban limitations and the prospects of BwN (see Section 2.2 and Chapter 3 for more detailed information).

BwN is defined as ‘the employment of natural processes to serve societal goals, such as coastal safety’ (De Vriend et al., 2014; Van Bergen et al., 2021). It is the promotion of (soft) infrastructure that works with nature rather than against it. This approach emerged in the 1970s when Dutch sand-nourishment pilots proved nourishment to be a successful alternative to hard coastal infrastructures. This led to a paradigm shift in Dutch national policy (the First Kustnota, 1990; Ministry of Infrastructure & Water, 1990) from hard techniques to sediment-based techniques in the practice of coastal defence.

Over the last two decades (2000–2020), the Dutch coast has been nourished with an average of 12 million m³ of sediment per year, maintaining the shoreline by compensating for the coastal erosion caused by sea level rise. This volume may triple or more (Delta Programme Coast, 2013; Haasnoot et al., 2018) by 2100 in order to keep the sand volume of the coastal system in equilibrium with the sea level. These nourishments have stabilized the Dutch coast, facilitating a rise in beach urbanization. Besides coastal maintenance, sand nourishments have also been applied as reinforcement measure against flood risks along the Dutch coast. First examples were the hybrid, compact ‘Dike in dune’ constructions served to reinforce seaside resorts in Noordwijk (2008) and Katwijk (2015). To investigate the efficiency of large-scale nourishments, the Sand Motor pilot was executed (21 million m³, 2011–2031) (Mulder & Tonnon, 2010, Mulder & Stive, 2011; Figure 1.6), which

combined 20 years of coastal maintenance and showcased large-scale sediment transport along the Dutch coastline via natural wave and wind dynamics. Since then, mega-nourishments have also been implemented to replace former sea walls, such as the Hondsbossche dunes (2015), but with a less dynamic, more stable character. Alongside these pilots computational modelling on shoreline dynamics is developed, that offer validated insights into the dynamic evolution of nourishments, albeit still within restricted parameters. A spatial benefit of larger seaward nourishments is that they temporarily offer more room for multiple functions (e.g., beach sports, recreation, ecology). However, this aspect of mega-nourishment has not yet been fully explored due to its pioneering status, engineering context and the significant geomorphological dynamics involved.



FIG. 1.6 Aerial photo of the Sand Motor, a Dutch mega-nourishment pilot in action (2012).
Source: Rijkswaterstaat / Joop van Houdt.

Dune formation as a coastal buffer

Dunes constitute an important coastal barrier against flooding, but depend on wind-driven sand transport to counter sea level rise and recover from storm erosion (Carter, 1991; Morton et al., 1994; Keijsers, 2015; De Winter & Ruessink, 2017). This makes the supply and transport of sediment essential to support dune formation as coastal buffer.

Dunes profit from nourishments as sediment source as well as the temporary widening of the beach, which stimulates sediment transport and offers accommodation space for dunes to develop. However, nourishment techniques are still under development, therefore insights into the dynamics of dune formation following nourishment remain limited (Van der Wal, 1999, 2004; De Vries, 2012; Van der Weerd & Wijnberg, 2016). Dutch quantitative studies (e.g., Van der Wal, 1999) indicate that accretion at non-urbanized nourished beaches accounts for up to 25% of nourishment volume, illustrating the potential of nourishments to promote BwN-based dune formation. This could add up to a substantial reinforcement of the dune barrier in the long term, so long as sediment is provided and spatial conditions are met. However, more knowledge on the effects of different types of nourishments on dune formation is necessary, - especially in an urbanized setting. This would require the extension of computational models to predict aeolian sediment transport for beach and dune development in nourished and urban contexts (e.g., Dubeveg, Aeolis). For these reasons, a better understanding of wind-driven sedimentation processes is needed, including the effect of buildings and urban use.

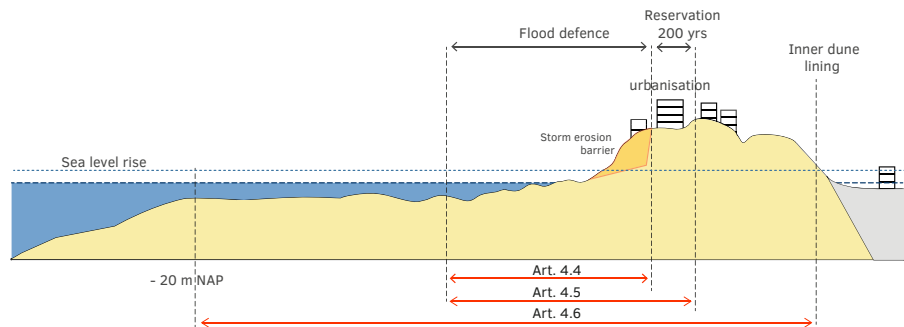

FIG. 1.7 Cross-section of a sandy shore from the inner dune lining to the -20m contour with the dunes constituting the main barrier against storms. Source: Delta Programme Coast, 2013.

In the Netherlands, part of the coastal foundation is appointed as flood-defence zone (in red), including the front dunes as a storm erosion barrier. These zones need to grow at pace with sea level rise.

The impact of coastal urbanization

Coastal urbanization constrains natural dune development by obstructing sediment flows to dunes and destabilizing vegetation. Studies on the impact of urbanization on dune formation are sparse (Tsoar, 1983; Jackson & Nordstrom, 2011; Hoonhout & Van Thiel de Vries, 2013). While 25% of nourishment volume is able to land ashore (Van der Wal, 1999), coastal profile monitoring indicates that this figure drops to 5–15% along urbanized stretches (Quartel, 2007; Giardino et al., 2012, 2013–B, 2014), highlighting the potential loss of dune formation caused by urbanization. Current typologies (e.g., boulevards, beach row housing) obstruct sediment transport to dunes (Hoonhout & Van Thiel de Vries, 2013) and are ill-equipped to anticipate dynamic land-shaping processes. Furthermore, urban tramping diminishes vegetation, which is crucial for dune stability. Buildings affect airflow, aeolian sediment transport, morphology and vegetation in their surroundings (Hunt, 1971; Luo et al., 2006; Mitteager et al., 2006; Jackson & Nordstrom, 2011; Poppema, 2022). Although there is significant research available on wind flow around buildings, knowledge on the resulting sand deposition patterns is still lacking (Wijnberg et al., 2016).

One complicating factor is that nourishment and urban strategies are often planned sectoral and in separate disciplinary contexts. Nourishment solutions are mainly developed from an engineering perspective, restricting or not addressing other functions of the coastal landscape, such as nature or recreation. Beach urbanization, such as beach housing, is mostly located at the dune foot, blocking natural dune growth. In addition, ecological coastal values do not always correspond to a nourished or recreational shoreline. Without coordination, coastal urbanization can lead to a negative spiral, destabilizing foredunes as a coastal buffer and, in turn, leading to an increase in coastal erosion (Figure 1.8).

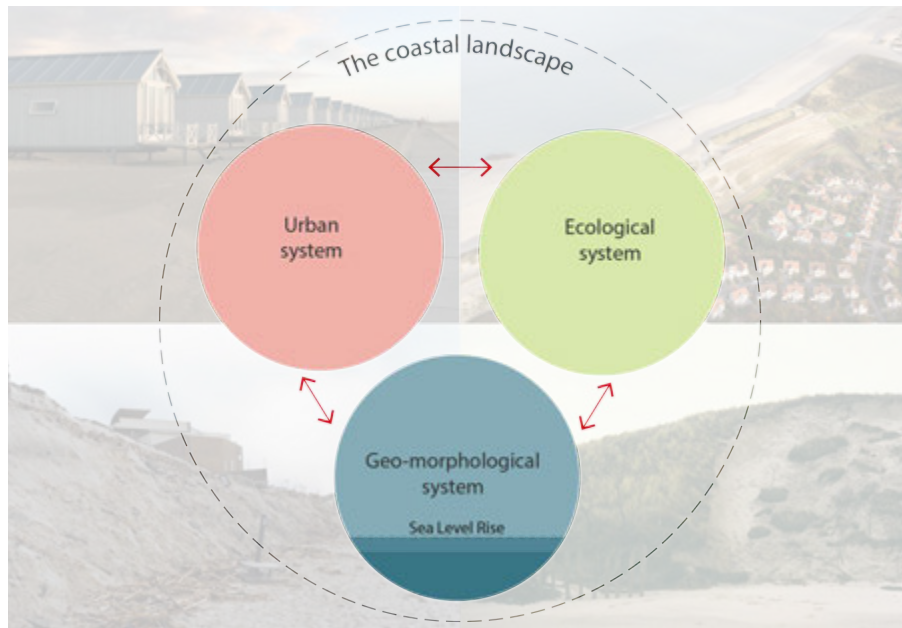

FIG. 1.8 Current interactions between coastal functions don't always run smoothly and can lead to a negative spiral. Image by the author, photos by J. van Bergen and Rijkswaterstaat / Joop van Houdt & COW.

Coastal erosion, for example, threatens coastal settlements, while intense beach recreation blocks dune formation and diminishes vegetation, leading to an increase in coastal erosion by wind and storms.

Prospects for BwN: The coastal zone as an integrated design assignment

BwN-based nourishments offer a sustainable technique to compensate for coastal erosion and develop coastal buffers over time. They provide sediment for dunes to establish this coastal buffer naturally but are dependent on sediment transport, natural succession and tailored urban arrangements to succeed. By extending BwN from an hydraulic to an aeolian technique for sediment transport, dune formation could be harvested naturally over time, a result of regular nourishments for coastal maintenance.

However, BwN nourishment techniques are still in development and place new demands on spatial coastal planning: to anticipate nourishment dynamics and unpredictability, for example, or to give way to dune formation within urbanizing recreational zones. In order to improve BwN processes ashore, a more integrated approach is necessary—one that not only improves the effects of nourishments in terms of dune formation but also creates a responsive urban environment that incorporates these dynamics and multiple values for the coastal landscape as a whole.

1.3 Problem statement

To consolidate urbanized sandy shores around the world and protect them from coastal erosion, flooding and sea level rise, new sustainable techniques for coastal reinforcement are necessary. BwN-based nourishment offers a system-based, sustainable technique for coastal adaptation, restoring the sediment balance and providing space for natural processes to build up a coastal buffer over time. However, three knowledge gaps must be overcome to establish this buffer: (1) the effects of nourishments on dune formation, (2) the integration of ecological and urban conditions to support dune formation and (3) the employment of aeolian sedimentation patterns to reinforce the dunes. This requires an integrated design approach.

To make BwN-based nourishment compatible with urbanized shores and build up the coastal buffer over time, its dynamic processes must be embedded in the coastal landscape. This requires a better understanding of the land-shaping processes that take place following nourishment (knowledge gap 1) and the integration of these processes with other coastal systems, such as ecology and urbanism, which set the biological and spatial conditions for BwN dune formation to evolve (knowledge gap 2). Greater collaboration between these systems offers opportunities to improve the BwN dune-formation process for coastal safety and increase its benefits for the coastal landscape as a whole. This collaboration asks for a design approach that not only crosses disciplinary boundaries and scales to arrive at more integrated solutions but also incorporates dynamics and temporal designs to allow for the sustainable adaptation of coastal buffer zones over time.

This integration requires the active application of BwN techniques to multifunctional coastal design. Thus, a greater understanding of the dune-formation process with regard to different types of nourishment (knowledge gap 1) is necessary. It also requires a closer look at the sedimentation patterns resulting from wind-driven or aeolian transport, especially in interaction with the built environment (knowledge gap 3). Furthermore, a connection must be made between these asynchronous and scaled processes to tune these processes for dune formation over time.

To employ BwN techniques for dune formation ashore, a responsive landscape design is needed, that employs natural and urban forms of adaptation in the slipstream of nourishment programmes. This would facilitate operation across different spatio-temporal scales, safeguarding flood safety in the face of sea level rise while maintaining the coast as a vital economic, ecological and recreational landscape.

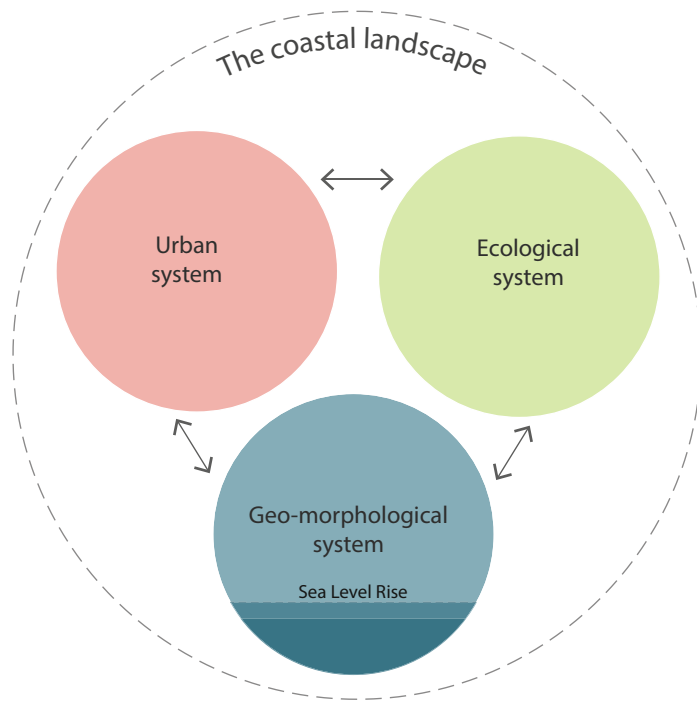

FIG. 1.9 The coastal landscape represented as an interplay of the geomorphological, ecological and urban system. Image by the author.

Due to sea level rise (below), the coastal foundation, as part of the geomorphological system, must grow at pace with sea level rise to cope. The challenge is to sync hydraulic interventions with ecological and urban development to maximize BwN flood safety efforts, while raising benefits for other coastal functions.

1.4 Research aim and questions

This research explores the development of coastal buffer zones by employing BwN solutions to their fullest potential, combining geomorphological dynamics from nourishments with ecological processes and urban development to enhance natural dune formation. The overarching hypothesis is that through the development of landscape design principles, sediment harvesting from nourishments can be increased, natural succession for dune formation can be promoted and adverse urban effects can be reduced. Ultimately, this thesis aims to develop responsive ecological and urban typologies for landscape construction, stimulating and adapting to accretionary patterns to enhance dune formation as a coastal buffer.

The main objective of this research is to compose spatial design principles that support the aeolian build-up of a sandy coastal buffer by integrating geomorphological, ecological and urban dynamics to promote the development of adaptive coastal landscapes.

In order to meet this objective, the following questions are addressed throughout the thesis:

- 1 **How can a landscape perspective support the development of an integrated approach to BwN coastal engineering ashore by connecting geomorphological, ecological and urban processes to build up a dynamic, adaptive and multifunctional coastal zone?**
This research question is addressed in Chapter 2: BwN as a landscape approach.
- 2 **Which spatial design principles support BwN dynamics for dune formation, tuning system interventions and aeolian sediment transport in scale and time?**
This research question is addressed in Chapter 3: Landscape design principles for natural coastal adaptation.
- 3 **How can the spatial design approach and principles be differentiated and aligned with varying nourishment and urban contexts to compose spatial arrangements that enhance the gradual, natural adaptation of the coastal landscape?**
This research question is addressed in Chapter 4: Application: case studies.

1.5 Research methodology

1.5.1 Research by design

The effects of climate change and coastal urbanization are incredibly complex, therefore cannot be adequately addressed by individual specializations alone. Most BwN research is highly specialized and needs to be translated back to its spatial and societal context. 'Research by design' has the capacity to spatially integrate different types of knowledge and specializations, offering a positive feedback loop to the feasibility of research outcomes. This thesis employs research by design as a vehicle to explore, understand and represent BwN as an integrated approach. One of the key qualities of research by design is the ability to combine different demands into spatial arrangements that synthesize multiple aspects. It entails experimentation, monitoring and modelling.

According to De Jong et al.(2002), research by design can be divided into four types of inquiries (see Figure 1.10). When faced with a variable (nourished) context and variable (built) objects, as is the case for BwN ashore, 'study by design' offers a method through which to determine the scope of future designs. This is done by an alteration of two types of research by design (see Figure 1.10):

- **Typological research:** Finding object constancies (types) based on research on variable contexts and historical survey, such field-experiments on sedimentation patterns or boulevard development in various coastal cities.
- **Design study:** Finding distinct conditions based on object design within an established context, such as the application of design principles in a case study.

In this research both types of research by design have been employed. In the first phase typological research on accretion patterns was carried out to formulate preliminary design principles to promote dune formation. In the second phase these design principles were applied and upscaled in four design (case) studies, to test their feasibility in various nourished and urban contexts. Both methods are described below, including their validation methods.

CONTEXT	OBJECT	
	determined	variable
determined	Design research	Design study
variable	Typological research	Study by design

FIG. 1.10 Schematic overview of the different types of research by design as resultant of context or object variables. Source: De Jong et al., 2002.

1.5.2 Typological research

The first part of this thesis features two types of typological research. The first type is multi-sourced research on sedimentation patterns around natural and built objects derived from existing literature, fieldwork and CFD modelling. The second type is a GIS study on dune formation related to different types of nourishment. From these aeolian sedimentation patterns, design principles for sediment allocation were derived, supporting the dynamic build-up of the coastal buffer.

Literature review

An inventory was made of the relevant literature regarding coastal processes, the effects of nourishment, dune formation and ecology (see Figure 1.11). Furthermore, an overview was made of the anthropogenic spatial development of coastal landscapes and the different stages of urbanization based on a quick-scan of ten global cases (van Bergen, 2017). Within these cases, special attention was paid to the interaction between the morphological, ecological and occupation or urban system, and its main spatial drivers such as nourishments or beach housing. This contextual research and the analysis of the interacting systems was input for BwN as systems approach (see Section 2.3). Additionally, a review was conducted of the literature on airflow around built objects and the effects of built objects on dune formation; as the basis for the fieldwork and design principles.

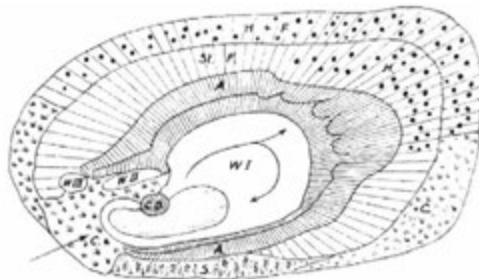

FIG. 1.11 Typology and eco-morphological development of a blowout by Van Dieren (1934), who was one of the pioneers of research on the symbiosis between dune shape and vegetation, including succession.

GIS studies on dune formation following specific types of nourishment

Due to recent developments in coastal monitoring via Lidar laser scanning, more precise and temporal data on coastal landscape dynamics is now available. In this thesis's case studies, Lidar data and aerial pictures of the Sand Motor (2013–2018) and North Holland (2015–2020) were geomorphologically analysed with QGIS software, to produce temporal landscape maps and data on dune formation following specific types of (mega-)nourishment (see Figure 1.12). Due to the increased Lidar resolution, it also offered real-time insights into local profile development and accretion patterns around built objects, such as fences and elevated buildings, validating the outcomes of the fieldwork and initial design principles.

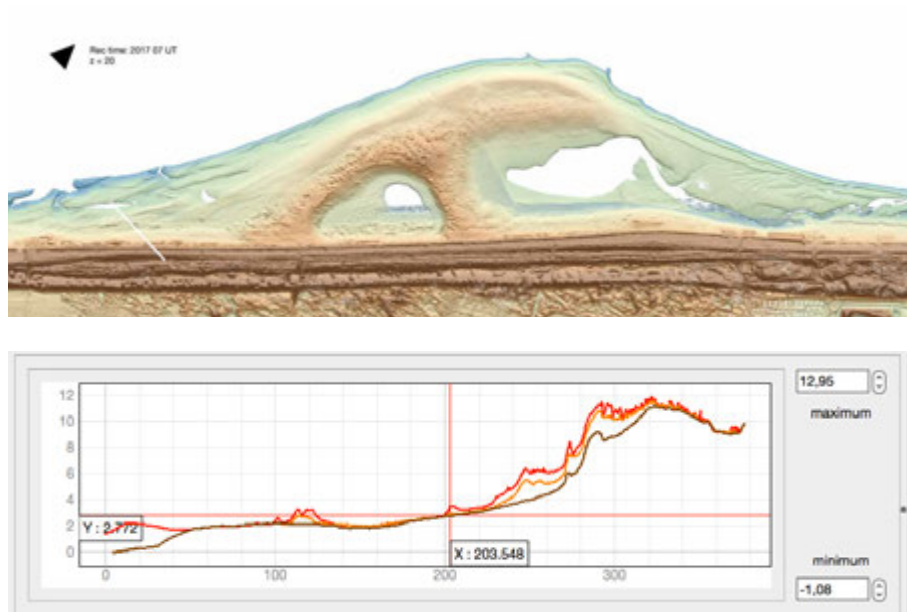

FIG. 1.12 Example of a Sand Motor (2018) elevation mapping and profile (2015; 2017; 2018), illustrating dune development as output of Lidar data in QGIS. Images by the author.

Fieldwork

To bridge the knowledge gap on accretion patterns around built objects and their long-term effects on dune formation, this thesis included two field experiments with scale models. The aim of these experiments was to gather elementary insight into sedimentation patterns caused by altered airflow around built objects, to see how they could contribute to dune formation.

The first field experiment was focused on deposition patterns around beach housing on poles. 1:5-scale models with stepped pole heights were placed at the open beach and dune foot for a six-week period to investigate the resulting accretion patterns (see Figure 1.13a). During the last week, an additional test with 50%- and 100%-closed low windscreens was conducted. Both tests were monitored using drone photography and Lidar laser scanning (at time intervals), enabling 3D reconstructions of the erosive and accretion patterns around the objects over time.

In 2020 a qualitative day test was conducted on the Dutch island of Vlieland to study the effects of the joined accretion patterns of beach row housing angular to the dominant wind (see Figure 1.13b). This test generated insights into the combined effects of row configuration and object rotation, in addition to the singular object field work of D. Poppema (2022, ShoreScape). Furthermore, two V-shaped row configurations (the ‘boomerang’ and the ‘funnel’) were tested to investigate the effects of wind convergence on deposition patterns.

From the resulting sedimentation patterns of both fieldtests an initial set of aeolian design principles was derived to support dune formation, as documented in Chapter 3.



FIG. 1.13 Two examples of fieldwork carried out under the umbrella of the ShoreScape project: on the left, the testing site at the Sand Motor (2019), where the sedimentation patterns of beach housing on poles were tested; on the right, a field test at Vlieland beach (2020) investigating the tail pattern of row housing with a 45° dominant wind direction. Images by the author.

CFD modelling

Under the umbrella of the ShoreScape project and in collaboration with Geomatics students at Delft University of Technology (2020–2021), two inquiries with computational fluid dynamics (CFD) models were made to obtain a deeper understanding of the airflow around larger building configurations (see Figure 1.14). Additionally, CFD models were used to test some row configurations parallel to dunes in order to investigate combined tail patterns and tail length. These models generated insights into how gap width, building orientation and deposition tail length affect dune build-up (dune widening versus dune heightening).



FIG. 1.14 Examples of CFD modelling of beach row housing: left the potential erosion and deposition patterns around beach row housing and right the nearbed wind field (speed and direction) Source: P. Pourtemouri, ShoreScape, 2021.

Validation of the typological research

The initial design principles on deposition patterns derived from the fieldwork were validated by the literature review and GIS study on real-time deposition patterns around buildings at the Sand Motor and in North Holland, as documented in Chapter 3. CFD modelling generated deeper insights into interactions between morphology and spatial design and was used to confirm pole effects and elaborate more complex row configurations, as observed in the fieldwork.

Finally, the design principles were validated in the case studies to ensure their feasibility across different nourishment and urban contexts and identify how they could contribute to multifunctionality and landscape differentiation (beyond flood safety).

1.5.3 Design studies

In the second half of the research, four design studies were conducted to investigate how the generic design principles would respond to various nourishment regimes and urban dynamics. In these contexts, the principles were applied, differentiated and aligned to form spatial arrangements that promote the development of coastal buffers over time. Depending on the nourishment phase and coastal programme, the arrangements were optimized to promote aeolian sediment harvesting for coastal safety and to explore their potential to build multifunctional and diverse coastal landscapes.

Design process

The goal of design studies was to find the optimal conditions for BwN design through object (or principle) variations within a specific context (De Jong et al., 2002). These conditions are generated within a complex set of projected and contextual criteria through a dialectical and converging design process. According to Van Dooren et al. (2013), this process contains five characteristic elements: experiments (fieldwork, CFD, principles), guiding themes (such as BwN), domains (morphology, ecology and urbanism), a frame of reference (e.g. standards for coastal safety, or other functional or qualitative values) and an architectural laboratory of sketching and modelling as a tool for reflection (see Figure 1.15).

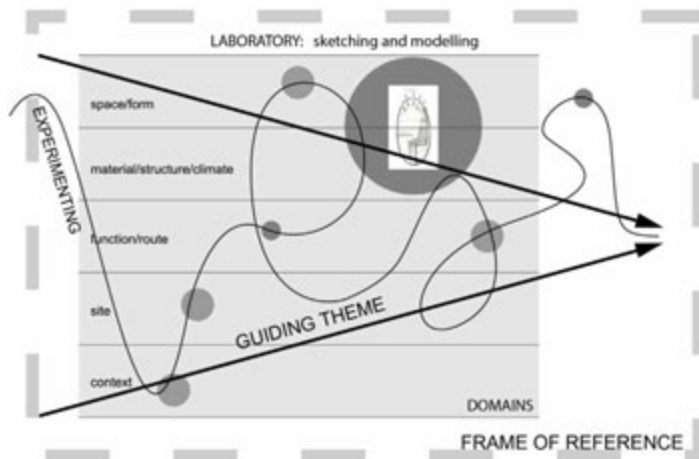

FIG. 1.15 Schematic overview of the dialectical, converging design process crossing different domains, which, through representation in drawing and models as decision models, will arrive at the most optimal solution. Source: Van Dooren et al., 2013.

Research by design as an integrative method

Through its dialectical framework, research by design has the capability to absorb and synthesize a broad range of criteria and domains and, in turn, act as a mediating instrument between scientific requirements and societal demands (Meyer, 2016). Research by design requires a different way of thinking that combines analysis and creation. Nijhuis et. al. (2017) formulate this dual process as 'design thinking': on the one hand using analysis to translate data into a design solution (discovery); on the other hand generating new knowledge through synthesis and spatial translation (invention), see Figure 1.16. The interaction between these two approaches, which lies at the core of design thinking, is represented by a visual outcome (e.g., drawing, model). Design thinking can operate in two directions:

- 1 **Abductive:** analysing data to compile or validate a certain design concept (e.g., typological research, computational modelling, field experiments).
- 2 **Deductive:** using design invention (and synthesis) to explore and confirm a hypothesis (e.g., the contextualisation and integration of the BwN design principles in the case studies).

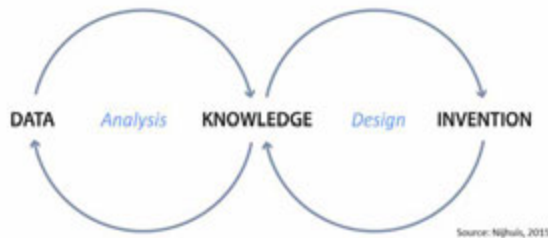

FIG. 1.16 Model of the work forms of design thinking: abductive design thinking, composing or validating a design based on data or observations, versus deductive design thinking, using design invention (right) to explore or confirm a hypothesis. Source: Nijhuis, 2015.

In this thesis, design thinking has been applied as a research method that combines abductive and deductive research throughout different stages of the project. Analytical inventory research was carried out via typological research: a literature review on coastal systems, GIS studies (Oct 2018, 2021) on dune formation and fieldwork (2019, 2020) aimed at identifying potential aeolian mechanisms that could support dune formation. From these different types of data input (knowledge), initial design principles were drawn (invention) to be implemented in the case studies.

The projections and synthesis of these principles were made in the case studies. The five characteristic elements of the design process (Van Dooren et al., 2013) were represented in the three research-by-design loops (inventory, projection and synthesis; see Chapter 2.6). The combination of fieldwork, GIS (inventory), contextual design (projection) and synthesis enabled the dialectical process to set the scope of each case study, with BwN as its main pursuit and guiding theme. Within the varying contexts, the principles were tested and allocated in local dynamic profiles as design studies for integrative research.

Validation of the design studies: GIS referencing & peer reviewing

Insights from the design studies and applications of the design principles were compared with real-time GIS data from similar locations and interventions to assess how such principles would develop over a longer period as part of temporal coastal design. Furthermore, the design process was reviewed by peers and experts (Nijhuis & de Vries, 2020) who judged the applicability of the design principles within the given context as well as the spatial integration of the principles for multifunctionality and the differentiation of the coastal landscape (beyond mere flood safety).

Interdisciplinary research

This thesis entailed an explicit search for synergy between three disciplines (coastal morphology, urban & landscape design and ecology) as well as collaboration between societal partners, such as water-management authorities and engineering and design practices. These differ not only in their general area of study but also in their communication and research methodology. These differences align with the divide between natural sciences and social sciences—a divide that has to be bridged when developing BwN solutions. Despite the differences, aim of this interdisciplinary collaboration was to combine research approaches for innovative insights that could not be achieved through mono-disciplinary research alone.

1.6 Research framework

To achieve the research objectives, a research framework was devised based on research by design as combination of typological research and design studies. This framework can be divided into six components, illustrated in Figure 1.17 and described below.

1 **Problem Statement**

The problem statement explores the problems of climate change and sea level rise along urbanized sandy shores. BwN nourishments represent a promising and sustainable technique for the maintenance and reinforcement of coastal zones. However, improvements to enhance dune formation (knowledge gap) and to integrate BwN dynamics into urbanized landscapes (integration gap) are both necessary.

2 **Development of the conceptual framework: From BwN to a landscape approach**

In the first part of the research, BwN is redefined from an engineering method to an integrated landscape approach. It repositions BwN ashore as the result of interactions between three main coastal systems: geomorphology, ecology and urbanism. By increasing the synergy among these coastal systems, BwN processes can be improved, contributing to a safer, more sustainable and more inclusive coastal zone. This requires the alignment of scaled and temporal processes in and between the systems through spatial design. To this end, an integrated landscape approach is developed that optimizes BwN functionalities and coastal zones' spatial qualities, in response to research question 1.

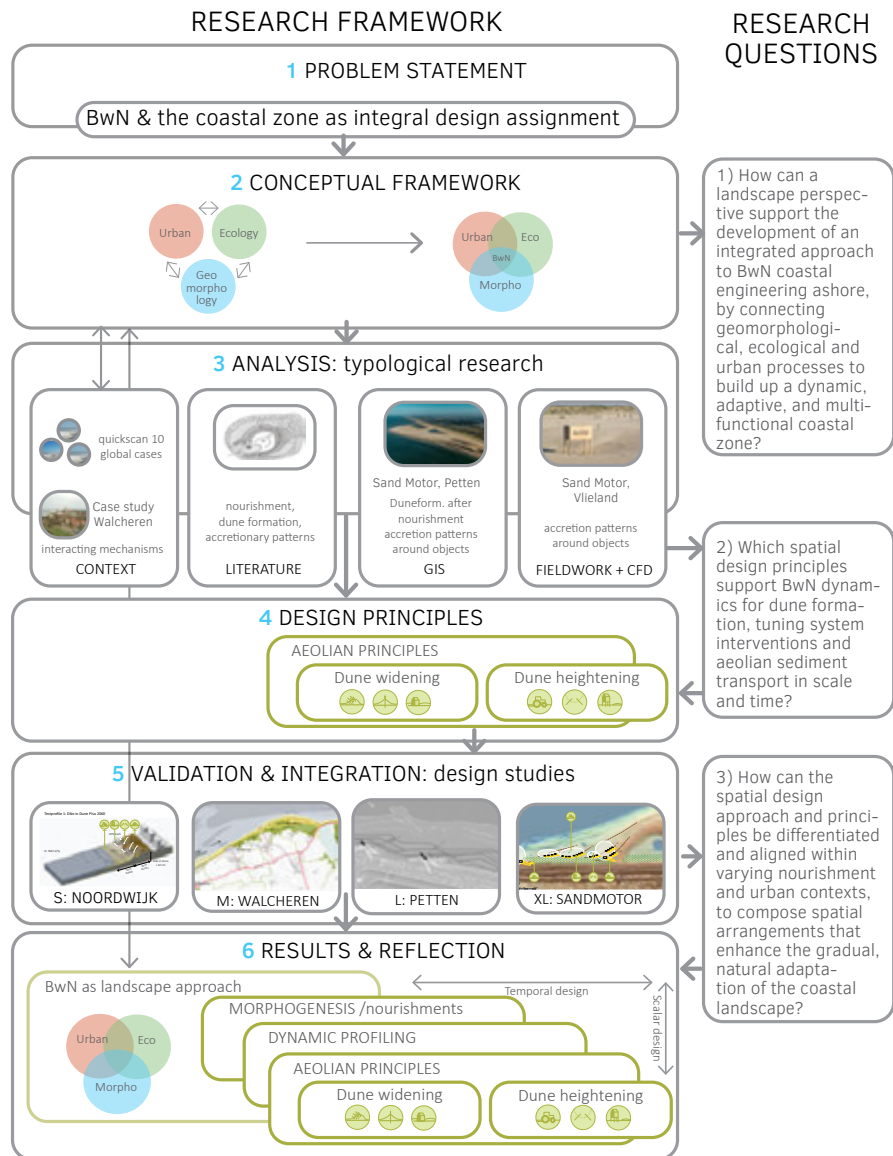

FIG. 1.17 Research framework. Image by the author

3 Typological research: Dune formation and deposition patterns

To improve interactions between coastal systems to support BwN dune formation, typological research (De Jong et al., 2002) is conducted on the sedimentation processes at the (built) sea-land interface in four studies: literature review, GIS studies, fieldwork and computational modelling (CFD). From these findings local spatial mechanisms were derived that link coastal occupation to dune formation.

Following the literature review, post-nourishment dune formation around buildings was studied in greater detail via GIS. Difference-in-elevation (DEM) maps provide insights into the spatial and temporal effects of dune formation following nourishment as well as the sedimentation patterns around buildings. These patterns were analysed closely in scale model field tests. Additional testing was done through CFD modelling of accretion patterns in more complex row configurations. The outcomes of these inquiries generated insights into how spatial design can enhance BwN dune formation, addressing research question 2.

4 Design principles

Based on the typological research, a preliminary set of local, aeolian design principles was derived to stimulate positive interactions between wind-driven sediment transport and urban construction for dune formation. These principles entail the use of wind-driven (aeolian) processes, ecological and urban interventions for sediment allocation to promote dune formation. The principles, which were derived from the literature review, fieldwork, GIS studies, fieldwork and computational modelling (CFD), were arranged to promote specific profile alterations. To bring these principles to a more substantial (landscape) level, they were applied and upscaled across four case studies.

5 **Validation and integration: Dutch design studies**

In the last phase of the research (NL lab), the design principles were validated across four different case studies to differentiate and align them with varying nourishment and urban contexts. From their application, spatial arrangements were composed that promote the development of the coastal buffer as part of the integral approach, addressing research question 3. The design studies provided insights into the feasibility of the design principles at multiple stages and across diverse contexts and offered guidance to compose larger configurations supporting specific profile development over time. This iterative process led to the definition of two overarching design steps in dune formation—temporal mapping and profile design—addressing research question 2. The case studies were subject to GIS comparison and peer reviews for validation.

6 **Results and reflection: Design method & principles for adaptive, integrated coastal landscaping**

The conclusion reflects on the applicability of the BwN design principles to different coastal settings and spatial arrangements supporting BwN dune formation. It translates the outcomes of the case studies into a general design strategy for adaptive coastal landscaping along sandy shores. Within this design strategy, large-scale nourishment dynamics are linked to local harvesting methods via urban and ecological design, steering sediment dynamics to designated areas. In this way, sediment can be allocated to strengthen coastal buffers and facilitate a multitude of coastal functions as part of an integrated BwN-based design approach.

1.7 Scope, relevance and limitations

Scope

This research focuses on the development of sandy shores— the Dutch coast above all—taking BwN-based sand nourishments as central strategy to counter the effects of sea level rise. This strategy looks specifically at the onshore, aeolian effects of nourishments on dune formation, considering the nourishment strategy to be a given. Within this spatial context, it elaborates on BwN profile development and dune formation along urbanized shores, as urban use inevitably affects sediment flow and ecology, affecting the building of dunes. Vice versa, nourishment and dune formation also impact other coastal functions. Therefore, BwN ashore requires an integrated approach to coastal safety, multifunctionality and spatial quality, as elaborated in this research.

Societal relevance: design principles for nourished sandy shores

This research contributes to the development of integral, nature-based, adaptive solutions along sedimentary, nourished coasts in urbanizing deltas around the world to compensate the negative effects of sea level rise. The results will support designers, engineers, local authorities and policymakers by defining effective ways to sustainably develop coastal buffer zones using scientifically supported and feasible design principles. These design principles can be employed to improve BwN-based adaptation of urban coastal zones (and their nourishment programmes), such as the application of flexible seasonal urban typologies to support BwN dune formation.

Scientific contributions

This research contributes to science by generating insights into the effects of different nourishment types on dune formation (via GIS: Geographical Information Systems) and into the spatial parameters affecting accretion patterns, as a base for BwN coastal design. Furthermore, the case studies illustrate how BwN dynamics can be integrated into the coastal landscape at various scales, tailored to include other coastal functions, such as ecology and urbanism. The main contribution of this research is the development of spatial design principles that connect geomorphological, urban and ecological aspects to support the integrated build-up of coastal buffer zones. These principles are validated by typological research and design studies.

Collaboration

This research is part of ShoreScape, a joint interdisciplinary research project of the University of Twente (UT) and Delft University of Technology (TUD) led by Prof. Kathelijne Wijnberg. It also features a partnership among HHNK, Rijkswaterstaat, H+N+S, Witteveen + Bosch, Deltares and Imares pertaining to research and end-use (user group). For more details on this partnership, please refer to the NWO proposal (Wijnberg et al., 2016).

In the joint ShoreScape project, the UT (two) and TUD (one) doctoral students, together with their supervisors and representatives from civil society partners, worked to develop and validate design principles for coastal buffer zones. Shared research has entailed field experiments and the CFD (Computational Fluid Dynamics) computer models to calibrate the design principles and Dubeveg (dune beach vegetation) model outcomes. The user group was invited to workshops for peer reviewing and expert judgment on the outcomes.



FIG. 1.18 Joint Sand Motor fieldwork between UT and TUD, spring 2019. Photo by the author.

Limitations

- Various types of sedimentary coastal systems exist, each characterized by its own bio-morphological processes and system-specific natural and urban dynamics. This research focuses on urban sandy shores characterized by beach-dune morphology to explore possibilities of sedimentary land-shaping (BwN) processes interacting with the built environment. This (largely) excludes unbuilt shorelines and shorelines lacking in dune formation (rocky shores for example).
- This research focuses on nourished shorelines. The aim is to develop BwN design principles that can also be applied to unnourished shorelines (to slow down erosive processes for example, or to make the maximum use of natural accretion processes).
- Due to the extensive literature on BwN-based nourishment design in the engineering discipline, the scope of this research is limited to interventions at the sea-land interface. In all of the case studies, the nourishment strategy is considered to be a given, with nourishment design only documented in general terms. In some cases, feedback is given on the initial nourishment strategy to facilitate potential improvements to BwN ashore.
- The research on ecological aspects of coastal adaptation is limited for two reasons. First, elaborate coastal ecological research on dune development is already available. Second, most ecological coastal research focuses on rural and inland dune areas, whereas this project focuses on the dynamics of aeolian sand transport in nourished and urbanized coastal zones.
- This research focuses on design principles that enhance the natural aeolian development of a coastal buffer. Thus, the emphasis is on viewing the spectrum as a means to build up coastal landscapes rather than conducting in-depth research on specific deposition tail patterns. However, the knowledge gap on the aeolian effects of buildings must be overcome. This is why the first part of the research is dedicated to local sedimentation patterns (Chapter 3) before application in landscape design (Chapter 4).

1.8 Thesis outline

This dissertation comprises the following five Chapters

Chapter 1: Introduction (problem statement and research outline)

This chapter analyses the problem of climate change and sea level rise and its consequences for sandy shores around the world. In response, sand nourishments are executed to compensate for coastal erosion and restore the sediment balance in line with the principle of 'Building with Nature'. However, this technique is still in development. Insights into the resulting dune formation remain limited, causing complications and setbacks in accretion at urbanized shores. A more integrated approach is necessary to enhance BwN processes ashore, to maintain coastal safety and contribute to multifunctional coastal landscapes.

Chapter 2: Building with Nature as a landscape approach (conceptual framework)

This chapter details the conceptual framework underlying this thesis. It begins with an overview of BwN as an adaptive coastal strategy for sandy shores, as main ambition and technique to support nature-based dune formation. To improve BwN processes in urbanized sea-land interfaces, its main operating systems have to be aligned to address and incorporate sediment dynamics, ecology and urbanity. This requires a systemic and integrative landscape approach that tunes dynamic processes and multifunctionality in scale and time.

Chapter 3: Landscape design principles for natural coastal adaptation

This chapter provides an overview of the developed design principles for the application of BwN as a landscape design approach backed up by literature review, GIS studies, fieldwork and CFD modelling. These principles connect the different scales and phases of dune formation; from initial nourishment, via sediment transport, to the allocation of sediment within the coastal profile supported by local aerodynamic configurations. This approach gives way to directed sediment dynamics to improve the dunes as coastal buffer and the multifunctionality of the coastline.

Chapter 4: Application: case studies

This chapter provides an overview of the design studies on four cases along the Dutch coast, addressing different types of nourishments and urbanity. In these case studies, the developed BwN principles were contextualized and upscaled to a landscape level to derive spatial arrangements for dune formation at different scales. The design studies constituted an iterative process that resulted in a design approach and method for achieving integral coastal adaptation, as described in Chapters 2 and 3.

Chapter 5: Synthesis

This chapter reflects on the applicability of the BwN design principles to different coastal settings and the potential of spatial arrangements to facilitate BwN dune formation. It translates the specific outcomes of the case studies into a generic design strategy for adaptive coastal landscaping along sandy shores. This includes key design choices to synergize systems for BwN dune formation and means of maximizing coastal design for multiple functions.



Aerial photo of sediment dynamics at the north wing of the Sand Motor.
Source: Rijkswaterstaat / Joop van Houdt.



2 Building with Nature as a landscape approach

2.1 Introduction

This research takes Building with Nature (BwN) as the central motive for sustainable coastal development. It aims to enhance the BwN process of dune formation following nourishment to achieve a natural and integrated build-up of the coastal buffer in response to sea level rise.

To properly employ BwN as a dynamic, nature-based and multifunctional strategy for urbanized shorelines, a deeper understanding of how coastal systems operate and interact is necessary. Section 2.2 details the BwN approach as well as its parameters for application as a coastal strategy.

To extend BwN from an engineering approach to an integrated systemic perspective, the coastal landscape is defined as an interplay of three main systems: the geomorphological system, the urban system and the ecological system. All systems interact and create the conditions for BwN processes to evolve. Current interactions (e.g., erosion, urban development, de-vegetation) often obstruct dune formation processes, needed for coastal adaptation. Another complicating factor is that each system is guided by a separate discipline with its own approach, method and language.

However, analysis of the overlapping mechanisms also provides pointers to improve the collaboration between coastal systems, creating a positive cycle for BwN. Once systems dynamics are identified and aligned, they offer opportunities to develop the coastal buffer zone in a natural and multifunctional way. System interventions (e.g., nourishment, ecological development, urban development) become linked, based on the interacting mechanisms that they offer to BwN dune formation. Overall, three bridging concepts and processes can be defined to enhance BwN ashore: *natural succession*, *dune farming* and *urban harvesting*, maximizing the sedimentation process for dune formation following nourishment. These concepts and processes are documented in Section 2.3.

In order to shift from a functional systems perspective to a spatially integrated perspective, BwN is reframed as a landscape approach. The operationalization of BwN processes for coastal landscaping requires the bridging of the spatial and temporal gaps between the relevant interventions. Nourishments constitute the primary driver of change and feature high dynamic processes on a regional scale, while dune-formation and urbanization are low,- to mid-dynamic processes on a local scale. At the same time, BwN solutions not only serve coastal safety, but they also offer land-shaping processes to support integrated coastal design and serve multiple coastal functions and values. This landscape approach is elaborated in Section 2.4.

To bridge the spatial and temporal scales involved with BwN, three design steps were defined: *morphogenesis*, *dynamic profiling* and *aeolian principles*. These steps enhance and align the interactions between the separate system interventions, to support BwN processes in space and time. As design instruments, they promote the integration of landscape functionalities and values at various levels and offer a neutral canvas for interdisciplinary collaboration. They can be applied within an iterative design process as a form of research by design. This design approach, including its application in this research, is explained in Section 2.5.

2.2 Building with Nature as an adaptive strategy for sandy shores

Building with Nature can be defined as ‘the employment of natural processes and resources to serve societal goals, such as coastal safety’ (de Vriend et al., 2014; van Bergen et al., 2021). As an emerging philosophy in hydraulic engineering, it promotes (soft) infrastructure that works with nature rather than against it. Sand nourishments, for example, strengthen coastal buffers in a natural and system-specific way. They constitute a driver of change, facilitating land-shaping processes that support dune formation. However, to employ BwN as an adaptation strategy for sandy shores, a deeper understanding of how coastal dynamics and nourishments operate is necessary. This Section discusses the goal, definition and the key features of BwN-based nourishments as well as (Dutch) strategies for sandy coastal adaptation, including examples and limitations.

2.2.1 BwN via nourishment: Restoring the sediment balance

Sandy shores around the world are suffering from coastal erosion due to a lack of sediment input and sea level rise. Their long-term physical existence is dependent on sediment balance to compensate for sea-level rise. Therefore, sediment resources and -dynamics are conditional to any spatial design to sustain sandy shores. In response, coastal sand nourishments are increasingly executed using the so-called ‘Building with Nature’ technique (BwN). Sand nourishments entail the mechanical placement of sand in a coastal zone to restore the coastline or maintain the sediment volume in the littoral system (Stronkhorst et al., 2020). Nourishments counter the negative sediment balance caused by sea level rise, and employ natural processes (e.g., currents, waves, wind) to redistribute the sediment to beaches and dunes as coastal buffer. This buffer is more effective during storms and more compatible with the natural coastal system than hard structures, such as seawalls. This makes the dune system a vital part of BwN coastal design.

In the Netherlands, the first goal of nourishment is to maintain the shoreline and provide flood safety. The maintenance and growth of beaches and dunes also serve various design objectives, including the provision of opportunities for nature (e.g., restoring, expanding and/or creating habitats), recreation (e.g., larger beaches, waterfronts, scenery) and economic growth (e.g., tourism, fishing, recreation).

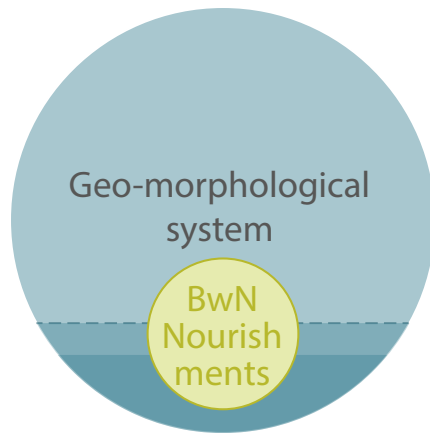

FIG. 2.1 Representation of the geomorphological coastal system, including BwN-based nourishments to restore the shoreline and sediment balance. Image by the author.

Offering a sustainable alternative

Although hard structures (e.g., seawalls, groynes) seem to be an economical and reliable means of sea defence in the short term and medium term, they do not solve the underlying erosion problem in the long term (i.e. the sediment deficit of the coastal foundation) and, therefore, are less effective. Moreover, hard structures often disturb or divert local currents along sandy shores, leading to greater erosion in adjacent areas. Although harbour dams or groynes can promote the local accretion of beaches within their direct vicinity, they can also lead to more erosion along neighbouring shorelines, displacing the problem.

Due to their soft and sandy nature, nourishments don't cause adjacent erosion but promote accretion and restore the system's sediment balance. Another advantage of nourishments compared to seawalls is that, if a seawall breaks, its function as a flood-defence is lost. If a dune erodes during a storm, the sediment is dispersed into the water, still mitigating waves due to its heavier suspension. Furthermore, the dune system has the capacity to recover naturally after storm erosion, as observed along many sandy shores (e.g., Vousdoukas et al., 2012; Scott et al., 2016; Phillips et al., 2017). Through the use of system-based material, nourishments are able to integrate more swiftly into the natural local system. By anticipating local currents and sediment dynamics, natural processes can be employed to move sediment ashore. Because the foreshore ecosystem is well-equipped to handle dynamic conditions, such as storm surges, it is able to recover reasonably well following nourishment (Loffler, 2013). Additionally, nourishments can offer space and sediment for the development of new habitats, such as embryonal dune development.

However, a precondition for sustainable nourishment is sediment availability within a reasonable distance, as is the case in the North Sea. Without these resources, transport reduces the sustainability of the solution. Some initiatives have begun to investigate nourishments powered by wind mills at sea to make dredging more sustainable (e.g., Kollen, 2021). If sufficient sediment sources are nearby, nourishments can be carried out for a long time, making them a sustainable strategy for long-term coastal development.



FIG. 2.2 Photo of 'streamers' with suspended sand at Westkapelle Beach (January 2022), enabling substantial sediment transport to the upper beach and dunes. Photo by the author.

From nourishment to dune formation

Following nourishment, sediment is transported by natural processes (e.g., waves, tide, wind) to become part of the beach and dune system. These dunes depend on wind-driven sand transport to recover from storm erosion and counter both sea level rise and increasingly intense storms stemming from climate change (Carter, 1991; Morton et al., 1994; Keijsers, 2015; De Winter & Ruessink, 2017). The buffer function of dunes against storm erosion is enforced by sand nourishments through the supply of sediment, which enable the maintenance or enlargement of the beach. This guarantees wind-driven sand transport to the dunes and accommodation space for dune development. Accretion at non-urbanized beaches accounts for up to 25% of nourishment volume (Van der Wal, 1999), illustrating nourishments' potential to enhance nature-based dune formation. However, this rate can decline to 5–15% along urbanized stretches (Quartel, 2007; Giardinio et al., 2012, 2013, 2014). Computational modelling of aeolian sediment transport is still in an early stage of development. In the future, such modelling will enable more precise predictions of the contribution of nourishments to dune formation, including in urbanized environments.

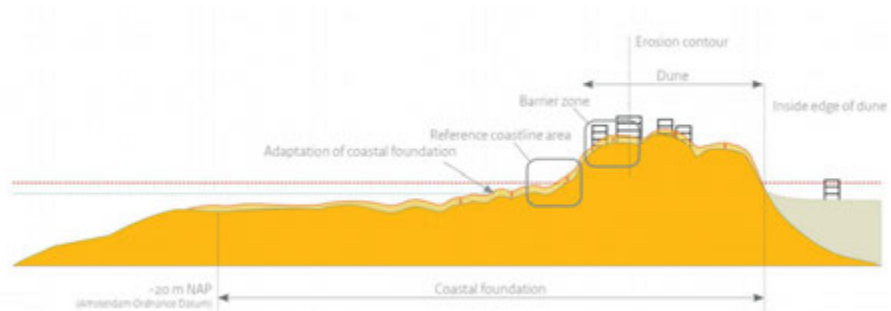

FIG. 2.3 Section of the coastal foundation from the inner dune lining to the -20m line, as regulated by Dutch coastal policy. Source: Deltaprogramme Coast, 2013.

The coastal foundation includes the reference coastline ('BKL'), which is maintained by the nourishment program. It also includes the dune erosion contour and barrier zone, which is subject to erosion during extreme storms and, therefore, restricted for urban development.

2.2.2 Origins and definition of BwN

Building with Nature is defined as ‘the employment of natural processes and resources to serve societal goals, such as coastal safety’ (de Vriend et al., 2014; van Bergen et al., 2021). As an emerging philosophy in hydraulic engineering, it promotes (soft) infrastructure that works with nature rather than against it as an alternative to hard infrastructure.

The approach dates back to the 1970s, when Dutch nourishment pilot programmes were first executed as a successful alternative to hard coastal infrastructure. This led to a paradigm shift in Dutch national policy (Eerste Kustnota, 1990) from hard to sediment-based techniques as the foundation of coastal defence. Since then, sand nourishments have been widely employed in Dutch coastal management—reaching an average yearly nourishment volume of 12 million m³ of sand since 2001.

The launch of more advanced nourishments, such as the Sand Motor, led to an early definition of BwN as the design of infrastructure that (a) is aligned with natural processes rather than against them; (b) is adaptable to changing conditions, such as sea level rise and climate change; and (c) serves multiple purposes (de Vriend & Koningsveld, 2012).

This definition, which closely links BwN to ecological research (‘by nature for nature’), initiated the second generation of hybrid BwN solutions (van Bergen et al., 2021) serving a wide range of purposes, including coastal, lakeside, port and urban solutions (Ecoshape, 2021).

An international series of urban flood disasters around 2010 made the need for urban climate adaptation more evident. BwN was promoted as one of many potential nature-based solutions, defined as ‘solutions that are inspired and supported by nature, which are cost-effective, simultaneously provide environmental, social and economic benefits and help build resilience. Such solutions bring more, and more diverse, nature and natural features and processes into cities, landscapes and seascapes, through locally adapted, resource-efficient and systemic interventions’ (EU, 2016). It placed urban adaptation on the agenda, as well as the need to serve multiple values in a systemic approach. Furthermore, a distinction emerged between nature-based solutions and BwN solutions: while nature-based solutions promote all solutions inspired or supported by nature, BwN explicitly employs natural processes as part of its solution (expressed in the word ‘building’), not just natural resources.

One way to address multiple values through nature-based or BwN solutions is to define them in terms of ecosystem services (ESS). They entail support services provided by the substratum (including nourishment) in service of other coastal functions, such as the regulating layer (e.g., flood safety) and production layer (e.g., housing, economy). Although ecosystem services include cultural services and values, such as scenery, these values are often overruled or marginalized by top-down functional specifications that prioritize other values, such as flood safety. Additionally, interdependencies between ESS layers are difficult to specify.

One attempt to restore these ecosystem relationships was made by the University of Oxford (2020). In its framework for urban nature-based solutions, they target the 'co-production of ecosystem services' through collaboration between the socio-economic, physical and ecological systems (Raymond et al., 2017). Rather than isolated functionalities, it focuses on co-productive processes, such as resilience, regeneration and participation. Other values, such as biodiversity, emerge directly from the rebalancing of systems. However, the definitions of these systems remain abstract and, therefore, are difficult to operationalize.

In conclusion, the debate over climate change and nature-based solutions has adopted a more urban agenda to increase the resilience and adaptivity of urbanized coastal zones. BwN's focus on natural processes led to an early link between BwN-based hydraulic solutions and ecological solutions but left the incorporation of urban and landscape processes underdeveloped. Beyond the technical challenge to predict, employ and direct natural BwN dynamics, an additional challenge is repositioning BwN within the urban coastal landscape.

2.2.3 Sediment as a coastal strategy

About one fifth of global shorelines is sandy (Bird, 1985), including 4% of sandy shores that are currently nourished on a regular basis. To compensate for erosion and prevent economic losses, this percentage has to grow to 18–33% by 2100 (Hinkel et al., 2013) based on IPCC scenarios. These volumes make it necessary to expand, upscale and optimize nourishment strategies to restore the sediment balance of sandy shores.

A nourishment strategy is defined by its goal, volume, type and frequency. This Section provides an overview of Dutch strategies as one of the more advanced examples of sediment-based shoreline maintenance and flood protection, followed by a summary of nourishment types and limitations.

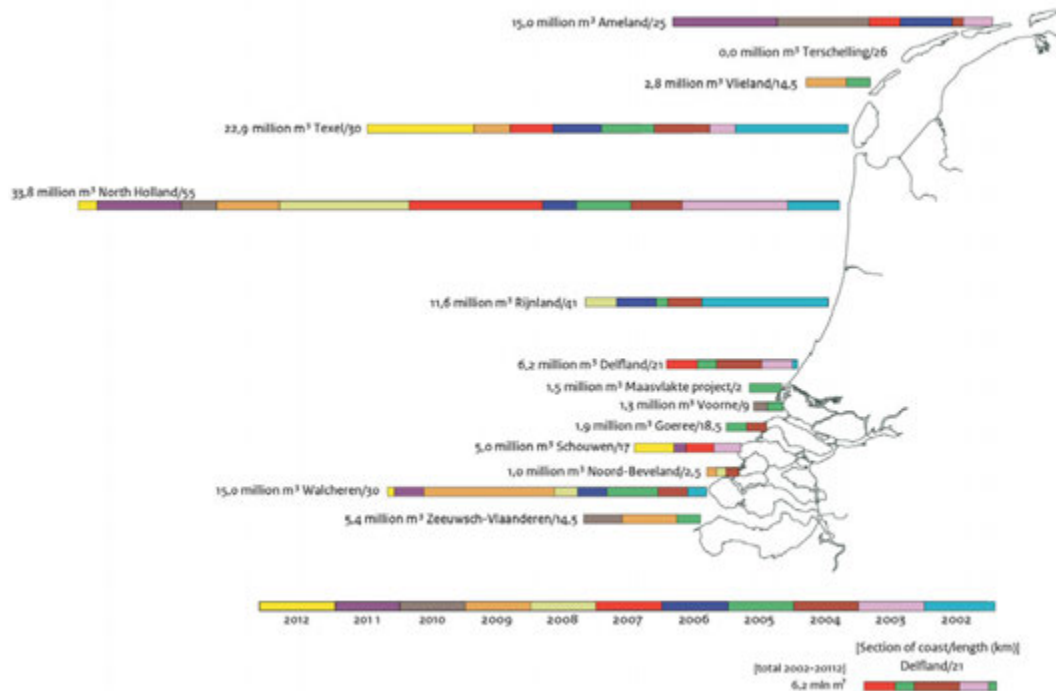

FIG. 2.4 Overview of nourishments in the Netherlands (2003–2013; each colour represents one year). Nourishments vary along coastal trajectories depending on local conditions. For example, near-shore trenches (e.g., those at Walcheren and North Holland) require more sediment. Source: Rijkswaterstaat / National Coastal Strategy 2013.

Dutch sand strategies

In 1990, in response to persistent coastal erosion, the Dutch government decided to change from hard coastal interventions to a soft, sandy strategy, proclaiming a new motto: 'soft where possible, hard when needed'. These nourishments rebalance the 'sand-sharing' coastal system and serve multiple strategic objectives: shoreline maintenance and flood protection aimed at preserving the urban, economic and ecological functions of the coastal zone.

The Dutch coastal strategy is divided into two separate programmes. The first programme aims to sustainably maintain the coastline and preserve urban, economic and ecological functions. It is effectively a 'hold-the-line' strategy, maintaining the so-called 'reference coastline' by restoring territorial losses within the sea-land interface from -5m to the dune foot. The total annual volume for the Dutch coastline amounts to 12 million m³. The maintenance program is carried out via regular small-scale nourishments (ca 1 million m³) every five years based on coastline monitoring (see Figure 2.4). Program results are positive, leading to seaward trends and improved safety levels (Giardino et al., 2012, 2013-B, 2014).

The current maintenance volumes may triple or more (Delta Programme Coast, 2013; Haasnoot et al., 2018) by 2100 in order to keep the sand volume of the coastal system in equilibrium with the sea level. In other words, upscaling the current nourishment strategy will be necessary to maintain flood safety and coastal functions. To this end, an experimental mega-nourishment (Sand Motor pilot (20 million m³, 2011)) has been executed, combining 20 years of the maintenance budget in one intervention (see Figure 2.5).

Another programme, the High Water Protection Program, focuses entirely on safety against flooding including the flood-prevention function of dunes. This programme monitors and secures a minimal buffer against erosion during an extreme storm event, the so called 'storm erosion profile' ('afslagprofiel'). LIDAR monitoring of coastal profiles, regional waterboard surveys and new insights into future storm conditions can all indicate potential weak spots, which can be reinforced through additional sandy reinforcement. Recent examples include the (hybrid) reinforcements in Noordwijk (2008), Scheveningen (2011) and Katwijk (2015) as well as the large-scale sandy reinforcements replacing former sea walls in Zeeuws-Vlaanderen (2014), Petten (2015) and Texel (2018).

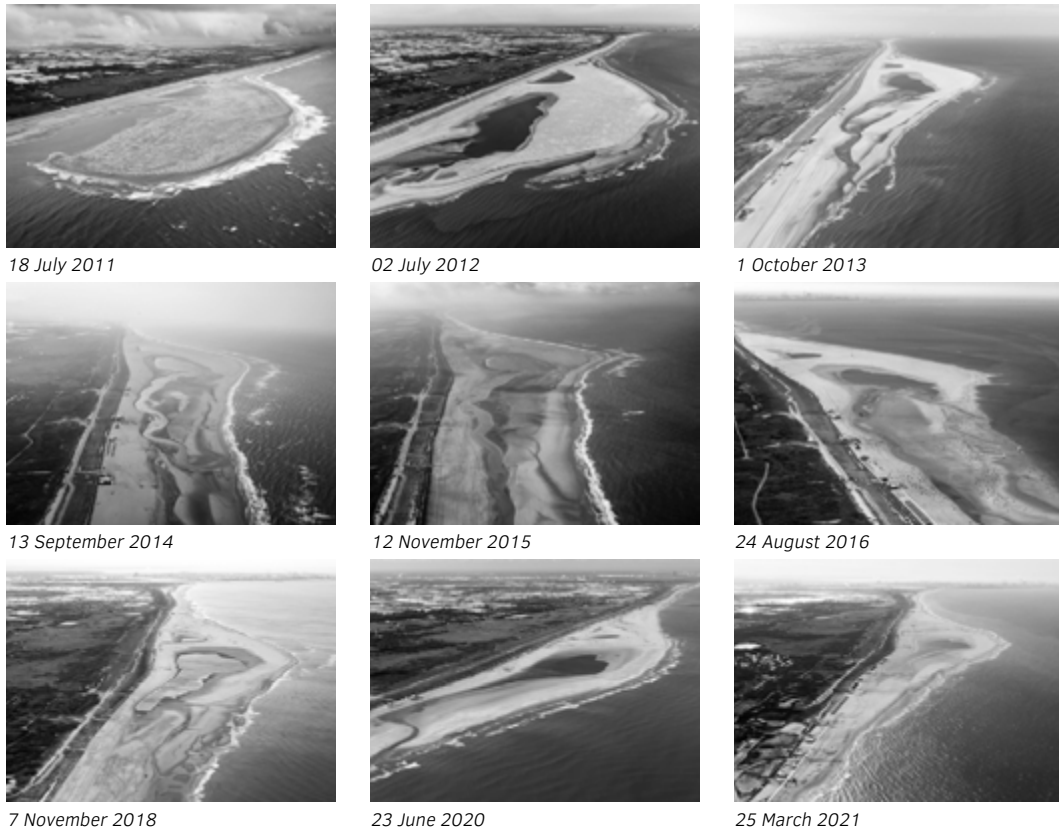

FIG. 2.5 Overview of aerial pictures of mega-nourishment at the Sand Motor (2011–2021) showing its transformation caused by the (BwN) employment of coastal dynamics (e.g., waves, currents, wind). Photo's: Rijkswaterstaat / Joop van Houdt (2012, 2013) and by Zandmotor (www.dezandmotor.nl).

The initial peninsula was around 1x2km, but it has spread due to the process of erosion and sedimentation along 15km of coastline (both northward and southward), benefitting from the extra supply of sediment. The lake in the middle was added for ecological reasons, and a second laguna was created by the dynamic 'tail' of the Sand Motor, providing unique conditions for sheltered water sports.

2.2.4 Examples of sandy solutions

As illustrated by Dutch coastal strategies, sandy solutions come in various volumes, forms and frequencies. They can be divided into the following categories: BwN-based nourishments, nature-based sandy reinforcements, and sandy land reclamations.

1 BwN based nourishments

BwN-based nourishments are sand nourishments that restore the sediment balance of the coastal foundation. These nourishments employ both system-based material and natural processes for sediment transport to achieve societal goals. From Dutch coastal practise, three main types of BwN-based nourishment were derived (Brand et al., 2022).

- **Beach nourishment**, adding sediment to the beach surface between the low tide and dune foot zone (see Figure 2.6).
- **Shoreface nourishment**, adding sediment underwater in the foreshore zone (ca -5m NAP, see Figure 2.7).
- **Channel wall nourishment**, adding sediment to the landward side of the channel for seaward migration (e.g., Walcheren, 1985; see Figure 2.8).

A fourth type is **Ebb tidal delta nourishment**, an innovative systemic approach, adding sand to the outer ebb-delta as a sediment source for the tidal basins and the adjacent barrier islands. An example is the 5 million m³ nourishment pilot to the Amelander Zeegat, 2019)

Beach nourishments (and dune reinforcements) were the first types to be applied. Today, beach and shoreface nourishments are the most common types, promoting dune formation in a direct way. Most nourishments are around 1 million m³ in volume. One notable exception is the Sand Motor, a mega-nourishment of 20 million m³ of sand, as combined volume for 20 years of Dutch shoreline-maintenance (see Figure 2.5).



FIG. 2.6 Beach nourishment in Texel, NL 2020 (left). Source: Texelinformatie.nl.



FIG. 2.7 Shoreface nourishment in North Holland, NL 2020 (middle). Source: Rijkswaterstaat.



FIG. 2.8 Channel wall nourishment by hopper dredger 2011 (right). Source: Rijkswaterstaat / Deon Slagter WG 2011.

2 Nature-based sandy reinforcements

Nature-based sandy reinforcements also reinforce the coast with sediment, but have a more stable character compared to BwN-based nourishments. These nourishments employ system-based material (sediment) but do not actively employ natural processes (despite being subject to them) to stay in place for as long as possible.

In Dutch nature-based sandy reinforcements, beach nourishment and dune reinforcement are often combined, to replace seawalls for example, as executed in Petten (2015) and Texel (2018). Furthermore, a series of hybrid solutions have been developed for the reinforcement of waterfronts, such as dike in dune-constructions (e.g., Noordwijk (Figure 2.10), Scheveningen, Katwijk), beach-breaker-constructions (e.g., Bacton, 2019) and the hybrid sandbar breakwater and harbour expansion built in Lekki, Nigeria in 2019 (van der Spek et al., 2014). These examples show that sandy reinforcements are still in development in both scale and (hybrid) nature.



FIG. 2.9 Dune reinforcement in Renesse, NL 2014 (left). Image by the Sinke group.



FIG. 2.10 Dike in dune reinforcement of the coastal resort in Noordwijk (right). Photo by the author.

3 Sandy land reclamations

A third category is sandy solutions for land reclamation, such as the construction of artificial islands or land expansions with sand. While the Netherlands has a longstanding tradition of BwN-based land reclamations, such as the silting of polders ('kwelderwerken'), modern sediment-based land reclamations (e.g., Maasvlakte II) have a static character and are often protected by hard structures. Therefore, they cannot be categorized as BwN or nature-based solutions.

2.2.5 Limitations of nourishments and sandy reinforcements

Reliance on sediment availability and transport

Although BwN nourishments and sandy reinforcements are known for their numerous system benefits, they feature notable limitations. Sediment is a natural material that needs to be mined in large quantities to nourish the coast. The 12 million m³ per year of sediment currently being used for the Dutch coast is equivalent to about 4,000 dredging shiploads per year. Projections indicate that this number could triple to 12,000 ships per year by 2100. These transports require fuel—currently meaning oil—which increases CO₂ emissions and exacerbates climate change. This dynamic is especially relevant for coastlines without nearby sediment availability. To reduce the ecological footprint of sand nourishments, more research on sustainable energy sources is necessary (e.g., solar or wind (Kollen, 2021)).



FIG. 2.11 Map of the planned and abandoned sand mining areas (in yellow) within the 12 mile coastal zone of the North Sea, reserved for sand extraction for nourishments Source: Noordzee-atlas, 2022.

Ecological effects of sand nourishments

The practices of sand mining and nourishment, although nature-based, have ecological effects. The mining of sand entails disturbing the seabed and associated habitats. Depending on the nourishment type, it can also affect onshore habitats. Foreshore nourishments cause the least disturbance, as most foreshore habitats are resilient to harsh impacts, such as those of severe storms. Dynamic onshore habitats, such as embryonal dunes and white foredunes, can profit from increased sediment transport from nourishment. Seaward nourishments can also promote biodiversity (Marchand et al., 2012).

However, medium-dynamic habitats in the upper and landward parts of beach dune systems are negatively affected, such as the reduction of fauna (Schlacher et al., 2012; Stronkhorst et al., 2020). Nourishments alter the sediment type and coastal profile, affecting, for example, the feeding habitats for sea birds. Additionally, they impact the type and amount of sediment transport, changing erosive dune fronts to accreting dune fronts, that potentially reduce calcium-rich sediment transport to the inner grey dunes. This issue could be mitigated by the construction of artificial blowouts (Arens & van der Wal, 1998). Finally, low-dynamic dune habitats, such as dune streams (duinrellen), should be sheltered from dynamic overload, as recovery will be hard (Doing, 1988). In the future, greater customization of nourishment types is expected to meet the demands of and conditions for local habitats.

Dealing with uncertainty

One of the key elements of BwN is the employment of natural processes to serve societal goals through self-regulation (de Vriend et al., 2014, 2015; van Bergen et al., 2021). Here, natural processes are the vehicle to establish an intervention for crucial goals as coastal safety. These natural processes do have a drawback, however, in that they are hard to predict and, therefore, unreliable. The sequence of storms, for example, may vary by year or even by decade, but the next super-storm may also appear next year. Although trend lines aid in predicting weather dynamics, seasonal variation may turn out otherwise. The same notion applies to dune formation. The process to grow a new row of dunes through BwN can take as long as 30–50 years, indicating the need for nourishment programmes that match this timeline. Coastal buffers are, thus, dependent on continual nourishment for natural dune development to succeed. Uncertainties in climate development and nourishment regimes must therefore be incorporated into the BwN coastal design (e.g., through the use of uncertainty margins in the profile development).

Reliance on advanced knowledge and computational models

One way to tackle uncertainty is predicting BwN dynamics over time using computational models. These models are still in their pioneering phase but steadily progressing; becoming more reliable over time (Wijnberg et al., 2021). However, they require specialist knowledge and state-of-the-art modelling skills—plus substantial investment—to achieve a sufficient level of reliability. This investment will be harder to acquire for developing countries, increasing their dependency on foreign, specialist knowledge to implement BwN.

2.2.6 Conclusions: BwN as an adaptive coastal strategy

BwN constitutes a promising technique in coastal engineering that entails the creation of soft, system-based solutions to maintain coastal safety along sandy shores. Since its emergence as a strategy aimed at coastal maintenance and reinforcement, various nourishment types have been developed, including mega-nourishments, which offer a sustainable alternative to compensate for sea level rise, safeguarding the sandy qualities of the coastal landscape.

However, not much is yet known about the dune-formation processes resulting from the increase in sediment transport following nourishment. Furthermore, adjustments must be made for urbanized shores, since beach urbanization limits the space and sediment transport necessary to build dunes as coastal buffer (see Section 1.1). Another complicating factor is that most BwN projects stem from engineering practices, meaning that they lack the expertise necessary to incorporate urban programmes into a BwN solution. In other words, BwN can be developed into a more systemic and integrated approach, not only to improve BwN as onshore technique, but also to develop multifunctional and differentiated coastal landscapes.

2.3 Building with Nature as a systems approach

Originating from hydraulic engineering, BwN is a successful technique applying natural resources and processes to perform societal measures. However, to improve BwN-based nourishments as a buffering strategy for urbanized shores, a more spatially integrated approach is needed. One way to address and integrate multiple functions is the *systems approach*, in which functionalities and spatial interventions from each coastal system are related. This approach focuses on the functional synergy between coastal systems to identify mechanisms that support BwN dune formation ashore. This approach is elaborated below.

2.3.1 The coastal landscape as a landscape of interacting systems

The coastal landscape may be viewed as a complex system in which natural and cultural processes interact with different dynamics of change (Braudel, 1966; Xiong & Nijhuis, 2019; Xiong, 2020). One of its main drivers is the geomorphological system and its processes of erosion and sedimentation, which reshape the coastline and give expression to ecological and urban processes (Zonneveld, 1995).

From the layer approach to a systems approach

Deconstructing landscape into layers is a common method to analyse complex systems and their relationships. Well-known is the layer approach, which divides the landscape into a substrate layer, a network layer and an occupation layer, each with specific temporal dynamics (McHarg, 1969; de Hoog et al., 1998). Within the occupation layer, one can address the mental values—or the 'orgware'—of the landscape, such as coherence, concepts and aesthetics (Dobrov, 1979; Nijhuis, 2020). Another method is the Triplex model (Kerkstra et al., 1976, 1988; Zonneveld, 1987), which defines the landscape from an ecological perspective, dividing it into an abiotic, biotic and anthropogenic layer, including their dynamic processes (see Figure 2.12).

Since the employment of natural processes plays a central role in BwN, with sediment balance and natural succession at the core of dune formation, the Triplex model was employed in this research for spatial system analysis. The abiotic and biotic layer were translated into the geomorphological and ecological system (Figure 2.13) as the natural carrying systems for BwN dune formation (van Bergen & Nijhuis, 2020). Each of the three systems includes human interventions to sustain the system (e.g., nourishments, succession resets and urban regulation zones). Therefore, the anthropogenic layer is present as a driver across every system. At the same time, socio-economic developments constitute spatial actors within the coastal zone that manifest themselves through urbanisation, infrastructure and production landscapes. Their spatial occupation patterns—the urban system (Berry, 1964)—influence the dynamic processes of BwN towards the coastal buffer. Therefore, the urban system is defined as the third spatial system that is conditional for coastal development.

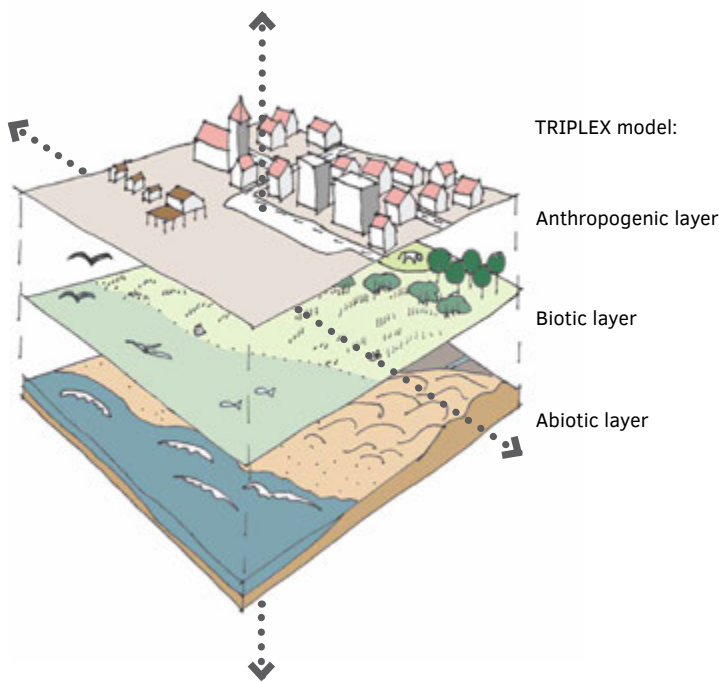

FIG. 2.12 Schematic representation of the Triplex layer approach (after Kerkstra et al., 1976). Image by the author, adapted from P. Dauvellier (2022).

Systems analysis: interaction among coastal systems

For the systems analysis, the geomorphological, ecological and urban systems are considered the main defining spatial systems to facilitate BwN ashore (see Figure 2.13). Each system interacts with and creates conditions for other systems in the coastal zone. Current interactions (e.g., erosion, urban development, loss of stabilizing vegetation) have a negative impact on dune formation, and need improvement. A complicating factor is that each system is guided by a separate discipline with its own approach, method and language. However, an analysis of the overlapping mechanisms offers a way to improve BwN collaboration between the systems, creating a positive feedback loop. The question is: How can an integrated spatial design rearrange morphological, ecological and urban processes to create greater synergy and enhance BwN-based dune formation as coastal protection? The following Section offers an overview of the three coastal systems and suggested steps for integration.

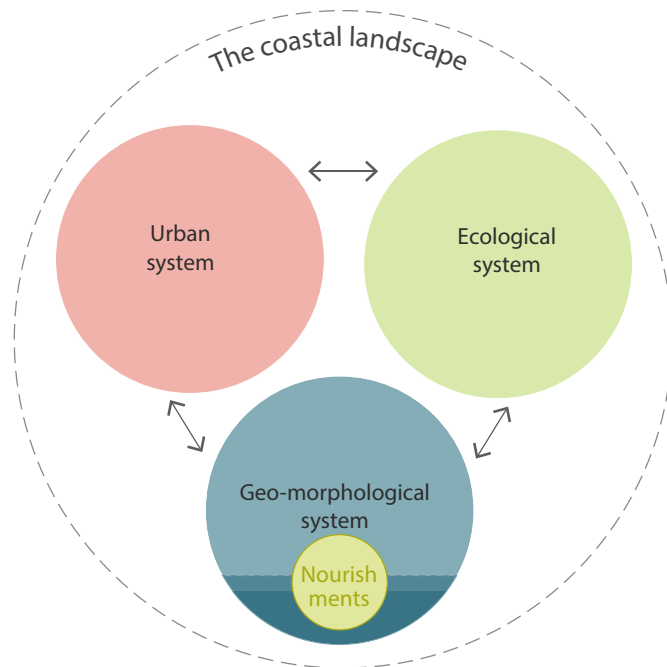

FIG. 2.13 Schematic representation of the coastal landscape as an interplay of three main spatial systems conditioning BwN ashore. Image by the author.

The geomorphological system (including sea level rise and nourishment interventions), the ecological system (including dune formation through succession) and the urban system. BwN as a systems approach offers a chance to bridge the systemic interventions and processes.

Coastal formation processes and archetypes

The larger contours of sandy shores are formed by large-scale geomorphological processes, such as sea level rise, river flows and sediment transport. Depending on the existing coastal profile and its interactions with marine processes (sea level changes, currents, fluvial processes, wave-climate and sediment supply) and climate processes (e.g. rainfall, moisture, wind-climate), a multitude of shore types is produced. Each shore can be regarded as a chain of sediment 'cells', each with its own sediment input and output (see Figure 3.2). Within each cell or trajectory, typical coastal zones occur (e.g., foreshores, beaches, near-shore areas, dunes). Shore and beach formations depend on tides, waves, wind and sediment, e.g. fine sediment resulting in low-gradient beaches (Loffler et al., 2013).

Overall, two types of beach systems can be discerned: 'reflective' beaches, which feature steep linear beach faces that reflect wave energy and 'dissipative' beaches, which usually have concave near-shore surfaces and wide flat surf zones. At dissipative beaches, waves usually break 75–300m seaward, dissipating their energy before reaching the beach, causing sandbar,- and 3D onshore topography (Wright et al., 1979). Wave-dominated sandy shores always feature beach ridge systems that migrate alongside changes in the sea level. When the sea level rises, the beach ridges move landward as a transgressive barrier system. When the sea level declines, the system stabilizes or leads to a seaward accretion of beach ridges, as a prograding barrier system (so long as the sediment balance is positive). Alternations of these systems throughout history can be found on multiple shores, such as New South Wales in Australia and the Netherlands (Roep et al, 1991; Van der Spek, 1999, see Figure 2.14).

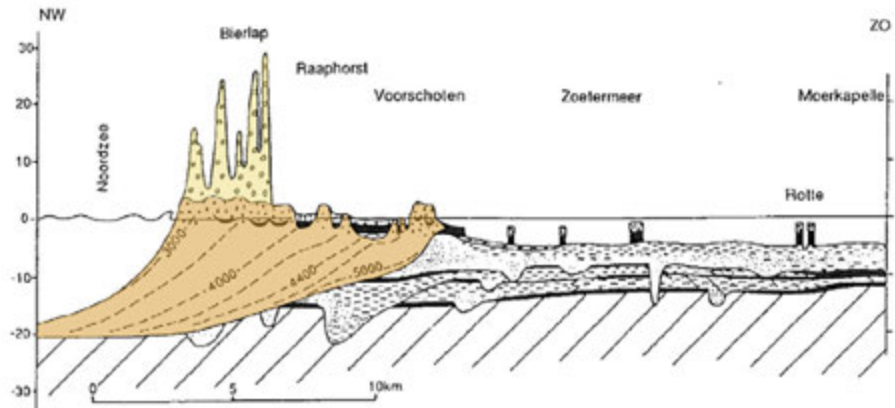

FIG. 2.14 Section of the South Holland coast in Wassenaar, near Noordwijk, illustrating the evolution of the transgressive dune barrier stemming from a sequence of erosive and accretive periods driven by sea level rise. Source: Roep et al, 1991.

Conditions for dune formation

Dunes are a natural coastal phenomenon that can take on many forms and expressions (van Dieren, 1934). The development of dunes is dependent on geomorphological and ecological mechanisms that react on the conditions generated by their spatial and geographical context. Geomorphological changes (e.g. nourishments) and human interventions in accretion zones can alter the type of dune formation. In general, there are three main factors behind dune formation: sediment supply, sediment transport and sediment deposition.

Sediment supply

The development of a sandy coastline is the result of the demand for and supply of sediment. The supply of sediment depends on the natural and artificial sources available. When this sediment balance is negative (e.g., due to sea level rise or currents), the coast is likely to erode. When the sediment balance is positive (e.g., due to nourishments, fluvial input), the coast is likely to expand (Nichols et al., 1989;

Mulder et al., 2008). Sustainable dune formation occurs when the supply of sediment exceeds the pace of coastal erosion. The sediment demand varies across coastal trajectories (so-called 'sediment cells', Mulder, 2000). Some parts of the coast, such as open estuaries, need more sediment than more stable shorelines (e.g., the Holland arc). Local sediment demands are mainly determined by water depth and coastal profile (Loffler et al., 2013).

Sediment transport

Wind-driven (aeolian) transport is essential for dune formation and post-storm recovery. Sediment is picked up by the wind (e.g., at the upper beach) and transported to dunes (see Section 3.3). Nourishments can offer temporarily wider and gradually sloping beaches, a positive condition for dune formation (Puijenbroek et al., 2017; Puijenbroek, 2019). Wider beaches not only provide accommodation space for dunes to form (Galiforni Silva et al., 2019) but also enlarge the so-called fetch length: the length of (dry) beach where wind can blow and pick up sediment (Delgado-Fernandez, 2010).

Sediment deposition

Sediment accretes when wind speeds decrease and deposited at the lee side of objects, the (vegetated) dune foot or the winter flood mark. In spring seeds from pioneering vegetation germinate at the winter flood mark, enhancing and growing alongside sand deposition. If no large storms occur, the first dunes will form.

Two types of dune-formation processes may occur depending on the sediment balance (Loffler et al., 2013):

- Along expanding coasts, embryonal dunes form that develop into larger dune rows through interactions with pioneering vegetation.
- Along erosive coasts, secondary dunes (e.g., sand pits, parabolic dunes) form.

These elementary dune types are subject to onward wind-driven sediment transport and/or natural succession, generating different dune habitats with specific spatial and temporal dynamics (see Section 2.3.2).

Natural dune dynamics

The beach and the first dune rows form the coastal foundation to protect the hinterland from flooding. During storms, sediment from beaches and front dunes is swept away as part of the storm erosion barrier. This sediment is dispersed in the water, reducing wave energy. After the storm, sediment is transported back to shore via landward-moving sandbars, restoring the beach and the dunes as part of a dynamic equilibrium.

In recent centuries, many sandy shores have become erosive, retreating shorelines due to a negative sediment balance and sea level rise. This has led to the prominence of steep coastal profiles (in the Netherlands for example) as a result of erosive foredunes. It has also led to landward dune-formation processes, such as blowouts and parabolic dunes, which feed inner dunes with sediment.

Nourishments and dune formation

Nourishments form an extra buffer against storm waves and provide sediment for new dune formation (Loffler et al., 2013). The most common types of nourishments are foreshore and beach nourishments. In smaller-scale maintenance nourishments (0.5–1 million m³), dune growth amounts to about 10m³/m/year (e.g., the Holland arc; Ecoshape, 2019). Mega-nourishments and coastal reinforcements maintain the coastline for a longer period of time (20 years instead of four years). These nourishments provide temporarily wider beaches (250–500m) to pick up and transport sediment to the dunes. This can amount to up to 35 m³/m/year of dune growth (see Petten case study in Section 3.4) in the early years following reinforcement. Wider beaches (>100m) can also cause new beach ridges to form.

The discipline of hydraulic engineering

Coastal dynamics constitute the object of study in hydraulic engineering and coastal morphology. Hydraulic engineering is the application of principles of fluid dynamics to water-related problems, such as protection against flooding. Coastal morphology is the study of natural processes along coastlines and the impact of human interventions on coastal zones (TU Delft).

In the Netherlands, the coastal foundation is appointed as the main sea defence (see Section 2.2.1). Erosion in this zone (along the Reference coastline for example) is monitored by Rijkswaterstaat via the LIDAR scanning of coastal sections ('JARKUS raaien') as input for the nourishment strategy (renewed every 4–5 years). Field surveys are conducted by regional water-management authorities.

2.3.3 The ecological coastal system

Influenced by tides, waves, wind, rainfall and temperature, abiotic coastal processes create distinct conditions to facilitate natural development, such as dune formation and sediment transport. Micro-scale processes, such as sediment grains and nutrients, influence biological processes and, in turn, succession. Close to the shore, natural habitats are high dynamic by nature, more inland these dynamics decrease.

Ecological succession: evolution from a beach to a dune system

The existence of habitats is dependent on sediment and natural dynamics with the sea as the main resource. Sediment is transported from the sea to the shore by the swash zone followed by six phases of dune formation. First, a berm of sediment is created by the swash zone. At the winter flood mark, pioneering vegetation sprouts to trap sediment in (Van Dieren, 1932), initiating embryonal dune growth. Here, Marram grass acts as a bio-builder, as its foliage stimulates accretion. Marram grass is also able to withstand a significant degree of sand burial, building a new dune ridge formation within 2–3 years. Part of the landward sediment transport is blown upward and settles in the white dunes, grey dunes and mature dunes depending on the type and amount of vegetation (see Section 3.3). Notably, dune formation differs along erosive coasts: the front dune row erodes via blowouts, and sediment is blown landwards through the air to form parabolic dunes (Brooks & Agate, 1986).



FIG. 2.15 Stages of dune formation. Source: Studio Coastal Quality TU Delft / Paridon & De Groot 2011.

Coastal landscape types

In the Netherlands, geomorphological transitions in response to sea level rise have led to a sequence of old and new dune ridges (alternating dune lakes and valleys) known as the beach ridge landscape. Within this sequence, several sub-landscapes can be discerned based on their morpho-dynamics, species and interactions. Most seaward is the Marram landscape, which includes beaches and foredunes with pioneering vegetation, such as sand couches and Marram grass, and lots of birdlife feeding on the beach. The second type is the Dewberry—or white dune landscape—which features young, calcium-rich and dynamic (parabolic) dunes interacting with grasses and herbal vegetation. Behind the white dunes are the grey dunes—moderately dynamic but still dependent on calcium input—with some low bushes, such as Dunethorn, and birches in the valleys, which constitute important feeding grounds for migrating birds. Due to nitrogen problems, this habitat often shifts from pioneering to mature and overgrown, requiring a reset to restore sediment dynamics (e.g., de-vegetations, blowouts). Once sediment and calcium input decline, the grey dunes are replaced by the Heather landscape. In the most calcium-deficient areas, torch grass (*Koeleria Albescens*) often emerges, resulting in a low and open area that is often called an ‘old sea village’ landscape. Most landward are the ‘old’ dune ridges, which were completely forested until the Middle Ages. Today, they alternate between humid dune valleys and meadows. These dunes hold precious, largely non-dynamic habitats with a development horizon of 200 years or more (Doing, 1988). Therefore, they should be retained from an increase of abiotic dynamics (Doing, 1979). Within this research, the focus is on the most seaward and dynamic landscapes, such as the embryonic, white dune and grey dune landscapes, since these will be mostly affected by aeolian transport and nourishments.

Ecological preservation under nourished conditions

European legislation (Natura 2000) requires ecological coastal management to focus on the preservation of vulnerable habitats. Some of them, such as dune slacks, are positioned inland, therefore not directly influenced by coastal nourishments. Other habitats, such as grey dunes, prefer an erosive coast—as a result of centuries of sea level rise—with calcium-rich sediment blown in. For these erosive habitats, larger nourishments with a lower frequency are preferred (Loffler et al., 2013). New nature legislation has ushered in nature-compensation for large-scale coastal projects, such as Maasvlakte in the Netherlands; initiating a new string of constructed nature projects along the coast. The interest in new coastal dynamics has also encouraged projects to reintroduce of sediment dynamics into dunes (e.g., the blowouts at the Schoorl dunes).

The ecological discipline

Ecology is the branch of science that focuses on interactions between organisms and their environment. It is a broad discipline featuring many perspectives, including those pertaining to the coastal zone. The coast is a dynamic and diverse environment that hosts a broad range of habitats. This is reflected in the large number of ecological specializations, including marine science, landscape ecology, geomorphology, vegetation and fauna. This leads to a dispersion of ecological coastal knowledge across specializations, habitats and regions.

2.3.4 The urban coastal system

Sandy shores are inherently dynamic, and their close relationship with the sea makes it a difficult environment to settle in. Urban settlement is a dominant form of land use, and it is crucial in typecasting environmental conditions and human activities (Meyer, 2017). The density, spatial distribution and physical characteristics of urban settlements are important drivers of social and environmental change at multiple levels (Massey, 2005). In a spatial sense, urban settlement can be regarded as a network of towns and cities linked together by various forms of social and economic interaction on multiple scales (Rogers et al., 2013). This network can be defined as an urban system: entities comprising interdependent parts or sub-systems with varying degrees of interaction and self-regulation (Berry, 1964; Pred, 1977). In terms of ecosystem services, urban areas are primarily sites of consumption, which, for coastal towns, often means the consumption of specific shoreline conditions and services (e.g., beaches, sea view, cool breezes) (McGranaham et al., 2007)

Coastal urban evolution

Every coast has a unique history, features and needs stemming from morphological, technical and societal changes. This makes it difficult to describe the urban process in overall terms. From a Northern European historical perspective, four different stages of coastal urbanization can be identified (van Bergen, 2017) based on literature review:

- **Early sediment-based settlement** (e.g., fishing villages) with a direct link to the coastal morphology such as mounds, natural harbours or lee dune valleys.
- **Modernized coastal landscape** with land reclamations, agricultural estates and new infrastructural networks becoming more independent of coastal dynamics, such as flooding.
- **Colonization by leisure**, leading to the rapid (linear) urbanization of waterfronts due to increased mobility and inland urban expansion.
- **Coastal reinforcement** for military or flood protection, leading to the substantial transformation of urban waterfronts through, for example, the demolition of waterfronts, the construction of seawalls or the application of nourishments.

These stages can be sequential, but also run parallel to one another. Each stage contains certain urban typologies and mechanisms regarding coastal dynamics that can be re-employed to improve coastal interactions and future coastal designs. A striking example is the extensive network of mounds that existed in Friesland between 600 BC and 1200 AC as a form of sediment-based adaptive urbanism (see Figure 2.16)

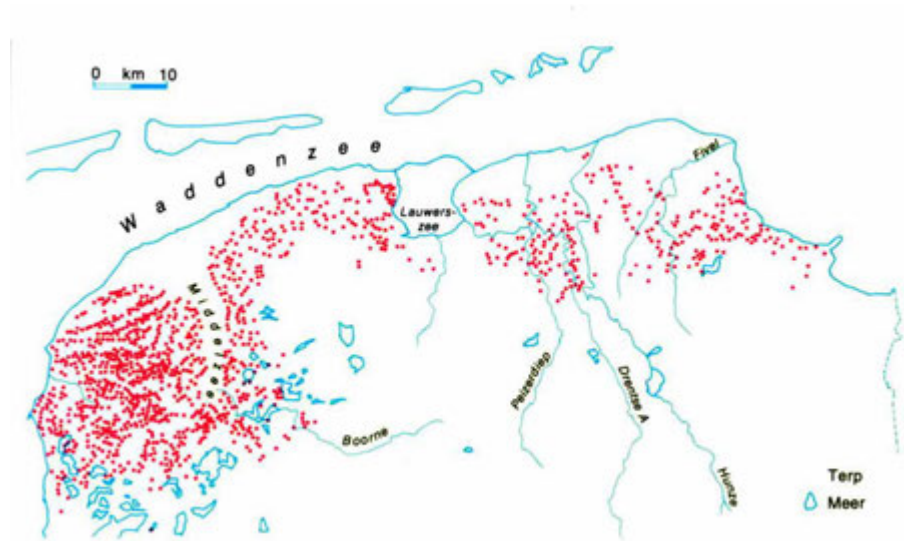

FIG. 2.16 Sediment-based urbanism: Map of mounds in Friesland (600 BC–1200 AC). Source: Halbertsma.

Coastal urbanization and coastal squeeze

One major concern is that coastal zones are becoming increasingly urbanized, both in the Netherlands and around the world (Hall, 2001; Schlacher et al., 2008; Malavasi et al., 2013; Hoonhout & Waagmeester, 2014). This rise in urbanization extends to recreation, traffic, beach housing and waterfront development. This urbanization, combined with erosion, is leading to a coastal squeeze—more urban pressure on a shrinking coastal zone, as seen in Miami (US) and Accra (Ghana). Also in the Netherlands the urban coastal pressure grows. PBL (Van Duinen et al., 2016) has predicted that one million new homes may realistically be built by 2040, expanding urban and recreational programmes in the coastal zone and, in turn, increase the need for coastal planning. The stabilization of the Dutch coastline through nourishments has already attracted more economic development and led to a twenty-fold increase in beach housing over the last decade (Broer et al, 2011; Panteia, 2012; Armstrong et al., 2016; Buth, 2016).

Urbanization and coastal adaptation

These forms of urban occupation may have significant—but still poorly understood—effects on sediment transport and dune development (Nordstrom & Jackson, 2013). Current forms of beach urbanization, such as beach pavilions and beach row housing, create physical obstacles for sediment transport and dune formation. Furthermore, intense urban use of coastal zones can lead to a decline in dune vegetation (e.g., trampling, intensive groundwater use), destabilizing sediment and making the area more vulnerable to erosion. This is especially true for foredunes, which constitute a buffer against storms. The key is to plan urban waterfronts that are adaptive to future sea level rise and coastal reinforcement. This requires close collaboration between engineering and urban planning. Some solid examples exist of hard infrastructure in this vein, such as the adaptive urban waterfront in Vlissingen and the Dike in dune constructions along the coastlines of Noordwijk, Katwijk and Scheveningen, preserving part of the boulevard typology (see the Noordwijk case study in Section 4.2). Although adaptable, their constructions are not yet prepared for sediment dynamics as part of a BwN strategy.

Spatial coastal planning and design

The spatial design of urban coastal landscapes is primarily covered by two disciplines: 1) urban planning and design and 2) landscape architecture.

Urban planning and design

The main role of urban planning and design is to integrate socio-economic interests with the natural conditions of a site with the aim of shaping and organizing the process of urban development. Spatial interventions occur at all levels of this development process. Urban design concerns the design of good city forms (Lynch, 1981) that feature robustness and sustainability of spatial structures, adaptable to changing and uncertain futures (Meyer & Nijhuis, 2015). Coastal zones often contain specialist sea-related programmes within a wider urban context, such as harbours, water-extraction sites and sea side resorts. Urban growth is closely related to the investment climate and can change rapidly. The most significant coastal planning factors are infrastructure, real estate development and legal restrictions.

Landscape architecture

Landscape architecture 'employs the principles of art and the physical and social sciences to the processes of environmental planning, design and conservation, which serve to ensure the long-lasting improvement, sustainability and harmony of natural and cultural systems or landscape parts thereof, as well as the design of outdoor spaces with consideration of their aesthetic, functional and ecological aspects' (Evert et al., 2010). It entails the systematic investigation of existing social, ecological, and soil conditions and processes in the landscape and the design of interventions to produce the desired outcome. This includes the design of public space, stormwater management, environmental restoration and recreational planning at various levels relevant for the design of coastal zones.

2.3.5 **Conceptual framework: Integration of the coastal systems**

Section 2.3.2 defined the coastal zone as a landscape of three main interacting systems: geomorphology, ecology and urbanism. Each coastal system produces a certain part of the coastal landscape that interacts with and creates the conditions for other programmes in the coastal zone, leading to positive or negative trends for coastal adaptation. Coastal recreation, for example, can lead to a decrease in stabilizing dune vegetation, increasing wind and storm erosion and, in turn, increasing the flood risk for coastal communities. However, the same interacting processes offer a way to improve collaboration between the systems. This paragraph provides a general overview of the main systems' interactions and potential steps towards improved interaction for BwN as part of an integrated systems approach.

BwN as an integrated systems approach

Coastal landscape processes take place across multiple systems, scales and time zones, leading to a complex network of relationships. The structuring of these processes in landscape architecture is referred to as 'relational structuring', in which the relationships of the objects of study are considered within their context and constituted through a process of insertion, transitions, sequences and transplantation (Marrot, 1999). This research addresses natural (BwN) adaptation (object) and nourishment (insertion) in the context of the morphological, ecological and urban systems. To address and manage complex landscape systems, Parrott and Meyer (2012; see also Freeman et al., 2015) give five recommendations:

- 1 represent the landscape complexity in a conceptual model;
- 2 map emergent landscape patterns and processes on multiple scaled and temporal scales;
- 3 build and maintain adaptive capacity as a buffer against change;
- 4 anticipate the system's internal memory (e.g., by mimicking natural processes);
- 5 work with potential alternatives and future scenarios.

In this research, the coastal systems and their interactions were schematically conceptualized as three overlapping systems, with BwN—as the main ambition—repositioned to the centre. The overarching aim is to identify the system interventions, processes and interacting mechanisms that contribute to the BwN process ashore.

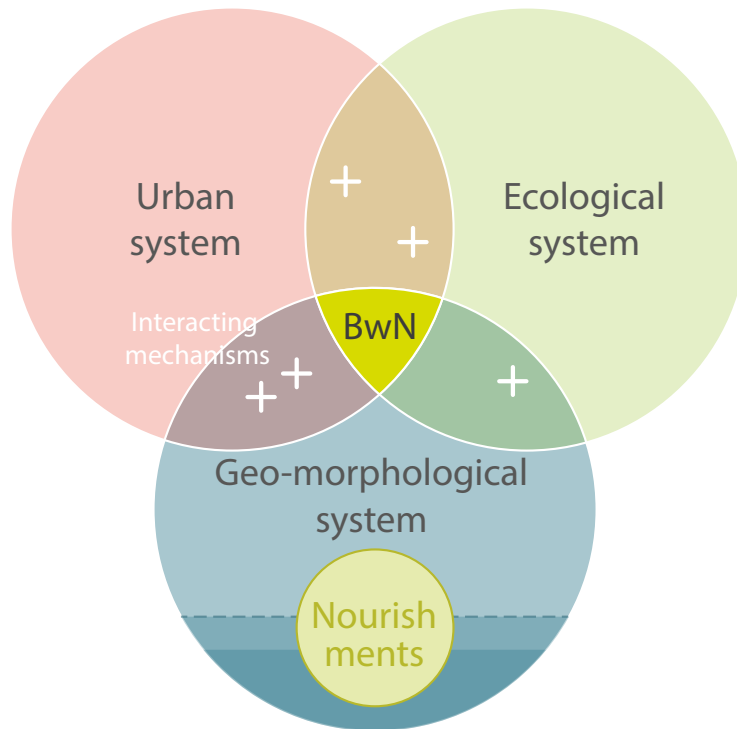

FIG. 2.17 Conceptual framework of the integrated systems approach for BwN (bright green) as the interplay between the geomorphological, ecological and urban systems. Image by the author.

BwN-based nourishments constitute a significant driver of change. Within this overlap of systems, interacting spatial mechanisms can enhance or sabotage the process of dune formation (e.g., sediment transport affected by beach urbanisation or embryonal dune growth due to increased sediment transport following nourishment). They provide the key to sync the systems for BwN.

Integrating the systems for BwN

The three defined coastal systems (geomorphology, ecology and urban) feature various interventions and processes that lead to a positive or negative coastal evolution. Within the overlap of these systems, mechanisms of spatial interaction can be identified (see Figure 2.18) that stimulate (or obstruct) the BwN process from nourishment to dune formation. The initial nourishment, ecological succession, urban usage and occupation all make substantial contributions to land-shaping coastal processes. Each process has key spatial features that influence the dune-formation process.



Downwind sand tail development behind beach buildings in Hargen, North-Holland.



Sand screens in Belgium that could be employed for dune growth as part of the urban beach typology.



Traditional planting of Marram grass and sand screens near Cadzand, around 1900. This old BwN technique could be re-employed in the creation of safe grounds for urban beach development.



A sand pit, typical for erosive coasts, transporting sediment deeper into the dunes. Sediment mobility could be enhanced by blowouts, beach buildings on poles and recreational use.

FIG. 2.18 Examples of interacting mechanisms between geomorphology, ecology and urbanism that could contribute to BwN dune formation. Sources: Top left: K. Wijnberg, 2021. Top right: J. van Bergen. Bottom left and right: Rijkswaterstaat.

System interventions as drivers of change

BwN nourishments compensate for coastal erosion and restore sediment balance to maintain flood safety. These BwN nourishments constitute the main driver of change within coastal system interactions (see Figure 2.17), leading to a process of BwN-based land and dune formation. Other drivers of change are urbanization, which often limits the space available for coastal adaptation, and natural succession, which develops habitats, such as embryonic dunes, in response to sediment transport following nourishment.

Interacting mechanisms and processes

Several spatial mechanisms that support dune formation were identified through literature review, field observations (see Figure 2.18) and GIS studies. Up to a quarter of nourished sediment is able to land ashore. Pioneering vegetation, such as Marram grass, has a positive and stabilizing effect on sediment accretion. Shadow dune formation behind buildings can contribute to dune formation. Additionally, fencing is an effective way to not only protect but also increase dune formation. These spatial mechanisms provide the basis for design principles in support of BwN dune-formation processes and create synergy between the morphological, urban and ecological systems.

2.3.6 Synergizing systems: bridging concepts for BwN design

Interacting spatial mechanisms are the key to synergizing the systems for BwN design ashore. By analysing the relationships and spatial mechanisms between the coastal systems, three linking processes or bridging concepts were identified for BwN dune formation: *natural succession*, *dune farming* and *urban harvesting* (van Bergen & Nijhuis, 2020; see Figure 2.19).

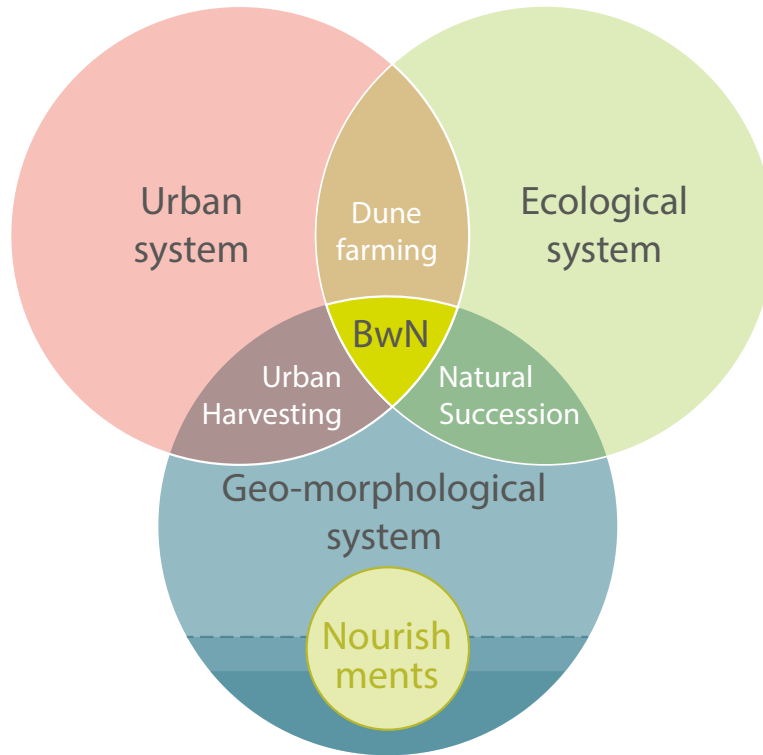

FIG. 2.19 Overview of integrated coastal systems as a conceptual framework, including the three bridging concepts (white text) aimed at improving BwN processes ashore by stimulating natural succession or proactively applying dune farming or urban harvesting from an urban system perspective (overlay). Image by the author.

1 **Natural succession: bridging geomorphological and ecological dynamics**

The concept of (induced) natural succession focuses on the interaction of geomorphological and ecological dynamics. Geomorphological processes and interventions create the conditions for natural (dune-formation) processes and succession. In turn, natural succession can enhance or delay morphological processes, such as dune formation and coastal erosion. Natural succession entails the ecosystem colonizing the sea-land interface (following nourishment for example). The resultant vegetation helps to catch and stabilize the sediment, resulting in embryonal dune growth.

However, some coastal ecological habitats, such as grey dunes prefer more inland sediment dynamics as result of coastal erosion. In both cases, coastal BwN design can create specific conditions to induce or revert natural succession (e.g. nourishment, controlled erosion or profile design). It gives way to BwN solutions that combine flood-safety solutions (nourishment) and local habitat regeneration.



FIG. 2.20 Pioneering vegetation as part of the natural succession and the start of natural dune formation. Image by the author.

2 Dune farming: bridging ecological and urban dynamics

The concept of dune farming focuses on the interaction between urban and ecological dynamics to cultivate dunes for urban functions. Ecologically, there are means of directing sediment (e.g., cultivating stabilizing vegetation). The planting of Marram grass, for example, can accelerate accretion, resulting in higher grounds to prevent flooding or for recreational purposes. The installation of brushwood fencing also represents a proactive measure to enhance dune formation or ‘dune farming’. These are traditional BwN defence techniques that have new prospects in nourished contexts. Dune farming can be seen as a form of dune production for flood safety (for urban protection) and/or urban usage. In some cases, it may also involve a downgrade in urban dynamics in favour of landscape values, prioritizing the protection or enhancement of certain dune habitats (zoning), for example. It gives way to combined BwN solutions between nourishment, landscape and urban dynamics aimed at increasing the sustainability, diversity and multifunctionality of the coastal zone.



FIG. 2.21 Fencing as a nature-based measure to increase dune formation. Image by the author.

3 Urban harvesting: bridging urban and morphological dynamics

The concept of urban harvesting focuses on the interaction between urban dynamics and geomorphological dynamics. Dune formation can be enhanced by accretion patterns provoked by urban configurations or interventions. The principle of urban harvesting stems from theories of urban resource management and is formulated as follows: ‘a strategy to investigate all possible options for re-using the full output, and the potential sources within the system itself, within the urban environment’ (Rovers, 2007). It addresses unused harvesting potentials and employs a systems approach to select technologies and adaptation strategies aimed at making them harvestable (Leduc et al., 2009). In this research, sediment is considered as a prime source that, in interaction with the wind and built objects, can be harvested at the local scale to contribute to the coastal buffer zone on a trajectory scale. Urban harvesting addresses sediment patterns around built objects to mobilize and integrate BwN dynamics in an urbanized context. Alternatively, it can also relocate urban elements (zoning) to support the coastal buffer for (urban) flood protection.



FIG. 2.22 Sedimentation behind a beach pavillion in Cadzand—bad; as form of urban harvesting. Image by the author.

Each of the ‘bridging concepts’ contains a range of interacting mechanisms that gives BwN the potential to develop coastal buffer zones. These mechanisms can be applied as design principles on multiple scales. However, it requires spatial design to direct and integrate these mechanisms across different scaled and temporal zones. While a systems approach can work as a conceptual and integrative analysis tool, it needs to be transferred to a spatial, scaled and temporal approach for BwN design, as described in Section 2.4.

2.4 Building with Nature as a landscape approach

2.4.1 Definition of 'landscape approach'

A landscape can be defined as a holistic and dynamic 'system of systems' and an expression of spatial and ecological processes (Zonneveld, 1995). A landscape comprises formal elements (e.g., form, patterns, spaces, proportions), temporal elements (e.g., succession, seasons, sequences; Zonneveld, 1987) and a scale continuum (connecting scales; S. Marrot, 1999; Nijhuis, 2015). Landscape systems feature certain characteristics:

- They contain structures, processes and various dynamics.
- They operate across multiple interconnected scales.
- They develop over time and can make alterations (system jumps or new equilibria), causing uncertainty with regard to functional development.
- They are connected to other (sub)systems, requiring an integrated approach.

Framing landscape processes in space and time

With processes as one of the perspectives or 'lenses' (Marrot, 1999), landscape approaches have the capacity to negotiate between scaled and temporal windows and address levels of uncertainty. These processes operate on different scales, each providing specific organizing principles for urban transformation, biodiversity, resource management, recreation, cultural identity and economic development. Given their capacity to operate on a systemic level, landscape approaches are often employed as research-by-design methods to track down conditional relationships between scales (from regional to local development and vice versa) or temporal dynamics (from short- to long-term).

Several landscape concepts have been developed to negotiate between dynamic processes, such as the Casco concept (Sijmons, 1991), the 'two networks' concept (Tjallingi, 2015) and the Robust Adaptive Framework concept (RAR; Meyer et al., 2015). All concepts aim to organize low dynamic (e.g., nature, housing) and high dynamic developments (e.g., infrastructure, flooding) within a regional landscape framework.

Conceptual framework: From a systems approach to a landscape approach

In this research the coastal landscape has been defined as a system of interacting systems (Figure 2.23a). Their functional interactions could be tuned to enhance BwN processes for coastal adaptation, as part of a systems approach (Figure 2.23b). However, these interactions are all part of larger landscape processes that need to be linked in space and time. This is represented in Figure 2.23c by system scales (circles) that are bridged by landscape processes (arrows) activated by system interventions. The landscape approach directs these processes to support spatial coastal design serving multiple goals and values: coastal safety, multifunctionality and/or spatial quality (Section 2.4.4). This landscape approach is illustrated in Figure 2.23c and elaborated in Sections 2.4.2 and 2.4.3.

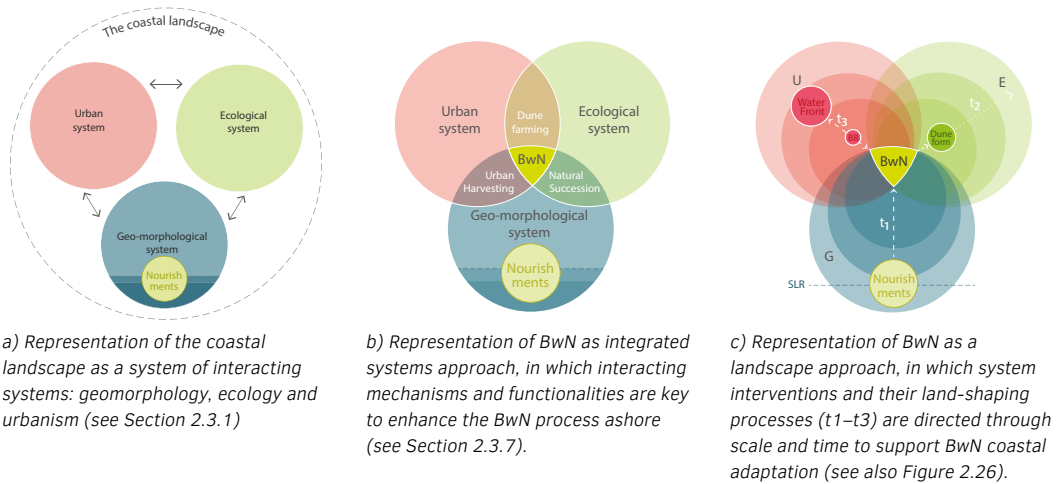

FIG. 2.23 Evolution of the conceptual BwN model from mono-functional, via integrated systems, to a landscape approach. Images by the author.

2.4.2 Dealing with landscape processes: tuning coastal dynamics

Sea level rise and new coastal dynamics encourage the development of a new landscape framework that negotiates between coastline dynamics related to sea level rise and BwN processes caused by nourishment. This framework is aimed at finding new equilibria within the coastline's sediment balance, ranging from coastal erosion (deficit), to consolidation (balance) and to accretion (surplus) (Nicholls, 1989; Mulder et al., 2008). In most cases, artificial sediment nourishments are necessary to compensate for sea level rise, making them a key driver in the transition process. They amplify the sediment balance at the regional level, resulting in temporarily accreting coastlines and regeneration of dune formation, supporting coastal adaptation.

Beyond geomorphology, coastal ecology and human settlements have adapted to coastal dynamics over time, developing coast-specific habitats and settlements, such as blowouts and sea village landscapes. These ecological transitions or urban interventions can even be re-activated for BwN-based landscape design, stimulating land-shaping processes to achieve multiple values, such as coastal safety, multifunctionality and landscape differentiation. A good example is the afforestation of the inner dune lining of Walcheren in the 1700s to halt transgressive dunes. It resulted in a unique coastal estate habitat that has developed distinct nature values since (see Chapter 4.3).

Mapping landscape transitions

The employment of natural forces for BwN requires a deeper understanding of the natural and cultural forces that shape the coastline. Via temporal mapping or projections estimations can be made on the past, present and future coastal behaviour and land formation. These mappings can be made from a historical perspective to generate insights into coastal responses to currents and sea level rise. Also new techniques, such as GIS and computer modelling, can be employed to predict current and future coastal behaviours (e.g., following nourishment). Furthermore, these mappings provide the opportunity to study interactions between landscape layers. By mapping landscape processes, specific organizing principles can be derived for spatial transformation (Parrott & Meyer, 2012; Freeman et al., 2015; Nijhuis, 2015, Nijhuis & de Vries 2020; see Figure 2.24).

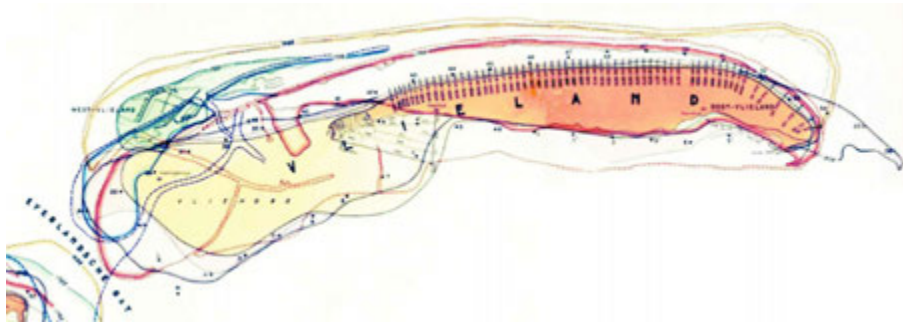

FIG. 2.24 Temporal mapping of the (unnourished) coastal dynamics of the Isle of Vlieland (1688–1933), illustrating its natural landward movement as well as its dynamic cape and tail development. Source: Rijkswaterstaat NH, 1946; Deltares, 2016.

2.4.3 Bridging spatial and temporal scales

To design the BwN land-shaping process from nourishment to dune formation, two major disparities—in scale and in dynamics—must be overcome. Most system interventions and dynamics, such as nourishments or beach housing, operate on different scales and need to be interrelated. Nourishments operate on a regional scale, are high dynamic and have a life span of 5–20 years (see Figure 2.25). They temporarily widen the coastal profile, beneficial for dune formation. In contrast, dune formation is low dynamic and has a long life span to mature (2–200 years). This long-term process can be frustrated by local urban dynamics (5–50 years) blocking sediment flow and vegetation in the foredune zone.

By matching nourishment types and urban typologies to specific types of dune formation, returns on nourishments can be increased. Specific spatial arrangements (e.g., shadow dune formation, blowouts) can direct and stabilize sediment, contributing to the coastal buffer (van Bergen et al., 2021). This requires a design process that mediates between the relevant intervention scales and dynamics involved, to tune land-shaping processes for dune formation.

Scaled BwN processes

System interventions and natural dynamics enhancing BwN operate on diverse scales and affect one another. BwN starts with nourishments and coastal dynamics on the regional scale; resulting in wind-driven sediment transport and dune formation on the mid-scale, affected by beach urbanisation on a local scale. Linking these scaled

interventions could increase the development of dunes as a natural buffer against sea level rise. Overall, three design scales (in line with de Jong et al., 2002) can be defined that include most interventions and design choices underlying the activation of BwN for coastal buffering: the regional, the trajectory,- and the local scale. Its context is determined by two overarching scales: the global scale of climate change and sea level rise (which determines nourishment needs) and the national policy scale (which determines the legal preconditions and decision frameworks behind nourishment strategies and other spatial developments) (see Section 2.2).

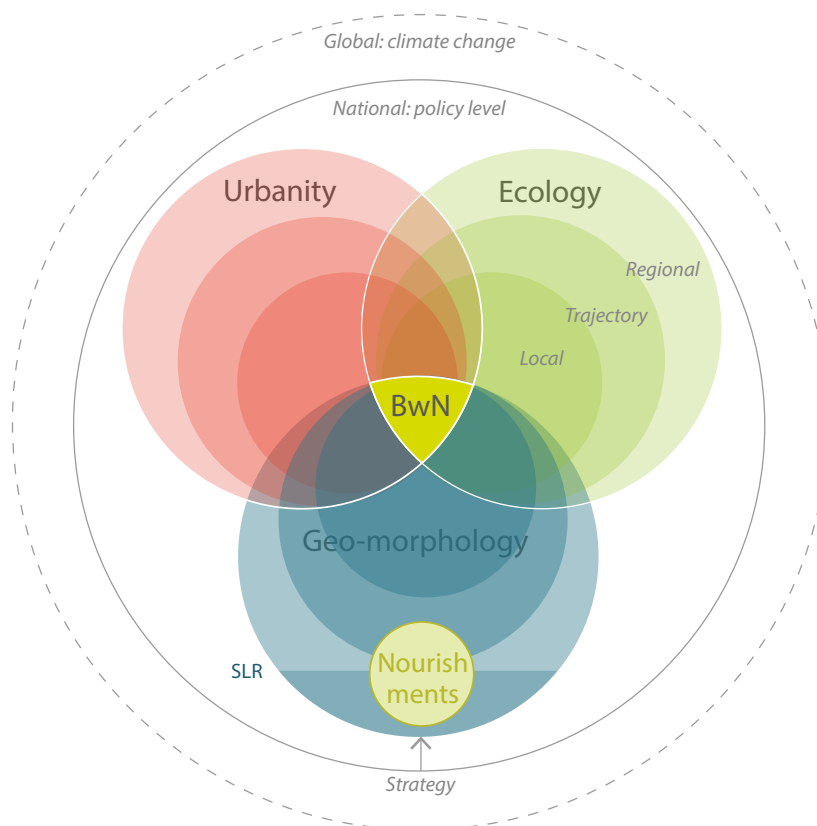

FIG. 2.25 Division of three coastal systems into the local, trajectory and regional scales, affected by two contextual levels: the national and global scale. Image by the author.

Sea level rise occurs on a global scale as a result of climate change. Strategies to counter sea level rise (e.g., nourishment strategies, nature preservation, urban planning) are dependent on the political context on a national scale. System interventions and related processes occur across multiple scales: regional (nourishments), trajectory (e.g., natural succession) or local (e.g., beach housing). These scales must be bridged to align the interventions for BwN.

Regional scale (30km): Nourishment types, dune zones and urban sprawl

At the regional scale, three types of developments are influential with regard to BwN: the nourishment strategy (which depends on the rate of coastal erosion and sediment deficit linked to sea level rise); long-term dune formation (which determines the safety level against flooding); and coastal urbanization. Notably, sediment balance and coastal erosion both vary by coastal region. Closed, stable coastlines require less sediment than open, dynamic estuaries. These conditions affect the type of nourishment in terms of volume, placement and frequency, with different spatial impacts. Coastline-maintenance nourishments generate small-scale profile alterations compared to those of mega-nourishments and sandy reinforcements, which substantially change the profile and time window of accretion on a trajectory scale.

In all cases, the extra supply of sediment leads to a process of temporal accretion, resulting in embryonal dune formation parallel to the shore. However, the development of mature dunes can take 10–200 years, a long-term process. To enhance this process, sediment supply must be secured for a longer period of time, as is the case with long-term periodic nourishment programmes and mega-nourishments. This process of natural succession is affected by urban dynamics, such as waterfront development. Recently, the nourished, stabilized Dutch shores—as result of three decades of coastal maintenance—have attracted more economic development, such as beach housing. Furthermore, inland urbanization increases day tourism to the coastline. These developments can have negative effects on dune formation up to a regional scale.

Trajectory scale (10km): Onshore nourishment dynamics, dune habitats, profile and waterfront development

At the trajectory (sub-regional) scale, the effects of nourishments and sandy reinforcements become evident. Due to waves and currents, the shores adjacent to nourishments receive more sediment, while larger nourishments start to erode following construction. This leads to an erosive profile at the nourishment location and accreting profiles in its coastal vicinity. These coastal profile changes can be anticipated to in the design process. The temporarily wider beach profiles offer favorable conditions for increased sediment transport and dune formation. Depending on ecological and urban needs, a profile surplus can be leveraged to generate optimal spatial conditions for urban or dune habitats, such as terraces, beach ridges and blowouts. It requires a temporal layout of the main functions (i.e., the nourishment, dune-formation, ecological, recreational and urban functions) to align the local accretion processes building towards a consistent and optimized profile over time.

Local scale (1–3km): dune formation, urban and ecological arrangements

At the local scale, increased sediment transport and wider beaches from nourishments can induce new dune formation. At the winter flood mark, seeds of pioneering vegetation sprout and accrete sediment to form embryonal dunes within 2–3 years. Intense urban usage, maintenance and beach row housing can disturb or destroy this natural process. At the same time, however, beach buildings have the capacity to support accretion (e.g., through shadow dune formation) or onward sediment transport. The design of such local spatial arrangements—featuring local ecological, dune-farming and/or urban interventions over time—could improve the BwN process for dune formation.

Scale interdependencies

As described above, BwN interventions and land-shaping processes act on different scales but are conditional for one another. Nourishments on a regional scale—restoring the sediment balance to a surplus—act as a trigger of dune formation at the trajectory scale. However, this dune formation is dependent on local spatial mechanisms, such as planting and shelter, to succeed. In order for BwN design to be successful across all systems, it needs to bridge these processes across multiple scales. An important mediator is the coastal profile design, which links the regional scale of nourishment to the local scale of dune formation and urbanization. Furthermore, interventions can be tuned towards the desired BwN dune-formation process. The nourishment type, for example, can be adjusted to feature conditions and dynamics that support BwN ashore (e.g., wide beaches, differentiation of sediment flow over time). With an optimal nourishment profile, sediment harvesting becomes more effective and can increase the rate of return from 5–15% in urban zones like Noordwijk (Quartel & Grasmeijer, 2007; Giardinio, 2012, 2014) to 25% (van der Wal, 1999). These figures illustrate the impact of scaled design, in which interventions are connected and optimized across multiple scales.

Tuning BwN processes over time

Sandy shores evolve over time due to various coastal dynamics. These dynamics operate along different timeframes and can vary substantially within each system. Sea level rise is a gradual development (+1 cm per year), but can add up to +100–200cm or more by 2100, depending on the prognoses on the melting of the ice caps (Haasnoot et al., 2018; IPCC 2022-A, 2022-B). In Dutch coastal practice, nourishments have a life span of 4–20 years (t1; see Figure 2.26). Maintenance nourishments have a short life cycle (4–5 years), resulting in accreting beaches in the first 1–2 years. Mega-nourishments and sandy reinforcements can induce a wider profile for 20 years or more. All nourishments feature higher aeolian sediment transport rates in the first years after their construction, offering a valuable window of opportunity for BwN dune formation. Natural dune development occurs within 2–3 years following nourishment (vegetated embryonal dunes), to form foredunes within 5–10 years, resulting in mature dunes after 30–200 years (t2). Sustainable dune development therefore requires a stable supply of sediment, depending on repeated nourishment.

Urban waterfronts develop over longer periods of time (50–100 years), but beach urbanization is more flexible due to the permit policy of 4–5 years. This temporary nature of beach buildings provides opportunities to adapt them to BwN dynamics (t3).

By tuning these processes over longer periods of time, BwN-based nourishments can be optimized for sustainable dune formation, facilitated by dynamic forms of urbanism. To arrive at mature dunes as a coastal buffer, a sequence of nourishment and profile design enhanced by adaptive local aeolian principles is necessary. These arrangements may vary temporally on account of the systemic dynamics involved. The sediment dynamics resulting from this sequence should be incorporated into the coastal design to contribute to the coastal buffer and maintain safety in response to sea level rise. The sooner this tuning process begins, the greater the chance to properly anticipate sea level rise and build mature dunes to counter it.

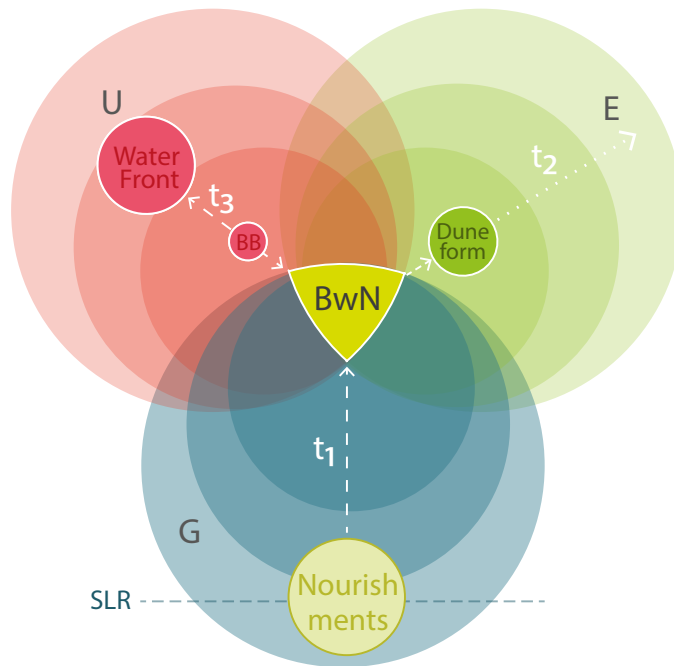

FIG. 2.26 Representation of coastal BwN as a landscape approach in which system interventions (e.g., nourishment, dune growth, beach urbanisation) and their land-shaping processes (t1–t3) are directed through scale and time to support BwN-based coastal adaptation by dune formation. Image by the author.

Conclusion: Coastal BwN as a landscape approach

By connecting systemic interventions, BwN processes can be aligned in scale and time to support the natural development of dunes as a coastal buffer. System interventions (e.g., nourishment, dune growth, beach urbanization) and their land-shaping processes (t1–t3) are positioned and synchronized to support BwN-based dune formation as part of the landscape approach.

2.4.4 Adding values: Towards a multifunctional and diverse landscape

From a landscape perspective, BwN not only connects landscape processes in space, scale and time, but also connects them to the societal goals and values of the landscape as a whole. The latter requires more than a functionalist approach, bringing us to the topic of landscape values and spatial quality.

Points of departure

Initially, BwN projects are defined by their formal project goals, which often include coastal safety, recreation, nature preservation and/or production elements, as part of a multifunctional perspective. Most flood-safety projects, for example, have coastal safety and flood prevention as their primary aims with the preservation of natural values as a supplementary (legally defined) aim. A common approach to translating project goals to functional goals is through systems engineering, translating top-level demands, such as coastal safety, into subsystem aims; and nature values into the preservation or mitigation of specific habitats. Some programmes, such as Room for the River (Ruimte voor de Rivier, 2005), went a step further and added 'the improvement of spatial quality' as its secondary project goal. However, spatial quality is relatively difficult to specify in functional terms and, therefore, is often marginalized in systems engineering.

Additionally, projects must be embedded within the existing landscape, -featuring functionalities, structures and processes-, that is already perceived and valued in a certain way. Some values, such as nature, cultural heritage and property, are legally protected (e.g., Natura 2000). Other values, such as spatial quality, are subject to project-specific definitions (e.g., via stakeholder meetings) (Luiten et al., 2017). This means that a BwN project must tackle three aims: 1) comply with its goals; 2) embed its intervention in the existing landscape; and 3) serve and/or add multiple values that emerge from steps 1 and 2.

Definition of spatial quality

While project goals and existing functionalities are usually well-defined, the definition of values, such as spatial quality, generally remains large-scale, abstract and difficult to quantify (Nillesen, 2019). Spatial or landscape quality is often defined as the sum of 1) functionality, 2) sustainability and 3) attractiveness or public amenity value (Vitruvius, 60 BC; Ruimte voor de Rivier, 2005). Functionality refers to the efficacy and functional coherence of a spatial arrangement. Sustainability (future value) refers to durability, adaptability and maintenance. Attractiveness refers to diversity, identity and aesthetics (Ministry of Foreign Affairs, 2019; At Osborne, 2021).

Stakeholder involvement

The definition of spatial quality values is essential for a project to meet local conditions and demands, related to regional ambitions and perceptions. This will allow a region to accept and anticipate the project (e.g. Room for the River, co-financing). The spatial values can be divided into static 'prescribed' demands (van der Toorn Vrijthoff & Talstra, 2004) and dynamic 'participatory' definitions of spatial quality (van Gerwen, 2006). Since the coast is a carrier of multiple functions, it is important to address other functions (e.g. nature, recreation), their quality and sustainability when setting the scope of a flood safety project. Involving multi-disciplinary experts (e.g. a quality-team) is instrumental to achieve proper project criteria for spatial quality as part of the decision making process within a specific context (Janssen-Jansen et al., 2009; Nillesen, 2019). Furthermore, structural participation in planning and design phases guides functional and value integration (Nillesen, 2019).

Conceptual frameworks for spatial quality

Several conceptual frameworks exist that can aid in systematically defining spatial or landscape quality. One is offered by Habiforum (Hooimeijer et al., 2001), who divide spatial quality into four categories of interest: economic, ecological, social and cultural. The advantage of this model is that it provides multiple perspectives to evaluate spatial design. Attractiveness, for example, is quite different when considered from an ecological or an economical perspective. However, to properly value these aspects for BwN solutions, more attention must be paid to the dynamic landscape processes involved.

Along with multifunctionality, the coastal landscape can be defined by its overarching spatial values. From 2008 to 2013, Studio Coastal Quality established a series of over 30 interactive design studios along the Dutch coast featuring experts, stakeholders and residents, to discuss long-term sandy strategies for the Dutch shore. From the studios results four overarching landscape values were derived to value the coast (Hoekstra, van Bergen et al., 2013. see Figure 2.27).

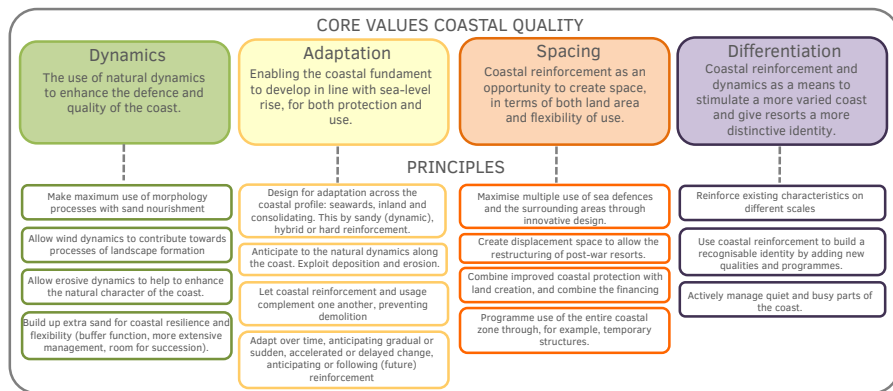

FIG. 2.27 The core values of spatial coastal quality according to Studio Coastal Quality (2013):

- *Dynamics: The employment of natural dynamics to enhance the defence and quality of the coast;*
- *Adaptation: Enabling the coast to develop in line with sea level rise for both protection and use;*
- *Space creation: Coastal reinforcement as an opportunity to create space and flexibility in use.*
- *Differentiation: The use of coastal reinforcement and dynamics to foster more diverse coastlines and give resorts more distinct identities.*

Coastal BwN from a spatial value perspective

The core values and principles of Studio Coastal Quality are closely linked to the functionality and values of BwN. In BwN projects, functional quality is related to the 'employment of natural processes and resources' to serve societal goals, such as flood safety (de Vriend et al., 2014; van Bergen et al, 2021). Therefore, BwN boasts three main values:

- 1 It is nature-based and system-based (e.g. sand as material), and can be sustained for a long time.
- 2 It gives way to self-regulating and dynamic natural processes to improve the coastal landscape.
- 3 It serves (a multitude of) societal goals, not just coastal safety but also nature, recreation or other production services, including their spatial values.

This research positions BwN as a landscape approach that connects the three main systems. The four themes from Studio Coastal Quality can be regarded as overarching values across all three systems. Dynamics, for example, not only supports BwN but also supports ecological processes and landscape differentiation. Adaptation refers to spatial flexibility across all three systems as a core value of sustainability. Space creation is necessary not only for dune formation but also for

the integration of urban and ecological habitats. Differentiation makes nourishments more effective and contributes to the development of diverse landscapes and habitats along the coastline, supporting ecological and cultural values. Due to their process-based, overarching and integrative qualities, these core values can be adopted as agenda and evaluation instrument for spatial quality in BwN projects, as illustrated in Figure 2.28 and the case studies in Chapter 4.

Spatial quality	Coastal values (V)	BwN landscape values*
Functionality	#V1 Employing natural dynamics	<ul style="list-style-type: none"> - Nourishments compensating for coastal erosion and restoring the sediment balance for flood safety - Allowing for natural processes - Self-regulating, cost-effective
	#V2 Space creation / multifunctionality	<ul style="list-style-type: none"> - Wider beaches, accommodation space - Multifunctional solutions - Room for recreation and economic development - Restoring beach-dune habitats
Sustainability	#V3 Nature-based adaptation	<ul style="list-style-type: none"> - System-based material - Supporting dune formation as a coastal buffer - Landscape-based adaptation, supporting natural processes - Flexibility, adaptive in time
Attractiveness	#V4 Differentiation	<ul style="list-style-type: none"> - Diversifying the coastal landscape - Strengthening unique local identities - Modulating public-private relationships

* Listed are generic examples of BwN landscape values derived from the overall definition of BwN, coastal values and Habiforum perspectives. For future BwN projects it would be best to translate these generic values to project- and context specific values, as part of an interactive stakeholder process.

FIG. 2.28 Overview of the core values of spatial quality (left), connected with the overarching coastal values as defined by Studio Coastal Quality (2013), translated to generic landscape values for BwN projects (right).

2.5 Building with Nature as a design approach to integrated coastal adaptation

2.5.1 Designing for the coastal buffer

To design BwN processes in scale and time, coastal design can be divided into an initial component and a dynamic component, the latter evolving towards a new equilibrium over time. This requires a systemic, scaled and temporal landscape approach (Section 2.4.3). To bridge the spatial and temporal gaps between the system interventions and sync nourishment dynamics to support BwN dune formation, this research defined a three-step design approach (Figure 2.29). This approach was derived from design studies on four coastal cases, implementing aeolian processes for dune formation across different nourishment, ecological and urban contexts.

The first design step: **morphogenesis** regards aspects of natural succession at the regional level, including nourishment evolution, as conditions for dune formation. Additionally, it considers the long-term prospects for coastline development and habitats. By mapping landscape processes, specific organizing principles can be derived for spatial transformation (Parrott & Meyer, 2012; Freeman et al., 2015; Nijhuis, 2015; Nijhuis & de Vries 2020).

The second design step: **dynamic profile design** is an important mediator between regional nourishment level and local spatial arrangements in the design and management of dune formation or 'dune farming'. The profile design is built out of the existing coastal profile, nourishment-enhanced dune formation, the projected future safety profile and profile optimizations for other coastal functions. To meet the future safety profile, the dynamic profile development is optimized and harvested from the nourishment in time, followed by profiling for multifunctional development.

The third design step: **aeolian principles** entail sediment allocation over time through the application of local aeolian principles as urban or ecological arrangements to build up of the desired future profile. The principles are based on principles of anthropogenic intervention aimed at stimulating natural dune formation as a form of 'urban sediment harvesting'.

Below is an overview of the three design steps aimed to link BwN dynamics in scale and time to enhance natural dune formation. Chapter 3 offers a more elaborate description of the design steps and principles.

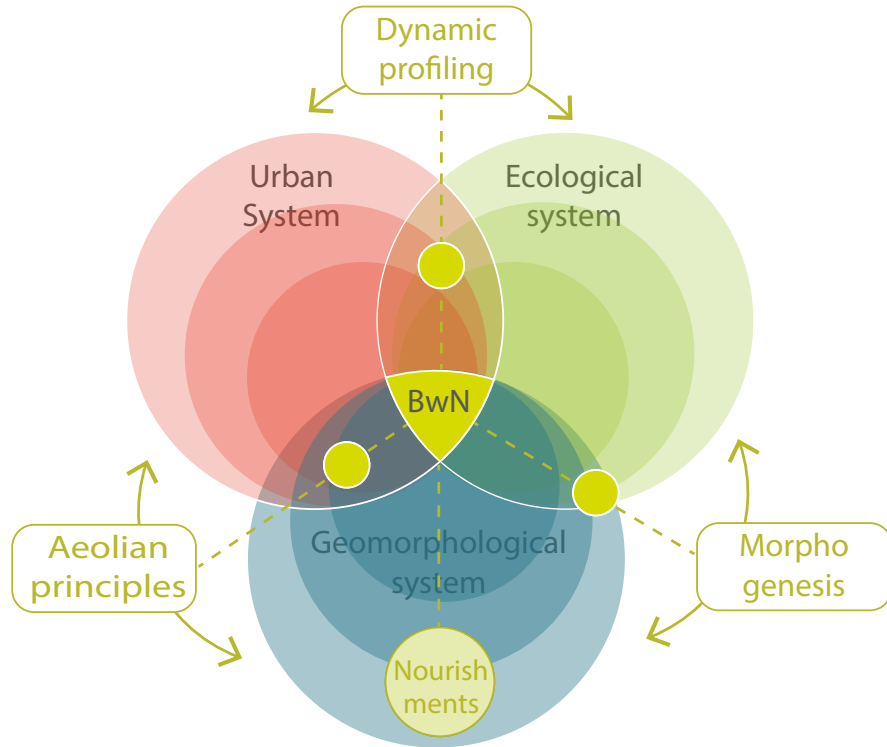

FIG. 2.29 Overview of the scales within the three systems and three design steps, facilitating the tuning of BwN dynamics across different levels: *morphogenesis* at the regional level, *dynamic profiling* at the trajectory level and *aeolian principles* at the local level. Although all steps apply to all systems, their centre of gravity lies in the overlap, as illustrated above (green dots). Image by the author.

2.5.1.1 Morphogenesis

The employment of natural forces in BwN requires a deeper understanding of the natural and cultural forces that have shaped coastlines through a historical continuum or coastal ontology. Through temporal mapping—or morphogenesis—an estimation can be made regarding expected coastal behaviours and land formations. Historical analysis generates insights into coastal responses to sea currents and sea level rise. Additionally, new techniques (e.g., GIS, modelling) facilitate the accurate documentation and prediction of coastal behaviour following nourishment (Figure 2.30). From these mappings organizing principles can be derived to induce spatial transformation (Parrott & Meyer, 2012; Freeman et al., 2015; Nijhuis, 2015, Nijhuis & de Vries 2020). Furthermore, morphogenesis provides the opportunity to study interactions between landscape layers. Beyond geomorphology, coastal ecology and human settlement have been responsive to coastal dynamics for centuries, informing specific landscape types, such as sea villages and multiple dune habitats (Doing, 1988). These landscape types represent the natural equilibria within the coastal system, some more open to new dynamics than others. The identification of these habitats and their dependencies are important parameters for integral BwN design. This design step is elaborated in Sub-Section 3.5.2.

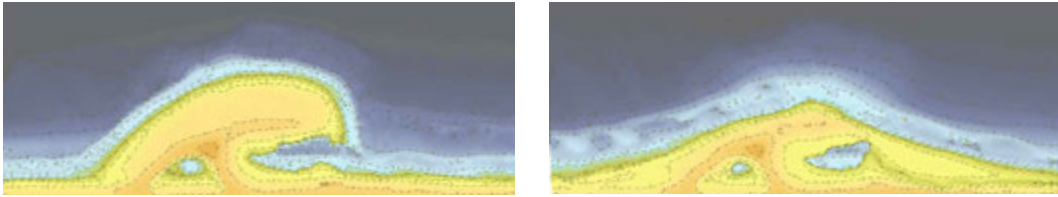

FIG. 2.30 Height monitoring at the Sand Motor: in August 2011 (left) and July 2015 (right). Source: zandmotor.nl - Shore Monitoring.

2.5.1.2 Dynamic profiling

The dynamics between the geomorphology, current and future coastal functions can be documented by a dynamic profile design that shapes the accretion process for flood safety as well as to facilitate other coastal functions. This profile design is based on buffer demands (m³ of sand) to maintain coastal safety, combined with the expected sediment transport rates following nourishment (see Figure 2.31). This combination acts as a scaled and temporal framework for fine-tuning and integrating other coastal functions, making profile design an important instrument for formal, multifunctional and transdisciplinary integration. This design step is elaborated in Sub-Section 3.5.3.

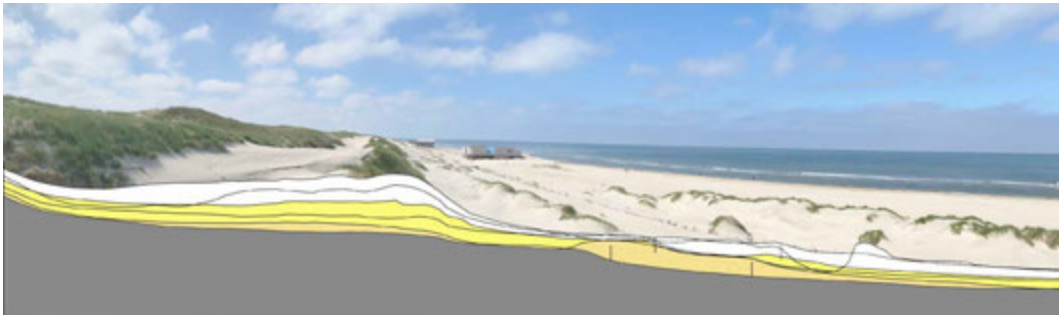

FIG. 2.31 GIS section of foredune development and sand accumulation around brushwood fences in Petten following sandy reinforcement(2015–2020; see also Chapter 4.4.3). Image by the author.

2.5.1.3 Aeolian design principles

The desired profile dynamics are directed by a set of aeolian principles, that allocate the sediment to the designated places within the profile. This is done by the employment of sedimentation patterns as a result of ecological or urban interventions, such as sand tail development behind buildings (see Figure 2.32) Some profile alterations, such as dune widening, require a set of principles decelerating wind; in contrast to dune heightening, that requires acceleration of wind (and sediment transport). These principles and their application are elaborated in Sections 3.6 and 3.7.



FIG. 2.32 Sedimentation pattern around a scale model of beach row housing on an angle with the dominant wind. Sand tail development can be employed to collect sediment in the foredune zone. Image by the author.

2.5.2 BwN landscape design as an iterative process

With design principles at a local level, alterations can be made within the coastal profile, in response to the type of nourishment and associated sediment transport. In this way, a consistent design loop is created between regional nourishment typology, trajectory profiles and local aeolian design, maximizing BwN following nourishment. In return, this loop can also affect the nourishment strategy, as nourishment volume, location and frequency are all design parameters that can be optimized for dune formation, such as the resulting beach width as fetch for sediment transport. BwN landscape design is an iterative process that combines elements of research as factual input and spatial design, entailing a cyclical process between the two (see Figure 2.33). Design is employed as a vehicle not just for the visual representation of spatial problems, but also for the spatial exploration of multiple possibilities, that through variant studies, arrives at the integrated optimum (Cannatella & Nijhuis, 2020; Parrott & Meyer, 2012; see Section 1.5.3). Within this optimization process, the multifunctional and cultural values of the landscape and its perception as a place can be addressed and incorporated via differentiation and scenic design, creating specific coastal habitats and a wide range of solutions.

The inquiries and design loops to complete coastal BwN as a landscape design approach (including the design steps) can be represented as follows:

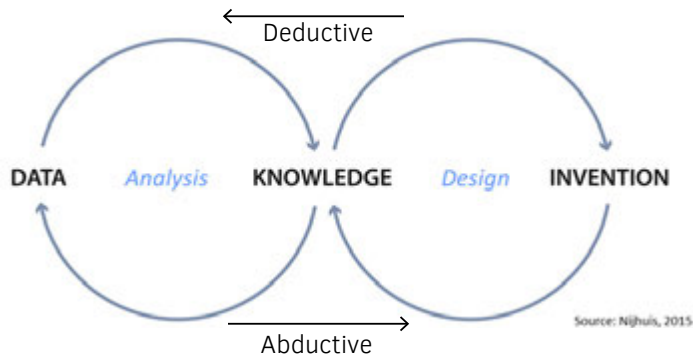

FIG. 2.33 Model of the work forms of design thinking: abductive design thinking, composing or validating a design based on data or observations, versus deductive design thinking, using design invention (right) to explore or confirm a hypothesis. Source: adapted from Nijhuis, 2015.

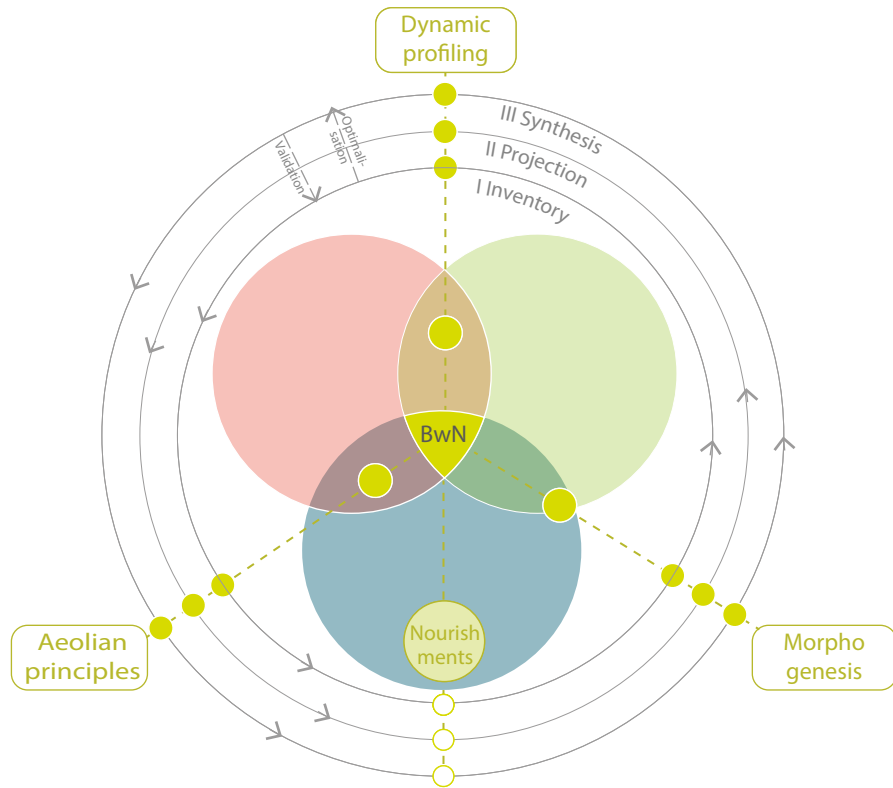

FIG. 2.34 Overview of the research and design loops for BwN landscape design, syncing systems and BwN dynamics. Image by the author.

The grey loops represent different phases of the design thinking process, from analysis (I. Inventory) to invention (II. projection) and integrated design (III. synthesis). By alternating between the outer and inner loops, cyclic processes of optimization and validation can be incorporated into the design process.

I Inventory of dynamic processes

The first 'abductive' design loop, from data to knowledge, requires an inventory process along the scaled BwN processes. This process begins with the inventory of (a) the goals and values of the project (e.g., flood safety, nature, waterfront, production) and (b) the analysis of the regional coastal processes (e.g., coastal erosion, sediment needs, urbanisation, habitat development, nourishment type, development (morphogenesis)). These processes affect the existing coastal profile. At the local scale, the inventory extends to (c) the existing and expected geomorphological, ecological and urban programmes within the coastal zone, including a preselection of feasible aeolian principles.

II Projection of evolution and future needs

In the second design loop, future sediment-nourishment needs and supplies are projected in terms of both plan (morphogenesis) and profile. This indicates the dynamic design component, which evolves over time. Depending on the desired profile for future coastal functions, sediment allocation can be planned through the use of the aeolian principles (nature-based or urban).

III Synthesis: Spatial optimization of nourishment, multifunctionality and values

In the last design loop, an optimization is made between the nourishment and profile development in time (e.g., adjustment of the initial profile and/or the aeolian sediment input) to support ongoing dune formation within the profile. Additionally, a match is made with the other functions and values within the project, optimized by typological and contextual studies, to achieve multifunctionality and a spatial quality beyond flood safety.

The steps from inventory to synthesis (abduction) can be regarded as an optimization process from technical input data to a complete design. The process of synthesis back to inventory (deduction) can be seen as a process of validation in which the design outcome is linked back to the initial data or tested within a specific (scientific) context (e.g., the testing of aeolian principles derived from fieldwork to promote dune formation in a specific nourished context and coastal profile).

2.5.3 Application of the landscape design approach within the research

The landscape approach and the iterative design process have been employed in this research as a research-by-design method. This involved both typological research (e.g. fieldwork) and design studies on Dutch cases. They included a set of inquiries to support the three-step approach as part of the cyclical design processes. These inquiries are illustrated below and can be used as points of reference for other coastal design processes.

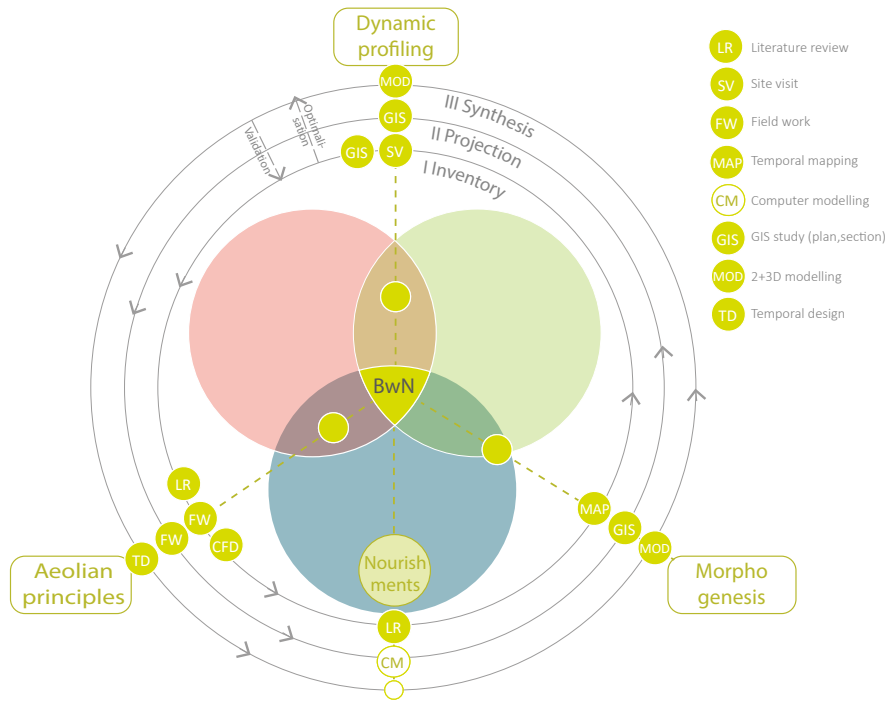

FIG. 2.35 Overview of the research and design loops, syncing systems and relevant dynamics used by the ShoreScape project and in the design (case) studies. Image by the author.

The green icons indicate the different research-by-design tools that have been applied throughout the process, developing and serving different scales and steps (morphogenesis, profiling and principles) of the BwN design process.



Marram grass planting to protect the dunes, ca. 1930.
Source: Nationaal Archief/Collectie Spaarnestad/Het Leven/Photographer unknown.



3 Landscape design principles for natural coastal adaptation

3.1 Introduction: design approach and principles

The ShoreScape research merges insights from coastal engineering and spatial design to formulate BwN design principles that combine nourishment strategies and ecological and urban development to strengthen the dunes as a coastal buffer and multifunctional landscape. These principles employ wind-driven (aeolian) processes after nourishment and spatial interventions for sediment allocation, promoting dune formation. This approach is linked to contextual factors such as the sediment supply from the nourishments in terms of type, volume and frequency (Mulder et al., 2011), ecological habitats and (adaptive) urban arrangements for waterfront development on the regional scale. The principles set the preconditions for integrated development on the local scale, to build towards sustainable profiles on a trajectory scale, as first outlined by Van Bergen and Nijhuis (2020).

This chapter provides an overview of the design approach and principles that lead to the BwN-based and integrated adaptation of urbanized sandy shores (see Figure 3.1). These support inter-systemic BwN dynamics and sediment transport for dune formation in scale and time, thus addressing research question 2.

In Section 3.2, we discuss the features of the most common types of nourishment as drivers of change in the coastal landscape. Although nourishments are taken as a contextual given in this research, it is important to understand their spatial parameters. These set the spatial and temporal preconditions for aeolian sediment transport to take place. In Section 3.3, the processes of wind-driven sediment transport and natural dune formation are explained, as well as the fundamental choices for sediment allocation. Section 3.4 explains the effects of urbanization in the coastal zone, which constrain the natural aeolian process of dune formation.

In Section 3.5, the landscape design method and principles for integrated coastal adaptation are described, including the three subsequent design steps for BwN ashore: **morphogenesis**, **dynamic profiling** and **aeolian principles** (see Figure 3.1). These design steps organize BwN sediment dynamics into different scales to build towards a flood-safe and multifunctional coastal landscape. Sections 3.6 (dune widening) and 3.7 (dune heightening) give an overview of the design choices for coastal profiling and its aeolian activation. Section 3.8 focuses on temporal design and illustrates the evolution of these principles in time, which maximizes sediment harvesting in different phases of the nourishment and dune formation process. Section 3.9 reflects on the proposed design method and principles for dynamic, adaptive and multifunctional coastal landscapes.

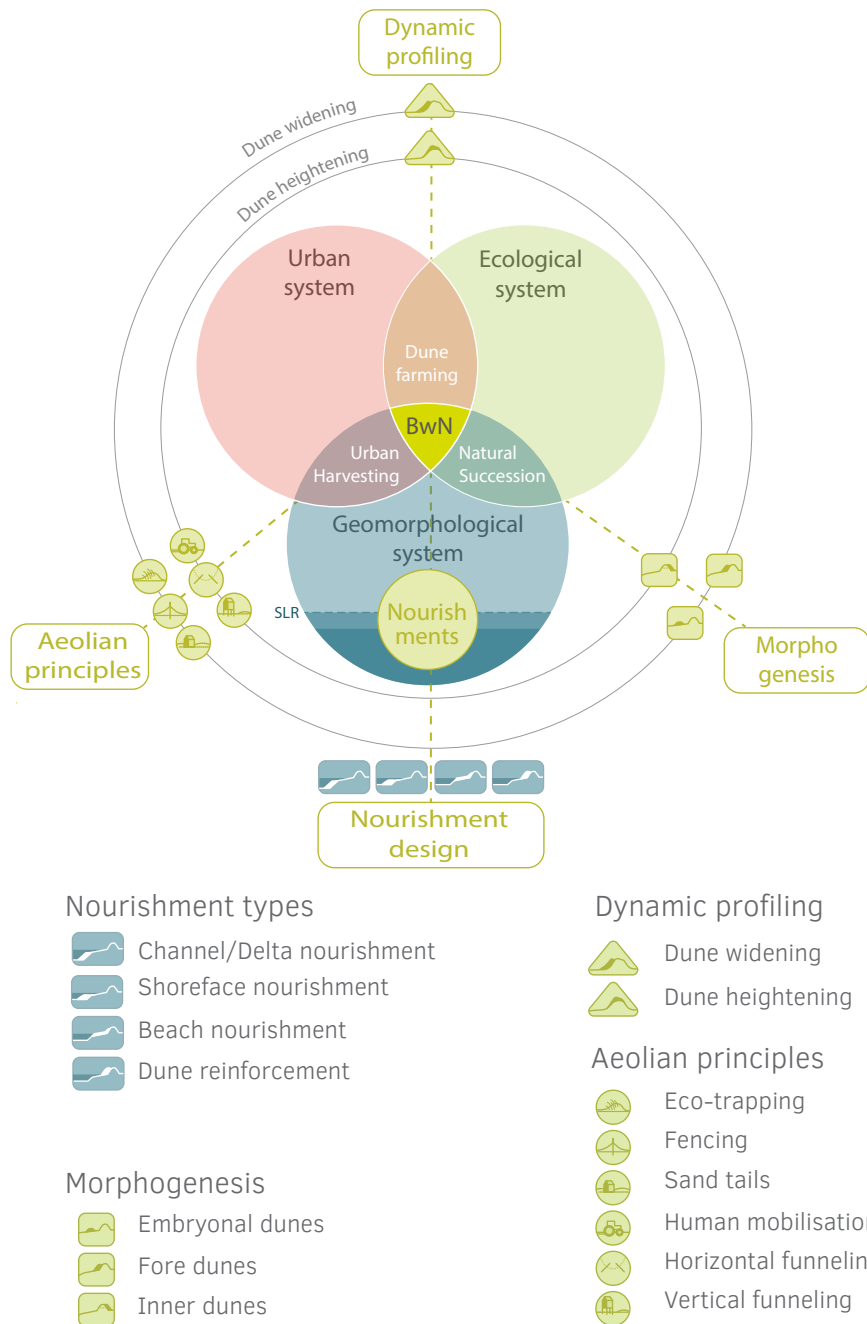

FIG. 3.1 Toolbox with design steps and principles for natural coastal adaptation. Image by the author.

3.2 Intervention: types and design of sandy solutions

Sandy shores are valuable areas for flood safety, nature and recreation, but also subject to erosion, especially when facing sea-level rise, land subsidence and the reduction of fluvial sediment input (Stive et al., 1990; Beets & Van der Spek 2000; Van der Meulen et al., 2007; Van der Spek & Lodder, 2015; Brand et al., 2022). To combat erosion, ensure flood safety and coastal functions, sand nourishments take place, restoring the sediment balance and maintaining the shoreline and flood defence. In Chapter 2, nourishment and sandy reinforcement strategies were introduced. This Section zooms in on the spatial parameters of nourishments and sandy reinforcements that condition BwN processes ashore.

Context: strategic choices for sandy strategies in the Netherlands

Nourishment design starts with the definition of its purpose: serving societal goals such as compensating for erosion, strengthening coastal safety, securing the beach, the dunes, cities and infrastructure or a combination of those. Once the objective is known, the sediment required to fulfil it can be quantified.

In the Netherlands, the overall objective of the coastal policy is to maintain all values and functions of the coast sustainably. Considering that on a sandy coast, 'sand is the carrier of all functions' and, thus, that the total sand volume of the coast determines the potential of all functions, the overall objective has been translated in operational terms as maintaining the sand volume of the active coastal system. This is defined by calculating the sediment deficit within the coastal foundation (from -20 m to the inner dune lining). These losses are partly compensated to restore the sediment balance and maintain the coastline (see Figure 3.3). This can vary across regions. The Dutch coast, for example, can be divided into several coastal cells (see Figure 3.2), which are defined by their specific current and wave characteristics and sediment demand. Near trans-grading tidal channels and open estuaries (e.g. Zeeland, Wadden), this demand is higher than on more stable shorelines such as the Holland Arc (the coast between The Hague and Alkmaar). In line with the societal objective, this demand is (partly) compensated by small-scale (0.5–1 Mm³) frequent nourishments (every 4–5 years) to maintain the reference coastline (BKL). These nourishments use natural wave dynamics (BwN) to disperse the sediment across and along the shore.

Additional sandy reinforcements are made on weak trajectories for flood safety, providing enough sediment in the foredune zone to withstand a severe storm. These sandy reinforcements are usually larger in scale (20 Mm³ or more), low-frequent (every 20 years) and less dynamic to keep sediment in place as much as possible (i.e. 'nature based'). However, due to their larger volumes, they often imply a seaward extension of the shoreline, which will gradually erode in time, feeding the adjacent shores and dunes with sand.

Depending on the scenarios for sea-level rise, maintenance and reinforcement volumes are expected to double or triple in the second half of the millennium, upscaling nourishment strategies. The feasibility of nourishments as a strategy to counteract the effects of sea-level rise depends on the availability of sediment. In the Netherlands, the North Sea represents a tremendous and close sediment source. The sediment is harvested beyond the -20 m line, transported and deposited by ships in the nearshore, increasing the available sediment budget to land ashore.



FIG. 3.2 Map of the Dutch coast divided into coastal cells, each with specific dynamics and sediment needs. Source: Mulder, 2000.

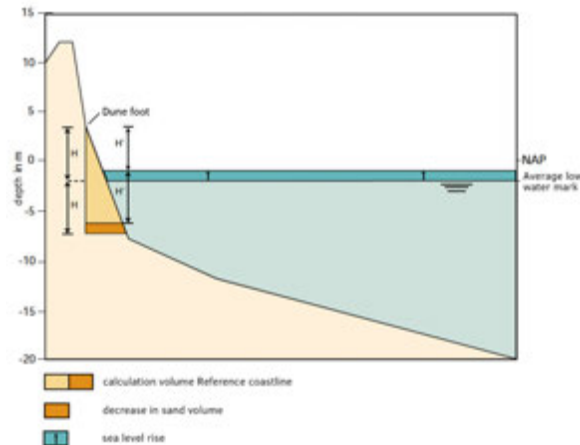

FIG. 3.3 Dutch coastal section with the coastal maintenance zone (yellow). To balance out sea-level rise (dark blue), more volume must be added (dark orange) within the reference coastline zone (dark yellow). Source: Mulder, 2000.

Nourishment typologies and design

In Chapter 2, different types of coastal sandy solutions were explained: BwN-based maintenance nourishments and nature-based sandy reinforcements. The choice of a certain type of nourishment is dependent on the objective and six spatial conditions (context, position, volume, dynamics, form and frequency). Although nourishments are regarded as a given in this study, their spatial features condition aeolian transport. Nourishments alter the shoreline's evolution on a trajectory level as a base for landscape development (morphogenesis). Therefore, a general understanding of nourishment design and evolution over time is needed before moving to aeolian and onshore design. In the end, onshore BwN design can even require the optimization of the nourishment design (e.g. volume or frequency) to maximize aeolian sediment harvesting for dune formation over time.

Local conditions such as sea currents and shoreface slopes but also sediment availability can limit the spatial capacity to apply and sustain nourishment. When local conditions and the position are known, the amount of (future) coastal erosion and the loss of volume as a result of relative sea-level rise (see Figure 3.3) determine what volume of sediment is needed. This is done by calculation and/or modelling. In general, nourishment volumes can vary from small-scale nourishments (1–2 Mm³/4y) for coastal maintenance, for example, to large-scale ones (e.g. 5–20 Mm³ every 20 years).

The choice of dynamics will also affect the nourishment's form. The Sand Motor pilot, for instance, contains 20 Mm³ of sand that will be transported ashore by natural dynamics over 20 years, altering the coastal profile. This requires advanced computational modelling to predict the dynamic transport of the nourished volumes along and across the shore.

Finally, the nourishment frequency or the repetition of the nourishment to maintain its function is closely related to the initial goal(s) of the nourishment (e.g. shoreline maintenance or sandy reinforcement). The longer the time frame of the nourishment strategy, the greater the chances for a BwN-based build up of the dunes as coastal buffer.

Once the nourishment objective and strategy are known, different types of nourishment can be applied to reinforce the shore. From a coastal maintenance perspective, three types of BwN-based nourishments can be distinguished (Brand et al., 2022):



- **Shoreface nourishments**, which add sediment underwater in the foreshore zone (around -5 m NAP in the Netherlands).



- **Beach nourishments**, which add sediment to the beach's surface between the low tide and dune-foot zone.



- **Channel-wall nourishments**, which add sediment to the landward side of the channel for seaward migration.



- A fourth innovative type is **Ebb tidal-delta nourishment**, where sand is placed on the outer-ebb delta (e.g. 5 Mm³ in Ameland, 2019) as a sediment source for the tidal basins and the adjacent barrier islands.



- Sandy reinforcements are often the combination of beach nourishment (see above) and **dune reinforcement** carried out above the dune foot (around +3 m NAP in the Netherlands). Dune reinforcement has been added as a fifth type.

In this research, we focus on the types of nourishment that lead to direct stimulation of BwN dune formation: shoreface nourishments, beach nourishments and dune reinforcements. They instantly alter the dry coastal profile, increasing the fetch and sediment flow towards the dunes. These are documented below.

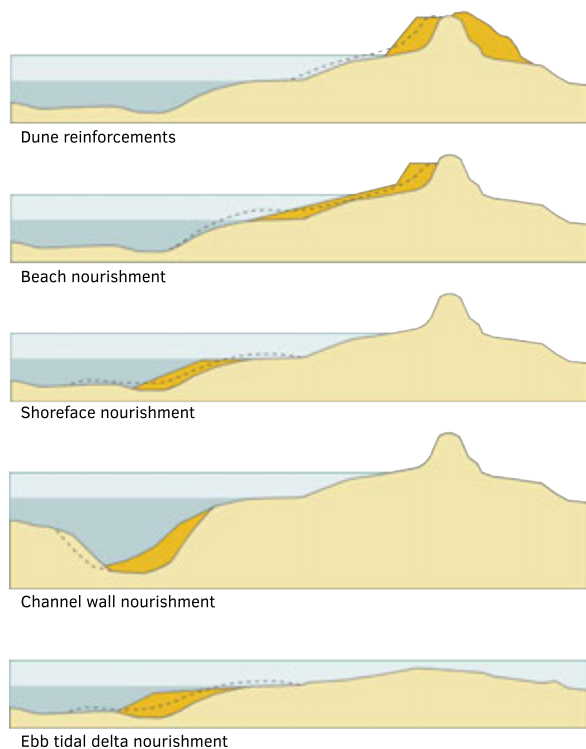

FIG. 3.4 Schematic overview of sandy solutions in the Netherlands: dune reinforcement (top), beach, shore-face, channel-wall and tidal-delta nourishment (below). Source: J. van Bergen, adapted from Brand et al., 2022.

1 Shoreface nourishments



Shoreface nourishments add sediment to the foreshore below low tide (around -5 m NAP) and help to reduce wave attacks. Part of the sediment is washed ashore (10% in the first year, up to 20–30% in the following years), maintaining the shoreline (Witteveen & Bos, 2006) and nourishing up to 2 km of coastline adjacent to the initial nourishment (Van der Spek et al., 2007). Shoreface nourishments are more cost effective than beach nourishments (3.5 €/m³ versus 5.5 €/m³) and capable of handling larger volumes. For this reason, they have become the most common type of nourishment along the Dutch coast.

Usually, shoreface nourishments are placed at the seaward side of the outer bar within an active along-shore sandbar system (Grunnet & Ruessink, 2005; Van der Spek et al., 2007, 2013). They not only stop bar migration but may even initiate a landward migration of the bars, resulting in an increase of sediment at the sea-land interface. To migrate bars, shoreface nourishment needs to be sufficiently large, around 250–500 m³/m (Wijnberg, 1995; Steijn, 2005; Witteveen & Bos, 2006), with an average length of 4 km and a total volume of 1.6 Mm³ (Brand et al., 2022). Their lifespan depends on local conditions but is estimated to be between 4–10 years (Witteveen & Bos, 2006; Vermaas et al., 2013, 2019), with an average maintenance frequency of 5.2 years (Brand et al., 2022).

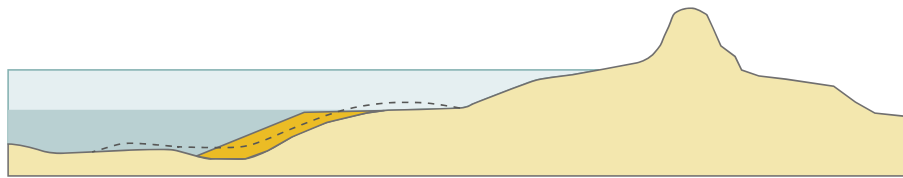

FIG. 3.5 Schematic section of a shoreface nourishment (orange) that will evolve over time (dotted line.)
Source: J.van Bergen, adapted from Brand et al., 2022.



FIG. 3.6 Shoreface nourishment on the North Holland coast, Netherlands (2020). Source: © Rijkswaterstaat.

2 Beach nourishments



Beach nourishments add sediment to the beach surface between the low tide and dune-foot zone, also known as the coastline position zone ('Momentane KustLijn' or 'MKL'). Due to their instant effect on the volume in this zone, beach nourishments are very efficient at shoreline maintenance (Brand et al., 2022) and are therefore applied often (70%) in the Netherlands. Beach nourishments are usually limited in volume (0.5 Mm^3 or $200 \text{ m}^3/\text{m}$ on average) and highly frequent (nourished every 4–5 years). Within the coastal profile, beach nourishments are usually placed against the dune foot (+3 m NAP), with a slope that is similar to the natural beach profile (gradient around 1:30, maximum 1:20 to prevent beach scarps; Brand et al., 2022; see Figure 3.7). Beach nourishments are susceptible to rapid erosion and thus have a short lifespan of 2.9 years on average (Brand et al., 2022). In sandy reinforcements, the expected beach erosion is included in the initial design (e.g. Hondsbossche dunes).

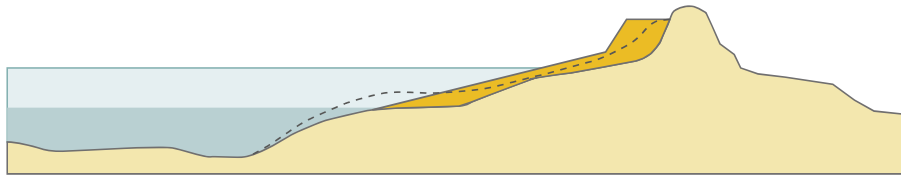

FIG. 3.7 Schematic section of a beach nourishment (orange) that will evolve over time (dotted line).



FIG. 3.8 Beach nourishment at Texel, Netherlands (2020). Source: Texelinformatie.nl.

3 Dune reinforcements



Dune reinforcements either add sediment directly to the existing dunes or create a new dune for flood safety (e.g. Nieuwvliet, Petten and Texel). Dune nourishments were a common measure in the past, utilized to restore storm erosion, for instance, but their use has declined in favour of (cheaper) shoreface nourishments. In some recent cases, dune nourishments were part of more compact, hybrid solutions, such as dike-in-dune constructions for the seaside resorts of Noordwijk (2010, see also Section 4.1) and Katwijk (2015). In most cases, the dune design includes a buffer zone for 50 years, excluding new sediment transport to the dunes. If this is included, the constructed volumes could be lower, as long as current safety levels are maintained due to nourishment (Ecoshape, 2019).

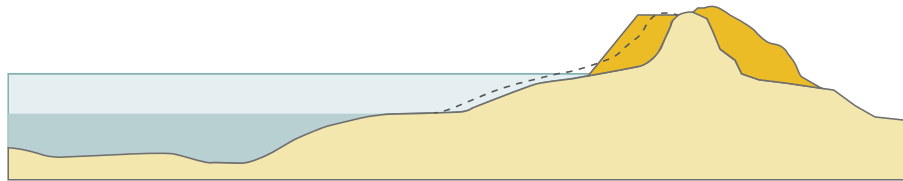

FIG. 3.9 Schematic section of a dune nourishment (orange) that will evolve over time (dotted line). Source: J.van Bergen, adapted from Brand et al., 2022.



FIG. 3.10 Dune reinforcement at Renesse, Netherlands (2014). Source: Sinke Group.

Nourishment types and dune formation

After nourishment, part of the sediment is transported ashore to be deposited at the sea-land interface. There, it is picked up by the wind and transported inland to trigger dune formation. In the framework of the ShoreScape research, difference-in-elevation mappings (DEMs) were analyzed to see how different types of nourishment lead to different accretionary patterns ashore.

For example, regular maintenance nourishments (Figure 3.1 1a) such as shoreface nourishments, generate a temporal but limited seaward extension of the shoreline. Although the beach is temporarily broadened for the wind to pick up sediment (fetch), the accommodation space for new dunes to develop is limited. This is especially the case for urbanized shores, where beach buildings obstruct sediment flow to the dunes and tramping and beach maintenance reduce vegetation, as essential component for dune formation.

Medium- to large-scale nourishments (10–20 Mm³/20y; Figure 3.1 1b) feature wider beaches of 100–250 m in width. This largely increases the fetch for wind-driven sediment transport, as well as the dry, storm-free part of the beach for new foredunes to develop. Foredunes take advantage of local shoreline erosion and increased sediment flow in the first years after nourishment, leading to increased growth rates of 35 m³/m/y or higher (see par. 4.5)

Mega-nourishments, such as Sand Motor (Figure 3.1 1c), feature extensive beaches (500 m) and possibly additional features such as lakes within the profile. Although the fetch is largely increased, initial or evolving profiles (beach ridges, lakes) can obstruct inland sediment transport. Due to the extensive beach, the new embryonal dunes form around the storm watermark, resulting in new beach ridges halfway. When vegetated, they block much of the sediment transport and can leave the foredunes deprived of sediment (Van Bergen et al., 2021).

This analysis shows that the type and amount of nourishment as well as its initial profile determine the type and location of subsequent dune formation. Depending on the goal of BwN adaptation, nourishment types could be fine-tuned to meet the profile alterations and dune formation needed.

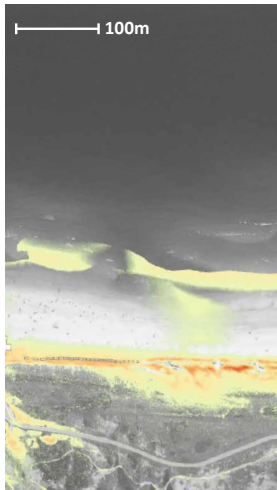

a) Regular coastline maintenance nourishment resulting in foredune growth and blowouts at Schoorl (2015–2020).

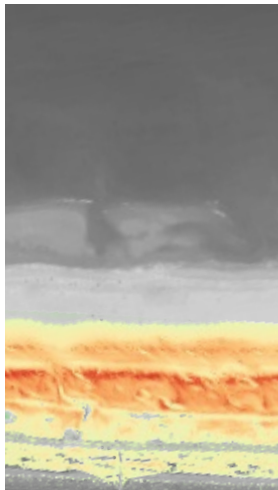

b) Double foredune formation as a result of fencing and vegetation at the large-scale sandy reinforcement of the Honschbossche dunes (2015–2020).

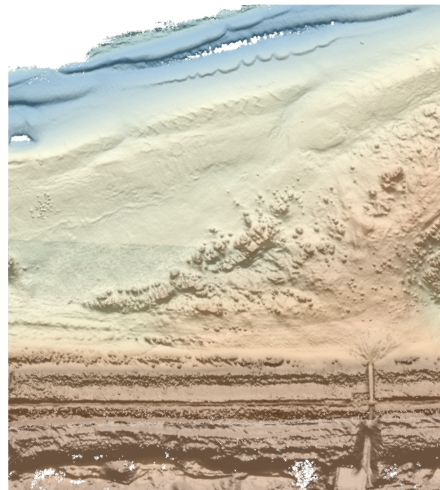

c) Embryonal dune formation at the extensive beach of the Sand Motor (2011–2018), leading to new beach-ridge formation but depriving the foredunes of sediment.

FIG. 3.11 Mapping of the dune development (in the same scale) for three different types of nourishment. Images by the author; Lidar data courtesy of HHNK, TUD and UT.

3.3 Succession: natural processes enhancing dune formation

The design of onshore sediment dynamics as coastal buffer through BwN, requires a deeper understanding of sediment transport and the process of dune formation. Nourished sediment is transported ashore by natural processes (waves, tide and wind) contributing to beach and dune development. Up to 25% of the initial nourished volume is capable of landward transport to the dunes (Van der Wal, 1999; Arens, 2010), but this figure can fall to 5–15% on urbanized shores (Quartel & Grasmeyer, 2007; Giardino et al., 2012, 2013, 2014) due to foredune blockage caused by beach buildings and maintenance. Sustainable dune formation occurs when the supply of sediment exceeds coastal erosion. Nourished wide beaches offer a good fetch for the wind to pick up sediment and accommodation space for dunes to develop. This can increase dune accretion rates from 10 to 30 m³/m/y or more, especially in the first 1–3 years after nourishment (Petten case study; Section 4.4). Since 2000, the average yearly dune volume along the Holland coast increased by 10–15 m³/m/y as a result of the coastal maintenance programme and reduced dune-foot storm erosion (Ijff et al., 2019). The process of dune formation after nourishment involves three constructive phases dominated by different actors: the *mobilisation phase*, where fine sediment is exposed by natural dynamics, the *transition phase*, where sediment is transported from the beach to the dunes by the wind, and accretion or the *stabilisation phase* through natural succession, relevant for building and sustaining the coastal buffer.

3.3.1 Mobilisation: preconditions for aeolian sediment transport

Wind-driven (aeolian) transport is essential to dune formation and recovery after storms. This transport is dependent on the exposure of (fine) sediment and enhanced by natural dynamics such as waves and wind. Nourishments can offer temporary wider and gradually sloping beaches, a positive condition for dune formation (Puijtenbroek et al., 2017; Puijtenbroek, 2019). Wider beaches not only provide accommodation space for dunes to form (Galiforni Silva et al., 2019) but also enlarge the so-called fetch length, that is, the length of (dry) beach where wind can blow and pick up sediment (Delgado-Fernandez, 2010). The fetch length is related to the wind direction: at more oblique directions (SW and NW in Holland), the wind covers a larger stretch of beach before reaching the dunes. Wind-driven sediment transport is also dependent on the beach slope (De Vries et al., 2012) and the erodibility of the beach's surface,

which is related to grain size (Van IJzendoorn, 2022) and moisture levels and affects the development of the dune topography (Galiforini Silva et al., 2018). Furthermore, nourished sediment may be coarser and contain more shells, leading to an armouring layer of shells that prevents the wind from picking up sediment (Hoonhout, 2019). Thus, sediment availability, fetch length, beach slope, groundwater level and sediment composition are determining preconditions for enhancing dune formation.

3.3.2 Transition: aeolian sediment transport towards the dunes

The wind has three mechanisms for sediment transport: creep, saltation and suspension (Figure 3.12). Creep (sediment rolling over the beach) generally starts at wind force Beaufort 4. Saltation occurs when grains are picked up from the bed and make short jumps before hitting the bed again and expelling new grains. Around wind force Beaufort 5–6, sediment transport becomes more substantial, and so-called ‘streamers’ (Williams, 2019) – episodic clouds of repeatedly bouncing particles moving close to the beach – occur. Smaller particles can even become suspended and are carried by the wind over long distances. Most sand transport takes place in summer due to high temperatures (providing dry sand) and in autumn because of storms that can transport large amounts of sediment rapidly. Spring is also an important season due to the sprouting of vegetation, which accelerates accretion (Van Dieren, 1934).

Sand transport has different features, such as wind ripples, streamers, whirlwinds, shield dunes and solitary dunes (during mass transport). Around the winter flood mark, sand is trapped to form larger sandbars (‘zandschilden’). These expand in the direction of the wind, overflow and connect to each other to form embryonic dunes above spring-tide level, colonized by salt-loving vegetation (van Oosten, 1986; see also Figure 3.13).

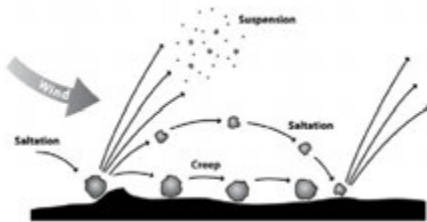

FIG. 3.12 Three modes of aeolian sediment transport. Source: Presley & Tatarko, 2009.

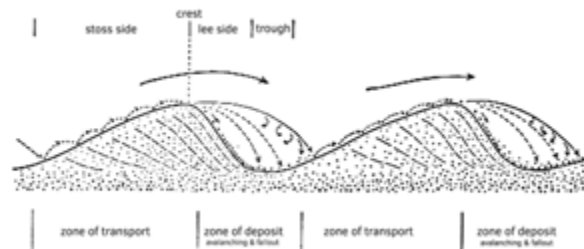

FIG. 3.13 Illustration of dynamic sand movement to form ripples. Source: Roberts, 1970; columbia.edu.

3.3.3 Stabilization and dune formation via natural succession



Sediment is deposited when wind speeds decrease, for instance, behind seaweed and driftwood, at the (vegetated) dune foot or on the lee side of (built) objects. Dune formation can be expected for beach widths of 80–100 m or more (Puijenbroek, 2019) as embryonic dunes at the beach or the dune foot.

The growth of vegetated dunes is not regular but rhythmic (Van Dieren, 1934). The start of dune formation is often the colonization of the open, dynamic beaches by one-year pioneering vegetation. This starts at the winter flood mark, where seedlings germinate in the spring with salt-loving species such as sea rocket (*Cakile maritima*). Sea couch grass (*Elymus farctus*) and lyme grass (*Leymus arenarius*) catch sediment and promote embryonal dune growth (1–3 years), to be taken over by marram grass (*Ammophila arenaria*) as long as no large storms occur.

Marram grass has the exceptional capacity to grow along with sedimentation up to 1 m/y but needs fresh water to survive. Therefore, it grows higher up the beach plane. Marram grass also needs salt spray and calcium as nutrients and is thus dependent on aeolian dynamics from the sea. Without this supply, it will eventually die (Van Dieren, 1934).

Prograding dune systems



When sediment is abundant (e.g. in nourished situations) and the backshore is broad (determined by the storm tide water level), dunes can develop on the beach in a seaward 'prograding' system (Van der Spek, 1999). After the formation of embryonal dunes (2–3 years), accretion can build up to form a closed beach ridge or a new row of fore dunes (10–30 years) as part of the white dune habitat (20–50 years). White shell sands are able to build steeper dunes (up to 42°) than yellow quartz sands (25°). With marram grass, slopes of 45° can be achieved regardless of the type of sediment (Nature Conservancy, 1969).

Once the dune stabilizes and sediment interaction has declined, other species take over, such as sea holly (*Blauwe zeedistel/Eryngium maritimum*), sea bindweed (*Calystegia soldanella*) and sand fescue (*Festuca rubra* var. *Arenaria*) as part of the grey dune habitat, alternated with lower, humid dune valleys. Over time, the dune vegetation will be replaced with more specialized, nutrient-poor and low-dynamic biotopes and species such as heather (H2130, H2140), scrubs (*Dunethorn*, H2160) and dune forests (H2180) (see Figure 3.14).

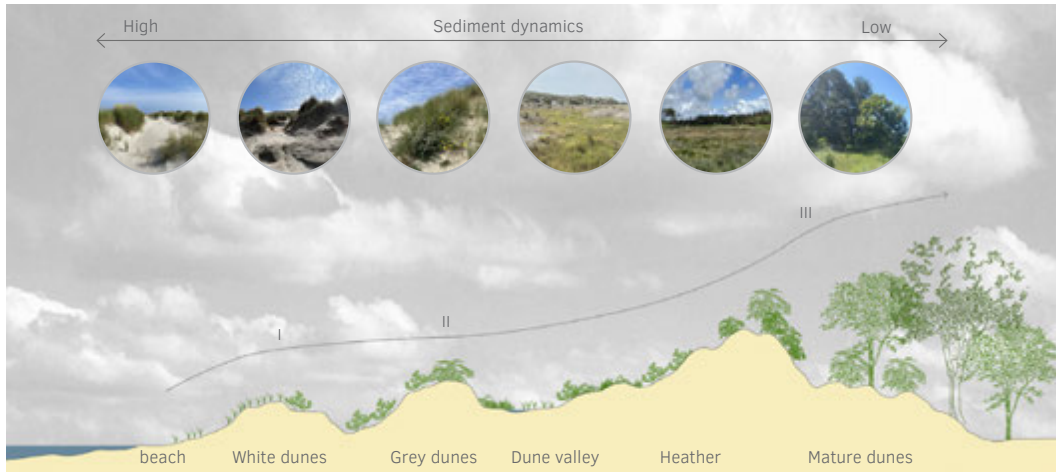

FIG. 3.14 Overview of the main dune biotopes on sandy shores, including aeolian vegetation zones (I-III). Biotopes (circles) from left to right: embryonal dunes, white dunes, grey dunes, humid dune valley, heather, mature & forested dunes. Image by the author.

Wind-deflecting vegetation zones

The sequence of vegetation zones also relates to their adaptation to the local wind climate (Australian LWC department, 2001), which is divided into three typical aeolian zones. The first zone (I) or 'primary vegetation' consists of pioneering vegetation at the beach and incipient dunes, such as marram grass, which traps and stabilizes the sediment thanks to their foliage and root system. The first row of dunes acts as a wind barrier, diverting the wind flow upward. Vegetation and shrubs in the upper foredunes (grey dunes) or secondary zone (II) act as a storm shutter, reducing wind velocity and sheltering the back-dune system. The tertiary zone (III), or mature dunes, houses more upward vegetation, such as taller shrubs and trees, which form interlocking tiles as part of a closed, aerodynamic canopy, deflecting the wind (see Figure 3.14).

Transgressive dune systems



When the beach is narrow and sediment supply is limited, beach ridges are likely to erode unless the fetch is still long (e.g. because of oblique winds). Foredunes may grow to a certain height before they erode and are blown inland as part of a landward or 'transgressive' system (Van der Spek, 1999). The destabilization of vegetation by storms (or trampling) can cause foredune ridges to deform over time and develop transitional grey dune systems (7–20 years; Van Dieren, 1934) featuring cliffs and blowouts (100–150 years), which can evolve into more mature and parabolic dunes (200 years, low-dynamic) (Brooks & Agate, 1986; Figure 3.15). Storm-eroded sediment may form offshore bars that travel landward for renewed dune formation, in a dynamic equilibrium (Ritchie, 1972; Brooks & Agate, 1986)

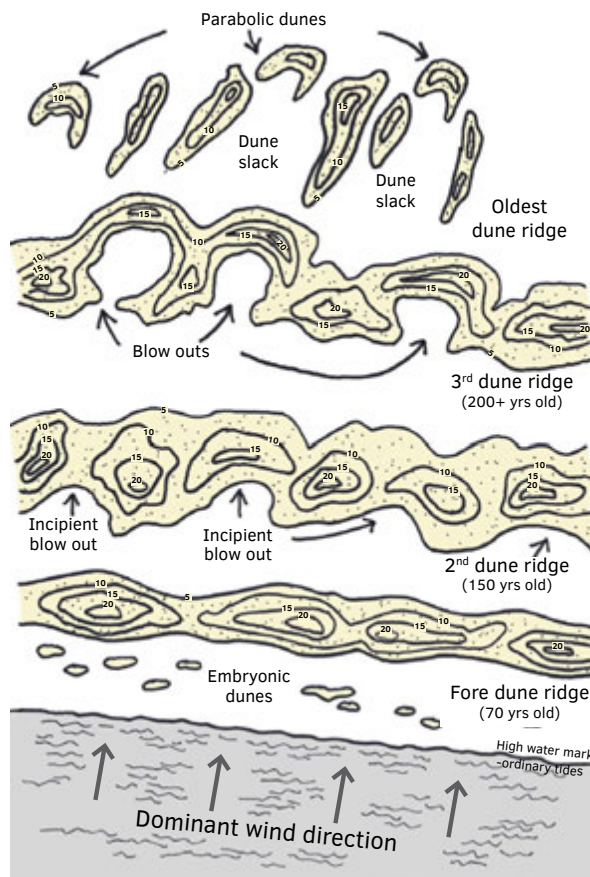

FIG. 3.15 Temporal overview of the different stages of dune formation and dynamics, from embryonic dunes (below) to parabolic dunes (top). Image by the author, adapted from Brooks & Agate (TCV, 1986).

3.3.4 **Natural dune succession and nourishment**

Succession shows that some habitats, such as embryonal and white dunes, can profit from the excess of sediment transport caused by nourishments. The wider accreting beaches might lead to the enclosure of green, upper beaches by new beach ridges to form new humid dune slacks (Hoekstra & Pedroli, 1992; Schotman, 2012). Other habitats, like grey dunes that thrive on erosive dune fronts, might suffer from extended beaches and new beach ridges caused by nourishment. Besides sediment, coastline extension can also have indirect (a)biotic effects, such as the introduction of wetlands with more freshwater and saltwater gradients (e.g. Kwade Hoek Goeree) and new dune slacks (e.g. De Groene Punt at Voorne). It can also enlarge the freshwater well in the dunes to promote new dune lakes (e.g. De Muy and De Geul at Texel; Bakker, 1979). These mechanisms are relevant to the development of new dune slacks in nourished profile designs (for instance, as nature compensation project).

3.3.5 **Conclusion: guiding aeolian processes for BwN dune formation**

The phases of dune formation have so far been described as natural or enhanced processes initiated by nourishment. Three aeolian mechanisms can be derived from these processes to enhance BwN dune formation by directing sediment transport and natural succession.

1 Mobilization of sediment

Wide beaches (resulting from nourishments, for instance) extend the fetch of dune-ward sediment transport. Sediment composition and dry conditions (e.g. caused by higher, gradual profiles) can also promote sediment transport. Furthermore, urban traffic (tramping, car traffic, maintenance, see Figure 3.16) can increase the exposure of fine sediment to foster sediment mobility from the foredunes towards the upper dunes.

2 Deceleration of wind to stimulate local accretion

Obstacles create diversion, turbulence and a reduction of wind flow, leading to a local increase in deposition (and erosion). The reduction of wind speed via a layout of half-open obstacles, such as vegetation (Figure 3.17), promotes deposition, for instance, to widen the dunes. Buildings also alter and reduce wind speed, causing local accretion. These mechanisms can enhance sediment allocation in the foredune zone.

3 Acceleration of wind to stimulate onward sediment transport to the upper dunes

The acceleration of wind causes local erosion, the pick-up of sediment and increased sediment transport. This can be induced by expanding fetch in the (dominant) wind direction, as with (mega-)nourishments, and by using ‘funnel’ effects produced by the vertical or horizontal convergence of the wind flow. Examples are notches and blowouts created in the foredunes (Figure 3.18) or narrowing spaces between or below buildings.

These aeolian mechanisms for natural sediment allocation have been translated into **aeolian design principles** that can be applied proactively to promote BwN dune formation on urbanized shores. These are described in Section 3.6 and 3.7.



FIG. 3.16 Recreation and beach traffic as a way to mobilize sediment. Image by the author.



FIG. 3.17 Marram grass as a bio-builder at the Sand Motor. Image by the author.



FIG. 3.18 Beach access in Vlieland, overblown due to a blowout or ‘funnel’ effect caused by wind acceleration. Image by the author.

3.4 Limitations: the effects of beach urbanization on dune formation



FIG. 3.19 Urbanised beach at IJmuiden, North Holland. Photo by J. van Bergen.

3.4.1 Introduction

As a flood defence system, dunes need to grow along with the sea-level rise to maintain the current level of flood safety. At the same time, sandy shores are important recreational zones, resulting in the urbanization of beaches. The stabilization of the Dutch coast through nourishments has led to a twentyfold increase in built objects (pavilions and beach housing) on its beaches in the last decade (Broer et al., 2011; Panteia, 2012; Buth, 2016). These built objects can obstruct aeolian sediment transport to the dunes (Hoonhout & Van Thiel de Vries, 2013).

In this research, several studies were conducted to investigate the effects of built objects on sediment flow to the dunes. Besides literature review, they entailed fieldwork, GIS and CFD (Computational Fluid Dynamics) modelling to provide a qualitative and quantitative overview of the effects of beach urbanization on natural dune formation. This Section summarizes the impact of built objects on sediment transport and the accumulative effect of the urbanization of beaches on dune formation, regarding different types of beach buildings.

In the first sub-section, the accretionary patterns of singular built objects (grounded and elevated) are discussed. Built objects divert the wind flow and can lead to the deceleration or acceleration of sediment transport, promoting accretion or erosion. Elevated buildings also divert the wind flow but reduce upwind deposition and can result in the local acceleration of wind flow underneath buildings, fostering onward sediment transport to the back of the building.

In the second sub-section, the effects of beach row buildings are documented. GIS outcomes have shown that rows of beach buildings have a negative effect, halving the volumes for dune formation, compared to unbuilt situations. However, some sedimentation patterns could be harnessed to support dune formation, for instance, to widen the dunes, or as blowout. These insights were translated into urban aeolian principles for sediment allocation, as documented in Sections 3.6 and 3.7.

3.4.2 Sedimentation patterns around singular built objects

Beach buildings alter the wind field and, therefore, affect sediment transport in their vicinity (Jackson & Nordstrom, 2011; Nordstrom & McCluskey, 1984; Smith et al., 2017, Poppema et al., 2021). The diversion of airflow around a building can decelerate the wind, causing local sedimentation (e.g. in front or on the lee side of buildings) in a typical horseshoe deposition pattern (Figure 3.21). Conversely, the deflection of wind around buildings can also lead to an acceleration of wind, promoting scour and an increase in sediment transport, such as below beach housing on poles (Peterka et al., 1985; Nordstrom, 2000; Jackson & Nordstrom, 2011; Smith et al., 2017). Both mechanisms can modify the geomorphology in the direct vicinity of buildings (Nordstrom & McCluskey, 1984).

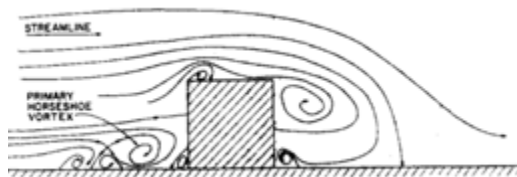

FIG. 3.20 Wind vortices around a building, reattaching at the top. Source: Peterka et al., 1985.

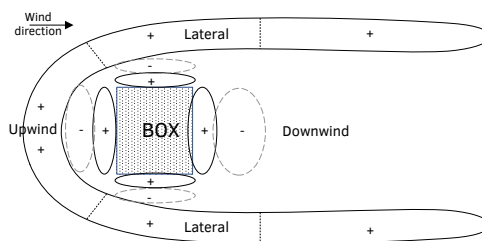

FIG. 3.21 Horseshoe pattern of sediment deposition (+) and erosion (-) around a built object. Source: Poppema et al., 2019.

Within the ShoreScape project, research was carried out on the accretionary patterns around singular built objects by the University of Twente (Poppema, 2022) and the TU Delft (Van Bergen et al., 2021). Poppema (2022) used onsite scale models to study the effects of building size on sand-tail development and found that building width (w) perpendicular to the wind direction has a greater influence on sedimentation patterns than building height (h) (Poppema et al., 2021). The study of scale models resulted in a new rule of thumb for predicting day-deposition length around buildings, with the scaling factor $B = w^{2/3} * h^{1/3}$, the upwind tail length $L_{upwind} = 2.3B + 0.1$, and the downwind tail length $L_{downwind} = 4.3B + 2.2$ (see Section 3.6, principle W3).



FIG. 3.22 Day accretionary pattern around a scale model during fieldwork. Source: Poppema et al., 2019.

Additionally, the accumulative pattern around non-elevated scale models was studied during fieldwork (Van Bergen et al., 2021). The results showed that small-scale boxes of 0.25 m^3 can accumulate around 7 m^3 of sediment in 6 weeks, indicating the potential for built objects to induce local accretion (see Section 3.6, design principle W3).

The influence of wind-facing surface on accretionary patterns was confirmed by CFD modelling (Pourteimouri et al., 2021). Enlarging the building width increases the diversion of wind vortices around the building, lengthening the side tails and expanding the lee area at the back of the building (Figure 3.23). This expansion of this lee separation bubble (blue) could limit the sediment flow to the dunes (see also 3.4.4), compared to undisturbed flow.

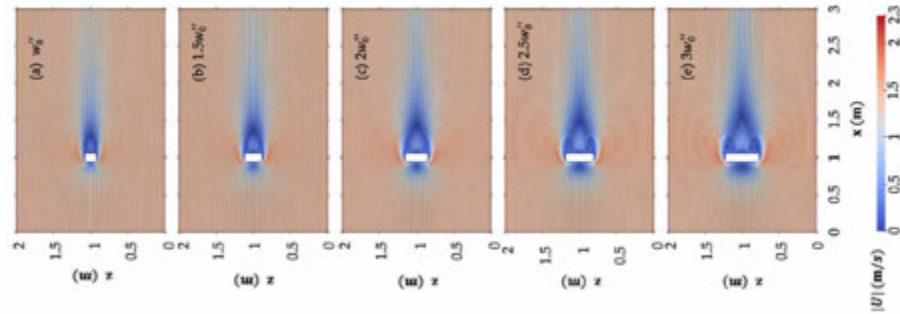

FIG. 3.23 CFD modelling of buildings with varying widths, indicating flow speeds around the building. Source: Pourteimouri et al., 2021.

In blue, the area with lower wind speed, susceptible to deposition. In red, the area with higher wind speed. Streamlines indicate the flow direction. Because of the (nonlinear) relation between flow and sediment transport, regions of flow divergence mostly correspond to divergence of sediment transport and hence erosion.

3.4.3 Sedimentation patterns around elevated beach buildings

In the last decades, the number of beach pavilions on Dutch and global beaches has increased, also due to shoreline maintenance. At beach resorts, the pavilions and terraces usually cover 10–30% of the dune-foot zone and even up to 70–90% (e.g. Zandvoort and Scheveningen) as a secondary waterfront. Besides the building, they usually feature wind-screened terraces, covering larger surfaces (150 m² or more), oriented parallel to the shore. About half of the pavilions are seasonal (built on sand banquets of +5 m NAP), but more and more pavilions operate year-round and are therefore built on 1–4 m-high poles. The effects of these elevated beach pavilions were investigated via a literature review (CFD), fieldwork and a GIS inquiry.

Literature review on elevated beach buildings

An elementary study on flow dynamics in a CFD computer model (Van Onselen, 2018) indicated that buildings on low poles (< 0.5 m) still make wind flow stagnate below and directly behind the building, whilst buildings on higher poles (1–2 m) can accelerate the wind compared to non-built situations (see Figure 3.24-left, wind acceleration in orange below the elevated building). This study also revealed that regular pole structures (1–4m) reduce upwind deposition in front of the building and lead to dispersed and increasing tail patterns behind the poles, accumulating to a joint downwind tail in the dominant (SW) wind direction (Figure 3.24-right).

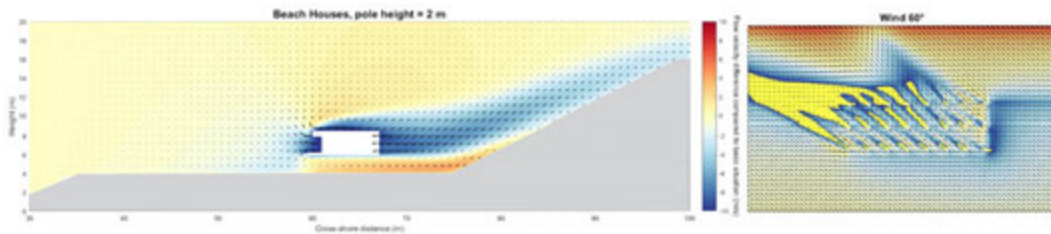

FIG. 3.24 On the left, CFD section with increased (orange) and decreased (blue) wind velocity around a beach building on 2 m-high poles. On the right, CFD plan with flow velocities around a pole structure in oblique wind conditions. Expected deposition in bright yellow. Source: Van Onselen, 2018.

Fieldwork research on elevated buildings at Sand Motor (2019)

The effects of elevated beach housing on sediment transport have been investigated in the ShoreScape project during a field experiment in the spring of 2019, with 1:5 scale models with increasing pole heights (in 25 cm increments) placed on an open beach plain at the Sand Motor (Figure 3.25) for 6 weeks. In weeks 1, 3 and 6, morphological changes around the boxes were measured via terrestrial laser scanning. Sections, difference in elevation maps and volume calculations were derived from the laser data (see Section 3.6-W3 and 3.7-H3 for the results).

The analysis of the Difference in Elevation Maps (DEMs) and sections shows that the lower the poles, the more local deposition (and erosion) of sediment occurs (9 m³ for no poles versus 6 m³/6 weeks for 1 m poles), probably due to the larger disturbance of wind speed at ground level. Furthermore, the deposition pattern of the elevated boxes is more dispersed and farther from the object (see Figure 3.25), keeping the deposited sediment available for further wind transport (i.e. the tail is less sheltered by the building). This pattern of a local scour below and a dispersed deposition tail behind an elevated building is also visible at existing pavilions, such as the Branding at Terschelling (Figure 3.26).



FIG. 3.25 Final drone photograph of the deposition patterns around the scale models with increasing pole height and tail length, from 0 m (right) to 1 m (left) in steps of 25 cm. For output results, see 3.6 and 3.7. Image by the author.



FIG. 3.26 Photograph of the year-round beach pavilion 'De Branding' at Terschelling (2018, 4 m-high poles). Visible is the scour below the pavilion resulting from local wind acceleration, as well as downwind deposition (right) in the dominant NW direction. Due to maintenance, not all deposition remains. Image by the author.

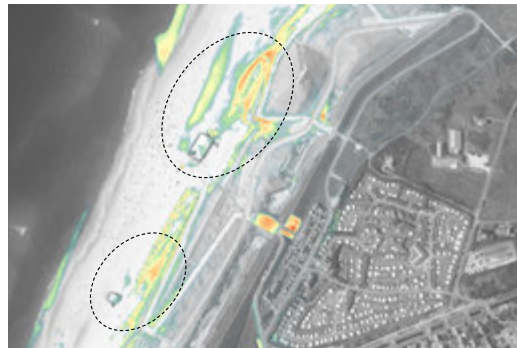

FIG. 3.27 GIS DEM of the elevated pavilion 'Zee en zo' at Petten (2019–2020). Clearly visible is the downwind tail pattern parallel to the shore generated by the SSW wind (large oval). At the small pavilion below (small oval), a concentrated downwind tail is visible on the NNW side. Image by the author.

GIS studies on accretionary patterns of beach pavilions

To study the effect of existing elevated beach pavilions in highly nourished conditions, a GIS study was performed on the profile development behind a permanent beach pavilion, 'The Coast', in the southern part of Sand Motor, in front of Ter Heijde (see Figure 3.29). There, the beach has been accreting due to the erosion of the central Sand Motor peninsula (see Chapter 4.5). The pavilion is around 40 m long and 25 m wide, totalling 1000 m² and placed on 4 m-high poles positioned 25 m from the dune foot on an artificial sand banquet of +5 m. A field visit in the spring of 2018 revealed that this beach pavilion had generated a lot of deposition (1–2 m) at an adjacent terrace located 80 m north of the pavilion.

A GIS section confirmed that in the period 2015–2018, much sedimentation occurred behind the pavilion parallel to the dominant SW wind direction (Figure 3.28). A similar concentrated tail pattern was found for the beach pavilion at the sandy reinforcement of Petten (2019–2020; Figure 3.27). This confirms that buildings on higher poles (>1m) locally accelerate wind speed underneath the building to promote onward sediment transport, for example, to heighten the (fore)dunes. These sedimentation patterns could be used to enhance (fore)dune formation, as documented in Section 3.7.

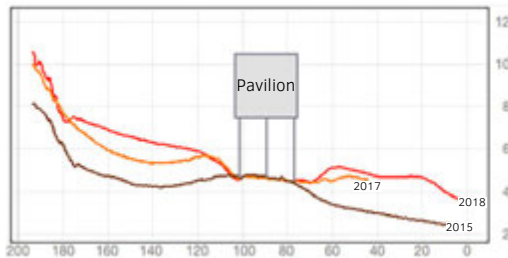

FIG. 3.28 GIS section (left) of the elevated pavilion 'The Coast' at the Sand Motor from the SW (right) to the NE direction (left), showing the 2 m downwind deposition in 3 years' time. Image by the author; Lidar data courtesy of the University of Twente and TU Delft.



FIG. 3.29 Right: photo of the beach pavilion 'the Coast', on the left the extended deposition tail of the elevated pavilion is visible, heightening the beach and foredunes. Photo: S. Veldhuisen (2023).

3.4.4 The effects of beach row housing on dune formation (GIS)

Continuous rows of beach buildings can act as a barrier to sand transport, detaching dunes from natural sediment resources such as the beach (Jackson & Nordstrom, 2011; Smith et al., 2017; Poppema et al., 2021). This can impact sediment transport rates and long-term dune development (Hoonhout & Van Thiel de Vries, 2013; Reinders et al., 2014). During this research, two GIS studies were conducted to investigate the effect of beach row housing on dune development, at the coast of Schoorl (2015–2020), which is maintained by nourishment, and at Camperduin beach (2015–2020), in high-nourishment conditions due to sandy reinforcement. In both cases, the dune formation behind the row housing was evaluated and compared with an adjacent unbuilt profile. The results of the two studies are summarized below.



FIG. 3.30 Photograph of the beach pavilion and row housing on the regularly maintained shore of Schoorl. Source: M. Leonhart & I. Hamelink (2023).



FIG. 3.31 Photograph of the beach row housing and pavilion of Camperduin after sandy reinforcement. Sediment is transported between the gaps against brushwood fences. Image by the author.

Case 1: Beach row housing and pavilion at Schoorl Beach in low-nourishment conditions

At the regularly maintained beach of Schoorl (North Holland), an elevated seasonal pavilion (21x30 m, +4 m poles) and a 145 m-long row of seasonal beach houses are built at the dune foot (houses at the southside: 1.8x2.5 m, 1 m apart; houses at the north side: 2x3 m, 3 m apart; see Figures 3.30 and 3.32).

In GIS, 1-year and 5-year DEM maps were produced, showing the sand deposition around the built objects. On the 5-year map (Figure 3.32, excluding erosion), the downwind tails of the pavilion are visible (B) as well as the reduced foredune deposition behind the dense southern row (A) with 1 m gaps. The northern part of the row, featuring 3 m gaps, enables larger sediment flow to the dune foot and foredune (C), but this flow still remains significantly lower compared to the unbuilt profile (D).

The comparison of the sand deposition volumes derived from the GIS sections (2015–2020, Figure 3.34) shows that the unbuilt profiles grow at the normal average rate of **11** m³/m¹/y (total average: 55 m³/m¹/5y). These rates drop for the built profiles to a yearly **6** m³/m¹/y (total average 31 m³/m¹/5y). This indicates a substantial decline of nearly **50%** in dune formation at the built foredunes compared to the unbuilt foredunes. Additionally, sediment flow from the dune foot to the foredunes is largely reduced (see combined profiles in Figure 3.34, Section I). At the larger separated beach houses in the north (3 m apart), the deposition is slightly higher (**7** m³/m¹/y), but the deposition rate is still **35%** lower than in the unbuilt situation. These differences are considerable and could be explained by the narrow gaps, the absence of vegetation and the mechanical removal of sand around the beach row housing.

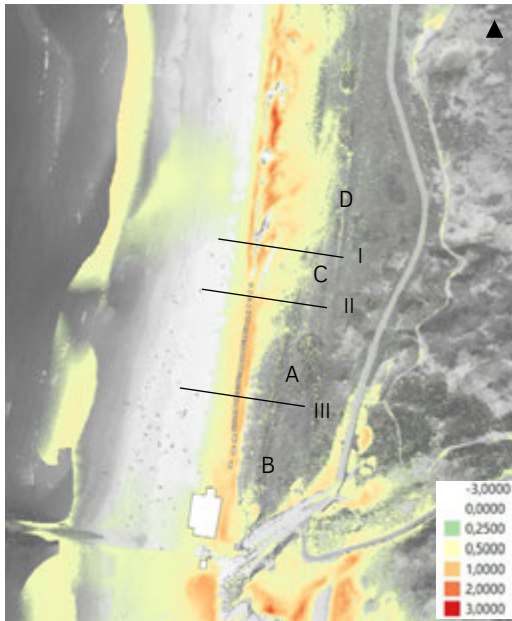

FIG. 3.32 GIS mapping of beach housing at Schoorl, showing the difference in height after 5 years (2015–2020). Clearly visible is the absence of dune growth behind the pavilion (B) and row housing (A). Images by the author.

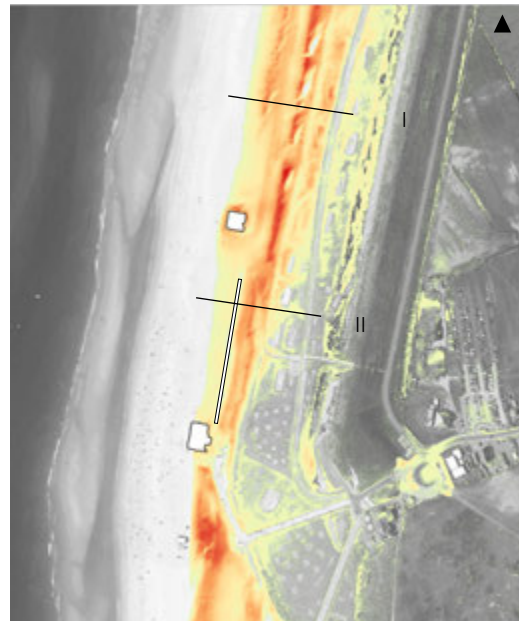

FIG. 3.33 GIS mapping of beach housing at Camperduin, showing the difference in height after 5 years (2015–2020). Clearly visible is the absence of upper dune transport and incipient dune formation near the pavilions and row housing.

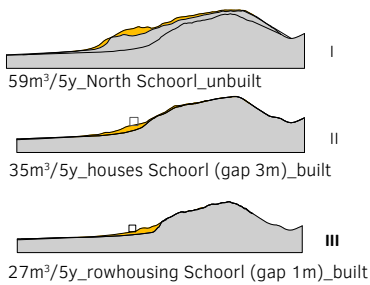

FIG. 3.34 GIS sections of the foredune profile at Schoorl aan Zee, unbuilt/built. In yellow, the accretion over 5 years. In Section I, the dotted line of (built) Section III illustrates the difference in deposition. Image by the author.

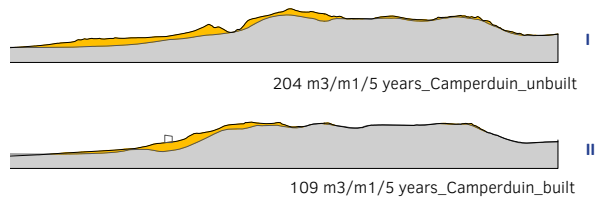

FIG. 3.35 GIS sections of the foredune profile at Camperduin, unbuilt/built. In yellow, the accretion over five years. Image by the author.

Case 2: Effects of beach housing at Camperduin in high-nourishment conditions

Camperduin is situated on a narrow beach and a 60 m-wide dune complex with gradual foredunes. In 2015, the former seawall was replaced by a 32 Mm³ sandy reinforcement featuring a 120 m-wide beach, which eroded back to a 60–80 m by 2020. Due to this erosion, it was re-nourished in 2018 with a beach nourishment.

Camperduin features a year-round beach pavilion (30x18 m on 4–5 m-high poles). In the summer, a 165 m-long row of 46 small beach cabins (2x2.5x2.5 m; gap: 1.8 m) is placed north of the pavilion on a 5-m-high artificial terrace located 3–5 m from the dune foot.

In GIS, 1-year and 5-year DEM (50 cm grid) were produced (see Figure 3.33; illustrating differences in elevation after 5 years). Again, the reduction of onward sediment flow to the foredunes is clearly visible, as well as the absence of incipient foredunes. The GIS sections (Figure 3.35) and derived deposition volumes over a 5-year period (2015–2020) show that whilst the unbuilt profiles north of Camperduin (profile 3S) grow at a rate of **41** m³/m¹/y (total average 204 m³/m¹/5y), these rates drop at the built profile to a yearly **22** m³/m¹/y (total average 109 m³/m¹/5y). This means a substantial decline of nearly **50%** in dune formation at the built foredunes compared to the unbuilt foredunes, even in high-nourishment conditions and with 1.8 m gaps. A close-up of the sections shows that transport to the back of the dune is minimized in built conditions and a (vegetated) beach ridge formation is lacking (possibly enhanced by mechanic removal), resulting in a lower back-beach and steeper foredune profile.

Conclusion: the negative impact of conventional beach row housing on foredune formation

The results of GIS regarding larger configurations of (non-elevated) beach row housing show that the blockage of sediment flow to the foredunes by the row housing has a negative impact on dune formation in the long run. Over a 5-year period, semi-closed row housing (gaps of 1–2 m) led to a 50% decrease in dune accretion compared to unbuilt profiles and a 35% decrease for more open row housing (gaps of 3 m). This volume decrease is considerable. Therefore, conventional beach row housing should be reconsidered at dune profiles where coastal safety is an issue.

3.5 Landscape design methodology integrating BwN dynamics

In the first part of this chapter, an overview is given of nourishment interventions and spatial processes (succession, urbanization) that affect dune formation. These interventions and processes all take place on different scales and are directed by different disciplines. To apply them to BwN dune formation as a coastal buffer, it is important to combine their interactions and effects, and bridge the spatial and temporal scales involved.

Designing through the scales

As computer modelling is increasingly capable of predicting high-dynamics processes such as nourishment or dune formation, it is possible to incorporate dynamics into the spatial design of coastal zones, whether in regional planning, trajectory profiling or local waterfront development. In BwN dune formation, all scales and programmes (morphology, ecology and urbanism) have a role to play (see also sub-Section 2.4.3).

To bridge the scaled and temporal gaps between the system interventions and synchronize nourishment dynamics and ecological and urban development for BwN dune formation, a three-step approach is defined (Figure 3.36), consisting of **morphogenesis**, **dynamic profiling** and **aeolian principles**. Morphogenesis studies coastal dynamics on a regional scale, including the evolution of the nourishment and the spatial conditions for dune formation. Dynamic profiling links the sedimentation from the nourishment to dune development, in interaction with ecological and urban programmes (multifunctionality). Aeolian principles on the local scale facilitate ecological and urban BwN-based design to promote specific BwN-based dune formation. Sediment allocation relying on these principles helps to sustain the coastal buffer and increase the sediment harvesting after nourishment. All three steps are detailed below.

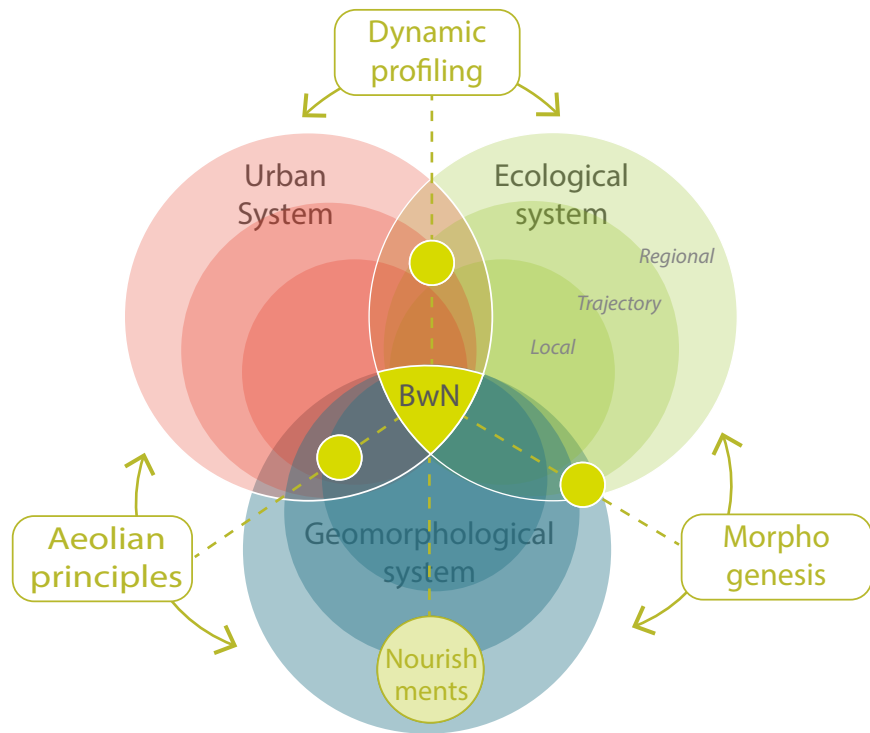

FIG. 3.36 Schematic model of the scaled interaction of the three main coastal systems: geomorphology (blue), ecology (green) and urbanism (red). To activate their interactions for BwN, a three-step approach is defined: *morphogenesis*, *dynamic profiling* and *aeolian principles* (see also 2.4.3). Image by the author.

3.5.1 Morphogenesis: contextual study of coastal dynamics

The use of natural forces for BwN requires studying the natural and cultural forces that have shaped the coast, as a historical continuum or coastal ontology. Marrot (1999) refers to this anamnesis as palimpsest 'that evidences all activities that contributed to the shaping of this unique landscape, detecting site potentialities upon the tracks overlaid by the march of time'. It is also related to his second principle of preparation, which treats the landscape as a continuous process rather than a fixed product: 'landscape is in a continuous state of becoming, fully bound into the effects of nature and time', and its design should be 'an open-ended strategy, staging or setting up future conditions' (Marrot, 1999).

Morphogenesis provides a broader and longer-term perspective on coastal evolution and insights into the erosive and more stable places of coastal development. These places can be matched by coastal and urban programmes, for instance, for the development of recreational sites on more stable parts and natural biotopes on more erosive parts ('form follows sediment'). This match can be *responsive*, with urban programming responding to certain morphological development, such as withdrawal (see Figure 3.37), or *directive*, for example, guiding aeolian sediment transport to designated places for profile alteration, as illustrated by the design studies in Chapter 4.

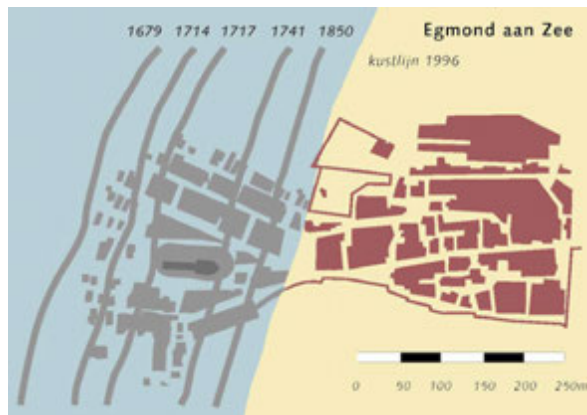

FIG. 3.37 The loss of the village of Egmond aan Zee due to progressing coastal erosion as a result of sea-level rise. Adapted from the Derde kustnota, 2000.

Via temporal mapping the coastal behaviour and expected land formations can be estimated. This may be done from a historical perspective to generate insights into coastal response to sea currents and sea-level rise (Figure 3.38).

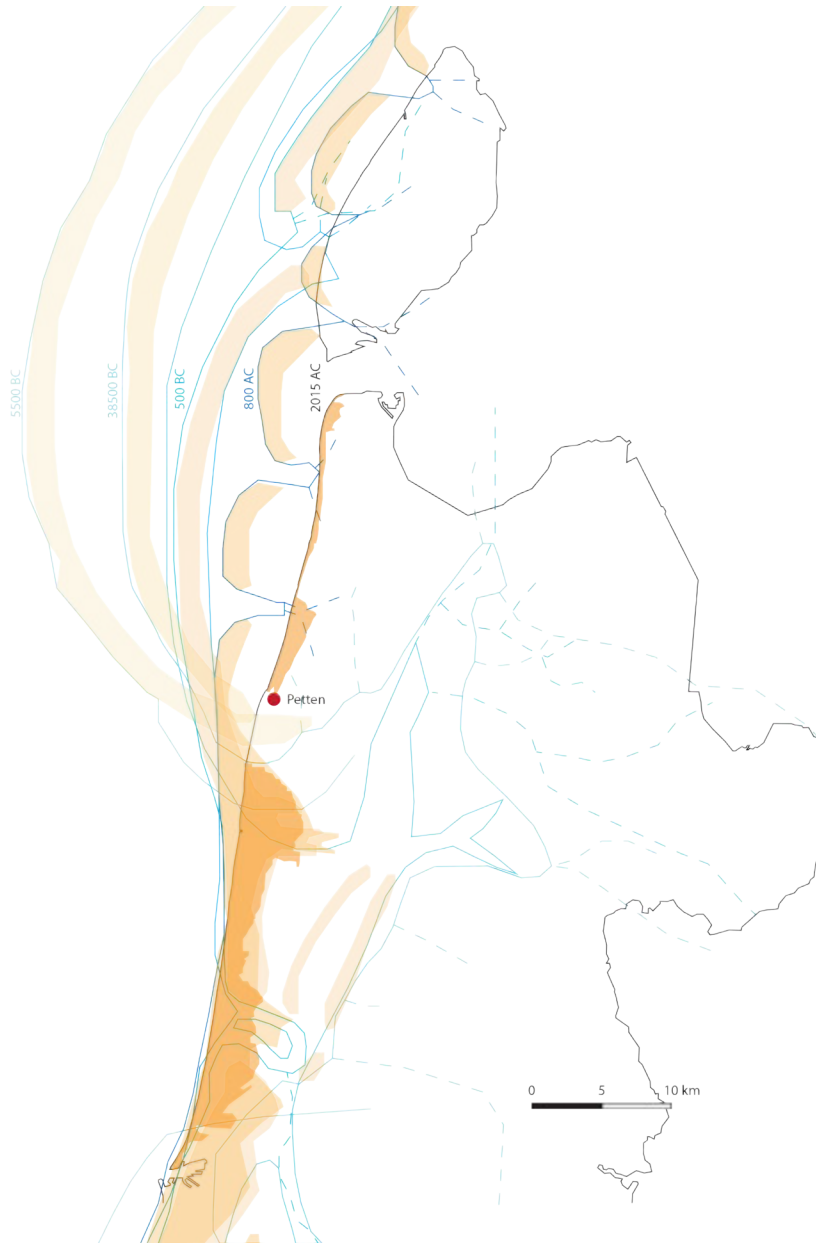

FIG. 3.38 Example of a morpho-temporal mapping of the coastline development of the north of Holland. Source: J. van Bergen, adapted from paleo-graphical maps from RACM & TNO, 2007.

The southern coastline was initially a tidal delta, leading to estuary depositions, including the inlet south of Petten. Due to sea-level rise, the northern closed dune row was perforated, turning into a Wadden system with tidal inlets that were reclaimed later on. The ongoing coastline retreat also led to the erosion of former inlet banks. This erosive process has made Petten a weak link in the Dutch coastline since the 1900s.

New techniques such as GIS and computational modelling provide data about the coast's present and future behaviour and offer a more and more precise prediction of coastal behaviour in interaction with natural dynamics (for instance, modelling of nourishment development in time, see Figure 3.39).

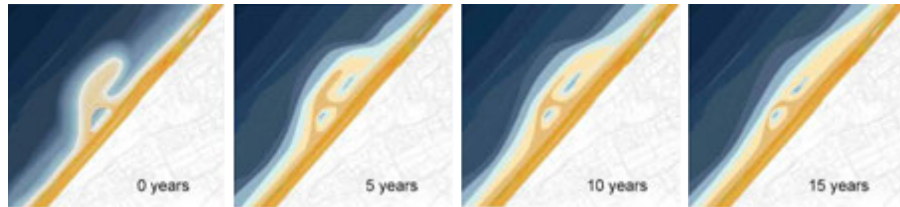

FIG. 3.39 Predicted development of the Sand Motor nourishment using computer modelling after 0, 5, 10 and 15 years. Source: www.dezandmotor.nl.

Furthermore, morphogenesis offers the chance to study the interaction between the landscape's layers. Besides geomorphology, coastal ecology and human settlement have for centuries been responsive to coastal dynamics, leading to specific types of landscapes, such as sea villages and a range of dune habitats (Doing, 1988). They represent the natural equilibria in the coastal system, with some more open to new dynamics than others. The identification of these habitats and their dependencies are important parameters for integrated BwN design.

At the start of the design process, the historical evolution can be mapped to study how sea currents have shaped the coast and how coastal erosion had impacted the shoreline and occupation layers. In addition, a mapping of the ecological and urban evolution can be produced, including expected (urban) development, especially along infrastructural lines. If nourishments are planned or have already taken place, an additional mapping of the initial nourishment's construction and evolution over time (see Figure 3.39) can be used to identify the more erosive, stable and accretive zones of the coastline. As a result, a spatial and temporal zoning map can be composed that illustrates the (potential) geomorphological development over time, matched with urban and ecological development (see also the Walcheren case study in Section 4.3).

3.5.2 **Dynamic profiling: transferring BwN dynamics to coastal design**

The current, dynamic and future states of the coast can be documented in the dynamic profile design. The profile design acts as a mediator between the natural accretion (or erosion) process for coastal safety and the facilitation of other coastal functions. Temporal profile mappings make the dynamic effects of the nourishment evident, as well as how they correspond to the desired urban and ecological program. Depending on the type of nourishment (volume, location and frequency), sediment is added to the coastal fundament, widening the beaches and altering the coastal profile. From there, fine sediment is transported inland by the wind to form dunes, especially when the beach is 80 m wide or more. Sediment transport rates give an indication as to the dynamics and potential profile transformation. It involves three different phases (and actors): the *expansion phase* (profile extension via nourishment), a *transition phase* (sediment transport from the beach to the dunes, from 10 m³ to 35 m³/m¹/y or more) and a *stabilisation phase* through natural succession.

Profile composition

The first step is to map the initial nourished profile and its transition in time as a result of the (expected) sediment transport. In the Netherlands, 10 m³/m/y is a common rate of sediment transport for stable, maintained shorelines. This can increase to 25–35 m³/m/y or more in the first years after mega-nourishment or coastal reinforcement (see also the Petten case study in Chapter 4.4). Depending on the estimated sediment transport rates, a prognosis can be made on the extra dune volume that may be gained in this process. Due to advanced computer models of nourishment dynamics, these estimates can become more precise.

The second step is to project the future profile to maintain coastal safety given a certain scenario of sea-level rise. Along the Dutch coast, up to 200–300 m³ may be needed to maintain safety for 50 years (sea-level rise of 85 cm by 2100; Van Bergen et al., 2021; Ecoshape, 2019). A BwN ambition would be to harvest these volumes naturally from the nourishment strategy as a basis for other spatial arrangements.

The third step is to match the expected natural accretion with the future safety profile and determine the time frame (and nourishment programme) needed to meet these volumes. Repeated nourishment or an adjustment in type and volume may also be required to secure the necessary sand volumes for dune formation. An important design choice at this stage is how the desired sand volume should be attached to

the existing dune system: by *widening* (reducing wind flow to promote accretion) or *heightening* the dunes (accelerating wind flow to promote onward sediment flow to the inner dunes). This choice requires specific construction profiles, local arrangements and principles that support these conditions (see Figure 3.40).

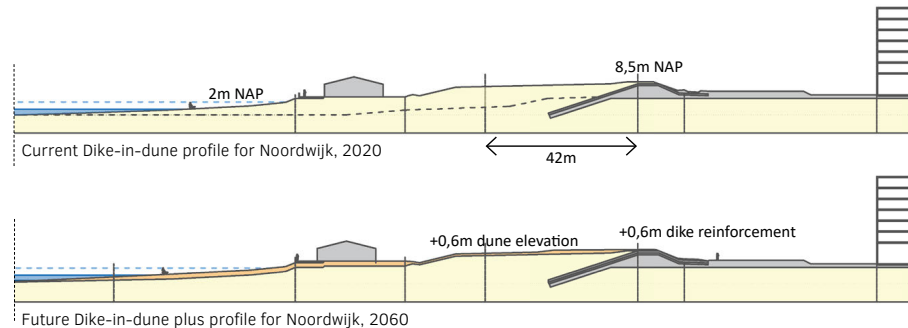

FIG. 3.40 Example of the current profile of the Noordwijk aan Zee coastal resort, with a dike-in-dune construction to maintain as much sea view from the boulevard as possible. Below is a projection of the future safety profile for Noordwijk aan Zee in 2060, with a limited amount (0.6 m) of dike reinforcement and dune heightening in combination with 60m of dune widening. Image by the author.

The dune reinforcements could be realized with regular BwN nourishments in two phases: the first phase to heighten the dunes (e.g. using aeolian principles such as blowouts and elevated pavilions) and the second phase with dune-widening principles such as fencing, planting and using the sand tails of non-elevated housing (see also the Noordwijk case study in Section 4.2).

Profile choices: enhancing dune formation

Widening the dunes

Widening the dunes provides a long wind fetch and space to accommodate dune growth next to stable, vegetated foredunes to collect and fixate the sediment. This is matched by larger nourishments and design principles such as vegetation, fencing and sand tails behind buildings (see Figure 3.41-left). On trajectories with narrow or urbanized dunes (20% of the Holland coast, Zeeland), and especially at coastal resorts with boulevards, dune widening is opportune, notably to maintain sea view. In the first years after (mega-)nourishment, accretion rates can increase from 10 to 30 and up to 60 m³/m/y (Petten case study, see Section 4.4), offering a favourable time window for constructing new dunes. Around 70% of the wind-transported sediment is deposited at the dune foot and 30% at the first dune row (Ecoshape, 2019), altering the dune profile.



FIG. 3.41 Widening (left) or heightening (right) of the dunes requires different sediment transport mechanisms and design principles. Images by the author.

Dune widening necessitates a reduction in wind speed in the foredune zone (e.g. using vegetation or brushwood screens, as seen left in Petten) for accretion to take place. Dune heightening requires an acceleration of wind (e.g. through blowouts, as seen right at Terschelling), picking up sediment in the beach-dune zone for transport to the upper and inner dunes.

Heightening the dunes

Heightening the dunes is a slow sedimentation process requiring sediment to be tilted to the back dunes. This is promoted by a mobilized, dynamic dune-foot zone, a gradual slope of foredunes and accelerated wind flow stimulated by blowouts (see Figure 3.41-right) and elevated buildings. On trajectories with wide dune complexes (around 80% of the Holland coast and the Wadden isles), dune heightening is usually preferred. By transporting sediment across the first dune row deeper into the dunes, the complex can grow along with the sea-level rise. The calcium-rich sand also nurtures grey dune habitats in this zone.

Profile optimization and temporal design

Once the expected transport rates have met the volumes needed for (future) flood safety (widening or heightening the dunes), the fourth step is to shape the BwN dune formation to facilitate multiple functions, such as ecological habitats and beach housing, each with specific conditions. Humid dune slacks, for example, require a low-dynamic, protected valley close to the groundwater level. Beach housing necessitates a sea view and a +5 m NAP level to prevent storm flooding, next to a recreational beach that is ideally 80 m wide but often 50 m or less due to coastal erosion (Broer et al, 2014). These specific needs can be addressed in the coastal profile design, making it an important mediating tool for formal, multifunctional and transdisciplinary integration. It results in a series of coastal profiles along the nourished trajectory, customized for coastal safety and multifunctional usages.

The last step is to allocate sediment to achieve this profile over time, enhanced by the application of *aeolian design principles*, as documented in Sections 3.6 and 3.7. These principles may change over time – for instance, dune heightening followed by dune widening (see Figure 3.40).

The profile design steps above show how aeolian sediment transport from nourishments can be allocated within the coastal profile to a) serve (future) coastal safety and b) optimize the profile to facilitate other coastal functions, such as recreation and ecology. Here, the coastal profile design translates the regional scale of the nourishment to the local scale of the trajectory and helps the involved disciplines to arrive at an integrated design. In addition, it brings back the fluid process of sediment deposition to temporal and spatial dimensions, as part of a more allocated BwN coastal design, serving (future) flood safety and multiple functions.

3.5.3 **Aeolian design principles: directing sediment transport for dune formation**

Once the coastal profile is defined, aeolian design principles on the local scale facilitate the allocation and consolidation of the sediment within the profile. In the paper 'Urban Dunes' (Van Bergen et al., 2021), six preliminary design principles were formulated to promote sedimentation for dune formation. Design principles are spatial concepts used to organize or arrange structural elements of design – in this case, the aeolian sedimentation process. Sections 3.2, 3.3 and 3.4 described the geomorphological and urban mechanisms that influence aeolian sediment transport for dune formation. Their spatial parameters can be employed as design principles for sediment allocation at the sea-land interface based on the three basic manipulations of aeolian sediment transport: *mobilization*, *acceleration* and *deceleration* (see 3.3.5). Their application is dependent on the desired coastal profile alteration (i.e. dune widening or dune heightening). For each choice, specific spatial principles apply that promote either local accretion or onward sediment transport. For dune widening, wind deceleration is needed, enhanced by vegetation or built objects. For dune heightening, wind acceleration is needed to transport sediment from the lower beach to the higher dunes.

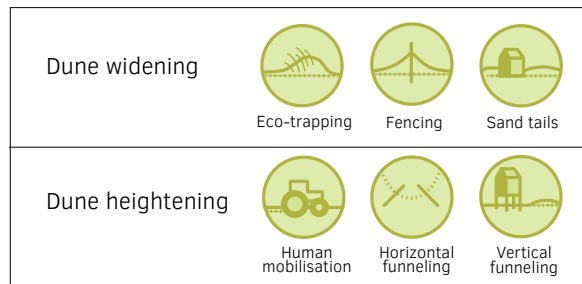

FIG. 3.42 Overview of the six aeolian principles for dune widening and dune heightening. Images by the author.

In Sections 3.6 and 3.7, an overview is given of the aeolian design principles for dune widening and dune heightening via sediment allocation. These principles are derived from the findings of multiple sources (literature, GIS, fieldwork and CFD modelling performed within the ShoreScape project). For each design principle, the principle of the aeolian intervention is described as well as the resulting deposition patterns on an elementary level. For these interventions to work on a more substantial level to contribute to the coastal buffer, the upscaling and extrapolation of the elementary findings were necessary to compose larger landscape configurations for dune formation.

The line of reasoning for the design principles consists of three levels. The first scientific level describes the principal mechanisms of aeolian flow around singular objects on an open plain, based on a literature review and the ShoreScape research. At the second level, these findings were extrapolated to develop multiple object combinations supporting a certain type of sediment allocation. These combinations were investigated through fieldwork, GIS and CFD modelling as a proof of concept. Rules of thumb were then derived for the design of spatial configurations that support a certain type of dune development.

The principles have been developed and applied to a general Dutch coastal context serving as a spatial laboratory with specific conditions, such as a north-south orientation and a dominant SW wind (see Figure 3.43). In this general coastal context and wind climate, several spatial configurations were composed, illustrating a line of reasoning applicable to other shores.

These configurations should be tested further to confirm their functionality on a larger scale. Although proofs of concept could not be provided for all design principles in the ShoreScape project, most findings – as a form of typological research (De Jong et al., 2002) – converge to support a specific solution space, narrowing the scope of further research from possible to plausible solutions. The contextualisation and real-time application of the generic principles via GIS and design study also generated new perspectives on their functionality and feasibility. This included their application in a more rural or urban situation, for example, or the performance of deposition patterns in achieving a specific coastal profile, as illustrated in the case studies in Chapter 4.

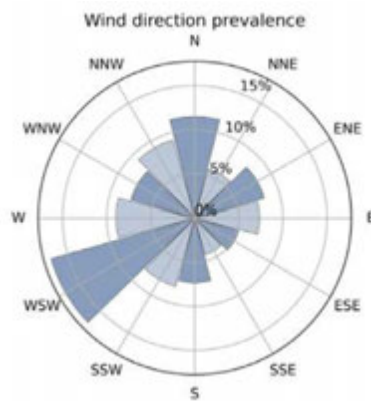

FIG. 3.43 Wind rose of the Holland coast in summer, with the prevailing wind directions above Beaufort force 5 in percentages. Source : V. Stevers 2021/KNMI, 2019.

3.6 Design principles for dune widening

The aeolian design principles, as part of the last step of the design approach (see Section 3.5), can be divided in principles for dune widening, versus principles for dune heightening. This Section focusses on the aeolian principles for *dune widening*, decelerating wind flow at the sea-land interface to promote local deposition at the dune foot to widen the dunes. In the first years after nourishment, when sediment transport rates are high (from 25 up to 35 m³/m1/year), this process can lead to the rapid formation of new dunes, altering the coastal profile. Design interventions can guide sediment to the right places to become part of the desired dune profile. Later, when accretion drops to more average rates (10–20 m³/m1/year), other principles such as eco-trapping are useful for stabilizing the dunes. Therefore, design principles for dune widening are often sequential and responsive to transport rates, nourishment phases and dune formation.

3.6.1 Deceleration of sediment transport

The general mechanism for dune widening is to decelerate windspeed using obstacles to promote local sedimentation in the dune foot or foredune zone. This deceleration can be enhanced by natural or artificial, half-open or closed obstacles, such as vegetation, fencing or buildings. Obstacles divert wind flow (creating vortexes; see Figures 3.20, 3.45 and 3.48), causing a local reduction of windspeed and the release or deposition of sediment. The resulting object-based deposition patterns can be employed for dune widening and contain several spatial typologies for sediment allocation. They are summarized below.

Principle W1: Eco-trapping



The foliage of plants decreases wind speeds, leading to a natural, local increase of deposition. By entrapping sediment, vegetation supports the build-up of the dunes in width and height (Van Dieren, 1934). Vegetation plays a central role in eco-trapping, both passively through natural succession and actively via planting (Figure 3.44). This includes perennial pioneering species such as sand couch and marram grass at the beach and in the foredunes, and scrubs and tree canopies in the mature back dunes, which prevent sediment from blowing inland. Furthermore, vegetation is very effective in stabilizing sediment due to its extensive root system.

The entrapment of sediment at the (nourished) beach usually begins at the winter flood mark, where seeds sprout. Beach maintenance, raking or tramping can negatively impact this process, limiting natural succession (Nordstrom & Jackson, 2013).

Marram grass can grow along with depositions of up to 1 m/y due to its layered root system and is thus an effective bio-builder. A burial rate of 30 cm per season provides the ideal circumstances for marram grass to grow, with a maximum of 80–100 cm per year (Nolet, 2021). Marram grass is vulnerable to saltwater intrusion and therefore occurs mostly at the upper beach and foredune zone (Van Dieren, 1934; Klijn, 1981), where new seedlings cluster around the deposition tails of grown, half-buried versions (Figure 3.45). Within 2–3 years, these clusters can form new rows of incipient (fore)dunes. However, the sand-trapping qualities of grown beach ridges can also block sediment transport to the (fore)dunes as a storm erosion zone, such as at the Sand Motor (Van Bergen et al., 2021).



FIG. 3.44 Planting marram grass as a bio-builder for dune formation on the coast of Sylt, 1989. Source: Gerhardt, 1900.

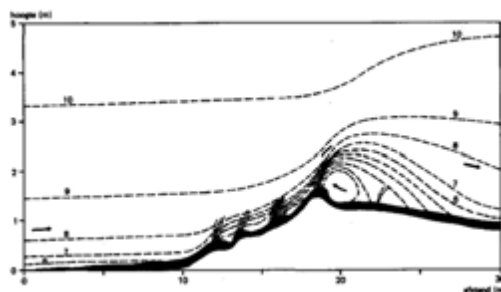

FIG. 3.45 Illustration of wind flow around a vegetated embryonal dune, resulting in a decline of wind speed and promoting local deposition. Source: Klijn, 1981, adapted from Chapman, 1976.

In a field experiment (spring 2019; Van Bergen et al., 2021; Kuschnerus & Lindenbergh, 2019), the local deposition was measured for built objects on the open beach and at the dune foot of the Sand Motor, behind a vegetated beach ridge. Whilst the beach field objects accreted 7 m³/box/6 weeks, at the dune field, this deposition was reduced by 90%, to 0.7 m³/box/6 weeks. This shows that the location of vegetation is crucial for the type and amount of dune formation: on the one hand, vegetation can sprout and grow on the beach to entrap sediment and form new beach ridges; on the other hand, vegetated beach ridges can also prevent or delay the accretion of sediment at the foredunes as a storm erosion zone.

Marram grass planting for dune formation

Marram grass has long been known for its dune-building and stabilizing qualities. In the 'Handbuch des Deutschen Dunenbau' (Gerhardt, 1900), Marram grass has been part of dune-building schemes to promote (fore)dune growth of 2–3 m-high over 2–3 years (see Figures 3.44 and 3.46). Planting rows and intervals should enable the free passage of winds to prevent blowouts (Goldsmith, 1985; Tsuriell, 1974). Seedlings could be protected by brush screens (Walsh, 1968).

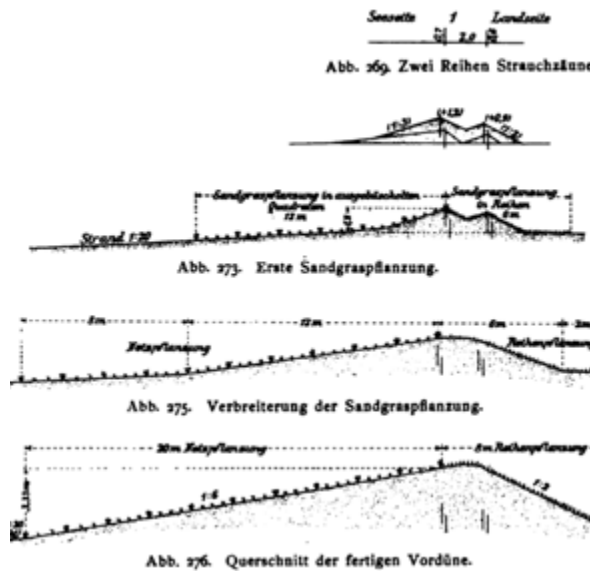

FIG. 3.46 Example of the BWN construction of an artificial dune, enhanced by a sequence of fences and planting. Source: Gerhardt, 1900.

Besides location, timing is also relevant to eco-trapping. GIS studies have shown that sediment transport in the first years after nourishment (25–35 M³/m/y) can exceed the natural burial rates of marram grass (> 1 m/y). In this phase, fencing is a better alternative (see Figure 3.47, profiles 2015 and 2018). When transport rates decrease to more natural rates (< 10–20 m³/m/y) over time, vegetation becomes more effective than fencing at accreting sediment for dune formation, growing along with deposition at the (upper) foredunes (see Figure 3.47, profile 2020).

The conclusion is that eco-trapping is most effective for dune formation with moderate sediment transport rates (10–20 m³/m/y). In high-nourishment conditions (sediment transport > 25–35 m³/m/y, burial rates > 1 m/year), fencing is recommended.

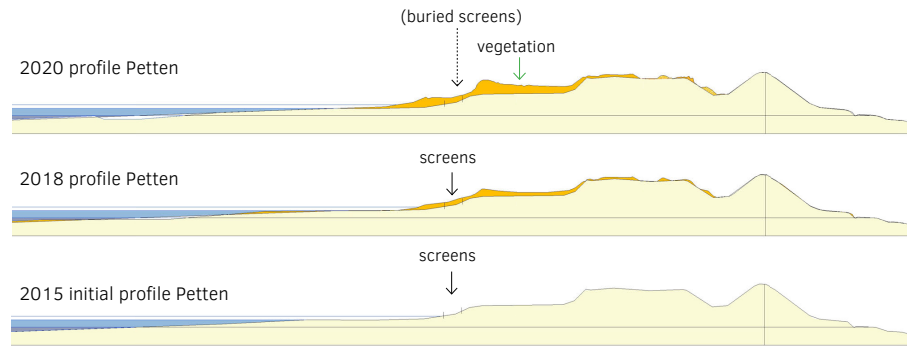

FIG. 3.47 GIS analysis of the evolution of the coastal profile of Petten south (3S) 0, 3 and 5 years after nourishment. Brushwood screens promote initial foredune formation (+ 20 m³/y) immediately after nourishment, taken over by vegetation in later years, when sediment transport reduced. The profile accumulated 270 m³ in 5 years (i.e. 50 m³/m/y). GIS sections by the author; see also Photograph 3.51.

Principle W2: Fencing



Besides vegetation, natural and artificial constructions can promote the local deposition of sediment. One of these principles is fencing, where a closed or semi-closed structure on the beach or dunes reduces the wind speed to promote local deposition. There are two types of fences: closed non-permeable fencing and half-open fencing. The latter reduces local erosion upwind from the screen and is therefore applied most frequently at sandy shores. Due to the half-open structure, the wind is mainly decelerated rather than diverted, leading to a local deposition of sediment of around 1 m³/per meter of fence/year in the US in unnourished conditions (Goldsmith, 1985). The local deposition can be used to build up (fore) dunes, for example, in non-vegetated (urban) places. Fencing made of natural materials such as brushwood can dissolve naturally after burial and is thus more sustainable. The resulting accretion is dependent on sediment availability, fence porosity and the wind climate (Hotta & Harikai, 2011).

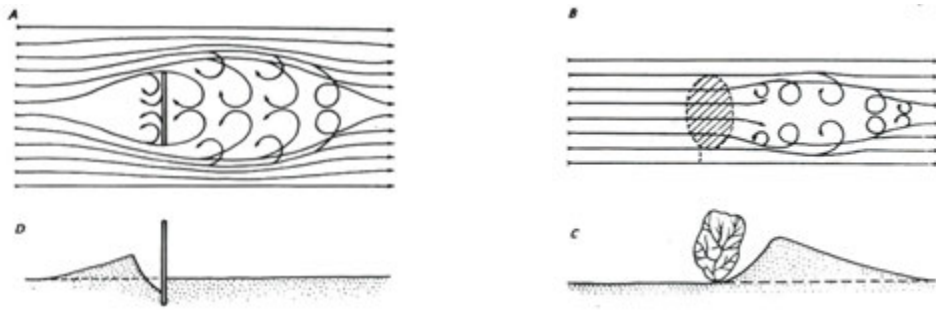

FIG. 3.48 Illustration of wind vortexes and deposition around closed (left) or half-open fences (right). Source: Goldsmidt, 1985.



FIG. 3.49 Example of artificial fencing in a cross-formation on the Belgian coast to prevent sediment from blowing onto the boulevard (left) and natural brushwood screens at Petten (right). Images by J. van Bergen.

Like planting, brushwood screens have been utilized for centuries to promote dune formation, for instance, for dune restoration after a storm. To anticipate changing wind directions and entrap saltation particles, most fencing structures are placed in rows (2–4 m), perpendicular to the dune foot (10–15 m) or the prevailing wind (Hotta & Harikai, 2011) or as a grid with planting between.

Once buried, the screen can be replaced seaward to promote dune widening (Figure 3.50b) or on top to promote dune heightening (see Figure 3.50a) to build up substantial profile alterations, as long as sediment is provided (e.g. Robin et al., 2020).

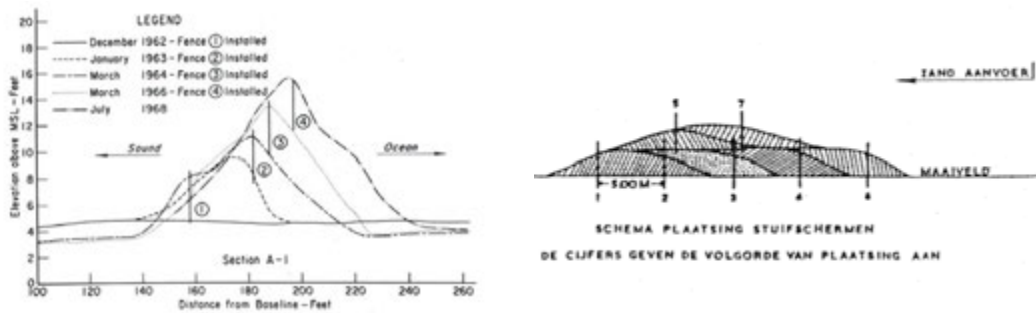

FIG. 3.50 Two examples of progressive fencing as a means to create an artificial dune. Left: fencing in North Carolina, accumulating to 3.65 m of dune height in 6 years. Source: Goldsmidt, 1985. Right: fencing proposal for dune building on the Wadden Isles, ca. 1920.

Fencing capacity and technique

Fencing (e.g. with brushwood screens) is a powerful means of manipulating the coastal profile in the early years after nourishment, when the beaches are wide and the transport rates are high, exceeding burial rates for vegetation ($> 1 \text{ m/y}$). At the more narrow, erosive coastal profiles (beach $< 50 \text{ m}$) with limited sediment transport ($< 10 \text{ m}^3/\text{m/y}$), fences are less successful or can become subject to storm erosion in later years.

The burial time (T) of half-open fences ($> 30\%$ open) can be calculated depending on the type of sediment and expected transport rates (Kawata, 1949, 1951; Hotta & Harikai, 2011): $T = (\rho H^2 \cot \alpha)/q$, where ρ is the sediment density ($1300\text{--}1600 \text{ kg/m}^3$), H the fence height (m), α the angle of the accretion slope against the fence (usually $7\text{--}8^\circ$) and q the sediment transport rate (kg/m/y). For less permeable screens (porosity $< 30\%$), the accretion profile becomes asymmetrical: more upwind, less downwind (Hotta & Harikai, 2011).

The final volume M per fence can be derived from $M = H \cdot \cot \alpha$ ($\alpha = 7.5^\circ$). For 1 m-high brushwood screens, this can accumulate to $7 \text{ m}^3/\text{m}$. This volume indicates how many fences could be placed to complete the coastal profile design. Combined with burial time T , it determines how often they should be replaced in the given sediment-transport conditions q . This can reach 2.5 months in high-nourishment conditions ($q = 35 \text{ m}^3/\text{m/y}$) or 9 months in low-nourishment conditions ($q = 10 \text{ m}^3/\text{m/y}$). Over time, the entrapment of sediment by fences becomes less efficient when accretion against the fence progresses (Hotta & Horikawa, 1987, 1991).

After burial, fences must be replaced to remain effective as dune builders. Over a longer period (5–20 years), they could build towards substantial coastal profile alterations, especially dune widening, as long as sediment transport rates are maintained. For dune widening, sequential fences could be placed 2.5–5 m apart parallel to the dune foot or perpendicular to the dominant wind (see Petten case study in 4.3) or in grids of 2–5 m for shores with varying wind climates.

GIS: effectivity of fencing in nourished conditions

Fencing can be a beneficial measure for allocating sediment on nourished beaches (e.g. Freestone & Nordstrom, 2001). A GIS study at the sandy reinforcement of the Hondsbossche dunes has shown positive results for sequential fencing (see GIS profile evolution in Figure 3.47). The fences placed at the dune foot were successful in promoting the local deposition of sediment, especially in the wider mid-profiles just after reinforcement (2015–2018), when sediment transport was abundant (30–60 m³/m/y). These fences were able to allocate the sediment rapidly and extend the dune foot forward. Once buried, the fences were replaced in the first and second years with new seaward fences. A consequence of the rapid accretion/burial was that vegetation could only sprout in front of or behind the screens, leaving the screen zone largely unvegetated. This lack of vegetation caused blowouts and aeolian erosion in the fencing zone in later years (> 3y) but also promoted accretion in the upper planted foredunes (see location on Figure 3.51).

At the more narrow erosive coastal profiles in Petten and Camperduin, aeolian sediment transport remained limited (average of 10 m³/m/y). There, fences were less successful and became subject to storm erosion in later years.



FIG. 3.51 (+ sections in Figure 3.47): Buried fences (right) at Camperduin (2021) providing a substantial seaward extension of the dunes ($> 250 \text{ m}^3/5 \text{ y}$), combined with vegetated foredunes (middle, left) and embryonal dunes (right). Image by the author.

Conclusions regarding fencing

Half-open fencing (brushwood screens for example) is a powerful tool for manipulating the coastal profile in the early years after nourishment, when the beaches are wide and the transport rates are high, exceeding burial rates for vegetation ($> 1 \text{ m/y}$). One-meter-high half-open brushwood screens can accumulate around $7 \text{ m}^3/\text{m}^1$ in 3 to 9 months depending on local transport rates. After burial, they need to be replaced to maintain their function as dune builders. Over a longer period (5–20 years), fencing could build towards substantial coastal profile alterations as long as sediment transport rates are maintained and storm erosion is prevented (e.g. through shoreline maintenance).

3.6.2 Fencing as a design study: Oerol Terschelling, 2018



FIG. 3.52 Aerial overview of the Aeolis fencing installation at the Oerol festival (2018). Source: LA TU Delft / drone photography: Jelte Keur.

In 2018, ShoreScape collaborated with an elective course of the TU master's degree programme in landscape architecture to investigate the conceptual, technical, architectural and societal impact of fencing on Dutch beaches (Van der Velde et al., 2018). During the Oerol festival, a 200 m-long interactive installation was placed on the Midland beach in Terschelling. This location was chosen specifically because of the former tidal inlet here, that once divided the island into the isles of Wexalia and Schelling (see Figure 3.53a). Around 1850, the two isles merged to become the island of Terschelling, possibly enhanced by the use of early BwN techniques such as fencing and planting.

The **Aeolis** installation was constructed out of 300 18 m-long hessian screens in an angular and stepped formation. This formation was chosen to entrap sediment from different wind directions and investigate how sediment transport rates in different zones of the beach (from the swash zone to the dunes) would affect the structure. During the 2-week festival, the structure was successful in handling both seaward and landward wind directions, leading to an accumulation of sediment at the wind-facing sides of the structure.

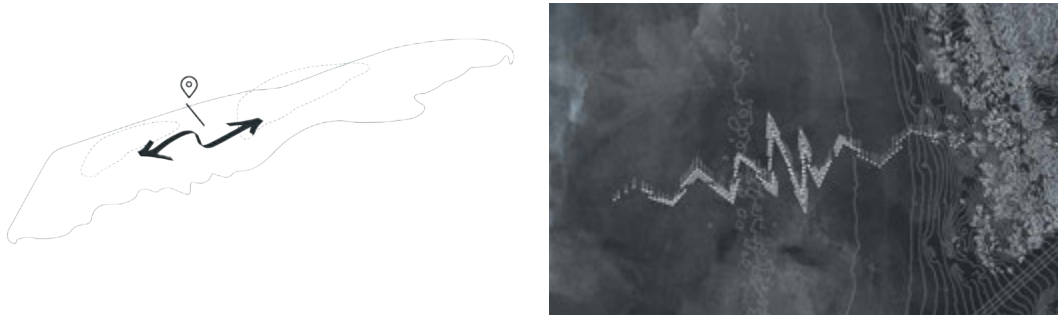

FIG. 3.53 Infographic (left) and plan view of Aeolis (right). Source: LA students TU Delft, 2018.

Stepped fences at the corners of the structures proved to be less effective in promoting deposition (see Figure 3.55), mainly guiding sediment along the screens to the inside of the structure. Other screens were placed at higher positions to frame some of the beach views. These led to the occurrence of blowouts within the structure, where wind accelerated through the lower openings of the screened walls, resulting in large deposition tails on the inside of the structure. These blowouts were most prominent near the swash zone, where sediment transport rates were highest, compared to the lee dune-foot zone, which was sheltered by a vegetated beach ridge halfway.

During the festival programme, visitors could visit the structure, monitor the deposition along the route and leave their comments on the concept of fencing as a means to adapt sandy shores to sea-level rise. The installation was perceived positively, pointing out the urgency for adaptation to sea-level rise, as well as the potential of BwN to preserve the coast and land from flooding not only in a technical but also in a cultural and architectural way.



FIG. 3.54 Sand tail deposition by blowouts in the fences. Source: LA students TU Delft, 2018.



FIG. 3.55 Sediment deposition and transport around the low fences. Source: LA students TU Delft, 2018.

Although the installation was not equipped for scientific output, as a conceptual model, it produced some valuable insights for the course of development on coastal fencing. These concerned the anticipation of a changing wind climate, for example, the value of artificial blowouts (see aeolian principles H2 and H3) and the guiding and accumulation of sediment by fencing (principle W2), which remains visible in the landscape four years after the intervention.

Principle W3: sand tails of non-elevated buildings



The diversion of wind around beach buildings causes the wind to accelerate (picking up sediment) and decelerate, leading to the local deposition of sediment on the lee sides, that is, the formation of sand tails. The deposition begins in horseshoe patterns (Poppema et al., 2019, see Figure 3.21) but can accumulate in combined tails at the back of the building under changing wind conditions. The surplus in deposition can be used to locally harvest sediment, for instance, for the seaward extension of the foredunes. The spatial parameters of sand-tail patterns caused by various building configurations are summarized below. A more elaborate description can be found in the appendix.

Deposition tail length and wind-facing surface

Built objects produce deposition patterns as a result of the divergence of wind and sediment flows (see Figures 3.20 and 3.21). This generates upwind deposition (e.g. in front of houses) and downwind deposition via side tails. The most influential design parameter for promoting deposition is the wind-facing surface. When wind hits a building surface, two-thirds of the wind is diverted upwards over the building and one-third downward and to the sides. (Peterka et al., 1985; Poppema, 2022). Expanding the wind-facing surface increases the wind divergence, and the tails lengthen. In the context of the ShoreScape research, fieldwork (2018) was carried out to investigate deposition tails around scaled objects (Poppema et al., 2021; Poppema, 2022). The findings show that related sedimentation patterns scale to the (wind-facing) geometry of the building, especially building width. Their initial (day) deposition length can be calculated by $L_{\text{downwind}} \approx 4.3B + 2.2$, with scaling factor $B = w^{2/3} * h^{1/3}$ for buildings within a ($0.2 < w/h < 4$) range in an open plain.

Behind regular beach houses (3x3x3 m), this amounts to an initial deposition tail of ~ **15 m**; for non-elevated beach pavilions (w = 20 m, h = 5 m), the tail reaches ~ **56 m**. Both tail patterns will lengthen over time, increasing the initial tail length by a factor of ~ 2 (Poppema, 2022; see Figure 3.61; Van Bergen et al., 2021). To use these sand tails for foredune formation, the building distance to the dune foot D becomes $D = B \cdot \sin a^\circ$ (a for the dominant wind angle). This varies between 7.5 m for small beach houses and up to 28m for beach pavilions, exceeding the general planning zones of 5 m dune-foot distance (Dutch Water Board regulations).

For dune widening, it would be best to shorten the tails to allocate sediment in the foredune zone and orient the narrowest façade towards the dominant wind.



FIG. 3.56 Example of downwind tail development behind an elevated pavilion and non-elevated houses at Hargen, North Holland. Source: K. Wijnberg, UT, 2021.

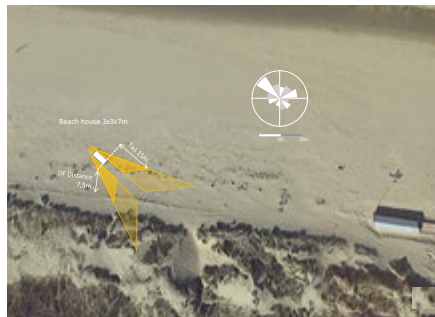

FIG. 3.57 The calculated deposition tail pattern around an average beach house. Initial tail in yellow, progressing tail semi-transparent. Source: J.v.Bergen. Aerial photo: Google Earth

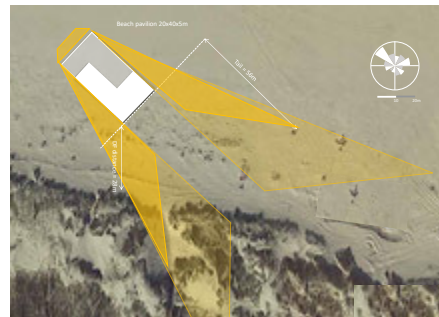

FIG. 3.58 The calculated deposition tail pattern around an average beach pavillion. Initial tail in yellow, progressing tail semi-transparent. Source: J.v.Bergen. Aerial photo: Google Earth

Deposition volume

A field experiment with non-elevated scale models (0.25 m^3) at the Sand Motor beach (Van Bergen et al., 2021) indicated that the local deposition around built objects can be considerable (7 m^3 over 6 weeks). Most deposition occurred within 5–10 m of the (non-elevated) scale models, one-third upwind and two-thirds downwind. Therefore, buildings are a potential measure for promoting local accretion, for dune widening, for example. Local erosion and upwind deposition can be reduced with the use of low poles (see appendix).



FIG. 3.59 Resulting deposition pattern around a non-elevated scale model after 6 weeks. Image by the author.

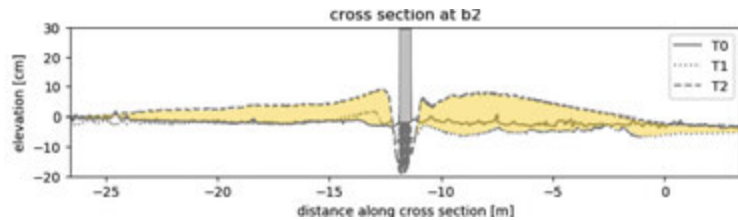
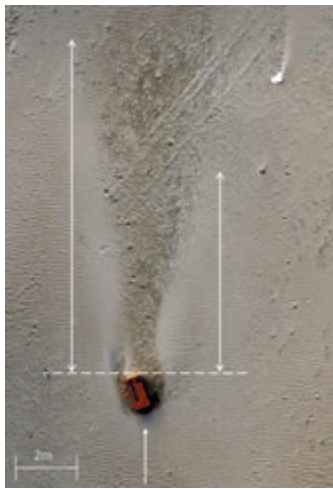

FIG. 3.60 Cross-section of the deposition (one-third upwind [left], two-thirds downwind) around a non-elevated scale model (B2) after a 6-week field test. Source : M. Kuschnerus/J. van Bergen.

Deposition tails of oblique-oriented objects

The predominance of angular winds along sandy shores causes the development of asymmetrical tails around built objects, especially rectangular buildings. Depending on the incoming angle, a second wind-facing wall comes into play, increasing the wind-facing surface and, therefore, deposition. At the same time, the angle between the wall and the wind also determines the amount of diversion and turbulence. For instance, wind flow along aerodynamically positioned walls is reduced less significantly, resulting in a longer side tail. A field test of a scale model with a 70° angle to the wind revealed sand tails that were 1.5 and 2.5 times longer than in a symmetrical setup (see Figure 3.61a and the appendix) Due to their longer side tails, asymmetrical side tails could be used to promote (fore)dune heightening.



Asymmetrical tail development around a 70° turned scale model, producing side tails that are 1.5 and 2.5 times the length of a symmetrical tail.

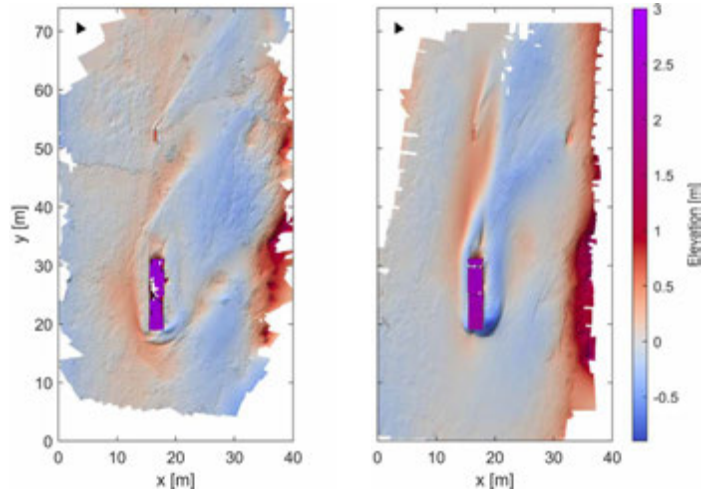

Example of asymmetrical deposition tail patterns around a shipping container parallel to the dune foot at Beach the Noordwijk beach resort. In the middle, the asymmetrical deposition pattern after a 3-day South West storm. On the right, the asymmetrical tail pattern after 5 weeks of varying wind directions (mainly SSW), lengthening the tail.

FIG. 3.61 Documentation of deposition tails of oblique-oriented objects. Source: ShoreScape, Poppema, 2022.

Complex deposition patterns: beach row housing and gap-distance

Beach buildings mostly occur as part of larger rows. The vicinity of neighbouring buildings will affect the deposition tail pattern. A closed row of buildings with small gaps between the buildings will diminish the occurrence of side tails between buildings and has a negative effect on foredune development (see Section 3.4). Larger gaps between buildings can let the wind pass and locally accelerate to transport sediment to the lee side of the buildings. This can help reduce upwind deposition and promote deposition in the foredune zone.

Within the ShoreScape project, fieldwork (Poppema, 2022) was carried out to investigate the effect of building spacing on deposition patterns via scale models at an open beach plain (Figure 3.62). The gap ratio observed is $g^* = G/y$ (where G is the gap width and y is the heart-to-heart distance of the row housing).

The analysis of varying compositions showed that if the gap ratio (g^*) is lower than 0.33, most of the deposition will occur upwind (in front of the row), limiting downwind deposition. With a gap ratio above 0.67, the inner tails between the

houses become similar to the side tails of the rows, featuring slight acceleration due to partial overlap. At a ratio of 0.8, the inner tails start splitting into individual side tails that become wider and lower, reducing the row effects (see Figure 3.62c).

The inner deposition tails are longer when buildings are oriented obliquely to the wind (Poppema, 2022, see Figure 3.62D; CFD modelling by Pourtemouri, 2021, see Appendix). This orientation could be beneficial for foredune heightening or to allow for more dense row housing oblique to the wind ($0.67 < g^* < 0.75$).

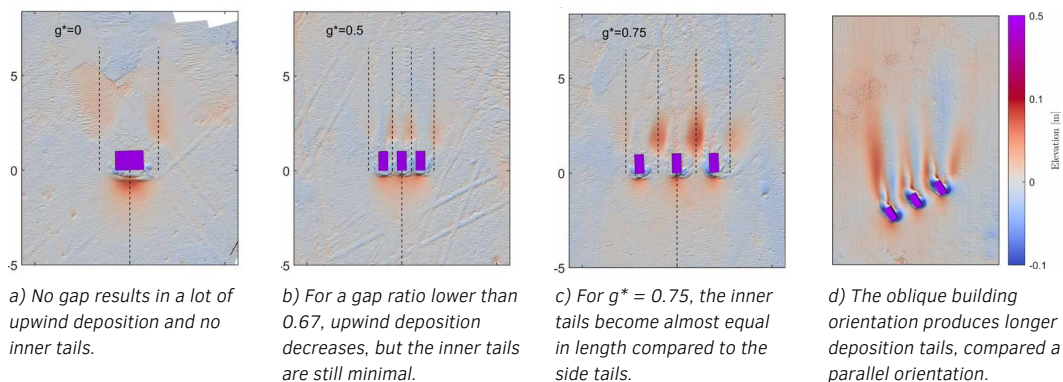
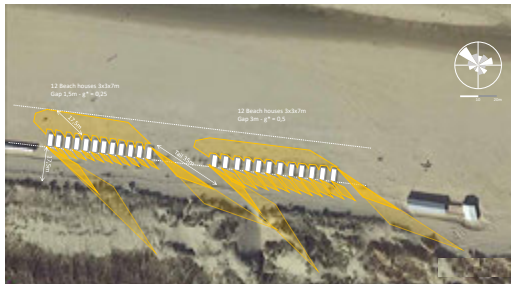

FIG. 3.62 Test results of a scale-model row with varying gap-distances (gap of 0, 1 and 3 times the building's width) and 3 times the buildings width with a 60° wind angle. Measurements (x,y) in meters. Source: Poppema, 2022.

Conclusions of W3: building configurations for promoting dune widening

Several mechanisms have been discussed so far that lead to downwind deposition behind built objects: symmetrical tails, with the wind-facing building width and height as important spatial parameters, asymmetrical tails, which promote extended deposition tails, and row effects, which produce shorter or longer inner tails. For dune widening, the most beneficial setup is no beach buildings at all, enabling sediment to accrete at the dune foot enhanced by vegetation (eco-trapping) or fencing. Traditional beach pavilions and row housing usually block larger parts of the foredune zone, reducing dune formation by up to 50% (see Section 3.4 and Figures 3.63a and b).



a) Configuration 0: traditional beach row housing typology (houses 3x7m, 3m high, gap 1.5m (left) and 3m (right))



b) Configuration P0: traditional beach pavilions typology (Pavilion around 20x40m including terrace, 5m high)

FIG. 3.63 Illustration of deposition patterns around common beach-building typologies, depriving the foredunes of sediment on the lee side of the building and row (up to 50% reduction). Source: J.v.Bergen. Aerial photo: Google Earth

Spatial conditions for promoting dune widening

In specific profiles, beach buildings could help to allocate sediment in the foredune zone and partly compensate for their negative effect on dune formation. In general, dune widening is promoted by:

- shortening downwind deposition tails of buildings by reducing the wind-facing surface to the dominant wind.
- leaving a greater distance between the dune foot and the building (e.g. > 10 m) to accommodate the deposition.
- planting the dune foot and foredune slope with marram grass to increase deposition and stabilization.
- reducing inland sediment flow with vegetation, fencing and/or oblique beach accesses perpendicular to the dominant wind.

Beach pavilion configurations for dune widening

Due to their large width (e.g. 40–50 m including terraces), seasonal non-elevated beach pavilions produce long side tails of 50–60 m or more in oblique settings (configuration P0/Figure 3.63b). To promote dune widening and allocate sediment in the foredune zone, it is best to shorten the deposition tail as much as possible by turning the smallest façade towards the dominant wind, with generous spacing (configuration P1/Figure 3.64a, $g^* > 0.67$; gap > 130 m) to avoid upwind deposition and allow sediment to reach the dune foot. This effect could be increased by further reducing the front façade (configuration P2/ Figure 3.64b) and providing large spacing between the building and the dune foot (if possible). Furthermore, tail shortening can be enhanced with a steeper foredune slope, fencing and vegetation.

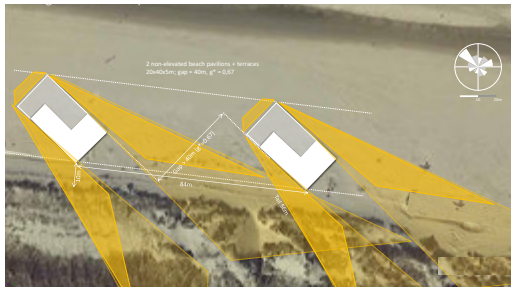

a) Pavilions configuration P1: oblique orientation

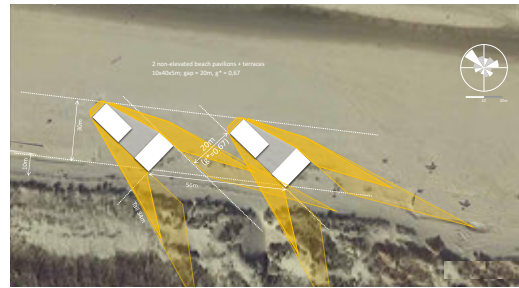

b) Pavilions configuration P2: optimized architecture

FIG. 3.64 Illustration of deposition patterns around beach pavilions, optimized for shorter tail development to widen the dunes. Source: J.v.Bergen. Aerial photo: Google Earth

Seasonal beach row housing configurations for dune widening

To avoid dune-foot blockage and larger upwind deposition, it is best to leave larger gaps ($g^* > 0.75$, 3 times the building's width) between buildings (Figure 3.65 -configuration A). However, this reduces the number of beach houses considerably. As a compromise, the houses could be placed at $g^* = 0.67$, taking advantage of the overlapping longer inner tails for dune-foot deposition (Figure 3.65 -configuration B, but also with more upwind deposition than in A).

To achieve a certain urban density, houses could be combined to form rows or slats parallel to the dominant wind (Figure 3.65 -configuration C), exploiting the lee side behind the front building. Due to the longer side tails produced, the distance of the buildings to the dune foot should be greater (~ 12.5 m). By turning the front house parallel to the wind, the side-tail length can be reduced further (Figure 3.65 -configuration D), allowing closer row distances.

Since the beach row housing is seasonal (only at the beach between april and oktober), one could alternate in placement each year. This can help to steer the sand deposition (caused by the sand tails) to other locations and let the foredunes recover. This temporal absence of beach housing also allows for natural vegetation to develop and stimulate further foredune heightening.

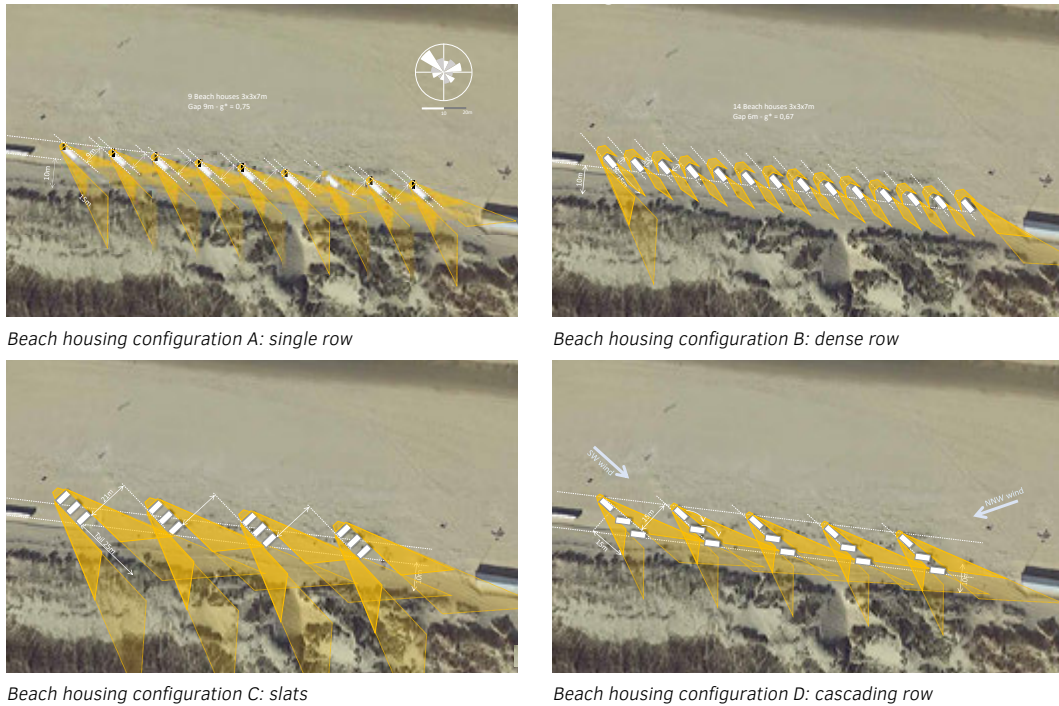

FIG. 3.65 Illustration of deposition patterns around beach row housing, optimized for shorter tail development to widen the dunes. Source: J.v.Bergen. Aerial photo: Google Earth.

Dune widening configurations for multiple wind directions

So far, all configurations have been designed to fit the most dominant wind in summer above Beaufort force 5, which is SW wind in Holland (17% of the time). The second prevailing wind is NNW (12%), and configurations should also be tested in this direction.

For rectangular pavilions, the wind surface is larger in the other (NNW) direction, increasing tail length. A steep dune front might help to stop sediment transport inland. Figure 3.64 -Configuration P2 could be adjusted to fit both wind angles as long as the mid-terrace is not shielded.

For beach row housing, NNW wind will lead to longer side tails (Figure 3.65 configurations A, B and D) due to the larger wind-facing surface. Figure 3.65 -configuration C or D may be most optimal for both wind directions if the gaps can be generous ($g^* > 0.67$) to minimize upwind deposition.

3.7 Design principles for dune heightening

The aeolian design principles, as part of the last step of the design approach (see Section 3.5), can be divided in principles for dune heightening, versus principles for dune widening (see Section 3.6). The aeolian principles for *dune heightening* in this Section focus on the mobilization of sediment and acceleration of wind flow at the sea-land interface to promote sediment transport to the upper dunes. Due to the fine sediment suspended in the wind, dune heightening is a slow process, and several years are needed to build up larger volumes. Studies on nourished beaches show that two-thirds of the aeolian deposition takes place at the seaward slope of the foredune, and only one-third reaches the top of the foredune for transport to the inner dunes (Ecoshape, 2019). This limits the volumes that can be achieved within regular nourishment windows (5–20 years). Coastal profile design can positively influence sediment transport by providing wide gradual beaches (which increase the fetch for the wind to pick up sediment) and gradual (unvegetated) foredune slopes to enhance upward sediment transport.

Although the process of dune heightening is difficult, two general mechanisms can be applied to foster it. The first is the mobilization of (fine) sediment by natural (e.g. waves or coastal erosion) or human dynamics. The second is the convergence and acceleration of wind flow to support onward sediment transport to the upper and inner dunes. Both mechanisms are explained below.

3.7.1 Mobilization of sediment

Sediment is brought ashore by the tidal and wave-driven currents, mobilized by waves and then wind to be blown from the beach to the dunes. This aeolian transport requires fine sediment to be exposed to the wind. In natural conditions, this is facilitated by wave dynamics in the surf zone. However, human beach traffic can also promote sediment mobility for onward transport.

Principle H1: Human mobilization



Besides waves, recreation and tramping in coastal zones can cause an increase in sediment mobility, exposing fine sediment to the wind due to grouting caused by traffic (cars, visitors), beach maintenance and sand removal. This urban mechanism could be employed to mobilize sediment at the beach and in the dune-foot zone to stimulate upward sediment transport (user group ShoreScape, November 2019).

Tramping at the upper beaches can also reduce (stabilizing) dune vegetation (Hernandez-Cordero et al., 2017; Hernandez-Calvento et al., 2014). On Dutch nourished beaches, such as the Sand Motor, a disruption of embryonic dune growth was seen near urban beach accesses, beach housing and driveways due to intense tramping, car traffic and beach maintenance (Van Bergen et al., 2021; see Figure 3.66). Additionally, beach maintenance, including the clearance of the winter flood mark, which removes seeds for vegetation, can set back embryonic dune growth.

The examples above show two sides of the same coin in terms of human effects on sediment mobility. On the one hand, human traffic can destroy vegetation, reducing embryonic dune growth and dune widening via natural succession. On the other hand, de-vegetation caused by human traffic can also promote the exposure of fine sediment for onward transport, for instance, on the beach ridges of mega-nourishments or in foredune zones, to promote dune heightening. Thus, depending on the goal of sediment allocation, human traffic may be prevented (zoning) or promoted.



FIG. 3.66 Example of urban mobilization via tramping at beach access points (white circles), decreasing embryonal dune growth (green) and promoting sediment availability for aeolian transport. Image by the author; aerial photograph: PDOK.nl.

3.7.2 Acceleration of Aeolian sediment transport

The acceleration of wind speed can lead to an increase in sediment mobility and transport. In this research, two spatial mechanisms were identified that stimulate sediment transport: funnel effects through the *horizontal convergence* of the wind flow (H2; e.g. through narrow passages in the front dunes, such as beach accesses or blowouts, or between buildings); or through the *vertical convergence* of wind flow (H3) underneath buildings. Some of these principles (or leads) are still in the conceptual phase, but their contribution could be valuable since most sandy shores are narrow and erosive, and therefore more suited for consolidation than for seaward strategies.

Principle H2 Horizontal funnelling: blowouts, oblique placement and V-formations



Wind directed into a funnel shape is locally accelerated, causing erosion. Behind the funnel, this sand is deposited by the subsequent deceleration of the wind. Two spatial mechanisms can be employed for horizontal funnelling to promote dune heightening: (a) the convergence of wind flow triggered through blowouts of V-shaped building formations, leading to local erosion and accelerated sediment flow to the upper and inner dunes, and (b) the oblique placement of buildings, producing longer asymmetrical tails and guiding wind flow along towards the dunes.

Blowouts

Natural examples of funnel shapes are blowouts, dune notches or (narrow) beach access points, where sediment is blown in, accelerated and transported upward to be deposited at the top. A blowout is a saucer, cup or trough-shaped depression or hollow formed by wind erosion on a pre-existing sand deposit, surrounded by a depositional lobe (Glenn, 1979; Carter, 1991; Hesp 1996, 2002; see Figure 3.67), featuring specific zones of deflation, erosion and deposition. Blowouts can also be constructed artificially through cut-outs in the foredunes to support inward sediment transport. In addition, beach accesses can function as blowouts, with deposition at the top in the dominant wind direction. Blowouts are valuable means for adapting inner dune fields and as sources of calcium-rich sediment for grey dune habitats.

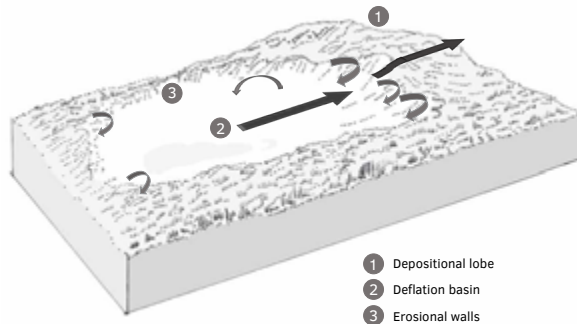

FIG. 3.67 Drawings of a saucer blowout with typical wind flow patterns. Image by the author, adapted from Hesp, *Geomorphology*, 2002.

Oblique placement

Beach buildings considerably reduce dune formation and should therefore be used reluctantly or not at all in zones that necessitate dune heightening. If beach buildings are unavoidable, they can promote dune heightening by oblique placement, producing asymmetrical, elongated, downwind tails to reach the upper dunes. Oblique building façades are more aerodynamic, causing a lesser reduction in wind speed and, consequently, producing a longer tail (see also principle W3). This is especially the case for pavilions as they produce tails of 50 m or more (see Figure 3.69). A pavilion positioned perpendicular to the dunes generates a longer asymmetrical tail that reaches deeper into the dunes than with parallel positioning (see Figure 3.68, right orientation).

Because of their shorter downwind tails, beach housing is not recommended for dune heightening. In the best case, beach row housing oblique to the wind with wider gaps ($g^* < 0.75$ or 3 times the building's width) could support foredune heightening due to their extended (inner) tails.



FIG. 3.68 Tail development of pavilions, elongated by their oblique setting with the wind. Source: J.v.Bergen. Aerial photo: Google Earth Pro.



FIG. 3.69 Aerial photograph of Noordwijk beach, April 2018, showing the downwind deposition tails of the beach pavilions and the blowout patterns of the beach accesses, overflowing the dunes in the SW direction. Source: Google Earth Pro.

V-shape formations as an artificial blowout

Another way to make wind flow converge is V-shaped spacing between buildings. In this scenario, side tails do not merely overlap but also converge, which leads to local wind acceleration and longer tails to reach the upper dunes, mimicking a natural blowout.

During a weeklong experiment at the Sand Motor (2019), fully closed screens in a funnel set up (45° to the dominant wind) produced a substantially longer and higher combined inner tail than the parallel and perpendicular screens (Figure 3.70). Such a funnel shape could be beneficial for (fore)dune heightening.

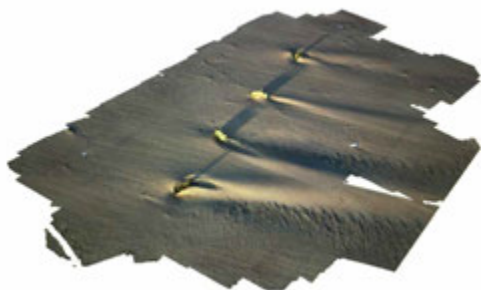

FIG. 3.70 Drone overview of 50 cm tall, fully closed screens on an open beach plain, with deposition patterns after a week of strong northern wind at the Sand Motor. In the front, two 45° screens facing each other in a funnel shape, producing a larger and higher combined inner tail than the orthogonal screens in the back. Source: J.v.Bergen (2019, i.c.w. D. Poppema)



FIG. 3.71 (right) Field test of a V-shaped scaled row house configuration on an open beach plain in Vlieland (2020), combining wind convergence and oblique placement to lengthen tails and guide sediment to the back as an artificial blowout. Image by the author.

This pattern of longer side tails is confirmed by the field experiments conducted by Poppema (2022) and the CFD modelling of Pourteimouri et al. (2021), illustrating that in oblique wind conditions, longer asymmetrical side tails are produced along a built object (see 3.6, principle W3). Due to the oblique wind, one side of the building will receive more sediment and be more aerodynamic and, therefore, produce a longer tail (see Figure 3.61). Wind convergence could be enhanced further by enforcing a gap width between buildings ($0.67 < g^* < 0.75$) that leads to an overlap of side tails (see 3.6-W3 and Figure 3.62).

The mechanisms of wind convergence generated by oblique placement and overlapping side tails could be combined to compose larger V-shaped building configurations that overlap and converge to lengthen deposition tails to the back, mimicking V-shaped goose flight formations. This concept was tested during a short field experiment (Vlieland, 2020; see Figure 3.71) to observe the resulting deposition pattern. The boxes were oriented 30° to the dominant wind in a low-angled (30°) funnel shape and with a gap width $g^* = 0.5$. The test confirmed the occurrence of a singular, concentrated downwind deposition tail, whilst upwind deposition was reduced due to the oblique imbricated placement of the boxes, guiding wind flow along the row.

Although more research on V-formations is still needed, as artificial blowouts, they are a promising building concept for guiding and directing sediment to the (upper) foredune zone. The concept could be applied to both combined beach pavilions (configuration 3.72b, middle) and beach row housing (configuration 3.72c, right).



a) Natural blowout at Terschelling.

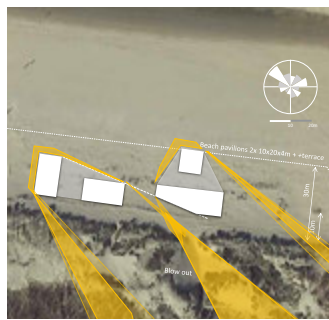

b) Beach pavilions in a conceptual funnel setup to make sediment flow accelerate and converge to the back.

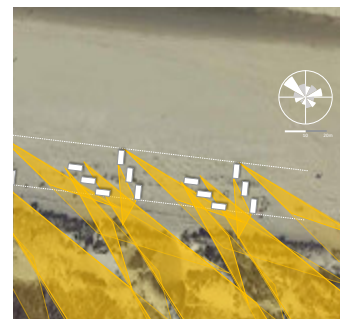

c) Similar conceptual setup for beach housing, with converging and overlapping side tails for accelerated sediment flow to the upper dunes.

FIG. 3.72 Overview of natural and artificial blowouts to guide sediment to the upper dunes. Source: J. van Bergen. Aerial photo: Google earth.

Principle H3 Vertical funnelling: elevated buildings and dispersed tails



The convergence of wind can also be applied vertically to support upward sediment flow to the dunes. The diversion of wind around built objects on poles (> 0.5 m) causes a convergence and, therefore, an acceleration of wind flow below and behind the building, extending deposition tails for transitional sediment transport.

In 2018, a CFD study was performed by Van Onselen on the effects of elevated beach pavilions on poles. It showed that a local acceleration of wind flow can occur below the pavilions as well as behind the building, in combination with the dune slope (Figure 3.73). This acceleration was mostly observed for pole heights between 1.5 m and 2 m. This tail pattern was confirmed by field observations and a GIS study of a permanent beach pavilion, 'The Coast', at Sand Motor south, revealing substantial downwind deposition at the NE side behind the pavilion (+ 2 m/3y), with slight erosion and armoring underneath the building (Figure 3.74).

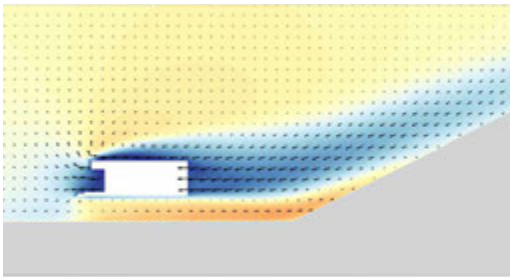

FIG. 3.73 Increased flow velocity (orange) below beach housing on 2 m-high poles. Source: Van Onselen, 2018.

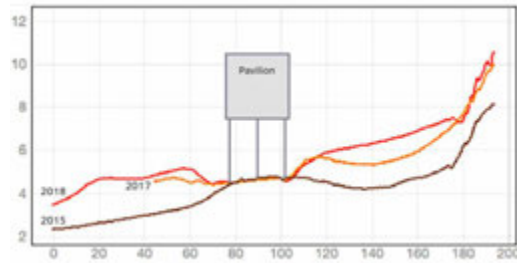

FIG. 3.74 GIS section of pavilions on poles at the Sand Motor, showing the 2 m-high downwind deposition at the dune foot over 3 years (2015, 2017, 2018), as well as increased deposition at the foredune slope. Image by the author.

Fieldwork on elevated buildings at Sand Motor (2019)

The effects of elevated beach housing on sediment transport have been investigated in this ShoreScape project through a field experiment in the spring of 2019.

1:5 scale models with increasing pole heights (in 25 cm increments) were placed at a wide beach at the Sand Motor for 6 weeks and periodically monitored using terrestrial laser scanning (Figure 3.75). The analysis of the DEMs and sections indicates that the higher the poles, the more dispersed and the longer the downward

tail (B5 and B6) compared to non-elevated boxes (B1 and B2; Figure 3.75b). The deposition tail is twice as long and located at a greater distance from the object, keeping the deposited sediment available for further wind transport (i.e. the tail is less sheltered by the building). In sections derived from the laser scanning, this difference is visible: the 1 m elevated box B6 features a detached, 15 m-long downwind tail (Figure 3.76 below), compared to the 5 m tail of non-elevated box B2 (Figure 3.76 above). The local volume change of the elevated boxes was slightly lower ($6.5 \text{ m}^3/6w$ compared to $7 \text{ m}^3/6w$) except for the 0.75 m-high poles, which gathered 9 m^3 (Kuschnerus & Lindenbergh, 2019), possibly due to the change in recirculation cells below the boxes. The location of the tail away from the (elevated) buildings is beneficial for sites where transitional sediment transport towards the dunes is needed (see Figures 3.75b (boxes B5 and B6) and 3.76d).

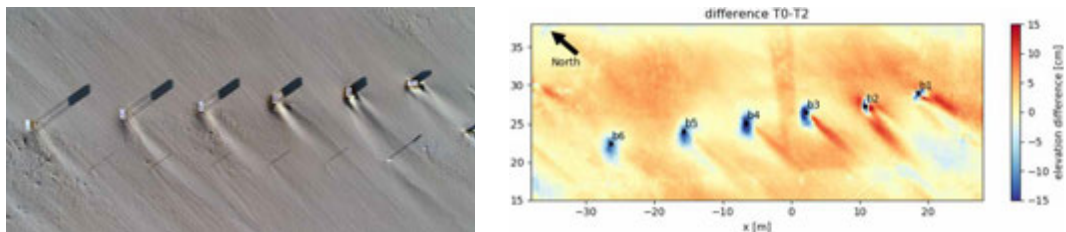

FIG. 3.75 Aerial photograph (source: J.van Bergen) and DEM/TLS map (source: M.Kuschnerus) of the beach group.

On the right picture, in red, the concentrated local deposition (upwind and downwind) around the non-elevated boxes (B1, B2). In blue, local erosion and dispersed tails around the boxes with increasing pole height (B3: 25 cm; B6: 1 m).

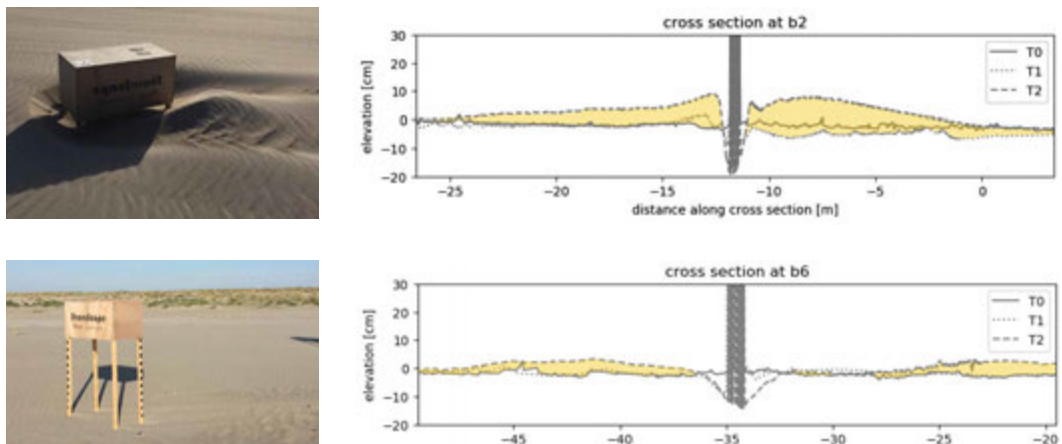

FIG. 3.76 Photographs and mid-sections of the non-elevated B2 model and the 1 m elevated B6 model (left= upwind), illustrating the difference in tail length and deposition height. Source: J. van Bergen/M. Kuschnerus.

Conclusion H3: vertical funnelling as a design principle

The vertical convergence of wind flow can cause local wind acceleration and an increase in sediment transport benefitting (fore)dune heightening. This can be induced by elevated beach buildings on poles (> 1.5 m for pavilions, > 1 m for beach housing), which compress airflow below and behind the building and release wind flow and sediment afterwards. To maximize the effect for dune heightening, buildings should be placed close to the dune foot to compress airflow as long as possible, extending the release path as high as possible (see Figure 3.73).

3.7.3 Conclusions of principles H2 and H3: spatial configurations for dune heightening

Several mechanisms can mobilize and accelerate sediment transport for dune heightening. The key is to accelerate (inland) wind speed as much as possible, picking up sediment for onward transport to the upper dunes. Beach buildings are not advised when the coastal buffer needs to be consolidated because they disturb and, therefore, reduce sediment flow to the dunes. Natural or constructed blowouts can promote inland sediment transport. For buildings to contribute to dune heightening, they should produce the longest deposition tails possible. This can be achieved with oblique placement towards the wind and/or the vertical or horizontal convergence of wind flow for acceleration (funnelling), for instance, by positioning the buildings on high poles or in V-shaped formations as artificial blowouts. These configurations are still in the conceptual phase, and further research is required to substantiate their contribution to dune heightening. The foredune slope should be gradual and low vegetated to maximize the effects.

Beach pavilion configurations for dune heightening

For beach pavilions to support dune heightening, it is important to harness their long, downwind deposition tails as much as possible and make use of horizontal and/or vertical funnelling to accelerate wind flow to the back (in combination with sufficient wide gaps).

The first option is to place the pavilions in an oblique setup with (extending) asymmetrical tail lengths (see Figure 3.77). If the pavilion is perpendicular to the dunes (right), the longest side tail starts right at the dune foot, reaching deeper into the dunes. Alternatively, building walls could be placed at a lower angle with the wind (e.g. as part of aerodynamic architecture) to stimulate onward sediment flow.

The second option is to use vertical funnelling by placing the pavilion on poles (1,5-2m see Figure 3.78). This allows for compressed flow below and behind the building, accelerating wind speed for onward sediment transport. Placement close to the dune on a limited amount of poles and a gradual low-vegetated foredune slope (with a natural blowout) further enhance this process.

The last option is horizontal funnelling achieved by placing the pavilions in an aerodynamic V-shape configuration oriented towards the dominant wind as an artificial blowout (see Figure 3.79). The converging V-shaped gap and the overlap between the two mid-tails can promote further wind acceleration. However, additional testing is needed to confirm this hypothesis.

Based on the knowledge available, it is recommended to place pavilions oblique to the wind (Figure 3.77) on poles (> 1.5 m, Figure 3.78) close to the dune foot and with an oblique-shaped section (Figure 3.78) to extend the deposition tails as much as possible on the side and behind the building, combined with a gradual unvegetated slope and/or natural blowout at the top in the direction of the sand tails. Furthermore, the width of the pavilions (including shielded terraces) should be limited (< 50 m) so as not to excessively deprive the foredune of sediment.

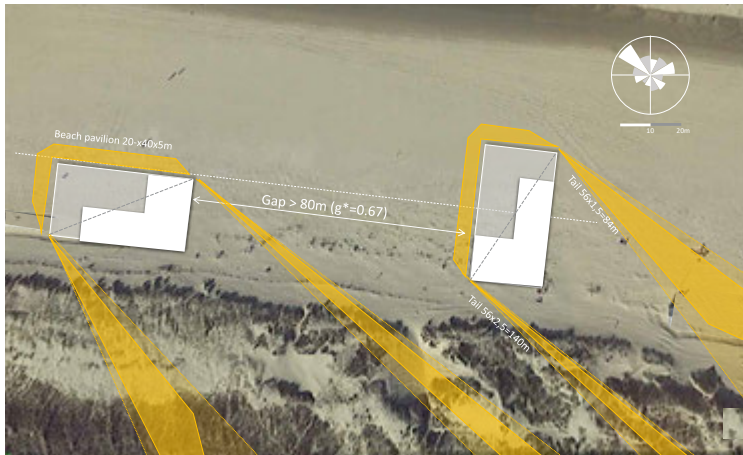

FIG. 3.77 Oblique placement of beach pavilions to promote longer sandtails to the dunes. Source: J.v.Bergen, aerial picture: Google earth.



FIG. 3.78 Compressed, accelerated windflow below and behind a beach pavilion on poles to increase sediment flow to the dunes. Image by the author.

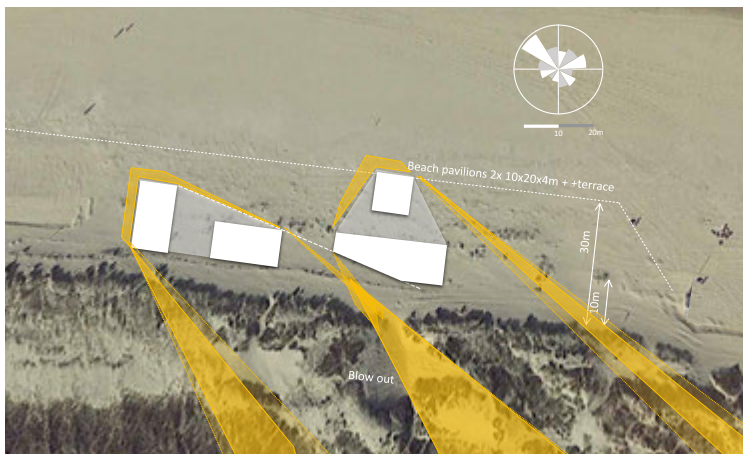

FIG. 3.79 Source: J.v.Bergen, aerial picture: Google earth

Beach housing configurations for dune heightening

Due to the higher wind speeds needed for dune heightening, the best scenario features no beach housing at all. Beach housing always causes a disturbance of wind speed, and their side tails are not substantial enough (15–25 m) to reach the upper dunes.

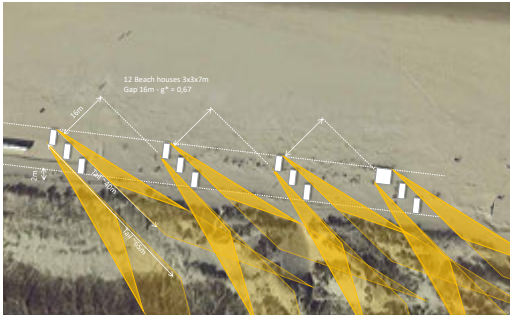

FIG. 3.80 Source: J.v.Bergen, aerial picture: Google earth

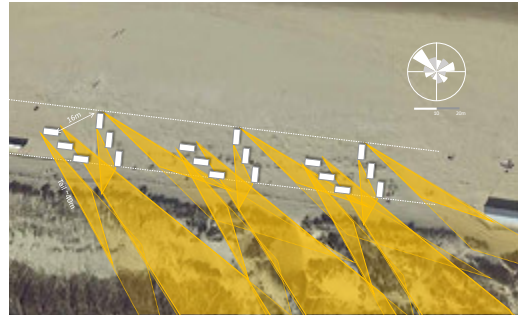

FIG. 3.81 Source: J.v.Bergen, aerial picture: Google earth

If beach housing must be facilitated, the best option is to place buildings in slats, oblique to the wind (configuration 3.90/E) with generous gaps between them ($g^* > 0.67$), keeping the dune foot open for accumulation, combined with gradual slopes. The oblique and aerodynamic tile-wise placement generates longer tails (50 m instead of 25 m); however, this is not sufficient to reach the upper dunes, especially when the foredunes are vegetated. For multiple wind directions (e.g. NNW), the back houses could be turned to stand obliquely to the secondary wind. Further study is needed on the topic.

Another option is to place these slats of houses in a V-shape configuration turned towards the wind (Figure 3.81). This 'artificial blowout' formation provides the same advantages as the slat configuration but with a more converging (and possibly accelerated) downwind tail in the middle. This needs further study.

Based on the knowledge available, the slats configuration (Figure 3.80) with generous gaps ($g^* > 0.67$) is recommended due to its open dune-foot structure and cascading tail construction. Further research is needed to confirm this concept and elaborate on the benefits of artificial blowout constructions.

3.8 Harvesting and temporal design

In the previous section, the three steps for scaled BwN-based coastal design were elaborated: **morphogenesis**, **dynamic profiling** and **aeolian principles** for dune formation. The latter include *eco-trapping*, *fencing* and *sand tails* for dune widening and *human mobilisation*, *horizontal funnelling* and *vertical funnelling* for dune heightening.

With these principles, sediment can be allocated to specific parts of the (fore) dune zone, promoting dune growth as a coastal buffer. Each of these principles produces specific tail patterns that can be combined or alternated to build up the desired coastal profile. However, this profile development requires a combination of principles and sequential design, as detailed below.

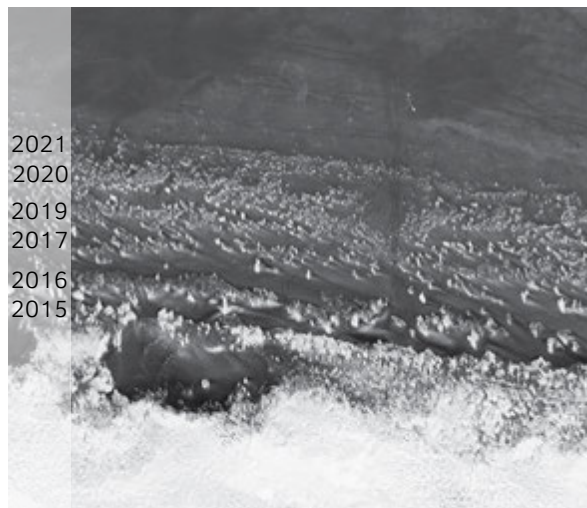

FIG. 3.82 Inverted aerial photograph of the foredunes north of Petten, which accumulated an additional 60 m of foredune in 5 years as a result of the nearby sandy reinforcement. Adapted from Google Earth.

3.8.1 Temporal design for dune widening

Dune widening is often desired in urbanized zones, for example, to maintain sea view or prevent sediment from being blown inland. The beach must be wide enough (> 80 m) to accommodate new dune formation, as is the case with larger nourishments. The aim is to add volume to the foredunes as part of the storm erosion buffer. Therefore, new sand ridges at the beach should be avoided, for instance, via beach maintenance or human mobilisation (H1).

Natural evolution

In non-urban, unbuilt conditions, eco-trapping (W1) is the most efficient way to widen foredunes. In most cases, this vegetation process starts naturally (e.g. around the winter flood mark, where seeds are washed ashore and blown into the dune foot). There, a new foredune row can grow within 2–3 years. Often, a sequence of these ridges can be noticed at the dune foot (e.g. at Petten; see Figure 3.82).

With fences (W2), the widening of the dune could be further promoted (to protect the vegetation as well). In the first years after nourishment, when sediment transport rates are high (up to 25–35 m³/m¹/y), fencing can lead to a rapid formation of new dunes, changing the coastal profile. Later, when accretion drops to more average rates (10–20 m³/m¹/y), other principles, such as eco-trapping, are useful for stabilizing dunes. Therefore, design principles for dune widening are often sequential and responsive to transport rates and phases of nourishment and dune formation.

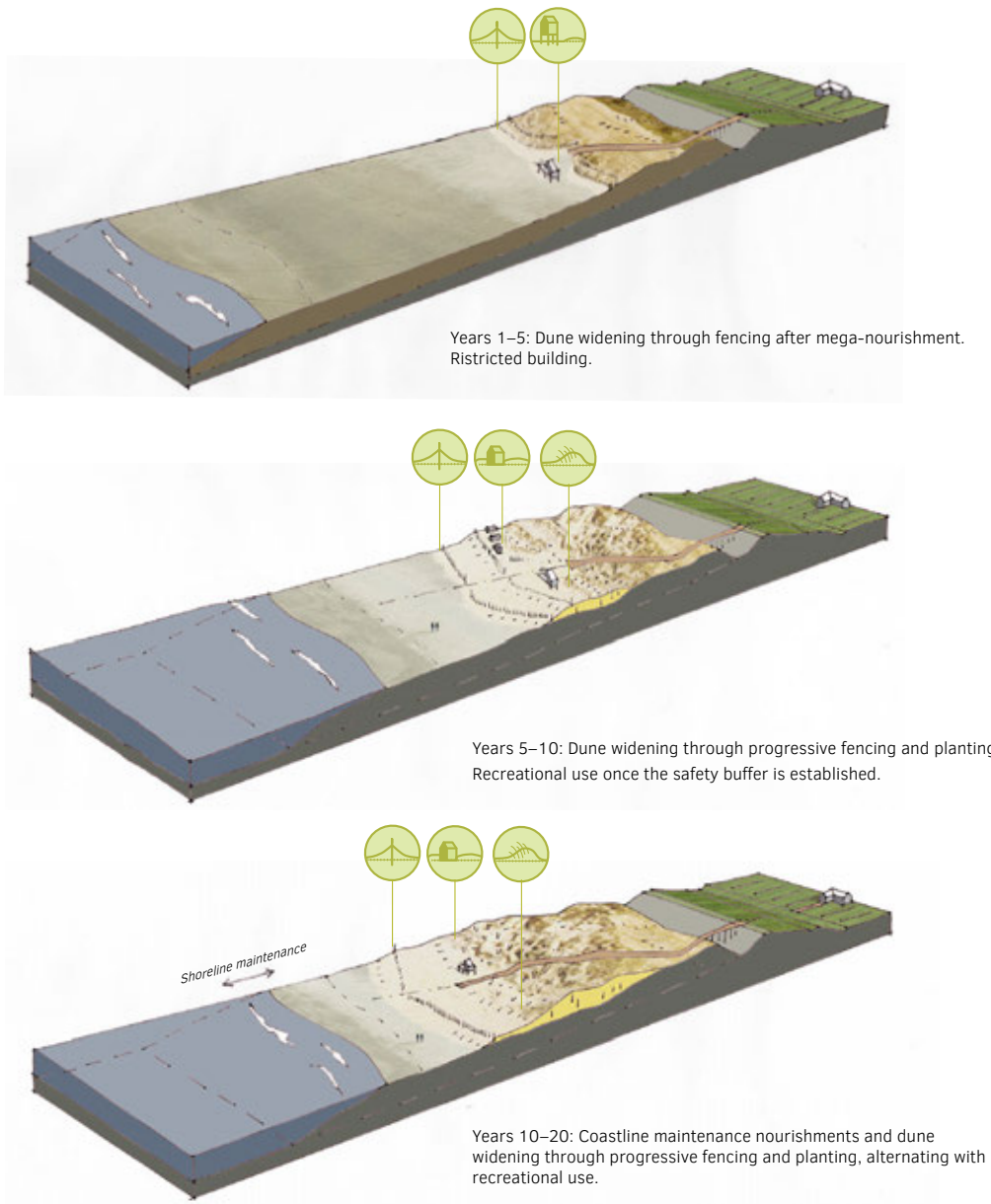

FIG. 3.83 Example of a sequential 3D profile design for dune widening. Images by the author.

Top image: In the first years, the coastal safety buffer is harvested via brushwood fences from the high sediment transport rates of the mega-nourishment. Middle: Once the buffer is established, terraces (+ 5 m NAP) can host beach housing protected by a wind barrier and runner-up dune. The buildings' tail development contributes to terrace or foredune heightening. In the final stage (below), regular maintenance nourishments still provide sediment (10 m³/m/y) to strengthen the dunes. Beach buildings could be moved every 4–5 years for regeneration, enhanced by planting of the tails.

Urban design sequence

When dune widening is required in urban situations for future coastal safety, it is best to keep the dune foot as open as possible by clustering buildings (see Noordwijk case study in Chapter 4.2) and protect foredune vegetation to facilitate natural evolution. Beach buildings always negatively affect this process (-35–50% depending on density; see Section 3.3) and should thus be placed reluctantly. In most Dutch cases, beach pavilions are placed on a 2 m-high artificial sand terrace at + 5 m NAP to prevent flooding. In nourished conditions, this terrace could be constructed in a BwN way by using fences (W2), taking advantage of the abundant sediment transport in the first years after nourishment (see Figure 3.83).

Additionally, buildings could be placed in an aerodynamic setup, with the smallest façade towards the dominant wind, to shorten their tails for sediment allocation in the foredune zone (see 3.6-W3). To accommodate the tail deposition, it is best to place the beach buildings at a greater distance from the dune foot (> 10m). A steep, planted foredune slope could help to prevent sediment from being blown over to the inner dunes.

After 5 years, the buildings could be relocated along the dune foot to concentrate their tails on deprived areas. The short tails of smaller-scale beach housing offer a good way to allocate sediment to the dune foot as long as they feature gaps wide enough ($g^* > 0.67$) to avoid upwind row deposition. Short tails could be promoted by turning the smallest façade towards the dominant wind. In a rotated row or 'slat' configuration, more houses could be combined, leaving the dune foot as open as possible (see 3.6-W3).

The tail depositions could be planted in the spring season (W1) after the first year to promote further growth, possibly enhanced and protected by fencing. Once a first row of foredunes is developed in 2 or 3 years, the orientation of the houses could be changed to a more oblique setup and/or placed on poles to promote the further heightening of the foredune.

3.8.2 Temporal design for dune heightening

In coastal zones with narrower beaches or coasts that already have a larger dune massive, dune heightening could be the preferred strategy. Dune heightening can also be beneficial in supporting grey dune habitats.

Dune heightening is a slow process. Therefore, it is important to mobilize and accelerate upward sediment transport as much as possible. Wave dynamics and human traffic (e.g. near beach entrances) can help to mobilize fine sediment. A gradual foredune slope can also facilitate the upward flow of sediment. De-vegetation and cut-outs in the dunes can induce natural blowouts to transfer sediment from the foredune to the inner-dune system (see Figure 3.84).

Buildings are not recommended if dune heightening is required for coastal safety. Exceptionally, buildings can act as artificial blowouts through horizontal and vertical funnelling. Placing the buildings on poles (1–2 m) and close to/at the dune foot accelerates the wind flow below and behind the building to reach the upper foredunes (see 3.7-H3). To maximize the funnel effect, the space underneath and behind the building should be converging and free from obstacles (e.g. minimal poles) to allow for onward accelerated flow.

In the Dutch context, the downwind building tails are often parallel to the dominant SW wind, oblique to the foredunes. Since these oblique tails are quite long (50–100 m), it is important to place pavilions with larger gaps between them (> 130 m, $g^* > 0.67$). The sand tails of the pavilions could be combined with blowout openings in the dunes to stimulate sediment transport from the top foredune to the inner dunes, especially when located in the direction of the downwind tails of the building. After 5 years, the pavilions could be moved to build up other parts of the dunes.

Beach housing is smaller in scale and features shorter downwind tails. Consequently, it is not recommended in areas in need of dune heightening. If the safety profile is guaranteed, beach housing may be placed higher up in the foredunes on poles, in slats or in a V-shape formation, lengthening tails to stimulate onward sediment transport. Its recreational use (tramping) can also mobilize sediment in the foredune zone. To prevent row blockage, the houses should have gaps of around twice the width of the building ($g^* = 0.67$). This gap width entails overlapping and longer inner tails that can further accelerate sediment transport to the foredunes. In wintertime, when houses are removed, and if vegetation is absent, winter storms can pick up this sediment and transport it landward. Additionally, cut-outs in the foredunes could further facilitate this process. Beach-house locations and year-round beach houses could be moved every 3–5 years to spread the concentrated foredune formation along the trajectory.

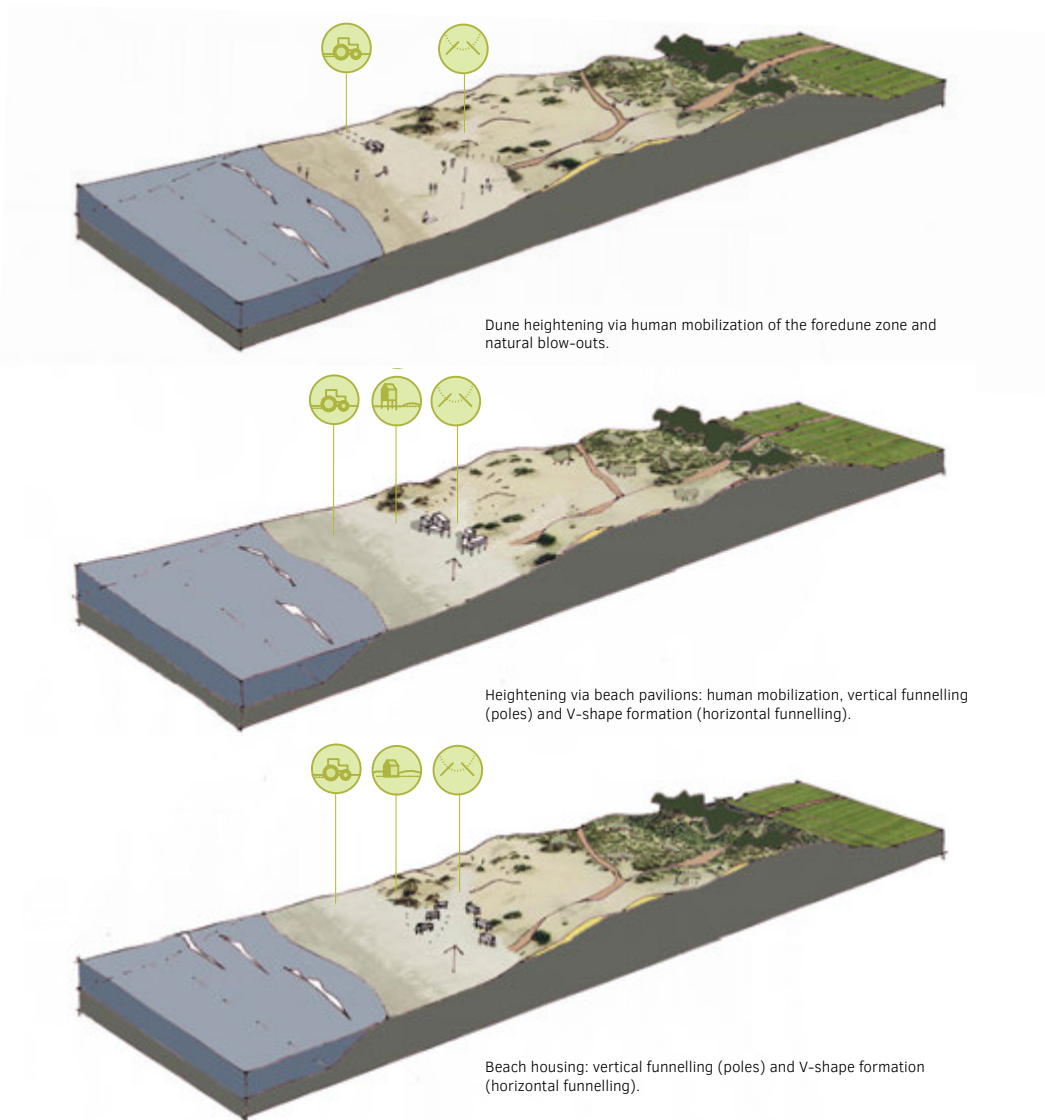

FIG. 3.84 3D profile designs for dune heightening. Images by the author.

Top: Mobilization of the foredune zone through human mobilization and the creation of blowouts in the foredunes. Middle: Positioning of beach pavilions on poles close to the foredune for vertical funnelling, as well as dispersed tails for sediment transport to the upper foredunes. By placing the beach pavilions in a V-shape formation (horizontal funnelling), an artificial blowout can be created to accelerate wind transport to the upper dunes. Below: Placement of beach houses in a V-shape formation (horizontal funnelling), accelerating the wind to the upper foredunes. Although their downwind deposition tails are not as long as those of pavilions, the concentrated tail development could help to elevate the foredunes as the final stage of the dune heightening process. NB: For dune zones where a build-up of the coastal buffer is required, beach buildings are not recommended because they obstruct sediment transport (see Section 3.3).

3.9 Conclusions regarding BwN as a landscape design approach: towards a dynamic, adaptive and multifunctional coastal landscape

Toolbox for BwN-based dynamic design

This Section overviews the interventions, steps and design principles that facilitate BwN as a landscape approach to enhanced dune formation as a coastal buffer. The proposed design steps were not developed a priori but in close interaction with the design case studies (see Chapter 4). In these cases, the design process from *inventory* (morphogenesis, study of the dynamics) to *projection* (dynamic profiling) and *synthesis* by the application of the aeolian design principles was represented, testing ways to allocate sediment for the build-up the coastal buffer. The aeolian design principles were developed based on a literature review, a GIS analysis of real-time nourishment situations, fieldwork and CFD modelling. All steps constitute the toolbox that should facilitate the BwN process from initial nourishment to grown dunes. In the nourishment design, the pre-conditions for aeolian sediment transport (e.g. wider beaches) are set to start the process of natural dune formation. This interaction is studied in the *morphogenesis*. From there, profile development can be derived and modelled as a multifunctional coastal buffer in *dynamic profiling*. The profile design is constructed through spatial arrangements over time, using *aeolian principles* for the natural and urban harvesting of sediment after nourishment. However, these steps and principles are generic; that is, they must be selected to fit a specific nourishment context, desired profile and available time frame. This selection process is illustrated in the case studies (Chapter 4).

Promoting the multiplicity of BwN

Since dune formation is a low-dynamism process and natural adaptation takes a long time, it is important to combine the process of adaptation with multiple coastal uses. In the proposed design steps and aeolian principles, a multifunctional perspective is included to harvest BwN's potential for multiplicity. In the morphogenesis, the multiple perspective entails documenting not just the geomorphological but also the ecological and urban development. In doing so, it is possible to track down spatial

equilibria between these systems, given the nourishment scale and time window (e.g. the elaboration of more dynamic and stable zones as grounding for further ecological or urban development, or *'form follows sediment'*).

Dynamic profiling is essential to plan multifunctionality since it maps and allocates the nourished sediment dynamics ashore. After the construction of the future safety profile, sediment dynamics can be shaped to host multiple functions, such as dune valleys or recreational terraces (see also Chapter 4). This often requires an alteration of dune widening and dune heightening principles.

Different coastal functions are represented and activated by the aeolian principles, such as vegetation and buildings, contributing to both the BwN process and other coastal uses. By clustering the design principles to form larger configurations, coastal trajectories and profiles dedicated to certain functions (safety, ecological or recreational habitats) can be composed, as illustrated in the case studies.

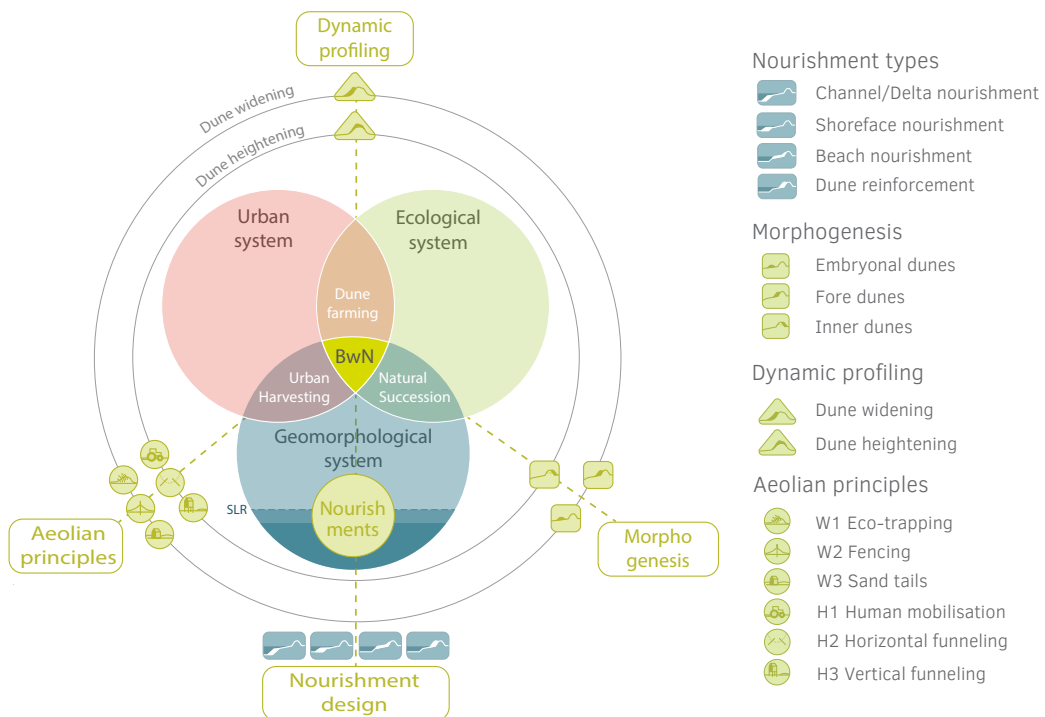

FIG. 3.85 Toolbox with the design principles for natural coastal adaptation. Image by the author.

Sequential design for long-term natural adaptation

The main goal of the design approach is to enhance the build-up of the coastal buffer in a natural, BwN way, adapting to (accelerating) sea-level rise. In the best-case scenario, this would result from sediment harvesting from regular shoreline maintenance nourishments. In the Netherlands, these nourishments generate positive onshore sediment transport of around $10 \text{ m}^3/\text{m}/\text{y}$, which could, in 25 years, build up to an additional coastal buffer of $250 \text{ m}^3/\text{m}$ needed to respond to sea-level rise scenarios of + 45 cm in 50 years (see case study Petten). However, this requires a sequential design over 25 years and, depending on the profile, a combination of principles for dune widening and dune heightening. This long-term horizon will make coastal planning challenging, but it could also be facilitated by the seasonal and temporal character of many coastal programmes such as beach buildings and nourishment. If this BwN process is safeguarded and adaptive to multiple use, a long-term adaptation of the coastal profile can be successful, avoiding costly reinforcement and optimizing space for multifunctionality. Incorporating a long-term perspective is also beneficial in mitigating one of the downsides of BwN: its unpredictability due to its dependency on natural circumstances, such as wind and storm climates.

Evaluation of the landscape design methodology

Every method is only validated once applied. To evaluate the BwN design method in generic terms, the impact of foregoing one of the design steps or principles could be examined. Without [morphogenesis](#), no insights into the natural or enhanced evolution of the shoreline would be available. Therefore, it would be difficult to anticipate shoreline and profile dynamics in the design given that these dynamics vary across trajectories and situations.

Without [dynamic profiling](#), it would be challenging to translate (2D) data scapes from nourishment computational modelling into spatial conditions at the sea-land interface. Additionally, it would be difficult to predict how sediment transport from the nourishment will accumulate within the profile and the dunes, let alone allocate it for safety or other coastal functions. Therefore, profile design is not only essential to address and allocate the sediment dynamics generated by the nourishment (or coastal dynamics) but also to optimize these dynamics for multiple functions.

Without **aeolian principles**, coastline reinforcement would have to match traditional urban planning (e.g. the increase in beach row houses and other buildings along the coast). This would mean a reduction of the aeolian harvesting from the nourishment from a potential 25% to a mere 5–15% on urbanized beaches and a reduction of fore dune formation by 35–50% – a missed chance for adaptation to (accelerating) sea-level rise.

The aeolian principles respond to potential setbacks in dune formation caused by the urbanisation of beaches (Section 3.3) and underline the value of traditional dune-building methods like planting and fencing as natural means to expand and sustain the coastal buffer. They also include new principles, such as sand tails and funnelling, generating new building typologies as ‘urban responsive designs’ to widen or heighten the dunes. Without these urban principles, only natural means of dune reinforcement would be available, which are hard to implement in highly urbanized conditions.



Aerial overview of the Sand Motor from the Argus tower during a storm in 2018.
Image compilation: J. van Bergen, photos from the Argus observation tower.

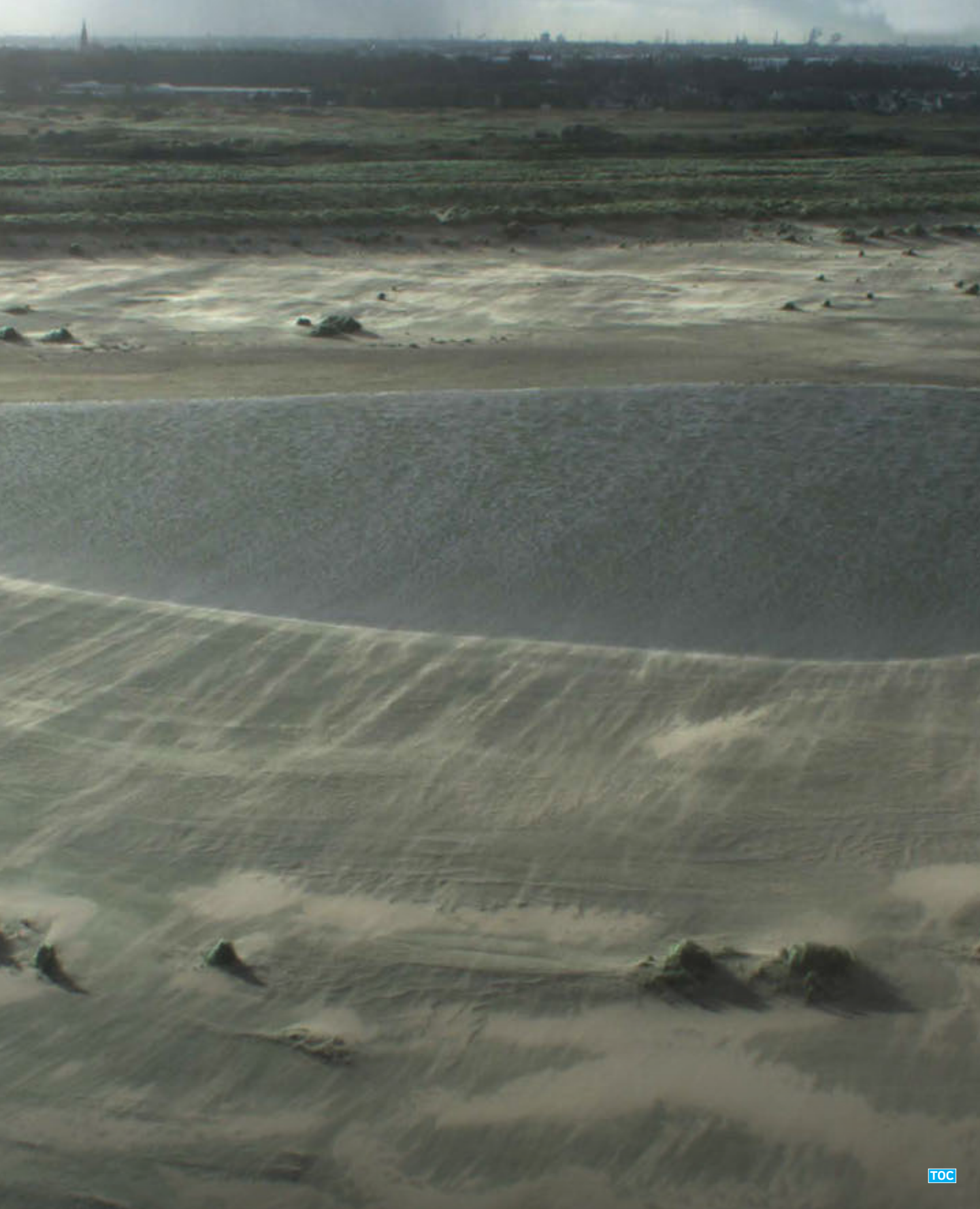

4 Application: case studies

Design approach and principles tested in site-specific contexts

4.1 Introduction

In this chapter, the landscape design approach and the initial design principles are applied and contextualized in four case studies as a form of site-specific testing. The goal is to compare the potential of BwN adaptation in different urban and nourishment settings and explore the spatial arrangements and principles that support dune formation for a natural gradual adaptation of the coastal landscape (research questions 2 and 3). The case studies also enable a reflection on BwN as a landscape approach, expanding its application from coastal safety to serving multifunctionality and the differentiation of coastal landscapes ('shore-scapes'). Four cases were selected for design study (De Jong et al., 2002), each with a contrasting profile, nourishment regime and level of urbanity:

- The compact profile of a coastal resort, Noordwijk, featuring a high-frequent, low-volume nourishment strategy (5 Mm³/5y) in a highly urbanized setting.
- The narrow, varying profile of the coast of Domburg, Walcheren, featuring a low-frequent, high-volume and dynamic nourishment strategy as an alternative to regular coastline maintenance in a suburban setting.

- The sandy reinforced seawall profile of Petten (Hondsbossche dunes), featuring a low-frequent, high-volume and low-dynamic sandy reinforcement in a rural but urbanizing setting.
- The vast profile of a mega-nourishment (Sand Motor), featuring a low-frequent and high-volume nourishment strategy (21,5 Mm³/20y) with dominant geomorphological dynamics in a rural setting.



FIG. 4.1 Map of the Netherlands and the four case-study locations. Source: J.v. Bergen, background map: kaartenatlassen.nl.

All cases are located in the Netherlands. This is because the country has advanced nourishment strategies using multiple nourishment typologies, and multiple coastal data are available due to monitoring programmes and proximity.

All case studies explored how the three-step design method and aeolian principles can be employed to compose spatial arrangements accommodating nature-based dune formation. This requires an interplay of nourishment, the desired coastal buffer profile and directed sediment transport at the beach-dune interface. The dune formation resulting from different nourishment types was evaluated to determine how this process can be enhanced on different levels, such as the coastal profile design and the application of aeolian principles.

First, the system characteristics (nourishment programme, current and future coastal profiles) were studied as part of the morphogenesis. In addition, the type of dune formation following nourishment was analyzed through GIS Difference-in-Elevation Mappings (DEM's). Next, the dynamic profile design was composed to include future flood safety, dynamic sand deposition and multifunctional requirements.

Based on the design objectives and desired profile, aeolian design principles were applied and fine-tuned to support sediment allocation for dune formation and profile alteration. This generated dynamic spatial arrangements for each case study, illustrating whether and how multiple uses of the coastal profile can be made compatible with BwN dune-formation processes, as well as the long-term perspective for integrated coastal adaptation.

The case studies are concluded with reflections on the applicability of the BwN design principles to different coastal and nourishment settings and spatial arrangements to facilitate BwN dune formation. In addition, the initial and BwN-improved design were evaluated on the core values for spatial quality for coastal zones (see Sub-Section 2.4.6):

- **BwN adaptation (V1):** supporting BwN processes ashore and the natural build-up of the coastal buffer.
- **Natural dynamics (V2):** supporting and incorporating natural dynamics into the spatial arrangement (dynamic profiling, aeolian principles).
- **Multifunctionality (V3):** working towards (future) coastal safety but also incorporating other coastal functions, such as recreation and nature conservation.
- **Differentiation (V4):** differentiation of spatial arrangements (design principles, profile design etc.) within coastal trajectories, to enhance natural or nourishment dynamics and produce a variety of landscapes along and across the shore.

4.2 Noordwijk: BwN-based adaptation of a highly urbanized waterfront

Noordwijk aan Zee is a seaside resort along the coast of South Holland. It features an urbanized waterfront maintained via a regular high-frequent low-volume nourishment strategy (2 Mm³/4y since 1998). In 2008, Noordwijk was reinforced with a so-called 'Dike in dune' construction, altering the historical boulevard setting. The question was how Noordwijk could be sustainably adapted by BwN after the reinforcement, including spatial (re)arrangements of the beach and waterfront.

In this design study, several coastal profiles were developed that promote BwN dune formation in the context of the current nourishment strategy for coastal maintenance. These profiles were evaluated on the urban waterfront scale and the local scale; to examine how spatial arrangements based on the Aeolian design principles could stimulate sediment transport for profile alteration. This study was published in *Research in Urbanism Series #7: BwN Perspectives* (2021).



FIG. 4.2 Photograph of the Noordwijk boulevard in 1920. Source: deoudedorpskernnoordwijk.nl.



FIG. 4.3 Photograph of the Noordwijk boulevard after reinforcement in 2008. Image by the author.

Geomorphology

Positioned on a relatively stable part of the Holland Arc, the Noordwijk coast is part of a transgressive barrier system. The local coastline was first formed by coastal erosion, which created a series of old dunes (5500–4500 BC), followed by a period of seaward extension and the emergence of new dunes and beach ridges (< 4500 and 2500–2000 BC). Another period of coastal erosion then occurred, in which some of the new dunes transgressed landward onto the old dune system (> 2000 BC) (Van der Spek, 1999; see Figure 4.5).

Within this transgressive barrier system, the village of Noordwijk is positioned at the north bank of the former inlet of the Rhine and hence called 'North-wick' (from the Latin word vicus, 'settlement'). Because of this inlet, much sediment was transported from the river to the sea, creating a cape. However, this sediment also caused the Old Rhine to silt up in the Middle Ages, reducing the sediment input to the shore. Afterwards, the coastal drift eroded the former outlet, including a Roman fortress and earlier settlements of Noordwijk. These former fishing villages were usually situated in a dune valley, protected from the wind, but near a lower beach passage for easy access to and transport from the fishing boats. This lower position explains why villages such as Noordwijk face flood-safety issues today, even when positioned in a larger dune system. Furthermore, sea-level rise has aggravated shoreline erosion, erasing the protective layer of the front dunes.

Urban morphology

In the recent past, Noordwijk has faced several urban transformations. It began as a fishing village but developed into a (luxury) seaside resort around 1900, turning the front dunes into a coastal strip of hotels along a boulevard. During World War II, this strip was partly torn down for military defence purposes as part of the Atlantikwall, but it was later reconstructed and densified. The resort now receives 1.1 million daily visits and 0.5 million overnight stays a year, which includes conferences, upmarket lodging and beach development (Municipality of Noordwijk et al., 2018).

In 2003, Noordwijk was appointed as a weak link in the coastal defence line and transformed once more with a Dike-in-dune reinforcement in 2008 (Figure 4.6-S0), anticipating future climate change and sea-level rise. Although close access to the beach and the sea view from the hotels were maintained, the northern boulevard

lost its direct contact with the beach (Figure 4.3). Since 2003, Noordwijk beach has been nourished following the hold-the-line policy, with a regular frequent low-volume nourishment strategy (2 Mm³/4y). For the Holland Arc, this strategy results in a positive trend in dune growth of around 10 m³/m/y (Ecoshape, 2019). However, for urbanized stretches, this figure can be halved or even lower (Giardino, 2013-B; Quartel & Grasmeijer, 2007).

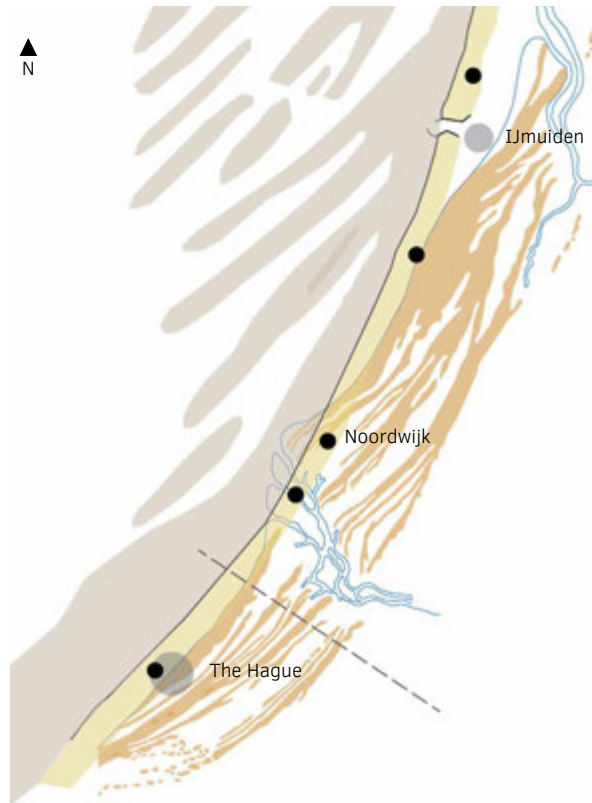

FIG. 4.4 The morphogenesis of the South Holland coast. Image by the author, adapted from van der Spek, 1999.

In dark orange, the series of dune ridges and valleys resulting from the historical transgressive barrier system. Clearly visible is the outward mouth of the Old Rhine, where Noordwijk is situated. Most of this cape eroded away, leading to a landward retreat and safety issues for the seaside resort of Noordwijk. In yellow and light orange, the existing coastal fundamant and sand-bank system.

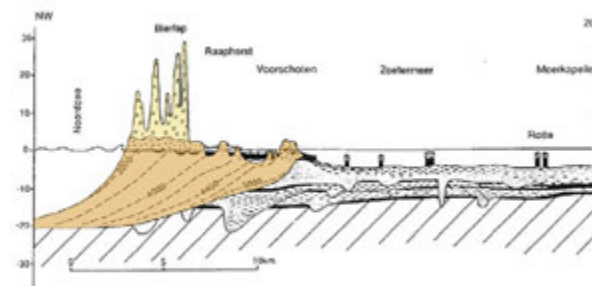

FIG. 4.5 Section of the South Holland coast at Wassenaar, near Noordwijk, illustrating the evolution of the old and young transgressive dune barrier as the result of a sequence of erosive and accretive periods due to sea-level rise. Adapted from Roep at al. (1991) and van der Spek (1999).

4.2.2 Profile design

The present flood-safety level of the Noordwijk Dike in dune construction accounts for a sea-level rise of 30 cm in 2050 (60 cm in 2100). To withstand higher sea-level rise scenarios, future reinforcements will be inevitable. Investigating the feasibility of BwN solutions to provide a necessary reinforcement after 2060, Mulder et al. (2013) took a two-step approach. First, using a DUROS+ dune-erosion model (Vellinga, 1986), a number of potential sandy reinforced profiles were calculated (Mulder et al., 2013), able to withstand storm conditions after a sea-level rise of 85 cm in 2100 (Figure 4.6). The study generated two feasible options to reinforce the Noordwijk shore in 2060.

The first option is the 'Dike-in-dune plus' model (see Figure 4.6 -profile S1). In this option, the existing hybrid construction of an underground seawall and dune volume is consolidated in height. In the event of a superstorm, the beach and dune will erode, but the seawall functions as a second barrier to withstand wave attacks. The heightening of the seawall is costly but limited to maintain the sea view for the apartments on the boulevard. For this hybrid solution, the amount of sediment is lower than with option S2.

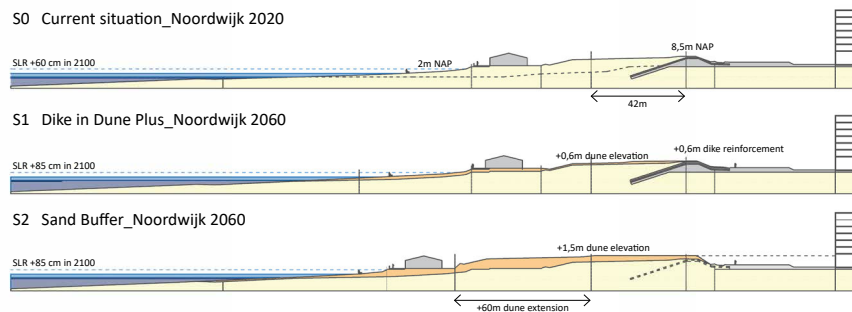

FIG. 4.6 Current and potential future cross-sections of Noordwijk boulevard. Images by the author, adapted from Mulder et al., 2013.

Cross-section S0: Current situation in 2020 with the dike-in-dune reinforcement implemented in 2008. Cross-section S1: potential reinforcement model to counteract the effects of a sea-level rise of 85 cm by 2100 through a slight heightening of the existing dike (+ 60 cm) and dunes (+ 60 cm). Cross-section S2: potential reinforcement model via a sand buffer only, avoiding a costly dike reinforcement.

The second option is the Sand buffer (see Figure 4.6c - profile S2). In this option, the seawall is replaced by a larger sand volume, adding 60 m to the width of the dunes and 1.5 m in height. This variant is cheaper than S1 due to the nourishments, but it will block the sea view from the boulevard. Alternatively, the boulevard could be elevated, with parking space underneath, for example. Next, a nourishment evaluation tool ('Ntool'; Huisman et al., 2013; Giardino et al., 2013A) was applied to confirm that a regular, very frequent sand nourishment strategy (increased sea-level rise, 4-year intervals) would be able to deliver (most of) the required seaward extensions for both profiles by 2060. However, these calculations are based on the free natural transport of sediments, which is crucial to its success. The current high occupancy rate (50-70%) of the beach and dune foot by pavilions can affect this process.

Because option S1 requires less sediment than the sand buffer in S2, it will be easier to realize naturally as a result of regular small-scale and frequent nourishments. S2 requires more sediment and a heightening of the existing dune by 1.5 m. This will be more difficult to achieve naturally and will take longer to develop. It also requires 60 m of seaward accommodation space for the extra foredune to develop. To offer space and speed up the process, larger, low-frequent and low-dynamic nourishments could be considered, which provide wider beaches over time for the dune to develop.

In terms of urban design, both options require a further compromise on the sea view from the boulevard. The Dike in dune plus will be easier to implement as it remains close to the existing profile. In the Sand buffer profile, the distance between the boulevard and the beach pavilions increases. This could be beneficial for the economic competitiveness of the boulevard because most profit is now made on the beach.

4.2.3 Urban models for the future waterfront development of Noordwijk

The future reinforcement profiles of Noordwijk, as elaborated in the previous section, show that more room is needed in the existing coastal profile to adapt to sea-level rise. The expected dune reinforcement pressures the existing values of the current waterfront, such as the sea view and proximity to the beach, and makes a reassessment necessary. In this design study, four future urban models were composed to facilitate future urban coastal occupation. These urban models are based on two main choices that (re)define the urban coastal profile (Figure 4.7).

- 1 **Reassessment of the waterfront layout.** The current boulevard typology (U1) acts as a distributor for close beach access parallel to the shore whilst offering sea view and public facilities. These qualities are best matched with compact (but costly) reinforcements, such as the Dike in dune. The boulevard can be elevated (U2, with parking space below) to provide extra room for reinforcement in height.

An alternative is the corridor typology (U3, U4), which gives direct perpendicular beach access, reorganizing the urban programme along public routes from the town to the sea. This offers opportunities for dune extension between the corridors. These dunes would marginalize the current boulevard but could offer a more exclusive landscape setting for the hotels and room for urban dune development instead, creating differentiated spheres of urbanity along the coast.

- 2 **(Re)arrangement of the urban beach layout,** for instance, with beach pavilions and houses. The current beach layout is linear (U1, U2), featuring a strip of 16 beach pavilions and terraces (half of them seasonal) with an equal spatial layout. They cover around 70% of the foredunes, obstructing sediment transport to the dunes. An alternative could be to cluster pavilions around the main beach corridors (U3) or distribute them within the dune landscape (U4, terraces model) to differentiate spatial quality and urban use along the beach and in the dunes. The resulting, more open dune foot enables natural dune growth.

Parallel access

Urban typology: Boulevard

Waterfront access: parallel

Flood safety model: Dike in dune

Beach layout: linear

U1: Traditional boulevard

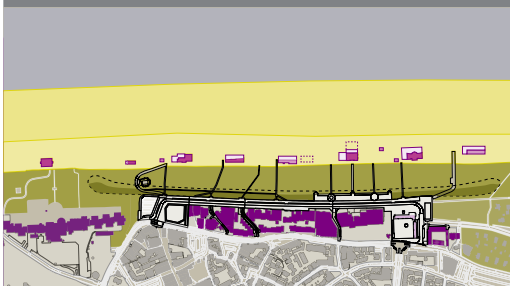

U2: Elevated boulevard

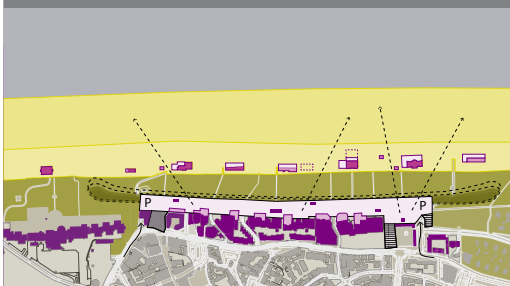

Perpendicular access

Urban typology: Corridors

Waterfront access: perpendicular

Flood safety: Sand buffer

Beach layout: clustered/distributed

U3: Corridor model

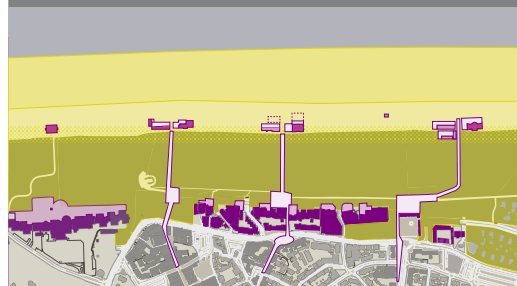

U4: Terraces model

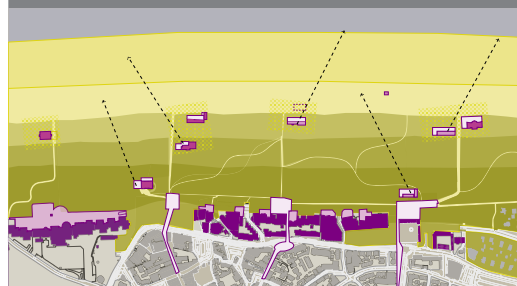

FIG. 4.7 Overview of four urban models for the future waterfront development of Noordwijk, based on parallel versus perpendicular access and varying beach layouts. Images by the author.

Matching models for future flood safety reinforcement and urban development

The combination of the two reinforcement variants (S1 Dike in dune and S2 Sand buffer, Figures 4.7b and 4.7c) and urban models (U1–U4, Figure 4.7) leads to two feasible future coastal profiles for Noordwijk, each with its own distinct features. Test profile T1, Dike in dune plus (=S1 + U1, Figure 4.8b), stays close to the traditional boulevard typology as an urban balcony at the sea with the most compact Dike-in-dune reinforcement. Test profile T2, Sand buffer (=S2 + U4, Figure 4.8c), rearranges and concentrates the urban programme onto two main routes to the beach, allowing for more free sediment flow to widen the dunes.

4.2.4 **Application of aeolian design principles to stimulate BwN dune formation**

The success of BwN dune formation depends not only on the nourishment strategy and coastal profile design, but also on the spatial layout of the sea-land interface, which affects wind-driven sand transport. The highly urbanized context and the current narrow coastal profile of Noordwijk (Figure 4.8a) make the free flow of sediment and natural dune formation a major challenge. In this context, aeolian design principles (see Chapter 3) can be applied to stimulate the gradual build-up of the desired test profiles (Figures 4.8b and 4.8c).

a) Current profile T0: Dike in dune (2018)

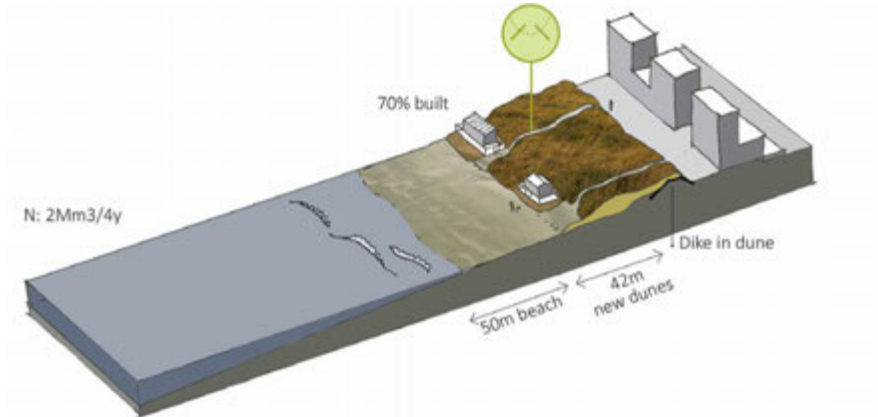

b) Test profile T1: Dike in dune plus (2060)

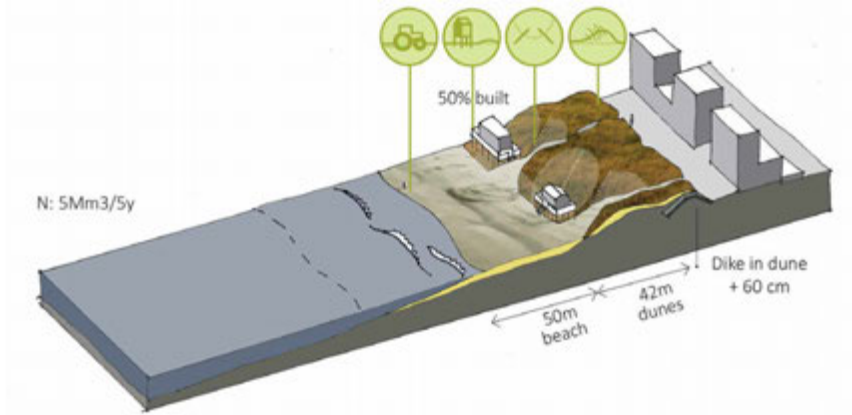

c) Test profile T2: Sand buffer (2060)

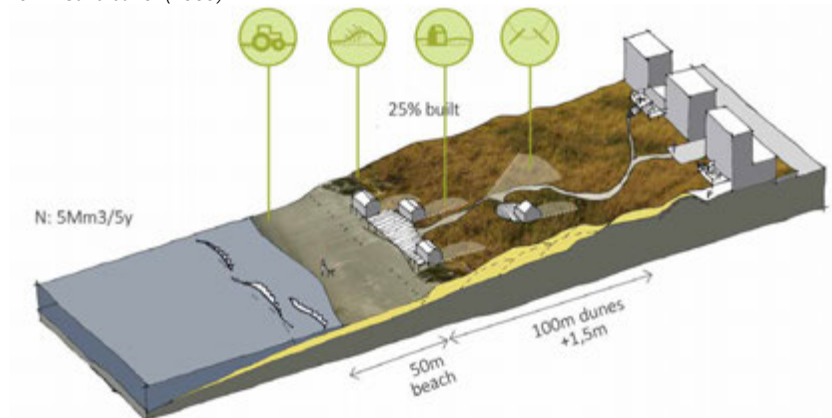

FIG. 4.8 Overview of the current and future test profiles for Noordwijk, including principles. Images by the author.

Current profile T0: Dike in dune (2018)

The current profile of Noordwijk (Figure 4.8a, top) features a 6.5 m-high dike-in-dune construction with 42 m-wide dunes. The beach is relatively narrow (50 m), limiting the fetch and space for dune formation. Beach buildings block a large part (50–70%) of the dune front, limiting sediment flow. Although this profile design does not intentionally incorporate BwN processes, the numerous beach access points help to transport sediment deeper into the dunes (in line with the design principle of horizontal funnelling, see Figure 3.69).

Test profile T1: Dike in dune plus (2060)

The 2060 Dike-in-dune plus profile of Noordwijk (Figure 4.8b, middle) requires a 60 cm elevation of the existing dike and dunes. To this end, a regular nourishment strategy is necessary to compensate for a sea-level rise of 85 cm by 2100. The current boulevard typology is maintained. To stimulate dune growth, the principle of human mobilization of the beach and foredune zone helps to keep sediment mobile for inland transport. A nature-based (BwN) elevation of the dunes (+60 cm) is stimulated by an open dune foot (reduced occupation rate) with alternating pavilions on poles (dispersed tales) and beach accesses (horizontal funnelling) to facilitate sediment transport inland (+60 cm). Eco-trapping stabilizes sediment in the back dunes and prevents it from reaching the boulevard.

Test profile T2: Sand buffer (2060)

The 2060 Sand-buffer profile of Noordwijk (Figure 4.8c, below) consists of a dune that gradually grows in height (+1.5 m) and width (+60 m) due to successive nourishments starting in 2020 (compensating for a sea-level rise of 85 cm by 2100). The former boulevard has been transformed and provides a new landscape setting for the hotels, with parking space below. A central beach access ends in a boardwalk with clustered beach houses, leaving 75% of the dune foot open for BwN dune formation. In the first stage, elevated pavilions (dispersed tails), beach access points and blowouts (horizontal funnelling) facilitate sediment transport for dune elevation (similar to test profile 1, but with a more open dune foot). In the second phase (Figure 4.8c), eco-trapping and the sand tails of the concentrated (seasonal) pavilions facilitate the extension of the dunes. A wide beach (fetch) could further enhance this process.

4.2.5 Conclusions

The Noordwijk case study features two relatively compact profiles for future reinforcement, which are dependent on small frequent nourishments. Without a vast beach as a resource, the design principles play an important role in the harvesting and steering of sediment to the designated places: dune morphology now follows the urban layout, and urban arrangements facilitate dune growth as a form of *directive* spatial design. Furthermore, in Noordwijk, urban parameters such as sea view, beach access and beach housing have a defining role in the coastal profile design and are balanced with the (future) requirements for coastal safety. The optimization of these profiles for BwN could eventually lead to an alteration of the existing waterfront layout, such as the transformation of the Noordwijk boulevard, or a nourishment strategy creating more room for natural BwN adaptation ashore.

In terms of BwN landscape values (see Section 4.1 and Sub-Section 2.4.4), the design study shows that the current Dike-in-dune solution can be developed further to incorporate natural dune dynamics (spatial value V2, see Sections 2.4.4 and 4.1) resulting from regular maintenance nourishments. In this way, the Dike in dune can transform into a more adaptive concept like Dike in dune plus and Sand buffer, as long as beach-building typologies are adapted accordingly (nature-based adaptation, V1). Although the boulevard is compromised further by this adaptation, it could regain its position if elevated. This requires buildings to adapt as well (multifunctionality, V3), for instance, via renovation with 6 m-high ground-floor ceilings that can be adjusted in height to reconnect to the elevated boulevard (as applied in Vlissingen), with parking space below. As an alternative to the (elevated) boulevard, the dune landscape could be extended to reach the hotel terraces, providing them with a new landscape setting and strengthening the concept of Noordwijk as an exclusive dune resort (differentiation, V4).

Legend FIG. 4.9

-
- a) Current situation of Noordwijk as a Dike in dune construction, with beach pavilions and adjacent terraces on a raised sand bed in front of the dunes, covering about 50–70% of the dune foot.

 - b) Noordwijk as a Dike in dune plus (or Sand buffer phase 1) reinforcement, with clustered elevated beach buildings (leaving the dunefoot open) and human mobilization promoting upward sediment flow for dune heightening.

 - c) Noordwijk as a Sand buffer phase 2. Buildings are clustered around a few beach access points, with more compact layouts, placed at a distance from the front dunes to allow for sand tail development for dune widening.

 - d) Noordwijk as a sand buffer phase 3, with a covered boulevard (parking) as a dune landscape as a natural setting for the waterfront hotels. The dune foot is left open for embryonal dune growth to promote dune widening. Due to the oversize in the dune profile, Beach pavilions are allowed within the (terraced) dune-scape, overlooking the sea. Images by J. van Bergen & OKRA landscape architects.
-



a) Noordwijk current Dike in dune construction with beach pavilions



b) Noordwijk as a Dike in dune plus-, or Sand buffer phase 1 reinforcement, promoting BwN-based dune heightening



c) Noordwijk as a Sand Buffer phase 2 reinforcement, promoting BwN-based dune widening



d) Noordwijk as a Sand buffer phase 3 reinforcement, promoting BwN-based, terraced dune widening

FIG. 4.9 overview of the current and future test profiles for Noordwijk, including principles. Images by the author & OKRA.

4.3 Walcheren: coastal landscape regeneration via BwN nourishment

4.3.1 Introduction

The Isle of Walcheren is situated in the Dutch Southwest Delta. It began as a dune-ridged sand bank and was reclaimed centuries later. Because of its position in an open estuary and sea-level rise, its shores became subject to severe coastal erosion. This diminished the dunes as a natural coastal buffer, partly replaced by a sea wall around the cape of Westkapelle.

This case study is a regional design study of the positioning of a BwN-based (mega-) nourishment to feed the narrow dune system and complement the urban programme in a collaborative way. The case study investigates how the zoning and staging of the nourishments and urban use combine into a dynamic multifunctional coastal programme supporting the morphological, urban and ecological system. The study was published in Coastal Management 2019 (Van Bergen & Nijhuis, 2020)

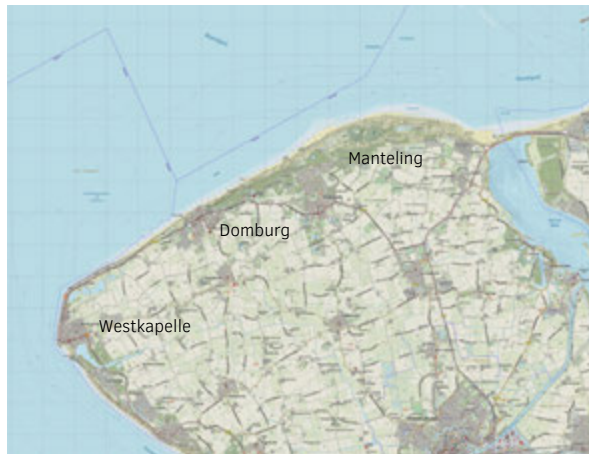

FIG. 4.10 Map of west Walcheren. Source: J.W. van Aalst, Opentopo.nl.



FIG. 4.11 The historical seaside resort of Domburg. Source: © Rijkswaterstaat / Simon Warner.

4.3.2 **Morphogenesis**

Walcheren is naturally protected by a row of dunes on the west side of the island. However, due to sea-level rise and tidal-channel dynamics, this dune system became erosive and moved landward. The severe erosion of the west cape around 1500 even forced the village of Westkapelle to retreat and turn the dunes into a double seawall (Figure 4.12). The mobile northern dunes were finally stopped by foresting, an old BwN method. The resulting forest is still visible today (the so-called Manteling, Figure 4.15) and now hosts a beautiful landscape of dunes, forest and countryside.



FIG. 4.12 Westkapelle in 1558: construction of a double-dike system in response to severe dune erosion. Source: Stichting Cultuurbehoud Westkapelle.

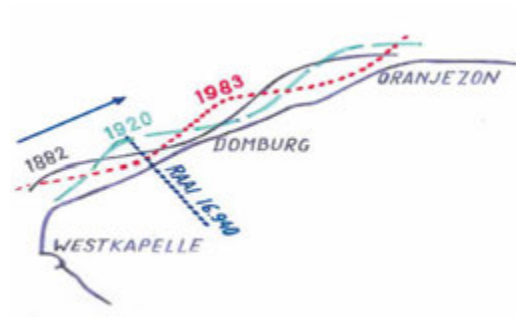

FIG. 4.13 The system of travelling sand banks along the Walcheren coast over time. This system alternates periods of accretion with periods of erosion. Source: Studio Coastal Quality / Rijkswaterstaat, 2012.



FIG. 4.14 The Manteling and Domburg in 1850. On the left, forestry as an ancient BwN method against erosive, transgressive dunes visible on the right. Source: Zeeuws archief / Zeeuws genootschap.



FIG. 4.15 The Manteling in the present day, hosting a beautiful landscape of dunes, forest and countryseats. Photo: J. van Bergen.

4.3.3 Coastal safety in Walcheren

The dynamic coastal system of Walcheren presents a number of challenges, including the consolidation of advancing tidal channels off Noord-Beveland and Westkapelle. Without corrective actions, these channels threaten the coastal safety and stability of the shore. Locally, erosion along the north coast of Walcheren narrowed the beaches to the extent that they were no longer suitable for recreation. Since the 1990s, the littoral strip has been nourished to prevent further erosion, and this has held the shoreline in place. At the moment, 12% of the Dutch national nourishment programme is implemented here, making Walcheren an intensive zone of nourishment. Most of the nourishments are beach nourishments in smaller volumes recurring every 4 years (Figure 4.16). They maintain the coastline but do not anticipate the need for increased dune formation as a storm erosion buffer in the long term.



FIG. 4.16 Mapping of the 2015 nourishment programme for Walcheren, supplying sediment to maintain the coastline. Adapted from Province of Zeeland (2017).



FIG. 4.17 Erosive dunes near Domburg around 1900, which were planted with Marram Grass for recovery. Source: Kooiman, M (2022)/ RCE / collective MK.

4.3.4 **Design study: an alternative BwN-based nourishment scenario for Walcheren**

In 2013, the long-term vision for the Dutch coast (Delta Programme Coast) was explored, notably via regional workshops with stakeholders (Hoekstra, van Bergen et al., 2013). It focussed on a nourishment strategy until 2100, with the optimization of social-economic and ecological functions. The study resulted in a regional seaward design for Walcheren that includes a BwN-based mega-nourishment, fine-tuned for functions along its route. The central notion in the proposed strategy is to project a mega-nourishment ($\sim 20 \text{ Mm}^3$) on the cape (Figure 4.18), the weakest point in the coastal defence, to employ the natural dynamics of sand waves in this area moving from west to east (Figure 4.13), distributing sediment eastwards along the shore. This intervention creates a temporary beach that could incentivize beach sports and recreation in this western (now seawall) area, with flexible recreational services to match its highly dynamic development. Temporary beach pavilions or a laguna for surfing are some examples (see Figure 4.24).

This mega-nourishment could then gradually feed the eastward beaches of Domburg, a historical seaside resort with a close connection to the sea. The gradual annual flow of sediment might offer a more stable beach and swimming environment suited for this historical family seaside resort.



FIG. 4.18 Mega-nourishment design for west Walcheren, covering the seawall of Westkapelle with a mega-nourishment feeding the waterfront of Domburg, and leaving dynamic dune fronts to support the ecology of the Manteling in the north. Source: Studio Coastal Quality, TUD (2013).

Differentiation of dune development

In the nourished zones, new dunes will start to form. The extensive beaches at the heart of the nourishment near Westkapelle are likely to develop new ridges of embryonic dunes, creating gradients and shelter for seabirds and flora, similar to the Sand Motor landscape (see Figure 4.24a &b).

Near Domburg, the nourished beach will remain modest (80–100 m in width) and could lead to new foredune growth (10–20 m³/y) as long as the beach is not urbanized. Since the waterfront of Domburg hosts beach cabins, it is recommended to only place cabins in foredune zones once the future storm erosion buffer has been established and adjust their typology to allow for sediment flow between the cabins (gaps > 3 times the building's width). Alternatively, they could be placed in slats facing the dominant SW wind direction (see Section 3.6 on dune widening).

Further to the north-east, the Manteling is known for its calcium-deficient grey dune habitats. These habitats benefit from erosive dune cliffs, which allow sediment to blow deeper into the dunes. Nourishments stimulate new foredune growth, that can obstructing sediment transport to the inner dunes. Therefore, in the regional design, nourishments in the eastern area could be reduced in favour of the grey dune habitats and increased sediment dynamics (blowouts) perpendicular to the coast (Figure 4.18). The dune zone here is wide enough to enable natural coastal erosion within the contours of coastal safety. Nature values are secured by zoning recreation to more central places, such as north of Domburg and along Veerse Dam.



Embryonal dune growth on the extended beach at the Sand Motor mega-nourishment, which could be similar for the concentrated mega-nourishment at Westkapelle.



The current beach profile of Domburg, which could be sustained by the nearby mega-nourishment feeding the shore with sediment. The current beach row housing is blocking sediment transport to the foredunes, retaining a steep coastal profile. The buildings' typology could be altered to allow for more sediment transport to pass through (e.g. wider gaps or diagonal slats).



Example of an erosive foredune with blowouts that guide sediment to the inner dunes to sustain the grey dune habitats.

FIG. 4.19 Samples of different dune types that could develop along the different zones of the BwN-based mega-nourishment in Walcheren. Images by the author.

Towards a BwN-based coastal landscape framework

The design study shows that an alternative mega-nourishment regime for west Walcheren can provide a sustainable perspective for coastal safety but may also induce a re-zoning of the whole coastal trajectory. The combination of the new sandy profile, improved beach width and a range of hydraulic and wind dynamics provides unique opportunities for the differentiation of specific coastal habitats, both urban and ecological, as part of a larger landscape framework or 'casco'-concept (Figures 4.20-4.22)

Morphology: The BwN-based mega-nourishment strategy can be divided in three characteristic zones: a highly dynamic 'core' of the nourishment, with extensive beaches and new dune formation; a medium dynamic 'tail', with more stable beach conditions and foredune growth; and an erosive part, where nourishment is reduced in favour of an erosive dune profile for sediment transport inland (Figure 4.20).

Urbanism: The new (mega-)nourishment regime has two major urban benefits. First, it transforms the current seawall of Westkapelle back into a beach dune system featuring a large range of nature, sports and other recreational facilities. This is likely to attract new urban-waterfront development that could be concentrated at the middle of the nourishment, where beaches are wide. This may have a more temporal character (e.g. seasonal buildings) to anticipate the erosive aspect of the mega-nourishment (Figure 4.21). Second, the nourishment provides more stable and accreting conditions for the historic waterfront of Domburg. Here, the current steep profile may be redeveloped in a seaward terrace-shaped profile, combining the build-up of the future coastal buffer with recreational facilities (see also the case study on the waterfront of Petten in Section 4.4.7).

Ecology: The new sediment dynamics created provide conditions for natural succession. At the core and flanks of the mega-nourishment, this could trigger new embryonic dune growth on the beach. In the midsection, foredune growth can be expected as long as closed beach row housing is reduced. This seaward extension of the coastal profile could act as an eco-corridor between Domburg and Westkapelle, in combination with inland nature development (comparable to the Manteling). In the northern erosive part, sediment transport via blowouts sustains the low-dynamism grey dune habitats. The inward extension of sediment dynamics can lead to an increase in gradients in the coastal profile (Figure 4.22).

With the combination of the three system dynamics, a coastal landscape framework or 'casco' can be composed, alternating between high dynamics (nourishment, urban development) and low dynamics (nature). Here, the new nourishment conditions alter the spatial framework, combining waterfront dynamics with inland corridors for sustainable coastal development.

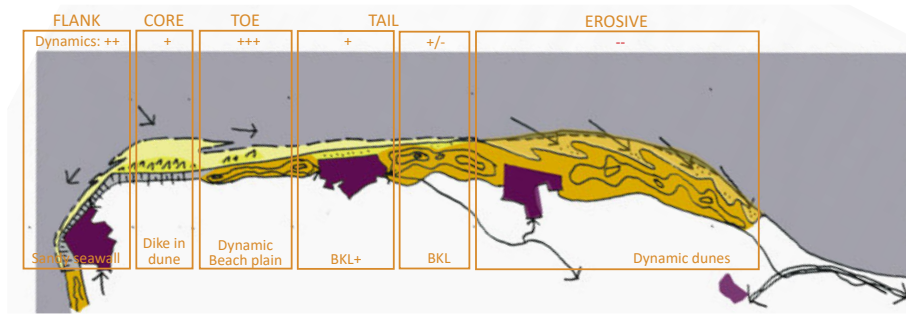

FIG. 4.20 Geomorphological system: mega-nourishment zones and corresponding dynamics. Image by the author.

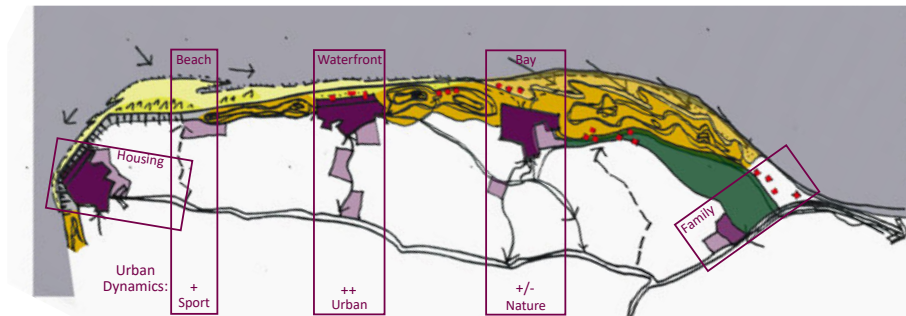

FIG. 4.21 Urban system: corridor development in response to new coastal conditions and dynamics. The inland perpendicular corridors (as opposed to linear) offer a no-regret option for a retreat strategy in case of a high sea-level rise. Image by the author.

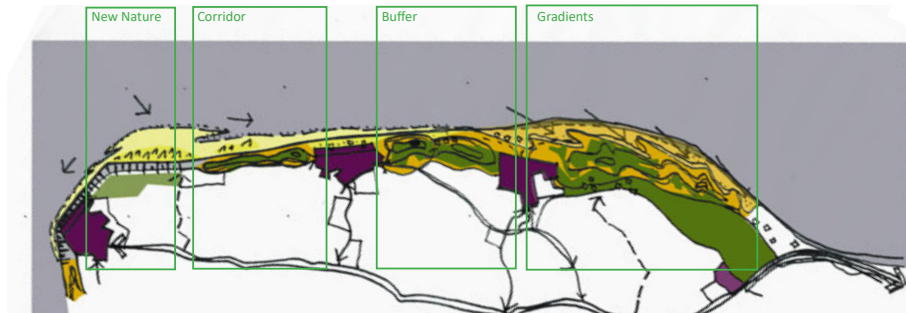

FIG. 4.22 Ecological system: natural succession in response to varying conditions and sediment dynamics from the nourishment and erosion. Image by the author.

4.3.5 Findings: integral design optimizing BwN-based nourishment for coastal functions

The regional design for Walcheren illustrates how BwN-design can offer opportunities for more efficient coastal nourishment by making maximum use of natural dynamics. Furthermore, it shows how the different stages of development of the nourishment can be fine-tuned with other regional coastal programmes (urban, ecological) to reach an optimum in functional use. The fine-tuning is based on the desired coastal profile, the amount of dynamics and trajectory development over time and is planned in three optimized zones: a highly dynamic extended zone at the head of the nourishment, a gradually fed, more stable mid-section supporting the waterfront functions, and an erosive part where nourishment is reduced to support inland dune habitats. The sequential design and zoning are steppingstones for integrated regional planning of BwN mega-nourishments at urbanized shores. They allow for more dynamics (seaward/landward) in rural or ecological areas whilst offering more stable beach conditions in urban areas.

This integrated and participatory design study, in which the joint planning is greater than the sum of its separate components, has proven its value during the later reassessment of the nourishment strategy for the isles of Zeeland. It gave, for example, incentive to the transfer of a planned beach nourishment at the cape of Schouwen (2015, north of Walcheren) to Brouwersdam in favour of the dynamic grey dune ecology and landscape.



FIG. 4.23 Design study phase 0: the current seawall of Westkapelle - Domburg before BwN reinforcement.
Photo: © Rijkswaterstaat / Rens Jacobs.



Design study phase 1: visualisation of a BwN-based mega-nourishment and new dune massive replacing the sea wall of Walcheren, with opportunities for beach recreation.



Design study phase 2: Visualisation of the progressing mega-nourishment with dune growth as coastal buffer, eco-corridor and new green waterfront.

FIG. 4.24 Visualizations of the transition of the Westkapelle seawall into a mega-nourishment with dune formation. Source: J. van Bergen. Visualisations: OKRA landscape architects.

4.4 Petten: BwN prospects after sandy reinforcement

4.4.1 Introduction



FIG. 4.25 The coast of Petten as a seawall (1980).
Source: © Rijkswaterstaat.



FIG. 4.26 The coast of Petten after sandy reinforcement (2018), including a new 60 m-wide dune system.
Source: J. van Bergen.

The Hondsbossche and Pettemer sea defence is a 5 km-long reinforced coast in the north of Holland. Due to coastal erosion, the original dune system gradually diminished and was reinforced from the 1500s onwards (Figure 4.27). In 2015, the massive seawall (Figure 4.25) was replaced by a 35 Mm³ sandy reinforcement, restoring the sandy shoreline and reintroducing a beach and dune system. This transition generated multiple advantages for sustainable coastal safety, nature and leisure (Figure 4.26). Furthermore, GIS analysis of the dune formation following sandy reinforcement opened up new prospects to enhance BwN ashore, as elaborated in the design studies.

The case study was performed in two steps. First, the morphogenesis of the coast of Petten was mapped to understand how the coastal systems have evolved and interacted over time. Furthermore, a GIS inquiry was conducted on the recent evolution of the coastal profile after reinforcement to identify spatiotemporal optimizations for dune formation in profile and local arrangements.

The GIS findings were applied in three design studies on BwN-based coastal profile alterations for Petten to increase benefits for coastal functions such as future safety, sustainable recreation and ecology. Aeolian design principles including fencing and new building typologies were applied to enable the BwN profile build-up over time.



FIG. 4.27 Morphogenesis of the coast of Petten from an open tidal inlet system (1350, left) into a closed seawall (1850). In 2015, the seawall was replaced with a mega-nourishment, re-engineering the defence line back to the sandy system of before 1730. Images by the author, adapted from H. van Zijl.

4.4.2 Morphogenesis and profile evolution of the Hondsbossche and Pettemer seawall

Historical morphogenesis

Petten is situated in North Holland and was traditionally part of the cape around Texel (see Figure 3.38, Sub-Section 3.5.1). Since the Middle Ages, the cape has been subject to coastal erosion and was perforated by the sea, which reshaped the coast into a series of tidal inlets, including the Zijpe north of Petten. (ca. 1350; see Figure 4.27a). Since then, progressive coastal erosion (~ 110 m/century) eroded away most of the dune massive. The eroded sediment was transported northward by coastal drift to fill out the tidal inlet and beach plain north of Petten. There, new dune ridges formed, which were later used as a base for the embankment. Still, the village of Petten was lost to sea twice and relocated inland (see Figure 4.28c, in purple).

From 1500 onwards, coastal reinforcement took place to combat erosion with a series of (retreating) seawalls and pole structures (see Figures 4.27b–e), ending in a 5 km-long continuous seawall from 1850 onwards. The last reinforcement took place in 1981 when the crown of the dike was raised to +11.5 m NAP as part of the Dutch Delta works.

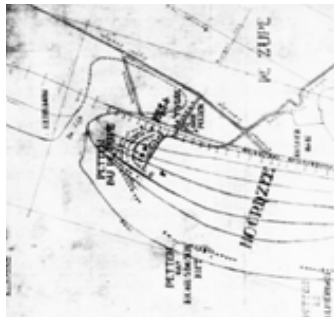

a) The positioning of the village of Petten on the higher (parabolic) dunes near the mouth of the Zijpe, including retreating coastlines since 1350.



b) The village of Petten around 1552 by Jan van Scorel, with pole construction as the last sea defence.

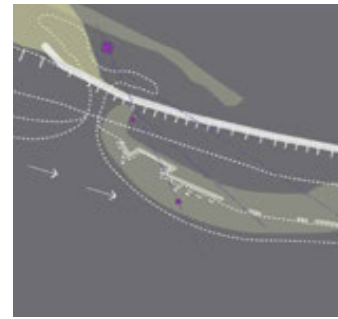

c) Temporal mapping of the shoreline dynamics around Petten since 1350, including the coastal drift, dune formation and the retreat of the village of Petten due to coastal erosion, in purple.

FIG. 4.28 Cultural syntaxis of Petten. Sources: Beeldbank Zijper Museum (a, b) and Image by the author (c).

Sandy evolution following sandy reinforcement (2015–2020)

In 2015, the seawall of Petten was replaced with a sandy reinforcement of 35 Mm³ of sand over 5 km of shoreline, for a lifespan of 20 years. This meant a paradigm shift from hard to soft solutions for Petten and a seaward extension back to the 1730 shoreline. A new beach-dune system was created, divided into five coastal profiles, with beaches varying from 150–250 m and a 60 m-wide dune barrier (see Figure 4.39). It also included two urban beach access points and a humid dune slack in the middle as an ecological habitat.

Since construction, the sandy reinforcement has eroded due to the northward coastal drift and the compressed flows around the edges of the nourishment. These have reduced the corner beaches by more than half (from 120 m to 60 m in 5 years), and in 2018, an additional beach nourishment became necessary at the south edge. Remarkably, most of the touristic programme, which includes beach housing and pavilions, has been planned on these cornering erosive beaches as an extension of the existing villages inland. Plans for an extra 80 beach holiday homes were cancelled for the protection of (inland) nature values.

In terms of ecological development, the sandy reinforcement has created a wide range of embryonal and white dune growth due to the high sediment transport rates. This transport has also filled in some of the constructed dune slack in the middle, which struggled to develop due to restricted seed transport (Ecoshape, 2019). At the same time, the inner grey dunes (featuring planted sea buckhorn) suffered from drought and limited sand supply (Ecoshape, 2019).



June 2015



April 2018



September 2020

FIG. 4.29 Aerial photographs of the Hondsbossche dunes in June 2015, April 2018 and September 2020, showing the gradual decline in beach width due to coastal erosion, especially on the cornering beaches. Source: Google Earth pro.

Profiling: natural dune development (2015–2020)

Since the sandy reinforcement in 2015, part of the nourished sediment is transported by the southwest winds towards the dunes, initially estimated at $25 \text{ m}^3/\text{m}/\text{y}$. Ecoshape (2019) monitored an average dune growth of $33 \text{ m}^3/\text{m}/\text{y}$ (+3 NAP) for 2015–2018, with most of the accumulation occurring at the seaward stoss slope (70%) and crest of the dunes (25–30%) (Ecoshape, 2019, 2021). However, GIS sections for the period 2015–2020 (Figure 4.31) show that this dune growth only reached $14\text{--}22 \text{ m}^3/\text{m}/\text{y}$ at the cornering profiles (2N and 2S), while the mid-profiles (3 and 4) performed above average in terms of dune formation ($+38\text{--}61 \text{ m}^3/\text{m}/\text{y}$; see Figure 4.31, middle). These results reveal a clear difference in the accretion of profiles 1 and 2 versus 3 and 4 given the same sandy reinforcement and wind climate. The differences in accretion are partly caused by the initial profile design and by varying shoreline erosion rates. Furthermore, the steep stoss slopes of profiles 2N and 2S were initially designed to stop inland sediment transport, limiting accommodation space for foredune growth. In contrast, the higher deposition of the ‘stepped’ profiles 3 and 4 could be explained by the combination of stable wide beaches, the stepped gradual stoss slopes and the use of brushwood fences. These success factors may be relevant for other profiles to improve their BwN dune development.

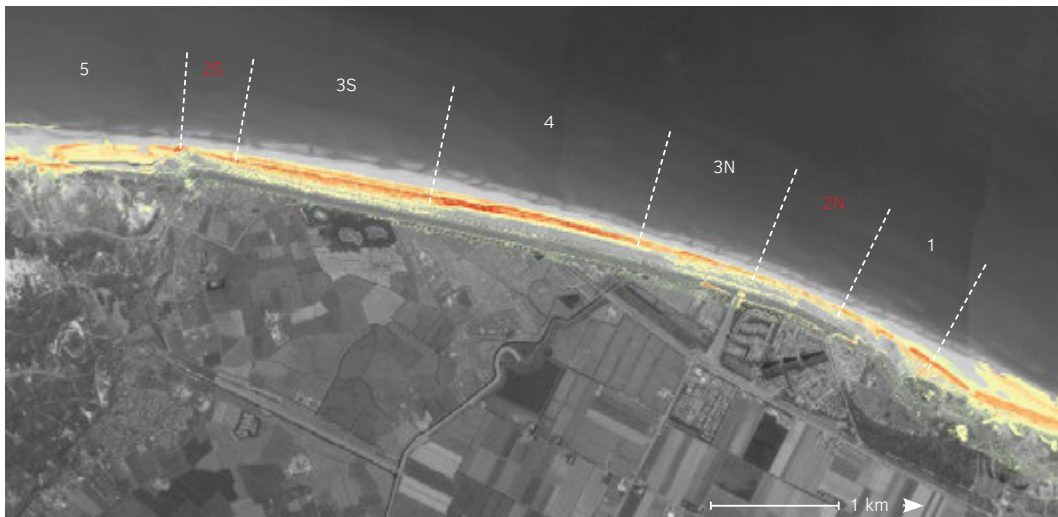

FIG. 4.30 GIS-mapping (DEM) of the dune development at the Hondsbosche dunes, including sections (Figure 4.31). The midsection (profiles 4 and 3S) exhibits the highest dune-growth rates (orange and red), whilst the dune formation at the cornering beaches (2S and 2N, in red) has lagged behind. Image by the author.

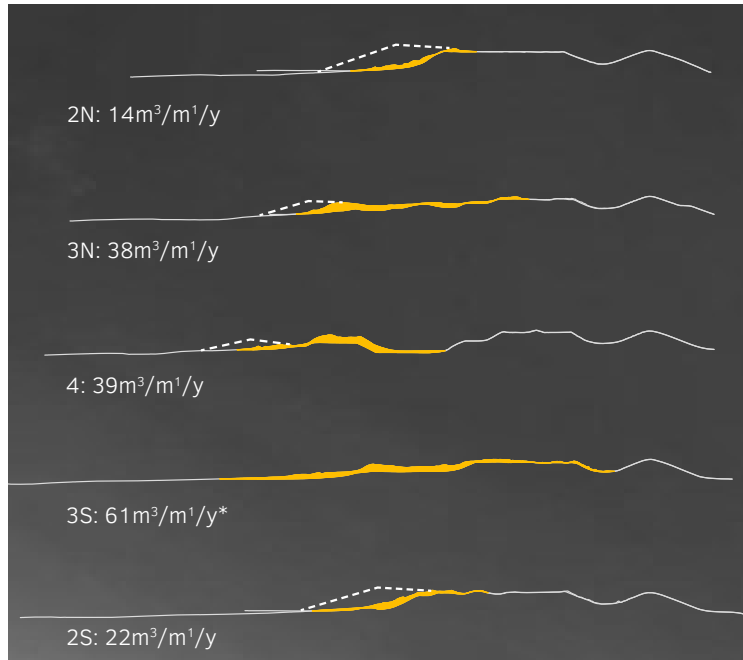

FIG. 4.31 GIS-sections of the dune development per profile type (2, 3 and 4), including volumes accumulated in the first 5 years (2015–2020). Images by the author; Lidar data courtesy of HHNK.

*The expected sand deposition rate was $25 \text{ m}^3/\text{m}^1/\text{y}$ (Ecoshape, 2019). The cornering profiles produced less, and the mid-profiles far exceeded this estimate. Dotted, the projection of the remaining volume needed for the future safety profile in 2065 (+250m³, anticipating to a sea-level rise of 85 cm by 2100). *: Profile 3S was renourished in 2018.*

Future profiles: demands and dynamics

Extrapolating the current sedimentation rates at Petten provides a prognosis of future profile development for the remaining 15 years and beyond. According to Ecoshape (2019), the accretion rate 3 years after reinforcement will decline to around $10 \text{ m}^3/\text{m}/\text{y}$, in line with the Holland coast's average. Based on the recorded profile performance in GIS, this rate may be higher ($25\text{--}35 \text{ m}^3/\text{m}/\text{y}$) for the more stable mid-profiles 3 and 4.

To maintain coastal safety for 50 years (2015–2065) with a sea-level rise scenario of $+0.45 \text{ m}/50\text{y}$, an additional dune volume of $+200\text{--}300 \text{ m}^3/\text{m}$ is needed, corresponding to a minimum accretion rate of $4\text{--}6 \text{ m}^3/\text{m}/\text{y}$ (Ecoshape, 2019). This volume becomes most effective when applied to the foredunes as a storm erosion barrier.

With a current transport rate of $+35 \text{ m}^3/\text{m}/\text{y}$, this volume can easily be reached in 7 years ($250/35 = 7.1$ years) in profiles 3 and 4. For the steep erosive corner beaches (profiles 1 and 2), this will be more difficult to achieve as it will require 25 years ($250/10 = 25$ years), exceeding the timeframe of the current reinforcement. Furthermore, the narrow beach and steep stoss slope make it harder to accommodate this extra dune growth.

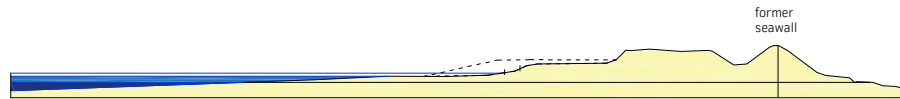

FIG. 4.32 Section of profile 3-south, north of Camperduin (height x2), with the initial nourished profile and the 250 m^3 coastal buffer (dotted) required to maintain safety from 2065 onwards. On the right-hand side, the former seawall profile. Image by the author.

4.4.3 Profile development: fencing and beach housing

Fencing

To study the shoreline and dune evolution and the effect of fencing, a close-up GIS study was conducted on the foredune development north of Camperduin. Here, 1 m-high brushwood fencing turned out to be successful in expanding the dune profile. Especially in profiles 3 and 4, where progressive fencing was applied, considerable dune growth was achieved, accumulating a new foredune ridge of $\sim 20 \text{ m}^3/\text{m}$ in the first year, exceeding burial rates for marram grass ($> 1 \text{ m}$). In 2016 and 2017, the buried fences were replaced by new screens (5 m seaward), which brought the total extension of the foredunes to $\sim 25 \text{ m}$ in width and $\sim 2.5 \text{ m}$ in height over 5 years (Figure 4.33). However, a follow-up GIS study showed that over time, when transport rates declined, adjacent vegetation became more effective in dune heightening (see Figure 4.33, years 2016–2017 in yellow and 2018–2020 in white). Therefore, a combination of fences (transition phase) and planting (stabilization phase) is preferable. This is in line with the literature, notably the *Handbuch des Deutsches Dunesbau* (1900; see Section 3.6, principles W1 and W2), which promotes such a combination of fencing and planting for rapid dune farming to reshape the coastal profile in the first years after reinforcement.

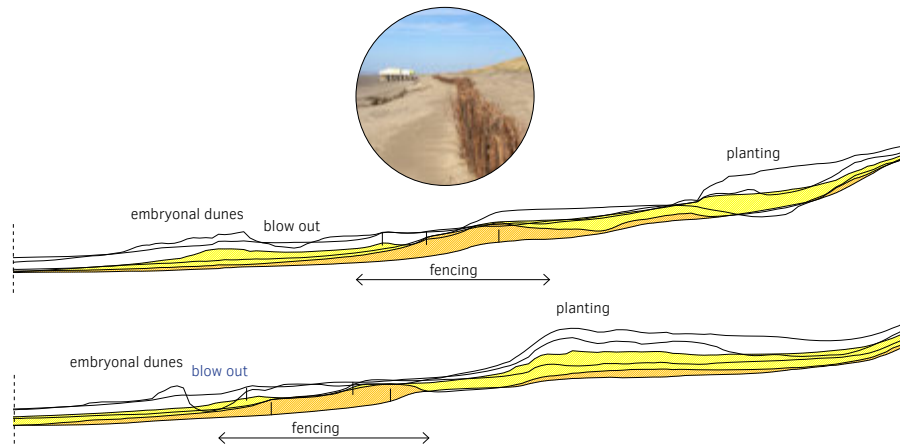

FIG. 4.33 Photo and GIS sections (2015–2020) of foredune development at Camperduin. Images by the author.

Top: GIS section of profile 2 South (Camperduin-north) as a sequence of single 1 m-high brushwood screens. Below: GIS section (2015–2020) at profile 3 South (Camperduin-north) as a sequence of double 1 m-high brushwood screens. The screens accumulated an extra foredune ridge of $\sim 20 \text{ m}^3/\text{m}$ in the first year (2015–2016 in orange, transition phase). In the second and third year, vegetation in front and planting behind the screens took over in terms of deposition (2016–2018 in yellow, stabilization phase). In white, the final years (2019–2020), which created blowouts in the lee fencing zone without vegetation.

Effects of beach housing at Camperduin

A close-up GIS study of the urbanized profile development at Camperduin showed that beach row housing has a negative effect on the dune formation process. At Camperduin, a seasonal 100 m row of beach housing reduced the sand flux to the dunes by 50% compared to the unbuilt profile (see Figures 4.34 and 4.35 and Section 3.4) even in a highly nourished context, where the sediment transport rates are four times higher than normal ($45 \text{ m}^3/\text{m}/\text{y}$). Possible causes are the mechanical removal of sand and the blocking of aeolian sand transport to the inner dunes by the closed row, with only 1.8 m gaps between the houses. Due to this decline in dune growth, beach row housing should be avoided on high erosive stretches with a safety profile requirement, such as the Petten profiles 2N and 2S.

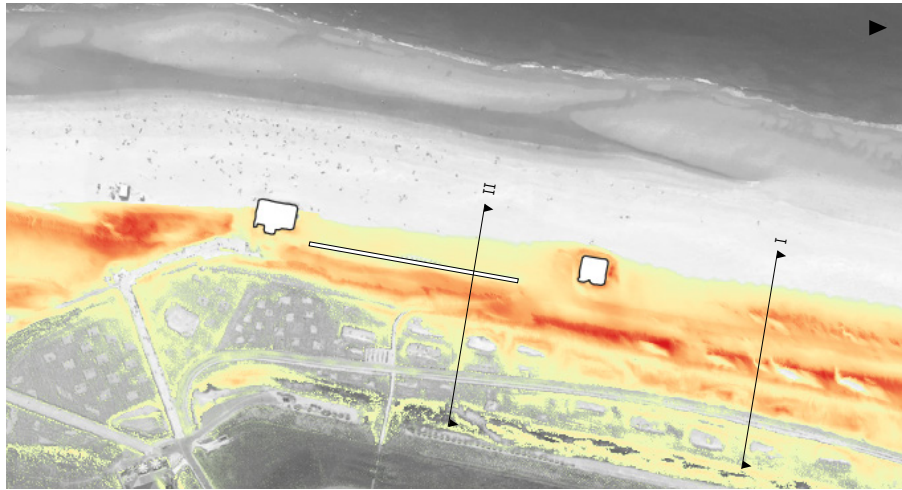

FIG. 4.34 GIS mapping of beach housing at Camperduin showing the difference in height after 5 years (2015–2020). Source: J. van Bergen.

The absence of upper dune transport and incipient dune formation near the pavilions and row housing are clearly visible. Due to 1.8 m gaps between the houses, some short inner tails are produced and deposited against the fences behind the row (red double lines).

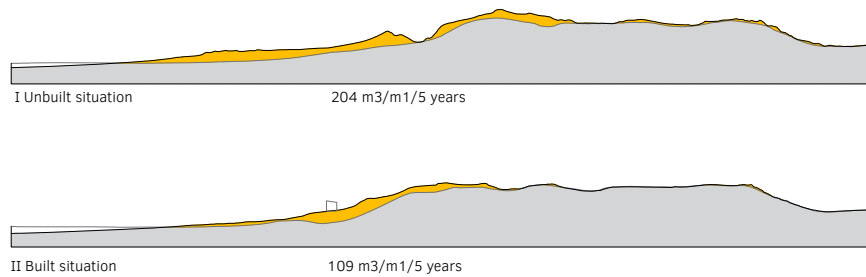

FIG. 4.35 Two GIS sections of the dune growth at Camperduin in the first 5 years after the sandy reinforcement (2015–2020, below). The row housing (section below) reduced accretion by 50% compared to the unbuilt situation. Source: J. van Bergen.

4.4.4 Design studies Petten

The GIS studies of the 5-year evolution of the sandy reinforcement in Petten (2015–2020) have revealed that depending on the morphogenesis, profiling and local spatial arrangements, considerable dune development can be achieved that exceeds natural rates ($> 35 \text{ m}^3/\text{m}/\text{y}$). These success factors were transferred to redesigns of the Petten sandy reinforcement maximizing the BwN dune development for coastal safety and multiple functions. All take advantage of the crucial first years after reinforcement, when sediment transport rates are high and use fencing to articulate the coastal profile. The design studies zoomed in on three areas:

- The reshaping of the contours of the wider profile 3S Camperduin-north to facilitate beach recreation, in addition to safety.
- Beach ridge development at the wider midprofile 4 to support dune habitats, in addition to safety.
- The adjustment of the narrow erosive profile type 2 at Petten village to meet future safety standards and support an urban waterfront.

In these design studies, the initial sandy reinforcement design and constructed profiles were taken as a given. In this context, we maximized BwN dune formation and landscaping by relocating sediment to the assigned places. This is done via dynamic profiling through fencing and planting, combined with aeolian building typologies to reduce their negative impact. These design principles articulate the profile for safety and the hosting of other coastal functions, such as ecology and recreation.

4.4.5 Design study 1: BwN for safety and recreation in the wide accreting profiles at Camperduin-north

Rapid profiling in the first years after reinforcement

Profile 3 south of the Hondsbossche dunes features a stable wide beach north of Camperduin. Since sediment transport in this profile is abundant (up to $60 \text{ m}^3/\text{y}$), the required future safety profile of $+250 \text{ m}^3$ by 2065 can be reached within 5 to 10 years by placing brushwood fences in the dune-foot zone, accompanied by planting. Once the safety profile in the foredunes is achieved, the surplus of sediment can be allocated to expand the foredunes for other coastal functions, such as recreation and nature conservation.

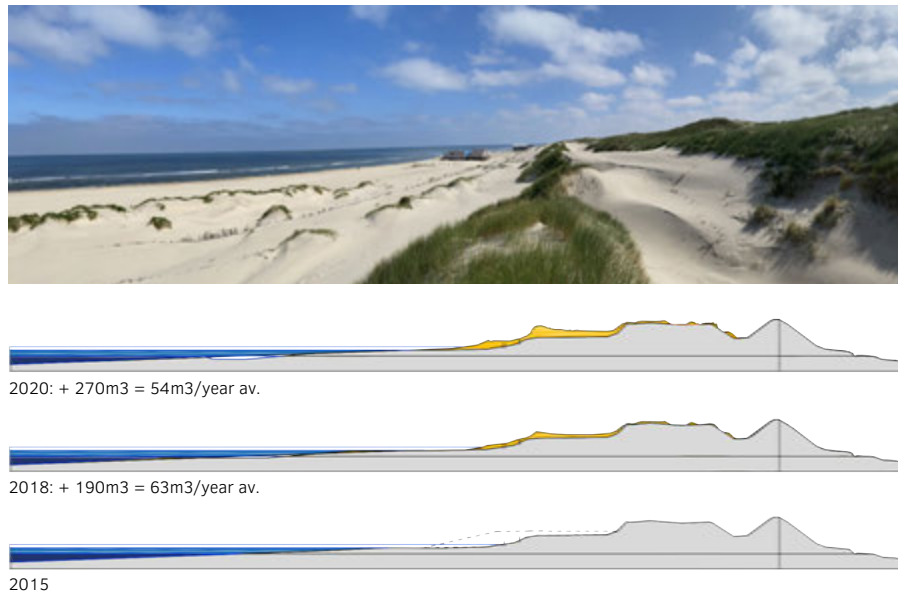

FIG. 4.36 Photo (2021, top) and GIS sections (2015-2020, below) of the current profile development 3 South, featuring the initial profile (2015, including the future safety profile of 250 m^3 , dotted) and GIS sections after 3 (middle) and 5 years (top, all height $\times 2$). Source: J. van Bergen.

In orange, the natural sand deposition at the dune foot resulting from fencing, followed by foredune heightening via vegetation in front and behind the fences (2020). The application of the fences accumulated an additional $\sim 20 \text{ m}^3/\text{y}$ in the first 3 years (new foredune ridge). From 2015 -2020 a total of 270 m^3 of sediment accreted in the foredunes, enough to complete the future safety buffer of 250 m^3 for 2065.

Urban profiling: secluded recreational terraces

Since the start of the reinforcement, the regional ambition was to create 80 holiday houses at the Hondsbossche dunes. Rather than planning them at the erosive corner beaches, they could be integrated into the wider dune landscape of the more stable mid-profiles (3S) as part of a 'nature' resort. This location provides enough sediment for safety and beach width for landscaping to create a more spatial and secluded setting for the beach housing.

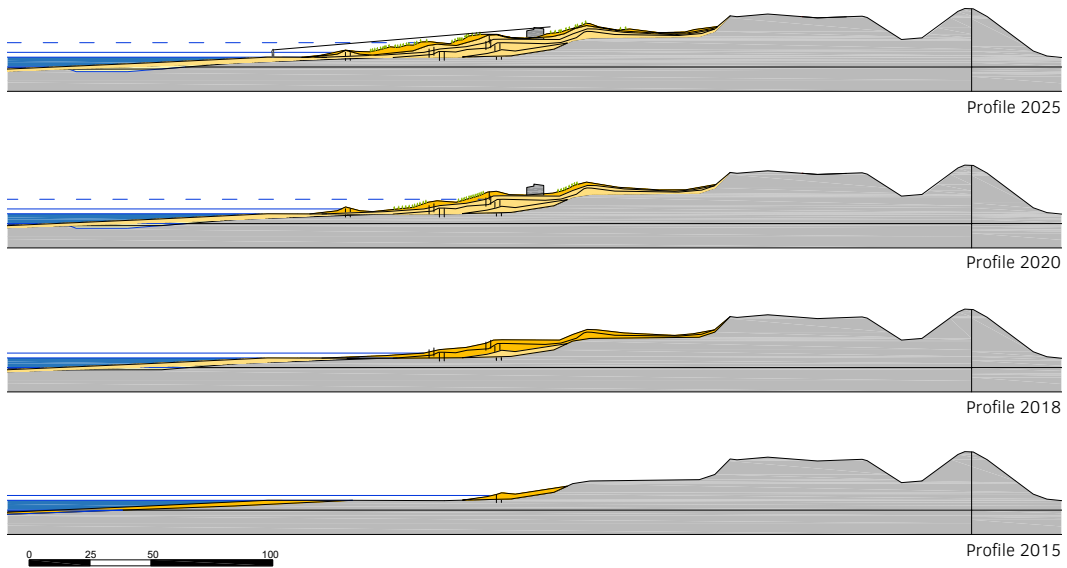

FIG. 4.37 Improved temporal sections of the waterfront of Camperduin (height x2). Images by the author.

First, the future safety volume (250 m^3) is achieved via dynamic fencing in the dune-foot zone (around 4–5 years, 2020; deposition of $\sim 60 \text{ m}^3/\text{m}/\text{y}$). Second, fencing is continued to modify the coastal profile for multifunctionality (deposition declining from ~ 40 to $\sim 15 \text{ m}^3/\text{m}/\text{y}$). Terraces and canyons could be created in the extended foredunes to accommodate beach housing as a secluded resort, where the tails facilitate dune or terrace heightening. In the later years, when sediment transport is reduced, planting (eco-trapping) is employed for foredune heightening.

First, the safety profile of $250 \text{ m}^3/\text{m}$ is established by foredune extension through dynamic fencing over 4 to 5 years ($\sim 60 \text{ m}^3/\text{year}$, derived from GIS-analysis, see Figure 4.36). The fences are directed towards the dominant SW wind to maximize wind deceleration and deposition, creating sawtooth-shaped terraces. In time, deposition around these progressive fences builds up to a flood-proof terrace at a +5 m NAP level (Figure 4.37- profiles 2018 & 2020). On top, a row of fences could be placed to create a wind barrier for the upper terrace, later planted for stabilization. Behind this barrier, beach houses can be placed in a secluded, more private setting, promoting foredune and terrace heightening. The houses/pavilions can be positioned on small poles (to prevent local erosion) turned towards the dominant wind to produce short sand tails for foredune heightening; and with gaps of > 2 times the building's width (Figure 4.37- top profile 2025).

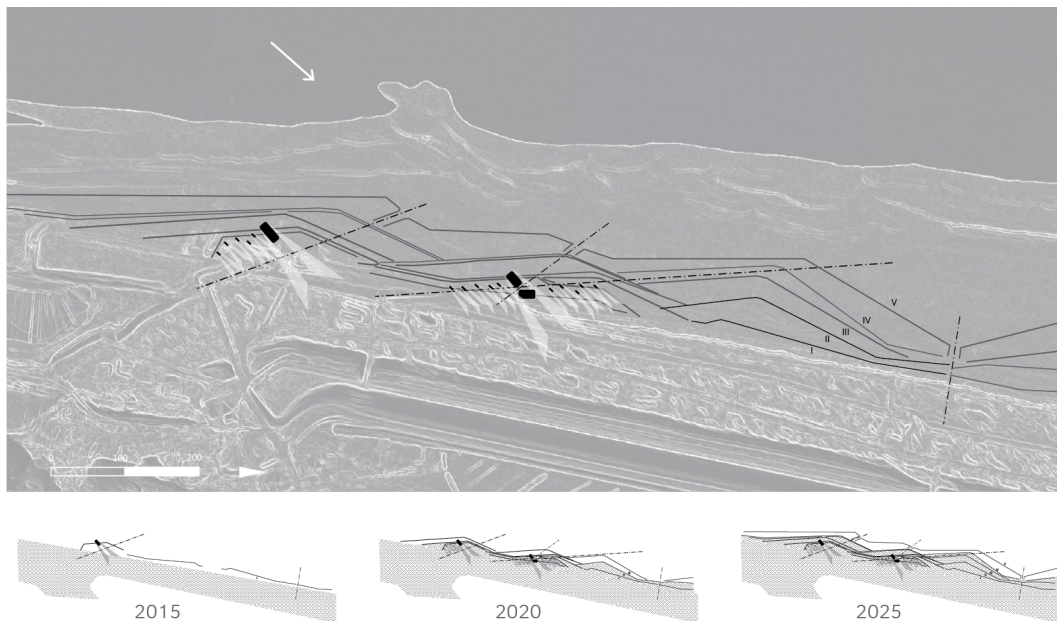

FIG. 4.38 Plan (a, top) and temporal schemes (b, below) for the urban development of the coastal profile at Camperduin (3 South), corresponding to the sections in Figure 4.37. Images by the author, estimated dune development derived from GIS analysis (see Figure 4.36).

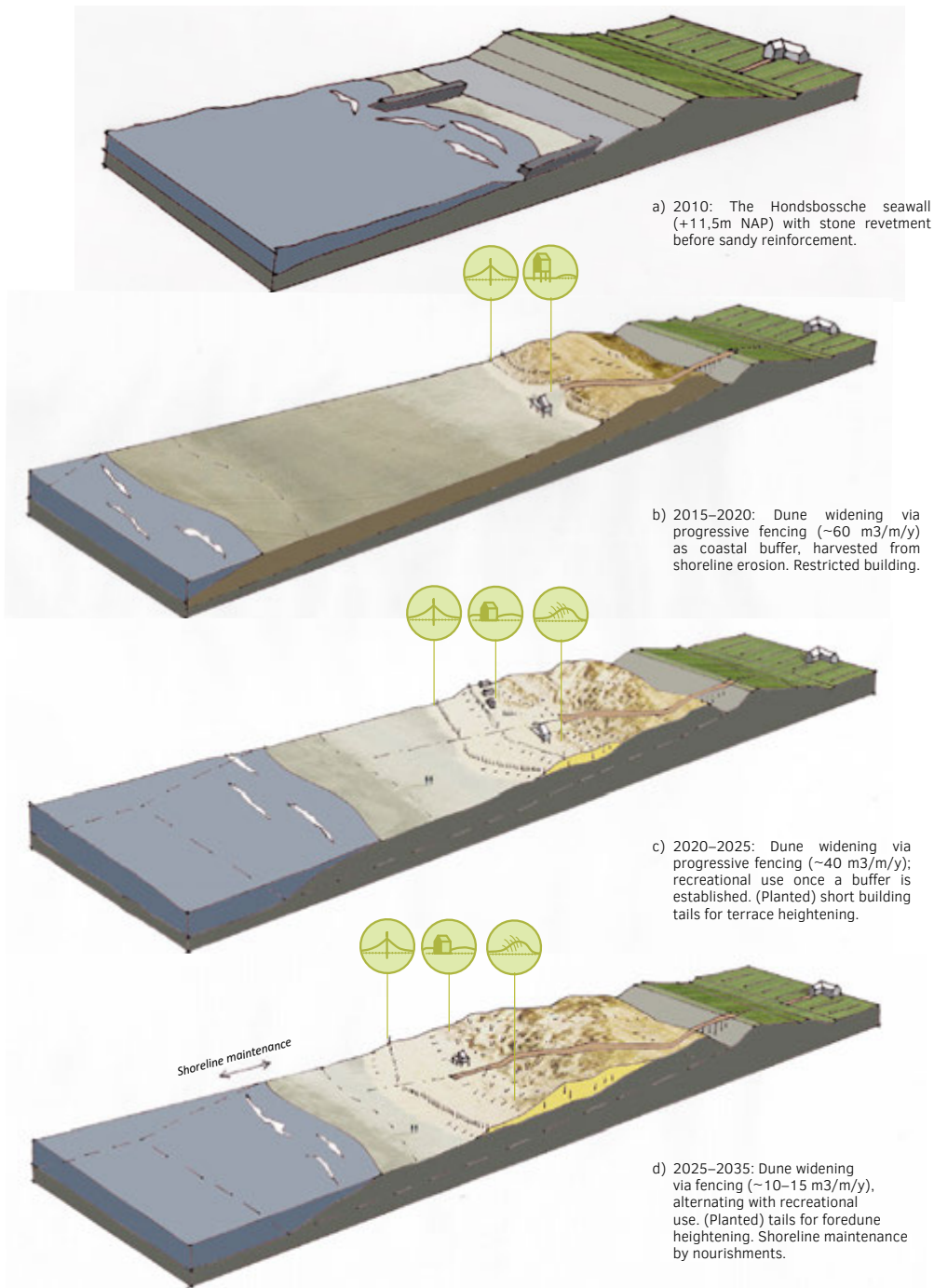

FIG. 4.39 Sequential dynamic profile design (3s) for dune widening at Camperduin. Images by the author.

4.4.6 **Design study 2: ecological profiling and dune-slack development**

Besides foredune formation, dynamic fencing can also be employed at the beach plain to create new beach ridges, as flood barrier against storm erosion for example. It could also advance the process of natural succession, such as the creation of humid dune slacks (habitat type H2190) on higher, protected parts of the beach. This type of habitat may be reintroduced in sections of accreting, nourished shorelines and could evolve from an 'outer dune' beach plain via a secluded green beach and to a freshwater dune valley (Hoekstra & Pedroli, 1992; Schotman, 2012). The real-time reference is the beach of West Vlieland, where a humid dune slack was established on a wide beach 200 m from the surf zone after a process of beach-ridge formation over 8 years (2014–2022, see Figure 4.41). From this example three stages of ecological formation were derived that could be accelerated by BwN ('bio-mimicry'). In advance, the future coastal buffer is established by dynamic fencing in the first years after nourishment, when sediment transport is abundant ($\sim 60 \text{ m}^3/\text{m}/\text{y}$). To start the dune slack development, a sand barrier is created by fencing facing the dominant SW and NW wind, to shelter part of the beach. This new dune row induced by the fences reduces tidal flow to peak events only (possibly combined with the lowering of the beach towards the fresh groundwater level). This will prepare the soil to receive clay substrate necessary for freshwater collection. During this (unvegetated) phase, the dominant SW wind can also reform some of the sediment deposited. The second step is to dam up the inlet by fencing for a less saline environment to develop, as the start of the dune slack development. The third and final step is the development of the humid dune slack vegetation by natural succession related to the rainwater collection in the clay basin created.

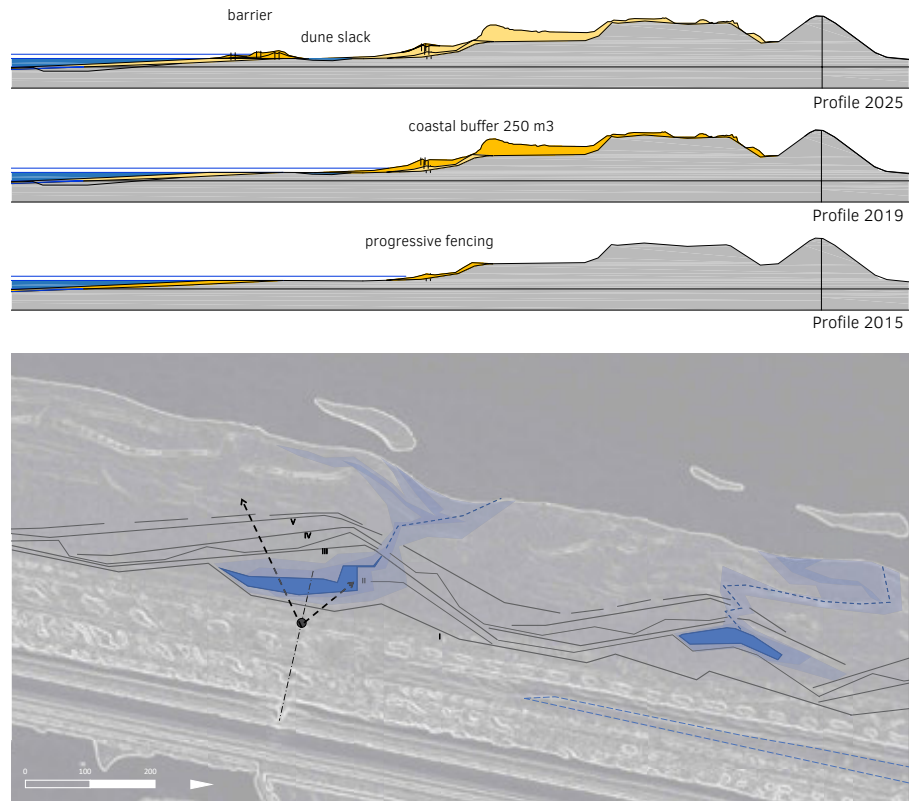

FIG. 4.40 Sections (top) and plan (below) of the sequence of fences, widening the coastal profile to include a small dune slack, dammed up from the sea. Images by the author, dune development from GIS.

In this way, the natural ecological development of humid dune slacks can be promoted and possibly accelerated as a valuable habitat for coastal nature development. Because the placement of fencing is sequential, most of the (inner) fences as drawn will not be visible in the landscape but will be buried in the earlier stages and replaced by (enhanced) dune-ridge development (see also Figure 4.39).



FIG. 4.41 Photograph of dune slack development at the Vliehors on the island of Vlieland, NL (2021). In 8 year time (2014-2022), new beach ridges were formed (foreground), sheltering off part of the beach where humid (fresh-water) dune slacks developed afterwards. Image by the author.

4.4.7 **Design study 3: BwN dune formation in the narrow urbanized profile of Petten beach**

In this design study the narrow erosive profile type 2N at Petten village is adapted by BwN measures to meet future safety standards and support the development of an urban waterfront.

Morphogenesis

The (former) village of Petten was situated at the Zijpe, a tidal inlet that was reclaimed in the period 1550–1575. Due to sea-level rise and also, possibly, this reclamation, the south cape of the inlet progressively eroded (see white lines in Figure 4.42).

To stabilize the remaining dunes and shore and reclaim the last remains of the Zijpener Gat (inlet), a series of dikes were constructed, which are still visible today (black dotted lines in Figure 4.42). Because of the coastal erosion of the cape, the village of Petten was relocated several times, including a half-circular setup facing the Zijpe inlet (around 1600–1700), with built terraces (see Figure 4.28a).

The current village was planned in the polders of the former inlet and has therefore been detached from the shore. At the moment (2020), Petten features a narrow beach and a steep foredune to prevent sediment from being blown inland (see the existing profile in Figure 4.44a).

Design strategy

In this design study, the dune profile of Petten beach is reshaped to a) enhance the aeolian build-up of the future safety profile; and (b) to create a more gradual, terraced profile through brushwood fencing. Once this safety profile is achieved (see Figure 4.44b) the terraces can be extended and consolidated for recreational use to establish a new waterfront for the village of Petten, restoring its historical relationship with the sea (see Figure 4.44c). In line with the former cape, the dune foot is extended seaward to accommodate the terraces while re-establishing the cape as part of the identity of Petten (spatial value V4: coastal differentiation). This contouring is established by using dynamic fences to stimulate accretion in the transition phase directly after the sandy reinforcement, when sediment transport rates are high. These fences partly overlap with the initial dunes to create a gradual slope and accommodation space for the aeolian build-up of the foredunes.

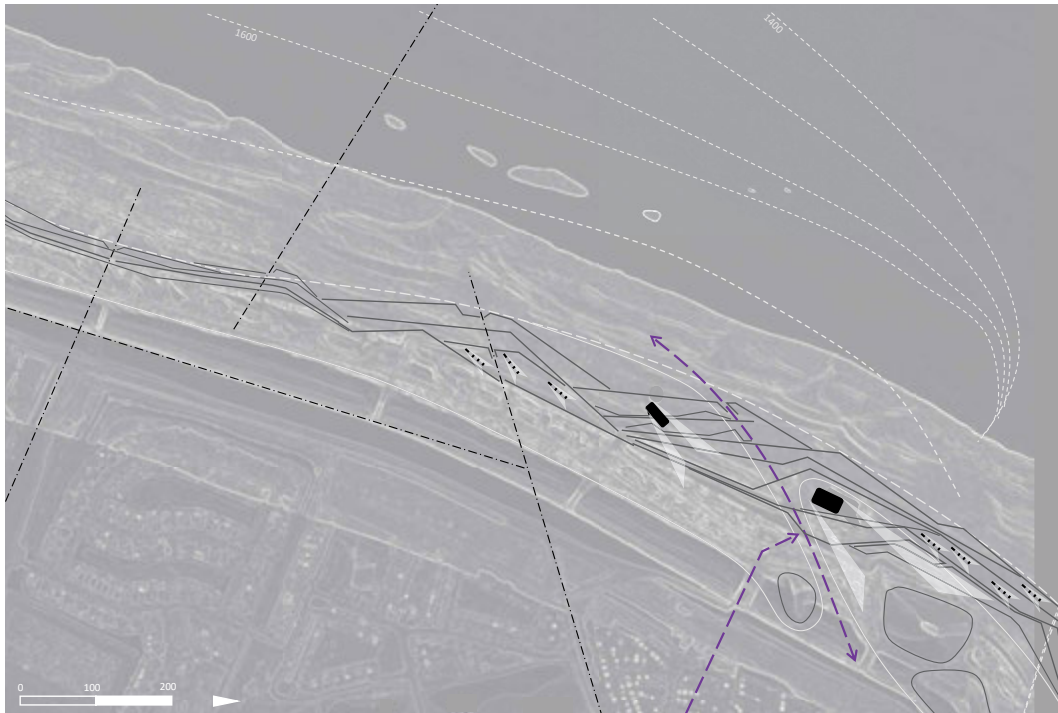

FIG. 4.42 Sketch plan of the BwN-based terraced design for the beach front of Petten. Image by the author, dune development derived from GIS.

The initial, steep foredune profile has been extended via dynamic fencing, creating terraces to accommodate the volume of 250 m³ to guarantee safety until 2065 (sea-level rise of 85 cm by 2100). Once this volume is achieved, further landscaping can take place through fencing to heighten the terraces for urban development (e.g. beach housing). Regular maintenance nourishments from 2023 onwards should guarantee the beach's function as a storm buffer and fetch for aeolian transport.

In the plan (Figure 4.42), the former dike-defence lines have been used as anchor and access points for the sawtooth-shaped fencing design facing the dominant SW and NW winds. A match with the existing dune scape, with higher dune tops and a viewing dune, is made to construct a scenic entry route for Petten Beach (Figure 4.42, purple lines), with the terraces unfolding as large steps towards the beach (V4- sequence of spaces, see also Figure 4.46). On these terraces, two pavilions are placed that mark and facilitate the beach entrance. Their tail development contributes to the further build-up of the terraces. In the last stage 20-30 seasonal houses could be added to the top terraces in a diagonal or 'slat' formation pointed towards the dominant SW wind, producing short tails for terrace- and foredune heightening.



Waterfront Petten sandy reinforced (year 0)



Waterfront Petten fencing (1-2 years)



Waterfront Petten fencing & terraces (2-5 years)



Waterfront Petten terraces & beach buildings (10-20 years)

FIG. 4.43 3D visualisation of the Petten waterfront with the build-up of the terraces through dynamic fencing. Images by J.van Bergen & OKRA landscape architects. Once the safety profile is established, the terraces can be colonized by beach buildings. Their tail development can enhance the heightening of the terraces (short tails) or foredune (medium or asymmetrical tails).

Dynamic profiling: stepped BwN aeolian build-up of the coastal profile

In the first 10 years after reinforcement, accretion at Petten beach (profile 3N) is enhanced via progressive fencing in the foredune zone combined with planting to stabilize the sediment. In this way, the accumulation could increase from the current $14 \text{ m}^3/\text{m}/\text{y}$ to the initial estimation of $25 \text{ m}^3/\text{m}/\text{y}$ (Ecoshape, 2019). The first aim is to establish the $+250 \text{ m}^3$ safety profile for 2065 with improved BwN measures (fences). This will take approximately 10 years (instead of 18 years) to achieve. This buffer is executed as a stepped profile, with three advantages: (a) the sediment is transported upward more easily (Figure 4.31); (b) the first terraces offer accommodation space to build up the coastal buffer, protecting it from storm erosion at the lower beach; (c) once the safety volume is achieved, further BwN extensions through fencing, planting and building types can be made to optimize the conditions for other coastal functions, anticipating the expected prevailing wind climate and transport rates.

First, a backward sequence of fences is put up to heighten the dune foot and lower the slope to establish the coastal buffer (Figure 4.44b). Second, a seaward middle terrace is created, which is first heightened landward and later completed seaward (Figure 4.44c). To guarantee the required sediment flow and accommodate the seaward extension of the dune foot, the initial shoreline should be maintained via nourishment every 4–5 years, providing a wide beach as a storm buffer for the dunes and fetch for sediment transport.

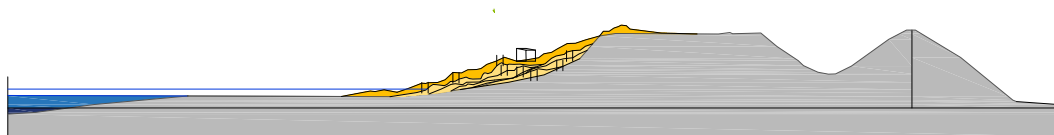

c) Profile terrace design 2025–2035, including beach housing once the future coastal buffer is achieved.

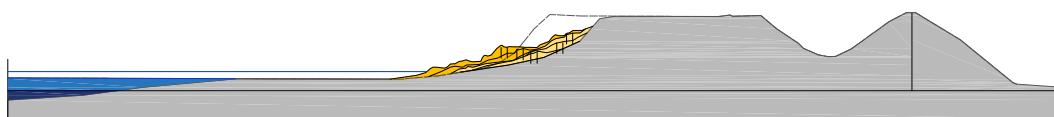

b) Safety profile (250 m³) established through dynamic fencing in a terraced design, 2015–2025.
Improved aeolian transport estimate: 25 m³/m/y combined with shoreline maintenance.

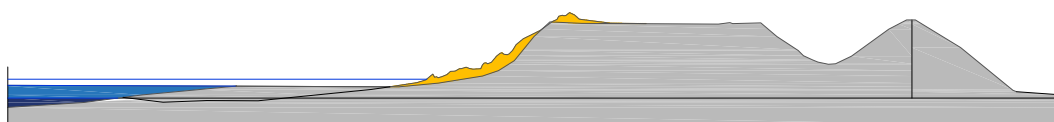

a) Petten beach: autonomous development 2015–2020 derived from GIS.
Aeolian transport: +70 m³/m/5y = 14 m³/m/y.

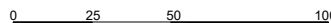

FIG. 4.44 Sections of the BwN-improved coastal profile at Petten (2 North). Images by the author.

The initial, steep foredune profile has been extended with terraces to accommodate the volume of 250 m³ to guarantee safety until 2065 (sea-level rise of 85 cm by 2100). Once this volume is achieved, further landscaping can take place through fencing to heighten the terraces and create a flood-proof (+5 m NAP) platform for urban development.

Urban arrangement

As illustrated in Sub-Section 4.4.3 and 3.3, beach row housing has a negative effect on dune formation and should therefore be placed only once the safety profile is achieved. The current beach pavilion on poles has a downwind deposition tail towards the northern dunes, which could be stabilized through fencing to become a terraced profile for recreation (+5 m NAP). Beach housing can help to collect more sediment to heighten the terraces over time. This can be done by building non-elevated housing with medium gaps (~2 times the building's width) to maximize the extended inner sand-tail patterns due to overlap. By reducing the wind-facing surface of the beach houses oriented towards the dominant SW wind ('slats'), the sand tails are shortened to reach the dune-foot zone for terrace heightening. These tails could be planted the next spring to extend this process as a dune farming method. To avoid aeolian sediment transport inland, the back dunes can be planted with shrubs to filter out sediment (eco-trapping).

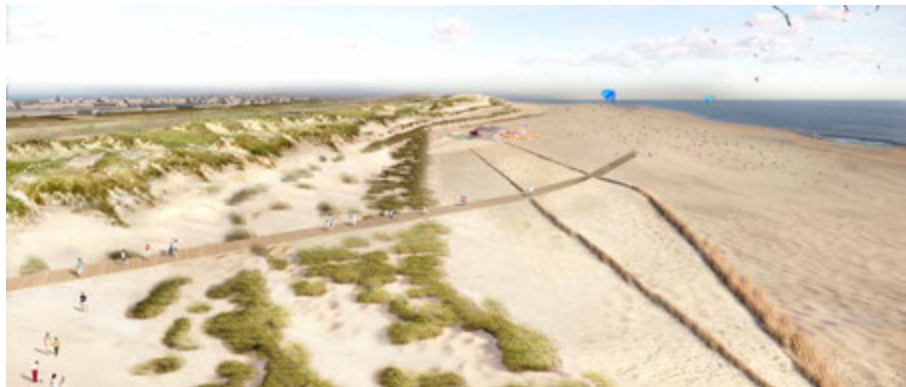

FIG. 4.45 3D visualisation of the Petten waterfront with the build-up of the terraces through dynamic fencing. Images by J. van Bergen & OKRA landscape architects.

Above: starting situation with fences catching sediment in the first years after sandy reinforcement. Middle: once the safety profile is established (10-15 years, including shoreline maintenance), the terraces can be colonized by beach pavilions. Their tail development can enhance the heightening of the terraces (short tails) or foredune (medium or asymmetrical tails). Below: expanding terraces (15-30 years) with beach housing.

4.4.8 Findings of the Petten design case study

When applying the three-step method of **morphogenesis**, **dynamic profiling** and **aeolian principles** to the sandy reinforcement of Petten, several observations can be made. The morphogenesis shows that the cornering beaches (profiles 2S and 2N) are more erosive than the midsection (profiles 3 and 4) due to compressed currents. This collides with the urban beach programme at these edges. Furthermore, the beach row housing and steep profiles on these trajectories reduce the dune formation needed to secure the future safety profile.

In the midsection, the terraced profiles (3 and 4) are successful at sediment transport and accretion in the foredune zone, reducing storm erosion. Their success was extended by the placement of progressive fences, which accumulated extra sediment in the first 3 years after nourishment, when transport rates exceeded natural succession. Vegetation later took over as an accreting and stabilisation mechanism. Due to these measures the future storm erosion buffer was already achieved in 5 years after sandy reinforcement.

Building on these findings, BwN-based redesigns for Petten were proposed for the period after the reinforcement (2015–2035), promoting BwN dune formation whilst facilitating multiple functions. In the narrow erosive profiles N2, a stepped approach was chosen with the creation of terraces through fencing in the first phase, followed by aerodynamic beach buildings in the second phase. Due to the low sediment transport rates caused by the erosive beaches ($14 \text{ m}^3/\text{m}/\text{y}$), the establishment of the terraces and safety buffer (250 m^3) will take up to 20 years. An adjustment of the initial steep profile in combination with dynamic fencing and shoreline maintenance by nourishment can possibly speed up this process to 10 years. Beach housing will always impact dune formation and should therefore be placed reluctantly and only in locations where the future safety profile has been achieved.

In contrast, the wider accreting profiles 3 and 4 feature rapid dune growth in the first years, which can be shaped to host multiple coastal functions, such as ecological and urban habitats, once the future safety profile is established (5–10 years). Via local arrangements of aeolian principles (e.g. fencing), the coastal profile can be reshaped to promote terraces or dune widening, whilst planting or blowouts can promote dune heightening. These arrangements can also mimic and possibly speed up natural coastal processes, notably the creation of beach ridges as a precondition for humid dune slacks. Furthermore, these arrangements can be implemented for landscape differentiation – to create a sequence of varying foredunes and inlets, for example, enlarging natural gradients, or to fit in beach housing in a secluded bay, away from the public beach.

Through the local, progressive application of aeolian principles, the coastal profile can be adapted over time, taking maximum advantage of the initial abundant nourishment conditions and the natural wind climate to enhance dune formation.

The GIS analysis shows that BwN dune formation is already successful at the current Petten sandy reinforcement thanks to stepped profiles and fencing. This benefit can be enhanced further by using fencing to create terraces, extending the foredune profile for future safety and multiple functions. Additionally, the variation in fences and profiling can contribute to greater differentiation along the trajectory (spatial value V4). With aeolian formation (in position, orientation and elevation) and temporal planning, beach housing typologies can become more sustainable and integrated into the landscape, giving way to natural BwN processes for coastal adaptation.

4.5 Sand Motor: optimizing dune dynamics for coastal safety and recreation



FIG. 4.46 Aerial photograph of the Sand Motor mega-nourishment just after construction in 2012, showing accretion on the south side. Source: © Rijkswaterstaat / Joop van Houdt

4.5.1 Introduction

The Delfland Coast Sand Motor is a prime BwN experiment for mega-nourishment in the province of South Holland. The hook-shaped peninsula of about 21,5 Mm³ of sand (128 ha) was constructed in 2011 and was designed to erode and nourish the shore with sediment for 20–50 years. Since then, the pilot project has slowly eroded, spreading sediment along the coast (Taal et al., 2016) and resulting in an accreting shoreline and new embryonic dune formation. The inner lakes have attracted beach sports and recreation.

This case study analyses how the initial nourishment design has affected the dune formation pattern. Further, the design study explores how spatial design integrating morphological development with urban and ecological arrangements can improve the aeolian BwN process, directing more sediment to the foredunes as a coastal buffer. The study relied on field observations and GIS analyses of the coastal profile development (fall 2018). It was published at an early stage of the research (ICE, 2019), and its initial findings have been input for the compilation of the aeolian design principles.

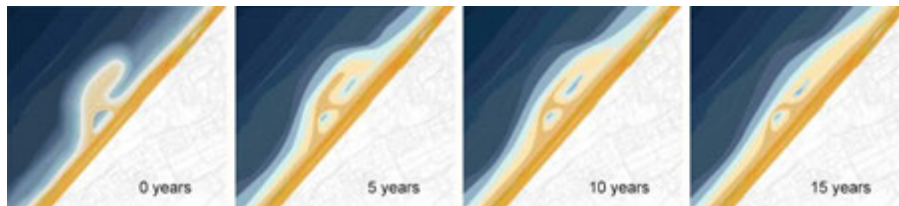

FIG. 4.47 Predicted progress of the Sand Motor. Source: www.dezandmotor.nl.

4.5.2 Morphogenesis

Historical shoreline development

The South Holland coast has a dynamic history due to the Meuse estuary, a tidal sea arm that silted up around 5000 BC and became a river that moved southward from 1000 AC onwards. Its inlet was characterized by seaward sand banks and a series of arc-shaped seaward beach ridges at the mouth of the river (Klijn, 1981, see also Figure 4.48). These eroded away, explaining the current narrow state of the dunes. The lower lands around the inlet were reclaimed and included a ‘sleeper’ dike system as a backup against dune breach. The eroding narrowing dunes were of concern from 1800 onwards (including building losses) and became subject to reinforcement early on. In 1900, a railway was even constructed across the dunes for ongoing reinforcement, turning it into a sand dike.

In the 1960s, the Maasvlakte I harbour was constructed, and the sediment (19 Mm³) was deposited at Hook of Holland, known as the ‘Van Dixhoorn triangle’. Although several plans were drawn for the urbanisation of this new territory, politics prevented it from being built. North of this trajectory, the dunes as a coastal defence line have remained narrow. For this reason, the shore was nourished since 1953 and chosen for the Sand Motor pilot, a concentrated mega-nourishment maintaining the shoreline.



FIG. 4.48 Morphogenesis from the Meuse inlet from 1100 AC onwards, showing its southward movement as well as the coastal erosion of its former banks. Source: R. Waterman/De Ontwerpers, 2005.

Dune formation processes after mega-nourishment

In 2011, the Sand Motor mega-nourishment was constructed to maintain the shoreline for 20 years. The main goal of the Sand Motor is ‘the encouragement of natural dune growth on the Delfland Coast between Hook of Holland and Scheveningen. This dune growth is not only to improve coastal safety, but also nature and leisure activities’ (Taal et al., 2016). The newly created landscape (2011–2019) features extensive beaches, increased recreation (e.g. beach pavilions, water sports) and highly dynamic geomorphology. The erosion of the peninsula and the continuous dispersion of sediment along the coast have induced accretion on the (north and) south side(s) of the shore in the first years (Figure 4.49a). This was followed by a retreating shoreline and embryonic dune growth on the beach beginning in 2016 (Figure 4.49b). These embryonic dunes catch and stabilize sediment, but they have slowed down foredune formation. In the evaluation report (Taal et al., 2016), the reduced foredune formation was related to the profile design of the Sand Motor: design features such as the central lake, the lagoon and the high barrier have obstructed fine-sediment and seed transport and delayed the embryonic (vegetated) dune growth by 5 years. For example, the first vegetated embryonic dunes only appeared in 2016 (Figure 4.49). In addition, car transport routes along the foredunes have reduced dune-building vegetation.

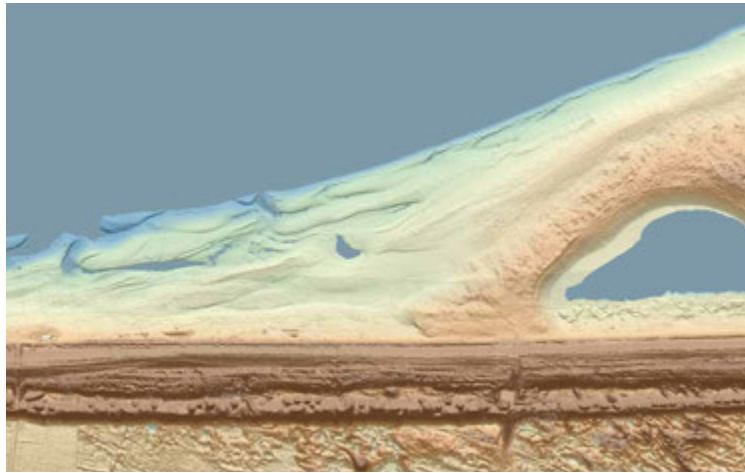

Accreted shoreline (2011–2015)

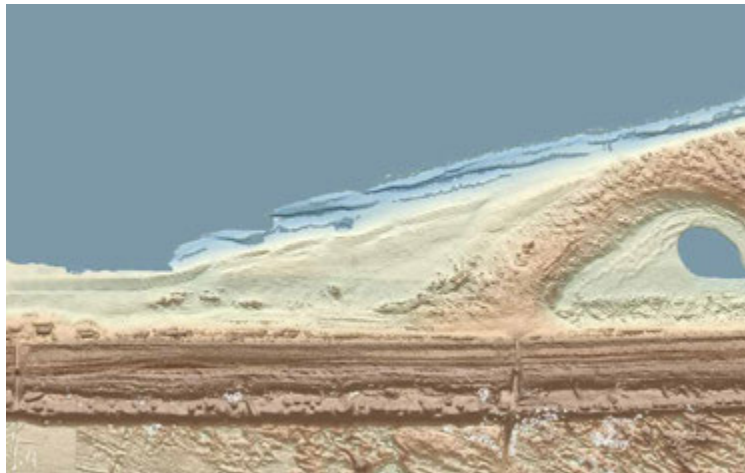

Eroding shoreline and embryonic dune growth (2016–2018).

FIG. 4.49 GIS elevation maps of the south side of the Sand Motor. Images by the author.

Zooming in on the south wing of the Sand Motor, ShoreScape fieldwork monitoring (2019) reported that accretion at the open beach (in front of the embryonic dunes) was 90% higher than accretion in the dune-foot zone (Van Bergen, 2021; see also Chapter 3). This difference confirms that much inland sediment transport is blocked by the newly formed beach ridges. In the long term, the peninsula will erode and flatten further. This means that eventually, the new beach ridges will become subject to erosion again and act as a sediment source for inland transport to the foredunes (Figure 4.50). However, this process may take 20 years or more to be completed. Intervention in the embryonic dune formation process could decrease this delay.

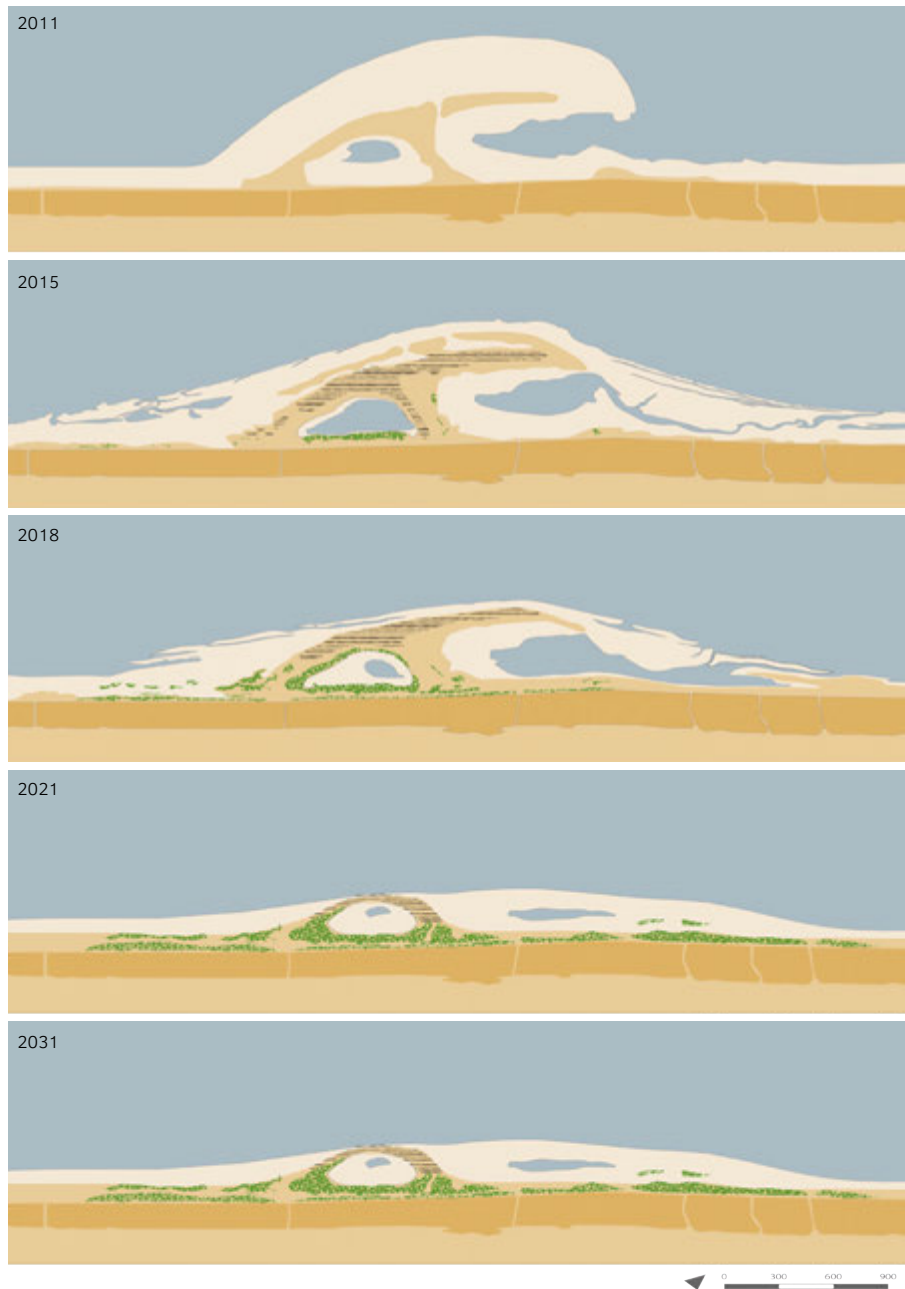

FIG. 4.50 Morphogenesis of the Sand Motor. Morphological development predicted by computational modelling (adapted from Luijendijk et al., 2017) combined with GIS data on dune development (2011–2019) extrapolated to 2031. Clearly visible are the new beach ridges formed in front of the foredune. Although they positively affect storm resistance, they are not officially part of the storm erosion barrier and delay the sediment transport to the foredunes. Images by the author.

4.5.3 Building towards a coastal buffer

For future coastal safety, it is important to build up the foredune zone as a storm erosion barrier. The initial volume of the Sand Motor (21 Mm³) corresponds to the volume needed for 50 years of coastal maintenance between Hook of Holland and Scheveningen (Taal et al., 2016). Vegetated foredunes are a desirable final state for the sediment to accrete sustainably way (Vliet et al., 2017) and offer maximum resistance during storms. Assuming that a quarter of the nourished sediment of the Sand Motor becomes available for dune formation (Van der Wal., 1999), this volume (5 Mm³) would correspond to an additional foredune of around +100 m in width and 3 m in height and an estimated construction time of 21 years (~15 m³/year). This calculation shows the potential of mega-nourishment to contribute to BwN foredune formation as a coastal buffer. However, monitoring has shown that foredune formation (so far) has been lagging behind (Taal et al., 2016).

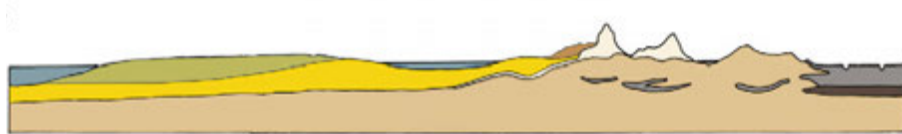

FIG. 4.51 Section of the Sand Motor, its initial volume and aspired coastal buffer. In dark brown, 10–25% of the nourished, erosive volume (in green). Image by the author.

Key mechanisms for improving foredune formation

A closer look at the observed land shaping processes and their interaction with urban use offers other opportunities to enhance the desired landward sediment transport. By rearranging the local effects of urban use and morphological build-up, integral spatial design can help to improve the sediment flow to the foredunes. A spatial design study was conducted to see how direct sediment flow to the foredunes could be improved to accelerate the BwN build-up of the coastal buffer via the application of several aeolian design principles.

Based on fieldwork, aerial photographs and GIS analysis, two key aeolian mechanisms were detected that could improve wind-driven sediment transport to the foredunes at the Sand Motor.

The first mechanism is 'human mobilisation' or tramping caused by the urban public use of the beach to reduce embryonal dune growth. Aerial photographs of beach accesses and beach pavilions show that embryonic dune growth is interrupted due to loss of vegetation resulting from recreational use and coastal maintenance (e.g. the removal of the winter flood mark). This mechanism could be employed to reduce embryonal dune growth at the beach, keeping sediment mobile for transport inland towards the foredune zone (human mobilization).

Furthermore, beach pavilions at the south end of the Sand Motor show substantial lateral horseshoe deposition or 'sand tails' behind the building, caused by turbulence: accelerated and decelerated airflow results in the pickup and accretion of sediment (see GIS Section 4.54). This sand tail principle could be employed to collect sediment as an aeolian source for onward transport or the allocation of sediment to the foredune zone.

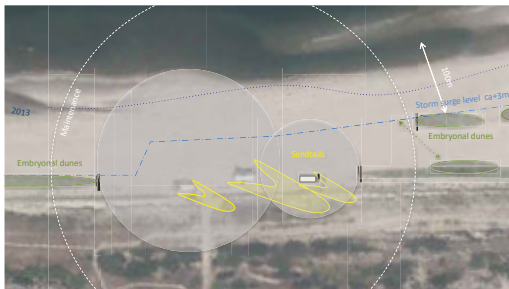

FIG. 4.52 Tramping around a beach (white circles) limiting embryonal dune (green) growth south of the Sand Motor. In yellow the sand tails produced by the beach buildings. Image by the author; aerial photograph: PDOK.nl.

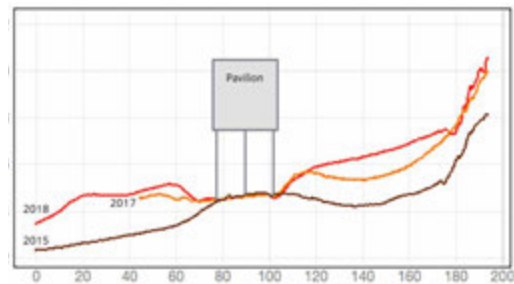

FIG. 4.53 GIS section with shadow dune formation behind a beach pavilion south of the Sand Motor, stimulating foredune growth. Image by the author.

4.5.4 **Design study: spatial arrangements to accelerate BwN foredune formation**

The results of the monitoring and the aeolian mechanisms offer opportunities to improve the BwN process for foredune formation at the Sand Motor. First, the initial nourishment profile design could be altered to eliminate some of the obstructions to wind-driven sediment transport, such as the lake and the high barrier. To improve aeolian sediment transport for foredune formation, the urban programme (beach access and buildings) could be relocated to the south accretion zone of the Sand Motor. More intense urban use and traffic limit the growth of (vegetated) beach ridges, keeping sediment mobile for transport inland (design principle human mobilization, see Figure 4.54).

At the same time, the sand-tail pattern of seasonal beach buildings on poles offers chances to collect and direct sediment transport to the back to reinforce the dunes as a coastal buffer (design principle vertical funnelling/dispersed tails). This sediment can be collected during a sequence of summers (S1, 2, 3, 4) in a dynamic urban set-up that moves along with the shifting shore and transport zone. The resulting sand-tail patterns then act as local aeolian sand sources during the winter season to feed the foredunes inland. Converging corridors between the beach buildings can offer accelerated inland transport during storms (Figure 4.54, horizontal funnelling).

Once sediment is transported inland, planting (eco-trapping) can be used for its accretion and stabilization in desired foredune locations. The Netherlands has a very long tradition of sediment catchment via nature, such as planting marram grass in foredune areas or by placing brushwood wind fences. These BwN methods could be introduced in the Sand Motor area to speed up foredune formation. For example, planting marram grass is very effective due to its extensive root system and ability to build up the foredunes in height. The literature also suggests that dynamic fencing could increase accretion (Goldsmith, 1985) and reduce the construction time of foredunes substantially. These ways of accelerating (fore)dune formation will become more important in the future when the lifespan of nourishments will be reduced due to increasing sea-level rise and coastal erosion.

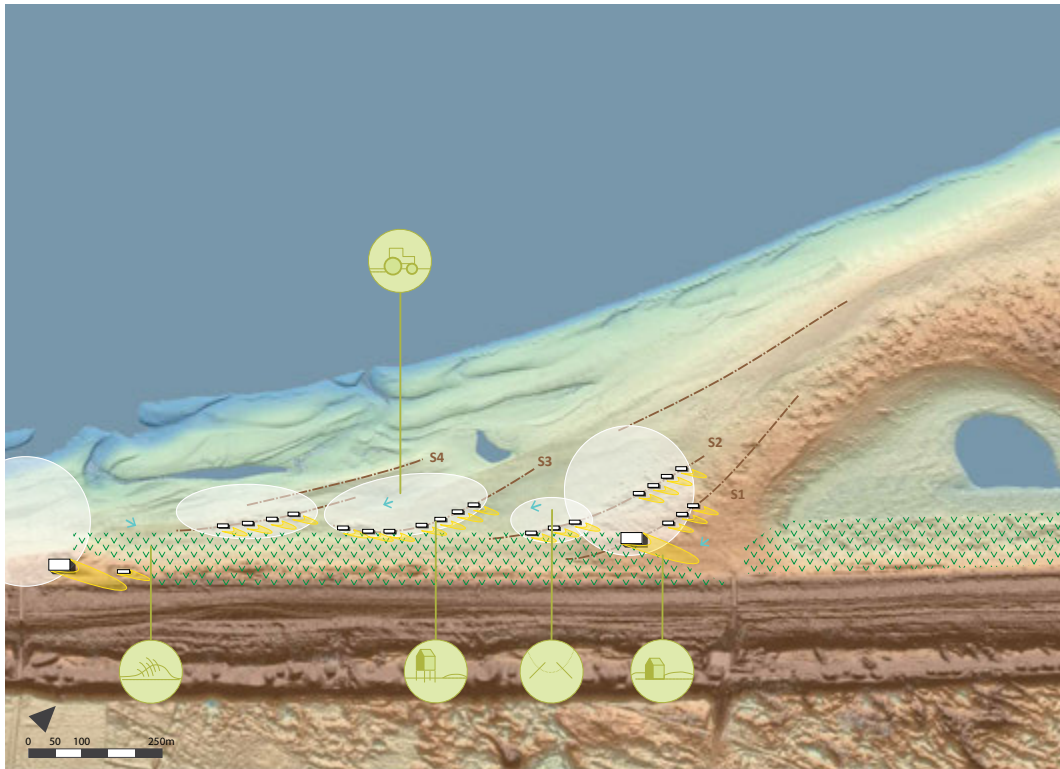

FIG. 4.54 BwN ensemble of beach houses situated on beach ridges of the south Sand Motor to keep sediment mobile (white circles) and harvest sediment (yellow) for landward foredune formation (green). GIS image and graphics by the author.

4.5.5 Findings of the Sand Motor study: spatial design integrating systemic interventions to support BwN dune formation

The Sand Motor design study is an example of the optimization of sediment flow and urban and ecological design aiming to induce and accelerate BwN-based foredune formation. This dune formation is needed for the formation of a sustainable coastal buffer zone protecting South Holland from flooding. By redirecting morphological development, urban and ecological programmes through design intervention, both the efficiency of the BwN nourishment and the multifunctional use of the coastal zone can be improved.

Aeolian BwN to build up the coastal buffer

Once the goal of the aeolian sediment flow is set (in this case, the reinforcement of the foredunes as a coastal buffer), aeolian design principles such as human mobilisation help to prevent the growth of beach ridges. Furthermore, the accretion via the dispersed tails behind beach buildings (vertical funnelling) can help to collect and keep sediment mobile for inland transport. Zoning and vegetation planting (eco-trapping) in the foredune zone can help to accrete and stabilize sediment to extend the coastal buffer (Figure 4.55). These are examples of local design principles for the layout of mega-nourishments steering and allocating sediment within the coastal profile. These principles support BwN dune formation whilst providing room for urban and ecological development. These spatial design arrangements have been explored further in the ShoreScape research to compose a palette of integral BwN design principles for coastal buffer zones (see Chapter 3).

Optimizing spatial quality

In terms of spatial quality (see Sections 2.4.4 and 4.1), the Sand Motor mega-nourishment already performs well on values such as *natural dynamics* (V2), with a highly dynamic performance (hydraulic and aeolian), and *differentiation* (V4), comprising different zones, gradients and landscape features along and across the shore. The design study aimed to improve *aeolian dynamics* (V2) to arrive at a better allocation of sediment and build up the foredunes as a (future) coastal buffer (*natural adaptation*, V1). By doing so, the introduction of more urban programmes at the Sand Motor also increased the *multifunctionality* of the nourishment (V3), allowing for human traffic and beach housing to improve landward sediment mobility.

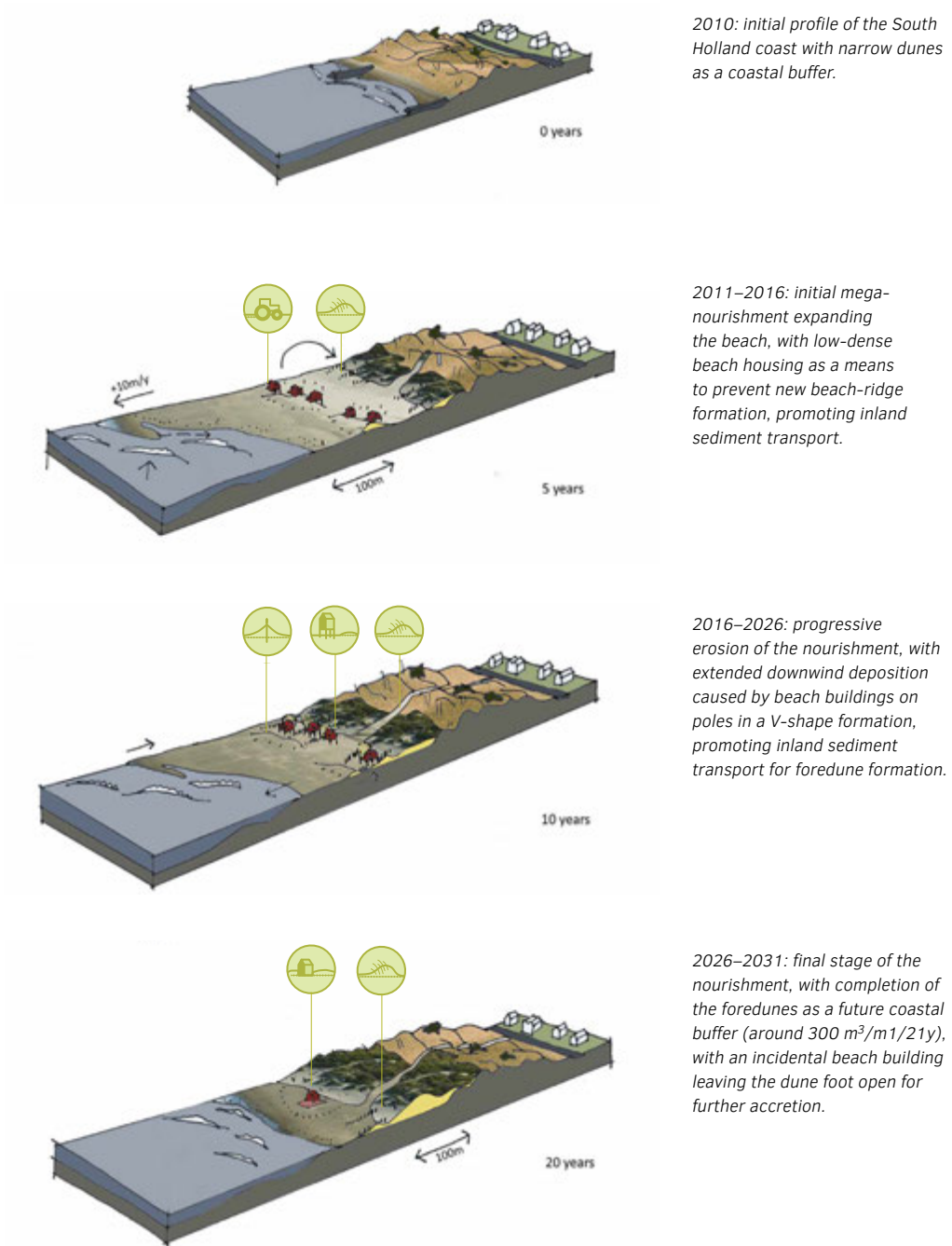

FIG. 4.55 Design sequence of BwN foredune formation following mega-nourishment. Images by the author.



FIG. 4.56 3D visualisation of beach house development within the beach ridges of Sand Motor. Image by J.v.Bergen & OKRA landscape architects.

Tramping by guests reduces vegetation and enhances sediment mobility. To reduce upwind deposition and prevent flooding, the houses can be placed on poles. This will induce local scour beneath the buildings and generate extended tails at the back (following the design principle of vertical funnelling).



FIG. 4.57 In a later phase of Sand Motor, beach housing can be re-positioned in the foredunes once the coastal safety buffer is established, preferably in a secluded (non-visible) way. Image by J.v.Bergen & OKRA landscape architects.

Here, the houses can be placed in slats or with small wind-facing façades, enhancing shorter tail development for foredune widening. The year-round beach pavilion is placed at the beach on poles, featuring extended downwind deposition tails to heighten the foredunes (vertical funnelling).

4.6 Conclusions case studies

4.6.1 Conclusions of the design studies and methodology

The landscape design approach and aeolian design principles were tested and contextualized in four case studies to compare their potential for BwN adaptation in different coastal settings. They explore the spatial arrangements and principles that enhance dune formation for flood safety, multifunctionality and spatial quality. The goal was to answer research question 3: How can the spatial design approach and principles be differentiated and aligned within varying nourishment and urban contexts to compose spatial arrangements that enhance the gradual, natural adaptation of the coastal landscape?

First, GIS studies of the morphogenesis generated insights into the transition process from coastal dynamics and nourishment to dune formation over time, as well as the effects of spatial interventions such as beach housing and fencing on sediment transport and deposition. This was followed by design studies to explore how aeolian principles and spatial arrangements could support the process of BwN dune formation as a coastal buffer and carrier of multiple functions. In all cases, the nourishment acted as a driver of change and provided sediment to build up the coastal buffer, but varying types and volumes generated different conditions for BwN ashore, altering the role of the BwN arrangement.

The **Noordwijk** case features frequent low-volume nourishments for shoreline maintenance, which can be harvested for dune formation as a future coastal buffer (inventory phase). In the design study (projection phase), two future profiles were composed: a Dike in dune plus and a Sand buffer. Because of its waterfront boulevard setting, urban parameters such as sea view, beach access and beach housing have a defining role in the coastal profile design and must be balanced with the (future) requirements for coastal safety. The BwN-based adaptation of these profiles could eventually lead to an alteration of the waterfront layout (synthesis phase), for instance, the transformation of the boulevard into a new dune-scape setting (for V4 differentiation & coastal identity), or to larger-scale nourishment strategies, creating more room for (future) BwN-based adaptation (V1).

In a highly urbanized context and without a vast beach as a resource, the aeolian design principles play an important role in the harvesting and steering of sediment to the designated places as a form of directive spatial design. Depending on the required profile, different aeolian principles come into play, such as sand tails for dune widening or blowouts for dune heightening, resulting in specific arrangements.

The cape of **Walcheren** is a strong erosive shore and requires high coastal maintenance now and in the future. The case study shows that an alternative BwN-based mega-nourishment and related dynamics could not only improve the coastal maintenance regime to respond to future sea-level rise but also create specific spatial conditions for the regional coastal programme to evolve. The different stages and zones of the nourishment development can be fine-tuned with other coastal programmes (urban, ecological) to reach an optimum in functionality and spatial quality: a dynamic cape for sports, a stable middle for a beach and waterfront recreation and a controlled erosive tail for inland sediment transport to support grey dune habitats. The design study shows the potential of mega-nourishment design as a catalyst for spatial development (morphogenesis), with its emergence in different dynamic zones preceding the profile's alteration, dune formation and functional integration as a spin-off. The sequential design and functional zoning make room for a landscape framework to support future coastal development as a *casco* of alternating high and low morphological and urban dynamics, regulating functions and maximizing landscape qualities.

The **Hondbossche dunes at Petten** are a large-scale sandy reinforcement replacing a former seawall as a coastal defence, creating a new beach-dune system. The morphogenesis (GIS) showed that the (urbanized) nourishment edges have faced severe erosion, whereas the mid-section has been more stable, with extensive beaches and large foredune formation enhanced by fencing and vegetation (inventory phase).

Subsequently, a BwN-based redesign for Petten was elaborated for the first decade after reinforcement, incorporating different types of BwN dune formation whilst facilitating multiple functions. At the narrow erosive profile, terraces could be created by fencing and eco-trapping to widen the dunes as a future coastal buffer (projection phase). However, due to the low transport rates from the narrowed beaches, this would take over 20 years to achieve (and provide a reason to evaluate the profile and nourishment strategy). Once accomplished, the terraces could be occupied by aerodynamic open beach housing to further enhance dune formation (synthesis phase).

In contrast, the wider mid-section provides rapid dune growth in the first years (up to 60 m³/m/y) enhanced by fencing in the first abundant years of accretion after reinforcement. Once the future safety profile is established (5–10 years), the surplus of sediment can be shaped to host multiple coastal functions, such as ecological and urban habitats. An example is the creation of beach ridges using fences as a precondition for humid dune slacks, or new foredunes as terraces for beach housing. Furthermore, design principles such as fencing also enhance landscape differentiation (V4) for multifunctional usage and values (V3; synthesis phase), for example, to create a sequence of alternating foredunes and inlets, enlarging natural and public-private gradients or to fit in beach buildings in a secluded bay.

The **Sand Motor** case study illustrates the applicability of design principles to a mega-nourishment situation featuring an extensive dynamic profile and their potential to stimulate sediment transport from the beach to the foredunes. Human mobilization helps to mobilize sediment and reduce vegetation, whilst beach housing on poles (dispersed tails) diverts sediment for inland transport. Eco-trapping finally stabilizes sediment in the foredunes to extend the coastal buffer. Here, the BwN-based spatial arrangement acts as a form of responsive design, following morphological development and adapting in time.

In the nourished contexts of the case studies, the initially developed aeolian design principles were upscaled to a profile and landscape level to derive organizing principles for dune formation in different settings. These led to spatial arrangements for future adaptation in a long-term perspective. By optimizing the spatial arrangement via design principles and profile design, aeolian sediment harvesting for dune formation could be increased substantially as well as the multifunctionality and spatial quality of the coastal landscape. The tuning of these arrangements is an iterative process (inventory, projection and synthesis; see Section 2.4) and can also affect the nourishment's design. To alter the initial, constructed profile for example, allowing for a gradual foredune slope and/or wider beach for dunes to develop. Or to stabilize the beach more or less often via shoreline maintenance to serve coastal functions. Overall, the arrangements evidence the large potential of BwN design to sustain the coastal profile, with dune formation as a natural result of the coastal nourishment, not just for coastal adaptation but also for the functional and spatial optimization of the coastal landscape.

These scaled transitions of sediment dynamics informed BwN as a landscape design approach, relating the local aeolian design principles to the trajectory-profile demands and the large-scale dynamics of the nourishment. This scaled approach was translated into three generic design steps to enhance onshore BwN dynamics for integral coastal adaptation: *morphogenesis*, *dynamic profiling* and *aeolian design principles*, as documented in Section 3.5-3.7.

4.6.2 **Lessons learned for enhancing BwN ashore: supporting adaptive, multifunctional and qualitative coastal landscapes**

Six generic lessons and related design choices emerged from the case studies, which facilitate a BwN-based, multifunctional and spatial qualitative adaptation of sandy shores in response to sea level rise.

1 Maximizing sediment harvesting after nourishment for BwN adaptation

The design studies indicate that it is possible to harvest the sediment needed for the future coastal buffer from regular shoreline maintenance nourishments (e.g. Noordwijk case study), with an accretion rate of around 10 m³/m¹/y (Ecoshape, 2021) in non-urbanized conditions.

In the first 1–3 years after (mega-)nourishment, higher sediment transport rates of up to 30–60 m³/m/y can occur (see Petten). Therefore, this time frame is vital for profile alterations to be made, for instance, through dynamic fencing to expand the coastal profile as a coastal buffer.

Anticipating the expected transport rates, the initial (nourishment) profile can preset some of the desired conditions, such as slope, beach width and accommodation space for dune widening or heightening, or parts of the future profile.

2 The importance of the dynamic profile design as a mediating instrument

The design studies highlighted the importance of dynamic profiling by nature as a mediating design tool between (expected) nourishment dynamics and sediment allocation by the aeolian principles. It is an important planning and design instrument for establishing the future coastal profile by harvesting sediment after nourishment and to upscale the design principles to a more regional and long-term perspective. Through dynamic profiling, the coastal buffer can be established and profile articulation can take place to facilitate other coastal functions, such as recreation and nature, and the differentiation of landscape qualities along the coast.

The type of profile alteration and sediment harvesting is highly dependent on the goal it serves – for instance, foredune formation as a coastal buffer, new dune shoulders as recreational terraces or erosive blowouts to support inland habitats – requiring different design principles for sediment allocation. These arrangements can vary in time (e.g. heightening of the existing dune, followed by widening of the foredunes).

Urban spatial parameters such as sea view, beach vicinity and beach buildings can have a defining role in the type of profile alteration to build a (future) coastal buffer. Similarly, the choice to harness natural sediment dynamics as a means of BwN adaptation could have a transformative effect on the urban coastal layout (e.g. from a boulevard to a dune-resort setting).

Terraced coastal profiles have multiple benefits. They offer accommodation space and more stability for new foredune formation as well as promote upward sediment transport through gradual slopes. Furthermore, they provide safe grounds for recreation, articulating public-private relationships and diversifying the coastal landscape. The terraces could be established using BwN measures (fencing for example) in the first phase, to be occupied in a later phase once the safety profile is secured. To protect the terraces from storm erosion, a ‘run-up control ridge’ could be installed (see Hotta & Harikai, 2011).

3 Typecasting Aeolian principles for specific dune formation

Depending on the type of profile alteration, dune widening or dune heightening, specific aeolian principles apply. Dune widening, for example, requires a reduction of wind flow to promote accretion, whereas dune heightening necessitates an increase in wind flow to promote upward sediment transport. This results in different accretionary patterns.

The *aeolian principles* allocate the sediment within the profile and are sequential (e.g. widening the dunes in the first phase, followed by heightening). In time, transport rates will drop and other processes come into play to reach new equilibria, such as stabilization by planting, as seen in the Petten case, for example.

Dynamic fencing is a powerful tool for manipulating the coastal profile in the early years after (mega-) nourishment. It is capable of handling larger sedimentation volumes and can be placed in more seaward or urbanized locations than eco-trapping. Its land-shaping potential supports the coastal buffer and offers ways to articulate the profile to serve multifunctionality and landscape differentiation.

4 **New beach-building typologies to reduce the negative impact on dune formation**

Beach row housing or pavilions have a negative effect on dune formation (-35–50%) and should thus be placed reluctantly and only in locations where the future safety profile has been achieved (see the GIS analysis of Petten and Section 3.4) and dune heightening is not needed. They also lead to the partial privatization of the public beaches, restricting the space for natural adaptation.

Beach buildings can partly mitigate their own negative effect by featuring short sand tails to promote dune widening, notably through the reduction of wind-facing surface or wider gaps. On an urban scale, beach buildings could be clustered to leave as much of the dune-foot zone open as possible (e.g. Noordwijk case) for dune formation, in combination with fencing and protected planting as a dune farming typology.

Alternatively, larger beach pavilions on poles could support dune heightening, for instance, by producing longer sand tails (as artificial blowout), possibly combined with a natural blowout in the foredune for onward transport, and large gap distances (> 150 m). See Sub-Section 3.7.3.

5 **Temporal design to guide long-term coastal adaptation**

The alteration of the coastal profile requires temporal design. Often, (future) safety profiles necessitate a combination of dune heightening and dune widening (e.g. Noordwijk profiles). In combination with nourishment dynamics (high sediment transport in the early years, lower after), design principles can be fine-tuned to fit every stage – for example, dune widening in the beginning for maximum harvesting, followed by dune heightening arrangements (e.g. blowouts), finalized with planting or buildings for foredune widening.

These generic lessons emerged partly from the GIS analysis of the case studies and from the contextual application of the initial design principles. They supported the elaboration of the BwN design approach and principles, as described in Chapter 3.



Beach housing at the sea-land interface of the Sand Motor.
Source: J. van Bergen.



5 Synthesis

Conclusions and reflection on the design method and principles for integrated coastal adaptation

5.1 Introduction

Due to climate change and sea-level rise, sandy shores worldwide have become erosive, and protective measures are needed to secure coastal settlements. At the same time, warmer temperatures cause more inland drought, increasing coastal urbanisation. This combination of erosion and urbanization leads to a '*coastal squeeze*' and lack of space, requiring multifunctional solutions for adaptation.

Sand nourishments have proven to be a successful 'Building with Nature' (BwN) technique to reinforce sandy shores naturally. They employ system-based materials and forces and offer temporal space for strengthening and reorganizing the coastal buffer. This technique is still in development, with progressing insights into the prediction of sediment dynamics and their contribution to dune formation. To successfully use these aeolian BwN processes on urbanized shores, their dynamics must be integrated into the ecological and urban programme and spatial layout of waterfront development.

This research explored the development of coastal buffer zones by employing aeolian BwN solutions to their fullest potential, combining the geomorphological dynamics resulting from the nourishments with ecological processes and urban development to enhance natural dune formation. The hypothesis is that through the development of landscape design principles, sediment harvesting from the nourishments can be increased, natural succession for dune formation can be promoted and adverse

urban effects can be reduced. This can be done by developing responsive ecological and urban typologies for landscape construction, stimulating and adapting to accretionary patterns to enhance dune formation as a coastal buffer.

The main objective of the research was to compose spatial design principles that support the aeolian build-up of the sandy coastal buffer by integrating geomorphological, ecological and urban dynamics to promote the development of adaptive coastal landscapes.

To meet this objective, the following questions were addressed in dedicated chapters:

- 1 How can a landscape perspective support the development of an integrated approach to BwN coastal engineering, maximizing BwN ashore by connecting geomorphological, ecological and urban processes to build up a dynamic, adaptive and multifunctional coastal zone?

This question was examined in Chapter 2: BwN as a landscape approach.

- 2 Which spatial design principles support BwN dynamics for dune formation, tuning system interventions and aeolian sediment transport in scale and time?

This question was examined in Chapter 3: Landscape design principles for natural coastal adaptation.

- 3 How can the spatial design approach and principles be differentiated and aligned within different nourishment and urban settings to compose spatial arrangements that enhance the gradual, natural adaptation of the coastal landscape?

This question was examined in Chapter 4: Application: case studies.

5.2 Response to the research questions

5.2.1 BwN as a landscape approach

Research question 1: How can a landscape perspective support the development of an integrated approach to BwN coastal engineering, maximizing BwN ashore by connecting geomorphological, ecological and urban processes to build up a dynamic, adaptive and multifunctional coastal zone?

In Chapter 2, a landscape approach is proposed that reframes BwN from an engineering to an integrated perspective. In this approach, BwN dynamics are addressed and optimized for an adaptive landscape design ashore. It begins with an integrated *systemic approach*, combining interventions in the geomorphological, ecological and urban systems to align BwN mechanisms for dune formation as a coastal buffer (Figure 2.17). Nourishments amplify these processes, and adaptive urban and ecological design can improve and even promote dune development.

However, to align BwN dynamics for dune formation, a scaled and temporal approach is needed because system interventions operate on different scales and within different timeframes. BwN as a *landscape approach* focusses on the alignment of these BwN processes, operationalized in a three-step scaled design method derived from GIS-analysis and case studies: **morphogenesis**, **dynamic profiling** and **aeolian design principles** (Figure 5.1). In *morphogenesis*, the coastal and nourishment dynamics are analysed over time to predict volumes and timeframes for shoreline development and dune formation. *Morphogenesis* also tests the adaptivity of the regional urban and ecological programme. This information is transferred to the coastal profile in *dynamic profiling*, which mediates between the regional scale of the nourishment and local coastal functions. It also enhances the temporal projections of (future) dune development to derive the allocation of the sedimentation process. Via *aeolian design principles*, spatial arrangements facilitate sediment allocation and the build-up of the coastal profile over time, for instance, as a future storm erosion barrier. These principles were derived from the literature, GIS analysis, fieldwork and CFD modelling to compose urban adaptive typologies for sediment allocation. Through this consecutive design approach, all intervention scales and systems are connected to direct BwN dynamics for dune formation.

Finally, reframing BwN as an integrated landscape design approach supports the integration of BwN dynamics not only for coastal safety but also to increase the multifunctionality and spatial quality of the coastal landscape, supporting recreation, ecological habitats and landscape differentiation. Besides the functional integration and optimization of landscape processes, it entails the inclusion of landscape values, derived from natural, cultural and community perceptions.

It is the role of design to explore and optimize functions, dynamics and values in different phases of the design process to arrive at an optimal and integrated solution with the stakeholders. This design process is iterative convergent and starts from the *inventory* of the coastal programmes, through profile variants (*projection*), to arrive at the integrated solution (*synthesis*), as illustrated in Section 2.5.2 and the design studies.

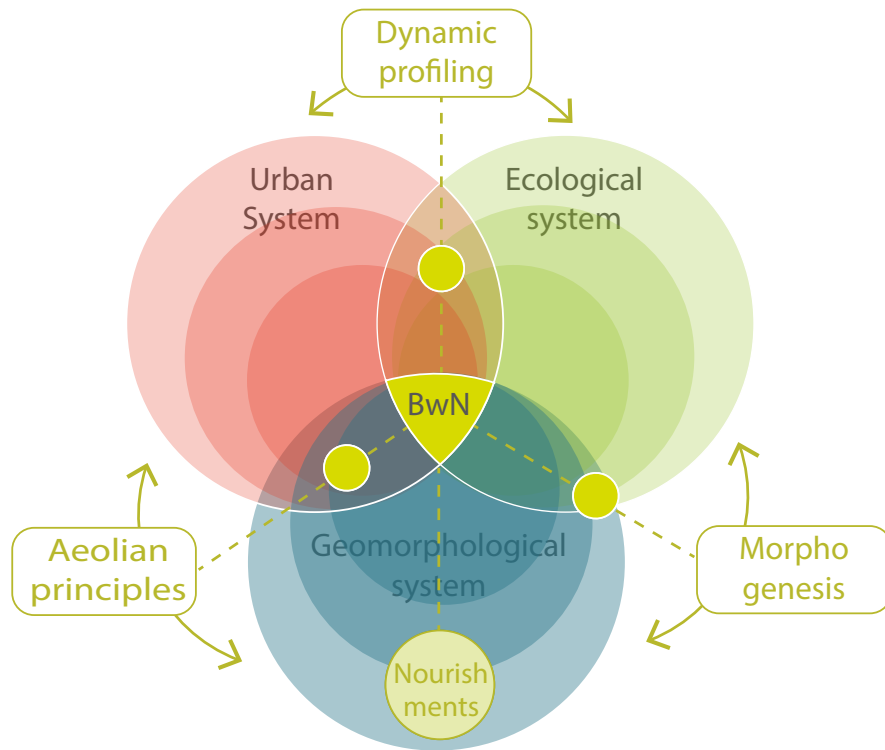

FIG. 5.1 Overview of BwN as a landscape design approach to dune nourishment dynamics on different scales: morphogenesis on a regional scale, dynamic profiling on a trajectory scale and aeolian principles on a local scale. Image by the author.

5.2.2 BwN design principles for integrated coastal landscapes

Research question 2: Which spatial design principles support BwN dynamics for dune formation, tuning system interventions and aeolian sediment transport in scale and time?

To operationalize BwN as a landscape design approach, a preliminary set of *aeolian design principles* was developed in this study based on a literature review, fieldwork, GIS and CFD modelling. They were categorized on their modulation of sediment flow (mobilization, deceleration and acceleration). These BwN principles illustrate how the natural process of dune formation can be enhanced by spatial intervention to increase sediment harvesting from the nourishment and stimulate specific dune profiles through sediment allocation. Up to 25% of nourished volumes is capable of transport ashore, but this rate is halved on urbanized beaches (see Section 2.2.1), illustrating the potential for improvement. The design principles supporting BwN ashore operate on different system scales connected by a stepped design approach: *morphogenesis*, *dynamic profiling* and *aeolian design principles* (see Section 2.5.1 and 3.5) and a cyclic design process of *inventory*, *projection* and *synthesis* (see Section 2.5.2).

Morphogenesis: nourishment design as a driver of change

Morphogenesis gives us a broader and longer perspective on coastal evolution and insights into the erosive and more stable places of coastal development. These coastal dynamics can be matched by urban or natural programmes, such as the development of recreational sites on more stable parts and ecology on more erosive parts ('form follows sediment'). This match can be *responsive* – for instance, reacting to certain geomorphological developments, such as shoreline dynamics – or *directive* – guiding sediment transport to designated places (e.g. the coastal buffer or recreational terraces).

Along the coast, a wide spectrum of nourishment types is possible (S, M, L, XL) that affect dune dynamics in various ways. The GIS studies carried out in this research show that increasing beach width via nourishment, for example, has a significant impact on the sediment fetch as well as the location of dune formation, as documented in the case studies (morphogenesis). Narrow beaches (<80m) will limit dune formation, whereas excessively wide beaches (> 500 m), resulting from mega-nourishment for instance, can induce new beach ridge formation, reducing sediment transport to the foredunes. The optimum for foredune formation as a coastal buffer lies somewhere in the middle, as seen in case study Petten (125–250 m, see Figure 5.2).

Furthermore, BwN nourishments develop over time due to wind, waves and currents and therefore affect adjacent coastal trajectories. These different stages and zones of nourishment development can be fine-tuned with other urban and ecological programmes to reach an optimum in functionality and spatial quality, as illustrated by the design studies on Walcheren (Section 4.3.4) and Petten (Section 4.4.5). This sequential design and functional zoning of nourishments could even become part of a landscape framework for future coastal development.

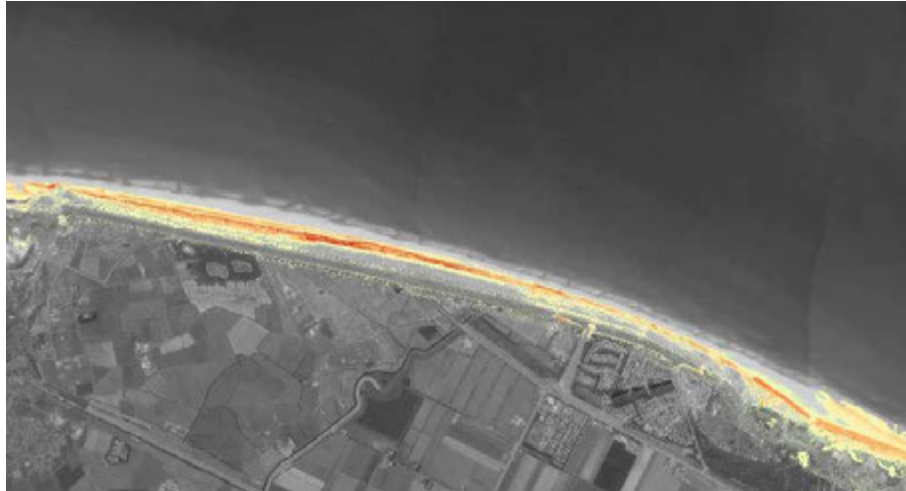

FIG. 5.2 Morphogenesis study via GIS-mapping (DEM) of dune formation following sandy reinforcement at the Hondsbosse Dunes (2015-2020; including profile developments, see Figure 4.31). Image by the author.

Dynamic profiling and enhanced natural succession

Once the nourishment design is known, predictions can be made about the expected transport rates ashore (*inventory* phase, see Section 2.5.2, via computational models for example) and the spatial development of the coastal profile. However, the coast is subject to natural variation in wave and wind climate, such as storms, therefore the real time evolution remains uncertain, and might face set backs or lag behind. Functional programming should therefore be adaptive to these circumstances, or only follow once the safety profile is achieved (*inventory* phase).

Through dynamic profiling (*projection phase*), the predicted sand transport rates and volumes can be translated to the expected dune formation over time and related to the minimal volumes needed to maintain safety in the future. Within or on top of these volumes, the coastal profile can be shaped to host multiple functions, such as dune habitats or recreational facilities (variant studies as part of the *synthesis phase*, see Paragraph 2.5.2). Overall, dunes can grow in two directions: in width, which requires wind deceleration in the dune-foot zone to stimulate accretion, and in height, which entails the mobilization and acceleration of wind transport to bring sediment to the upper dunes.

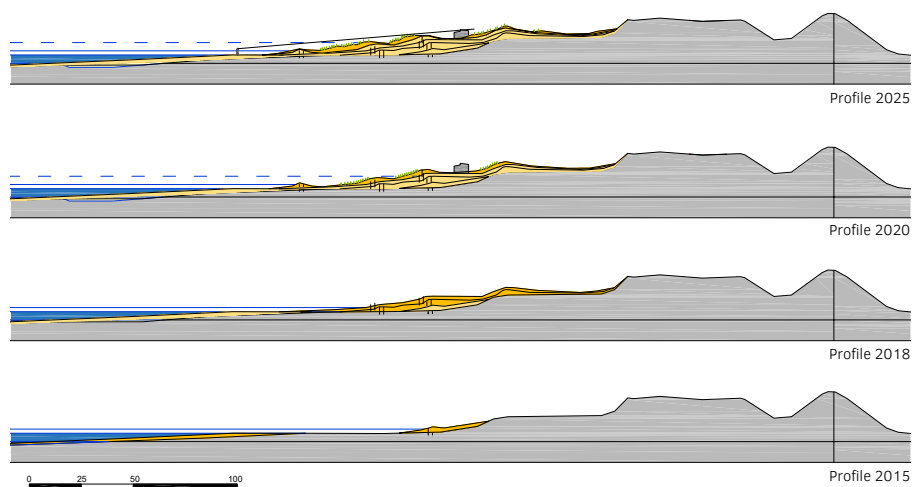

FIG. 5.3 Dynamic profile design study for BwN-based dune formation as coastal buffer and multiple use at Camperduin, following sandy reinforcement (2015). Images by the author, height x2.

Deposition estimates were derived from real-time GIS-analysis of Section 3S (2015-2020). Once the future coastal buffer volume is achieved (250m³ for 2065) via dynamic fencing in the first years after nourishment, the coastal profile is modified into terraces to host recreational functions such as (secluded) beach housing. See also Section 4.4.4.

Once sediment is transported to the dunes, vegetation plays an important role in enhancing its deposition and stabilization. In natural conditions, this usually takes place around the high-watermark, where seedlings sprout for new beach ridges or foredunes to develop. These forms of natural succession can be enhanced by profile design and planting. However, in the first one to three years after (mega-) nourishment, the sediment transport rates are substantial (25–35 m³/y, even up to 60 m³/y including fences) and sometimes exceed the natural burial rates (>1 m/y) for planting in the dune-foot zone. In these highly dynamic circumstances, brushwood fencing is an excellent predecessor for sediment allocation, not only

for the coastal buffer but also for profile articulation to host multiple functions and landscape differentiation (Figure 5.3). Once the desired profile is established and transport rates drop back to 10–25 m³/m/y, sediment is stabilized via planting (eco-trapping, see Section 4.4.3). In the case of dune heightening, further mobilization of sediment is needed, enhanced by natural or artificial blowouts, for example.

Aeolian principles: sediment harvesting through spatial design

From the literature, fieldwork, GIS and CFD, six aeolian design principles were extracted that promote sediment allocation through wind field alteration for dune formation as a coastal buffer (see Sections 3.5.3, 3.6 and 3.7). These principles are generic, but their application, sequence and context are specific to the type of dune formation aimed for.

Widening the dunes depends on a wider beach as long wind fetch and space to accommodate dune growth, next to stable vegetated foredunes to collect and fixate the sediment. This is matched by design principles such as eco-trapping, fencing and sand tails behind buildings (see Section 3.6). Marram grass, for example, is an excellent bio builder for eco-trapping, decelerating wind for deposition and able to withstand the burial of sand (< 1 m/y). For higher transport rates, fencing is recommended. Sand tails, or accretion patterns around buildings (W3), are another way to stimulate sediment deposition. Fieldwork monitoring (Van Bergen et al., 2021) has shown that scale model boxes of 0.25 m³ were able to accrete as much as 7 m³ in six weeks. This highlights the potential of buildings to naturally harvest and allocate sediment through their deposition patterns (as long as these are not removed mechanically).

Heightening the dunes is a slow sedimentation process, where (fine) sediment needs to be tilted to the upper dunes. This is promoted by a mobilized, dynamic dune-foot zone (human mobilization), a gradual, de-vegetated foredune slope and accelerated wind flow stimulated by the design principles of horizontal and vertical funnelling - dispersed tails (see Section 3.7). Larger buildings, such as beach pavilions, produce longer deposition tails (50–100 m), which are able to reach the upper dunes. Buildings on poles locally accelerate wind transport, as do V-shapes or blowouts.

The application of local aeolian principles can increase the return of the nourishment for dune formation. Through dedicated spatial arrangements, the future coastal buffer could be harvested naturally from regular maintenance nourishments (e.g. Noordwijk case study, see Section 4.2.2).

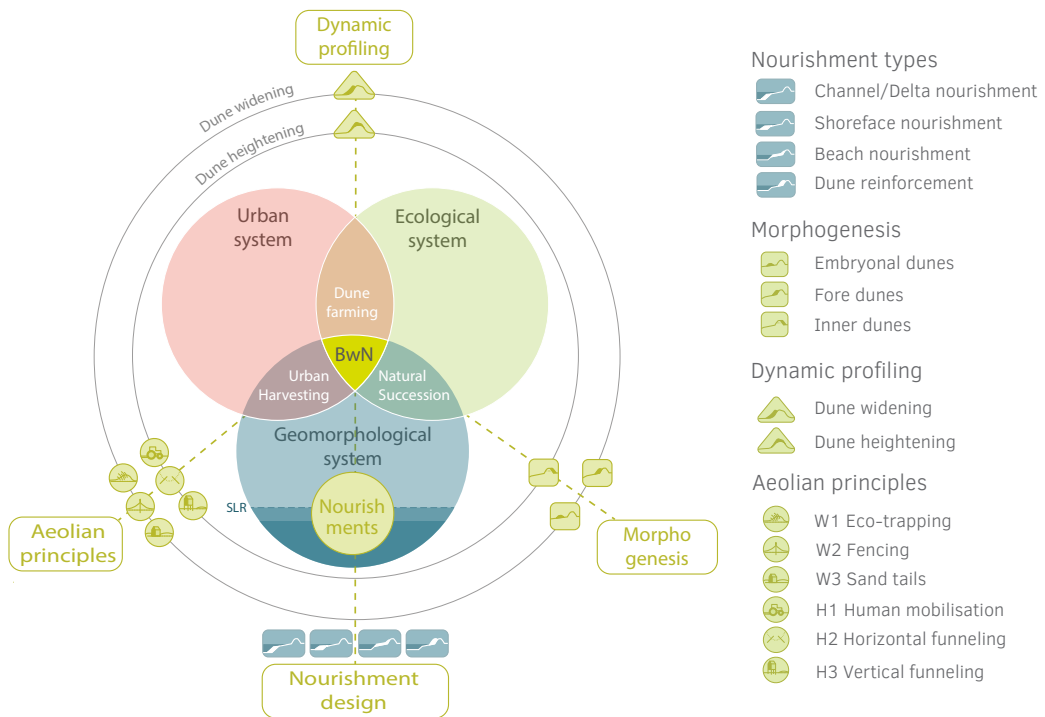

FIG. 5.4 Toolbox with the design steps and principles for natural coastal adaptation. The three-step design method of morphogenesis, dynamic profiling and aeolian design principles was derived from the design (case) studies (Chapter 4). The aeolian design principles were derived from literature review, GIS, fieldwork and CFD modelling (Chapter 3), and were tested in the case-studies. Image by the author.

Urbanization affects dune formation. The GIS analysis of two beach row housing locations in varying conditions of nourishment showed that dune formation was reduced by 50% over five years compared to the unbuilt profiles (see Figure 5.6 and Section 3.4). It emphasizes that conventional, dense beach row buildings should be avoided on beaches where coastal reinforcement is needed, especially in cases of dune heightening. Once the coastal buffer is established, beach buildings and their accretion patterns can help to direct and allocate sediment transport, for example, to widen the dunes.



FIG. 5.5 Dense beach row housing at Camperduin (2021). Image by the author.

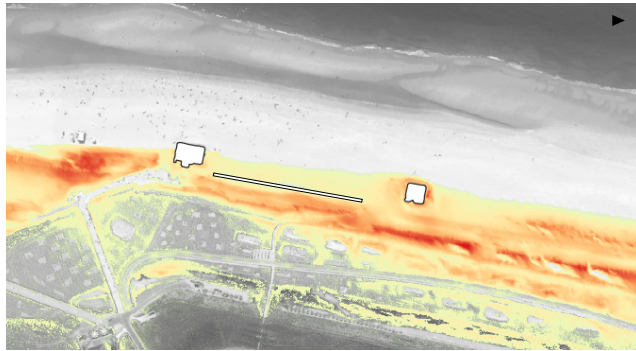
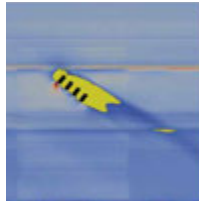

FIG. 5.6 GIS analysis in plan and section (2015–2020) has shown that dense beach row housing (e.g. at Camperduin, Figure above) negatively impacts dune formation (-50%), and therefore should be avoided in places where dunes as storm erosion buffer are needed. See also Section 3.4. GIS-DEM mapping by the author.



a) Fieldwork at the Sand Motor (2019) on deposition patterns around buildings.



b) CFD modelling of row-configurations and deposition.

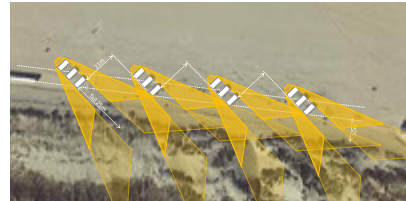

c) Spatial arrangement of beach housing in 'slats', featuring short tails to promote dune widening, as applied in case study Petten.

FIG. 5.7 Multi-sourced research into the aspects of sand-tail development as aeolian design principle to promote dune widening. Sources: J. van Bergen (a, c), V. Stevers i.c.w. ShoreScape (2021) (b)

The GIS analysis of real-time situations and the first (field-)test results show that spatial arrangements, such as fencing and planting can be effective in promoting dune widening, especially in nourishment conditions when beaches are wide and transport rates are high (see Section 3.6). Although row buildings had a negative impact on dune formation in GIS, their typology could be altered to reduce their impact and optimize sediment allocation in the dune-foot zone (see Figure 5.7 and Section 3.6-W3 + Appendix). Widening the gaps between buildings from 1m to 3m, for example, reduced their adverse effects from 50% to 35% (GIS study Schoorl, see Section 3.4)

For dune heightening, some promising mechanisms have been detected, such as artificial blowouts (below or in between buildings, see Section 3.7); however, further research is needed to substantiate these concepts.

Overall, the role of spatial design within the landscape approach is multiple. Mapping, as part of *morphogenesis*, supports the understanding of natural dynamics and coastal evolution towards the future. *Dynamic profiling* connects the interventions on various scales, relating regional nourishments to dune development on the local scale and enabling the projection of expected sediment dynamics as well as multifunctional optimization. *Aeolian design principles* build up the profile alteration over time in an adaptive and inclusive process. Integral design tunes the multitude of developments towards a common goal, in this case, the natural adaptation of the coastal profile (see example in Figure 5.8). It facilitates the interplay of coastal functions and values over time as part of the spatial arrangement, supporting a safe, multifunctional and qualitative coastal landscape.



FIG. 5.8 Form follows sediment: BwN-based beach house development within the beach ridges of Sand Motor to promote onward sediment transport. Image by J.v.Bergen & OKRA landscape architects.

Above: tramping by guests reduces embryonic dune growth and enhances sediment mobility for transport to the foredunes (human mobilisation, dispersed tails). Below: beach development in a later phase, where a year-round beach pavilion and wind-facing rows of beach houses producing deposition tails for foredune heightening. In both cases, sediment transport is promoted, as well as the multifunctionality and spatial quality of the coastal zone, leading to distinct landscapes.

5.2.3 **Application: contextualisation and integration of the design approach and principles in case studies**

Research question 3: How can the spatial design approach and principles be differentiated and aligned within different nourishment and urban settings to compose spatial arrangements that enhance the gradual natural adaptation of the coastal landscape?

In Chapter 4, the integrated landscape approach and three-step design method for BwN ashore were applied to four case studies representing different nourishment and urban conditions:

- Noordwijk, featuring small and frequent nourishments (S) in a highly urbanised setting;
- Walcheren, featuring a large and highly dynamic nourishment (M) in a suburban context;
- Petten, featuring a lowly dynamic and infrequent sandy reinforcement (L) in a rural context;
- Sand Motor, a highly dynamic, infrequent mega-nourishment (XL) in a suburban setting.

Learning environment for sediment dynamics in different contexts

These case studies served several purposes in the research. First, they were evaluated in GIS to analyse the impact of BwN nourishment types on coastal evolution and dune formation (morphogenesis). Second, their profile development after nourishment was studied (GIS), including urban and ecological interactions. Design principles for sediment allocation were derived from these analytical findings, combined with literature review and fieldwork.

From generic principles to a responsive design

The case design studies elaborated on how the generic three-step design approach and principles could be applied to a specific context, given a certain nourishment type, coastal profile, wind climate, programme and timeframe.

In all cases, the nourishment strategy provided a positive sediment budget to build up the coastal profile, but it generated different conditions for BwN ashore to take place, altering the role of the BwN arrangement.

The Sand Motor case (see Section 4.5) illustrated how design principles in a mega-nourishment situation (XL) – featuring an extensive dynamic profile – could stimulate sediment transport from the beach to the foredunes. ‘Human mobilization’ helps to source sediment and stop vegetation on the beach, whilst beach housing on poles (‘dispersed tails’) directs sediment for inland transport. ‘Eco-trapping’ finally stabilizes sediment in the foredunes to extend the coastal buffer. Here, the spatial BwN arrangement acts as a form of responsive design, following morphological development and transforming in time. (Figure 5.8)

In the Noordwijk case (S, see Section 4.2), two profile variants for future coastal safety were developed: a Dike in dune plus (dune heightening) and a Sand buffer (dune widening). These profile differences highlighted the distinct qualities of the six aeolian principles, some of which promote dune heightening (such as blowouts and ‘dispersed tails’) and others enhance dune widening (‘sand tails’, ‘eco-trapping’) (Figure 5.9).

In all cases, the nourishments operate on a regional scale and must be translated into a *dynamic profile design*. This profile design projects and allocates the resulting (erosion and/or) deposition volumes within the coastal profile (see Section 3.5.2) to guide the application of the local aeolian principles in space and time (see Figure 5.9). These design relations stress the importance of an integrated landscape design approach to connect BwN processes across systems and spatiotemporal scales.

Current profile: Dike in Dune 2020

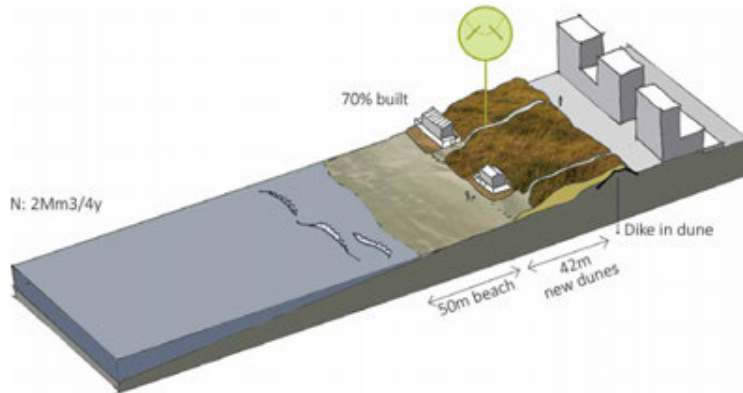

Testprofile 1: Dike in Dune Plus 2060



Testprofile 2: Sand Buffer 2060

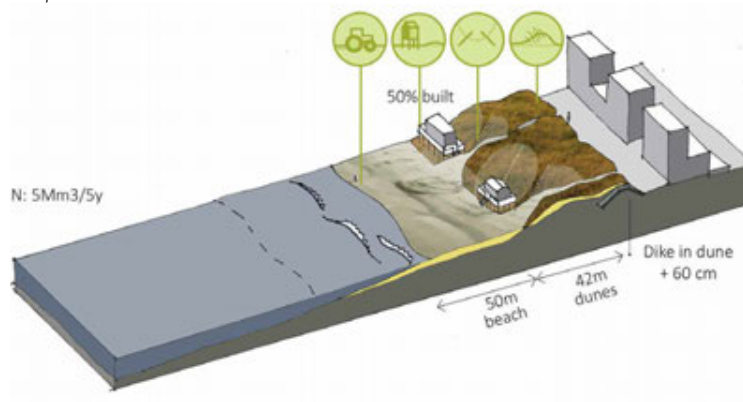

FIG. 5.9 Current and future reinforcement profiles for Noordwijk, enhanced by sediment harvesting from regular maintenance nourishments. Images by the author.

Towards an integrated BwN adaptation of urban sandy shores

The challenge is not merely to improve BwN for coastal adaptation but also to increase the multifunctionality of the coastal zone via BwN. In the case studies, different profiles and spatial arrangements were spatially tested to stimulate natural dune growth and facilitate multiple coastal functions. For instance, through terraces for beach housing or via urban adaptive typologies to enhance specific dune formation. These profiles and spatial arrangements (profile design and aeolian principles) illustrate how BwN-dynamics ashore can promote coastal safety, multifunctionality and spatial quality in response to local conditions and programmes. The profile design plays an essential role in translating nourishment dynamics into landscape construction. This design is temporal, which means that nourishment frequencies pulsate along with dune formation and that spatial arrangements act in response. This results in a dynamic arrangement over time, but could also lead to the optimization of the nourishment strategy, for example.

Based on site-specific testing, the following main recommendations were formulated to promote integrated BwN adaptation on urbanized sandy shores.

- **Incorporating BwN dynamics**

To enable BwN adaptation, spatial coastal design has to incorporate sediment dynamics. This begins with BwN-based (mega-)nourishment, allowing natural forces to transport sediment along and across the shore, featuring different zone dynamics to be matched by coastal programmes.

In the profile design, (nourished) sediment dynamics can be allocated and employed to both strengthen the coast for future coastal safety and serve multiple functions, for instance, by using the surplus of sediment for landscape differentiation guided by fencing, planting and urban arrangements.

In the first years after mega-nourishment, higher sediment transport rates of up to 30-60 m³/m/y are observed. Spatial arrangements, such as progressive fencing, are essential in this timeframe to promote BwN adaptation ashore, allocating sediment for the profile build-up as a coastal buffer. In time, transport rates from nourishments will decline (10m³/m/y), altering the sedimentation processes to reach new equilibria, such as stabilization through natural succession or the occurrence of blowouts. These can be anticipated by aeolian design principles fine-tuned for every stage. The manipulation of sediment dynamics by aeolian design principles can increase the speed of dune formation (e.g. by avoiding blockage), mimic natural succession for ecological restoration or articulate the profile for urban and recreational purposes.

- Coastal profiling

Matchmaking is needed between the nourishment type and profile alteration, determining the space, time and type of dune formation. Beach width, for example, has a major impact on the fetch, the accommodation space and the location of dune formation. This beach width is determined by the nourishment type and the rate of coastal erosion. Depending on the desired profile alteration, specific aeolian design principles apply, supporting either dune widening or heightening (see also research question 2).

Urban spatial parameters such as sea view, beach vicinity and beach buildings can be defining spatial factors for the type of profile alteration as a (future) coastal buffer. Vice versa, the choice to harness natural sediment dynamics for BwN adaptation could have a transformative effect on the urban coastal layout, for instance, from a boulevard to a dune-resort setting (see case study Noordwijk in Section 4.2.3).

Terraced coastal profiling has multiple benefits: it offers stability and accommodation space for the (future) coastal buffer, enhances upward sediment transport and offers safe grounds for recreation and a way to articulate the landscape for public-private relationships, diversifying the coastal landscape. The terraces could be established through BwN measures in the first phase after nourishment (e.g. fencing), to be occupied once the safety profile is established (see case study Petten in Section 4.4 and Figure 5.10).

- Urban impact

Beach row buildings have a substantial negative effect on dune formation (-50%, see research question 2 and Section 3.4). Beach buildings should be avoided when accretion for the coastal buffer is still needed, and, when present, they should provide optimal conditions for sediment allocation by applying the aeolian design principles in their spatial arrangement. However, once the coastal buffer is established, beach buildings could help to allocate sediment for further profile development, such as generous spacing and short tail development for dune widening or long tail development and blowouts for dune heightening.

- Scaled design

The case studies offered opportunities to zoom out from local arrangements to the coastal setting as a whole – for example, the development of alternative urban layouts (Noordwijk, Petten) as a result of the sediment flow or more dynamic nourishment types as an alternative to regular coastal maintenance, as proposed for Walcheren. This regional scale also provides ways to analyse long-term development, such as the extension or erosion of the dune barrier over time or the (re)location of waterfront development. Regular, small-scale maintenance nourishments, for instance, could be replaced by a more dynamic mega-nourishment, providing a sequence of conditions for existing and new programmes, such as surfing in the south, stable beaches in the middle and (controlled) erosion in the north to support the grey dune system. This could eventually lead to a re-articulation of urban development in the regional coastal zone as a new impulse closing the design cycle from local principles to future regional morphogenesis (case study Walcheren, Section 4.3.4).

- Temporal design

BWN adaptation requires a temporal design. Often, profile alterations require combinations of dune widening and dune heightening enabled by contrasting aeolian transport principles. Therefore, the spatial arrangement has to be fine-tuned to fit every stage, for instance via fencing for maximum foredune harvesting and profile articulation immediately after nourishment (See Figure 5.10), blowouts to promote dune heightening, and planting or aerodynamic buildings to consolidate the profile.



Initial fences working towards the safety buffer in the first years after reinforcement.

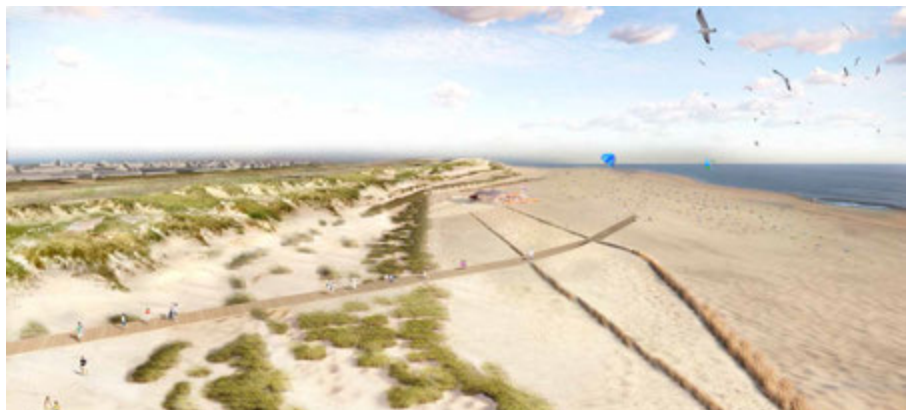

Established coastal buffer (10-15 years) with 1-2 pavilions.



Completed terraces including beach housing (15-30 years).

FIG. 5.10 Temporal fencing strategy of a BwN-based terraced design for the waterfront of Petten, following sandy reinforcement and coastline maintenance. Images by J.v.Bergen & OKRA landscape architects.

5.3 Conclusion: reflection on the research aim

To meet the main objective of the research, this thesis proposes a landscape design approach and a set of spatial design principles that support the aeolian build-up of the sandy coastal buffer by integrating geomorphological, ecological and urban dynamics to promote the development of adaptive coastal landscapes.

By reframing BwN from an engineering to an integral landscape perspective, a broader spectrum of solutions is generated, ranging from natural succession and dune farming to urban harvesting. These design principles induce pro-active spatial arrangements for sediment allocation and multifunctional profile alteration, as illustrated by the case studies.

The stepped design strategy of **morphogenesis**, **dynamic profiling** and **aeolian design principles** provides the tools to address and match scaled dynamics in a site-specific context. *Morphogenesis* helps to understand the historical and present geomorphological, ecological and urban dynamics and their future projection. From this analysis, spatial opportunities and critical conditions can be tracked and transferred to coastal design to improve the onshore BwN performance after nourishment, notably in terms of erosion rates, foredune growth and urban effects.

Once the safety volumes are achieved, the BwN dune formation can be shaped into a specific profile and conditions to facilitate multiple functions and values, such as coastal habitats and recreation. This makes *dynamic profiling* an important mediating tool for formal, multifunctional and interdisciplinary integration.

With the *aeolian design principles*, ambitions within the coastal profile are operationalized, and the sediment dynamics are incorporated into the local design. Their performance will enhance the profiling aimed for as part of the temporal design. Within ShoreScape planning, it was not possible to perform in-depth research on all principles as proof of concept. However, due to the contextual approach of GIS analysis and case design studies, the main systemic relationships for dune formation were identified, as well as a palette of scaled design solutions and their main design parameters to compose spatial arrangements promoting dune formation.

Overall, BwN as a landscape approach has four main benefits:

- 1 It generates insights into the onshore dynamic processes that contribute to dune formation after nourishment as part of the coastal buffer.
- 2 It transfers BwN from a mono-/transdisciplinary to an interdisciplinary systems approach.
- 3 It offers a scaled set of design tools for addressing and matching site-specific dynamics in space and time.
- 4 Through the process of research by design and variant studies, optimizations can be made, and a bandwidth of tailored solutions can be developed that incorporate sediment dynamics for multiple values: coastal safety, multifunctionality and spatial quality.

Spatial arrangements can be composed over time based on the six aeolian design principles, which facilitate dynamic profile alteration as a coastal buffer and carrier for functions and values. Although beach buildings affect dune formation negatively, alternative typologies (e.g. building width and orientation) can direct sediment transport for specific allocation within the profile to support dune widening or dune heightening.

The case studies illustrate how coastal nourishment, ecological and urban development can be intertwined to support the BwN build-up of the coastal buffer. Synergizing these developments creates chances to improve dune formation as a coastal buffer in pace with sea-level rise, but also makes way for BwN-based solutions that contribute to a vital, multifunctional and qualitative landscape. The case studies show that the aeolian design principles developed are applicable in diverse settings, but their position and sequence vary depending on the target coastal profile.

Research by design can assess each profile and identify the various zones needed for the BwN process. With research by design, the design principles can be categorized, clustered and combined to form spatial arrangements fitted to each zone in a specific coastal profile. This includes the assessment of related boundary conditions such as nourishment type and urban demands. These enable the integration of BwN for coastal adaptation as a new symbiosis between natural dune formation and coastal occupation.

5.4 Reflection: BwN as an interdisciplinary approach

Due to the wide territory involved and the high complexity of coastal dynamics, BwN cannot be understood from a single point of view. It entails a comprehensive and hybrid approach, in which nourishments, natural processes, spatial functions and values as well as BwN's societal perception converge (Van Bergen et al., 2021B). In this research, BwN ashore was redefined as an integrated approach synergizing coastal morphological, ecological and urban developments. This realm is covered by different disciplines, such as hydraulic engineering, ecological engineering, urban planning and landscape architecture, therefore requiring an interdisciplinary approach. Whilst hydraulic and ecological engineering has a science-based approach, landscape architecture focusses on spatial design, as a result of applied science and invention. Whereas science seeks to explain reality, the nature of design is ultimately to change it (Lee, 2011). This distinction in approach also explains why the language, methods and validation differ across these disciplines.

Research and design: the antithesis of deduction and convergence

Scientific research entails a process of deduction of reality to explain its partial nature. However, this is only possible for a controlled set of parameters or reduced complexity. In contrast, research by design engages with (complex) reality via invention, starting with observation(s), followed by interference (Sober, 2013) to arrive at a broader understanding of the reality change needed, gathering insights into the spatial relationships between the main spatial programmes or drivers. Aim is to optimize these spatial relationships, reframing the scope from possible to feasible solutions. This requires a systematic search, where the problem and objective can be refined or changed (Nijhuis et al, 2017).

In this research, scientific and design research were alternated and combined. On the one hand, elementary (field) observations filled the knowledge gap on dune formation in nourished and/or urbanized contexts, such as the accretion patterns around buildings. On the other hand, design studies explored the contextual relationships of nourishments and dune formation, scanning for BwN potential and feasible aeolian design principles. Both scientific analysis and design research contributed to an understanding of, and a design method for BwN dynamics ashore. This required bridging scales, transferring and extrapolating scientific insights into

aeolian transport on a local (object) level (e.g. fieldwork and CFD) back to their possible contribution to the coastal buffer on a regional landscape level and vice versa. This combination also initiated the development of a shared language from science-based to design-based approaches and vice versa, as experienced during the ShoreScape research. The interdisciplinary collaboration generated innovative insights that would not have been revealed by mono-disciplinary studies alone (Wijnberg et al., 2016).

Common grounds: modelling and the anthropogenic perspective to BwN

Besides the differences, there are also merging common grounds for BwN as an interdisciplinary field of knowledge. The first one is the rise of computational models to represent reality as a digital twin. These models are increasingly capable of representing and evaluating highly complex dynamic processes such as sediment transport after nourishment. They also enable design disciplines and stakeholders to become part of the optimization process, including modelling for multiple societal functions and values. A first step in enhancing the interdisciplinary design process would be the use of digital models as an interactive testing environment for *rapid prototyping*, as illustrated by the CFD experiments in this research. Another step is digital modelling to evaluate solutions in a long-term perspective, as in Dubeveg (Poppema et al., 2022) in the ShoreScape research. This could add to the sustainability of both engineering and design solutions.

The second common ground lies in the shared challenge of applying BwN to urbanized contexts. Whilst the first generations of BwN coastal engineering projects performed well in natural conditions, human occupation patterns, functions and perceptions are vital but non-operationalized elements that can determine BwN's future success (Van Bergen et al., 2021b). The integration of this anthropogenic perspective can expand the range of BwN solutions, as illustrated by this research.

5.5 Recommendations

Recommendations for future research

In this research, several forms of dune formation after nourishment were evaluated. However, dune formation is the result of multiple local circumstances. Therefore, it is recommended to compare more cases of dune formation related to specific types of nourishment. In particular, the relationships between beach width (fetch), sediment transport and embryonal dune growth are determining factors for BwN-based coastal profile adaptation and development.

The GIS analysis of the sedimentation patterns around beach buildings has revealed that they have a substantial negative effect on dune formation, especially in row formation. These first findings emerged from two inquiries on beach housing in mild and high nourishment conditions. To confirm these findings, further research is recommended, particularly on the effects of elevated beach housing and the tail development of larger objects, such as beach pavilions, against vegetated foredunes.

On the local scale, the sedimentation patterns of built objects and tail development were investigated. These findings, as proof of concept, are based on a literature review, CFD modelling and fieldwork on sedimentation patterns in an open plain environment. Over time, these tail developments will be affected by the dune slope, vegetation and accretion, altering the profile. Further research is needed to confirm these patterns in local and temporal conditions. Furthermore, building combinations, such as V shapes, have only been tested qualitatively. Thus, more field testing is needed to confirm the desired local wind acceleration and extended sedimentation pattern as proof of concept.

Aside from sediment transport, dune formation is dependent on vegetation to accrete, stabilize and develop into mature dunes. In this research, the ecological process and interventions (eco-trapping, blowouts) were only examined on the level of principle. Especially in urban environments, it is harder for these natural processes to develop. At the same time, there is high potential when local urban arrangements can include vegetation in the dune building process as a form of '*dune farming*'. The ecological effects of profile alteration and spatial arrangements for dune farming can be explored further in future research.

Recommendations for landscape practices

For landscape practices it is important to address the dynamic aspect of BwN design, such as nourishment and dune dynamics, via morphogenesis study. This can be done using temporal mappings, for instance, through historical and aerial surveys or computational modelling. This endeavour will generate a greater understanding of the natural and/or nourished coastal evolution to identify windows of opportunity for multiple coastal programmes, notably in places where the profile is wider and/or more stable.

The next step is to compose the dynamic profile, based on the estimated deposition after nourishment, and optimize it to include the coastal buffer as well as other coastal functions and qualities. A coastal profile should contain enough sediment to act as a storm erosion buffer but could be differentiated into various zones or terraces to strengthen the local identity of the waterfront and induce landscape variety. Within these profiles, spatial arrangements of aeolian design principles can be made that facilitate the desired sedimentation process for dune formation. Several aerodynamic beach house arrangements have been composed that support inward or onward sediment flow and local identity. Here, the aeolian principles can be taken as a palette or guide for inclusive coastal development.

Recommendations for coastal management

In this research, GIS studies showed that dense beach row housing, a common type of urban development, deprives the foredunes of sediment. Therefore, beach row housing and pavilions should be built reluctantly and only in places where the foredune as (future) storm erosion profile is sufficient.

Coastal *dynamic profile design* including both nourishment and dune dynamics can improve the harvesting of nourished sediment and increase the multifunctionality and spatial quality of the coastal landscape. An example is the dynamic development of stepped profiles, which facilitate upward sediment transport and natural zoning for recreation (see Sub-Section 4.4.2). The nourishment design could also be improved to support aeolian sediment transport, for instance, by providing wide and stable beaches.

Within the coastal profile, alternative spatial arrangements of beach buildings could be tested to evaluate their tail development on dune widening for example (see also sub-Section 3.6 – principle W3). A starting point is the reduction of the wind-facing surface of beach houses (heads in the wind), which, in combination with generous spacing (> 2–3 times the building's width) could lead to shorter tail development

to widen the foredunes. By moving the beach housing every two to three years, the former site could be planted to promote further foredune heightening.

For areas where dune heightening or sediment transport to the inner (grey) dunes is recommended, it is advised to avoid beach row housing and create a gradual slope with blowouts (see also Section 3.7). Larger objects, such as beach pavilions, have longer tail development and could be placed in combination with natural blowouts. Further research (e.g. CFD) is needed to confirm this hypothesis.



Dune formation around a beach access in Ameland, the Netherlands.
Source: © Rijkswaterstaat / J. van Houdt.



APP. A Appendix

In this appendix, the research on the aeolian design principle W3, Sand tails, is documented (see summary in Section 3.6-W3), as one of the focal points of the ShoreScape research. This principle elaborates on the sand deposition caused by (non-elevated) buildings to promote dune widening.

APP. A.1 Principle W3 Sand tails of non-elevated buildings



The diversion of wind around beach buildings causes the wind to accelerate (picking up sediment) and decelerate, leading to the local deposition of sediment on the lee sides, that is, the formation of sand tails. The deposition begins in horseshoe patterns (Poppema et al., 2019, see Figure 3.21) but can accumulate in combined tails at the back of the building under changing wind conditions. The surplus in deposition can be used for the local harvesting of sediment, for instance, for the seaward extension of the foredunes. In this Section various aspects of deposition tail development around buildings are documented, concluded with spatial arrangements to promote dune widening.

APP. A.1.1 Deposition tail length and wind-facing surface

Within the ShoreScape research, fieldwork (2019) was carried out to investigate deposition tails around scaled objects (Van Bergen et al., 2021; Poppema et al., 2021, 2022). The findings show that related sedimentation patterns scale to the (wind-facing) geometry of the building, especially building width. Sand transport at beaches generally occurs close to the bed (0–50 cm; Dong et al., 2003; Rotnicka, 2013). Therefore, little sand is blown over buildings, depending on their height. Building length (parallel to the wind) has very little effect (Poppema, 2022).

When wind hits a building surface, it is diverted upwards over the building, downward and to the sides. At around two-thirds or three-quarters of the building's height, upward and downward winds are separated (Peterka et al., 1985; Poppema, 2022).

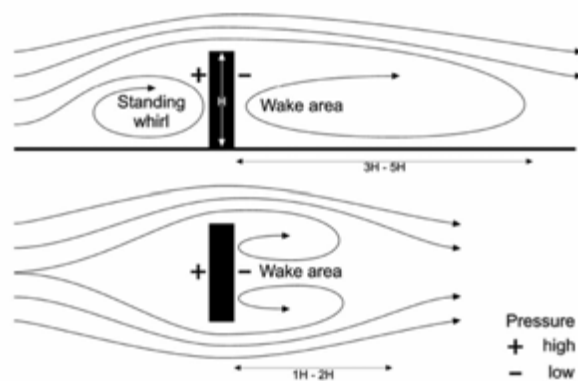

FIG. APP.A.1 Example of wind vortices around a rectangular building. Source: Sustainable design, 2011.

From there, the downward wind is diverted to the sides and back of the building in a spiral horseshoe-shaped pattern, resulting in two wing tails on the lee side of the building. The downwind recirculation length of the wake/side tails can be described by:

$$R_{\text{downwind}} = \min(w, h)^{2/3} * \max(w, h)^{1/3} \text{ (ASHRAE, 2005; Wilson, 1979)}$$

where w is the width of the building and h is the height of the building.

Literature (Schulman et al., 2000; Poppema, 2022) shows that R predicts not only the length but also the width of the recirculation cell around buildings. Thus, R could also be used as a scaling length for deposition.

Deposition also depends on wind speed: the higher the wind speed, the greater the suspension of sediment and the larger the deposition. Therefore, a new scaling length, B , is introduced for the prediction of sand deposition. In field experiments (Poppema, 2022), the correlation between deposition patterns and building geometry (w , h) was investigated, confirming a new scaling length B for deposition around buildings:

$$B = w^{2/3} * h^{1/3}$$

where B represents the resulting width and length of the deposition tails and is applicable to buildings within the range $0.2 < w/h < 4$. For buildings with a square wind-facing façade $w = h$, the equation is $B = w$.

From B , the downwind tail length L can be derived:

$$L_{\text{downwind}} \approx 4.3B + 2.2$$

This calculation represents the deposition pattern of a single wind event (e.g. the pattern after one day). For larger objects such as beach pavilions, this period may be longer (2–3 days). After this first wind event, more deposition will take place over time, extending the initial deposition tail. Over a 5–6-week period, this tail is likely to double in length (by a factor of 2–2.5), as derived from the fieldwork at the Sand motor (see Figure APP.A.4) and Noordwijk (see Figure APP.A.10). Furthermore, these calculations concern deposition patterns in an open field. When buildings are placed in front of a dune slope, the tails are likely to become shorter due to wind resistance.



FIG. APP.A.2 Example of side tail development behind a pavilion at Hargen, North Holland. Source: K. M. Wijnberg, UT, 2021.

Extrapolation of the findings to a Dutch coastal context

The formula above can be applied to common beach-building types to predict their sand-tail length as a means to promote foredune formation.

For an average **seasonal beach house** of $w = 3$ m and $h = 3$ m (square) the downwind tail length can be calculated as follows: Scaling length $B = w = 3$ m. The downwind tail length becomes $L_{\text{downwind}} \approx 4.3B + 2.2 = 4.3 \cdot 3 + 2.2 = 15$ m.

For an **average non-elevated beach pavilion** (with a terrace) of $w = 40$ m, $b = 20$ and $h = 5$ m, the w/h ratio is > 4 , outranging the applicability of the B formula. To approach its effect, we take the maximum $w/h = 4$. This generates a $w_{\text{max}} = 4 \cdot h = 4 \cdot 5 = 20$ m. B then becomes: $B = 20^{2/3} \cdot 5^{1/3} = 7.4 \cdot 1.7 = 12.5$ m. The downward tail length is then: $L_{\text{downwind}} \approx 4.3B + 2.2 = 4.3 \cdot 12.5 + 2.2 = 56$ m.

To promote dune widening, these tail lengths could be taken as a rule of thumb to determine the ideal building distance from the dune foot (D) in the most dominant wind direction exceeding Beaufort force 5. In most Dutch cases, this dominant wind direction is SW and 45° oblique to the shore. The dune foot distance D can be derived via $D = L \cdot \sin a^\circ$, where a is the angle between the wind and the dune foot.

The dune foot distance D then becomes $D = L \cdot \sin a^\circ$. Thus, D beach house = $15 \cdot 0.5 = 7.5$ m, and D beach pavilion = $56 \cdot 0.5 = 28$ m (see Figure APP.A.3). These tail distances B are calculated for a building facing the wind. However, in most cases, the wind will be oblique to the buildings and, therefore, produce longer asymmetrical side tails (see below).



FIG. APP.A.3 Schematic sand-tail pattern of a beach house (left 3x7m, 3m high) and beach pavilion (right, 20x40m incl. terrace, 5m high). In dark yellow, the initial tails; in transparent yellow, the extended tails over time, doubling in length. Source: J. van Bergen, Aerial photo: Google earth.

Conclusions

Built objects produce deposition patterns as a result of the divergence of wind and sediment flow. This generates upwind deposition (e.g. in front of houses) and downwind deposition via side tails. One of the most determining design factors in promoting deposition is the **wind-facing surface**. When the wind-facing surface increases, wind divergence becomes larger and the tails longer. Fieldwork (Poppema, 2022) has shown that their initial length can be calculated as $L_{\text{downwind}} \approx 4.3B + 2.2$, where $B = w^{2/3} * h^{1/3}$ for buildings within a $0.2 < w/h < 4$ range. For common beach housing ($w = h = 3$ m), the deposition tail behind the building is ~ 15 m. For larger beach pavilions ($w = 20$ m, $h = 5$ m), the tails become as long as ~ 56 m. Furthermore, both tail patterns will become longer in time, increasing the initial tail length by a factor of 2.

To use these **sand tails** for foredune formation, the distance from the building to the dune foot D becomes $D = B * \sin a^\circ$, ($a =$ wind angle) varying between **7.5 m** for small beach houses and **28 m** for beach pavilions. This global calculation shows that especially for large beach objects such as pavilions, sand-tail lengths are substantial and far exceed the general planning zones of 5 m dune-foot distance (i.e. Dutch Water Board regulations).

Deposition volume around built objects

In the spring of 2019, a field experiment was conducted (Van Bergen et al., 2021) to investigate accumulative deposition around non-elevated boxes. Three 1 m-long, 50 cm-wide and 50 cm-high scale models were placed on a wide and open beach and secured in the sand by poles. The first box, B1, was placed perpendicular to the shoreline. The second box, B2, was positioned parallel to the shoreline (NE/SW direction). A third box, B3, was placed parallel to the shore on 25 cm-high poles. After 0 (T0), 21 (T1) and 42 (T2) days, volume changes around the boxes were monitored via terrestrial laser scanning. During this period, the boxes were exposed to a varying wind climate. The most dominant wind direction during the entire observation period was N/NNE for the strongest winds ($>$ Beaufort force 4). Just before the measurements at T1, the wind turned briefly to a SE direction. During the second period (T1–T2), the wind was stronger and continued to blow from the North.



FIG. APP.A.4 Photograph of the sand-tail patterns behind scale models B1, B2 and B3 after 6 weeks, with the downwind deposition tails clearly visible (left). Source: J. van Bergen.

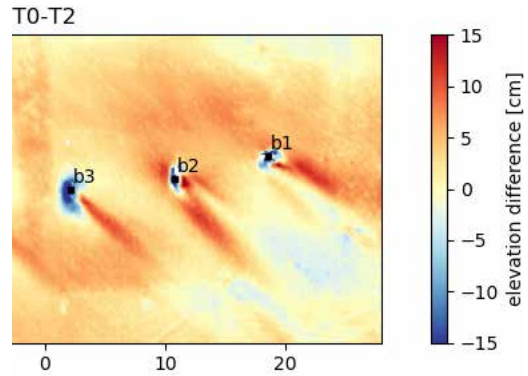
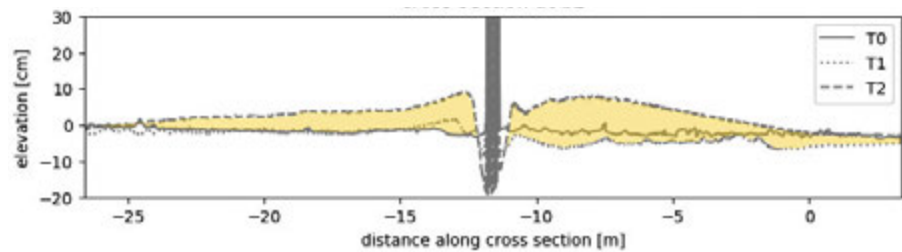

FIG. APP.A.5 Lidar mapping of the sand tails (red) of boxes B1, B2 and B3 after 6 weeks, with an average deposition of 7 m³/box. Source: M. Kuschnerus.

The mapping of the Lidar measurements shows the deposition patterns produced by the boxes in 6 weeks (Kuschnerus & Lindenbergh, 2019, see Figure APP.A.5). Here, B2 features a more upwind deposition than B1, which faced heavy erosion below the box, reducing the wind divergence. The tails are similar in length but asymmetrical due to the oblique dominant wind direction. The calculation of the volume changes (T0–T2) revealed that 6.9 m³ was collected in 6 weeks in the B1 zone (30x10 m) and 6,8 m³ in the B2 zone (around 2 cm/m²). Cross-sections indicate that autonomous beach development was erosive in the first phase (T0–T1) and accreting in the second phase (T1–T2), amounting to around 0 m³/m². In the first period (T0–T1), the wind changed from NE to SE. Here, B2 eroded slightly more due to a greater wind-facing surface towards the east. During the second period (T1–T2), the wind was stronger and more continuous from the N/NNW direction, at an angle of approximately 45° with the boxes. In this windier period, zone B1 accreted 7.6 m³ in 3 weeks and zone B2 7.2 m³. The 5% difference between them may be due to the NNW angle, which increased the wind-facing surface for box B1.

	stilt height [m]	Volume changes in m ³			Standard Deviation T0-T2 10 ⁻³ m ³
		T0 - T1	T1 - T2	T0 - T2	
Dominant wind direction > 5 Bf		SE-NE	N-NNW	N-NNE	
Beach: autonomous development	-	-3	+3	0	0
B1	0.0	-1.9	+9.6	+7.6	6.9
B2	0.0	-2.2	+9.3	+7.2	6.8
B3	0.25	-1.2	+8.2	+7.0	6.2

FIG. APP.A.6 Overview of the volume changes per box (m³) during the 6-week field experiment. Source: J. van Bergen; Lidar measurements by M. Kuschnerus, 2019.



Cross section of scale model B2 (0 cm poles)

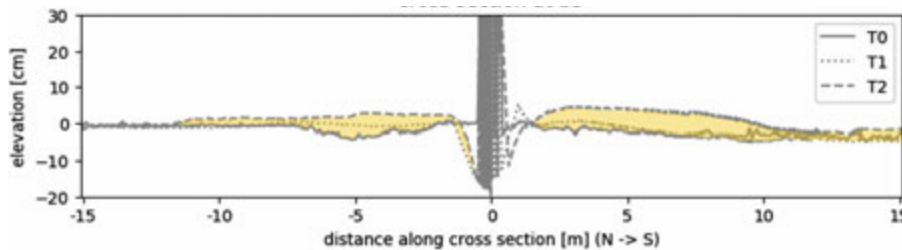

Cross section of scale model B3 (25 cm poles)

FIG. APP.A.7 Cross-sections of the scale models B2 and B3 derived from the Lidar laser measurements, showing the upwind (left) and downwind deposition (right) around the boxes (middle). Source: M. Kuschnerus, J. van Bergen.

The section of the deposition pattern of B2 (including side tail; see Figure APP.A.7 above) after 6 weeks reveals considerable upwind deposition (35%, left), but most deposition (65%) occurs at the lee side of the building during the period T1–T2. According to Poppema (2022), for square buildings, the scaling length $B = w = 0.5$.

This corresponds to $L_{\text{downwind}} \approx 4.3B + 2.2$, that is, $L = 4.3 \cdot 0.5 + 2.2 = 4.4 \text{ m}$ downwind tail length after 1 day. In sections 6.7a and 6.7b, the downwind deposition (right) builds up to a perimeter of approximately **5 m** in the first 3 weeks (T0–T1) and **10 m** in 6 weeks. This confirms the accumulative effect of deposition exceeds day patterns by a factor of $\sim 2\text{--}2.5$.

For B1 and B2, the local erosion directly around the boxes was considerable, reaching up to 10–20 cm. This erosion was 60% lower for box B3, which was placed on 25 cm-high poles, possibly due to reduced wind divergence to the sides of the box. The deposition of B3 was only 5% lower than that of B1 and B2; therefore, small poles are a potential mitigating measure to reduce scour around beach houses. Additionally, the deposition section of B3 (Figure APP.A.7 below) shows that upwind deposition declined to 25% compared to B2 (35%).

Conclusions field experiment

The field experiment with non-elevated scale models at the beach reveals that local deposition around built objects can be considerable (7 m^3 over 6 weeks). Consequently, buildings could become a potential measure to promote local accretion, for example, for dune widening. Local erosion around built objects may be reduced by the utilization of small poles. In 6 weeks, most of the deposition occurred within 5–10 m of the (non-elevated) scale models, multiplying the initial (day) tail length by a factor of 2.

APP. A.1.3

Deposition tails for oblique-oriented objects

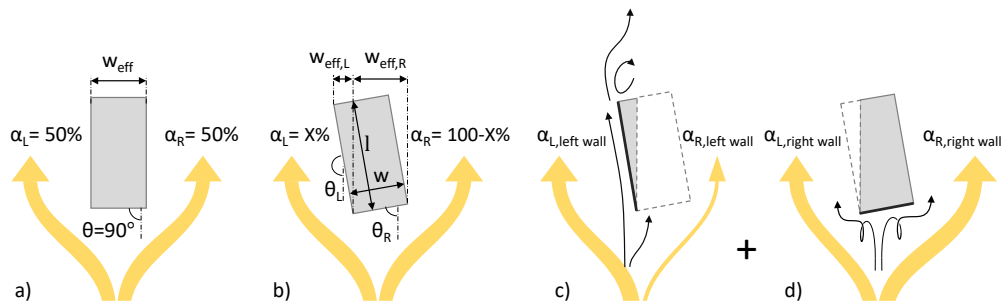

FIG. APP.A.8 The asymmetrical side-tail division resulting from wind divergence caused by building orientation. Source: D. Poppema, 2022.

In Section APP.A.1.1, we explained the occurrence of deposition tails behind built objects oriented perpendicular (90°) to the wind and, therefore, featuring only a single wind-facing wall. However, in most coastal situations, the (dominant) wind arrives from a lower angle and thus meets two wind-facing walls obliquely. The orientation of the walls determines how sediment transport is diverted to the sides of the buildings and whether a recirculation vortex is formed (Figure APP.A.8 a-d).

For a building with an oblique approaching wind, the divergence of flow has to be combined, taking into account the wind-facing width of both walls and their angles (Poppema, 2022). The sediment-flow partitioning ratio for the front wall, α_L , can be calculated as follows:

$$\alpha_L = \frac{\theta_R}{180} + \frac{0,5}{\tan(\theta) \cdot \frac{\omega}{l} + 1}$$

where ω is the width of the front wall, l is the width of the sidewall, and θ_R is the angle of the wind with ω . Although this ratio indicates the proportional difference and volume of the two side tails, it is not related to the absolute length of the asymmetrical tails and requires further research.

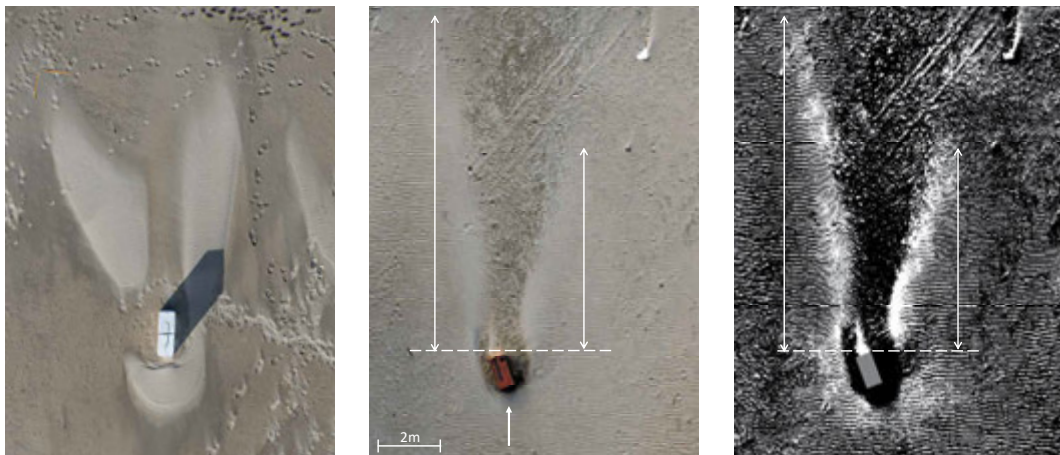

FIG. APP.A.9 Example of a symmetrical (left, 96x32x70 cm) and asymmetrical tail pattern (box, 50x100 cm, 50 cm-high, turned 70°), causing the left-side tail to become longer than the right-side tail. Source: D. Poppema, 2022.

However, from fieldwork an indication of a-symmetrical tail-length can be derived. In the binarized photograph of a scale model of 0.5x0.5x1 m (Figure APP.A.9 right), an **asymmetrical tail** is produced caused by the object's 70° orientation with the wind. If the box were oriented parallel to the wind, the length of the deposition tail would be $L_{\text{downwind}} \approx 4.3B + 2.2 = 4.3 \cdot 0.5 + 2.2 = 2.15 + 2.2 = 4.4$ m long. However, due to its oblique position, the left-side tail is now about 11 m long and the right-side tail 6.5m long –that is, **1.5 and 2.5 times longer** as a result of the more aerodynamic wind flow along the sides to the back. The asymmetrical tail pattern is caused by the asymmetrical diversion of flow between the front and side walls. Here, the side wall will add more wind-facing surface, producing a larger side tail than with the front façade only (Figure APP.A.9 middle). At the same time, when the side wall is placed at an angle $< 45^\circ$ with the wind, the wind is guided along the side façade more aerodynamically, therefore limiting wind-speed reduction compared to the front façade, which has a wind diversion $> 45^\circ$. This may also explain why one side tail is longer. In short, oblique winds along rectangular objects produce asymmetrical and longer side tails due to the combined effects of wind-facing surface and aerodynamic wall angles.

Although the length of asymmetrical tails cannot be calculated yet, it is clear that oblique-oriented rectangular objects produce much longer (2–2.5 times) tails than parallel-oriented objects. These longer tails could be beneficial to promote dune heightening. However, for dune widening, shorter tails would be preferable to allocate more sediment to the dune-foot zone.

Accumulative effects of asymmetrical tail development

On most shores, the wind direction is dynamic. Therefore, tail development changes directions and is accumulative over time. To illustrate these dynamics, an example is given of heightmaps created around a (non-elevated) shipping container in Noordwijk (2.5x2.5x12 m; Poppema, 2022). On the left, the asymmetrical tail pattern that occurred after a 3-day SW storm clearly evidences the asymmetrical horseshoe-shaped deposition pattern in front and at the sides of the container. Here, the sidewall of the container facing the wind added considerably to the wind-facing width, explaining the larger upwind deposition. On the right, the resulting tail pattern after 5 weeks is shown. The most dominant SSW wind direction is visible, leading to a reduction in the wind-facing width and, consequently, lower upwind deposition. The earlier SW storm upwind deposition has been transported to become part of the left-side tail, which is more pronounced. The left tail is now around 30 m in length, compared to the 15 m right-side inner tail, multiplying the initial tail length ($L_{\text{downwind}} \approx 4.3 \cdot 2.5 + 2.2 = 13$ m) by a factor of ~ 2 .

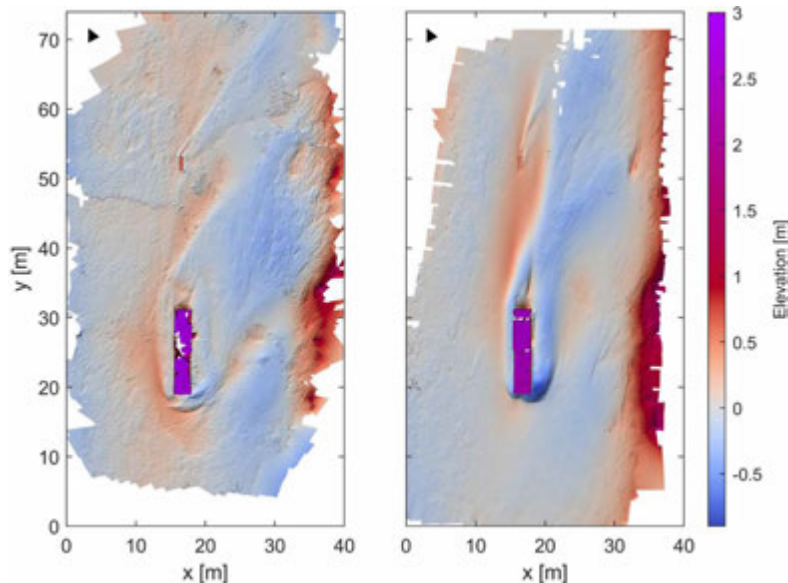

FIG. APP.A.10 Examples of asymmetrical deposition tail patterns around a shipping container parallel to the dune foot at the Noordwijk beach resort. Source: Poppema, 2022.

On the left, the asymmetrical deposition pattern after a 3-day Southwest (SW) storm. On the right, the asymmetrical tail pattern after 5 weeks of varying wind directions, mainly from the SSW direction.

Extrapolation of the findings to the coastal context

The predominance of angular winds along sandy shores causes the development of asymmetrical tails around built objects, especially rectangular buildings. Because of the incoming angle, a second wind-facing wall is added, increasing the wind-facing surface and, therefore, deposition. At the same time, the angle between the wall and wind also determines the amount of diversion and turbulence. For instance, the wind flow along aerodynamically positioned walls is reduced less significantly, resulting in a longer side tail.

Because of their longer side tails, asymmetrical side tails could be employed to promote (fore)dune heightening. For dune widening, it would be best to shorten the tails to allocate sediment to the foredune zone. Thus, orienting the narrowest façade towards the dominant wind would be preferable.

Combined deposition patterns: beach row housing and gap-distance

Beach buildings are often placed in larger rows. The proximity of neighbouring buildings will affect the deposition tail pattern. A closed row of buildings with narrow gaps between the buildings will diminish the occurrence of side tails between buildings and has a negative effect on foredune development (see Section 3.4). Larger gaps between buildings can let the wind pass and locally accelerate for sediment to be transported and deposited on the lee side of the buildings. This can be beneficial in reducing upwind deposition and promoting deposition in the foredune zone.

Within the ShoreScape project, fieldwork (Poppema, 2022) was carried out to investigate the effect of building spacing on deposition patterns. The effects on the sedimentation tail patterns were studied using scale models on an open beach plane (Figure APP A.11), leading to the gap ratio $g^* = G/y$ (where G is the gap width and y is the heart-to-heart distance of the row housing).

An analysis of various compositions showed that:

If the gap ratio (g^*) is < 0.33 , as is the case with conventional (semi-)closed beach row housing, most of the deposition will occur upwind (in front of the row) and little deposition at the lee side of the row due to the limited inner tails produced.

With a gap ratio $g^* > 0.67$, the wind can pass more freely through the gaps, resulting in the formation of inner tails downwind of the gaps comparable to the side tails at the ends of the row. The increased gap width also leads to a decrease in upwind deposition, gap erosion and row side tails.

Spacing of 2–3 times the building's width or more ($g^* = 0.67$ – 0.75) shows combined inner tails at the lee side of the gaps, leading to a locally concentrated deposition that could be beneficial for dune widening. For 2.5 m-wide seasonal beach houses, this would correspond to a gap width of 5–7.5 m.

At a ratio $g^* > 0.8$, inner tails start splitting into individual side tails that become wider and lower, decreasing the row effects (see Figure APP.A.11C).

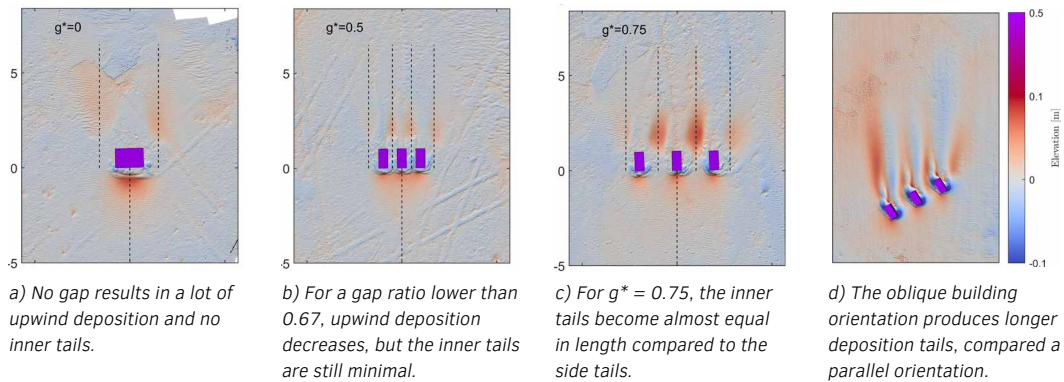

FIG. APP.A.11 Test results of a scale-model row with varying inter-distances (gap of 0, 1 and 3 times the building's width) and 3 times the buildings width with a 60° wind angle. Measurements (x,y) in meters. Source: Poppema, 2022.

Effects of oblique spacing: CFD modelling

Sub-section APP.A.1.3 explained that objects with an oblique orientation to the wind produce longer side tails than those with a perpendicular orientation because of the aerodynamic orientation of the side walls. A similar effect is seen in a row setup, where the inner deposition tails are larger when the gap is oblique to the wind (e.g. at 60°; Poppema, 2022), possibly due to the oblique wind-facing surface combined with local convergence and, therefore, the acceleration of wind flow. In other words, when placing a more closed row of beach housing ($0.67 < g^* < 0.75$; gap of 2–3 times the building's width), it may be beneficial to orient the houses obliquely to the dominant wind to allow a more aerodynamic passage of wind and sediment flow, resulting in a better production of inner tails.

Preliminary (qualitative) CFD modelling (Pourteimouri et al., 2021) confirms that local acceleration in oblique building gaps can lead to longer tail patterns and more deposition to the upper foredunes (Figure APP.A.12A - left) than building gaps that are parallel to the wind (Figure APP.A.12C -right).

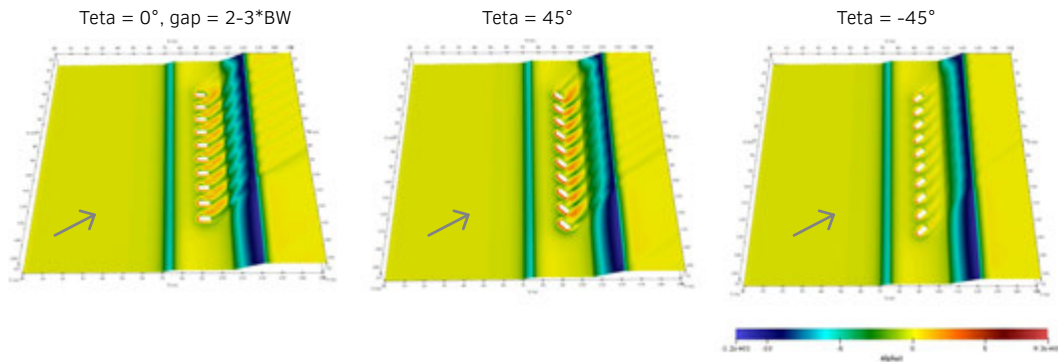

FIG. APP.A.12 Test results of CFD modelling, where beach row houses with a gap size of $3 \cdot w$ (building's width) and an object orientation of 0° , 45° and -45° degrees to the dune foot in a profiled environment are combined with a dominant SW wind. Source: Pourteimouri et al., 2021

The deposition patterns show that deposition tails (green-blue) are most pronounced for the perpendicular orientation (Figure A left) because of the aerodynamic orientation of the side wall. Figure B in the middle shows that the most erosive pattern is close to the houses, due to a larger wind-facing surface. The larger wind-facing width also produces longer deposition tails than the configuration in Figure C. Figure C (right) represents the shortest deposition tails due to the smallest wind-facing surface. Depending on the desired sediment allocation, configuration A (left) could be beneficial to the allocation of sediment to the upper foredunes, and configuration C (right) may be advantageous to promote deposition at the dune foot. Configuration B (middle) is less desirable due to local erosion.

Similar CFD results were achieved in a master study by V. Stevers (2021, in collaboration with ShoreScape) on row rotation with a limited gap width (3 m, $g^* = 0.5$). Although all four configurations had a negative effect on sediment transport to the upper foredunes, the row oriented obliquely to the WSW wind (Figure APP.A.13 - configuration A) performed best in sediment transport to the top of the foredune, possibly because of the asymmetrical side-tail development. The study also confirms that the smaller the wind-facing surface, the shorter its tails (Figures APP.A.13B and C). It also confirmed the acceleration of wind speed between the buildings caused by overlapping side vortices (Figure APP.A.13A, in red between houses), resulting in longer inner tails. More CFD modelling is necessary to confirm and further quantify these differences.

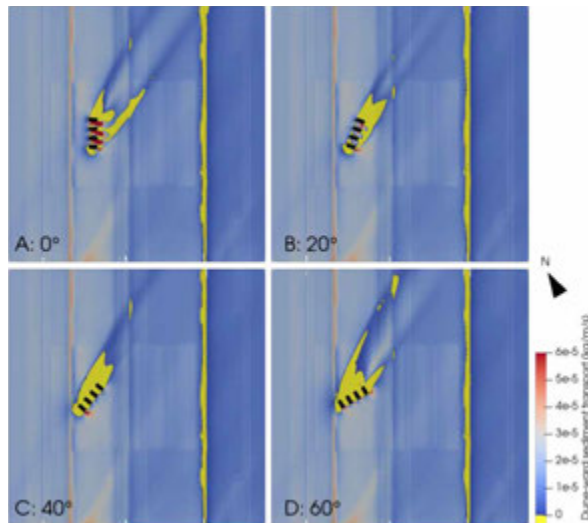

FIG. APP.A.13 CFD output of a rotated row of beach houses of 3x3x7 m with a gap of 3 m, oriented at varying angles to the wind. Source: V. Stevers, 2021.

The calculation of annual deposition showed that configuration A (top left) produces slightly more sediment accumulation at the dune top as a result of the longer tails resulting from oblique wind orientation. In yellow, the lee areas where deposition is expected.

Conclusions: building configurations promoting dune widening

So far, several mechanisms have been discussed that lead to downwind deposition behind built objects: symmetrical tails, with the wind-facing building width and height as important spatial parameters; asymmetrical tails, which promote extended deposition tails; and row effects, which produce shorter or longer inner tails depending on the gap width and orientation. For dune widening, the most beneficial setup is no beach buildings at all (see Section 3.4). This enables sediment to accrete at the dune foot enhanced by vegetation (eco-trapping). In specific profiles, once the safety profile is assured, beach buildings could help to allocate sediment in the foredune zone (to maintain sea view on the boulevard, for example) and partly compensate for their negative effect on dune formation.

Overall, dune widening through urban configurations is enabled by:

- reducing the wind-facing surface to the dominant wind to produce side tails that are as short as possible.
- leaving larger gaps ($g^* > 0.75$, or 3 times the building width) between buildings, avoiding row effects to reduce upwind deposition.
- leaving a greater distance between the dune foot and the building (e.g. > 10 m) to accommodate the deposition.

- (protected) planting at the dune foot and foredune slope to increase deposition and stabilization.
- fencing and/or oblique beach access points perpendicular to the dominant wind to reduce sediment flow inland.

APP. A.1.5.1 Seasonal beach row housing and dune widening

For traditional row housing with no or small gaps (< 1 time the building's width), most of the deposition will take place in front of the row (and is often bulldozed away), depriving the foredunes of sediment (Figure APP.A.14 - configuration O).

However, if coastal safety is not an issue and dune widening is the preferred BwN strategy, a configuration with the shortest side tails possible would be preferable to allocate sediment right behind the buildings in the dune-foot zone. For this reason, beach housing with a smaller wind-facing surface and larger gaps ($g^* > 0.75$, row effects diminished) is most beneficial. For beach row housing, this would mean orienting the narrowest façade towards the dominant wind and gaps larger than 3 times the building's width (Figure APP.A.14 - configuration A, SW wind). However, this reduces the number of beach houses considerably. The houses should be put at a 7.5 m distance from the dune foot to accommodate the tail deposition (see Sub-section APP.A.1.1).

A denser row configuration (Figure APP.A.14 - configuration B; gap = 2 times the building's width; $g^* = 0.67$, overlapping side tails) will lead to more upwind deposition. To maintain a certain urban density, houses could be combined to form rows or slats parallel to the dominant wind (Figure APP.A.14, configuration C), exploiting the lee side behind the front building. Although tail length increases (~25 m) due to the larger wind-facing surface, the greater distance between the front house and the dune foot (12.5 m) allows for deposition at the dune foot. This configuration could be improved further by turning the front house parallel to the wind, reducing the side tails even further (Figure APP.A.14, configuration D) and making closer row distances possible. By turning the backhouses 45°, their wind-facing surface becomes more aerodynamic, enabling a cascading airflow to the back (see also Sub-Section 3.7.2, principle H2). When combined with NNW winds, the oblique gaps between the houses could act as a funnel, with longer tails towards the dune foot. It is recommended to place all beach housing on small poles (0.5–1 m) to reduce upwind deposition and local erosion.

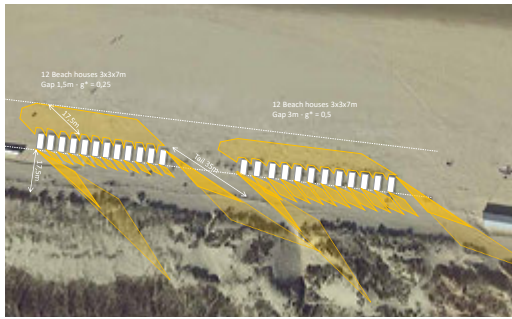

Configuration 0: traditional rows of beach houses (3x7x3m)

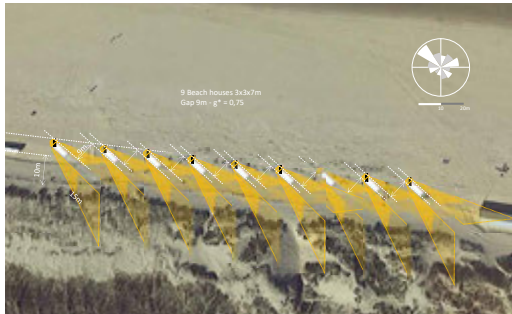

Beach housing configuration A: single row



Beach housing configuration B: dense row

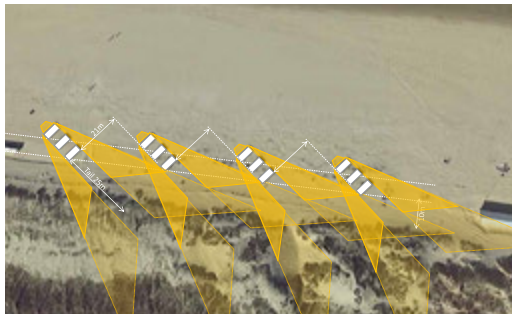

Beach housing configuration C: slats

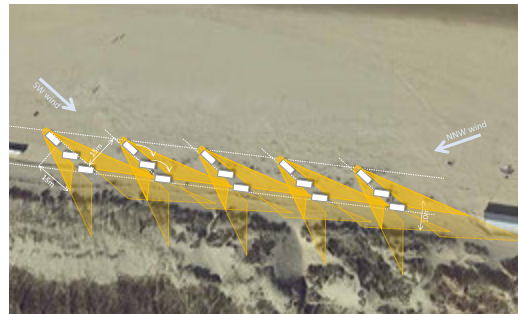

Beach housing configuration D: dense cascading row

FIG. APPA.14 Overview of the principal sand-tail development of beach house configurations in the dominant wind direction promoting dune widening (0, A-D). Images by the author. Aerial photograph: Google Earth.

APP. A.1.5.2 Beach pavilions and dune widening

Seasonal non-elevated beach pavilions usually have a rectangular setup (e.g. 20x40 m, including terraces with windscreens) and can therefore block large parts of the dune foot. Due to their large width, they produce long tails of 50–60 m or more (Figure APP.A.16, configuration P0). Most are oriented parallel to the shore/dunes, resulting in an oblique orientation with the (SW) wind and, thus, longer asymmetrical tails (see Figure APP.A.16, P0). To allow these long tails to be transported to the dunes and avoid upwind row deposition, generous **spacing** between the pavilions (effective gaps of 2 times the building's width, **130 m or more**) is needed.

To promote dune widening and allocate sediment to the foredune zone, it is best to shorten the deposition tail as much as possible. This can be done by turning their smallest façade towards the dominant wind and allowing for ample spacing (Figure APP.A.16, configuration P1; $g^* = 0.67$). This effect could be increased via a further reduction of the front façade facing the wind, resulting in an aerodynamic configuration with short tails (Figure APP.A.16, configuration P2). Tails can be shortened further by a steeper foredune slope, fencing and vegetation. Since the tails are still quite long, it is recommended to place the pavilions away from the dune foot to provide space for deposition. Because of the long tail development (50–100 m) along the foredunes, it is best not to position beach access points in the same (SW) direction to avoid silting up.



FIG. APP.A.15 Aerial photograph of the Noordwijk beachfront with sand deposition in the dunes, caused by beach buildings and accesses, April 2018. Source: Google Earth.

Clearly visible are the downwind deposition tails of the beach pavilions, as well as the blowout patterns of the beach accesses, overflowing the dunes in the SW direction.



FIG. APP.A.16 Overview (PO (top), P1 and P2 (right)) of the principal sand-tail development of beach pavilion configurations in the dominant wind direction promoting dun- widening. Images by the author. Aerial photograph: Google Earth.

APP. A.1.5.3 Dune-widening configurations for multiple wind directions

So far, all configurations have been designed to fit the most dominant wind above Beaufort force 5, which, in the Netherlands, is SW (occurring 17% of the time, mostly during summer). The second most prevalent wind is NNW (12%). Configurations should also be tested in this direction. For beach row housing, wind from the other direction will lead to longer side tails (configurations APP.A.14 A, B and D) due to the larger wind-facing surface. Configuration APP.A..14 C may be optimal for both wind directions as long as the gaps can be generous ($g^* > 0,67$) to avoid upwind deposition.

For pavilions, the reduced wind surface in one direction is larger in the other direction, increasing tail length. A steep dune front may help to stop sediment transport inland. Configuration P2 (Figure APP.A.16) could be adjusted to fit both wind angles if the mid-terrace is not shielded. Another option is to place the pavilion on (low) and limited poles (at a greater distance from the dune), reducing the wind-facing surface in smaller components (poles) with shorter tails.

Acknowledgments

From childhood onwards, I've always been fascinated by the sea. My family owned a small holiday home on the Dutch coast, where we would spend our holidays. My favourite activity was to build a sandcastle and wait for the tide to arrive; watching it being washed away by the sea. My professional career allowed me the opportunity to get acquainted with the sea once more. In 2009 I joined the Delta programme, whose aim was to come up with a long-term vision for the Dutch coast. In this vision, sand nourishment became the central strategy for sustaining this coastline in the long term, building upon the regenerative powers of our sandy coastal system. This concept of Building with Nature fascinated me right from the start, not just for preserving our coast at times of sea-level rise, but also for building landscapes that can host a variety of functions, from nature to living, working and recreation. This new sandy strategy produced a new range of landscapes, which we explored in Studio Coastal Quality as part of a long-term vision for the Dutch coast. This gave me the inspiration to take a closer look at the design parameters for building such landscapes; and to get a deeper understanding of the dynamic processes that shape our shores.

Together with Jan Mulder, Kathelijne Wijnberg and Steffen Nijhuis we outlined the scope for the ShoreScape research, an interdisciplinary collaboration between the sections coastal morphology of the University of Twente and landscape architecture of the Technical University of Delft. The proposal was grant-funded by the NWO, the Dutch Institute for scientific research. With Daan Poppema and Paran Pourteimouri, we started this journey as PhDs, studying the interaction between aeolian sediment dynamics and the built environment. These interactions affect dune formation at larger scales, especially in nourished conditions. Here the Dutch shoreline, invigorated by the arrival of a new range of nourishment types, became a valuable source for research.

At the start of the research, field tests proved to be a precious and inspiring source of information on aeolian patterns on the beach and around buildings, leading to a first set of design principles. However, these had to be upscaled and implemented in the nourished, coastal landscape, which was a challenge in itself. In order to do this, four case studies were made, applying the principles in varying nourishment and urban conditions. Each case study led to new insights for the design principles and sharpened the range of feasible solutions for reinforcing our shores in a natural and inclusive way.

Both the fieldwork and the case studies taught me the enormous potential that nature has to offer, so long as we are willing to look and listen. I feel honoured to have been given the time to do so, slowly revealing the secrets of sediment and dune dynamics. It was sometimes hard and complex, each question leading to new sets of questions, especially during the upscaling of the spatial principles into larger landscape compositions. This is when design became essential, since it was able to look beyond the threshold of knowledge and explore the contours of a possible future, all brought closer to our imagination and our means, to compose a viable future for our shores.

I would like to thank the ShoreScape team for their valuable contribution to this research. My promotor, Steffen Nijhuis, for his enthusiasm, intelligence and honesty, lifting the project to an academic conceptual level. I thank Eric Luiten for his trust, bringing the project back to its essence and positioning it within the academic and professional context. I thank Jan Mulder for his enthusiasm, valuable sources of knowledge and unremitting support.

I would also like to thank Jan Mulder and Kathelijne Wijnberg for this initiative, their open minds and their patience in crossing the bridge of interdisciplinary collaboration. I thank Daan for his patience, clarity and the theoretical foundation of this research, and for the fond memories of our joint fieldwork. I thank Paran, Geert and Geomatics TU Delft for our pioneering collaboration on CFD. I thank Mieke and the remote sensing group for their support on laser measurements and analysis. I would also like to thank Suzanne Hulscher and the ShoreScape user group for their valuable comments, especially Jan Dirk Hoekstra, for his feedback on the research approach and case design studies. And I would like to thank NWO for making this project possible.

I would like to thank Emmy Bolsius for her support, enthusiasm, and valuable comments. I would like to thank all my colleagues, students and fellow PhDs from landscape architecture and urbanism for their support and inspiration, with special thanks to Michiel, Frits, Rene, Inge, Marcin, Gregory, Henk en Vero for their support and valuable contribution to this project. I would like to thank my colleagues from OKRA for their support and contribution to this project. I would like to thank all my friends for their interest and sticking up with me in this lonely process, giving me sparks of joy to carry on. Special thanks to K&S, Yuka, Chris, Martine, Nienke and Na for their valuable support.

I would like to thank my family, my parents Jan & Marijke van Bergen and my sister Koosje for their love, encouragement and great support in making this possible. Finally, I would like to thank Erin and Isa for their never-ending love, support and inspiration to pursue and complete this project, you are the light in my life!

References

- Arens, B. Van der Wal, D. (1998). Zeereep open voor invloed natuur. *Geografie* april 1998.
- Arens, S.M. (2010). Wandelende duinen voor kustverdediging en natuur. *Bodem* 3-2010
- Armstrong, S. B., Lazarus, E. D., Limber, P. W., Goldstein, E. B., Thorpe, C., & Ballinger, R. C. (2016). Indications of a positive feedback between coastal development and beach nourishment. *Earth's Future*, 4(12), 626–635. <https://doi.org/10.1002/2016ef000425>
- ASHRAE (2005). 2005 ASHRAE Handbook: fundamentals-SI edition. American Society of Heating, Refrigerating and Air-Conditioning Engineers.
- At Osborne (2021). Ruimtelijke kwaliteit in wateropgaven – een verkenning naar verbetermogelijkheden. At Osborne. <https://www.omgevingsweb.nl/wp-content/uploads/po-assets/612444.pdf>
- Australian LWC department (2001). Coastal Dune management. A Manual of Coastal Dune Management and Rehabilitation Techniques. NSW Department of Land and Water Conservation. ISBN 0 7347 5202 4
- Bakker, T.W.M., Klijn, J.A., van Zadelhoff, F.J. (1979). Duinen en duinvalleien: een landschapsecologische studie van het Nederlandse duingebied. TNO, Pudoc, Wageningen. <https://repository.tno.nl/islandora/object/uuid%3Af95553e3-a67f-4102-ad5b-9e6ff1437461>
- Beets, D., & Van Der Spek, A. (2000). The Holocene evolution of the barrier and the back-barrier basins of Belgium and the Netherlands as a function of late Weichselian morphology, relative sea-level rise and sediment supply. *Geologie En Mijnbouw*, 79(1), 3–16. <https://doi.org/10.1017/s0016774600021533>
- Berry, B. J. L. (1964). Cities as systems within systems of cities. *Papers in Regional Science*, 13(1), 146–163. <https://doi.org/10.1007/bf01942566>
- Bird, E. (1986). Coastline Changes: A Global Review. *The Geographical Journal*, 152(1), 108. <https://doi.org/10.2307/632970>
- Bisker et al. (2016). Rebuild By Design, www.rebuildbydesign.org
- Brand, E., Ramaekers, G., & Lodder, Q. J. (2022). Dutch experience with sand nourishments for dynamic coastline conservation – An operational overview. *Ocean & Coastal Management*, 217, 106008. <https://doi.org/10.1016/j.ocecoaman.2021.106008>
- Broer, J., de Pater, M. & Blikman, D. (2011). Ruimte voor recreatie op het strand: Onderzoek naar een 'recreatiebasiskustlijn'. *Decisio*.
- Brooks, A., Agate, E., & Volunteers, B. T. F. C. (1986). Sand Dunes: A Practical Handbook – practical conservation handbooks series, rev. 2005, The Conservation Volunteers (TCV), www.conservationhandbooks.com
- Buth, G. (2016). Analyse van recent gerealiseerde bebouwing en nieuwe bouwplannen aan de Nederlandse kust. *Natuurmonumenten*.
- Cannatella, D. & Nijhuis, S. (2020). Assessing urban landscape composition and configuration in the pearl river delta (China) over time. *Journal of Digital Landscape Architecture* 5-2020.
- Carter, R. W. G. (1991). Near-future sea level impacts on coastal dune landscapes. *Landscape Ecology*, 6(1), 29-39. [Doi:10.1007/bf00157742](https://doi.org/10.1007/bf00157742)
- CNN (2022). Indonesia names new capital, approving shift from Jakarta. CNN website 18-01-2022.
- Dauvellier (2022). Lagenbenadering. <http://ruimtexmilieu.nl/wiki/ontwikkelconcepten/lagenbenadering>.
- De Hoog M., Sijmons D., Verschuuren S., 'Herontwerp van het Laagland' In: Frieling D. H. (1998). *Metropolitane debat*, Bussum, Thoth.
- De Jong, T. M., van der Voordt, T. (2002). *Criteria voor wetenschappelijk onderzoek en ontwerp*. TU Delft.
- De Vriend, H., van Koningsveld, M. (2012). *Building with Nature. Thinking, acting and interacting differently*. November 2012. Publisher: EcoShape, Building with Nature, Dordrecht, the Netherlands. ISBN: 978-94-6190-957-2.

- De Vriend, H.J., van Koningsveld, M., Aarninkhof, S. (2014). 'Building with nature': the new Dutch approach to coastal and river works. *Proceedings of the Institution of Civil Engineers – Civil Engineering*, 167(1), 18-24. <https://doi.org/10.1680/cien.13.00003>
- De Vriend, H., Van Koningsveld, M., Aarninkhof, S., De Vries, M. R., & Baptist, M. J. (2015). Sustainable hydraulic engineering through building with nature. *Journal of Hydro-environment Research*, 9(2), 159–171. <https://doi.org/10.1016/j.jher.2014.06.004>
- De Vries, S., Southgate, H.N., Kanning, W., Ranasinghe, R. (2012). Dune behavior and aeolian transport on decadal timescales. *Coastal Engineering*, Volume 67, Pages 41-53, <https://doi.org/10.1016/j.coastaleng.2012.04.002>.
- De Winter, R. C., & Ruessink, B. G. (2017). Sensitivity analysis of climate change impacts on dune erosion: case study for the Dutch Holland coast. *Climatic Change*, 141(4), 685-701. doi:10.1007/s10584-017-1922-3
- Delgado- Fernandez, (2010). A review of the application of the fetch effect to modeling sand supply to coastal foredunes. *Aeolian research* 2(2): 61-70. DOI: 10.1016/j.aeolia.2010.04.001
- Delta programme Coast (2013). National Coastal Strategy, pp 37, Ministry of Infrastructure & Environment. This vision predicts volumes between 30 till 66 million m³/year or more based on the sea level prognosis of the Delta Programme (2013), referring to the report Zandsuppleties in de 21^{ste} eeuw, onderzoek naar alternatieve lange termijn suppleties t.b.v. Deltaprogramma Kust, final rapport, Deltares, 2012.
- Derde kustnota (2000). Traditie, Trends en Toekomst. Ministry of Infrastructure & Water, The Hague, 2000.
- Dobrov, G. (1979). The strategy for organized technology in the light of hard-, soft-, and org-ware interaction. *Long Range Planning*, 12(4), 79–90. [https://doi.org/10.1016/0024-6301\(79\)90124-9](https://doi.org/10.1016/0024-6301(79)90124-9)
- Doing, H. (1979). Variaties op de blonde top. In: *De Nederlandse Landschappen*, Het Spectrum.
- Doing, H. (1988). *Landschapsoecologie van de Nederlandse kust. Een landschapskartering op vegetatiekundige grondslag*. Stichting Duinbehoud / Stichting Publicatiefonds Duinen, Leiden, 228 pp. .
- Dong, Z., Liu, X., Wang, H., Zhao, A., Wang, X.(2003). The flux profile of a blowing sand cloud:a wind tunnel investigation. *Geomorphology*, 49(3) 219-230. [https://doi.org/10.1016/S0169-555X\(02\)00170-8](https://doi.org/10.1016/S0169-555X(02)00170-8)
- Dooren, E. van, Boshuizen, E., Van Merriënboer, E., Asselbergs, M.F., Van Dorst, M.J. (2013). Making explicit in design education: generic elements in the design process. *International Journal of Technology and Design Education* 24 (1), 2014; Authors version. <https://doi.org/10.1007/s10798-013-9246-8>
- Ecoshape (2019). Innovatieproject Hondsbossche duinen – Eindrapportage, definitief 0.1. Wageningen Marine Research Rapport nr C002/19.
- Ecoshape (2021). Sand Nourishment - Hondsbossche Dunes - lessons learned. (n.d.). Ecoshape. Retrieved 18 August 2021, from <https://www.ecoshape.org/en/cases/sand-nourishment-hondsbossche-dunes-nl/lesson-learned/>
- Eerste kustnota (1990). *Kustverdediging na 1990*. Ministry of Infrastructure & Water, The Hague, 1990.
- EU (2016). Handbook for the Implementation of Nature-based Solutions for Water Security: Guidelines for designing an implementation and financing arrangement, NAIAD GA No 730497. <http://naiad2020.eu/wp-content/uploads/2021/03/D7.3REV.pdf>
- Evert, K. J. (Ed). (2010). *Encyclopedic Dictionary of Landscape and Urban Planning*. London:Springer-Verlag
- F. Braudel (1966). *La Méditerranée. La part du milieu*, Parijs 1966
- Freeman, O. E., Duguma, L. A., & Minang, P. A. (2015). Operationalizing the integrated landscape approach in practice. *Ecology and Society*, 20(1). <https://doi.org/10.5751/es-07175-200124>
- Galiforni Silva, F.G., Wijnberg, K.M., de Groot, A.V. et al. (2018). The influence of groundwater depth on coastal dune development at sand flats close to inlets. *Ocean Dynamics* 68, 885–897. <https://doi.org/10.1007/s10236-018-1162-8>
- Galiforni Silva, F., Wijnberg K.M., de Groot A.V., Hulscher S.J.M.H. (2019). The effects of beach width variability on coastal dune development at decadal scales. *Geomorphology*, 329, P 58-69. <https://doi.org/10.1016/j.geomorph.2018.12.012>.
- Gerhardt, P. (1900). *Handbuch des Deutsches Dunesbau*. Verlagsbuchhandlung Paul Parey, Berlin
- Giardino, A., Santinelli, G., & Bruens, A. (2012). The state of the coast (Toestand van de kust). Case study: North Holland. Deltares report, (1206171-003-ZKS-0001).

- Giardino, A, W. de Boer, K. den Heijer, B. Huisman, J. Mulder, D.J. Walstra, (2013-A). Innovative Approaches and Tools for Erosion Control and Coastline Management. Proceedings EMECS 10 - Medcoast 2013 Conference, Marmaris, Turkey, January 2013, Volume: 2 https://www.researchgate.net/publication/258833896_Innovative_Approaches_and_Tools_for_Erosion_Control_and_Coastline_Management. (pp. 1281–1292). MEDCOAST.
- Giardino, A., G. Santinelli, (2013-B). The state of the Coast (Toestand van de Kust), Case Study: South Holland, Deltares report 1206171-003-ZKS-0001, 27 June 2013, final. 142pp.
- Giardino, A., Santinelli, G., & Vuik, V. (2014). Coastal state indicators to assess the morphological development of the Holland coast due to natural and anthropogenic pressure factors. *Ocean & Coastal Management*, 87, 93–101. <https://doi.org/10.1016/j.ocecoaman.2013.09.015>
- Glenn, M. (1979). Glossary. In: McKee, E.D. (Ed.), *A Study of Global Sand Seas*. United States Geological Survey Professional Paper, vol. 1052. US Gov. Printing Office, Washington, pp.
- Goldsmith, V. (1985). *Coastal Dunes, Coastal Sedimentary Environments*, second Revised, Expanded Edition, by R.A. Davis, Springer-Verlag New York, p303-370
- Grunnet, N., & Ruessink, B. (2005). Morphodynamic response of nearshore bars to a shoreface nourishment. *Coastal Engineering*, 52(2), 119–137. <https://doi.org/10.1016/j.coastaleng.2004.09.006>
- Haasnoot, M., Bouwer, L., Diermanse, F., Kwadijk, J., Van Der Spek, A., Essink, G. O., Delsman, J., Weiler, O., Mens, M., Ter Maat, J., Huisman, Y., Sloff, K., & Mosselman, E. (2018). Mogelijke gevolgen van versnelde zeespiegelstijging voor het Deltaprogramma: een verkenning. (Possible effects of accelerated sea level rise for the Deltaprogramme) , Deltares rapport 11202230-005-0002.
- Hall, C. M. (2001). Trends in ocean and coastal tourism: the end of the last frontier? *Ocean & Coastal Management*, 44(9), 601-618. Doi:10.1016/S0964-5691(01)00071-0
- Hallegatte, S., & Corfee-Morlot, J. (2011). Understanding climate change impacts, vulnerability and adaptation at city scale: an introduction. *Climatic Change*, 104(1), 1–12. <https://doi.org/10.1007/s10584-010-9981-8>
- Hallegatte, S., Green, C., Nicholls, R. et al. (2013). Future flood losses in major coastal cities. *Nature Clim Change* 3, 802–806. <https://doi.org/10.1038/nclimate1979>
- Halbertsma, H. (1963). Terpen tussen vlie en eems een geografisch-historische benadering. In J.B. Wolters eBooks. J.B. Wolters. <http://ci.nii.ac.jp/ncid/BA22587100>
- Hernandez-Cordero, A.I., Hernandez-Calvento, L., Perez-Chacon, E. (2017). Vegetation changes as an indicator of impact from tourist development in an arid transgressive coastal dune field. *Land Use Policy*, vol. 64, p 479-491. <https://doi.org/10.1016/j.landusepol.2017.03.026>.
- Hernández-Calvento, L., D.W.T. Jackson, R. Medina, A.I. Hernández-Cordero, N. Cruz, S. Requejo (2014). Downwind effects on an arid dunefield from an evolving urbanised area, *Aeolian Research*, 15, P 301-309, <https://doi.org/10.1016/j.aeolia.2014.06.007>.
- Hesp, P. A., & Hyde, R. (1996). Flow dynamics and geomorphology of a trough blowout. *Sedimentology*, 43(3), 505–525. <https://doi.org/10.1046/j.1365-3091.1996.d01-22.x>
- Hesp, P. A. (2002). Foredunes and blowouts: initiation, geomorphology and dynamics. *Geomorphology*, 48(1–3), 245–268. [https://doi.org/10.1016/s0169-555x\(02\)00184-8](https://doi.org/10.1016/s0169-555x(02)00184-8)
- Hinkel, J., Nicholls, R. J., Tol, R. S., Wang, Z., Hamilton, J. F., Boot, G., Vafeidis, A. T., McFadden, L., Ganopolski, A., & Klein, R. G. (2013). A global analysis of erosion of sandy beaches and sea-level rise: An application of DIVA. *Global and Planetary Change*, 111, 150–158. <https://doi.org/10.1016/j.gloplacha.2013.09.002>
- Hoekstra, A., & Pedroli, G. (1992). Sluftervorming en natuurontwikkeling. T0857 WL Rapport.
- Hoekstra, J.D.; Bergen, van, J. et al. (2013). *Ontwerpen aan de Zandige kust*, TU Delft.
- Hooimeijer, P., Kroon, H. J. J., & Luttkik, J. (2001). Kwaliteit in meervoud: conceptualisering en operationalisering van ruimtelijke kwaliteit voor meervoudig ruimtegebruik. <http://www.habiforum.nl/upload/documents/20090804%20ESSAY%20RUIMTELIJKE%20KWALITEIT.pdf>
- Hoonhout, B. & Van Thiel de Vries, J (2013). Invloed van strandbebouwing op zandverstuiving. Deltares report 12077724-000.
- Hoonhout, B. M., & Waagmeester, N. (2014). Invloed van strandbebouwing op zandverstuiving, Een verkenning naar methoden, meetgegevens en modellen. Delft: Deltares.
- Hoonhout, B. (2019). Why more sand not always results in larger dunes. In: *The Sand Motor: A nature-based response to climate change: findings and reflections of the Interdisciplinary Research Program NatureCoast*. Delft University Publishers-TU Delft Library, 2019

- Hotta, S., N.C. Kraus and K. Horikawa (1987). Functioning of sand fences in controlling wind-blow sand, Proceedings. Coastal sediments 1987, ASCE, 261-275.
- Hotta, S., N.C. Kraus and K. Horikawa (1991). Functioning of multi-row sand fences in forming foredunes. Proceedings. Coastal sediments 1991, ASCE, 772-787.
- Hotta, S., & Harikai, S. (2011). STATE-OF-THE-ART IN JAPAN ON CONTROLLING WIND-BLOWN SAND ON BEACHES. Coastal Engineering Proceedings, 1(32), 110. <https://doi.org/10.9753/icce.v32.sediment.110>
- Huisman, B., Wang, Z., De Ronde, J., Stronkhorst, J., & Sprengers, C. (2013). Coastline modelling for nourishment strategy evaluation. 6th SCACR: International Short Course and Conference on Applied Coastal Research, Lisbon, Portugal, 4-7 June 2013.
- Hunt, J.C.R (1971). The effect of Single Buildings and Structures. Philosophical Transactions of The Royal Society A Mathematical Physical and Engineering Sciences 269(1199):457-467. DOI: 10.1098/rsta.1971.0044
- IPCC (2007). Summary for Policymakers. In: Climate Change 2007: Impacts, Adaptation and Vulnerability. Contribution of Working Group II to the Fourth Assessment Report of the Intergovernmental Panel on Climate Change, Cambridge University Press, Cambridge, UK, 7-22.
- IPCC (2021). Climate Change 2021: The Physical Science Basis. Contribution of Working Group I to the Sixth Assessment Report of the Intergovernmental Panel on Climate Change [Masson-Delmotte, V., P. Zhai, A. Pirani, S.L. Connors, C. Péan, S. Berger, N. Caud, Y. Chen, L. Goldfarb, M.I. Gomis, M. Huang, K. Leitzell, E. Lonnoy, J.B.R. Matthews, T.K. Maycock, T. Waterfield, O. Yelekçi, R. Yu, and B. Zhou (eds.)]. Cambridge University Press, Cambridge, United Kingdom and New York, NY, USA, In press, doi:10.1017/9781009157896.
- IPCC (2022-A): Summary for Policymakers [H.-O. Pörtner, D.C. Roberts, E.S. Poloczanska, K. Mintenbeck, M. Tignor, A. Alegría, M. Craig, S. Langsdorf, S. Lösschke, V. Möller, A. Okem (eds.)]. In: Climate Change 2022: Impacts, Adaptation, and Vulnerability. Contribution of Working Group II to the Sixth Assessment Report of the Intergovernmental Panel on Climate Change [H.-O. Pörtner, D.C. Roberts, M. Tignor, E.S. Poloczanska, K. Mintenbeck, A. Alegría, M. Craig, S. Langsdorf, S. Lösschke, V. Möller, A. Okem, B. Rama (eds.)]. Cambridge University Press. In Press.
- IPCC (2022-B). Climate Change 2022: Impacts, Adaptation, and Vulnerability. Contribution of Working Group II to the Sixth Assessment Report of the Intergovernmental Panel on Climate Change [H.-O. Pörtner, D.C. Roberts, M. Tignor, E.S. Poloczanska, K. Mintenbeck, A. Alegría, M. Craig, S. Langsdorf, S. Lösschke, V. Möller, A. Okem, B. Rama (eds.)]. Cambridge University Press. In Press.
- Jackson, N. L., & Nordstrom, K. F. (2011). Aeolian sediment transport and landforms in managed coastal systems: A review. Aeolian Research, 3(2), 181–196. <https://doi.org/10.1111/j.1365-3091.1983.tb00694.x>
- Janssen-Jansen, L. B., Klijn, E. H., & Opdam, P. (2009). Ruimtelijke kwaliteit in gebiedsontwikkeling. Habiforum.
- Kawata, S. (1949). Sand fences, Forestry Conservation Report No.1, Forestry Agency, Ministry of Agriculture and Forestry, Japanese Gov., 11-15. (in Japanese)
- Kawata, S. (1951). Sand fences and their effectiveness, Forestry Conservation Report No.4, Forestry Agency, Ministry of Agriculture and Forestry, Japanese Gov., 14-15.
- Keijsers, J. (2015). Modelling foredune dynamics in response to climate change. Wageningen University.
- Kerkstra, K., Struik, J.B., and Vrijlandt, P.(1976). Denkraam: instructie KB2-studio landschapsarchitectuur, unpublished, University of Wageningen.
- Kerkstra, K. and Vrijlandt, P. (1988). Het landschap van de zandgebieden: Probleemverkenning en Oplossingsrichting , Directie Bos- en Landschapsbouw, Utrecht.
- Klijn, J.A. (1981). Nederlandse kustduinen Geomorfologie en bodems. Centrum voor landbouwpublicaties en landbouwdocumentatie Wageningen.
- Kollen, (2021). Zandwindmolen. Baggernet 2021. [https://www.baggernet.info/doc/webinarreeks-juni-2021/24-jun2021%20De%20geologische%20processen%20in%20de%20juiste%20richting%20sturen%20\(Jan%20Kollen\).pdf](https://www.baggernet.info/doc/webinarreeks-juni-2021/24-jun2021%20De%20geologische%20processen%20in%20de%20juiste%20richting%20sturen%20(Jan%20Kollen).pdf)
- Kooiman, M. (2022). Droge voeten: de kust als waterkering. Erfgoed essay #5. Duinenenmens.nl/RCE.
- Kuschnerus, M; Lindenberg, R. (2019). ShoreScape: Evaluation of measurements results using Terrestrial Laser Scanning. Internal report Department of Geoscience and Remote Sensing, Delft University of Technology, version 2, 1-10-2019.

- Kustpact (2017). Ministry of Infrastructure and Environment. <https://www.rijksoverheid.nl/documenten/convenanten/2017/02/21/kustpact>
- Leduc, W., Vera, C. A., Rovers, R., & Mels, A. (2009). Expanding the exergy concept to the urban water cycle. SASBE 2009 Book of Abstracts of the 3rd CIB International Conference on Smart and Sustainable Built Environments, Delft, the Netherlands, 15-19 June 2009, 101.
- Lee, L., South Australia Department of the Premier and Cabinet, Cabinet, S. A. D. P., & Adelaide Thinkers in Residence (Project). (2011). An Integrated Design Strategy for South Australia. Department of the Premier and Cabinet.
- Loffler et al, (2013). Ecologie van de NL kust – Essay Ecologie, Streefbeelden voor een ecologisch waardevolle kust, Atelier Kustkwaliteit
- Luijendijk, A., Velhorst, R., Hoonhout, B., De Vries, S., & Ranasinghe, R. (2017). Integrated modelling of the morphological evolution of the sand engine mega-nourishment. Coastal Dynamics, 1874–1885. https://ris.utwente.nl/ws/files/64128743/157_Luijendijk_Arjen.pdf
- Luijendijk, A., Hagenaars, G., Ranasinghe, R. et al (2018). The State of the World's Beaches. Sci Rep **8**, 6641. <https://doi.org/10.1038/s41598-018-24630-6>
- Luijendijk, A., and van Oudenhoven A.P.E. (2019). The Sand Motor: A nature-based response to climate change: findings and reflections of the Interdisciplinary Research Program NatureCoast. Delft University Publishers-TU Delft Library.
- Luiten, E., Sijmons, D., Feddes, Y., Feddes, F., Nolden, M.(2017) Room for the River – Safe and attractive landscapes. Blauwdruk. ISBN 978-94-9247-496-4.
- Luo, W., Dong, Z., Qian, G., & Lu, J. (2012). Wind tunnel simulation of the three-dimensional airflow patterns behind cuboid obstacles at different angles of wind incidence, and their significance for the formation of sand shadows. Geomorphology, 139, 258–270. <https://doi.org/10.1016/j.geomorph.2011.10.027>
- Lynch, K. (1981). A theory of Good City Form. Cambridge, Ma: MIT Press
- Malavasi, M., Santoro, R., Cutini, M., Acosta, A. T. R., & Carranza, M. L. (2013). What has happened to coastal dunes in the last half century? A multitemporal coastal landscape analysis in Central Italy. Landscape and Urban Planning, 119, 54-63. Doi: 10.1016/j.landurbplan.2013.06.012
- Marchand, M., Thrinh Thi Long, Sawarendo (2012). Adaptive water management for Delta regions: Towards GREEN water defense in East Asia. Delft, report 1205471
- Marrot, S. (1999). The reclaiming of Sites. In: Recovering landscape, p44-57, Princeton architectural press
- Massey, D.S.(2005). Stranger in a Strange land: Humans in an Urbanizing World, New York
- McGranaham, G., Balk, D., Anderson, B. (2007). Environment & Urbanization Vol 19(1): 17–37. DOI: 10.1177/0956247807076960
- McHarg (1969). Design with Nature. New York: Natural History Press.
- Meyer, V.J., Bregt, A.K., Dammers, E., Edelenbos, J. (2015). IPDD-cahier: Nieuwe perspectieven voor een verstedelijkte delta, Delft: Urban Regions in the Delta. MUST publishers
- Meyer H., Nijhuis, S. (2015). Urbanized deltas in transition, Techne press
- Meyer, H. (2016). Uittreerede, TU Delft
- Meyer, H. (2017). memo The future of urbanism, TU Delft
- Ministry of Foreign Affairs (2019). Document Ruimtelijke Activering (beleidsrapportage), Ministry of Foreign Affairs.
- Ministry of Infrastructure & Water (1990). Kustverdediging na 1990: beleidskeuze voor de Kustlijn zorg. Tweede Kamer 5–6, 1989-1990, 21 136
- Ministry of Infrastructure & Environment (2017). Kustpakt. <https://open.overheid.nl/repository/ronl-df6191de4b2e37544e0cf3fa3e070a4f2f539947/1/pdf/kustpact.pdf>
- Mitteager, W. A., Burke, A., & Nordstrom, K. F. (2006). Restoring natural landscapes on private shorefront properties in New Jersey, USA. Journal of Coastal Research, 890–897.
- Morton, R. A., Paine, J. G., & Gibeau, J. C. (1994). Stages and Durations of Post- Storm Beach Recovery, Southeastern Texas Coast, USA. Journal of Coastal Research, 10(4), 884-908.
- Mulder, J.P.M. (2000). Zandverliezen in het Nederlandse kuststelsel. Advies voor Dynamisch Handhaven in de 21^e eeuw. RIKZ 2000.36.
- Mulder, Jan P.M. , Ad J.F.van der Spek and Michiel J. van der Meulen (2008). Coastal zones and climate change: a sediment perspective on adaptation, Proc. 31st Int. Conf. Coast. Eng., Hamburg 2008 , 4053 - 4064

- Mulder, J.P.M., Tonnon, P.K. (2010). "Sand Engine": Background and design of a mega-nourishment pilot in the Netherlands, *Coastal Engineering Proceedings*, no 32.
- Mulder, J.P.M., S. Hommes and E.M. Horstman, (2011). Implementation of coastal erosion management in the Netherlands, *Ocean and Coastal Management* 54 (2011) 888–897; DOI: 10.1016/j.ocecoaman.2011.06.009
- Mulder, P.M., Stive, M.J.F. (2011). Zandmotor (Sand Motor): Building with nature. Paper III-21. *Deltares / TU Delft*
- Mulder J., Boers M., Giardino A., Santinelli G., Huisman B., Den Heijer K., (2013). Katwijk en Noordwijk; mogelijke groeimodellen voor versterkingsvarianten na 2060, *Deltares*, april 2013 DOI 120778.201
- Municipality of Noordwijk et. al., (2018). Herontwikkelingsopgave verblijfstoerisme Noordwijk
- Natuurmonumenten (2016). Bescherm de Kust. <https://www.natuurmonumenten.nl/bescherm-de-kust>
- Nichols, M. M. (1989). Sediment accumulation rates and relative sea-level rise in lagoons. *Marine Geology*, 88(3–4), 201–219. [https://doi.org/10.1016/0025-3227\(89\)90098-4](https://doi.org/10.1016/0025-3227(89)90098-4)
- Nijhuis, S. (2015). Characteristics of landscape design, in: *GIS-based landscape design research*. Delft: A+BE, p. 37
- Nijhuis, S, Vries, J de & Noortman, A (2017). Ontwerpend onderzoek, in: Simons, W & Van Dorp, D (red.), *Praktijkgericht onderzoek in de ruimtelijke planvorming*. Methoden voor analyse en visievorming. Wageningen: Uitgeverij Landwerk, p. 256–283
- Nijhuis, S. & De Vries, J. (2020). Design as Research in Landscape Architecture. *Landscape journal* 38:1-2.
- Nijhuis, S. (2020). Landschappelijke authenticiteit. *Bulletin*, 32–37. <https://doi.org/10.48003/knob.119.2020.4.702>
- Nillesen, A. L. (2019). Spatial Quality as a Decisive Criterion in Flood Risk Strategies: An integrated approach for flood risk management strategy development, with spatial quality as an ex-ante criterion. *A+BE | Architecture and the Built Environment*. <https://doi.org/10.7480/abe.2019.1>, p100
- Nolet, C. (2021). Biogeomorphic feedback drives dune development along nourished shorelines. *WUR Soil Physics and Land management*
- Nordstrom, K. F., & McCluskey, J. (1984). Considerations for control of house construction in coastal dunes. *Coastal Zone Management Journal*. <https://doi.org/10.1080/08920758409361972>
- Nordstrom, K. F. (2000). *Beaches and dunes of developed coasts*: Cambridge University Press.
- Nordstrom, K.F. and N.L. Jackson, (2013). Foredune restoration in urban settings, in M. L. Martínez et al. (eds.), *Restoration of Coastal Dunes*, Springer Series 17 on Environmental Management, Springer-Verlag Berlin Heidelberg 2013 DOI: 10.1007/978-3-642-33445-0_2 ; p. 17-31
- Palmboom, F. (2014). De Delta Paradox, inaugural speech, TU Delft
- Panteia (2012, rev. 2013). De kracht van de kusteconomie: een foto van de economische motoren, een doorkijk naar hun ontwikkeling en een SWOT analyse. *Delta program Coast 2013*
- Paridon, R., De Groot, K. (2011). De toekomst van de stille kustlandschappen. *Werkboek #4 Atelier Kustkwaliteit*. TU Delft / Provincie Zuid-Holland.
- Parrott, L., Meyer, W. (2012). Future landscapes: managing within complexity. *Frontiers in Ecology and the Environment* 10(7): 382–389. DOI: 10.2307/41811423
- Peterka, J. A., Meroney, R. N., & Kothari, K. M. (1985). Wind flow patterns about buildings. *Journal of Wind Engineering and Industrial Aerodynamics*, 21(1), 21–38. Doi:10.1016/0167-6105(85)90031-5
- Phillips, M. R., Harley, M. D., Turner, I., Splinter, K. D., & Cox, R. (2017). Shoreline recovery on wave-dominated sandy coastlines: the role of sandbar morphodynamics and nearshore wave parameters. *Marine Geology*, 385, 146–159. <https://doi.org/10.1016/j.margeo.2017.01.005>
- Poppema, D.W., Wijnberg, K.M., Mulder, J.P.M., & Hulscher, S.J.M.H. (2019). Scale experiments on aeolian deposition and erosion patterns created by buildings on the beach. *Coastal Sediments 2019* (pp. 1693–1707): World Scientific. DOI: 10.1142/9789811204487_0146
- Poppema, D.W., Wijnberg, K.M., Mulder, J.P.M., & Hulscher, S.J.M.H. (2022). Deposition patterns around buildings at the beach: Effects of building spacing and orientation. *Geomorphology*, Volume 401, 108114. DOI: 10.1016/j.geomorph.2022.108114. Data available at <https://doi.org/10.4121/16860145.v3>.
- Poppema, D.W., Wijnberg, K.M., Mulder, J.P.M., Vos, S.E., & Hulscher, S.J.M.H. (2021). The effect of building geometry on the size of aeolian deposition pattern
- Poppema, D.W., Baas, A.C.W., Hulscher, S.J.M.H. and Wijnberg, K.M. (2022). Cellular automaton modelling of the effects of buildings on aeolian bedform dynamics. *Aeolian Research*. <https://doi.org/10.1016/j.aeolia.2022.100840>
- Poppema, D.W. (2022). Morphological effects of buildings in a sandy beach environment. *Dissertation University of Twente*. DOI: 10.3990/1.9789036553520.

- Pourteimouri, P., Campmans, G.H.P., Wijnberg, K.M., Hulscher, S.J.M.H. (2021). CFD evaluation of airflow patterns around beach houses with different wind facing sides. Conference proceedings ETMM13 Rhodes, Greece sept. 2021, p 364-366.
- Pourteimouri, P., Campmans, G. H. P., Wijnberg, K. M., & Hulscher, S. J. M. H. (2022). A numerical study on the impact of building dimensions on airflow patterns and bed morphology around buildings at the beach. *Journal of Marine Science and Engineering*, 10(1), 13. <https://doi.org/10.3390/jmse10010013>
- Pred, A. (1977). *City systems in advanced economies : past growth, present processes, and future development options*. Wiley, New York
- Presley, D. and Tatarko, J. (2009). *Principles of Wind Erosion and its Control*. K-State Research and Extension Publication. MF-2860.
- Province of Zeeland (2017) *Gebiedsanalyse Manteling van Walcheren*. Province of Zeeland. *Gebiedsanalyse Manteling van Walcheren (natura2000.nl)*
- Puijtenbroek, M. E., Limpens, J., De Groot, A. V., Riksen, M., Gleichman, M., Slim, P. A., Van Dobben, H., & Berendse, F. (2017). Embryo dune development drivers: beach morphology, growing season precipitation, and storms. *Earth Surface Processes and Landforms*, 42(11), 1733–1744. <https://doi.org/10.1002/esp.4144>
- Puijtenbroek, M. (2019). Embryo dune development. The sandmotor; a nature-based response to climate change. Delft university publishers, p 93-95
- Quartel, S., Grasmeyer, B.T. (2007). Dynamiek van het strand bij Noordwijk aan Zee en Egmond aan Zee en het effect van suppletie. University of Utrecht, Faculty of Geosciences. www.coastalresearch.nl.
- Raymond, C. M., Frantzeskaki, N., Kabisch, N., Santos, R., Breil, M., Nita, M. D., Geneletti, D., & Calfapietra, C. (2017). A framework for assessing and implementing the co-benefits of nature-based solutions in urban areas. *Environmental Science & Policy*, 77, 15–24. <https://doi.org/10.1016/j.envsci.2017.07.008>
- Reinders, J., Van der Valk, B., & Van der Meulen, F. (2014). Effecten van tijdelijke strandbebouwing op de ontwikkeling van de jonge zeeoep (H2130: Wit Duin) aan de zeezijde van de Duincompensatie Delftlandse Kust (1206682-000-ZKS-0014). Deltares.
- Rijkswaterstaat (1988). *Handboek kustsuppleties*. DWW, Rijkswaterstaat.
- Roberts, A. (1970). Plate 24 bed forms: eolian dunes. In *Sedimentographica*, University of Columbia. *Sedimentographica: Plate 24 (columbia.edu)*
- Roep, B., van der Valk, L., Beets, D.J. (1991). Strandwallen en zeegaten langs de Hollandse kust. *Grondboor en Hamer* 45-issue 5/6 p. 115-124, november 1991.
- Rogers, A., Castree, N., & Kitchin, R. (2013). *A Dictionary of Human Geography*. In Oxford University Press eBooks. Oxford University Press. <https://doi.org/10.1093/acref/9780199599868.001.0001>
- Rotnicka, J. (2013). Aeolian vertical mass flux profiles above dry and moist sandy beach surfaces. *Geomorphology*, 187, 27-37. <https://doi.org/10.1016/j.geomorph.2012.12.032>
- Rovers, R. (2007) Urban Harvest, and the hidden building resources. In *Proceedings of the CIB world congress 2007*, Cape Town.
- Ruimte voor de Rivier (2005). *Ontwerp Planologische kernbeslissing*. Ministry of Infrastructure & Water. <https://zoek.officielebekendmakingen.nl/kst-30080-1-b2.pdf>
- Schlacher, T. A., Schoeman, D. S., Dugan, J., Lastra, M., Jones, A., Scapini, F., & McLachlan, A. (2008). Sandy beach ecosystems: key features, sampling issues, management challenges and climate change impacts. *Marine Ecology*, 29(s1), 70-90. doi:10.1111/j.1439-0485.2007.00204.x
- Schotman (2012). *Ecologie van de toekomstige kust. Bouwsteden voor de nationale visie kust*. Alterra no 2353. ISSN 1566-7197.
- Schulman, L.L., Strimaitis, D.G., and Scire, J.S. (2000). Development and evaluation of the PRIME plume rise and building downwash model. *Journal of the Air and Waste Management Association*, 50(3), 378-390. <https://doi.org/10.1080/10473289.2000.10464017>
- Scott, T., Masselink, G., O'Hare, T. J., Saulter, A., Poate, T., Russell, P., Davidson, M., & Conley, D. J. (2016). The extreme 2013/2014 winter storms: Beach recovery along the southwest coast of England. *Marine Geology*, 382, 224–241. <https://doi.org/10.1016/j.margeo.2016.10.011>
- Smith, A. B., Jackson, D. W. T., Cooper, J. A. G., & Hernández-Calvento, L. (2017). Quantifying the role of urbanization on airflow perturbations and dunefield evolution. *Earth's Future*, 5(5), 520-539. doi:10.1002/2016ef000524
- Sober, E. (2013). *Core Questions in Philosophy: A Text with Readings (6th ed.)*. Boston: Pearson Education. p. 28. ISBN 9780205206698. OCLC 799024771.

- Steijn, R. (2005). Effectiviteit van vooroeversuppleties langs de waddenkust: Aanzet tot ontwerprichtlijnen voor het ontwerp van vooroeversuppleties. Alkyon rapport A1539 voor Rijkswaterstaat, RIKZ.
- Stevens, V. (2021). The effects of beach house configurations on dune-ward sediment transport. Master thesis TU Delft – A+BE / Geomatics 21-06-30.
- Stive, M. J., Roelvink, D., & De Vriend, H. J. (1990). Large-Scale Coastal Evolution Concept. Coastal Engineering, 1(22), 1962–1974. <http://resolver.tudelft.nl/uuid:ac1adaff-fa2c-49a7-ae39-109cbcd11868>
- Stronkhorst, J., Bruens, A., Van Vliet, L., Schasfoort, F., Van Oeveren, M.C. (2020). Effect van zandsuppleties of de kust en het wad. Deltafactsheet Stowa, 2020.
- Taal, M.D. et al., (2016). Development of the Sand Motor, Deltares. <https://www.dezandmotor.nl/uploads/2016/09/monitoring-and-evaluation-report-sand-motor-eng.pdf>
- Tooar, H. (1983). Dynamic processes acting on a longitudinal (seif) sand dune. Sedimentology Vol. 30, issue 4, p567-578. <https://doi.org/10.1111/j.1365-3091.1983.tb00694.x>
- Tsuriell, D.E., (1974). Sand dune stabilization in Israel. Intl. J. Biometeor. 18 89-93.
- US Army Corps (2018). Engineering with Nature (EWN). <https://ewn.erdc.dren.mil>
- Usergroup ShoreScape, (2019-11). Report user group workshop 5-11-2019. Internal report Shorescape, TU Delft / University of Twente.
- Van Bergen, J. (2017). ShoreScape – Designing sustainable coastal buffer zones (internal report). TU Delft.
- Van Bergen, J. E. a. M., & Nijhuis, S. (2020). ShoreScape: Nature-Based Design for Urban Coastal Zones. In Coastal Management. Taylor & Francis. <https://doi.org/10.1680/cm.65147.319>
- Van Bergen, J., Mulder, J., Nijhuis, S., Poppema, D., Wijnberg, K., & Kuschnerus, M. (2021). Urban dunes: Towards BwN design principles for dune formation along urbanized shores. Research in Urbanism Series, 8, 101-108. <https://doi.org/10.47982/rius.7.130>
- Van Bergen, J., Nijhuis, S., Brand, N., & Hertogh, M. (2021-B). Building with Nature as a cross-disciplinary approach: The role of hybrid contributions. Research in Urbanism Series, 7, 283–292. <https://doi.org/10.47982/rius.7.138>
- Van Der Meulen, M. J., Van Der Spek, A., De Lange, G., Gruijters, S., Van Gessel, S., Nguyen, B., Maljers, D., Schokker, J., Mulder, J., & Van Der Krogt, R. a. A. (2007). Regional Sediment Deficits in the Dutch Lowlands: Implications for Long-Term Land-Use Options (8 pp). Journal of Soils and Sediments, 7(1), 9–16. <https://doi.org/10.1065/jss2006.12.199>
- Van Duinen, I., B. Rijken & E. Buitelaar (2016). Transformatiepotentie: woningbouwmogelijkheden in de bestaande stad. Den Haag, Planbureau voor de Leefomgeving.
- Van der Spek, A.J.F., Cleveringa, Van Heteren, Van Dam, Schrijver (1999). Reconstructie van het ontstaan van de Hollandse kust in de laatste 2500 jaar. TNO-rapport NITG-99-143-A.
- Van der Spek, A.J.F., de Kruif, A.C., Spanhoff, R. (2007). Richtlijnen Onderwatersuppleties. RIKZ Rapport 2007.012.
- Van der Spek, A., Elias, E., (2013). The effects of nourishments on autonomous coastal behaviour. Coastal Dynamics. Proc. 7th Int. Conf. Coast. Dyn. 1753–1763.
- Van der Spek, B.J. et al, (2014). Design and realization of a Sandbar Breakwater, Lekki, Nigeria. Abstract ICCE 2014
- Van Der Spek, A., & Lodder, Q. J. (2015). A NEW SEDIMENT BUDGET FOR THE NETHERLANDS; THE EFFECTS OF 15 YEARS OF NOURISHING (1991-2005). In Coastal Sediments 2015. https://doi.org/10.1142/9789814689977_0074
- Van der Toorn Vrijthoff, W., & Talstra, M. (2004). Ruimtelijke kwaliteit (ig). In I. Bruil, F. Hobma, G-J. Peek, & G. Wigmans (Eds.), Integrale gebiedsontwikkeling (pp. 157-174). SUN.
- Van der Velde, R., Van Bergen, J., Pouderoijen, M. et al. (2018). Aeolis Gap the Border (Booklet). TU Delft / A+BE/ LA.
- Van der Wal, D. (1999). Aeolian transport of nourishment sand in beach-dune environments, p129, Uva.
- Van Der Wal, D. (2004). Beach-dune interactions in nourishment areas along the dutch coast. Journal of coastal research, 20(1), 317-325. [https://doi.org/10.2112/1551-5036\(2004\)20\[317:BIINAA\]2.0.CO;2](https://doi.org/10.2112/1551-5036(2004)20[317:BIINAA]2.0.CO;2)
- Van Der Weerd, A. J., & Wijnberg, K. M. (2016). Aeolian Sediment Flux Derived from a Natural Sand Trap. Journal of Coastal Research. <https://doi.org/10.2112/si75-068.1>
- Van Dieren (1932). Organogene dunenbildung, dissertation, UVA
- Van Dieren J.W. (1934). Organogene dunenbildung. Eine geomorphologische Analyse der Dunenlandschaft der West-Friesischen Insel Terschelling mit pflanzensoziologischen Methoden. Martinus Nijhoff.

- Van Gerwen, H. (2006). Sturing van de ruimtelijke kwaliteit door het Rijk in twee Nieuwe Sleutelprojecten. Utrecht University, Master thesis.
- Van IJzendoorn, C. (2022): Measurements of vertical grain size variability in the intertidal zone: method, data and analysis. 4TU.ResearchData. Collection. <https://doi.org/10.4121/c.5736047.v1>
- Van Onselen, E.P. (2018). Analysing measures to improve beach-dune interaction in the presence of man-made structures using computational fluid dynamics (CFD). Utrecht University. <https://dspace.library.uu.nl/handle/1874/364279>
- Van Oosten M.F. (1986). Bodemkaart van Nederland. Stichting voor bodemcartering, Wageningen.
- Vellinga, P. (1986), Beach and Dune Erosion during Storm Surges, Thesis TU Delft, Delft Hydraulics Communications No. 372, 1986
- Vermaas, T., Elias, E., Vonhogen-Peeters, L. (2013). Ontwikkeling Gefaseerde Suppletie Ameland 2010-2011. Deltares Rapport Nr. 1207724-002.
- Vermaas, T., Boersen, S., Wilmink, R., Lodder, Q. (2019). National Analysis of Nourishments; Coastal State Indicators and Driving Forces for Bergen-Egmond, the Netherlands. Rijkswaterstaat and Deltares, 2019.
- Vitruvius (60 BC / 1999). Vitruvius: 'Ten Books on Architecture' (I. Rowland & T. Howe, Eds.). Cambridge: Cambridge University Press. doi:10.1017/CBO9780511840951
- Vliet, X.X. et al (2017). Reserveringszone. Stowa / Foundation For Applied Water Research.
- Vousdoukas, M., Almeida, L., & Ferreira, Ó. (2012). Beach erosion and recovery during consecutive storms at a steep-sloping, meso-tidal beach. *Earth Surface Processes and Landforms*, 37(6), 583–593. <https://doi.org/10.1002/esp.2264>
- Walsh, B. N., & Forestry, S. a. D. O. (1968). Some Notes on the Incidence and Control of Driftsands Along the Caledon, Bredasdorp and Riversdale Coastline of South Africa. S.A. Dept. Forestry Bull. 44, Pretoria, S.A. 79pp
- Waterman, R.E. & Engineering Bureau Oranjewoud (2005). Map of the South Holland Coast. In: Stive, M. and Vrijling, H. (2005) A dynamic Coastal Landscape. In: the Atlas of Dutch water cities. TU Delft / Uitgeverij Sun.
- Wijnberg, K.M. (1995). Morphologic Behaviour of a Barred Coast over a Period of Decades. Proefschrift Universiteit Utrecht.
- Wijnberg, K., Nijhuis, S. & Hulscher, S. (2016). SHORESCAPE: Sustainable co-evolution of the natural and built environment along sandy shores. University of Twente, Faculty of Engineering Technology, Dept. Water Engineering & Management & Delft University of Technology, Faculty of Architecture and The Built Environment. NWO Top Sector Water grant ALWTW.2016.038.
- Wijnberg, K., Poppema, D., Mulder, J., Campmans, G., Galiforni-Silva, F., Hulscher, S., & Pourteimouri, P. (2021). Beach-dune modelling in support of Building with Nature for an integrated spatial design of urbanized sandy shores. *Research in Urbanism Series*, 7, 241-260. <https://doi.org/10.47982/rius.7..136>
- Williams, I. (2019). Observations of aeolian sand transport. The sandmotor; a nature-based response to climate change. Delft university publishers, p 89-91.
- Wilson, D.J. (1979). Flow patterns over flat roofed buildings and application to exhaust stack design. *ASHRAE Trans.*, 85, 284-295.
- Witteveen+Bos, (2006). Evaluatie onderwatersuppleties Noord- en Zuid-Holland. Eindrapport. Witteveen+Bos rapport Rw1472-2.
- Wright, L.D., Chappell, J., Thom, B.G., Bradshaw, M.P., Cowell, P.J. (1979). Morphodynamics of reflective and dissipative beach and inshore systems, Southeastern Australia. *Marine Geology* 32, 105-140
- Xiong, L., & Nijhuis, S. (2019). Exploring Spatial Relationships in the Pearl River Delta. In X. Ye & X. Liu (Eds.), *Cities as spatial and social networks* (pp. 147–163). Springer. <https://doi.org/10.1007/978-3-319-95351-9>
- Xiong, L. (2020). Pearl River Delta: Scales, Times, Domains. *Architecture & the Built Environment*. <https://doi.org/10.7480/abe.2020.21>
- IJff, S.D., Smits, B., Van Zeist, V., Arens, B. (2019). Natuurlijk Veilig -Landschapsvormende processen. Invloed van suppleties en beheer op dynamiek in de zeeoep. Deltares report.
- Zonneveld, J.I.S. (1987). *Levend Land; de geografie van het Nederlandse landschap*. Bohn, Scheltema & Holkema, Utrecht/Antwerpen.
- Zonneveld, I.S. (1995). *Land ecology: an introduction to landscape ecology as a base for land evaluation, land management and conservation*, Amsterdam: SPB Academic Publishing

List of Figures

- 1.1 Overview of urban deltas around the world and economic loss estimates if the flood defence structures surrounding these deltas were to fail amid extreme weather conditions in 2050. Source: S. Hallegatte et al., 2013. [22](#)
- 1.2 Global map of sandy shores and their rates of erosion (red) and accretion (green). On average, current rates of erosion are still moderate. However, accelerated sea level rise can increase these erosion rates up to 10–20m a year, as is already the case for some shores, such as those in Ghana and India. Source: Luijendijk et al., 2018. [22](#)
- 1.3 The seawall at Den Helder in 1900 (left), 1970 (middle) and 2015 (right). Due to coastal reinforcement, the seaside setting of the fishing village was disrupted over time, cutting the town off from the sea with a 12m-high sea wall. Sources: E. de Jong (middle) and Rijkswaterstaat / Simon Warner (right). [23](#)
- 1.4 3D section of a Dutch sandy shore, showing sea level rise leading to coastal retreat (1–10m/y) and the need to compensate for this sediment deficit by nourishing the coastal foundation in pace with sea level rise. Image by the author. [24](#)
- 1.5 Speculative real estate development in Belgium, diminishing dunes as coastal buffer. Image by the author. [26](#)
- 1.6 Aerial photo of the Sand Motor, a Dutch mega-nourishment pilot in action (2012). Source: Rijkswaterstaat / Joop van Houdt. [29](#)
- 1.7 Cross-section of a sandy shore from the inner dune lining to the -20m contour with the dunes constituting the main barrier against storms. Source: Delta Programme Coast, 2013. [30](#)
- 1.8 Current interactions between coastal functions don't always run smoothly and can lead to a negative spiral. Image by the author, photos by J. van Bergen and Rijkswaterstaat / Joop van Houdt & COW. [32](#)
- 1.9 The coastal landscape represented as an interplay of the geomorphological, ecological and urban system. Image by the author. [34](#)
- 1.10 Schematic overview of the different types of research by design as resultant of context or object variables. Source: De Jong et al., 2002. [37](#)
- 1.11 Typology and eco-morphological development of a blowout by Van Dieren (1934), who was one of the pioneers of research on the symbiosis between dune shape and vegetation, including succession. [37](#)
- 1.12 Example of a Sand Motor (2018) elevation mapping and profile (2015; 2017; 2018), illustrating dune development as output of Lidar data in QGIS. Images by the author. [38](#)
- 1.13 Two examples of fieldwork carried out under the umbrella of the ShoreScape project: on the left, the testing site at the Sand Motor (2019), where the sedimentation patterns of beach housing on poles were tested; on the right, a field test at Vlieland beach (2020) investigating the tail pattern of row housing with a 45° dominant wind direction. Images by the author. [39](#)

- 1.14 Examples of CFD modelling of beach row housing: left the potential erosion and deposition patterns around beach row housing and right the nearbed wind field (speed and direction) Source: P. Pourtemouri, ShoreScape, 2021. 40
- 1.15 Schematic overview of the dialectical, converging design process crossing different domains, which, through representation in drawing and models as decision models, will arrive at the most optimal solution. Source: Van Dooren et al., 2013. 41
- 1.16 Model of the work forms of design thinking: abductive design thinking, composing or validating a design based on data or observations, versus deductive design thinking, using design invention (right) to explore or confirm a hypothesis. Source: Nijhuis, 2015. 42
- 1.17 Research framework. Image by the author 45
- 1.18 Joint Sand Motor fieldwork between UT and TUD, spring 2019. Photo by the author. 49
- 2.1 Representation of the geomorphological coastal system, including BwN-based nourishments to restore the shoreline and sediment balance. Image by the author. 60
- 2.2 Photo of 'streamers' with suspended sand at Westkapelle Beach (January 2022), enabling substantial sediment transport to the upper beach and dunes. Photo by the author. 61
- 2.3 Section of the coastal foundation from the inner dune lining to the -20m line, as regulated by Dutch coastal policy. Source: Deltaprogramme Coast, 2013. 62
- 2.4 Overview of nourishments in the Netherlands (2003–2013; each colour represents one year). Nourishments vary along coastal trajectories depending on local conditions. For example, near-shore trenches (e.g., those at Walcheren and North Holland) require more sediment. Source: Rijkswaterstaat / National Coastal Strategy 2013. 65
- 2.5 Overview of aerial pictures of mega-nourishment at the Sand Motor (2011–2021) showing its transformation caused by the (BwN) employment of coastal dynamics (e.g., waves, currents, wind). Photo's: Rijkswaterstaat / Joop van Houdt (2012, 2013) and by Zandmotor (www.dezandmotor.nl). 67
- 2.6 Beach nourishment in Texel, NL 2020 (left). Source: Texelinformatie.nl. 68
- 2.7 Shoreface nourishment in North Holland, NL 2020 (middle). Source: Rijkswaterstaat. 68
- 2.8 Channel wall nourishment by hopper dredger 2011 (right). Source: Rijkswaterstaat / Deon Slagter WG 2011. 68
- 2.9 Dune reinforcement in Renesse, NL 2014 (left). Image by the Sinke group. 69
- 2.10 Dike in dune reinforcement of the coastal resort in Noordwijk (right). Photo by the author. 69
- 2.11 Map of the planned and abandoned sand mining areas (in yellow) within the 12 mile coastal zone of the North Sea, reserved for sand extraction for nourishments Source: Noordzee-atlas, 2022. 70
- 2.12 Schematic representation of the Triplex layer approach (after Kerkstra et al., 1976). Image by the author, adapted from P. Dauvellier (2022). 74
- 2.13 Schematic representation of the coastal landscape as an interplay of three main spatial systems conditioning BwN ashore. Image by the author. 75
- 2.14 Section of the South Holland coast in Wassenaar, near Noordwijk, illustrating the evolution of the transgressive dune barrier stemming from a sequence of erosive and accretive periods driven by sea level rise. Source: Roep et al, 1991. 77
- 2.15 Stages of dune formation. Source: Studio Coastal Quality TU Delft / Paridon & De Groot 2011. 80

- 2.16 Sediment-based urbanism: Map of mounds in Friesland (600 BC–1200 AC). Source: Halbertsma. 84
- 2.17 Conceptual framework of the integrated systems approach for BWN (bright green) as the interplay between the geomorphological, ecological and urban systems. Image by the author. 88
- 2.18 Examples of interacting mechanisms between geomorphology, ecology and urbanism that could contribute to BWN dune formation. Sources: Top left: K. Wijnberg, 2021. Top right: J. van Bergen. Bottom left and right: Rijkswaterstaat. 89
- 2.19 Overview of integrated coastal systems as a conceptual framework, including the three bridging concepts (white text) aimed at improving BWN processes ashore by stimulating natural succession or proactively applying dune farming or urban harvesting from an urban system perspective (overlay). Image by the author. 90
- 2.20 Pioneering vegetation as part of the natural succession and the start of natural dune formation. Image by the author. 91
- 2.21 Fencing as a nature-based measure to increase dune formation. Image by the author. 92
- 2.22 Sedimentation behind a beach pavillion in Cadzand—bad; as form of urban harvesting. Image by the author. 93
- 2.23 Evolution of the conceptual BWN model from mono-functional, via integrated systems, to a landscape approach. Images by the author. 95
- 2.24 Temporal mapping of the (unnourished) coastal dynamics of the Isle of Vlieland (1688–1933), illustrating its natural landward movement as well as its dynamic cape and tail development. Source: Rijkswaterstaat NH, 1946; Deltares, 2016. 97
- 2.25 Division of three coastal systems into the local, trajectory and regional scales, affected by two contextual levels: the national and global scale. Image by the author. 98
- 2.26 Representation of coastal BWN as a landscape approach in which system interventions (e.g., nourishment, dune growth, beach urbanisation) and their land-shaping processes (t1–t3) are directed through scale and time to support BWN-based coastal adaptation by dune formation. Image by the author. 102
- 2.27 The core values of spatial coastal quality according to Studio Coastal Quality (2013): 105
- 2.28 Overview of the core values of spatial quality (left), connected with the overarching coastal values as defined by Studio Coastal Quality (2013), translated to generic landscape values for BWN projects (right). 106
- 2.29 Overview of the scales within the three systems and three design steps, facilitating the tuning of BWN dynamics across different levels: *morphogenesis* at the regional level, *dynamic profiling* at the trajectory level and *aeolian principles* at the local level. Although all steps apply to all systems, their centre of gravity lies in the overlap, as illustrated above (green dots). Image by the author. 108
- 2.30 Height monitoring at the Sand Motor: in August 2011 (left) and July 2015 (right). Source: zandmotor.nl – Shore Monitoring. 109
- 2.31 GIS section of foredune development and sand accumulation around brushwood fences in Petten following sandy reinforcement(2015–2020; see also Chapter 4.4.3). Image by the author. 110
- 2.32 Sedimentation pattern around a scale model of beach row housing on an angle with the dominant wind. Sand tail development can be employed to collect sediment in the foredune zone. Image by the author. 111
- 2.33 Model of the work forms of design thinking: abductive design thinking, composing or validating a design based on data or observations, versus deductive design thinking, using design invention (right) to explore or confirm a hypothesis. Source: adapted from Nijhuis, 2015. 112

- 2.34 Overview of the research and design loops for BwN landscape design, syncing systems and BwN dynamics. Image by the author. [113](#)
- 2.35 Overview of the research and design loops, syncing systems and relevant dynamics used by the ShoreScape project and in the design (case) studies. Image by the author. [115](#)
- 3.1 Toolbox with design steps and principles for natural coastal adaptation. Image by the author. [121](#)
- 3.2 Map of the Dutch coast divided into coastal cells, each with specific dynamics and sediment needs. Source: Mulder, 2000. [123](#)
- 3.3 Dutch coastal section with the coastal maintenance zone (yellow). To balance out sea-level rise (dark blue), more volume must be added (dark orange) within the reference coastline zone (dark yellow). Source: Mulder, 2000. [124](#)
- 3.4 Schematic overview of sandy solutions in the Netherlands: dune reinforcement (top), beach, shore-face, channel-wall and tidal-delta nourishment (below). Source: J. van Bergen, adapted from Brand et al., 2022. [126](#)
- 3.5 Schematic section of a shoreface nourishment (orange) that will evolve over time (dotted line.) Source: J.van Bergen, adapted from Brand et al., 2022. [127](#)
- 3.6 Shoreface nourishment on the North Holland coast, Netherlands (2020). Source: © Rijkswaterstaat. [127](#)
- 3.7 Schematical section of a beach nourishment (orange) that will evolve over time (dotted line). [128](#)
- 3.8 Beach nourishment at Texel, Netherlands (2020). Source: Texelinformatie.nl. [128](#)
- 3.9 Schematic section of a dune nourishment (orange) that will evolve over time (dotted line). Source: J.van Bergen, adapted from Brand et al., 2022. [129](#)
- 3.10 Dune reinforcement at Renesse, Netherlands (2014). Source: Sinke Group. [129](#)
- 3.11 Mapping of the dune development (in the same scale) for three different types of nourishment. Images by the author; Lidar data courtesy of HHNK, TUD and UT. [131](#)
- 3.12 Three modes of aeolian sediment transport. Source: Presley & Tatarko, 2009. [133](#)
- 3.13 Illustration of dynamic sand movement to form ripples. Source: Roberts, 1970; columbia.edu. [133](#)
- 3.14 Overview of the main dune biotopes on sandy shores, including aeolian vegetation zones (I-III). Biotopes (circles) from left to right: embryonal dunes, white dunes, grey dunes, humid dune valley, heather, mature & forested dunes. Image by the author. [135](#)
- 3.15 Temporal overview of the different stages of dune formation and dynamics, from embryonal dunes (below) to parabolic dunes (top). Image by the author, adapted from Brooks & Agate (TCV, 1986). [136](#)
- 3.16 Recreation and beach traffic as a way to mobilize sediment. Image by the author. [138](#)
- 3.17 Marram grass as a bio-builder at the Sand Motor. Image by the author. [138](#)
- 3.18 Beach access in Vlieland, overblown due to a blowout or 'funnel' effect caused by wind acceleration. Image by the author. [138](#)
- 3.19 Urbanised beach at IJmuiden, North Holland. Photo by J. van Bergen. [139](#)
- 3.20 Wind vortexes around a building, reattaching at the top. Source: Peterka et al., 1985. [140](#)
- 3.21 Horseshoe pattern of sediment deposition (+) and erosion (-) around a built object. Source: Poppema et al., 2019. [140](#)
- 3.22 Day accretionary pattern around a scale model during fieldwork. Source: Poppema et al., 2019. [141](#)
- 3.23 CFD modelling of buildings with varying widths, indicating flow speeds around the building. Source: Pourteimouri et al., 2021. [142](#)

- 3.24 On the left, CFD section with increased (orange) and decreased (blue) wind velocity around a beach building on 2 m-high poles. On the right, CFD plan with flow velocities around a pole structure in oblique wind conditions. Expected deposition in bright yellow. Source: Van Onselen, 2018. [143](#)
- 3.25 Final drone photograph of the deposition patterns around the scale models with increasing pole height and tail length, from 0 m (right) to 1 m (left) in steps of 25 cm. For output results, see 3.6 and 3.7. Image by the author. [144](#)
- 3.26 Photograph of the year-round beach pavilion 'De Branding' at Terschelling (2018, 4 m-high poles). Visible is the scour below the pavilion resulting from local wind acceleration, as well as downwind deposition (right) in the dominant NW direction. Due to maintenance, not all deposition remains. Image by the author. [144](#)
- 3.27 GIS DEM of the elevated pavilion 'Zee en zo' at Petten (2019–2020). Clearly visible is the downwind tail pattern parallel to the shore generated by the SSW wind (large oval). At the small pavilion below (small oval), a concentrated downwind tail is visible on the NNW side. Image by the author. [144](#)
- 3.28 GIS section (left) of the elevated pavilion 'The Coast' at the Sand Motor from the SW (right) to the NE direction (left), showing the 2 m downwind deposition in 3 years' time. Image by the author; Lidar data courtesy of the University of Twente and TU Delft. [145](#)
- 3.29 Right: photo of the beach pavilion 'the Coast', on the left the extended deposition tail of the elevated pavilion is visible, heightening the beach and foredunes. Photo: S. Veldhuisen (2023). [145](#)
- 3.30 Photograph of the beach pavilion and row housing on the regularly maintained shore of Schoorl. Source: M. Leonhart & I. Hamelink (2023). [146](#)
- 3.31 Photograph of the beach row housing and pavilion of Camperduin after sandy reinforcement. Sediment is transported between the gaps against brushwood fences. Image by the author. [146](#)
- 3.32 GIS mapping of beach housing at Schoorl, showing the difference in height after 5 years (2015–2020). Clearly visible is the absence of dune growth behind the pavilion (B) and row housing (A). Images by the author. [148](#)
- 3.33 GIS mapping of beach housing at Camperduin, showing the difference in height after 5 years (2015–2020). Clearly visible is the absence of upper dune transport and incipient dune formation near the pavilions and row housing. [148](#)
- 3.34 GIS sections of the foredune profile at Schoorl aan Zee, unbuilt/built. In yellow, the accretion over 5 years. In Section I, the dotted line of (built) Section III illustrates the difference in deposition. Image by the author. [148](#)
- 3.35 GIS sections of the foredune profile at Camperduin, unbuilt/built. In yellow, the accretion over five years. Image by the author. [148](#)
- 3.36 Schematic model of the scaled interaction of the three main coastal systems: geomorphology (blue), ecology (green) and urbanism (red). To activate their interactions for BwN, a three-step approach is defined: *morphogenesis*, *dynamic profiling* and *aeolian principles* (see also 2.4.3). Image by the author. [151](#)
- 3.37 The loss of the village of Egmond aan Zee due to progressing coastal erosion as a result of sea-level rise. Adapted from the Derde kustnota, 2000. [152](#)
- 3.38 Example of a morpho-temporal mapping of the coastline development of the north of Holland. Source: J. van Bergen, adapted from paleo-graphical maps from RACM & TNO, 2007. [153](#)
- 3.39 Predicted development of the Sand Motor nourishment using computer modelling after 0, 5, 10 and 15 years. Source: www.dezandmotor.nl. [154](#)

- 3.40 Example of the current profile of the Noordwijk aan Zee coastal resort, with a dike-in-dune construction to maintain as much sea view from the boulevard as possible. Below is a projection of the future safety profile for Noordwijk aan Zee in 2060, with a limited amount (0.6 m) of dike reinforcement and dune heightening in combination with 60m of dune widening. Image by the author. [156](#)
- 3.41 Widening (left) or heightening (right) of the dunes requires different sediment transport mechanisms and design principles. Images by the author. [157](#)
- 3.42 Overview of the six aeolian principles for dune widening and dune heightening. Images by the author. [159](#)
- 3.43 Wind rose of the Holland coast in summer, with the prevailing wind directions above Beaufort force 5 in percentages. Source : V. Stevers 2021/KNMI, 2019. [160](#)
- 3.44 Planting marram grass as a bio-builder for dune formation on the coast of Sylt, 1989. Source: Gerhardt, 1900. [162](#)
- 3.45 Illustration of wind flow around a vegetated embryonal dune, resulting in a decline of wind speed and promoting local deposition. Source: Klijn, 1981, adapted from Chapman, 1976. [162](#)
- 3.46 Example of the BwN construction of an artificial dune, enhanced by a sequence of fences and planting. Source: Gerhardt, 1900). [163](#)
- 3.47 GIS analysis of the evolution of the coastal profile of Petten south (3S) 0, 3 and 5 years after nourishment. Brushwood screens promote initial foredune formation (+ 20 m³/y) immediately after nourishment, taken over by vegetation in later years, when sediment transport reduced. The profile accumulated 270 m³ in 5 years (i.e. 50 m³/m/y). GIS sections by the author; see also Photograph 3.51. [164](#)
- 3.48 Illustration of wind vortexes and deposition around closed (left) or half-open fences (right). Source: Goldsmidt, 1985. [165](#)
- 3.49 Example of artificial fencing in a cross-formation on the Belgian coast to prevent sediment from blowing onto the boulevard (left) and natural brushwood screens at Petten (right). Images by J. van Bergen. [165](#)
- 3.50 Two examples of progressive fencing as a means to create an artificial dune. Left: fencing in North Carolina, accumulating to 3.65 m of dune height in 6 years. Source: Goldsmidt, 1985. Right: fencing proposal for dune building on the Wadden Isles, ca. 1920. [166](#)
- 3.51 (+ sections in Figure 3.47): Buried fences (right) at Camperduin (2021) providing a substantial seaward extension of the dunes (> 250 m³/5 y), combined with vegetated foredunes (middle, left) and embryonal dunes (right). Image by the author. [168](#)
- 3.52 Aerial overview of the Aeolis fencing installation at the Oerol festival (2018). Source: LA TU Delft / drone photography: Jelte Keur. [169](#)
- 3.53 Infographic (left) and plan view of Aeolis (right). Source: LA students TU Delft, 2018. [170](#)
- 3.54 Sand tail deposition by blowouts in the fences. Source: LA students TU Delft, 2018. [171](#)
- 3.55 Sediment deposition and transport around the low fences. Source: LA students TU Delft, 2018. [171](#)
- 3.56 Example of downwind tail development behind an elevated pavilion and non-elevated houses at Hargen, North Holland. Source: K. Wijnberg, UT, 2021. [173](#)
- 3.57 The calculated deposition tail pattern around an average beach house. Initial tail in yellow, progressing tail semi-transparent. Source: J.v.Bergen. Aerial photo: Google Earth [173](#)
- 3.58 The calculated deposition tail pattern around an average beach pavillion. Initial tail in yellow, progressing tail semi-transparent. Source: J.v.Bergen. Aerial photo: Google Earth [173](#)

- 3.59 Resulting deposition pattern around a non-elevated scale model after 6 weeks. Image by the author. [174](#)
- 3.60 Cross-section of the deposition (one-third upwind [left], two-thirds downwind) around a non-elevated scale model (B2) after a 6-week field test. Source : M. Kuschnerus/ J. van Bergen. [174](#)
- 3.61 Documentation of deposition tails of oblique-oriented objects. Source: ShoreScape, Poppema, 2022. [175](#)
- 3.62 Test results of a scale-model row with varying gap-distances (gap of 0, 1 and 3 times the building's width) and 3 times the buildings width with a 60° wind angle. Measurements (x,y) in meters. Source: Poppema, 2022. [176](#)
- 3.63 Illustration of deposition patterns around common beach-building typologies, depriving the foredunes of sediment on the lee side of the building and row (up to 50% reduction). Source: J.v.Bergen. Aerial photo: Google Earth [177](#)
- 3.64 Illustration of deposition patterns around beach pavilions, optimized for shorter tail development to widen the dunes. Source: J.v.Bergen. Aerial photo: Google Earth [178](#)
- 3.65 Illustration of deposition patterns around beach row housing, optimized for shorter tail development to widen the dunes. Source: J.v.Bergen. Aerial photo: Google Earth. [179](#)
- 3.66 Example of urban mobilization via tramping at beach access points (white circles), decreasing embryonal dune growth (green) and promoting sediment availability for aeolian transport. Image by the author; aerial photograph: PDOK.nl. [182](#)
- 3.67 Drawings of a saucer blowout with typical wind flow patterns. Image by the author, adapted from Hesp, Geomorphology, 2002. [183](#)
- 3.68 Tail development of pavilions, elongated by their oblique setting with the wind. Source: J.v.Bergen. Aerial photo: Google Earth Pro. [184](#)
- 3.69 Aerial photograph of Noordwijk beach, April 2018, showing the downwind deposition tails of the beach pavilions and the blowout patterns of the beach accesses, overflowing the dunes in the SW direction. Source: Google Earth Pro. [184](#)
- 3.70 Drone overview of 50 cm tall, fully closed screens on an open beach plain, with deposition patterns after a week of strong northern wind at the Sand Motor. In the front, two 45° screens facing each other in a funnel shape, producing a larger and higher combined inner tail than the orthogonal screens in the back. Source: J.v.Bergen (2019, i.c.w. D. Poppema) [185](#)
- 3.71 (right) Field test of a V-shaped scaled row house configuration on an open beach plain in Vlieland (2020), combining wind convergence and oblique placement to lengthen tails and guide sediment to the back as an artificial blowout. Image by the author. [185](#)
- 3.72 Overview of natural and artificial blowouts to guide sediment to the upper dunes. Source: J. van Bergen. Aerial photo: Google earth. [186](#)
- 3.73 Increased flow velocity (orange) below beach housing on 2 m-high poles. Source: Van Onselen, 2018. [187](#)
- 3.74 GIS section of pavilions on poles at the Sand Motor, showing the 2 m-high downwind deposition at the dune foot over 3 years (2015, 2017, 2018), as well as increased deposition at the foredune slope. Image by the author. [187](#)
- 3.75 Aerial photograph (source: J.van Bergen) and DEM/TLS map (source: M.Kuschnerus) of the beach group. [188](#)
- 3.76 Photographs and mid-sections of the non-elevated B2 model and the 1 m elevated B6 model (left= upwind), illustrating the difference in tail length and deposition height. Source: J. van Bergen/M. Kuschnerus. [188](#)

- 3.77 Oblique placement of beach pavilions to promote longer sandtails to the dunes. Source: J.v.Bergen, aerial picture: Google earth. 191
- 3.78 Compressed, accelerated windflow below and behind a beach pavilion on poles to increase sediment flow to the dunes. Image by the author. 191
- 3.79 Source: J.v.Bergen, aerial picture: Google earth 191
- 3.80 Source: J.v.Bergen, aerial picture: Google earth 192
- 3.81 Source: J.v.Bergen, aerial picture: Google earth 192
- 3.82 Inverted aerial photograph of the foredunes north of Petten, which accumulated an additional 60 m of foredune in 5 years as a result of the nearby sandy reinforcement. Adapted from Google Earth. 193
- 3.83 Example of a sequential 3D profile design for dune widening. Images by the author. 195
- 3.84 3D profile designs for dune heightening. Images by the author. 198
- 3.85 Toolbox with the design principles for natural coastal adaptation. Image by the author. 200
- 4.1 Map of the Netherlands and the four case-study locations. Source: J.v. Bergen, background map: kaartenatlassen.nl. 208
- 4.2 Photograph of the Noordwijk boulevard in 1920. Source: deoudedorpskernnoordwijk.nl. 210
- 4.3 Photograph of the Noordwijk boulevard after reinforcement in 2008. Image by the author. 210
- 4.4 The morphogenesis of the South Holland coast. Image by the author, adapted from van der Spek, 1999. 212
- 4.5 Section of the South Holland coast at Wassenaar, near Noordwijk, illustrating the evolution of the old and young transgressive dune barrier as the result of a sequence of erosive and accretive periods due to sea-level rise. Adapted from Roep et al. (1991) and van der Spek (1999). 212
- 4.6 Current and potential future cross-sections of Noordwijk boulevard. Images by the author, adapted from Mulder et al., 2013. 213
- 4.7 Overview of four urban models for the future waterfront development of Noordwijk, based on parallel versus perpendicular access and varying beach layouts. Images by the author. 216
- 4.8 Overview of the current and future test profiles for Noordwijk, including principles. Images by the author. 218
- 4.9 overview of the current and future test profiles for Noordwijk, including principles. Images by the author & OKRA. 221
- 4.10 Map of west Walcheren. Source: J.W. van Aalst, Opentopo.nl. 222
- 4.11 The historical seaside resort of Domburg. Source: © Rijkswaterstaat / Simon Warner. 223
- 4.12 Westkapelle in 1558: construction of a double-dike system in response to severe dune erosion. Source: Stichting Cultuurbehoud Westkapelle. 224
- 4.13 The system of travelling sand banks along the Walcheren coast over time. This system alternates periods of accretion with periods of erosion. Source: Studio Coastal Quality / Rijkswaterstaat, 2012. 224
- 4.14 The Manteling and Domburg in 1850. On the left, forestry as an ancient BwN method against erosive, transgressive dunes visible on the right. Source: Zeeuws archief / Zeeuws genootschap. 224
- 4.15 The Manteling in the present day, hosting a beautiful landscape of dunes, forest and countryside. Photo: J. van Bergen. 224

- 4.16 Mapping of the 2015 nourishment programme for Walcheren, supplying sediment to maintain the coastline. Adapted from Province of Zeeland (2017). 225
- 4.17 Erosive dunes near Domburg around 1900, which were planted with Marram Grass for recovery. Source: Koolman, M (2022)/ RCE / collective MK. 226
- 4.18 Mega-nourishment design for west Walcheren, covering the seawall of Westkapelle with a mega-nourishment feeding the waterfront of Domburg, and leaving dynamic dune fronts to support the ecology of the Manteling in the north. Source: Studio Coastal Quality, TUD (2013). 227
- 4.19 Samples of different dune types that could develop along the different zones of the BwN-based mega-nourishment in Walcheren. Images by the author. 228
- 4.20 Geomorphological system: mega-nourishment zones and corresponding dynamics. Image by the author. 230
- 4.21 Urban system: corridor development in response to new coastal conditions and dynamics. The inland perpendicular corridors (as opposed to linear) offer a no-regret option for a retreat strategy in case of a high sea-level rise. Image by the author. 230
- 4.22 Ecological system: natural succession in response to varying conditions and sediment dynamics from the nourishment and erosion. Image by the author. 230
- 4.23 Design study phase 0: the current seawall of Westkapelle - Domburg before BwN reinforcement. Photo: © Rijkswaterstaat / Rens Jacobs. 231
- 4.24 Visualizations of the transition of the Westkapelle seawall into a mega-nourishment with dune formation. Source: J. van Bergen. Visualisations: OKRA landscape architects. 232
- 4.25 The coast of Petten as a seawall (1980). Source: © Rijkswaterstaat. 233
- 4.26 The coast of Petten after sandy reinforcement (2018), including a new 60 m-wide dune system. Source: J. van Bergen. 233
- 4.27 Morphogenesis of the coast of Petten from an open tidal inlet system (1350, left) into a closed seawall (1850). In 2015, the seawall was replaced with a mega-nourishment, re-engineering the defence line back to the sandy system of before 1730. Images by the author, adapted from H. van Zijl. 234
- 4.28 Cultural syntaxis of Petten. Sources: Beeldbank Zijper Museum (a, b) and Image by the author (c). 235
- 4.29 Aerial photographs of the Hondsbossche dunes in June 2015, April 2018 and September 2020, showing the gradual decline in beach width due to coastal erosion, especially on the cornering beaches. Source: Google Earth pro. 236
- 4.30 GIS-mapping (DEM) of the dune development at the Hondsbossche dunes, including sections (Figure 4.31). The midsection (profiles 4 and 3S) exhibits the highest dune-growth rates (orange and red), whilst the dune formation at the cornering beaches (2S and 2N, in red) has lagged behind. Image by the author. 237
- 4.31 GIS-sections of the dune development per profile type (2, 3 and 4), including volumes accumulated in the first 5 years (2015–2020). Images by the author; Lidar data courtesy of HHNK. 238
- 4.32 Section of profile 3-south, north of Camperduin (height x2), with the initial nourished profile and the 250 m³ coastal buffer (dotted) required to maintain safety from 2065 onwards. On the right-hand side, the former seawall profile. Image by the author. 239
- 4.33 Photo and GIS sections (2015–2020) of foredune development at Camperduin. Images by the author. 240
- 4.34 GIS mapping of beach housing at Camperduin showing the difference in height after 5 years (2015–2020). Source: J. van Bergen. 241

- 4.35 Two GIS sections of the dune growth at Camperduin in the first 5 years after the sandy reinforcement (2015–2020, below). The row housing (section below) reduced accretion by 50% compared to the unbuilt situation. Source: J. van Bergen. [241](#)
- 4.36 Photo (2021, top) and GIS sections (2015–2020, below) of the current profile development 3 South, featuring the initial profile (2015, including the future safety profile of 250 m², dotted) and GIS sections after 3 (middle) and 5 years (top, all height x2). Source: J. van Bergen. [243](#)
- 4.37 Improved temporal sections of the waterfront of Camperduin (height x2). Images by the author. [244](#)
- 4.38 Plan (a, top) and temporal schemes (b, below) for the urban development of the coastal profile at Camperduin (3 South), corresponding to the sections in Figure 4.37. Images by the author, estimated dune development derived from GIS analysis (see Figure 4.36). [245](#)
- 4.39 Sequential dynamic profile design (3s) for dune widening at Camperduin. Images by the author. [246](#)
- 4.40 Sections (top) and plan (below) of the sequence of fences, widening the coastal profile to include a small dune slack, dammed up from the sea. Images by the author, dune development from GIS. [248](#)
- 4.41 Photograph of dune slack development at the Vliehors on the island of Vlieland, NL (2021). In 8 year time (2014–2022), new beach ridges were formed (foreground), sheltering off part of the beach where humid (fresh-water) dune slacks developed afterwards. Image by the author. [248](#)
- 4.42 Sketch plan of the BwN-based terraced design for the beach front of Petten. Image by the author, dune development derived from GIS. [250](#)
- 4.43 3D visualisation of the Petten waterfront with the build-up of the terraces through dynamic fencing. Images by J. van Bergen & OKRA landscape architects. Once the safety profile is established, the terraces can be colonized by beach buildings. Their tail development can enhance the heightening of the terraces (short tails) or foredune (medium or asymmetrical tails). [251](#)
- 4.44 Sections of the BwN-improved coastal profile at Petten (2 North). Images by the author. [253](#)
- 4.45 3D visualisation of the Petten waterfront with the build-up of the terraces through dynamic fencing. Images by J. van Bergen & OKRA landscape architects. [254](#)
- 4.46 Aerial photograph of the Sand Motor mega-nourishment just after construction in 2012, showing accretion on the south side. Source: © Rijkswaterstaat / Joop van Houdt [257](#)
- 4.47 Predicted progress of the Sand Motor. Source: www.dezandmotor.nl. [258](#)
- 4.48 Morphogenesis from the Meuse inlet from 1100 AC onwards, showing its southward movement as well as the coastal erosion of its former banks. Source: R. Waterman/De Ontwerpers, 2005. [259](#)
- 4.49 GIS evation maps of the south side of the Sand Motor. Images by the author. [260](#)
- 4.50 Morphogenesis of the Sand Motor. Morphological development predicted by computational modelling (adapted from Luijendijk et al., 2017) combined with GIS data on dune development (2011–2019) extrapolated to 2031. Clearly visible are the new beach ridges formed in front of the foredune. Although they positively affect storm resistance, they are not officially part of the storm erosion barrier and delay the sediment transport to the foredunes. Images by the author. [261](#)
- 4.51 Section of the Sand Motor, its initial volume and aspired coastal buffer. In dark brown, 10–25% of the nourished, erosive volume (in green). Image by the author. [262](#)

- 4.52 Tramping around a beach (white circles) limiting embryonal dune (green) growth south of the Sand Motor. In yellow the sand tails produced by the beach buildings. Image by the author; aerial photograph: PDOK.nl. [263](#)
- 4.53 GIS section with shadow dune formation behind a beach pavilion south of the Sand Motor, stimulating foredune growth. Image by the author. [263](#)
- 4.54 BwN ensemble of beach houses situated on beach ridges of the south Sand Motor to keep sediment mobile (white circles) and harvest sediment (yellow) for landward foredune formation (green). GIS image and graphics by the author. [265](#)
- 4.55 Design sequence of BwN foredune formation following mega-nourishment. Images by the author. [267](#)
- 4.56 3D visualisation of beach house development within the beach ridges of Sand Motor. Image by J.v.Bergen & OKRA landscape architects. [268](#)
- 4.57 In a later phase of Sand Motor, beach housing can be re-positioned in the foredunes once the coastal safety buffer is established, preferably in a secluded (non-visible) way. Image by J.v.Bergen & OKRA landscape architects. [268](#)
- 5.1 Overview of BwN as a landscape design approach to dune nourishment dynamics on different scales: morphogenesis on a regional scale, dynamic profiling on a trajectory scale and aeolian principles on a local scale. Image by the author. [282](#)
- 5.2 Morphogenesis study via GIS-mapping (DEM) of dune formation following sandy reinforcement at the Hondsbossche Dunes (2015-2020; including profile developments, see Figure 4.31). Image by the author. [284](#)
- 5.3 Dynamic profile design study for BwN-based dune formation as coastal buffer and multiple use at Camperduin, following sandy reinforcement (2015). Images by the author, height x2. [285](#)
- 5.4 Toolbox with the design steps and principles for natural coastal adaptation. The three-step design method of morphogenesis, dynamic profiling and aeolian design principles was derived from the design (case) studies (Chapter 4). The aeolian design principles were derived from literature review, GIS, fieldwork and CFD modelling (Chapter 3), and were tested in the case-studies. Image by the author. [287](#)
- 5.5 Dense beach row housing at Camperduin (2021). Image by the author. [288](#)
- 5.6 GIS analysis in plan and section (2015-2020) has shown that dense beach row housing (e.g. at Camperduin, Figure above) negatively impacts dune formation (-50%), and therefore should be avoided in places where dunes as storm erosion buffer are needed. See also Section 3.4. GIS-DEM mapping by the author. [288](#)
- 5.7 Multi-sourced research into the aspects of sand-tail development as aeolian design principle to promote dune widening. Sources: J. van Bergen (a, c), V. Stevers i.c.w. ShoreScape (2021) (b) [288](#)
- 5.8 Form follows sediment: BwN-based beach house development within the beach ridges of Sand Motor to promote onward sediment transport. Image by J.v.Bergen & OKRA landscape architects. [290](#)
- 5.9 Current and future reinforcement profiles for Noordwijk, enhanced by sediment harvesting from regular maintenance nourishments. Images by the author. [293](#)
- 5.10 Temporal fencing strategy of a BwN-based terraced design for the waterfront of Petten, following sandy reinforcement and coastline maintenance. Images by J.v.Bergen & OKRA landscape architects. [297](#)

Biography



Photograph by Joost Bataille

Janneke van Bergen (Vierlingsbeek, 1975) graduated with honours as an Architect at the Delft University of Technology (2003), completing her master's study with a specialization in Landscape Architecture.

Her graduation project for a river park at the Meuse was nominated for the Archiprix 2004.

Water has been a recurring theme in her career, working on projects such as the Dutch Water Line, the programme Room for the River (with projects Deventer, Nijmegen-Lent, Munnikenland and Noordwaard), Studio Coastal Quality and the National Coastal Strategy; cumulating in the PhD research ShoreScape – a landscape approach to the natural adaptation of urbanized sandy shores (Delft University of Technology 2017-2022).

She was project leader in several area development projects such as Den Helder, Hoofddorp and Hoeksche Waard, in which sustainability and participation played an important role. She currently works as a project architect at OKRA landscape architects, where she focuses on climate adaptation and water-related projects.

Besides her work as an architect, she has been teaching at the TU Delft and abroad. She is the author of various publications, including 'Inspiratieboek Routeontwerp' (Chief Government Architect) and 'Building with Nature Perspectives' (Research in Urbanism Series – TU Delft Open).

List of publications

Peer reviewed journal articles

- Van Bergen, J., Mulder, J., Nijhuis, S., Poppema, D., Wijnberg, K., & Kuschnerus, M. (2021). Urban dunes. *Research in Urbanism Series*, 7, 101–128. <https://doi.org/10.47982/rius.7.130>
- Van der Velde, R., Pouderoijen, M., Van Bergen, J., Bobbink, I., Van Loon, F., Piccinini, D., & Jauslin, D. (2021). Building with landscape. *Research in Urbanism Series*, 7, 129–148. <https://doi.org/10.47982/rius.7.131>
- Wijnberg, K., Poppema, D., Mulder, J., Van Bergen, J., Campmans, G., Galiforni Silva, F., Hulscher, S., & Pourteimouri, P. (2021). Beach-dune modelling in support of Building with Nature for an integrated spatial design of urbanized sandy shores. *Research in Urbanism Series*, 7, 241–260. <https://doi.org/10.47982/rius.7.136>
- Van Bergen, J., & Nijhuis, S. (2020). ShoreScape: Nature-Based Design for Urban Coastal Zones. *Coastal Management*. <https://doi.org/10.1680/cm.65147.319>

Books

- Van Bergen, J., Nijhuis, S., Brand, N., Hertogh, M., (2021) Building with Nature perspectives – Cross-disciplinary BwN approaches in Coastal Regions. *Research in Urbanism series (RiUS) Vol. 7, DIMI & TU Delft Open*. ISBN 978-94-6366-379-3. <https://doi.org/10.47982/rius.7.122>

Conference papers and abstracts

- Van Bergen, J. (2021) ShoreScape – Nature-based design for coastal resilience. Deltalinks 2021. https://flowsplatform.nl/#/shorescape--nature-based-design-for-coastal-resilience-1624309725403_____
- Van Bergen, J., Nijhuis, S., Mulder, J., & Wijnberg, K. M. (2020). Urban dunes: Promoting BwN dune formation at nourished beaches through spatial design. *Proceedings of . . . Conference on Coastal Engineering*, 36v, 23. <https://doi.org/10.9753/icce.v36v.management.23>
- Van Bergen, J., Nijhuis, S. (2019) ShoreScape: Nature Based Design for Urban Coastal Zones (abstract). ICE conference coastal Management

Other relevant publications

- Ettema, M. (2019). An art installation on the island of Terschelling illustrates how people and nature create dunes – and helps us understand how wind plays with the sand. *Blauwe kamer yearbook 2019*, p124-127.
- Bergen van, J. (2018) *Gap the Border: design experiment as incubator for nature-based solutions*. Book *Aeolis Gap the Border*, TU Delft, section Landscape architecture
- Dähne, C. & Van Bergen, J. (2017). Rewriting the 'Zone'. *Cinematic Narratives for Postindustrial Landscapes. Narrating Urban Landscapes, OASE, (98)*, 98–102. Retrieved from <https://oasejournal.nl/en/Issues/98/Rewritingthezone>
- Wijnberg, K. M., Nijhuis, S., Hulscher, S. J., Mulder, J., Van Bergen, J., Meyer, H., Hoonhout, B., Janssen, M. A., Hoekstra, J., De Groot, A., Goessen, P., & Van Gelder-Maas, C. (2017). *ShoreScape : sustainable co-evolution of the natural and built environment along sandy shores*. *NCK days 2017*, 102.
- Van Bergen, J., et. al. (2015) *Post-Deltaprogramma: van lange termijn adaptatie terug naar het 'nu'. / Post-Deltaprogramme: from long term adaptation back to the 'now and here'*. *Water governance #1*, Baltzer Science Publishers, p 17-23.
- Van Bergen, J. et al. (2016) *Integral adaptive concepts applied to urban deltas*. *Adaptation Futures conference 2016*
- Van Bergen, J. (2016) *Gebiedsontwikkeling Goudswaard: werkboek ruimtelijke kwaliteit*. SOHW
- Van Bergen, J. (2015) *Hoeksche Waard West: gebiedsstudie integrale delta ontwikkeling*. TU Delft/VP & SOHW
- Sijmons, D., Van Bergen, J. et al. (2014) *Integral adaptation models for urban deltas*, NWO proposal *The New Delta*
- *Delta programme Coast (2014) Handreiking Meegroeiconcepten*. Ministry of I and M.
- *Delta programme Coast, (2013) National Coastal Strategy: Compass for the Coast*. Ministry of I and M.
- *Atelier Kustkwaliteit (2013) Safety and Quality of the Dutch Coast: towards 2100*. TU Delft / *Delta program Coast*
- *Atelier Kustkwaliteit (2013) Ontwerpen aan de zandige kust*. TU Delft / *Delta program Coast*
- *Delta programme Coast (2011) Nationaal kader kust*. Ministry of I and M.
- *Atelier Kustkwaliteit (2012) Ontwerpstudie dwarsdoorsneden kust – vier kustdoorsneden*. TU Delft.

ShoreScape

A landscape approach to the natural adaptation of urbanized sandy shores

Janneke van Bergen

Urbanized sandy shores around the world suffer from coastal erosion due to a lack of sediment input and sea level rise. These dynamics place new demands on coastal spatial planning. To compensate for coastal erosion in a more natural and systemic way, sand nourishments are deployed as a 'Building with Nature' technique, restoring the sediment balance and promoting dune formation as coastal defence.

In this research, Building with Nature is reframed as a landscape approach, regenerating the coastal landscape by tuning the interactions between the geomorphological, ecological, and urban system, to adapt to sea level rise. To this end, design principles have been developed that integrate nourishment dynamics, natural succession, and adaptive urban design to build towards safe and multi-functional coastal landscapes— Shore-Scapes. They focus on spatial coastal configurations utilizing wind-driven sedimentation processes to build up the coastal buffer, supporting dune formation, multifunctionality, and landscape differentiation.

To direct sediment dynamics for coastal reinforcement and landscaping, three subsequent tools for dynamic design have been derived: morphogenesis, dynamic profiling, and aeolian design principles. With these principles, validated by fieldwork, GIS, and computational modelling, spatial arrangements can be composed enhancing the aeolian build-up of the coastal landscape over time. These principles were applied and contextualized in four case studies along the Dutch coast. They illustrate how dunes along urbanized shores can grow naturally after nourishment and allow coastal safety, recreation, and nature to complement each other.

A+BE | Architecture and the Built Environment | TU Delft BK