

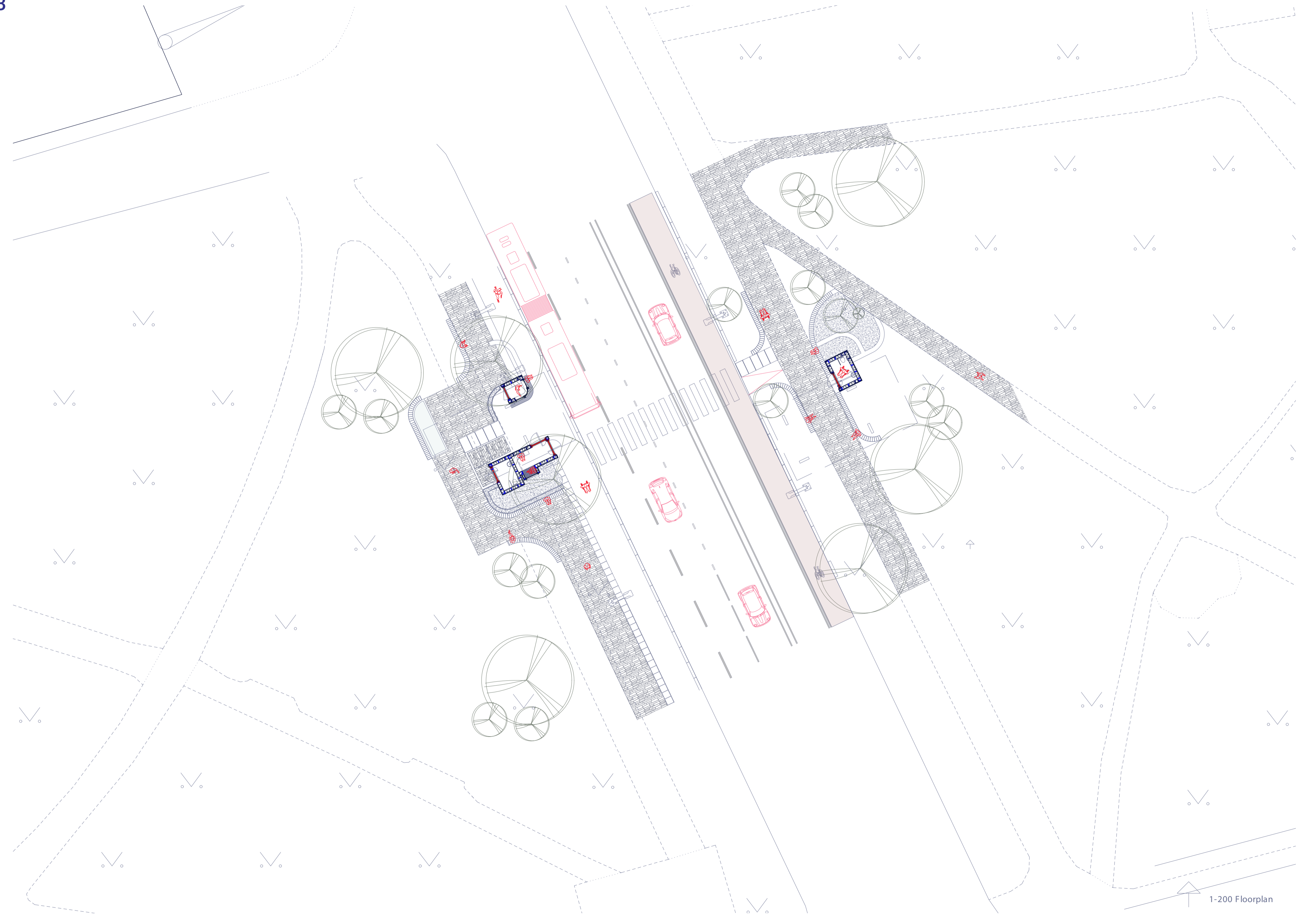

1-200 Floorplan



1-200 Floorplan



1-200 Floorplan

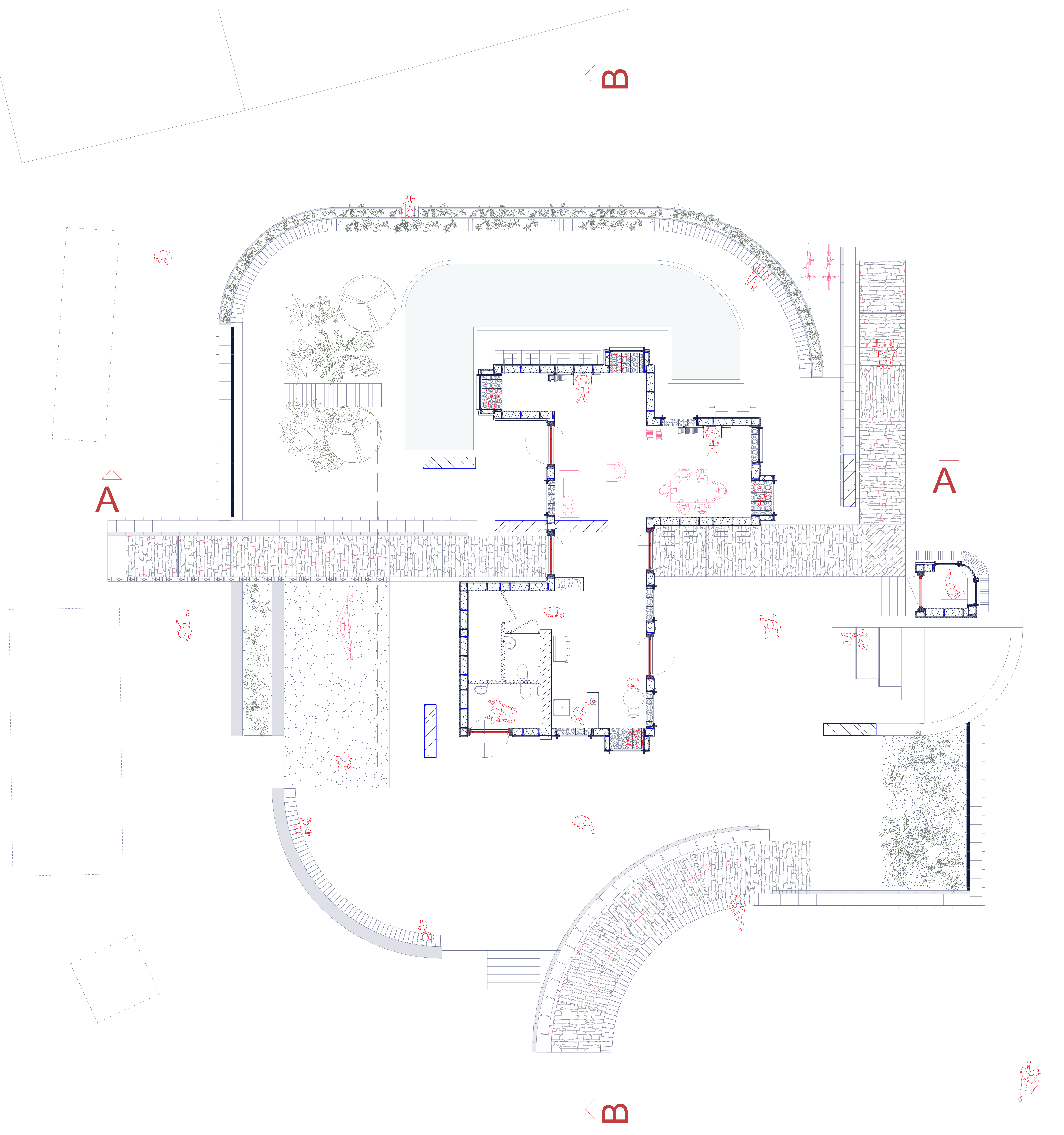

1-50 Floorplan

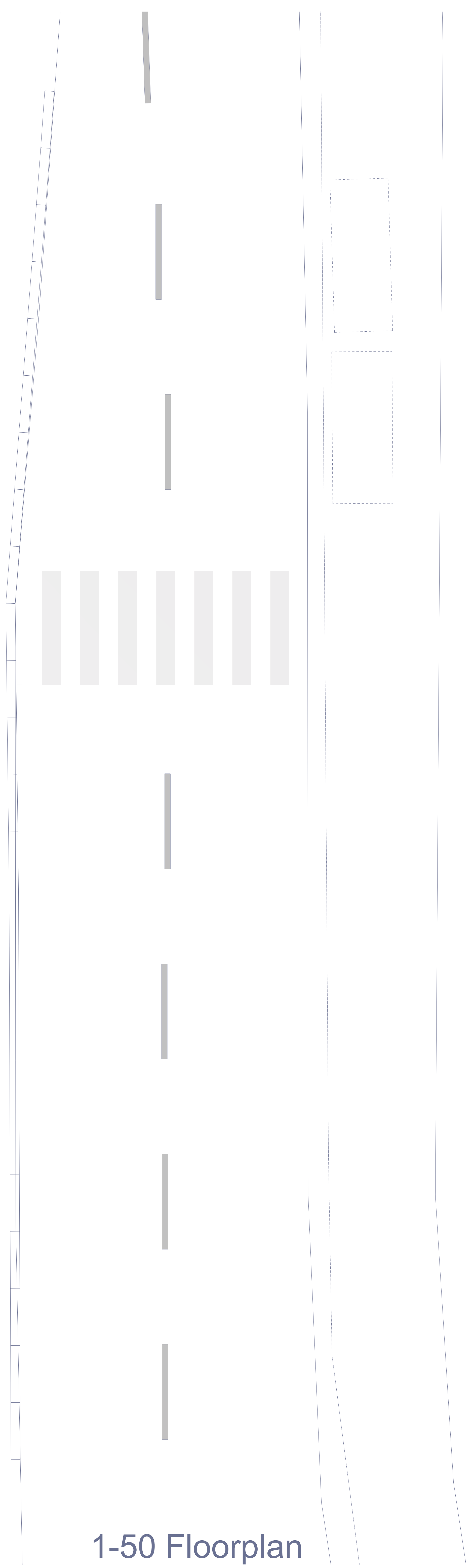

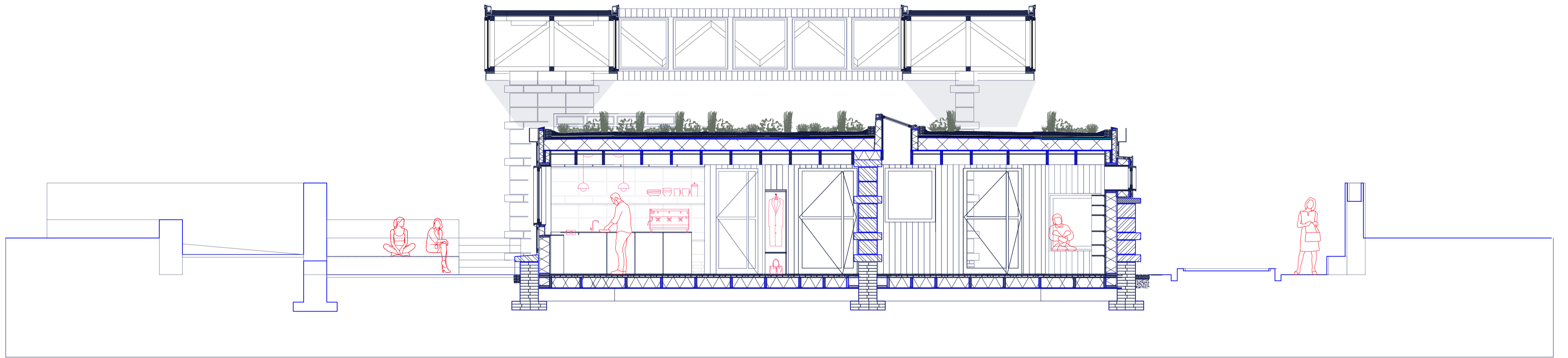

B-B
1:50



East

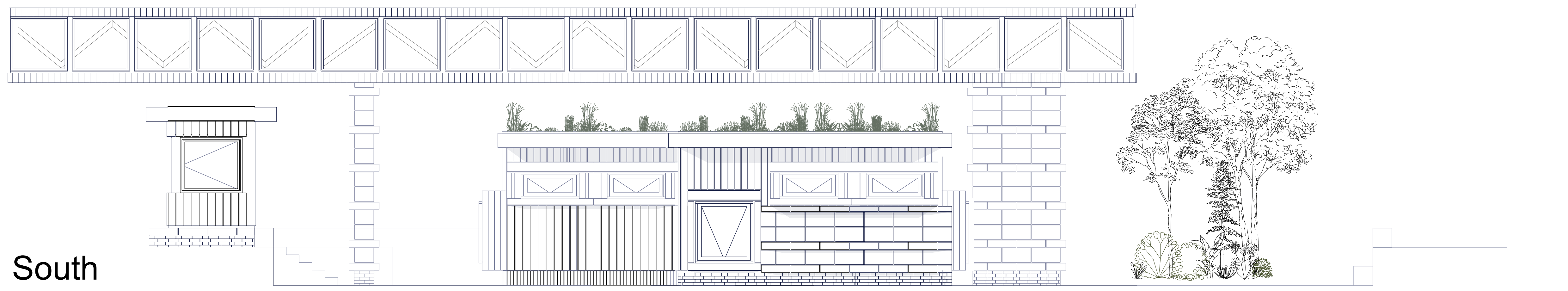

South

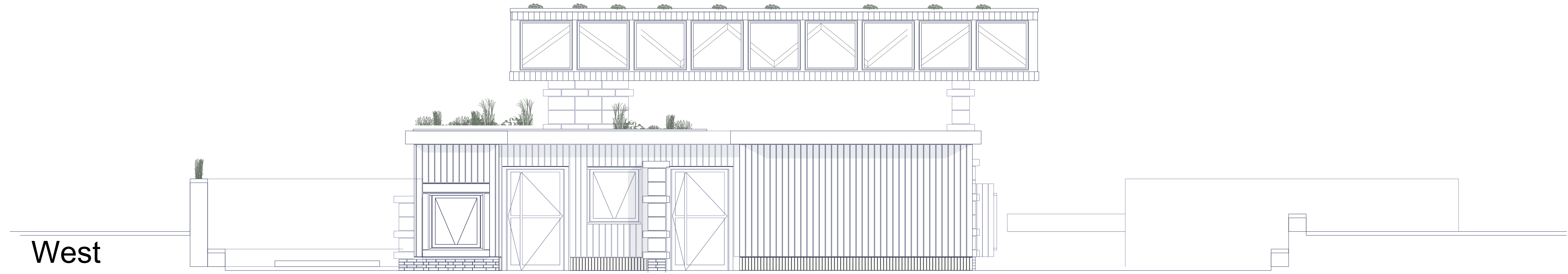

West

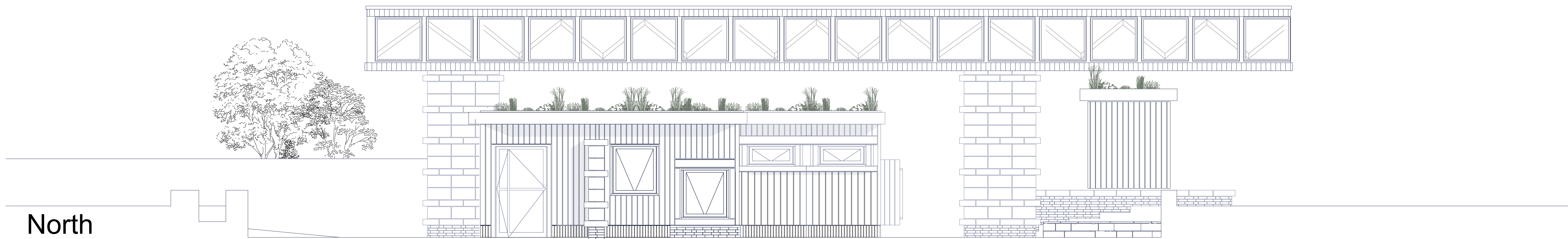
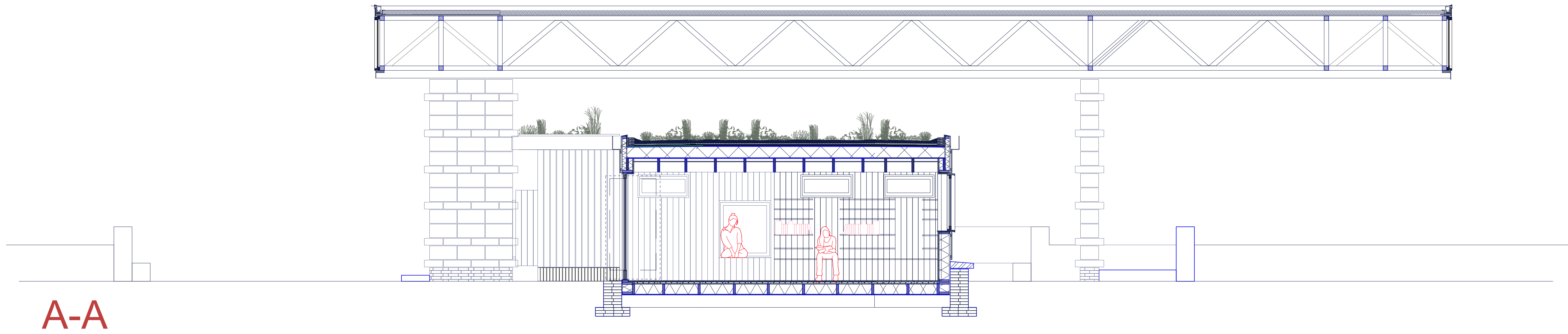

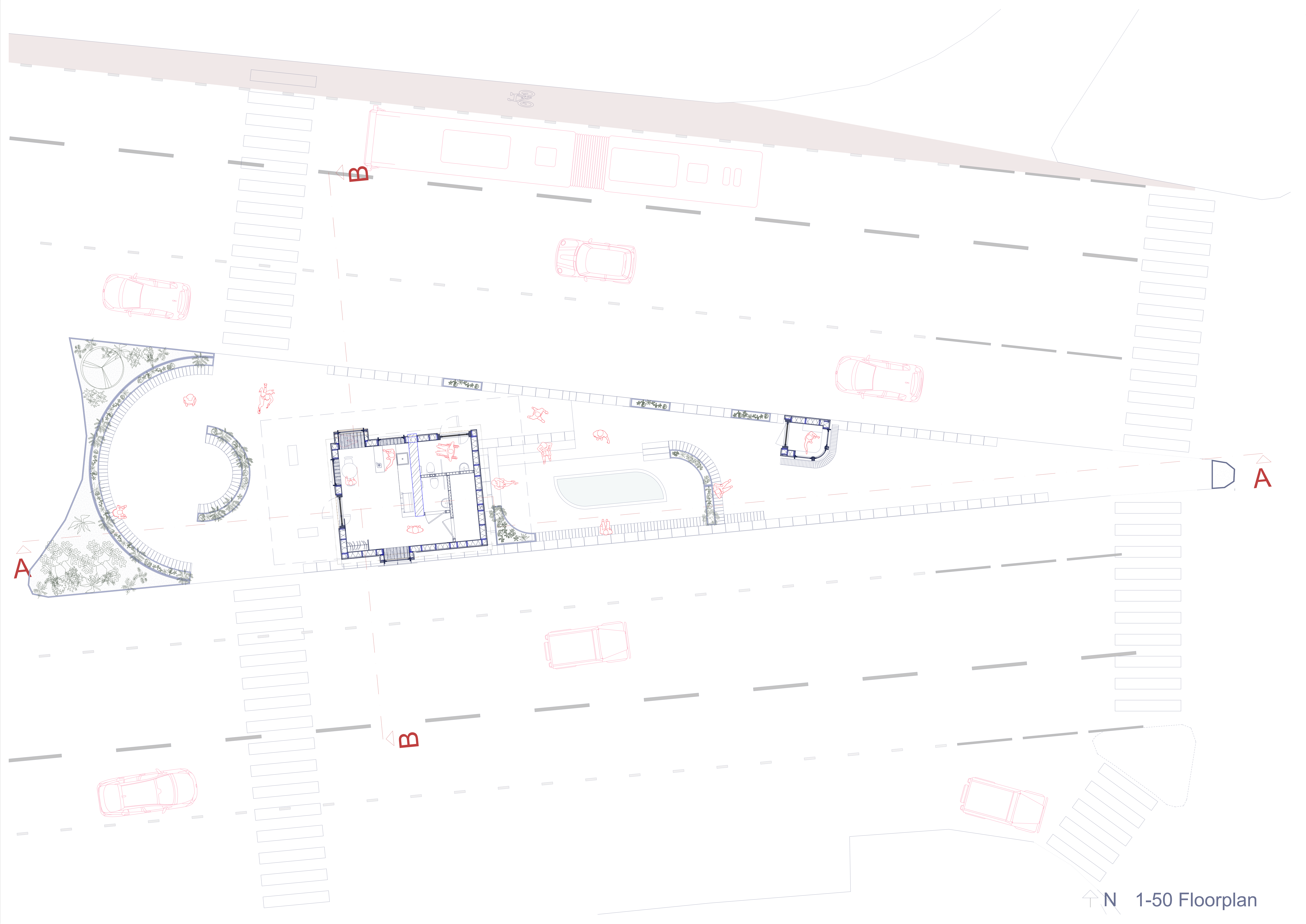

B-B
1:50

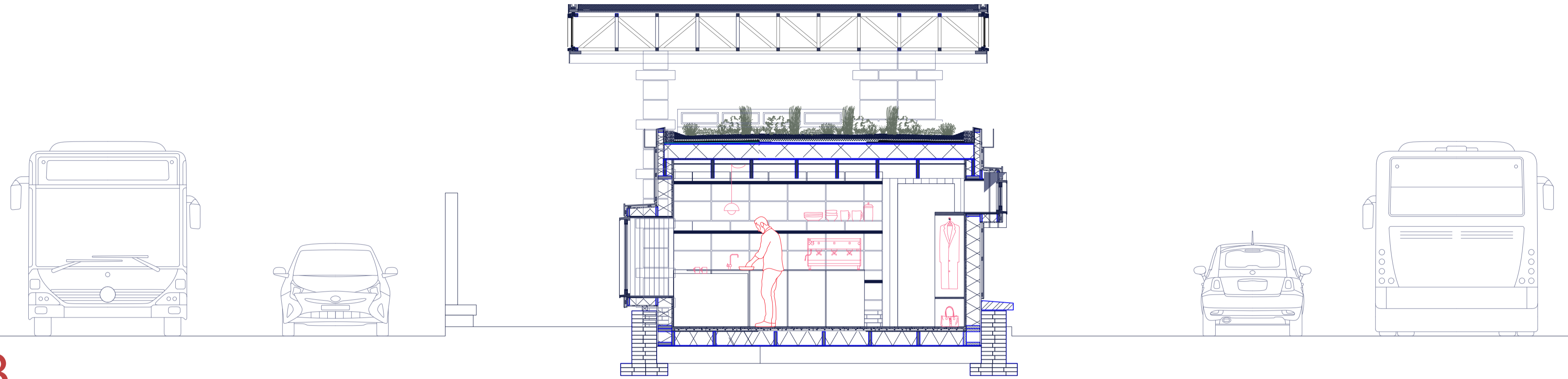

East

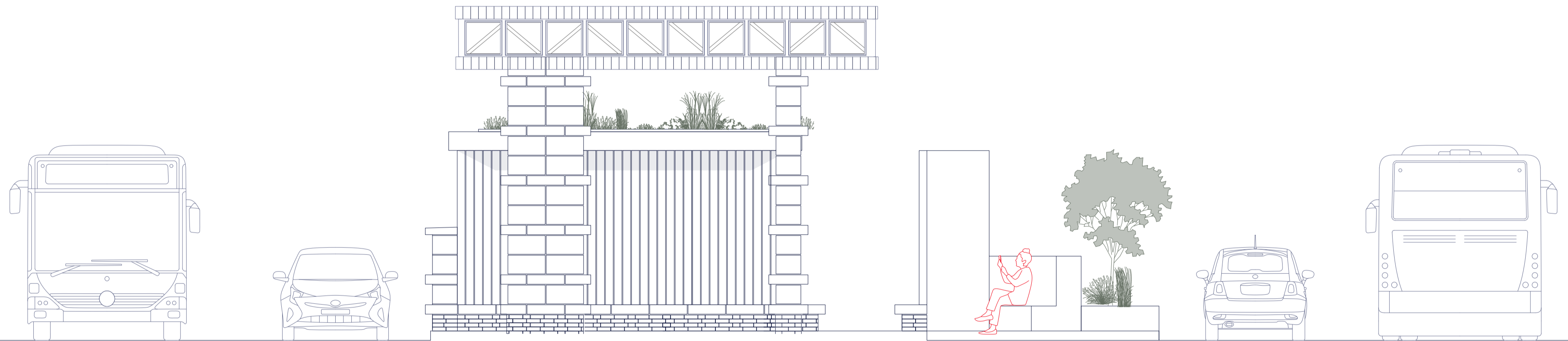

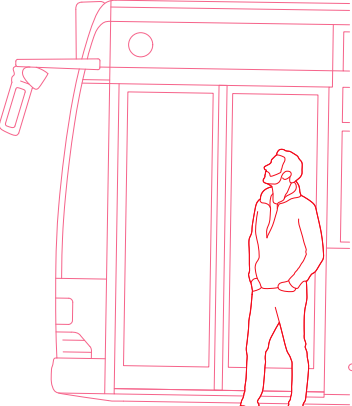
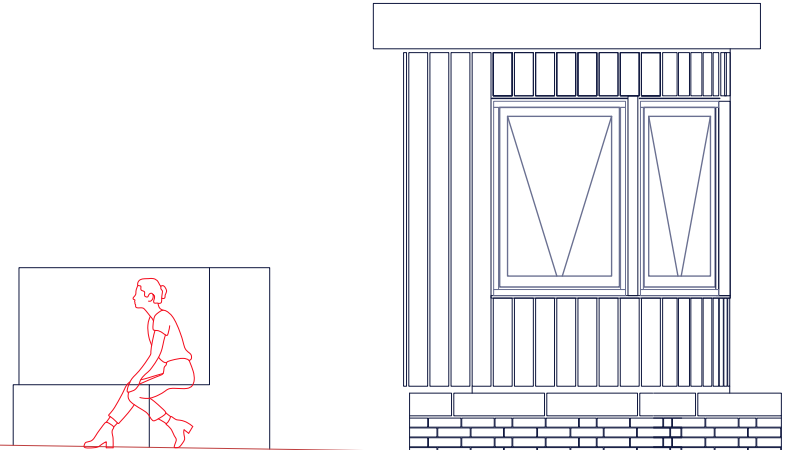
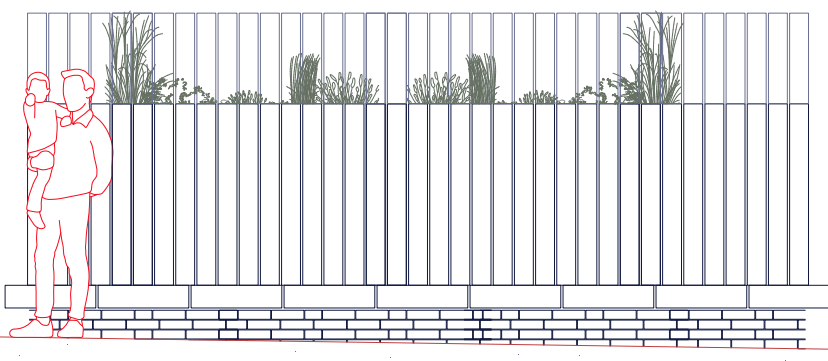
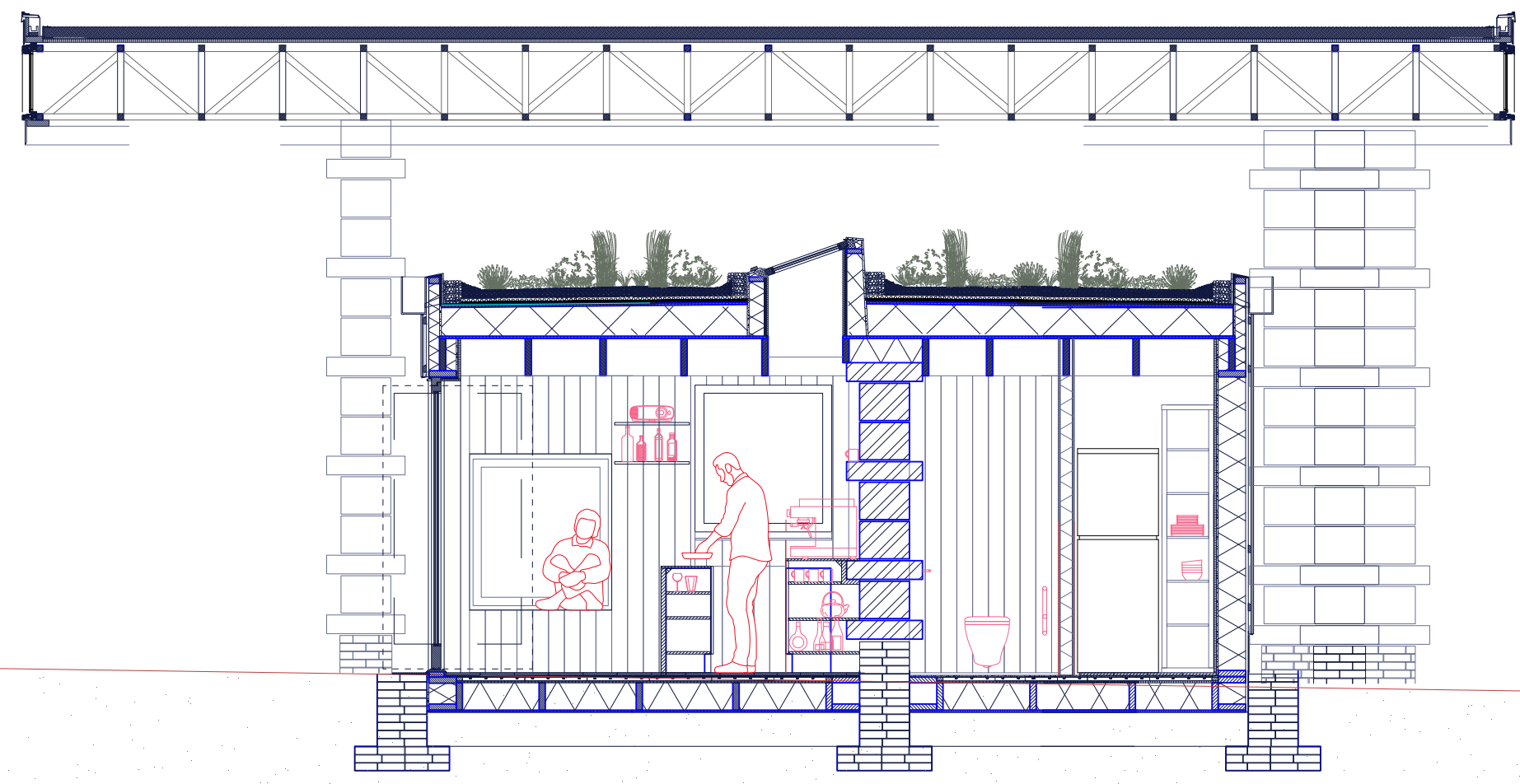

A-A
1:50

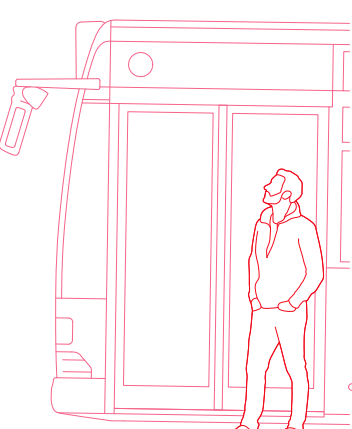
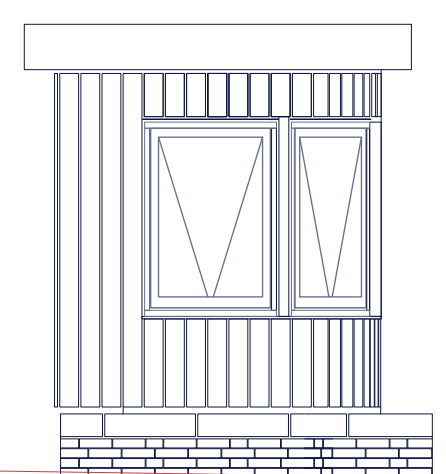
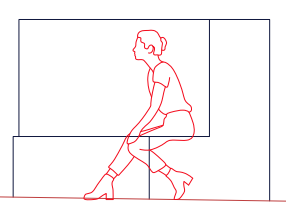
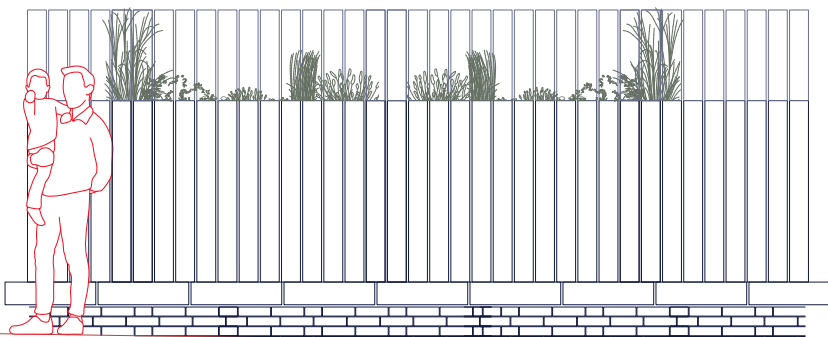
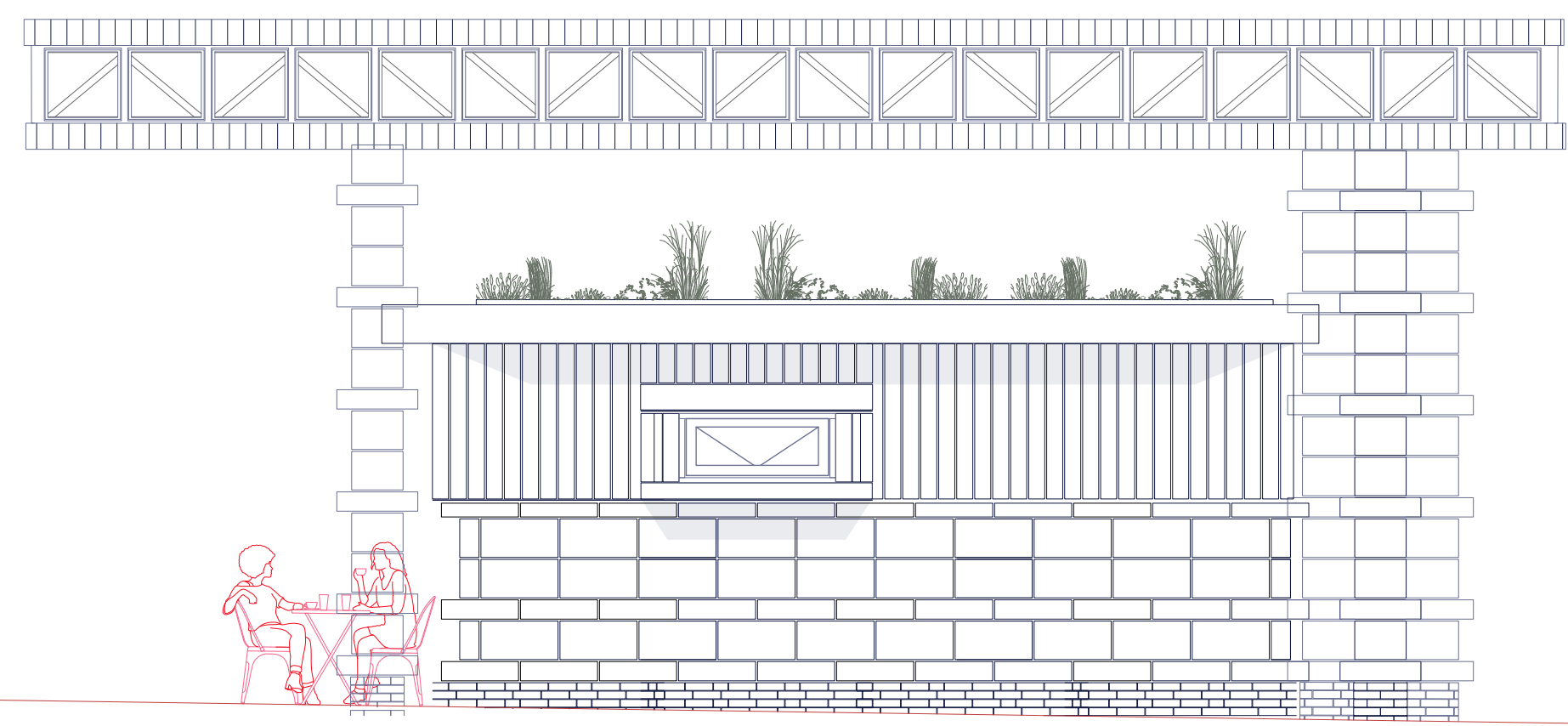

North

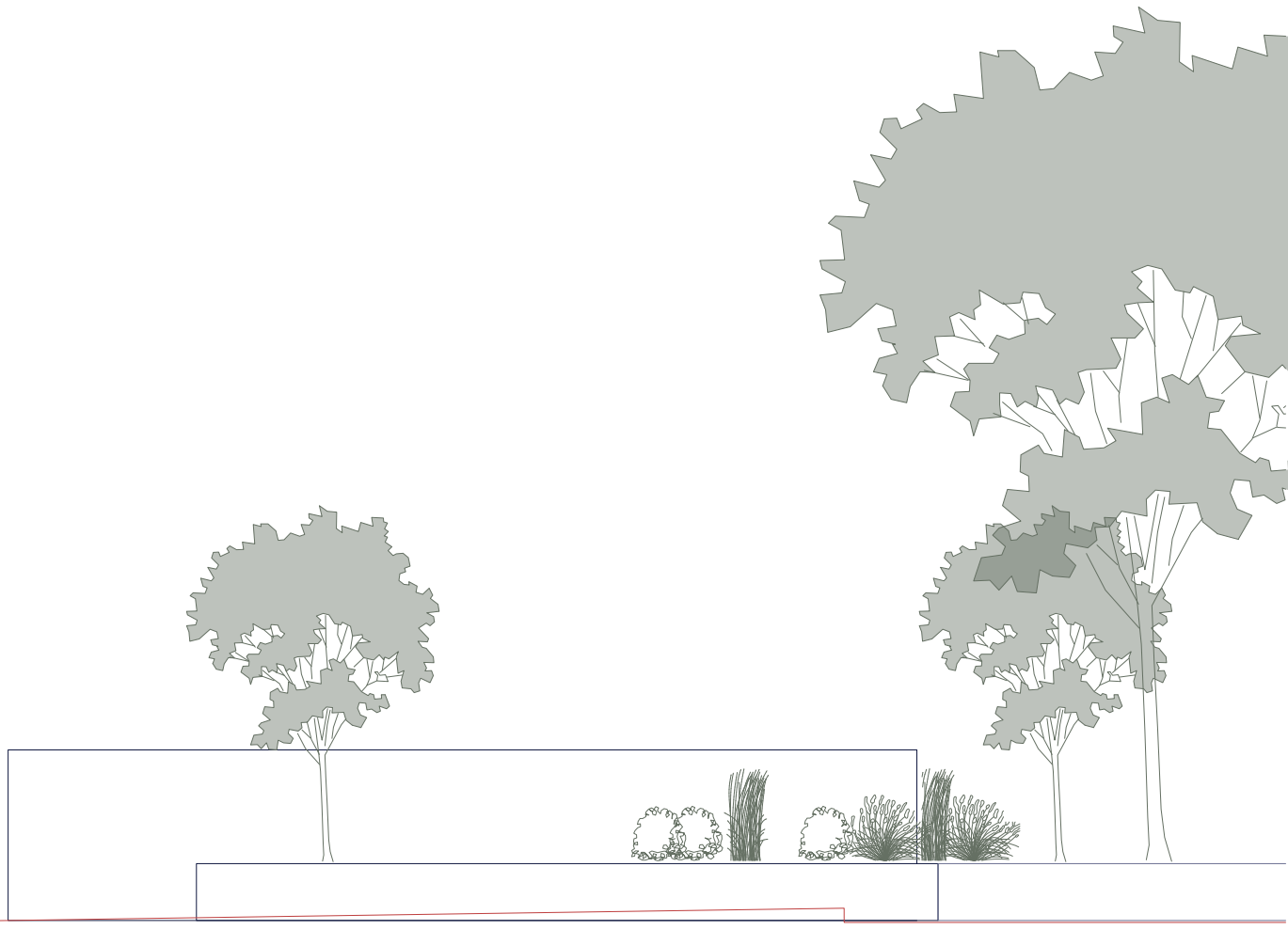
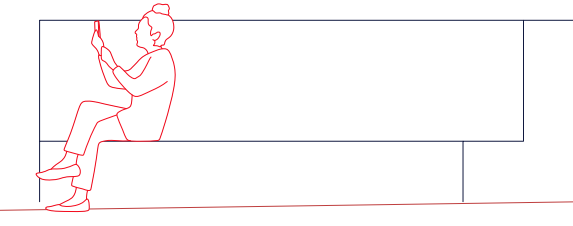
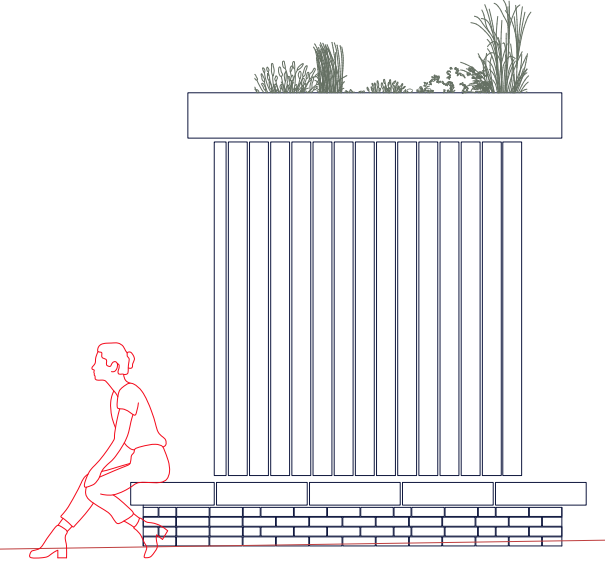
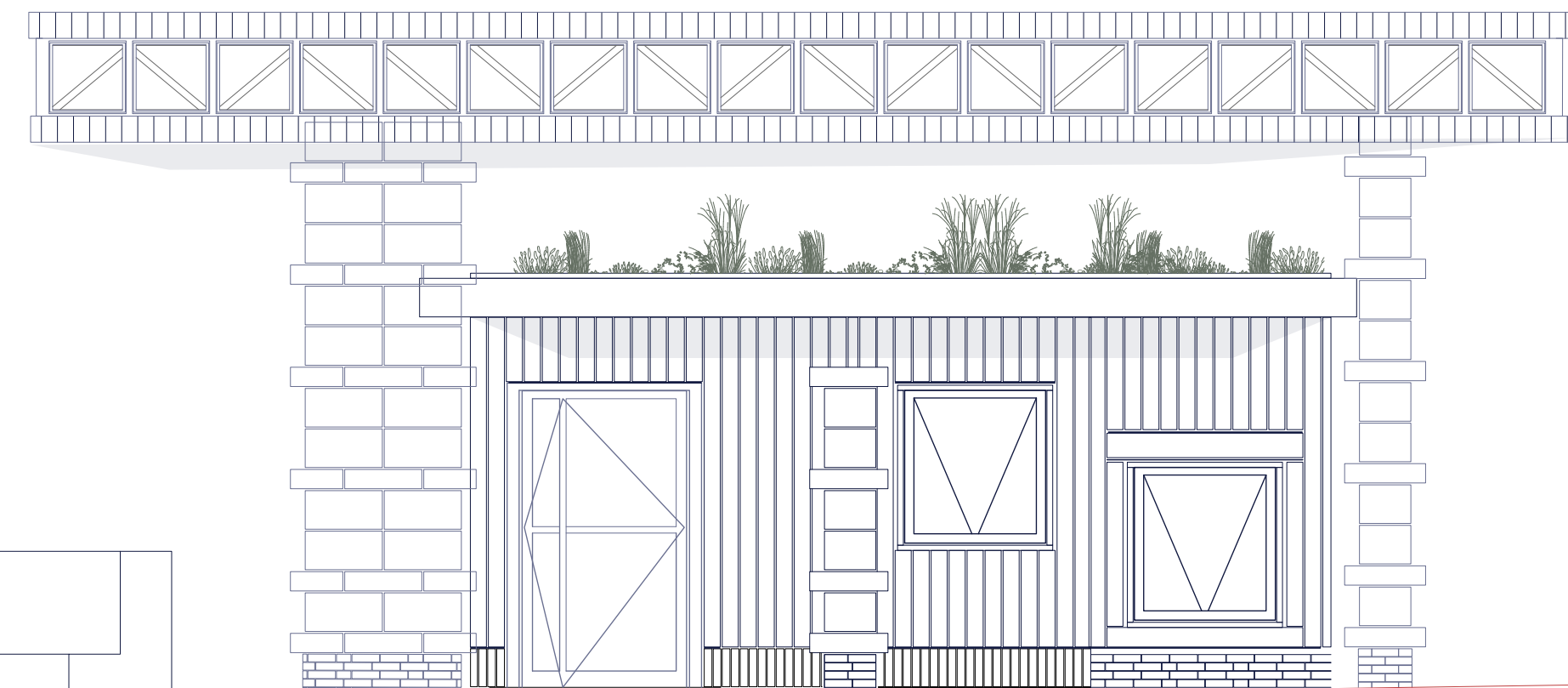

South

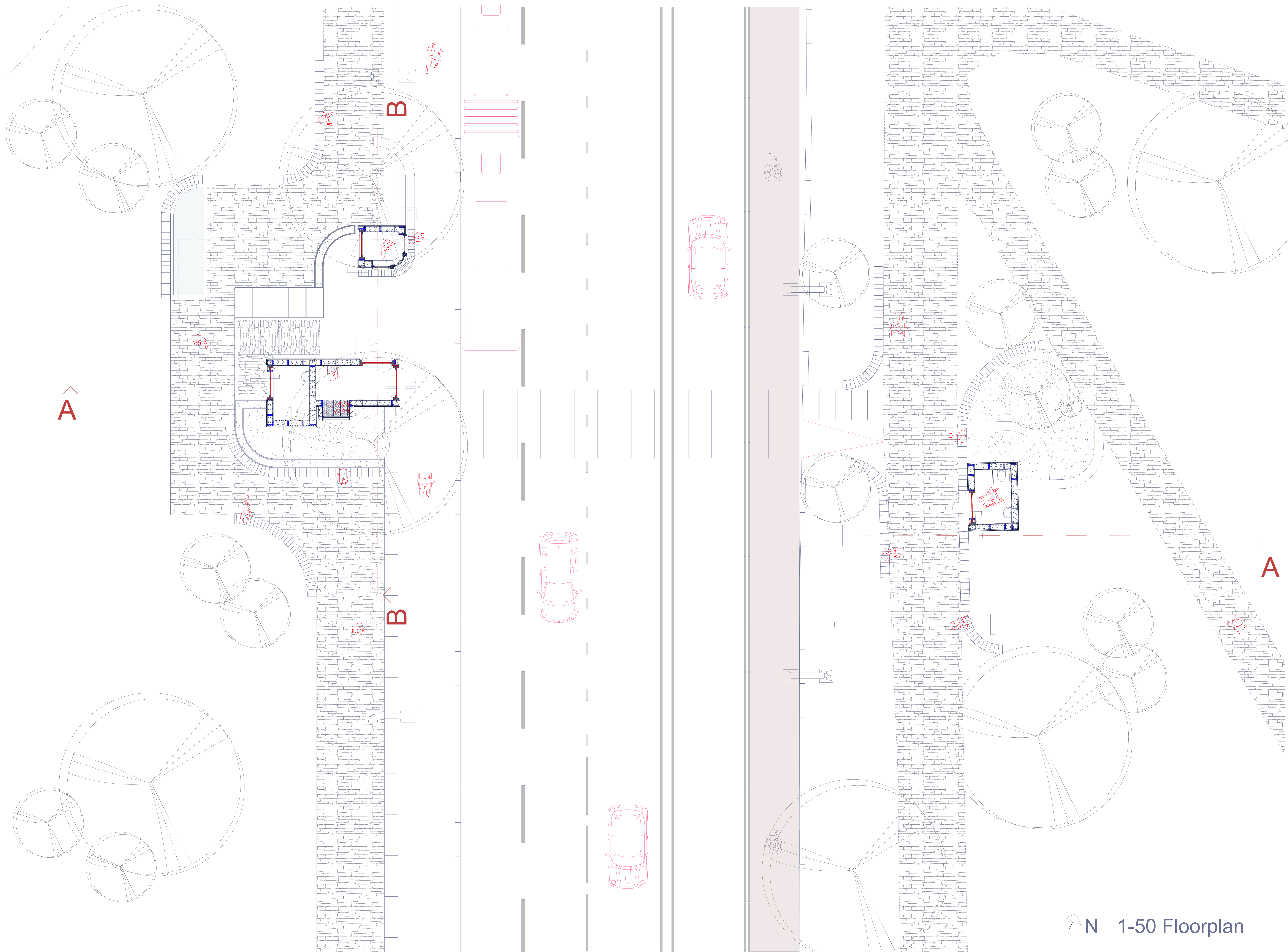

A

B

B

A

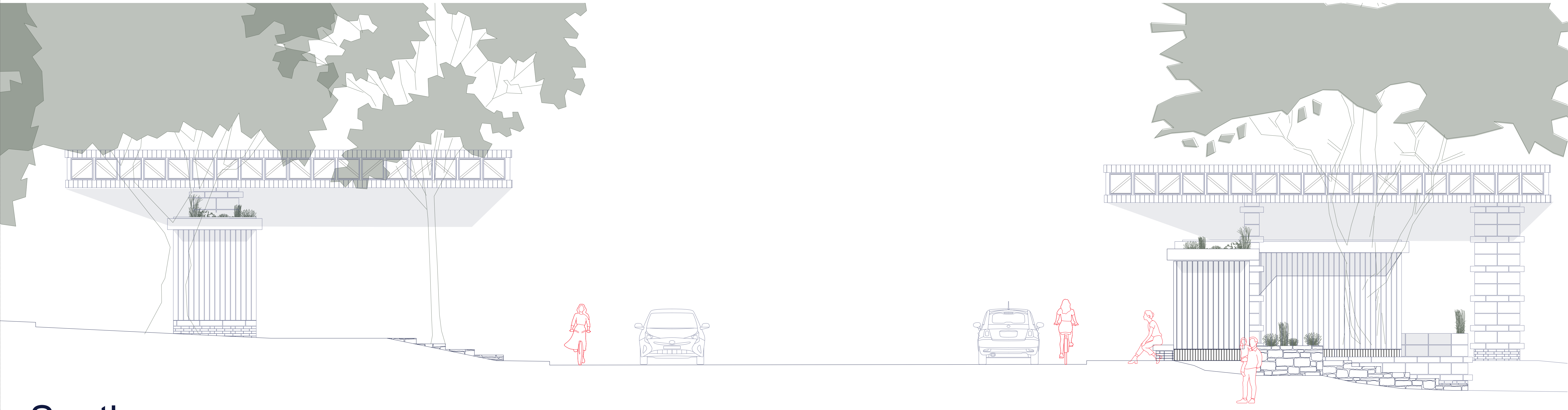

South



West

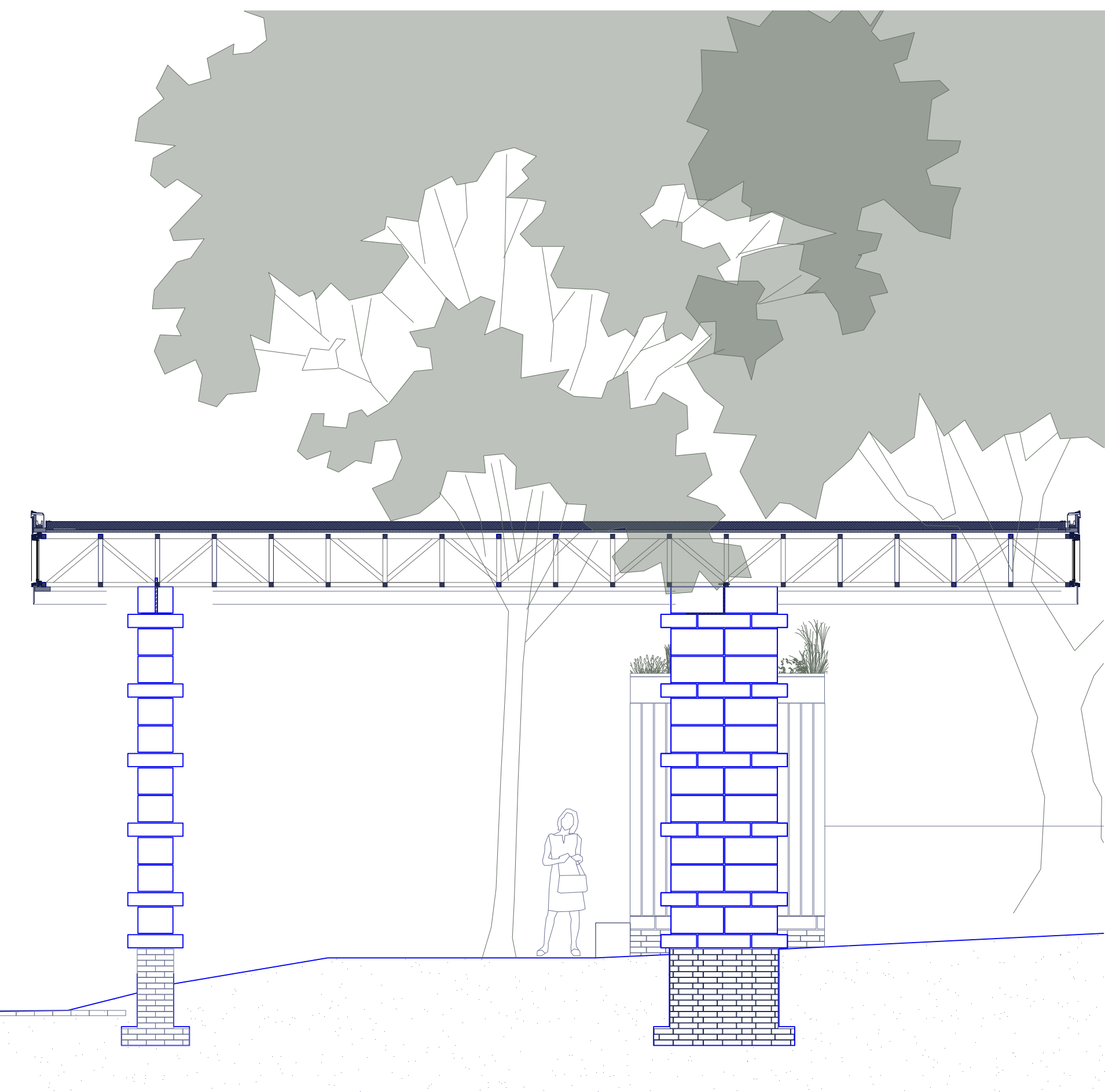
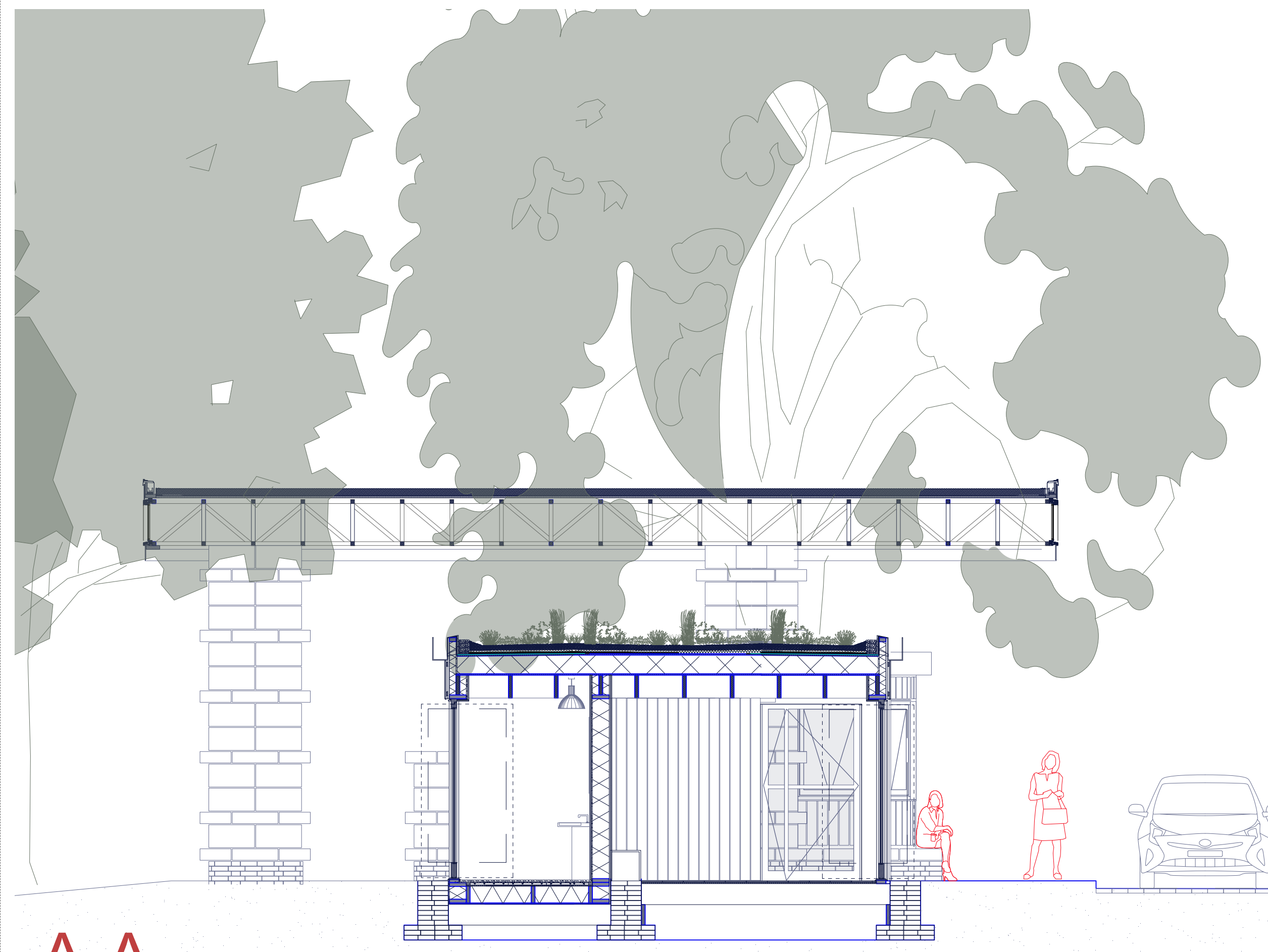

A-A
1:50

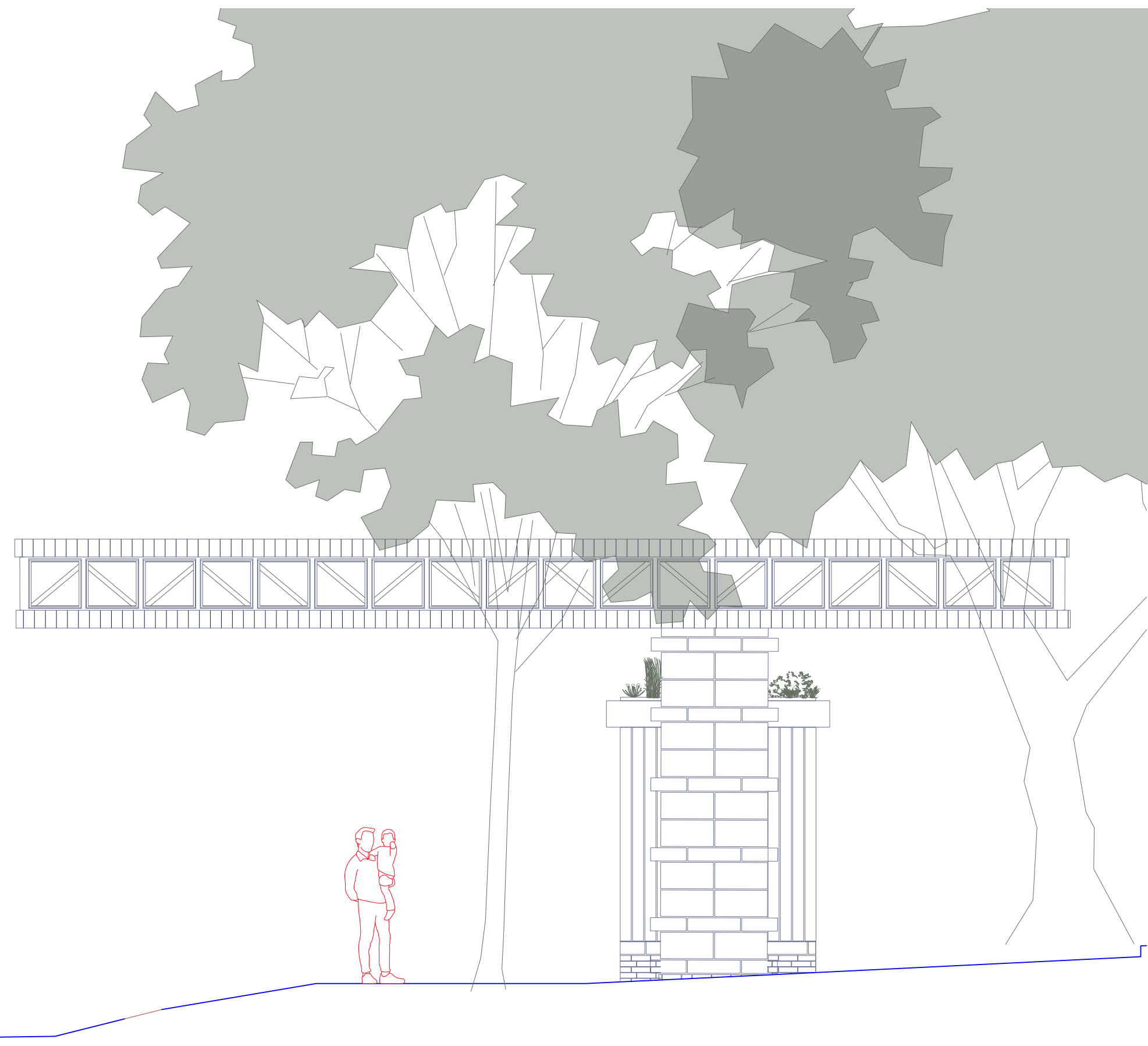
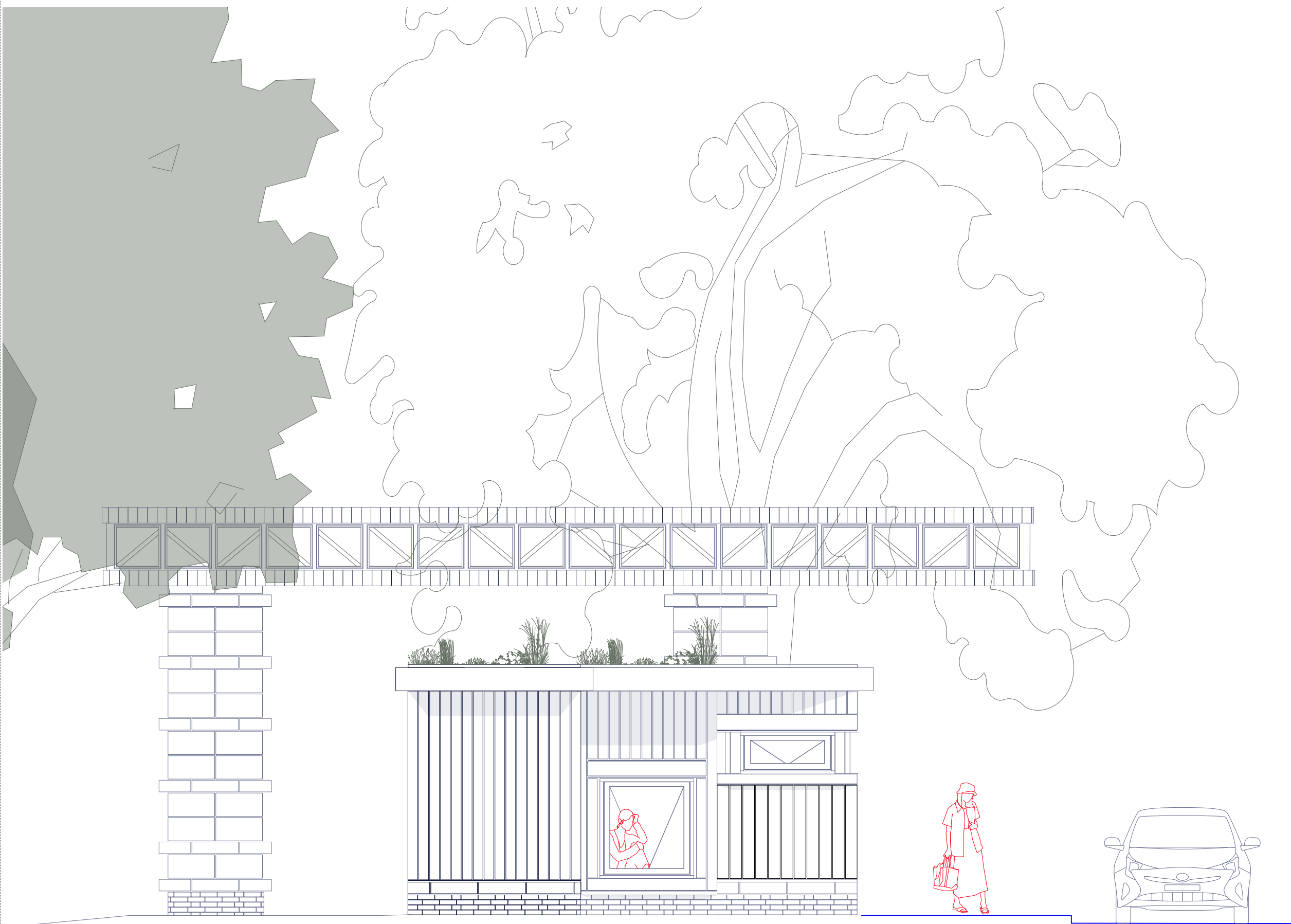

North

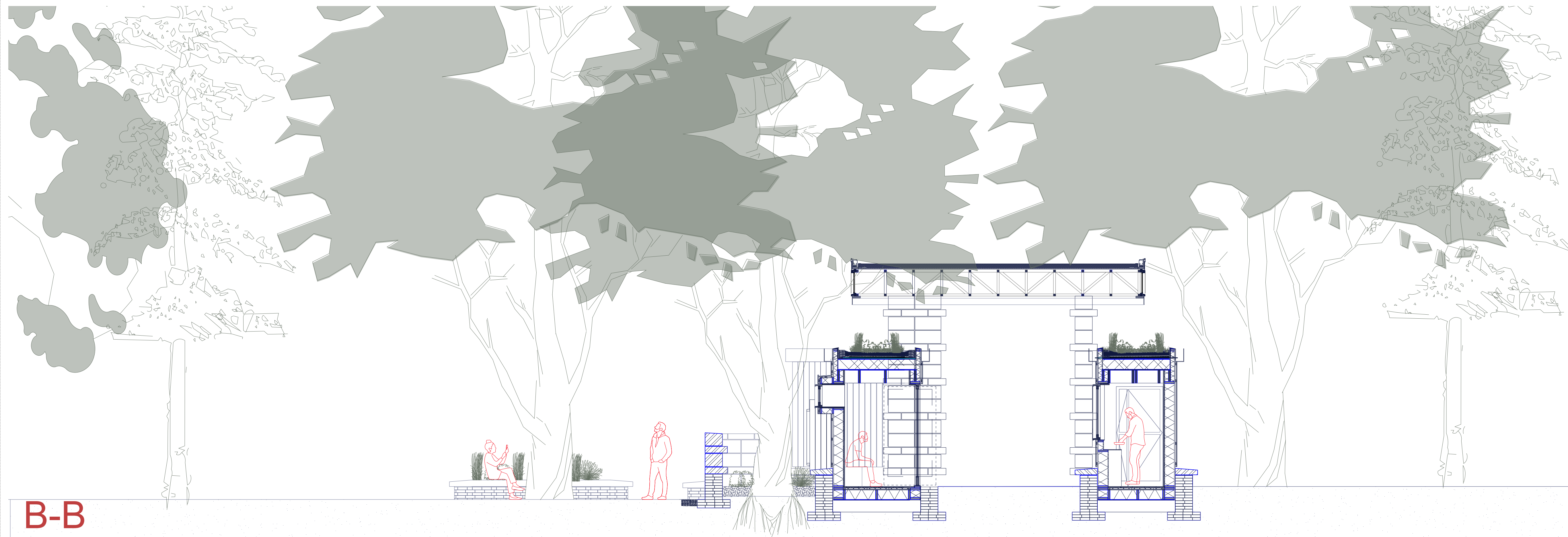

B-B
1:50

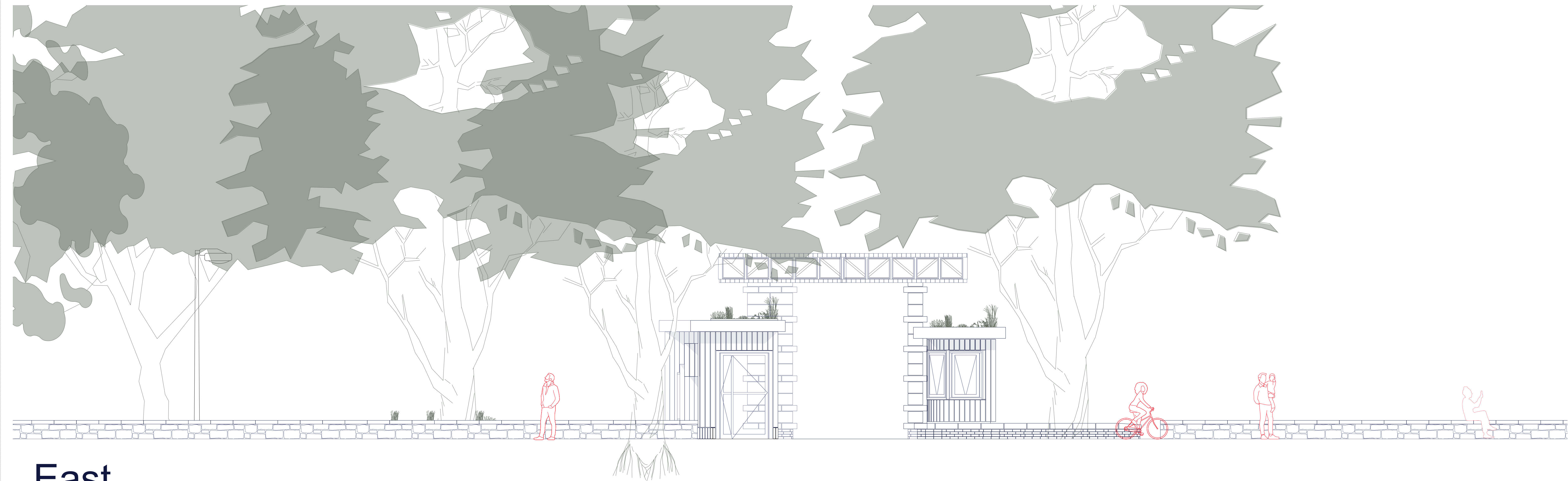

East

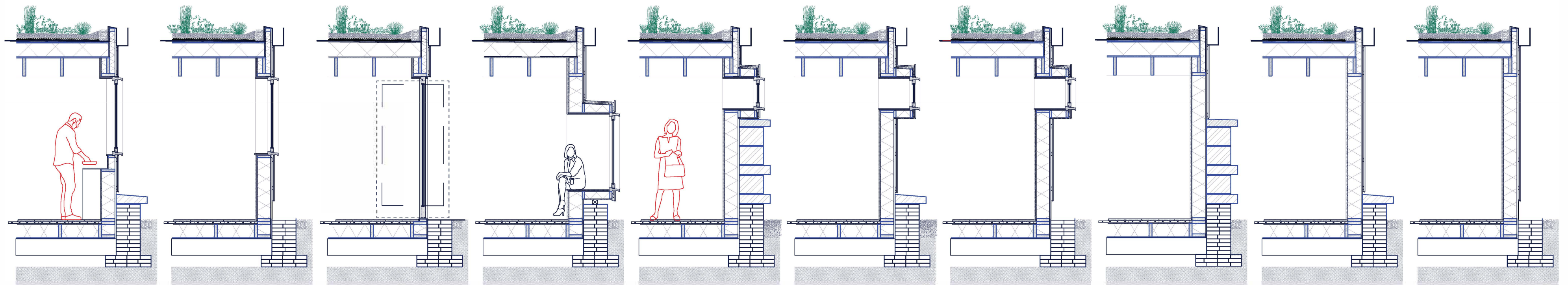

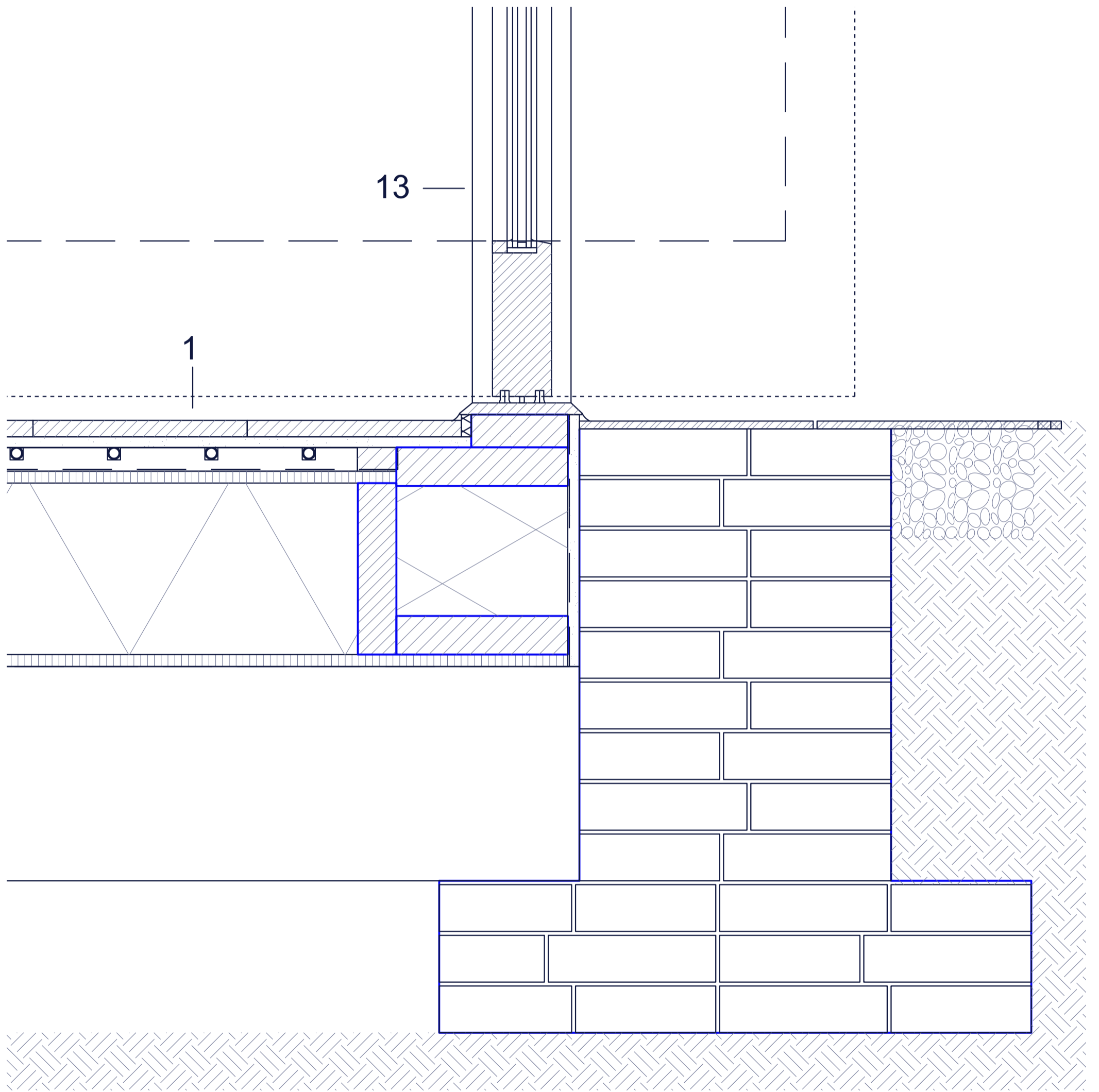

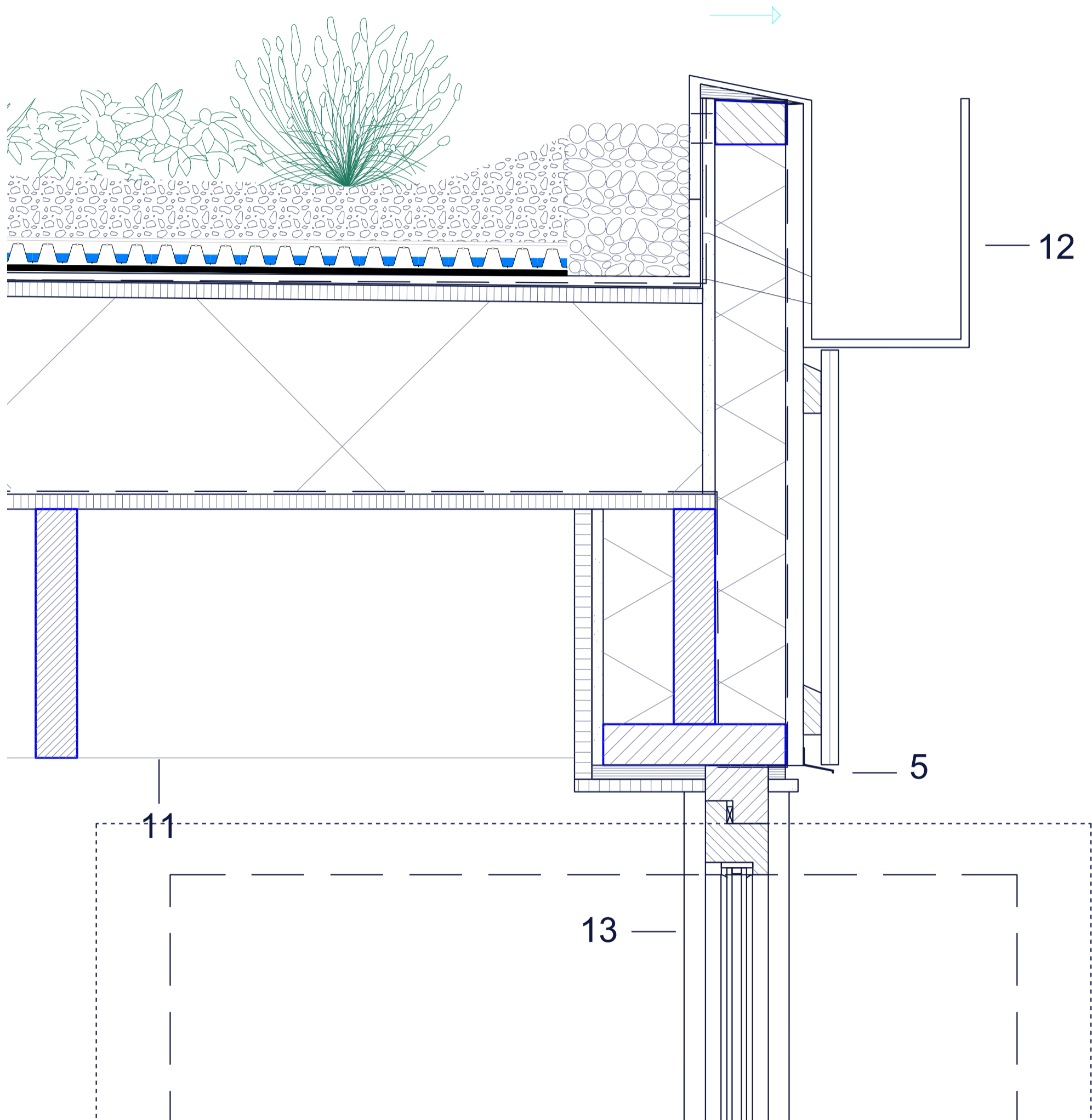

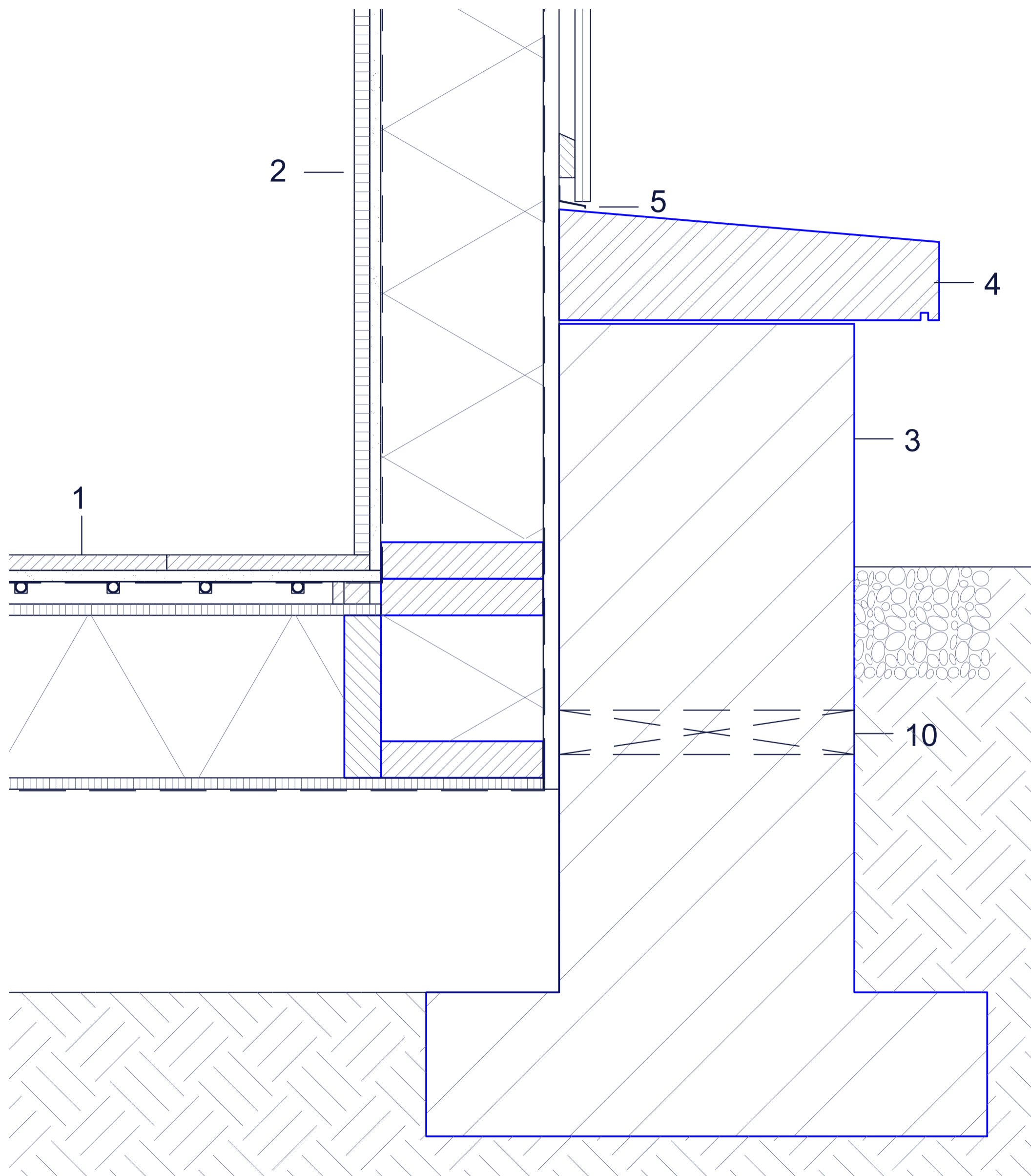

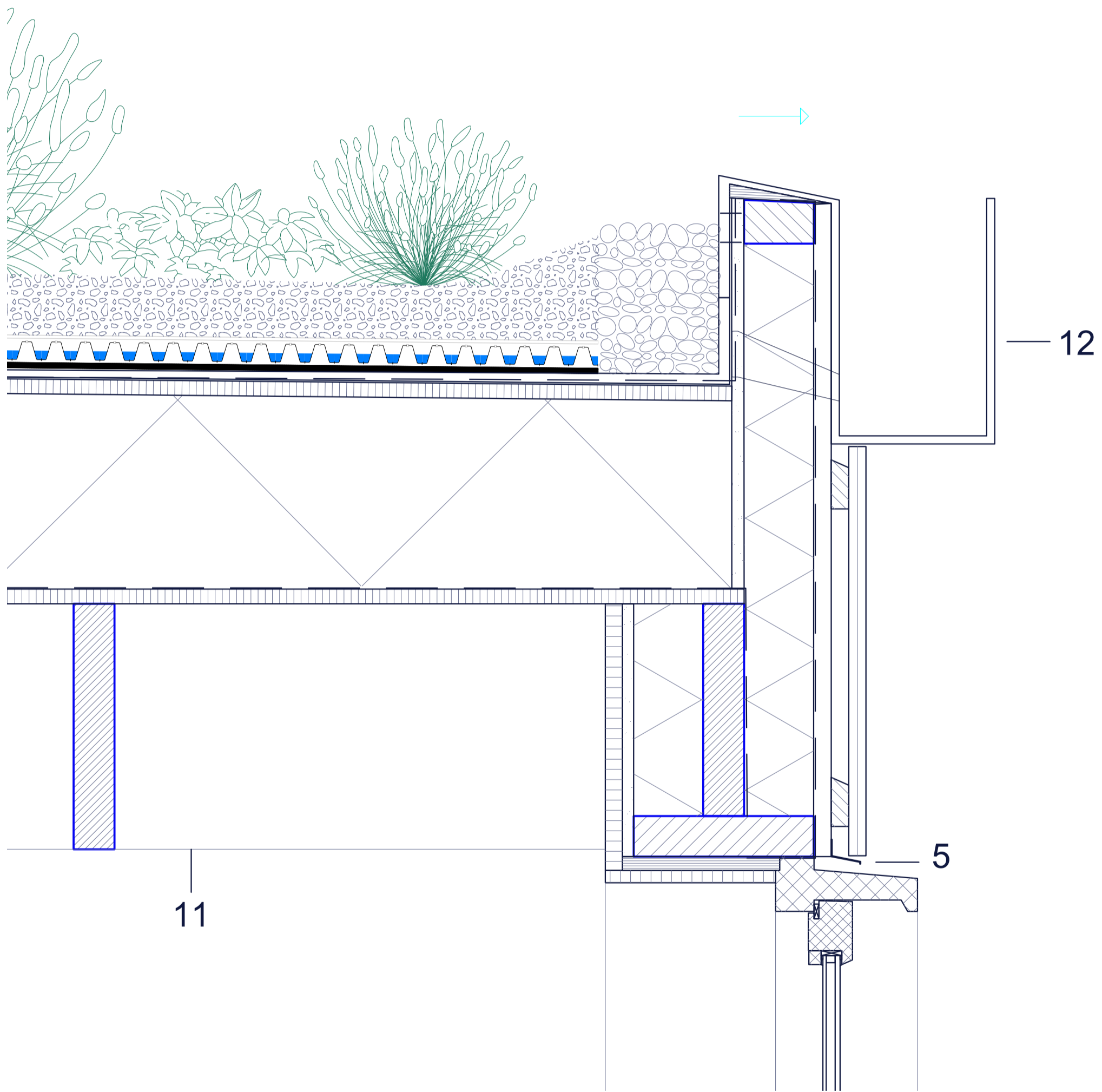

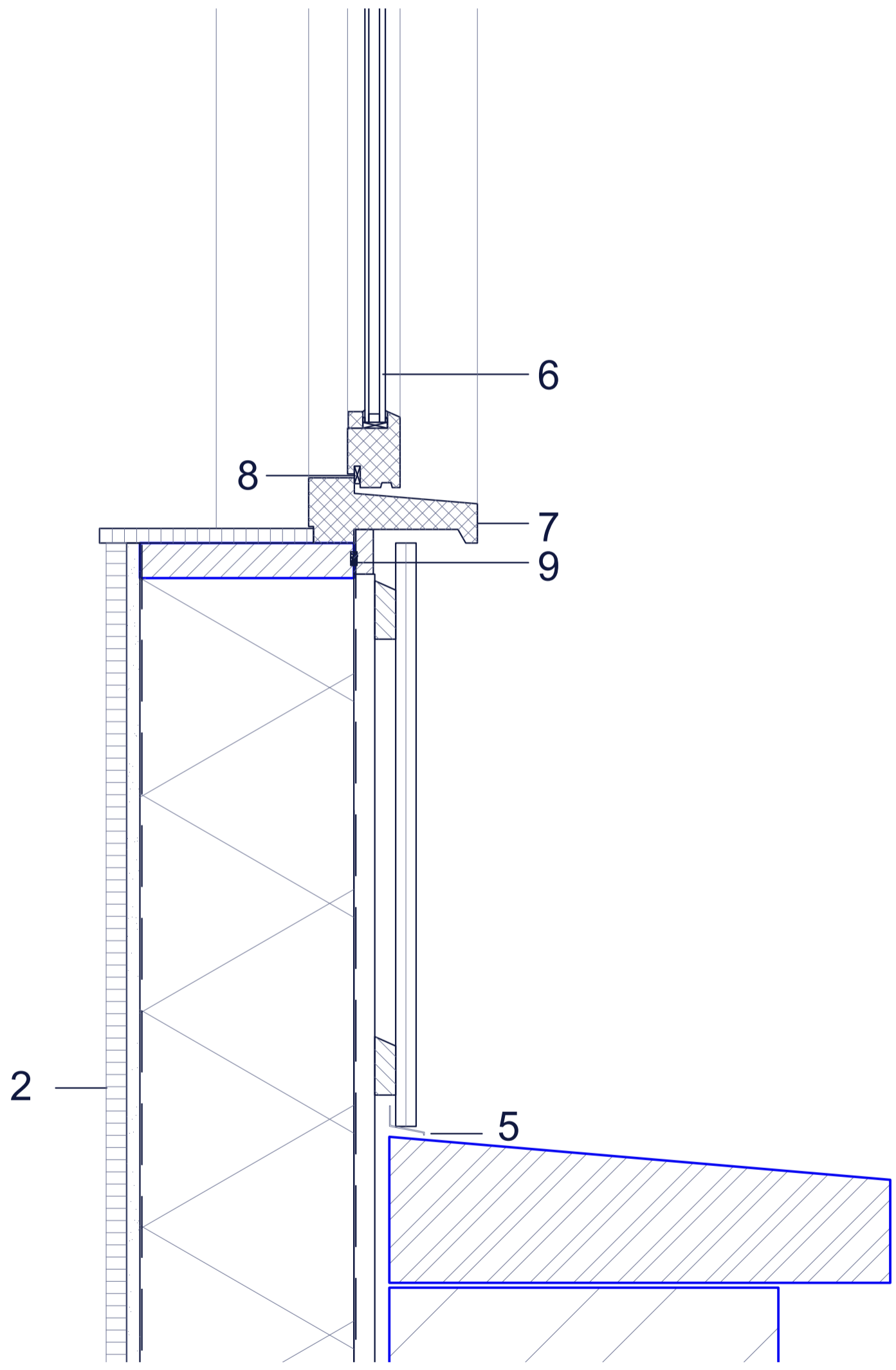

Materials Description

1 Rc: 5.3

Douglas Pine finishing	21x275mm
Okö Surface Heating	30 mm
Vapour Barrier	0,5 mm
Greenful Sheathing Board	15. mm
Hemp Insulation with	230 mm
Douglas beam	230x50mm
Greenful Sheathing Board	15 mm
Breather Membrane	0,5 mm
Douglas Beam	250x50mm

2 Rc: 5.2

Douglas Pine finishing	21x275mm
Greenful Sheathing Board	15 mm
Vapour Barrier	0,5 mm
Hemp Insulation	220 mm
Douglas Columns	220x50mm
Breather Membrane	0,5 mm
Greenful Sheathing Board	15 mm
Ventilated Cavity with	21.5. mm
Timber Batten 2X	60x21,5mm
Douglas Façade Finishing	21x125 mm

3

Recycled Concrete	900x400 mm
Pavement Tiles	195x760 mm
with mortar as foundation	
with 300mm above ground	

4

Limestone brick	600x400x 300mm
-----------------	-------------------

5

Aluminium Drip Sill	20x35 mm
---------------------	----------

6

Double Glazing in an oak frame	4-13-4 mm
-----------------------------------	-----------

7

Oak Window Sill

8

Gap Sealing

9

Seam Sealing

10

Weep hole

11 Rc: 5.3

Douglas beams, in cassette	
Douglas fir plywood	300x50mm hoh 600mm
Vapour barrier	15 mm
Hemp insulation	0,5 mm
Douglas fir plywood	230 mm
Breather membrane	15 mm
Water retaining protection layer	0,5 mm
Floradrain FD 25-E	0,5 mm
System filter SF	30 mm
Substrate layer	0,5 mm
Vegetation	80 mm
	-

12

Aluminium plated gutter 200x300mm - 10mm

13

Pivoting Door:
Double glazing in oak frame 4- 16 - 4mm