

*Experimental research on the effects  
of surface screens on a mobile bed*

## MAIN TEXT

Experimental research on the effects of surface screens on a mobile bed



MSc. Thesis

Supervising committee:

Prof.dr.ir. H.J. de Vriend  
Prof.dr.ir. W.S.J. Uijttewaal  
Dr.Ir. E. Mosselman  
Dr.Ir. C.J. Sloff  
Ir. H. Havinga

Delft University of Technology, Deltares  
Delft University of Technology  
Delft University of Technology, Deltares  
Delft University of Technology, Deltares  
Delft University of Technology, Rijkswaterstaat

## **PREFACE**

This graduation thesis is the final examination of my study Civil Engineering, specialisation River Engineering, at Delft University of Technology. The report consists of two parts: The main study and the Appendices, which together contain the results of my thesis.

In this study physical experiments have been executed in order to find a solution to sediment problems in secondary channels, using the natural energy of the river. The solution tested is the use of surface screens, which do not interfere with the bottom directly underneath the structure.

During execution of this thesis, many people were of great assistance, I would like to point out a few of them. A special thanks goes out to Dr.ir. E. Mosselman for his intensive assistance in many challenges.

I thank Prof.dr.ir. H.J. de Vriend for his guidance and comments. My gratitude goes to Dr.ir. C.J. Sloff, Prof.dr.ir. W.S.J. Uijttewaal and Ir. H. Havinga, for taking part in my graduate committee and for the remarks made on the draft version of the report.

I would like to thank Delft University of Technology for the possibility of using the research flume in the Environmental Fluid Mechanics Laboratory. I would like to thank Ing. S. de Vree and Mr. A.M. den Toom for their assistance on practical problems. Finally I would like to thank Deltares for the working place and support during the execution of this thesis.

S.T. Troost  
Delft, June 2010

## SUMMARY

In 2000 the Dutch government chose a new point of view for the Dutch rivers: “Room for the River”. This viewpoint is the basis for a new approach of high water protection in the Netherlands. Instead of strengthening and raising the dikes, solutions must be based on space and spatial quality. One of the suggested measures is the addition of secondary channels. The purpose of these channels is enlarging the conveyance area and the ecological role of the river. Maintaining the profile of these channels involves substantial financial consequences.

Finding a sustainable solution for undesired erosion or sedimentation is the main focus of this study. The research question is stated as follows: “How can the undesired erosion or sedimentation in secondary channels be corrected with a temporary but sustainable solution in the form of surface screens?” Several sub questions have been stated within this study. The ongoing physical processes around the screen, the model set up, the water motion, the morphological development and the practical use of surface screens have been evaluated.

First of all a literature study has been done to explore the state of the art knowledge on this subject. Attention is paid to bottom screens, surface screens, pile rows and vegetation. As most research has been done to bottom screens, the physical processes of these structures have been studied in detail. The angle of attack and the penetration depth proved to be the most important parameters for the effect of the screen. A general description of bifurcation relationships has been added to the literature study, as a dividing wall was added in the second series of the tests.

Part two of this study is an experimental study on the effects of surface screens on a mobile bed. The design of the physical experiments requires choices about the geometry of the flume. Four different variants have been evaluated using a multicriteria analysis. This analysis gives insight in the choices made. The actual experiments were carried out with a straight flume with just one screen applied (A-series) and with a dividing wall (B-series). The B-series also contained one screen, which was located one metre in front of the bifurcation.

The next choice was the use of sediment, which can be applied in several manners. First of all a bed without sediment can be a test set-up, creating a fixed concrete bottom. Sediment can be introduced qualitatively, using sediment particles. Particle tracking gives information about the transport direction, but no information is gathered about the morphological development of the bottom. The third variant for the use of sediment is a fully mobile bed. This variant has been chosen, it provides the most information on the use of surface screens. The flow-bed interaction can be seen in erosion or sedimentation areas.

Preparing the experiments requires information about the flume facility. The experiments have been carried out in the Environmental Fluid Mechanics Laboratory of Delft University of Technology. The flume used had an effective length of 21 metres and a width of 60 cm. The upstream boundary conditions are the discharge and the velocity distribution. With aid of a flow divider and a perforated plate the stream was smoothened. The downstream boundary condition consisted of a fixed water level in the pump compartment. The water level was kept constant along the natural slope of the free surface, using an overflow. Measuring the data comes with the use of different measurement equipment. The equipment has been described generally, the accuracy has been determined and the measurement location is stated. Taking measurements about the sediment concentration was a great challenge. Several measurement techniques have been tried, finally measurements about the sediment concentration were taken in the return pipe.

The experiments consist of taking detailed velocity and bed level measurements on a total of 15 different screen set-ups. The angle of attack and the penetration depth were chosen to be the variables. The angle of attack was varied between 15 and 25 degrees. With these relatively small angles the screen acts as guidance for the flow, instead of an obstruction. The penetration depth was varied between 20% and 60% of the water column. In the A-series all 9 possible set ups have been measured, in the B-series the 20% penetration depth was not measured.

After the execution of the experiments the test results were analyzed, the goal was finding the key parameters which influenced the morphological development most. The initial test run determined the optimal measurement duration, the initial equilibrium and thereby the actual flume parameters. Four representative cases have been described in detail, giving support to the general conclusions. The flow pattern changes under influence of the surface screen. The main flow direction is guided by the screen, introducing a transverse velocity at the surface. As flow continuity in the flume has to be maintained, the water near the bottom is forced to have a transverse velocity in opposite direction. The existence of a spiral motion was clear. These velocities influenced the morphological development, as a redistribution of the suspended transport and the bottom transport was induced. This generated locations where the actual transport did not meet the transport capacity, which gives rise to local morphological changes.

Next to the spiral motion the screen had an effect on the longitudinal flow velocities. The attacked side of the flume experiences a higher velocity, thereby having a higher transport capacity. This higher capacity gives rise to local erosion of the bed. At the unattacked side, sedimentation occurs, thereby rising the bed level.

In the B-series of the experiment a dividing wall was added to the flume. This gave rise to a higher resistance and the discharge had to be lowered in order to stay within the geometrical boundaries of the flume. As the dividing wall extended to the downstream boundary of the flume, two different channels were formed. The screen in front of the bifurcation gave rise to the same processes as described above, but the wall introduced an extra effect. The screen influenced the bifurcation relationship. As the walls of the 60 cm wide flume were fixed, the bed level adapted to the new conditions. This changed the conveyance area. The upstream effect of the bifurcation can be explained by changes in water level topography, thereby influencing the backwater curve. In general the wall amplified the morphological development of the mobile bed.

Finally some suggestions have been made for the practical application of surface screens. In general the screens can be applied in a (secondary) channel or in front of a bifurcation. The use of a screen inside a secondary channel has an advantage not to interfere with the navigation channel. The advantage of a screen in front of a bifurcation is influencing two channels simultaneously. One of the main disadvantages of the latter is the possibility of disturbing the delicate bifurcation relationship, thus introducing undesired morphological development. When carefully implemented this effect can simultaneously be the main advantage of this screen layout, as the morphological response increases. Applying several successive screens in a channel could influence the length in which a single screen is effective to morphological development.

The actual structure can be applied as a floating screen between two barges. These barges can be towed to the right location and fixed with anchors. This way of applying the structure provides flexibility, the screen can be used at several locations. When applying the screens in a small channel, another method of supporting the structure could be used. Slender piles with the screen mounted on top could be an option. The main disadvantages are losing flexibility and the construction of the pile system.

## Table of Contents

<b>1.0</b>	<b>INTRODUCTION</b>	<b>10</b>
1.1	Background	10
1.2	Project description	10
1.3	Approach	11
1.4	Motivation of choice for surface screens	12
1.5	Outline	12
<b>2.0</b>	<b>OVERVIEW LITERATURE STUDY ON SCREENS AND VANES</b>	<b>13</b>
2.1	Introduction	13
2.2	Bottom screens	13
2.3	Surface screens	17
2.4	Pile row	17
2.5	Vegetation	18
2.6	Bifurcation relationship	18
<b>3.0</b>	<b>DESIGN OF PHYSICAL EXPERIMENTS</b>	<b>20</b>
3.1	Introduction	20
3.2	Variants in geometry	20
3.3	Multicriteria analysis geometry	23
3.4	Application of sediment	26
3.5	Description of tests	27
3.6	Restrictions experiment	28
<b>4.0</b>	<b>PREPARATION OF PHYSICAL EXPERIMENTS</b>	<b>30</b>
4.1	Introduction	30
4.2	Description of the flume	30
4.3	Input parameters	33
4.4	Measuring plan	37
4.4.1	Coordinate system	37
4.4.2	Measurement equipment and locations	37
4.4.3	Optimal measuring duration	39
<b>5.0</b>	<b>RESULTS OF FLUME EXPERIMENTS</b>	<b>41</b>
5.1	Introduction	41
5.2	Initial test and equilibrium	41
5.3	Case 1, 15 degrees H=20%	44
5.4	Case 2, 25 degrees, H=60%	46
5.5	Case 3, 25 degrees, H=60%, wall	48
5.6	Case 4, 25 degrees, H=60%, wall, long run	51
5.7	General conclusions	52
<b>6.0</b>	<b>DISCUSSION</b>	<b>59</b>
6.1	Experiments	59
6.2	Practical use of surface screens	59
<b>7.0</b>	<b>CONCLUSION AND RECOMMENDATIONS</b>	<b>62</b>
7.1	Conclusion	62
7.2	Recommendations for application	63
7.3	Recommendations for further research	63
	<b>REFERENCES</b>	<b>65</b>

## LIST OF FIGURES

Figure 1 Schematic flow around a single bottom screen by Odgaard & Wang (1991a).....	14
Figure 2 Changes in bed level after applying bottom screens at Porabari (BUET-DUT linkage project) .....	17
Figure 3 Spiral water motion in offtaking channel, including sand arrow (Mosselman, 2001) .....	18
Figure 4 Variant 1, one channel, single screen.....	20
Figure 5 Variant 2, one channel, two depths and a semi-mobile bed.....	21
Figure 6 Variant 3, two channels, division wall .....	22
Figure 7 Variant 4, two channels, bifurcation .....	23
Figure 8 Sideview flume (top), positive coordinate system (middle, right), and topview (bottom) of test location .....	31
Figure 9 Perforated plate at upstream boundary, looking from downstream .....	32
Figure 10 Topview of downstream boundary with overflow, sediment weir at bed level and natural slope water surface .....	33
Figure 11 Graph of sediment sieve analysis, $D_{50}=238 \mu\text{m}$ .....	35
Figure 12 Relative error on average velocity as function of measurement duration .....	40
Figure 13 Changes in longitudinal bed slope over time .....	41
Figure 14 Sediment concentration in return pipe over different measurement durations .....	43
Figure 15 General flow pattern behind the screen, 0 degrees, $H=60\%$ .....	44
Figure 16 Top view velocity vectors behind the screen .....	45
Figure 17 Morphological development under influence of the screen, 15 degrees, $H=20\%$ ..	46
Figure 18 General flow pattern behind the screen, 25 degrees, $H=60\%$ .....	47
Figure 19 Top view velocity vectors behind the screen, case 2.....	47
Figure 20 Morphological development under influence of the screen, 25 degrees, $H=60\%$ ..	48
Figure 21 General flow pattern behind the screen, 25 degrees, $H=60\%$ , division wall .....	49
Figure 22 Top view velocity vectors behind the screen, case 3.....	49
Figure 23 Morphological development under influence of the screen, 25 degrees, $H=60\%$ , wall. Viewpoint 60 cm upstream from the screen (semi-transparent), looking in downstream direction .....	50
Figure 24 Morphological development under influence of the screen, 25 degrees, $H=60\%$ , duration of 72 hours .....	51
Figure 25 Hardly any effect in bed level change 60 cm behind the screen, $H=20\%$ .....	53
Figure 26 Bed level change 60 cm behind the screen, $H=40\%$ , $H=60\%$ , trend for development of transverse slope .....	54
Figure 27 Bed level change 160 behind the screen, $H=40\%$ , $H=60\%$ .....	55
Figure 28 Bed level change 60 cm behind screen, with dividing wall.....	56
Figure 29 Bed level change 160 cm behind screen, with dividing wall.....	57
Figure 30 Example of the use of a floating surface screen (taken from Mosselman) .....	60

## LIST OF TABLES

Table 1 Performance matrix of variants in geometry.....	26
Table 2 Overview of experimental runs executed .....	28
Table 3 Geometrical parameters of the flume, screen and dividing wall .....	30
Table 4 Result of sediment sieve analysis (Crosato, 2009).....	34
Table 5 Summary initial input parameters .....	36
Table 6 Morphological influence of different screen layouts, no division wall .....	52
Table 7 Morphological influence of different screen layouts, with division wall .....	55

## LIST OF SYMBOLS

Symbol	Description	Unit
$A$	Cross-sectional area of the flume	$[m^2]$
$b$	Flume width	$[m]$
$B$	Channel width	$[m]$
$C$	Chézy coefficient	$[m^{0.5}s^{-1}]$
$C_c$	Curvature coefficient of sediment	$[-]$
$C_d$	Drag coefficient	$[-]$
$C_u$	Non-uniformity coefficient of sediment	$[-]$
$D$	Hydraulic diameter	$[m]$
$D_{10}$	Grain size, not exceeded by 10% of sediment mixture	$[\mu m]$
$D_{30}$	Grain size, not exceeded by 30% of sediment mixture	$[\mu m]$
$D_{50}$	Grain size, not exceeded by 50% of sediment mixture	$[\mu m]$
$D_{60}$	Grain size, not exceeded by 60% of sediment mixture	$[\mu m]$
$D_{90}$	Grain size, not exceeded by 90% of sediment mixture	$[\mu m]$
$Fr$	Froude number	$[-]$
$g$	Acceleration due to gravity	$[m\ s^{-2}]$
$h$	Water depth	$[m]$
$h_e$	Normal depth	$[m]$
$h_g$	Critical depth ( $Fr=1$ )	$[m]$
$H_v$	Screen height penetrating the water column	$[m]$
$i_b$	Bottom slope	$[-]$
$i_w$	Slope of water surface	$[-]$
$L_f$	Flume length	$[m]$
$L_{s,w}$	Distance between surface screen and front of dividing wall	$[m]$
$L_v$	Screen length	$[m]$
$p$	Exponent in bifurcation relationship with variable width	$[-]$
$P$	Wetted perimeter	$[m]$
$q$	Specific discharge	$[m^2\ s^{-1}]$
$q_b$	Exponent in bifurcation relationship with variable width	$[-]$
$Q$	Discharge	$[m^3\ s^{-1}]$
$Q_{s,asymm}$	Total sediment transport, asymmetrical discharge distribution	$[m^3\ s^{-1}]$
$Q_{s,symm}$	Total sediment transport, symmetrical discharge distribution	$[m^3\ s^{-1}]$
$R$	Hydraulic radius	$[m]$
$Re$	Reynolds number	$[-]$
$S$	Volumetric rate of sediment transport	$[m^3\ s^{-1}]$
$s$	Volumetric rate of sediment transport per unit of width	$[m^2\ s^{-1}]$
$T$	Water temperature	$[\text{degrees C}]$
$u$	Flow velocity in x-direction	$[m\ s^{-1}]$
$\bar{u}$	Average flow velocity in x-direction	$[m\ s^{-1}]$
$u_*$	Shear velocity	$[m\ s^{-1}]$
$v$	Flow velocity in y-direction	$[m\ s^{-1}]$
$w$	Flow velocity in z-direction	$[m\ s^{-1}]$
$w_s$	Fall velocity of sediment particles	$[m\ s^{-1}]$
$\alpha$	Angle of attack of screen	$[-]$
$\alpha_b$	Factor in bifurcation relationship	$[-]$
$\beta$	Offset factor in bifurcation relationship	$[-]$
$\Delta z_{b,40cm}$	Bed level change at $x = 40$ cm behind the screen	$[cm]$
$\Delta z_{b,60cm}$	Bed level change at $x = 60$ cm behind the screen	$[cm]$
$\Delta z_{b,80cm}$	Bed level change at $x = 80$ cm behind the screen	$[cm]$



$\theta$	Shields parameter	[-]
$\mu$	Dynamic viscosity	[N m <sup>-2</sup> s]
$\rho$	Mass density	[kg m <sup>-3</sup> ]
$\rho_s$	Mass density of sediment	[kg m <sup>-3</sup> ]
$\rho_w$	Mass density of water	[kg m <sup>-3</sup> ]
$\nu$	Kinematic viscosity	[m <sup>2</sup> s <sup>-1</sup> ]

## 1.0 INTRODUCTION

### 1.1 Background

In recent years Dutch rivers had to deal with high discharges. The critical situations in 1993 and 1995 are good examples of the vulnerability of the Rhine and Meuse. In 1995 the government had doubts about the stability of dikes for which the reinforcement works had not been completed yet and about 250,000 people had to be evacuated. The flood problems have their origin in high discharges as well as in regulation of the river. Urbanization is one of the causes of the river having less room to follow its natural path.

In 2000 the former parliament chose a new point of view: "Room for the River". This viewpoint is the basis for a new approach of flood protection in the Netherlands. Instead of strengthening and raising the dikes, solutions must be based on space. Dealing with peak discharges should cause fewer problems.

Several measures are planned for Dutch rivers within the "Room for the River" project. Examples are removing obstacles, lowering of flood plains, replacing dikes and digging secondary channels. A second objective of secondary channels, in addition to increasing the rivers flood conveyance capacity, is to increase spatial quality and to restore ecological conditions.

Modern rivers have several other functions, e.g. navigation. In order to maintain sufficient navigation depth, secondary channels should not convey water in times of normal discharge. Thus the main channel can be kept at the necessary depth.

In times of high discharges, and thus high flow velocities, a large amount of sediment is mobilized and deposited elsewhere. In case of excessive sedimentation inside a channel, dredging works are executed in order to keep navigation channels at the desired profile. This maintenance has substantial financial consequences. An example is a sub project in the "Room for the River" project in the Netherlands. The proposed measures around the city of Deventer require active sediment management with an estimated annual budget of about € 500,000. This is just one example within the "Room for the River" project, many more locations require an active sediment management.

The costs of the maintenance are the reason for Deltares and Rijkswaterstaat to think about alternatives for sediment problems. Possible measures are preferably based on using the available energy of the river itself. A possible solution is the use of screens, vanes, piles or vegetation in or around secondary channels. All these measures influence the flow pattern, causing the flow to have other properties. To prevent extra hydraulic resistance in times of high discharges, solutions must be based on flexible, low-cost measures.

Several experiments on (bottom)screens have been executed in the past, but other measures could also result in desirable solutions. One of these is the use of surface screens. This thesis describes the experimental research on the use of such screens.

### 1.2 Project description

#### Objective of study

The objective of this thesis is to explore the possibility of using temporary, flexible and low-cost measures to correct the morphological development of (secondary) channels. The solution must be based on the use of the natural energy of the river in times of moderately high discharges. The increasing role of the river system in ecology requires these flexible

measures, as dredging works have large financial consequences and interfere with the ecological development.

Examples of these measures could be: screens, pile-rows, added vegetation or something similar. In this study the focus is on surface screens, flexible structures which only partly penetrate the water column from the surface. The current knowledge on such screens is relatively low, however some research has been done in the past, these experiments are poorly documented. The fundamental physical processes are hardly known. The research within this thesis is based on exploring these processes and a qualitative description of the practical use of the screens. The following research questions form the basis for the execution of this thesis.

### **Research question**

How can undesired erosion or sedimentation in secondary channels be corrected with a temporary but sustainable solution in the form of surface screens?

### **Sub-questions**

- Which physical processes are involved when applying surface screens in, or in the vicinity of, secondary channels?
- How should an experiment be set up and which main parameters can be changed in order to get reliable test data?
- Which general conclusions can be drawn on the water motion?
- Which conclusions can be drawn on the morphological development?
- What is the influence of a surface screen applied in front of a bifurcation?
- Which strategies can be applied to correct the morphological development in, or around, a secondary channel?

## **1.3 Approach**

### **Literature study**

First of all a literature study has been carried out to get insight in the current state of the art knowledge on applying screens in river practice. For which purposes screens have been used in the past? Where have the structures been applied? Backgrounds and existing theories have been explored, as well as the physical processes involved. One of the possible set-ups regards influencing sediment transport at bifurcations, therefore some attention is paid to bifurcation relationships in general. As a final part of the literature study research has been done on the best set-up of physical experiments, measurement equipment and the current knowledge on execution of experiments.

### **Experimental study and past experiments**

The experimental part of the study generated the actual data set on the effects of surface screens on morphological development. This part was executed in the Environment Fluid Mechanics Laboratory of Delft University of Technology. The design and preparation phase pays attention to the input parameters and their relevance. Different possible model set-ups have been evaluated using a multi criteria analysis. The weighted outcome was used to explain the choices made when setting up the model in the flume.

Information about the different measuring methods and instruments was collected and analyzed in order to use the best suitable equipment.

The actual execution of the experiments consisted of collecting a lot of data. The initial run determined the equilibrium stage and the timescales of several processes. A total of 15

different screen set ups were intensively measured. The execution phase consisted of processing all data, for example the spikes from the measurement signals have been removed. Other data have been coupled and edited to be able to give a clear presentation. These operations have mainly been done by using Matlab, a numerical computation and visualization software package.

### **Interpretation of experimental data**

The interpretation phase started after collecting all data. This phase mainly consisted of finding the key parameters that influence the morphological development most. In order to fully understand the results, the dominating processes were analyzed. With interpretation of the data a numerical model could, if necessary, be constructed, adapted or improved. The next part of the interpretation phase was finding a way to present the results in order to give a clear view on the outcome of the results. Special Matlab scripts were developed for the presentation. Appendix J shows all information about the used, adapted and developed scripts.

Finally the results have been analyzed in a practical manner, as several secondary channels are planned along the Dutch rivers in the coming years. This study highly focuses on the actual application of the surface screens in reality. With the test results of this study, a translation is made to real river practice. Suggestions have been made for the right application of the screens.

## **1.4 Motivation of choice for surface screens**

After the literature study the choice has been made to investigate the processes when applying surface screens. This highly contributes to the state of the art knowledge, as very little publications are available on the use of such screens. Surface screens have been applied in the past, as can be seen in section 2.3, but never a reliable theory has been developed. The use of surface screens is a great advantage compared to the use of bottom screens, as no local erosion is expected directly underneath the structure. The screens can be used as floating structures, thereby not penetrating the bottom. The flexibility of a floating structure is the main advantage in an always dynamic river system, as the location of the screen can be adapted without too much effort.

Using scale experiments, the basic physical processes around surface screens have been explored. The results found should be useful for input in a numerical model, but developing such a model is beyond the scope of this study.

## **1.5 Outline**

The report can be read as follows: Readers with interest in some literature about the subject are advised to read Chapter 2. Chapters 3 and 4 give an overview of the preparation and execution phase of the experiments. Chapter 5 describes the results of the physical experiments. Suggestions for the practical use of surface screen in river engineering are made in Chapter 6.

## 2.0 OVERVIEW LITERATURE STUDY ON SCREENS AND VANES

### 2.1 Introduction

This chapter describes a brief overview of some of the available literature on screens and vanes. Attention is paid to the background, experiments and researches from the past, working up to the state of the art knowledge. Only some basic knowledge will be presented here. For more insight in the studies and theories, the reader is advised to selectively read articles and publications from the reference list.

Most work done by other investigators was on bottom screens. In order to contribute to the state of the art knowledge, other structures have been evaluated as well. All considered structures are based on using the natural energy of the river to influence morphological development. For example surface screens, pile rows and added vegetation. As far as the knowledge on publications extends, no intensive research has been done on these measures.

### 2.2 Bottom screens

Bottom screens have already been studied in the past (King, 1918). Bottom screens are applied in the bed, partly extending through the water column. The screens can be used under different angles of attack. When using a small angle of attack, the processes around and behind the screen are based on spiral motion (Odgaard and Wang, 1991). The growing vortex produces transverse velocities. The effect of a bottom screen applied under a large angle of attack, >40 degrees (Marelius and Sinha, 1998), becomes more and more based on blockage and turbulence principles.

#### Background of bottom screens

Redistribution of sediment in an alluvial river is one of the most studied aspects in river engineering. Adapting flow patterns, flow velocities and water levels have been investigated for centuries. Protection against floods was mainly focused on raising dikes and keeping water bounded in a restricted area. Recently more attention is paid to natural development of rivers, giving rivers a possibility to play a greater role in the ecological system.

Adapting flow patterns with aid of bottom vanes or screens is based on influencing the direction of sediment transport. This direction depends first of all on the primary flow direction, defined as the direction that emerges when the flow is averaged over depth. By influencing the primary water motion, the transported material is redirected. Next to a change in primary transport direction, the screen gives rise to a spiral motion. These secondary velocities give a redistribution of the transport in transverse direction. The water at the bottom, which contains a relatively large amount of sediment, is guided along the screen. The water at the surface is forced in opposite transverse direction in order to guarantee flow continuity. Natural river bends give rise to a secondary flow, by applying screens, this flow can be counteracted. The third influence of the screen on sediment transport is turbulence. The screen introduces differences in velocity, thereby giving rise to extra turbulence. When reaching the mobile bed, these turbulent fluctuations generate a locally higher sediment transport capacity.

Bottom vanes are structures which are mounted vertical to the river bed. The studied literature shows that the aspect ratio,  $H_v/L_v$ , and the vertical blockage ratio,  $H_v/h$ , are found to be important parameters. Here  $H_v$  is the screen height above the bottom,  $L_v$  the screen length and  $h$  is the water depth. These parameters influence the vane induced effects like extension of the generated vortex, flow resistance and turbulence.

The aspect ratio usually is a small number in order to smoothly guide the flow along and around the solid plate. The vertical blockage ratio is the extent of the main flow blocked by the solid screen. This parameter is mostly varied between 0.2 and 0.6. The angle the screen makes to the attacking flow mainly determines the processes behind the screen. At higher angles of attack, the screen more and more contributes to the blockage of the main stream. Analyzing the flow behind the screen, separation of flow can be seen. As a result, the turbulence increases and larger scour holes develop around the screen system. The local scour hole proved to be one of the main structural disadvantages of the bottom screen. Another disadvantage is that higher angles create significantly more hydraulic resistance in the river.

### Studies

The idea of applying bottom vanes arose in the beginning of the 20<sup>th</sup> century by King (1918). More detailed investigation was done in the 50s of the same century. Influencing stream with aid of bottom vanes or screens was studied by Potapov (1950). The main focus of this study was preventing erosion from banks and local shoals. Still these research projects were very much based on practical application.

### Small angles of attack

Small angles of attack have been studied in several investigations, but theoretical basis was formed by Odgaard and Spoljaric (1986), Odgaard and Mosconi (1987) and Odgaard and Wang (1991). The latter publication includes an extensive theoretical analysis.

In these studies the focus was on small angles of attack, about 5 – 20 degrees. The physical basis of these studies was derived from aerodynamics by considering the screens as a wingtip of an airplane. On the leading edge of the vane (pressure side) the stream is upwards and on the trailing edge (suction side) the water moves downwards, see Figure 1. The induced pressure difference can only exist as long as the stream is along the vane. At the end of the vane, both streams meet, thereby creating a spiral motion. The downstream flowing spiral motion, called a vortex, grows in transverse width. The growth is bounded by both the bottom and the free surface. In this vortex the transverse flow causes a change in shear stress and therewith a change in sediment transport capacity.

Applying the screen with a small angle of attack only gives rises to a small increase in upstream water level, which is considered the main advantage of this set-up. The screen guides the water motion, instead of blocking it.

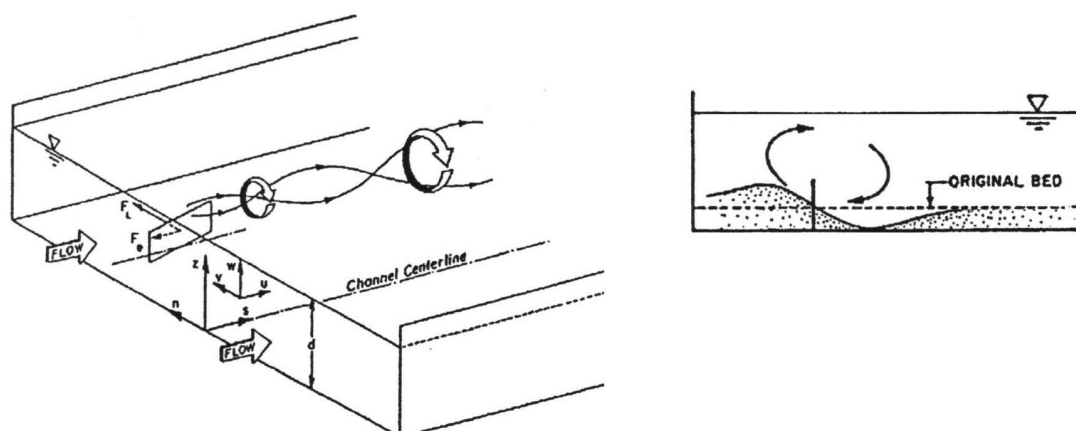

Figure 1 Schematic flow around a single bottom screen by Odgaard & Wang (1991a)

The theory developed by Odgaard suggests that the efficiency of a screen is weakly dependent on the vane length. Jongeling and Flokstra (2001) decided to investigate this, because construction costs highly depend on the screen length. The measurements were done with an angle of attack of 17.5 degrees. Different screen heights were investigated, 0.03, 0.06 0.09 and 0.12 m. The vane length was chosen to be 0.40 m in all cases. Analyses of the test results demonstrated that the theoretical relations developed by Odgaard are unable to predict the lift and drag forces on the screen. This means that ongoing physical processes are still poorly understood.

Flokstra et al (2003) implemented two ways of modelling vanes in the Delft3D-MOR environment. The described type 1 vanes are based on the theory of Odgaard. Low angles of attack were calculated to be most effective, 13 degrees was found an optimal angle. Assuming the vane being less effective when the surrounding flow separates, the effect of the vane is lost when the angle of attack exceeds 22 degrees. Larger angles of attack have another effect by raising the flow resistance significantly. In the same study screens of type 2 are described as long, submerged or surface screens, with a large length. In this set-up only one or a few screens have to be used to achieve the desired effect. The simulation of the type 2 screens showed the expected effects on flow, sediment transport and bed level, but these results could not be checked by experimental data.

Islam (2005) compared the experimental results from the BUET-DUT project (Hossain and Mosselman, 2006), with the results from a Delft3D model. The numerical model solves the fully three-dimensional Reynolds-averaged Navier-Stokes (RANS) equations by using the standard k- $\epsilon$  turbulence closure. The results from the simulation show that the model does not reproduce the direction, the shifting and the damping of the vortex line. The model was only able to reproduce the damping of vortex strength and the sediment transport direction for a flat bed condition. The scoured bed situation was not reproduced with sufficient accuracy. The model of the type 2 screens was unable to predict the morphological effects. The model did not reproduce any significant effect of the vane on the sediment transport direction. The physical processes as the spiral flow, vortex growth, deformation of the vortex and induced sediment transport in longitudinal direction were not properly predicted by the model.

### **High angles of attack**

Marelius and Sinha (1998) investigated larger angles of attack, the focus was on 25 – 50 degrees. Special attention was given to extra resistance and to the development of scour holes. The investigators concluded that the vortex, and thus the transverse flow velocities, reaches its maximum strength for an angle of 40 degrees. The dominant flow structures were two suction side vortices and two horseshoe vortices. According to the conclusions of Marelius and Sinha, the scour hole contributed to a larger effective width of the vortex. Although this study showed more about high angles of attack, the study did not broaden or improve the theory developed by Odgaard.

In 2000 the same investigators performed a numerical study to get more insight in the precise flow pattern around the vane. The numerical model solves the fully three-dimensional Reynolds-averaged Navier-Stokes (RANS) equations by means of the standard k- $\epsilon$  turbulence closure. In general the model could reproduce the physical experiments with quite good accuracy.

In the above mentioned study of Flokstra et al. (2003) a numerical model was set up for higher angles of attack. The conclusion drawn from the simulations was that physical model tests are necessary to judge the reliability of the numerical modelling.

## Applications

Bottom vanes and screens have been applied in the Netherlands and Bangladesh. The projects in the Netherlands and Bangladesh are documented in pretty detailed way, thereby giving good background information for this new study on surface screens.

### *The Netherlands, River IJssel* J.J.P. Lambeek (1994)

In 1992 Rijkswaterstaat completed the construction of bottom screens in the IJssel River near Fortmond, the project was set up as a pilot. The field consisted of 11 times 3 screens in the outer bend of the river. The angle of attack was calculated to be 17.5 degrees. The distance in between three screens in one row was 10 m and the length between the rows was 50 m. This design was based on the equations presented by Odgaard and Wang (1991).

After an intensive review of the project the screens seemed to have failed their purpose. The cause of this failure according to Lambeek is the angle of attack of some screens. Deviations from the calculated angle of attack of 17.5 degrees were found. Several screens were even installed in the wrong direction, significantly reducing the effectiveness of the screen system. The second reason for failure was the influence of groynes. Groynes caused the main flow to have another direction than predicted, thereby influencing the processes around the screen system.

Finally the discharge in this system played a dominant role. When the river exceeds the bankfull discharge the flood plains causes the main flow direction to change. With the change in angle of attack, the effectiveness of the screens falls dramatically.

### *Bangladesh, Elanjani River* BUET-DUT Linkage Project, final technical report, Hossain & Mosselman (2006)

After a period of intensive testing in the model facility of Bangladesh University of Engineering and Technology, in 2005 bottom vanes were installed in the Elanjani River. The Elanjani River is a tributary of the Dhalaswari River in the Jamuna basin. The design was based on counteracting the natural spiral motion by a motion induced by the screens. The selected bend (near village Porabari) had an erosion rate of approximately 6 m/year. In total 9 bottom vanes with an angle of attack of 20 degrees were installed with locally available material at low cost. The objective of the project was to protect the outer bend from eroding. The most favourable situation was sedimentation of the outer bend.

Measurements were taken before constructing the screens and after the yearly flood. It was clearly indicated that sediment from the inner bank was eroded. Figure 2 shows the outer bank, where enormous sedimentation occurred. On average about 2-3 m was added to the bank, instead of the mentioned bank erosion of 6 m/year. In the conclusion of the report it was stated that more research is necessary on larger river systems, but the screens worked for this relatively small project.



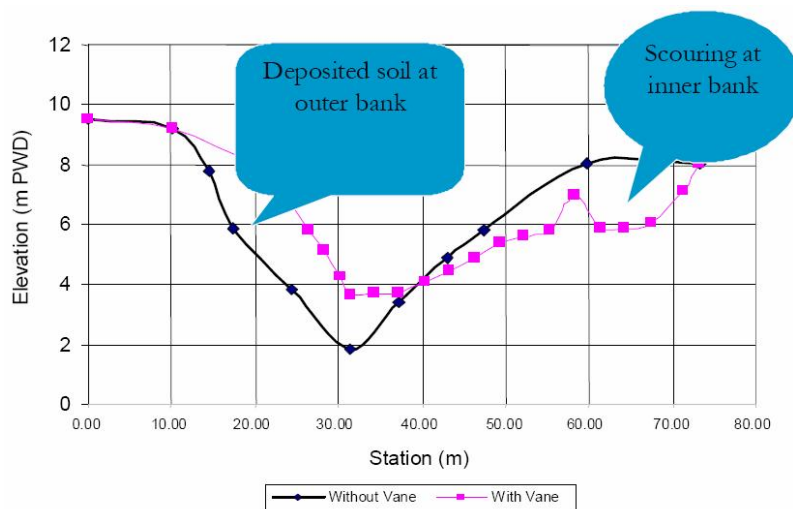

Figure 2 Changes in bed level after applying bottom screens at Porabari (BUET-DUT linkage project)

### 2.3 Surface screens

Surface screens are screens applied from the free surface of a water body, partly extending through the water column. In practice, these screens can be floating objects, fixed with anchors.

These screens have not been studied in great detail, as far as the publications describe. WL/Delft hydraulics did some investigations on floating surface screens (Filarski,1966), but the level of documentation of these investigations is relatively low. A lot of fundamental processes are still to be explored, so an experiment with surface screens adds to the state of art knowledge.

Surface screen have been applied in practice in the former Soviet Union. The documentation in English of the projects in the former Soviet Union is limited, but some general information can be filtered from the publications.

#### Applications

*Soviet-Union, River Volga*  
Potapov (1951)

Based on the work of Potapov, deflector screens have been applied in the river Volga in the former Soviet-Union. The first part of the project consisted of creating a trench to improve navigation in the main channel. Floating deflector (surface)screens were installed and changed in position every single day. The system of screens was able to influence an area of 24-30 m wide. In a working day 20 m could be ‘dredged’ at very low cost.

After creating a deeper main channel, the system had to be maintained. A field of deflector screens was installed in order to keep the main flow in the deepened channel.

The results of this project were registered in a rough way, a good conclusion on basis of the available literature was not possible.

### 2.4 Pile row

A construction with a row of piles is an open structure penetrating the river bed. The piles, with separation space in between, extends over the full water column. The main process around the piles seems to be based on small local vortices and turbulence.

Investigations on this application of pile rows have not been reviewed in this study.

## 2.5 Vegetation

Besides using solid and non-natural materials, use could be made of vegetation. Selectively added vegetation could contribute to morphological behaviour by locally raising the roughness and turbulence. No research was done to this subject in the past, experiments could therefore add to the state of art knowledge. Questions to be stated are the realization of the vegetation areas and whether the vegetation will be stable under all river discharges.

## 2.6 Bifurcation relationship

As screens could be applied in front of a bifurcation, the processes around a bifurcation are briefly explained, based on Mosselman (2001). Modelling a bifurcation can be done in several ways, a 2D/3D morphological model, or a 1D model.

Bifurcation relationships are a set of equations for predicting the development of a bifurcation system. The set of equations, called nodal point relationships, are mainly empirical relations, depending on the ratio of the sediment transports into the main channel and the side channel. This ratio is a function of other parameters, but usually the details are poorly known. The flow which enters the channel transports sediment. Inside the channel the transport capacity changes under influence of the changed flow conditions. The transport capacity will be fulfilled if sediment is available, thereby changing the morphological development.

In practice the morphological development of bifurcations seems to depend on many more parameters, e.g. the bifurcation angle, the ratio between the lengths of the channels, difference in roughness and differences in bottom slope. The simple nodal point relation proves not to be sufficient to predict all the ongoing processes.

The influence of the bifurcation angle is explained from flow inertia and results from experiments done by Bulle (1926). Bulle found the deflection of water near the surface to be to the outer bend and water near the bed to be directed to the inner bank, proving a spiral motion. As most sediment is transported near the bed, a large part of the available sediment is transported to the branch with the largest bifurcation angle. The sedimentation which results from this process forms a sand arrow, increasing the bifurcation angle, see Figure 3. This process enhances the flow curvature and the Bulle effect, with the risk of erosion of the nose of the floodplain wedge between the branches.

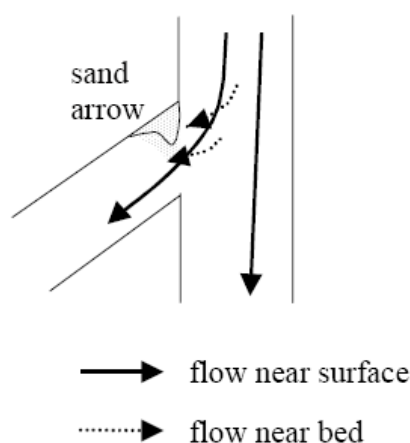

Figure 3 Spiral water motion in off-taking channel, including sand arrow (Mosselman, 2001)

The effect of differences in length of the branches can be explained from the differences in water level slope and thus flow velocity. In steeper and shorter branches, flow velocities are higher, in longer and flatter branches flow velocities are lower. Shorter branches tend to erode and longer branches tend to experience sedimentation.

The roughness highly determines the slopes and flow conditions in a channel. Differences in roughness between channels have upstream effects and thereby the upstream boundary condition of the bifurcation.

### Models

Distribution of water in a 1D model is calculated straightforwardly, for example using SOBEK. Sediment diversion in a 1D variant requires a nodal point relation. The ratio of sediment transport into the two branches is calculated as a function of other parameters, including the discharge ratio. The morphological development can be calculated if the details of the nodal point relation are known.

$$\frac{S_{1,in}}{S_{2,in}} = \alpha_b \left( \frac{Q_1}{Q_2} \right) + \beta \quad (1)$$

$$\frac{S_{1,in}}{S_{2,in}} = \left( \frac{Q_1}{Q_2} \right)^p \left( \frac{B_1}{B_2} \right)^{q_b} \quad (2)$$

where B is the width of the channel. S denotes the sediment transport, Q the discharge and subscripts 1 and 2 refer to a main channel and offtaking channel. The subscript “in” expresses that S is an actual sediment supply into the channel, instead of the transport capacity. Smaller as well as larger offtake angles lead to lower values of  $\alpha_b$  and p. Similarly,  $\beta$  and  $q_b$  are found to reach minimum values when the offtake angle equals 90 degrees. In this experimental set-up, the width of the channel is constant. Therefore the changes are in bottom level and thus in the conveyance area of each of the branches.

However, the nodal point relation is usually poorly known, leading to the conclusion that a 2D or 3D model is more appropriate. Using a 2D/3D model, the nodal point relation is no input for the calculation, it is an implicit calculation output, still depending on the sub-model used. The sediment transport is calculated from the same morphological equations as the development of the bed. Modelling with 2D/3D models also comes with problems. Relative contributions of the bed load and suspended load require different modelling approaches. To have a reliable calculation, the sediment transport over (upward) slopes must be modelled, an accurate model is not yet available.

In this study the bifurcation relationship is of importance when trying to understand the results from the test series with a diversion wall applied. Although the analysis is descriptive instead of mathematical, the basic bifurcation relationships have been used to create insight in the morphological development of the bed.

### 3.0 DESIGN OF PHYSICAL EXPERIMENTS

#### 3.1 Introduction

Designing an experiment comes with a lot of choices. In this chapter the most important ones are discussed and an assessment has been made. The most important factors for this project are: the choice in geometry and how sediment is introduced into the investigation.

#### 3.2 Variants in geometry

Making the right choice for the experiments requires evaluation of several variants in geometry. Advantages and disadvantages have been investigated. Each variant brings challenges and the question is which geometry simplifies reality as far as possible, without losing relevant information about the main physical processes. The main reason for this simplification is finding data for the development of generic knowledge. The second reason is the flume facility, which has geometrical restrictions.

##### **Variant 1 One channel, single screen**

The most basic variant is the variant of one channel with only one screen placed in the flume, see Figure 4. The attacking water is relatively undisturbed and the flow behind the screen is only influenced by the walls, bottom and free surface. Intensive flow measurements can be done in order to investigate the dominating physical processes around the screen. The variant simulates a surface screen which is applied inside a (secondary) channel.

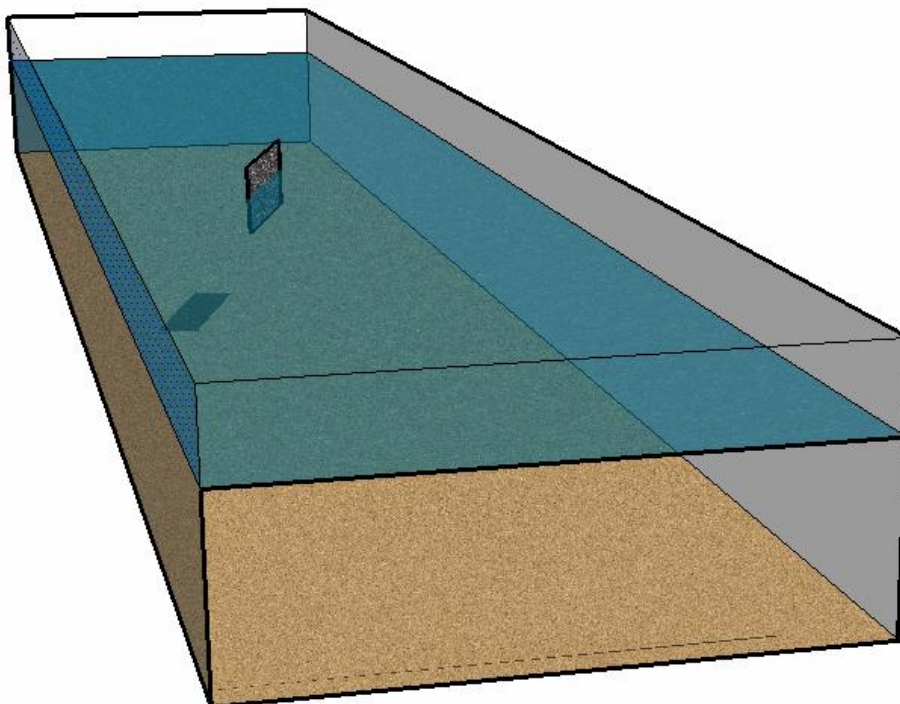

*Figure 4 Variant 1, one channel, single screen*

### **Variant 2 One channel, two depths**

The variant with one channel with two different depths simulates the situation of different depths over the river profile, see Figure 5. The depth difference can, in most cases, be found between the main channel and the floodplain during moderate flood. The ability to control the transport of sediment over a non-flat bottom profile can be simulated with this variant. The attacking flow is more disturbed compared to the first variant, since processes around the discontinuity in bottom profile play a role. The model is suitable for describing the sediment transport in a qualitative manner. No equilibrium is possible when applying a full mobile bed over both halves of the flume. Only the lower half of the flume can be applied with sediment, the other half is fixed. In real river practice, both the main channel and the flood planes have a mobile bed, therefore this variant is highly schematized.

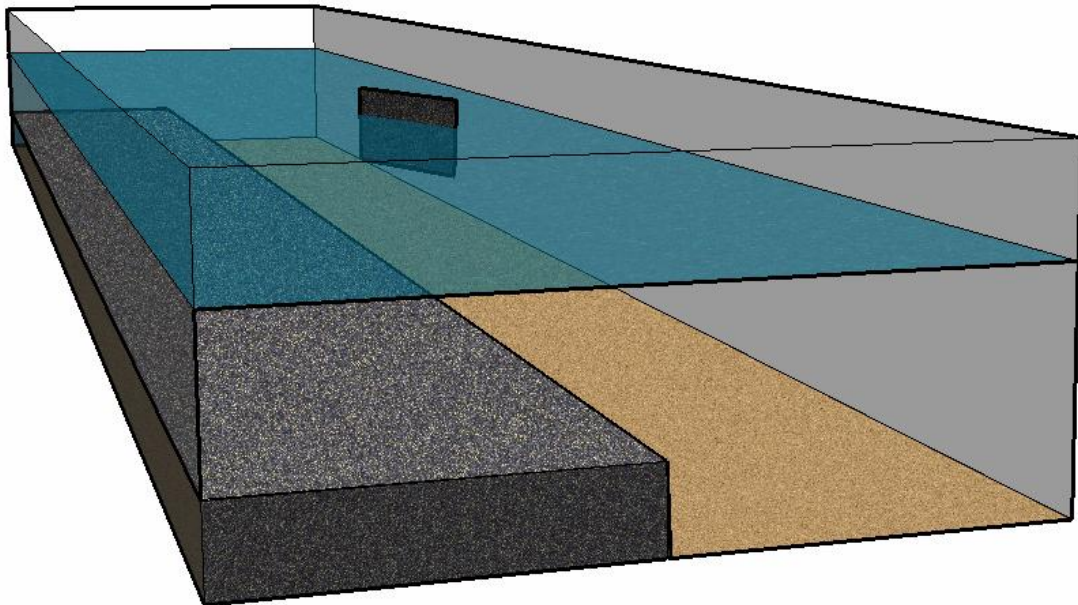

*Figure 5 Variant 2, one channel, two depths and a semi-mobile bed*

### **Variant 3 Two channels, division wall**

Variant 3, with two channels and a division wall, simulates a basic form of a bifurcation, see Figure 6. This experiment has already been executed with bottom screens in the BUET-DUT linkage project, performed by several investigators from 2003-2006, final report by Hossain and Mosselman (2006). Water movement is well documented, a clear conclusion could be made. Behind the screen the spiral motion dominates the flow pattern in transverse direction. Sediment transport is described in a highly qualitative manner, with more measurements to morphological development, more intensive research to this variant still adds to the state of the art knowledge. When applying surface screens, a completely new research has been tested. No publications about the use in front of a bifurcation have been found in the literature study. In practice this variant simulates the use of a surface screen in front of a bifurcation.

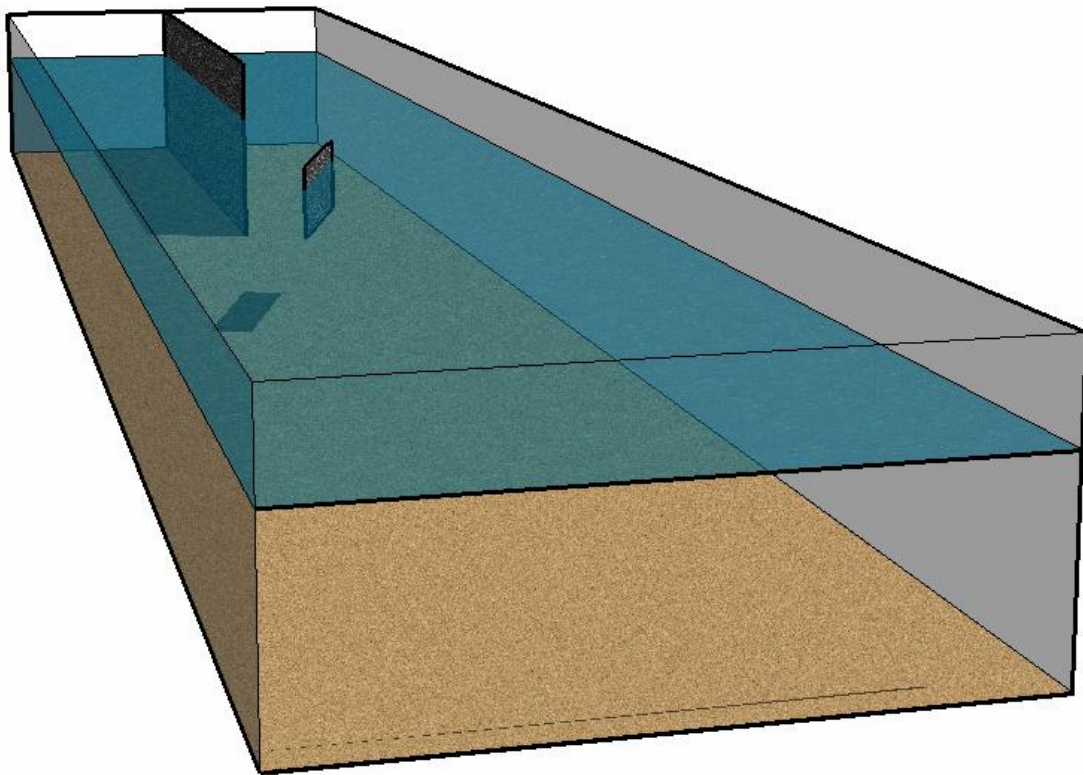
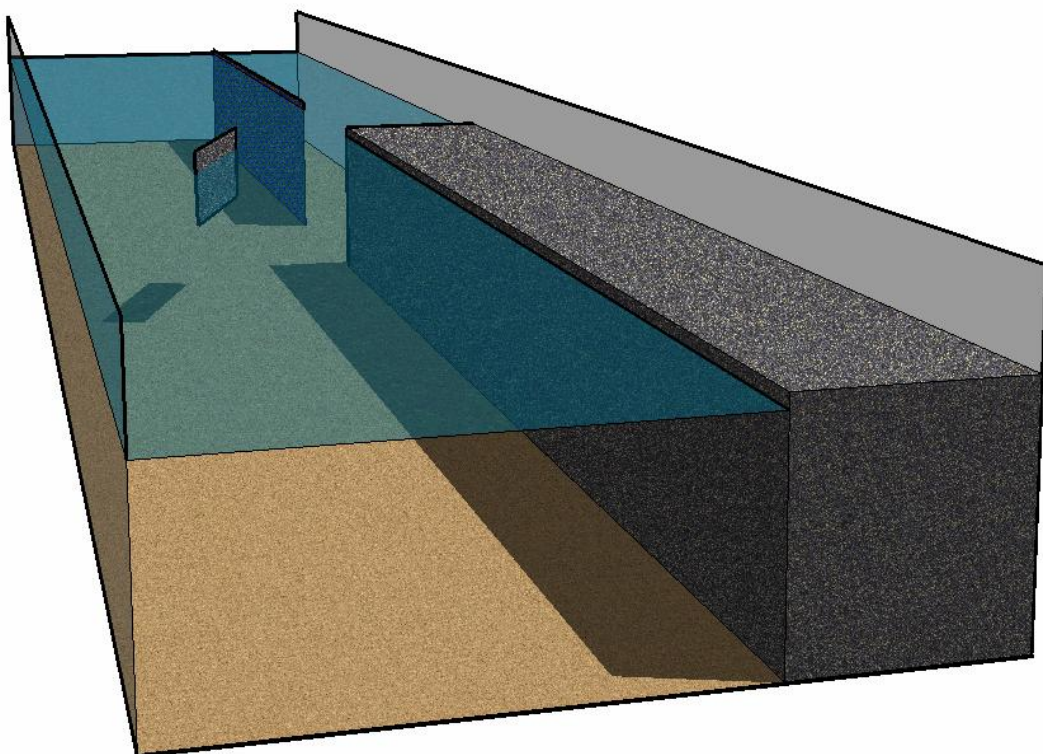

*Figure 6 Variant 3, two channels, division wall*



#### **Variant 4 Two channels, bifurcation**

The final variant is the two channels and a bifurcation variant, see Figure 7. A secondary channel is constructed by the use of a closed wall in the upstream side of the flume. At about half the length of the flume, an opening has been made, directly followed by a dividing wall. The flow bifurcates, although there is no floodplain flow. The straight bifurcation angle (90 degrees in this case) and the absence of a sill at the entrance are seldom seen in rivers. The problem of this variant is that it introduces more parameters, and thus physical processes, thereby losing generality. Model variables like length of the bifurcation opening, the bifurcation shape and the local flow pattern with respect to the screen give rise to a lot of questions. In order to have a good result, a lot of test runs should be made with different values for each variable.



*Figure 7 Variant 4, two channels, bifurcation*

### **3.3 Multicriteria analysis geometry**

A multi-criteria analysis has been used to find the preferred variant in geometry. This analysis is a subjective way to create insight in the considerations about the layout of the flume. All alternatives are weighted against different criteria and put in a performance matrix, see Table 1. The criteria have been assigned with numerical weights on a scale from 0 to 1. The expected consequence of each variant is assigned with a score on a preference scale for each criterion, a scale of 1 to 10 will be used. More preferred options get higher marks.

## Criteria

### *Representativeness*

For understanding the processes, the physical model should be simplified as far as possible. The challenge is to be still able to describe reality in a solid way. The model should be representative to as many actual river situations as possible. Although no representation of a specific river has been made in this thesis, some attention has been made to scaling. The experiments executed should at least be representative for rivers in general. The comparison between the physical experiments and real rivers has been made using data from the Dutch Rhine branches (Zeekant, 1983).

### Reynolds number

The Reynolds number is the ratio between inertial forces and viscous forces. The dimensionless number is used to determine different flow regimes. Low Reynolds numbers indicate laminar flow. Turbulent flow is dominated by inertial forces and consequently has a high Reynolds number. This flow is characterized by the formation of eddies and other flow instabilities. The number determines the drag factor on sediment particles, therefore it is an important parameter for the sediment transport.

The Reynolds number can be used to compare the physical experiments with situations in real river practice, as a minimum requirement the flow regime should correspond. The flow in rivers is characterized by turbulent flow, which meets the flow regime in the flume.

$$Re = \frac{\rho \bar{u} D}{\mu} = \frac{\bar{u} D}{\nu} = \frac{4R\bar{u}}{\nu} \quad (3)$$

$$\text{Were: } R = \frac{A}{P} = \frac{0.16 * 0.6}{0.60 + (0.16 * 2)} = 0.1044$$

$$Re = \frac{4 * 0.1044 * 0.35}{0.801 * 10^{-6}} = 1.83 * 10^5 \text{ [-]}$$

The Reynolds number in Dutch rivers during moderate flood is at least a factor 10 higher.

This means that the water motion is more turbulent than in the experimental set-up.

At higher Reynolds numbers, the drag factor on the particles does not increase significantly.

From Reynolds number higher than  $10^4$ , the relation between the two parameters is relatively weak. Therefore the experiments are still representative for actual river flow.

### Froude number

The Froude number can be used to determine the ratio between inertial forces and gravity forces in the flow. When the Froude number is equal to one, the flow is in critical state. If the Froude number is larger than one, the flow is super critical. The propagation speed of disturbances is smaller than the flow velocity. Profiles are calculated from the upstream boundary condition. When the Froude number is smaller than one, the propagation speed of disturbances is larger than the flow velocity. This flow is sub-critical, disturbances in the flow can travel in upstream direction and the flow profiles are calculated from the downstream boundary.

The normal flow condition in the rivers of interest is a sub-critical flow. The experiments are also based on this flow regime.

$$Fr = \frac{\bar{u}}{\sqrt{gh}} = \frac{0.35}{\sqrt{9.81 * 0.16}} = 0.279 \quad (4)$$



The Froude number in real river practice is around 0.15-0.20 during moderate flood. The actual Froude number in the flume is in the same order of magnitude, and thus the flow regime roughly corresponds.

#### Shields parameter

The Shields parameter is used to calculate the start of motion of sediment in flowing water. The shear stress is made dimensionless, denoted by  $\theta$ . The shear velocity near the bottom is denoted as  $u_*$ .

Because:

$$u_* = \sqrt{gh_i} \quad (5)$$

$$\theta = \frac{u_*^2}{g\Delta D_{50}} = \frac{hi_w}{\Delta D_{50}} = \frac{0.16 * 1.40 * 10^{-3}}{1.65 * 0.000238} = 0.57 \quad (6)$$

This value of the Shields parameter can be compared with the parameter of the Bovenrijn and river Waal during moderate flood (Zeekant, 1983).

#### Width to depth ratio

The width to depth ratio in the flume experiments (3.79) cannot match the actual ratio (10-30) in river practice. As the river is wide and relatively shallow, the physical experiment should have enormous dimensions when representing the actual ratio. In the 60 cm wide flume the corresponding water depth would have been in the order of 2 cm. Placing a surface screen in a water depth of 2 cm would imply a set-up in which the dominating processes are not measurable.

Next to the consequences for the model facility the width to depth ratio has consequences for the stream pattern in the flume. As the ratio becomes smaller, the influence of the fixed walls becomes larger.

For gathering valuable data from the experiments, the main processes influencing the morphological development must be measurable. Therefore each of the processes has to be isolated to see its specific influence. Examples of data to be measured are primary flow pattern, spiral motion, turbulence and transport volumes of sediment. Even with state of the art measurement equipment, fundamental small scale turbulence processes are still unexplored. Therefore, the variant is checked on the measurability of the processes.

#### *Progress with respect to previous work*

The purpose of executing a physical experiment is broadening or deepening the existing knowledge. Several investigations were already done in the past, variants with an overlap to these experiments get a lower preference mark. All variants are checked on the level of contribution to state of the art knowledge.

A distinction between different disciplines must be made within this criterion. The focus in executing these experiments can be on river engineering, but also on fluid mechanics. This study gives more weight to the river engineering criterion. All geometries have been given a consequence mark on both sub-criteria.

#### *Preparation and execution*

First of all the considered variant should fit within the geometrical boundaries of the flume. Another important factor in the analyses is the execution factor. This includes all the work to prepare the models, i.e. preparing sediment, production of structures and placing the

experiment. The different variants may need several test runs or adaptations, so the flexibility of the system also plays an important role.

Performance matrix					
Criteria	Weight factor	Variant			
		1 channel, single screen	1 channel, 2 depths	2 channels, division wall	2 channels, bifurcation
Representativeness	0.40	7	4	7	3
Progress	0.40				
• river engineering	0.25	6	8	5	8
• fluid mechanics	0.15	6	7	8	7
Prep. and execution	0.20	9	3	9	5
<b>Total</b>	<b>1.00</b>	<b>7.0</b>	<b>5.25</b>	<b>7.05</b>	<b>5.25</b>

Table 1 Performance matrix of variants in geometry

### Conclusion of MCA

Using the results of the Multi Criteria Analyses it can be stated that variant 1, one channel with a single screen only, in combination with variant 2, two channels and a division wall, are considered the most valuable variants in this study. The advantage of applying variant 1 is the relative small amount of basic physical processes involved. The other variants involve more processes in the total flow pattern. Not having too many processes leads to more reliable test data for input in a numerical model.

The preparation for this combination of variants takes less effort than for the other two. The available flume at Delft University of Technology has been used in an early stage to check whether the design of the experiments gives reliable answers to the research questions. Due to time constraints the preparation and execution criterion has been weighted relatively high.

### 3.4 Application of sediment

Executing physical experiments requires a choice in the application of a mobile or a fixed bed. This research evaluates three different ways of applying sediment.

#### Fixed bed

Without sediment a lot of valuable measurements on water motion can be done, thereby giving detailed insight. Although this set-up would give very valuable results, it has not been used in this study. The option of not using sediment would have great consequences for the main point of interest of this study. The aim is to solve sediment problems in secondary river channels. Without sediment the water motion can be investigated in detail, but the translation to morphology would cause too many uncertainties. The change in bed topography will modify the flow pattern and vice versa. This interaction is considered crucial for the efficiency of the surface screens.

#### Qualitative description of transport

Sediment transport can be investigated in a qualitative manner, the focus is on describing the direction in which the sediment is transported. A fixed bed is applied in this variant. The track which the inserted sediment packages follow is studied in detail. The locations of erosion and sedimentation are not being investigated in detail. The advantage of working with this concept is the time needed both for preparation and execution. A full morphological

experiment will take more time in the set-up phase, as creating clean sediment takes effort. The test duration decreases considerably when just following packages of sediment. The disadvantage of the qualitative description is having less information. Valuable data like the morphological development of the bottom and the bed-flow interaction are not collected.

### **Mobile bed**

Mobile bed experiments are preferable from a point of view of contributing to state of the art knowledge. The effect of flow processes can be seen in the development of sedimentation or erosion locations. Time-dependent measurements of the bottom profile can be taken to explore the morphological development. Therefore this variant generates the largest amount of valuable data.

A disadvantage of running a full morphological experiment is the long duration. Preparation and execution take a lot of effort. Clean sediment has to be used to construct a representative bed. The optimal measurement duration in this variant is significantly longer than that for the aforementioned two variants. The timescale of development of the overall bed slope, which mainly determines the time needed to reach equilibrium, is in the order of several days up to a week. The local processes of erosion and sedimentation around the screen have a timescale in the order of several hours.

### **Choice in application of sediment**

The choice has been made to work with a full morphological experiment. This gives good insight in the flow-bed interaction under influence of the screen. The mobile bed gives insight in local transport capacity and distribution of discharge in the bifurcation branches. Next to global sedimentation and erosion it can be checked whether a local scour hole underneath the screen is formed. The scour hole development is found to be the main hazard for a bottom screen, which has to be prevented for any structure.

## **3.5 Description of tests**

The number of experiments depends on the cycle time needed for one complete experiment. This includes time needed for preparing the set-up, measurement equipment, constructions to be made on the flume and the measurements. A complete measurement plan has been set up. The first test run has determined the timescale of the experiment. An initial run has been executed in order to establish a new equilibrium. Optimal locations of the screen, measurement equipment and downstream boundary condition have been investigated. The first series (A) of tests are executed with a single screen only. In part two (B) of the experiments, a division wall is constructed downstream of the screen location.

### **A. Single screen**

The goal of this series of test runs was determining how the bed level changes over time under influence of the screen. The changes are as close to the screen as possible, as well as in the influence area further downstream. The interpretation of this series is based on the change of the bed level as function of the angle of attack and the blockage ratio. Only one screen has been applied in a flume with a mobile bed and without a bifurcation. The full morphological development has been investigated during a period of 8 hours, as followed from the timescale of the test run. The development of the scour hole behind the screen was intensively measured. In the return pipe a sediment tap has been constructed to determine the total transport.

## B. Diversion wall

A dividing wall is added in the second test series. When using the division wall in the test runs, the variables have been limited due to time reasons. From run A optimum angles and penetration depths have been taken and applied to this geometry. For this series of tests, sediment has been removed from the downstream part of the flume. The diversion wall was placed and the sediment was put back in the flume. After a new initial run, the equilibrium was reached again.

### Overview of tests

Number	Angle [degrees]	Depth screen % of watercolumn	Sediment	Discharge [l/s]	Wall
A1.1	15	20	Yes	29.5	No
A1.2		40			
A1.3		60			
A2.1	20	20	Yes	29.5	No
A2.2		40			
A2.3		60			
A3.1	25	20	Yes	29.5	No
A3.2		40			
A3.3		60			
B1.1	15	40	Yes	28.8	Yes
B1.2		60			
B2.1	20	40	Yes	28.8	Yes
B2.2		60			
B3.1	25	40	Yes	28.8	Yes
B3.2		60			

Table 2 Overview of experimental runs executed

### 3.6 Restrictions experiment

#### Model facility

With the use of physical models, reality is reproduced as far as possible. As a full scale model would have had enormous consequences on the facility, compromises have been made when setting up a model. The available model facility gives restrictions for the set-up of the model.

One of the restrictions introduced is a flume width of 60 cm. The surface screen generates a transverse velocity, which is directed onto the wall of the flume. The wall influences the velocity field. In a wider flume, the influence on the development of the vortex is smaller. Although this is a restriction for the morphological development in the flume, the tests are still considered valuable. In real river engineering practice, the screens could be applied in relatively small secondary channels. This would also introduce the effects of the wall, as the width of a secondary channel generally is limited.

The discharge in the B-series could not be kept equal to the discharge in the A-series. The dividing wall gave rise to a higher resistance, the maximum flume discharge capacity was reached. The discharge was changed for this test series to a value of 28.8 l/s. It was to be preferred if the discharge could be kept equal. In analyzing the exact influence of the wall, an equal discharge would have given a clearer view.

In the model set-up used, it was not possible to take measurements on flow velocity and bottom profile simultaneously. Therefore the choice has been made to take full time velocity

measurements and to take the bottom profile only after a longer period of 8 hours. Taking bed level measurements with a shorter time interval would have given more information about the timescale of the processes involved.

The water used in the flume was taken from the water supply system, which has a temperature of 10 degrees Celsius. The water temperature in the flume reached an equilibrium value of 28.3 degrees Celsius during the initial run. This unexpected high temperature can be explained by the set-up of the pump system. As the pump had more capacity than the discharge used, a valve in the return flow has been used to regulate the actual discharge. The power of the pump does not change when a valve is introduced and the result is a higher pressure upstream of the valve. The energy the pump uses is finally transferred into heat, which is absorbed by the water.

Viscosity is a measure of the resistance of a fluid when being deformed by stresses. A higher temperature causes the water to be less viscous. At a temperature of 10 degrees Celsius, water has a dynamic viscosity of  $1.307 \times 10^{-3} \text{ N.s.m}^{-2}$ . At a temperature of 30 degrees the viscosity is  $0.798 \times 10^{-3} \text{ N.s.m}^{-2}$ . This influences the fall velocity of particles, as less resistance provides a larger fall velocity. Therefore warmer water has a smaller transport capacity, something to be considered when trying to reproduce the results of this study in a numerical model.

A constant colder temperature was preferred during the study, but as a frequency regulator was not available to lower the output power of the pump, this was not possible.

### **Time**

When exploring the possibilities for the collection of valuable data, many variants are interesting to investigate. A lot of choices had to be made and several set-ups could not be measured, as time is limited. For example test on several screens and with a small penetration in combination with the wall could have lead to interesting results. Another interesting experimental set-up is applying a screen field.

## 4.0 PREPARATION OF PHYSICAL EXPERIMENTS

### 4.1 Introduction

Executing physical experiments comes with many parameters. Setting up a valuable experiment takes consideration about several variables and their influence on the system. This chapter briefly describes the preparation phase of the experiments.

In the first part of the physical experiments use has been made of an existing model set-up (Crosato, 2009). The discharge in this experiment was kept constant at a value of 6.8 l/s. The corresponding water depth was around 4-6 cm. The final bottom slope of the last experiment was 0.354 percent.

To able to investigate the effects of the screen at several locations in z-direction, more water depth is required. The discharge chosen for these experiments is 29.5 l/s. After introducing new boundary conditions, a new equilibrium must be established in the flume. All calculations on the new situation can be found in Appendix B.

### 4.2 Description of the flume

The facility used for this study was the 2 metre wide flume in the Environmental Fluid Mechanics Laboratory of Delft University of Technology. Because of the available pump discharge the choice was made to construct a 60 cm wide sub-flume, to be called “The flume” in the rest of the report. At the downstream part of the flume a pump was installed with the possibility of pumping the water-sediment mixture. In this way a closed system was created with recirculation of water and sediment. Detailed information about the complete layout of the flume can be found in Table 3 and Figure 8.

Parameter	Amount	Unit
<b>Flume</b>		
Width	0.60	m
Length, effective	21	m
Length, total	30	m
Depth	15.8	cm
Width to depth ratio	3.79	-
Density water	1000	kg m <sup>-3</sup>
Dynamic viscosity of water	0.798x10 <sup>-3</sup>	Ns m <sup>-2</sup>
Temperature of water	28.3	degrees C
<b>Screen</b>		
Height	3.16 – 9.48	cm
Length	22	cm
Global x-location	1,400	cm
Y-location	0	cm
Thickness	2	mm
<b>Dividing wall</b>		
Global x-location	1,500 – 2,300	cm
Y-location	0	cm
Length	800	cm
Thickness	18	mm

Table 3 Geometrical parameters of the flume, screen and dividing wall

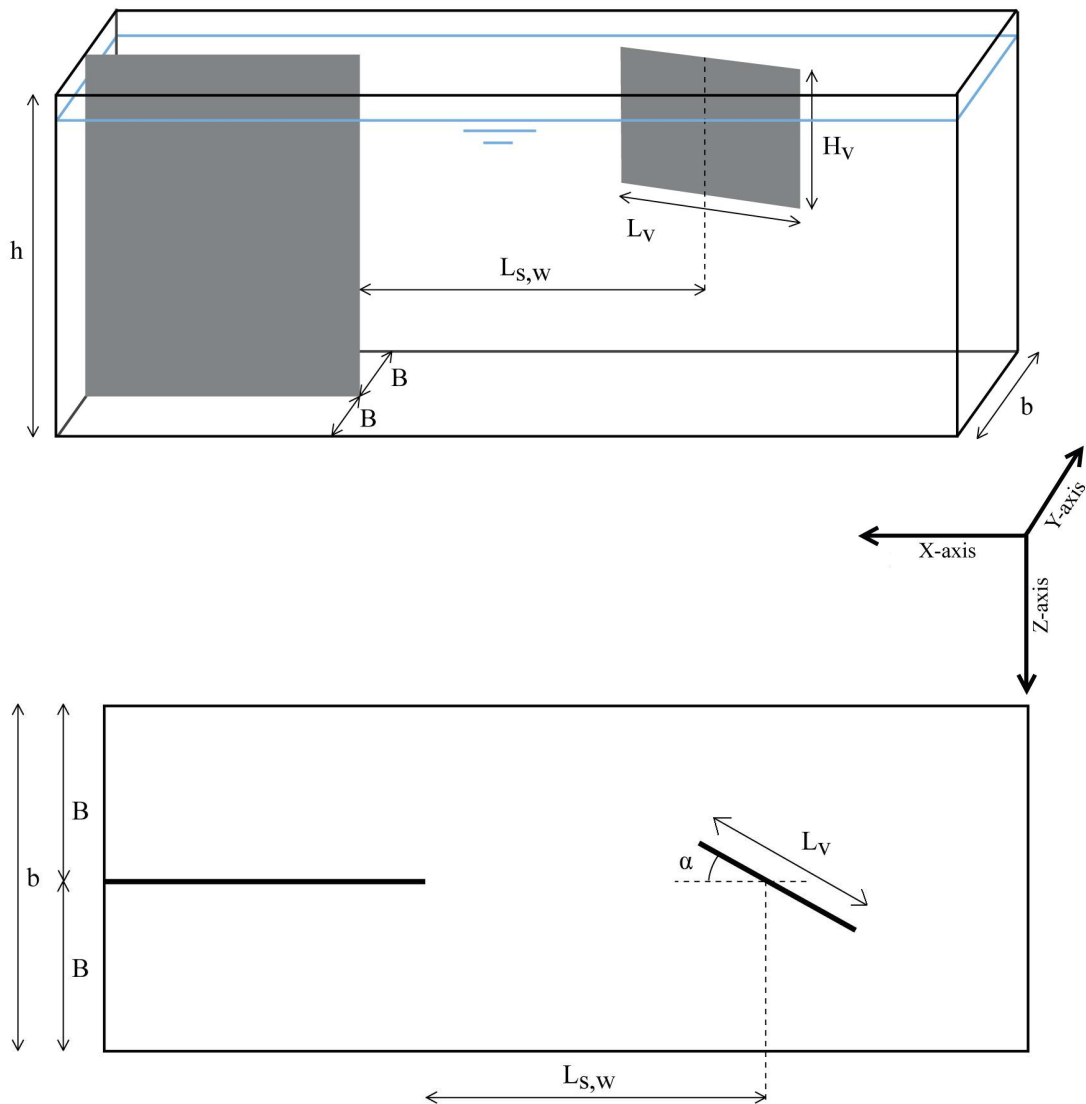

Figure 8 Sideview flume (top), positive coordinate system (middle, right), and topview (bottom) of test location

### Upstream boundary conditions

The discharge in the system was regulated with the aid of a valve. The discharge has been taken as constant as possible, as the discharge highly influences the morphological development. As mentioned before, the discharge in the B-series was not equal to the discharge in the A-series as a result of a higher resistance.

In the upstream part of the flume, a flow divider was installed to guarantee a uniform velocity profile as much as possible. Already without measuring a velocity field, it became clear that the divider alone was not sufficient, which can be seen in Appendix A, Figure A.4. In order to smoothen the flow, a perforated plate was added just behind the flow divider. The plate, fully penetrating the bottom, reached up to the top of the flume walls. Water flowing out of the flow divider flows over the plate, falling through the holes in the plate, thereby levelling out all the pressure and velocity differences. Figure 9 shows the layout of the upstream boundary.



*Figure 9 Perforated plate at upstream boundary, looking from downstream*

### **Downstream boundary conditions**

At the downstream boundary the influence of the pump was made as small as possible by maintaining the natural slope of the water level. This means the pump compartment was filled till the downstream water level. The water level was fixed with aid of an overflow in the back of the pump compartment, see Figure 10. A small pump constantly added water to the 60 cm flume to compensate for small losses due to leakage in the return flow. The surplus of water added by the small pump was able to flow away through the overflow. Checks have been done behind the overflow to investigate whether sediment losses occurred. The overflow, located at the end of the pump compartment in the upper water layer, only conveyed clear water without sediment.



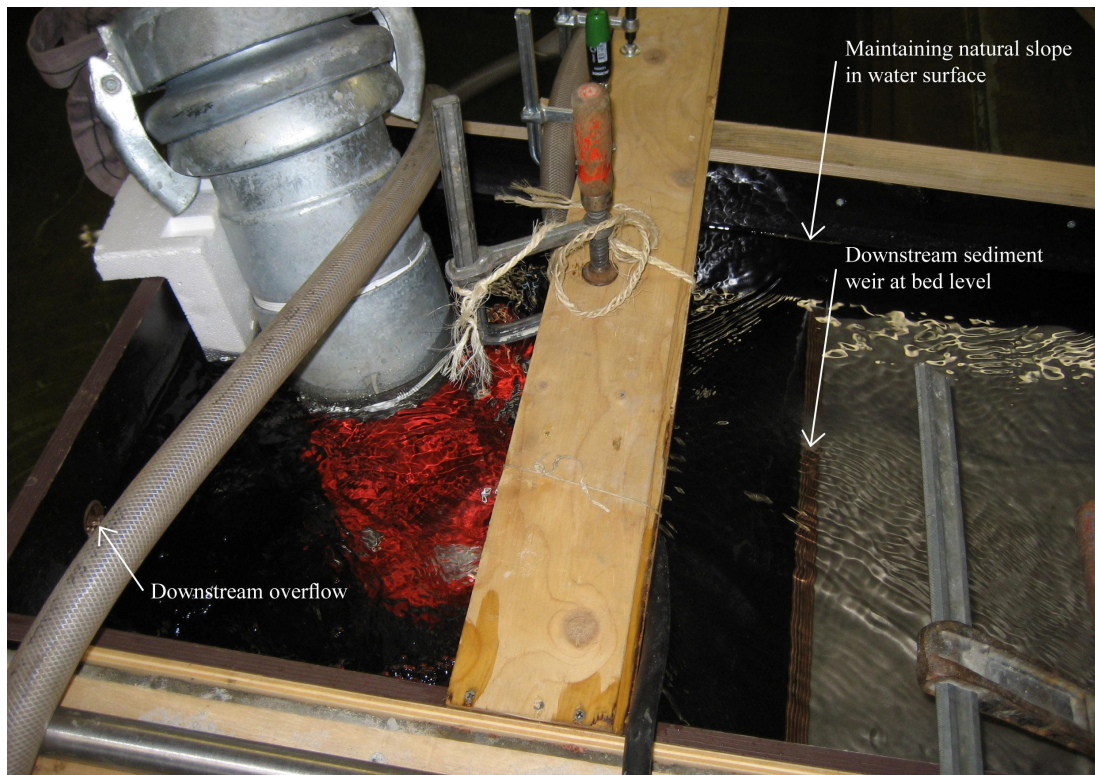

Figure 10 Topview of downstream boundary with overflow, sediment weir at bed level and natural slope water surface

The influence on the bed level in and around the pump compartment is kept as small as possible. This is done by placing a sediment weir just beneath the downstream bed level. This prevents the sediment from local erosion due to the higher flow velocity in the pump compartment.

#### 4.3 Input parameters

A theoretical consideration (Appendix B and G) has been carried out prior to the execution of the experiments. The presented flume parameters in the next sections have been calculated and compared to the actual flow velocities and bottom slope.

##### Discharge

The discharge in the flume mainly determines the ongoing processes in the experiment. Water depth, flow velocity and sediment transport are dictated by the discharge. The transport needed to get valuable results in reasonable time, depends on flow velocity and thus on discharge. Practically the water depth should be above a minimum value in order to apply an acoustic velocity measuring device. A minimum water depth of 10 cm is preferred for these experiments, as it allows three different measurements in the water column. With a discharge of 29.5 l/s the predicted water depth is 0.16 m.

##### Water depth

In order to take three measurements over depth, the water level should be more than 10 cm. With the depth of 16 cm the measurement equipment has sufficient accuracy on several locations in z-direction. As aforementioned the discharge to fulfil this requirement is calculated to be 29.5 l/s.

Besides having influence on the measurements, the water depth also influences the dimensions of the screens. Together with the height of the screen, the water depth determines the blockage ratio of the water column.

The water depth is expected to limit the growth of the screen induced vortex. The vertical vortex growth stops when bounded by the free surface and the bottom. In horizontal direction the vortex is still expected to grow, but further downstream damping causes the spiral motion to loose intensity.

### Flow velocity

The flow velocity is one of the most important parameters for the sediment concentration. With a discharge of approximately 29.5 l/s the resulting flow velocity is calculated to be 0.35 m/s, which is sufficient to reach the velocity needed for the start of motion for the sediment particles.

### Bottom slope

The initial bottom slope is determined by the layout of the flume after the last test. Reports by Crosato (2009) have shown the bottom slope to be 0.354 percent. The bottom slope will change under the aforementioned conditions of the experiments; the flume has to reach a new equilibrium. Therefore an initial experiment without interventions has been done before starting the main experiments. This also helps to determine the timescale of the system. The calculation result predicts the bottom slope to reach a value of 0.14 percent, which means a height difference of about 3 cm over the whole flume.

### Sediment

For the start of the experimental study use has been made of the sediment already available in the flume. The sediment sizes are  $D_{10} = 164 \mu\text{m}$ ,  $D_{50} = 238 \mu\text{m}$  and  $D_{90} = 337 \mu\text{m}$ . The results of the previous analysis are presented below.

Sieve size (mm)	Weight retained (g)	% Retained cumulative	% passing
0.500	0.03	0.15	99.84
0.425	0.19	0.34	98.85
0.355	0.87	1.21	94.31
0.300	2.57	3.78	80.89
0.250	4.73	8.51	56.19
0.212	4.75	13.26	31.38
0.180	3.15	16.41	14.93
0.150	1.90	18.31	5.01
0.125	0.69	19.00	1.41
0.112	0.15	19.15	0.62
Pan (closed)	0.12	0.12	0.00

Table 4 Result of sediment sieve analysis (Crosato, 2009)

A sieve analysis was carried out by Crosato in order to determine the relative proportions of different grain sizes that make up the sediment mixture. Sieve sizes smaller than 500  $\mu\text{m}$  were used and mechanical analyses were done for 15 minutes. In total a representative sample of 20 grams was sieved. The results from this analysis can be found in Table 4 and Figure 11.

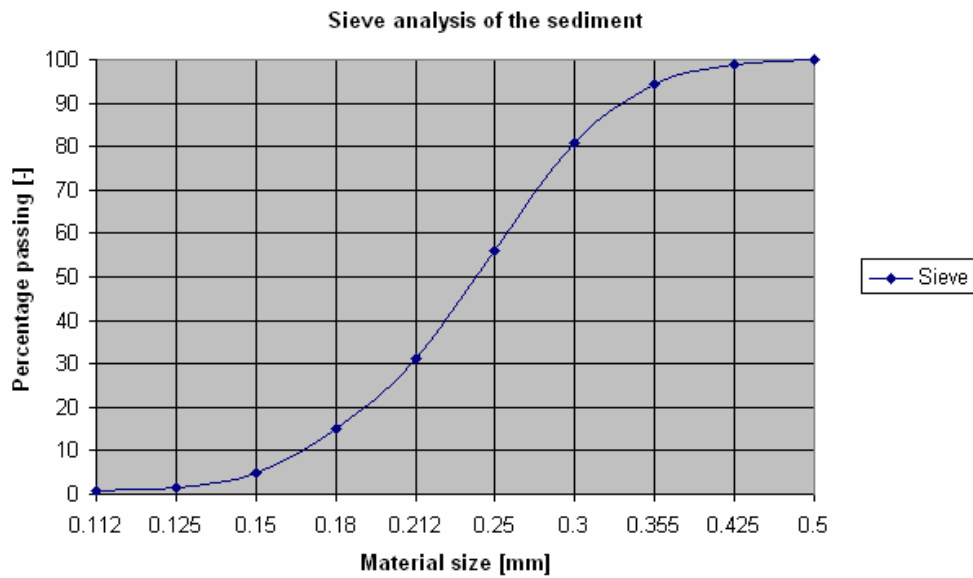

Figure 11 Graph of sediment sieve analysis,  $D_{50}=238 \mu\text{m}$

The steepness of the graph determines the uniformity of the sediment mixture. In uniform sediment grains have the same size, in that case the graph has a steep gradient. Mathematically the uniformity of the mixture is determined by the non-uniformity coefficient  $C_u$ .

$$C_u = \frac{D_{60}}{D_{10}} \quad (7)$$

The coefficient for the sediment used is  $C_u = 1.6 < 3$ , which indicates the mixture to be relatively uniform. The particle size distribution of the sediment mixture can be studied by analyzing the curvature of the sieve analysis result, see equation 8.

$$C_c = \frac{D_{30}^2}{D_{10}D_{60}} \quad (8)$$

The curvature coefficient of the sand is 0.817, this is in the range of 0.5 to 2, which indicates well graded sand.

Sediment transport is mainly dominated by bottom transport. Only a small part is transported as suspended load, since  $w_s/u_* > 1$ . In Appendix B calculations about the predicted transport rate are presented. With a discharge of 29.5 l/s and a stream velocity of 0.35 m/s the calculated transport rate is 0.19 g/l for the Meyer-Peter-Müller formula and 0.74 g/l for the Engelund-Hansen formula.

By analyzing the timescale of the processes in the flume, a rough estimate can be made of the time needed to adapt to interventions. The timescale highly depends on the transport, which is an uncertainty in the calculations. The calculated timescale for the relatively fast processes behind the screen is in the order of 4-8 hours.

### Angle of attack

The angle of attack mainly determines the processes occurring behind the screen. The flow around the screen separates with a large angle of attack. The amount of turbulence increases

significantly. For this study a relatively small angle of attack in the range of 15 – 25 degrees has been chosen. The spiral motion is expected to dominate the processes behind the screens with this angle of attack.

### Aspect ratio

The aspect ratio, as mentioned before, is important for a smooth flow along the vane. The maximum value of the aspect ratio in these experiments was 0.3. In several investigations on bottom screens, this maximum value is found optimal for a smooth flow around the screen.

### Blockage ratio

The blockage ratio and the angle of attack determine the blockage of the flow. The higher the screen compared to the water depth, the more hydraulic resistance it generates. The blockage ratio thus determines the processes introduced behind the screen.

The blockage ratio had a maximum value of 0.6. This value has been found in experiments to bottom screens. In practice this means that the maximum penetration of the screen is 60% of the water column in the flume.

### Roughness

Calculating the actual roughness prior to the experiments was an uncertain parameter. The calculation methods are not reliable enough to predict the roughness exactly. For the start of the experiments the roughness at the end of the measurements of Crosato has been taken. The first assumption for the test runs is  $25 \text{ m}^{0.5} \text{ s}^{-1}$ . The predicted Chézy roughness according to the calculation of van Rijn is  $30 \text{ m}^{0.5} \text{ s}^{-1}$ ; the reliability of this outcome however is low. Therefore a first run without interventions has been executed, the roughness has been closely calculated from the slope developed in the flume and final adaptations have been made.

### Summary of parameters

Parameter		Amount	Unit
Discharge	Q	29.5	$\text{l s}^{-1}$
Water depth	h	0.16	m
Velocity	u	0.33	$\text{m s}^{-1}$
Slope	$i_b$	1.40	$\text{‰}$
Chézy coefficient	C	25	$\text{m}^{0.5} \text{ s}^{-1}$
Grain size	$D_{10}$	164	$\mu\text{m}$
	$D_{50}$	238	$\mu\text{m}$
	$D_{90}$	337	$\mu\text{m}$
Density sediment	$\rho_s$	2650	$\text{kg m}^{-3}$
Relative density	$\Delta$	1.65	-
Gravity	g	9.81	$\text{m s}^{-2}$
Water temperature	T	28.5	degree C
Density water	$\rho_w$	1000	$\text{kg m}^{-3}$
Kinematic viscosity of water (30°C)	$\nu$	$0.801 \times 10^{-6}$	$\text{m}^2 \text{ s}^{-1}$
Dynamic viscosity of water (30°C)	$\mu$	$0.798 \times 10^{-3}$	$\text{Nm}^{-2} \text{ s}$

Table 5 Summary initial input parameters

## 4.4 Measuring plan

### 4.4.1 Coordinate system

A Cartesian coordinate system has been used for the experiments. The x-direction is taken over the length of the flume and has the positive axis in downstream direction. The zero position is initially just behind the perforated plate at the most upstream side of the flume. After equilibrium is reached in the first run, a new zero value in x-direction is taken. The centre of the screen gives the new zero value. The presented results in the next chapters use the centre of the screen as zero in x-direction.

The y-direction is taken perpendicular to the side walls of the flume, where  $y = 0$  is taken in the centre of the flume, which corresponds to the screen location. The z-direction starts at the surface of the water with the zero-value and is positive towards the bottom. The water level has a fixed value in this research. As the bed level is constantly influenced under the different screen set-ups, this gives rise to the somewhat unusual zero value of the z-direction. Figure 8 (middle) already showed the positive coordinate system.

### 4.4.2 Measurement equipment and locations

The equipment used for the experiments has been described in the following paragraphs. A brief overview of the measuring method, the accuracy and the location are presented. A description of the measuring procedures, pictures of the set-up and other information can be found in Appendix C.

#### **Flow velocity**

##### *General*

Flow velocities have been measured using a Vectrino. The Vectrino is a high-resolution acoustic velocimeter developed to measure 3D water velocity. The basis of this measurement technology is coherent Doppler processing, which is characterized by accurate data with no appreciable zero offset. The sensor operates with a frequency of 10 MHz with a sampling rate of 25 Hz. The velocity range can be set in horizontal and vertical direction, thereby optimizing the measurements in all directions.

##### *Accuracy*

The sensor head of the device is as small as possible to prevent local disturbance of the flow. Actual accuracy of the sensor according to the supplier is  $\pm 0.5\%$  of the measured value. A sampling volume is measured 5 cm from the probe, with a diameter of 6 mm. In practice this means that measurements very close to the bottom cannot be executed. The measurements are taken as close to the bottom as possible.

The signal from the Vectrino was not always found stable, the data contained a lot of spikes. In order to get reliable flow velocities, a de-spiking routine was used to remove the incorrect measurements from the data set. A standard routine for measurement signals of the Vectrino was applied using a Matlab script. No filtering of the data was needed, de-spiking alone was enough for having a good dataset.

##### *Location*

Measurement of the velocity starts at the upstream boundary of the flume. In order to know under which conditions the flow approaches, intensive measurements are taken here. The first 8 m of the flume has not been measured, as this area is still within the adaptation length of the flow. The available space around the screen was very limited due to the frame of the screen and the screen itself. Therefore it was not possible to execute velocity measurements

very close to the screen. Measurements were taken behind the screen, the actual area of interest, to get insight in the processes and the length of the influence area.

## **Discharge**

### *General*

A Proline Prosonic Flow 91W has been used to measure the total discharge in the return flow. It is suitable for bidirectional measurement of pure or slightly contaminated liquids, regardless of pressure, temperature, conductivity and viscosity. Proline Prosonic Flow 91W operates on the principle of transit time difference. An acoustic, ultrasonic, signal is sent in both directions from one measuring sensor to another. A transit time difference arises because the propagation velocity of the sound waves is greater in the direction of flow. This difference is directly proportional to the flow velocity. The device calculates the flow from the pipe cross sectional area and the measured transit time difference. The discharge has been measured during the whole test run, but was kept as constant as possible.

### *Accuracy*

For flow velocities greater than  $0.3 \text{ m s}^{-1}$  and a Reynolds number greater than 10000 the accuracy of the device is reported to be 0.5%. The dry calibration represents additional uncertainty due to mounting and actual pipe properties. Those properties can be programmed into the device, therefore having an output with high accuracy discharge values.

### *Location*

The discharge has been measured in the return flow.

## **Sediment and transport**

### *General*

Crosato (2009) determined grain sizes by sieving. As the report states, the sieve is constructed from a wire mesh with square opening of specific size, where particles only pass when their size is smaller than the size of the opening. The sieves are moved mechanically for 15 minutes. Larger particles are in the upper sieves and smaller particles are in the bottom sieves. The material in each sieve has been weighted in order to determine the grain size distribution.

Determining the sediment concentrations and the total transport has been a challenge in many physical experiments. Still no reliable measuring device is developed for the sediment size of this research. Therefore several measuring options for the transport were prepared. The total transport of sediment in the mixture is determined using a tap in the return pipe. The measurements are taken with an interval of 10 minutes, taking 10 litres of mixture. In total 6 buckets are taken from the return flow. The mixture captured is dried and the sediment is weighted to determine the sediment proportion.

The second option to determine transport is by using a sediment trap at the downstream boundary of the flume. A very dense wire mesh can sieve the sediment from the water. The trap is left in the flow for a period of 15 minutes. Thereafter the sediment is removed from the trap, dried and weighted. The third option is to take sediment measurements just downstream of the regulation valve, at the upstream boundary of the flume.

The last option tried was in the return flow again, after lowering the total pump capacity with aid of a frequency regulator.

### *Accuracy*

The accuracy of the weight instrument is 0.1 mg, which is insignificant in comparison with the total sieved amount of sediment. The standard procedure of measurement recommends a maximum difference before and after the sieving of 10%. The difference found by Crosato was 3.65%, which was within the margin.

The accuracy of the sediment concentration depends on the technique used for drying and weighting the sediment. If water remains in the fraction, the wrong weight is calculated, and the sediment transport is overestimated. A standard procedure is used for drying the sediment.

#### *Location*

The sieve analysis was done prior to this set of experiments.

Measuring sediment transport has been tried in the return flow, at the end of the flume in a sediment trap, and in the area just behind the regulation valve. After all tests another location generated the desired data about the total transport in the return flow.

### **Water levels and bottom profile**

#### *General*

Laser radiation has been used to measure the water depth and the development of the bathymetry. The equipment used is called Micro-Epsilon optoNCDT1300 and finds its application in industrial areas for measuring displacement, distance, position, elongation, quality control and dimensional testing. The device is based on a semi conductor laser with a wavelength of 670 nm (red) and it operates in a pulsed mode. The maximum optical output is 1 mW, the laser is classified as laser class 2. The sensor uses the principle of optical triangulation, as visible modulated point of light is projected onto the target surface. Depending on the distance the diffuse fraction of the reflection is focused on the position sensitive element (CCD-array). The controller calculates the distance from the data of the CCD-array.

#### *Accuracy*

The accuracy of the data is affected by many physical parameters. The vibration of the cart in which the laser is mounted affects the accuracy. The bedforms being generated lead to a constant changing bottom profile.

For the accuracy of the device it is important to mount it tilt free to the measuring chart. Before every test series the laser was checked to be in the right vertical position. The final accuracy of the device was 0.1 mm.

#### *Location*

The measurement equipment was mounted on a cart, which is able to ride along the entire flume, thereby collecting data on almost as many locations as desired. These measurements are taken to determine the undisturbed equilibrium of the new flow conditions. In the actual runs, the water level and bottom profile are measured in the area of interest behind the screen. Slices in transverse direction are made every 20 cm up to a distance of 10 times the screen length.

### **Water temperature**

A water temperature sensor is embedded in the Vectrino. The temperature measurement is taken at the upstream velocity measurement location. The resolution of this measurement is 0.1°C, with an accuracy of 1°C. As the temperature measurement in the Vectrino was not found reliable, a daily reference measurement was executed with a manual thermometer.

#### **4.4.3 Optimal measuring duration**

#### *Velocity*

First of all several velocity measurements with a long duration have been executed in order to determine an optimal measuring duration for flow velocities. The mean value of the whole

duration was compared with the mean value of shorter durations in order to judge the accuracy of shorter measurements. In this way the relative error is calculated in comparison to what would be the value of a long measurement. Figure 12 shows the results of this analysis.

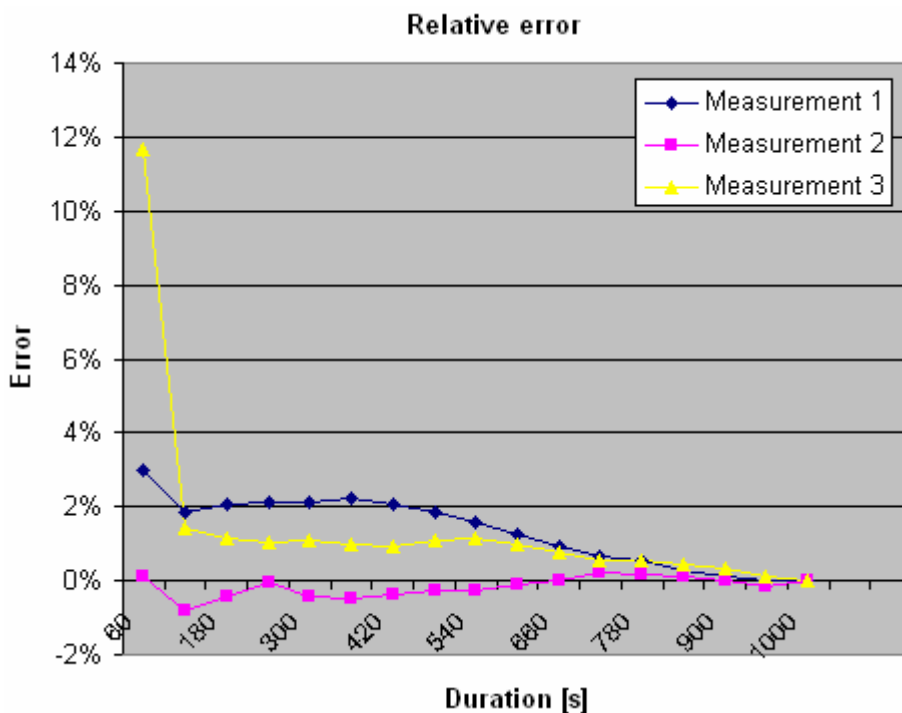

Figure 12 Relative error on average velocity as function of measurement duration

With this analysis the choice is made to have a measurement duration of 200 seconds. The error made is around a maximum value of 2%, which is found acceptable for these runs.

*Morphological time scale*

Calculating the morphological time scale prior to the tests was not possible with high accuracy, as it depends on several processes. To collect as much data as possible on different screen set-ups, the choice is made to measure the bed after approximately 8 hours. This time was found sufficient for seeing the relatively fast adaptation of the bed in the area of influence of the screen. A longer test has been executed in order to check whether the 8 hour duration is not underestimating the total effect of the screen.



## 5.0 RESULTS OF FLUME EXPERIMENTS

### 5.1 Introduction

This chapter presents the most important and remarkable results of the experimental tests. Four cases are presented and explained in detail. The chosen cases contain distinct information, some set-ups did not show any clear result on bed development, some set-ups had a large effect on the bottom. Both will be presented and analyzed. A distinction has been made between the variants with, and without the division wall. After the study cases, general conclusions on the test runs are presented. The complete set of results can be found in Appendices D, E and F.

### 5.2 Initial test and equilibrium

#### Morphological development

The purpose of the initial test run was to establish an equilibrium in the longitudinal bed slope. The bed slope is a function of many parameters, in which the discharge is a very important one. The discharge is kept as constant as possible at a value of 29.5 l/s. Under the new discharge conditions, the bed slope will adapt to a new equilibrium. No screen or other structure was applied in the flume in order to see an undisturbed equilibrium. In the first week of the initial run several measurements have been done to the bed level. In Figure 13 an overview is drawn of the time dependent development of the bed slope. The largest change is during the first days. Thereafter the slope only slowly adapts and becomes stable after one week of continuous testing.

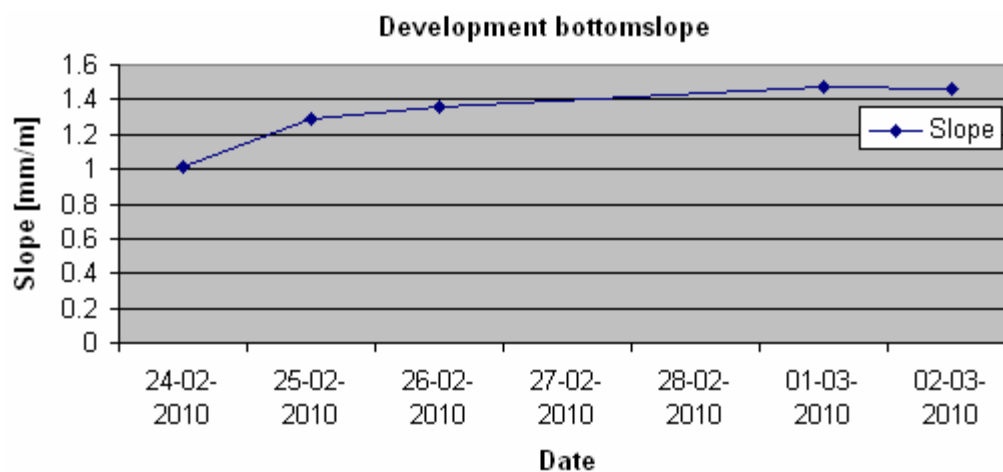

Figure 13 Changes in longitudinal bed slope over time

In the equilibrium stage, sand dunes are propagating on the bed (illustrated in Appendix A). Therefore the bed level is not constant. Although the exact details of the dunes are beyond the scope of this study, their dimensions are important to know. The bed level is one of the most important parameters in this study, it determines the effectiveness of the screen set-up. The dunes have been measured and the average dimensions are an amplitude of circa 25 mm and a length of circa 150 mm. The dimensions were not found constant over the y-direction of the flume. The extra resistance added in the region close to the wall causes differences in dune formation.

The measured and presented bed levels in this report have not been compensated for the dunes, as it would filter out crucial information about the morphological development.

## Transport

The total transport in the system is an important parameter when the experiment is modelled numerically. The transport is not expected to have a constant value, as the total transport includes the suspended transport and the bed load transport. The migrating bedforms contribute to the transport through any cross-section. When falling over the sediment weir into the pump compartment they cause peaks in the total transport.

As described in the measuring plan, sediment measurements have been taken at several locations in the flume. First of all the total transport was measured in the return flow, through a tap in the pipe. The measured sediment concentrations showed large fluctuations. In the first two measurement series, the concentration varied between 0.0446 g/l to 0.3170 g/l. As this difference with a factor 7 was not explained by the actual variations in concentration, a reference measurement has been done. This was done by opening the sediment tap a little, in order to have a small discharge from the return pipe. The next measurement was taken in a shorter time period, with a larger opening of the tap. This reference measurement was executed within a period of 3 minutes. The expectation is the transport being in the same order of magnitude. The mixture was analyzed and the results showed large variations again. The first measurement resulted in a concentration of 0.148 g/l, the second test in 0.435 g/l, a difference with a factor 3. The conclusion drawn from this reference experiment is that determining transport from the return pipe was not reliable and therefore not useful.

The second option to determine transport was the use of a sediment trap at the downstream boundary. A wire mesh of 100  $\mu\text{m}$  was placed inside the pump compartment. This mesh did not allow the sand particles to pass through, whereas the water was expected to penetrate easily. In practice this structure caused a backwater effect in the flume, resulting in lower flow velocities. This changed the equilibrium of the system and thereby the total transport. This type of measurement is not repeated, as it destroyed the whole experimental set up. The next option for taking transport measurements is a tap at the upstream boundary of the flume. Just behind the regulation valve, a tap was drilled into the pipe. A tube with a 90 degrees angle was mounted into the system. The tube was orientated exactly opposite to the flow direction. When the tap was used, no water could be collected, as an underpressure occurred in this part of the pipe. Pumps to actively take the mixture from the pipe proved not to be sufficient.

The last measurement method has been tried at the end of the experiments. The pump capacity was lowered using a frequency regulator, thereby lowering the pressure in the return pipe. During this procedure the discharge was kept constant at 28.8 l/s. The lower pressure introduces fewer problems for taking sediment, the tap could be fully opened. This guaranteed a constant outflow discharge over the different measurements.

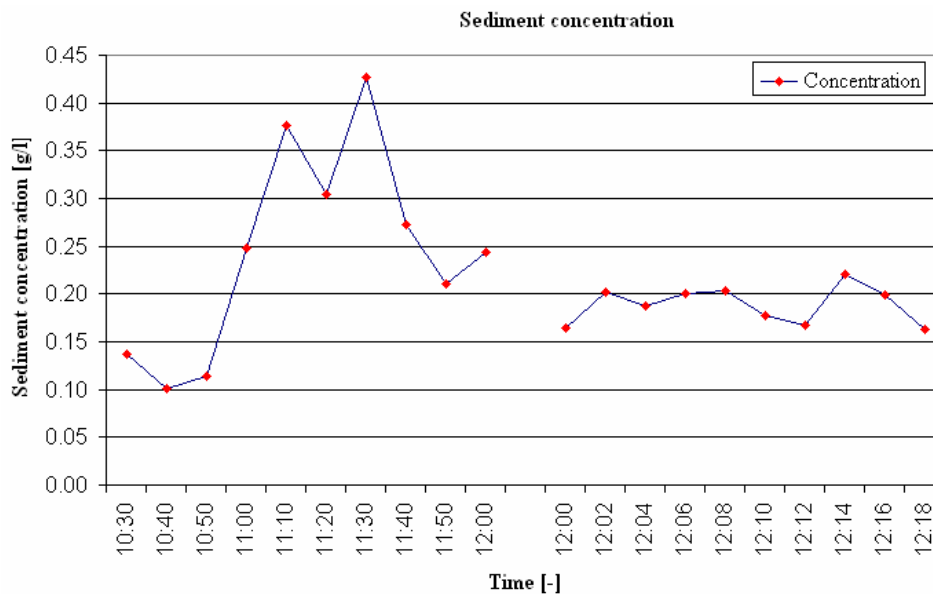

Figure 14 Sediment concentration in return pipe over different measurement durations

Figure 14 shows the results of the sediment measurements. Two different measurement durations have been used. In the first series (left line) 8 litres of mixture was taken every 10 minutes from the return flow. In this set of measurements still a lot of variation was observed. The average sediment concentration was found to be 0.24 g/l, with a standard deviation of 0.11 g/l. The second measurement series (right line) were taken every 2 minutes, a volume of 1 litre was collected. This determines the accuracy of the first measurement series. The average concentration was 0.19 g/l, with a standard deviation of 0.02 g/l. These concentrations seem to support the order of magnitude of the predictions (0.12 g/l) made with the Meyer-Peter-Müller transport formula (Appendix G).

### Flow velocity

After the final morphological equilibrium was reached, intensive measurements have been done on the upstream velocity field. This is of great importance, as it is the upstream boundary condition directly on the screen in the rest of the tests. A surface screen has been added to the flume for the initial measurement. The angle of attack was set exactly at 0 degrees and the penetration depth was 60% of the water column. The importance of the test is seeing the velocity field behind the screen. As the screen is a very thin plate of 2 mm, its influence in the 0 degrees set-up is insignificant.

Figure 15 shows the flow velocity field behind the screen. The cones represent the average vectoral velocity including 3 directions. The larger the cone, the higher the velocity at that location. The orientation of the cone gives information about the local direction of the velocity. The colours in the figure give information about the transverse velocities, indicated as the y-direction. Negative y-velocities are blue coloured and have their work line along the negative y-axis. Positive velocities are coloured red.

Comparing this flow field with the upstream flow field, hardly any differences can be seen. At the bottom some small velocity variations in transverse direction occur, but those seem to be induced by the dune structure on the bottom.

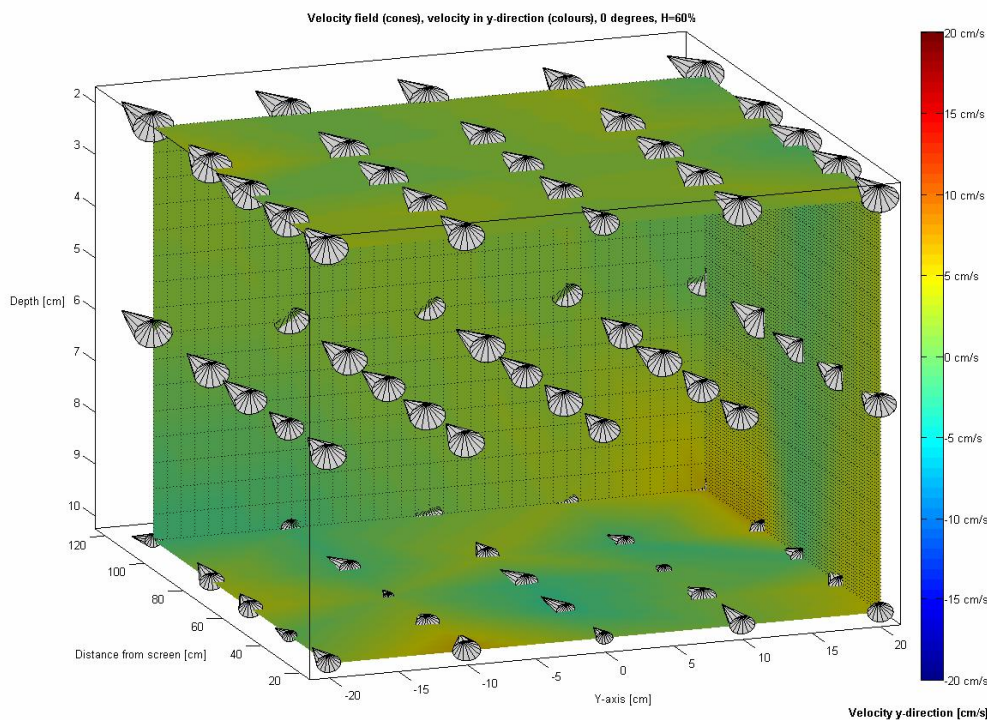

Figure 15 General flow pattern behind the screen, 0 degrees, H=60%

### Actual flume parameters

The new equilibrium requires new calculations about the actual flume parameters. This determined roughness, water depth and stream velocity. The results of calculations in this equilibrium stage can be found in Appendix G. An important parameter is the actual roughness, which is found to be  $C = 21 \text{ m}^{0.5} \text{ s}^{-1}$ .

New calculations have been made after introducing the dividing wall, presented in Appendix H. The wall proved to add extra resistance to the system. The Chézy value was found to be  $20 \text{ m}^{0.5} \text{ s}^{-1}$ . The discharge in the flume had to be lowered to 28.8 l/s in order to stay within the flume maximum water level limits.

### 5.3 Case 1, 15 degrees H=20%

#### Flow pattern

Case 1 corresponds with test number A.1.1 (15 degrees, H=20%). The test is selected for the lack of effect on the morphological development. Figure 16 shows the velocity vectors just behind the screen. As can be seen, the parallel flow attacking the screen, is hardly influenced by the screen. The vectors are found to be relatively parallel. The penetration depth of the screen is too small to influence a large enough part of the water column, therefore relatively low transverse velocities are observed. No proves of a growing vortex are found in this experimental set-up. If a small vortex existed in this set-up, it is expected to grow, but it lost its intensity before reaching the bottom.

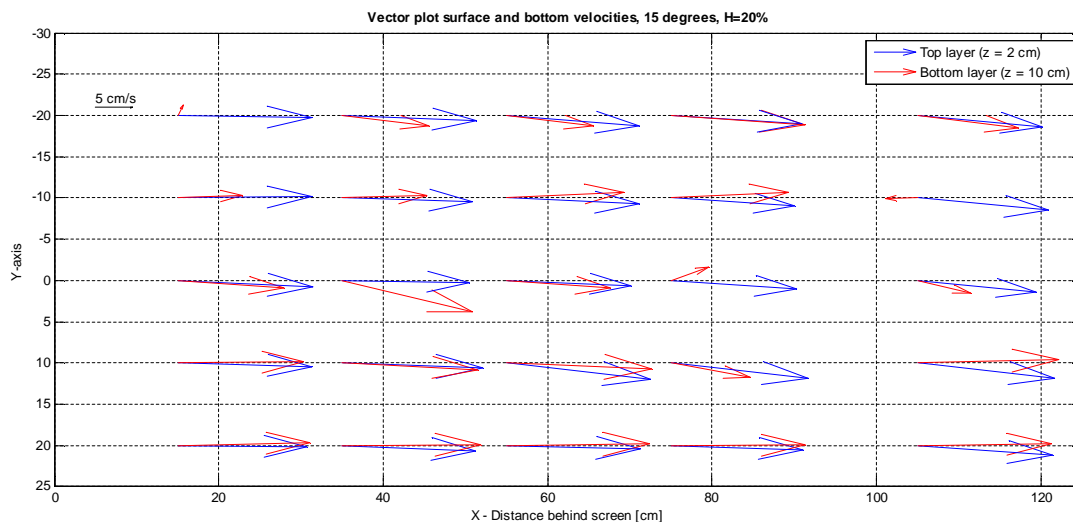

Figure 16 Top view velocity vectors behind the screen

### Morphological development

As stated, the water motion was hardly influenced by this screen set-up. The morphological development is initiated by the water motion, so no significant influence of the screen could be found. Figure 17 illustrates this statement. The different subplots show the cross-sectional bed profile at different x-locations behind the screen. The blue line in the figure at  $y=0$  cm indicates the water level, which is taken as the zero  $z$ -value. The black line is the bed level in the undisturbed reference measurement and the red line is the bed level after a test period of 8 hours. The bed level has changed during the test period, but in this case this is induced by the migrating bed forms. These dunes had an amplitude of around 25 mm. The changes visible in the figure are all around this margin. Even no effect on the bottom is seen directly behind the screen. The vortex which could have been developed by the screen (not measurable) has not enough strength to grow to the bottom. No significant transverse slope in bed level has been observed.

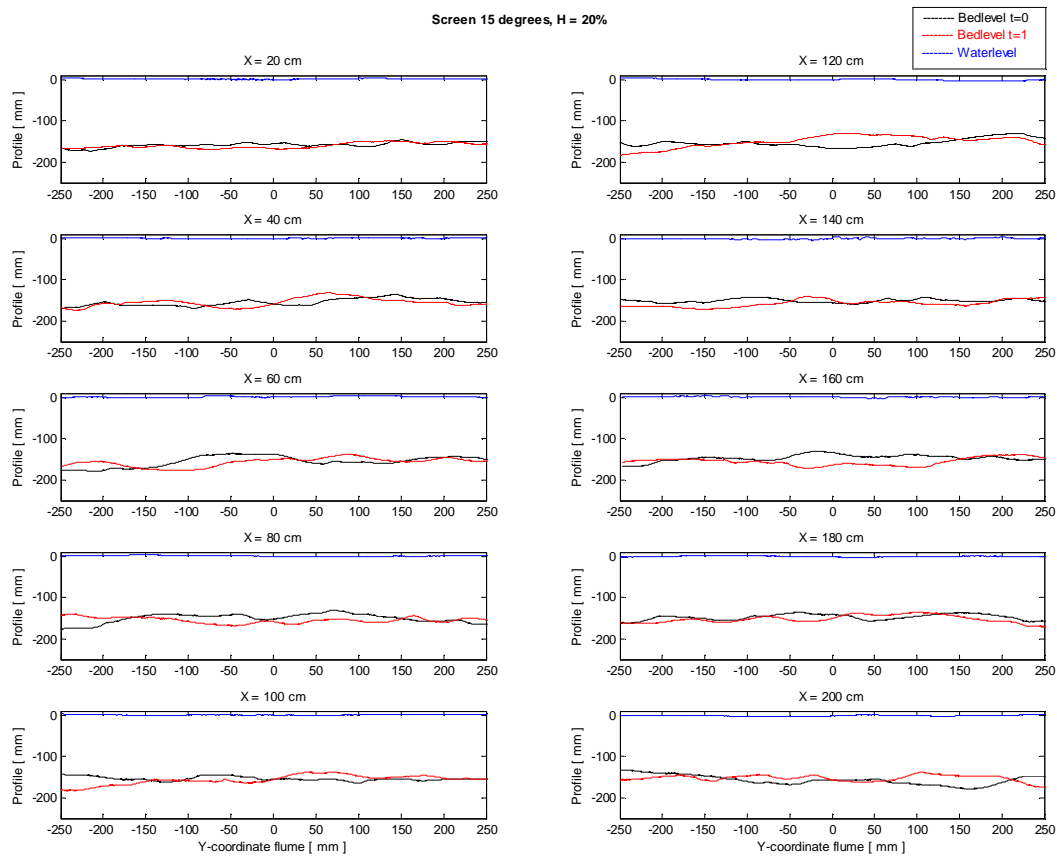

Figure 17 Morphological development under influence of the screen, 15 degrees, H=20%

## 5.4 Case 2, 25 degrees, H=60%

### Flow pattern

Test number A.3.3, angle of 25 degrees and penetration of 60%, has been selected as case 2. The reason for this choice is a large effect in bed level without a wall applied. Figure 18 shows the general flow pattern. Large transverse velocities are introduced by the screen. The dark blue area around the first vector at location  $y=0$ ,  $z=2$  indicates a transverse velocity of -15 cm/s. On location  $z=10$  cm, near the bottom of the flume, a transverse velocity of +12 cm/s was observed. The difference in direction of the vectors clearly indicates a spiral flow, growing larger in the positive x-direction. As the vortex grows, it loses intensity. This can be seen in Figure 19. Especially in the area of  $x=15$  till  $x=75$  cm the spiral motion dominates the flow pattern. Seeing the transverse velocities along  $y=0$ , the vectors in the  $y=-10$  stretch are expected to have a more transverse component. This could indicate the influence of the wall of the flume, which acts as a deflection wall.

When analyzing the  $y=10$  cm region, the influence of the spiral motion can still be observed close to the bottom of the flume. This indicates the spiral motion to grow through the axis of the screen.



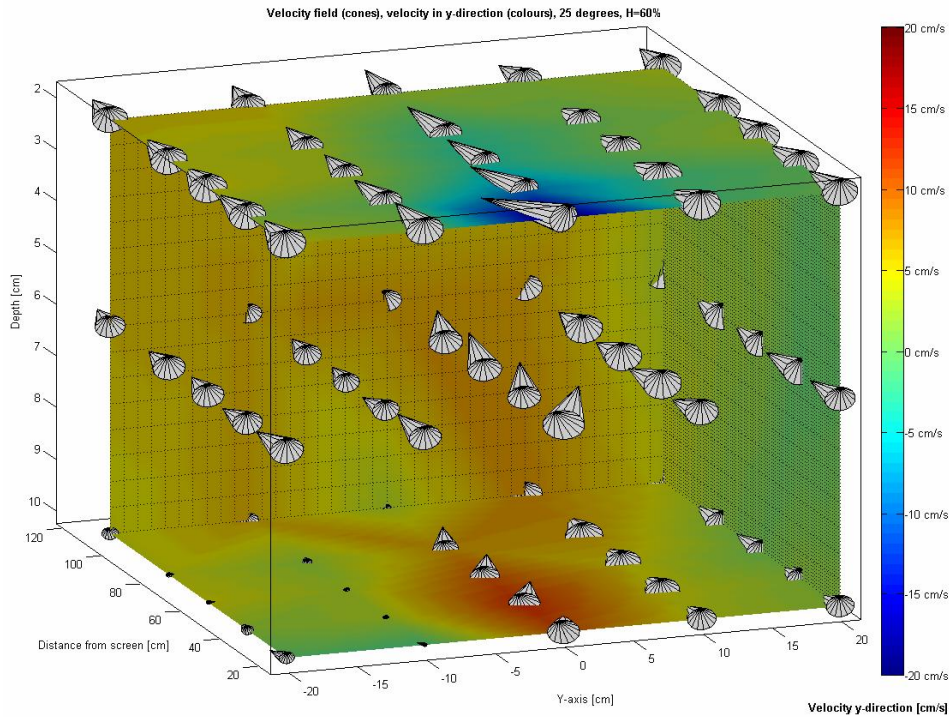

Figure 18 General flow pattern behind the screen, 25 degrees, H=60%

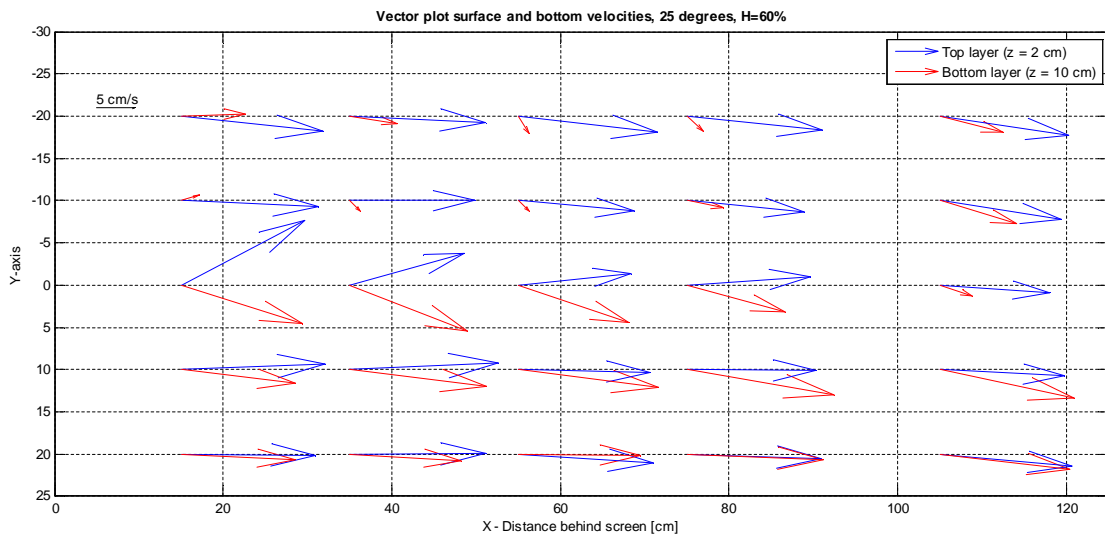

Figure 19 Top view velocity vectors behind the screen, case 2

**Morphological development**

A morphological influence is expected as the influence of the screen on the flow pattern is large. The black line in Figure 20 shows a clear difference with the red line, which respectively indicates the bed level at  $t_0$  and  $t_1$ . The trend in all graphs of the figure is a tilt around the x-axis of the flume, thus a transverse gradient in bed level. A deepening of 8 cm is found in the bed level on the attacked side, as well as a rise of around 3 cm at the unattacked side of the flume. The erosion component is larger than the accumulation. The location in x-direction where the screen still has influence is denoted as the effective length. In this case the effective length extends 160 cm behind the screen. After 80-100 cm

behind the screen, the effect on the bed level decreases. This can be explained by longitudinal damping of transverse velocities.

These transverse velocities redistribute sediment. The upper water layer, which is directed along the orientation of the screen, contains a relatively small amount of sediment. In order to guarantee flow continuity, the water near the bed obtains a transverse velocity in opposite direction. Because the water near the bottom contains the bed transport, large changes in sediment distribution occur. Under influence of this uneven distribution, the local transport capacity does not match the actual transport. This fact gives rise to local morphological changes. In downstream direction the transverse velocities are damped, therefore having less capacity to generate changes in bed level. This explains the smaller morphological response further downstream of the screen.

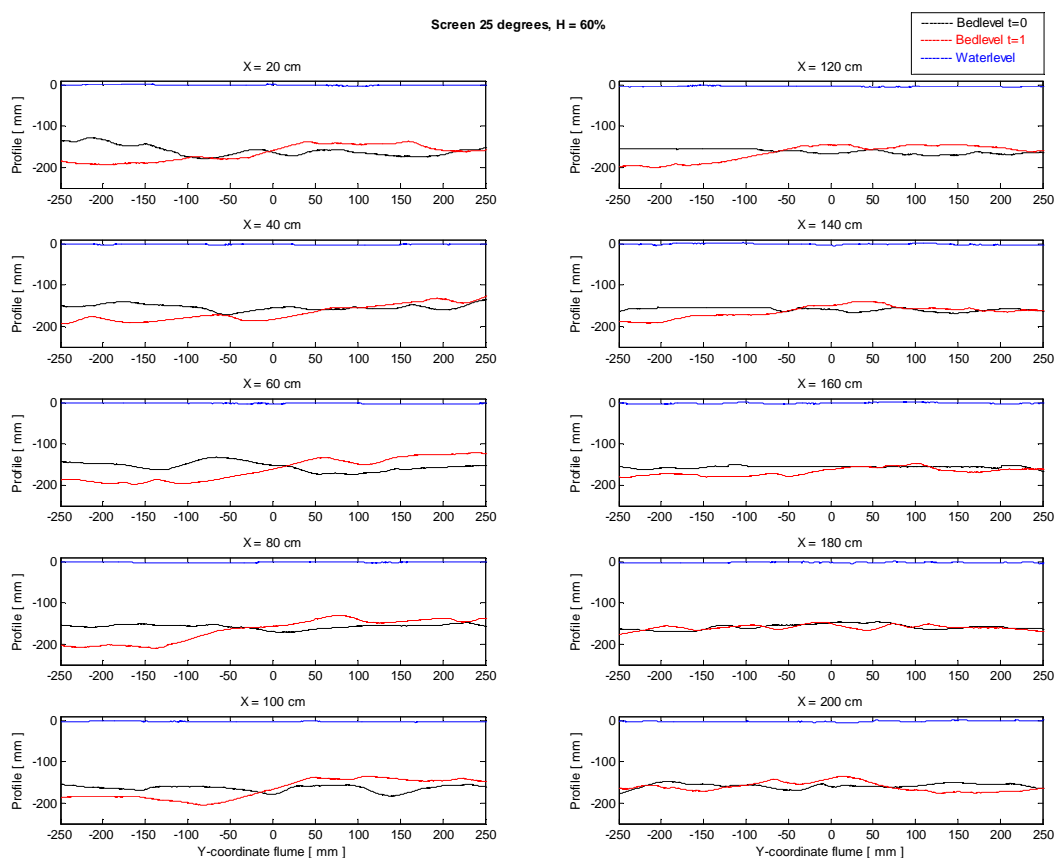

Figure 20 Morphological development under influence of the screen, 25 degrees, H=60%

### 5.5 Case 3, 25 degrees, H=60%, wall

#### Flow pattern

Test number B.2.2, angle 25 degrees, penetration 60% and a division wall has been used as case number 3, as a clear difference is found in comparison with case 2. The flow pattern, Figure 21 and Figure 22, shows almost the same situation as in case 2. Large transverse velocities can be found on the surface as well as on the bottom. The interesting difference between case 2 and case 3 is the distribution of water in both channels. The attacked channel is having a larger discharge, already after a short time. The flow velocity figure only partly gives support to this statement, as only 3 depths were measured. Figure 23 shows a large difference in conveyance area between the branches. As the measured flow velocities are in



the same order of magnitude, the discharge is unevenly distributed. This can be explained by a change in bifurcation relationship induced by the screen.

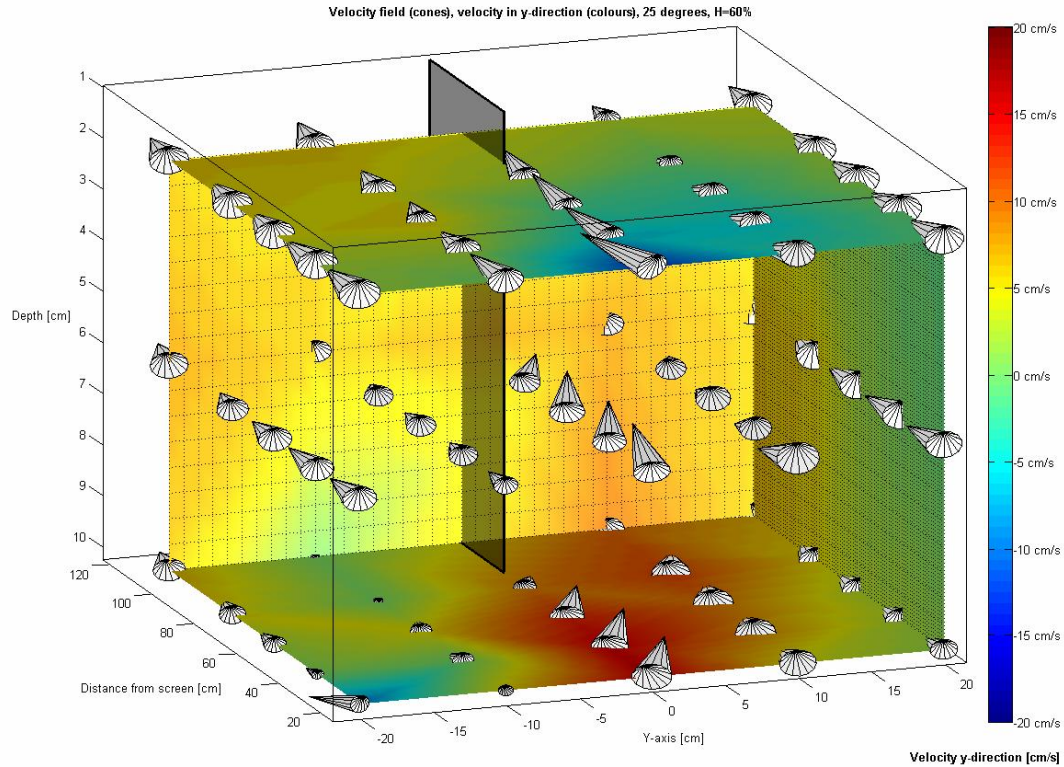

Figure 21 General flow pattern behind the screen, 25 degrees, H=60%, division wall

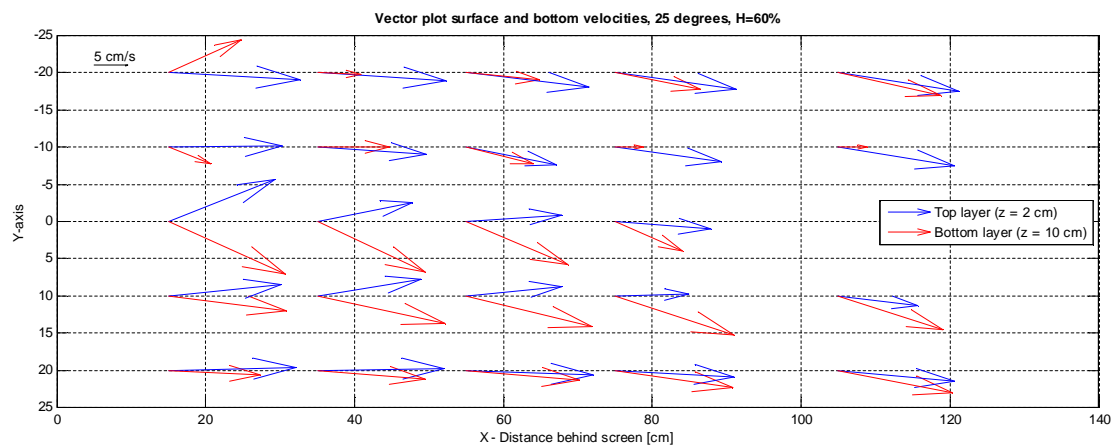

Figure 22 Top view velocity vectors behind the screen, case 3

### Morphological development

Figure 23 shows the bed level after a test run of 8 hours. A clear difference in bed level can be observed behind the screen. The viewpoint of the picture is approximately at 60 cm upstream of the screen, which was made semi-transparent in order to give a clearer view. The angle of the screen to the attacking flow was 25 degrees and the penetration depth 60%. The initial direction of the scour hole is aligned with the orientation of the screen. As can be seen, the maximum effect on the bed level change is not directly behind the screen, but at a

distance. The growing vortex is expected to reach the bottom in the area with the maximum amount of erosion.

Interesting to see is the change of bottom topography between the screen and the dividing wall. Compared to case 2, a larger morphological response is found. This area seems not to be influenced by the screen only, but also by the presence of the wall. This could be a result of a change in nodal point relation, but also a result of a morphological feedback under a constant nodal point relation. The presented nodal point relation in Chapter 2.6 only contains Q and B. The width of the channel can not change, as the walls are fixed boundaries. A change in Q in the simplified 1D relation would not explain the development. The changes in bottom topography just behind the screen, could for example be induced by a transverse slope in the water level. This can be induced by an initial change in discharge, which causes the slope and roughness inside the channels to change. The backwater effect can introduce the slope in the water level. This can not fully be proven by the results of this study, because the water levels were not measured with enough accuracy.

The morphological changes inside both channels can especially be seen in the first 40 cm behind the bifurcation point. The attacked channel is deepened by approximately 6-7 cm. The bed of the unattacked channel is raised by approximately 4 cm. The morphological development plot in Appendix F.6 illustrates these statements. The wall acts as a geometrical boundary condition, thereby maintaining the discharge and velocity differences between the channels. As the whole bifurcation relation changes, a risk of closure of one of the branches exist, this is treated in more detail in case 4.

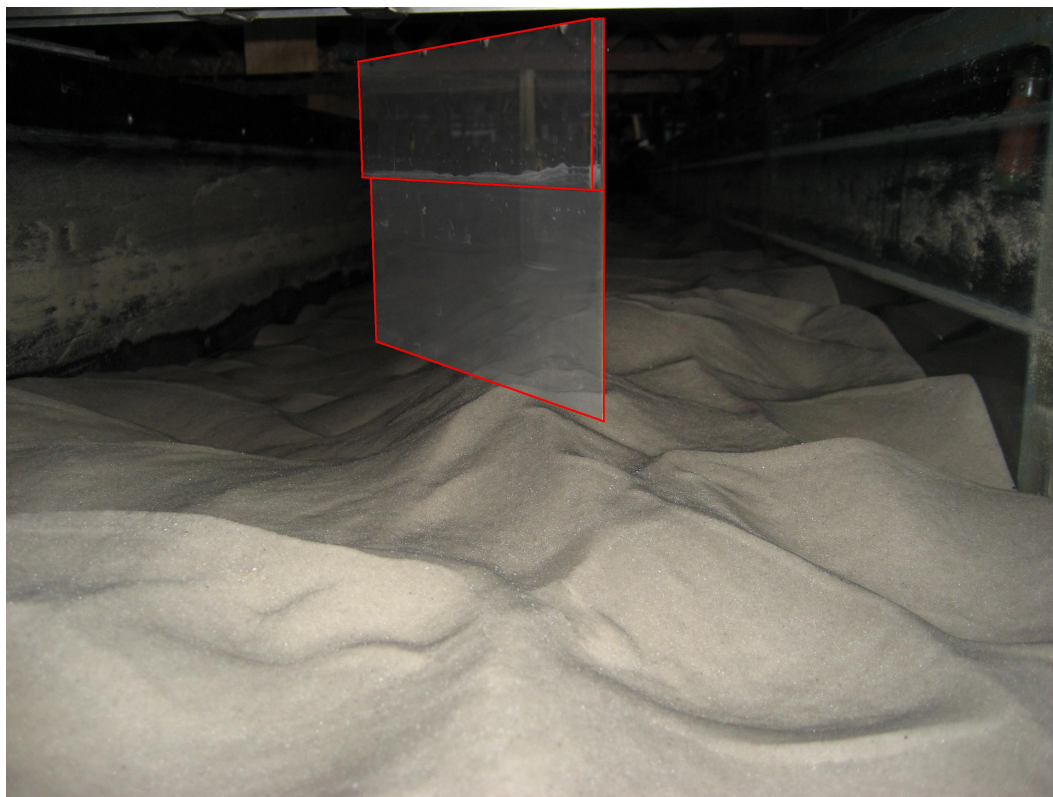

*Figure 23 Morphological development under influence of the screen, 25 degrees,  $H=60\%$ , wall. Viewpoint 60 cm upstream from the screen (semi-transparent), looking in downstream direction*

### 5.6 Case 4, 25 degrees, H=60%, wall, long run

After the initial run, the choice was made to execute one screen set-up per day. This means the resulting influence on the bed was measured after approximately 8 hours. In order to check whether this duration is sufficient to understand the ongoing processes, a test with a longer duration has been executed. Next to the fact that this test determines the timescale, it is valuable to see what the long term effect of the screen is. The chosen set-up is an angle of 25 degrees and a penetration of 60%, as this layout proved to have the largest morphological effect. Duration chosen is 3 days, 72 hours. The resulting bed levels are presented in Figure 24.

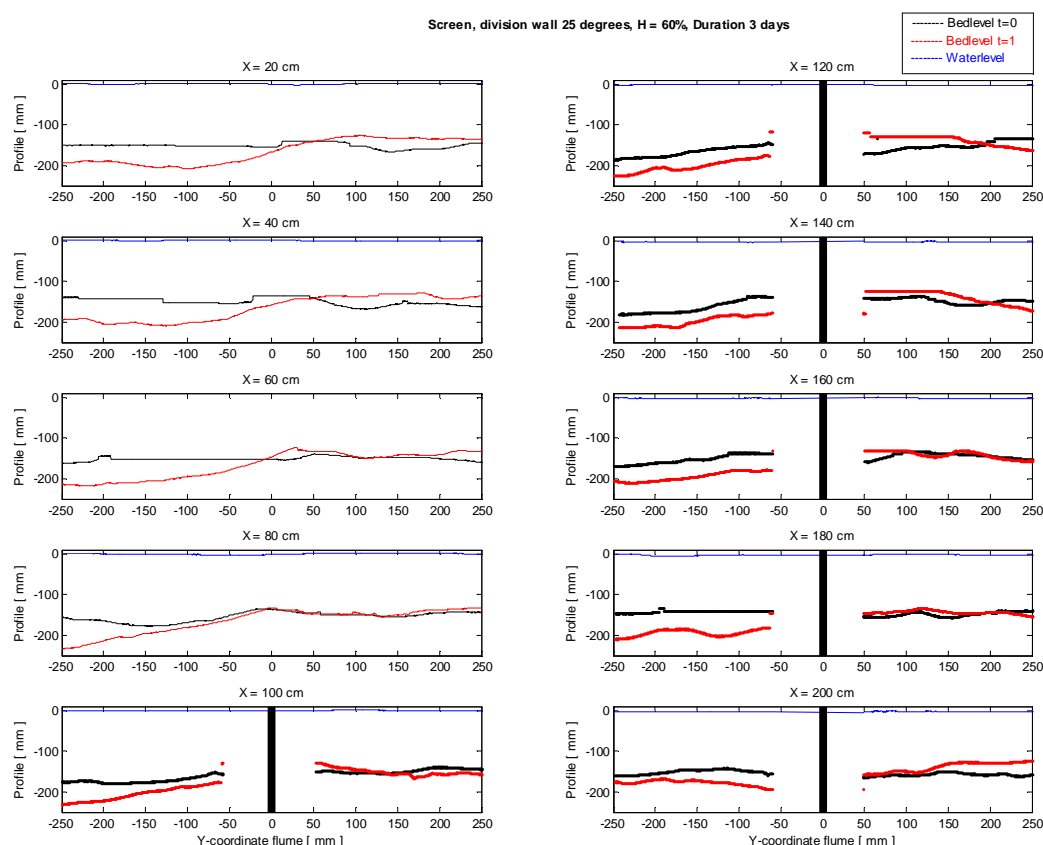

Figure 24 Morphological development under influence of the screen, 25 degrees, H=60%, duration of 72 hours

The figure shows large similarity with the resulting bed levels of the 8 hour run, presented in case 3. The effect of a longer run on the bed level is relatively small, this indicates the equilibrium was almost reached within the 8 hour test.

The second purpose of this run is determining the long term effect of the screen on the bifurcation layout. The risk of interfering with the delicate relationship is closure of one of the branches. No complete closure of one of the branches occurred within the test period. As the equilibrium was reached, no closure is expected with this bifurcation layout. General conclusions can only be made after tests on more parameters. For example the offtake angle is not included, as the orientation of the branches was fixed.

## 5.7 General conclusions

With the aid of the above described cases, general conclusions can be drawn on the morphological effect of the screen. A distinction has been made between the A-series without wall and the B-series. The morphological development shows a clear difference between those two geometrical set-ups.

### Local scour

In previous experiments and applications of bottom screens local scour around the structure proved to be a potential hazard to its stability. These local scour holes are undesirable, as deep erosion pits can be formed. During the experiments the sand bed underneath the surface screen has been checked on the presence of a local scour hole. Development of a scour hole occurred only in one of the 15 tests. As no detailed measurement could be taken underneath the screen, the dimensions have been estimated. The depth was around 4 cm, the length 20 cm and the width about 6 cm. The scour hole existed approximately 1 hour and was filled thereafter.

### Without dividing wall

The A-series contained a total of 9 set-ups which were intensively measured. In the A-series the dividing wall was not yet constructed. Table 6 shows the results of the bed level change and the length in which the screen has a morphological influence. The latter is denoted as  $L_{eff}$ . Understanding the influence of the different parameters, the interpretation of trends is important. The table is used to search for trends when varying the angle of attack and penetration depth. A remark on this table is the missing measurement of an angle of 15 degrees with a penetration depth of 40%. No reference measurement of the bottom was made, so no useful conclusion can be drawn about the development of the bed level.

Angle	Effect	Unit	Penetration depth		
			20%	40%	60%
15°	$\Delta z_{b,40cm}$	[cm]	0	No measurement	0
	$\Delta z_{b,60cm}$	[cm]	0		1
	$\Delta z_{b,80cm}$	[cm]	0		4
	$L_{eff}$	[cm]	0		100
	$L_{eff}$ – screen lengths	[-]	0		5
20°					
	$\Delta z_{b,40cm}$	[cm]	3	3	3
	$\Delta z_{b,60cm}$	[cm]	2	2	3
	$\Delta z_{b,80cm}$	[cm]	1	3	3
	$L_{eff}$	[cm]	120	140	180
$L_{eff}$ – screen lengths	[-]	6	7	9	
25°					
	$\Delta z_{b,40cm}$	[cm]	2	6	7
	$\Delta z_{b,60cm}$	[cm]	2	8	7
	$\Delta z_{b,80cm}$	[cm]	1	8	8
	$L_{eff}$	[cm]	100	180	160
$L_{eff}$ – screen lengths	[-]	5	9	9	

Table 6 Morphological influence of different screen layouts, no division wall

The influence of a fixed penetration depth with a varying angle of attack can be observed when one column of the table is considered. This trend is called the vertical trend of the tests.

- No significant increase in effect on the bottom is seen when applying a fixed low penetration of 20% and increasing angle;

- When applying 60% penetration depth,  $\Delta z_b$  significantly increases with the angle of attack;
- With penetration depths of 40% and 60% the effective length increases with an increasing angle of attack.

The horizontal trend is defined as a fixed angle with a varying penetration depth.

- A fixed small angle and an increasing penetration depth only gives rise to a small increase in  $\Delta z_b$ ;
- The effective length increases with an increasing penetration depth;
- The penetration depth gets more influence when applying larger angles of attack.

The diagonal trend is defined as simultaneously varying the angle of attack and the penetration depth.

- Large effect on  $\Delta z_b$  as well as on  $L_{eff}$  if the angle and the penetration depth simultaneously become larger;
- Small effect when applying a large angle with a small penetration, going to a smaller angle and a larger penetration.

Overall trend

- The effective length is slightly more determined by the angle of attack than by the penetration depth, although more information is useful to support this statement.

In Figure 25 the effect of the different screen layouts on the bed level change has been plotted. The figure presents the effect with 20% penetration. As can be seen, small penetrations hardly have any effect on the bottom. This supports the statement made about the small vortex intensity in case 1. The visible changes are mainly caused by the migrating sand dunes. This can be supported by the amplitude of the dunes, which was observed to be around 25 mm.

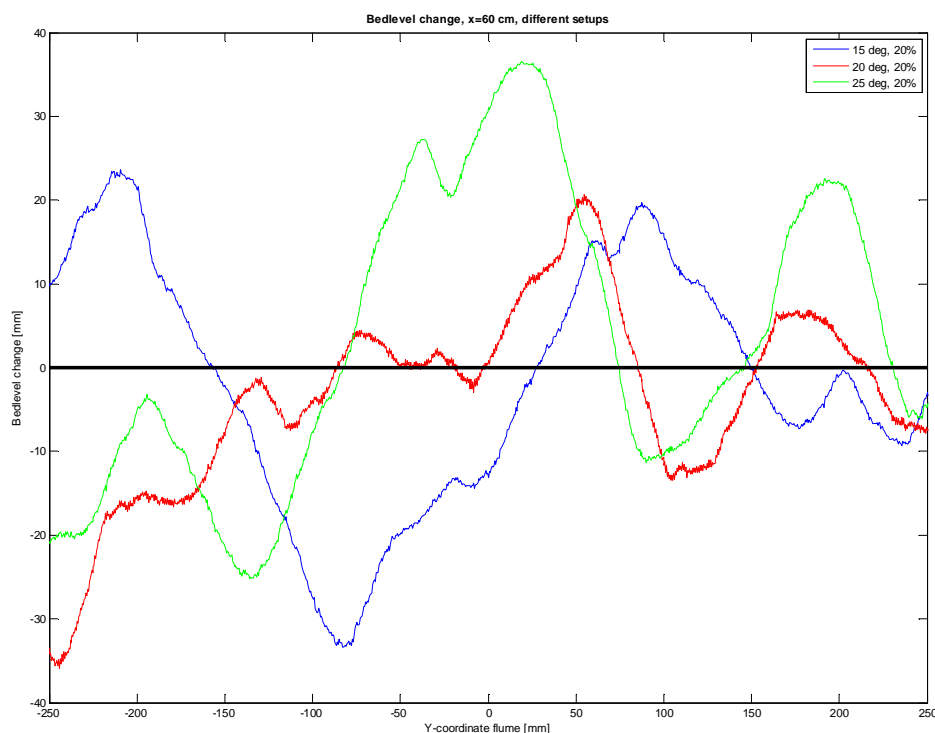

Figure 25 Hardly any effect in bed level change 60 cm behind the screen,  $H=20\%$

The trend of the screen influence on the bed can be seen more clearly when presenting the larger penetration depths, see Figure 26. For larger angles and larger penetrations, an increase in bed level change can be concluded. A larger part of the water column is directed by the screen, inducing a stronger spiral motion. This gives rise to larger transverse velocities, thereby generating a transverse slope of the bed around the axis of the screen. The erosion on the attacked side of the flume is showing a larger change in depth than the sedimentation on the other side. The screen thus induces a nett erosion.

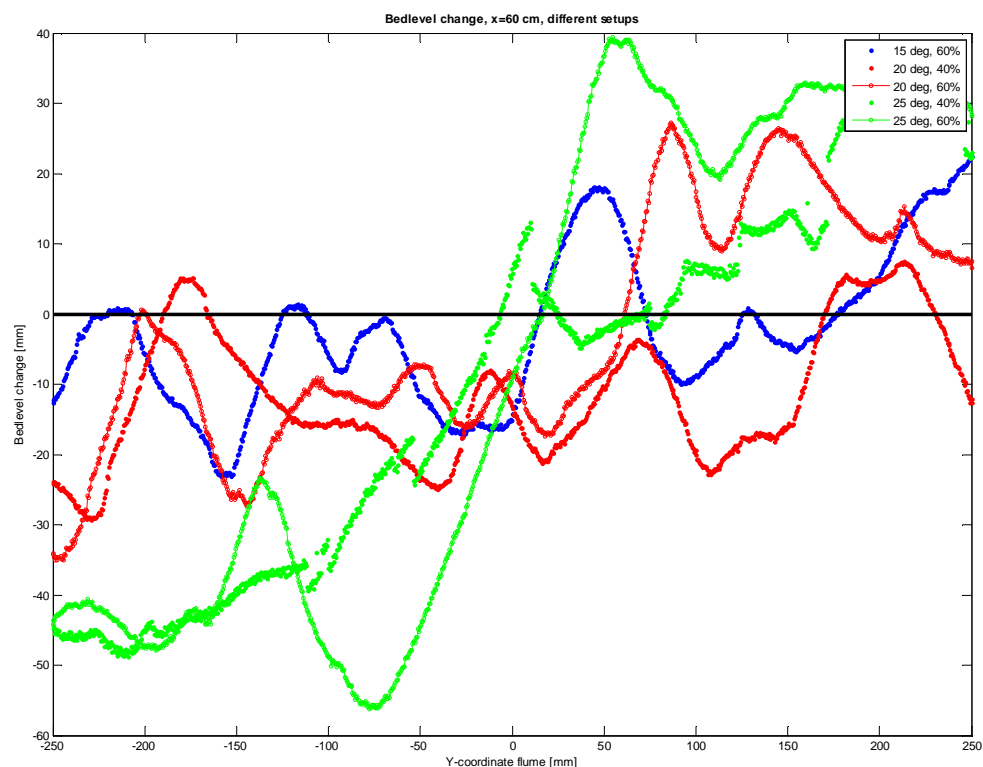

Figure 26 Bed level change 60 cm behind the screen,  $H=40\%$ ,  $H=60\%$ , trend for development of transverse slope

Figure 27 shows the morphological development of the bed level at a distance of 160 cm behind the screen. Although the resulting bed level is not as clear as closer to the screen, the trend in bed level can still be observed. The trend shows a transverse bed slope, with a deepening at the attacked side of the flume. The eroding effect of the screen is larger than the sedimentation effect. In general a larger angle and penetration depth give more morphological response. This supports the earlier statement when describing the overall trends of the A-series.

Further downstream from the screen, the morphological changes become smaller. This can be explained by the development of the spiral motion. The vortex grows in downstream direction, thereby loosing intensity. The lower velocities resulting from this process are not able to generate changes in the local bed level. Next to the fact of having lower flow velocities, the smaller morphological response can be explained by the local transport capacity. Within the area of morphological adaptations, the transport capacity is fulfilled. After several screen lengths, a new equilibrium is reached between the transport capacity and the actual transport.



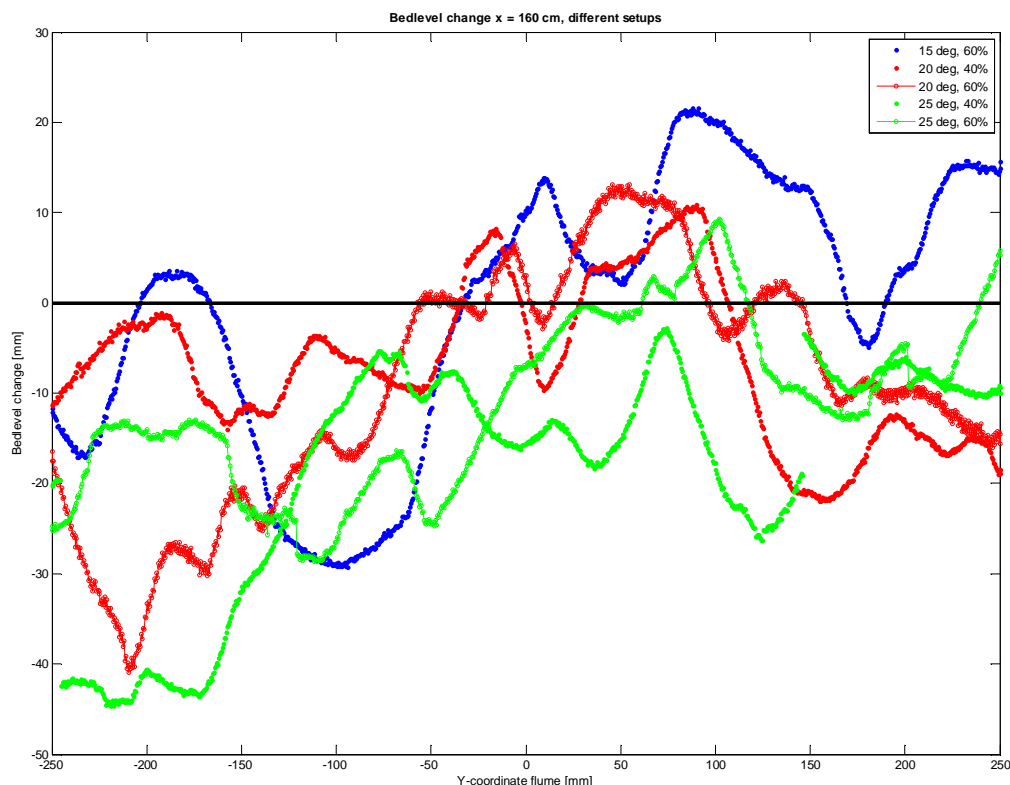

Figure 27 Bed level change 160 behind the screen, H=40%, H=60%

### With dividing wall

A total of 6 runs have been executed in the B-series. A few set-ups from the A-series have not been repeated. As can be concluded from the A-series, the small penetration of 20% did not have a large effect on morphological development. Before the test it was expected that adding a dividing wall would not significantly increase the influence of this small penetration. Therefore these tests are not executed. As fewer tests are done on the set-up with a dividing wall a reliable trend is more difficult to find. General conclusions can be drawn, and they are presented in this section.

Angle	Effect	Unit	Penetration depth	
			40%	60%
15°	$\Delta z_{b,40cm}$	[cm]	4	3
	$\Delta z_{b,60cm}$	[cm]	4	4
	$\Delta z_{b,80cm}$	[cm]	6	5
	$L_{eff}$	[cm]	200	200
	$L_{eff} - \text{screen lengths}$	[-]	10	10
20°	$\Delta z_{b,40cm}$	[cm]	4	2
	$\Delta z_{b,60cm}$	[cm]	5	4
	$\Delta z_{b,80cm}$	[cm]	4	4
	$L_{eff}$	[cm]	200	200
	$L_{eff} - \text{screen lengths}$	[-]	10	10
25°	$\Delta z_{b,40cm}$	[cm]	5	8
	$\Delta z_{b,60cm}$	[cm]	5	7
	$\Delta z_{b,80cm}$	[cm]	4	5
	$L_{eff}$	[cm]	200	200
	$L_{eff} - \text{screen lengths}$	[-]	10	10

Table 7 Morphological influence of different screen layouts, with division wall

The overall trend of the A-series can be recognized in Table 7. Larger angles and larger penetration depths give rise to a larger morphological response of the bed. A remarkable conclusion of the B-series is the effective length. Under influence of the dividing wall the length increases significantly. This will be explained in more detail.

Figure 28 shows the bottom level change after 8 hours of screen influence at a distance of 60 cm behind the screen. It should be noted that this location was in front of the bifurcation point, which was located at a distance of  $L_{s,w}=100$  cm behind the screen. With the used penetration depths, a clear conclusion can be drawn about the effect of the screen. Under influence of the flow pattern the bed tilts around the axis of the flume, in which the screen was located. The effect on the bottom level change is larger than without the dividing wall.

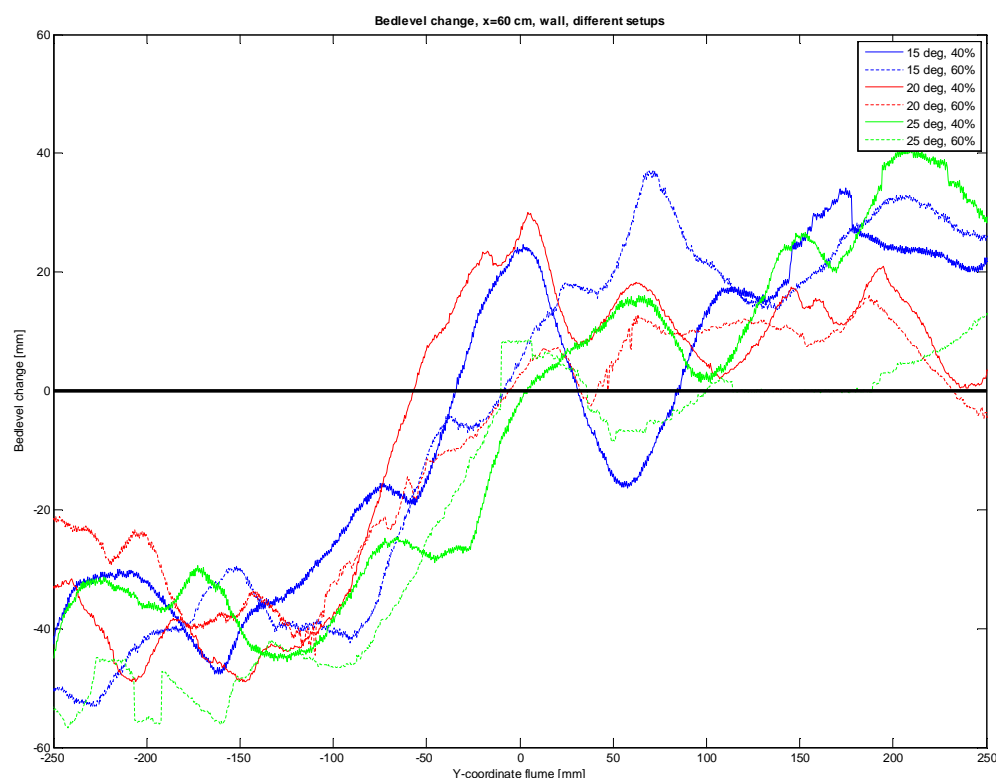

Figure 28 Bed level change 60 cm behind screen, with dividing wall

The morphological response of the screen seems to amplify when the wall is added to the flume. For all angles and penetration depths the resulting bed level change has a larger value than in the A-series. The wall was unexpected to have such a large influence 40 cm upstream of the bifurcation point. The measured velocities on both sides of the wall are approximately the same.

The morphological effect inside the channels could be explained by the discharge distribution and corresponding water levels in the branches. From the most effective set-up in the B-series (25 degrees,  $H=60\%$ ) the discharge distribution have been studied in detail. The measured velocities in both branches are in the same order of magnitude: 0.35-0.40 m/s. Because the attacked channel is deeper, a rough estimation about the discharge distribution can be made. Approximately 60% (18 l/s) is discharged by the deepened channel. The unattacked channel conveys approximately 40% of the total discharge. When having a closer look at the bed level just downstream of the bifurcation, a large difference can be found



between the branches. The attacked branch is deepened and the unattacked channel is accumulating sediment. This causes the conveyance area and resistance to change, which has an effect on the water level. As the water flows in sub-critical condition, disturbances downstream have the ability to travel upstream. The change in water level inside the channels can be seen as a local disturbance. This causes a backwater effect, this could explain the larger morphological response in the B-series just downstream the surface screen. This can not be fully proved as the water levels were not measured in such a dense manner.

Next to a redistribution of discharge a spiral motion can be found in the velocity measurements. The effect of this motion is strongest at a small distance behind the screen. As the generated vortex grows in height and width, its intensity decreases. This explains the other part of the sedimentation at the location of  $y=50$  till  $y=250$  mm.

In Figure 29 the bed level change is plotted at a distance of 160 cm behind the screen. This is 60 cm behind the bifurcation point. As can be seen in the area of  $y=-250$  till  $y=-50$  mm, the change in bed level is becoming less with the distance to the screen. The large bed level change in the area of  $y=50$  till  $y=250$  mm can partly be explained by the discharge distribution between the branches. An initial change in discharge distribution is induced by the screen. The water is guided along the surface screen, thereby generating a local asymmetry in discharge. One side of the channel encounters a higher flow velocity. In the area of influence at this side, the larger transport capacity is fulfilled by local erosion, thereby deepening the bed. In the unattacked channel a lower flow velocity induces a lower transport capacity. The available sediment settles, thereby causing local sedimentation.

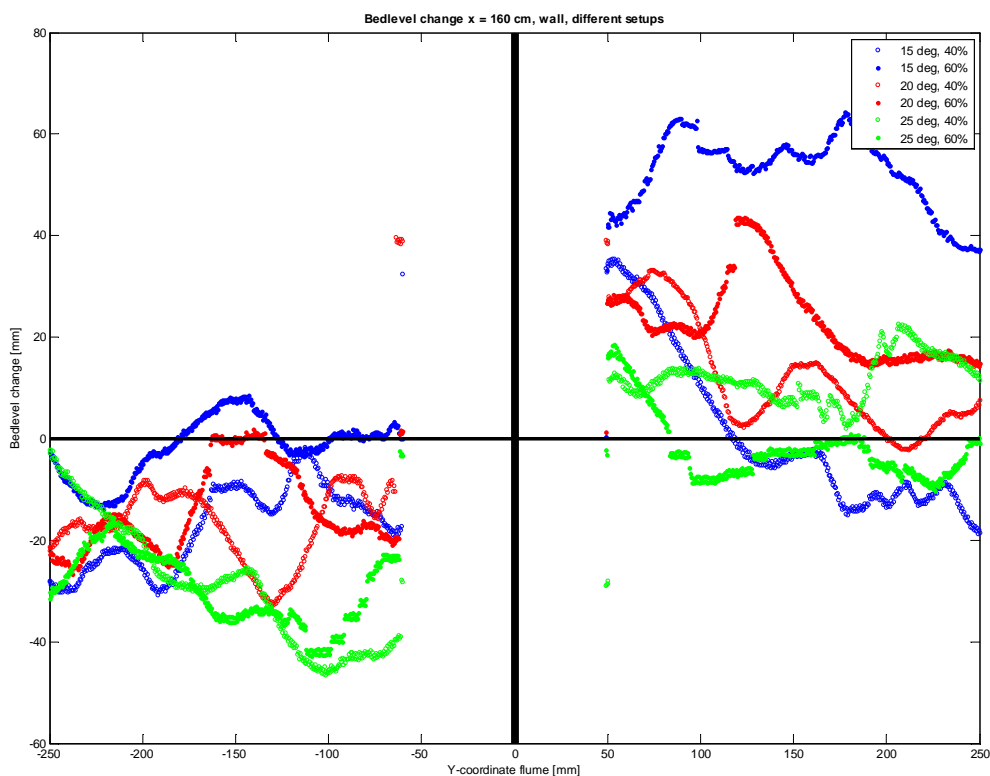

Figure 29 Bed level change 160 cm behind screen, with dividing wall

### Effect of asymmetry in discharge distribution

The results of the dividing wall can partly be explained by a difference in discharge between the channels. It is interesting to know whether this asymmetry in discharge causes a larger total transport capacity. Therefore an analysis has been made the total transport capacity with symmetrical discharge, denoted as  $Q_{s,symm}$ , compared with the capacity with asymmetrical discharge,  $Q_{s,asymm}$ .

$$\frac{Q_{s,asymm}}{Q_{s,symm}} = \frac{\left(\frac{1}{2}Q + \Delta Q\right)^{\frac{b}{3}} + \left(\frac{1}{2}Q - \Delta Q\right)^{\frac{b}{3}}}{\left(\frac{1}{2}Q\right)^{\frac{b}{3}} + \left(\frac{1}{2}Q\right)^{\frac{b}{3}}}$$

Assume  $b = 6$

$$\begin{aligned} \frac{Q_{s,asymm}}{Q_{s,symm}} &= \frac{\frac{1}{4}Q^2 + Q\Delta Q + \Delta Q^2 + \frac{1}{4}Q^2 - Q\Delta Q + \Delta Q^2}{\frac{1}{4}Q^2 + \frac{1}{4}Q^2} \\ &= 1 + \frac{2\Delta Q^2}{\frac{1}{2}Q^2} \\ &= 1 + 4\frac{\Delta Q^2}{Q^2} > 1 \end{aligned}$$

From these equations it can be concluded that the asymmetry in the discharge in the flume enlarges the total transport capacity. In practice this means that the nett effect of the screen is erosion. This explains the results from both test series, in which an uneven tilt of the transverse bed level was observed. The erosion side was in almost all cases deeper than the sedimentation side, so nett erosion was found. Therefore the screen does not only influence the profile in cross direction, but also influences the profile in longitudinal direction. This supports the statement of a larger effect of a screen in front of a bifurcation. This might also support the statement that several screens behind each other amplify the morphological effect. More research is required to support this latter statement.

## 6.0 DISCUSSION

### 6.1 Experiments

A reconsideration of an earlier statement is required after having executed the test with the wall applied. The result of the A-series stated a small penetration to have a small, or even no, effect on the bottom development. After analyzing the results of the B-series, it can be concluded that the wall amplifies the effect of the screen. The effect of 20% penetration could have been larger than expected. Therefore it might have been a valuable set-up for this set of experiments.

Setting up a physical model requires considerations about the layout of the test facility. The experiments should create insight in the processes involved. Therefore a schematization of reality cannot be avoided. The challenge is to have valuable test series which can still be analyzed, without losing the practical relevance.

Both test series are measured in the 60 cm wide flume. The small width to depth ratio has influence on the morphological changes behind the screen. The fixed walls of the flume acted as a reflection wall, thereby influencing the stream pattern. The morphological development could be amplified by the walls, as the introduced transverse velocities are concentrated in a bounded area. A wider flume would have caused smaller influence on the downstream flow pattern. This is a better representation of a river system, in which the width to depth ratio commonly has a larger value.

The walls of the flume were fixed. In river engineering practice, the banks of a secondary channel are not fixed. In fact, the banks have the possibility to adapt to the new conditions. The effect of the screens on bank development can not be determined from the results of this research. As secondary channels are mostly located in an area with room for natural development some changes in topography might be allowed. The changes of the bank lines have to be monitored carefully in order to prevent undesired development.

### 6.2 Practical use of surface screens

With the knowledge of the physical experiments in mind, this section gives a view on the practical use of surface screens. The description is qualitative, as a pilot project in real river practice should verify the results found with this set of physical experiments. A possible application of a surface screen is influencing morphological development in a secondary channel with an excessive amount of sedimentation or erosion.

Applying surface screens requires considerations about the structure itself. Although the actual design of a surface screen was not within the scope of this study, some suggestions can be made. The screen could, for example, be mounted between two floating barges. The penetration depth can be varied with a vertical movement of the screen along the side of the barge. The complete structure can be prepared in a harbour. When the water level satisfies the design requirements, the floating structure can be towed to the desired location using tugs. The angle of attack can be determined by the orientation of the barges, which are fixed by anchors. Anchoring the barges requires considerations about the available room at the location. In case of not having enough room, another strategy can be investigated. Secondly a structure as applied in the Southern part of Asia can be used. The surface screens used partly penetrate the water column, as in this research. Instead of using barges and anchors, small poles are used to support the structure. The applied bandals, as the structures are called, are mainly longer than the screen set ups in this research. The use of surface screens mounted on slender, wooden piles could be an option if anchoring is not possible.

The disadvantage of this structure is interfering with the bed, those slender piles have to be driven into the bed. The construction takes effort and the flexibility is lost, as the angle of attack can not be changed without completely rebuilding the structure.

The angle of attack and the penetration depth depend on the desired erosion depth. As 25 degrees and 60% gives the largest morphological response, this set-up seems an obvious choice. The actual parameters of the screen depend on many more factors, i.e. the structural design, the anchoring forces and other practical issues.

The downstream morphological development could have an effect on the upstream flow direction. The angle of attack is one of the most important parameters for the effectiveness of a surface screen. Therefore the interaction between morphological development and upstream flow directions should be monitored carefully.

### **In channels**

In a river which is intensively used for navigation, the surface screen can be applied inside the secondary channel itself. This can be compared with the A-series of this thesis. Placing the screen in this set-up prevents hinder to navigation or undesired erosion or sedimentation in the main channel. Dutch rivers are intensively used for navigation. Therefore this option seems to suit the Dutch system.



*Figure 30 Example of the use of a floating surface screen (taken from Mosselman)*

When placing the screen in the channel, the effect will be a transverse bed slope, as can be seen in all tests of this thesis. The screen should be rotated in order to get the desired deepening at all locations of the channel. The discharge asymmetry introduced by the screen gives rise to a higher transport capacity. Therefore the nett effect over the channel width is erosion. In practice the screen can be placed just behind the entrance of the channel. The same structure can be replaced to the end of the effective length to erode the channel further downstream. This sequence should be repeated to erode the full length of the channel. Another option is applying a field of successive surface screens, which could amplify the morphological response.

During the execution of the intervention, the location of the banks should be monitored. The walls of the flume acted as fixed boundaries in the experimental research. No information about the development of banks was collected.

### **Bifurcations**

When enough room is available, the screen could be applied just in front of the bifurcation point. This can be compared with the B-series of this thesis. As concluded in section 5.7 the effect of the screen is larger when placed in front of a bifurcation. From effectiveness point of view, this variant is to be preferred. Although the morphological effect is larger, using the screen in this set-up comes with more uncertainties. The structure directly interferes with the bifurcation relationship, this introduces the risk of undesired channel development. This interference could simultaneously be a great advantage, as a large morphological response can be generated. Careful monitoring should prevent the channels from closure.

When placing the screen at the right angle of attack, the process of erosion starts at the attacked channel. Sedimentation occurs in the other channel, as can be seen in the results of the B-series. It should be noted that the unattacked channel accumulates sediment, therefore this channel becomes shallower. The set-up can only be applied when this sedimentation is allowed.

### **Bank protection**

Next to the use of surface screens by adapting the depth of a channel, a screen could influence the development of banks and shorelines. Bank erosion could be prevented by placing the surface screens as current deflection walls. This set up of the screens is mainly based on influencing the main flow direction. No research has been done in this study to this application of surface screens, but as the screens are flexible and have large morphological influence, more research might be valuable.

## 7.0 CONCLUSION AND RECOMMENDATIONS

### 7.1 Conclusion

This research involved physical experiments to understand the ongoing physical processes when using surface screens above a mobile bed. Different model set ups have been used, the angle of attack, the penetration depth and the geometrical set up of the flume were taken variable. Two main measurement series have been investigated within the boundaries of the available flume. The A-series were executed without the use of a dividing wall. This simulates the use of a surface screen inside a river branch. In the B-series a wall was added in the centre of the flume. With this set-up insight is created in influencing morphology around bifurcations.

In general, water at the surface is guided in the direction of the screen, thereby generating a transverse velocity in line with the orientation of the screen. To guarantee flow continuity, at the bottom the transverse water motion is in opposite direction. From the summation of these transverse velocities, a spiral motion can be concluded. The strength of this spiral motion is highly dominated by a combination of the angle of attack and the penetration depth. The angle of attack has been varied between 15 and 25 degrees. The 20% penetration set-up did not give significant results in the flow pattern. Hardly any transverse velocities have been observed. From the 40% and 60% penetration it can be concluded that larger penetration depths give rise to a larger spiral motion with a higher intensity.

General conclusions about the morphological development under influence of the screen can be made. The total morphological effect on the bottom seems to consist of two parts: Transverse velocities (spiral motion) and redistribution of sediment and larger velocity in x-direction in the attacked side and lower at the non-attacked side.

The angle of attack is an important parameter for the effectiveness of the surface screen. Larger angles give rise to a larger morphological response, as the spiral motion is stronger. The influence of the spiral motion causes the bed level to have a transverse slope. This can be explained by the redistribution of sediment. The relatively clean surface water, which contains small amount of the (suspended) transport, is orientated in the direction of the screen. This redistribution of sediment transport cares for locations where the actual transport is unequal to the transport capacity. Sediment is eroded or deposited in order to fulfil the transport capacity. These processes cause the mobile bed to develop under influence of the screen. The angle of attack also determines the initial direction of the erosion behind the screen. The first part of the scour hole is aligned with the angle of the screen.

The penetration depth is the second parameter with a large influence on the spiral motion and thus the morphological development. The small penetration of 20% in the A-series of the test had no effect on the bottom. The spiral motion is not expected to reach the bottom, therefore not influencing the development. Larger penetrations gave rise to a larger morphological response.

A larger morphological effect is found when applying a dividing wall in the flume. This is not only based on the spiral motion and larger velocities, but also on the third part of the morphological effect: a change in bifurcation relationship. Under influence of the screen the initial discharge distribution changes. The velocities at the surface of both branches are almost the same, but the conveyance area changes significantly. The proportion of the distribution directly depends on the angle and penetration depth. Because the wall is a solid boundary, the discharge and velocity differences do not dissipate with the longitudinal distance. In the 1D nodal point relation the width of the channel is a variable but changes in width were not possible in the flume. The changed transport capacity has to be fulfilled with

local erosion or sedimentation. As this is not included in the simplified 1D relation, the conclusion is that the development of a bifurcation depends on more parameters. Interfering in the bifurcation relationship comes with the risk of destroying a delicate equilibrium. One of the branches could completely be closed off. This has been investigated in a test with a longer duration. In this run the bed level was carefully monitored during 72 hours, but still no signs of complete closure of one of the branches were observed.

The effect on morphology just downstream of the screen, could be explained by a change in water level topography. The local disturbances inside the channels can travel upstream, a gradient in water level is expected. This gradient influences the bifurcation curves and thereby the stream pattern and the response of the bed just behind the screen.

No structural local scour holes were observed directly under the structure. Erosion and sedimentation processes start just behind the screen. This is a great advantage compared to bottom screens, where the local bottom protection takes great effort. If a scour hole occurs underneath the surface screen, the structure is not threatened because it is floating and not mounted on the bottom.

## **7.2 Recommendations for application**

A translation of the theory to reality has been made in order to make the results of this study applicable in river engineering practice. The application of surface screens can roughly be done in two different set-ups. The screen can be used inside a channel, influencing the morphological development in this branch only. In order to reach the desired effect on both sides of the screen, it should be rotated. A single screen only has effect within a certain length. When a longer stretch has to be influenced, the structure has to be repeated in downstream direction. A series of several, simultaneously placed screens could also be used to achieve the desirable effect. An advantage of applying screens inside the secondary channel is minimum hinder to navigation.

A second option is applying the screen in front of a bifurcation. In this set-up the screen influences the bifurcation relationship, and thus the development of both branches. The attacked branch erodes and the unattacked channel accumulates sediment. This redistribution of sediment should be kept in mind in order to prevent undesired changes in morphology. As interfering in the bifurcation relationship comes with the danger of closure, thorough monitoring is required.

The structure itself can consist out of many variants. It is possible to construct a screen between two barges which can be anchored onto the right location. The influence of the barges on the flow must be investigated. The anchoring layout could be a problem due to navigation or available space. A second option is to construct the screen on top of a row of slender piles. The stability of this structure has to be checked, as no data was collected on the scour around these supporting piles.

## **7.3 Recommendations for further research**

Although this study gives good insight in the processes around the surface screen, several recommendations for future study can be made. By analyzing the results, it was found that the dividing wall amplified the morphological effect of the screen. A screen with a penetration of 20% of the water column was not investigated in combination with the wall. It could be possible that the amplification effect would have led to significant morphological changes.

In both measurement series, the walls of the 60 cm wide flume had an influence on the flow pattern. As no water penetrates the wall, it acts as a reflection wall. With a wider flume, the transverse velocities are expected to extend further in y-direction, thereby losing more intensity when travelling downstream. The use of a wider flume would give more insight in the actual development of the vortex behind the screen.

Applying surface screens in river engineering practice requires more insight in the processes on full scale. It is recommended to run the experimental set-up in a suitable numerical model. If and when the model is able to reproduce the fundamental processes influencing morphology in the flume, checks can be done on the effectiveness of the screen at full scale.

When applying the screens in front of a bifurcation, the bifurcation parameters should be introduced to the model. For example the offtake angle, which was not included in this research. Neither were branches with a different width or banks which could freely adapt to new stream conditions.

Application of several screens behind each other would give a more clear insight in the interaction between screens. The effective length has been studied, but the exact layout of a screen field can not be determined from the test results. For example the optimal distance between consecutive screens is still unknown. Although the results from the B-series suggest that the interaction may amplify the effects of individual screens, it can not be proven from the experiments in this thesis.

Reducing the time interval between the bed level measurements would give insight in the time needed to adapt the local bed level.



## REFERENCES

- Crosato, A (2009), Report experiment-draft. Delft University of Technology
- Filarski, R. (1966), Oriënterende proeven oppervlakteschermen. Rapport M777, Waterloopkundig Laboratorium. River training (in Dutch)
- Flokstra, C., H.R.A. Jagers, F.E. Wiersma, E. Mosselman & T.H.G. Jongeling (2003), Numerical modelling of vanes and screens. Delft Cluster publication DC1-331-3
- Hossain, M.M. & E. Mosselman (2006). Final technical report, BUET-DUT Linkage project phase 3. Capacity building in the field of water resources engineering and management in Bangladesh
- Hossain, M.M., Islam, M.Z. & Mosselman, E (2006). Applicability of Delft3D on Flow Field Simulation around Bottom Vanes. Proceedings of the 15<sup>th</sup> Congress of APD-IAHR IIT Madras, Chennai, India. August 7-10, 2006. pp 1333-1340.
- Islam, M.Z. & M.M. Hossain (2004), Modelling of bottom vanes in Delft3D. BUET-DUT project report
- Islam, M.Z. (2005), Reproduction of physical model tests by mathematical model. BUET-DUT Linkage Project, Phase III : capacity building in the field of water resources engineering and management in Bangladesh. Research project no. 3: research on effect of bottom vane on river flow and morphology. I.s.m. Delft Cluster
- Jongeling, T.H.G. & C. Flokstra (2001), Bodemschermen; Stromingskrachten en snelheidsveld voor verschillende schermhoogten. Report Q2677/Q2849, WL | Delft Hydraulics (in Dutch)
- King, H.W. (1918), Exclusion of heavy silt from channels by vaned pitching. Pakistan Engrg. Congress, Annual sessions, Tech. paper No.41
- Kleinhans, M.G. (2006), Nodal point relation for bifurcations in meandering rivers. Faculty of Geosciences, Utrecht University
- Kleinhans, M.G., Jagers H.R.A., Mosselman, E., and Sloff, C.J. (2008), Bifurcation dynamics and avulsion duration in meandering rivers by one-dimensional and three-dimensional models. WATER RESOURCES RESEARCH, VOL. 44, W08454, doi:10.1029/2007WR005912
- Lambeek, J.J.P. (1994), Evaluatie bodemschermproef IJssel. Rapport Q1930, Waterloopkundig Laboratorium (in Dutch)
- Marelius, F. & S.K. Sinha (1998), Experimental investigation of flow past submerged vanes. J. Hydr. Engrg., ASCE, Vol.124, No.5. pp.542-545
- Mosselman, E (2001), Morphological development of side channels. CFR project report 9, IRMA-SPONGE and Delft Cluster
- Mosselman, E. (2003), Bodemschermen kunnen rivier diep houden. Land + Water, Vol.43, No.6, pp.44-45 (in Dutch)

Odgaard, A.J. & A. Spoljaric (1986), Submerged vanes for sediment control in rivers. Proc. ASCE Conf. Water Forum '86, Long Beach, USA, August 4-6, 1986

Odgaard, A.J. & C.E. Mosconi (1987), Stream bank protection by Iowa vanes. IIHR Report No.306, Iowa Institute of Hydraulic Research, Univ. Iowa, January 1987, 34 pp

Odgaard, A.J. & Y. Wang (1991), Sediment management with submerged vanes. I: Theory. J. Hydr. Engrg., ASCE, Vol.117, No.3, pp.267-283

Potapov, M.V. (1950), Regulation of water streams by method of artificial transverse circulation. Complete works, Vol.2, Part 3, pp.101-onwards, Abbreviated abstracts in translation from Russian by R. Batalin

Potapov, M.V. (1951), Collected works of Potapov. English translation.

Sinha, S. K., Marelius, F. (2000): Analysis of flow past submerged vanes. Journal of Hydraulic Research, IAHR, 38(1)

Zeekant, J. (1983), Enkele hydraulische en morfologische parameters van de Nederlandse Rijntakken. Nota 83.12, TOW Nr.: A35, Rijkswaterstaat.