

REDESIGN DISASTER:

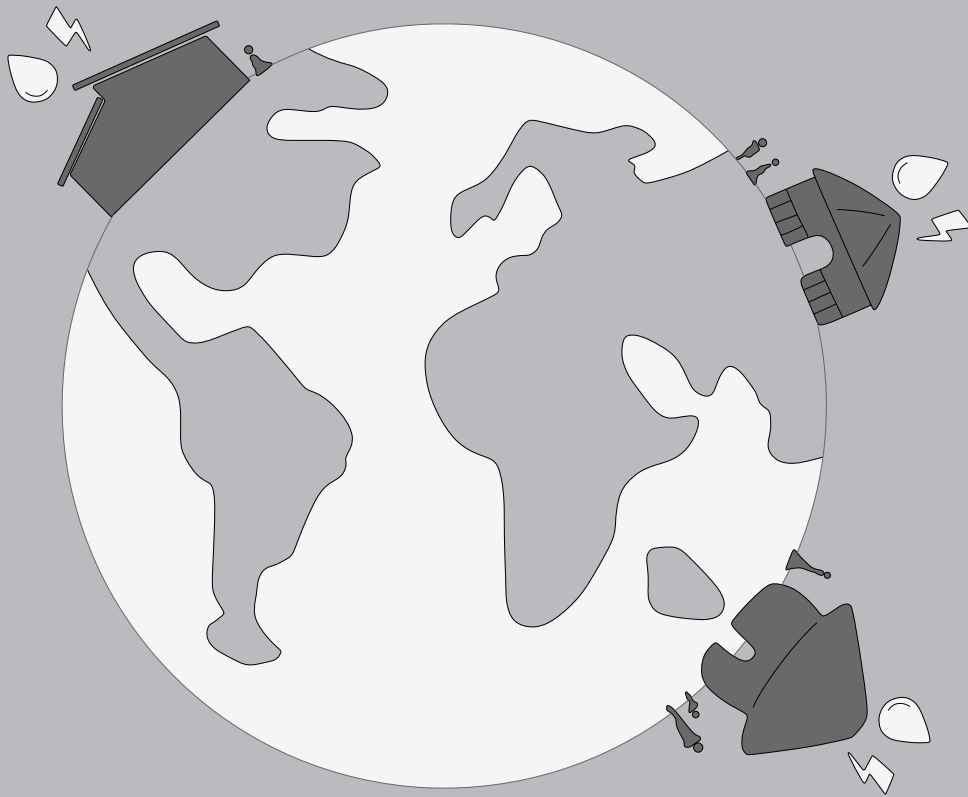

WATER & ENERGY HUB.

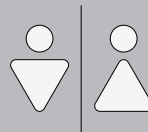

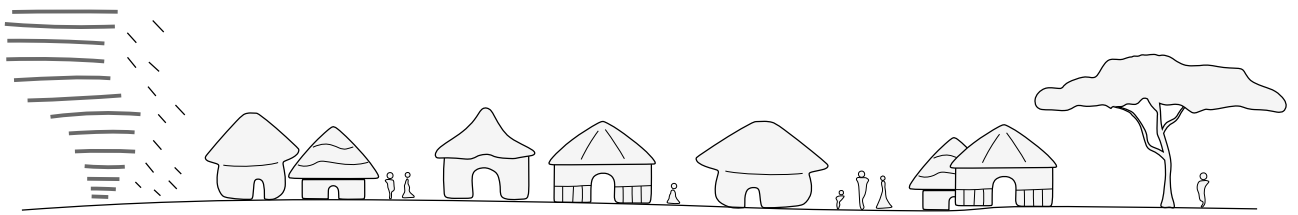

March 14, 2019

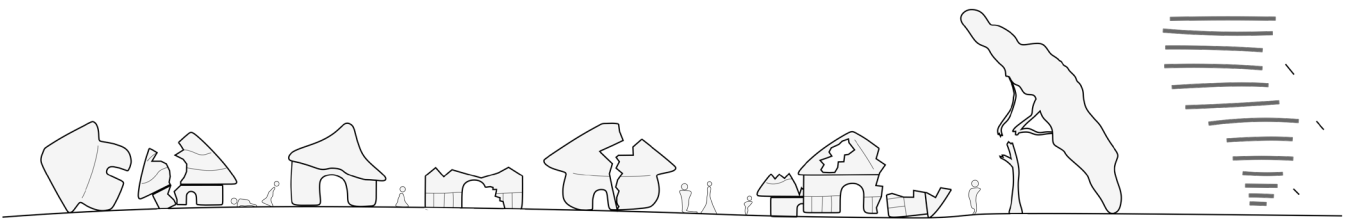

March 15, 2019





Preface



Name: Filip Zielinski
Student number: 4746376
Project: MSc Graduation Project 2020
University: Delft University of Technology
Faculty: Faculty of Architecture
Track: Building Technology
Studio: Sustainable Design Graduation Studio
Topic: Redesign Disaster: Water & Energy Hub.
Mentors: Main mentor: Dr.ing. Marcel Bilow
Second mentor: Ir. Eric van den Ham
Board of Examiners delegate: Dr. Lei Qu

As part of my master's degree, I wanted to create something useful for those who really need it. This graduation project has the goal to improve the living conditions of rural African communities by showing them how to construct off-grid, self-sufficient, and what is most important affordable clean water, energy, and sanitation system. I believe it can be easily adapted by communities of poor regions. Those communities struggle with poor quality water for living which is the cause of many deaths. To change it, a solar-based system is proposed to purify any kind of input water. Widely known simple solar stills are typically designed as single units serving only individuals, moreover, its efficiency is usually low. Therefore, an improved solar still concept is adapted in this research, and its principles are used in the roof system to produce water for the basic living needs of 50 people daily. This report aims to draw attention to two faces of disaster in Mozambique: consequences of climate change and poor living conditions.

During my research, I was greatly supported by both mentors. Their knowledge and practical experience are irreplaceable and are inspiration and motivation for me. Marcel Bilow and Eric van den Ham, thank you for your endless enthusiasm, great ideas, and for keeping me focused all the time. Your guidance through the project helped me to stay on track and let me be where I am now.

The prototyping phase would not be possible without the help of several people and companies. I would like to thank my father for sharing and having almost everything in his workshop, what not only once saved the mock-up phase from failure. Texwipe an ITW Company for sharing Texwipe TX609 wipes and Tokai Carbon CB for sharing SR511 Carbon Black pigment, both products working together as an essential component of the water system. FLONTEX.EU Sp. z o.o. Sp. k. company for sharing ETFE film for testing. Corex Polska Sp. z o.o. company for sharing cardboard tubes as an interesting alternative for bamboo beams.

My family and friends for the constant support.
Thank you.

Contents

Preface	6
Contents	8
Introduction	10
Background Context	12
Problem Statement	14
Objectives	16
Research Questions	18
Research Methodology	20
Relevance	22
Design by Research	24
Climate Conditions	26
1.1.1 Climate Conditions Change	26
Drinking Water	29
1.2.1 Access & Consumption	30
1.2.2 Minimum Water Amount	32
1.2.3 Solar-based Purification	34
1.2.4 Simple Solar Still	36
1.2.5 Improved Solar Still	38
Electricity	41
1.3.1 Access & Consumption	42
1.3.2 Electricity Usage	44
1.3.3 Providing Energy	48
Sanitation	51
1.4.1 Situation in Rural Areas	52
1.4.2 Pit Latrines	54
1.4.3 Constructed Wetland	56
Local Architecture	59
1.5.1 Local Architecture	60
Conclusions	66
1.6.1 Project Scale	66
1.6.2 Design Brief (PoR)	68
Research by Design	70
Architecture	73
Form of the Building	74
2.1.1 Form	74
Functional Plan	78
2.2.1 Space Layout	78
2.2.2 Central Hub	80
Building Frame	82
2.3.1 Bamboo	82
2.3.2 Foundations	84
2.3.3 Frame Design	86
2.3.4 Walls	92

2.3.5 Roof	94
Water System	101
2.4.1 Evaporation & Condensation	104
2.4.2 Water Flow	106
2.4.3 Water Source	108
2.4.4 Water Tanks	110
2.4.5 Solar Still System	114
2.4.5.1 Water Basin	116
2.4.5.2 Polystyrene Block	118
2.4.5.3 Transparent Cover	120
2.4.6 Maintenance	124
2.4.7 Mock-up	126
2.4.7.1 Prototyping	128
2.4.7.2 Testing	140
2.4.7.3 Simulation	146
2.4.7.4 Testing	150
Electricity System	153
2.5.1 Electricity System	154
2.5.2 PV Instalation	156
Sanitation Strategy	159
2.6.1 Waste Water Strategy	160
2.6.2 Biogas System	164
Sustainability	170
2.7.1 Sustainability & Circularity	170
Business Model	172
2.8.1 Business Model	172
Final Conclusion	174
Literature	176
List of Figures	178

Introduction

Climate change is one of the main concerns in the world nowadays. One of the most visible consequences of rising temperatures on our planet is the increase in the frequency and intensity of extreme weather events. Only in 2018, there were more than 100 recorded floods, which affected almost 35 million people and caused almost 3 thousand deaths (Natural Disasters 2018; CRED, 2019).

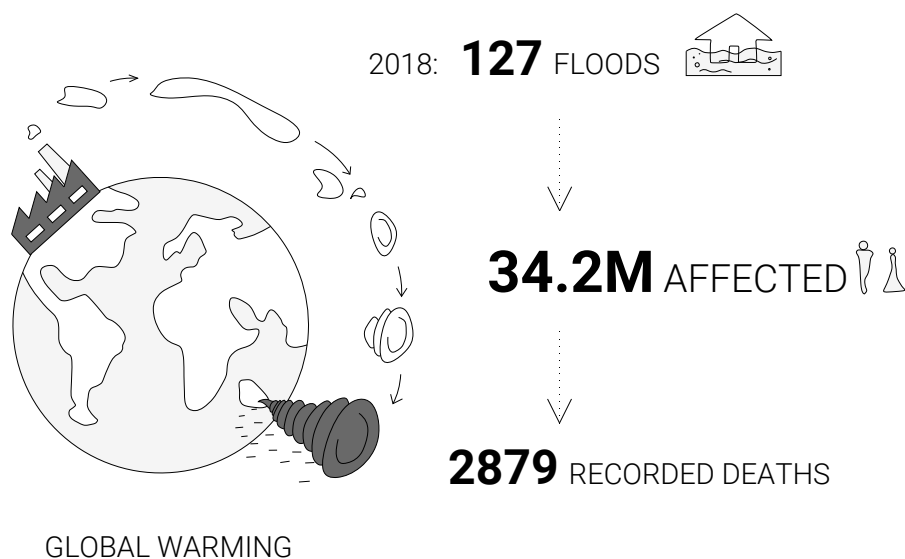

Fig. 1 2018 Natural disasters. Author's graphics. Data source: (Natural Disasters 2018; CRED, 2019)

Natural disasters occur all over the globe, but what does it mean for a developed country and how the situation looks in a poor region? A developing country does not have the same capability to cope with it. Their emergency service is not as good as one working in a developed country where prediction media works better. A poor country will not be able to evacuate or save people and totally relies on other rich and developed countries to help with the situation. Furthermore, these emerging countries will take a great time to recover, because they do not have the resources and money to repair the damage. This is the area where this research will be focused on. Regardless of the geographical location, natural disasters carry great havoc affecting the lives of millions of people, cause many deaths and huge economic losses. For many developing countries, damage consequences often last over many years and significantly delay their further development.

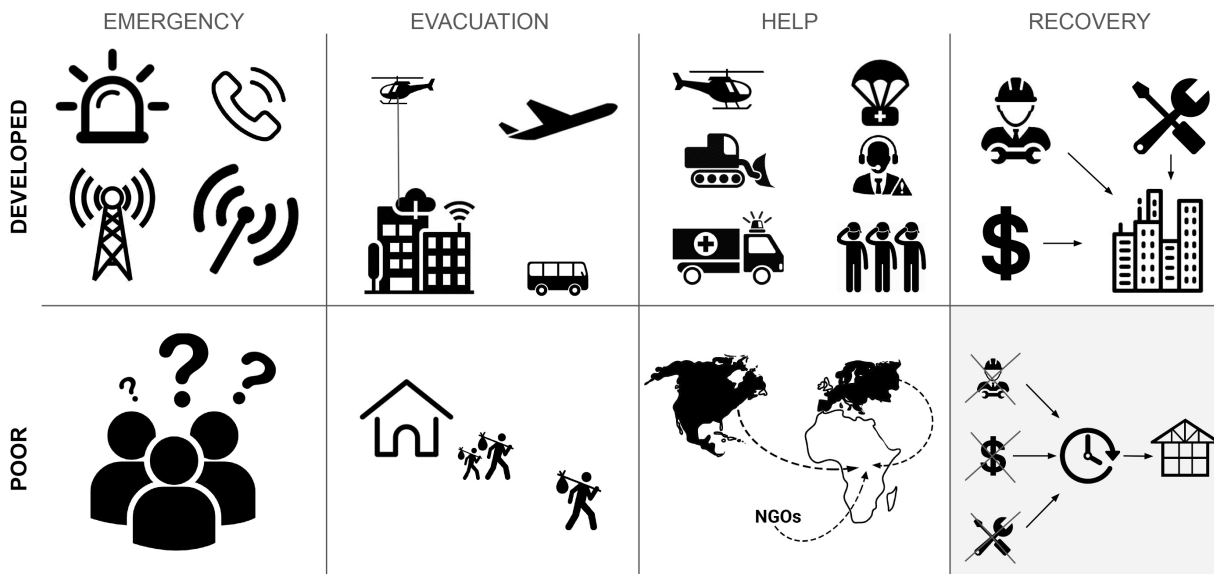

Fig. 2 Developed and poor countries comparison. Author's graphics.

Phase 1 of this report will present current living conditions in most of the African rural areas, thus the disaster in the topic of this research can be understood in two ways. The main goal of this thesis is to help small communities of rural Beira with a design of decentralized hub improving their living quality and accelerate recovery after the last natural disaster. A small rural community of 50 people is considered in this research. A typical household in the region consists of 4-5 people (United Nations, 2017). While a pilot building designed in this research will have a public function, the facility and production systems can be also considered to serve 10 families.

Background Context

Africa is a region of the world that is particularly suffering from natural disasters. Only in 2018, Africa recorded 46 natural disasters, including droughts, earthquakes, storms, and floods, which account for 40% of all cases (Natural Disasters 2018; CRED, 2019). Africa is the 2nd largest continent with a 1.3B population that is expected to double in the next 30 years. Although, it is a generally poor continent of Third World it has rapidly urbanizing populations. There are large differences between countries and between urban and rural areas. Still, 50% of the people earn less than \$1.5/day, and one of the examples of this region is Mozambique, considered as one of the poorest and most undeveloped countries in the world. It has a 30M population, with 60% of people living in rural areas. The project will be designed for one of the major country cities. Beira is located at the Mozambique Channel of the Indian Ocean. It is 4th biggest city by population with half a million people, from which 300 000 live in informal settlements (Anthony et al., 2017).



Fig. 3 Idai Tropical Cyclone facts - Africa. Author's graphics. Data source: (Garrigos, 2019)

In March 2019, the tropical cyclone Idai hit the port city of Beira on the Mozambique coast before moving further into the region. Millions of people from Mozambique, Malawi, and Zimbabwe have been affected by the worst natural disaster that has been registered in the last two decades in southern Africa. Less than 2 months later, cyclone Kenneth hit northern Mozambique, it was the first time in history when 2 strong tropical cyclones have strike the country in the same season. The destruction

caused by the cyclones was enormous, in Mozambique alone more than 600 people lost their lives. Thousands of homes, schools, and hospitals, as well as all technical infrastructure, were destroyed, leaving hundreds of thousands of people without shelter, access to clean water, electricity, or food (Garrigos, 2019). Beira was an epicenter of the disaster, 90% of the city was damaged or destroyed, and around 483,000 people lost their homes. Six months after the disaster a lot of buildings remained without roofs and only parts of the city were reconnected to the water and energy networks, mainly in more urbanized districts, leaving rural areas without access to clean drinking water (Wright & Brackett, 2019).

BEIRA → **EPICENTER**



Fig. 4 Idai Tropical Cyclone facts - Mozambique. Author's graphics. Data source: (Wright & Brackett, 2019)

Problem Statement

90% of Beira, the seaport city of Mozambique, has been significantly destroyed by Cyclone Idai leaving more than 250,000 people without access to basic living needs.

WHO estimates that **more than billion people around the world have limited or no access** to clean drinking water and most of these people come from rural areas where the low population density makes it difficult to build typical water networks. A lot of Mozambicans must use unsanitary water for living. UNICEF reports that **only half of the country's population (13.7 million people) has access to drinking water.** The life expectancy in Mozambique is 20 years lower than in developed countries like the U.S. which is mainly due to communicable diseases that are spread by the poor water quality (Roser, Esteban, & Ritchie, 2019).

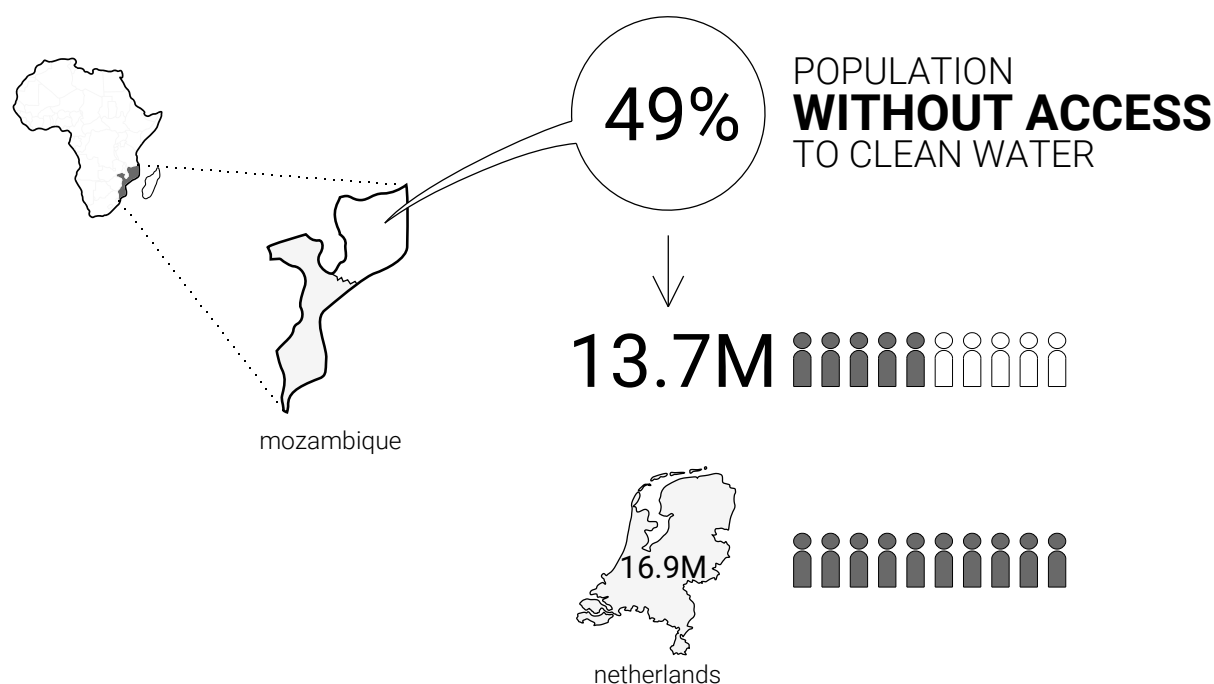

Fig. 5 Mozambique facts - Water. Author's graphics. Data source: UNICEF

Around **610 million people in Africa have limited or no access to electricity** and cuts from the national grid occur on a daily basis in most of the African countries. The average electricity energy consumption per capita in sub-Saharan Africa (excluding South Africa) was only 153kWh/year in 2009. To compare, this was only one-fourth of the consumption in India and just 6% of the global average. (Monari, 2011).

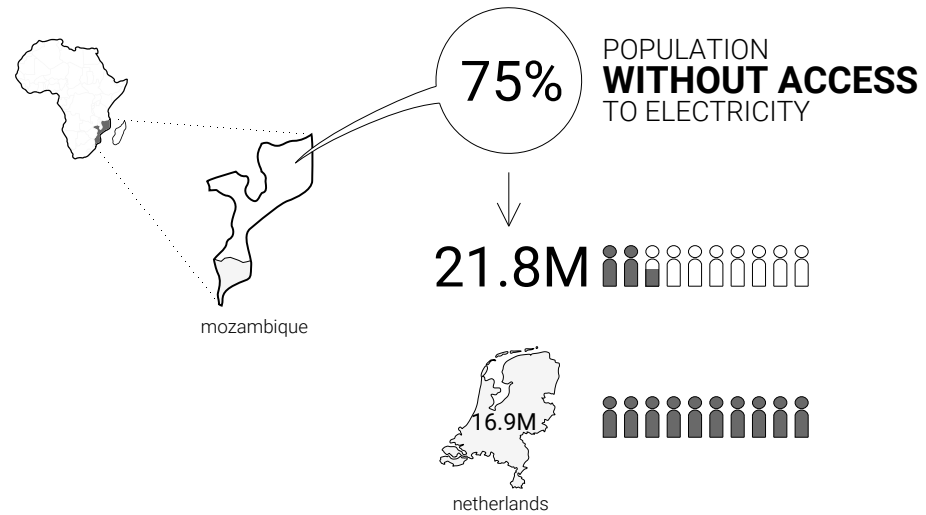

Fig. 6 Mozambique facts - Electricity. Author's graphics. Data source: UNICEF

According to the World Health Organisation, diseases caused by **unhealthy sanitation cause two million deaths globally each year**. Effective sanitation is one of the most crucial humanitarian issues in Africa today. UNICEF reports that due to lack of sanitation facilities **40 percent of Mozambicans still need to defecate outdoor**. Only 40 percent of rural schools have clean water and sanitation. Even buildings like health centers, that should have access to safe sanitation, suffer from this shortage. The consequences of these living conditions are huge, ranging from poor health to low productivity due to the time needed for bringing water.

Only part of the Beira region is covered by a sewer network, mainly in the urbanized and wealthier areas. The rural population relies on poorly built and maintained onsite sanitation facilities. Most of the sewage systems cannot cope with stormwater and floodings. During periods of heavy rainfall, **untreated wastewater is released into the environment** polluting both surface and groundwater sources (WSUP, 2019).

Most of the small-scale objects are not built to suit the dangers of extreme weather events occurring more frequently and with increasing intensity in the Beira region. **Lack of proper foundations, weak building walls, and poor roof-wall connections** do not provide resistance to strong winds and rains causing huge damage to the entire community.

Objectives

Small scale, sustainable building supplying drinking water and energy to the affected community.

Research from 2015 (The World Bank) shows that **half of Mozambique's population lives without access to fresh water.** The main goal of the project is to design a **low-tech solar-based water purification system and provide clean water and energy for 50 people community of rural Africa.**

A detailed **construction manual of the small off-grid water and energy production hub will be the final product** of this research. The building will be designed with the use of locally available materials. It will include **sustainable, healthy sanitation system, and will be designed as a pilot public facility.** Water will be reused by a building itself. Blackwater, after being treated properly, will be used for biogas production, then turned into compost for agriculture and released to the environment in a controlled way. Both water and energy production components will be integrated with the hub's roof. Due to the large footprint required for the systems, it will be designed as a **free-standing structure with the open-space adaptable floorplan.**



Fig. 7 Rural village after cyclone. Author's graphics.

Research Questions

How to supply drinking water and energy for small rural communities of Beira with the use of a low-tech, solar-based decentralized system?

The water purification system elaborated in this research will require 200 square meters to be able to produce 1600 liters per day (32 liters per person), while the energy production system consisting of 30 PV panels will need additional 50 square meters (installation with a capacity of 13300kWh). It is clear that combined 250 square meters are more than an area needed for the building itself. Sanitation and additional functions for the target group will require around 50 square meters, thus part of the production system will be designed as a free-standing roof structure, giving not only shade but also freedom of hub adaptation for local functions and public space. From this, a question of **how to combine all systems with the building for proper functioning** is posed. The building will need to deal with the characteristics of the region and the social and economic situation of the targeted community. Considering specific weather conditions in which building will be meant to operate a question of **how to properly design main building components connections (foundations-walls-roof), that are capable to withstand strong wind and rain** arises. The hub is meant to be a project that provides solutions to broadly understood problems of rural communities, **it needs to be universal, reproducible and simple to construct by local people using locally available materials**, like bamboo culm. Also, this research will address the question of **how to properly design an on-site, decentralized, and sustainable system to protect the environment and natural resources, and release waste in a controlled, safe way**.

Research Methodology

In the first phase of the project, Design by Research, the thesis is mainly supported by extensive literature research. To collect as many relevant references as possible, search queries related to the topic were applied to Google Scholar, TU Delft Library, and Web of Science databases. The resources explored in the research were focused on Beira's existing situation and conditions, solar-based water purification, PV energy production, and low-tech sanitation. Sources were cross-checked with each other to gain a coherent image of the topic. Several keywords, like e.g. "solar water purification"; "solar distillation"; "solar still" were used as a method to collect reliable information about the research project and to find the right literature. These keywords describe the most important subjects of this paper. The literature found is reliable due to the scientific publishers or they come from the databases of universities. In the light of climate change that is happening now and the current country's social and economic situation, the year of the research has also been taken into account.

Most of the information is gathered from technical reports and is supported by other articles and books. Particular focus was placed on (Liu et al, 2017) where reliable research was conducted by producing and testing improved solar still device. Literature is categorized into 5 main sections: site context; water; energy; sanitation; local materials and construction techniques. First one is related to current situation in Beira, second is focused on solar-based water purification techniques and systems, the third section contains literature about solar energy production and its potential in Mozambique, the next section is related to sanitation situation of the country and its possible improvements, and the last one is referred to the locally available materials and construction techniques. This division helped to make analytical consideration of the topic. The literature found is relevant because mostly it focuses on the technical aspects and possibilities of relatively cheap and low-tech water and energy production techniques. The one problem of the literature found is the lack of most recent, reliable data about water, energy, and sanitation access in Mozambique's rural areas.

In the second phase of the project, Research by Design, water and energy demand calculations were conducted to specify the demand and then scale of the building. In the next step,

a concept derived from the first phase is developed in details to specify the Programme of Requirements (PoR), functional plan, and material selection. A CAD model of the hub with all systems will be prepared and used for water production system mock-up. Based on the prototyping phase and mock-up performance test, design for system improvements will be implemented. The final deliverables will consist of 2D drawings, 3D axonometries, visualizations, scaled project maquette, and construction manual, to give a full, reliable, and clear overview of the project.

Relevance

Building Technology is seen as a binder between architecture and engineering. Technical innovation can become a starting point for architectural strategy and design. The project aims to use an innovative low-tech solution and introduce it as a utility product for a small rural community, providing it with better living conditions and the possibility of faster development. The project will be based on extensive technical research and existing case studies. It will scale the technical, solar-based solution of providing clean water in a survival situation to a building scale, a structure that can daily serve up to 50 people, improving their quality of life.

The main target of the project are low to mid-low income African rural areas. A pilot project can teach the local community how to build houses that are resistant to extreme weather conditions using locally available materials. It will reduce the need for frequent building repairs, saving both money and time. In the light of limited available fresh water resources and water scarcity in African rural areas, the growth of alternative cleaning water systems and techniques is crucial. In 2015, UN countries signed up to a commitment to provide electricity to every household on Earth by 2030, however, current statistics show that it will not be possible to reach that goal in such a short time. This project aims to make both authorities and rural communities aware of problems they have to face and show a possible solution. The project will present a mini-grid solution as one of the most beneficial for providing clean water and electricity for low-density rural areas, where the extension of national grids is not viable. Moreover, decentralized systems avoid the problem of cuts from the main grid, ensuring a less intermittent supply, what has a positive impact not only on households but also on local businesses and clinics.

Design by Research

In Phase 1 of this report, extensive research into the economic, social, and cultural situation of the region is made. Research involves the process of planning and elaborates on many complex problems, like climate change or living conditions in African rural areas. The goal of this part is to give a comprehensive overview of the background of this project and define the most promising ideas for testing by systematizing the available knowledge.

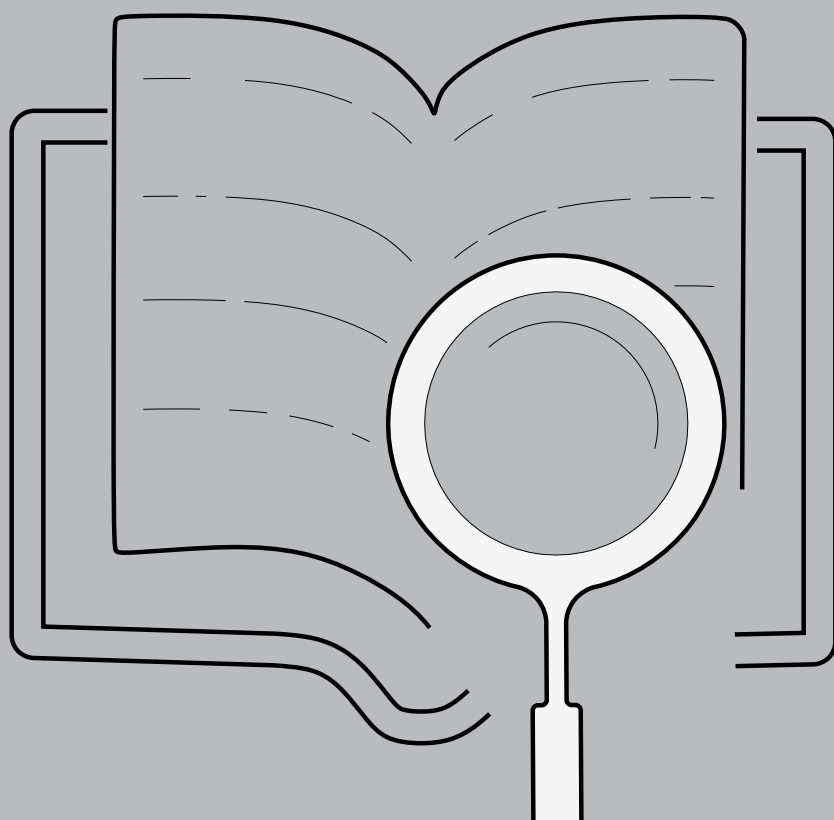

Climate Conditions

1.1.1 Climate Conditions

Mozambique is located on the east coast of southern Africa 11-26 degrees south of the equator. The country has a tropical to sub-tropical climate. It is one of the poorest countries in the world and at the same time one of Africa's most vulnerable countries to climate change. Every year it is exposed to numerous weather anomalies including droughts, floods, and tropical cyclones. The rapid economic expansion of Mozambique over the past decades has only had a moderate impact on poverty reduction and mainly took place in urban districts, leaving rural areas unchanged to this day. The frequency of extreme weather anomalies has increased since 1950. Climate change and exposure to extreme weather events further delay the development of the country and often threaten to completely destroy current achievements.

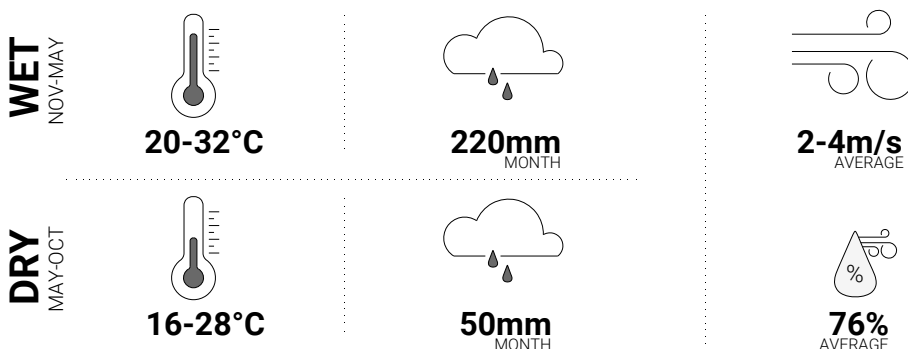

Fig. 8 Beira's climate conditions. Author's graphics. Data source: (Weather & Climate, 2019)

Mozambique has a tropical to subtropical climate. It has both dry and wet seasons, with temperatures ranging from around 15 to 30 degrees. Between 1960 and 2006, the average annual temperature of Mozambique increased by 0.6°C. Predictions show that the average annual temperature will continue to rise, and the intensity, frequency, and threats of climate change will also increase. The region has quite high precipitation with up to 220mm during the wet season. To compare, monthly average precipitation in the Netherlands varies between 40 and 70 mm. Projections also show raising the sea level by more than 0.5m over the next few decades, which only increases the likelihood of flooding in coastal cities, slowly transforming their low lying areas into floating cities and villages. In the worst-case scenario, the total cost of damage could reach \$103 million a year in the 2040s (Winthrop, Kajumba, & Mclvor, 2018). The costs of disaster response and their consequences are already high, not only in Mozambique but everywhere around the world. We must adapt to climate change, simply trying to reduce it is no longer enough.



Africa



Mozambique

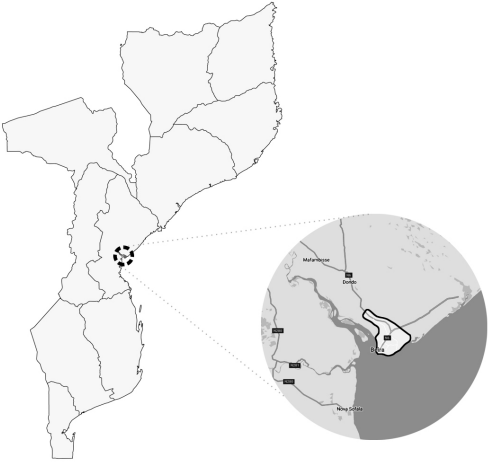

Beira

Fig. 9 Project location. Author's graphics. Data source: Google Maps

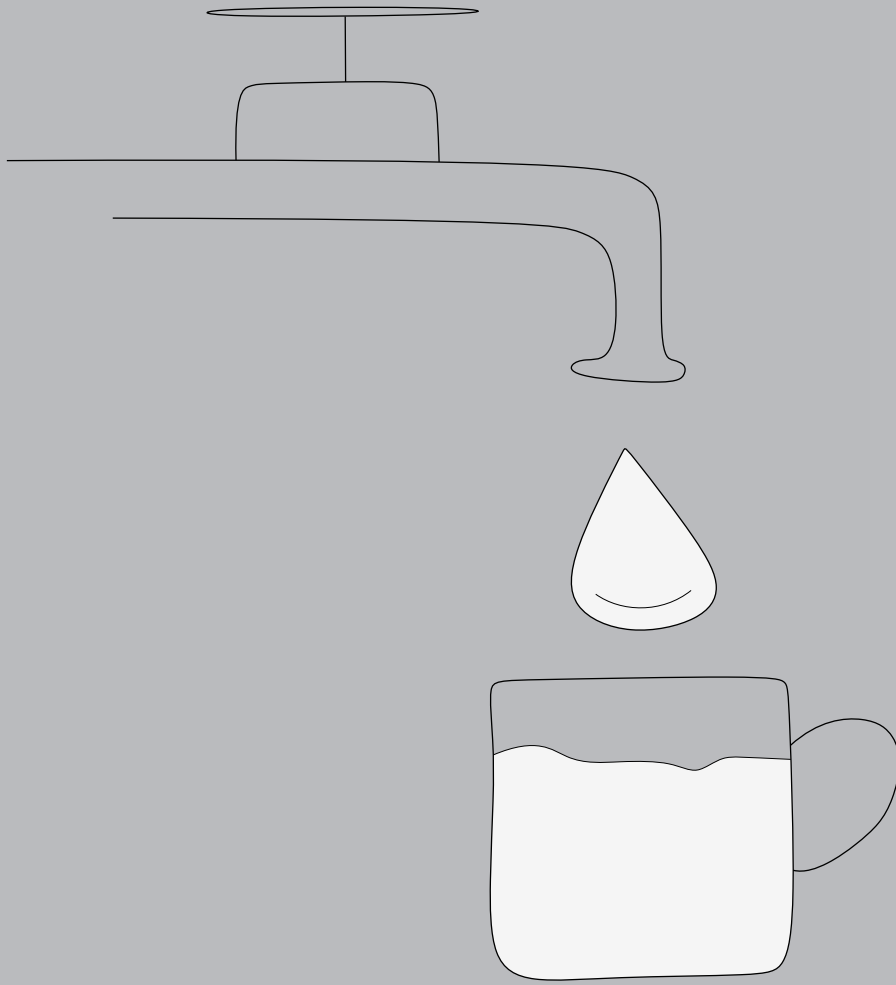

Drinking Water

Drinking Water

1.2.1 Access & Consumption

Half a year after the disaster in Beira only parts of the city have been reconnected to the water network - mainly more urbanized districts, leaving rural areas behind. Overall, a huge number of Beira's residents do not have daily access to clean drinking water, which leads to outbreaks of life-threatening diseases. The main water source for the city is the Pungwe river, but the water is affected by the population of the region, the geology and soil, and vegetation. Human settlements constantly change the natural quality of both surface and groundwater by using it for agriculture, industrial and domestic purposes (Alferes & Choga, 2006). In not treated water, many bacteria, parasites, salt, and heavy metals can be found. Only 35% of the rural population have access to clean water, compared to 80% in urban areas. The natural disaster that occurred in March 2019 only worsen this situation.

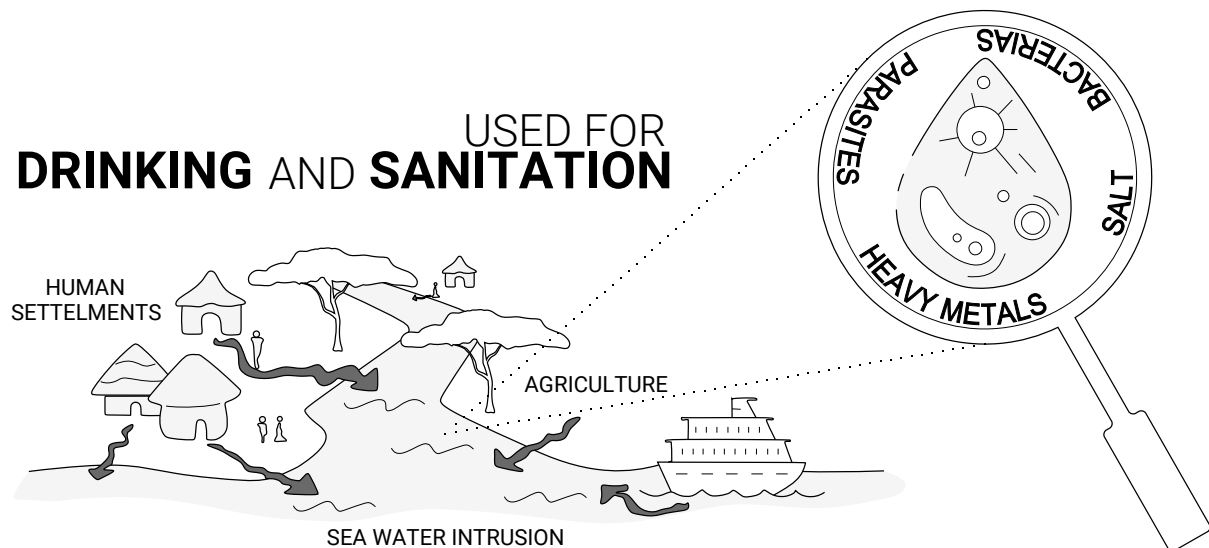

WATERBORNE DISEASES AMONG THE MAIN CAUSES OF **DEATH OF CHILDREN** IN BEIRA

Fig. 10 Beira's water source - Pungwe river. Author's graphics. Data source: (Alferes & Choga, 2006)

Drinking Water

1.2.2 Minimum Water Amount

Developed countries, on the example of Europe, consume on average 100-150 liters of water a day. The average consumer in the U.S. uses approximately 380 liters of water per day for domestic purposes only. In most African rural areas, on average, people use only 20-30 liters of water, and in the remotest areas do not have more than 4 liters per day, just enough for drinking (European Commission, Statista, 2014/15; WHO, 2016). Consumption does not just mean drinking, it also includes showering, cooking, sanitation, and other household needs. 20 liters is the quantity of water that typical showerhead uses in 2 minutes.

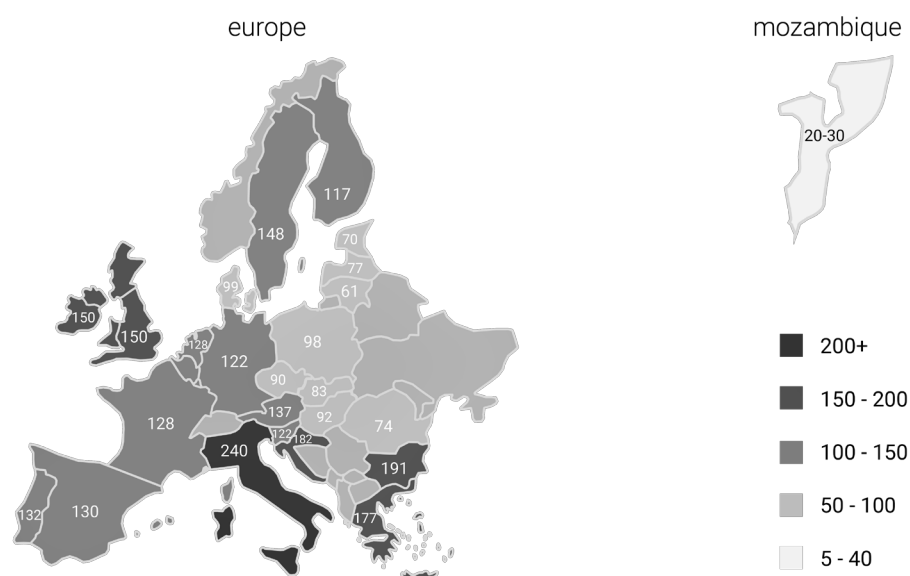

Fig. 11 Water consumption in Europe and Mozambique. Author's graphics. Data source: (EC, Statista, 2014/15; WHO, 2016)

The UN reports that a human needs a minimum of 50 liters of clean water per day to have enough for cooking and personal hygiene. It is a necessary amount of water to avoid diseases and to retain efficiency. The Water Research Foundation from the City of Cape Town (South Africa) in 2016 developed a guide on how to effectively use 50 liters of water a day to make sure that there is enough for all human living needs. Moreover, research says that by adhering to additional recommendations on efficiency and greywater use, it can be reduced to 32 liters per day, what will be used in this research as the required amount of water per person for water production system calculations.

PETS	1L
COOKING	1L
TEETH AND HANDS	2L
DRINKING	3L
<small>WATER/TEA/COFFEE</small>	
HOUSE CLEANING	5L
<small>EVERY 2nd DAY</small>	
DISH WASHING	9L
<small>1 SINK WASH</small>	
FLUSHES	9L
LAUNDRY	10L
<small>1 LOAD (70L)/WEEK</small>	
SHOWER	10L

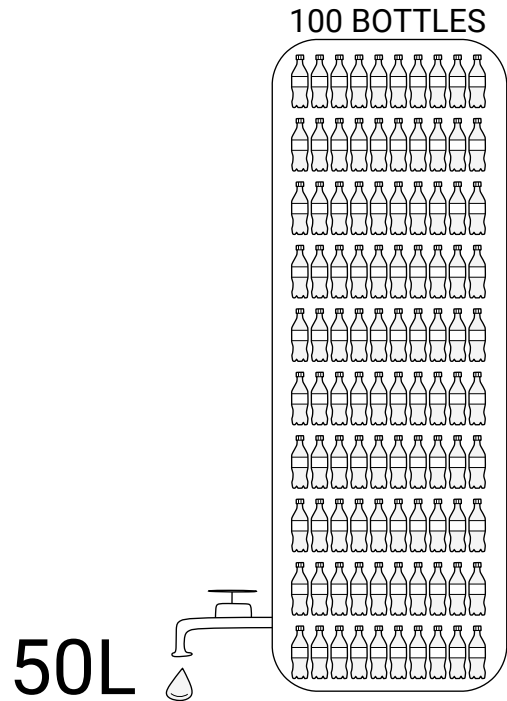

Fig. 12 Use of 50L of water per person per day. Author's graphics. Data source: The Water Research Foundation from the City of Cape Town

PETS	1L
COOKING	1L
TEETH AND HANDS	2L
DRINKING	3L
<small>WATER/TEA/COFFEE</small>	
HOUSE CLEANING	5L
<small>EVERY 2nd DAY</small>	
DISH WASHING	9L
<small>1 SINK WASH</small>	
FLUSHES	9L
LAUNDRY	10L
<small>1 LOAD (70L)/WEEK</small>	
SHOWER	8L

WATERLESS

GREY WATER

STOP-START

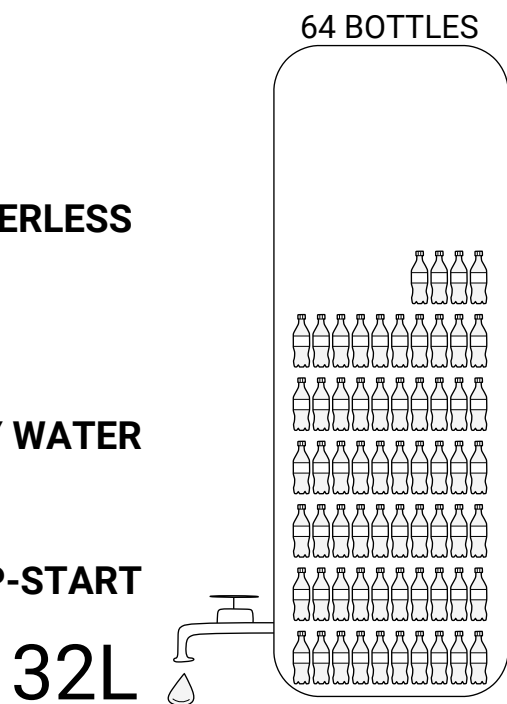

Fig. 13 Use of 32L of water per person per day. Author's graphics. Data source: The Water Research Foundation from the City of Cape Town

Drinking Water

1.2.3 Solar-based Purification

A technique that will effectively purify polluted water is needed. Moreover, having the social and economic situation of the region in mind, the system should use relatively low technology and be as cheap as possible. The project site, due to its proximity to the equator, has high yearly solar radiation (1950kWh/m²), which leads to consideration of solar-based water production systems as those with a great potential for rural communities (Cuamba et al., 2006).

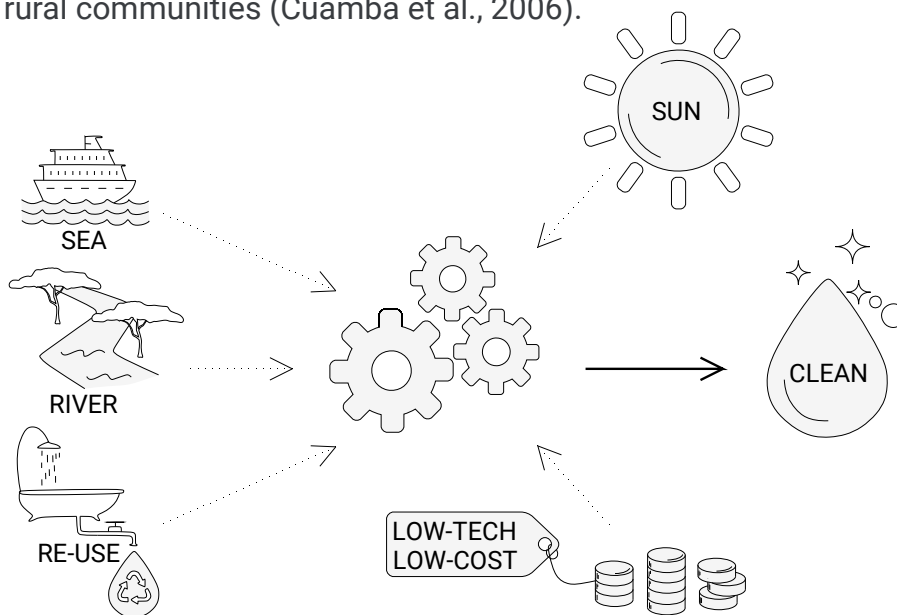

Fig. 14 Water purification methods requirements. Author's graphics.

Solar disinfection, air-to-water, and solar-still are the three most commonly used and elaborated low-cost water production systems that are based on solar radiation and temperature difference. Other, more advanced techniques were not considered in this research due to their higher running costs and difficult maintenance. Solar disinfection is a very low-tech and cheap technique which uses UV radiation and high temperature to purify water. Unsanitary water is placed on a sun-exposed roof, typically in 2 liters plastic bottles, for at least 6 sunny hours. In some cases, it can take up to 2 days to purify the raw water, thus it is a solution that can be used on a very small scale only and its efficiency is hardly predictable. Furthermore, when removed from the sun, the remaining bacteria may again reproduce in dark, so water should not be stored. Solar disinfection does not change the smell and taste of water, which is crucial when the water is from the open surface source reservoir (Luzi, Tobler, Suter, & Meierhofer, 2016). The second technique obtains water from the air by

simple condensation and collection. An example of this system can be a plastic sheet stretched over a dug hole in a survival situation, when overnight condensed air can fill a cup with water for drinking. The technique is conditioned by the relatively high humidity and high daily temperature differences directly affecting air condensation. Although it is a very low-tech and cheap technique, it requires a large footprint surface and due to its very low flow rate, it cannot be considered as a daily clean water source. The third system, a simple solar still is based on the principles of evaporation and condensation. The technique uses solar radiation that passes through a transparent cover to heat the water in a basin. Evaporated water is collected into a clean bag or container and can be directly consumed (Saidur et al, 2011). Solar-still seems to be the best technical solution to supply rural villages or settlements with fresh water without depending on high technology and expertise, and will be further considered in this research as the system with high potential for water production in an off-grid hub.

SOLAR DISINFECTION

6H - 2DAYS

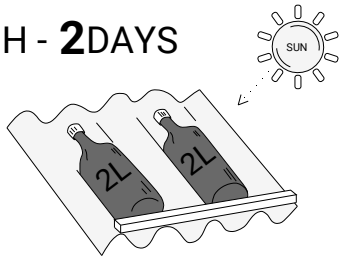

**HIGH TEMP
UV-A RADIATION**

**SMALL
SCALE**

**NEED TO BE
PREFILTERED**

**VERY
CHEAP**

AIR TO WATER

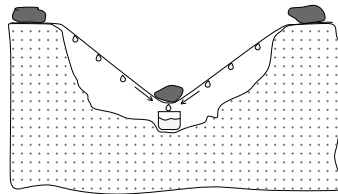

**VERY LOW
FLOW RATE**

**DAMAGE
VULNERABLE**

**RELATIVE HUMIDITY
DEPENDENT**

**LOW
TECH**

SOLAR STILL

**1-5L
M2/DAY**

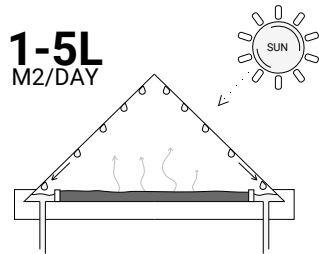

**EVAPORATION
CONDENSATION**

**MIDDLE
SCALE**

**ANY WATER
SOURCE**

**LARGE
FOOTPRINT**

Fig. 15 Solar-based water purification methods. Author's graphics. Data source: (Luzi, Tobler, Suter, & Meierhofer, 2016; Saidur et al, 2011)



Drinking Water

1.2.4 Simple Solar Still

DESIGN BY RESEARCH

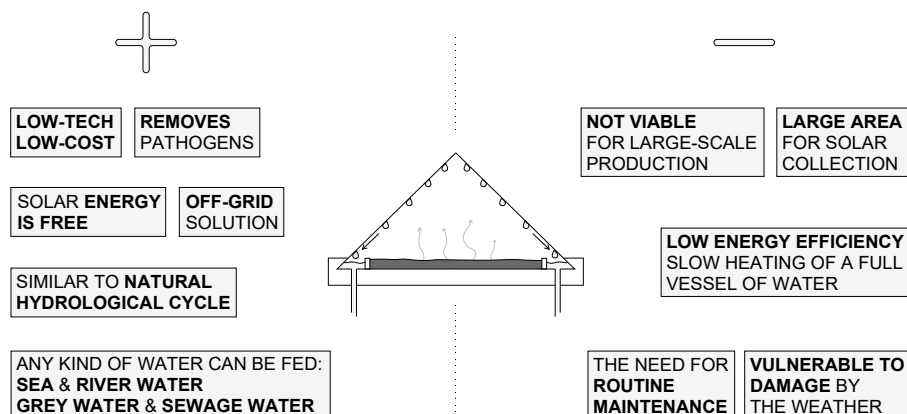

Fig. 16 Simple solar still advantages and disadvantages. Author's graphics. Data source: (Saidur et al, 2011)

In simple solar-still, the surface of the water basin is typically painted black to maximize heat absorption. When heat is generated, the temperature of water increases which causes its evaporation. The water vapor rises in the still until it reaches the transparent cover, which is typically sloped, has a form of a pyramid or a dome, creating a structure much like a greenhouse. The vapor condenses on the inclined glass or plastic sheet and runs down the sides to be collected. A simple solar still can produce up to 5 liters of clean water per day per 1m² (Saidur et al, 2011).

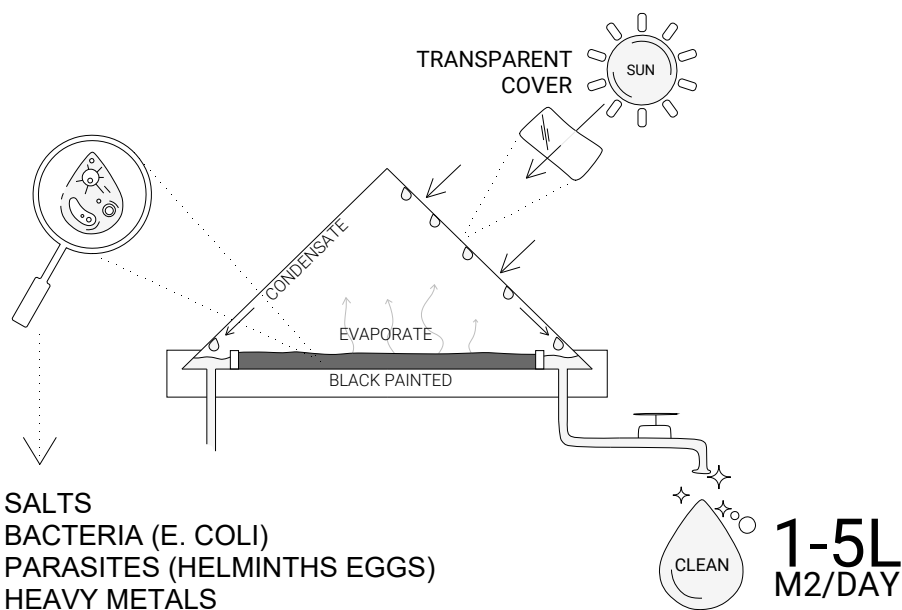

Fig. 17 Simple solar still performance. Author's graphics. Data source: (Saidur et al, 2011; Cannon & Au, 2008; Ligy, Ramprasad, & Krithika, 2019)

It can effectively remove salts and minerals, bacteria (*E. coli*), parasites (Helminthes eggs), and heavy metals from the input water, with its efficiency comparable to more-expensive treatment methods, so any kind of water can be fed, including sea or river water, greywater or raw sewage (Cannon & Au, 2008; Ligy, Ramprasad, & Krithika, 2019). This system requires a relatively large footprint area for solar collection and is not economically viable for large scale production, however, it can be suitable for a small community, especially where solar energy and low-cost labor are abundant. The startup costs tend to be relatively higher than those of other presented techniques, also due to its weather vulnerability to damage, maintenance costs need to be taken under consideration while designing the system (Shatat & Riffat, 2014). Inexpensive and locally available materials should be used for still construction.

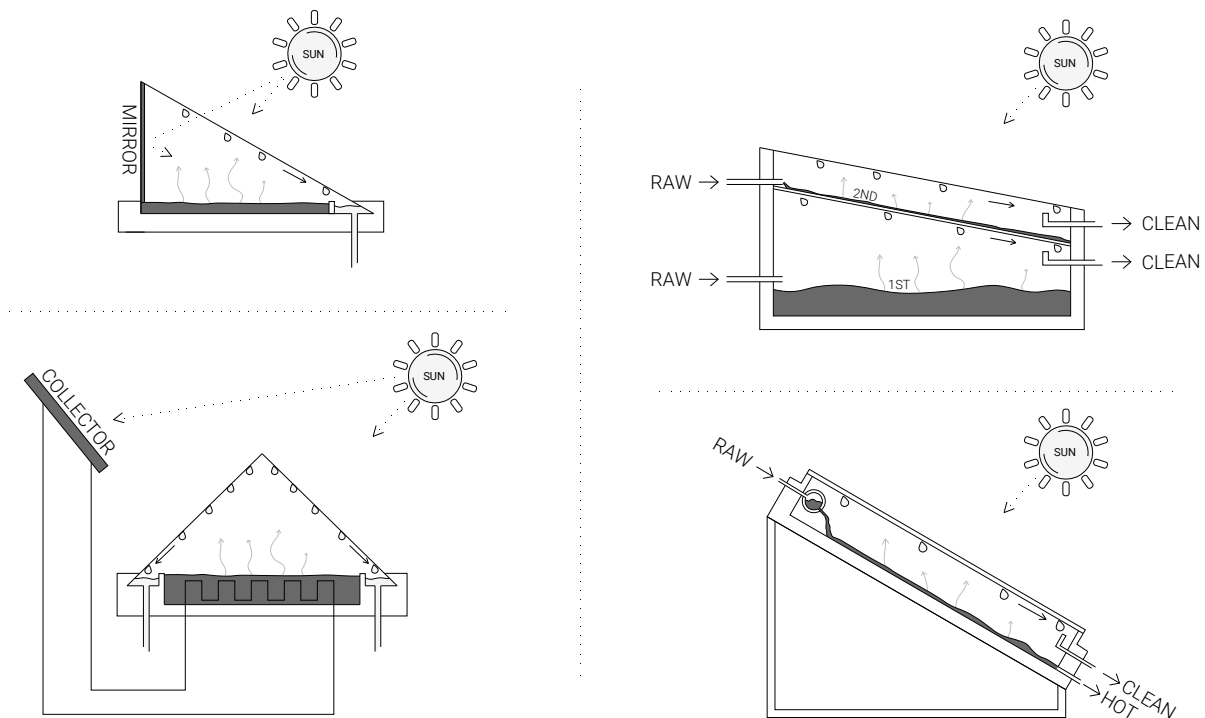

Fig. 18 Improvements for solar still. Author's graphics. Data source: (Al-hayek, Badran, 2004; Adberachid, Abdenacer, 2013; Manchanda & Kumar, 2015; Ayber et al, 2005)

Drinking Water

DESIGN BY RESEARCH

1.2.5 Improved Solar Still

Simple solar-still relatively low production rate and efficiency can be improved by multiple modifications. By adding reflective mirrors, solar collectors for pre-heating input water, or using multiple-stage effects, its efficiency can be increased (Manchanda & Kumar, 2015). Liu et al research from 2017 presents an improved solar-still and its results are proving to be a viable method of producing fresh water from a polluted source.

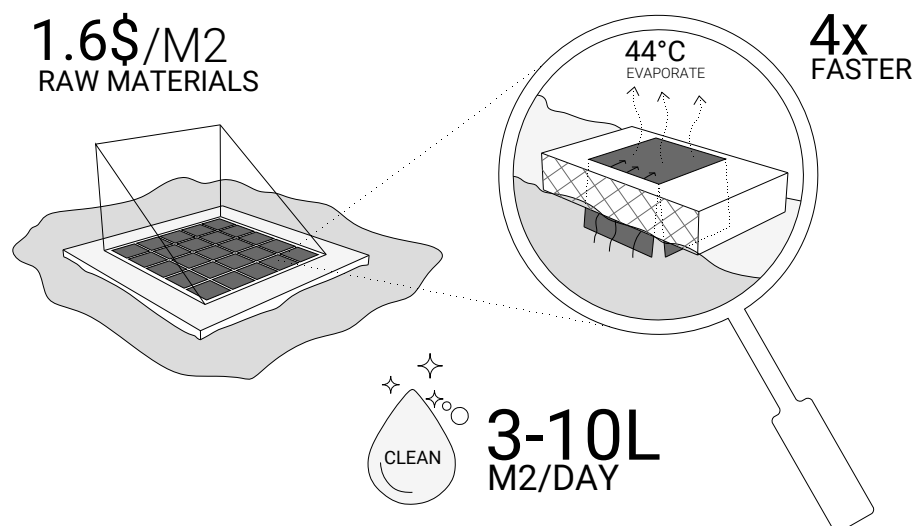
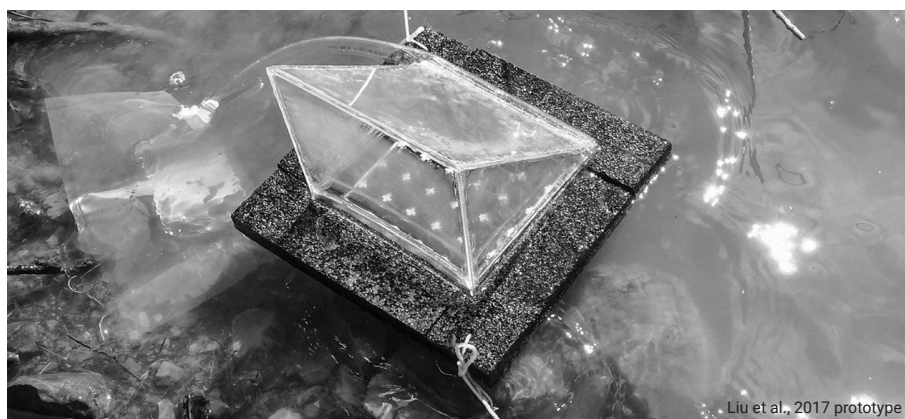

Fig. 19 Liu et al., 2017 solar still improvement. Author's graphics. Data source: (Liu et al., 2017)

Rather than heating the whole basin of water, the prototype focuses solar energy only on the surface water, which evaporated during tests at 44°C. Input water is isolated from the amount of water meant to be evaporated by polystyrene block. The block has carbon-coated paper going through, which fiber-rich structure wicks input water upward to the top surface of the polystyrene block (capillary effect), where the wet paper is exposed to solar radiation.

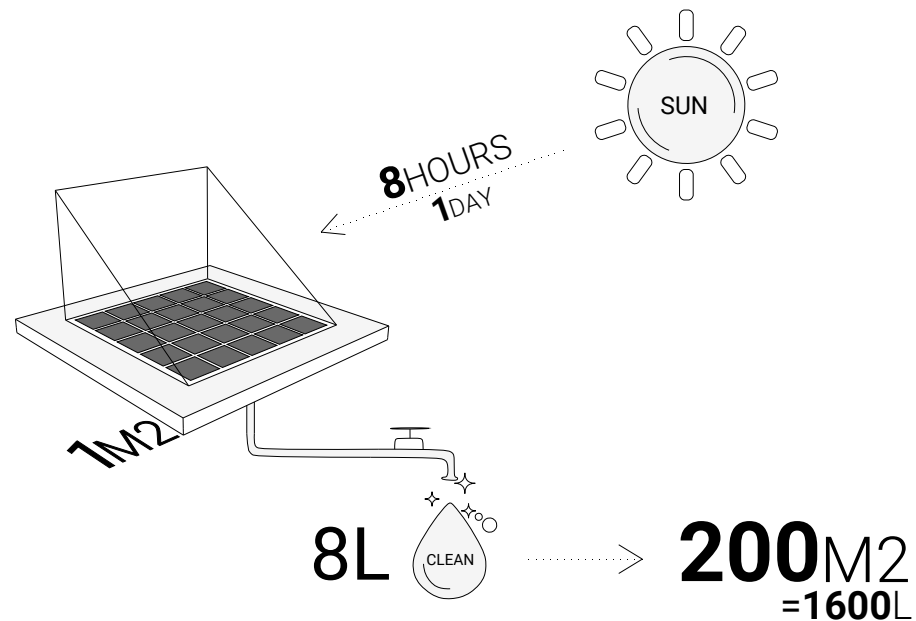

Fig. 20 Concept design performance and requirements. Author's graphics.

Since only the top layer of the input water is heated, the evaporation process is faster and less energy is lost. Presented results show that the prototype can purify water up to 4 times faster than a currently available commercial version of comparable size. Depending on weather conditions the device can produce up to 10 liters of clean water per day, which is 1 liter per hour per 1m². Furthermore, the materials used for the prototype are very cheap and cost less than \$2 per 1m². The prototype was designed as a floating still on the water surface intended for emergency situations. The concept will be investigated in this research and scaled-up to be able to serve as an off-grid clean water production system for a small rural community. Instead of floating solar still, the design will be based on a fixed device on a building's roof with a water basin automatically refilled with input water. As a safety factor, the production of 8 liters per square meter per day is taken. For the calculated daily demand of 1600 liters of clean water, 200 square meters of the solar-still system is needed.



Electricity

Electricity

DESIGN BY RESEARCH

1.3.1 Access & Consumption

Energy Information Administration, 2011 report shows that average electrical energy consumption in sub-Saharan Africa in 2011 was only 124kWh/year, which was hardly enough to power one light bulb for 6 hours per day. Average electricity energy consumption per capita in typical Mozambique's household in 2005 was 26.18kWh, 57 less than in the Netherlands (1484.82kWh) (NationMaster, n.d.). A significant part of the Beira, as a result of infrastructure damage caused by the natural disaster, was deprived of access to the electricity network. It will take a long time for the city to restore the whole system, especially in rural areas, where national grid repairs and extensions are not financially viable due to the low density of the area.

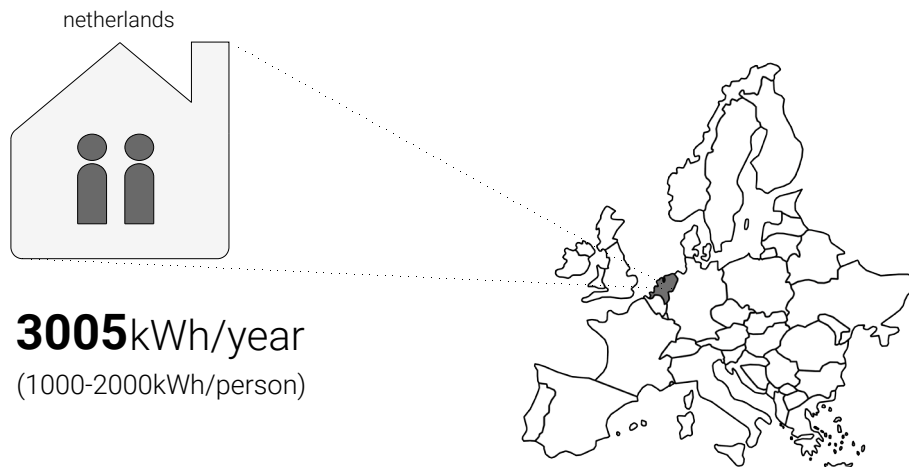

Fig. 21 Average energy consumption in a typical Dutch household. Author's graphics. Data source: (City Centre Retreat, 2018)

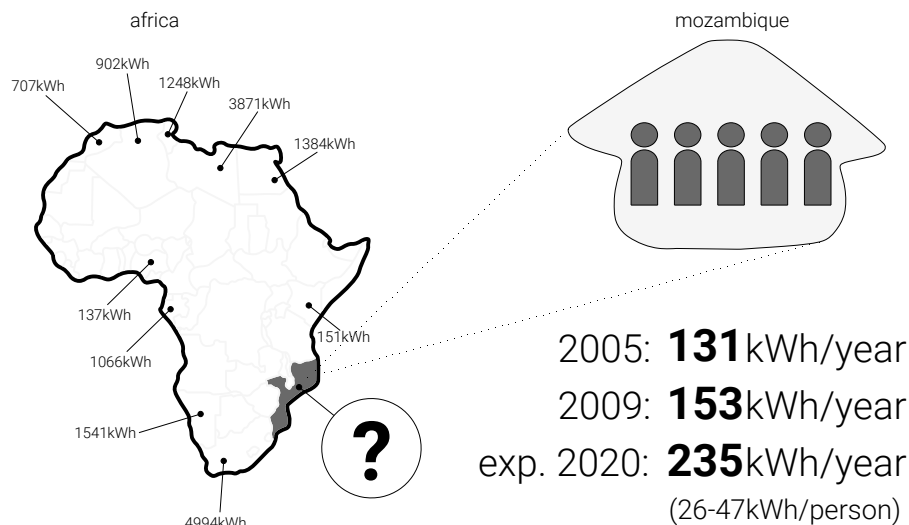

Fig. 22 Average energy consumption in a typical African household. Author's graphics. Data source: (NationMaster, 2005; Monari, 2011)

Electricity access is an important social and economic indicator. It is difficult to define what access to electricity means and there is no universally used definition. Most of them are focused on the delivery of electricity for safe cooking facilities and a required minimum level of consumption. IEA (The International Energy Agency) broadens the definition, giving a specified minimum level of electricity for a rural and urban household. The agency emphasizes that it will increase over time because consumption will grow until households gaining access to electricity will reach the regional average level. The initial threshold level of electricity consumption is calculated based on an assumption of 5 people per household and for a rural household is assumed to be 250kWh per year and 2 times more for an urban one. For rural households, consumption at the level of 250kWh/year could provide the use of a mobile phone, a ceiling fan, and 2 lightbulbs for 5 hours per day. For urban households, with consumption of 500kWh/year, it might also include a refrigerator, a second mobile phone, and a TV or a computer (International Energy Agency, 2017). It is clear that the minimum threshold level is only enough to provide limited access to modern energy services, however, for low-income rural areas without access to the national grid it is much more than what they have on a daily basis.

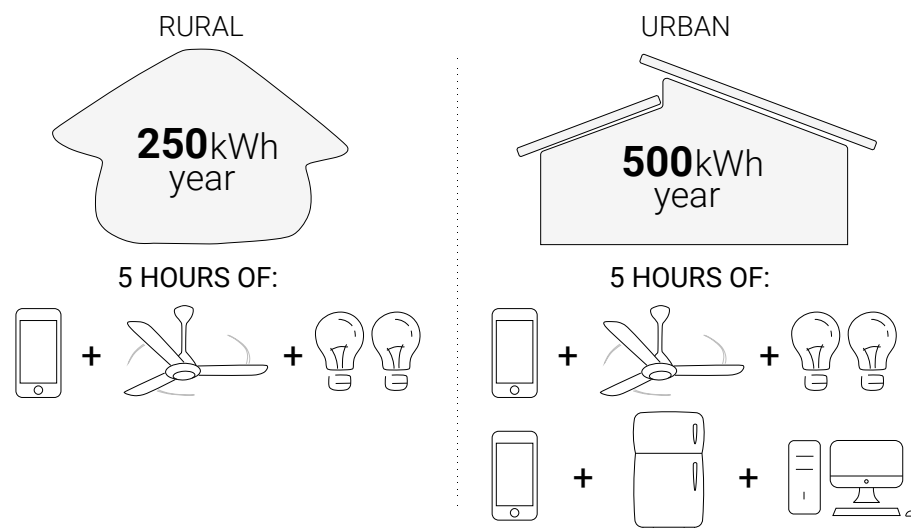













Fig. 23 IEA rural and urban minimum level of electricity. Author's graphics. Data source: (International Energy Agency, 2017)













Electricity

1.3.2 Electricity Usage













Calculation of electricity consumption in a household at a typical, optimal, and necessary level was conducted to define minimum demand for energy production by the designed system. First calculations (Typical Use, Fig. 24) imitate typical household in a developed country with the use of 4 smartphones, ceiling fan, TV, computer, fridge, cooking device, 10 lightbulbs, sewing machine, water heater, dishwasher, coffee machine, and laundry on a daily basis. The result of 3372kWh/year, which is 13 times higher than the IEA's definition assumes for rural households, coincides with globally available statistics (Odyssee-Mure, 2015). The second calculation (Optimal Use, Fig. 24) reduces the number of smartphones to 2, lightbulbs to 6 and eliminates the use of ceiling fan, sewing machine, dishwasher, coffee machine, and laundry, which allow to reduce and keep yearly consumption at the level of 1776kWh, what is still 7 times higher than the IEA's definition. The last calculation (Necessary Use, Fig. 24) assumes the use of only necessary appliances like 2 smartphones, fridge, cooking device, 2 lightbulbs, and water heater and results in 792kWh/year.

	WATTS	HOURS/DAY	kWh/DAY
SMARTPHONE 	6	1	0.024
CEILING FAN 	120	5	0.600
TV 	140	3	0.420
COMPUTER 	200	5	1.000
FRIDGE 	35	24	0.840
ELECTRIC COOKING 	1200	0.4	0.480
LED BULB 	10	5	0.500
SEWING MACHINE 	100	1	0.100
ELECTRIC WATER HEATER 	1500	0.5	0.750
DISHWASHER 	1500	1	1.500
COFFEE MACHINE 	1000	0.2	0.200
LAUNDRY 	800	1	0.800

TYPICAL: **3372 kWh/YEAR** (13x)

	WATTS	HOURS/DAY	kWh/DAY
SMARTPHONE 	6	1	0.012
CEILING FAN 	120	5	0.600
TV 	140	3	0.420
COMPUTER 	200	5	1.000
FRIDGE 	35	24	0.840
ELECTRIC COOKING 	1200	0.4	0.480
LED BULB 	10	5	0.300
SEWING MACHINE 	100	1	0.100
ELECTRIC WATER HEATER 	1500	0.5	0.750
DISHWASHER 	1500	1	1.500
COFFEE MACHINE 	1000	0.2	0.200
LAUNDRY 	800	1	0.800

OPTIMAL: **1776 kWh/YEAR** (7x)

	WATTS	HOURS/DAY	kWh/DAY
SMARTPHONE 	6	1	0.012
CEILING FAN 	120	5	0.600
TV 	140	3	0.420
COMPUTER 	200	5	1.000
FRIDGE 	35	24	0.840
ELECTRIC COOKING 	1200	0.4	0.480
LED BULB 	10	3	0.060
SEWING MACHINE 	100	1	0.100
ELECTRIC WATER HEATER 	1500	0.2	0.300
DISHWASHER 	1500	1	1.500
COFFEE MACHINE 	1000	0.2	0.200
LAUNDRY 	800	1	0.800

NECESSARY: **792 kWh/YEAR** (3x)

Fig. 24 Typical, Optimal, and Necessary use of electricity. Author's graphics. Data source: (Products technical sheets)

Electricity

DESIGN BY RESEARCH

Although the calculated consumption is 3 times higher than the IEA's definition provides for a rural household, 800kWh/year will be used for further demand calculations in this research. The World Bank, 2013 projections show that billions of people who are currently in energy poverty, will not reach the level of electricity consumption comparable with developed countries over the next quarter-century, but the minimum level of consumption for rural areas will fall between 420 and 1250kWh/year depending on the efficiency of appliances.

2014:

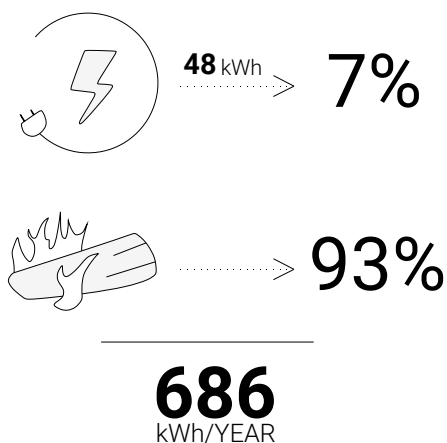

exp. 2035:

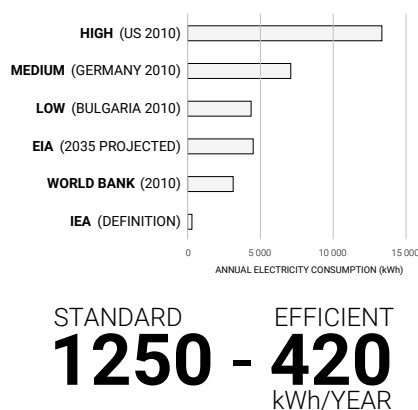

Fig. 25 2014 rural Africa and exp. 2035 energy consumption. Author's graphics. Data source: (Kammen & Kirubi, 2008; IEA, The World Bank, 2013)

An increase in the initial threshold level to 800kWh/year will accelerate development and will ensure safer living conditions. A household will be able to give up existing, unhealthy, and dangerous open-fire cooking facilities for safer, electric solutions. Similar to the water purification technique, electricity will be produced with the use of solar energy. Public facility and/or 10 households will require 8000kWh per year and the building itself will need an additional 5300kWh.

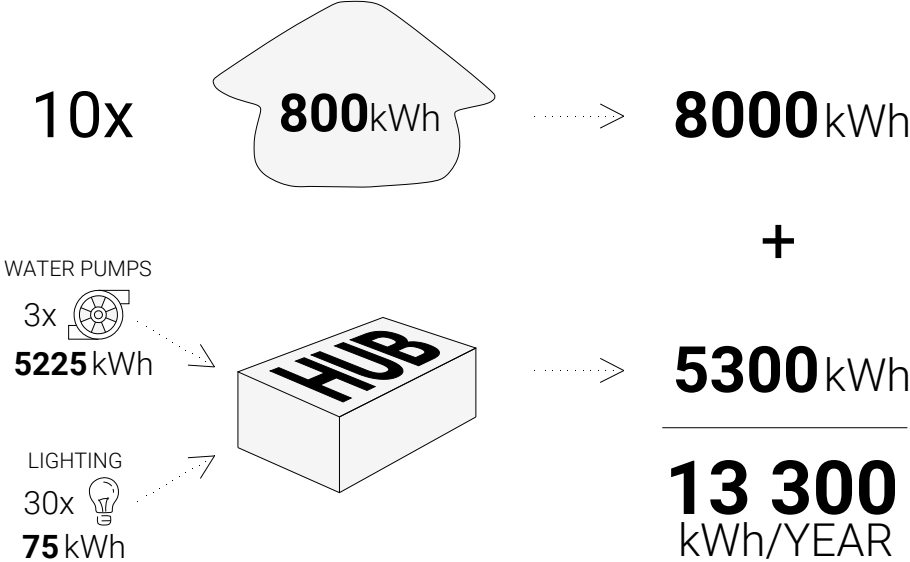

Fig. 26 Concept design energy requirements Author's graphics.

Electricity

1.3.3 Providing Energy

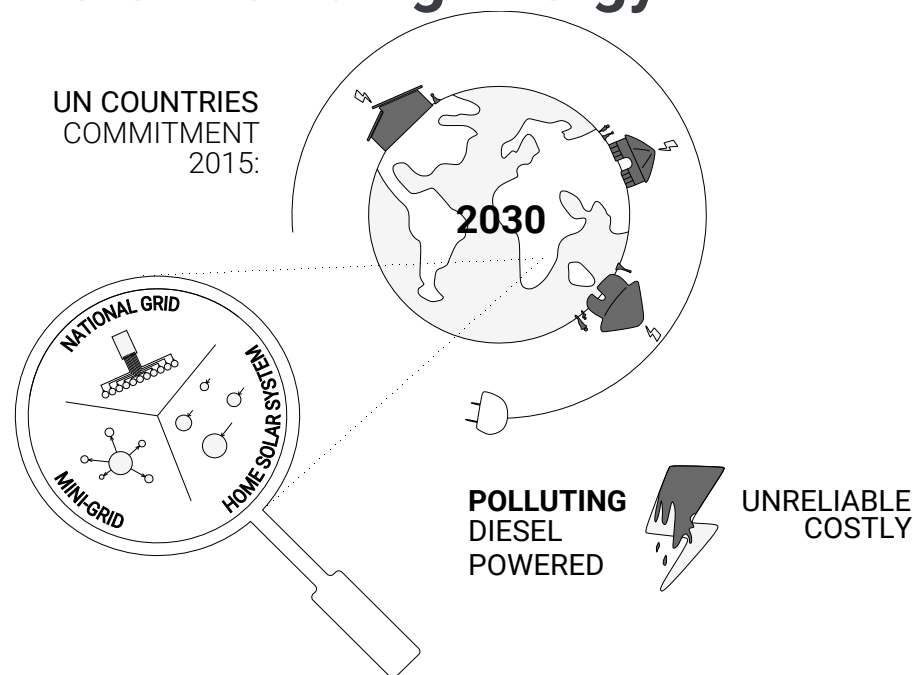

Fig. 27 2030 electricity full coverage goal and methods of providing energy. Author's graphics.

Providing energy can be achieved by a national grid extension, standalone system, or mini-grid. Grid extension is based on extending existing, national grid to areas without access to the network. It is the most typical and economically viable solution for connecting relatively large and densely populated areas, with households and facilities located close to the grid. The cost of grid extension is related to the area density and significantly rises when population density falls, thus it is the most commonly used solution in urbanized regions. The second solution, individual - standalone system, is the best for facilities located in the most remote areas. Usually, it can only provide output for basic household needs and may struggle with larger demands. Also, this solution is often related to high startup costs and is not optimal for medium populated rural areas. The third option is a mini-grid, which operates in between the other mentioned systems when a target community is too small for grid extension and a standalone system is not viable for larger needs. Mini-grid is an independent, decentralized network that can operate separately from a national grid and can generate output for local consumption only. Mini-grid is a solution that excludes unpredictable network cuts from the national grid, ensuring a less intermittent supply (Zajicek, 2019). The designed building, a product of this research, will function for the small community as a mini-grid hub producing clean water and energy for their domestic needs.

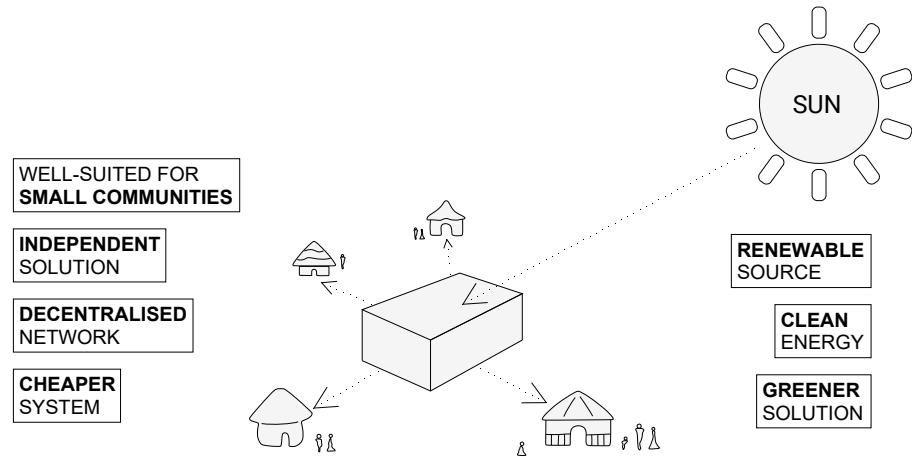
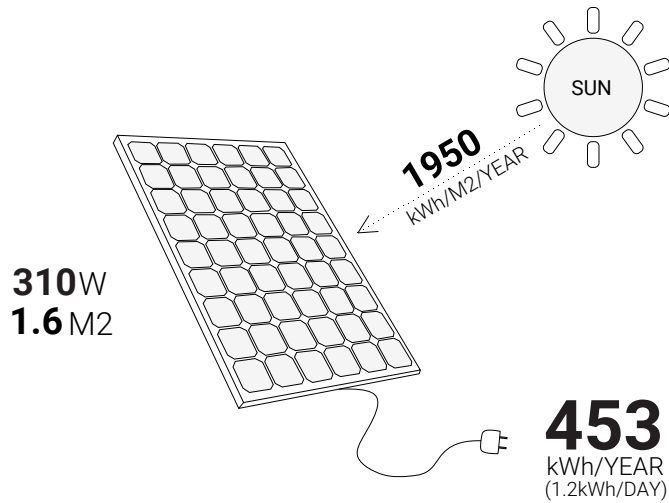

Fig. 28 Solar mini-grid advantages. Author's graphics. Data source: (Zajicek, 2019)

The target location has yearly solar radiation at a level of 1950kWh per square meter per year (Cuamba et al., 2006). The calculations have shown, that a conventional photovoltaic panel with an area of 1.6m² and maximum power 310W in site solar conditions can produce up to 453kWh over a year. To meet the energy demand of the designed facility, 30 PV panels are needed.



$E = A * r * H * PR$	$E=1.6*0.19375*1950*0.75=453.375kWh/year$
E = Energy (kWh)	
A = Total solar panel Area (m ²)	A=1.6m ²
r = solar panel yield or efficiency (%)	r=0.31/1.6=0,19375
H = Annual average solar radiation	H=1950 kWh/m ² /year
PR = Performance ratio, coefficient for losses (0.5-0.9, default value = 0.75)	PR=0.75
13500/453=29,8=30PV panels	

Fig. 29 PV system calculation. Author's graphics. Data source: (Cuamba et al., 2006; Photovoltaic-Software.com, 2019)

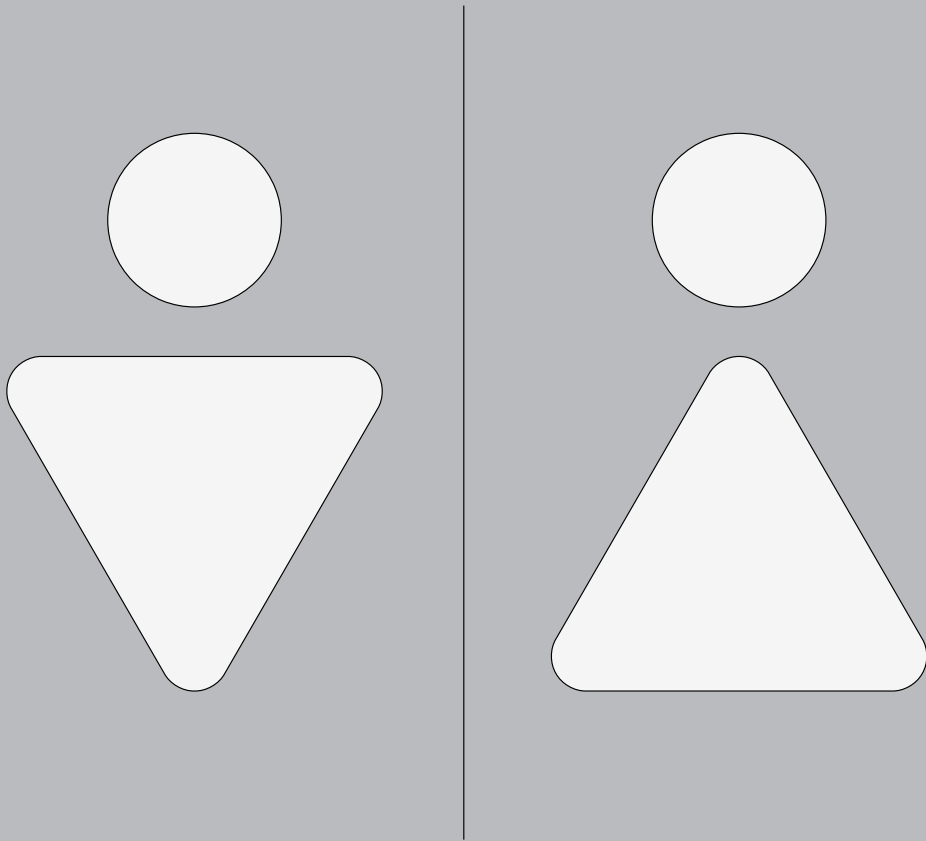

Sanitation

Sanitation

1.4.1 Situation in Rural Areas



Fig. 30 Sanitation situation in rural Africa. Author's graphics. Data source: (WHO and UNICEF, 2008)

Typically, in this region, rural communities use sanitation facilities based on a system that collects and store human excreta, like ventilated improved pit (VIP) latrine or twin pit latrine (WHO and UNICEF, 2008). Both systems assume the release of waste to the ground over the specified period of time. This conventional sanitation approach should not be used in areas with a high water table and no less than 30 m upstream of a drinking water source (Tilley et al, 2014). However, the lack of necessary infrastructure for wastewater containment, treatment, and safe disposal leaves no choice for rural areas of developing countries. Often, waste from latrines pollutes both surface and groundwater sources and surrounding agriculture, with negative effects on the population's living conditions. An ecological approach to sanitation system is needed to prevent the spread of waterborne diseases. It should be socially acceptable, economically viable, and technically appropriate, to be considered as a possible solution to the existing problem. VIP latrine potentially can be easily improved by a waste container which, instead of releasing not treated human excreta to the environment, turns it into compost applicable for agriculture (Jenkins, 2009). Moreover, a more advanced approach can assume the use of biogas formed in the tank for cooking purposes.

The designed hub, beside the digester tank for black water, will reuse greywater for flushing. The rest of the greywater will be fed back to the solar still system for the water production process. The overflow of the black water will be used as fertilizer for agriculture or filtered with constructed wetland before redirected back to the system.

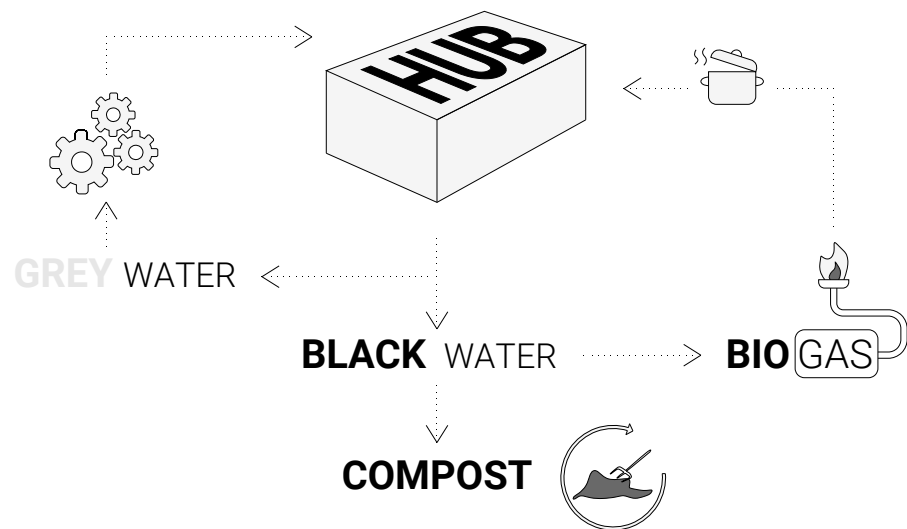

Fig. 31 Concept design sanitation strategy. Author's graphics.

Sanitation

1.4.2 Pit Latrines

Pit latrines are the most common type of human excreta disposal facilities in rural areas in Africa (WHO and UNICEF, 2010). The most popular types of pit latrines in rural regions include traditional Twin Pit Latrine (Fig. 32) that are made of wood poles and mud, and Ventilated Improved Pit latrines (VIP) (Fig. 33). Usually, in most of the rural African regions, latrines are shared by a few households as a result of poverty, limited space, and high population density. Typically, this type of sanitation is built with locally available materials. Latrines can be easily repaired by unskilled people, and have very low capital costs. Pit latrines do not require water for their functionality.



Infiltration of the black water into the ground and overflows after heavy rains from the excreta collection chamber have made this type of sanitation the main reason for groundwater contamination (Howard et al., 2003; Kulabako et al., 2007). Pit latrines are usually elevated without proper foundations in areas with a high water table. The high water table, floodings during wet seasons, and not sufficient drainage increase the likelihood of pollution of drinking water sources. In the remotest regions, without accessibility for cars, local workers manually empty latrines. There are health risks to the labors, furthermore, there is no control over where the disposal is released. While this practice is often the cheapest solution to provide the most basic sanitation in rural areas, sanitation strategy needs to be improved because of the high threat to life.

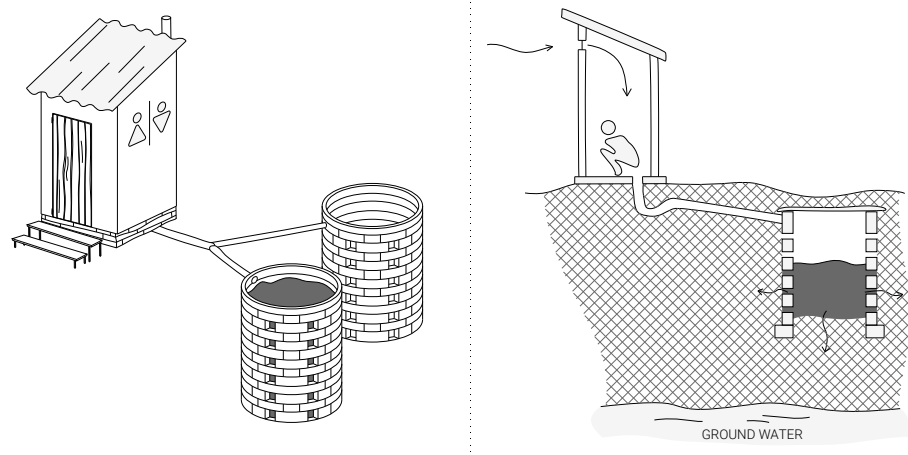

Fig. 32 Twin Pit Latrine. Author's graphics. Redrawn from: (Tilley et al, 2014)

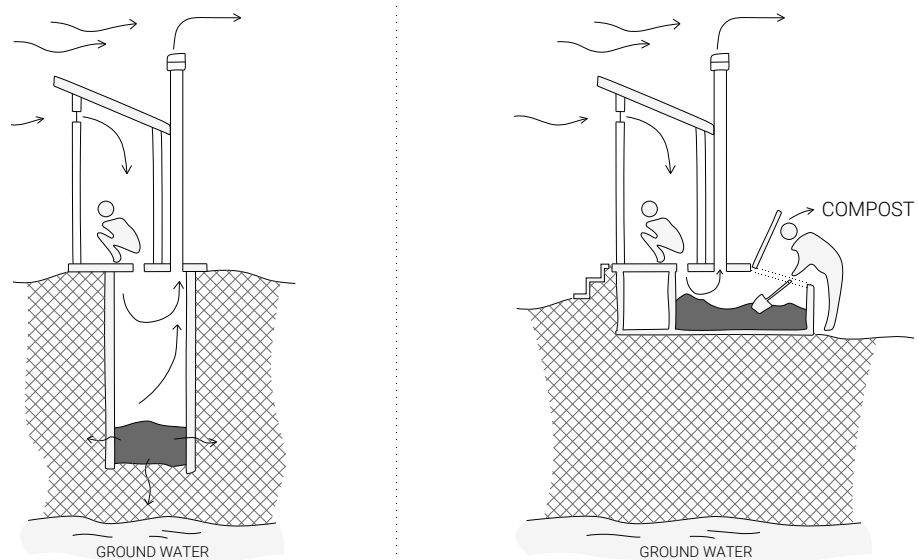

Fig. 33 Improved Ventilated Pit Latrine. Author's graphics. Redrawn from: (Shaw, WEDC, 2010; Jenkins, 2009; Tilley et al, 2014)

Sanitation

1.4.3 Constructed Wetland

Constructed wetland technology is suitable for rural areas. Typically, it is a simple, cost-effective, and locally manageable biological wastewater treatment system. Constructed wetlands consist of wetland plants, soils, and their associated microorganism to mimic natural ecosystems processes. It can help to solve problems in wastewater and sludge management and minimize uncontrolled releases to the environment. Constructed wetlands use vegetation and can operate without any energy consumption, thus it is widely known as 'green' technology. When the wastewater flows through the constructed wetland, it is treated by natural processes. Contaminations in the water are mechanically filtered, chemically transformed, and biologically consumed. It is an environmentally friendly and sustainable solution for areas without a grid sanitation system. Furthermore, wetlands fit very well within a rural landscape and can be easily organized as wastewater gardens without producing any unpleasant impact (like odors or mosquitoes), even close to households (Obarska-Pempkowiak, Gajewska, Wojciechowska, & Kolecka, 2015).

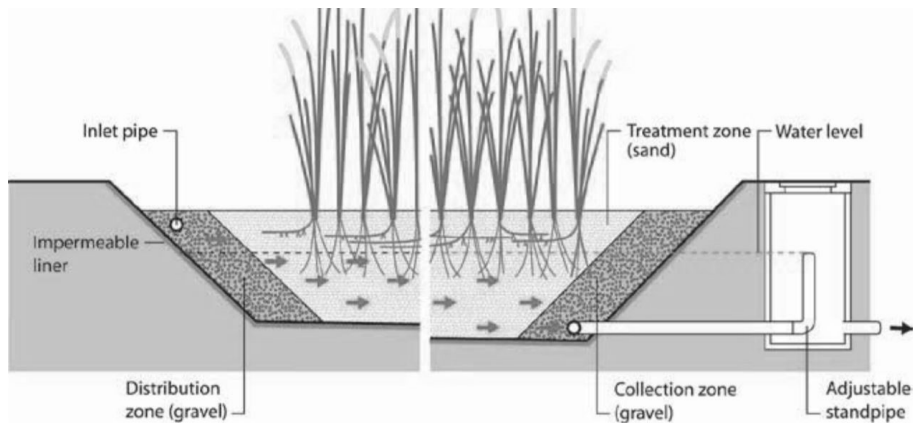

Fig. 34 Horizontal Flow Constructed Wetland. Source: (Morel & Diener, 2006)

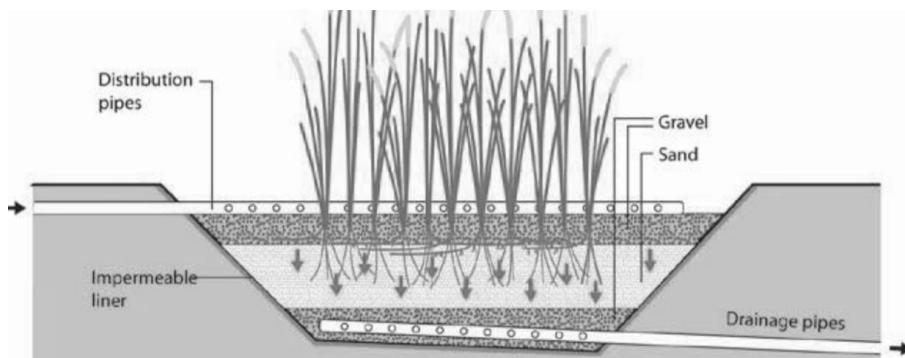

Fig. 35 Vertical Flow Constructed Wetland. Source: (Morel & Diener, 2006)



Depends on the direction of wastewater flow (vertical/horizontal), constructed wetlands are divided into Horizontal Flow Constructed Wetlands (Fig. 34), also known as reed beds, and Vertical Flow Constructed Wetlands (Fig. 35), also known as vertical flow planted gravel filters. For effective wetland's operation, pre-treatment of wastewater (like digester or settlement tanks) for removal of oil, fat, and large solids by sedimentation and floatation is necessary. Constructed wetland's bed must be separated by a waterproof membrane or concrete from the native soil to prevent ground pollution. Preliminary treated water is loaded by gravity and physics onto a surface or inner layers of constructed wetland. Quality of output water is suitable for non-potable use like irrigation, surface application, and other outdoor needs. The water can be collected in a storage tank for later use or transferred for disinfection and purification.

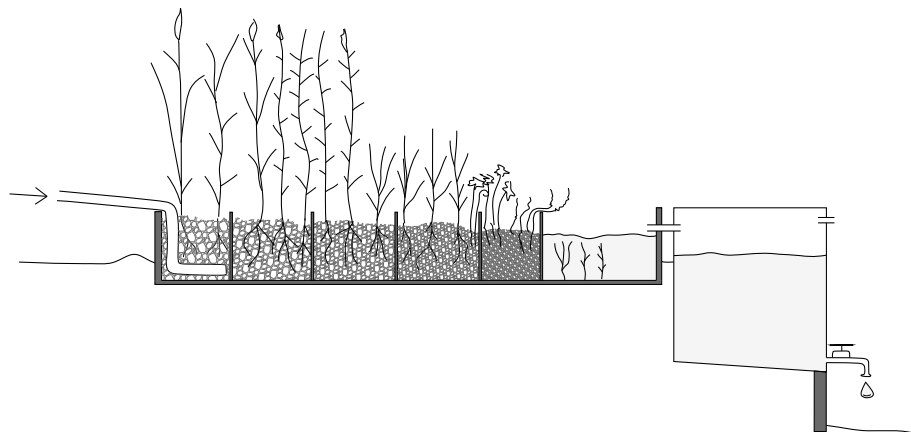
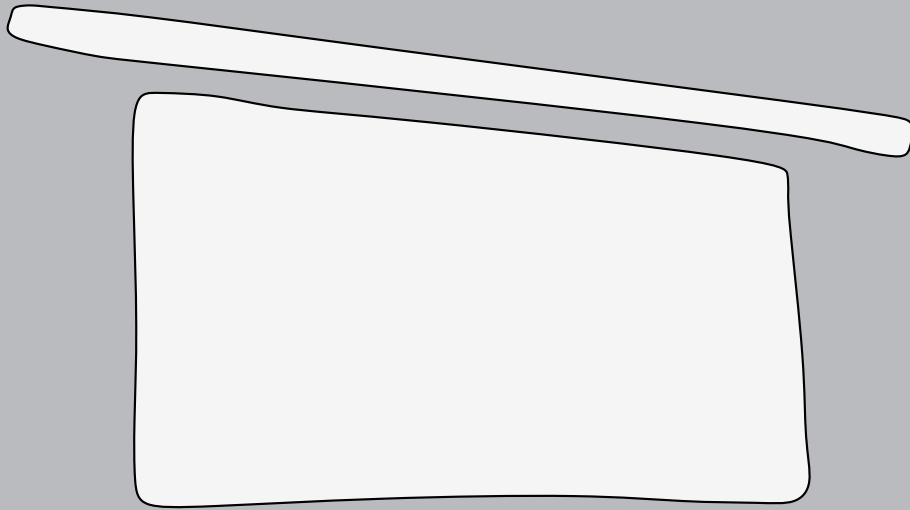

Fig. 36 Constructed wetland strategy. Author's graphics.



Local Architecture

Local Architecture

1.5.1 Local Architecture

Architecture is derived from knowledge application into practice. It is crucial to understand the potential and limitations of the design. In locations such as Mozambique, economical, logistic, and material limitations have a significant impact on the building industry. Potential for the architecture for rural areas lies in regional, vernacular building techniques. In the traditional Mozambican community, buildings are typically small and contain basic functions such as a bedroom or kitchen. Each facility is considered as the sum of its interior and exterior spaces, with most of the social life taking place outside. In northern Mozambique, a house with a rectangular plan is usually seen. This type spread throughout the region and in many areas replaced the most traditional round huts (Schetter, 2010). The rectangular space is more practical and has many functional possibilities. Furthermore, usually, it is easier to build and, by local communities, is more often identified with both traditional and modern typology.





Vernacular house in Mozambique, Betty Muess

In the vernacular architecture, the roof is typically dominant. Its construction shape and logic determines the form and size of the building. When the roof structure is small enough, it is assembled on the ground and placed on top of the walls as a whole. Mozambican typical house has a single pitched roof unless it is a circular hut. To create a slope one of the two supporting walls is higher. Traditionally, building components are tied together with organic ropes, while the modern industry is shifting connection techniques for using nails and metal wires. Most of the rural buildings are using bamboo or coconut wood for wall construction, filled with soil and rocks and plastered with earth.



House in Beira after Idai Cyclone. Yasuyoshi Chiba/AFP/Getty Images

Local Architecture



A woman repairs a wall after Idai Cyclone. Beira, Mozambique. Yasuyoshi Chiba/AFP/Getty Images

Vernacular architecture usually uses only natural, locally available materials. Buildings of the region are typically made of bamboo or coconut wood, rocks, earth, and thatch. Industrial materials such as corrugated iron sheet, cement, laminated timber or metal profiles can be found in more urbanized districts of the region. They are less popular in rural areas since they require greater capital and building knowledge. However, they are becoming more and more popular in rural areas, contrasting with traditional vernacular architecture.



Fig. 37 Construction materials used in Beira region. Author's graphics.

Currently, many negative opinions about African vernacular architecture exist. People perceive it as substandard or for the poor (Sojkowski, 2017). Rural communities, just like people from urban districts, desire modern constructions for a reason of status. Unfortunately, the potential and principles of the traditional way of building are underestimated. Most of the architecture schools on the continent do not put enough

emphasis and attention to the history of traditional African architecture (Mathias, 2018). Usually, local architects and builders are not equipped with knowledge of the history of the regional architecture. While only a few design schools in Africa teach about vernacular architecture as a standalone course, others put the greatest emphasis on the theory and history of classical western styles.

One of the goals of this project is to present vernacular architecture and natural, locally available materials in a new light for the local communities. People in urban regions partially lose knowledge of traditional construction techniques when they move out of traditional rural society. Modern materials and styles are gradually displacing regional architecture by which it begins to be identified with poverty and temporary constructions. Most of the African countries have no set the protection and promotion policy for the vernacular way of construction. While regional architecture is in the middle of a transition between traditional and modern systems it is a chance to prove the potential of vernacular architecture by combining traditional craftsmanship, local materials, and modern design techniques to create a refreshed contemporary African architecture style. It is important to make this type of architecture more acceptable aesthetically and functionally and shows that African vernacular architecture is relevant, diverse, and beautiful.

It is very important to understand that traditional African architecture will never meet requirements and specifications for every project due to its physical, structural, and form limitations. However, the affordability of this architecture type is the most appropriate for low-income housing and public buildings, like markets, hospitals, and schools in rural areas (Mathias, 2018). Examples made by contemporary architects and designers presented below, show possibilities of traditional construction techniques.

Local Architecture

DESIGN BY RESEARCH

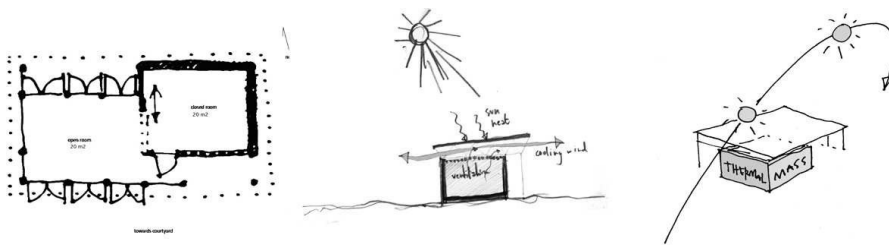

2009: Educational Building in Govuro, Mozambique.
Architect: Masterstudents of Bergen School of Architecture



2018: The Econef Children's Center in Kingori, Tanzania
Architect: Asante

Conclusions

1.6.1 Project Scale

To sum up the first phase of this research - Design by Research, the decision to design a public facility seems to be the most logical. The concept and design of the public building for Beira's rural community will be presented in the second part of this report - Research by Design.

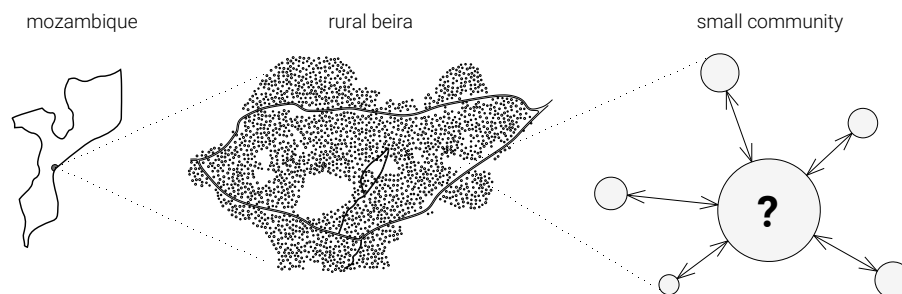

Fig. 38 Concept design target community. Author's graphics.

The building will be designed as a pilot facility aimed at developing and disseminating the concept of the self-sufficient, off-grid building hub. For both logistic (construction) and economic (financing) reasons, the building is supposed to act as a place intended for the local community and should be managed by a non-governmental organization. The facility will be designed for 50 people, responding to the basic living needs of inhabitants of 10 average size households of the region.

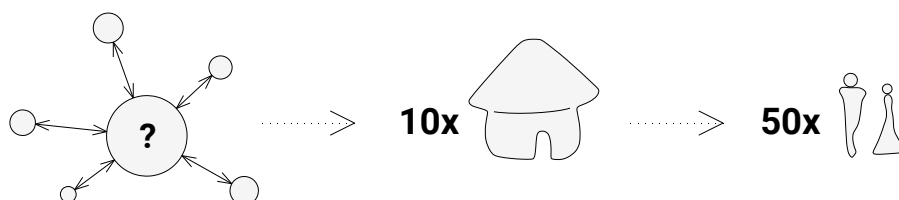

Fig. 39 Concept design target scale. 10 households/50 people. Author's graphics.

The production of clean water and electricity requires a minimum space of 250m² which is 5m² per person. To most effectively use the area intended for construction, the space under the production systems will be designed as open, semi-open, and closed rooms. All functions will complement the needs of residential areas and finance facility service costs by renting the space for small local businesses and organizations. The facility has been divided into 12 modules with the scale corresponding to the local residential buildings. The further development of the project and its multiplication has a chance to fit into the characteristics and scale of the surroundings. Additionally, further development of the project will allow the use of the same technology and modules to build sustainable and self-sufficient affordable houses. Thus, one of

the most important goals of the project is to prepare it in an understandable, self-explanatory way for the local community. This assumption, together with the use of easily available local materials, aims to teach and improve building skills of local craftsmen, and thus to improve the socio-economic situation in suburban areas inhabited by a low-income part of society. One of the main final product of this theoretical project will be 'Ikea-like' construction manual, which can be easily read and used by local people.

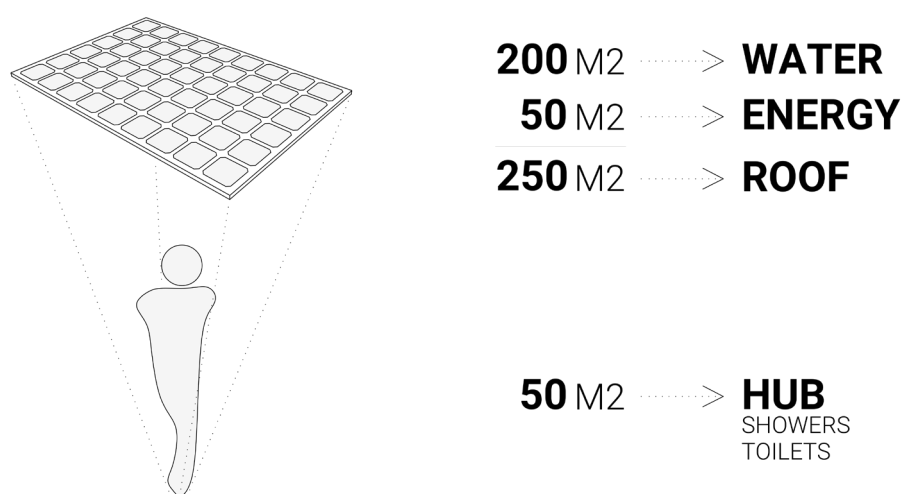

Fig. 40 Concept design system area requirements. Author's graphics.

The project will use 2 middle modules for common building's functions, such as the sanitary part with showers and the technical space supporting production systems. These two modules later in this report are described as the water and energy hub. The remaining 10 modules, in the case of a public facility, will be divided into space for a local educational center, open-space shaded gathering space, rooms for small businesses or shops, a semi-open market where everyone will be able to sell their products, and community center managed by a non-governmental organization. The building module corresponds to the scale of a typical local residential home, and the capacity of the production systems is designed for 50 people. As a result, the same system can be used for 10 affordable housing units. The water and energy hub with the change of sanitation layout will stay the same and use 2 modules, while the remaining 10 modules can be spread and serve as 10 individual houses. Area of the roof for solar stills and PV panels will stay the same, however, this will allow designing a less compact project - better suited to the loose urban layout of residential districts in this region.

Conclusions

1.6.2 Design Brief (PoR)

Programme of Requirements (PoR) has been prepared to take into account all guidelines for the designed facility:

1. The building is intended for 50 people, corresponding to a number of inhabitants of 10 average local households.
2. A minimum of 200m² of surface intended for water purification is needed
3. A minimum of 50m² of surface intended for electricity production is needed
4. A minimum of 50m² of functional space for technical and sanitary rooms is needed. For a public facility, the hub should be divided into male and female sanitary rooms, each with 3 showers and 2 sinks. Furthermore, the female part should include 4 toilets, with 1 intended for people with mobility limitations, while the male part should contain 1 urinal and 3 toilets, including one for the disabled people. For a residential function, the sanitary section should be divided into 5 private bathrooms - each with shower, toilet, and sink (1 for 2 households).
5. The technical section should contain a clean water tank, a dirt water tank with a sand filter, biogas powered water heater, water pumps, and the technical infrastructure of a photovoltaic installation.
6. Water and electricity production systems should properly face the sun to maximize the outputs of these systems. For the selected location, the optimal system setting is a surface facing north and inclined at an angle of 10-15 degrees.
7. The form of the roof should let and, what is more, improve airflow through the covered space. Additionally, it should completely or partially shade the external walls, in particular openings, to prevent excessive heating of the interior. The roof should be equipped with a rainwater collecting system.
8. The building, due to the hydrological situation of the area and climate change, should be erected on a 40-50 cm rammed earth slab, preventing water from entering the interior, during periodic floods, and minimize their effects.
9. The main structure should be designed on a modular design grid that allows free arrangement and division of space. The structure should be designed in the spirit of the circular economy ideology, therefore special attention should be given to the system of structural component connections, enabling subsequent disassembly, re-construction, or expansion of the structure.

10. The building should mainly use materials available locally and the same as the architecture of the region.

11. The technology of external partitions should use local construction technique which is well understood by the local community. However, due to adverse weather conditions abundant in strong winds, the wall structure should be reinforced with structural elements to prevent frequent damage. In this case, walls should be improved with diagonal beams stiffening the main load-bearing structure.

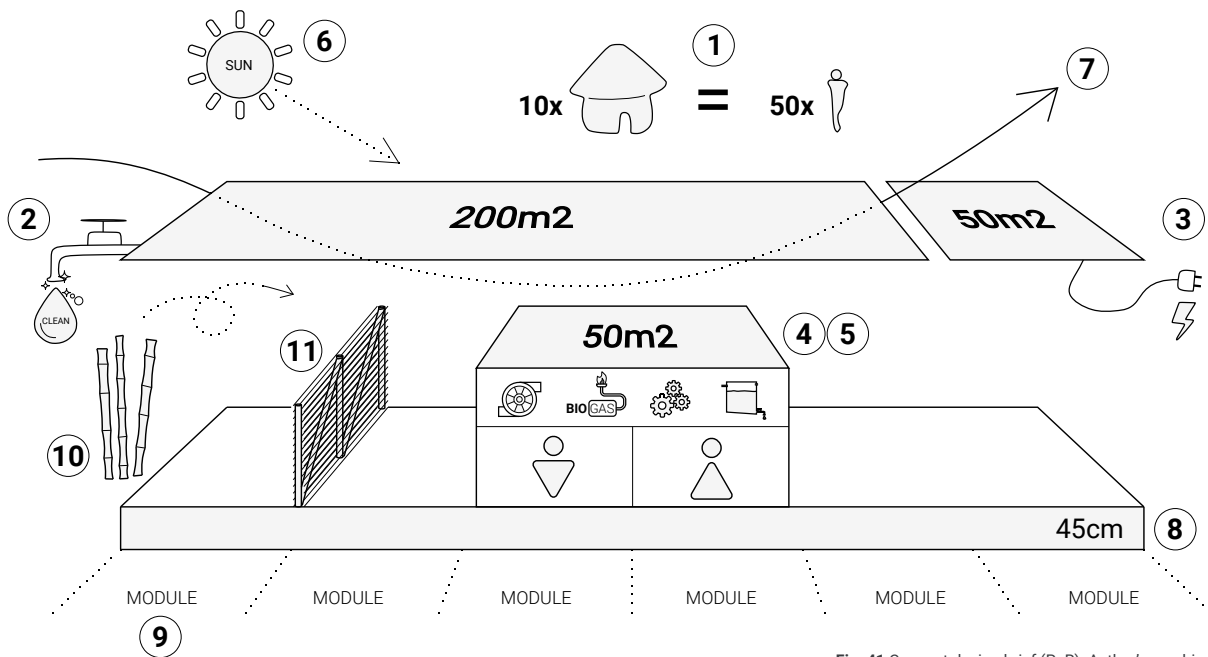
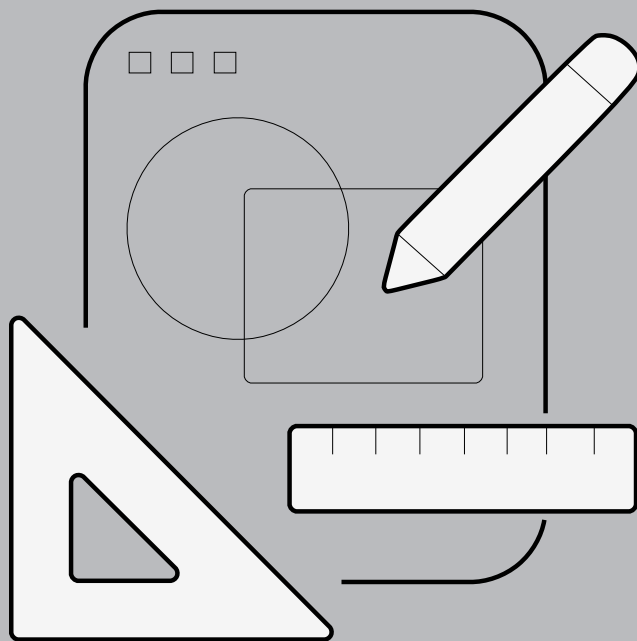
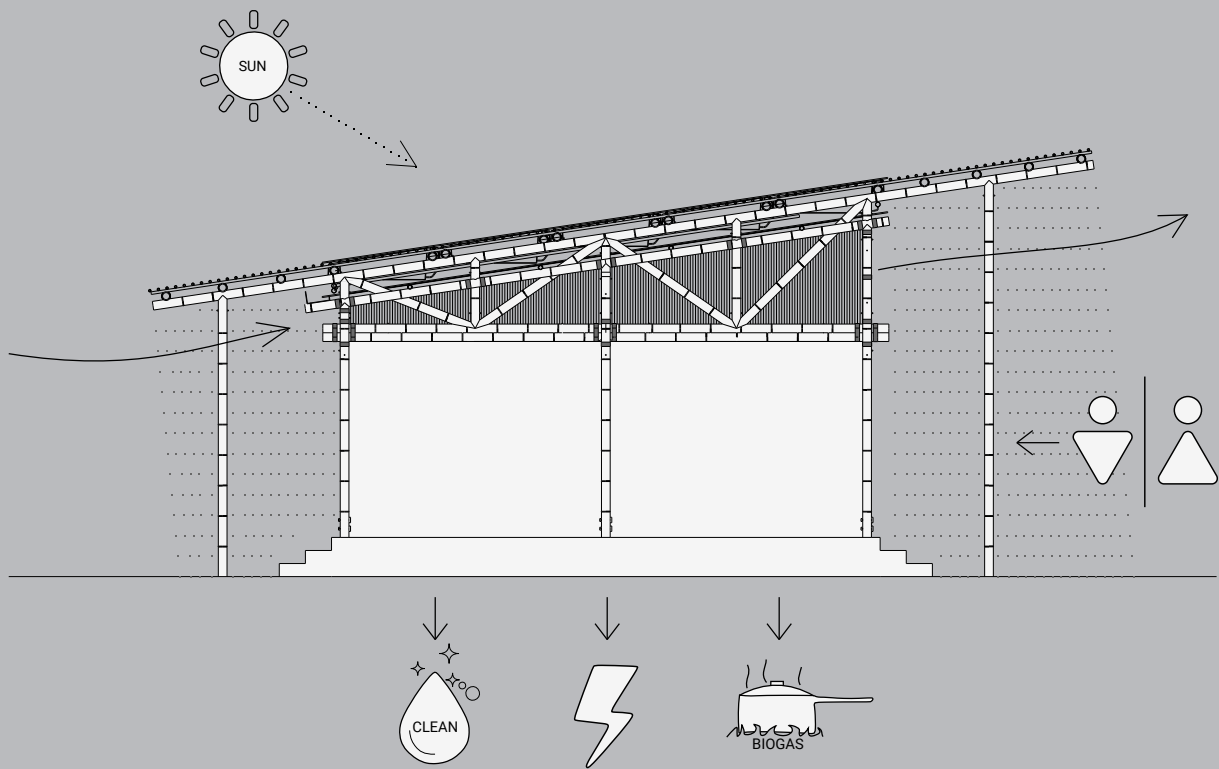

Fig. 41 Concept design brief (PoR). Author's graphics.

Research by Design

In this part, the idea of Water and Energy Hub is developed. Both the study of design and the process of output production occurs simultaneously. Design involves a deep investigation of the Phase 1 conclusions, as well as testing of ideas and technology. Design is explored in various ways in which the project can go to answer research questions. First ideas are confronted with each other and sometimes slightly change the point of view, design conditions, and programme. This chapter is supported by the first part of this report and intended to make creative jumps in thinking and solving problems. The goal is to push conceptual project development and turn into final product design, by linking partial solutions into a spatial strategy for the hub.





Architecture

Form of the Building

RESEARCH BY DESIGN

2.1.1 Form

Bearing in mind the spatial conditions of the model location and the characteristic form of the region's architecture, the designed object in form and scale falls within the framework of local vernacular architecture. This type of architecture is often equated with traditional architecture strongly associated with the construction techniques and culture of the region. The aesthetics of the building is to refer to traditional forms of the region, but in particular to present the potential of local materials and cease them to be equated with the architecture of temporary, substandard, or for the poor.

'The architecture of place should be more important than the architecture of time.'
(Gunnar Asplund)

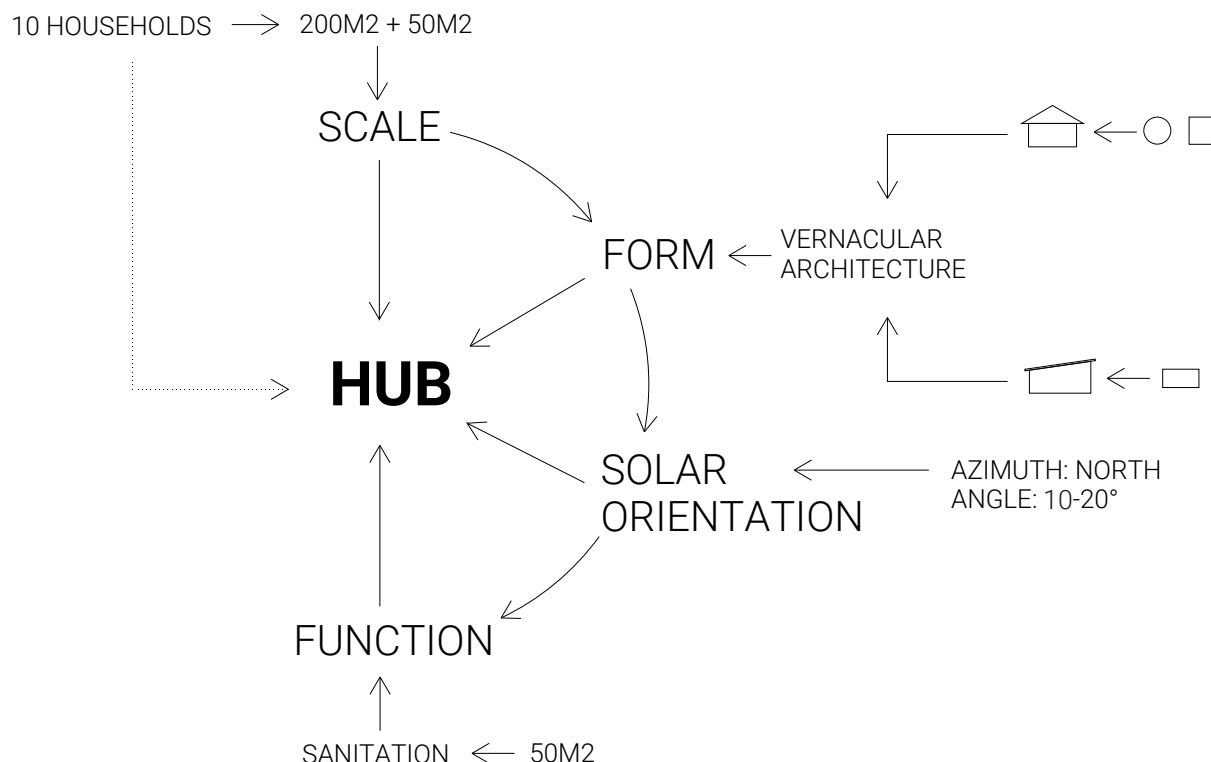

Fig. 42 Concept architectural requirements. Author's graphics.

Based on the research results collected and studied in the Phase 1 of this report (1.5.1), the object in size and shape (cross-section) resembles a typical single-family house in the region. The entire building consists of 12 modules designed on a 4.6m wide and 6m deep modular grid. The main component determining the aesthetics of the building is a single-pitched roof inclined at an angle of 10 degrees to the north, founded on a rectangular-shape block with a minimum height of 2.5 m inside. The shape of the roof allows it to be most efficiently used for the production of both clean water and electricity. Besides production functions, the roof collects rainwater, and through protruding from both the front and back of the building openwork structure, shades the walls, significantly slowing interior's heating. Furthermore, the roof supported by bamboo columns was additionally raised above the partition's top edge to improve the natural ventilation of the building.

The entire structure is elevated on a 45cm slab made of compacted soil mixed with cement, to prevent water from entering the building and have a negative impact on bamboo culms. Due to the floor's elevation, 3 steps - each 15 cm high and ramps for people with reduced mobility provide access to the facility.





Functional Plan

RESEARCH BY DESIGN

2.2.1 Space Layout

The main, unchanging function of the facility is the central, 2 modules hub, containing the sanitary space with showers and a technical room for water and energy production systems. It is the heart of the facility and regardless of whether the facility will be intended for public or residential use, the distribution of clean water will take place in these 2 modules. In the case of a public building designed as 12 modules in a row, the central location is the most optimal for water circulation between the technical room and solar still units located on the roof. Water meant to be purified needs to be transported from Dirt Tank to the highest solar still row. By increasing this distance, the pressure in the water pump would have to be higher what results in higher system operation costs. The purified water flows from the solar still system on the roof to the Clean Tank located in the technical room by gravity only. If the technical room was located at one of the ends of the building, the piping would have to have sufficiently large slopes to ensure the sufficient flow of water, which is not the optimal solution for the designed object. Furthermore, the central location ensures optimal access to toilets for all building users, both in the public and residential cases, minimizing the walking distance.

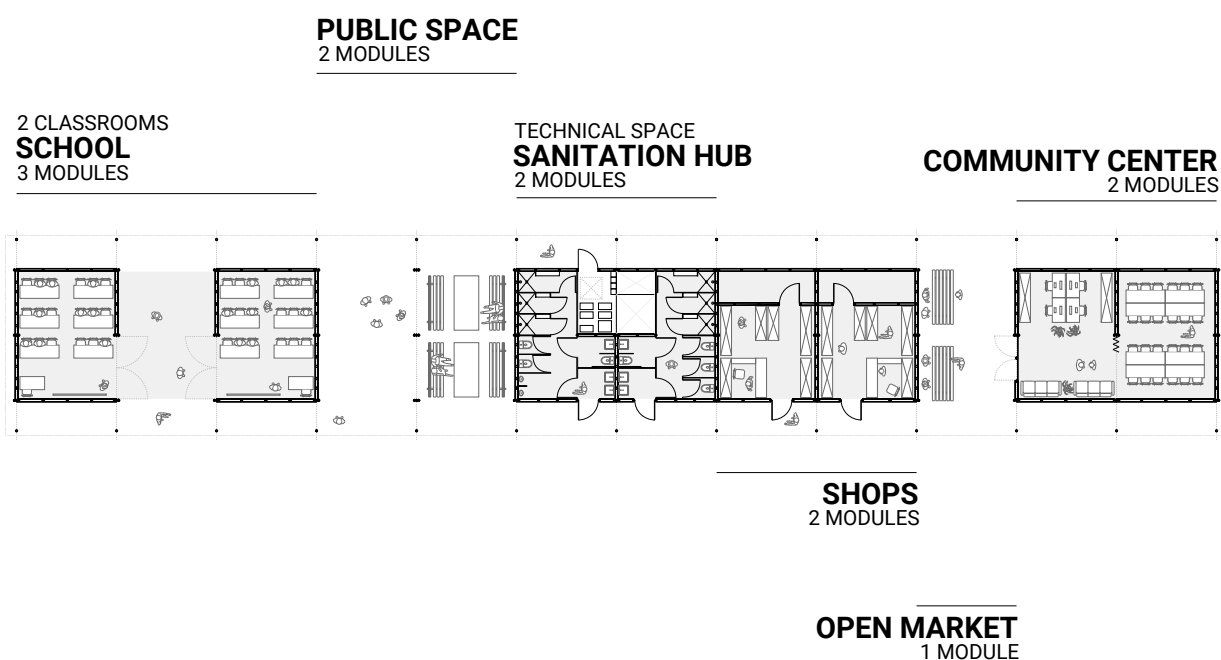

Fig. 43 Concept public facility space layout. Author's graphics.

The remaining 10 modules have been divided into public functions that will work best for the considered location of the building (Fig. 43). From the west, the first 3 modules are intended for an educational center with 2 classrooms and a semi-open space between them. This semi-open space can be incorporated through additional moving partitions into classrooms, increasing their area if needed. The next 2 modules were designed as an open shaded gathering space, available not only to all users of the object but also to the surrounding community. It should serve as a place of social activity intended for spending time together. This type of space has a special role in the considered building because it is a place of meetings and the development of ties between the community members. Furthermore, it can serve as an additional space for the educational part, giving the possibility of conducting workshops in comfortable conditions. The next 2 building's modules are the central hub part that will be elaborated in the next paragraph of this section (2.2.2). East from the central hub, 2 modules are intended for small shops and local businesses serving the local community. This space is intended for rent, which should finance the facility's operating costs. The next module is intended for the open-space market, where each of the members of the surrounding households can come and trade their products. The area covered by the roof allows for comfortable use of the space each day. The last 2 modules are intended for the community center, managed by a non-government organization, responsible for the proper functioning of the facility. This space is mainly intended for social consultations and organization of workshops to teach how the designed system works and how to build it with the use of local techniques and materials. The goal is to improve the skills of local builders and to disseminate the potential of self-sufficient systems for the production of clean water and electricity. This model guarantees proper maintenance of the building and its systems. It has the chance to spread the project among the rural communities of the region, which is especially important in the face of the recent natural disaster that has significantly slowed down the development of the region. Furthermore, the community's awareness of proper construction techniques resistant to worsening weather conditions should be constantly raised.

Functional Plan

2.2.2 Central Hub

The central hub has been divided into two separate symmetrical sanitary spaces for men and women, and a technical room (Fig. 45). The entrances to the sanitary rooms are located in the front facade. These two rooms have been designed with the most intimate space (showers) located in the deepest part of the room. The part with showers is preceded by a toilet section, which is accessible from the vestibule with washbasins. Such a scheme ensures high comfort of use and does not introduce walk-through zones for functions that should be intimate. Both the male and female parts contain 2 sinks and 3 showers, including one intended for use by disabled people or parents with children. The women's zone with toilets has been divided into 4 cabins, including one for the people with limited mobility, while the male part has 3 toilet cabins and 1 urinal, which is in line with generally accepted design standards for the designed number of users.

The entrance to the technical room is on the opposite side of the object. The room has 10.2 square meters and is mainly filled by a Clean Water Tank and Dirt Water Tank with a capacity of 8m³ and 2m³ respectively. Additionally, the Gray Water Tank with a capacity of 1m³ is located directly below the technical room, into which water from the sinks and showers goes through gravity. The room also has a biogas-powered heating boiler and a system of five water pumps that are responsible for the proper circulation of water in the system. In addition to the infrastructure for water production and circulation, the room houses the technical infrastructure of the photovoltaic installation mounted on one of the interior walls of the room. Due to its large dimensions (25m³), the Rain Water Tank is located outside of the building.

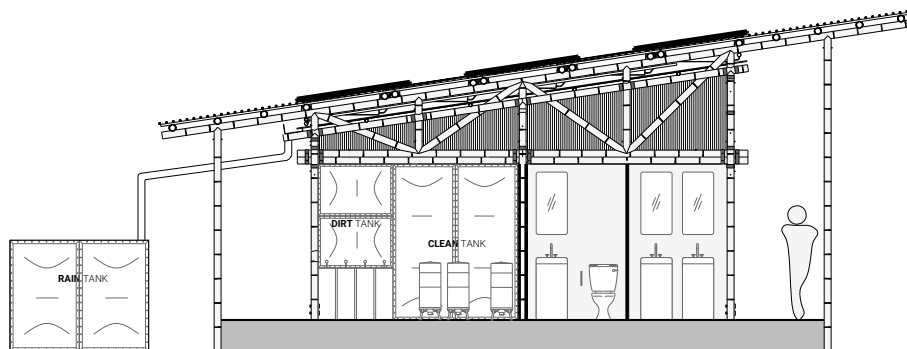

Fig. 44 Central HUB A-A section. Author's graphics.

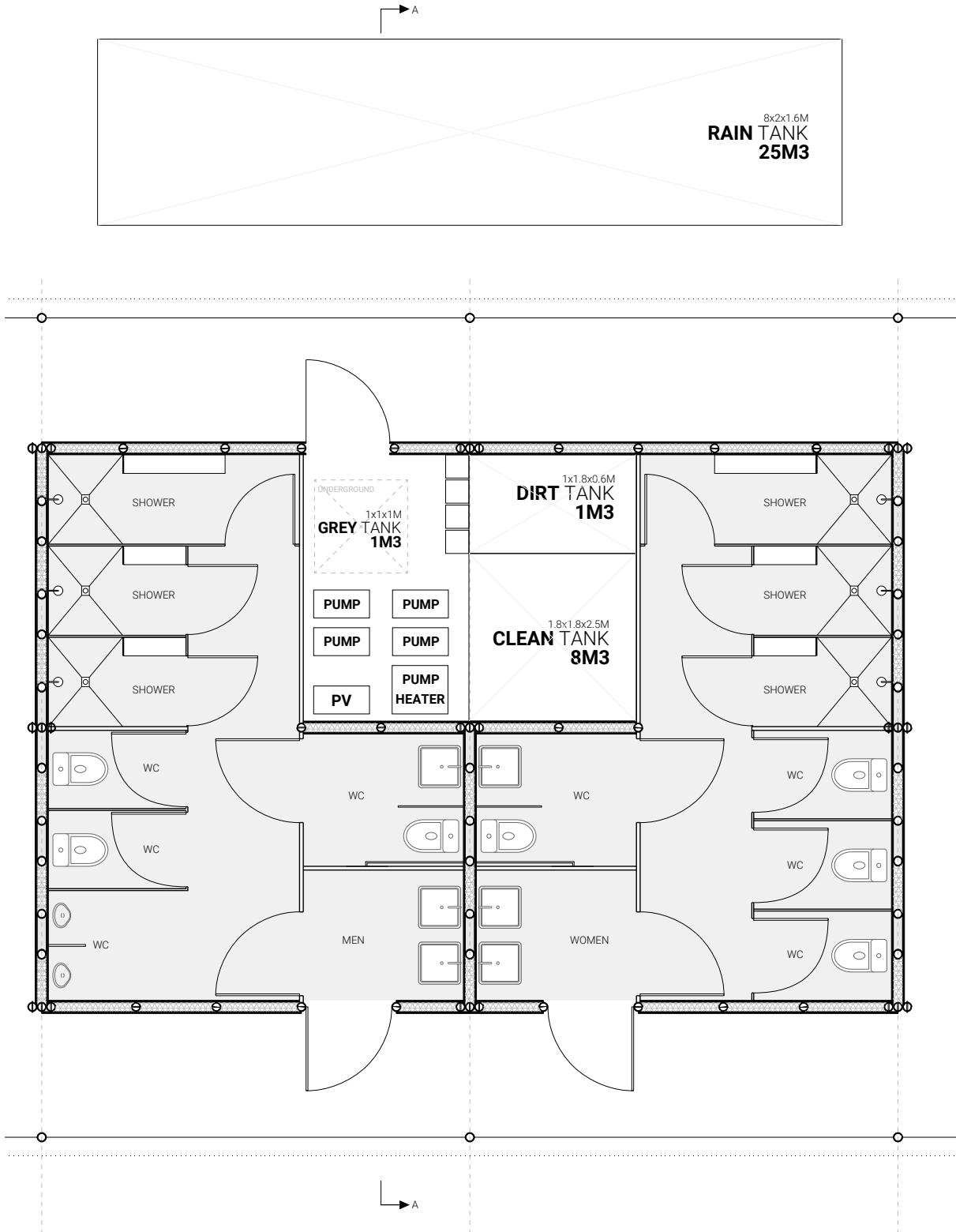

Fig. 45 Central HUB floorplan. Author's graphics.

Building Frame

2.3.1 Bamboo

The main support structure is designed from bamboo. The choice of this material for the construction of the facility not only affects the technique of construction but merge the building with local architecture. This material is widely available and used in the region, and particular finds application in the architecture of small objects, such as houses or small public facilities in non-urbanized rural areas. This part of the research is not supposed to elaborate deeply on physical and mechanical properties or characteristics, possible processing, and treatment methods of bamboo. While the water production system is the main topic of this research, an overview of bamboo is given since it is an important element of the whole building. Most of the knowledge comes from (Hidalgo-López, 2003), which is widely known as 'bamboo bible'.

The goal of the bamboo structure is to make the local community not only aware of sustainable solutions but present the potential of local resources. This is significant for low-income, rural and remote areas where modern construction materials are not affordable and applicable. Bamboo is a remarkable, versatile natural material. It grows rapidly within three to five years and can be described as an endless source of raw material. Bamboo does not require a lot of maintenance. If there is sufficient rainfall, it does not require any fertilizer because fallen leaves nourish the plant itself. Since it can be used in place of wood, it helps to minimize deforestation of the natural tropical forests. Its extensive root system and high water storing capacity does not contribute to soil erosion and can deal with water scarcity. Bamboo can be used completely without producing any waste because even small parts and culms can be used in furniture and interior industry.

This sustainable, raw, and endless resource has many positive aspects such as high growth rate and mechanical properties. It is appreciated by engineers and constructors for its compressive strength even higher than concrete and its tensile strength comparable to steel while being lightweight construction material. In the context of the designed facility, it is the best when all bamboo components and connections avoid machine-intensive processing on site. During the design process, it was important to keep short angle-cuts that are manageable by hand saw and other simple tools.

The (Fig. 46) below shows the principles of using bamboo in the construction industry.

DONT USE FOR CONSTRUCTION

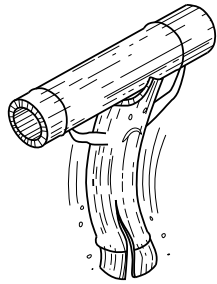

Culms with low compression strength. These include:
 1) Young culms less than three years old,
 2) Culms which are or have been attacked by insects or fungi,
 3) Culms which have flowered,
 4) Culms with cracks or which have transversal cuts made by a machete

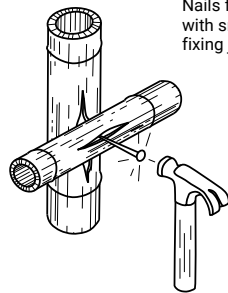

Nails for fixing lateral culms with smaller diameter, or for fixing joints.

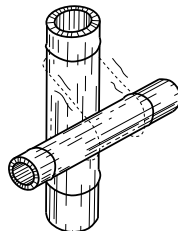

Green bamboos used structurally in permanent constructions and tied with wire or ropes. When green culms become dry, they shrink and the ties become free

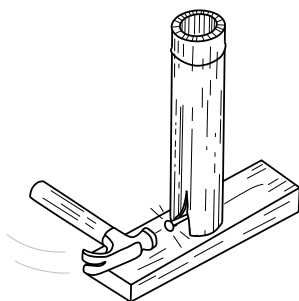

Temporary vertical supports or columns without any node at the lowest end which can present cracks at the moment of being fixed.

USE

1) Mature culms three years old or older
 2) Giant culms with appropriated dimensions and thick walls (more than 9mm)
 3) Culms with appropriate joints

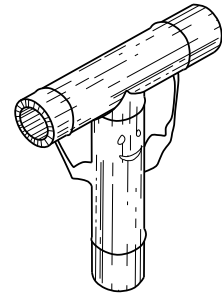

If it is necessary to use nails for fixing small diameter culms (4 to 5 cm) or joints of giant bamboos, it is recommended to open a hole previously with a drill bit slightly smaller than the nail's diameter
 2) For fixing horizontal and vertical structural members in temporary structures use wire ties, nylon or strong vegetal cords

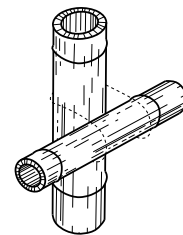

In this case it is convenient to check frequently the ties, or to use dry culms

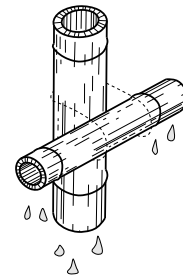

In this case it is convenient that the temporary column has a node in the lowest end, in order to avoid the cracks.

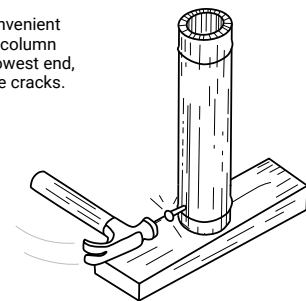

Fig. 46 Principles of using bamboo in the construction industry. Author's graphics. Redrawn from: (Hidalgo-López, 2003)

Building Frame

2.3.2 Foundations

The first connection used in the building is the connection of the supporting structure (columns) with foundations (Fig. 48). The foundation is designed as cuboidal cement blocks under each of the main columns. Each of the 30x60cm foundations is placed 45 cm below the ground level (Fig. 47) and protrudes above 45 cm to align with the designed elevated floor (Fig. 49). Three wooden dowels embedded in each block correspond to the location and cross-section of the internal diameter of the main support columns (8cm). To securely fasten columns, the dowels should have a minimum length of 60 cm and be embedded in the foundation to a minimum depth of 30cm. The protruding part serves the connection of the column with the foundation block. Bamboo culm is placed on the wooden dowel and both elements are joined with a perpendicular wooden dowel. Transverse wooden rods with a diameter of 15 mm should be driven into the drilled holes in columns and wooden foundation dowels to properly anchor the columns. Bamboo culm should lean the entire cross-sectional base against the cement block to transfer the load from the roof in the most effective way.

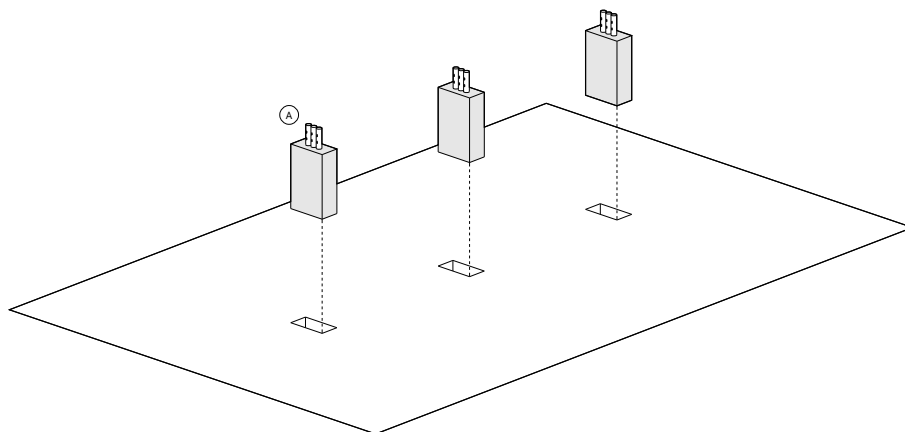

Fig. 47 Step 1. Foundations placed 45 cm below the ground level. Author's graphics.

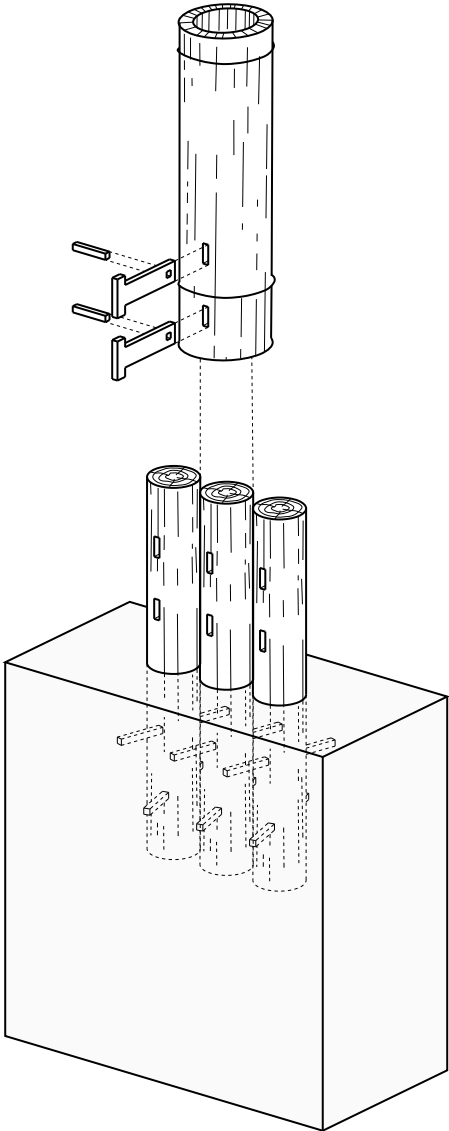

Fig. 48 Det. A. Connection of the supporting structure (columns) with foundations (concrete block). Author's graphics.

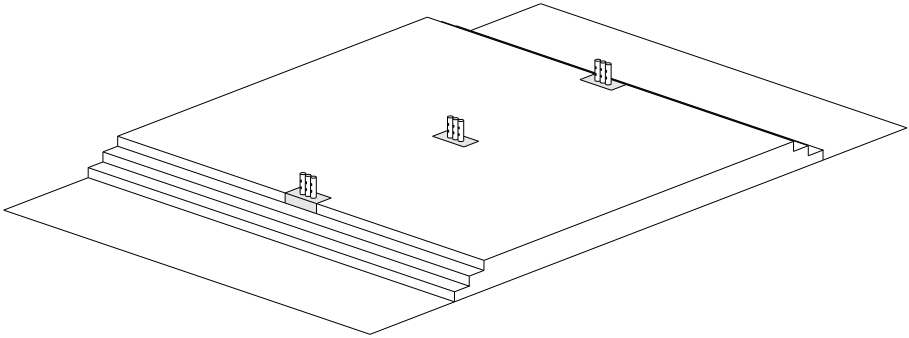

Fig. 49 Step 2. Elevated floor. Author's graphics.

Building Frame

2.3.3 Frame Design

The facility is designed with a column-beam bearing structure based on a modular design grid. Figures in this chapter show the main construction components and assembly steps.

One module consists of 2 rows of columns with distance 4.6m between rows. Each row has 3 columns at 3m spacing. Each row serves 2 design modules, therefore, one module is supported on 6 main bamboo columns, each consisting of 3 bamboo culms with a diameter of 10cm. Between the main columns, additional single-culm columns are designed, additionally supporting roof but mainly used for the wall construction. In-between columns are not placed if space between 2 modules is designed as a single room. The main beam is supported by a row of columns. Between the vertical elements of the structure, diagonal beams were designed to stiffen the entire structure. Then a bamboo truss is designed and placed on the main beam and columns. Its upper beam is inclined 10 degrees to the horizontal surface. Roof culm-beams have been designed on trusses to support water and electricity production systems and the roof cover. Columns consisting of 3 bamboo culms allow the stable construction of both the front and back walls as well as the internal partition.

One of the main goals of the project is to use the least amount of materials that are not natural for the production of the building. Therefore, during research, mainly connection methods that do not use metal components were considered adequate to the designed architecture. Furthermore, designing in the spirit of circular economy focuses on methods of joining structural elements that can be disassembled and reused. The main source of possible connections commonly used in construction technology using natural bamboo was the book (Hidalgo-López, 2003), which reliably presents multiple possibilities. All the details have been redrawn from the book and adapted for this project. To clearly present all connections used in the project, they are described in this report in relation to the main elements of the designed building. Figures in this chapter show the connections and details used in the bamboo structure.

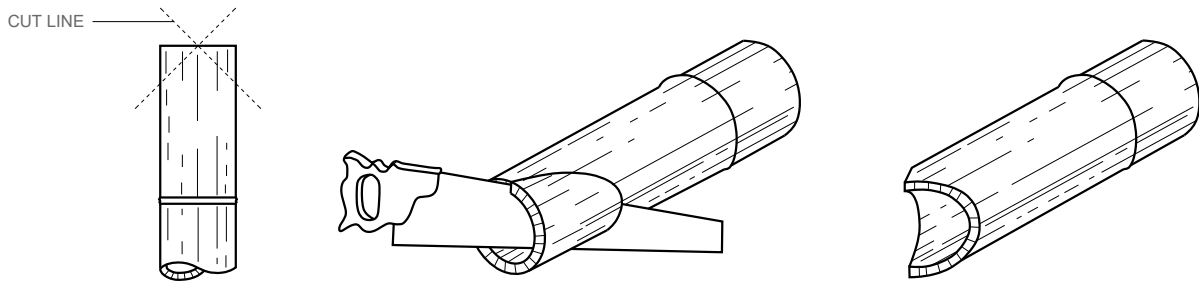

Fig. 50 Det. B Bamboo cutting. Author's graphics. Redrawn from: (Hidalgo-López, 2003)

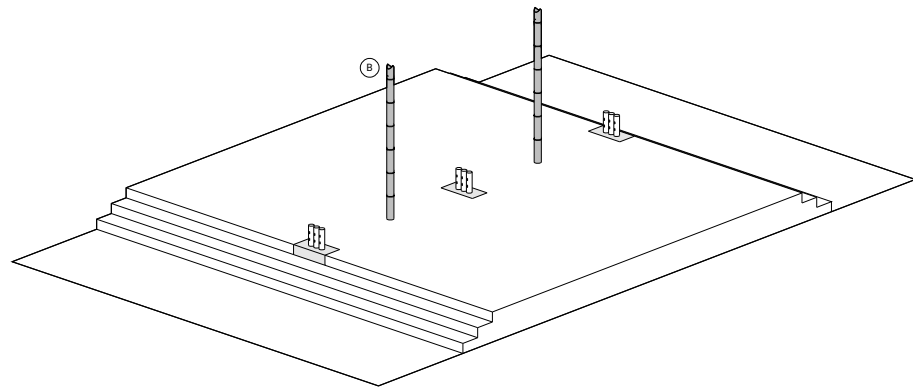

Fig. 51 Step 3. Single-culm bamboo columns. Author's graphics.

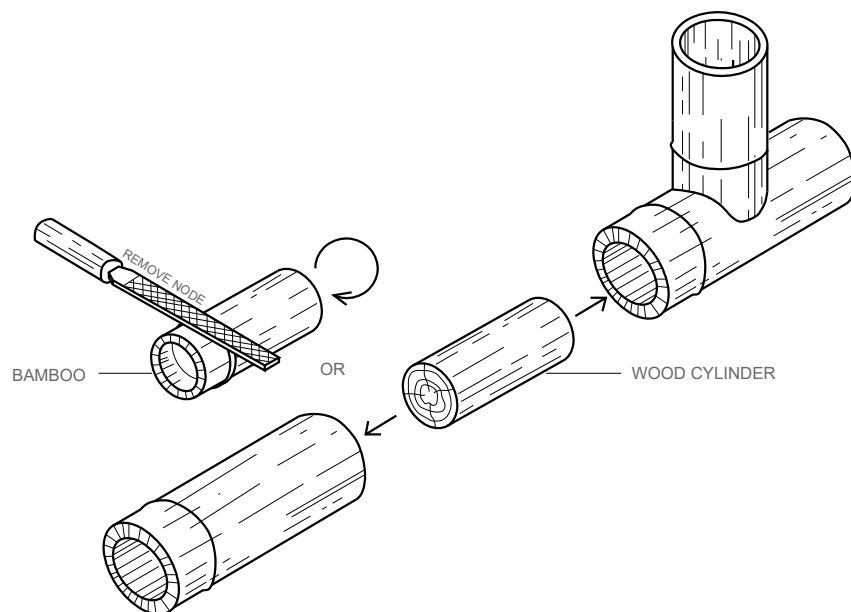

Fig. 52 Det. C. Bamboo horizontal joining technique. Author's graphics. Redrawn from: (Hidalgo-López, 2003)

Building Frame

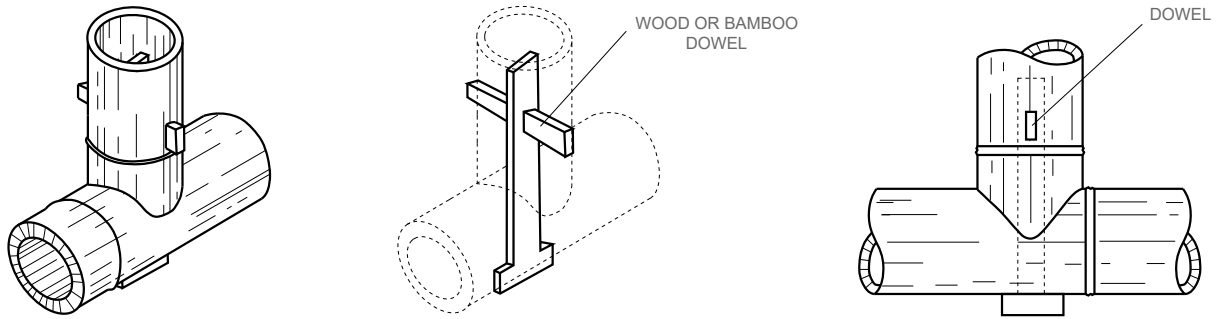

Fig. 53 Det. D. Bamboo perpendicular joining technique. Author's graphics. Redrawn from: (Hidalgo-López, 2003)

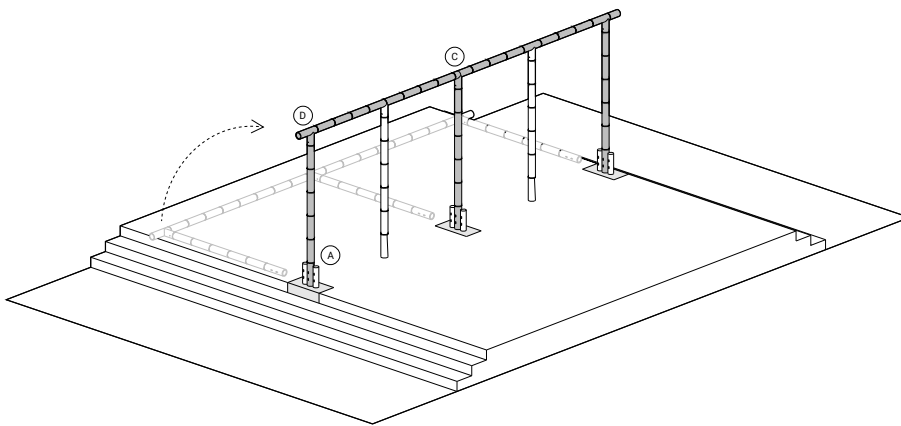

Fig. 54 Step 4. Main columns and beam. Author's graphics.

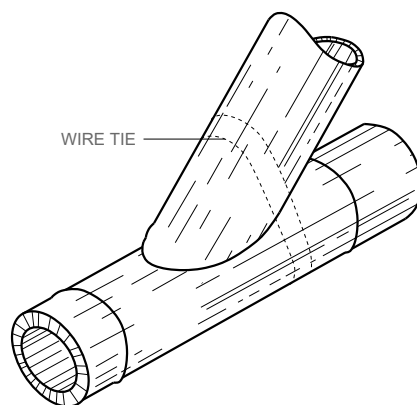

Fig. 55 Det. E. Bamboo diagonal joining technique. Author's graphics. Redrawn from: (Hidalgo-López, 2003)

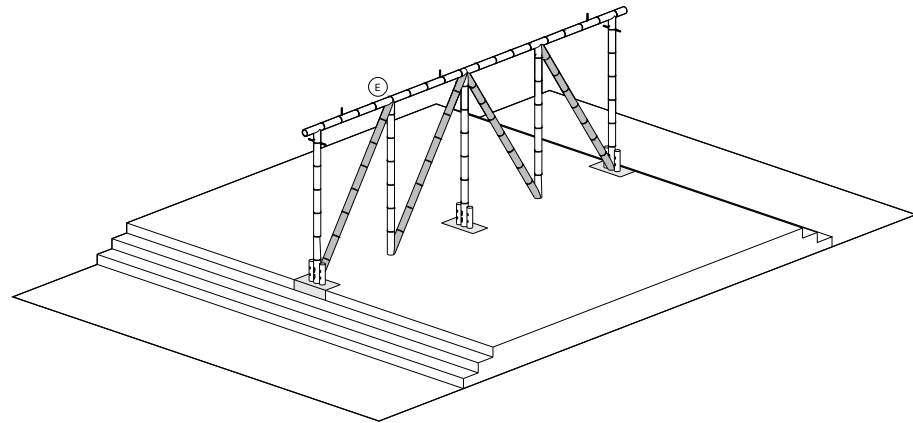

Fig. 56 Step 5. Diagonal beams. Author's graphics.

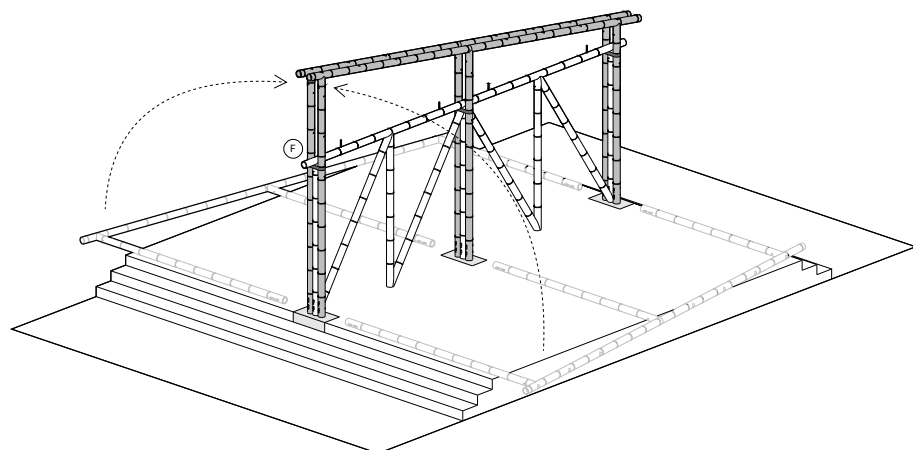

Fig. 57 Step 6. Main columns and roof beams . Author's graphics.

The truss is designed as a triangular, one-slope span of 6.5 m and a slope of 10 degrees. The connection between the main beam and the truss is designed in such a way that the assembly of the truss can be carried out on the ground with manpower use only. The lower beam (parallel to the ground plane) has a length of 6.5m, and the upper beam (inclined 10 degrees to the ground plane) is 10.95m long. For simple construction and easier transport of materials to the construction site, beams are divided into fragments and connected with an internal wooden or bamboo cylinder (Fig. 52). Cross-section of the cylinder needs to correspond to the internal diameter of bamboo culms and should be inserted at least 40 cm into each of the beams. For the inclined beam, 3 bamboo culms with a diameter of 10 cm and lengths of 3m, 4.55m, and 3.40m are

Building Frame

used. To ensure the correct connection of the roof beam with the truss, the inclined beam has recesses corresponding to the spacing of the culms supporting solar stills. The vertical and diagonal elements of the truss are joined together with its lower and upper beam as shown in (Fig. 55). Parallely, 2cm diameter wooden dowels should be placed in the main beam on the columns, projecting vertically from the beam to a height of a minimum of 15 cm. The dowels should not pass through the beam located on the columns, but only through its upper part (to prevent them from sliding out). The pins are designed to allow the correct placement of the truss on the beam, additionally, they exclude the possibility of truss slipping off the main beam. The front and back single columns of the truss are driven into the ground just like single-culm wall columns. Then ropes connection is applied (Fig. 59). Ropes are placed on both sides of each column horizontally and vertically. The connection diagram of the truss with the main beam and columns structure is shown in (Fig. 58).

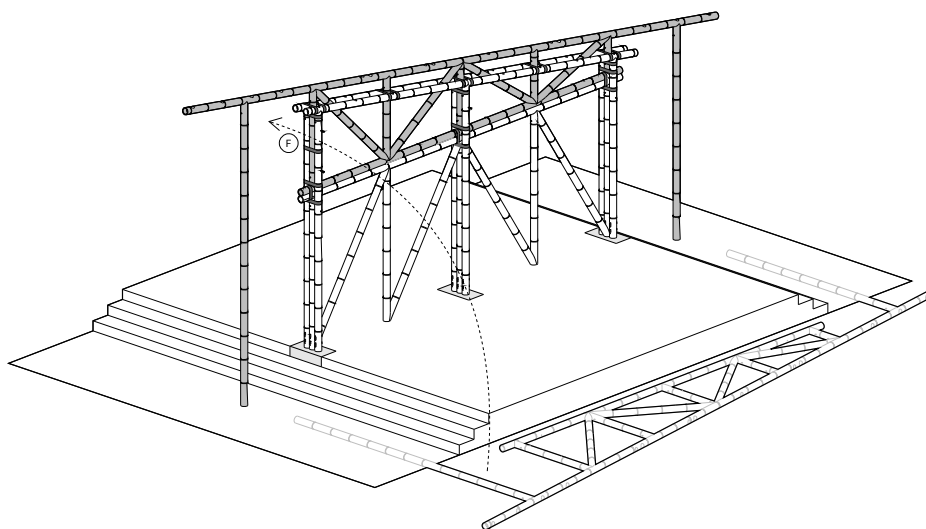

Fig. 58 Step 7. Truss placed on main columns and beams. Author's graphics.

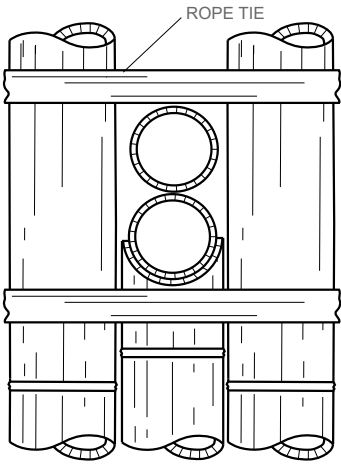
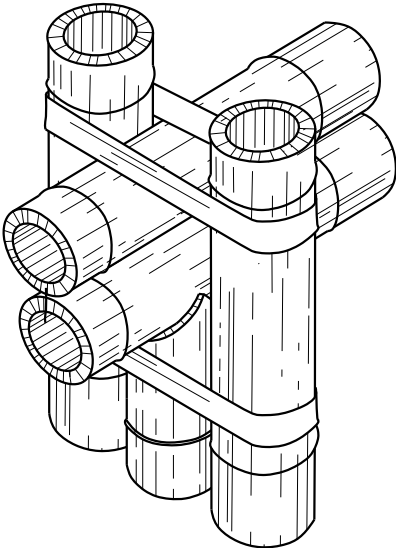

Fig. 59 Det. F. Bamboo rope joining technique. Author's graphics. Redrawn from: (Hidalgo-López, 2003)

Building Frame

2.3.4 Walls

The entire structure has been designed to make the assembly process as simple as possible for unskilled builders. The 3 bamboo culms, making up one main column, are connected in the upper part. The connection uses a transversely placed wooden dowel and additionally, bamboo culms are tensed with rope (Fig. 59). This type of connection ensures the correct positioning of the culms relative to each other and prevents possible shifts. If a partition (external or internal) is added to the main column, additionally bamboo culms should be connected with another wooden dowel in the middle of the column. Between the main columns, single bamboo culms are placed - designed mainly as a sub-structure for the wall and diagonal elements - stiffening the entire bamboo structure. These single-culm columns do not require a cement foundation block but are simply driven into the ground. They should be placed at least 30cm below the ground level, so taking into account the raised floor (+45 cm), the single-culm columns are 75cm longer than their designed height. After positioning all columns, the main support beam is placed on top of them. The connection of the beam with the columns is shown in (Fig. 53). This is a standard connection of elements perpendicular to each other using a wooden mounting stud. To make it possible to place the roof truss, which was described above in this report, the wooden stud is designed to be recessed into the culm - to not protrude above its upper surface. This type of connection allows disassembly of the structure and reuse of bamboo culms in the future. Then diagonal bamboo culms are placed between the vertical columns. Their main task is to stiffen the load-bearing structure, but they also serve as a sub-structure for wall construction. To make the building stiff in all directions, the diagonal elements should be mounted in the opposite direction, as shown in (Fig. 60).

Other elements of the wall construction correspond to the traditional technique of building partitions in the region described in Phase 1 of the report (1.5.1). However, instead of wooden sticks, bamboo slats are used to construct the transverse wall elements. To cut a bamboo culm and make slats of it, the radial knife should be used (Fig. 61). The first step is to place bamboo slats on vertical and diagonal culms every 10 -15 cm. Slats can be attached to bamboo culms by thin ropes, nails, or metal wires. Then the space between slats and bamboo culms needs to be filled with stones and/or compacted

soil. In the last step, the entire wall's surface is plastered with clay, if available, mixed with cement or lime to improve water resistance and minimize cracking.

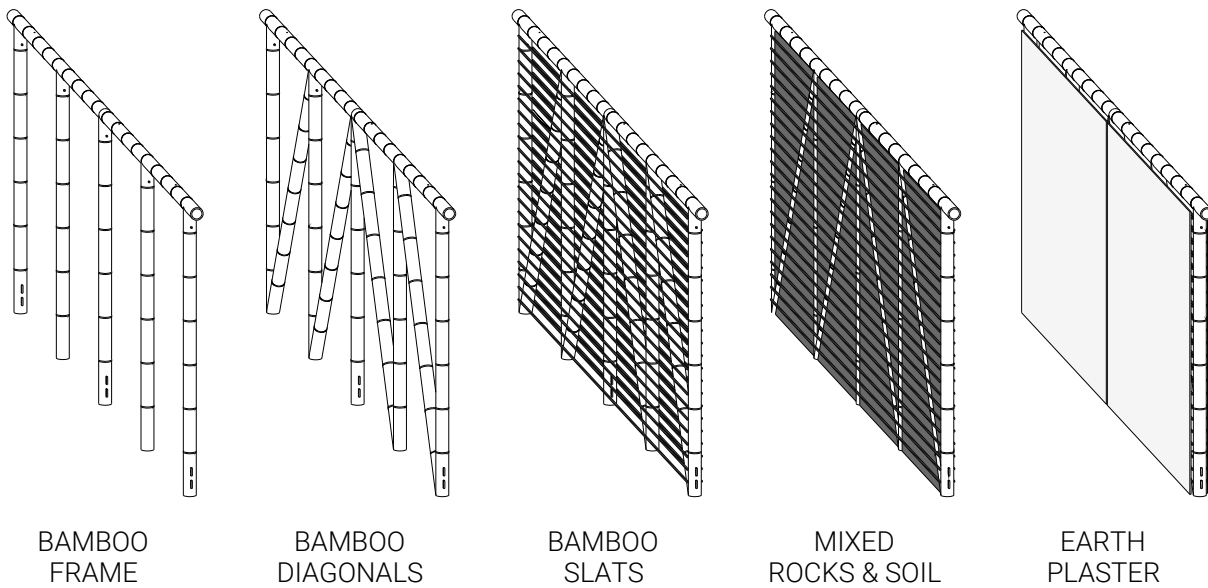

Fig. 60 Wall construction steps. Author's graphics.

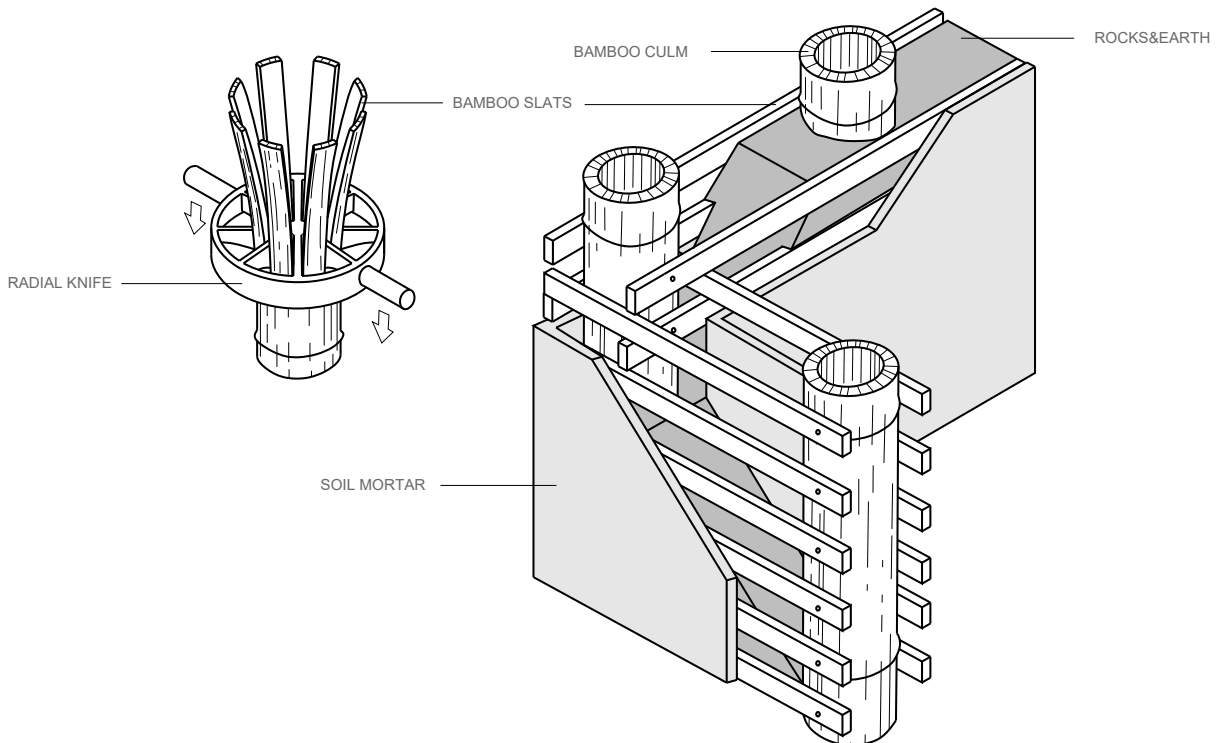

Fig. 61 Det. G. Wall construction technique. Author's graphics. Redrawn from: (Hidalgo-López, 2003)

Building Frame

2.3.5 Roof

The roof in the architectural object plays a key role. In the climate in which it is designed, it protects against strong rains that occur during wet seasons, and in the remaining time, provides shade for residents of the hot sun region. Due to its characteristic, roof usually serves as a meeting place, because outdoor functioning is very difficult and challenging. In this research, the main purpose of the roof is the location of water purification and electricity production systems as well as protection against rain and sun, and rainwater collection. The space under the roof can be freely used. It can serve for closed functions, such as toilets or shops, as well as for open activities or semi-open needs like workshop or gathering space.

The roof structure has been designed for installation in steps without the need for any heavy machinery. The first step is to assemble the truss on the ground, then attach it with the front and back columns, and finally connect it to the main beam and columns (Fig. 58). Then roof support bamboo culms can be placed on top of the trusses. On such a prepared structure, production systems and roofing can be mounted. Distance between roof beams corresponds to solar still basin size. Regardless of whether the building will be intended for public or residential purposes, the roof structure and its construction system are unchanged.

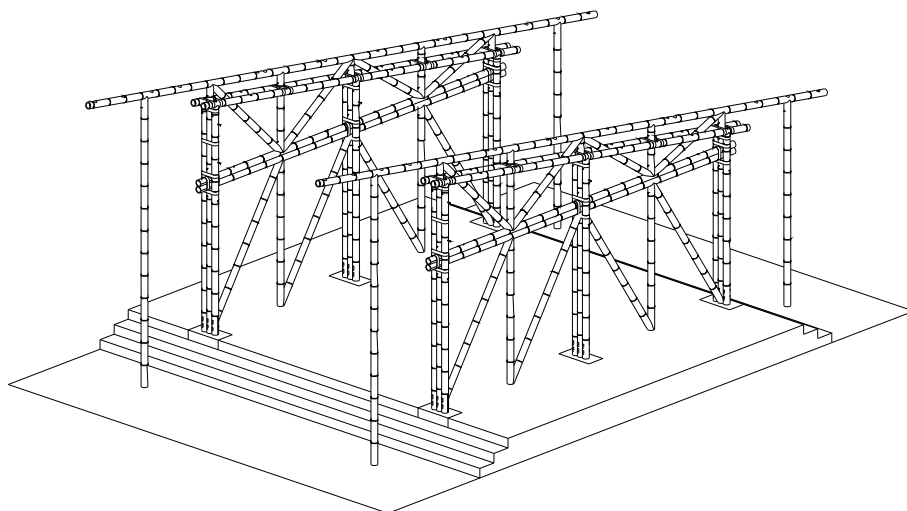

Fig. 62 Step 8. Two walls for one building module. Author's graphics.

The roof surface above the sanitary and technical space has been allocated for the location of 30 solar panels. The remaining roof area will be assigned to the water purification system. The building must be covered properly to protect the interior from both the sun and rainwater. Research on vernacular architecture conducted in the first part of this report, rises two roof covering methods typical for the region. The first is corrugated iron sheets fixed to the roof construction by thin ropes, metal wires, or screws, and the second option is straw in several layers. Both versions have their advantages and disadvantages. While using a straw is more sustainable it results in a thicker roof layer (up to 35cm). Due to its water absorption, it is often a place of the growth of micro-organism. Moreover, it typically requires a lot of maintenance and has to be replaced every 2-3 years. On the other hand, the metal sheet represents more expensive material but is less time-consuming during the construction and use phase. However, its one of the biggest disadvantage is poor thermal properties. Without any insulation, heat from the sun is directly transferred to the interior significantly increasing its temperature. One of the important benefits of using a metal sheet is its waterproof property, also it can easily lead the rainwater to a storage tank, while in the case of the straw roof version, the collected water quality is affected by bacterias born inside straw layers.

In conclusion, it seems to be more logical to use metal sheets below both PV panels and solar still units. While PV panels and solar still units will almost completely shade the roof surface, metal covering will not be directly exposed to the sun. Furthermore, the roof is elevated on bamboo construction and allows for constant airflow so sun heat will not be transferred to the interior. Rainwater will be easily transported to a storage tank. Also, considering circularity of the building it will be easier to disassembly and reuse building components if metal iron sheets will be used.

Building Frame

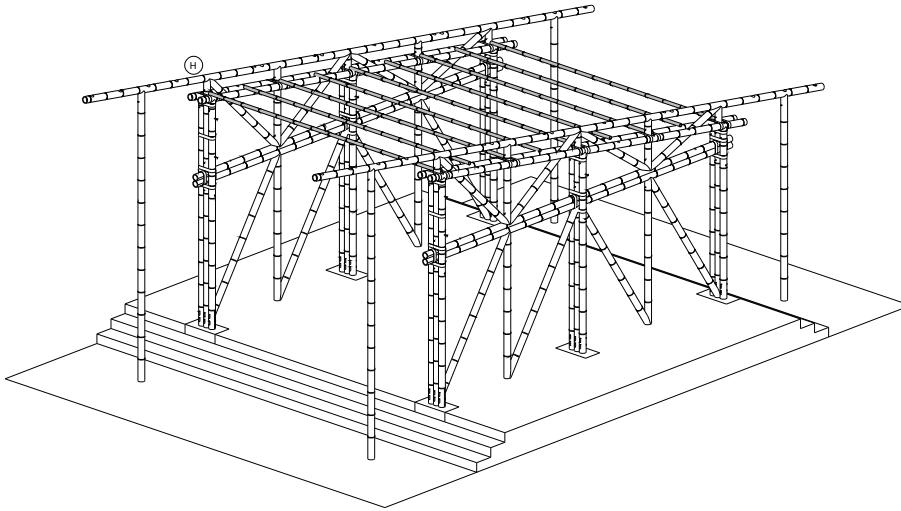

Fig. 63 Step 9. Beams for metal sheet panels. Author's graphics.

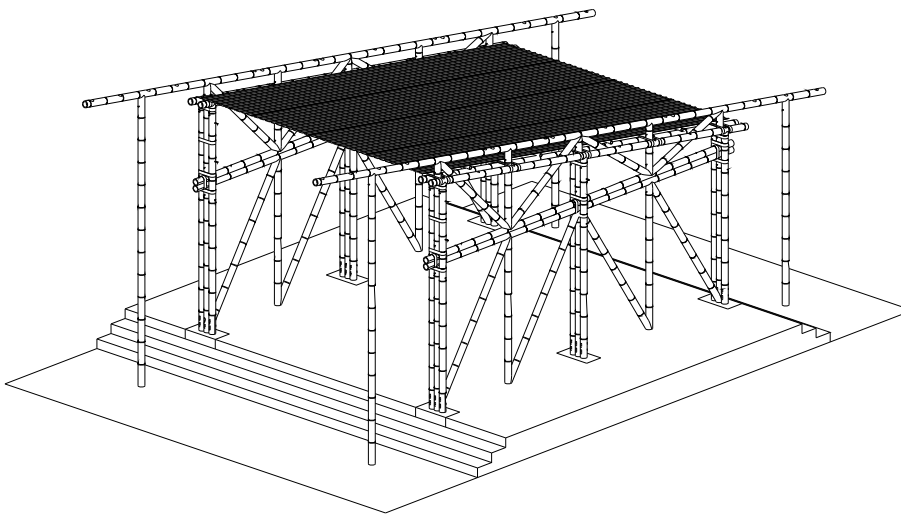

Fig. 64 Step 10. Metal sheet panels. Author's graphics.

The metal iron sheet covering is designed below solar still units and PV panels. Firstly, bamboo beams of a diameter of 5cm are placed on the inclined beam on top of the side columns (Fig. 63). Then a bamboo mat is attached on top of the beams with the use of thin ropes. Finally, metal sheets are attached by screws to the beams (Fig. 64). Bamboo mat is placed for aesthetic reasons and hides metals surface from the interior. The main task of the metal sheet covering is rainwater collection that will pass through solar-still units and PV panels. At the lower edge of the metal covering, a gutter is mounted that discharges water to a storage tank.

The supporting structure for solar still units is also made of bamboo culm beams with a diameter of 10 cm. Beams are placed on the trusses in previously prepared recesses in their inclined beams. The connection of the roof culms with the truss is shown in (Fig. 65). The front and back part of the roof designed for shading is firstly covered with bamboo culms with a diameter of 3 cm and a spacing of 40 cm perpendicular to the main beams. Then on top of them, perpendicular bamboo culms with the same diameter and 10cm spacing are placed (Fig. 68). The roof covering consisting of alternating thin bamboo culms creates an openwork structure aimed at shading the front and back of the building and slower its sun heating. A thin rope or metal wire is used to connect these elements.

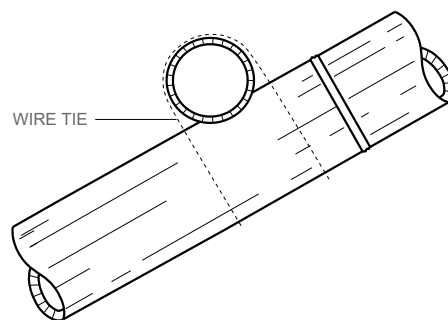

Fig. 65 Det. H. Perpendicular roof beams joining technique. Author's graphics. Redrawn from: (Hidalgo-López, 2003)

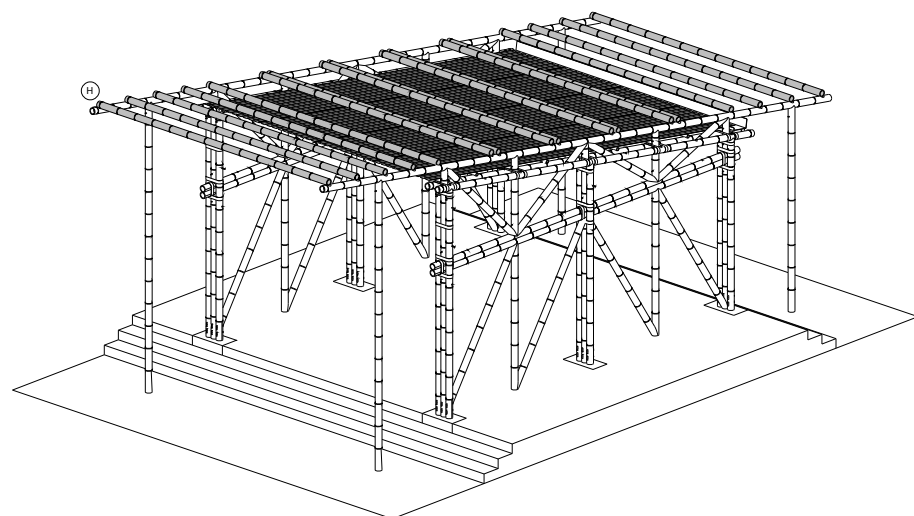

Fig. 66 Step 11. Beams for water and electricity production systems. Author's graphics.

Building Frame

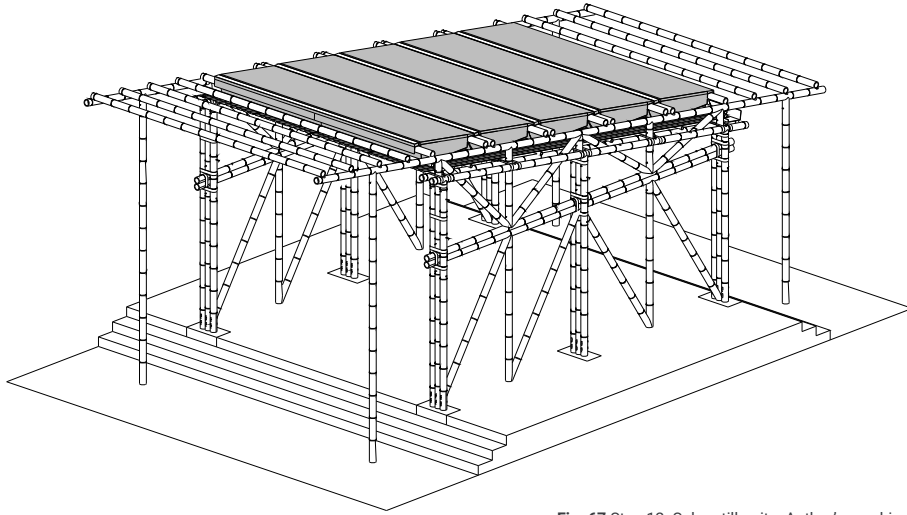

Fig. 67 Step 12. Solar still units. Author's graphics.

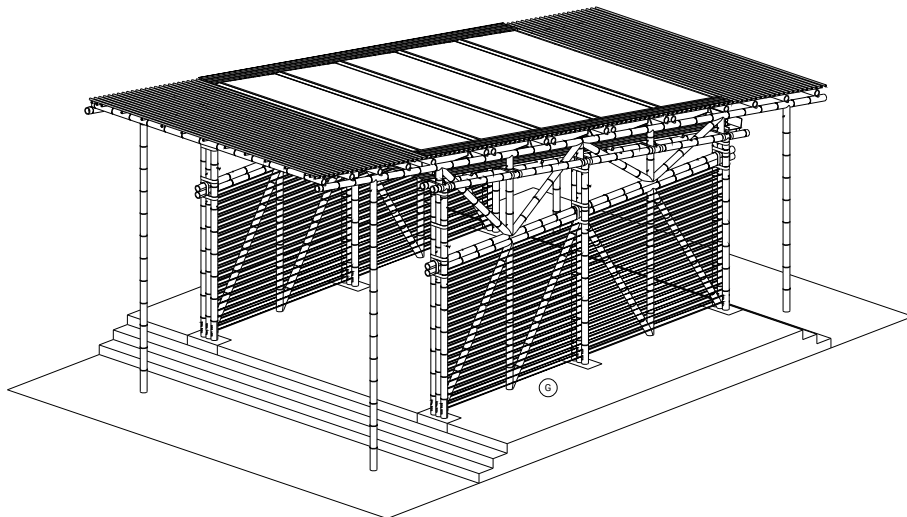

Fig. 68 Step 13. Shading openwork and walls bamboo slats. Author's graphics.

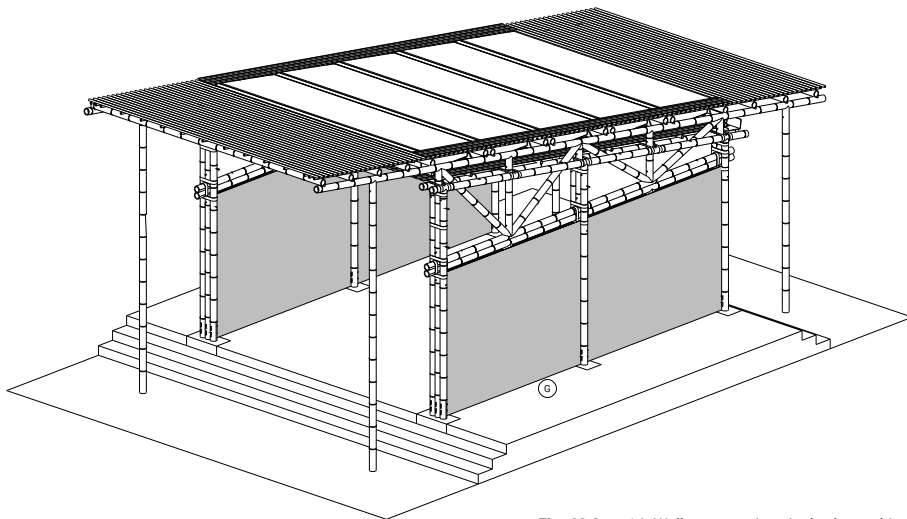
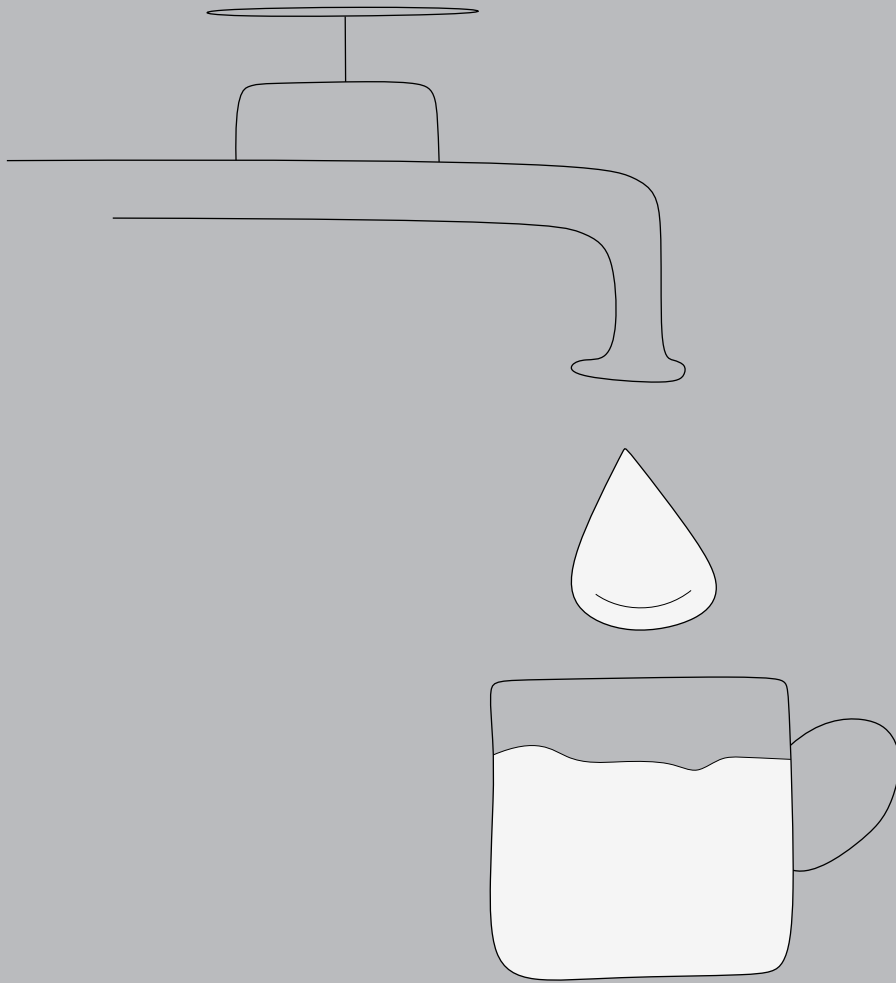

Fig. 69 Step 14. Wall construction. Author's graphics.



Fig. 70 Pictures of 1:10 physical model .



Water System

Water System

Providing clean water to rural communities without access to the national grid is crucial and the most important aspect of this project. Based on the research elaborated in Phase I of this report, the most adequate to both climate and the economic-social situation prevailing in Beira, way to provide water is to purify raw water on-site using the energy of the sun. This solution not only does not require the construction of additional infrastructure outside the construction site but has a chance to be developed and multiplied in the least urbanized areas - often inhabited by a significant part of the region's population. A clean water production system capable of providing water for the basic living needs of 50 people every day, which corresponds to the number of inhabitants of 10 average region's households, is the main goal of this project. Due to the situation in the region, the use of only low-tech solutions and very cheap materials for the entire project is very important. In this chapter, the water system and its main components will be presented.

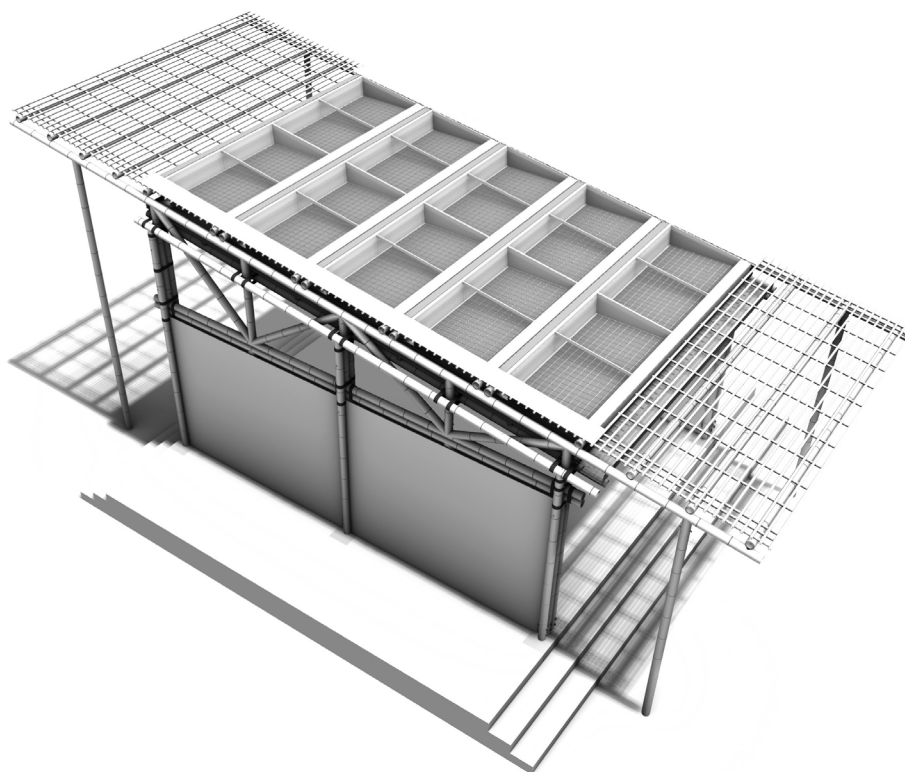

Fig. 71 Water production module with 10 solar still units on the roof. Author's graphics.

Water System

2.4.1 Evaporation & Condensation

The designed water purification system is based on evaporation and condensation. Evaporation and condensation represent two processes in which matter is converted from one state to another. Gas, liquid, and solid are 3 different states of a matter. When a matter is changed from a liquid to gas, evaporation can be observed. The reverse process, when the gas turns into a liquid, is called condensation. Any matter consists of small moving particles called molecules. When these tiny particles gain or lose energy, evaporation and condensation happen. In both processes, energy exists in the form of heat (Britannica, 2020).

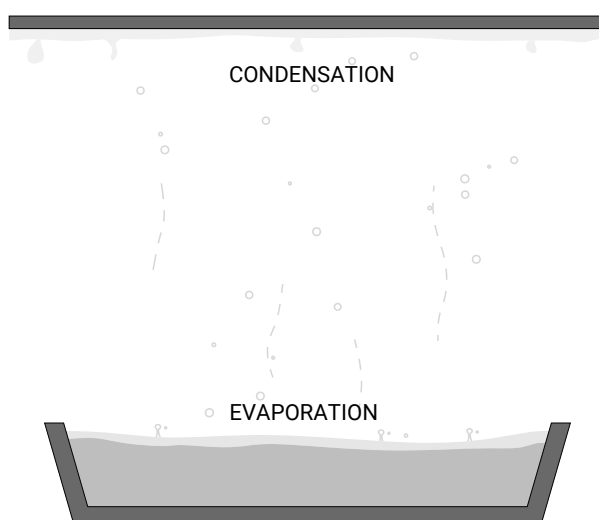

Fig. 72 Evaporation and condensation diagram. Author's graphics.

Evaporation takes place when the temperature of liquid increases. A good example of this process is a situation after rain when the sun heats the water in a puddle. It can be observed that the puddle slowly shrinks until it disappears and the surface is dry. The water seems to disappear, however, in fact, it changes its phase from liquid and rises into the air as a gas called water vapor. All molecules in a liquid are constantly moving but some of them move more quickly than others. When particles at the top surface of a liquid gain heat, they begin to move faster what gives them enough kinetic energy to overcome the intermolecular attractive forces in the liquid. When the molecules are moving around quickly enough, they are able to break the bonds, escape and leave the liquid's surface as gas particles.

It is worth mentioning that evaporation is not the only process that can transform a liquid into a gas. The same effect can

be achieved through boiling. When the temperature of liquid increases by heating, similarly its particles absorb heat and move more quickly. As the liquid starts to boil, small bubbles of vapor are created in the liquid and rise to the top surface. Each liquid has its boiling point, which represents the minimum temperature level to initiate this process. Two main differences between boiling and evaporation can be observed. The most important is the fact that during evaporation change of state from liquid to gas occurs only at the surface of a liquid, while during boiling the whole volume of a liquid participates in the process. In boiling, the change of state takes place everywhere where bubbles are formed. This can be observed when bubbles in a liquid rise and then break at the top surface of the liquid. The second difference between boiling and evaporation is the temperature at which the process takes place. The evaporation process can be observed at any temperature, while boiling occurs only at the boiling point of the liquid. Again a good example that can be observed in nature is a puddle of water. Compared to a warm day, the rate of evaporation will be slower but a puddle of water will evaporate on a cold day too.

A good example of condensation in nature can be seen when dew is formed on the grass overnight. Another example can be drops of water formed on the outside surface of a glass of cold water. The drops are formed from water vapor in the air. This process takes place when molecules in a gas cool down. Molecules by losing their heat, lose their kinetic energy and slow down. They do not push away from each other anymore and move closer to other gas particles until they collect together to form a liquid (Britannica, 2020).

The designed system represents a natural evaporation and condensation process in a closed environment. As described in Phase I of this report, evaporated water is pure, contains no hazardous particles and is suitable for direct consumption. The specific design of the solar-still is designed to maximally accelerate the evaporation process and make possible its effective collection into a Clean Water Tank. The system will rely on a constant flow of the input and output water, thus it is crucial to determine the amount of water in the system. The next chapter presents water flow per person, which directly affects the size of the entire clean water production installation.

Water System

2.4.2 Water Flow

The system performance is designed for 50 users with an assumption of 32 liters of filtered water for each person. To calculate the size of all system components and the amount of water needed from an external source that will need to be supplied to the system, it is important to understand the flow of water through the entire system. The calculations presented in the paragraph (1.2.2) show exactly how 32 liters of water will be divided for the basic living needs of each user. The diagram presented on (Fig. 73), divides used water into 3 categories: water that will be used without recovery, water that can be reused within the system, and water that needs to be supplied to the system from an external source. Water intended for human consumption and small pets cannot be recovered. The water used for a shower (8l), laundry (10l), and dishwashing (9l) was divided into 3 categories. Taking into account the characteristics of its use, the first part of water (4l) will be lost as a result of evaporation from clothes, during bathing or washing dishes. The second part (9l) of this water will be used in the greywater system and intended for flushing toilets before it goes to the digester tank. Whereas the third part (14l) will be redirected in the system for secondary cleaning. Water from cooking will be directly discharged into the digester tank, from where, together with the water from the toilets, after the biogas production process it will be used as a fertilizer or filtered through a constructed wetland. It is assumed that only 50% of the water drained into the digester tank will return to the system. To sum up, 19l of water will be able to be reused and the remaining 13l will have to be supplied from an external source.

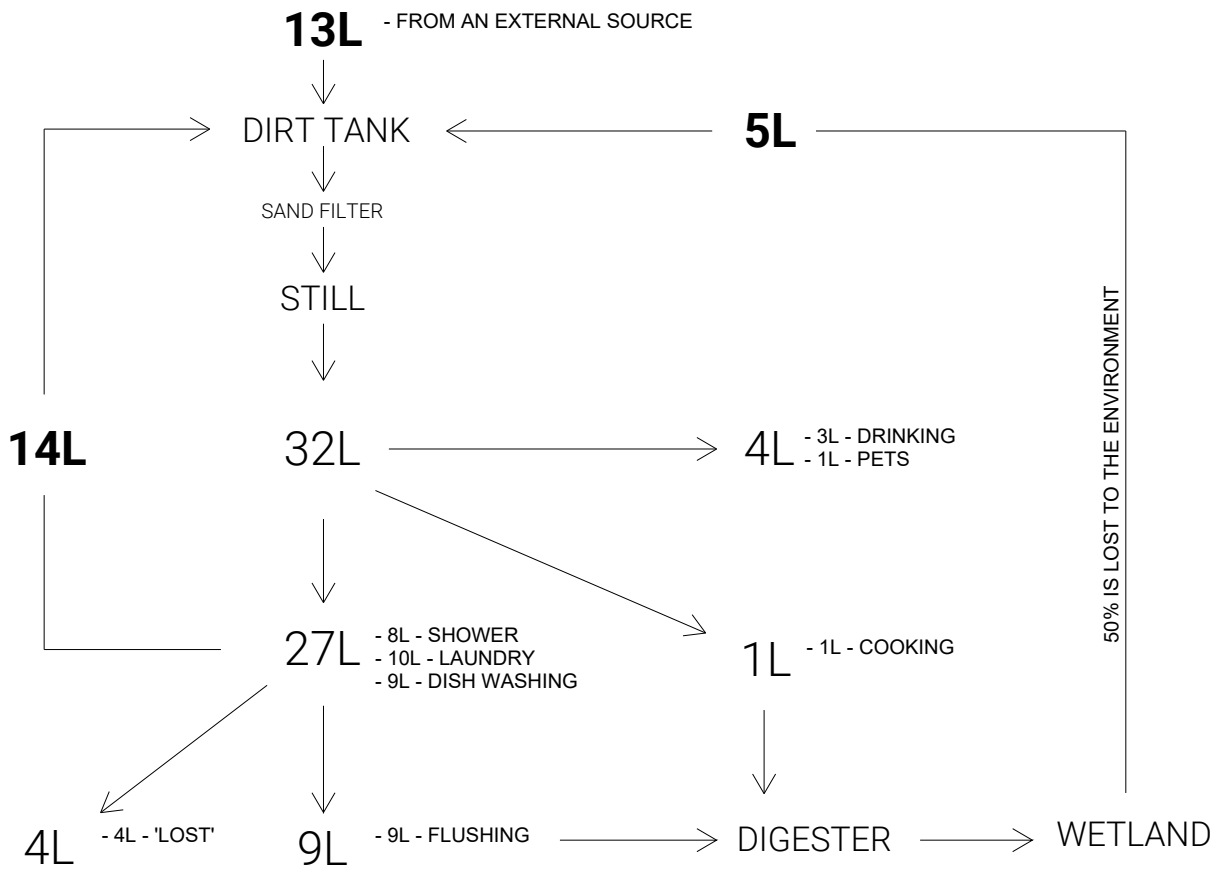

Fig. 73 System water flow per person. Author's graphics.

Water System

2.4.3 Water Source

One of the main goals was to design an off-grid self-sufficient system. The designed facility is located in a region that has wet and dry seasons. Given the heavy rainfall during the wet season, rainwater is considered as the main source of external water supplied to the system. For 50 people, 650l of water (50x13l) will have to be delivered to the system every day (19.5m³ each month). The (Fig. 74) presents the average rainfall for Beira and the amount of water collected by the designed 300m² roof each month. It can be seen that it typically rains from 3 to 12 days depending on the month, thus external rainwater tank is needed to provide water for the system on each day of the month. The rainwater tank is designed with a capacity of 25m³. By collecting rainwater, 8 months (Nov-Jun) will not require water supply from an off-site external source. In the remaining 4 months, 6-12m³ of water per month will have to be supplied to the system from an independent external source or temporary collecting structure with storage tank should be built.

DEMAND FOR WATER FROM EXTERNAL SOURCE ROOF AREA = **25M2/MODULE**
13L x 50PEOPLE = 650L/DAY **12MODULES=300M2**

650x30DAYS = 19 500L

25 000L (RAIN) STORAGE TANK

BEIRA AVERAGE PRECIPITATION												
MONTH	JAN	FEB	MAR	APR	MAT	JUN	JUL	AUG	SEP	OCT	NOV	DEC
MM	250	300	275	140	85	50	45	40	25	40	110	230
DAYS	11	12	12	8	7	7	8	5	3	5	7	10
L FOR 300M2 L/DAY (1/30)	75 000 2500	90 000 3000	82 500 2750	42 000 1400	25 500 850	15 000 500	13 500 450	12 000 400	7 500 250	12 000 400	33 000 1100	69 000 2300
	RAIN WATER COVERED	RAIN WATER COVERED	RAIN WATER COVERED	RAIN WATER COVERED	RAIN WATER COVERED	RAIN WATER COVERED	RAIN WATER COVERED	6 000L TO BRING	7 500L TO BRING	12 000L TO BRING	7 500L TO BRING	RAIN WATER COVERED
						5 500L FROM TANK						RAIN WATER COVERED

Fig. 74 Beira's precipitation and rain water storage. Author's graphics. Data source: (Climates To Travel, 2019)

Water System

RESEARCH BY DESIGN

2.4.4 Water Tanks

For the correct operation of the installation, 4 different water tanks are necessary. Digester tank is also involved in the flow of water, however, it is considered as part of the biogas system and will be described later in this research paper. The amount of water and the direction of its flow between the tanks is shown in (Fig. 75).

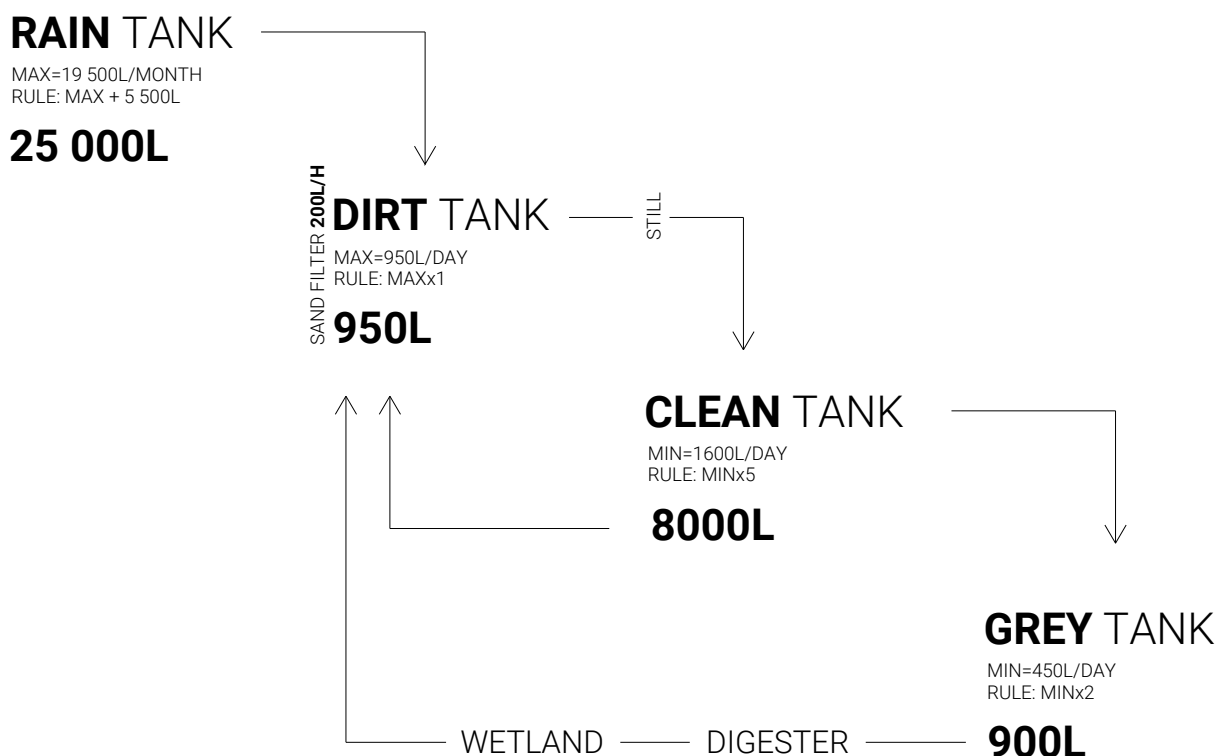

Fig. 75 Amount of water and the direction of its flow between the tanks. Author's graphics.

The rainwater tank described in the previous paragraph has a capacity of 25m³. Although the system will require each month only 19.5m³ of the water from an external source, an additional 5.5m³ of capacity has been designed for water to be used for outdoor needs and as an input for biogas digester.

The second tank, Dirt Tank, stores raw water for the facility. Water coming from the rain tank, as well as recovered water from the system, is pre-filtered by a sand filter. The main task of the filter is to clean the raw water of larger dirt particles that could clog the pipes, pump, and solar-still units, reducing their efficiency. For this purpose, a 180x100x120cm tank was placed in the technical room and consists of 3 parts. Its construction is shown in (Fig. 76).

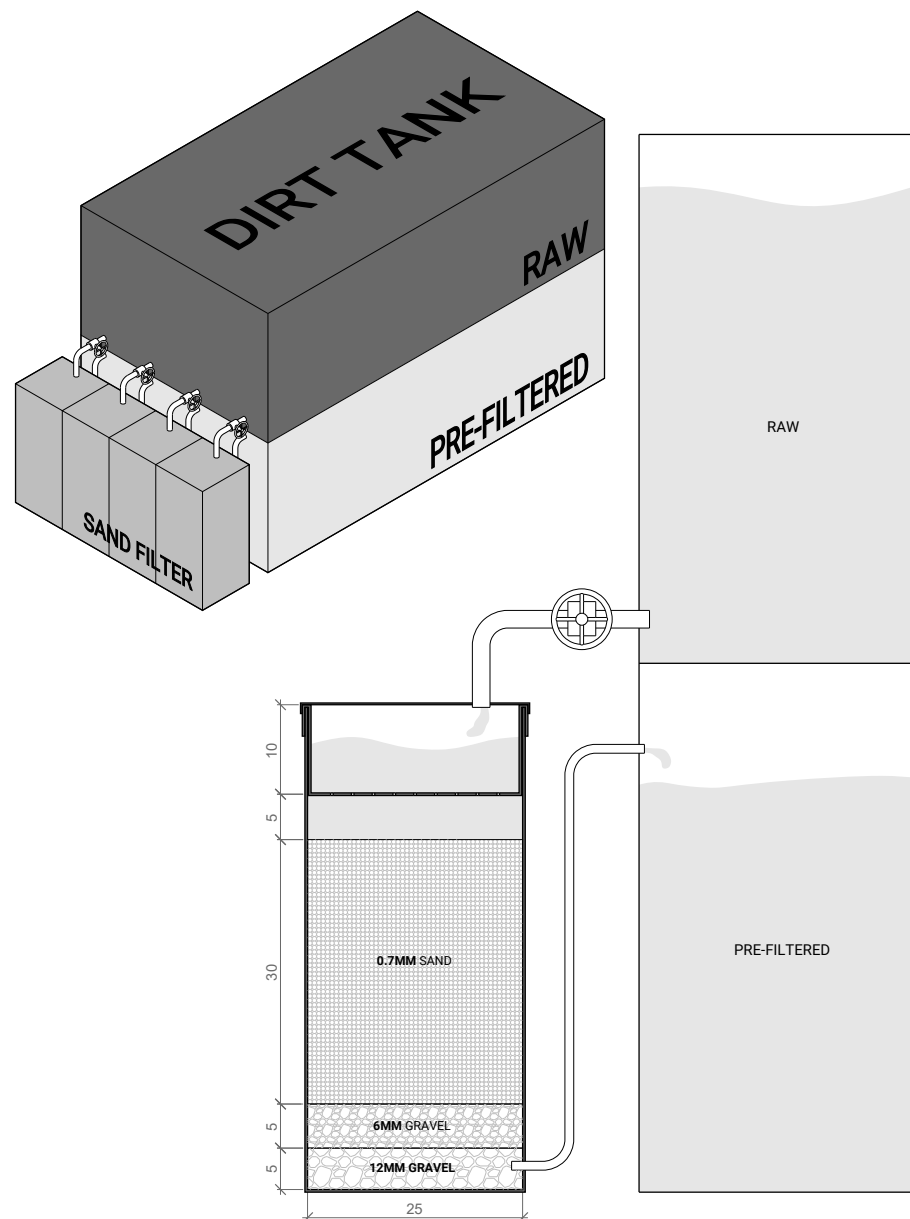

Fig. 76 Dirt Tank and Sand Filter. Author's graphics.

The upper part is a collecting tank with a capacity of 1m³, the middle part is the sand filter with a height of 55cm, and the bottom part is a tank for pre-filtered water also with a capacity of 1m³.

The water from the upper chamber goes to the sand filter. The filter system consists of four 25x25x55cm containers. Each container can be easily disassembled and cleaned when

Water System

necessary. The filter container can be made of steel or plastic and is filled with layers of sand and gravel. First, water goes to the filter's chamber with a diffuser, it prevents disturbing the filtration sand layer and protects it when water is poured into the filter. Afterward, water goes through a sand layer (0.7mm sand) where dirt particles are removed from it. At the bottom of the container, separating gravel layer (6mm gravel) supports the filtration sand and prevents it from going into the drainage layer and outlet tube. The last layer of gravel (12mm gravel) is supporting separating gravel layer and helps water to flow into the outlet tube. The technology of sand filter is very similar to Biosand Filter Manual (CAWST, 2009), where a domestic device with sand filter is described. The water prepared in this way is clear but not clean yet and should not be directly consumed. Not all bacterias and pathogens are removed in the sand filtration process, however, the raw water is pre-filtered and should not clog the fiber-rich paper in solar still units.

The capacity of the Dirt Tank corresponds to the amount of water intended for secondary filtration. It is the maximum amount of recovered water that can be collected during one day from the system. Water flows through the sand filter by gravity and water pressure. Layers of sand and gravel are designed to pass and clear 200 liters of raw water per hour. Pre-filtered water from the lower chamber is the input water for solar-still units.

The third and most important tank is a Clean Tank that collects filtered water from solar-still units. The tank, like the Dirt Tank, is placed in a closed technical room with controlled access. Water from the roof system goes to the tank only by the influence of gravity. The required solar-still surface has been designed considering good weather conditions, like a sunny day when it works with high efficiency. Clean water must be available in the facility during other cloudy or rainy days as well, which is why the capacity of the Clean Tank is 8m³. It corresponds to the 5-day demand for clean water for 50 users. According to the principles of the evaporation process, clean water will be produced constantly but efficiency without direct sun will be significantly decreased, thus storage for clean water is needed. This safety measure ensures that even if the water production system will not work, the hub will operate without interference for 5 days. The tank should be equipped with a system that

automatically replenishes mineral salts in filtered water. Minerals and water ingredients good for health are removed from water filtered by solar-still just like life-threatening compounds and should be added back.

The last tank of the system is a Grey Tank. Water from shower and taps is transported to the Gray Tank by gravity only, therefore the tank is placed below floor level, under the technical room. It is not possible to design water flow in the system with high accuracy, therefore tanks should have slightly oversized capacities. This is mainly due to time slots in which the users use different facilities. Water will not always be used in parallel for all activities (flushing, shower, etc.). Water to the Grey Tank will be supplied from sinks and shower drains, and used for flushing toilets. To guarantee flush water in the early morning when showers or sinks are not used yet, the tank capacity is designed as 1m³, which is a 2-day water demand for flushing toilets.

Water System

2.4.5 Solar Still System

The water filtration process takes place in a solar-still system located on the roof of the facility. In Phase 1 of this research, the minimum production area, based on studied materials, was calculated as 200m². This size of the installation, in the conditions prevailing in Beira, should provide a minimum of 32l of water a day for each of the 50 users of the facility, what gives 1600l of clean water for the entire building every day. Each square meter of the system will produce 8l of water per day, what results in 4m² of system surface for each user.

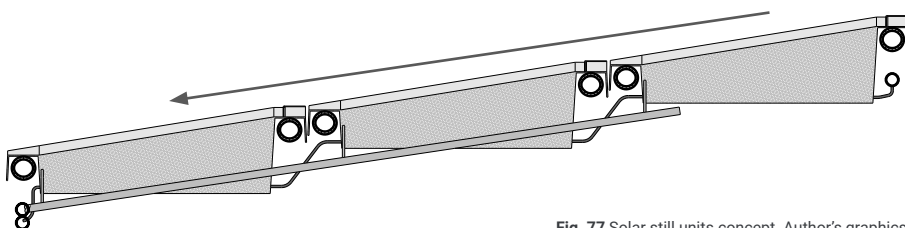

Fig. 77 Solar still units concept. Author's graphics.

The 200m² system has been divided into 100 equal units with an area of 2m² each (2 units for each user). In each of the 10 building's modules, which are intended for the solar-still system, 10 solar-still units will be placed on the roof. As mentioned before, the building module corresponds in size to the typical regional single-family house. Therefore, one building module can produce 160l of clean water during the day. If, in the next stages of the project, the facility will be extended or turned into affordable houses, each of the modules will provide clean water for a family of 5 people. The modularity of the project allows building independent house units with the clean water production system on its roof. To ensure easy maintenance and efficient performance of the system, each unit has a 1x2m dimension, which provides easy access to the interior of the water basin when it needs to be cleaned. The size of the unit has been chosen to optimize the use of materials and the production process. More units would require more production work, money, and time. At the same time, the units should not be too large to allow easy transport and assembly. Furthermore, the system has been designed in such a way that in the event of damage to one of the units, the rest will work with their designed performance, so the optimal size plays an important role. If the units were too large, damage to one would result in a significant reduction in production. On the other hand, if the units were too small in the event of damage, more units would require repair. The maintenance of the units is associated with providing access to each of them, in the case of small units,

it would result in an unnecessary increase in the technical space on the roof - resulting in a much larger area of the entire structure. The scale of the unit is also important in the event of damage to a significant part of the system (up to 50%). Since there are 2 units for each person, in the worst case when one is damaged, the other will provide water (16l) for necessary living needs like drinking, cooking, and basic personal hygiene.

Units are arranged on the roof in cascade rows to optimize the elements supplying and draining water from the system. Input water is delivered only to the highest row of units, then through gravity flows to the next, lower rows of units. The water flow resembles a natural mountain stream, where water flows from the highest point of the stream under the influence of gravity resulting from the slope of the terrain. Water between units should flow freely so that all of them have the required amount of the input water at the same time.

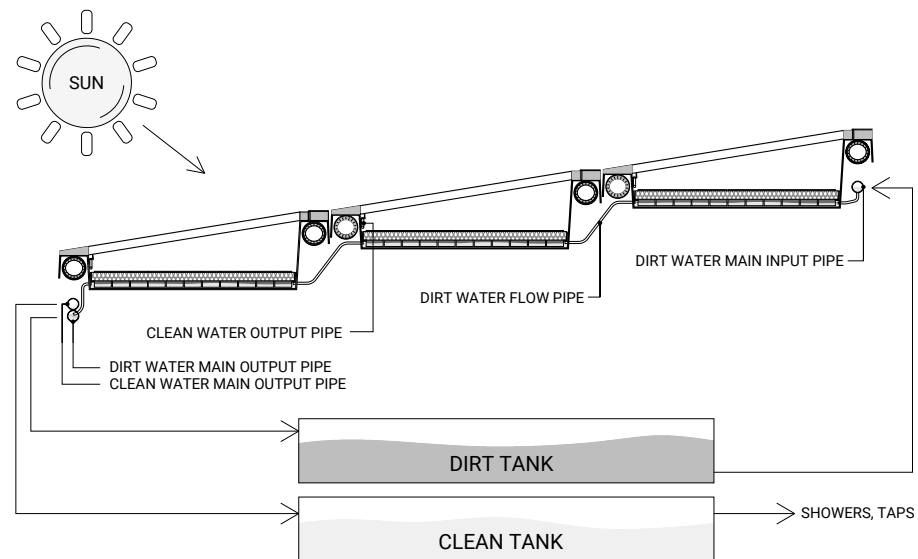

Fig. 78 Water production system concept. Author's graphics.

In this paragraph, one of the 100 units will be described in detail. The design and optimization of a single unit directly reflect the efficiency of the entire system. Solar still unit elements have been selected to minimize the costs and weight of the entire system keeping maintenance and possible repairs as simple as possible. Each unit consists of a water basin, polystyrene block with fiber-rich paper, and transparent cover. The total weight of each unit is approximately 40kg. Additionally, 60L of water will be constantly in each unit while operating.

Water System

2.4.5.1 Water Basin

The main element of the unit is a water basin with dimensions of 1x2m. Its task is to provide water for filtration. The water basin is designed as a one-piece element to minimize water leaks. Its form is designed to ensure a simple installation on the roof. In principle, the water basin will keep constantly 3cm of water inside (60L) and polystyrene block with fiber-rich paper above the water. Also, a water channel for clean condensed water will be attached inside. The water basin is presented in (Fig. 79).

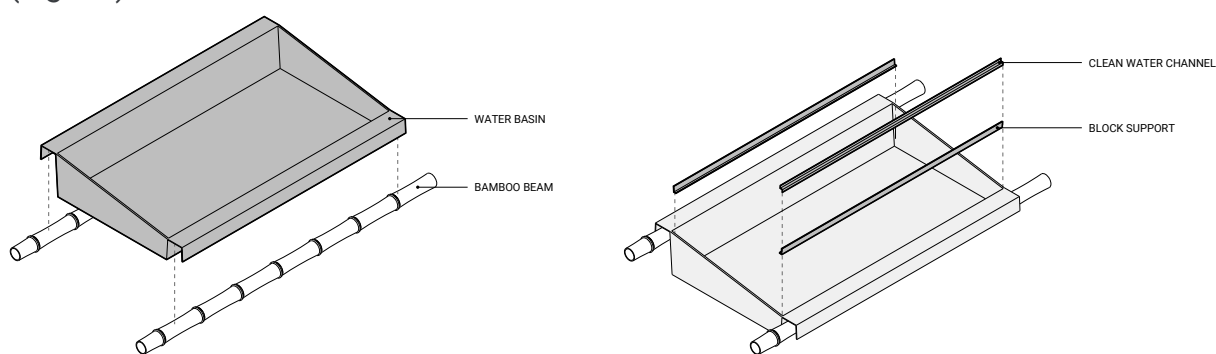

Fig. 79 Water basin. Author's graphics.

Two materials were considered for production. The first option is the water basin made of thin metal sheets and the second is a form made of composite material - Glass Fiber Reinforced Polymer (GFRP). Both options have benefits and disadvantages. While the water basin made of GFRP is made seamless, the basin made of metal will have to be welded from single sheets elements. However, taking into account the target region and its economic and technological situation, a metal sheet and welding process seem to be a more affordable solution. GFRP is not a technology widespread in this part of Africa and any repairs and production would have to be done by an external company that works with this type of technology and material on a daily basis. Furthermore, GFRP is a less sustainable material, biobased replacements are available, however, they are more expensive. Theoretically, the metal basin could be recycled what is not possible for composite material. The water basin will be in constant contact with water, including saltwater. GFRP surface corrosion by water, in contrast to most metals, is not a very important issue (Bedford, 2017). While GFRP has very good water resistance, the metal will corrode over time, which increases the likelihood of leaks and frequent repairs. Water basin made of metal will weight 72kg (4.5m²; 16kg/m² for 2mm metal sheet), while GFRP form only 13.5kg (4.5m²; 3kg/m² for 2mm GFRP sheet).

Taking into account all aspects, for the production of water basin GFRP will be used. Its low weight, mechanical strength, and chemical resistance make it attractive construction material for the basin. Besides, two FRP water tanks manufacturers were found in Mozambique and Zimbabwe. They could not only provide water tanks for the facility but also produce water basins. Ultimately, a non-government organization will hold workshops in the facility for the local community to teach them how all systems in the building works and how to construct them by yourself. The main goal of the project is to teach local people not only how to build facilities and houses resistant to changing weather conditions but also an easy-to-use off-grid water production system. The water basin production process will be described later in this report (2.4.7.1 Prototyping). A form of the water basin has been designed to be placed directly on bamboo culms, without the need for additional connections. To keep units in place and for leveling purposes, the basin should be screwed to culms from the top at each corner. Bamboo is a natural material that differs in its dimensions between each single bamboo culm, thus, 30mm tolerances were designed to accommodate this and make sure that basin will fit on each culm. More precise dimensions of bamboo sections come at a higher cost. This tolerance should also accommodate not perfectly straight bamboo beams. Inside the water basin, supporting profiles for polystyrene block and channel for clean water collection will be attached by screws. To make all connections watertight, a strip of rubber gasket is placed between the basin and each profile and channel.

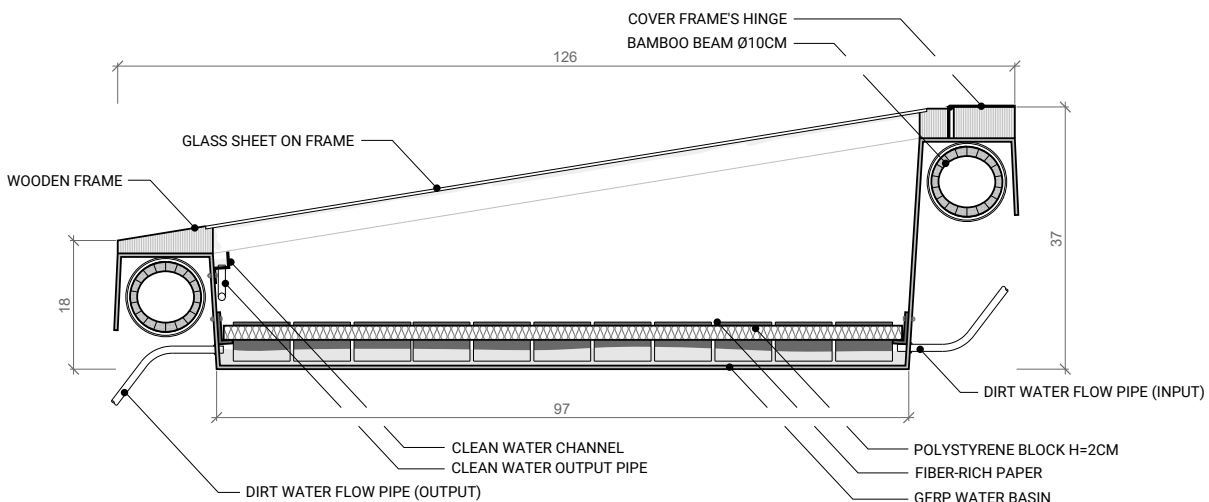

Fig. 80 Solar still unit section. Author's graphics.

Water System

2.4.5.2 Polystyrene Block

To maximize the production of clean water from the solar-still system, input water is isolated from the space under transparent cover through a polystyrene block. The thermal barrier is a 95x200x2cm block.

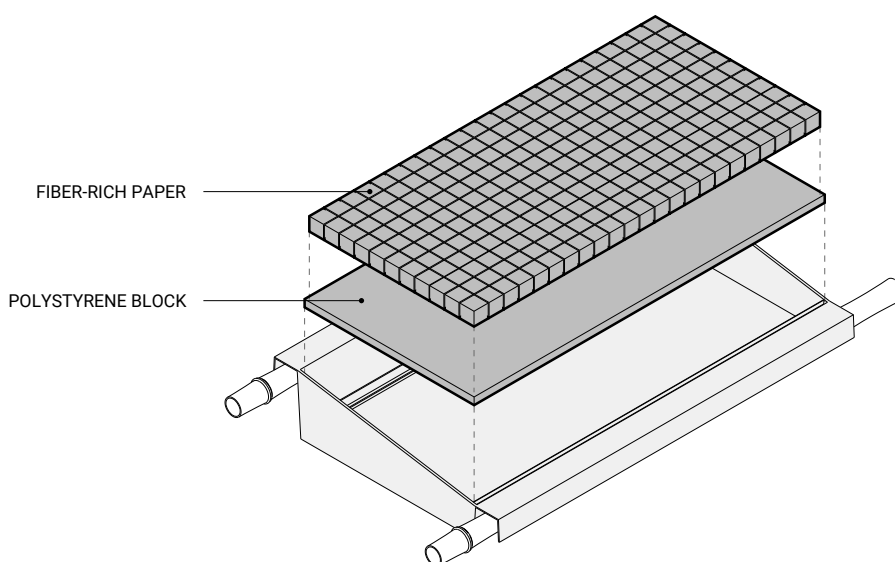

Fig. 81 Polystyrene block with fiber-rich paper. Author's graphics.

As described in (2.4.1) evaporation process takes place only on the surface of the liquid. The device is designed to keep only the top surface of the input water in the sun-heated space under a transparent cover. The evaporation process of the input water takes place above the polystyrene block. Water transport between the water basin and the upper surface of the polystyrene block is carried out by a fiber-rich paper. The material wicks up the water and moves it towards the upper surface. The material used in this project is the same, which was tested by (Liu et al, 2017) in the solar-still device prototype described in Phase I of this thesis. Similarly, the material should be dyed by low-cost carbon black powder. Paper is coated to increase absorption spectra and speed up solar-to-heat conversion and thus the evaporation process. Detailed paper preparation steps are described in (2.4.7.1 Prototyping). The main task of the paper is constant transport of the water meant to be purified from the basin to the top surface of the polystyrene block. The smaller amount of water is exposed to the sun, the evaporation process is faster. In a standard solar still, all water basin is located under transparent cover and the temperature difference between space under transparent cover and input water lower the rate of evaporation. As described in (2.4.1) evaporation process is faster when the temperature

of the liquid is higher. In the case of the designed device, only a small amount of the input water is directly exposed to the sun, thus temperature increases faster, compared to the conventional device, with whole water in the basin exposed to the sun. The block has 253 papers spread in the 11x23 grid. Each end of the paper passes through the block and protrudes 3 cm below its bottom surface, which guarantees constant immersion in input water. For better heat accumulation, the upper surface of the water basin should be painted black. This is to maintain a higher temperature under the transparent cover.

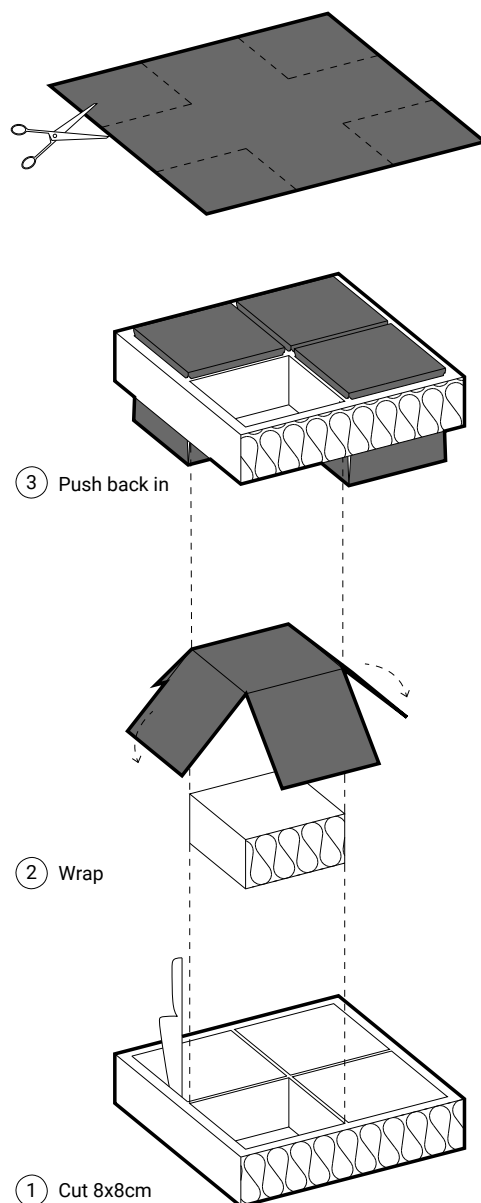

Fig. 82 Polystyrene block with fiber-rich paper going through. Author's graphics.

Water System

2.4.5.3 Transparent Cover

As described in (2.4.5), the weight and size of the system are important for its operation and possible repairs. The main element that will affect the maintenance is the transparent cover. The cover is meant to create a closed environment and speed up the water evaporation process. Besides, the cover takes part in the water collection process. Condensed water runs down on the inner surface of the transparent cover and then is collected by a channel attached to the lower end of the water basin. Channel is slightly inclined (1%) to one side of the unit, where water pipe transport purified water to the Clean Tank. Following assumptions from Phase 1 of this report, the cover will be inclined 10 degrees. This angle ensures the optimal solar radiation and is enough for water collection.

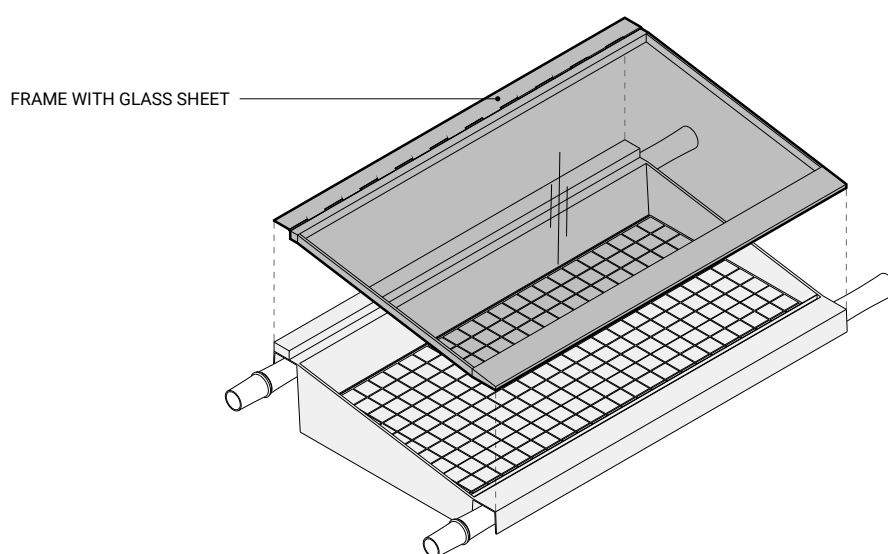

Fig. 83 Transparent cover. Author's graphics.

Solid glass or plastic sheets and ETFE foil were considered as a cover material. Transparent cover has 2m² (1x2m). While a glass or plastic sheet can provide good resistance to external weather conditions and possible damage, both materials are relatively heavy (20kg and 11kg respectively for considered size). The use of solid glass or plastic sheet makes the maintenance more difficult, however, ETFE foil was tested during the mock-up phase (2.4.7) of this report and failed to properly collect the condensed water. Therefore, glass was chosen to cover the still because the plastic sheet could deform over time when exposed to the hot sun.

Glass 4mm sheet is designed on the lightweight wooden frame. All wooden elements should be protected with a coating that prevents water absorption. The frame is attached with a hinge to the lower ends of two corresponding water basins. This allows two people, standing on both sides to open together two units at the same time and clean them if necessary. To close the cover, the frame has toggle latch clamps on each side. To make connections watertight, rubber gaskets are designed on the inner surfaces of the frame.

Water System

RESEARCH BY DESIGN

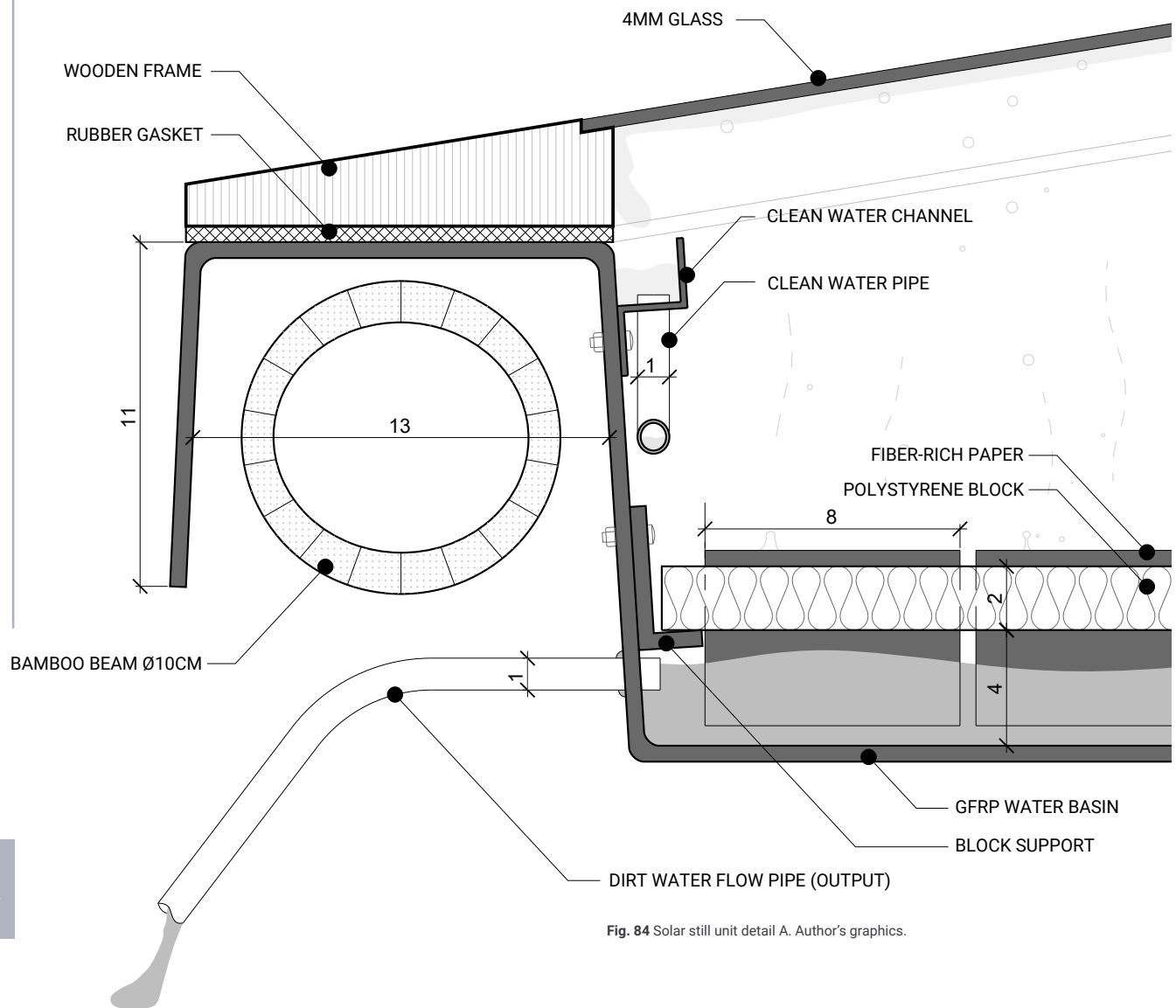

Fig. 84 Solar still unit detail A. Author's graphics.

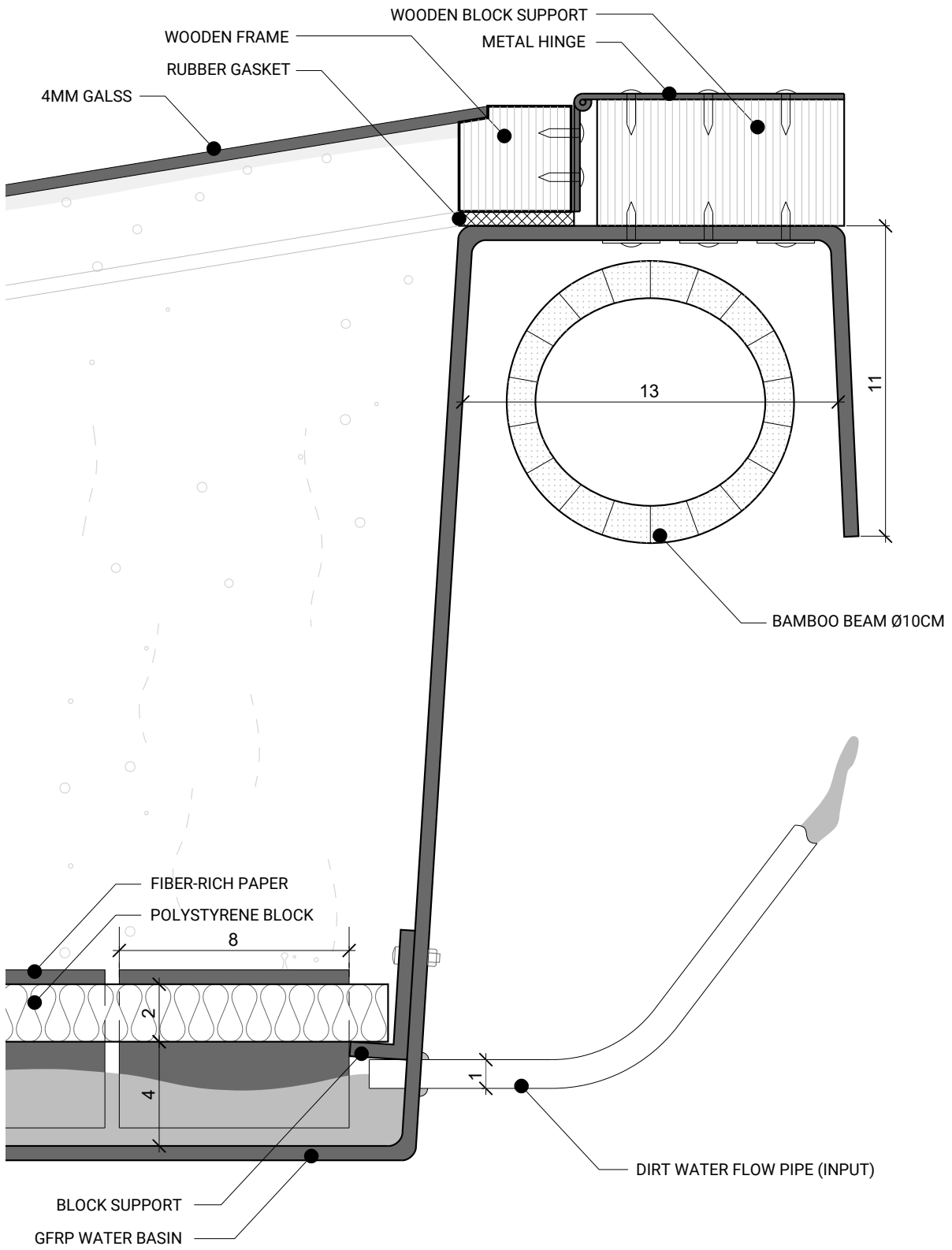

Fig. 85 Solar still unit detail B. Author's graphics.

Water System

2.4.6 Maintenance

The system has been designed as maintenance-free to make it as comfortable as possible to use. Only periodic cleaning of water-basins will be required. Water between tanks is transported by gravity and water pumps. The (Fig. 86) shows a diagram of water flow between tanks and the way it is transported (pump/gravity). Rainwater is collected by the roof and goes by gravity to rain storage tank outside of the building, from where it is pumped to the dirt tank through a sand filter. Next, water from the Dirt Tank is pumped to the solar-still units on the roof. Both, overflow of the input water and purified clean water go by gravity to Dirt and Clean Tanks respectively. Then, clean water is pumped and distributed to taps and showers. While greywater goes to the underground tank by gravity only, a pump is needed to provide water for flushing toilets and pass overflow to the Dirt Tank. Blackwater from toilets goes to digester tank by gravity and then to constructed wetland before it is pumped back to the Dirt Tank.

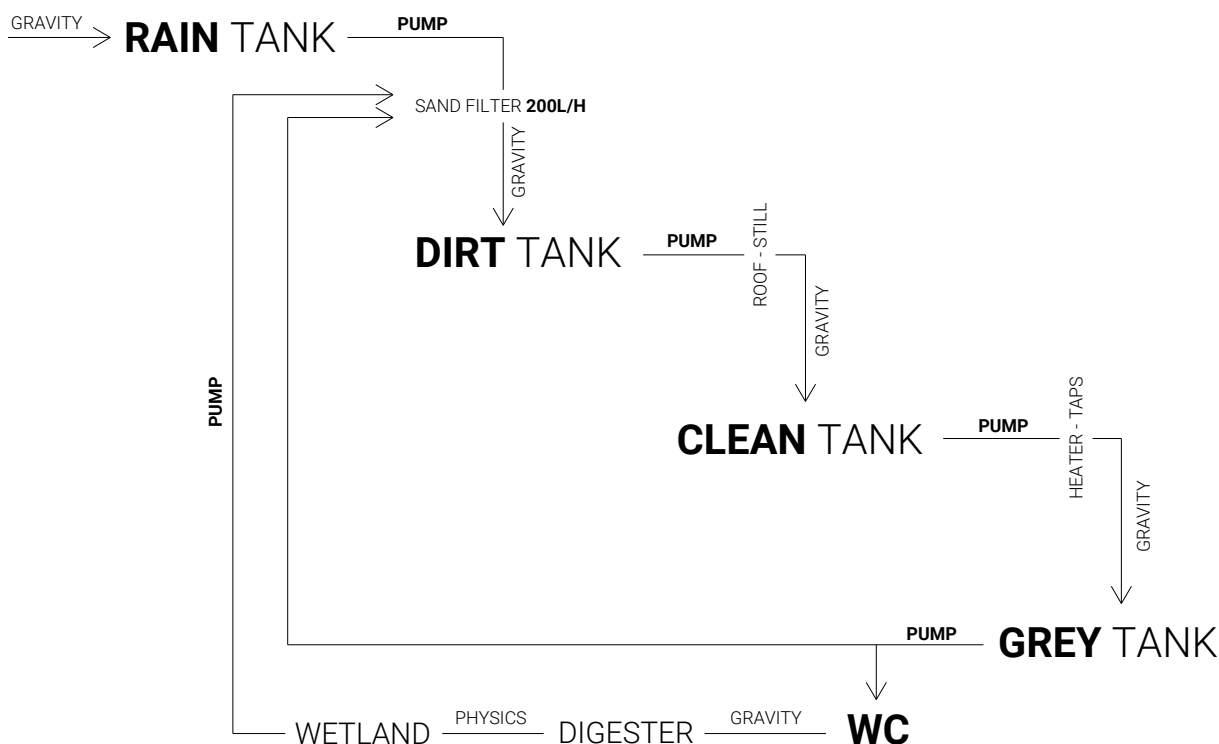

Fig. 86 Water flow between tanks. Author's graphics.

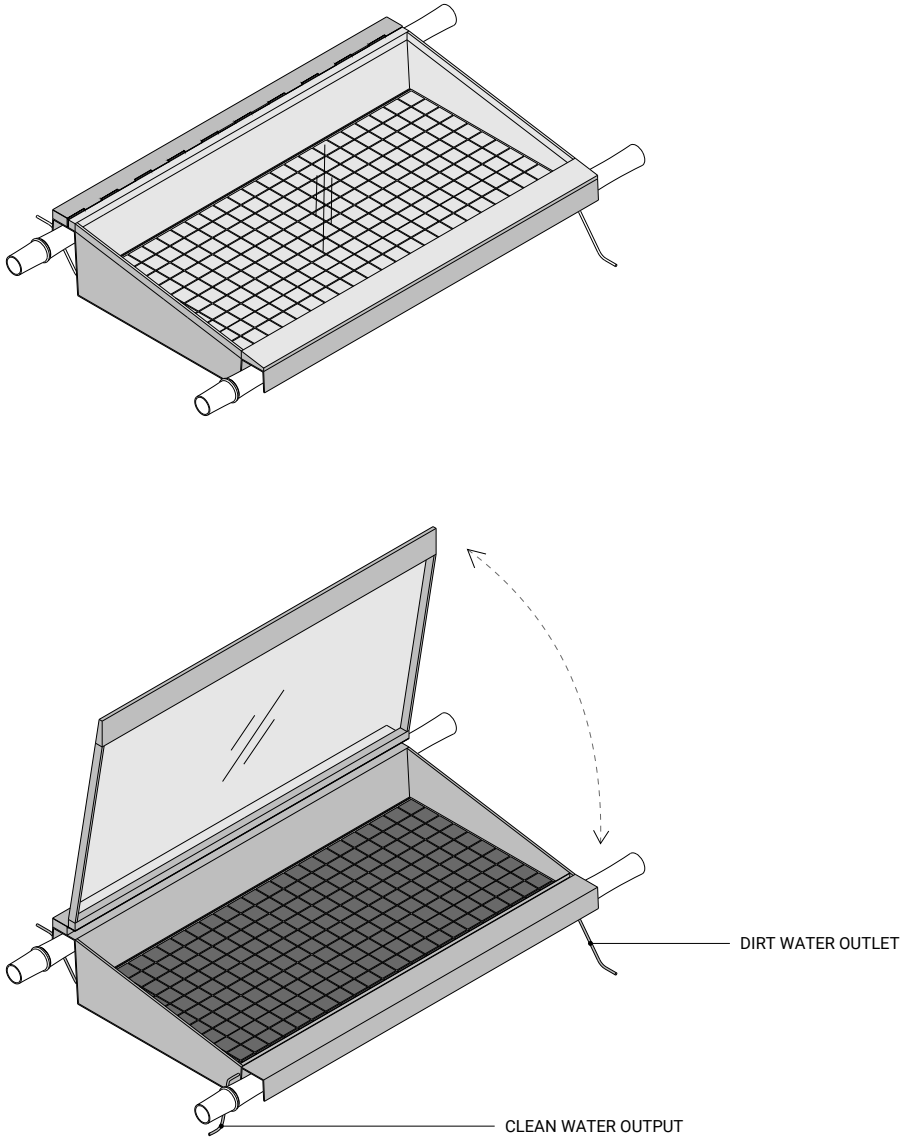

Fig. 87 Solar still maintenance. Author's graphics.

Water System

2.4.7 Mock-up

This chapter will present construction and testing phase of the water production system. The mock-up plan assumes prototyping a part of the project in a 1-1 scale and testing it. According to the plan, two half-units were prepared to understand production steps, materials characteristics, and performance, as well as, relations between them in terms of assembly and maintenance. The ambition was to give an insight into the system, provide better understanding and improvements.

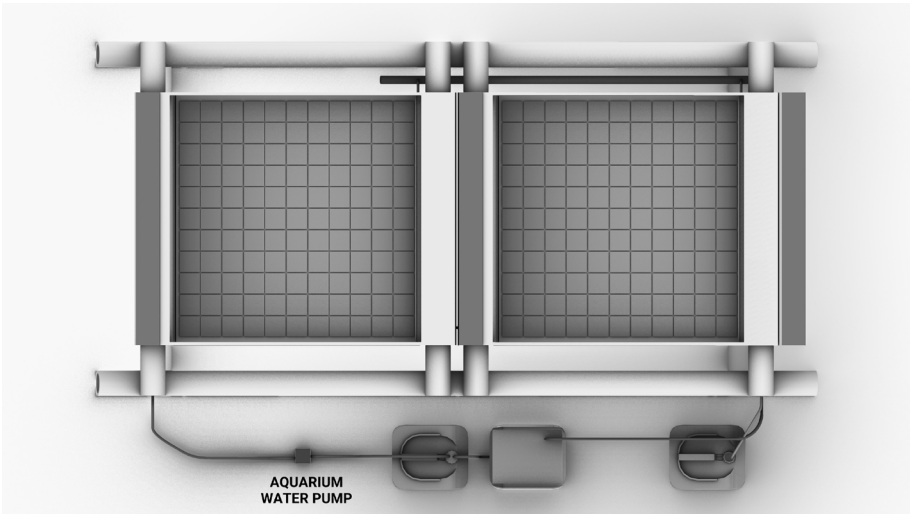
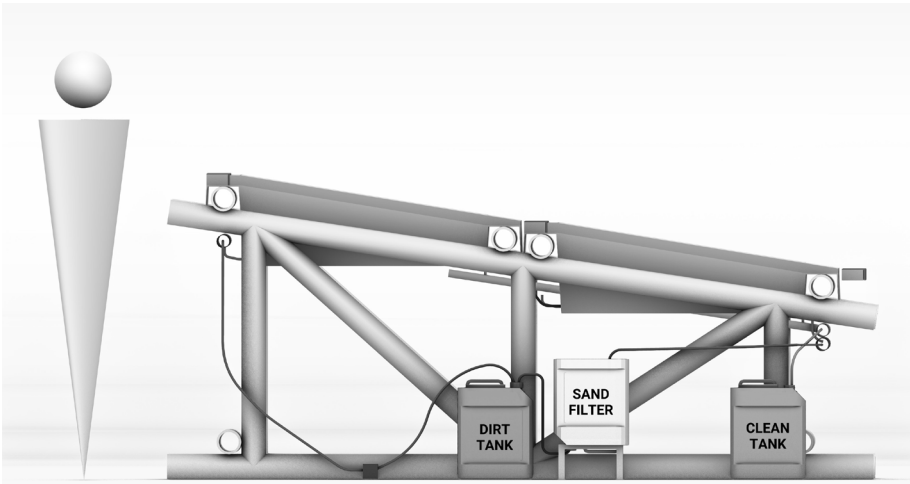
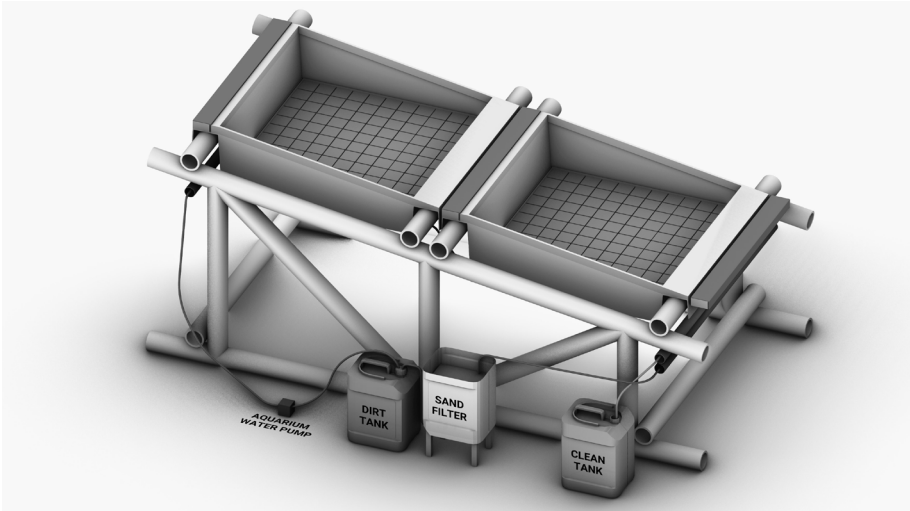

Fig. 88 Mock-up planning. Author's graphics.

Water System

2.4.7.1 Prototyping

Mock-up consists of several elements that together represent the designed system. The most important elements for testing are solar stills placed on a supporting structure imitating part of the designed bamboo roof. Besides, a water pump, pipes, and sand filter have been built and prepared to accurately reflect the water flow through the system.

Two solar stills with 1x1m dimensions represent halves of two designed real size units. Therefore, the results of the tested prototype can be seen as one real size unit output. The preparation of two full-size units was impossible due to logistic and time reasons. The goal was to test the entire system, so solar stills had to be cascaded relative to each other. Size does not affect the performance of tested prototype, as it is assumed that their efficiency will be very similar.

First of all, a plywood mold for GFRP casting was prepared. Elements of the mold were designed to be able for disassembly and easy GFRP cast remove. For the mold 12mm plywood was used to make sure that the form will be stiff enough during casting. The mold was used for casting two water basins, however, for mass production more durable material (e.g. steel) is recommended. Gaps between plywood elements were filled with car putty filler and then the mold was covered with 2 layers of transparent lacquer to prevent the resin from soaking into the wood (Phot. 1-7).

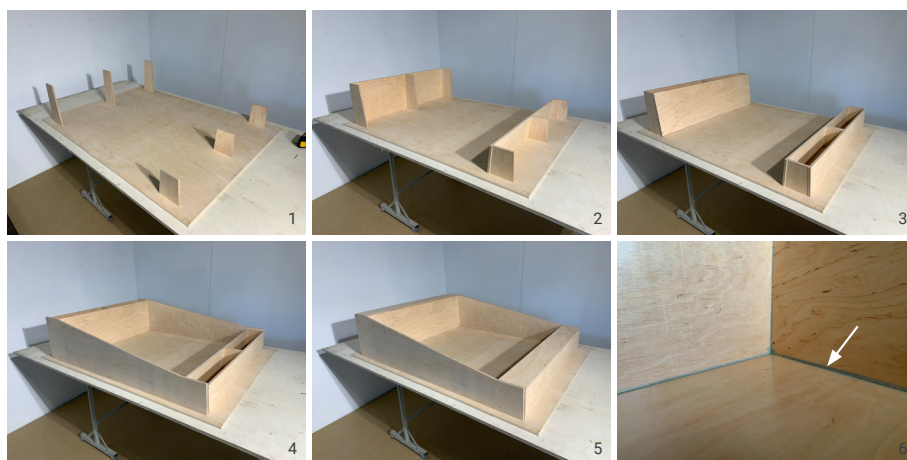

Phot. 1-6 . Plywood mold construction steps. Author's photography.



Phot. 7 Plywood mold covered with transparent lacquer. Author's photography.

To cast the water basin three layers of 300g fiberglass chopped strand mat were used. For an efficient casting process, the mat was divided into smaller fragments and cut out following the prepared mold (Phot. 8-9). For each water basin, 12m² of fiberglass mat were required. Before actual casting, a small sample test was prepared to try resin with catalyst proportions, curing time, form removing, and water tightness (Phot. 10-14). One sample was prepared directly on plywood mold while the second mold was firstly covered with wax paste. No significant difference while removing cast was noticed, therefore no additional wax was used during the basin casting. Tested resin to catalyst proportions as well as to fiberglass mat (Tab. 1) were sufficient, each layer of the mat was covered uniformly. The form was filled with water and no leaks were noticed.



Phot. 8-9 Fiberglass mat cutting. Author's photography.

Water System

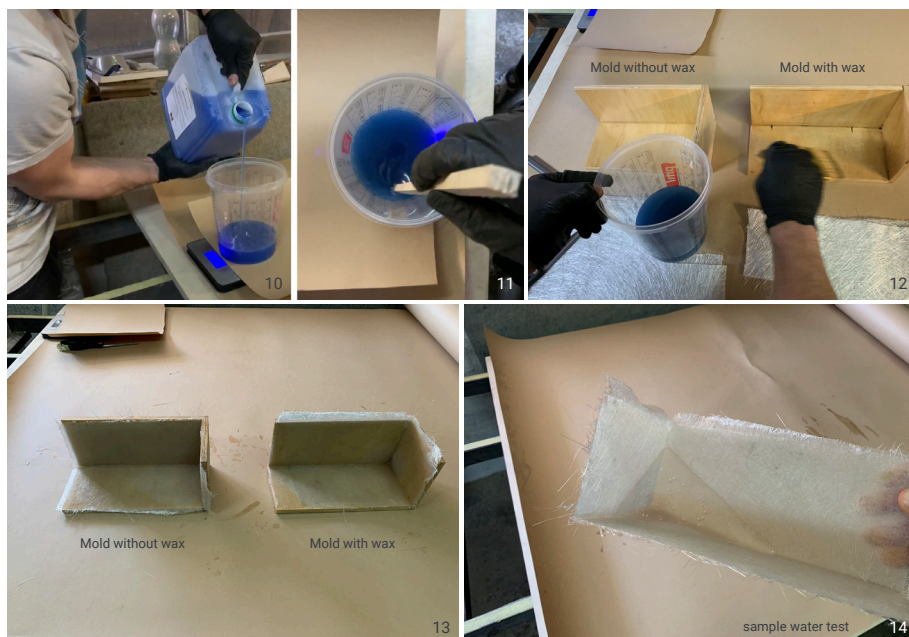

Phot. 10-14 GFRP sample test. Author's photography.

Surface	Resin (g/m ²)
Mold	500
300g Fiberglass chopped strand mat	650

Catalyst = 1% of Resin

Tab. 1 Proportions for GFRP casting. Products manufacturer recommendations.

For casting the 1x1m basin two people were necessary. All tools and materials were prepared before casting (Phot. 15) because while the resin and catalyst are mixed there is no time to waste. With used proportions the bonding time is around 30-40 minutes, therefore mixture was prepared in smaller portions (around 1.5kg) – manageable by two people. The casting was held in a closed room, with controlled ventilation and temperature. After 5 hours, when the GFRP was cured enough, the mold was disassembled and the form was removed (Phot. 16-18). The basin was drying further for another 12 hours before the next processing. Chopped strand mat is not precise, thus 2-3cm additional material has been cast and trimmed later to the desired size. The basin surface was sanded with sandpaper to remove all protruding fibers (Phot. 19-24).

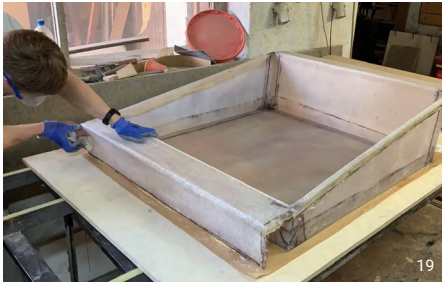
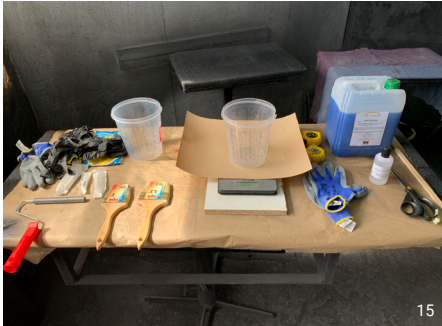

Phot. 15-24 GFRP water basin. Author's photography.

Water System

Before moving further all necessary pipes and channels for the system were prepared. For transporting and collecting water PVC pipes and profiles were used. The prototype system consists of three 40mm and one 25mm pipes. These are the main water input and output elements. The water between the main pipes and water basins is transported by 10mm pipes. All necessary reductions and caps were 3D printed (Phot. 25-29).



Phot. 25-29 Piping system. Author's photography.

The finished GFRP basin was drilled and connected with 10mm input and output pipes. A PVC L-profiles for polystyrene block support and U-profile for condensed water collection were attached with bolts and nuts to the casted form. All connections were sealed with silicone to make them watertight (Phot. 30-33).

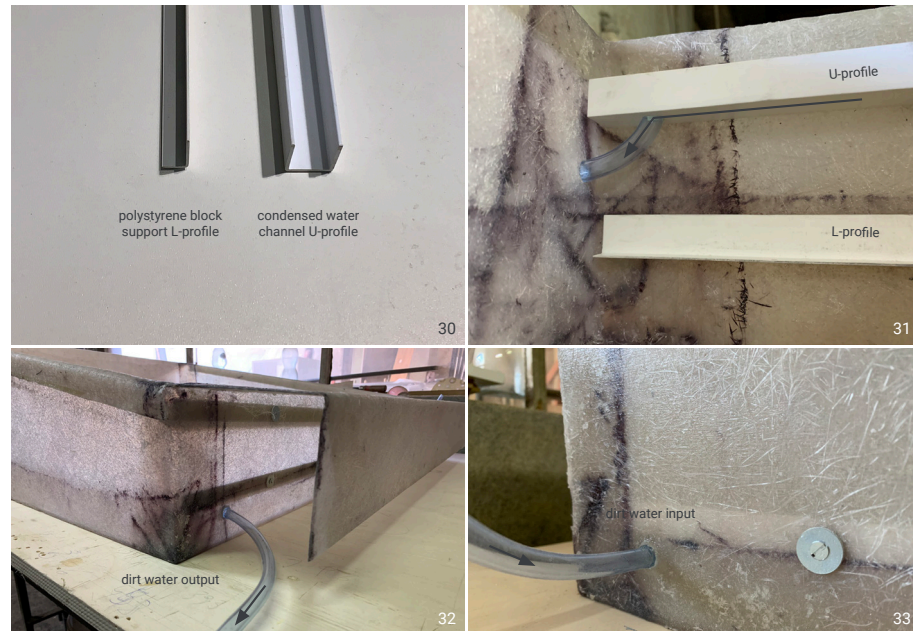

Phot. 30-33 Polystyrene and condensed water profiles. Dirt water input and output pipes. Author's photography.

The designed transparent covered was prepared from 12mm plywood. All elements were connected by screws to form a rectangular frame. The ETFE foil was cut and wrapped around wooden elements in a way that prevents water from coming into contact with wood. The edge touching the GFRP form was covered with a rubber gasket to make the basin water and airtight. In the next step, the cover was attached to the basin with a wooden beam and metal hinges. On the other side, two toggle latches were attached to the wooden frame and GFRP basin (Phot. 34-38).

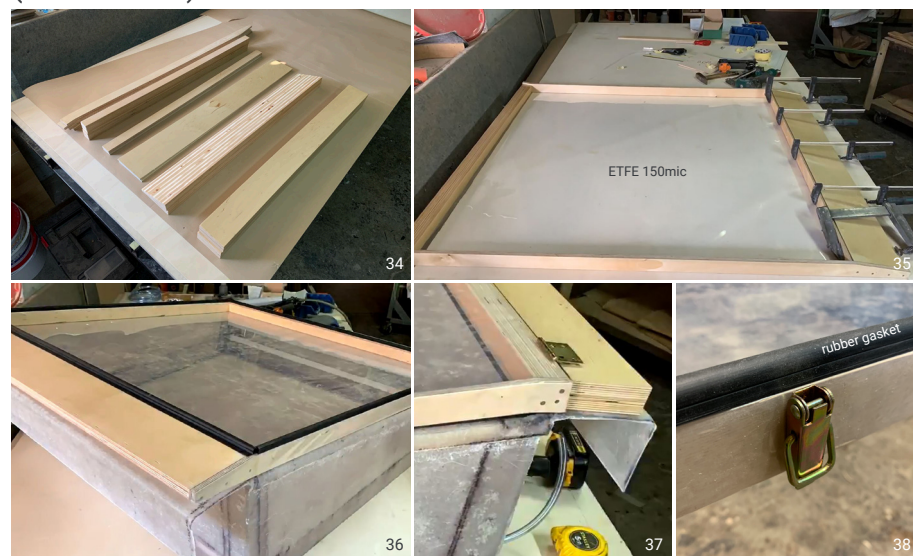

Phot. 34-38 Transparent cover. Author's photography.

Water System

When the unit was finished, the first test was held. The water basin was placed on temporary metal frames and filled with water. After a couple of minutes, small leaks appeared on the bottom of the basin and the test was stopped. Two options were considered to fix the problem. One idea was to use an additional layer of resin with fiberglass mat and second to use a gelcoat/topcoat. The second option seemed to be more logical, however, due to lack of materials and time, the basin was covered with black polyester lacquer, which was available at the workshop and considered as a good replacement. The second water test succeeded with the watertight basin. All steps were repeated and the second water basin was prepared in the same way (Phot. 39-48).



Phot. 39-48 Water test. Polyester topcat. Final unit assembly. Author's photography.

To reliably test the device and its efficiency, an important aspect was to use the same wipes for polystyrene block as used in the referred (Liu et al., 2017) research. The first test was prepared to check the limit of wicking water by wipes. For this, two samples were prepared. Both had 8x8cm top square, the first had additional 5.5cm 'arms' while the second had 7.5cm arms. Two tables with the same dimensions were 3D printed for testing. The basin with blue-dyed water was prepared to expose water wicking. The samples with tables were then placed into the basin. The smaller sample was fully wet after 90 seconds while taller had still dry spots even after 5 minutes, what can be noticed on the (Phot. 55). The conducted test resulted in polystyrene block thickness reduction compared to the original design. Next, the polystyrene was tested together with the wipe. Firstly, 8x8cm square was cut out, wrapped with the wipe, and placed back. Secondly, the prepared sample was placed on the dyed water. The second test succeeded with wipe fully wet after 60 seconds (Phot. 56-61).

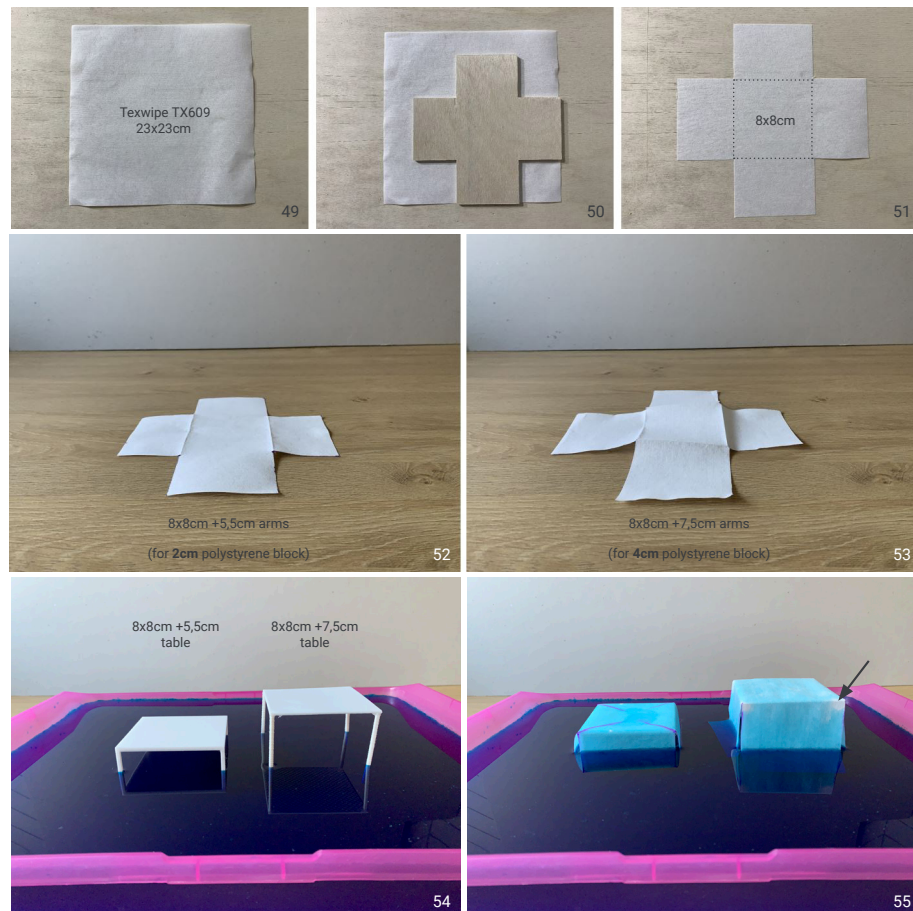

Phot. 49-55 Fiber-rich paper test. Author's photography.

Water System

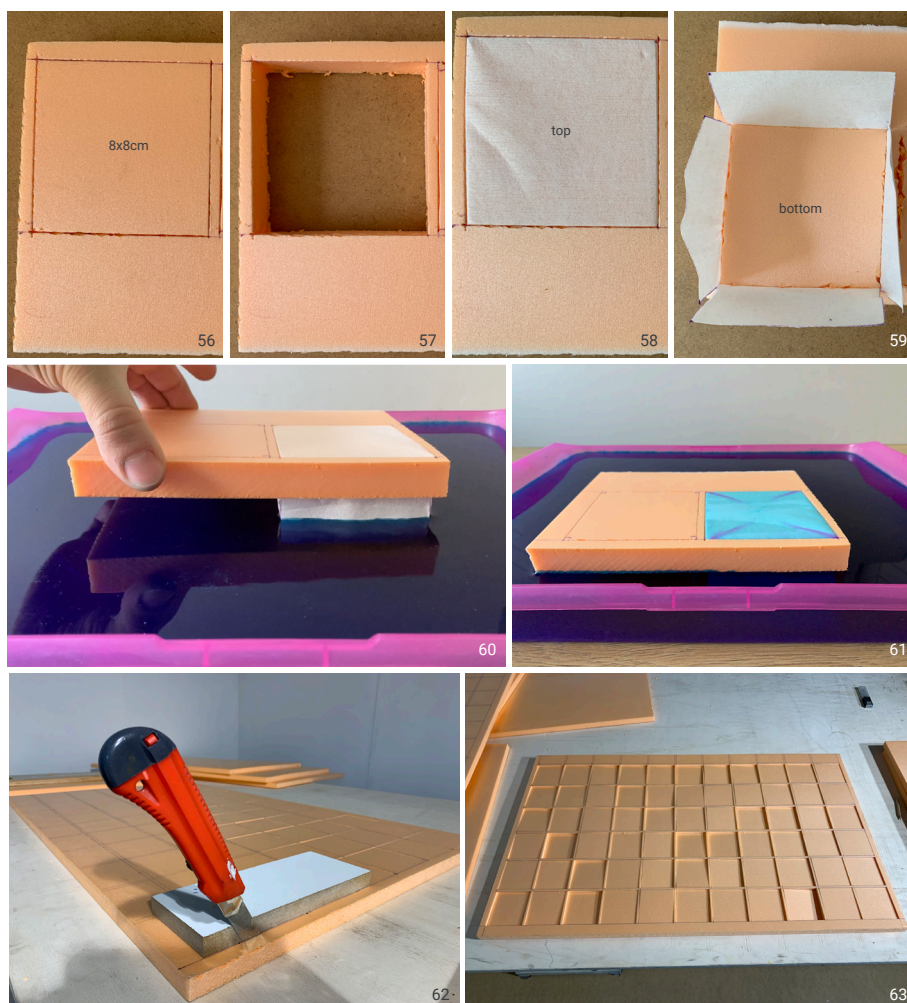

Phot. 56-63 Polystyrene block test and cutting. Author's photography.

Similarly to wipes, the same black pigment for dyeing wipes was used to build the prototype as in (Liu et al., 2017) research. The Carbon Black powder was used in similar water and acetic acid proportions, however, several tests were necessary to understand and properly prepare all wipes. First of all, (Liu et al., 2017) used mechanical devices for dyeing, rinsing, and drying wipes, while in the case of this research it was done manually. Wipes are very soft and easy to break when they are wet. They have to be dyed several times to turn deep black and rinsed a few times to remove the powder from them. If the powder is not removed enough it clogs the wipes and stops water wicking, what can be noticed on (Phot. 68-69). A few methods and sequences were tested to get the desired effect (Phot. 70). The chosen option consists of two coating and 3 rinsing sequences with drying between.



Phot. 64-71 Wipes coating test. Author's photography.

For the prototype 260 wipes had to be prepared in the same way. What was working with one sample was unsuitable for bigger batches. Wipes were dyed in batches of 65 and rinsed in batches of 5. While they turned black well enough, they had to be rinsed 7 times instead of 3. In the meantime, two 1x1m polystyrene blocks with 8x8cm square cuts were prepared (Phot. 62-63). When both components were finished, the blocks were connected with wipes. (Phot.74-75) show its top and bottom. The polystyrene block thickness reduction made it bend in the middle under the influence of its own weight, that is why additional supports were 3D printed to keep it flat (Phot. 76).

Water System



Phot. 72-77 Wipes coating. Polystyrene block with wipes. Two solar still units. Author's photography.

The designed system assumes the possibility of using any kind of water. To prefilter input water the sand filter was also prepared as part of the mock-up. The filter was made from a 20L plastic bottle, turned upside down. A 10mm hole was drilled in the cap and connected with a 10mm pipe by silicone and perpendicular nail. A piece of cloth was placed under the cap to make sure that any sand particle will not go to the pump. The bottom of the bottle was cut. It was filled with 6 fractions of gravel and sand, gradually changing with the biggest at the bottom for easier water drainage. A diffuser has been prepared at the top of the filter so that incoming water does not disturb the sand. (Phot. 78-89) show the materials and steps used for the sand filter. To test the filter dirt water was prepared by mixing the rainwater with earth and mud (Phot. 90, left glass). The water was passed through the filter and compared with tap water (Phot. 90, middle and right glass respectively). The sand filter succeeded in removing all bigger dirt particles that could clog the pump, pipes, and wipes or settle in the water basins.

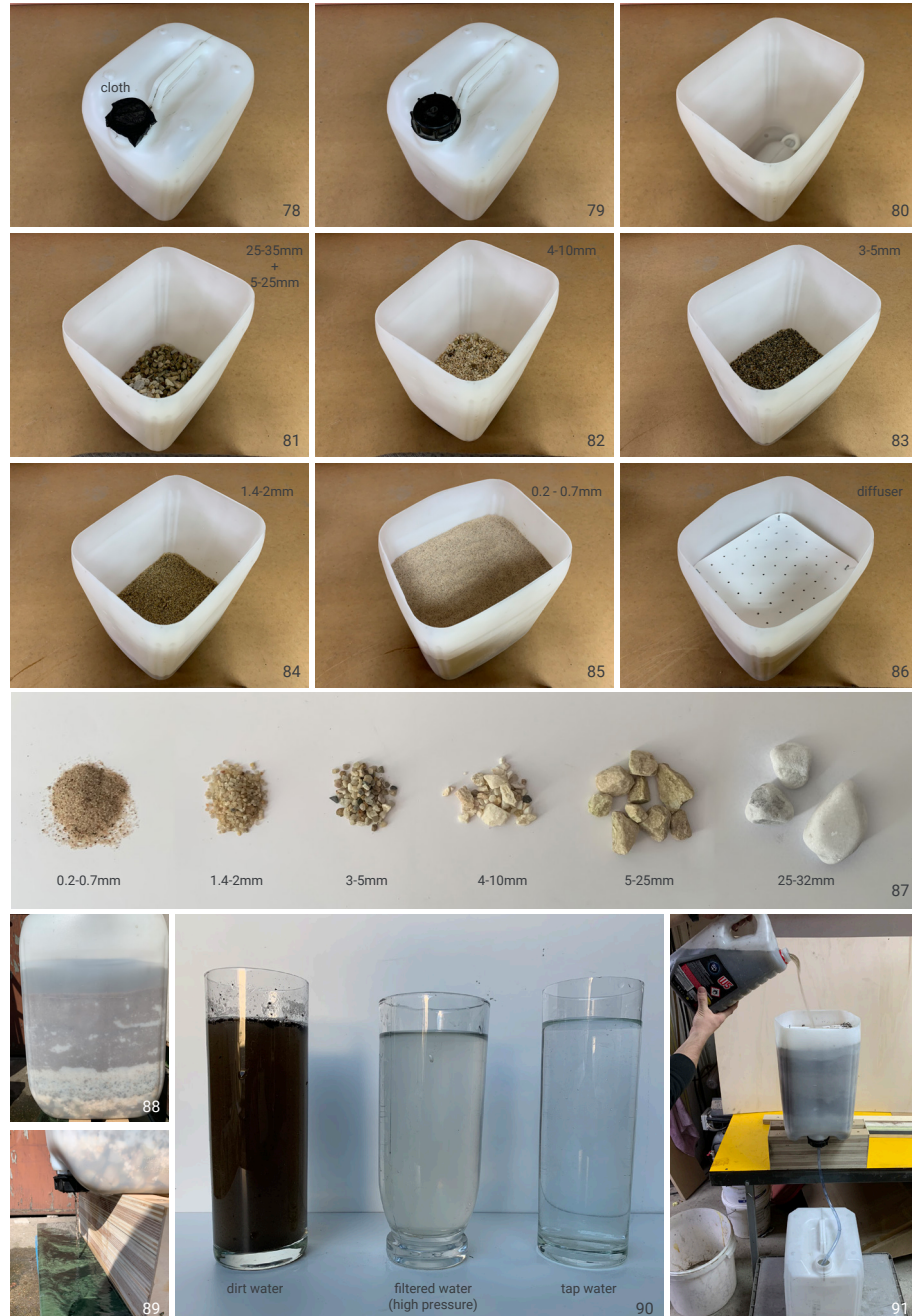

Phot. 78-91 Sand filter construction steps and test. Author's photography.

The epidemiological situation caused by Coronavirus affected the prototyping phase and caused significant delays in materials delivery. To make the testing phase possible the temporary supporting structure with metal frames and plywood was constructed. The cardboard tubes arrived when this phase was finished, however, the support structure was built after the testing phase for the final presentation and second testing. The final setup can be seen on (Phot. 119-131) in the next chapter.

Water System

2.4.7.2 Testing

For the final testing, all system components were assembled and connected together. Two solar stills were placed on the supporting structure (Phot. 92). The 10L bucket of water with an 8W aquarium submerge pump was placed next to the solar stills (Phot. 93-95). The dirt water input pipe (40mm) was connected to the higher solar still and water pump by 10mm pipes, then both solar-stills basins were connected diagonally by 10mm pipe (Phot. 96-98). The dirt water output pipe (40mm) was connected to the lower solar still and sand filter by 10mm pipe. The output from the sand filter, by 10mm pipe, goes back to the 10L bucket with the pump to close the water loop (Phot. 99-101). Finally, condensed water was collected by 10 and 25mm pipes to 40mm main clean water pipe. The water from the main pipe was collected in the 20L water bottle (Phot. 102-103). Where necessary, 3D printed pipe connectors were designed for the easy assembly process.



Phot. 92-98 Mock-up assembly steps. Author's photography.



Phot. 99-107 Mock-up assembly steps. Author's photography.

Water System

In the real case scenario, the sand filter also receives input water from the grey tank, rain tank, and constructed wetland. In the mock-up case, it was unnecessary to attach additional inputs since the evaporation rate for two solar still units is slow enough and the refill can be done manually. The 10L bucket of water with the pump controlled the amount of dirt water in the system. When the water from the loop was lost (evaporated and collected in 20L bottle) the amount of water in the 10L bucket decreased with the same rate. During testing, it was enough to fill the bucket once. However, it is necessary to keep the bucket full since it ensures that all wipes are uniformly immersed in water (the water table in water basins will stay on the same level). When everything was assembled and connected the system was filled with water and the first test was carried.



Phot. 108-110 ETFE fail test. Author's photography.

While the evaporation rate was noticed to be high and water condensed relatively quickly on the inner surface of the transparent cover, the ETFE film failed to collect it in the channel at its bottom (Phot. 108-110). Water did not stick hard enough to the surface of ETFE and drops of water were falling straight down before they reached collecting channel. The first test resulted in 0L of clean water. The cover angle was temporarily changed from 10° to around 45° but the problem remained (Phot. 110). Improvised 1x1m 4mm glass panel was mounted in place of the wooden frame with ETFE film at one of the stills. When condensed water was noticed to run on the surface properly, the glass replaced ETFE film in the second still as well. An unforeseen change caused detail problem with water collection, thus a thin plastic strip was glued on the inner surface of the glass to guide the condensed water drops fall into the collecting channel (Phot. 111-116).



Phot. 111-116 Glass for transparent cover. Author's photography.

Water System

Two final tests were conducted at the end of April in Swarzedz, Poland. Both tests took place between 10 am – 6 pm. The first-day outdoor temperature was 15-17°C and the second 16-21°C. The tests resulted in 4L and 6L of condensed water respectively.

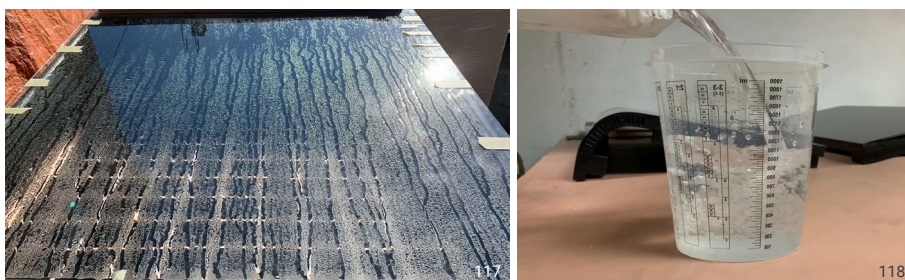

Phot. 117-118 Condensed water. Author's photography.

According to calculations from Phase 1 of this report, 1m² should produce 8L of clean water per day. Two units were expected to purify 16L of water during a day. The system did not give the expected amount of water due to several limitations. First of all, the production rate is calculated for hot climate or summer sun and outdoor temperatures ranging from 25 to 30°C. Temperature and direct sun have a huge impact on evaporation speed. Even during tests, 1-4°C difference in relatively low-temperature range, increased production by 50%. The sky during tests was not clear and the sun was partially covered by clouds. Furthermore, due to space limitations, the system was not optimally oriented. While the best orientation in Poland would be facing South, it was only possible to face West. Moreover, low East and West sun caused self-shading in solar still and a significant part of wicks was not exposed to the sun (Fig. 89). Lastly, glass cover was improvised during testing and caused leaks of condensed water and decreased airtightness, letting warm air going out. Nevertheless, the prototyping phase resulted in many improvements to the system. Even with a low production rate, the system can be considered as working properly.

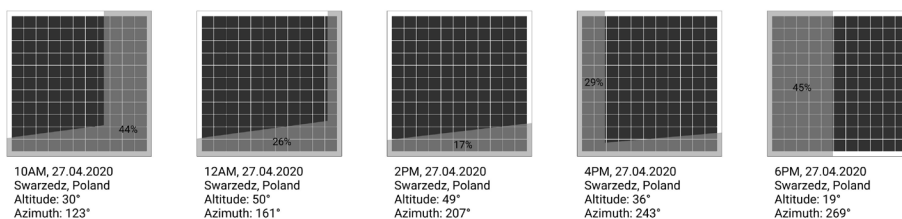

Fig. 89 Self-shading in solar still during test day in Swarzedz, Poland on 27.04.2020. Author's graphics.

Improvements and conclusions derived from prototyping and testing:

1. Polystyrene block's thickness reduction (from 4cm to 2cm).
2. Polystyrene block cutting needs to be automated (e.g. water jet cutting) for time and precision. Manual cutting caused many imperfections and took a lot of time and effort. While it was manageable in the case of 2m² of solar still it may cause a problem for the 200m² system.
3. Wipes coating process needs to be automated due to damages caused by manual processing and a large number of wipes (2m² = 242 wipes, 200m² = 24200 wipes).
4. Gelcoat should be applied on the mold for easier cast remove and water-tightness.
5. Topcoat or additional resin with fiberglass layer has to be applied for water-tightness. It is recommended to use black topcoat which in case of prepared prototype helped to heat the air under transparent cover by absorbing the sunlight.
6. In real size unit (1x2m) it is recommended to use more than 4 people for casting the water basin.
7. ETFE film has a lot of benefits for the system (e.g. lightweight, and easy maintenance) but is not suitable for collecting condensed water and needs to be replaced by glass. The frame had to be redesigned to fit the glass panel and effectively collect condensed water.
8. For prototyping locally available materials were used regardless its original purpose. For the final system, all components that are in contact with purified water should be health safe and do not react with water changing its quality.

Water System

RESEARCH BY DESIGN

2.4.7.3 Simulation

To validate mock-up testing results, numerical simulation was conducted. While evaporation and condensation processes inside the still are affected by many variables, the goal of the simulation was to get an approximated hourly production rate. The numerical model is simplified and the evaporation process is mainly affected by solar irradiation. The scheme (Fig. 90) presents the main variables which affect the still performance as well as heat balance equations for glass and wipes/water.

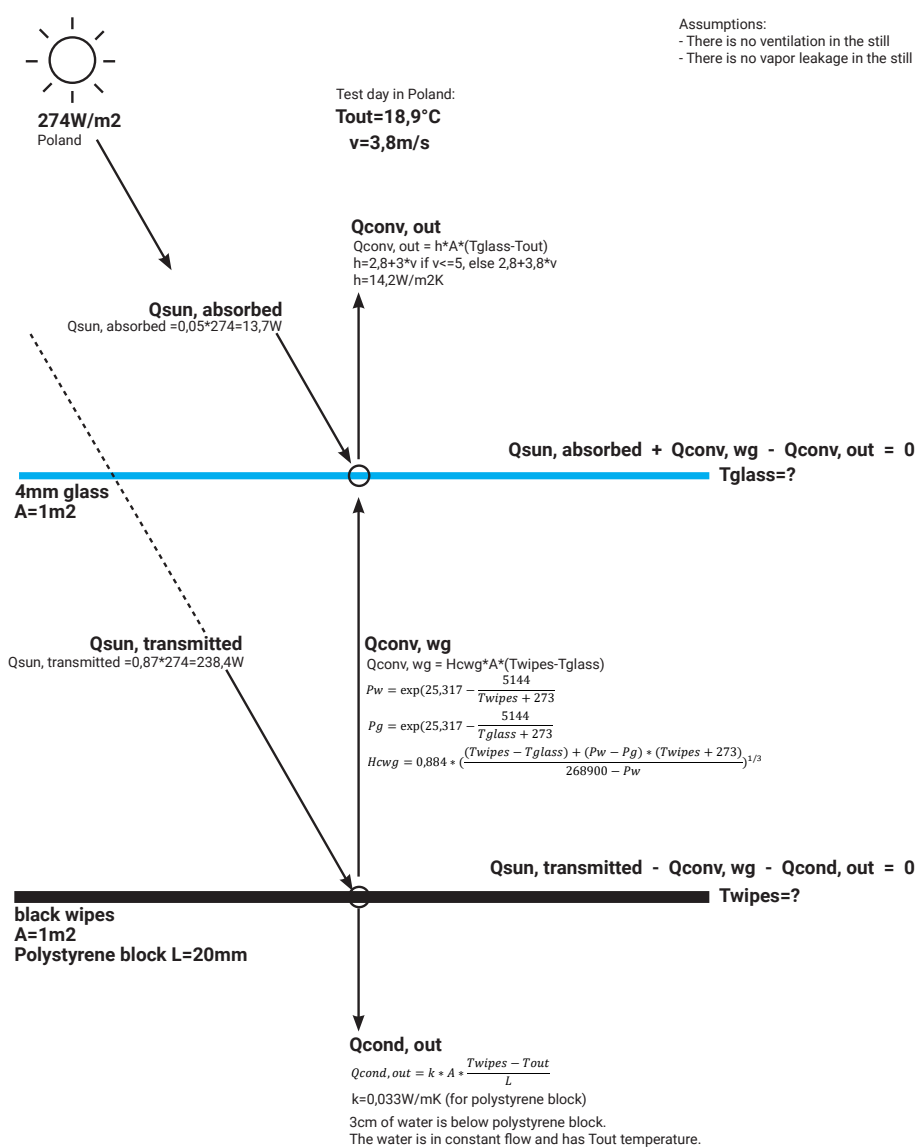

Fig. 90 Solar-still simulation scheme. Author's graphics.

From heat balance equations approximated glass and wiper temperatures are derived by iterative calculation. These temperatures are used to calculate water and vapor partial pressures and evaporative heat transfer rate within solar-still from water to glass cover surface. Hourly productivity from solar-still is measured in kg/m² per hour.

$$Q_{\text{sun, absorbed}} + Q_{\text{conv, wg}} - Q_{\text{conv, out}} = 0$$

$$I * \alpha_a + H_{\text{cwg}} * A * (T_{\text{wipes}} - T_{\text{glass}}) - (2,8 + 3 * v) * A * (T_{\text{glass}} - T_{\text{out}})$$

$$T_{\text{glass}} = \frac{I * \alpha_a + H_{\text{cwg}} * T_{\text{wipes}} + 14,2 * T_{\text{out}}}{14,2 + H_{\text{cwg}}}$$

H_{cwg}=3,8
T_{glass}=30,6°C
T_{wipes}=70,8°C

Steady state after 100 iterations

$$T_{\text{wipes}} = \frac{I * \alpha_t + H_{\text{cwg}} * T_{\text{glass}} + 1,65 * T_{\text{out}}}{1,65 + H_{\text{cwg}}}$$

$$H_{\text{ewg}} = 0,01628 * H_{\text{cwg}} * \frac{P_{\text{w}} - P_{\text{g}}}{T_{\text{wipes}} + T_{\text{glass}}}$$

$$Q_{\text{ewg}} = H_{\text{ewg}} * (T_{\text{wipes}} - T_{\text{glass}})$$

$$M_{\text{w}} = \frac{Q_{\text{ewg}i}}{L_{\text{v}}}$$

Fig. 91 Heat balance and hourly productivity formulas.

H_{cwg} =Conductive heat transfer coefficient from wiper to glass outer surface	[W/m ² K]
H_{ewg} =Evaporative heat transfer coefficient from wiper to glass cover surface	[W/m ² K]
I =Sun irradiation	[W/m ²]
L_v =Latent heat of vaporization	[kJ/kg]
M_w =Hourly productivity from solar-still	[kg/m ² h]
P_g =Partial vapor pressure	[Pa]
P_w =water pressure	[Pa]
Q_{cond, out} =Conductive heat transfer rate from wiper/water to outdoor	[W/m ²]
Q_{conv, out} =Convective heat transfer rate from glass to outdoor	[W/m ²]
Q_{conv, wg} =Convective heat transfer rate from wiper/water to glass	[W/m ²]
Q_{ewg} =Evaporative heat transfer rate from water to glass cover surface	[W/m ²]
Q_{sun, absorbed} =Absorbed sun irradiation	[W/m ²]
Q_{sun, transmitted} =Transmitted sun irradiation	[W/m ²]
T_g =Glass cover temperature	[°C]
T_{out} = Outdoor Temperature	[°C]
T_{wiper} =Wiper (Water) Temperature	[°C]
α_a =Glass absorptivity	
α_t =Glass transmittance	

Water System

The simulation resulted in an output close to the mock-up testing outcome. With weather condition variables from test day (27.04.2020, Swarzedz, Poland) both simulation and mock-up resulted in around 3 liters of condensed water per m² per day. However, with solar conditions like in Mozambique, the simulation gives output higher than expected and based on (Liu et al., 2017) research, therefore the model should be refined to include all variables and heat gains and losses. Furthermore, the production rate will vary based on a day-to-day, as well as hour-to-hour weather variations. Ideally, a parametric tool should be build to define the scale of the water production system. The solar-still production rate could be derived from the numerical simulation in Excel software and be based on weather conditions from .epw file (specific location weather data). Next, the same file and Excel output could be used in Grasshopper software to define the geometry of the solar-still unit, the most efficient orientation, and the size of the entire water production system for a considered number of people (Fig. 92). Furthermore, the model would provide useful information for an investor, constructor, and other experts involved.

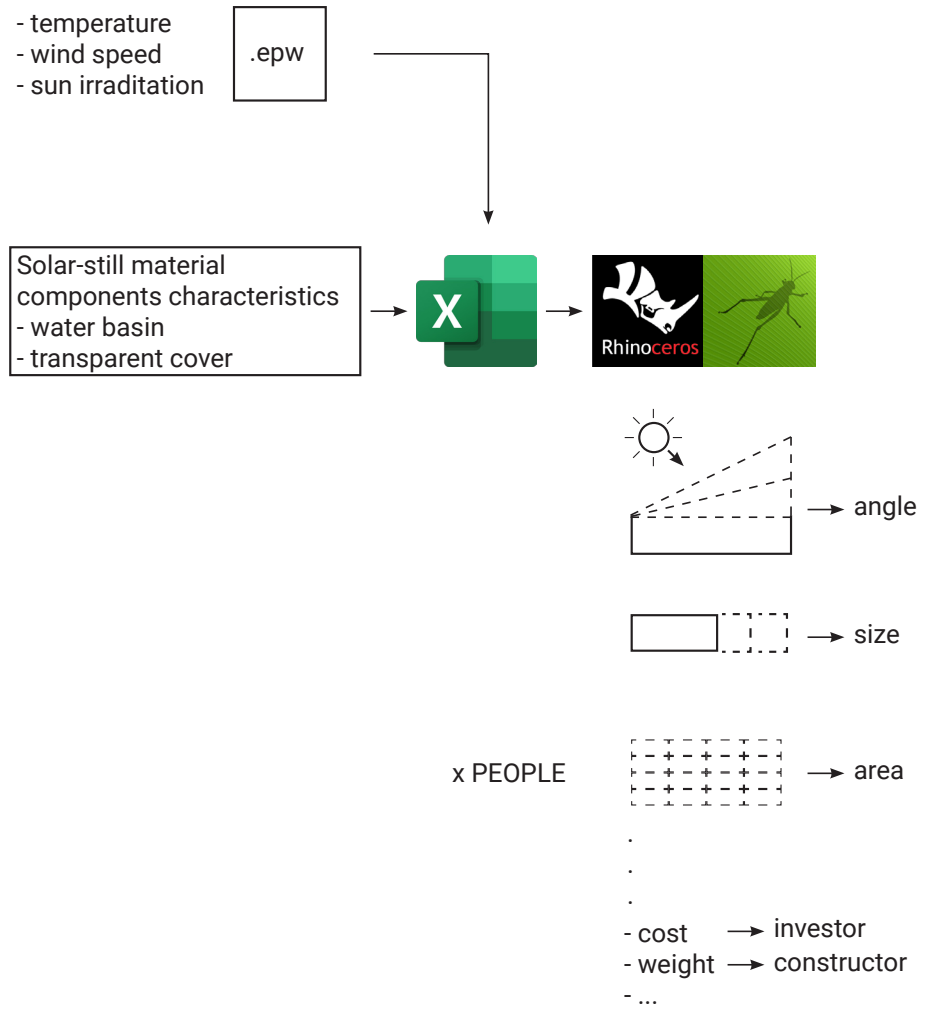

Fig. 92 Parametric simulation and model ideogram. Author's graphics.

Water System

2.4.7.4 Testing

Good weather conditions in the middle of June allowed to perform another set of tests on the prototype. Solar-stills were improved based on conclusions from the previous testing. Firstly, the glass was fitted to the transparent cover frame and the gap between was sealed properly, so the warm air was better kept inside the chamber. The collection channel was improved with a piece of foil which directly transferred water from glass to PVC profile. Both improvements reduced leaking and improved condensed water collection. Furthermore, the prototype during the second testing was better oriented facing south what reduced self-shading and provided more direct solar radiation to wiper.



Phot. 119-125 2nd testing prototype set-up. Author's photography.

The second testing was conducted in Swarzedz, Poland on 17th and 18th June 2020 with outdoor temperatures 26°C and 22°C respectively. During the first test day, the sky was mostly clear, however, on 18th there was unexpected rain and clouds for most of the day and measurements were not carried out.

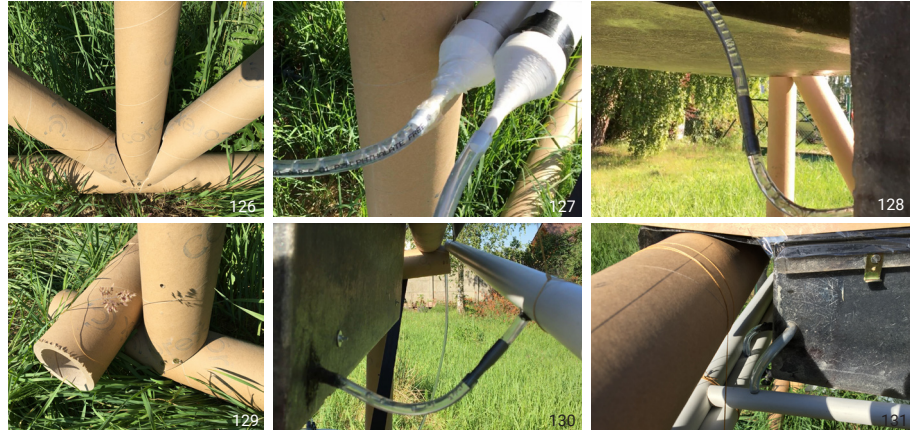

Phot. 126-131 2nd testing prototype set-up. Author's photography.

During the test, humidity and temperature measurements were collected inside the solar-still and outside (both in sun and shadow) (Phot. 132-134). The measurements were carried four times during the test period. The measurement results can be found in the table below.

	Inside solar-still		Outdoor (sun)		Outdoor (shade)	
	Hum. [%]	Temp. [°C]	Hum. [%]	Temp. [°C]	Hum. [%]	Temp. [°C]
8.00	56%	53°C	50%	30°C	67%	26°C
12.00	70%	65°C	26%	47°C	55%	26°C
15.00	99%	81°C	24%	50°C	60%	28°C
18.00	99%	55°C	35%	37°C	60%	24°C



Phot. 132-134 Humidity and temperature measurement tools. Author's photography.

The mock-up test resulted in 6.5L on the first day (measured between 8.00 and 18.00). Compared to the test from April, the production rate increased by 10 percent. The test confirmed the outcome from mathematical simulation and the main effect of solar radiation on the production rate. On average the sun irradiation in April and June in Poland is the same, therefore outcome from solar-still is similar. Summarizing, the solar-still purification method is significantly conditioned by weather conditions and direct sun. In regions with high solar radiation like Mozambique 4m² of the system should produce enough water for all basin living needs of one person.



Electricity System

Electricity System

2.5.1 Electricity System

Rural electrification is crucial nowadays, especially in low-income regions with a disadvantage in terms of access to electricity. From an economic point of view, the most efficient way to achieve electricity access in rural areas are small-scale solar photovoltaic (PV) stand-alone systems. This renewable energy source has huge potential in helping deliver affordable electricity to small communities of Mozambique. An off-grid system is a key in remote areas as the least-cost way to provide power for living. Furthermore, an on-site production system has no electricity losses caused by long-distance grid distribution. Next to clean water for 50 people, electric energy is the second goal of this project. This part of the research is not supposed to go into depth of principles, characteristics, and properties of photovoltaics, and commonly available formulas and calculators of PV output were used to estimate the size and capacity of the installation.

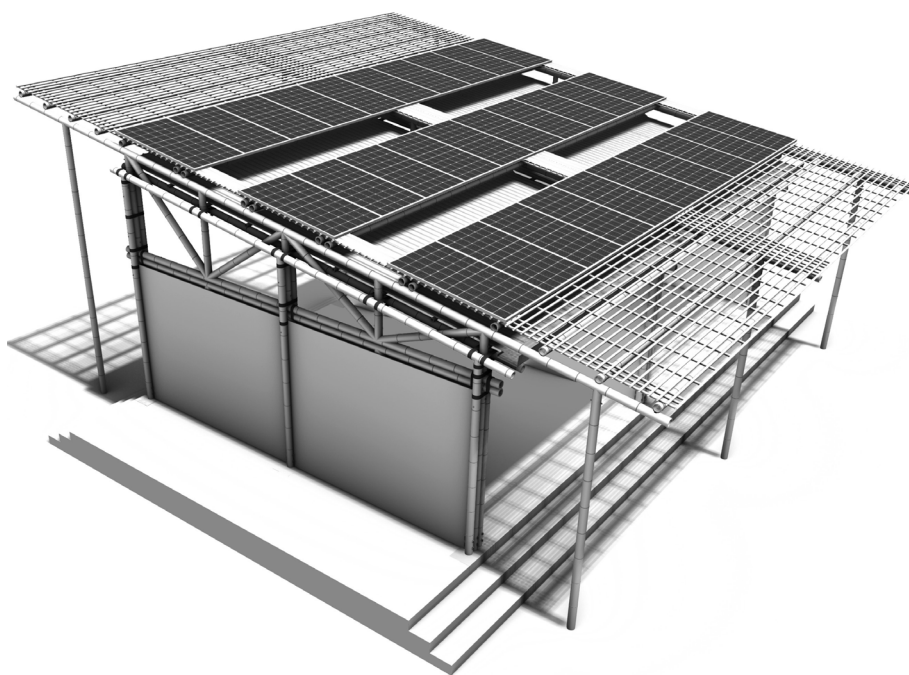

Fig. 93 Energy production modules with PV panels on the roof. Author's graphics.

Solar energy analysis described in Phase 1 of this report presents the potential of a solar installation for the area without access to the national grid. One photovoltaic panel described in (1.3.3) can produce up to 453kWh per year and provide over half of the electricity demand for one rural household (800kWh/year). The capacity of the installation has been selected to be able to serve both 10 typical rural households and the pilot public facility. The surface of the two-module central hub allows the installation of 30 photovoltaic panels on the roof, with a total power of 9.3kWp. Panels can be mounted directly on the main roof beams described in (Fig. 66) in a place where solar-stills on the other modules of the object are designed. Similar to the water production system, metal sheet roof covering is designed under the PV installation, making this part of the roof waterproof. Furthermore, the distance between metal sheets and PV panels allows for free airflow under the panels, which prevents overheating of the installation and decrease in its efficiency.

Electricity System

2.5.2 PV Instalation

Standard small-scale photovoltaic installations in developed countries are typically designed as on-grid systems. This arrangement means that the overproduction of electricity in the installation is sent to the national grid and taken back when needed. Usually, during peak electricity production hours (8 am to 5 pm depending on location), system users are away from home and cannot use produced energy directly. The bidirectional meter allows this energy to be sent to the electricity grid, and then in the evening or even at another season to receive it from an energy supplier with a small commission. In the context of the designed facility, the installation is off-grid, which means that to make full use of the energy produced by photovoltaic panels, additional energy accumulators are needed. The functions of the facility, such as shops or educational centers, require electricity in the evening and during the night for their proper functioning (computers, fridges e.t.c). Furthermore, the hub itself will need energy for water pumps and lighting during the early and late hours. The (Fig. 94) shows the daily required energy for storage.

Public HUB	Off-sun hours energy demand
4 Fridges - Shops (12h)	1.70kWh
6 Computers (2h)	1.80kWh
Water pumps (3h)	1.20kWh
Lighting	0.1kWh
	4.80kWh

Residential HUB	Off-sun hours energy demand
Fridge (12h)	0.42kWh
Lighting (5h)	0.20kWh
Computer (1.5h)	0.23kWh
TV (1h)	0.10kWh
	0.95kWh/house=9.50kWh/hub
Water pumps (3h)	1.20kWh
Lighting	0.1kWh
	10.80kWh

Car accumulator	
$P=U \cdot I$ [W]	$P=200 \cdot 12=2400W=2.4kWh$
U - electric voltage	U=200Ah
I - electric current	I=12V
30% loss	$2.4 \cdot 0.7=1.7kWh$

Fig. 94 Daily required energy for storage calculation.

As shown by the calculations, 4.8kWh daily will be needed after sun hours. This is a relatively small amount of energy that can be stored using three standard car batteries with a capacity of 200Ah. Standard batteries operate at a voltage of 12V, while home appliances are typically using 220/230V. To convert the current from 12V to 220/230V, a power inverter is needed. Usually, in low-quality devices, up to 30% of energy is lost, which was taken into account in the calculations. In the case of the hub for a residential project (10 households), seven car accumulators and two power inverters are needed. Although the energy storage system increases the costs of the entire system, it will allow full use of produced energy and will significantly improve the quality of life of users, which is the main goal of this project.

Photovoltaic technical infrastructure - inverter, as well as storage accumulators, are placed in the technical room of the hub. Photovoltaic installations are becoming popular in all regions of Africa, which is why more PV companies appear. The main reason for the slow development of this market is the high price of the system. Cost is crucial, which is why installations are not yet widely used in single households. The hub is designed to centralize the system for 50 people of the local community, and thus reduce capital costs avoiding duplicating infrastructure for each house separately. In the case of the pilot public facility, electricity is used by the building itself and the functions located in the facility. In the case of a hub designed for a residential function, produced energy is distributed to ten individual residential modules via electric cables.

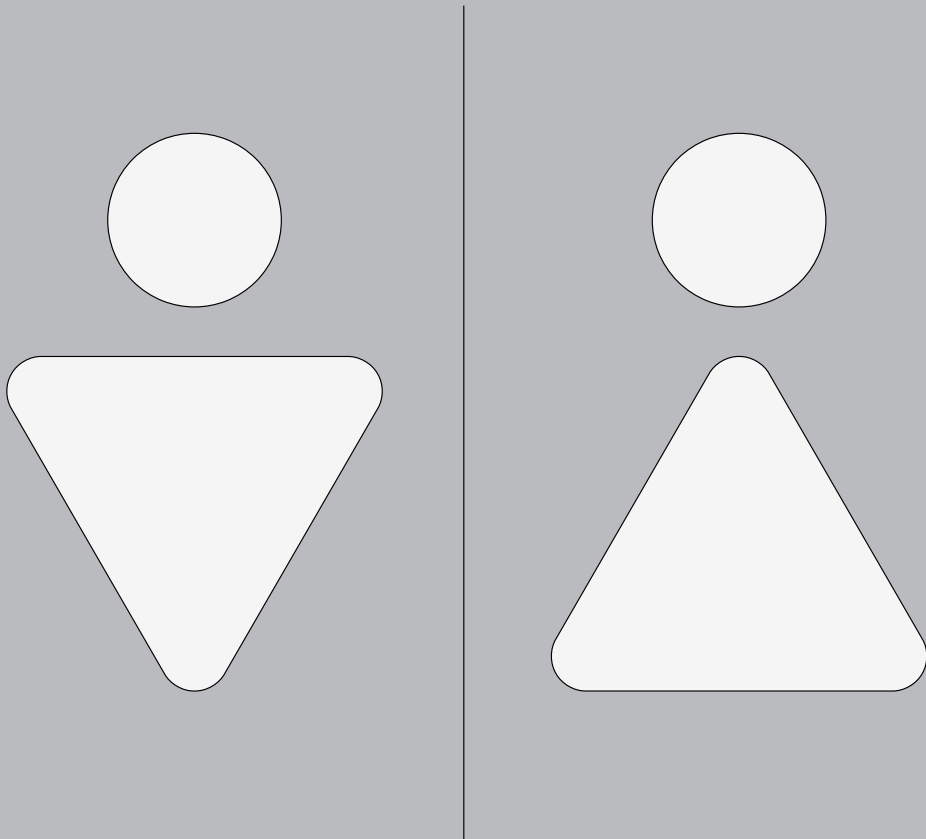

Sanitation Strategy

Sanitation

2.6.1 Waste Water Strategy

Healthy sanitation is the third main goal of this project. Most people living in rural regions do not have access to well functioning toilets, and maintaining basic hygiene is associated with an economic and logistical challenge. The idea of a self-sufficient facility that has a neutral impact on the environment requires the development of a human waste management strategy in the facility. From the perspective of a typical inhabitant of the rural part of the region, each organized form of sanitary facilities significantly improves his comfort of living. For people with limited access to basic living needs, it is challenging to care about the environment and the consequences of its pollution since they do not have appropriate resources. They must worry about themselves and their loved ones in the first place. In this context, an important role is played by the architect, whose task is to design the object and system that will be at the same time easy to use, affordable, will improve living conditions and reduce the negative impact on the environment. The hub houses public toilets, sinks, and showers that meet basic hygiene and social standards. The facility is adapted to users and their physiological needs both in the case of the pilot public facility and the hub prepared for affordable housing units.

The flow of water, both clean and used, is carefully designed in the facility. In the climatic context of the region, water is not widely available and often requires a long hike to the draw point. Also, as mentioned in Phase 1 of this report, this water is usually dirty and contains life-threatening bacteria and parasites. One of the main points of the water circulation strategy in the facility is its maximum reuse. Water reuse is divided into two stages.

In the first place, greywater from showers and sink taps is directly passed for re-use in toilets. This water does not have to be prepared or filtered in any way and significantly reduces the need for clean water. The Water Research Foundation from the City of Cape Town in 2016 estimated usage of water for flushing as 9 liters per person per day. The greywater system in the facility, assuming 50 users, helps to reduce the demand for clean water by 450 liters per day. Secondly, the excess of greywater from showers and sink taps that is not used for flushing toilets is directed to the Dirt Tank for re-filtration. While the sand filter removes larger dirt particles, hair, fat, and oils,

solar-still units completely clean the water and prepare it for consumption.

It is assumed that the building site is not equipped with the national sanitation sewage system. Black Water, used for flushing toilets, is not only released to the environment in a safe and controlled way but is also used to produce biogas for the facility. The Biogas system is described in the next paragraph of this report. Most often in low-income rural areas, water-free sanitation systems can be seen. This is usually associated with unpleasant smells, making latrines individual units located outside the building. Besides, cleaning this type of toilet involves a lot of work, which in most cases is not done correctly and exposes employees' health. Pollutants are thrown into the environment and contaminate soil and groundwater. The goal of this project's sanitary strategy is to reduce this phenomenon and ensure that it has zero or minimal environmental impact, not only in the context of the materials used and their carbon footprint but also during daily operation. Water after the biogas production process is an excellent fertilizer applicable to agriculture. Excess water from the digester tank is first directed to constructed wetland, where it undergoes natural purification processes that mimic the basic process in nature. Such filtered water is already applicable for outdoor needs and irrigation but not ready for consumption. Secondly, naturally filtered water is directed back to the Dirt Tank and subjected to sand filtration and solar-still purification process on the roof of the facility. It is obvious that part of the water in the whole process is lost to the environment, but closed-loop allows for additional water savings and reduces the demand for its supply from an external off-site source.

Sanitation

RESEARCH BY DESIGN

One of the threats to the acceptance of the project by the local community is the psychological aspect of the use of recycled water. Despite the fact that the filtered water is clean, the fact that it has already been used often makes users feel uncomfortable. The technology of water treatment has been designed to mimic a natural process that can be observed in nature. This process has been accelerated to maximize the efficiency of the entire system and be able to adapt it for continuous work for 50 people. It is assumed that in the short time of operation of the facility, the local community will accept not only the object itself but also the fact that water is circulating within the system. Both the factor of using water that is safe for living and its availability directly on-site is a huge advantage of the entire project. It will be a matter of time before the local community will overcome the mental comfort-barrier and trust the quality of the water from the facility system.

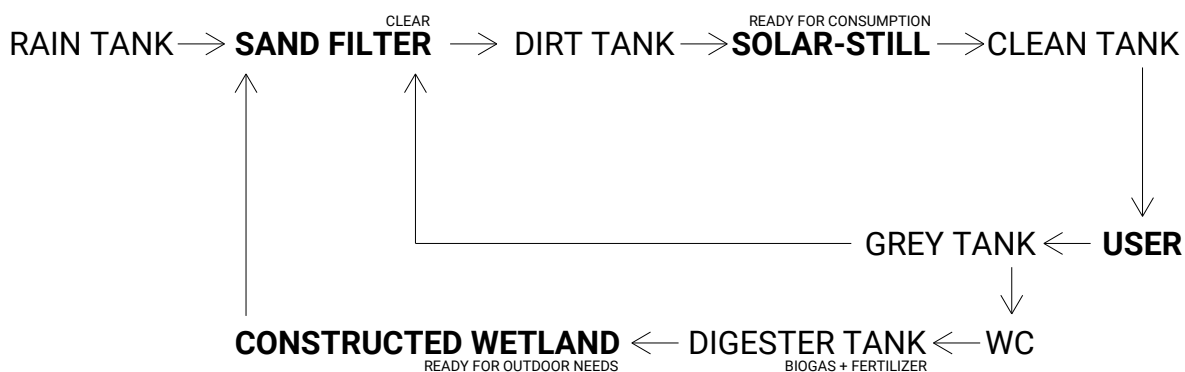

Fig. 95 Water flow stages. Author's graphics.

Sanitation

2.6.2 Biogas System

The idea of biogas production was created at the design stage of the facility. The challenge is to design a user-friendly, low-cost wastewater management system. The centralized sewer-based collection and treatment systems used in developed countries are too expensive, too complex, and too high energy-consuming to use them in low-income rural areas (Colón, Forbis-Stokes, & Deshusses, 2015). The goal of the system is to reduce the negative impact of human waste on the environment and to improve the performance of other systems producing water and electricity. Besides, one of the issues of concern in simple rural households is indoor air pollution. Most of them rely on solid fuels for cooking, lighting, and heating. These fuels are usually burned inefficiently which results in substantial emissions of air pollutants that affect human health and living quality. Cooking with biomass is the main cause of pollution and risk of the fire, therefore the main goal of biogas production is to replace open-fire stoves with biogas powered stoves to make smoke-free kitchens. Also, biogas will be used to prepare hot water for showers and sink taps.

Biogas can be seen as an alternative source of energy to typical fossil fuel for a variety of applications. Biogas is relatively non-toxic, has no color, and produces no odor when burned. It is also safe since due to the smell of natural gas can be immediately detected by a person during a possible leak. Biogas is produced during the natural decomposition of organic matter in a closed environment under the specific temperature conditions and can be considered as a non-polluting renewable source. Human and organic waste can be turned into a source of clean heating energy. Furthermore, waste can be used to produce organic fertilizer for agriculture (Polit, 2013). In the case of this project, waste can become useful and help with the economy of the facility.

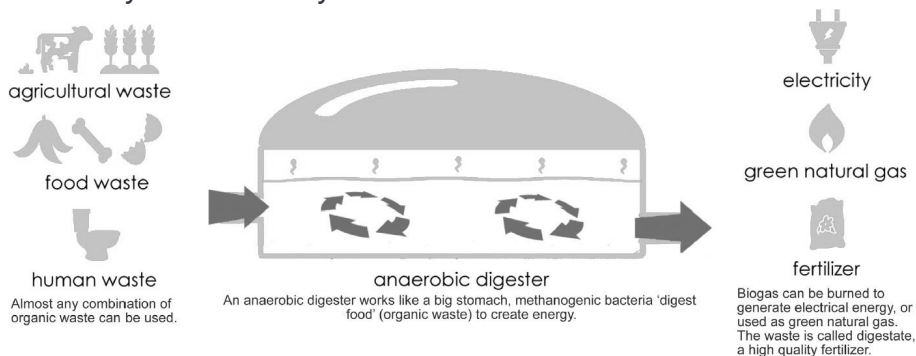

Fig. 96 Biogas Flowchart. Source: (Polit, 2013)

The size of the system depends on the expected gas production, but many factors influence the choice of its shape and size. The main part of a biogas plant is the digester tank. It is a container system holding water, waste, and bacterias. When organic matter is fed to the container it is broken down as a result of the decomposition process and biogas is produced. The sludge, as well as a liquid waste (slurry), which remains in the tank after the fermentation process can be used as organic fertilizer. The tank must be air and watertight to ensure the right system operation, prevent polluted water leaks to the ground, and biogas loss (Polit, 2013).

Based on the research, an underground fixed dome tank seems to be the most logical option. In the considered location, the temperature and sun exposition is very high. In small-scale plants, the bacteria that produce biogas work most effectively when the temperature of the slurry is 20-45 ° C (IRENA, 2016). Inside the underground tank, the more stable temperature is expected what is important for an efficient gas production process. The capacity of a biogas plant is the maximum total volume of gas and waste with water that it can contain. In a small-scale system, biogas is typically produced continuously, however, its consumption usually takes place during a few periods of the day. The generated biogas needs to be stored within the system until it will be used, therefore considered digester tank must be oversized to be able to store the gas inside. The easiest way to store biogas is in a low-pressure unit such as a gas storage bag (balloon) or in a fixed-dome itself, it must be pressure-resistant and UV, weather, and temperature proof (IRENA, 2016). The upper part of a fixed-dome digester serves as a gas storage chamber. Since the tank is air-tight, when the biogas accumulates in the dome, the gas pressure will increase and push the slurry out to the compensation tank (Fig. 97). Part of the slurry will be used as fertilizer and the overflow will be redirected for filtration to the constructed wetland.

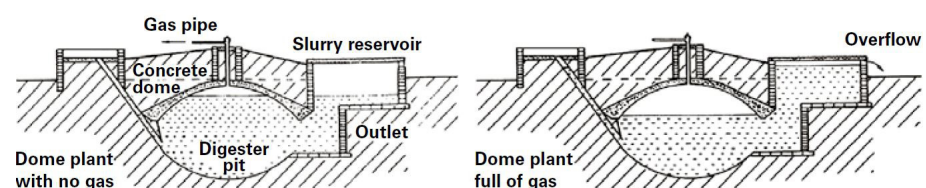

Fig. 97 Fixed Dome Digester Tank. Source: (Voegeli et al, 2014)

Sanitation

The digester tank size is estimated based on Biogas Plant Calculation Tables from (IRENA, 2016). While the pilot public facility will require less biogas for cooking, the size is calculated to meet residential hub demand. The five-people average family will require 1-2 cubic meters of biogas per day for cooking purposes, which results in 10-20 cubic meters for 50 users. Water heating for a shower, dish and personal hygiene (16 liters per day per person of water at 50°C) will result in additional 16 cubic meters of biogas needed (0.02m³ of biogas can heat 1 liter of water to 50°C) (Voegeli et al, 2014). Summarizing, the biogas plant capacity needs to be designed to be able to produce up to 36 cubic meters of biogas per day. Based on the tables from (IRENA, 2016), the fixed-dome digester tank should have 80 cubic meters volume. The scheme of the system is presented in (Fig. 98). While the digester tank is designed as underground and a relatively big hole needs to be dug the removed soil will be used for the elevated building floor.

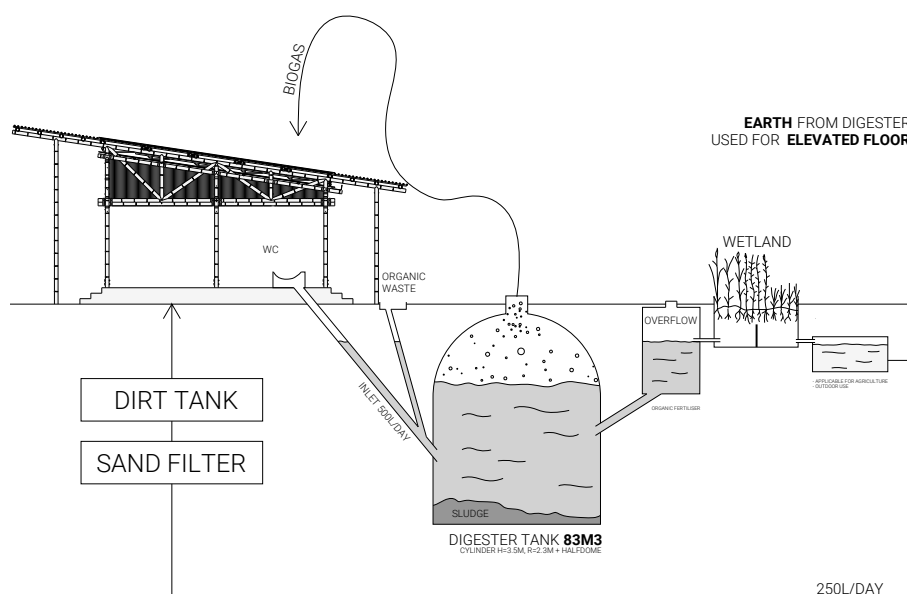

Fig. 98 Sanitation system. Author's graphics.

The digester can be fed by many types of biomass such as human, animal, food, and agricultural waste, except materials that are difficult for bacteria to digest (like wood). Biogas production depends on the type and amount of biomass used as well as the digester tank size and temperature (IRENA, 2016). In the considered facility, mainly blackwater and kitchen organic waste will be fed into the biodigester, additionally, agriculture waste can support input load when necessary.

Blackwater from 50 users can produce around 8 cubic meters of biogas per day (0.4kg/person/day produce 0.16m³ of biogas; Ahmedabad & Panjwani, 2019). And remaining 18-23 cubic meters of biogas will be produced by feeding household green waste (food waste) and/or animal and plant waste (agriculture waste).

A low-cost single chamber biogas digester tank is an appropriate solution for rural applications, due to its relatively low investment costs, simple technology, and easy maintenance. The use of biogas in the facility has positive both ecological and economical effects. The biogas system with a simple digester tank can be installed and run at a small household scale with simple training and support. The gas produced by a small-scale plant is not significant enough to take extreme safety measures or hire professionals for installation (Polit, 2013). The technology is simple enough to be taught during workshops conducted in the pilot facility. The biogas system not only helps to protect the natural environment but in the case of the designed hub directly improve the quality of users life. It contributes to the creation of a smoke-free healthy indoor environment, produces organic fertilizer for increased agricultural production, and thanks to the possibility of eliminating electric devices such as electric cooking stove and electric water heater, the same amount of electricity produced by photovoltaic panels can be better used by users. Elimination of electric heating devices can benefit in four smartphones per household (instead of two), four lightbulbs for five hours per day (instead of two per three hours) computer and TV use for three and two hours per day respectively (Fig. 99). Even though building a digester tank is associated with additional capital cost, it significantly improves the quality of life of residents and this system should not be missed.





	WATTS	HOURS/DAY	kWh/DAY
SMARTPHONE 	6	1	0.024
TV 	140	2	0.280
COMPUTER 	200	3	0.600
FRIDGE 	35	24	0.840
LED BULB 	10	5	0.200
			700 kWh/YEAR

Fig. 99 Biogas improved electricity distribution. Author's graphics.

Sustainability

2.7.1 Sustainability & Circularity

The goal of this research is to make the addressed community aware of sustainable solutions and opportunities. All building and system components were considered to cause the smallest negative environmental footprint with the use of relatively durable materials. Locally available resources were prioritized from both environmental and economic points of view. Having progressing climate change in mind, the building is designed to face worsening weather conditions. The construction manual is meant to spread designed technology and appropriate construction techniques among the region's communities. It is worth mentioning that the system has also the ability to generate income by renting the space and sanitary facilities, what can have a positive impact on the local economy. An off-grid solution is a must in rural African regions where the extension of national grids will take many years. The self-sufficient facility is an answer not only for poor regions but also is desired in developed countries. The system uses only renewable solar energy for both clean water and electricity production and produces no waste from these processes.

During the entire research and design phase, the circular economy was an important factor supporting most of the decisions made. Poor building techniques currently used in the considered region are more familiar with a linear economy, while not treated properly materials turn into waste at the end of the cycle. To make sure that bamboo construction will last many years it has to be treated properly to avoid material degradation caused by weather and insects. Furthermore, all connections have been designed to make building components possible for disassembly and reuse. Also, from a maintenance point of view, it is easier to replace a single element. The water, as the most important element of the project, was designed in line with 'reduce – reuse – produce' philosophy. Lowering demand for fresh water by its smart use and closing it within the building loop with maximum reuse, helped to design an effective system for 50 people.

Business Model

2.8.1 Business Model

The most logical option to build the pilot facility is a private organization involved in the project. The company that deals with the construction of affordable housing in the proposed region on a daily basis will be the most oriented and informed in the situation and construction possibilities. This type of company knows the local authorities and rules related to the construction sector. Besides, it should not have a problem with obtaining materials, laborers, and equipment for building the facility. The company involved in the project would be responsible for the acquisition of land, and in particular in obtaining financing for it. In the case of the public pilot building, the ideal solution would be to establish cooperation between a private company and a non-government organization operating in the region. The company responsible for the construction would be the owner of the object that would directly benefit from renting the space. However, the non-government organization should be the facility manager that will disseminate and teach the local community building techniques of the structural and production systems in the form of workshops. This way, the facility will be properly serviced and the technology will spread among rural communities. Also, the construction company could reproduce the project by building and selling it in a version of 10 affordable housings.

The technological and material solutions chosen are the result of a compromise between quality and price. Considering the economic situation of the region, every possible reduction in the price of the system is of great importance and is reflected in the reality of its construction. The tables below show the estimated material costs of the water production unit and the bamboo facility module.

Material costs of one bamboo building module (27,6m²):

Item	quantity	cost
Foundation	0,97m ³ (100€/m ³)	97€
Bamboo:		
Φ10cm	420m (3,5€/m)	1470€
Φ5cm	54m (2€/m)	108€
Φ3cm	65m (1€/m)	65€
Metal sheet	14(7,5€/m ²)	105€
Gutter	5m (3€/m)	15€
Bamboo mat	14m ² (2€/m ²)	28€
Ropes	90m (1€/m)	90€
Dowel connection	104(1€)	104€
Optionally	Front+Back walls	226€
		2308€

Material costs of one solar-still unit (2m²):

Item	quantity	cost
GFRP	18m ² (5,5€/m ²)	99€
Plywood frame	0,5m ² (12€/m ²)	6€
Glass	4m ² (6€/m ²)	24€
Silicon	1 (3€/m)	3€
Rubber gasket	6m(0,5€/m)	3€
Hinges	2 (1€)	2€
Toggle latches	2 (1€)	2€
Pipe Φ1cm	1m (0,5€/m)	0,5€
Support PVC profile	4m (0,5€/m)	2€
Collecting PVC profile	2m (0,5€/m)	1€
Polystyrene block	2m ² (2€/m ²)	4€
Wipes	13,5m ² (1€/m ²)	13,5€
Dying powder	0,3kg (4€/kg)	1,2€
		161,2€

Final Conclusion

How to supply drinking water and energy for small rural communities of Beira with the use of a low-tech, solar-based decentralized system?

A modular building and system for improving living conditions in Mozambique rural areas are designed. The low-tech approach based on solar energy is incorporated into the decentralized and self-sufficient hub. Modular design lowers the complexity of the project and allows for simple expansion, reconstruction, and most importantly reproduction. The construction of the building and the system is designed to be as simple as possible and easy to understand. It can be built by not highly skilled laborers with the use of simple tools. All systems are combined within the building and placed on its roof. The form and building module scale correspond with vernacular architecture and has a chance to be quickly adapted by local people. Locally available materials have great potential to be used for constructing the facility with improved resistance to changing weather conditions.

Although the building seems to be equipped with many modern technologies, they are in fact very simple, low-tech, and financially feasible. The water production system with improved solar still design has a chance to decrease water scarcity and deaths caused by the use of unsanitary water in the considered region. A mini solar grid with 30 PV panels can provide electricity for 5 typical region's households. The benefits of rural electrification have a wide range, from leisure and domestic benefits to improved security and health conditions. Research results show that the designed facility can accelerate the socio-economic development of the region by improving the living conditions of small rural communities. According to the findings designed system with 200m² of improved solar stills can provide fresh water for the basic living needs of 50 people daily. While in tested conditions the system performed less promising, it is expected that in hot sun region it will purify 8L/m²/day of water. Additionally, the biogas production system can replace unhealthy and unsafe kitchen stoves and stop the release of waste into the environment.

The goal was to design a facility that is sustainable for both environment and society. The driving force for changes should be the local community. Therefore, a pilot building, clearly prepared guidance, and construction manual is crucial to let them learn and gain skills. The project can speed up Mozambique recovery after Idai Tropical Cyclon and improve the quality of life in rural regions. It opens up new chances and can help to redesign disaster.

Literature

SITE CONTEXT

Anthony, D., You, D., Hug, L., Beise, J., Choi, Y., Lee, S., & Mshvidobadze, A. (2017). *Generation 2030 Africa 2.0: Prioritizing Investments in Children to Reap the Demographic Dividend*. Retrieved from https://www.unicef.org/publications/files/Generation_2030_Africa_2.0.pdf

Asante, K., Brito, R., Brundrit, G., Epstein, P., Fernandes, A., Marques, M. R., ... Vilankulos, A. (2009). National Institute for Disaster Management Study on the Impact of Climate Change on Disaster Risk in Mozambique: Synthesis Report Acknowledgements. (May).

Garland, R. M. (2017). Risk and Vulnerability. A handbook for Southern Africa. In *Introduction to International Disaster Management*. <https://doi.org/10.1016/b978-0-12-801477-6.00003-4>

Garrigos, P. (2019). From emergency to recovery: Mozambique one month after Cyclone Idai. Retrieved December 28, 2019, from [msf.org/mozambique-treating-hiv-cyclone-devastated-city-beira](https://www.msf.org/mozambique-treating-hiv-cyclone-devastated-city-beira)

Gwimbi, P. (2009). The link between livelihoods and disaster exposure in rural areas. *JAMBÁ: Journal of Disaster Risk Studies*, 2(1), 71–79.

Hiroki, K. (2019). HELP Global Report on Water and Disasters. HELP, 6–8.

Lumbroso, D., Ramsbottom, D., & Spalveiro, M. (2008). Sustainable flood risk management strategies to reduce rural communities' vulnerability to flooding in Mozambique. *Journal of Flood Risk Management*, 1(1), 34–42. <https://doi.org/10.1111/j.1753-318x.2008.00005.x>

Max Roser, Esteban Ortiz-Ospina and Hannah Ritchie (2019) - "Life Expectancy". Retrieved December 28, 2019, from [OurWorldInData.org](https://www.ourworldindata.org/life-expectancy). website: <https://ourworldindata.org/life-expectancy>

Nicchia, R., & Diamantini, C. (2013). Understanding the urbanisation process in sub-Saharan Africa: the Mozambican rural towns. *International Journal of Society Systems Science*, 5(3), 229. <https://doi.org/10.1504/ijsss.2013.055887>

Nwamarah, U. U., Balgis, O.-E., Bahri, A., Theriault, K., Ngomba, C. M., Duru, U., ... Jehu-Appiah, C. (2012). Solutions for a Changing Climate: The African Development Bank's Response to Impacts in Africa. African Development Bank, 8.

Ripoll, S., & Jones, T. (2019). The context of Sofala and Manica in relation to cyclone Idai response in Mozambique. (May), 1–46. Retrieved from <https://www.socialscienceinaction.org/resources/context-sofala-manica-relation-cyclone-idai-response-mozambique/>

Thieken, A. H., Mariani, S., Longfield, S., & Vanneville, W. (2014). Preface: Flood resilient communities - Managing the consequences of flooding. *Natural Hazards and Earth System Sciences*, 14(1), 33–39. <https://doi.org/10.5194/nhess-14-33-2014>

Winthrop, M., Kajumba, T., & Mclvor, S. (2018). Mozambique Country Climate Risk Assessment Report. Irish Aid, 44. Retrieved from <https://www.climatelearningplatform.org/>

Wright, P., & Brackett, R. (2019). Mozambique Destruction "Massive and Horrifying" After Cyclone Idai; Hundreds Dead, Thousands of Homes Destroyed. Retrieved December 28, 2019, from www.weather.com/news/2019-03-13-tropical-cyclone-idai-impacts-mozambique-malawi-0

WATER

Alferes, J., & Choga, V. (2006). Development of the Pungwe river basin joint. Integrated water resources management strategy. The Pun-gwe Project.

Bedford. (2017). Key facts about Fiberglass Reinforced Polymers. Retrieved February 24, 2020, from Bedford Reinforced Plastics website: <https://bedfordreinforced.com/2017/02/15-key-facts-about-frp/>

Brand, D. (n.d.). What Life Is Like on 13 Gallons of Water a Day – Cape Town's New Reality. Retrieved December 28, 2019, from [globalcitizen.org/en/content/6-things-13-gallons-water-cape-town-ration/](https://www.globalcitizen.org/en/content/6-things-13-gallons-water-cape-town-ration/)

Britannica, B. E. (2020). Matter and Energy: Evaporation and condensation. 1–7.

Cannon, S. R., & Au, V. (2008). (12) Patent Application Publication (10) Pub. No.: US 2008/0230367 A1. 1(19).

CAWST. (2009). Biosand filter manual: Design, construction, installation, operation and maintenance. Centre for Affordable Water and Sanitation Technology, (September). Retrieved from www.cawst.org

Jackson, T. (2009). Africa's Water – Who Uses How Much? Africa Geographic, November. Retrieved from <https://showme.co.za/lifestyle/africas-water-who-uses-how-much/>

Jefferson, N., Praetorius, B., & Ramos, C. (2015). Greywater Recycling Systems for Southwest Morocco. In Association Dar Si Hmad. Retrieved from https://www.wpi.edu/Pubs/E-project/Available/E-project-101615-173527/unrestricted/WPL_Greywater_Recycling_Systems_IQP-Supplemental_Document.pdf

Johnson, A. M. (2019). ANALYSIS OF A SINGLE SLOPE SOLAR STILL: A THEORETICAL APPROACH USING MATLAB. NEW MEXICO STATE UNIVERSITY.

Ligy, P., Ramprasad, C., & Kritchika, D. (2019). Water Scarcity and Ways to Reduce the Impact. Springer International Publishing.

Liu, Z., Song, H., Ji, D., Li, C., Cheney, A., Liu, Y., ... Gan, Q. (2017). Extremely Cost-Effective and Efficient Solar Vapor Generation under Nonconcentrated Illumination

Using Thermally Isolated Black Paper. *Global Challenges*, 1(2). <https://doi.org/10.1002/gch2.201600003>

Luzi, S., Tobler, M., Suter, F., & Meierhofer, R. (2016). SODIS manual Guidance on solar water disinfection. Retrieved from www.sodis.ch.

Manchanda, H., & Kumar, M. (2015). A comprehensive decade review and analysis on designs and performance parameters of passive solar still. *Renewables: Wind, Water, and Solar*, 2(1). <https://doi.org/10.1186/s40807-015-0019-8>

Nascimento, F. T., Nascimento, C. A., Spilki, F. R., Staggemeier, R., & Júnior, C. M. L. (2018). Efficacy of a solar still in destroying virus and indicator bacteria in water for human consumption. *Ambiente & Água*. <https://doi.org/10.4136/1980-993X>

Pichel, N., Vivar, M., & Fuentes, M. (2017). Performance study of a hybrid photovoltaic and solar water disinfection system considering climatic variations over a year. *Energy Conversion and Management*, 144, 312–321. <https://doi.org/10.1016/j.enconman.2017.04.080>

Service, R. F. (n.d.). Sunlight-powered purifier could clean water for the impoverished. <https://doi.org/10.1126/science.aal0699>

Shatat, M., & Riffat, S. B. (2014). Water desalination technologies utilizing conventional and renewable energy sources. *International Journal of Low-Carbon Technologies*, 9(1), 1–19. <https://doi.org/10.1093/ijlct/cts025>

Shatat, M., Worall, M., & Riffat, S. (2013). Opportunities for solar water desalination worldwide: Review. *Sustainable Cities and Society*, 9, 73–76. <https://doi.org/10.1016/j.scs.2013.03.004>

Wijte, C. J. S. (2012). Direct evaporative cooling in buildings. Delft, The Netherlands. useful website: <https://supplycentre.oxfam.org.uk/water-2-c.asp>

ENERGY

Auziane, G. (2015). Energy Efficiency in Residential Buildings in Mozambique - Measurements and Simulations (Lund University). <https://doi.org/10.1103/PhysRevB.75.195207>

Booth, J. (2019). How much energy does a solar panel produce? Retrieved December 28, 2019, from solarmonsters.com/help-advice/solar-panels-advice/how-many-kwh-does-a-solar-panel-produce/

Cuamba, B. C., Chenene, M. L., Mahumane, G., Quissico, D. Z., Lovseth, J., & O'Keefe, P. (2006). A solar energy resources assessment in Mozambique. *Journal of Energy in Southern Africa*, 17(4), 76–85. <https://doi.org/10.17159/2413-3051/2006/v17i4a3234>

International Energy Agency. (2017). WEO Energy Access Outlook 2017, Methodology for Energy Access Analysis. 1–9.

IRENA. (2012). Prospects for the African power sector. Scenarios and Strategies for Africa Project, 33–35.

Kamunda, C. (2014). A Study on Efficient Energy Use for Household Appliances in Malawi. *Malawi Journal of Science and Technology*, 10(1), 53–58.

Mokveld, K., & von Eije, S. (2018). Final Energy report Mozambique. Netherlands Enterprise Agency, 2–11, 25–28.

Monari, L. (2011). Africa energy access challenges. Presentation to the International Energy Agency, Paris, 13 May 2011

NationMaster. (n.d.). Energy Stats: Mozambique vs. Netherlands. Retrieved December 28, 2019, from www.nationmaster.com/compare/Mozambique/Netherlands/Energy

Odyssee-Mure. (2015). ELECTRICITY CONSUMPTION PER DWELLING. Retrieved December 28, 2019, from www.odyssee-mure.eu/web-site/ <https://www.odyssee-mure.eu/publications/efficiency-by-sector/households/electricity-consumption-dwelling.html>

Risseeuw, N. (2012). Household Energy in Mozambique: stove and fuel transitions. Amsterdam, Netherlands.

Zajicek, C. (2019). How solar mini-grids can bring cheap, green electricity to rural Africa. Retrieved December 28, 2019, from www.odi.org/blogs/10730-how-solar-mini-grids-can-bring-cheap-green-electricity-rural-africa

SANITATION

About Greywater Reuse. (2018). Retrieved December 28, 2019, from greywateraction.org/greywater-reuse/

Ahmedabad, I., & Panjwani, R. (2019). Cooking gas from Biogas using Human feces, reduce GHG gases and Generate Carbon Credit. Retrieved January 22, 2020, from www.changemakers.com/discussions/entries/cooking-gas-biogas-using-human-feces-and-generate-carbo

Colón, J., Forbis-Stokes, A. A., & Deshusses, M. A. (2015). Anaerobic digestion of undiluted simulant human excreta for sanitation and energy recovery in less-developed countries. *Energy for Sustainable Development*, 29, 57–64. <https://doi.org/10.1016/j.esd.2015.09.005>

IRENA. (2016). Measuring small-scale biogas capacity and production. Abu Dhabi: The International Renewable Energy Agency (IRENA).

Jenkins, J. (2009). Humanure Sanitation: The "no waste, no pollution, nothing to

dispose of" toilet system. Joseph Jenkins Inc.

Katukiza, A. Y., Ronteltap, M., Niwagaba, C. B., Foppen, J. W. A., Kansime, F., & Lens, P. N. L. (2012). Sustainable sanitation technology options for urban slums. *Biotechnology Advances*, 30(5), 969–975. <https://doi.org/10.1016/j.biotechadv.2012.02.007>

Mara, D. D. (2008). Sanitation Now: What is Good Practice and What is Poor Practice? IWA International Conference 'Sanitation Challenge: New Sanitation and Models of Governance', (May), 19–21. Wageningen, Netherlands: Sub-department of Environmental Technology, Wageningen University.

Morel, A., & Diener, S. (2006). *Greywater Management in Low and Middle-Income Countries*.

Obarska-Pempkowiak, H., Gajewska, M., Wojciechowska, E., & Kolecka, K. (2015). Sewage gardens - Constructed wetlands for single family households. *Environment Protection Engineering*, 41(4), 71–82. <https://doi.org/10.5277/epe150406>

Polit, D. J. (2013). *Biogas - Energy is not a Waste of Time*. Delft, The Netherlands.

Reed, B. (2014). Ventilated Improved Pit Toilets (VIP). WEDC Loughborough University, 1–16. Retrieved from <http://www.sswm.info/print/1739?tid=816>

Sarmiento, V. de B. A. (2001). *Low-cost Sanitation Improvements in Poor Communities: Conditions for Physical Sustainability*. University of Leeds.

Tilley, E., Lüthi, C., Morel, A., Zurbrügg, C., & Schertenleib, R. (2014). *Compendium of Sanitation Systems and Technologies (2nd revise)*. Retrieved from www.sandec.ch/compendium

Werner, C., Panesar, A., Rüd, S. B., & Olt, C. U. (2009). Ecological sanitation: Principles, technologies and project examples for sustainable wastewater and excreta management. *Desalination*, 248(1–3), 392–401. <https://doi.org/10.1016/j.desal.2008.05.080>

WSUP. (2019). Supporting the provision of universal water services in Beira and Dondo. Retrieved December 28, 2019, from Water & Sanitation for the Urban Poor www.wsup.com website: <https://www.wsup.com/where-we-work/mozambique/beira/>

Vögeli, Y., Riu, C., Gallardo, A., Diener, S., & Zurbrügg, C. (2014). Anaerobic Digestion of Biowaste in Developing Countries. In *Sandec: Department of Water and Sanitation in Developing Countries*. Retrieved from <http://www.eawag.ch/forschung/sandec/publikationen/swm/dl/biowaste.pdf>

wordpress.com

Tessema, F., Taipale, K., & Bethge, J. (2010). *Sustainable buildings and construction in africa*. Berlin.

LOCAL MATERIALS & CONSTRUCTION TECHNIQUES

Amado, M. P., Lopes, T., & Ramalhe, I. (2013). Eco-Wall : Modular Solution for Low-Cost Houses. (January 2013), 121–126.

Charles, K. J., & Paul, U. (2009). *Low Cost Construction Technologies and Materials - Case Study Mozambique*. 11th International Conference on Non-Conventional Materials and Technologies, NOCMAT 2009, (September 6-9). Bath, UK.

Cruz, A. S., Fernandes, F., Mafambissa, F. J., & Pereira, F. (2018). The construction sector in Mozambique: An overview (No. 2018/117). Helsinki, Finland.

Disén, K., & Clouston, P. L. (2013). Building with bamboo: A review of culm connection technology. *Journal of Green Building*, 8(4), 83–93. <https://doi.org/10.3992/jgb.8.4.83>

English, E. (2009). Amphibious foundations and the buoyant foundation project: innovative strategies for flood-resilient housing. Road Map Towards a Flood Resilient Urban Environment International Conference on Urban Flood Management, (November), 25–27. Retrieved from www.buoyantfoundation.org

Frith, O., Adhikary, N., Peldon, S., Mukhia, P. K., & Dukpa, G. (2015). Bamboo Construction in Bhutan: a feasibility and market study. 53(9), 16–22. <https://doi.org/10.1017/CBO9781107415324.004>

Hidalgo-López, O. (2003). *Bamboo: The Gift of The Gods*. Bogota: Oscar Hidalgo-López.

Husri, Z., Rashid, M. S., Said, S., & Kamisan, R. (2015). Bamboo Modular System (BMS) for New Eco Architecture. *International Colloquium of Art and Design Education Research (i-CADER 2014)*, (January 2015), 525–539. <https://doi.org/10.1007/978-981-287-332-3>

Mathias, A. J. (2018). Why African Vernacular Architecture Is Overdue for a Renaissance. Retrieved January 18, 2020, from *Archdaily* website: <https://www.archdaily.com/889350/why-african-vernacular-architecture-is-overdue-for-a-renaissance>

Minke, G. (2016). *Building with Bamboo: Design and Technology of a Sustainable Architecture Second and Revised Edition (2nd ed.)*. Retrieved from <https://ebookcentral-proquest-com.tudelft.idm.oclc.org/lib/delft/detail.action?docID=4533878>

Schetter, O. (2010). "How come there's a window in our wall?" The Construction of Knowledge in Mozambican Vernacular. *Journal for Architectural Knowledge*, 03(0207), 105–135.

Sojkowski, J. (2017). *African Vernacular Architecture: Documentation For Preservation*. Retrieved January 18, 2020, from <https://theculturetrip.com/africa/articles/african-vernacular-architecture-documentation-for-preservation/>

Sollien, S. E. (2011). The Macuti House, Traditional Building Techniques and Sustainable Development in Ilha De Moçambique. Retrieved from <http://macuti>.

List of Figures

Fig. 1 2018 Natural disasters. Author's graphics. Data source: (Natural Disasters 2018; CRED, 2019)	10
Fig. 2 Developed and poor countries comparison. Author's graphics.	11
Fig. 3 Idai Tropical Cyclone facts - Africa. Author's graphics. Data source: (Garrigos, 2019)	12
Fig. 4 Idai Tropical Cyclone facts - Mozambique. Author's graphics. Data source: (Wright & Brackett, 2019)	13
Fig. 5 Mozambique facts - Water. Author's graphics. Data source: UNICEF	14
Fig. 6 Mozambique facts - Electricity. Author's graphics. Data source: UNICEF	15
Fig. 7 Rural village after cyclone. Author's graphics.	16
Fig. 8 Beira's climate conditions. Author's graphics. Data source: (Weather & Climate, 2019)	26
Fig. 9 Project location. Author's graphics. Data source: Google Maps.	27
Fig. 10 Beira's water source - Pungwe river. Author's graphics. Data source: (Alferes & Choga, 2006)	30
Fig. 11 Water consumption in Europe and Mozambique. Author's graphics. Data source: (EC, Statista, 2014/15; WHO, 2016)	32
Fig. 12 Use of 50L of water per person per day. Author's graphics. Data source: The Water Research Foundation from the City of Cape Town	33
Fig. 13 Use of 32L of water per person per day. Author's graphics. Data source: The Water Research Foundation from the City of Cape Town	33
Fig. 14 Water purification methods requirements. Author's graphics.	34
Fig. 15 Solar-based water purification methods. Author's graphics. Data source: (Luzi, Tobler, Suter, & Meierhofer, 2016; Saidur et al, 2011)	35
Fig. 16 Simple solar still advantages and disadvantages. Author's graphics. Data source: (Saidur et al, 2011)	36
Fig. 17 Simple solar still performance. Author's graphics. Data source: (Saidur et al, 2011; Cannon & Au, 2008; Ligy, Ramprasad, & Krithika, 2019)	36
Fig. 18 Improvements for solar still. Author's graphics. Data source: (Al-hayek, Badran, 2004; Adberachid, Abdenacer, 2013; Manchanda & Kumar, 2015; Ayber et al, 2005)	37
Fig. 19 Liu et al., 2017 solar still improvement. Author's graphics. Data source: (Lie et al., 2017)	38
Fig. 20 Concept design performance and requirements. Author's graphics.	39
Fig. 21 Average energy consumption in a typical Dutch household. Author's graphics. Data source: (City Centre Retreat, 2018)	42
Fig. 22 Average energy consumption in a typical African household. Author's graphics. Data source: (NationMaster, 2005; Monari, 2011)	42
Fig. 23 IEA rural and urban minimum level of electricity. Author's graphics. Data source: (International Energy Agency, 2017)	43
Fig. 24 Typical, Optimal, and Necessary use of electricity. Author's graphics. Data source: (Products technical sheets)	45
Fig. 25 2014 rural Africa and exp. 2035 energy consumption. Author's graphics. Data source: (Kammen & Kirubi, 2008; IEA, The World Bank, 2013)	46
Fig. 26 Concept design energy requirements Author's graphics.	47
Fig. 27 2030 electricity full coverage goal and methods of providing energy. Author's graphics.	48
Fig. 28 Solar mini-grid advantages. Author's graphics. Data source: (Zajicek, 2019)	49
Fig. 29 PV system calculation. Author's graphics. Data source: (Cuamba et al., 2006; Photovoltaic-Software.com, 2019)	49
Fig. 30 Sanitation situation in rural Africa. Author's graphics. Data source: (WHO and UNICEF, 2008)	52
Fig. 31 Concept design sanitation strategy. Author's graphics.	53
Fig. 32 Twin Pit Latrine. Author's graphics. Redrawn from: (Tilley et al, 2014)	55
Fig. 33 Improved Ventilated Pit Latrine. Author's graphics. Redrawn from: (Shaw, WEDC, 2010; Jenkins, 2009; Tilley et al, 2014)	55
Fig. 34 Horizontal Flow Constructed Wetland. Source: (Morel & Diener, 2006)	56
Fig. 35 Vertical Flow Constructed Wetland. Source: (Morel & Diener, 2006)	56
Fig. 36 Constructed wetland strategy. Author's graphics.	57
Fig. 37 Construction materials used in Beira region. Author's graphics.	62
Fig. 38 Concept design target community. Author's graphics.	66
Fig. 39 Concept design target scale. 10 households/50 people. Author's graphics.	66
Fig. 40 Concept design system area requirements. Author's graphics.	67
Fig. 41 Concept design brief (PoR). Author's graphics.	69
Fig. 42 Concept architectural requirements. Author's graphics.	74
Fig. 43 Concept public facility space layout. Author's graphics.	78
Fig. 44 Central HUB A-A section. Author's graphics.	80
Fig. 45 Central HUB floorplan. Author's graphics.	81
Fig. 46 Principles of using bamboo in the construction industry. Author's graphics. Redrawn from: (Hidalgo-López, 2003)	83
Fig. 47 Step 1. Foundations placed 45 cm below the ground level. Author's graphics.	84
Fig. 48 Det. A. Connection of the supporting structure (columns) with foundations (concrete block). Author's graphics.	85
Fig. 49 Step 2. Elevated floor. Author's graphics.	85
Fig. 50 Det. B Bamboo cutting. Author's graphics. Redrawn from: (Hidalgo-López, 2003)	87
Fig. 51 Step 3. Single-culm bamboo columns. Author's graphics.	87
Fig. 52 Det. C. Bamboo horizontal joining technique. Author's graphics. Redrawn from: (Hidalgo-López, 2003)	87
Fig. 53 Det. D. Bamboo perpendicular joining technique. Author's graphics. Redrawn from: (Hidalgo-López, 2003)	88
Fig. 54 Step 4. Main columns and beam. Author's graphics.	88
Fig. 55 Det. E. Bamboo diagonal joining technique. Author's graphics. Redrawn from: (Hidalgo-López, 2003)	88
Fig. 56 Step 5. Diagonal beams. Author's graphics.	89
Fig. 57 Step 6. Main columns and roof beams . Author's graphics.	89
Fig. 58 Step 7. Truss placed on main columns and beams. Author's graphics.	90
Fig. 59 Det. F. Bamboo rope joining technique. Author's graphics. Redrawn from: (Hidalgo-López, 2003)	91
Fig. 60 Wall construction steps. Author's graphics.	93
Fig. 61 Det. G. Wall construction technique. Author's graphics. Redrawn from: (Hidalgo-López, 2003)	93

Fig. 62 Step 8. Two walls for one building module. Author's graphics.	94
Fig. 63 Step 9. Beams for metal sheet panels. Author's graphics.	96
Fig. 64 Step 10. Metal sheet panels. Author's graphics.	96
Fig. 65 Det. H. Perpendicular roof beams joining technique. Author's graphics. Redrawn from: (Hidalgo-López, 2003)	97
Fig. 66 Step 11. Beams for water and electricity production systems. Author's graphics.	97
Fig. 67 Step 12. Solar still units. Author's graphics.	98
Fig. 68 Step 13. Shading openwork and walls bamboo slats. Author's graphics.	98
Fig. 69 Step 14. Wall construction. Author's graphics.	98
Fig. 70 Pictures of 1:10 physical model.	99
Fig. 71 Water production module with 10 solar still units on the roof. Author's graphics.	102
Fig. 72 Evaporation and condensation diagram. Author's graphics.	104
Fig. 73 System water flow per person. Author's graphics.	107
Fig. 74 Beira's precipitation and rain water storage. Author's graphics. Data source: (Climates To Travel, 2019).	109
Fig. 75 Amount of water and the direction of its flow between the tanks. Author's graphics.	110
Fig. 76 Dirt Tank and Sand Filter. Author's graphics.	111
Fig. 77 Solar still units concept. Author's graphics.	114
Fig. 78 Water production system concept. Author's graphics.	115
Fig. 79 Water basin. Author's graphics.	116
Fig. 80 Solar still unit section. Author's graphics.	117
Fig. 81 Polystyrene block with fiber-rich paper. Author's graphics.	118
Fig. 82 Polystyrene block with fiber-rich paper going through. Author's graphics.	119
Fig. 83 Transparent cover. Author's graphics.	120
Fig. 84 Solar still unit detail A. Author's graphics.	122
Fig. 85 Solar still unit detail B. Author's graphics.	123
Fig. 86 Water flow between tanks. Author's graphics.	124
Fig. 87 Solar still maintenance. Author's graphics.	125
Fig. 88 Mock-up planning. Author's graphics.	127
Fig. 89 Self-shading in solar still during test day in Swarzedz, Poland on 27.04.2020. Author's graphics.	144
Fig. 90 Solar-still simulation scheme. Author's graphics.	146
Fig. 91 Heat balance and hourly productivity formulas.	147
Fig. 92 Parametric simulation and model ideogram. Author's graphics.	149
Fig. 93 Energy production modules with PV panels on the roof. Author's graphics.	154
Fig. 94 Daily required energy for storage calculation.	156
Fig. 95 Water flow stages. Author's graphics.	162
Fig. 96 Biogas Flowchart. Source: (Polit, 2013)	164
Fig. 97 Fixed Dome Digester Tank. Source: (Voegeli et al, 2014)	165
Fig. 98 Sanitation system. Author's graphics.	166
Fig. 99 Biogas improved electricity distribution. Author's graphics.	167

Phase	Week	Task	Meetings
P1	1	02.09.2019 - 08.09.2019 Project goal	
	2	09.09.2019 - 15.09.2019	11.09 Marcel Bilow
	3	16.09.2019 - 22.09.2019	
	4	23.09.2019 - 29.09.2019 Natural disasters/floodings	27.09 Andy vd Dobbelsesteen
	5	30.09.2019 - 06.10.2019	
	6	07.10.2019 - 13.10.2019	07.10 Nick ten Caat
	7	14.10.2019 - 20.10.2019 Africa/Mozambique/Beira Problem Statement	15.10 Eric van den Ham
	8	21.10.2019 - 27.10.2019	
	9	28.10.2019 - 03.11.2019	
	10	04.11.2019 - 10.11.2019 Objectives	
P2	11	11.11.2019 - 17.11.2019 11.11 P1 presentation Research Questions NGOs contact	Marcel Bilow Faidra Oikonomopoulou
	12	18.11.2019 - 24.11.2019 Partners search	20.11 Mentors meeting
	13	25.11.2019 - 01.12.2019 Literature Research	
	14	02.12.2019 - 08.12.2019	04.12 Marcel Bilow
	15	09.12.2019 - 15.12.2019 Concept Draft	13.12 Eric van den Ham
	16	16.12.2019 - 22.12.2019	
	17	23.12.2019 - 29.12.2019 PoR	
	18	30.12.2019 - 05.01.2020 Research Framework	
P3	19	06.12.2020 - 12.01.2020 08.01 P2 presentation Presentation Feedback Finalizing concept	Marcel Bilow, Eric vd Ham, Lei Qu
	20	13.01.2020 - 19.01.2020 Building Scheme & Frame Foundations	
	21	20.01.2020 - 26.01.2020 Water purification system, Sanitation	22.01 Marcel Bilow Eric van den Ham
	22	27.01.2020 - 02.02.2020 PV system Walls	
	23	03.02.2020 - 09.02.2020 Roof Connections	
	24	10.02.2020 - 16.02.2020	
	25	17.02.2020 - 23.02.2020 CAD model 2D drawings	20.02 Marcel Bilow Eric van den Ham
	26	24.02.2020 - 01.03.2020 Mock-up planning	Budget
	27	02.03.2020 - 08.03.2020	
	28	09.03.2020 - 15.03.2020	12.03 Marcel Bilow Eric van den Ham
P4	29	16.03.2020 - 22.03.2020 Conceptual Thesis Report Financing plan	
	30	23.03.2020 - 29.03.2020 26.03 P3 presentation	Marcel Bilow, Eric vd Ham, Lei Qu
	31	30.03.2020 - 05.04.2020	
	32	06.04.2020 - 12.04.2020 Mock-up preparation	
	33	13.04.2020 - 19.04.2020 Testing prototype Costs	17.04 Marcel Bilow Eric van den Ham
	34	20.04.2020 - 26.04.2020 Final drawings Axonometries	
	35	27.04.2020 - 03.05.2020 Construction Manual Bussiness plan	Marcel Bilow Eric van den Ham
	36	04.05.2020 - 10.05.2020 Presentation Final Report Draft Final Reflection	
P5	37	11.05.2020 - 17.05.2020 15.05 P4 presentation	Marcel Bilow, Eric vd Ham, Lei Qu
	38	18.05.2020 - 24.05.2020 Maquette drawings Feedback improvements	
	39	25.05.2020 - 31.05.2020 Maquette preparation	Marcel Bilow Eric van den Ham
	40	01.06.2020 - 07.06.2020 Visualizations	
	41	08.06.2020 - 14.06.2020 Poster	Marcel Bilow Eric van den Ham
	42	15.06.2020 - 21.06.2020 Final Presentation Final Thesis	
	43	22.06.2020 - 28.06.2020 23.06 P5 presentation	Marcel Bilow, Eric vd Ham, Lei Qu
	44	29.06.2020 - 05.07.2020	