

Design of Multivariable PI Controller Using Evolutionary Algorithms for VSP based AC/DC Interconnected Systems

Naveh, Iman Mohammad Hosseini; Rakhshani, Elyas; Mehrjerdi, Hasan; Torres, José Rueda; Palensky, Peter

DOI

[10.1109/SGRE46976.2019.9020691](https://doi.org/10.1109/SGRE46976.2019.9020691)

Publication date

2020

Document Version

Final published version

Published in

2nd International Conference on Smart Grid and Renewable Energy, SGRE 2019 - Proceedings

Citation (APA)

Naveh, I. M. H., Rakhshani, E., Mehrjerdi, H., Torres, J. R., & Palensky, P. (2020). Design of Multivariable PI Controller Using Evolutionary Algorithms for VSP based AC/DC Interconnected Systems. In *2nd International Conference on Smart Grid and Renewable Energy, SGRE 2019 - Proceedings* (pp. 1-6). Article 9020691 IEEE. <https://doi.org/10.1109/SGRE46976.2019.9020691>

Important note

To cite this publication, please use the final published version (if applicable). Please check the document version above.

Copyright

Other than for strictly personal use, it is not permitted to download, forward or distribute the text or part of it, without the consent of the author(s) and/or copyright holder(s), unless the work is under an open content license such as Creative Commons.

Takedown policy

Please contact us and provide details if you believe this document breaches copyrights. We will remove access to the work immediately and investigate your claim.

Green Open Access added to TU Delft Institutional Repository

'You share, we take care!' - Taverne project

<https://www.openaccess.nl/en/you-share-we-take-care>

Otherwise as indicated in the copyright section: the publisher is the copyright holder of this work and the author uses the Dutch legislation to make this work public.

Design of Multivariable PI Controller Using Evolutionary Algorithms for VSP based AC/DC Interconnected Systems

Iman Mohammad Hosseini Naveh⁽¹⁾, Elyas Rakhshani⁽²⁾, Hasan Mehrjerdi⁽³⁾, José Rueda Torres⁽²⁾, and Peter Palensky⁽²⁾

⁽¹⁾ Department of Electrical Engineering, Gonabad Branch, Islamic Azad University, Gonabad, Iran

⁽²⁾ Department of Electrical Sustainable Energy, Delft University of Technology (TUD), Netherlands

⁽³⁾ Electrical Engineering Department, Qatar University, Doha, Qatar

Abstract— A new application of Multivariable Proportional-Integral (MPI) controller with using evolutionary algorithms for a VSP based AC/DC interconnected power system model is proposed. The VSP based HVDC model is added for mitigation of system frequency dynamics by emulating virtual inertia. The designed heuristic-based multivariable PI controller is proposed for better performance of the system's states during contingencies. The proposed MPI (MPI) controller is modified by adding optimisation-based evolutionary algorithms to improve characteristic performance model versus conventional control methods. Simulations results demonstrate how the proposed MPI controller can optimally improve the performance of the power system, especially when a VSP base inertia emulation is activated in the system.

Keywords—Load frequency control, VSP, AC/DC interconnected systems, MPI Controller, PSO, GA, ICA.

I. INTRODUCTION

Load frequency controller plays a very important role in keeping the frequency on its acceptable ranges. It can help to ensure the reliability of electric power especially with a high share of renewable-based generation units [1]-[5]. Systems with low inertia are the result of the phase-out of the conventional power plants, due to increasing the share of power electronic-based components like HVDC links, solar photovoltaic systems and wind power plants [6]-[12]. Considering the intermitted behavior in this kind of system, developing new concepts like synthetic inertia [13] and virtual synchronous generator (VSG) are essential for maintaining the stability of the system [14]. Until now several authors have proposed embedding the behavior of synchronous machines to some extent in converter control systems [15]-[19]. As it was reported in these references, different methods are used to modify the reference of power converters for providing synthetic inertia emulation. Inertia emulation based on the derivative of frequency for HVDC interconnected systems is one of the common technique for emulating inertia [20]-[21]. An alternative controller with no need for frequency measurement, which is based on Virtual Synchronous Power (VSP) strategy is also proposed in [22]. In this approach, the input signal of the virtual inertia controller is the power deviation instead of frequency in previous methods. Existing works on inertia emulation especially using VSP based methods are devoted to controller design considering system modeling and analysis, which is usually connected to sensitivity based approaches for tuning the control parameter gains. Nevertheless, designing advanced control methods for improving the impacts of inertia emulation controllers at the system level is needed. This paper is going to address this gap by

proposing a multivariable PI (MPI) controller for AC/DC interconnected power systems.

Among the controller variety, Proportional-integral (PI) becomes the controller that is most applied in a physical system [23]. The reason is that it has a characteristic that offers simplicity, clear functionality, and ease of use [24]. However, Ho et al. [25] reported that only one-fifth of PI control loops are in good condition. The others are not, where 30% of PI controllers are not able to perform well due to the lack of tuning parameters, 30% due to the installation of a controller system operating manual, and 20% due to the use of default controller parameters. In recent years, many researchers have paid attention to the multivariable PI (MPI) controllers design for various systems such as in Industrial Scale-Polymerization Reactor [26], Coupled Pilot Plant Distillation Column [27], Narmada Main Canal [28], Quadruple-Tank Process [29], Boiler-Turbine Unit [30], and Wood-Berry Distillation Column [31]. Research by Kumar et al. [26] had proposed a synthesis method of PI controllers based on approximation of relative gain array (RGA) concept to the multivariable process. The method was further improved by relative normalize gain array concept (RNGA). Controller based on RNGA concept provides better performance than the RGA concept. Both concepts use the nonstandard PI controller which requires Maclaurin series expansion [32]. In the work by Sarma and Chidambaram [27], P/PI controllers based on Davison and Tantt-Lieslehto method extended to non-square systems with right-half plane zero were applied. Results show that the Davison method gives better performance with less settling time than Tantt-Lieslehto method. However, both methods are not applicable to the square system.

In this work, a new application for the evolutionary-based multivariable PI (EMPI) controller design is proposed. This method is focused on the heuristic-based optimization algorithms, such as particle swarm optimization (PSO) and genetic algorithm (GA) and also Imperialist Competitive Algorithm (ICA). The designed control algorithm is then tested on different interconnected power system models, such as the classical model of two area LFC system, the model with high voltage direct current (HVDC) and also with the virtual synchronous power (VSP) strategy. The proposed method is based on the minimization of a performance index, which is designed by attention to the transfer function characteristics matrix in a multi-input-multi-output (MIMO) system. EMPI controller design method is performed on the systems to improve characteristics performance model versus conventional control methods. Simulations results demonstrate how the proposed EMPI controller can optimally improve the

performance of the power system, especially when a VSP based virtual inertia emulation is activated in the system.

II. MATHEMATICAL POWER SYSTEM MODEL

A typical system for presenting a generic model of interconnected systems is the modified Kundur model as an interconnected system with two areas which is shown in Figure 1. It is modified by adding a DC link with two generation units and one load demand in each area.

The state space of a classical LFC with two areas can be presented as follows:

$$\dot{\Delta X}_{LFC} = A_{9 \times 9} \Delta X_{LFC} + B_{9 \times 2} \Delta U_{LFC} \quad (1)$$

$$\Delta U_{LFC} = [\Delta P_{d1} \ \Delta P_{d2}]^T \quad (2)$$

$$\Delta X_{LFC} = [\Delta \omega_1 \ \Delta \omega_2 \ \Delta P_{m1} \ \Delta P_{m2} \ \Delta P_{m3} \ \Delta P_{m4} \ \int ACE_1 \ \int ACE_2 \ \Delta P_{tieAC,12}]^T \quad (3)$$

It has 9 state variables as explained in [3]. While $\Delta \omega_i$ ($i = 1, 2$) is the frequency deviation in both areas in p.u., ΔP_{mk} ($k = 1, 2, 3, 4$) is the output power of each generation unit, ΔP_{ref} is the set point for each generator coming from area control error and $\Delta P_{tieAC,12}$ is the deviation in the AC transmitted power.

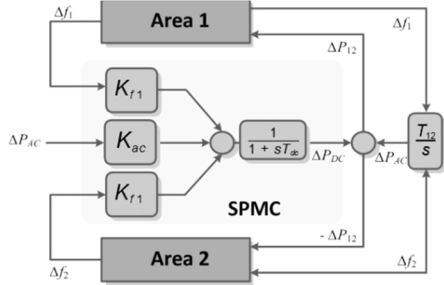

Fig. 1. A two-area system with a parallel AC/HVDC link.

while the state-space model with parallel HVDC/AC links, as shown in figure 1, can be modified as follows [22]:

$$\dot{\Delta X}_{HVDC} = A_{10 \times 10} \Delta X_{HVDC} + B_{10 \times 2} \Delta U_{HVDC} \quad (4)$$

$$\Delta U_{HVDC} = [\Delta P_{d1} \ \Delta P_{d2}]^T \quad (5)$$

$$\Delta X_{LFC} = [\Delta \omega_1 \ \Delta \omega_2 \ \Delta P_{m1} \ \Delta P_{m2} \ \Delta P_{m3} \ \Delta P_{m4} \ \Delta P_{ref1} \ \Delta P_{ref2} \ \Delta P_{tieAC,12} \ \Delta P_{DC}]^T \quad (6)$$

where ΔP_{DC} is the DC power deviation defined by a new state in the model. Furthermore, the impact of emulated inertia by VSP controller can be analyzed through the modifications of classical LFC as presented in Figure 2. According to Figure 2, it is assumed that there is a parallel AC/HVDC link between area i and Area k , where both converter stations of the HVDC link are facilitated by VSP functionalities. Therefore, in a two-area AC/DC interconnected power system, which will have two synchronous controllers, four new states variables of synchronous controllers will be added to the system [22]. The overall system will have thirteen state variables as it is written as follows:

$$\dot{\Delta X}_{VSPHVDC} = A_{13 \times 13} \Delta X_{VSPHVDC} + B_{13 \times 2} \Delta U_{VSPHVDC} \quad (7)$$

$$\Delta U_{VSPHVDC} = [\Delta P_{L1} \ \Delta P_{L2}]^T \quad (8)$$

$$\Delta X_{LFC} = [\Delta \omega_1 \ \Delta \omega_2 \ \Delta P_{m1} \ \Delta P_{m2} \ \Delta P_{m3} \ \Delta P_{m4} \ \Delta ACE_1 \ \Delta ACE_2 \ \Delta x_{f,vsp1} \ \Delta x_{p,vsp2} \ \Delta x_{f,vsp2}]^T \quad (9)$$

By attention to the proposed method, a transfer function matrix using two inputs and two outputs is designed by (10). In all strategies, $\Delta \omega_1$ and $\Delta \omega_2$ are output variables:

$$G(s) = \begin{bmatrix} G_{11}(s) & G_{12}(s) \\ G_{21}(s) & G_{22}(s) \end{bmatrix}_{2 \times 2} \quad (10)$$

More details can be described by given equations:

$$\Omega_1(s) = G_{11}(s)U_1(s) + G_{12}(s)U_2(s) \quad (11)$$

$$\Omega_2(s) = G_{21}(s)U_1(s) + G_{22}(s)U_2(s) \quad (12)$$

where $\Omega_i(s) = L\{\Delta \omega_i\}$ ($i = 1, 2$).

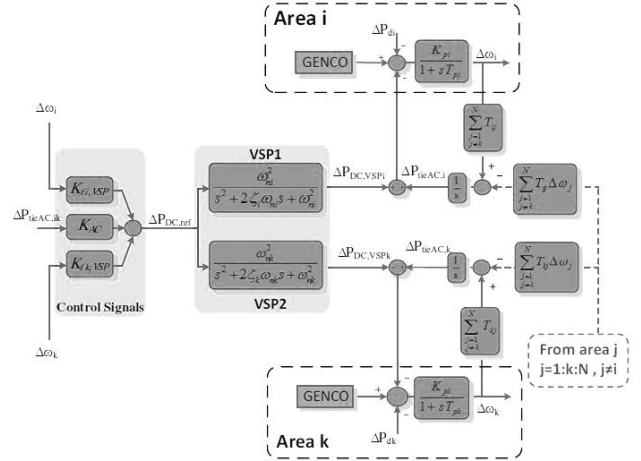

Fig. 2. The basic frame of AGC in multi-area systems with a VSP based AC/DC transmission.

III. CONVENTIONAL MPI CONTROLLER DESIGN

The problem of determining an MPI controller for a linear multivariable stable plant is discussed in [33]–[34]. Therefore the conventional MPI tuning method eventually is based on MP tuning. On the other hand, at first, a method for constructing an MP controller, which uses interactions of the plant, is developed. While it is assumed that the MIMO system can be given by the block diagram presented in Figure 3.

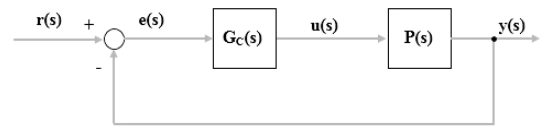

Fig. 3. MIMO block diagram.

By attention to the MIMO block diagram, it can be seen:

$$u(s) = G_c(s)e(s) = \left(K_p + \frac{K_i}{s} \right) e(s) \quad (13)$$

So at first for MP tuning method, it is represented by:

$$\dot{x}(t) = (A - BK_p C)x(t) + BK_p u(t) \quad (14)$$

By assuming initial conditions:

$$x(t) = e^{(A - BK_p C)t} \int_0^t e^{-(A - BK_p C)\tau} BK_p r(\tau) d\tau \quad (15)$$

Therefore we have:

$$x(t) = -(A - BK_p C)^{-1} BK_p r + e^{(A - BK_p C)t} (A - BK_p C)^{-1} BK_p r \quad (16)$$

By replacement to the state equation:

$$y(t) = -C(A - BK_p C)^{-1} BK_p r + C e^{(A - BK_p C)t} (A - BK_p C)^{-1} BK_p r \quad (17)$$

By attention to Fourier series definition:

$$y(t) = CBK_p r t + C \left[\sum_{k=2}^{\infty} (A - BK_p C)^k \frac{t^k}{k!} \right] BK_p r \approx CBK_1 r t \quad (18)$$

where K_1 matrix is given by:

$$K_1 = (CB)^+ \begin{bmatrix} k_1 & \dots & 0 \\ \vdots & \ddots & \vdots \\ 0 & \dots & k_m \end{bmatrix} \quad (19)$$

and $(CB)^+$ is the left inverse matrix for CB and it is given by:

$$(CB)^+ = B^T C^T (C B B^T C^T)^{-1} \quad (20)$$

while in the square matrix it is defined by:

$$(CB)^+ = (CB)^{-1} \quad (21)$$

This equation will be in regular MIMO systems. In these situations, the integral coefficient (K_2) is given by:

$$K_2 = G^{-1}(0) \quad (22)$$

So for the conventional MPI controller design, equation (19) and (22) can be used for tuning of coefficients.

IV. PROPOSED EVOLUTIONARY MPI CONTROLLER DESIGN

The most important part of the proposed method is the definition of a cost function to minimize the performance index Z . This cost function is calculated according to the step information such as settling time (ST), overshoot (OS) and stability index (SI), in every iteration on evolutionary algorithm. While the index Z has a linear combination by weighted coefficients.

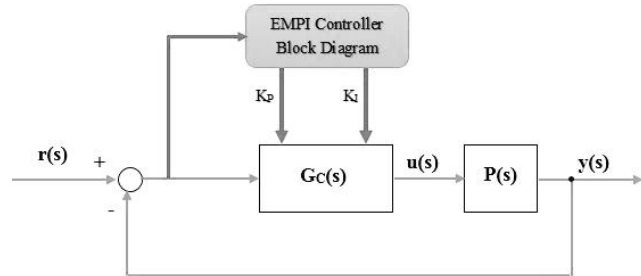

Fig. 4. MIMO model using EMPI controller Schematic diagram.

Fig. 4 illustrates a general block diagram from the proposed EMPI controller. It shows how the best coefficients, K_p and K_i , are selected and performed for the basic platform. It is cleared that the closed-loop transfer function of the system will be the junction point between the EMPI controller diagram and main plant. The generation process till finding the best solution is shown in Fig. 5. This process is done using PSO, GA and ICA algorithms as the evolutionary methods.

So we can design a performance index as below equation:

$$Z = w_1 \times (OS) + w_2 \times (ST) + w_3 \times (SI) \quad (23)$$

By attention to system models, the below performance indexes can be defined:

$$Z_1 = w_1 \times (OS_{LFC}) + w_2 \times (ST_{LFC}) + w_3 \times (SI_{LFC}) \quad (24)$$

$$Z_2 = w_4 \times (OS_{HVDC}) + w_5 \times (ST_{HVDC}) + w_6 \times (SI_{HVDC}) \quad (25)$$

$$Z_3 = w_7 \times (OS_{VSP-HVDC}) + w_8 \times (ST_{VSP-HVDC}) + w_9 \times (SI_{VSP-HVDC}) \quad (26)$$

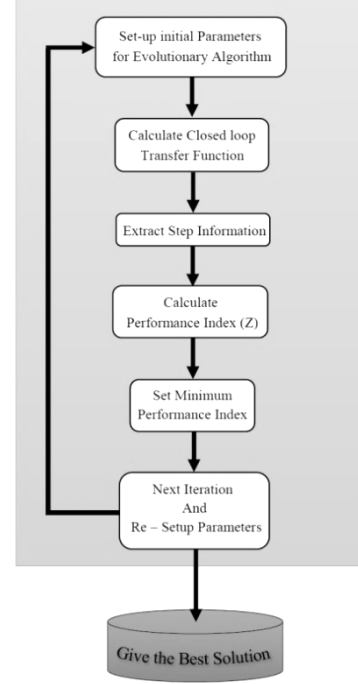

Fig. 5. EMPI controller design process block diagram.

For the realization of the main target and improving the minimization process, the following structure is proposed between Z functions:

$$Z_{LFC} = Z_1 \quad (27)$$

$$Z_{HVDC} = (w_{10} \times Z_2) + Z_{LFC} \quad (28)$$

$$Z_{VSP-HVDC} = (w_{11} \times Z_3) + Z_{HVDC} \quad (29)$$

where weighted coefficients w_1 to $w_9 = 1$ and $w_{10} = w_{11} = 10$ in all EMPI controller design process.

V. THE PROPOSED EVOLUTIONARY ALGORITHMS

A. Implementation of PSO for the proposed EMPI

The particle swarm optimization (PSO) algorithm is introduced herein since it has been used widely as a problem-solving method in engineering and computer science. The PSO simulates a commonly observed social behavior, where members of a group tend to follow the lead of the best of the group. The PSO algorithm consists of a swarm of particles, which are initialized with a population of random candidate solutions. They move to search for the new solutions [35].

In this paper, the setting parameters for the PSO algorithm are selected as below. In this scenario all parameters have to be designed and installed in a way that the gains of K_i ($i = 1,2,3,4$) in the below MPI controller can be calculated:

$$K(s) = \begin{bmatrix} K_1 & 0 \\ 0 & K_2 \end{bmatrix} + \frac{1}{s} \begin{bmatrix} K_3 & 0 \\ 0 & K_4 \end{bmatrix} \quad (30)$$

$$\text{Maximum Number of Iterations} = 400 \quad (31)$$

$$\text{(Population) Size} = 100 \quad (32)$$

$$\text{Number of Variables} = 4 \quad (33)$$

B. GA for the proposed EMPI

The genetic algorithm (GA) represents one branch of evolutionary computation that it applies the principles: genetics, mutation, natural selection, and crossover. A set of initial candidates is created, and their corresponding fitness values are calculated [36]–[38]. In GA, many processes are random, like in evolution. However, this optimization technique allows setting random levels and levels of control. In this way, GA is considered as a robust and comprehensive search algorithm. The executable GA may be specified in Figure 6.

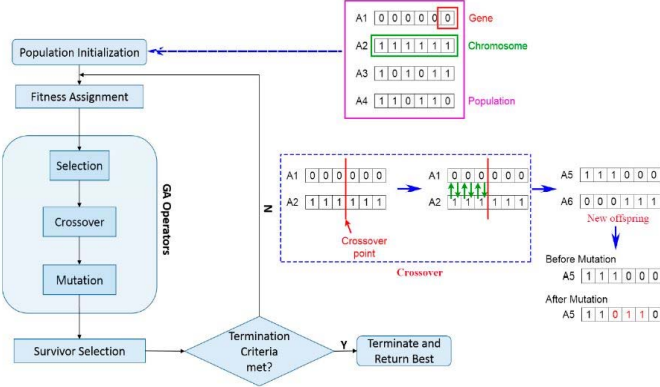

Fig. 6. Flow chart of a genetic algorithm (GA).

C. ICA for the proposed EMPI

Imperialist Competitive Algorithm (ICA) is an evolutionary computation algorithm based on social and political transformation of the human. The algorithm begins by initializing the initial population called the population of the country. The most powerful countries of the population are called the empires and the rest are called the imperials' colonies [35]. It is one of the swarm intelligence techniques that can effectively solve continuous functions. Briefly, ICA is a global search algorithm inspired by imperialistic competition and based on social policy of imperialism. Accordingly, the most potent empire will dominate many colonies and their sources of use. If an empire collapses, other realms will compete for the territory.

VI. SIMULATION SCENARIOS

The two area model with VSP based HVDC system is used to test the performance of the EMPI controller compared with other scenarios. It is assumed that two load step changes are happening at 3 sec and 30 sec. All the simulations are performed in the Matlab platform. For implementing EMPI different heuristic algorithms, PSO, GA and ICA methods, are designed and installed to calculate the gains of K_{P_i} and K_{I_i} ($i = 1, 2$) in the below EMPI controller:

$$K_P = \begin{bmatrix} K_{P1} & 0 \\ 0 & K_{P2} \end{bmatrix} \quad (34)$$

$$K_I = \begin{bmatrix} K_{I1} & 0 \\ 0 & K_{I2} \end{bmatrix} \quad (35)$$

The obtained values for the controller gains with different models are compared in Table 2. These values are used to run the simulation scenarios with the proposed EMPI controller. The changes of the composed cost function for different models are presented and compared in Figs. 7 to 9.

According to the obtained results, the ICA method has better performance for convergence with less iteration.

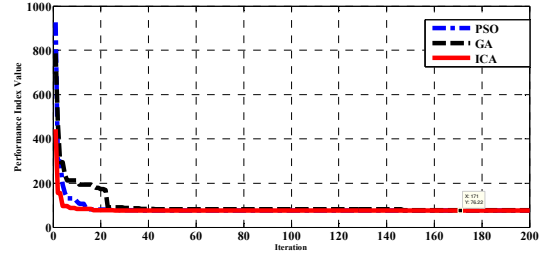

Fig. 7. Cost function value in PSO, GA and ICA for LFC model.

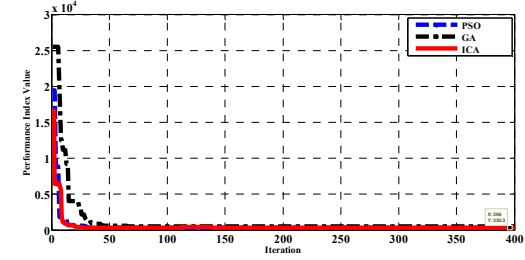

Fig. 8. Cost function value in PSO, GA and ICA for AC/HVDC model.

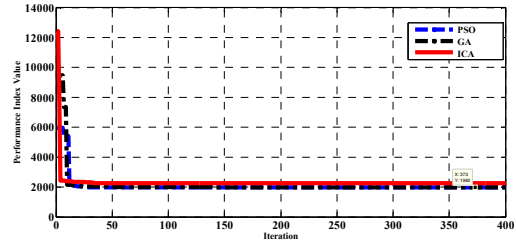

Fig. 9. Cost function value in PSO, GA and ICA for VSP-HVDC model.

Table 2. Obtained values for EMPI gains for different heuristic methods.

LFC Model Parameters		EMPI
$K_P = \begin{bmatrix} -0.0276 & 0 \\ 0 & -0.1770 \end{bmatrix}, K_I = \begin{bmatrix} 0.0046 & 0 \\ 0 & 0.0369 \end{bmatrix}$		PSO-EMPI
$K_P = \begin{bmatrix} -0.0409 & 0 \\ 0 & -0.1550 \end{bmatrix}, K_I = \begin{bmatrix} 0.0116 & 0 \\ 0 & 0.0270 \end{bmatrix}$		GA-EMPI
$K_P = \begin{bmatrix} -0.0277 & 0 \\ 0 & -0.1773 \end{bmatrix}, K_I = \begin{bmatrix} 0.0046 & 0 \\ 0 & 0.0369 \end{bmatrix}$		ICA-EMPI
HVDC Model Parameters		EMPI
$K_P = \begin{bmatrix} -0.0357 & 0 \\ 0 & 0.0397 \end{bmatrix}, K_I = \begin{bmatrix} 0.0059 & 0 \\ 0 & -0.0083 \end{bmatrix}$		PSO-EMPI
$K_P = \begin{bmatrix} -0.0366 & 0 \\ 0 & 0.0390 \end{bmatrix}, K_I = \begin{bmatrix} -0.0041 & 0 \\ 0 & 0.0155 \end{bmatrix}$		GA-EMPI
$K_P = \begin{bmatrix} -0.0357 & 0 \\ 0 & 0.0397 \end{bmatrix}, K_I = \begin{bmatrix} 0.0059 & 0 \\ 0 & -0.0083 \end{bmatrix}$		ICA-EMPI
VSP Model Parameters		EMPI
$K_P = \begin{bmatrix} -1.1203 & 0 \\ 0 & -0.0764 \end{bmatrix}, K_I = \begin{bmatrix} 0.0049 & 0 \\ 0 & -0.0073 \end{bmatrix}$		PSO-EMPI
$K_P = \begin{bmatrix} -1.0513 & 0 \\ 0 & -0.1383 \end{bmatrix}, K_I = \begin{bmatrix} -0.0051 & 0 \\ 0 & -0.008 \end{bmatrix}$		GA-EMPI
$K_P = \begin{bmatrix} -1.0387 & 0 \\ 0 & -0.1288 \end{bmatrix}, K_I = \begin{bmatrix} -0.0086 & 0 \\ 0 & -0.009 \end{bmatrix}$		ICA-EMPI

More comparison is also performed (shown in Figure 10) by simulation of classical LFC model with different controls. It shows that the performance of the controller with PSO and ICA are much better than the rest. But considering the results from Figs. 7 to 9, a faster convergence makes the ICA as the preferable algorithm for this study.

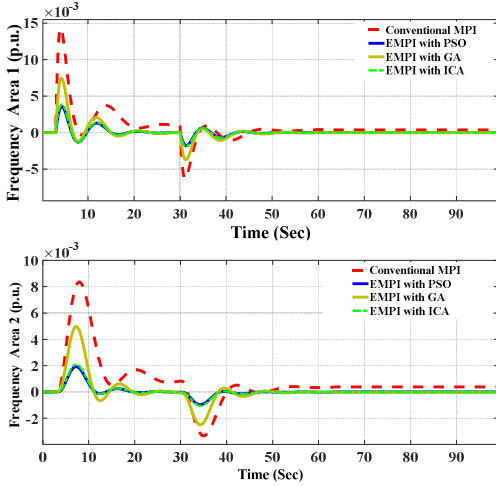

Fig. 10. Comparisons between MPI controller scenarios on classical two-area LFC model for outputs: (a) ω_1 , (b) ω_2 .

As it is mentioned above, implementation of the ICA algorithm in the proposed EMPI controller, as an evolutionary method, has more accuracy in the performance of the model. Thus, the other simulation results will be presented based on the conventional and evolutionary MPI controller design using the ICA algorithm. The response of the frequency in both areas for the two area system with parallel ac and HVDC link is presented in Figure 11. It is clear that the performance of the system with the proposed EMPI using ICA algorithm can significantly improve the deviations and also damp out the oscillations of the frequency. The same comparison is also presented in Figure 12 for the two area system with VSP based HVDC system and again, the obtained results show the successful implementation of the proposed controller.

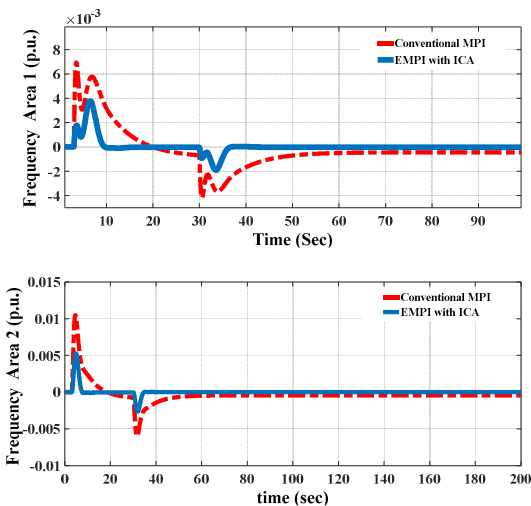

Fig. 11. Comparisons between MPI controller scenarios on the LFC model with AC/HVDC links for the outputs ω_1 and ω_2

Also by attention to the obtained results, it is possible to analyze the performance of the model with VSP based HVDC system versus other interconnected LFC models.

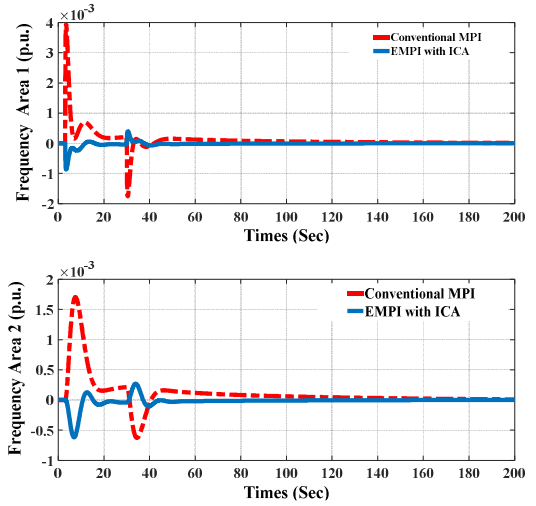

Fig. 12. Comparisons between EMPI controller scenarios on the LFC model with VSP based HVDC link for the outputs ω_1 and ω_2

Therefore, as shown in Figure 13, the selected EMPI controller with ICA algorithm is implemented in all models and used for complete comparisons between normal LFC, LFC with HVDC link and the LFC model with VSP based HVDC system. The simulation results are focused on the outputs ω_1 and ω_2 . It is cleared that the model with the VSP based HVDC system gives the best damping with satisfactory accuracy versus other models.

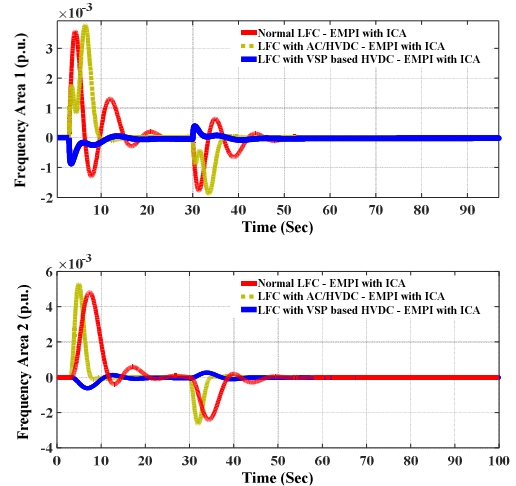

Fig. 13. Comprehensive analysis between EMPI controller scenarios using ICA on LFC, HVDC and VSP - HVDC models for output ω_1

VII. CONCLUSIONS

A new application for the proposed heuristic-based MPI controller for a VSP based AC/DC interconnected power system model is proposed. The performance of the controller in the VSP model has been discussed and compared with other LFC models. According to the obtained results, the model which has the VSP based inertia emulation capabilities show significant enhancement in mitigation of frequency deviation and damping the oscillations.

For evaluating the interconnected model, first for the sake of comparison with the proposed final EMPI controller, the conventional MPI controller has been designed. Then a suitable new EMPI controller using PSO, GA and ICA algorithms has been studied. According to the finding of this study, the most important part of the proposed EMPI method is the definition of a suitable cost function for minimizing the

performance index Z. This function is calculated based on step information such as settling time (ST), overshoot (OS) and stability index (SI), in every iteration on evolutionary algorithm. Based on the obtained results, the designed EMPI controller can keep the accuracy in the results obtained from simulations at an appropriate level versus conventional MPI method. The ICA algorithm has a more suitable effect on the performance systems, with faster convergence, versus other algorithms.

ACKNOWLEDGMENT



This research was carried out as part of the MIGRATE project. This project has received funding from the European Union's Horizon 2020 research and innovation program under grant agreement No 691800. This reflects only the authors' views and the European Commission is not responsible for any use that may be made of the information it contains.

REFERENCES

- [1] P. Kundur et al., "Definition and Classification of Power System Stability," *IEEE Trans. Power Syst.*, Vol. 19, No. 3, 2004.
- [2] P. Tielens and D. Van Hertem, "The relevance of inertia in power systems," *Renew. Sustain. Energy Rev.*, vol. 55, pp. 999–1009, 2016.
- [3] E. Rakhshani, J. Sadeh, "Practical Viewpoints on Load Frequency Control Problem in a Deregulated Power System", *Energy conversion and management*, Vol. 51. Issue 6. pp. 1148-1156. June 2010.
- [4] H. Mortazavi., H. Mehrjerdi., M. Saad, S. Lefebvre, and D. Asber. « A Monitoring Technique for Reversed Power Flow Detection with High PV Penetration Level," *IEEE Transactions on Smart Grid*, vol. 6, no.5, pp. 2221-2232, Sep 2015.
- [5] E. Rakhshani, D. Gusain, V. Sewdien, Jose Luis Rueda Torres, Mart Van der Meijden, "A Key Performance Indicator to Assess the Frequency Stability of Converter Dominated Power System", *IEEE Access*, vol. 7, pp. 130957-130969, 2019.
- [6] E. Rakhshani, K. Rouzbehi, A.J. Sánchez, and E. Pouresmaeil, "Integration of Large Scale PV based Generation to Power Systems: A Survey", *Energies*, Vol. 12, No. 8: 1425, 2019.
- [7] Hasan Mehrjerdi, Elyas Rakhshani, "Vehicle-to-grid technology for cost reduction and uncertainty management integrated with solar power," *Journal of Cleaner Production*, Vol. 229, pp. 463-469, 2019.
- [8] Hasan Mehrjerdi, Elyas Rakhshani, "Optimal operation of hybrid electrical and thermal energy storage systems under uncertain loading condition," *Applied Thermal Engineering*, Elsevier, Vol. 160, 2019.
- [9] E. Rakhshani, P. R. Cortes, "Inertia Emulation in AC/DC Power Systems Using Derivative Technique Considering Frequency Measurement Effects", *IEEE Transactions on Power Systems*, Volume: 32, Issue: 5, 2017.
- [10] R. Eriksson, N. Modig, and K. Elkington, "Synthetic inertia versus fast frequency response: a definition," *IET Renew. Power Gener.*, Vol. 12, No. 5, pp. 507–514, 2018.
- [11] M. Dreidy, H. Mokhlis, and S. Mekhilef, "Inertia response and frequency control techniques for renewable energy sources: A review," *Renew. Sustain. Energy Rev.*, Vol. 69, 2017.
- [12] F. Ha and A. Abdenour, "Optimal use of kinetic energy for the inertial support from variable speed wind turbines," *Renew. Energy*, Vol. 80, pp. 629–643, 2015.
- [13] F. M. Gonzalez-Longatt, "Effects of the synthetic inertia from wind power on the total system inertia: Simulation study," in *Proc. 2nd Int. Symp. Environ. Friendly Energies Appl.*, pp. 389–395, 2012.
- [14] J. Driesen and K. Visscher, "Virtual synchronous generators," in *Proc. IEEE Power & Energy Soc. General Meeting*, pp. 1–3, 2008.
- [15] E. Rakhshani, D. Remon, P. R. Cortes, "Modeling and Sensitivity Analyses of VSP based Virtual Inertia Controller in HVDC links of Interconnected Power Systems", *Electric Power systems Research*, Elsevier, vol. 141, pp. 246–263, 2016.
- [16] M. C. Luis and A. Enrique, "On the provision of frequency regulation in low inertia AC grids using HVDC systems," *IEEE Trans. Smart Grid*, Vol. 7, Issue 6, 2016.
- [17] M. Guan, W. Pan, J. Zhang, Q. Hao, J. Cheng, and X. Zheng, "Synchronous generator emulation control strategy for voltage source converter (VSC) stations," *IEEE Trans. Power Syst.*, Vol. 30, 2015.
- [18] J. Alipoor, Y. Miura, and T. Ise, "Power system stabilization using virtual synchronous generator with alternating moment of inertia," *IEEE J. Emerg. Sel. Topics Power Electron.*, Vol. 3, No. 2, Jun. 2015.
- [19] E. Rakhshani, J. Rueda Torres, Mart van der Meijden, and P. Palensky, "Determination of Maximum Wind Power Penetration Considering Wind Turbine Fast Frequency Response", 2019 *IEEE PowerTech conference*, Milan, 2019, pp. 1-6.
- [20] E. Rakhshani, D. Remon, A. Mir Cantarellas, and P. Rodriguez, "Analysis of derivative control based virtual inertia in multi-area high-voltage direct current interconnected power systems," *IET Gener. Transm. Distrib.*, Vol. 10, No. 6, pp. 1458–1469, 2016.
- [21] J. Zhu and J. M. Guerrero, "Generic inertia emulation controller for multiterminal voltage-source-converter high voltage direct current systems," *IET Renew. Power Gener.*, Vol. 8, No. 7, 2014.
- [22] E. Rakhshani, D. Remon, A. M. Cantarellas, J. M. Garcia and P. Rodriguez, "Virtual Synchronous Power Strategy for Multiple HVDC Interconnections of Multi-Area AGC Power Systems," *IEEE Transactions on Power Systems*, Vol. 32, No. 3, pp. 1665-1677, 2017.
- [23] L. D. S. Coelho and M. W. Pessôa, "A tuning strategy for multivariable PI and PID controllers using differential evolution combined with chaotic Zaslavskii map," *Expert Systems with Applications*, vol. 38, no. 11, pp. 13694–13701, 2011.
- [24] K. H. Ang, G. Chong, and Y. Li, "PID control system analysis, design, and technology," *IEEE Transactions on Control Systems Technology*, vol. 13, no. 4, pp. 559–576, 2005.
- [25] W. K. Ho, T. H. Lee, and O. P. Gan, "Tuning of multiloop proportional-integral-derivative controllers based on gain and phase margin specifications," *Industrial and Engineering Chemistry Research*, vol. 36, no. 6, pp. 2231–2238, 1997.
- [26] V. V. Kumar, V. S. R. Rao, and M. Chidambaram, "Centralized PI controllers for interacting multivariable processes by synthesis method," *ISA Transactions*, vol. 51, no. 3, pp. 400–409, 2012.
- [27] K. L. N. Sarma and M. Chidambaram, "Centralized PI/PID controllers for nonsquare systems with RHP zeros," *Indian Institute of Science*, vol. 85, no. 4, pp. 201–214, 2005.
- [28] A. Montazar, P. J. Van Overloop, and R. Brouwer, "Centralized Controller for the Narmada Main Canal," *Irrigation and Drainage*, vol. 54, no. 1, pp. 79–89, 2005.
- [29] F. Morilla, F. Vázquez, and J. Garrido, "Centralized PID control by decoupling for TITO processes," in *Proceedings of the 13th IEEE International Conference on Emerging Technologies and Factory Automation (ETFA '08)*, pp. 1318–1325, Germany, September 2008.
- [30] J. Garrido, F. Morilla, and F. Vázquez, "Centralized PID control by decoupling of a boiler-turbine unit," in *Proceedings of the European Control Conference*, pp. 4007–4012, Budapest, August 2009.
- [31] M. Willjuice Iruthayarajan and S. Baskar, "Covariance matrix adaptation evolution strategy based design of centralized PID controller," *Expert Systems with Applications*, vol. 37, no. 8, 2010.
- [32] Y. Lee, S. Park, and M. Lee, "PID controller tuning to obtain desired closed loop responses for cascade control systems," *Industrial and Engineering Chemistry Research*, vol. 37, no. 5, 1998.
- [33] C. J. Harris, "Self – Tuning and Addaptive Control: Theory and Applications", IEEE Control Enginnering Series, 1984.
- [34] J. Penttinen and H. N. Koivo, "Multivariable Tuning Regulators for Unknown Systems", *Automatica*, Vol. 16, pp 393-398, 1980.
- [35] E. Rakhshani, "Intelligent Linear-Quadratic Optimal Output Feedback Regulator for a Deregulated Automatic Generation Control System", *Electrical Power Components and Systems*, Vol. 40, issue. 5, 2012.
- [36] H. R. Vanani, M. Shayannejad, et al, "A Simple Method for Land Grading Computations and its Comparison with Genetic Algorithm (GA) Method", *Int. J. Res. Stud. Agric. Sci.*, 2017.
- [37] D. Goldberg, "Genetic Algorithms in Search, Optimization, and Machine Language", Addison-Wesley: Reading, UK, 1989.
- [38] Y. Zheng, M. Huang, Y. Lu and W. Li, "Fractional stochastic resonance multi-parameter adaptive optimization algorithm based on genetic algorithm", *Neural Comput. Appl.*, 2018.