

Growing old independently in a cohesive environment

P5 Presentatie
vrijdag 3 juli 2020



Actueel > Door verdwijnen verzorgingshuis moeten ouderen langer thuis blijven wonen: 'Er is geen alternatief meer'

Door verdwijnen verzorgingshuis moeten ouderen langer thuis blijven wonen: 'Er is geen alternatief meer'

15-01-2020 11:03 | [Zorg en leven](#) | Auteur: [Miriam Heijenga](#)



“Geachte minister De Jonge, toen ik mijn dromen voor het nieuwe jaar overpeinsde, kwam ik tot één wens: een eigen leven. Ik ben al meer dan 10 jaar mantelzorgster voor mijn ouders en ik kan niet meer.”

EenVandaag, January 15th, 2020

'Leven zonder liefde, dat kan hier'

Tien jaar lag ze dood in huis, Bep de Bruin. Buurman Jan was blij met zo'n stille buur. Vroeger woonde hij naast een onrustig, groot en buitengewoon lawaaiig gezin

Volkskrant, John Schoorl, 30 november, 2013



Twentse mantelzorgster schrijft hartenkreet aan minister de Jonge: 'Hugo, wat moet ik?'

VRIEZENVEEN - Ragnild Grouwstra (49) uit Vriezenveen is al tien jaar mantelzorgster voor haar ouders. Maar het gaat niet meer. In een open brief roept ze minister Hugo de Jonge op om het verzorgingshuis in ere te herstellen.

Wilco Louwes 12-01-20, 13:02 Laatste update: 13:06

Tubantia, Wilco Lauwens, 12 januari 2020

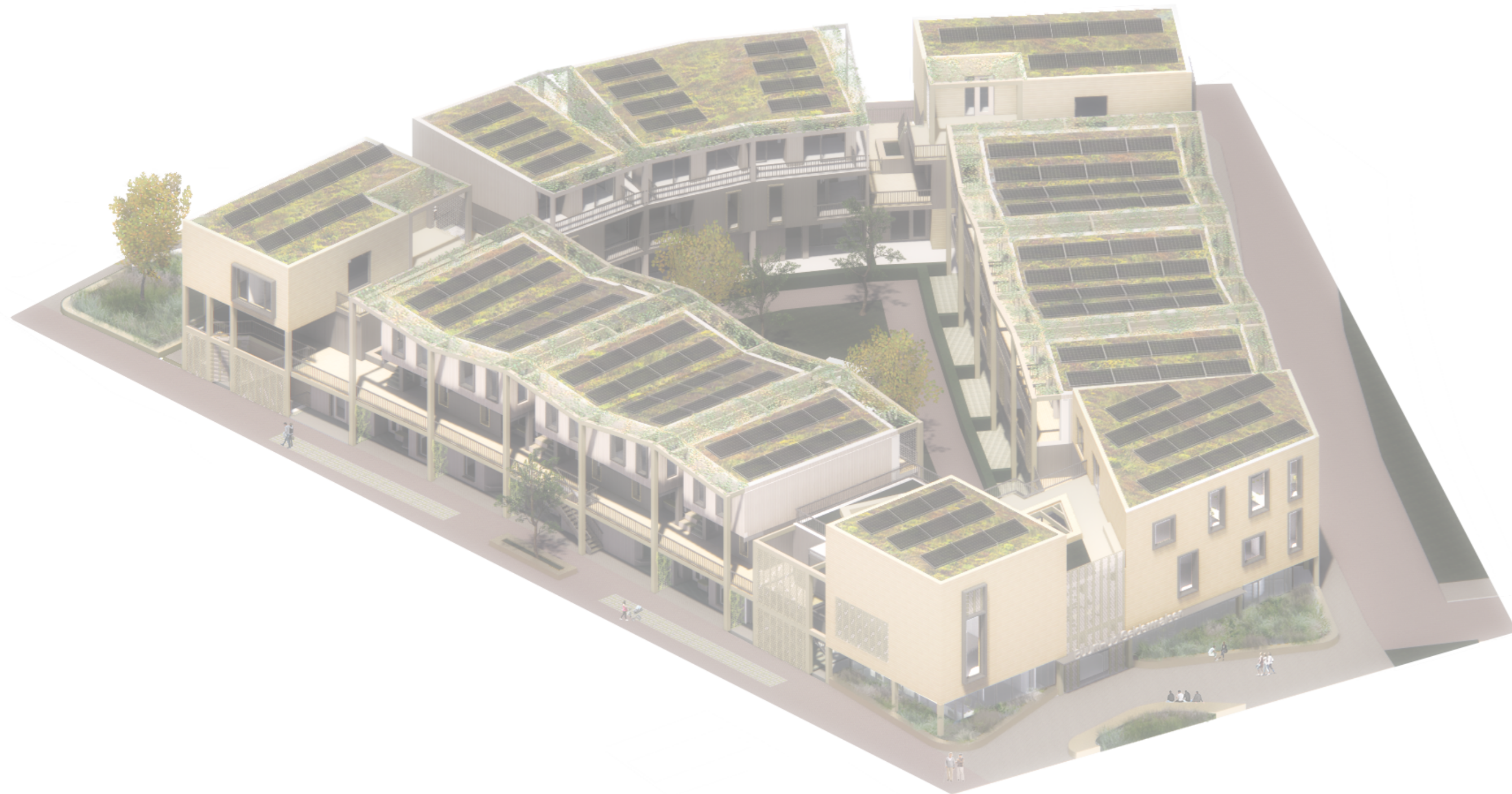

1 Onderzoek
oriëntatie
concept
sociale cohesie

2 Ontwerp
stedelijke omgeving
gebouw
woning

1 Onderzoek



Oriëntatie op het onderwerp
Onderzoek



Woningcomplex BuitenZorg, Zuid-Scharwoude (eigen afbeeldingen)



Getransformeerde verzorgingshuizen

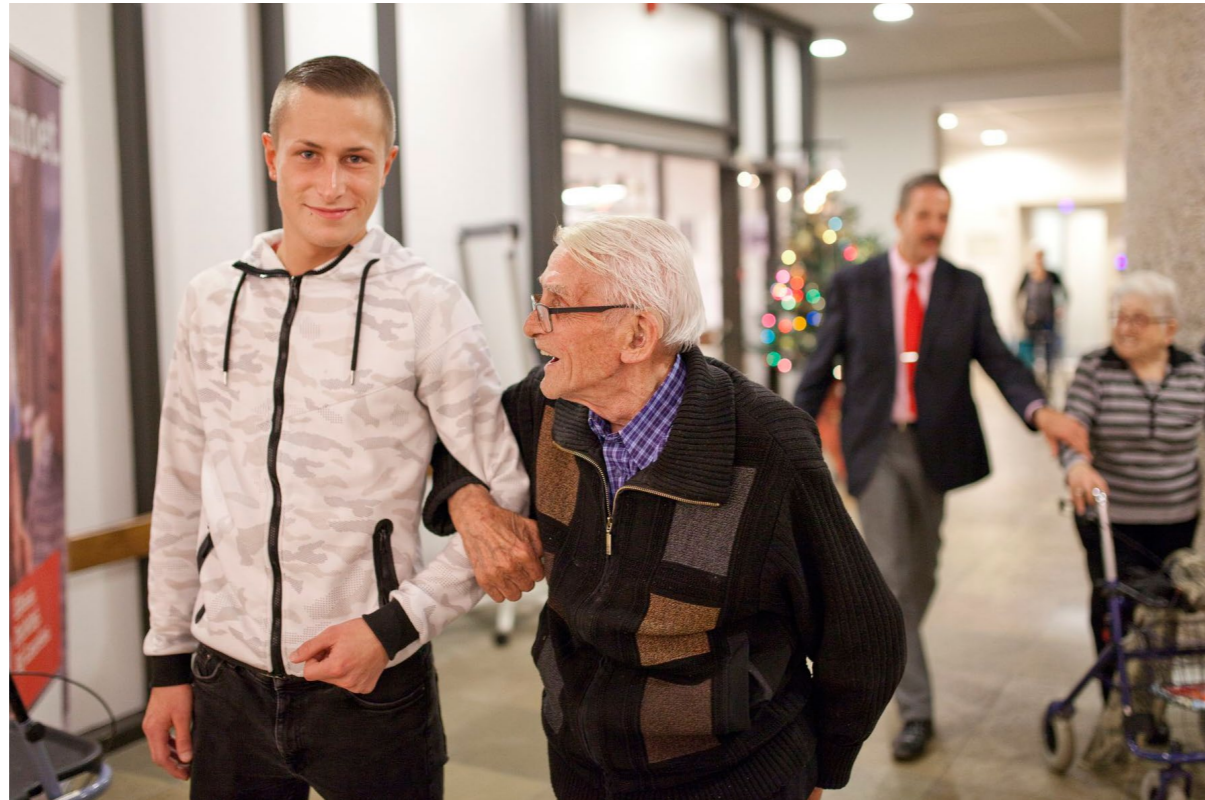

(www.aedesmagazine.nl)



(Van der Velden, 2016)

Knarrenhof



(RTV Oost)



(from: www.knarrenhof.nl)



▲ Boodschappen worden bij ouderen bezorgd. Er is geen contact, de boodschappentas wordt bij de deur neergezet, waarna de bezorger afstand neemt. © Frans Nikkels

Boodschappen doen een probleem? Telefoonlijn helpt Hengelose ouderen

HENGELO - Voor sommige ouderen is het momenteel een flinke uitdaging om boodschappen te doen. Daar bedachten Caroline de Vries (51) en Marcel Herink (48) iets op. Een gratis boodschappenservice voor 75-plussers.

Algemeen Dagblad, Kim Jansen, 21 maart 2020

Is het idee van burenhulp toe te passen op wijkniveau?

Hoe vertaald dit zich in architectuur?

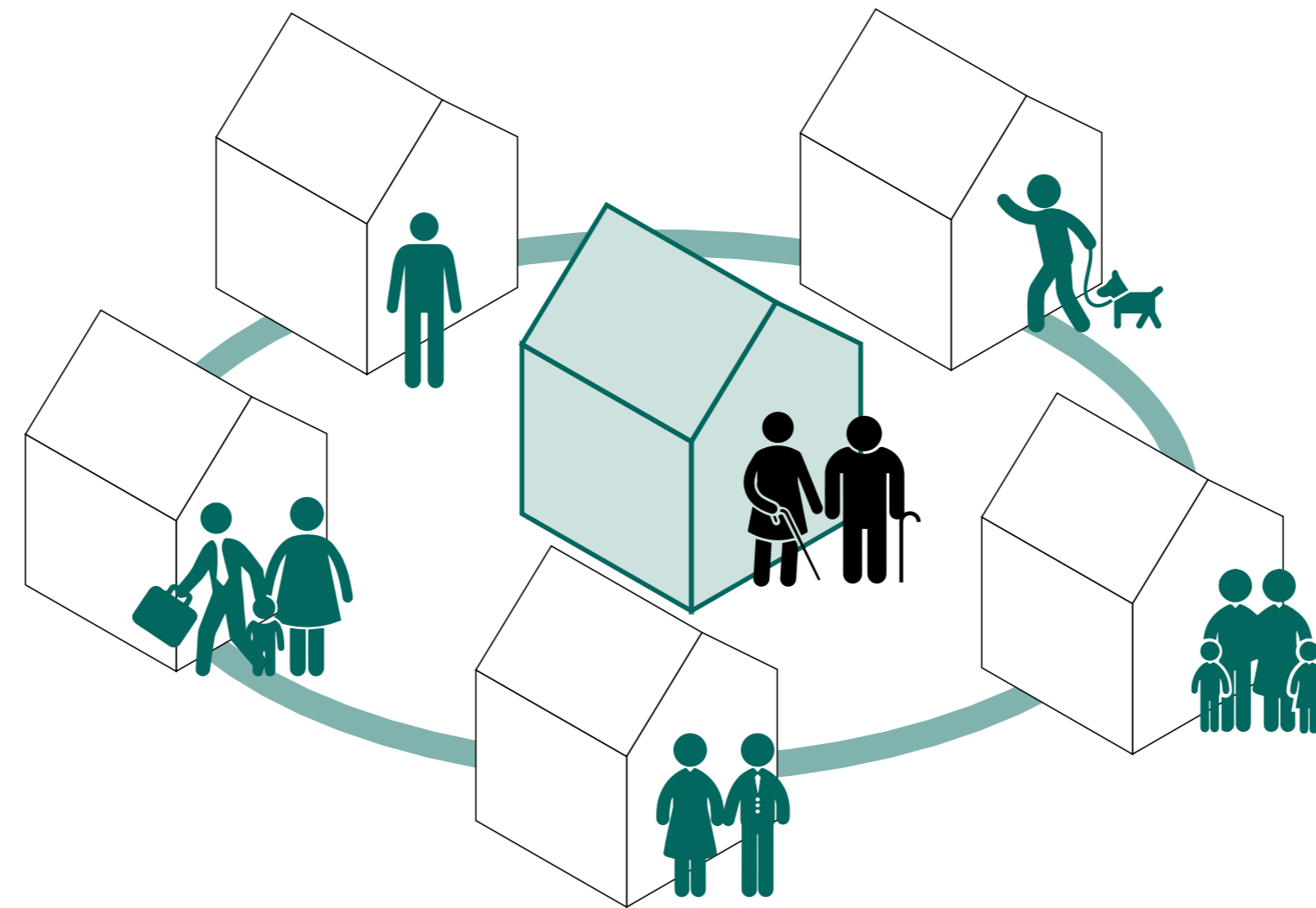

Het inbedden van (zorgbehoevende) ouderen in een woonomgeving waarin ze onderdeel uit kunnen maken van, en toegang hebben tot een ondersteunende buurtgemeenschap die het mogelijk maakt ouderen langer thuis te laten wonen

Sociale omgeving die
gemeenschapsvorming stimuleert

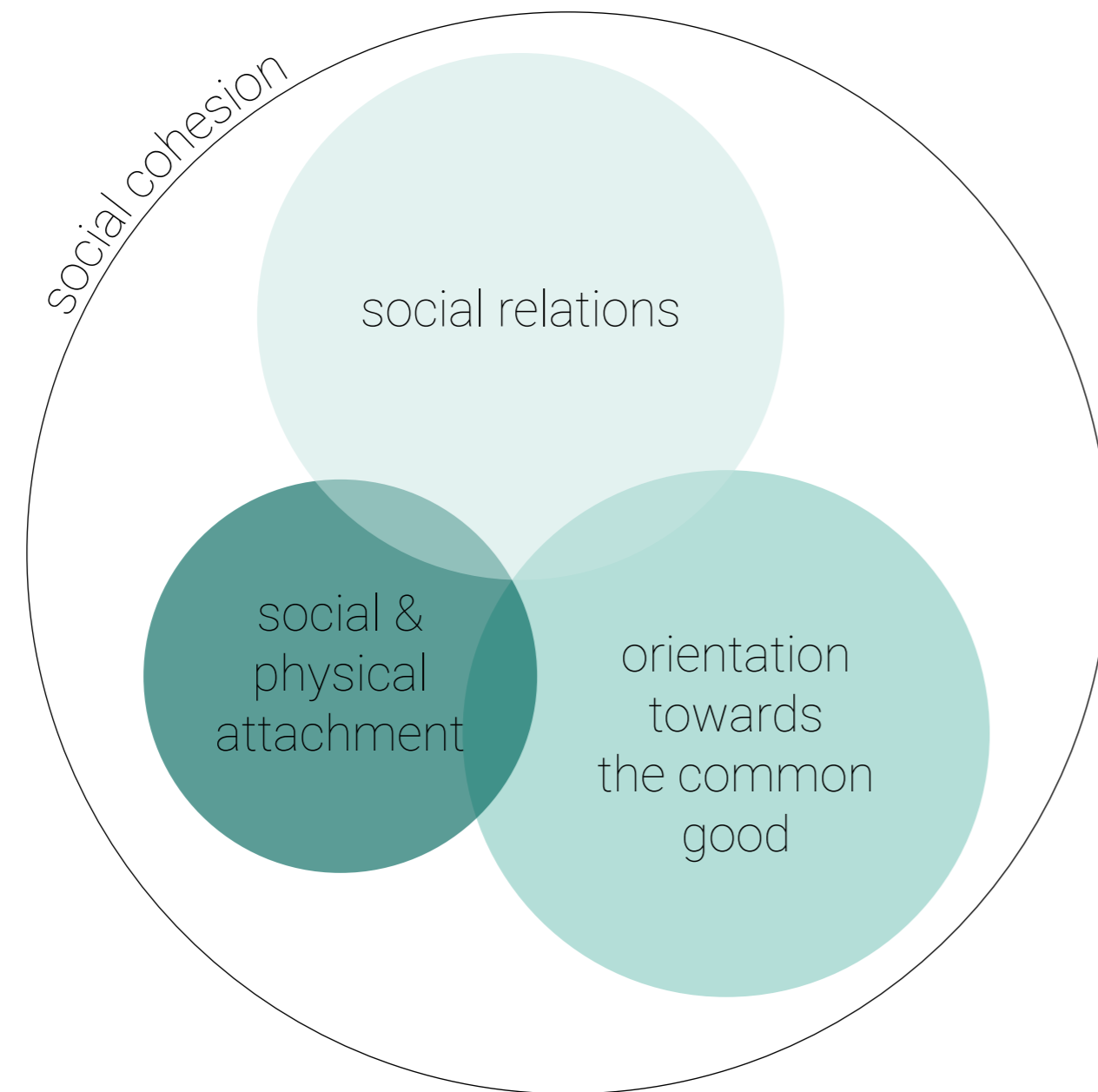

Schiefer & Van der Noll, 2016

Omgeving die zich kan aanpassen aan de
levensfase en zorgbehoefte



Wat vraagt dit van de architectuur?
Onderzoek

2 **Ontwerp**



Geldermalsen en omgeving



Locatie en directe omgeving



Locatie Geldermalsen (eigen afbeeldingen)



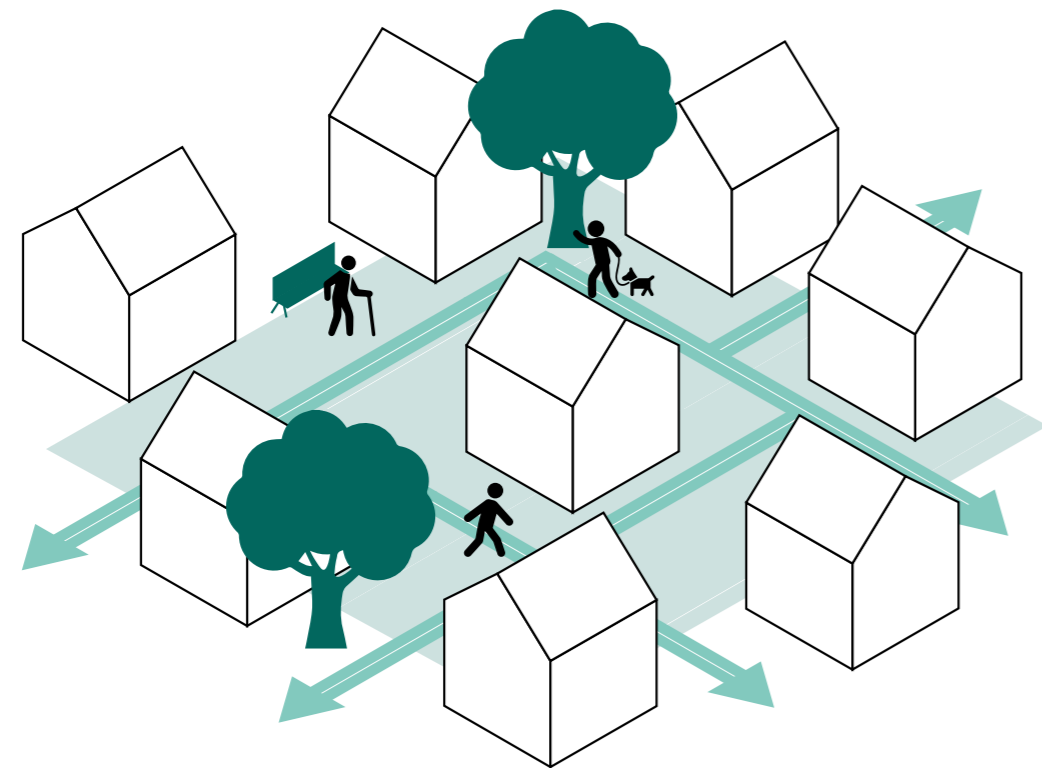

toegankelijke, aantrekkelijke en levendige publieke ruimtes om sociale interactie en activiteiten de stimuleren



Schaken op het Max Euweplein, Amsterdam (Bart van Dijk)

Senses, distance & communication

Jan Gehl, Life between buildings, p 63-79



distance for meaningful contact

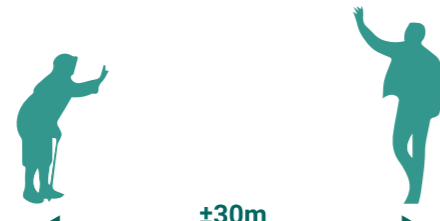

distance for identifying individuals
*could be less for elderly people

Invite or repel

Jan Gehl, Life between buildings, p 113-120

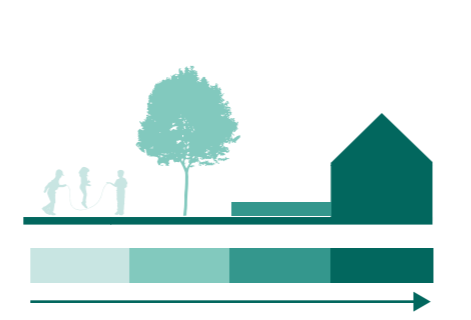

smooth transition from public to private space

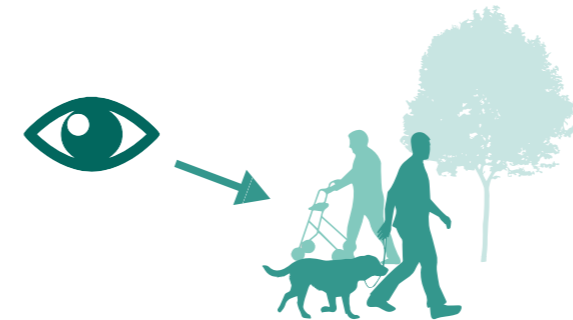

being able to see the public space is an element of invitation

A pleasant place in every respect

Jan Gehl, Life between buildings, p 171-182



being able to experience the weather



good protection against bad weather elements, access to good weather elements

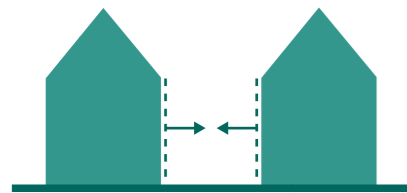

close distances and narrow streets create intimate, warm and personal cities



low speed increases interaction

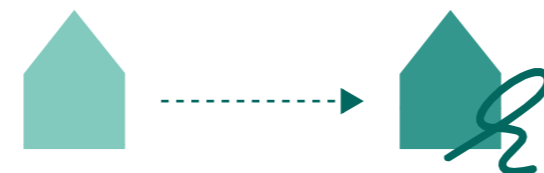

short & managable routes

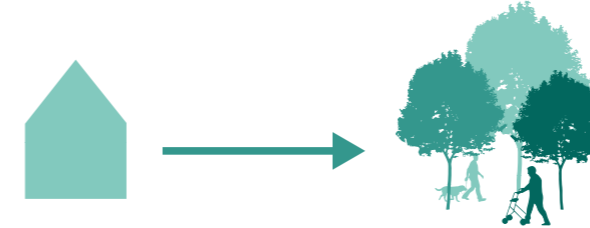

somewhere to go

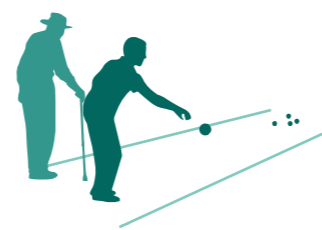

something to do

Walking

Jan Gehl, Life between buildings, p 133-145

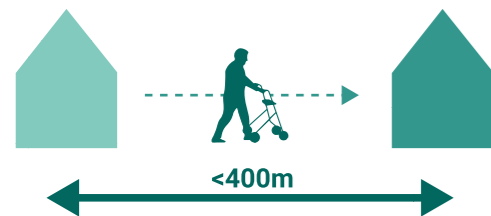

keep walking distances less than 400m
*considerably less for elderly

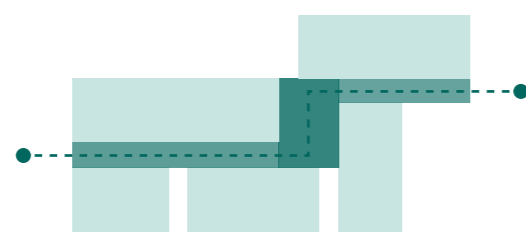

spatial sequences shorten the perceived distance

Staying: standing

Jan Gehl, Life between buildings, p 147-153



places in between two transitional zones, with a view on both of them are attractive for staying



spaces in half shade and with a view are attractive for staying

Staying: sitting

Jan Gehl, Life between buildings, p 155-162



good opportunities for sitting make people stay longer in public

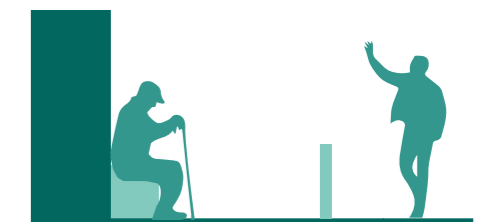

seating alongside the facade invites for sitting and staying



irregular facades are inviting for staying out in



Seating with a view invites to stay

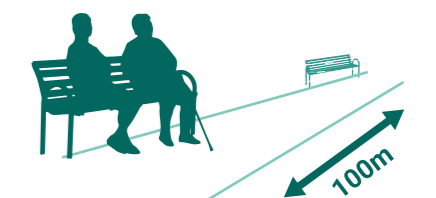

benches for resting every 100m



Stedelijke omgeving

Routing Stedelijke omgeving

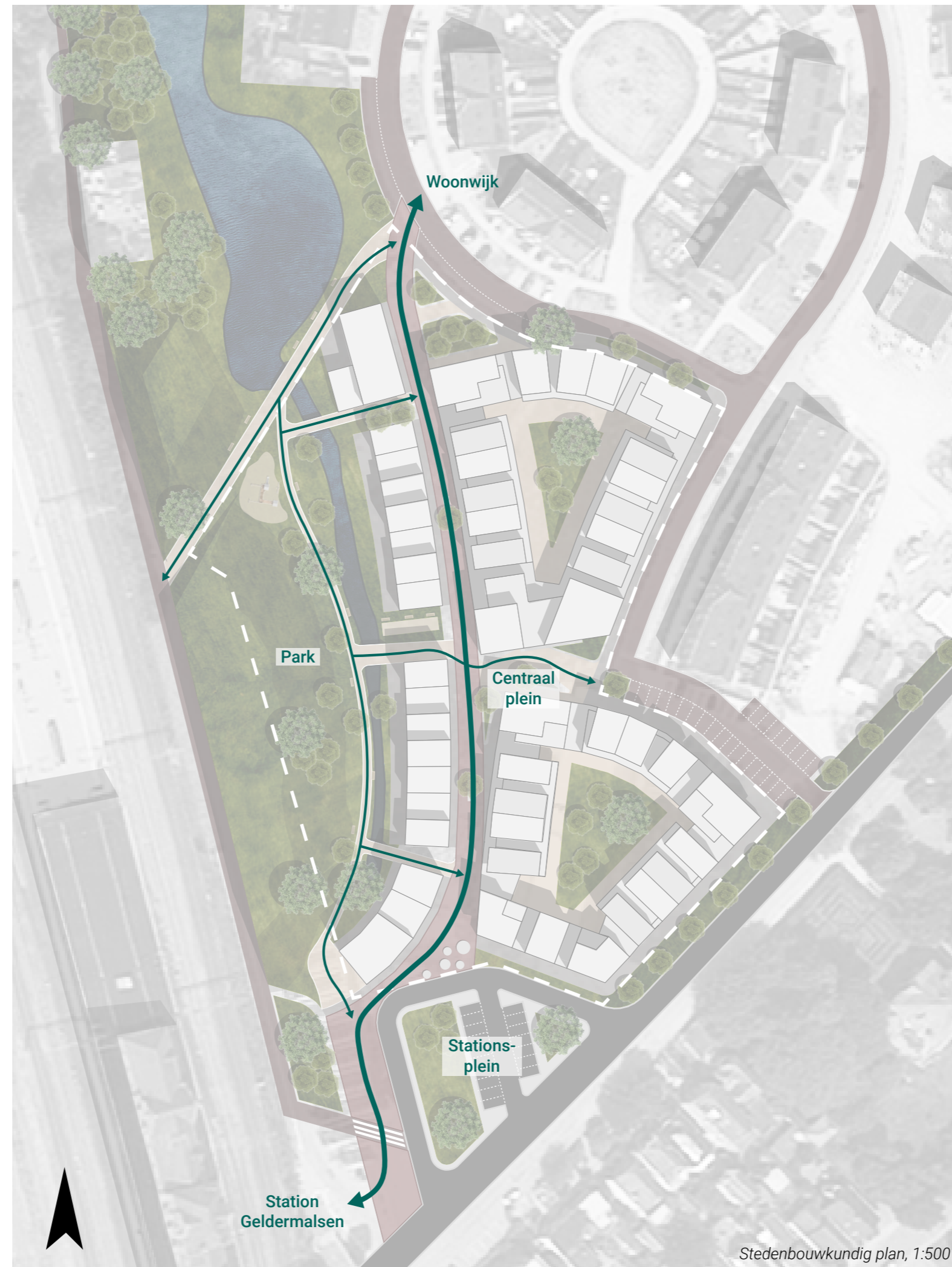













Stedelijke omgeving

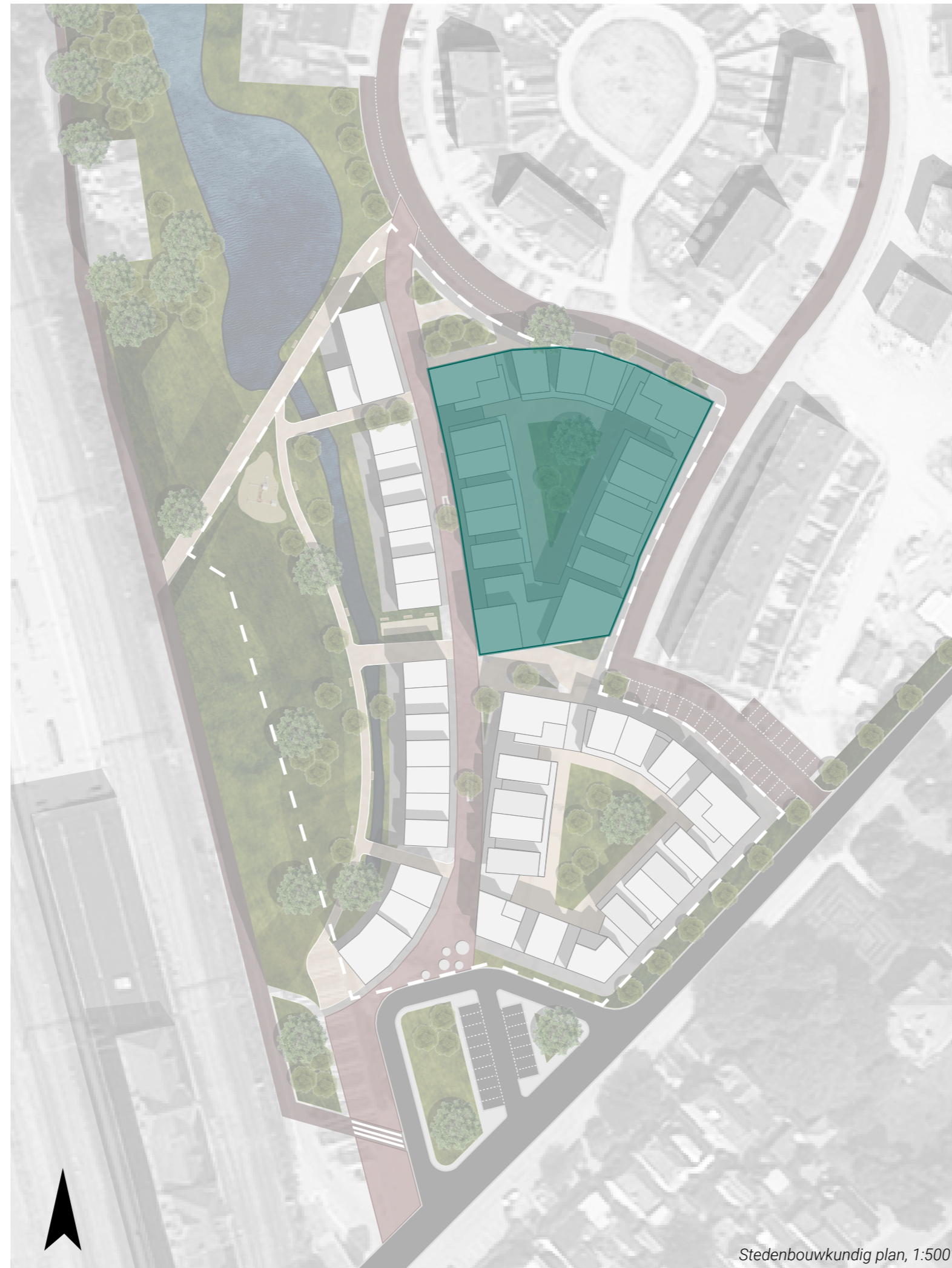

Stedelijke omgeving

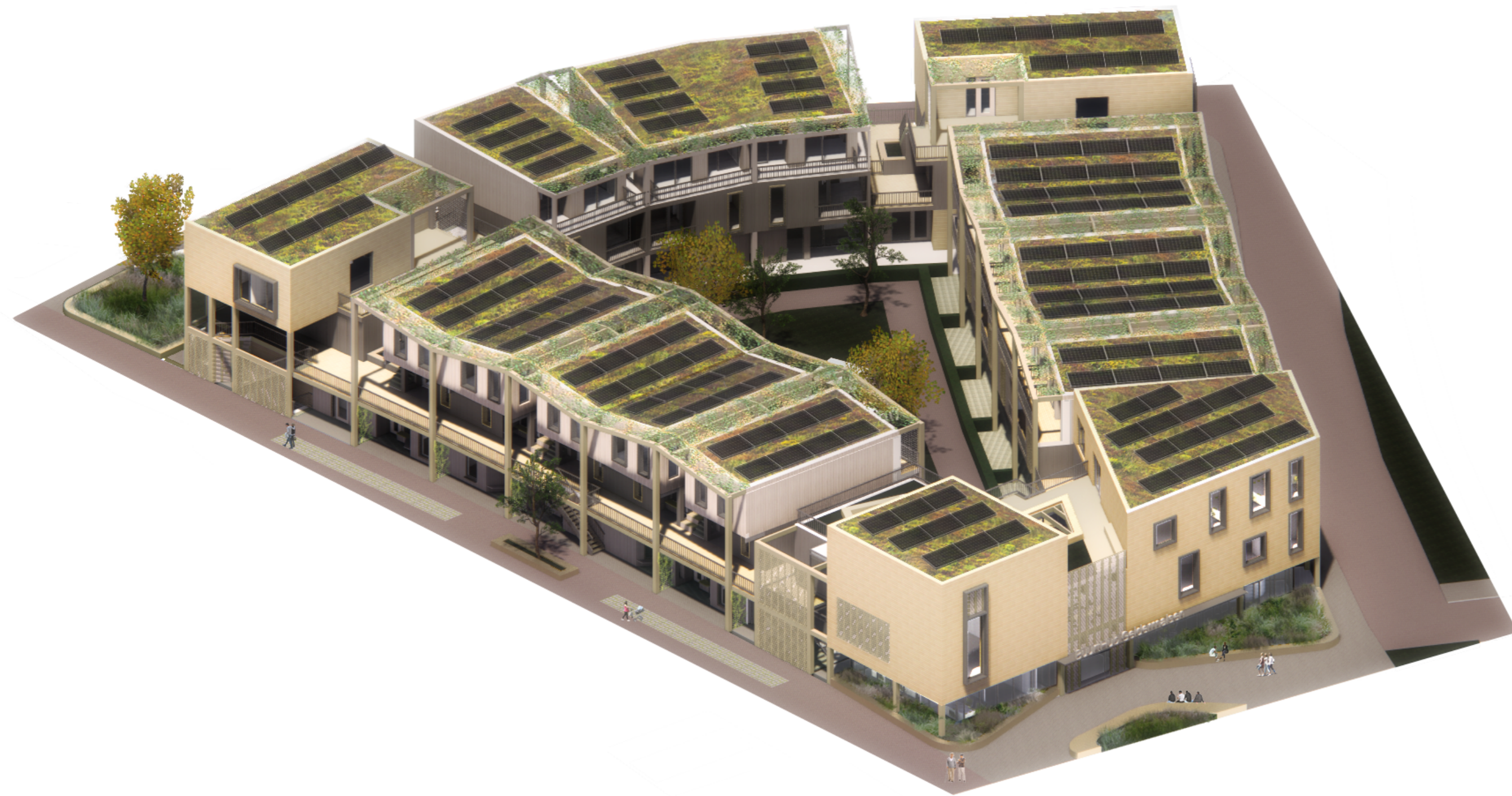

Woningen



Aanpasbare woningvoorraad
15 - 45 woningen



Divers woningaanbod voor
verschillende generaties



Woningen aanpasbaar aan
(ouderen)zorg

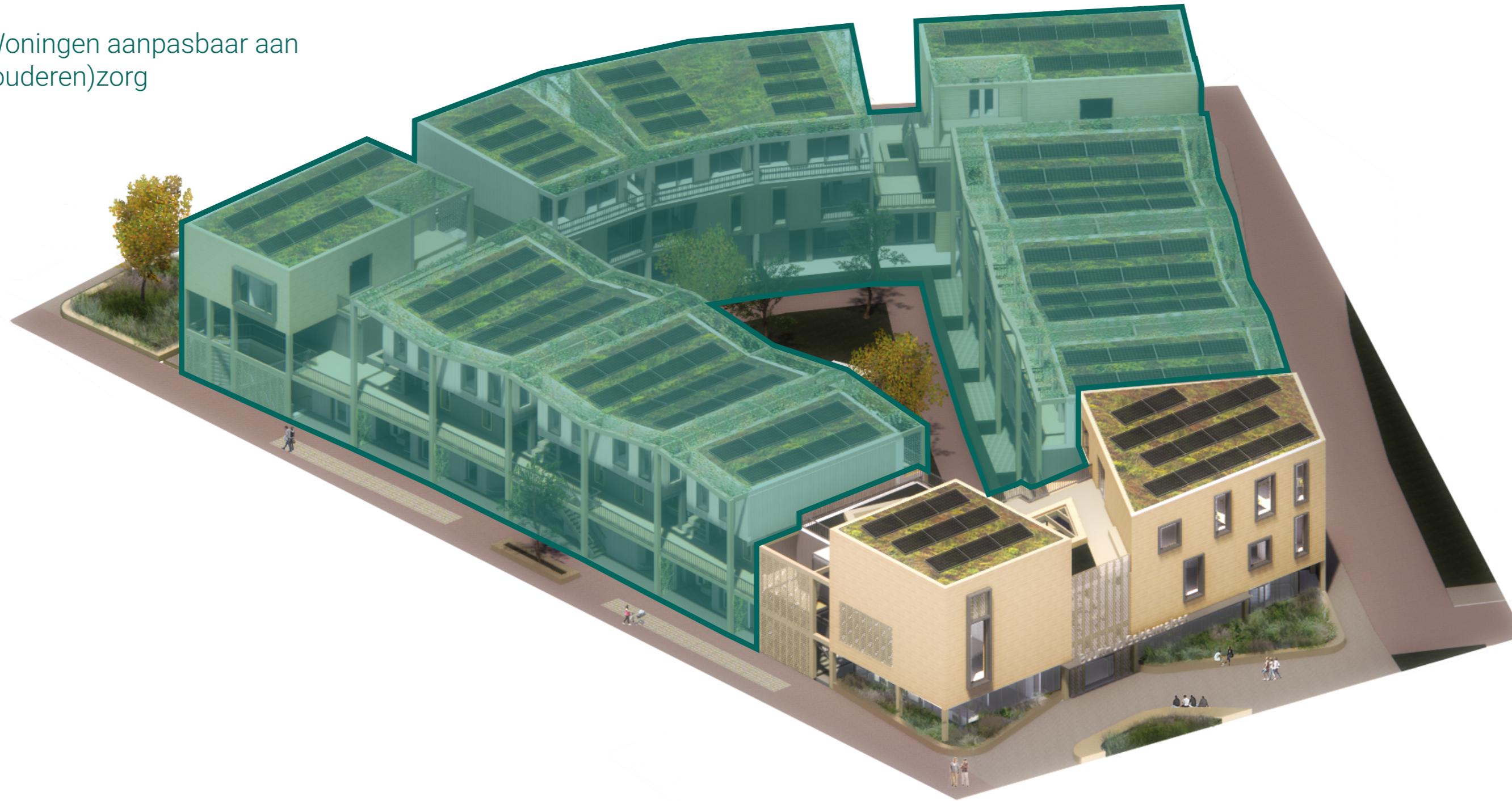

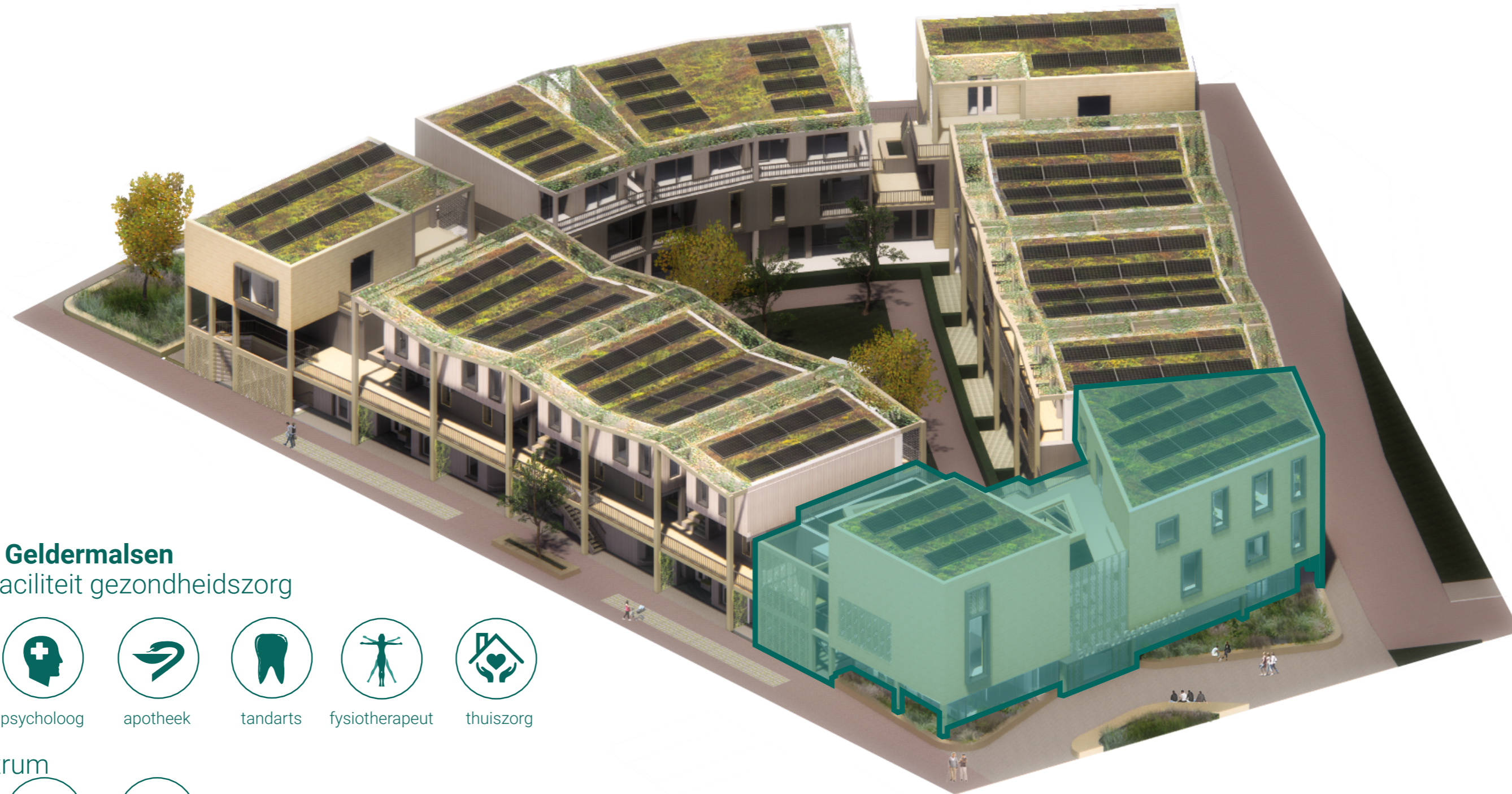

Buurthub Geldermalsen
Centrale faciliteit gezondheidszorg



huisarts



psycholoog



apotheek



tandarts



fysiotherapeut



thuiszorg

Buurtcentrum



ontmoeten



activiteiten



dagbesteding

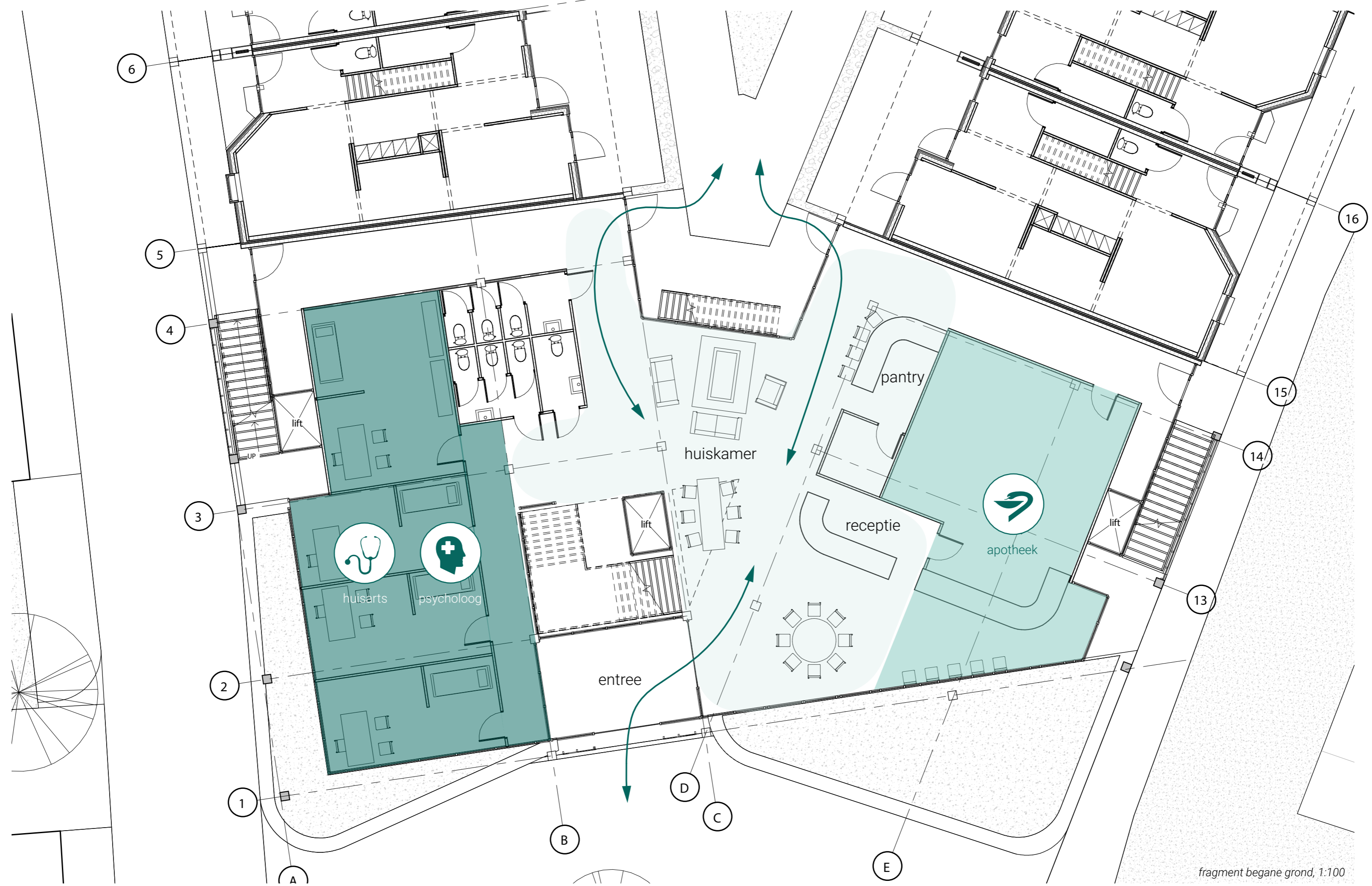





begane grond, 1:200



begane grond, 1:200



Buurtbarbeque (Van der Velden, 2016)



Generatietuin Den Haag (OmroepWest.nl, 2013)



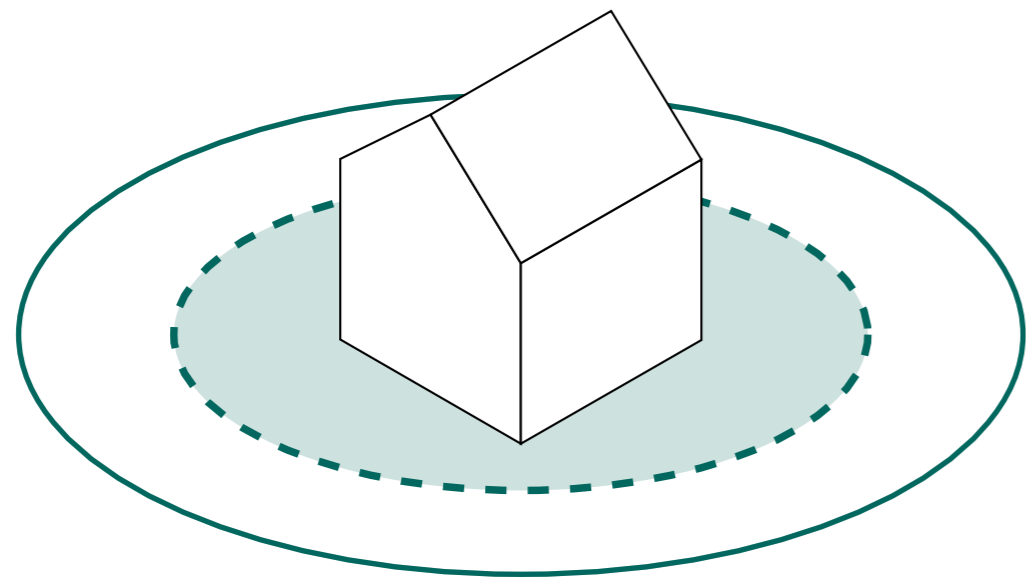

implementatie van *soft edges* om sociale interactie te stimuleren en privacy te waarborgen



Pilgrim Gardens, PRP



Weespergilde, Braakma & Roos Architectenbureau

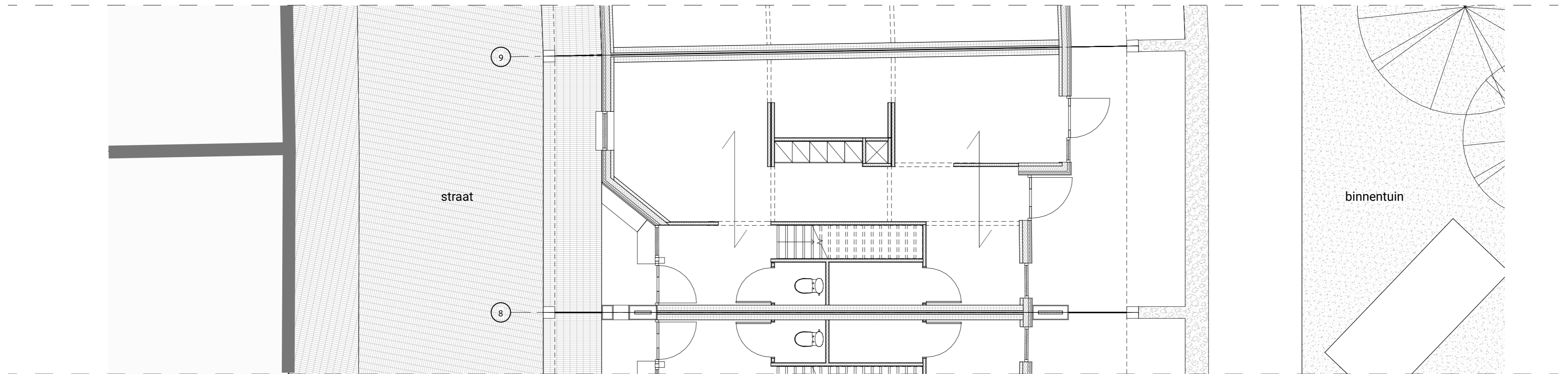

Fragment begane grond, 1:50

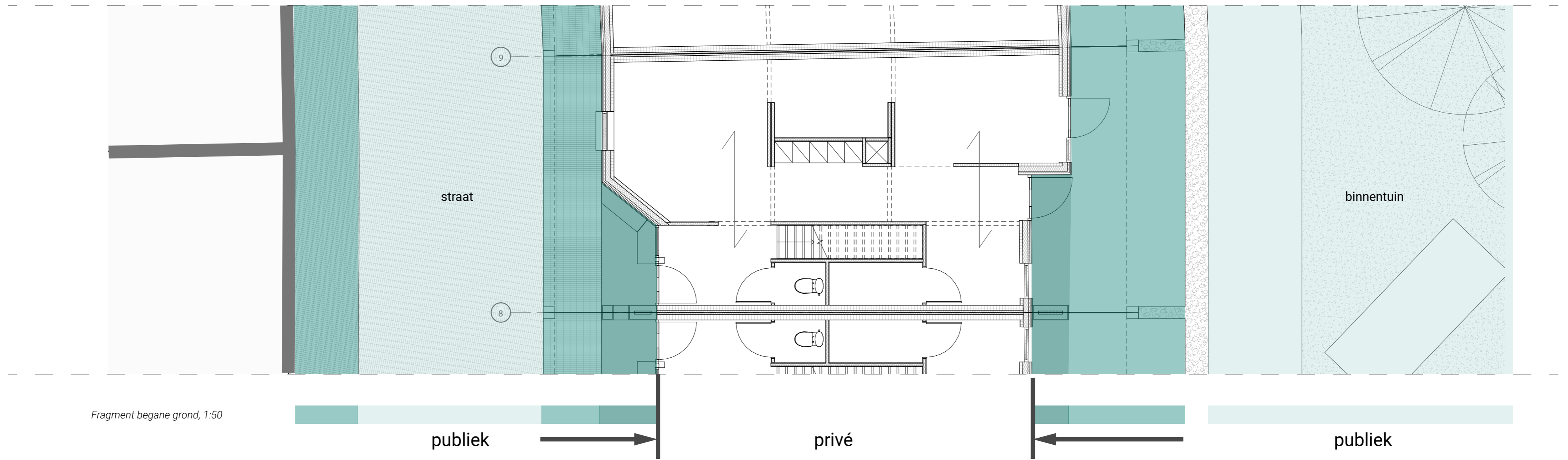

Fragment begane grond, 1:50

Soft edges: begane grond
Gebouw



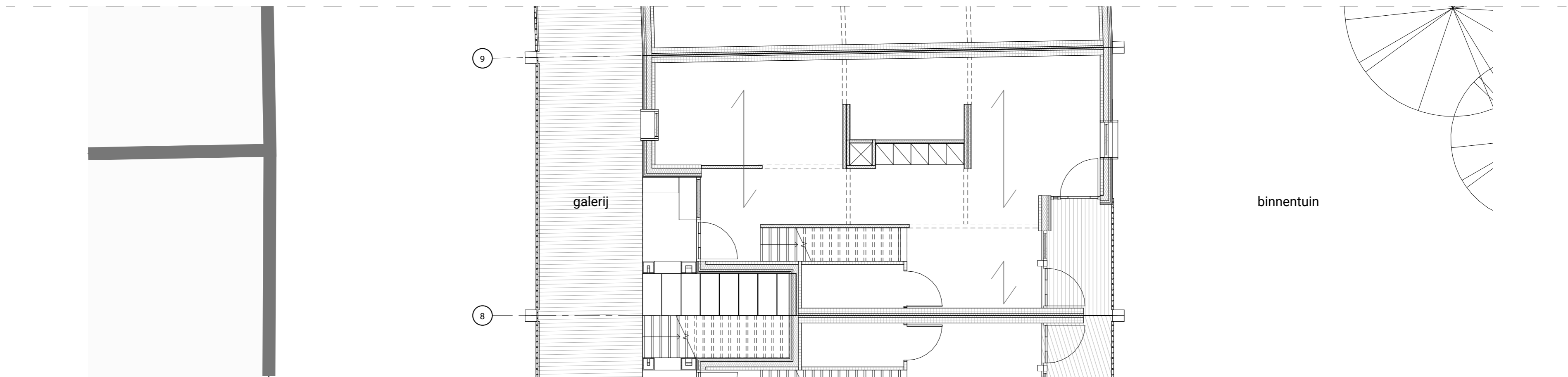

Fragment eerste verdieping, 1:50

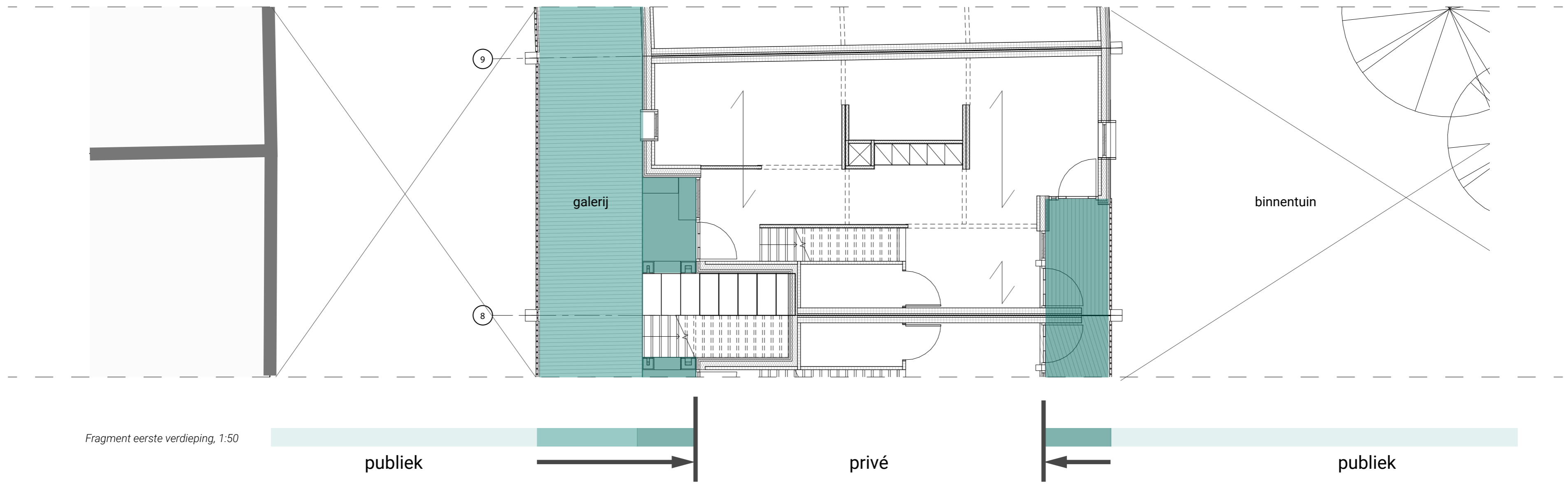

Soft edges: eerste verdieping
Gebouw



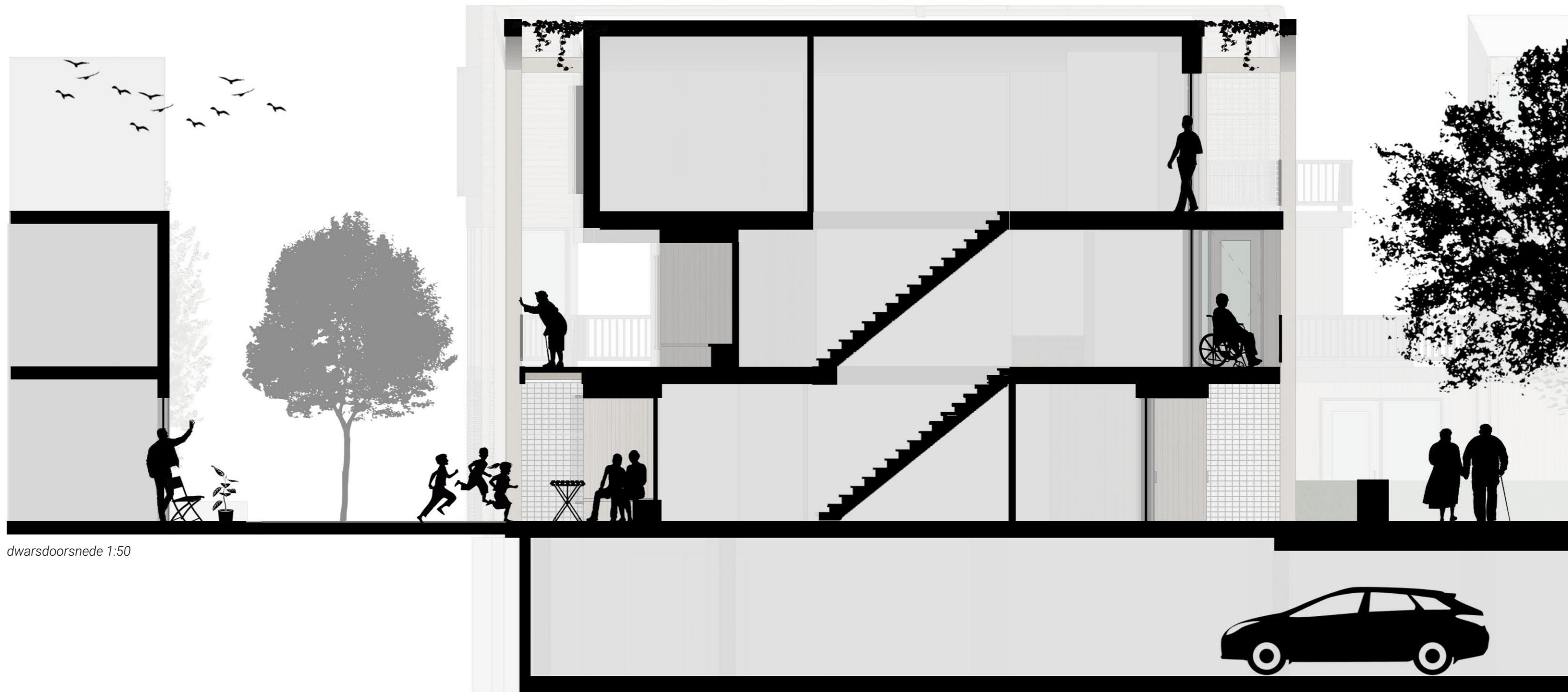

dwarsdoorsnede 1:50

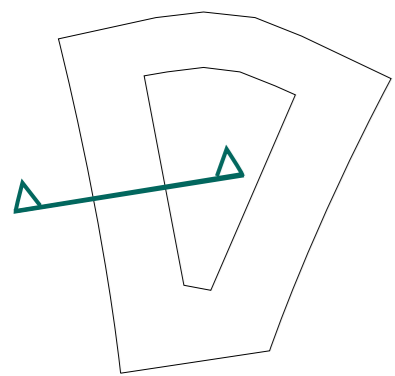

Soft edges: doorsnede
Gebouw

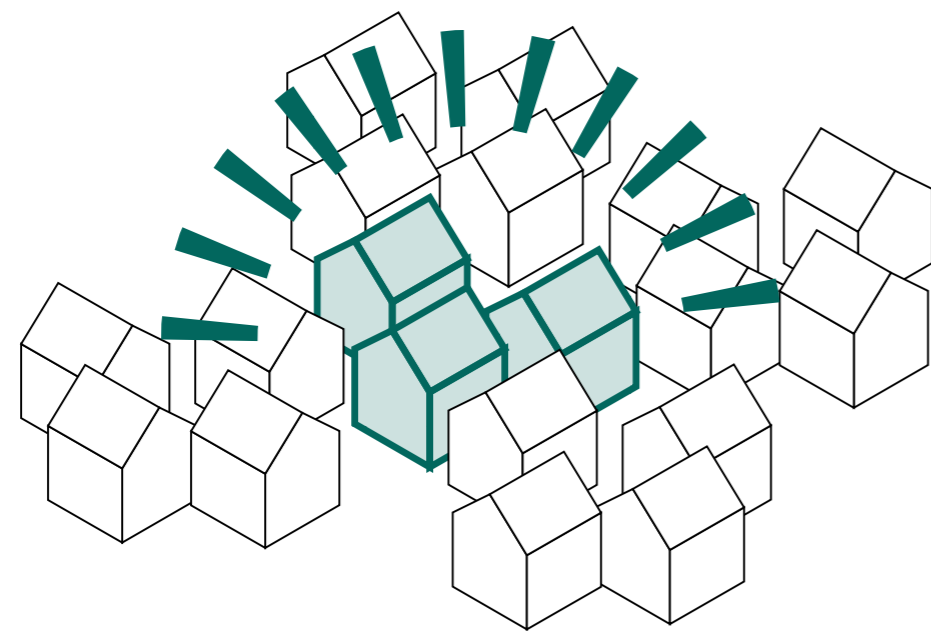

een herkenbare buurt met een duidelijke eigen expressie om fysieke verbondenheid te stimuleren



Justus van Effenblok, Rotterdam (Archined.nl)



Materialisatie in de directe omgeving (eigen afbeeldingen)



Westgevel, 1:200



hoeken



begane grond en tweede verdieping

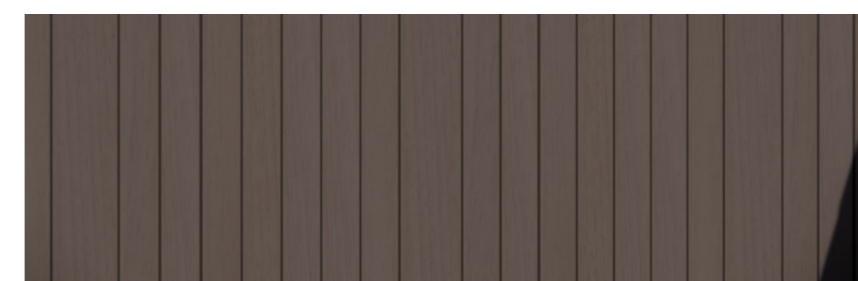

eerste verdieping

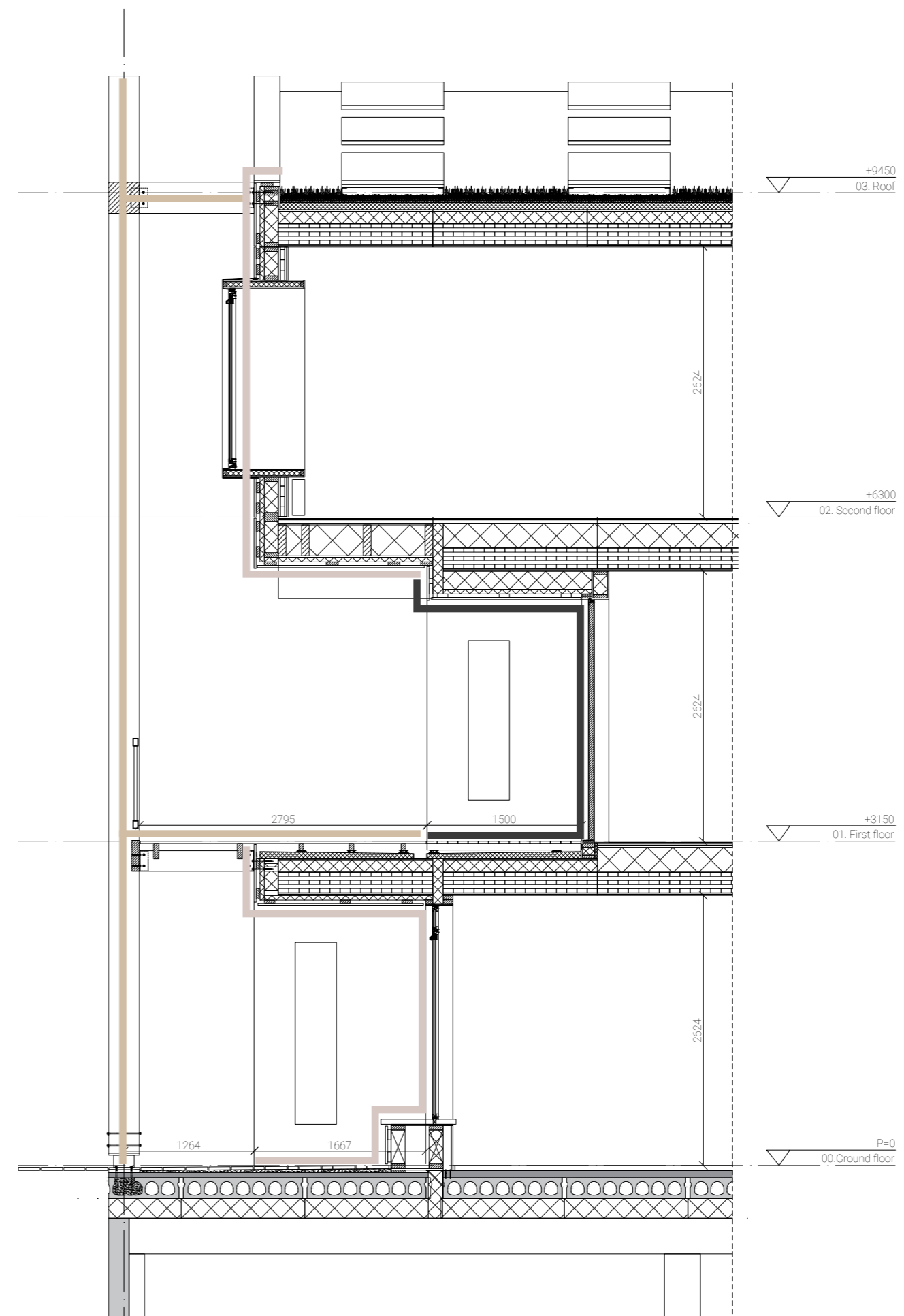



Natuurlijke uitstraling
Gebouw





Woning

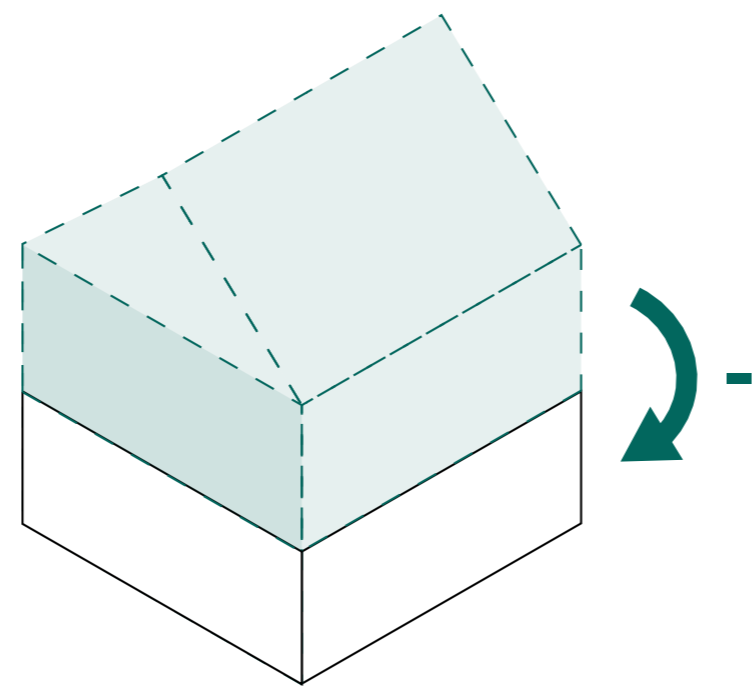

aanpasbare woningen houden ouderen langer thuis



Knarrenhof Zwolle, Het Aanhof (RTV Oost)

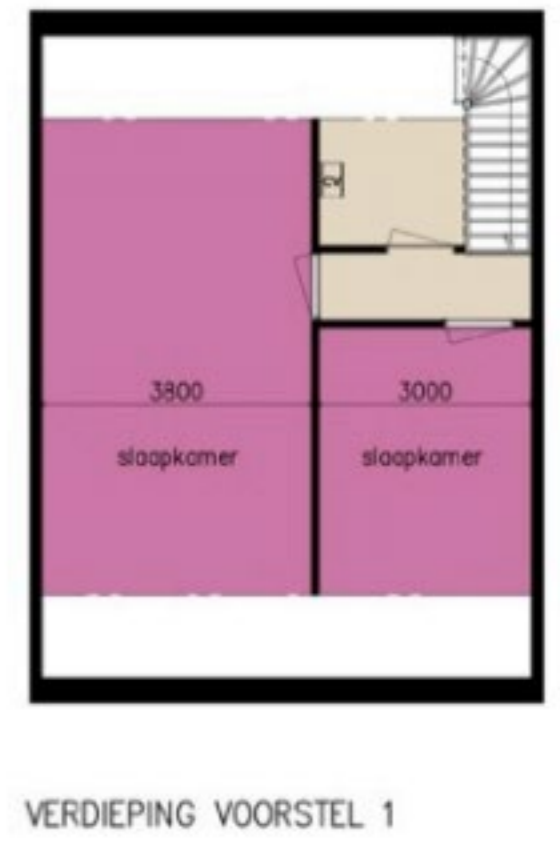

plattegronden (Knarrenhof)

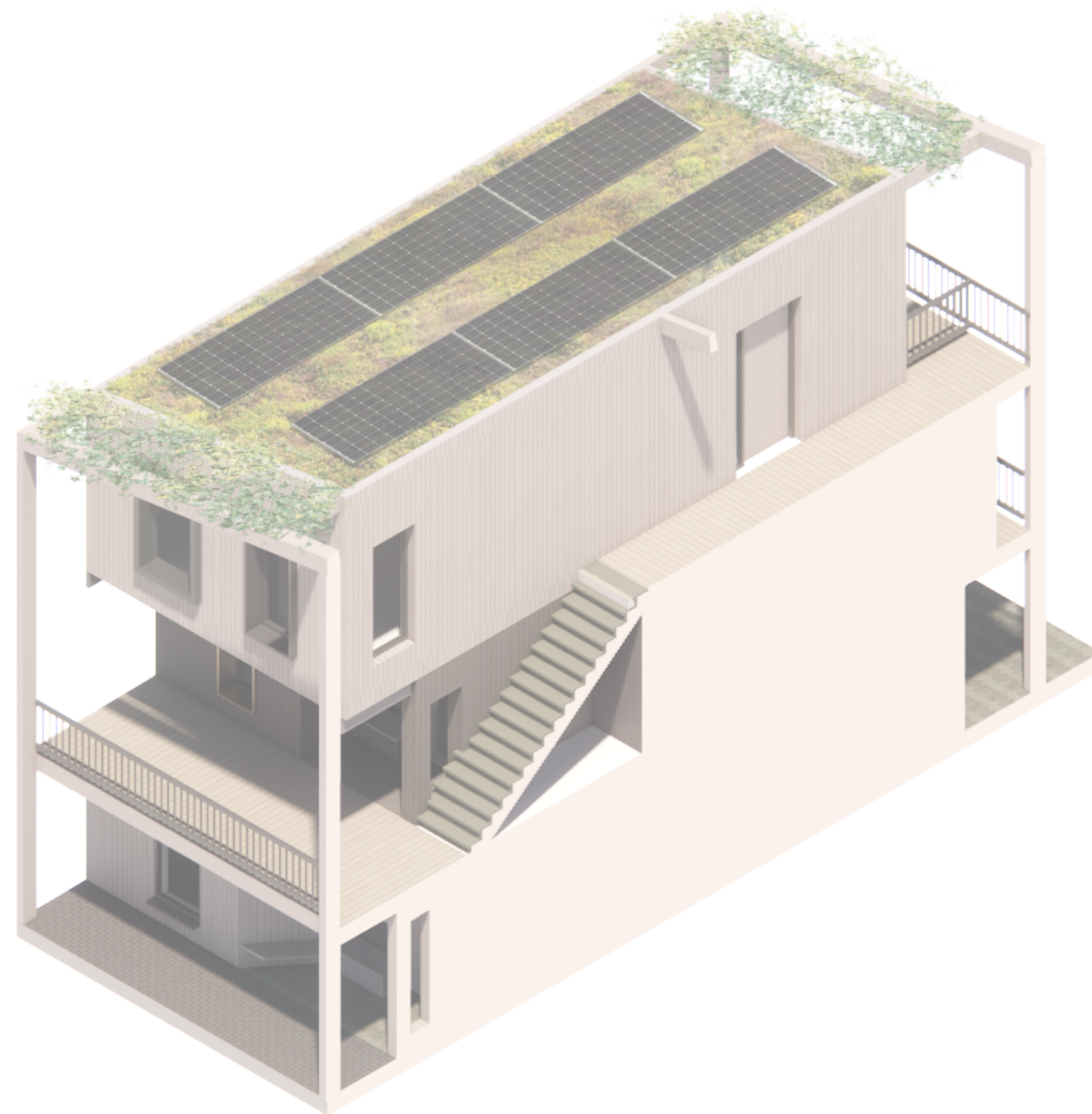

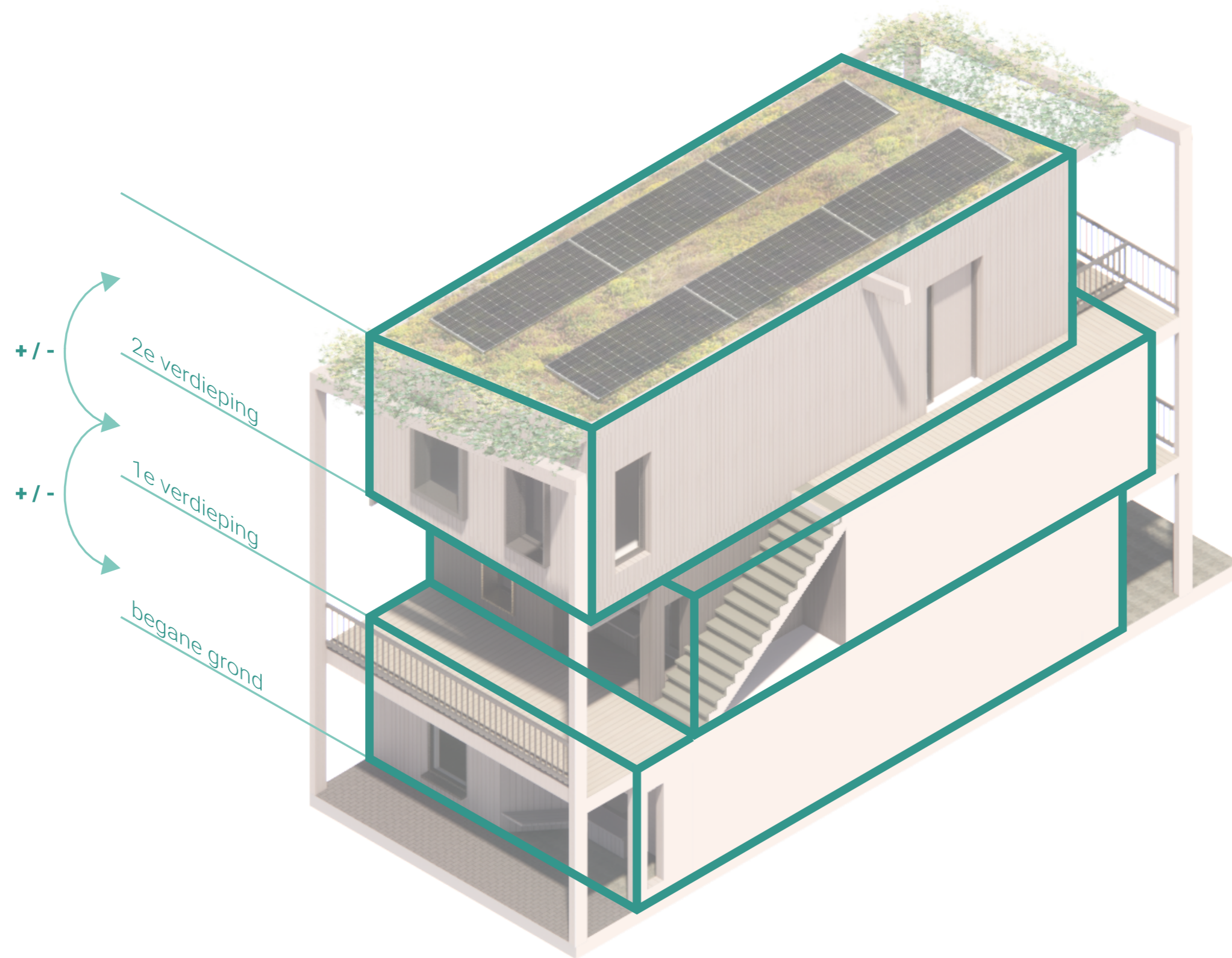

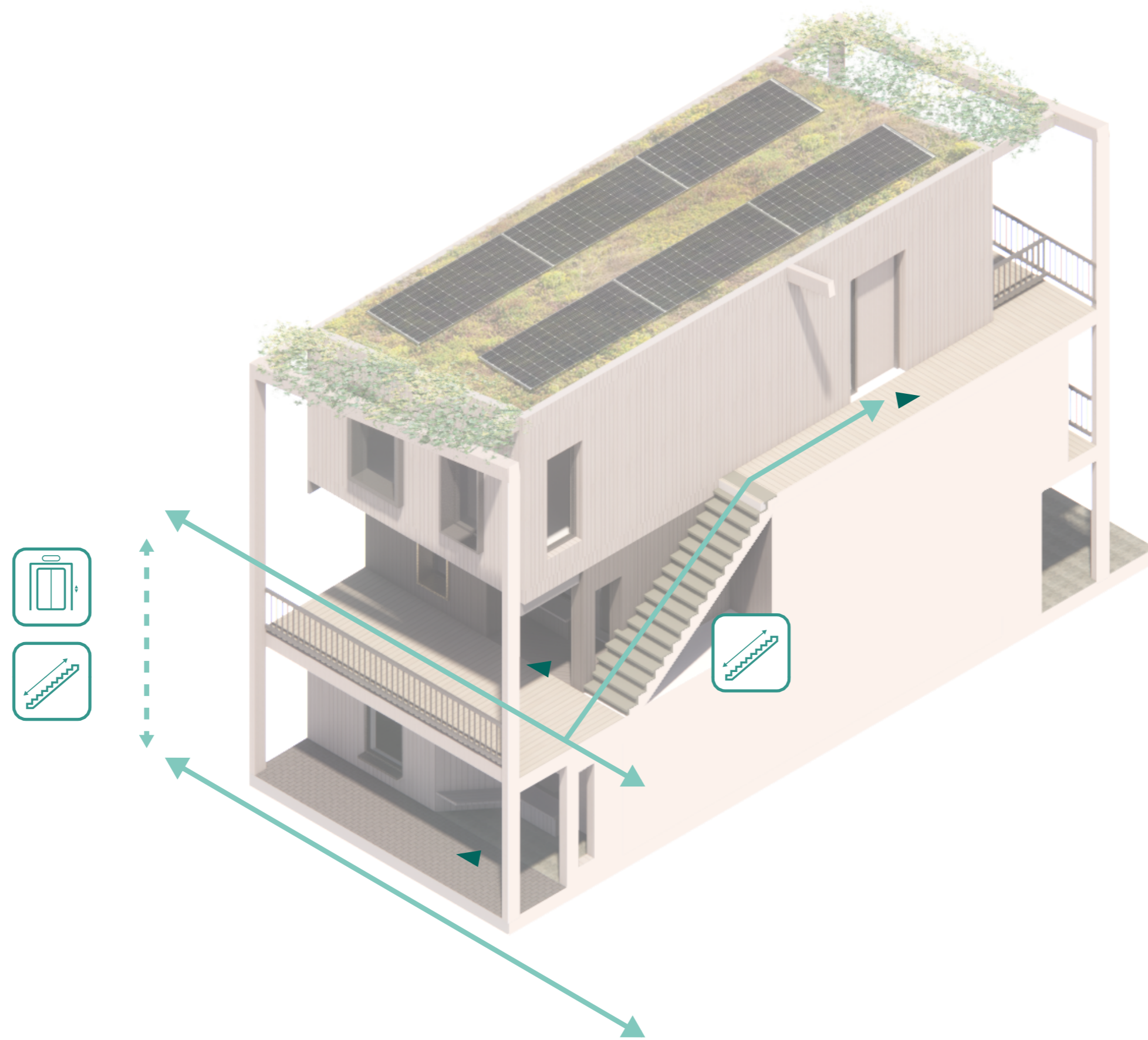

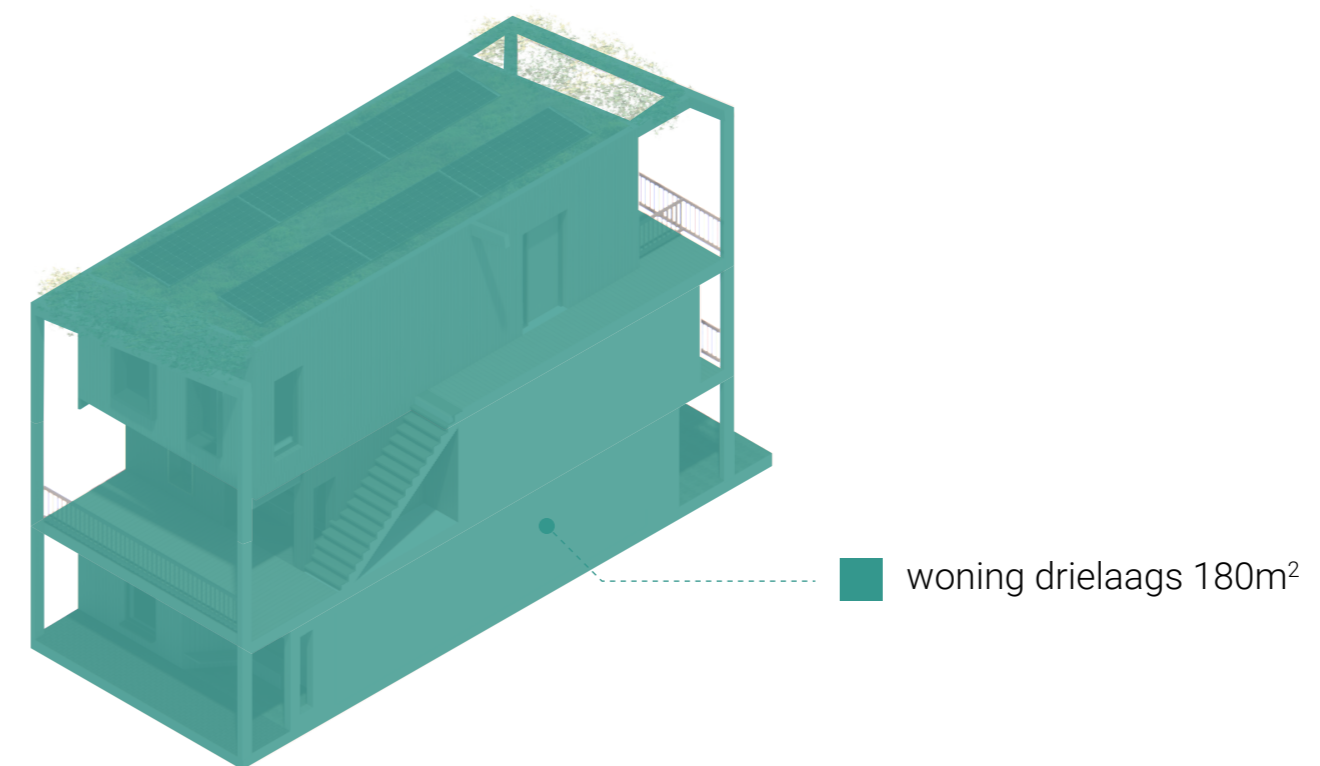
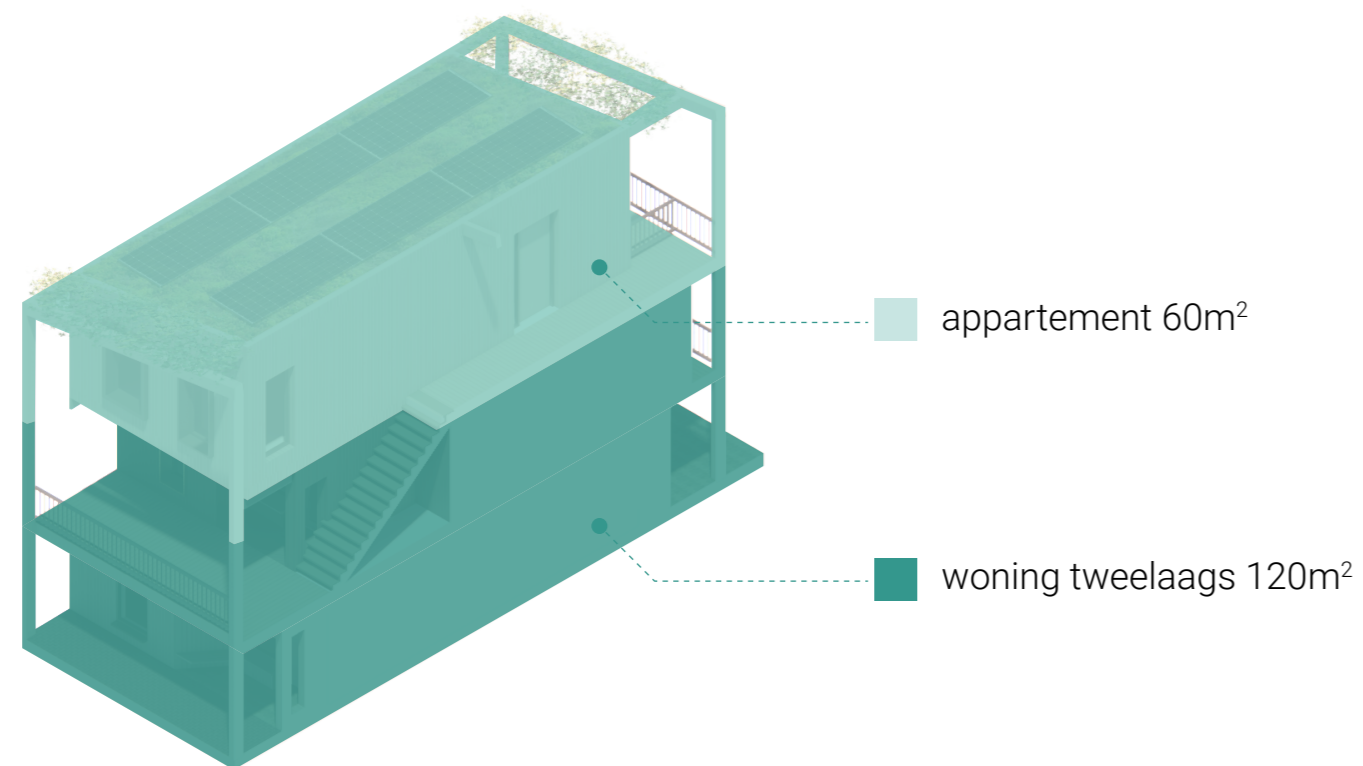
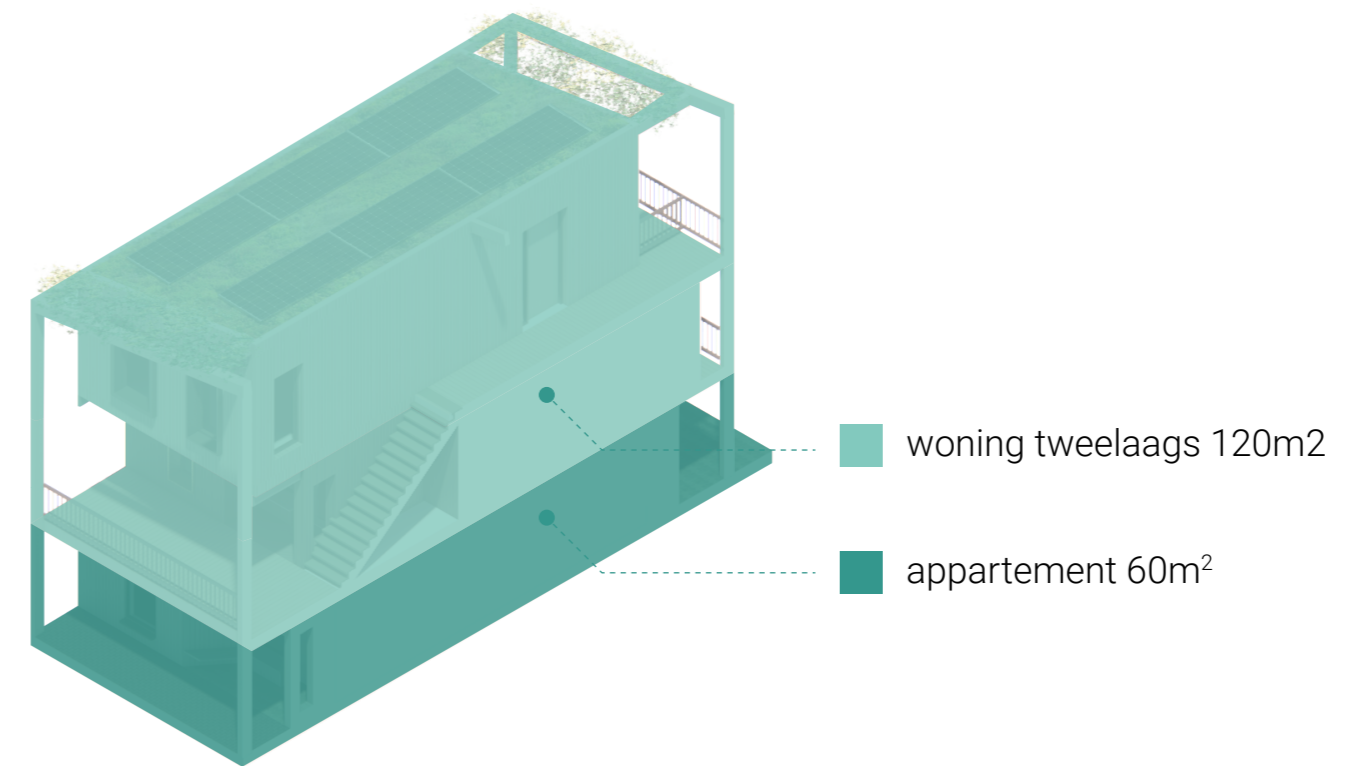
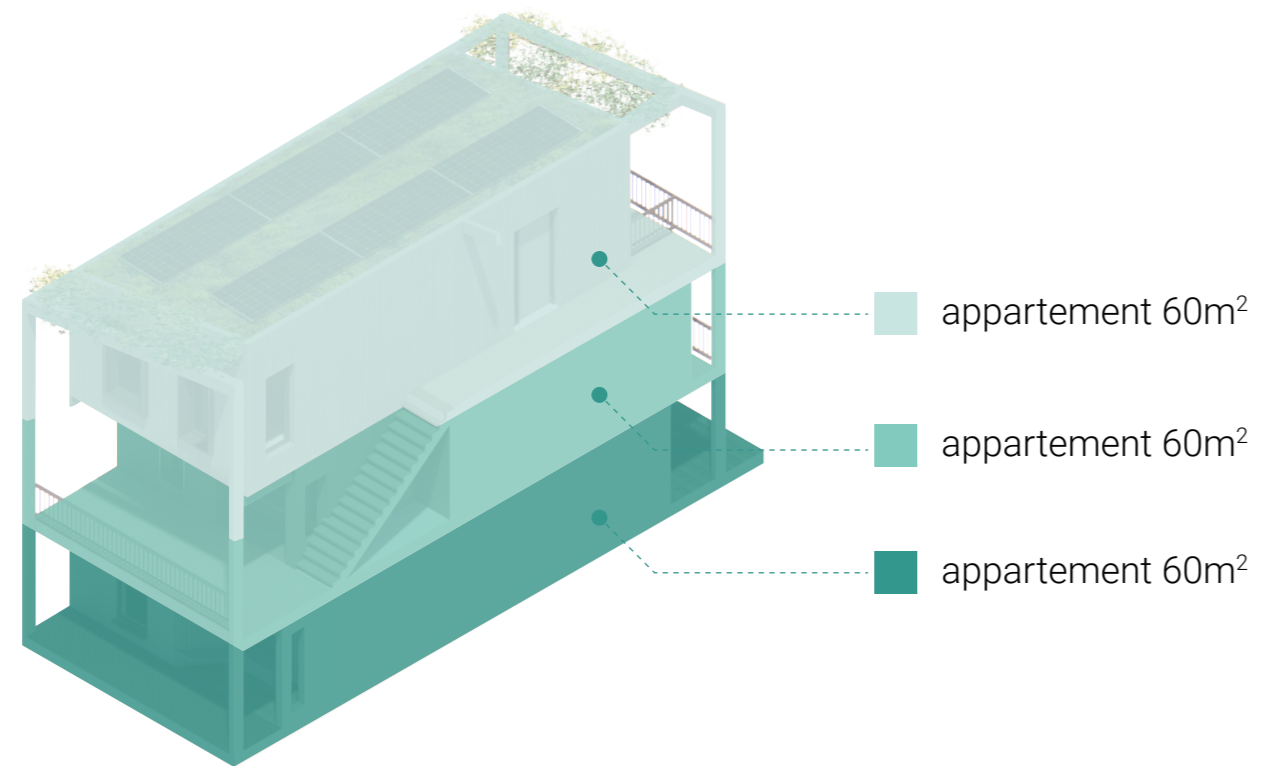

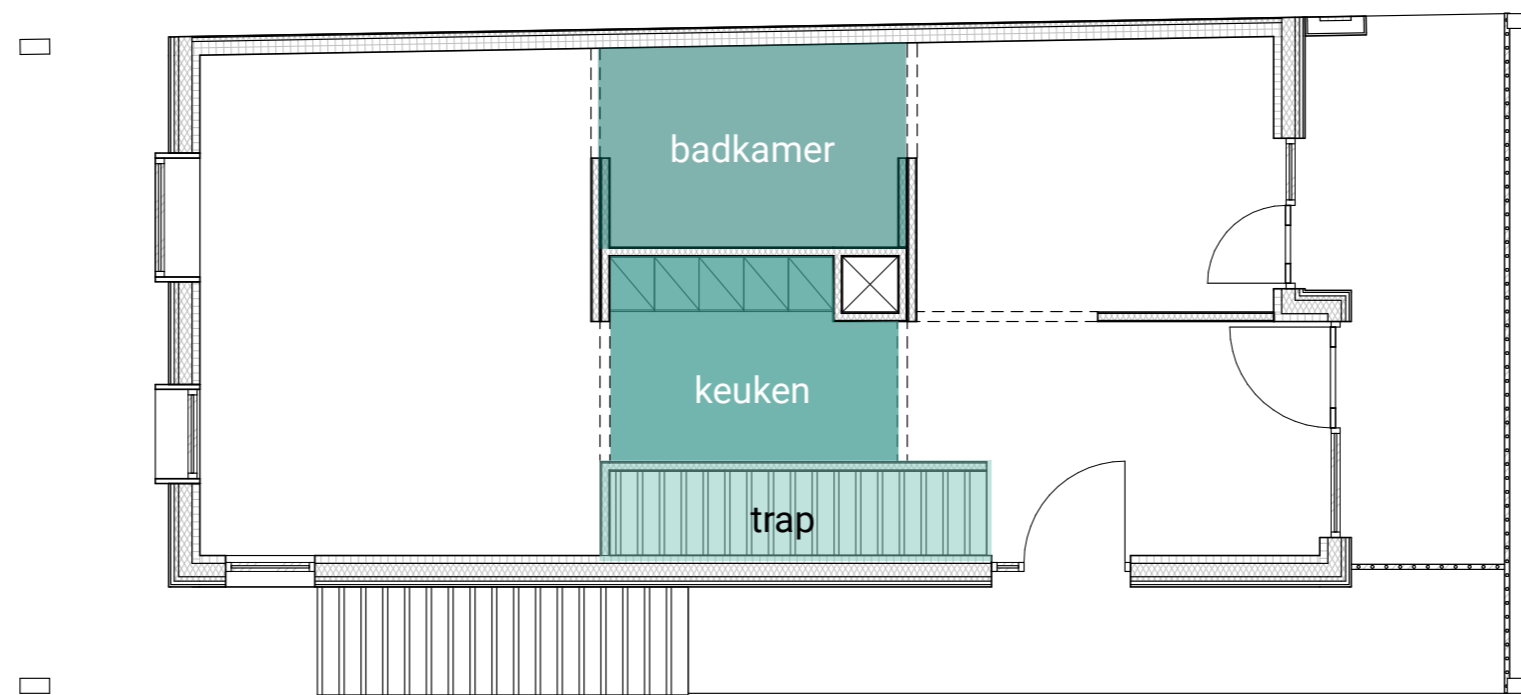

tweede verdieping

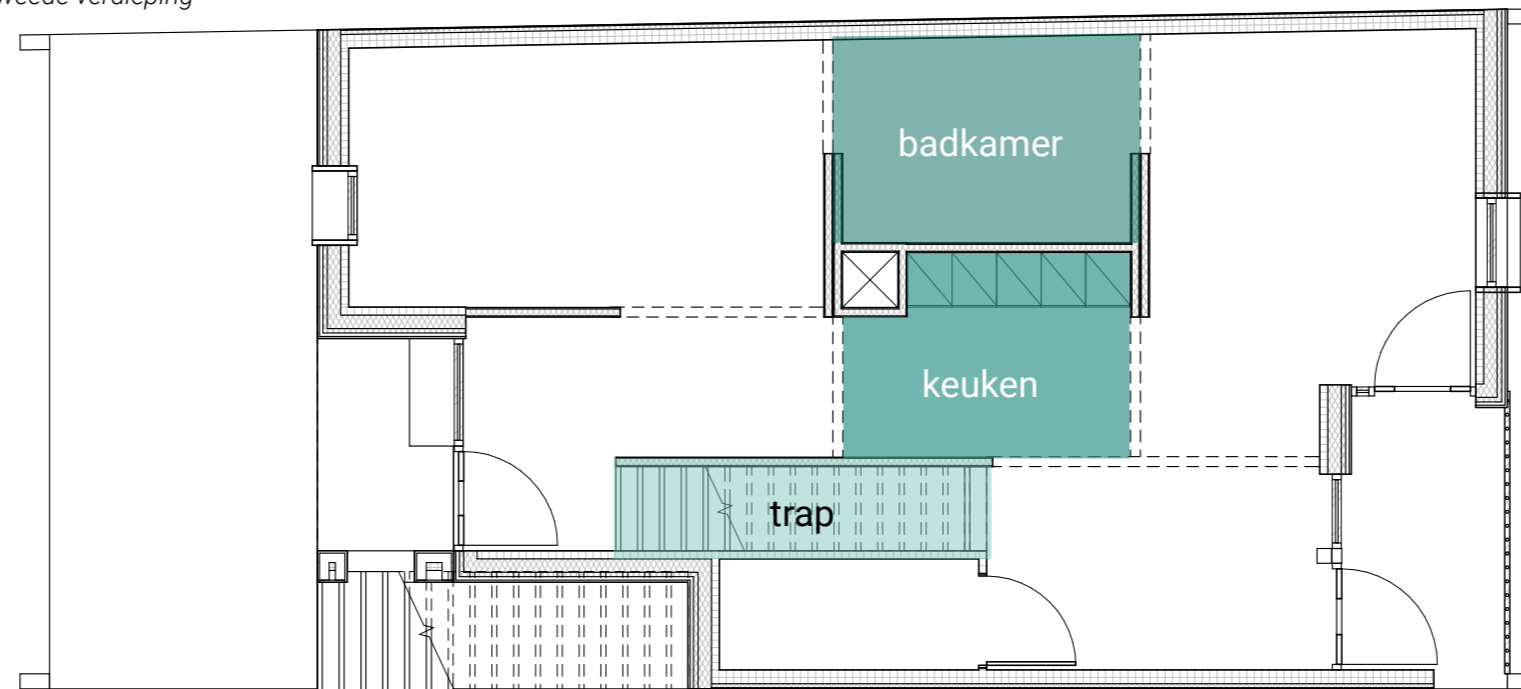

eerste verdieping

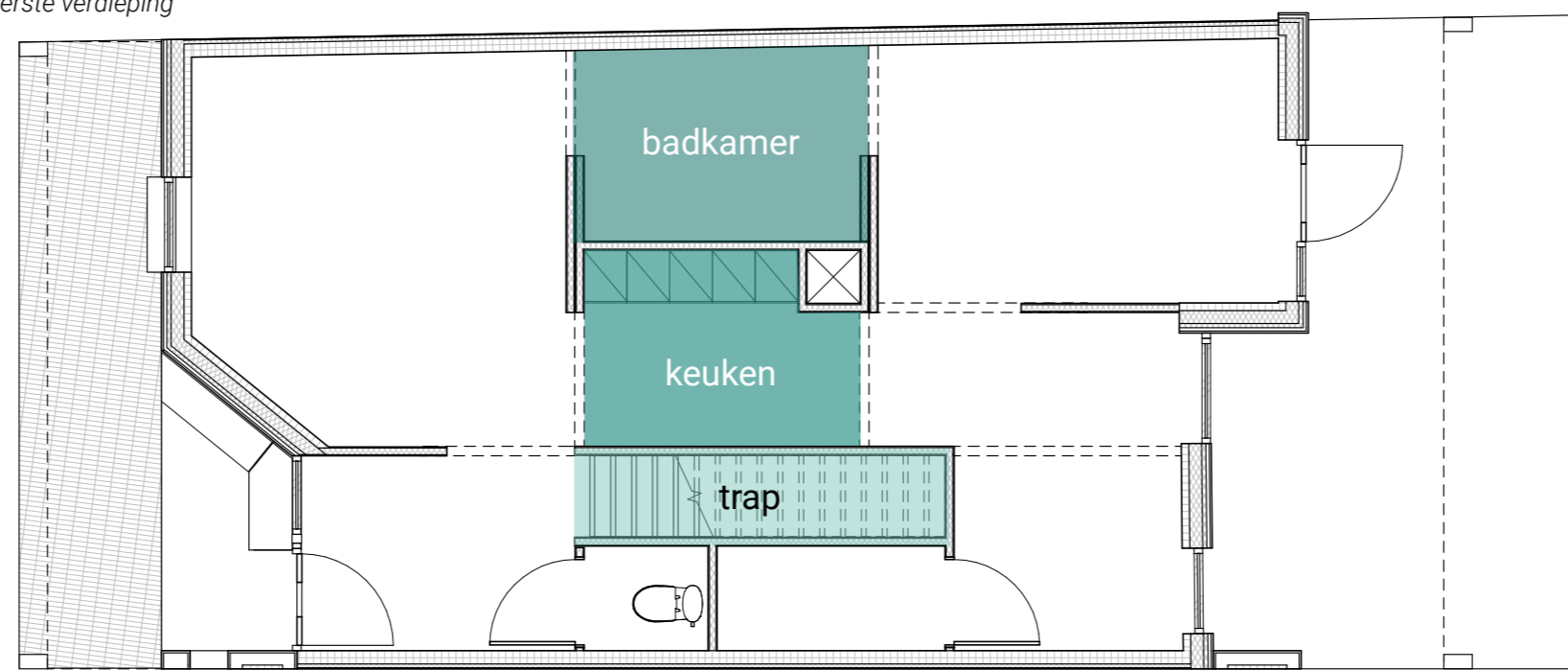

begane grond

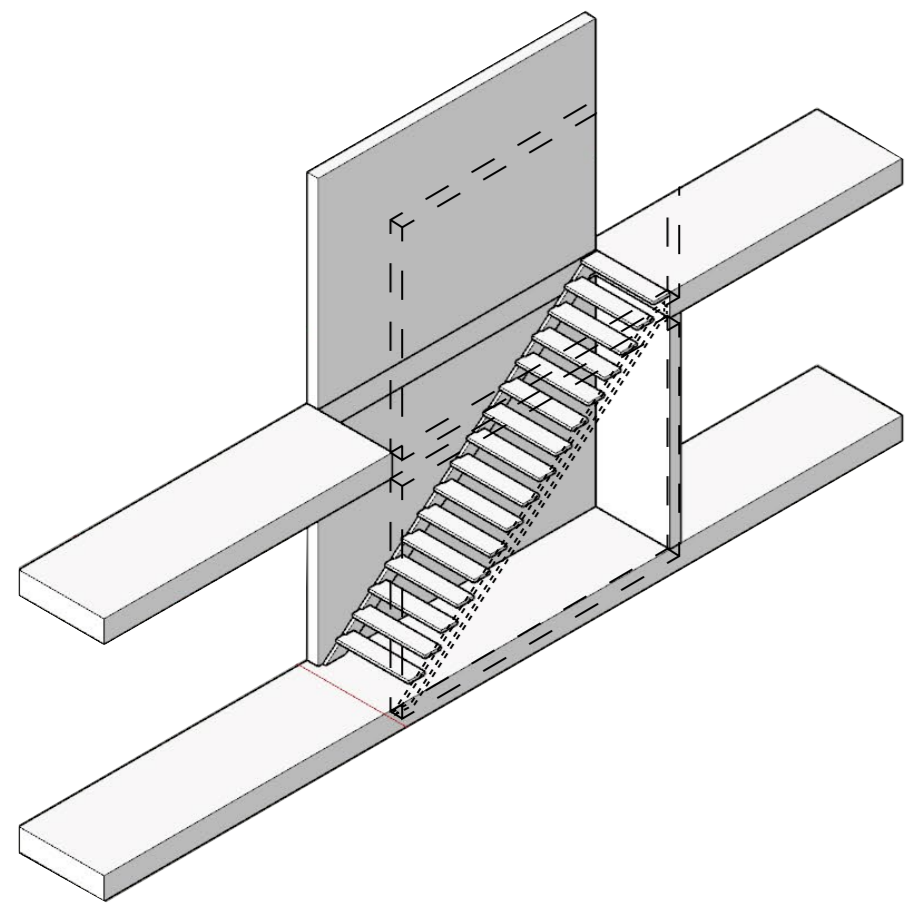

Trap

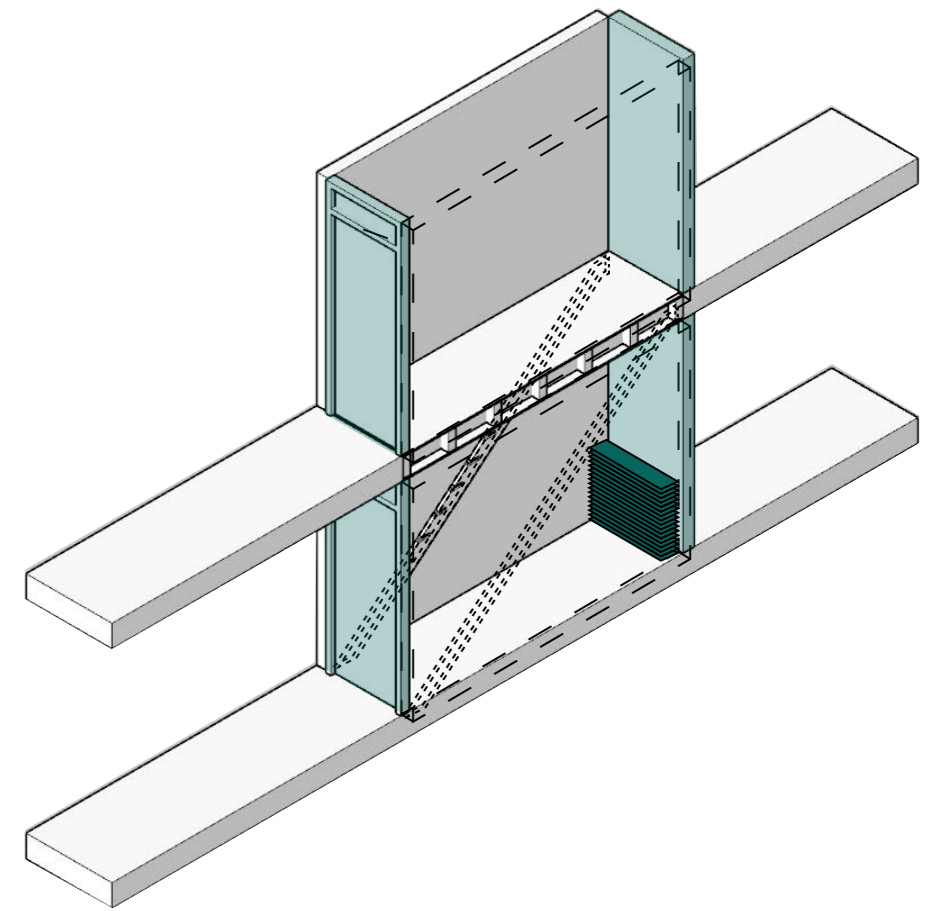
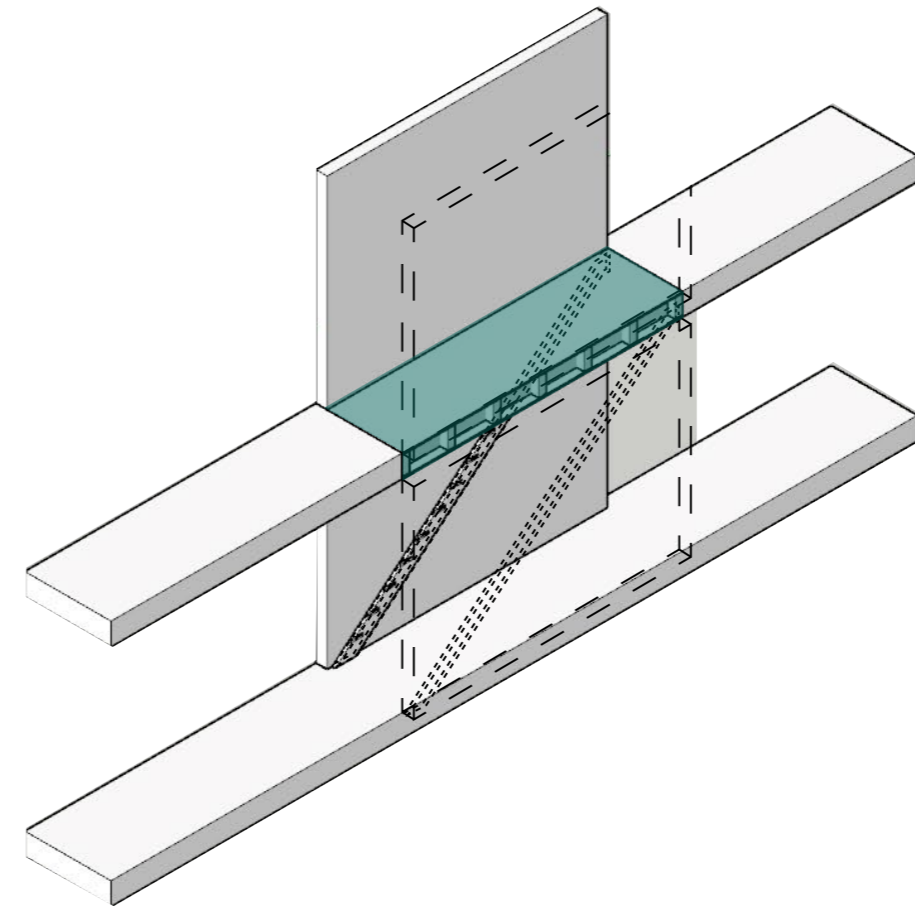
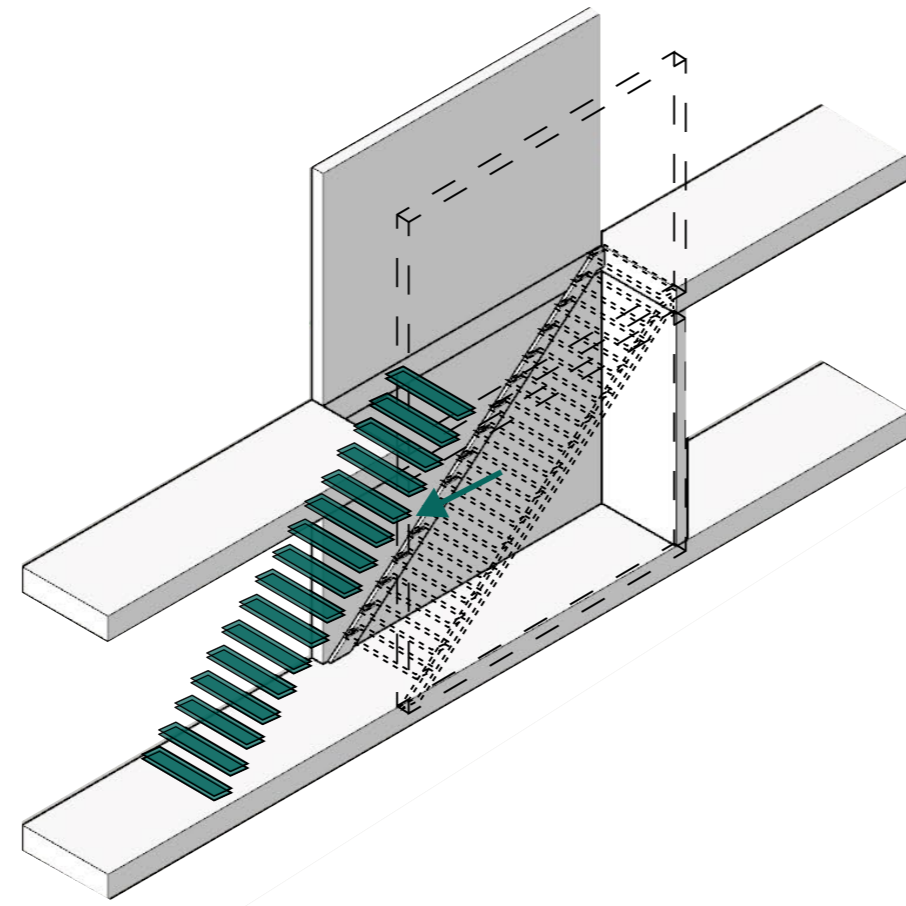

Berging

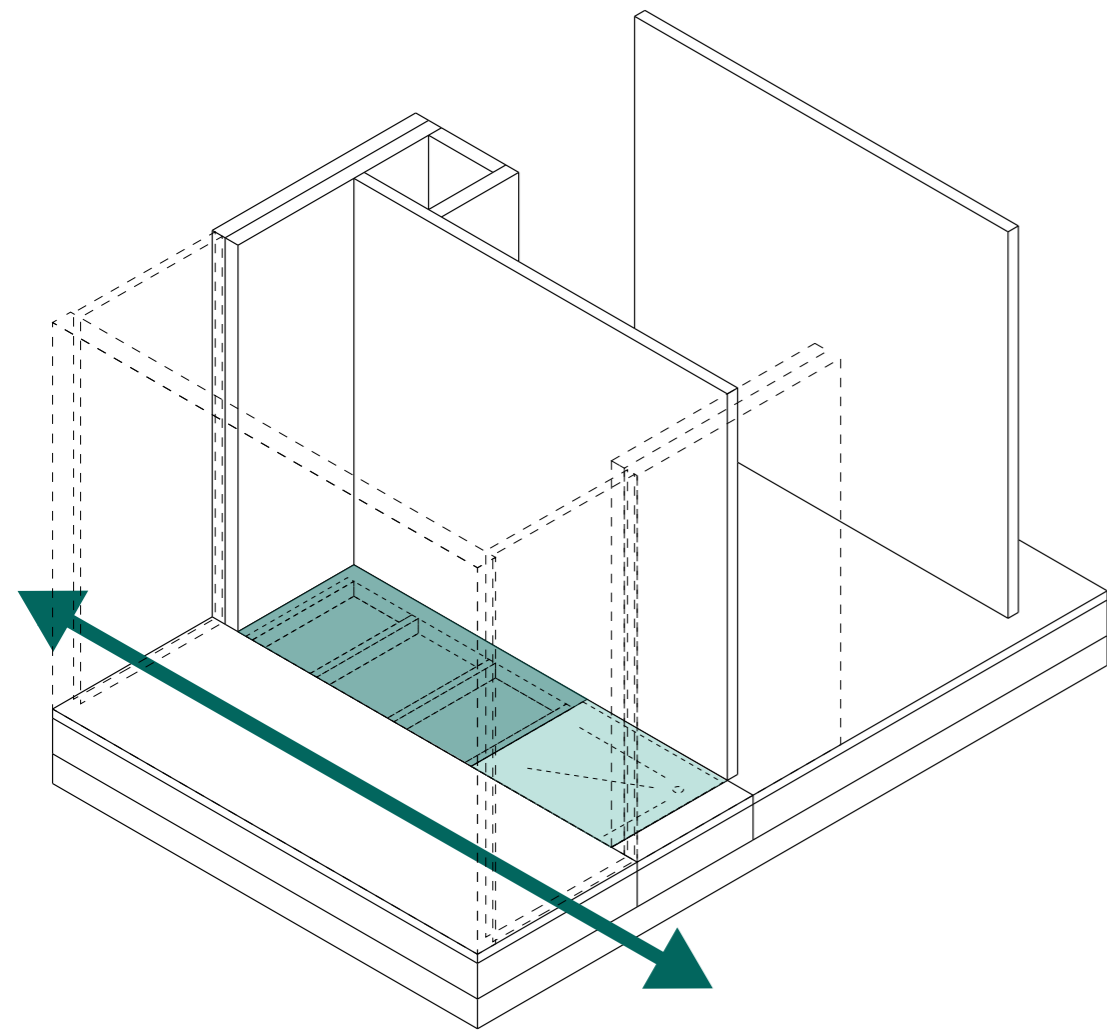

Open verbinding voor-
en achterzijde woning

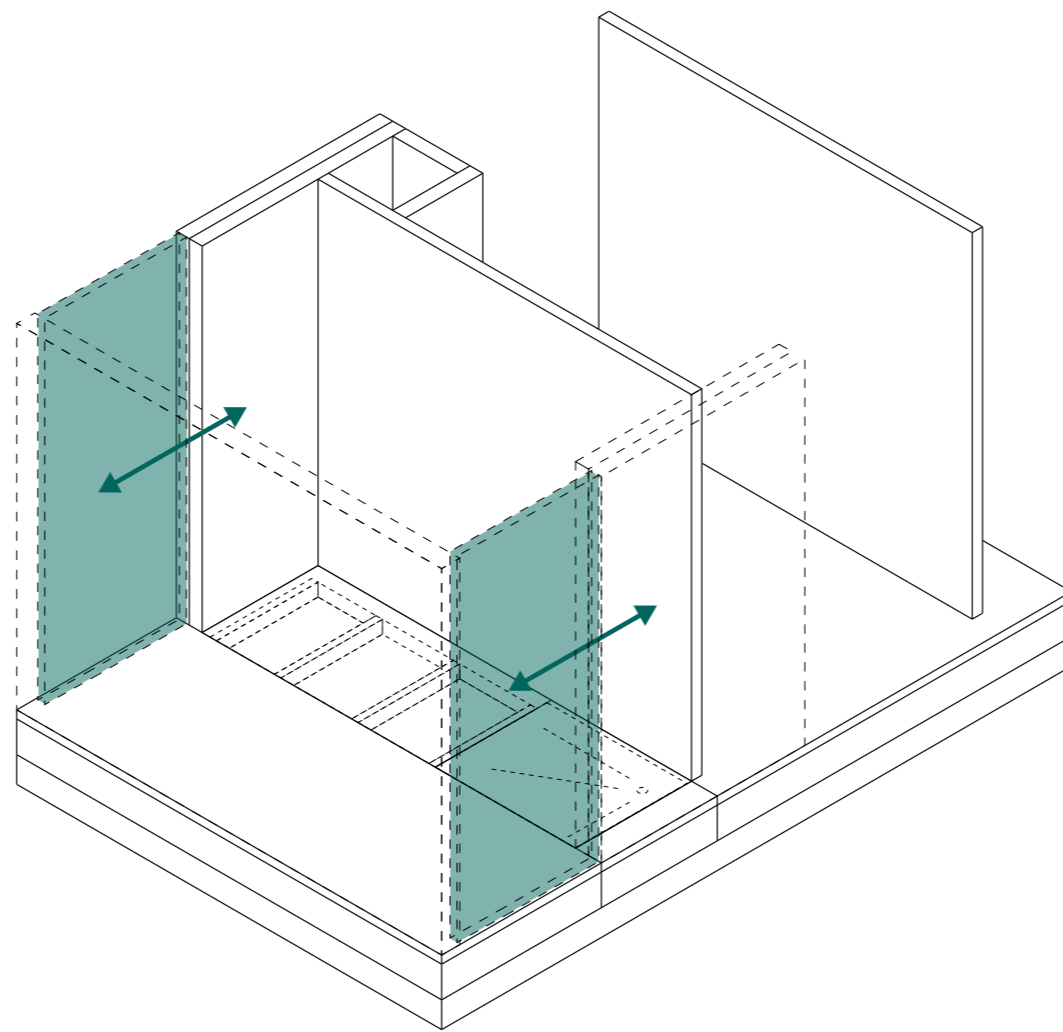

Berging

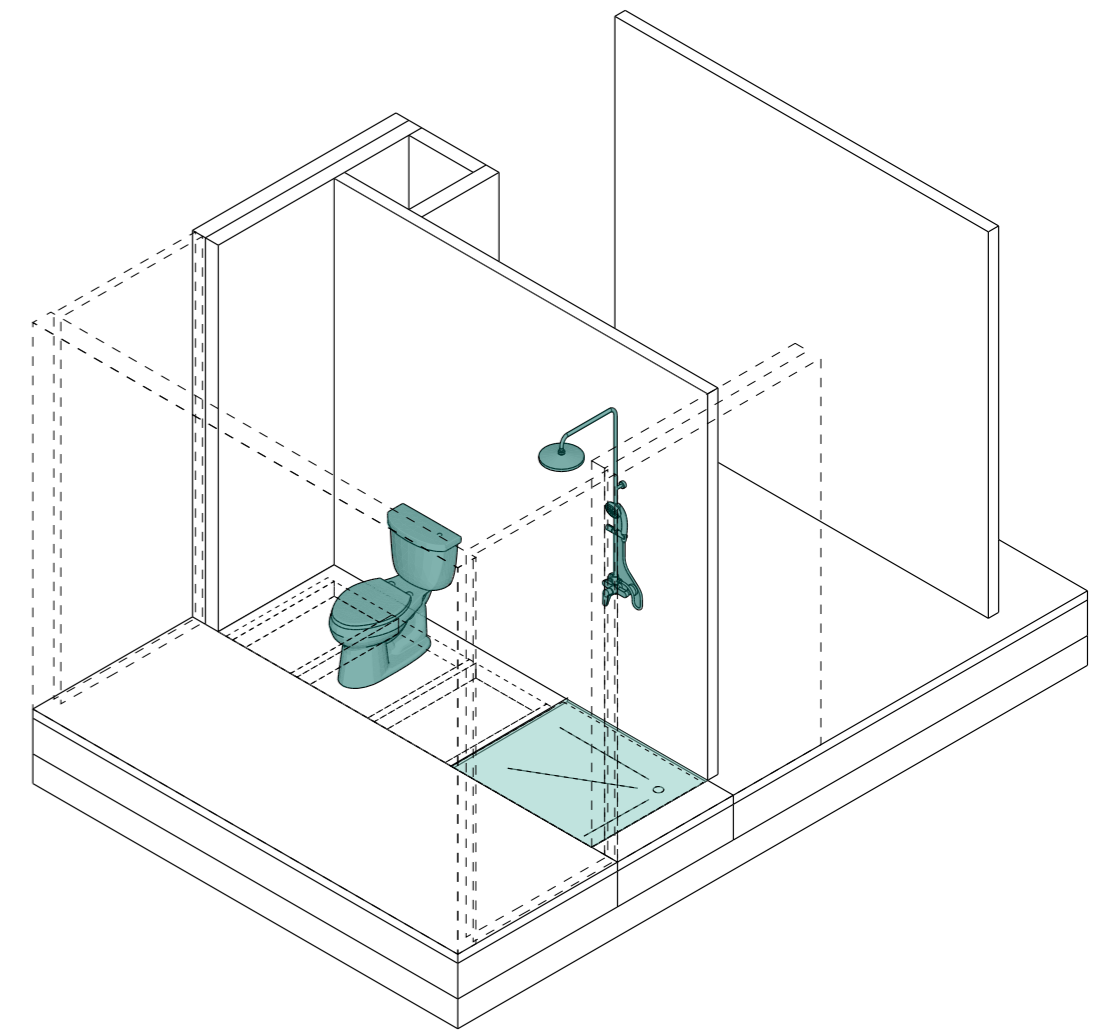

Badkamer

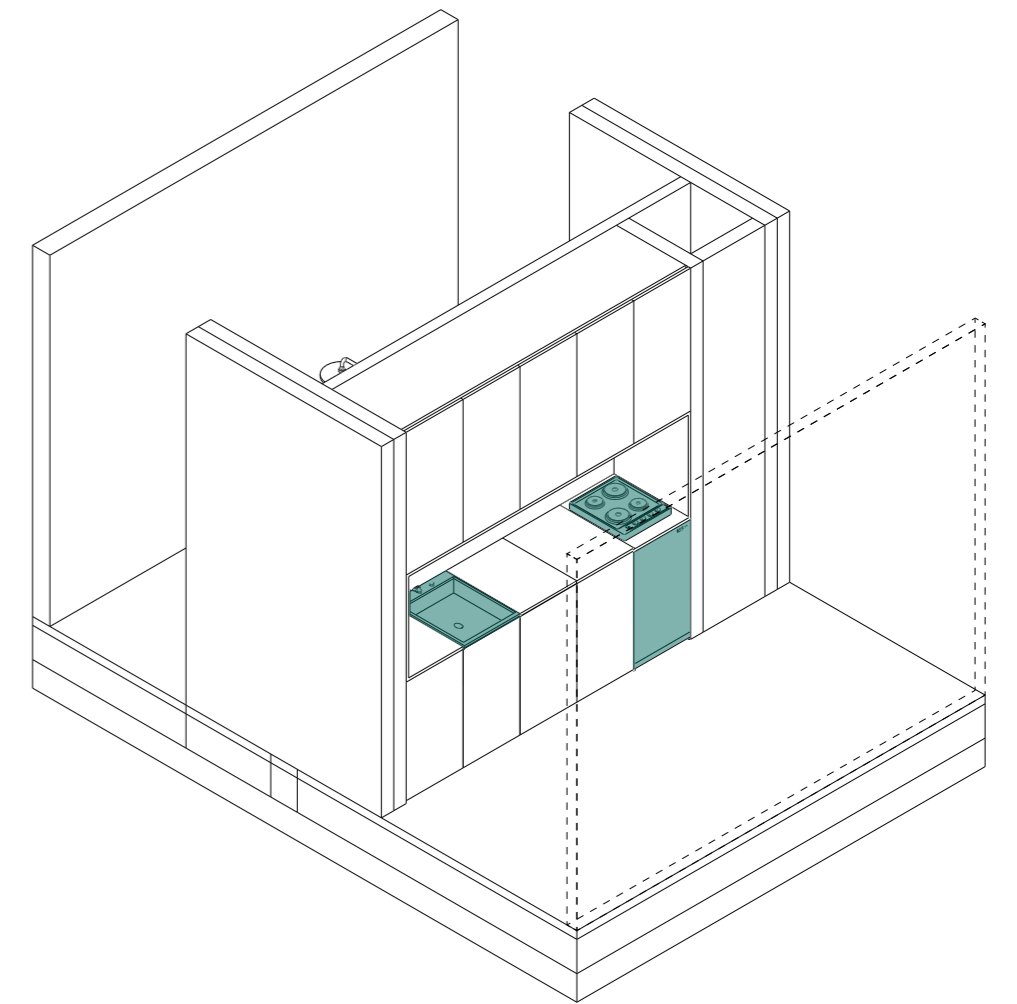
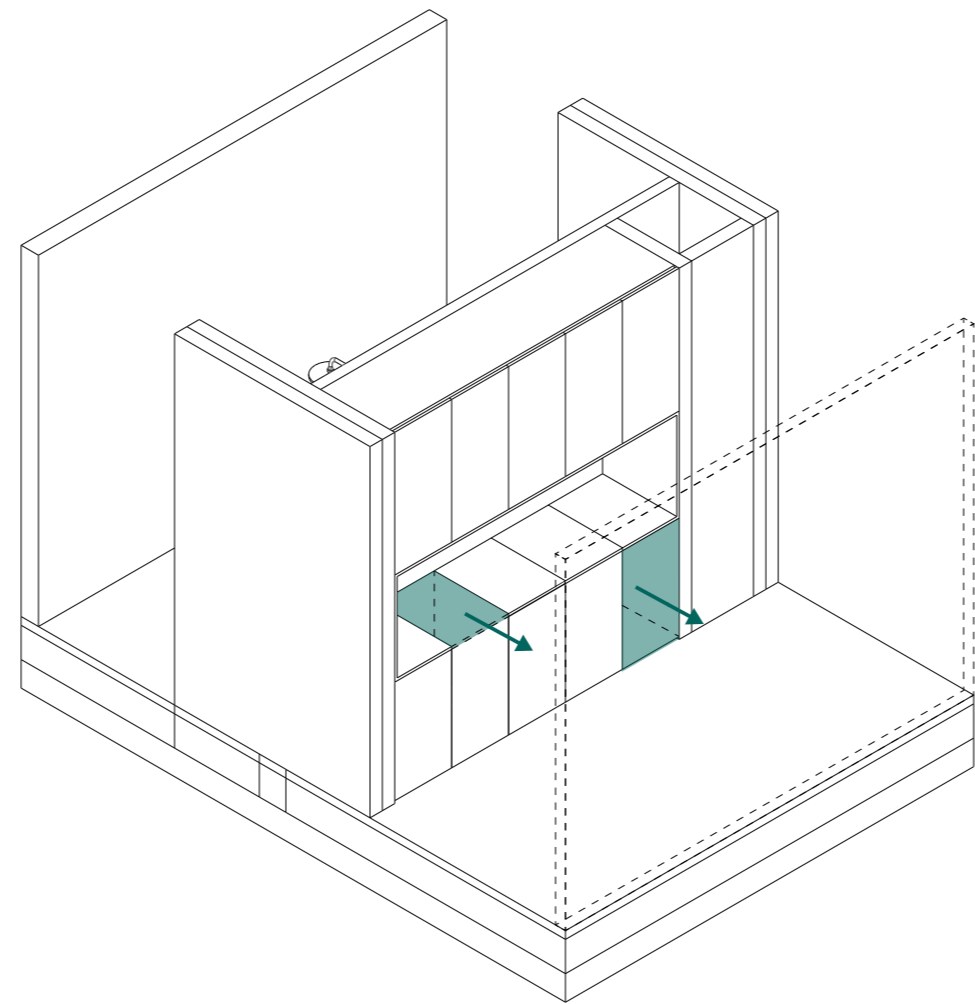
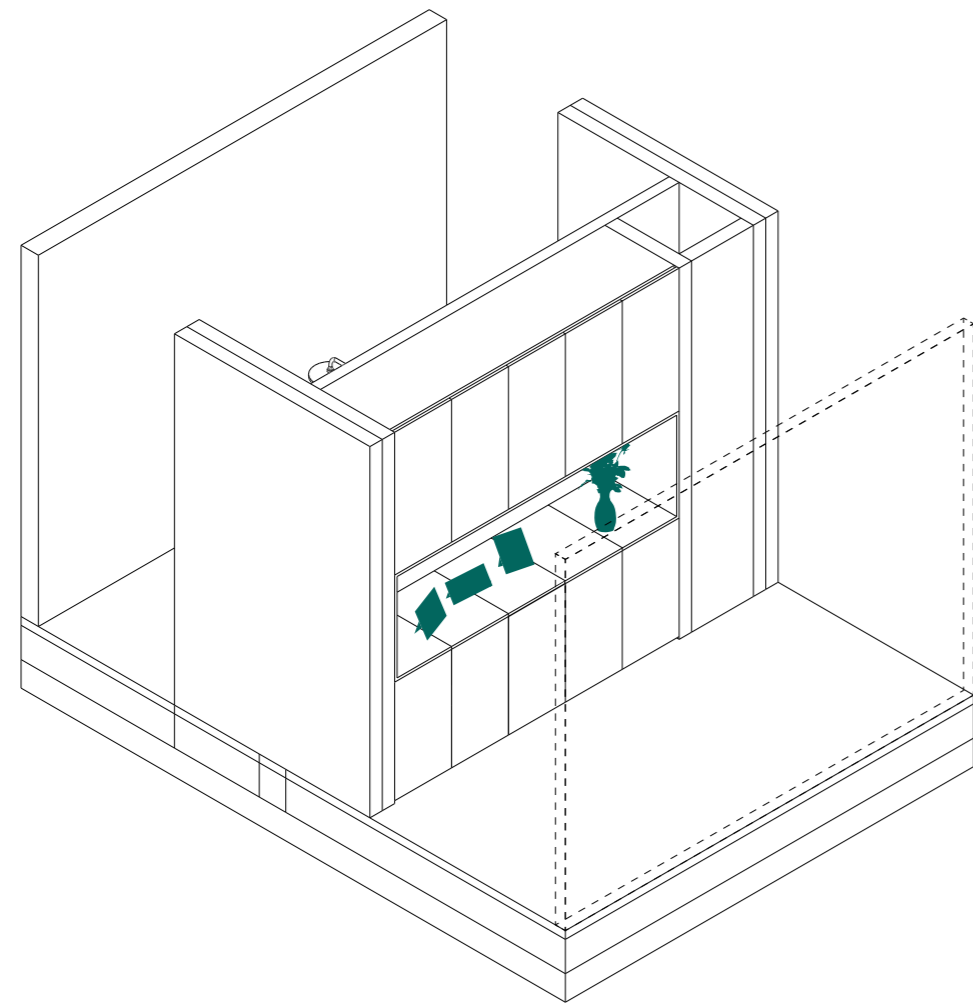

Kastenwand



Keuken

Ouderenwoning, appartement 60m2

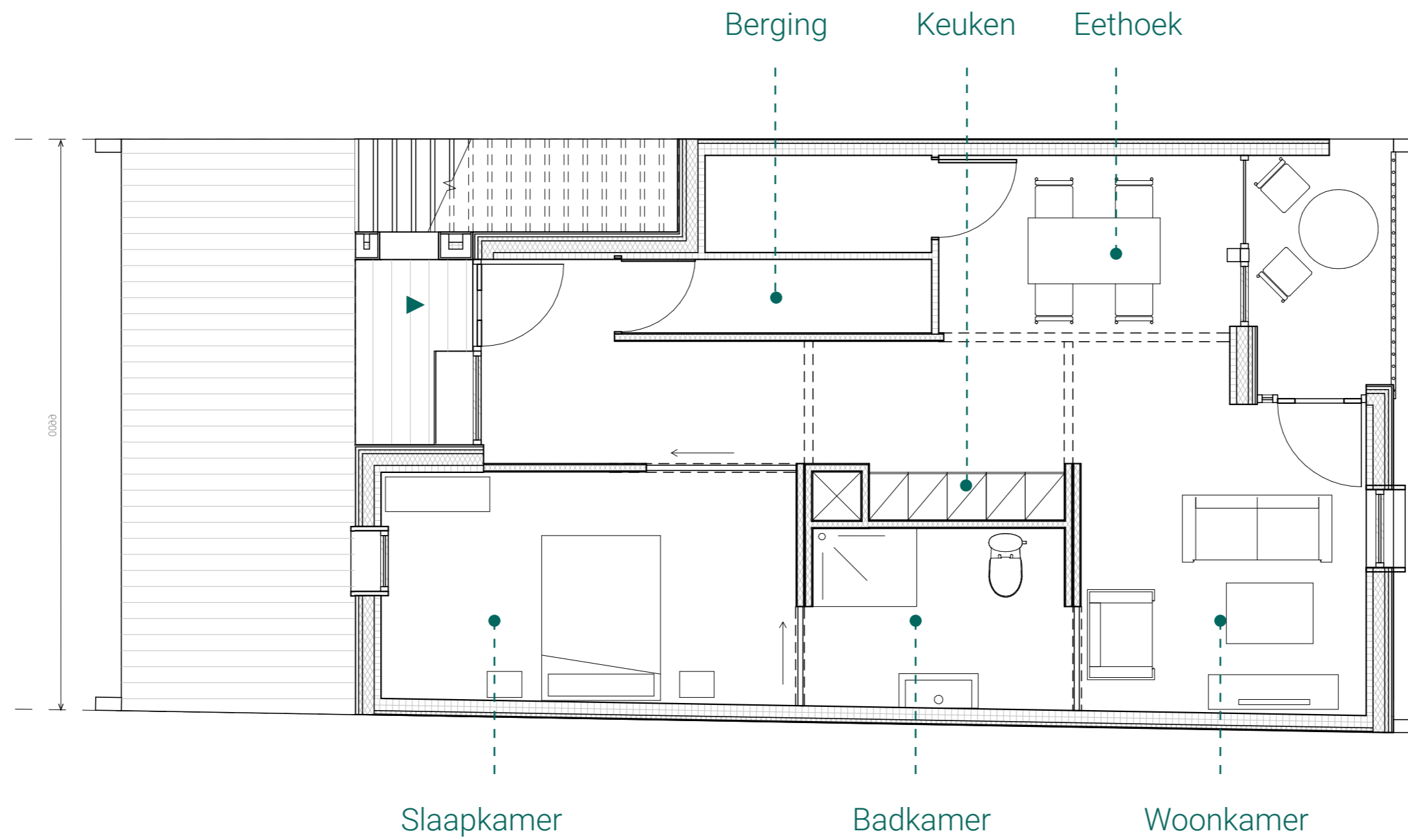



Gezinswoning, tweelaags 120m2

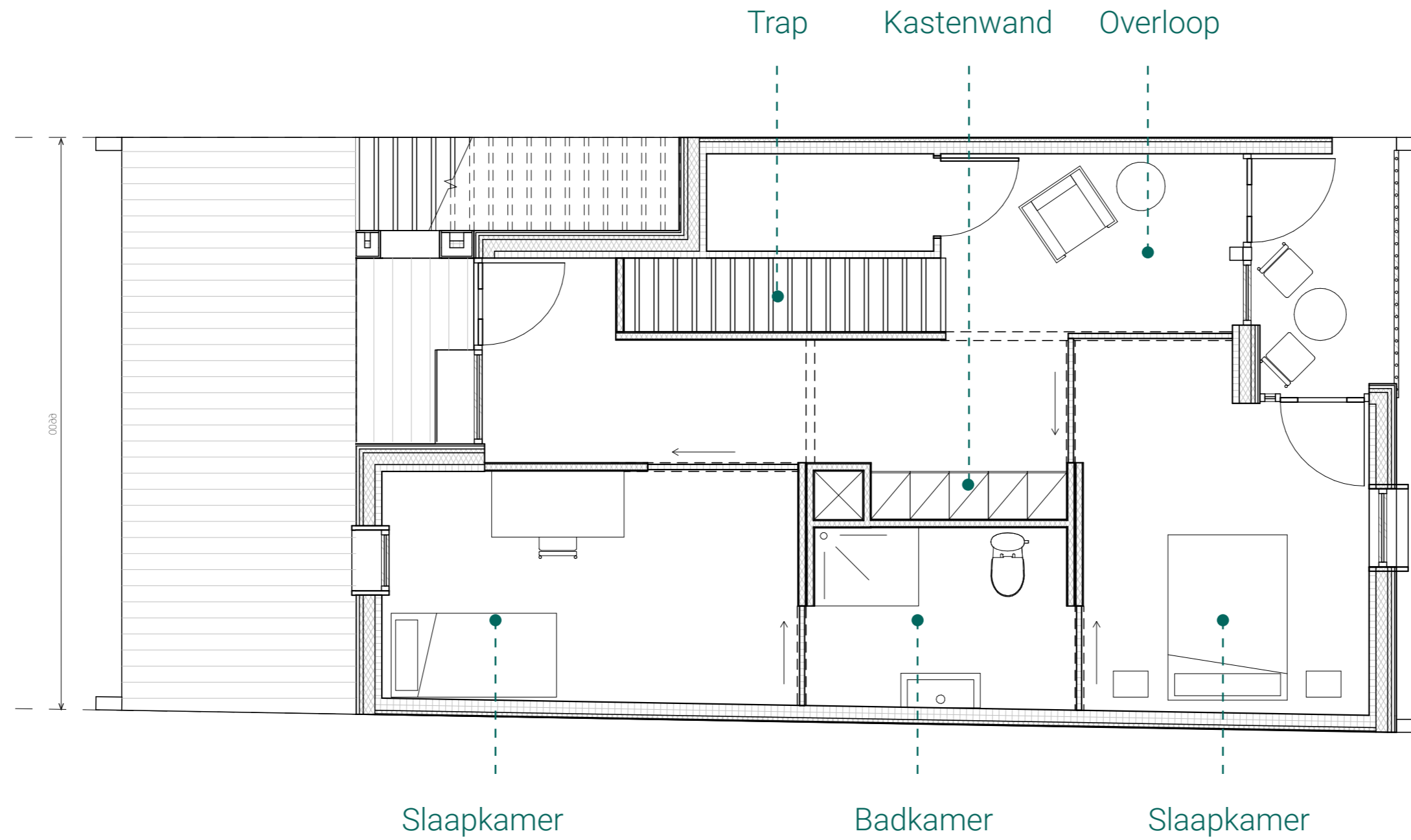



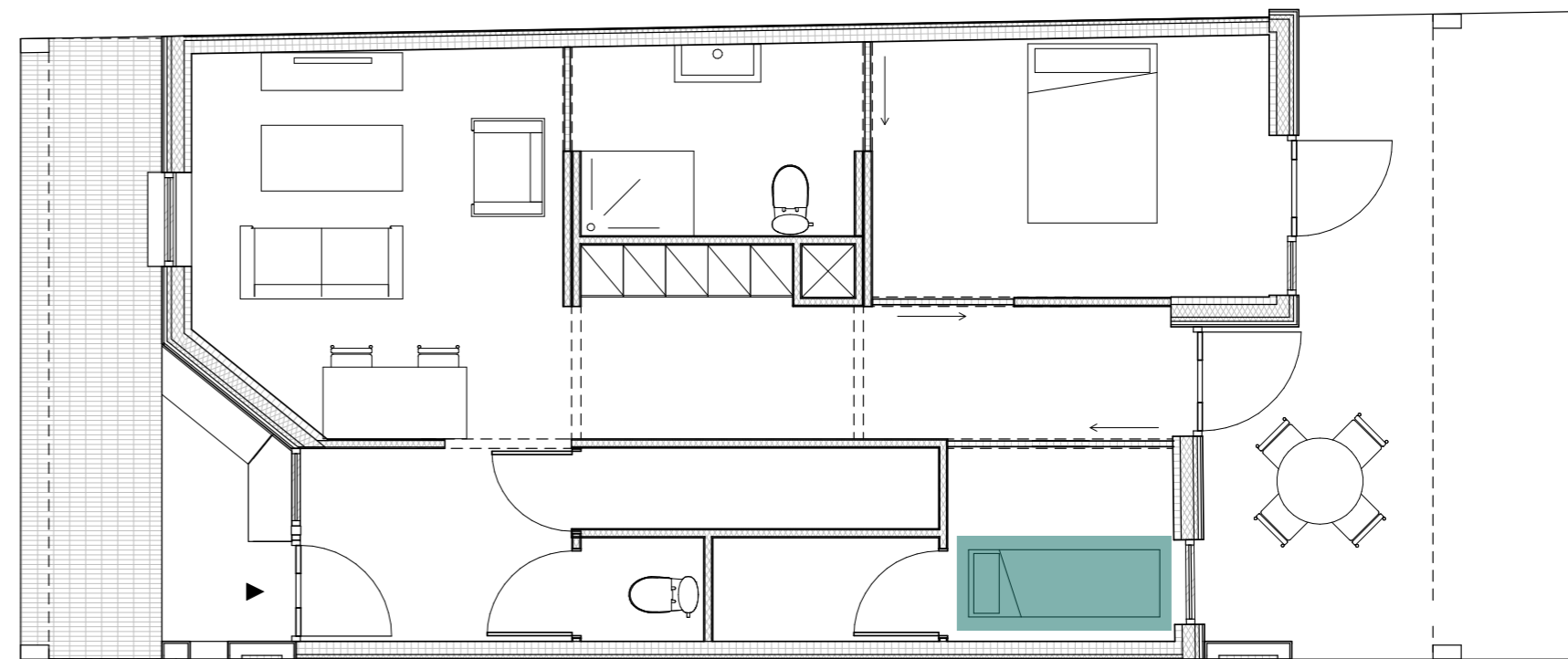
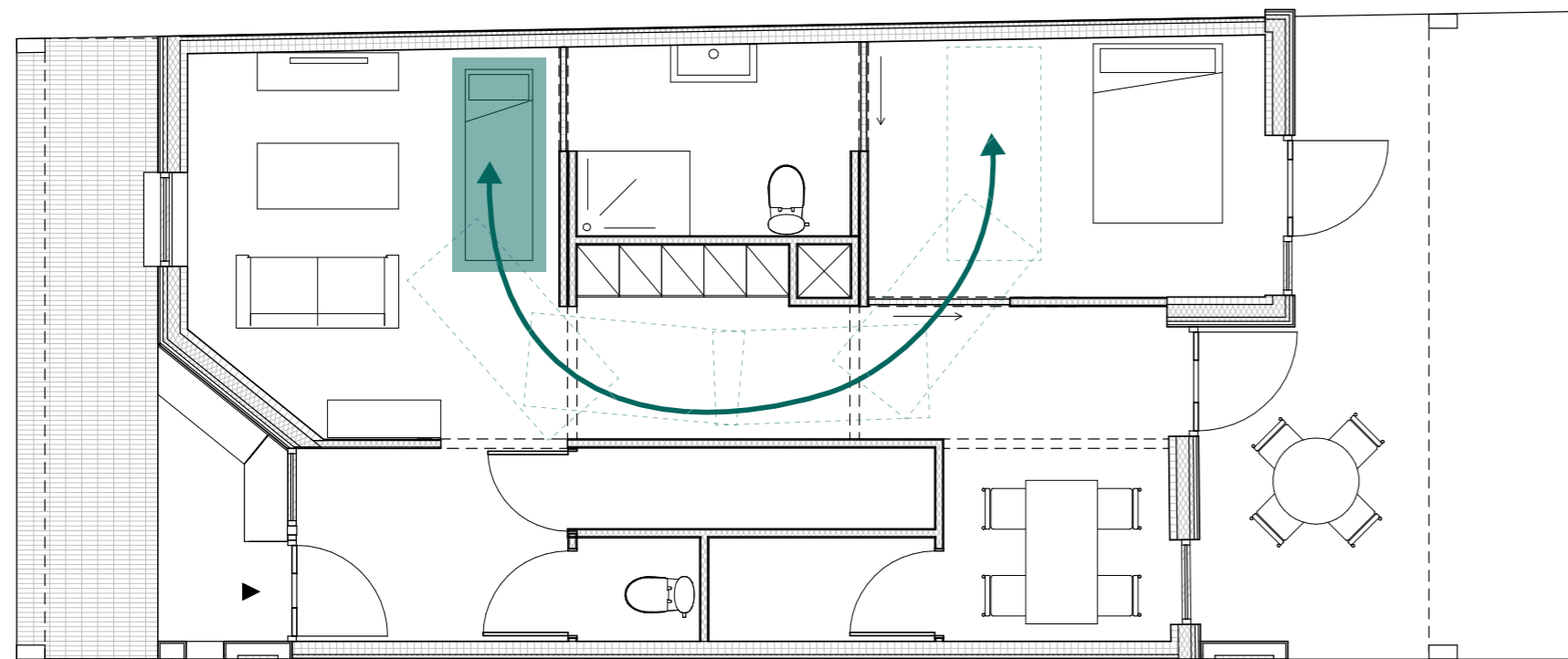
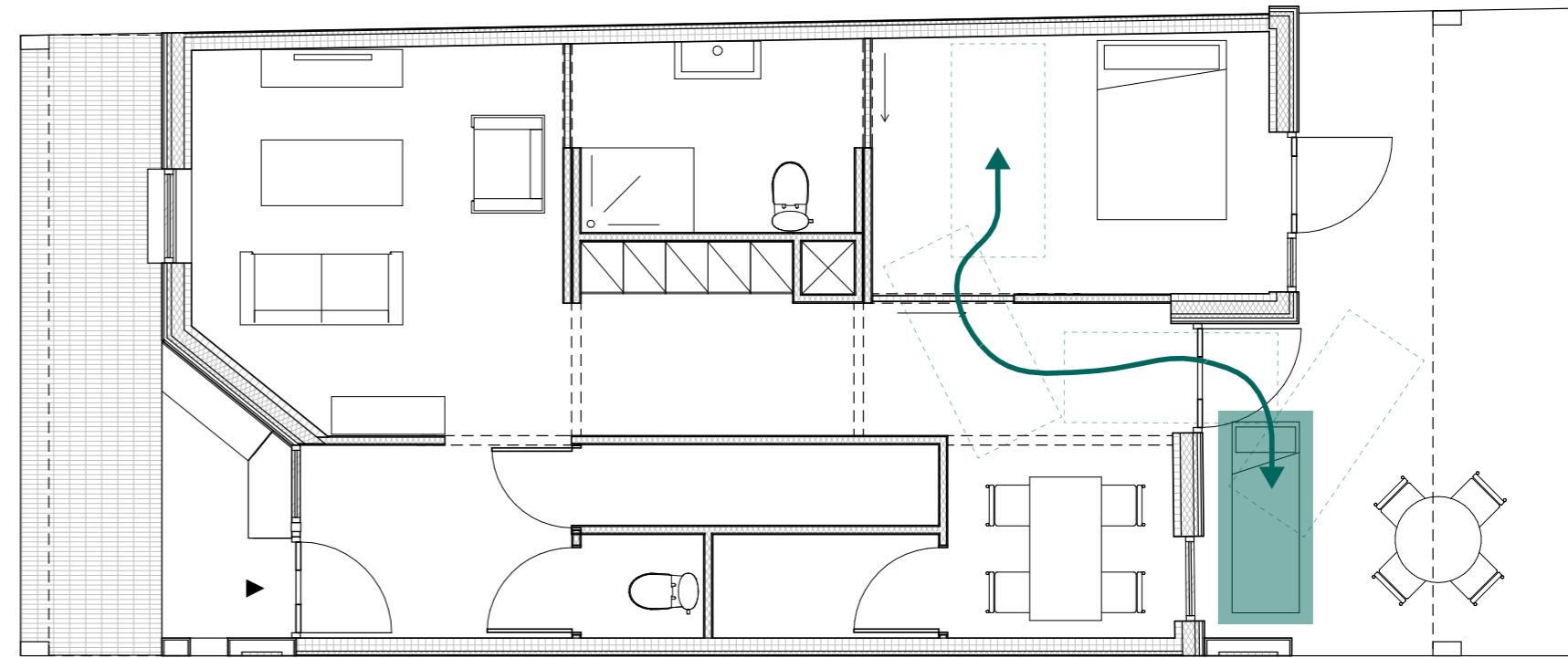
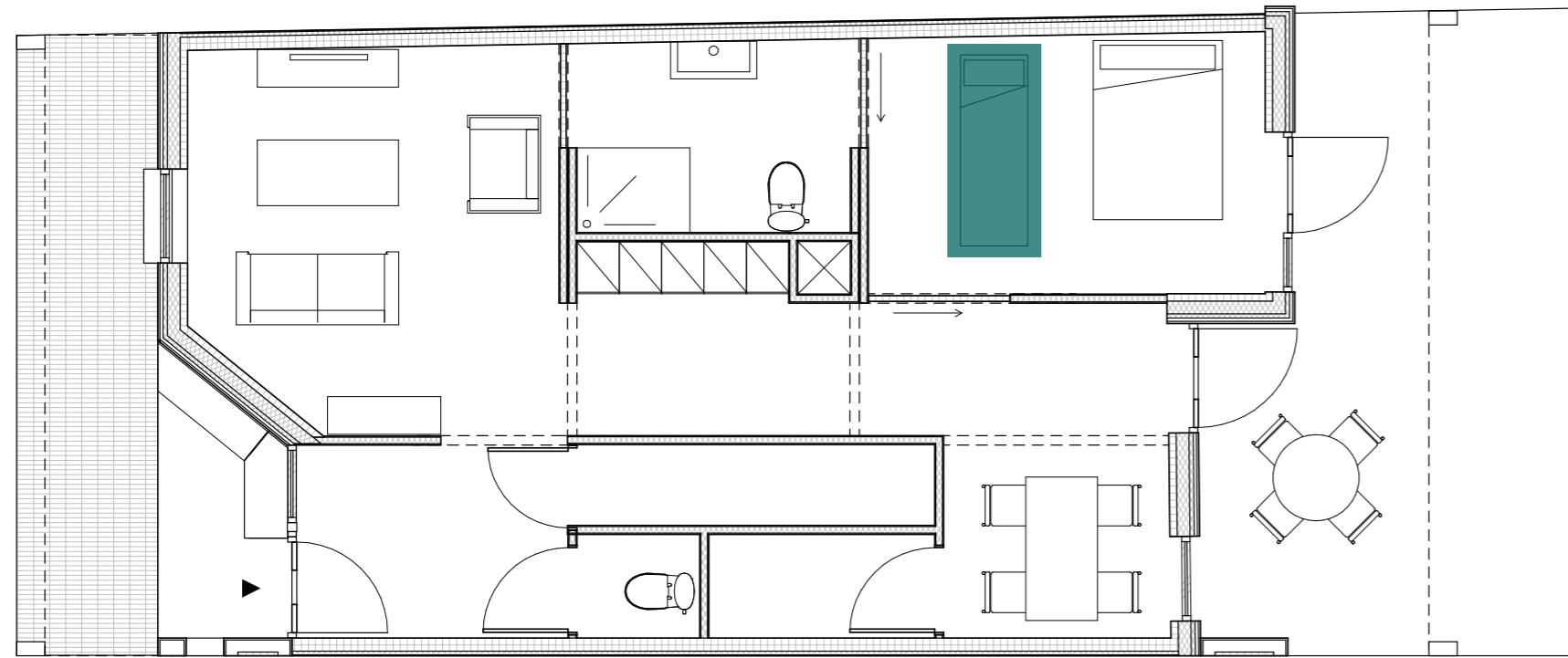



Is dit de toekomst?

1V EenVandaag Actueel Video & audio Opiniëpanel De Peiling Contact avrotros

Actueel > Door verdwijnen verzorgingshuis moeten ouderen langer thuis blijven wonen: 'Er is geen alternatief meer'

Door verdwijnen verzorgingshuis moeten ouderen langer thuis blijven wonen: 'Er is geen alternatief meer'

15-01-2020 11:03 | [Zorg en leven](#) | Auteur: [Miriam Heijenga](#)



Bron: EenVandaag

 "Geachte minister De Jonge, toen ik mijn dromen voor het nieuwe jaar overpeinsde, kwam ik tot één wens: een eigen leven. Ik ben al meer dan 10 jaar mantelzorger voor mijn ouders en ik kan niet meer."



EenVandaag, January 15th, 2020

Twentse mantelzorger schrijft hartenkreet aan minister de Jonge: 'Hugo, wat moet ik?'

VRIEZENVEEN - Raghniid Grouwstra (49) uit Vriezenveen is al tien jaar mantelzorger voor haar ouders. Maar het gaat niet meer. In een open brief roept ze minister Hugo de Jonge op om het verzorgingshuis in ere te herstellen.

Wilco Louwes 12-01-20, 13:02 Laatste update: 13:06

Tubantia, Wilco Louwes, 12 januari 2020



de Volkskrant

Columns & Opinie Video Wetenschap Mensen De Gids Cultuur & Me

'Leven zonder liefde, dat kan hier'

Tien jaar lag ze dood in huis, Bep de Bruin. Buurman Jan was blij met zo'n stille buur. Vroeger woonde hij naast een onrustig, groot en buitengewoon lawaaiig gezin

olkskrant, John Schoorl, 30 november, 2013

Bedankt voor uw aandacht!

