

## Generalized Computer Model of Sea, Land and Atmospheric Clutter

Ianovskyi, Felix; Prokopenko, Igor ; Rudiakova, Anna ; Rhee, Huinam

**DOI**

[10.23919/IRS54158.2022.9905001](https://doi.org/10.23919/IRS54158.2022.9905001)

**Publication date**

2022

**Document Version**

Final published version

**Published in**

Proceedings of the 2022 23rd International Radar Symposium (IRS)

**Citation (APA)**

Ianovskyi, F., Prokopenko, I., Rudiakova, A., & Rhee, H. (2022). Generalized Computer Model of Sea, Land and Atmospheric Clutter. In *Proceedings of the 2022 23rd International Radar Symposium (IRS)* (pp. 431-436). IEEE. <https://doi.org/10.23919/IRS54158.2022.9905001>

**Important note**

To cite this publication, please use the final published version (if applicable). Please check the document version above.

**Copyright**

Other than for strictly personal use, it is not permitted to download, forward or distribute the text or part of it, without the consent of the author(s) and/or copyright holder(s), unless the work is under an open content license such as Creative Commons.

**Takedown policy**

Please contact us and provide details if you believe this document breaches copyrights. We will remove access to the work immediately and investigate your claim.

***Green Open Access added to TU Delft Institutional Repository***

***'You share, we take care!' - Taverne project***

**<https://www.openaccess.nl/en/you-share-we-take-care>**

Otherwise as indicated in the copyright section: the publisher is the copyright holder of this work and the author uses the Dutch legislation to make this work public.

# Generalized Computer Model of Sea, Land and Atmospheric Clutter

Felix Yanovsky

1) Dept. of Electronics, Robotics,  
Monitoring & IoT Technologies  
National Aviation University  
Kyiv, Ukraine  
yanovsky@nau.edu.ua

2) Dept. of Geoscience and Remote  
Sensing, Faculty of CEG  
Delft University of Technology  
Delft, The Netherlands  
F.Ianovskyi-3@tudelft.nl

Igor Prokopenko

Dept. of Telecommunication and  
Radioelectronic Systems  
National Aviation University  
Kyiv, Ukraine  
prokopenko@nau.edu.ua

Huinam Rhee

Dept. of Aerospace Engineering /  
Aerospace Research Center  
Sunchon National University  
Republic of Korea  
hnrhee@scnu.ac.kr

Anna Rudiakova

Dept. of Electronics, Robotics,  
Monitoring & IoT Technologies  
National Aviation University  
Kyiv, Ukraine  
rudiakova@nau.edu.ua

**Abstract**—The generalized mathematical and computer model of clutter is developed. It is based on K-distribution and can be used for simulation of sea, atmospheric, and land clutter with different characteristics. Examples of model application for testing rank algorithm for clutter suppression are considered and analyzed.

**Keywords**—radar clutter, K-distribution, clutter suppression, rank algorithm

## I. INTRODUCTION

The performance of radar for the separation of different targets is normally decreased substantially under the conditions of sea, land or atmospheric clutter presence. The problem of suppressing nonstationary interference or reducing their impact on the characteristics of the equipment arises in the design and operation of the vast majority of information measuring radio-electronic systems. Usually this is solved by constructing adaptive band-stop filters using Fourier transformation. Most known methods and algorithms provide high effectivity in the case of Gaussian probability distribution of interferences, in particular clutter. With deviations from the Gaussian distribution, which often happens in real situations, and especially under the influence of impulse noise, the effectiveness of these methods dramatically worsens and leads to information losses. System noise immunity can be increased by applying non-parametric methods and algorithms for signal processing.

The beginning of research in this area of mathematical statistics can be attributed to the 60s of the last century [1, 2]. Since the 70s of the twentieth century, the attention of radar equipment developers during several years was attracted to robust statistics, the theory of order statistics and rank rules. Some results in this direction are presented in [3 – 6]. These works devise ideas for the removal of abnormal data deviating from the Gaussian model or methods of heuristic nonlinear processing using statistics of signals and noise based on order statistics. Later due to different reasons these ideas seemed not enough important and were not used in practice. Today the reality is different. New modern level of science and technology has changed the situation drastically. Analysis of recent publications and conference materials indicates a great interest in non-parametric methods and algorithms [7 – 11].

In order to design effective methods for the clutter suppression, the adequate enough models of different clutter

phenomena should be built first. These models should be able to take into account the possible non-Gaussian and nonstationary character of the scattered response in case of high-resolution radar, as well as the spectral/correlation properties.

Despite, the problem of clutter investigation, description and simulation is studied at least during the recent half of century by many researchers [12 – 15], the task of adequate and universal modelling clutter is still actual for the different scattering conditions such as sea, land and atmosphere.

This article is devoted to the development of a generalized mathematical and computer models of clutter in case of their different sources, in particular sea, land, and rain. As an example of possible applications of the model we consider testing of a rank non-parametric algorithm for suppressing all these kinds of clutter.

## II. GENERALIZED CLUTTER MODEL

### A. Compound K-distribution

Compound K-distribution clutter model allows the physical interpretations unlike the Weibull or the Log-Normal models. Moreover, it allows to take into account correlation properties [12] and spectral characteristics of the clutter conditions that is really important. Considered K-distribution is able to represent a Rayleigh process with mean power averaged by the Gamma distribution [13]:

$$f(E) = \int_0^{\infty} f(E|x) f_g(x) dx, \quad 0 \leq E \leq \infty \quad (1)$$

where  $f_g(x) = \frac{b^\nu}{\Gamma(\nu)} x^{\nu-1} \exp(-bx)$ ,  $0 \leq x \leq \infty$  is the Gamma

distribution of the local power with shape parameter  $\nu$  and scale parameter  $b$ , and  $f(E|x) = 2E/x \cdot \exp(-E^2/x)$ ,  $0 \leq E \leq \infty$  is a Rayleigh distribution of the mean power  $x$ .

The resulting form of the K-distribution can be written as:

$$f(E) = \frac{4b^{(\nu+1)/2} E^\nu}{\Gamma(\nu)} K_{\nu-1}(2E\sqrt{b}), \quad 0 \leq E \leq \infty \quad (2)$$

with  $K_{\nu-1}(\cdot)$  as the modified Bessel function.

The simplified diagram of the algorithm for K-distributed samples generation is shown in Fig. 1.

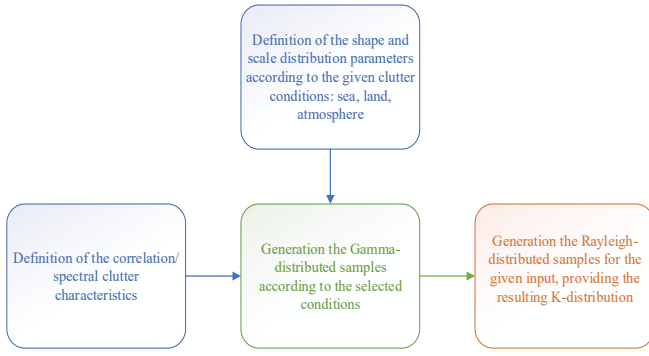

Fig. 1. Simplified diagram of the algorithm for the generation of K-distributed samples

Below we shall see that under the condition of corresponding values of just two parameters, namely shape and scale parameters, for given kinds of clutter (sea, land, and atmosphere), expression (2) can be accepted as the generalized clutter model.

### III. CLUTTER MODEL PARAMETERS

#### A. Sea Clutter

The relation for the shape parameter  $\nu$  definition that is based on the empirical model is proposed in [13]:

$$\log_{10}(\nu) = \frac{2}{3} \log_{10}(\phi_{gr}^o) + \frac{5}{8} \log_{10}(A_c) - k_{pol} - \frac{\cos(2\theta_{sw})}{3}, \quad (3)$$

where  $\phi_{gr}^o$  is the grazing angle,  $A_c$  is the illuminated area of the clutter zone (depends on the slant range, antenna pattern, grazing angle, and range resolution),  $k_{pol}$  depends on the polarization of the sounding waveform,  $\theta_{sw}$  is the angle between the radar beam and swell direction.

The shape  $\nu$  and scale  $b$  factors of K-distribution are related with the power of the clutter  $P_c = \nu/b$ , which can be expressed in a usual form by the radar equation (as an example, suppose that we are dealing with the sea clutter):

$$P_c = \frac{P_t \mu_c G^2 \lambda^2 \sigma^0 A_c}{(4\pi)^3 R^4 L_a L_\mu} \quad (4)$$

where  $P_t$  is the radar transmitting power,  $\mu_c$  is the pulse compression factor,  $G$  is the antenna gain,  $\lambda$  is the radar wavelength,  $\sigma^0$  is the normalized sea clutter RCS,  $L_a$  and  $L_\mu$  are the propagation and radar system losses.

According to [14] the normalized RCS  $\sigma^0$  of the sea surface for the horizontal (HH) and vertical (VV) polarizations can be represented as:  $\sigma_{HH}^0 = 10 \log_{10}(\lambda \phi_{gr}^{0.4} A_i A_u A_w) - 54.09$ ;  $\sigma_{VV}^0 = \sigma_{HH}^0 - 1.05 \ln(h_{av} + 0.015) + 1.09 \ln(\lambda) + 1.27 \ln(\phi_{gr} + 0.0001) + 9.7$ , where  $A_i$  is the multipath interference parameter,  $A_u$  depends on wind direction, and  $A_w$  represents the variation on the sea state. In more detail, these parameters are defined by the following expressions:

$$A_i = \sigma_\phi^4 / (1 + \sigma_\phi^4), \quad (5)$$

$$A_u = \exp(0.2 \cos(\theta_w) (1 - 2.8 \phi_{gr}) (\lambda + 0.015)^{-0.4}), \quad (6)$$

$$A_w = [1.94U / (1 + 0.065U)]^{1.1 / (\lambda + 0.015)^{0.4}}. \quad (7)$$

In the above expressions, roughness parameter  $\sigma_\phi$  and wind velocity  $U$  are given as following:

$$\sigma_\phi = (14.4\lambda + 5.5) \frac{\phi_{gr} h_{av}}{\lambda}, \quad (8)$$

$$U = 3.16s^{0.8}, \quad (9)$$

where  $h_{av} = 0.00452U^{2.5}$  is average wave height, while  $s$  corresponds to the sea state. Thus, we use parameter  $s$ , that is, the sea state as the sea clutter criterion. Description of the sea state  $s$  (from 1 to 7) is given in Table 1.

TABLE I. SEA CLUTTER CRITERION AS THE SEA STATE

Sea state (grade) $s$	Description	Wave height, m
1	calm-rippled	0–0.1
2	smooth-wavelet	0.1–0.5
3	slight	0.5–1.25
4	moderate	1.25–2.50
5	rough	2.5–4.0
6	very rough	4–6
7	high	6–9

An example of modelling results for the sea clutter is given in Fig. 2. It was calculated for the following conditions: sea state  $s=6$ ; carrier frequency is 10GHz; polarization is vertical; transmitting power equals 500W; wind direction angle is  $30^\circ$ .

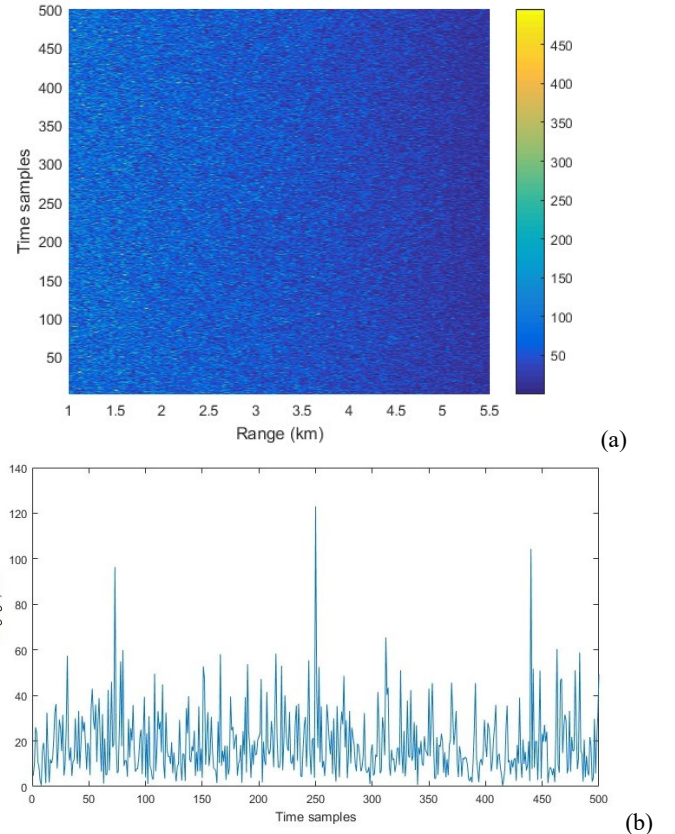

Fig. 2. Example of the sea clutter reflectivity simulation: (a) slant range varies from 1 to 5.5 km; (b) time sample slice for the 5.5 km slant range.

In Fig 2a, the chaotic distribution of the simulated sea clutter over the field 'slant range - time' is represented. The intensity of clutter is coded by colour in accordance with the scale shown on the right in millivolts (a voltage at the output of a detector). One can see that on average the intensity of unwanted reflection is slightly decreasing with increasing range. At the fixed range, the clutter 'signal' fluctuates in time as is shown in Fig. 2b.

### B. Land Clutter

Reflective properties of land are described by  $\sigma^\circ$ , RCS per unit area. It depends on ground complex permittivity (conductivity and permittivity), surface roughness and inhomogeneity. Huge amount of numerical data on the reflective ability of different kinds of land have been published [9]. From the point of view of radar designers and researchers it is reasonable to define the characteristics of land clutter independently on the specific type of terrain. This is because of two circumstances: 1) a radar system should keep the required performance in various places and situations; 2) very often even relatively small areas of terrain as a clutter source are very complex and mixed. The character of the influence of such factors as the grazing angle, carrier frequency, polarization and resolution are quantified regardless of the specific type of terrain. In particular, the empirical fitting results of the various land clutter conditions are adopted for using Weibull distribution in [13]. However, as our approach supposes using a generalized model based on K-distribution for all three wide classes of clutter (sea, land and atmosphere), an adequate transition from Weibull to K-distribution model should be done. This can be implemented on the basis of the relation between the K-distribution shape parameter  $\nu$  and Weibull distribution shape parameter  $a_w$  :

$$\frac{1}{\nu} = \frac{\Gamma(1+2a_w)}{2\Gamma^2(1+a_w)} - 1. \quad (10)$$

This equation [15] gives good transition to desirable K-distribution parameter, and Weibull shape parameter  $a_w$  data are given in [15] at different grazing angles.

### C. Atmosphere Clutter

There are many different atmospheric formations that may be sources of clutter. However, the most powerful clutter in the atmosphere is definitely from strong rain. That is why in this consideration of the atmospheric clutter we will limit by the case of rain only, though more sophisticated scenarios with consideration non-spherical particles and atmospheric turbulence, taking into account spectral and polarimetric characteristics of signals are quite possible [16, 17, 18].

The rain is characterized by the rain rate. Clutter intensity due to rain can be estimated using shape parameter of K-distribution  $\nu = 1.5$ . This was determined according to expression (4) for Weibull shape parameter  $a_w = 2$ . It is interesting that at  $a_w = 2$ , Weibull distribution coincides with Rayleigh distribution. That is, for rain, at  $\nu = 1.5$  K-distribution is reduced to a form, close to Rayleigh distribution. Second K-distribution parameter, the scale coefficient  $b$ , should be determined based on the reflected power  $b = \nu / P_c$ . Obviously,

the reflected power  $P_c$  is estimated with application of radar equation (4) for corresponding normalized RCS of the rain (over the unit of volume). An empirical expression can be used to couple the relative reflectivity of rain clutter  $\sigma_r$ , with rain rate  $R$  in mm per hour:  $\sigma_r = \alpha R^\beta$  where  $\alpha = 1.3 \cdot 10^{-8}$  and  $\beta = 1.6$  are empiric coefficients.

## IV. MATLAB/SIMULINK CLUTTER MODEL DEVELOPMENT

The computer software was developed to implement the math models described above. The software is implemented in Matlab/Simulink with friendly interface. It gives a possibility to select kind of clutter (sea, land, atmosphere) and to set the intensity of the selected clutter, for example the state of the sea. The software consists of the units to implement different tasks, such as setting: radar parameters; clutter mode and K-distribution model parameters calculation; clutter generation in accordance with particular setting. Moreover, the software is able to generate a reflected signal from a target and simulate a signal detection procedure to demonstrate clutter suppression using the locally optimal rank detector [19]. The scheme of the software for clutter modeling in accordance with the described approach is shown in Fig. 3.

## V. APPLICATION OF THE MODEL

The developed math models and the software can be applied to solve different tasks, in particular to test algorithms for clutter suppression. As an example, we consider testing nonparametric rank algorithm described in detail in [19] as an effective instrument for clutter suppression. This is a locally optimal rank detector, structure of which is shown in Fig. 4 [19, 20].

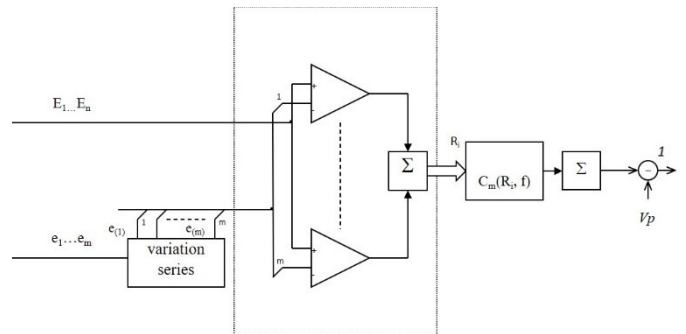

Fig. 4. Structural diagram of a locally optimal rank detector.

The sequence of samples of the envelope (signal)  $E$  (ie, reflected signal from a range bin that is being tested at the moment) is fed to the input of the Rank Calculator unit, which consists of  $m$  Comparators and Adder. This signal is fed to the positive (+) inputs of the comparators. The negative (-) inputs of the comparators are fed with  $m$  clutter samples (for example, reflections from adjacent range bins), which previously are ranked in the Variation Series unit. Thus, each signal reading is compared to  $m$  clutter samples on comparators. The outputs of the comparators are summed on the adder, the output of which forms the reference rank of the envelope  $R$ .

Block  $C(R, f)$  calculates the value of the function from the ranks accumulated in the adder  $\Sigma$ , and the calculated value is compared with the decision threshold  $V_p$  on the presence or absence of a target [19].

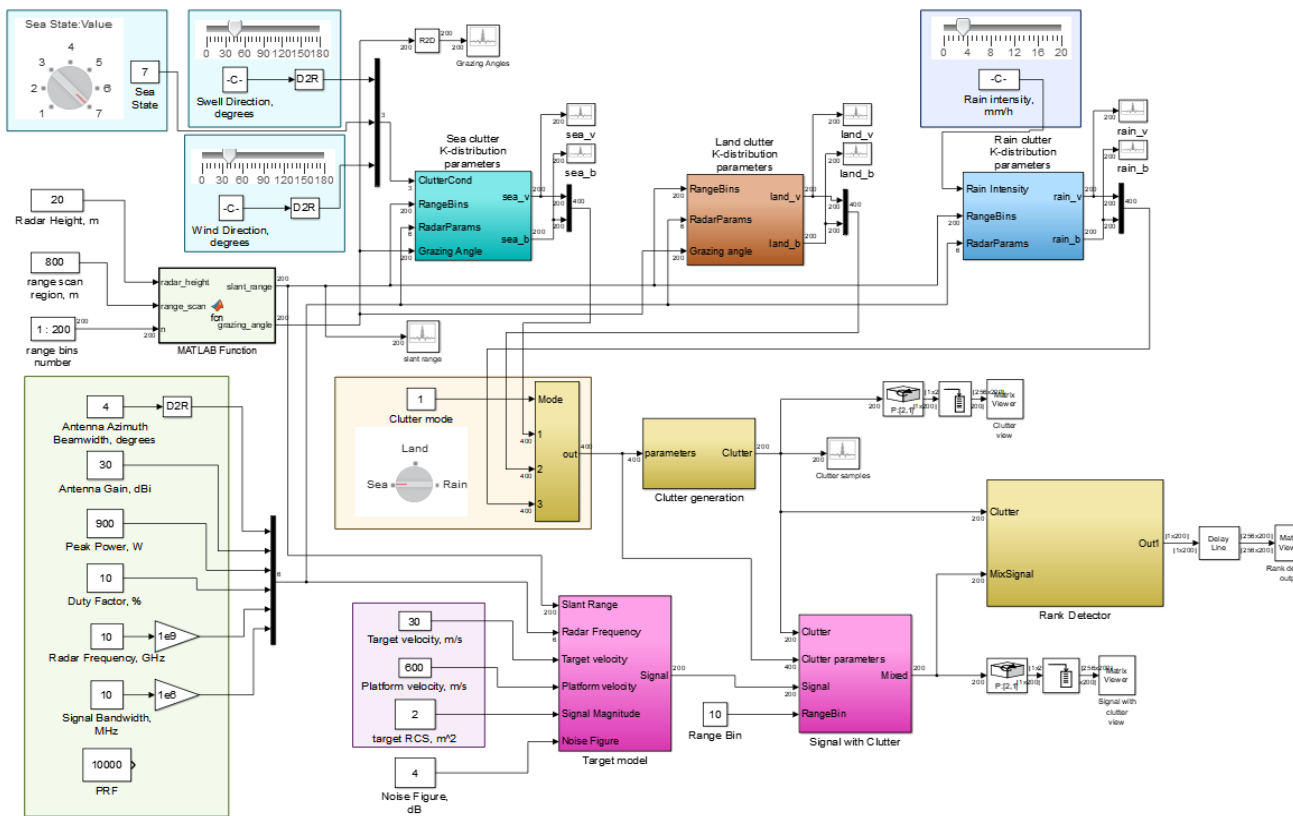

Fig. 3. Matlab/Simulink generalized clutter model.

The visualizing blocks are included into the model to show all necessary information such as the K-distribution parameters, examples of clutter 'signal', the 2D views of the clutter evolution for the selected range-bins, as well as the mixture of clutter & target signal and the suppressed clutter cases. Example simulation results for different initial data are shown below. In Fig. 5 and 6, X-axis indicates range bin numbers, Y-axis indicates time in pulse repetition period numbers, Z-axis (in color scale) shows the intensity.

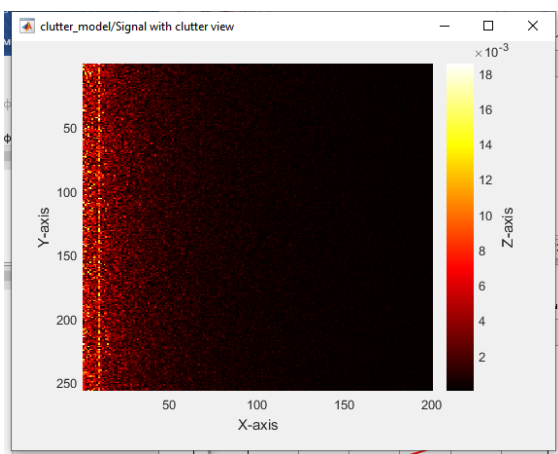

Fig. 5. Sea case. Mixture of clutter and target signal. Sea state 3, target RCS 2 m<sup>2</sup>, radar height 20 m, slant range 150 m (10<sup>th</sup> range bin, 15 m each).

In Fig.6, one can see the same situation as was shown in Fig. 5, however in this case the locally optimal rank detector, described above (see Fig. 4) is switched on for clutter suppression.

This is resulted in clear detection of the target in the correspondent range bin in all pulse repetition periods that forms a white strait line. Alternatively, the sea clutter in all other range bins is reliably suppressed in this case.

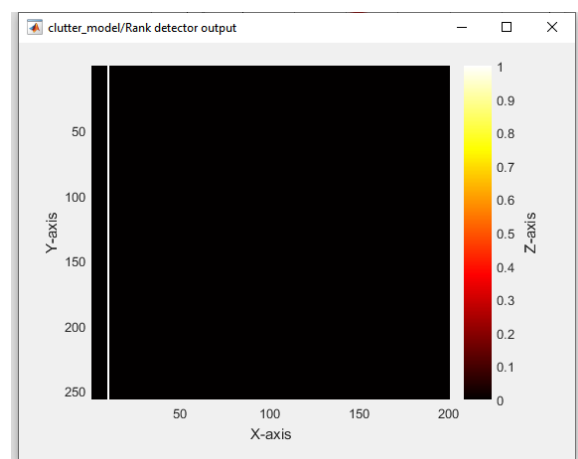

Fig. 6. Sea case. Mixture of clutter and signal. Sea state 3, target RCS 2 m<sup>2</sup>, radar height 20 m, slant range 150 m. Clutter suppression result.

The developed software allows also to demonstrate 2D mixture of a target signal and the clutter, as well as a result of target detection in range and azimuth. In this case the target is represented by the rectangle, whose sides are given in the Simulink by selection the desired range and azimuth regions. Examples of simulation results are shown in Fig. 7 and 8. At these examples, in particular, it is supposed that a target occupies 2 range bins and 10 azimuth bins. However, different bin numbers and location of the target can be easily set in the Simulink model.

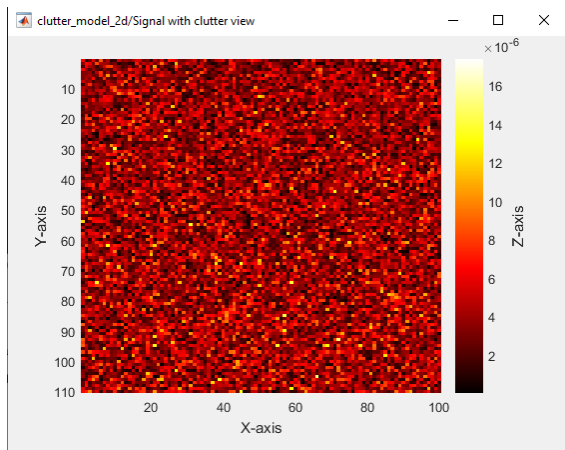

Fig. 7. Sea case. Mixture of clutter and signal. Sea state 5, target RCS  $30 \text{ m}^2$ , radar height 2 km, slant range 11.9 km.

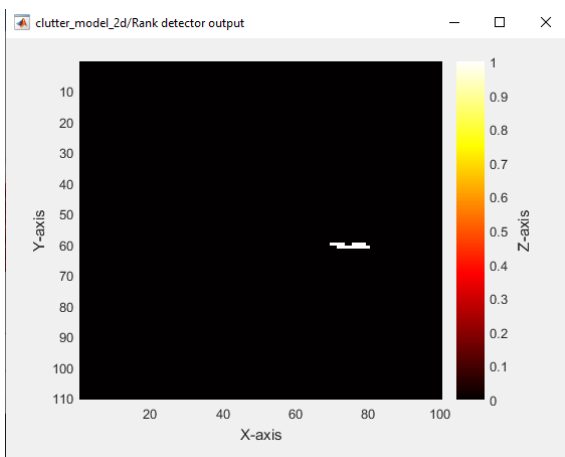

Fig. 8. Sea case. Mixture of clutter and signal. Sea state 5, target RCS  $30 \text{ m}^2$ , radar height 2 km, slant range 11.9 km. Clutter suppression result.

In Fig. 7, the target is practically invisible in the mixture. However, it is clearly detected in Fig.8 as a result of clutter suppression.

Example of rain clutter simulation is done in Fig. 9 and 10. In this case (Fig.9) a rather “small” target is not seen practically on the background of 10 mm per hour rain, when Signal-to-Clutter Ratio (SCR) is -2 dB. However, the target is clearly detected, using the rank algorithm at sample size  $N=64$  as is illustrated (Fig. 10).

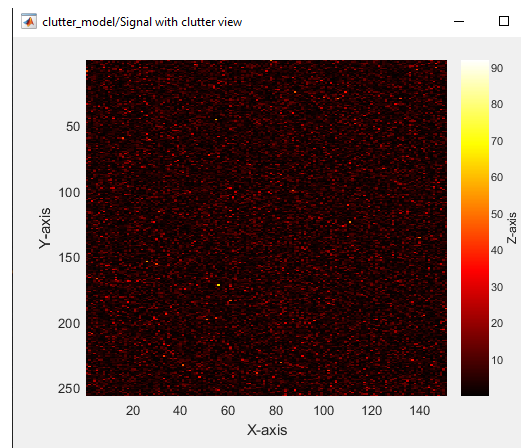

Fig. 9. Rain case. Mixture of clutter and signal.  $R= 10\text{mm/h}$ ,  $\text{SCR}= -2\text{dB}$ .

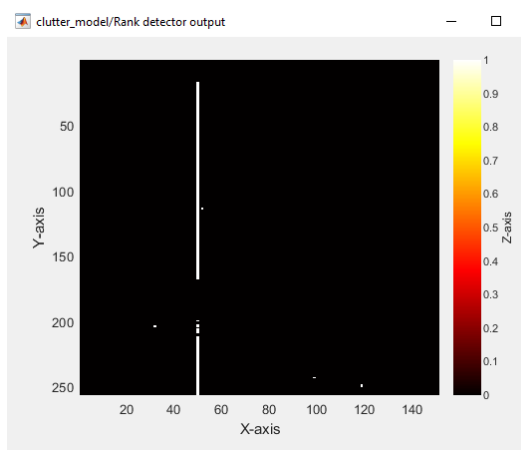

Fig. 10. Rain case. Mixture of clutter and signal.  $R= 10\text{mm/h}$ ,  $\text{SNR}= -2\text{dB}$ ,  $N=64$ . Clutter suppression result.

The most reasonable way to estimate the effectivity of clutter suppression in such case is making analysis of detection characteristics on the background of clutter. As an example, we calculated the detection characteristics of the signal on the background of clutter using statistical simulation (Monte-Carlo method). The visualizing block presented in the model shows the detection probability calculated for the given radar system, target and clutter parameters at the fixed slant range to the target.

Examples of simulation results are shown in Fig. 11. They were simulated for the case of atmospheric clutter, in particular, rain of 10 mm per hour rain rate, which was illustrated in Fig. 9.

Each detection characteristic was simulated at different sample size ( $N= 8, 16, 32,$  and  $64$ ). False alarm probability is approximately  $10^{-4}$  for all cases. X axis represents SCR and Y axis is detection probability. If antenna pattern is in stable position, the time of one forming the sample is equal to  $NT$  with  $T$  as the pulse repetition period (PRP).

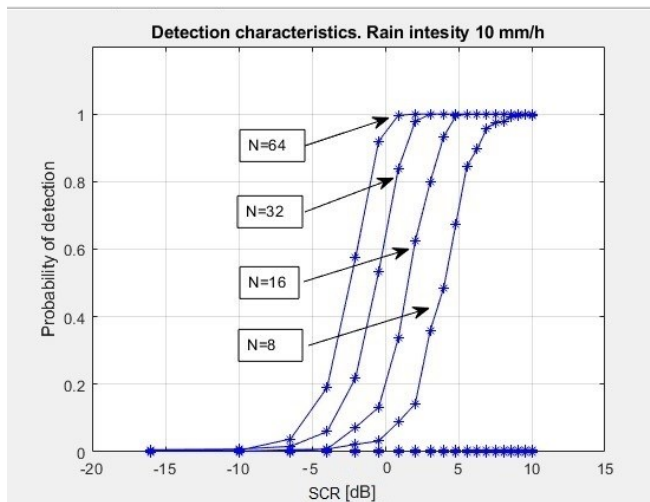

Fig. 11. Rain case. Detection characteristics by rank algorithm. Harmonic signal on the background of rain clutter. Rain rate  $R = 10$  mm per hour. False alarm probability  $F = 10^{-4}$ . Here  $N$  is the sample size.

Thus, the curve at  $N=64$  in Fig. 11 corresponds to the case illustrated in Fig. 10. From this curve one can see that at  $SCR=-2$  the probability of detection is approximately 0.8. In order to reach the same probability of detection for shorter time of observation, for example during 8 PRP, the SCR should be a little bit more than 5 dB.

Considered examples show that the developed computer model of clutter can be successfully used to solve various tasks of clutter simulation, testing and compare different signal processing algorithms for signal detection on the background of clutter, or clutter suppression.

## VI. CONCLUSION

The math models for the sea, land, and atmosphere clutter have been generalized on the base of the K-distribution. A universal computer model has been developed for simulation of various kinds of clutter (sea, land, and rain).

The Matlab/Simulink clutter model has been built. The distributions of its shape and scale parameters have been defined for the sea clutter, for the general mixed rural terrain (land clutter), and for the atmospheric clutter accounting rain rate (intensity of rain).

A software tool for investigation of different situations related with clutter simulation and suppression has been developed. This tool includes the additional Matlab/Simulink model that allows to build the detection characteristics which are suitable for estimation of clutter suppression effectivity. The developed software has friendly interface and is suitable for further modernization.

The Matlab/Simulink model of locally optimal rank detector has been combined with the universal clutter model. This detection algorithm has been used for clutter suppression as a nonparametric robust detection algorithm suitable for suppressing different kinds of clutter especially under the condition of non-Gaussian clutter that often happens in real situations.

The effectivity analysis of clutter suppression has been conducted as one of possible applications of the software developed.

## ACKNOWLEDGMENT

This article reflects some results of the international joint project of the National Aviation University, Kyiv, Ukraine

and The Department of Aerospace Engineering & the Industry-Academy Cooperation Foundation (IACF) of the Suncheon National University (SCNU), Republic of Korea.

## REFERENCES

- [1] E.A. Korniliev, "Nonparametric methods for detecting radar signals against a background of Gaussian noise with unknown dispersion," *Issues of aviation radio engineering (Voprosy aviatsionnoy radiotekhniki)*, No. 6, Kyiv, Ukraine, pp. 28-30, 1971 (in Russian).
- [2] R.V. Hogg, "Adaptive Robust Procedures: A Partial Review and Some Suggestions for Future Applications and Theory," *Journal of the American Statistical Association*, 69 (348), 1974, pp. 909-923.
- [3] P.J. Huber, *Robust statistics*, New York: John Wiley & Sons, Inc., 1981, 2nd ed., Wiley, 2009.
- [4] H. Rohling, "Radar CFAR Thresholding in Clutter and Multiple Target Situations," *IEEE Trans. on AES*, Vol. 19, No. 4, pp. 608-621, July 1983.
- [5] E.A. Kornil'ev, I.G. Prokopenko, and V.M. Chuprin, *Stable algorithms in automated information processing systems (Ustoychivyye algoritmy v avtomatizirovannykh sistemakh obrabotki informatsii)* Kyiv, Ukraine: Tekhnika, 1989, 224 pp. (in Russian).
- [6] B. Leibe, A. Leonardis, and B. Schiele, "Robust object detection with interleaved categorization and segmentation," *International Journal of Computer Vision (IJCV)*, 77 (1-3), pp. 259-289, 2008.
- [7] M. Tao, F. Zhou, J. Liu, Y. Liu, Z. Zhang, and Z. Bao, "Narrow-Band interference mitigation for SAR Using Independent Subspace Analysis," *IEEE trans. GRS*, vol. 52, no. 9, pp. 5289-5301, Sep. 2014.
- [8] L.P. Ligthart, F.J. Yanovsky, and I.G. Prokopenko, "Adaptive algorithms for radar detection of turbulent zones in clouds and precipitation," *IEEE Trans. on AES*, Vol. 39, No1, pp. 357-367, 2003.
- [9] R.B. Sinitsyn and F.J. Yanovsky, "Acoustic noise atmospheric radar with nonparametric copula-based signal processing," *Telecommunications and Radio Engineering*, Vol. 71, No. 4, 2012, pp. 327-335.
- [10] R.B. Sinitsyn and F.J. Yanovsky, "MIMO radar copula ambiguity function," European Microwave Week 2012: "Space for Microwaves", EuMW 2012, Conference Proceedings - 9th European Radar Conference, EuRAD 2012, 31 Oct.-2 Nov. 2012, Amsterdam, Netherlands, pp. 146-149.
- [11] R.B. Sinitsyn and F.J. Yanovsky, "Acoustic noise atmospheric radar with nonparametric copula-based signal processing," *Telecommunications and Radio Engineering*, Vol. 71, No. 4, pp. 327-335, 2012.
- [12] C.J. Oliver and R.J.A. Tough, "On the Simulation of Correlated K-distributed Random Clutter," *Optica Acta: International Journal of Optics*, Vol. 33, No 3, pp. 223-250, 1986.
- [13] K.D. Ward, R.J.A. Tough, and S. Watts, "Sea clutter: Scattering, the K distribution and radar performance," *Waves in Random and Complex Media*, Vol. 17, Issue 2, pp. 233-234, 2007.
- [14] S. Watts, K. Ward, M. Greco, "Radar Performance in Clutter - Modelling, Simulation and Target Detection Methods," *EuRAD*, 2016. Available: <https://intranet.birmingham.ac.uk/eps/documents/public/emuw2/WF02.pdf>
- [15] J. Barrie Billingsley, *Low angle radar land clutter: measurements and empirical models*, USA: William Andrew Publishing, 2002.
- [16] F. J. Yanovsky, "Inferring microstructure and turbulence properties in rain through observations and simulations of signal spectra measured with Doppler-polarimetric radars," In: *Polarimetric Detection, Characterization, and Remote Sensing*, M.I. Mishchenko et al. (eds.), NATO Science for Peace and Security Series C: Environmental Security, Springer Science+Business Media B.V., pp. 501-542, 2011.
- [17] A.N. Rudiakova, Y.A. Averyanova, and F.J. Yanovsky, "Advanced Spectral Model of Doppler-Polarimetric Meteorological Radar Signal," The 15th European Radar Conference, pp.107-110, 2018.
- [18] D.N. Glushko and F.J. Yanovsky, "Analysis of differential Doppler velocity for remote sensing of clouds and precipitation with dual-polarization S-band radar," *International Journal of Microwave and Wireless Technologies*, Vol. 2, issue 3-4, pp. 391-398, 2010.
- [19] F.J. Yanovsky, I.G. Prokopenko, A.N. Rudiakova, Huinam Rhee, and A.A. Pitertsev, "Robust Algorithm for Signal Detection on the Background of Strong Passive Interferences," *EuMW-2022, European Radar Conference*, Submitted paper, Milano, Italy, 2022.
- [20] I.G. Prokopenko, *Statistical Signal Processing (Statystychna obrobka sygnaliv)*, Kyiv, Ukraine: NAU, 2009, 250 pp. (in Ukrainian).