

## Integration of Power-to-Gas Conversion into Dutch Electrical Ancillary Services Markets

Suárez, Víctor García ; Rueda, José L.; Tuinema, Bart; Perilla Guerra, Arcadio; van der Meijden, Mart

**Publication date**

2018

**Document Version**

Final published version

**Published in**

12th Conference on Energy Economics and Technology

**Citation (APA)**

Suárez, V. G., Rueda, J. L., Tuinema, B., Perilla Guerra, A., & van der Meijden, M. (2018). Integration of Power-to-Gas Conversion into Dutch Electrical Ancillary Services Markets. In *12th Conference on Energy Economics and Technology* (pp. 1-7)

**Important note**

To cite this publication, please use the final published version (if applicable).  
Please check the document version above.

**Copyright**

Other than for strictly personal use, it is not permitted to download, forward or distribute the text or part of it, without the consent of the author(s) and/or copyright holder(s), unless the work is under an open content license such as Creative Commons.

**Takedown policy**

Please contact us and provide details if you believe this document breaches copyrights.  
We will remove access to the work immediately and investigate your claim.

# Integration of Power-to-Gas Conversion into Dutch Electrical Ancillary Services Markets

Víctor García Suárez<sup>1</sup>, José L. Rueda Torres<sup>1</sup>, Bart W. Tuinema<sup>1</sup>, Arcadio Perilla Guerra<sup>1</sup> and M.A.M.M van der Meijden<sup>1,2</sup>

<sup>1</sup>Delft University of Technology, Delft, The Netherlands

<sup>2</sup>TenneT TSO B.V., Arnhem, The Netherlands

V.GarciaSuarez@student.tudelft.nl, J.L.RuedaTorres@tudelft.nl, B.W.Tuinema@tudelft.nl, A.Perilla@tudelft.nl, Mart.vander.Meijden@tennet.eu

**Abstract**— This paper investigates the viability of the integration of demand side response of large scale electrolyser facilities into electrical ancillary services markets. A review of the current structure and mechanisms of balancing markets, voltage control and congestion management in the Netherlands is presented, taking into consideration future market harmonization measures proposed by transmission system operators of central Europe. The conducted research includes the assessment of the technical adequacy of electrolysers with respect to existing prequalification requirements, as well as basic notions on the expected revenue from participation in these markets. Furthermore, to illustrate the value of electrolyser support for electrical networks, a case study derived from the predicted Groningen-Drenthe-Overijssel area for the year 2030 is developed. This section of the northern Dutch transmission grid includes the upcoming HVDC interconnection with Denmark (COBRACable) and one of the largest offshore wind parks located in the North Sea (Gemini). Computer based simulations are performed with DIGSILENT PowerFactory. The obtained results highlight the potential benefits of electrolyser utilization for power system operation, particularly for frequency control.

**Index Terms**— Power-to-gas, electrolysers, ancillary services, balancing markets, multi-energy sector coupling.

## I. INTRODUCTION

Driven by environmental directives striving for the reduction of CO<sub>2</sub> emissions, the integration of stochastic renewable energy sources is reshaping the operational planning of power systems. Mitigating uncertainty, which imperils the balance of generation and demand, urges the search of new sources of ancillary services (typically provided by bulky synchronous generators). Multi-energy sector coupling reveals promising flexibility solutions for power systems through energy conversion and storage. Specifically, this paper studies the interplay of the electricity and gas sectors, broadly known as power-to-gas, in the context of European Synergy Action TSO 2020 [1].

The high usage of natural gas in the Netherlands, including the presence of one of the leading chemical industry clusters in the world [2], explains why the synergy between the electricity and gas systems raises special interest. In 2017, 16 GW out of 30 GW of installed capacity corresponded to natural gas fired power plants (54%), accounting for 44 TWh out of the 98 TWh of gross electricity generation (45%) [3]. In 2016, the total

natural gas consumption in the country was 33,600 million m<sup>3</sup> and 1980 m<sup>3</sup> per capita [4]. Out of the top members of the EU with highest gross domestic product, the Netherlands owns the most gas dominant energy mix, ahead of Italy (35%). Similarly, Italy (42%) and the UK (40%) come next in total electricity generation with such source. The consumption of natural gas in absolute value is low compared to Germany and the UK (80,500 and 76,700 million m<sup>3</sup> respectively), but the consumption per capita is clearly the greatest, followed by the UK (1180 m<sup>3</sup>).

By using hydrogen as the medium of storage in between conversions, the power-to-gas coupling has the potential to become an attractive flexibility alternative moving forward. As exemplified by Fig. 1, stored hydrogen can be directly used for industry applications, or as feedstock for fuel cell mobility and electricity production. It can also be combined with carbon oxides to form syngas (i.e. methanation), which can be injected into the natural gas network for further household consumption, or electricity generation. The gas infrastructure offers a large storage capacity as well, that could be potentially used to manage seasonal demand by medium to long term storage. Moreover, the actual conversion of electricity into hydrogen (i.e. electrolysis), by means of electrolysers, could emerge as a useful resource as grid ancillary services provider.

This paper aims to provide a comprehensive analysis of ancillary services markets in the Netherlands, in order to outline an appropriate strategy for the integration of electrolysers. The operation of a hypothetical large scale power-to-gas station located in the future Dutch network is also tested, to understand the technical effectiveness of this technology when applied for power system supporting duties.

The organization of the remaining paper is the following: Section II presents a brief overview on the state of the art of PEM electrolyser technology (Polymer Electrolyte Membrane). Section III discusses the framework of ancillary services markets in the Netherlands, the evaluation of the technical adequacy of electrolysers, and the business opportunities that ancillary markets offer. Section IV analyzes the proposed case study. Section V summarizes the conclusions and gives an outlook for future research.

## II. PEM ELECTROLYSER TECHNOLOGY

Over the last few years, electrolyser development has shifted from alkaline to PEM technology due to faster time responses. Research on kilowatt range PEM electrolysers has proved the capability to complete changes of electricity demand within 1 second (hundreds of milliseconds), and to startup and shutdown within minutes [5]. On top of that, reduced load conditions can be maintained for an unlimited amount of time. In the context of the TSO 2020 project, a pilot 1 MW PEM electrolyser recently

This work has received funding from the European Union's Connecting Europe Facility (CEF) programme under the grant agreement No INEA/CEF/SYN/A2016/1336043 – TSO2020 Project (Electric “Transmission and Storage Options” along TEN-E and TEN T corridors for 2020). This paper reflects only the authors' views and the European Commission is not responsible for any use that may be made of the information it contains.



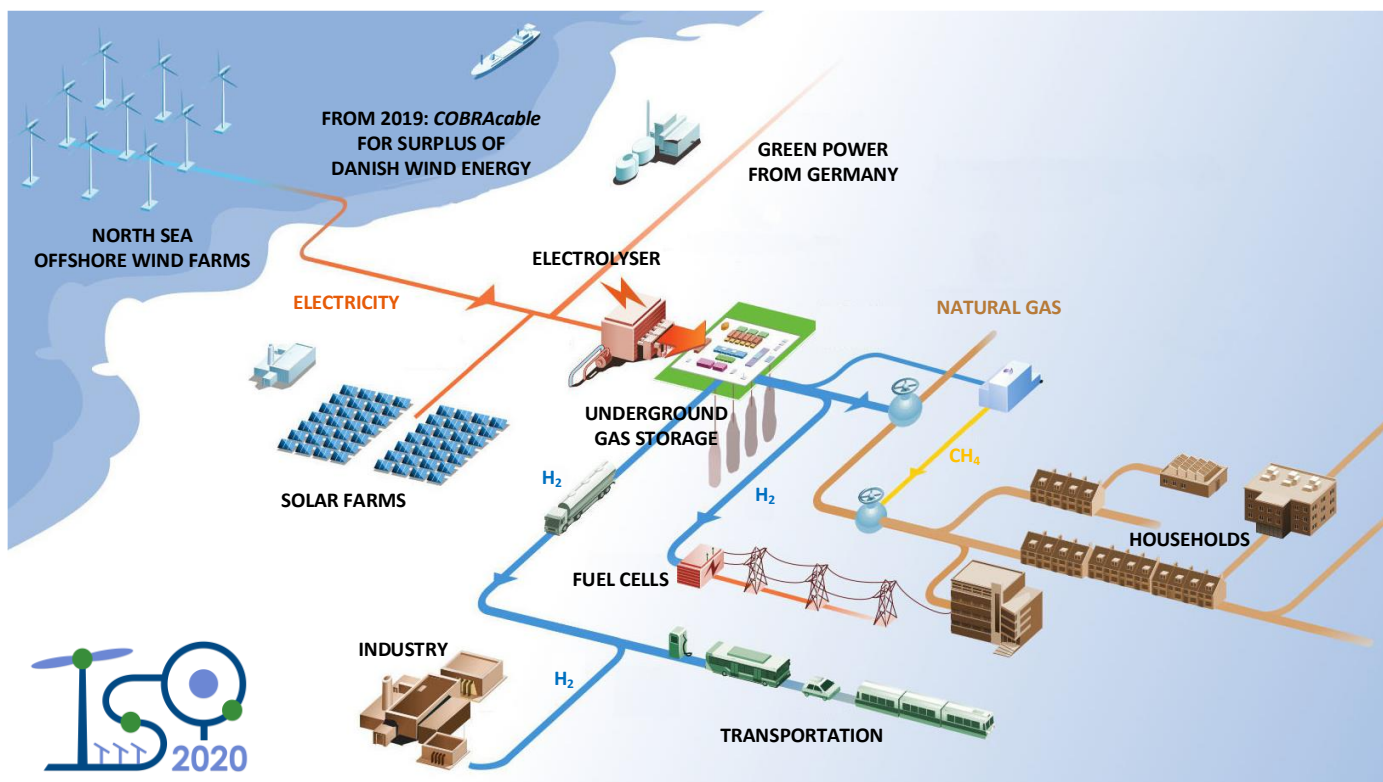

Fig. 1: Concept illustration of Synergy Action TSO 2020. Figure adapted from [1].

installed in Veendam (Groningen) will be used, among other purposes, to gather information about the dynamic performance of larger units and the interaction with the electrical network [6].

As of early 2018, the maximum size of an individual PEM stack is 3 MW [7]. Scalability through a modular approach is currently being adopted in the pursue of 100 MW systems [8]. The efficiency of PEM electrolyzers lies between 75-85%, and it is further influenced by the loading level. The stack and the balance of plant (i.e. other equipment) are the main source of losses for high and low load conditions respectively [8]. The maximum lifetime of a PEM electrolysis stack is roughly 80,000 hours (about 9 years of continuous operation), whereas the rest of the plant can work up to 30 years [9]. In terms of finances, the capital cost (CAPEX) of PEM electrolyzers is valued on 1 M€/MW, with operational costs of 2-5% of the capital cost. As a consequence of economies of scale, CAPEX competitiveness is expected to increase, aspiring to 500 k€/MW midway through the 2020s decade [8].

### III. DUTCH ANCILLARY SERVICES MARKETS

Ancillary services are contracted by transmission system operators (TSOs) to guarantee the correct functioning of the power system, which deals with problems such as frequency or voltage deviations. The procurement of ancillary services around the globe is subjected to the specific framework of each country. The definition of the offered services, contracting methods, instructing procedures, remuneration settlement rules, and prequalification requirements differ from one country to the next, making it hard to develop a joint analysis.

This paper focuses on balancing markets, voltage control and congestion management in the Netherlands. Manual frequency restoration reserve (mFRR), formerly known as tertiary frequency control, is only activated when a severe outage occurs

at a large power plant. In TenneT TSO B.V., mFRR is referred to as incident reserve. Because it is hardly ever used and due to large minimum size required to apply for the available capacity product [10], mFRR is judged as a low interest service for electrolyzers and it is therefore not included in the study.

#### A. Frequency Containment Reserve (FCR)

Commonly known as primary frequency control, FCR serves as the first barrier against active power imbalances. This service is designed to limit frequency excursions within the first 30 seconds after a disturbance, and it is based on the regulation of electricity generation or consumption in response to the change of frequency.

In the synchronous area of continental Europe, an overall capacity of  $\pm 3000$  MW is allocated for FCR, further divided proportionally among the different TSOs. In the Netherlands, FCR is auctioned on the common trading platform Regelleistung [11]. As of 2018, this shared market has an approximate total size of  $\pm 1400$  MW, and it gathers the TSOs from Germany (50Herzt, Amprion, TenneT TSO GmbH and TransnetBW), the Netherlands (TenneT TSO B.V.), Austria (APG), Switzerland (Swissgrid), Belgium (Elia) and France (RTE). Although not currently participating, the Danish operator (Energinet) is also involved in the cooperation group for FCR, thus being able to join the market anytime [12].

In the Dutch control area, the size of FCR was originally  $\pm 101$  MW when TenneT TSO B.V. joined the auction in 2014, and it has progressively grown up to  $\pm 110$  MW in 2017 [11]. This size boost was caused by the subsequent increase in total energy demand and production in the country. Out of the overall FCR capacity, 30% is auctioned exclusively for Dutch providers, while the 70% remaining is actioned in the shared market and physically exchanged through the existing interconnections [11].

The FCR market is constructed around a symmetric capacity product. The minimum bid size is  $\pm 1$  MW and the maximum bid size is the prequalified volume. The auction takes place once a week, and both generators and loads are able to participate in it. Similarly, the product resolution lasts for an entire week, meaning that the providers must commit for that interval of time. Remuneration is based on a pay-as-bid settlement rule, favoring the cheapest offers available [11]. By the end of 2020, this framework will have been modified according to the recommendations of the member TSOs: the auction frequency will be daily, the product resolution will be shortened to 4 hours, and marginal pricing will be the settlement rule [12].

Technically, FCR requests the activation of the full bid within 30 seconds in case of a  $\pm 200$  mHz frequency deviation. For providers without a limited energy supply, FCR support must persist for the entire deviation period. The control implementation is decentralized and follows a classic droop characteristic, so that the change in active power is proportional for smaller frequency deviations [13].

The fast speed performance of electrolyzers indicates notable ability to participate in FCR, as any variation of demand can be achieved within just 1 second. For load suppliers, the control scheme can be designed as an inverse droop characteristic, such that consumption is reduced for a frequency drop and increased for a frequency rise.

### *B. Automatic Frequency Restoration Reserve (aFRR)*

Also referred to as secondary frequency control, aFRR acts right after FCR, in order to restore the active power balance in every control area within 15 minutes after a disturbance. When frequency is below the nominal value, upward regulation is activated. Conversely, downward regulation is requested when frequency sits above the nominal value. aFRR deployment is divided into Programme Time Units (PTUs) of 15 minutes each.

Contrary to the FCR market, no common trading platform exists at the moment, making the framework disparity between countries more noticeable. In the Netherlands, a minimum of  $\pm 350$  MW of aFRR capacity is required for 2018, effectively guaranteed via bilateral contracts of monthly or weekly duration [14]. The offered capacity must be symmetric and must have a minimum size of 1 MW and a maximum size of 999 MW [15]. Suppliers are remunerated on a pay-as-bid scheme [16].

For each PTU, all the contracted parties are obliged to bid their agreed capacity for upward and downward regulation. Additionally, non-contracted suppliers are allowed to send voluntary capacity bids, which in this case can be asymmetric and at least 1 MW in size. When all the bids have been received, they are inserted into a common bid ladder. In the event of an imbalance, the units are activated according to a merit order (i.e. cheapest bids first) [15], and the last participant unit sets the marginal price used to settle the energy usage in the PTU [16]. It is worth mentioning that TSOs pay the suppliers for upward regulation, but suppliers pay the TSOs for downward regulation.

The procurement of aFRR is handled by TenneT TSO B.V. in a centralized manner with Load Frequency Control (LFC). Power setpoints are realized in steps of 1 MW, a minimum ramp rate of 7% of the bid per minute must be provided, and full activation of the bid must be completed within 15 minutes [15]. The speed capabilities of electrolyzers are well above the cited requirements, hence the provision of upward regulation aFRR by reducing consumption is a possibility.

For the next years, the harmonization and development of a joint European aFRR framework is being targeted [17]. In such scenario, a common cross-border merit list would determine the order of energy activation, while cross-border marginal pricing would ideally become the settlement rule (in depth impact study in progress). Another focal point is the mitigation of the uncertainty of renewable energy sources, which will be addressed by shifting the market gate closure time as close as possible to real-time and by shortening the full bid activation time to 5-8 minutes. In the zone of central Europe, some degree of coordination is already implemented through International Grid Control Cooperation (IGCC) [18]. This initiative applies imbalance netting to avoid the simultaneous activation of aFRR in opposite directions among different control areas.

### *C. Voltage control*

The injection or absorption of reactive power is the main mechanism for voltage control in power systems. Generators, transformers, FACTS, HVDC links and several industrial loads can contribute to voltage regulation. In the Netherlands, these sources must act within 15 minutes when commanded [19].

TenneT TSO B.V. manages the use of reactive power based on its own experiences, studies and local needs. For generators with installed capacity  $> 5$  MW, voltage control is a mandatory and contracted service [16]. A yearly tender is organized for external reactive power suppliers, where bilateral contracts for a duration of the entire year can be arranged. Remuneration is settled on a pay-as-bid rule, and depending on the contract terms, a yearly fixed fee or an hourly variable fee is agreed [19].

Since electrolysis stacks are purely DC loads and limited reactive power is consumed by other equipment of the power-to-gas plant, participation in voltage control can be achieved by varying the active power demand of large units. Using the electronic converter to manage reactive power would be a more desirable solution, but an oversized converter would be required to allow working at rated active power simultaneously. For both options though, the response can be completed within 1 second.

### *D. Congestion management*

Dealing with power congestion in transmission lines can be addressed from different angles. Investing in grid infrastructure and making use of available cross-border capacity are strictly internal TSO relieving efforts. On the other hand, power re-dispatch or demand side response depend only on external assets. In TenneT TSO B.V., the enhancement of the grid infrastructure is the current action plan [3]. However, if a congestion issue is identified, a bilateral contract can be drawn with generators or industrial loads [19].

Large scale electrolyzers can contribute to the reduction of critical peak loads by modulating or curtailing their electricity demand. Furthermore, their bidirectional fast ramping capability could potentially help mitigate the fluctuations of renewable energy sources and lessen energy curtailments [5].

### *E. Business model as ancillary services provider*

Power-to-gas systems are conceived to operate during low priced electricity hours to produce cheaper hydrogen than if purchased on the market. The sale of hydrogen and syngas constitutes the principal stream of revenue for this business, which can be supplemented by partaking in ancillary services provision [20].



Since 2015, the increased competitiveness and the inclusion of new technologies in the FCR market (e.g. batteries), have resulted in a progressive decline of prices [3]. Based on the data published in Regelleistung [11], the price evolution in the FCR Dutch exclusive auction during 2017 is displayed in Fig. 2. It is estimated that a supplier contracted for all 52 weeks would have had a revenue of 124-134 k€/MW. Considering that the prices of the joint auction are slightly lower [3], the overall cost of the FCR market in the Netherlands was approximately 13 M€. If marginal pricing was already implemented, it would have translated into a 3% increment in cost for the TSO and revenue for the suppliers.

For energy markets like aFRR, it is more difficult to compute revenue, due to the unpredictability of imbalances and the merit order activation. From the data provided by TenneT TSO B.V. [21], the energy price duration curve for upward regulation in 2017 is plotted in Fig. 3. In total, 51% of the PTUs requested activation, with an average settlement price of 68 €/MWh during off-peak hours (00:00 to 08:00 and 20:00 to 24:00), and a price of 74 €/MWh for the remainder of the day (08:00 to 20:00). For suppliers under contract, the average capacity price in 2017 was 10 €/MWh [3], totaling a revenue of around 88 k€/MW if contracted for the entire year.

Prices for voltage control and congestion management are not available, as they are negotiated bilaterally. Both services are fundamentally dependent on local needs, and therefore the prospect of a market expansion is improbable. For voltage control, electrolyser owners may not be interested in purchasing reactive power compensation equipment or in oversizing the electronic converter if the contracting is not guaranteed.

Conforming with the fast time response of electrolysers and the functioning of ancillary markets, it is deduced that this technology is best suited for FCR participation. From 2020, the shortening of the FCR product resolution to 4 hours will benefit the operational flexibility of suppliers. For power-to-gas plants, this opens up the opportunity to provide FCR support while exploiting cheap electricity (e.g. at off-peak hours, at night). The implementation of asymmetric bidding would give even more freedom to suppliers, as being able to bid exclusively for either upward or downward regulation would allow an optimal use of available capacity. Nevertheless, asymmetric bidding is not planned for the next years because of the consequent increase in market complexity [22]. Concerning remuneration, capacity payments tend to be more attractive than energy payments. Nonetheless, engaging in the aFRR market through voluntary bidding for upward regulation should be considered a feasible option for electrolysers.

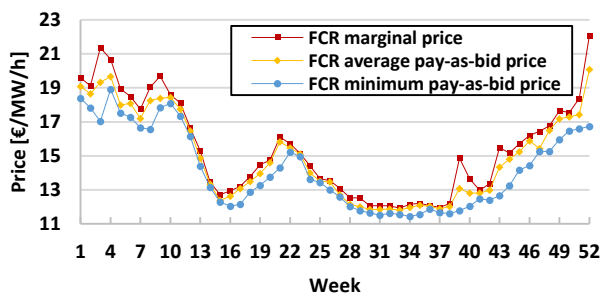

Fig. 2: FCR price in the Dutch exclusive auction in 2017.

As last remark, several countries are creating new products for fast frequency regulation purposes. For instance, the UK has launched the Enhanced Frequency Response (EFR) service, which demands providers to change their output power within 1 second [23]. Likewise, future procurement of balancing services in Ireland will reward suppliers able to respond within 150 to 300 milliseconds [24]. Technically, electrolysers should be able to cope with such tasks if products of similar characteristics were to be developed in other European markets at some point.

#### IV. CASE STUDY

##### A. The test system: Groningen-Drenthe-Overijssel area (2030)

To evaluate the influence of large scale power-to-gas support on power system performance, a case study set in the northern region of the Netherlands is proposed. The test system, shown in Fig. 4a, covers the electrical transmission grid in the future Groningen-Drenthe-Overijssel area. The network was modeled in PowerFactory in accordance with TenneT TSO B.V.'s expected technical evolution, topology, electricity demand and operating conditions for the year 2030, as reported in [25].

In the considered scenario, conventional generation is kept to a minimum level to account for its progressive phase out. A substantial share of the total electricity demand comes from the excess hydro and wind power from Norway and Denmark respectively, and it is imported via NorNed (700 MW) and COBRACable (700 MW) HVDC links. The installed capacity in the network is divided between Gemini wind park (600 MW) and a combined cycle gas turbine power plant (525 MVA). Meanwhile, a large scale power-to-gas conversion facility (300 MW) is located in Eemshaven.

The single line diagram of the test system is illustrated in Fig. 4b. The electrolysers of the power-to-gas plant (P2G) were modeled as an aggregated dynamic load, capable of ramping up and down within 1 second to complete any power setpoint change. The combined cycle gas turbine power plant (CCGT) and the wind park are generic models of their respective technologies. Both HVDC links were represented as a voltage source to only depict the power transfer. Regarding the loading, equivalent demand models for the 220 kV northern ring, the northeastern interconnection with Germany and the rest of the 380 kV network were implemented.

Previous research has outlined how the size and location of fast demand side response with electrolysers can influence power system stability [26]. In this case study, the effectiveness of power-to-gas conversion for FCR provision, the prospect for voltage control and congestion management in the area for 2030, and the interaction with renewable energy sources are examined.

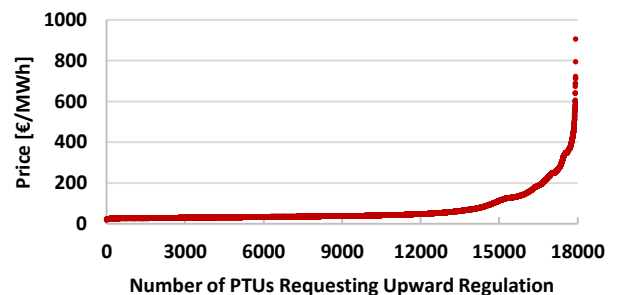
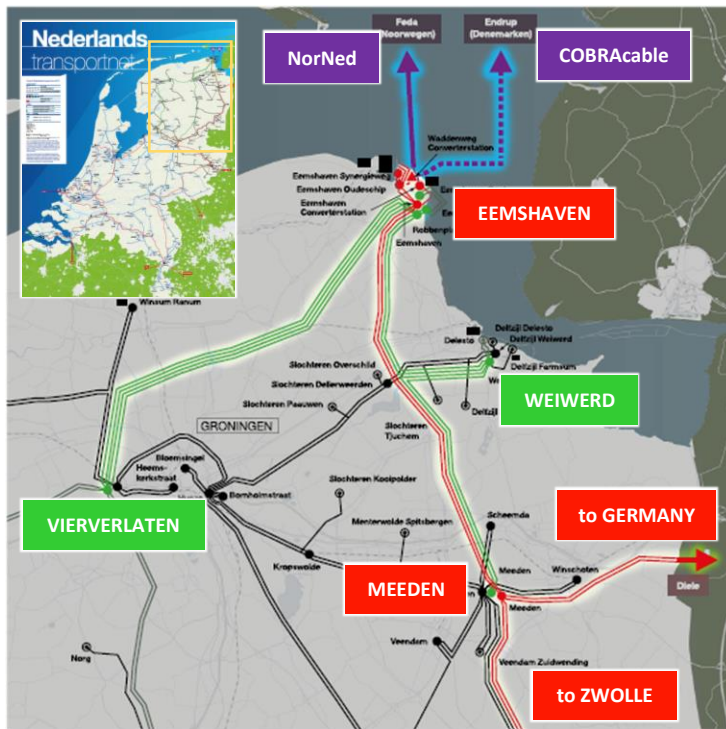
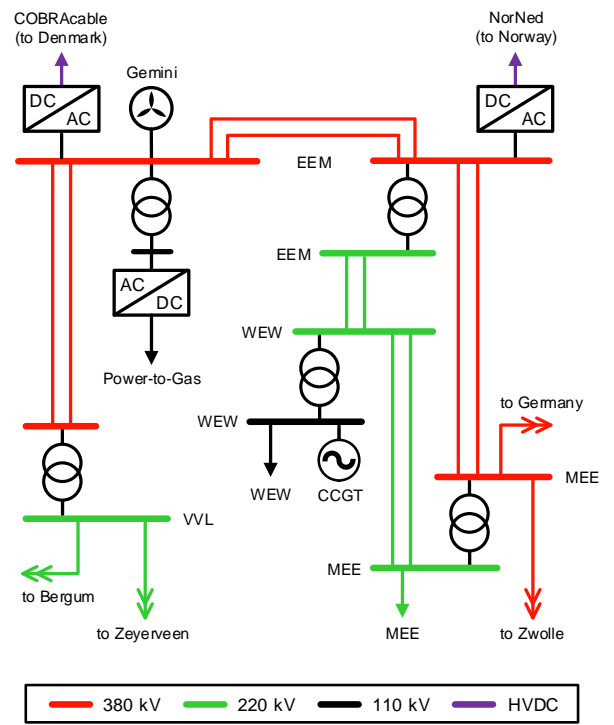

Fig. 3: Energy price duration curve for upward regulation aFRR in 2017.



(a) Current network of the Groningen-Drenthe-Overijssel area. Adapted from [27].



(b) Associated single line diagram for the year 2030.

Fig. 4: Overview of the modeled section of the Dutch transmission grid.

**B. Provision of FCR**

The P2G facility and the CCGT power plant are the only providers of FCR in this case study. An inverse droop controller was attached to the electrolysers, and a generic turbine-governor model with droop control was implemented for the CCGT. For the same disturbance, different allocation of capacity bids between the suppliers were tested: exclusive support from CCGT, initial support from CCGT plus increasingly integration of P2G, and exclusive support from P2G. The simulation event was a sudden loss of power generation, originated by the disconnection of several wind turbines from Gemini.

In Fig. 5, the nadir frequency for each of the considered scenarios is portrayed. It is observed that with limited CCGT support, the power drop triggers the lower frequency bound of 49.80 Hz. This effect is alleviated with extra FCR capacity. When P2G is introduced in the control loop, the nadir frequency quickly improves, resulting in better values for increasingly

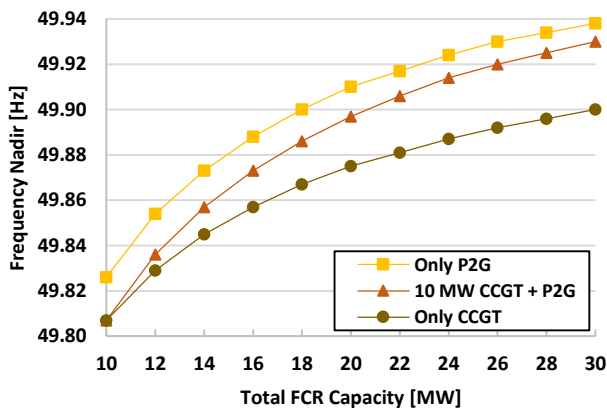

Fig. 5: Frequency nadir for different allocations of FCR capacity.

larger P2G capacity. The best outcome was obtained when FCR support came only from the P2G plant, rather expected due to the faster dynamics of electrolysers.

The frequency response for different distributions of FCR, while maintaining the same total amount of capacity, is shown in Fig. 6. It can be perceived that the increment of the P2G share translates into more linear system dynamics, in contrast to the inherent oscillating response of the CCGT. In addition, the network reaches steady state faster, and smaller rates of change of frequency are achieved, as indicated in TABLE I.

In this example, a reduced size of the actual total available FCR capacity was included. As frequency is a global variable in the grid, the distinct technologies participating in FCR in neighboring countries will influence the overall performance of the frequency response. As a result, the impact of fast reacting technologies like electrolysers will depend on the ratio of integrated capacity. In any case, improvements shall be noticed with respect to exclusive support with synchronous generators.

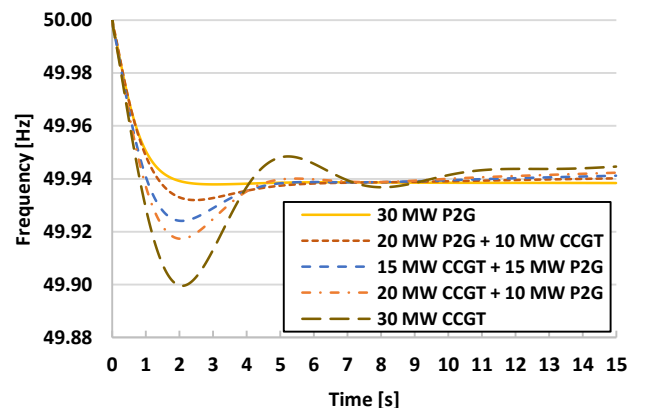

Fig. 6: Frequency response for different allocations of FCR capacity.

TABLE I: Initial Rate of Change of Frequency (RoCoF) for different allocation of FCR capacity.

	30 MW CCGT	20 MW CCGT + 10 MW P2G	15 MW CCGT + 15 MW P2G	20 MW P2G + 10 MW CCGT	30 MW P2G
RoCoF [mHz/s]	77.404	72.254	69.782	62.476	62.378

### C. Voltage control and congestion management

As already mentioned, the contracting of voltage regulation and congestion management depends on the specific needs of local areas. Large renewable energy power plants and HVDC interconnectors have direct control on reactive power regulation, while electrolyzers can provide voltage support through the variation of active power consumption. The electrical grid at Eemshaven is sufficiently strong, meaning that COBRACable and the connected offshore wind parks could be expected to guarantee enough voltage control.

In general terms, the most effective location of power-to-gas capacity to alleviate congestions is being close to renewable energy generation or to vulnerable nodes in the network [28]. According to a preliminary analysis, no congestion issues have been identified in the Dutch transmission network for 2030. As stipulated in TenneT TSO B.V.'s development plan [25], the reinforcement of the northern section of the grid, like new 380 kV lines connecting Eemshaven with Vlieland, will add enough capacity to successfully integrate COBRACable and potential new projects.

### D. Interaction with wind energy generation

Besides the provision of the traditional range of electrical ancillary services, electrolyzers could offer other functionalities for the short-term balancing of renewable energy sources. In particular, the stochastic variability of these sources could be controlled by adapting the consumption of nearby electrolyzers to the fluctuations of wind speed and solar irradiance [5].

For the test system, a theoretical example of the coordinated operation between the offshore wind park and the P2G plant is proposed in Fig. 7. As both facilities are connected to the same node, it could be possible to forecast a constant active power injection to the remainder of the grid at some hours, in a similar fashion to dispatchable generators. The electrolyzers could still be controlled to achieve their planned hydrogen production, without compromising working at the highest capacity during periods of cheap electricity. When the price of electricity is not competitive, the system can shutdown or even operate at partial load level. If shutdown, wind variability should be solved by other technologies or control strategies. However, electrolyzers could be ordered to increase their consumption at any moment, to avoid the curtailment of surplus wind power.

### V. CONCLUSIONS

The use of electrolyzers to convert electricity into hydrogen is a promising flexibility solution for future power systems. The fast dynamics of the electrolysis process can be exploited to procure electrical ancillary services, which add extra value to the power-to-gas business model and can improve the performance of the grid. In this paper, a review of the framework of ancillary services in the Netherlands was presented, to evaluate the feasibility of the integration of electrolyzers. The analysis showed that this technology is able to partake in balancing markets, voltage control and congestion management.

In light of the structure and bidding rules of the cited markets, and the estimated revenue that can be obtained from them, it is concluded that electrolyzers should prioritize involvement in FCR, followed by voluntary bidding for upwards regulation aFRR. If the power-to-gas facility is installed in an area of the network in need of voltage control or congestion management, it could also be contracted for such purposes. The modifications of the framework of balancing markets to be introduced in the next years will allow broader operating flexibility for suppliers. For electrolyzers, this would mean the chance to work during periods of inexpensive electricity price, and at the same time, to provide frequency support.

A case study, based on the Groningen-Drenthe-Overijssel area of the year 2030, showed the technical benefits of the participation of power-to-gas for FCR support. After a power imbalance disturbance, the nadir frequency is improved and the frequency time response is smoothed. Both effects depend on the amount of integrated capacity and are accentuated for larger shares. For 2030, COBRACable and the North Sea offshore wind parks, are in principle, sufficient resources to control voltage. Congestion issues are not expected, as upgrades in transmission lines will take place. Finally, the coupling of power-to-gas with renewable energy is able to contribute to the mitigation of its instantaneous variability and to the reduction of its curtailment.

In future research, a thorough description of the dynamics of the electrolyser, such as the control of the electronic converter, will be featured in the model. Similar FCR testing will be performed, exploring the possibility of including COBRACable in the control loop. To achieve more accurate results, the Real Time Digital Simulator (RTDS) will be used for the simulations.

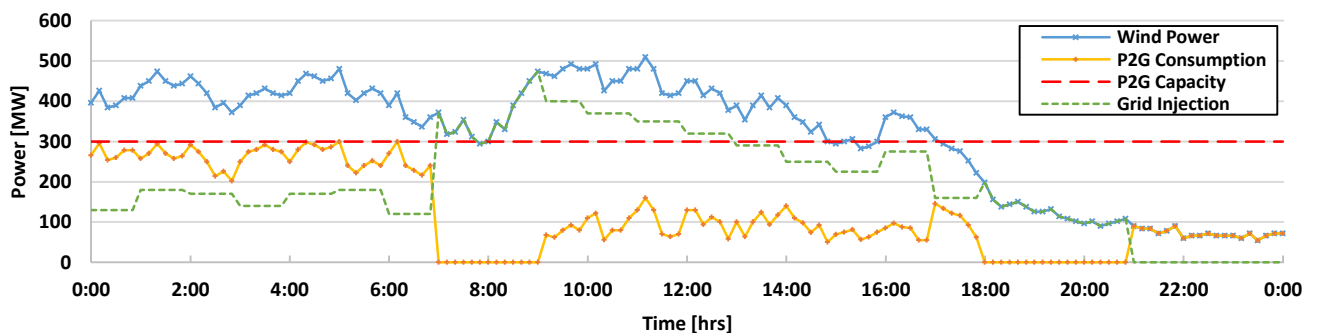

Fig. 7: Example of the coordinated operation of a wind park and a large scale power-to-gas plant.

## REFERENCES

- [1] TSO 2020 (2018). *TSO 2020: Electric “Transmission and Storage Options” along TEN-E and TEN-T corridors for 2020* [Online]. Available: <http://tso2020.eu/>
- [2] Deloitte, “The Chemical Industry in the Netherlands: World Leading Today and in 2030 – 2050,” the Netherlands, Feb. 2012.
- [3] TenneT, “Market Review 2017 – Electricity Market Insights,” Arnhem, the Netherlands, Mar. 2018. [Online]. Available: [https://www.tennet.eu/fileadmin/user\\_upload/Company/Publications/Technical\\_Publications/Dutch/2017\\_TenneT\\_Market\\_Review.pdf](https://www.tennet.eu/fileadmin/user_upload/Company/Publications/Technical_Publications/Dutch/2017_TenneT_Market_Review.pdf)
- [4] BP, “BP Statistical Review of World Energy 2017,” London, UK, June 2017.
- [5] J. Eichmann, K. Harrison and M. Peters, “Novel Electrolyser Applications: Providing More Than Just Hydrogen,” National Renewable Energy Laboratory, Denver, CO, Technical Report NREL/TP-5400-61758, Sep. 2014.
- [6] EnergyStock B.V. (NL) (2018). *Waterstofproject* [Online]. Available: <https://www.agbw.nl/projecten/waterstofproject>
- [7] Hydrogenics (2017). *Hydrogenics Unveils 3 Megawatt PEM Electrolyzer Stack* [Online]. Available: <http://www.hydrogenics.com/2017/04/25/hydrogenics-unveils-3-megawatt-pem-electrolyzer-stack/>
- [8] ITM Power, “Scaling PEM Electrolysis to 100 MW,” Hannover Messe, Germany, Apr. 2017. [Online]. Available: <https://www.h2fc-fair.com/hm17/images/forum/tf/2017-04-25-1100.pdf>
- [9] Siemens, “Silyzer 200 Electrolyzer,” Nuremberg, Germany, May 2017. [Online]. Available: <https://www.industry.siemens.com/topics/global/en/pem-electrolyzer/silyzer/Documents/2017-04-Silyzer200-boschure-en.pdf>
- [10] Elia, “Potential Cross-Border Balancing Cooperation between the Belgian, Dutch and German Electricity Transmission System Operators,” Oct. 2014. [Online]. Available: [http://www.elia.be/~media/files/Elia/users-group/141008\\_Final\\_report.pdf](http://www.elia.be/~media/files/Elia/users-group/141008_Final_report.pdf)
- [11] regelleistung.net (2018). *Internetplattform zur Vergabe von Relleistung* [Online]. Available: <https://www.regelleistung.net>
- [12] ENTSO-E, “Proposal for the Establishment of Common and Harmonised Rules and Processes for the Exchange and Procurement of Frequency Containment Reserve,” Jan 2018. [Online]. Available: [https://consultations.entsoe.eu/markets/draft-proposal-for-fcr-cooperation-market-design/supporting\\_documents/FCR%20Draft%20Proposal.pdf](https://consultations.entsoe.eu/markets/draft-proposal-for-fcr-cooperation-market-design/supporting_documents/FCR%20Draft%20Proposal.pdf)
- [13] TenneT TSO B.V., “Productspecificatie FCR,” Nov. 2015. [Online]. Available: [https://www.tennet.eu/fileadmin/user\\_upload/Bijlage\\_B\\_-\\_Productspecificaties\\_FCR\\_ENG.pdf](https://www.tennet.eu/fileadmin/user_upload/Bijlage_B_-_Productspecificaties_FCR_ENG.pdf)
- [14] TenneT TSO B.V., “Regel- en Noodvermogen per 1 januari 2018,” Oct. 2017. [Online]. Available: [https://www.tennet.eu/fileadmin/user\\_upload/Company/News/Dutch/2017/Notitie\\_FRR\\_2018\\_V1.0.pdf](https://www.tennet.eu/fileadmin/user_upload/Company/News/Dutch/2017/Notitie_FRR_2018_V1.0.pdf)
- [15] TenneT TSO B.V., “Productinformatie aFRR (Regulating power),” Jan. 2018. [Online]. Available: [https://www.tennet.eu/fileadmin/user\\_upload/Company/Publications/Technical\\_Publications/Dutch/Product\\_informatie\\_aFRR\\_-regulating\\_power\\_-16-01-2018.pdf](https://www.tennet.eu/fileadmin/user_upload/Company/Publications/Technical_Publications/Dutch/Product_informatie_aFRR_-regulating_power_-16-01-2018.pdf)
- [16] ENTSO-E, “Survey on Ancillary Services Procurement, Balancing Market Design 2016,” Mar. 2017. [Online]. Available: [https://www.entsoe.eu/Documents/Publications/Market%20Committee%20publications/WGAS\\_Survey\\_final\\_10.03.2017.pdf](https://www.entsoe.eu/Documents/Publications/Market%20Committee%20publications/WGAS_Survey_final_10.03.2017.pdf)
- [17] EXPLORE, “Target Model for Exchange of Frequency Restoration Reserves,” Oct. 2016. [Online]. Available: [https://www.tennet.eu/fileadmin/user\\_upload/Company/Publications/Technical\\_Publications/Dutch/20161021\\_EXPLORE\\_FRR\\_TARGET\\_MODEL.PDF](https://www.tennet.eu/fileadmin/user_upload/Company/Publications/Technical_Publications/Dutch/20161021_EXPLORE_FRR_TARGET_MODEL.PDF)
- [18] ENTSO-E (2018). *Imbalance Netting* [Online]. Available: <https://www.entsoe.eu/major-projects/network-code-implementation/electricity-balancing/igcc/Pages/default.aspx>
- [19] A. Kakorin, L. Laurisch and G. Papaefthymiou, “FLOW Dynamic Power Management, WP2.2: Market Interaction,” ECOFIS Netherlands B.V., Utrecht, Netherlands, Report WIENL14568, Dec. 2014.
- [20] J. Eichmann, A. Townsend and M. Melaina, “Economic Assessment of Hydrogen Technologies Participating in California Electricity Markets,” National Renewable Energy Laboratory, Denver, CO, Technical Report NREL/TP-5400-65856, Feb. 2016.
- [21] TenneT TSO B.V. (2018). *Settlement Prices* [Online]. Available: [http://www.tennet.org/english/operational\\_management/System\\_data\\_relating\\_processing/settlement\\_prices/index.aspx](http://www.tennet.org/english/operational_management/System_data_relating_processing/settlement_prices/index.aspx)
- [22] ENTSO-E, “Consultation Report: FCR Cooperation,” May 2017. [Online]. Available: [https://www.entsoe.eu/Documents/Consultations/20170601\\_FCR\\_Consultation\\_Report.pdf](https://www.entsoe.eu/Documents/Consultations/20170601_FCR_Consultation_Report.pdf)
- [23] K. Smethurst, S. Williams and V. Walsh, “Testing Guidance for Providers of Enhanced Frequency Response Balancing Service,” National Grid, Mar. 2017. [Online]. Available: <https://www.nationalgrid.com/sites/default/files/documents/EFR%20Testing%20Guidance%20VD3%20%28Final%29.pdf>
- [24] EirGrid, “Consultation on DS3 System Services Volume Capped Competitive Procurement,” Mar. 2018. [Online]. Available: <http://www.eirgridgroup.com/site-files/library/EirGrid/Consultation-on-DS3-System-Services-Volume-Capped-Competitive-Procurement.pdf>
- [25] TenneT TSO B.V., “Samenvatting KCD 2017,” Arnhem, the Netherlands, 2017. [Online]. Available: [https://www.tennet.eu/fileadmin/user\\_upload/Company/Publications/Technical\\_Publications/Dutch/TenneT\\_KCD2017\\_samenvatting.pdf](https://www.tennet.eu/fileadmin/user_upload/Company/Publications/Technical_Publications/Dutch/TenneT_KCD2017_samenvatting.pdf)
- [26] V. García, P. Ayivor, J.L. Rueda, and M.A.M.M. van der Meijden, “Demand Side Response in Multi-Energy Sustainable Systems to Support Power System Stability,” *16<sup>th</sup> Wind Integration Workshop*, Berlin, Germany, Oct. 2017.
- [27] TenneT TSO B.V., “Nederlands Transportnet,” Oct. 2017, [Online]. Available: [https://www.tennet.eu/fileadmin/user\\_upload/Company/Publications/Gridmaps/NL/netkaart\\_extern-2017.pdf](https://www.tennet.eu/fileadmin/user_upload/Company/Publications/Gridmaps/NL/netkaart_extern-2017.pdf)
- [28] I. Marjanovic, T. Bongers, J. Lichtigshagen and A. Moser, “Influence of Power-to-Gas-Technology on Unit Commitment and Power System Operation,” *2017 6th International Conference on Clean Electrical Power (ICCEP)*, Santa Margherita Ligure, 2017, pp. 536-540.