

---

**DESIGN** OF A 3D PRINTED,  
BREATHABLE,  
VOLUME ADJUSTABLE, PROSTHETIC  
SOCKET FOR TRANSRADIAL AMPUTEES  
IN LOW-INCOME COUNTRIES

---

MSC Thesis

Mechanical  
Engineering

Hilde Jansen  
TU Delft

# DESIGN OF A 3D PRINTED, BREATHABLE, VOLUME ADJUSTABLE, PROSTHETIC SOCKET FOR TRANSRADIAL AMPUTEES IN LOW-INCOME COUNTRIES

MSC THESIS

BY

Hilde Jansen

**Biomechanical Design**  
Mechanical Engineering

Thesis committee:

Dr. Ir. D.H. Plettenburg  
Prof. Dr. Ir. F.C.T vd Helm  
Dr. J. Zhou

TU Delft  
TU Delft  
TU Delft

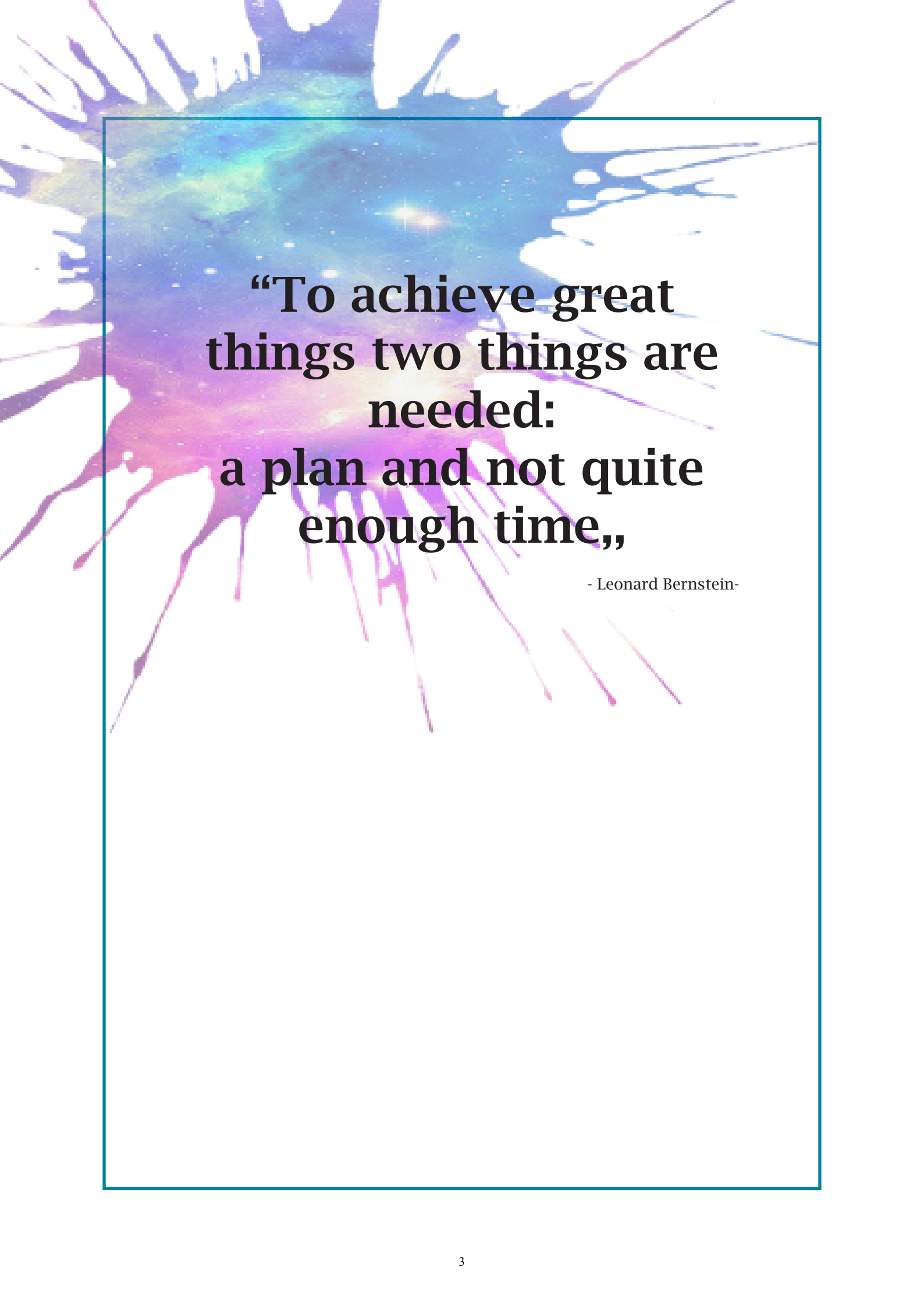

**“To achieve great things two things are needed:  
a plan and not quite enough time,,**

- Leonard Bernstein-

# PREFACE

This thesis is the final project done to complete the master Mechanical Engineering (Track: Biomechanical Design) at the Faculty of Mechanical, Maritime and Materials Engineering (3mE) at the Delft University of Technology.

This project is about helping the patient and improving the quality of life for people in low-income countries, with a lower arm amputee.

For the past year, I have been dedicated to this project to obtain a satisfying result. It started with an internship, printing 3D prostheses in Colombia, where I was confronted with the unfortunate circumstances people can live in, and the need for guidance. This experience allowed me to learn a lot about living in low-income countries, and I became passionate about this project. After Colombia, I worked with all the satisfaction on this research, and I

didn't want to stop until I had what I wanted. This worked out, and I am very proud of the final result!

Working on this project was one of the best practices I experienced during my complete mechanical engineering study. Although I secretly would like to continue, it is time to end.

Enjoy reading!

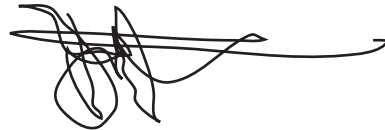
A handwritten signature in black ink, consisting of several loops and a long horizontal stroke extending to the right.



# ACKNOWLEDGMENTS

I would like to give a Thank You, Dank U Wel and Muchos Gracias to the following people for helping me during my graduation project:

- Dr. Ir. Dick Plettenburg - For helping and guiding me throughout the whole project with his positive view on everything.
- Jan van Frankenhuyzen - For helping me printing all the parts over and over again till everything worked out.
- Ir. J.S. Cuellar Lopez - For guiding me during my internship in Colombia and for being the best Supervisor ever.
- Madelon Kusters - For the *brabantse nuchterheid*, together we are a good team!
- Pauline Muñoz Balvi - For your objective review about this paper.
- Prof. Dr. Ir. F.C.T vd Helm - For reviewing this paper with a critical eye to achieve the best result.

Also, a big thanks to my family (Ton what should I do without your equipment?), friends (Ghi, for the unlimited coffee) and my new Colombian family (thanks for introducing the Chiva) for supporting me in everything.

# CONTENTS

Preface .....	4
Acknowledgements .....	5
<b>1 Scientific paper</b>	
I Introduction .....	9
II Current Design .....	10
III Materials and methods .....	12
A Material selection .....	12
B Adjustable socket design.....	14
C Final design .....	17
D Manufacturing proces .....	17
IV Results .....	18
A In depth design .....	18
B Strength tests.....	22
V Discussion .....	23
VI Conclusion .....	25
<b>2 Appendix</b>	
A. Internship report .....	29
B. Material study .....	38
C. Literature study .....	49
D. Socket concepts .....	65
E. Breathability .....	78
F. Manual .....	81
G. Strength test I .....	89
H. Strength test II .....	98
I. Engineering drawings .....	104

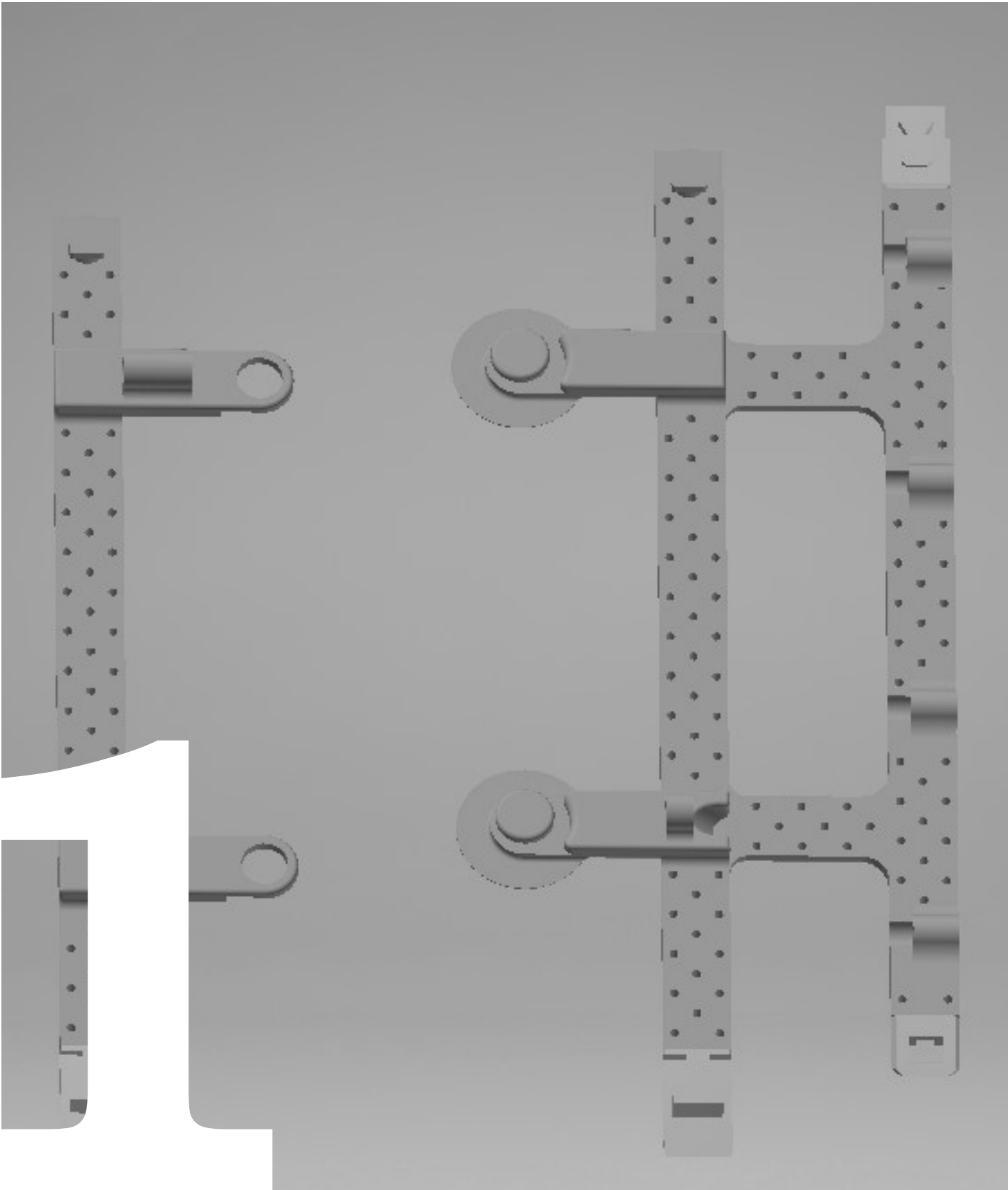

# SCIENTIFIC PAPER

Chapter 1 is a scientific paper where the introduction, methods, results, discussion and the conclusion are presented. It is a short paper of 18 pages, which gives a compelling overview of the study. The scientific paper is divided into two parts: a material study and the design to make the socket adaptable. For both parts, the method is written separately. Afterwards, these parts are combined to obtain the final design.

This design is tested, and conclusions are drawn from these results.

# Design of a 3D printed, breathable, volume adjustable, prosthetic socket for transradial amputees in low-income countries

H. Jansen

**Abstract**—Prostheses are challenging to obtain in low-income countries due to a lack of experts, remote locations, unfortunate production circumstances and an inadequate amount of research. A 3D printed WILMER open fitting for transradial amputees has been developed, which can solve this problem. It is entirely 3D printed and connects the prosthesis to the residual limb. However, the current design is not breathable nor volume adjustable. This is a significant obstacle since the residual limb perspires and dilates/diminishes during the day. Therefore, the aim of this paper is to design a breathable, volume adjustable, parametric, 3D printed socket for transradial amputees in low-income countries. This new design consists of straps connected with hinges which improve the range of motion. The material used for the socket is TPU 95A. The straps are perforated to improve the breathability of the socket. Furthermore, a clickable spacer, which is strong enough to withstand a force of 200 N, is attached to make the socket volume adjustable. The complete socket is also subjected to strength tests which resulted in a maximum manageable force of 100 N, attached to the prosthetic hand. However, the socket has not been evaluated by patients, which means that real-life wearing conditions are not achieved. Therefore, it would be a recommendation for future research to examine the socket on patients. Overall, this study provides the design of an affordable, comfortable, aesthetically pleasing, durable, parametric socket for amputees in low-income countries.

**Key words** — Prosthesis, Prosthetic, Prostheses, Socket, Fitting, Adjustable, Attachment, Transradial, Amputee, Breathability, Low-income countries

## I. Introduction

THE majority of people with disabilities live in low-income countries [5]. Colombia is one of those countries, where landmines are the major cause of limb disabilities, amputees and injuries. Another important cause of limb loss in low-income countries is diseases such as polio, malignancy or bone joint inflammation [4]. The World Health Organization estimated that there are around 40 million people in low-income countries who need prostheses. Only 5% of these people have access to rehabilitation service, because primary health care takes priority [14] [10]. Nevertheless, prostheses are essential in order to improve the emotional- and physical satisfaction of

patients as well as the mental satisfaction achieved by the cosmetic appearance of the prosthesis [21] [27].

It is challenging to design a suitable prosthesis for amputees living in low-income countries because of the remote location, the unfortunate production circumstances and the lack of trained professionals [11]. The design of a traditional prosthesis is a time-consuming labour process which requires a skilled prosthetist [9]. Currently, 3D printed prostheses are being developed to resolve the existing problems and to personalize prostheses. A traditional body-powered transradial prosthetic hand ranges from \$4,000 to \$20,000 [30]. However, with a 3D printer, these costs can be reduced due to lower material costs, a decrease of assembly time, personalized designs, affordable replacements of parts and the possibility of working remotely [30].

Fused deposition modelling (FDM) is a printing technique with a continuous filament of a thermoplastic material which is mostly used for 3D printing prostheses [12]. This printing technique is most suitable for printing 3D prostheses in low-income countries due to the low costs and easy process compared to other 3D printers [12].

Nevertheless, there is still improvement feasible in 3D printing prostheses. The project operators (mostly volunteers, designers and students) are not professional prosthetists and do not always take the specific needs of an amputee into account [12]. Moreover, there is only a limited amount of research about the durability of these 3D printed prostheses [12].

Another difficulty which still needs to be resolved is the design of the socket of these transradial prostheses. The socket is the connection between the stump and the prosthesis. The function of the socket is to provide a suitable operation of the prosthesis and to distribute the loads. An appropriate socket fitting is a critical factor in the rehabilitation of amputees [29]. An improper fitting can lead to a considerable amount of problems.

Firstly, when the residual limb dilates or diminishes, excessive pressure around the stump can cause sores such as blisters, ulcers, irritations and hyperplasia [15] [16]. Examples of causes for volume fluctuations of the residual limb are alcohol consumption, physical activity and weather conditions. A range of around 15% is consistent with trends in short-term and long-term volume fluctuations for mature limbs [26] [3].

Secondly, the socket applies forces on the skin, which can lead to mechanical changes and can finally

cause damage to the area underneath the skin of the residual limb [21].

Thirdly, Caldwell et al. (2017) have reported that one of the most frequent problems of sockets is the perspiration between the interface and residual limb [2]. Perspiration influences the skin which can result in infections [18], blisters [20] or disruptions of the suspension forces [13].

The goal of this study is to design a breathable, volume adjustable, 3D printed prosthetic socket for transradial amputees in low-income countries.

## II. Current Design

The original WILMER open fitting is a strong, lightweight, volume adjustable, breathable socket composed of stainless steel, covered with foam. This socket, as presented in figure 1, leaves 75% of skin uncovered to minimize perspiration [22].

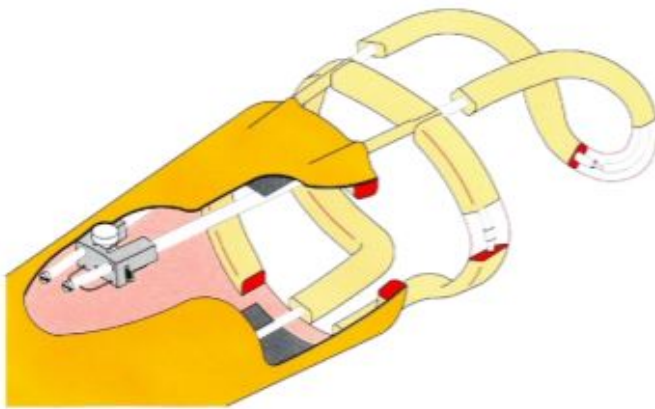

Fig. 1: *The original WILMER open fitting: a strong, lightweight, volume adjustable, breathable socket composed of stainless steel, covered with foam.*

This original WILMER open fitting is redesigned to be 3D printed [17]. The material of this 3D printed socket is TPU 95A. To improve the print reliability and to achieve optimal material properties, this socket is printed flat and folded around the residual limb afterwards (see figure 2). The flat printed socket consists of straps that are attached by two different locking mechanisms (see figure 3). Lock A is the permanent locking mechanism which is located on the strap attached to the prosthesis and only needs to be reassembled once, after the printing. Lock B is the temporary lock which is required for donning and doffing. The socket is attached to the 3D printed

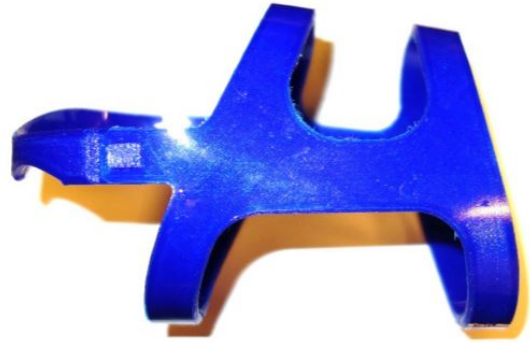

Fig. 2: *The previous 3D printed WILMER open fitting. This socket is composed of TPU 95A, 3D printed flat and folded around the residual limb after printing. The attached condyle brace (the left strap) disconnects when extending the elbow.*

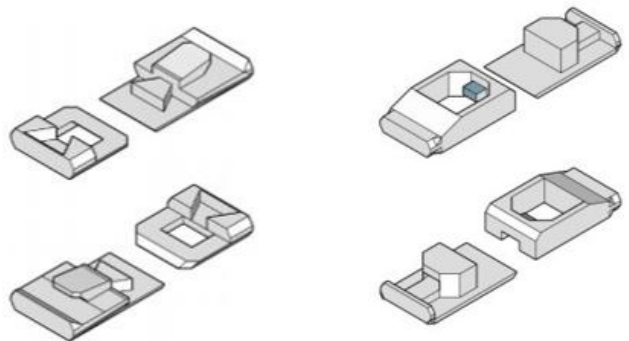

Fig. 3: *Lock A (the permanent locking mechanism which is located on the strap attached to the prosthesis) and Lock B (the temporary lock which is required for donning and doffing), respectively [17].*

lower arm with screws.

Test prints were conducted which showed that this design did not work appropriately for a 3D printed socket.

Firstly, it is impossible to execute extension / flexion of the elbow. With this design, the elbow is locked at an elbow flexion of 90°. When extending the elbow, the condyle brace (the strap above the epicondyles) disconnects. Moreover, the material scours the skin when moving the residual limb only a little bit, which causes irritation and blisters. Besides, no material study has been conducted in the previous research to

determine the most suitable material.

Furthermore, the previous socket design can not be implemented on every residual limb. Residual limbs differ from each other and are difficult to standardize. In this parametric model, it was assumed that every residual limb was long and wide in the form of a perfectly formed cone. Parameters of four patients were tested, and the original parametric design got errors for all of the patients.

Therefore, a new socket was designed based on the previous 3D printed WILMER open fitting (see Appendix A). The design consists of straps connected with hinges to ensure freedom of movement and the ability to withstand forces of the prosthesis (see figure 4). These hinges improve the range of motion in terms of flexion and extension. Moreover, it ensures that the straps stay in place without scouring. This design is still as breathable as the previous 3D printed WILMER open fitting, but better suited for 3D printing. The socket can be applied to every residual limb due to the characteristics. A residual limb is divided into four categories (left, right, short stump, long stump). For every patient, the most suitable option can be chosen. Thereafter, the parameters of the patient can be entered, and the socket will be scaled to the desired fit.

This current 3D printed WILMER open fitting (see figure 4) has three significant limitations.

Firstly, this socket is not volume adjustable. This is in contradiction to the original WILMER open fitting (see figure 1) where the fitting of the elbow can be adapted.

Secondly, the socket still has perspiration between the interface and the skin. Sweat can build up moisture between the socket interface and the residual limb, which can lead to blisters or disruption of the suspension forces.

Finally, the design of lock B results in a strap in the shape of a droplet. The upper part looks weak with a buckle in it (see figure 5).

The objective of this study is to adapt the current 3D printed WILMER open fitting to make a breathable socket with a suitable fitting, which will adjust for volume differences of the residual limb and small fluctuations in design/manufacturing errors. Moreover, this socket should be able to be 3D printed on the Ultimaker printer.



Fig. 4: The current 3D printed WILMER open fitting: a socket with hinges to connect the straps and to improve the range of motion.



Fig. 5: Weak part of lock B, with a buckle in it.



### III. Materials and methods

In order to solve the design problem, the method is divided into two studies to achieve the perfect performing socket. Firstly, there will be a material study in order to find the most suitable material. Subsequently, the current 3D printed WILMER open fitting design will have an upgrade to deal with volume fluctuation in the residual limb.

Consequently, the two categories are; material selection and adjustable socket design. These categories will be divided into design criteria, conceptualization, a weighted decision matrix and finally, a winning concept.

#### A. Material selection

##### 1) Design criteria

The main focus of the previous 3D printed WILMER open fitting was form and function, so no material study has been conducted [17]. Therefore, a material study will be done in this research to see if TPU 95A (the material of the previous 3D printed WILMER open fitting) is the optimal material. To narrow down the search for materials, only those materials that met these two requirements were considered:

##### 1. The material has to be compatible with an Ultimaker printer

Due to limited resources, it is chosen to use the Ultimaker printer, a FDM printer, for this study. It is of great importance that the Ultimaker Printer supports the material. Supported material will lead to a more reliable print, with less clogging or deformed prints and a desired printing speed. Therefore, the material has to be included on the Ultimaker website as supported material [28].

##### 2. The material has to be flexible enough to make a socket from a flat 3D print

A material with a low flexural modulus is needed to bend the interface of the flat 3D printed socket around the residual limb. Another advantage of a flexible material is the fact that it will dissipate the forces over a more extensive interface on the stump, which improves the comfortability [6]. Therefore, the material should be classified as flexible material on the website of Ultimaker.

Subsequently, a program of requirements is made to find the optimal material. Later on, an assessment is made with a weighted decision matrix.

##### 3. The material must be durable

The idea is that the prosthesis is worn every day by the amputee and used during all everyday conditions. Consequently, the material must be resistant to oxidation and abrasion. Furthermore, it has to withstand grease, chemical, water, mud, oil and UV.

##### 4. The material may not be too elastic in relation to the flexibility

To have a reasonable force transition between the socket and the prosthesis and to avoid deformability of the straps, the straps may not be too elastic. The tensile modulus estimates the capacity of a material to resist changes when under tension/compression. Therefore, the tensile modulus should be high.

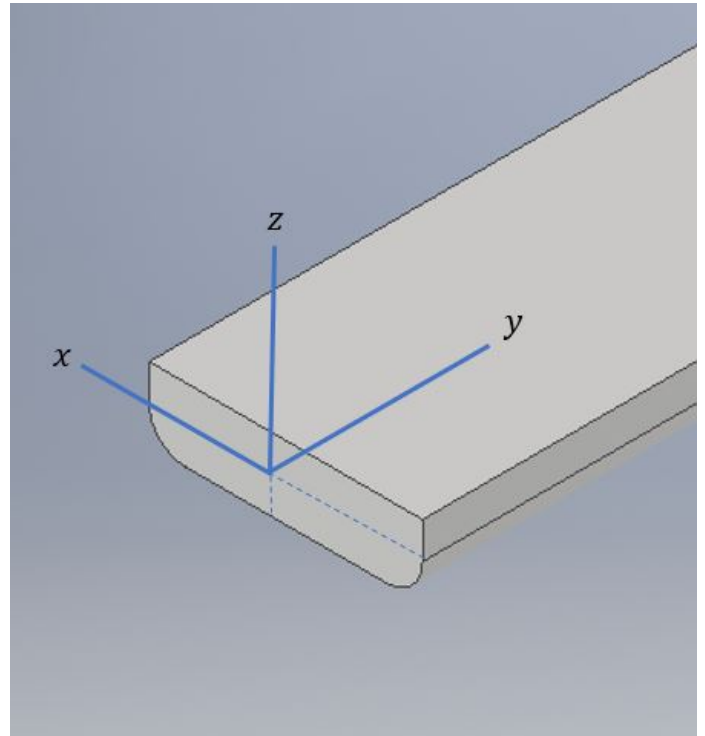

Fig. 6: The profile of the straps of the current WILMER open fitting: 15 mm x 4 mm [17].

On the other hand, the straps should be flexible enough to be folded around the residual limb. Therefore, the flexural rigidity has to be small. This is in contradiction with the previous statement because the tensile modulus is related to the flexural rigidity according to the following formula [1]:

$$D = E * I$$



Where:

D = Flexural rigidity

E = Tensile modulus

I = Moment of inertia

To obtain a low flexural rigidity, either the tensile modulus has to decrease, or the moment of inertia has to decrease.

With the profile of the straps already known (15 mm x 4 mm, see figure 6) and assumed the strap can be approached as a beam, the moment of inertia can be calculated:

About the x-axis:

$$I_x = \frac{1}{12} * b * h^3$$
$$I_x = \frac{1}{12} * 15 * 4^3 = 80 \text{ mm}^4$$

About the z-axis:

$$I_z = \frac{1}{12} * h * b^3$$
$$I_z = \frac{1}{12} * 4 * 15^3 = 1125 \text{ mm}^4$$

As formulated, the moment of inertia about the z-axis is approximately 14 times higher than the moment of inertia about the x-axis. This indicates that the strap is 14 times more flexible around the x-axis than about the z-axis, if the tensile modulus is identical.

Because the flexibility is already 14 times higher around the x-axis, it is acceptable to have a medium elasticity. Because this will lead to a 14 times stiffer strap around the z-axis. In this study, only flexible materials are investigated. Therefore, the flexible material should have a medium tensile modulus within the range of flexible materials.

## 5. It is more important to minimize the process costs than the material costs

The main goal of this prosthesis is that it can also be bought and produced in low-income countries. The minimum wage in Colombia is 267 dollars per month [19]. To achieve a affordable prosthesis for all people (including the ones with no insurance), the costs of the total prosthesis should not exceed the monthly income. The total costs of a 3D printed transradial prosthesis include:

- Data gathering/processing;
- Printing material for socket, lower arm and hand;

- Energy used by the 3D printing;
- Location costs;
- Maintenance costs.

The material costs of the socket are approximately 3% of the total costs [25], which would lead to maximum material costs in Colombia of:

$$0,03 * 267 = 8 \$$$

The current 3D printed WILMER open fitting is 57 grams [17]. Therefore, the material costs per kg will be:

$$\frac{\text{price}}{\text{kg}} = \frac{1000}{57} * \text{material costs}$$

As can be seen, the material costs are only a small expense of the total costs. Consequently, the material costs will not affect the total costs much if they have an increment. Therefore, it is more important to economize on the other process costs than on the material costs.

## 6. Low density/Light weighted

The socket should have a weight as low as possible. Increased weight of a socket may cause excessive muscle forces [7]. The density of the material of the previous 3D printed WILMER open fitting (TPU 95A) is  $1,22 \text{ g/cm}^3$ . This resulted in a socket with a weight of 57 grams [17], which is approximately the same weight as the original WILMER open fitting. To obtain the same or decreased weight, the material density may not exceed  $1,22 \text{ g/cm}^3$  or the print infill settings have to be adapted to lower the socket density. A lower socket density can influence the strength of the socket. Therefore, strength tests should be conducted to conclude if the material is strong enough and still lightweight.

## 7. Hardness should be a maximum of 50 shore D

The shore hardness measures the resistance of a material to indentation. The hardness on the shore D scale should be high to obtain a good force transition. On the other hand, the hardness should be low to make the socket more comfortable. There is a direct relationship between the flexural modulus and the shore hardness in the TPE family. An increased shore D hardness will lead to an increased flexural modulus, which means a stiffer material [24]. Therefore, the hardness should be a maximum of 50 shore D, which is approximately the same as the hardness of a rubber caster.

## 8. Medium friction coefficient

A low friction coefficient possibly leads to slip between the stump and the prosthesis. On the other hand, when the friction coefficient is high, there will be high shear stresses which can cause skin irritation or other skin problems. Therefore, the friction coefficient should be medium to avoid both problems. In the literature, there are no resources available about the friction coefficient of the materials; therefore, it should be reviewed after 3D printing the sockets.

## 9. Comfortable

The material of the socket should be non-toxic, smooth on the skin and should not cause allergic reactions.

## Wishes

An asset would be a material which is recyclable, reusable and already in medical use, because there is only a limited amount of research available about the durability of these materials [12].

### 2) Conceptualization

The two criteria the material had to have indisputably were the fact that the material has to be flexible and compatible with an Ultimaker. A study has been done about flexible materials which are compatible with the Ultimaker (see Appendix B). This resulted in seven different materials, buyable in four companies:

1. TPU 95A, Ultimaker.
2. PP, Ultimaker.
4. Arnitel ID2045, DSM.
5. 3D TPU F98A, Lubrizol.
6. 3D TPU F94A, Lubrizol.
7. IROPRINT F80213, Huntsman.

### 3) Weighted decision matrix

With the given design criteria, a weighted decision matrix has been made (see table I). It evaluates the materials with scores against the given design criteria. To make a comparison between the materials and to ensure an accurate analysis of the weighted decision matrix, a guideline is made (see table II). A wish is an asset which cannot be scored because it is not possible to compare between the different materials. Therefore, when a material fulfils the wish, it will receive 5 bonus points in the weighted decision matrix.

TABLE I: *Weighted decision matrix of the materials.*

Criteria	Weighting	TPU 95A		3D XFLEX TPE		PP		ID2045	
		Score	Total	Score	Total	Score	Total	Score	Total
Durability	4	3	12	4	16	2	8	4	16
Price	3	4	12	3	9	5	15	4	12
Density	5	3	15	3	15	4	20	3	15
Shore D hardness	3	3	9	3	9	3	9	4	12
Tensile modulus	4	4	16	2	8	0	0	4	16
Already medical used	Wish +5		+5						+5
<b>Total:</b>			69		57		52		71

Criteria	Weighting	IROPRINT		3D TPU F94A		3D TPU F98A	
		Score	Total	Score	Total	Score	Total
Durability	4	2	8	2	8	1	4
Price	3	4	12	4	12	4	12
Density	5	3	15	3	15	3	15
Shore D hardness	3	4	12	3	9	3	9
Tensile modulus	4	4	16	4	16	4	16
Already medical used	Wish +5						+5
<b>Total:</b>			63		60		61

TABLE II: *Guideline of the materials to make a valid comparison.*

Criteria	Score (0 = poor, 5 = very good)					
	0	1	2	3	4	5
Durability	Not Durable	Little Durable	Medium Durable	Very Durable	Highly Durable	Impressive Durable
Price [\$/kg]	250 and higher	200 – 250	150 – 200	100 – 150	50 – 100	0 – 50
Density [g/cm <sup>3</sup> ]	2,50 and higher	2,00 – 2,50	1,50 – 2,00	1,00 – 1,50	0,50 – 1,00	0 – 0,50
Shore D hardness	100 and higher	80 – 100	60 – 80	40 – 60	20 – 40	0 – 20
Tensile modulus [MPa]	0 80 >	0 70 – 80	0 – 10 60 – 70	10 – 20 50 – 60	20 – 30 40 – 50	30 – 40

### 4) Winning material

After the material study (see Appendix B), two materials were chosen: TPU 95A and Arnitel ID2045. These two materials both met all criteria. For Arnitel ID2045 the specific flexural modulus is unknown, but it is described as a highly flexible material. By 3D printing the concepts in both materials and performing several tests, it will be examined which material is most suitable for a 3D printed socket.

## B. Adjustable socket design

### 1) Design criteria

A few approaches have been used to establish the design criteria. Firstly, a literature study about existing adjustable sockets was performed (see Appendix C). Secondly, the experiences and feedback of an internship in Colombia are used (see Appendix A). Furthermore, blogs and studies are consulted about problems, pain and future recommendations.

With this information, the following design criteria are determined.

**1. The socket should consist of a minimum amount of printing material**

To have low costs and to get a minimum printing time, it is essential to have as few elements as possible and a minimum amount of printing material. This will result in a light socket and a reduction of power usage. The socket and the prosthesis should be as light as possible; as already discussed in the material selection, the material density should not exceed  $1,22 \text{ g/cm}^3$ . Moreover, the printing settings of the complete socket can be adapted to achieve a low density. Working with a prosthesis results in roughly 12% more energy consumption [7]. Therefore, it is of great interest to have a socket with a low weight to decrease excessive muscle work.

**2. The socket should not be bulky or contain loose elements**

The socket should not contain bulky parts or loose straps which can adhere to clothes or other objects. The maximum height for the locking mechanisms was set to 7.5 mm [23], which results in a maximum height above the strap of 3.5 mm.

Hence, the socket has to be aesthetic/ good looking/ visual appealing and not have an out of ordinary design. An asset is a socket made in skin colour.

**3. The donning and doffing of the socket have to be possible to be done with only one hand**

Since the patient only has one free hand, it should be possible to open and close the socket with only this hand without the help of another person. Furthermore, no tools should be needed for donning and doffing.

**4. The socket has to be adjustable for small and big volume fluctuations of the upper- and lower arm of the residual limb**

Due to volume fluctuations of the residual limb, the socket should be able to be adapted in medial-lateral direction.

**5. The socket has to be adapted as precisely as possible**

An asset would be if the socket can be adapted precisely, with an accuracy of 2 mm to achieve a highly accurate fit.

**6. There has to be a good transition between the residual limb and the prosthesis**

A highly accurate fit around the residual limb is preferred for a good transition. Furthermore, the socket has to be strong enough to hold the prosthesis and to transfer the forces. The maximum applied force the socket should withstand is 100 N. Then it is possible for the patient to carry a bag of around 10 kg.

**Wishes**

A wish cannot be scored individually with a scale, and therefore, it would be a bonus if it could be fulfilled.

**1. The socket should be completely 3D printed**

It is an asset if the complete socket can be 3D printed because of limitations in material stocks and implements in low-income countries.

**2. The labour for the design, assembly and maintenance of the socket should be of minimum time**

Not only the material costs are a factor in the total costs of a 3D printed prosthesis. Power usage, location and equipment have also to be taken into account. Furthermore, the working hours used for the design, assembly and maintenance of the socket should be of minimum time. Decreased labour time results in lower costs. For this research, it is assumed these costs are approximately the same for each concept and therefore negligible when comparing the different concepts. Nevertheless, if a socket is designed with exceptional labour time, it would be an appealing factor to study.

**3. The socket has to be easy to maintain/clean**

The socket should be designed in a way that it will not get dirty quickly or that it is easy to clean.

**4. The design has to fit on the printer plate of an Ultimaker S5**

The maximum dimensions of the socket are 330 mm x 240 mm when laying flat (inclusive brim). If it does not fit, the design has to split, which will cause a longer printing time. This also means the demand for more connections/locks which can result in a more critical force transfer.

**2) Conceptualization**

Eleven concepts were designed of a socket which is able to be flat printed and folded around the residual limb. These concepts are divided into three categories (see figure 7).

The first category consists of sockets with straps

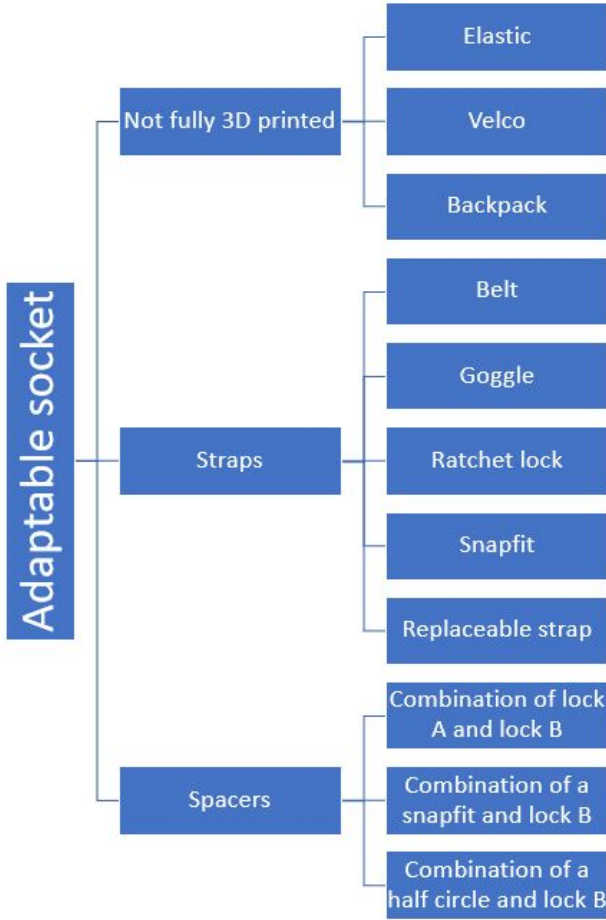

Fig. 7: Eleven concept designs of an adjustable socket are made. These concepts are divided into three categories: Not fully 3D printed sockets, sockets which consisted of straps and sockets in combination with spacers (see Appendix D).

which are made adjustable by using another (not 3D printed) material to close the straps. The second category contains sockets which can be made adjustable by tightening a strap, for example, a belt. The final category consists of sockets which are locked with spacers. These spacers can be printed in multiple sizes and can be replaced to make the socket adjustable. In Appendix D, the in-depth design of these concepts can be found.

### 3) Weighted decision matrix

All design criteria are put together in a weighted decision matrix (see table III). Every design criterion was rated on importance. To illustrate: the force transfer is an important criterion and therefore has a high weight. Subsequently, each concept is scored on

TABLE III: Weighted decision matrix of the socket concepts: concept 9, 10 and 11. See Appendix D for the weighted decision matrix of concepts 1-11.

		Score (0 = poor, 5 = very good)						
	Criteria	Weighting	Concept 9		Concept 10		Concept 11	
			Score	Total	Score	Total	Score	Total
1	As few as possible material	2	2	4	2	4	2	4
2	Not bulky	2	4	8	4	8	4	8
3	Easy donning and doffing (with one hand)	4	4	16	4	16	5	20
4	Adaptable for volume fluctuations in multiple directions	4	4	16	4	16	4	16
5	Precisely adaptable	4	5	20	5	20	5	20
6	Good transition between residual limb and prosthesis	4	5	20	5	20	5	20
	Fully 3D printed	Wish +5		+5		+5		+5
	Easy to clean	Wish +5		+5		+5		+5
	Fit on the printer plate of an Ultimaker 5	Wish +5		+5		+5		+5
	<b>Total:</b>			99		99		103

these criteria on a scale 0 (poor) to 5 (excellent). The wishes can not be scored individually, and therefore a concept retrieves 5 bonus points if it fulfils the wish.

As shown in Appendix D and table III, concept 11 has the highest score, followed by concept 9 and 10. Interesting is that these concepts are all from the same category: spacers. In contrast to the other concepts, the main advantage of the concepts with spacers is the fact that the spacers do not have bulkiness and still have a reasonable force transition. Furthermore, the spacers can be produced precisely, and the socket is entirely 3D printed.

The adjustable sockets consisting of other materials (such as elastic or Velcro straps) have a weak force transition which is a significant limitation.

The main disadvantage of the sockets with straps is the fact that they are not precise and that there is a remaining piece of strap dangling, which makes the socket bulky.

Another design option was the recommendation in the research of the previous 3D printed WILMER open fitting [17]. In this research, it was advised to replace the full condyle brace (as done in concept 1). This is not sufficient because a complete new strap has to be printed in multiple sizes which will lead to a lot of printing material. In addition, it is not possible to have a stock of straps because the dimensions are different for each patient.

#### 4) Winning concept

The concept with the highest total score is the one where there is a spacer between the straps to make a volume adjustable socket. This spacer can be 3D printed in different sizes. Hence every socket can be delivered with a few spacers to make the socket a few millimetres smaller or larger in circumference.

### C. Final design

The two winning concepts, of the material and the socket, are combined to a final design. This socket is designed based on the previous 3D printed WILMER open fitting. It has the same size straps, and the same type locks as the previous 3D printed WILMER open fitting.

The design consists of straps, connected with hinges which ensure that the socket has freedom of movement and is strong enough to withstand forces. Moreover, the hinges ensure that the straps stay in place without scouring. The original WILMER open fitting leaves 75% skin uncovered, and users still complain about the perspiration [23]. Therefore, this design will be more breathable due to holes perforated in the straps. The spacers make sure that the socket can be volume adapted without losing its strength. Another upgrade is lock B, which is made stronger and thicker to avoid the buckling. The final material will be TPU 95A or Arnitel ID2045. Later on, strength tests will be conducted to conclude which material is most suitable for this socket.

### D. Manufacturing process

The residual limbs of the patients have to be measured in a precise manner to achieve a suitable socket. This can be achieved through the use of a measurement tool (see figure 8) and a small manual (see Appendix F). This method only needs minimal anthropometric dimensions of the residual limb for proper scaling and fitting, which makes it also possible to conduct the measurements without years of training. The measurement tool is put on the pivot point of the elbow when the elbow is at a flexion of  $90^\circ$ . From there, a tapeline is put on the notches of the tool to determine the circumference at these points (see figure 9, circumference F and C).

When the residual limb is short, it is only possible to fold one strap around the lower arm. When the residual limb is long, two straps are preferred. Therefore, a second circumference of the lower arm

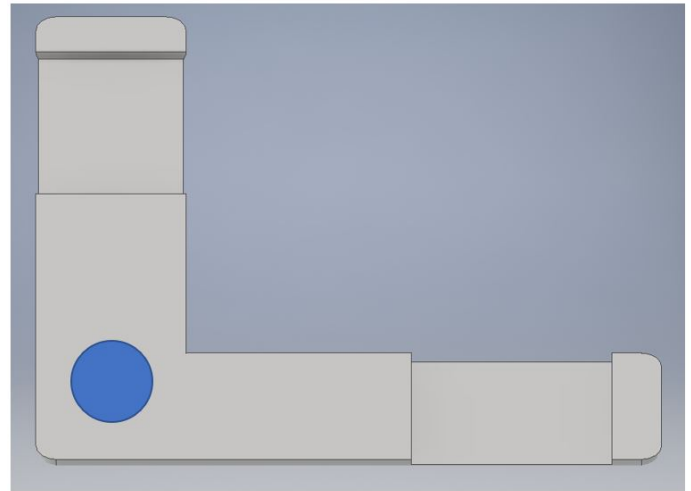

Fig. 8: Measurement tool to measure the circumferences  $F$  and  $C$  of the residual limb which are needed to design a socket.

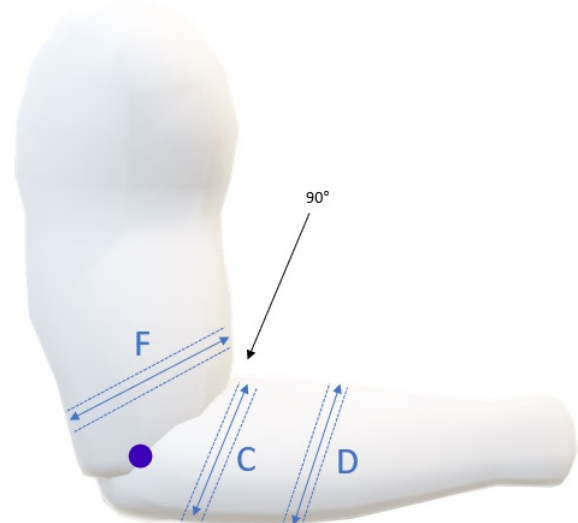

Fig. 9: The place of circumferences  $F$  and  $C$  are determined with the use of the measurement tool. The place of circumference  $D$  is determined by studying the tissue.

should be measured for a second strap (see figure 9, circumference  $D$ ). The place of this strap is variable, depending on the presence of scars, painful tissue and muscles. After that, the distance between these two lower arm circumferences is measured.

When it is decided which socket has to be 3D printed (left or right / one strap or two straps), the measurements can be put in Inventor. Inventor



is a CAD software developed by Autodesk, which visualizes and develops digital 3D models of products. When the values of the circumferences are put in Inventor (following the manual in Appendix F), the socket automatically scales. This makes it very easy to produce a custom-made 3D model in less than 5 minutes. When the socket is finished in Inventor, a stl. model can be created and put in Cura, which is an open-source application for 3D printers. In Cura, specific printing settings of the socket have to be entered to retrieve a durable result (see Appendix F). After that, the 3D models are converted to g.codes and implemented in the Ultimaker printer.

The 3D print of the socket is supported with PVA, which can decompose in water. This is an asset compared to other support materials which adhere too much to flexible materials. Therefore, it is tough to peel the support material off the socket without causing permanent deformations. After solving the PVA in the water, the only thing left is to assemble the whole socket.

The socket is made from a flexible material; therefore, it is possible to assemble the hinges by using force to pull the hole over the pole. When the socket is assembled, it can be attached to the prosthetic lower arm by screws.

## IV. Results

### A. In depth design

The socket consists of straps with a height of 4 mm and a width of 15 mm, see Appendix I for further dimensions. These straps are attached to the 3D printed lower arm of the prosthesis with four screws, and folded around the residual limb. Every socket consists of a strap around the upper arm to withstand the forces of the prosthesis. This strap is connected with hinges to the lower arm strap(s). The hinges make sure that it is possible to flex and extend the elbow without scouring (see figure 10).

The part of the socket on the lower arm can consist of one strap or two straps. The amount of straps depends on the size and shape of the residual limb. When the residual limb is short, it is only possible to have a socket with one strap folded around the upper arm and one strap folded around the lower arm: the 1-1-socket (see figure 11). When the patient has a long residual limb, the socket has one strap folded around the upper arm and two straps folded around



Fig. 10: *Final socket design. Side view of the hinge, which makes it possible to flex and extend.*

the lower arm: the 1-2-socket (see figure 12). A patient with a short residual limb is more challenging to help than a patient with a long one. This can be observed in the following formulas, where it is assumed that the socket of a short residual limb is 1/3 of the total length of the lower arm, including the prosthesis. The socket of the long residual limb is assumed to be 2/3 of the total length of the lower arm, including the prosthesis;

There are two common ways to carry a bag; with an elbow flexion of  $90^\circ$  and with a shoulder abduction of  $0^\circ$  (see figure 13) [23].

For the 1-1-socket the following formulas apply when carrying a bag with an elbow flexion of  $90^\circ$  (see figure 14):

$$R_1 = R_2$$

$$\sum M = 0$$

$$-R_2 * \frac{1}{3}x + F * \frac{2}{3}x = 0$$

$$R_2 = 2 * F$$

$$\sum F = 0$$

$$R_2 + R_4 + F = 0$$

$$R_4 = -3 * F$$

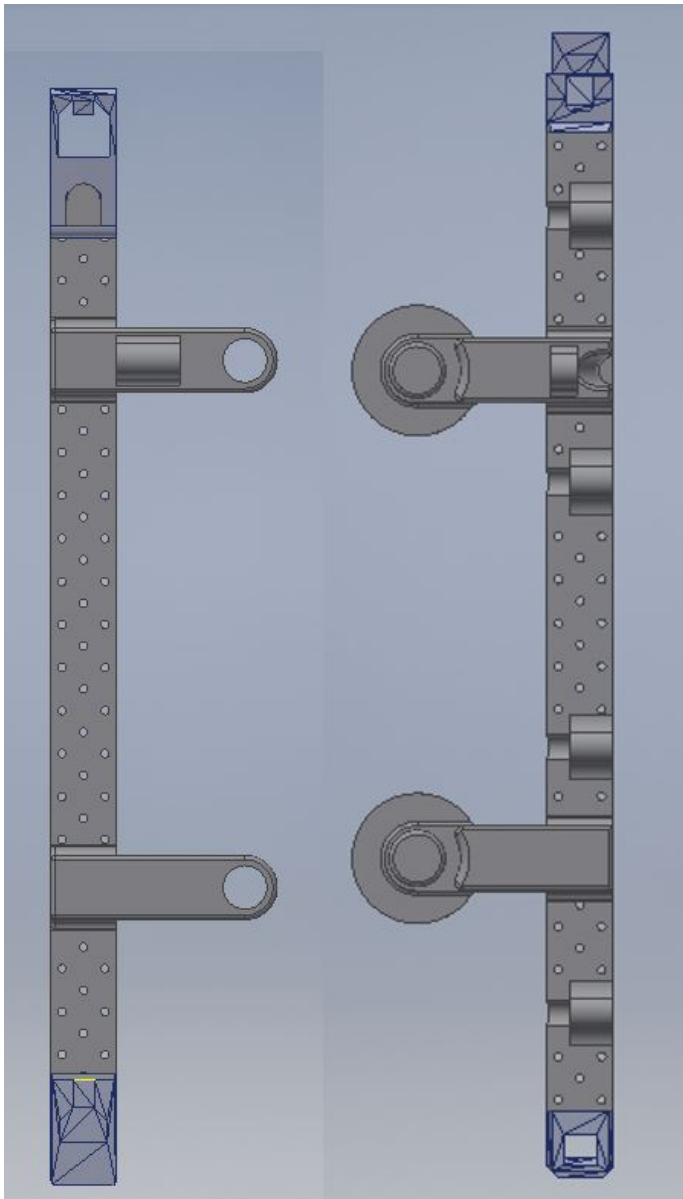

Fig. 11: The complete socket design for a short residual limb consisting of one strap folded around the upper arm and one strap folded around the lower arm: the 1-1-socket.

For the 1-2-socket, the following formulas apply when carrying a bag with an elbow flexion of 90° (see figure 14):

$$R_1 = R_2$$

$$\sum M = 0$$

$$R_2 * \frac{2}{3}x - R_3 * \frac{1}{3}x + F * \frac{1}{3}x = 0$$

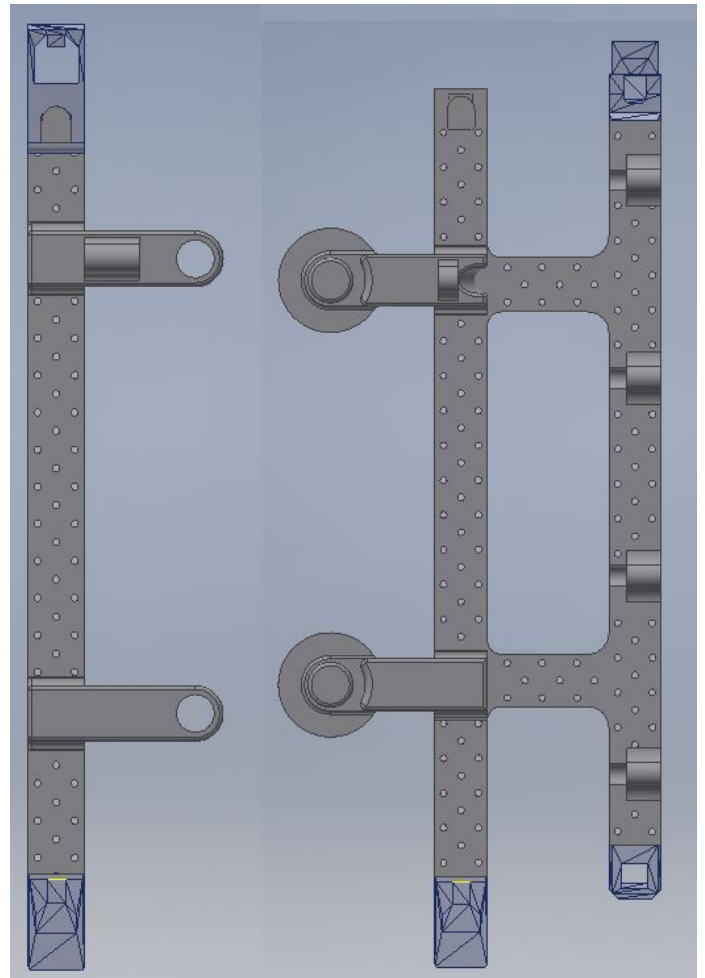

Fig. 12: The complete socket design for a long residual limb, consisting of one strap folded around the upper arm and two straps folded around the lower arm: the 1-2-socket.

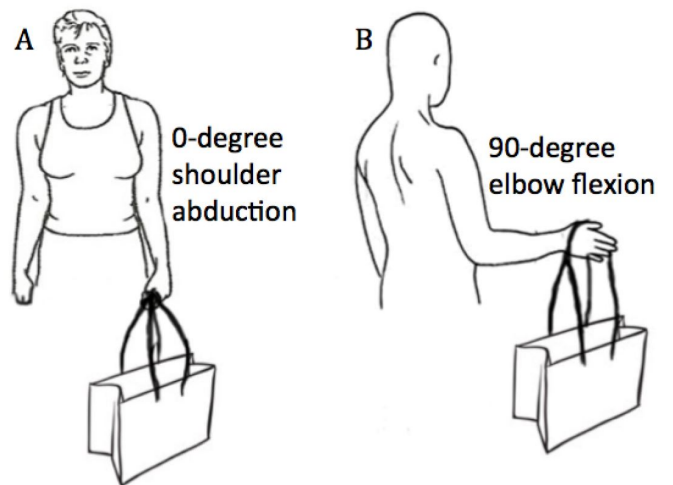

Fig. 13: Carrying a bag with an elbow flexion of 90° and with a shoulder abduction of 0°, respectively [23].

$$R_2 = \frac{1}{2}(R_3 - F)$$

$$\sum F = 0$$

$$R_2 + R_3 + R_4 + F = 0$$

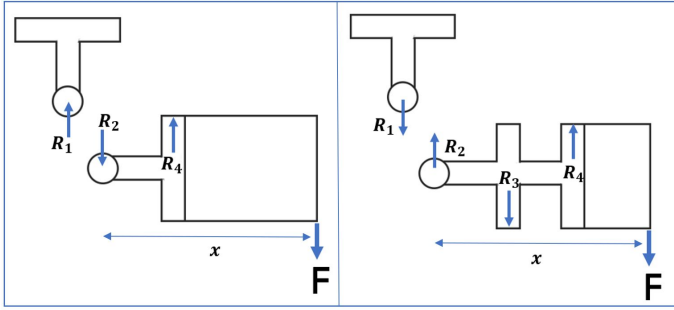

Fig. 14: Reaction forces on the 1-1-socket and the 1-2-socket, when holding an object with an elbow flexion of 90°.

As can be observed, the 1-2-socket has smaller reaction forces than the 1-1-socket (see figure 14). Moreover, the reaction forces  $R_1$  and  $R_2$  have opposite directions in the 1-2-socket compared to the 1-1-socket. The upper strap will push the hinge downwards when it has one strap on the lower arm. At the 1-2-socket the upper strap will pull the hinge upwards because the reaction force is in the opposite direction.

The moment is related to the applied force and the length of the 3D printed lower arm. A longer lower arm will lead to an increased moment on the socket:

$$M = F * L$$

Where:

M = Moment on the socket

F = Force applied

L = Length lower arm

As can be seen in figure 14, the moment of the external force will have more impact on the 1-1-socket than on the 1-2-socket because of the extended lower arm. Therefore, the moment of the 1-2-socket can be remarkably smaller than the moment of the 1-1-socket. In the situation of figure 14, this moment would even become two times as small:

$$M_{1-1-socket} = F * \frac{2}{3}x$$

$$M_{1-2-socket} = F * \frac{1}{3}x$$

When holding an object with a shoulder abduction of 0° the moment arm will be the same for the 1-1-socket and the 1-2-socket due to the same length of moment arm (see figure 15).

Because of the high moment on the hinges, the straps connected to the hinges will get a higher infill density in the printing settings to become stronger and less flexible/deformable.

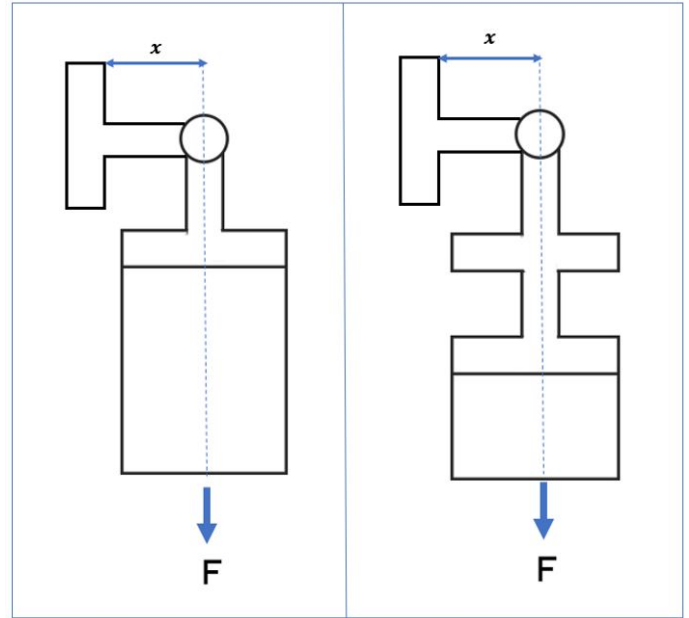

Fig. 15: Moment arm is the same for the 1-1-socket and the 1-2-socket, when holding an object with a shoulder abduction of 0°.

The design of a right amputee socket is different compared to the design of a left amputee socket. Tunnels are made on the socket to guide a control cable which ensures the fingers of the 3D printed hand to bend. This flexible metal cable with a wrapped wire housing is a control cable adopted from the bicycle industry. This control cable is guided on the inner arm so it can be connected to the inside of the hand (see figure 16). After that, it is guided through two tunnels on the inside of the socket. Consequently, the control cable will be connected to a harness which is fastened to the shoulder on the opposite side of the prosthesis. When the patient rotates his shoulder internally, the control cable will be tightened, which leads to bending fingers. This makes it possible for the patient to grab a bag, a drink or another object.

When the straps are folded around the residual limb, they can be closed by locks. Lock A (see figure 3)



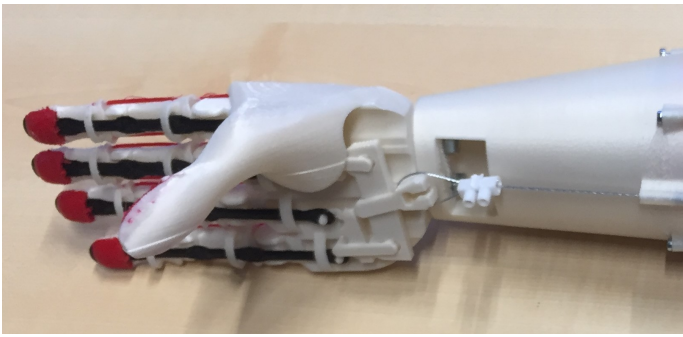

Fig. 16: *Internal rotation of the shoulder leads to a tightened control cable, which manages the fingers to bend.*

is chosen for the lock of the strap attached to the prosthesis because this lock can be locked irreversible and is only needed for reassembly. Lock B (see figure 3) is chosen for the remainder closures because this lock is used for donning and doffing.

In this design, lock B is adapted. Firstly, the lock is made more durable by making it thicker in certain parts. Secondly, lock B is divided into two parts: the strap and a spacer. The spacer is an extension of the strap in combination with lock B, which is designed to make the socket adjustable (see figure 17). This spacer can be printed in different sizes in advance to handle volume fluctuation of the residual limb. The socket can be made volume adjustable not only on the upper arm but also on the lower arm and is still entirely 3D printed.

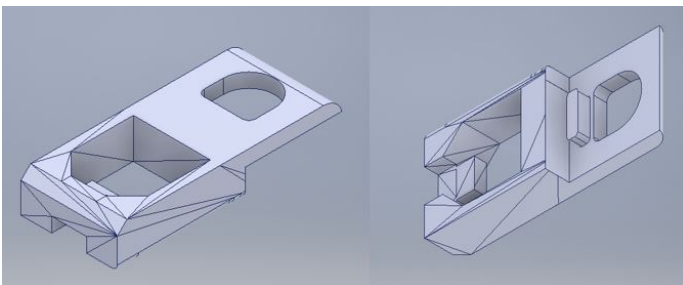

Fig. 17: *The spacer, which can be attached to the straps and makes the socket adjustable for volume fluctuations.*

This spacer can be attached to the strap by first slice it over the half-circle, then turn it 180° (see figure 18) and then click it, see figure 19 for further explanation. This mechanism makes sure the spacer stays attached without disconnecting, during donning and doffing.

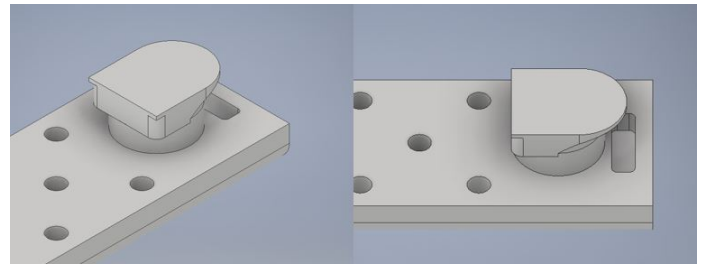

Fig. 18: *Attachment of the spacer to the straps by a click system.*

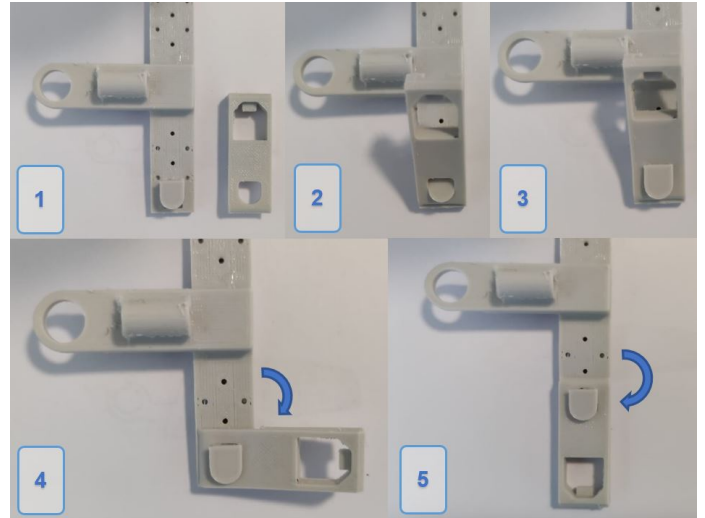

Fig. 19: *1. Face the circle of the spacer in the same direction as the circle of the strap 2. Pull the hole over the half circle 3. Slide 4. Rotate the spacer 180° 5. Click*

Instead of a condyle brace (see figure 2), a strap is folded around the complete circumference of the upper arm, to make it easier to flex and extend. Consequently, almost the same percentage of skin is covered by the straps since the straps connected to the hinges do not touch the skin. Moreover, all straps are perforated to encourage more breathability. The uncertainty of perforating the socket is the fact that if the holes are too big, the skin will get sucked in the holes, which will lead to a bubbled skin. On the other hand, when the holes are too small, the socket is hard to clean, and the breathability will decrease. Furthermore, the holes can affect the strength of the socket. A small study has been conducted (see Appendix E) about which holes were the perfect combination between strength, cleanliness and comfort. This resulted in holes with a diameter of 2 mm, separated with a horizontal centre distance of 10 mm. In this design, the straps have approximately 6% more skin uncovered (see Appendix E).

## B. Strength tests

### 1) Methods

Two strength tests are performed to test the performance of the material, the spacer and the complete socket. The force transfer in the 1-1-socket is the most critical. Therefore, this socket will undergo strength tests.

#### Strength test 1: Spacer

A strength test (see figure 20) is conducted for both materials (TPU 95A Arnitel ID2045) to test their performance. This strength test is practised to examine if the spacer is strong enough to withstand the forces. A homemade set-up is used for this end. The straps, connected with a spacer (see figure 21), are folded around a pipe, which has approximately the same thickness as an arm. Therefore, it forces the straps to form around the pipe to mimic the same situation as donning and doffing the socket around a residual limb. A bucket is hanging at the end of the straps with a hook. Water is slowly added up (every minute, 1 kg of water) to an intended 10 kg, see Appendix G for the whole set-up. When the maximum weight of 10 kg is reached, it will be examined how many minutes the spacer can hold this weight before it starts to deform, with a maximum time period of 24 hours.

#### Strength test 2: Overall design

Another strength test (see figure 22) is performed to test the everyday performance of the complete socket (see Appendix H) [23]. PVC pipe coils are used to mimic a residual limb. Two set-ups are used. In the first set-up, the axial force of the socket was tested, which is the same as holding an object with a shoulder abduction of  $0^\circ$ . In the second set-up (holding a bag with an elbow flexion of  $90^\circ$ ), the radial force of the socket was tested to see if it is able to lift an object (see figure 13). A bag was attached on the end of the prosthetic arm, where weight was slowly added up (every minute, 1 kg) to an intended 10 kg. This applied weight is chosen as the maximum load for every day activities, like cooking or doing groceries. When the socket begins to get a visual elongation, a strap breaks or when the 10 kg is reached, the test will be stopped.

### 2) Results

#### Strength test 1: Spacer

TPU 95A and Arnitel ID2045 could both withstand the maximum weight of 10 kg ( $\approx 100N$ ) for more than one day without any deformation. To continue



Fig. 20: *Strength test 1: testing the materials and the performance of the spacer.*

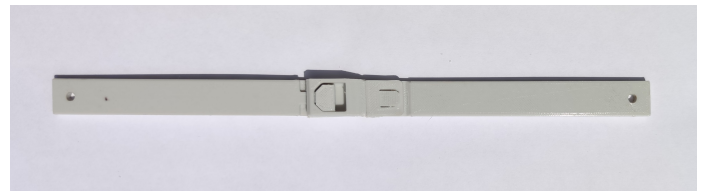

Fig. 21: *Top view of the straps connected with the spacer (strength test 1).*

the test, both materials were also subjected to a weight of 20 kg for the same time period. The spacers of both materials could also withstand this weight without deformation. After 24 hours, the maximum time period was reached, and the test was finished. Both straps/spacers are printed with the same settings, as can be seen in Appendix G. None of the spacers broke, elongated or deformed.

#### Strength test 2: Overall design

As can be seen in Appendix H, both materials could withstand the weight add up (every minute, 1 kg) until the maximum weight of 10 kg ( $\approx 100N$ ) in the first set-up was reached. The material TPU 95A could also withstand the weight add up (every minute, 1 kg) until the maximum weight of 10 kg in the second



Fig. 22: Strength test 2: testing the performance of the complete socket. Set-up 1 (holding a bag with a shoulder abduction of  $0^\circ$ ) and set-up 2 (holding a bag with an elbow flexion of  $90^\circ$ ), respectively.

set-up was reached. However, this did not last for long, and after a few seconds, the strap of the lower arm disconnected. On the other hand, Arnitel ID2045 already began to deform from a weight of 5 kg and the lower part of the socket disconnected when 1 kg more was added. The strap of the upper arm was again still attached, but the complete prosthesis was just not connected to the stump anymore (see figure 23).

## V. Discussion

An adjustable, breathable, parametric, 3D printed socket is designed for usage in low-income countries. The results of the present study show that the 3D printed WILMER open fitting leaves approximately 6% more skin uncovered, in comparison to the original WILMER open fitting. Furthermore, the socket is made volume adaptable by using a spacer. It can be concluded that this spacer is a great asset because of its strength. Overall, this socket device led to satisfactory results;

### Adjustability

The spacer, which is an extension of the strap in combination with lock B, is designed to make the socket adjustable (see figure 17). This spacer can be printed in different sizes in advance, to handle volume fluctuation of the residual limb. The results of the present study indicated that the designed spacer is strong enough to withstand the forces subjected to the straps. In the previous design of the WILMER



Fig. 23: Arnitel ID2045: the lower part of the socket was disconnected from the PVC pipe coil when a weight of 6 kg was applied to the end of the prosthesis.

open fitting, Lock B could handle loads up to 106.6 N [17]. In this design, the loads applied were up to 200 N (see strength test 1), and the spacer could still withstand the forces for more than 24 hours continuously. Therefore, this spacer is an excellent addition to make the socket volume adjustable. A limitation in the design of the volume adjustable socket is the strap attached to the 3D printed lower arm with screws. This strap is closed by lock A (see figure 3) without a spacer. This strap is not made volume adjustable because it had to have the same size circumference as the 3D printed lower arm to have an accurate attachment. Further research is needed to establish if it would be an asset to design a volume adjustable lower arm and connecting strap.

### Breathability

In this socket design the strap has covered the complete circumference of the upper arm. Which means that there is more contact between the socket and the skin on the upper arm, compared to the original WILMER open fitting design. On the other hand, the contact



between the socket and the skin around the elbow is decreased because only the hinges touch the skin. This is beneficial since it has been experienced that the skin is often more damaged in the area close to the amputation (see Appendix A). Due to holes in the straps, the socket leaves approximately 6% more skin uncovered than the original WILMER open fitting (see Appendix E). Currently, the socket is made more breathable, but a part of the stump is also positioned in the 3D printed lower arm tube of the prosthesis. Therefore it is recommended to also further look into perforating the upper part of the 3D printed lower arm.

### 3D printing

Test prints have been manufactured on the Ultimaker S5 printer. A limitation in 3D printing the sockets is the size of the building plate of the Ultimaker. The building plate of the Ultimaker S5 has a dimension of 330 mm x 240 mm. Thus, the maximum strap length is around 300 mm (including brim), which is larger than the circumference of an average residual limb. However, when 3D printing with the Ultimaker 3, the building plate is smaller. Then the maximum dimension of the circumference of the residual limb can only be 200 mm. If this dimension is larger, the strap has to be divided into parts and connected with locks, which can lead to a more critical force transition. Therefore, it is advised to use the Ultimaker S5 or another 3D printer with a large building plate.

It is beyond the scope of this study to investigate other 3D printers than the Ultimaker. Therefore, only the materials that were suitable for the Ultimaker printer were studied to obtain reliable 3D prints. A limitation in choosing the correct material is the number of unknown material properties of 3D printable materials. Furthermore, the mechanical material properties change after printing. Therefore, the material first needed to be tested before it was possible to decide if it was suitable for a 3D printed volume adjustable socket. A future recommendation is to research in a broader range of 3D printers and other corresponding flexible materials.

The socket is printed with the print settings recommended by Ultimaker.com for a flexible, strong material [28]. These settings can be optimized for a flexible prosthetic socket by performing mechanical tests. Currently, there is still some printing material underneath the straps that contains bubbles. This can be removed by adjusting the printing settings (or the printing settings of the support material) to a different

layer height, infill density or infill shape.

### Strength

It was not possible to test the socket on patients or to use strength machines due to the circumstances. The homemade set-ups were a suitable approach. Nevertheless, it did not mimic exactly the same situation as wearing a socket. The PVC pipe coil, used to mimic a stump, is very smooth and does not have a lot of friction. Furthermore, it is not possible to dent the pipe (like a residual limb). Therefore, the socket could not be fitted correctly on the pipe, and a little bit of space was left between the pipe and the straps. Another obstacle was the fact that the inside of the 3D printed lower arm was leaning on the PVC pipe coil. This could lead to unreliable results. In realistic wear conditions, the strength tests may result in less favourable outcomes.

In this study, a socket with one strap folded around the upper arm and one strap folded around the lower arm is designed for a short residual limb: the 1-1-socket. A socket with one strap folded around the upper arm and two straps folded around the lower arm is designed for a long residual limb: the 1-2-socket. The straps of the upper arm and the lower arm are connected by hinges.

According to the calculations, the 1-2-socket could better withstand the force than the 1-1-socket. The reaction force in the hinge has a different direction in the 1-1-socket compared to the 1-2 socket (see figure 14). The upper strap will push the hinge downwards when it has one strap on the lower arm. Therefore it is of great importance that the straps connected to the hinge are strong and stiff. Consequently, the printing settings of the straps around the hinges are adapted to a higher infill. At the 1-2-socket the upper strap will pull the hinge upwards because the reaction force is in the opposite direction. This is an advantage because it is easier to handle the moment. Therefore, a recommendation for a surgeon is to amputate the injured arm as long as possible. This will make it possible to design a 1-2-socket, which will minimize the moment caused by carrying an object. Future research is needed to conduct strength tests with the 1-2-socket and to compare it to the strength tests of the 1-1-socket.

The socket is strong enough to withstand the applied forces in strength test 2, without breaking. In this strength test, 1 kg of weight was added every minute with a maximum of 10 kg. This test was conducted in

two set-ups: with a shoulder abduction of  $0^\circ$  and an elbow flexion of  $90^\circ$  (see figure 22).

The socket composed of Arnitel ID2045 could withstand the maximum applied weight during a shoulder abduction of  $0^\circ$ . On the other hand, it was limited to an applied weight of 5 kg during an elbow flexion of  $90^\circ$ . When the weight of 5 kg was applied, the socket started to deform. Once another kg was added after one minute, the lower part of the socket disconnected from the PVC pipe coil. These results are in line with the previously calculated moments which were remarkable smaller with a shoulder abduction of  $0^\circ$  than with an elbow flexion of  $90^\circ$ .

The socket composed of TPU 95A could withstand the maximum applied weight in both set-ups. This is contradictory to what is expected considering that the 1-1-socket retrieves a high moment when it has an elbow flexion of  $90^\circ$ , see figure 14. Although TPU 95A could withstand the weight up until 10 kg, the socket disconnected a few seconds later. The reason why TPU 95A could withstand the applied weight could be because of the lower flexibility and higher friction coefficient than Arnitel ID2045. The disadvantage of a higher friction coefficient is that it can lead to a painful skin. Meanwhile, the socket has a smaller chance of disconnecting from the stump. Therefore a questionnaire should be conducted to see if the patients are experiencing pain or other discomforts when wearing the socket.

It can be concluded that TPU 95A is better suitable for a prosthetic socket than Arnitel ID2045. Nevertheless, some further research is needed to minimise the moment when the socket is limited to only one strap on the lower arm due to a short residual limb.

### **Overall socket design**

The strength tests showed suitable results, but no research has been done concerning the durability. The custom made 3D printed sockets are immediately supplied to the patient without testing. The next step in this process is to fit the socket onto a patients residual limb and to test and evaluate the socket. Essential aspects to evaluate are the comfort and strength of the socket, the process of donning/doffing and flexing/extending, the agility of the patient and the opinion of the patient on the design and the appearance of the socket. In every culture, other colours and shapes of prostheses are accepted. Future research could be done to examine the most suitable aesthetic of the prosthesis per low-income country.

Due to the minimal anthropometric dimensions needed to design the socket, it is possible to conduct the measurements without years of training. Traditional prosthetists are broadly educated in prostheses attached to all the limbs. The main topics they study are physiology, biology, mechanical engineering, communication, cultural education and psychology [8]. Hence, only a small fraction of the study covers learning how to attach a transradial prosthesis. Therefore, it would be beneficial for non-professionals to follow a short course specialised in the transradial arm prosthesis to see where the painful tissue, scars and muscles are and to optimise the 3D printed sockets.

The goal of this study was to design a socket affordable for amputees in low-income countries. Nevertheless, this socket could also be a suitable option for patients in developed countries. Therefore, more research is recommended to establish the gap in satisfaction between amputees living in a low-income country and amputees living in a developed country. Consequently, the design and manufacturing process of the socket could be adapted to make it equally suitable to be purchased by patients in developed countries.

## **VI. Conclusions**

The obtained results of the socket are summarized as follows:

- The design is parametric and suitable for every residual limb;
- The hinges make sure that both flexion and extension is possible again;
- The socket is made breathable by perforating the straps;
- The new design is adjustable to volume fluctuations due to a spacer.

This study provides the design of an affordable, comfortable, aesthetically pleasing, durable, parametric socket for amputees in low-income countries.

## References

- [1] Abbott, T. B. (2009). Why Choose Magnesium? *Materials Science Forum*, 618–619, 3–6. <https://doi.org/10.4028/www.scientific.net/msf.618-619.3>
- [2] Caldwell, R., & Fatone, S. (2017). Technique for Perforating a Prosthetic Liner to Expel Sweat. *Journal of Prosthetics and Orthotics*, 29(3), 145–147. <https://doi.org/10.1097/jpo.0000000000000136>
- [3] Cornell, K. (2010). US20120041567. CJ SOCKET TECHNOLOGIES Inc.
- [4] Dillingham, Timothy R., et al. "Limb amputation and limb deficiency: epidemiology and recent trends in the United States." *Southern Medical Journal*, Aug. 2002, p. 875+. Academic OneFile, Accessed 1 May 2019
- [5] Eide, A. H., & T. Oderud. (2009). Assistive technology in low-income countries. In *Disability & International Development: Towards Inclusive Global Health*, ed. M. Maclachlan and L. Swartz, 149-160. New York: Springer.
- [6] Erenstone, J. (2016, January 12). 3D Printing Tips and Techniques 5: Prosthetics—the True HMIs. Retrieved April 15, 2020, from <https://www.machinedesign.com/3d-printing/3d-printing-tips-and-techniques-5-prosthetics-true-hmis>
- [7] Faulkner, V., Field, M., Egan, J. W., & Gall, N. G. (1987). Evaluation of High Strength Materials for Prostheses. *Orthotics and Prosthetics*, 40(4), 44–58. Retrieved from [http://www.oandplibrary.org/op/pdf/1986\\_04\\_044.pdf](http://www.oandplibrary.org/op/pdf/1986_04_044.pdf)
- [8] Fishman, S. (1960). Professional Education In Prosthetics And Orthotics. *Orthotics and Prosthetics*, 14(3), 86–92. [http://www.oandplibrary.org/op/1960\\_03\\_086.asp](http://www.oandplibrary.org/op/1960_03_086.asp)
- [9] Frillici FS, Rissone P, Rizzi C, Rotini F. The role of simulation tools to innovate the prosthesis socket design process. Pham, DT, Eldukhri, EE, Soroka, AJ *Innov ProdMach Syst MEC Cardiff Univ Cardiff*. 2008:214-219.
- [10] Harkins, C. S., McGarry, A., & Buis, A. (2013). Provision of prosthetic and orthotic services in low-income countries: A review of the literature. *Prosthetics and Orthotics International*, 37(5), 353–361. <https://doi.org/10.1177/0309364612470963>
- [11] Hussain, S., Sanders, E., & Steinert, M. (2012). Participatory Design with Marginalized People in Developing Countries: Challenges and Opportunities Experienced in a Field Study in Cambodia. *Internal Journal of Design*, , 91–109. <https://doi.org/10.1155/2014/849073>
- [12] ten Kate, J., Smit, G., & Breedveld, P. (2017). 3D-printed upper limb prostheses: a review. *Disability and Rehabilitation: Assistive Technology*, 12(3), 300–314. <https://doi.org/10.1080/17483107.2016.1253117>
- [13] Legro MW, Reiber G, del Aguila M, et al. Issues of importance reported by persons with lower limb amputations and prostheses. *J Rehabil Res Dev*. 1999;36(3):155-163.
- [14] Limbs international. (z.d.).Technology Development. Retrieved from <https://www.limbsinternational.org/technology-development.html>
- [15] Lyon, C. C., Kulkarni, J., Zimerson, E., Van Ross, E., & Beck, M. H. (2000). Skin disorders in amputees. *Journal of the American Academy of Dermatology*, 42(3), 501–507. [https://doi.org/10.1016/s0190-9622\(00\)90227-5](https://doi.org/10.1016/s0190-9622(00)90227-5)
- [16] Mak, F. T., Zhang, M., & Boone, D. A. (2001). State-of-the-art research in lower-limb prosthetic biomechanics-socket interface: A review. *Journal of Rehabilitation Research and Development*, 38(2), 161–174. Retrieved from <https://www.rehab.research.va.gov/jour/01/38/2/pdf/mak.pdf>
- [17] Mazereeuw, M. (2018). An AM optimised transradial interface for low-income countries. Retrieved from <https://repository.tudelft.nl/islandora/object/uuid%3Ac6b15882-fa2c-485b-89a7-2561dbbc6b89>
- [18] Meulenbelt, H. E. J., Dijkstra, P. U., Jonkman, M. F., & Geertzen, J. H. B. (2006). Skin problems in lower limb amputees: A systematic review. *Disability and Rehabilitation*, 28(10), 603–608. <https://doi.org/10.1080/09638280500277032>
- [19] Moss, L. (2019, 28 december). Finance Colombia. Colombia's New Minimum Wage For 2020 Rises 6 To 877,803 Pesos Per Month. <https://www.financacolombia.com/colombias-new-minimum-wage-for-2020-rises-6-to-877803-pesos-per-month/>
- [20] NAYLOR, P. F. D. (1955). EXPERIMENTAL FRICTION BLISTERS. *British Journal of Dermatology*, 67(10), 327–342. <https://doi.org/10.1111/j.1365-2133.1955.tb12657>
- [21] Pirouzi, G., Abu Osman, N. A., Eshraghi, A., Ali, S., Gholizadeh, H., & Wan Abas, W. (2014). Review of the Socket Design and Interface Pressure Measurement for Transfemoral Prosthesis. *The Scientific World Journal*, 2014, 1–9. <https://doi.org/10.1155/2014/849073>
- [22] Plettenburg, D. H., & Cool, J. C. (1992). The Wilmer Open Socket for Children. *International Society for Prosthetics and Orthotics*. <https://www.tib.eu/en/search/id/BLCP%3ACN006355160/The-Wilmer-Open-Socket-for-Children/>
- [23] Pogolian, M. (2015, juni). Design of a 2nd generation WILMER open socket. Retrieved from <https://repository.tudelft.nl/islandora/object/uuid%3A25b6bc4f-1278-4d41-8ad6-c8cc6f0f59a4>
- [24] Ponte, E. (2017, September 20). Shore Hardness and Soft TPES. Retrieved May 2, 2020, from <https://www.teknorapex.com/thermoplastic-elastomers-and-measuring-shore-hardness-chart>
- [25] Radosh, A., Kuczko, W., Wichniarek, R., & Górski, F. (2017). Prototyping of Cosmetic Prosthesis of Upper Limb Using Additive Manufacturing Technologies. *Advances in Science and Technology Research Journal*, 11(3), 102–108. <https://doi.org/10.12913/22998624/70995>
- [26] Sanders, J. E., & Fatone, S. (2011). Residual limb volume change: Systematic review of measurement and management. *Journal of Rehabilitation Research & Development*, 48(8), 949–986. <https://doi.org/10.1016/j.otrs.2015.03.020>
- [27] Strait, E. (2006, januari). Prosthetics in developing countries. <http://www.doc-developpement-durable.org/file/sante-hygiene-medecine/handicaps/Protheses-Propylene/DevelopingCountries.pdf>
- [28] Using the Ultimaker Marketplace. (2020, February 21). Retrieved April 10, 2020, from <https://support.ultimaker.com/hc/en-us/articles/360011968360-Using-the-Ultimaker-Marketplace>
- [29] Vaughan, M. R. (2014). A Low-Cost Volume Adjustable Lower Limb Prosthetic Socket: Design and Evaluation. Retrieved from <https://repositories.lib.utexas.edu/handle/2152/27148>
- [30] Zuniga, J., Katsavelis, D., Peck, J., Stollberg, J., Petrykowski, M., Carson, A., & Fernandez, C. (2015). Cyborg beast: a low-cost 3d-printed prosthetic hand for children with upper-limb differences. *BMC Research Notes*, 8(1). <https://doi.org/10.1186/s13104-015-0971-9>





# APPENDICES

Appendix A describes the experiences and discoveries during the internship in Colombia. Appendix B gives a more detailed description of the conducted study to find which material is most suitable for the socket. Appendix C provides the literature study, which is an overview of the existing adaptable prosthetic sockets.

Appendix D shows the different concepts to make the current socket adjustable. In Appendix E, tests are done to discover the optimal hole size for the best balance in comfort/breathability. In Appendix F, there is a manual which describes the fitting procedure of the new socket and how to import it in Inventor. Appendix G and H show the strength tests conducted on the final design. Finally, in Appendix I are the engineering drawings of the ultimate, optimal socket.



# APPENDIX A

## Internship report

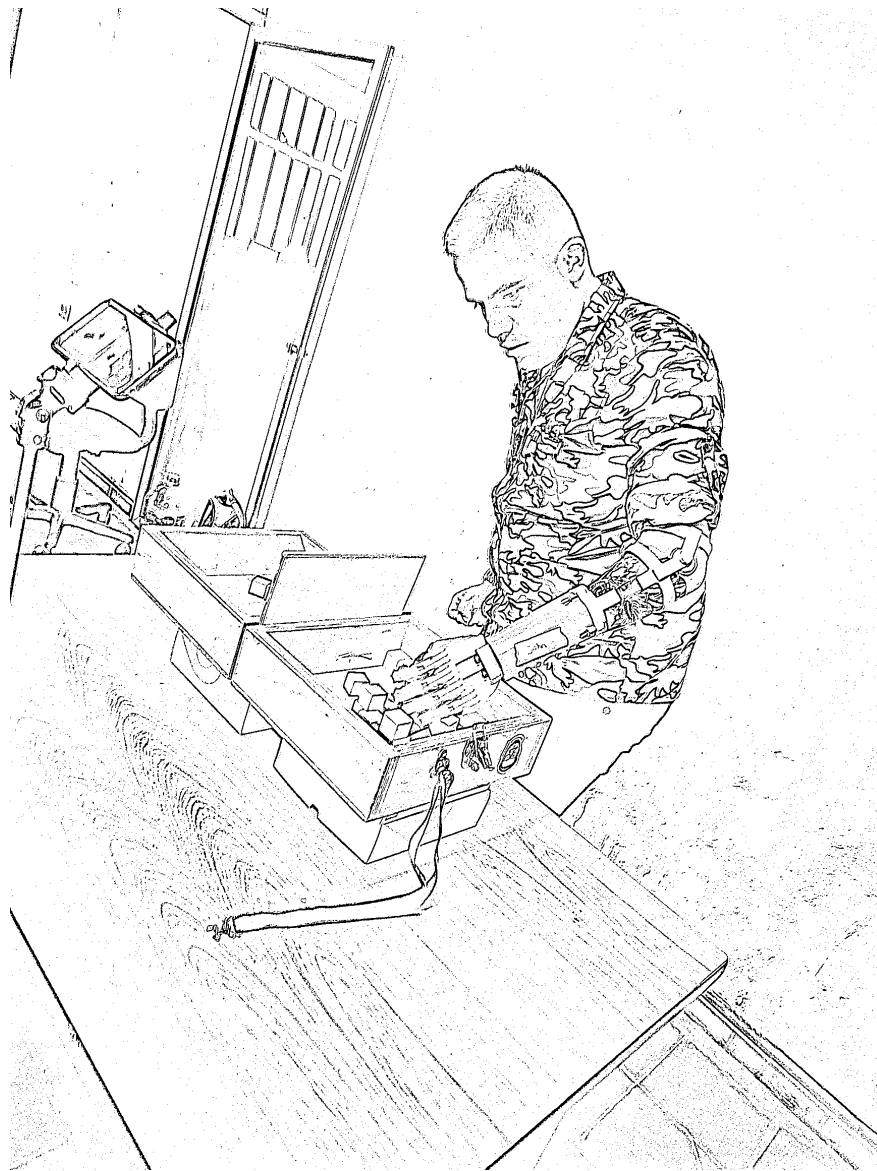

# APPENDIX A: INTERNSHIP REPORT



3D PRINTED PROSTHESES IBAGUÉ

Cooperation between TU Delft and Universidad del Tolima



**Hilde Jansen**

**4301773**

**December – February**

**Website: <https://juanqr7.wixsite.com/arm3d>**

## Project summary

Arm3D is a project started from the TU Delft, where a smartphone is used as a scanner to make a 3D printed active hand prosthesis and socket: The WILMER Open Fitting. The advantage of a 3D printed prosthesis is the low costs of which a personalized design can be made. This was in great importance for this project, which has taken place in Ibaguè, Colombia. Normally, in low-income countries it is hard to have a prosthetic device with the limited amount of prosthetic healthcare and it is very expensive to buy one. Therefore, a lot of people don't have a prosthetic device in Colombia.

The WILMER Open Fitting still needed to be clinically tested and questioned. This has taken place in Ibaguè where Juan Cuellar Lopez (PhD-student), Madelon Kusters, Pieter van Spaendonck, Iris Meijer, Elisabeth van Berckel and I worked together with the Secretary of Healthcare of the city. Juan, Madelon and I did the designing part of the project. Pieter, Iris and Elisabeth did the business part of the project. From December till February experiments with the 3D-printed prosthesis have been done. Patients with a trans-radial amputation visited us and we printed a personal prosthesis, improved the prosthesis, performed tests and made an assessment.

## Internship description



In our design-team the role of Juan was mostly the programming part of the scanning and designing the lower arm/hand, Madelon mostly designed special cases (shoulder prosthesis and a hand prosthesis for someone with one finger for example). My role in Arm3d was to design the socket with Inventor.

But first the Prusa printer needed to be built up from scratch: With the use of a manual we were able to assemble the printer in one week and it was possible to start printing. This printer is famous for the low costs and performance. The Prusa i3 MK3S is ranked as the best printer under 1000 dollars. This is of great benefit for us because the prostheses must be as cheap as possible to make it available for people with a low income. Next step

in the process was meeting the patients to take measurements of the residual limb.

A lot of amputees in Ibaguè lost their arm when they were working. The working conditions in Colombia are not as good as in the Netherlands. There are no rules about the machinery and when a machine gets stuck people will try to fix it by sticking their hand inside. This results in terribly hand injuries. We met one man whose whole hand was cut off in a lawn mower. He first had to walk for 1 km to the closest house and then had to travel to a hospital for three hours. The blood was clotted and travelled up to his heart which caused a heart attack. Nevertheless, he was very grateful like an angel brought him back to life.

I made a measurement tool and a small manual about how to measure all the patients and putted all the values in an excel sheet (Appendix 1). All the residual limbs differ a lot of each other, therefore this tool makes it easier to measure everyone equally. With this tool the straps are 40 mm away from the pivot point. This is a good point to start measuring. When a residual limb has a major deviation, it is still possible to adapt the prosthesis. For example, this happened with patient 5, therefore custom- made measurements have been made and a prosthesis has been developed based on the original prosthesis.

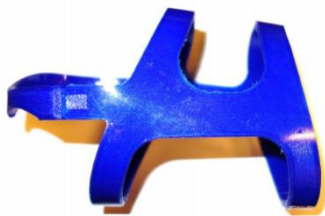

Figure 3: Original 3D printed WILMER Open Fitting, Matthijs Mazereeuw

The original 3D printed WILMER open socket design (designed by Matthijs Mazereeuw) is a breathable socket with straps that are fixed to each other. After a few testprints we discovered this design isn't working very well for a 3D printed socket. The TPU 95A material sheds a lot over the skin when moving the residual limb, which causes irritation and blisters. Furthermore, the original parametric design of the WILMER Open fitting didn't work. Residual limbs are very different of each other and difficult to standardize. In this model it

was assumed every residual limb was long and wide in the form of a cone. Four patients were tested with this parametric design, they all had a different shape of residual limb. Therefore, the program gave errors to the design and it wasn't possible to design the socket parametric.

Hence, a new socket is designed based on the WILMER Open fitting. This socket has the same size straps and the same locks as the WILMER Open Fitting. The design consists of straps, connected to each other with a hinge which ensures that the socket has a lot of freedom of movement and is strong enough to withstand forces. Moreover, it makes sure that the straps stay in place without shedding. This design is still as breathable as the WILMER open fitting, but better suited for 3D printing. This custom-made socket can be printed in 6 different ways (Appendix 2):

- Right: 1 upper arm strap, 1 lower arm strap
- Right: 1 upper arm strap, 2 lower arm straps
- Right: 1 upper arm strap, 2 lower arm straps, printed in 3 pieces
- Left: 1 upper arm strap, 1 lower arm strap
- Left: 1 upper arm strap, 2 lower arm straps
- Left: 1 upper arm strap, 2 lower arm straps, printed in 3 pieces



Depending on the size of the residual limb we choose if it was better to have a socket with one or two lower arm straps. Sometimes the residual limb was so big that it was not possible to print the lower double strap in once, and the design had to be split.

When it was decided which socket we wanted to print, I only had to put the measurements in the Inventor part, and the socket automatically scaled. This is due the fact that it is a parametric design with the measurements as the parameters. This makes it very easy to make a custom-made 3D model in less than 5 minutes.

In the meantime, Juan made the lower arm for the patient. This arm is connected to the socket with screws. The hands were already printed in the Netherlands. Personally, I think that for the cosmetic appearance of the hand the next time more research should be done. These hands were bright red, which is very remarkable. Not everyone with a prosthesis wants to show he/she wears a prosthesis.

When the socket is finished in Inventor, it is time to slice it. We used the program PrusaSlicer for it:

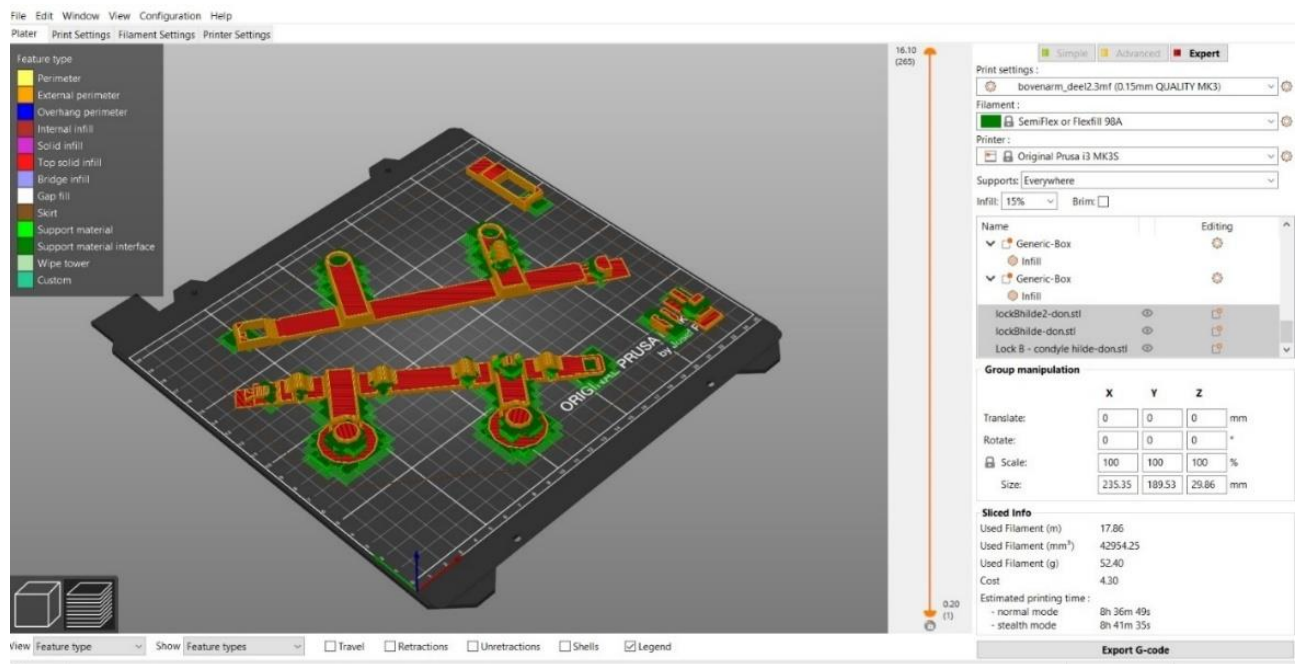

Figure 4: Prusa slicer

After the slicing, the socket is ready to print! After around 8 hours printing it is ready and the only thing left to do was removing the support material, refining the socket and assemble the whole prosthesis. A limitation was the support material, which got really fixed to the TPU 95A. This led to painful, not accurate removals which took a long time. This could be improved by using a water-soluble support material the next time.



We tested the prosthesis on the patients by doing the box and blocks test. This test is used to measure the gross manual dexterity of the prosthetic device. After one week of wearing the prosthesis, the patient had to fill in a questionnaire.

## **Overview of internship experience**

During my internship experience with Arm3d I was able to develop my teamwork, designing skills, Inventor skills, 3D printing and Spanish skills. I particularly found the printing skills to be useful in improving my Inventor and designing skills. After printing things a few times, I learned how to design better parts in Inventor taking in account the limitations of the printer. Although I found speaking Spanish to be challenging, I found it to be valuable in developing my communication skills with patients.

I really liked this internship because we had a lot of responsibility. It almost felt like my own project. First interacting with the people, then make something special for them and then see how happy they were was the best feeling ever.

There were also parts of the internship where it was a big difference doing an internship abroad in Colombia compared to doing an internship in the Netherlands. A few unsuspected problems got in our path. In Colombia it is not easy to make appointments, planning's or schedules. For example, when we had an appointment with a patient, we never knew if she/he would show up and most of the time the patient came a few hours later than planned. Furthermore, In Colombia it was also not sure if the University was open, there were a lot of strikes or other protests. In addition, the printer had a lot of breakdowns, errors and stops. Therefore, we didn't know in forehand if we could print a prosthesis in 1 day or in 1 week. So, we had to work from day to day and not plan too much. This was first hard for me, but it was good for my patience skill.

## **Ongoing consideration**

While I had many useful experiences in Colombia, I still feel that I want to continue the project. There are a lot of small things which can be improved easily, but we didn't have more time for it. I really liked this project and hope it will be taken over by some other phd'er. We helped six patients now, but there are still a lot more, waiting for help. Furthermore, the patients which were helped don't have a 3D printing expert now if something breaks down or something needs to be fixed. Therefore, I hope a better cooperation between the TU Delft and Universidad del Tolima will be obtained.

In conclusion, I really liked this internship. Working in Colombia is a big difference with working in the Netherlands. Everybody there is very open and welcoming, and I can't wait to revisit Colombia. Because of this internship I want to continue with working in 3D printing prosthetics (or other medical devices) in low-income countries and hopefully help a lot of people!

# INTERNSHIP APPENDIX 1

## MEASUREMENTS RESIDUAL LIMB

*Lengths*

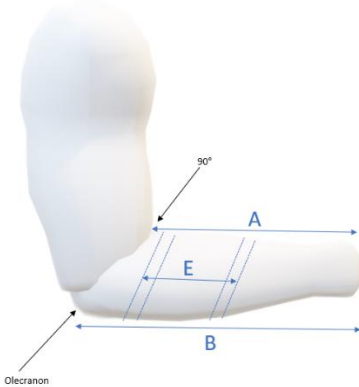

*Lengths*



*Circumferences*

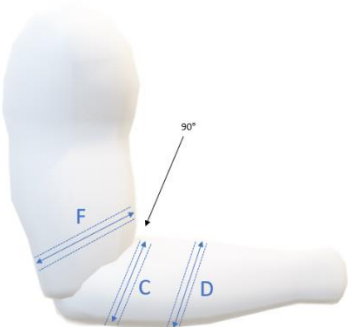

## MEASUREMENTS OTHER ARM

*Lengths*

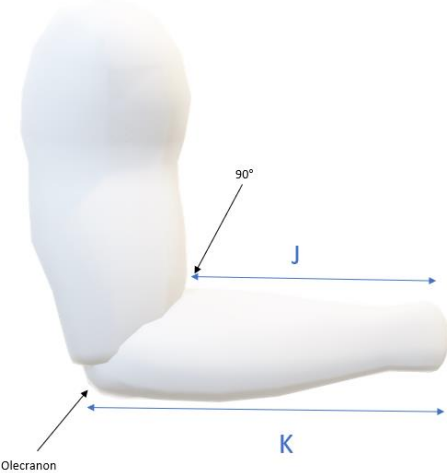

## Measurements

<b>A</b>	Ventral length stump
<b>B</b>	Dorsal length stump
<b>C</b>	Proximal circumference lower arm
<b>D</b>	Distal circumference lower arm (optional)
<b>E</b>	Length between the outsides of the 2 straps (measured in the middle)
<b>F</b>	Circumference upper arm
<b>H</b>	From the end of the arm till the end of the stump (measured in the middle)
<b>I</b>	Dimple elbow -> beginning of the strap
<b>J</b>	Ventral length other arm
<b>K</b>	Dorsal length other arm

## Measure tool for circumference F and C:

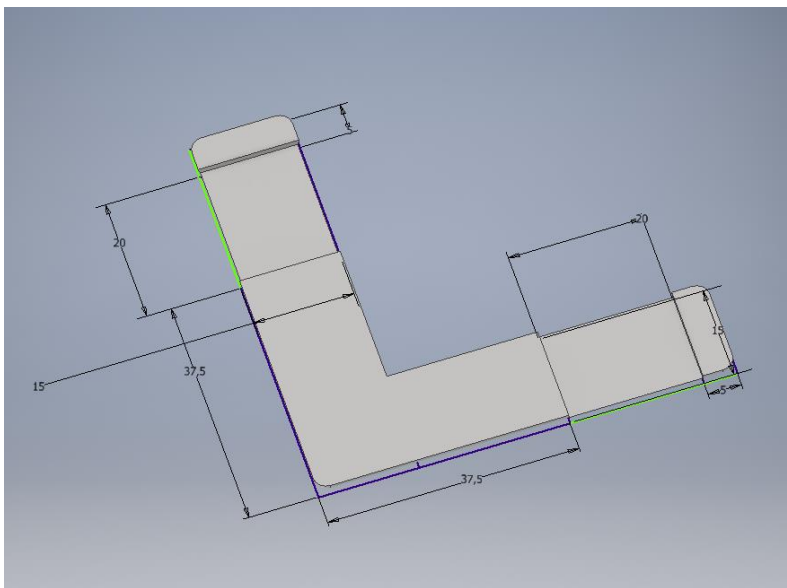

## Patientregister:

	A	B	C	D	E	F	G	H	I	J	K	L	M	N	O	P
1		<b>Left or right arm?</b>	<b>A</b>	<b>B</b>	<b>C</b>	<b>D</b>	<b>E</b>	<b>F</b>	<b>G</b>	<b>H</b>	<b>I</b>	<b>J</b>	<b>K</b>	<b>Radius C</b>	<b>Radius D</b>	<b>Radius F</b>
2	1	Right	4	8	19,5	16	4,5	20	13				10	3,10352139	2,546479089	3,183098862
3	2	Left	8	12	24	21,5	6,5	22,5	15		4,5			3,819718634	3,421831276	3,58098622
4	3	Left	16,5	19	25	17,5	11	26,5	20,5	23	4	23	27,5	3,978873577	2,785211504	4,217605992
5	4	Right	15	19	15,5	12	7,5	17,4	9	18	4	21	24	2,466901618	1,909859317	2,76929601
6	5	Right														
7	6	Right	5,5	8,5	18,5	x	x	17	12	10,5	4	23,5	26	2,944366447	x	2,705634033
8	7															
9	8															



# INTERNSHIP APPENDIX 2

- Upper arm:

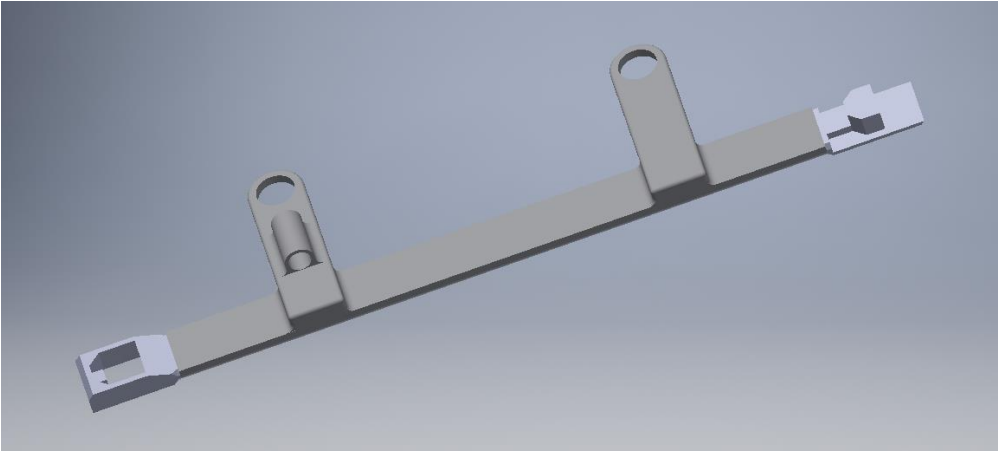

- Lower arm, 1 strap:

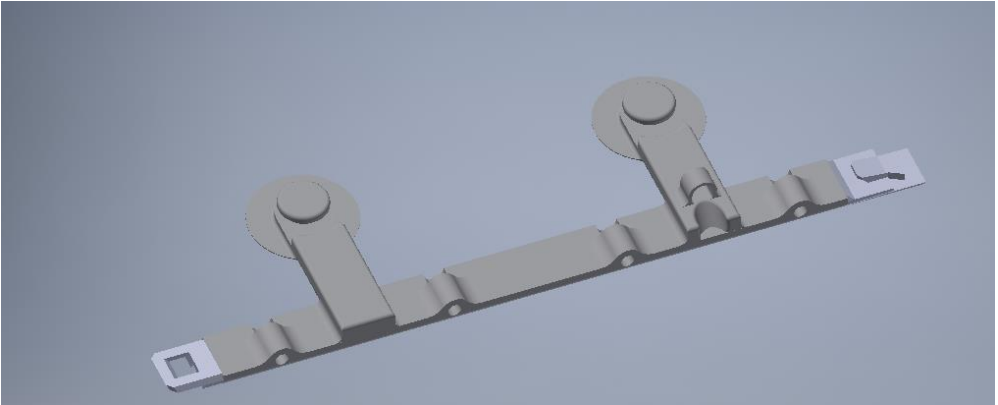

- Lower arm, 2 straps:

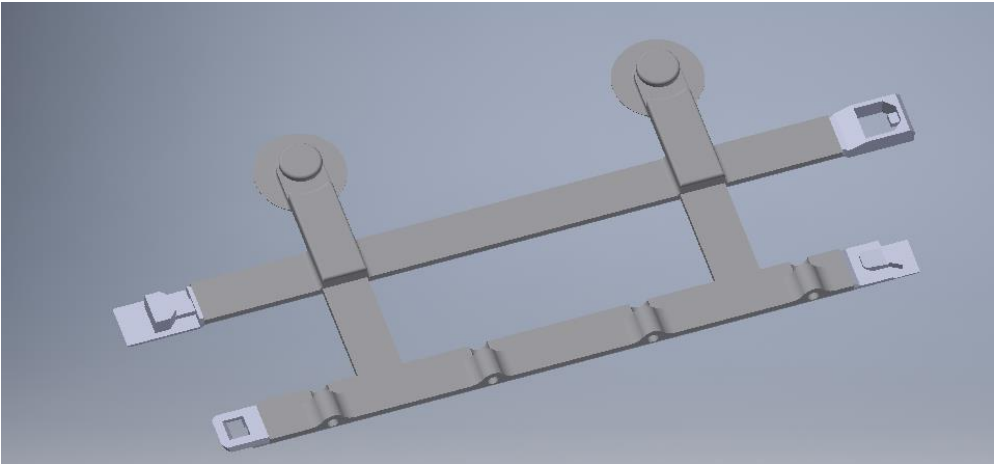

# APPENDIX B

## Materialstudy

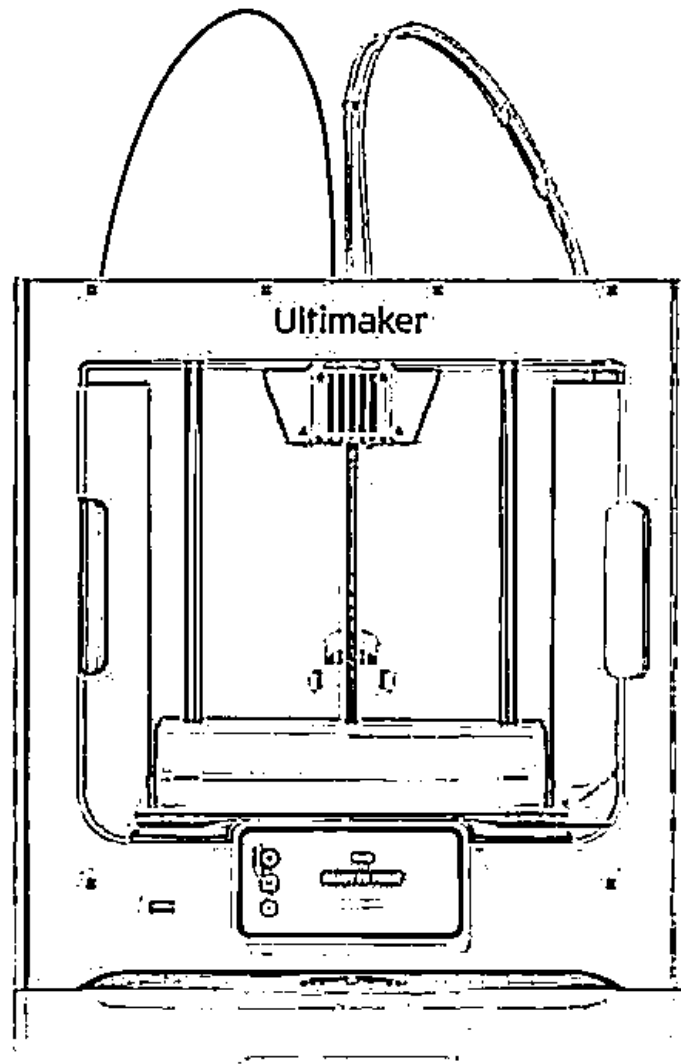

# APPENDIX B: MATERIAL STUDY

A material study has been conducted using the Ultimaker marketplace. In the Ultimaker marketplace all supported materials can be found. The requirement was that the material was a flexible material. This resulted in these supported materials:

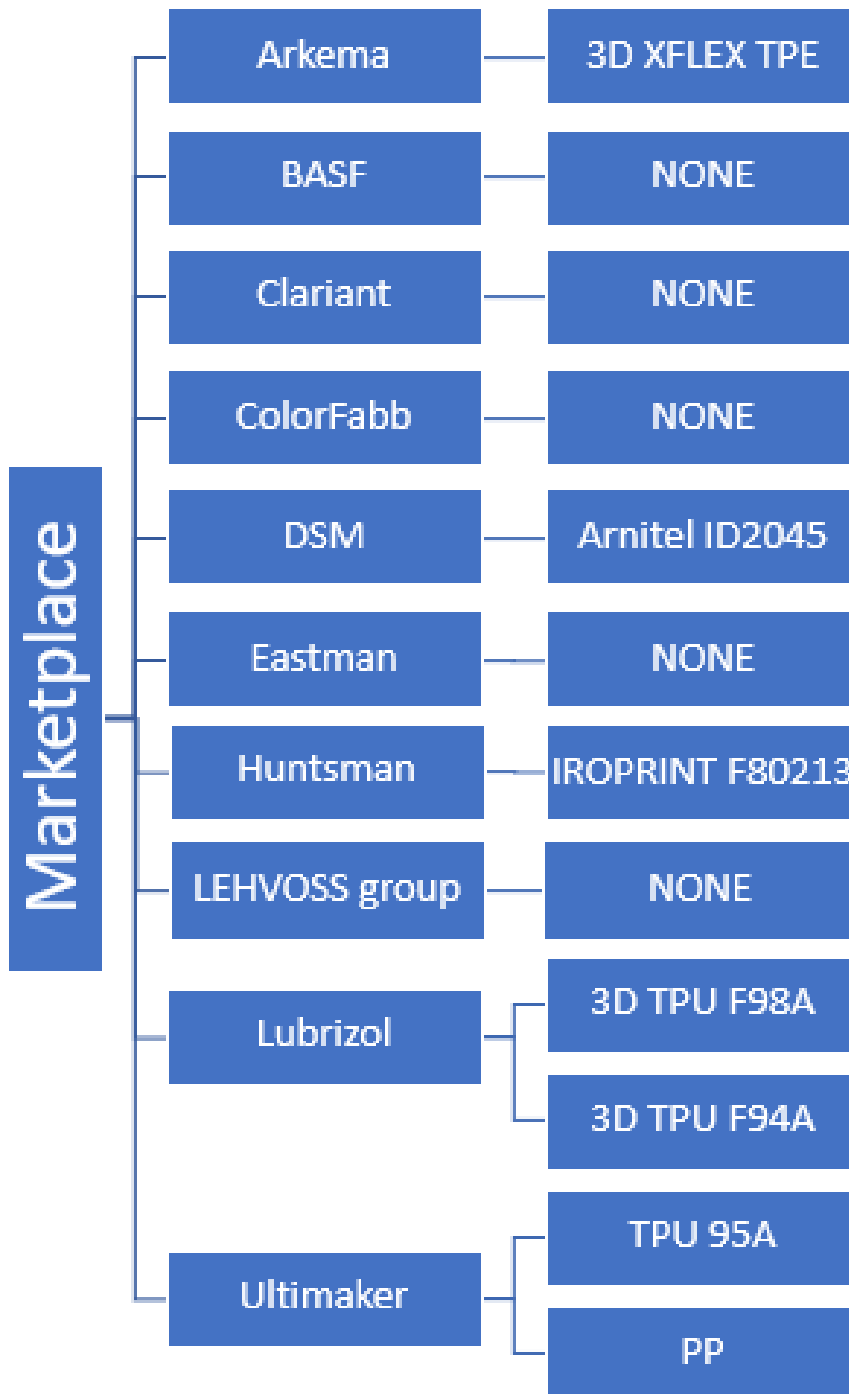

# ULTIMAKER

## TPU 95A

<https://ultimaker.com/nl/materials/tpu-95a>

- Very durable
- Flexible
- Strong layer bonding
- Exceptional wear and tear resistance
- High impact strength
- Long term UV and/or moisture immersion and applications where the printed part is exposed to temperatures higher than 100 °C
- Exceptional wear and tear resistance
- Rubber-like flexibility -> semi-flexible
- Great choice for industrial coatings or prototyping consumer products
- Good corrosion resistance to common industrial oils and chemicals

	<b>Value</b>	<b>Test method</b>
<b>Tensile modulus</b>	26 MPa	ASTM D638
<b>Tensile stress at yield</b>	8.6 MPa	ASTM D638
<b>Tensile stress at break</b>	39 MPa	ASTM D638
<b>Elongation at yield</b>	55%	ASTM D638
<b>Elongation at break</b>	580 %	ASTM D638
<b>Flexural strength</b>	4.3 MPA	ISO 178
<b>Flexural modulus</b>	78.7 MPa	ISO 178
<b>Hardness</b>	95 (shore A) 46 (shore D)	ASTM D2240 Durometer
<b>Abrasion resistance</b>	0,06 gram	ASTM D4060
<b>Melting temperature</b>	220 °C	DSC
<b>Moisture absorption</b>	0,18 %	ASTM D570

$$\frac{\textit{Flexibility}}{\textit{Elasticity}} = 3$$

# ULTIMAKER

## PP (ULTIMAKER)

<https://ultimaker.com/nl/materials/pp>

- Chemical resistant to a wide range of acids and bases
- Retains its form after torsion, bending or flexing
- High chemical, temperature and electrical resistance
- Lightweighted
- Durable
- High toughness
- Exceptional fatigue resistance
- Low friction
- Excellent layer bonding
- Long term UV and/or moisture immersion and applications where the printed part is exposed to temperatures higher than 105 °C

	<b>Value</b>	<b>Test method</b>
<b>Tensile modulus</b>	220 MPa	ISO 527
<b>Tensile stress at yield</b>	8.7 MPa	ISO 527
<b>Tensile stress at break</b>	No break within test range	ISO 527
<b>Elongation at yield</b>	18%	ISO 527
<b>Elongation at break</b>	>300 %	ISO 527
<b>Flexural strength</b>	13 MPA	ISO 178
<b>Flexural modulus</b>	305 MPa	ISO 178
<b>Hardness</b>	55 (shore D)	Durometer
<b>Abrasion resistance</b>	-	-
<b>Melting temperature</b>	130 °C	DSC
<b>Moisture absorption</b>	-	-

$$\frac{\text{Flexibility}}{\text{Elasticity}} = 1,4$$

# Arkema

## 3D XFLEX TPE

[https://www.3dxttech.com/content/Flex\\_PEBAX\\_TPE\\_v1.pdf](https://www.3dxttech.com/content/Flex_PEBAX_TPE_v1.pdf)

- Lightweight (density of 1.0 g/cc)
- High energy return
- Ease of printing
- Excellent layer bonding
- Bonds to other plastics
- Low printing odor
- Retains flexibility even at low temperatures
- Styrene and BPA free

	<b>Value</b>	<b>Test method</b>
<b>Tensile modulus</b>	70 MPa	ISO 527
<b>Tensile stress at yield</b>	-	-
<b>Tensile stress at break</b>	8 MPa	ISO 527
<b>Elongation at yield</b>	-	-
<b>Elongation at break</b>	>400 %	ISO 527
<b>Flexural strength</b>	7 MPA	ISO 178
<b>Flexural modulus</b>	65 MPa	ISO 178
<b>Hardness</b>	92-95 (shore A)	ISO 7619-1
<b>Abrasion resistance</b>	-	-
<b>Melting temperature</b>	147 °C	DSC
<b>Moisture absorption</b>	-	-

$$\frac{\textit{Flexibility}}{\textit{Elasticity}} = 0,9$$



## DSM

### Arnitel ID 2045

<https://plasticsfinder.com/en/datasheet/Arnitel%C2%AE%20ID%202045/K5BqL>

- Highly flexible TPC
- Very good UV and chemical resistance compared to TPU
- ECO label
- Prints twice as fast as other TPC
- Excellent inter-layer adhesion
- The material past the ISO irritation, ISO cytotox and the USP VI tests

*Bars printed in direction: 0 °C – 90 °C:*

	<b>Value</b>	<b>Test method</b>
<b>Tensile modulus</b>	29 MPa	ISO 527-1/-2
<b>Tensile stress at yield</b>	-	-
<b>Tensile stress at break</b>	8 MPa	ISO 527-1/-2
<b>Elongation at yield</b>	-	-
<b>Elongation at break</b>	350 %	ISO 527-1/-2
<b>Flexural strength</b>	-	-
<b>Flexural modulus</b>	-	-
<b>Hardness</b>	34 (shore D)	ISO 868
<b>Abrasion resistance</b>	-	-
<b>Melting temperature</b>	158 °C	ISO 11357-1/-3
<b>Humidity absorption</b>	0,04 %	Sim. to ISO 62
<b>Density</b>	1100 kg/m <sup>3</sup>	ISO 1183

*Bars printed in direction: 45 °C – 45 °C:*

	<b>Value</b>	<b>Test method</b>
<b>Tensile modulus</b>	29 MPa	ISO 527-1/-2
<b>Tensile stress at yield</b>	-	-
<b>Tensile stress at break</b>	7,6 MPa	ISO 527-1/-2
<b>Elongation at yield</b>	-	-
<b>Elongation at break</b>	390 %	ISO 527-1/-2
<b>Flexural strength</b>	-	-
<b>Flexural modulus</b>	-	-
<b>Hardness</b>	34 (shore D)	Durometer
<b>Abrasion resistance</b>	-	-
<b>Melting temperature</b>	158 °C	ISO 11357-1/-3
<b>Humidity absorption</b>	0,04 %	Sim. to ISO 62
<b>Density</b>	1100 kg/m <sup>3</sup>	ISO 1183

# Huntsman

## IROPRINT F80213

[https://www.iroprint.com/sites/default/files/media/files/2019-10/preliminary\\_product\\_data\\_sheet\\_-\\_iroprint\\_f\\_80213.pdf](https://www.iroprint.com/sites/default/files/media/files/2019-10/preliminary_product_data_sheet_-_iroprint_f_80213.pdf)

- Elastic
- Strong
- Easy to print
- Quality look and haptics
- Abrasion resistance
- Cut and scratch resistance
- Good low temperature performance

	<b>Value</b>	<b>Test method</b>
<b>Tensile modulus</b>	29 MPa	DIN 53504
<b>Tensile stress at yield</b>	-	-
<b>Tensile stress at break</b>	-	-
<b>Elongation at yield</b>	-	-
<b>Elongation at break</b>	590 %	DIN 53504
<b>Flexural strength</b>	-	-
<b>Flexural modulus</b>	-	-
<b>Hardness</b>	35 (shore D)	ISO 7619
<b>Abrasion resistance</b>	-	-
<b>Melting temperature</b>	-	-
<b>Humidity absorption</b>	-	-
<b>Density</b>	1004 kg/m <sup>3</sup>	ISO 1183

# Lubrizol

## 3D TPU F94A

<https://www.lubrizol.com/Engineered-Polymers/Products/Estane-TPU/Estane-3D>

- High heat performance
- Easy to extrude
- Excellent mechanical properties, with special resistance to thermo-oxidative aging (tested up to 175 °C)

	<b>Value</b>	<b>Test method</b>
<b>Tensile modulus</b>	43 MPa	ISO 527
<b>Tensile stress at yield</b>	-	-
<b>Tensile stress at break</b>	>20 MPa	ISO 527
<b>Elongation at yield</b>	-	-
<b>Elongation at break</b>	315%	ISO 527
<b>Flexural strength</b>	-	-
<b>Flexural modulus</b>	-	-
<b>Hardness</b>	94 (shore A)	ISO 868
<b>Abrasion resistance</b>	-	-
<b>Melting temperature</b>	-	-
<b>Humidity absorption</b>	-	-
<b>Density</b>	-	-

# Lubrizol

## 3D TPU F98A

<https://www.lubrizol.com/Engineered-Polymers/Products/Estane-TPU/Estane-3D>

- High clarity and printed part quality
- Excellent flexibility and mechanical strength
- Impressive impact resistance and tensile strength
- Durable in heat aging conditions (tested up to 140 °C)
- High printing speed
- Excellent chemical and abrasion resistance
- High transparency

	<b>Value</b>	<b>Test method</b>
<b>Tensile modulus</b>	28 MPa	ISO 527
<b>Tensile stress at yield</b>	-	-
<b>Tensile stress at break</b>	-	-
<b>Elongation at yield</b>	-	-
<b>Elongation at break</b>	380%	ISO 527
<b>Flexural strength</b>	-	-
<b>Flexural modulus</b>	-	-
<b>Hardness</b>	98 (shore A)	ISO 868
<b>Abrasion resistance</b>	-	-
<b>Melting temperature</b>	-	-
<b>Humidity absorption</b>	-	-
<b>Density</b>	-	-

All important material properties of the selected materials are combined in a table:

	TPU 95A	PP	3D XFLEX TPE	ID2045	IRO PRINT F80213	3D TPU F94A	3D TPU F98A
<b>Durability</b>	Very Durable	Durable	Highly durable	Highly durable	Durable	Durable	-
<b>Price in dollars per kg</b>	113,7	98,90	160	114,6	95	79,9	75
<b>Density g/cm<sup>3</sup></b>	1,22	0,89	1,0	1,10	1,04	1,21	1,23
<b>Shore D hardness</b>	46 (D)	45 (D)	43 (D)	34 (D)	35 (D)	45 (D)	54 (D)
<b>Already medical used</b>	yes			yes			yes
<b>Tensile modulus MPa</b>	26	220	70	29	29	43	28

To select the best material a weighted decision matrix is executed with the following guidelines:

Score (0 = poor, 5 = very good)						
	0	1	2	3	4	5
<b>Durability</b>	Not Durable	Little Durable	Medium Durable	Very Durable	Highly Durable	Impressive Durable
<b>Price [\$/kg]</b>	250 <i>and higher</i>	200 – 250	150 – 200	100 – 150	50 – 100	0 – 50
<b>Density [g/cm<sup>3</sup>]</b>	2,50 <i>and higher</i>	2,00 – 2,50	1,50 – 2,00	1,00 – 1,50	0,50 – 1,00	0 – 0,50
<b>Shore D hardness</b>	100 <i>and higher</i>	80 – 100	60 – 80	40 – 60	20 – 40	0 – 20
<b>Tensile modulus [MPa]</b>	0 80 >	0 70 – 80	0 – 10 60 – 70	10 – 20 50 – 60	20 – 30 40 – 50	30 – 40

This resulted in the following weighted decision matrix:

Criteria	Weighting	TPU 95A		3D XFLEX TPE		PP		ID2045	
		Score	Total	Score	Total	Score	Total	Score	Total
Durability	4	3	12	4	16	2	8	4	16
Price	3	4	12	3	9	5	15	4	12
Density	5	3	15	3	15	4	20	3	15
Shore D hardness	3	3	9	3	9	3	9	4	12
Tensile modulus	4	4	16	2	8	0	0	4	16
Already medical used	Wish +5		+5						+5
	<b>Total:</b>		69		57		52		71

Criteria	Weighting	IROPRINT		3D TPU F94A		3D TPU F98A	
		Score	Total	Score	Total	Score	Total
Durability	4	2	8	2	8	1	4
Price	3	4	12	4	12	4	12
Density	5	3	15	3	15	3	15
Shore D hardness	3	4	12	3	9	3	9
Tensile modulus	4	4	16	4	16	4	16
Already medical used	Wish +5						+5
	<b>Total:</b>		63		60		61



# APPENDIX C

## Literature review

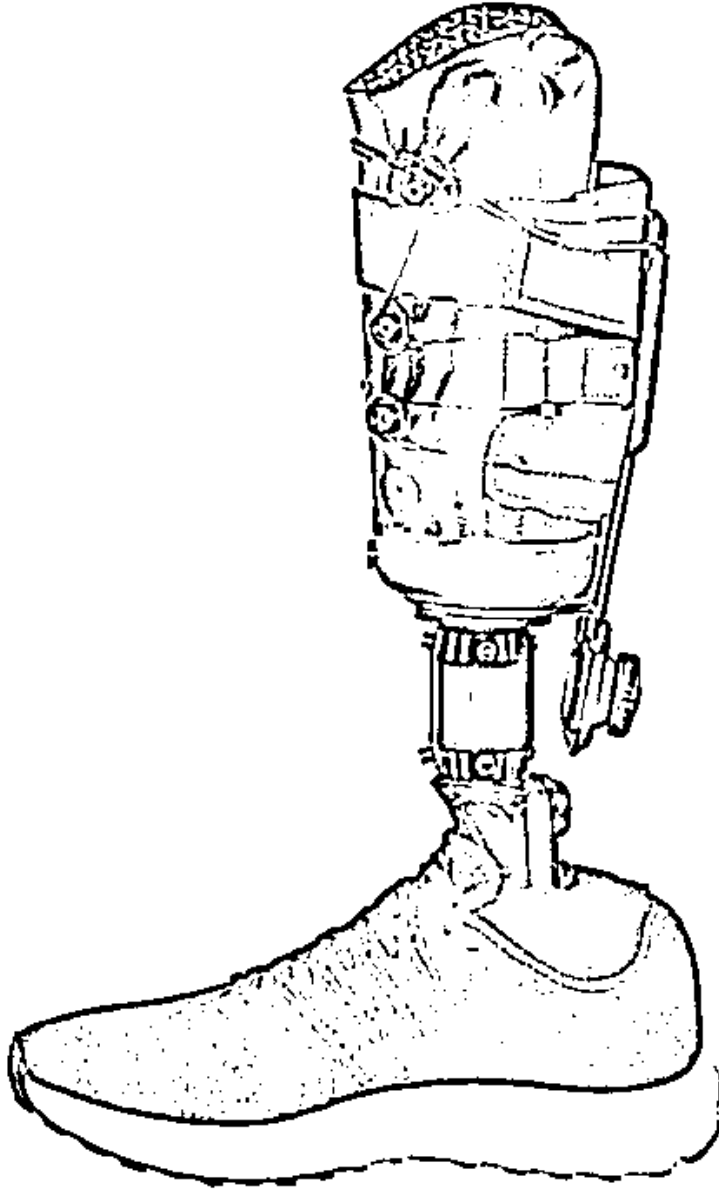

# Adjustable prosthetic sockets for transradial arm defects - how to cope with residual limb fluctuation

H. Jansen (4301773)

**Abstract**—One of the most critical subjects in the prosthetic field is the socket, the interface between the residual limb and the prosthesis. A residual limb can dilate or diminish daily and therefore a proper socket design is of great interest to get an optimal interaction between the socket and the stump. The aim of this paper is to systematically review and objectively compare different adaptable mechanisms to fit a prosthesis on patients with an amputation level below the elbow. It would be an asset if this socket can also accommodate the needs of amputees in underdeveloped countries. In this review, multiple adjustable mechanisms applicable on sockets, recommended in the literature, are described together with a distinct amount of advantages and disadvantages of the different mechanisms. The paper divides these multiple mechanisms in categories and sub-categories and provides some existing socket examples together with these mechanisms. It can be concluded that a mechanical socket, preferably consisting of a lace-tension mechanism, would be the best adaptable socket to apply on a transradial socket prosthesis in underdeveloped countries. This is the best solution due to the low manufacturing costs and the simplicity of the mechanism. Nevertheless, a combination of multiple mechanical mechanisms could also be a good solution to look into.

**Index terms**— Prosthesis, Prosthetic, Prostheses, Socket, Fitting, Adaptable, Adjustable, Attachment, Adaptive, Transradial, Amputee

## I. Introduction

COLOMBIA is one of the countries with the highest amount of citizens with limb disabilities and injuries from landmines. According to the Landmine monitor it is ranked as the country with the second most landmine victims in the world [1]. Landmines still have an enormous effect on the civilian population, causing physical problems such as amputations. Another important cause of limb loss in underdeveloped countries is diseases such as polio, malignancy or bone joint inflammation [2]. A substantial part of this disabled population does not have a prosthesis due to the high costs. Nevertheless, prostheses are an important aspect to improve the emotional satisfaction of patients [3]. Designing a suitable prosthesis for people in third world countries is extremely challenging because of

the remote location, the poor production circumstances and the small amount of research [4].

Currently, 3D printed prostheses are being made to challenge these problems and to personalize prostheses. These prostheses are designed with the use of an application, which is in development. This application scans the residual limb with a smartphone camera. The scan will be transferred to a model which can be 3D printed to a well fitted prosthesis [5]. A regular upper limb prosthesis can cost approximately 7000 dollars [6]. However, with the use of this new technology, where 3D printers are used to manufacture prostheses, these costs can be reduced remarkably [7].

A challenge which still needs to be completed, is to optimize the socket of these prostheses. The function of the socket is to provide a proper operation of the prosthesis, to distribute the loads and to connect the prostheses to the residual limb [3] [8]. The material which is generally used for sockets is carbon fiber/epoxy composites CFRP (Carbon Fiber Reinforced Polymer), which is almost a rigid body [9]. This is in contradiction to the fact that a stump can be dilated or diminished daily under certain conditions. Examples of causes for daily volume fluctuations of the residual limb are alcohol consumption, physical activity and weather conditions. A range of around 15% is consistent with trends in short-term and long-term volume fluctuations for mature limbs [10] [11].

It can be concluded that an appropriate socket fitting is a critical factor in the rehabilitation of amputee [8]. Therefore, it is of great importance that the socket fits for both swelling and shrinkage of the residual limb. An improperly fitting of a socket can lead to a considerably amount of skin problems.

Firstly, the excessive pressure around the stump can cause sores such as blisters, ulcers, irritations and hyperplasia [12] [13]. Secondly, the forces from the prosthesis on the skin can lead to mechanical changes, which can also cause reaction and damage to the area underneath the skin of the residual limb [3]. Therefore, an adaptable fitting of the socket is from great aspect.

A good socket design can be achieved by a maximized weight-bearing surface area by having pressure points over the whole surface area. Furthermore, the friction between the socket and the skin should be as small as possible. Finally, the socket should be adjustable to adapt to decreasing and increasing volume of the stump [15]. Regrettably, the research about volume fluctuations in a mature residual limb is only limited [10].

In underdeveloped regions a transradial prosthesis is

hardly manufactured very precisely within low design and manufacturing costs. Nevertheless, it should also be able to redesign a below elbow prosthesis for low costs because it is already possible to produce other limb prostheses with minimized costs [16]. For example the Jaipur Foot [17], which only costs 10 dollars to manufacture (see fig. 1).

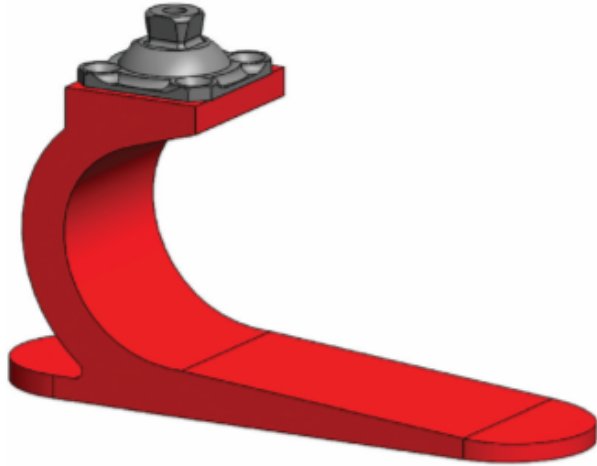

Fig. 1: The Jaipur Foot

Therefore, it is recommended to design an adaptable prosthesis socket that will adjust for the differences in the volume of the residual limb and small fluctuations in design/manufacturing errors.

The objective of this literature study is to systematically review and objectively compare different adaptable mechanisms to fit a transradial prosthesis on patients with an amputation level below the elbow which accommodates the needs of amputees in under-developed countries.

## II. Methods

### A. Systematically literature research

The study was performed in line with the recommendations of the Preferred Reporting Items for Systematic Reviews and Meta-Analyses (PRISMA) statement. The Scopus, Google Scholar, TU Delft library and Pubmed databases were searched between the 1st of March and 1st of May. Scopus and Pubmed were chosen because of the medical scientifically knowledge they contain. Google Scholar is chosen because it is a big multidisciplinary database. The TU Delft library is selected because of the amount of different databases it contains.

### 1) First search

#### Google Scholar

First, Google Scholar was used to specify the right search terms. After some searching it was specified that the word 'prosthesis' had to be include in the title and the words 'adaptable' or 'adjustable' or 'adaptive' or 'fitting' or 'attachment' or 'adjustment' had to be in the keywords, abstract or title.

Subsequently, a few full-text articles were read to determine if some keywords were missing. It was noticed that some relevant articles in the source list did not include the word 'prosthesis' but did include the word 'prosthetic'. This term was added to the list of search terms. Furthermore, the amount of results were too broad, so it was specified that the title should also contain the words 'adjustable' or 'adaptive' or 'fitting' or 'attachment' or 'adjustment'. The new search terms for the Google Scholar search became: *allintitle:'prosthesis adaptable OR adjustable OR adaptive OR fitting OR attachment OR adjustment'* and *allintitle:'prosthetic adaptable OR adjustable OR adaptive OR fitting OR attachment OR adjustment'* This resulted in 382 papers and 352 papers respectively.

After scanning the articles from Google Scholar, it was discovered that there were some articles which were not interesting to look at. Only articles with limb prosthesis are important to study. Therefore, articles about dental care prostheses, visual prostheses, or auditory prostheses ect. are excluded. Subsequently, the words 'Denture' 'Dental' 'Orbital' 'Teeth' 'Auditory' 'Orthopaedic' 'Hearing' 'Ear' 'Visual' 'Endoluminal' 'Spinal' 'Intraluminal' 'Neural' 'Penile' 'Ossicular' were removed from the search terms in Google Scholar. This resulted in:

*allintitle:'prosthesis adaptable OR adjustable OR adaptive OR fitting OR attachment OR adjustment -dental -myoelectric -endoluminal -ossicular -neural -penile -orthopaedic -spinal -denture -teeth -orbital -auditory -hearing -ear -visual -intraluminal'* (231 results)

*allintitle: 'prosthetic adaptable OR adjustable OR adaptive OR fitting OR attachment OR adjustment -dental -myoelectric -endoluminal -ossicular -neural -penile -orthopaedic -spinal -denture -teeth -orbital -auditory -hearing -ear -visual -intraluminal'* (335 results)

Google Scholar received a total of 231 + 335 = 561 articles. Thereafter the irrelevant articles after screening the titles were deleted from the list. This resulted in 111 (prosthesis) + 121 (prosthetic) articles.

After removing duplicates the final amount of articles from the prosthesis and prosthetic in Google scholar is of a total of 163 articles.

### PUBMED

Secondly, PUBMED was investigated with the requirement that 'prosthesis' or 'prosthetic' had to be in the title together with the keywords 'adaptable' or 'adjustable' or 'adaptive' or 'fitting' or 'attachment' or 'adjustment'. The final search resulted in the following search term: *((Prosthetic[Title] OR prosthesis[Title])) AND (adaptable [Title] OR adjustable [Title] OR adaptive [Title] OR fitting [Title] OR attachment [Title] OR adjustment[Title])*. The amount of articles in the outcome were 106 articles.

### Scopus

Scopus was used to search for literature articles with the word 'prosthesis' or 'prosthetic' in the title and with the words 'adaptable' or 'adjustable' or 'adaptive' or 'fitting' or 'attachment' or 'adjustment' in the title. This resulted in this search term: *TITLE ( ( prosthetic OR prosthesis ) AND ( adaptable OR adjustable OR adaptive OR fitting OR attachment OR adjustment ) )*. This resulted in an outcome of 46 open access articles and 726 others.

### TU Delft Library

The Technical University Delft library was also looked in, but when applying the following filter: *ti:(prosthesis OR prosthetic) AND ti:(adaptable OR adjustable OR fitting)*, nothing useful was found during the reading of the abstracts and titles, or a duplicate was found.

During globally reading of some articles, it was found that the word 'socket' is an important replacement for 'fitting'. Furthermore, a lot of titles included the word 'protheses'. Therefore, a completely new search had to be started including the words 'socket' and 'protheses'. The best manner to include this in the previous results is to restart the whole literature study because of the big importance of these words. This is done in all the databases used:

## **2) Second search**

### Google Scholar

In Google scholar multiple searches had to be made to include every search term otherwise it was impossible to include everything, see fig. 2.

1) *allintitle: prosthetic fitting adaptable OR adjustable OR adaptive OR attachment OR socket -*

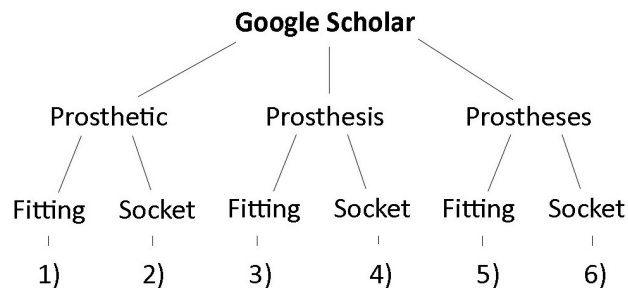

Fig. 2: How every search term is included in the Google Scholar search

*dental -endoluminal -ossicular -neural -penile -spinal -denture -teeth -orbital -auditory -hearing -ear -visual -intraluminal* resulted in 26 articles.

2) *allintitle: prosthetic socket adaptable OR adjustable OR adaptive OR attachment OR fitting -dental -endoluminal -ossicular -neural -penile -spinal -denture -teeth -orbital -auditory -hearing -ear -visual -intraluminal* resulted in 58 articles.

3) *allintitle: prosthesis fitting adaptable OR adjustable OR adaptive OR attachment OR socket -dental -endoluminal -ossicular -neural -penile -spinal -denture -teeth -orbital -auditory -hearing -ear -visual -intraluminal* resulted in 11 articles.

4) *allintitle: prosthesis socket adaptable OR adjustable OR adaptive OR attachment OR fitting -dental -endoluminal -ossicular -neural -penile -spinal -denture -teeth -orbital -auditory -hearing -ear -visual -intraluminal* resulted in 18 articles.

5) *allintitle: protheses fitting adaptable OR adjustable OR adaptive OR attachment OR socket -dental -endoluminal -ossicular -neural -penile -spinal -denture -teeth -orbital -auditory -hearing -ear -visual -intraluminal* resulted in 0 articles.

6) *allintitle: protheses socket adaptable OR adjustable OR adaptive OR attachment OR fitting -dental -endoluminal -ossicular -neural -penile -spinal -denture -teeth -orbital -auditory -hearing -ear -visual -intraluminal* resulted in 1 article.

This resulted in a total of articles in Google scholar of 114. After scanning and screening the titles the total amount of articles remained at 45 articles.

### PUBMED

In Pubmed one search term was enough to include and exclude every term needed. The new search term in Pubmed resulted in:

*((prosthetic[Title] OR protheses[title] OR pros-*

*thesis[Title]) AND (socket[title] OR fitting[title] OR adaptable[Title] OR adjustable[Title] OR adaptive[Title] OR attachment[Title])) NOT denture NOT hemipelvic[title] NOT dental[Title] NOT endoluminal[Title] NOT ossicular[Title] NOT hip[Title] NOT neural[Title] NOT penile[Title] NOT spinal[Title] NOT denture NOT teeth[Title] NOT orbital[Title] NOT auditory[Title] NOT hearing[Title] NOT ear[Title] NOT visual[Title] NOT intraluminal[Title]*

This resulted in 339 articles before sorting. After sorting and scanning the amount of remaining articles was 31 articles.

### Scopus

In Scopus one search term was enough to include and exclude every term needed. The new search term in Scopus resulted in:

*( TITLE ( prosthetic OR prosthesis OR prostheses ) TITLE ( adaptable OR socket OR adjustable OR attachment OR fitting ) AND NOT TITLE ( hemipelvic OR dental OR endoluminal OR ossicular OR hip OR neural OR penile OR spinal OR denture OR teeth OR orbital OR auditory OR hearing OR ear OR visual OR crown OR intraluminal OR obturator[ ) ) ) AND NOT ( denture ).* This resulted in 781 articles before sorting. After sorting and scanning the titles, the amount of remaining articles was 45 articles.

A total of 1234 (114 + 339 + 781) research papers were found in all databases. After assessing the titles and when in doubt the abstracts of every article, several articles were excluded. After refinement a total of 121 articles of all papers remained. After removing the duplicates a total of 106 articles remained. All articles before the year 2000 were screened and objected if they were relevant.

A total of 69 articles remained. The abstracts of these articles were read careful and the articles were screened and judged with the following selection criteria:

1. The article should be written in English.
2. If the article is older than 20 years it should be of any relevance.
3. The article should contain information about the fitting/socket of a prosthesis.
4. An article about the design of a random prosthetic socket should also be applicable on a transradial prosthetic socket in a certain manner.
5. The fitting mechanism should be an adjustable mechanism.
6. The adjustable socket should be manufactured for

less than 300 dollars, which is the average income for a family in underdeveloped countries [14].

7. The socket should not be a direct skeletal attachment.

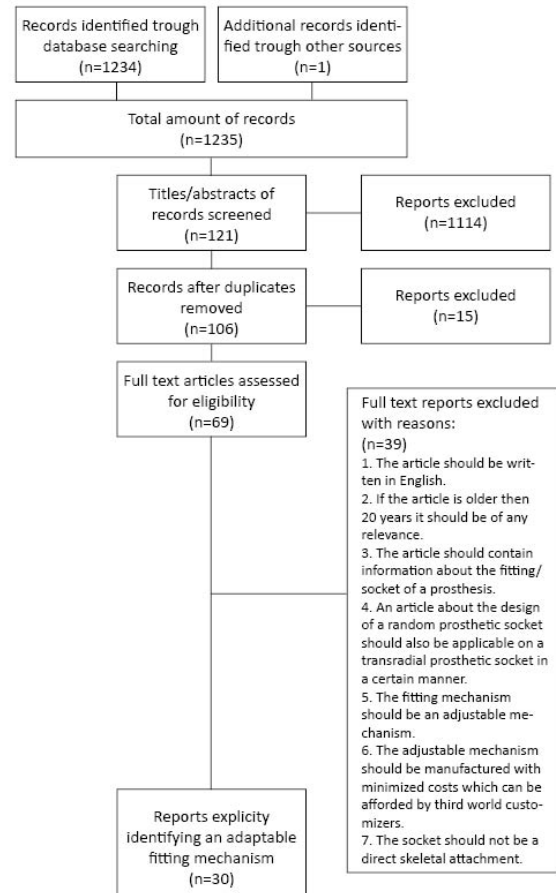

Fig. 3: Literature review, PRISMA diagram

After the screening, there are 30 articles remaining, see fig. 3. These articles have been read carefully and connecting references are also studied.

## B. Patent research

A patent research is also conducted to find existing designs which can be connected to the adaptable mechanisms found in the articles. The resulting 30 articles of the systematic literature review included 9 patents. These patents were read careful and all connecting/cited patents of these patents were also screened. The bibliography of these resulting patents is systematically explored by opening every cited source. The before mentioned selection criteria is applied to these sources. When a patent was explicitly identifying an adaptable mechanism, the sources of this

patent were explored again etcetera, until no sources remained. Finally, this patent research resulted in a total of 15 interesting patents which were useful for this literature study.

### III. Results

There are distinct methods designed for regulating daily volume fluctuations in the residual limb. Although not a lot of adaptable sockets for transradial prosthesis exist, there are a noticeable amount of adaptable sockets for lowerlimb prostheses. This is due the fact that walking provides a lot of pressure points, with changing volume, so it is of great importance to have a flexible or adaptable prosthesis. Furthermore, there has been done a lot of research in paedric prosthesis because children have a conventional grow potential [15] These previous researches can also be interesting, because it may also be applicable on transradial prostheses. The existing adjustable sockets can be divided in several categories: Flexible sockets, mechanical sockets, sockets with air filled bladders, sockets with a liquid actuation system and sockets with suction techniques.

#### A. Flexible sockets

Most transradial prostheses are rigid, this is because of the fact that a rigid prosthesis can control swelling and protect the wound for external danger. Furthermore, a rigid socket can easier transfer the arm forces to the prosthesis. [18] When elastic material is used it is required to apply even pressure to the stump, taken with enough regard to avoid the chance on flap necrosis. [18]. To deal with this problem plus still have an adaptable socket, a lot of flexible socks exist of a soft polyethelyne or silicone elastomer inner shell together with an outer sock with holes which has a more rigid structure. The flexible soft material takes care of the areas with less pressure while the outer shell contributes to the weight bearing areas. [20]

US4842608A [21] is an example of an adjustable distal elasticized sleeve which is applicable on below knee prostheses, see figure 4. This elasticized sleeve will accommodate for contraction and expansion.

#### B. Mechanical sockets

There are a lot of various types of sockets for lower and upper limb with movable panels. This can be subdivided in several categories: Hook and loop fastening device, adjustable hose clamps, rotational lace-tension mechanism, ratchet lock and ladder lock.

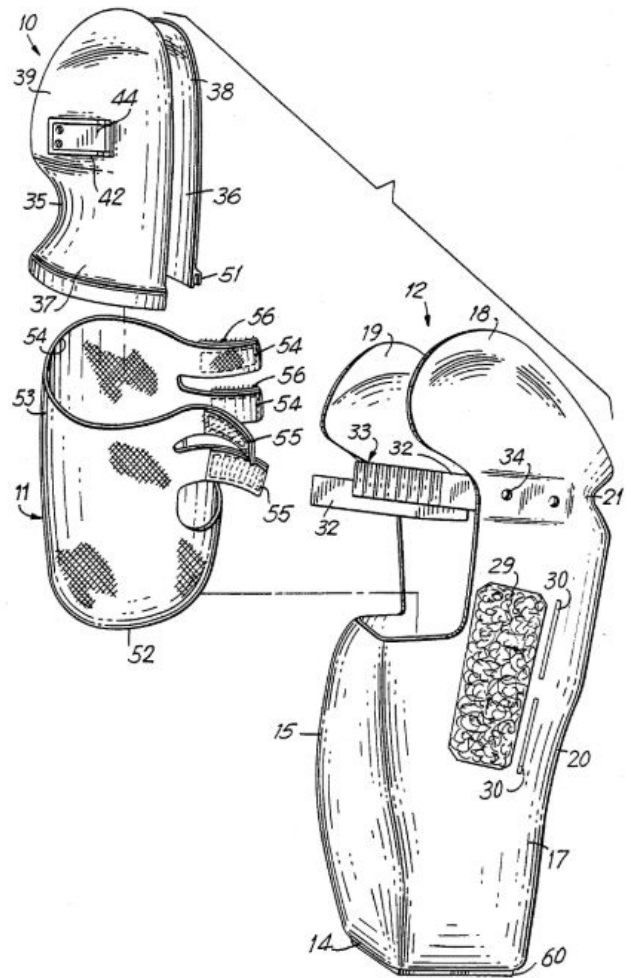

Fig. 4: Example of socket with a sleeve made of elasticized material (nr.11) : US4842608A [21]

#### 1) Hook and loop fastening device

A hook and loop fastening device consists of two strips which can be temporarily attached to each other; the hook and the loop, see fig. 5. A hook and loop device is a safe mechanism which is easy to use with only a limited amount of maintenance. The advantage of this mechanism is the high life time of the material and the strength. Some hook and loop mechanisms can support up to 80 kg loads [22]. The disadvantages are the nuisance of the noise when doffing or donning and the fact that a lot of materials can stick to the hook. US4872879A [23] (see fig. 6 is an example of a socket with a hook and loop mechanism. The sleeve-like body includes a medial, lateral and anterior wall. The interfaces of the walls ensure that the socket can be adaptable by sliding and overlapping. The extension of the lateral wall overlaps the anterior wall which forms a peripheral discontinuity which ensures an adaptable



socket. These interfaces are attached to each other with a hook and loop fastening device, see figure 5.

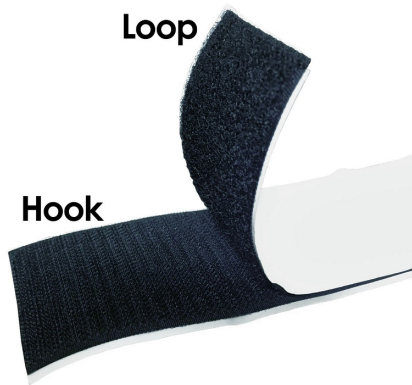

Fig. 5: *Hook and Loop. Retrieved from <https://www.electriduct.com/Hook-Loop-Fastening-Tape.html>*

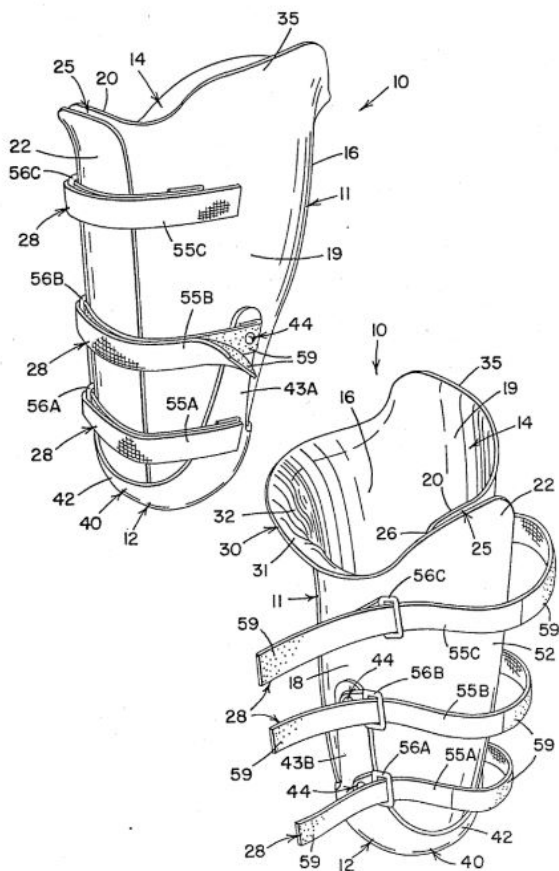

Fig. 6: *Example of socket with a hook and loop mechanism (nr.5): US4872879A [23]*

US20160058584A1 [24] has a Loop lock in the shape of a V. US5653766A [25] is another fitting technique with hook and loop fastening device which

also uses sliding interfaces in ischial containment's sockets. It is a sleeve with two portions, including a longitudinal slit. This slit enables an adjustable inner surface circumference of the first portion. US20060009860A1 [26] combines these patents and includes a socket with a cup (with multiple portions), a lateral wall and a brim. Both the brim and the lateral wall can be adapted in respectively upper open portion and lateral cutaway. US8945237B2 [27] is a socket which can be manually adjusted with hook and loop fastening. This socket has a flexible support and a rigid support which does not cover the whole limb.

## 2) Adjustable hose clamps



Fig. 7: *Hose Clamp. Retrieved from <https://www.globalindustrial.com>*

A hose clamp is a device which attaches and clamps a hose to a bracket plane [19] (fig. 7). Limitations of a hose clamp are moderate pressures which can cause the hose sliding off the nipple.

An example of a socket with an adjustable hose clamp is the Variable Volume Socket (VVS). In this socket the wall can slide both proximal and distal. Hose clamps are used to make the back plate adjustable [20], see fig 8. The two-piece construction enables the prosthesis to don and doff without damaging the skin of the residual limb due to shear forces [28].

## 3) A rotational Lace-Tension mechanism

There is an enormous amount of sockets connected with all kind of struts and/or straps with the use of a tension mechanism. The most recently design is the infinite socket [29], see figure 9.

The infinite socket is manually adaptable and only for above the knee prostheses. In this socket four struts attached to a base are arranged along the residual limb, connected with straps [20]. The disadvantage of

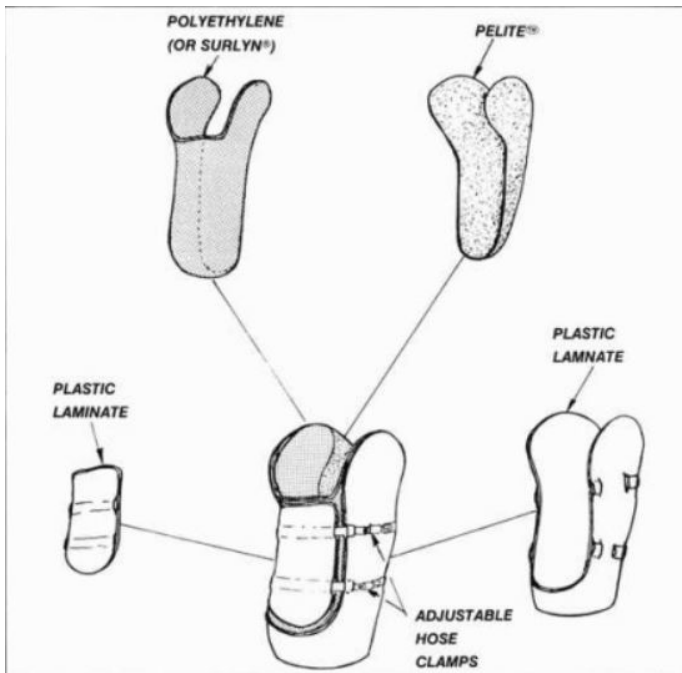

Fig. 8: Example of a socket with hose clamps: The Variable Volume Socket (VVS) [28]

the infinite socket is the manual tightening which can cause excessive tightening. This is dangerous because it can eventually lead to deformation and/or mass loss of the residual limb. Therefore, it is recommended to make the tightening automatically [29].

US9962273B2 [30] and US9050202B2 [31], accommodating for every residual limb, include a flexible and a rigid spine. This socket uses a lacing system with a tension mechanism which can be adjusted manually. These tensioners can be turned in two directions to increase or decrease the length of the cable and therefore adjust the diameter volume of the socket.

The REVOLimb Socket (see fig 10) is connected through wires and a Boa and also uses a lacing system with tensioners. Adjustment of the BOA will fasten the wires and the socket will become stiffer. [20]

US8978224B2 [32] and US9248033B2 [33] are designs where the socket is connected through encircling bands with internal tensioning cables inside it. These bands can be tightened or loosened manually with the use of a tension mechanism. These sockets use interconnected vertebrae elements to connect two components to each other and can be adjusted with the help of a dial tensor.

The high fidelity (Hi-Fi) socket is a non-adjustable socket which uses compression stabilization. The residual limb is compressed by a frame of struts longitudinally to the bone. This will lead to a stiffer and more stable socket [34]. Recently (2019) a new



Fig. 9: Example of socket connected with a rotational Lace-Tension mechanism: The Infinite Socket. Retrieved from [www.liminnovations.com](http://www.liminnovations.com) )

patent is released: the Quatro Compression Socket (see fig 11. This socket (for above the knee of elbow amputees) is the same as the Hi-Fi socket but then with an adaptable lace-tension mechanism which allows volume changing throughout the day.

#### 4) Ratchet lock

The ratchet lock is another manner to adjust a socket manually, see fig. 12.

The socket-less socket (see fig 13) is an example of a transtibial socket which enables to overcome macro volume changes with the use of a ratchet lock and micro volume changes with the rotational lace-tension mechanism [29]. Just like the infinite socket, the disadvantage of the socket-less socket is the chance of excessive tightening in case of incorrect use.



Fig. 10: Example of socket connected with a rotational Lace-Tension mechanism: The REVOLimb Socket. Retrieved from <https://www.orthopartners.eu/revolimb-systeem/>



Fig. 12: A ratchet lock. Retrieved from [http://specialequipment.com/product\\_info.phpproducts\\_id164](http://specialequipment.com/product_info.phpproducts_id164)

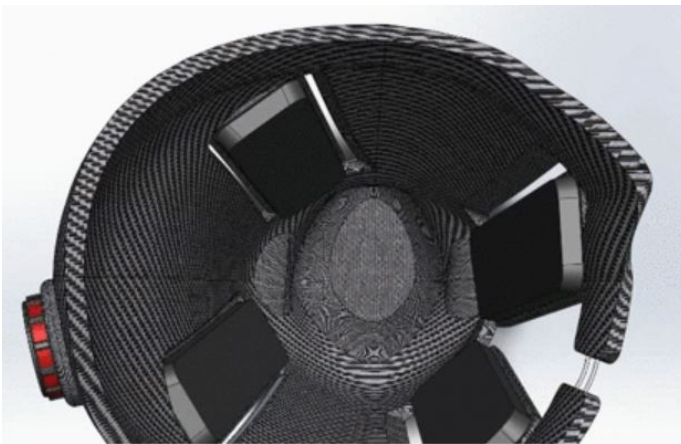

Fig. 11: Newest release of a socket connected with a rotational Lace-Tension mechanism: The quatro socket. Retrieved from <https://www.opquorum.com/>



Fig. 13: Example of socket connected with a ratchet lock: The Socket-less-Socket. Retrieved from <https://www.martinbionics.com/socket-less-socket-transfemoral/>

## 5) Ladder lock

The ladder lock (see fig 14) is useful to correct for macro volume adjustments. KISS LANYARD (see figure 15) is a prosthesis for above the knee amputees. The socket includes a ladder lock as well as a hook loop.





Fig. 14: Ladder lock. Retrieved from <http://luggage-sets.net/shop/liberty-mountain-ladderlock-strap-pack-of-2/>



Fig. 15: Example of socket connected with a ladder lock: the KISS LANYARD. Retrieved from <https://shop.ottobock.us/>

### C. Sockets with air filled bladders

Sockets can also be volume adjusted when they are inflatable. This can be done by bladders or by pressure actuators. Air bladders are a good solution to deal

with the varying loads a user experiences (for example during grasping or doing a natural movement) due to the variable stiffness and sizes [35]. The function of air bladders is to counter act against the pressure received by an external load. There are a distinct amount of sockets with air filled bladders.

#### 1) Manually controlled air bladder as interface between residual limb and socket

There are a certain amount of available air-filled bladders working as interface between the residual limb and the socket. In the article of Sanders et al. [35] the performance of each of these sockets is rated. The main problems of the function of air-filled bladders are the relatively high pressure and high compressibility. This will cause losses and a very big volume range. Moreover, air filled bladders have a harder control in comparison to liquid actuation systems [36]. Furthermore, the reason why air as an interface is not working properly is the simple fact that it does not give the rotational stability needed for controlling a prosthesis properly.

#### 2) Manually inflatable pad or bladder inside the socket

There are also a few sockets with an inflatable bladder inside it. This bladder can be manually inflated by the user with air pressure. However, only a limited area can be effected by the bladder which can cause a reaction pressure to the limb on places the pad is not worn. This is because a bigger pad will lead to a squeeze of the residual limb on the other side of the socket.

#### 3) Manually controlled air bladder as interface between inner and outer socket

In US5724714A [37] the air bladder is integrated in the prosthesis socket design. This bladder is located between the inner and outer socket. Movement and rotational stability is controlled by holes in the inner socket.

Another example of an air filled bladder as an interface between an inner and outer socket is the Pump it up socket, see figure 16. This socket can be used in lower limb prostheses. A bladder which is located between the inner and outer socket can be inflated or deflated with a manually controllable pump.

US6149691A [38] is an example of a socket with a self inflating foam path, also located between the inner and outer covers. The covers are covered with a gelatinous material which absorbs shock. Between the



Fig. 16: Example of socket with air filled bladder: The Pump it up socket. Retrieved from <http://www.amputee-center.com/pump-it-up.html>

inner and outer covers a self inflating air bladder is positioned with a valve mechanism. This mechanism ensures air flowing in and flowing out when the volume of the residual limb changes.

#### 4) Manually controlled air bladder as interface between exterior socket and prosthesis

US5108456A [39] is an example of an inflatable air filled bladder, which can manually be inflated or deflated with the help of a squeeze bulb. With an inflating bladder the pressure to the socket increases which ensures a better fitting.

The danger of the before mentioned air filled bladders is the fact that they are manually controlled so it could be possible to manually blow it up and damage the tissue of the residual limb. Therefore, an automatically inflated bladder would be the solution to minimize the risk:

#### 5) Automatically sensorized air inflatable pressure actuators in socketwall

Although air filled bladders are a step in the right direction in the way to an optimal prosthesis fit, it is still not ideal. An optimal prosthesis socket should also be adaptive in volume in certain areas of a residual limb. Sensorized inflatable pressure actuators located in pockets within the socket wall are a possible solution for this problem. A F-socket sensor detects when the volume changes, which will lead the actuators to

grow or shrink to get an optimal fit. [40]

The APSS (air pneumatic suspension system) is a all-covering bladder with an air cuff inside the socket (for transtibial prostheses) in which the pressure can be controlled by an APSS microcontroller. When the desired pressure level is reached, the pressure stays constant [41].

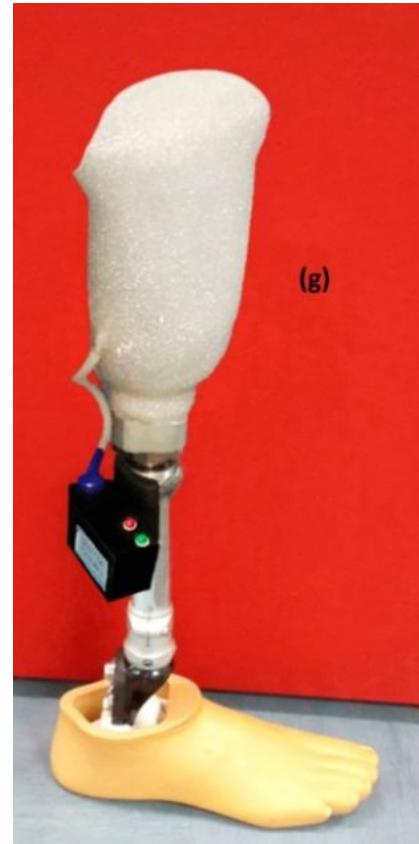

Fig. 17: Example of socket with an air pneumatic suspension system [41]

### D. Sockets with a liquid actuation system

In contrast to air filled bladders, there are also liquid filled bladders. Liquid-filled solutions would be preferable in comparison to air filled solutions, because they are easier to control [36]. Liquidate actuation systems can be manually and/or automatically controlled.

#### 1) Automatically fluid filled bladder located inside the socket

Active Contact System (ACS) is an example of an automatically socket project with a fluid filled bladder. This design only works for above the knee. The system works automatically, the fluid will be sucked during

walking and compressed when stagnated. The ASC consists of a fluid reservoir, a control circuit and some bladders which are attached in the socket. Nevertheless, this million dollar project did not continue because the socket was so expensive that no company would insure it. [20]

Another example of an existing liquid filled bladder is the SVGS, the Smart Variable Geometry Socket (see fig. 18). This system also works automatically at the same way the ACS does. In this system, fluid is used to pump in the bladders located inside the sockets from the fluid reservoir with the use of a mechanical control circuit [42].



Fig. 18: Example of socket with liquid filled bladder: the Smart Variable Geometry Socket [42]

## 2) Automatically and/or manually fluid filled bladder located between the socket and liner

US20130218296A1 [43] is an example of a socket with a suspension system with a pump which is automatically or manually adjustable. Fluid can be moved in the space between the liner and the socket. When the area between the liner and socket decreases, it causes the liner to be pulled into the socket wall which increases the volume inside the socket. On the other hand, when the area between the socket and liner

increases, this will pull away the liner from the socket interface with a result of a decreasing volume. This area volume can be either manually or automatically regulated with a pump and a fluid reservoir.

## 3) Magneto Rheological filled bags located on the inner size of the socket

In a MR socket (for lower limb amputees) Magneto Rheological fluid is used (see fig. 19). Specific about this material is the ability to not only change in volume but also change in stiffness. A magnet is attached outside the socket which can influence the viscosity of this fluid. Furthermore, a cylinder attached to the socket can change the pressure. With these two aspects the overall stiffness can be regulated freely [44]. However, the mechanical control circuit and the power supply required for the regulation mechanism are rather bulky.

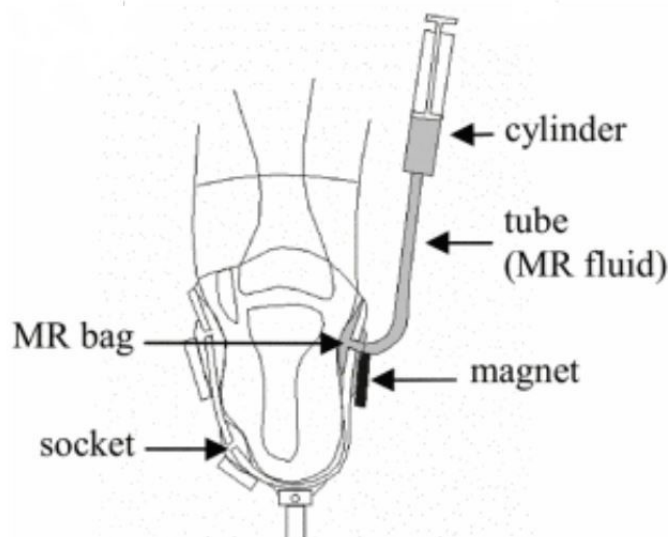

Fig. 19: Magneto Rheological filled bags located on the inner size of the socket [44]

## E. Sockets with suction techniques

There are different types of suction techniques. Vacuum suspension, valve suspension and suction suspension are the techniques used in sockets to adjust prostheses.

### 1) Suction suspension

In contrast to a pin lock suspension, suction suspension does not use a pin. In a small air gap sealed between a gel liner and the socket a development of suction occurs during the sliding of the liner. This



occurs during swing phase when the liner moves relative to the socket. Furthermore, a one-way valve is in line with the airspace.

The air space is sealed by a gel sleeve covering the proximal socket and liner along with a one-way valve at the distal expulsion port of the socket [45].

## 2) Valve suspension

A passive suction technique is valve suspension where the air is only blown out of the system and not into the system. In this technique the liner/limb can be separated from the socket [46] [47]. This is a negative aspect because it can result in a smaller elongation of the tissue, a limited pressure drop and a decreased amount of fluid drawn into the limb. Another disadvantage of valve suspension techniques is the fact that there is volume loss of the residual limb during the day.[47]

## 3) Vacuum suspension

In contrast to suction and valve suspension, the skin stays close to the socket in vacuum suspension [47] (see fig. 20). In an active vacuum assisted suspension system (VAS), tiny air molecules are evacuated from the seal between the liner and the socket with a pump. This results in fixation of the liner to the socket because of the suspension force [47]. This will ensure a reduction of pistoning and the likelihood on injuries on soft tissues. Furthermore, the proprioception and the socket comfort will be expanded [48]. In comparison with the other suspension techniques, there is almost no fluctuation of limb volume during the day [49] [47]. There are VAS existed in electrical, mechanical and hybrid (existing of both electrical and mechanical) systems.

The benefits of Mechanical VAS Pumps are the fact that there are no batteries part of it which makes it easy to work in the field. Furthermore, there is no charging needed and the pump is not noisy. On the other hand, it takes longer to evacuate the same volume compared to Electric VAS Pumps. These pumps correct and maintain vacuum continuously and avoid skin issues. When you combine these two pumps it results in a Hydric VAS Pump. This pump has the advantages of both pumps with a minimization of the noise and the battery lifetime.

## IV. Discussion

An adaptable mechanism can be the solution to solve the artefacts of the volume fluctuations a residual limb has. Daily volume fluctuations can be

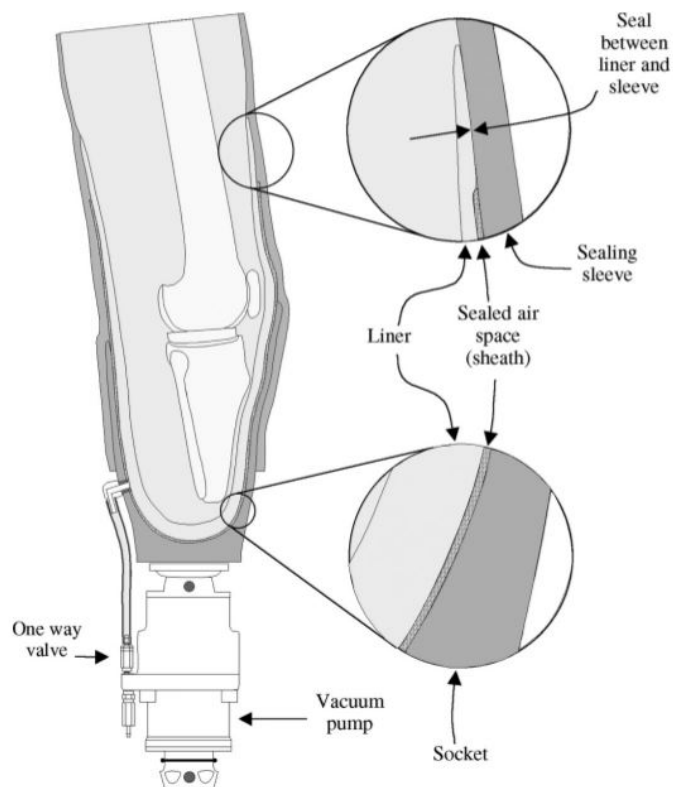

Fig. 20: Vacuum suspension [47]

caused by fluids in the residual limb, while there can also be longterm volume fluctuations caused by external factors. The fit of the socket is of great importance to fix this problem. The applicability of prosthetic sockets together with the different amounts of manufacturing is the biggest challenge of comparing different studies in adaptable prosthetic sockets. Remarkable is the major amount of adaptable sockets which already exist. These are mostly only applicable on one certain residual limb (mostly transtibial) and does not fit on multiple prostheses. Only a limited amount of adaptable sockets which can be used on multiple limbs exists. An example of such a socket is US20120041567 [11], which can be applicable on several types of amputations including transfemoral amputations, transtibial amputations, transhumeral amputations, transradial amputations, and other types of amputations.

When comparing the different adaptable sockets, flexible sockets are normally not recommended because of the bad transfer of force to the prosthesis. When there is still chosen for an elastic socket the best is to combine a soft polyethylene or silicone elastomer inner shell together with an outer socket with holes

which has a more rigid structure [20]. Nevertheless, flexible sockets are easy to produce and have low manufacturing cost.

The disadvantage of a mechanical device is the chance of over excessive forces on the residual limb. The advantages are the low costs and the easy manufacturing. The rotational Lace-Tension mechanism is the most recommended adaptable mechanism because of its precision. Nevertheless, it is also simple to combine multiple mechanical mechanisms with each other. The infinite socket for example, combines the Lace-Tension mechanism with other mechanical adjustment mechanisms such as hose clamps and hook and loop devices [29].

Air bladders are a good solution to deal with the varying loads an user experiences. The main problems of the function of air-filled bladders are the relatively high pressure and high compressibility. This will cause losses and a very big volume range [36]. Moreover, air filled bladders have a harder control in comparison with liquid actuation systems. The disadvantage of the air/liquid filled bladders are the higher costs/manufacturing processes in comparison to a mechanical mechanism.

When comparing the sockets with suction techniques, vacuum suspension is the best mechanism because of the smallest amount of pistoning [47]. A mechanical vacuum suspension is the easiest and cheapest to work with of all the suction techniques. Therefore, it can be a good alternative to the Lace-Tension mechanism. Some sockets combine multiple adaption mechanisms to get an optimal adjustable socket. Therefore, it is difficult to make an extensive systematic comparison between these different sockets.

Not only the different adaptable mechanisms can influence the total experience of the fit of a socket. Another challenge is the way the prosthetist and the user manufacture/use the socket. Incorrect use can cause big problems such as excessive tightening, while a certain adaptable socket could be outstanding when correctly used. Therefore, good instructions, skills and knowledge are also of great interest.

## V. Conclusions

A mechanical mechanism would be the best adaptable mechanism to apply on a transradial socket prosthesis in third world countries. Firstly, because of the low manufacturing costs most mechanical mechanisms have. Furthermore, the use of these mechanisms is less complex than dynamic systems [29]. Finally, no

batteries are needed which makes it easier to work in the field.

The mechanism which is most suited for an adaptable transradial prosthesis socket is the lace-tension because of the micro precision. This can be the optimal adaptable socket mechanism for amputees in third world countries with the only limitation that it should be used correct to avoid excessive tightening. Therefore, good instructions to the user are of great interest. Nevertheless, a combination of multiple mechanical mechanisms could also be a good solution.

## A. Future Recommendations

There is a gap between the existing adaptable transtibial sockets and the limited amount of adaptable transradial sockets. More research in overcoming this gap is recommended. The combination of different mechanical mechanisms in one socket is also an interesting design to explore, to look at which adaptable mechanisms fit best together. Another interesting direction to research are the studies about sockets which are not adjustable, but which do account for volume fluctuations, like the Wilmer open socket [5]. Furthermore, more research in hydrostatic sockets should be done, because at this moment there are only a limited amount of inventions in mechanically or automatically vacuum assisted suspension pumps, while hydrostatic would have the advantages of both.

## References

- [1] Landmines — The Issues — Monitor. (n.d.). Retrieved May 1, 2019, from <http://www.the-monitor.org/en-gb/the-issues/landmines.aspx>
- [2] Dillingham, Timothy R., et al. "Limb amputation and limb deficiency: epidemiology and recent trends in the United States." *Southern Medical Journal*, Aug. 2002, p. 875+. Academic OneFile, Accessed 1 May 2019
- [3] Pirouzi, G., Abu Osman, N. A., Eshraghi, A., Ali, S., Gholizadeh, H., & Wan Abas, W. (2014). Review of the Socket Design and Interface Pressure Measurement for Transtibial Prosthesis. *The Scientific World Journal*, 2014, 19. <https://doi.org/10.1155/2014/849073>
- [4] Hussain, S., Sanders, E., & Steinert, M. (2012). Participatory Design with Marginalized People in Developing Countries: Challenges and Opportunities Experienced in a Field Study in Cambodia. *Internal Journal of Design*, , 91109. <https://doi.org/10.1155/2014/849073>
- [5] Mazereeuw, M. (2018). An AM optimised transradial interface for low-income countries. Retrieved from <https://repository.tudelft.nl/islandora/object/uuid%3Ac6b15882-fa2c-485b-89a7-2561dbbc6b89>
- [6] Resnik, L., Meucci, M. R., Lieberman-Klinger, S., Fantini, C., Kelty, D. L., Disla, R., & Sasson, N. (2012). Advanced Upper Limb Prosthetic Devices: Implications for Upper Limb Prosthetic Rehabilitation. *Archives of Physical Medicine and Rehabilitation*, 93(4), 710717. <https://doi.org/10.1016/j.apmr.2011.11.010>

- [7] Zuniga, J., Katsavelis, D., Peck, J., Stollberg, J., Petrykowski, M., Carson, A., & Fernandez, C. (2015). Cyborg beast: a low-cost 3d-printed prosthetic hand for children with upper-limb differences. *BMC Research Notes*, 8(1). <https://doi.org/10.1186/s13104-015-0971-9>
- [8] Vaughan, M. R. (2014). A Low-Cost Volume Adjustable Lower Limb Prosthetic Socket: Design and Evaluation. Retrieved from <https://repositories.lib.utexas.edu/handle/2152/27148>
- [9] Pohl, M., & Monner, H. P. (2011). Numerical and Experimental Investigation of an Adaptive Socket System for Leg Prosthetic. ASME 2011 Conference on Smart Materials, Adaptive Structures and Intelligent Systems, Volume 1, . <https://doi.org/10.1115/smais2011-5020>
- [10] Sanders, J. E., & Fatone, S. (2011). Residual limb volume change: Systematic review of measurement and management. *Journal of Rehabilitation Research & Development*, 48(8), 949986. <https://doi.org/10.1016/j.otrs.2015.03.020>
- [11] Cornell, K. (2010). US20120041567. CJ SOCKET TECHNOLOGIES Inc.
- [12] Lyon, C. C., Kulkarni, J., Zimerson, E., Van Ross, E., & Beck, M. H. (2000). Skin disorders in amputees. *Journal of the American Academy of Dermatology*, 42(3), 501507. [https://doi.org/10.1016/s0190-9622\(00\)90227-5](https://doi.org/10.1016/s0190-9622(00)90227-5)
- [13] Mak, F. T., Zhang, M., & Boone, D. A. (2001). State-of-the-art research in lower-limb prosthetic biomechanics-socket interface: A review. *Journal of Rehabilitation Research and Development*, 38(2), 161174. Retrieved from <https://www.rehab.research.va.gov/jour/01/38/2/pdf/mak.pdf>
- [14] Strait, E. (2006). Prosthetics in Developing Countries. Prosthetic Resident. Retrieved from <http://citeseerx.ist.psu.edu/viewdoc/download?doi=10.1.1.551.4255&rep=rep1&type=pdf>
- [15] Griffet, J. (2016). Amputation and prosthesis fitting in paediatric patients. *Orthopaedics & Traumatology: Surgery & Research*, 102(1), 161175. <https://doi.org/10.1016/j.otrs.2015.03.020>
- [16] Rispin, K., Husk, C., Lew, S., Schufeldt, T., & Gonzalez, R. (2010). FUNCTIONAL COMPARISON OF THE LEGS MI KNEE TO COMMONLY AVAILABLE DEVELOPING WORLD ALTERNATIVES. Retrieved from [https://www.researchgate.net/publication/268261649\\_FUNCTIONAL\\_COMPARISON\\_OF\\_THE\\_LEGS\\_MI\\_KNEE\\_TO\\_COMMONLY\\_AVAILABLE\\_DEVELOPING\\_WORLD\\_ALTERNATIVES](https://www.researchgate.net/publication/268261649_FUNCTIONAL_COMPARISON_OF_THE_LEGS_MI_KNEE_TO_COMMONLY_AVAILABLE_DEVELOPING_WORLD_ALTERNATIVES)
- [17] Olesnavage, K. M., Prost, V., Johnson, W. B., & Winter, A. G. (2018). Passive Prosthetic Foot Shape and Size Optimization Using Lower Leg Trajectory Error. *Journal of Mechanical Design*, 140(10). <https://doi.org/10.1115/1.4040779>
- [18] Ouellette, M. D. (n.d.). Surgical Principles. Retrieved May 1, 2019, from <http://www.oandplibrary.org/alp/chap08-01.asp>
- [19] Funk, G. & Hartig, T. (1991). US5203056A. ambro Dialysatoren GmbH.
- [20] Van Sitteren, M. M. (2016, March 30). A new 3D printed Volume Adaptive Prosthetic Socket for below-the-knee amputees — TU Delft Repositories. Retrieved May 1, 2019, from <https://repository.tudelft.nl/islandora/object/uuid%3Ae854673e-8fd6-4d41-b076-6b6253fd99a>
- [21] Marx, H., & Marx, N. (1988). US4842608A. New York: ORTHO-BIONICS LABORATORY.
- [22] Schwarcz, J. (2003). Dr. Joe and what You Didnt Know. Canada: ECW Press.
- [23] Shamp, D. (1987). US4872879A. Ohio: PROSTHETIC CONSULTANTS.
- [24] Cespedes, J., Hurley, G., & Williams, W. (2014). US20160058584A1. LIM INNOVATIONS.
- [25] Naser, A. (1996). US5653766A. Michigan Orthopedic Service.
- [26] Price, J. (2004). US20060009860A1.
- [27] Cornell, K. (2010). US8945237B2. CJ SOCKET TECHNOLOGIES Inc.
- [28] Wilson, A., Schuch, C., & Nitschke, R. (1987). A Variable Volume Socket for Below knee Prostheses. *Clinical Prosthetics and Orthotics*, 11(1), 1119. Retrieved from [http://oandplibrary.org/cpo/pdf/1987\\_01\\_011.pdf](http://oandplibrary.org/cpo/pdf/1987_01_011.pdf)
- [29] Paterno, L., Ibrahimi, M., Gruppioni, E., Menciassi, A., & Ricotti, L. (2018). Sockets for Limb Prostheses: A Review of Existing Technologies and Open Challenges. *IEEE Transactions on Biomedical Engineering*, 65(9), 19962010. <https://doi.org/10.1109/tbme.2017.2775100>
- [30] Bache, A., Egilsson, E., Birgisdottir, L., & Marlin, D. (2015). US9962273B2. Ossur Iceland ehf.
- [31] Bache, A., & Tuttle, P. (2012). US9050202B2. Ossur hf.
- [32] Hurley, G., & Williams, J. (2011). US8978224B2. LIM INNOVATIONS Inc.
- [33] Bache, A. (2010). US9248033B2. Ossur hf.
- [34] Sengeh, D., & Herr, H. (2013). A Variable-Impedance Prosthetic Socket for a Transtibial Amputee Designed from Magnetic Resonance Imaging Data. *Journal of Prosthetics and Orthotics*, 25, 129137. Retrieved from <https://pdfs.semanticscholar.org/d973/5ac67cc5eabd78459c6e624cdb435e4a5500.pdf>
- [35] Sanders, E., & Cassisi, V. (2001). Mechanical performance of inflatable inserts used in limb prosthetics. *Journal of Rehabilitation Research & Development*, 38(4), 365374. <https://doi.org/10.1115/1.4030507>
- [36] De Volder, M., & Reynaerts, D. (2010). Pneumatic and hydraulic microactuators: a review. *Journal of Micromechanics and Microengineering*, 20(4). Retrieved from <https://iopscience.iop.org/article/10.1088/0960-1317/20/4/043001/meta>
- [37] Love, M. (1993). US5724714A.
- [38] Fay, J., & Fay, C. (1998). US6149691A.
- [39] Coonan, T. (1991). US5108456A.
- [40] Carrigan, W., Nothnagle, C., Savant, P., Gao, F., & Wijesundara, M. B. J. (2016). Pneumatic actuator inserts for interface pressure mapping and fit improvement in lower extremity prosthetics. 2016 6th IEEE International Conference on Biomedical Robotics and Biomechatronics (BioRob), . <https://doi.org/10.1109/biorob.2016.7523687>
- [41] Pirouzi, G., Abu Osman, N. A., Oshkour, A., Ali, S., Gholizadeh, H., & Wan Abas, W. (2014). Development of an Air Pneumatic Suspension System for Transtibial Prostheses. *Sensors*, 14(9), 1675416765. <https://doi.org/10.3390/s140916754>
- [42] Greenwald, R., Dean, R., & Board, W. (2003). Volume Management: Smart Variable Geometry Socket (SVGS) Technology for Lower-Limb Prostheses. *JPO Journal of Prosthetics and Orthotics*, 15(3). Retrieved from <https://ovidsp.tx.ovid.com/sp-3.33.0b/ovidweb.cgi?QS2=434f4e1a73d37e8c031d611929c3674059ec52122875e66e675153fbb4a440700568a76337d3e32eb34160196b147d7110a8635e03d9c51fa37e55fa4470ba60860c62dc09872e97fd80f—e6b615df26123674a3447f69294c8e95a19681725668f3d9a19e4d3896048ff0f31d3c5c99ec5d5ba993d7370a7a171a0592f2189b4bac89b3f10327288cb3ffb42252cc1f6e6565058606183cbe8e9f7a06931213c62b17bfe9f3405cdb0ee907b34034d5916961d998d5eaa312ede80731550987608451d0e75de5957713b197bef71dd4c8274fee7f3ee2ef1e0d77f60bef6ae4142255718f319baeb363dbca2a2c44df586e99e92a459c0fc5d6e35a270ab6980bb29918a053bb0>
- [43] Koniuk, W., & Hurley, G. (2012). US20130218296A1.

- [44] Ogawa, A., Obinata, G., Hase, K., Dutta, A., & Nakagawa, M. (2008). Design of lower limb prosthesis with contact pressure adjustment by MR fluid. 2008 30th Annual International Conference of the IEEE Engineering in Medicine and Biology Society, . <https://doi.org/10.1109/iembs.2008.4649157>
- [45] Beil, T., & Street, G. (2004). Comparison of interface pressures with pin and suction suspension systems. *Journal of Rehabilitation Research & Development*, 41(6), 821828. Retrieved from <https://www.rehab.research.va.gov/jour/04/41/6/pdf/Beil.pdf>
- [46] Suction Suspension — P & O Care. (n.d.). Retrieved May 1, 2019, from <http://www.pandocare.com/suction-system/>
- [47] Street, G. M. (2007). Vacuum Suspension and its Effects on the Limb. *Orthopadie-Technik*, . Retrieved from <http://opmarketing.com/storage/Research%20EncyclOPedia/Vacuum%20Assisted%20Suspension/Street%20Vac%20Effect%20on%20RL.pdf>
- [48] Samitier, C. B., Guirao, L., Costea, M., Cams, J. M., & Pleguezuelos, E. (2014). The benefits of using a vacuum-assisted socket system to improve balance and gait in elderly transtibial amputees. *Prosthetics and Orthotics International*, 40(1), 8388. <https://doi.org/10.1177/0309364614546927>
- [49] Major, M. J., Caldwell, R., & Fatone, S. (2015). Evaluation of a Prototype Hybrid Vacuum Pump to Provide Vacuum-Assisted Suspension for Above-Knee Prostheses. *Journal of Medical Devices*, 9(4), 044504. <https://doi.org/10.1115/1.4030507>

# APPENDIX D

## Socket concepts

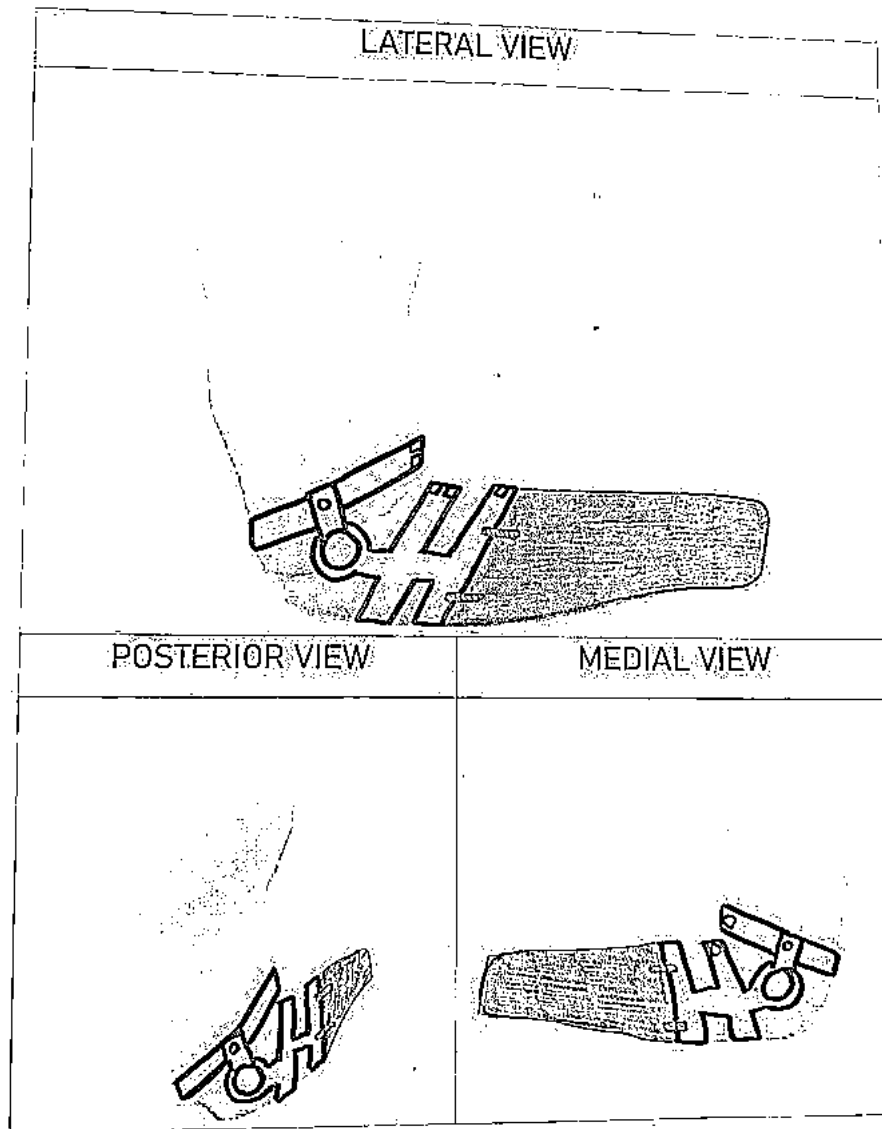

# APPENDIX D: SOCKET STUDY

A few concepts have been made. These can be divided in the next categories:

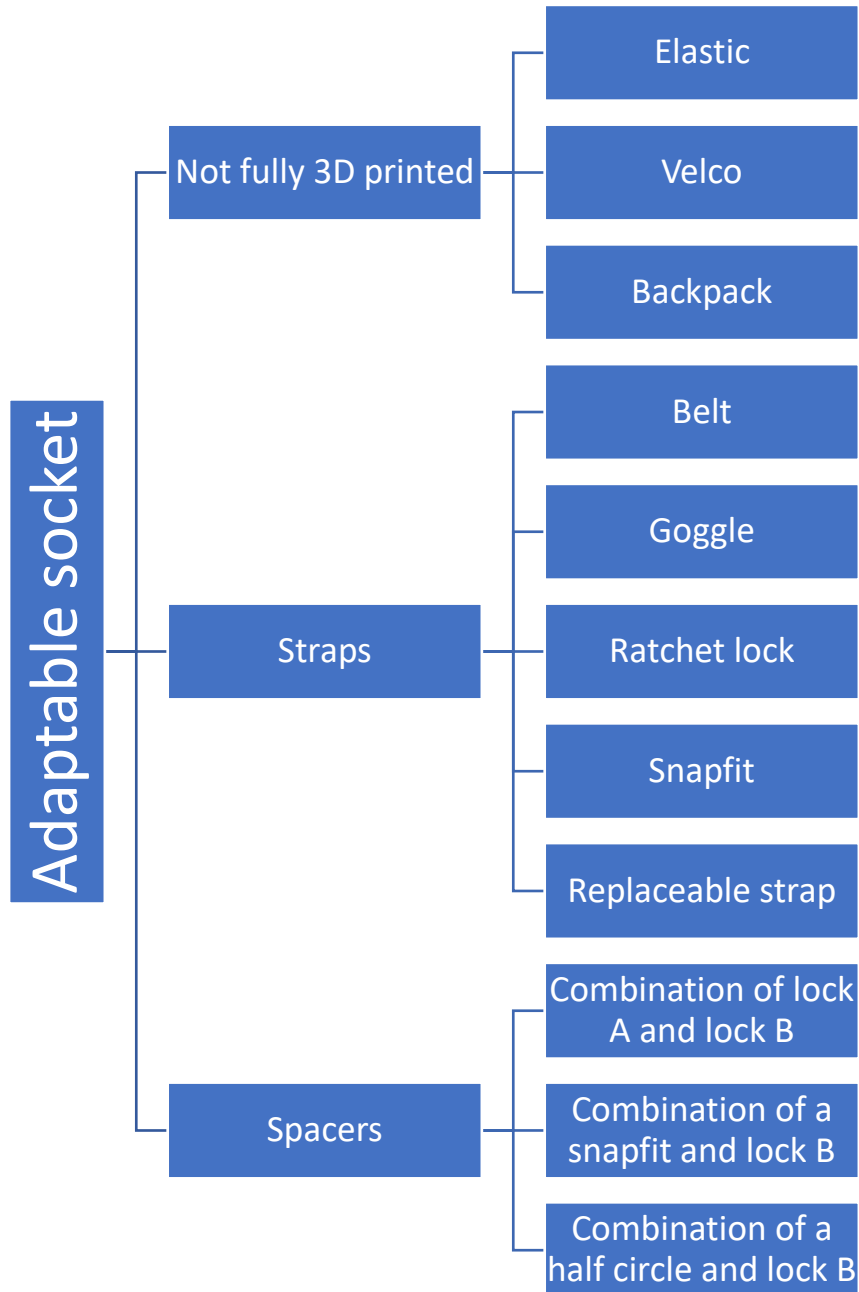

## Concept 1

Replaceable straps, attached to the hinges with a snapfit.

- A lot of material is needed to provide multiple sizes
- Impossible to have all sizes in stock
- Not exact
- Only upper strap can be replaced

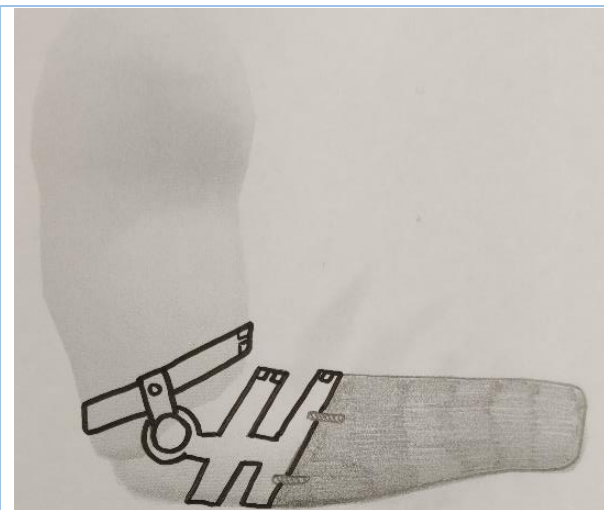

Lateral view



Medial view

## Concept 2

Snapfit used as locking mechanism

- Not properly working with flexible materials (MATTHIJS)
- Not exact (as exact as the space between the holes)
- Upper and lower strap can be adapted
- Leftover strap can hook
- Bulky

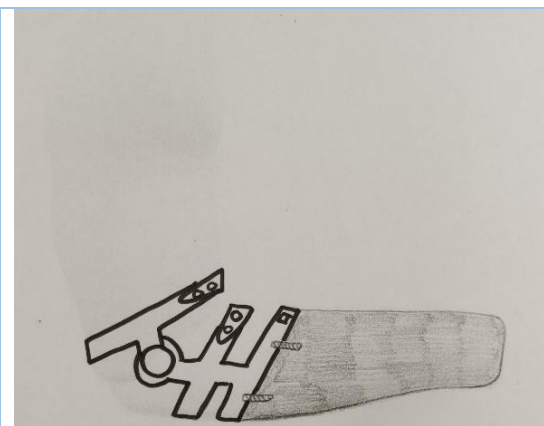

Lateral view

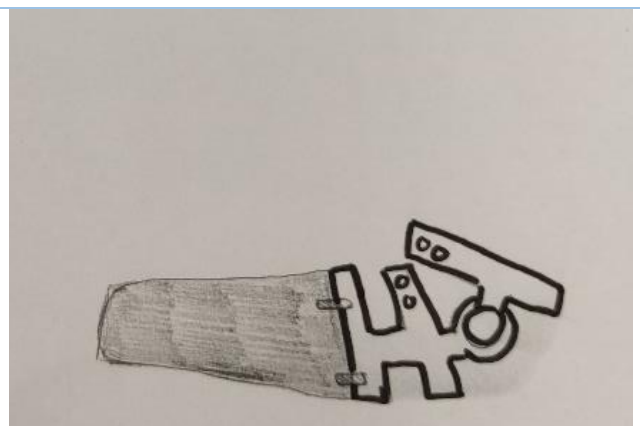

Medial view



### Concept 3

Ratchetlocks used as a locking mechanism

- Hard to print in 3D
- Bad shape
- Bulky
- Quite exact
- Leftover strap can hook

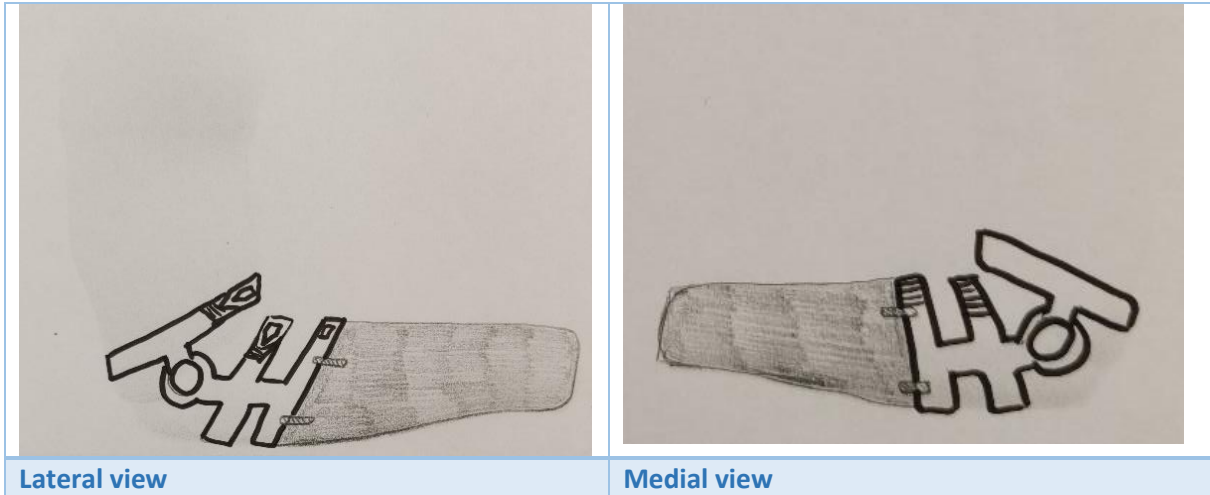

### Concept 4

Elastic condylbrace

- Very exact
- Pinching is possible
- Not strong
- The socket is then not totally made out of 3D printed material
- Bad force transfer between stump and socket



## Concept 5

The goggles

- Not exact
- Not strong
- Easy breakable
- Leftover strap can hook



## Concept 6

3D printed flexible belt

- Not exact
- A lot of components
- Bulky
- Leftover strap can hook

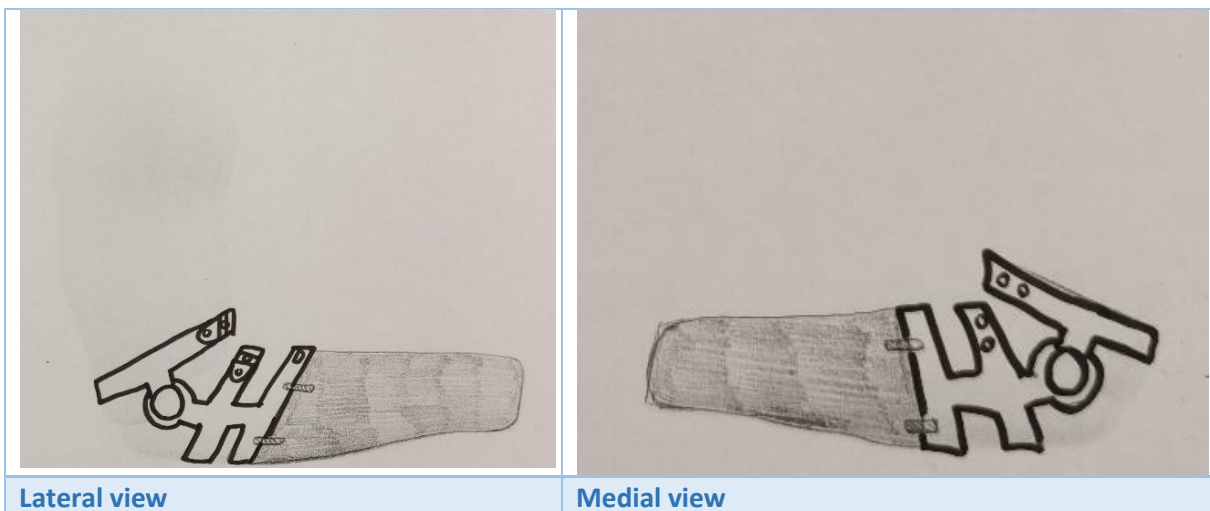

## Concept 7

### Velcro fasteners

- Attaches to clothes
- Very exact
- Not very strong
- Bad force transfer

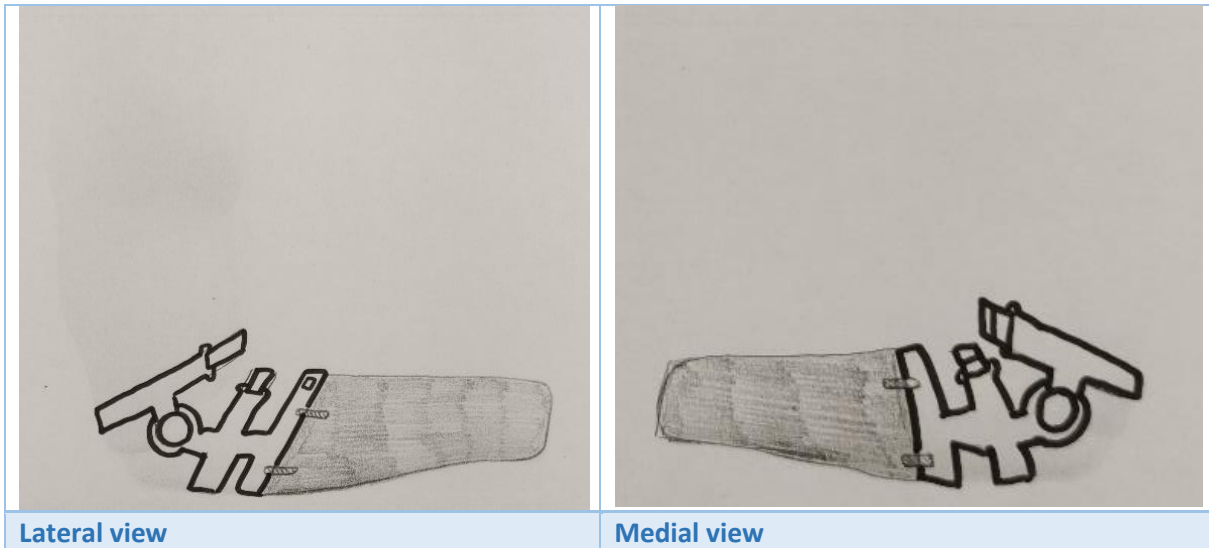

## Concept 8

### The backpack

- Very exact
- Thick/bulky
- Bad force transfer

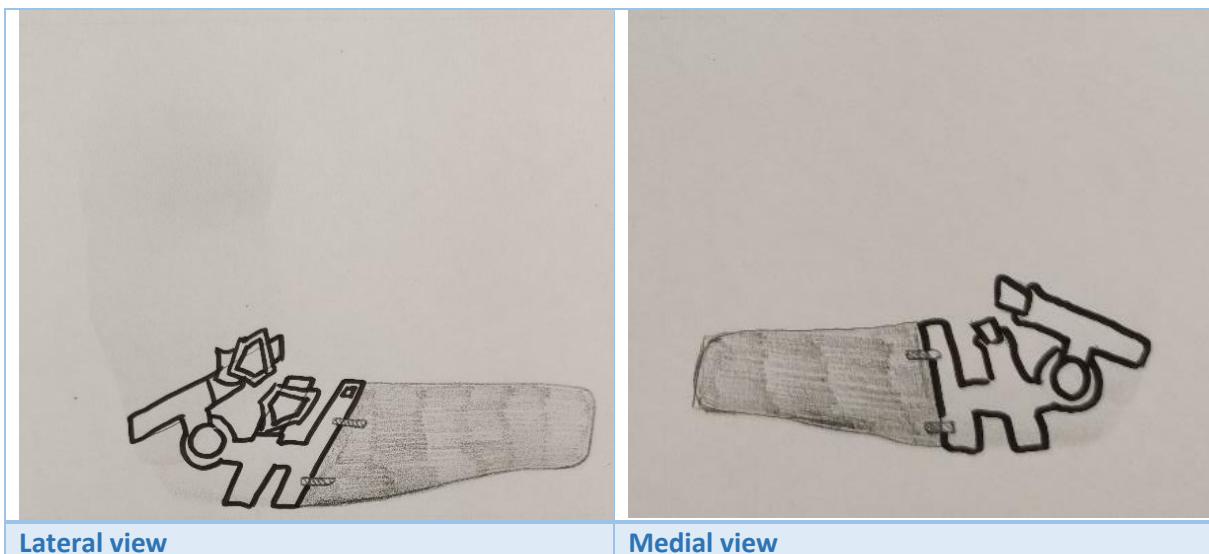

## Concept 9

A replaceable spacer, which is a combination of lock A and lock B. The replaceable spacer can be printed in different sizes.

- Only the spacer has to be changed
- Very exact
- Not bulky
- Disadvantage: Possible to open lock A side and lock B side
- Lock A opens to easy/fast

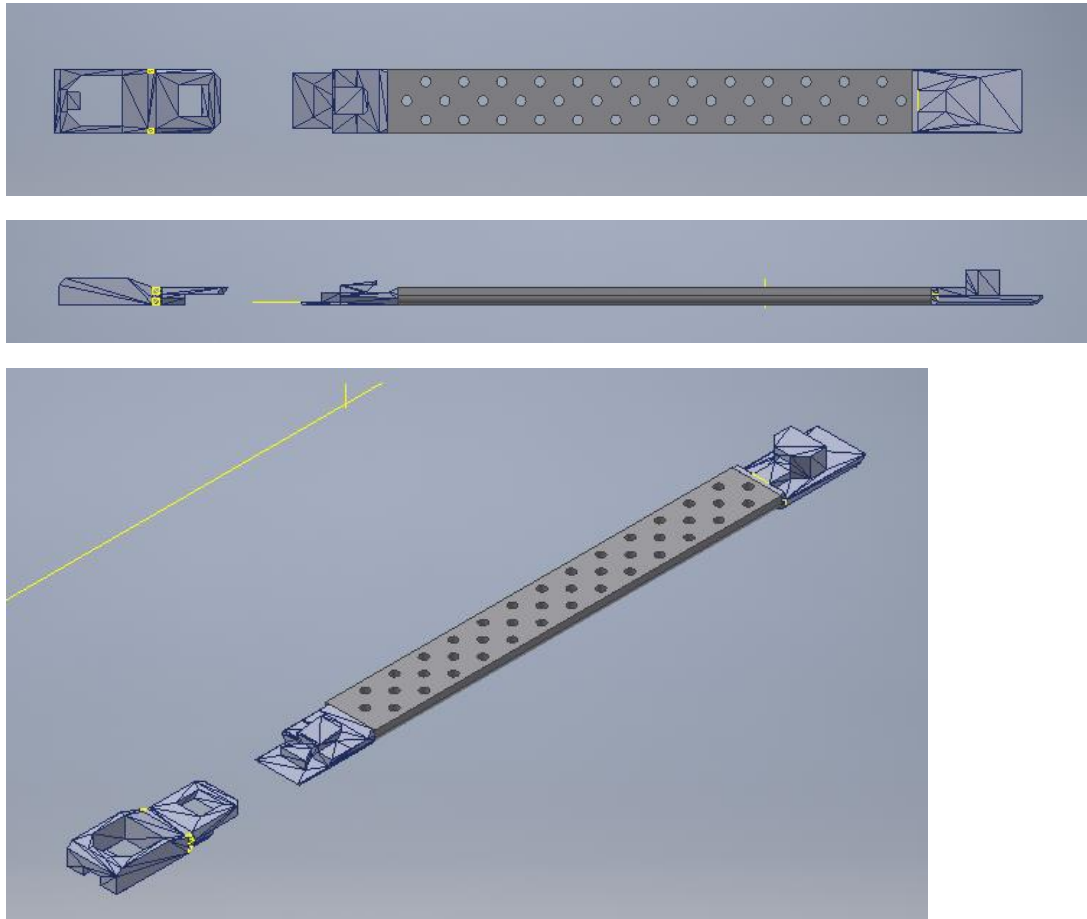
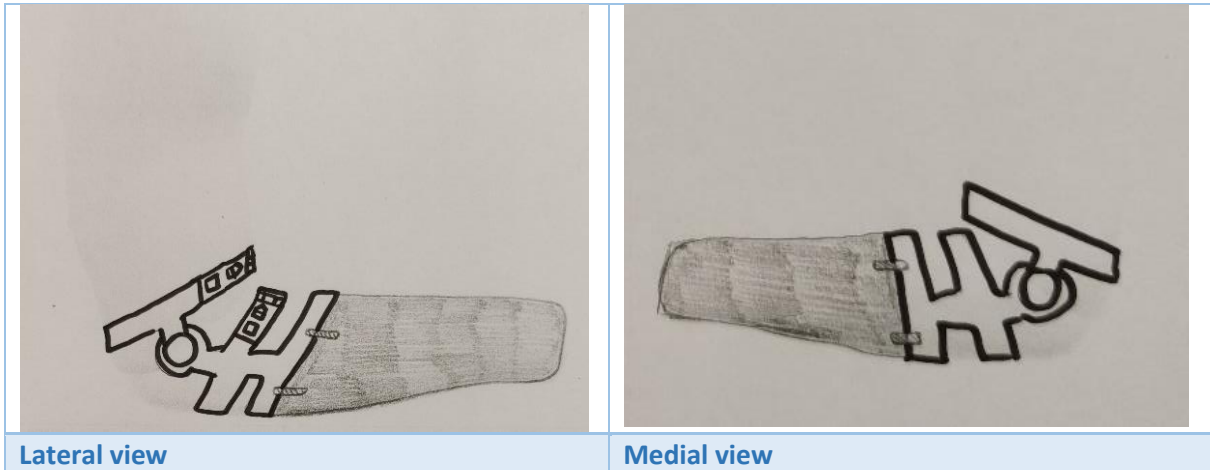

## Concept 10

A replaceable spacer using a square snapfit on the one side and lock B on the other side. The replaceable spacer can be printed in different sizes.

- Only the spacer has to be changed
- Very exact
- Not bulky
- Advantage: One side is locked
- Difficult to change -> tool needed?

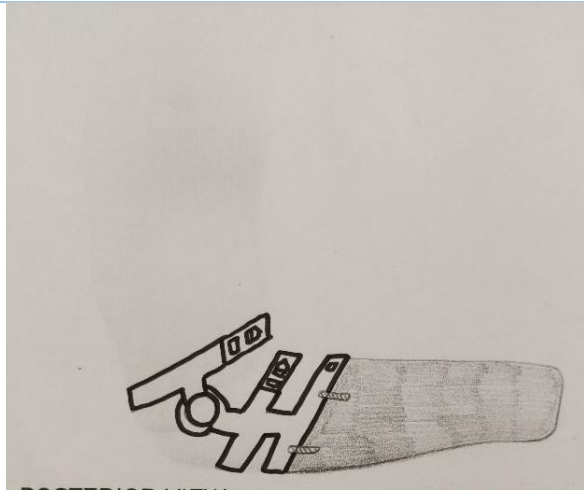

Lateral view

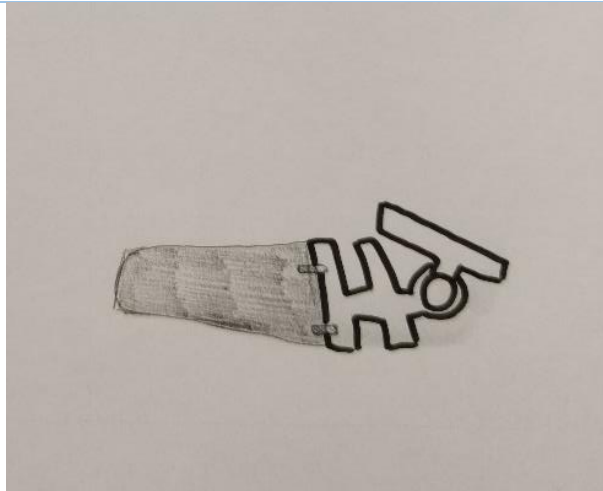

Medial view

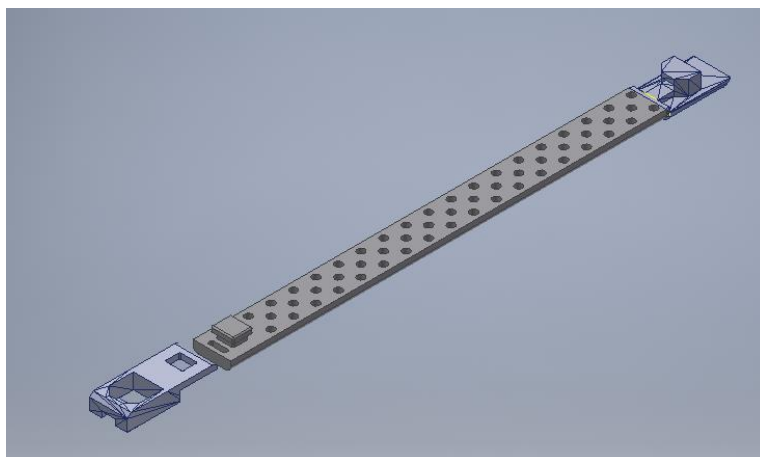
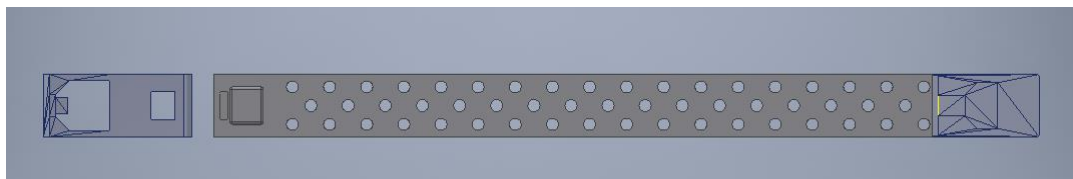

## Concept 11

A replaceable spacer using a half circle on the one side and lock B on the other side. First slide the spacer over the half circle and then turn in to get the spacer locked. The replaceable spacer can be printed in different sizes.

- Only the spacer has to be changed
- Very exact
- Not bulky
- Advantage: One side is locked

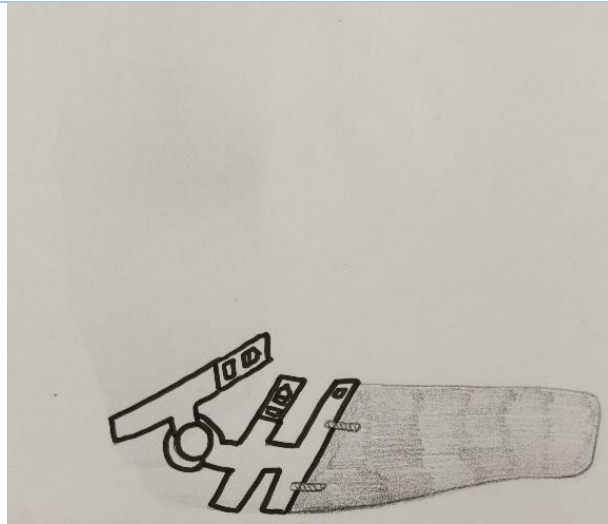

Lateral view

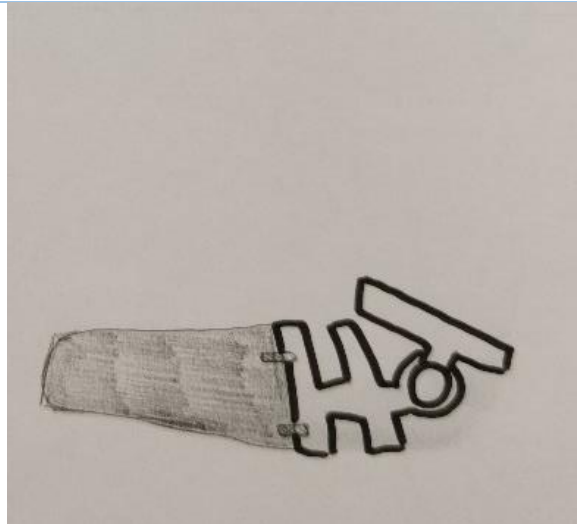

Medial view

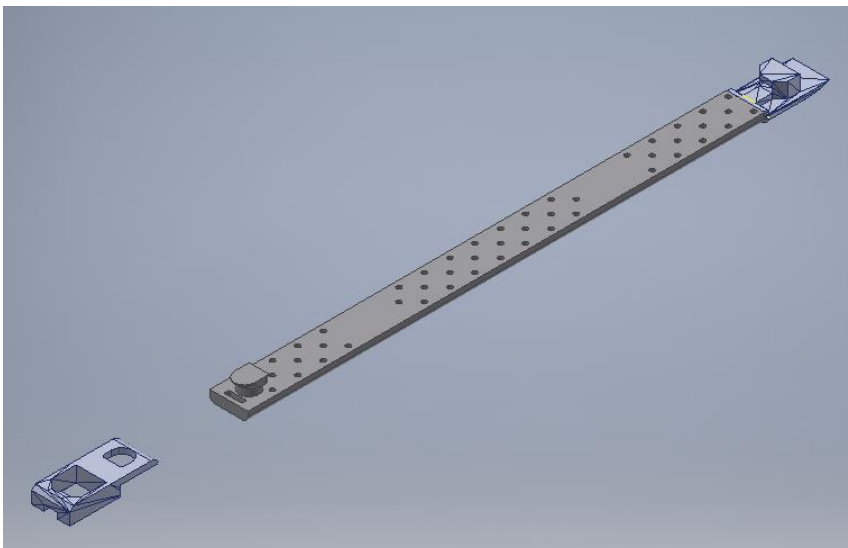
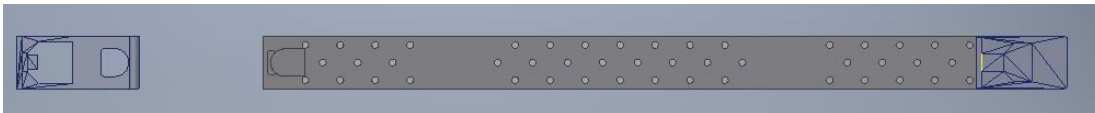

## Lock A – reassembly lock

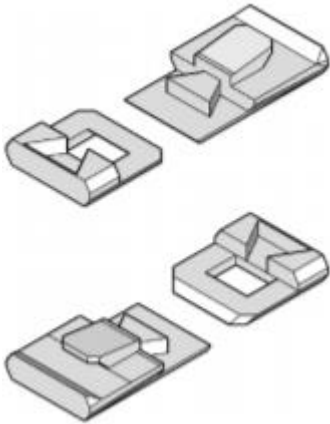

M. Mazereeuw, 2018

## Lock B - donning and doffing lock

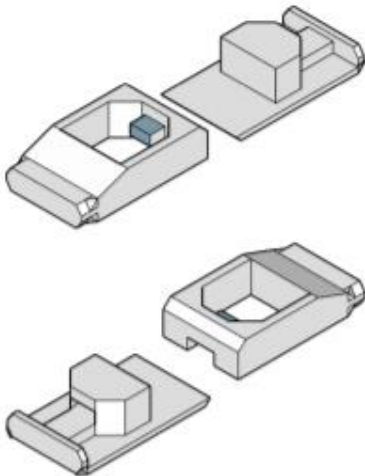

M. Mazereeuw, 2018



## Weighted decision matrix

Score (0 = poor, 5 = very good)										
	Criteria	Weighting	Concept 1		Concept 2		Concept 3		Concept 4	
			Score	Total	Score	Total	Score	Total	Score	Total
1	As few as possible material	2	0	0	2	4	2	4	5	10
2	Not bulky	2	4	8	2	4	2	4	4	8
3	Easy donning and doffing (with one hand)	4	4	16	3	12	3	12	4	16
4	Adaptable for volume fluctuations in multiple directions	4	2	8	4	16	4	16	4	16
5	Precisely adaptable	4	5	20	2	8	2	8	5	20
6	Good transition between residual limb and prosthesis	5	5	25	5	25	5	25	1	5
	Fully 3D printed	Wish +5		+ 5		+ 5		+ 5		
	Easy to clean	Wish +5		+ 5		+ 5		+ 5		
	Fit on the printer plate of an Ultimaker 5	Wish +5		+ 5						+ 5
		<b>Total:</b>		93		79		79		80

Score (0 = poor, 5 = very good)										
	Criteria	Weighting	Concept 5		Concept 6		Concept 7		Concept 8	
			Score	Total	Score	Total	Score	Total	Score	Total
1	As few as possible material	2	2	4	2	4	3	12	3	12
2	Not bulky	2	2	4	2	4	3	12	3	12
3	Easy donning and doffing (with one hand)	4	2	8	3	12	4	16	3	12
4	Adaptable for volume fluctuations in multiple directions	4	4	16	4	16	4	16	4	16
5	Precisely adaptable	4	2	8	2	8	5	20	5	20
6	Good transition between residual limb and prosthesis	4	4	16	5	20	1	4	1	4
	Fully 3D printed	Wish +5		+ 5		+ 5				
	Easy to clean	Wish +5		+ 5		+ 5				
	Fit on the printer plate of an Ultimaker 5	Wish +5						+ 5		+ 5
		<b>Total:</b>		66		74		80		81

Score (0 = poor, 5 = very good)								
	Criteria	Weighting	Concept 9		Concept 10		Concept 11	
			Score	Total	Score	Total	Score	Total
1	As few as possible material	2	2	4	2	4	2	4
2	Not bulky	2	4	8	4	8	4	8
3	Easy donning and doffing (with one hand)	4	4	16	4	16	5	20
4	Adaptable for volume fluctuations in multiple directions	4	4	16	4	16	4	16
5	Precisely adaptable	4	5	20	5	20	5	20
6	Good transition between residual limb and prosthesis	4	5	20	5	20	5	20
	Fully 3D printed	Wish +5		+ 5		+ 5		+ 5
	Easy to clean	Wish +5		+ 5		+ 5		+ 5
	Fit on the printer plate of an Ultimaker 5	Wish +5		+ 5		+ 5		+ 5
		<b>Total:</b>		99		99		103

# APPENDIX E

## Breathability

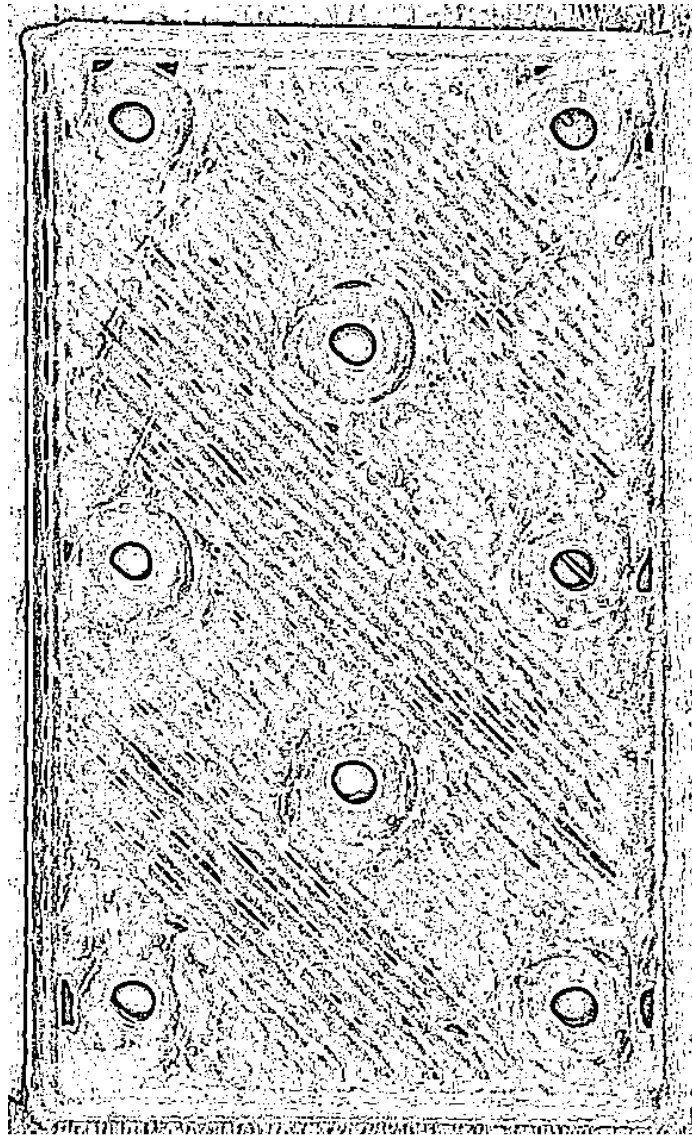

# APPENDIX E: BREATHABILITY

A test has been conducted to examine the perfect combination of the highest possibility of breathability without blister formation. How bigger the holes how better it is for cleanliness, printability and breathability. Nevertheless, how bigger the holes, how bigger the skin bulbs in the holes which can lead to blisters. At a specific hole size, the skin stops bubbling in the holes. This is the perfect size for this socket because the holes are then as big as possible without generating tissue damage.

The same size straps were all worn overtightened (impossible to shake the strap off) in the middle of the left arm for 2 hours. After these two hours, photos have been made to review it. An anatomic landmark is used to achieve reproducible results. This landmark was the birthmark on the left arm. The strap needed to be attached around this point.

The holes are separated 10 mm in a horizontal direction from each other to obtain the strength of the straps. Due to a limited amount of research about the space between the holes, the space is set to 10 mm horizontal. In Appendix G and H, strength tests are done to exclude that the straps are made weaker by the holes.

## BREATHABILITYTEST

		
1 mm	1,5 mm	2 mm
		
2,5 mm	3 mm	

As can be concluded from this appendix, 2 mm is the perfect hole size because it is big enough to be breathable, to print and to clean, but small enough to avoid blisters. Another test is also conducted to see if the dimensions of the TPU 95A and the Arnitel ID2045 change during washing. There was no visible change of dimensions when cleaning a test piece in a dishwasher of 70 degrees. Nevertheless, it can change the material properties. Therefore, it is recommended to wash the straps in a dishwasher of 30 degrees or lower or do a hand wash.

**Breathability**

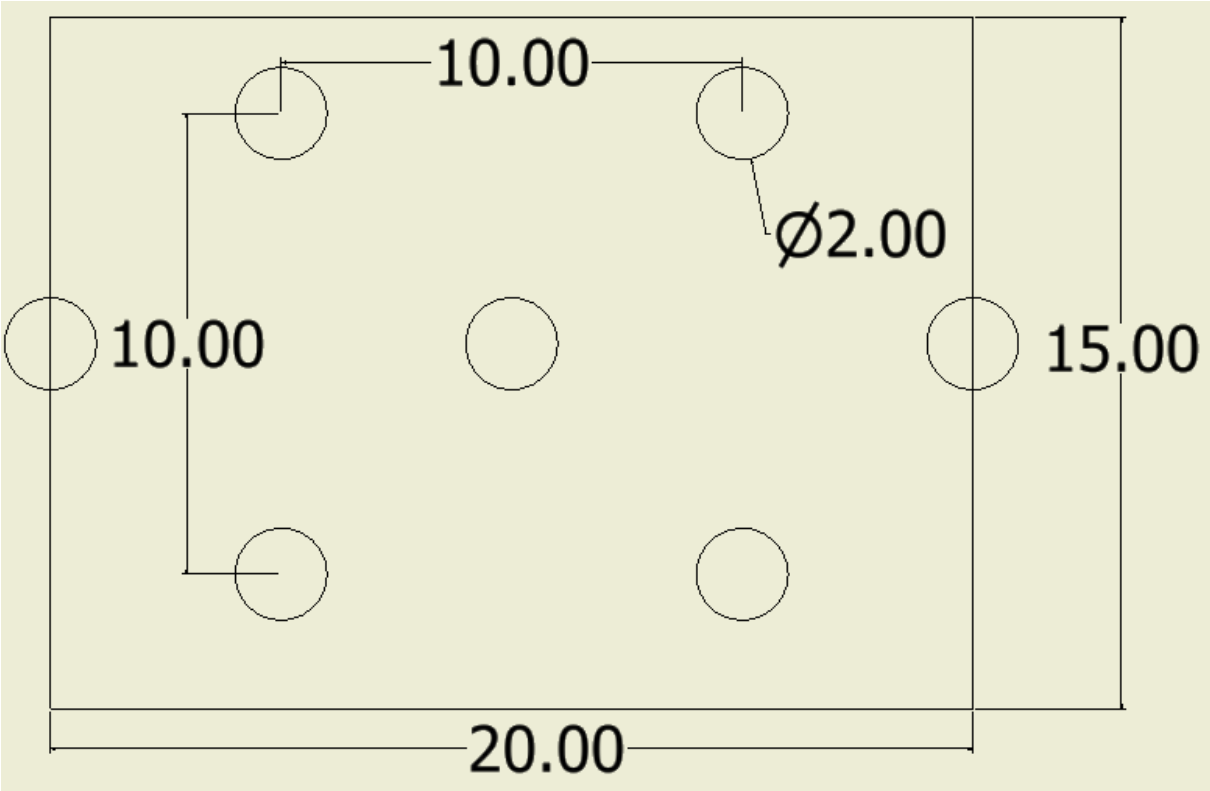

As can be seen in the figure, in a surface of 20mm x 15mm, there are 6 holes perforated.

These holes have a total surface of:

$$S_{holes} = 6 * \frac{\pi}{4} * d^2$$

$$S_{holes} = 6 * \frac{\pi}{4} * 2^2 = 18,84 \text{ mm}^2$$

The total surface is:

$$S_{total} = 15 * 20 = 300 \text{ mm}^2$$

$$\frac{S_{holes}}{S_{total}} * 100\% = \frac{18,84}{300} * 100\% = 6,3\%$$

Therefore, the holes cover 6,3 % of the total surface of the straps

# APPENDIX F

## Manual

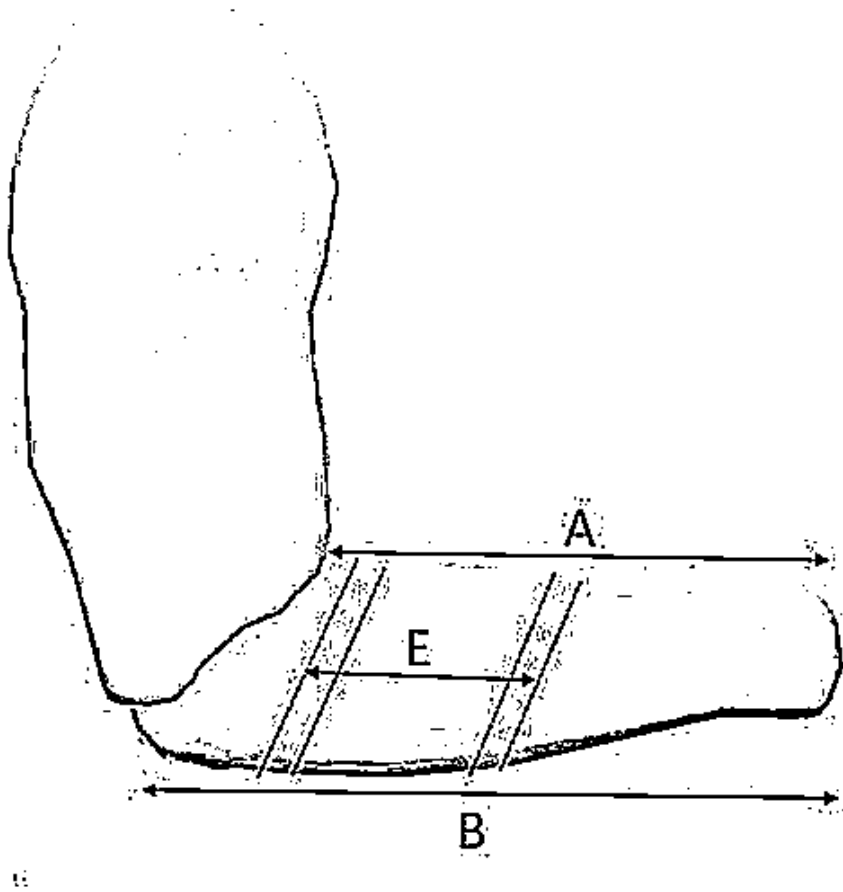





**MEASUREMENTS AMPUTATED ARM**

*Lengths*

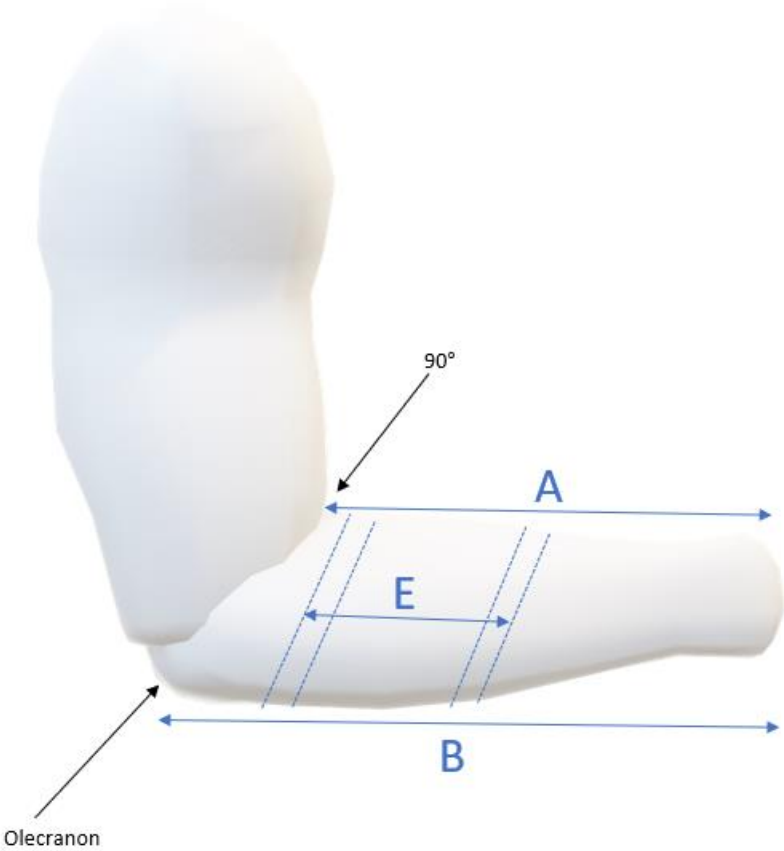

*Circumferences*

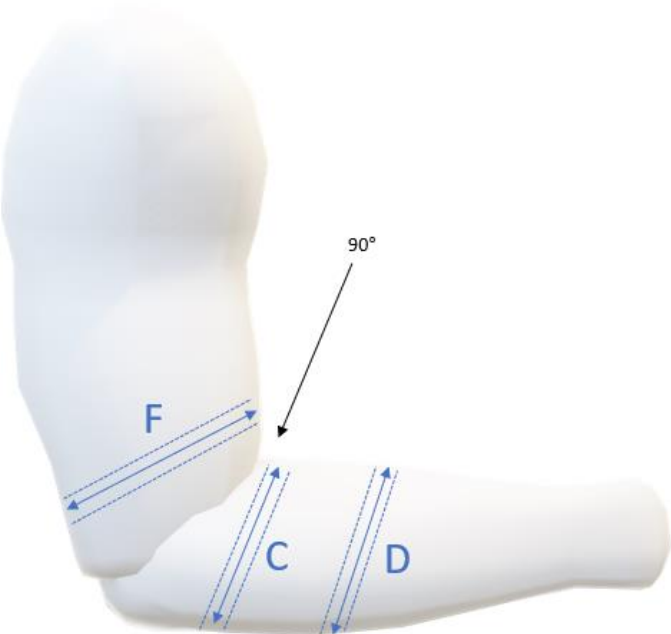

*Lengths*



**MEASUREMENTS OTHER ARM**

*Lengths*

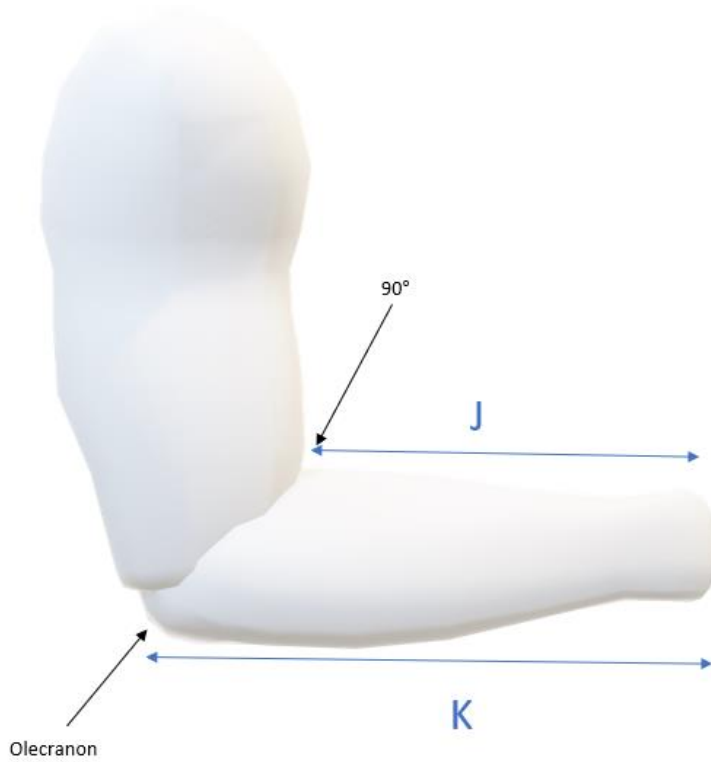

## Measurements

A		Ventral length stump
B		Dorsal length stump
C		Proximal circumference lower arm
D		Distal circumference lower arm (optional)
E		Length between the outsides of the 2 straps (measured in the middle)
F		Circumference upper arm
H		From the end of the arm till the end of the stump (measured in the middle)
I		Dimple elbow -> beginning of the strap
J		Ventral length other arm
K		Dorsal length other arm

## Measure tool for circumference F and C:

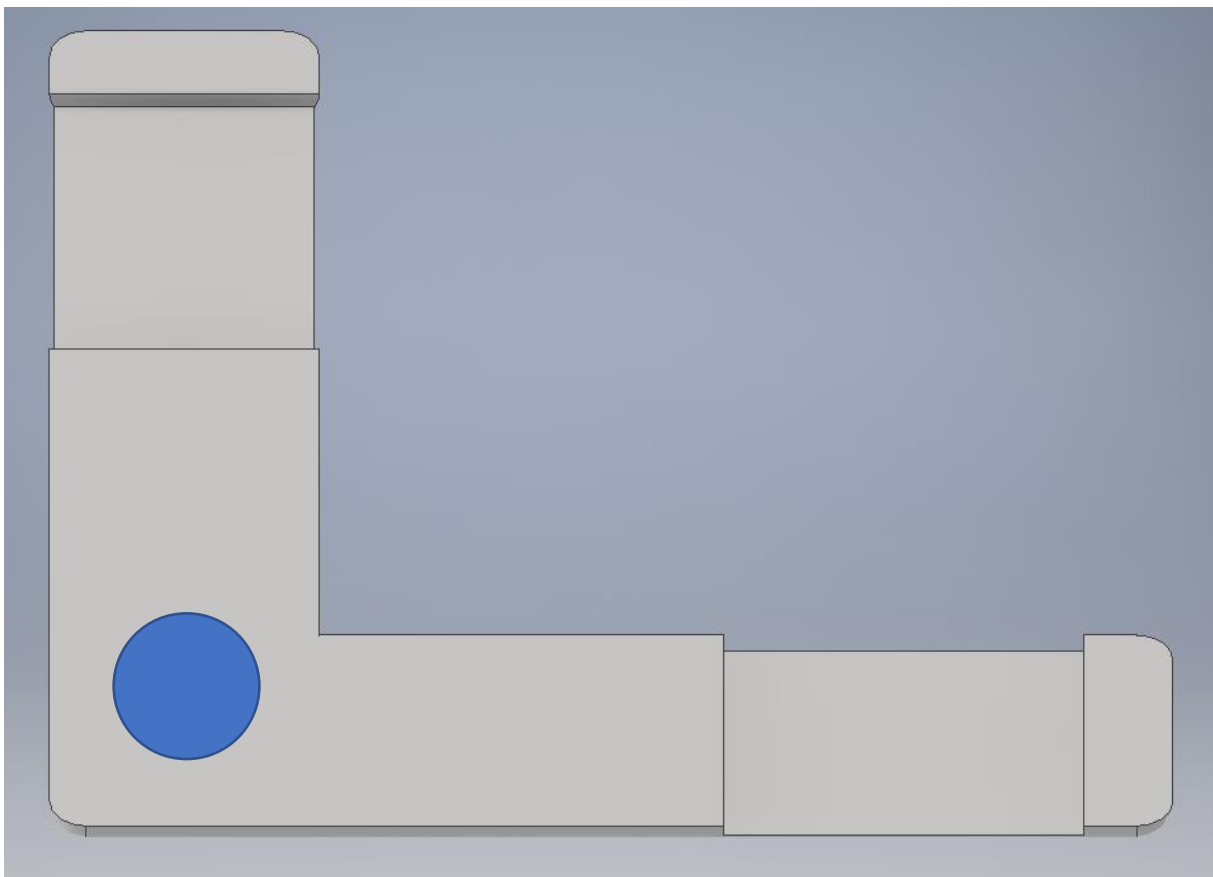

With this tool, the midpoint of the straps is 45 mm away from the pivot point, the epicondyles. This is an excellent point to start measuring because then the socket will fit right on a standard cone shape stump. This distance of 45 mm makes sure that the straps will not contact each other with flexion/extension of the elbow on the one hand and are located under the biceps on the other.

## ENTERING THE VALUES IN INVENTOR

- 1 Download the zip map "Final design"
- 2 Choose the right of left amputee
- 3 Choose the socket which is best applicable on this particular residual limb
- 4 Go to the steps of which socket you did choose and fill in the measured parameters:

Final socket, 1 strap	Final socket 2 straps
<u>Upperarm total -&gt; Upper arm -&gt; Sketch 1:</u>	<u>Upperarm total -&gt; Upper arm -&gt; Sketch 1:</u>
D14 = Upperarm circumference F	D14 = Upperarm circumference F
D13 = Circumference C	D13 = Circumference C
<u>Lowerarm total -&gt; Lower arm -&gt; Sketch 1:</u>	<u>Lowerarm total -&gt; Lower arm -&gt; Sketch 1:</u>
D44 = Circumference C	D44 = Circumference D
	<u>Lowerarm total -&gt; Lower arm -&gt; Sketch 7:</u>
	D391 = Circumference C

To edit the holes in the straps, do the following:

Open *Upperarm total -> Upperarm -> Edit sketch 4*

Now click on the holes you want to suppress (underneath the hinge straps) or unsuppress.

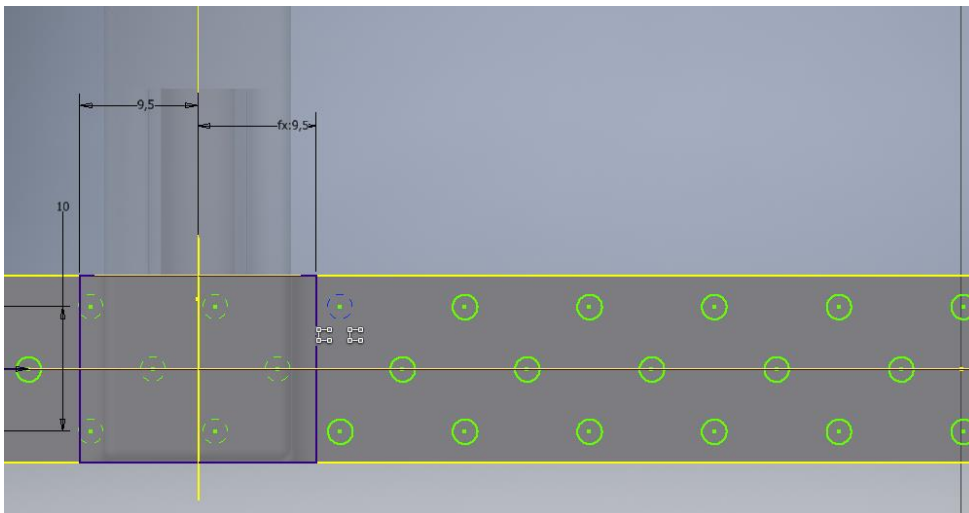

*Finish sketch*

Right click on *Extrusion 5*

*Edit feature*

Click on the holes you want to add:

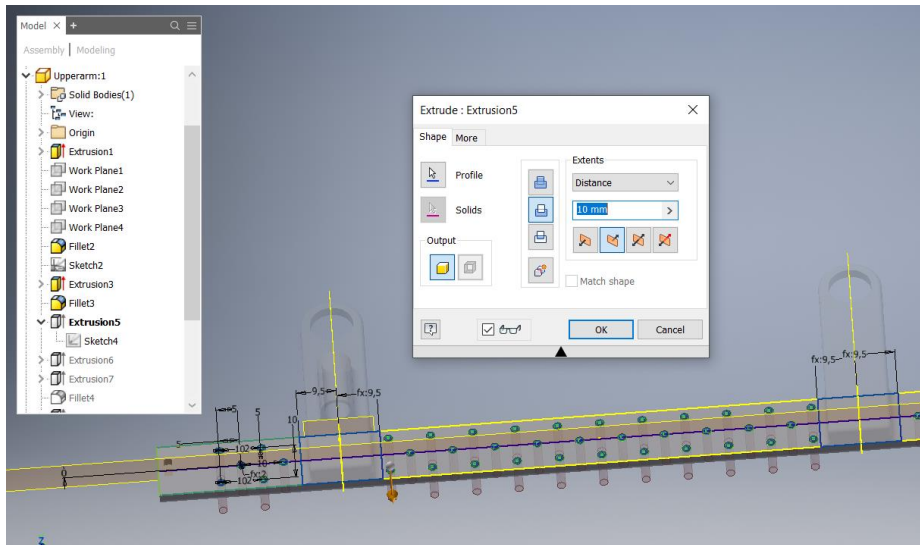

Do the same thing for the underarm to be sure the holes are only on the places where no straps are attached.

After finishing the socket:

*File -> Export -> Cad format -> STL*

Download the Cura program for the Ultimaker

Load the STL file

Adjust the printing settings in Cura (see next page)

*Slice*

# PRINTSETTINGS CURA

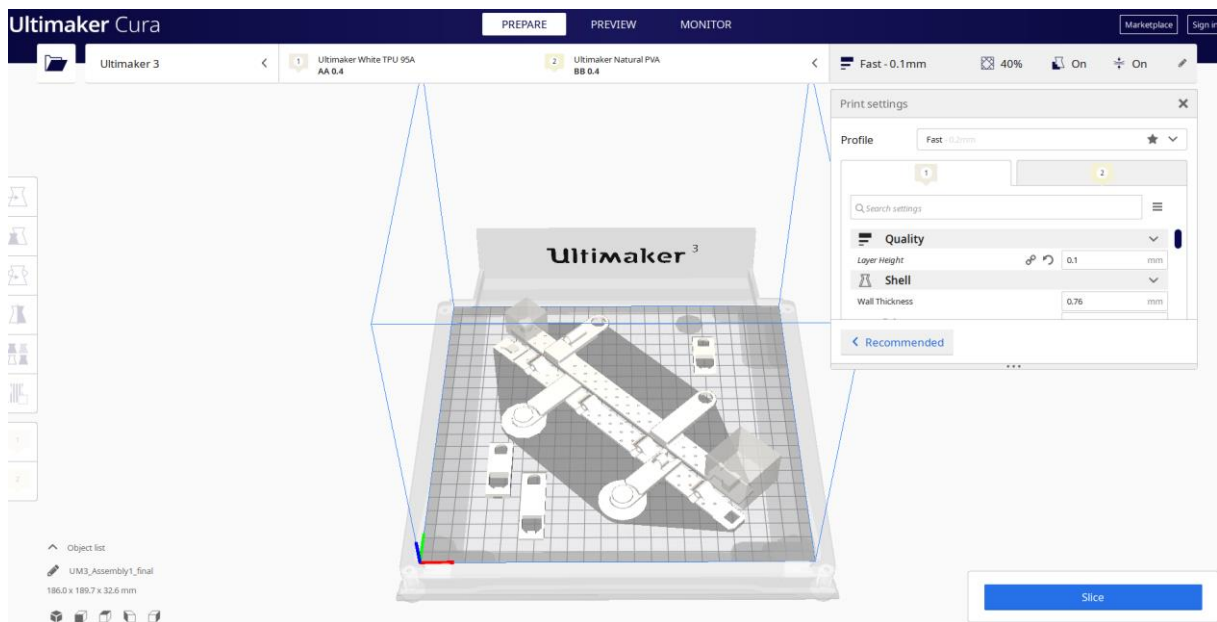

Material: TPU 95A

Support material: Natural PVA

Layerheight: 0,1 mm

Infill: Cross 3D 40%

Modifier blocks with infill 60% cross 3D on the weak parts

Supports everywhere

Support infill: Triangles, 20%

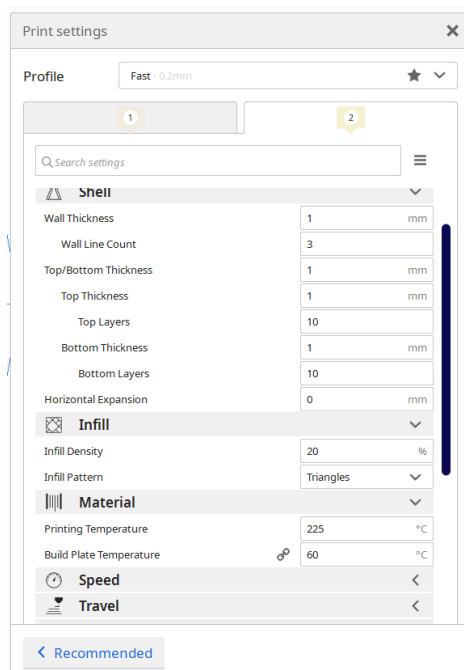
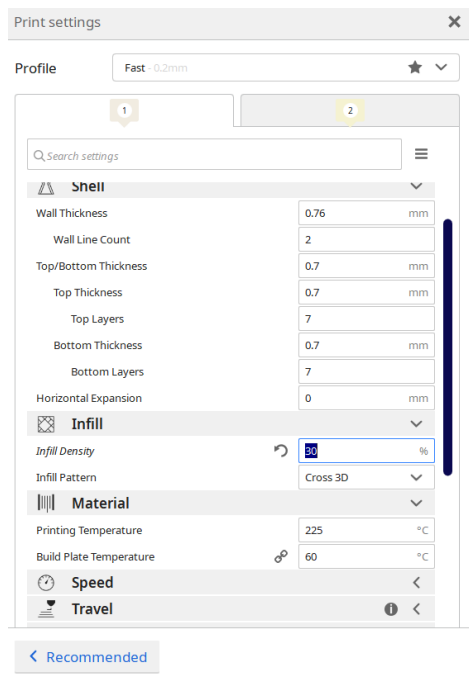



# APPENDIX G

## Strength test I

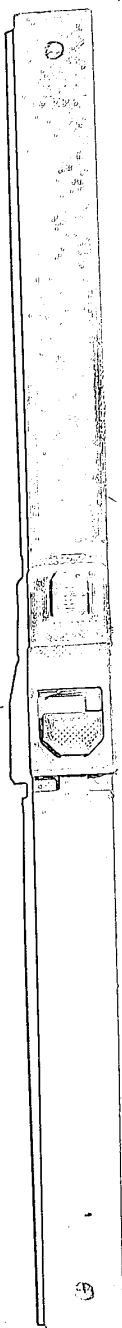

# APPENDIX G: STRENGTH TEST I







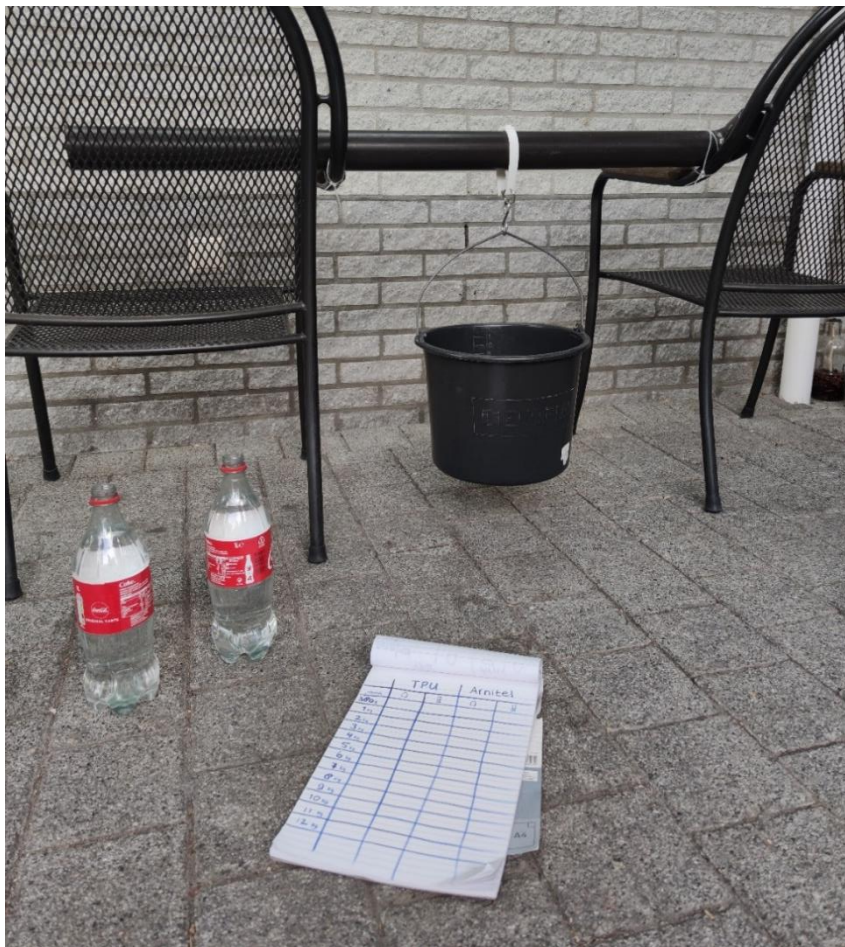

A strength test is conducted for both materials (TPU9 95A and Arnitel ID2045) and both spacers (concept 9 and concept 11) to test the performance. Concept 9 is a spacer which is a combination of lock A and B. Concept 11 is a spacer with a half circle. See Appendix D. Concept 11 was the winning concept, but concept 9 is also tested to have a back-up if concept 11 fails during the strength test. Due to Corona circumstances, a homemade set-up is used for this end.

## SET - UP

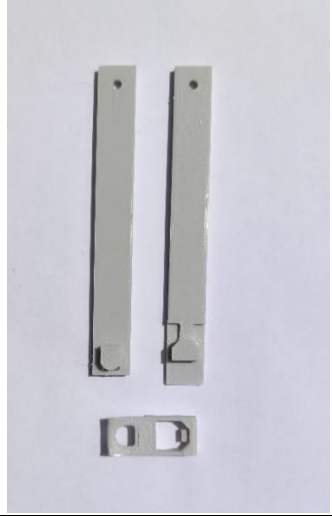
Straps are attached to each other with the spacer. The straps are fold around a pipe with the same width as an arm. Therefore, it forces to form around the pipe to mimic the same situation as using a prosthesis. A bucket is attached on the end of the straps with a hook and ring. Every minute an increment of 1 kilo water is added, up to an intended 10 kg. When the maximum weight of 10 kg is reached, it will be examined how many minutes the spacer can hold this weight before it starts to deform, with a maximum time period of 24 hours. After these 24 hours every minute an increment of 1 kilo water is added, up to an intended 20 kg. When the maximum weight of 20 kg is reached, it will be examined how many minutes the spacer can hold this weight before it starts to deform, with a maximum time period of 24 hours.



# NECESITTIES

		
TPU 95A	TPU 95A	Ring
		
Arnitel ID 2045	Arnitel ID 2045	Hook
		
Bucket of 20 liters	Pipe attached to 2 chairs	1 litre bottle water

# PRINT SETTINGS

It is important that both materials have the same printing settings to have an optimal comparison of the results. Therefore, the beforehand defined print settings are as followed:

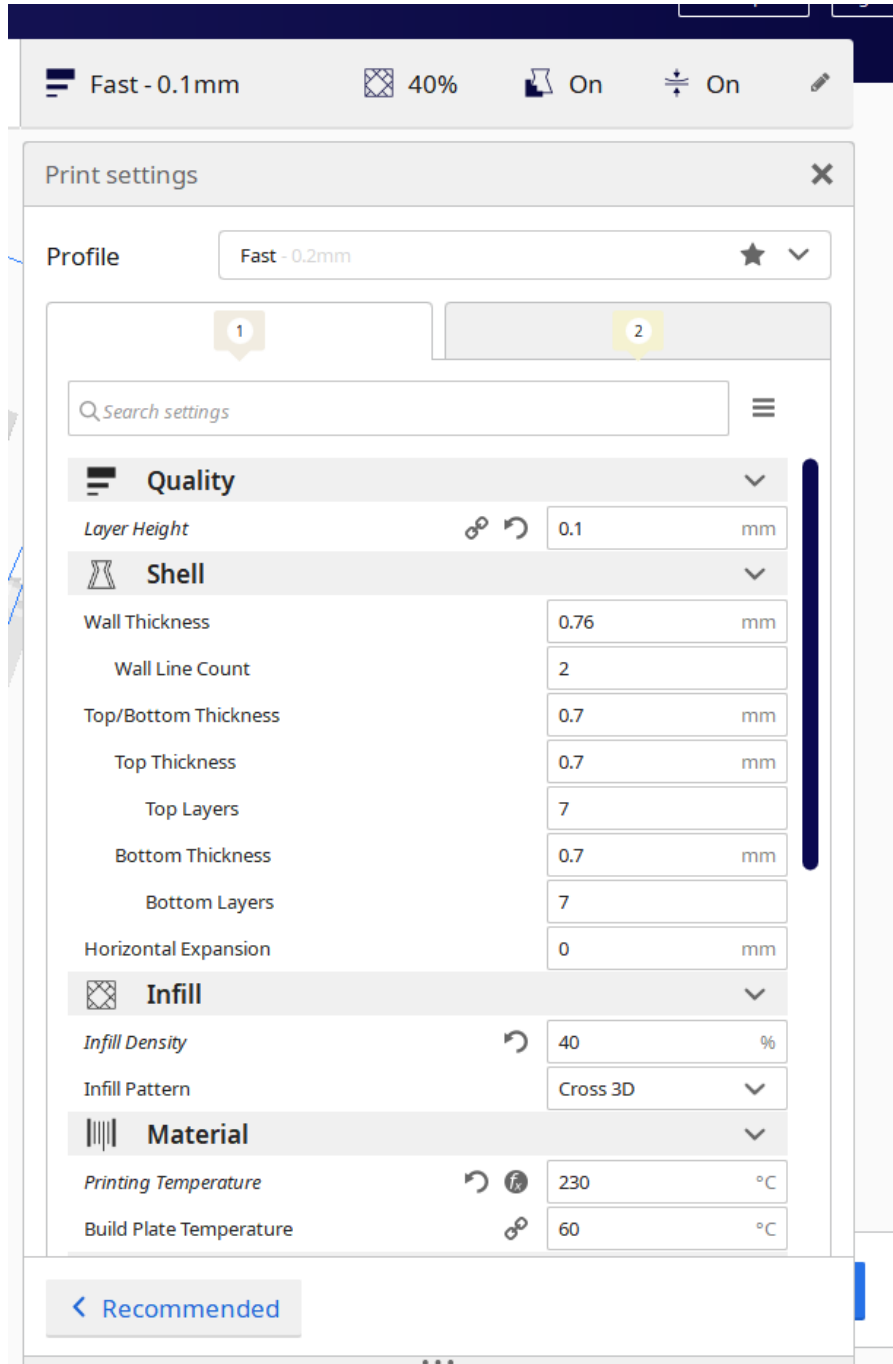

## TPU CONCEPT 1





## TPU CONCEPT 2



# ARNITEL CONCEPT 1









## ARNITEL CONCEPT 2



## RESULTS

	TPU		Arnitel	
				
Bucket (380 g)	✓	✓	✓	✓
1 kg	✓	✓	✓	✓
2 kg	✓	✓	✓	✓
3 kg	✓	✓	✓	✓
4 kg	✓	✓	✓	✓
5 kg	✓	✓	✓	✓
6 kg	✓	✓	✓	✓
7 kg	✓	✓	✓	✓
8 kg	✓	✓	✓	✓
9 kg	✓	✓	✓	✓
10 kg	24+ hours	24+ hours	24+ hours	24+ hours
11 kg	✓	✓	✓	✓
12 kg	✓	✓	✓	✓
13 kg	✓	✓	✓	✓
14 kg	✓	✓	✓	✓
15 kg	✓	✓	✓	✓
16 kg	✓	✓	✓	✓
17 kg	✓	✓	✓	✓
18 kg	✓	✓	✓	✓
19 kg	✓	✓	✓	✓
20 kg	24+ hours	24+ hours	24+ hours	24+ hours

## CONCLUSION

As can be seen in the previous table, both materials and both spacers can withstand all the forces. Furthermore, all set/ups have lasted for more than a full day. Therefore, both materials and both spacers are suitable. A disadvantage from the triangle spacer is that it can be opened on two sides and therefore it is easier to fall off. This is not the intention, because with donning and doffing the spacer should stay attached to the socket.

Therefore, the spacer with the click and rotate system is preferable to use.

# APPENDIX H

## Strength test II

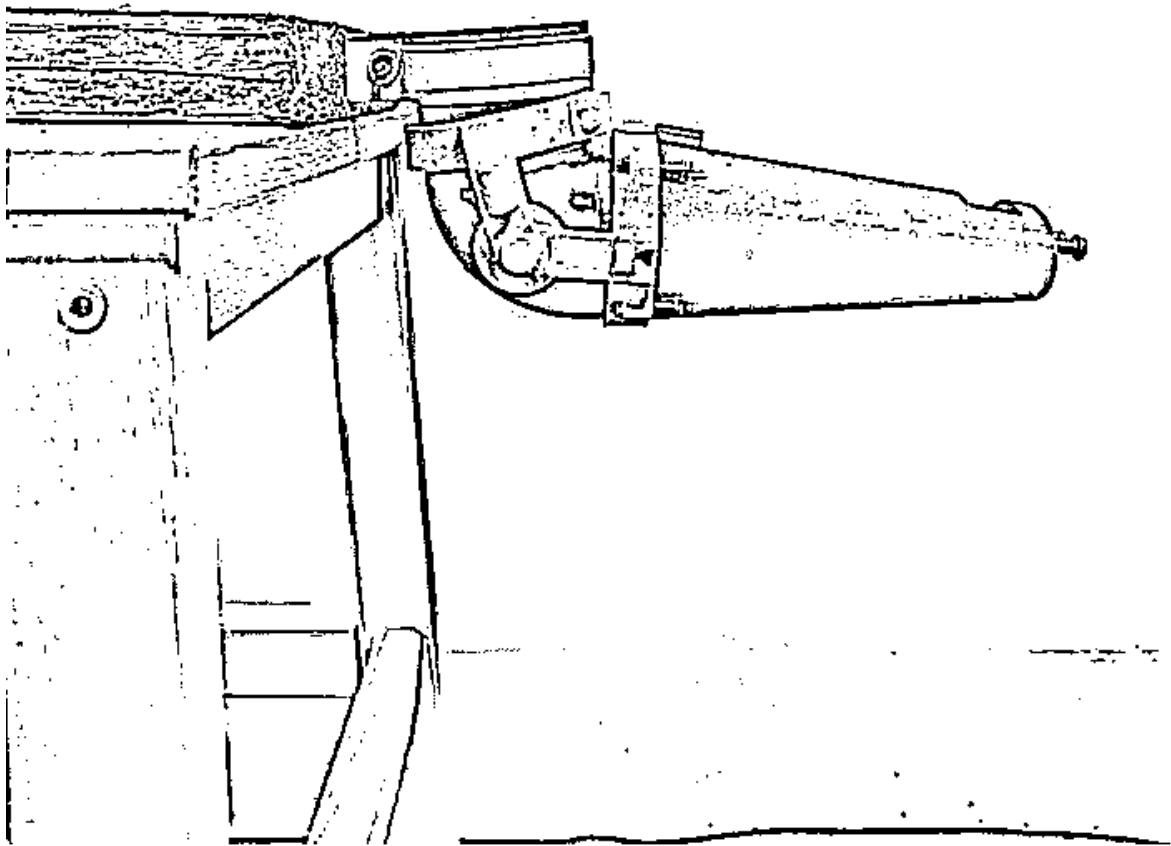

# APPENDIX H: STRENGTH TEST

A strength test is also conducted for both materials (TPU9 95A and Arnitel ID2045) to see which material can withstand the forces when the socket is subjected to everyday life loads. A PVC pipe coil is used to mimic a residual limb. This coil is attached to a wooden block with a connector. At the end of the underarm, two bolts are attached to make it possible to hang a bag there. Tie wraps are used to make sure the bag does not fall off the bolts. 1 litre bottles of water and gym-weights are used to increase the weight in the bag. This is almost the same strength test as used in the Wilmer open socket 2nd generation, and the 3d printed Wilmer open socket, which is useful to compare the results.

In the first set-up, the axial force of the socket was tested, which is the same as holding something at zero degrees. In the second set-up, the radial force of the socket was tested to see if it is able to lift, for example, a bag. Weights were attached on the end of the prosthetic which were added up to an intended 10 kg.

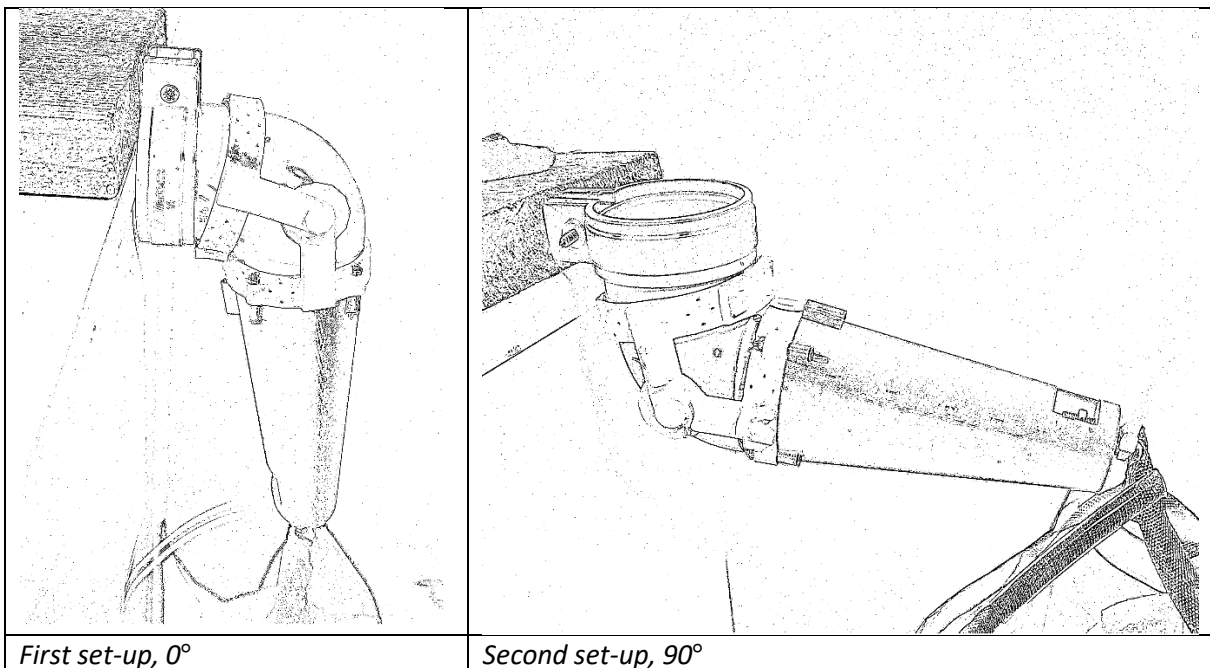

When the socket begins to get a visual lasting deformation, a strap breaks or when the 10 kg is reached, the test will be stopped.

# PRINT SETTINGS

It is important that both materials have the same printing settings to have an optimal comparison of the results. Therefore, the beforehand defined print settings are as followed:

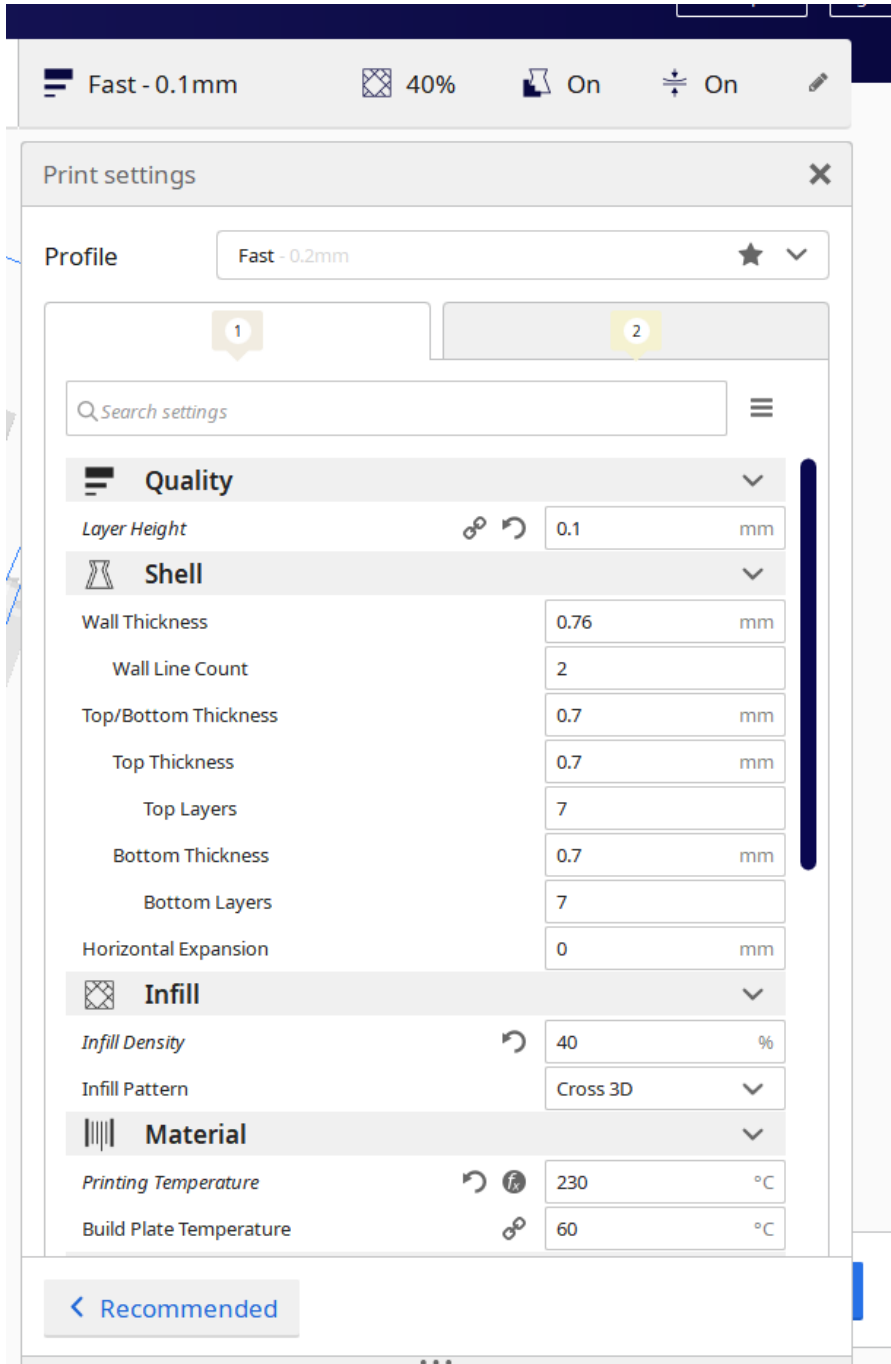

## CLOSE BY LOOK

A screw is screwed in a wooden block. The PVC pipe is held by a connector which is fitted by a screw through the opening of the first screw:



The underarm is attached to the socket with bolts and nuts. At the end of the underarm two nuts are attached to make it able to hang the bag on the underarm (with tie wraps used to avoid the bag from falling off).



## SET-UP

The final set ups looks as followed:



Both the Arnitel ID2045 socket and the TPU95A socket are tested in both set-ups.

## RESULTS

	TPU		Arnitel	
	0°	90°	0°	90°
1 kg	✓	✓	✓	✓
2 kg	✓	✓	✓	✓
3 kg	✓	✓	✓	✓
4 kg	✓	✓	✓	✓
5 kg	✓	✓	✓	<i>Deformation</i>
6 kg	✓	✓	✓	<i>Socket falls off</i>
7 kg	✓	✓	✓	X
8 kg	✓	✓	✓	X
9 kg	✓	✓	✓	X
10 kg	✓	✓	✓	X



## CONCLUSION

The straps (including the locks and the spacer) are strong enough to withstand the applied forces. Furthermore, the socket is also strong enough to receive the forces without breaking. Nevertheless, Arnitel is too flexible and will deform to withstand the forces when the arm is at a 90° angle. As can be seen in the picture, the socket starts falling off the residual limb. This deformation started at a weight of 5kg in the bag:



Due to circumstances, it was not possible to test the socket on patients or use strength machines. The homemade set-ups were a suitable approach. Nevertheless, it did not mimic exactly the same situation as wearing a socket. The PVC pipe coil, used to mimic a stump, is very smooth, with not a lot of friction. Furthermore, it is not possible to dent the pipe (like a residual limb). Therefore, the socket could not be fitted correctly on the pipe, and a little bit of space was left. Another obstacle of the PVC pipe coil was the fact that it was also leaning on the inside of the 3D printed lower arm. This could lead to unreliable results. In realistic wear conditions, the strength tests may have less favourable results.

# APPENDIX I

## Engineering drawings

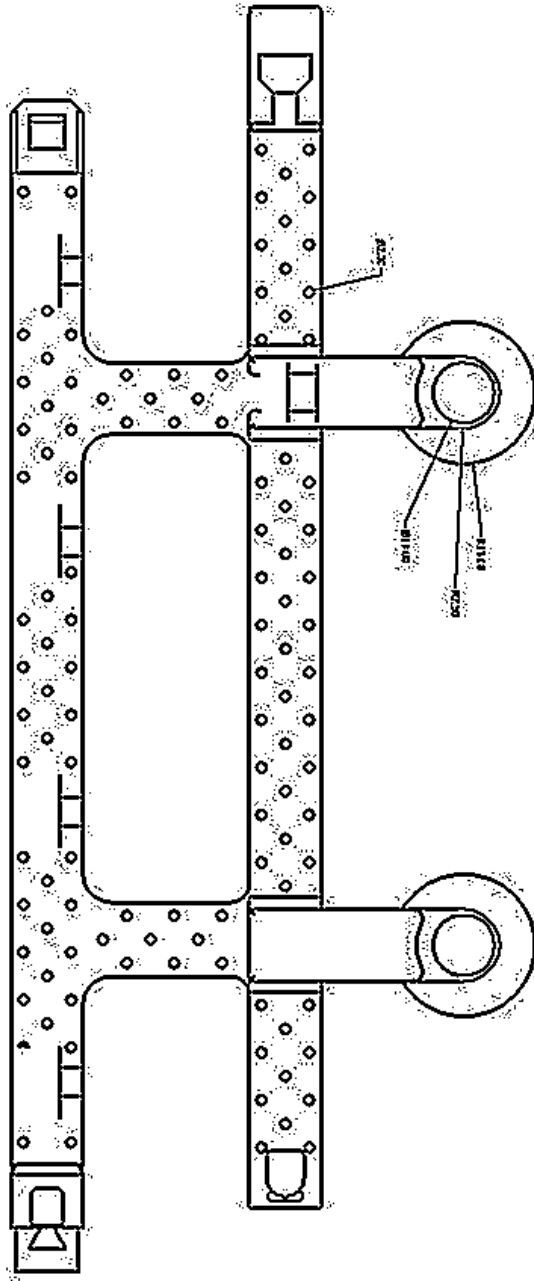

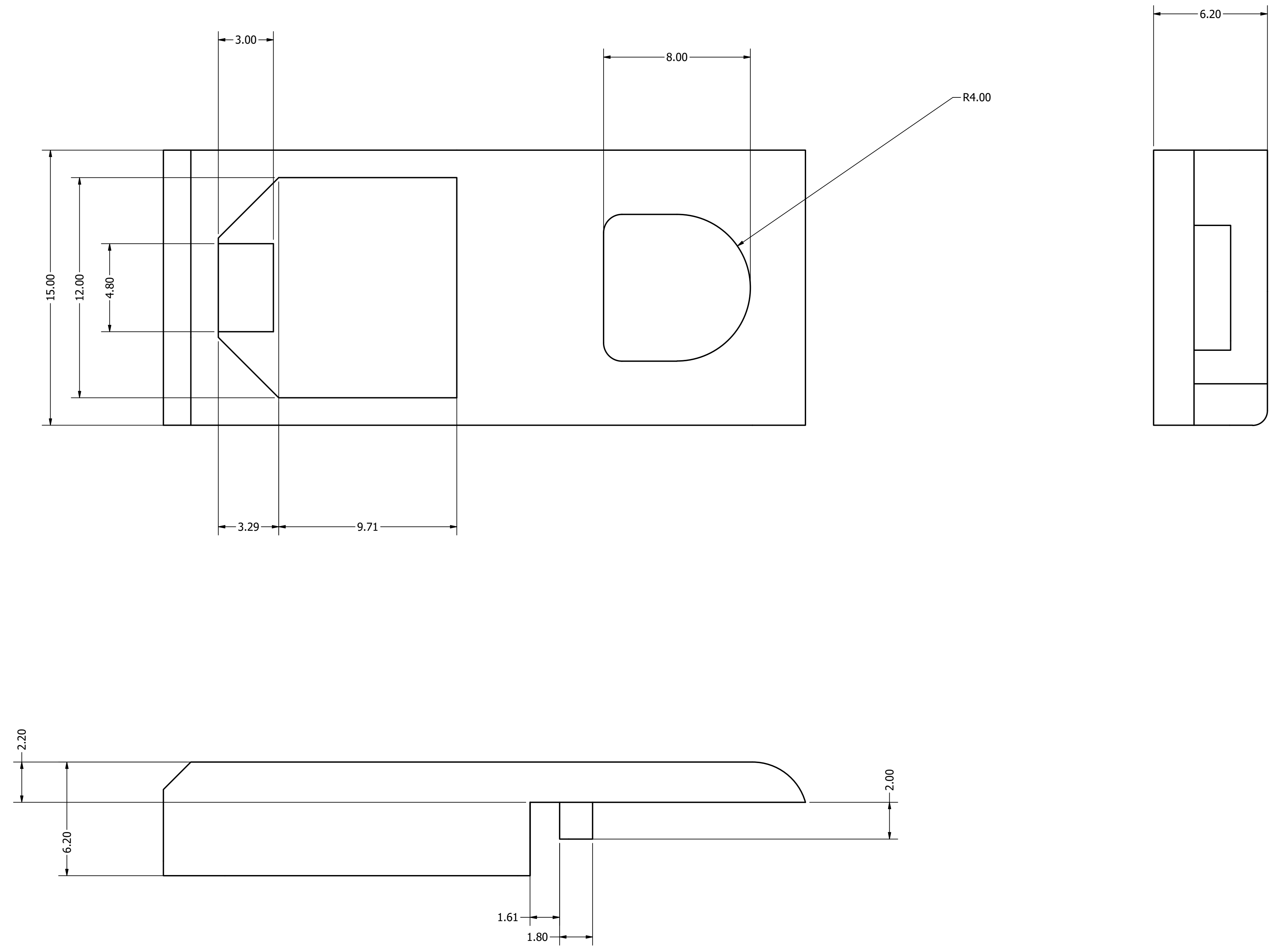
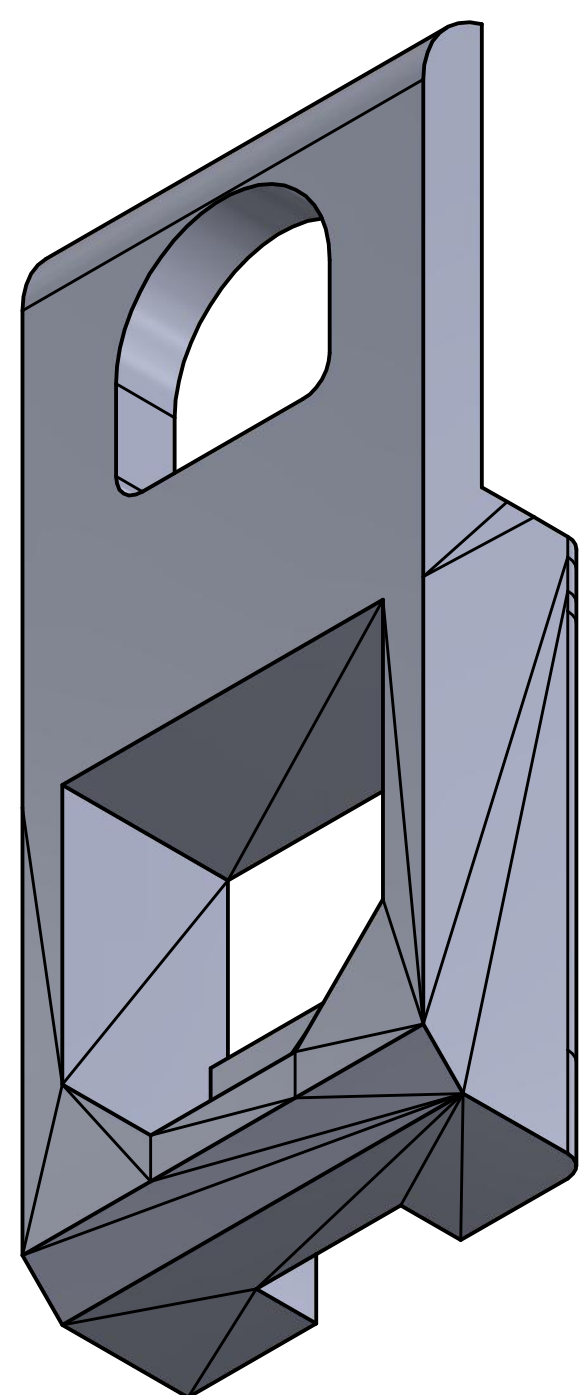

DRAWN	Hilde	2-7-2020			
CHECKED			TITLE		
QA					
MFG					
APPROVED					
			SIZE	DWG NO	REV
			D	Spacer	
			SCALE	5 : 1	SHEET 1 OF 1

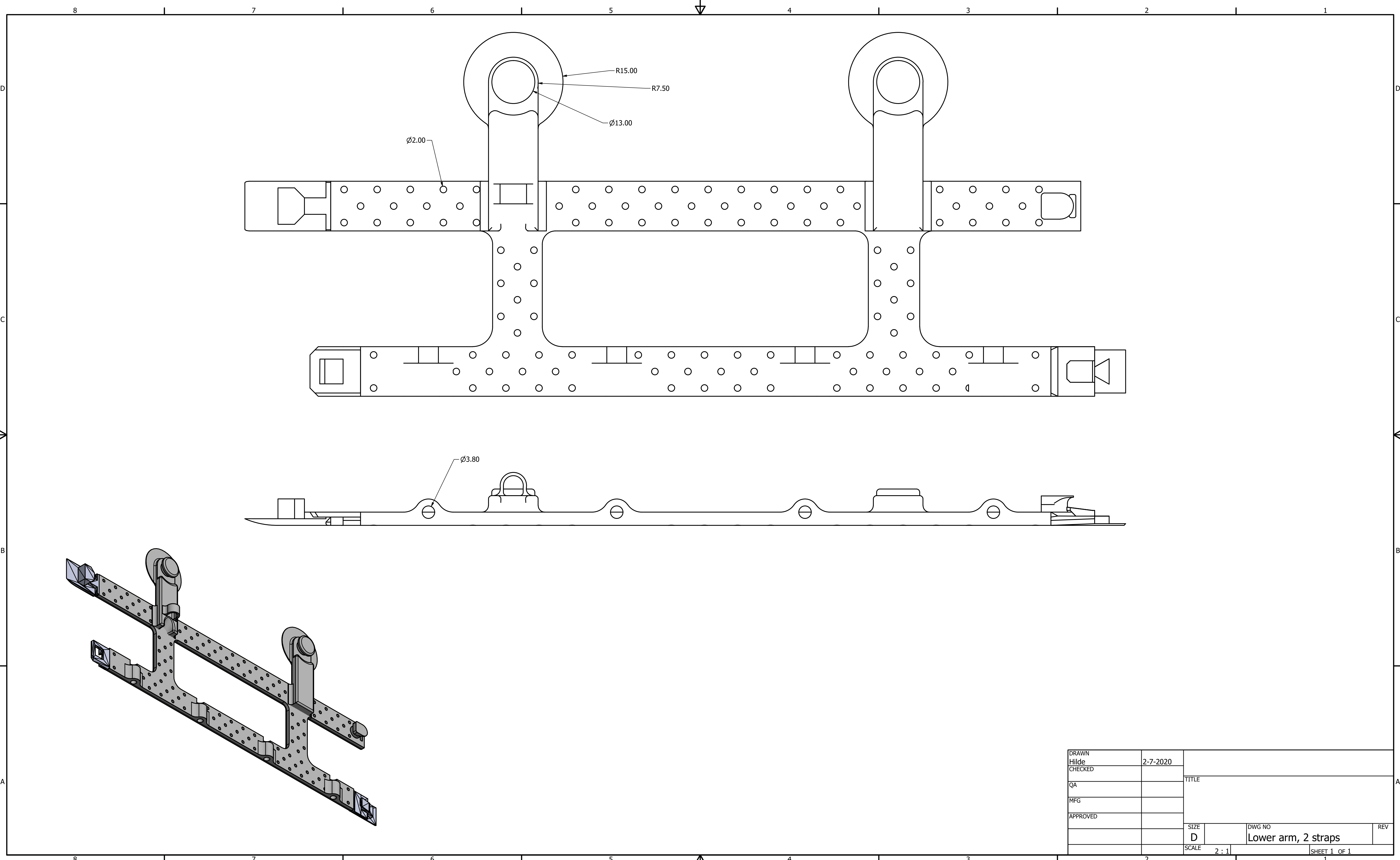

DRAWN	Hilde	2-7-2020		
CHECKED			TITLE	
QA				
MFG				
APPROVED				
		SIZE	DWG NO	REV
		D	Lower arm, 2 straps	
		SCALE	2 : 1	SHEET 1 OF 1

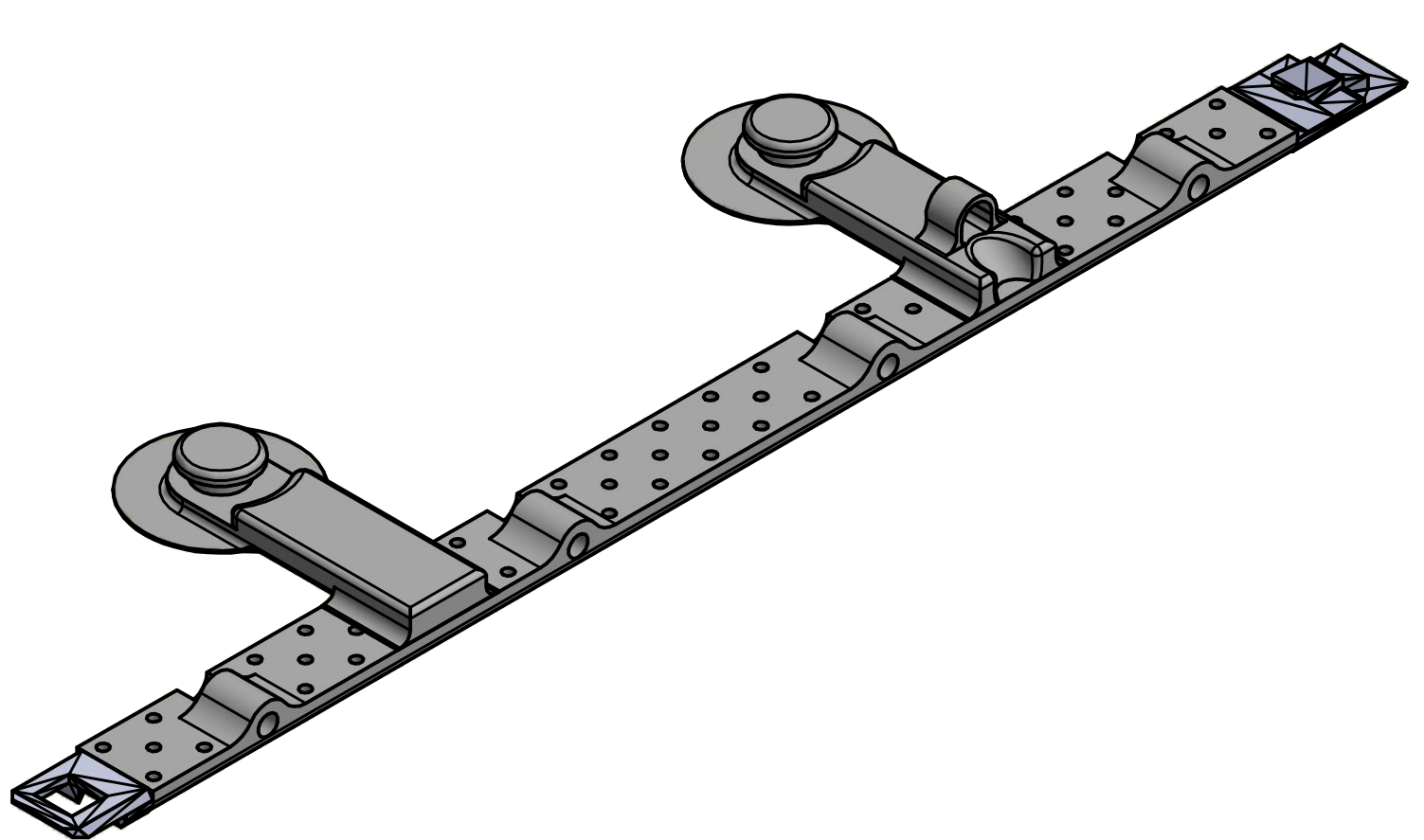
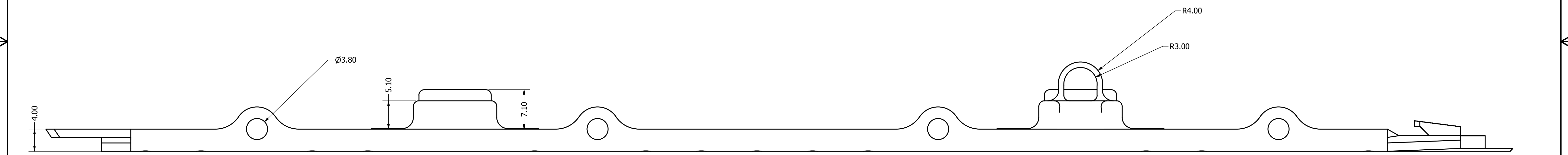
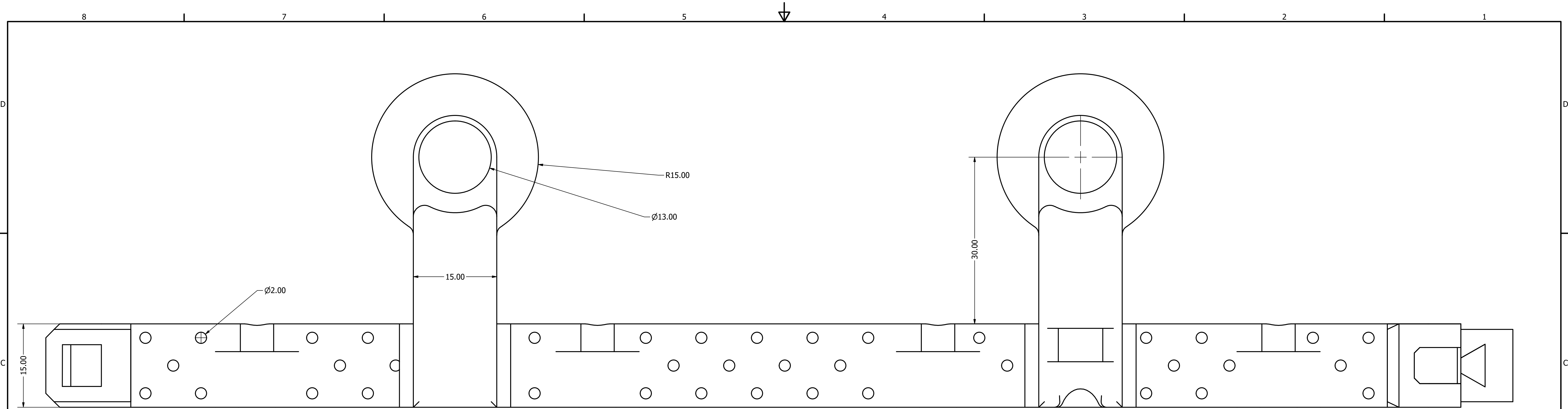

DRAWN	Hilde	2-7-2020		
CHECKED			TITLE	
QA				
MFG				
APPROVED				
			SIZE	DWG NO
			D	Lowerarm, 1 strap
			SCALE	3 : 1
				SHEET 1 OF 1

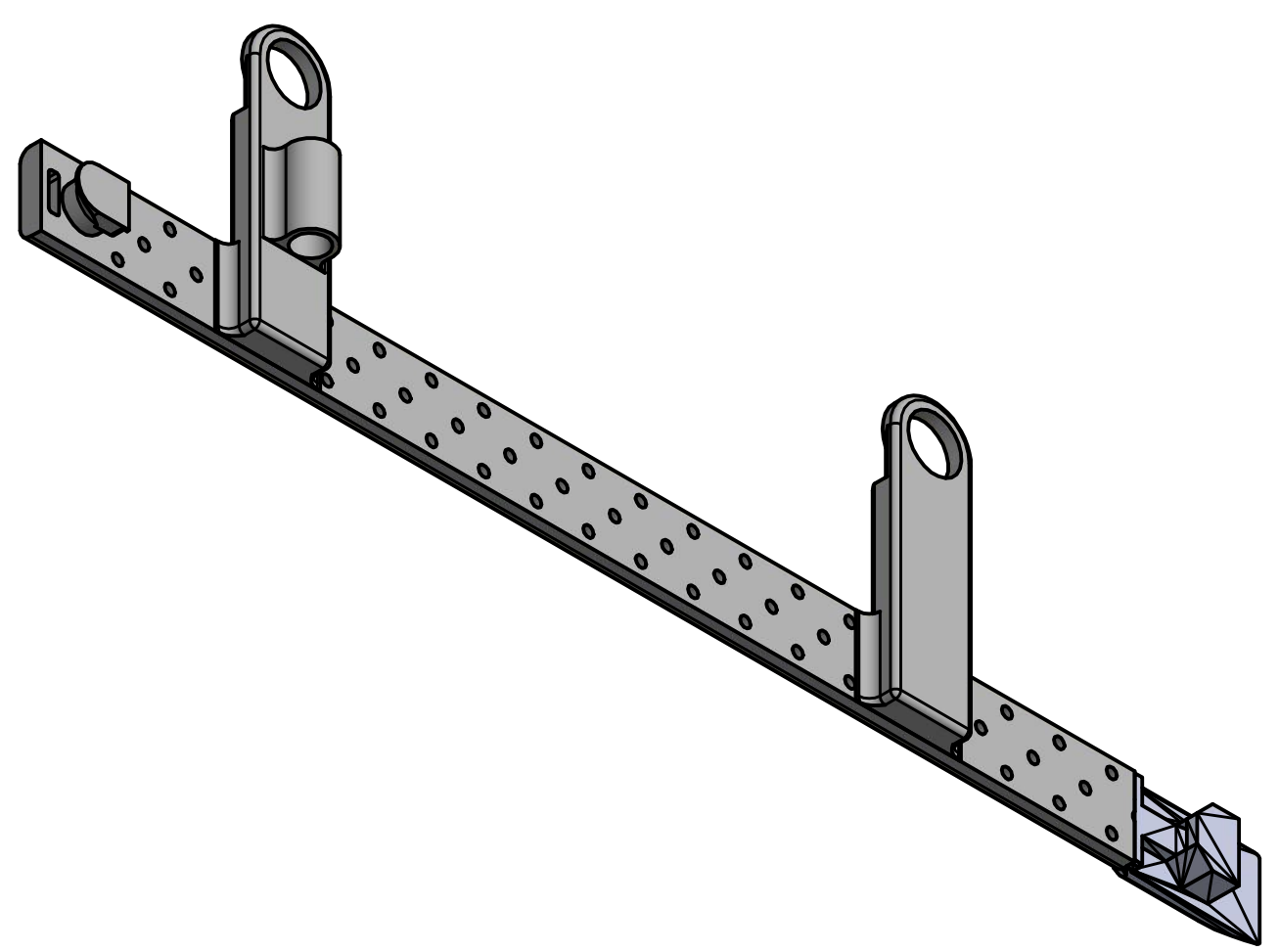
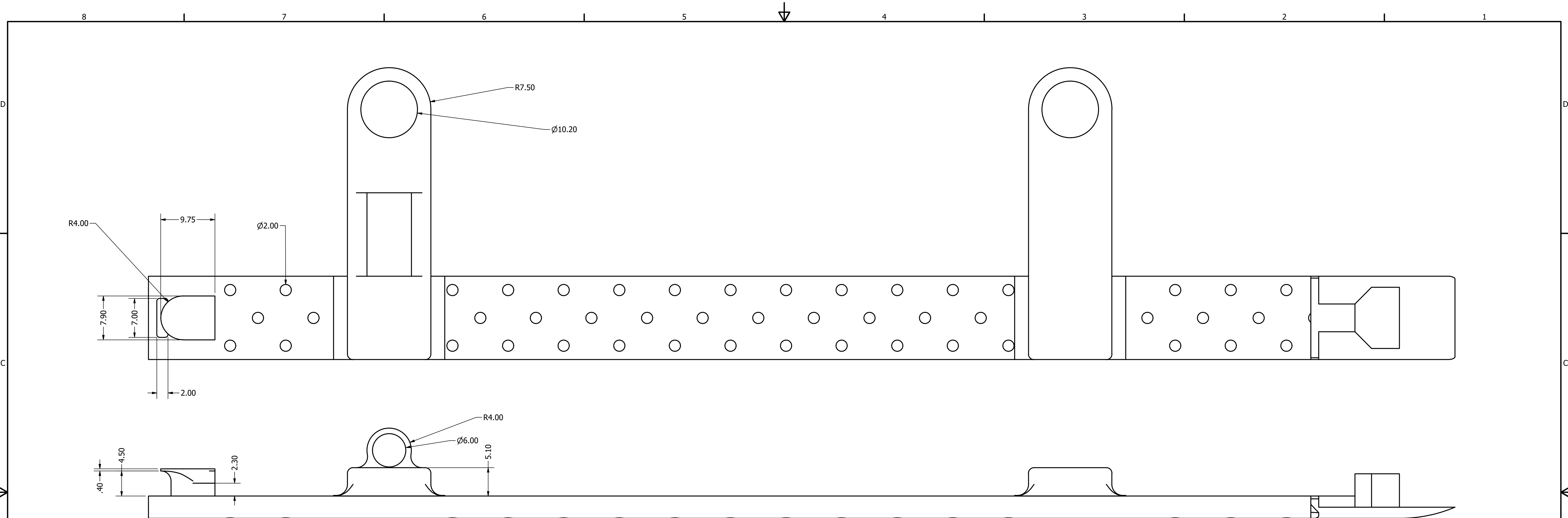

DRAWN	Hilde	2-7-2020		
CHECKED			TITLE	
QA				
MFG				
APPROVED				
			SIZE	DWG NO
			D	Upperarm
			SCALE	3 : 1
				SHEET 1 OF 1