

Optimal Battery Energy Storage Dispatch in Energy and Frequency Regulation Markets While Peak Shaving an EV Fast Charging Station

Argiolas, Luca; Stecca, Marco; Ramirez-Elizondo, Laura M.; Soeiro, Thiago Batista; Bauer, Pavol

DOI

[10.1109/OAJPE.2022.3198553](https://doi.org/10.1109/OAJPE.2022.3198553)

Publication date

2022

Document Version

Final published version

Published in

IEEE Open Access Journal of Power and Energy

Citation (APA)

Argiolas, L., Stecca, M., Ramirez-Elizondo, L. M., Soeiro, T. B., & Bauer, P. (2022). Optimal Battery Energy Storage Dispatch in Energy and Frequency Regulation Markets While Peak Shaving an EV Fast Charging Station. *IEEE Open Access Journal of Power and Energy*, 9, 374-385. Article 9855507. <https://doi.org/10.1109/OAJPE.2022.3198553>

Important note

To cite this publication, please use the final published version (if applicable). Please check the document version above.

Copyright

Other than for strictly personal use, it is not permitted to download, forward or distribute the text or part of it, without the consent of the author(s) and/or copyright holder(s), unless the work is under an open content license such as Creative Commons.

Takedown policy

Please contact us and provide details if you believe this document breaches copyrights. We will remove access to the work immediately and investigate your claim.

Optimal Battery Energy Storage Dispatch in Energy and Frequency Regulation Markets While Peak Shaving an EV Fast Charging Station

**LUCA ARGIOLAS^{ID}, MARCO STECCA^{ID} (Graduate Student Member, IEEE),
 LAURA M. RAMIREZ-ELIZONDO^{ID} (Member, IEEE),
 THIAGO BATISTA SOEIRO^{ID} (Senior Member, IEEE),
 AND PAVOL BAUER^{ID} (Senior Member, IEEE)**

Electrical Sustainable Energy Department, Delft University of Technology, 2628 CD Delft, The Netherlands
 CORRESPONDING AUTHOR: M. STECCA (m.stecca@tudelft.nl)

ABSTRACT Battery Energy Storage Systems typically procure their primary revenues from regulated energy and ancillary services markets; nonetheless, they have great potential in supporting distribution network operators and their users. This paper evaluates the potential business case of battery storage systems integrating market application and services to a photovoltaic assisted electric vehicle fast-charging station. A mathematical deterministic optimization problem is formulated using mixed-integer linear programming to combine battery storage system operation in the day-ahead and frequency regulation market and the remunerated services offered to the charging station. The technical and economic feasibility of the solution and the applicability of the proposed framework is verified through a case study reflecting an existing photovoltaic assisted charging station in the Netherlands and considering the Dutch energy market framework and prices. The study shows that such battery storage system implementation is economically and technically advantageous for the players involved. The battery storage system can stack additional revenues on top of the market revenues. The charging station benefits from a reduced peak power and a 30% tariff reduction, and the system operator would indirectly benefit from the shaved charging station profile. Furthermore, the analysis shows that providing services to the charging station from the battery storage system does not significantly impact its market-related revenues.

INDEX TERMS Battery energy storage system, day ahead market, distribution network, electric vehicle, fast charging station, financial analysis, mixed integer linear programming, primary frequency regulation.

NOMENCLATURE

β	Minimum bid for Frequency Containment Reserve market.	$C_{\text{fcr-r}}$	Ramp Cost for Frequency Containment Reserve market.
δ	Binary variable for BESS charging/discharging.	C_r	Ramp Cost for Day-ahead market.
η_c	BESS charging efficiency.	DAM	Day-ahead market revenues.
η_d	BESS discharging efficiency.	E^*	Nominal BESS energy capacity.
Γ	Minimum BESS state of charge to be accepted in the FCR market.	FCR	Frequency Containment Reserve revenues.
γ_{fcr}	Binary variable for Frequency Containment Reserve dispatch.	P_{bk}	BESS power reserved for additional service operation.
λ	Day-ahead market price.	P_c^*	Nominal BESS charging power.
λ_{fcr}	Frequency Containment Reserve market price.	P_d^*	Nominal BESS discharging power.
		$P_{\text{fcr-d}}$	Frequency Containment Reserve downward activated bid.

$P_{\text{fcr-u}}$	Frequency Containment Reserve upward activated bid.
P_{fcr}	Accepted upward/downward bid to Frequency Containment Reserve power market.
P_{out}	BESS rated power.
SoC	BESS state of charge.
SoC_{bk}	BESS state of charge reserved for additional service operation.
t	Day-ahead market time step/simulation time step.
z	Frequency Containment Reserve time step.

I. INTRODUCTION

BATTERY Energy Storage Systems (BESSs) are a crucial technology for allowing both a widespread deployment and integration of Renewable Energy Source (RES) based generation in the electrical network and higher electrification of the transportation sector [1], [2], [3]. BESSs can relieve the distribution networks of peak demand, line congestion, and power quality issues, which are caused by RES generator and electric vehicles (EVs) Fast Charging Stations (FCS) [4].

Furthermore, BESSs are generally allowed to participate in energy markets. They can buy and sell energy for profits, leveraging on the intraday price spread or during a week of operation. However, the sole participation in energy products underestimates revenues and the batteries' capabilities. The combination with TSO's ancillary services makes BESS capitalize on higher revenues, e.g., providing primary frequency control to the grid [5], [6], [7]. In this context, the dual participation of BESS in remunerated energy and ancillary services markets has been proven to be profitable in several European countries [8].

Previous literature has investigated the application of BESS in energy and ancillary services markets, both in terms of its technical performance and schedule definition [5], [6], [7], [9], [10]. A multi-layer hierarchical approach can be applied for the joint optimization of DSO and customer services in distribution systems [11]. However, this approach either considers the optimization problem of DSO or customers as the main optimization problem. In this way, the overall benefits of DSO and customers are not considered since one is given the priority [11]. In literature, BESS support in terms of voltage and reactive power control to DSO and TSO has been investigated [12]. However, the evaluation of the impact on the economic performance of BESS providing other services in distribution grids is missing. Currently, in Europe, due to the unbundling of the DSOs, which cannot act as market actors, there are no regulations framing how to quantify the service offered. A first pilot project aiming to shape an intrinsic DSO market for flexible services is ongoing in the United Kingdom [13], [14]. In this paper, it is assumed that once the regulation is in place, the simplest way to quantify the service is through direct contracts between the BESS and the DSO for the congestion waiving and between the BESS and third-party network users to reduce their peak power.

The provision of multiple services has been proven essential for an overall revenue increase concerning the supply of the single service separately [9], [15], [16]. Furthermore, the unceasing shift towards a more decentralized production has started shifting the attention to the distribution grid. The stochasticity of renewable generation assets, as well as the new electrified demand, such as EV charging and heat-pumps, has scaled up the necessity of providing flexibility to the distributed system operators (DSOs) [12]. Additionally, several studies have presented the benefits of deploying BESS in the premises of a FCS, or a RES plant [17], [18], [19].

Many authors have used linear programs, and especially Mixed Linear Programming (MILP), to represent systems of different sizes in energy systems design. MILP is often applied in power systems to solve the day-ahead unit commitment problem for generators and near real-time economic dispatch. As for the latter, using BESSs for multiple applications has been implemented in the literature employing MILP to integrate the energy arbitrage of BESS with ancillary services applications. Constraining specific variables as integer returns is beneficial for problems where there are on/off states of specific assets, such as storage facilities triggered to provide both upward and downward regulation [20], [21]. Furthermore, MILP simplifies non-linear problem formulation since non-linear functions can be approximated through piece-wise linear functions built through binary variables. However, MILP problems are harder to solve, and the computational time required for their solution can be exponential relative to the number of integer variables. [22].

Nonetheless, the stacking of these two service categories has not been widely investigated due to technical and regulatory issues. Moreover, the lack of an explicit remuneration scheme makes the usage of BESS for supporting the distribution grids do not hold a clear business case. In this regard, it is crucial to assess the feasibility of providing support to a third-party network user, such as a FCS. Stacking such functionality on top of the market-related activities can lead to a reduced BESS availability for market activities, decreasing the revenues from the energy markets.

This paper evaluates the potential of stacking these functionalities. Additionally, it focuses on assessing the potential revenues of a BESS operating in distinct energy and ancillary service markets, adding services to a third-party Photovoltaic (PV) assisted FCS as an extra revenue stream. In this way, the BESS can simultaneously operate in profitable and regulated markets, and provide technical aid to a PV-FCS, reducing its grid exchange and demand for power and the impact of the FCS on the distribution grid. While the participation of BESSs in the energy and ancillary services market has already been explored in literature and industrial applications, the coordination of these market activities with the provision of remunerated services to a third party is more innovative and worth exploring. Therefore, this study aims to provide a case study for grid-connected BESS, which generate its revenues from regulated market activities and has the possibility of supporting other network users connected nearby.

A discrete optimization model, which optimally dispatches the BESS operation between the Day-Ahead Market (DAM), the Frequency Containment Reserve (FCR) market, and at the same time supports an EV FCS in reducing its peak demand, has been developed. As a case study, an environment reflecting the electrical system framework of the Netherlands has been considered, applying the developed model following the Dutch DAM and FCR prices and a PV-FCS located in the Netherlands. The studied system consists of four charging stalls of 50kW, a 500kW PV system, and a BESS rated 500kW/500kWh. The contributions of this paper are:

- a discrete dispatch optimization strategy that enables the participation of BESS in both the energy market and the ancillary service market, considering the provision of remunerated services to a third party;
- a quantitative assessment of the potential revenues of a Dutch-based case study in which a BESS operates following the proposed optimization strategy. The BESS under evaluation participates in both the energy and ancillary service markets.

The paper is structured as follows. Section II illustrates the optimization model's objective functions, design constraints, and working principle. In Section III the case study of a BESS integrated with a PV-FCS and the input data related to the Dutch energy markets are presented. In Section IV the outcome of the case studies is illustrated in terms of financial and technical benefits for the involved stakeholders. Section V provides the concluding remarks.

II. BESS OPTIMAL DISPATCHING MODEL

This section illustrates the model of a profit-maximizing BESS operating in different markets. The proposed model considers that the BESS can perform energy arbitrage in the DAM, provide FCR, and offer recompensed services to an FCS or a RES owner with grid power injection and absorption.

The model developed is provided with perfect foresight; therefore, actual market prices are assumed to be known upfront, leading to an estimation of the maximum reachable revenues. This approach was chosen to show the maximum revenue potential, and not to evaluate the impact of using non-perfect forecasting methods, as there are many deviations between existing state-of-the-art and commercial forecasting methods. However, a forecasting method can be implemented for real-time application to provide the input to the model [23]. This would add a higher computation burden for accurate forecast prices [23] When the market is cleared, a bid may be accepted or rejected. Including forecasting of price and quantity bids into the problem, the model becomes a stochastic programming problem. Studies have proved that stochastic price-quantity MILP formulation provides a higher cumulative profit under different forecasting techniques than a deterministic one. However, it correspondingly generates a higher risk exposure and higher BESS cycles. Since adjustments are made, the battery grooms to place more bids in

the DAM. In this context, increased revenue from the energy market must be weighed against the cycling costs and risk exposure for the specific battery [21]. In this work, the considered asset acts as a price-taker. Hence, it does not report effective changes in the market, and the bids in the spot market and the FCR market are both assumed to be entirely accepted.

A. THE OPTIMIZATION PROBLEM

1) OBJECTIVE FUNCTION

The objective function, which aims at maximizing the BESS revenues from the DAM and FCR market, is defined as:

$$\text{Maximize}_{P_d, P_c, P_{fcr}} (t, z) DAM[t] + FCR[z] \quad (1)$$

$$DAM[t] = \sum_t^{t_n} (\lambda - C_r) \cdot P_d[t] \cdot t - \sum_t^{t_n} (\lambda + C_r) \cdot P_c[t] \cdot t \quad (2)$$

$$FCR[z] = \sum_z^{z_m} P_{fcr}[z] \cdot (\lambda_{fcr} - C_{fcr-r}) \cdot z. \quad (3)$$

where t and z are the time step of the DAM and FCR market respectively, P_d and P_c are respectively the discharging and charging power bidden in the DAM, and P_{fcr} the power offered for FCR. Equations (2) and (3) represent the revenues from the volumes of electricity sold on the DAM and the FCR markets multiplied by the respective market price (λ and λ_{fcr}) of that time slot. A ramp cost C_r is instituted to guide the decision-making process and reduce the battery cycles. The value of this parameter represents the marginal cost of the system, considered as the O&M cost, which is based on the average of one cycle per day considered as full energy throughput [24]. Such opportunity cost means that at least an 8 €/MWh price spread is needed in the DAM for the BESS to be profitable. The same strategy has been adopted for the maximization of FCR market participation. In here, C_{fcr-r} represents the ratio of the sum of the cost of the battery system and the Balance of Plants on the max operative hours in a year [24]. The value oscillates around 13-14 €/MW. Utilizing those two ramp costs, the battery number of cycles is constrained and lower than 400 per year to avoid excessive cycling and, therefore, fast degradation, which leads to lower performance over the years [25].

2) CONSTRAINTS

The system's constraints are divided into battery operative boundaries, market requirements, and external third-party operations.

The first set of constraints, (5)-(8), includes the modelling of the battery functioning. The power battery boundaries are shown in (5) and (6), where P_c^* and P_d^* are respectively the battery power charging and discharging limits.

For physical limits, the BESS cannot be charged and discharged simultaneously:

$$P_c[t] \cdot P_d[t] = 0 \quad (4)$$

To linearize (4), the binary variable δ is introduced. The energy limits expressing the maximum charging and discharging capacity for each time step are so defined in (7) and (8)

$$0 \leq P_d[t] \leq P_d^* \forall t \quad (5)$$

$$0 \leq P_c[t] \leq P_c^* \forall t \quad (6)$$

$$P_d[t] \leq \delta[t] \cdot P_d^* \quad (7)$$

$$P_c[t] \leq (1 - \delta[t]) \cdot P_c^* \quad (8)$$

The updated State of Charge (SoC) of the battery in each time interval is calculated in (9). It ensures the proper battery operation, charging or discharging, according to the limits on the SoC and to the charging and discharging efficiency, η_c and η_d . In (9), the State of Charge is indicated with the variable SoC and expressed as percentage of the total battery energy E^* . The limits for battery SoC are defined in (10). Since the model is not linked with specific battery size and technology, the SoC is expressed in per unit and can span between 0 and 1. Nonetheless, these values can be adapted to reflect the physical limitations of specific technology. Equation (11) assumes that the battery has an initialized state of charge and ensures that the battery has 50% of capacity at the beginning and at the end of the optimization period. This constraint is not enforced in the daily operation but in the full yearly optimization period.

$$SoC[t+1] = SoC[t] + \left(P_c[t] \cdot \eta_c - \frac{P_d[t]}{\eta_d} \right) \cdot \frac{t}{E^*} \quad (9)$$

$$0 \leq SoC[t] \leq 1 \forall t \quad (10)$$

$$SoC[t_0] = SoC[t_n] = 0.5 \quad (11)$$

The DAM and FCR markets have different block duration. The DAM operates on an hourly basis, while the FCR on four-hour blocks. Therefore time discretization is based on two levels. Level 1 comprises one-hour time intervals in the day-ahead market $t \in [t_0 \dots t_n]$. While level 2 corresponds to the four-hours frequency market $z \in [z_0 \dots z_m]$, four hours time interval. The market with the lowest resolution (DAM) is used as the default time step for that purpose. Hence with t_0 , we indicate the first hour of operation, and t_n denotes the last hour of the year. An indexed mapping is derived to couple the time step of the model. According to the time increment employed by the market, the device will charge or discharge at the commanded power level over the market time increment. Hence, the BESS would maintain a constant charge or discharge level for the 1-hour time step.

The constraints defining FCR operations are gathered in (12)-(16).

$$\beta \cdot \gamma_{fcr}[z] \cdot \leq P_{fcr-u}[z] \leq \gamma_{fcr}[z] \cdot P_d^* \quad (12)$$

$$\beta \cdot \gamma_{fcr}[z] \cdot \leq P_{fcr-d}[z] \leq \gamma[z] \cdot P_c^* \quad (13)$$

$$-SoC[z] \cdot E^* \leq -P_{fcr-u}[z] \cdot \Gamma \quad (14)$$

$$(SoC[z] - 1) \cdot E^* \leq -P_{fcr-d}[z] \cdot \Gamma \quad (15)$$

$$P_{fcr-u}[z] = P_{fcr-d}[z] \quad (16)$$

According to the European Transmission System Operators (TSOs) associations, the minimum bid of FCR capacity is 1 MW, which is constrained as (12) and (13) [26], [27]. The binary variable, γ_{fcr} , is introduced to indicate whether the TSO requires FCR regulation. It is assumed that the electricity flowing into the battery does not influence the SoC during the service and once completed, since an internal SoC management algorithm, which focuses on maintaining the SoC to a specified level, is necessary to operate in the FCR market [10], [28], [29]. An 80% factor is used to limit the P_{fcr} and take into account the SoC management power that should be reserved for FCR. This choice is driven by the necessity of withholding a percentage of the BESS power for SoC management to ensure the continuous FCR delivery [10], [28].

For limited energy sources, the TSO requires that the FCR supply must occur as soon as the deviation happens and for at least 15 minutes [26]. Since the frequency perturbations are not predictable, the only way to ensure the respect of this constraint is to operate the BESS with a SoC between 25% or above 75%, to always have energy available for full power delivery for 15 minutes. The equation's reference SoC value is indicated as Γ . This constraint is expressed via (14) and (15). Furthermore, in many European countries the FCR bid is symmetric. The symmetrical bidding for upward P_{fcr-u} and downward P_{fcr-d} regulation capacities are constrained as (16).

The possibility to split the power and bid simultaneously in both markets is shown in equations (17) and (18). Additionally, these equations determine that buying and selling within one time step is allowed in the model. For example, electricity purchased on the DAM can be directly committed to the FCR market, yet it cannot be sold to DAM again. Nevertheless, if it is established to commit only frequency regulation, (19) and (20) are enforced, and bidding in both markets is avoided.

$$P_d[t] + P_{fcr-d}[z] \leq P_d^* \quad (17)$$

$$P_c[t] + P_{fcr-u}[z] \leq P_c^* \quad (18)$$

$$P_d[t] \leq (1 - \gamma_{fcr}[z]) \cdot P_d^* \quad (19)$$

$$P_c[t] \leq (1 - \gamma_{fcr}[z]) \cdot P_c^* \quad (20)$$

In order to integrate the provision of services by the BESS to other grid users in the optimization problem, the following constraints are introduced:

$$P_{out}[t] + P_{fcr}[z] + P_{bk}[t] = P_r^* \quad (21)$$

$$P_{out}[t] \cdot \eta_d = P_d[t] + P_{fcr}[z] \quad (22)$$

$$P_{in}[t] = (P_c[t] + P_{fcr}[z]) \cdot \eta_c \quad (23)$$

First of all, (21), where P_r^* is the rated power of the battery, expresses the power balance of the system for every time step. The power flowing in and out of the battery system, P_{in} and P_{out} respectively, needs to be equal to the energy sold

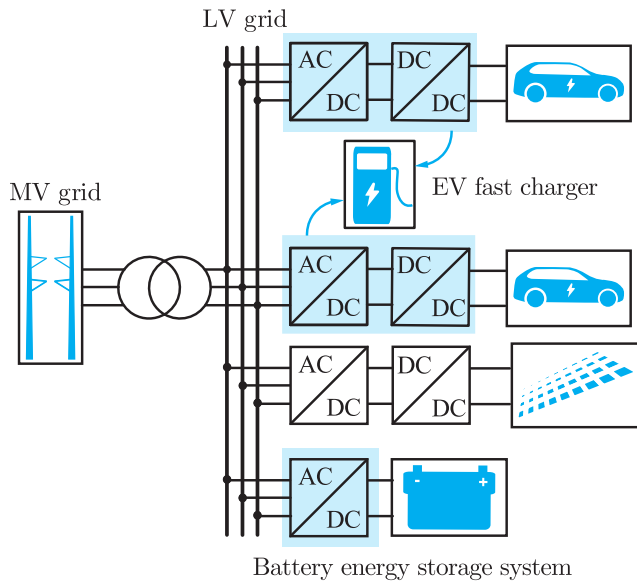

FIGURE 1. Schematic of a BESS assisted PV-FCS, highlighted an example of two level converter used for interfacing the battery storage system with the distribution grid.

or bought on the DAM and the power used to procure FCR. Furthermore, some of the available power, P_{bk} , and the SoC, SoC_{bk} , has been reserved for auxiliary operations. Therefore blocks parameters are introduced to simulate the activities related to the FCS. In particular, (9) is updated as follows:

$$SoC[t + 1] = SoC[t] + \left(P_c[t] \cdot \eta_c - \frac{P_d[t]}{\eta_d} \right) \cdot \frac{t}{E^*} + SoC_{bk} \quad (24)$$

in which the block values are negative if the battery has to provide energy and positive when energy is stored into the system. Moreover, the outflow and inflow of electricity to the BESS is subject to efficiency loss. These statements lead to the constraints (22) and (23).

III. CASE STUDY: PV-FCS LAYOUT AND INPUT ANALYSIS

A scenario composed of a PV-FCS equipped with a BESS owned by a third-party owner that can provide services to the charging station is considered. This scenario is used to validate the proposed model and case study. The system layout for the FCS consists of four DC fast charging stalls of 50kW for a total power of 200kW, a 500 kW solar system, a 500kW/500kWh BESS, and an LV/MV transformer that couples the station to the MV grid. The schematic of a PV-FCS is shown in Fig. 1. The BESS used as a reference in the case study is rated 500kW/500kWh, which can be fully charged in one hour or one time step, and the round trip energy efficiency is assumed to be equal to 90% [30]. In this study, a fixed round trip efficiency value is used. Despite that this choice brings a simplification of the actual BESS behavior since it does not capture the variations of efficiency according to the output

power, this approach has been widely used in literature and is adequate for planning and investigating potential evaluation studies [9], [31]. A higher level of detail is necessary mainly for real-time or near real-time operation scheduling of the battery [3], [32], [33]. The selection of the appropriate battery model is discussed in [3]. Nevertheless, since the scope of the study is to understand and evaluate the BESS potential in the proposed framework, using a simplified and conservative approach strongly reduces computational time and formulation problems. Furthermore, the implemented MILP can be easily adapted to more complex linearized efficiency curves by introducing additional constraints.

A. PV AND FC POWER PROFILES ANALYSIS

An existing reference environment of a PV-FCS in the Netherlands has been selected. The demand profiles extracted from energy measurements performed for the 2020 year roll-out at a sampling frequency of one minute are used as input data. Stedin, a dutch DSO, has provided these. The task intended for the BESS is to perform load-shaving on the EV demand, renewable firming, and boost the self-consumption of solar energy to restrict the grid power exchange. Furthermore, the BESS will operate in the energy and ancillary services markets. The tasks are related to the grid stability; therefore, load and peak shaving of the PV-FCS are prioritized concerning the market activities. Hence, the first step is to evaluate the FCS requirements regarding power and energy from the BESS to be reserved to accomplish such operations.

Fig. 2 shows the power flowing through the grid of the considered PV-FCS when no BESS is included. It can be seen that the EV load is relatively high throughout the year, with the values evenly distributed around the mean of 40 kW, with a peak load of 200kW. It can be concluded that there is no perfect timing between the necessity of charging the EV and the power produced by the PV plant, with excess in both directions, which fosters a battery system integration. Furthermore, it is relevant to mention that the power shaving will be performed both on the power injected into the grid due to PV overproduction and on the power absorbed from the grid due to EV charging.

As a direct consequence of the curtailment, the FCS would benefit from lower contracted grid power and so lower connection fees. Additionally, the DSO would indirectly benefit by relieving the grid from high peak demand and line congestion. The BESS owner would ask the FCS to remunerate for this service.

As mentioned in Section II the parameters P_{bk} and SoC_{bk} have to be extracted to be implemented in the optimization algorithm. Hence, after investigating the excess of power, the respective energy needed is examined. Such values are rationalized with the battery nameplate capacity, which is 500kWh in this case study, and the SoC_{bk} is defined. The P_{bk} , instead, is a direct result of the shaving. Several values of the BESS power, which will shave the FCS power profiles, have been investigated to achieve the optimal compromise between revenues and technical aid to the PV-FCS owner. In Figure 3

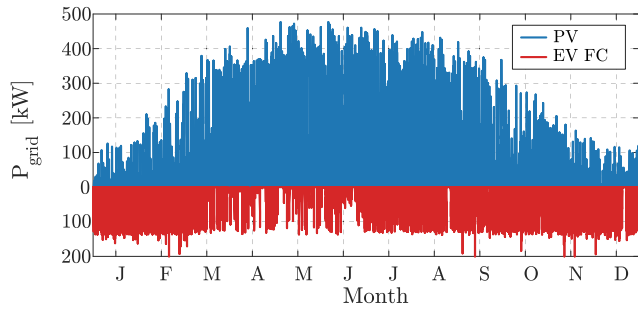

FIGURE 2. PV-FCS power exchange with the distribution grid. The power flow above zero represents the power produced by the solar plant, while the one below zero the power demand due to EV charging.

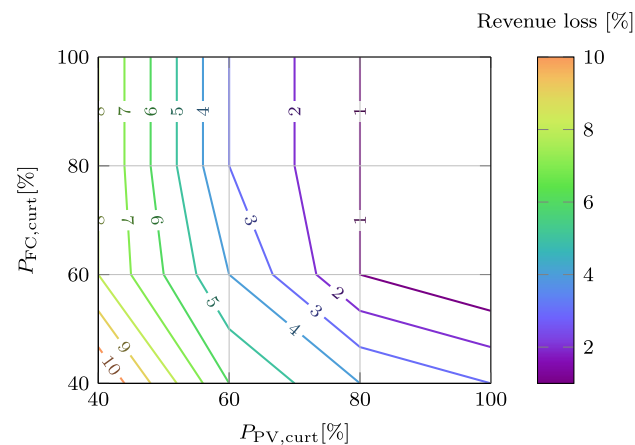

FIGURE 3. Revenues decrease depending on the power shaved from the PV-EV charging station.

the drop of market related revenues depending on the power shaved of the PV, $P_{PV,curt}$, and of the FCS, $P_{FCS,curt}$, is drawn. This reduction is the outcome of the amount of time step blocked by the P_{bk} and SoC_{bk} parameters. Fig. 3 displays that an outcome with less than 5% of market revenues losses would mean shaving 20% of the PV power and up to 40% of the FCS intake.

The output mentioned above has been used as a reference example in Figure 4 to show which volume and how often the storage system will be called upon. It is worth highlighting how the solar intake is null during winter, while the FCS requests a more periodic, although lower in power, demand.

B. DAM AND FCR PRICE ANALYSIS

The DAM price λ and the FCR prices λ_{fcr} are essential inputs to the optimization model. The Netherlands is used as the reference country. The dutch DAM market prices between 2017 and 2020 are shown in Fig. 5 [34]. Observing the normal distribution of the values in Figure 6, several observations can be made. Firstly, there seem to denote long and thick tails and significant outliers. Secondly, although not a strict condition for a linear model, the distribution seems slightly negatively

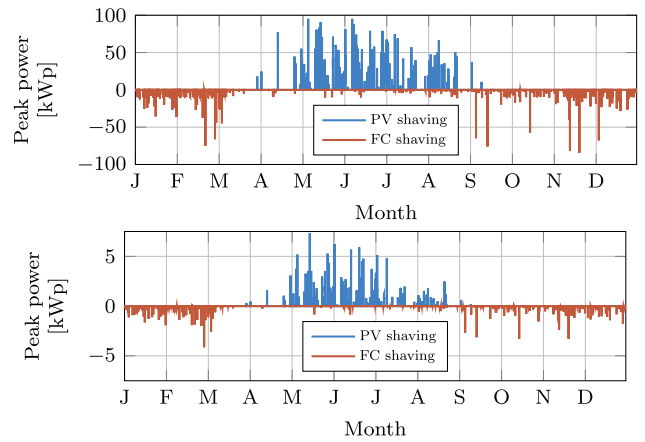

FIGURE 4. Example of power block and SoC block profile obtained after have shaved 20% of the PV power and 40% of the FCS.

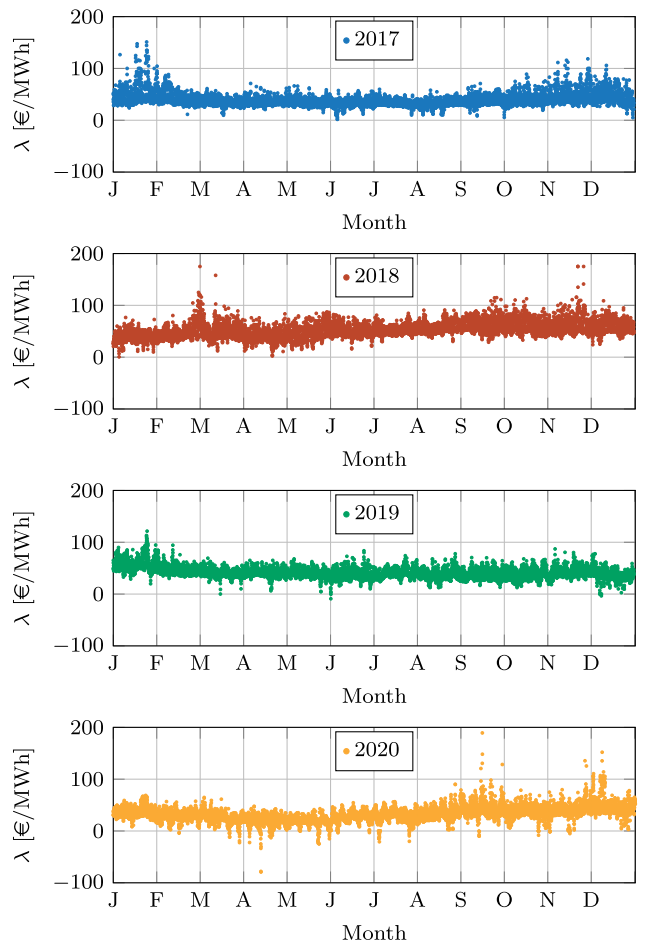

FIGURE 5. Scattered plot of the dutch DAM market price plotted in a single year roll-out.

skewed. Median and mean values result to be 39.5 €/MWh and 38 €/MWh, respectively.

In the grid of continental Europe, a market has been set to secure sufficient FCR volumes. Due to the technical

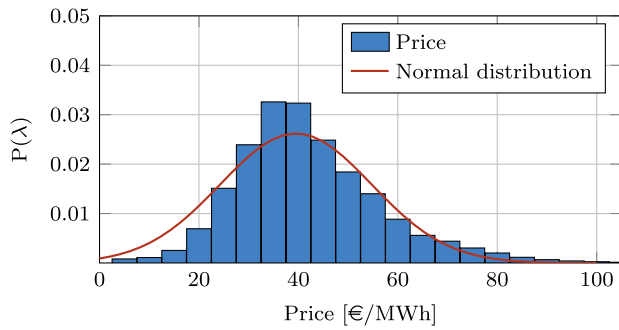

FIGURE 6. Histogram of normalized historic dutch day-ahead market data (2017-2020).

requirements, the potential providers are usually power generators with fast ramping rates, i.e., fire gas power plants or hydro generators [35]. Consequently, in some countries like the Netherlands, the FCR price has increased. This price increment encourages evaluating other solutions for providing these reserves, such as BESSs. The dutch FCR prices from mid 2019 to end 2020 are shown in the heat-map of Fig. 7 [34], [36].

From the heat-map of Figure 7 it is hard to visualize a recurrent pattern. Nevertheless, it is noticeable how the prices increase after July 2020. Such an event could be a direct consequence of the fact that until July 2020, the FCR market was split into daily delivery periods. The price data are given only from July 2020 onward as four-hour blocks. From Figure 7 it is also visible that intraday price spike does not occur often. However, the Dutch market usually has the highest prices for the 08-11 and 16-19 hour blocks. Unlike energy arbitrage in this market, the revenues will be more driven by the high average price than its volatility. Therefore, prices for FCR behave very differently than DAM prices, which are usually higher when consumption is high. Among the factors influencing the price, since natural gas generators account for most FCR provisions, aspects affecting the commodities prices are likely to influence the FCR price. Moreover, DAM price is also correlated with FCR prices related to the opportunity cost for a producer to deviate from its optimal output level to provide FCR [35].

IV. RESULTS AND DISCUSSION

In this section the operation and results of the performed simulation are displayed and discussed.

A. MODEL OPERATION

The linear problem has been modeled into a Python-based simulation environment using the Pyomo optimization library. Any MILP solver compatible with Pyomo is applicable for executing the optimization model. Fig. 8 depicts the algorithm's block structure, with their corresponding interconnection data exchange. The Python-based framework offers state-of-the-art single objective optimization algorithms and is designed to be extendable and applicable to

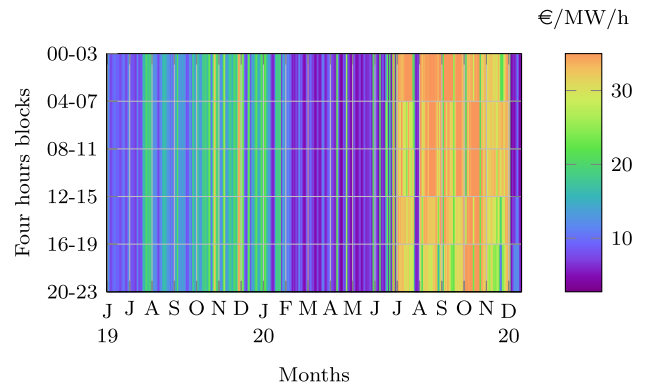

FIGURE 7. Heat-map of hourly FCR prices of the Netherlands from June 2019 to December 2020. Warmer colors indicate higher prices.

various battery technology and national electricity markets due to its modularity in code development. An example of the linear optimization applied to the BESS operation is shown in Fig. 9 and 10, where the BESS operation is evaluated in the studied PV-FCS environment considering 24 hours astride of the 5th of November.

Fig. 9 illustrates how the system dispatches the power and how the price-driven optimization performs in the DAM and FCR markets, showing bid amount and price. The battery is commissioned to perform FCR for 8 hours during the highest price blocks. Additionally, it performs energy arbitrage during the most favorable price slots of the day, i.e., discharging at the highest price and charging at the lowest. However, due to FCR and FCS-operation model constraints, this double market bidding schedule is not always possible. This can be noted in Fig. 9 when right before midnight, although the price was not optimal, i.e., it is higher than a couple of hours later, the BESS buys energy from the market. In this way, the BESS is recharging to properly participate in the FCR market in the next period since its SoC was nearly zero, and it would have excluded the possibility of performing FCR for the following settlement period. Thus, the BESS charges enough to satisfy the constraints (14) and (15) by leveling the SoC at 25%.

Additionally, in Fig. 9, from the time slot, 3 am to 6 am, the double bidding function is shown, which means that no constraint limiting the participation in both markets is active. As noted, in the same slots, the optimization algorithm controls the discharge by placing consecutive bids to increase the battery's level of charge gradually. Due to the perfect foresight strategy, the algorithm is aware that the price would maintain low for some time step. Hence, the optimization prefers to fill the battery cells progressively. Consequently, reducing the effect of cycling degradation on the battery cells thanks to a low C-rate charge, rather than using a total cycle bid.

Figure 10 shows the SoC of the battery. Comparing the SoC trend with the overall power output of the system, it may be noted how only the DAM bid and SoC_{bk} influence the

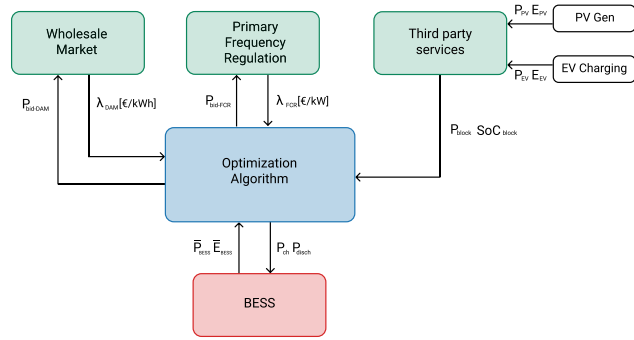

FIGURE 8. The algorithm's block structure shows the exchange of information among the different modules: Wholesale market, primary frequency regulation, third party operations and the BESS.

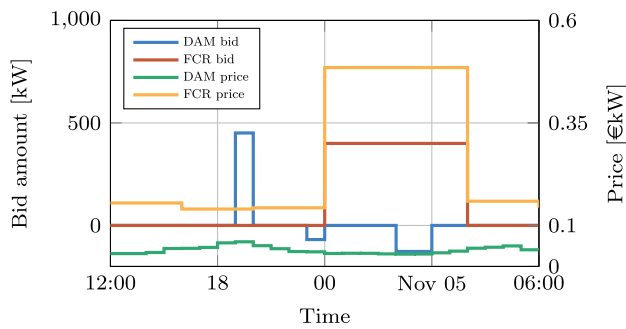

FIGURE 9. Profit maximizing BESS participation in Day-ahead market and Primary frequency regulation market for a sample 24h time-shift.

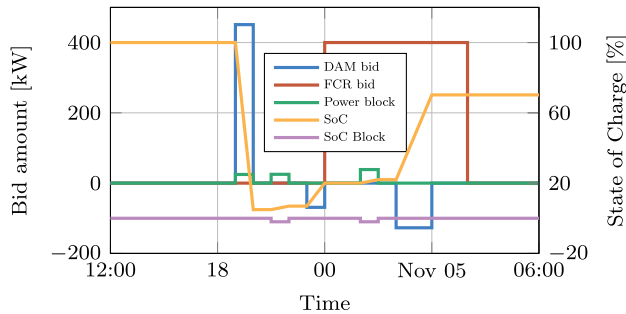

FIGURE 10. Comparison between BESS operations and its state of charge for a sample 24h time-shift.

SoC variation. As a direct consequence of being an energy market, the volume traded in the DAM drives the charging level of the battery. On the other hand, the charging station demanding extra battery capacity, i.e., negative SoC_{bk} values, leads the SoC to drop accordingly. The primary frequency regulation also affects the SoC by generating a continuous oscillation. Nevertheless, such behavior has not been modeled. It is assumed that the SoC at the beginning and end of the service does not change, thanks to the SoC management algorithm that BESSs providing FCR typically implement [10], [29], [37]. At 18.00h in Figure 10, the plot displays why the

TABLE 1. Revenues from different markets and avoided connection costs of a BESS coupled with a PV-FCS considering prices and tariffs of the Dutch electricity market 2020.

	DAM	FCR	PV-FCS
Revenues [k€]	3.1	76	3.5
Activations [h]	450	1850	495
Cycles	240	-	105

battery did not dispatch the total capacity in DAM, answering why the SoC was nearly zero before performing FCR. This limitation is forced by the BESS allocation of a fraction of power for the FCS, P_{bk} .

B. FINANCIAL ANALYSIS

The different revenue streams for the BESS considered in this paper are the profits from the energy and ancillary services market and the avoided grid connection costs of the PV-FCS. In subsection III-A it has been highlighted how possible shaves of power could be performed on the PV-FCS case study considered. In particular, it has been assessed that shaving 20% of the PV power and 40% of the FCS intake would lead to less than 5% of market revenue loss. This revenue loss is because the BESS cannot participate in market operations when load-peak shaving the PV-FCS, and this could happen during the profitable hours of the day. Such peak shaving level, 20% of the PV power and 40% of the FCS, is then a valid trade-off and will be considered in the remainder of the study.

Table 1 displays the revenues and activation hours of a BESS deployed for market participation and load-peak shaving the PV-FCS considered. These have been calculated by the model presented in Section II running the input data and case study of Section III. FCR leads to a considerably higher amount of revenue than DAM. Thus, it confirms that European wholesale market prices, at the present day, might not be high enough to deem energy arbitrage as the only revenue stream for a grid-connected BESS, as also reported in other studies [38]. Despite the high revenues, the number of activations is also noteworthy. Simultaneous participation in DAM and FCR markets occurs 320 times a year. Overall, when the constraints (19) and (20) are not enforced, and a double bid is allowed, the BESS is online for about 1950 h/year, combining DAM and FCR activation, which corresponds to slightly more than 20% of the year. Furthermore, as stated earlier, the decrease in revenues due to the FCS operation is minimal; however, the number of operations increased. Therefore, online and idling time is price-driven and determined by additional input constraints. The additional service offered to the FCS increased the BESS's online time by almost 500 hours in a year, reducing the overall idling time by 23%. Such a high number of activations and cycles may be addressed to the unexpected block provided by the FCS, limiting the power output and changing the BESS SoC.

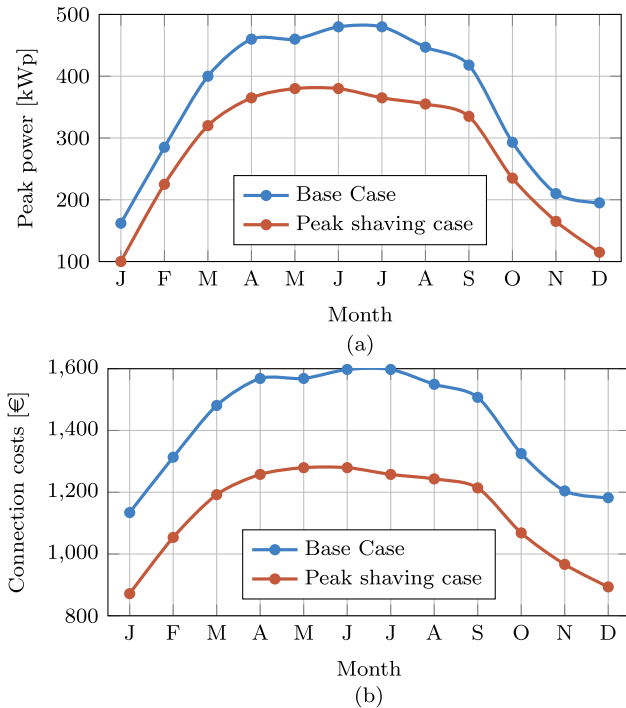

FIGURE 11. Monthly PV-FCS maximum grid exchange power (a), and relative connection charge (b), with and without a BESS deployed to shave 20% of the PV rated power and 40% of the FCS rated power.

Regarding the connection costs, the BESS is used for peak shaving and load shifting. As previously detailed, a power shaving of 20% of the PV power and 40% on the FCS demand results in a limited decrease of market-related revenues, and therefore this condition is considered. In Figure 11 the monthly maximum grid exchange power, which is used to calculate the connection fees, and the relative connection fees of a PV-FCS are displayed with and without the BESS aid on peak and load shaving. Thanks to the BESS operation, the overall grid peak connection has been reduced by around 100kW. In particular, a notable reduction is registered during the central months of the year due to high PV power production during the summer season. It also results in a relatively higher shaving in other periods of the year, where the grid congestion is mainly dominated by the EV charging demand. Given the maximum power, it is possible to derive the connection fees to be paid to the DSOs. These are based on the publicly available tariffs from Stedin [39], a dutch DSO operating in the region of Rotterdam, whose tariffs are a representation of the DSOs tariffs in the Netherlands. The connection charges are split in two, a one-off fee at the time of the new connection, related to the type of connection and proportional to the rated requested power, and a monthly periodic tariff, which is composed of several factors, such as contracted power, maximum measured power, and transported energy [39].

The BESS operation leads to an overall 30% of connection cost savings. In particular, the PV-FCS owner could save

more than 3500 euros a year on the variable transport tariff fees related to the peak power of the connection to the DSO. This economic benefit is transferred to the BESS owner for the service offered. This could be accomplished via bilateral contracts between the two parties. Additionally, such avoided cost is achieved with a very low time utilization of the BESS since this will provide services to the PV-FCS for 495 hours in the analyzed year, which corresponds to about 6 % of the year's total hours, as listed in Table 1. Moreover, it is essential to mention that the benefits of a possible feed-in tariff of selling green power to the grid and other bilateral agreements on the increased PV self-consumption in the act with the DSO are not considered. As mentioned, DSO and BESSs owners would stipulate a direct contract for the service. Therefore, the revenues from the BESS installation are underestimated. All in all, it is shown that an FCS or RES plant owner can benefit from the operation of BESS installed on its premises.

The German DAM and FCR prices have been used to estimate the near future revenues of a BESS placed in The Netherlands. The main reasons behind this choice are that the German energy map is intensively determined by RES production, whose unpredictability strongly influences the spot market prices. Furthermore, higher uncertainty is driven by factors that influence such prices, i.e., gas price, grid expansion, integration of new European platforms, and European tendency of FCR prices to decrease due to new green assets participating in the market. Additionally, as studied in [8], Germany has been highlighted as a country where BESSs are a mature technology exploited in procuring ancillary services. Therefore, it has been assumed that Dutch DAM and FCR prices will follow that direction, and German data are a suitable reference for the near future price trends. Instead, the grid connection savings are assumed constant in the following years.

Given the revenue streams, it is possible to estimate the financial performance of the BESS in the PV-FCS environment. In this context, CAPEX, OPEX, and the discount rate of the BESS are fixed to 330 €/kWh, 150 €/kW, 8 €/kWh, and r 3.5%, respectively [10]. In Figure 12 the projected cash flow of Case A and Case B, which refer respectively to when only remuneration coming from electricity market application and when the FCS shaving revenues are also taken into account, are compared. In green, it is highlighted the potential proposed extra income based on FCS service speculation. Interestingly, the projected annual profit increases compared to the base case only thanks to the additional revenues stream due to the FCS operation. In a future scenario characterized by a saturation of the FCR market and consequent price decrease, such service will become almost a quarter of the total forecasted profit. Given the estimated cashflow due to market revenues and services to the FCS, and the investment costs, the Net Present Value (NPV), of the BESS project can be calculated as:

$$NPV = \sum_{t=1}^n \frac{R_t}{(1+r)^t}, \quad (25)$$

TABLE 2. Financial analysis of a BESS participating to only energy and FCR market, Case A, and of a BESS participating to markets activities and also providing services to the FCS, Case B.

Parameter	Case A Only market	Case B PV-FCS addition
Cycles [n]	233	243
NPV [k€]	95	108
IRR [%]	11	12
Payback time [years]	4	3.9

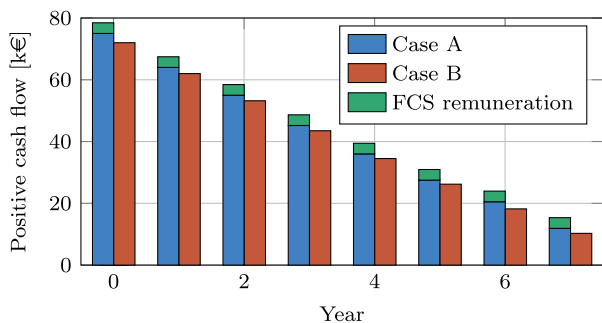

FIGURE 12. Projected cash flow of a 500kW/500kWh BESS operating in electricity markets and with FCS operation included. Case A indicates the cash flow coming only from market applications and Case B the cash flows with the FCS extra remuneration.

where R_t is the net cash flow during a time period t , which can be seen in Fig. 12, r is the discount rate, and n the number of the considered time periods. Additionally, the Internal Rate of Return (IRR) can be found setting the project NPV to zero and finding the IRR coefficients that respects the equation:

$$0 = NPV = \sum_{t=1}^n \frac{R_t}{(1 + IRR)^t} - R_0, \quad (26)$$

where R_0 corresponds to the total investment costs.

These two indicators, NPV and IRR, are financial parameters that help evaluate the economic feasibility of a project. In Table 2 these are summarized. The table shows that by adding the revenue stream from the PV-FCS, the monetary return has improved from 11% to 12% and that the payback time, which is the time when the cumulative project cash flow reaches zero, can be slightly reduced below four years. Furthermore, the NPV increases from 95 k€ to 108 k€, with an increase of 14%. Then, additional remunerated services are beneficial from an investor’s point of view. Although deviations from the optimal market revenues occur, the financial indicators display positive results.

Additionally, if the DAM and FCR market are less profitable in the future, the BESS will presumably cycle less along the years since its activation will be primarily linked to local grid services. It will be even more beneficial if the DSO will pay for availability rather than actual activation time. Due to this conceivable scenario, degradation factors to estimate future revenues are not assessed. However, a detailed analysis

of battery capacity fading is left to future research in this domain.

All in all, it can be concluded that installing a BESS in the considered case study is a technical and economically beneficial investment for the players involved in the distribution grids.

V. CONCLUSION

The paper presented a mixed-integer linear model which can be used as a flexible tool to evaluate the economic feasibility of a BESS operating in distribution networks. In the analyzed case study, which reflects the Dutch energy market, a BESS of 500 kW / 500 kWh coupled with a PV-FCS is shown to be economically profitable. The system NPV, in fact, is calculated to be 95k€. Furthermore, by adding the service to the third party, the FCS, the system NPV can be increased, and it is calculated to be 108 k€. As discussed, BESSs can be coupled with PV-FCSs to flatten their generation and load profiles, decreasing the maximum power exchange at the connection point with the grid. By reducing the power exchanged to the grid, the owner of the PV-FCS would benefit from the lower grid connection costs. Additionally, BESSs can participate in energy and ancillary services markets, such as FCR and DAM. Nowadays, BESSs are still an expensive technology; therefore, combining ancillary services and other grid services will drive to capitalize higher revenues. In the future, with less attractive electricity markets, it will turn out to be the main source of income. The analysis has shown that such configuration allows economic and technical benefits for the players involved in the case study, namely the BESS owner, the FCS owner, and the local DSO indirectly. The BESS owner would profit from a positive NPV and a low payback time which could be reduced in under four years whether higher speculation is executed on the FCS remuneration agreement described. Economically speaking, no assessment is outlined for the DSO. Its benefit relies on the technical aid that the BESS could provide by waiving the grid from power peaks, which are detrimental to the distribution network operation. Finally, the PV-FCS owner would benefit from an overall 30% of grid connection tariff reduction, and such a solution can boost the self-consumption of locally produced solar energy.

All in all, it can be concluded that such BESS implementation is economically and technically advantageous for the involved parties in the distribution grids. The BESS can stack additional revenues on top of the market revenues, the FCS benefits from a reduced peak power and consequently tariff reduction, and the system operator would indirectly benefit from the shaved FCS profile.

REFERENCES

[1] M. Müller, “Stationary lithium-ion battery energy storage systems a multi-purpose technology,” Ph.D. thesis, Tech. Univ. Munich, Munich, Germany, 2018, p. 169. [Online]. Available: https://mediatum.ub.tum.de/604993?query=Stationary+Lithium-Ion+Battery+Energy+Storage+Systems+A+Multi-Purpose+Technology&show_id=1388076&srcnodeid=604993

- [2] M. Farrokhifar, S. Grillo, and E. Tironi, "Loss minimization in medium voltage distribution grids by optimal management of energy storage devices," in *Proc. IEEE Grenoble Conf.*, Jun. 2013, pp. 1–5.
- [3] M. Stecca, L. Ramirez Elizondo, T. Batista Soeiro, P. Bauer, and P. Palensky, "A comprehensive review of the integration of battery energy storage systems into distribution networks," *IEEE Open J. Ind. Electron. Soc.*, vol. 1, pp. 46–65, 2020.
- [4] L. Wang, Z. Qin, T. Slangen, P. Bauer, and T. van Wijk, "Grid impact of electric vehicle fast charging stations: Trends, standards, issues and mitigation measures—An overview," *IEEE Open J. Power Electron.*, vol. 2, pp. 56–74, 2021.
- [5] B. Cheng and W. B. Powell, "Co-optimizing battery storage for the frequency regulation and energy arbitrage using multi-scale dynamic programming," *IEEE Trans. Smart Grid*, vol. 9, no. 3, pp. 1997–2005, May 2018.
- [6] Y. J. A. Zhang, C. Zhao, W. Tang, and S. H. Low, "Profit-maximizing planning and control of battery energy storage systems for primary frequency control," *IEEE Trans. Smart Grid*, vol. 9, no. 2, pp. 712–723, Mar. 2018.
- [7] T. A. Nguyen, R. H. Byrne, R. J. Concepcion, and I. Gyuk, "Maximizing revenue from electrical energy storage in MISO energy & frequency regulation markets," in *Proc. IEEE Power Energy Soc. Gen. Meeting*, Jul. 2017, pp. 1–5.
- [8] M. Killer, M. Farrokhsheresht, and N. G. Paterakis, "Implementation of large-scale li-ion battery energy storage systems within the EMEA region," *Appl. Energy*, vol. 260, Feb. 2020, Art. no. 114166, doi: 10.1016/j.apenergy.2019.114166.
- [9] C. Opathella, A. Elkasrawy, A. A. Mohamed, and B. Venkatesh, "Optimal scheduling of merchant-owned energy storage systems with multiple ancillary services," *IEEE Open Access J. Power Energy*, vol. 7, pp. 31–40, 2020.
- [10] M. Stecca, T. B. Soeiro, L. R. Elizondo, P. Bauer, and P. Palensky, "Lifetime estimation of grid-connected battery storage and power electronics inverter providing primary frequency regulation," *IEEE Open J. Ind. Electron. Soc.*, vol. 2, pp. 240–251, 2021.
- [11] P. Zhuang and H. Liang, "Hierarchical and decentralized stochastic energy management for smart distribution systems with high BESS penetration," *IEEE Trans. Smart Grid*, vol. 10, no. 6, pp. 6516–6527, Nov. 2019.
- [12] N. Savvopoulos, C. Y. Evrenosoglu, T. Konstantinou, T. Demiray, and N. Hatziaargyriou, "Contribution of residential PV and BESS to the operational flexibility at the TSO-DSO interface," in *Proc. Int. Conf. Smart Energy Syst. Technol. (SEST)*, Sep. 2021, pp. 1–6.
- [13] U.K. Power Networks. *U.K. Power Networks Report*. Accessed: Feb. 17, 2022. [Online]. Available: <https://smartgrid.ukpowernetworks.co.uk/flexibility-hub/>
- [14] ESB Network. (2021). *Phased Flexibility Market Development Plan*. [Online]. Available: <https://www.esbnetworks.ie/publications>
- [15] A. W. Dowling, R. Kumar, and V. M. Zavala, "A multi-scale optimization framework for electricity market participation," *Appl. Energy*, vol. 190, pp. 147–164, 2017, doi: 10.1016/j.apenergy.2016.12.081.
- [16] S. Englberger, A. Jossen, and H. Hesse, "Unlocking the potential of battery storage with the dynamic stacking of multiple applications," *Cell Rep. Phys. Sci.*, vol. 1, no. 11, Nov. 2020, Art. no. 100238, doi: 10.1016/j.xcrp.2020.100238.
- [17] M. S. Islam, N. Mithulananthan, and K. Y. Lee, "Suitability of PV and battery storage in EV charging at business premises," *IEEE Trans. Power Syst.*, vol. 33, no. 4, pp. 4382–4396, Jul. 2018.
- [18] S. Hashemi and J. Østergaard, "Efficient control of energy storage for increasing the PV hosting capacity of LV grids," *IEEE Trans. Smart Grid*, vol. 9, no. 3, pp. 2295–2303, May 2018.
- [19] X. Li, D. Hui, and X. Lai, "Battery energy storage station (BESS)-based smoothing control of photovoltaic (PV) and wind power generation fluctuations," *IEEE Trans. Sustain. Energy*, vol. 4, no. 2, pp. 464–473, Apr. 2013.
- [20] B. M. T. Lawder *et al.*, "Battery energy storage system (BESS) and battery management system (BMS) for grid-scale applications," *Proc. IEEE*, vol. 102, no. 6, pp. 1014–1030, Jun. 2014.
- [21] D. Krishnamurthy, C. Uckun, Z. Zhou, P. R. Thimmapuram, and A. Botterud, "Energy storage arbitrage under day-ahead and real-time price uncertainty," *IEEE Trans. Power Syst.*, vol. 33, no. 1, pp. 84–93, Jan. 2018.
- [22] C. A. Frangopoulos, "Optimization methods for energy systems," *Exergy, Energy Syst. Anal. Optim.*, vol. 2, pp. 233–258, Feb. 2017.
- [23] J. Contreras, R. Espinola, F. J. Nogales, and A. J. Conejo, "ARIMA models to predict next-day electricity prices," *IEEE Trans. Power Syst.*, vol. 18, no. 3, pp. 1014–1020, Aug. 2003.
- [24] Lazard. (2019). *Lazard's Levelized Cost of Storage Analysis-V5*. [Online]. Available: <https://www.lazard.com/media/451087/lazards-levelized-cost-of-storage-version-50-vf.pdf>
- [25] D.-I. Stroe, "Lifetime models for lithium ion batteries used in virtual power plants," Ph.D. thesis, Aalborg Univ., Aalborg, Denmark, 2014. [Online]. Available: <https://vbn.aau.dk/en/publications/lifetime-models-for-lithium-ion-batteries-used-in-virtual-power-p>
- [26] *FCR Manual for BSPs Requirements and Procedures for Supply of FCR*, TenneT, Arnhem, The Netherlands, 2019.
- [27] ENTSO-E. (2021). *Transparency Platform*. [Online]. Available: <https://transparency.entsoe.eu/dashboard/show>
- [28] National Grid. (2018). *State of Charge Management Guidance for FRR Providers*. [Online]. Available: <https://www.nationalgrid.com/uk/electricity/balancing-services/future-balancing>
- [29] D.-I. Stroe, V. Knap, M. Swierczynski, A.-I. Stroe, and R. Teodorescu, "Operation of a grid-connected lithium-ion battery energy storage system for primary frequency regulation: A battery lifetime perspective," *IEEE Trans. Ind. Appl.*, vol. 53, no. 1, pp. 430–438, Jan./Feb. 2017.
- [30] G. Zubi, R. Dufo-López, M. Carvalho, and G. Pasaoglu, "The lithium-ion battery: State of the art and future perspectives," *Renew. Sustain. Energy Rev.*, vol. 89, pp. 292–308, Jun. 2018.
- [31] R. H. Byrne, T. A. Nguyen, D. A. Copp, B. R. Chalalama, and I. Gyuk, "Energy management and optimization methods for grid energy storage systems," *IEEE Access*, vol. 6, pp. 13231–13260, 2018.
- [32] K. Christakou, M. Paolone, and A. Abur, "Voltage control in active distribution networks under uncertainty in the system model: A robust optimization approach," *IEEE Trans. Smart Grid*, vol. 9, no. 6, pp. 5631–5642, Nov. 2018.
- [33] S.-J. Lee *et al.*, "Coordinated control algorithm for distributed battery energy storage systems for mitigating voltage and frequency deviations," *IEEE Trans. Smart Grid*, vol. 7, no. 3, pp. 1713–1722, May 2016.
- [34] Noord Pool. (2021). *Market Data*. [Online]. Available: <https://www.nordpoolgroup.com/Market-data/Dayahead/>
- [35] J. Jomaux, A. Latiers, and E. De Jaeger, "Cost-based dimensioning of battery energy storage and energy management system for frequency containment reserves provision," in *Proc. IEEE Power Energy Soc. Gen. Meeting*, Jul. 2015, pp. 1–5.
- [36] Regelleistung. *Regelleistung Data Center*. Accessed: Feb. 17, 2022. [Online]. Available: <https://www.regelleistung.net/>
- [37] National Grid. (2018). *State of Charge Management Guidance for FFR Providers*. [Online]. Available: <https://www.nationalgrideso.com/balancing-services/frequency-response-services/firm-frequency-response-ffr>
- [38] B. Zakeri, S. Syri, and F. Wagner, "Economics of energy storage in the German electricity and reserve markets," in *Proc. 14th Int. Conf. Eur. Energy Market (EEM)*, Jun. 2017, pp. 1–6.
- [39] Stedin. *Elektricitet Tarieven 2020*. Accessed: Feb. 17, 2022. [Online]. Available: <https://www.stedin.net/zakelijk/betalingen-en-facturen/tarieven>



LUCA ARGIOLAS received the bachelor's degree in energy engineering from the University of Bologna, Italy, in 2018, and the master's degree in electrical engineering with specialization in sustainable energy technology from the Delft University of Technology, The Netherlands, in 2021. Since August 2021, he has been working at Enel X in the demand response service business line. His main focus is on new growth initiatives to expand globally Enel X portfolio in the flexibility markets.



MARCO STECCA (Graduate Student Member, IEEE) received the bachelor's degree in energy engineering from the University of Padova, Italy, in 2016, and the master's degree in electrical engineering from the Politecnico di Milano, Italy, in 2018. He is currently pursuing the Ph.D. degree in grid scale battery energy storage systems with the Delft University of Technology. His research interests include grid connected DC-AC power electronics converters and energy storage system integration in distribution grids.



THIAGO BATISTA SOEIRO (Senior Member, IEEE) received the B.Sc. (Hons.) and M.Sc. degrees in electrical engineering from the Federal University of Santa Catarina, Florianopolis, Brazil, in 2004 and 2007, respectively, and the Ph.D. degree from the Swiss Federal Institute of Technology, Zurich, Switzerland, in 2012.

During the master's and Ph.D. studies, he was a Visiting Scholar at the Power Electronics and Energy Research Group, Concordia University, Montreal, QC, Canada, and the Center for Power Electronics Systems, Blacksburg, VA, USA, respectively. From 2012 to 2013, he was a Researcher at the Power Electronics Institute, Federal University of Santa Catarina. From October 2013 to April 2018, he worked at the Corporate Research Center, ABB Switzerland Ltd., Baden-Dattwil, Switzerland, where he was a Senior Scientist. From May 2018 to January 2022, he worked at the DC Systems, Energy Conversion and Storage Group, Delft University of Technology, Delft, The Netherlands, where he was an Associate Professor. Since January 2022, he has been working at the Power Management and Distribution Section (TEC-EPM) for the European Space Research and Technology Centre, Noordwijk, The Netherlands. His research interests include advanced high power converters and dc system integration.

Dr. Soeiro was a recipient of the 2013 IEEE Industrial Electronics Society Best Conference Paper Award and the Best Paper Awards in the IEEE conferences, such as the International Conference on Power Electronics (ECCE Asia 2011), the International Conference on Industrial Technology (ICIT 2013), the Conference on Power Electronics and Applications EPE'15 (ECCE Europe 2015), and the International Conference on Power Electronics and Motion Control 2020 (PEMC 2020).



LAURA M. RAMIREZ-ELIZONDO (Member, IEEE) received the B.Sc. degree in electrical engineering from the Universidad de Costa Rica in 2003 and the M.Sc. degree (*cum laude*) in electrical power systems from the Delft University of Technology (TU Delft) in 2007. From September 2007 to December 2011, she worked on her Ph.D. project on the topic of optimization of low voltage distribution networks with multiple energy carriers. She is currently an Assistant Professor at the

DC Systems, Energy Conversion and Storage Group, Delft University of Technology, Delft, The Netherlands. She is also involved in projects related to the integration of renewable sources and storage, multi-carrier energy systems, and the development and deployment of direct current distribution grids and microgrids.



PAVOL BAUER (Senior Member, IEEE) received the master's degree in electrical engineering from the Technical University of Kosice, Košice, Slovakia, in 1985, and the Ph.D. degree from the Delft University of Technology, Delft, The Netherlands, in 1995.

He is currently a Full Professor with the Department of Electrical Sustainable Energy, Delft University of Technology, and the Head of DC Systems, Energy Conversion and Storage Group. He is an author or the coauthor of eight books, holds four international patents, and organized several tutorials at the international conferences. He has worked on many projects for industry concerning wind and wave energy, power electronic applications for power systems, such as Smarttrafo, HVDC systems, projects for smart cities such as photovoltaic (PV) charging of electric vehicles, PV and storage integration, and contactless charging. He has participated in several Leonardo da Vinci and H2020 EU projects as a Project Partner (ELINA, INETELE, and E-Pragmatic) and a Coordinator (PEMCWebLab.com-Edipe, SustEner, and Eranet DCMICRO).

Prof. Bauer is the Former Chairperson of Benelux IEEE Joint Industry Applications Society, Power Electronics and Power Engineering Society Chapter, the Chairperson of the Power Electronics and Motion Control Council, a member of the Executive Committee of European Power Electronics Association, and a member of the international steering committee at numerous conferences.