

SOUTH ELEVATION

EAST ELEVATION

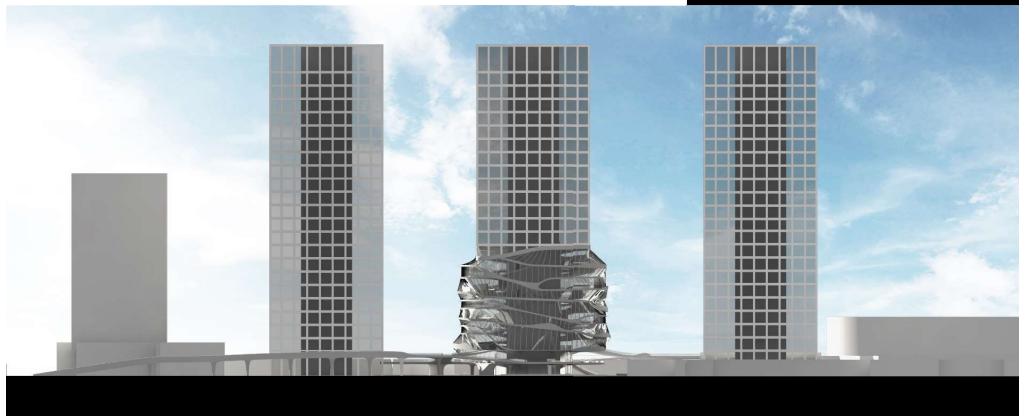

NORTH ELEVATION



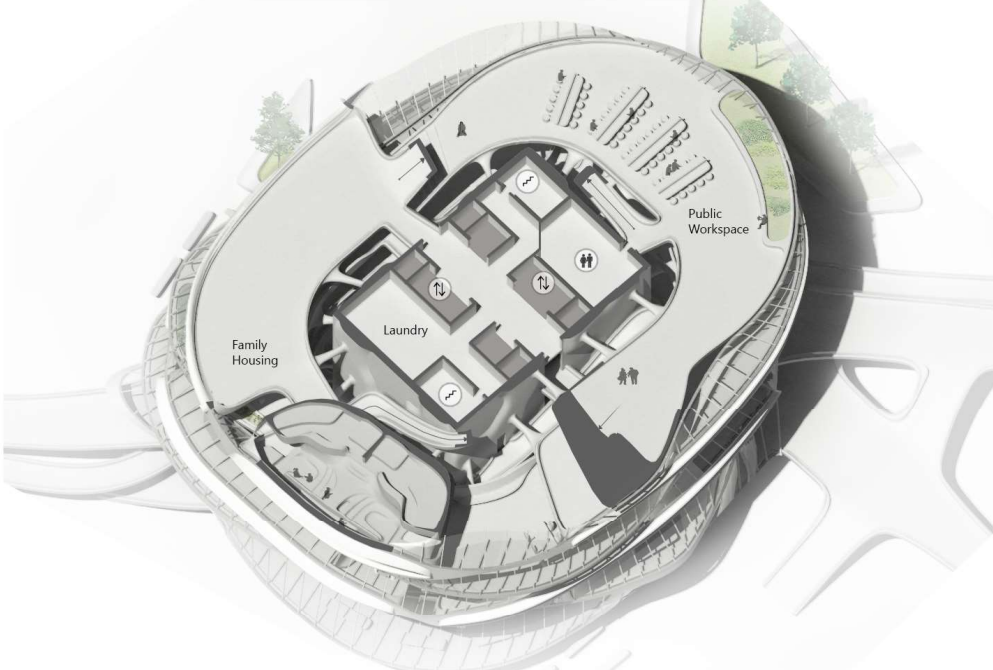
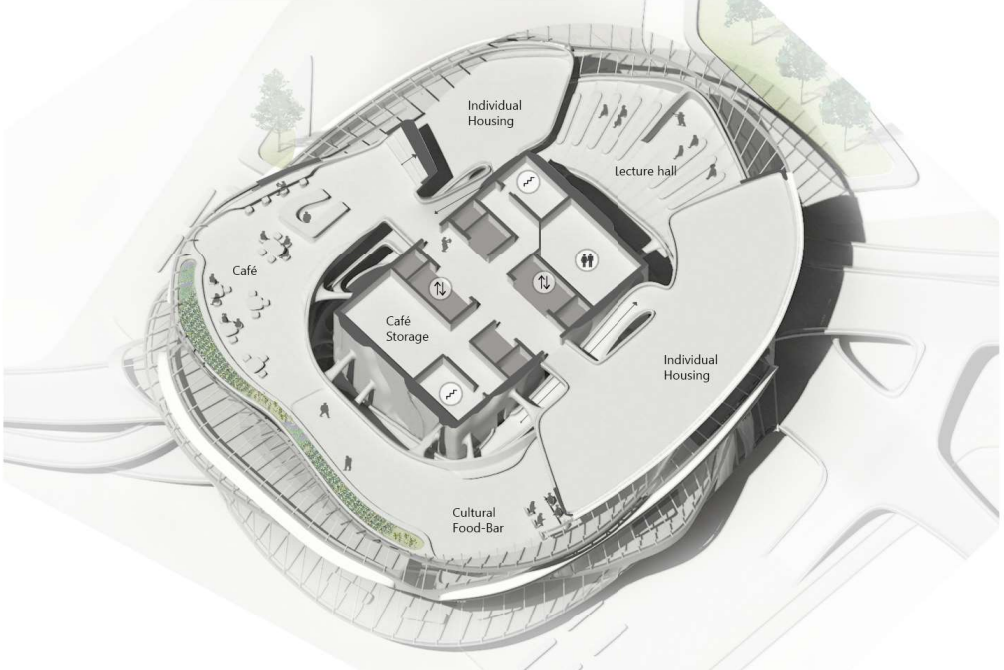
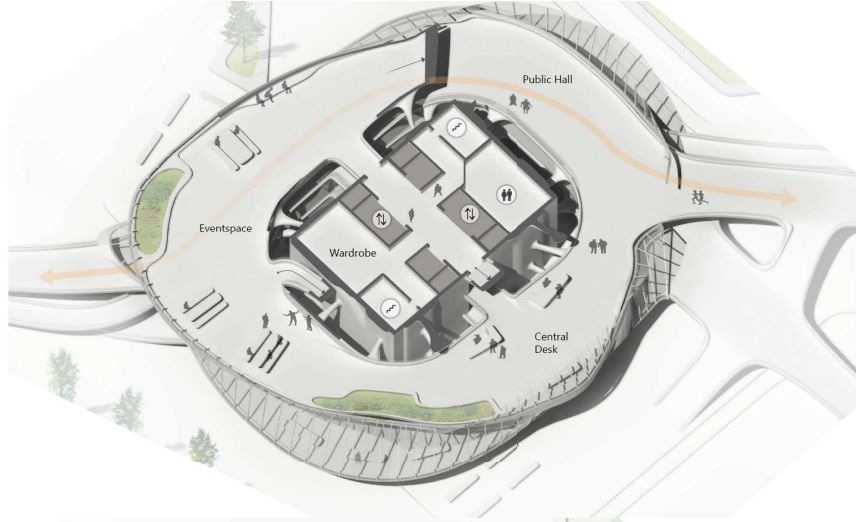
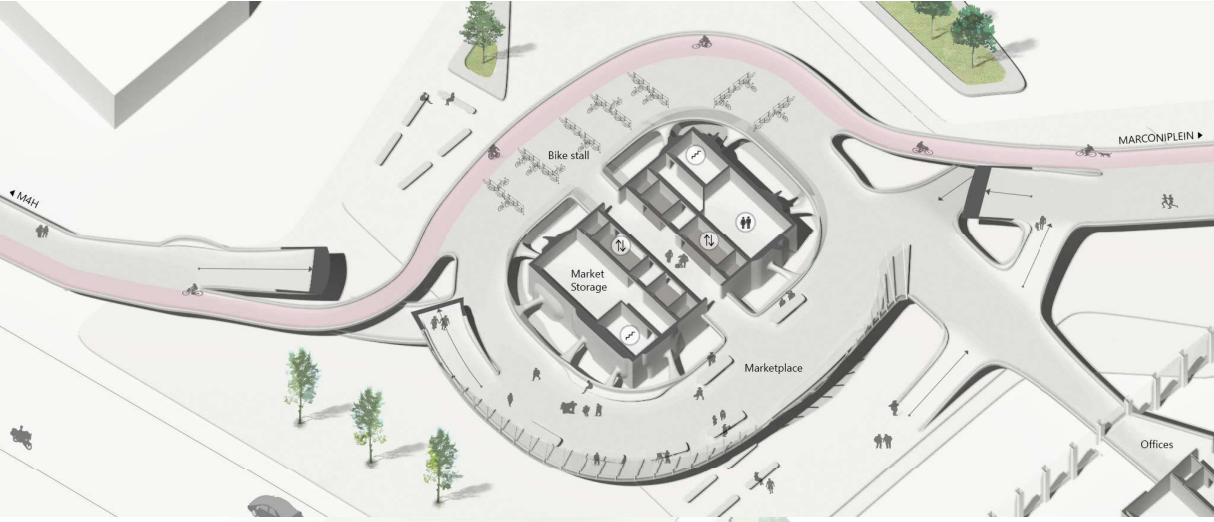

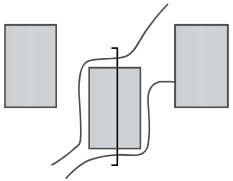
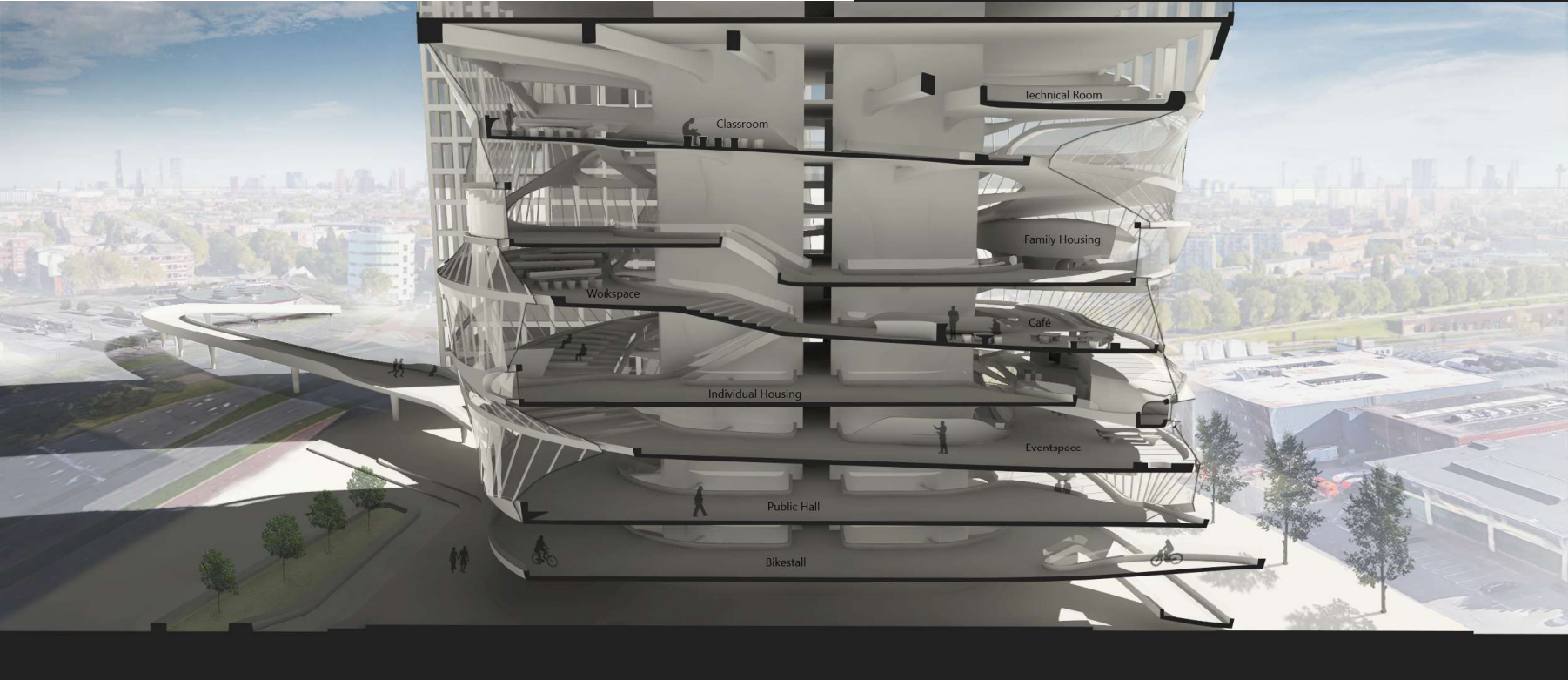
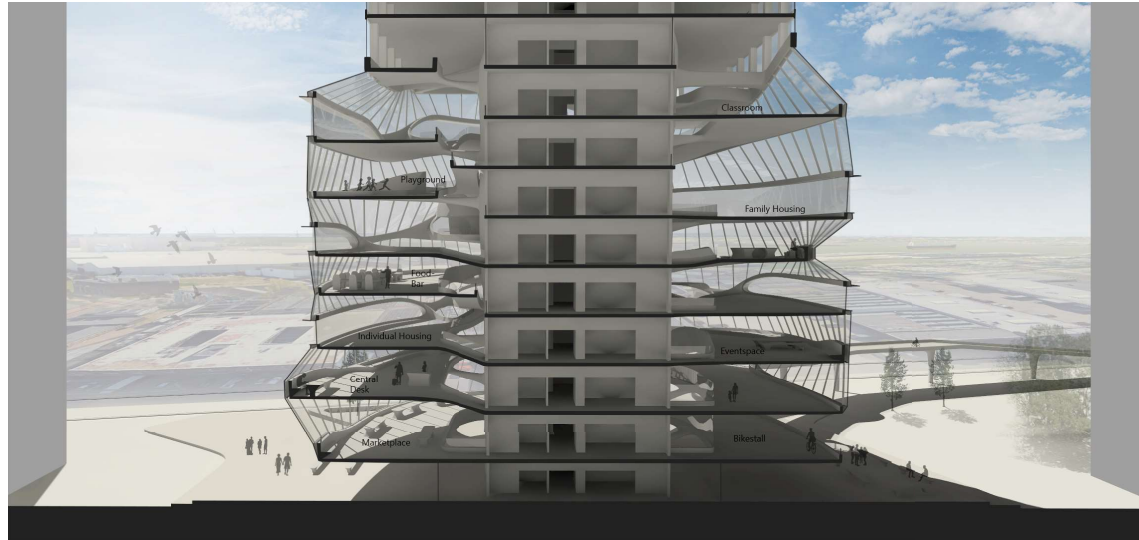
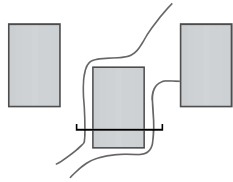

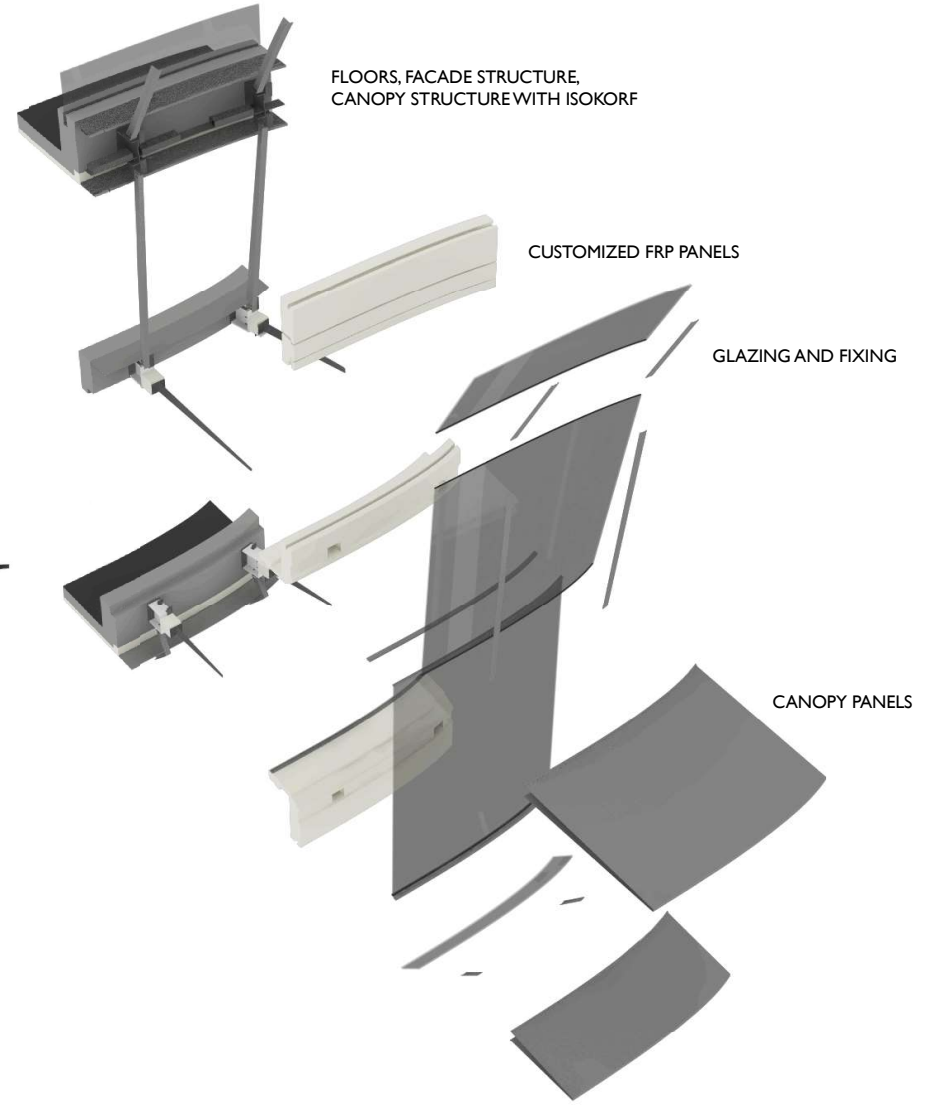
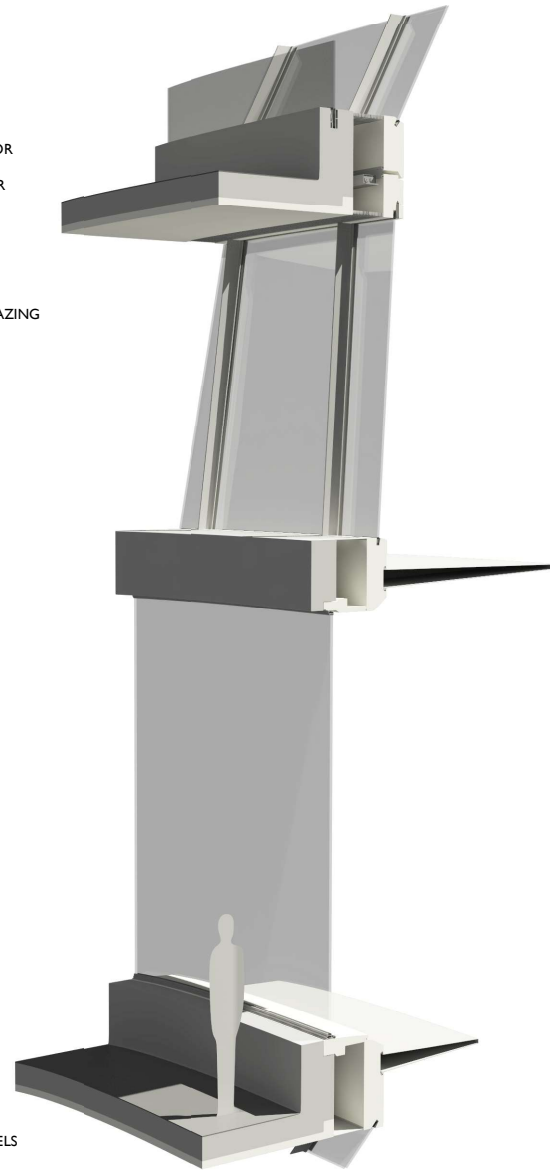



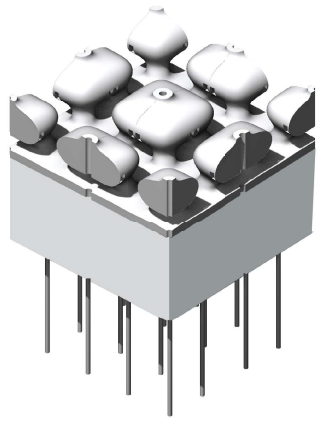

PLACE AND CONNECT EPS COMPONENTS ON TEMPORARY SUPPORT STRUCTURE

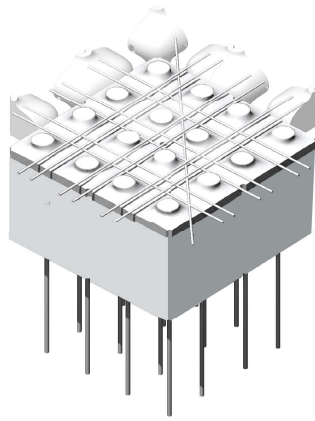

ADD REBAR IN MULTIPLE DIRECTIONS (AND ALSO FLOOR HEATING TUBES)

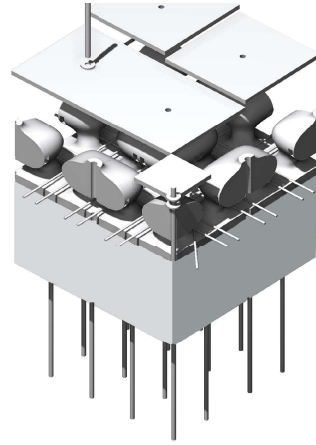

PLACE TOP COVERS AND TIGHTEN PACKAGE TOGETHER WITH GENERAL FORMWORK TECHNIQUE



AFTER POURING CONCRETE, EPS COMPONENTS REMAIN IN THE FLOOR AND FORM CEILING FINISH

