

# Wave attenuation in mangrove wetlands

*Red River Delta, Vietnam*



Willem-Jan de Vos, June 2004



Delft University of Technology  
Faculty of Civil Engineering and Geosciences  
Section of Hydraulic Engineering



# Wave attenuation in mangrove wetlands

*Red River Delta, Vietnam*

Master of Science thesis in Civil Engineering  
Delft, June 2004

Student: Willem-Jan de Vos  
Study number: 1054244  
E-mail: [wjdevos@hotmail.com](mailto:wjdevos@hotmail.com)

Committee:

Prof.dr.ir. M.J.F. Stive (TU Delft)  
Ir. H.J. Verhagen (TU Delft)  
Ir. M.J. Baptist (WL | Delft Hydraulics)  
Drs. W.N.J. Ursem (TU Delft)



## **PREFACE**

This report is the finalization of my Master of Science thesis in Civil Engineering at Delft University of Technology. This study lasted from October 2003 until June 2004, including a two-month visit to the Hanoi Water Resource University in the Socialist Republic of Vietnam.

First of all, I would like to thank the members of my graduation committee for their contribution to this report. Especially Ir. H.J. Verhagen for ‘daily’ coaching and providing this opportunity to discover beautiful Vietnam and its people. I also want to thank the Lamminga Foundation for the ticket to Vietnam.

At HWRU, I would like to thank dr. Vu Minh Cat, Linh, Nguyen Hoang Ha, and Bui Huy Hoang for his assistance during the fieldtrip. I owe a special thank to Michel Tonneijck for his support in so many ways in, and outside, room 220, and to *ban* Tran Thanh Tung for all practical assistance in ‘coastal engineering’, for his enthusiasm and for all the walks down the boulevard of Do Son.

Finally, I would like to thank the local people in Do Son and Tan Tanh village for their help and hospitality, Phuong Anh, Thuy, Thuong, Cuong and Hoa for their friendship, for showing me around in Hanoi and teaching me Vietnamese, my parents and Marlinde for their support and Willem for the too many coffee breaks at ‘Civiel’.

Willem-Jan de Vos  
Delft, June 2004



## **ABSTRACT**

Mangrove forests cover the shores of many tropical and sub-tropical coastlines. These trees are tolerant to saline environments, which enables them to grow in the tidal zone. They are known for their often complex and impressive root system. From a Civil Engineering point of view, mangrove forests are interesting for since they reduce transmitted wave energy of incident waves and thus serve as a natural coastal protection.

In Vietnam, mangroves grow in the deltas of the Red river Delta and Mekong River where they protect valuable aquacultural and agricultural lands. Although awareness on the value of mangrove forests has risen in recent years, there is still little known about how (much) waves are reduced in these forests and how to investigate this effect. The aim of this study is to make inventory of all the necessary elements for a wave measurement campaign in mangrove forests and should act as a guide during future fieldwork. This study deals with both the physical processes involved in the dissipation of wave energy by vegetation and with wave measurements in mangrove forests.

From the analysis of the physical processes, it followed that the dissipation of wave energy is relative to the vegetated cross-area exposed to waves and the third power of the amplitude of horizontal particle velocities. It also turned out that the effect of shoaling was very small on slopes, typical in mangrove forests. That means that parameters like water depth, wave celerity and wave length can be averaged between measurements, simplifying calculations.

This study also included a trip to Vietnam for wave measurements in a mangrove forest. This fieldwork was carried out together with the Hanoi Water Resource University. Unfortunately, no wave measurements were carried out successfully. However, the fieldwork did yield interesting information about mangrove vegetation and its habitat that is useful for future measurements.

After a literature study on mangroves in general the physical processes are discussed, followed by a first set-up for outdoor measurements. This is followed by a description of the fieldwork and a discussion in which the results are discussed with regard the initial theoretical approach.

This leads to conclusions and recommendations on the following subjects, as summarized in the final chapter:

- Site conditions; the requirements for a suitable study area?
- Wave measurement; the set-up of measurements and the processing of the data
- Field survey; the (im)possibilities of traditional methods and alternatives
- Vegetation characteristics; their role in dissipation and survey results from the field
- Bottom condition; the difficulties in determining relevance and magnitude friction





## **TABLE OF CONTENTS**

<b>PREFACE</b>	<b>I</b>
<b>ABSTRACT</b>	<b>III</b>
<b>TABLE OF CONTENTS</b>	<b>V</b>
<b>1 PROBLEM ANALYSIS</b>	<b>1</b>
1.1 Introduction	1
1.2 Problem definition and objectives	2
1.3 Methodology	2
1.4 Reader's guide	3
<b>2 MANGROVE DISTRIBUTION</b>	<b>4</b>
2.1 Introduction	4
2.2 Latitudinal distribution	4
2.3 Longitudinal distribution	5
2.4 Floristic diversity	5
<b>3 BIOLOGY OF MANGROVES</b>	<b>6</b>
3.1 Introduction	6
3.2 Species	6
3.3 Root structures	7
3.4 Reproduction	10
<b>4 THE MANGROVE ECOSYSTEM</b>	<b>13</b>
4.1 Introduction	13
4.2 Geomorphological settings of mangroves	13
4.3 Forest types	15
4.4 Zonation and succession	16
4.5 Mangroves as landbuilders	17
4.6 Important factors for growth and threshold values	19
<b>5 THE VALUE OF MANGROVE ECOSYSTEMS</b>	<b>22</b>
5.1 Introduction	22
5.2 Mangroves as coastal protection	22
5.3 Resource values or goods	25
5.4 Negative impact of human activities	26
5.5 Reforestation of mangroves	30
5.6 Final comments	30
<b>6 PHYSICAL PROCESSES</b>	<b>32</b>
6.1 Introduction	32
6.2 Wave energy	32
6.3 Theoretical background of wave energy dissipation	33
6.4 Characteristics of mangrove vegetation	39
6.5 Summary	42
<b>7 FURTHER ANALYSIS FOR FUTURE FIELDWORK</b>	<b>44</b>
7.1 Introduction	44

7.2	Required data from fieldwork	44
7.3	Bottom characteristics	44
7.4	Profile determination	44
7.5	Wave measurements	46
7.6	Vegetation survey	49
<b>8</b>	<b>DESCRIPTION OF THE CASE STUDY</b>	<b>51</b>
8.1	Introduction and objectives	51
8.2	Framework of the fieldwork	51
8.3	Study area	51
8.4	Results	54
<b>9</b>	<b>DISCUSSION</b>	<b>65</b>
9.1	Introduction	65
9.2	Site conditions	65
9.3	Tide	66
9.4	Hydraulic measurements	67
9.5	Field survey	68
9.6	Vegetation and bottom characteristics	71
9.7	Final Comments	74
<b>10</b>	<b>CONCLUSIONS AND RECOMMENDATIONS</b>	<b>76</b>
<b>11</b>	<b>REFERENCES</b>	<b>79</b>
<b>APPENDIX I</b>	<b>MANGROVE SPECIES</b>	<b>83</b>
<b>APPENDIX II</b>	<b>PHYSICAL PROCESSES</b>	<b>85</b>
<b>APPENDIX III</b>	<b>WAVES</b>	<b>89</b>
<b>APPENDIX IV</b>	<b>MEASUREMENT EQUIPMENT</b>	<b>95</b>
<b>APPENDIX V</b>	<b>MORE DETAILS OF STUDY AREA</b>	<b>99</b>
<b>APPENDIX VI</b>	<b>OVERVIEW FIELDWORK</b>	<b>105</b>

# 1 PROBLEM ANALYSIS

## 1.1 Introduction

Mangrove vegetation occupies the upper inter-tidal zone on many shores of estuaries, lagoons, open coasts and rivers. They occur especially on tropical coasts but extend into the temperate zone as well. Until recently, these mangrove-occupied areas were considered to have little or no value and unfit for most uses. Mangrove forests are, however, among the most productive ecosystems of the planet. Their ability to survive in saline environments enables them to live where land and sea meet.

Due to the high production of organic matter, mangrove forests are very suitable environments for large populations of fish, shellfish and wildlife and are prime breeding and nursery ground for many species. Most fish caught for human consumption depends on coastal (marsh) ecosystems. For this reason fish and shrimp farms often develop near mangrove forests, contributing to (global) food supply and local economies. Mangrove forests also form an effective wave and storm protection for agricultural, industrial or urban lands that lie behind them. Even when drained and reclaimed for agriculture uses, the substrate of the former mangrove forest proves to be fertile and productive. However, reclamation of mangrove habitats causes coastal erosion, the result often being the loss of vast areas of land.

This MSc-thesis focuses on the hydraulic features of mangroves and mangrove forests. Mangroves obviously form a protection against hydraulic loads on the shores they grow along. Their presence reduces water velocities due to tidal flow, their roots, stems and canopies reduce wave energy, and their root system reinforces and flattens the substrate. In Vietnam alone, over 400,000 ha of crops were lost in coastal provinces as a result of tropical cyclone impact over the ten-year period 1977-1986. Mangrove vegetation could be used as natural coastal protection, reducing vulnerability of coastal areas in a nation where resources are limited (Tri *et al.* 1998). Therefore, these forests can have great socio-economic value, and since reforestation of mangroves proves to be little successful, they should be preserved when present.

It is, however, not known to what extent mangroves can act as buffer against waves and (tropical) storms. A large-scale investigation on wave attenuation in mangrove forests will increase knowledge on this subject and increase awareness on the importance and value of these wetlands. In the case of Vietnam, the Coastal Engineering faculty of Hanoi Water Resource University (HWRU) could be the right party to carry out such a measurement campaign.

The HWRU/CE-faculty is established only recently as part of a CICAT<sup>1</sup>-project and has therefore little experience in carrying out field studies. They are, nevertheless, willing to gain more experience on fieldwork. Since the contribution of mangrove

---

<sup>1</sup> CICAT is the central liaison office of DUT providing its faculties and departments with management support in the field of development cooperation activities.

forests on wave attenuation is of great interest, and knowledge on this subject is still limited, this MSc-study was carried out. This study was partly carried out at in the Netherlands, at Delft University of Technology (DUT) and partly in Vietnam, facilitated by HWRU.

## 1.2 Problem definition and objectives

### 1.2.1 Problem definition

There is a lack of both quantitative and qualitative knowledge on how waves are dissipated in mangrove forests and to what extent. Carrying out wave measurements and comparing these measurements with mangrove characteristics can increase knowledge on this subject. The Coastal Engineering faculty of HWRU is interested in such a measurement campaign, but no information is available on how to carry out these measurements.

### 1.2.2 Objective of the thesis

In general, the objective of the required investigation is to obtain field measurements of waves propagating through mangrove forests in order to increase knowledge about dissipation of wave energy in relation to the forests characteristics.

The primary objectives of *this* study are:

- Finding all relevant parameters that should be determined by measurements;
- Finding survey methods to obtain required data from the field;
- Gaining experience in working in mangrove forests.

A case study in the Red River Delta will be used as a pilot project, conducting a small field investigation under specific Vietnamese conditions, in order to gain the experience mentioned in the latter objective.

## 1.3 Methodology

To learn about mangroves, their habitat and their importance for coastal protection, and to get insight in all possible features of mangroves and mangrove forests that might be important for this study, an extensive literature study on mangroves has to be carried out first. This includes also a study focussed on the relevant physical processes involved in this investigation. After this, an inventory can be made about the data that is required from the field. When this is clear, a first methodology can be developed on how to obtain the required information by field measurements. The next step is a field trip to Vietnam to execute measurements, experience a typical mangrove environment and encounter possible problems that were unforeseen in the initial plans. The experiences from the fieldwork will be used to evaluate the initial research methodology.

## **1.4 Reader's guide**

The first chapters will subsequently deal with the global distribution of mangroves (Chapter 2), some basic biological features of mangroves (Chapter 3), a brief discussion about the mangrove habitat or ecosystem (Chapter 4), the socio-economical value of mangroves and the impact of human acting on mangroves (Chapter 5). A chapter on the physical processes that are relevant for this investigation follows (Chapter 6). After this, survey methods to obtain the required data from fieldwork are discussed (Chapter 7). Following next is the case study in the Red River Delta, Vietnam (Chapter 8). The experiences and results, gained in the field, will be used to discuss the used methods of investigation (Chapter 9) and to give recommendations for future field research (Chapter 10).

## 2 MANGROVE DISTRIBUTION

### 2.1 Introduction

'Mangroves' is an ecological term referring to a taxonomically diverse assemblage of trees and shrubs that form the dominant plant communities in tidal, saline wetlands along sheltered tropical and subtropical coasts, including estuaries and river deltas (Blasco *et al.* 1996). Although all mangrove species share the ability to grow in salty environments, they are not all strict halophytes<sup>2</sup>. Species of *Sonneratia* were recorded in Indonesia at 175 m above sea level and species of *Avicennia* and *Rhizophora* have been recorded in the inlands of respectively Western Australia and Jamaica (Chapman 1984). However, these cases are mere exceptions; mangroves are generally slow growing and competition with faster growing mesophytic<sup>3</sup> tropical trees will eliminate them in environments that are not saline.



Figure 2.1 Global distribution of mangroves

### 2.2 Latitudinal distribution

Mangroves are limited on a global scale by temperature and their lack of tolerance to frost. Their extension beyond the tropics (between 23°12'N and 23°12'S) is usually an extension of a continuous coast or island chain (Tomlinson 1986) where warm ocean currents carry propagules (see chapter 3) from rich mangrove regions into colder areas. Although the latitudinal limits of mangrove distribution vary in literature, latitudes between 25° and 30° on both hemispheres are mostly mentioned as outer boundaries. There are however outliers in higher latitudes. The most northern points of occurrence are found at St. Georges Parish (32°N) in Bermuda (Woodroffe 1990) and the Japanese island of Kyushu (31°N) while the southern limit of occurrence is at Corner Inlet (38°S), Australia (Tomlinson 1986).

<sup>2</sup> A plant adapted to living in a saline environment

<sup>3</sup> A land plant that grows in an environment having a moderate amount of moisture

## 2.3 Longitudinal distribution

Longitudinal mangrove distribution is usually divided in an Eastern group and a Western group. The Eastern group includes East Africa, India, Southeast Asia, Australia and the Western Pacific. The Western group includes West Africa, Atlantic South America, the Caribbean, Florida, Central America, and Pacific North and South America. They are sometimes referred to as the *Old World* or Indo West Pacific and the *New World* or Atlantic East Pacific. This comes down to the eastern and the Western Hemisphere, divided by the meridian. The presence of mangroves on the Hawaiian Islands and Fiji are human introductions (Chapman 1984).

## 2.4 Floristic diversity

Decreasing temperature and increasing thermic amplitudes (daily and annual) cause differences in floristic distribution between latitudes. The effects of increasing latitude are manifest in reduction in species richness, forest height and maximum size of trees. There is a spectacular difference in floristic distribution between the *New World* and the *Old World*. Mangroves reach their maximum development and diversity in the *Old world* and the ratio between the number of species in the *Old World* and the *New World* is five to one (Tomlinson 1986). Only three genera of mangroves are common in both the *New* and the *Old World*. These are *Avicennia*, *Rhizophora* and *Xylocarpus*.

## **3 BIOLOGY OF MANGROVES**

### **3.1 Introduction**

Apart from referring to the aforementioned assemblage of trees and shrubs, the name mangrove is also used for the habitat in which those species grow. In literature this habitat is also often called ‘mangrove ecosystem’, ‘mangrove swamp’, ‘mangrove wetland’ or ‘mangrove forest’, although not consequently. Additionally, Macnae (1968) introduced the use of the term ‘mangal’ to describe the mangrove community or the living component of the mangrove ecosystem. The term ‘mangrove’ would therefore only apply to the mangrove trees (or shrubs) themselves. In this report, this differentiation is followed to avoid misunderstanding as much as possible.

### **3.2 Species**

As mentioned before, mangroves are trees that share certain characteristics. They are often not genetically related and individual mangroves may belong to many different genera and families. What mangroves do have in common is a variety of physiological and reproductive adaptations that enable them to grow in a particular kind of (harsh and saline) environment. The name ‘mangrove’ is therefore not defining a distinct (sub) division in taxonomy<sup>4</sup> and is more related to habit than form. Many authors of literature on mangroves and botanists still disagree over what constitutes a mangrove. Because of this, the number of mangrove species varies throughout literature. One of the best-documented definitions of mangroves is by Tomlinson (1986). Tomlinson himself states that his assessment is somewhat subjective since he set arbitrary limits that could be subject to discussion. In this report, Tomlinson’s subdivision is followed, but there may be other possibilities.

Tomlinson recognizes three groups; major elements of mangrove communities (Appendix I), minor elements of mangroves communities (Appendix I) and mangrove community associates. The distinction between the first two groups is often not made in literature, and depends mostly on the level of taxonomic isolation from terrestrial relatives and the stage of development of root and reproduction characteristics. The mangrove associates are plants that are often part of the mangrove habitat (e.g. ferns and lianas), but do not have the tree like characteristics of the species in the first two groups. The biological features of the associates are beyond the scope of this report.

---

<sup>4</sup> The classification of organisms in an ordered system that indicates natural relationships



Although the exact number of mangrove genera and species remains unclear, the difference in species richness between both hemispheres is striking. According to Chapman (1984) only ten species are found in the *New World* against sixty-two in the *Old World*. Others find smaller differences, forty-four against eight (Teas, 1980) and sixty against twenty (Blasco *et al.* 1996), but the difference in longitudinal distribution is clear.

Of all these species, the most well known and most common are the species of the genera *Rhizophora* and *Avicennia*. Together, the representatives of these genera in the *New World* constitute 80 per cent of the mangroves on Atlantic shores. These representatives, *Avicennia germinans* and *Rhizophora mangle*, are often referred to as, respectively, the 'Black mangrove' and the 'Red mangrove'. Together with the 'White mangrove', *Laguncularia racemosa*, they are the main mangrove species in the *New World* (Teas, 1980).

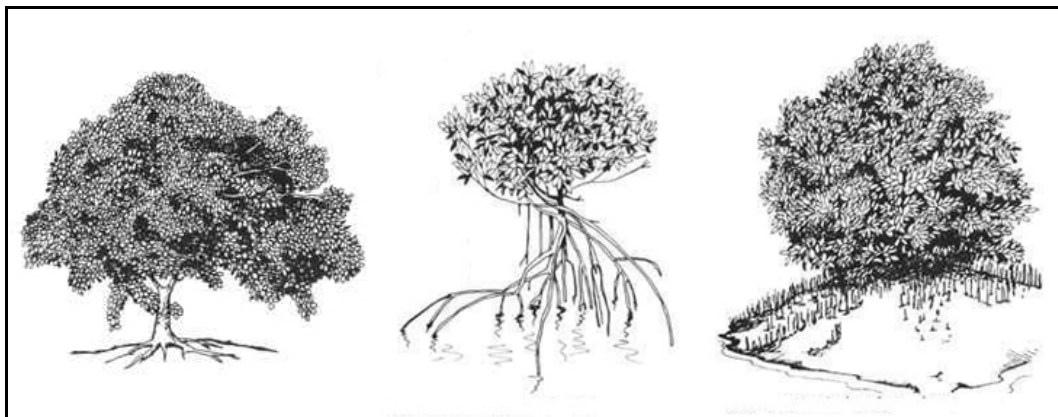

Figure 3.1 White mangrove (l), Red mangrove (m), and black mangrove (r)

Because of their occurrence on both hemispheres and their distinctive root structure, the *Avicennia* and *Rhizophora* are the main characters in mangrove literature. Especially the root system is an important feature in literature on hydrodynamic aspects of mangrove forests. The *Rhizophora* species are usually found at the frontline of coastal mangrove forests or bordering tidal creeks and channels. Their recognizable prop roots enable them to withstand wind and wave stresses and to grow in areas that are inundated permanently. The *Avicennia*, characterized by their snorkel-like roots (pneumatophores), occur higher up the tidal range than the *Rhizophora* species because of their tolerance to high salinities (due to irregular flooding) and the necessity for several hours of aerial exposure between submergences (Bird 1986).

### 3.3 Root structures

Like all plants, mangroves need ventilation of their root system. In terrestrial forests, the ventilation of the root system is provided by the absorbing part of the roots. These plants and trees have a root system that consists of a cable component and absorbing or anchoring components. The absorbing or anchoring component provides anchoring in the ground and absorbs nutrients and oxygen from the substrate. The absorbing or anchoring components usually grow downward as

appendages of the horizontally orientated cable components. Since the surface on which mangroves grow is inundated for at least part of the day, the substrate is usually of anaerobic nature. In order to ventilate the root system they have a third component that is exposed to the atmosphere, at least during low tide. These aerial roots diffuse oxygen throughout the root system and enable carbon dioxide to be vented out. Although the various types of aerial roots may look quite different from one and another, their function is the same and their existence is one of the features that distinguishes mangroves from other trees. The exposed roots of the mangroves are important for this investigation and therefore the main types of aerial roots, according to Tomlinson (1986), are summarized below and discussed briefly.

1. Stilt roots. These are the branched, looping aerial prop roots that arise from the trunk and lower branches of the species of the *Rhizophora* genus. The name 'stilt' refers to the supportive character these roots have. They are not only for aerial ventilation but gradually take over the supportive function of the lower part of the trunk, as the tree gets older. The spread of the *Rhizophora* stilt roots is regarded as opportunistic since new roots arise where the roots are damaged. It is believed that the number of roots and the complexity of the root structure is a response to the intensity of present wind and wave stresses (Unesco 1983). In a limited extent, stilt roots are found in species of *Bruguiera* and *Ceriops* and sporadically in some species of *Avicennia*. In the latter case the development of aerial roots is a response to wounding of the trunk.

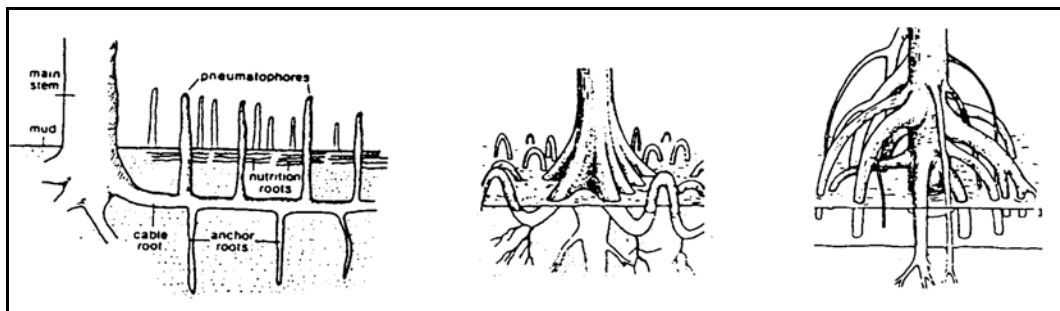

Figure 3.2 Pneumatophores (l), knee roots (m), and stilt roots (r)

2. Pneumatophores in *Avicennia* and *Sonneratia*. Pneumatophores are erect lateral branches of the horizontal cable roots, which are themselves growing underground. The pencil-like pneumatophores are the visible part of the root system of several mangrove species. They are spaced at regular intervals along the primary cable roots. In *Avicennia* species the aerial roots reach a maximum height of 30 cm and develop little secondary thickening. Secondary thickening is the expansion of the root component after it reached its maximum length. In *Sonneratia* species the aerial roots develop for a longer period and display secondary thickening. They can reach heights up to 3 m. The surface of the *Avicennia* pneumatophores is smooth and spongy while the ones from *Sonneratia* have a more wood-like structure. Pneumatophores usually remain unbranched but have the capability to do so. This probably only happens after damaging.

3. Pneumatophores in *Laguncularia*. This genus is often considered to have no visible aerial roots. However, under certain circumstances they do develop aerial roots,

rarely exceeding the height of 20 cm. The development of aerial roots in this genus is thus facultative and populations at some localities lack them. The *Laguncularia* pneumatophores are more frequently branched than the ones of *Avicennia* and *Sonneratia*.



Figure 3.3 *Rhizophora* stilt roots

4. Root knees in *Bruguiera* and *Ceriops*. In these genera the horizontal cable component of the root system surfaces periodically while growing away from the tree. The surfacing root forms a loop before continuing its horizontal growth. These loops, or knees, develop secondary thickening and it is here that most of the branching takes place and where the root system develops new cable components and anchor roots.
5. Root knees in *Xylocarpus*. This type of aerial root is found at the *Xylocarpus mekongensis* species. These knees are formed entirely by local secondary growth in the primary cable components. This is a fundamental difference with the root knees of *Bruguiera* and *Ceriops*, where the knees are consequence of change in direction of primary root growth. The root knees in *Xylocarpus* can reach heights of 50 cm.
6. Pneumatophores in *Lumnitzera*. The root knees of *Lumnitzera* are not very pronounced and are considered to be structures intermediate between pneumatophores and knees.
7. Plank roots. In *Xylocarpus granatum* the horizontal roots become extended vertically over their entire length due to eccentric cambial activity. These roots are propagating sinuous in their course. The result is a series of wavy, plank-like structures growing away from the tree. Less pronounced plank roots are found in *Heritiera* (mangrove) species and many rain forest trees.



Figure 3.4 Solitary *Avicennia* tree in fish pond, Vietnam

Some mangrove species lack aerial roots. These species have other ways to regulate their system. This is, however, not the subject of this study and therefore beyond the scope of this report.

## 3.4 Reproduction

### 3.4.1 Flowering

Most mangrove species are hermaphrodite, so trees have both male and female flowers. Mangroves are almost exclusively pollinated by animals. Pollination can take place at night by bats and moths and during the day by birds, bees, butterflies and other insects. In general, bees are the most common mangrove visitor and pollinator. There is one exception to this; *Rhizophora* species are mainly pollinated by wind (Tomlinson 1986).

### 3.4.2 Seeds and seedlings

Establishment of the seedling is important to all seed plants. Due to tidal influence and wave attacks, the mangrove habitat is a tough environment for ordinary seeds to establish. Some mangrove species are adapted to this problem and produce seedlings instead of seeds. When the fruit of these species matures, the embryo of a new plant begins to grow inside while still attached to the parent. The result is a seedling that, after falling of the parent tree, can quickly establish itself once it reaches a favourable substrate. The development of seedlings is known as vivipary. In the extreme condition of 'true vivipary' the embryo first grows out of the seed and then out of the fruit before falling of the parent. In this case, the seedling resembles a green wooden

dart. True vivipary occurs in *Bruguiera*, *Ceriops*, *Rhizophora*, *Kandelia* and *Nypa* genera. In *Aegialitis*, *Avicennia*, *Aegiceras*, *Laguncularia* and *Pelliciera*, the embryo grows out of the seed but not out of the fruit. This condition is called cryptovivipary. The *Rhizophora* seedlings can reach a length of 70 cm (Tomlinson 1986), but in general, they are considered to be some 30 cm on average (UNECISO 1983).



Figure 3.5 Propagules of *Kandelia candel*

### 3.4.3 Dispersal and settlement

All mangrove propagules are dispersed by water, and the propagule has at least some initial ability to float. Most propagules float away with the tide when they fall of the parent tree, and only few establish in the sediment at the base of the parent tree. One of the main reasons why only few propagules survive near the parent is the lack of open sunlight under the mangrove canopies. The light intensity at ground level under a full mangrove forest canopy may be only 5 to 10 per cent of the open sun values (Teas 1980). Since mangrove propagules usually become established on soil exposed to air and sunlight for at least 6 hours a day development under the parent tree stand very little change (Ligtvoet *et al.* 1996). The influence of light on seedlings is illustrated in cases where lightning strike kills individual trees and creates open space. Dense growth of young seedlings is found on these exposed spots while the growth in the surrounding forest is still suppressed (Teas 1980). Another reason for the limitation on development of seedlings within the forest is the presence of aerial roots. Johnstone (1983) concludes from observation that the 'pavement' of knee roots in a *Bruguiera* forest makes the establishment of any seedlings very unlikely.

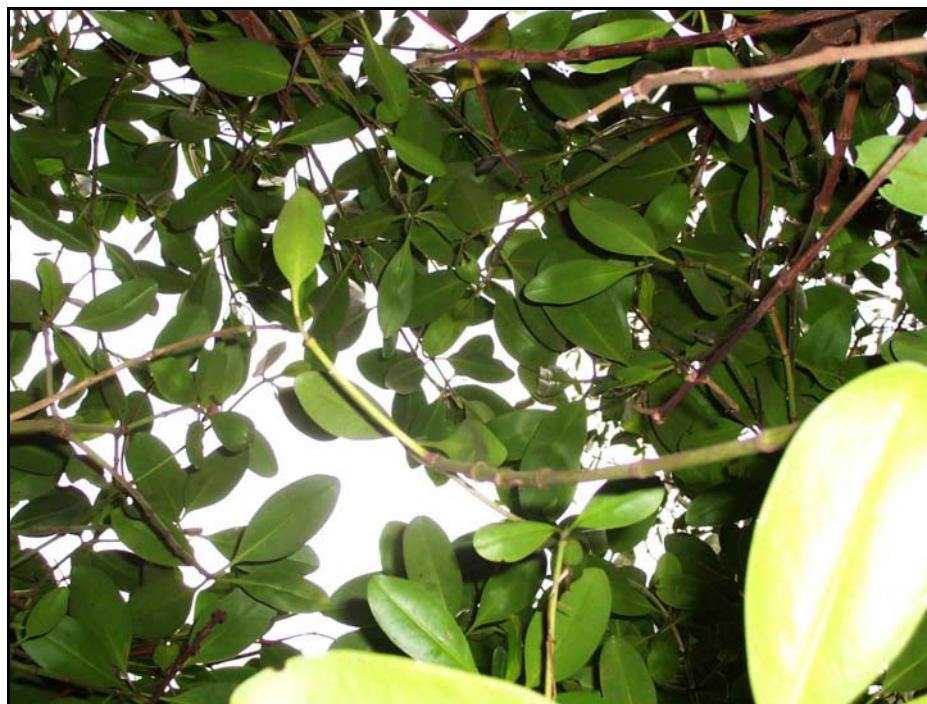

Figure 3.6 Dense cover by canopy of *Kandelia candel*

Propagules that are taken away by the tidal current can float for long periods, up to a year. The saltier the water, the longer they float. They can be transported for thousands of miles remaining alive for a year or longer sometimes even producing secondary (anchor) roots while afloat. At first they drift horizontally, but as they grow older they will rotate more and more to the vertical. After a month most seedlings are floating vertically, root end downward, ready to take root when they make contact with the bottom. Even those that sink and remain submerged have a chance to survive, and when circumstances are favourable it will root in the bottom and send a shoot to the surface and produce leaves.

The length of the propagule is an important factor in the settlement of the new trees. Larger propagules are stranded in deeper water while smaller propagules can establish in shallower water i.e. higher up in the tidal zone. This is believed to be one of the reasons that *Rhizophora* species are dominant in the outer fringes of a great number of mangrove forests (Unesco 1983) and the cause of shore-parallel zonation in mangrove communities in general (Blasco *et al.* 1996).

## 4 THE MANGROVE ECOSYSTEM

### 4.1 Introduction

Literature on mangrove ecosystems appears to be a rather chaotic gathering of studies on specific cases and related subjects. However, to get an idea of the mangrove habitat, as a possible 'laboratory' for hydraulic measurements, some subjects need to be discussed. This chapter starts with the classification of mangrove forests and the coasts where they occur. The subjects following this, are the most frequently discussed in literature on mangroves; zonation and landbuilding. Finally, a short summary follows of the most relevant factors that influence the occurrence and growth of mangroves. Although the mangrove ecosystem is a field of study on its own, several studies and books dedicated to this subject alone, a brief overview is given in this chapter.

### 4.2 Geomorphological settings of mangroves

Mangroves are mainly associated with the inter-tidal zone of various tropical and sub-tropical coast and shores. Although every stand of mangroves is the unique consequence of various local factors influencing the growth of the trees, their geomorphological setting is rather restrictive. Since they best thrive in sheltered situation, they particularly develop well in estuaries and deltas, where they grow on the sediment deposited by rivers. In these situations, tidal forests can extend up to twenty kilometers inland along gentle slopes, and it is here where the most complex and biologically diverse mangrove ecosystems are found (Ligtvoet *et al.* 1996).

Thom (1982) classified deltas by describing five environmental settings (Figure 4.1) in which mangrove colonization often occurs. Although it may not be well suited in all cases, and exceptions do exist, this classification is widely accepted and often used in other studies. These settings are discussed briefly below.

1. This setting consists of river-dominated deltas along coastlines of low tidal range. Rapid deposition of sands, silts, and clays causes progradation over a flat, gently sloping continental shelf. Wave energy along the shoreline is low. Because of high freshwater discharge, the river outlet and its branches may not themselves be inhabited by mangroves; however, the adjacent chenier plains (tidal flats with series of sandy or shelly ridges) are ideal sites for mangrove colonization. River dominated deltas are also characterized by rapid morphological change and diverse flora and fauna. The Mississippi delta in the USA and the Atrato delta in Colombia are examples of this.
2. This setting is tide dominated. The main river branches are fed by numerous tidal creeks and are usually funnel-shaped, separated by extensive tidal-flat surfaces and dominated by strong, bi-directional tidal currents. Also in this setting, wave energy is low due to dissipation over the large tidal flats. Mangroves are found along the tidal flats and the shores of the river branches. Examples are the Klang delta in Malaysia and the Ord River delta in Australia.

3. This setting is wave dominated with relatively low river discharge. High wave energy results in a more steeply sloped continental shelf than in the other settings. The wave-dominated setting is characterized by the presence of barrier islands that enclose drowned river valleys or lagoons, and act to dissipate wave energy. Mangroves are found on the protected leeward side of the barriers and along the shores of the lagoon or drowned river valley. Examples are the barrier coastline of El Salvador and the coast of Tabasco, Mexico (Thom 1967).
4. This setting is a combination of wave and river dominated processes (settings 1 and 3), with a coastal plain characterized by sand beach ridges and narrow coastal lagoons. Mangroves colonize along abandoned river branches, near river mouths, and along lagoon shores. Examples are the Grijalva delta in Mexico (Thom 1967) and the Purari delta in Papua New Guinea.
5. The last setting is a drowned river valley system with low river discharge, low wave action, and low tidal range. Sediment deposition is minimal, creating an open estuarine system. Mangroves occur on the heads of the drowned river branches and along the shores of lagoons behind bay barriers near the mouth of the estuary. An example of this setting is Broken Bay, Australia.

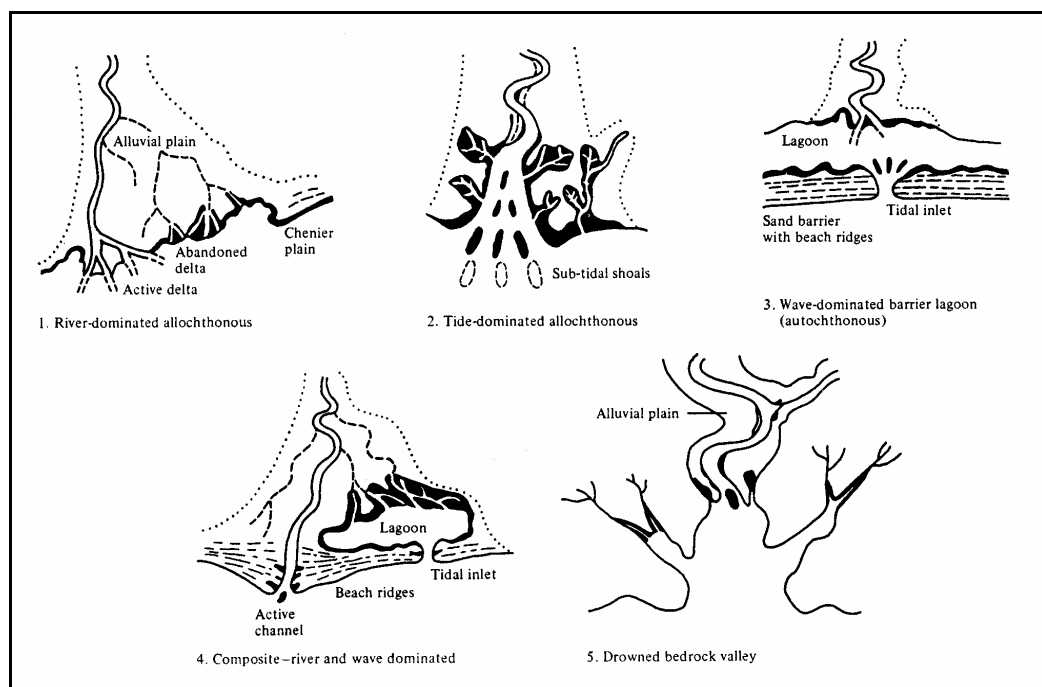

Figure 4.1 Geomorphologic setting for mangrove colonisation (shaded). After Thom (1982)

Elsewhere, for example, on reefs, coralline tidal flats or sandy beaches open to the sea, mangroves may grow in the tidal zone, but extensive forests are less likely to develop. On these exposed shores, mangroves are often located at the leeward side of landforms, or protected by other landforms, such as barrier islands or in bay areas (Woodroffe 1983). However, deltas are by far the most common geomorphological setting for mangrove colonisation.



### 4.3 Forest types

The most frequently used classification of mangrove forests is that of Lugo & Snedaker (1974). Originally, these authors recognized six basic forest types, resulting from different geological and hydrological processes. This classification was originally developed for the mangrove communities of South Florida but has also been applied to mangrove throughout the whole Caribbean (Unesco 1983). The community types recognized by Lugo & Snedaker are shown in (Figure 4.2) and discussed briefly hereafter, based on Delft Hydraulics (1993).

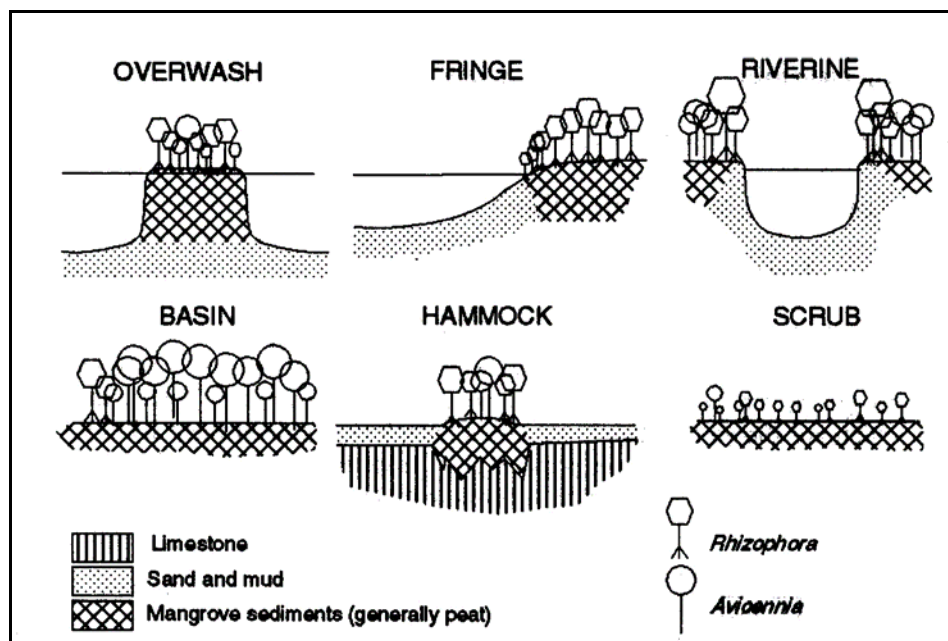

Figure 4.2 Mangrove forest types. After Lugo & Snedaker (1974)

- **Overwash.** These islands are frequently overwashed by tides and thus have high rates of organic transport. All species of mangroves may be present, but *Rhizophora sp.* usually dominate. Maximum height of the mangrove is about 7 meters.
- **Fringe.** Mangroves form a relatively thin fringe along waterways and coasts. These are best defined along shorelines whose elevations are higher than mean high tide. Maximum height of trees is about 10 meters.
- **Riverine.** This community type includes the tall floodplain forests along flowing waters such as tidal rivers and creeks. Although a shallow, low berm often exists along the creek bank, the entire forest is usually flushed by daily tides. Mangroves may reach heights of 18 to 20 meters in Florida. For other regions, mangrove forests with heights up to 40 meters have been reported.
- **Basin.** These forests occur inland in depressions channelling terrestrial run-off toward the coast. Close to the coast, they are influenced by daily tides and are usually dominated by *Rhizophora sp.* Further inland, the influence of the tide decreases and species that are more salt-tolerant dominate these forests. Trees may reach heights of 15 meters.

- Hammock. This type is similar to the basin forest type except that they occur on ground that is slightly elevated relative to the surrounding areas. Trees rarely exceed 5 meters in height.
- Scrub or dwarf. These types on the landward side of fringes and basins in seasonally dry areas. These areas are characterized by high evapotranspiration and low precipitation rates causing high levels of soil salinity. The high level of salinity is the dwarfing factor in these forests, and trees are usually not higher than 1.5 meters.

Because this classification was originally developed for mangroves in Florida in particular, and mangroves on the Western Hemisphere in general, it should be used with caution in other areas. However, this classification can be simplified by considering hammock and dwarf a type of basin and incorporating the overwash forests as a type of fringe (Unesco 1983). This simplification, resulting in a classification in 'Fringe', 'Riverine', and 'Basin' forests, allows application on a larger scale (Taal 1994) and has already been used in recent literature on mangroves in Vietnam, (Mazda *et al.* 1997a) and (Mazda *et al.* 2002), and mangroves in Japan (Mazda *et al.* 1997b).

#### 4.4 Zonation and succession

Mangroves usually grow in the upper tidal zone, between Mean Sea Level (MSL) and High Water Spring Level (HWS). Below MSL, the seedlings have trouble settling, and at higher levels, mangroves cannot compete with other plant species (Figure 4.3). The coastline in front of mangroves often consists of mud flats with typical slopes of approximately 1:1000. Behind the mangroves, between HWS-level and the level of occasional flooding by the sea, a hyper saline area develops. In this area, salt marshes can be found with halophytic herbs and grasses (Schiereck 2001). The width of the tidal forests, with typical slopes of about 1:300, is determined mainly by the tidal range.

Within the mangrove forests, communities are often zoned parallel to the shoreline, with series of different species dominating distinct sections from shore to the landward limits. These zones are separated by a transitional area, occupied with a mixture of mangroves from the adjacent zones. Zonation within mangrove forests is widely discussed in literature; however, there is no agreement yet on the cause of this phenomenon. In his classical view on zonation, Davis (1940) recognized *succession* in species perpendicular to the shore. He argued that *Rhizophora sp.* act as the pioneer species, preparing the way for other species. As this species grows toward the sea, accretion takes place and at the inner part of this fringing forest, *Avicennia* takes over. After this, *Laguncularia* replaces the *Avicennia* stands and eventually will be followed by fresh water swamps and the climatic climax: a tropical forest.

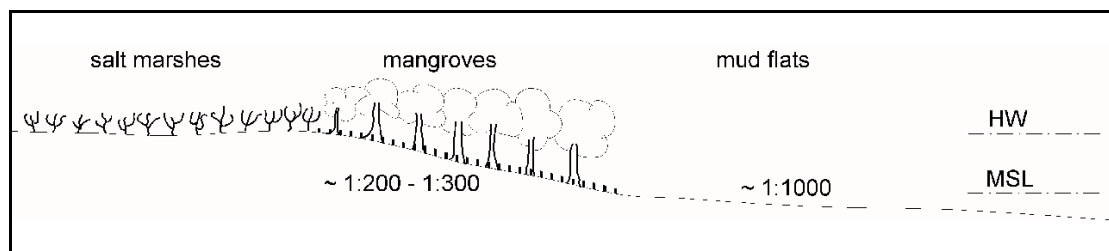

Figure 4.3 Typical mangrove fringed shoreline. After Schiereck (2001)

Although the existence of the zones described by Davies is widely accepted, the succession of species as a cause of zonation is often questioned. Thom (1967) and Thom *et al.* (1975) suggested external physical forces such as variation in frequency of tidal inundation, tidal range, and salinity cause zonation. Johnstone (1983), states that most mangrove species can grow anywhere within the normal mangrove tidal range. He argues that the difference in favourable conditions causes species to dominate the habitat in which they grow best. *Competition* between species is thus the main cause of zonation in this view. Those opposing Davis (1940) have in common that they consider mangroves to be mere followers of changes in their habitat and that active colonising by mangroves only takes place when a shoreline is already progradating. This ability to colonize new grounds is called 'landbuilding' and will be discussed in the next paragraph.

In addition, the *Rhizophora* species is not always the pioneer within a forest. Numerous observations of *Avicennia* being the pioneering species, have been reported (Bird 1971, 1986; Thom 1967, 1975).

## 4.5 Mangroves as landbuilders

### 4.5.1 Introduction

Landbuilding is a widely discussed subject in mangrove literature. Although the term landbuilding is mostly used for the offshore advance of mangroves, accretion within coastal forests plays an important role as well. Both phenomena are discussed separately below.

### 4.5.2 Colonising new grounds

As outlined in the previous paragraph, Davis (1940) supposed that red mangroves are active landbuilders, colonizing fronting mudflats, thereby promoting a higher rate of vertical accretion of the bottom profile. By doing so, they prepare the way for other species that will follow. Davis thought that mangroves could therefore be used to extend coastlines or form islands. Since then, the geomorphological role of mangroves has been the subject of a considerable discussion. Van Steenis (1941) disagrees with Davis and states that mangroves only occur on sheltered coasts where accretion takes already place, and the adjacent mudflat has been raised to a suitable level for settlement. In addition, *Avicennia* appears to be the pioneer species on these mudflats while *Rhizophora* is the pioneer on sandy, turbid, shores. Bird (1971) also concludes that mangroves cannot directly cause shoreline advance, for they spread forward only

after the adjacent mudflat has sufficiently been raised by accretion to be suitable for colonisation. One of the reasons for this is that mangroves cannot spread below specific tidal levels, usually approximating MSL (Bird 1972).

Wells & Coleman (1981) noticed that longer periods (months to years) of lower than normal tides create conditions that are favourable for mangrove advance due to exposure of new areas. Once established, mangroves can withstand the 'normal' tides and consolidate the soil they stand on. Observations in Surinam learned that periods of lower than normal tides coincided with sudden coastal progression and mangrove settlement on new grounds.

In addition, mangroves not only grow on progressive, or at least stable, shores. Semeniuk (1980) found mangroves developing well on retreating coasts in Australia. New growth (pioneer zone) was initiated on the landward side of the forest, as the seaward was lost due to erosion. Landward migration of these forests proves that mangroves follow changes in their habitat.

Although there will be exceptions, mangroves are probably not the acting agents in coastal progradation they were thought to be by Davis (1940). Mangroves are mere followers of sediment deposition and vertical accretion or erosion, rather than a cause of it and their behaviour can be considered as opportunistic.

Nevertheless, Bird (1980) argues that there is a way in which mangroves may contribute to the build-up of adjacent mudflats, and thereby prepare the way for their own advance. He observed that offshore winds hardly move the water surface in a zone of up to 20 meters wide in front of a mangrove forest. Where mangroves are not present, these winds generate currents that can move sediment away from the shore, just as onshore winds can bring sediments toward the shore. By creating a sheltered zone of still water, and thus creating an opportunity for sediment to sink, mangroves might be able to promote the accretion of the adjacent mudflat.

#### 4.5.3 *Role of root systems in sedimentary processes*

Although many authors doubt that mangroves are actual landbuilders, the fact that within a mangrove forest deposition is accelerated, is widely accepted. Bird (1971) concludes during field observation that there is no doubt vertical accretion is taking place within mangrove forests. Bird (1972) investigated mangroves in Cairns Bay, Australia, and found steeper bottom slopes within the forest than at the adjacent mudflat. He found slopes of 1:1000 for the mudflat, 1:300 within the *Avicennia* stands, and 1:500 in *Rhizophora* zones and believed that this is due to an increased rate of deposition, caused by the mangrove vegetation.

The deposition of sediments is influenced mostly by the roots of the mangroves, creating a calm water environment between them in which suspended materials can sink instead of being washed away. Bird (1972) used a network of pegs to simulate the effect of the pneumatophores of *Avicennia*. Within a month, a mud layer of 0.3 cm had accumulated between the pegs, disappearing as soon as the pegs were removed.

However, Bird (1972) forgot to describe the size of his pegs and the spacing between them. Spenceley (1977) conducted a similar investigation and varied the spacing between his 0.6 cm thick pegs. He found that a spacing of 10 cm had no effect on the sedimentation pattern. A spacing of 1 cm within grid was too dense for deposition, causing a scour and eventual toppling over of the frame. A frame with a spacing of 2.5 cm proved to have significant effect. The 2.5 cm spacing is a close approximation to the average pneumatophore spacing in dense accumulations. Although they found similar results in their investigations, Bird (1972, 1986) and Spenceley (1977) had different ways to explain them. The latter argues small rootlets between the pneumatophores are responsible for binding the sediment, while the former recognised only the role of the pneumatophores themselves. Spenceley (1977) also mentions that especially *Rhizophora* prop roots have good sediment binding qualities and significantly reduce the velocity in tidal currents.

## 4.6 Important factors for growth and threshold values

### 4.6.1 Introduction

In this paragraph, a few important factors influencing the growth of mangroves will be discussed briefly. Some of these subjects might have fitted better in the chapter on the biology of mangroves. However, these factors together form the characteristics of mangrove ecosystems. Therefore, they are summarized in this chapter on mangrove ecosystems.

### 4.6.2 Protection from wave action

Although mangroves are capable of withstanding wave and tidal action, the settlement of propagules and seedlings requires a low (wave) energy environment. Therefore, mangroves usually occur in sheltered areas (paragraph 4.2). However, clear definitions of a low energy environment or threshold values for settlement are not mentioned throughout literature.

### 4.6.3 Tidal range

Together with substrate slope, tidal range determines the area where mangroves can grow in the tidal zone. The larger the tidal range, the wider the area influenced by tidal action and thus a wider area suitable for mangroves. There appears to be no minimum or maximum tidal range for mangroves. Kusler & Kentula (1990) observed mangroves on the coast of Puerto Rico with tidal ranges as small as 0.24 m while Semeniuk (1980) mentions a tidal range of 11.5 m in Australia. The species diversity within a mangrove forest is strongly influenced by the tidal range. On coasts with large tidal range, there will be more different species within a forest, their distribution determined by the differences in inundation level and varying salinity within the forest.

### 4.6.4 Air temperature

As mentioned before, the distribution of mangroves is limited to tropical and subtropical regions, due to their poor ability to withstand low temperatures. Although there are exceptions, extensive mangrove swamps are generally associated with areas where

the average winter temperature is above 20°C and the seasonal temperature fluctuations stay within a range of approximately 10°C (Chapman 1984). According Blasco (1984) a minimum of 16°C for the average temperature in the coldest month will make mangrove occupation impossible. Some species, however, can withstand lower temperatures for shorter periods. Some *Avicennia sp.* are reported to have survived temperatures as low as -4°C (Blasco 1984). The response of mangrove forests to decreasing temperatures and increasing thermic amplitude are reduction in species richness, forest height and maximum size of trees.

There is not a clear maximum air temperature although Kjerve (1990) reports a case of an *Avicennia* tree that died after a 48 hour exposure to a temperature 40°C.

#### 4.6.5 *Water temperature*

The presence of extensive mangrove communities seems to correlate with those areas where the water temperature of the warmest month exceeds 24°C. In waters that never exceed 24°C throughout the year, mangroves appear to be absent (Blasco *et al.* 1996).

As for air temperature, there is not a clear maximum for water temperature. There are reports of seedling of *Avicennia* species that died after 48 hours in water with temperatures between 39°C and 40°C. These temperatures can occur in shallow, stagnant waters and areas close to cooling water outlets of electricity generating plants (Unesco 1983). It is clear, however, that above water temperatures of 38°C mangrove forests begin to deteriorate and trees are limited in height and produce dwarfed seedlings and leaves (Unesco 1983).

#### 4.6.6 *Salinity*

As outlined before, mangroves do not require salt water, but only tolerate it. This unique feature enables them to grow in coastal areas without competition of plant species that do not tolerate salt water. In several botanic gardens throughout the world mangrove species have successfully been grown while watered solely with freshwater (Teas 1980).

Although all mangroves tolerate salt water, the level of tolerance is not the same for all species. *Rhizophora sp.* (red mangroves) have low tolerances to high salinities and thrive best at the borders of coastal fringe forests and tidal creeks where salinity is low (10-20‰). They are however capable of forming forests in higher salinities (40-55‰). *Avicennia sp.* (black mangroves) have higher tolerances, and develop well in salinities of 60-65‰, but can survive salinities of up to 90‰ (Unesco 1983). Because salinity changes from sea to shore in mangrove swamps, the difference in tolerance level can cause zonation within the mangrove community (paragraph 4.4). According to Marius & Lucas (1991), differences in level of salinity mainly determine the zonation of mangrove forests on the West African coast.

As for all factors in this paragraph, reaching the threshold values results in less developed trees and forests. On the landward side of a mangrove forest, salinity can

reach high values in periods of draught or due to low inundation frequency. Even within boundaries of these values, salinity influences the growth of trees. Between 30 and 72‰, tree height was found to be inversely proportional to soil salinity (Odum *et al.* 1982).

#### 4.6.7 *Substrate*

Mangroves can grow on sand, mud, peat and coral rock. However, the most extensive forests are found on muddy soils, typical in deltas, lagoons, bays and estuaries. These muddy soils depend on the input of sediments by tidal currents or river discharges. The substrate is fertilized by nutrients in freshwater run-off, river discharges or organic litter produced within the forest itself.

#### 4.6.8 *Aridity and Rainfall*

Rainfall is important for mangrove forests for two reasons. Firstly, rainfall reduces soil salinity within a forest. Especially in forests that are inundated irregularly or between long intervals, salinity of the substrate can rise locally to levels unfavourable for mangroves. Secondly, heavy rainfall causes freshwater run-off, bringing a lot of sediments and nutrients from land into the mangrove swamps. In situations where fresh water run-off is diverted or alternated, e.g. after construction of dykes or changes in (agriculture) land use, existing mangrove forests might decrease or disappear, due to lack of nutrients or erosion (Midun & Lee 1989).

Blasco (1984) investigated the combined effect of rainfall and humidity on mangrove distribution. He used the ratio  $P/Etp$  as a measure for aridity in which  $P$  is the mean annual rainfall and  $Etp$  the potential evapotranspiration. At least 90 per cent of the world area in mangroves is found in humid areas where  $P/Etp > 0.75$ . Mangroves are found occasionally under sub-humid climates ( $0.50 < P/Etp < 0.75$ ), such as Kenya, Tanzania, Australia, and Mexico. In semi-arid conditions ( $0.20 < P/Etp < 0.50$ ), mangroves are exceptional and mainly found in the Indus delta, India, and Ecuador. Finally, under arid climates ( $0.03 < P/Etp < 0.20$ ), mangroves are practically unknown, except for some areas around the Red Sea, the Persian Gulf and the gulf of California. When present under non-humid conditions, mangroves tend to be smaller and less developed.

## 5 THE VALUE OF MANGROVE ECOSYSTEMS

### 5.1 Introduction

In this chapter, we will take a closer look on mangroves as a natural resource. As a part of the coastal zone, mangroves have value in many different ways for just as many different users. The interests of different users are often contradictory and in many cases, the negative impact of human activities on mangrove forests is likely to be greater than the individual profit of the activity. The importance of mangrove ecosystems takes two distinct forms. First, once drained and reclaimed, they provide valuable land for urban expansion and productive agriculture. Second, these ecosystems have great value in their natural state. The focus of this chapter is on the value of mangrove forests and salt marshes in their natural state. In the following paragraphs, we will consequently deal with mangroves as part of the coastal defence system, the utilisation of mangroves, negative impacts of human activities and attempts of mangrove rehabilitation after damage.

### 5.2 Mangroves as coastal protection

#### 5.2.1 Introduction

From a Civil Engineering point of view, the most relevant value of mangroves is their ability to protect shorelines against hydrodynamic loads. Mangroves not only provide protection against wave attack and flow erosion under normal conditions, but also in extreme situations, during storm surges and cyclones, mangroves appear to be very useful.

#### 5.2.2 Protection against waves

When propagating through an exposed mangrove forest, waves are dissipated when exposed to the trees. There is a growing awareness of the importance of mangroves as a natural coastal defence. Although there is no question about the fact that wave energy dissipates in mangrove forests, there is still little known about the level of this wave reduction. Mangroves can therefore serve as (extra) protection of dykes and revetments. In countries with low technical or financial resources where large communities are depending on yields from near-shore aquaculture or agriculture, mangroves should be preserved or, if possible, rehabilitated.

Midun & Lee (1989) reports field observations of wave attenuation by mangroves in Malaysia. He states that waves of 1m in height were completely attenuated in a mangrove stand of 30 to 50 meters wide. There are, however, no results from measurements included in this study, and the rate of attenuation seems rather high.

The study by Mazda *et al.* (1997a) appears to be of more value and includes results from field measurements in Thai Binh Province in Vietnam. They found reduction of wave heights over 100 m of *Kandelia sp.* of up to 20%. Using the results of the measurements, they calculated that over a forest width of 1500 m, incident waves with



an average height of 1 m would be reduced to no more than 0.05 m at the landside of the forest (Figure 5.1). The relatively weak dykes of fishponds behind the forest depending on the protection by this mangrove stand. Without a mangrove forest, the wave height would still be 0.75 m after propagating over 1500 m of mudflat without mangroves. These results were derived from measurements in a mature mangrove stand, with 5-6 years old trees. However, measurements in considerable younger stands (0.5-1 year old and 2-3 year old trees) were also carried out in this study, showing little to no effect on the incident waves.

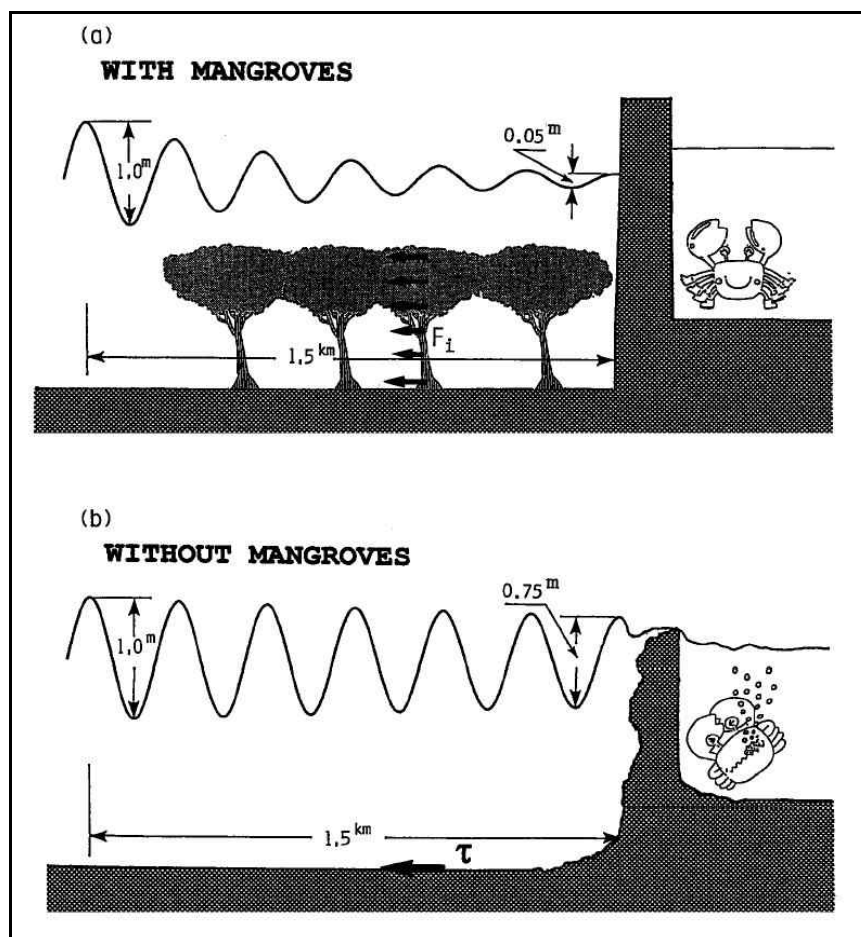

Figure 5.1 Results by Mazda et al. 1997a

In his MSc-thesis, Groen (1993), investigated wave attenuation by pneumatophores and stems and found that pneumatophores are effective wave dissipaters of small waves ( $<0.15$  m) in combination with low water levels ( $<0.30$  m). A reduction of 50% was found over 6 m of aerial roots with a spacing of 0.041 m. In higher water levels, stems became more important. Dissipation by pneumatophores was effective within several meters of propagation while dissipation by stems became significant over distances of a few hundred meters or more. The influence of tree canopies was beyond the scope of this study.

In addition, Tri *et al.* (1998) state that a mature mangrove stand with a width at least comparable to the wavelength of the incident waves, will reduce annual maintenance costs on sea dikes in Vietnam with 30 per cent.

### 5.2.3 *Flow resistance*

Mangrove forests reduce, like all submerged vegetation, particle velocities in tidal current or river discharge. The drag force exerted by the trees can slow down erosion or even cause sedimentation and accretion (Chapter 4). The level of flow reduction depends strongly on the density of the mangrove stand. Besides local effects, mangrove forests can also influence morphological processes at considerable distance from their habitat. In Ho Chi Minh province, Vietnam, large amounts of mangroves disappeared in the 20<sup>th</sup> century due to settlement of rice paddies and aquaculture and the use of herbicides during the American war (1962-1974). The deforestation of these riverine forests several kilometers inland caused severe coastal erosion due to changes in discharge regime and the influence of this on long-shore currents (Mazda *et al.* 2002).

### 5.2.4 *Cyclones and storm surge*

The effect of cyclones on mangroves can be quite different from case to case. The effects of cyclones are, however, relatively large. Changes in morphology, that normally take place over periods of months or years, can take place overnight during a tropical storm.

Steinke & Ward (1989) described the effects of two tropical storms passing over St. Lucia, South Africa, in 1984. The tropical storms were accompanied with heavy rainfalls, causing large flooding of the river system of the area. The direct effects of the cyclones were the breakage of trees by the impact of floodwaters and the uprooting or collapse of trees by high velocity streams with water leaving the river system after the storms. However, the bases and roots of the trees, broken by the floodwaters, still protected the substrate from erosion. There was also a delayed effect of the storms. A layer of fine sediments, deposited within the forest by the floods, had dried out to form a hard, almost impervious crust. This probably disturbed the interactions between roots and surrounding and caused the death of trees. The forest recovered from the damage, and a very high propagule production was recorded a year after the storms. It is not known if the latter is some kind of compensation mechanism.

Hopely (1974) observed the effects of cyclone Althea that hit the Townsville area, Australia, in 1971 and found very little direct damage to the mangrove population. Sandy sediments, blown into the forest by the storm, did most damage. These sediments buried pneumatophores, causing high mortality rates in the 12 months following the cyclone.

The extreme water levels during storm surges have two very different effects on mangroves. When trees are completely submerged, wind has no effect on the canopies, providing a better chance for surviving (Smith III 1986). However, when

trees are submerged for longer periods there is a chance they will drown (Steinke & Ward 1989). Even submerged, mangroves still have their resisting effect on flow and waves. Since cyclones and storm surges also do most harm on the hinterland, the effect of mangroves under these conditions is interesting for further study.

The recovery of mangrove forests after storm damage varies per mangrove species. This is mainly determined by the ability of stump sprouting of a mangrove species. This capability enables a new sprout to grow from the base of a (partly) destroyed tree. Species of the *Excoecaria*, *Avicennia* and *Lumnitzera* genera have this capability (Smith III 1986).

Although individual mangroves will not always survive tropical storms, the forests as a whole usually survive and damage to mangroves is usually smaller than to non-mangroves and their recovery is faster (Saenger & Siddiqi 1993). Even when trees die, due to the effects of a storm, they still protect the coastline during the event.

#### 5.2.5 Wind reduction

The canopies of mangrove trees reduce salt-water spray, protecting crops and other sensitive forms of land use (Sato 1984). There is little knowledge of the maximum wind speeds mangroves can survive. When comparing the effects of two cyclones in Australia, Smith III (1986) concluded that the difference in wind speed between the storms explained the difference in mortality rates. He believed that this threshold value might be between 170-185 km/hr. This is, however, only one case.

### 5.3 Resource values or goods

Mangroves and mangrove ecosystems have always been very important to local communities in coastal areas, providing them with food, fuel, charcoal or construction materials. The number of resources and goods that are harvested or extracted from mangrove ecosystems is enormous and will only be discussed briefly in this study.

Mangrove ecosystems are very suitable nursery areas for numerous species such as crabs, shrimps, fish and oysters (Figure 5.2). The biologic waste from the forests provides an attractive habitat for these species and makes these coastal wetlands very suitable for the settlement of fisheries and aquaculture ponds. The export of seafood and related product to Japan, Europe and the US is very important for many countries in Asia. For example, Thailand and Vietnam have a worldwide market share of frozen shrimp of respectively 18 and 3 per cent (Lebel *et al.* 2002).

Additionally, the trees themselves also provide various types of food and associated products. For example, condiments made of bark, vinegar, cooking oil or honey. One of the most resourceful inhabitants of mangrove forest is the *Nypa* palm. The sap in its leaves contains sugars and is suitable for the production of (fuel) alcohol and vinegar. Its roots are used in medicinal applications and food supplements.



Figure 5.2 Local villagers looking for clams in front of mangrove forest in Vietnam

## 5.4 Negative impact of human activities

### 5.4.1 Introduction

In the 20<sup>th</sup> century, mangrove resources became attractive to a larger public, causing large-scale exploitation of mangrove ecosystems. The extensive exploitation of these forests has reduced the total area of mangrove wetlands in the world drastically. The destruction of mangrove forests is caused by human activities within the forest itself, but also by activities unrelated to mangrove resources that somehow influence the mangrove habitat. Some destructive activities are discussed in the remainder of this paragraph.

### 5.4.2 Mining/Mineral extraction

Many coastal areas have rich alluvial deposits of tin, chromium and titanium. Mining of these mineral deposits has destructive effects on the present mangrove communities. The result can be total destruction of a mangrove ecosystem when mining takes place within the forest. When mining and related activities, such as partial refining, take place upstream, the deposition of overburden material can cause excess sedimentation in downstream forests. These sedimentations disturb the exchange of water, nutrients and gases within the forests, and easily destroy an entire ecosystem. This will have its effect on the fishery yields and thus on local economies.

### 5.4.3 Diversion of freshwater

The importance of freshwater run-off for mangrove forests, regulation of soil salinity and input of nutrients, is already outlined in paragraph 4.6.8. Various human activities in the catchment area may alter the amount, timing and quality of water entering

mangrove communities. Examples are the construction of roads, urban development, irrigation or diversion of water supply.

#### 5.4.4 *Forest exploitation*

Traditionally, mangrove forests have been very useful for country people in coastal areas. The forests are used for firewood, construction material and the production of charcoal. Where annual extraction is less than the annual regrowth of wood, the mangrove forests serve as a sustainable resource and its existence is not endangered. However, large-scale exploitation of forests takes place at a much higher pace, and regrowth can often not keep up with the clear felling of entire forests. Decisions to exploit are usually based on recognition of economic gain for what had been considered a worthless swamp forest. Large areas of mangrove have been lost in Indonesia and Venezuela, due to large-scale exploitation.

#### 5.4.5 *Conversion to agriculture and aquaculture*

When mangrove forest is converted into agricultural land, trees are removed, small dikes are built and a number of drainage canals is dug. Lacking the protection of the removed forest, these new farmlands are often not well protected against wave attacks and are often flooded. However, the main problem is often not due to saline conditions but to the mangrove associated acid sulphate soil conditions. Many mangrove areas have soil containing large amounts of pyrite sulphur ( $\text{FeS}_2$ ). When exposed to air, oxidation releases sulphuric acid, which strongly reduces the productivity of the land. The failure rate of this type of reclamation is therefore rather high.

The construction of fishponds or shrimp farms in mangrove forests includes the clearfelling of trees and the construction of dykes with sluice gates to retain water at all stages of the tide (Figure 5.3). Negative effects are the loss of trees and changes in drainage and run-off conditions, influencing also the adjacent parts of the forests. Other problems are the disposal of polluted water from the ponds, the vulnerability to diseases and parasites of the ponds, leading to abandonment and pyretic soil conditions. However, mangrove forests are suitable environments for aquaculture and when the relative area of ponds to mangroves remains low, the negative effects can be kept to a minimum. According to Sharid and Pramanik (1986), the ideal ratio between mangrove area and aquaculture is 4 to 1. With smaller ratios, productivity of the ponds will decrease.



Figure 5.3 Conversion from mangrove forest to shrimp ponds in Vietnam

The problems of diseases, parasites and pollution are smallest in extensive near-shore farms, where water is exchanged as a part of the daily tidal cycle. This exchange also brings in nutrients and food, reducing the need for fertilizers. Most problems are encountered in inland fisheries and large intensified farms where water exchange is less frequent and of lower quality. An additional problem with inland fisheries is that the disposal of polluted and saline water has effects on other downstream users such as rice farms. However, wave attack contributes also substantially to the failure rate of the often poorly designed ponds in near-shore waters. These dykes are usually simple structures, built with material from on-site excavation. Even the removed mangrove trees are used as construction material. When these trees start to decompose, they undermine the dykes, increasing the risk of breach (Figure 5.4).

Although fish and shrimp farms may yield several hundreds of kilograms of fish biomass, studies showed that the loss of one ha mangroves results in the loss of more than 100kg of on-site biomass, and another 600kg of finfish and 600kg of shrimp in nearby coastal waters (Lebel *et al.* 2002). Adding to this the high failure rate due to poor pond design and inappropriate management, the question arises if the overall benefits of the conversion to aquaculture were worth the sacrifice of the original ecosystem.



Figure 5.4 Breached dyke of shrimp farm, built of clay and trees

#### 5.4.6 Coastal development

Urban development in the coastal zone in general has many negative effects on nearby coastal forests. Especially in high-income countries, the conversion of mangrove land to domestic and industrial areas is becoming a growing threat to coastal wetlands. The most common forms of conversion are to housing and residential development, coastal tourist facilities and industry, including small port development. The effects are direct loss of mangrove wetland, changed and polluted freshwater run-off, disturbance of wildlife, noise pollution and the use of pesticides.

#### 5.4.7 Salt pond construction

Mangrove ecosystems are very suitable for the construction of salt pond because they are close to the sea and relatively flat. The construction of salt ponds often requires the complete eradication of the trees, levelling and dyking of the land, construction of a flooding canal system and intensive compaction of the soil surface. These ponds may later be abandoned for various reasons, leaving an area unsuitable for recolonisation by mangroves.

#### 5.4.8 Construction of channels and harbours

The direct effect of construction of harbours and (access) channels is the loss of all trees in the construction area. Indirectly, the increasing activity in the area will disturb the ecosystem and the loading and unloading facilities are potential spill sites for oil and chemicals.

#### **5.4.9** *Solid waste disposal*

With growing human populations in coastal areas, the amount of solid waste materials and garbage increased. In countries with inadequate waste management large amounts of waste material and garbage has been dumped in mangrove forests that were believed to have little value. Apart from the direct loss of trees, the dangers of these activities come from toxics that leach from the waste material.

#### **5.4.10** *Liquid waste, oil and other hazardous chemicals*

As a result of increasing urban, agricultural and industrial activities, the discharge of liquid waste has also increased, forming potential danger for downstream mangrove communities. A special case is the disposal and spilling of oil that eventually reaches the forests. The oil covers the stems and roots of mangroves, disturbing the exchange of gases and water. This can be lethal within a few days. A long-term effect of oiling of mangroves is the chronic poisoning of the mangroves and associated fauna.

### **5.5** **Reforestation of mangroves**

Reforestation of mangroves is very difficult and often unsuccessful. Additionally, the recovery of mangrove forests cannot be compared to the rate of destruction by human activities. Therefore, the most effective way to preserve this potentially sustainable natural resource is to protect it from the effects of human activities.

Nevertheless, reforestation projects can still be useful and successful on a local scale. Especially when local communities are involved in reforestation projects, awareness of the value of mangrove forests and their vulnerability is also improved. This way, the loss of mangrove forests due to overburden of their resources is also fought.

In Vietnam, recent reforestation in the northern coastal provinces has been fairly successful. This reforestation was executed by the Vietnam Red Cross Society and funded by the Japanese Red Cross. Since 1997, over 5,000 ha of mangroves were planted along dyke systems of 53 communes in 6 provinces. After a survey in 2002, up to 87 per cent of the newly planted trees was still well growing (Tao<sup>5</sup>, pers. comm.). Local authorities and villagers were involved in this reforestation project that included planting of mangroves, upgrading sea dykes and training of local people in disaster control. Among the objectives of this project were: an increase in supply of food from the sea, improvement of protection of human life and property, improvement of the socio-economic conditions of the involved communities, and increased awareness of the need of integrated management of the coastal zone.

### **5.6** **Final comments**

Mangroves are valuable elements of the coastal zone. They protect and stabilize shorelines, and provide local communities with employment, food and other

---

<sup>5</sup> Dang Vang Tao is Program Officer Disaster Management of the VN Red Cross Society, Hanoi, Vietnam



resources. Human activities would not be so destructive if they were in balance with nature, but this is often not the case. Traditionally, human activity in mangrove forests was limited to coastal people, serving local economies. In time, coastal wetlands became important for a larger public and large-scale intensive use of mangrove forests and related resources now has to serve national economies. Decisions to utilize mangrove forests are usually based on short-term economic gain and those who decide and benefit from the exploitation are often not the same people who will suffer from negative side effects (Lebel *et al.* 2002). In the end, loss of mangroves can lead to erosion and the loss of land. The question is, if the benefits from the activities that destroyed the mangroves will compensate for the loss of valuable land in the coastal zone.

## 6 PHYSICAL PROCESSES

### 6.1 Introduction

In order to design a measurement method on wave attenuation in mangrove vegetation, we need to have a clear picture of the physical processes involved. This chapter describes a theoretical approach to the mechanism of wave energy dissipation due to vegetation. First, the basics of respectively wave energy and dissipation of wave energy are discussed. After that, an attempt is made to relate the formulae for energy dissipation to mangrove vegetation characteristics. In the final paragraph, the findings of this chapter are summarized in order to derive what data from field research is relevant for an investigation on wave energy dissipation in mangrove forests.

### 6.2 Wave energy

Waves contain a certain amount of potential and kinetic energy. The total amount of wave energy is the sum of both potential and kinetic energy and is, per unit width, calculated by

$$E = \frac{1}{8} \rho g H^2 \quad (6.1)$$

In which  $\rho$  is the specific gravity of the water,  $g$  the gravitational acceleration and  $H$  the wave height.

During wave propagation, wave energy is transmitted in the horizontal direction of the propagation. The propagation velocity of the transmitted energy is equal to the group velocity of the waves. This is determined by

$$c_g = n \cdot c \quad (6.2)$$

In which  $c$  is the wave celerity of a single wave, and  $n$  a dimensionless factor depending on the ratio between water depth and wavelength. The wave celerity is calculated by

$$c = \frac{\omega}{k} \quad (6.3)$$

and  $n$  is described as

$$n = \frac{1}{2} \left( 1 + \frac{2kh}{\sinh 2kh} \right) \quad (6.4)$$

Herein,  $\omega$  represents the rotational speed of the waves and  $k$  is the wave number.  $h$  is the water depth. Both  $\omega$  and  $k$  are given by

$$\omega = \frac{2\pi}{T} \quad (6.5)$$

and

$$k = \frac{2\pi}{L} \quad (6.6)$$

The only parameters left are now the wave period  $T$  and the wavelength  $L$ . The calculation of the wavelength is not very easy to calculate. Because of the dispersion relation the wavelength is a function of itself:

$$L = L_0 \tanh \frac{2\pi h}{L}, \text{ with } L_0 = \frac{gT^2}{2\pi} \quad (6.7)$$

The calculation of the wavelength is thus an iterative process, with  $L_0$  as the wavelength at deep water and  $h$  the water depth. Finally we can determine the flux  $F$ , the transmitted wave energy in the direction of the wave propagation:

$$F = E \cdot c_g, \text{ or } F = E \cdot n \cdot c \quad (6.8)$$

When no dissipation occurs,  $F$  remains constant in the direction of wave propagation. Wave heights, thus wave energy and group velocity vary when water depth changes during propagation.

## 6.3 Theoretical background of wave energy dissipation

### 6.3.1 Introduction

The most effective way for wave energy dissipation is the breaking of waves. However, waves are usually transmitted over large distances in mangrove forests, losing a lot of their energy, before braking near the coast, if breaking at all occurs. When breaking of waves is left out of consideration, two energy dissipation mechanisms remain present in the mangrove forests: interaction of wave motion with mangrove vegetation, and bottom friction (Figure 6.1). Both will be discussed separately in this paragraph. Besides friction losses, waves undergo another alteration. Since the wave celerity will decrease when waves propagate into shallower water, wave heights will increase to maintain the same energy flux. This effect is called *shoaling* and will be analyzed in the end of this paragraph.

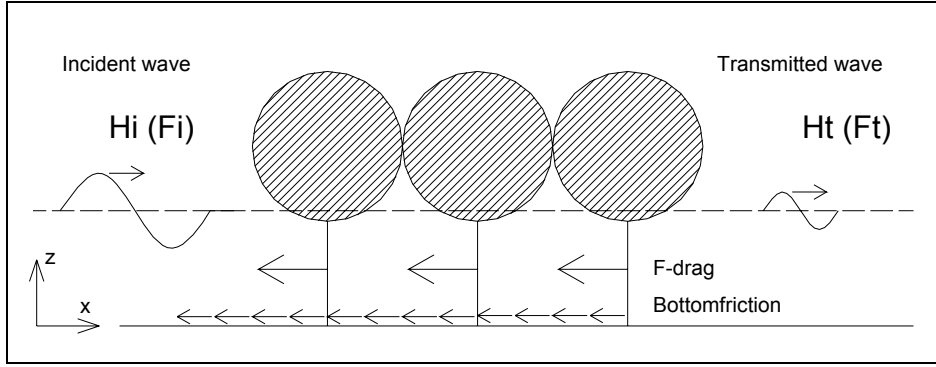

Figure 6.1 Wave energy dissipation mechanisms

We will now set up an energy balance for a control volume, stretching from a unit area on the bottom to the water surface. Starting-point is a periodically movement of the water and wave propagation in one direction. Taking all this into account, this will lead to the differential equation

$$\frac{dF}{dx} + D = 0 \quad (6.9)$$

In which  $F$  is the flux of wave energy in the direction of propagation per unit width and  $D$  the dissipation of wave energy per unit area. The dissipation in turn can be subdivided in dissipation due to bottom friction and dissipation due to interaction with the mangrove vegetation. Equation (6.9) now becomes

$$\frac{dF}{dx} + D_{bottom} + D_{vegetation} = 0 \quad (6.10)$$

### 6.3.2 Dissipation due to bottom friction

Bottom friction is often neglected in studies on wave energy dissipation in vegetation and even in situations without vegetation, it is considered to be very small (Battjes 2000). However, in transitional and shallow water depths the influence of bottom friction can become more important. In mangrove forests, water depths cannot be considered ‘deep’ when short waves are investigated. Additionally, the derivation of bottom friction provides also a good starting point for calculating the influence of the mangroves.

The time-averaged dissipation of energy in the boundary layer near the bottom ( $D_{bottom}$ ) per unit area equals (Battjes 2000)

$$D_{bottom} = \overline{\vec{\tau}_b \cdot \vec{U}_b} \quad (6.11)$$

In which  $\tau_b$  is friction tension exerted by the water to the bottom, while  $U_b$  the horizontal particle velocity just outside the boundary layer. The friction tension is proportional to the square of the particle velocity and is given by

$$\bar{\tau}_b = c_f \rho |\bar{U}_b| \bar{U}_b \quad (6.12)$$

In which  $c_f$  is a resistance coefficient that is proportional to the roughness of the bed material. On a smooth bed, this coefficient usually equals several times the grain size of the bed material. The question is if the surface in a mangrove forest can be considered smooth. Local irregularities in the bed profile or organic litter might be a more significant measure for the roughness. For sandy bed material an average value of  $c_b=0.01$  is often used (Battjes 2000).

Combining (6.11) and (6.12) gives

$$D_{bottom} = \overline{\bar{\tau}_b \cdot \bar{U}_b} = c_f \rho |\bar{U}_b|^3 \quad (6.13)$$

The horizontal particle velocity in short waves can be considered irrotational, and is given with the periodic function

$$U_b = \hat{U}_b \sin(\omega t) \quad (6.14)$$

In which  $\hat{U}_b$  is de amplitude of the horizontal particle velocity just outside the boundary layer at the bottom.

The dissipation per unit area per unit time is equal to time averaged work done by the friction force. When we substitute (6.14) into (6.13) and isolate the time-dependant factors, this leads to the following integration

$$D_{bottom} = \frac{c_f \rho \hat{U}_b^3}{T} \int_0^T \sin^3(\omega t) dt \quad (6.15)$$

which yields

$$D_{bottom} = \frac{4}{3\pi} c_f \rho \hat{U}_b^3 \quad (6.16)$$

### 6.3.3 Dissipation due to cylinders

Theoretical approaches to relate (mangrove) vegetation to the dissipation of wave energy are usually based on wave forces on cylindrical structures, similar to methods used in offshore engineering. In offshore engineering, the submerged components of the structures (piles) have dimensions that are at most of the same order as the wavelength. Of course, a mangrove forest cannot be considered as a wave filter of

evenly distributed, vertical, cylinders (stems and roots). Nevertheless, it can provide a useful starting point on introducing mangrove vegetation characteristics into theoretical formulae on wave energy dissipation.

As mentioned, the dissipation of wave energy due to the presence of a cylindrical body is caused by interaction of the water motion with the structure. The fluid force on a vertical cylinder is the sum of an inertia force and a drag force. In a real, viscous fluid, flow will separate from the structure, causing a wake downstream of the body. Hence, water pressures are not the same on the forward and the rearward side of the structure, and no longer cancel. The latter is the case in an ideal, non-viscous fluid. The resulting force is called the drag force. Additionally, due to the presence of a fixed and impermeable body, the flow has to be diverted around the structure. The force, exerted on the water to divert the flow is related to the volume of the displaced water and is called the inertia force.

The time-averaged dissipation of energy on the incremental length of a single cylinder equals the rate of work done by the above-mentioned forces and can be expressed as

$$dD_{cylinder} = \overline{(d\vec{F}_D + d\vec{F}_I) \cdot \vec{U}_{orb}} \quad (6.17)$$

In which  $F_D$  and  $F_I$  are respectively the drag force and the inertia force on a cylinder of incremental length,  $dz$ ;  $U_{orb}$  is the horizontal orbital particle velocity, expressed by

$$\vec{U}_{orb} = \hat{U}_{orb} \sin(\omega t) \quad (6.18)$$

In which  $\hat{U}_{orb}$  is the amplitude of the horizontal orbital particle velocity.

The inertia force depends on the derivative of the particle velocity  $dU_{orb}/dt$  and should thus cancel over each wave period when waves are periodic and symmetric. In nature, not many waves are perfectly symmetric. However, for cylinders of small diameter compared to the wavelength inertial forces are small compared to drag forces (Ippen *et al.* 1962). Mangrove roots and stems have typical diameters in order of centimeters (Tomlinson 1986, Sato 1989). The wavelength of wind waves and swell, subject of this study, are likely to be one or two orders of magnitude greater than the average root diameter. In this case the drag forces become dominant and inertia forces can be neglected (Battjes 2000). The remaining drag force, per unit length per cylinder is expressed by

$$dF = \frac{1}{2} \rho C_D d \vec{U}_{orb} \left| \vec{U}_{orb} \right| dz \quad (6.19)$$

Where  $d$  is the diameter of the cylinder and  $C_D$  is the drag coefficient. The drag coefficient is a function of the Reynolds number (Re) and the shape and orientation of the structure (Appendix II).

When we let  $n$  be the density of the cylinders (number  $\text{m}^{-2}$ ) and substitute (6.19) into (6.17) the dissipation per unit area per unit length becomes

$$dD_{n \text{ cylinders}} = \frac{1}{2} \overline{\rho C_D n d |\vec{U}_{orb}|^3} dz \quad (6.20)$$

substitution of (6.18) in (6.20) and time-average integration over a wave period yields, analogue to (6.15)

$$dD_{n \text{ cylinders}} = \frac{\rho C_D n d \hat{U}_{orb}^3}{2T} dz \int_0^T \sin^3(\omega t) dt = \frac{2}{3\pi} \rho C_D n d \hat{U}_{orb}^3 dz \quad (6.21)$$

To find the total  $D_{n \text{ cylinders}}$  we need to integrate equation (6.21) over the full depth. It is here where the characteristics of mangroves begin to play a role. For an array of cylinders with constant diameter this is not very difficult. Integration over the full depth would yield  $D_{n \text{ cylinders}}$  and could, together with (6.16), be added to (6.10). Solving (6.10) would yield an equation in which the wave height is a function of the distance travelled by the waves. However, mangroves cannot just be schematized as an array of vertical cylinders with constant diameter over the full depth. A closer look will be taken upon the characteristics of mangroves in paragraph 6.4.

In the remainder of this paragraph we will take a closer look at two terms used in the previous sub-paragraphs, the particle velocity and shoaling.

#### 6.3.4 Horizontal particle velocity

In equation 6.18 we introduced the horizontal particle velocity. Although it is obvious that a periodically wave can be described with a sine, the amplitude of this velocity still needs to be defined. For relatively small waves, linear wave theory can be applied to describe the waves (Battjes 2000). The limits of validation for linear wave theory are defined by  $H/gT^2 < 0.01$  and  $h/gT^2 > 0.02$  (see Appendix II), but has proved to be applicable outside this range (Schierreck 2001). The tidal range on mangrove-fringed coasts varies from a few decimeters up to 11 meters, but 3 to 4 meters is a normal average (Kjerve 1990). In linear wave theory, the limits for transitional water depth are often defined as  $1/20 < h/L < 1/2$ . However, these limits are not very strict. In the case of transitional depth, the amplitude of the horizontal particle velocity is described by

$$\hat{U}_{orb}(z) = \omega a \frac{\cosh k(h+z)}{\sinh kh} \quad (6.22)$$

In which  $a$  is the amplitude of the waves,  $1/2H$ . The particle velocity in equation 6.21 is now defined along the vertical  $z$ -axis.

In Mazda *et al.* (1997a) waves with periods of 5-8 seconds were measured on a mangrove vegetated shoreline. The recorded water depths were ranging from 0 to 1.5 m with wave heights in the order of 0.2 m. When we use equation 6.7 to calculate the

wave length at a depth of 1.5 m and a period of 5 second we find  $L = 18.75$  m and  $h/L = 0.08$ . This is within the limits of transitional water depth. It is, however, possible that conditions are met outside these limits. Additionally, there is also a phenomenon that in dense vegetation, horizontal particle velocities decrease rapidly in top of the vegetation. Further down, the velocities remain constant (Mol 2003). When this happens, the horizontal velocities can become more or less constant over the water depth. This would approximate shallow water conditions. When these conditions are met when  $h/L < 0.05$ ,  $\sinh(kb)$  then approaches  $kb$  and  $\cosh(kb)$  approaches 1.

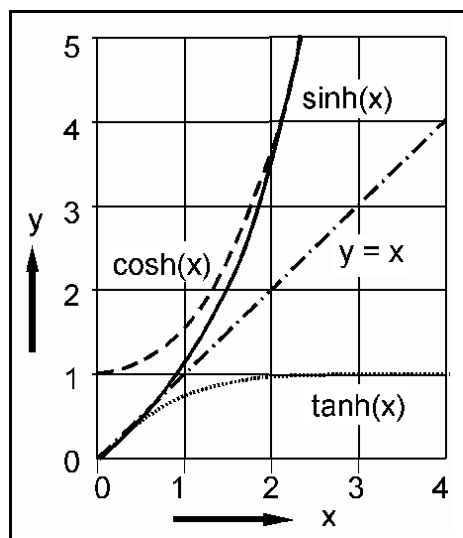

Figure 6.2 Hyperbolic functions,  $x$  represents  $kb$

The horizontal particle velocity will then read

$$\hat{U}_{orb} = a \sqrt{\frac{g}{h}} \quad (6.23)$$

The particle velocity is now constant over the water depth and the pressure distribution hydrostatic. In turn, integration of equation 6.21 in  $z$ -direction becomes less complicated. Even if shallow water conditions are not met, dense mangrove vegetation might cause a depth constant velocity profile, resulting in simplified calculations. Comparison of field measurements will have to answer this question. However, we will first assume that water depths are transitional. The case of shallow water conditions is also covered by equation 6.22.

### 6.3.5 Shoaling

As mentioned before, wave heights tend to increase when waves travel into shallower water. If we neglect the dissipation in equation 6.9 and solve it, we get

$$E \cdot n \cdot c = const \quad (6.24)$$



The wave celerity will decrease and wave heights will increase. This effect can be described with linear wave theory. Slopes of around 1:300 are common within mangrove forests (Schierreck 2001), but more gentle slopes have been reported (see paragraph 4.5.3). We take again the example from paragraph 6.3.4, use a slope of 1:400 and calculate the effect of shoaling.

		X=0 m	X=100 m
h	[m]	1.5	1.25
n	[-]	0.989	0.983
c	[m/s]	3.73	3.39
H	[m]	0.200	0.209

Table 6.1 Example of shoaling for typical mangrove forest conditions

Although water depth decreased 17 %, wave heights only increased by less than 5 %. This suggests that *shoaling* will not have great influence on the outcome of equation 6.10 when dissipation by vegetation is significant. It also means that  $h$ ,  $n$  and  $c$  can be kept constant (or averaged) over this interval and 6.10 becomes a differential equation for the wave height,  $H(x)$ .

## 6.4 Characteristics of mangrove vegetation

### 6.4.1 Introduction

In this paragraph, we will take a closer look on mangrove vegetation and ways to introduce its characteristics in calculations on dissipation. A brief discussion on some earlier studies on wave energy dissipation in vegetation and some practical solutions are also included.

### 6.4.2 Problems with introducing mangrove characteristics in dissipation formulae

Equation 6.21 shows that the dissipation due to cylindrical objects is proportional to a drag coefficient  $C_D$ , some vegetation characteristics forming the exposed cross-area to waves, and the third power of the amplitude of the horizontal orbital velocity. As mentioned before, a mangrove forest is not an evenly distributed array of cylinders. The problems of introducing vegetation characteristics can be sub-divided into problems with integrating equation 6.21 over the full depth and, after that, problems with solving equation 6.10 for  $x$ .

The problems in vertical direction are:

- The number of roots and stems is not constant in vertical direction;
- The diameters of roots and stems are not constant in vertical direction;
- Root structures vary with mangrove species;

After obtaining  $D_{vegetation}$ , equation 6.10 can be solved in horizontal direction  $x$ . Here, we encounter the following problems:

- $C_D$  is a function of  $Re$  and might not be constant in horizontal direction;
- Due to zonation, vegetation characteristics are not constant in horizontal direction;
- Due to zonation, bottom slopes may vary in horizontal direction;

Additionally, it is not certain if bottom friction can be neglected. It remains unclear what is a representative measure for the roughness, and thus what is a reasonable value for  $c_f$ .

#### 6.4.3 *Some earlier studies on dissipation in vegetation*

Earlier studies have been conducted on energy dissipation in vegetation. The ones that are considered useful by the present author are briefly discussed below.

Groen (1993) calculated and measured wave attenuation through pneumatophores at DUT. His study focused primarily on wave dissipation in pneumatophore. This situation is not very realistic since the average length of pneumatophores is only a fraction of the average tidal range on mangrove-fringed coasts. This study focuses more on waves that are potentially destructive for the hinterland. However, the theoretical approach in Groen (1993) has been useful for this study.

Mazda et al (1997a) did very interesting research on wave attenuation in mangrove forests. They measured waves along a transect with unmanned data recorders and measured vegetated cross-areas in the forest. However, they added the mangrove contribution as an (empiric) bottom friction parameter in Brettscheider's formula. This is physically not correct.

The theoretical approach by Mol (2003) has also been very useful for this study. His measurements salt marshes confirmed his calculations. Although equation 6.27 seems too much in detail for mangrove forests, with the right choice of  $d_z$  it is useful. It is also physically correct.

#### 6.4.4 *Introducing mangrove vegetation characteristics*

When we use the methodology of Mol (2003) and consider the drag coefficient constant in vertical direction for given water depth, solving equation 6.21 would mean, in transitional water depth

$$D_{vegetation} = \frac{2}{3\pi} \rho C_D \int_0^h n(z) d(z) \hat{U}(z)_{orb}^3 dz \quad (6.25)$$

Where  $n(z)$  is now the number of tree elements and  $d(z)$  the diameter of these elements. Although variable vegetation characteristics in vertical direction are now defined, it is possible that density and diameter are not smooth, continuous functions of the water depth. Additionally, when all elements have different diameters the integration above will have to be executed  $n$  times because the depth dependent functions can not be treated separately, since

$$\int_0^h n(z) d(z) \hat{U}(z)_{orb}^3 dz \neq \int_0^h n(z) dz \cdot \int_0^h d(z) dz \cdot \int_0^h \hat{U}(z)_{orb}^3 dz \quad (6.26)$$

There are, however, some possibilities for simplification. Sato (1989) found some relationships between diameter of roots and distance from the stem in some *Rhizophora* species. However, only 5 trees were used for this study, and nothing was found in literature on vertical distribution of pneumatophore-diameters and the distribution of the length of these roots. Information about other root systems is very sparse, although prop roots and stilt roots are the most occurring form of root systems.

Nevertheless, the basic principle of 6.24 is that a vegetated cross-area is multiplied by the third power of the amplitude of the horizontal orbital velocity. Thus, 6.25 can be written as

$$D_{vegetation} = \frac{2}{3\pi} \rho C_D \int_0^h A'(z) \hat{U}(z)_{orb}^3 dz \quad (6.26)$$

In which  $A'$  is the cross-area of the vegetation in the horizontal plane. Solving equation 6.26 for general purposes is only possible by numerical integration since  $A'(z)$  might not always be a clear function in vertical direction. That means that an average  $U_{orb}$  has to be calculated for each  $\Delta z$ . After applying a 3<sup>rd</sup> power to these velocities, these values have to be multiplied by  $\Delta z$  and  $A'$  over  $\Delta z$ . Thus, the following approach is used:

$$\int_0^h A'(z) \hat{U}(z)_{orb}^3 dz = \sum_{z=1}^{h/\Delta z} A' \bar{U}_{orb}^3 \cdot \Delta z \quad (6.27)$$

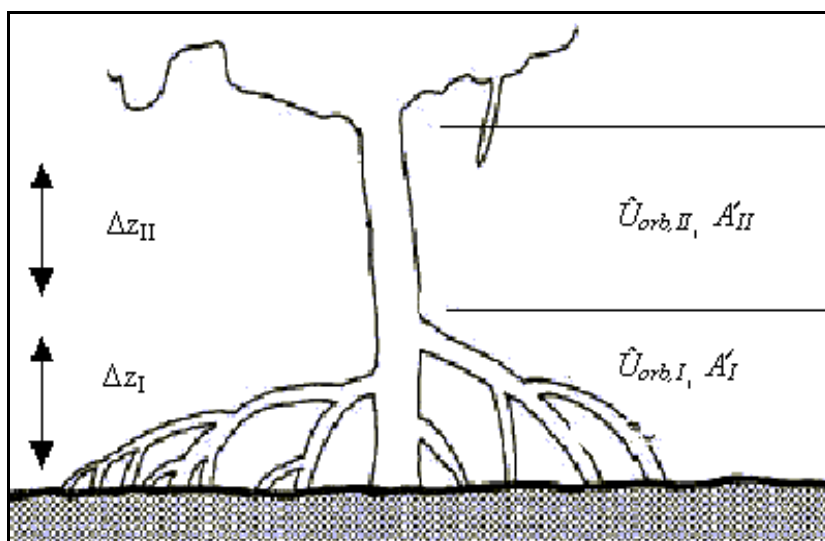

Figure 6.3 Numerical approach to dissipation mechanism by vegetation

Mazda *et al.* (1997b) found relative ‘smooth’ vertical distributions of cross-areas for some *Bruguiera* and *Rhizophora sp* (see Appendix II). Although this is limited to only two genera, the results are promising and more comparable information for other species will be useful.

The actual formula to calculate the dissipation per unit area for mangroves is now:

$$D_{vegetation} \approx \frac{2}{3\pi} \rho C_D \sum_{z=1}^{h/\Delta z} A' \overline{U}_{orb}^3 \cdot \Delta z \quad (6.27)$$

It is important to choose  $\Delta z$  not too big, because an average  $U_{orb}$  will not be representative. On the other hand, a too small  $\Delta z$  will lead to unnecessary calculations.  $\Delta z$  should at least make distinction in significant changes in vertical direction, e.g. pneumatophores, prop roots, branches, etc.

## 6.5 Summary

From this theoretical approach, the following aspects are important for future fieldwork:

- A transect has to be laid out within a mangrove forest, preferably in the direction of wave propagation. Measurement will have to be taken along this transect and it will function as  $x$ -axis.
- To neutralize the problems caused by zonation in mangrove forests, field research should be conducted within these zones. Mangrove vegetation will be more or less homogeneous in lateral direction and slopes will be constant. Transitional zones should be avoided.

Dissipation in (mangrove) vegetation is caused by bottom friction and by interaction with the trees. In bottom dissipation it remains unclear what the friction coefficient for typical ‘mangrove’ bed material is. It is, however, likely that bottom friction can be neglected in dense vegetation.

The dissipation by mangroves is relative to the vegetated cross-area of the submerged trees and the horizontal particle velocity. The (vertical) distribution of the cross-area needs to be determined and varies per species. The dissipation per unit area can be calculated by numerical integration of cross-area and particle velocity. When tree characteristics are constant in horizontal direction between measurements, and water depth and group velocity are averaged over the same interval, attenuation is found by solving the following differential equation, of which all elements are discussed the previous paragraphs:

$$\frac{dF}{dx} + D_{bottom} + D_{vegetation} = 0$$

Fieldwork should thus include:

- A field survey. This will yield information on vertical elevation and bottom slopes along the transect.
- Wave measurements. This will provide the distribution of waves along the transect and thus information about the flux of wave energy and particle velocities.
- The vegetation survey of the (mangrove) vegetation will provide the vertical distribution of the vegetated cross-area per unit area and density in lateral direction.

Other important subjects

- The parameters  $\rho$  and  $c_f$  have to be determined. The first one by sampling during wave measurements, the second one by soil sampling of bed material (in case of smooth bed) or by determination of an equivalent roughness.
- When all other parameters are determined, it can be evaluated if  $C_D$  by Mazda *et al.* (1997b) for cylinders can be used, despite the fact that orientation and texture of mangrove roots and stems may differ from case to case.

The following chapters will subsequently deal with the methods how to obtain the required data and with the experiences from a fieldtrip to Vietnam.

## **7 FURTHER ANALYSIS FOR FUTURE FIELDWORK**

### **7.1 Introduction**

This chapter forms a rough design for field measurements in mangrove vegetation. It will start with an overview of the findings of the previous chapter regarding to data collection from field measurements. The various elements of these measurements are discussed in more detail in this chapter. The initial design in this chapter will be discussed together with the experience of the field trip in chapter 9.

### **7.2 Required data from fieldwork**

In the previous chapter, it became clear that investigation of wave attenuation in mangrove forests requires the following activities or measurements:

- Determination of bottom profile and roughness along measurement transect;
- Determination of vegetation characteristics in vertical and horizontal direction;
- Wave measurement at subsequent locations in direction of propagation;
- Determination of water density at each wave measurement;
- Determination of water depth at each wave measurement.

In the following paragraph we take a closer look at the importance and determination of the above mentioned aspects.

### **7.3 Bottom characteristics**

As mentioned in Chapter 6, it is very likely that dissipation of wave energy due to bottom friction is insignificant when compared to dissipation by mangrove vegetation. However, since mangroves usually grow on muddy shores, formed by fine sediments from river discharges (paragraph 4.6.7), the actual friction coefficient may not be determined by characteristic grain size of the substrate. Irregularities in the substrate or (biological) debris might then cause a thicker boundary layer and form a more realistic measure for bed roughness. In this case, an assessment of the soil texture might be needed, supported by photographs or measurements in order to model the roughness at a later stage to isolate its influence.

### **7.4 Profile determination**

#### *7.4.1 Introduction*

Topographic measurements along transects are needed for two reasons. Firstly, it can be used to determine water depths when tidal information is available. Secondly, it provides information of the bottom slope within the forest. This is also a possible indication for zonation of the vegetation (paragraph 4.5.3). After topographic measurements a profile of the transect can be drawn (Figure 7.1) and linked to tidal information.

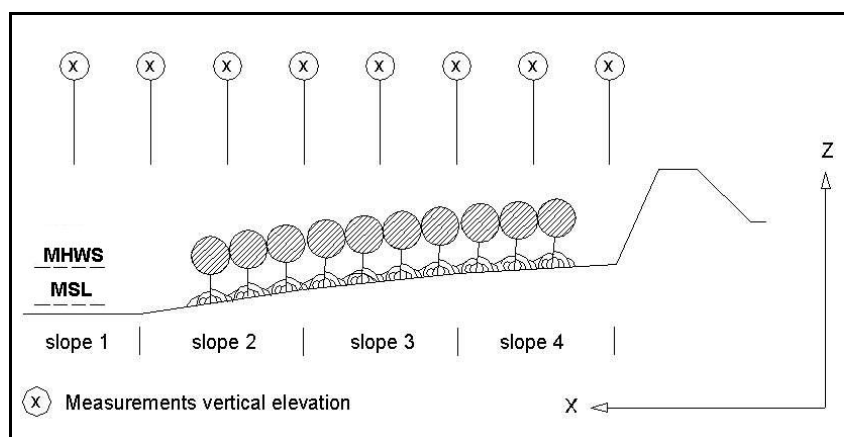

Figure 7.1 Example of profile sketch

#### 7.4.2 Level instrument

There are two basic methods for topographic measurements in mangrove wetlands. First method is to use a level instrument and rod and measure at certain intervals along a transect. Measurements have to be related to established benchmarks. These are usually tied to national elevation network and can be found on structures like dykes and bridges or in harbours. If these benchmarks are not available, or located too far from the mangrove area, it is necessary to establish a relative benchmark. This can be done by pounding a metal or wooden post firmly into the ground, or create a marker on a nearby solid structure. This relative benchmark can later be related to a national network using tidal measurements or execute a land survey to the nearest established benchmark.

#### 7.4.3 Tidal measurement

The second method is to use tidal information and mark water levels on a series of rods or on the trees. In combination with the time of the measurement, the level of the marker can be determined and measured back to the surface. The latter method can be executed in a faster but less accurate way, by only measuring the water depth and note depth and time of measurement. The elevation of the substrate can be calculated at a later time with the help of tidal information. This method requires up-to-date and accurate tidal information such as tide tables.

#### 7.4.4 Frequency

There is not a clear definition of the frequency of elevation measurements in horizontal direction. Kjerve (1990), states that measurements should be taken every 10-30m. No further arguments for are given for this interval. It is obvious that more measurements give more information, but slopes in mangrove forest are usually very gentle and in the order of 1 to several hundred meters (paragraph 4.5.3). Since level instruments are designed to be used within a range of approximately 75m and have an accuracy of 10-15mm (Zondag 1997), intervals between measurements of several meters are too small. The limits given by Kjerve are therefore not very strange and will provide useful readings. However, the determination of the interval for elevation measurements should always take into account the conditions of the study area. Local

disturbances could require more readings and depending on the distance between subsequent wave measurements, intervals might be adjusted. It is recommended to have at least one or two measurements between to subsequent wave measurements to determine if vertical elevations are evenly distributed between wave measurements.

#### 7.4.5 Possible difficulties

Travelling with level instrument and rod through a mangrove forest is not an easy task because of soft and unstable substrates, the presence of tidal creeks and mangrove root systems. Additionally, instrument readings can be difficult or even impossible due to dense vegetation. A possible solution for this is to execute the measurements from an elevated position (e.g. a dyke or platform built for the occasion). This requires limited height of the trees and a visible horizon in case the distance instrument and rod exceeds the maximum range. An example is given in Figure 7.2.

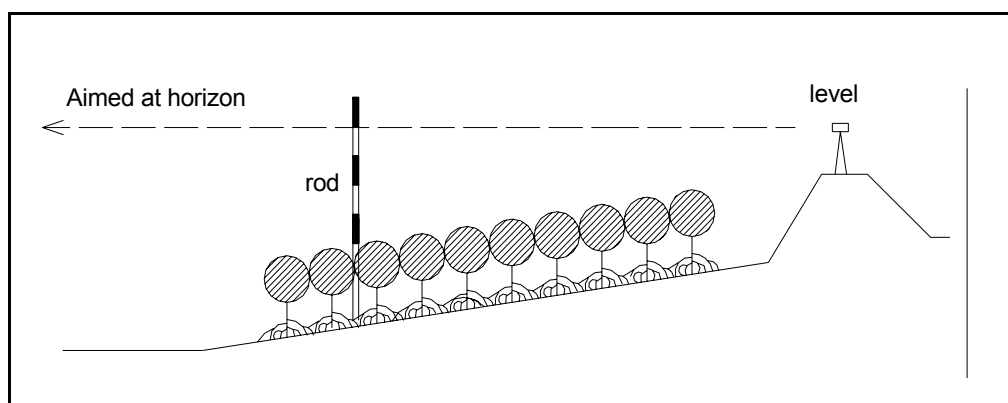

Figure 7.2 Levelling from elevated position

### 7.5 Wave measurements

#### 7.5.1 Introduction

To determine the dissipated wave energy between two points, i.e. the reduction of energy flux, wave height, wave period and water depth need to be recorded at these two locations. With the wave period and water depth, wavelength can be determined and the energy fluxes can be calculated. The reduction of wave heights can be calculated by formula 6.10 and compared with measurements. The rate of reduction of wave heights is defined as

$$r = \frac{H_I - H_T}{H_I} \quad (7.1)$$

Where  $H_I$  is the incident wave height and  $H_T$  the transmitted wave height.

#### 7.5.2 Location of measurements

Waves should be measured at two or more subsequent locations along the chosen transect. The number of locations depends on the size and the level of zonation of the forest. It is a possibility to measure at only two locations; in the front of a forest and



on the landward side of it. This will provide information of wave attenuation in one particular forest on one particular location. However, when vegetation characteristics such as species, root system and tree dimensions are not constant in horizontal direction, it will be difficult to relate these distinct features to the dissipation of wave energy. It is therefore recommended to take wave measurements at the front and the end of one or each separate zone within the forest

### 7.5.3 Measurement techniques

Wave can be measured by recording the vertical fluctuations of the water surface, or by recording of pressure fluctuations somewhere below the water surface. Using the first method, wave heights are found directly. Using the second method, wave heights have to be recorded from the pressure data. Calculation of wave heights from pressure data is included in (Appendix III).

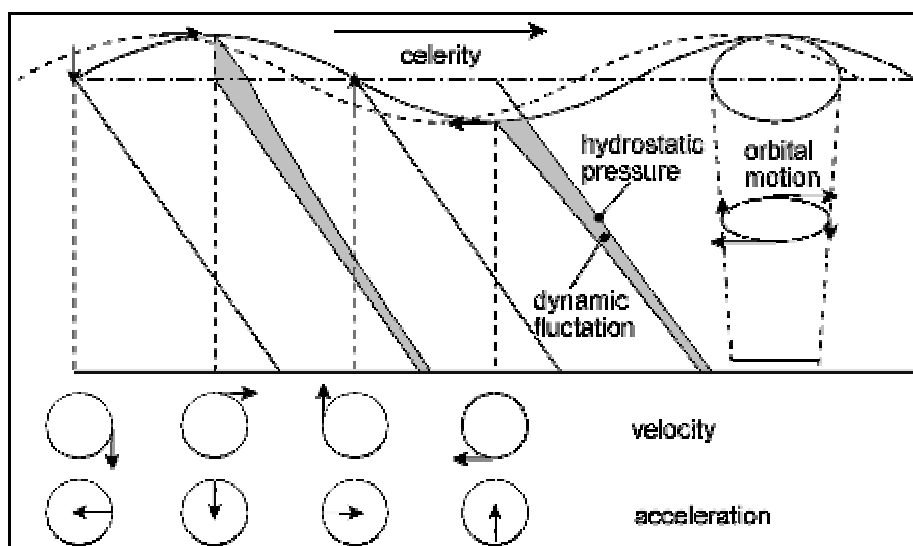

Figure 7.3 Wave motion and pressure distribution in periodic waves. After Schiereck (2001).

In short waves in deep water and in transitional water depths the vertical acceleration of water particles cannot be neglected (Figure 7.3). Pressure distribution is therefore not hydrostatic and water pressure consists of a hydrostatic component, caused by the water depth, and a dynamic component, caused by wave induced water movement<sup>6</sup>.

The pressure is calculated by (Battjes 2000):

$$p = -\rho g z + \rho g a \frac{\cosh k(h+z)}{\cosh kh} \sin(\omega t - kx) \quad (7.2)$$

After eliminating the hydrostatic component and adding the water depth, wave period and calculated wavelength, the surface fluctuations  $a$  can be calculated from the pressure data, using (7.2).

<sup>6</sup> Note that when a pressure gauge is deployed too deep, no dynamic fluctuation is recorded and only hydrostatic pressure is observed. This happens when  $h/L > 0.5$  and the pressure gauge is deployed at or near the bottom ( $z \approx -h$ ). In that case,  $\cosh k(h+z) \rightarrow 1$  and  $\cosh(kh) \rightarrow \infty$  (see also Figure 6.2)

#### 7.5.4 Logistics

Waves have to be measured at different stages of the tide i.e. at different levels of tidal inundation of the vegetation. In this way, the effect of increasing or decreasing exposed area of the trees can be investigated. Each series of measurements consists of wave and water depth recordings along a transect at more or less the same levels of tidal elevation. When measurements are executed with one set of equipment, travelling from one location to the next is required. Depending on distance between measurements and tidal range, the maximum time between measurements can be very short. Wave heights vary with tidal elevation (Mazda *et al.* 1997a). The influence of changing water levels, and thus wave heights, might contaminate the data if there is too much time between recordings.

The best method is to measure simultaneously at multiple locations. If this is not possible, equipment has to be moved quickly between locations. This requires a boat or the construction of a boardwalk above the water surface.

#### 7.5.5 The use of significant wave heights

Since wave measurements will show that no single wave is alike, a representative wave is needed to compare between different recordings. The significant wave height ( $H_s$ ) is a value that is often used for this purpose (Appendix III). The significant wave height is the average of the highest  $1/3$ -part of the recorded wave heights, and appears to approximate visual observations of waves (Battjes 2000). There is a possibility to determine a  $T_s$  analogue to  $H_s$ , but avoid complexity, the average wave period  $T_{av}$  can also be used.

#### 7.5.6 Determination of water depth

Water depth at the location of the wave measurements can be measured at location during wave recording. It can also be calculated at a later time from tide tables and the measured elevation profile. A third method is to derive the water depth from the data of the wave measurements. The latter is only possible when a pressure gauge is used for wave measurements. Calculation of water depths based on tide tables and survey data is not very reliable; tidal information is usually accurate within 5 or 10 centimeters and, depending on the distance between study area and tide station that provides the information, times at which tidal elevations occur may differ from the tables.

The most effective way is thus to measure the water depth during the wave measurements. To cancel the fluctuations in the water surface, a perforated tube can be used. The small perforations prevent short wave fluctuations to influence the water surface in the tube, i.e. the average water level. When the height of the tube relative to the ground is determined, water depths can be measured from the top of the tube down to the water surface inside.

It is also possible to insert a floating body with a scaled rod in the tube. This is interesting to deploy at some distance offshore for tide recordings when there is insufficient or no tidal information at all (Figure 7.4).

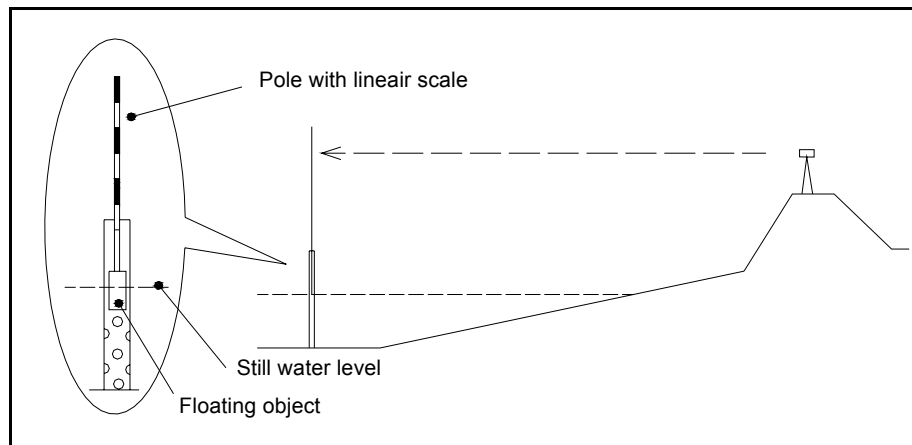

Figure 7.4 Long-distance water level readings

## 7.6 Vegetation survey

### 7.6.1 Introduction

As shown in Figure 7.5, the vegetation density within a mangrove forest can be divided into a vertical density and a horizontal density. In vertical direction, the stages of immersion determine which part of the trees is exerting force on the waves. In horizontal direction, the number of trees and roots per unit area determines the density and thus the contribution to drag forces. Distinction can be made between inundation of the root system, the root system and the stems, and inundation of the tree including the canopy.

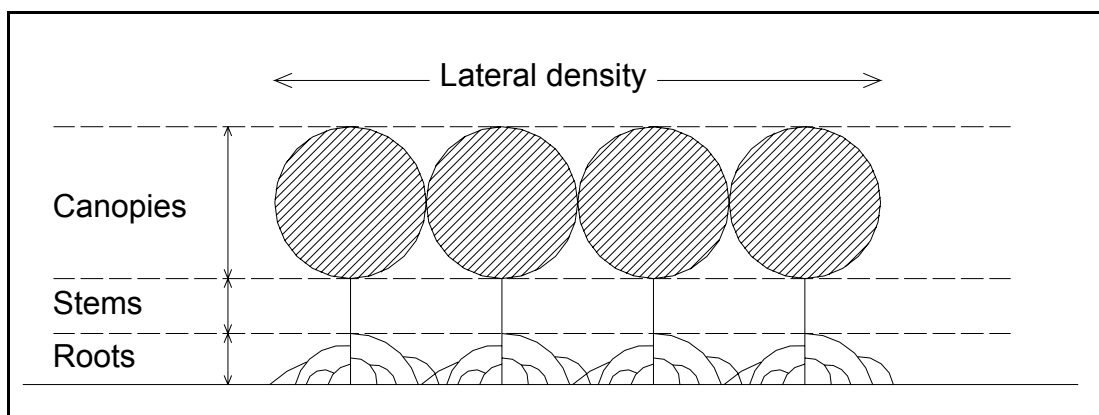

Figure 7.5 Mangrove densities in vertical and horizontal direction

### 7.6.2 Difficulties

For the calculation model outlined in chapter 6 a depth integrated exposed cross-area of the vegetation per unit area is needed. The complex root systems in mangrove forest will make this a difficult task. In earlier studies on wave attenuation in mangrove forests, vegetation is usually modelled as cylinder-like structures, evenly distributed over a certain area. In real mangrove forests, this will only partly be the case (e.g. pneumatophores and tree stems), and the orientation of roots will be quiet

irregular. Additionally, tree elements such as small branches and canopies are flexible structures on which the theory in chapter 6 may not be applicable.

### 7.6.3 Approach

Tree characteristics should preferably be introduced in the dissipation calculations as a parameter per square meter. However, some of these features such as tree spacing and dimensions of a single root system may be of a larger order than one meter. Therefore, vegetation survey should be carried out in larger quadrants and averaged per square meter.

A vegetation survey start with the recording of species along the transect. This information can, like the topographic survey, be useful to identify possible zonation patterns within the forest. After the identification of different zones, tree characteristics can be recorded in quadrants of approximately  $5 \times 5$  or  $10 \times 10 \text{ m}^2$  at regular intervals, depending on the forests conditions. The best result is to investigate the entire transect, but this very time consuming. In earlier studies (Mazda *et al.* 1997a) it became clear that within distinct zones, tree characteristics were more or less constant. The challenge is to find the tree or forest characteristics that allow a classification of mangrove forests related to the rate of energy dissipation

Depending on the type of tree element, the survey can include determination of density per square meter (i.e. pneumatophores), tree spacing, measurement of diameter (all elements) and orientation. An overview is given in Figure 7.6.

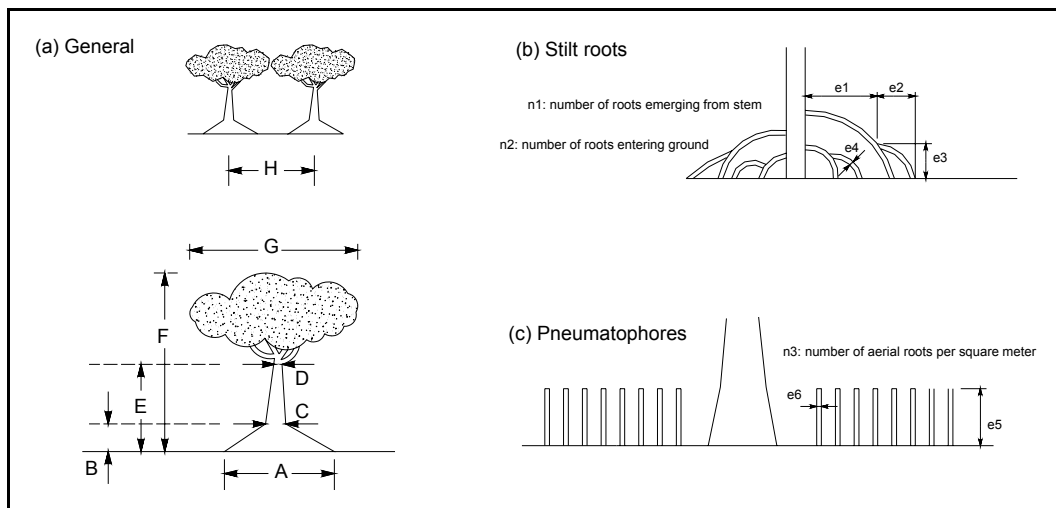

Figure 7.6 Tree elements

## **8 DESCRIPTION OF THE CASE STUDY**

### **8.1 Introduction and objectives**

A case study in the Red River Delta, Vietnam is included in this thesis as a pilot-project for future fieldwork. The visit to Vietnam lasted from 13<sup>th</sup> of January to 18<sup>th</sup> March 2004, including three weeks of fieldwork in a mangrove forest.

The main objective of the case study was to gain experience on working in mangrove swamps in order to make this study as complete as possible. To gain this experience, a small-scale investigation on wave attenuation was executed including the following activities:

- Measurement of waves in a mangrove forest;
- Execute a field survey to gain information on vertical elevation and slope within the forest;
- Observation of mangrove habitat and (tree) characteristics useful for investigation;

Additionally, the overall objective of this fieldwork was to experience conditions and difficulties that influenced the work and should be taken into account in the future.

### **8.2 Framework of the fieldwork**

The Hanoi Water Resource University (HWRU) in Hanoi, Vietnam, hosted the visit to Vietnam and helped finding a study area and preparing the fieldwork. The HWRU also assigned one of their students to participate in the fieldwork and act as assistant and interpreter. Delft Cluster supported the project financially and practically, by the use of their office facilities.

The fieldwork was executed with permission of the Haiphong Dyke Department. Local dyke authorities, People's Committee, Coastguard and forestry authorities were notified at the start of the work.

### **8.3 Study area**

#### *8.3.1 Choice of the study area*

On arrival the choice of a study area has been discussed at the HWRU. The main requirements were an area with considerable mangrove vegetation and nearby accommodation in order to limit the distance that had to be travelled daily. Main difficulties were the bureaucratic procedures that are needed to get permission for the work. In order to limit procedures, Hai Phong Province was chosen because the HWRU and the Hai Phong Dyke Department are both part of the Ministry for Agriculture and Rural Development (MARD) and permission could be arranged on short notice. A one-day fieldtrip was organized to inspect a mangrove forest near Do Son. This area was chosen for the fieldwork because the forest seemed suitable for the

investigation and accommodation in Do Son was only a few kilometers away from the site.

### 8.3.2 Description of the study area

The study area is located at the coastal area of Tan Tanh village in Kien Thuy district, Hai Phong province, Vietnam (Figure 8.1). Hai Phong province is part of densely populated Red River Delta in northern Vietnam and located on the coast of the Gulf of Tonkin. With approximately 1.5 million inhabitants, Hai Phong City is the third largest city of Vietnam. With its harbor facilities, many waterways, industry and highway connection with Hanoi, Hai Phong province is an active part of the coastal zone and has great value for the national economy. Hai Phong province, with an area of 1518 km<sup>2</sup>, has a population of 1.67 million people (1997) of which approximately 457 thousand are working in agriculture, forestry or fishery (Minot *et al.* 2003).

The average rainfall in the area is around 2000 mm/yr of which 500-700 mm falls in the wettest month, September. Average winter temperature (January) is 17°C and average summer temperature (July) is 28°C. The region has a diurnal tide with an annual maximum range of 4 m and is crossed by typhoons twice a year on average (Toms *et al.* 1996).

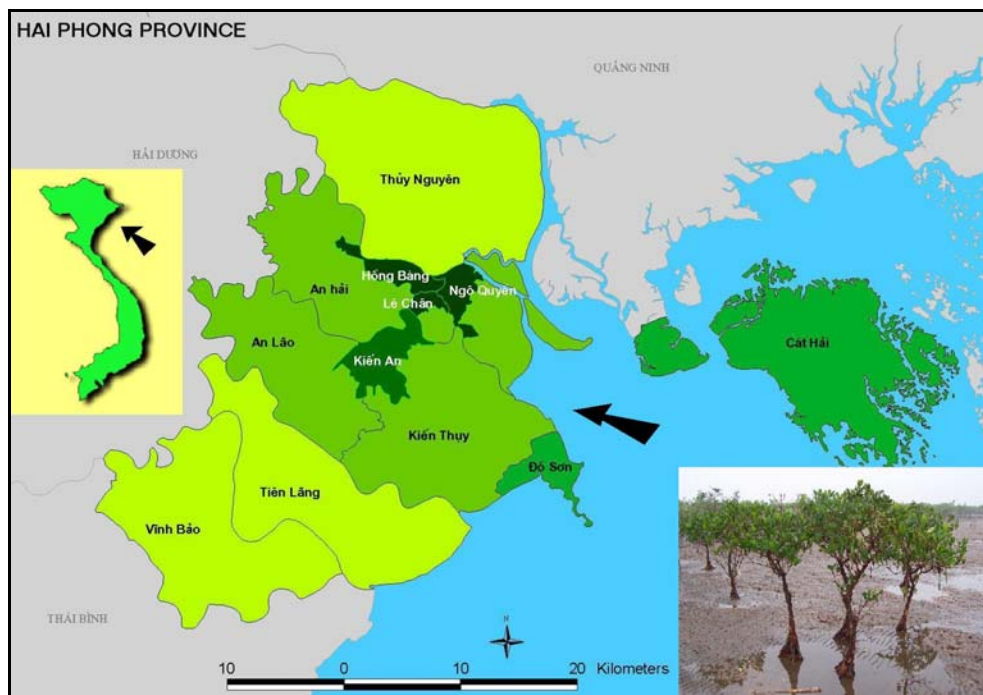

Figure 8.1 Study area

Tidal marshes are mainly distributed along Vietnam's northern coast (74,520 ha), 80% of which consist of mangroves (nearly 100 species) and sea grasses. However, the area of present tidal wetland represents only 30% of the wetland area covered in 1940. Vietnam's war years had a devastating effect on the wetlands due to bombing and defoliant spraying (Toms *et al.* 1996). Hai Phong province has a total of 100 km sea dikes, 50 km of which are fronted by fishponds and mangroves in poor condition; another 10 km is fronted only by mangroves in good condition while the remainder is

fronted by bare (sandy) flats. The forest width along these dykes varies between 500-3000 m. Recovery efforts have been fairly successful in the recent years, but the replanting effort has been overtaken by the expansion of aquaculture activities with the creation of ponds for shrimp farming (Toms *et al.* 1996).

### 8.3.3 Description of the study site

The study site itself is a mangrove forest of approximately 3.5 km long, 0.5 km wide and located along Sea Dike 1 in Tan Tanh village (20°45'N, 106°46'E). Sea Dike 1 was upgraded in 1996 as part of a World Food Program project. In the years 1999 and 2000, the Vietnamese Red Cross Society planted a total of 200 ha of mangroves in the study area and nearby forests in order to improve the existing forests (see also paragraph 5.5).



Figure 8.2 Harvesting of sea grass from shrimp farms on seaside of dyke

The study area is located along the southern side of the Lach Tray River mouth, a branch of the Red River. Behind the dyke, the area is covered for several square kilometers with shrimp ponds of the intensive type. A network of canals connects these ponds and regulates water levels. The whole system is flushed through sluices that are built in the dyke. On the seaside of the dyke, smaller extensive shrimp farms are created within the mangrove forest. Destruction of some of the small dykes by typhoons has led to abandonment of several of these ponds. The presence of aquaculture creates a lot of activities on and around the sea dyke (Figure 8.2). The forest is fronted by a one-kilometer wide mudflat.

A large ring dike, constructed two years ago by foreign investors for large-scale aquaculture, borders the forest on one side. The other side of the forest is almost completely fronted by a natural sandbar. The height of this dune is high enough not to be overtopped during spring tides, therefore leaving only a small opening from forest to the sea (Figure 8.3).

In the study area three different mangroves were identified, *Avicennia marina* is the natural inhabitant of the forest, *Kandelia candel* and *Sonneratia caseolaris* were planted during the Red Cross reforestation project (see also paragraph 5.5). More detail about the area and creating the map are included in Appendix V.

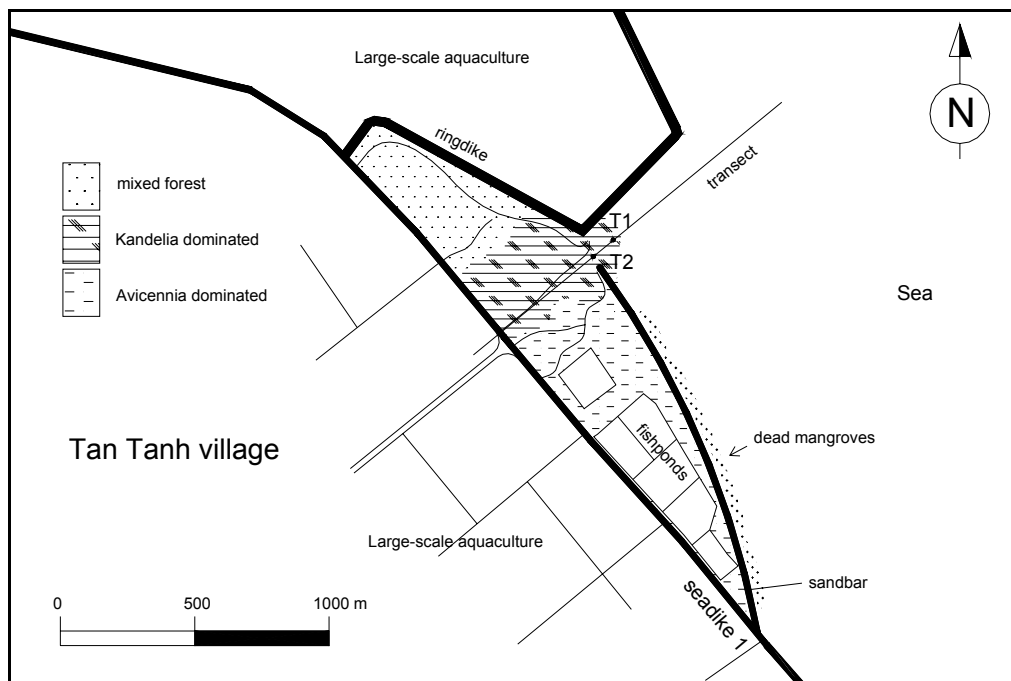

Figure 8.3 Map of study site

### 8.3.4 Preparations

Fieldwork was prepared as much as possible in Hanoi. This included purchasing small tools, renting a motorbike, constructing of external battery for the laptop, preparing documents for authorities and making a time schedule for the activities.

For the measurements of waves, a pressure gauge was deployed. This pressure gauge was connected to a laptop that recorded the pressure signal at regular intervals. This equipment was brought to Vietnam from The Netherlands, including the laptop. To work with a laptop in the field for several hours per day, external power was needed. Two 12V car batteries were connected in series to the laptop, one of the batteries used only half, to provide the required 18V DC current. A closer description of this solution and specifications of the pressure sensor are included in Appendix IV.

## 8.4 Results

### 8.4.1 Introduction

This paragraph deals with the actual fieldwork in Vietnam. It includes a report of all activities during the works and an overview of the results. A series of pictures of the study area and a more detailed map are included in Appendix V. The scope of works is drawn in Figure 8.4 together with tidal information during the activities. The tidal information comes from a weather station at Hon Dau Island, located 11 km from the study site. Water levels and vertical terrain elevations in this chapter are all related to Hon Dau Chart Datum (HD).



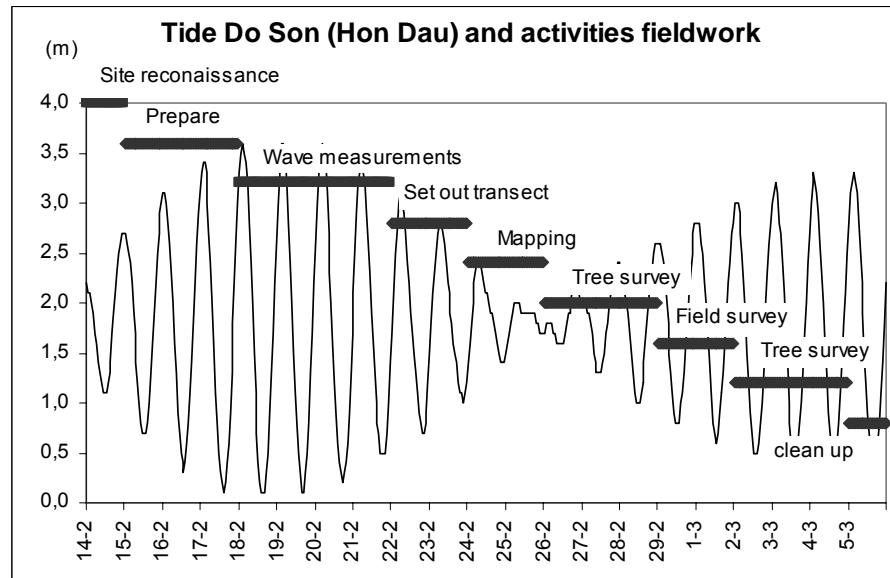

Figure 8.4 Activities and tide curve

#### 8.4.2 Wave measurements

The first week was dedicated to wave measurements (Figure 8.4) because it was spring tide in this period and there was thus a better chance for good waves. Two bamboo towers were constructed (Figure 8.5) to provide an elevated position for measurements. These towers were approximately 45 m separated from each other and located at front of the forest, as close to the sea as possible. A vertical plastic pipe with small perforations was added to both towers to take water depth measurements. At four subsequent days attempts were made to measure waves. A boat was used to travel from the sea dyke to the towers and between the towers. High water level usually occurred between 03:00 and 04:00 a.m., so work started as early as possible, at 05:00 a.m. At each attempt the pressure gauge was deployed, water depth measured and a water sample was taken.



Figure 8.5 Measurement frame

The wave measurements failed when it comes to useful wave heights for dissipation calculations. This was caused by:

- Failure of batteries in pressure meter;
- Insufficient waves;
- Failure of pressure gauge.

The pressure recording equipment converted pressure fluctuations into a discrete AC-signal. The difference between two readings had to be at least 0.6 Pa to get a fluctuating signal. This was not the case because on most occasions and only a fluctuation between two values was recorded. This suggests that waves were at most 10-15 cm high. This corresponds with observations during measurements.

The only day wave heights were sufficient to get useful readings the pressure meter gave no signal. An extra measurement was taken approximately 50 m in front of the forest in an attempt to measure higher waves. This had to be done from the boat because there was no tower at this location. Here, the equipment recorded also no waves. The most probable cause for this failure was the pressure gauge sinking in the mud, blocking the sensor inside. Even on this occasion, with considerable wave action and a high tide, water only reached the lower part of the dyke and hardly moved. This observation at least proves that waves in front of the forest are dissipated within the forest.

One series of measurements at two locations lasted approximately one hour and within this time, water depth sometimes decreased from 1.5 m to 1.0 m at the front of the forest. This is a considerable difference and since wave heights are correlated with

water depth (paragraph 7.5.4), data obtained this way might be unsuitable to compare with each other.

### 8.4.3 Water density

Water samples taken during wave measurements were brought back to Hanoi and tested for density. The densities are shown in Table 8.1. All samples were taken approximately halfway the water depth. Except on the last day, when samples were taken near the bottom, halfway the water depth and in the top layer at T1.

		<b>T1</b>	<b>T2</b>
		<b>[kg/m<sup>3</sup>]</b>	<b>[kg/m<sup>3</sup>]</b>
2-18-2004		No data	No data
2-19-2004		1017.89	1017.23
2-20-2004		1018.23	1019.00
	top	1018.80	
2-21-2004	middle	1019.77	1019.28
	bottom	1019.12	

Table 8.1 Water densities at towers T1 and T2 during measurements

### 8.4.4 Field survey

It turned out to be impossible to use a level instrument in the forest. The subsoil was too soft and unstable to place the instrument and the forest was too dense to read the rod. Additionally, trees were too high to measure from the dyke and visibility too poor to see the horizon. Therefore a 60 m long hose, filled with water, was used to execute the land survey. Because the ends of the hose were open, water surfaces were exposed to atmospheric pressure on both sides, thus in the same horizontal plane. A series of bamboo sticks was set out every 50 m and a mark was put on the first stick. From there, this height was transported through the forest and marked at every stick with tape. The heights from substrate to mark were measured and recorded. Finally, the mark at the first stick was related to a benchmark on top of the dyke, also by using the water filled hose. In the last week, the water level was recorded at its highest level during night and compared with field survey data. The water level reading was 3.10 m at that time while it was supposed to be 3.00 m according to the tide table. This difference can be caused by imperfections in the field survey, as well as wave set-up at the front of the forest.

The elevation profile (Figure 8.8) shows that the slopes within the forest are very gentle (1 to 350) and that the area in front of the forests appears to be practically flat. It is visible that the slopes are not the same throughout the forest and this seems to coincide with changes in specie distribution patterns (paragraph 8.4.5). This would confirm the earlier findings in literature that profile slopes are indicators of (slightly) different vegetation patterns.

### 8.4.5 Tree survey

Because there was not enough time to count and measure all trees along the transect, the number, species and height of trees within 5 m x 5 m squares were recorded every 50 m. This was in order to find possible zonation patterns. It is clear from Figure 8.6 that the *Kandelia candel sp.* is dominant along this transect. The *Sonneratia sp.* is evenly distributed over the full length of the transect and is the only one growing in the transitional area between forest and mudflat. *Avicennia's* presence is significant in the middle of the forest, but is outnumbered in the remaining areas.

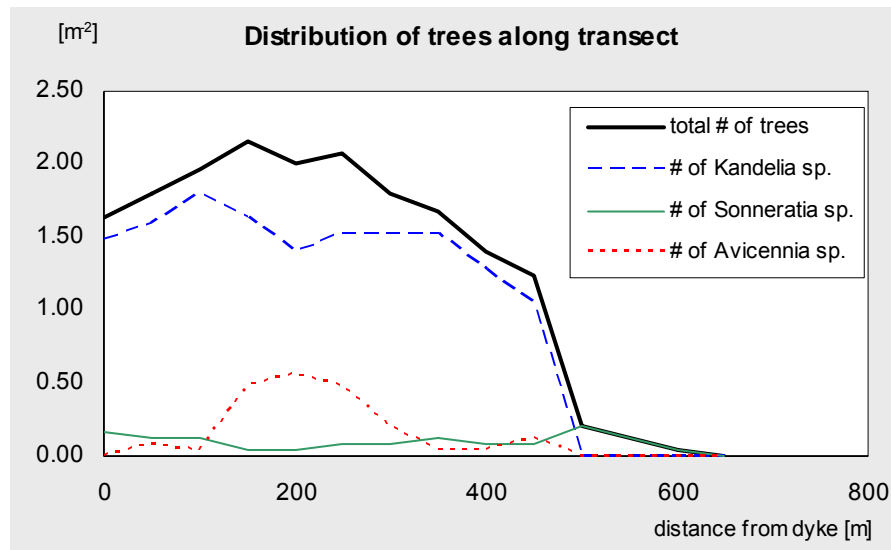

Figure 8.6 Tree distribution along transect

When we look at the average tree height for each species (Figure 8.7) it appears that tree height is rather constant over the width of the forest except for the *Sonneratia sp.*, where solitary trees on the mudflat fronting the forest are considerably smaller.

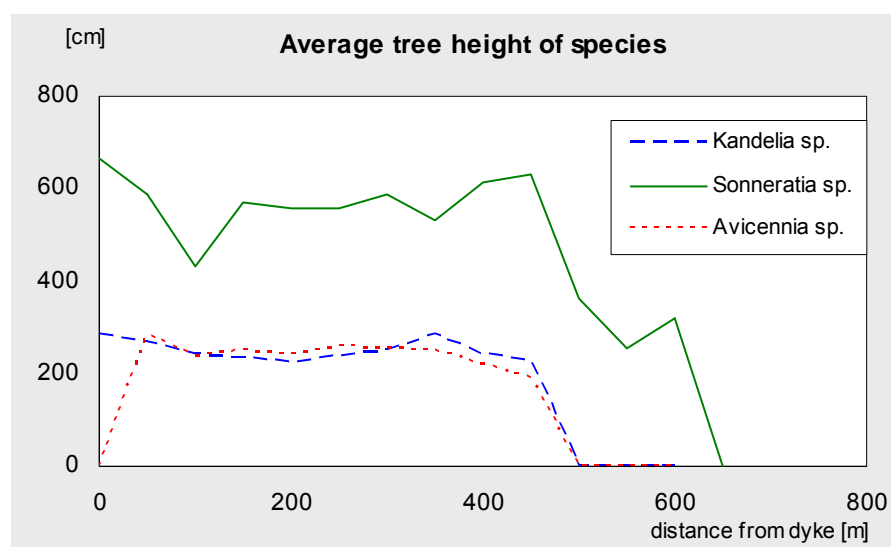

Figure 8.7 Average tree height per species

When these heights are plotted together with the vertical terrain elevations (Figure 8.8) it is visible that the tops of the trees indicate changes in vertical elevation of the substrate by following it.

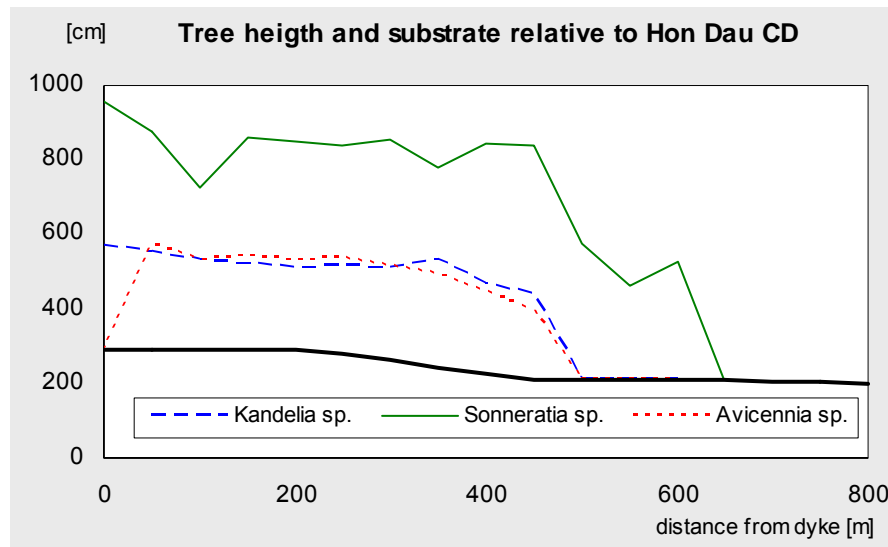

Figure 8.8 Tree height and terrain level relative to HD

After this, a closer look was taken at the trees with this section of the forest in order to get some insight in how to use the characteristics of these mangroves in dissipation calculations, described in chapter 6. All three represented species are shown in Figure 8.9.



Figure 8.9 *Kandelia candel*, *Sonneratia* and *Avicennia marina*

In the forest it was clearly visible that the dominant species, *Kandelia*, has a very simple anatomy. This tree consists of a distinct stem ( $d = 5-10$  cm) that is a little thicker near the ground (a light form of plank roots, see paragraph 3.3) and a canopy. The thickening of the bottom of the stem seemed less pronounced or even absent closer to the dyke. After digging up some stems, the thickening appeared present, but buried under the subsoil. Complex root systems are absent in this species. However, the

transition between stem and canopy includes a lot of thin (mainly dead) twigs and branches. Although these elements might have little influence on waves and flow individually, their combined effect can be significant. The *Sonneratia sp.* also has a distinct, erect, stem with a diameter of 10-20 cm. Their canopy starts above the *Kandelia* canopies, that is, when the canopy is considered that part of the tree where the branches bear leaves. However, branches do grow at lower levels, starting close to the ground and from them, smaller twigs grow. The *Sonneratia sp.* also has vertical aerial roots, pneumatophores. Finally, the *Avicennia sp.* is a difficult species to introduce in calculations where a vegetated cross-area is required. Leaf bearing branches start near the ground and their growth is capricious. Their pneumatophores are smaller than the *Sonneratia sp.* roots and not widespread.

Although especially the *Avicennia* species appeared to be a shrub-like tree in this case and difficult to parameterize, there is still a pattern in the vegetation. As mentioned, the dominant species, *Kandelia*, can be divided in vertical direction into an area with only stems, an area with only stems and relative thick branches without leaves, and the canopy. The first two areas can be considered one, since stems and thick branches are both wooden elements that exert a drag force on wave-induced currents. This leaves the canopy as the other tree element. Because this canopy is a very complex and flexible structure it is not possible to apply the theory of chapter 6. The transitions between stems and canopies are plotted together with the tide during the fieldwork in Figure 8.10. These transitions appear to be more or less horizontal. This and the fact that the thickening of the stems was present but buried at trees on higher elevated subsoil, might indicate that growth pattern and anatomy of the trees is more related to tidal action than to terrain elevation.

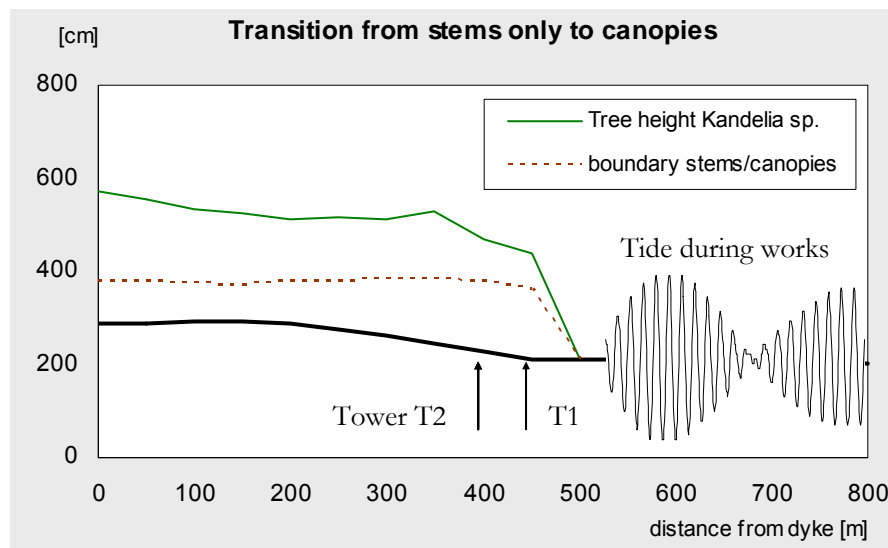

Figure 8.10 Transition stems to canopies *Kandelia*, vertical elevation relative to HD

The transition between the stem sections and the canopies is not a clear distinct line in a real situation. However, when looking through the forest it is clearly visible that this transition coincides with the height at which the seeds (propagules) are hanging in the

tree. This knowledge provides an easy way to determine and measure the tree's transition into a canopy (Figure 8.11).



*Figure 8.11 Propagules as indicators for transition stems to canopies*

The maximum annual water level during spring tide at Hon Dau is approximately 4.0 m. Figure 8.10 shows that in this case water levels (and waves) reach the canopies of all trees in the forest. An additional 2 to 3 m storm surge, which is normal for the area (Toms *et al.* 1996), will completely inundate the dominant species in the forest. Since storm surges are usually accompanied by strong waves, these situations are very interesting for investigations to wave damping in mangrove wetlands. The canopies are therefore important elements of the forest.

In the more exposed areas in front of the forest, trees are smaller and canopies start at a lower level. These trees are almost completely inundated even during 'normal' spring tides (Figure 8.12).



Figure 8.12 *Kandelia* trees during high water, in the background taller *Sonneratia* species

#### 8.4.6 *Pneumatophores*

In order to investigate the characteristics of pneumatophores, the density of these roots was determined at various distances of a mother tree (Table 8.2). These pneumatophores were from a *Sonneratia* sp. Tree.

Distance from mother tree		1.0 m	4.0 m	6.0 m
Number of pneumatophores	[m <sup>-2</sup> ]	130	38	9
Average height	[cm]	18	11	15
Standard deviation	[cm]	10	7	5

Table 8.2 Average lengths of pneumatophores at various distances from mother tree

Additionally, a number of these roots was investigated in order to see how their diameter was distributed over their length. This is shown in Figure (Figure 8.13). The cross-area of these pneumatophores is plotted against their individual length in (Figure 8.14). Although pneumatophores are related to the non-dominant species in this case, they still are spread throughout the whole forest. In order to find a relationship between cross-area and length, a linear and an exponential function are fitted in Figure 8.14.



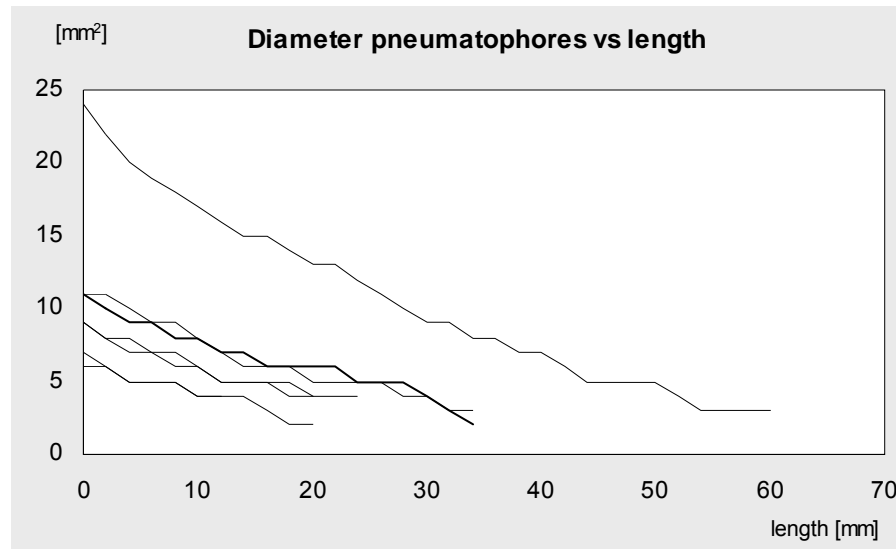

Figure 8.13 Distribution of diameter over length of *Sonneratio* sp. Pneumatophores

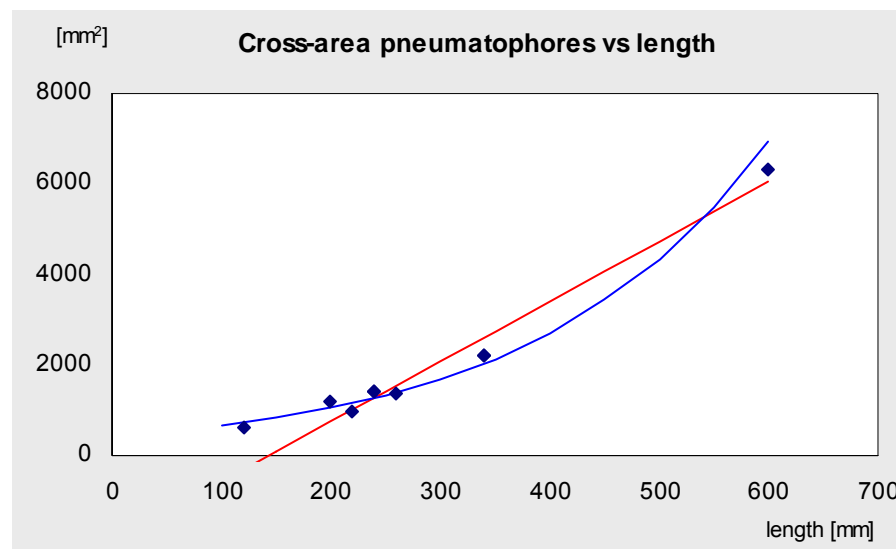

Figure 8.14 Pneumatophore cross-area as function of their length, incl. fitted curves

#### 8.4.7 Assessment bottom conditions

The substrate in the forest consists of very soft sediment material, mixed with organic litter from the trees. Although no data on the bed material was obtained from the field, it could clearly be observed that on the mudflat in front of the forest, the bed material was shifting from fine sediments to a more sandy material. The subsoil however, remained very soft. Inside the forest, an adult person easily sank 50 cm in the mud while navigating through the forest.

When it comes to finding a measure for the roughness of the substrate, several difficulties are encountered. At first, a network of small and bigger gullies that drains and fills the forest during tidal fluctuation characterizes the transition from mudflat to forest. These gullies form irregularities in the bottom profile, and thus influence the propagating waves. The exposed root systems in these areas (Figure 8.15) also

influence the waves by forming an extra bottom roughness. Secondly, a large amount of organic debris remains in the forest in the upper part of the tidal zone (i.e. the part of the forest closest to the dyke) due to relatively weak tidal currents in this area. It is clear that this debris also increases roughness when on the surface. Observation during high tides learned that part of this debris is afloat when the forest is inundated. When this happens, it is likely that some of it gets stuck in the trees, contributing to the exposed cross-area of the forest. The problem is that it is not clear where and if this happens.



*Figure 8.15 Substrate in front of forest, in the middle of the forest and close to the dyke*

The middle of the forest is characterized by a very smooth bed profile, free of organic debris. Because tidal action is stronger, and inundation occurs more frequent, organic litter is transported out of the forest by tidal current. However, creeks and gullies were present throughout the whole forest. These channels were usually oriented more or less normal to the dyke. As mentioned before, these irregularities might influence the propagation of waves.

## 9 DISCUSSION

### 9.1 Introduction

Mangrove wetlands are harsh environments to work in. Like all tropical forests, the humid weather conditions make mangrove swamps an ideal environment for insects such as mosquito's and midges. The soft subsoil makes navigating through the forest on foot an adventurous and time-consuming enterprise. The salt water and risk of theft are a constant threat to equipment and materials. Additionally, wild animals such as snakes can form an extra danger to those working in these areas. These, and other factors, had their influence on this investigation. The results from the previous chapter, and the circumstances under which they were obtained, are discussed in this chapter.

### 9.2 Site conditions

#### 9.2.1 Morphology

Due to the presence of the ring dyke and the sandbar in front of the forest, the site in the case study appeared to be not very suitable for the investigation. The area with mangroves directly exposed to the sea was relatively small and waves entering the forest are very likely to be influenced by refraction around the sandbar and reflection against the ring dyke (see Appendix V). An additional problem was the active morphology of the sandbar. Dead mangrove canopies sticking out of the sandbar indicate that this dune is still expanding in the direction of the ring dyke. During the fieldwork, the substrate under the bamboo frame near the sandbar was raised by 5 cm in three weeks. It is unknown and beyond the scope of this study whether this process is temporarily or has a permanent character. It is, however, clear that such morphologic activities do not create favourable conditions for this kind of fieldwork.



Figure 9.1 Sandbar expanding at the expense of mangroves

### 9.2.2 *Tidal creeks*

The presence of creeks and gullies is an inevitable feature of mangrove swamps and this is hard to avoid. In this case study, the network of channels was very irregular in front of the forest. Inside the forest, however, there were fewer creeks and these were orientated normal to the dyke. Since the forest was very dense, and visibility through the trees was very poor, these channels turned out to be useful for navigation through the forest. The transect described in the previous paragraph was located alongside one of these channels. Actual land and vegetation survey took place a few meters away from the gully, inside the forest. For the rest, the channel provided good accessibility to the forest. Additionally, the GPS receiver did not work below the tree canopies and the forest was too dense to navigate by magnetic compass and rope. It would therefore not have been possible to set out a more or less straight transect without the presence of the channel.

Another advantage of tidal creeks was the possibility to navigate through the forest by boat. During spring tides, water level reaches the tree canopies. Without these small waterways, it would have been impossible to travel the 500 m through the dense forest.

## 9.3 **Tide**

### 9.3.1 *Accessibility*

The environmental boundary that has most influence on fieldwork in mangrove wetlands is the tide. It determines when the forest is accessible by foot for land survey and vegetation inventories as well as when wave measurements should be carried out.

Mangroves grow in the upper tidal range (Figure 8.10) and the forest is therefore accessible every low tide, once or twice a day, depending on the type of tide. In the case study, high tides occurred during the nights or early mornings. This had the advantage that the forest was accessible during most of the daytime. Land survey and measurements in the forest could therefore be carried out in daylight. For safety reasons, wave measurements were carried out at the first daylight, usually just after the highest water level of that day. This meant travelling from Do son to the site, and navigating by boat through the forest, in the dark. This is, however, a better situation than a tide cycle with high water during the day and ebb during night. That would mean working in the forest by night, which is more difficult if not impossible.

### 9.3.2 *Tidal window*

Another consequence of mangroves growing in the upper tidal range is that the tidal window for measurements is relatively short. In the case study, the 500 m wide mudflat in front of the forest was also just above mean sea level, meaning a further decrease of the tidal window for measurements. Even with the best efforts, no more than one series of measurements could be taken at two locations. Because the pressure gauge was connected to a laptop with car batteries as power supply, each measurement required moving the equipment from the boat to one of the towers and starting up the computer. After two measurements and moving once from on tower

to another, water depth had decreased to such a level that the boat had to return in order to make it all the way back to the sea dyke. The question arises if these conditions allow measurements with one set of equipment, operated by hand, because large differences in water depth between two measurements can make the data useless.

### *9.3.3 Tidal current*

Finally, working in the tidal range means that tidal currents have to be encountered. In the case study, this caused considerable problems due to the presence of the sandbar and ring dyke. These two obstacles left the narrow space between them as the only connection between the sea and the forest, forming a tidal inlet. This led to high tidal currents (up to 2 m/s) that made navigation with a rowing boat almost impossible, sometimes even dangerous. A motorized boat allows faster and safer access to the forest and travelling between measurement stations. The tidal window for measurements, however, remains small. Simultaneous measurements at multiple locations will provide much more useful data. When unmanned equipment is used, measurement can be taken during the entire tidal cycle, without the need for facilities that human operators require.

## **9.4 Hydraulic measurements**

### *9.4.1 Wave measurements*

Although no useful data was obtained from the wave measurement, the experience gained some insight in the way waves should, or should not, be measured.

The two bamboo frames, or towers, were easy to build and very cheap. During the campaign, they turned out to be very useful. Few attempts were made to measure from a boat, but it was difficult to keep the boat in position due to currents. The towers also provide fixed locations in the forest. This way, data can always be collected at the same places.



*Figure 9.2 Navigation through forest only possible through creeks*

Due to tidal fluctuations, wave conditions change relatively fast. This will have its influence on measurements when these are carried out in succession. A measuring campaign on a larger scale with multiple-location measurements should not be carried out with one set of equipment because of these changing conditions.

The distance between towers T1 and T2 was approximately 50 m. Navigation between these towers appeared to be difficult due to strong tidal current and dense foliage of the canopies. The presence of open spots and some gullies provided an accessible connection between the towers. In case where vegetation is denser and fewer creeks are present, this will be a problem. It turned out to be impossible to navigate the boat through the tree tops without the aid of these 'natural' navigation channels.

As mentioned several times in this report, the interesting situations in which the dissipating features of a mangrove forest are useful, is during storms and other occasions that are associated with strong wave action. However, these conditions are potentially dangerous when manned stations are used. The use of small boats and sensitive equipment can also cause problems under these harsh circumstances. The 'normal' conditions during this study formed no threat or whatsoever to the sea dyke.

The above-mentioned states, that the most suitable conditions for measurements are the least suitable those who carry them out. Adding to this that simultaneous measurements are recommended, the best solution is to deploy a set of unmanned pressure gauges or wave-riders connected to waterproof data recorders.

#### *9.4.2 Water densities*

Because the number of density recordings is very small it is not very suitable for a very deep analysis. However, it is clear that the water densities on the first day are considerable lower than on the other days (Table 8.1). It is also clear that the difference in densities between samples taken at different depths is rather small. Although the reason for differences in densities is not the subject of this study, it illustrates that density measurements should be taken at each wave measurement because they vary in time.

### **9.5 Field survey**

#### *9.5.1 Accuracy*

The part of a mangrove swamp that is interesting for wave measurements is the actual forest, which starts behind the transitional zone between mudflat and forest. In this case study, the subsoil turned out to be relatively smooth within the forest. Although the irregularities were larger than the possible accuracy of a level instrument, it was still feasible to measure a vertical elevation profile with an accuracy of 5 to 10 cm. At first sight, a higher accuracy seems possible, but disturbances by local fishermen, small scour holes around tree bases and local depressions do not allow this (Figure 9.3).



Figure 9.3 Scour hole at tree base and disturbance by humans

### 9.5.2 Traditional methods

In Literature on bathymetric measurements in tidal wetlands usually only two methods for field survey are mentioned. These are a survey with a level instrument and using the tide (paragraph 7.4). In the previous paragraph it became clear that during the case study, using a level instrument was not possible. It is, however, possible to use a level instrument in the forest when there is enough time for preparations. This requires the construction of a few solid platforms that provide support for the instrument. The rod can be placed on a (marked) part of the tree or a series of pegs. One still needs a considerable line of sight without obstructions. In a dense forest this is only possible in tidal creeks or when the platforms are high enough to look over the trees.

The second way to use a level instrument is to place it on a dyke or elevated position (paragraph 7.4). Especially when a level instrument is placed on an elevated position and measurements are taken over a considerable distance, a few factors might limit the possibilities:

- Weather conditions (when the instrument's range is exceeded the horizon is needed);
- The eye of the observer (to read the rod);
- The person holding the rod (a long rod is difficult to hold vertically);
- Communications (a set of signals or radios should be available to communicate).

Measurement by using the tide is only possible if tidal information is available. This method would have required survey during the night in this study. At the study site, only a few days every month were suitable for this kind of survey because high tides did not reach the higher part of the forest every cycle. Additionally, this method has some more disadvantages:

- Water levels are not marked at the same time and need to be derived from tide tables;
- Markers have to be measured relative to subsoil during low tide, thus a second visit;
- Tide tables are not very accurate, not always from a nearby station or not available at all.

### 9.5.3 *Water hose*

The field survey in this case study was carried out with the use of a plastic hose, filled with water. This method appeared to be very effective and is characterized by flexibility and mobility. The water hose can also be equipped with wider sections at each end, in order to make it less sensitive for fluctuations.



Figure 9.4 Highly mobile level instrument in dense forest

### 9.5.4 *Final comments*

Since it follows from the theoretic analysis in Chapter 6 that areas with different slopes should be separated in measurements, it is recommended to execute a field survey before wave measurements. Together with the vegetation inventory, the elevation profile provides a tool to choose locations for wave recordings.

The one problem all of these methods for field survey have in common is that they all include measurements from the instrument that is used, to the surface. Since the subsoil might not always be as smooth as in this case study, this can turn out to be a



difficult task. A good solution to this problem is to mark the measurements to more solid structures such as trees or pegs, and then take a closer look to the surface and confer about how to make the final measurement. During this study, a piece of timber was put on the ground and used to measure from. Consequence of this is that the heights of irregularities determine the profile.

## 9.6 Vegetation and bottom characteristics

### 9.6.1 Zonation

The results in Chapter 8 show that by recording species, tree densities and tree height a pattern in vegetation can be discovered. In Figure 8.6 it becomes clear that *Kandelia sp.* is the dominant species in the forest. This figure also shows a distinct section in which *Avicennia sp.* becomes more important. The presence of the *Avicennia sp.*, however, does not fully coincide with the section where the profile has a divergent slope (Figure 8.8). It is also clear from Figure 8.6 that the distribution of *Kandelia sp.* is more or less constant throughout the forest. The question arises if there is any zonation involved at all since *Kandelia sp.* is the dominant species throughout the forest. Although aspects such as slopes and the presence of other species also indicate zonation, this section of the forest tends to be a single zone with some fluctuations in species distribution within certain limits.

It is more likely that presence of *Avicennia sp.* is a consequence of the nearby section of the forest where this species is dominant (Figure 8.3). Adding to this the fact that *Kandelia sp.* was introduced in the forest by reforestation programs, filling up gaps in the natural *Avicennia* community, the question is whether there are any zones to be discovered in this forest.

With respect to vegetation characteristics that are necessary for dissipation calculations, this forest can be considered as a relative homogeneous *Kandelia* forest with a local disturbance of *Avicennia sp.*

### 9.6.2 Tree characteristics

Looking to the forest as a whole, measurements can be taken in front of the forest and behind it in order to get insight in its capabilities as a wave filter. However, to relate tree characteristics to measurements, a forest with more or less constant characteristics is more suitable to get representative results. The front and rear of mangrove forests are not very suitable for this purpose (see Figure 8.15 and Figure 9.5). These sections should therefore be avoided in such a campaign.



Figure 9.5 Mudflat in front of forest, transition into forest and rear side of the forest

Although the dominant species in the study area has a relative simple structure, without a complex root system, the presence of smaller, flexible, tree elements such as twigs make it difficult to measure a very accurate cross-area as function of the height.

When tropical storms, and the accompanying storm surges, are the most relevant events that could emphasize the importance of mangroves, measurements during these situations will yield the most interesting results. Dissipation is then caused by the combined effect of stems and canopies. In the case study, the transition between stems and canopies occurred more or less along a horizontal line, which makes calculations and measurements easier.

In Chapter 6 it was mentioned that most wave energy in short waves is situated in the top layer of the water depth. When waves propagate through dense canopies, this area will also experience most friction, induced by the trees. Adding to this that the fine bed material might possibly come into suspension during high tides, forming a dense boundary layer that could strongly reduce orbital velocities near the bottom, it might well be possible that the horizontal velocities profile will approach shallow water conditions. In this case, a single cross area over the entire stem area will do for calculations. If this is not the case, horizontal velocities have to be averaged over a few intervals in vertical direction, over which the vegetated cross-area also will have to be determined.

Although it will be a time consuming task, the only way to obtain tree characteristics is to measure as much as possible in mangrove forests and collect data on how cross-areas of various mangrove species develop in vertical direction. This can be done during a vegetation survey as described in Chapter 8. In each quadrant, an additional few trees have to be measured more thoroughly, and their characteristics (Figure 7.6) recorded. This will yield a vegetated cross-area as a discrete function in vertical direction. After this, the calculations described in Chapter 6 can be followed.

The theory in Chapter 6 is not applicable for the flexible and complex canopies. This subject needs further research. Hopefully, the future will yield useful measurements in mangrove wetlands that include inundated canopies. Their influence on wave attenuation can then be investigated.

### 9.6.3 *Pneumatophores*

Because the distribution of *Avicennia* and *Sonneratia* species is relatively sparse, the distribution of pneumatophores is not very evenly throughout the forest. From Table 8.2 it is clear that the number and length of pneumatophores strongly varies with the distance from the mother tree. Additionally, the standard deviations are relatively large, indicating a large variety in length of pneumatophores. Finally, pneumatophores are relatively flexible elements compared to the rather rigid tree stems. Averaging the density and length of the roots is therefore not very representative for the real situation. However, these elements cannot be neglected and there is no alternative to take their influence into account.



Figure 9.6 Dense accumulations of pneumatophores around tree base

The average length and diameter of the pneumatophores can be added in bottom friction calculations. Another option is to add their cross-area to the cross-area of the trees. Since no clear definition for bottom roughness has been found in this study, it might be wise to choose the latter option, adding the pneumatophores to the vegetation characteristics and avoid further complexity of the bottom friction. Another reason to do this is that in both *Sonneratia* and *Avicennia* species, a part of the pneumatophores forms a dense cover around the basis of the tree (Figure 9.6). In this case, this pneumatophores accumulation can be parameterised as a thickening of the stem of the tree.

The possible exponential relation between the cross-area of pneumatophores and their length is interesting when these roots are surveyed. This way, only their length needs to be measured. When density and length of pneumatophores is averaged, only a single cross-area is needed (i.e. the one belonging to the average root length). The number of samples in this study, however, was too small to draw firm conclusions and the sampling was limited to only one species. In Figure 8.14, both linear and exponential fitted lines seem possible. Additionally, it is not clear whether the diameter-function (Figure 8.13) is hyperbolic or powers function. In both cases, however, it is not likely that the cross-area is a linear function of pneumatophore length. Since there appears to be at least some kind of relationship and little is known about this phenomenon, further investigation is recommended.

#### 9.6.4 *Bottom characteristics*

As mentioned already in paragraphs 8.4.7 and 9.5.1, the substrate in most of the forest is relatively smooth and typical irregularities such as footprints and scour holes around trees are in the order of magnitude of centimeters. When it comes to roughness of the subsoil, these dimensions are more likely to be a measure for the friction coefficient ( $c_f$ ) in equation 6.12 than the bed material. Like for tree characteristics, the front and rear of the forest are not very representative for the rest of the system (Figure 8.15).

It has also become clearer in this study that the most interesting conditions for wave measurements are the higher springtides or even tropical storms. This means strong wave action and high water levels. This, in turn, would reduce the importance of bottom friction.

However, it is not clear how the fine material inside the forest react to the hydraulic loads and no real attempt were made during this study to find information on this subject in literature. If considerable amounts of bed material come into suspension as suggested in paragraph 9.6.2, a sediment-laden boundary layer develops and changes the importance of bottom friction dramatically. The behaviour of muddy slopes under hydraulic loads should be the subject of future study. If possible, a site should be found with two adjacent mudflats with similar bottom conditions, one with mangroves and one without. In this way, the influence of bottom friction can be isolated from wave dissipation data. The question is if sites like this exist, since the typical bed conditions in mangrove forests are strongly influenced by the mangroves and vice versa.

## 9.7 **Final Comments**

Unfortunately, no wave measurements were obtained from the field. Therefore, no calculations can be made relating possible dissipation to the present vegetation. Due to lack of biodiversity in mangrove species, the knowledge of vegetation survey remains also limited.

Additionally, some conflicting matters came up during the field research. Tidal creeks are disturbances of bottom profile and forest on the one hand, but turned out to be essential for accessibility of the forest and transportation by boat on the other hand. The most interesting conditions for wave dissipation research being the least favorable to work in, is another example.

However, the field trip did gain useful experience about several survey techniques, working in mangrove wetlands in general, and natural boundaries such as tidal restrictions and periods with calm wave climate.

## 10 CONCLUSIONS AND RECOMMENDATIONS

After combining the theoretical analysis in Chapter 6 and the results of the fieldtrip in Vietnam, several conclusions can be drawn. However, some questions still remain and new ones have risen. Both conclusions and recommendations are summarized below.

### **With regard to site conditions:**

- Sites with morphologic active elements should be avoided; site conditions should be as constant as possible for long-term measurement campaigns.
- Wave measurements should be carried out in forests exposed to the sea. Nearby structures such as dykes, breakwaters, and san bars cause reflection and refraction and influence the wave climate and should thus be avoided.
- The presence of tidal creeks and other morphological features in the forest should be kept to a minimum; they can, however, be useful or even necessary when boats are used for measurements or transportation of materials.
- A site with high tides during night allows surveys and other measurements in the forest during daytime.
- Areas with large tidal ranges favour the growth and width of mangrove forests and are therefore interesting to find a suitable site.
- Events with strong waves combined with storm surge are potentially devastating for both near shore aquaculture and agriculture and therefore relevant for this type of research. Shores in North and Central Vietnam meet these conditions.

### **With regard to wave measurements:**

- Operating with one set of equipment is not recommended because there will be a delay between measurements. Tidal elevation and wave heights can change within this time. Therefore, simultaneous measurements at multiple locations, lined up along a transect, is the best option.
- The accuracy of the equipment should be sufficient to register the waves. An estimation of the expected wave heights is required to check this.
- Since the best circumstance for measurements is during high wave events and high tides during night are preferable, unmanned data recorders are recommended.
- Water densities vary in time, water samples should therefore be taken at regular intervals when data is used for dissipation calculations.

- Further study is recommended on horizontal particle velocity induced by waves in dense (mangrove) vegetation. It is recommended for this study to check if these velocities approximate a depth-constant velocity profile, even when shallow water conditions are not met. When particle velocities become constant over the water depth, water pressure becomes hydrostatic.

**With regard to field survey:**

- Using a plastic hose filled with water turned out to be a flexible and effective method for field survey in densely vegetated wetlands.
- Operating a level instrument in a mangrove forest is very difficult due to soft subsoil and dense vegetation. Measuring from an elevated position could be a solution but is subject to several practical problems.
- Using tidal information requires accurate tidal information and more calculations. It is, however, a good method to compare with other survey techniques and also enable one to relate tidal information to the bottom profile.

**With regard to vegetation characteristics:**

- Due to litter and irregularities in the front and rear of the forest, these areas should be excluded from measurements that will be related to actual vegetation characteristics.
- The dominant *Kandelia candel* species in this study is characterised by a relative clear distinction between stem and canopy. The transition between these elements occurs on a more or less horizontal level throughout the forest.
- The section with stems has to be measured in order to produce a vegetated cross-area exposed to incident waves. The relationship between the vertical distribution of the cross-area and mangrove species is recommended for future study.
- The canopies turned out to be partially submerged during high tides. The theory of Chapter 6 is not applicable to these structures. No solution was found for this except that their influence should be isolated in future measurements. Further study on this subject is recommended.
- Counting trees and recording species at regular intervals is a good method to discover zonation in the forest. Although no real zonation was discovered in this case study, it would have been found if present with this survey method.
- Because no zonation in vegetation was discovered at this site, a separation between wave measurements should be based on differences in slopes of the bottom profile.

- In order to isolate uncertainties regarding behaviour and roughness of bed material, pneumatophores should be added to the vegetated cross-area. The cross-area of pneumatophores appears to be a function of their length, but further study is needed to confirm this.

**With regard to bottom conditions:**

- The exposed subsoil is relatively smooth in a large part of the forest during low tides with typical irregularities in order of centimeters.
- Pronounced gullies and creeks, exposed root systems and large irregularities characterize the subsoil in front of the forest and in the transition from mudflat to forest. These areas should therefore be excluded from measurements to avoid their influence.
- It remains unclear whether bottom roughness is determined by grain size, size of irregularities, or by suspended bed material during flooding. Further study on this subject is recommended in order to find a representative resistance coefficient. Until then,  $c_f = 0.01$  can be used, but this is probably too low.



## 11 REFERENCES

- Battjes, J.A.;** *Korte Golven*, Collgedictaat Ctwa4320, Faculteit Civiele Techniek en Geowetenschappen, Technische Universiteit Delft, 2000.
- Bird, E.C.F.;** *Mangroves as landbuilders*, Victoria Naturalist, Vol. 88, pp 189-197, 1971.
- Bird, E.C.F.;** *Mangroves and coastal morphology in Cairns Bay, North Queensland*, The Journal of Tropical Geography, Vol. 35, pp 11-16, 1972.
- Bird, E.C.F.;** *Mangroves and Coastal Morphology*, Victoria Naturalist, Vol. 97, pp 48-58, 1980.
- Bird, E.F.C.;** *Mangroves and intertidal morphology in Westenport Bay, Victoria, Australia*, Marine Geology, Vol 69, Issues 3-4, pp 251-271, 1986.
- Blasco, F.;** *Climatic factors and the biology of mangrove plants*, The Mangrove Ecosystem: research methods (Snedaker, S.C. and Snedaker, J.G. ed.), UNESCO, Paris, pp 18-35, 1984.
- Blasco, F.; Saenger, P.; Janodet, E.;** *Mangroves as indicators for coastal change*, Catena, Vol. 27, Issues 3-4, pp 167-178, 1996.
- Chapman, V.J.;** *Mangrove biogeography*, Hydrobiology of the mangal (Por, F.D. and Dor, I. ed.), pp 15-24, 1984.
- Davis Jr., J.H.;** *The Ecology and Geologic Role of Mangroves in Florida*, Papers from Tortugas Laboratory, Vol. 32 No. 16, pp 303-412, 1940.
- Delft Hydraulics;** *Review of the Ecological Basis for Environmental Assessment of Mangrove Ecosystems*, Report No. T1153, 1993.
- Groen, R.A.;** *Mangroven als kustverdediging*, Afstudeerverslag, Technische Universiteit Delft, 1993.
- Hopley, D.;** *Coastal changes produced by tropical cyclone Althea in Queensland: December 1971*, The Australian Geographer, Vol 12, pp 445-456, 1974.
- Ippen, A.T.; Raichlen, F.; Sulliva, R.K.;** *Wave induced oscillations in harbors: effects of energy dissipators in coupled basin systems*, Appendix, Hydrodynamics Laboratory Department of Civil Engineering, Massachusetts Institute of Technology, Report No. 52, 1962.
- Johnstone, I.M.;** *Succession in zoned mangrove communities: where is the climax?*, Tasks for vegetation science (Teas, H.J. ed.), Vol. 8, pp 131-139, 1983.

- Kjerve, B.;** *Manual for investigation of hydrological processes in mangrove ecosystems*, University of South Carolina, 1990.
- Kusler, J.A.; Kentula, M.E.;** *Wetland creation and restoration, the status of the science*, Island Press, Washington D.C., 1990.
- Lebel, L.; Tri, N.H.; Saengnoee, A.; Pasong, S.; Buatama, U.; Thoa, L.K.;** *Industrial transformation and shrimp aquaculture in Thailand and Vietnam: pathways to ecological, social and economic sustainability?*, *Ambio*, Vol. 31 No. 4, pp 311-323, 2002.
- Ligtvoet, W.; Hughes, R.H.; Wulffraat, S.;** *Re-creating a mangrove forest near Jakarta*, *Land & Water International*, Vol. 84, pp 8-11, 1996.
- Lugo, A.E.; Snedaker, S.C.;** *The ecology of mangroves*, Annual review of Ecology and Systematics, Vol. 5, pp 39-64, 1974.
- MacNae, W.;** *A general account of the fauna and flora of mangrove swamps and forests in the Indo-West Pacific region*, *Advances in Marine Biology*, Vol. 6, pp 73–270, 1968.
- Mazda, Y.; Magi, M.; Kogo, M.; Hong, P.N.;** *Mangroves as a coastal protection from waves in the Tong King delta, Vietnam*, *Mangroves and Salt Marshes*, Vol. 1, pp 127-135, 1997 (a).
- Marius, C.; Lucas, J.;** *Holocene mangrove swamps of West Africa: Sedimentology and soils*, *Journal of African Earth Science*, Vol. 12, pp 41-54, 1991.
- Mazda, Y.; Wolanski, E.; King, B.; Sase, A.; Ohtsuka, D.; Magi, M.;** *Drag force due to vegetation in mangrove swamps*, *Mangroves and Salt Marshes*, Vol. 1, pp 193-199, 1997 (b).
- Mazda, Y.; Magi, M.; Nanao, H.; Kogo, M.; Miyagi, T.; Kanazawa, N.; Kobashi, D.;** *Coastal erosion due to long-term human impact on mangrove forests*, *Wetlands Ecology and Management*, Vol. 10, pp 1-9, 2002.
- Méhauté, Le, B.;** *An Introduction to Hydrodynamics and Water Waves*, Springer, New York, 1969
- Midun, Z bin; Lee, S.;** *Mud Coast Protection – The Malaysian Experience*, Coastal Zone '89 Conference Proceeding (Magoon, O.T. et al. ed.), pp 806-820, 1989.
- Minot, N.; Baulch, B.; Epprecht, M.;** *Poverty and inequality in Vietnam: Spatial patterns and geographic determinants*, International Food Policy Research Institute of Development Studies, Hanoi, Vietnam, 2003.

- Mol, A.C.S.;** *Wave Attenuation by vegetation*, Report of internship at WL|Delft Hydraulics, 2003.
- Odum, W. E.; McIvor, C. C.; and Smith III, T. J.;** *The Ecology of the Mangroves of South Florida: A Community Profile*, FWS/OBS-81/24, U.S. Fish and Wildlife Service, Biological Services Program, Washington D.C., Report FWS/OBS-81/24, 1982.
- Saenger, P.; Siddiqi, N.A.;** *Land from the Sea: The Mangrove Afforestation Program of Bangladesh*, Ocean & Coastal Management, Vol. 20, pp23-39, 1993.
- Sato, K.;** *Studies on the protective function of the Mangrove Forest against Erosion and Destruction IV*, Science Bulletin Coll. Agr. Univ. Ryukyus, vol. 31, pp 189-200, 1984.
- Sato, K.;** *Studies on stilt root of *Rhizophora stylosa* and properties of sedimentation in mangrove forest*, Galaxea, Vol. 8, pp 43-48, 1989.
- Schiereck, G.J.;** *Introduction to bed, bank and shore protection*, , Delft University Press, 2001.
- Semeniuk, V.;** *Mangrove zonation along an eroding coastline in King Sound, North-Western Australia*, Journal of Ecology, Vol. 68, pp 789-812, 1980.
- Shahid, M.A.; Pramanik, M.A.H.;** *The application of remote sensing techniques to study the relationship between the shrimp/fish farms and the mangrove ecosystem of the Bangladesh coastal region*, Proceedings of the Regional Seminar on the Application of Remote Sensing Techniques to Coastal Zone Management and Environmental Monitoring, Dhaka, Bangladesh, 18-26 November, 1986, SPARRSO-UNDP/ESCAP, pp 108-119, 1986.
- Smith III, T.J.;** *Comparative effects of cyclone damage to mangrove forests: Kathy versus Winifred*, Proceedings of a Workshop on the offshore effects of tropical cyclone Winifred, held at the Townsville International Hotel, June 20, 1986 (Dutton, I.M. ed.), pp 60, 1986.
- Spenceley, A.P.;** *The role of pneumatophores in sedimentary processes* Marine Biology, Vol. 24, pp M31-M37, 1977.
- Steenis, C.G.G.J. van;** *Kustaanwas en mangrove*, Natuurwetenschappelijk Tijdschrift voor Ned. Indië, dl. 101 afl. 3, 1941.
- Steinke, T.D.; Ward, C.J.;** *Some effects of the cyclones Domoina and Imboa on mangrove communities in the St. Lucia Estuary*, South African Journal of Botany, Vol. 55(3), pp 340-348, 1989.
- Taal, M.D.;** *Communications on hydraulic and geotechnical engineering, flow and salt transport in mangrove swamps*, PhD Thesis, Delft University of Technology, The Netherlands, 1994.

**Teas, H.J.;** *Mangrove swamp creation, Rehabilitation and Creation of Selected Coastal Habitats: Proceedings of a workshop, Sapelo Island, Georgia, 16-20 May, 1976.* US Fish and Wildlife Service, Biological Services Program, Washington D.C., Report FWS/OBS-80/27, pp 63-90, 1980.

**Thom, B.G.;** *Mangrove ecology and deltaic geomorphology: Tabasco, Mexico,* Journal of ecology, Vol. 55, pp 301-343, 1967.

**Thom, B.G.; Wright, L.D.; Coleman, J.M.;** *Mangrove ecology and deltaic-estuarine geomorphology: Cambridge Gulf-Ord River, Western Australia,* Journal of Ecology, Vol. 63, pp 203-232, 1975.

**Thom, B.G.;** *Mangrove ecology - a geomorphological perspective,* Mangrove ecosystems in Australia (Clough, B.F. ed.), Australian National University Press, Canberra, pp. 3-17, 1982.

**Tomlinson, P.B.;** *The botany of mangroves,* Cambridge University Press, 1986.

**Toms, G.; Hoozemans, F.J.M.; Zeidler, R.B.; Huan, N.N.;** *Vietnam Coastal Zone Vulnerability Assessment,* Final Report Vietnam VA Reports, Government of the Netherlands, Ministry of Foreign Affairs and Government of the Socialistic Republic of Vietnam, Hydrometeorological Service, 1996.

**Tri, N.H.; Adger, W.N.; Kelly, P.M.;** *Natural resource management in mitigation climate impacts: the example of mangrove restoration in Vietnam,* Global Environmental Change, Vol. 8 No 1, pp 49-61, 1998.

**Unesco;** *Coral reefs, seagrass beds and mangroves: Their interaction in the coastal zones of the Caribbean,* Report of a workshop, held at West Indies Laboratory, St. Croix, U.S. Virgin Islands, May 1982, (Ogden, J.C. and Gladfelter, E.H ed.), 1983.

**Wells, J.T.; Coleman, J.M.;** *Periodic mudflat progradation, Northeastern coast of South America: a hypothesis,* Journal of Sedimentary Petrology, Vol. 51 No. 4, 1981.

**Woodroffe, C.D.;** *The impact of sea-level rise on mangrove shorelines,* Progress in Physical Geography, Vol. 14 No 1, pp 483-520, 1990.

**Woodroffe, C.D.;** *Development of mangrove forests from a geological perspective,* Tasks for vegetation science (Teas, H.J. ed.), Vol. 8, pp 1-17, 1983.

**Zondag, Ing. N.;** *Landmeten 1,* Educatieve Partners Nederland BV, Houten, 1997.

Website:

**Ministère de la défense,** service hydrographique de la marine, France (tide tables):  
[www.shom.fr/fr\\_page/fr\\_serv\\_prediction/ann\\_marees\\_f.htm](http://www.shom.fr/fr_page/fr_serv_prediction/ann_marees_f.htm)

## Appendix I MANGROVE SPECIES

Table I.1 Major components of mangal (strict mangroves)

Family	Genus	Number of species
Avicenniaceae	<i>Avicennia</i>	8
Combretaceae	<i>Laguncularia</i>	1
	<i>Lumnitzera</i>	2
Palmae	<i>Nypa</i>	1
Rhizophoraceae	<i>Bruguiera</i>	6
	<i>Ceriops</i>	2
	<i>Kandelia</i>	1
	<i>Rhizophora</i>	8
Sonneratiaceae	<i>Sonneratia</i>	5
Total	9	34

Table I.2 Minor elements of mangal

Family	Genus	Number of species
Bombacaceae	<i>Camptostemon</i>	2
Euphorbiaceae	<i>Excoecaria</i>	2
Lythraceae	<i>Pemphis</i>	1
Meliaceae	<i>Xylocarpus</i>	2
Myrsinaceae	<i>Aegiceras</i>	2
Myrtaceae	<i>Osbornia</i>	1
Pellicieraceae	<i>Pelliciera</i>	1
Plumbaginaceae	<i>Aegialitis</i>	2
Pteridaceae	<i>Acrostichum</i>	3
Rubiaceae	<i>Scyphiphora</i>	1
Sterculiaceae	<i>Heritiera</i>	3
Total	11	20



## Appendix II PHYSICAL PROCESSES

### Validity of wave theories

After LeMéhauté, 1969.

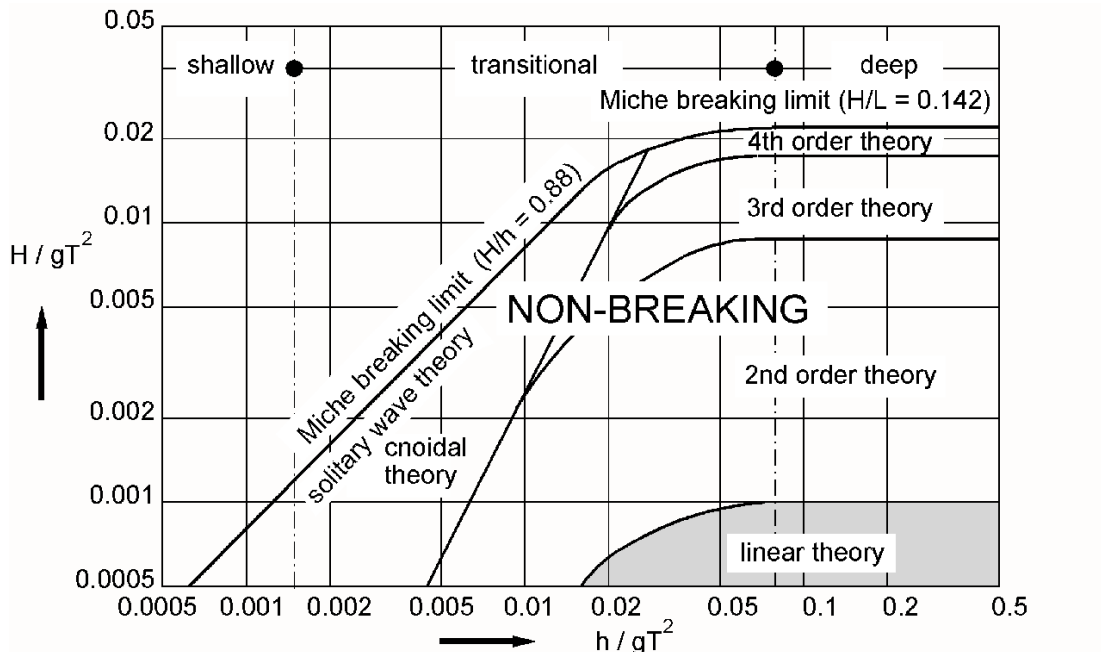

### Reynolds (Re) number

The Reynolds number is a dimensionless number and used for determining whether a flow is laminar or turbulent. Laminar flow within e.g. pipes occurs when the Reynolds number is below the critical Reynolds number ( $Re_{crit}$ ) and turbulent flow when it is above this value. The critical Reynolds number depends on the flow type and the definition of the Reynolds number. Typically it is given as:

$$Re = \frac{uL}{\nu}$$

With:

- $v_s$  - mean fluid velocity,
- $L$  - characteristic length
- $\nu$  - kinematic fluid viscosity

$L$  is a characteristic length in the flow. This can be the water depth, but also the size of obstacles or space between obstacles.





### Drag coefficient $C_D$ and mangroves

Between  $Re=10^3$  and  $Re=10^5$ ,  $C_D$  is more or less constant for circular cylinders ( $C_D \approx 1$ ). However, measurements show that in mangrove vegetation  $C_D$  varies within this range. The relationship between the drag coefficient  $C_D$  and Reynolds number for mangrove vegetation is shown in the figure below, after Mazda *et al.* 1997b.

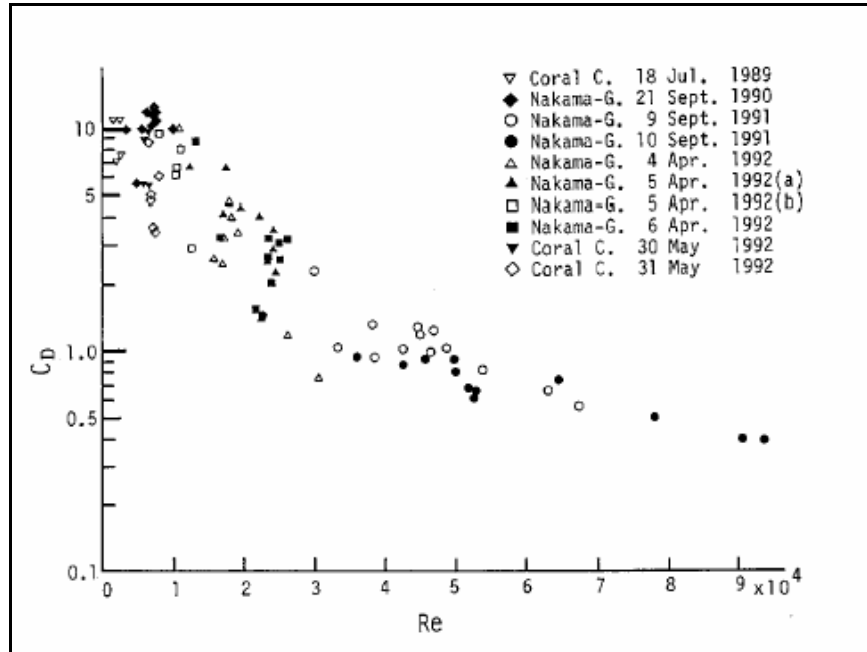

### Vegetated cross-area

Some results by Mazda *et al.* (1997b) are shown below.  $A$  is the cross-area,  $V$  is the volume of the submerged roots per unit area. Although  $A$  is divided by  $V$ , the shape of the curve for  $A$  only has the same shape since correction for the depth is linear.

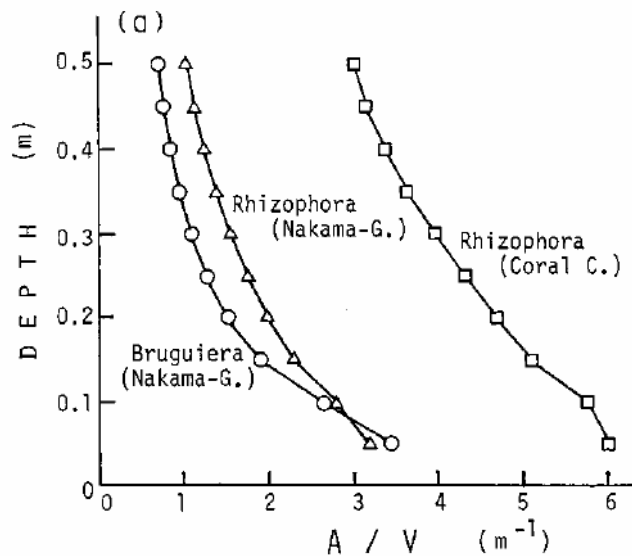



## Appendix III WAVES

### Significant wave height

Although the definition of  $H_{1/3}$  as the significant wave height is rather arbitrary it is a widely used method. Significant wave height methods are used to characterize short-term wave height distributions and represent thus the state of the sea at a certain moment. The wave spectrum has to be relatively narrow and Rayleigh-distributed (Battjes 2000). This method is valid in water that is deeper than  $\sim 3H_s$  with regard to the breaking of waves. The Rayleigh-distribution formula and an example are shown below.

$$P\{H > H_s\} = \exp\left[-2\left(\frac{H}{H_s}\right)^2\right]$$

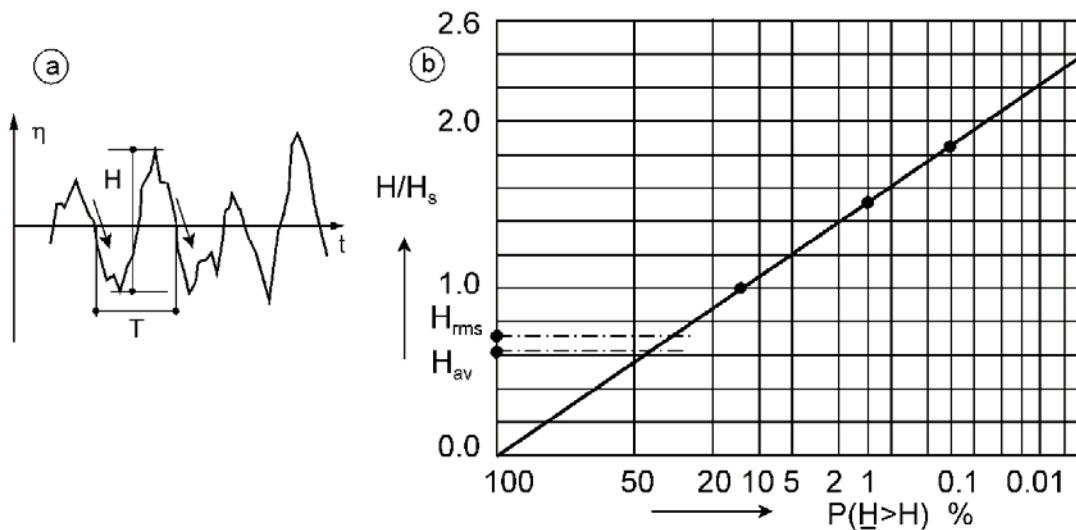



### Calculation of $H_{1/3}$ from pressure recordings

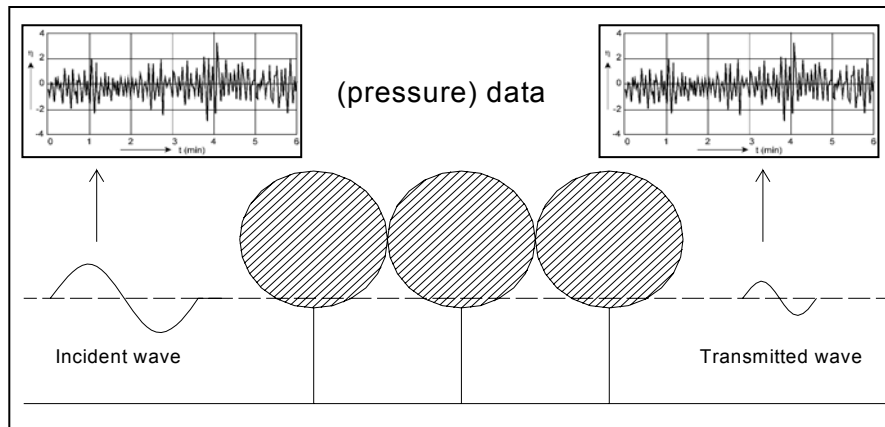

When waves are measured at two subsequent location, a significant wave height has to be derived from the data in order compare both wave fields. This data can either be pressure data or wave data from elevation recordings. Below we will discuss the steps to get from rough pressure data to  $H_s$ , in this case  $H_{1/3}$ , in a spreadsheet. The numbers between brackets corresponds with the numbers of the columns in the example on the next page.

1. Import data from pressure recording to a spreadsheet program
2. Divide pressure data by  $\rho g$ , the data is now in [m]. Note that pressure is NOT hydrostatic and the data now obtained are NOT actual fluctuations of the water surface (2).
3. Calculate the average of the data in (2) and subtract this average from the data in (4)
4. Derive extreme values from the data set (6). Since intervals between readings are  $\ll 1$  s, these extreme values are easily recognized.
5. Calculate the distance between subsequent values (7) and determine the number of waves.
6. Sort the values from (7) in descending order (8).
7. Derive highest  $1/3$ -part of (8) and calculate the average value (10).
8. Determine the wavelength  $L$  with formula (6.7) and  $k$  with formula (6.6).
9. Determine  $\cosh k(k+z)/(kb)$  (11) and divide (10) by this value.  $H_{1/3}$  is now determined.

The above summarized steps are analogue to deriving  $a$  from formula (7.2):

$$p = -\rho g z + \rho g a \frac{\cosh k(h+z)}{\cosh kh} \sin(\omega t - kx)$$



The example below is executed with an imaginary data set.

T <sub>av</sub>	(recording time/# of waves)	3,15	[s]
L	(calculate with formula 6.7)	13,0	[m]
z	(position of recorder)	-0,75	[m]
h	(waterdepth)	2,85	[m]
k	(calculate with formula 6.6)	0,48	[m <sup>-1</sup> ]

1	2	3	4	5	6	7	8	9	10	11	12
# of reading	readings divided by pg [m]	average readings [m]	deviation from average [m]	# of wave	extreme values [m]	'wave' heights [m]	wave heights descending [m]	highest 1/3 part [m]	average of 1/3 part [m]	cosh k(h+z)/kh [-]	Significant wave height [m]
2-3											10/11
1	1,2402	1,09436	0,1458		0,1458		0,5512	0,5512	0,39962	0,7403	<b>0,54</b>
2	1,2402		0,1458	1	-0,0609	0,2067	0,5512	0,5512			
3	1,2402		0,1458		0,1458		0,4823	0,4823			
4	1,2402		0,1458	2	-0,1298	0,2756	0,3445	0,3445			
5	1,2402		0,1458		0,1458		0,3445	0,3445			
6	1,2402		0,1458	3	-0,1298	0,2756	0,3445	0,3445			
7	1,1713		0,0769		0,0769		0,3445	0,3445			
8	1,1713		0,0769	4	0,0080	0,0689	0,3445	0,3445			
9	1,1713		0,0769		0,0769		0,3445	0,3445			
10	1,1024		0,0080	5	-0,0609	0,1378	0,3445	0,3445			
11	1,1024		0,0080		0,0769		0,2756				
12	1,1024		0,0080	6	-0,0609	0,1378	0,2756				
13	1,0335		-0,0609		0,0769		0,2756				
				7	-0,0609	0,1378	0,2756				
					0,0769		0,2756				
				8	-0,1298	0,2067	0,2756				
					0,1458		0,2067				
				9	-0,1298	0,2756	0,2067				
					0,1458		0,2067				
				10	-0,1987	0,3445	0,2067				
					0,1458		0,1378				
				11	-0,1987	0,3445	0,1378				
					0,2147		0,1378				
				12	-0,1298	0,3445	0,1378				
					0,1458		0,1378				
				13	-0,1298	0,2756	0,1378				
					0,0769		0,1378				
				14	-0,0609	0,1378	0,1378				
					0,0769		0,0689				
				15	-0,1298	0,2067	0,0080				
					0,1458						
				16	-0,1298	0,2756					
					0,0769						
				17	-0,0609	0,1378					
					0,1458						
				18	-0,1987	0,3445					
					0,2836						
				19	-0,1987	0,4823					
					0,2836						
				20	-0,2676	0,5512					
					0,2147						
				21	-0,3365	0,5512					
					0,2147						
915	1,0335		-0,0609	22	-0,1298	0,3445					
916	1,0335		-0,0609		0,0769						
917	1,0335		-0,0609	23	-0,1298	0,2067					
918	1,0335		-0,0609		0,1458						
919	1,0335		-0,0609	24	-0,1987	0,3445					
920	1,0335		-0,0609		0,1458						
921	1,0335		-0,0609	25	-0,1987	0,3445					
922	1,0335		-0,0609		0,1458						
923	1,0335		-0,0609	26	-0,1298	0,2756					
924	1,0335		-0,0609		0,0769						
925	1,0335		-0,0609	27	-0,0609	0,1378					
926	1,1024		0,0080		0,0080						
927	1,1024		0,0080	28	-0,1298	0,1378					
928	1,1024		0,0080		0,0769						
929	1,1024		0,0080	29	-0,0609	0,1378					

29 waves





## Appendix IV MEASUREMENT EQUIPMENT

The measurement equipment is shown schematically in the figure below. The various elements are discussed briefly in this appendix.

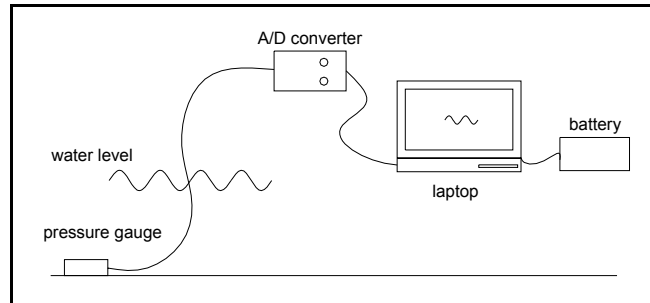

### Pressure gauge

The pressure gauge was built around a pressure sensor made by Honeywell®, serial number 24PCBFA6D. The gauge was made out of a plastic casing. The sensor was separated from the water by rubber membrane. A small opening, closed off with a bolt, allowed for adjustment to local atmospheric pressure.

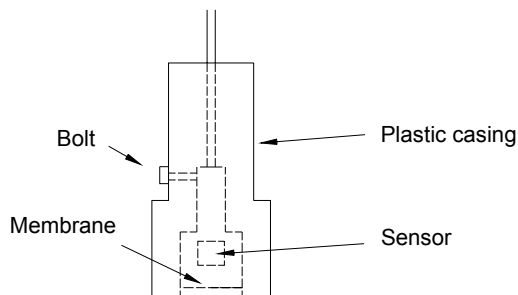

**Honeywell**



24PC And 26PC Series Pressure Sensors

### Converter

The pressure signal was converted by this device to an electric signal that could be recorded by the software on the laptop. This converter required two 9V batteries to operate.

### Batteries

Laptop batteries do have enough power to work several hours on subsequent days without recharge. For this study a Dell-made laptop was used that operated on 18V DC, provided by a AC/DC converter that transfers standard 110/220 AC signal to the required current.



To obtain 18V DC current by an external power source, two car batteries (12V) were used. The batteries had two extra knobs that allowed the use of half the battery. This way, two batteries as shown in the figure below could produce 18V.

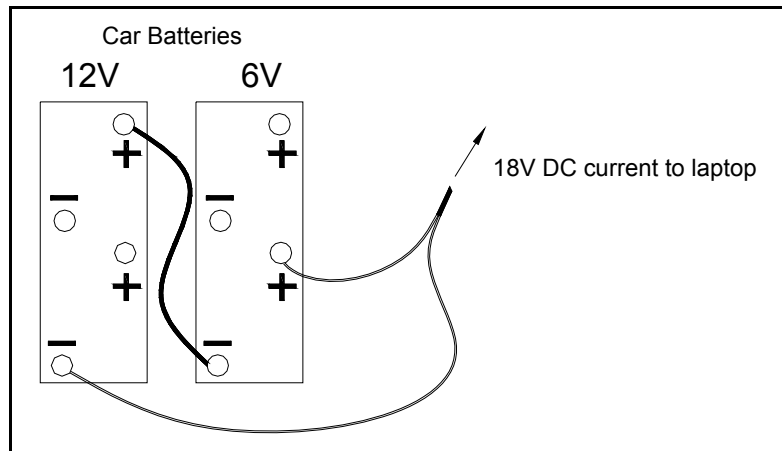

The original AC adaptor was not used anymore. The pictures below show the assemblage of the configuration, the first operational test on the boulevard of Do Son, and the final application during fieldwork.



By-passing the AC adaptor

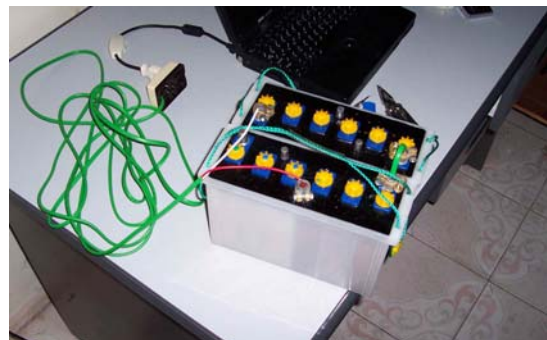

18V DC current attached to computer



Equipment tested



Equipment operational



## Appendix V MORE DETAILS OF STUDY AREA



Mixed forest



Measurement towers



Ringdyke

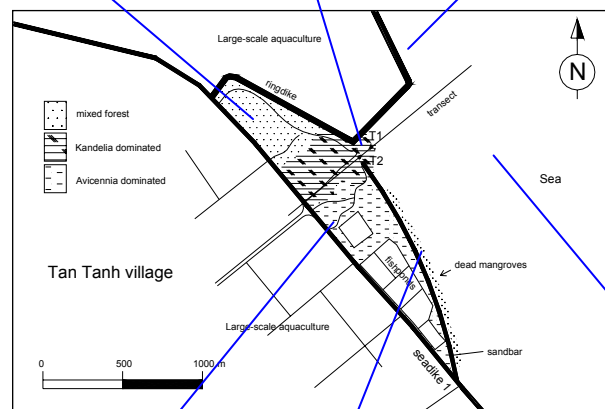

Main entrance channel



Fishing tower on mudflat



Sand bar with dead mangroves



A GPS-receiver was used during fieldwork for navigation through the forest. It also proved to be a useful tool for mapping and recording the position of landmarks. The first figure below shows the surrounding area of the study site, the second figure shows waypoints from the GPS-receiver, plotted on a U.S. Army map from 1963.

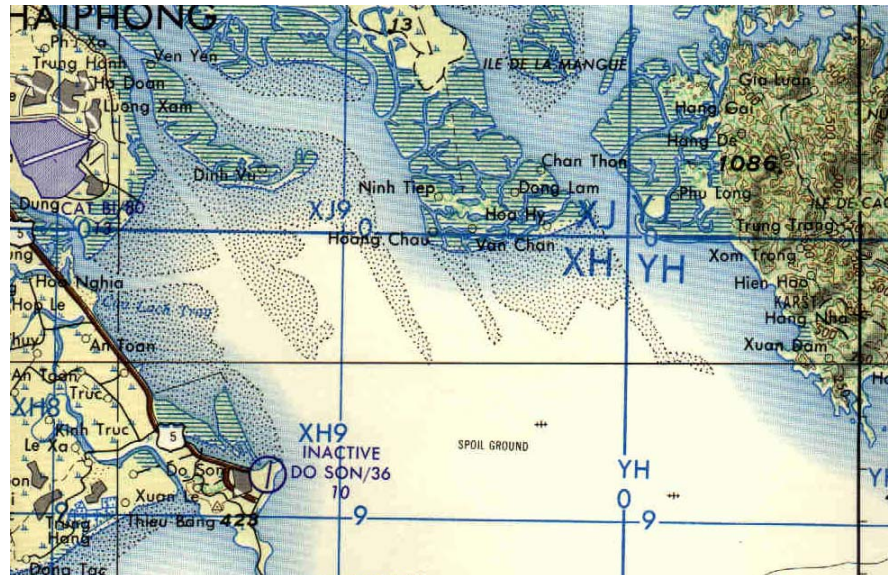

It is clearly visible that the coastline (Sea dyke 1) has shifted in the years. The area between the old coastline and the new one used to be covered by mangroves and is now completely occupied by shrimp ponds. This is also a good example of what is described in paragraph 5.4.5.



The data from the GPS-receiver is imported in a CAD program and used to draw a map of the study site, showing the layout of the area and important events and locations. The waypoints and a rough sketch are shown in the next figure





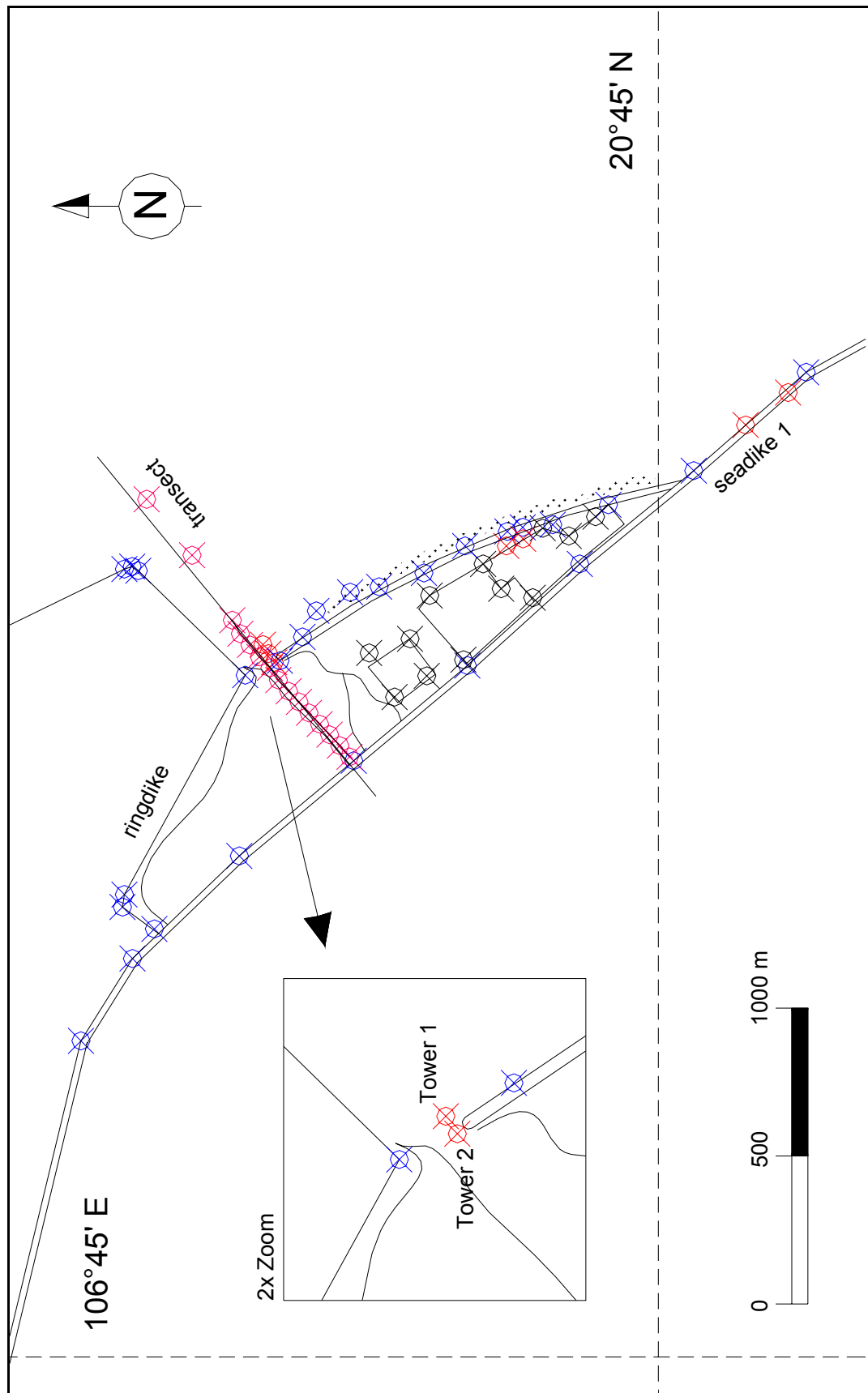



## Appendix VI OVERVIEW FIELDWORK



Paperwork at Coastguard



Transport materials to front forest



Construction of tower



05.00 a.m.



05.30 a.m.



Just in time to navigate back to dyke



Vietnamese hospitality



Front of forest



Aqua culture in forest



Setting out transect



5x5 square tree survey



Field survey with water hose



Working in the forest





Goodbye diner local people



Goodbye diner local fishermen



Powered by Minsk