



Delft University of Technology

Infrastructure as a Service: An analysis of the circular effectiveness

Schraven, D.F.J.; Teigiserová, D.A.; Noppers, Frederike

Publication date

2023

Document Version

Final published version

Citation (APA)

Schraven, D. F. J., Teigiserová, D. A., & Noppers, F. (2023). *Infrastructure as a Service: An analysis of the circular effectiveness*. (2 ed.) Delft University of Technology.

Important note

To cite this publication, please use the final published version (if applicable). Please check the document version above.

Copyright

Other than for strictly personal use, it is not permitted to download, forward or distribute the text or part of it, without the consent of the author(s) and/or copyright holder(s), unless the work is under an open content license such as Creative Commons.

Takedown policy

Please contact us and provide details if you believe this document breaches copyrights. We will remove access to the work immediately and investigate your claim.

Infrastructure as a Service: An analysis of the circular effectiveness

The Circular Road 2022





"Roads were made for journeys, not destinations."

Confucius

"One's destination is never a place, but rather a new way of seeing things."

Henry Miller

The circular road partners



This research was made possible with additional contributions from



Report prepared by Daan Schraven and Dominika Alexa Teigiserova with contributions from Frederike Noppers

March 2023 Netherlands

<https://decirculairweg.nl>

Cite as: Schraven, D. Teigiserova, D. A. Nopper, F. 2023. Infrastructure as a service: An analysis of the circular effectiveness. 2nd Edition, English report on De Circulaire Weg. March 2023 Netherlands.

Note: A 2nd edition was issued to recalibrate some of the analyses from the 1st Edition.

Foreword

The stocks of raw materials and fossil energy the earth can provide us are finite. In order to continue to meet our needs as a society in the long term, we will have to rearrange our system. From consuming raw materials to using them while enabling reuse in the same or other applications. The importance of building renewable and regenerative systems is also recognized in the construction & infrastructure sector. The Dutch government aims to be fully circular by 2050 and with 50% achieved by 2030. A circular construction economy means that we succeed in meeting the socio-economic needs for housing and infrastructure without exceeding the carrying capacity of the earth in the form of depletion, CO₂ emissions, pollution, biodiversity loss, and other environmental damage.

This transition from a linear to a circular construction economy is a system change of unprecedented magnitude. Every breakthrough in the field of circular procurement, the new application of materials, or high-quality reuse contributes to that. But acceleration is only possible by approaching this challenge systemically. With all chain partners and with an eye for the social, technical, and legal innovations that are needed.

"To become circular, we have to train in doing what is necessary" Thomas Rau

A number of pioneers from different organizations have joined forces to meet this challenge at the system level. Our proposition: We can boost circularity in infrastructure projects by applying Infra as a Service (IaaS). The long-term vision and the business model created the space to invest in circular innovations in design, lifespan, and reuse at the end of the lifecycle. This idea started with the insight of Dura Vermeer that solely technical innovations do not suffice to form a fully circular system. What if the constructor remained the owner of the materials after construction while being responsible for maintenance, renovation, harvesting, and reuse? Is that going to stimulate different thinking and acting? The concept was devised by various experts, and the province of Overijssel joined in. Based on their project, the model was theoretically tested and seen as feasible to enhance circularity. The next step was testing in practice. In order to properly experience the teething problems and remove them quickly, this was picked up in an partner program. At the beginning of 2020, 11 different organizations set up The Circular road program (De Circulaire Weg) to contribute to the practical research for Infrastructure as a Service (IaaS). Each with its own expertise and role to play, from client and contractor to financier and knowledge institution. The seven potential pilots were chosen, and the Delft University of Technology has closely followed them. In this report, you can read the findings of their research.

From my overarching role, I saw beautiful patterns emerge in the pilots. For example, this working method ensures a different conversation between client and contractor and sharing of responsibility for the environment and materials. But we have also sometimes experience setbacks, for example in case when an idea turned out not to be immediately feasible. The learning process and its effect were great; we looked for alternative solutions, and the next pilots could stand on the shoulders of their predecessors and take the model a step further. Not all bumps on the road could be solved in 1 series of pilot projects. The application of Infrastructure as a Service has also exposed (potential) legal, social and technical barriers that need to be further investigated. The crucial point that The Circular Road has brought the partners, in my opinion, is the challenge to go further than they initially thought possible. The joint drive to create an acceleration towards circular construction has kept them constantly sharp and ensured that they tested ideas in practice and learned from them. That is a real innovation!

With this, the partners of The Circular Road have taken the first steps to arrive at a system approach to the desired market transition. In order to make optimal use of the circular effects, remove the obstacles, and apply the laaS model on a larger scale, follow-up projects and research are needed. The Circular Road, therefore, continues. In the future, we will focus on questions such as: How can we scale laaS? How can we further develop the measurement and stimulation of circularity? Which technological innovations will follow? We will also work on the coherence between laaS and other market initiatives to learn from each other and strengthen each other in our pursuit of a circular construction economy by 2050. Sharing our insights and results with the sector is the first step in this.

I would like to thank everyone who has contributed to this program. We could not have achieved this result without your courage, solution-orientated approach, and perseverance. And my special thanks to Dominika Teigiserova and Daan Schraven, who have reported on our learning experiences with great patience and precision and know how to interpret them and translate them into interesting insights and recommendations. Relevant for The Circular Road and the entire infrastructure sector.

Frederike Noppers

Program Manager The Circular Road

Summary

This research asks the question: *Under what conditions does the applied As a Service model on infrastructure lead or not to a higher level of circularity and lower or equal life cycle costs?*

To answer this question, we followed and evaluated seven pilots that experimented with IAAS in practice at the municipalities of Amersfoort, Utrecht, and Amsterdam and in the provinces of Overijssel, North-Holland, and North Brabant. We looked at the As-a-Service level, the degree of circularity, and the degree of the costs. In addition, we also outlined the underlying circumstances within which the pilots were carried out, such as the organizational, financial, and technical similarities and differences.

Overall, we can conclude that each pilot had a unique set of circumstances and that they each walked their own path with the As-a-Service. This demonstrates the importance of contextual conditions for establishing a successful model. We found these conditions in the patterns we discovered in the data from these pilots.

The levels of the As-a-Service models are fairly close to each other for all pilots, with the median predominantly between specifying functional effects (FL1) and specifying functional solutions (FL2). Utrecht Croeselaan, as the only non-AAS used for comparison, also appears to have a high level of circularity (namely FL1). Therefore, the condition seems to be less distinctive at the level of IAAS itself. It seems to have more to do with the directionality, or direction, that a client gives to the project. A higher degree of directionality can be seen in Utrecht, for example, with a pronounced focus on sustainability, without an AAS working model, but with a lot of freedom for the contractor to make proposals. A high degree of directionality can also be seen in the AAS model, such as Overijssel, with a strong focus on sustainability as a common thread within a regular project. In general, AAS models, with less prominent directionality, show that direction is given in (partly) value propositions in sustainability and circularity and in a fairly wide range of demand items, such as safety and maintenance.

The division of circularity initiatives led to a more unsolicited initiative by the contractor for small AAS assignments (PNH, Amersfoort, and PNB) with fewer instructions by the client. However, this does not necessarily lead to better or more circularity. However, the contractor seems to take more initiative in parts of the assignment where it is not initially discussed or requested. Thus, the contractor draws circular initiatives more broadly when an AAS model is set up with less direction. The number of proposed elements can thus increase as unsolicited initiatives become a conversation between the client and the contractor. Low directions and open client-contractor conversations can become a catalyst to enhance circularity in the market. In addition, we see that largely together defining measures gives a very effective model (pilot PNB).

Table A. Summary of data for the pilots from The Circular Road. MCI (Material Circularity Index), MKI (Environmental Costs Indicator), NPV (Net Present Value).

Pilot name	MCI scores * (index 0 to 1)			MKI scores * (in k€)			NPV scores * (in k€)		
	a) Pilot	b) Ref.	c) = a-b MCI Δ	d) Pilot	e) Ref.	f) = d-e MKI Δ	g) Pilot	h) Ref.	i) = g-h NCW Δ
Amersfoort <i>Replacement bicycle bridge decks</i>	0,85	0,98	-0,13 (-13%)	-	-	-	326	340	-14 (-4%)
Amersfoort <i>Reconstruction of residential road</i>	0,65	0,59 ¹	+0,06 (+10%) ¹	29	66	-37 (-57%)	-	-	-
Province North Brabant <i>Road light as a service</i>	0,33	-	-	-	-	-	286	0	+286 (N/A)
Province North Holland <i>Guide rail as a service</i>	0,79 ¹	0,27	+0,51 (+186%) ¹	23	44	-21 (-48%)	244	371	-128 (-34%)
Province Overijssel <i>Sustainable management provincial road</i>	0,43	0,14 ¹	+0,29 (+208%) ¹	239	345	-105 (-31%)	985	108	+877 (+811%)
Utrecht <i>Reconstruction of Croeselaan city road (non-AAS)</i>	0,42	-	-	42	123	-80 (-65%)	-	-	-

*see section 2.3.1.2 in the report for calculation method

The material circularity index (MCI) is increased for most of the pilots when compared to the reference projects (BAU). However, MCI is influenced when materials are used for low R strategies (e.g., recycling), which increases the risk of unusable waste (through processing). This led to a lower MCI score in the Amersfoort bridge deck. AAS seems to generate a higher MCI in small and defined pilots, especially at Province North Holland. With small assignments, the circumstances seem clear enough for a contractor to optimize a defined service. More complex assets (such as provincial roads) have a lower MCI, regardless of IAAS or not, but can also reap larger profits with targeted customer requirements. However, it should be noted that MCI is based on cb23 data, which includes direct measurements, but also assumptions based on expert opinions and proxy (such as environmental product declaration). Thus, the data need a higher level of accuracy to not deviate from the real-life situation.

The environmental cost indicators (MKI) are decreased in all pilots when following IAAS. A possible explanation for the fairly equal chance for MKI reduction is that the MKI is already a well-known and practical tool for contractors. This means that the contractor can make good use of the instruments for MKI and that the MKI parameters can be optimized well compared to a reference project. However, it should be noted that the accuracy of MKI data still needs to be improved in general, as data are partially based on

¹ Disclaimer: after verification the data has changed from the originally published report (Dutch version) in June 2022.

information from the producers, data from the construction company, but also proxy and approximations.

In the net present values (NPV), we see a mixed picture of increases (Province of North-Brabant and Overijssel) and decreases (Municipality of Amersfoort and North-Holland) compared to non-AAS references. The change in scores depends very much on the planned interventions at the front end of the As-a-Service contract. An increase can come from adding new functions to an asset (such as dimmable road light in North Brabant) compared to the traditional start of the contract (reference). However, where an equal function is retained (e.g., at the bicycle bridge deck of the municipality of Amersfoort), or intervention in both the pilot and a reference is necessary (e.g., for the guide rail of North Holland), the difference in scores is less impacted, or even decrease with efficient implementation. It shows that the initial value depends on the main value proposition (i.e., new or added function/effects versus retaining the same function/effects). The degree of circularity will have to prove itself in the two not included indicators of value loss and preservation over time.

The life cycle costs of AAS models are, in most cases, lower than the non-AAS references, with the exception of PNB. This is because this pilot also involves a large investment at the beginning of the assignment (the installation of dimmable lighting). This means that the total costs are also higher. However, it does not necessarily mean that circularity will deteriorate as a result. On the contrary, the investment made can mean higher circularity and lower costs in the longer term. It shows that IAAS both promotes circularity and can partially reduce life cycle costs. However, it depends on the realization costs at the beginning and to what extent the costs will be higher or lower.

Since some AAS models require an upfront investment, that means that not every AAS starts at the same starting point. Thus, the financing requirement depends on the intended costs. First, smaller projects can probably be financed without problems by the contractor and client directly. Secondly, project financing is a suitable method when a large investment has to be made. However, in project financing, special attention needs to be paid to managing risks and drawing up a joint venture. Finally, as soon as a consortium of companies can keep short lines of communication during the realization and maintenance of an asset, leasing becomes an interesting option. In essence, parties must draw up a common risk profile for each of these forms and find a way to jointly bear it.

The stakeholder analysis also shows that IAAS is an attractive way of working for stakeholders. A number of enablers work in favor of both achieving systemic change and higher circularity. However, IAAS does have barriers to implementation. Among other things, the level of knowledge in exports (at the level of implementation?) and among

decision-makers are clear obstacles. The report provides recommendations based on the stakeholder analysis.

Finally, we would like to take this opportunity to express our gratitude to the countless colleagues and partners who have assisted us in producing this report. There are a lot of names to mention. That is why we would like to be the first to express our thanks to the most important group underlying this study: all members and stakeholders of the partner program; without your enthusiasm and energy, this study simply could never have existed.

For the preparation of the report, we would like to thank a number of people in particular. The graduation work of Denise Huizing, Matias Biese, Menouschka Baldew, and Sjef Hereijgers have laid an important foundation for the study. We are indebted to Colin Reit and Rijkswaterstaat for their help in the search for circular measurements via DuboCalc. In addition, we would also like to thank Marianne Breijer of Erasmus University Rotterdam for her attentive eye to the Dutch language for the Dutch version of this report. Last but not least, we would like to thank Frederike Noppers for her rock-solid help within the program.

We would also like to thank our colleagues who have inspired us along the way. First of all, the members of the user group of this study Prof. Hans Bakker, Claartje Vorstman, Paul Janssen, Jeroen van Wijgaarden and Ronald Dirksen. In addition, the colleagues of Inclusive Wise Waste Cities, and Triple-A Infrastructures, thank them for their interest at the time of the research.

"A circular road shows new things with every cycle."

Dr. Daan Schraven (Delft University of Technology)

Principal investigator The Circular Road

Dr. Dominika Alexa Teigiserova (Delft University of Technology and Erasmus University Rotterdam)

Postdoc fellow The Circular Road

Abbreviations

AAS	As a service
BAU	Business as usual
Bonus/malus	Bonus-money are paid to the contractor; malus-contractor pays to the client
CE	Circular Economy
EoL	End of life
IAAS	Infrastructure as a service
LCA	Life cycle assessment
LCC	Life cycle cost
MCI	Material Circular Indicator
MKI	Environmental Cost Indicator
NPV	Net Present Value
PNB	Province North Brabant
PNH	Province North Holland
POV	Province Overijssel

Table of Contents

Foreword	III
Summary	V
Abbreviations.....	IX
1. Introduction of the study, setup, and report	1
1.1 Setup.....	2
1.1.1 As a Service model	2
1.1.2 Societal Costs and Benefits.....	5
1.1.3 Contextual characteristics.....	10
1.2 Methodological overview.....	12
1.3 Reporting structure.....	13
2. Program analysis: common features and analysis of IAAS and circularity.....	15
2.1 Summary and highlights.....	15
2.2 Infra a service model	17
2.2.1 Responsibility (client, contractor distinction)	19
2.2.2 Client-Contractor Transits and As a Service levels	19
2.3 Societal Costs and Benefits.....	20
2.3.1 Circular measurements	20
2.3.2 Life cycle costs	37
2.4 Financial models	38
3. The pilots.....	43
3.1 Pilots Overview.....	43
3.2 Amersfoort: Bridge deck	44
3.2.1 Pilot description.....	44
3.2.2 As a service framework	45
3.2.3 Pilot highlights.....	49
3.3 Amersfoort: Residential road.....	49
3.3.1 Pilot description.....	49
3.3.2 As a service framework	50
3.3.3 Pilot highlights.....	54
3.4 North Holland: Guide rails	55

3.4.1	Pilot description.....	55
3.4.2	As a service framework	57
3.4.3	Pilot highlights.....	60
3.5	North Brabant: Road lights	60
3.5.1	Pilot description.....	60
3.5.2	As a service framework	63
3.5.3	Pilot highlights.....	67
3.6	Overijssel: N739 provincial road.....	67
3.6.1	Pilot description.....	67
3.6.2	As a service framework	71
3.6.3	Pilot highlights.....	74
3.7	Amsterdam: Temporary Road	74
3.7.1	Pilot description.....	74
3.8	Utrecht: City road (traditional contract).....	76
3.8.1	Pilot description.....	76
3.8.2	Sustainable and circular aspects	78
3.8.3	IAAS considerations.....	81
4.	Stakeholder analysis: enablers and barriers	84
4.1	Summary.....	86
4.2	Enablers	87
4.2.1	Contextual aspects	89
4.2.2	Economic aspects	90
4.2.3	Technical aspects.....	91
4.2.4	Inter-organizational aspects.....	91
4.2.5	Intra-organizational aspects	94
4.3	Barriers	94
4.3.1	Political and legal aspects.....	96
4.3.2	Intra-organizational aspects	96
4.3.3	Inter-organizational aspects.....	97
4.3.4	Intra- and Inter-organizational aspects.....	98
4.3.5	Economic aspects	100

4.3.6	Technical aspects.....	100
4.3.7	Contextual aspects	100
4.4	Dissensus	101
4.4.1	Political aspects.....	102
4.4.2	Economic aspects	103
4.4.3	Technical aspects.....	104
4.4.4	Intra- and inter-organizational aspects.....	105
5.	Recommendations.....	107
5.1	Conditions for circularity with IAAS.....	107
5.2	From a barrier to a solution.....	109
5.3	10-step guide.....	115
5.4	The Circular Road 2.0/Further research.....	117
Annex 1	119
References	122

1. Introduction of the study, setup, and report

The transition to a circular economy is of key importance to all industrial sectors concerned. It involves technological innovations to be developed and implemented and the social innovations to go along with it. The infrastructure sector is known for its rigid market division, making this tandem of technological and social innovation especially hard. Luckily, it does not mean that actors within the infrastructure sector cannot acquire healthy naivety and stubbornness to embark on a disruptive journey to create new novel social innovations in the form of new collaboration forms in order to boost technological innovations with it. The Circular Road program is a testament to this.

The Circular Road is a 2-year project to test the added value of disrupting traditional contractual arrangements between public clients and contractors with social innovation in the circular transition. It consists of 7 pilots that experiment with a new contract form, known as the As a Service model. It includes different infrastructure objects: bridge deck, residential road, guide rails, road lights, provincial road, temporary road, and city road. This model stems from the product-service system, a type of circular business model that seeks to translate the value of an arrangement through its services rather than the products sold. It is known for its potential sustainable outcomes in other sectors, like textiles and washing machines (Bocken et al., 2018; Tukker, 2004). By placing emphasis on the service (one washing round) rather than the product (washing machine), a user and producer become much more aware of the impact of the extent of use and extent of energy and material needed for that usage. This awareness is perceived to help and break the intensive usage and inefficient deployment of products in these bulk and commodity industries.

As the product-service system has kept the promise in these industries, the novel transfer to the infrastructure industry can be imagined as a viable route to explore. This is what The Circular Road program facilitates with its network of partners from Development and Commercial Banks, Local, regional and national government, contractor, engineering firms, and academic partners. In order to test the feasibility, viability, and desirability of the As a Service model for infrastructure projects, the program was guided academically by TU Delft to answer the following question: *Under which conditions does or doesn't the As-a-Service model applied to infrastructure lead to a higher level of circularity, and a lower or equal life cycle cost?*

This report is organized to provide an answer to this question through a series of research steps that were conducted from October 2020 until April 2022. The remainder of this chapter describes the overview of the research setup and report structure.

1.1 Setup

The research setup is organized along with the theoretical framework below in Figure 1. In response to the research question, the study looks at the influence that As a Service has on circularity and the life cycle costs. It is theorized that each pilot has variations in their context that modify this influence. The logic of the theoretical framework conveys that the research should be able to find which contextual elements prove helpful or unhelpful in generating higher circularity and lower life cycle costs through the As a Service way of working. For this to be transparent for this research, it is key that we show define and operationalize each of these elements before we describe the results that the program overall and the 7 pilots studies separately come to.

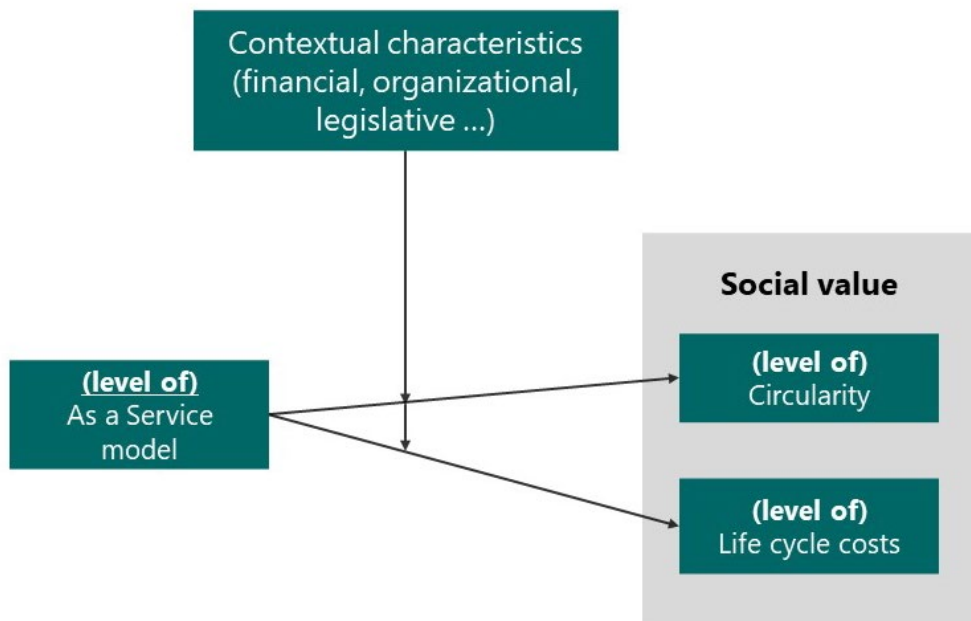

Figure 1 Theoretical Framework for The Circular Road Program

1.1.1 As a Service model

The product-service system is a concept that is known for its various levels of Service provision. Several academics have developed a classification of these levels in the past decades. The most notable example of such a classification was provided by Arnold Tukker (Tukker, 2004), who distinguished between product, use, and result-oriented product-service systems. For this research, the classification system of Arnold Tukker provides specific difficulties due to:

- a) the nature of infrastructures as a technical system; and

b) b) the sector as a contract-based market.

First, the variations are not clearly coupled to a decomposition of the service and product components of that system, which is important to understand the engineered system and its relation to service provision in the form of functionalities (e.g., a road providing mobility). In addition, the classification by Arnold Tukker does not yet provide clear translations to the different revenue mechanisms that result from a certain level of service, which can be different per contract in the infrastructure industry. For these reasons, the refined classification by Van Ostaeyen et al. (2013) is preferred for this research.

The framework includes a blue part and a grey part. The blue part represents the engineered system of a product service system which shows the decomposition of abstract demand to concrete solutions. It is a way in which the public client demands the service, and the contractors' ideas for services and solutions are visualized for a comprehensive understanding of the entire system.

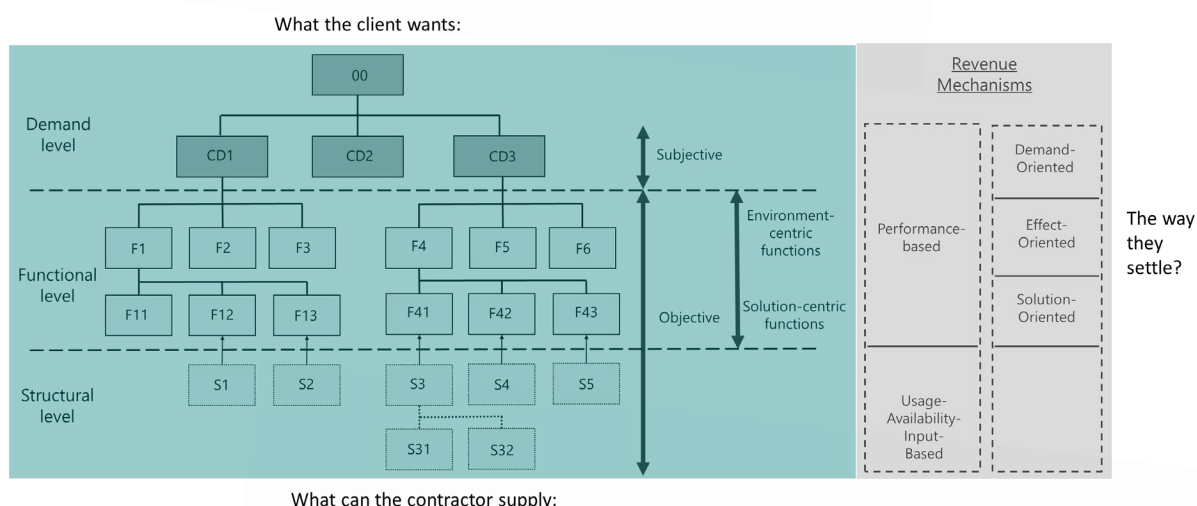

Figure 2 Refined classification of Product Service Systems, adapted from Van Ostaeyen et al.(2013). CD is Customer Demand, F is function and S is structure.

The blue part shows that the decomposition takes place at 3 levels. At the demand level, the public client formulates the demand of the project or overall project objectives for which they would like a contractor to provide solutions or services. An example here could be that a newly constructed bridge will be constructed circular. At a functional level, sometimes the public client has a very clear idea of the underlying details they expect, but sometimes they don't. In any case, the project objectives are translated into decomposed functional effects (e.g., reducing the number of CO₂ emissions during construction) and functional solutions to achieve them (e.g., the emissions produced by machines on the construction site). At the Structural level, most of the time, the contractor will take the lead in formulating the system, for example, only working with electric

machines on the construction site. The idea is that this decomposition allows for a visualization of which parts are defined by the client and which parts are left open for the contractor to define. The level of As a Service is considered of a higher level when a contractor is defining the system in the green part at the higher orders of the decomposition, so for example, at the functional effects level or the demand level.

The grey part of the framework shows the levels of captured revenue mechanisms that are expected to fit with the predominant level of as service coming from the green part. Revenue mechanisms here are defined as the ways in which the public client and contractor arrange payments to cover the services offered. It spells out the levels of performance-based (payment by performance), usage (payment by usage), availability (payment by availability), and input-based (payment by offered input) revenue mechanisms. In addition, it describes three levels of performance base: demand-oriented (pay when demand is met), effect-oriented (pay when the effect is met), and solution-oriented (pay when the solution is effective) product-service systems. This classification allows for the engineering system to be theoretically linked to a revenue model that would best fit with a certain As a Service level. In essence, Van Ostaeyen et al. (2013) framework helps to understand the product-service systems that are designed in each of the pilots following this technique.

Provided that this framework is highly visual in approach and given the fact that the data collection had to be done during the coronavirus pandemic, a visual, interactive, online data collection technique had to be developed. For the research, we established real-time online interview sessions with public clients and contractor parties per client to iterate the engineered system that is agreed to for each pilot. The visual aspect was provided through an online whiteboard platform, where the blue area of Figure 2 is personified per pilot and saved for iteration between the parties through interviews. The first version of the As a Service model was prepared based on shared documents provided by the pilot teams related to meeting minutes, agreements, contracts, studies, and reports related to the pilots. This was then offered to the representative respondents of the public client and contractor side for additional input and modifications. Per pilot, every whiteboard visualization was established and validated with a total of 4 to 5 interviews.

Data: Against this background, As a Service will be measured as an As a Service Level (AASL). The As a Service model includes a number of elements in the model where the responsibility is transferred from the client (demand) to the contractor (to supply the demand), which we call Client-Contractor Transits. A fictitious example is shown in Figure 3. This turnover can take place at the Functional Effect Level of AAS, Client-Contractor Transit between Item B (demand) and Item D (supply), or at the transition between functional to structural level, Item E (demand) and Item F (supply). AAS can include several of these transits based on the effectiveness of the desired solution.

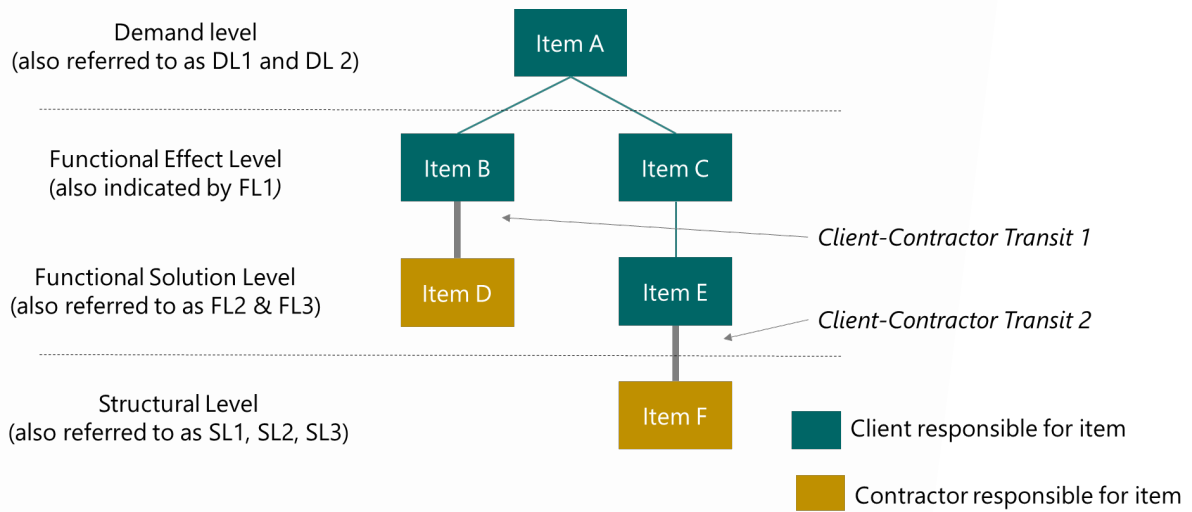

Figure 3 Determining As a Service Level using Client-Contractor Transits

These transits also represent a hierarchical level between supply and demand. We propose that the median of a series of transits accurately reflects the most prominent As a Service level in the models. The example would result in an As a Service level of FL1 and FL2, i.e., the settlement for this model should take place between the performance of an effect and the performance of a solution.

Because these figures cannot capture everything in the context of a pilot, we also work with visualizations, which will be explained separately in the results, namely the '*Initiative distribution*' and the '*As a Service profiling per question*'.

1.1.2 Societal Costs and Benefits

The social added value lies in the costs and benefits of circularity impact. The degree of circularity represents benefits, and the associated life cycle costs represent costs. The measurement of circularity is based on the indicators proposed by Platform CB'23 (Platform CB'23, 2020), Figure 4. CB'23 indicators, namely indicators 1, 2, and 3, were applied because:

- It reflects the 'state of the art' for measuring circularity in construction.
- It is representative of the Dutch context.
- The elaboration of this guideline contributes directly to the needs of the Dutch construction industry.

1.1.2.1 Circular measurements

What are platform CB'23 and its indicators?

“Platform CB'23 (Circular Construction 2023) has committed to drafting agreements on circularity in the construction sector. The platform brings representatives of stakeholder parties (including market parties, policymakers, and scientists) together to talk to each other and achieve generally supported agreements”.

The indicators have three key goals of circular construction: 1. to protect stocks of materials (indicators 1-3); 2. environmental protection (indicator 4); and 3. value retention (indicators 4-7).

This report includes indicators 1-3, which are the core indicators for protecting existing stocks of materials matching the materials balance used in environmental impact analyses considering all phases of the construction cycle.

(Platform CB'23, 2020)

Circularity is measured through many proxies and at very different levels of scale and scope (industrial parks, projects, cities, and nations). For this research, it is important to measure circularity in a way that is attainable for the practitioners in both public (client) and private sector (contractor). That's why we decided to focus on two ways to measure circularity. On the one hand, we want to map the circularity around the behavioral effect in order to capture the social innovation power. On the other hand, we want to map circularity as a physical effect, for which we use the indicators laid down in the CB'23 guidelines for measuring circularity (Platform CB'23, 2020). It is important to mention that we can only measure these indicators at the start and not during the project.

For the behavioral effect, we collect the value propositions, initiatives, and circular incentives that we can find in the As a Service models per pilot.

1. Value propositions: These are the initial objectives of the pilot and are mainly qualitative propositions. These statements indicate what is central to the question and whether circularity is also included at the start of the project. It thus provides information about the principles that have helped shape the various pilots.
2. Initiatives: The hypothesis from As a Service models is that this helps the contractor to see the financing of measures as a business investment instead of a cost item. This should therefore lead to more circular initiatives. We identify the number of initiatives from the models. We then classify and count these to

measure the degree of circularity initiatives and the distribution of initiatives taken between client and contractor.

3. Circular incentives: In order to really understand the underlying incentives of an As a Service model, we then make a distinction between the possible incentives that led to circular initiatives in the pilots.

It is good to report that the method for measuring the circularity incentive has changed as a result of the unavailable data about the circularity incentive for the reference projects without AAS. As a replacement, the incentive within the AAS model themselves is discussed on the basis of the visualization of the 'degree of circularity incentive of As a Service and Customer Demand.'

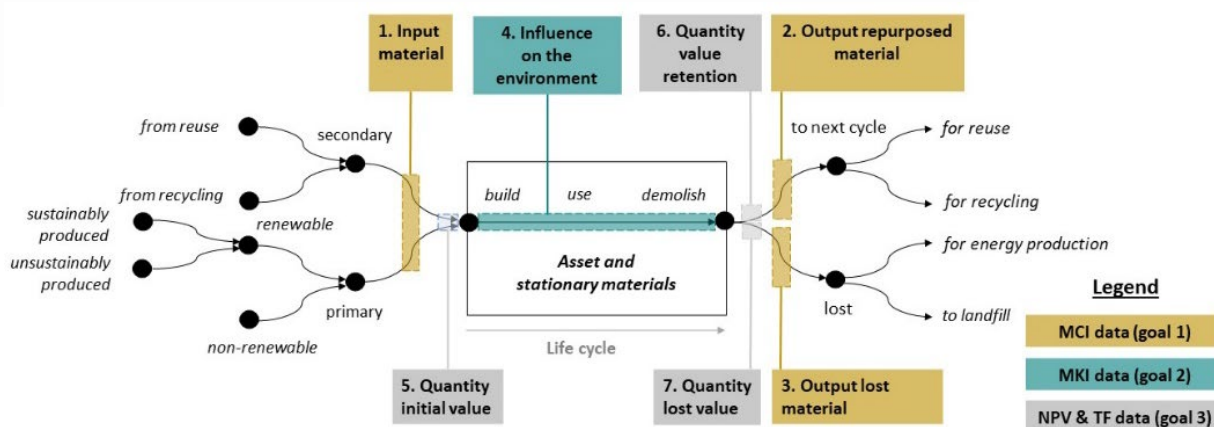

Figure 4 Schematic representation of 7 circularity indicators of CB23 (own figure)

What is MCI?

Material Circularity Indicator (MCI) is an indicator developed by Ellen MacArthur Foundation to measure how circular, restorative, and regenerative the material flows of a product or company are. It is based on the following six principles:

1. Sourcing biological materials from sustained sources⁵
2. Using feedstock from reused or recycled sources
3. Keeping products in use longer (e.g., by reuse/redistribution/increase durability)
4. Reusing components or recycling materials after the use of the product
5. Making more intensive use of products (e.g., via service, sharing, or performance models)
6. Ensuring biological materials remain uncontaminated and biologically accessible

(Ellen MacArthur Foundation, 2019).

In this report, CB23 indicators 1-3 are used as input for calculating MCI.

For the physical effects, we follow the CB23 data. CB23 is a Dutch community of practice that has proposed seven indicators to pursue three goals for circularity (1) protecting the material stock, 2) protecting the environment, and 3) protecting the existing value. Figure 4 shows the schematic for the evaluation of the three goals (with the data for the corresponding indicators for each):

1. ***Protecting material stocks:*** This is the goal to prevent the material stocks from exhaustion by paying close attention to the purchase and resale of materials before and after keeping the part (objects) operational. We use the CB23 indicators 1 to 3 for input and output materials. We use this data to monitor the target with the Material Circularity Index indicator (from the Ellen MacArthur Foundation). This is expressed by the following formula:

$$\Delta \text{MCI} = \text{MCI}_{\text{with AAS}} - \text{MCI}_{\text{without AAS}}$$

Input: MCI = Material Circularity Index; 'with AAS' means the pilot; 'without AAS' means a reference project.

Output: It measures the average score of protecting the material stocks with the pilot between 0 and 100%, where 0% states no material is protected, and 100% of all materials in the project are protected. The delta indicates the proven effectiveness of the AAS working method.

2. ***Protecting the environment:*** The goal is to limit the impact of the stationary use of the (sub)objects as much as possible. We use the CB23 indicator 4 for this. This data will be used to calculate the Environmental Cost Indicator for the (sub)objects.

$$\Delta \text{MKI} = \text{MKI}_{\text{with AAS}} - \text{MKI}_{\text{without AAS}}$$

Input: MKI = Environmental Cost Indicator; 'with AAS' means the pilot; 'without AAS' means a reference project.

Output: It measures the cost of the project as a burden on the environment. The higher the cost, the more impact the project causes on the environment. The delta indicates the proven effectiveness of the AAS working method.

3. ***Protecting existing value:*** Is the goal to preserve the existing value of incoming material as much as possible and remain in its stationary position for a new destination after the end of the life cycle of the (sub)object. We ideally use indicators 5.1, 6.1, and 7.1 (on economic value), as well as indicators 5.2, 6.2, and 7.2 (on technical-functional value). Basically, indicators 5.1 and 5.2 are calculated as the initial value. Indicators 6.1, 6.2, 7.1, and 7.2 depend on the information available at the end of the life cycle. This must be monitored on the basis of expectations.

$$\Delta \text{NPV} = \text{NPV}_{\text{with AAS}} - \text{NPV}_{\text{without AAS}}$$

Input: NPV = Net Present Value²; 'with AAS' means the pilot; 'without AAS' means a reference project.

Output: It measures the initial value of the (sub)objects based on the expected investment and life cycle costs and the intended payments for the service during the intended contract.

² NPV values are not rounded up and disputed, provided the residual value calculations have been examined as instruments for this purpose 3. At the time of writing this report, the authors participate in a community of practice working on an accepted valuation method, in the context of CB23.

An important point of attention is the measurements Technical-Functionality and Measurement of Circularity Stimulus. This measurement is not reported in this report. The Technical Functionality Value has not been specified for any current value due to the delays. At the start of the study, the measurement of the Circularity incentive was based on data that were no longer available. It has therefore been operationalized differently. The change is accounted for in Chapter 2.

1.1.2.2 Life Cycle Costing

The costs are provided in the service costs for the contractor over the service period. These costs are provided by the project and expressed in euros per pilot in Net Present Value of both the realization costs, as well as the projected maintenance and additional costs related to the keeping of the functionality of the asset. The life cycle costs are used to establish a Cost-Benefit ratio where the costs of the overarching service are put in ratio to the achieved values of various measures of circularity.

For this measurement, the life cycle costs of the pilot, as well as the reference project, were included. The difference between these shows the efficiency of the As a Service model compared to a non As a Service model for an equivalent project.

1.1.3 Contextual characteristics

Preconditions provide a qualitative indication of the influence of the context in which the As a Service agreements are implemented in determining circularity. For example, the object involved (road, lighting, viaduct), specific project tasks (maintenance, renovation, new construction), and client (province, municipality, national government). The framework of Huizing (2019), in Figure 5, forms the basis for the preconditions study as it a) provides a starting point of preconditions for As a Service for infrastructure; b) provides semi-quantitative measurements by using dummy variables. The data for measuring the preconditions have been collected through in-depth qualitative studies per pilot via stakeholder analysis.

CONDITIONAL REQUIREMENTS	NECESSARY CHANGES
<ul style="list-style-type: none"> • 1. Include the end of life phase of materials in the project lifecycle • 2. Distribute power and responsibility to the party that carry them best • 3. Prepare the internal organisation for changes • 4. Partnering of stakeholders • 5. Create added value for all stakeholders 	<ul style="list-style-type: none"> • 1. Functional specification instead of technical specification • 2. Contract: <ul style="list-style-type: none"> • 2.1. Contractual agreements • 2.2. Broad applicability to all size of projects • 3. Financial system <ul style="list-style-type: none"> • 3.1. Pay for the function instead of product • 3.2. Need for external financing • 3.3. Incorporation of value of materials • 4. High value technical design • 5. End-of-contract must be taken into account from the start of a project

Figure 5 Preconditions and necessary adjustments for AAS in infrastructure (Huizing, 2019).

1.1.3.1 Stakeholder analysis

Stakeholder analysis is one of the most common methods to better understand the interests of the main parties. The aim of the analysis is to see how actors representing different levels and pilots view political, technical, economic, inter-organizational, intra-organizational, and contextual aspects. Each of the aspects includes specific elements (e.g., trust among the partners for the inter-organizational aspects), which have various levels of agreement among the stakeholder. There can either be an agreement (i.e., consensus) that an element is perceived as a barrier or as a driver for the project or a disagreement (i.e., dissensus) when stakeholders do not agree or are uncertain about the elements.

The chosen method for evaluation of these aspects was: a) surveys 1 on precondition factors, b) survey 2 on process-related factors and future state, and interviews with key stakeholders and personnel involved in the pilots. The surveys included statements that were formulated for the variance of agreement level using a Likert scale of 7 (1- Very strongly disagree, 7- Very strongly agree). Both surveys contained categories of statements, where each statement represents a different element grouped into political, technical, economic, contextual, intra-organizational (within the company), and inter-organization aspects (between the companies). The elements and the categories were chosen based on previous studies in the field of industrial symbiosis, where several organizations try to form a symbiotic relationship by exchange of materials and services. Some examples of the elements are knowledge capacity and dissemination, relational capacity, facilitation, benefits sharing, commitment, lack of information, lack of knowledge, aversion to change, outdated regulations, technology readiness, and others (Bacudio et al., 2016; Domenech et al., 2019; Kosmol and Otto, 2020; Mortensen and Kørnøv, 2019; Neves et al., 2019; Park et al., 2018; Zhang et al., 2015).

Additionally, interviews were also performed to add more detailed context and specificity for each pilot and organization.

Data: The resulting output from the stakeholder analysis pinpoints specific barriers and enablers where there is a prominent consensus among the stakeholders and uncertain factors caused by dissensus. All factors are based on the perception of the stakeholders and thus do not represent unbiased validation. The analysis also allowed us to identify recommendations with project specifics. Recommendations include the solution to the barriers identified but also further recommendations for the contractors, client, contract, and infrastructure asset specifics.

1.2 Methodological overview

The overview of all of the data points is represented in the theoretical framework in the picture below (Figure 6). A number of distinctions apply to this setup. First, the study for the physical circularity measurements is based on the comparison of the IAAS pilot and the comparison of values for a reference project (BAU). The observed differences that occur can be partly explained by several factors, which are discussed in chapter 2 (circularity and AAS levels) and chapter 4 (contextual factors based on stakeholder analysis). Secondly, it is important to emphasize that the results relate to the data available for the pilot at the time of the finalization of the designs. The development of pilots continues after this report. The significance of these limitations will be further discussed at the end of the report in light of the obtained results.

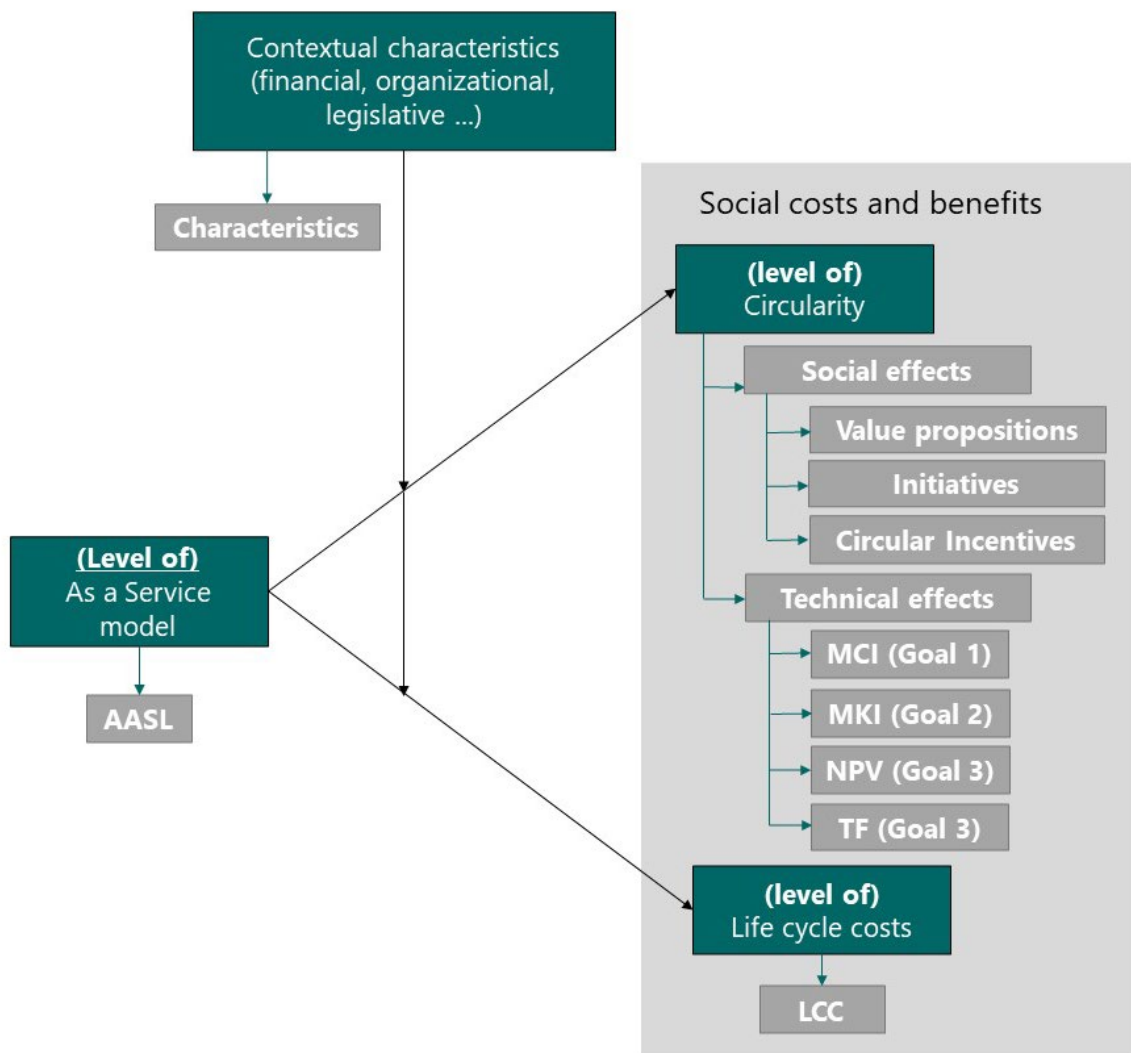

Figure 6 Methodological overview of study setup

At the start of the program, 7 pilots focused on the possibility of integrating IAAS. Dura Vermeer is a chosen contractor for all IAAS investigations, a deviation from a traditional

bid contract. However, Utrecht did not pursue the IAAS model at a later stage but strived for high circularity with the traditional award of Dura Vermeer. The pilot in Amsterdam is part of a larger project and remained in the early development phase due to unforeseen delays. This pilot was therefore excluded from the analysis. Table 1 includes details on the analysis included for all 7 pilots. The participants of all pilots were included for the stakeholder analysis, as all pilots have gone through the IAAS process at various levels (albeit only under consideration).

Table 1 Pilots in the De Circular Road Program and their inclusion in the analysis

Municipality/ Province	Pilot	Status	IAAS analysis	MCI	LCC
Amersfoort	Replacement bicycle bridge decks	Implementation	Yes	Yes	Yes
Amersfoort	Reconstruction of JP Heijelaan residential road	Contract	Yes	Yes	Yes
North Brabant	Road light as a service	Executed - Performance/monitoring	Yes	Yes	Yes
North Holland	Guide rail as a service	Contract	Yes	Yes	Yes
Overijssel	Sustainable management of N739 provincial road	IAAS design finalized – Not continuing as a service	Yes	Yes	Yes
Amsterdam	Temporary road at ArenA	Offer	No	No	No
Utrecht	Reconstruction of Croeselaan city road	Executed – Not as a service	Included as control		No

1.3 Reporting structure

We first look at the results at the program level in Chapter 2. Here we discuss all measures across the pilots in order to draw generic lessons from all pilots. Second, we discuss all measures per pilot in Chapter 3, in order to draw generic lessons from the specific contexts per pilot. Finally, we discuss the stakeholder analysis in order to ultimately provide an answer to the preconditions under which circularity in infra as a service can thrive in chapter 4. Subsequently, the insights are discussed and based on these insights, and practical advice is given and concluded in chapter 5.

Program analysis

**Common features and
differences of IAAS and
circularity**

2. Program analysis: common features and analysis of IAAS and circularity

In this part, we comparatively analyze each of the core concepts across the pilots. This does not talk about the specific situation per pilot but draws on common features across the As a Service pilots to gain the overarching lessons. First, we discuss the Infra as a service model and comparisons. Next, we discuss the outcomes from the stakeholder analysis, and then we discuss the circularity aspects.

2.1 Summary and highlights

This chapter includes the analysis of three main aspects: IAAS models, material circularity, and financial aspects (NPV, LCC, and financial models). Firstly, the analysis of IAAS models revealed *common features* such as safety and maintenance and *differences*, which includes a different degree of integration of R-strategies, circularity, and sustainability elements into the service provision. These specifications happen across *three levels: demand level, functional level, and structural level*.

IAAS models also have a distinct differentiation between *client and contractor responsibilities*. This means that at some point in the formulation of the contract, the client stops defining the service and leaves the responsibility to the contractor. For example, the client desires to have a reduction of the materials but does not specify how this should be achieved. When the analysis combines the responsibilities and generic versus circular features, it allows us to see which actor in the model had the initiative to propose the measure. *The initiative distribution* shows that all IAAS models have at least one circular element at the demand level. All pilots took a different approach to integrate circular measures, with Amersfoort pilots having active client involvement and the highest level of circular elements. Overijssel also included a high level of client involvement when defining circularity, while North Holland had high contractor initiative but more generic and task-oriented elements. North Brabant shows the largest number of circular measures taken by the contractors' initiative but has, in general, fewer circular features than other pilots. On the other hand, it is the only case that includes collaborative elements (defined by both contractor and client). At a closer look at the demand level, with the exception of North Brabant, safety remains the domain of the client for all pilots. Availability and maintenance have a higher level of contractor involvement in all pilots. Out of all elements in the contracts, there is less circular than generic measures, with three pilots having more dominant initiative taken by the contractor (Overijssel, North Brabant, North Holland), and two pilots having more dominant client circular measures (both pilots of Amersfoort).

Material circularity was accounted for via platform CB'23 indicators and Material Circularity Indicator (MCI). All pilots with provided references show decreased input of primary materials from 4.9% (Amersfoort Residential road) to 87.3% (North Holland Guide rails) decrease. The amount of materials available for reuse and recycling improved as well. The best-improved case is the bridge deck in Amersfoort, where it is assumed that wood can be fully recycled and reused. MCI scores show improvement of circularity up to 330% for the road in Overijssel, 186% improvement for guide rails (North Holland), 11% circularity increase for the materials used in the residential road in Amersfoort, and a slight decrease of circularity by 13% for the bridge deck caused by the high level of unusable material released from recycling.

The environmental costs are represented by Milieu Kosten Indicator (MKI) or Environmental Cost Indicator, which is a common practice measurement in the Netherlands. However, MKI was provided only for 3 out of 5 IAAS pilots, where the improvement was achieved by 56.5% for the residential road in Amersfoort, 48.1% for guide rail in North Hollands, and 30.5% for the provincial road in Overijssel.

And while MKI had a clear improvement, **Net Present Value (NPV)** shows an increase for the Province of North-Brabant and Overijssel and a decrease for the Municipality of Amersfoort and North-Holland. This highly depends on the initial value proposition. For example, adding a dimmable light system add to the initial costs for road light in North Brabant. Due to higher initial costs, the **Life cycle costs (LCC)** of North Brabant are 30% higher compared to the reference, but ultimately it is expected to lead to large savings over the years due to a large decrease in energy use. The largest decrease of LCC by 35% was observed in North Holland. The analysis of the **financial models** highlights that it is too early to fully evaluate whether as-a-service contracts can contribute to a more circular infrastructure, as the implementations of IAAS have not started in some cases. NPV of an IAAS contract needs to be evaluated at the end of the economic contract period to account for elements like maintenance costs, periodic payments, specific bonus/malus amounts (e.g., MKI), and a residual value. Bonus-malus arrangements are viewed as important circular incentives in combination with MCI, where rewards are given for smarter use of materials. Specific aspects of residual value need to be agreed upon beforehand between the client and contractor. The contractor can face the risk of cost overruns, which are not compensated in the periodic payments, and thus an indexation scheme should be added to compensate for cost increases (materials). A certain size of the contract is important to avoid financing weigh be heavily on the transaction costs.

2.2 Infra a service model

In this section, we discuss the insights gained by comparing the various As a Service models. We describe the following:

- Characterizing the agreements made in the As-a-Service models;
- The division of responsibilities per pilot; and
- As-a-Service levels per pilot.

Figure 7 shows the generic overview of As a Service agreement that we have seen in the pilots. Although IAAS is a new way of working (as discussed in Chapter 1), Figure 7 shows that there are known functions included in the contract and the model. The main feature included in all pilots is safety and guidelines. These may relate to the specific safety and technical requirements for specific infrastructure objects, for example, the road type has a particular requirement that is different from the bridge, etc. Other guidelines that may be included are municipal or provincial internal guidelines, such as following certain aesthetic rules.

Another familiarity is in the maintenance elements. In a way, the IAAS is both a construction contract and a maintenance contract in one. The object stays in the ownership of the contractor and needs to be maintained for the contract duration.

IAAS also has new features. Innovative aspects that have been incorporated into the contract and the models in particular: circularity and/or sustainability. This is, of course, partly due to the program's circularity goals. The way in which circularity or sustainability is implemented is specific to each case. However, some similarities have been found. For example, circularity thinking requires that reused/recycled input is used while at the same time the output is recycled/reused. Some of these are limited based on the material. For example, asphalt cannot be easily reused, but it can be recycled to a very high degree (depending on the type of asphalt).

Other innovative aspects can come from digitalization, as maintenance and circularity are provided in a new way, such as in the case of dimming the road lights via digital solutions. As a service reached differentiate based on the level of circularity elements and specifications of the maintenance.

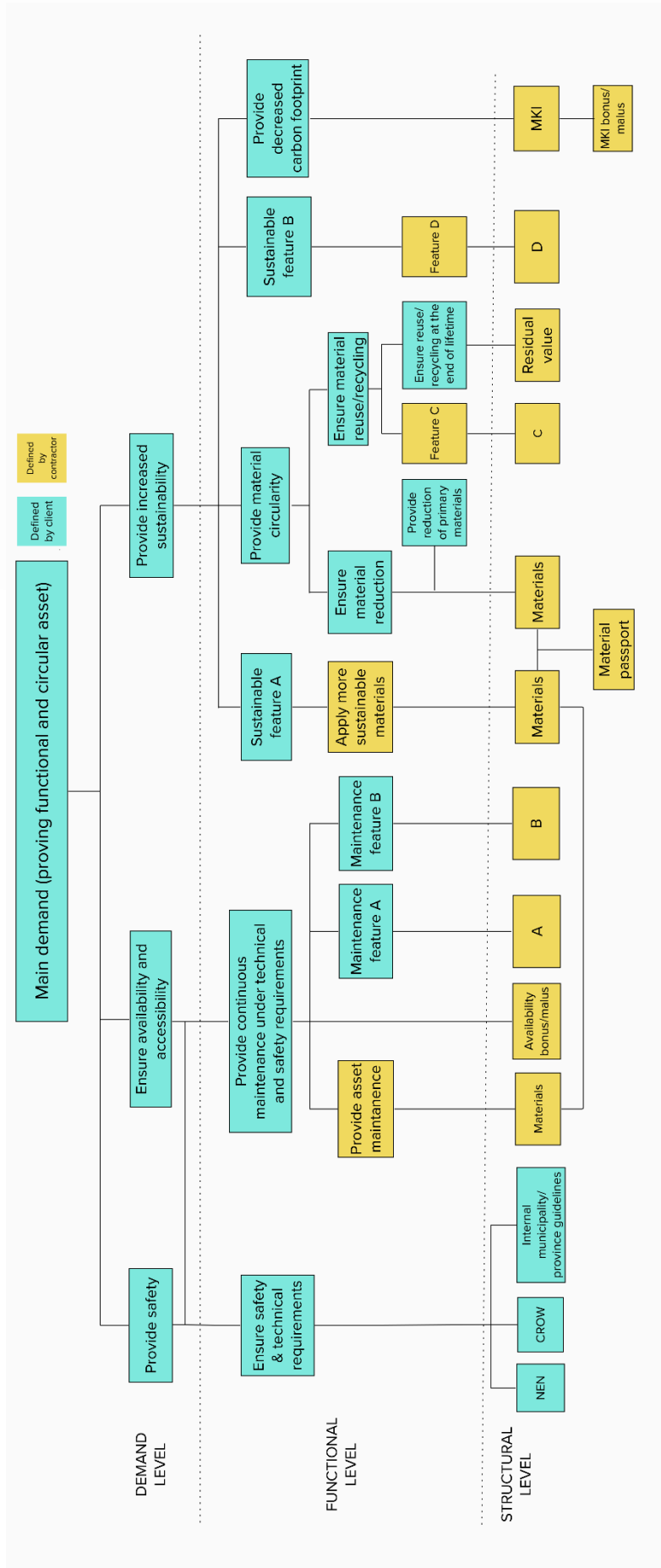

Figure 7 Generic observed patterns across all the pilots in The Circular Road

2.2.1 Responsibility (client, contractor distinction)

The IAAS model visualizes where the responsibility lies with the customer (client) or contractor. The demand level is formulated by the client as it shows the desire for what is to be achieved with the service. It is less frequent in the models that the demand is formed in collaboration between the two parties. However, this is an observed positive development of the As a Service method. In the pilots of North-Brabant and Amersfoort, this has led to more joint ownership and a less clear division of responsibilities (this is discussed in Chapter 3). Despite these exceptions, we were able to determine and visualize the distribution for all pilots with the IAAS models. We have seen that most pilots transfer demands from the client to the contractor, as is usually the case with Business As Usual (BAU) contracts.

While specifying the functional requirement of the demand, the client usually stops at some level and leaves the decision on how to reach a function to the contractor. For example, the client can specify that the materials need to be reused/recycled at the end of the lifetime, but how much and how they will be recycled is up to the contractor.

At the structural level, responsibility mostly lies with the contractor. These are the distinct elements to reach the functional requirements, such as materials, MKI calculation, technical features, and requirements for the object. The common features that are specified at the technical (structural) level by the contractor are the specific guidelines. The client is responsible for following all safety and technical requirements (for example, NEN and CROW guidelines for infrastructure objects).

2.2.2 Client-Contractor Transits and As a Service levels

In addition to these generic observations, we observed the number of Client-Contractor Transitions (CCTs) for each model and calculated the median as an indicator of the AAS level for the pilots. The result of this is shown in Table 2.

Table 2 shows that the majority of the pilots (PNH, PNB, and Utrecht) pass on the responsibility to the contractor after the FL1 level, which according to Van Ostaeyen (2013), best fits a performance as an effect-oriented turnover mechanism).

The Amersfoort pilots are both in between the FL1 and FL2 levels. This is because the median of the CCTs is exactly between these two levels. It shows that there are as many CCTs on FL1 as on FL2. It means that a contract can use more than 1 revenue mechanism in the contract since the same number of functional effects and functional solutions are requested from the contractor. These can each be accounted for at their own level, i.e., the performance-as-effect and performance-as-solution conversion mechanisms. It demonstrates the possibility of multiple payment methods in the contract design.

Finally, the Province of Overijssel appears to have the main Client-Contractor Transits at the FL2 level, opting for a Performance-Based Solution-oriented revenue mechanism, and underlines that no AAS pilot enters into a service on a structural level with the client and therefore does not need revenue mechanisms based on availability, use or input.³

Table 2 Client-Contractor Transit Medians and main target revenue mechanism

Pilot	Median of Client-Contractor Transit	Main target revenue mechanism
Amersfoort Bridge Deck	FL1 / FL2	PB-EO / PB-SO
Amersfoort Residential Road	FL1 / FL2	PB-EO / PB-SO
PNH Guide rails	FL1	PB-EO
PNB Light	FL1	PB-EO
POV provincial road	FL2	PB-SO
Utrecht Croeselaan (non-AAS)	FL1	PB-EO

2.3 Societal Costs and Benefits

This part reports on the societal costs and benefits of the IAAS. Specifically, we operationalize the societal benefits as circularity and the societal costs as the life cycle costs resultant from the designed As a Service Models. First, we report on the circularity measurements, and thereafter we report on the life cycle costs. It is important to note that these reported results are collected during the design stage of the AAS models before the actual activities and effects have occurred. This affects the interpretation of the data.

2.3.1 Circular measurements

In this section, we discuss the circularity aspects of the models in terms of physical and behavioral effects that are set for the resultant AAS models that were established for each pilot.

2.3.1.1 Measurements of human behavior

2.3.1.1.1 Circularity and value propositions

The circular measurements are often driven by the value proposition that is stated by the Public Clients in the pilot. Table 3. provides an overview of these value propositions for all the pilots. It can be observed in this table that some value propositions call for circular

³ It is important to note here that Utrecht is not an As a Service model, as Croeselaan was not intentionally initiated as an As a Service model, underlining that higher Client-Contractor Transitions can still apply to non- AAS models

solutions, like Amersfoort Bridge Deck and PNH Guide rails. However, certainly, this is not the majority. Some keep more abstract sustainability positions, like Amersfoort Residential Road and Utrecht Croeselaan. Remarkable is that some value propositions do not mention any sustainability or circularity-related goal, most notably Province of North Brabant calls for effective lighting, and Overijssel calls for a safe and available road. So there is certainly no specific pattern here other than a diversity that can be observed. The significance is that the purposeful enactment of circularity occurs at both direct and indirect propositions.

Table 3 Value propositions of the Pilots

Pilot	Value Propositions
Amersfoort Bridge Deck	<i>Provide circular and functional bridge deck</i>
Amersfoort Residential Road	<i>Functional and sustainable road</i>
Province of North Holland – Guide rails	<i>Provide increased circularity for guide rails</i>
Province of North Brabant – Light	<i>Provide effective lighting service</i>
Province Overijssel – Provincial road	<i>Provide safe and available road (over 15 years)</i>
Utrecht – Croeselaan city road	<i>Build a sustainable and functional road</i>

2.3.1.1.2 Circular strategies (10Rs)

The most common circular economy principles, or 10Rs, are refuse, rethink, reduce, reuse, repair, refurbish, remanufacture, repurpose, recycle, and recovery (Morseletto, 2020), see Figure 8. The top strategies are refuse, rethink, and reduce, as these lead to smarter product use and manufacture. The strategy of reuse until repurpose, extend the lifespan of products and its part. The recycle and recovery make a useful application of the materials (when compared to landfilling). The application of these strategies is mostly considered and focused on the products, not services. The present pilot each implements various strategies from refuse and rethink to recycling. Recovery is not foreseen for the current materials used for the asset in consideration.

Smarter product use and manufacture	R0 Refuse	Make product redundant by abandoning its function or by offering the same function with a radically different product
	R1 Rethink	Make product use more intensive (e.g., through sharing products or by putting multi-functional products on market)
	R2 Reduce	Increase efficiency in product manufacture or use by consuming fewer natural resources
Extend lifespan of product and its parts	R3 Reuse	Reuse by another consumer of discarded product which is still in good condition and fulfils its original function
	R4 Repair	Repair and maintenance of defective product so it can be used with its original function
	R5 Refurbish	Restore and old product and bring it up to date
	R6 Remanufacture	Use parts of discarded product in a new product with the same function
	R7 Repurpose	Use parts of discarded product or its parts in a new product with a different function
Useful application of materials	R8 Recycle	Process materials to obtain the same (high grade) or lower (low grade) quality
	R9 Recovery	Incineration of materials with energy recovery

Figure 8 The R strategies (Morseletto, 2020).

Table 4 shows how each pilot engages with the 10R strategies. It confirms that recycling is a base strategy that all pilots have in place. The highest strategy reached is refuse. In the case of Amersfoort, the municipality initiated this by implementing a radically different design, which decreased half of the materials. Utrecht (being the only non-AAS pilot) also shows refuse strategies where they use compost instead of new soil and avoid installing the rainwater drainage system.

Utrecht notes that they aimed to integrate all R strategies according to Cramer (2014), which includes nine strategies (all except rethink). However, as these strategies were grouped and not addressed individually, some are not directly implemented in the contract.

For all of the IAAS pilots, rethink is established, which is mainly due to the repair being implemented as one of the contract features. Usually, this is split from traditional contracts. Similar rethink examples can be found when a company offers maintenance and repair as part of the price when buying products such as washing machines or laptops for the duration of the lifetime.

R3 to R8 are included in the various levels in the pilots. The details per pilot can be found in chapter 3. These latter strategies are included due to the asset management that requires repair and refurbishment for infrastructures at some point in their life cycle. Reuse and recycling are mostly implemented at the end of the lifetime of the materials.

Table 4 Direct adoption of the 10R strategies per pilot. *referring to the reduction of energy, not materials

Pilots	10R strategies									
	Refuse	Rethink	Reduce	Reuse	Repair	Refurbish	Remanufacture	Repurpose	Recycle	Recover
Amersfoort Bridge Deck		X	X	X	X	X		X	X	
Amersfoort Residential Road	X	X	X		X				X	
PNH Guide rails		X	X	X	X	X			X	
PNB Road light		X	X*	X	X	X			X	
Overijssel Provincial Road		X	X		X				X	
Utrecht Croeselaan (non-AAS)	X		X	X					X	

The IAAS makes an effort to implement both top-down and bottom-up approaches for R strategies. Recycling and reuse are more widely implemented because they can be incorporated at the end of the pipe (end of the lifetime) and can be measured more directly. The top-down strategies, mainly refuse and rethink, can be harder to implement as they require more systemic change than simple recycling material. Such changes are harder to measure. The IAAS pilots in this program considered all available options (within the given time scope of the projects), with the initiative taken by the client and contractor.

2.3.1.1.3 Circularity in IAAS models

The circular features in the IAAS are visible in each IAAS model per pilot included in this report (the circled elements). The circular measures are visualized in each IAAS model with a circle. These models can be found in chapter 3 in the respective subsections associated with the pilots. Table 5 shows the count of all circular measures found in the AAS models per pilot (see models in Chapter 3).

Table 5 Count of circularity elements in As a Service model per pilot. DL1 or DL2 = Customer requirement (1 for first level, 2 for the second level); FL1 = Functional Effect; FL2 & FL3 = Functional Solution (2 for the first level, 3 for the second level); SL1 -3 Technical measure (1 for the first level, 2 for the second level)

Pilot/ IAAS Level	DL1	DL2	FL1	FL2	FL3	SL1	SL2	# of all elements
Amersfoort Bridge	1	0	1	5	4	4	0	41
Amersfoort Residential road	1	1	3	4	1	5	0	38
North Holland Guide rail	1	0	2	3	0	4	0	29
North Brabant Road lights	1	0	2	1	0	3	3	42
Overijssel Provincial road	1	1	2	2	0	5	0	36
Utrecht Croeselaan	1	0	2	3	0	6	0	38

From the Table, we can see that the residential road in Amersfoort reached the highest level while North Brabant reached the lowest level of service circularity.

Amersfoort integrates sustainability demand at the highest level, together with circularity (i.e., two demands, while others have one). In Amersfoort's Road, sustainability also includes citizens' input for the design of the road. This is the only case that was actively influenced by residents and thus integrates directly implements social sustainability. The pilot has overall 15 circular elements. The bridge deck in Amersfoort also includes 15 circular elements, which is the highest number of circular elements included in their IAAS models.

The pilot of Overijssel and the road in Amersfoort both integrate sustainability and circularity at the demand level.

The functional level of the North Holland pilot is very similar to other cases. It features fewer circular elements (i.e., ten) with a strong focus on the material circularity of the guide rails. This results in a more simplistic IAAS model (i.e., 29 elements) with a very direct focus.

From the start, North Brabant's pilot focused on decreasing energy via digital solutions. Therefore, it has fewer circular features with regard to materials. The pilot takes the existing system as the starting situation, whereas other pilots start with a reconstruction. The agreed service is the most elaborate IAAS among the pilots with the most elements, i.e., 42. This shows that successful service and collaboration can be reached with fewer circular elements.

2.3.1.1.4 Circularity initiative distribution between Client and Contractor

Next to a certain level of circularity, it is also worth looking at the distribution of which actor in the model had the initiative to propose the measure. For this purpose, an Initiative distribution was prepared. Figure 9 a – f outline all of the measures taken by the client and the contractor and separates whether measures are circular measures or generic measures (e.g., on safety, availability, etc.). A few important notes can be made here.

North Brabant shows the largest number of circular measures taken by the contractors' initiative at levels FL3, SL1, and SL2. The contractor in the PNB Light case stays rather low with circularity initiatives but appears to propose many initiatives of more generic types higher in the Product Service System in direct collaboration with the Province. They are the only ones doing so via a Joint Venture called Lumi-us.

The guide rail pilot of PNH shows a high circularity initiative taken by the contractor but takes a task-oriented approach to other measures of a more generic type in this pilot.

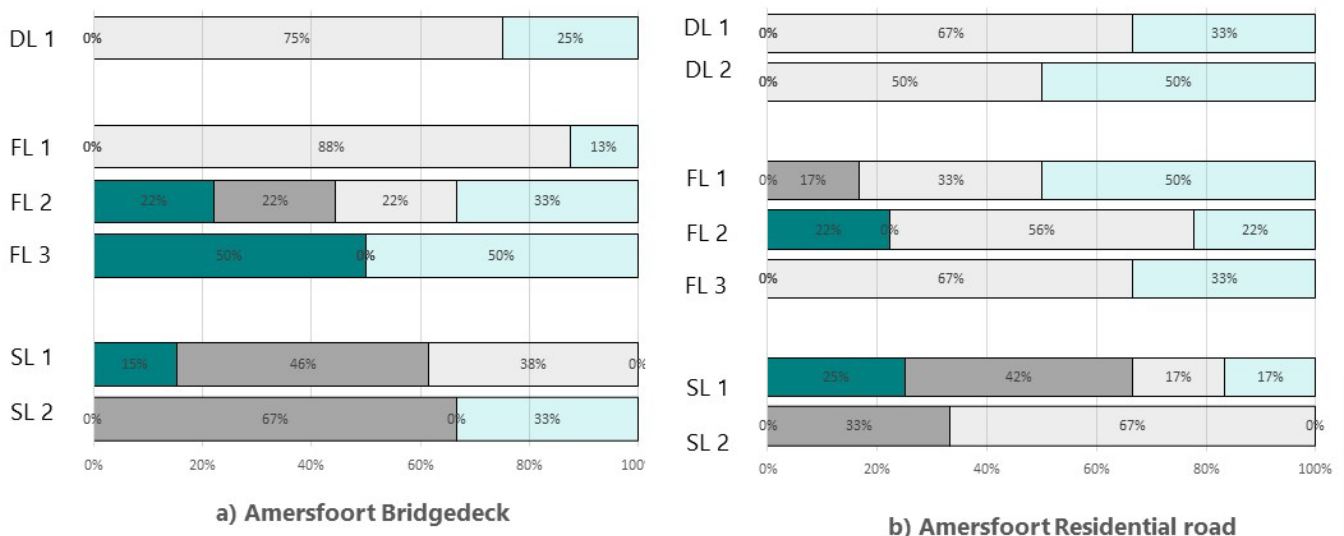

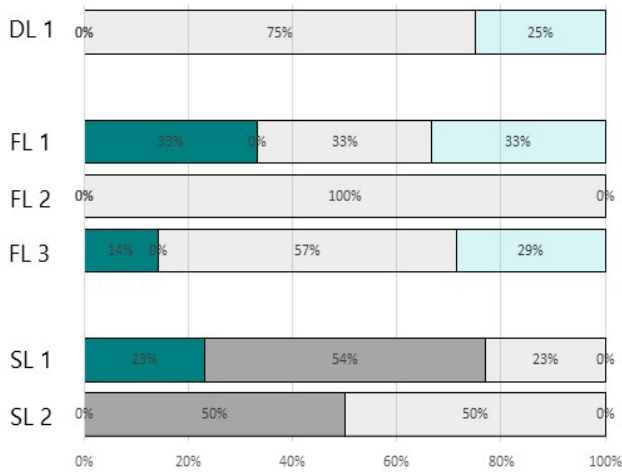

c) PNH Guide rails

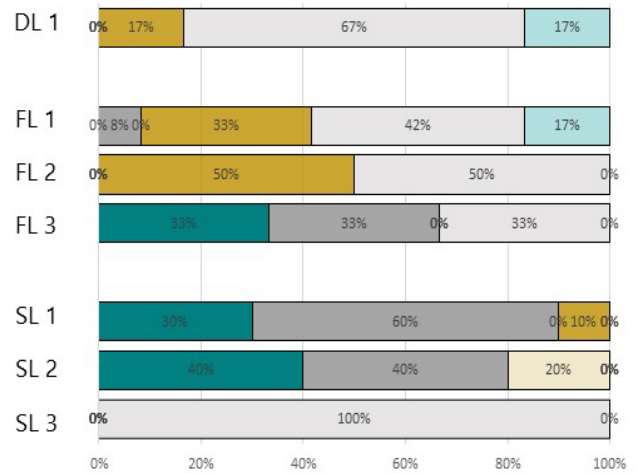

d) PNB Road light

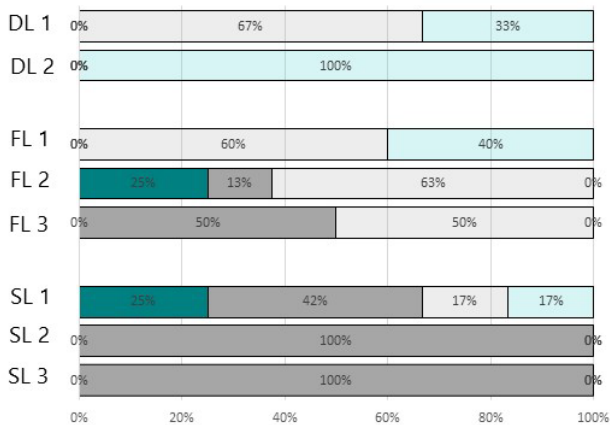

e) Overijssel Provinciale road

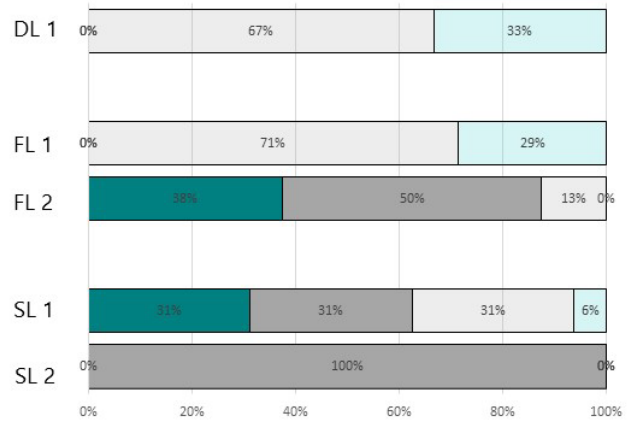

f) Utrecht Croeselaan city road



Figure 9 a – f. Initiative Distribution of all Circularity and Generic measures. DL demand level, FL functional level, SL structural level, PNH Province North Holland, PNB Province North Brabant.

2.3.1.15 Initiative distribution for the extent of Circularity and Contractor

As circularity initiatives in IAAS models can be defined by both client and contractor, which allowed identifying which demand item within each IAAS model had a strong contractor initiative and resulting circularity initiative. This is important for getting at the core of the AAS contribution toward circularity, as it is expected to be a social innovation in the infrastructure sector. Figure 10 a – f shows each demand item with respect to the

contractor initiative and circularity initiative. The closer the demand items are plotted in the upper right quadrant, the higher the contractor took its initiative space to propose circularity initiatives.

The first important observation here is the fact that only a few demand items score in the upper right quadrant. More specifically, POV-PR 3 on 'Ensure sustainability of the road' of the Overijssel pilot and the PNH-GR 3 on 'Provide circularity.' Both of these demand items are explicit sustainability or circularity-oriented demand items.

The case of Amersfoort on the Residential Road scores the highest degree of circularity initiatives taken for a demand item, but this is predominantly done by the municipality itself.

Another interesting observation that can be drawn from these plot graphs is the fact that most of the PNB Light demand items score high on the contractors' initiative, albeit predominantly on generic measures.

Finally, it is also useful to note that aspects like safety are typically client-dominant initiatives. This can be explained by the fact that safety remains the responsibility of the client when it comes down to an incident.

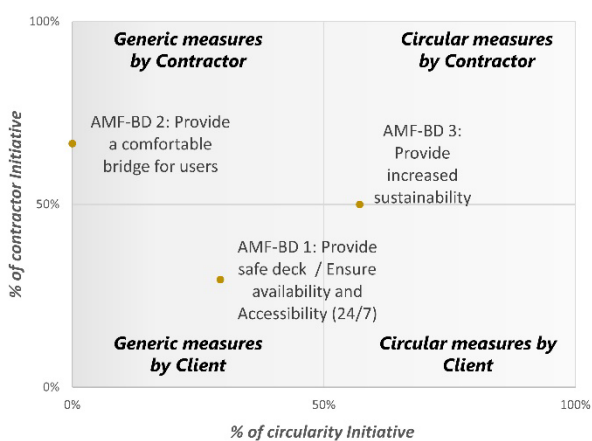

a) Amerfoort Bridge deck

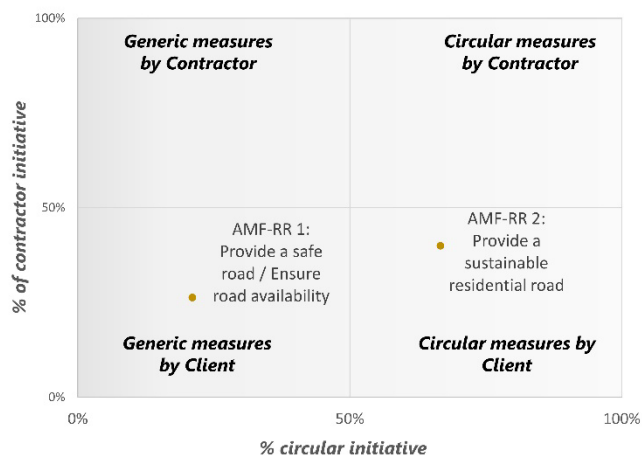

b) Amerfoort Residential road

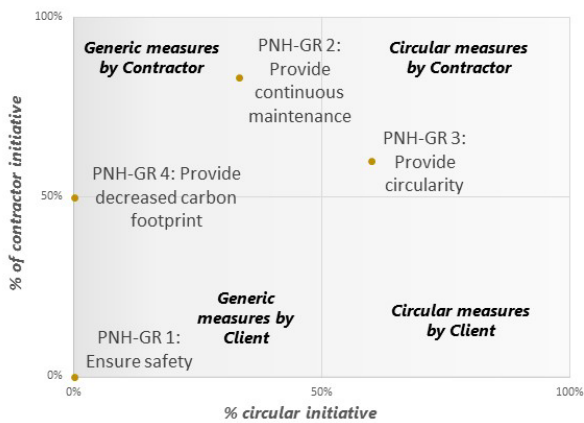

c) Province Noord Holland Guide rails

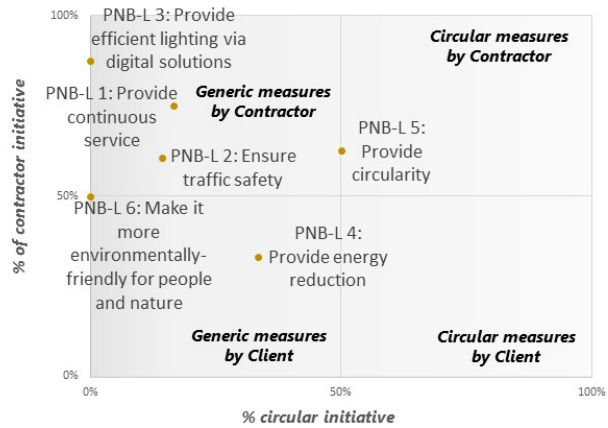

d) Province Noord Brabant Road lights

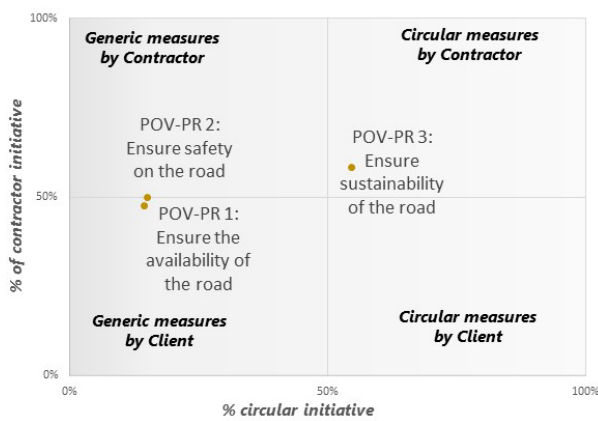

e) Province Overijssel Provincial road

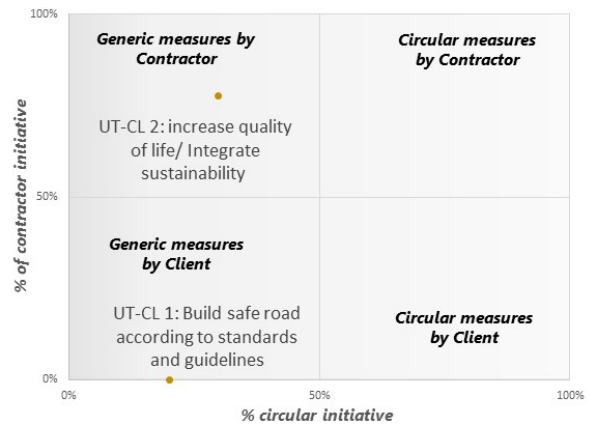

f) Utrecht Croeselaan city road

Figure 10 a – f. Plotting extent contractor and circularity initiatives in each demand items per pilot. The number of the dots refer to separate measures in the as-a-service model.

2.3.1.1.6 Incentives for Circularity initiatives in AAS explained

We see varying degrees of contractors' initiatives on circularity and generic measures, and insofar, this did not elucidate possible explanations of what are key circular behaviors. This is, however, important to understand, as we like to know better to which degree the AAS model can incentivize contractors to exert circular behavior.

One dimension of the AAS model data that can elucidate a key insight on this is to separate whether contractor initiatives on circularity were solicited (i.e., with a client initiative higher up) or unsolicited (i.e., without a client initiative higher up). To keep consistent, we counted these solicited and unsolicited initiatives at the level of demand items. Figure 11 shows the distribution of whether initiatives were mainly taken when the

client did it first or whether the contractor proposed circular measures unsolicited to the client.

An important insight here can be seen when separating the demand items per pilot. It can be observed that the demand items belonging to Utrecht and Overijssel are positioned to the right, meaning that the circularity initiatives made by the contractor were mostly after the client initiation, hence solicited proposals.

However, the other pilots, Amersfoort Bridge Decks and Residential Road, and the PNH Guide rail and PNB Lighting show a different picture. These are mostly positioned to the left of Figure 11. This shows that contractor initiatives on circularity were made unsolicited in these pilots. This tells an important story. These pilots show more unsolicited proposals by the contractor without the interference of the client as an explained factor. It, therefore, reveals that the contractor in these pilots took more opportunities to make unsolicited proposals on circularity.

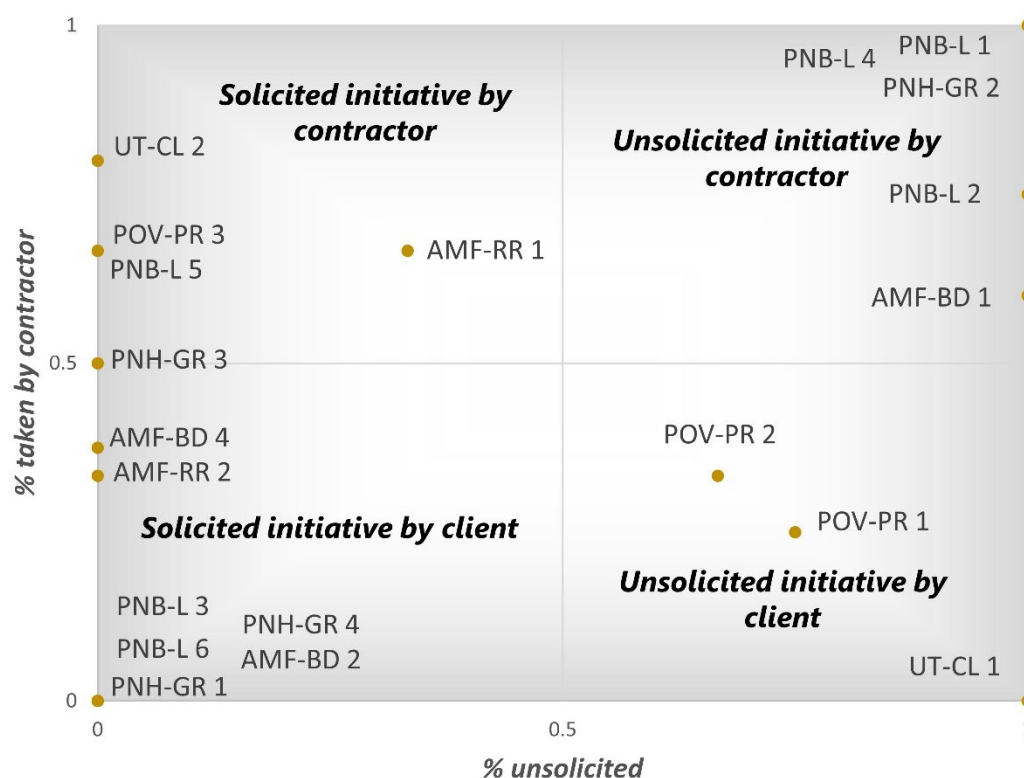

Figure 11 Circularity initiative taken solicited or unsolicited.

2.3.1.2 Measurements on Physical Effect (based on Platform CB'23 indicators)

2.3.1.2.1 Material Circularity Index (MCI) and CB'23 indicators – Goal 1

Table 6 represents the summary of CB'23 indicators for the pilots. The calculation is based on the materials used. However, there are some categories that are similar to the infrastructure objects under evaluation. The indicator 1.1.2a accounting for sustainably produced materials is 0 for all but Bridge decks in Amersfoort, which use half of the material from the FSC wood. FSC certified (Forest Stewardship Council, 2022). While this is among the best available labels for wood (Sánchez-Almendro et al., 2018), there is a lack of independent evaluation to confirm that the labeling is truly sustainable (Conniff, 2018). The indicator 1.1.2b on unsustainably produced renewable materials is thus 0 for all cases.

Indicator 1.2.1, which includes secondary materials from reuse, is 0 for all the roads, as the road can only have recycled but not reused content in the asphalt mixtures and materials. Similar goes for BAU guide rail (reference scenario for North Holland).

Indicator 1.3 on physically scarce materials is not available with current information.

Indicator 1.4.1 on socio-economically scarce raw materials used is prescribed by the cb23 guidelines (i.e., there is a list of materials that belong to this category) (p.43 (Platform CB'23, 2020)). Only steel includes material from this category due to its content of coking coal, which is accounted as a socio-economically scarce raw material according to CB'23 (Platform CB'23, 2020). In not considered in 1.4.1, the material is accounted for as abundant (the indicator 1.4 .2).

With the currently available data, no material is used for energy production (indicator 3.1). Some materials are sent to landfill (indicator 3.2), which is in accordance with the Environmental Product Declaration (EPD) or Life cycle Assessment (LCA) found for steel (i.e., guide rails), and it is the assumption for the anti-slippery layer at the wood deck in Amersfoort and assumption for the color used on the road (thermoplastics colors) – here it was included that in future 20% of the coloring can be recycled according to the producers.

The data Amersfoort bridge deck and Overijssel provincial road were provided by Dura Vermeer experts. The data for Amersfoort road was 95% provided by Dura Vermeer experts and 5% supplemented by TUD (namely for: sidewalk gullies, pit edges, curbstones, locking band, and pavement layer of crushed sand). The sand used results in an overall 1% loss (assumed loss due to weather conditions – rain and maintenance), while sand is not used in the reference scenario. North Holland data for guide rail were partially provided by Dura Vermeer and supplemented with the data found by TUD.

North Brabant data for the materials were not available from the contractor and thus provided by TUD mostly using the software Dubocalc. Therefore, the North Brabant case is an approximation and not a direct reflection of the pilot.

The reporting of the CB'23 indicator for the reference and pilot is made independently. The input materials for the pilot represent 100% of the materials, and the input for the reference are as well 100% materials. Therefore, the increase of materials for pilot versus reference is not visible. This difference plays a role in two cases in particular: Amersfoort Residential road and North Holland Guide rails. Both cases decrease half of the materials when compared to the reference. Amersfoort by choosing to implement a different design for the road (R strategy: refuse), and North Holland by choosing an already available design that uses half of the materials (single-sided guide rail instead of double-sided).

Table 6 The summary of cb23 indicator per pilot, with the addition of material losses. Reference is a business-as-usual scenario (BAU) ¹3-5% of materials quantity provided by TUD ²Data quantities were not available, it was assumed wood is 99% of the material, 100% wood for the reference ³reported by Sweco. There is no reference for the North Brabant road lights and Utrecht Croeselaan road. A – Amersfoort; PNB – Province North Brabant; PNH – Province North Holland; O – Overijssel; U- Utrecht

Pilot Indicator	A Residential Road ¹ (%)	A Residential Road - Reference ¹ (%)	A Bridge deck ² (%)	A Bridge deck Reference ² (%)	PNB Road lights (%)	PNH Guide rails (%)	PNH Guide rails - Reference (%)	O Provincial road (%)	O Provincial road - Reference (%)	U Croeselaan ³ (%)
1.1 The quantity of primary materials	14,1	19,0	75,3	100	61,4	10,6	97,9	44,9	93,4	100
1.1.1 The quantity of non-renewable primary materials	14,1	19,0	1,0	0,0	61,4	10,6	97,9	44,9	93,4	65,9
1.1.2a The quantity of sustainably produced, renewable primary materials	0,0	0,0	74,3	100	0,0	0,0	0,0	0,0	0,0	1,9
1.1.2b The quantity of unsustainably produced, renewable primary materials	0,0	0,0	0,0	0,0	0,0	0,0	0,0	0,0	0,0	0,0
1.2 The quantity of secondary materials	85,9	81,0	24,7	0,0	38,6	89,4	2,1	55,1	6,6	32,2

1.2.1 The quantity of secondary materials from reuse	0,0	0,0	24,7	0,0	0,0	40,3 ⁴	0,0	0,0	0,0	16,1
1.2.2 The quantity of secondary materials from recycling	85,9	81,0 ⁴	0,0	0,0	38,6	49,1	2,1	55,1	6,6 ⁴	16,1
1.3 The quantity of physically scarce materials	N/A	N/A	N/A	N/A	N/A	N/A	N/A	N/A	N/A	N/A
1.4.1 The quantity of socio-economically scarce raw materials used	0,0	0,0	0,0	0,0	0,3	0,8 ⁴	1,5	0,0	0,0	0,0
1.4.2 The quantity of socio-economically abundant raw materials used	100	100	100	100	99,6	99,2	98,5	100	100	42,9
2 Amount of output material	99,0	99,9	95,0	95,0	98,4	97,3	97,4 ⁴	99,6	99,6	100
2.1 The quantity of end-of-life materials available for reuse	7,8	0,2	49,5	0,0	0,0	44,3	30,6	0,0	0,0	22,8
2.2 The quantity of end-of-life materials available for recycling	91,2	99,7	44,6	0,0	98,0	49,1	62,8	99,5	99,4	76,5
3.1 The quantity of end-of-life materials used for energy production	0,0	0,0	0,0	95,0	0,4	0,0	0,0	0,0	0,0	0,0
3.2 The quantity of end-of-life materials sent to landfill	0,0	0,0	1,0	0,0	0,0	4,0	4,0	0,2	0,2	0,8
Material losses (use, re-processing etc)	1,0	0,1	5,0	5,0	1,6	2,6	2,6	0,4	0,4	0,0

⁴ Disclaimer: after verification the data has changed from the originally published report (Dutch version) in June 2022..

The Material Circularity Indicator (MCI) was developed by The Ellen MacArthur Foundation (Ellen MacArthur Foundation, 2022). The MCI can be calculated based on indicators 1 to 3 of CB23 as input values. An important note must be made here to express

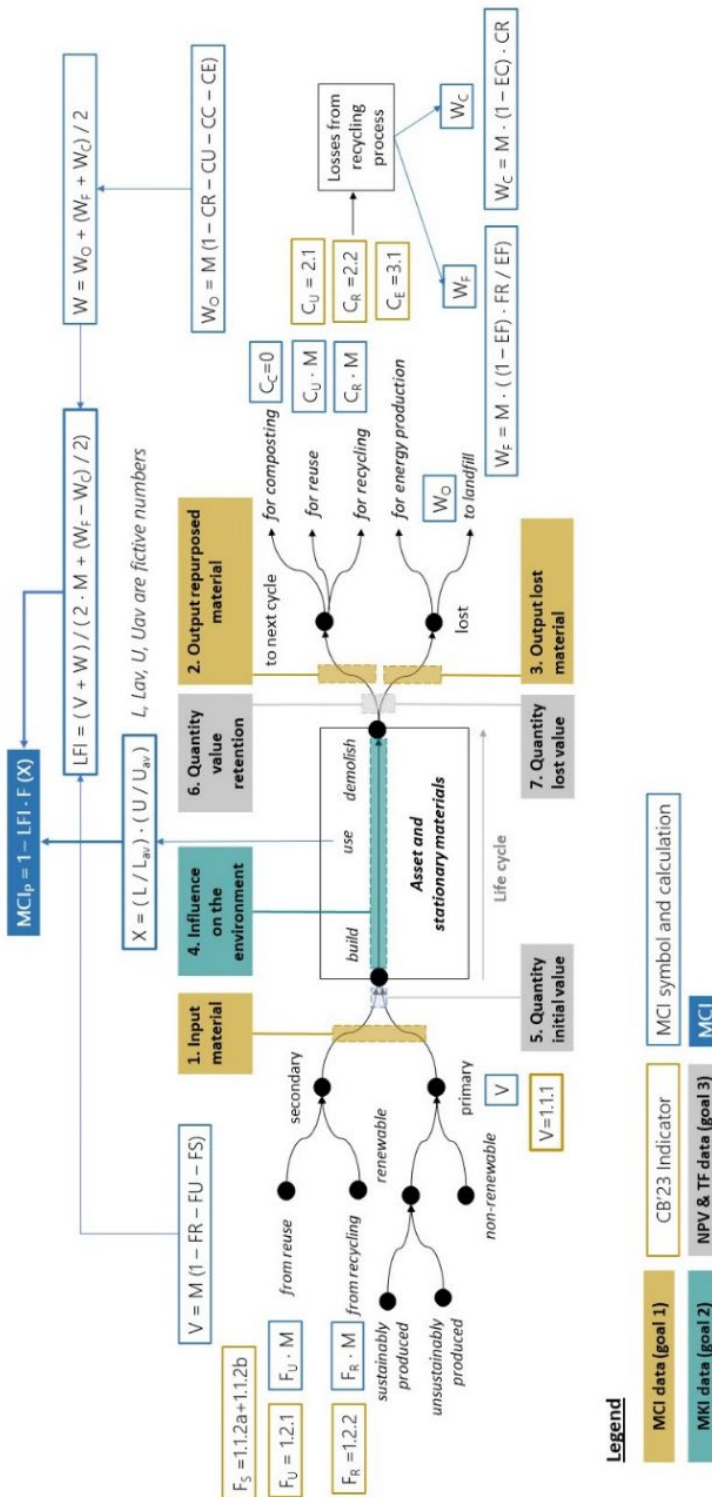

Figure 12 Assumptions on MCI calculation using CB23 data

that a range of assumptions lies at the basis of these scores in Table 6. These assumptions are expressed in Figure 12. Details on the MCI calculation and definitions are in Annex 1.

The indicator shows how circular and restorative the material flows of a product are. The indicator is an index measure between 0 (i.e., little circularity) and 1 (i.e., maximal circularity). Table 7 shows the MCIs for the pilots, their reference project, and the delta.

Table 7 shows that for PNH Guide rails, the MCI score improves from 0,27 to 0,79, increasing 186%. Also, Overijssel shows a high degree of improvement, where the reference project only had 0,14, the pilot would have improved the MCI to 0,43, which is a 208% increase. Amersfoort Residential Road also improved, albeit with a more conservative figure from 0,59 to 0,65, thereby increasing 10%. This data shows that the AAS design can at least make sensible improvements in circularity, irrespective of which incentive lies behind the improvements.

The Amersfoort Bridge deck scored slightly lower at 13%. This decrease is due to the piece of wood with an anti-slip layer that becomes unusable as a result of the planks after the end of their lifespan. On the other hand, it is due to an assumption in the MCI calculation that the efficiency of recycling, reuse, and energy recovery are the same. If more realistic efficiencies are used, the MCI difference will become smaller. For the Amersfoort Bridge deck, it is therefore important to also look at the underlying figures of output indicators 2.1, 2.2, and 2.3 (table 6). These show that approximately 95% of the materials will be reused or recycled in the laaS model after the end of life, instead of disappearing as energy recovery (reference).

Table 7 Material Circularity Index for the AAS pilots.

Pilots	MCI for		
	Pilot	Reference	%Δ
Amersfoort Bridge deck	0,85	0,98	-13%
Amersfoort Residential Road	0,65	0,59 ⁵	10% ⁵
North Holland Guide rails	0,79 ⁵	0,27	186%
North Brabant Lighting	0,33	N/A	N/A
Overijssel Provincial road	0,43	0,14 ⁵	208% ⁵
Utrecht Croeselaan	0,42	N/A	N/A

⁵ Disclaimer: after verification the data has changed from the originally published report (Dutch version) in June 2022.

2.3.1.2.2 Environmental Cost Indicator (MKI) – Goal 2

The MKI measures the environmental impact of activities and is a common value made for projects in the Netherlands. MKI is a measure consistent with Indicator 4 of the CB23 guideline on measuring circularity for Goal 2, represented in Table 8. The indicator expresses these effects in euros, putting a financial value on the environmental impact. The height of these values is not directly of interest to this analysis, yet their percentage improvement between an AAS and a reference project is. It shows that Utrecht has the highest improvement of the MKI with a reduction of costs of 65,4 %. Yet, it has to be noted here that this is not an As a Service pilot, albeit that it scores quite high on entrepreneurial freedom according to the product-service system levels.

Other pilots show similar strong improvements of the AAS pilot versus their reference, mainly the Amersfoort Residential Road reduced environmental impact by -56,5 % and North Holland Guide rails improved it by 48,1 % with the as a service design in place.

Overijssel also shows an improvement in their As a Service design, with a decrease of -30,5 %, albeit a little smaller change than the other pilots.

Table 8 Environmental Cost Indicator/Milieu Kosten Indicator (MKI) for IAAS pilots

MKI in € for:				
Pilot	(a) As a Service Pilot	(b) Reference Project	(c) Δ MKI = (a) - (b)	(d) %Δ MKI = (c) / (b)
Amersfoort Bridge Deck			€0,00	
Amersfoort Residential Road	€28.695,00	€66.008,00	-€37.313,00	-56,5%
North Holland Guide rails	€22.954,00	€44.229,00	-€21.275,00	-48,1%
North Brabant Lighting			€0,00	
Overijssel Provincial road	€239.415,00	€344.561,00	-€105.146,00	-30,5%
Utrecht – Croeselaan (non-AAS)	€42.375	€122.600	-€80.225,00	-65,4%

2.3.1.2.2 Net Present Value (NPV) – Goal 3

The NCW value expresses the initial value in economic terms for the As a Service design that is proposed. It is debated which measurement or valuation method is most proper to use here. For conservative purposes, the realization costs in the first year are taken in the table below as the initial value as with indicator 5.2 of the CB23 guideline. Table 9 shows the NPV values obtained for the respective pilots. The NPV value expresses the initial value in economic terms for the proposed As a Service design. Two things are

important when drawing up a good method for this indicator. First, there is currently no consensus on the most appropriate valuation methodology to use. Second, it was stated in 1.1.2.1 that target 3 indicators could not all be used. We explain that we only use indicator 5.2 of the CB23 guideline, namely: measuring the economic value of the materials at the initial stage. For this reason, a conservative valuation is chosen by using only the Net Present Value (NPV) of the realization costs from the first year of the contract as the initial value.

Table 9. Net Present Value for AAS pilots

Pilot	NPV in €		Years	% discount rate	Δ NPV	%Δ NPV
	(a) As a Service pilot	(b) Reference project				
Amersfoort Bridge deck	€ 326k (Circular wood)	€ 340k (Wood + top layer)	25	3%	-€ 14k	-4,0%
Amersfoort residential road	-	-	50	3%	€ 0	-
North Holland Guide rail	€ 244k (Circular guide rails)	€ 371k (Replacement at new places)	60	3%	-€ 127k	-34,3%
North Brabant Road light	€ 286k (Dynamic dimble LEDs)	€ 0 (Using existing LEDs)	8	3%	€ 286k	-
Overijssel Provincial road	€ 985k (New coating Ecopave XL)	€ 108k (Maintenance - 10% Local Repair and Apply EAB)	40	3%	€ 877k	810,2%

Table 9 shows the NPV values obtained for the respective pilots. The NPV scores show a mixed picture of increases (Province of North-Brabant and Overijssel) and decreases (Municipality of Amersfoort and North-Holland). The change in scores depends very much on the planned interventions at the front of the As a Service contract. An increase can come from adding new functions to an asset (such as dynamic low beam in the case of North-Brabant) compared to the traditional start of the contract (reference). However, where an equal function is maintained (e.g., at the bicycle bridge deck of the municipality of Amersfoort), or intervention in both the pilot and a reference is necessary (e.g., at the guide rail of North-Holland), the scores will change less radically, or even decrease with efficient implementation. It shows that the initial value depends on the value proposition. The degree of circularity will have to prove itself in the two not included indicators of value loss and retention over time.

2.3.2 Life cycle costs

Life cycle costs were measured as part of the social costs of the IAAS pilots. It is used to benchmark the extra costs incurred to achieve the circularity benefits. The life cycle costs are taken from the contractor's cash flow statements. This analysis is a standard procedure for preparing an offer based on a project proposal, and therefore was also applied to the AAS pilots after the design had been established. Ultimately, the most important result of this analysis is the difference in LCC between the As a Service pilot and the reference project.

Table 10 shows the available LCC data from 5 pilots. The most striking thing about these data is that all AAS pilots (with the exception of the Overijssel and North-Brabant pilots) show a lower LCC compared to the reference project. These values appear to be relatively close to each other, 18.7% to 34.8%. The absolute value shows PNH has the largest decrease. This is due to the lifetime of 60 years.

The LCC of the PNB is almost 30% more expensive compared to the reference project. This is partly due to the high realization costs at the front of the route by investing in the conversion of dynamic low-beam headlights. However, it is balanced by large energy savings (58% savings) that was achieved due to the switch to a digital LED dimming system.

The LCC of Overijssel is not comparable to the given values. This is because the LCC of the reference project was created in 2022. This is 2 years later compared to the costs for the As a Service, which was drawn up in 2020. If the LCCs are discounted to the same years, the costs for the As a Service are slightly higher than the reference project. For example, the cost of the As a Service would result in a cost of $5.686k \times 1.032 = 6.032k$. This is $6.032k - 5.902k = 130k$ more expensive.

Table 10 Life cycle cost per IAAS pilot

Pilot	LCC in €		Lifetime	% discount rate	Δ LCC	%Δ LCC
	(a) As a Service Pilot	(b) Reference Project				
Amersfoort Bridge deck	€ 647k	€ 795k	25	3%	-€ 149k	-18,7%
Amersfoort Residential road	€ 284k	€ 387k	50	3%	-€ 103k	-26,7%
North Holland Guide rails	€ 662k	€ 1.016k	60	3%	-€ 354k	-34,8%

North Brabant Road light	€ 746k	€ 576k	8	3%	+€ 170k	+29,5%
Overijssel Provincial road	€ 5.686k (date: 2020)	€ 5.902k (date: 2022)	40	3%	N/A	N/A

2.4 Financial models

As soon as the pilots have produced a successful concept of a service, scaling up is the next step. Because the pilots themselves have not yet been implemented, there have been no experiments with a financing request in the pilots. In order to also pay attention to this in the research, this section examines the question of how an IaaS can be financed via the banking system. The picture presented below is the result of the financial working group and the residual value working group of The Circular Road, both of which have worked on this. This working group consisted of banks, the contractor, clients and the program manager of The Circular Road. It shows how the chosen business model works and how potential financing is viewed in case of financing applications.

How does the business model work?

A contractor pays a fee for the use of the service (periodic fee). In the infrastructure sector it is common to close contracts of 7 to 15 years (with a few exceptions to 20 years) while the assets last (decades) years longer. In fact, the service is not purchased over the entire term, but is terminated in the interim, after which a new service provider is sought to maintain the asset and/or the service. To terminate the service, the residual value of the asset is reimbursed by the client to the contractor. This creates the incentive to transfer the road at the end of the contract in the best possible way and thereby receive a higher residual value.

The fee structure consists of a series of installments (periodic fee), a predetermined residual value and a delta residual value to settle the actual surplus or net value delivered. A simplified version is shown below. Installment payments consist of a fixed base amount and this fluctuates with bonus (green) or malus (lower amount) (Figure 13). The final installment payment (shown as blue) is the ex ante residual value. If the contractor delivers a better road than agreed at upfront, he will also receive the generated added value (green). If the contractor delivers a worse road, the residual value (blue) will be lower).

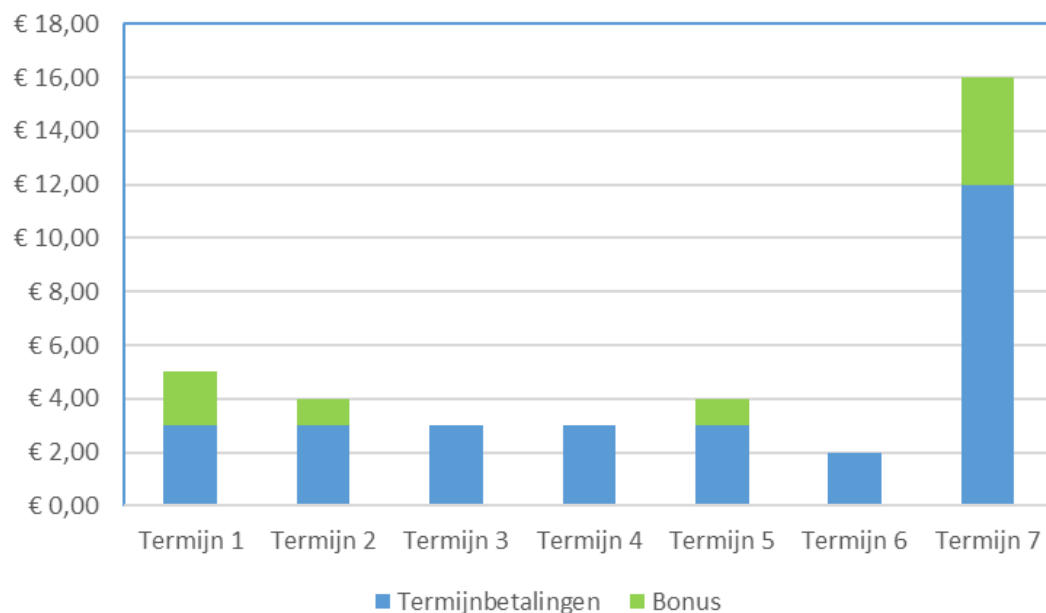

Figure 13 Instalment payments for laaS model

Residual value in the business model

This business model therefore works with a residual value that is agreed upfront. The residual value must therefore also be determined using a method. The program shows that this is not an easy task, partly because value encompasses multiple dimensions (such as technical, functional and economic). There are various methods for each of these value dimensions, which means that the sum of calculations is not by definition valid. This makes the residual value determination a complex task that will require further research. The program has requested a practice-oriented study from Rebel Group to draw up a residual value calculation. The method assumes that valuation can be made on the contract, and not on the assets. This is a simplification of the complexity, but has therefore been found to be sufficiently workable to be able to continue in the pilots. This has therefore been adopted by a number of pilots and elaborated for the drafting of the contracts. The next question, however, is how the projects can be financed with this residual value in the business model.

How does the financier view the business model?

The banks indicate that laaS is complex, more complex than other PaaS models they finance. An example is the fact that the contract expires before the economic life of the assets. Because of those transfer moments, at the end of the contract, you have a risk that the circular or laaS idea is reduced or lost. Good solutions must be devised for this, such as using residual value or placing a (dynamic) materials passport in a separate entity

that always goes along with the asset. During the term of the contract, there are incentives to work circularly (bonus/malus system in periodic compensation and in the residual value). We see that thinking from laaS promotes circular working, so it is now important to see how this can be further developed into a proven and scalable model.

Ideally, a scalable PaaS model is a standard model. A number of characteristics of circular construction form a basis for this, such as:

- the client must remain legally responsible;
- the duration of a contract lasts longer than the life of an asset;
- there is still a limited market for secondary products and materials.

The final form of the business model has taken this into account. It therefore strikes a balance between achieving circular construction and weighing up other interests in the sector, such as preventing a long-term lock-in for the client and stimulating market forces. Ultimately, such a consideration also ensures the attractiveness of the model and the further upscaling of laaS with it.

What is needed for scaling up?

As initiator, Dura Vermeer finances itself with equity in this phase. Based on Dura Vermeer's experience as an equity investor in infrastructure projects, the risk profile is acceptable. The entire investment, including the required return on equity, is repaid over the life of the contract. The obligations for the design, realization and maintenance have been passed on to entities of Dura Vermeer that have the necessary experience and expertise.

During the duration of the program it has become apparent that clients, as government bodies, can borrow cheaply. The interest rate was even 0% for the government. This raised the option that clients could perhaps play a role in the cheap financing of an laaS in scaling up. In the longer term, however, this is not a stable source of financing, given the length of contracts and the potential political changes that could frustrate rather than promote continuity. To this end, the market therefore serves as a more stable source that is less subject to such fluctuations.

Scaling up will therefore require external bank financing in due course. This is necessary because financing is not the primary activity of Dura Vermeer and it results in a long-term capital requirement. In the follow-up to this programme, the conditions are defined that are necessary to obtain bank financing. It has been established that standardisation, predictability of the cash flows and the size of the project are important points in this respect. The bank checks whether the parties can meet their obligations, in this case local authorities and reputable construction companies. Standardizing the contracts and business model also contributes to predictability and reliability. The desired size of a

project or financing from the perspective of a bank and the contractor is ideally achieved by entering into large projects or by combining a set of comparable projects in 1 application (portfolio financing). It is therefore recommended to develop a proposition for 1 or a few assets, so that it is possible to build up a portfolio of comparable and standardized projects.

- In conclusion, the following could be advised regarding how the IaaS model can be financed: the bank can finance on the payment flows up to the 'ex ante residual value' (= last term) and the underlying asset.
- the risk of depreciation (= 'delta residual value') of this last term lies with the contractor
- to include this last term in the financing, the contractor must provide a guarantee.

In the future, it will have to be assessed whether this value proposition is interesting for all those involved.

The pilots

Amersfoort – Bridge decks

Amersfoort – Residential road

Amsterdam – Temporary road

North Brabant – Road light

North Holland – Guide rails

Overijssel – Provincial road

Utrecht – City road

3. The pilots

In this chapter, we describe the seven pilot studies on all topics covered in chapter 2 in general.

3.1 Pilots Overview

Seven pilots have been carried out in the program. Not every project has already gone through all phases of the infrastructure as a service model. Table 11 represents the status of each pilot in June 2022. This chapter reports on all the 7 pilots considered, including Amsterdam, which did not finalize the design (thus, IAAS is not included), and Utrecht, which remained as a traditional contract but was used as a control to compare against other IAAS models. The pilots with full analysis (IAAS, stakeholder analysis, and material circularity) include a section on pilot highlights, where R strategies, circular elements, CB'23 indicators, and main barriers and enablers are summarized.

Table 11 Pilot status

Pilot	Planning	Program requirements	Offer	Contract	Implementation	Performance / monitoring
Amersfoort Replacement bicycle bridge decks	Finished	Finished	Finished	Finished	Current phase (June '22)	
Amersfoort Reconstruction of JP Heijelaan Residential Road	Finished	Finished	Finished	Current phase (June '22)		
North-Holland Guide rail as a service	Finished	Finished	Finished	Current phase (June '22)		
North Brabant Road light as a service	Finished	Finished	Finished	Finished	Finished	Current phase (June '22)
Overijssel Sustainable management of provincial road N739	Finished	Finished	Finished	Not as a service		
Amsterdam Temporary road at ArenA	Finished	Finished	Current phase (June '22)			
Utrecht Reconstruction of Croeselaan city road	Not as a service	Not as a service	Not as a service	Not as a service	Not as a service	Not as a service

- Finished
- Current phase (June '22)
- Not as a service

3.2 Amersfoort: Bridge deck

Amersfoort is located in the province of Utrecht and has around 150 thousand inhabitants in the wider municipality and 140 thousand inhabitants in the district. It has a population density of about 2500 inhabitants per square kilometer. Two projects were realized in Amersfoort, two bridge decks and a residential road.

The aim of these pilots is to determine to what extent a collaboration based on 'as-a-service' in an urban environment leads to an ideal contract form that results in maximum circularity and lower LCC.

The project is focused on the top of the R strategies: Rethink! In this way, the design takes priority as it considers that less consumption of materials is better. After this, the use of sustainable materials while enabling reusability and recycling is considered.

3.2.1 Pilot description

The IAAS considers the replacement of the wooden bridge decks with improved sustainability. The bridge is used by pedestrians and cyclists primarily, and it is not intended for vehicle usage (with the exception of maintenance and emergency vehicles).

The approach to costs and budget to find solutions is based on an 'open book.' The aim is to remedy the noise pollution with the modification of the bridge decks. Resident participation was considered but later abandoned due to the small scale.

The municipality sees potential in the business case optimization since the dynamics between lifespan and environmental effects could be played within the choice of materials between wood and plastic for the bridge.

The aim of the project was to investigate the feasibility of reusing wooden planks for the pedestrian path. The testing was still ongoing during the reporting on this case. The early finding shows that the preparation of these planks can be intensive and inefficient. In hindsight, this could have led to a different goal-setting.

3.2.1.1 Current state

Currently, the wooden bridge decks are not in their optimal state and represent a nuisance to comfort (especially for cyclists) and a nuisance due to noise emissions.

3.2.1.2 The Scope

Project replaces two bridge decks of the Nieuwland bridges: B297 Watersteeg – Grote Poelslak (1998), B311 Watersteeg – Rietvoorn (2002). It considers the replacement of the wooden bridge decks and maintenance. Other bridge elements, like joints, base, handrails, and others, are outside scope. The bridge and the bridge deck are visible in Figure 14.



Figure 14 Bridge and bridge deck in Amersfoort

3.2.2 As a service framework

The IAAS model includes three parts: tasks of the service, division of responsibility (client, contractor), and circular strategies in the service. The IAAS model is represented in Figure 15, with color distinction for the client (blue) and contractor (yellow). Amersfoort municipality as a client form the demands and how to achieve them (functional and structural level) and features that are left for the contractor to decide, represented by yellow (functional and structural level).

The IAAS model for the bridge deck incorporates circularity at the highest demand level with a request to “provide a circular and functional bridge deck” see Figure 15. The functionality of the asset is essential at a high level for all infrastructure, as it provides the function to the public. Four lower demands are created to fulfill the main demand, which concerns safety, availability, comfort, and sustainability.

Safety is a common feature among all assets, and here it concerns national guidelines, technical parameters (such as deflection), and also internal municipality guidelines (Handboek Inrichting Openbare Ruimte). The latter includes circular elements (at the structural level). The technical parameters for the IAAS only include the bridge deck specification, as the bridge structure overall is out of scope. Not all technical parameters

are listed in the figure, as these are specified in the guidelines and contract. Another functional aspect of safety for bridges is the zone separation for cyclists and pedestrians (the bridge is not used as a vehicle traffic bridge). Similar to safety, the element of zone separation is prescribed by the standards. Small elements are left for the contractor to decide, such as color. While it is specified that red and grey are used for bicycle and pedestrian zone, respectively, it is up to the contractor to choose the type of color. Municipality expressed hope that these restrictions are eased up in the future so that contractors may have more freedom (without compromising safety). Moreover, the color used on the bridge has an influence on circularity. For example, the colored parts may have to be removed, thus decreasing the amount of possible reuse and recycling.

The next demand is the availability of the bridge (24/7). This demand is linked to safety and maintenance. Maintenance must be performed in such a way that it enables the use of the bridge while adhering to safety standards. A bonus/malus was applied here (structural level) to ensure the availability of the bridge, i.e., financial consequences if the bridge is available for less/more days than set in the contract.

During the contract formulation, it was discussed if the drainage features could be included. It was decided that only the bridge deck is the scope of the contract and the present features (such as gargoyles) are sufficient, but the contract does not extend to them. The deck maintenance itself is up to the contractor to decide (yellow color). This is connected to the well-designed disassembly at the circular demand level (right side of Figure 15), as the reparation of the bridge needs to be both circular and limit the nuisance to the public. This is reflected by the circular features for deck **reparation** and materials used (yellow and circled).

The comfort of the bridge is an important demand for this IAAS as the nuisance of noise and cycling discomfort was the initiator for changing the bridge decks. The comfort has several elements: the use of material itself (ex. smooth, but not slippery), the gaps between the planks on the bridge, and the noise it makes while the bridge is used. The latter can be measured if needed, but the main indicators are complaints from the residents (who previously complained about the noise level). If any complaint occurs, the municipality (client) is contacted first, as that is what residents are used to. Adding separate contact just for two small bridges was not seen as useful. The complaints are then forwarded to the Dura Vermeer (contractor), and it is up to them to solve/handle the complaint (maintain the bridge).

The last demand feature is sustainability. There are three functionalities to this demand: improving material quality of the current state, providing circularity, and lowering carbon footprint. While the material stays largely the same, i.e., wooded planks, the quality of the planks is improved as the wood has an additional layer of grips and structure to improve cycling comfort. It is resistant to salt (winter). The salt distribution is handled by

the municipality in the wintertime, and it is not part of the maintenance. Wood was also chosen as applying sustainable materials is important for the Amersfoort municipality. This concerns renewable or reused materials from non-virgin (primary) sources. At the circularity level, this is translated to having a reduction of the primary materials. It refers to the top strategy of the client, which is to **rethink** and **reduce**: if materials can be avoided, they should be avoided. While wood is the primary renewable material, 50% of the materials are **reused** at the same location (wood from bicycle paths is applied to the pedestrian path). The primary wood used in the bridge is FSC certified (Forest Stewardship Council, 2022). Wood as a material offers a high level of reusability and **recycling** at the end of its lifetime. It is expected that the materials can be partly reused for bridges or **repurposed** otherwise locally, and the parts which are not of high enough quality can be recycled.

The last sustainability function is the decrease of the carbon footprint, which is measured as decreased MKI value. It was also discussed to what extent biodiversity should be included as part of the contract. While it is excluded for now from the IAAS, monitoring of the birds nesting under the bridge happens outside of the scope. It is also formulated that no debris can enter the water body under the bridge as part of the renovation and maintenance to prevent any environmental impacts, including harm to the biodiversity.

Performance requirements and elements

- Noise pollution: decibel is not a problem. It is the experience (irritation). Noise pollution during execution should be as limited as possible (but does not limit the project). The noise production of the use of the bridge must not exceed the current situation.
- Cycling comfort and pedestrian comfort. For example, flatness and openings (max. 10mm). However, there is no objective method to measure this.
- Safety. Separation should be made between the bicycle-pedestrian zone with a beveled profile and a height of 50mm. A scare strip should be fitted along the edges of the bridge deck. The color of the wear layer is preferably red for the bicycle zone and gray for the pedestrian zone.
- Stiffness. (According to NEN 2873) According to CROW—The warning level
- Smoothness on deck. They are in a scattering route and are equipped with salt boxes – however, that is not a requirement for the project. The materials themselves should be able to withstand prolonged exposure to moisture.
- Availability 24/7: limited inhibition during execution. The bridge is available to pedestrians during execution. Bonus/malus on number of days closed for work
- Materials must be resistant to road salt, and the substructure must be protected against the spreading salt.
- Maintainability: when repairing deck damage, it should be easy to exchange the deck parts.

- During the execution, it is necessary to prevent materials from entering the underlying water.
- MKI (lower MKI than reference design)

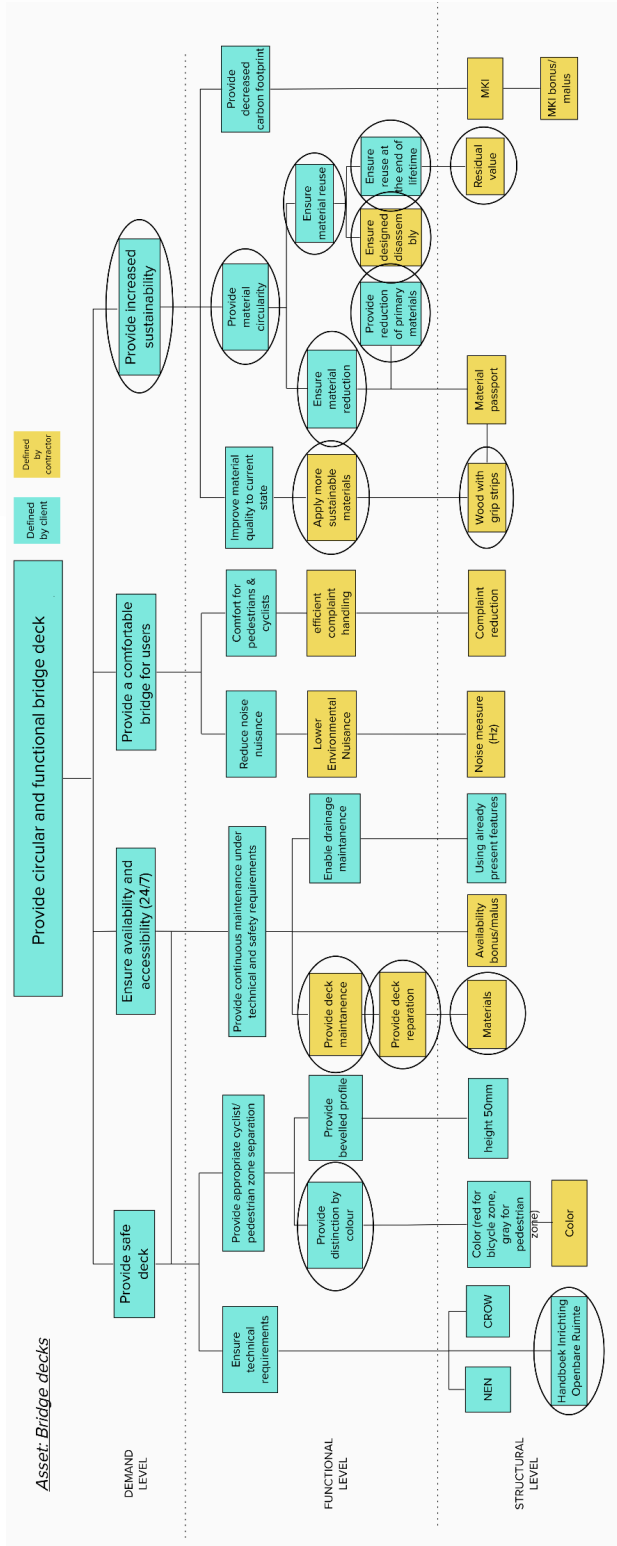

Figure 15 As a service model for bridge deck in Amersfoort. Based on Van Ostaeven et al. (2013), the hierarchy includes three levels: demand, function, and structure. Additionally, there is a distinction between the elements defined by the client (blue) and contractor (yellow). Both contractor and client defined the circled elements as circular elements.

3.2.3 Pilot highlights

Pilot Card: Amersfoort Bridge Deck				
10Rs integrated	IAAS circular elements	CB'23 indicator 1-3	Main Enablers (Top 5)	Main Barriers (Top 5)
<p>Rethink <i>Implemented in the design, sustainable materials, and prolonged lifetime of the materials.</i></p> <p>Reduce <i>Implemented in the design, "if materials can be avoided, they should." Primary materials were reduced</i></p> <p>Reuse <i>Implemented: old wood planks are reused in the pedestrian path</i></p> <p>Repair <i>Implemented deck repair and maintenance</i></p> <p>Refurbish <i>Implemented: old wood planks are refurbished (layer is added)</i></p> <p>Recycle <i>The wood can also be recycled at the end of life</i></p> <p>Potential: Repurpose wood locally</p>	<p>Demand level (1) <i>Increase sustainability</i></p> <p>Functional level (10) <i>Providing material circularity, Applying sustainable materials, Ensuring material reduction, Reduction of primary materials, Ensuring material reuse, Reuse at the end of life</i></p> <p><i>Well-designed disassembly</i></p> <p><i>Circular maintenance</i></p> <p><i>Circular repair of the deck</i></p> <p><i>Color application</i></p> <p>Structural level (4) <i>Materials (2) Residual value Internal guidelines</i></p>	<p>Indicator 1.1 – 75,3%</p> <p>Indicator 1.1.1 - 1%</p> <p>Indicator 1.1.2a – 74,3%</p> <p>Indicator 1.1.2b - 0%</p> <p>Indicator 1.2 – 24,7%</p> <p>Indicator 1.2.1 – 24,7%</p> <p>Indicator 1.2.2 - 0%</p> <p>Indicator 1.3 – N/A</p> <p>Indicator 1.4.1 - 0%</p> <p>Indicator 1.4.2 - 100%</p> <p>Indicator 2 – 95%</p> <p>Indicator 2.1 – 49,5%</p> <p>Indicator 2.2 – 44,6%</p> <p>Indicator 3.1 – 0,0%</p> <p>Indicator 3.2 – 1,0%</p> <p>Material losses – 5%</p>	<ul style="list-style-type: none"> - Knowledge gained - The need for change/initiating change -Bouwteam-like' cooperation/initial facilitations - Sharing knowledge freely - Supporting attitude of managers 	<ul style="list-style-type: none"> - Aversion to procedure/need for persuasion (internally) -Knowledge gap and knowledge transfer -Misalignment between wanting to change and willingness to change -Complex projects -Hard to identify benefits ex-ante

Figure 16 Pilot card for Amersfoort Bridge Deck.

3.3 Amersfoort: Residential road

3.3.1 Pilot description

Project Dr. Jan Pieter Heijelaan is a small road in the residential area. The road runs from the Stichtse Rotonde (from the cycle path), including the Potgieterlaan (to the cycle path Utrechtseweg). It is an access road with sidewalks on both sides. It falls under protected cityscape. The design had the same principles as the bridge deck, i.e., less is better. The residents were involved in the design phase, where the two-sided road was changed to a one-sided road. The new design for the road came from the client independently of the IAAS process. The precise activities and scope were then discussed as part of the IAAS. The lighting was consciously excluded from the scope to keep IAAS at the complexity that can be handled with the first-time contract.

The reference variant represents the "patching up" of the current road with the same materials as now.

3.3.1.1 Scope

Road paving: Asphalt and foundation

Drilling cylinders are made of the entire structure to determine the quality of the materials used and, therefore, in what capacity they are still usable and what work is needed. The

current estimate concerns 20 cm of asphalt, 30 cm of foundation, with 50 cm of sand underneath. For example, research still needs to be done into the tar content of the asphalt and the properties of the sand body. Without tar, it can be fully recycled.

Road layout: sidewalk, drainage, road signs

A further consideration is that the rainwater can infiltrate naturally and does not end up in the (mixed) sewer. This has consequences for the location (height) of the road construction. Currently, the assumption is that there is a lot of sand present, so the possibility of infiltration is large. This can be taken into account from the design. The sewer system is not in the scope, but there are other possibilities to ensure that rainwater is infiltrated locally. This contributes to the sustainability of the street and the city. The roadside and moving cables and pipes are not part of the scope.

3.3.1.2 Alternatives (Considerations before reaching IAAS contract)

Three scenarios for different lifespans have been considered and calculated (10, 20, and 50 years). The final scenario sets the technical lifespan at 50 years, so that (environmental) costs due to construction, management, and all are taken into account.

Several scenarios regarding the scope of the service were considered:

1. Reconstruction only (which does not make sense for a service contract)
2. Reconstruction + maintenance
3. Reconstruction + maintenance + management (whereby the eyes and ears are also placed with the contractor)

Scenario 2 was chosen as maintenance is viewed as one of the requirements for the service model. The idea of including management was taken into account, but the scope is too small to make it efficient. Maintenance is limited to only scope projects (e.g., road paving) or supplemented with minor maintenance and care (such as patchwork, removing weeds, and keeping it clean/ sweeping).

During the decision process, it has been agreed to look for circular solutions with the lowest LCC in mind with these activities in mind and then to determine later what does/ does not come within the final scope of the service. The aim is to look for optimal solutions with regard to the maintenance of the value of raw materials and LCC (round 1) and then see what really fits (round 2).

3.3.2 As a service framework

Amersfoort's top-down approach for the R strategies is visible in the IAAS model for the residential road. The main demand is to provide functional and sustainable roads, similar to the bridge deck demand (circular and functional).

There are three demands that were chosen to fulfill the main demand: safety, availability, and sustainability. Sustainability includes two demands with regard to circularity and aesthetics. Figure 17 represents the main features and elements of the IAAS contract, with a distinction between what is defined by the client (in blue) and elements left for the contractor to decide upon (in yellow).

Safety regarding the residential road concern upholding the national guidelines, including technical parameters. Some examples are listed at the structural level, such as road signs and traction; other technical parameters include smoothness of the road, stiffness, road markings, etc. Besides national requirements for the residential road, the municipality also has internal guidelines that apply to IAAS and include circular elements.

The availability of road needs to be provided in a safe manner, and the activities include maintenance of the road. Maintenance itself needs to include circular elements. The same principle of **rethink** and **reduce** applies here, as avoiding repairs can lead to more circularity and sustainability. Thus, the maintenance should be effective and smart to adhere to those principles. All of the functional features of the maintenance are specified by the client (in blue). The exception is the reparation features of the maintenance, which are the responsibility of the contractor. The materials used during maintenance need to include the same circular features as circularity and sustainability demands. As with the bridge deck, the complaint handling of the residents is one of the key functionality features. This also includes reconstruction of the road, which should minimize the nuisance to the residents. Maintenance also occurs when the residents notify the municipality, for example, holes and crack on the road. The complaint is forwarded to Dura Vermeer, and the handling of the complaint is left to the contractor. The complaint can also consider noise nuisance due to the state of the road or maintenance. The noise emissions are not measured periodically but are included here as an example of the indicator in case of the complaints handling. The boundaries of who is responsible for what are also open for discussion regarding concrete complaints, as some may be outside of the scope included in the contract. There is also a consideration for efficient maintenance, which is connected to the costs as the client wants to ensure that a cost-wise approach is taken.

Biodiversity was discussed as part of the scope. The aim of the municipality is to integrate more greenery to strengthen biodiversity, help with heat distribution (overheating and heat island), and improve the filtration of rainwater. However, it was concluded that such features would be too complex for the first try at IAAS. This was simplified to ensure no harm to biodiversity is done during the reconstruction and maintenance of the road. However, at the point of finalizing this report, such features were not yet determined and

thus will be determined when the issue becomes relevant during the service. Biodiversity consideration can also be counted as sustainable action.

Sustainability demand has underlying demand of circularity. It is achieved first by considering if materials, in general, can be avoided (refused). **Refuse** was implemented by radically changing the design and avoiding half of the materials. Next, the consideration is to avoid primary materials if possible and to apply sustainable alternatives. Before reaching a conclusion on this, Dura Vermeer calculated alternatives, including LCC and MKI, to choose the most optimal materials (this includes maintenance aspects). The example representing the materials here is the asphalt mixture. There are several asphalt mixtures used in this project, all with various levels of recycled input. How these materials are **recycled** at the end of their lifetime (also during the reparation-maintenance) is left to the contractor. The majority of the asphalt can be recycled again, and the chosen alternatives also provide a longer lifetime for the road (Ecopave asphalt mixture, a product of Durva Vermeer). All elements under the circularity demand have circularity features (circle in Figure 17). Material passport is not circled because it is merely a method to showcase the usage of materials (similarly, MKI is not circular). The choice of materials contributes to a lower MKI score, which is under the functional requirement to lower the carbon footprint of the road.

Lastly, neighborhood aesthetics need to be ensured. This case integrated active input from the residents regarding the design (social level of sustainability) following the rethink and reduce strategies. As a result, the design changed from two-sided to one-sided pavement, saving double the materials. While some features are dictated by the internal guideline (Handboek Inrichting Openbare Ruimte), for example, the use of yellow brick, the way to each of those requirements is left up to the contractor (yellow).

Overall, the contract aims to have continual open communication with the contractor to solve any additional issues that may arise. The municipality also leaves the construction of the project to the contractor. For example, it is suggested that repairs may take place during large-scale re-asphalting or reconstruction, which can save the resources (labor, energy, machinery, etc.) that would be needed for the separate work on the pilot.

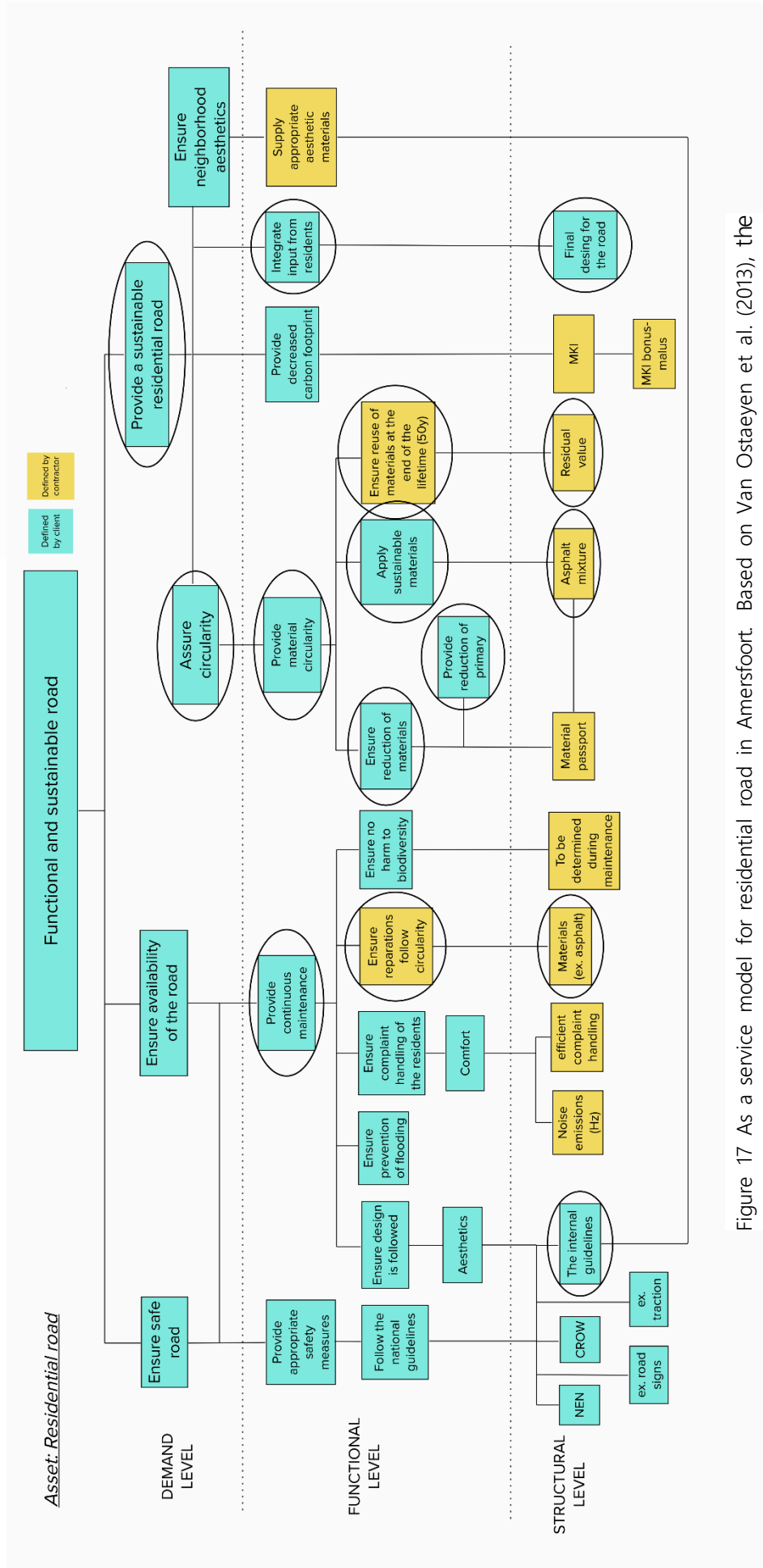

Figure 17 As a service model for residential road in Amerfoort. Based on Van Ostaeeyen et al. (2013), the hierarchy includes three levels: demand, function, and structure. Additionally, there is a distinction between the elements defined by the client (blue) and contractor (yellow). Both contractor and client defined the circled elements as circular elements.

3.3.2.1 Performance requirements

The periodic availability fee is paid if Dura Vermeer meets the (performance) requirements. Some of these elements include:

- MKI (lower MKI than reference design)

The road must fit within a protected cityscape (intern policy document of the municipality of Amersfoort – yellow stones for the streetscape and cityscape)

- Technical requirements
 - Compliance with the type of road (access road within built-up area 30 km/h area)
 - The design must comply with ASVV 2021
- Material requirements
 - Optimal use of materials
 - Environmental impact material
 - Detailing / design
 - Reusable materials
 - Easy removal after the end of use

3.3.3 Pilot highlights

Pilot Card: Amersfoort – Residential Road				
10Rs integrated	IAAS circular elements	CB'23 indicator 1-3	Main Enablers (Top 5)	Main Barriers (Top 5)
<p>Refuse <i>Implemented in the design by halving the amount of materials</i></p> <p>Rethink <i>Implemented in the design, input from residents, sustainable materials, and prolonged lifetime of the materials.</i></p> <p>Reduce <i>Implemented in the design, "if materials can be avoided, they should." Primary materials were reduced by around 50% with the new design</i></p> <p>Repair <i>Implemented for maintenance of the road</i></p> <p>Recycle <i>Most materials implemented can be recycled at the end of life</i></p>	<p>Demand level (2) <i>Increase sustainability Assure circularity</i></p> <p>Functional level (8) <i>Providing material circularity, Applying sustainable materials, Ensuring material reduction, Reduction of primary materials, Ensuring material reuse, Circular maintenance, Circular repair, Integrated design (with input from residents)</i></p> <p>Structural level (5) <i>Design of the road, Materials (2) Residual value Internal guidelines</i></p>	<p>Indicator 1.1 – 14,1% Indicator 1.1.1 – 14,1% Indicator 1.1.2a – 0% Indicator 1.1.2b 0% Indicator 1.2 – 85,9% Indicator 1.2.1 - 0% Indicator 1.2.2 – 85,9% Indicator 1.3 – N/A Indicator 1.4.1 - 0% Indicator 1.4.2 - 100% Indicator 2 – 99% Indicator 2.1 – 7,8% Indicator 2.2 – 91,2% Indicator 3.1 - 0% Indicator 3.2 - 0% Material losses - 1%</p>	<p>- Knowledge and experience gained</p> <p>- The need for change/initiating change</p> <p>-Bouwteam-like' cooperation/initial facilitations</p> <p>- Sharing knowledge freely</p> <p>- Supporting attitude of managers</p>	<p>- Aversion to procedure/need for persuasion (internally)</p> <p>- Knowledge gap and knowledge transfer</p> <p>-Misalignment between wanting to change and willingness to change</p> <p>-Complex projects</p> <p>-Hard to identify benefits ex-ante</p>

Figure 18 Pilot card for Residential road in Amersfoort as a service model.

3.4 North Holland: Guide rails

North Holland is a province in the northwest of the Netherlands. The province has about 3 million inhabitants. The capital of the province is Haarlem. The province aims to integrate sustainable projects and has been doing so in the past. The underlying ambition of this pilot is to contribute to a market transition for infrastructure towards circularity. With this model, circularity is not only an 'add-on' to a linear economy system but taking a step towards a truly circular economy.

3.4.1 Pilot description

The roadside has been chosen as an area for IAAS in North Holland. Initially, the idea was to re-process grass growing on the roadside into a new product or enhance waste management options. However, readily available options for grass-based products are limited (insulation materials for the building have been highlighted as a possible future usage). At the same time, the land is owned by Dura Vermeer. Thus, the ownership would not change. This project idea was abandoned in favor of guide rail. The final pilot is guide rail-as-a-service for the province of North-Holland. According to the province, the impact-oriented service needs to provide more circularity concentrating on the reuse of materials. Other features include lower LCC and feasibility of the IAAS model (legal, financial, management aspects, organizational) for both clients and contractors.

The guide rail is among the roadside objects with the highest CO₂ footprint. A higher environmental footprint is due to materials used (predominantly steel and small amounts of zinc) and their production processes. Furthermore, there is no real policy in the field of guide rails other than complying with the regulations and existing requirements. Currently, the guide rails are replaced by a completely new guide rail when they no longer meet the requirements (rusted state).

The chosen circular variant is composed of renovated guide rails. The guide rail is a modular and demountable object with a safety certification. The object consists of uprights, shelves, connectors, and connecting material (bolts and nuts). The object must be quickly replaceable (e.g., after a collision). To achieve circular design, the old guide rails are inspected, de-zinked, and re-galvanized a while before the end of technical life and then reused with the same technical new value. If the guide rail renovation method is applied to a larger area, there will be considerable savings in material (steel, zinc), costs (cost price is lower), and environmental impacts.

This pilot is an experiment to see the possibilities of guide rail renovation. As not much is known, only by practical (not theoretical) experiments all points of attention can be answered and proven. PNH works with area contracts for a longer period of time but without circular conditions or KPIs.

With the triple helix integrated into the DCW program, this pilot concentrates on the circularity of the material and gathering knowledge on legal aspects (contract, risks, governance) and financial aspects (a form of financing, governance, programming). For this purpose, an additional contract (UAV-CE) is drawn up on the area contract. As a service is seen by the client as a driver to encourage the contractor to come up with a new solution for fulfilling a task or assignment.

3.4.1.1 Current state

There have been two proposed locations assessed on the possibilities for renovating and/or sustainably treating the existing guide rail at N248 and N250 road. N248 is in the section 4.550 km– 37.000km and was built in 2013. This section includes approximately 1900m of the guide rail. The inspection showed that the guide rail is following the specification from 2013 and is in very good condition, with the (remaining) service life still more than 20 years. The state of maintenance in terms of height and tilting tooth also complies with the applicable guidelines. Thus, the most sustainable option is not to carry out any work but to monitor the quality (height and skew).

N250 includes sections 113.300km – 119.900 km with construction in the year 2009 and older. There is approximately 3100m guide rail of the well-known standard Dutch system in accordance with the NEN5190/5191. The section between 113,350km and 115,500km is from 2009 (probably older), where the (remaining) service life is less than two years. Therefore, it is in a very poor condition in terms of residual life (skew and altitude). Therefore, this section has been chosen for renovation.

3.4.1.2 The scope of the pilot

Renovation of the guide rail located at N250 between 113,350 and 115,500km.

Four alternatives have been examined:

1. Remove existing guide rail as scrap and deliver and install new guide rail.
2. Dismantling existing guide rail for renovation and supplying and installing renovated guide rail (NEN5190/5191).
3. Dismantle existing guide rail for renovation and deliver and install new guide rail with renovated planks (NEN5190/5191).
4. Dismantle existing guide rail for renovation and supply and install new guide rail with renovated planks (NEN-EN 1317).

The first rough estimates on the management, circularity aspects, and costs revealed that the fourth alternative is the most feasible. The first alternative is the least circular since no renovation of the old guide rails occurs. The second and third alternative follows the older NEN, which specified a 2-sided guide rail, while the fourth alternative includes a 1-

sided guide rail in accordance with the new NEN. The comparison is represented in Figure 19.

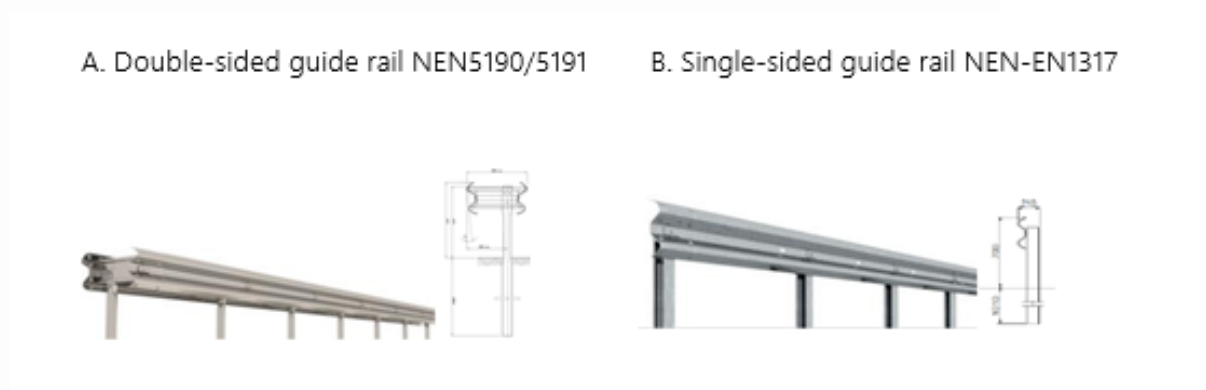

Figure 19 Different guide rail type. The A) is reference, i.e., previously applied and B) is currently applied by the pilot.

Thus, the chosen alternative uses fewer materials while also enabling modular design for the renovation. The existing guide rail is disassembled into parts for the renovation of the planks only. The planks are inspected in accordance with a new single-sided (1 shelf) guide rail system (NEN-EN1317), and the rejected parts are removed to an approved scrap processor. The scrap is returned back into the supply chain as a material processed for recycled part of the steel. Next, the approved guide rail for reuse is re-galvanized approved, and supplemented with newer parts, so that a completely new single-sided (1 shelf) guide rail system (NEN-EN1317) is fitted with a lifetime of >30 years.

The main disadvantage of this method is mainly during the execution, and these activities are carried out in 2 corridors in two times traffic measures so that more nuisance is present for the road user and the environment. However, it has been agreed that the work on guide rails will be performed at the same time as road maintenance as part of a larger contract that Dura Vermeer has with the PNH. There is also a buffer plank necessary for calibration to be able to replace the first part and replace the coming materials.

3.4.2 As a service framework

The IAAS for the guide rail was the fastest and most direct IAAS from idea formation to contract. As seen in Figure 20, the main demand is to provide increased circularity for the guide rails. Similar to other cases, four demands are formed to reach the main demand: safety, maintenance, circularity, and decreased carbon footprint. Most of the functional level is dominated by the blue color, i.e., prescribed by the province (client). While certain

functional features and structural levels are the responsibility of the contractor to decide on the way it is fulfilled. More client requirement (blue) and less freedom and creativity for the contractor is due to guide rails being a very regulated feature on the road.

The safety feature includes relevant documents and specifications for the “safety object” on the road (mostly NEN and CROW guidelines). The maintenance needs to be performed in a way that does not compromise the availability of the road. No specific availability features are formulated for IAAS as the guide rails fall under the larger overarching contract of Dura Vermeer for the province of North Holland. The reconstruction of the guide rail will also be undertaken when work on the road is performed, thus not causing any nuisance in the availability.

The maintenance itself considers structural elements specific to the guide rails (such as monitoring of height and skew), and must be performed with circular features, such as recycled and reused materials. Additionally, no harm to biodiversity should occur due to maintenance. However, specific features will be addressed later when more experience is gained and the issue becomes relevant. For now, the general work follows the environmental code (omgevingswet). Preserving biodiversity and safety on the roads remains a precondition, according to the client.

Circularity as demand is fulfilled by functions of renovation and reduction of the materials. The design of the guide rails was changed from 2-sided to 1-sided construction, **reducing** material need by half. At the same time, the materials applied are renovated (**refurbished**). It is achieved via Saferoad company (Saferoad, 2022), which is a Dutch company that renovates the old guide rails. Moreover, the guide rail is reused in the same area for this project. Firstly, the guide rails are inspected, and the rejected parts are sent to scrap dealers for **recycling**. The parts that can be reused are treated, re-galvanized (new zinc layer), calibrated, and prepared for reuse. Renovation rails are equivalent to new guide rails, so it is 100% interchangeable.

Steel can be **reused** for various purposes (from recycling to direct reuse), but the residual value will need to be dealt with at the end of the contract/lifetime, and not much planning can be done as the price of steel has a highly volatile market and thus cannot be predicted ahead of time. Naturally, the chosen alternative represents a lower MKI score and decreases the environmental burden of guide rails.

A part of the follow-up to this program is **rethink** strategy with high-quality repurposing anti-demolition principles considered from the beginning with optimal replacement strategy.

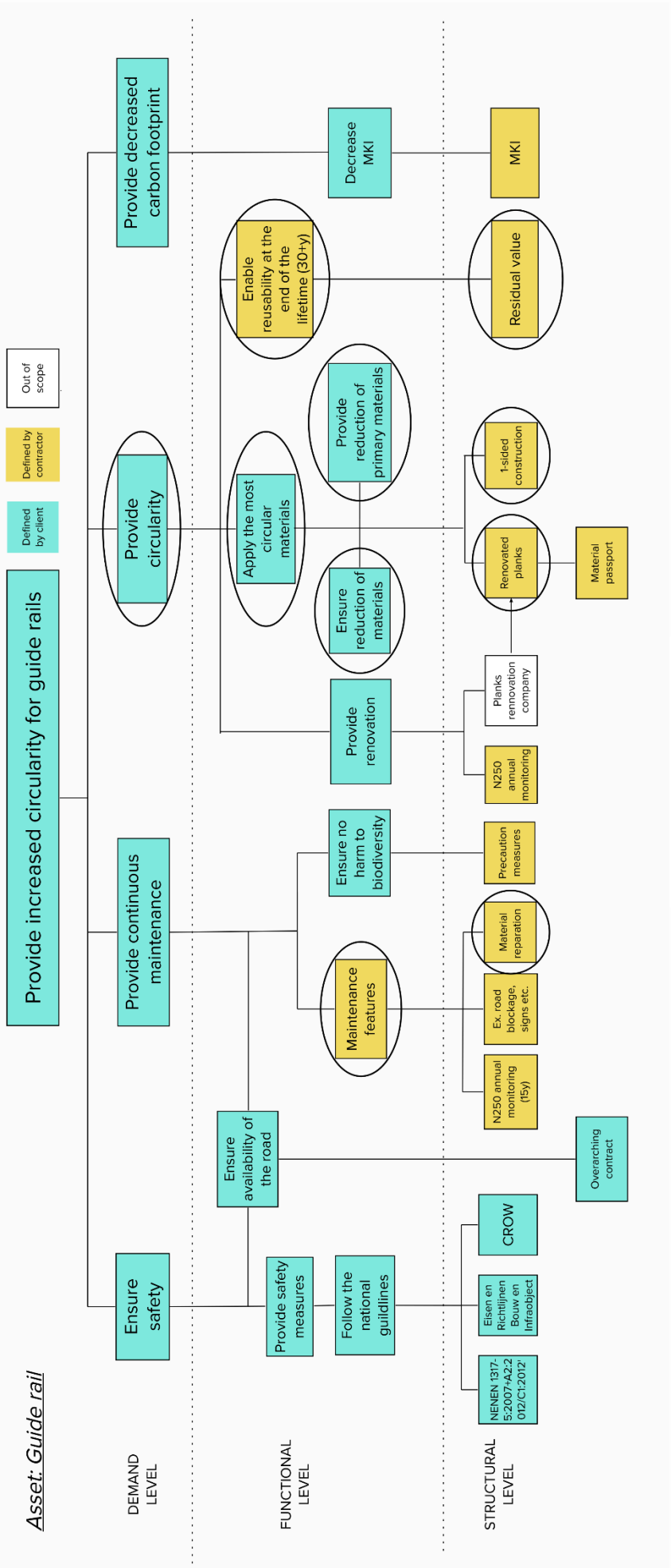

Figure 20 As a service model for North Holland Guide rail pilot. Based on Van Ostaeyen et al. (2013), the hierarchy includes three levels: demand, function, and structure. Additionally, there is a distinction between the elements defined by the client (blue) and contractor (yellow). Both contractor and client defined the circled elements as circular elements.

3.4.3 Pilot highlights

Pilot Card: Noord Holland – Guide Rails				
10Rs integrated	IAAS circular elements	CB'23 indicator 1-3	Main Enablers (Top 5)	Main Barriers (Top 5)
<p>Rethink <i>Implemented at the design</i></p> <p>Reduce <i>implemented by choosing the design option of one-sided (instead of double-sided) rail</i></p> <p>Reuse <i>Steel can be reused</i></p> <p>Repair and Refurbish <i>implemented as renovation of the guide rail as input and maintenance</i></p> <p>Recycle <i>The lower quality parts of steel can be recycled (scrap dealers)</i></p>	<p>Demand level (1) <i>Provide circularity</i></p> <p>Functional level (5) <i>Applying the most circular materials, Ensuring material reduction, Reduction of primary materials, Ensuring material reuse at the end of the lifetime, Provide circular maintenance</i></p> <p>Structural level (4) <i>Materials reparations, Renovated planks, 1-sided construction, Residual value</i></p>	<p>Indicator 1.1 – 10,6%</p> <p>Indicator 1.1.2 – 10,6%</p> <p>Indicator 1.1.2a – 0%</p> <p>Indicator 1.1.2b 0%</p> <p>Indicator 1.2 – 89,4%</p> <p>Indicator 1.2.1 – 40,3%</p> <p>Indicator 1.2.2 – 49,1%</p> <p>Indicator 1.3 – N/A</p> <p>Indicator 1.4.1 – 0,8%</p> <p>Indicator 1.4.2 – 99,2%</p> <p>Indicator 2 – 97,3%</p> <p>Indicator 2.1 – 44,3%</p> <p>Indicator 2.2 – 49,1%</p> <p>Indicator 3.1 - 0%</p> <p>Indicator 3.2 – 4,0%</p> <p>Material losses – 2,6%</p>	<p>- Trust in contractor and DCW partners</p> <p>- Initial exploration phase</p> <p>- Simple case with clear goals</p> <p>- Prior experience (maintenance contract)</p> <p>- To gain experience with IAAS</p>	<p>- Challenging to formulate a contract for Infra as a service when compared to business as usual</p> <p>- Long process</p> <p>- Inexperience and lack of knowledge</p> <p>- Current market is restricted</p> <p>- Uncertainty about business model/finance</p>

Figure 21 Pilot card for Guide rails in North Holland as a service model.

3.5 North Brabant: Road lights

North Brabant is a province in the south of the Netherlands. The province has about 2.5 million inhabitants. The capital of the province is Den Bosch. The province is the first one to integrate the IAAS model in collaboration with Dura Vermeer (Lumi-US) and Hoeflake Infratechniek. The added value that the Province sees in applying As a Service to lighting is:

- Being able to try something new through as a service.
- Dynamic dimming of lighting
- Long-term partnership
- Savings on expensive FTEs in the organization.
- Get energy reduction.

3.5.1 Pilot description

Compared to other cases, light as a service is already at the execution and service provision stage with proven benefits. The province has already made an investment together with Dura Vermeer in new light fixtures with dynamic dimming. The main aim was to achieve lower environmental impact and decrease costs by means of energy-saving. The general framework for the pilot was set in 2018 based on everyone's individual and joint pilot goals. The pilot plan was drawn up, including requested preparation and financial agreements, with the letter of intent signed in January 2019. The preparation phase for the pilot took place between January and July of 2019,

including the elaboration of the offer and financial agreement. The dynamic dimming is based on weather and traffic and is linked with real-time traffic data. The implementation phase took place from July 2019 to July 2020. Adjustments were made to public lighting in autumn 2019, the dimming regime was elaborated in autumn 2019. The assessment of the dimming regime among stakeholders was performed in early 2020. The transition to dimming was made from March to May 2020.

An important lesson that emerges from the case first in progress is the *long-term relationship* and internal relationship that both organizations have with each other. From the start, the principles of the pilot included the understanding that flexibility is needed from both sides and willingness to make interim adjustments, being reasonable and fair. The investments made have been as co-investments. This has strengthened trust in each other partly due to the visible interdependence in the pilot. North-Brabant had to transfer tasks and decision-making power to Dura Vermeer, but Dura Vermeer also had to learn to deal with responsibility in that new position (for example, new responsibilities included installation responsibility of the luminaires). This has brought about an understanding and a sense of equality on both sides.

Another important lesson from this case is coming up with new solutions together. New partners have been formed with Tenouki, a data service provider on traffic information, with which the lighting equipment has been able to provide an optimized service: light on demand. It illustrates two key features that As a Service can help give with data:

- To tailor the solutions to the actual need and thereby achieve the efficiency that can translate into lower costs;
- Be able to provide evidence about the quality of the service provided.

It has been highlighted that the benefits of these pilots are seen in the collaboration instead of the typical client-contractor relationship, where finding solutions together is possible even when outcomes are uncertain. Even though this pilot did not concentrate on the technical characteristics of the circularity but mainly on the energy savings, it is an example of how such a small pilot can lead to positive results with great potential for scalability.



Figure 22 N279 road light in North Brabant

3.5.1.1 The scope

The IAAS is performed in the brownfield situation (i.e., working with the already present system). The service is provided on the N279 Hertogenbosch road over 17km with 2x2lanes. The sections of the road with the light are represented at Figure 22 and 23. It comprises 442 light towers (616 luminaries) for public lighting (OV), including light poles, luminaires, cabling, illuminated signposts, and public transport cabinets.

The main responsibilities light-as-a-service concern:

- Fixed maintenance
- Fault recovery
- Local replacement
- Damage cancellation
- Installation responsibility

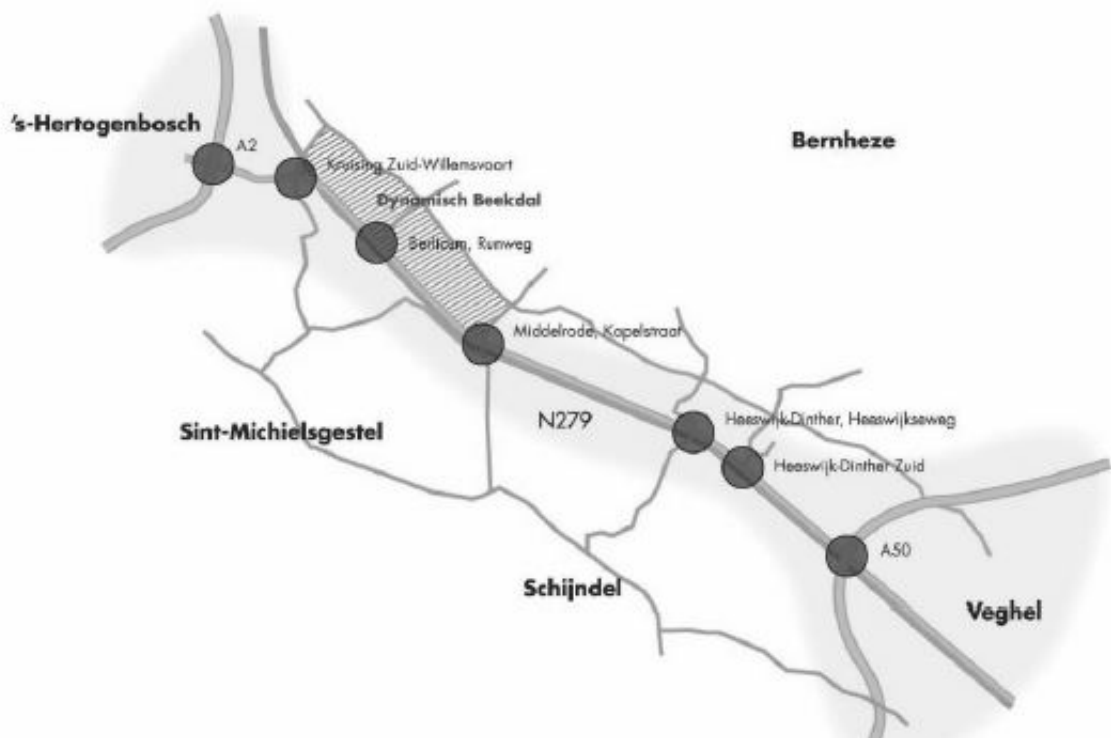

Figure 23 N279 sections with service provisions (circled)

3.5.2 As a service framework

The light as a service is provided with a quarterly fee on contractual bases (UAV-CE). The client stated the main demand as "during the dark hours, to provide road users with sufficient visibility for the sake of road safety." This main demand is further translated into six separate demands, Figure 24: providing continuous service, safety, efficient light via digital solutions, reduction of energy, circularity, and making the light more environmentally friendly. In this IAAS model, there is also a distinction between elements that have been defined in collaboration by both client and contractor, which is also reflected at the demand level with the task to reduce energy usage (in grey), while the elements defined by the client are in blue, and those defined by the contractor are in yellow. Reducing energy is the main value proposition for the service.

Similarly, providing continuous service has been collaboratively defined at the functional level. The maintenance should be performed without disturbing the traffic. At the structural level, this means maintenance of the physical light system but also maintenance of the digital system. This system monitors failures as well, which is connected to ensuring safety. At the physical level, this means circular replacement of the materials: the old light poles are replaced by a new modular design, which is **repairable** in a circular manner.

The safety of the traffic is connected to the appropriate light quality, which needs to be connected to the current system as the light system is in brownfield situations (already existing). The switch to LED is made at the same time as the digital control, which must follow the technical requirements and internal standards of North Brabant. Change to LED is planned for the Dutch sector for the light infrastructure. Thus, this is, in a way two-in-one service. The technical (physical) aspects are dealt with in a circular manner. Both incident and accident monitoring are relevant for safety to monitor if light service has any influence and ensure an appropriate response. The number of accidents is monitored by the province, thus outside of the scope of the contract. However, the client-contractor communication then allows for providing appropriate measures to the contractor (structural level), such as an increase of light intensity if necessary.

The efficient lighting achieved via digitalization is up to the contractor to handle (yellow and grey). It consists of management and dynamic dimming of light, which is enabled by the digital solution (called "floating car"), software, and energy supply. The latter is outside of the scope but is included in the IAAS model as, without it, all parts of the service are compromised.

The energy reduction is measured by the decreased utility. It was found that energy savings (period March to September had a 58% decrease ($>10,000\text{kWh}/\text{year}$) that can be achieved at the Middelrode section (representative of the entire route). This is equivalent to around 60 tonnes of annual CO_2 reduction ($1\text{ kWh} = 0.6536\text{kg CO}_2\text{ eq}$ in 2020 Emission factors nl, 2022) $0.523\text{ kg CO}_2\text{ eq}$ in 2022 for grey power). The circular features at the structural level are under the assumption that dimming also provides a prolonged lifetime for the lights. However, this has not been proved yet as time needs to pass in order to observe if it can actually be achieved.

The functional level of the circularity concentrates on the modular design rather than conditions of decrease of the materials since it is more relevant to the replacement of the old light system. The new circular design for the light system might have more materials than the old light system, but it enables a higher level of **reuse** and **recycling** due to its modular design. The faulty parts can be readily replaced instead of the need to replace the whole lighting pole. The new modular poles are installed gradually when the old poles are at the end of their lifetime.

Similarly to the prolonged lifetime, it is expected that the dimming will be more environmentally friendly to the people and nature as the intensity of the light is reduced. It was discussed that the future input from the ecologist could provide more proof and details on the reduced impacts on the surrounding biodiversity. Another possible change is the application of different colors, but that has not been integrated at this location.

Listed important factors for the formulation of IAAS were:

- Willingness from both sides to make the adjustment
- Collaboration instead of work
- Enthusiasm on both sides
- Trust (from the initial conversation) – openness as a facilitator of trust
- Patience for the start-up (legal and technical issues)
- Setting a clear common goal (listed as crucial)
- Joint and individual goals are prepared at the initial stage
- Prepping financial agreement

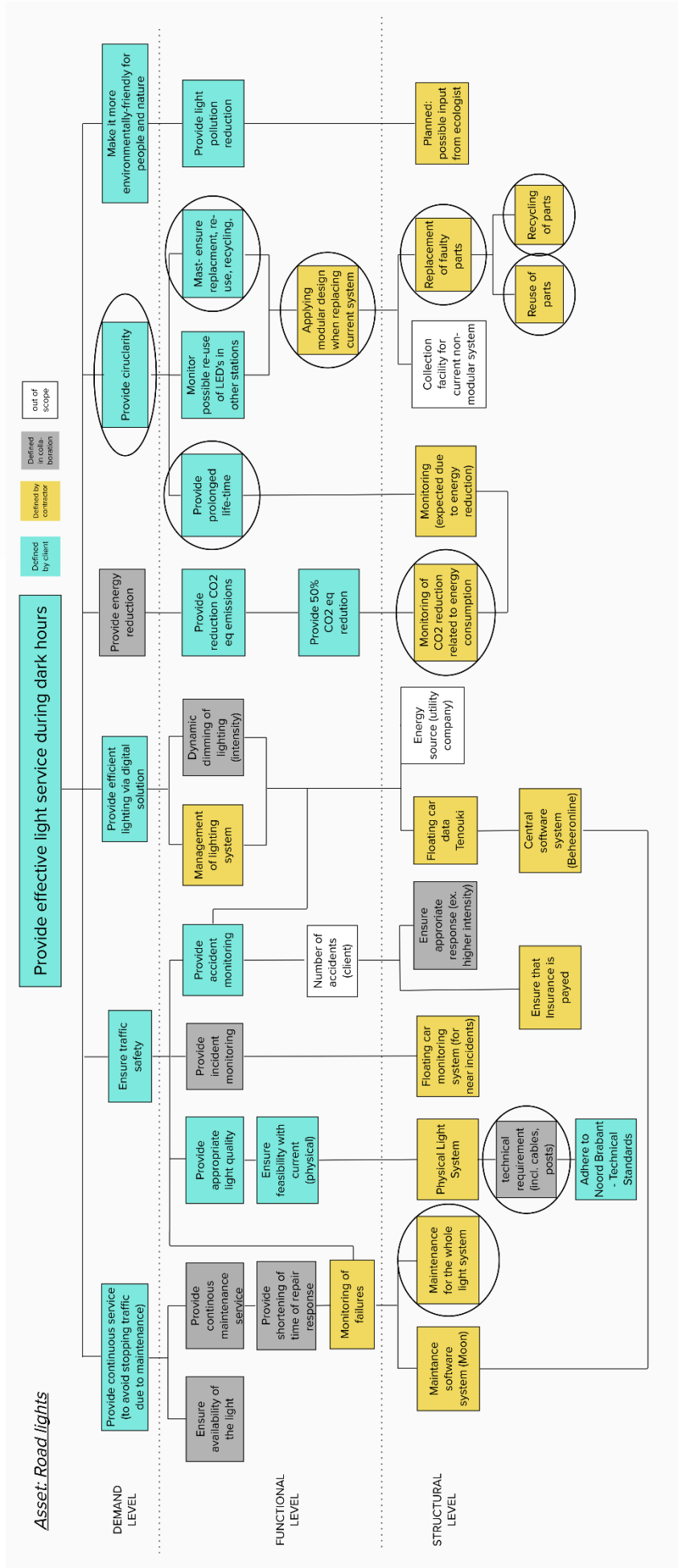

Figure 24 As a service model for road lights in North Brabant pilot. Based on Van Ostaeyen et al. (2013), the hierarchy includes three levels: demand, function, and structure. Additionally, there is a distinction between the elements defined by the client (blue) and contractor (yellow) and elements defined in collaboration by both in grey. Both contractor and client defined the circled elements as circular elements.

3.5.3 Pilot highlights

Pilot Card: Noord Brabant - Dimmable Road Lights				
10Rs integrated	IAAS circular elements	CB'23 indicator 1-3	Main Enablers (Top 5)	Main Barriers (Top 5)
<p>Rethink <i>More intensive use of the materials - a prolonged lifetime of the materials.</i></p> <p>Reduce <i>Refers here to a 58% reduction of energy (not materials)</i></p> <p>Reuse <i>A new modular design will allow reuse</i></p> <p>Repair and Refurbish <i>Implemented as modular repair and maintenance</i></p> <p>Recycle <i>Materials can be recycled at the end of life</i></p>	<p>Demand level (1) <i>Provide circularity</i></p> <p>Functional level (3) <i>Providing a prolonged life for the light system</i> <i>Ensure replacement, reuse, and recycling of masts,</i> <i>Applying modular design</i></p> <p>Structural level (6) <i>Maintenance of the light system,</i> <i>Technical requirements (cables, posts...)</i> <i>Energy reduction (as input to potential prolonged lifetime),</i> <i>Replacement of faulty parts,</i> <i>Reuse of parts,</i> <i>Recycling of parts</i></p>	<p>Indicator 1.1 – 61,4%</p> <p>Indicator 1.1.1 – 61,4%</p> <p>Indicator 1.1.2a – 0%</p> <p>Indicator 1.1.2b 0%</p> <p>Indicator 1.2 – 38,6%</p> <p>Indicator 1.2.1 – 0%</p> <p>Indicator 1.2.2 – 38,6%</p> <p>Indicator 1.3 – N/A</p> <p>Indicator 1.4.1 – 0,3%</p> <p>Indicator 1.4.2 – 99,6%</p> <p>Indicator 2 – 98,4%</p> <p>Indicator 2.1 – 0%</p> <p>Indicator 2.2 – 98%</p> <p>Indicator 3.1 – 0,4%</p> <p>Indicator 3.2 - 0%</p> <p>Material losses – 1,6%</p>	<p>- Willingness from both sides to make the adjustment</p> <p>- Trust (from the initial conversation) and openness as a facilitator of trust</p> <p>- Patience for the start-up (legal and technical issues)</p> <p>- Setting a clear common goal, with joint and individual goals prepared at the initial stage</p> <p>-Future use on the market and stimulating market</p>	<p>- Challenging to formulate a contract for Infra as a service when compared to business as usual.</p> <p>- Outdated regulations</p> <p>- Restriction of current market</p> <p>- Bureaucratic processes</p> <p>- Misalignment between wanting to change and willingness to change</p>

Figure 25 Pilot card for Road lights in North Brabant as a service model.

3.6 Overijssel: N739 provincial road

Overijssel is a province in the northeast of the Netherlands. The province has about 1 million inhabitants. The capital of the province is Zwolle.

3.6.1 Pilot description

The province has chosen part of the provincial road N739 for the exploration of the IAAS concept. The main aims of the pilot are the preservation of raw materials, the reduction of management costs, and a new way of working together that leads to new, future-proof organizational and revenue models. Central to this pilot is learning from each other and sharing these experiences in the market. Equal cooperation and joint responsibility between the client and contractor are important factors for collaboration. Input for the agreement comes from the components of sustainability, quality, material value, and availability. The added value of IAAS is considered here as:

- Learn by doing
- Circularity that can be requested at the market (in the future)
- Functionally specificity
- Successful Interim sessions

In terms of organization, **Overijssel did not expect too many changes**. However, they prioritize learning activities before assessing the possible consequences on the organization.

The province aimed to explore in detail the collaboration and IAAS possibilities during the formation of IAAS. In order to explore these goals, the province had several groups working on sub-themes here, including circularity experts (Copper8). Three main teams were created for cooperation: strategic, tactical, and operational teams. Some of the tasks included: the tactical team (project managers from both organizations) responsibility for adding a budget and a proposal for the cost distribution of that relevant phase to the phase plan and progress report. The report was jointly prepared by the two project leaders as often as requested. Project administrators were also set up to consistently report on the joint cost responsibility for Progress Report to the Steering Committee (Strategic Team). The agreement of the Steering Committee on the estimate and cost distribution of that phase was required before the start of each phase. The planning also included guidance for the cases of dispute. The parties need to consult each other within one month of receipt of the party's communication, and if the consultation has not resulted in an agreement within two months, the parties will engage a mediator to settle the dispute.

Some points of discussion were:

- Handling materials: if the contractor owns materials, then the province's question is how to deal with function retention of service. A shift in market values of materials could shift priorities regarding the use of those materials.
- Partnership: mutual advocacy must be ensured; the contractor should not have an information advantage over the province. At the same time, the province must be open to providing assistance as soon as more expensive raw materials are.
- The potential of this case is, in particular, that the open and inclusive attitude of the province can ensure the creation of important sub-products, which are essential for the better starting position of future IAAS tenders. For example, the preparation of the functional requirements through the joint teams.

The challenge for the pilot was the different starting points of the two parties and the mutual impressions towards each other on this. For example, Overijssel saw the project teams and lunch lectures as part of the pilot, whereas the contractor saw "taking action outside" mainly as part of the pilot. Therefore, continuing with mixed teams was important for working on the sub-products and finding mutual intentions. Other challenges included the long mobilization of the project team and the determination of a common starting point (to get everyone to the right level of knowledge about the circular road). The project also identified five potential risks:

1. Exceeding response and review times
2. Geographical dissemination of project(s) involved
3. No or late availability of resources (available documentation)
4. Project involved(s) unavailable
5. Project assignment/objectives unclear (correct level of abstraction)

The first two risks didn't occur. The third risk was influenced by the pandemic and the switch to a fully digital environment, which took 2 to 3 months to establish (SharePointOnline environment). Not all team members have worked from SharePoint, which created some knowledge and information transfer issues. Risk 4 occurred due to the availability of the team members as many people "add" to the project, but it remained difficult to structurally bind team members, making this risk a top risk. The last risk consisted of unclear project assignments, but it had been clarified and corrected within two steering committee consultations. It was found that it is not easy to describe the pilot correctly at the beginning and clear scope demarcation in advance helps in the development of the request. That is why the discussions about the starting point were longer.

However, having many conversations with each other about the circular road and how it could ideally best be designed (on paper) provided a deeper level of knowledge with informed choices. Some elements that were highlighted as advantageous were:

- Team composition
 - Power of a diverse group, including different areas of expertise
 - More/better insight into each other's "worlds," namely topics/starting points/considerations you have to deal with/that get in the way
 - Connecting external expertise to bring in missing knowledge helps to accelerate the process
 - Involvement/enthusiasm of team members to participate
- Attention to process
 - Process/experience is more important than the outcome, and it is part of the achievement of this pilot. The contract is not the backbone of the project.
 - Open and relaxed approach and feeling of safety to share information and explain them.
 - The separation between plenary and individual work.
 - Further, concretize abstract subjects in small steps/iteration layers. Working out topics in working groups
 - Digital meetings worked well and saved time.

The provincial road proved to be too large of an asset for IAAS with the state of knowledge in 2021. It was by far the largest asset in the DCW program, and giving up its ownership did not have clear benefits for the province, and at the same time, it included many uncertainties and risks. Here, "large" also refers to the boundaries of the project

that aim to explore in detail many interconnected factors (finance, project management, organization, collaboration, etc.) at the same time. The intensive early effort and knowledge gained throughout the formulation of the project helped to identify some of the key aspects of reaching IAAS in the early phases of the program. The greatest benefit of this pilot was the learning points that helped to create a push for successful conversations and decision-making.

3.6.1.1 The scope

Important factors were the province award criteria for the project to contain availability (40%), circularity (40%), and availability fee (20%). Thus, the key performance indicator was availability. The most important precondition for the Province of Overijssel was for the contractor to limit nuisance to road users as a result of the work to a minimum in a traffic-friendly manner and to realize the work that causes inconvenience to road users in the shortest possible time frame. The contract would aim to have the routes of the N739 available as much as possible for the benefit of its public users. The province explored in detail the availability of the provincial road in the IAAS contract, from monitoring to measures to maintain availability during work. It was crucial that the road remained functional to allow traffic. For example, the duration of the closures was set for one block of up to 19 days per 4 years per route. Here, bonus/malus for availability was important, as more days would result in malus (i.e., the contractor needs to pay), and fewer days would lead to a bonus (the contractor gets paid).

The preferred variant was determined by LCC, MKI, and availability for different execution options for a period of 100 years. The calculations and the choice for the selected variant (asphalt with extra-long service life) were made for N739B because this part of the road had the most information on the traffic status of the road and involved the most variety of activities. The scope for the materials and activities included:

- Pavement and marking. Not: rubble foundation, Middle guide belts, glass spheres, reflector poles, hectometer boards.
- Activities resulting from Damage, Malfunctions, and Incidents (in Dutch SSIs) caused by third parties in the scope because they have an impact on the residual value of the N739.
- Partial closure of one of the routes is considered a complete closure. We assume that there is no question of traffic measures in this type of work which only requires a speed reduction.

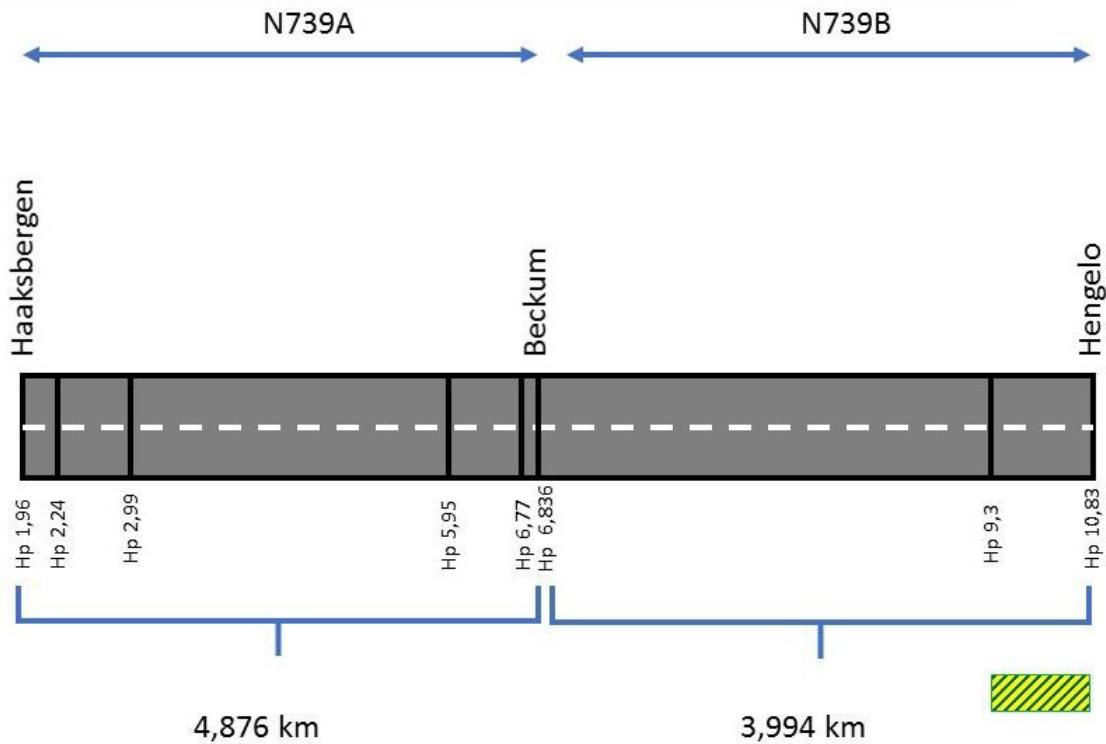

Figure 26 Scope definition of the N739, split into the N739a and N739b. The N739 consists of N739a: 1,960 km to 6,900 km, and N739b: 6,900 km to 10,083 km.

3.6.2 As a service framework

The main demand for the service provided is the safety and availability of the road for the duration of 15 years, Figure 27. The IAAS model includes tasks of the service, division of responsibility (client, contractor), and circular aspects (circled boxes). Three sub-demands are formulated to achieve the main demand: availability, safety, and sustainability. The demand and functional level are formulated by the client mostly (in blue), while some functional elements and most structural elements are the responsibility of the contractor to incorporate (yellow). The IAAS model includes three parts: tasks of the service, division of responsibility (client, contractor), and circular strategies in the service.

The availability is the main performance indicator, and it is ensured by the appropriate road maintenance. At the functional level, maintenance needs to be provided with circular features with material circularity during the road reparation and without compromising safety (only proven documented materials can be used). At the structural level, this is translated to the circular management of the materials used during maintenance. The circular maintenance features are the responsibility of the contractor.

The availability was one of the key points discussed during the contract formulation. For the purpose of IAAS, the availability was transformed into a number of closures over four years. It was chosen to keep room for the choice of optimal circular management and

maintenance plan. This is translated to bonus/malus for the availability of 19days per 4years (exceeding the agreed amount of closure or having fewer amounts of closures results in financial incentive). No other requirements regarding the duration of the closures other than a financial incentive are set. There was a discussion regarding a maximum of 39 days, which would offer certainty to the province that the contractor will not exceed this amount. However, this would hinder the freedom of choice for a circular solution and thus be abandoned.

Other maintenance features important for the IAAS were good and periodic communication, i.e., performance reporting and quarterly consultations. Any maintenance or damage to the road is required to be thoroughly documented. Incident and accident monitoring is also expected as it is a connection to safety on the road.

Safety, as with other assets, is mostly connected to compliance with standards and guidelines. As standards are prescribed by the institutions, they do not offer the choice for the contractors and are thus all in blue. Two reports include aspects of circularity (Strategic Asset management plan and BIK – specifying infrastructure object assets).

Safety is also connected to the choice of materials. While secondary materials are preferred, their use cannot compromise safety. Because of the absolute certainty that must come with using materials, less freedom is left for applications of new asphalt mixtures or other materials. However, asphalt mixtures are available with various input levels from **recycled** materials, which offers higher circularity.

The IAAS model includes circularity in two of its main demands. The sustainability of the road is translated to stimulating circularity and also lowering the environmental impact. The circularity is provided by applying the materials with recycled content with the aim to **reduce** primary materials. Ecopave mix is chosen as representative material as it is one of the main materials applied. It contains the highest amount of recycled content, and it also prolongs the road's lifetime (26years). The road can be recycled at a very high output ratio at the end of a lifetime. Thus, the residual value is circular as it accounts for the value of secondary materials available.

The decrease of the environmental impacts is reflected as lower MKI for the chosen materials (including maintenance) to the BAU alternative. Here, the province asks for a specific goal of a 20% reduction of MKI.

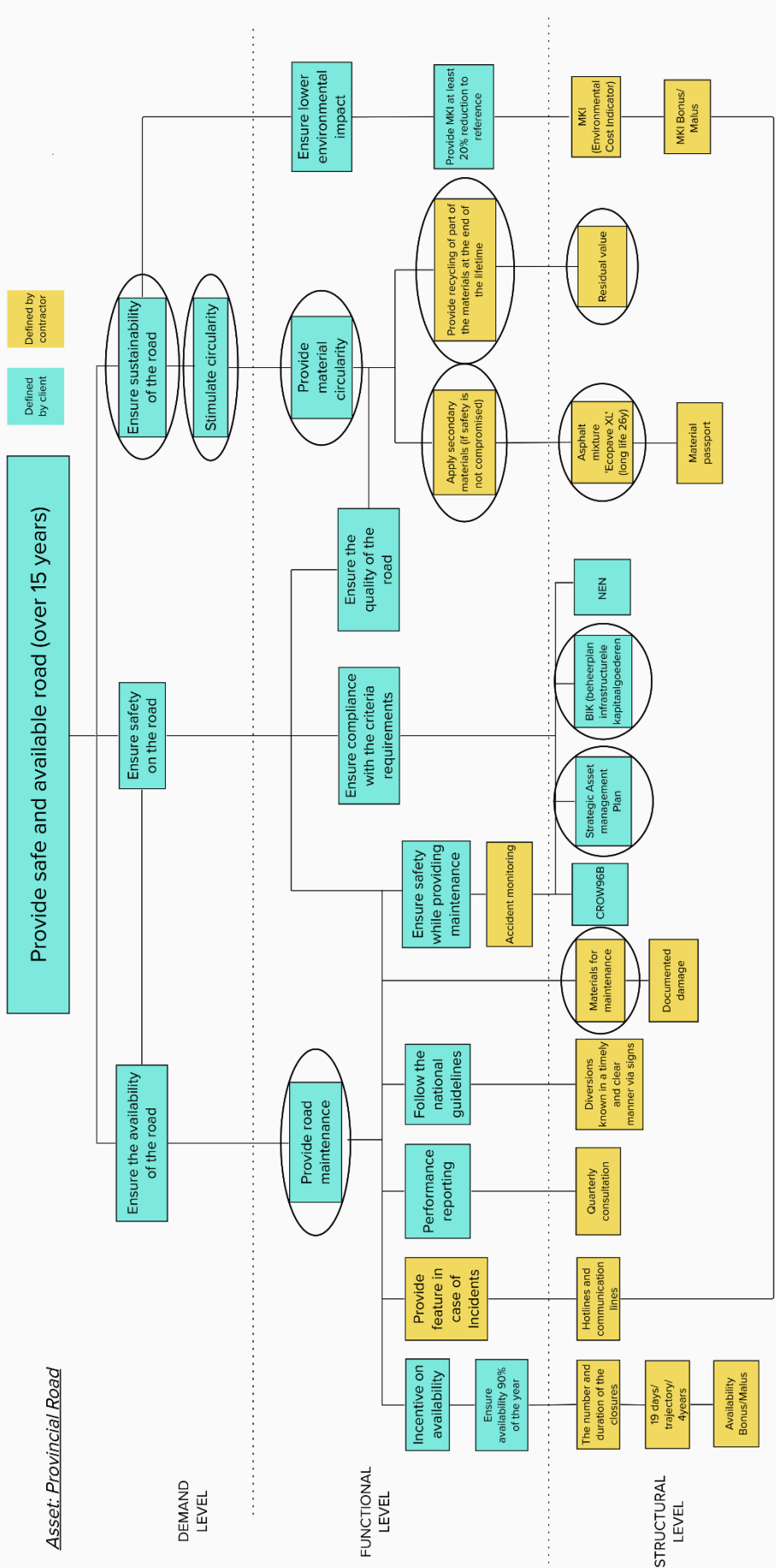

Figure 27 As a service model for Provincial road in Overijssel. Based on Van Ostaeyen et al. (2013), the hierarchy includes three levels: demand, function, and structure. Additionally, there is a distinction between the elements defined by the client (blue) and contractor (yellow). Both contractor and client defined the circled elements as circular elements.

3.6.3 Pilot highlights

Pilot Card: Overijssel – Provincial Road				
10Rs integrated	IAAS circular elements	CB'23 indicator 1-3	Main Enablers (Top 5)	Main Barriers (Top 5)
<p>Rethink <i>Implemented in the design and materials with a prolonged lifetime</i></p> <p>Reduce <i>implemented as lowered input of primary materials</i></p> <p>Repair <i>implemented as road maintenance</i></p> <p>Recycle <i>the asphalt can be recycled at a very high level at the end of life</i></p>	<p>Demand level (2) <i>Ensure sustainability</i> <i>Stimulate circularity</i></p> <p>Functional level (4) <i>Providing material circularity,</i> <i>Applying secondary materials,</i> <i>Ensure recycling at the end of life,</i> <i>Circular maintenance</i></p> <p>Structural level (5) <i>Materials for maintenance,</i> <i>Materials for reconstruction,</i> <i>Residual value,</i> <i>Strategic Asset Management Plan</i> <i>BIK (infrastructure guideline)</i></p>	<p>Indicator 1.1 – 44,9%</p> <p>Indicator 1.1.1 – 44,9%</p> <p>Indicator 1.1.2a – 0%</p> <p>Indicator 1.1.2b 0%</p> <p>Indicator 1.2 – 55,1%</p> <p>Indicator 1.2.1 - 0%</p> <p>Indicator 1.2.2 – 55,1%</p> <p>Indicator 1.3 – N/A</p> <p>Indicator 1.4.1 - 0%</p> <p>Indicator 1.4.2 - 100%</p> <p>Indicator 2 – 99,6%</p> <p>Indicator 2.1 - 0%</p> <p>Indicator 2.2 – 99,5%</p> <p>Indicator 3.1 - 0%</p> <p>Indicator 3.2 – 0,2%</p> <p>Material losses -0,4%</p>	<p>- Gaining knowledge and experience</p> <p>- Initial explorative style (i.e., forming a creative and disruptive project)</p> <p>- Openly sharing concerns with the facilitators</p> <p>- Strengthening the collaboration between government bodies and the private sector</p> <p>- Insights into the decision making of other parties</p>	<p>- Long process</p> <p>- Challenging to formulate the contract</p> <p>- Difficult to translate the non-financial benefits</p> <p>- The need for persuasion (internally)</p> <p>- Lack of knowledge and knowledge transfer</p>

Figure 28 Pilot card for Provincial road in Overijssel as a service model

3.7 Amsterdam: Temporary Road

3.7.1 Pilot description

Amsterdam is the capital of the Netherlands and has about 800,000 inhabitants. The case chosen for IAAS is a temporary road in the ArenA in southeast Amsterdam (Zuid-Oost). It concerns the area of the Johan Cruyff Arena, which is the main stadium of the Dutch capital, see Figures 29 and 30. The temporary road is necessary to build for the construction work that is going out in the area, with the possibility of removing it after the construction is finished. The temporary traffic system handles local traffic between the Holterbergweg-Passage intersection and the roundabout safely and smoothly via an alternative route. A lifespan of 2-5 years is foreseen.

Further, the municipality wants to experiment with circular economy principles during the procurement process involving:

- The technical aspects: the circular properties of products and circular design
- The process-related and organizational aspects: involvement of the most important stakeholders/ partners and how the organization is created
- The financial-economic aspects

The approach to the project is inspired by the 'city donut' of Amsterdam, which incorporates the Doughnut economy principle. The ambition is thus to bring the use of

primary materials as low as possible and improve MKI. To achieve that, the aim is to apply as much material as possible from the local environment (reuse and recycling of the road elements) and to be able to reuse the road (or materials from it) at the end of its life in high-quality output. After its lifetime, the road should be deconstructed, and materials incorporated into the other roads in the area. To set up an agreement on the IAAS, the city of Amsterdam is in open consultation with Dura to arrive at value propositions.

This case represents a challenge due to temporary aspects, as Dura Vermeer specializes in lasting roads with extended lifetimes. The road itself still needs to be safe to use and according to the technical requirements, such as proper drainage, surface, etc. However, some technical requirements differ as the road is not built to sustain long usage periods and heavy traffic. Minimal to no maintenance is planned (if included, it is only to retain the highest circular value).

At this time, the design and key aspects of the project are still being discussed between the client and contractor. The IAAS framework, circular and financial part are not yet decided upon. Thus, it is not part of this report.

RUIMTELIJK ONTWERP

Geschikt voor zwaar verkeer, veilige overstek voor sporters

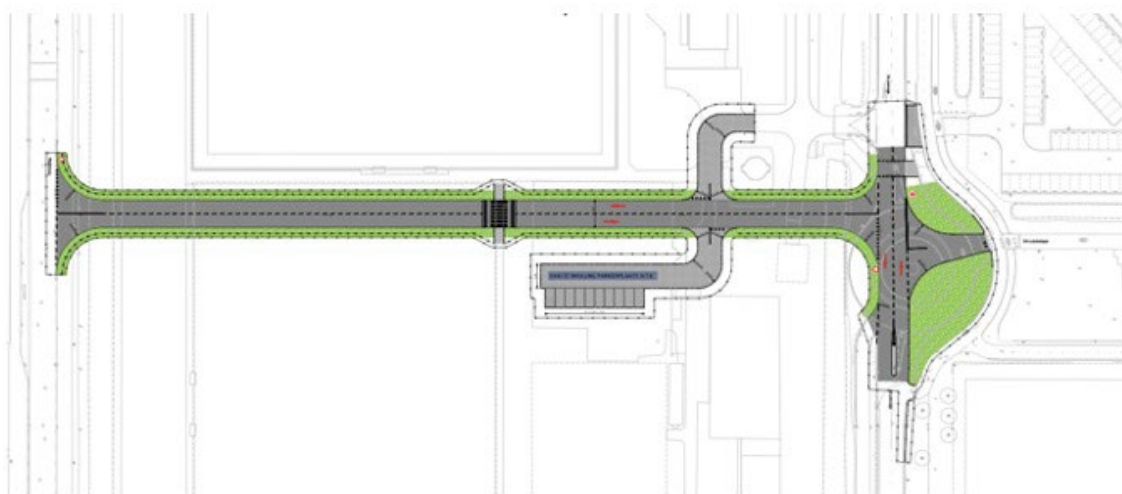

Figure 29 The area concerning temporary road in Amsterdam, ArenaA and Johan Cruyff Arena.

DE CIRCULAIRE PASSAGE

DuraVermeer en Gemeente Amsterdam realiseren hier de eerste circulaire weg



Figure 30 The road design made by Dura Vermeer.

3.8 Utrecht: City road (traditional contract)

Utrecht is the fourth-largest city in the Netherlands. It is located in the eastern corner of the Randstad conurbation, in the center of mainland Netherlands. The municipality sets sustainable goals to become a climate-neutral and circular city, intending to be 100% circular by 2050. Utrecht made a goal to save 30% CO₂ and increase the share of sustainably generated energy within the municipal boundaries to 20% by 2020. The municipality aims to create a good environment for residents, which is why both social and environmental aspects are taken into account in the purchasing process. The municipality joined the DCW program with their redevelopment program for Croeselaan street, which among others, integrates circular aspects. The contract was not provided as a service, but the contractor had the opportunity to contribute their vision of sustainability for the street.

3.8.1 Pilot description

Until a few years ago, the Croeselaan was a busy traffic artery right through the western city center. The Croeselaan is one of the connecting lines in the Station area and the main cycle route for bicycle traffic. It is an important connecting street, with many passers-by, offices, and connections to the Jaarbeurs.

In 2018, an ambitious redevelopment took place, making the northern part of the Croeselaan the (at the time) 'most sustainable road' in the Netherlands. Dura Vermeer transformed the road on behalf of the municipality. The aim of the project was to develop

a high-quality public space that integrates sustainability and creates attractive spaces for pedestrians, and improves bicycle quality.

The development of the design aspects started in 2015 (and earlier). In 2016, the municipality, together with its advisor Witteveen + Bos, extensively explored the possibilities and opportunities in the field of sustainability. The results of this exploration were partly incorporated into the preparation process and into the design of the Croeselaan. The description of the assignment for the contractors was provided in May 2017. The scope of the tender included award criteria as “to the tenderer with the most economically advantageous tender, based on the best price-quality ratio.” The municipality has invited four parties, which were selected through a market consultation, to make an offer on the basis of the UAV-GC (BAU contact form). The quality aspect in the tender assessment procedure included (weighted from highest to smallest assigned value): environmental performance, circular economy, maintainability, lifetime costs, innovative sustainability opportunities, and social return. The contractor was required to successfully reach the sustainable targets of the municipality (ex., reduction of carbon footprint). Utrecht expressed great confidence in all parties and thus greatly reduced the 'basic burden of requirements' in the contract. The municipality highlighted that they desire optimal cooperation through an open, honest, and transparent attitude towards each other. It was up to the Tenderer to determine the sustainability measures and to include them in the offer as the Croeselaan should become the most 'sustainable' street in the municipality of Utrecht. The work on the Croeselaan section Jaarbeursplein-Van Zijstweg was completed in April 2019, see Figure 31.

The new design has a distinctive wide center part surrounded by a one-way circuit for car traffic. The car speed limit was changed from 50km/h to 30km/h. Bicycle traffic is completely unbundled from car traffic. On the west side of the Croeselaan, there is a comfortable (red asphalt) and wide two-way cycle path free of crossings. The pedestrian sidewalk is wider in the new design (six meters). The design integrated input from stakeholders and the surrounding organization (such as Rabobank, RVB, and Jaarbeurs), and the residents. The latter collected input through the website, a door-to-door mailing, and an information evening.



Figure 31 Croeselaan road in Utrecht

3.8.2 Sustainable and circular aspects

3.8.2.1 Sustainable aim and strategies in the design

The emphasis in the ambition was on people and the planet “green street that residents and users feel comfortable with and will love, and where sustainability measures are both visibly and invisibly integrated into the streetscape.” The people side of sustainability was primarily included in the design with input from residents and organizations at Croeselaan. The ‘planet’ side of sustainability was incorporated as improved environmental performance measurable during the construction and use phase, the chosen materials, and their longer lifespan.

The 10R strategies following Cramer (2014) and Lansink's Ladder (Prevent, Reuse, Recycle, Waste-to-energy, incineration, landfill) were considered during the design phase. While these are almost identical to the figure (8) represented in section (2.3.1.1.2), there is a notable difference. Instead of a rethink strategy, there is renew (redesigning a product with circularity as a starting point), which according to (Morseletto, 2020), has a different definition than a rethink. Thus, a rethink was not considered for this pilot. The strategies were aggregated to a 4R model and not addressed individually:

- A. product innovation (Refuse, Reduce, Renew),
- B. renewed ownership (Reuse, Repurpose),
- C. longer service life (Repair, Refurbish, Remanufacture)
- D. processing (Recycling, Recovery), i.e., using as many existing and reusable raw materials as possible.

The strategies are then implemented in two ways:

- A. Translation into principles of circular construction and design
 - Smart design: Focusing on the smart design of buildings, with the aim of making buildings more suitable for repurposing and material reuse.
 - Dismantling and separation: efficient dismantling and separation of residual flows to enable high-quality reuse
 - High-quality reuse: The high-quality recovery and reuse of materials and components. Materials are sourced as much as possible from the immediate vicinity so that the transport distance is as low as possible.
- B. Translation to design and specification
 - Make sure that connections between materials are dry so that the building can be separated well.
 - Make sure that the materials applied can easily be transformed after use.
 - Make sure a material passport is provided.
 - Think beyond the ownership of materials towards their use.

Dura Vermeer implemented these strategies in several ways. The top-level Rs strategy, i.e., **refuse**, was implemented by preventing the installation of the rainwater drainage system, and the water is buffered locally. **Reduce** was implemented in general by reusing the materials locally, but also by implementing an asphalt mixture with high recycled input (thus decreasing the input of primary material). **Reuse** of several materials was implemented: granite tires as clamping for planting areas, mixed granulate reused in roads, and clinkers from bicycle path reused in parking spaces. Closing of the material cycle is also accomplished by recording them in a materials passport, which is linked to a 3D BIM model.

Other design elements included future-proofing, where future developments are taken into account. For example, the contractor expects that within five years, the switch from LED to the more energy-efficient OLED will become commercially viable, and thus modular street lighting design was included. Luminaires are easy to detach from the mast, and the mast itself can also be disconnected from the cable. The applied LED luminaires can also find a subsequent use in another location.

3.8.2.2 Sustainable and circular features

Sustainable and circular features added were:

- Lampposts are charged by solar panels.
- Dimmable LED lighting on the bike path.
Together with Hoeflake, smart dimmable lighting was employed. The light detects the movements with sensors and adjusts the light to the situation. With this system, energy savings of up to 70% are achieved. At the same time, light pollution is also decreased.
- Bamboo traffic signs. Bamboo grows quickly and absorbs CO₂ in the process.
- Lanes that partly consist of recycled material.
- Old, not so fertile soil was mixed with compost, which provided savings on bringing the new soil.
- Movement/play equipment is included.
- Social return is part of the contract.
- Art exhibitions with sculptures that had been previously displayed elsewhere.
- New innovative material was used on the bicycle path. RaMac is a very new product on the market with distinct red color. It is a geopolymers concrete with slightly better properties than concrete in terms of absorbing tensile forces. Maintenance is limited to sweeping and periodic replacement. According to the manufacturer, a 65% reduction in CO₂ can be achieved.

The elements of the contract are visible in Figure 32. Not all elements and details of the contract are visible in the framework. It was made to resemble the IAAS models included in this report, following the same distinction as previously: elements defined by the client are in blue, and those defined by the contractor are yellow.

Overall, 68% of the environmental costs were saved against the same budget, while MKI was reduced from 122,600€ to 42,375€. This is mainly due to RaMac application, but also the road surface laid with low-temperature asphalt, which has double the lifetime, and due to the reuse of soil, foundation and tiles.

Sweco analyzed the circularity of the road materials, this does not concern materials like light systems, road signs, and others. The input of the road materials includes:

- 66% primary non-renewable source, mainly asphalt, mixed granulate, and tars.
- 2% primary renewable sources (compost in topsoil)
- 16% is input from reuse from the project, mainly mixed granulate and baked clinkers
- 16% is input from reuse from elsewhere (recycling), mainly asphalt, mixed granulate, and concrete

The output at the end of life is expected to be:

- 24% for reuse directly in the project (brick and mixed granulate)

- 76% can be recycled
- 1% of landfilling.

3.8.3 IAAS considerations

It was highlighted that lower complexity is needed to better control the dynamics in the project. Croeselaan was deemed a complex project, and IAAS was not pursued. According to the municipality, at the time, IAAS did not fit in with the tender as it was initiated by the municipality. Additionally, they expressed that the currently considered contract duration is not sufficient to see the benefits. For example, maintenance is part of the IAAS contract, and the traditional contract time of around four years is too short to showcase the benefits, as not much maintenance happens for many infrastructure objects. The scale of the project is also important. Croeselaan was too small a project with a disproportionate investment made during the tendering phase. It was seen as not profitable for the IAAS contract.

According to the client, the organization needs to ensure that sufficient time is allocated to the tendering process so that tendering parties have time to come up with innovative ideas or sustainable optimizations. In terms of award criteria, the focus should be more on the process and cooperation with the IAAS, and the dialogue between the client and contractor should be ongoing for the contract duration. While the contractor should have sufficient freedom to arrive at the most sustainable and/or circular solution, the sustainable goal should be agreed upon jointly between the parties.

There was also concern about the residual value, i.e., the value of the asset at the end of the contract. There is a risk that more will have to be paid for the next contract term, something that will also happen when raw materials become scarcer and, therefore, more expensive. Even though IAAS was not chosen as a contract for Croeselaan, it was stated that it would probably have contributed to better cooperation, but not necessarily a greater circularity of materials.

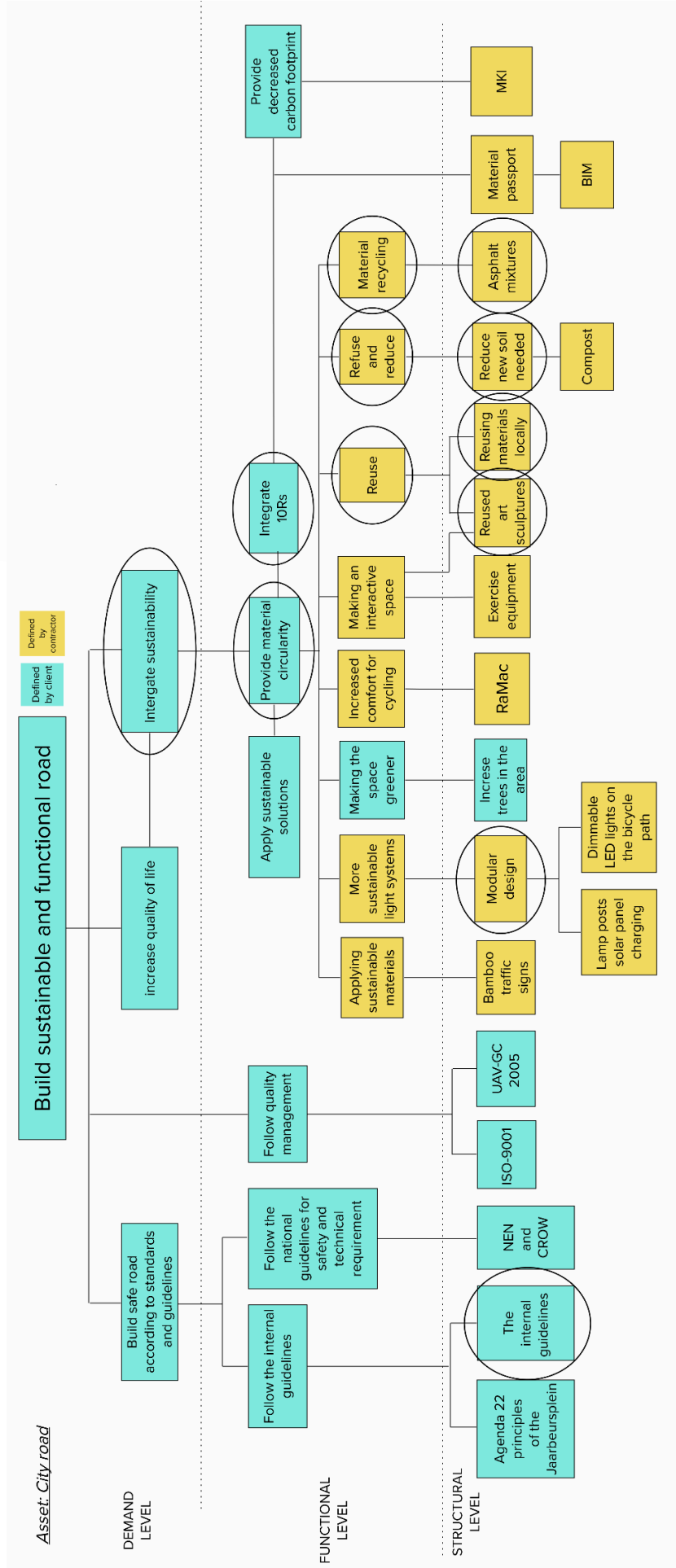

Figure 32 Contract framework for Croeselaan road in Utrecht. Utrecht was defined as a traditional contract where the contractor had the freedom to choose circular and sustainable elements. Not following as a service structure, the representation based on Van Ostaeyen et al. (2013) follows the hierarchy of the three levels based on the traditional contract. Additionally, there is a distinction between the elements defined by the client (blue) and contractor (yellow). The circled elements include circular features.

Stakeholder analysis

**Enablers, barriers, and
dissensus**

4. Stakeholder analysis: enablers and barriers

The human factor is perhaps one of the most influential factors in any project. Even more so when innovative and disruptive ideas are brought together in a completely new way. To evaluate the influence of the people involved, stakeholder analysis was performed (summary 4.1) to identify enablers (section 4.2), barriers (section 4.3), and dissensus (4.4). Each section includes factors ranging from contextual aspects (such as motivation and trust) to legal, economic, and organizational aspects.

What is stakeholder analysis?

Stakeholder analysis is one of the most common methods to understand the interests of the main parties better. Stakeholder analysis is helpful for project management as it gives insights into the diversity of opinions, here also the main hurdles and enablers. Taking them into account can help influence future projects favorably and advance the program as a whole. The aim of the analysis is to see how actors representing different levels and pilots view key aspects of the project. Stakeholder analysis also helps to obtain recommendations and possible improvements for the future.

Stakeholder analysis included two surveys and interviews, with further input from project managers to verify the validity of the results and the context of the factors. The surveys included statements with a Likert scale of 7 (1- Very strongly disagree, 7- Very strongly agree). Each statement represents an element, which was chosen based on DCW program specifics and previously identified factors in the formation of Industrial symbiosis.

Industrial symbiosis involves several industrial partners that aim to collaborate closely in a synergistic way, often exchanging materials (waste of one becomes an input of another) and sharing services. Due to similarities in interactions between stakeholders, this research was chosen to support the investigation of previously discovered factors such as knowledge capacity and dissemination, relational capacity, facilitation, benefits sharing, commitment, lack of information, lack of knowledge, aversion to change, outdated regulations, technology readiness and other (Bacudio et al., 2016; Domenech et al., 2019; Kosmol and Otto, 2020; Mortensen and Kørnøv, 2019; Neves et al., 2019; Park et al., 2018; Zhang et al., 2015).

While survey 1 focused on the preconditions, survey 2 concentrated on the process conditions and future (ex., building relations and common understanding, building

knowledge, and organizational change). The categories of political, technical, and economic aspects included a question on the level of certainty in knowledge (i.e., what is the level of certainty you have in your knowledge for the previous questions). The majority of the participants were certain about their knowledge in each category of survey 1, with the highest uncertainty of 11% for the political aspects. On the other hand, the economic and technical aspects of survey 2 included a 23% uncertainty level from the participants. These included questions on secondary materials input and output, scalability, increase in scope, financial opportunities, and compatibility of the current economic environment.

Semi-structured interviews were conducted with the project leaders for both client and contractor. The focus was to interview people engaged in the projects in later stages (the design was almost finalized or finalized), as it was assumed that more insights could be gained at this stage. The details of the surveys and interviews can be found in Table 12.

Table 12 Stages of stakeholder analysis.

Stage	Description	Period	Number of participants	Details
Survey 1	Focused on precondition	July 2022 – October 2022	27	80 statements
Survey 2	Focused on process conditions and future outlooks	October 2022- January 2022	22	47 statements and two written replies
Interviews	Semi-structured	October 2022- February 2022	9	Overijssel 2 Role: project manager, policy advisor/facilitator Amersfoort 2. Role: project owner, sustainability expert North Brabant 1 Role: project owner North Holland 1 Role: project owner Dura Vermeer 3 Role: project manager

The following sections represent the consensus on elements that were identified as enablers and barriers, as well as the elements that have dissensus among the stakeholders. We report on the main aspects found, i.e., those that were mentioned in more than three interviews or those aspects identified via scores in the interviews. Likert questionnaire permitted us to use a scoring system when scores closer to 1 represent barriers, scores close to 7 represent enablers, and the neutral score represents dissensus among the participants.

The scoring is based on stakeholders' perceptions and thus is not a neutral evaluation of the project. Enabler represents a systemic factor that drives the IAAS. This can be both a cause and an effect depending on the pilot's specifics, personal qualities, previous experience, etc. For example, *trust* among the partners is a cause that enables IAAS, while *gaining the experience* is the desired effect that helps with further motivation and also the cause to participate in DCW. Similar can be said if an element is identified as a barrier; *legal restrictions* can hamper IAAS formation, while lack of internal change can be a cause of why IAAS is hindered. When it is experienced throughout the project over a longer time, it can have a negative effect on the motivation and willingness of stakeholders.

The main enablers, barriers, and dissensus factors are grouped into comprehensive categories. The contextual, economic, technical, and intra-organizational aspects were found throughout all three categories of elements, while inter-organizational aspects were present in enablers and barriers. Further, barriers and dissensus were found for political aspects. These groups were chosen so that discussion on groups of elements can ensue and that solutions may be found more easily. In this way, one solution or a recommendation may be able to solve several of the found barriers.

4.1 Summary

The stakeholder analysis revealed a few key points regarding the enablers, barriers, and uncertainties of the As a Service model implementation. Firstly, the consensus for *the strongest enablers* (see Figures 33 and 34) among the Circular Road Program were:

- For the contextual aspects, the most enabling elements are *motivation, initiation of market change, and future usefulness of the knowledge gained*.
- For the economic aspects, the strongest element is the belief that *knowledge sharing increases economic potential* and that *future markets* will enable IAAS when more secondary resources are available.
- For the intra-organizational aspects, the *interest in other pilots besides their own* experiments made it attractive to join the program.
- And finally, for the inter-organizational aspects, there were three most prominent enablers: *enhancing collaboration between government and industry*, the benefits

it brings to *future collaborations*, and the *initial explorative style*, which was attractive to the vast majority of the stakeholders.

Secondly, the consensus reached for *the strongest barriers* (Figure 35) points to the following challenging aspects:

- For the political aspects, the main barrier is the *bureaucratic processes* involved, which slow down disruptive social change like IAAS.
- For intra-organizational aspects, the main barriers were the *need for internal persuasion* for the client organization and *the lack of internal procedural changes*.
- For contextual aspects, the main barriers were *lack of knowledge*, which hamper the effective development, *knowledge transfer*, and *willingness to change*.

Finally, a few topics were not met with consensus but dissensus, either due to equal disagreement among the stakeholders or due to uncertainty of at least 1/3 of the participant.

- For political aspects, the stakeholders are unsure how IAAS projects are *supported by the national government*, and there are divided agreements on whether *local governments support* IAAS. The latter naturally varies from case to case.
- For intra- and inter-organizational aspects, there 39% of the stakeholders are unsure whether there is really a *lack of internal change*. Almost the same amount feels unsure if *responsibility and power allocation* are distributed *appropriately*.

In essence, the aspects of consensus on enablers and barriers show the common forces that have helped and hampered the implementation of As a Service in all the pilots. The dissensus aspects are potential contextual aspects that may explain the different outcomes of the pilots.

4.2 Enablers

Figures 33 and 34 represent the main 30 enablers that help IAAS succeeds for inter-organizational, intra-organizational, technical, economic, and contextual aspects. Among these 30 separate enablers, 11 factors have been found as very strong enablers that are needed either actively throughout the project phases until the execution or serve as a motivation in the background for the project to be successful.

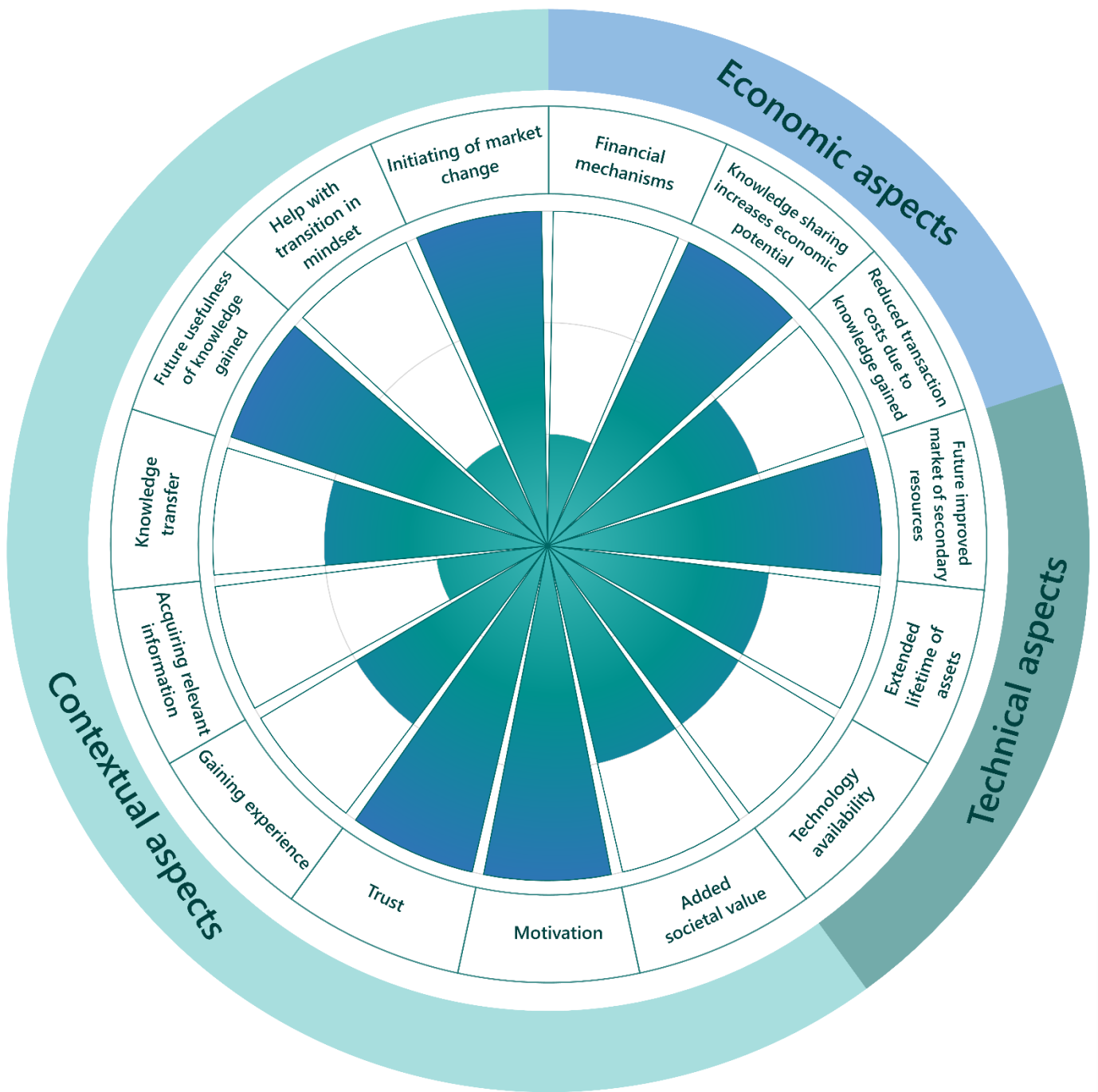

Figure 33 The main enablers for secondary materials, economic, and technical aspects. There are three strength levels: the weaker in the most inner circle, the middle in the second circle, and the strongest enablers reaching third, outer circle, which is also visible for the colour gradient change.

4.2.1 Contextual aspects

There are nine main contextual enablers. They are grouped into three categories to increase their comprehension: key enablers (the strongest and mentioned throughout the whole program), knowledge-related enablers (aspects connected directly to the acquisition of knowledge), and transitional enablers (aspects of change/transition in society).

Key enablers: Motivation and Trust

While many of these factors are common enablers for any kind of project, in IAAS, these factors play a more prominent role. A creative and disruptive project needs constant motivation, trust, and transparency. As soon as these factors are not there, it can cause serious problems. It was stated that the project can only go well if both trust and motivation are strongly present.

In the DCW program, it was found that there is trust in facilitators, in own organization, outside of own organization, and trust in sharing information with all in the program. *Transparency* is an important factor in creating trust among parties.

However, motivation is found to be a strong enabler that was hard to maintain and was missing at some moments.

Knowledge-related contextual enablers: Gaining experience, Acquiring relevant information, Knowledge transfer, and Future usefulness of knowledge gained

The main goal of DCW from the start was to gain experience and knowledge of IAAS. This has several layers. Firstly, it is to gain experience with the AAS model. Secondly, it is to gain information that is useful both internally for the organization itself and for the contractor-client relationship. Among these four factors, the strongest enabler was future usefulness. This was true for all pilots and stakeholders involved, which means that the vision of the future is a strong motivation for having IAAS. Both the client and contractor can only rely on their experience (own or others) to know if a service model is feasible and when to consider it. This is connected to the next set of enablers, which are related to the transition to the circular economy, as the shift happens with having the future state in mind.

Transitional enablers: Added societal value, Help with transition in mindset, Initiating market change

Among these three factors, initiating the market change was found to be the strongest enabler. It is the reason behind the DCW program. The stakeholders of DCW recognize that reaching circularity in the infrastructure and meeting the national goals requires a change of BAU.

"I think the market is ready to make those extra steps. And together, we can create the benefits." Bernard Smit, Dura Vermeer

In the background, there is a belief that IAAS adds a societal value, mainly because it helps change the mindset and the status quo. These two factors are not as prominent but need to be present to initiate market change. Thus, IAAS aims to both initiate the market change and is also a result of transformation towards CE.

While circularity is, in general, believed as achievable even without the IAAS model, for that to happen, all factors need to be known (the client needs to know exactly what to ask for), and the supply chain itself needs to be circular. Such transition is unlikely to happen, as this project also fleshed out that linear thinking and unwillingness to change persist. Often, the market change occurs over a more extended period of time, when failed projects and those that didn't move to execution are the critical points from which people learn how to do things better. It was mentioned that the initial progress of Overijssel helped to form other pilots as much was discovered. So even without moving to the execution stage, the Overijssel pilot served as an important lever.

"My hope is that this will help with the system change. It will align with our goals, and the contractor will not be involved just in building but will actually be thinking about reducing and reusing. Then with the government to understand that they are also involved, they cannot put everything on the contractor " Fanauw Hoppe, Amersfoort

4.2.2 Economic aspects

Knowledge sharing increases economic potential, Reduced transaction costs due to knowledge gained, Financial mechanisms

Knowledge sharing is viewed as a strong enabler to help increase economic potential. Knowledge gain represents a great financial stimulus by shortening the decision-making processes on asset feasibility and contractual agreements, hence reducing transaction costs. On the other hand, adopting more financial mechanisms to incentivize the use of IAAS (e.g., subsidies, tax relief, more financial aid, etc.) is a weak enabler. This is because most of the pilots were not in the final stages and were still discussing the design and other aspects at the time of the surveys and interviews. More knowledge on the investment and finance possibilities need to be known (see the section on dissensus), and these steps are planned for the future to enhance the IAAS.

4.2.3 Technical aspects

Extended lifetime of assets, Technology availability, Future improved market supply and demand of secondary resources

The future state of the market is the strongest enabler for the technology-related aspects. It has been acknowledged that the current market environment is not yet circular, which can hamper the circular project. While IAAS helps to initiate such changes, its circularity also depends on supply and demand. IAAS is viewed as the driver to decrease primary materials and increase the use of secondary materials, although this change is not considered a significant impact on the market. This is understandable as the pilots have a very small size, and such differences only become visible after several years of having a much larger project (either scale or scope-wise).

Due to the long lifetime of the infrastructure assets, extending the lifetime is currently an assumption as it can only be proven in time. There can be various factors that can help to extend the lifetime, such as modular design, where the product can be disassembled and reused and/or recycled. Nevertheless, it has been acknowledged that the technology needed to realize IAAS is there, and it is believed that IAAS will boost technological innovation in the future. However, technology readiness has dissensus among the stakeholders (see section dissensus – technical aspects).

4.2.4 Inter-organizational aspects

Inter-organizational aspects touch upon several groups of enablers that consider the relationship between the organizations: collaboration enablers, project-related enablers (those that directly influence the project work), and supporting enablers (those that play a supporting role in the inter-organization relationship).

Collaboration-related enablers: Beneficial for future collaborations, Need for enhancing communication, Creating value for all stakeholders, Non-competitive attitude

Among enablers helping collaboration between organizations, the most vital enabler is benefits gained towards future collaborations. This is supported by the previous contextual factors that showed that strengthening the relationship between the companies is a significant influence on the motivation behind IAAS projects. Equally, this was mentioned throughout the interviews by both client and contractor. While this factor shows that IAAS can be beneficial for future relationships between the organizations, the previous factor of future usefulness of information gained has a more individual element to it, as the organization itself can use insights and knowledge gained. Here the underlying enabler is the non-competitive attitude, which makes open communication and knowledge transfer possible. This is an important element as trust was found as extremely important. While trust can be maintained even with a competitive attitude, it

is usually in cases when most risks and elements of the projects are known. *IAAS made a big leap into the unknown, and going beyond competing interests was an important factor in making that possible.* Bringing all knowledge and experience gained, both positive and challenging, created value for all stakeholders, which is a mid-level enabler found important by the majority of people involved. The need for enhancing communication in this context is the enabler identified by the IAAS program. This doesn't speak about lack of communication, quite the opposite. It recognizes that in the background of all, we need these kinds of projects to experience different kinds of communication, which are brought about by having disruptive creative projects.

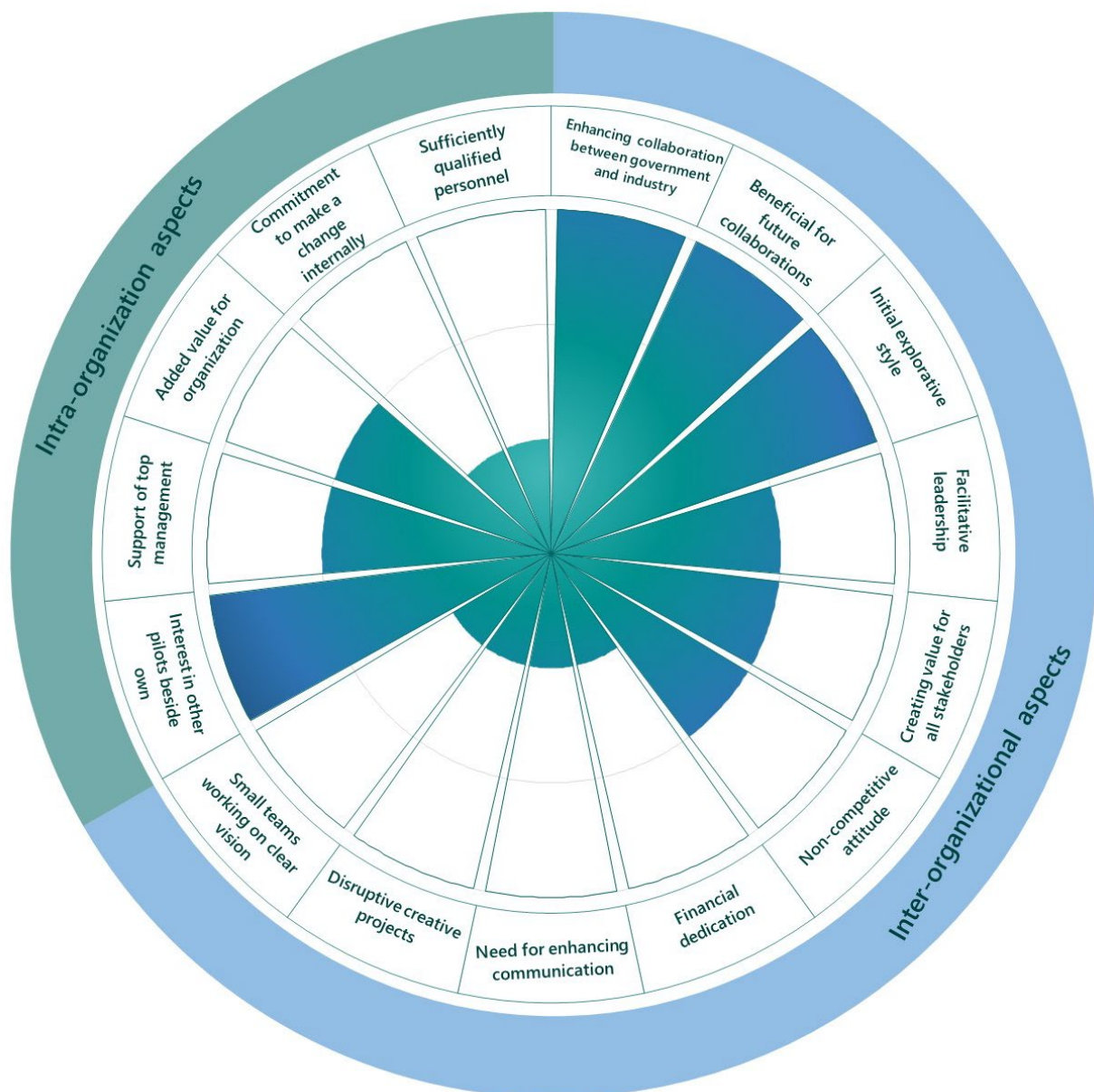

Figure 34 The main enablers for inter-organizational and intra-organizational aspects. There are three strength levels: the weaker in the most inner circle, the middle in the second circle, and the strongest enablers reaching third, outer circle, which is also visible for the colour gradient change.

Project-related enablers: Disruptive creative projects, Initial explorative style, Small teams working on a clear vision

Having disruptive creative projects has been highlighted by many as a positive side of IAAS. Here the strongest factor was the initial explorative style which was mentioned as one of the most enjoyable experiences throughout the IAAS stages. The small project size of IAAS pilots helped create a small dedicated force for dynamic thinking (contrary to BAU). This new way of working opens the door to the possibility of "going through the steps together" and enables ideas that would not usually form. While this stage can sometimes take longer, it is a significant one, as it also brings the first discussion on new things that can be included. *By having creative, open communication, rethinking becomes possible. While rethinking is one of the highest R strategies in the circular economy, business models often concentrate on measurable strategies such as reuse and recycling. But IAAS went beyond and recognized the need for change that happens by first changing the mindset. And that sometimes we can only "learn by doing."*

Supporting enablers: Facilitative leadership, Financial dedication, Enhancing collaboration between government bodies and industry

The program overall benefited from facilitative leadership. Having good facilitators has been recognized as an important factor among the stakeholders, which often shared words of appreciation. This brought encouragement to IAAS and created a frame for all to hold together and not scatter. The enabler that was a pre-cursor to IAAS was the financial dedication from all stakeholders and their willingness to use mobilize finance. The commitment can also show itself in the absence of financial discussion. After the first agreement on financial dedication, the trust can be increased if finance is not the predominant talking point until more concrete ideas on the contract are reached. For example, one of the success factors of North Brabant was excluding finance from initial talks.

IAAS also has a supporting effect for collaboration between government bodies and industry. It is among the main very strong enablers that help to motivate IAAS projects. The collaboration and communication needed between the government (client) and the contractor were mentioned as very different from the traditional way of communication for infrastructure projects. This, too, has been a big learning process, and both sides mentioned that they gained valuable insights into the consideration and consequences that the other party faces when making decisions. *This would not happen under the traditional contract and tender process.* The understanding of client for contractor and contractor for client enhances the usefulness of IAAS projects. Good communication and understanding are the cornerstones of every project. Hence, the insights gained can bring great benefits to any future project, whether it will be IAAS or other creative circular or sustainable projects.

4.2.5 Intra-organizational aspects

Intra-organization aspects account for enablers that play a role within a company internally. Five main enablers were identified by the stakeholders. They can be grouped into two categories: transitional enablers (aspects that help the organization make change/transition) and supporting enablers (those that play a supporting role within the organization).

Transitional enablers: Commitment to make a change internally, Added value for the organization, Sufficiently qualified personnel

While commitment to make a change internally is an enabler, it is a weak one. There is certainly room for improvement here as it is not universally viewed as the enabler, and many face challenges in their own organization. Thus, facilitating the competence of change needs more support. Added value for the organization and sufficiently qualified personnel are two essential factors that need to be recognized as enablers by stakeholders in order to make IAAS happen. While there can be some lack of knowledge, qualified personnel need to be present to make sure that disruptive projects can happen. Depending on the project, the experts should be from several fields, from technical qualifications to experts on sustainability, circularity, contract negotiations, and others.

Supporting enablers: Support of top management, Interest in other pilots besides own

Interest in other pilots besides their own was recognized as the strongest enabler among intra-organizational aspects of the program. Together with good support from top management and managers, this shows the underlying willingness to change and learn from each other. In addition, interest in other pilots can enhance the IAAS potential, and future use as other infrastructure assets can be considered and integrated besides the current pilot applied in the municipality province. For example, it has already been expressed by several clients that road light as a service is a point of interest.

"It's like a list of problems and solutions. If IAAS is not on the list, it will not happen. We need to put IAAS on the list for it to be even considered." Ric Vergeer, North Brabant

4.3 Barriers

The barriers are based on both surveys and interviews. Together, we identified 24 main barriers, of which 6 are very strong barriers to IAAS, see Figure 35. Similar to contextual enablers (such as motivation and trust), some of these barriers can be present in any new creative project. However, in a disruptive project like IAAS, these are more prominent

and have more influence on the project overall (for example, change of staff, lack of motivation...). The barriers can be grouped into several categories (visible in the outer circle of Figure 35). They are discussed in chronological order starting on the top right (political aspects) and ending with the top left (contextual aspects).

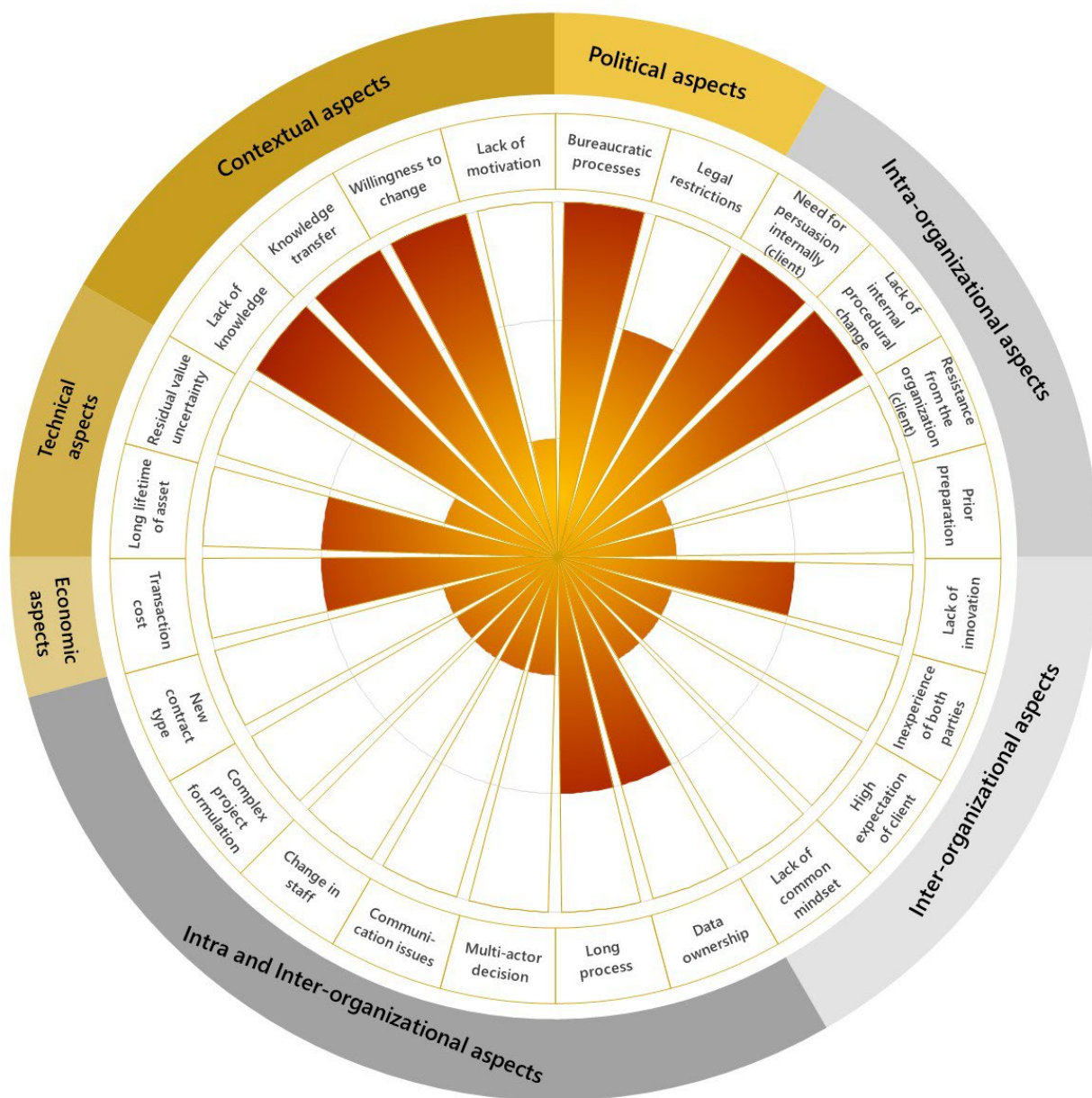

Figure 35 The main barriers. The factors include political, economic, technical, intra-organizational, inter-organizational, and contextual aspects of infrastructure as a service (IAAS). There are three strength levels: the weaker in the most inner circle, the middle in the second circle, and the strongest enablers reaching third, outer circle, which is also visible for the colour gradient change.

4.3.1 Political and legal aspects

Bureaucratic processes, Legal restrictions

While bureaucratic processes and legal restrictions can be a problem in any kind of project, they can be especially challenging in the IAAS. This is also related to the size of the pilot and the need to move fast once the decisions are made, like in the case *of long waiting for permits*. Because the IAAS involves a new way of working, when the work halts while waiting for approval, the momentum of work can be lost. After the permit comes in, a strong push is needed, but the staff is not in the same headspace and needs to re-motivate themselves again. Further, *tender law* is restricting as it may hamper the length of the contract. The benefits of the IAAS become more visible after a longer period of time. Short contracts can also be challenging due to residual value and maintenance. For many assets, little to no maintenance will happen over the course of a few years, and the asset itself will not change its value considerably (exceptions can be materials like steel, which have a very fluctuating market price).

Additionally, longer processes can also be linked to the absence of public procurement, which results in the need to communicate differently. Dura Vermeer was assigned the projects in a 1-on-1 situation, which is possible for a pilot but not usual for projects in general. *Giving tender to one contractor* may be seen negatively by the market set-up where tender bidding and rotation of the contractor are expected. However, for IAAS, it is more feasible to have longer contracts with one contractor who handles the assets. If not, the client needs to constantly buy back the asset and make a tender again, then re-evaluate the contract and sell it again every few years. But longer contracts have higher budgets that need to be approved, which is very unlikely to happen for small-sized projects such as current IAAS pilots. In addition, higher budgets are in contradiction to the ability to forego the regular 'European Tendering' procedures. *Restrictions posed by standards* have also been mentioned as a possible hurdle. *This is not an IAAS-specific issue, but it rather affects circularity within the project*. Due to the lifetime of the asset, some of the current standards are based on outdated information. This is the case, especially when it comes to sustainability aspects. For example, the guide rails have a certain lifespan to achieve (circa 25-30 years) before they should be replaced due to degradation of the material (as they are no longer safe). However, this decreases the reusability of the guide rails. If they are renovated a few years earlier, it is expected that most of the guide rails can be put back after a new zinc layer is added.

4.3.2 Intra-organizational aspects

Resistance from the organization (client), Need for persuasion internally (client), Lack of internal procedural change, Prior preparation

The need for persuasion internally for government bodies and the lack of internal procedural change is among the strongest barriers. There is a constant need for the persuasion of people internally, which puts pressure on the IAAS project in the early stages. This puts further pressure on IAAS as it requires additional effort and time. Sometimes despite the best effort, there is still resistance from the organization in the government bodies. A creative way of working is known in many industries where R&D is part of a normal procedure. As a client, the government is usually not part of the discussion when looking for a creative solution, and the feeling of "fight for it (IAAS) to be integrated" can be experienced. The construction industry, especially regarding infrastructure, has been known as one of the least creative industries globally, which means that disruptive and innovative projects can take longer to incorporate into the BAU. Thus, the lack of internal procedural change was expressed as a barrier by both contractor and client. IAAS hopes to initiate a change internally, but this has not yet been experienced.

Prior preparation was lacking. This also shows that not only contractors but also clients in IAAS need to do some prior preparation.

4.3.3 Inter-organizational aspects

Lack of innovation, Inexperience of both parties, High expectation from the client, Lack of a common mindset

Lack of innovation refers to the client's dissatisfaction with the technical level of innovation reached by the contractor when discussing the design. However, the contractor can only use the technology that has been proven not to compromise safety and adhere to the standards. It varies from case to case and is dependent on the length of the contract and initial communication. In general long-running contracts tend to favor known and proven technologies by both parties to limit the risks and possible continuous issues. While most client feels like a lack of innovation was experienced, the opposite is true for the North Brabant case, where innovative technology was the driver for the pilot (dimming light system).

This is combined with the high expectation from the client. Even though IAAS are disruptive projects, they do have time boundaries like any other project, and as discussed before, the contractor is bound by the current standards and technologies. As evident from the pilots, simple projects have higher success. Simple and more direct systems (like lights and guide rails) represent easier integration into a system that has been working in a status quo for decades.

Additionally, the vision of the client and contractor are not always aligned, which leads to a lack of a common mindset. While this factor is context-specific, the possible explanation can be a lack of tender procedure, which would help to align visions more

clearly. In the first cases of IAAS, when IAAS is not yet offered as tender, the alignment of the common mindset can be flesh-out and resolved during the initial creative stage when formulating the project. The challenge here lies in maintaining the momentum and energy past the initial stage to stay on the same page. The clients got amazing insights into the inner working of the contractor and understood a little bit more about the decision-making process and vice versa.

4.3.4 Intra- and Inter-organizational aspects

Project-related aspects: New contract type, Complex project formulation, Long process, Data ownership

New contract type certainly influences the project formulation and overall length of the process to reach decisions. Because the pilots started as a conversation, anything can be put on the table. Initial creativity and a dynamic way of working was the strong enabler for all. However, it makes the process lengthier, which is a fact that needs to be acknowledged. The new contract type is challenging, as Sweco also identified in their report evaluating IAAS for DCW (Sweco, 2022). After the initial creative process with plentiful communication between both parties, action is expected to be taken by both sides. It was stated that action did not follow as expected and was often derailed or postponed. This is also due to the small size of the projects, as there is usually not a priority but more a side project. When the solution is not at hand, it can be sidelined, prolonging the process, and having periods when "nothing happens." For the sake of looking for a solution, sometimes "too much time was dedicated to something that is not used." While this is a normal process in any creative industry or any time R&D or similar is involved, it is viewed here as a barrier where a much faster idea-implementation ratio is expected. Many ideas are discussed over months and then discarded.

The challenge in IAAS lies in the process of innovation. Technical innovations are easier to integrate as they are external and have clearly measurable success factors and progress. Thus, they can be engaged more objectively. In process innovation, those changes are harder to observe as it is challenging where one needs self-introspection, and solutions depend on more interconnected and less visible factors. Thus, in a way, IAAS is more difficult to implement than technological innovations are.

Additionally, data ownership needs to be more apparent in the future so that it doesn't pose a further strain to IAAS. It is unclear to all but the top management. It is left to the project manager to handle as this can have an influence on the motivation and work of some, but not others.

Collaboration-related barriers: Communication issues, Change in staff, Multi-actor decision

Communication issues have been experienced by most of the pilots. It is, however, less prominent in the North Brabant case, where good communication was the enabler for the project. From the start, the partners in the pilot put emphasis on the understanding that flexibility is needed from both sides, that willingness to make interim adjustments is required, and that solutions can be formulated together as responsibilities are shared. Some communication issues are expected in any unfamiliar disruptive project. It was not detailed to what extent these issues were experienced, but they were partially caused by the complexity of the projects, the variety of the elements included in the contract, and the new way of working that pushes people outside of the BAU scenario. These issues can be due to various other personal problems and can only be solved by improved communication, from openly stating uncertainties on topics to improved project management and one-on-one communication.

IAAS projects were negatively influenced by the change of staff. From lower to high-level employees leaving getting reassigned or leaving the organization. At the lower and mid-level, this means that a new person needs time to get to know the project; often, project managers (or others) need to explain the goals, motivate them, and highlight the need to step out of BAU and be creative. While the same is true for the change of staff at the higher-level employee, it can also mean that the motivator has left at a critical stage, which can halt the IAAS before contract formulation is reached. In the process of learning (especially during the creative phases), staff change can add difficulties to an already challenging project and increase the chance of stagnation. The staff change can also contribute to a longer process – also a barrier. On the other hand, it was expressed that change of staff can positively impact the project, and thus, in some cases, it can act as a driver for IAAS.

Multi-actor decisions are viewed as problematic by all except the project owners. Although, it is positive that multi-actor decision is seen only as a weak barrier, which means it doesn't substantially influence the projects. It is natural that in the transition to a new way of working, this is a barrier where contractor and client are viewed more as equals. The strength of this barrier will vary from case to case based on the dynamics of the project but is expected to decrease with gained experience.

"I think working on it together always creates better results, especially if you have complex goals and projects, like making infrastructure circular. And I think IAAS is helpful in reaching circular goals." Jeroen van Wijngaarden, Dura Vermeer

4.3.5 Economic aspects

Transaction cost

Transaction costs are usually very high in a new type of project when the long initial process is expected until the contract is reached. While the costs can be partially alleviated by the learnings from this program, they will vary from case to case. It is expected that a similar project to the present pilots will have lower transaction costs, especially if the same client-contractor for IAAS remains. Similar to the long process and time spent finding the solution, higher initial transaction costs are experienced in any innovation project, R&D, scale-up procedure, etc.

4.3.6 Technical aspects

Long lifetime of the asset, Residual value uncertainty

These two barriers are connected, as the residual value is uncertain when the asset's lifetime is long. It is tough to predict in what state the market will be in the future and how the materials -thus the take-back value- will be determined. This needs further work, which can only come from experience and time. However, it is highlighted that assets with shorter to medium lifespans (such as lights and guide rails) represent a lower risk when compared to roads or structures with a lifetime of 50+ years.

4.3.7 Contextual aspects

Knowledge-related barriers: Lack of knowledge, Knowledge transfer

Both lacks of knowledge and knowledge transfer are among the strongest barriers in the program. There were several reasons why lack of knowledge is a strongly experienced barrier. Firstly, as stated before, lack of knowledge is normal for new and innovative projects and was, in fact, the reason why the DCW program was formed. Still, this was expressed as a barrier in the later stages of the program. While it is mainly caused by the inexperience of both parties, there were expectations that knowledge will considerably increase during the program. Some of the contributing factors to this were unclear terminologies and concepts, lack of clear instructions, and lack of prior desk research.

However, IAAS is a new concept, and very little is known from the literature. Gathering knowledge requires speaking to experts in the field, probably outside of their own organization, with regard to technology solutions available, asset maintenance, sustainability, and possibilities in supply and demand. Instead of seeking knowledge, it was expressed that knowledge was expected to be delivered by others under unclear terms. Due to the novelty and small size of the projects, time spent on self-studying was limited.

Lack of knowledge also refers to circular design. It was mentioned that a similar circularity level could be reached with the traditional contract however, that requires the client to know exactly what to ask for, which is not the current state of the knowledge on the market for the infrastructure.

"It should not be an objective of Iaas to make a reconstruction of the road or part of the infrastructure. But it should be the expression of the functionality, and we as a municipality need to be able to describe what we want."

Philip ter Laak, Amersfoort

While stakeholders are able to develop proper knowledge with the pilots, they also need to ensure that the knowledge is distributed well. Knowledge transfer was lacking. This was mainly caused by the limited learning process due to the different schedules of the pilots, which were not only considering different assets but were in very different stages of the project. It was also caused by pandemics and limited opportunities to meet and exchange experiences in a more personal and dynamic manner. Overall, more examples of success factors, learnings, and hurdles are required to be shared during the project and contract formulation, i.e., waiting until the pilot is finished (moving to execution or later stages) is not feasible, while very few IAAS exist.

Collaboration-related enablers: Lack of motivation, Willingness to change

IAAS is an unfamiliar concept without clear, measurable benefits to show due to its novelty. The clients experience unwillingness to change from their internal organization due to uncertainty and/or lack of clear benefits regarding IAAS. Uncertainty often equals risks. The clients expressed the constant pressure and persuasion they undergo with IAAS. This program and report are trying to bridge this gap so that more is known about the process. Also, unwillingness to change was expected. Although the circular economy has been around for decades, little change and circular thinking were integrated regarding infrastructure, especially in the government sector. People do not want to break their habits. The boldness of DCW was to try to disrupt the normal way of working to see where it could take us. For some cases, this has proven to be more challenging than others. In order to pursue, one must be motivated and have a clear vision, which is hard to sustain when the processes are long, and resistance from others is experienced.

4.4 Dissensus

Dissensus includes two elements: 1/3 of the respondents were unsure, or stakeholders were almost equally divided in their answers. The latter means there is a strong opposition where roughly the same amount of respondents agree as disagree on the issue. There are several groups of aspects where stakeholders reached both or one of

the criteria for dissensus: political, economic, technical, and intra- and inter-organizational aspects.

4.4.1 Political aspects

Support by the national and local government

Despite DCW having most partners as government bodies, 33% of stakeholders are unsure how the national government supports both the circular economy and IAAS. This has consequences on the certainty level for the financial support offered by the national government (by extension, also support from the EU). At the time of the survey and interviews, this was also not clear because the concentration of the effort was on bringing pilots to the execution, and more knowledge on the national government support has already been acquired, and it is planned to continue the dissemination of relevant support. There is also some level of uncertainty regarding the support by the local government, see Figure 36. The stakeholders are, in general, divided in their opinion, but this is highly dependent on the case.

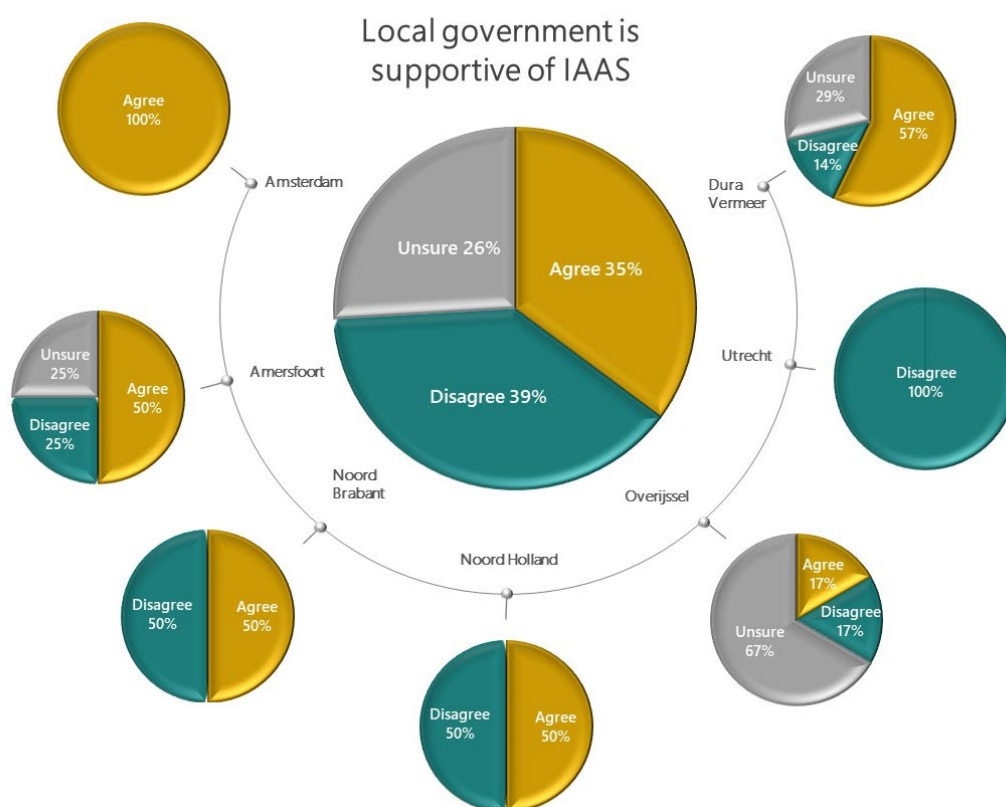

Figure 36 Stakeholder details per organization regarding support of local government for infrastructure as a service (IAAS).

4.4.2 Economic aspects

There is considerable uncertainty about **financial opportunities**, including attracting resources for future IAAS. AS high as 40% of stakeholders are unsure what funding opportunities exist for IAAS and how to attract them. Similar to the previous section, this can also be linked to the time when the survey and interviews were performed. Most pilots were still figuring out the contract specifics in the current projects and did not investigate future funding options. Knowledge on financial opportunities is expected to be disseminated and shared, and thus uncertainty regarding financial opportunities will be decreased considerably.

30% of stakeholders expressed uncertainty regarding the **compatibility of IAAS with the current (linear) economic system**. For example, the supply and demand chain is not yet developed for the circular infrastructure to be fully realized. Uncertainty about the market environment creates uncertainty for the residual value of the asset. If people participating in IAAS do not know if their efforts will be possible to implement, it can decrease their motivation and trust in IAAS.

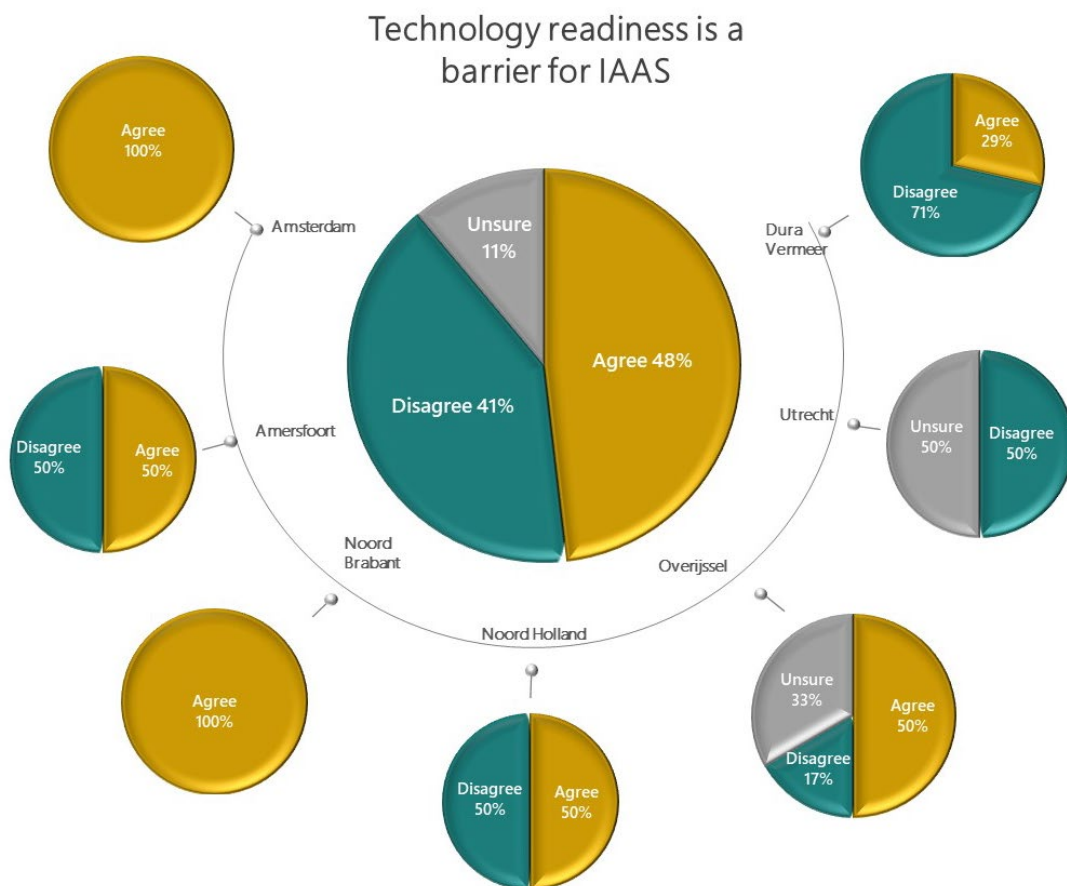

Figure 37 Technology readiness viewed by different organizations. Only a few technology experts has been part of the research, thus this graphs represent overall opinion of stakeholders.

4.4.3 Technical aspects

There is dissensus among stakeholders regarding technology readiness, which some view as a barrier, see Figure 37. However, the certainty level regarding technology is low (i.e., the survey included a question on certainty regarding the group of questions on technology). There is a certain detachment of the client regarding the technology as the client is not a technology expert. The opinion expressed regard technology in general without specifying if it includes state-of-the-art technology like innovative materials or complex design solutions. As visible in the Figure, the contractor, Dura Vermeer, does not express concern about technology. The technological solution implemented in the pilot vary, and clients have different experiences, as implementing road lights is different from having a new bridge deck or road.

The majority agreed that increasing the dimension of the contract is necessary for the future IAAS: a longer contract period and an increase in scope (more objects of a similar size) and scale (same object of a larger size/distance) seen in Figure 38.

However, there is dissensus among the stakeholders regarding the scope of the IAAS, see Figure 39. Slightly more people, 43%, think that more similar pilots are beneficial. However, at the time of the analysis, only one pilot had moved to the execution stage, with time passed after that (North Brabant). The rest of the pilots did not yet have results on the circularity, LCC, clarity of business models, etc.

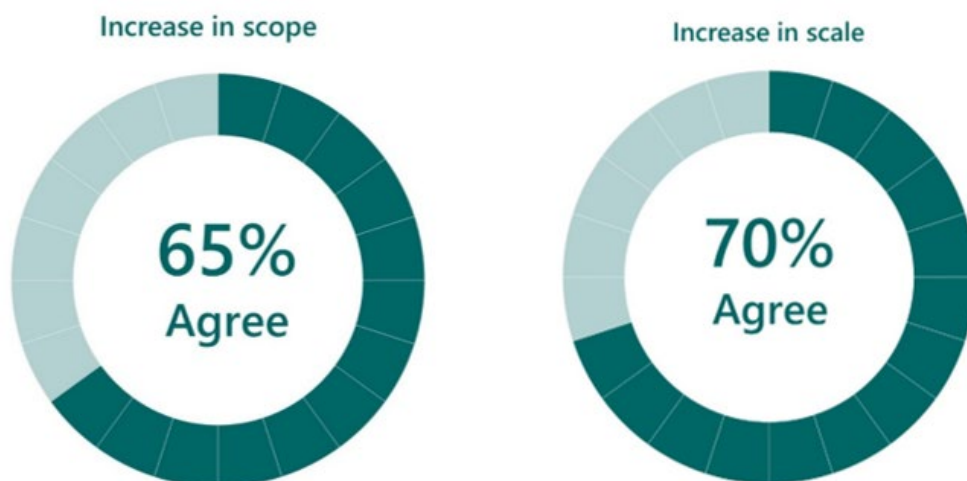

Figure 38 The Infrastructure as a service need and increase in scope (more similar sized objects), and scale (larger scale/longer distance). The agreement is based on the stakeholder analysis.

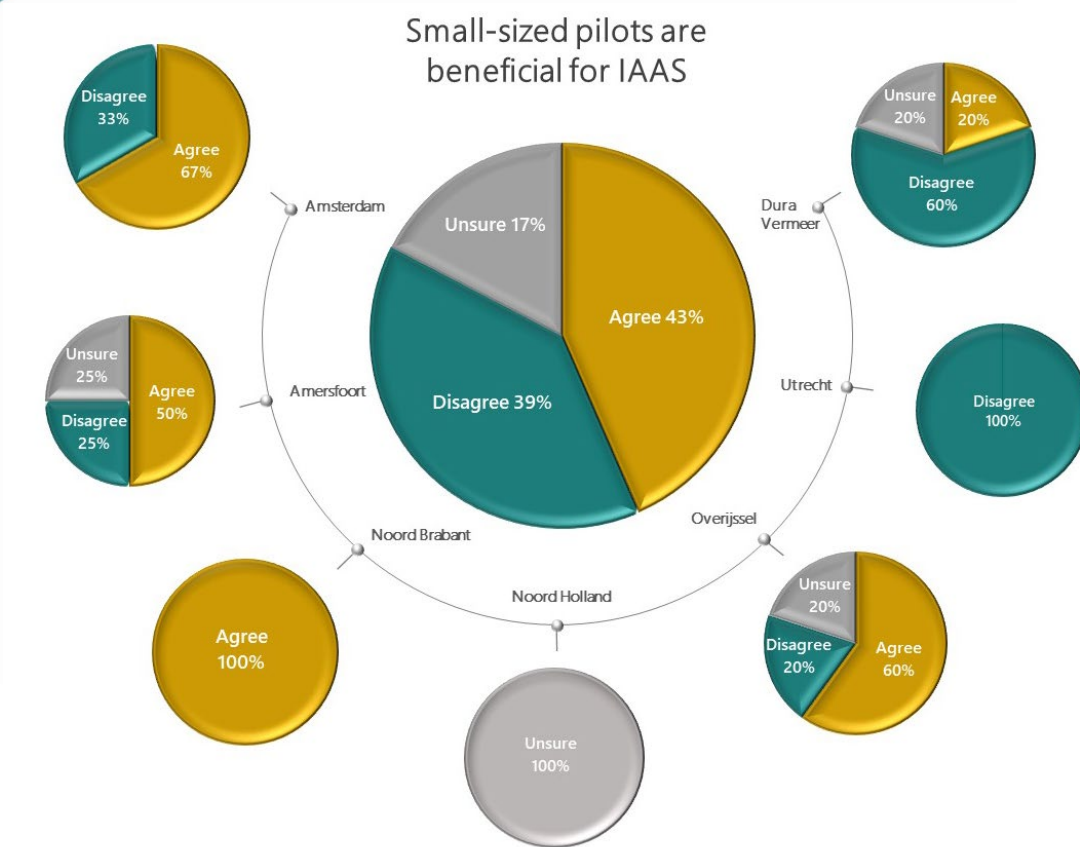

Figure 39 The stakeholder analysis of having small-sized pilots for infrastructure as a service (IAAS), with details per each organization: Amsterdam, Amersfoort, North Brabant, North Holland, Overijssel, Utrecht for clients, and Dura Vermeer representing contractor.

4.4.4 Intra- and inter-organizational aspects

Up to 39% of stakeholders are unsure if the **internal change** is happening. It has been mentioned that internal change within the organization, especially the government bodies, is needed for market change to happen to reach CE. While stakeholders are not sure if the internal change is happening, it was also identified as a barrier to reaching IAAS (see more in section Barrier). It is clear that internal change needs to be a point of interest as it is critical for CE, as rethinking and change of the BAU are vital to reaching circular industry and society.

37% of stakeholders are not sure if there is appropriate responsibility and power distribution. This needs to be defined more clearly, as lack thereof can create mistrust among the partners, both inside and between the organizations.

Recommendations and conclusions

5. Recommendations

5.1 Conditions for circularity with IAAS

This research asks the question: *Under what conditions does the applied As a Service model on infrastructure lead or not to a higher level of circularity and lower or equal life cycle costs?*

To answer this question, we followed and evaluated seven pilots that experimented with IAAS in practice in the municipalities of Amersfoort, Utrecht, and Amsterdam and the provinces of Overijssel, North Holland, and North Brabant. We looked at the As-a-Service level, the degree of circularity, and the degree of costs. In addition, we outlined the underlying circumstances in which the pilots were carried out, such as the organizational, financial, and technical similarities and differences.

Each pilot had a unique set of circumstances and followed their own path in exploring the As-a-Service. And although there are similar elements in the infrastructure asset studied (such as safety, maintenance, and circularity), there was no one fits all model. This highlights the importance of contextual conditions for building a successful model.

The levels of the As-a-Service reached in the models of the pilots are relatively similar for all pilots. The level reached (see section 2.2.2) predominantly depends on specifying functional effects (FL1) and specifying functional solutions (FL2). This was true even in the non-AAS pilot of Utrecht Croeselaan road, namely FL1. The condition, therefore, seems to be less distinctive at the level of IAAS per se. The level of service is connected to the direction that client gives to the project. You see a higher degree of direction in Utrecht, for example, with a pronounced focus on sustainability, without an AAS working model because there was a lot of freedom for the contractor to make proposals within the set direction. You also see a high degree of direction in the AAS model, such as Overijssel, with a strong focus on sustainability as a common thread within a traditional assignment. In general, AAS models, with less prominent directions coming from the client, focus more on main elements, such as safety and maintenance, with (partial) value propositions in sustainability and/or circular elements.

As seen in section 2.3.1 (Figures 9 and 10), the initiative distribution of circularity led to more unsolicited elements by the contractor in small AAS assignments (PNH, Amersfoort, and PNB) with fewer instructions from the client. However, this does not necessarily lead to better or more circularity. In the evaluated pilots, the contractor took the initiative to propose certain circular elements or solutions in parts of the assignment. Therefore, unsolicited initiatives can occur more often using the AAS model as they are a conversation between client and contractor to reach a common goal (e.g., higher circularity for the project). Less instruction requires more creativity from the contractor,

and the conversation with the client helps to make better-informed decisions, meaning it can become a catalyst in the market to enhance circularity. In addition, we see that defining measures closely together between client and contractor results in a very effective model (Road light pilot of PNB).

Overall, the material circularity was increased in the measured AAS pilots compared to the reference projects (BAU). However, MCI is influenced when materials are used for low R strategies (e.g., recycling), which increases the risk of unusable waste (through processing), leading to a lower MCI score (e.g., Amersfoort bridge deck). AAS model leads to higher MCI in small and well-defined pilots, such as guide rails in the PNH. Straightforward and clear elements for the asset (such as guide rails) create the circumstances where the contractor can more “easily” optimize a defined service. More complex and larger scopes (such as the provincial road) result in lower MCI, regardless of IAAS or not, but can also reap greater profits from targeted customer demands. However, it should be noted that the MCI was based on the platform CB23 data which were obtained largely from the contractor but included assumptions and expert opinion when data were unavailable. Thus the MCI at the end of the life of the project (i.e., recycling and reuse strategies) can be different.

The environmental costs indicator (MKI) is reduced in all pilots when following IAAS. A possible explanation for MKI reduction is the relative familiarity of this method for the contractors. The contractor can make good use of the instruments for MKI, and its parameters can therefore be well optimized compared to a reference project. However, MKI is dependent on lifecycle assessment data of the materials, which can be based on the LCA of the material itself, but also on the proxy and assumption. There is a need to improve the inventories for the construction materials to enhance the accuracy of the MKI.

In the NPV, we see a mixed picture of increases (Province of North-Brabant and Overijssel) and decreases (Municipality of Amersfoort and North-Holland) compared to non-IAAS references. The change in NPV values highly depends on the planned interventions at the front of the As-a-Service contract. An increase can come from adding new functions to an asset (such as a dimmable light system in PNB) compared to the traditional start of the contract (reference). However, the final value is similar or can even decrease with efficient implementation, where an equal function is maintained (e.g., at the bicycle bridge deck of the municipality of Amersfoort), or where an intervention in both the pilot and a reference is necessary (e.g., at the guide rail PNH). It shows that the initial value depends on the value proposition (i.e., added functionality/effect or retaining the same function/effect). The actually achieved circularity will be influenced by the final material treatment at the end of the lifetime of the asset or part of the assets (in case of material reparations).

The life cycle costs of AAS models are lower than the non-AAS references, except for the road lights in PNB. The road light installation required a larger initial investment (the installation of dimmable lighting), which increased the total costs. However, in this case, the investment enabled higher circularity (switch to LED and more modular and repairable design) and lower costs in the longer term (mainly for energy savings). Therefore, IAAS has the potential to not only enhance circularity but also partly reduce life cycle costs.

Since some AAS models require an upfront investment, this does not mean that every AAS starts from the same starting point. The financial requirement depends on the intended costs. In the case of smaller projects, the pilot's financial requirements can be obtained directly from the contractor and client. However, project financing might be necessary if major investments are needed. In such a case, special attention needs to be given to managing risks and setting up a joint venture. Finally, when a consortium of companies can keep short lines of communication, leasing (a possible form of the IAAS) represents an attractive option for the construction and maintenance of the asset. In essence, parties must draw up a joint risk profile and shared responsibilities.

The stakeholder analysis also shows that IAAS is an attractive method for stakeholders. While a number of enablers drive circularity and IAAS implementation, IAAS faces critical barriers to its implementation. Among other things, the level of knowledge at the level of implementation and among decision-makers needs to be bridged. The report provides recommendations based on the stakeholder analysis.

5.2 From a barrier to a solution

In the previous section, we have showcased the barriers identified by the stakeholder. Here, we aim to propose a solution (mentioned by participants) to these barriers. This section represents the summary of recommendations found in the survey and interviews and speaking to the experts. The amalgamation of the solutions to the barriers identified is represented in the diagram below (Figure 40).

Increasing knowledge, comprehension, and knowledge transfer

In general, it was mentioned that "the right people" are needed. Right people are needed in any kind of project that aims to be more sustainable. However, more clarity on knowledge, examples, and engaging activities can help balance wavering motivation.

Some solutions to the lack of knowledge are included in this report and a report prepared by Sweco (Sweco, 2022). We further recommend that a glossary document is formed and always available online with all terms and terminologies. It is recommended that the success factors, learnings, and hurdles need to be shared during the earlier stages of the pilots (after the first talks but before the final contract formulation). Additionally, more

organized materials need to be shared, both *before* the project starts and *during* the project. It was recommended that the client should better prepare for IAAS, firstly by familiarizing themselves with the concepts, which includes talking to the expert within or outside of their own organization, and secondly by making some preparation internally to let the key personnel and people know why such project is considered/will be undertaken.

Overall, for the IAAS to improve and for each organization to gather more knowledge (without which the right solution cannot be identified), it is recommended to engage with more experts from technology, asset management, maintenance, sustainability, and supply and demand experts. This also helps to shorten the process, as more information makes it more clear on what is possible to achieve and what will take time and can be integrated later.

While it cannot be expected that extensive individual study happens, the familiarity of the concepts needs to be clear to all in order to open the room for conversation and learning.

Changing the procedures and leading systemic change

The IAAS aim was to the evolution of business as usual from linear to circular, which includes the approach to work not only increasing recycling and reusability of materials in their input and output. Due to the novelty of the process and the small size of the projects, these are often not a priority and *risk being side-lined*.

It comes down to being able to "not stack too many ambitions on top of each other" for first experiences with IAAS. This means that only as many 'stairs' as can be climbed now should be placed in order to formulate a contract. More elements can be added to the contract after more experience with IAAS or similar projects. This can also help identify solutions and necessary changes beyond IAAS for the market overall. Thus, IAAS can function as a trigger for market change, as the knowledge and experience learned help to pinpoint *what needs to change* and even *in what order* it needs to change.

For example, we know that barriers like unwillingness to change, and resistance from the own organization are more prominent in government bodies. These small pilots help to draw out where in the organization the push-back is experienced, what these departments need in their adaptation towards as-a-service models and projects, and which departments (with the right mindset/ goals) lack the decision-making power to push these changes through. Many feel that time needs to pass, which will help not only to get more used to the idea of having complex and disruptive projects but also to make the benefits visible. Business models are not clear yet, and the maintenance and expenditure happen over time.

Having more simple projects now with *fewer technical element represent fewer risks*. More elements can be added to the contract once more certainty with IAAS is gained, and a new way of working becomes more familiar.

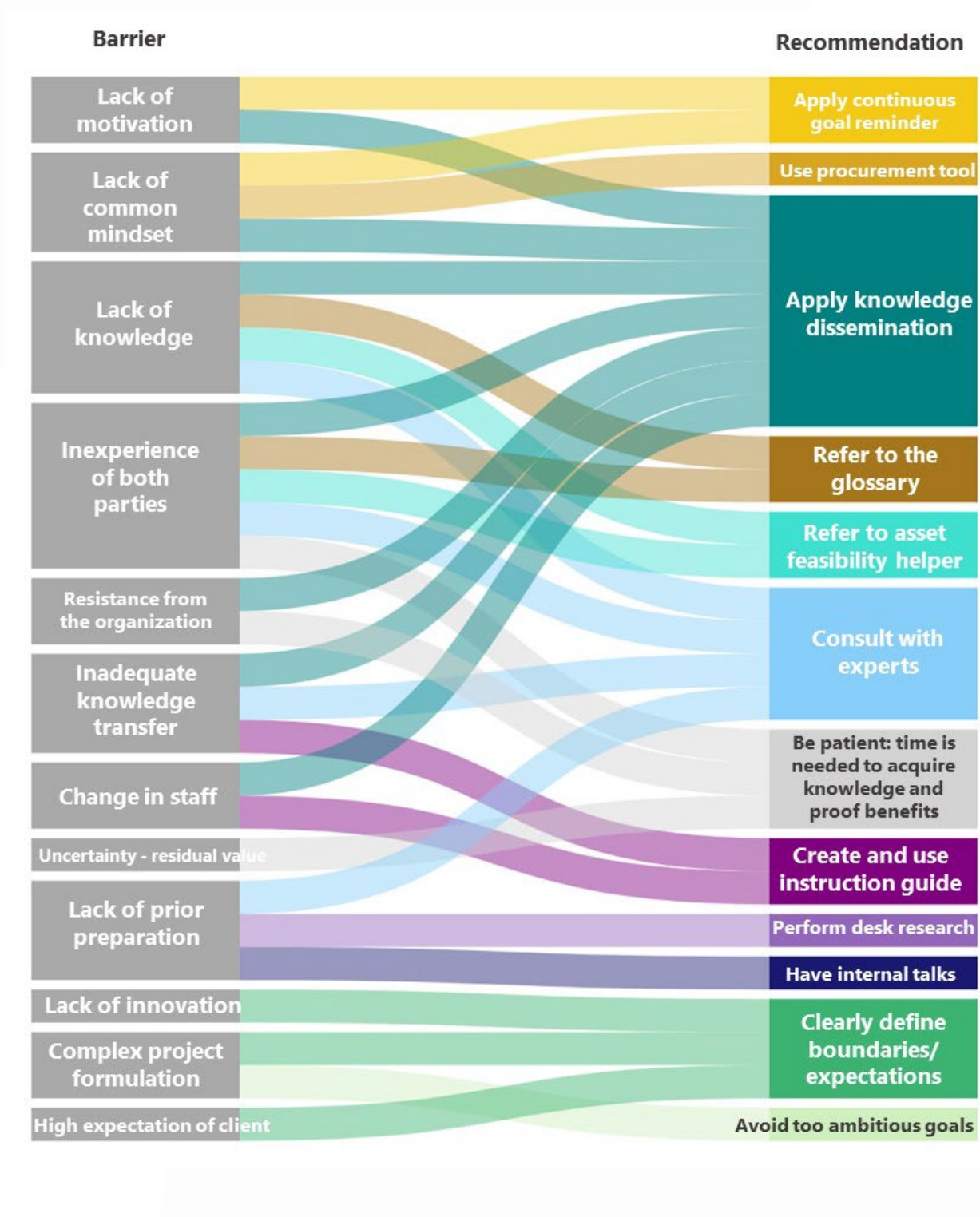

Figure 40 Sankey diagram for barrier to solution according to the stakeholder analysis

It was also identified that *residual value* needs further research from the Dutch community of practice on circular construction. Due to the long lifetime of the infrastructure, there is uncertainty about the amount of materials available for reuse and recycling at the end of the lifetime and even more uncertainty about the price of these materials.

Further, some recommended that the tender law and current standards need a closer look, as they might be restrictive not only for IAAS but for creating a circular sustainable system. Longer contracts are needed for IAAS, and at the same time, the IAAS itself needs to become tenderable. Here, maintenance experts should be consulted to determine the minimum contract length for the asset with the possibility of an extension. Without this, the benefits cannot be known as little to no maintenance happens over a short contract of several years. As seen from the IAAS framework represented in this report, maintenance is an integral part of the IAAS. *"The government is moving from building to maintenance, and we need to adapt to that."*

Clear boundaries

Regarding the solution to lack of innovation, as represented in Figure 40 (Sankey diagram), specifying boundaries is mainly for *the client* to be clear on what is included in the expected innovated (process, contract, communication, materials); and for *the contractor* to be clear on what can be innovated (explain what can be and cannot be innovated, especially with regards to technology and materials used). If the client desires to include innovative, reused, or recycled materials, they need to be aware if that is possible. First of all, the safety standards might not permit that (for example, biobased materials for guide rail need to be tested first, which is a costly process). Second of all, it might add another level of complexity to the project. However, as the IAAS projects are aimed at innovation and circularity, new and bio-based materials are part of the equation. It was suggested that such decisions should be made together by the contractor and the client, not made beforehand, especially when the level of knowledge may be limited, or the information may be outdated. It is also recommended to first engage in market consultation, market research, and sustainability expert (or engineer) in the early stages. Lastly, to make a business case, a cost assessment should be part of the analysis (for example, investigating if there are any upfront testing costs and if they can be compensated during the product's life cycle).

Further recommendations based on the stakeholder analysis for the IAAS are:

Contract

- Less focus on technicality and more on functionality (shift from material matters to functionality matters)

- Security and stability on the scope - should be determined after the initial exploration phase and not changed majorly after
- Talk about complexities at the beginning
- Do not stack too many ambitions
- Include maintenance experts and the asset management team
- The light version of the contract to speed up the work
- A shorter lifetime of the asset is less risky for IAAS
- Do not calculate as many alternatives
- Bonus/malus on sustainability
- Expanding the scope
- Expanding the scale
- Longer contract period
- Talk about complexities at the beginning
- Easier when IAAS asset is located on other government-owned assets
- Simple/direct solution
- Less external factors

Inter-organizational aspects

- Bring experts on board sooner
- Take time to explain to experts' project details
- Evaluate per case if contract managers should be involved sooner or later
- Bringing legal advisors together
- Earlier sharing of intermediate results/experiences

Intra-organizational aspects

- Systemic report for preparation and organization
- Share information within the company
- Clear instructions

Contractor

- Be clear on market opportunities
- List of suitable assets/objects
- Change in management style (contractor-to-client) 1. process-oriented 2. progress-oriented

To speed up the process, lower transaction costs, and reach higher effectiveness, it was recommended to switch the management style for the contractor to client communication. The initial stage of the IAAS is well suited for the process-driven management style due to the creative energy of the process (including bouwteam). After the agreements are reached on the main aspects of the contract more progress-driven

management style is better suited. This information is also relevant to know to the client, as when the change happens, they should be aware that the switch is main when faster feedback and direct decision need to be taken to reach the final contract.

Client

- More commitment needed
- Adapt to having complex projects
- Prior preparation needed: familiarity with concepts
- Make sure you have a good team (innovators and motivated people within your own team)
- Use IAAS as a transition finance system

Another great aspect of IAAS is its ability to function as a transitional finance system for the client (local government). IAAS and circular projects are possible with traditional contracts, but at the larger scale, this properly requires extra resources given, such as the need to hire extra personnel. A monthly fee is better, and it is easier for finance to transition from the old to the new system. Single assets often have smaller budgets, which means that the more sustainable and circular system cannot be done due to financial restrictions. IAAS enables to transition to the new way of work as it is based on a fee over a longer period of time instead of needing a bigger budget from the client to be given at the beginning of the project.

Additionally, it was advised to make use of external financing. Public authorities can borrow money at a significantly reduced rate, as opposed to the contractor. This needs further attention to explore the option of the municipality acting as a financier.

Other

- Making process tenderable
- Clear environmental and societal value
- Continue to trigger the market change
- Keep in mind: Uncertainty will diminish over time

Asset recommendation specifics

- Lifetime- shorter (around 35 years is less risky, road with 100year is a riskier due to uncertainty of future market which put pressure on right contract formulation)
- Elements- direct technology solution with fewer elements
- Technology – already proven materials and elements (ex. LED for light fixtures, ex. already used asphalt mix...)
- Less external factors – residential areas are more tricky
- Location - Easier when IAAS asset is located on other government-owned assets (ex. lights as IAAS on the government-owned road, the bridge connected at

both sides to government-owned land/road, electronic systems in/on bridges on the government-owned bridge – especially for the movable bridges on the canals)

5.3 10-step guide

In summary, there are ten enablers and recommendations that need to be cultivated as they have a particular influence on the IAAS model.

1. **Trust** within each organization, but also in the client-contractor relationship.
2. **Motivation** needs to be maintained throughout the whole formulation of the project (or at least until the execution). Use continuous goal reminders, and when motivation is lacking, use proper instructions and knowledge dissemination.
3. **Transparency.** Share your goals, but also your worries and internal struggle. Be clear on the boundaries of the project (client: new materials? The new way of cooperation? Biodiversity integrated? Social return integrated?; contractor: be clear on what is achievable, for example, safety standards may limit the option of use of the new innovative materials.) If you are not sure what can be in the scope, use the procurement tool (currently in development).
4. **Dynamic early environment.** This can include but is not limited to bouwteam cooperation. Create a space where ideas can be exchanged.
5. **Engage with experts from the field.** This should be done early on. Also, when experts, both internal and external, are included, take time to explain the project.
6. **Proper knowledge dissemination.** Both internally and in between the organizations, knowledge need to be shared and time allocated to prepare materials, presentations, and sessions.
7. **Switch from process to progress-oriented management.** After the initial creative period, progress needs to be achieved with deadlines and final decisions to move to the final contract.
8. **Decrease the complexity.** If you struggle with formulating the contract, decrease the complexity. Can we take something out of the scope?
9. **Check on your team.** Make sure that the project is not side-lined.
10. **You are part of the mindset change.** Remind yourself and your organization that the aim is to contribute to the change of the system and that top R strategies like rethink are needed. Embrace the complexity of the projects.

5.4 The Circular Road 2.0/Further research

The Circular Road continues its efforts with the second iteration. A number of things are essential for the next study round.

First, the empirical data must continue to be retrieved once the DCW 1.0 pilots proceed to implementation and more to the maintenance stage. This will allow us to continue the research for the pilots and to learn more from the actual circularity data and IAAS.

Secondly, the study clearly showed that measuring circularity depends on both publicly accessible data and private data (product statements, Environmental Product Declaration). However, a few gaps need to be addressed to enhance the evidence of circularity. For example, the MCI method is currently product-oriented and could be refined into a calculation relevant to infrastructure construction. There are also database gaps (such as data based on proxies). This means that we have to do action-oriented research to get accurate data in the field. A fundamental rethinking of the concept of 'value' is also needed for the asset and its materials. In this study, we have not been able to operationalize this concept due to a lack of consensus and the detailed complexity behind it. In particular, there is a need for fundamental research into calculations in the field of value preservation and residual value in the context of a circular economy.

Finally, it has become clear that clients want to remain in control over how they can properly influence the behavior of the contractor. Therefore, it is vital to determine the degree of control on circularity, in particular the management of the burden of proof (i.e., the task of showing accomplished results) and freedom of contractors, in relation to financing method and cooperation strategy. This should lead to reproducible IAAS models in the following program (The Circular Road 2.0) for dedicated procurement contracts and design methods that help guide all parties. One of the key elements of the IAAS lies behind the relationship and influence it can have on circularity and circular transition for the construction industry at the system level.

Annex and References

Annex 1

The following Table and MCI specifications in the Figure are based on Ellen MacArthur Foundation (2019), while the indication of CB'23 is based on Platform CB'23 (2020).

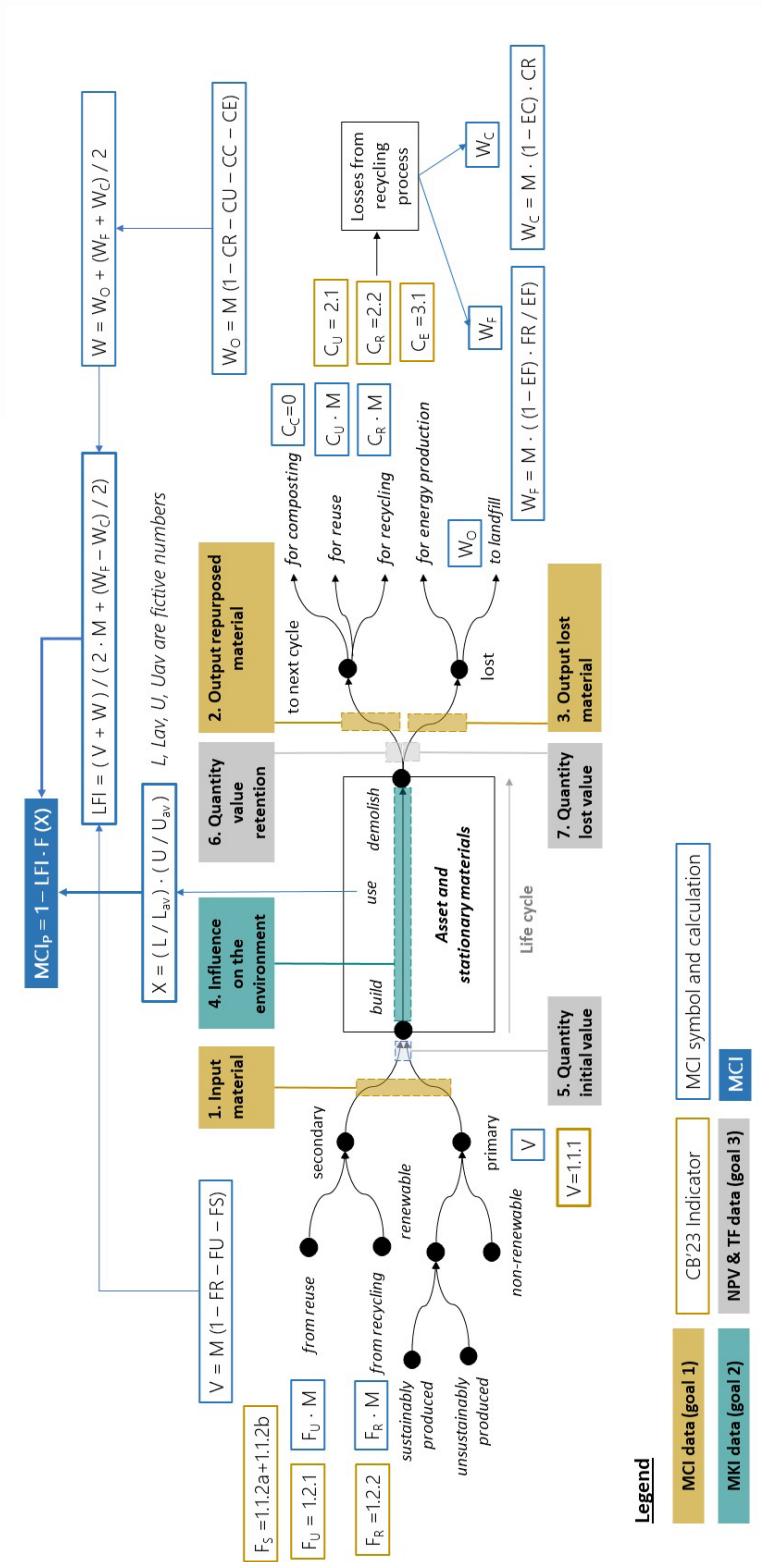

Symbol	Definition	Cb23 or calculation
C_C	Fraction of mass of a product being collected to go into a composting process	0 for all IAAS pilots
C_E	Fraction of mass of a product being collected for energy recovery where the material satisfies the requirements for inclusion.	Indicator 3.1 The quantity of end-of-life materials used for energy production
C_R	Fraction of mass of a product being collected to go into a recycling process	Indicator 2.2 The quantity of end-of-life materials available for recycling
C_U	Fraction of mass of a product going into component reuse	Indicator 2.1 The quantity of end-of-life materials available for reuse
E_C	Efficiency of the recycling process used for the portion of a product collected for recycling	Assumed 0
E_F	Efficiency of the recycling process used to produce recycled feedstock for a product	Assumed 0
$F(X)$	Utility factor built as a function of the utility X of a product	$X = (L / L_{av}) \times (U / U_{av})$
F_R	Fraction of mass of a product's feedstock from recycled sources	Indicator 1.2.2 The quantity of secondary materials from recycling
F_S	Fraction of a product's biological feedstock from Sustained Production. Biological material that is recycled or reused is captured as recycled or reused material, not biological feedstock	Indicator 1.1.2a The quantity of sustainably produced, renewable primary materials and Indicator 1.1.2b The quantity of unsustainably produced, renewable primary materials
F_U	Fraction of mass of a product's feedstock from reused sources	Indicator 1.2.1 The quantity of secondary materials from reuse
L	Actual average lifetime of a product	Chosen as 10
L_{av}	Average lifetime of an industry-average product of the same type	Chosen as 10
LFI	Linear Flow Index	$LFI = (V + W) / (2 \times M + (WF - WC) / 2)$
M	Mass of a product Fraction	
MCI_p	Material Circularity Indicator of a product	$MCI = 1 - LFI \times (F(X))$
U	Actual average number of functional units achieved during the use phase of a product	Chosen as 1
U_{av}	Average number of functional units achieved during the use phase of an industry-average product of the same type	Chosen as 1
V	Material that is not from reuse, recycling or, for the purposes of this methodology, biological materials from Sustained Production.	Indicator 1.1.1 The quantity of non-renewable primary materials $V = M(1 - FR - FU - FS)$

W	Mass of unrecoverable waste associated with a product	$W = W_O + (W_F + W_C) / 2$
W_O	Mass of unrecoverable waste through a product's material going into landfill, waste to energy and any other type of process where the materials are no longer recoverable	$W_O = M (1 - CR - CU - CC - CE)$
W_C	Mass of unrecoverable waste generated in the process of recycling parts of a product	$W_C = M \times (1 - EC) \times CR$
W_F	Mass of unrecoverable waste generated when producing recycled feedstock for a product	$W_F = M ((1 - EF) \times FR / EF)$

References

- Bacudio, L.R., Benjamin, M.F.D., Eusebio, R.C.P., Holaysan, S.A.K., Promentilla, M.A.B., Yu, K.D.S., Aviso, K.B., 2016. Analyzing barriers to implementing industrial symbiosis networks using DEMATEL. *Sustain. Prod. Consum.* 7, 57–65. <https://doi.org/10.1016/j.spc.2016.03.001>
- Bocken, N., Boons, F., Baldassarre, B., 2018. Sustainable business model experimentation by understanding ecologies of business models. *J. cle* 208, 1498–1512. <https://doi.org/10.1016/j.jclepro.2018.10.159>
- Conniff, R., 2018. Greenwashed Timber: How Sustainable Forest Certification Has Failed - Yale E360. *Yale Environ.* 360.
- Domenech, T., Bleischwitz, R., Doranova, A., Panayotopoulos, D., Roman, L., 2019. Mapping Industrial Symbiosis Development in Europe_ typologies of networks, characteristics, performance and contribution to the Circular Economy. *Resour. Conserv. Recycl.* 141, 76–98. <https://doi.org/10.1016/j.resconrec.2018.09.016>
- Ellen MacArthur Foundation, 2022. Material Circularity Indicator (MCI) [WWW Document]. URL <https://ellenmacarthurfoundation.org/material-circularity-indicator> (accessed 4.3.22).
- Ellen MacArthur Foundation, 2019. Circularity-Indicators An approach to Measuring Circularity. Methodology.
- Emission factors nl, 2022. List of emission factors | CO2 emission factors [WWW Document]. URL <https://www.co2emissiefactoren.nl/lijt-emissiefactoren/> (accessed 4.5.22).
- Forest Stewardship Council, 2022. Home Page | Forest Stewardship Council [WWW Document]. URL <https://fsc.org/en> (accessed 3.30.22).
- Huizing, D., 2019. Towards Circular Economy by Incorporating Product-Service System in Infrastructure Projects: Developing a model that provides insight into the application of PSS characteristics in the project lifecycle of infrastructure projects to support a circular ec.
- Kosmol, L., Otto, L., 2020. Implementation Barriers of Industrial Symbiosis: A Systematic Review, in: *Proceedings of the 53rd Hawaii International Conference on System Sciences*. Hawaii International Conference on System Sciences. <https://doi.org/10.24251/HICSS.2020.741>
- Morseletto, P., 2020. Targets for a circular economy. *Resour. Conserv. Recycl.* 153, 104553. <https://doi.org/10.1016/J.RESCONREC.2019.104553>
- Mortensen, L., Kørnøv, L., 2019. Critical factors for industrial symbiosis emergence process. *J. Clean. Prod.* 212, 56–69. <https://doi.org/10.1016/j.jclepro.2018.11.222>

- Neves, A., Godina, R., Azevedo, S.G., Pimentel, C., Matias, J.C.O., 2019. The Potential of Industrial Symbiosis: Case Analysis and Main Drivers and Barriers to Its Implementation. <https://doi.org/10.3390/su11247095>
- Park, J., Duque-Hernández, J., Díaz-Posada, N., 2018. Facilitating business collaborations for industrial symbiosis: The pilot experience of the sustainable industrial network program in Colombia. *Sustain.* 10. <https://doi.org/10.3390/su10103637>
- Platform CB'23, 2020. Measuring circularity. Working agreements for circular construction. Version 2.0.
- Saferoad, 2022. Leading supplier of road safety and road infrastructure solutions [WWW Document]. URL <https://www.saferoad.com/> (accessed 4.7.22).
- Sánchez-Almendro, A.J., Hidalgo, P.J., Galán, R., Carrasco, J.M., López-Tirado, J., 2018. Assessment and Monitoring Protocols to Guarantee the Maintenance of Biodiversity in Certified Forests: A Case Study for FSC (Forest Stewardship Council) Forests in Southwestern Spain. <https://doi.org/10.3390/f9110705>
- Sweco, 2022. HANDREIKING DE CIRCULAIRE WEG AS A SERVICE VERKREGEN INZICHTEN UIT HET PARTNERPROGRAMMA.
- Tukker, A., 2004. Eight types of product-service system: Eight ways to sustainability? Experiences from suspronet. *Bus. Strateg. Environ.* 260, 246–260. <https://doi.org/10.1002/bse.414> EIGHT
- Van Ostaeyen, J., Van Horenbeek, A., Pintelon, L., Duflou, J.R., 2013. A refined typology of product-service systems based on functional hierarchy modeling. *J. Clean. Prod.* 51, 261–276. <https://doi.org/10.1016/j.jclepro.2013.01.036>
- Zhang, Y., Zheng, H., Su, M., Liu, G., 2015. A review of industrial symbiosis research: theory and methodology. *Front. Earth. Sci.* 9, 91–104. <https://doi.org/10.1007/s11707-014-0445-8>

