



US Army Corps
of Engineers

SHORE PROTECTION MANUAL

VOLUME II

Coastal Engineering Research Center

DEPARTMENT OF THE ARMY
Waterways Experiment Station, Corps of Engineers
PO Box 631
Vicksburg, Mississippi 39180

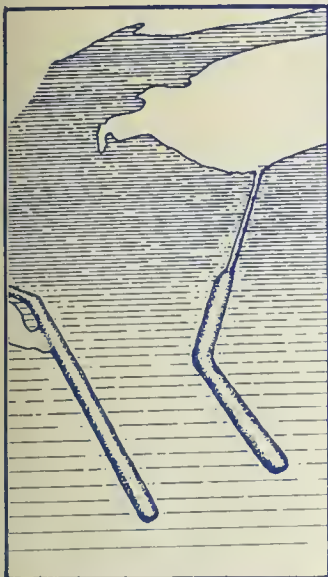

1984

Approved For Public Release; Distribution Unlimited



Prepared for

DEPARTMENT OF THE ARMY
US Army Corps of Engineers
Washington, DC 20314

edition

Arch Center 1984

RETURNED

SAP DEC 27 1985

SEP 15 1987

MAY 27 1992

WHOI
DOCUMENT
COLLECTION

DEMCO .

MBL/WHOI

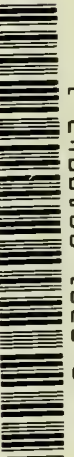

0 0301 0069943 1

SHORE PROTECTION MANUAL



VOLUME II

(Chapters 6 Through 8; Appendices A Through D)

DEPARTMENT OF THE ARMY
Waterways Experiment Station, Corps of Engineers
COASTAL ENGINEERING RESEARCH CENTER

1984

Fourth Edition

For sale by the Superintendent of Documents, U.S. Government Printing Office
Washington, D.C. 20402 (2-part set; sold in sets only)

TABLE OF CONTENTS

VOLUME I

CHAPTER 1. INTRODUCTION TO COASTAL ENGINEERING

I—Overview of Coastal Engineering and the SPM, page 1-1; II—The Coastal Area, page 1-2; III—The Beach and Nearshore System, page 1-4; IV—Dynamic Beach Response to the Sea, page 1-9; V—Causes of Shoreline Erosion, page 1-15; VI—Coastal Protection Methods and Navigation Works, page 1-17; VII—Conservation of Sand, page 1-25; Literature Cited, page 1-27

CHAPTER 2. MECHANICS OF WAVE MOTION

I—Introduction, page 2-1; II—Wave Mechanics, page 2-1; III—Wave Refraction, page 2-60; IV—Wave Diffraction, page 2-75; V—Wave Reflection, page 2-109; VI—Breaking Waves, 2-129; Literature Cited, page 2-137; Bibliography, page 2-147

CHAPTER 3. WAVE AND WATER LEVEL PREDICTIONS

I—Introduction, page 3-1; II—Characteristics of Ocean Waves, page 3-1; III—Wave Field, page 3-19; IV—Estimation of Surface Winds for Wave Prediction, page 3-27; V—Simplified Methods for Estimating Wave Conditions, page 3-39; VI—Wave Forecasting for Shallow Water, page 3-55; VII—Hurricane Waves, page 3-77; VIII—Water Level Fluctuations, page 3-88; Literature Cited, page 3-130; Bibliography, page 3-140

CHAPTER 4. LITTORAL PROCESSES

I—Introduction, page 4-1; II—Littoral Materials, page 4-12; III—Littoral Wave Conditions, page 4-29; IV—Nearshore Currents, page 4-46; V—Littoral Transport, page 4-55; VI—Role of Foredunes in Shore Processes, page 4-108; VII—Sediment Budget, page 4-113; VIII—Engineering Study of Littoral Processes, page 4-133; IX—Tidal Inlets, page 4-148; Literature Cited, page 4-182; Bibliography, page 4-208

CHAPTER 5. PLANNING ANALYSIS

I—General, page 5-1; II—Seawalls, Bulkheads, and Revetments, page 5-2; III—Protective Beaches, page 5-6; IV—Sand Dunes, page 5-24; V—Sand Bypassing, page 5-26; VI—Groins, page 5-35; VII—Jetties, page 5-56; VIII—Breakwaters, Shore-Connected, page 5-58; IX—Breakwaters, Offshore, page 5-61; X—Environmental Considerations, page 5-74; Literature Cited, page 5-75

VOLUME II

CHAPTER 6. STRUCTURAL FEATURES

I—Introduction, page 6-1; II—Seawalls, Bulkheads, and Revetments, page 6-1; III—Protective Beaches, page 6-14; IV—Sand Dunes, page 6-37; V—Sand Bypassing, page 6-53; VI—Groins, page 6-76; VII—Jetties, page 6-84; VIII—Breakwaters, Shore-Connected, page 6-88; IX—Breakwaters, Offshore, page 6-93; X—Construction Materials and Design Practices, page 6-95; Literature Cited, page 6-99

CHAPTER 7. STRUCTURAL DESIGN: PHYSICAL FACTORS

I—Wave Characteristics, page 7-1; II—Wave Runup, Overtopping, and Transmission, page 7-16; III—Wave Forces, page 7-100; IV—Velocity Forces—Stability of Channel Revetments, page 7-249; V—Impact Forces, page 7-253; VI—Ice Forces, page 7-253; VII—Earth Forces, page 7-256; Literature Cited, page 7-261; Bibliography, page 7-277

CHAPTER 8. ENGINEERING ANALYSIS: CASE STUDY

I—Introduction, page 8-1; II—Statement of Problem, page 8-1; III—Physical Environment, page 8-1; IV—Preliminary Design, page 8-46; V—Computation of Potential Longshore Transport, page 8-85; VI—Beachfill Requirements, page 8-90; Literature Cited, page 8-93

APPENDIX A. GLOSSARY, page A-1

APPENDIX B. LIST OF SYMBOLS, page B-1

APPENDIX C. MISCELLANEOUS TABLES AND PLATES, page C-1

APPENDIX D. INDEX, page D-1

CHAPTER 6

Structural Features

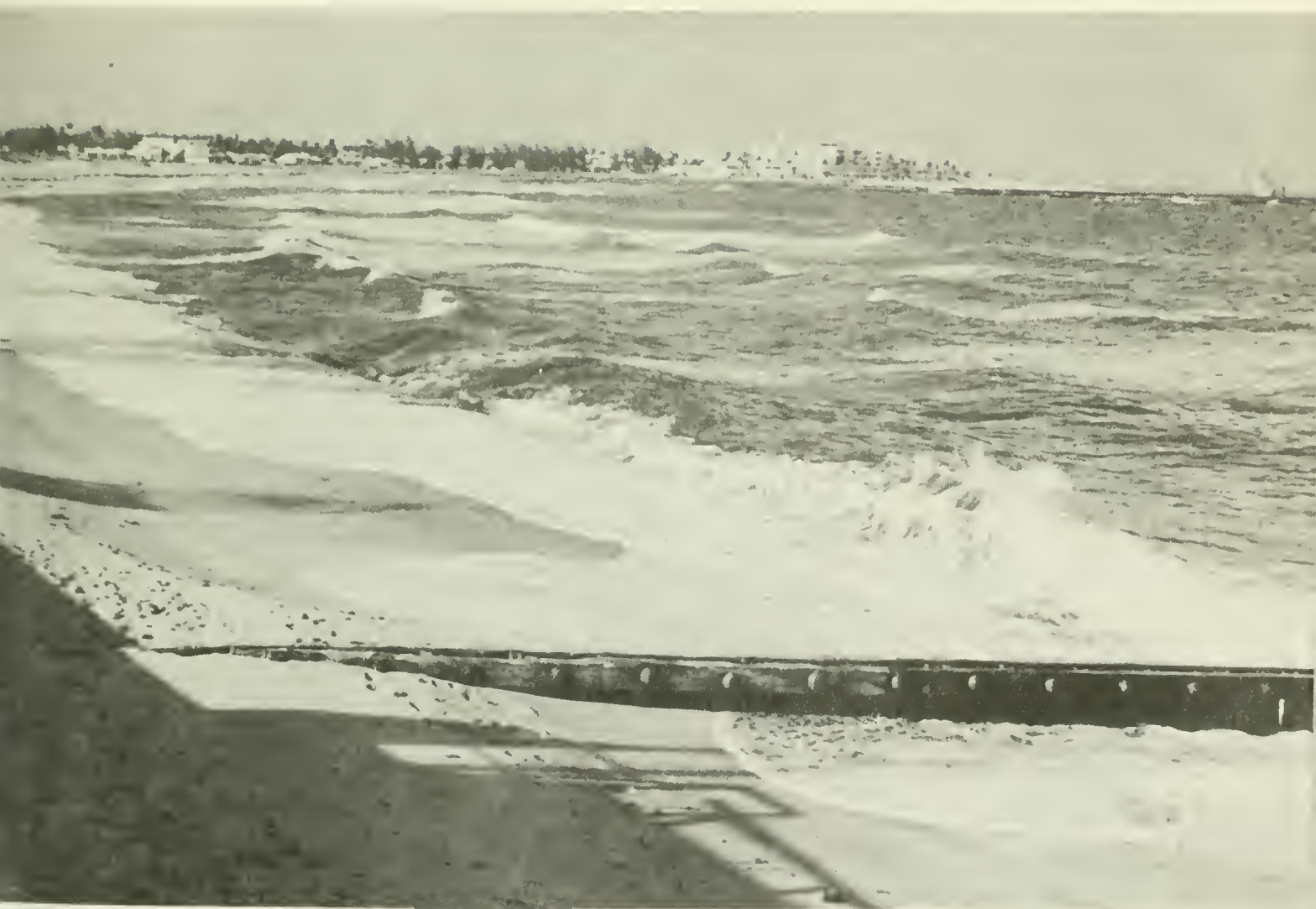

Palm Beach, Florida, 3 October 1964

CONTENTS

CHAPTER 6

STRUCTURAL FEATURES

	Page
I INTRODUCTION.....	6-1
II SEAWALLS, BULKHEADS, AND REVETMENTS.....	6-1
1. Types.....	6-1
2. Selection of Structural Type.....	6-13
III PROTECTIVE BEACHES.....	6-14
1. General.....	6-14
2. Existing Protective Beaches.....	6-16
IV SAND DUNES.....	6-37
1. Sand Movement.....	6-37
2. Dune Formation.....	6-38
3. Dune Construction Using Sand Fencing.....	6-38
4. Dune Construction Using Vegetation.....	6-43
V SAND BYPASSING.....	6-53
1. Fixed Bypassing Plants.....	6-54
2. Floating Bypassing Plants.....	6-59
3. Additional Bypassing Schemes.....	6-75
VI GROINS.....	6-76
1. Types.....	6-76
2. Selection of Type.....	6-84
3. Design.....	6-84
VII JETTIES.....	6-84
1. Types.....	6-84
VIII BREAKWATERS, SHORE-CONNECTED.....	6-88
1. Types.....	6-88
IX BREAKWATERS, OFFSHORE.....	6-93
1. Types.....	6-93
2. Segmented Offshore Breakwaters.....	6-95
X CONSTRUCTION MATERIALS AND DESIGN PRACTICES.....	6-95
1. Concrete.....	6-95
2. Steel.....	6-96
3. Timber.....	6-96
4. Stone.....	6-97
5. Geotextiles.....	6-97
6. Miscellaneous Design Practices.....	6-97
LITERATURE CITED.....	6-99

CONTENTS--Continued

TABLES

	Page
6-1 CERC research reports on the geomorphology and sediments of the Inner Continental Shelf.....	6-15
6-2 Beach restoration projects in the United States.....	6-25
6-3 Regional adaption of foredune plants.....	6-45
6-4 Planting and fertilization summary by regions.....	6-47
6-5 Comparisons of annual sand accumulation and dune growth rates.....	6-52

FIGURES

6-1 Concrete curved-face seawall.....	6-2
6-2 Concrete combination stepped- and curved-face seawall.....	6-3
6-3 Concrete stepped-face seawall.....	6-4
6-4 Rubble-mound seawall.....	6-5
6-5 Rubble-mound seawall (typical stage placed).....	6-6
6-6 Concrete slab and king-pile bulkhead.....	6-7
6-7 Steel sheet-pile bulkhead.....	6-8
6-8 Timber sheet-pile bulkhead.....	6-9
6-9 Concrete revetment.....	6-10
6-10 Quarrystone revetment.....	6-11
6-11 Interlocking concrete-block revetment.....	6-12
6-12 Interlocking concrete-block revetment.....	6-13
6-13 Protective beach, Corpus Christi, Texas.....	6-17
6-14 Protective beach, Corpus Christi, Texas.....	6-18
6-15 Protective beach, Wrightsville Beach, North Carolina.....	6-19
6-16 Protective beach, Wrightsville Beach, North Carolina.....	6-20
6-17 Protective beach, Carolina Beach, North Carolina.....	6-21
6-18 Protective beach, Carolina Beach, North Carolina.....	6-22

CONTENTS

FIGURES--Continued

	Page
6-19 Protective beach, Rockaway Beach, New York.....	6-23
6-20 Protective beach, Rockaway Beach, New York.....	6-24
6-21 Protective beach, Redondo Beach, California.....	6-29
6-22 Map of protective beach, Redondo Beach, California.....	6-30
6-23 View of protective beach facing north from 48th Street, Dade County, Florida.....	6-33
6-24 Project area depicting five phases of beach restoration, Dade County, Florida.....	6-34
6-25 Foredune system, Padre Island, Texas.....	6-37
6-26 Erecting snow-type sand fencing.....	6-39
6-27 Snow-type sand fencing filled to capacity, Padre Island, Texas.....	6-40
6-28 Sand accumulation by a series of four single-fence lifts, Outer Banks, North Carolina.....	6-41
6-29 Sand accumulation by a series of three double-fence lifts, Outer Banks, North Carolina.....	6-42
6-30 Sand fence dune with lifts positioned near the crest, Padre Island, Texas.....	6-42
6-31 Sand fence dune with lifts positioned parallel to the existing fence, Padre Island, Texas.....	6-43
6-32 Sand fence deterioration due to exposure and storms.....	6-44
6-33 Mechanical transplanting of American beachgrass.....	6-46
6-34 American beachgrass dune, Ocracoke Island, North Carolina.....	6-49
6-35 American beachgrass with sand fence, Core Banks, North Carolina....	6-50
6-36 Sea oats dune, Core Banks, North Carolina.....	6-50
6-37 Sea oats dune, Padre Island, Texas.....	6-51
6-38 European beachgrass dune, Clatsop Spit, Oregon.....	6-52
6-39 Types of littoral barriers where sand transfer systems have been used.....	6-55
6-40 Fixed bypassing plant, South Lake Worth Inlet, Florida.....	6-57
6-41 Fixed bypassing plant, Lake Worth Inlet, Florida.....	6-58

CONTENTS

FIGURES--Continued

	Page
6-42 Fixed bypassing plant, Rudee Inlet, Virginia.....	6-60
6-43 Sand bypassing, Port Hueneme, California.....	6-60
6-44 Sand bypassing, Jupiter Inlet, Florida.....	6-62
6-45 Sand bypassing, Sebastian Inlet, Florida.....	6-63
6-46 Sand bypassing, Channel Islands Harbor, California.....	6-64
6-47 Sand bypassing, Santa Barbara, California.....	6-65
6-48 Sand bypassing, Fire Island Inlet, New York.....	6-66
6-49 Sand bypassing, Hillsboro Inlet, Florida.....	6-67
6-50 Sand bypassing, Masonboro Inlet, North Carolina.....	6-68
6-51 Sand bypassing, Perdido Pass, Alabama.....	6-69
6-52 Sand bypassing, East Pass, Florida.....	6-70
6-53 Sand bypassing, Ponce de Leon Inlet, Florida, just south of Daytona Beach.....	6-71
6-54 Timber sheet-pile groin.....	6-77
6-55 Timber-steel sheet-pile groin.....	6-78
6-56 Cantilever-steel sheet-pile groin.....	6-79
6-57 Cellular-steel sheet-pile groin.....	6-80
6-58 Prestressed-concrete sheet-pile groin.....	6-81
6-59 Rubble-mound groin.....	6-82
6-60 Quadripod and rubble-mound jetty.....	6-85
6-61 Dolos and rubble-mound jetty.....	6-86
6-62 Cellular-steel sheet-pile jetty.....	6-87
6-63 Tetrapod and rubble-mound breakwater.....	6-89
6-64 Tribar and rubble-mound breakwater.....	6-90
6-65 Cellular-steel sheet-pile and sheet-pile breakwater.....	6-91
6-66 Segmented rubble-mound offshore breakwaters.....	6-94

CHAPTER 6

STRUCTURAL FEATURES

I. INTRODUCTION

This chapter provides illustrations and information concerning the various structural features of selected coastal engineering projects. This chapter complements information discussed in Chapter 5, Planning Analysis.

Sections II through IX of this chapter provide details of typical seawalls, bulkheads, revetments, protective beaches, sand dunes, sand bypassing, groins, jetties, and breakwaters. The details form a basis for comparing one type of structure with another. They are not intended as recommended dimensions for application to other structures or sites. Section X, Construction Materials and Design Practices, provides information on materials for shore structures and lists recommendations concerning the prevention or reduction of deterioration of concrete, steel, and timber waterfront structures.

II. SEAWALLS, BULKHEADS, AND REVETMENTS

1. Types.

The distinction between seawalls, bulkheads, and revetments is mainly a matter of purpose. Design features are determined at the functional planning stage, and the structure is named to suit its intended purpose. In general, seawalls are rather massive structures because they resist the full force of the waves. Bulkheads are next in size; their primary function is to retain fill, and while generally not exposed to severe wave action, they still need to be designed to resist erosion by the wave climate at the site. Revetments are generally the lightest because they are designed to protect shorelines against erosion by currents or light wave action. Protective structures for low-energy climates are discussed in detail in U.S. Army, Corps of Engineers (1981).

A curved-face seawall and a combination stepped- and curved-face seawall are illustrated in Figures 6-1 and 6-2. These massive structures are built to resist high wave action and reduce scour. Both seawalls have sheet-pile cutoff walls to prevent loss of foundation material by wave scour and leaching from overtopping water or storm drainage beneath the wall. The curved-face seawall also has an armoring of large rocks at the toe to reduce scouring by wave action.

The stepped-face seawall (Fig. 6-3) is designed for stability against moderate waves. This figure shows the option of using reinforced concrete sheet piles. The tongue-and-groove joints create a space between the piles that may be grouted to form a sandtight cutoff wall. Instead of grouting this space, a geotextile filter can be used to line the landward side of the sheet piles. The geotextile filter liner provides a sandtight barrier, while permitting seepage through the cloth and the joints between the sheet piles to relieve the buildup of hydrostatic pressure.



Galveston, Texas (1971)

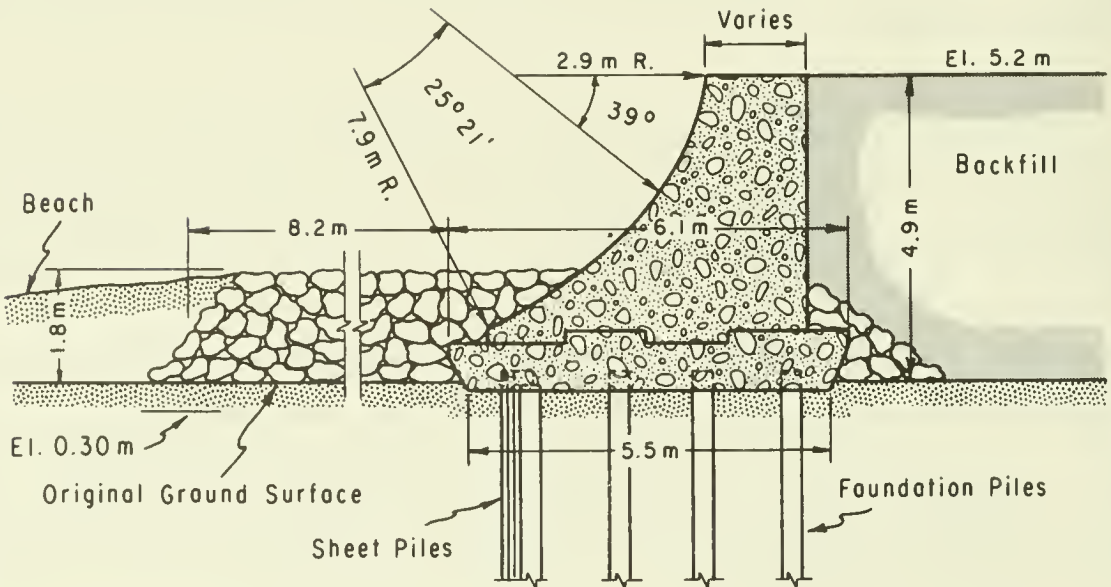

Figure 6-1. Concrete curved-face seawall.



San Francisco, California (June 1974)

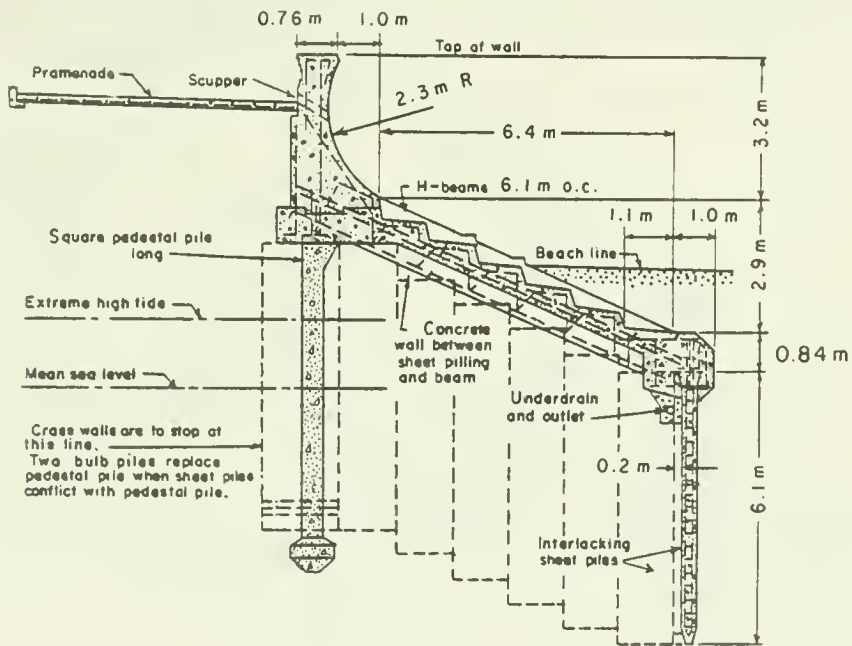

Figure 6-2. Concrete combination stepped- and curved-face seawall.



Harrison County, Mississippi (Sept. 1969)
 (1 week after Hurricane Camille)

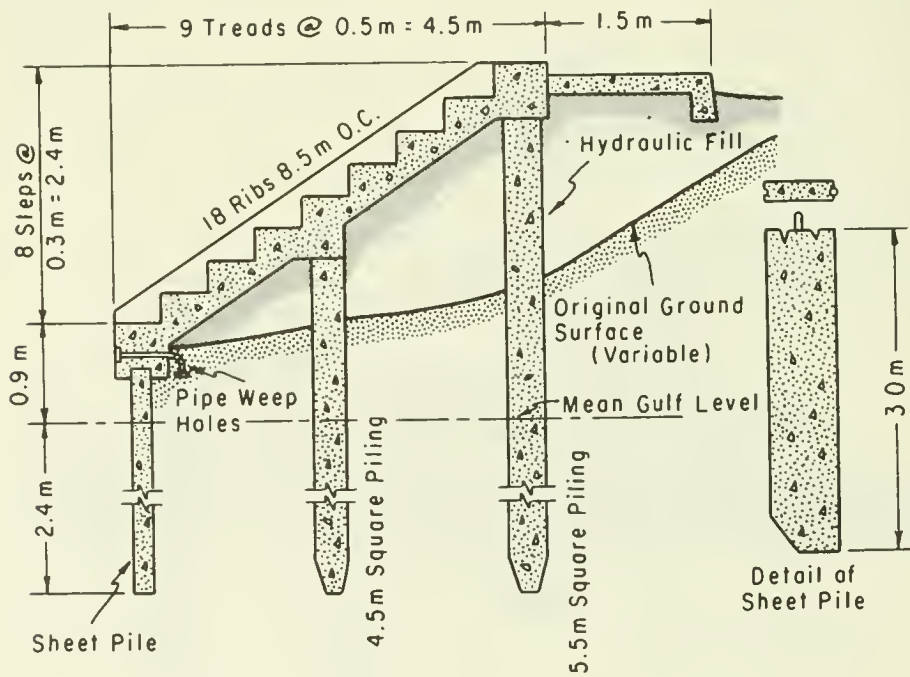

Figure 6-3. Concrete stepped-face seawall.

Rubble-mound seawalls (Fig. 6-4) are built to withstand severe wave action. Although scour of the fronting beach may occur, the quarrystone comprising the seawall can readjust and settle without causing structural failure. Figure 6-5 shows an alternative to the rubble-mound seawall shown in Figure 6-4; the phase placement of A and B stone utilizes the bank material to reduce the stone required in the structure.



Fernandina Beach, Florida (Jan. 1982)

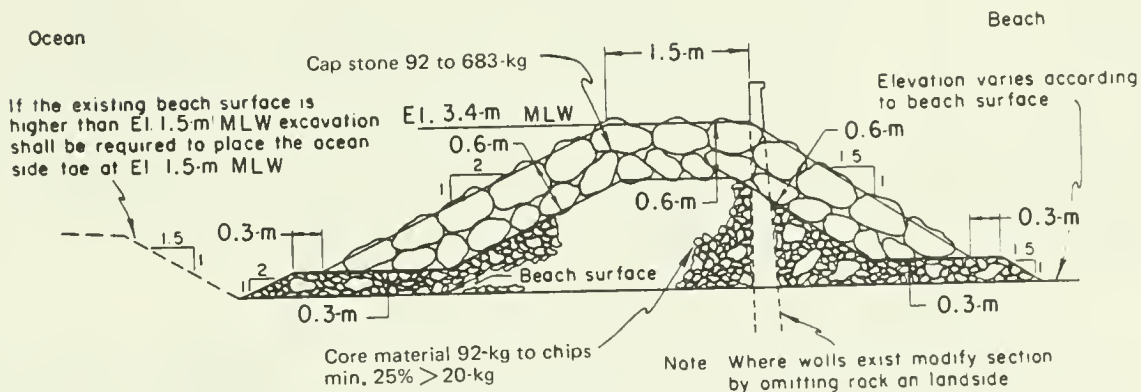

Figure 6-4. Rubble-mound seawall.

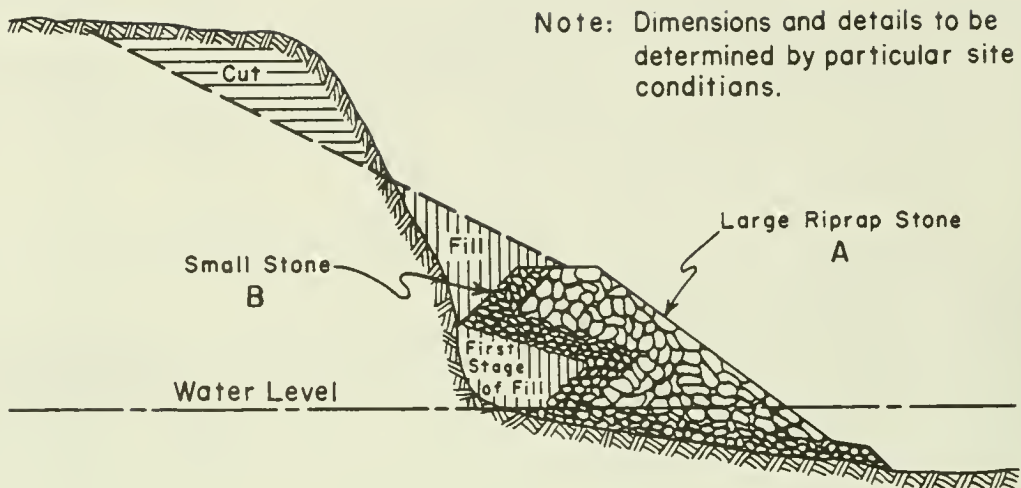

Figure 6-5. Rubble-mound seawall (typical stage placed).

Bulkheads are generally either anchored vertical pile walls or gravity walls; i.e., cribs or cellular steel-pile structures. Walls of soldier beams and lagging have also been used at some sites.

Three structural types of bulkheads (concrete, steel, and timber) are shown in Figures 6-6, 6-7, and 6-8. Cellular-steel sheet-pile bulkheads are used where rock is near the surface and adequate penetration is impossible for the anchored sheet-pile bulkhead illustrated in Figure 6-7. When vertical or nearly vertical bulkheads are constructed and the water depth at the wall is less than twice the anticipated maximum wave height, the design should provide for riprap armoring at the base to prevent scouring. Excessive scouring can endanger the stability of the wall.

The structural types of revetments used for coastal protection in exposed and sheltered areas are illustrated in Figures 6-9 to 6-12. There are two types of revetments: the rigid, cast-in-place concrete type illustrated in Figure 6-9 and the flexible or articulated armor unit type illustrated in Figures 6-10, 6-11, and 6-12. A rigid concrete revetment provides excellent bank protection, but the site must be dewatered during construction so that the concrete can be placed. A flexible structure also provides excellent bank protection and can tolerate *minor* consolidation or settlement without structural failure. This is true for the quarystone or riprap revetment and to a lesser extent for the interlocking concrete block revetment. Both the articulated block structure and the quarystone or riprap structure allow for the relief of hydrostatic uplift pressure generated by wave action. The underlying geotextile filter and gravel or a crushed-stone filter and bedding layer relieve the pressure over the entire foundation area rather than through specially constructed weep holes.

Interlocking concrete blocks have been used extensively for shore protection in Europe and are finding applications in the United States, particularly as a form of relatively low-cost shore protection. Typically, these blocks are square slabs with shiplap-type interlocking joints as shown in Figure 6-11. The joint of the shiplap type provides a mechanical interlock with adjacent blocks.



Virginia Beach, Virginia (Mar. 1953)

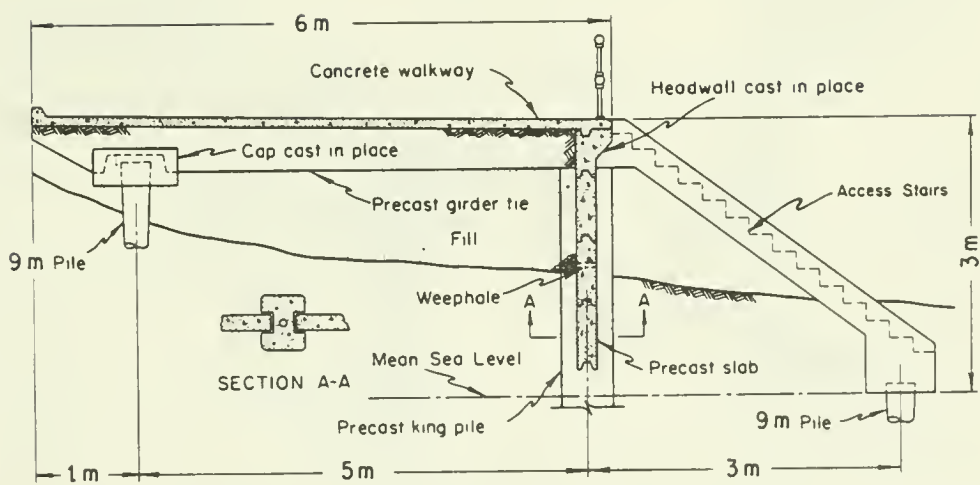

Figure 6-6. Concrete slab and king-pile bulkhead.



Nantucket Island, Massachusetts (1972)
 (photo, courtesy of U.S. Steel)

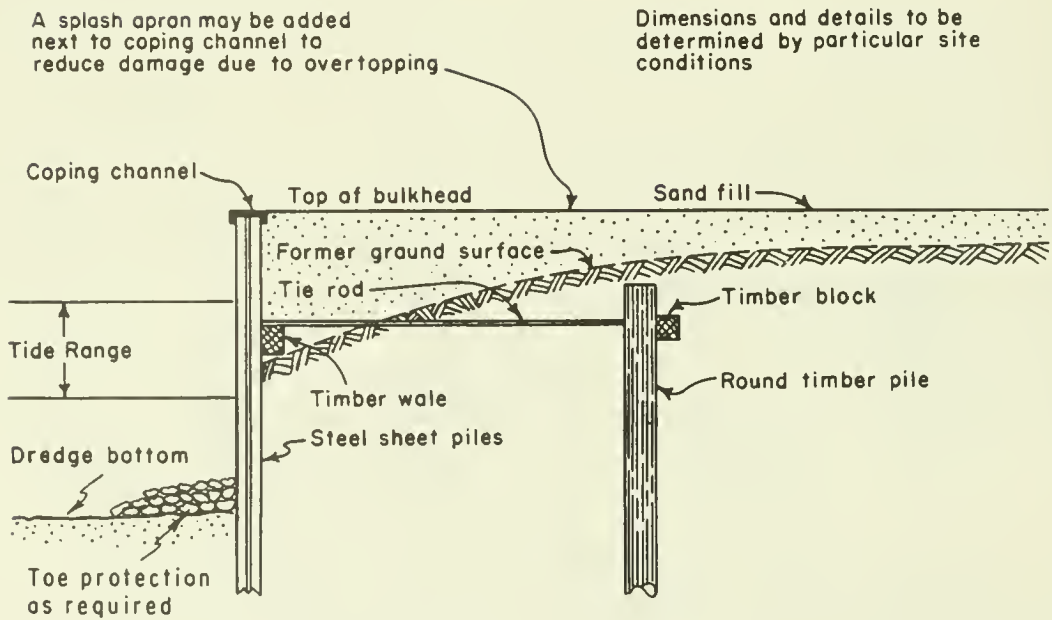

Figure 6-7. Steel sheet-pile bulkhead.



Avalon, New Jersey (Sept. 1962)

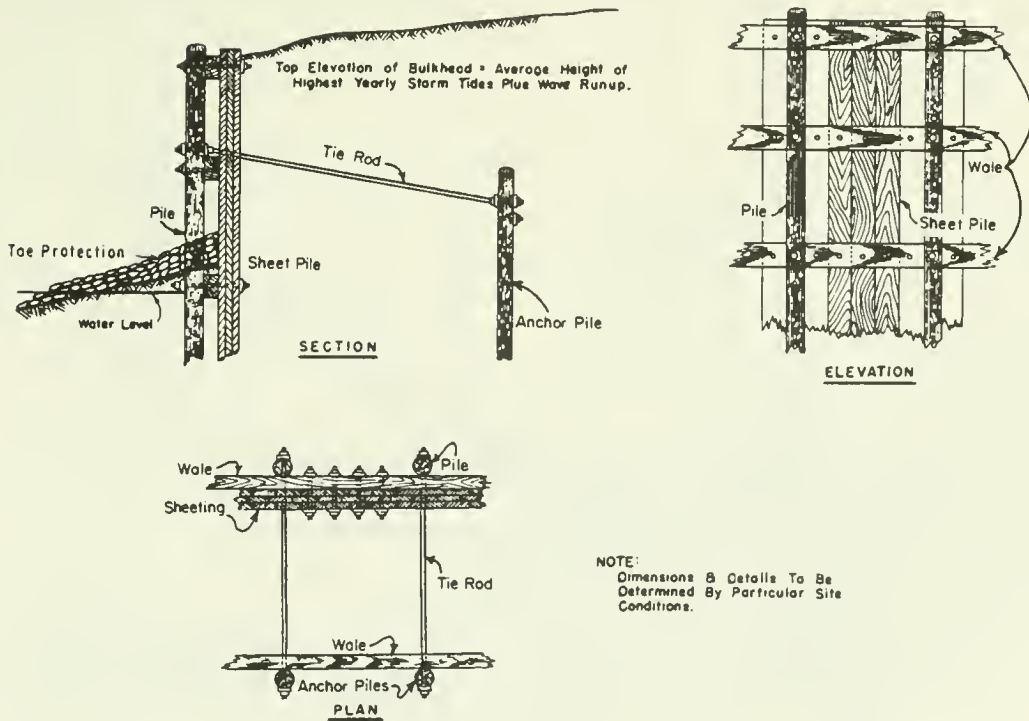

Figure 6-8. Timber sheet-pile bulkhead.



Pioneer Point, Cambridge, Maryland (before 1966)
 (photo, courtesy of Portland Cement Association)

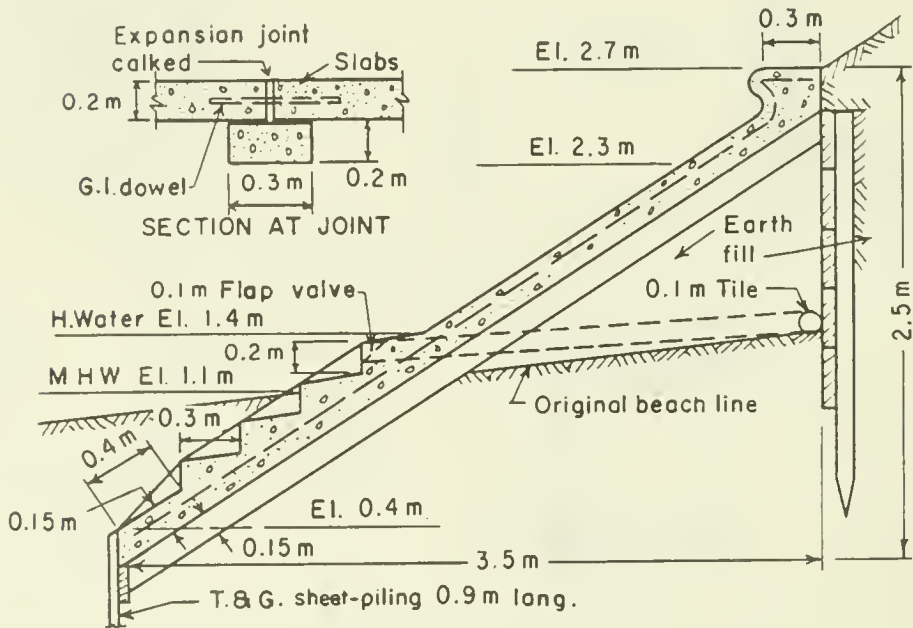

Figure 6-9. Concrete revetment.



Chesapeake Bay, Maryland (1972)

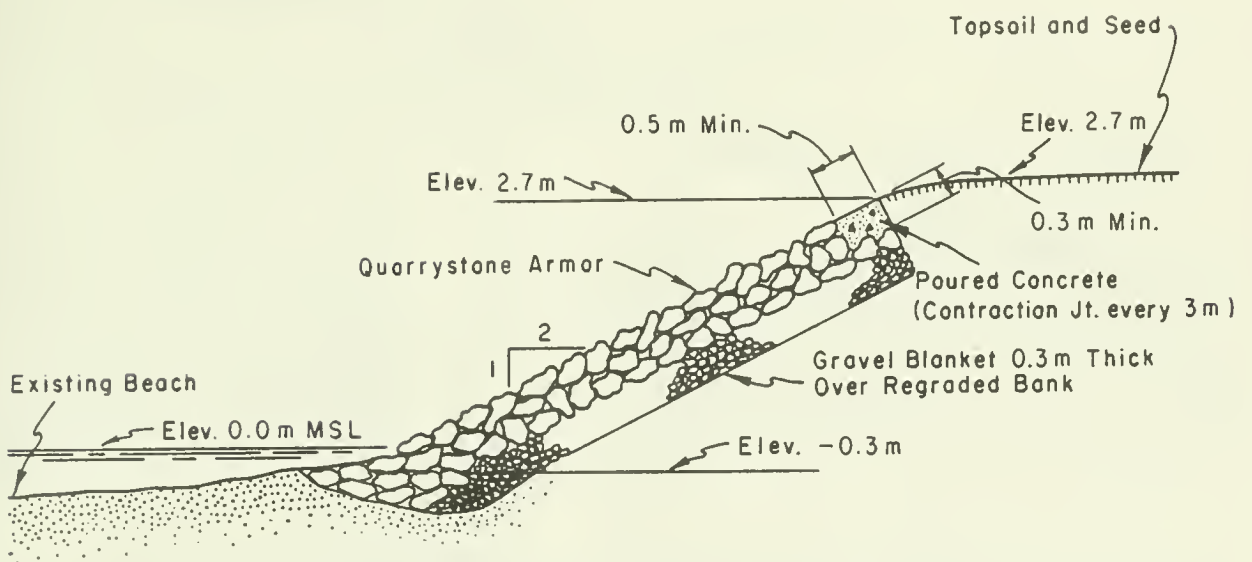

Figure 6-10. Quarrystone revetment.



Jupiter Island, Florida (1965)
 (photo, courtesy of Carthage Mills Inc.)

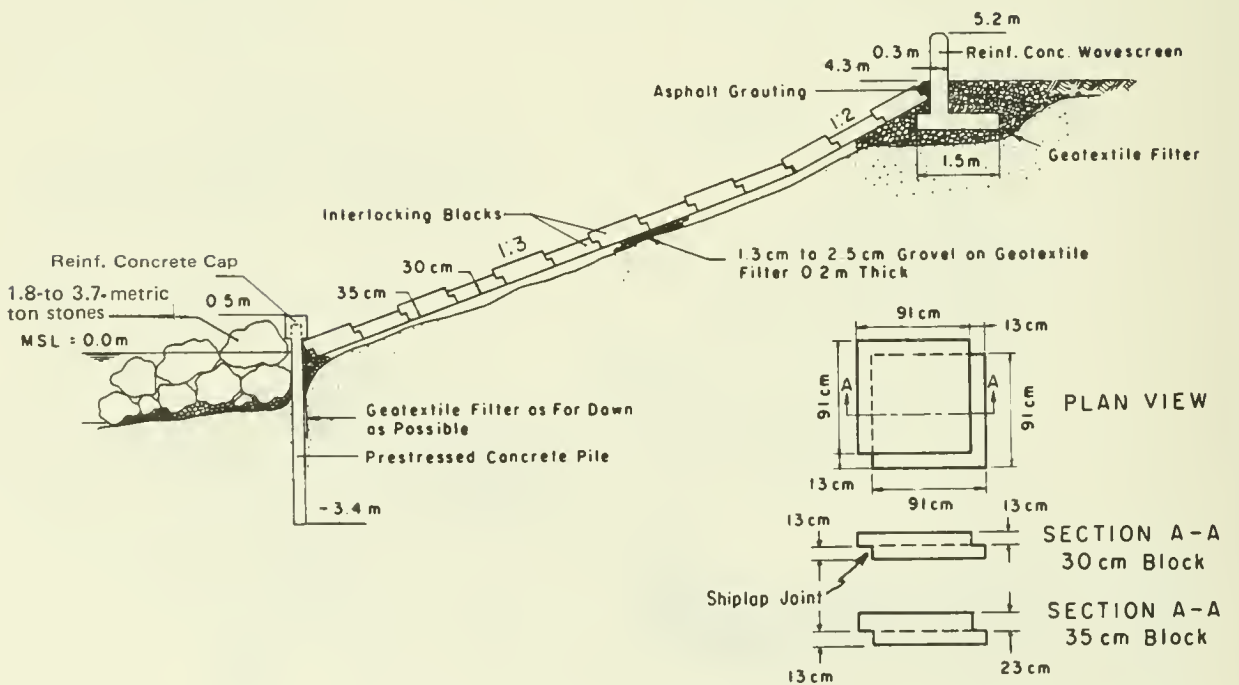
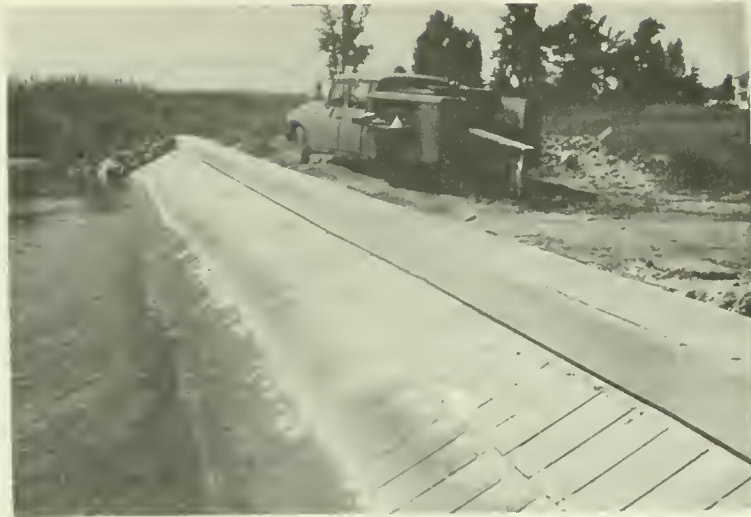

Figure 6-11. Interlocking concrete-block revetment.



Cedarhurst, Maryland (1970)

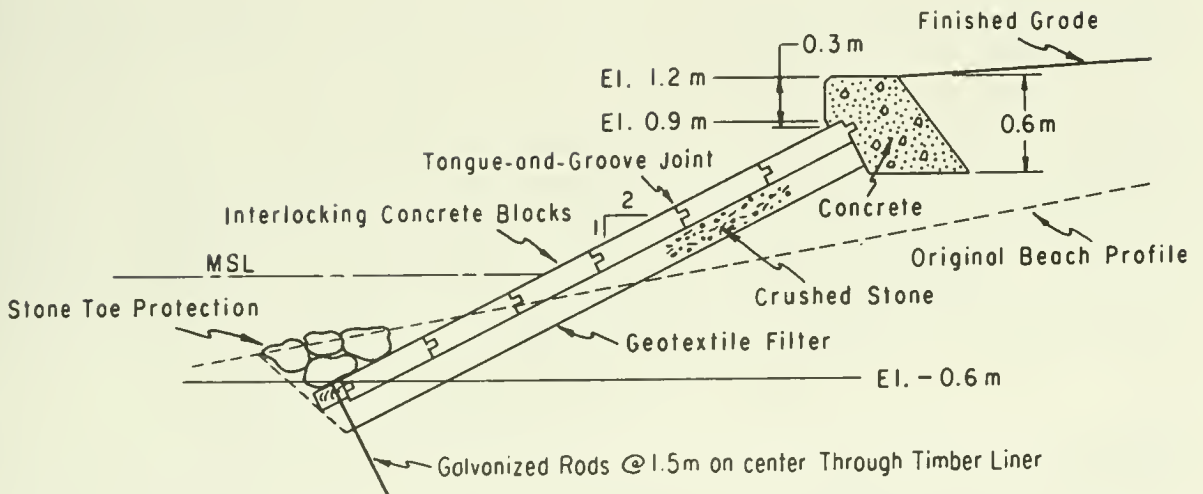

Figure 6-12. Interlocking concrete-block revetment.

The stability of an interlocking concrete block depends largely on the type of mechanical interlock. It is impossible to analyze block stability under specified wave action based on the weight alone. However, prototype tests at the U.S. Army Engineer Waterways Experiment Station Coastal Engineering Research Center (CERC), on blocks having shiplap joints and tongue-and-groove joints indicate that the stability of tongue-and-groove blocks is much greater than the shiplap blocks (Hall, 1967). An installation of the tongue-and-groove interlock block is shown in Figure 6-12.

2. Selection of Structural Type.

Major considerations for selection of a structural type are as follows: foundation conditions, exposure to wave action, availability of materials, both initial costs and repair costs, and past performance.

a. Foundation Conditions. Foundation conditions may have a significant influence on the selection of the type of structure and can be considered from two general aspects. First, foundation material must be compatible with the type of structure. A structure that depends on penetration for stability is not suitable for a rock bottom. Random stone or some type of flexible structure using a stone mat or geotextile filter could be used on a soft bottom, although a cellular-steel sheet-pile structure might be used under these conditions. Second, the presence of a seawall, bulkhead, or revetment may induce bottom scour and cause failure. Thus, a masonry or mass concrete wall must be protected from the effects of settlement due to bottom scour induced by the wall itself.

b. Exposure to Wave Action. Wave exposure may control the selection of both the structural type and the details of design geometry. In areas of severe wave action, light structures such as timber crib or light riprap revetment should not be used. Where waves are high, a curved, reentrant face wall or possibly a combination of a stepped-face wall with a recurved upper face may be considered over a stepped-face wall.

c. Availability of Materials. This factor is related to construction and maintenance costs as well as to structural type. If materials are not available near the construction site, or are in short supply, a particular type of seawall or bulkhead may not be economically feasible. A cost compromise may have to be made or a lesser degree of protection provided. Cost analysis includes the initial costs of design and construction and the annual costs over the economic life of the structure. Annual costs include interest and amortization on the investment, plus average maintenance costs. The best structure is one that provides the desired protection at the lowest annual or total cost. Because of wide variations in the initial cost and maintenance costs, comparison is usually made by reducing all costs to an annual basis for the estimated economic life of the structure.

III. PROTECTIVE BEACHES

1. General.

Planning analysis for a protective beach is described in Chapter 5, Section III. The two primary methods of placing sand on a protective beach are by land-hauling from a nearby borrow area or by the direct pumping of sand through a pipeline from subaqueous borrow areas onto the beach using a floating dredge. Two basic types of floating dredges exist that can remove material from the bottom and pump it onto the beach. These are the hopper dredge (with pump-out capability) and the hydraulic pipeline dredges. A discussion of the above dredges and their application to beach nourishment is presented by Richardson (1976) and the U.S. Army Corps of Engineers (1983a). Hydraulic pipeline dredges are better suited to sheltered waters where the wave action is limited to less than 1 meter (3 feet), but many of the recent nourishment projects have used an offshore borrow source. This has resulted in specially equipped dredges and new dredging techniques.

One of the earliest uses of a hydraulic pipeline dredge in an exposed high-wave energy offshore location was at Redondo Beach, Malaga Cove, California in 1968 (see Ch. 6, Sec. III,2,b). This dredge was held in position by cables and anchors rather than spuds and used a flexible suction

line with jet agitation rather than the conventional rigid ladder and cutterhead. Dredges with a rigid ladder and cutterhead were used on beach fills at Pompano Beach and Fort Pierce, Florida, where the borrow area was offshore on the open ocean.

Some hopper dredges are now available with pump-out capability. After loading at the borrow site (normally offshore), the hopper dredge then moves close to the fill site and pumps sand from the hoppers through a submerged pipeline to the beach. This method is particularly applicable to sites where the offshore borrow area is a considerable distance from the beach restoration project. This method was tested successfully in 1966 at Sea Girt, New Jersey (Mauriello, 1967; U.S. Army Engineer District, Philadelphia, 1967). As offshore borrow areas in the immediate vicinity of protective beach projects become scarce, the use of hopper dredges may become more appropriate.

The choice of borrow method depends on the location of the borrow source and the availability of suitable equipment. Borrow sources in bays and lagoons may become depleted, or unexploitable because of injurious ecological effects. It is now necessary to place increased reliance on offshore sources. CERC reports on the geomorphology, sediments, and structure of the Inner Continental Shelf with the primary purpose of finding sand deposits suitable for beach fill are summarized in Table 6-1. Hobson (1981) presents sediment characteristics and beach-fill designs for 20 selected U.S. sites where the use of offshore borrow sites has been suggested. Sand from offshore sources is frequently of better quality for beach fill because it contains less fine-grained sediments than lagoonal deposits. Equipment and techniques are currently capable of exploiting offshore borrow sources only to a limited extent; and as improved equipment becomes available, offshore borrow areas will become even more important sources of beach-fill material.

Table 6-1. CERC research reports on the geomorphology and sediments of the Inner Continental Shelf.

Region	Reference
Palm Beach to Miami, Florida	Duane and Meisburger (1969)
Cape Canaveral to Palm Beach, Florida	Meisburger and Duane (1971)
Chesapeake Bay Entrance	Meisburger (1972)
Cape Canaveral, Florida	Field and Duane (1974)
New York Bight	Williams and Duane (1974)
North Eastern Florida Coast	Meisburger and Field (1975)
Western Massachusetts Bay	Meisburger (1976)
Long Island Shores	Williams (1976)
Cape Fear Region, North Carolina	Meisburger (1977 and 1979)
Delaware-Maryland Coast	Field (1979)
Southeastern Lake Michigan	Meisburger, Williams, and Prins (1979)
Galveston, Texas	Williams, Prins, and Meisburger (1979)
Cape May, New Jersey	Meisburger and Williams (1980)
South Lake Erie, Ohio	Williams, et al. (1980)
Long Island Sound	Williams (1981)
Central New Jersey Coast	Meisburger and Williams (1982)

2. Existing Protective Beaches.

Restoration and widening of beaches have come into increasing use in recent years. Examples are Corpus Christi Beach, Texas (U.S. Army Engineer District, Galveston, 1969); Wrightsville Beach and Carolina Beach, North Carolina (Vallianos, 1970); and Rockaway Beach, New York (Nersesian, 1977). Figures 6-13 to 6-20 illustrate details of these projects with before-and-after photos. Table 6-2 presents a fairly complete listing of beach restoration projects of fill lengths greater than 1.6 kilometers (1 mile) that have been completed in the United States. In 1968, beach widening and nourishment from an offshore source was accomplished by a pipeline dredge at Redondo Beach, California. As previously mentioned, this was one of the first attempts to obtain beach fill from a high wave energy location exposed offshore using a pipeline dredge (see Ch. 6, Sec. III,2,b). The largest beach restoration project ever undertaken in the United States was recently completed in Dade County, Florida (see Ch. 6, Sec. III,2,c). Of the projects mentioned, Carolina Beach, Redondo Beach, and the Dade County beaches are discussed below.

a. Carolina Beach, North Carolina. A protective beach was part of the project at Carolina Beach (Figs. 6-17 and 6-18 illustrate the planning and effects of such a protective beach at Corpus Christi, Texas). The project also included hurricane protection; however, the discussion of protective beach planning in this chapter includes only the feature that would have been provided for beach erosion control. The report on which the project is based was completed in 1961 (U.S. Army Engineer District, Wilmington, 1961), and the project was partly constructed in 1965.

The predominant direction of longshore transport is from north to south. This conclusion was based on southerly growth of an offshore bar at Carolina Beach Inlet and on shoaling at Cape Fear, 19 kilometers (12 miles) south of Carolina Beach. Subsequent erosion south of Carolina Beach Inlet and accretion north of the jetty at Masonboro Inlet, about 14 kilometers (9 miles) north of Carolina Beach, have confirmed the direction. The long-term average annual deficiency in material supply for the area was estimated in the basic report at about 10 cubic meters per linear meter (4 cubic yards per linear foot) of beach. This estimate was based on the rate of loss from 1938 to 1957, from the dune line to the 7-meter (24-foot) depth contour. Carolina Beach Inlet, opened in 1952, apparently had little effect on the shore of Carolina Beach before 1957; therefore, that deficiency in supply was considered the normal deficiency without regard to the new inlet.

For planning, it was estimated that 60 percent of the material in the proposed borrow area in Myrtle Sound (behind Carolina Beach) would be compatible with the native material on the beach and nearshore bottom and would be suitable for beach fill. This estimate assumed that 40 percent of the borrow material was finer in size characteristics than the existing beach material, and therefore would be winnowed due to its incompatibility with the wave climate. The method of Krumbain and James (1965) was considered for determining the volume of fill to be placed. However, insufficient samples were taken from the foreshore and nearshore slopes to develop characteristics of the grain-size distribution for the native beach sand.



Before restoration

(Aug. 1977)



After restoration

(Mar. 1978)

Figure 6-13. Protective beach, Corpus Christi, Texas.

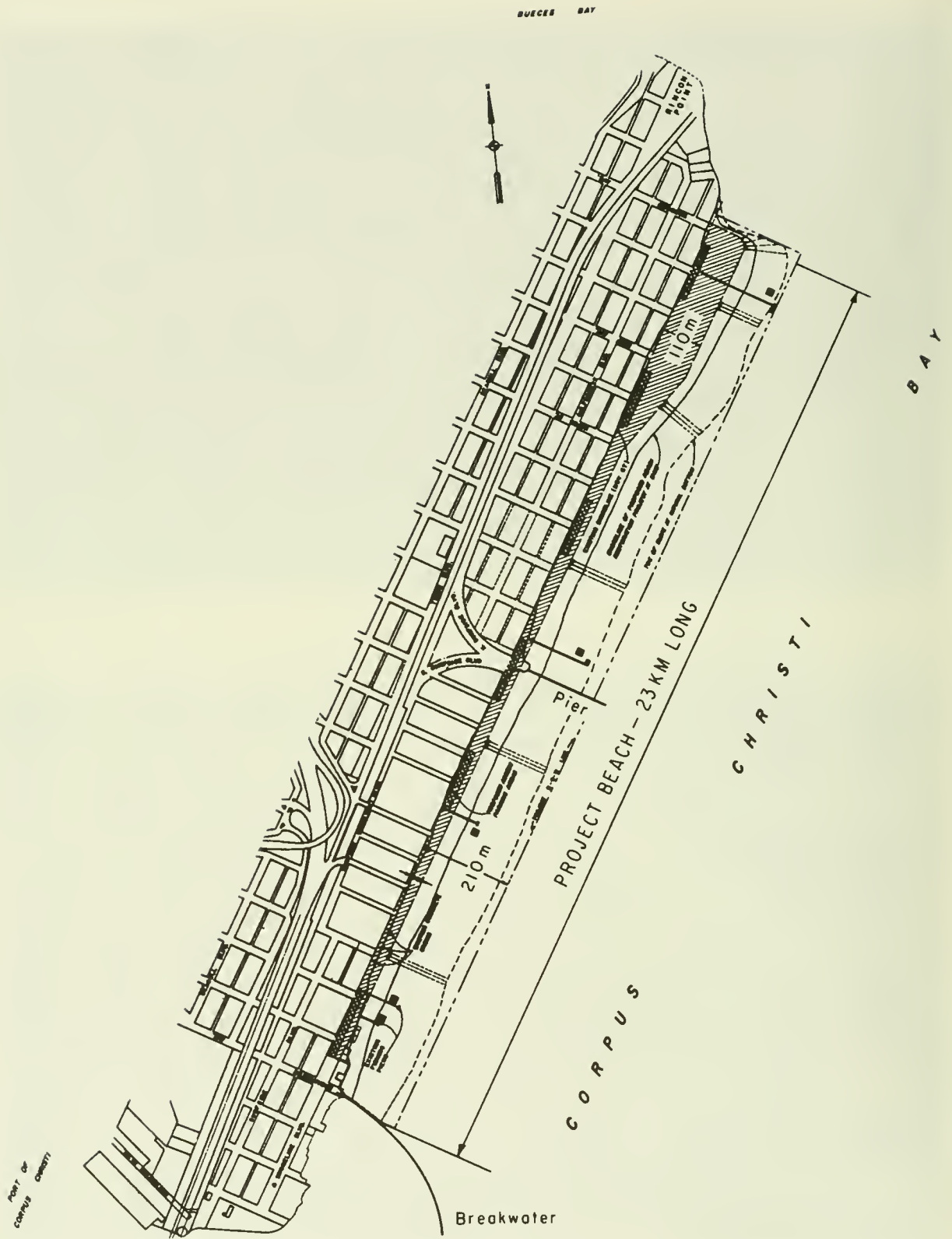

Figure 6-14. Protective beach, Corpus Christi, Texas.



(Feb. 1965)

Before restoration



(June 1965)

After restoration

Figure 6-15. Protective beach, Wrightsville Beach, North Carolina.



(Oct. 1979)

Fourteen years after restoration

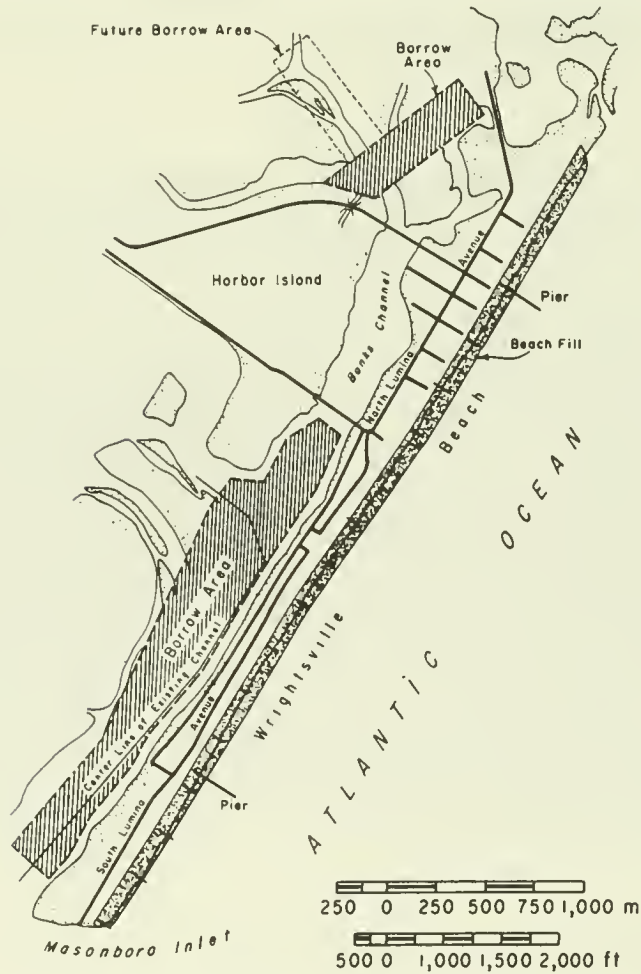

Figure 6-16. Protective beach, Wrightsville Beach, North Carolina.



Before restoration

(1964)



After restoration

(1965)

Figure 6-17. Protective beach, Carolina Beach, North Carolina.



(June 1981)

Sixteen years after restoration

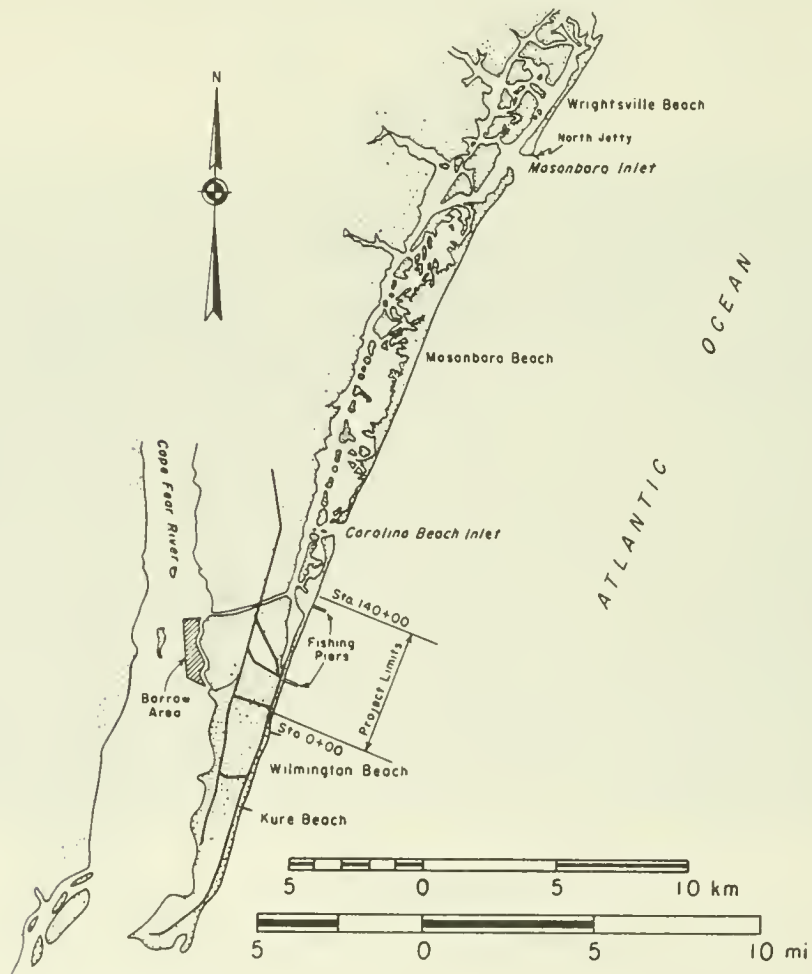
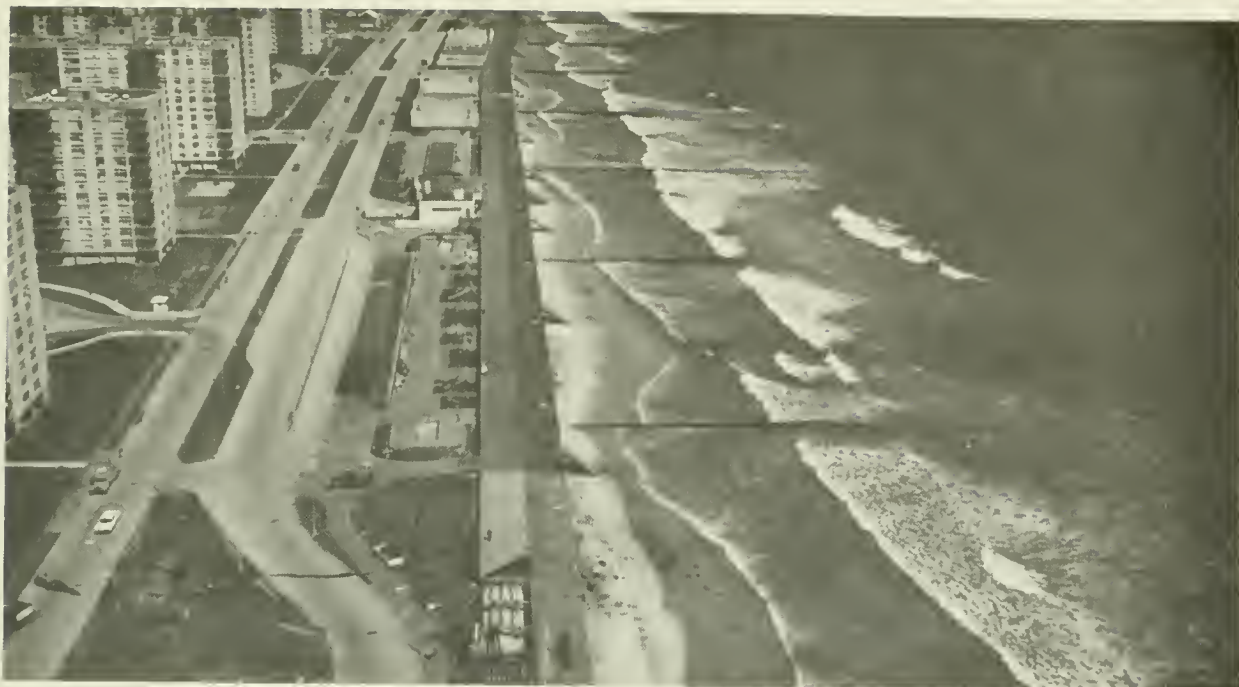

Figure 6-18. Protective beach, Carolina Beach, North Carolina.



Before restoration

(Apr. 1973)



During restoration

(July 1975)

Figure 6-19. Protective beach, Rockaway Beach, New York.

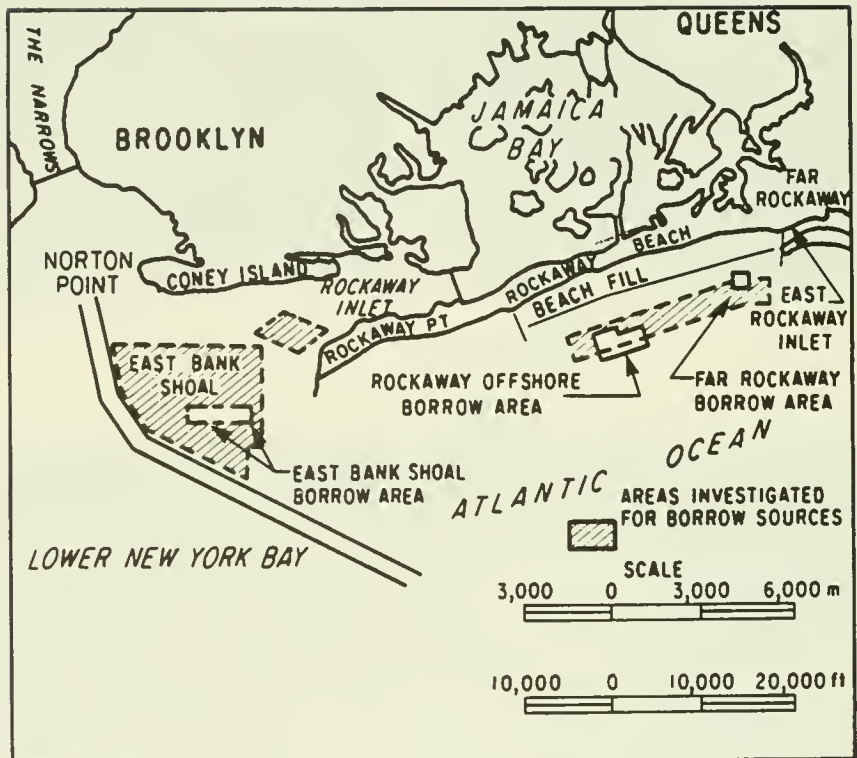

Figure 6-20. Protective beach, Rockaway Beach, New York.

Table 6-2. Beach restoration projects in the United States.

Project	Date	Length of fill		Volume of fill		Source of fill material	Method of placement	Periodic maintenance		
		(km)	(mi)	(m ³)	(yd ³)			(m ³)	(yd ³)	(date)
Hampton Beach, N.H.	1955	1.6	1.0	303,500	397,000	Hampton Harbor	Hydraulic dredge	105,500 43,600	138,000 57,000	1965 1973
Sand Hill Cove Beach Narragansett, R.I.	1955	1.6	1.0	32,000	42,000	Port Judith Harbor	Hydraulic dredge			
Sherwood Island State Park, Westport, Conn.	1957	1.8	1.1	401,400	535,000	Offshore	Hydraulic dredge			
Seaside Park Bridgeport, Conn.	1957	2.7	1.7	420,500	550,000	Offshore	Hydraulic dredge			
Prospect Beach West Haven, Conn.	1957	1.8	1.1	338,700	443,000	Offshore	Hydraulic dredge			
Hammonasset Beach Madison, Conn.	1955	3.0	1.9	268,400	351,000	Offshore	Hydraulic dredge			
Quincy Shore Beach Quincy, Mass.	1959	2.6	1.6	403,300	527,500	Land	Truck hauled			
Fire Island Inlet to Jones Inlet, N.Y.	1977	3.4	2.1	3,212,100	4,212,300	Navigation channel				
Rockaway Beach, N.Y.	1977	10.0	6.2	4,712,000	6,163,000	Offshore	Hydraulic dredge			
Barnegat Inlet, Long Beach Island, N.J.	1979	3.7	2.3	740,000	968,000	Barnegat Inlet	Hydraulic dredge			
Atlantic City, N.J.	1970	1.6	1.0	634,600	830,000	Abaecon Inlet	Hydraulic dredge			
Ocean City Beach, N.J.	1952	3.1	1.9	1,949,600	2,550,000	Lagoon	Hydraulic dredge			
Virginia Beach, Va.	1953	5.3	3.3	1,070,400	1,400,000	Owl's Creek	Hydraulic dredge	114,700	150,000	Estimated annually
Carolina Beach, N.C.	1965	4.3	2.7	2,012,300	2,632,000	Myrtle Sound	Hydraulic dredge	275,200 845,600 305,800	360,000 1,106,000 400,000	1967 1970 1981
Wrightsville Beach, N.C.	1966	5.2	3.2	2,517,700	3,293,000	Banka Channel Masonboro Inlet	Hydraulic dredge	1,022,200	1,337,000	1970
Fort Macon State Park, N.C.	NA	2.4	1.5	NA	NA	NA	NA			
Hunting Island Beach, N.C.	1968	3.1	1.9	573,400	750,000	Inlet	Hydraulic dredge	582,100 468,700 1,080,100	761,300 613,000 1,412,700	1971 1975 1980
Tybee Island, Ga.	1976	4.2	2.6	1,729,500	2,262,000	Sandbar off Tybee	Hydraulic dredge	76,500	100,000	Estimated annually
Cape Canaveral, Fla.	1975	3.4	2.1	1,758,500	2,300,000	Trident sub- marine basin	Hydraulic dredge			
Fort Pierce, Fla.	1971	2.1	1.3	549,000	718,000	Offshore	Hydraulic dredge			
Jupiter Island, Fla.	1974	8.0	5.0	2,581,100	3,376,000	Offshore	Hydraulic dredge			
Delray Beach, Fla.	1973	4.5	2.8	1,249,700	1,624,500	Offshore	Hydraulic dredge			
Pompsno Beach, Fla.	1970	5.1	3.2	789,800	1,033,000	Offshore	Hydraulic dredge			
Dade County, Fla.	1982	16.9	10.5	10,321,500	13,500,000	Offshore	Hydraulic dredge			
Duval County, Fla.	1979	16.1	10.0	1,720,200	2,250,000	Offshore	Hydraulic dredge			
Virginia Key, Fla.	1969	2.1	1.3	135,300	177,000	Offshore	Hydraulic dredge	76,500	100,000	1973
Key Biscayne, Fla.	1969	1.9	1.2	149,900	196,000	Offshore	Hydraulic dredge			
Treasure Island, Fla.	1969	2.7	1.7	606,300	793,000	Blind Pasa Offshore	Hydraulic dredge	58,100 118,500	76,000 155,000	1971 1972
Indian Rocks Beach, Fla.	1969 1973	1.7 7.3	1.1 4.5	76,500 305,800	100,000 400,000	Offshore	Hydraulic dredge Truck hauled			
Harrison County, Miss.	1951	40.2	25.0	5,355,000	7,004,000	Offshore	Hydraulic dredge	1,472,500	1,926,000	1973
Corpus Christi, Tex.	1978	2.3	1.4	646,000	845,000	Bay deposits Upland deposits	Hydraulic dredge Truck hauled			
Doheny Street Beach, Calif.	1966	1.8	1.1	714,100	934,000	Upland deposits	Truck hauled	17,600	23,000	Estimated annually
Oceanside, Calif.	1963	5.3	3.3	2,905,300	3,800,000	Oceanside small- craft harbor	Hydraulic dredge			
Redondo Beach, Calif.	1968	2.4	1.5	1,075,000	1,406,000	Offshore	Hydraulic dredge			
San Buenaventure Street Beach, Calif.	1967	3.7	2.3	674,300	882,000	Ventura Harbor	Hydraulic dredge			1975
Sunset Beach Surfside, Calif.	1971	2.8	1.7	4,865,600	6,364,000	Offshore to Feeder Beach	Hydraulic dredge			
Newport Beach, Calif.	1973	3.7	2.3	1,530,600	2,002,000	Offshore	Hydraulic dredge	688,100	900,000	1969
Ediz Hook, Port Angeles, Wash.	1977	4.8	3.0	68,800	90,000	Upland gravel	Truck hauled			

Although samples taken from the beach after construction may not be entirely indicative of the characteristics of the native sand, they do represent to some extent the borrow material after it has been subjected to wave action, presumably typical of the wave climate associated with sorting on the natural beach. Samples taken from the original borrow material and from the active beach profile in May 1967 were therefore used to estimate the amount of material lost from the original fill as a result of the sorting action.

Using the 1967 beach as the native beach, the standard deviations, $\sigma_{\phi b}$ and $\sigma_{\phi n}$, of the borrow and native materials are 1.28 and 0.91, respectively. The phi means, $M_{\phi b}$ and $M_{\phi n}$, of the borrow and native materials are 0.88 and 1.69, respectively. Using the older method of Krumbein and James (1965), the upper bound of the fill factor was computed to be 2.1, indicating that for every cubic meter of material on the active profile in 1967 not more than 2.1 cubic meters of borrow material should have been placed. Because the native beach material was not adequately sampled to develop the characteristics of the grain-size distribution, no further attempt is made to compare the project results with the procedures described in Chapter 5, Section III,3,c.

In April 1965, approximately 2,012,300 cubic meters (2,632,000 cubic yards) of borrow material were placed along the 4300 meters (14,000 feet) of Carolina Beach (Vallianos, 1970). Figure 6-17 shows the before-and-after conditions of the beach. The fill consisted of a dune having a width of 7.6 meters (25 feet) at an elevation of 4.6 meters (15 feet) above mean low water (MLW), fronted by a 15-meter-wide (50 foot) berm at an elevation of 3.7 meters (12 feet) above MLW. Along the northernmost 1,100 meters (3,700 feet) of the project, (Fig. 6-18), the berm was widened to 21 meters (70 feet) to provide a beach nourishment stockpile.

Following construction, rapid erosion occurred along the entire length of the beach fill. Initial adjustments were expected based on the use of a fill factor of 2.1 based on Krumbein and James (1965) criteria. This resulted in an excess of 1,032,000 cubic meters (1,350,000 cubic yards) of fill being placed on the beach to account for the unsuitability of part of the borrow material. However, the actual rates of change, particularly those evidenced along the onshore section of the project, were much greater than was originally anticipated considering that all the fill had not been subjected to winnowing by wave action.

In the first 2 years, erosion persisted at Carolina Beach along the entire length of the fill. The erosion along the southern 3,000 meters (10,000 feet) of the project was less than that along the northern 1,200 meters (4,000 feet).

During the period 1965-67, approximately 544,400 cubic meters (712,000 cubic yards) of the 1,263,000 cubic meters (1,652,000 cubic yards) initially placed on the southern 3,000-meter section moved offshore to depths seaward of the 7-meter contour. Although this loss was about 43 percent of the total original fill placed, in terms of fill protection, it was as planned considering the suitability of the borrow material. Beach changes resulted in a 25-meter (82-foot) recession of the high water line (HWL) and the loss of the horizontal berm of the design profile. By the end of the second year, the southern 3,000 linear meters of project was stabilized.

In the first 2 years after the initial placement of 749,300 cubic meters (980,000 cubic yards) of fill along the 1200-meter northern section of the project, beach changes were greater than those in the longer, southern section. Although about 420,500 cubic meters (550,000 cubic yards) of fill was lost from the active profile, amounting to a 56-percent reduction in the total in-place fill, this only exceeded the anticipated winnowing loss by about 9 percent. By March 1967, the HWL along this section receded 43 meters (140 feet), resulting in the complete loss of 460 linear meters (1,500 linear feet) of original fill and the severe loss of an additional 360 meters (1,200 feet) of fill. This erosion progressed rapidly in a southward direction and threatened the more stable southern section of the project.

In March 1967, emergency measures were taken. The north end of Carolina Beach was restored by placing about 275,000 cubic meters (360,000 cubic yards) of fill and by building a 123-meter (405 foot) groin near the north end. The groin was necessary because there was a reversal in the predominant direction of the longshore transport at the north end. In the next year, approximately 155,200 cubic meters (203,000 cubic yards) of emergency fill eroded, and most of the shoreline returned to about normal configuration before the emergency work. The shoreline immediately south of the groin, for a distance of about 120 meters (400 feet), remained nearly stable, and the loss of emergency fill along this small segment was about 42 percent less than the loss along the remaining emergency section.

Survey records from 1938 to 1957 (reported in the original project report) show that the average annual recession rate was about 0.3 meter (1 foot) per year, with a short-term maximum rate of 0.9 meter (2.8 feet) from 1952 to 1957, when the area had been exposed to four major hurricanes. The annual loss of material for the entire active profile was estimated to be about 10 cubic meters per linear meter (4 cubic yards per linear foot).

During the 2 years following the fill, the effects of shore processes were radically different from processes determined from historical records. During the periods April 1965 to April 1966 and April 1966 to April 1967, the shoreline receded 20 and 5 meters (67 and 15 feet), respectively, with corresponding losses of 283,000 and 261,500 cubic meters (370,000 and 342,000 cubic yards). In the third year, April 1967 to April 1968, a marked change occurred in fill response. The rate of shoreline recession dropped to 1.5 meters (5 feet) per year, and the volume change of material amounted to a slight accretion of about 13,000 cubic meters (17,000 cubic yards). Surveys in 1969 indicated that the project was in nearly the same condition as it was in 1968.

Rapid recession of the Carolina Beach shoreline during the first 2 years was a result of the profile adjustment along the active profile which terminates at depths between -7 and -9 meters (-22 and -30 feet) MLW, as well as net losses in volume resulting from the natural sorting action displacing the fine material to depths seaward of the active profile. The foreshore and nearshore design profile slope of 1 on 20 was terminated at a depth of 1.2 meters (4 feet) below MLW. The adjusted project profile of April 1968 shows the actual profile closing at a depth of about 7 meters below MLW, with a characteristic bar and trough system. Thus, displacement of the initial fill with the accompanying reduction of the beach design section resulted from a

normal sorting action and the reestablishment of the normal profile configuration.

Further protective action was completed on Carolina Beach in December 1970. A 340-meter (1,100-foot) rubble-mound seawall was constructed, extending southward from the northern limit of the project. At the same time 264,500 cubic meters (346,000 cubic yards) of fill, obtained from the sediment deposition basin in Carolina Beach Inlet, was placed along the northern 1200 meters of the project. This was followed up by the placement of 581,000 cubic meters (760,000 cubic yards) of fill along the southern 3500 meters (11,400 feet) of beach. Work on the southern section was completed in May 1971, and the beach-fill material was obtained from a borrow area in the Cape Fear River. The rubble-mound seawall was extended an additional 290 meters (950 feet) southward, with the work being completed in September 1973. This brought the total length of the seawall to 625 meters (2,050 feet).

Progressive erosion along the north end of the project and the occurrence of two "northeasters" during December 1980 resulted in the partial destruction and condemnation of about 10 homes immediately south of the southern end of the seawall. Non-Federal interests placed large sandfilled nylon bags (emergency protection devices) along 230 meters (750 feet) of the shoreline to prevent any further damage to upland property.

During May 1981, 230,000 cubic meters (300,000 cubic yards) of fill from Carolina Beach Inlet and 76,500 cubic meters (100,000 cubic yards) from the Atlantic Intercoastal Waterway was placed on the northern end of the project as an emergency measure. Present plans call for placement of 2,900,000 cubic meters (3,800,000 cubic yards) of fill to be obtained from an upland borrow area adjacent to the Cape Fear River. This work was scheduled for spring 1982. The photo in Figure 6-18 shows the condition of Carolina Beach in 1981. The view is facing southward from the northern fishing pier (approximately the same as Fig. 6-17).

b. Redondo Beach (Malaga Cove), California (Fisher, 1969; U.S. Army Engineer District, Los Angeles, 1970; Hands, in preparation, 1985). An authorized beach restoration project at Redondo Beach, California, provided another opportunity to use an offshore sand source (see Figs. 6-21 and 6-22). The availability of sand below the 9-meter contour immediately seaward of the project was investigated in two stages. The first stage, a geophysical survey with an acoustical profiler indicated that enough sand was available for the project. In the second stage, core samples were obtained from the ocean by use of a vibrating core-extraction device. An analysis of the core samples verified an offshore sand source of acceptable quantity and quality. This source covered an area 2.3 kilometers (1.4 miles) long by 0.8 kilometer (0.5 mile) wide about 340 meters offshore (shoreward limit). It would produce 1,900,000 cubic meters (2,500,000 cubic yards) of sand if it could be worked to a depth 16 meters (52 feet) below mean low low water (MLLW) between the 9- to 18-meter-depth (30- to 60-foot) contours. An additional 1,900,000 cubic meters of sand could be recovered by extending the depth of the excavation to



(Feb. 1965)

Before restoration



(Sept. 1968)

After restoration

Figure 6-21. Protective beach, Redondo Beach, California (photos courtesy of Shellmaker Corporation).

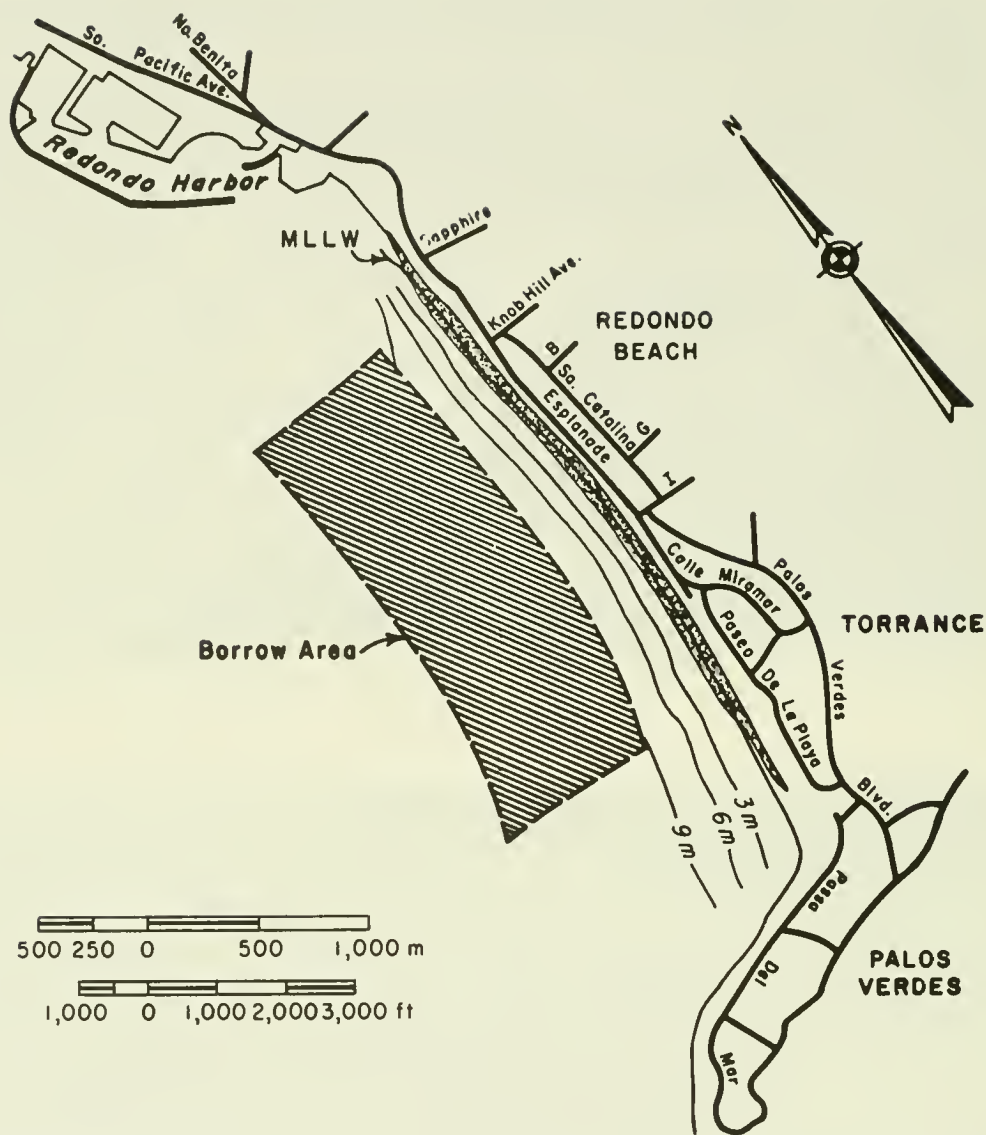

Figure 6-22. Map of protective beach, Redondo Beach, California.

18 meters below MLLW. The median diameter of the beach sand was 0.5 millimeter; the median diameter of the offshore sand ranged from 0.4 to 0.7 millimeter. The offshore sand was considered an excellent source of material for beach replenishment. Several land sources were also investigated and found suitable in quantity and quality for the project.

Bids received in August 1967 for land hauling or ocean dredging ranged from \$1.40 per cubic meter (\$1.07 per cubic yard) to more than \$2.60 per cubic meter (\$2.00 per cubic yard). A contract was awarded to obtain the sand from the ocean source. The contractor used a modified 40-centimeter-diameter (16-inch) hydraulic pipeline dredge, with a water-jet head on the end of a 27-meter (90-foot) ladder. Although the water-jet technique had been used in excavating channels, filling and emptying cofferdams, and prospecting for minerals in rivers, its application to dredging in the ocean appears to be

unique. Ultimately, the dredge operated in seas up to 1.5 meters; when the seas exceeded 2 meters (6 feet), it proceeded to Redondo Harbor for shelter. Of particular interest in this project is the use of a pipeline dredge in a high wave energy coastal area. This area is subject to high-energy waves with little advance warning. These waves can quickly exceed the operating conditions of the dredge.

The dredge was held in position with its beam to the sea by an arrangement of the stern and bowlines. On the end of the dredge ladder was a combination head that provided both cutting and suction action. The force to lift the suspended material was provided by a suction pump in the dredge well, assisted by water jets powered by a separate 185-kilowatt (250-horsepower) pump. Sand was removed by working the head down to the bottom of the cut and keeping it in that position until the sandy material stopped running to the head. The head was then raised, and the dredge would pivot about 12 meters (40 feet) to the next position in the cutting row, where the process would be repeated. The dredge could cut a row 76 meters (250 feet) wide. At the completion of a row, the dredge was moved ahead on its lines about 12 meters for the next row cut. For most of the Redondo Beach project it was possible to excavate to -17 to -20 meters (-55 to -65 feet) with a cutback of 6 to 9 meters (20 to 30 feet). This is desirable for high production because it minimizes moving and swinging of the dredge.

The sand slurry was transported ashore through a combination pontoon and submerged line. The pontoon line was a 40-centimeter-diameter pipe supported in 18-meter lengths by steel pontoons. The submerged steel pipeline was joined to the floating line by a flexible rubber hose. As the beach fill progressed, the submerged line was moved by capping the shore end of the discharge and then pumping water out of the line. This created a floating pipeline that was towed to the next discharge position. As pumping resumed, the pipeline filled and sank to the bottom.

The fill was accomplished by a double-pipe system. The system consisted of a yoke attached to the discharge line and, by use of a double-valve arrangement, the discharge slurry was selectively distributed to either one pipe or the other, or to both pipes simultaneously. The beach was built by placing the first discharge pipe at the desired final fill elevation, in this case at +3.7 meters MLLW, and pumping until the desired elevation was reached. By alternating between the two discharge lines, the beach width of 60 meters (200 feet) was built to the full cross section as they advanced. The final placement (see Fig. 6-21) totaled 1.1 million cubic meters (1.4 million cubic yards) at a cost of \$1.5 million. Between 3000 and 11,500 cubic meters (4,000 and 15,000 cubic yards) per day were placed on the beach, averaging 6,000 cubic meters (8,000 cubic yards) per day. The work was completed in October 1968.

A substantial reduction in beach width occurred during the first year. Some of the fill material was transported onto the backshore above the +3.7-meter MLLW contour. More material was transported offshore. While these initial changes did reduce the beach width, they also increased beach stability, and the rate of retreat dropped significantly in subsequent years. A recent study (Hands, in preparation, 1985) documents the long-term stability of the fill material at Redondo Beach. No additional maintenance material has been placed on the beach to date (1981), and after 12 years much of the

original fill material remains on the upper beach. During this time, the 1968 artificial borrow pit, which parallels the beach about 430 meters (1,400 feet) from shore, has shoaled to about half its original depth with sand moving in from deeper water. The position of the borrow zone, just seaward of the 9-meter MLLW contour, was thus well chosen for this site as it is beyond the zone of cyclic onshore and offshore sand transport of beach material. Large volumes of sand are transported offshore at Redondo Beach during storms and particularly during the winter season, then returned by natural onshore transport during summer swells. The offshore borrow pit is far enough seaward so that it does not trap this beach sand or interfere with its cyclic exchange between the beach and the nearshore profile.

This was the first project in the United States where a hydraulic pipeline dredge was operated successfully in a high wave energy coastal area. Although highly successful in this project, this procedure has a critical limitation--the necessity for a nearby harbor. The experience gained on this project and the hopper-dredge operation at Sea Girt, New Jersey (Mauriello, 1967; U.S. Army Engineer District, Philadelphia, 1967) provided the techniques for many subsequent beach nourishment projects that utilized offshore sand deposits.

c. Dade County, Florida (U.S. Army Engineer District, Jacksonville, 1975). The Dade County Beach Erosion and Hurricane Protection Project, which includes Miami beach, was designed to provide beach nourishment and storm surge protection for one of the most highly developed beach-front areas on the Atlantic coast. Erosion, greatly accelerated by manmade structures and modifications, had reduced the beach along this part of the barrier island to the point where ocean waves often reached the many protective seawalls built by hotel and private property owners.

The project includes about 16.1 kilometers (10 miles) of shore between Government Cut to the south and Bakers Haulover Inlet (see Figs. 6-23 and 6-24). The plan called for an initial placement of 10.3 million cubic meters (13.5 million cubic yards) of beach-fill material. This placement provided a dune 6 meters wide at 3.5 meters (11.5 feet) above MLW and a dry beach 55 meters (180 feet) wide at an elevation 3 meters (9 feet) above MLW, with natural slopes as shaped by the wave action. At Haulover Beach Park the plan provided a level berm 15 meters wide at elevation 3 meters above MLW with natural slopes. In addition, the project provides for periodic beach nourishment to compensate for erosion losses during the first 10 years following the initial construction. The nourishment requirements are estimated to be at the annual rates of 161,300 cubic meters (211,000 cubic yards) of material. Nourishment would be scheduled at 5-year intervals, or as needed. The estimated project costs of about \$67 million (1980 dollars), with the Federal share at 58.7 percent, include the 10-year beach nourishment.

In July 1975, the city of Bal Harbor initiated the project by the placement of 1,242,400 cubic meters (1,625,000) cubic yards) of beach fill over a 1.37-kilometer (0.85-mile) segment of shore fronting the city. In addition, the south jetty of Bakers Haulover Inlet was extended to a total length of about 245 meters (800 feet).

Because of the project size, the remaining 15.53 kilometers (9.65 miles)



(Feb. 1978)

Before restoration



(Oct. 1979)

After restoration

Figure 6-23. View of protective beach facing north from 48th Street, Dade County, Florida.

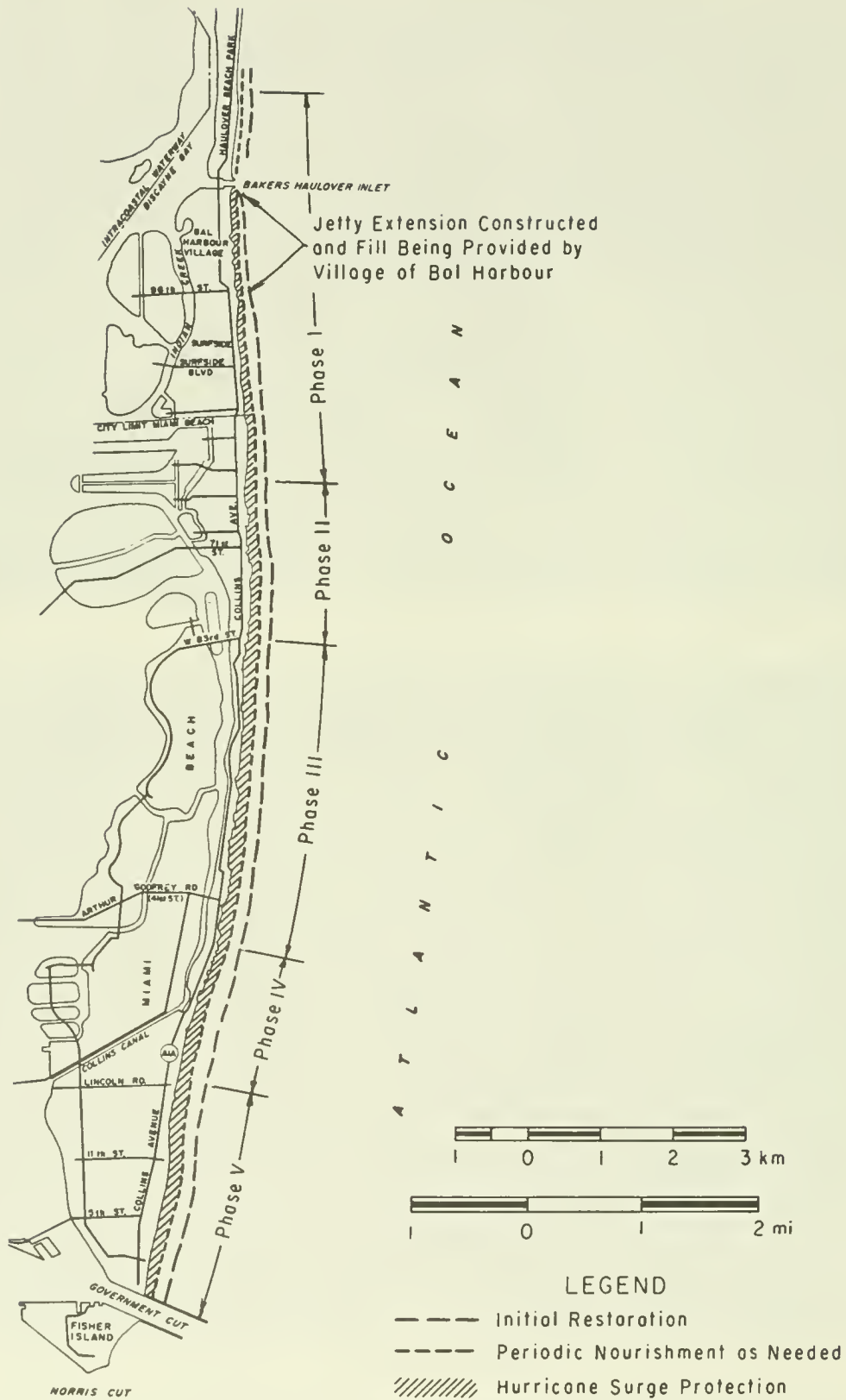

Figure 6-24. Project area depicting five phases of beach restoration, Dade County, Florida.

of shore was divided into five segments or phases; each was to be handled by a separate contract (see Fig. 6-24).

The *phase I* contract included the beach between 96th and 80th Streets at Surfside and about 0.8 kilometer of beach at Haulover Beach Park for a total of 4.35 kilometers (2.7 miles). A total estimate of 2,248,000 cubic meters (2,940,000 cubic yards) of beach-fill material was placed. Work began on this phase in May 1977 and had to be discontinued in October 1977 because of rough seas, which normally occur during the winter months. Work resumed in June 1978, with contract completion in November 1978.

The *phase II* contract covered the 2.25 kilometers (1.4 miles) of Dade County Beach between 80th and 83rd Streets, the northern part overlapping the southern end of the first contract. This overlapping was done in all phases to replace the losses experienced at the downdrift segment of the prior contract during the time between contracts. The phase II contract called for placement of 1,170,000 cubic meters (1,530,000 cubic yards) of beach fill, and after a delayed start, work began in August 1978 at 63rd Street and proceeded to the north. Prior to termination for the winter months, 56 percent of the beach included under this contract had been placed. The remaining sections were completed during the 1979 dredging season.

The *phase III* contract involved the placement of 2,429,000 cubic meters (3,177,100 cubic yards) of beach-fill material along 3.4 kilometers (2.1 miles) between 83rd and 86th Streets (see Fig. 6-23). In an attempt to complete this contract in one dredging season, a part of the work was subcontracted. Two dredges, the 70-centimeter (27-inch) dredge, Illinois, and the 80-centimeter (32-inch) dredge, Sensibar Sons, worked simultaneously on different sections of the beach. However, operations had to be discontinued for a month beginning in late August because of Hurricane David and persistent rough sea conditions. Dredging resumed for 2 weeks before termination for the winter season and was again resumed in July 1980. The contract was completed in October 1980.

The *phase IV* contract called for placement of 1,682,000 cubic meters (2,200,000 cubic yards) of fill on the beach, which extended from 36th to 17th Streets, a 2.6-kilometer (1.6-mile) length. An added requirement of this contract was the removal of all rock greater than 2.5 centimeters (1 inch) in diameter. To accomplish this, the contractor built a three story grizzly-grid rock separator on the beach. Any rock greater than 2.5 centimeters in diameter was either stockpiled and hauled offsite or passed through a centrifugal rock crusher. The crushed rock was conveyed and remixed with the screened dredge slurry. The screened beach-fill material was then pumped to the outfall.

A booster pump was necessary because of the long distance between the borrow and the fill areas and the utilization of the rock screening device. The dredging associated with this contract began in May 1980 and was completed in December 1981. Approximately 1,426,700 cubic meters (1,866,000 cubic yards) of material was placed on the beach.

The *phase V* contract called for the placement of 1,526,000 cubic meters (1,996,000 cubic yards) of beach fill along the remaining 2.9 kilometers (1.8 miles) of the project from 17th Street to Government Cut. This phase began in

June 1981 and was 80 percent completed by December 1981. During this phase a hopper dredge and a hydraulic pipeline dredge were employed.

Originally, it was intended to obtain beach-fill material from borrow areas located in back of the barrier beach in Biscayne Bay. Prior to beginning construction, the borrow area was relocated to the offshore areas to avoid possible adverse environmental impacts on the Key Biscayne estuary.

A variety of geological investigations were made to locate and define several borrow areas seaward of Miami Beach. The borrow areas consisted of trenches that ran parallel to the shoreline 1,800 to 3,700 meters (6,000 to 12,000 feet) offshore between submerged ancient cemented sand dunes. These trenches, filled with sand composed of quartz, shell, and coral fragments, vary up to 300 meters (1,000 feet) or more in width and from 1 meter to more than 12 meters in depth. The borrow sands generally have a high carbonate (shell) content. The sand size ranges from fine to coarse, with some silty fines generally present. Shells and coral fragments (gravel size to cobble size) are relatively common. The bulk of the sand was in the fine- to medium-size range. The silty fines form a small percent of the total and are within acceptable limits. The quartz present is usually of fine-grain size while the larger sizes are composed of locally derived shell and coral fragments. The sand sizes generally are finer grained in the deposits that lie farther from shore and in deeper water. The dredged sand is equal to or coarser than the beach sand.

The water depth in the borrow area is 12 to 18 meters (40 to 60 feet), and the excavation was accomplished primarily by either 70-centimeter (27-inch) diesel-electric dredges or by an 80-centimeter (32 inch) electric dredge running off land-based power. These large dredges excavate material at depths greater than 27 meters. The average daily yield was about 19,000 cubic meters (25,000 cubic yards), with a maximum of 32,000 cubic meters (42,000 cubic yards) being obtained for a 24-hour period.

When wave conditions exceeded 1 to 2 meters, the operations had to be curtailed due to the breaking up of the floating pipeline and possibility of damaging the cutterhead and ladder. For these reasons, dredging was conducted only during the calm season from the end of May to mid-October.

One problem area encountered during the project was the existence of a small percentage (usually less than 5 percent) of stones in the beach-fill material. Until the phase IV contract, the elimination of all stones had been considered impractical. Therefore, removal of stones greater than 5 centimeters (2 inches) in diameter was required only in the upper 30 centimeters (12 inches) of the surface. This was accomplished using a machine originally designed for clearing stones, roots, and other debris from farmland. Dade County has purchased one of these machines and also two smaller versions for conducting an active beach maintenance program.

The phase IV contract requirement to remove all stones larger than 2.5 centimeters in diameter was prompted by the problems involved in removing stones deposited subaqueously, which tend to concentrate in the nearshore trough. Several methods are being used to relieve this problem. This was not a problem in the phase IV and phase V contract areas.

The completed part of the beach has functioned effectively for several years, including the period when exposed to Hurricane David in 1979.

IV. SAND DUNES

Foredunes are the dunes immediately behind the backshore (see Ch. 4, Sec. VI and Ch. 5, Sec. IV). They function as a reservoir of sand nourishing beaches during high water and are a levee preventing high water and waves from damaging the backshore areas. They are valuable, nonrigid shore protection structures created naturally by the combined action of sand, wind, and vegetation, often forming a continuous protective system (see Fig. 6-25).



Figure 6-25. Foredune system, Padre Island, Texas.

(1976)

1. Sand Movement.

Winds with sufficient velocity to move sand particles deplete the exposed beach by transporting sand in the following three ways.

(a) Suspension: Small or light grains are lifted into the airstream and are blown appreciable distances.

(b) Saltation: Sand particles are carried by the wind in a series of short jumps along the beach surface.

(c) Surface Creep: Particles are rolled or bounced along the beach as a result of wind forces or the impact of descending saltating particles.

These natural transportation methods effectively sort the original beach material. Smaller particles are removed from the beach and dune area. Medium-sized particles form the foredunes. Larger particles remain on the beach. Although most sand particles move by saltation, surface creep may account for 20 to 25 percent of the moved sand (Bagnold, 1942).

2. Dune Formation.

Dune building begins when an obstruction on the beach lowers wind velocity causing sand grains to deposit and accumulate. As the dune builds, it becomes a major obstacle to the landward movement of windblown sand. In this manner, the dune functions to conserve sand in close proximity to the beach system. Foredunes are often created and maintained by the action of the beach grasses, which trap and stabilize sand blown from the beach.

Foredunes may be destroyed by the waves and high water levels associated with severe storms or by beachgrass elimination (induced by drought, disease, or overgrazing), which thereby permits local "blowouts." Fore dune management has two divisions--stabilization and maintenance of naturally occurring dunes, and the creation and stabilization of protective dunes where they do not already exist. Although dunes can be built by use of structures such as sand fences, another effective procedure is to create a stabilized dune through the use of vegetation. Current dune construction methodology is given by Knutson (1977) and Woodhouse (1978).

3. Dune Construction Using Sand Fencing.

Various mechanical methods, such as fencing made of brush or individual pickets driven into the sand, have been used to construct a foredune (McLaughlin and Brown, 1942; Blumenthal, 1965; Jagschitz and Bell, 1966a; Gage, 1970). Relatively inexpensive, readily available slat-type snow fencing (Fig. 6-26) is used almost exclusively in artificial, nonvegetative dune construction. Plastic fabrics have been investigated for use as sand fences (Savage and Woodhouse, 1969). Satisfactory, but short-term, results have been obtained with jute-mesh fabric (Barr, 1966).

Field tests of dune building with sand fences under a variety of conditions have been conducted at Cape Cod, Massachusetts, Core Banks, North Carolina, and Padre Island, Texas. The following are guidelines and suggestions based on these tests and observations recorded over the years:

(a) Fencing with a porosity (ratio of area of open space to total projected area) of about 50 percent should be used (Savage and Woodhouse, 1969). Open and closed areas should be smaller than 5



Figure 6-26. Erecting snow-type sand fencing.

centimeters in width. The standard wooden snow fence appears to be the most practical and cost effective.

(b) Only straight fence alignment is recommended (see Fig. 6-27). Fence construction with side spurs or a zigzag alignment does not increase the trapping effectiveness enough to be economical (Savage, 1962; Knutson, 1980). Lateral spurs may be useful for short fence runs of less than 150 meters (500 feet) where sand may be lost around the ends (Woodhouse, 1978).

(c) Placement of the fence at the proper distance shoreward of the berm crest may be critical. The fence must be far enough back from the berm crest to be away from frequent wave attack. Efforts have been most successful when the selected fence line coincided with the natural vegetation or foredune line prevalent in the area. This distance is usually greater than 60 meters shoreward of the berm crest.

(d) The fence should parallel the shoreline. It need not be perpendicular to the prevailing wind direction and will function even if constructed with some angularity to sand-transporting winds.

(e) With sand moving on the beach, fencing with 50-percent porosity will usually fill to capacity within 1 year (Savage and Woodhouse, 1969). The dune will be about as high as the fence. The dune slopes will range from about 1 on 4 to 1 on 7, depending on the grain size and wind velocity.

(f) Dunes are usually built with sand fencing in one of two ways:
(1) By installing a single fence and following it with additional



Figure 6-27. Snow-type sand fencing filled to capacity, Padre Island, Texas.

single-fence lifts as each fence fills (Fig. 6-28); or (2) by installing double-fence rows with the individual fences spaced about 4 times the fence height ($4h$) apart and following these with succeeding double-row lifts as each fills (Fig. 6-29). Single rows of fencing are usually the most cost-effective, particularly at the lower windspeeds, but double fences may trap sand faster at the higher windspeeds.

(g) Dune height is increased most effectively by positioning the succeeding lifts near the crest of an existing dune (see Fig. 6-30). However, under this system, the effective height of succeeding fences decreases and difficulties may arise in supporting the fence nearest the dune crest as the dune becomes higher and steeper.

(h) Dune width is increased by installing succeeding lifts parallel to and about $4h$ away from the existing fence (Fig. 6-31). The dune may be widened either landward or seaward in this way if the dune is unvegetated.

(i) Accumulation of sand by fences is not constant and varies widely with the location, the season of the year, and from year to year. Fences may remain empty for months following installation, only to fill within a few days by a single period of high winds. In order to take full advantage of the available sand, fences must be observed regularly, repaired if necessary, and new fences installed as existing fences fill. Usually where appreciable sand is moving, a single, 1.2-meter fence will fill within 1 year.

(j) The trapping capacity of the initial installation and succeeding lifts of a 1.2-meter-high sand fence averages between 5 and 8 cubic meters per linear meter (2 to 3 cubic yards per linear foot).

(k) CERC's experience has been that an average of 6 man-hours are required to erect 72 meters (235 feet) of wooden, picket-type fence or 56 meters (185 feet) of fabric fence when a six-man crew has materials available at the site and uses a mechanical posthole digger.

(l) Junk cars should not be used for dune building. They are more expensive and less effective than fencing (Gage, 1970). Junk cars mar the beauty of a beach and create a safety hazard.

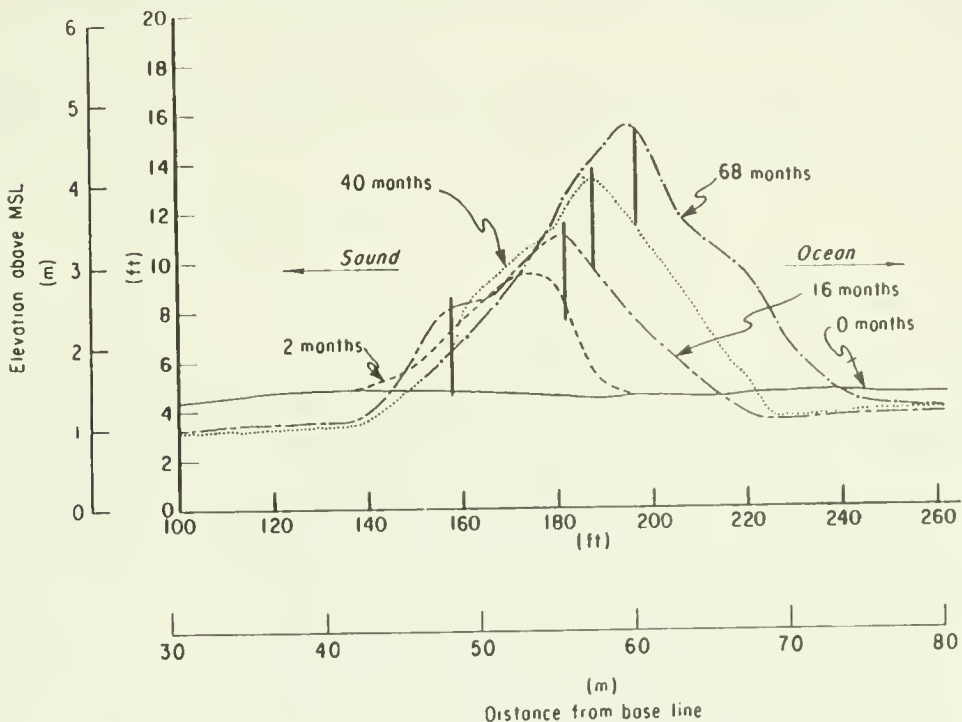

Figure 6-28. Sand accumulation by a series of four single-fence lifts, Outer Banks, North Carolina (Savage and Woodhouse, 1969).

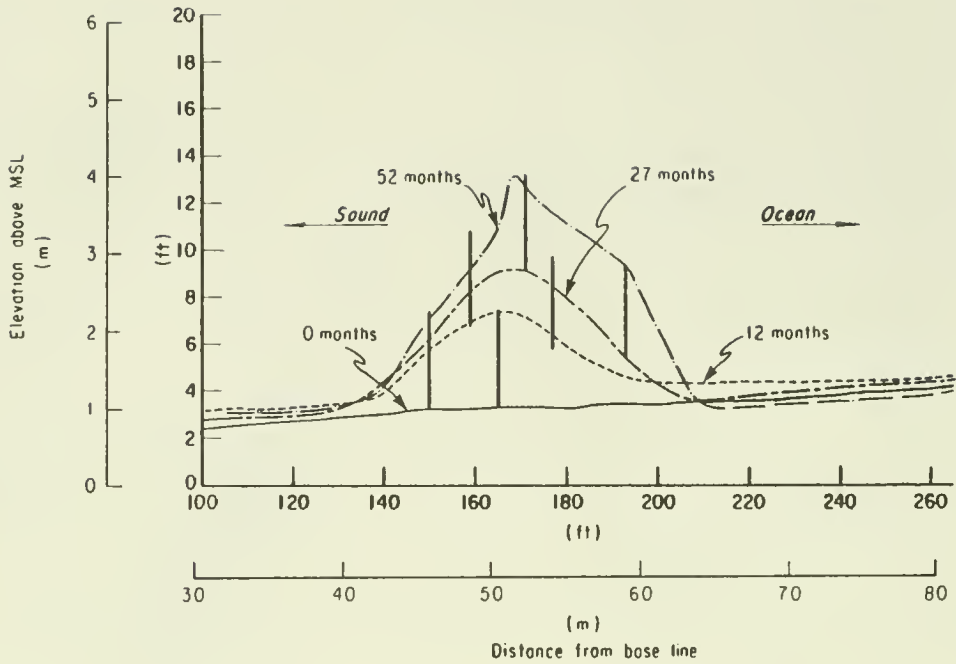

Figure 6-29. Sand accumulation by a series of three double-fence lifts, Outer Banks, North Carolina (Savage and Woodhouse, 1969).

SAND VOLUME			SCHEDULE FENCE ERECTION	
Time (Months)	m ³ /lin m of beach (yds ³ /lin ft of beach)		Time (Months)	Lift Number
	Cumulative	Interval		
0	0	0	0	1
12	8.5 (3.4)	8.5 (3.4)	12	2
24	15.3 (6.1)	6.8 (2.7)	24	3
36	26.1 (10.4)	10.8 (4.3)		

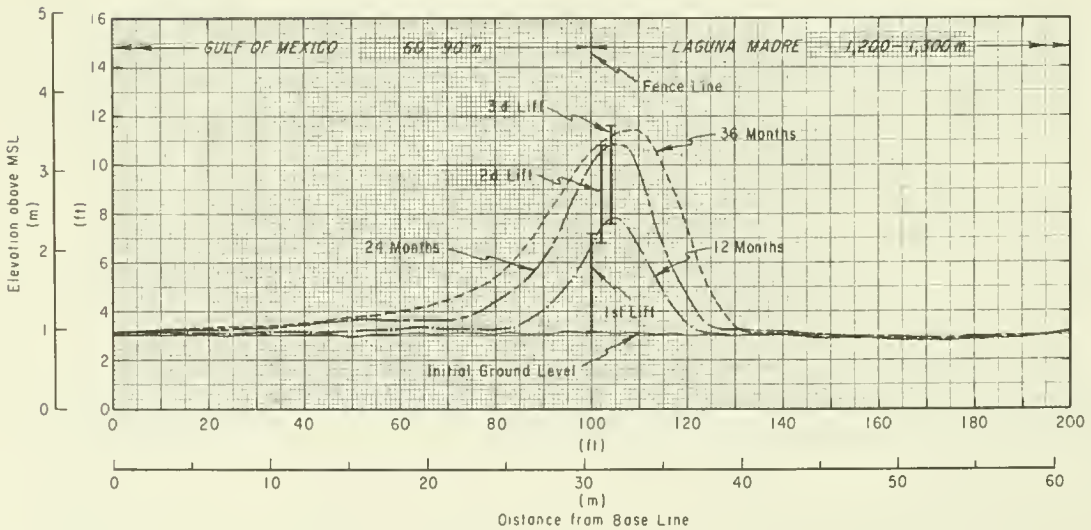

Figure 6-30. Sand fence dune with lifts positioned near the crest, Padre Island, Texas.

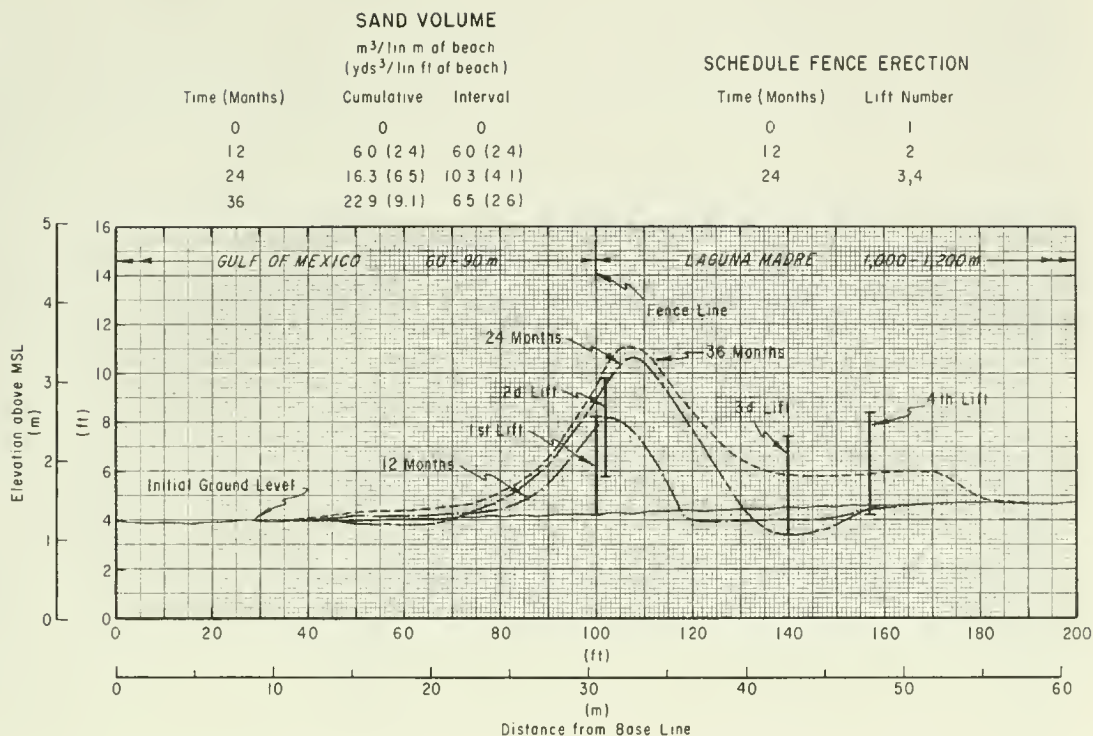

Figure 6-31. Sand fence dune with lifts positioned parallel to the existing fence, Padre Island, Texas.

(m) Fence-built dunes must be stabilized with vegetation or the fence will deteriorate and release the sand (Fig. 6-32). While sand fences initially trap sand at a high rate, established vegetation will trap sand at a rate comparable to multiple lifts of sand fence (Knutson, 1980). The construction of dunes with fence alone is only the first step in a two-step operation.

Fences have two initial advantages over planting that often warrant their use before or with planting: (a) Sand fences can be installed during any season and (b) the fence is immediately effective as a sand trap once it is installed. There is no waiting for trapping capacity to develop in comparison with the vegetative method. Consequently, a sand fence is useful to accumulate sand before planted vegetation is becoming established.

4. Dune Construction Using Vegetation.

a. Plant Selection. Few plant species survive in the harsh beach environment. The plants that thrive along beaches are adapted to conditions that include abrasive and accumulating sand, exposure to full sunlight, high surface temperatures, occasional inundation by saltwater, and drought. The plants that do survive are long-lived, rhizomatous or stoloniferous perennials with extensive root systems, stems capable of rapid upward growth through accumulating sand, and tolerance of salt spray. Although a few plant species



Figure 6-32. Sand fence deterioration due to exposure and storms.

have these essential characteristics, one or more suitable species of beach grasses occur along most of the beaches of the United States.

The most frequently used beach grasses are American beachgrass (*Ammophila breviligulata*) along the mid- and upper-Atlantic coast and in the Great Lakes region (Jagschitz and Bell, 1966b; Woodhouse and Hanes, 1967; Woodhouse, 1970); European beachgrass (*Ammophila arenaria*) along the Pacific Northwest and California coasts (McLaughlin and Brown, 1942; Brown and Hafenrichter, 1948; Kidby and Oliver, 1965; U.S. Department of Agriculture, 1967); sea oats (*Uniola paniculata*) along the South Atlantic and gulf coasts (Woodhouse, Seneca, and Cooper, 1968; Woodard, et al., 1971); panic grasses (*Panicum amarum*) and (*P. amarulum*) along the Atlantic and gulf coasts (Woodhouse, 1970; Woodard, et al., 1971). Table 6-3 is a regional summary of the principal plants used for dune stabilization.

b. Harvesting and Processing. The plants should be dug with care so that most roots remain attached to the plants. The clumps should be separated into transplants having the desired number of culms (stems). Plants should be cleaned of most dead vegetation and trimmed to a length of about 50 centimeters (20 inches) to facilitate mechanical transplanting.

Most plants may be stored several weeks if their bases are wrapped with wet burlap, covered with moist sand, or placed in containers with 3 to 5 centimeters of fresh water. Survival of sea oats is reduced if stored more than 3 to 4 days. To reduce weight during transport, the roots and basal nodes may be dipped in clay slurry and the plants bundled and wrapped in

Table 6-3. Regional adaption of foredune plants.¹

Major species	North Atlantic	South Atlantic	Gulf	North Pacific	South Pacific	Great Lakes
American beachgrass	1	1, 2	---	4	---	1
European beachgrass	--	---	---	1	1	4
Sea oats	--	3	3	---	---	--
Bitter panicum	3	1, 3	1	---	---	--
Saltmeadow cordgrass	4	4	4	---	---	--
American dunegrass	--	---	---	4, 6	4, 6	--
Secondary or regional species						
Seashore elder	--	6	6, 2	---	---	--
Bermuda grass	7	7	7	---	---	--
Knot grass or seashore paspalum	--	4	4	---	---	--
Ice plant	--	---	---	5, 2	5	--
Sand verbena	--	---	---	6	6	--
Beach bur	--	---	---	6	---	--
Wildrye	--	---	---	---	---	4
St. Augustine grass	--	7	7	---	---	--
Prairie sandreed	--	---	---	4	---	--
Beach morning glory	--	4	4	---	---	--
1 - Dominant planted species. 2 - Part of region only. 3 - Valuable in mixture. 4 - Widely distributed, seldom planted. 5 - Stabilization only. 6 - Valuable, planting methods undeveloped. 7 - Specialized uses.						

¹ Woodhouse (1978).

reinforced paper. Plants may be kept longer if refrigerated. Plants dug while dormant (winter) and held in cold storage at 1° to 3° Celsius may be used in late spring plantings.

c. Planting and Fertilization. Transplanting techniques for most species of beach grass are well developed. Transplanting is recommended for areas adjacent to the beach berm and for critical areas, such as sites subject to erosion. Most critical areas require densely spaced transplants to ensure successful stabilization. A mechanical transplanter mounted on a tractor is recommended for flat or moderate slopes (see Fig. 6-33). Steep and irregular slopes must be planted by hand. Table 6-4 provides a tabular summary of planting specifications for beach grasses.



Figure 6-33. Mechanical transplanting of American beachgrass.

Table 6-4. Planting and fertilization summary by regions.¹

Species	Planting				Fertilization	
	Date	Depth (cm)	Stems per hill	Spacing (cm)	First year	Maintenance
North Atlantic						
American beachgrass	Feb. to Apr.	20 to 35	1 to 5	45 to 60 or graduated	102 - 153 kg/ha N 31 - 51 kg/ha P ₂ O ₅	1/3 1st year to none
Bitter panicum	Mar. to May	20 to 35	1	In mixture	102 - 153 kg/ha N 31 - 51 kg/ha P ₂ O ₅	1/3 1st year to none
South Atlantic						
American beachgrass ²	Nov. to Mar.	20 to 30	1 to 3	45 to 60 or graduated	102 - 153 kg/ha N 31 - 51 kg/ha P ₂ O ₅	31 - 51 kg/ha 1- to 3-yr intervals
Bitter panicum	Mar. to June	20 to 35	1	45 to 60 or graduated	102 - 153 kg/ha N 31 - 51 kg/ha P ₂ O ₅	31 - 51 kg/ha 1- to 3-yr intervals
Sea oats	Feb. to Apr.	25 to 35	1	In mixture	102 - 153 kg/ha N 31 - 51 kg/ha P ₂ O ₅	31 - 51 kg/ha 1- to 3-yr intervals
Saltmeadow cordgrass	Feb. to May	15 to 30	5 to 10	45 to 60 or graduated	102 - 153 kg/ha N 31 - 51 kg/ha P ₂ O ₅	31 - 51 kg/ha 1- to 3-yr intervals
Gulf						
Bitter panicum	Feb. to June	20 to 30	1	60 to 90 or graduated	102 kg/ha N 31 kg/ha P ₂ O ₅	According to growth
Sea oats	Jan. to Feb.	20 to 35	1	60 to 90 or graduated	102 kg/ha N 31 kg/ha P ₂ O ₅	According to growth
North Pacific						
European beachgrass	Apr. ³	25 to 35	3 to 5	45 or graduated	41 - 61 kg/ha N	According to growth
American beachgrass	Jan. to Apr.	25 to 35	1 to 3	45 or graduated	41 - 61 kg/ha N	According to growth
South Pacific						
European beachgrass	Spring ³	25 to 35	3 to 5	45 or graduated	41 - 61 kg/ha N	According to growth
Ice plant (stabilization only)	Spring ⁴	10 to 15	1	60 or broadcast	41 - 61 kg/ha N	According to growth
Great Lakes						
American beachgrass	Feb. to May	20 to 35	1 to 3	45 to 60 or graduated	102 - 153 kg/ha N 31 - 51 kg/ha P ₂ O ₅ and K ₂ O	According to growth

¹ Woodhouse (1978).² Carolina coasts only.³ Early spring is best when temperatures are below 15° Celsius.⁴ Ground should be cool and wet.

Seeding is practical only when protection can be provided from eroding and drying winds by mulching or frequent irrigation, and is therefore not applicable to most beach areas. Beach-grass seeds are not generally available from commercial sources, and must be wild harvested during the fall for spring seeding.

Where field tested, beach grasses have responded to supplemental nutrients by increased foliage production. This in turn provides greater sand-trapping capacity. Rates of fertilizer are provided in Table 6-4. Only American beachgrass should be routinely fertilized the second growing season with 56 kilograms per hectare (50 pounds per acre) of fertilizer (nitrogen) in April and again in September. Other species should be fertilized if overall

growth or survival is poor or if plants do not appear healthy. In general, only areas of poor plant growth will require fertilization. During the third growing season, fertilizer can be applied as required to encourage growth. However, sea oats are not responsive to fertilizer after the second season. The response of beach grasses to slow-release fertilizers has been varied and results are inconclusive (Augustine, et al., 1964; Hawk and Sharp, 1967; Woodhouse and Hanes, 1967).

d. Disease and Stress. Beach grasses vary in their tolerance to drought, heat, cold, disease, and parasites. Plantings of a species outside its natural geographic zone are vulnerable during periods of environmental stress. American beachgrass is more susceptible to scale infestation when exposure to sandblasting is reduced. Deteriorating stands of American beachgrass, due to scale infestation (*Eriococcus carolinae*), have been identified from New Jersey to North Carolina (Campbell and Fuzy, 1972). South of its natural geographic zone (Nags Head, North Carolina), American beachgrass is susceptible to heat (Seneca and Cooper, 1971), and a fungal infection (Marasius blight) is prevalent (Lucas, et al., 1971).

South of Virginia, mixed species plantings are desirable and necessary. The slow natural invasion (6 to 10 years) of sea oats to American beachgrass dunes (Woodhouse, Seneca, and Cooper, 1968) may be hastened by mixed species plantings. Thus, with better vegetation cover, the chance of overtopping during storms is reduced.

Sea oats and panic grass occur together throughout much of their natural geographic zone. Mixed plantings of sea oats and beach grass are recommended since they produce a thick cover and more dune profile.

e. Planting Width. Plant spacing and sand movement must be considered in determining planting width. When little sand is moved for trapping, and plant spacing is dense, nearly all sand is caught along the seaward side of the planting and a narrow-based dune is formed. If the plant spacing along the seaward side is less dense under similar conditions of sand movement, a wider based dune will be formed. However, the rate of plant growth limits the time in which the less dense plant spacing along the seaward side will be effective. The spacing and pattern should be determined by the characteristics of the site and the objective of the planting. Functional planting guidelines for the various geographic regions in the United States are given by Woodhouse (1978).

The following example illustrates the interrelationship of the planting width, plant spacing, sand volume, and rate of plant growth. American beachgrass planted on the Outer Banks of North Carolina, at 45 centimeters (18 inches) apart with outer spacing of 60 to 90 centimeters (24 to 36 inches), accumulated sand over a larger part of the width of the planting for the first two seasons. By the end of the second season, the plant cover was so extensive along the seaward face of the dune that most sand was being trapped within the first 8 meters (25 feet) of the dune.

American beachgrass typically spreads outward by rhizomatous (underground stem) growth, and when planted in a band parallel to the shoreline it will grow seaward while trapping sand. Thus a dune can build toward the beach from the original planting. Seaward movement of the dune crest in North Carolina

is shown in Figures 6-34 and 6-35. This phenomenon has not occurred with the sea oats plantings at Core Banks, North Carolina (Fig. 6-36), or at Padre Island, Texas (Fig. 6-37).

The rate of spread for American beachgrass has averaged about 1 meter per year on the landward side of the dune and 2 meters per year on the seaward slope of the dune as long as sand has been available for trapping (see Figs. 6-34 and 6-35). The rate of spread of sea oats is considerably less, 30 centimeters (1 foot) or less per year.

Figure 6-35 shows an experiment to test the feasibility of increasing the dune base by a sand fence in a grass planting. The fence was put in the middle of the 30-meter-wide (100-foot) planting. Some sand was trapped while the American beachgrass began its growth, but afterwards little sand was trapped by this fence. The seaward edge of the dune trapped nearly all the beach sand during onshore winds. The landward edge of the dune trapped the sand transported by offshore winds blowing over the unvegetated area landward of the dune.

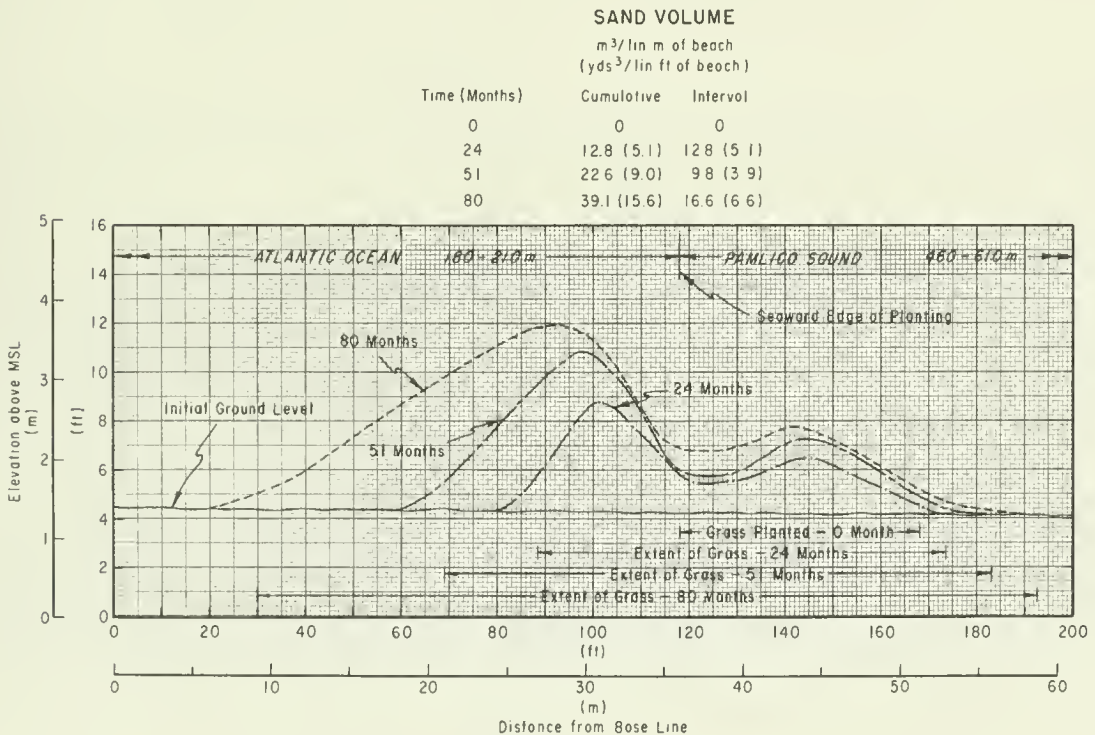

Figure 6-34. American beachgrass dune, Ocracoke Island, North Carolina.

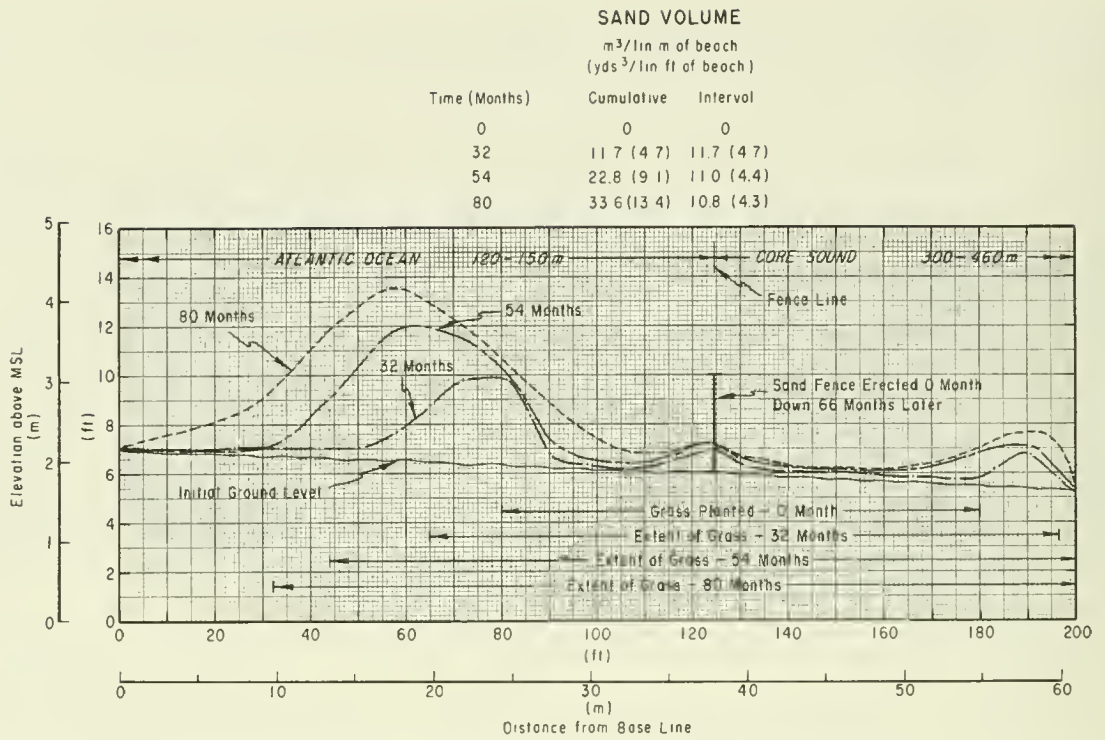

Figure 6-35. American beachgrass with sand fence, Core Banks, North Carolina.

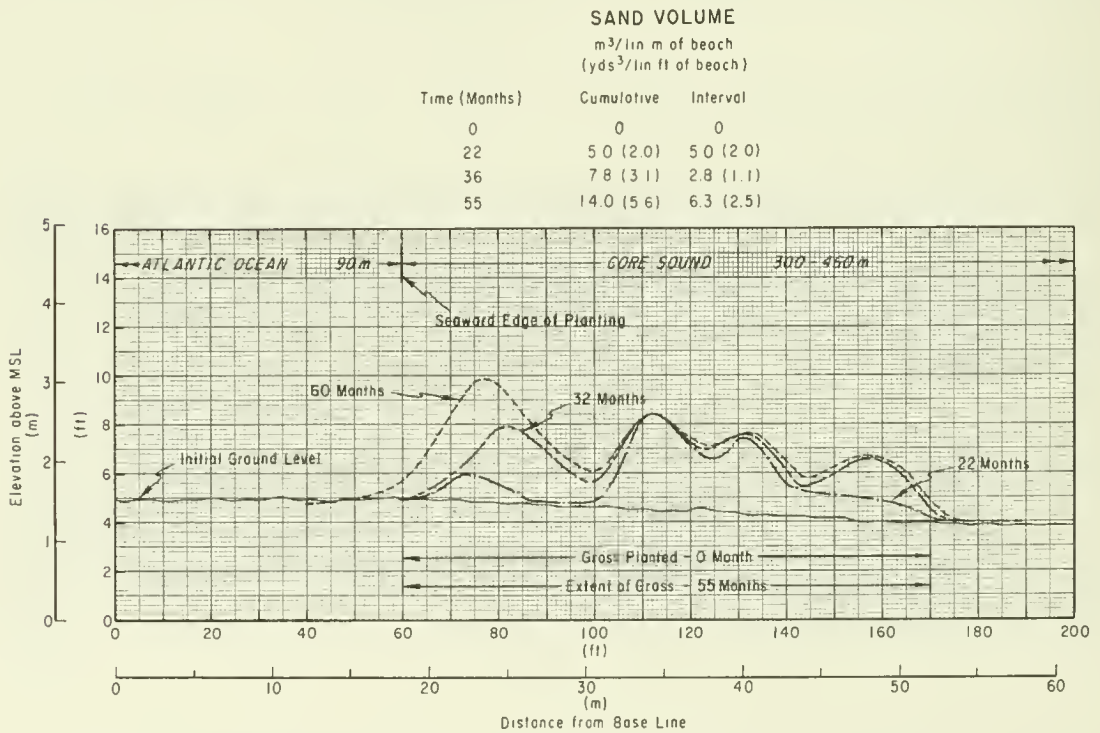

Figure 6-36. Sea oats dune, Core Banks, North Carolina.

SAND VOLUME (yds ³ /lin ft of beach)		
Time (Months)	Cumulative	Interval
0	0	0
36	29.6 (11.8)	29.6 (11.8)
96	72.2 (28.8)	42.6 (17.0)

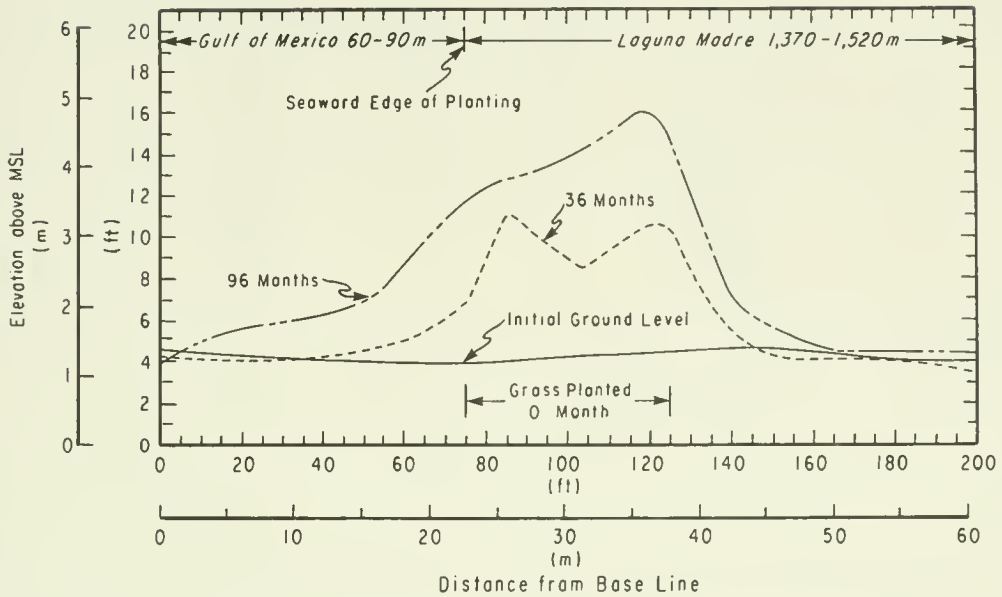

Figure 6-37. Sea oats dune, Padre Island, Texas.

Foredune restoration is most likely to succeed when the new dune coincides with the natural vegetation line or foredune line. The initial planting should be a strip 15 meters wide, parallel to the shore, and 15 meters landward of this line. It is essential that part of the strip be planted at a density that will stop sand movement sometime during the first year. If a natural vegetation or foredune line is not evident, restoration should begin at least 75 to 90 meters (250 to 300 feet) inland from the HWL. Where beach recession is occurring, the dune location should be determined from the average erosion rate and the desired dune life. Another 15-meter-wide strip may be added immediately seaward 4 to 5 years later if a base of 30 meters has not been achieved by natural vegetative spread.

f. Trapping Capacity. Periodic cross-sectional surveys were made of some plantings to determine the volume of trapped sand and to document the profile of the developing dune. Table 6-5 presents comparisons of annual sand accumulation and dune growth rates. The rates are averaged over a number of profiles under different planting conditions, and should be considered only as an indicator of the dune-building capability.

Table 6-5. Comparisons of annual sand accumulation and dune growth rates¹

Location	Species	Crest growth		Sand accumulation		Growth period (yr)
		(m)	(ft)	(m ³ /m)	(yd ³ /ft)	
Nauset Beach Cape Cod, Mass.	American beachgrass	0.3	0.9	8.3	3.3	7
Ocracoke Island, N.C.	American beachgrass	0.2	0.6	8.3 ²	3.3 ²	10
Padre Island, Tex.	Sea oats and beachgrass	0.5 to 0.6	1.5 to 2.0	8.3 to 13.0	3.3 to 5.2	5
Clatsop Plains, Oreg.	European beachgrass	0.3	0.9	13.8	5.5	30

¹After Knutson (1980).

²Three years growth.

The European beachgrass annual trapping rate on Clatsop Spit, Oregon, has averaged about 4 cubic meters (5 cubic yards). Although surveys were not taken until nearly 30 years after planting (Kidby and Oliver, 1965), the initial trapping rates must have been greater (see Fig. 6-38).

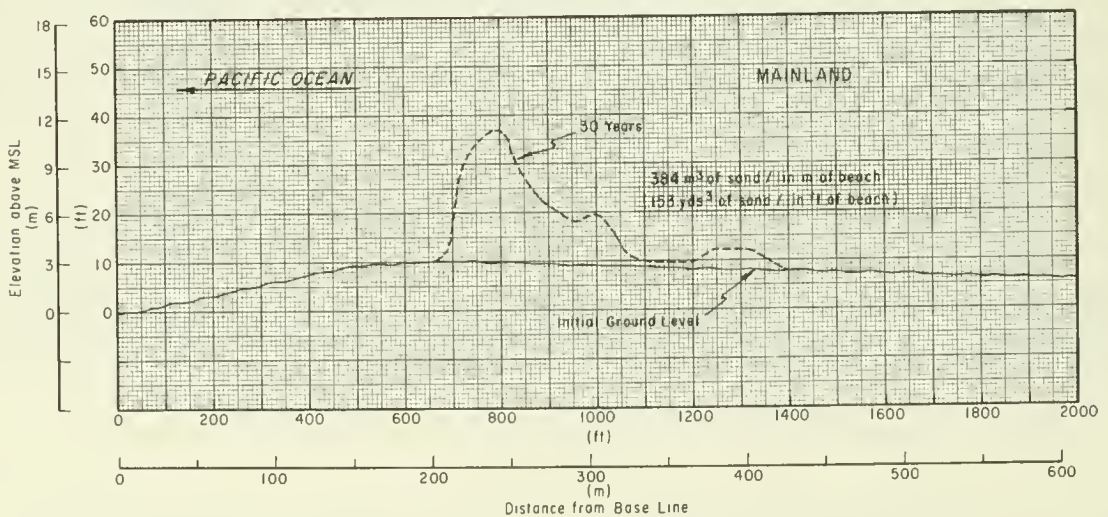

Figure 6-38. European beachgrass dune, Clatsop Spit, Oregon.

These rates are much less than the rates of vigorous grass plantings. Small plantings of 10 meters square (100 feet square) of American beachgrass that trap sand from all directions have trapped as much as 40 cubic meters per linear meter (16 cubic yards per linear foot) of beach in a period of 15 months on Core Banks, North Carolina (Savage and Woodhouse, 1969). While this figure may exaggerate the volume of sand available for dune construction over a long beach, it does indicate the potential trapping capacity of American beachgrass. Similar data for sea oats or panic grass are not available. However, observations on the rate of dune growth on Padre Island, Texas, following Hurricane Beulah (September 1967) indicate that the trapping capacity of sea oats and panic grass is greater than the annual rate observed for the planted dunes. This suggests that dune growth in most areas is limited by the amount of sand transported off the beach rather than by the trapping capacity of the beach grasses.

The average annual vertical crest growth, as indicated in Table 6-5, shows some variation over the range of test sites. However, in all cases the dune crest growth has been sufficient to provide substantial storm surge protection to the previously unprotected areas in back of the dune. This was evidenced on North Padre Island during Hurricane Allen in 1980. The storm surge at the location of the experimental dune building site has been estimated to be between 2 and 3 meters (8 and 10 feet). Although a substantial part of the dunes had eroded, they still provided protection from flooding in the areas landward of the dune. This area is undeveloped on North Padre Island (National Seashore), but the value of a healthy dune system can be readily appreciated.

g. Cost Factors. The survival rate of transplants may be increased by increasing the number of culms per transplant. This increase in survival rate does not offset the increase in cost to harvest multiculm transplants. It is less expensive to reduce plant spacing if factors other than erosion (such as drought) affect the survival rate.

Harvesting, processing, and transplanting of sea oats requires 1 man-hour per 130 hills, panic grass requires 1 man-hour per 230 hills. For example, a 15-meter-wide, 1.6-kilometer-long planting of sea oats on 60-centimeter centers requires about 500 man-hours for harvesting, processing, and transplanting if plants are locally available. Using a mechanical transplanter, from 400 to 600 hills can be planted per man-hour.

Nursery production of transplants is recommended unless easily harvested wild plants of quality are locally available. Nursery plants are easier to harvest than wild stock. Commercial nurseries are now producing American and European beachgrasses, panic grass, and sea oats. Some States provide additional information through their departments of conservation or natural resources. The Soil Conservation Service routinely compiles a list of commercial producers of plants used for soil stabilization.

V. SAND BYPASSING

The construction of jetties or breakwaters to provide safe navigation conditions at harbor entrances or tidal inlets along sandy coasts usually results in an interruption of the natural longshore transport of sand at the entrance or inlet. The resulting starvation of the downdrift beach can cause

serious erosion unless measures are taken to transfer or bypass the sand from the updrift side to the downdrift beaches.

Several techniques of mechanical sand bypassing have been used where jetties and breakwaters form littoral barriers. The most suitable method is usually determined by the type of littoral barrier and its corresponding impoundment zone. The five types of littoral barriers for which sand transfer systems have been used are illustrated in Figure 6-39. The basic methods of sand bypassing are as follows: fixed bypassing plants, floating bypassing plants, and land-based vehicles or draglines. Descriptions of selected projects illustrating sand bypassing techniques for various combinations of littoral barriers are presented in the following sections.

1. Fixed Bypassing Plants.

Fixed bypassing plants have been used at South Lake Inlet, Florida, and Lake Worth Inlet, Florida (both type I inlet improvements, see Fig. 6-39), and at Rudee Inlet, Virginia Beach, Virginia (type V inlet improvement).

In the past, in other countries, fixed bypassing plants were used at Salina Cruz, Mexico (U.S. Army Beach Erosion Board, 1951), and Durban, Natal, South Africa (U.S. Army Corps of Engineers, 1956). Both were located at breakwaters on the updrift sides of harbor entrances. The Salina Cruz plant rapidly became land-locked and was abandoned in favor of other methods of channel maintenance (U.S. Army Corps of Engineers, 1952, 1955). The Durban plant bypassed about 153,000 cubic meters (200,000 cubic yards) of sand per year from 1950 to 1954; afterward the amount decreased. Because of insufficient littoral drift reaching the plant, it was removed in 1959. No apparent reduction in maintenance dredging of the harbor entrance channel took place during the 9 years of bypassing operations. Starting in 1960, the material dredged from the channel was pumped to the beach to the north by a pump-out arrangement from the dredge with booster pumps along the beach.

a. South Lake Worth Inlet, Florida (Watts, 1953; Jones and Mehta, 1977). South Lake Worth Inlet, about 16 kilometers south of Palm Beach, was opened artificially in 1927 to provide increased flushing of Lake Worth. The dredged channel was stabilized by entrance jetties. The jetties caused erosion of the downdrift beach to the south, and construction of a seawall and groin field failed to stabilize the shoreline. A fixed sand bypassing plant began operation in 1937. The plant consisted of a 20-centimeter (8-inch) suction line, a 15-centimeter (6-inch) centrifugal pump driven by a 48.5-kilowatt (65 horsepower) diesel engine, and about 365 meters of 15-centimeter discharge line that crossed the inlet on a highway bridge and discharged on the beach south of the inlet.

The original plant, with a capacity of about 42 cubic meters (55 cubic yards) of sand per hour, pumped an average of 37,000 cubic meters (48,000 cubic yards) of sand per year between 1937 and 1941. This partially restored the beach for more than a kilometer downcoast. During the next 3 years (1942-45) pumping was discontinued, and the beach south of the inlet severely eroded. The plant resumed operation in 1945, stabilizing the beach. In 1948 the plant was enlarged by installation of a centrifugal pump, a 205-kilowatt (275-horsepower) diesel engine, a 25-centimeter (10-inch) suction line, and

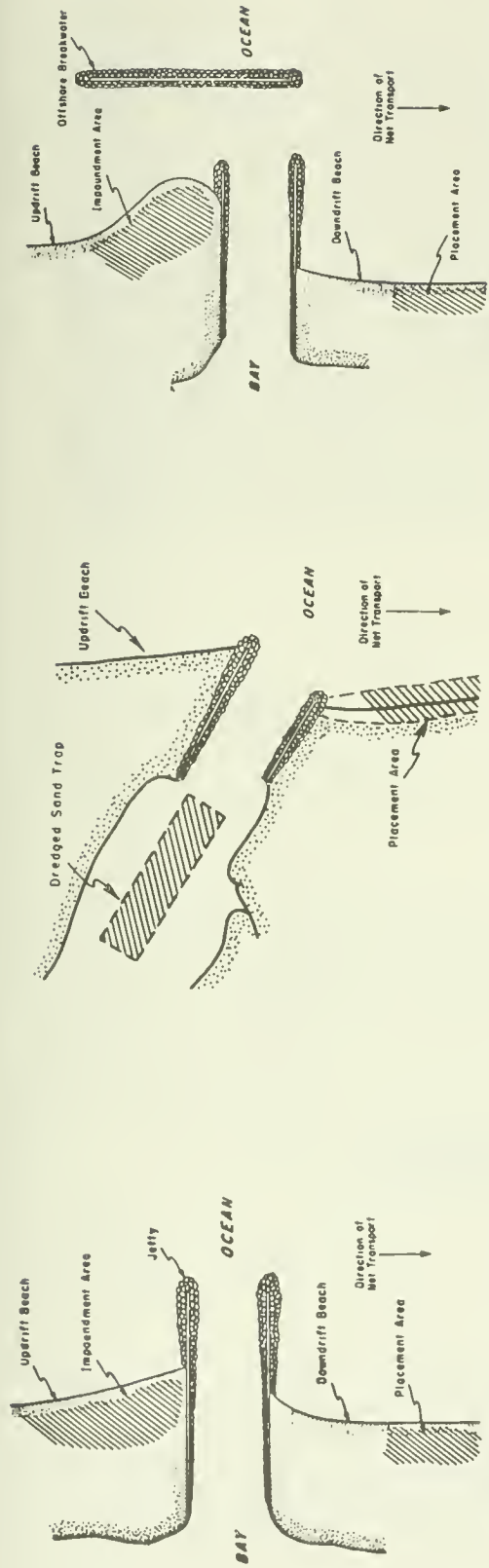

Type I: Jettied inlet

Type II. Inlet sand trap

Type III. Jettied inlet and offshore breakwater

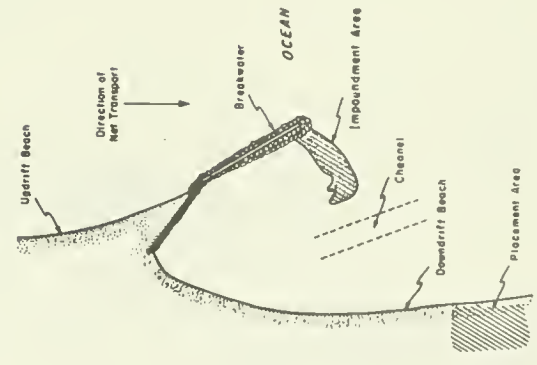

Type IV: Shore-connected breakwater (Impounding zone at seaward end of breakwater)

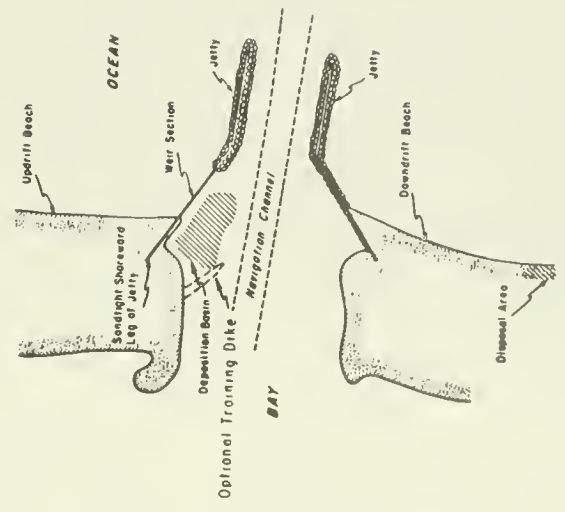

Type V: Shore-connected weir breakwater or jetty (Impounding zone at shoreward end of breakwater)

Figure 6-39. Types of littoral barriers for which sand transfer systems have been used (Weggel, 1981a).

a 20-centimeter discharge line. This plant yielded an average discharge of 75 cubic meters (100 cubic yards) per hour. The remainder of the littoral drift was transported by waves and currents to the offshore zone, the middle ground shoal, and the downdrift shore.

In 1967 the north jetty was extended and the bypassing plant was moved seaward (see Fig. 6-40). The current plant consists of a pump, a 300-kilowatt (400-horsepower) diesel engine, and a 30-centimeter-diameter suction line. The estimated discharge is 150 cubic meters (200 cubic yards) of sand per hour. During the period 1968 to 1976, the plant averaged 53,800 cubic meters (70,300 cubic yards) of bypassed material per year.

In addition to the fixed plant, a hydraulic pipeline dredge has also been used to bypass sand from the middle-ground shoals. Between 1960 and 1976, the average annual volume of bypassed dredge material was 20,000 cubic meters (26,000 cubic yards).

b. Lake Worth Inlet, Florida (Zermuhlen, 1958; Middleton, 1959; Jones and Mehta, 1977). Lake Worth Inlet, located at the northern limit of Palm Beach, was cut in 1918 and stabilized with bulkheads and jetties between 1918 and 1925. The fixed sand-bypassing plant began operation in 1958. The plant (see Fig. 6-41) consists of a 300-kilowatt (400-horsepower) electric motor and pump combination, a 30-centimeter suction line, and twin 25-centimeter discharge lines (added in 1967) which traverse the inlet on the channel bottom. A 240-meter section of the submerged discharge line can be removed during maintenance dredging of the navigation channel. The system was designed to handle 15 percent solids at more than 60 percent efficiency. Design capacity was about 130 cubic meters (170 cubic yards) per hour. The plant can dredge within a 12-meter sector adjacent to the north side of the plant to a depth of -3.7 meters MLW. A complex emergency flushing system, which was never used, was removed in 1971 because of high maintenance costs.

The average annual amount of bypassed material between 1958 and 1966 was 57,700 cubic meters (75,500 cubic yards) per year. In 1969 the groin to the north of the plant was removed. The original intent of the groin was to prevent the plant from bypassing too much material, which might cause the updrift beaches to recede. However, the effect of the groin was to impede the movement of sand toward the pumping area. After removal of the groin, the average annual amount of bypassed material increased to about 99,000 cubic meters (130,000 cubic yards) per year during the period from 1969 to 1976. This estimate, based on an average discharge rate of 150 cubic meters per hour, represents about 60 percent of the estimated annual littoral drift.

In addition to the fixed bypassing plant, material dredged during channel maintenance has been placed south of the inlet. In the 3-year period from 1970 to 1973, a total of 227,000 cubic meters (297,000 cubic yards) was bypassed by hydraulic dredge.

c. Rudee Inlet, Virginia Beach, Virginia (Richardson, 1977). Rudee Inlet, immediately south and updrift of Virginia Beach, was essentially nonnavigable until 1952 when two short jetties were built and a channel was dredged. The channel immediately began to shoal with littoral material, and erosion occurred on the downdrift beaches. A fixed bypassing plant with a small capacity was installed in 1955 with little effect, and a floating



(Circa 1968)

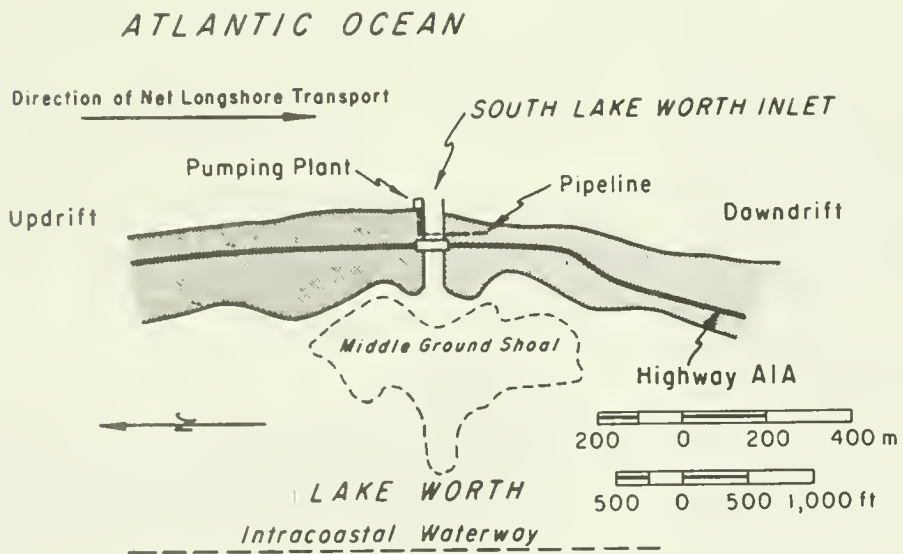

Figure 6-40. Fixed bypassing plant, South Lake Worth Inlet, Florida.



(Circa 1968)

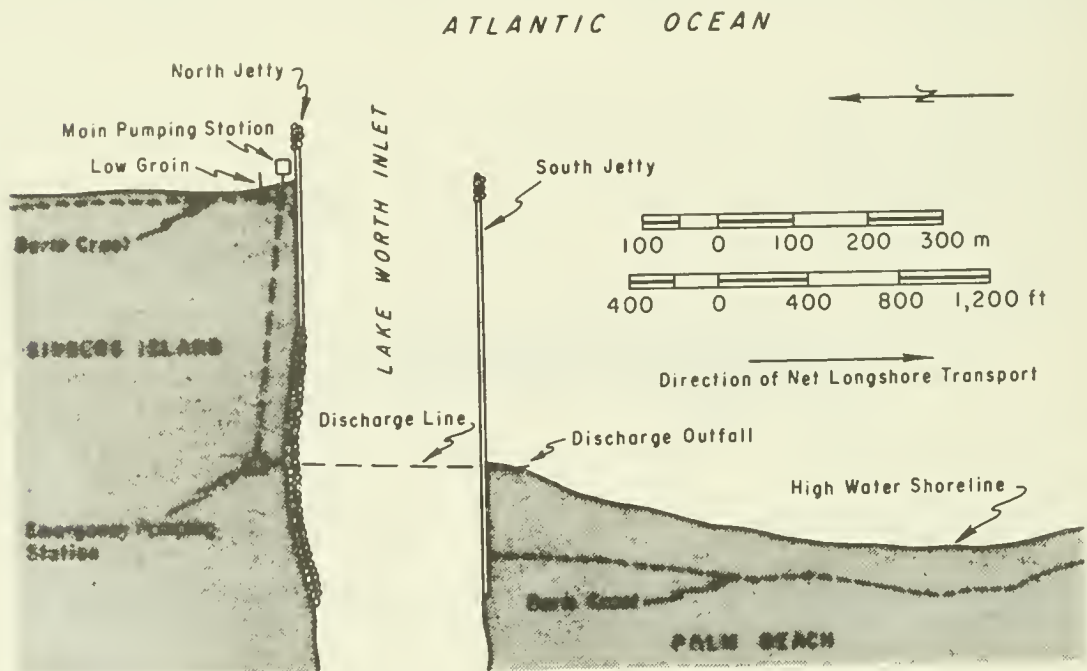

Figure 6-41. Fixed bypassing plant, Lake Worth Inlet, Florida.

pipeline dredge was added in 1956. The fixed plant was destroyed by a storm in 1962, and the inlet essentially closed, allowing the sand to bypass naturally. In 1968 the inlet was again improved with the construction of a jetty and a breakwater connected to the shore by a sand weir (see Fig. 6-42).

The weir jetty impoundment basin was never fully dredged initially, and the 25-centimeter dredge operations were hampered by wave action. From 1968 to 1972, sand bypassing was achieved by dredging material from the channel and back bay and pumping it to the downdrift beaches. In 1972, 76,000 cubic meters (100,000 cubic yards) of sand was removed from the impoundment basin. By 1975, the basin had refilled with littoral material, and bypassing was once again performed as before by the 25-centimeter dredge. Also in 1975, an experimental semimobile bypassing system was installed to bypass sand from the weir impoundment basin to the downdrift beach.

This system consists of two jet pumps attached by flexible rubber hoses to the steel pipes, which are supported on pilings in the impoundment basin (see Fig. 6-42). The steel pipes are connected to the pumphouse where two centrifugal pumps, having a combined nominal capacity of 115 cubic meters (150 cubic yards) per hour, discharge through a 20-centimeter pipe to the downdrift beaches. The jet pumps are pivoted about the ends of the steel pipes by cables from the shore. This enables the pumps to reach a large area of the impoundment basin.

During the first 6 months of operation, 60,400 cubic meters (79,000 cubic yards) of sand was bypassed from the impoundment basin by the jet-pump system, and approximately 23,000 cubic meters (30,000 cubic yards) was bypassed from the channel and impoundment basin by the floating dredge. Once operational procedures were established, the system could be successfully operated by a three-man crew in nearly all wave climates.

Since late 1975 the system has been owned and operated by local authorities who estimate the pumping capacity at 38 cubic meters (50 cubic yards) per hour and the effective pumping time at about 113 hours per month. The U.S. Army Engineer Waterways Experiment Station (WES) estimates the long-term pumping capacity at about 75 cubic meters per hour, assuming both pumps are operating. This estimate is based on the operating times from the first 6 months of operation. Using these two estimates as limits and assuming year-round operation, the system can pump between 51,800 and 103,700 cubic meters (67,800 and 135,600 cubic yards) per year. The estimated yearly littoral drift at Rudee Inlet is between 53,500 and 92,000 cubic meters (70,000 and 120,000 cubic yards).

2. Floating Bypassing Plants.

Sand bypassing has been achieved by floating plants at all five types of littoral barriers (Fig. 6-39). Those operations that are discussed and illustrated in this section are listed below:

(a) Type I: Jettied inlet--location at Port Hueneme, California (Fig. 6-43).

(b) Type II: Inlet sand trap--locations at Jupiter Inlet, Florida (Fig. 6-44), and at Sebastian Inlet, Florida (Fig. 6-45).

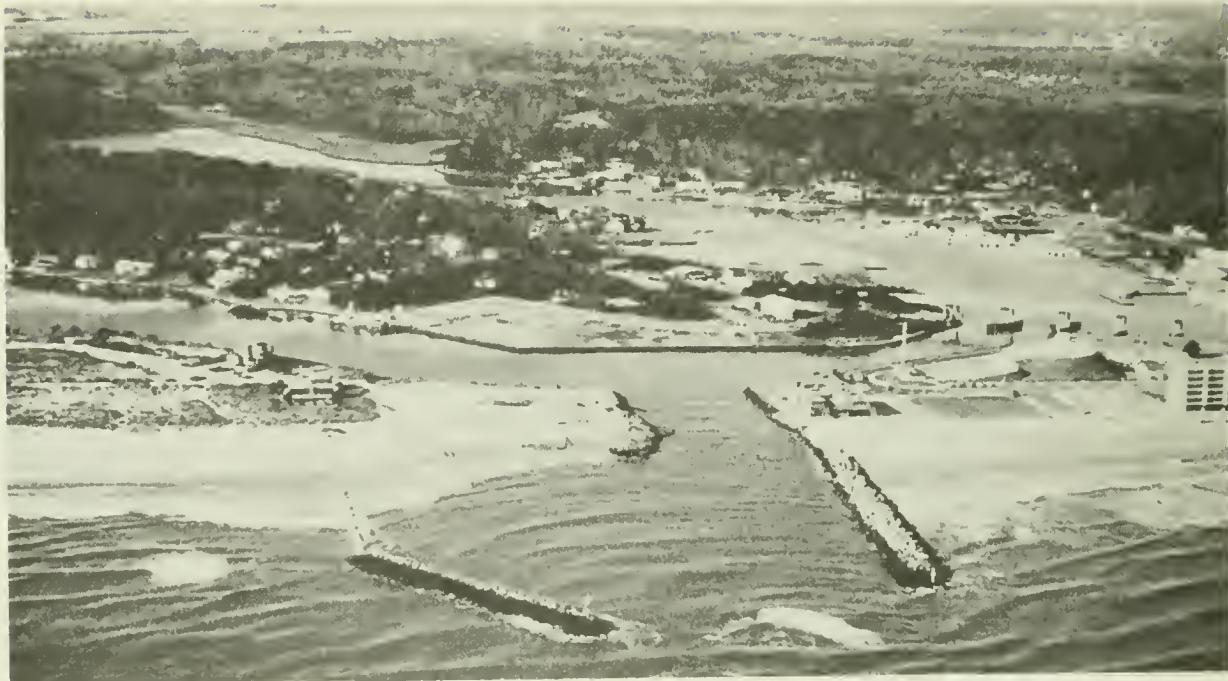

(Feb. 1980)

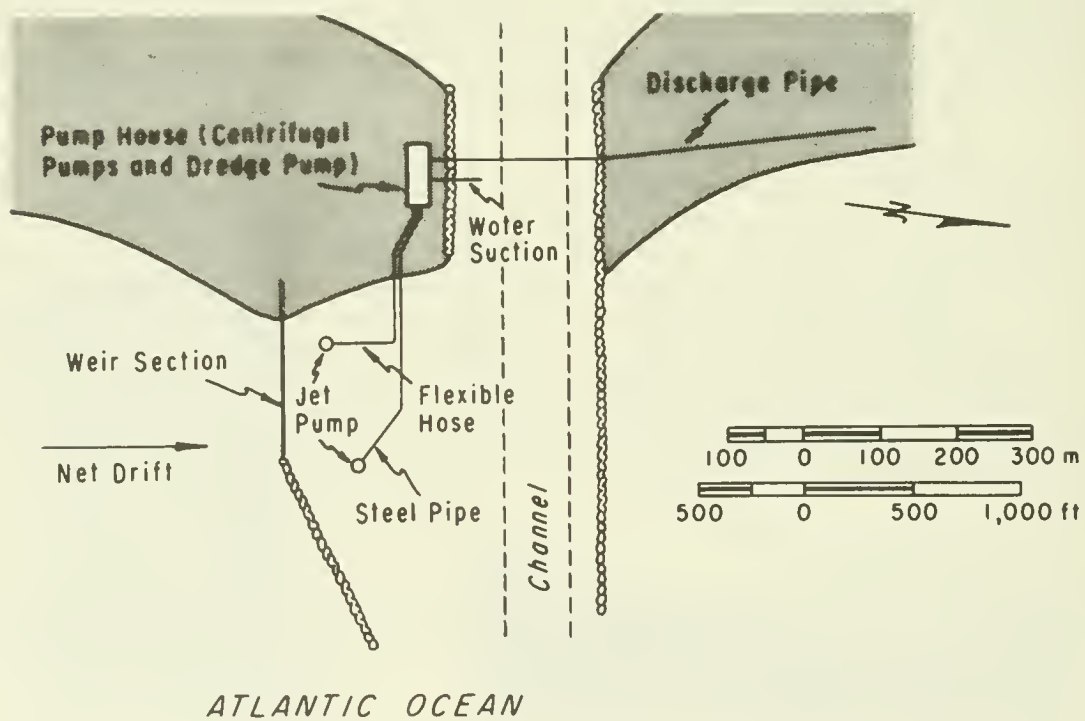

Figure 6-42. Fixed bypassing plant, Rudee Inlet, Virginia.

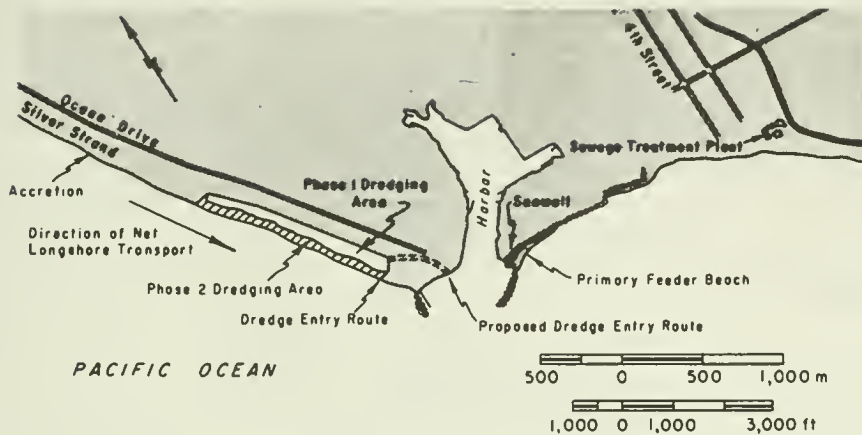

Figure 6-43. Sand bypassing, Port Hueneme, California.

(c) Type III: Jettied inlet and offshore breakwater--location at Channel Islands Harbor, California (Fig. 6-46).

(d) Type IV: Shore-connected breakwater--locations at Santa Barbara, California (Fig. 6-47), and at Fire Island Inlet, New York (Fig. 6-48).

(e) Type V: Shore-connected weir breakwater or jetty--locations at Hillsboro Inlet, Florida (Fig. 6-49), Masonboro Inlet, North Carolina (Fig. 6-50), Perdido Pass, Alabama (Fig. 6-51), East Pass, Florida (Fig. 6-52), and at Ponce de Leon Inlet, Florida (Fig. 6-53).

Other floating dredge sand-bypassing projects, not illustrated in this section, include the following:

- (a) Type II: Boca Raton Inlet, Florida (channel dredging).
- (b) Type III: Ventura Marina, California.
- (c) Type IV: Oceanside Harbor, California.
- (d) Type V: Murrells Inlet, South Carolina.

a. Port Hueneme, California (Savage, 1957; Herron and Harris, 1967). A unique application of a floating pipeline dredge to a type I littoral barrier was made in 1953 at Port Hueneme, California. Construction of the port and protective jetties in 1940 interrupted the littoral drift, estimated by Herron (1960) to be transported at the rate of 612,000 to 920,000 cubic meters (800,000 to 1,200,000 cubic yards) per year, by impoundment behind the west jetty and also by diverting the sand into the Hueneme Submarine Canyon, where it was permanently lost to the system. The result was severe erosion to the downdrift beaches.

In 1953 sand impounded by the updrift jetty was pumped across the harbor



(Sept. 1974)

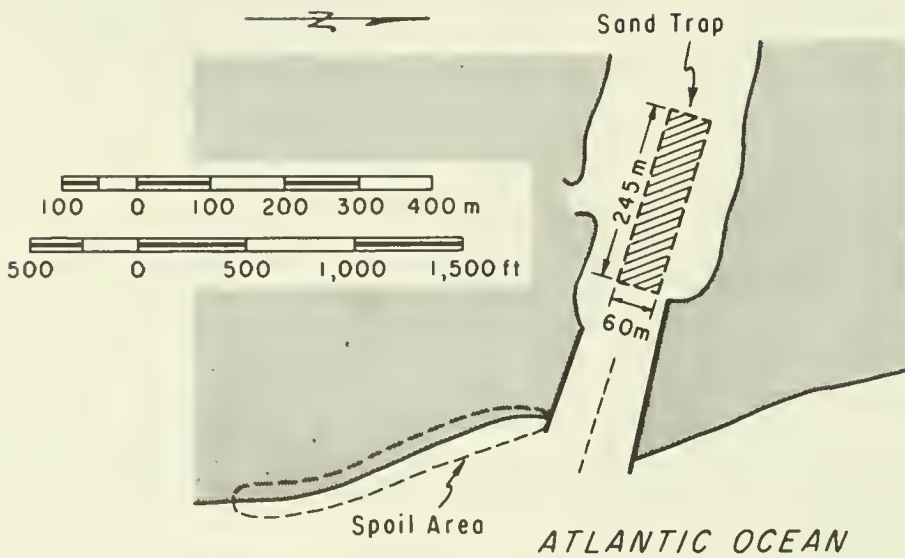

Figure 6-44. Sand bypassing, Jupiter Inlet, Florida (Jones and Mehta, 1977).



(photo courtesy of University of Florida, 1976)

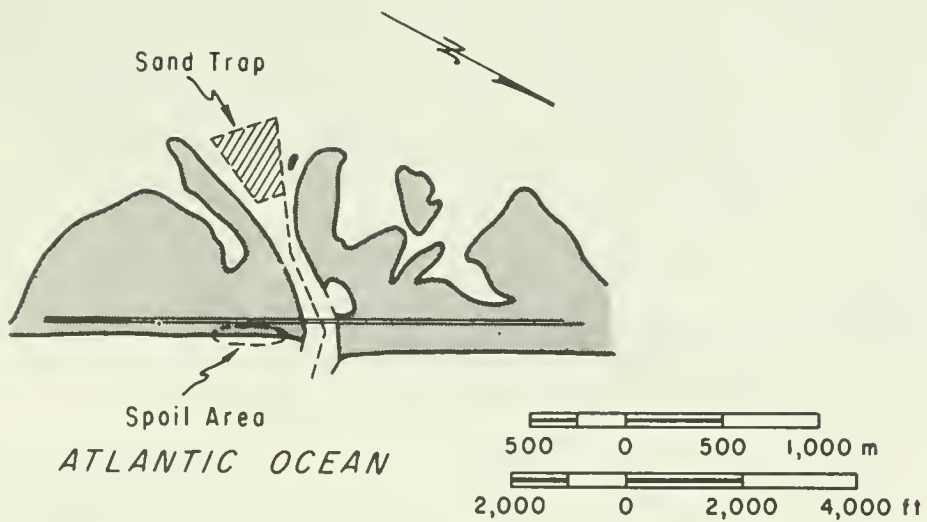

Figure 6-45. Sand bypassing, Sebastian Inlet, Florida (Jones and Mehta, 1977).



(Photo was taken just after 2.3 million cubic meters of sand had been dredged from the trap, Sept. 1965.)

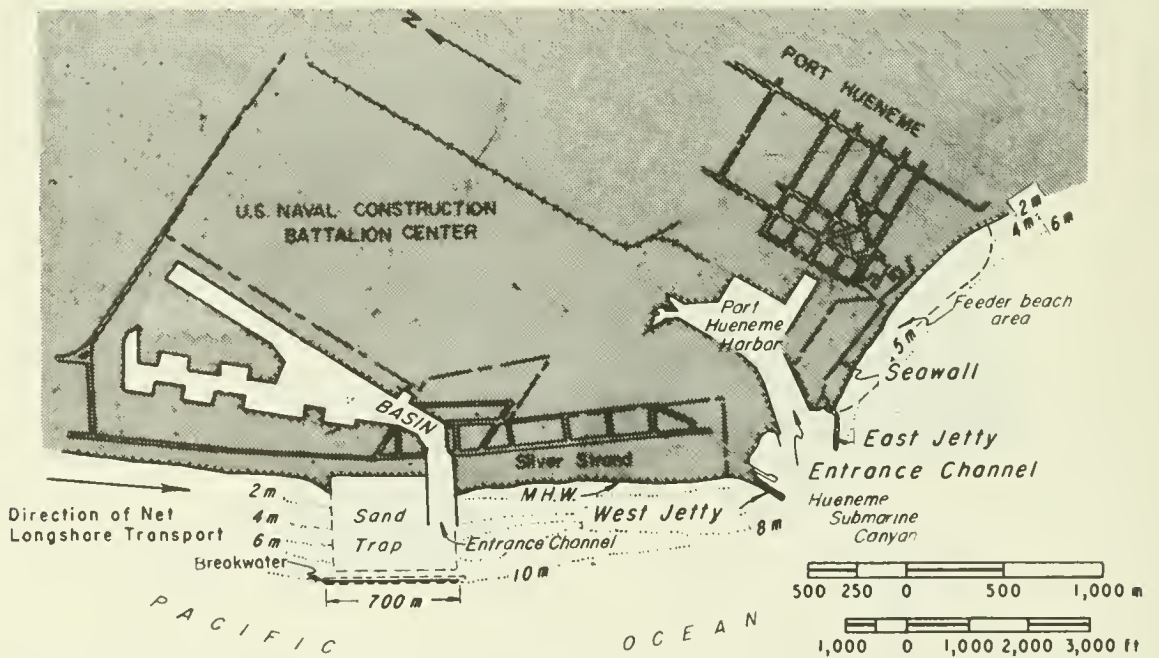

Figure 6-46. Sand bypassing, Channel Islands Harbor, California.



(July 1975)

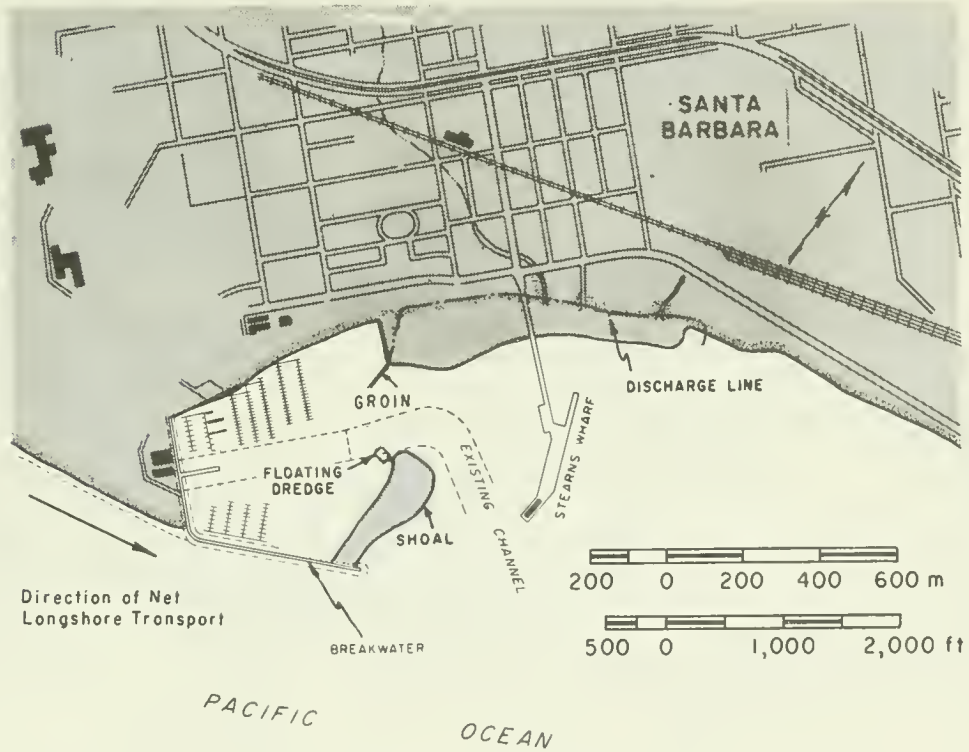

Figure 6-47. Sand bypassing, Santa Barbara, California.



(Sept. 1969)

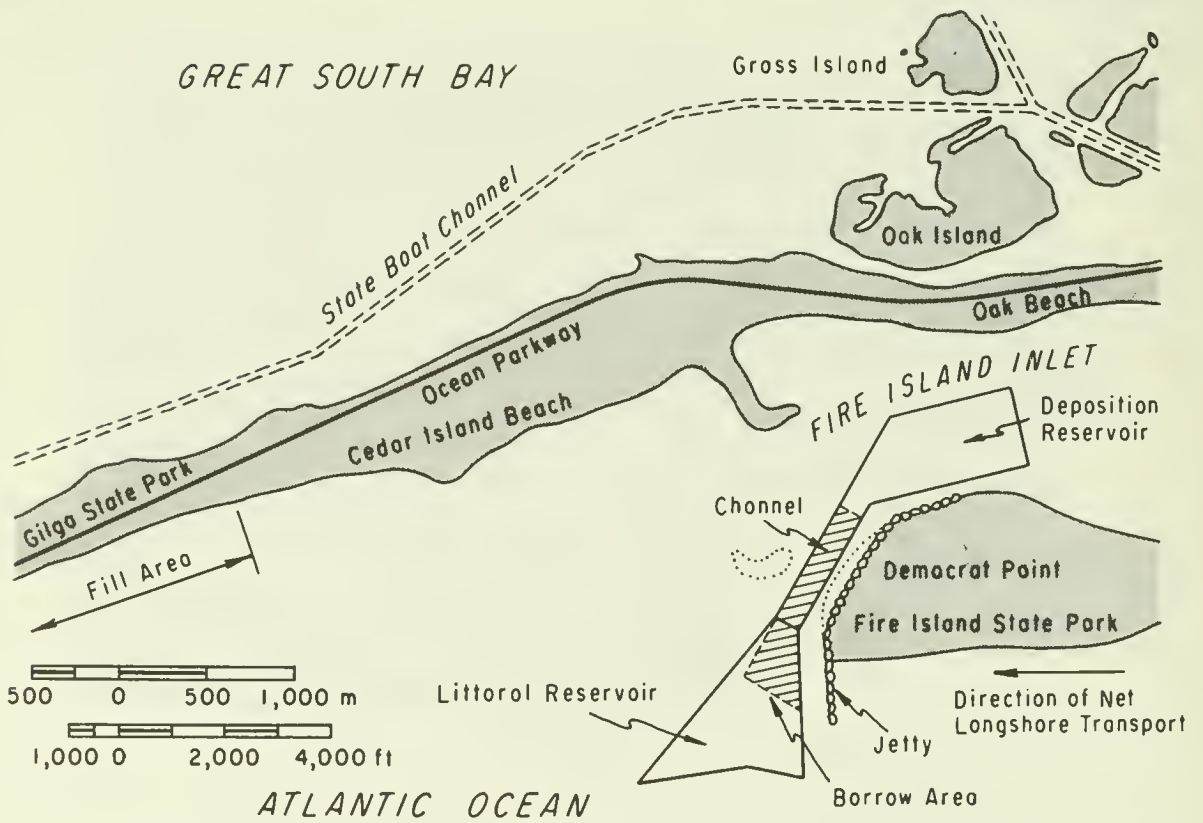

Figure 6-48. Sand bypassing, Fire Island Inlet, New York.



(Sept. 1974)

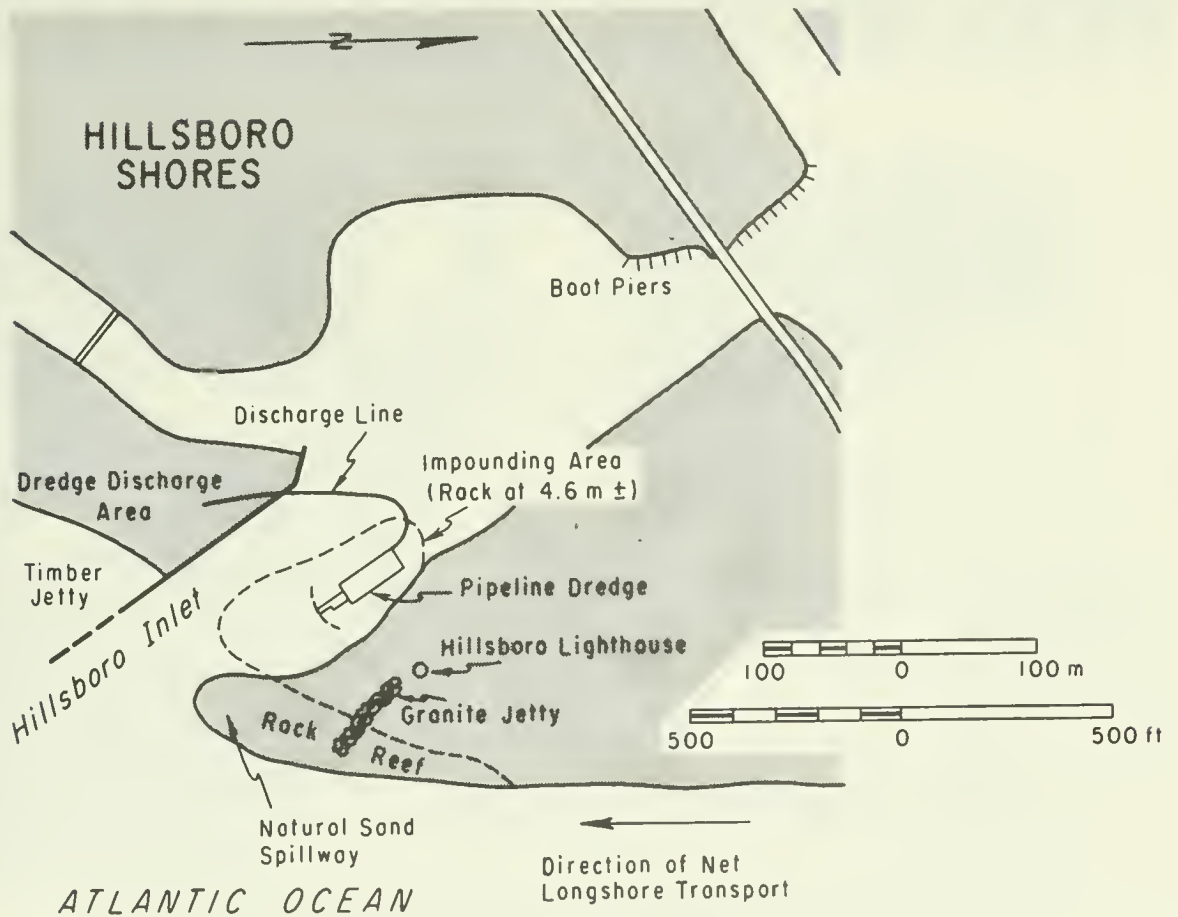
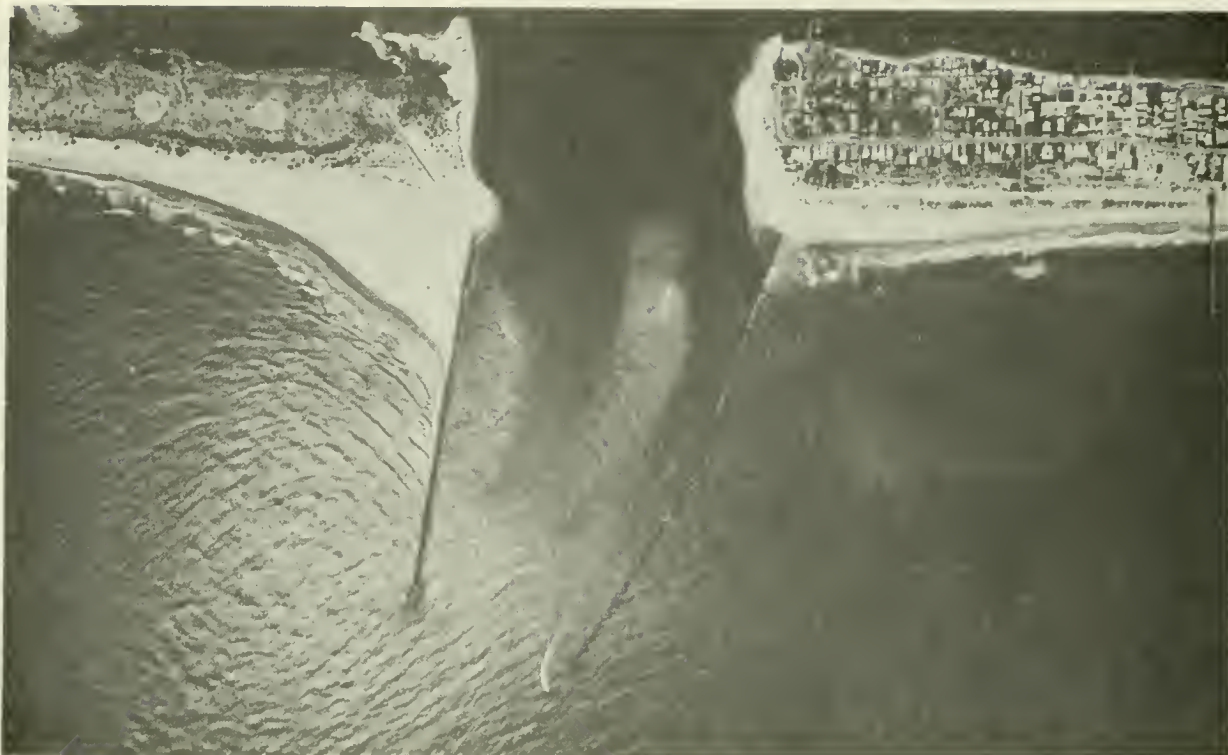

Figure 6-49. Sand bypassing, Hillsboro Inlet, Florida.



(May 1981)

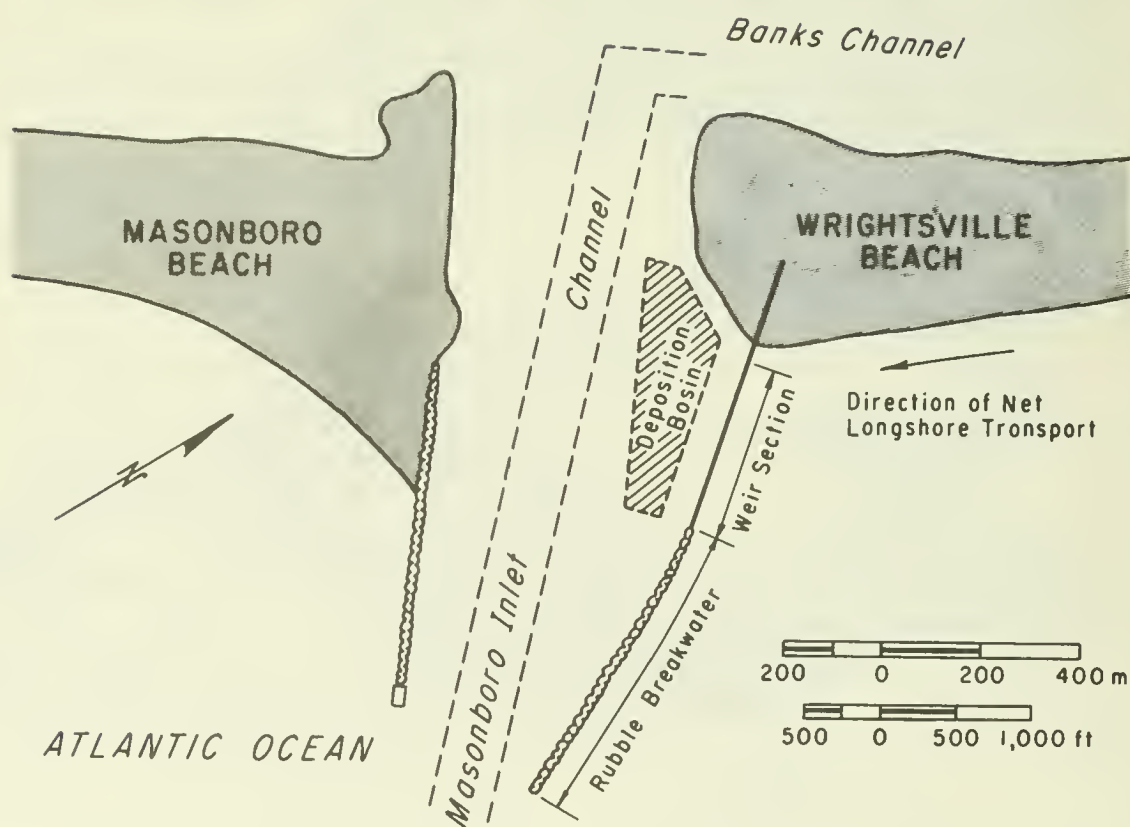

Figure 6-50. Sand bypassing, Masonboro Inlet, North Carolina.



(Apr. 1969)

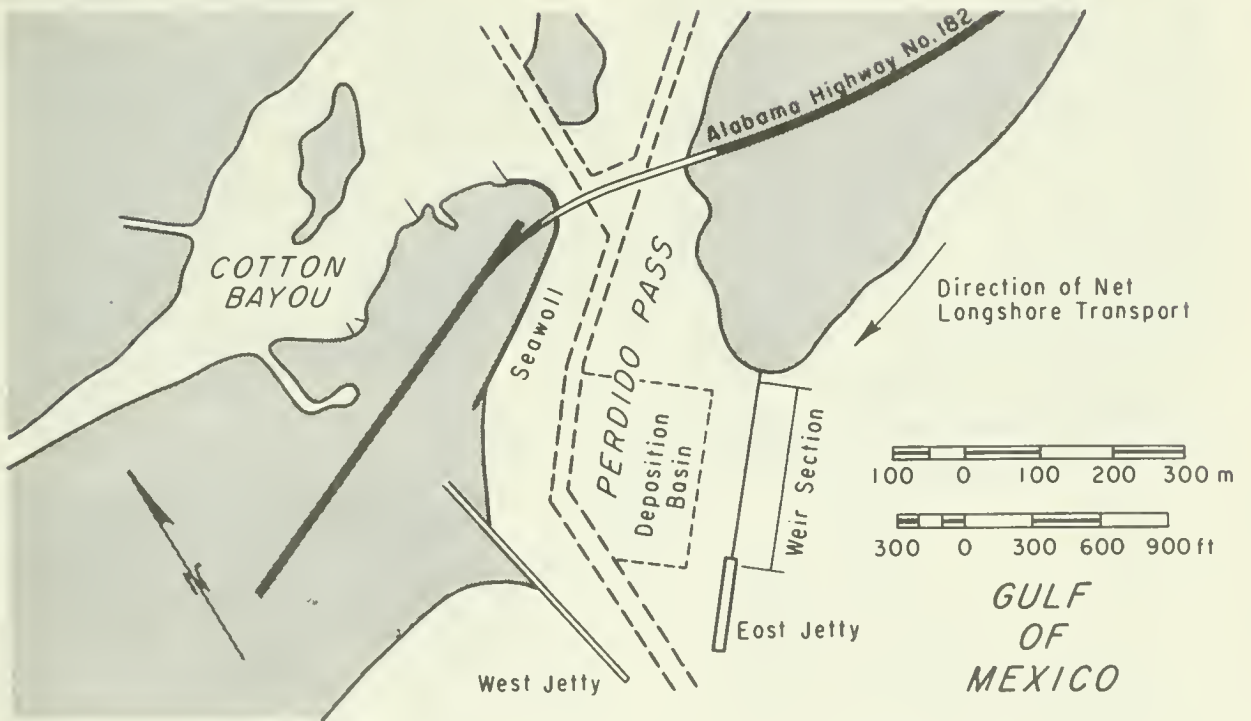

Figure 6-51. Sand bypassing, Perdido Pass, Alabama.



(Mar. 1972)

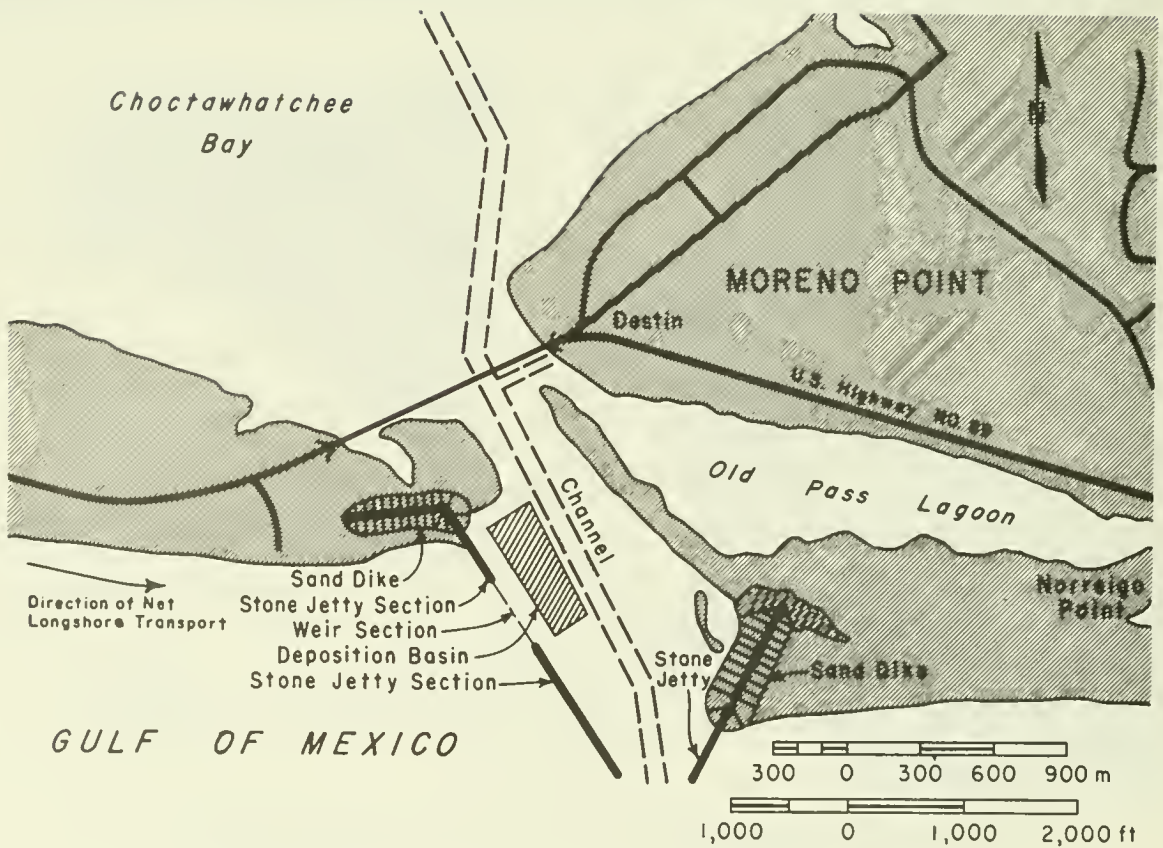

Figure 6-52. Sand bypassing, East Pass, Florida.



(Apr. 1971)

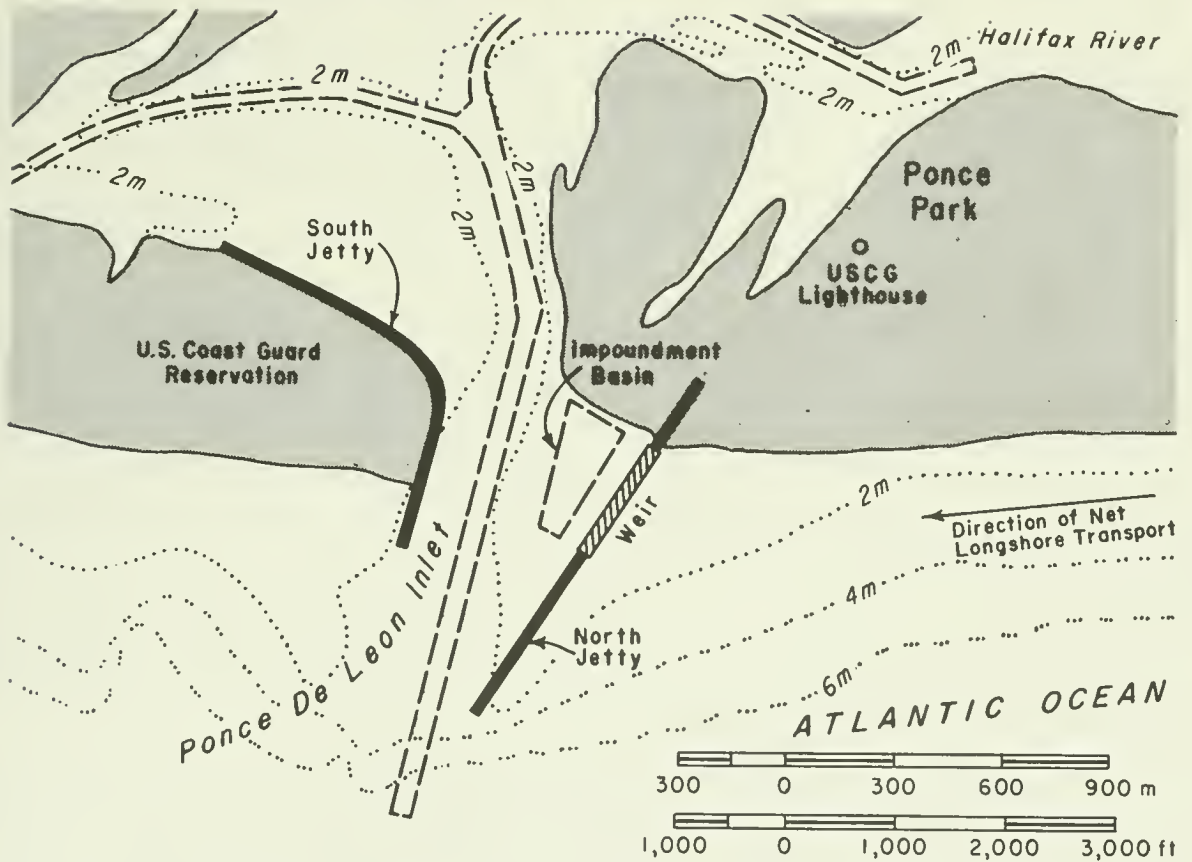

Figure 6-53. Sand bypassing, Ponce de Leon Inlet, Florida, just south of Daytona Beach.

entrance to the downdrift beach through a submerged pipeline. The unique feature of this operation was that the outer strip (or seaward edge) of the impounded fillet was used to protect the dredge from wave action. Land equipment excavated a hole in the beach, which was enlarged to permit a large dredge to enter from the open sea.

Since it was necessary to close the dredge entrance channel to prevent erosion of the protective strip, water had to be pumped into the dredged lagoon. This problem might have been avoided had the proposed entry route from inside the harbor been used and kept open during phase I dredging (see Fig. 6-43).

After completing the phase I dredging (see Fig. 6-43), the floating plant then dredged the protective barrier by making diagonal cuts from the phase I area out to the MLLW line.

From August 1953 to June 1954, 1,554,000 cubic meters (2,033,000 cubic yards) of sand was bypassed to downdrift feeder beaches. Subsequent development updrift at Channel Islands Harbor, discussed below, provided periodic nourishment to the downdrift beaches southeast of Port Hueneme Harbor.

b. Channel Islands Harbor, California (Herron and Harris, 1967). This small-craft harbor was constructed in 1960-61 about 1.5 kilometers northwest of the Port Hueneme entrance (see Fig. 6-46). The type III littoral barrier consists of a 700-meter-long (2,300-foot) offshore breakwater, located at the 9-meter-depth contour, and two entrance jetties. The breakwater is a rubble-mound structure with a crest elevation 4.3 meters (14 feet) above MLLW. It traps nearly all the littoral drift, prevents losses of drift into Hueneme Canyon, prevents shoaling of the harbor entrance, and provides protection for a floating dredge. The sand-bypassing dredging operation transfers sand across both the Channel Islands Harbor entrance and the Port Hueneme entrance to the downdrift beaches (U.S. Army Engineer District, Los Angeles, 1957). The general plan is shown in Figure 6-46.

In 1960-61 dredging of the sand trap, the entrance channel, and the first phase of harbor development provided 4.6 million cubic meters (6 million cubic yards) of sand. Since the initial dredging, the sand trap has been dredged 10 times between 1963 and 1981, with an average of 1,766,000 cubic meters (2,310,000 cubic yards) of sand being bypassed during each dredging operation. The 22.2 million cubic meters (29 million cubic yards) bypassed since operations began has overcome the severe erosion problem of the beaches downdrift of Port Hueneme.

c. Jupiter Inlet, Florida (Jones and Mehta, 1977). The type II sand bypassing method consists of dredging material from shoals or a sand trap located in the protected waters of an inlet or harbor entrance and discharging the spoil onto the downdrift beaches.

Jupiter Inlet is an improved natural inlet located in the northern part of Palm Beach County, Florida. Maintenance dredging of the inlet has been performed since the early 1940's, but bypassed amounts before 1952 are unknown. Between 1952 and 1964 dredging of the inlet produced approximately 367,900 cubic meters (481,200 cubic yards) of sand which was bypassed to the downdrift beaches south of the inlet. Since 1966 most maintenance dredging

has taken place in the sand trap area (see Fig. 6-44). Between 1966 and 1977 the sand trap was dredged six times for a total of 488,500 cubic meters (639,000 cubic yards), which results in an annual average of about 44,400 cubic meters (58,000 cubic yards) of bypassed sand.

d. Sebastian Inlet, Florida (Jones and Mehta, 1977). Sebastian Inlet, 72 kilometers (45 miles) south of Cape Canaveral, is a manmade inlet that was opened in 1948 and subsequently stabilized. The most recent jetty construction occurred in 1970. This inlet differs from most inlets on sandy coasts because the sides of the channel are cut into rock formations. This has limited the inlet cross-sectional area to about half the area that would be expected for the tidal prism being admitted. Consequently, the inlet currents are exceptionally strong and the littoral drift is carried a considerable distance into the inlet.

In 1962 a sand trap was excavated in a region where the inlet widens and the currents decrease sufficiently to drop the sediment load (see Fig. 6-45). This initial dredging produced 210,000 cubic meters (274,600 cubic yards) of sand and rock, which was placed along the inlet banks and on the beach south of the inlet. The trap was enlarged to 15 hectares (37 acres) in 1972 when 325,000 cubic meters (425,000 cubic yards) of sand and rock was removed. In 1978 approximately 143,400 cubic meters (187,600 cubic yards) of sand and 75,600 cubic meters (98,900 cubic yards) of rock were excavated, with the sand being bypassed to the downdrift beach.

e. Santa Barbara, California. The Santa Barbara sand-bypassing operation was necessitated by the construction of a 850-meter (2,800-foot) breakwater, completed in 1928, to protect the harbor (see Fig. 6-47.) The breakwater resulted in accretion on the updrift side (west) and erosion on the downdrift side (east). Bypassing was started in 1935 by hopper dredges which dumped about 154,400 cubic meters (202,000 cubic yards) of sand in 7 meters of water about 300 meters offshore. Surveys showed that this sand was not moved to the beach. The next bypassing was done in 1938 by a pipeline dredge. A total of 447,000 cubic meters (584,700 cubic yards) of sand was deposited on the feeder beach area, which is shown in Figure 6-47. This feeder beach was successful in reducing erosion downdrift of the harbor, and the operation was continued by periodically placing about 3,421,000 cubic meters (4,475,000 cubic yards) of sand from 1940 to 1952 (Wiegel, 1959).

In 1957 the city of Santa Barbara decided not to remove the shoal at the seaward end of the breakwater because it provided additional protection for the inner harbor. A small floating dredge was used to maintain the channel and the area leeward of the shoal, which was occasionally overwashed during storm conditions. Wave and weather conditions limited the dredging operations to 72 percent of the time.

In order to reduce the overwashing of the shoal, the city installed a bulkhead wall along 270 meters (880 feet) of the shoal in 1973-74. The top elevation of the wall is 3 meters (10 feet) above MLLW. This caused the littoral drift to move laterally along the shoal until it was deposited adjacent to and into the navigation channel. Since that time an estimated 267,600 cubic meters (350,000 cubic yards) of material per year has been dredged from the end of the bar and the navigation channel. A part of this

material is used to maintain the spit, with the remainder being bypassed to the downdrift beaches.

f. Hillsboro Inlet, Florida (Hodges, 1955; Jones and Mehta, 1977). Hillsboro Inlet is a natural inlet in Broward County, Florida, about 58 kilometers (36 miles) north of Miami. A unique aspect of the inlet is a natural rock reef that stabilizes the updrift (north) side of the channel (see Fig. 6-49). The rock reef and jetties form what is called a *sand spillway*. Southward-moving littoral sand is washed across the reef and settles in the sheltered impoundment area where it is dredged and bypassed to the south beaches. A 20-centimeter hydraulic dredge, purchased by the Inlet District in 1959, operates primarily in the impoundment basin, but also maintains the navigation channel. The total quantity of sand bypassed between 1952 and 1965 was 589,570 cubic meters (771,130 cubic yards), averaging 45,350 cubic meters (59,300 cubic yards) per year.

The north and south jetties were rebuilt and extended during 1964-65, and the navigation channel was excavated to -3 meters MSL. Between 1965 and 1977 the dredge bypassed 626,000 cubic meters (819,000 cubic yards) of sand for an annual average of 52,170 cubic meters (68,250 cubic yards) per year.

This sand-bypassing operation is the original *weir jetty*, and it forms the basis for the type V bypassing concept.

g. Masonboro Inlet, North Carolina (Magnuson, 1966; Rayner and Magnuson, 1966; U.S. Army Engineer District, Wilmington, 1970.) This inlet is the southern limit of Wrightsville Beach, North Carolina. An improvement to stabilize the inlet and navigation channel and to bypass nearly all the littoral drift was constructed in 1966. This phase of the project included the north jetty and deposition basin. The jetty consisted of an inner section of concrete sheet piles 520 meters (1,700 feet) long, of which 300 meters is the weir section, and a rubble-mound outer section 580 meters (1,900 feet) long. The elevation of the weir section (about midtide level) was established low enough to pass the littoral drift, but high enough to protect the dredging operations in the deposition basin and to control tidal currents in and out of the inlet. The midtide elevation of the weir crest appears to be suitable for this location where the mean tidal range is about 1.2 meters. The basin was dredged to a depth of 4.9 meters (16 feet) MLW, removing 280,600 cubic meters (367,000 cubic yards) of sand. A south jetty, intended to prevent material from entering the channel during periods of longshore transport reversal, was not initially constructed. Without the south jetty, sand that entered the inlet from the south caused a northward migration of the channel into the deposition basin and against the north jetty. Between 1967 and 1979 all dredging operations were involved in channel maintenance.

In 1980 the south jetty (see Fig. 6-50) was completed, and 957,000 cubic meters (1,250,000 cubic yards) of material was dredged from the navigation channel and from shoals within the inlet. This material was placed on the beach. It is expected that the south jetty will prevent the navigation channel from migrating into the deposition basin, and that the weir-jetty system will function as originally designed. It is projected that 230,000 cubic meters (300,000 cubic yards) of material will be impounded in the basin each year and hydraulic bypassing will alternate each year between Wrightsville Beach to the north and Masonboro Beach to the south.

h. Perdido Pass, Alabama. This weir-jetty project was completed in 1969 (see Fig. 6-51). Since the direction of the longshore transport is westward, the east jetty included a weir section 300 meters (984 feet) long at an elevation of 15 centimeters (6 inches) above MLW. The diurnal tidal range is about 0.4 meter (1.2 feet). A deposition basin was dredged adjacent to the weir and the 3.7-meter-deep channel. The scour that occurred along the basin side of the concrete sheet-pile weir was corrected by placing a rock toe on the weir. Nearly all the littoral drift that crosses the weir fills the deposition basin so rapidly that it shoals on the channel. The first redredging of the basin occurred in 1971. During the period from 1972 to 1974, two dredging operations in the basin and the navigation channel produced a total of 596,000 cubic meters (780,000 cubic yards) of sand. Three dredging operations between 1975 and 1979 removed a total of 334,400 cubic meters (437,400 cubic yards) of sand from the channel. In 1980, 175,400 cubic meters (229,400 cubic yards) was dredged from the channel and deposition basin. These figures indicate that approximately 138,000 cubic meters (181,000 cubic yards) of sand is being bypassed each year.

In 1979 Hurricane Frederic dislodged three sections of the concrete sheet piling in the weir and cut a channel between the weir and the beach. The discharge from the dredging operations that year was used to close the breach and to fill the beach to the east of the weir.

3. Additional Bypassing Schemes.

Several other methods of bypassing sand at littoral barriers have been tested. *Land-based vehicles* were used in a sand-bypassing operation at Shark River Inlet, New Jersey (Angas, 1960). The project consisted of removing 190,000 cubic meters (250,000 cubic yards) of sand from an area 70 meters (225 feet) south of the south jetty and placing this material along 760 meters (2,500 feet) of the beach on the north side of the inlet. On the south side of the inlet a trestle was built in the borrow area to a point beyond the low-water line allowing trucks access from the highway to a crane with a 2-meter (2.5-yard) bucket. Three shorter trestles were built north of the inlet where the sand was dumped on the beach, allowing wave action to distribute it to the downdrift beaches. This method is limited by the fuel expense and by the requirement for an easy access across the inlet and to the loading and unloading areas.

Split-hull barges and hopper dredges can be used to bypass dredged material by placing the spoil just offshore of the downdrift beaches. A test of this method was conducted at New River Inlet, North Carolina, during the summer of 1976 (Schwartz and Musialowski, 1980). A split-hull barge placed 27,000 cubic meters (35,000 cubic yards) of relatively coarse sediment along a 215-meter (705-foot) reach of beach between the 2- and 4-meter-depth (7- and 13- foot) contours. This material formed into bars that reduced in size as they moved shoreward. This final survey, 13 weeks later, indicated a slight accretion at the base of the foreshore and an increased width of the surf zone. The split-hull barge method was also used with commercially available equipment to place 230,000 cubic meters (300,000 cubic yards) at St. Augustine Beach, Florida, in 1979.

While this method provides some nourishment and protection to the beach, it is not known how it compares with conventional placement of sand on the

beach and foreshore. Drawbacks to the use of split-hull barges include the necessity for favorable wind and wave climate during operation and the possibility that storms may move the sediment offshore, where it can be lost to the littoral processes.

Side-cast dredging has been a successful means of maintaining and improving inlets where shallow depths and wave conditions make operation of a pipeline or hopper dredges hazardous (Long, 1967). However, the effectiveness of side-cast dredging as a bypassing method is limited by the length of the discharge pipe supporting boom. While it is possible to discharge in the downdrift direction, generally the dredged material is placed too close to the channel to be effectively bypassed. Reversals in the littoral current, and even changes in the tidal flow, can cause the dredged material to move back into the channel.

VI. GROINS

1. Types.

As described in Chapter 5, Section VI, groins are mainly classified as to permeability, height, and length. Groins built of common construction materials can be made permeable or impermeable and high or low in profile. The materials used are stone, concrete, timber, and steel. Asphalt and sandfilled nylon bags have also been used to a limited extent. Various structural types of groins built with different construction materials are illustrated in Figures 6-54 to 6-59.

a. Timber Groins. A common type of timber groin is an impermeable structure composed of sheet piles supported by wales and round piles. Some permeable timber groins have been built by leaving spaces between the sheeting. A typical timber groin is shown in Figure 6-54. The round timber piles forming the primary structural support should be at least 30 centimeters in diameter at the butt. Stringers or wales bolted to the round piles should be at least 20 by 25 centimeters, preferably cut and drilled before being pressure treated with creosote and coal-tar solution. The sheet piles are usually either of the Wakefield, tongue-and-groove, or shiplap type, supported in a vertical position between the wales and secured to the wales with nails. All timbers and piles used for marine construction should be given the maximum recommended pressure treatment of creosote and coal-tar solution. Ayers and Stokes (1976) provide timber structure design guidance.

b. Steel Groins. A typical design for a timber-steel sheet-pile groin is shown in Figure 6-55. Steel sheet-pile groins have been constructed with straight-web, arch-web, or Z piles. Some have been made permeable by cutting openings in the piles. The interlock type of joint of steel sheet piles provides a sandtight connection. The selection of the type of sheet piles depends on the earth forces to be resisted. Where the differential loads are small, straight web piles can be used. Where differential loads are great, deep-web Z piles should be used. The timber-steel sheet-pile groins are constructed with horizontal timber or steel wales along the top of the steel sheet piles, and vertical round timber piles or brace piles are bolted to the outside of the wales for added structural support. The round piles may not always be required with the Z pile, but ordinarily are used with the flat or

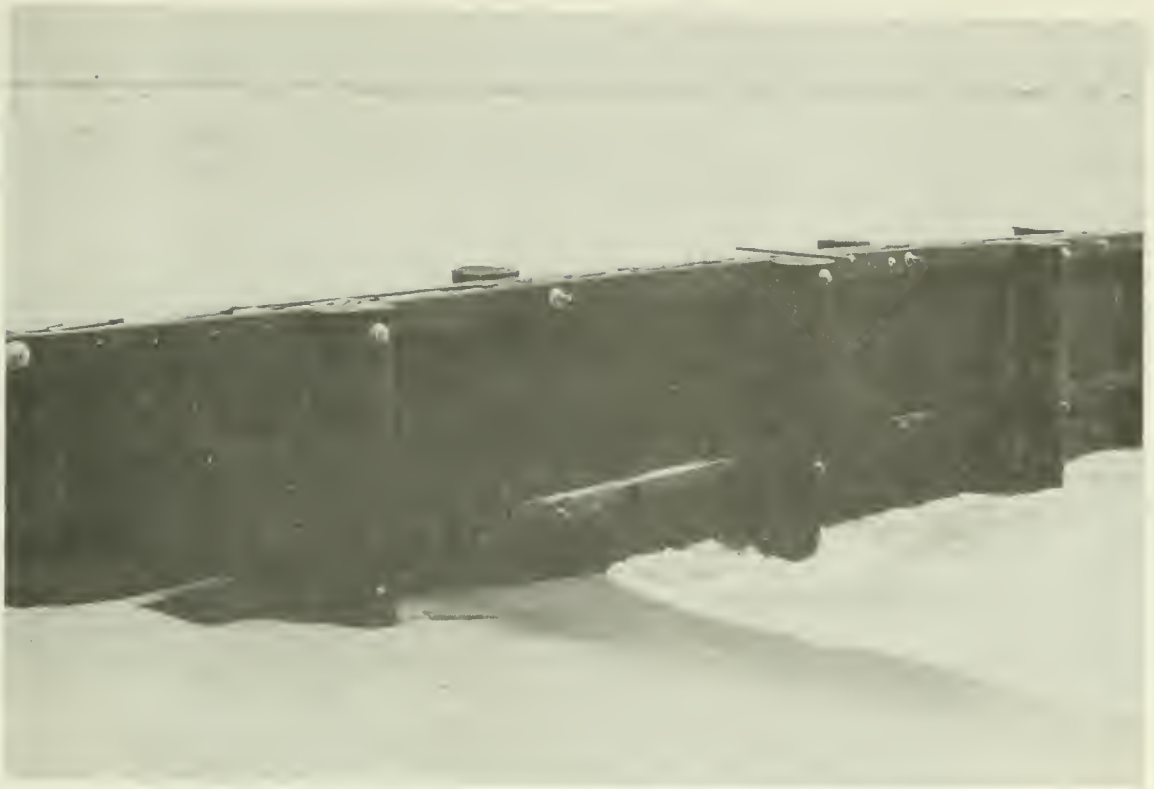

Wallops Island, Virginia (1964)

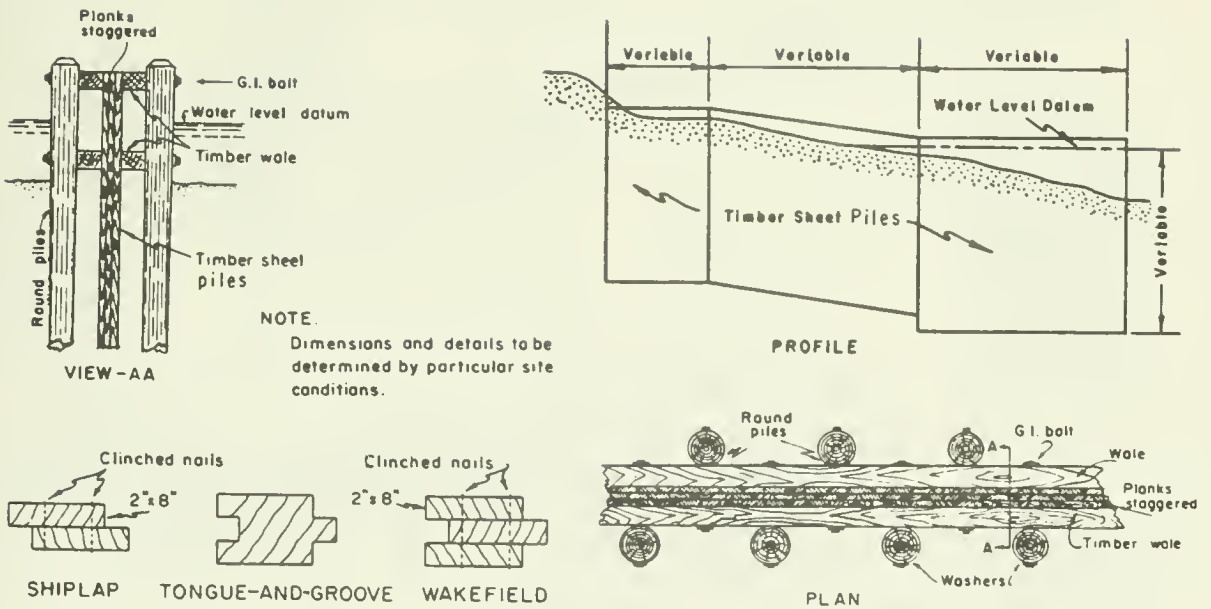
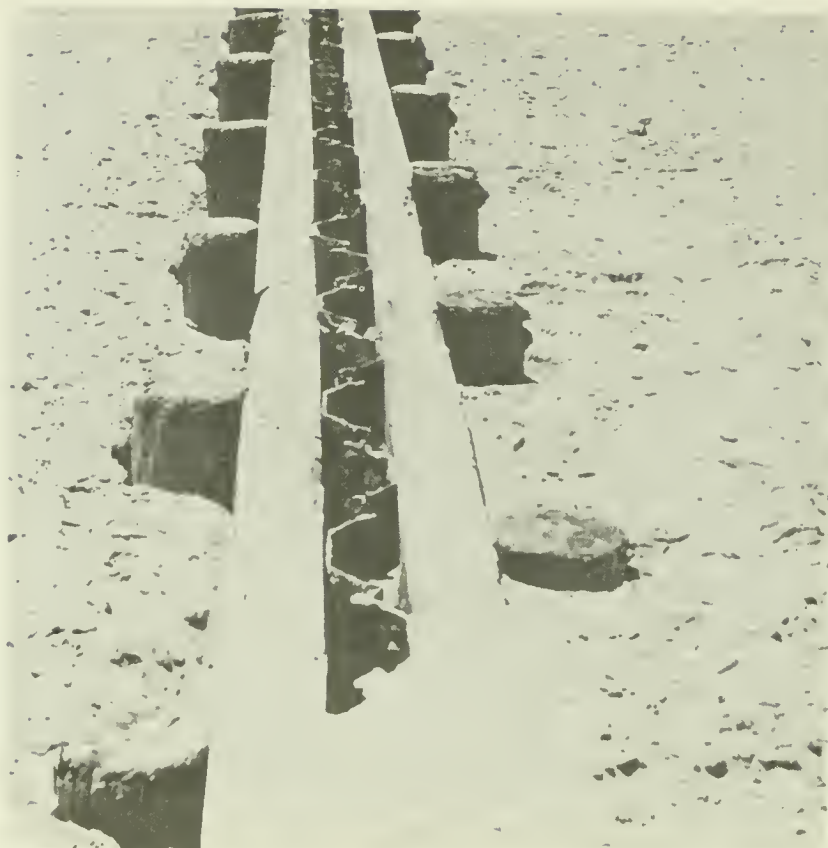

Figure 6-54. Timber-sheet pile groin.



New Jersey (Sept. 1962)

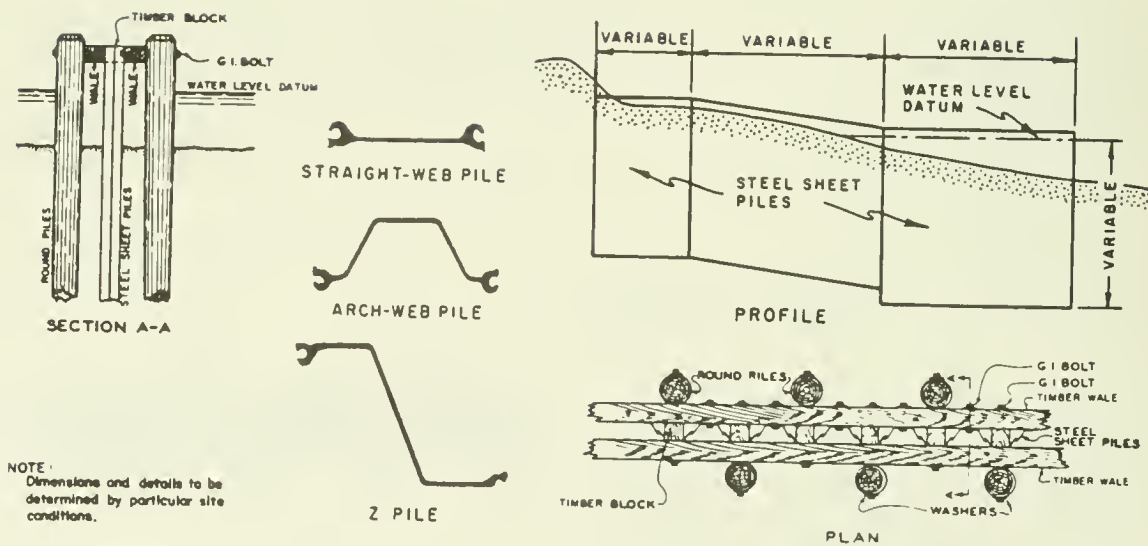

Figure 6-55. Timber-steel sheet-pile groin.



Newport Beach, California (Mar. 1969)

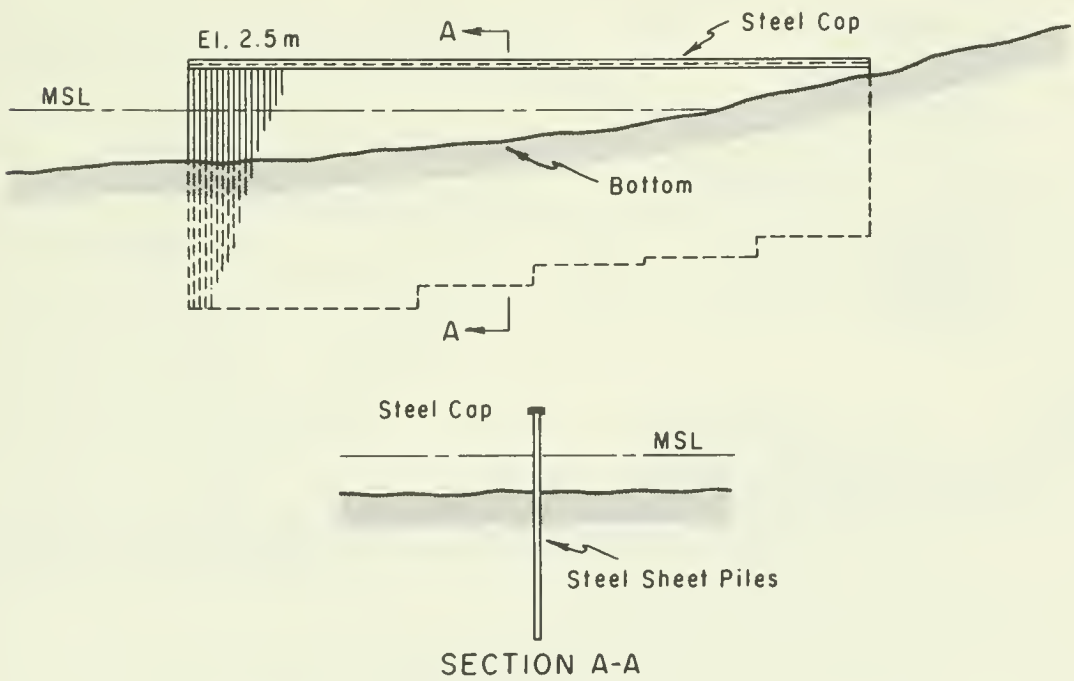

Figure 6-56. Cantilever-steel sheet-pile groin.



Presque Isle, Pennsylvania (Oct. 1965)

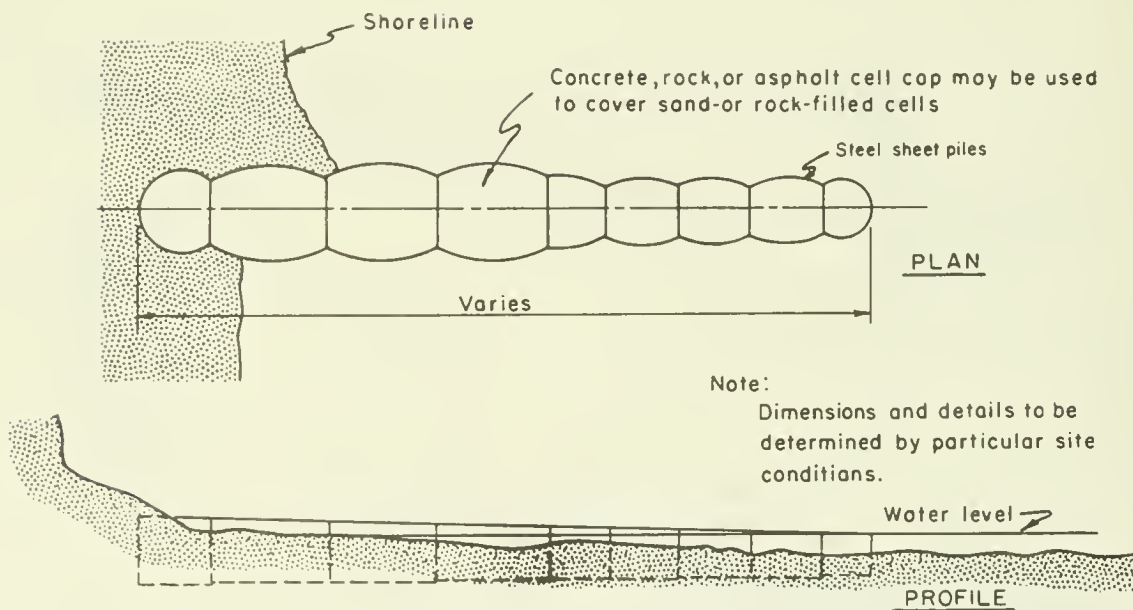

Figure 6-57. Cellular-steel sheet-pile groin.



Doheny Beach State Park, California (Oct. 1965)

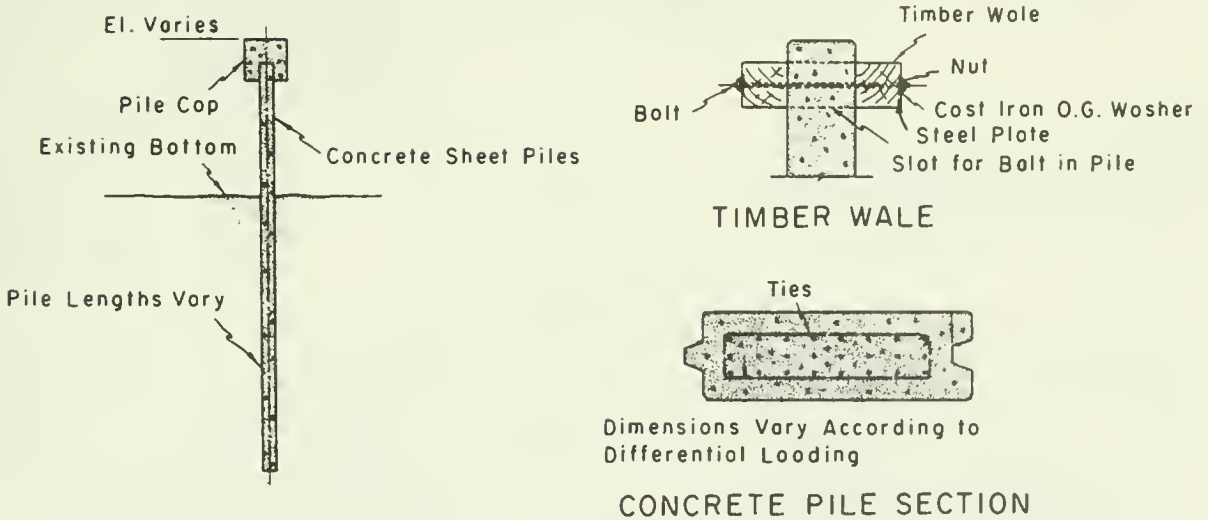
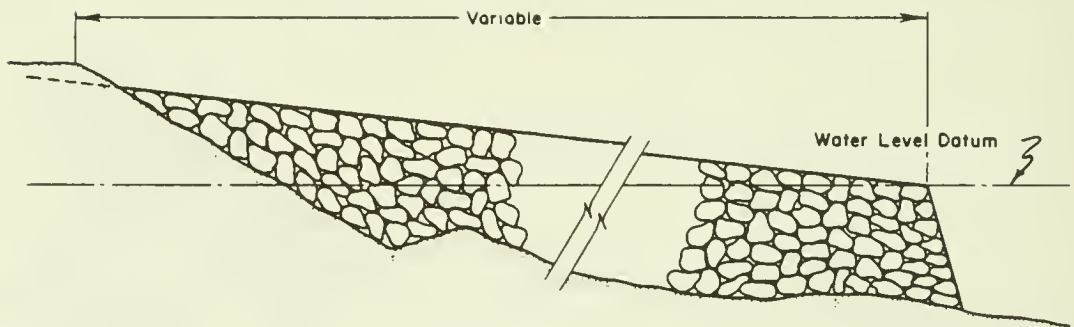

Figure 6-58. Prestressed-concrete sheet-pile groin.



Westhampton Beach, New York (1972)



PROFILE

NOTE. Dimensions and details to be determined by particular site conditions

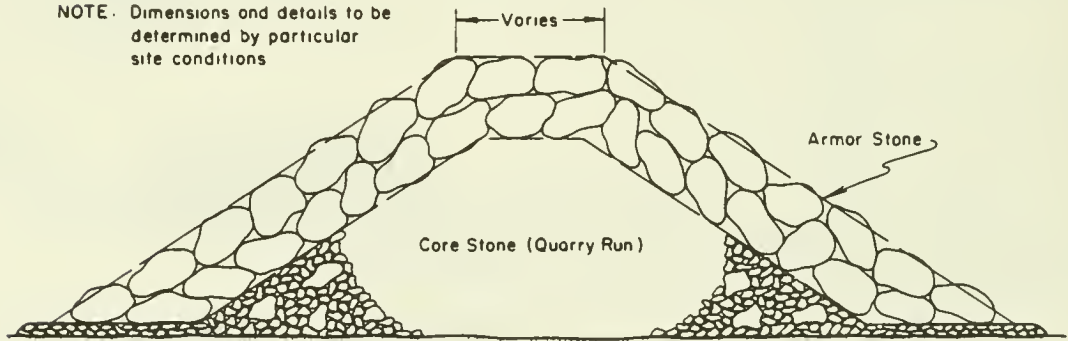

CROSS SECTION

Figure 6-59. Rubble-mound groin.

arch-web sections. The round pile and timbers should be creosoted to the maximum pressure treatment for use in waters with marine borers.

Figure 6-56 illustrates the use of a cantilever-steel sheet-pile groin. A groin of this type may be used where the wave attack and earth loads are moderate. In this structure, the sheet piles are the basic structural members; they are restrained at the top by a structural-steel channel welded to the piles. Differential loading after sediments have accumulated on one side is an important consideration for structures of this type.

The cellular-steel sheet-pile groin has been used on the Great Lakes where adequate pile penetration cannot be obtained for stability. A cellular-type groin is shown in Figure 6-57. This groin is comprised of cells of varying sizes, each consisting of semicircular walls connected by cross diaphragms. Each cell is filled with sand or aggregate to provide structural stability. Concrete, asphalt, or stone caps are used to retain the fill material.

c. Concrete Groins. Previously, the use of concrete in groins was generally limited to permeable-type structures that permitted passage of sand through the structure. Many of these groin designs are discussed by Portland Cement Association (1955) and Berg and Watts (1967). A more recent development in the use of concrete for groin construction is illustrated in Figure 6-58. This groin is an impermeable, prestressed concrete-pile structure with a cast-in-place concrete cap. At an installation at Masonboro Inlet, North Carolina, a double-timber wale was used as a cap to provide greater flexibility. Portland Cement Association (1969) and U.S. Army, Corps of Engineers (1971b) provide guidance on concrete hydraulic structure design.

d. Rubble-Mound Groins. Rubble-mound groins are constructed with a core of quarry-run material, including fine material to make them sandtight, and covered with a layer of armor stone. The armor stone should weigh enough to be stable against the design wave. Typical rubble-mound groins are illustrated in Figure 6-59.

If permeability of a rubble-mound groin is a problem, the voids between stones in the crest above the core can be filled with concrete or asphalt grout. This seal also increases the stability of the entire structure against wave action. In January 1963 asphalt grout was used to seal a rubble-mound groin at Asbury Park, New Jersey, with apparent success (Asphalt Institute, 1964, 1965, and 1969).

e. Asphalt Groins. Experimentation in the United States with asphalt groins began in 1948 at Wrightsville Beach, North Carolina. During the next decade, sand-asphalt groins were built at the following sites: Fernandina Beach, Florida; Ocean City, Maryland (Jachowski, 1959); Nags Head, North Carolina; and Harvey Cedars, Long Beach Island, New Jersey.

The behavior of the type of sand-asphalt groin used to date demonstrates definite limitations of their effectiveness. An example of such a structure is a groin extension placed beyond the low-water line which is composed of a

hot asphalt mixture and tends toward early structural failure of the section seaward of the beach berm crest. Failure results from lack of resistance to normal seasonal variability of the shoreface and consequent undermining of the structure foundation. Modification of the design as to mix, dimensions, and sequence of construction may reveal a different behavior. See Asphalt Institute (1964, 1965, 1969, and 1976) for discussions of the uses of asphalt in hydraulic structures.

2. Selection of Type.

After research on a problem area has indicated the use of groins as practicable, the selection of groin type is based on varying factors related to conditions at each location. A thorough investigation of existing foundation materials is essential. Borings or probings should be taken to determine the subsurface conditions for penetration of piles. Where foundations are poor or where little penetration is possible, a gravity-type structure such as a rubble or a cellular-steel sheet-pile groin should be considered. Where penetration is good, a cantilever-type structure made of concrete, timber, or steel-sheet piles should be considered.

Availability of materials affects the selection of the most suitable groin type because of costs. Annual maintenance, the period during which protection will be required, and the available funds for initial construction must also be considered. The initial costs of timber and steel sheet-pile groins, in that order, are often less than for other types of construction. Concrete sheet-pile groins are generally more expensive than either timber or steel, but may cost less than a rubble-mound groin. However, concrete and rubble-mound groins require less maintenance and have a longer life than timber or steel sheet-pile groins.

3. Design.

The structural design of a groin is explained in a number of Engineer Manuals (EM's). EM 1110-2-3300 (U.S. Army Corps of Engineers 1966) is a general discussion of the components of a coastal project. A forthcoming EM (U.S. Army Corps of Engineers (in preparation, 1984)) is a comprehensive presentation of the design of coastal groins. The basic soil mechanics involved in calculating the soil forces on retaining walls (and, therefore, sheet-pile groins) are presented in EM 1110-2-2502 (U.S. Army Corps of Engineers 1961). EM 1110-2-2906 (U.S. Army Corps of Engineers 1958) discusses the design of pile structures and foundations that can be used in the design of sheet-pile groins. Wave loading on vertical sheet-pile groins is discussed by Weggel (1981a).

VII. JETTIES

1. Types.

The principal materials for jetty construction are stone, concrete, steel, and timber. Asphalt has occasionally been used as a binder. Some structural types of jetties are illustrated in Figures 6-60, 6-61, and 6-62.

a. Rubble-Mound Jetties. The rubble-mound structure is a mound of stones of different sizes and shapes, either dumped at random or placed in



Santa Cruz, California (Mar. 1967)

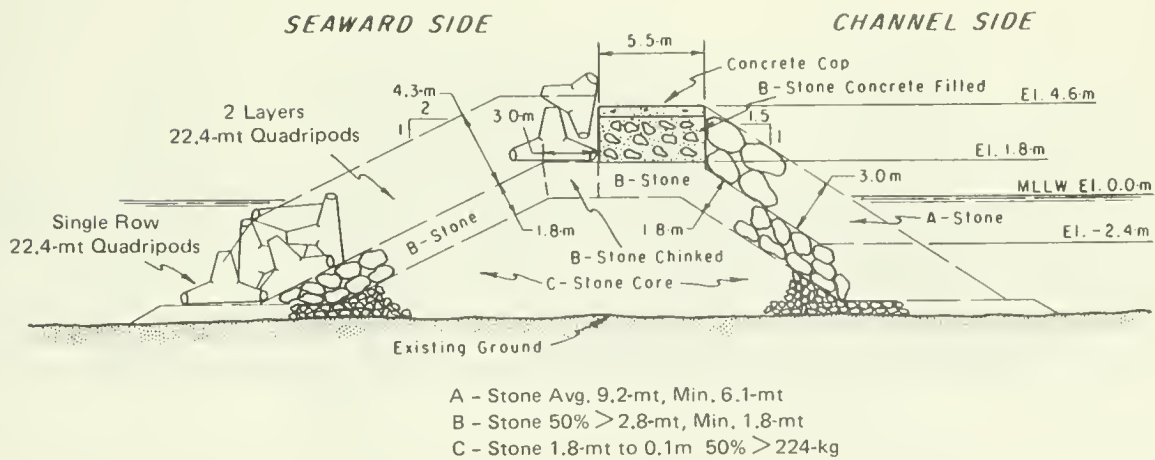
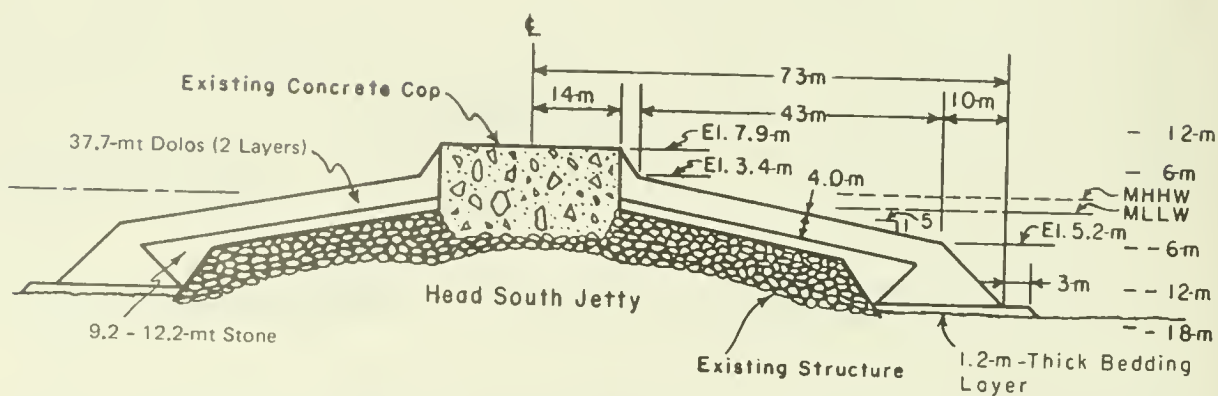

Figure 6-60. Quadripod and rubble-mound jetty.



Humboldt Bay, California (1972)



(after Magoon and Shimizu, 1971)

Figure 6-61. Dolos and rubble-mound jetty.



Grand Marais Harbor, Michigan (before 1965)

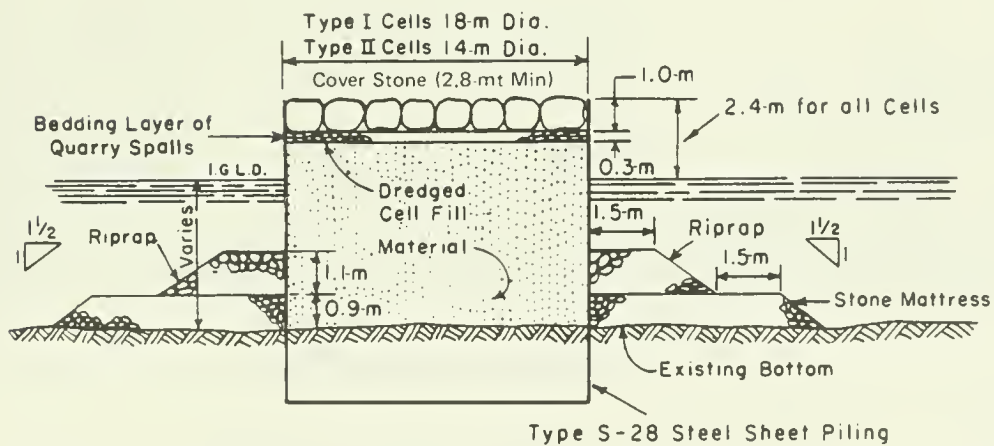

Figure 6-62. Cellular-steel sheet-pile jetty.

courses. Side slopes and armor unit sizes are designed so that the structure will resist the expected wave action. Rubble-mound jetties (see Figs. 6-60 and 6-61), which are used extensively, are adaptable to any water depth and to most foundation conditions. The chief advantages are as follows: structure settling readjusts component stones which increases stability, damage is repairable, and the rubble absorbs rather than reflects wave action. The chief disadvantages are the large quantity of material required, the high initial cost of satisfactory material if not locally available, and the wave energy propagated through the structure if the core is not high and impermeable.

Where quarystone armor units in adequate quantities or size are not economical, concrete armor units are used. Chapter 7, Section III,7,f discusses the shapes that have been tested and are recommended for consideration. Figure 6-60 illustrates the use of quadripod armor units on the rubble-mound jetty at Santa Cruz, California. Figure 6-61 illustrates the use of the more recently developed dolos armor unit where 38- and 39- metric ton (42- and 43- short ton) dolos were used to strengthen the seaward end of the Humboldt Bay, California, jetties against 12-meter breaking waves (Magoon and Shimizu, 1971).

b. Sheet-Pile Jetties. Timber, steel, and concrete sheet piles are used for jetty construction where waves are not severe. Steel sheet piles are used for various jetty formations which include the following: a single row of piling with or without pile buttresses; a single row of sheet piles arranged to function as a buttressed wall; double walls of sheet piles, held together with tie rods, with the space between the walls filled with stone or sand (usually separated into compartments by cross walls if sand is used); and cellular-steel sheet-pile structures (see Fig. 6-62), which are modifications of the double-wall type.

Cellular-steel sheet-pile structures require little maintenance and are suitable for construction in depths to 12 meters on all types of foundations. Steel sheet-pile structures are economical and may be constructed quickly, but are vulnerable to storm damage during construction. If coarse aggregate is used to fill the structure, the life will be longer than with sandfill because holes that corrode through the web have to become large before the coarse aggregate will leach out. Corrosion is the principal disadvantage of steel in seawater. Sand and water action abrade corroded metal near the mudline and leave fresh steel exposed. The life of the piles in this environment may not exceed 10 years. However, if corrosion is not abraded, piles may last more than 35 years. Plastic protective coatings and electrical cathodic protection have effectively extended the life of steel sheet piles. However, new alloy steels are most effective if abrasion does not deteriorate their protective layer.

VIII. BREAKWATERS, SHORE-CONNECTED

1. Types.

Variations of rubble-mound designs are generally used as breakwaters in exposed locations. In less exposed areas, both cellular-steel and concrete caissons are used. Figures 6-63, 6-64, and 6-65 illustrate structural types of shore-connected breakwaters used for harbor protection.



Crescent City, California (Apr. 1964)

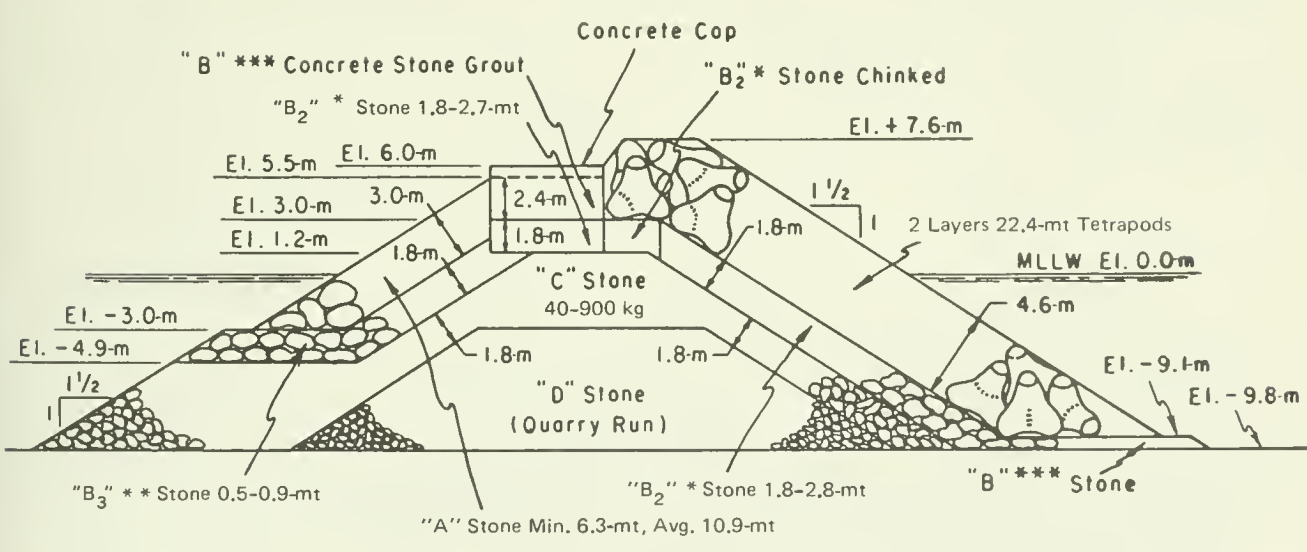

- * "B₂" - 0.9-mt Variation to 6.3-mt Max.
- ** "B₃" - 0.5-to 0.9-mt Min.; 6.3-mt Max. as Available
- *** "B" - 0.9-to 6.3-mt or to Suit Depth Conditions at Seaward Toe

Figure 6-63. Tetrapod and rubble-mound breakwater.



Kahului, Maui, Hawaii (1970)

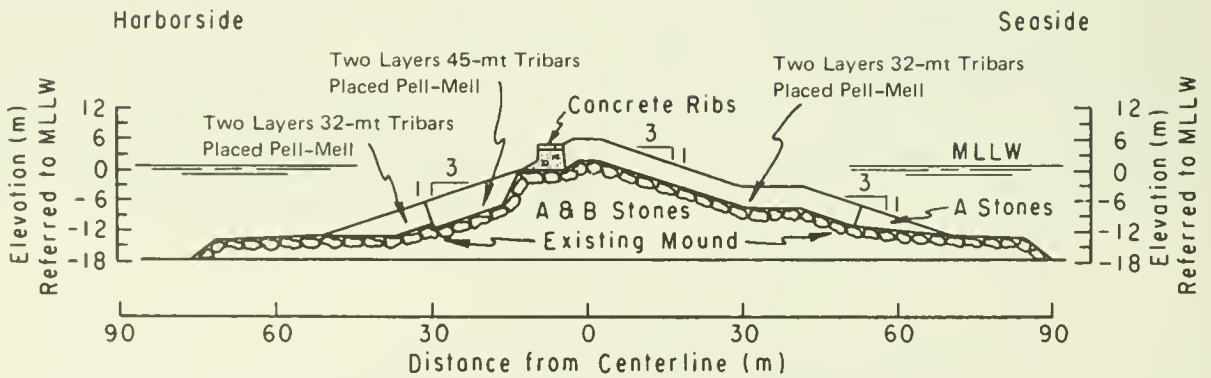
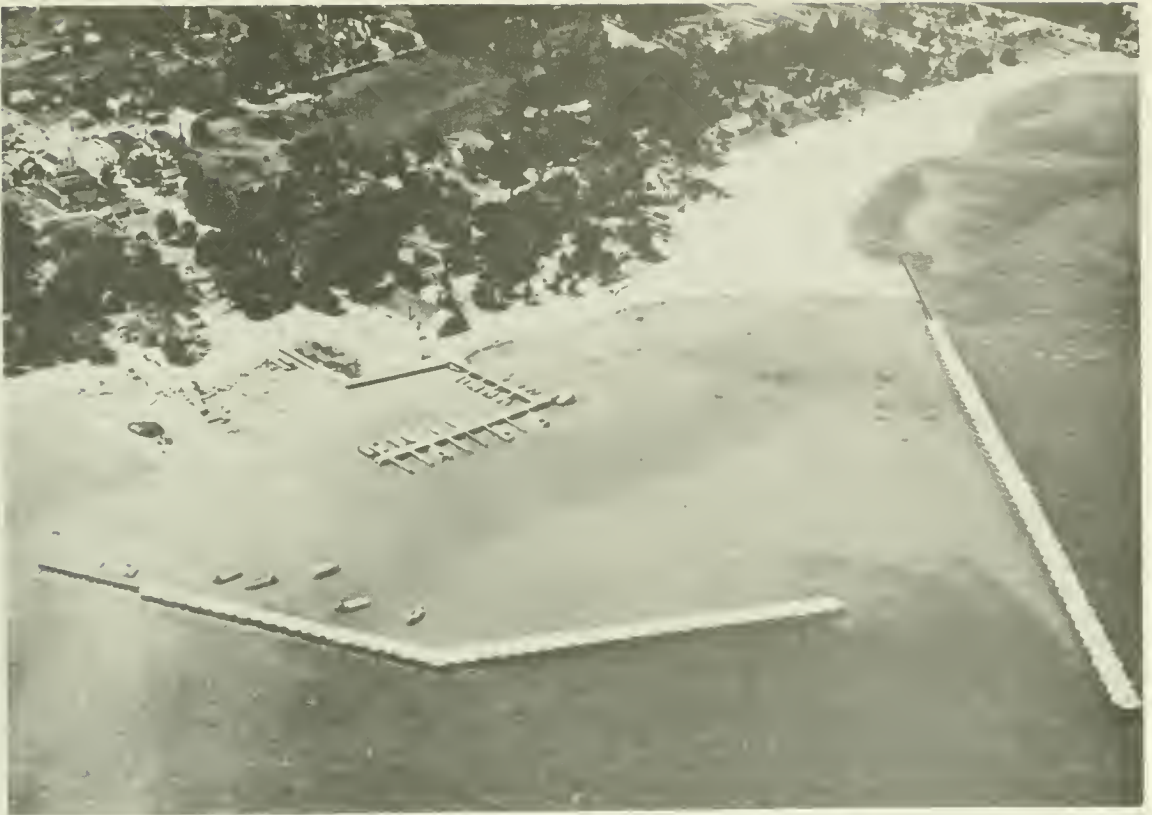

Figure 6-64. Tribar and rubble-mound breakwater.



Port Sanilac, Michigan (July 1963)

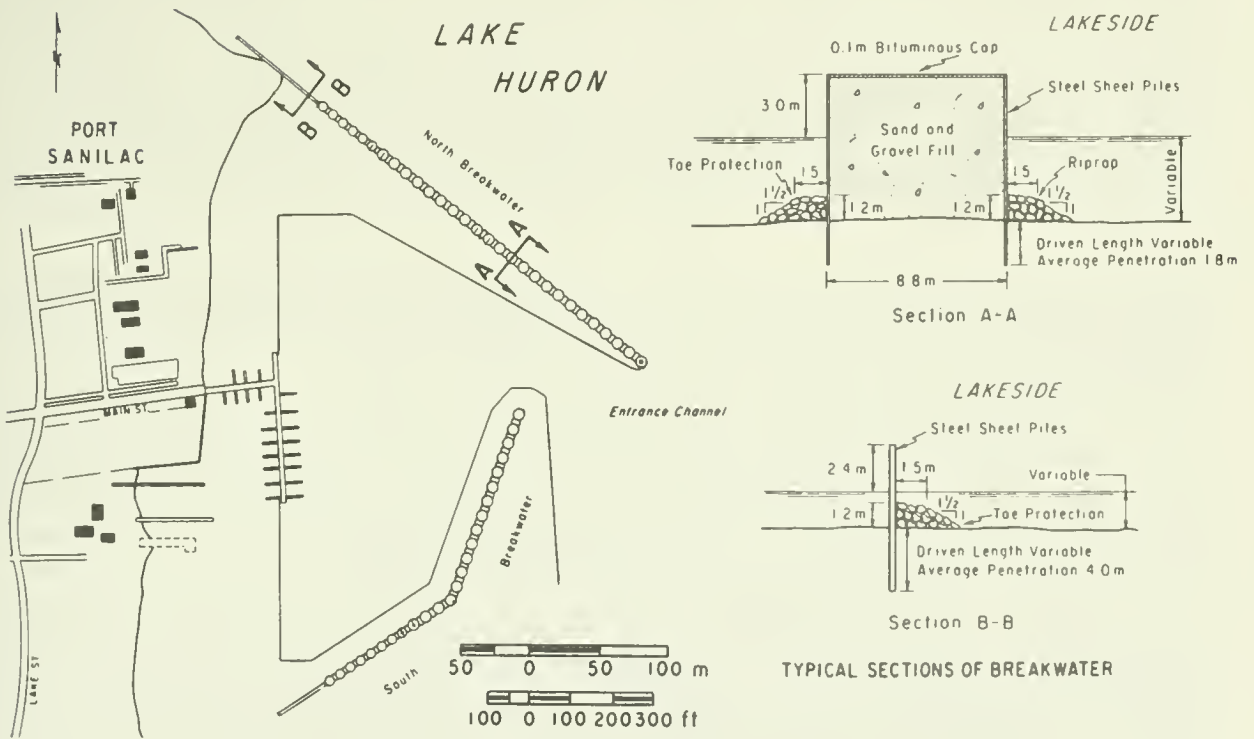

Figure 6-65. Cellular-steel sheet-pile and sheet-pile breakwater.

a. Rubble-Mound Breakwaters. The rubble-mound breakwaters in Figures 6-63 and 6-64 are adaptable to almost any depth and can be designed to withstand severe waves.

Figure 6-63 illustrates the first use in the United States of tetrapod armor units. The Crescent City, California, breakwater was extended in 1957 using two layers of 22.6-metric ton (25-short ton) tetrapods (Deignan, 1959). In 1965, 31.7- and 45.4-metric ton (35- and 50-short ton) tribars were used to repair the east breakwater at Kahului, Hawaii (Fig. 6-64).

b. Stone-Asphalt Breakwaters. In 1964 at Ijmuiden, the entrance to the Port of Amsterdam, The Netherlands, the existing breakwaters were extended to provide better protection and enable passage for larger ships. The southern breakwater was extended 2100 meters (6,890 feet) to project 2540 meters (8,340 feet) into the sea at a depth of about 18 meters. Then rubble breakwaters were constructed in the sea with a core of heavy stone blocks, weighing 300 to 900 kilograms (660 to 2,000 pounds), using the newly developed material at that time, stone asphalt, to protect against wave attack.

The stone asphalt contained 60 to 80 percent by weight stones 5 to 50 centimeters in size, and 20 to 40 percent by weight asphaltic-concrete mix with a maximum stone size of 5 centimeters. The stone-asphalt mix was pourable and required no compaction.

During construction the stone core was protected with about 1.1 metric tons of stone-asphalt grout per square meter (1 short ton per square yard) of surface area. To accomplish this, the composition was modified to allow some penetration into the surface layer of the stone core. The final protective application was a layer or revetment of stone asphalt about 2 meters thick. The structure side slopes are 1 on 2 above the water and 1 on 1.75 under the water. Because large amounts were dumped at one time, cooling was slow, and successive batches flowed together to form one monolithic armor layer. By the completion of the project in 1967, about 0.9 million metric tons (1 million short tons) of stone asphalt had been used.

The requirements for a special mixing plant and special equipment will limit the use of this material to large projects. In addition, this particular project has required regular maintenance to deal with the plastic-flow problems of the stone asphalt caused by solar heating.

c. Cellular-Steel Sheet-Pile Breakwaters. These breakwaters are used where storm waves are not too severe. A cellular-steel sheet-pile and steel sheet-pile breakwater installation at Port Sanilac, Michigan, is illustrated in Figure 6-65. Cellular structures provide a vertical wall and adjacent deep water, which is usable for port activities if fendered.

Cellular-steel sheet-pile structures require little maintenance and are suitable for construction on various types of sedimentary foundations in depths to 12 meters. Steel sheet-pile structures have advantages of economy and speed of construction, but are vulnerable to storm damage during construction. Retention of cellular fill is absolutely critical to their stability. Corrosion is the principal disadvantage of steel in seawater; however, new corrosion-resistant steel sheet piles have overcome much of this problem. Corrosion in the Great Lakes (freshwater) is not as severe a problem as in the ocean coastal areas.

d. Concrete-Caisson Breakwaters. Breakwaters of this type are built of reinforced concrete shells that are floated into position, settled on a prepared foundation, filled with stone or sand for stability, and then capped with concrete or stones. These structures may be constructed with or without parapet walls for protection against wave overtopping. In general, concrete caissons have a reinforced concrete bottom, although open-bottom concrete caissons have been used. The open-bottom type is closed with a temporary wooden bottom that is removed after the caisson is placed on the foundation. The stone used to fill the compartments combines with the foundation material to provide additional resistance against horizontal movement.

Caissons are generally suitable for depths from about 3 to 10 meters (10 to 35 feet). The foundation, which usually consists of a mat or mound of rubble stone, must support the structure and withstand scour (see Ch. 7, Sec. III,8). Where foundation conditions dictate, piles may be used to support the structure. Heavy riprap is usually placed along the base of the caissons to protect against scour, horizontal displacement, or weaving when the caisson is supported on piles.

IX. BREAKWATERS, OFFSHORE

Offshore breakwaters are usually shore-parallel structures located in water depths between 1.5 and 8 meters (5 and 25 feet). The main functions of breakwaters are to provide harbor protection, act as a littoral barrier, provide shore protection, or provide a combination of the above features. Design considerations and the effects that offshore breakwaters have on the shoreline and on littoral processes are discussed in Chapter 5, Section IX.

1. Types.

Offshore breakwaters can usually be classified into one of two types: the rubble-mound breakwater and the cellular-steel sheet-pile breakwater. The most widely used type of offshore breakwater is of rubble-mound construction; however, in some parts of the world breakwaters have been constructed with timber, concrete caissons, and even sunken ships.

A variation of offshore breakwater is the floating breakwater. These structures are designed mainly to protect small-craft harbors in relatively sheltered waters; they are not recommended for application on the open coast because they have little energy-dissipating effect on the longer period ocean waves. The most recent summary of the literature dealing with floating breakwaters is given by Hales (1981). Some aspects of floating breakwater design are given by Western Canada Hydraulics Laboratories Ltd. (1981).

Selection of the type of offshore breakwater for a given location first depends on functional needs and then on the material and construction costs. Determining factors are the depth of water, the wave action, and the availability of material. For open ocean exposure, rubble-mound structures are usually required; for less severe exposure, as in the Great Lakes, the cellular-steel sheet-pile structure may be a more economical choice. Figure 6-66 illustrates the use of a rubble-mound offshore breakwater to trap littoral material, to protect a floating dredge, and to protect the harbor entrance.

Probably the most notable offshore breakwater complex in the United

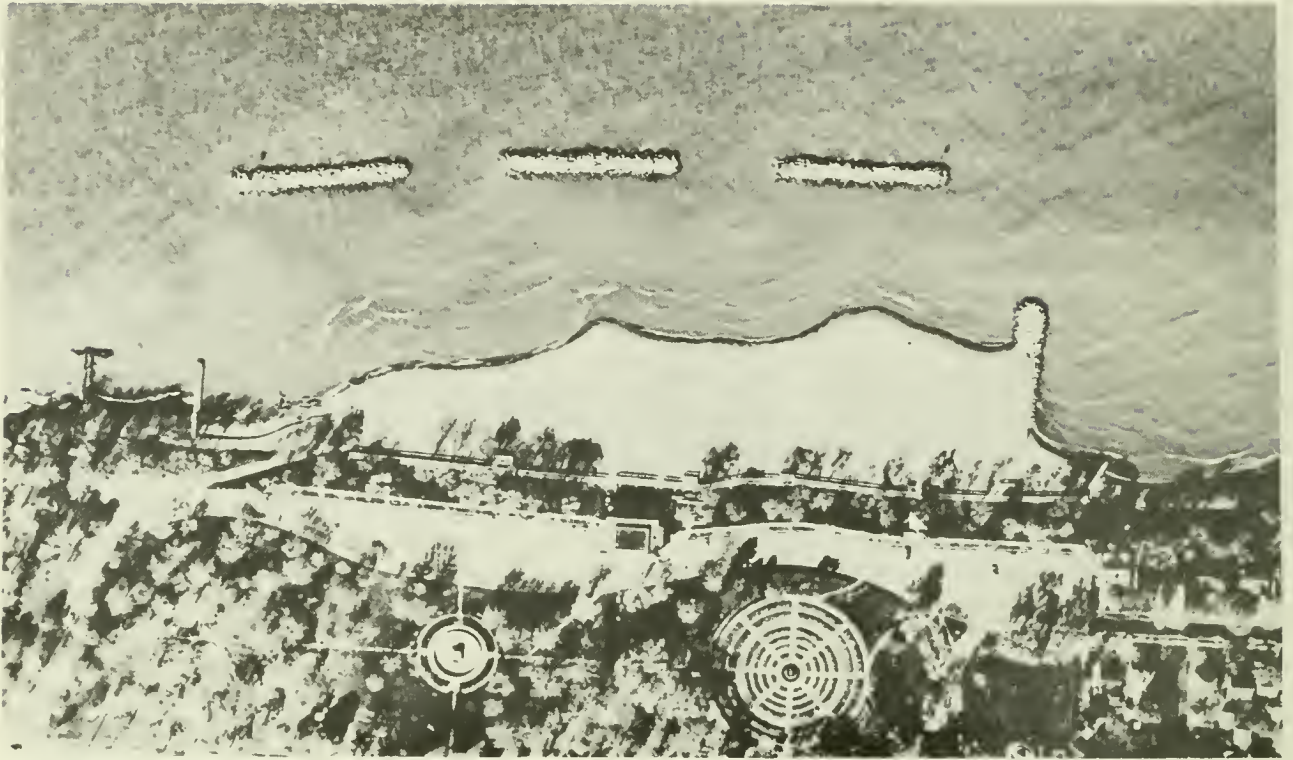

Lakeview Park, Lorain, Ohio (Apr. 1981)

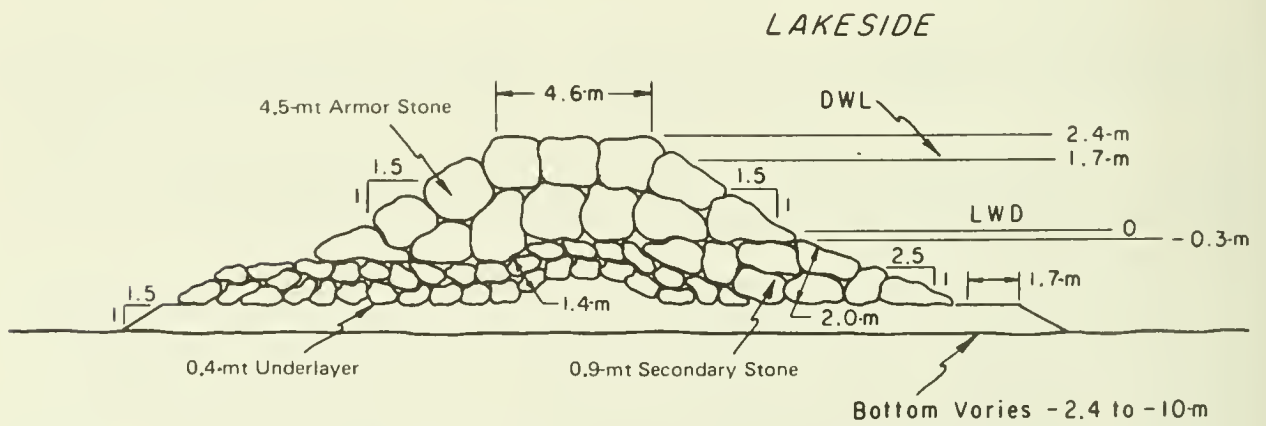

Figure 6-66. Segmented rubble-mound offshore breakwaters.

States is the 13.7-kilometer-long (8.5-mile) Los Angeles-Long Beach breakwater complex built between 1899 and 1949. Other U.S. offshore breakwaters are listed in Table 5-3 of Chapter 5.

2. Segmented Offshore Breakwaters.

Depending on the desired function of an offshore breakwater, it is often advantageous to design the structure as a series of short, segmented breakwaters rather than as a singular, continuous breakwater. Segmented offshore breakwaters can be used to protect a longer section of shoreline, while allowing wave energy to be transmitted through the breakwater gaps. This permits a constant proportion of wave energy to enter the protected region to retard tombolo formation, to aid in continued longshore sediment transport at a desired rate, and to assist in maintaining the environmental quality of the sheltered water. Additionally, the segmented breakwaters can be built at a reasonable and economical water depth while providing storm protection for the shoreline.

Figure 6-66 illustrates the structural details of the segmented rubble-mound breakwater at Lakeview Park, Lorain, Ohio, which is on Lake Erie. This project, which was completed in October 1977, consists of three detached rubble-mound breakwaters, each 76 meters long and located in a water depth of -2.5 meters (-8 feet) low water datum (LWD). The breakwaters are spaced 50 meters (160 feet) apart and are placed about 145 meters (475 feet) offshore. They protect 460 meters of shoreline. The longer groin located there was extended to 106 meters (350 feet), and an initial beach fill of 84,100 cubic meters (110,000 cubic yards) was placed. A primary consideration in the design was to avoid the formation of tombolos that would interrupt the longshore sediment transport and ultimately starve the adjacent beaches.

Immediately after construction, the project was monitored for 2 years. Findings indicated that the eastern and central breakwaters had trapped littoral material, while the western breakwater had lost material (Walker, Clark, and Pope, 1980). The net project gain was 3800 cubic meters (5,000 cubic yards) of material. Despite exposure to several severe storms from the west during periods of high lake levels, there had been no damage to the breakwaters or groins and no significant erosion had occurred on the lake bottom between the breakwaters.

X. CONSTRUCTION MATERIALS AND DESIGN PRACTICES

The selection of materials in the structural design of shore protective works depends on the economics and the environmental conditions of the shore area. The criteria that should be applied to commonly used materials are discussed below.

1. Concrete.

The proper quality concrete is required for satisfactory performance and durability in a marine environment (see Mather, 1957) and is obtainable with good concrete design and construction practices. The concrete should have low permeability, provided by the water-cement ratio recommended for the exposure conditions; adequate strength; air entrainment, which is a necessity in a

freezing climate; adequate coverage over reinforcing steel; durable aggregates; and the proper type of portland cement for the exposure conditions (U.S. Army, Corps of Engineers, 1971a, 1971b).

Experience with the deterioration of concrete in shore structures has provided the following guidelines:

(a) Additives used to lower the water-cement ratio and reduce the size of air voids cause concrete to be more durable in saltwater.

(b) Coarse and fine aggregates must be selected carefully to ensure that they achieve the desired even gradation when mixed together.

(c) Mineral composition of aggregates should be analyzed for possible chemical reaction with the cement and seawater.

(d) Maintenance of adequate concrete cover over all reinforcing steel during casting is very important.

(e) Smooth form work with rounded corners improves the durability of concrete structures.

2. Steel.

Where steel is exposed to weathering and seawater, allowable working stresses must be reduced to account for corrosion and abrasion. Certain steel chemical formulations are available that offer greater corrosion resistance in the splash zone. Additional protection in and above the tidal range is provided by coatings of concrete, corrosion-resistant metals, or organic and inorganic paints (epoxies, vinyls, phenolics, etc.).

3. Timber.

Allowable stresses for timber should be those for timbers that are continuously damp or wet. These working stresses are discussed in U.S. Department of Commerce publications dealing with American lumber standards.

Experience with the deterioration of timber shore structures (marine use) may be summarized in the following guidelines:

(a) Untreated timber piles should not be used unless the piles are protected from exposure to marine-borer attack.

(b) The most effective injected preservative for timber exposed in seawater appears to be creosote oil with a high phenolic content. For piles subject to marine-borer attack, a maximum penetration and retention of creosote and coal-tar solutions is recommended. Where borer infestation is severe, dual treatment with creosote and water-borne salt (another type of preservative) is necessary. The American Wood-Preservers Association recommends the use of standard sizes: C-2 (lumber less than 13 centimeters (5 inches) thick); C-3 (piles); and C-18 (timber and lumber, marine use).

(c) Boring and cutting of piles after treatment should be avoided. Where unavoidable, cut surfaces should receive a field treatment of preservative.

(d) Untreated timber piles encased in a Gunite armor and properly sealed at the top will give economical service.

4. Stone.

Stone used for protective structures should be sound, durable, and hard. It should be free from laminations, weak cleavages, and undesirable weathering. It should be sound enough not to fracture or disintegrate from air action, seawater, or handling and placing. All stone should be angular quarystone. For quarystone armor units, the greatest dimension should be no greater than three times the least dimension to avoid placing slab-shaped stones on the surface of a structure where they would be unstable. All stone should conform to the following test designations: apparent specific gravity, American Society of Testing and Materials (ASTM) C 127, and abrasion, ASTM C 131. In general, it is desirable to use stone with high specific gravity to decrease the volume of material required in the structure.

5. Geotextiles.

The proliferation of brands of geotextiles, widely differing in composition, and the expansion of their use into new coastal construction presents selection and specification problems. Geotextiles are used most often as a replacement for all or part of the mineral filter that retains soil behind a revetted surface. However, they also serve as transitions between in situ bottom soil and an overlying structural material where they may provide dual value as reinforcement. The geotextiles for such coastal uses should be evaluated on the basis of their filter performance in conjunction with the retained soil and their physical durability in the expected environment.

Two criteria must be met for filter performance. First, the filter must be sized by its equivalent opening of sieve to retain the soil gradation behind it while passing the pore water without a significant rise in head (uplift pressure); it must be selected to ensure this performance, even when subjected to expected tensile stress in fabric. Second, the geotextile and retained soil must be evaluated to assess the danger of fine-sized particles migrating into the fabric, clogging the openings, and reducing permeability.

The physical durability of a geotextile is evaluated by its wear resistance, puncture and impact resistance, resistance to ultraviolet damage, flexibility, and tensile strength. The specific durability needs of various coastal applications must be the basis for geotextile selection.

6. Miscellaneous Design Practices.

Experience has provided the following general guidelines for construction in the highly corrosive coastal environment:

(a) It is desirable to eliminate as much structural bracing as possible within the tidal zone where maximum deterioration occurs.

(b) Round members generally last longer than other shapes because of the smaller surface areas and better flow characteristics.

(c) All steel or concrete deck framing should be located above the normal spray level.

LITERATURE CITED

- ANGAS, W.M., "Sand By-Passing Project for Shark River Inlet," *Journal of the Waterways and Harbors Division*, Vol. 86, WW3, No. 2599, Sept. 1960.
- ASPHALT INSTITUTE, "Sentinel Against the Sea," *Asphalt*, Jan. 1964.
- ASPHALT INSTITUTE, "Battering Storms Leave Asphalt Jetty Unharmd," *Asphalt*, Oct. 1965.
- ASPHALT INSTITUTE, "Asbury Park's Successful Asphalt Jetties," *Asphalt Jetties*, Information Series No. 149, Jan. 1969.
- ASPHALT INSTITUTE, "Asphalt in Hydraulics," Manual Series No. 12, Nov. 1976.
- AUGUSTINE, M.T., et al., "Response of American Beachgrass to Fertilizer," *Journal of Soil and Water Conservation*, Vol. 19, No. 3, 1964, pp. 112-115.
- AYERS, J., and STOKES, R., "Simplified Design Methods of Treated Timber Structures for Shore, Beach, and Marina Construction," MR 76-4, Coastal Engineering Research Center, U. S. Army Engineer Waterways Experiment Station, Vicksburg, Miss., Mar. 1976.
- BAGNOLD, R.A., *The Physics of Blown Sand and Desert Dunes*, William, Morrow, and Company, Inc., New York, 1942.
- BARR, D.A., "Jute-Mesh Dune Forming Fences," *Journal of the Soil Conservation Service of New South Wales*, Vol. 22, No. 3, 1966, pp. 123-129.
- BERG, D.W., and WATTS, G.M., "Variations in Groin Design," *Journal of the Waterways and Harbors Division*, Vol. 93, WW2, No. 5241, 1967, pp. 79-100.
- BLUMENTHAL, K.P., "The Construction of a Drift Sand Dyke on the Island Rot-tumerplatt," *Proceedings of the Ninth Conference on Coastal Engineering*, American Society of Civil Engineers, Ch. 23, 1965, pp. 346-367.
- BROWN, R.L., and HAFENRICHTER, A.L., "Factors Influencing the Production and Use of Beachgrass and Dunegrass Clones for Erosion Control: I. Effect of Date of Planting," *Journal of Agronomy*, Vol. 40, No. 6, 1948, pp. 512-521.
- CAMPBELL, W.V., and FUZY, E.A., "Survey of the Scale Insect Effect on American Beachgrass," *Shore and Beach*, Vol. 40, No. 1, 1972, pp. 18-19.
- DEIGNAN, J.E., "Breakwater at Crescent City, California," *Journal of the Waterways and Harbors Division*, Vol. 85, WW3, No. 2174, 1959.
- DUANE, D.B., and MEISBURGER, E.P., "Geomorphology and Sediments of the Near-shore Continental Shelf, Miami to Palm Beach, Florida," TM 29, Coastal Engineering Research Center, U. S. Army Engineer Waterways Experiment Station, Vicksburg, Miss., Nov. 1969.
- FIELD, M.E., "Sediments, Shallow Subbottom Structure, and Sand Resources of the Inner Continental Shelf, Central Delmarva Peninsula," TP 79-2, Coastal Engineering Research Center, U. S. Army Engineer Waterways Experiment Station, Vicksburg, Miss., Va., June 1979.

- FIELD, M.E., and DUANE, D.B., "Geomorphology and Sediments of the Inner Continental Shelf, Cape Canaveral, Florida," TM 42, Coastal Engineering Research Center, U. S. Army Engineer Waterways Experiment Station, Vicksburg, Miss., Mar. 1974.
- FISHER, C.H., "Mining the Ocean for Beach Sand," *Proceedings of the Conference on Civil Engineering in the Oceans*, II, American Society of Civil Engineers, 1969, pp. 717-723.
- GAGE, B.O., "Experimental Dunes of the Texas Coast," MP 1-70, Coastal Engineering Research Center, U. S. Army Engineer Waterways Experiment Station, Vicksburg, Miss., Jan. 1970.
- HALES, L.Z., "Floating Breakwaters: State-of-the-Art Literature Review," TR 81-1, Coastal Engineering Research Center, U. S. Army Engineer Waterways Experiment Station, Vicksburg, Miss., Oct. 1981.
- HALL, J.V., Jr., "Wave Tests of Revetment Using Machine-Produced Interlocking Blocks," *Proceedings of the 10th Conference on Coastal Engineering*, American Society of Civil Engineers, Ch. 60, 1967, pp. 1025-1035 (also Reprint 2-67, Coastal Engineering Research Center, U. S. Army Engineer Waterways Experiment Station, Vicksburg, Miss., NTIS 659 170).
- HANDS, E.B., "Performance of Restored Beach and Evaluation of Offshore Dredging Site at Redondo Beach, California," Coastal Engineering Research Center, U. S. Army Engineer Waterways Experiment Station, Vicksburg, Miss., (in preparation, 1985).
- HAWK, V.B., and SHARP, W.C., "Sand Dune Stabilization Along the North Atlantic Coast," *Journal of Soil and Water Conservation*, Vol. 22, No. 4, 1967, pp. 143-146.
- HERRON, W.J., Jr., "Beach Erosion Control and Small Craft Harbor Development at Point Hueneme," *Shore and Beach*, Vol. 28, No. 2, Oct. 1960, pp. 11-15.
- HERRON, W.J., Jr., and HARRIS, R.L., "Littoral Bypassing and Beach Restoration in the Vicinity of Point Hueneme, California," *Proceedings of the 10th Conference on Coastal Engineering*, American Society of Civil Engineers, Vol. I, 1967, pp. 651-675.
- HOBSON, R.D., "Beach Nourishment Techniques - Typical U.S. Beach Nourishment Projects Using Offshore Sand Deposits," TR H-76-13, Report 3, U.S. Army Engineer Waterways Experiment Station, Vicksburg, Miss., May 1981.
- HODGES, T.K., "Sand By-Passing at Hillsboro Inlet, Florida," *Bulletin of the Beach Erosion Board*, Vol. 9, No. 2, Apr. 1955.
- JACHOWSKI, R.A., "Behavior of Sand-Asphalt Groins at Ocean City, Maryland," MP 2-59, U.S. Army, Corps of Engineers, Beach Erosion Board, Washington, D.C., May 1959.
- JAGSCHITZ, J.A., and BELL, R.S., "Restoration and Retention of Coastal Dunes with Fences and Vegetation," Bulletin No. 382, Agricultural Experiment Station, University of Rhode Island, Kingston, R.I., 1966a.

- JAGSCHITZ, J.A., and BELL, R.S., "American Beachgrass (Establishment--Fertilization--Seeding)," Bulletin No. 383, Agricultural Experiment Station, University of Rhode Island, Kingston, R.I., 1966b.
- JONES, C.P. and MEHTA, A.J., "A Comparative Review of Sand Transfer Systems at Florida's Tidal Entrances," *Proceedings of the Fifth Symposium of the Waterway, Port, Coastal and Ocean Division*, American Society of Civil Engineers, Nov. 1977, pp. 48-66.
- KIDBY, H.A., and OLIVER J.R., "Erosion and Accretion Along Clatsop Spit," *Proceedings of the Coastal Engineering Santa Barbara Specialty Conference*, American Society of Civil Engineers, 1965, pp. 647-672.
- KNUTSON, P.L., "Planting Guidelines for Dune Creation and Stabilization," CETA 77-4, Coastal Engineering Research Center, U. S. Army Engineer Waterways Experiment Station, Vicksburg, Miss., 1977.
- KNUTSON, P.L., "Experimental Dune Restoration and Stabilization, Nauset Beach, Cape Cod, Massachusetts," TP 80-5, Coastal Engineering Research Center, U. S. Army Engineer Waterways Experiment Station, Vicksburg, Miss., Aug. 1980.
- KRUMBEIN, W.C., and JAMES, W.R., "A Lognormal Size Distribution Model for Estimating Stability of Beach Fill Material," TM 16, Coastal Engineering Research Center, U. S. Army Engineer Waterways Experiment Station, Vicksburg, Miss., Nov. 1965.
- LONG, E.G., Jr., "Improvement of Coastal Inlets by Sidecast Dredging," *Journal of the Waterways and Harbor Division*, Vol. 93, WW4, Nov. 1967, pp. 185-199.
- LUCAS, L.T., et al., "Marasmius Blight, A New Disease of American Beachgrass," *Plant Disease Reporter*, Vol. 55, No. 7, 1971, pp. 582-585.
- MAGNUSON, N.C., "Planning and Design of a Low-Weir Section Jetty at Masonboro Inlet, North Carolina," *Proceedings of the Coastal Engineering Santa Barbara Specialty Conference*, American Society of Civil Engineers, Ch. 36, 1966, pp. 807-820.
- MAGOON, O.T., and SHIMIZU, N., "Use of Dolos Armor Units in Rubble-Mound Structures, e.g., for Conditions in the Arctic," *Proceedings of the First International Conference on Port and Ocean Engineering Under Arctic Conditions*, Vol. II, 1971, pp. 1089-1108 (also Reprint 1-73, Coastal Engineering Research Center, U. S. Army Engineer Waterways Experiment Station, Vicksburg, Miss., NTIS 757 973).
- MATHER, B., "Factors Affecting the Durability of Concrete in Coastal Structures," TM 96, U.S. Army Corps of Engineers, Beach Erosion Board, Washington, D.C., June 1957.
- MAURIELLO, L.J., "Experimental Use of Self-Unloading Hopper Dredge for Rehabilitation of an Ocean Beach," *Proceedings of the Conference on World Dredging*, 1967, pp. 367-396.

- McLAUGHLIN, W.T., and BROWN, R.L., "Controlling Coastal Sand Dunes in the Pacific Northwest," No. 660, U.S. Department of Agriculture, Washington, D.C., Sept. 1942, pp. 1-46.
- MEISBURGER, E.P., "Geomorphology and Sediments of the Chesapeake Bay Entrance," TM 38, Coastal Engineering Research Center, U. S. Army Engineer Waterways Experiment Station, Vicksburg, Miss., June 1972.
- MEISBURGER, E.P., "Geomorphology and Sediments of Western Massachusetts Bay," TP 76-3, Coastal Engineering Research Center, U. S. Army Engineer Waterways Experiment Station, Vicksburg, Miss., Apr. 1976.
- MEISBURGER, E.P., "Sand Resources on the Inner Continental Shelf of the Cape Fear Region, North Carolina," MR 77-11, Coastal Engineering Research Center, U. S. Army Engineer Waterways Experiment Station, Vicksburg, Miss., Nov. 1977.
- MEISBURGER, E.P., "Reconnaissance Geology of the Inner Continental Shelf, Cape Fear Region, North Carolina," TP 79-3, Coastal Engineering Research Center, U. S. Army Engineer Waterways Experiment Station, Vicksburg, Miss., Sept. 1979.
- MEISBURGER, E.P., and DUANE, D.B., "Geomorphology and Sediments of the Inner Continental Shelf, Palm Beach to Cape Kennedy, Florida," TM 34, Coastal Engineering Research Center, U. S. Army Engineer Waterways Experiment Station, Vicksburg, Miss., Feb. 1971.
- MEISBURGER, E.P., and FIELD, M.E., "Geomorphology, Shallow Structure, and Sediments of the Florida Inner Continental Shelf, Cape Canaveral to Georgia," TM 54, Coastal Engineering Research Center, U. S. Army Engineer Waterways Experiment Station, Vicksburg, Miss., July 1975.
- MEISBURGER, E.P., and WILLIAMS, S.J., "Sand Resources on the Inner Continental Shelf of the Cape May Region, New Jersey," MR 80-4, Coastal Engineering Research Center, U. S. Army Engineer Waterways Experiment Station, Vicksburg, Miss., July 1980.
- MEISBURGER, E.P., and WILLIAMS, S.J., "Sand Resources on the Inner Continental Shelf off the Central New Jersey Coast," MR 82-10, Coastal Engineering Research Center, U. S. Army Engineer Waterways Experiment Station, Vicksburg, Miss., 1982.
- MEISBURGER, E.P., WILLIAMS, S.J., and PRINS, D.A., "Sand Resources of Southeastern Lake Michigan," MR 79-3, Coastal Engineering Research Center, U. S. Army Engineer Waterways Experiment Station, Vicksburg, Miss., July 1979.
- MIDDLETON, S.R., "Installation and Operation of Fixed Sand Bypassing Plant at Lake Worth Inlet, Florida," *Shore and Beach*, Vol. 27, No. 9, June 1959.
- NERSESIAN, G.K., "Beach Fill Design and Placement at Rockaway Beach, New York, Using Offshore Ocean Borrow Sources," *Proceedings of the Fifth Symposium of the Waterway, Port, Coastal and Ocean Division*, American Society of Civil Engineers, Nov. 1977, pp. 228-247.
- PORTLAND CEMENT ASSOCIATION, *Concrete Shore Protection*, 2d ed., 1955.

- PORTLAND CEMENT ASSOCIATION, "Concrete for Hydraulic Structures," I5012.03W, 1969.
- RAYNER A.C., and MAGNUSON, N.C., "Stabilization of Masonboro Inlet," *Shore and Beach*, Vol. 34, No. 2, 1966, pp. 36-41.
- RICHARDSON, T.W., "Beach Nourishment Techniques - Dredging Systems for Beach Nourishment from Offshore Sources," TR H-76-13, Report 1, U.S. Army Engineer Waterways Experiment Station, Vicksburg, Miss., Sept. 1976.
- RICHARDSON, T.W., "Systems for Bypassing Sand at Coastal Inlets," *Proceedings of the Fifth Symposium of the Waterway, Port, Coastal and Ocean Division*, American Society of Civil Engineers, Nov. 1977, pp. 67-84.
- SAVAGE, R.P., "Sand Bypassing at Port Hueneme California," TM 92, U.S. Army, Corps of Engineers, Beach Erosion Board, Washington, D.C., Mar. 1957.
- SAVAGE, R.P., "Experimental Study of Dune Building with Sand Fences," *Proceedings of the Eighth Conference on Coastal Engineering*, American Society of Civil Engineers, 1962, pp. 380-396.
- SAVAGE, R.P., and WOODHOUSE, W.W., Jr., "Creation and Stabilization of Coastal Barrier Dunes," *Proceedings of the 11th Conference on Coastal Engineering*, American Society of Civil Engineers, 1969, pp. 671-700.
- SCHWARTZ, R.K., and MUSIALOWSKI, F.R., "Transport of Dredged Sediment Placed in the Nearshore Zone--Currituck Sand-Bypass Study (Phase I)," TP 80-1, Coastal Engineering Research Center, U. S. Army Engineer Waterways Experiment Station, Vicksburg, Miss., Feb. 1980.
- SENECA, E.D., and COOPER, A.W., "Germination and Seedling Response to Temperature, Daylength, and Salinity by *Ammophila breviligulata* from Michigan and North Carolina," *Botanical Gazette*, Vol. 132, No. 3, 1971, pp. 203-215.
- U.S. ARMY CORPS OF ENGINEERS, "Bypassing Littoral Drift at a Harbour Entrance," *The Bulletin of the Beach Erosion Board*, Vol. 5, No. 3, July 1951.
- U.S. ARMY CORPS OF ENGINEERS, "Sand Bypassing Plant at Salina Cruz, Mexico," *The Bulletin of the Beach Erosion Board*, Vol. 6, No. 2, Apr. 1952.
- U.S. ARMY CORPS OF ENGINEERS, "Status of Sand Bypassing Plant at Salina Cruz Harbor, Isthmus of Tehantepec, Mexico," *The Bulletin of the Beach Erosion Board*, Vol. 9, No. 1, Jan. 1955.
- U.S. ARMY CORPS OF ENGINEERS, "Beach Erosion at Durban, South Africa," *The Bulletin of the Beach Erosion Board*, Vol. 10, No. 2, July 1956.
- U.S. ARMY CORPS OF ENGINEERS, "Design of Pile Structures and Foundations," EM 1110-2-2906, Office, Chief of Engineers, Washington, D.C., July 1958.
- U.S. ARMY CORPS OF ENGINEERS, "Retaining Walls," EM 1110-2-2502, Office, Chief of Engineers, Washington, D.C., May 1961.

- U.S. ARMY CORPS OF ENGINEERS, "Beach Erosion Control and Shore Protection Studies," EM 1110-2-3300, Office, Chief of Engineers, Washington, D.C., Mar. 1966.
- U.S. ARMY CORPS OF ENGINEERS, "Details of Reinforcement--Hydraulic Structures," EM 1110-2-2103, Office, Chief of Engineers, May 1971a.
- U.S. ARMY CORPS OF ENGINEERS, "Standard Practice for Concrete," EM 1110-2-2000, Office, Chief of Engineers, Nov. 1971b.
- U.S. ARMY CORPS OF ENGINEERS, "Low-Cost Shore Protection," Final Report on the Shoreline Erosion Control Demonstration Program (Section 54), Office, Chief of Engineers, Washington, D.C., Aug. 1981.
- U.S. ARMY CORPS OF ENGINEERS, "Dredging and Dredged Material Disposal," EM 1110-2-5025, Office, Chief of Engineers, Washington, D.C. (March, 1983).
- U.S. ARMY CORPS OF ENGINEERS, "Hydraulic Design of Coastal Groins," Office, Chief of Engineers, Washington, D.C. (in preparation, 1984).
- U.S. ARMY ENGINEER DISTRICT, GALVESTON, "Survey Report on Corpus Christi Beach, Texas (Restoration Project)," Galveston, Tex., May 1969.
- U.S. ARMY ENGINEER DISTRICT, JACKSONVILLE, "Beach Erosion Control and Hurricane Surge Protection Project, Dade County, Florida," General Design Memorandum, Jacksonville, Fla., Sept. 1975.
- U.S. ARMY ENGINEER DISTRICT, LOS ANGELES, "General Design for Harbor and Shore Protection Works Near Port Hueneme, California," Los Angeles, Calif., 1957.
- U.S. ARMY ENGINEER DISTRICT, LOS ANGELES, "Cooperative Research and Data Collection Program of Coast of Southern California, Cape San Martin to Mexican Boundary, Three-Year Report, 1967-69," Los Angeles, Calif., 1970.
- U.S. ARMY ENGINEER DISTRICT, PHILADELPHIA, "Study on Use of Hopper Dredges for Beach Nourishment," Philadelphia, Pa., 1967.
- U.S. ARMY ENGINEER DISTRICT, WILMINGTON, "Carolina Beach and Vicinity, North Carolina; Combined Report on an Interim Hurricane Survey and Cooperative Beach Erosion Control Study," Wilmington, N.C., 1961.
- U.S. ARMY ENGINEER DISTRICT, WILMINGTON, "Atlantic Intracoastal Waterway Between Norfolk, Virginia and the St. Johns River, Florida, Wilmington District," Wilmington, N.C., 1970.
- U.S. DEPARTMENT OF AGRICULTURE, "Sand Dune Control Benefits Everbody: The Bodega Bay Story," Soils Conservation Service Pamphlet, Portland, Oreg., 1967.
- VALLIANOS L., "Recent History of Erosion at Carolina Beach, North Carolina," *Proceedings of the 12th Conference on Coastal Engineering*, American Society of Civil Engineers, Vol. 2, Ch. 77, 1970, pp. 1223-1242.

- WALKER, J.R., CLARK, D., and POPE, J., "A Detached Breakwater System for Beach Protection," *Proceedings of the 17th Conference on Coastal Engineering*, American Society of Civil Engineers, 1980.
- WATTS, G.M., "A Study of Sand Movement at South Lake Worth Inlet, Florida," TM 42, U.S. Army, Corps of Engineers, Beach Erosion Board, Washington, D.C., Oct. 1953.
- WATTS, G.M., "Trends in Sand By-Passing Systems," *Proceedings of the Coastal Engineering Santa Barbara Specialty Conference*, American Society of Civil Engineers, Ch. 34, 1966, pp. 779-804.
- WEGGEL, J.R., "Wave Loading on Vertical Sheet-Pile Groins and Jetties," CETA 81-1, Coastal Engineering Research Center, U. S. Army Engineer Waterways Experiment Station, Vicksburg, Miss., Jan. 1981a.
- WEGGEL, J.R., "Weir Sand-Bypassing Systems," SR-8, Coastal Engineering Research Center, U. S. Army Engineer Waterways Experiment Station, Vicksburg, Miss., Apr. 1981b.
- WESTERN CANADA HYDRAULIC LABORATORIES LTD., "Development of a Manual for the Design of Floating Breakwaters, *Canadian Manuscript Report of Fisheries and Aquatic Sciences*, No. 1629, Nov. 1981.
- WIEGEL, R.L., "Sand By-Passing at Santa Barbara, California," *Journal of the Waterways and Harbors Division*, Vol. 85, WW2, June 1959.
- WILLIAMS, S.J., "Geomorphology, Shallow Subbottom Structure, and Sediments of the Atlantic Inner Continental Shelf off Long Island, New York," TP 76-2, Coastal Engineering Research Center, U. S. Army Engineer Waterways Experiment Station, Vicksburg, Miss., Mar. 1976.
- WILLIAMS, S.J., "Sand Resources and Geological Character of Long Island Sound," TP 81-3, Coastal Engineering Research Center, U. S. Army Engineer Waterways Experiment Station, Vicksburg, Miss., May 1981.
- WILLIAMS, S.J., and DUANE, D.B., "Geomorphology and Sediments of the Inner New York Bight Continental Shelf," TM 45, Coastal Engineering Research Center, U. S. Army Engineer Waterways Experiment Station, Vicksburg, Miss., July 1974.
- WILLIAMS, S.J., PRINS, D.A., and MEISBURGER, E.P., "Sediment Distribution, Sand Resources, and Geological Character of the Inner Continental Shelf off Galveston County, Texas," MR 79-4, Coastal Engineering Research Center, U. S. Army Engineer Waterways Experiment Station, Vicksburg, Miss., July 1979.
- WILLIAMS, S.J., et al., "Sand Resources of Southern Lake Erie, Conneaut to Toledo, Ohio," MR 80-10, Coastal Engineering Research Center, U. S. Army Engineer Waterways Experiment Station, Vicksburg, Miss., Nov. 1980.
- WOODARD, D.W., et al., "The Use of Grasses for Dune Stabilization Along the Gulf Coast with Initial Emphasis on the Texas Coast," Report No. 114, Gulf Universities Research Corporation, Galveston, Tex., 1971.

- WOODHOUSE, W.W., Jr., "Use of Vegetation for Dune Stabilization," *Proceedings of the Coastal Processes and Shore Protection Seminar*, Coastal Plains Center for Marine Development Services, Series No. 1, 1970, pp. 36-39.
- WOODHOUSE, W.W., Jr., "Dune Building and Stabilization with Vegetation," SR-3, Coastal Engineering Research Center, U. S. Army Engineer Waterways Experiment Station, Vicksburg, Miss., Sept. 1978.
- WOODHOUSE, W.W., Jr., and HANES, R.E., "Dune Stabilization with Vegetation on the Outer Banks of North Carolina," TM 22, Coastal Engineering Research Center, U. S. Army Engineer Waterways Experiment Station, Vicksburg, Miss., Aug. 1967.
- WOODHOUSE, W.W., Jr., SENECA, E.D., and COOPER, A.W., "Use of Sea Oats for Dune Stabilization in the Southeast," *Shore and Beach*, Vol. 36, No. 2, 1968, pp. 15-21.
- ZURMUHLEN, F.H., "The Sand Transfer Plant at Lake Worth Inlet," *Proceedings of the Sixth Conference on Coastal Engineering*, American Society of Civil Engineers, 1958.

CHAPTER 7

Structural Design: Physical Factors



Praia Bay, Terceira, Azores, 2 March 1970

CONTENTS

CHAPTER 7

STRUCTURAL DESIGN: PHYSICAL FACTORS

	Page
I WAVE CHARACTERISTICS.....	7-1
1. Design Criteria.....	7-1
2. Representation of Wave Conditions.....	7-1
3. Determination of Wave Conditions.....	7-2
4. Selection of Design Wave Conditions.....	7-3
II WAVE RUNUP, OVERTOPPING, AND TRANSMISSION.....	7-16
1. Wave Runup.....	7-16
2. Wave Overtopping.....	7-43
3. Wave Transmission.....	7-61
III WAVE FORCES.....	7-100
1. Forces on Piles.....	7-101
2. Nonbreaking Wave Forces on Walls.....	7-161
3. Breaking Wave Forces on Vertical Walls.....	7-180
4. Broken Waves.....	7-192
5. Effect of Angle of Wave Approach.....	7-198
6. Effect of a Nonvertical Wall.....	7-200
7. Stability of Rubble Structures.....	7-202
8. Stability of Rubble Foundations and Toe Protection.....	7-242
IV VELOCITY FORCES--STABILITY OF CHANNEL REVETMENTS.....	7-249
V IMPACT FORCES.....	7-253
VI ICE FORCES.....	7-253
VII EARTH FORCES.....	7-256
1. Active Forces.....	7-256
2. Passive Forces.....	7-257
3. Cohesive Soils.....	7-260
4. Structures of Irregular Section.....	7-260
5. Submerged Material.....	7-260
6. Uplift Forces.....	7-260
LITERATURE CITED.....	7-261
BIBLIOGRAPHY.....	7-277

TABLES

7-1	Determination of design wave heights.....	7-15
7-2	Value of r for various slope characteristics.....	7-32
7-3	Some considerations of breakwater selection.....	7-64
7-4	Steady flow drag coefficients for supercritical Reynolds numbers.....	7-139

CONTENTS
TABLES--CONTINUED

		Page
7-5	Experimentally determined values of C_M	7-145
7-6	Example calculation of wave force variation with phase angle.....	7-153
7-7	Comparison of measured and calculated breaker force.....	7-159
7-8	Suggested K_D values for use in determining armor unit weight...	7-206
7-9	$H/H_{D=0}$ as a function of cover-layer damage and type of armor unit	7-211
7-10	Types of armor units.....	7-216
7-11	Concrete armor projects in the United States.....	7-226
7-12	Weight and size selection dimensions of quarystone.....	7-230
7-13	Layer coefficient and porosity for various armor units.....	7-234
7-14	Effects of ice on marine structures.....	7-255
7-15	Unit weights and internal friction angles of soils.....	7-258
7-16	Coefficients and angles of friction.....	7-260

FIGURES

7-1	Definition of breaker geometry.....	7-5
7-2	α and β versus H_b/gT^2	7-6
7-3	Breaker height index H_b/H'_o versus deepwater wave steepness H'_o/gT^2	7-7
7-4	Dimensionless design breaker height versus relative depth at structure	7-10
7-5	Breaker height index H_b/H'_o versus H_b/gT^2	7-12
7-6	Logic diagram for evaluation of marine environment.....	7-17
7-7	Definition sketch: wave runup and overtopping.....	7-18
7-8	Wave runup on smooth, impermeable slopes when $d/H'_o = 0$	7-19
7-9	Wave runup on smooth, impermeable slopes when $d/H'_o \approx 0.45$	7-20
7-10	Wave runup on smooth, impermeable slopes when $d/H'_o \approx 0.80$	7-21

CONTENTS

FIGURES--CONTINUED

	Page
7-11 Wave runup on smooth, impermeable slopes when $d_s/H_o \approx 2.0$	7-22
7-12 Wave runup on smooth, impermeable slopes when $d_s/H_o = 3.0$	7-23
7-13 Runup correction for scale effects.....	7-24
7-14 Wave runup on impermeable, vertical wall versus H_o/gT^2	7-25
7-15 Wave runup on impermeable, quarystone, 1:1.5 slope versus H_o/gT^2	7-26
7-16 Wave runup on impermeable, stepped, 1:1.5 slope versus H_o/gT^2 ...	7-27
7-17 Wave runup on impermeable seawall versus H_o/gT^2	7-28
7-18 Wave runup on recurved (Galveston-type) seawall versus H_o/gT^2 ...	7-29
7-19 Wave runup and rundown on graded riprap, 1:2 slope, impermeable base, versus H_o/gT^2	7-30
7-20 Comparison of wave runup on smooth slopes with runup on permeable rubble slopes.....	7-31
7-21 Calculation of runup for composite slope: example of a levee cross section.....	7-36
7-22 Successive approximations to runup on a composite slope: example problem.....	7-40
7-23 Probability of exceedance for relative wave heights or runup values.....	7-42
7-24 Overtopping parameters α and Q_o^* (smooth vertical wall on a 1:10 nearshore slope).....	7-45
7-25 Overtopping parameters α and Q_o^* (smooth 1:1.5 structure slope on a 1:10 nearshore slope).....	7-46
7-26 Overtopping parameters α and Q_o^* (smooth 1:3 structure slope on a 1:10 nearshore slope).....	7-47
7-27 Overtopping parameters α and Q_o^* (smooth 1:6 structure slope on a 1:10 nearshore slope).....	7-48
7-28 Overtopping parameters α and Q_o^* (riprapped 1:1.5 structure slope on a 1:10 nearshore slope).....	7-49

CONTENTS

FIGURES--CONTINUED

	Page
7-29 Overtopping parameters α and Q_o^* (stepped 1:1.5 structure slope on a 1:10 nearshore slope).....	7-50
7-30 Overtopping parameters α and Q_o^* (curved wall on a 1:10 nearshore slope).....	7-51
7-31 Overtopping parameters α and Q_o^* (curved wall on a 1:25 nearshore slope).....	7-52
7-32 Overtopping parameters α and Q_o^* (recurved wall on a 1:10 nearshore slope).....	7-53
7-33 Variations of $\bar{\alpha}$ with structure slope θ	7-54
7-34 Variations of Q_o^* between waves conforming to cnoidal theory and waves conforming to linear theory.....	7-55
7-35 $\frac{Q_{0.005}}{Q}$ and $\frac{\bar{Q}}{Q}$ as functions of relative freeboard and α	7-60
7-36 Wave transmission over submerged and overtopped structures: approximate ranges of d_s/gT^2 studied by various investigators.....	7-63
7-37 Selected wave transmission results for a submerged breakwater.....	7-65
7-38 Wave transmission coefficients for vertical wall and vertical thin-wall breakwaters where $0.0157 \leq d_s/gT^2 \leq 0.0793$	7-66
7-39 Wave transmission by overtopping.....	7-68
7-40 Transmitted wave height/incident significant wave height versus relative freeboard for wave transmission by overtopping due to irregular waves.....	7-69
7-41 Transmitted wave height as a function of the percentage of exceedance.....	7-70
7-42 Correction factor, CF, to multiply by $\frac{H_T P}{H_s}$ for $\frac{B}{h} > 0.1$	7-71
7-43 Wave transmission by overtopping for a breakwater with no freeboard.....	7-74
7-44 Wave runup on breakwaters and riprap.....	7-75
7-45 Selected wave transmission results for a subaerial breakwater.....	7-76

CONTENTS

FIGURES--CONTINUED

	Page
7-46	Sample wave transmission and reflection coefficients for a smooth, impermeable breakwater.....7-77
7-47	Monochromatic wave transmission, impermeable rubble-mound breakwater, where $\frac{h}{d_s} = 1.033$7-78
7-48	Monochromatic transmission, impermeable rubble-mound breakwater, where $\frac{h}{d_s} = 1.133$7-79
7-49	Influence of structure height on wave transmission for Example Problem 137-81
7-50	Wave transmission through a rubble-mound breakwater.....7-82
7-51	Wave transmission past a heavily overtopped breakwater with tribar armor units.....7-83
7-52	Wave transmission and reflection coefficients for a breakwater with a flat seaward slope in medium-depth water.....7-84
7-53	Wave transmission and reflection coefficients for a mostly armor breakwater in shallow water.....7-85
7-54	Monochromatic wave transmission, permeable rubble-mound breakwater, where $h/d_s = 1.033$7-86
7-55	Monochromatic wave transmission, permeable rubble-mound breakwater, where $h/d_s = 1.133$7-87
7-56	Predicted wave transmission coefficients for a rubble-mound breakwater using the computer program MADSEN.....7-88
7-57	Ponding for a smooth impermeable breakwater with $F = 0$7-90
7-58	Ponding for rubble-mound breakwaters.....7-90
7-59	Cumulative curves of relative wave energy with respect to azimuth from the principal wave direction.....7-91
7-60	Change of a maximum directional concentration parameter, S_{max} , due to wave refraction in shallow water.....7-91
7-61	Diffraction diagrams of a semi-infinite breakwater for directional random waves of normal incidence.....7-92
7-62	Diffraction diagrams of a breakwater gap with $B/L = 1.0$ for directional random waves of normal incidence.....7-95

CONTENTS

FIGURES--CONTINUED

	Page
7-63	Diffraction diagrams of a breakwater gap with $B/L = 2.0$ for directional random waves of normal incidence.....7-96
7-64	Diffraction diagrams of a breakwater gap with $B/L = 4.0$ for directional random waves of normal incidence.....7-97
7-65	Diffraction diagrams of a breakwater gap with $B/L = 8.0$ for directional random waves of normal incidence.....7-98
7-66	Classification of wave force problems by type of wave action and by structure type.....7-100
7-67	Definition sketch of wave forces on a vertical cylinder.....7-102
7-68	Relative wavelength and pressure factor versus d/gT^27-104
7-69	Ratio of crest elevation above still-water level to wave height..7-107
7-70	Wavelength correction factor for finite amplitude effects.....7-108
7-71	K_{im} versus relative depth, d/gT^27-113
7-72	K_{Dm} versus relative depth, d/gT^27-114
7-73	Inertia force moment arm, S_{im} , versus relative depth, d/gT^27-115
7-74	Drag force moment arm, S_{Dm} , versus relative depth, d/gT^27-116
7-75	Breaking wave height and regions of validity of various wave theories.....7-117
7-76	Isolines of ϕ_m versus H/gT^2 and d/gT^2 ...($W = 0.5$).....7-119
7-77	Isolines of ϕ_m versus H/gT^2 and d/gT^2 ...($W = 0.1$).....7-120
7-78	Isolines of ϕ_m versus H/gT^2 and d/gT^2 ...($W = 0.5$).....7-121
7-79	Isolines of ϕ_m versus H/gT^2 and d/gT^2 ...($W = 1.0$).....7-122
7-80	Isolines of α_m versus H/gT^2 and d/gT^2 ...($W = 0.5$).....7-123
7-81	Isolines of α_m versus H/gT^2 and d/gT^2 ...($W = 0.1$).....7-124
7-82	Isolines of α_m versus H/gT^2 and d/gT^2 ...($W = 0.5$).....7-125
7-83	Isolines of α_m versus H/gT^2 and d/gT^2 ...($W = 1.0$).....7-126
7-84	Variation of C_L/C_D with Keulegan-Carpenter number and H/gT^2 ...7-134

CONTENTS

FIGURES--CONTINUED

	Page
7-85	Variation of drag coefficient C_D with Reynolds number R_e7-137
7-86	Definition sketch: calculation of wave forces on a group of piles that are structurally connected.....7-151
7-87	Definition sketch: calculation of wave forces on a nonvertical pile.....7-156
7-88	Definition of terms: nonbreaking wave forces.....7-162
7-89	Pressure distributions for nonbreaking waves.....7-163
7-90	Nonbreaking waves; $\chi = 1.0$7-164
7-91	Nonbreaking wave forces; $\chi = 1.0$7-165
7-92	Nonbreaking wave moment; $\chi = 1.0$7-166
7-93	Nonbreaking waves; $\chi = 0.9$7-167
7-94	Nonbreaking wave forces; $\chi = 0.9$7-168
7-95	Nonbreaking wave moment; $\chi = 0.9$7-169
7-96	Pressure distribution on wall of low height.....7-174
7-97	Force and moment reduction factors.....7-175
7-98	Pressure distribution on wall on rubble foundation.....7-178
7-99	Minikin wave pressure diagram.....7-181
7-100	Dimensionless Minikin wave pressure and force.....7-185
7-101	Dimensionless Minikin wave pressure and force.....7-188
7-102	Minikin force reduction factor.....7-189
7-103	Minikin moment reduction for low wall.....7-190
7-104	Wave pressures from broken waves: wall seaward of still-water line.....7-193
7-105	Wave pressures from broken waves: wall landward of still-water line.....7-195
7-106	Effect of angle of wave approach: plan view.....7-199

CONTENTS
FIGURES--CONTINUED

	Page
7-107	Wall shapes.....7-200
7-108	Views of the tetrapod, quadripod, tribar, and dolos armor units.....7-217
7-109	Tetrapod specifications.....7-218
7-110	Quadripod specifications.....7-219
7-111	Tribar specifications.....7-220
7-112	Dolos specifications.....7-221
7-113	Toskane specifications.....7-222
7-114	Modified cube specifications.....7-223
7-115	Hexapod specifications.....7-224
7-116	Rubble-mound section for seaward wave exposure with zero-to- moderate overtopping conditions.....7-227
7-117	Rubble-mound section for wave exposure on both sides with moderate overtopping conditions.....7-228
7-118	Logic diagram for preliminary design of rubble structure.....7-231
7-119	Logic diagram for evaluation of preliminary design.....7-232
7-120	Stability number N_s for rubble foundation and toe protection.....7-244
7-121	Revetment toe scour aprons for severe wave scour.....7-248
7-122	Definition sketch for Coulomb earth force equation.....7-259
7-123	Active earth force for simple Rankine case.....7-259

CHAPTER 7

STRUCTURAL DESIGN: PHYSICAL FACTORS

I. WAVE CHARACTERISTICS

1. Design Criteria.

Coastal structures must be designed to satisfy a number of sometimes conflicting criteria, including structural stability, functional performance, environmental impact, life-cycle cost, and other constraints which add challenge to the designer's task. *Structural stability criteria* are most often stated in terms of the extreme conditions which a coastal structure must survive without sustaining significant damage. The conditions usually include wave conditions of some infrequent recurrence interval, say 50 or 100 years, but may also include a seismic event (an earthquake or tsunami), a change in adjacent water depths, or the impact of a large vessel. The extent to which these "survival" criteria may be satisfied must sometimes be compromised for the sake of reducing construction costs. Analysis may prove that the consequences of occasional damage are more affordable than the first cost of a structure invulnerable to the effects of extremely rare events. A range of survival criteria should be investigated to determine the optimum final choice.

Functional performance criteria are stated in terms of the desired effect of the structure on the nearby environment, or in terms of its intended function. For example, the performance criteria for a breakwater intended to protect a harbor in its lee should be stated in terms of the most extreme wave conditions acceptable in the harbor area; the features of the breakwater affecting wave transmission can then be designed to satisfy this criterion. The performance criteria for a groin intended to cause accretion of sand at a certain location will be dissimilar to those for a breakwater. Performance criteria may also require compromise for the sake of first cost, since repairing the consequences of performance limitations could be more affordable. The high construction cost of most coastal structures requires that risk analysis and life-cycle costing be an integral part of each design effort.

2. Representation of Wave Conditions.

Wind-generated waves produce the most powerful forces to which coastal structures are subjected (except for seismic sea waves). Wave characteristics are usually determined for deep water and then analytically propagated shoreward to the structure. Deepwater significant wave height H_0 and significant wave period T_s may be determined if wind speed, wind duration, and fetch length data are available (see Ch. 3, Sec. V). This information, with water level data, is used to perform refraction and shoaling analyses to determine wave conditions at the site.

Wave conditions at a structure site at any time depend critically on the water level. Consequently, a design stillwater level (SWL) or range of water levels must be established in determining wave forces on a structure. Structures may be subjected to radically different types of wave action as the water level at the site varies. A given structure might be subjected to

nonbreaking, breaking, and broken waves during different stages of a tidal cycle. The wave action a structure is subjected to may also vary along its length at a given time. This is true for structures oriented perpendicular to the shoreline such as groins and jetties. The critical section of these structures may be shoreward of the seaward end of the structure, depending on structure crest elevation, tidal range, and bottom profile.

Detailed discussion of the effects of astronomical tides and wind-generated surges in establishing water levels is presented in Chapter 3, WAVE AND WATER LEVEL PREDICTIONS. In Chapter 7, it is assumed that the methods of Chapter 3 have been applied to determine design water levels.

The wave height usually derived from statistical analysis of synoptic weather charts or other historical data to represent wave conditions in an extreme event is the significant height H_s . Assuming a Rayleigh wave height distribution, H_s may be further defined in approximate relation to other height parameters of the statistical wave height distribution in deep water:

$$H_{1/3} \text{ or } H_s = \text{average of highest 1/3 of all waves (an alternate definition of } H_s \text{ sometimes applied is 4 times the standard deviation of the sea surface elevations, often denoted as } H_{m_0} \text{)}$$

$$H_{10} \approx 1.27 H_s = \text{average of highest 10 percent of all waves} \quad (7-1)$$

$$H_5 \approx 1.37 H_s = \text{average of highest 5 percent of all waves} \quad (7-2)$$

$$H_1 \approx 1.67 H_s = \text{average of highest 1 percent of all waves} \quad (7-3)$$

Advances in the theoretical and empirical study of surface waves in recent years have added great emphasis to the analysis of wave energy spectra in estimating wave conditions for design purposes. Representation of wave conditions in an extreme event by wave energy as a function of frequency provides much more information for use in engineering designs. The physical processes which govern the transformation of wave energy are highly sensitive to wave period, and spectral considerations take adequate account of this fact. An important parameter in discussing wave energy spectra is the energy-based wave height parameter H_{m_0} , which corresponds to the significant wave height, H_s , under most conditions. An equally important parameter is the peak spectral period, T_p , which is the inverse of the dominant frequency of a wave energy spectrum. ^pThe peak spectral period, T_p , is comparable to the significant wave period, T_s , in many situations. The total energy, E , and the energy in each frequency band, $E(\omega)$, are also of importance (see Ch. 3, Sec. II,3, Energy Spectra of Waves).

3. Determination of Wave Conditions.

All wave data applicable to the project site should be evaluated. Visual observation of storm waves, while difficult to confirm, may provide an indication of wave height, period, direction, storm duration, and frequency of occurrence. Instrumentation has been developed for recording wave height,

period, and direction at a point. Wave direction information is usually necessary for design analysis, but may be estimated from directional wind data if physical measurements of wave direction are not available. Visual observations of wave direction during extreme events are important in verifying estimates made from wind data. If reliable visual shore or ship observations of wave direction are not available, hindcast procedures (Ch. 3, Sec. V, SIMPLIFIED METHODS FOR ESTIMATING WAVE CONDITIONS) must be used. Reliable deepwater wave data can be analyzed to provide the necessary shallow-water wave data. (See Ch. 2, Sec. II,3,h, Wave Energy and Power, and Ch. 2, Sec. III, WAVE REFRACTION, and IV, WAVE DIFFRACTION.)

4. Selection of Design Wave Conditions.

The choice of design wave conditions for structural stability as well as for functional performance should consider whether the structure is subjected to the attack of nonbreaking, breaking, or broken waves and on the geometrical and porosity characteristics of the structure (Jackson, 1968a). Once wave characteristics have been estimated, the next step is to determine if wave height at the site is controlled by water depth (see Ch. 2, Sec. VI, BREAKING WAVES). The type of wave action experienced by a structure may vary with position along the structure and with water level and time at a given structure section. For this reason, wave conditions should be estimated at various points along a structure and for various water levels. Critical wave conditions that result in maximum forces on structures like groins and jetties may occur at a location other than the seaward end of the structure. This possibility should be considered in choosing design wave and water level conditions.

Many analytical procedures currently available to estimate the maximum wave forces on structures or to compute the appropriate weights of primary armor units require the choice of a single design wave height and period to represent the spectrum of wave conditions during an extreme event. The peak spectral period is the best choice in most cases as a design wave period (see Ch. 3, Sec. V, SIMPLIFIED METHODS FOR ESTIMATING WAVE CONDITIONS). The choice of a design wave height should relate to the site conditions, the construction methods and materials to be used, and the reliability of the physical data available.

If breaking in shallow water does not limit wave height, a nonbreaking wave condition exists. For nonbreaking waves, the design height is selected from a statistical height distribution. The selected design height depends on whether the structure is defined as *rigid*, *semirigid*, or *flexible*. As a rule of thumb, the design wave is selected as follows. For *rigid* structures, such as cantilever steel sheet-pile walls, where a high wave within the wave train might cause failure of the entire structure, the design wave height is normally based on H_1 . For *semirigid* structures, the design wave height is selected from a range of H_{10} to H_1 . Steel sheet-pile cell structures are semirigid and can absorb wave pounding; therefore, a design wave height of H_{10} may be used. For *flexible* structures, such as rubble-mound or riprap structures, the design wave height usually ranges from H_5 to the significant wave height H_s . H_{10} is currently favored for most coastal breakwaters or jetties. Waves higher than the design wave height impinging on flexible structures seldom create serious damage for short durations of extreme wave

action. When an individual stone or armor unit is displaced by a high wave, smaller waves of the train may move it to a more stable position on the slope.

Damage to rubble-mound structures is usually progressive, and an extended period of destructive wave action is required before a structure ceases to provide protection. It is therefore necessary in selecting a design wave to consider both frequency of occurrence of damaging waves and economics of construction, protection, and maintenance. On the Atlantic and gulf coasts of the United States, hurricanes may provide the design criteria. The frequency of occurrence of the design hurricane at any site may range from once in 20 to once in 100 years. On the North Pacific coast of the United States, the weather pattern is more uniform; severe storms are likely each year. The use of H_s as a design height under these conditions could result in extensive annual damage due to a frequency and duration of waves greater than H_s in the spectrum. Here, a higher design wave of H_{10} or H_5 may be advisable. Selection of a design height between H_s and H_5 is based on the following factors:

- (a) Degree of structural damage tolerable and associated maintenance and repair costs (risk analysis and life-cycle costing).
- (b) Availability of construction materials and equipment.
- (c) Reliability of data used to estimate wave conditions.

a. Breaking Waves. Selection of a design wave height should consider whether a structure is subject to attack by breaking waves. It has been commonly assumed that a structure sited at a water depth d_s (measured at design water stage) will be subjected to breaking waves if $d_s \leq 1.3H$ where H = design wave height. Study of the breaking process indicates that this assumption is not always valid. The breaking point is defined as the point where foam first appears on the wave crest, where the front face of the wave first becomes vertical, or where the wave crest first begins to curl over the face of the wave (see Ch. 2, Sec. VI, BREAKING WAVES). The breaking point is an intermediate point in the breaking process between the first stages of instability and the area of complete breaking. Therefore, the depth that initiates breaking directly against a structure is actually some distance seaward of the structure and not necessarily the depth at the structure toe. The presence of a structure on a beach also modifies the breaker location and height. Jackson (1968a) has evaluated the effect of rubble structures on the breaking process. Additional research is required to fully evaluate the influence of structures.

Hedar (1965) suggested that the breaking process extends over a distance equal to half the shallow-water wavelength. This wavelength is based on the depth at this seaward position. On flat slopes, the resultant height of a wave breaking against the structure varies only a small amount with nearshore slope. A slope of 1 on 15 might increase the design breaking wave height by 20 to 80 percent depending on deepwater wavelength or period. Galvin (1968, 1969) indicated a relationship between the distance traveled by a plunging breaker and the wave height at breaking H_b . The relationship between the breaker travel distance x_p and the breaker height H_b depends on the nearshore slope and was expressed by Galvin (1969) as:

$$x_p = \tau_p H_b = (4.0 - 9.25 \text{ m}) H_b \quad (7-4)$$

where m is the nearshore slope (ratio of vertical to horizontal distance) and $\tau_p = (4.0 - 9.25 \text{ m})$ is the dimensionless plunge distance (see Fig. 7-1).

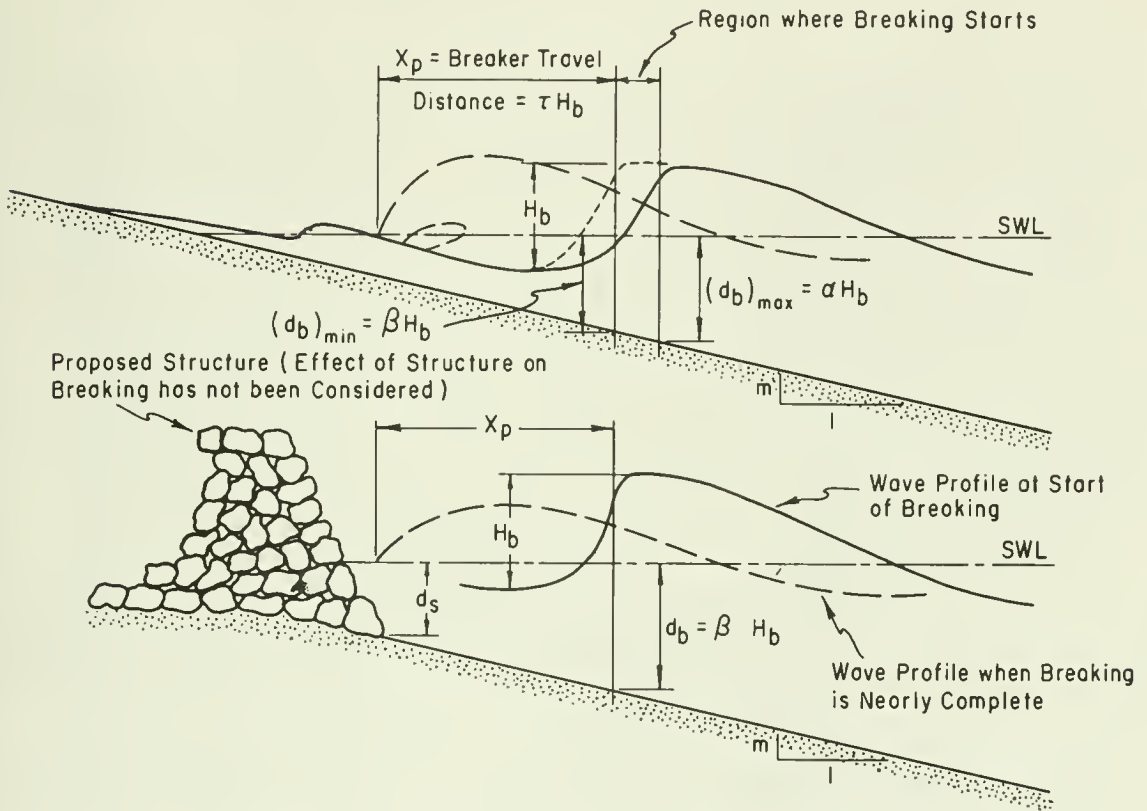

Figure 7-1. Definition of breaker geometry.

Analysis of experimental data shows that the relationship between depth at breaking d_b and breaker height H_b is more complex than indicated by the equation $d_b = 1.3 H_b$. Consequently, the expression $d_b = 1.3 H_b$ should not be used for design purposes. The dimensionless ratio d_b/H_b varies with nearshore slope m and incident wave steepness H_b/gT^2 as indicated in Figure 7-2. Since experimental measurements of d_b/H_b exhibit scatter, even when made in laboratory flumes, two sets of curves are presented in Figure 7-2. The curve of α versus H_b/gT^2 represents an upper limit of experimentally observed values of d_b/H_b , hence $\alpha = (d_b/H_b)_{max}$. Similarly, β is an approximate lower limit of measurements of d_b/H_b ; therefore, $\beta = (d_b/H_b)_{min}$. Figure 7-2 can be used with Figure 7-3 to determine the water depth in which an incident wave of known period and unrefracted deepwater height will break.

*****EXAMPLE PROBLEM 1*****

GIVEN: A Wave with period $T = 10 \text{ s}$, and an unrefracted deep-water height of $H_o = 1.5 \text{ meters (4.9 ft)}$ advancing shoreward over a nearshore slope of $m = 0.050 (1:20)$.

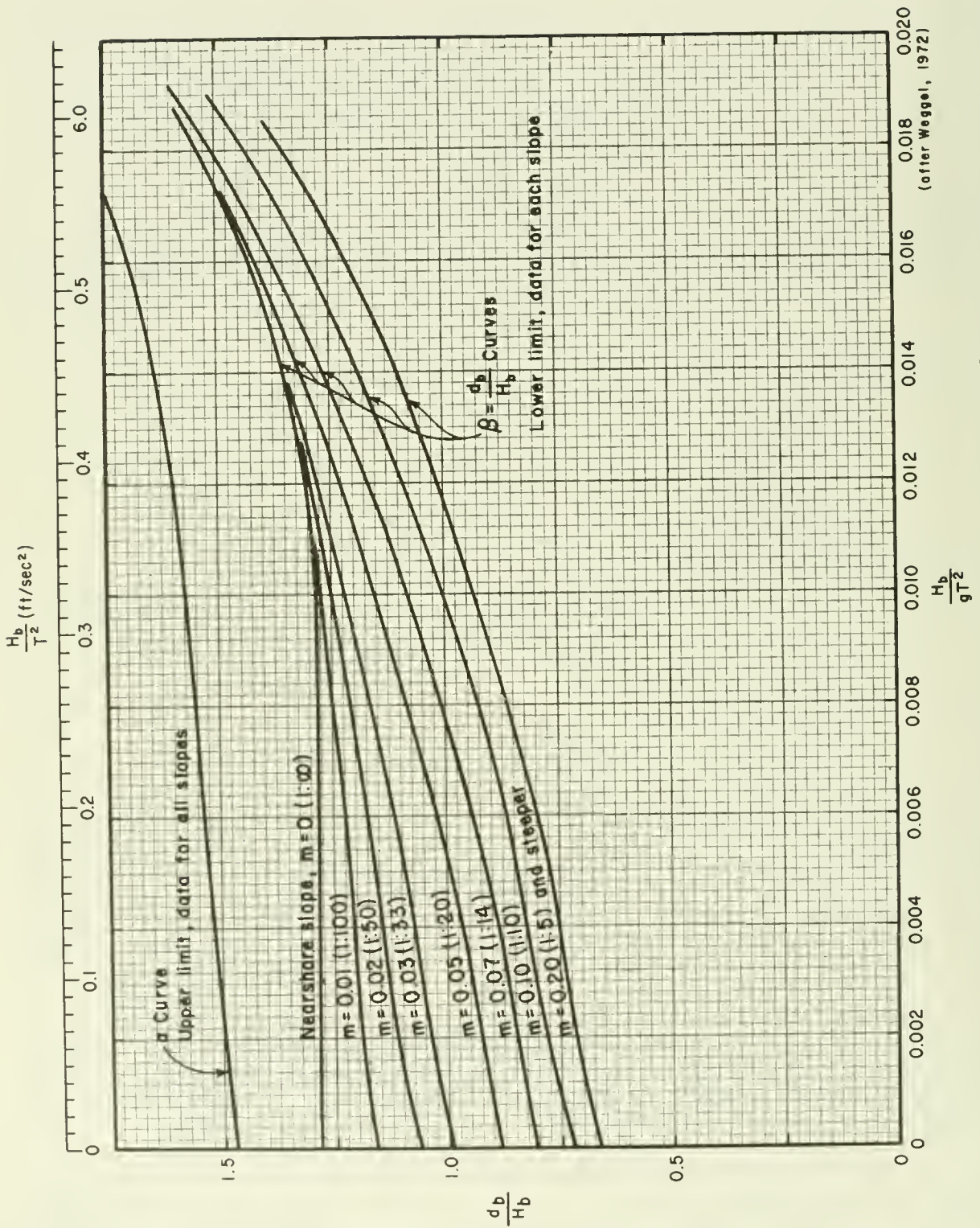

Figure 7-2. α and β versus H/gT^2 .

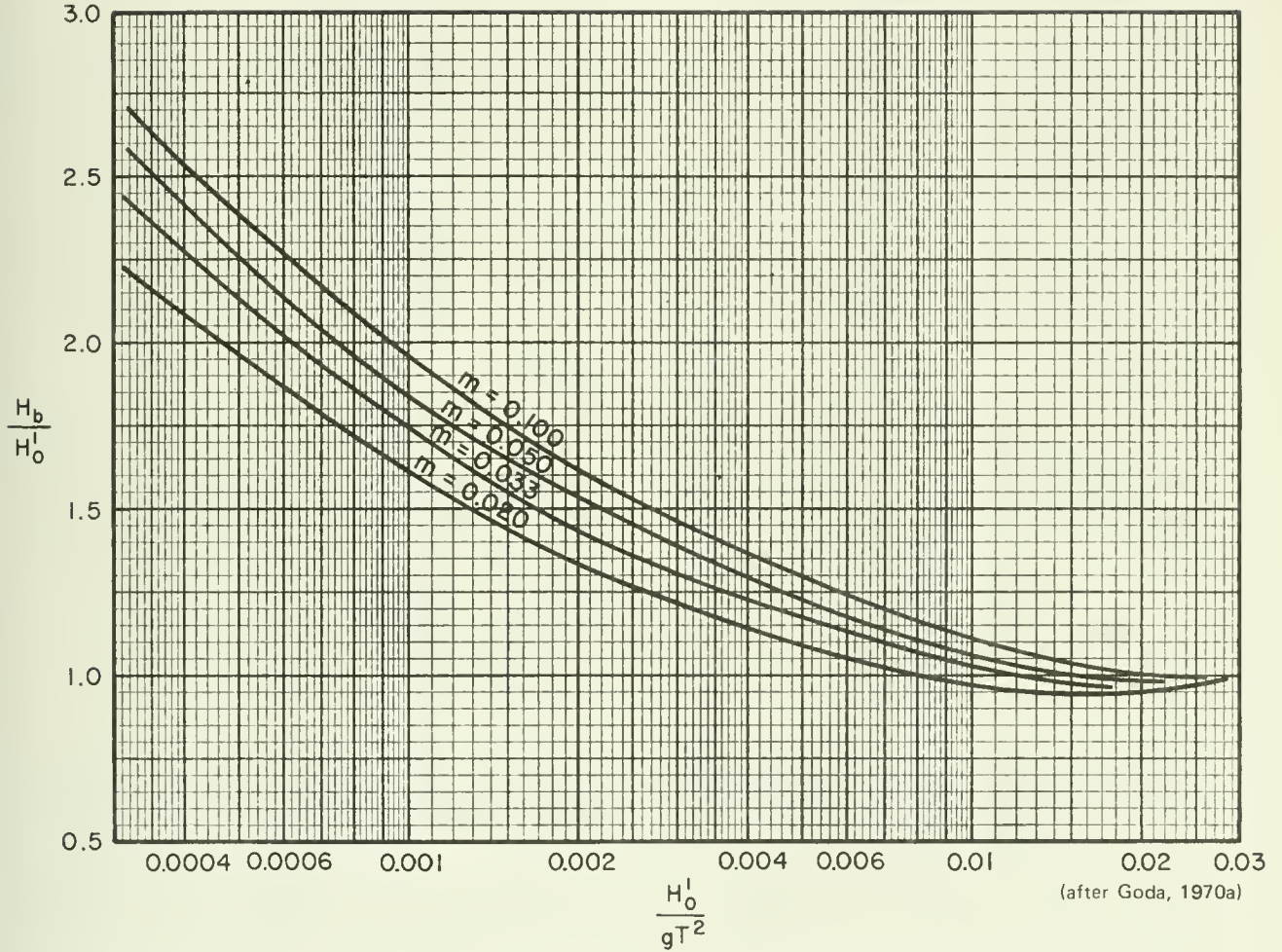

Figure 7-3. Breaker height index H_b/H_0^1 versus deepwater wave steepness H_0^1/gT^2 .

FIND: The range of depths where breaking may start.

SOLUTION: The breaker height can be found in Figure 7-3. Calculate

$$\frac{H'_0}{gT^2} = \frac{1.5}{(9.8)(10)^2} = 0.00153$$

and enter the figure to the curve for an $m = 0.05$ or 1:20 slope. H_b/H'_0 is read from the figure

$$\frac{H_b}{H'_0} = 1.65$$

Therefore

$$H_b = 1.65(H'_0) = 1.65(1.5) = 2.5 \text{ m (8.2 ft)}$$

H_b/gT^2 may now be computed

$$\frac{H_b}{gT^2} = \frac{2.5}{(9.8)(10)^2} = 0.00255$$

Entering Figure 7-2 with the computed value of H_b/gT^2 the value of α is found to be 1.51 and the value of β for a beach slope of 0.050 is 0.93. Then

$$(d_b)_{max} = \alpha H_b = 1.51(2.5) = 3.8 \text{ m (12.5 ft)}$$

$$(d_b)_{min} = \beta H_b = 0.93(2.5) = 2.3 \text{ m (7.5 ft)}$$

Where wave characteristics are not significantly modified by the presence of structures, incident waves generally will break when the depth is slightly greater than $(d_b)_{min}$. As wave-reflection effects of shore structures begin to influence breaking, depth of breaking increases and the region of breaking moves farther seaward. As illustrated by the example, a structure sited on a 1 on 20 slope under action of the given incident wave ($H'_0 = 1.5 \text{ m (4.9 ft)}$; $T = 10 \text{ s}$) could be subjected to waves breaking directly on it, if the depth at the structure toe were between $(d_b)_{min} = 2.3 \text{ m (7.5 ft)}$ and $(d_b)_{max} = 3.8 \text{ m (12.5 ft)}$.

NOTE: Final answers should be rounded to reflect the accuracy of the original given data and assumptions.

b. Design Breaker Height. When designing for a breaking wave condition, it is desirable to determine the maximum breaker height to which the structure might reasonably be subjected. The design breaker height H_b depends on the depth of water some distance seaward from the structure toe where the wave first begins to break. This depth varies with tidal stage. The design

breaker height depends, therefore, on critical design depth at the structure toe, slope on which the structure is built, incident wave steepness, and distance traveled by the wave during breaking.

Assuming that the design wave is one that plunges on the structure, design breaker height may be determined from:

$$H_b = \frac{d_s}{\beta - m\tau_p} \quad (7-5)$$

where d_s is depth at the structure toe, β is the ratio of breaking depth to breaker height d_b/H_b , m is the nearshore slope, and τ_p is the dimensionless plunge distance x_p/H_b from equation (7-4).

The magnitude of β to be used in equation (7-5) cannot be directly known until H_b is evaluated. To aid in finding H_b , Figure 7-4 has been derived from equations (7-4) and (7-5) using β values from Figure 7-2. If maximum design depth at the structure and incident wave period are known, design breaker height can be obtained using Figure 7-4.

***** EXAMPLE PROBLEM 2 *****

GIVEN:

- (a) Design depth structure toe, $d_s = 2.5$ m (8.2 ft)
- (b) Slope in front of structure is 1 on 20, or $m = 0.050$.
- (c) Range of wave periods to be considered in design

$$T = 6 \text{ s (minimum)}$$

$$T = 10 \text{ s (maximum)}$$

FIND: Maximum breaker height against the structure for the maximum and minimum wave periods.

SOLUTION: Computations are shown for the 6-second wave; only the final results for the 10-second wave are given.

From the given information, compute

$$\frac{d_s}{gT^2} = \frac{2.5}{(9.8)(6)^2} = 0.0071 \text{ (} T = 6 \text{ s)}$$

Enter Figure 7-4 with the computed value of d_s/gT^2 and determine value of H_b/d_s from the curve for a slope of $m = 0.050$.

$$\frac{d_s}{gT^2} = 0.0071 ; \quad \frac{H_b}{d_s} = 1.10 \text{ (} T = 6 \text{ s)}$$

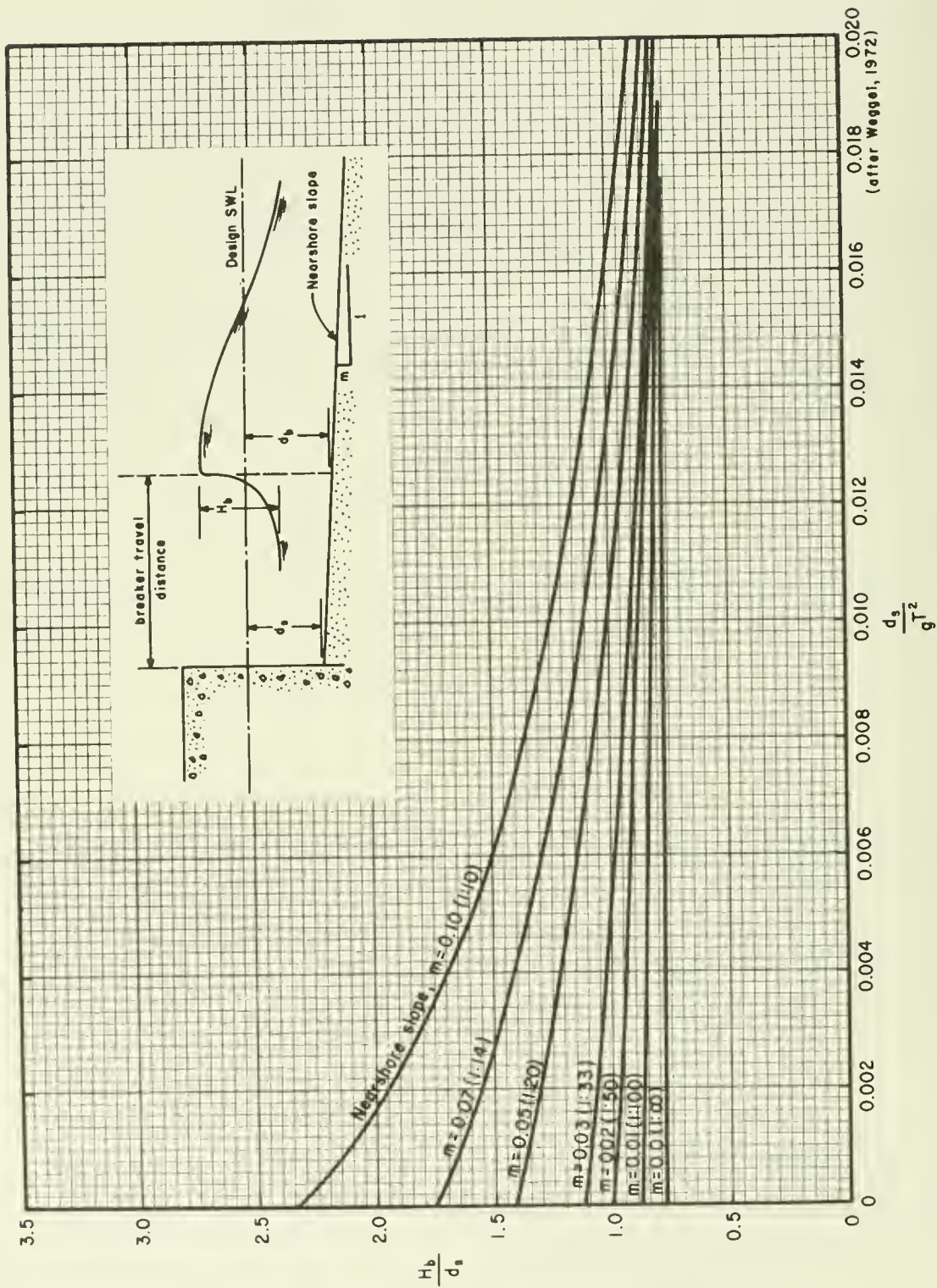

Figure 7-4. Dimensionless design breaker height versus relative depth at structure.

Note that H_b/d is not identical with H_b/d_b , where d_b is the depth at breaking and d_s is the depth at the structure. In general, because of nearshore slope, $d_s < d_b$; therefore $H_b/d_s > H_b/d_b$.

For the example, breaker height can now be computed from

$$H_b = 1.10 d_s = 1.10 (2.5) = 2.8 \text{ m (9.2 ft) (T = 6 s)}$$

For the 10-second wave, a similar analysis gives

$$H_b = 1.27 d_s = 1.27 (2.5) = 3.2 \text{ m (10.5 ft) (T = 10 s)}$$

As illustrated by the example problem, longer period waves result in higher design breakers; therefore, the greatest breaker height which could possibly occur against a structure for a given design depth and nearshore slope is found by entering Figure 7-4 with $d_s/gT^2 = 0$ (infinite period). For the example problem

$$\frac{d_s}{gT^2} = 0 ; \frac{H_b}{d_s} = 1.41 \text{ (m = 0.050)}$$

$$H_b = 1.41 d_s = 1.41 (2.5) = 3.5 \text{ m (11.6 ft)}$$

It is often of interest to know the deepwater wave height associated with the design height obtained from Figure 7-4. Comparison of the design associated deepwater wave height determined from Figure 7-4 with actual deepwater wave statistics characteristic of the site will give some indication of how often the structure could be subjected to breakers as high as the design breaker. Deepwater height may be found in Figure 7-5 and information obtained by a refraction analysis (see Ch. 2, Sec. III, WAVE REFRACTION). Figure 7-5 is based on observations by Iversen (1952a, 1952b), as modified by Goda (1970a), of periodic waves breaking on impermeable, smooth, uniform laboratory slopes. Figure 7-5 is a modified form of Figure 7-3.

*****EXAMPLE PROBLEM 3*****

GIVEN:

(a) $H_b = 2.8 \text{ m (9.2 ft) (T = 6 s)}$

and

$H_b = 3.2 \text{ m (10.5 ft) (see previous example) (T = 10 s)}$

(b) Assume that refraction analysis of the structure site gives

$$K_R = \sqrt{\frac{b_o}{b}} = 0.85 \text{ (T = 6 s)}$$

and

$$K_R = 0.75 \quad (T = 10 \text{ s})$$

for a given deepwater direction of wave approach (see Ch. 2, Sec. III, WAVE REFRACTION).

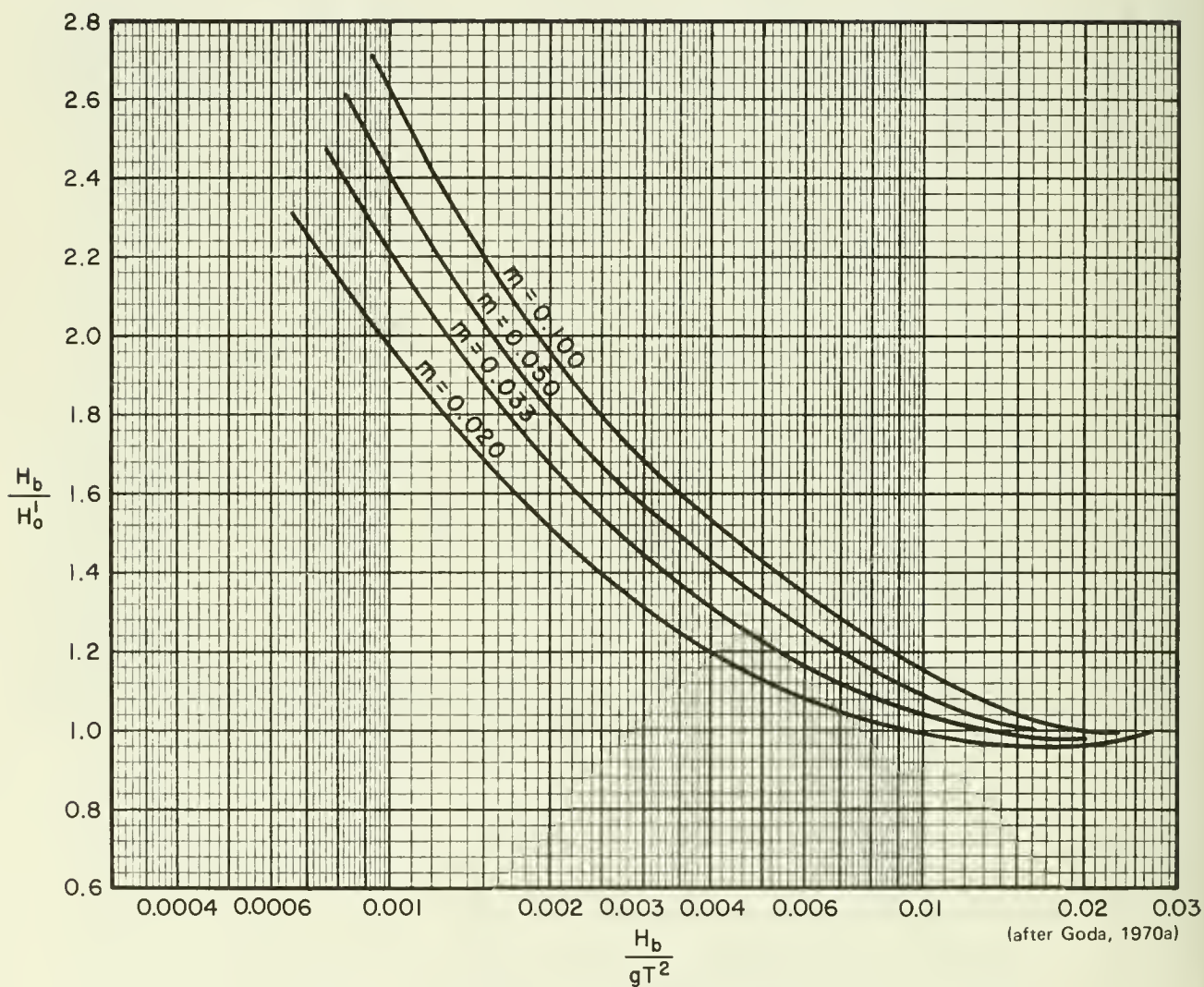

Figure 7-5. Breaker height index H_b/H_0 versus H_b/gT^2 .

FIND: The deepwater height H_o of the waves resulting in the given breaker heights H_b

SOLUTION: Calculate H_b/gT^2 for each wave condition to be investigated.

$$\frac{H_b}{gT^2} = \frac{2.8}{(9.8)(6)^2} = 0.0079 \quad (T = 6 \text{ s})$$

With the computed value of H_b/gT^2 enter Figure 7-5 to the curve for a slope of $m = 0.05$ and determine H_b/H_o' which may be considered an ultimate shoaling coefficient or the shoaling coefficient when breaking occurs.

$$\frac{H_b}{gT^2} = 0.0079 ; \frac{H_b}{H_o'} = 1.16 \quad (T = 6 \text{ s})$$

With the value of H_b/H_o' thus obtained and with the value of K_R obtained from a refraction analysis, the deepwater wave height resulting in the design breaker may be found with equation (7-6).

$$H_o = \frac{H_b}{K_R(H_b/H_o')} \quad (7-6)$$

H_o is the actual deepwater wave height, where H_o' is the wave height in deep water if no refraction occurred (H_o' = unrefracted deepwater height). Where the bathmetry is such that significant wave energy is dissipated by bottom friction as the waves travel from deep water to the structure site, the computed deepwater height should be increased accordingly (see Ch. 3, Sec. VII, HURRICANE WAVES, for a discussion of wave height attenuation by bottom friction).

Applying equation (7-6) to the example problem gives

$$H_o = \frac{2.8}{(0.85)(1.16)} = 2.8 \text{ m (9.2 ft)} \quad (T = 6 \text{ s})$$

A similar analysis for the 10-second wave gives

$$H_o = 2.8 \text{ m (9.2 ft)} \quad (T = 10 \text{ s})$$

A wave advancing from the direction for which refraction was analyzed, and with a height in deep water greater than the computed H_o , will break at a distance greater than x_p feet in front of the structure.

Waves with a deepwater height less than the H_o computed above could break directly against the structure; however, the corresponding breaker height will be less than the design breaker height determined from Figure 7-4.

* * * * *

c. Nonbreaking Waves. Since statistical hindcast wave data are normally available for deepwater conditions ($d > L_o/2$) or for depth conditions some distance from the shore, refraction analysis is necessary to determine wave characteristics at a nearshore site (see Ch. 2, Sec. III, WAVE REFRACTION). Where the continental shelf is broad and shallow, as in the Gulf of Mexico, it is advisable to allow for a large energy loss due to bottom friction (Savage, 1953), (Bretschneider, 1954a, b) (see Ch. 3, Sec. VII, HURRICANE WAVES).

General procedures for developing the height and direction of the design wave by use of refraction diagrams follow:

From the site, draw a set of *refraction fans* for the various waves that might be expected (use wave period increments of no more than 2 seconds) and determine refraction coefficients by the method given in Chapter 2, Section III, WAVE REFRACTION. Tabulate refraction coefficients determined for the selected wave periods and for each deepwater direction of approach. The statistical wave data from synoptic weather charts or other sources may then be reviewed to determine if waves having directions and periods with large refraction coefficients will occur frequently.

The deepwater wave height, adjusted by refraction and shoaling coefficients, that gives the highest significant wave height at the structure will indicate direction of approach and period of the design wave. The inshore height so determined is the design significant wave height. A typical example of such an analysis is shown in Table 7-1. In this example, although the highest significant deepwater waves approached from directions ranging from W to NW, the refraction study indicated that higher inshore significant waves may be expected from more southerly directions.

The accuracy of determining the shallow-water design wave by a refraction analysis is decreased by highly irregular bottom conditions. For irregular bottom topography, field observations including the use of aerial photos or hydraulic model tests may be required to obtain valid refraction information.

d. Bathymetry Changes at Structure Site. The effect of a proposed structure on conditions influencing wave climate in its vicinity should also be considered. The presence of a structure might cause significant deepening of the water immediately in front of it. This deepening, resulting from scour during storms may increase the design depth and consequently the design breaker height if a breaking wave condition is assumed for design. If the material removed by scour at the structure is deposited offshore as a bar, it may provide protection to the structure by causing large waves to break farther seaward. Experiments by Russell and Inglis (1953), van Weele (1965), Kadib (1962), and Chesnutt (1971), provide information for estimating changes in depth. A general rule for estimating the scour at the toe of a wall is given in Chapter 5.

e. Summary--Evaluating the Marine Environment. The design process of evaluating wave and water level conditions at a structure site is summarized in Figure 7-6. The path taken through the figure will generally depend on the type, purpose, and location of a proposed structure and on the availability of data. Design depths and wave conditions at a structure can usually be determined concurrently. However, applying these design conditions to structural design requires evaluation of water levels and wave conditions that

Table 7-1. Determination of design wave heights.

1	2	3	4	5
Direction	Significant Deepwater Wave Height (m)	Wave Period (s)	Combined Refraction and Shoaling Coefficients ¹ ($K_R K_S$)	Refracted and Shoaled Wave Height (m)
NW	5.0	8	0.20	1.0
		10	0.14	0.7
		12	0.08	0.4
WNW	4.0	8	0.30	1.2
		10	0.24	1.0
		12	0.18	0.7
W	3.0	10	0.60	1.8
		12	0.62	1.9
		14	0.40	1.2
		16	0.50	1.5
WSW	3.0	10	1.20	3.6
		12	1.00	3.0
		14	0.70	2.1
		16	0.70	2.1
SW	2.8	12	1.44	4.0 ²
		14	1.18	3.3
		16	0.80	2.2

¹ Refraction coefficient, $K_R = \sqrt{b_o/b}$ at design water level.

Shoaling coefficient, $K_S = H/H_o$ at design water level.

² Adopted as the significant design wave height.

NOTES:

Columns 1, 2, and 3 are taken from the statistical wave data as determined from synoptic weather charts.

Column 4 is determined from the relative distances between two adjacent orthogonals in deep water and shallow water, and the shoaling coefficient.

Column 5 is the product of columns 2 and 4.

can reasonably be assumed to occur simultaneously at the site. Where hurricanes cross the coast, high water levels resulting from storm surge and extreme wave action generated by the storm occur together and usually provide critical design conditions. Design water levels and wave conditions are needed for refraction and diffraction analyses, and these analyses must follow establishment of design water levels and design wave conditions.

The frequency of occurrence of adopted design conditions and the frequency of occurrence and duration of a range of reasonable combinations of water level and wave action are required for an adequate economic evaluation any proposed shore protection scheme.

II. WAVE RUNUP, OVERTOPPING, AND TRANSMISSION

1. Wave Runup

a. Regular (Monochromatic) Waves. The vertical height above the still-water level to which water from an incident wave will run up the face of a structure determines the required structure height if wave overtopping cannot be permitted (see Fig. 7-7 for definitions). Runup depends on structure shape and roughness, water depth at structure toe, bottom slope in front of a structure, and incident wave characteristics. Because of the large number of variables involved, a complete description is not available of the runup phenomenon in terms of all possible ranges of the geometric variables and wave conditions. Numerous laboratory investigations have been conducted, but mostly for runup on smooth, impermeable slopes. Hall and Watts (1953) investigated runup of solitary waves on impermeable slopes; Saville (1956) investigated runup by periodic waves. Dai and Kamel (1969) investigated the runup and rundown of waves on rubble breakwaters. Savage (1958) studied effects of structure roughness and slope permeability. Miller (1968) investigated runup of undular and fully broken waves on three beaches of different roughnesses. LeMehaute (1963) and Freeman and LeMehaute (1964) studied long-period wave runup analytically. Keller et al. (1960), Ho and Meyer (1962), and Shen and Meyer (1963) studied the motion of a fully broken wave and its runup on a sloping beach.

Figures 7-8 through 7-13 summarize results for small-scale laboratory tests of runup of regular (monochromatic) waves on smooth impermeable slopes (Saville, 1958a). The curves are in dimensionless form for the relative runup R/H'_0 as a function of deepwater wave steepness and structure slope, where R is the runup height measured (vertically) from the SWL and H'_0 is the *unrefracted deepwater wave height* (see Figure 7-7 for definitions). Results predicted by Figures 7-8 through 7-12 are probably smaller than the runup on prototype structures because of the inability to scale roughness effects in small-scale laboratory tests. *Runup values from Figures 7-8 through 7-12 can be adjusted for scale effects by using Figure 7-13.*

Runup on impermeable structures having quarrystone slopes and runup on vertical, stepped, curved and Galveston-type recurved seawalls have been studied on laboratory-scale models by Saville (1955, 1956). The results are

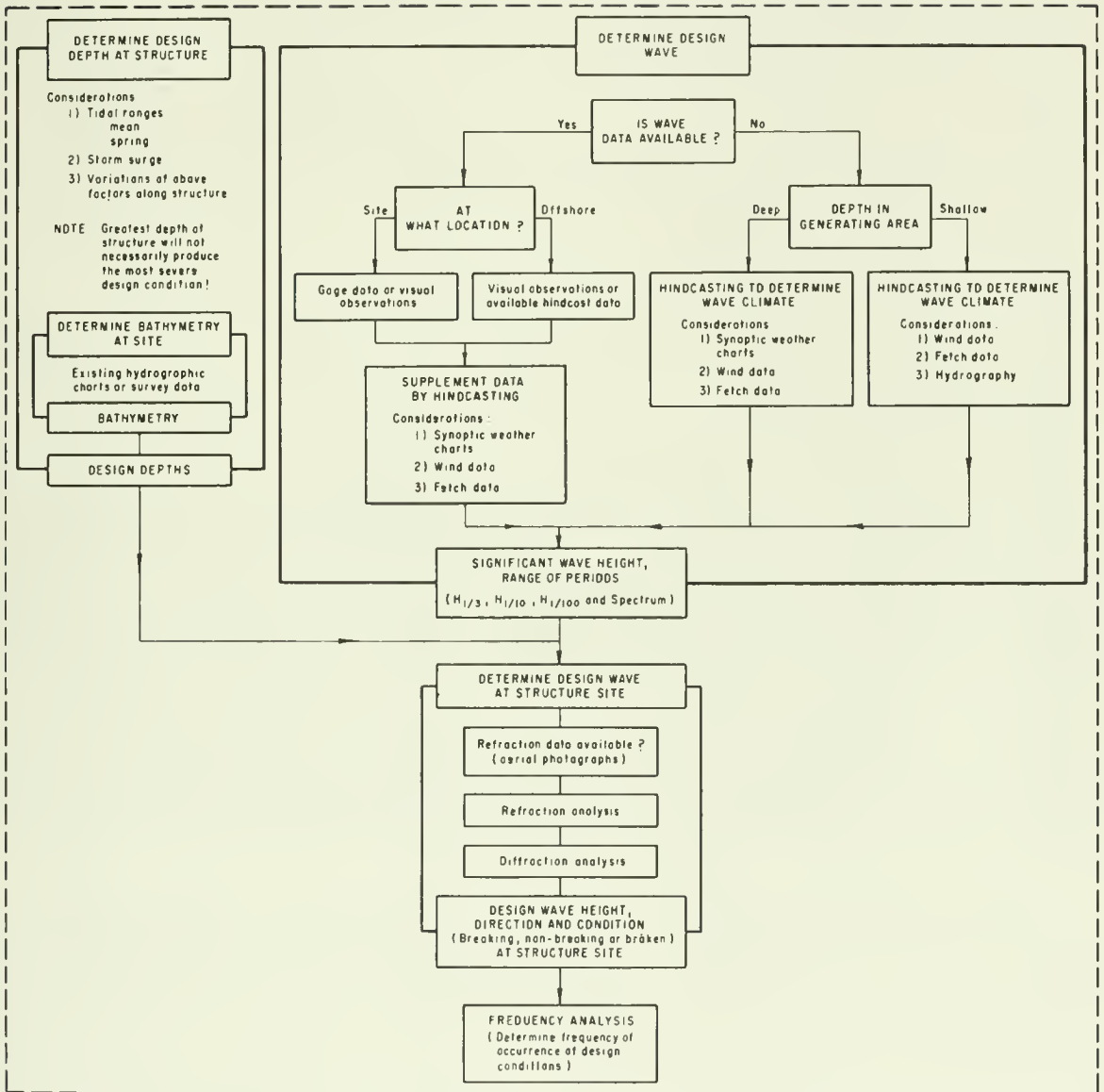

Figure 7-6. Logic diagram for evaluation of marine environment.

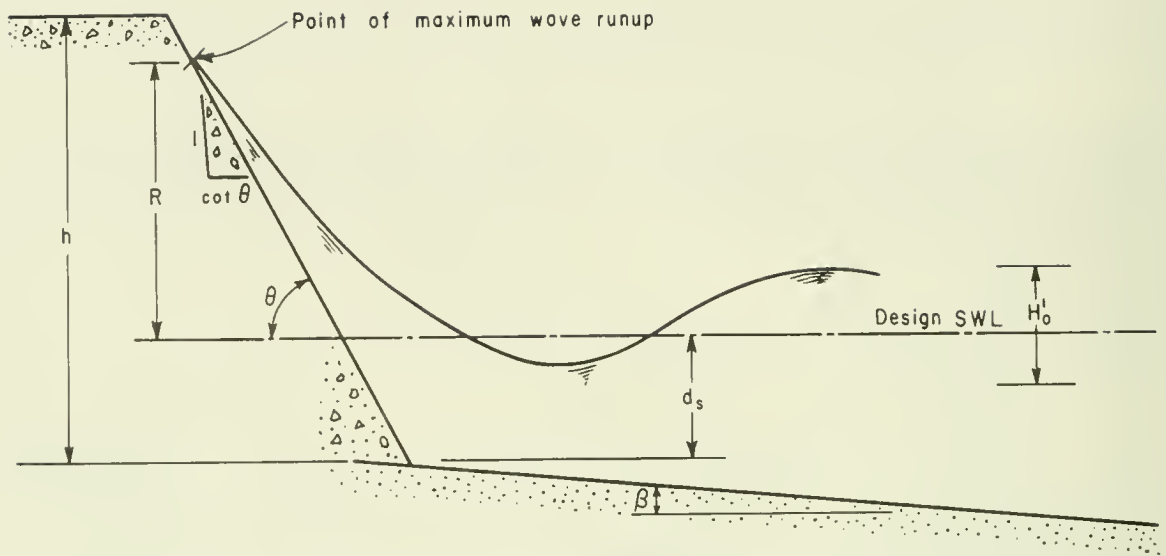

Figure 7-7. Definition sketch: wave runup and overtopping.

shown in Figures 7-14 through 7-18. Effects of using graded riprap on the face of an impermeable structure (as opposed to quarrystone of uniform size for which Figure 7-15 was obtained) are presented in Figure 7-19 for a 1 on 2 graded riprap slope. Wave rundown for the same slope is also presented in Figure 7-19. Runup on *permeable rubble slopes* as a function of structure slope and $\frac{H_0'}{gT^2}$ is compared with runup on smooth slopes in Figure 7-20.

Corrections for scale effects, using the curves in Figure 7-13, should be applied to runup values obtained from Figures 7-8 through 7-12 and 7-14 through 7-18. The values of runup obtained from Figure 7-19 and 7-20 are assumed directly applicable to prototype structures without correction for scale effects.

As previously discussed, Figures 7-8 through 7-20 provide design curves for smooth and rough slopes, as well as various wall configurations. As noted, there are considerable data on smooth slopes for a wide range of d_s/H_0' values, whereas the rough-slope data are limited to values of $d_s/H_0' > 3$. It is frequently necessary to determine the wave runup on permeable rubble structures for specific conditions for which model tests have not been conducted, such as breaking waves for $d_s/H_0' < 3$. To provide the necessary design guidance, Battjes (1974), Ahrens (1977a), and Stoa (1978) have suggested the use of a roughness and porosity correction factor that allows the use of various smooth-slope design curves for application to other structure slope characteristics. This roughness and porosity correction factor, r , is the ratio of runup or relative runup on rough permeable or other nonsmooth slope to the runup or relative runup on a smooth impermeable slope. This is expressed by the following equation:

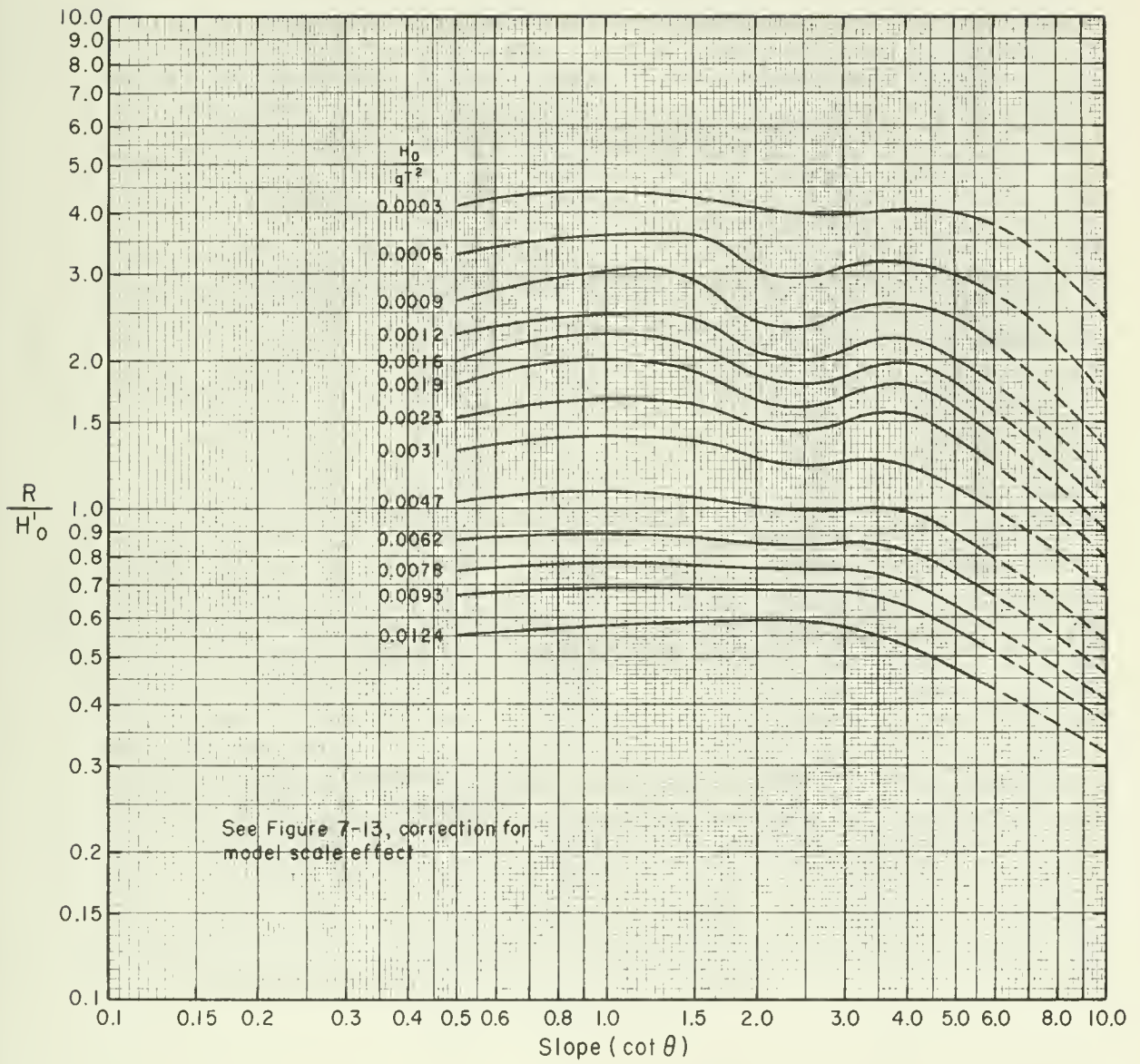

Figure 7-8. Wave runup on smooth, impermeable slopes when $d_s/H'_0 = 0$ (structures fronted by a 1:10 slope).

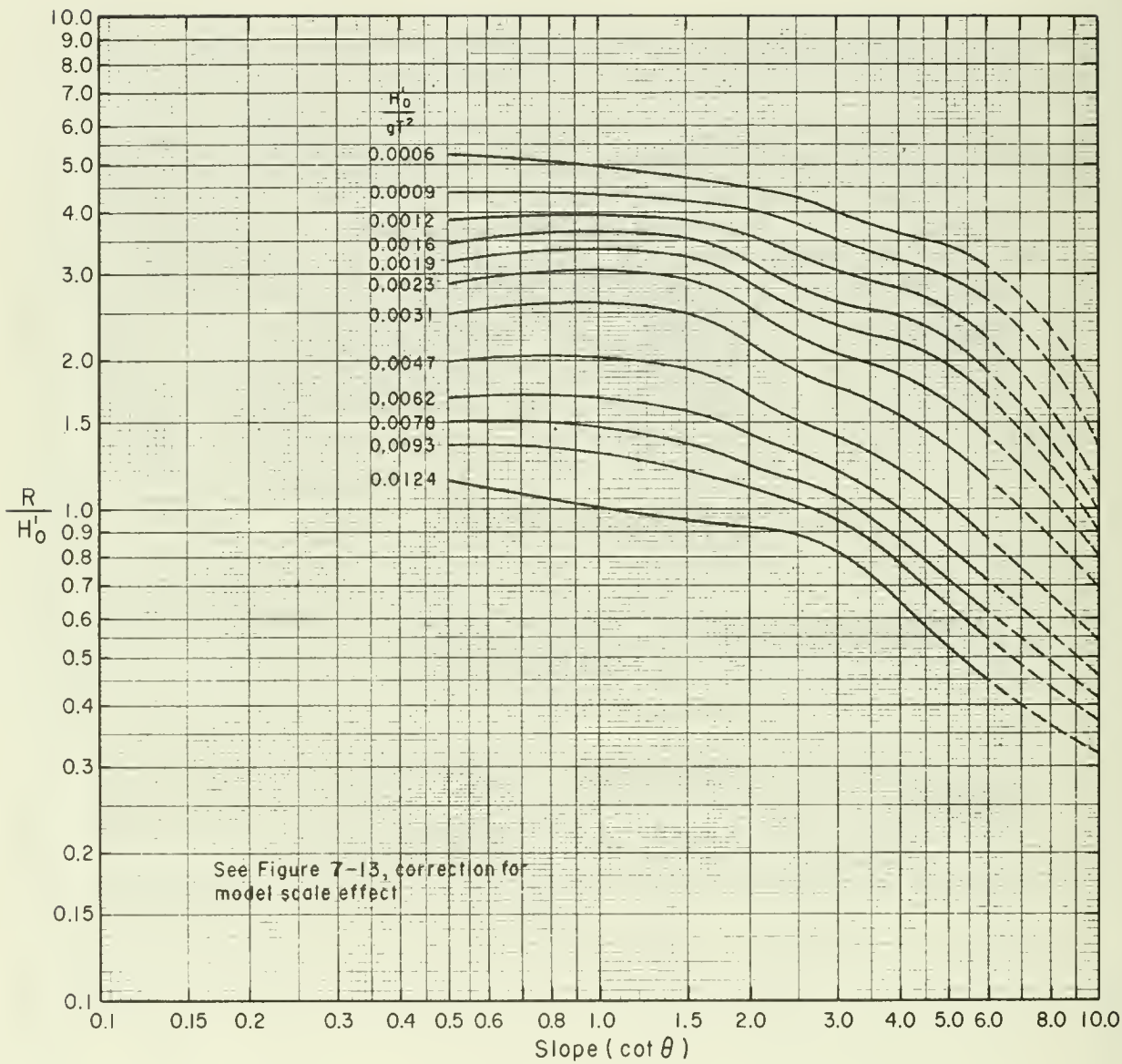

Figure 7-9. Wave runup on smooth, impermeable slopes when $\frac{d}{s_0} \approx 0.45$ (structures fronted by a 1:10 slope).

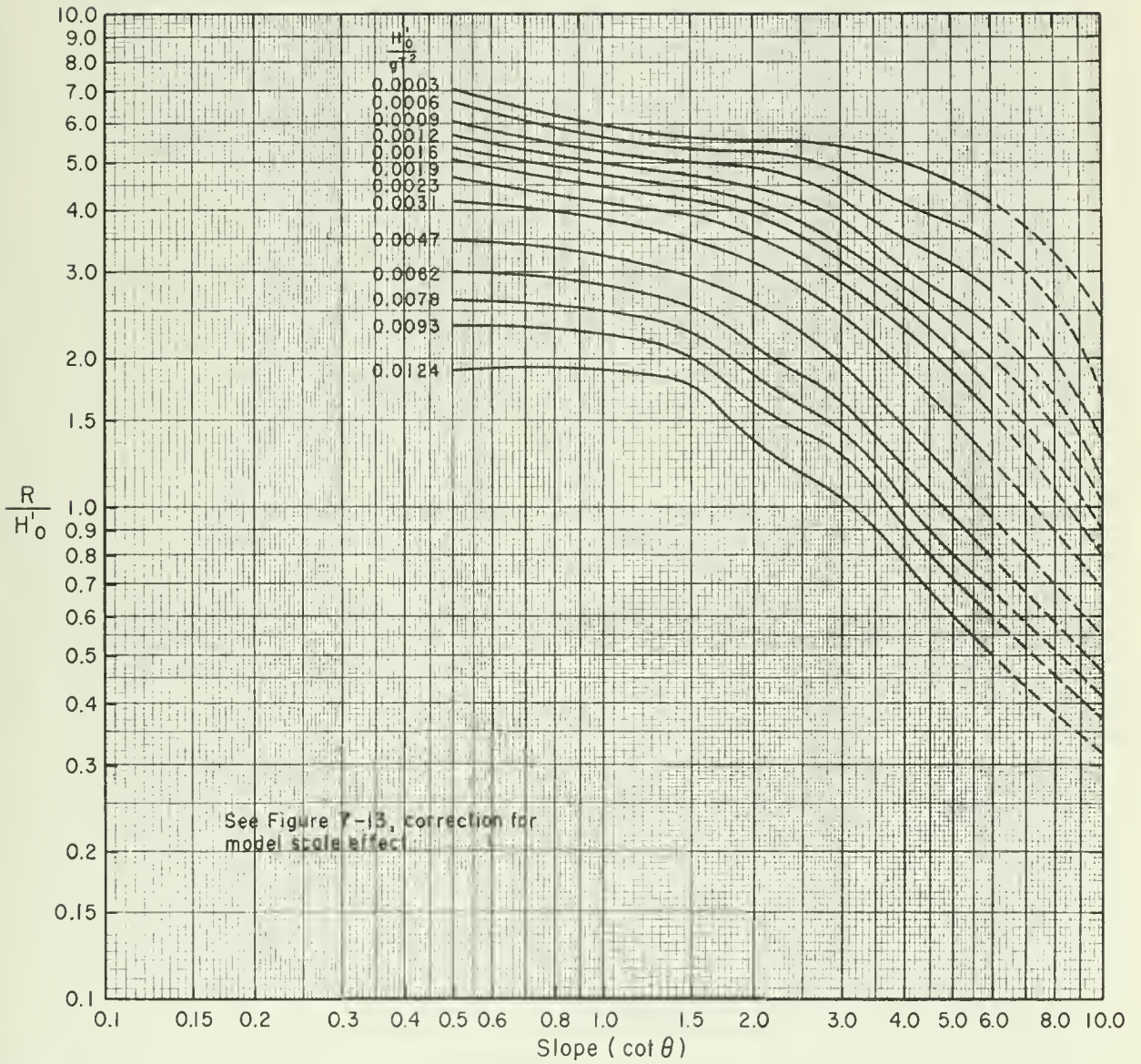

Figure 7-10. Wave runup on smooth, impermeable slopes when $\frac{d}{s H_0} \approx 0.80$ (structures fronted by a 1:10 slope).

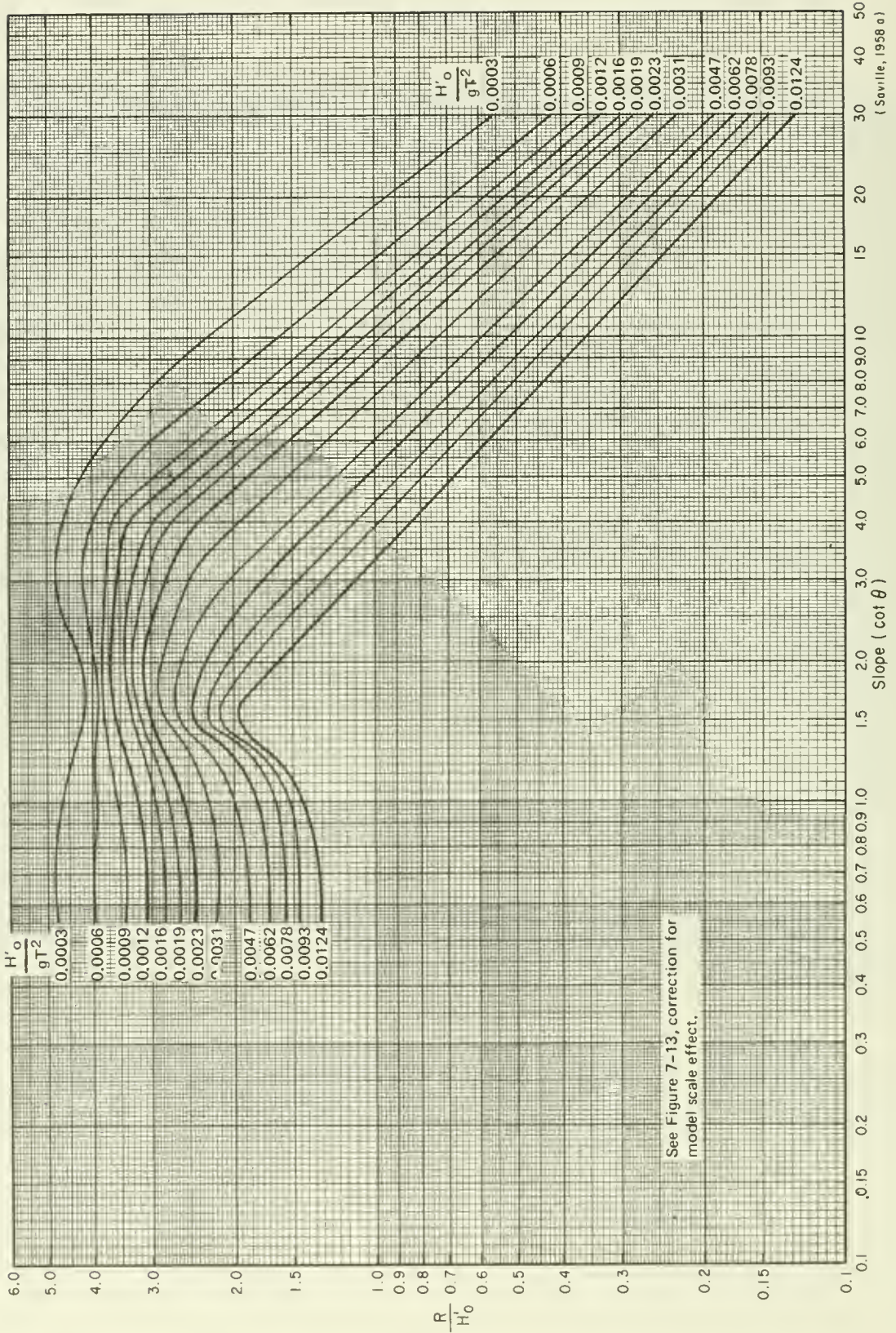

Figure 7-11. Wave runup on smooth, impermeable slopes when $d_g/H_0 \approx 2.0$.

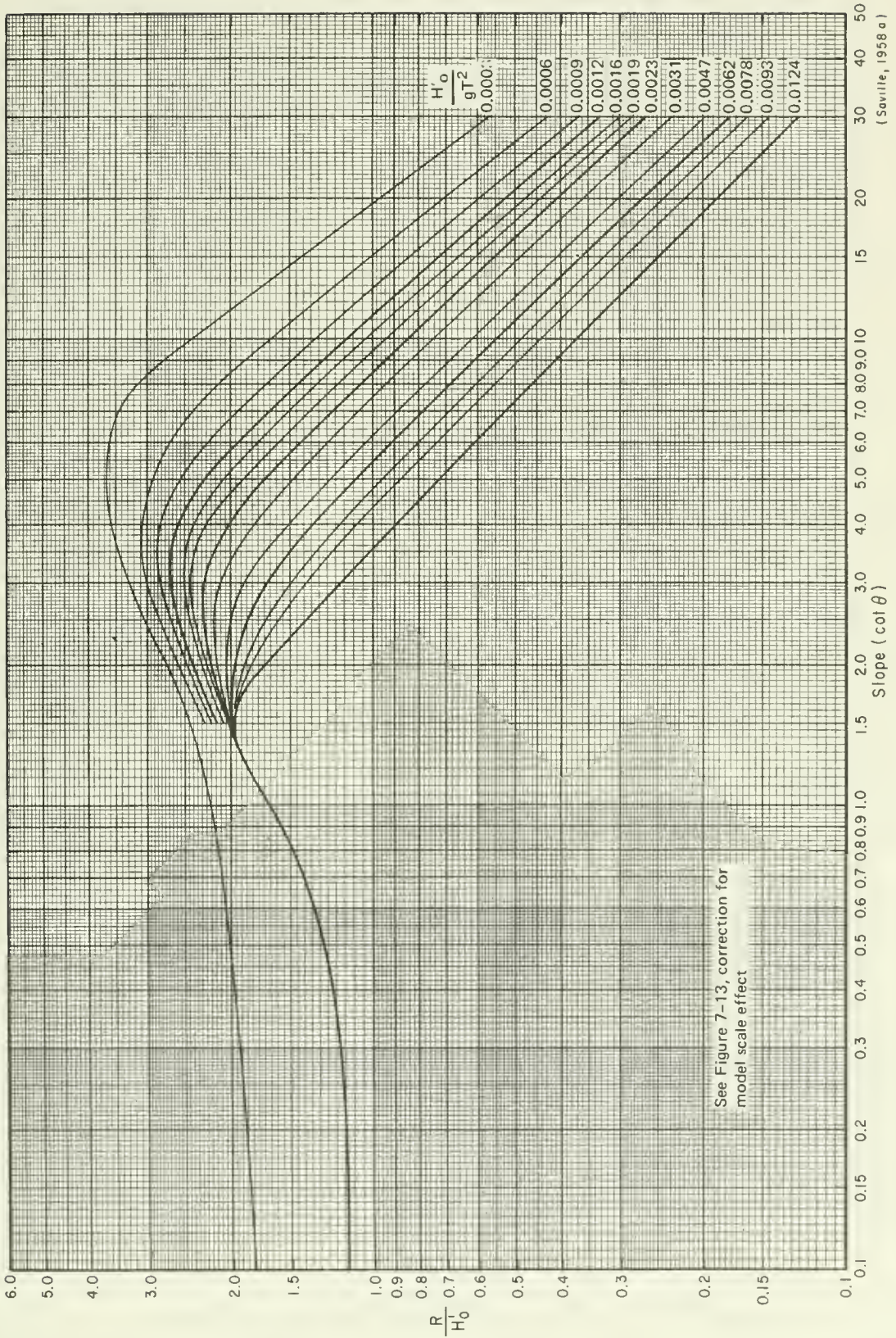

Figure 7-12. Wave runup on smooth, impermeable slopes when $d_s/H'_0 \cong 3.0$.

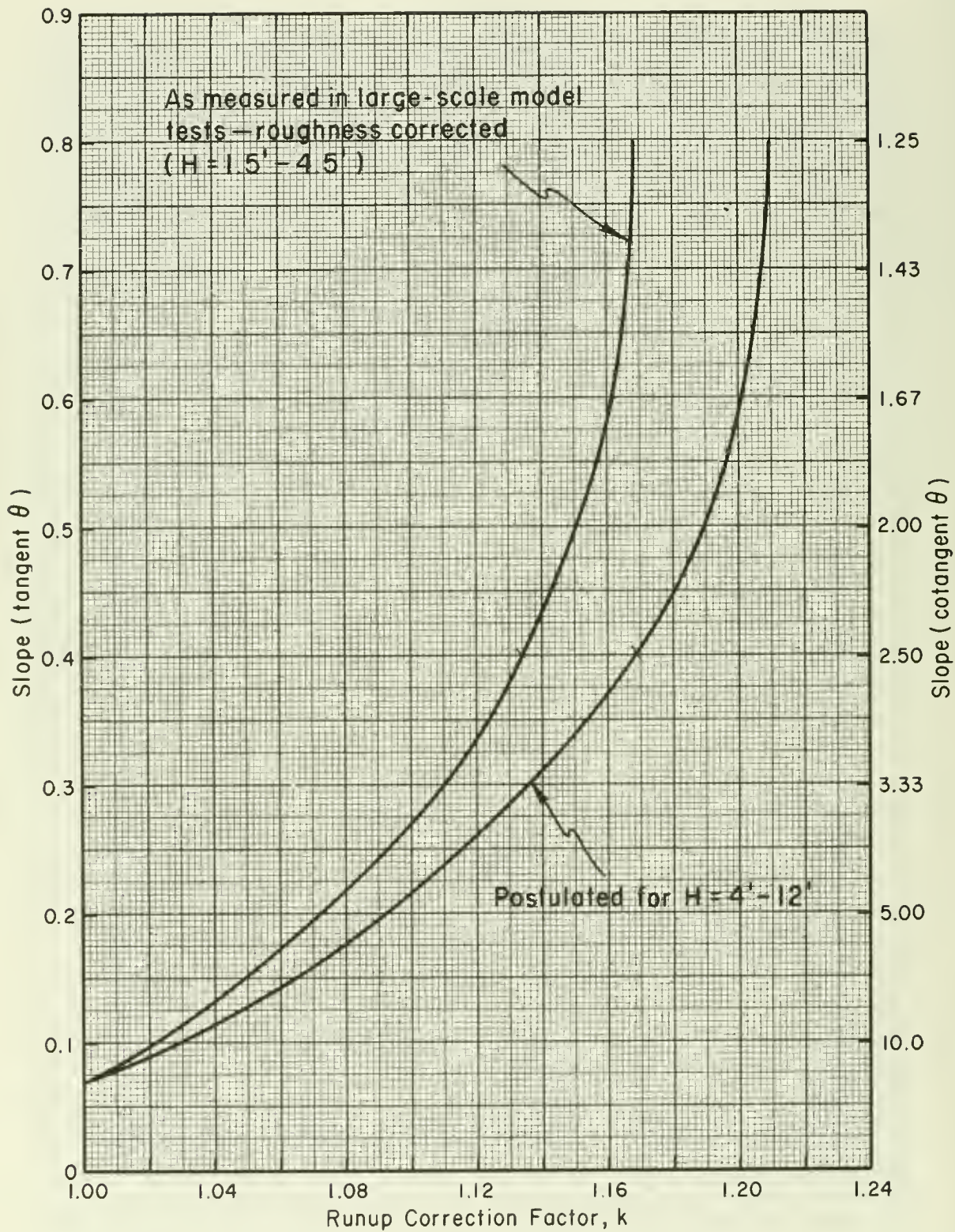
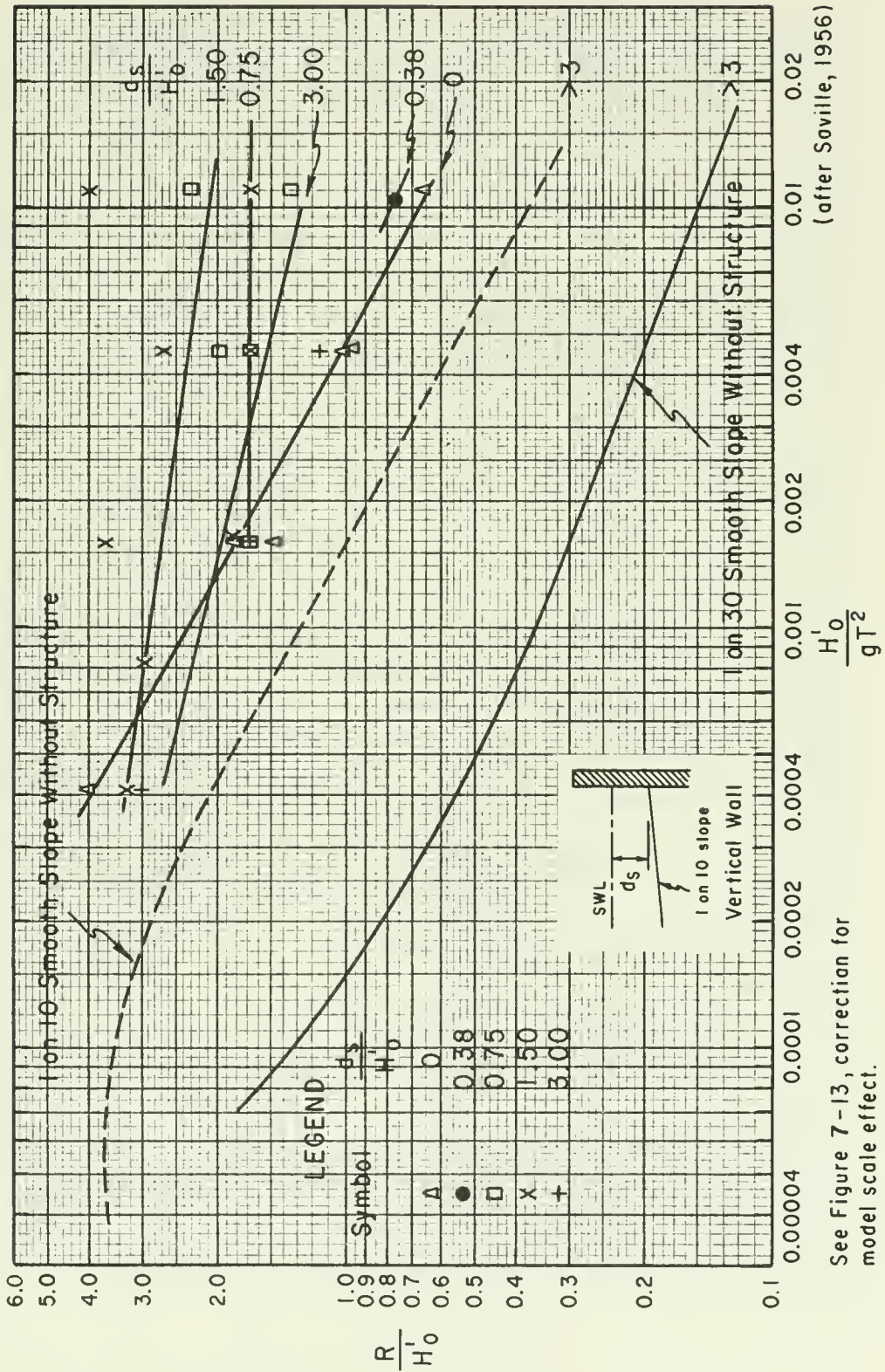
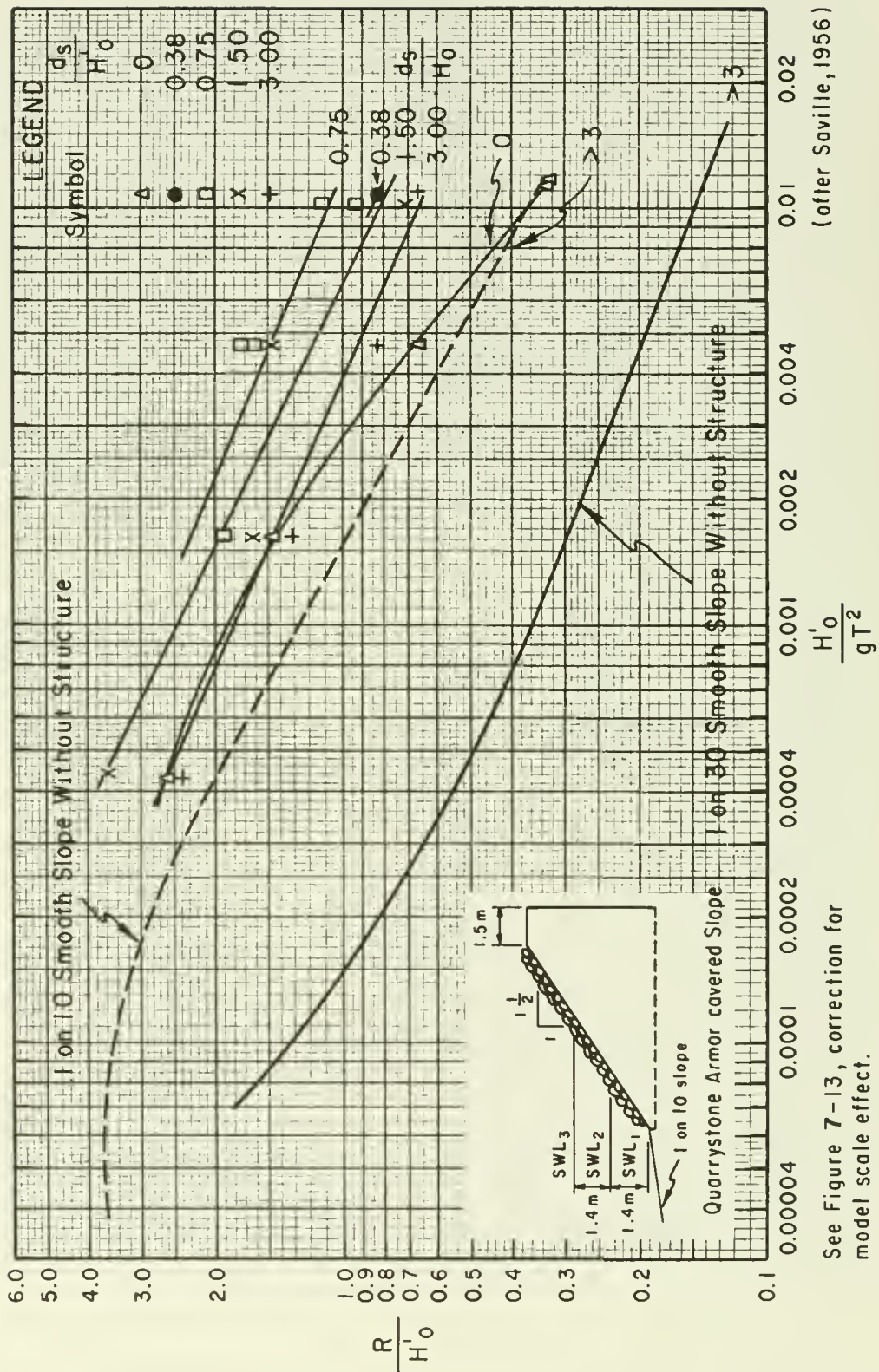

Figure 7-13. Runup correction for scale effects.



See Figure 7-13, correction for model scale effect.

Figure 7-14. Wave runup on impermeable, vertical wall versus H'_0/gT^2 .



(after Saville, 1956)

See Figure 7-13, correction for model scale effect.

Figure 7-15. Wave runoff on impermeable, quarrystone, 1:1.5 slope versus H_0'/gT^2 .

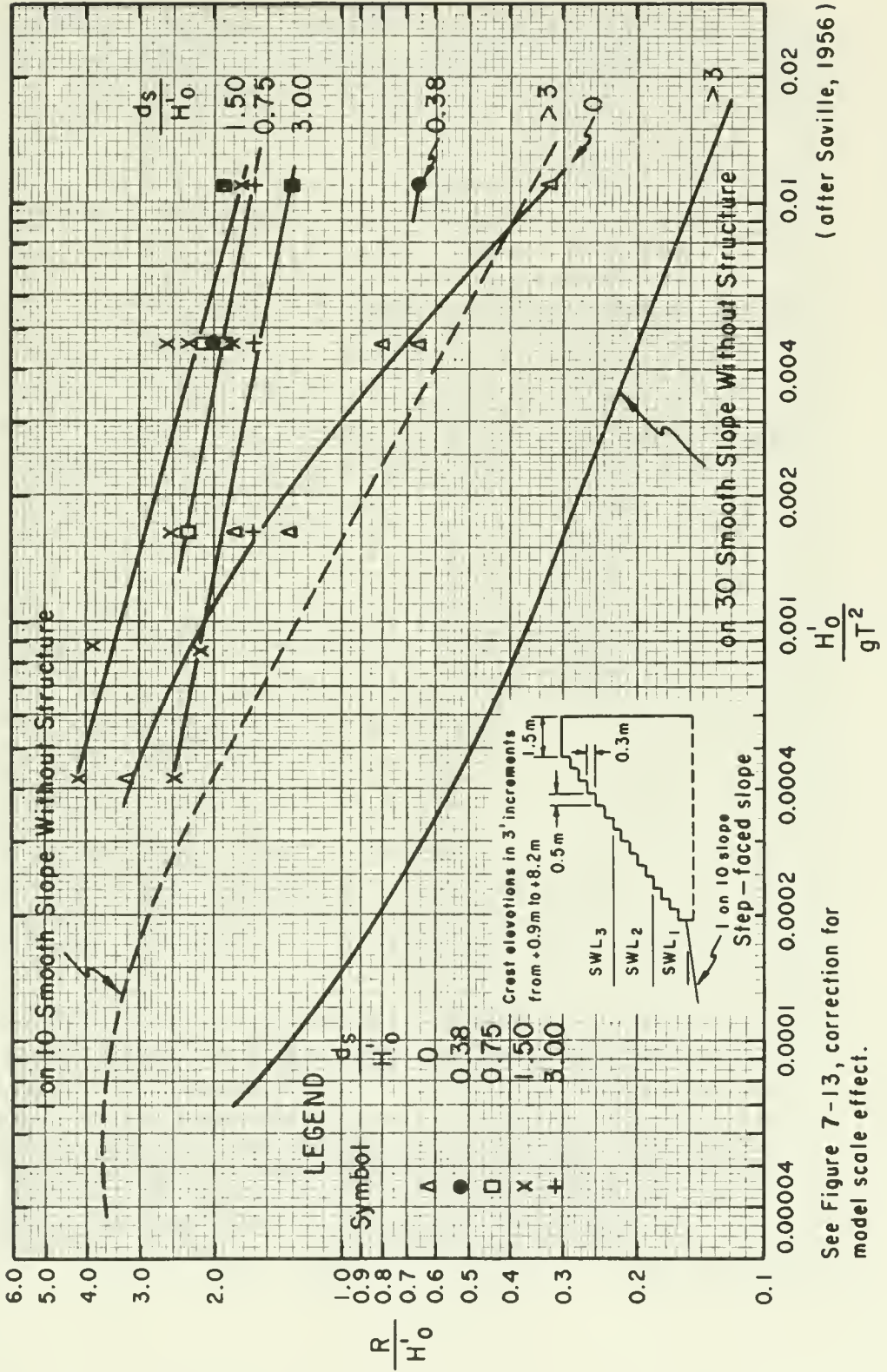

See Figure 7-13, correction for model scale effect.

Figure 7-16. Wave runoff on impermeable, stepped, 1:1.5 slope versus H'_0/gT^2 .

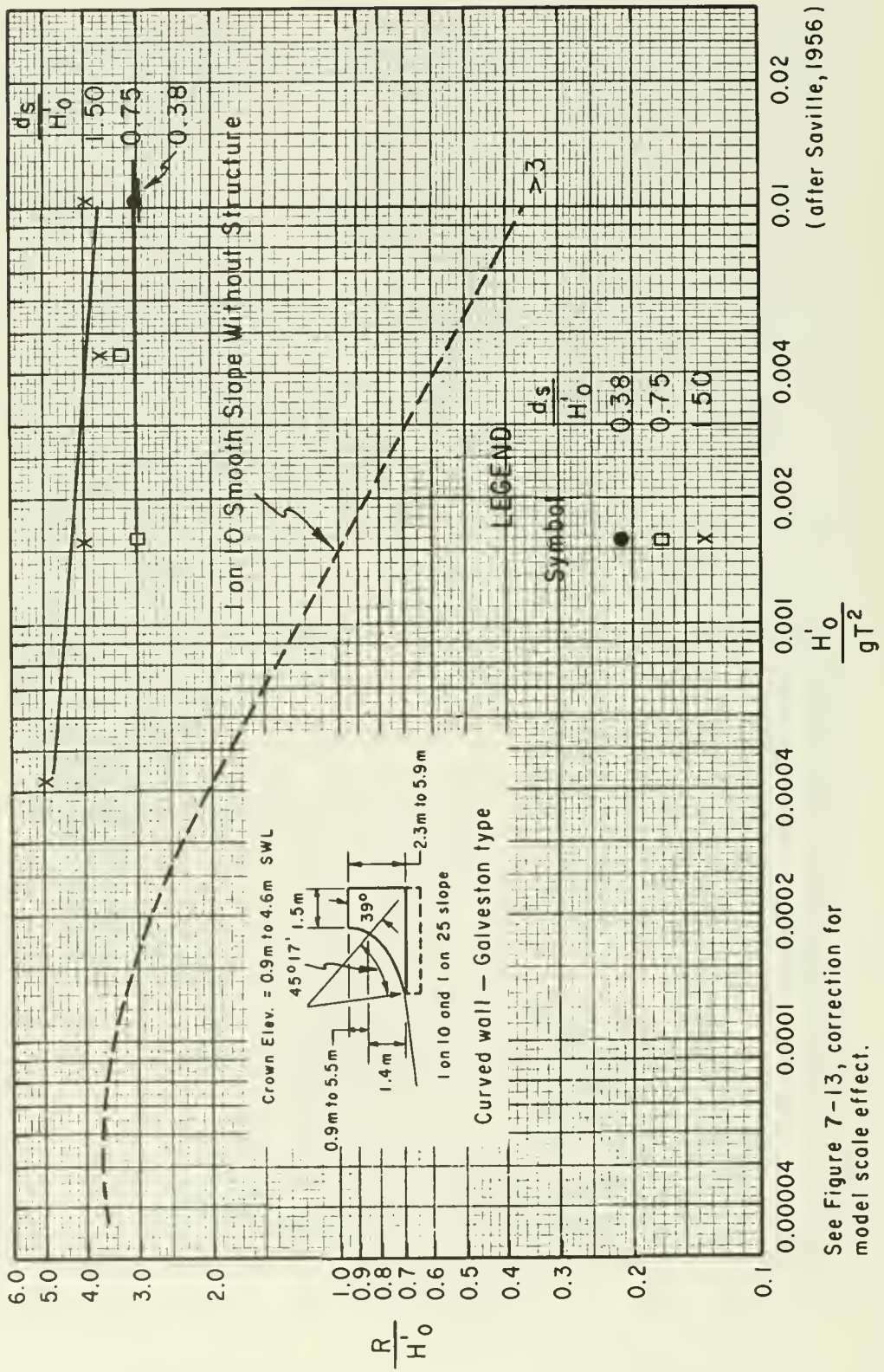

(after Saville, 1956)

See Figure 7-13, correction for model scale effect.

Figure 7-17. Wave runoff on impermeable seawall versus $\frac{H_0}{gT^2}$.

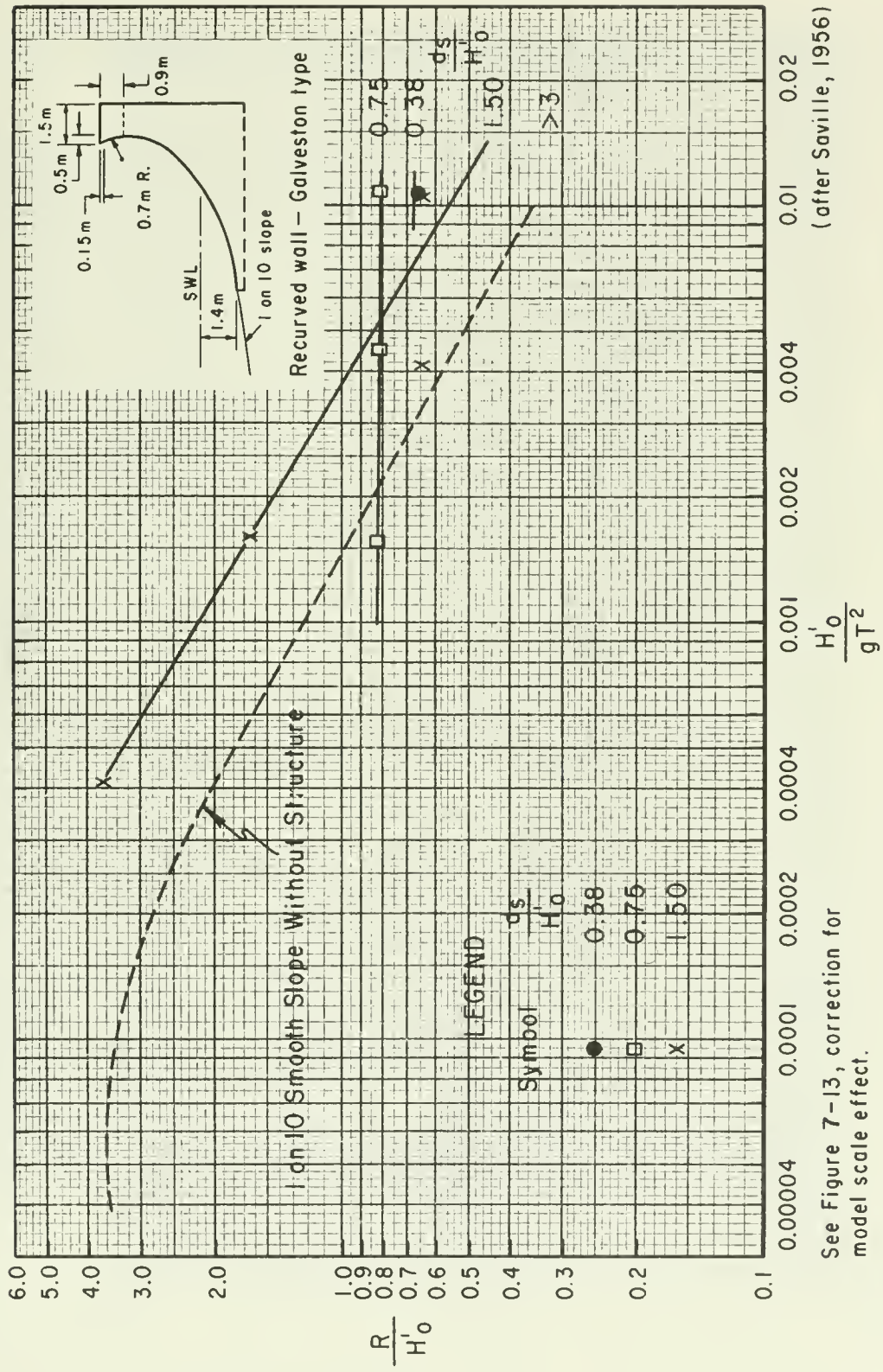
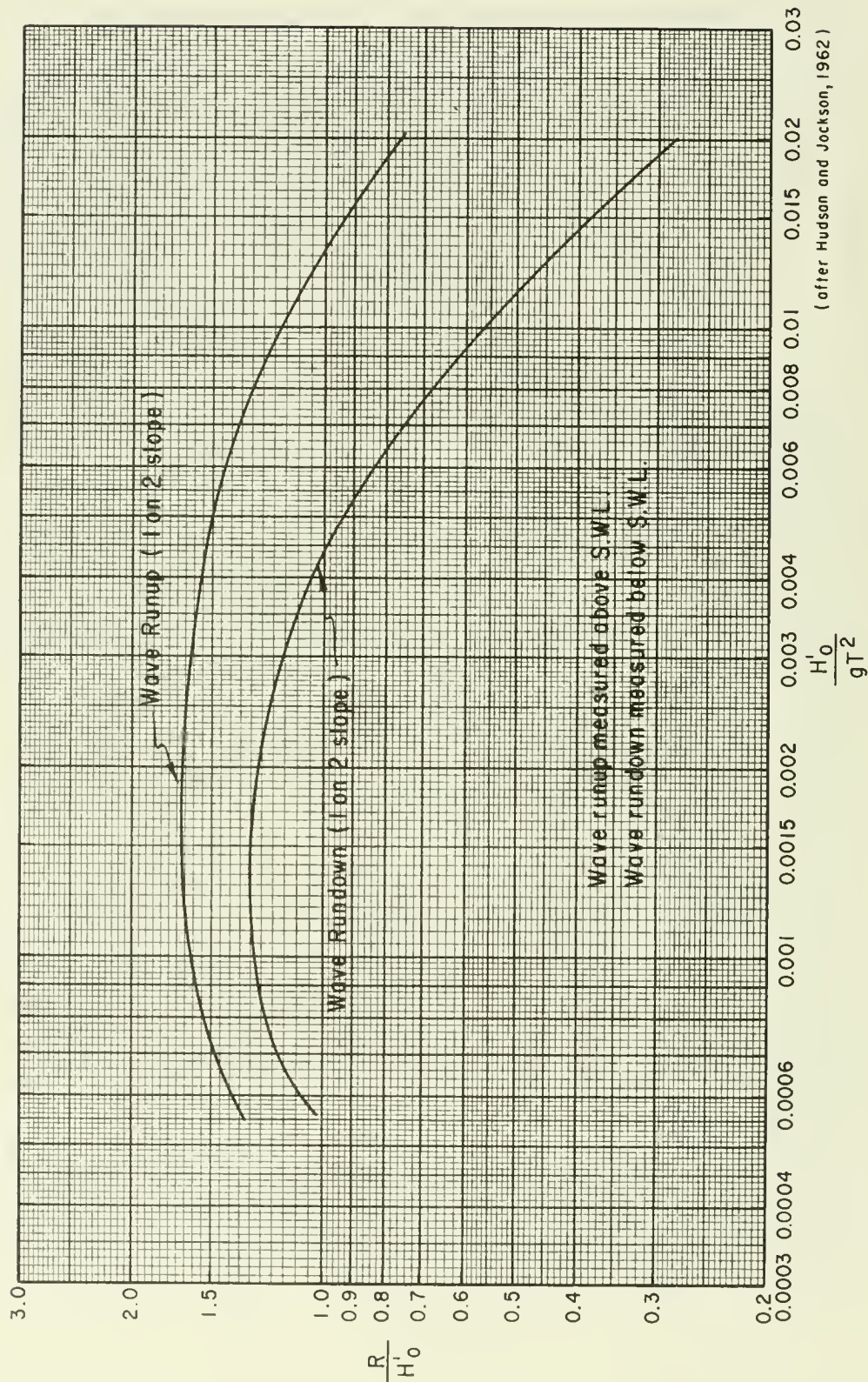

Figure 7-18. Wave runoff on recurved (Galveston-type) seawall versus H'_0/gT^2 .



(after Hudson and Jackson, 1962)

Figure 7-19. Wave runup and rundown on graded riprap, 1:2 slope, impermeable base, versus H'_0/gT^2 (data for $d_s/H'_0 > 3.0$).

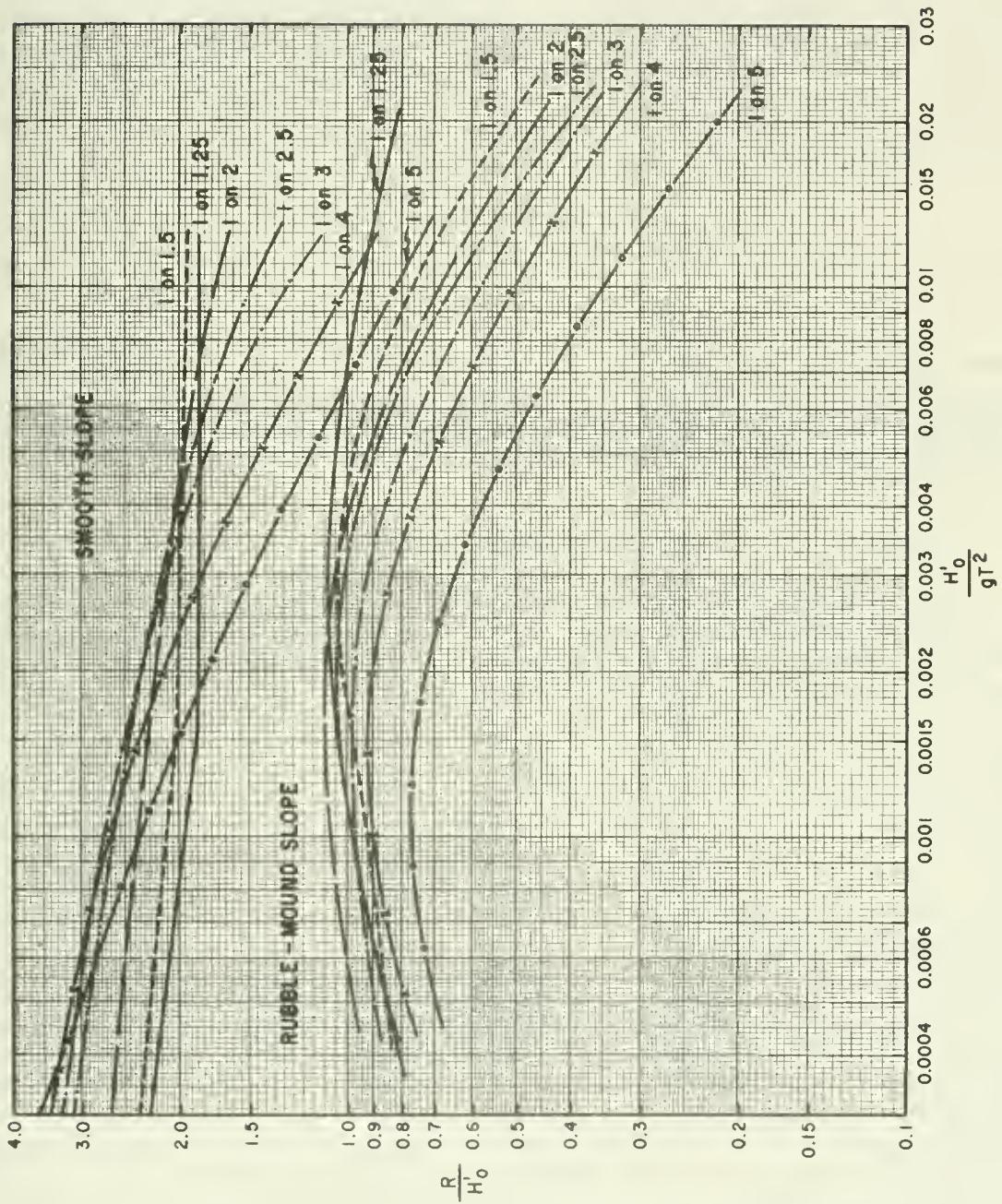

Figure 7-20. Comparison of wave runup on smooth slopes with runup on permeable rubble slopes (data for $d/H_0 > 3.0$).

$$r = \frac{R \text{ (rough slope)}}{R \text{ (smooth slope)}} = \frac{R / H'_0 \text{ (rough slope)}}{R / H'_0 \text{ (smooth slope)}} \quad (7-7)$$

Table 7-2 indicated the range of values of r for various slope characteristics.

This roughness and porosity correction factor is also considered applicable, as a first approximation, in the analysis of wave runup on slopes having surface materials with two or more different roughness values, r . Until more detailed guidance is available, it is suggested that the percentage of the total slope length, ℓ , subjected to wave runup of each roughness value be used to develop an adjusted roughness correction value. This is expressed by the equation

$$r \text{ (adjusted)} = \frac{\ell_1}{\ell} r_1 + \frac{\ell_2}{\ell} r_2 + \frac{\ell_3}{\ell} r_3 + \dots \quad (7-8)$$

where ℓ is the total slope length, ℓ_1 is the length of slope where the roughness value r_1 applies, ℓ_2 is the length of slope where the roughness value r_2 applies, and so on. This procedure has obvious deficiencies as it does not account for location of the roughness on the structure and the varying interaction of slope roughness characteristics to the depth of water jet running up the structure slope.

Table 7-2. Value of r for various slope characteristics (after Battjes, 1974).

Slope Surface Characteristics	Placement	r
Smooth, impermeable	-----	1.00
Concrete blocks	Fitted	0.90
Basalt blocks	Fitted	0.85 to 0.90
Gobi blocks	Fitted	0.85 to 0.90
Grass	-----	0.85 to 0.90
One layer of quarrrystone (impermeable foundation)	Random	0.80
Quarrrystone	Fitted	0.75 to 0.80
Rounded quarrrystone	Random	0.60 to 0.65
Three layers of quarrrystone (impermeable foundation)	Random	0.60 to 0.65
Quarrrystone	Random	0.50 to 0.55
Concrete armor units (~ 50 percent void ratio)	Random	0.45 to 0.50

The use of the figures to estimate wave runup is illustrated by the following example.

GIVEN: An impermeable structure has a smooth slope of 1 on 2.5 and is subjected to a design wave, $H = 2.0$ m (6.6 ft) measured at a gage located in a depth $d = 4.5$ m (14.8 ft) . Design period is $T = 8$ sec . Design depth at structure toe at high water is $d_s = 3.0$ m (9.8 ft) . (Assume no change in the refraction coefficient between the structure and the wave gage.)

FIND:

- (a) The height above the SWL to which the structure must be built to prevent overtopping by the design wave.
- (b) The reduction in required structure height if uniform-sized riprap is placed on the slope.

SOLUTION:

(a) Since the runup curves are for deepwater height H'_o , the shallow-water wave height $H = 2.0$ m(6.6 ft) must be converted to an equivalent deepwater value. Using the depth where the wave height is measured, calculate

$$\frac{d}{L_o} = \frac{2 \pi d}{gT^2} = \frac{2 \pi (4.5)}{(9.8) (8)^2} = 0.0451$$

From Table C-1, Appendix C, for

$$\frac{d}{L_o} = 0.0451$$

$$\frac{H}{H'_o} = 1.041$$

Therefore

$$H'_o = \frac{H}{1.041} = \frac{2.0}{1.041} = 1.9 \text{ m (6.2 ft)}$$

To determine the runup, calculate

$$\frac{H'_o}{gT^2} = \frac{1.9}{(9.8) (8)^2} = 0.0030$$

and using the depth at the structure toe

$$d_s = 3.0 \text{ m (9.8 ft)}$$

$$\frac{d_s}{H'_0} = \frac{3.0}{1.9} = 1.58$$

Interpolating between Figures 7-10 and 7-11, for a 1 on 2.5 slope, produces

Figure 7-10: $\frac{d_s}{H'_0} = 0.80$; $\frac{R}{H'_0} = 2.80$

Interpolated Value: $\frac{d_s}{H'_0} = 1.58$; $\frac{R}{H'_0} \approx 2.5$

Figure 7-11: $\frac{d_s}{H'_0} = 2.0$; $\frac{R}{H'_0} = 2.35$

The runup, uncorrected for scale effects, is

$$R = 2.5 (H'_0)$$

$$R = 2.5 (1.9) = 4.8 \text{ m (15.7 ft)}$$

The scale correction factor k can be found from Figure 7-13. The slope in terms of $m = \tan \theta$ is

$$\tan \theta = \frac{1}{2.5} = 0.40$$

The corresponding correction factor for a wave height $H'_0 = 1.9 \text{ m (6.2 ft)}$ is

$$k = 1.169$$

Therefore, the corrected runup is

$$R = 1.169 (4.8) = 5.6 \text{ m (18.4 ft)}$$

(b) Riprap on a slope decreases the maximum runup. Hydraulic model studies for the range of possible slopes have not been conducted; however, Figure 7-15 can be used with Figures 7-10 and 7-11 to estimate the percent reduction of runup resulting from adding riprap to a 1 on 1.5 slope and to apply that reduction to structures with different slopes. From an analysis similar to the above, the runup, uncorrected for scale effects, on a 1 on 1.5 smooth, impermeable slope is

$$\left[\frac{R}{H'_0} \right]_{\text{smooth}} = 3.04$$

From Figure 7-15 (riprap), entering with $H'_0/gT^2 = 0.0030$ and using the curve for $d_s/H'_0 = 1.50$ which is closest to the actual value of

$$\frac{d_s}{H'_0} = 1.58$$

$$\left(\frac{R}{H'_0}\right)_{\text{riprap}} = 1.43$$

The reduction in runup is therefore,

$$\frac{\left(\frac{R}{H'_0}\right)_{\text{riprap}}}{\left(\frac{R}{H'_0}\right)_{\text{smooth}}} = \frac{1.43}{3.04} = 0.47$$

Applying this correction to the runup calculated for the 1 on 2.5 slope in the preceding part of the problem gives

$$R_{\text{riprap}} = 0.47 R_{\text{smooth}} = 0.47 (5.8) = 2.7 \text{ m (8.9 ft)}$$

Since the scale-corrected runup (5.8 m) was multiplied by the factor 0.47, the correction for scale effects is included in the 1.7-m runup value. This technique gives a reasonable estimate of runup on riprapped slopes when model test results for the actual structure slope are not available.

Saville (1958a) presented a method for determining runup on composite slopes using experimental results obtained for constant slopes. The method assumes that a composite slope can be replaced with a hypothetical, uniform slope running from the bottom, at the point where the incident wave breaks, up to the point of maximum runup on the structure. Since the point of maximum runup is the answer sought, a method of successive approximations is used. Calculation of runup on a composite slope is illustrated by the following example problem for a smooth-faced levee. The method is equally applicable to any composite slope. The resultant runup for slopes composed of different types of surface roughness may be calculated by using a proportionate part of various surface roughnesses of the composite slope on the hypothetical slope. The composite-slope method should not be used where beach berms are wider than $L/4$, where L is the design wavelength for the structure. In the case where a wide berm becomes flooded or the water depth has been increased by wave setup (see Ch. 3, Sec. VIII) such as a reef, the wave runup is based on the water depth on the berm or reef.

***** EXAMPLE PROBLEM 5 *****

GIVEN: A smooth-faced levee (cross section shown in Fig. 7-21) is subjected to a design wave having a period $T = 8 \text{ s}$ and an equivalent deepwater height $H'_0 = 1.5 \text{ m (4.9 ft)}$. The depth at the structure toe is $d_s = 1.2 \text{ m (3.9 ft)}$.

FIND: Using the composite slope method, determine the maximum runup on the levee face by the design wave.

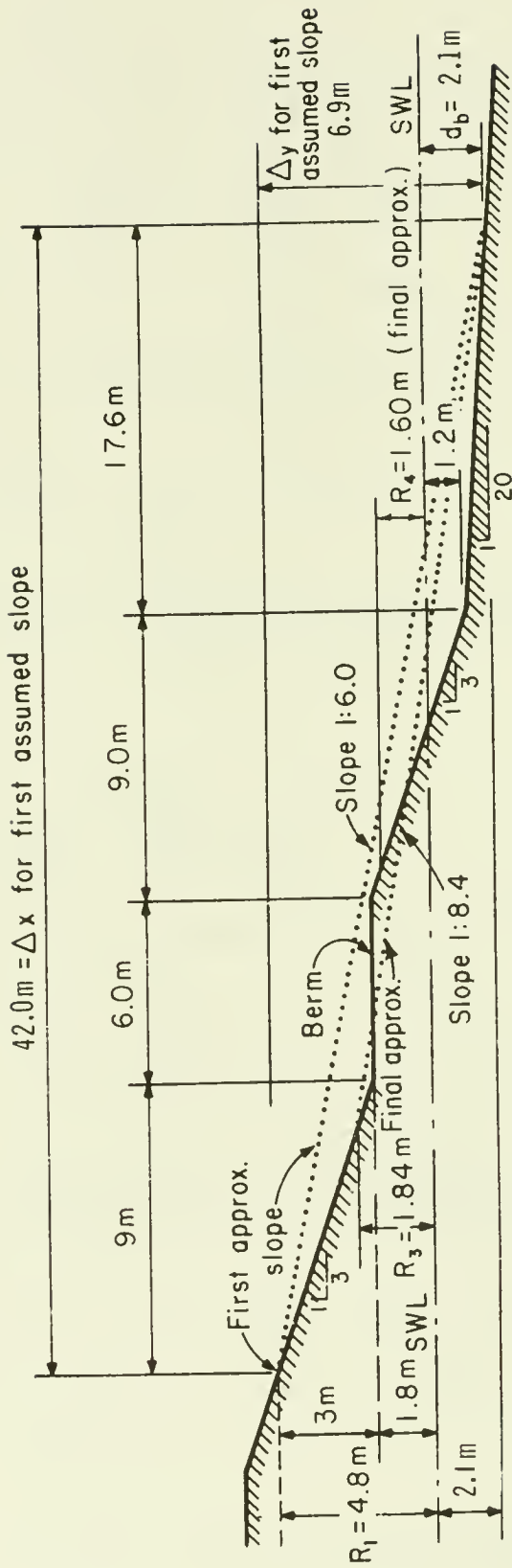

Figure 7-21. Calculation of runup for composite slope: example of a levee cross section.

SOLUTION: The runup on a 1 on 3 slope ($\tan \theta = 0.33$) is first calculated to determine whether the runup will exceed the berm elevation. Calculate

$$\frac{d_s}{H'_0} = \frac{1.2}{1.5} = 0.8$$

and

$$\frac{H'_0}{gT^2} = \frac{1.5}{(9.8)(8)^2} = 0.0024$$

From Figure 7-10 for

$$\frac{d_s}{H'_0} = 0.8$$

with

$$\cot(\theta) = 1/\tan(\theta) = 3.0$$

and

$$\frac{H'_0}{gT^2} = 0.0024$$

$$\frac{R}{H'_0} = 2.8$$

This runup is corrected for scale effects by using Figure 7-13 with $\tan \theta = 0.33$ and $H \approx 1.5$ m (4.9 ft). A correction factor $k = 1.15$ is obtained, and

$$R = 2.8 k H'_0 = 2.8 (1.15) (1.5)$$

$$R = 4.8 \text{ m (15.7 ft)}$$

which is 3.0 m (9.8 ft) above the berm elevation (see Fig. 7-21). Therefore, the composite-slope method must be used.

The breaker depth for the given design wave is first determined with

$$\frac{H'_0}{gT^2} = 0.0024$$

calculate

$$\frac{H'_0}{L_0} = \frac{2\pi(1.5)}{(9.8)(8)^2} = 0.015$$

Enter Figure 7-3 with $H'_0/gT^2 = 0.0024$, using the curve for the given slope $m = 0.050$ (1:20), and find

$$\frac{H_b'}{H_o'} = 1.46$$

Therefore

$$H_b = 1.46 (1.5) = 2.2 \text{ m (7.2 ft)}$$

calculate

$$\frac{H_b}{gT^2} = \frac{2.2}{(9.8)(8)^2} = 0.0035$$

Then from Figure 7-2, from the curve for $m = 0.05$

$$\frac{d_b}{H_b} = 0.95$$

and

$$d_b = 0.95 H_b = 0.95 (2.2) = 2.1 \text{ m (6.9 ft)}$$

Therefore, the wave will break a distance $(2.1-1.2)/0.05 = 18.0 \text{ m (59.0 ft)}$ in front of the structure toe.

The runup value calculated above is a first approximation of the actual runup and is used to calculate a hypothetical slope that is used to determine the second approximation of the runup. The hypothetical slope is taken from the point of maximum runup on the structure to the bottom at the breaker location (the upper dotted line on Figure 7-22). Then

$$\Delta x = 18.0 + 9.0 + 6.0 + 9.0 = 42.0 \text{ m (137.8 ft)}$$

and, the change in elevation is

$$\Delta y = 2.1 + 4.8 = 6.9 \text{ m (22.6 ft)}$$

therefore

$$\cot \theta = \frac{\Delta x}{\Delta y} = \frac{(42.0)}{(6.9)} = 6.1$$

This slope may now be used with the runup curves (Figs. 7-10 and 7-11) to determine a second approximation of the actual runup. Calculate d_b/H_o' using the breaker depth d_b

$$\frac{d_b}{H_o'} = \frac{2.1}{1.5} = 1.40$$

Interpolating between Figures 7-10 and 7-11, for

$$\frac{H_o'}{gT^2} = 0.0024$$

gives

$$\frac{R}{H_o} = 1.53$$

Correcting for scale effects using Figure 7-13 yields

$$k = 1.07$$

and

$$R = 1.53 (1.07) 1.5 \approx 2.5 \text{ m (8.2 ft)}$$

A new hypothetical slope as shown in Figure 7-22 can now be calculated using the second runup approximation to determine Δx and Δy . A third approximation for the runup can then be obtained. This procedure is continued until the difference between two successive approximations for the example problem is acceptable,

$$R_1 = 4.8 \text{ m (15.7 ft)}$$

$$R_2 = 2.5 \text{ m (8.2 ft)}$$

$$R_3 = 1.8 \text{ m (5.9 ft)}$$

$$R_4 = 1.6 \text{ m (5.2 ft)}$$

$$R_5 = 1.8 \text{ m (5.9 ft)}$$

and the steps in the calculations are shown graphically in Figure 7-22. The number of computational steps could have been decreased if a better first guess of the hypothetical slope had been made.

b. Irregular Waves. Limited information is presently available on the results of model testing that can be used for predicting the runup of irregular wind-generated waves on various structure slopes. Ahrens (1977a) suggests the following interim approach until more definitive laboratory test results are available. The approach assumes that the runup of individual waves has a Rayleigh distribution of the type associated with wave heights (see Ch. 3, Sec. II,2, Wave Height Variability). Saville (1962), van Oorschot and d'Angremond (1968), and Battjes (1971; 1974) suggested that wave runup has a Rayleigh distribution and that it is a plausible and probably conservative assumption for runup caused by wind-generated wave conditions. Wave height distribution is expressed by equation (3-7):

$$\frac{\hat{H}}{H_{rms}} = \left[-\text{Ln} \left(\frac{n}{N} \right) \right]^{1/2}$$

where, from equation (3-9), $H_{rms} = H_s / \sqrt{2}$, \hat{H} = an arbitrary wave height for probability distribution, and $n/N = P$ (cumulative probability). Thus, if equation (3-7) is rewritten, the wave height and wave runup distribution is given by

$$\frac{\hat{H}}{H_s} = \frac{R_P}{R_s} = \left(-\frac{\text{Ln}P}{2} \right)^{1/2} \quad (7-9)$$

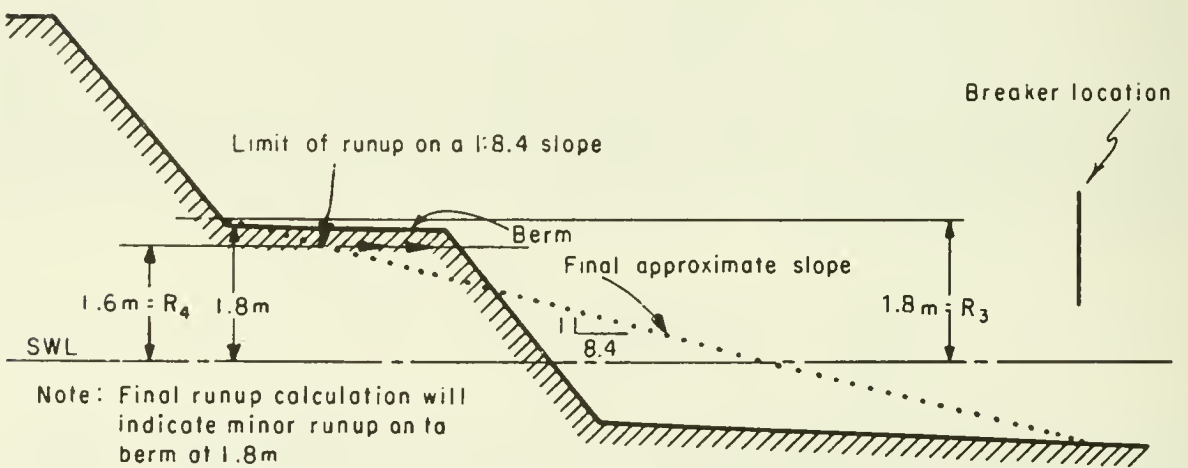
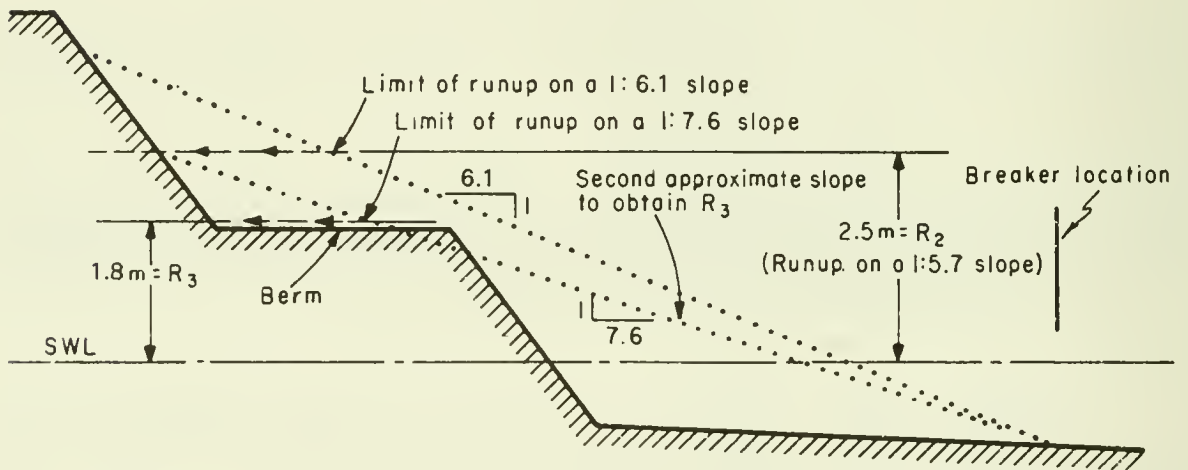
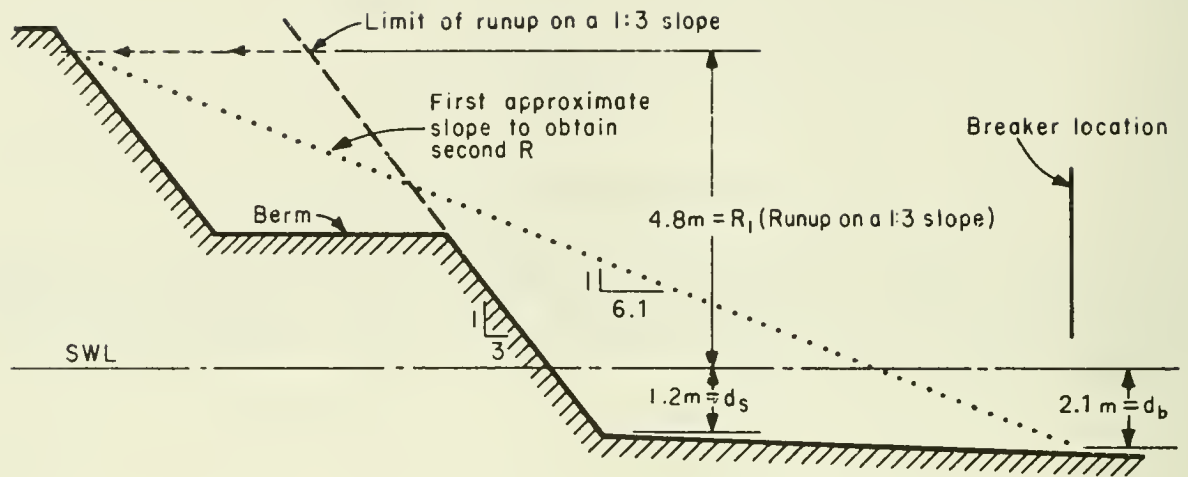

Note: Final runup calculation will indicate minor runup on to berm at 1.8m

Figure 7-22. Successive approximations to runup on a composite slope: example problem.

where R_p is the wave runup associated with a particular probability of exceedance, P , and R_s is the wave runup of the significant wave height, H_s . Figure 7-23 is a plot of equation (7-9). For illustration, if the 1 percent wave runup (i.e., the runup height exceeded by 1 percent of the runups) is used, then $P = 0.01$ and equation (7-9) yields

$$\frac{\hat{H}(1\%)}{H_s} = \frac{R_{0.01}}{R_s} = \left(-\frac{\text{Ln } 0.01}{2} \right)^{1/2} = 1.517$$

This example indicates that the 1 percent wave runup would be about 52 percent greater than R_s , the runup of the significant wave, H_s . $\hat{H}(1\%)$ should not be confused with the term H_1 which is the average of the highest 1 percent of all waves for a given time period. For the condition of a sloping offshore bottom fronting the structure, a check should be made to determine if a wave height greater than H_s breaks on the offshore bottom slope rather than on the structure slope for which the runup, R_s , was determined. Should the larger wave break on the offshore bottom slope, the runup would be expected to be less than that indicated by the ratio R_p/R_s .

The following problem illustrates the use of the irregular wave runup on a rough slope using smooth-slope curves.

***** EXAMPLE PROBLEM 6 *****

GIVEN: An impermeable structure with a smooth slope of 1 on 2.5 is subjected to a design significant wave $H_s = 2.0$ m (6.6 ft) and $T = 8$ s measured in a water depth ($d = 4.5$ m (14.8 ft)). The design depth at the toe of the structure $d_s = 3.0$ m (9.8 ft) at SWL.

FIND:

- (a) The wave runup on the structure from the significant wave H_s and the $H_{0.1}$ and $H_{0.01}$ waves.
- (b) The probability of exceedance of the wave height that will begin to overtop the structure with a crest at 7.5 m (24.6 ft) above SWL.

SOLUTION:

(a) From the example program given in Section II,1,a, Regular Waves, it is found that $R = R_s = 5.6$ m (18.4 ft). From equation (7-9) or Figure 7-23

$$\frac{H_{0.1}}{H_s} = \frac{R_{0.1}}{R_s} = \left(-\frac{\text{Ln } 0.1}{2} \right)^{1/2} = 1.07$$

and

$$R_{0.1} = 1.07 R_s = 1.07 (5.6) = 6.0 \text{ m (19.7 ft)}$$

Also

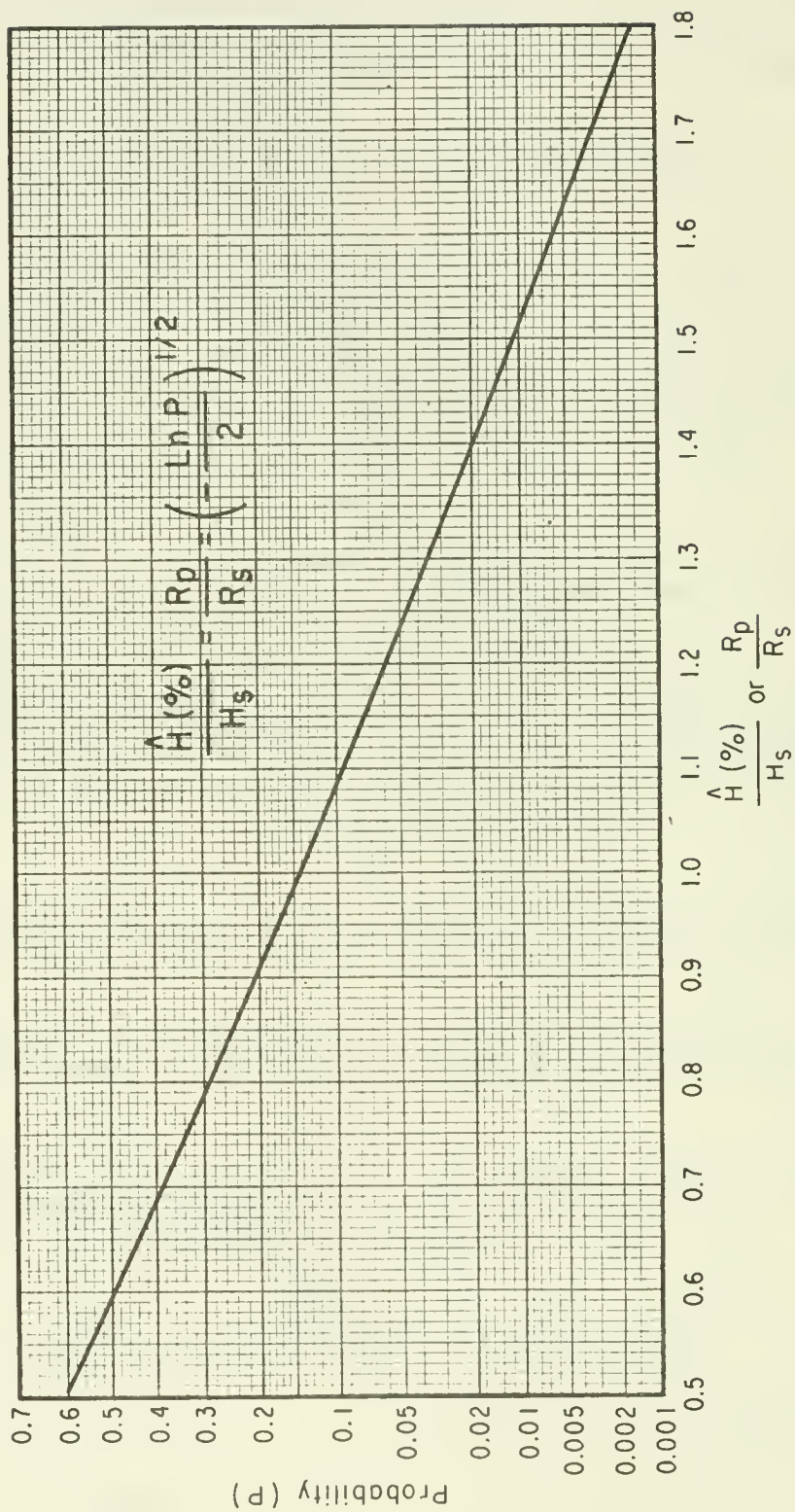

Figure 7-23. Probability of exceedance for relative wave heights or runup values.

$$\frac{H_{0.01}}{H_s} = \frac{R_{0.01}}{R_s} = \left(-\frac{\ln 0.01}{2} \right)^{1/2} = 1.52$$

and

$$R_{0.01} = 1.52 R_s = 1.52 (5.6) = 8.5 \text{ m (27.9 ft)}$$

(b) With $R_s = 5.6 \text{ m}$ and $R_p = 7.5 \text{ m}$ and if Figure 7-23 is used for

$$\frac{R_p}{R_s} = \frac{7.5}{5.6} = 1.34$$

then $p = 0.028$ or 3 percent of the runup exceeds the crest of the structure.

2. Wave Overtopping.

a. Regular (Monochromatic) Waves. It may be too costly to design structures to preclude overtopping by the largest waves of a wave spectrum. If the structure is a levee or dike, the required capacity of pumping facilities to dewater a shoreward area will depend on the rate of wave overtopping and water contributed by local rains and stream inflow. Incident wave height and period are important factors, as are wind speed and direction with respect to the structure axis. The volume rate of wave overtopping depends on structure height, water depth at the structure toe, structure slope, and whether the slope face is smooth, stepped, or riprapped. Saville and Caldwell (1953) and Saville (1955) investigated overtopping rates and runup heights on small-scale laboratory models of structures. Larger scale model tests have also been conducted for Lake Okeechobee levee section (Saville, 1958b). A reanalysis of Saville's data indicates that the overtopping rate per unit length of structure can be expressed by

$$Q = \left(g Q_o^* H_o^3 \right)^{1/2} e^{-\left[\frac{0.217}{\alpha} \tanh^{-1} \left(\frac{h-d}{R} \frac{s}{s} \right) \right]} \quad (7-10)$$

in which

$$0 \leq \frac{h-d}{R} \frac{s}{s} < 1.0$$

or equivalently by

$$Q = \left(g Q_o^* H_o^3 \right)^{1/2} e^{-\left[\frac{0.1085}{\alpha} \log_e \left(\frac{R+h-d}{R-h+d} \frac{s}{s} \right) \right]} \quad (7-11)$$

in which

$$0 \leq \frac{h-d}{R} \frac{s}{s} < 1.0$$

where Q is the overtopping rate (volume/unit time) per unit structure length, g is the gravitational acceleration, H'_0 is the equivalent deepwater wave height, h is the height of the structure crest above the bottom, d_s is the depth at the structure toe, R is the runup on the structure that would occur if the structure were high enough to prevent overtopping corrected for scale effects (see Sec. II, WAVE RUNUP), and α and Q^*_0 are empirically determined coefficients that depend on incident wave characteristics and structure geometry. Approximate values of α and Q^*_0 as functions of wave steepness H'_0/gT^2 and relative height d_s/H'_0 for various slopes and structure types are given in Figures 7-24 through 7-32. The numbers beside the indicated points are values of α and Q^*_0 (Q^*_0 in parentheses on the figures) that, when used with equation (7-10) or (7-11), predict measured overtopping rates. Equations (7-10) and (7-11) are valid only for $0 \leq (h-d_s) < R$. When $(h-d_s) \geq R$ the overtopping rate is taken as zero. Weggel (1976) suggests a procedure for obtaining approximate values of α and Q^*_0 where more exact values are not available. His procedure uses theoretical results for wave overtopping on smooth slopes and gives conservative results; i.e., values of overtopping greater than the overtopping which would be expected to actually occur.

It is known that onshore winds increase the overtopping rate at a barrier. The increase depends on wind velocity and direction with respect to the axis of the structure and structure slope and height. As a guide, calculated overtopping rates may be multiplied by a wind correction factor given by

$$k' = 1.0 + W_f \left(\frac{h-d}{R} + 0.1 \right) \sin \theta \quad (7-12)$$

where W_f is a coefficient depending on windspeed, and θ is the structure slope ($\theta = 90^\circ$ for Galveston walls). For onshore windspeeds of 60 mi/hr or greater, $W_f = 2.0$ should be used. For a windspeed of 30 mi/hr, $W_f = 0.5$; when no onshore winds exist, $W_f = 0$. Interpolation between values of W_f given for 60, 30, and 0 mi/hr will give values of W_f for intermediate wind speeds. Equation (7-12) is unverified, but is believed to give a reasonable estimate of the effects of onshore winds of significant magnitude. For a windspeed of 30 mi/hr, the correction factor k' varies between 1.0 and 1.55, depending on the values of $(h-d_s)/R$ and $\sin \theta$.

Values of α and Q^*_0 larger than those in Figures 7-24 through 7-32 should be used if a more conservative (higher) estimate of overtopping rates is required.

Further analysis by Weggel (1975) of data for smooth slopes has shown that for a given slope, the variability of α with incident conditions was relatively small, suggesting that an average α could be used to establish the Q^*_0 value that best fit the data. Figure 7-33 shows values of the average α ($\bar{\alpha}$) for four smooth, structure slopes with data obtained at three different scales. An expression for relating α with structure slope (smooth

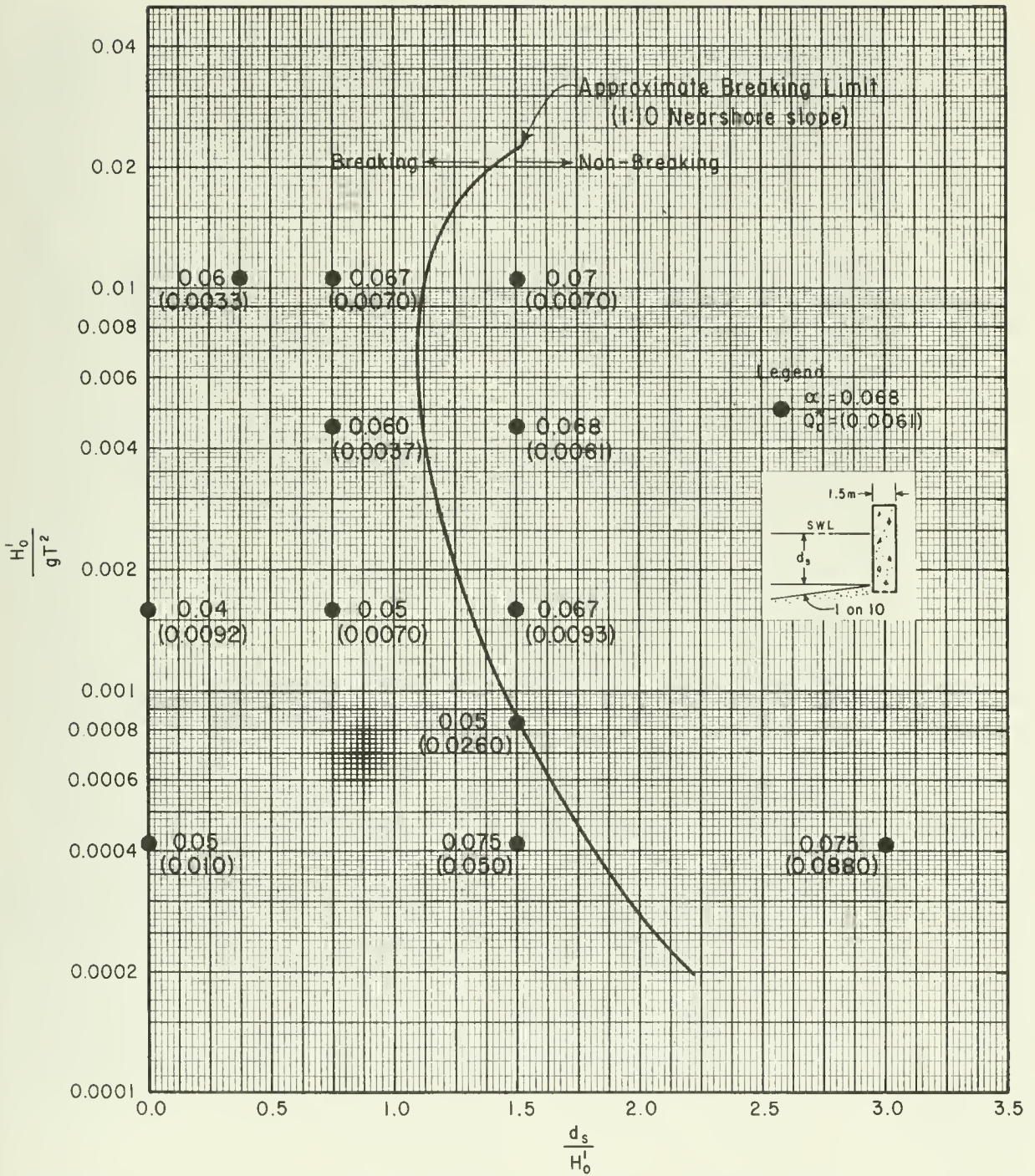

Figure 7-24. Overtopping parameters α and Q_o^* (smooth vertical wall on a 1:10 nearshore slope).

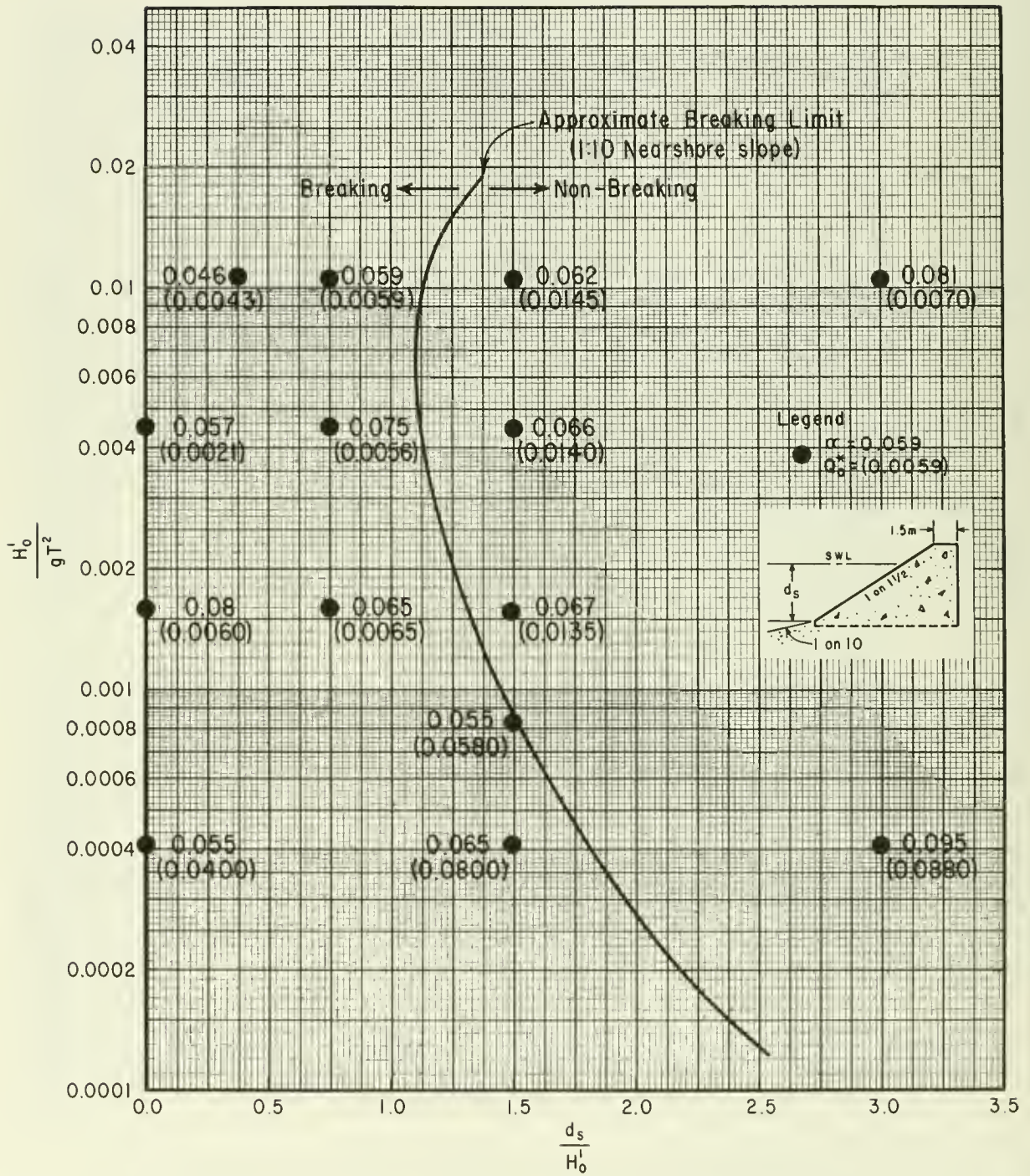

Figure 7-25. Overtopping parameters α and Q_o^* (smooth 1:1.5 structure slope on a 1:10 nearshore slope).

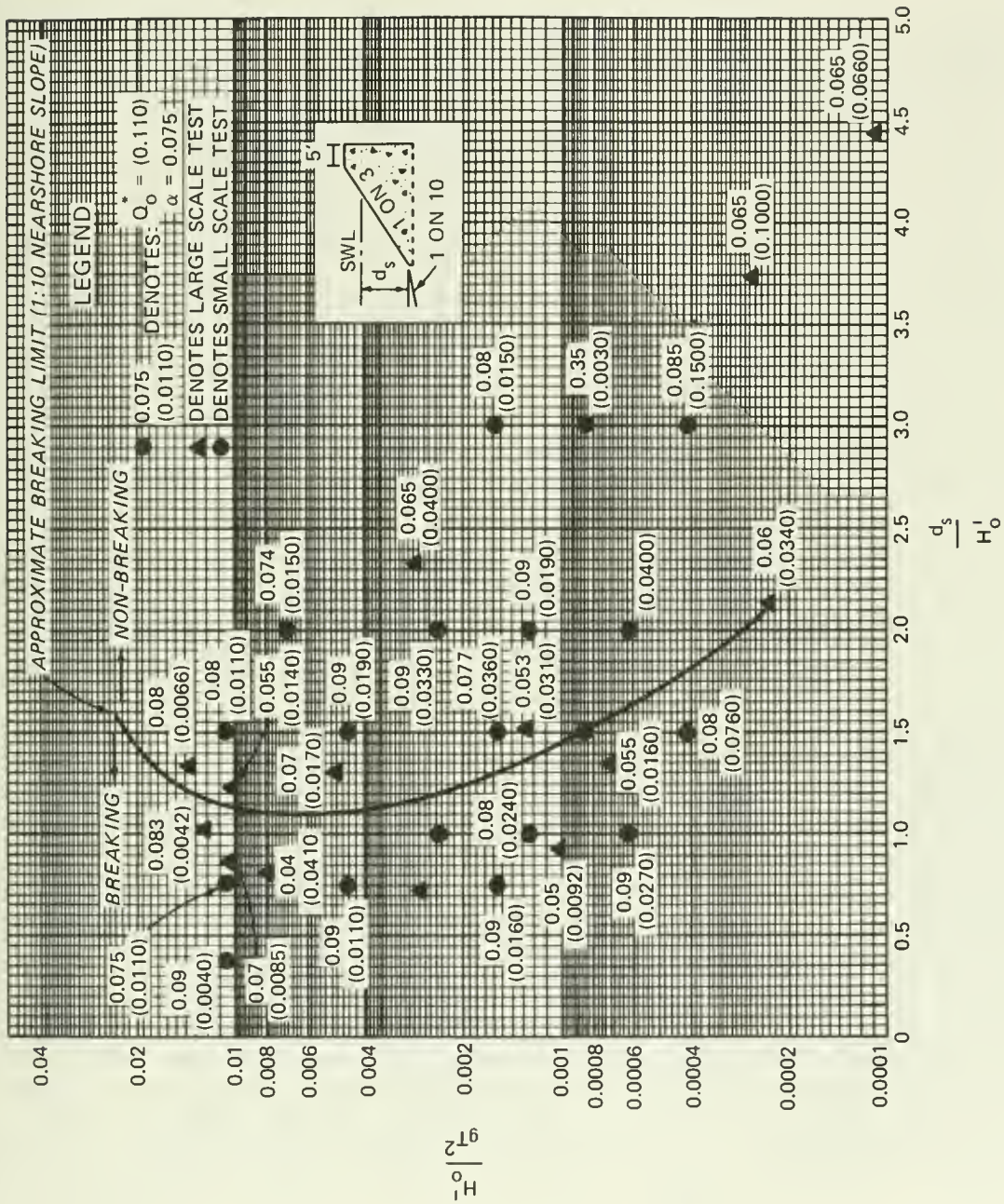

Figure 7-26. Overtopping parameters α and Q_o^* (smooth 1:3 structure slope on a 1:10 nearshore slope).

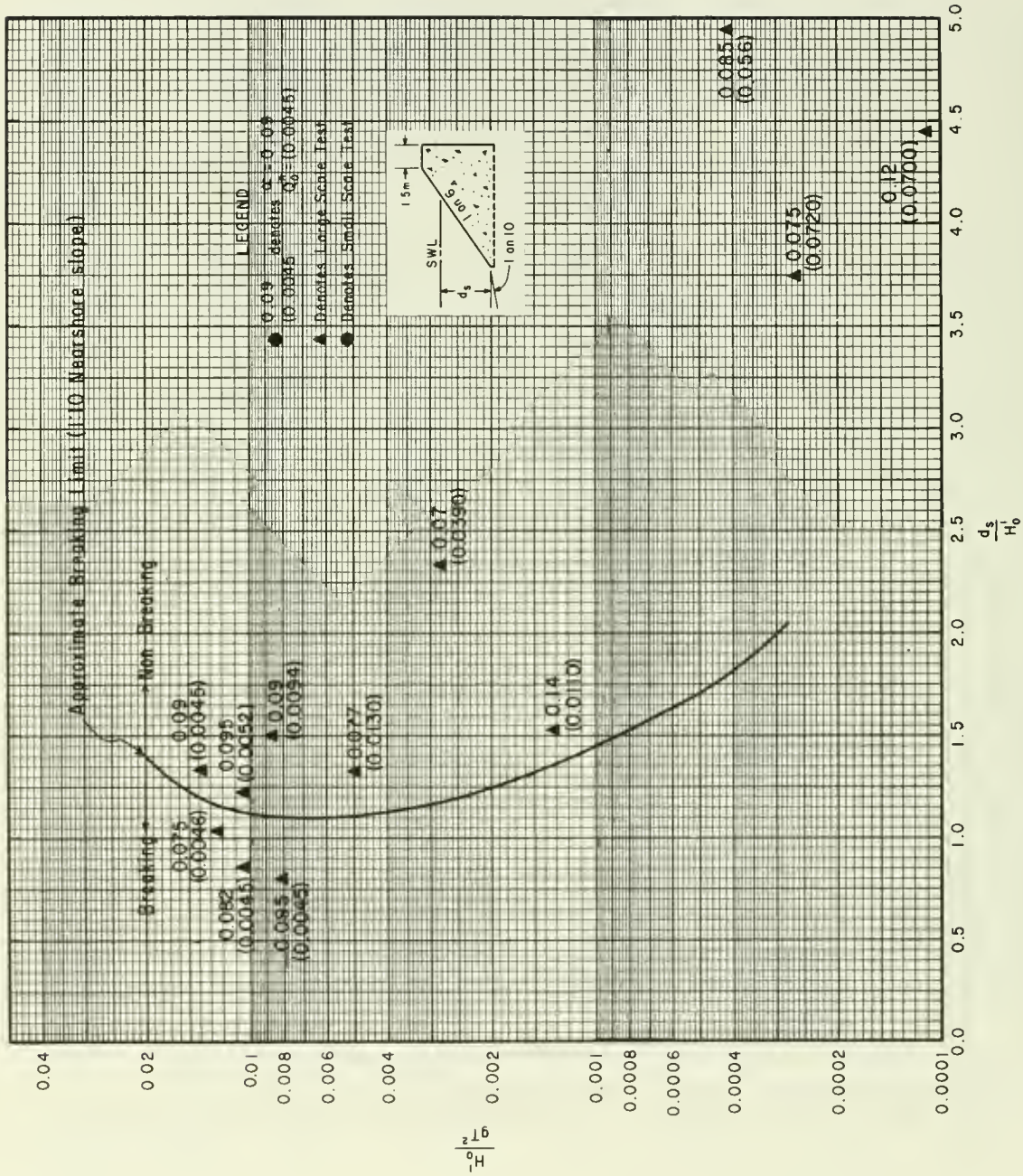

Figure 7-27. Overtopping parameters α and Q_0^* (smooth 1:6 structure slope on a 1:10 nearshore slope).

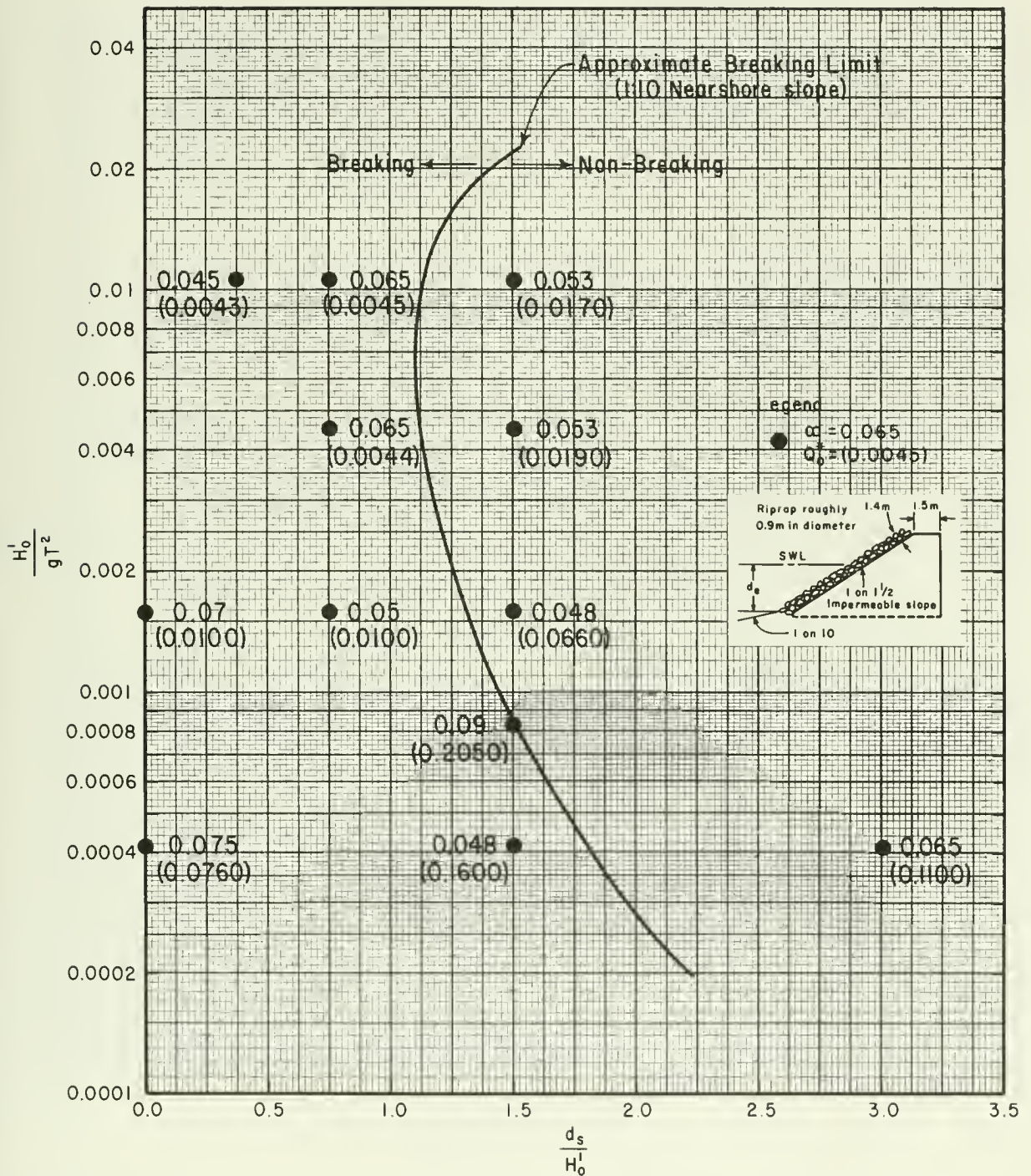

Figure 7-28. Overtopping parameters α and Q_0^* (riprapped 1:1.5 structure slope on a 1:10 nearshore slope).

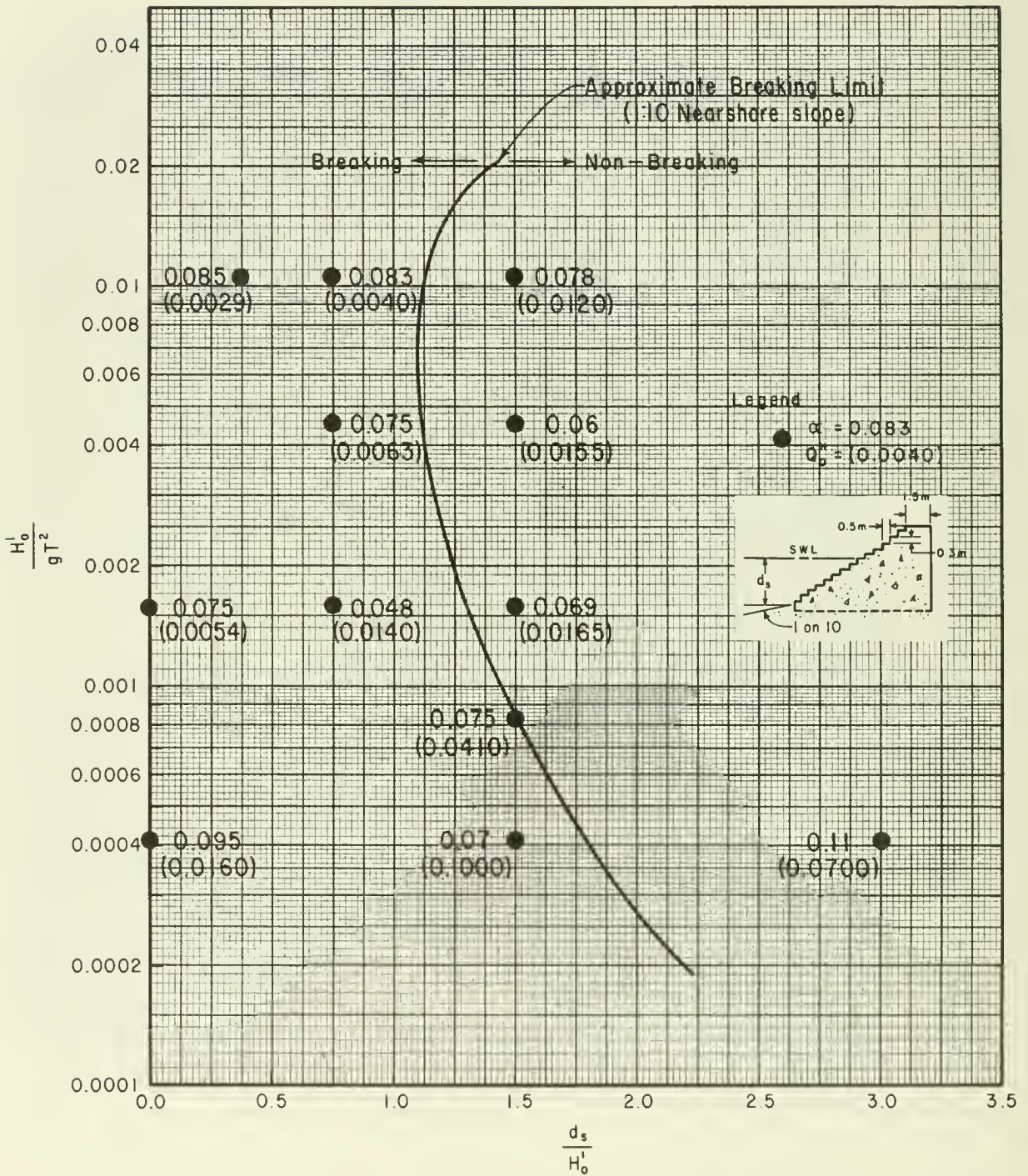

Figure 7-29. Overtopping parameters α and Q_0^* (stepped 1:1.5 structure slope on a 1:10 nearshore slope).

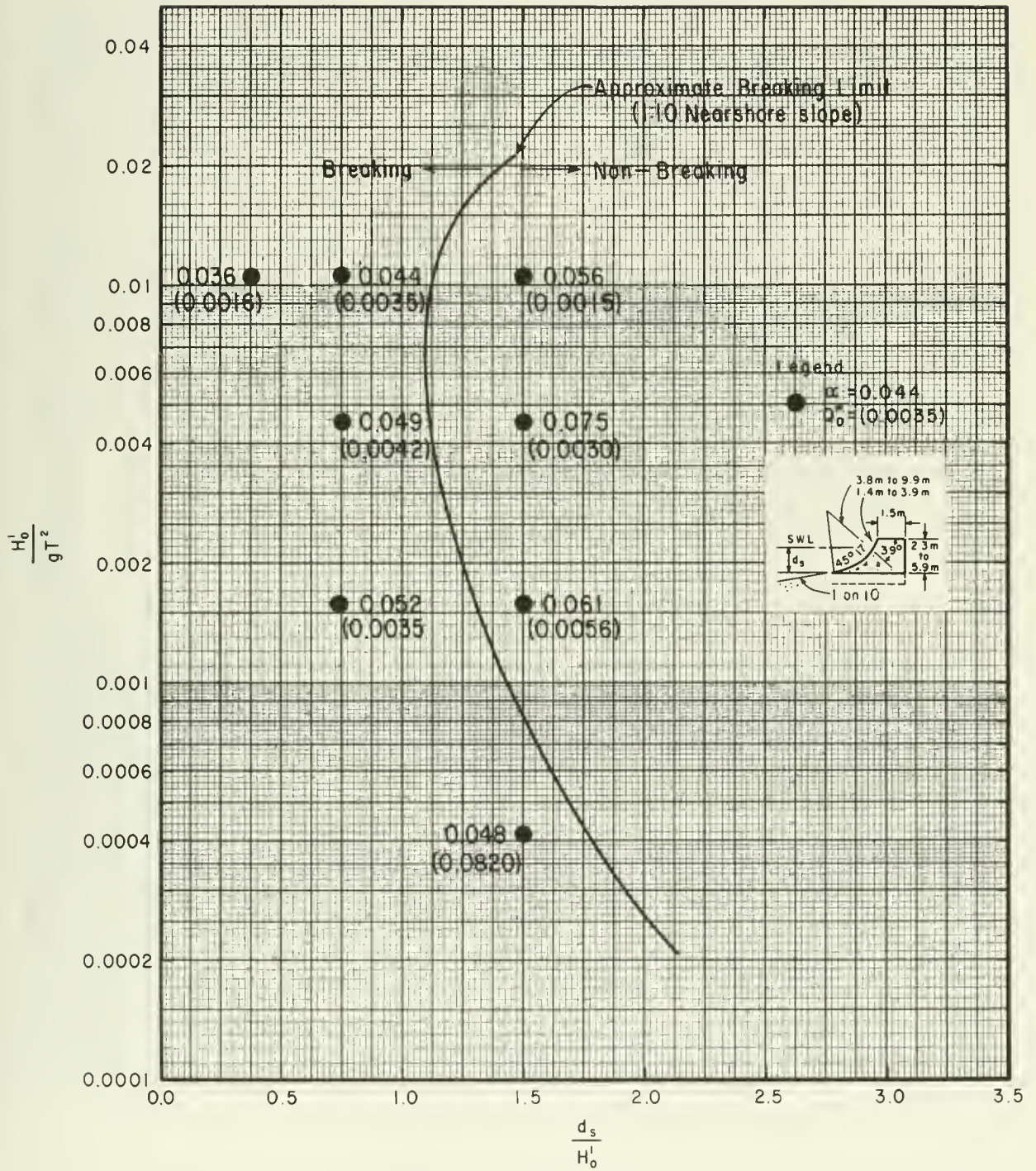

Figure 7-30. Overtopping parameters α and Q_o^* (curved wall on a 1:10 nearshore slope).

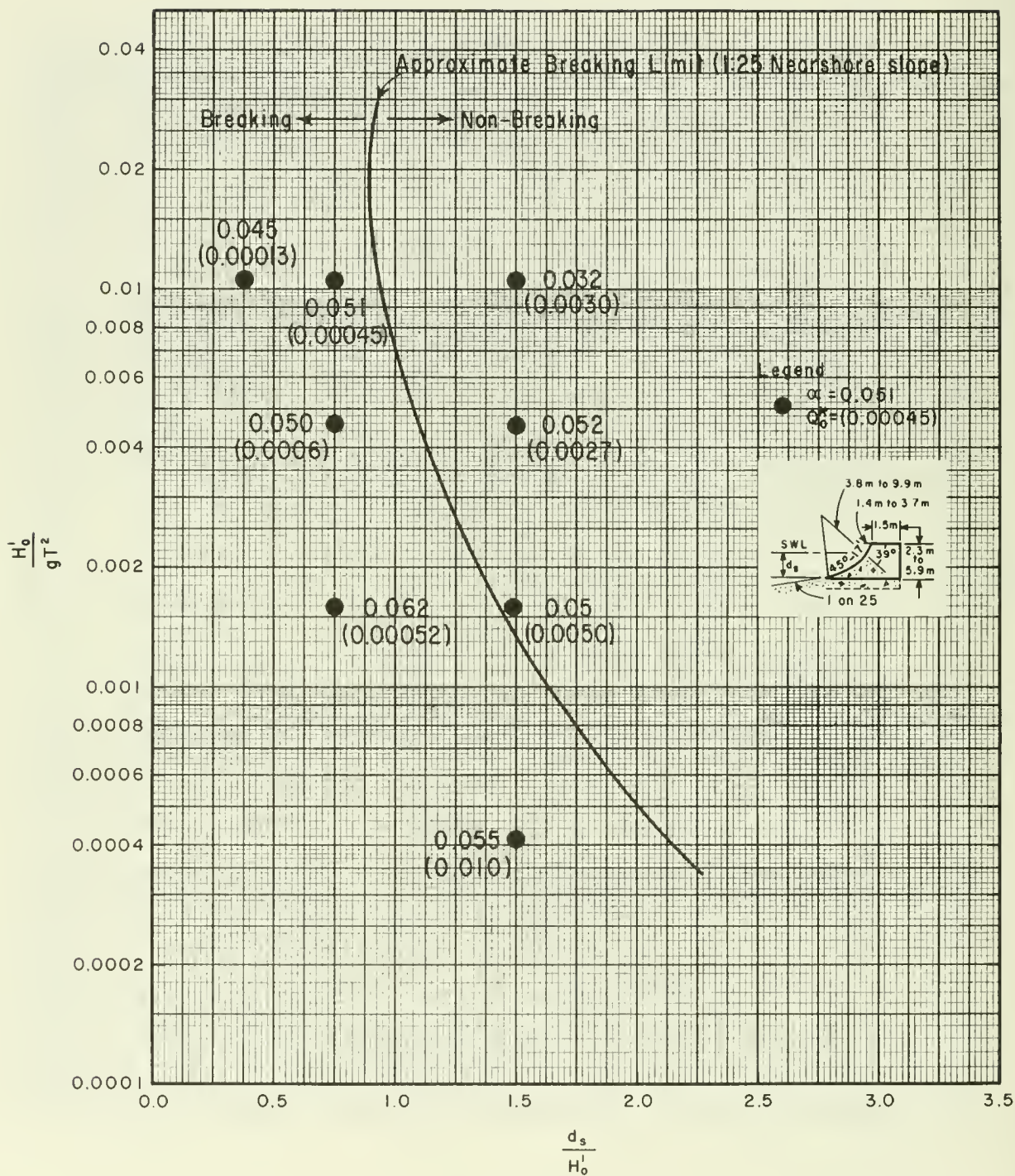

Figure 7-31. Overtopping parameters α and Q_0^* (curved wall on a 1:25 nearshore slope).

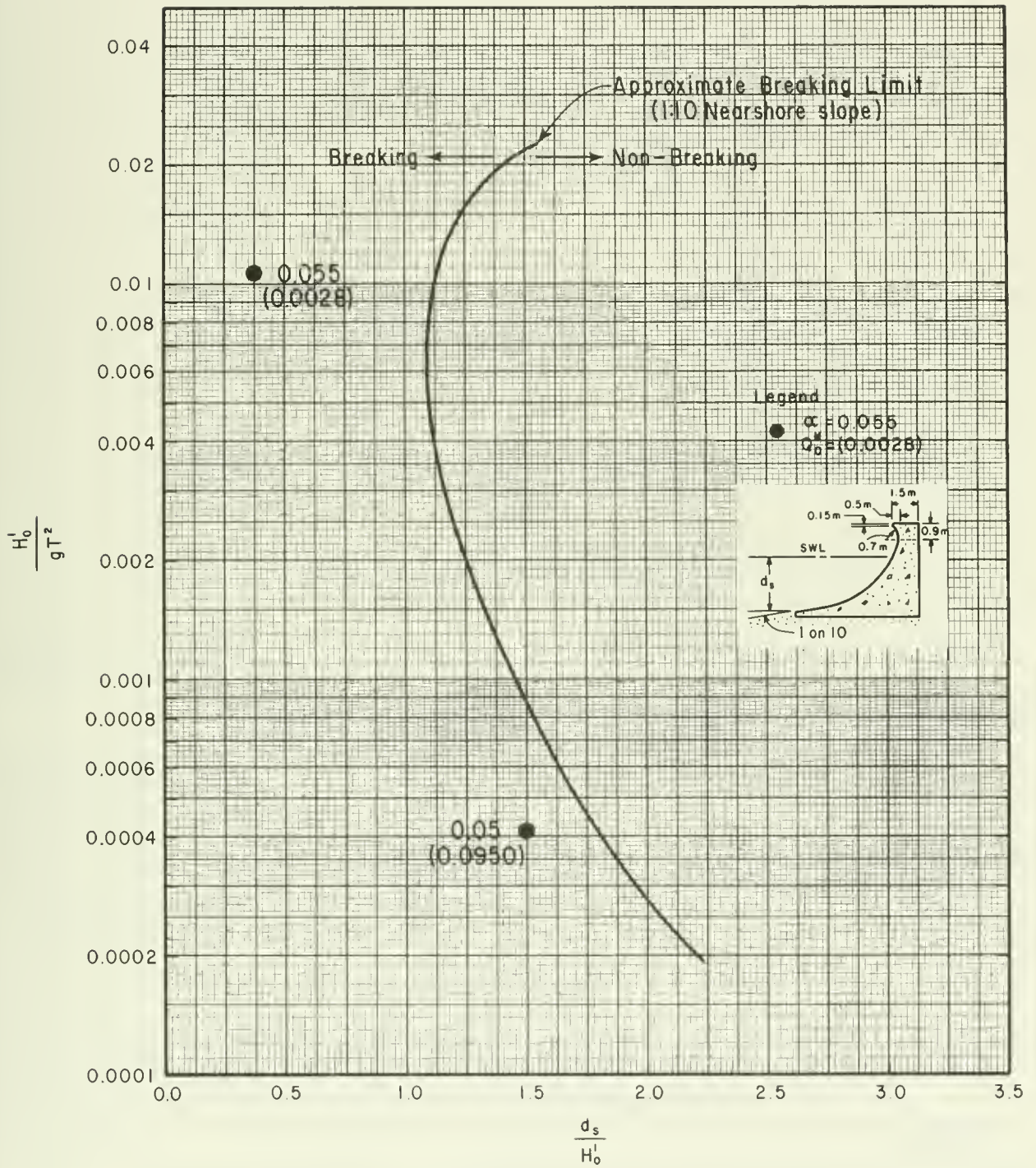

Figure 7-32. Overtopping parameters α and Q_O^* (recurved wall on a 1:10 nearshore slope).

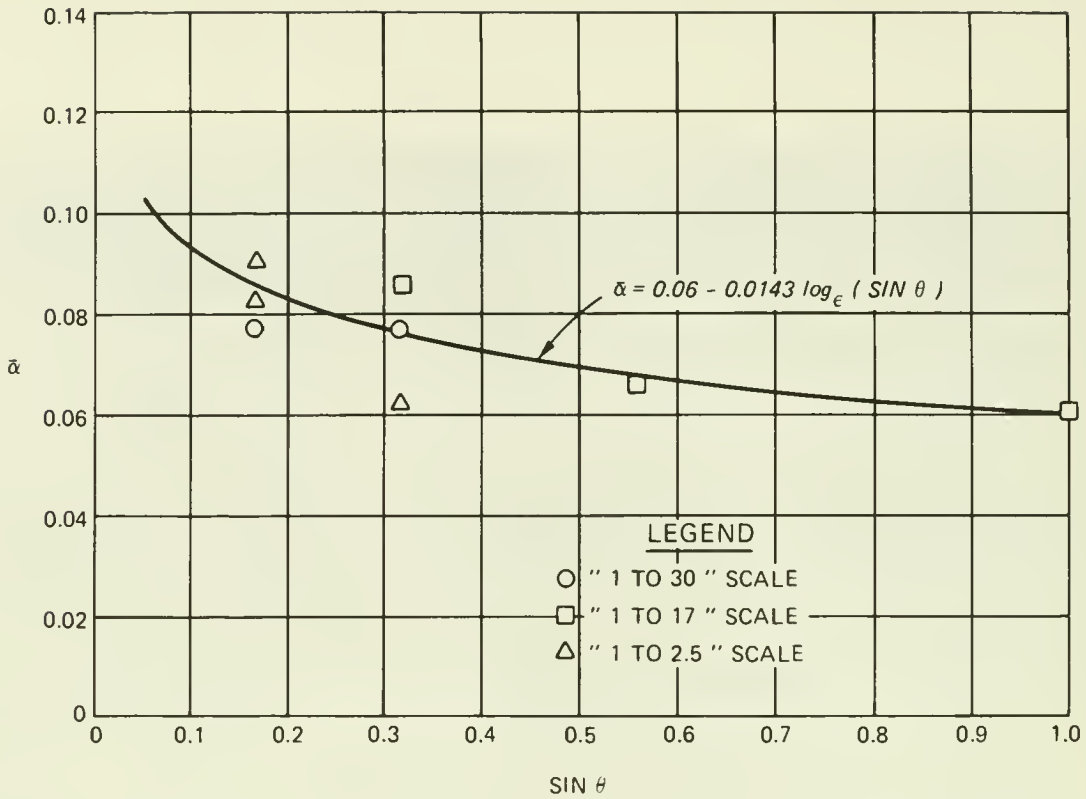

Figure 7-33. Variation of $\bar{\alpha}$ with structure slope θ .

slopes only), based on this analysis is given by equation (7-13)

$$\bar{\alpha} = 0.06 - 0.0143 \ln (\sin \theta) \quad (7-13)$$

where θ is the structure slope angle from the horizontal.

The variation of Q_o^* between waves conforming to linear theory and to cnoidal theory was also investigated by Weggel (1976). The findings of this investigation are illustrated in Figure 7-34. Q_o^* is shown as a function of depth at the structure d_o , estimated deepwater wave height H_o' , and period T , for both linear and cnoidal theory.

Calculation of wave overtopping rates is illustrated by the following example.

***** EXAMPLE PROBLEM 7 *****

GIVEN: An impermeable structure with a smooth slope of 1 on 2.5 is subjected to waves having a deepwater height $H_o' = 1.5$ m (4.9 ft) and a period $T = 8$ s. The depth at the structure toe is $d_o = 3.0$ m (9.8 ft); crest elevation is 1.5 m (4.8 ft) above SWL. Onshore winds of 35 knots are assumed.

FIND: Estimate the overtopping rate for the given wave.

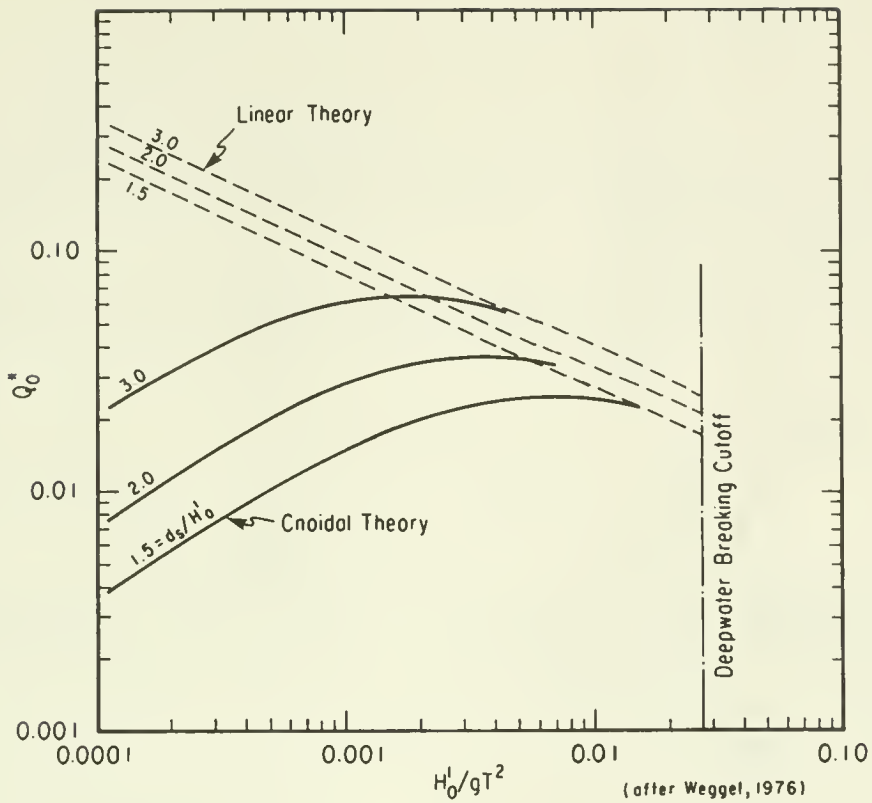

Figure 7-34. Variation of Q_0^* between waves conforming to cnoidal theory and waves conforming to linear theory.

SOLUTION: Determine the runup for the given wave and structure. Calculate

$$\frac{d}{H'_0} = \frac{3.0}{1.5} = 2.0$$

$$\frac{H'_0}{gT^2} = \frac{1.5}{(9.8)(8)^2} = 0.0024$$

From Figure 7-11, since

$$\frac{d}{H'_0} = 2.0$$

$$\frac{R}{H'_0} = 2.9 \text{ (uncorrected for scale effect)}$$

Since $H'_0 = 1.5 \text{ m (4.8 ft)}$, from Figure 7-13 the runup correction factor k' is approximately 1.17. Therefore

$$\frac{R}{H'_0} = 1.7 (2.9) = 3.4$$

and

$$R = 3.4 (H'_o) = (3.4) (1.5) = 5.1 \text{ m (16.7 ft)}$$

The values of α and Q_o^* for use in equation (7-10) can be found by interpolation between Figures 7-25 and 7-26. From Figure 7-26, for small-scale data on a 1:3 slope

$$\left. \begin{array}{l} \alpha = 0.09 \\ Q_o^* = 0.033 \end{array} \right\} \text{ at } \frac{d_s}{H'_o} = 2.0 \text{ and } \frac{H'_o}{gT^2} = 0.0024$$

Also from Figure 7-26, for larger scale data

$$\left. \begin{array}{l} \alpha = 0.065 \\ Q_o^* = 0.040 \end{array} \right\} \text{ at } \frac{d_s}{H'_o} = 2.33 \text{ and } \frac{H'_o}{gT^2} = 0.0028$$

Note that these values were selected for a point close to the actual values for the problem, since no large-scale data are available exactly at

$$\frac{d_s}{H'_o} = 2.0$$

$$\frac{H'_o}{gT^2} = 0.0024$$

From Figure 7-25 for small-scale data on a 1 on 1.5 slope

$$\left. \begin{array}{l} \alpha = 0.067 \\ Q_o^* = 0.0135 \end{array} \right\} \text{ at } \frac{d_s}{H'_o} = 1.5 \text{ and } \frac{H'_o}{gT^2} = 0.0016$$

Large-scale data are not available for a 1 on 1.5 slope. Since larger values of α and Q_o^* give larger estimates of overtopping, interpolation by eye between the data for a 1 on 3 slope and a 1 on 1.5 slope gives approximately

$$\alpha = 0.08$$

$$Q_o^* = 0.035$$

From equation (7-10)

$$Q = (g Q_o^* H_o^3)^{1/2} e^{-\left[\frac{0.217}{\alpha} \tanh^{-1} \left(\frac{h-d_s}{R} \right) \right]}$$

$$Q = \left[(9.8) (0.035) (1.5)^3 \right]^{1/2} e^{-\left[\frac{0.217}{0.08} \tanh^{-1} \left(\frac{h-d_s}{R} \right) \right]}$$

The value of $\frac{h-d_s}{R}$ is $\frac{4.5 - 3.0}{5.1} = 0.294$.

To evaluate $\tanh^{-1} \left[\frac{(h-d_s)}{R} \right]$ find 0.294 in column 4 of either Table C-1 or C-2, Appendix C, and read the value of $\tanh^{-1} \left[\frac{(h-d_s)}{R} \right]$ from column 3. Therefore

$$\tanh^{-1} (0.294) \approx 0.31$$

The exponent is calculated thus:

$$\frac{0.217 (0.31)}{(0.08)} = 0.84$$

therefore

$$Q = 1.08 e^{-0.84} = 1.08 (0.43) = 0.47 \text{ m}^3/\text{s-m}$$

or

$$5.0 \text{ ft}^3/\text{s-ft}$$

For an onshore wind velocity of 35 mi/hr, the value of W_f is found by interpolation

$$30 \text{ mi/hr } W_f = 0.5$$

$$35 \text{ mi/hr } W_f = 0.75$$

$$60 \text{ mi/hr } W_f = 2.0$$

From equation (7-12)

$$k' = 1 + W_f \left(\frac{h-d_s}{R} + 0.1 \right) \sin \theta$$

where

$$W_f = 0.75$$

$$\frac{h-d_s}{R} = 0.3$$

$$\theta = \tan^{-1} (1/2.5) \approx 22^\circ$$

$$\sin 22^\circ = 0.37$$

Therefore

$$k' = 1 + 0.75 (0.3 + 0.1) 0.37 = 1.11$$

and the corrected overtopping rate is

$$Q_e = k' Q$$

$$Q_e = 1.11 (0.47) = 0.5 \text{ m}^3/\text{s-m} \text{ (5.4 ft}^3/\text{s-ft)}$$

The total volume of water overtopping the structure is obtained by multiplying Q_e by the length of the structure and by the duration of the given wave conditions.

b. Irregular Waves. As in the case of runup of irregular waves (see Sec. II,1,b, Irregular Waves), little information is available to accurately predict the average and extreme rate of overtopping caused by wind-generated waves acting on coastal structures. Ahrens (1977b) suggests the following interim approach until more definitive laboratory tests results are available. The approach extends the procedures described in Section II,2,a on wave overtopping by regular (monochromatic) waves by applying the method suggested by Ahrens (1977a) for determining runup of irregular waves. In applying his procedure, note a word of caution: *some larger waves in the spectrum may be depth-limited and may break seaward of the structure, in which case, the rate of overtopping may be overestimated.*

Irregular wave runup on coastal structures as discussed in Section II,1,b is assumed to have a Rayleigh distribution, and the effect of this assumption is applied to the regular (monochromatic) wave overtopping equation. This equation is expressed as follows:

$$Q = \left(g Q_o^* H_o^3 \right)^{1/2} e^{-\left[\frac{0.217}{\alpha} \tanh^{-1} \left(\frac{h-d_s}{R} \right) \right]} \quad (7-10)$$

where

$$0 \leq \frac{h-d_s}{R_s} < 1.0$$

In applying this equation to irregular waves and the resulting runup and overtopping, certain modifications are made and the following equation results:

$$Q_p = \left[g Q_o^* \left(H_o^3 \right)_s \right]^{1/2} e^{-\left[\frac{0.217}{\alpha} \tanh^{-1} \left(\frac{h-d_s}{R_s} \right) \frac{R_s}{R_p} \right]} \quad (7-14)$$

in which

$$0 \leq \left(\frac{h-d_s}{R_s} \right) \frac{R_s}{R_p} < 1.0$$

where Q_p is the overtopping rate associated with R_p , the wave runup with a

particular probability of exceedance, P , and R_S is the wave runup of the equivalent deepwater significant wave height, $(H'_0)_S$. The term $h-d_S/R_S$ will be referred to as the relative freeboard. The relationship between R_P , R_S , and P is given by

$$\frac{R_P}{R_S} = \left(-\frac{\text{Ln}P}{2} \right)^{1/2} \quad (7-9)$$

Equation (7-14) provides the rate of overtopping for a particular wave height.

In analyzing the rate of overtopping of a structure subjected to irregular waves and the capacity for handling the overtopping water, it is generally more important to determine the extreme (low probability) rate (e.g., $Q_{0.005}$) and the average rate \bar{Q} of overtopping based on a specified design storm wave condition. The extreme rate, assumed to have a probability P of 0.5 percent or 0.005, can be determined by using equation (7-14). The upper group of curves in Figure 7-35 illustrates the relation between the relative freeboard, $(h-d_S)/R_S$, and the relative rate of overtopping, $Q_{0.005}/\bar{Q}$, in terms of the empirically determined coefficient, α , where \bar{Q} is the overtopping rate for the significant wave height. The average rate \bar{Q} is determined by first calculating the overtopping rate for all waves in the distribution using equation (7-14). For example, in Figure 7-35, this has been calculated for 199 values of probabilities of exceedance at intervals of $P = 0.005$ (i.e., $P = 0.005, 0.010, 0.015, \dots, 0.995$). Noting that R_P/R_S is a function of P , solutions will only exist for the previously stated condition that

$$0 \leq \left(\frac{h-d_S}{R_S} \right) \frac{R_S}{R_P} < 1.0$$

and $Q_P = 0$ for other values of P . The average of these overtopping rates is then determined by dividing the summation of the rates by 199 (i.e., the total number of overtopping rates) to obtain \bar{Q} . The lower group of curves in Figure 7-35 illustrates the relation between the relative freeboard and the relative average rate of overtopping \bar{Q}/Q in terms of the empirically determined coefficient α .

***** EXAMPLE PROBLEM 8 *****

GIVEN: An impermeable structure with a smooth slope of 1 on 2.5 is subjected to waves having a deepwater significant wave height $H'_0 = 1.5$ m (4.9 ft) and a period $T = 8$ s. The depth at the structure toe is $d_S = 3.0$ m (9.8 ft); crest elevation is 1.5 m (4.9 ft) above SWL ($h-d_S = 1.5$ m (4.9 ft)). Onshore winds of 35 knots are assumed.

FIND:

- (a) Estimate the overtopping rate for the given significant wave.
- (b) Estimate the extreme overtopping rate $Q_{0.005}$.
- (c) Estimate the average overtopping rate \bar{Q} .

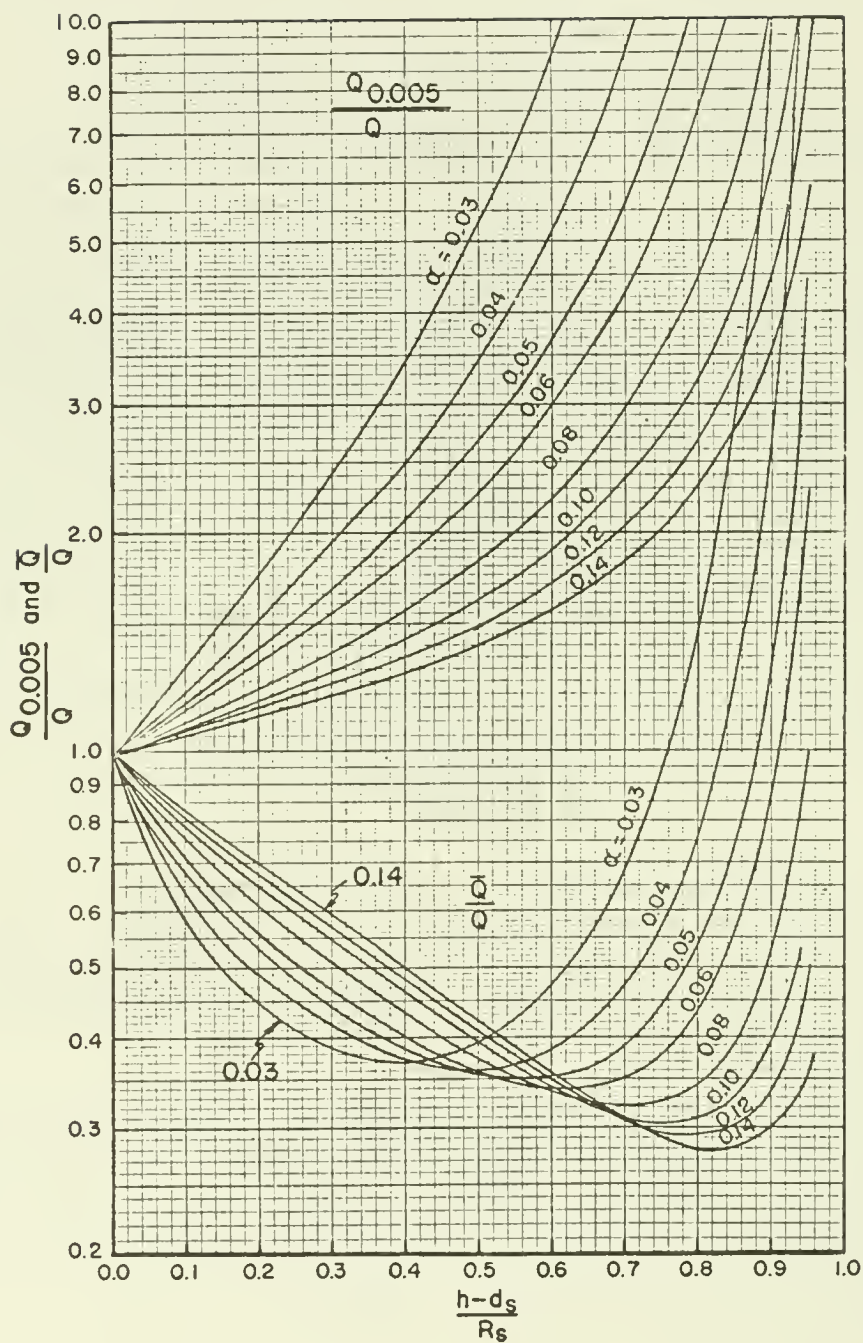

Figure 7-35. $\frac{Q_{0.005}}{Q}$ and $\frac{Q}{Q_0}$ as functions of relative freeboard and α .

SOLUTION:

(a) The previous example problem in Section II,2,a gives a solution for the overtopping rate of a 1.5-m (4.9-ft) significant wave corrected for the given wind effects as

$$Q = 0.5 \text{ m}^3/\text{s-m}$$

(b) For the value of $\alpha = 0.08$ given in the previous example problem, the value of $Q_{0.005}$ is determined as follows:

$$R_g = 5.1 \text{ m (16.7 ft) from previous example problem}$$

$$\frac{h-d_g}{R_g} = \frac{1.5}{5.1} = 0.294$$

From the upper curves in Figure 7-35, using $\alpha = 0.08$ and $(h-d_g)/R_g = 0.294$

$$\frac{Q_{0.005}}{Q} = 1.38$$

$$Q_{0.005} = 1.38 (0.5) = 0.7 \text{ m}^3/\text{s-m (7.4 ft}^3/\text{s-ft)}$$

(c) From the lower set of curves in Figure 7-35, using $\alpha = 0.08$ and $(h-d_g)/R_g = 0.294$,

$$\frac{\bar{Q}}{Q} = 0.515$$

$$Q = 0.515 (0.5) = 0.3 \text{ m}^3/\text{s-m (3.2 ft}^3/\text{s-ft)}$$

The total volume of water overtopping the structure is obtained by multiplying \bar{Q} by the length of the structure and by the duration of the given wave conditons.

3. Wave Transmission.

a. General. When waves strike a breakwater, wave energy will be either reflected from, dissipated on, or transmitted through or over the structure. The way incident wave energy is partitioned between reflection, dissipation, and transmission depends on incident wave characteristics (period, height, and water depth), breakwater type (rubble or smooth-faced, permeable or impermeable), and the geometry of the structure (slope, crest elevation relative to SWL, and crest width). Ideally, harbor breakwaters should reflect or dissipate any wave energy approaching the harbor (see Ch. 2, Sec. V, Wave

Reflection). Transmission of wave energy over or through a breakwater should be minimized to prevent damaging waves and resonance within a harbor.

Most information about wave transmission, reflection, and energy dissipation for breakwaters is obtained from physical model studies because these investigations are easy and relatively inexpensive to perform. Only recently, however, have tests been conducted with random waves (for example, Seelig, 1980a) rather than monochromatic waves, which are typical of natural conditions. One of the purposes of this section is to compare monochromatic and irregular wave transmission. Figure 7-36 summarizes some of the many types of structures and the range of relative depths, d_s/gT^2 , for which model tests have been performed.

Some characteristics and considerations to keep in mind when designing breakwaters are shown in Table 7-3.

b. Submerged Breakwaters. Submerged breakwaters may have certain attributes as outlined in Table 7-3. However, the major drawback of a submerged breakwater is that a significant amount of wave transmission occurs with the transmission coefficient

$$K_T = \frac{H_t}{H_i} \quad (7-15)$$

greater than 0.4 for most cases, where H_i and H_t are the incident and transmitted wave heights.

One of the advantages of submerged breakwaters is that for a given breakwater freeboard

$$F = h - d_s \quad (7-16)$$

water depth, and wave period, the size of the transmission coefficient decreases as the incident wave increases. This indicates that the breakwater is more effective interfering with larger waves, so a submerged breakwater can be used to trigger breaking of high waves. Figure 7-37 shows selected transmission coefficients and transmitted wave heights for a smooth impermeable submerged breakwater with a water depth-to-structure height ratio $d_s/h = 1.07$.

Figure 7-38 gives design curves for vertical thin and wide breakwaters (after Goda, 1969).

c. Wave Transmission by Overtopping. A subaerial (crest elevation above water level with positive F) will experience transmission by overtopping any time the runup is larger than freeboard ($F/R < 1.0$) (Cross and Sollitt, 1971), where R is the runup that would occur if the structure were high enough so that no overtopping occurred. Seelig (1980a) modified the approach of Cross and Sollitt (1971) to show that the transmission by overtopping coefficient can be estimated from

$$K_{T0} = C(1.0 - F/R) \quad (7-17)$$

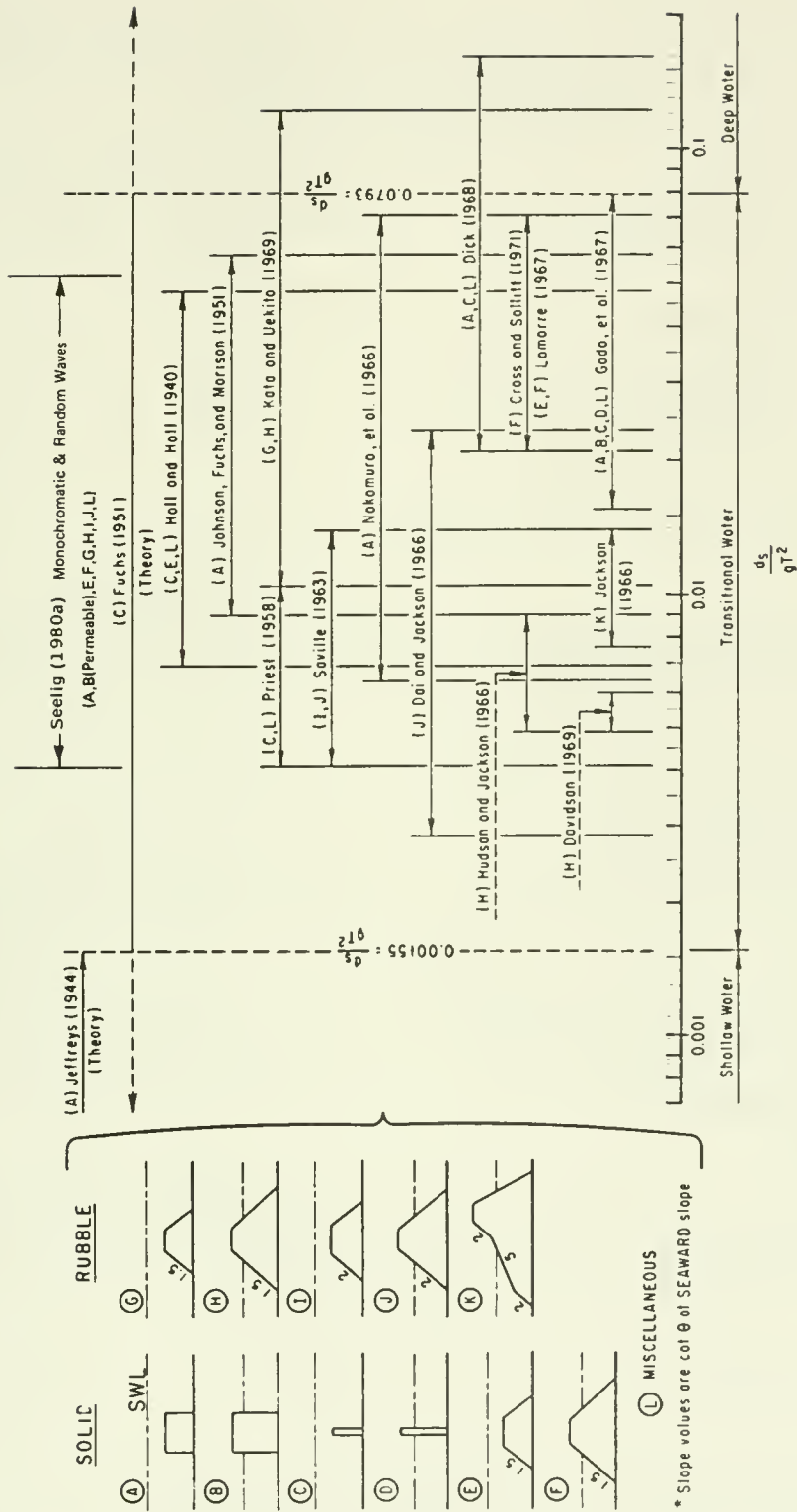
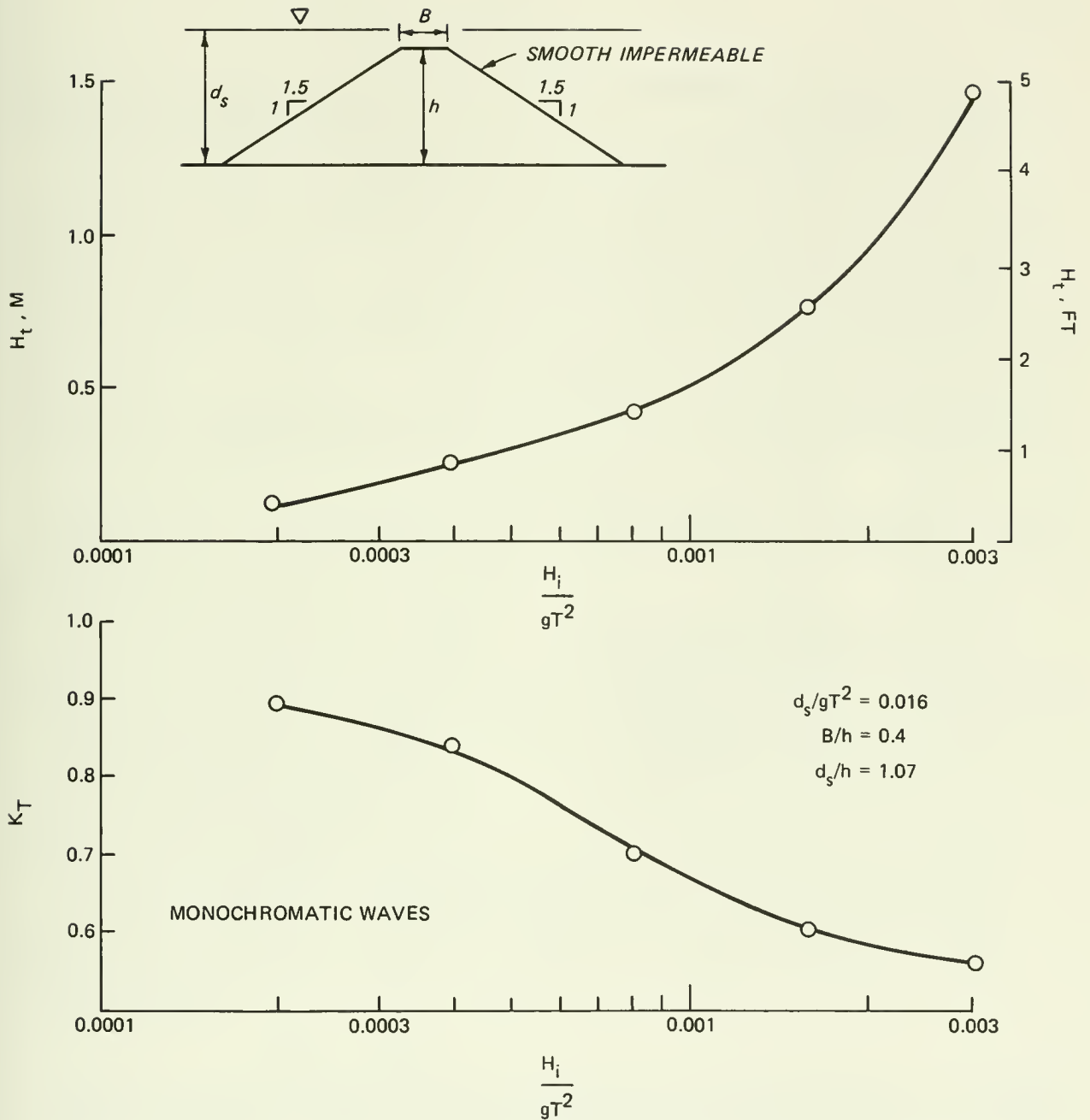

Figure 7-36. Wave transmission over submerged and overtopped structures: approximate ranges of d_s / gT^2 studied by various investigators.

Table 7-3. Some considerations of breakwater selection.

Increasing Permeability \longrightarrow			
	Impermeable	Permeable	
Increasing Structure Height \downarrow	Submerged	High wave transmission ($K_T > 0.4$)	Same
		Low reflection	Same
		Low amount of material	Same
		Does not obstruct view	Same
		May be a navigation hazard	Same
	Subaerial		Provides habitat for marine life
		Low transmission except where runup is extreme	Excellent dissipator of wave energy
		Good working platform	Low transmission
		High reflection	Low reflection
		Occupies little space	Deserves serious consideration if adequate armor material is available
	Failure may be dramatic	Structure can be functional even with some failure	
	Inhibits circulation	Provides habitat for marine life	
		Allows circulation due to low-steepness waves	



(after Seelig, 1980a)

Figure 7-37. Selected wave transmission results for a submerged breakwater.

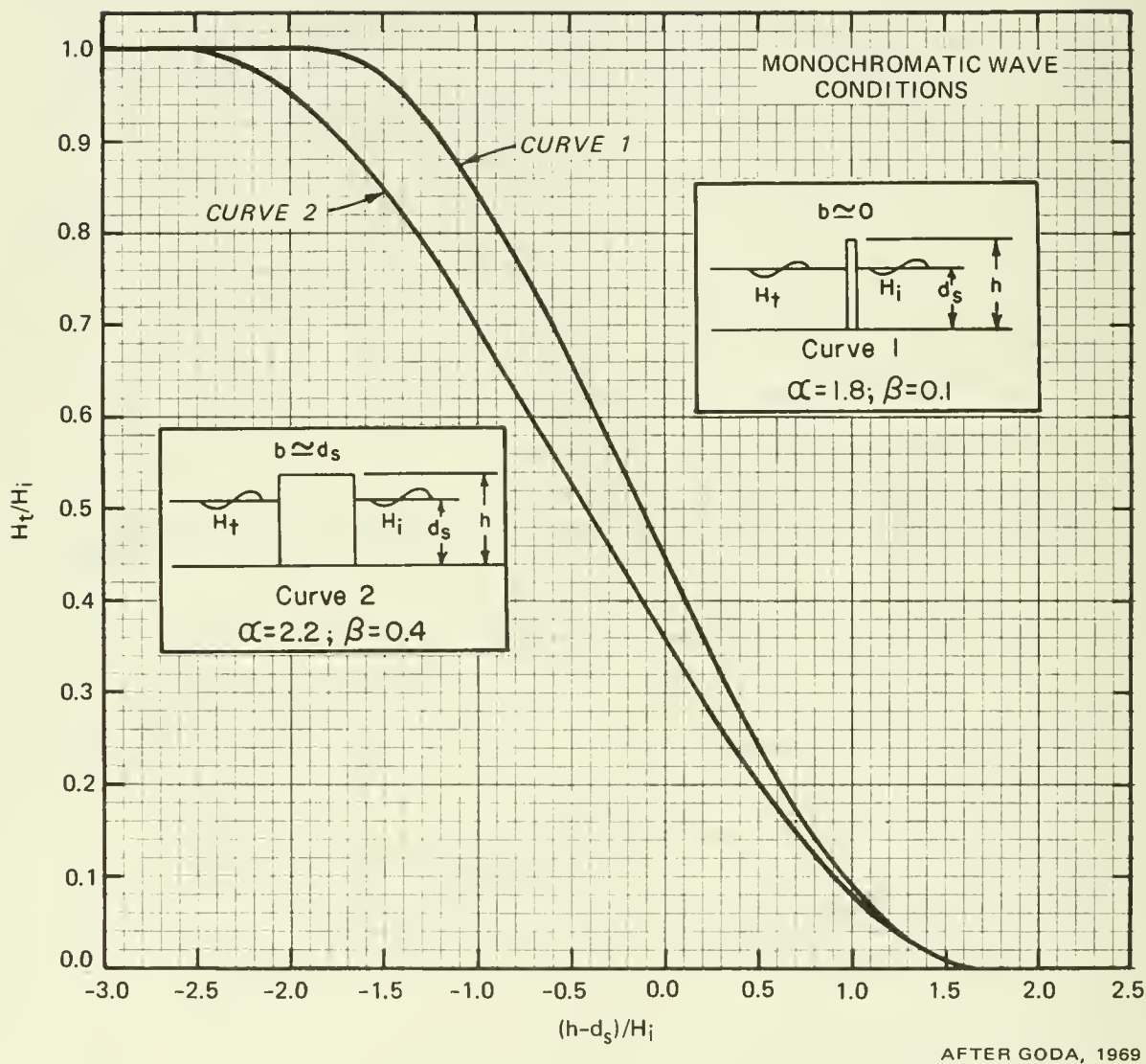

Figure 7-38. Wave transmission coefficients for vertical wall and vertical thin-wall breakwaters where $0.0157 \leq d_s/gT^2 \leq 0.0793$.

where the empirical overtopping coefficient C gradually decreases as the relative breakwater crest width B increases; i.e.,

$$C = 0.51 - 0.11 \left(\frac{B}{h} \right); \quad 0 < \frac{B}{h} < 3.2 \quad (7-18)$$

The case of monochromatic waves is shown in Figure 7-39 for selected structure crest width-to-height ratios.

In the case of irregular waves, runup elevation varies from one wave to the next. Assuming waves and resulting runup have a Rayleigh distribution, equation (7-17) can be integrated, with results shown in Figure 7-40 (note that for random waves R_s is the significant runup determined from the incident significant wave height H_s and period of peak energy density T_p). It can be seen by comparing Figures 7-39 and 7-40 that monochromatic wave conditions with a given height and period will usually have higher average wave transmission coefficients than irregular waves with the given significant wave height and period of peak energy density. This is because many of the runups in an irregular condition are small. However, high structures experience some transmission by overtopping due to the occasional large runup.

The distribution of transmitted wave heights for irregular waves is given in Figures 7-41 (see Fig. 7-42 for correction factor) as a function of the percentage of exceedance, p . The following examples illustrate the use of these curves.

***** EXAMPLE PROBLEM 9 *****

FIND: The ratio of the significant transmitted wave height to the incident significant wave height for an impermeable breakwater with

$$\frac{B}{h} = 0.1$$

and

$$\frac{F}{R_s} = 0.6 \text{ (irregular waves)}$$

SOLUTION: From Figure 7-40, the value is found to be

$$\frac{(H_s)_t}{H_s} = 0.13$$

so the transmitted significant wave height is 13 percent of the incident significant height.

***** EXAMPLE PROBLEM 10 *****

FIND:

(a) The percentage of time that wave transmission by overtopping occurs for

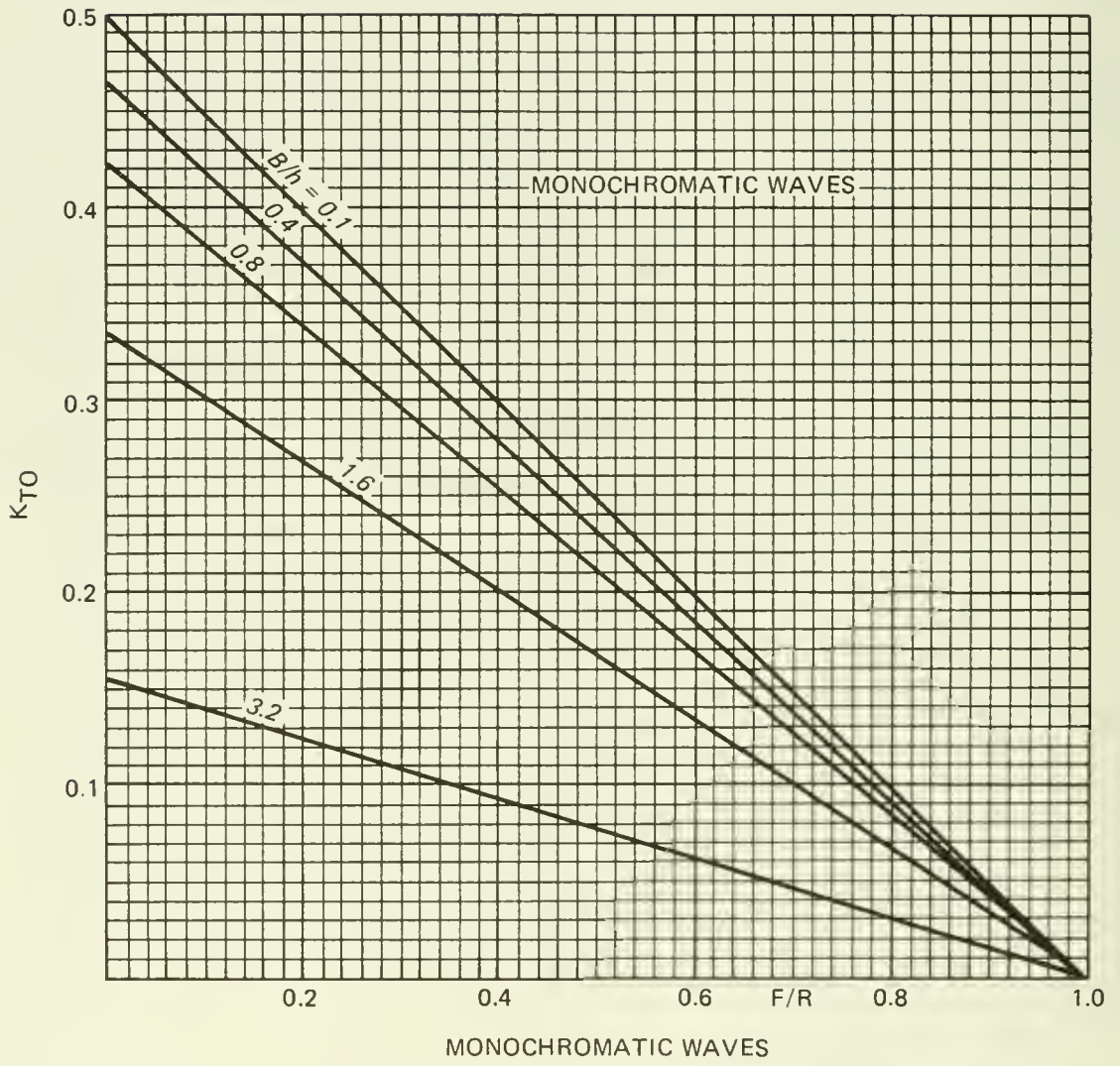

Figure 7-39. Wave transmission by overtopping.

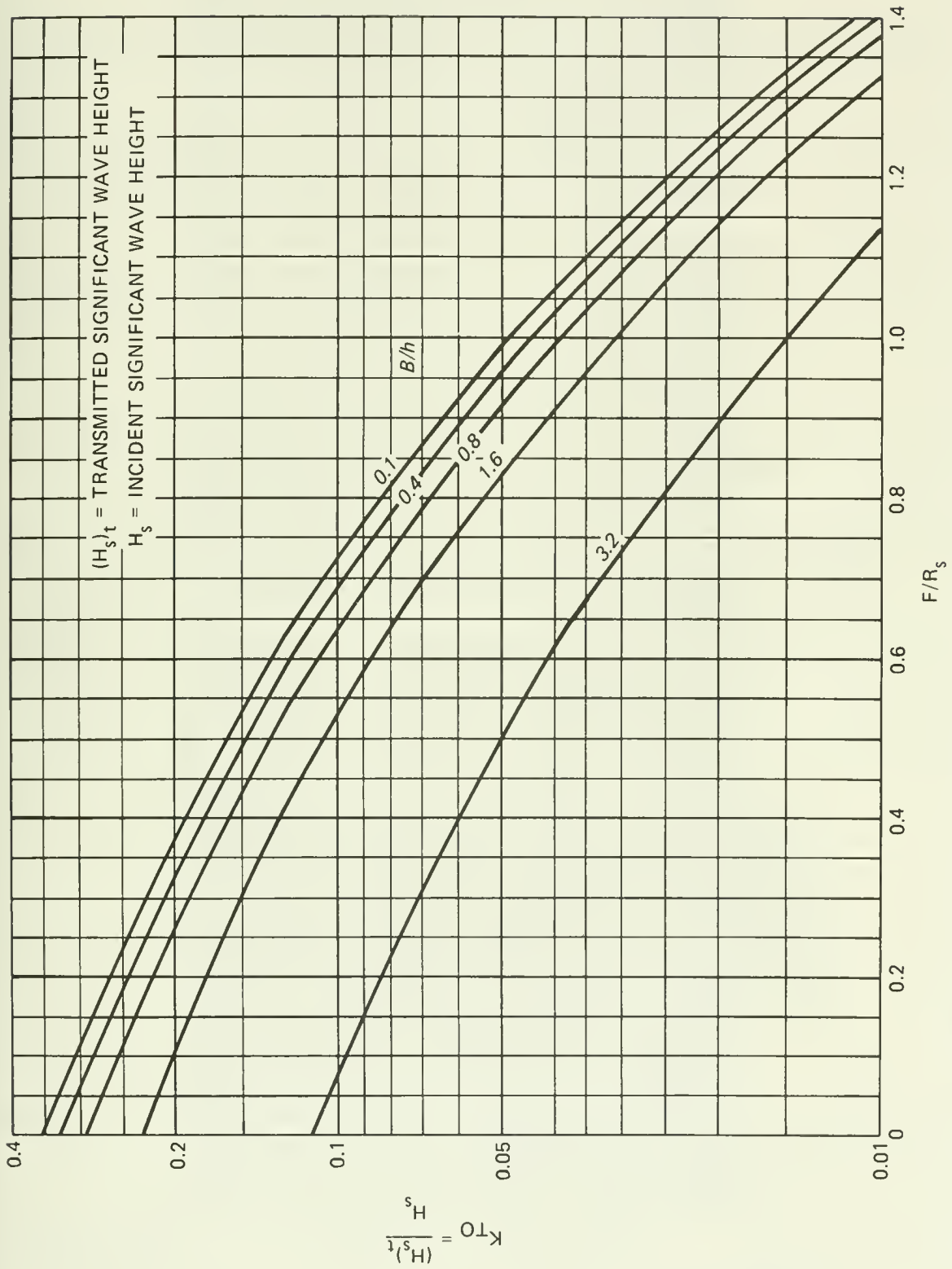

Figure 7-40. Transmitted wave height/incident significant wave height versus relative freeboard for wave transmission by overtopping due to irregular waves.

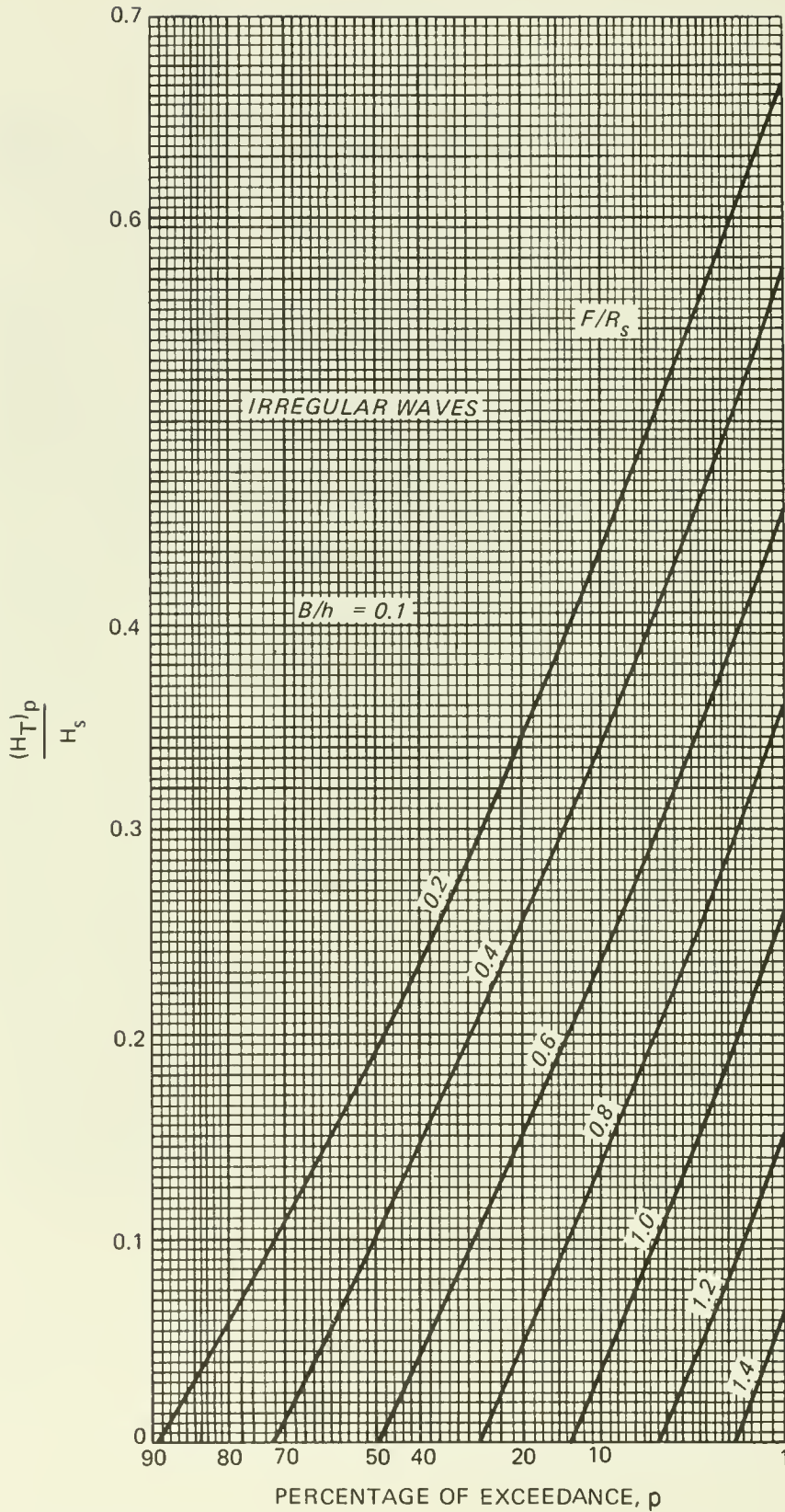

Figure 7-41. Transmitted wave height as a function of the percentage of exceedance.

$$\frac{B}{h} = 0.4 \quad \text{and} \quad \frac{F}{R_s} = 0.6$$

SOLUTION: From Figure 7-41 the transmission by overtopping coefficient is greater than 0.0 approximately 50 percent of the time for $F/R_s = 0.6$.

FIND:

(b) What is the wave height equaled or exceeded 1 percent of the time for this example, $(H_T)_{1\%}$?

SOLUTION: From Figure 7-42 $CF = 0.93$ for $\frac{B}{h} = 0.4$ and from Figure 7-41, $(H_T)_{1\%} = 0.45 H_s$, so

$$(H_T)_{1\%} = (0.45 H_s) (0.93) = 0.42 H_s$$

 ***** EXAMPLE PROBLEM 11 *****

FIND: The percentage of time that $\frac{(H_T)_P}{H_s}$ equals or exceeds a value of 0.2 for $F/R_s = 0.8$ and $\frac{B}{h} = 0.1$.

SOLUTION: From Figure 7-41, $(H_T)_P \geq 0.2 H_s$ for approximately 6 percent of the time.

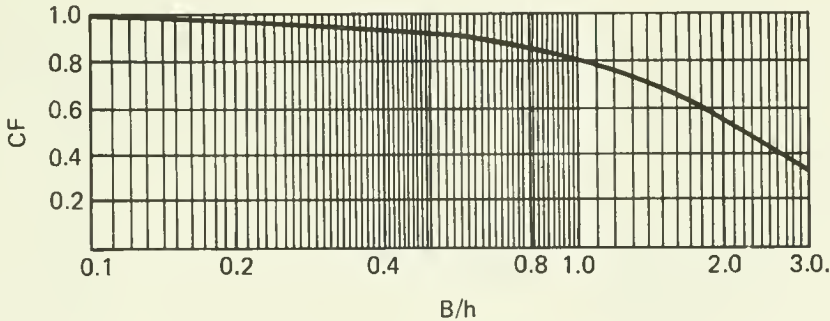
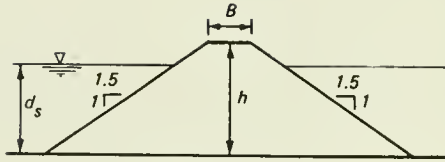

Figure 7-42. Correction factor, CF , to multiply by $\frac{(H_T)_P}{H_s}$ for $\frac{B}{h} > 0.1$.

***** EXAMPLE PROBLEM 12 *****

FIND: Transmitted wave heights for the following conditions for a smooth impermeable breakwater (assume irregular waves):



$$B = 2.0 \text{ m (6.56 ft)}$$

$$h = 2.5 \text{ m (8.2 ft)}$$

$$d_s = 2.0 \text{ m (6.56 ft)}$$

$$F = h - d_s = 0.5 \text{ m (1.64 ft)}$$

$$H_s = 1.0 \text{ m (3.28 ft)}$$

$$T_p = 10.0 \text{ s}$$

SOLUTION: Irregular wave runup on a 1:1.5 smooth slope was tested for scale models from Ahrens (1981a), who found the relative runup to have the following empirical relation to the dimensionless parameter (H_s/gT_p^2) :

$$\frac{R_s}{H_s} = 1.38 + 318 \left(\frac{H_s}{gT_p^2} \right) - 19700 \left(\frac{H_s}{gT_p^2} \right)^2$$

For this example

$$\frac{H_s}{gT_p^2} = 0.00102$$

so

$$\frac{R_s}{H_s} = 1.38 + 318 (0.00102) - 19700 (0.00102)^2 = 1.68$$

Therefore

$$\frac{F}{R_s} = \frac{\left(\frac{F}{H_s} \right)}{\left(\frac{R_s}{H_s} \right)} = \frac{0.5}{1.68} = 0.30$$

From Figure 7-39 the transmission by overtopping coefficient for $F/R_s = 0.3$ and $B/h = 2.0/2.5 = 0.8$ is

$$K_{To} = 0.295$$

so the transmitted significant wave height would be

$$(H_s)_t = H_s K_{T0} = 1.0(0.295) = 0.30 \text{ m (1.0 ft)}$$

Note that equation (7-17) gives conservative estimates of K_{T0} for $F = 0$ with the predicted values of the transmission coefficient corresponding to the case when the magnitude of the incident wave height is very small. Observed transmission coefficients for $F = 0$ are generally smaller than predicted, with transmission coefficients a weak function of wave steepness as illustrated by the example in Figure 7-43.

Wave runup values in equation (7-17) and for use with Figures 7-39, 7-40, 7-41, and 7-42 can be determined from Section II,1, Wave Runup. Runup for rough impermeable and permeable breakwaters can be estimated from Figure 7-44. The "riprap" curve should be used for highly impermeable rough structures and to obtain conservative estimates for breakwaters. The other curves, such as the one from Hudson (1958), are more typical for rubble-mound permeable breakwaters.

Note that for wave transmission by overtopping of subaerial breakwaters, the transmission becomes more efficient as the incident wave height increases (all other factors remaining constant) until K_{T0} reaches a uniform value (Figure 7-45). This is the opposite of the trend observed for a submerged breakwater (Figure 7-37). Figure 7-46 summarizes the transmission and reflection coefficients for a smooth impermeable breakwater, both submerged ($d_s/h > 1$) and subaerial ($d_s/h < 1$). Some examples of transmission for rough impermeable breakwaters are shown in Figures 7-47 and 7-48.

***** EXAMPLE PROBLEM 13 *****

FIND: The wave transmission by overtopping coefficient for a rough impermeable breakwater having the following characteristics:

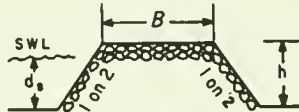

$$\frac{B}{h} = 0.57$$

$$B = 2.0 \text{ m (6.56 ft)}$$

$$h = 3.5 \text{ m (11.48 ft)}$$

$$d_s = 3.0 \text{ m (9.84 ft)}$$

$$F = h - d_s = 0.5 \text{ m (1.64 ft)}$$

$$H_i = 1.7 \text{ m (5.58 ft)}$$

$$T = 12.0 \text{ s}$$

○ MONOCHROMATIC WAVES $d_s/gT^2 = 0.016$
 ● RANDOM WAVES (JONSWAP SPECTRA) $d_s/gT_p^2 = 0.016$

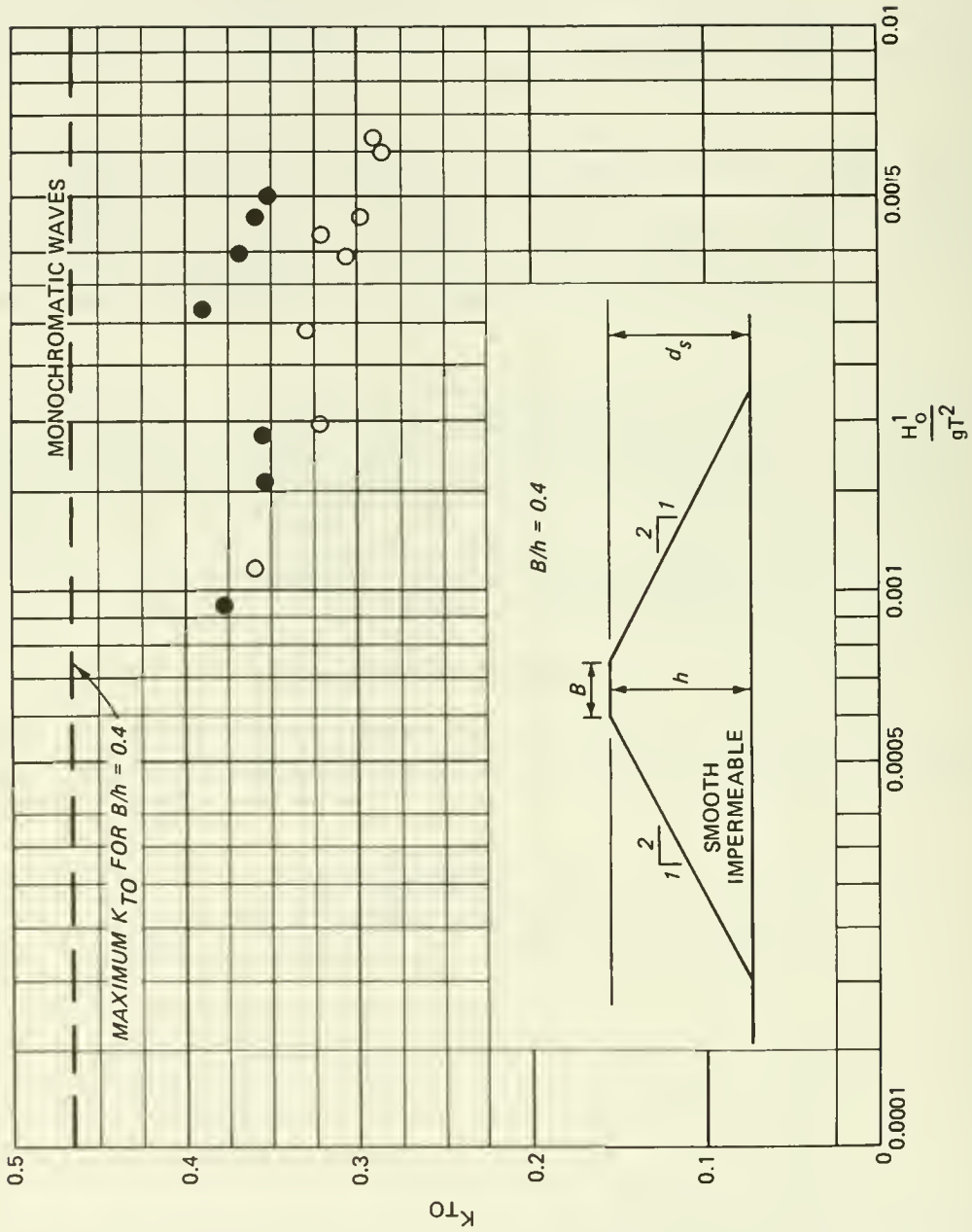
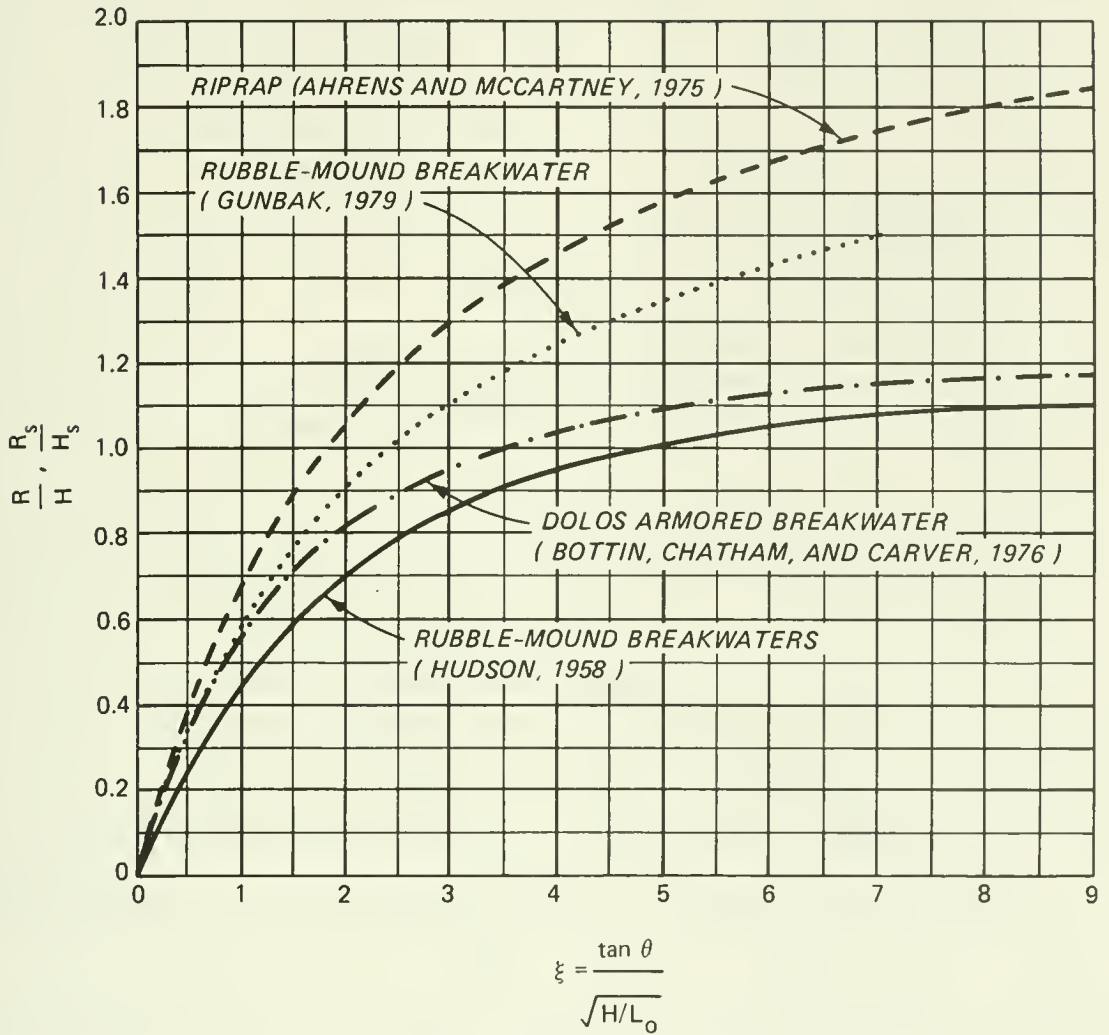
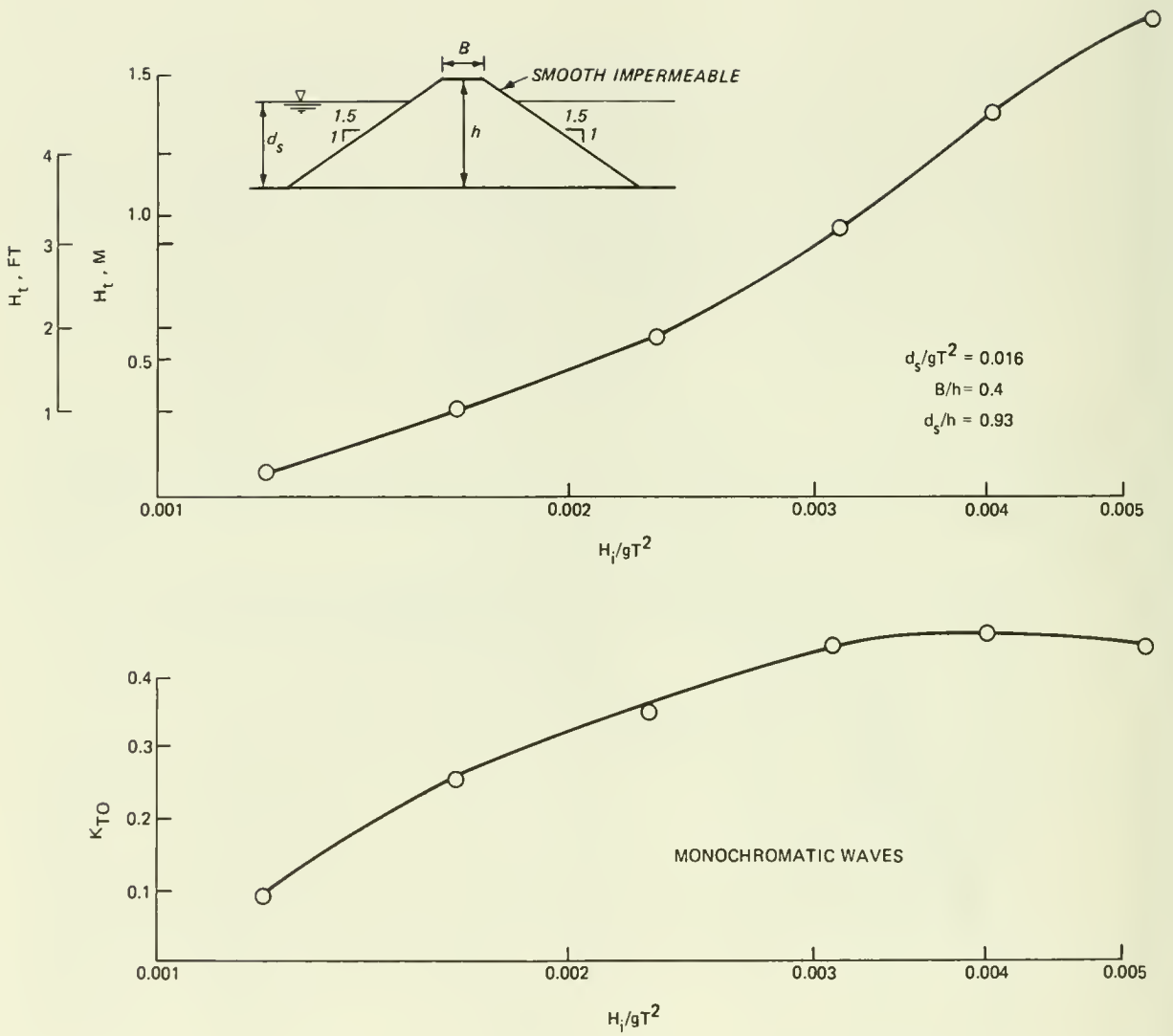

Figure 7-43. Wave transmission by overtopping for a breakwater with no freeboard.



(after Seelig, 1980a)

Figure 7-44. Wave runup on breakwaters and riprap.



(after Seelig, 1980a)

Figure 7-45. Selected wave transmission results for a subaerial breakwater.

$$B/h = 0.4$$

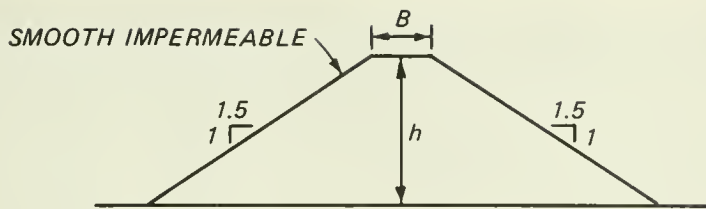

SYMBOL	d_s/H_s
○	1.20
▲	1.13
+	1.07
X	1.00
■	0.93
▽	0.87
◊	0.80
●	0.73
●	0.67
□	0.60

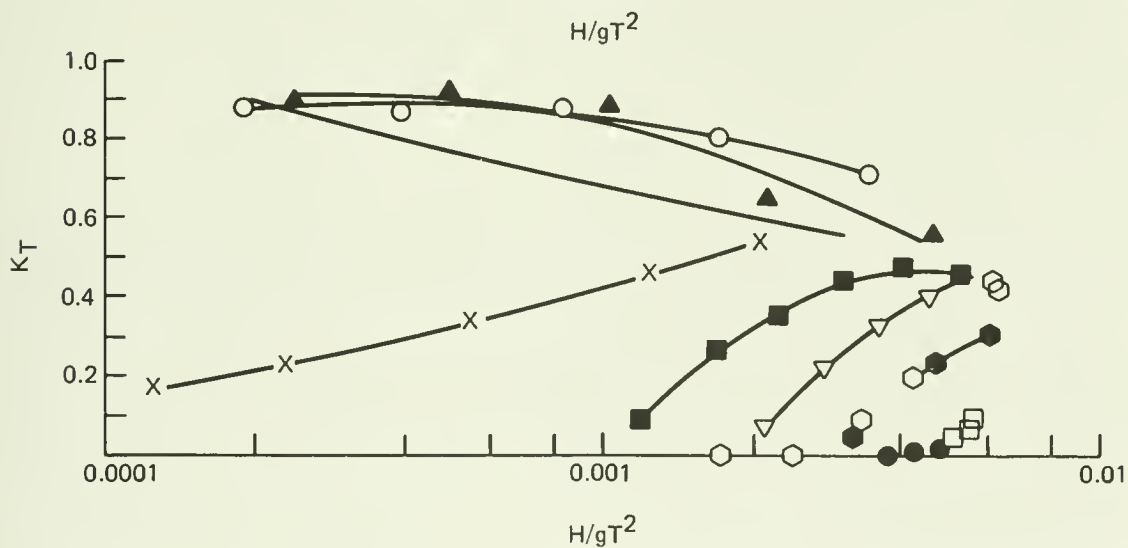
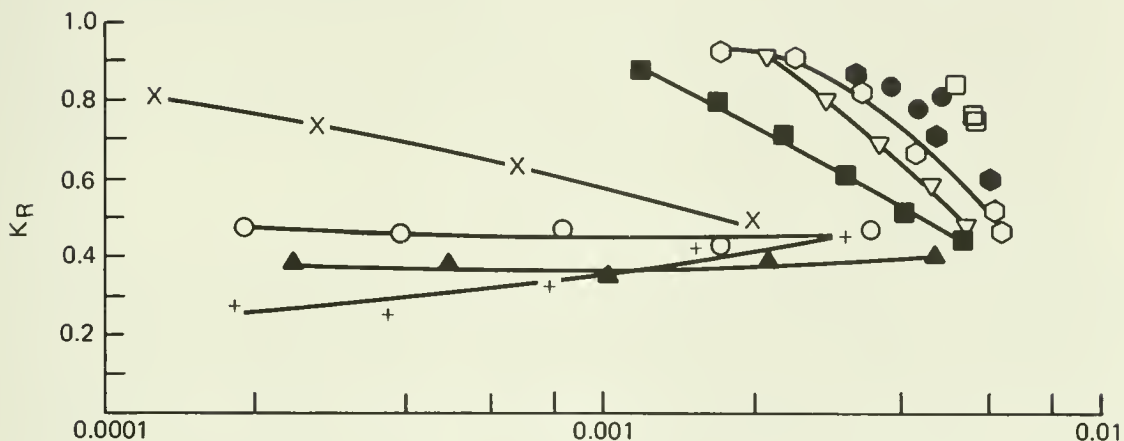

(after Seelig, 1980a)

Figure 7-46. Sample wave transmission and reflection coefficients for a smooth, impermeable breakwater.

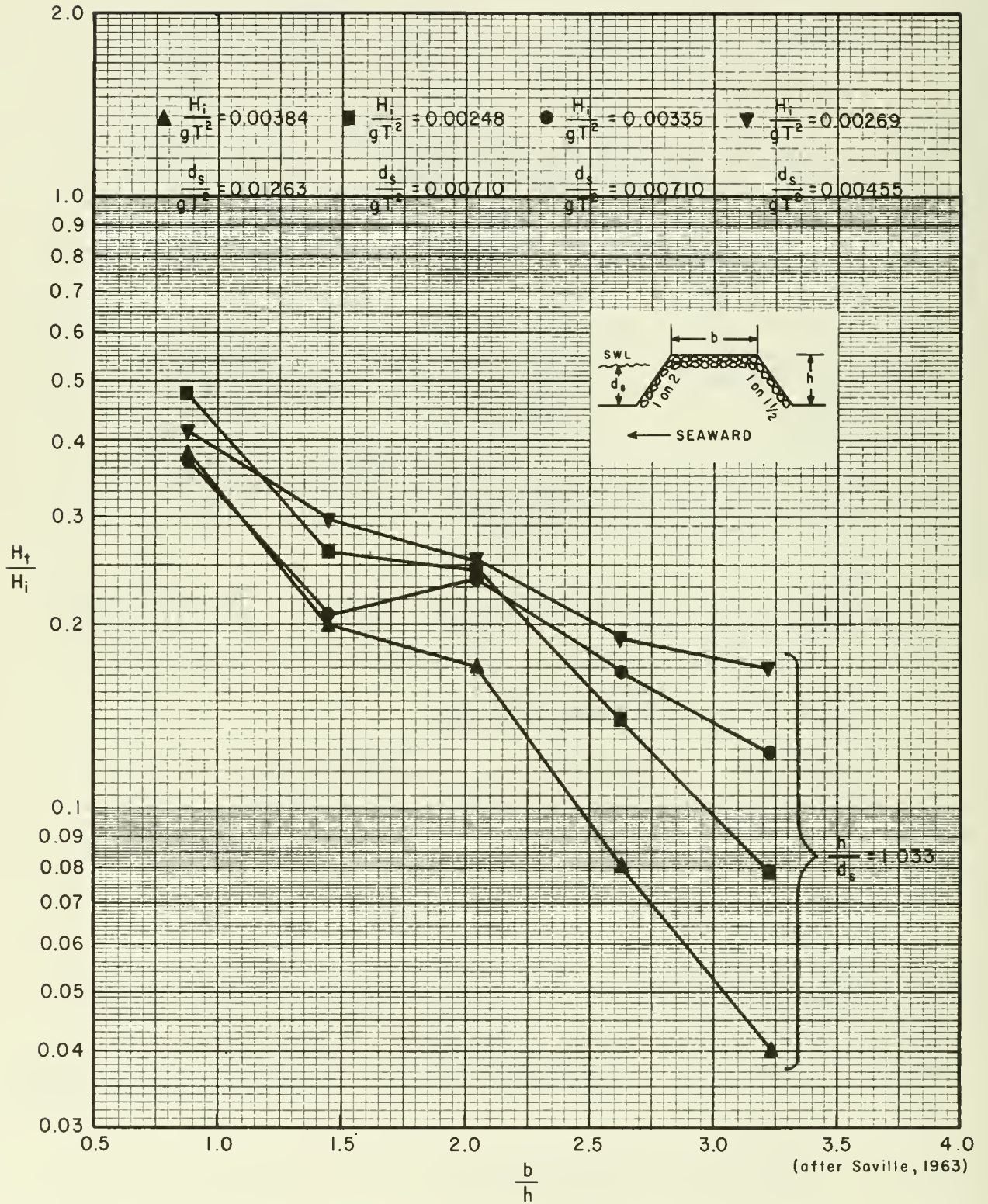

Figure 7-47. Monochromatic wave transmission, impermeable rubble-mound breakwater, where $\frac{h}{d_s} = 1.033$.

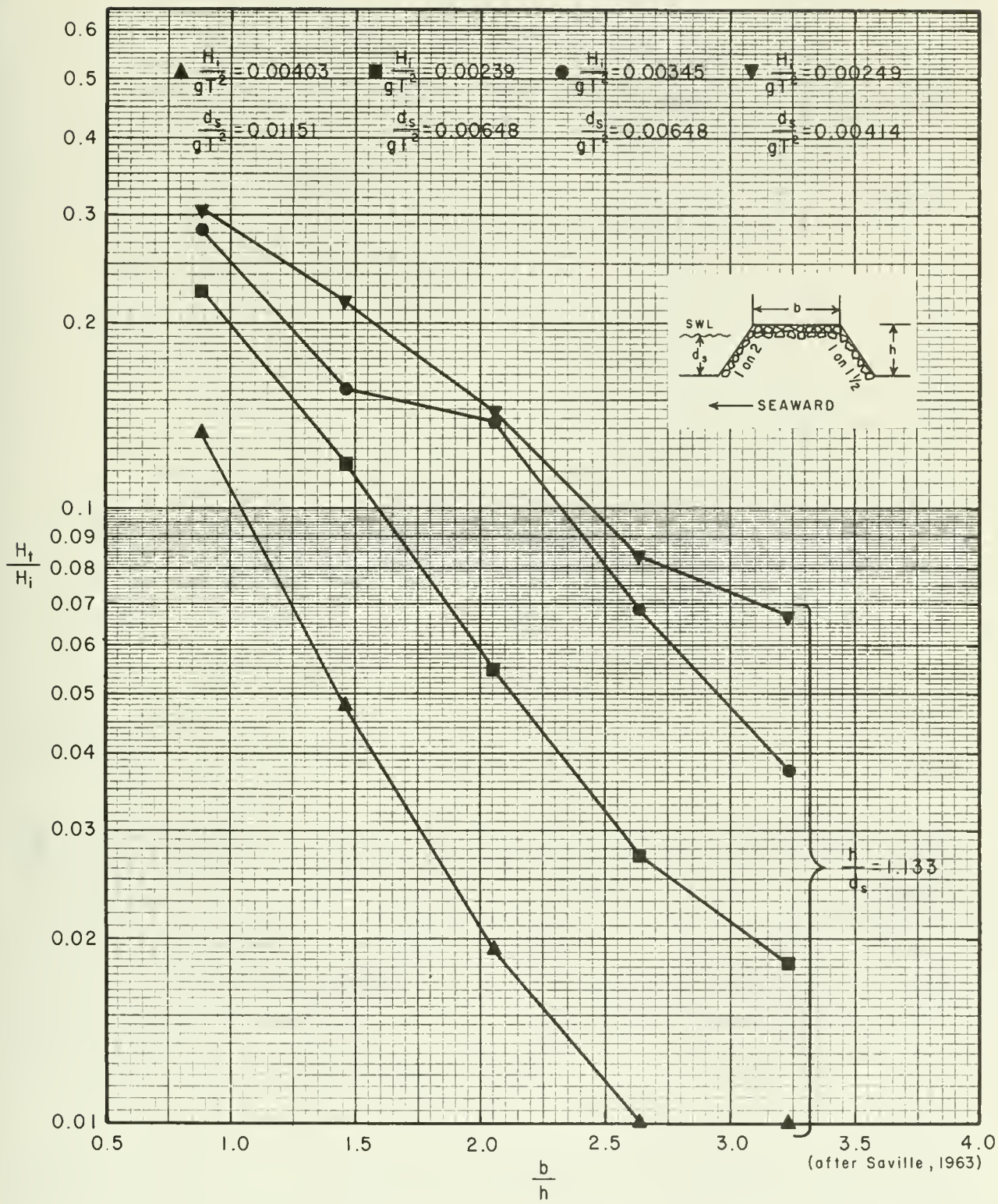

Figure 7-48. Monochromatic transmission, impermeable rubble-mound breakwater, where $\frac{h}{d_s} = 1.133$.

(a) For monochromatic waves, this example has a value of

$$\xi = \frac{\tan \theta}{\sqrt{H_i/L_o}} = \frac{0.5}{\sqrt{1.7\text{m}/(1.56 * 12^2)}} = 5.7$$

From Figure 7-44 (riprap is used for a conservative example)

$$\frac{R}{H_i} = 1.65$$

therefore

$$R = H_i \left(\frac{R}{H} \right) = 1.7 \text{ m} (1.65) = 2.805 \text{ m} (9.2 \text{ ft})$$

and

$$\frac{F}{R} = \frac{0.5}{2.805 \text{ m}} = 0.178$$

From equation (7-18)

$$C = 0.51 - 0.11 \left(\frac{B}{h} \right) = 0.51 - 0.11(0.57) = 0.447$$

and from equation (7-17)

$$K_{T_o} = C(1 - F/R) = 0.447 (1 - 0.178) = 0.37$$

so

$$H_T = K_{T_o}(H_i) = 0.37 (1.7 \text{ m}) = 0.63 \text{ m} (2.1 \text{ ft})$$

(b) For irregular wave conditions: in Figure 7-40 the case with $F/R_s = 0.178$ and $B/h = 0.57$ shows $K_{T_o} = 0.25$, which is 32 percent smaller than for the case with monochromatic waves (a).

(c) Find the influence of structure height on wave transmission. Calculations shown in (a) and (b) above are repeated for a number of structure elevations and results presented in Figure 7-49. This figure shows, for example, that the structure would require the following height to produce a transmitted significant wave height of 0.45 m (1.5 ft):

<u>Condition</u>	<u>Structure Height</u>
Monochromatic waves	4.2 m (13.8 ft)
Irregular waves	3.4 m (12.1 ft)

d. Wave Transmission for Permeable Breakwaters. Wave transmission for permeable breakwaters can occur due to transmission by overtopping and transmission through the structure, where the transmission coefficient, K_T , is given by

$$K_T = \sqrt{K_{T_o}^2 + K_{T_t}^2} \tag{7-19}$$

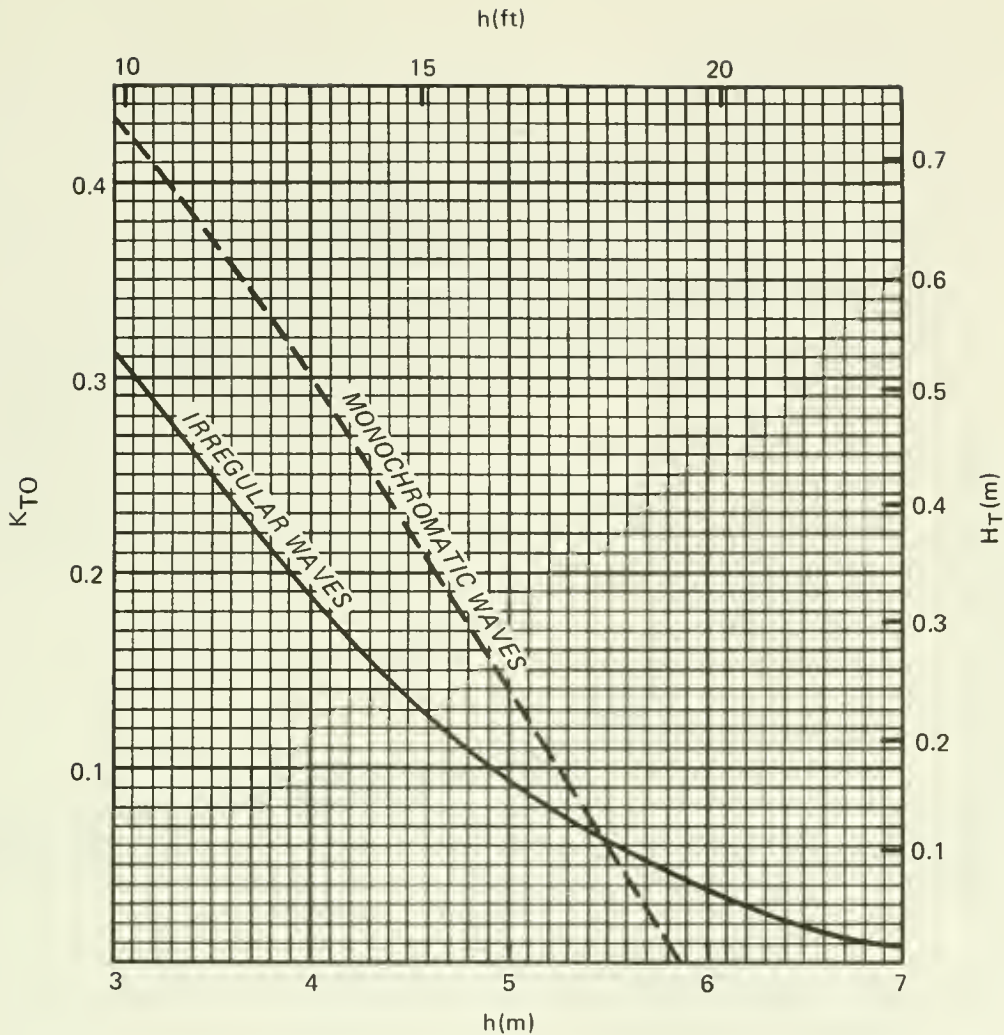

Figure 7-49. Influence of structure height on wave transmission for Example Problem 13.

where K_{Tt} is the coefficient for wave transmission through the breakwater.

The wave transmission through the structure, K_{Tt} , is a complex function of the wave conditions; structure width, size, permeability, and location of various layers of material; structure height; and water depth. Very low steepness waves, such as the astronomical tides, may transmit totally through the breakwater ($K_{Tt} \approx 1.0$), while wind waves are effectively damped. Locally generated storm waves with high steepness may be associated with low transmission coefficients (Fig. 7-50), which helps explain the popularity of permeable breakwaters at many coastal sites.

Note, however, that when transmission by overtopping occurs, the opposite trend is present: the transmission coefficient increases as incident wave height increases, all other factors being fixed. Figure 7-51, for example, shows the case of wave transmission for a breakwater armored with tribars. K_T initially declines, then rapidly increases as transmission by overtopping begins. The large transmission coefficients for this example are in part due to the high porosity of the tribar armor.

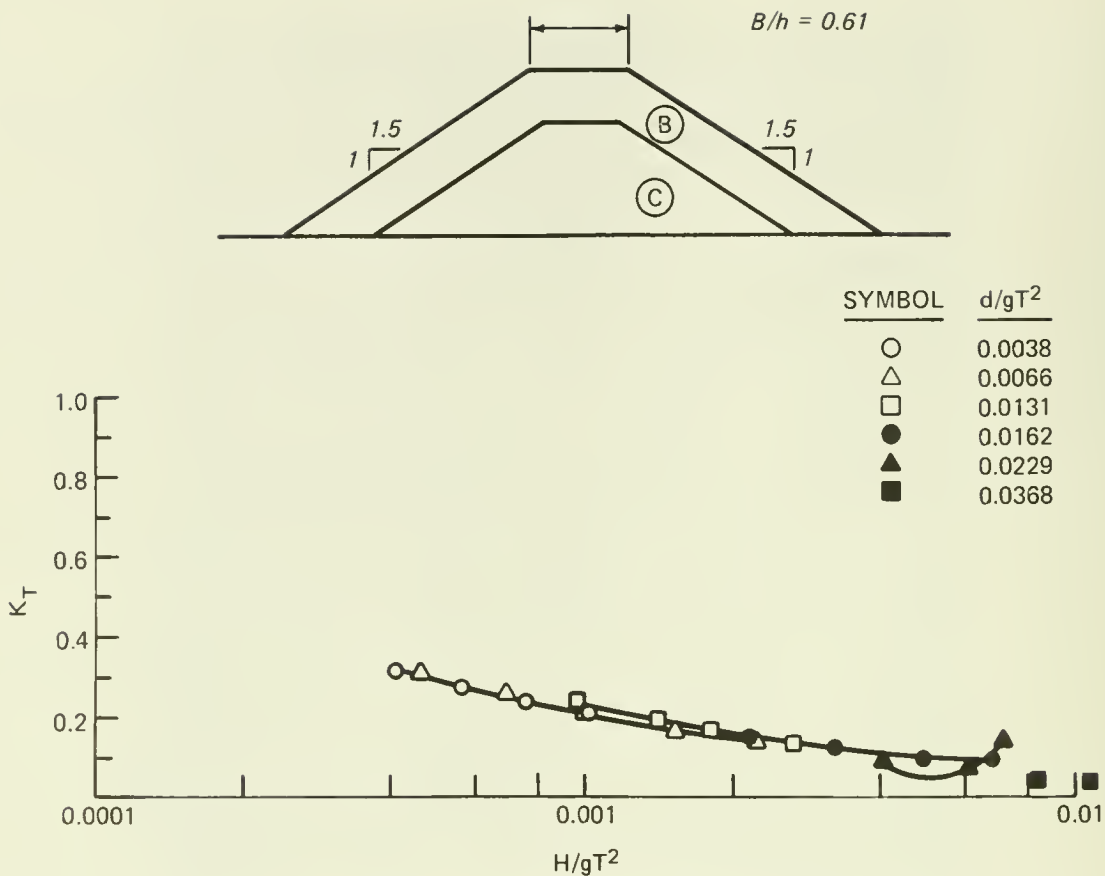

Figure 7-50. Wave transmission through a rubble-mound breakwater ($d_s/H_s = 0.69$).

e. Estimating Wave Transmission Coefficients for Permeable Breakwaters. There are several approaches to estimating transmission coefficients for permeable breakwaters.

(a) One approach is to use results from previous model studies. Figure 7-52, for example, gives transmission and reflection coefficients for a breakwater with a flat seaward slope that might be built in moderate-depth water. Another example, for a structure composed primarily of armor that would be built in relatively shallow water, is illustrated in Figure 7-53. Several examples showing the effects of structure height and width are given in Figures 7-54 and 7-55.

(b) Another approach is to use the computer program available in Seelig (1979). This program uses the model of Madsen and White (1976), together with the overtopping model in Section II,3,c, Wave Transmission by Overtopping, above, to estimate local transmission coefficients. The advantages of the program are that it can be used to make a preliminary evaluation of a large number of alternative structure designs, water levels, and wave conditions quickly and at low cost. Example program predictions are shown in Figure 7-56.

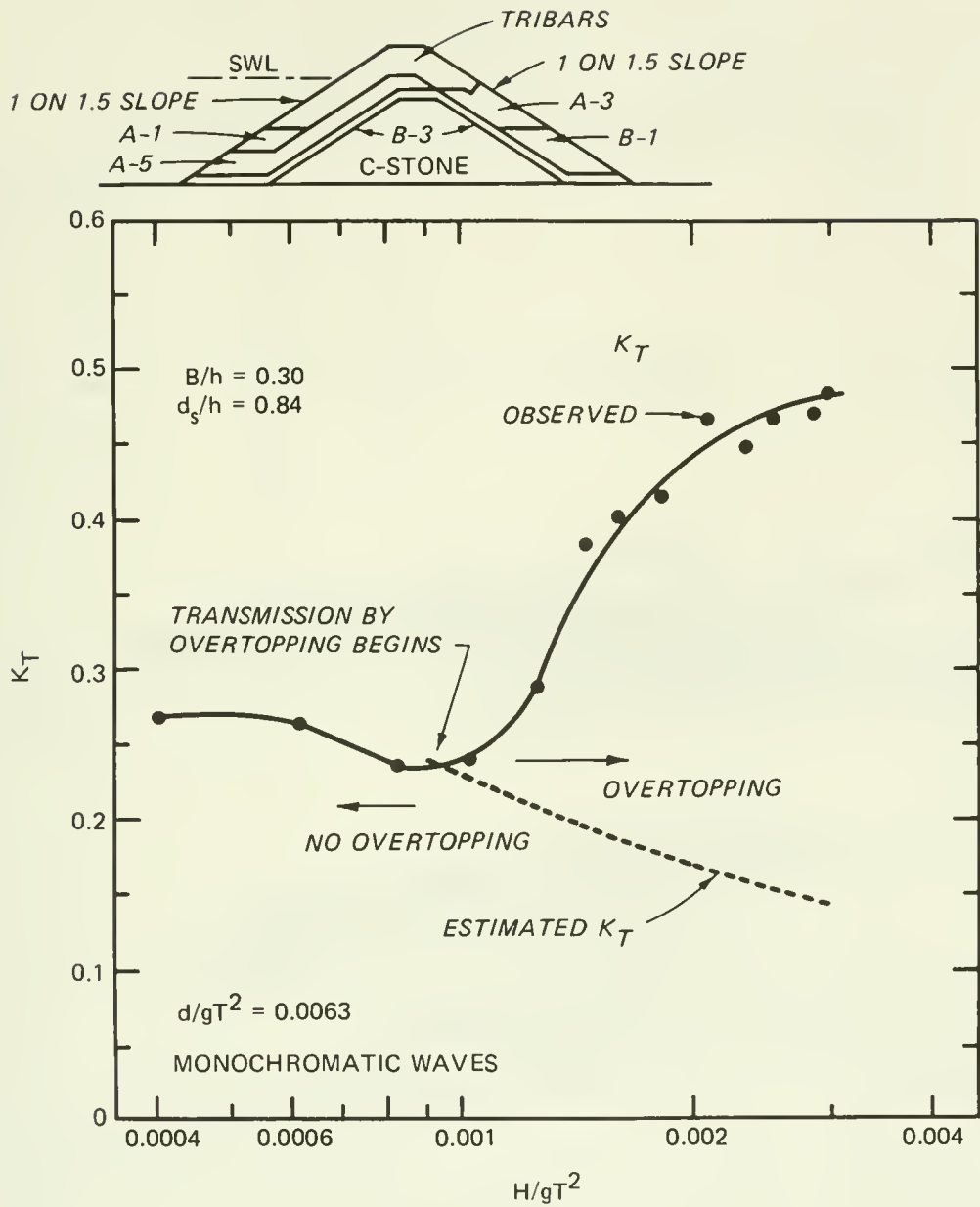

Figure 7-51. Wave transmission past a heavily overtopped breakwater with tribar armor units (laboratory data from Davidson, 1969).

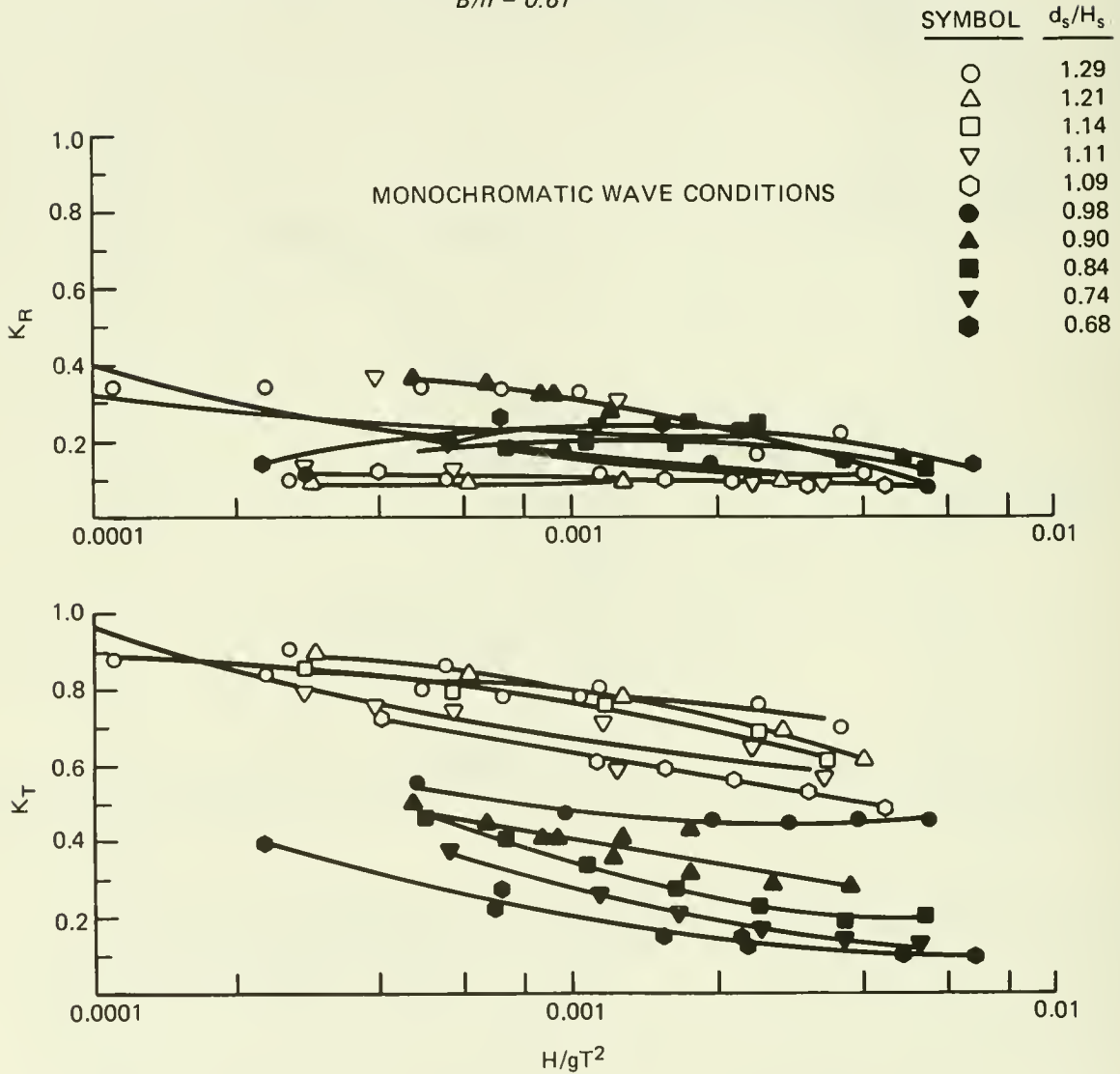
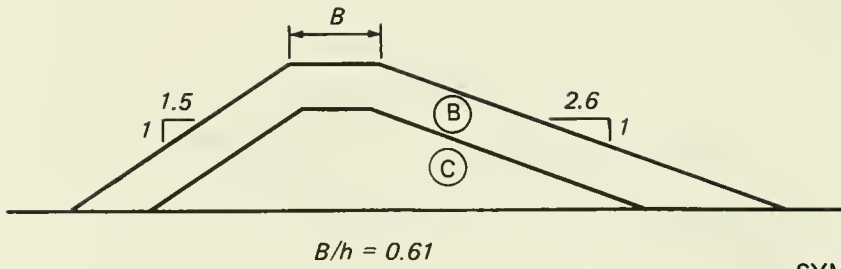

Figure 7-52. Wave transmission and reflection coefficients for a breakwater with a flat seaward slope in medium-depth water ($d/gT^2 = 0.015$).

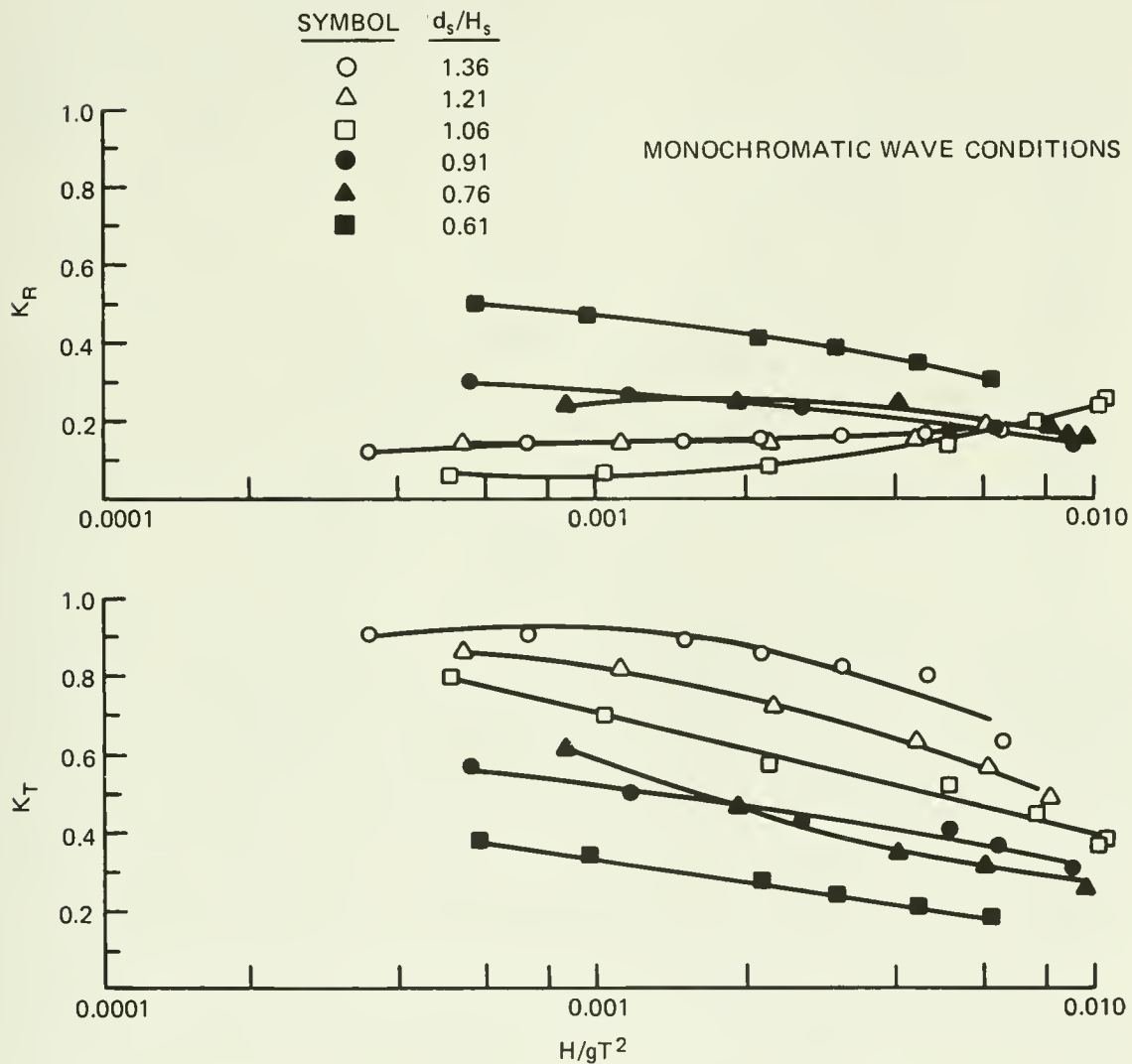
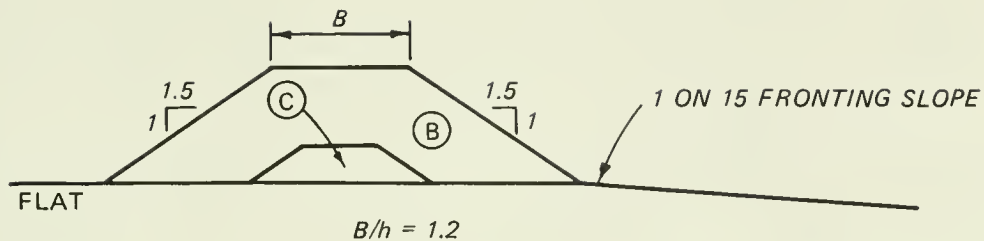

Figure 7-53. Wave transmission and reflection coefficients for a mostly armor breakwater in shallow water (d/gT^2) = 0.016.

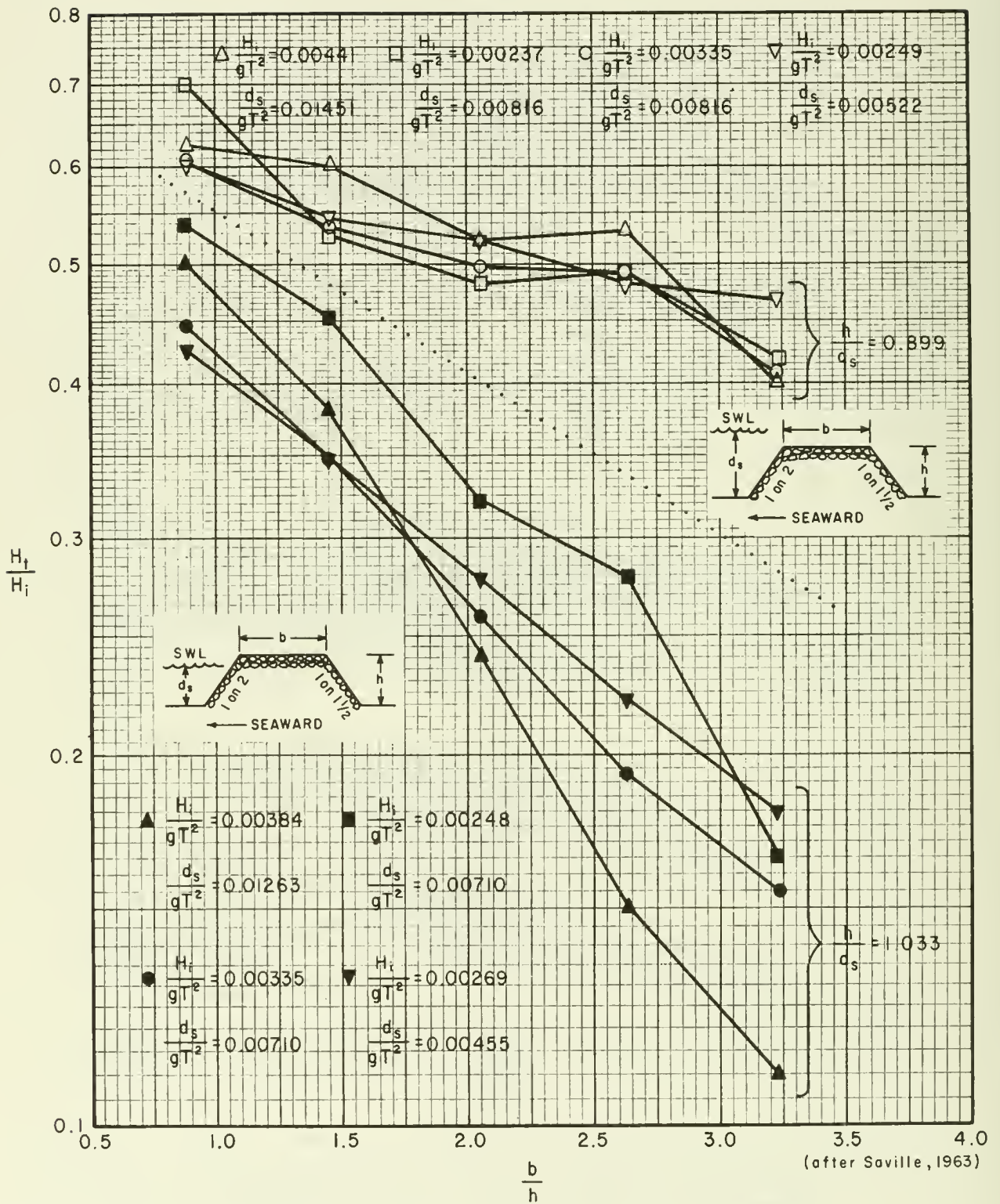

Figure 7-54. Monochromatic wave transmission, permeable rubble-mound breakwater, where $h/d_s = 1.033$.

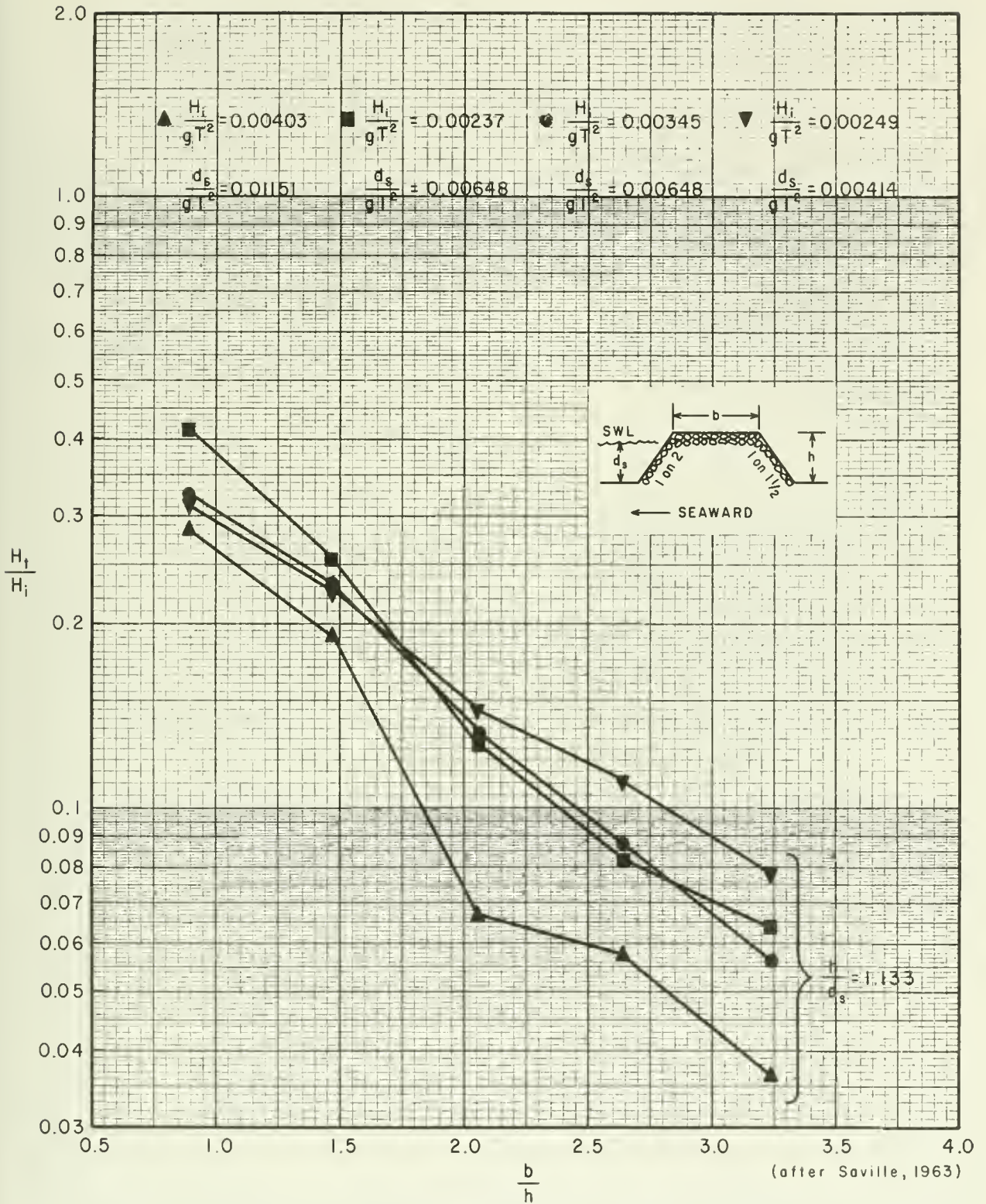
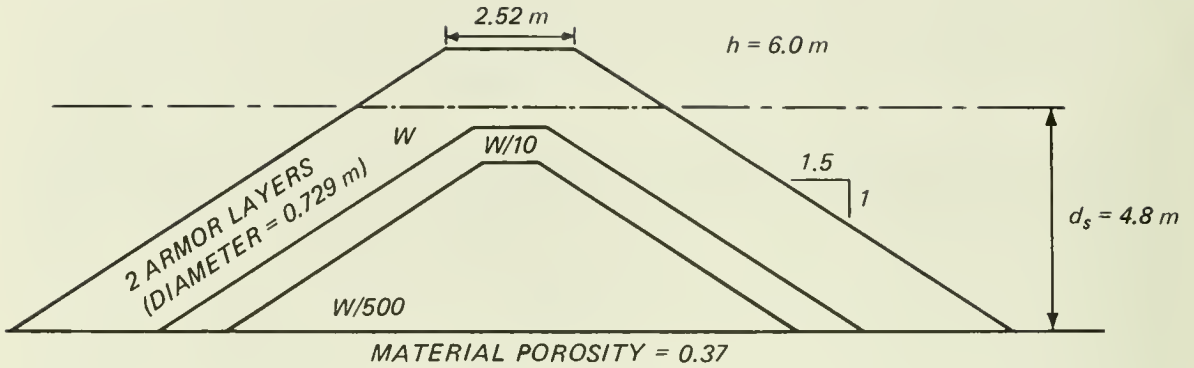

Figure 7-55. Monochromatic wave transmission, permeable rubble-mound breakwater, where $h/d_s = 1.33$.



BREAKWATER CROSS SECTION

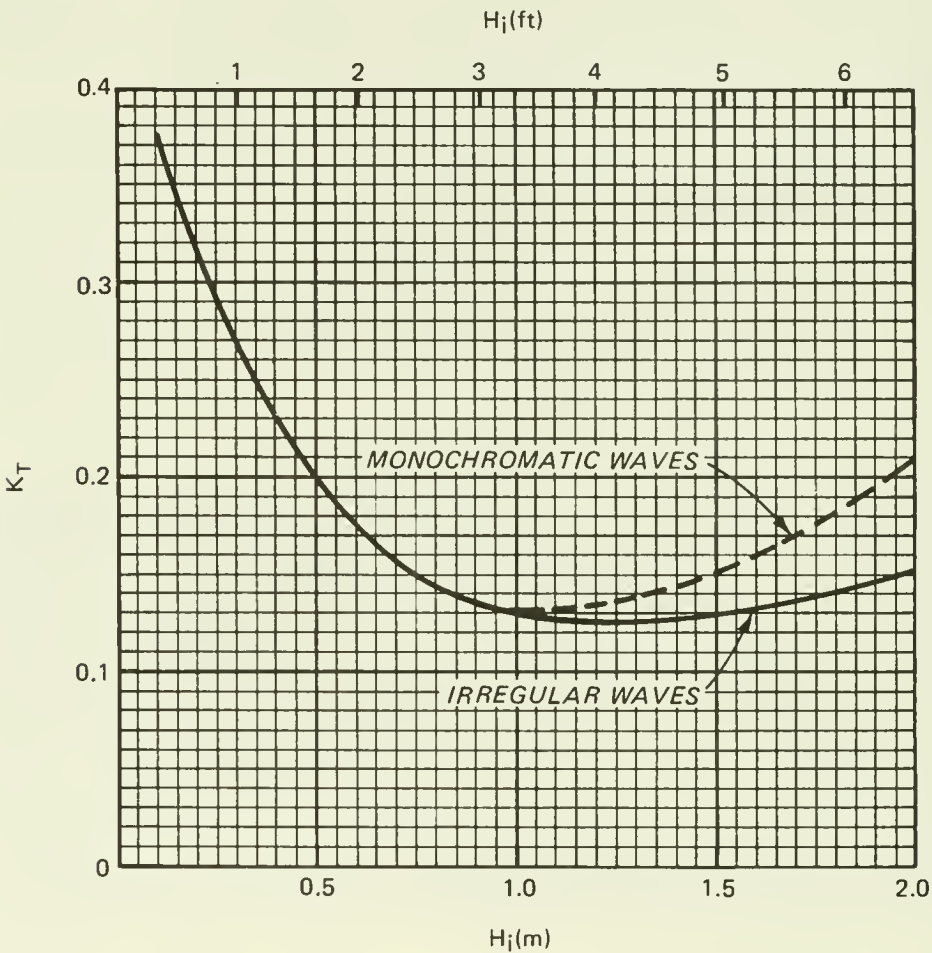

Figure 7-56. Predicted wave transmission coefficients for a rubble-mound breakwater using the computer program MADSEN ($t = 10\text{ s}$).

(c) Site-specific laboratory scale model studies are recommended, when feasible, to finalize design. The advantages of a model study are that structural stability, wave transmission, and reflection can all be examined in a single series of model tests (Hudson et al., 1979).

f. Ponding of Water Landward of Breakwaters. Wave transmission of breakwaters causes water to build up landward of breakwaters. If a breakwater completely encloses an area, the resulting ponding level can be estimated from Figure 7-57. Note that, for the special case of $F = 0$, ponding level is a weak function of deepwater steepness (Fig. 7-58). Irregular waves have lower ponding levels than swell because of reduced overtopping and seaward flow that occurs during the relatively calm intervals between wave groups.

If gaps or a harbor entrance are present, the ponding level will be lower than given in these figures due to a new seaward flow through the gaps. A method of predicting this flow rate is given in Seelig and Walton (1980).

g. Diffraction of Wave Spectra. The diffraction of monochromatic waves around semi-infinite breakwaters and through breakwater gaps of various widths is made up of numerous waves having various frequencies, each propagating within a range of directions. Goda, Takayama, and Suzuki (1978) have calculated diffraction diagrams for the propagation of irregular, directional waves past a semi-infinite breakwater and through breakwater gaps of various widths. The diagrams are based on the frequency-by-frequency diffraction of a Mitsuyasu-modified Bretschneider spectrum (Bretschneider, 1968; Mitsuyasu, 1968). The results, however, are not very sensitive to spectral shape; therefore, they probably also pertain to a JONSWAP spectrum. The results are sensitive to the amount of directional spreading of the spectrum. This spreading can be characterized by a parameter, S_{max} . Small values of S_{max} indicate a large amount of directional spreading, while large values of S_{max} indicate more nearly unidirectional waves. For wind waves within the generating area (a large amount of directional spreading), $S_{max} = 10$; for swell with short to intermediate decay distances, $S_{max} = 25$; and for swell with long decay distances (nearly unidirectional waves), $S_{max} = 75$. The amount of directional spreading for various values of S_{max} is shown in Figure 7-59. The value of S_{max} , or equivalently the amount of directional spreading, will be modified by refraction. The amount that S_{max} is changed by refraction depends on its deepwater value and on the deepwater direction of wave propagation relative to the shoreline. For refraction by straight, parallel bottom contours, the change in S_{max} is given in Figure 7-60 as a function of d/L for deepwater waves making angles of 0, 30, and 60 degrees with the shoreline.

The diffraction of waves approaching perpendicular to a semi-infinite breakwater is shown in Figures 7-61a and 7-61b for values of $S_{max} = 10$ and $S_{max} = 75$, respectively. In addition to diffraction coefficient contours, the figures show contours of equal wave period ratio. For irregular wave diffraction there is a shift in the period (or frequency) of maximum energy density (the period or frequency associated with the peak of the spectrum) since different frequencies have different diffraction coefficients at a fixed point behind the breakwater. Thus, in contrast to monochromatic waves, there will be a change in the characteristic or peak period.

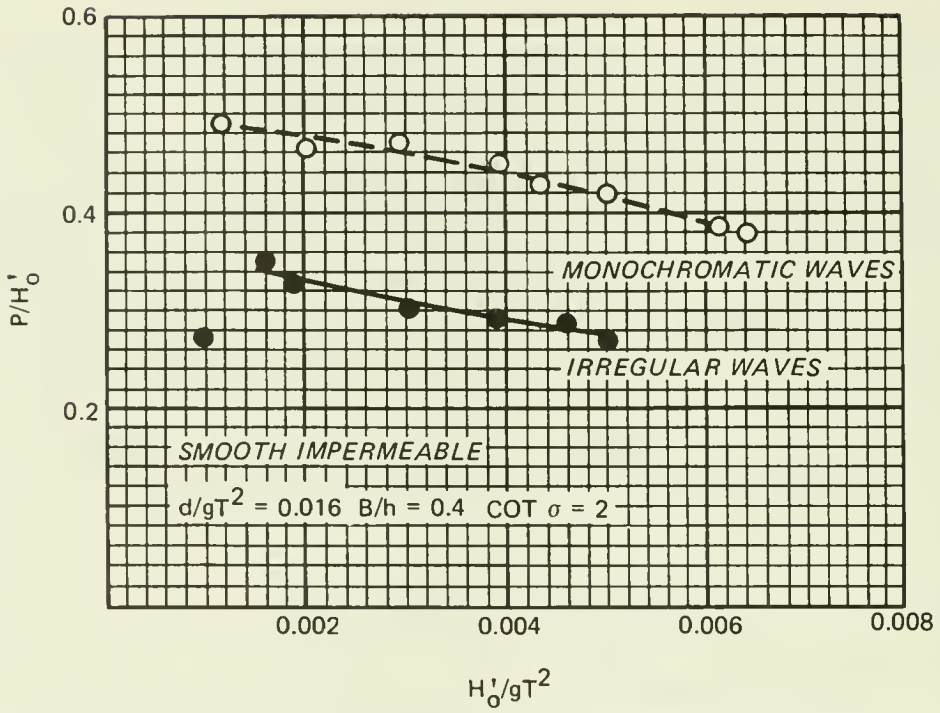

Figure 7-57. Ponding for a smooth impermeable breakwater with $F = 0$.

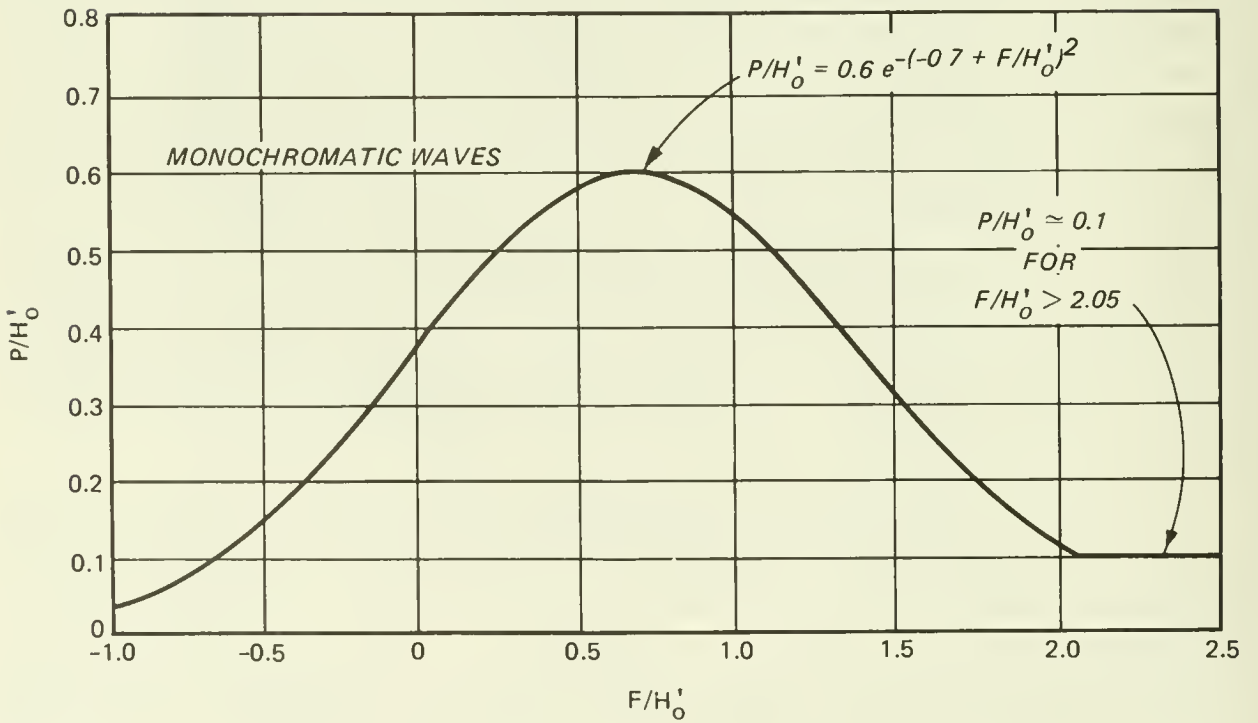

Figure 7-58. Ponding for rubble-mound breakwaters.

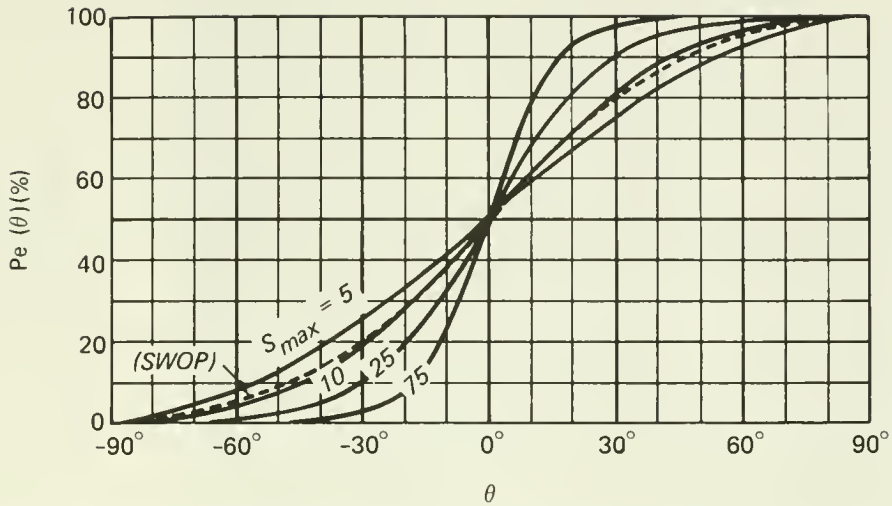

Figure 7-59. Cumulative curves of relative wave energy with respect to azimuth from the principal wave direction.

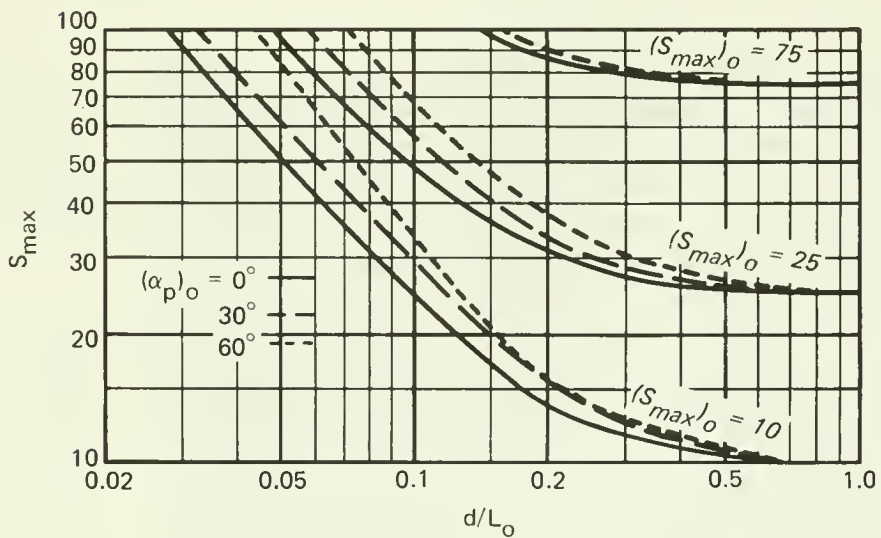
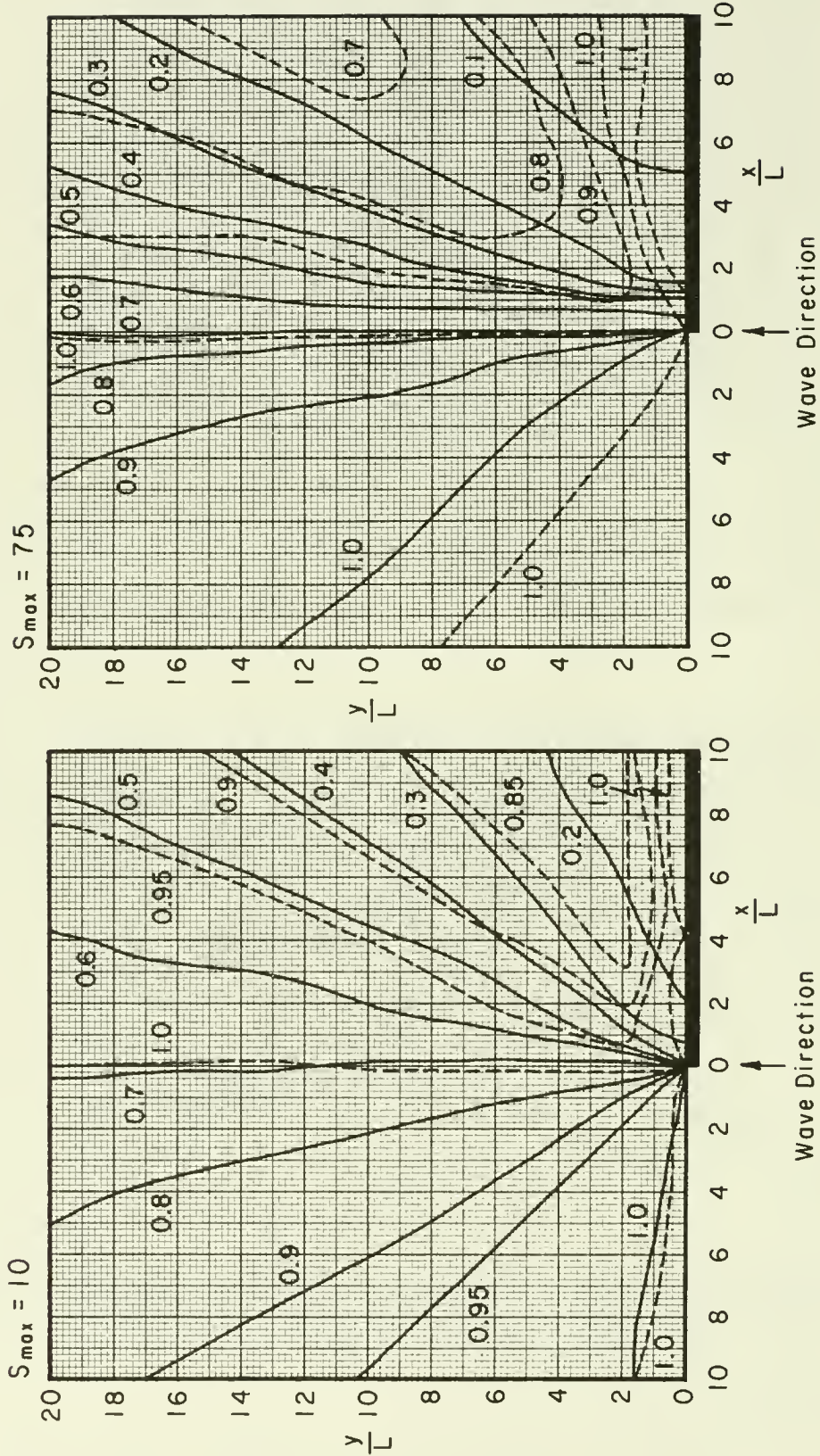

Figure 7-60. Change of maximum directional concentration parameter, S_{max} , due to wave refraction in shallow water.

—— Height Ratio
 - - - - Period Ratio



a. $S_{\max} = 10$

b. $S_{\max} = 75$

Figure 7-61. Diffraction diagrams of a semi-infinite breakwater for directional random waves of normal incidence.

GIVEN: A semi-infinite breakwater is sited in 8 meters (26.2 feet) of water. The incident wave spectrum has a significant height of 2 meters (6.56 feet) and a period of maximum energy density of 8 seconds. The waves approach generally perpendicular to the breakwater.

FIND: The significant wave height and period of maximum energy density at a point 500 meters (1640 feet) behind and 500 meters in the lee of the breakwater for wave conditions characteristic of wide directional spreading and for narrow directional spreading.

SOLUTION: Calculate the deepwater wavelength, L_o , associated with the period of maximum energy density, T_p

$$L_o = 1.56 T_p^2 = 1.56(64)$$

$$L_o = 99.84 \text{ m (327.6 ft)}$$

Therefore, $d/L_o = 8/(99.84) = 0.0801$. Entering Table C-1 with $d/L_o = 0.0801$ yields $d/L = 0.1233$. The wavelength at the breakwater tip is, therefore,

$$L = d/(0.1233)$$

$$L = 8/(0.1233) = 64.9 \text{ m (212.9 ft)}$$

The 500-meter (1640-foot) distance, therefore, translates to $500/64.9 = 7.7$ wavelengths. From Figure 7-61a, for $S_{max} = 10$ (wide directional spreading) for a point 7.7 wavelengths behind the tip and 7.7 wavelengths behind the breakwater, read the diffraction coefficient K' equals 0.32 and the period ratio equals 0.86. The significant wave height is, therefore,

$$H_s = 0.32(2) = 0.6 \text{ m (2.1 ft)}$$

and the transformed period of maximum energy density is

$$T_p = 0.86(8) = 6.9 \text{ s}$$

From Figure 7-61, for $S_{max} = 75$ (narrow spreading), read $K' = 0.15$ and the period ratio = 0.75. Therefore,

$$H_s = 0.15(2) = 0.3 \text{ m (1.0 ft)}$$

and

$$T_p = 0.75(8) = 6.0 \text{ s}$$

The spectrum with narrow spreading is attenuated more by the breakwater, but not so much as is a monochromatic wave. The monochromatic wave diffraction coefficient is approximately $K' = 0.085$; hence, the use of the monochromatic wave diffraction diagrams will underestimate the diffracted wave height.

Diffraction of directional spectra through breakwater gaps of various widths are presented in Figure 7-62 through 7-65. Each figure is for a different gap-width and shows the diffraction pattern for both wide directional spreading ($S_{\max} = 10$) and narrow directional spreading ($S_{\max} = 75$). Diagrams are given for the area near the gap (0 to 4 gap-widths behind it) and for a wider area (a distance of 20 gap-widths). Each diagram is divided into two parts. The left side gives the period ratio, while the right side gives the diffraction coefficient. Both the period ratio patterns and diffraction coefficient patterns are symmetrical about the center line of the gap. All the diagrams presented are for normal wave incidence; i.e., the center of the directional spreading pattern is along the center line of the breakwater gap. For waves approaching the gap at an angle, the same approximate method as outlined in Chapter 3 can be followed to obtain diffraction patterns.

***** EXAMPLE PROBLEM 15 *****

GIVEN: A wave spectrum at a 300-meter- (984-foot-) wide harbor entrance has a significant wave height of 3 meters (9.8 feet) and a period of maximum energy density of 10 seconds. The water depth at the harbor entrance and inside the harbor is 10 meters (32.8 feet). The waves were generated a large distance from the harbor, and there are no locally generated wind waves.

FIND: The significant wave height and period of maximum energy density at a point 1000 meters (3281 feet) behind the harbor entrance along the center line of the gap and at a point 1000 meters off the center line.

SOLUTION: Since the waves originate a long distance from the harbor, the amount of directional spreading is probably small; hence, assume $S_{\max} = 75$. Calculate the deepwater wavelength associated with the period of maximum energy density:

$$L_o = 1.56 T_p^2 = 1.56 (100)$$

$$L_o = 156 \text{ m (512 ft)}$$

Therefore

$$d/L_o = 10/156 = 0.0641$$

Entering with $d/L_o = 0.0641$, yields $d/L = 0.1083$. The wavelength at the harbor entrance is, therefore,

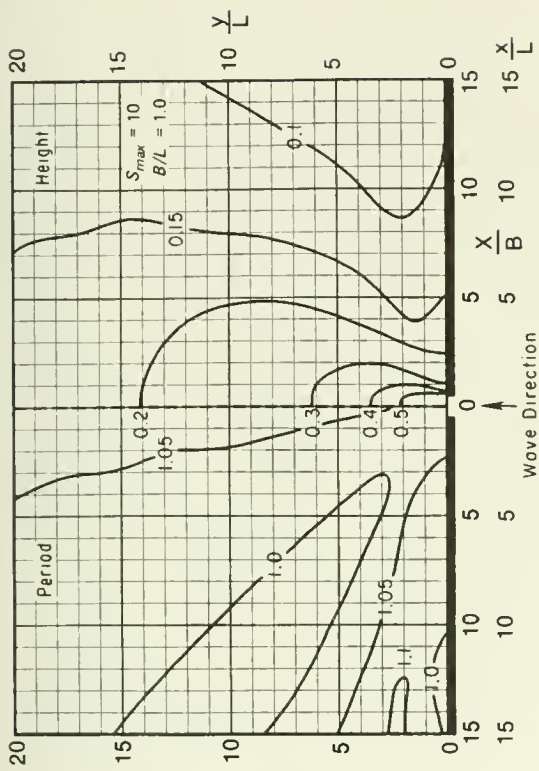

a. WHEN $S_{max} = 10$

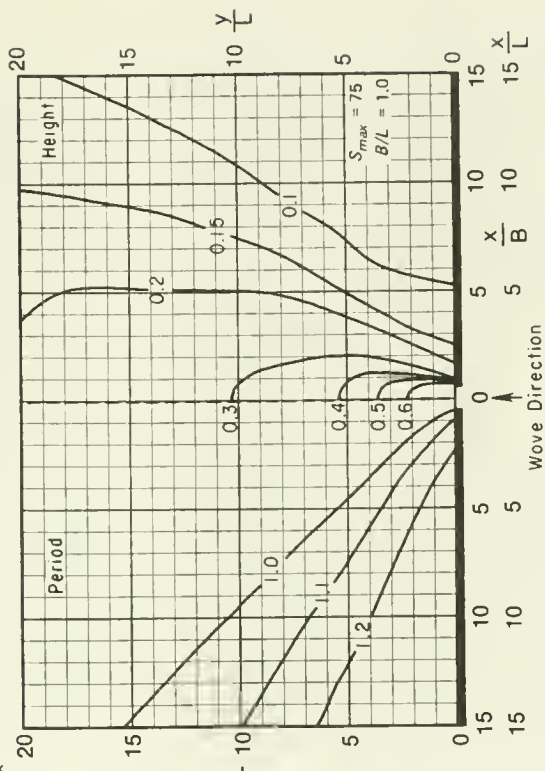

b. WHEN $S_{max} = 75$

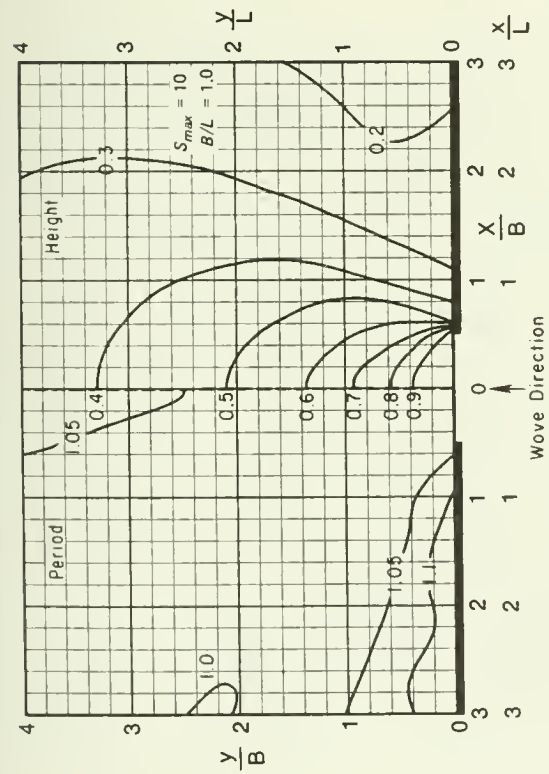

a. WHEN $S_{max} = 10$

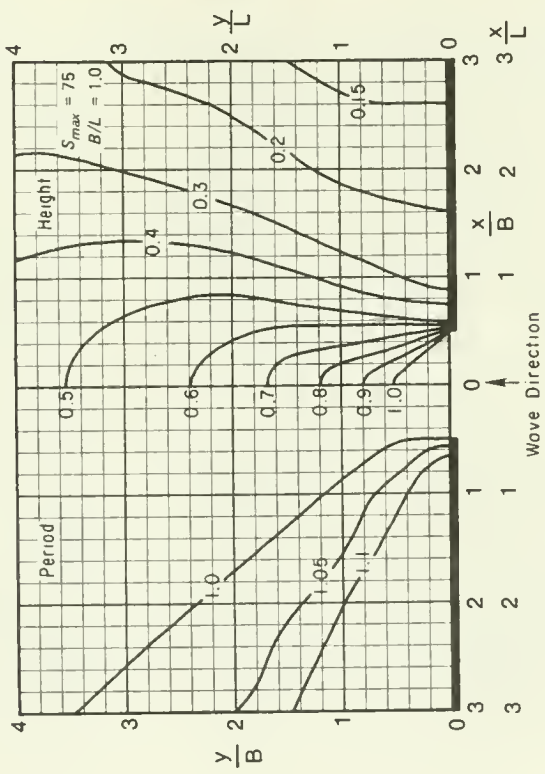

b. WHEN $S_{max} = 75$

Figure 7-62. Diffraction diagrams of a breakwater gap with $B/L = 1.0$ for directional random waves of normal incidence.

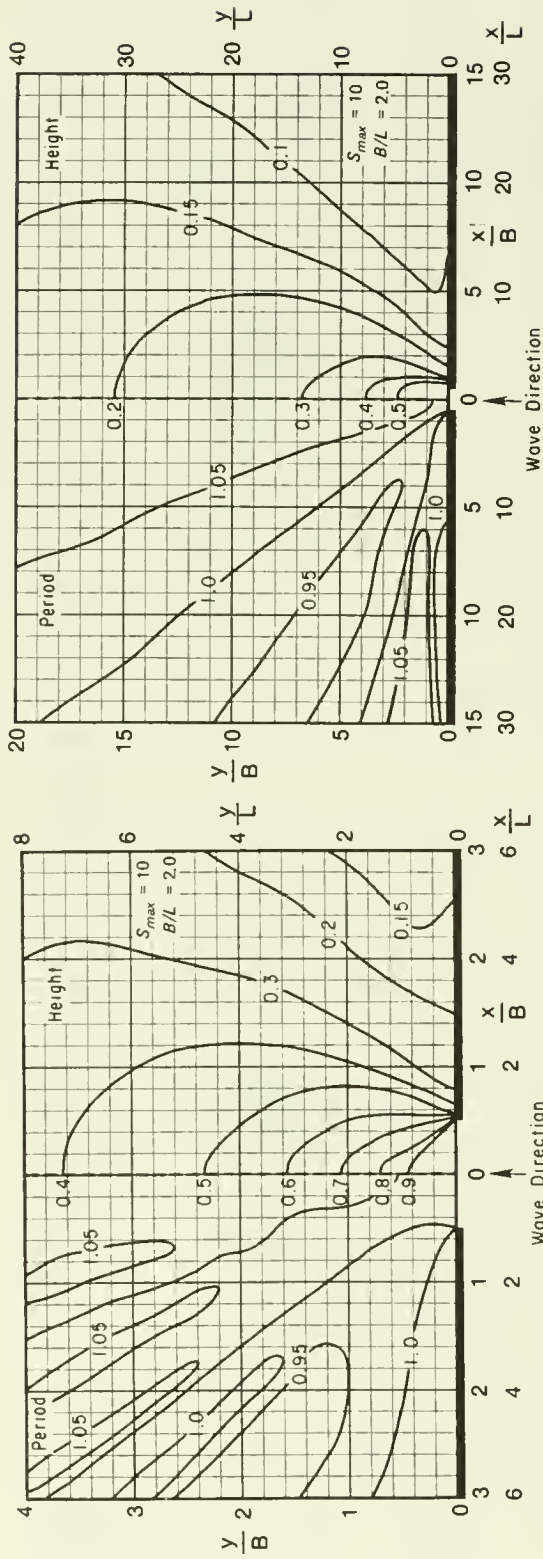

a. WHEN $S_{max} = 10$

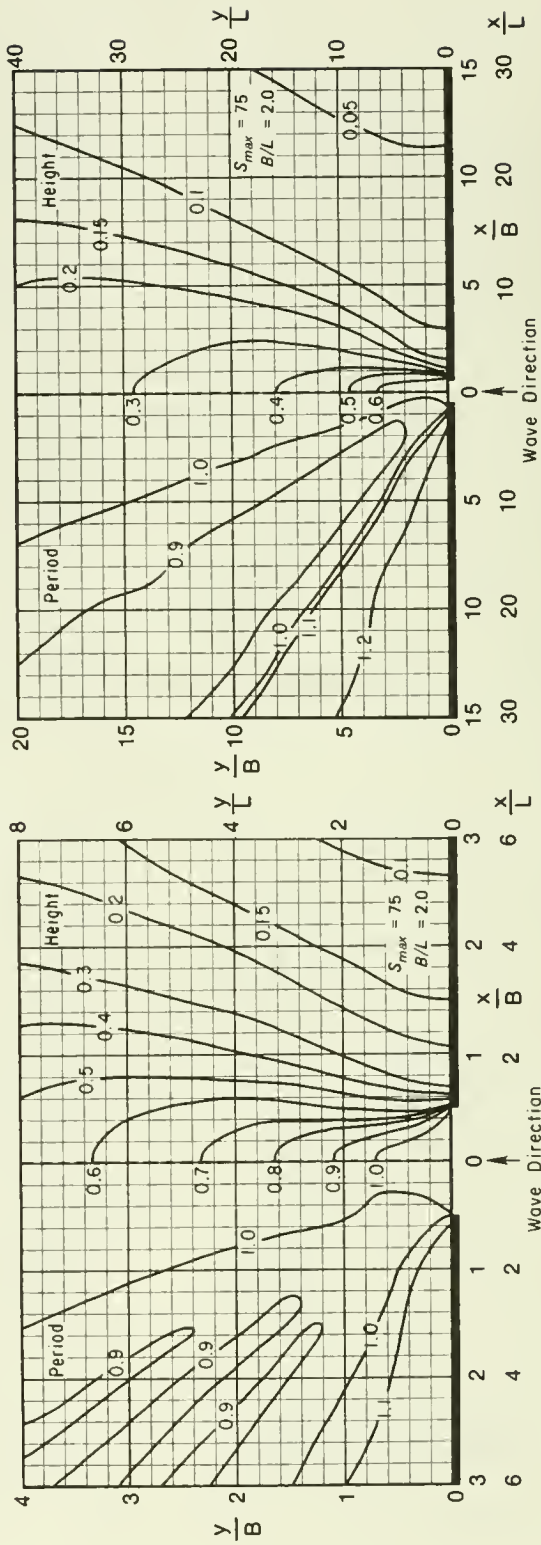

b. WHEN $S_{max} = 75$

Figure 7-63. Diffraction diagrams of a breakwater gap with $B/L = 2.0$ for directional random waves of normal incidence.

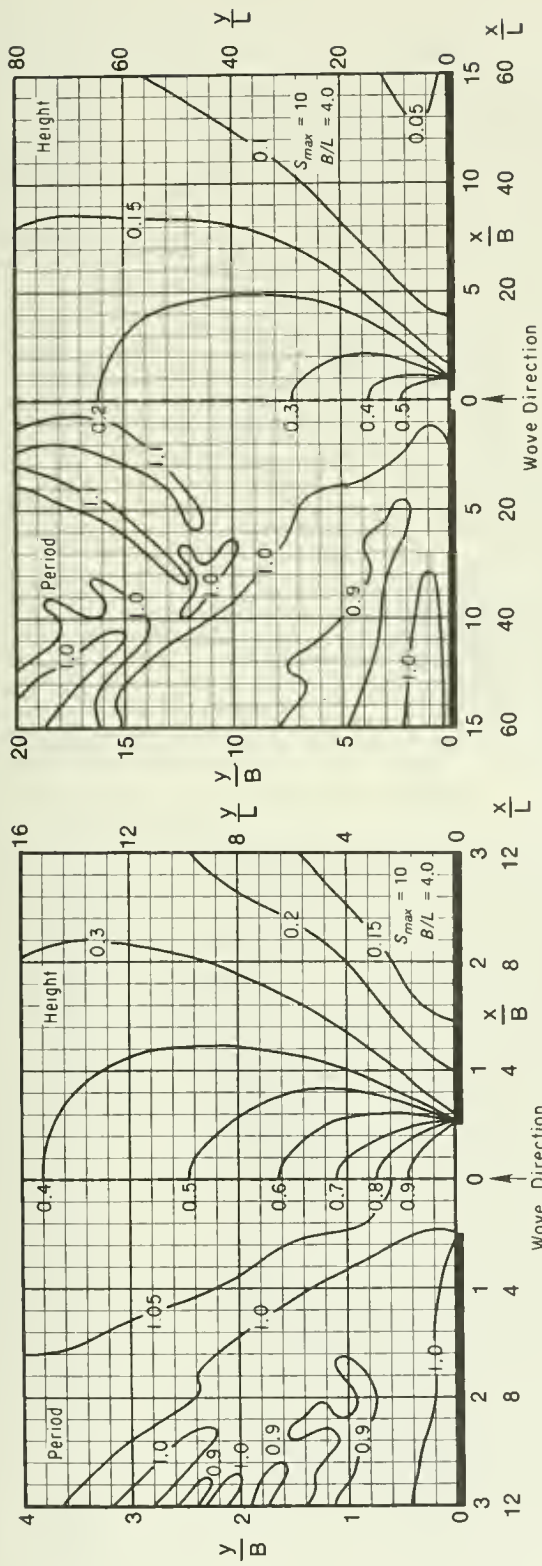

a. WHEN $S_{max} = 10$

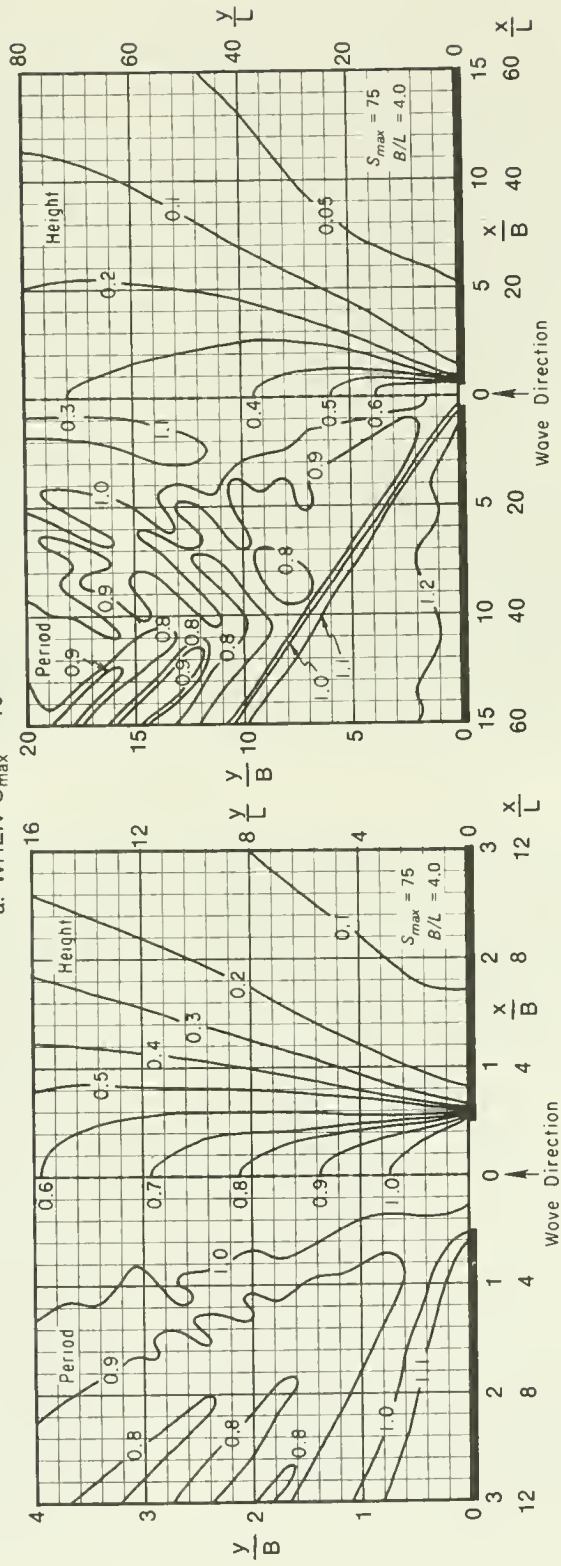

b. WHEN $S_{max} = 75$

Figure 7-64. Diffraction diagrams of a breakwater gap with $B/L = 4.0$ for directional random waves of normal incidence.

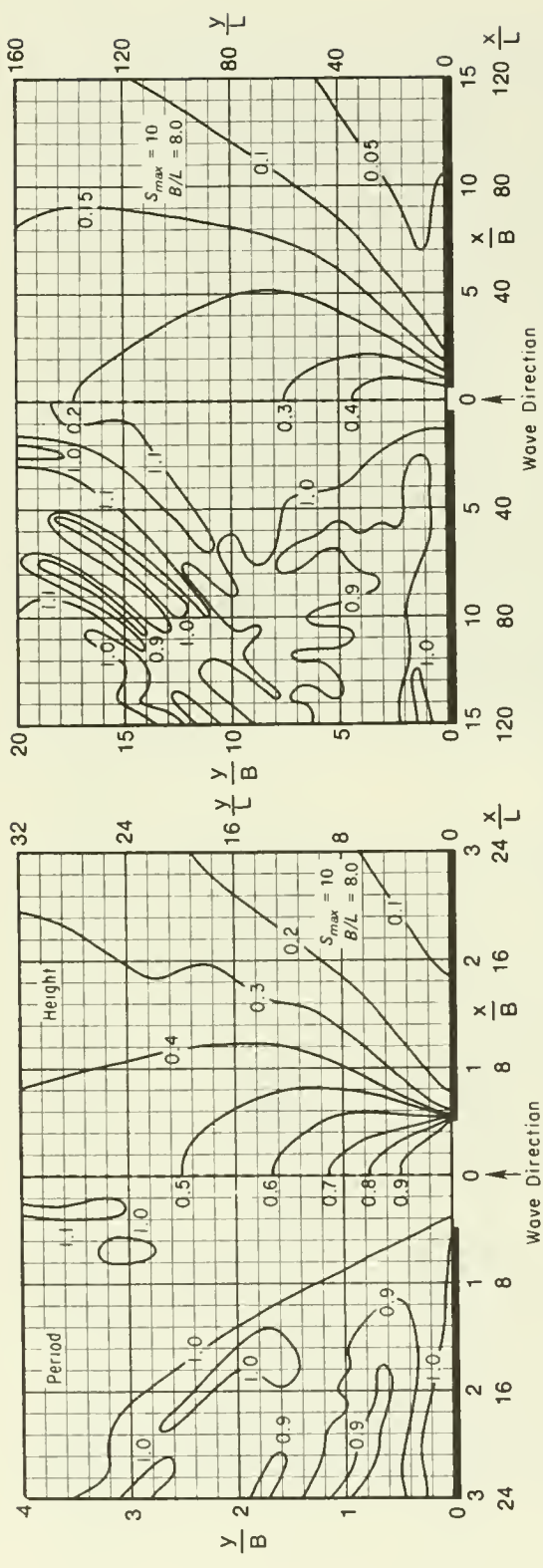

a. WHEN $S_{max} = 10$

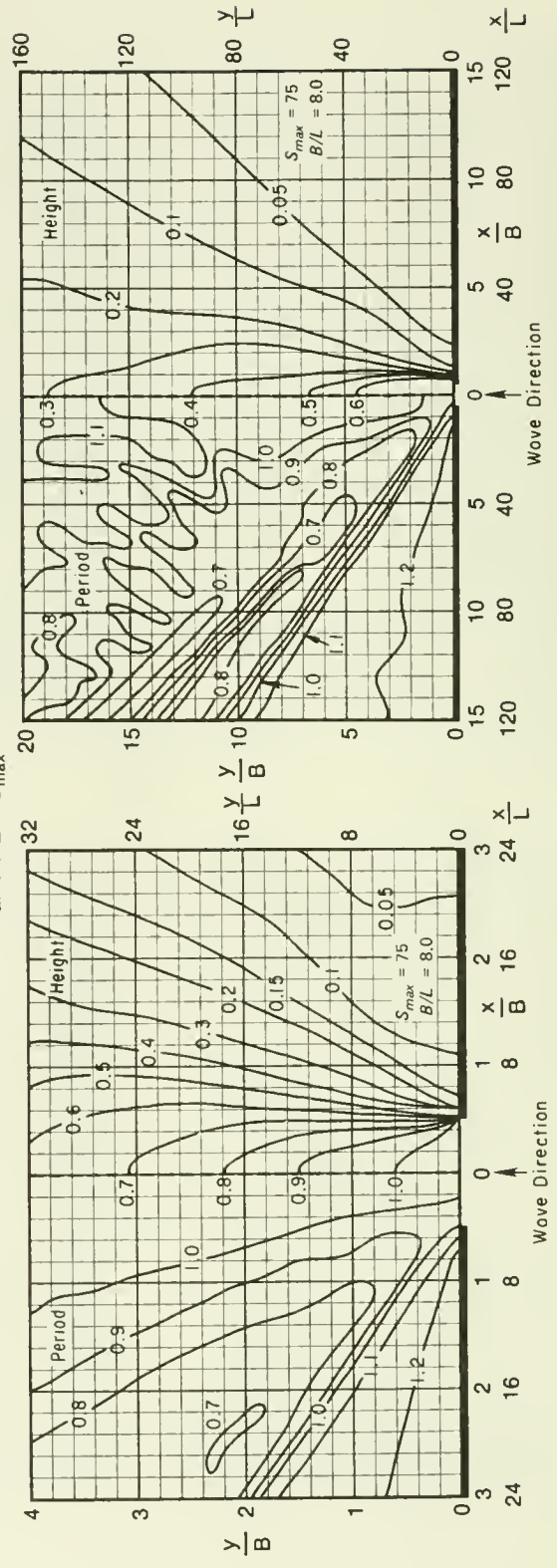

b. WHEN $S_{max} = 75$

Figure 7-65. Diffraction diagrams of a breakwater gap with $B/L = 8.0$ for directional random waves of normal incidence.

$$L = d/(0.1083)$$

$$L = 10/(0.1083) = 92.34 \text{ m (303 ft)}$$

The harbor entrance is, therefore, $300/92.3 = 3.25$ wavelengths wide; interpolation is required between Figures 7-63 and 7-64 which are for gap-widths of 2 and 4 wavelengths, respectively. From Figure 7-63, using the diagrams for $S_{\max} = 75$ and noting that 1000 meters equals 5.41 gap-widths (since $B/L = 2.0$ and, therefore, $B = 2(92.34) = 184.7$ meters (606 feet)), the diffraction coefficient 5.41 gap-widths behind the harbor entrance along the center line is found to be 0.48. The period ratio is approximately 1.0. Similarly, from Figure 7-64, the diffraction coefficient 2.71 gap-widths behind the gap is 0.72 and the period ratio is again 1.0. Note that the gap width in Figure 7-64 corresponds to a width of 4 wavelengths, since $B/L = 4.0$; therefore, $B = 4(92.34) = 369.4$ meters (1212 feet), and 1000 meters translates to $1000/(369.4) = 2.71$ gap widths. The auxiliary scales of y/L and x/L on the figures could also have been used. Interpolating,

B/L	K'	Period Ratio
2.0	0.48	1.0
3.25	0.63	1.0
4.0	0.72	1.0

The diffraction coefficient is, therefore, 0.63, and the significant wave height is

$$H_s = 0.63(3) = 1.89 \text{ m (6.2 ft)}$$

There is no change in the period of maximum energy density.

For the point 1000 meters off the center line, calculate $y/L = 1000/(92.34) = 10.83$ wavelengths, and $x/L = 1000/(92.34) = 10.83$ wavelengths. Using the auxiliary scales in Figure 7-63, read $K' = 0.11$ and a period ratio = 0.9. From Figure 7-63, read $K' = 0.15$ and a period ratio = 0.8. Interpolating,

B/L	K'	Period Ratio
2.0	0.11	0.9
3.25	0.135	0.86
4.0	0.15	0.8

The significant wave height is, therefore,

$$H_s = 0.135(3) = 0.4 \text{ m (1.3 ft)}$$

and the period of maximum energy density is

$$T_p = 0.86(10) = 8.6 \text{ s}$$

III. WAVE FORCES

The study of wave forces on coastal structures can be classified in two ways: (a) by the type of structure on which the forces act and (b) by the type of wave action against the structure. Fixed coastal structures can generally be classified as one of three types: (a) pile-supported structures such as piers and offshore platforms; (b) wall-type structures such as seawalls, bulkheads, revetments, and some breakwaters; and (c) rubble structures such as many groins, revetments, jetties and breakwaters. Individual structures are often combinations of these three types. The types of waves that can act on these structures are nonbreaking, breaking, or broken waves. Figure 7-66 illustrates the subdivision of wave force problems by structure type and by type of wave action and indicates nine types of force determination problems encountered in design.

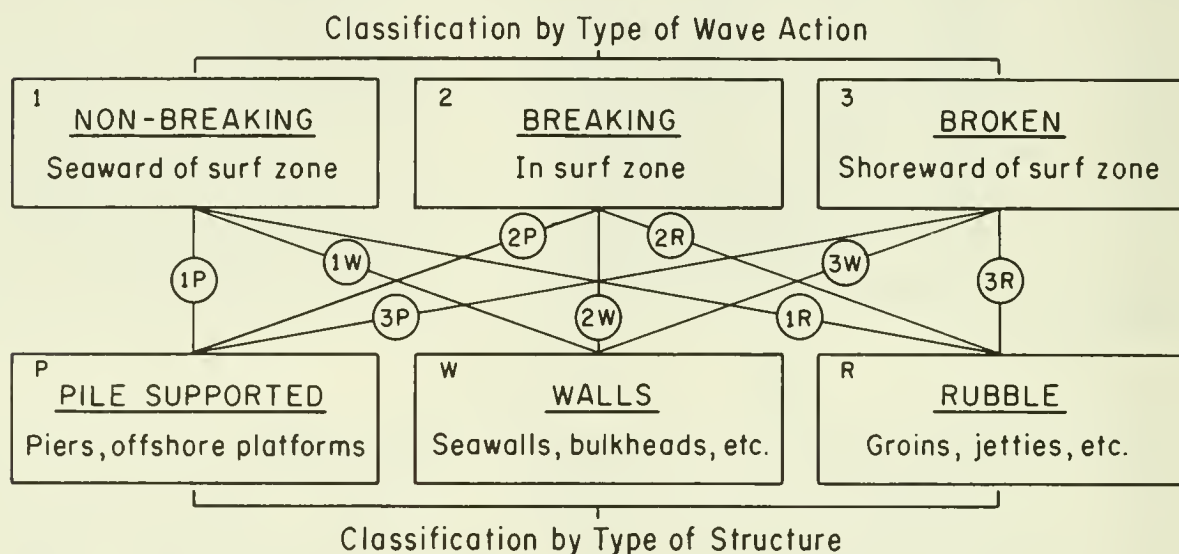

Figure 7-66. Classification of wave force problems by type of wave action and by structure type.

Rubble structure design does not require differentiation among all three types of wave action; problem types shown as 1R, 2R, and 3R on the figure need consider only nonbreaking and breaking wave design. Horizontal forces on pile-supported structures resulting from broken waves in the surf zone are usually negligible and are not considered. Determination of breaking and nonbreaking wave forces on piles is presented in Section 1 below, Forces on Piles. Non-breaking, breaking, and broken wave forces on vertical (or nearly vertical) walls are considered in Sections 2, Nonbreaking Wave Forces on Walls, 3, Breaking Wave Forces on Vertical Walls, and 4, Broken Waves. Design of rubble structures is considered in Section 7, Stability of Rubble Structures. NOTE: A careful distinction must be made between the English system use of pounds for weight, meaning force, versus the System International (SI) use of newtons for force. Also, many things measured by their weight (pounds, tons, etc.) in the English system are commonly measured by their mass (kilogram, metric ton, etc.) in countries using the SI system.

1. Forces on Piles.

a. Introduction. Frequent use of pile-supported coastal and offshore structures makes the interaction of waves and piles of significant practical importance. The basic problem is to predict forces on a pile due to the wave-associated flow field. Because wave-induced flows are complex, even in the absence of structures, solution of the complex problem of wave forces on piles relies on empirical coefficients to augment theoretical formulations of the problem.

Variables important in determining forces on circular piles subjected to wave action are shown in Figure 7-67. Variables describing nonbreaking, monochromatic waves are the wave height H , water depth d , and either wave period T , or wavelength L . Water particle velocities and accelerations in wave-induced flows directly cause the forces. For vertical piles, the horizontal fluid velocity u and acceleration du/dt and their variation with distance below the free surface are important. The pile diameter D and a dimension describing pile roughness elements ϵ are important variables describing the pile. In this discussion, the effect of the pile on the wave-induced flow is assumed negligible. Intuitively, this assumption implies that the pile diameter D must be small with respect to the wavelength L . Significant fluid properties include the fluid density ρ and the kinematic viscosity ν . In dimensionless terms, the important variables can be expressed as follows:

$$\frac{H}{gT^2} = \text{dimensionless wave steepness}$$

$$\frac{d}{gT^2} = \text{dimensionless water depth}$$

$$\frac{D}{L} = \text{ratio of pile diameter to wavelength (assumed small)}$$

$$\frac{\epsilon}{D} = \text{relative pile roughness}$$

and

$$\frac{HD}{T\nu} = \text{a form of the Reynolds' number}$$

Given the orientation of a pile in the flow field, the total wave force acting on the pile can be expressed as a function of these variables. The variation of force with distance along the pile depends on the mechanism by which the forces arise; that is, how the water particle velocities and accelerations cause the forces. The following analysis relates the local force, acting on a section of pile element of length dz , to the local fluid velocity and acceleration that would exist at the center of the pile if the pile were not present. Two dimensionless force coefficients, an inertia or mass coefficient C_M and a drag coefficient C_D , are used to establish the wave-force relationships. These coefficients are determined by experimental

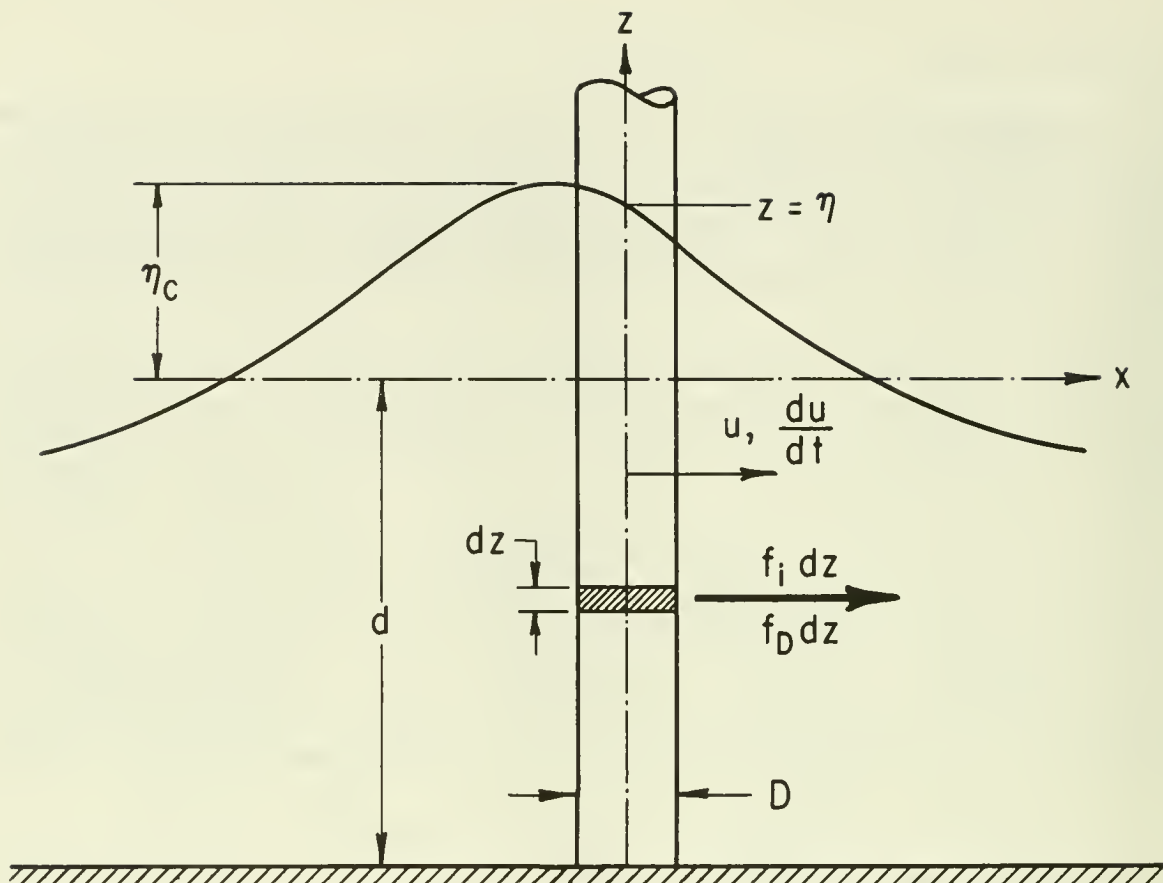

Figure 7-67. Definition sketch of wave forces on a vertical cylinder.

measurements of force, velocity, and acceleration or by measurements of force and water surface profiles, with accelerations and velocities inferred by assuming an appropriate wave theory.

The following discussion initially assumes that the force coefficients C_M and C_D are known and illustrates the calculation of forces on vertical cylindrical piles subjected to monochromatic waves. A discussion of the selection of C_M and C_D follows in Section e, Selection of Hydrodynamic Force Coefficients, C_D and C_M . Experimental data are available primarily for the interaction of nonbreaking waves and vertical cylindrical piles. Only general guidelines are given for the calculation of forces on noncircular piles.

b. Vertical Cylindrical Piles and Nonbreaking Waves: (Basic Concepts). By analogy to the mechanism by which fluid forces on bodies occur in unidirectional flows, Morison et al. (1950) suggested that the horizontal force per unit length of a vertical cylindrical pile may be expressed by the following (see Fig. 7-67 for definitions):

$$f = f_i + f_D = C_M \rho \frac{\pi D^2}{4} \frac{du}{dt} + C_D \frac{1}{2} \rho D u |u| \quad (7-20)$$

where

f_i = inertial force per unit length of pile

f_D = drag force per unit length of pile

ρ = density of fluid (1025 kilograms per cubic meter for sea water)

D = diameter of pile

u = horizontal water particle velocity at the axis of the pile
(calculated as if the pile were not there)

$\frac{du}{dt}$ = total horizontal water particle acceleration at the axis of the
pile, (calculated as if the pile were not there)

C_D = hydrodynamic force coefficient, the "drag" coefficient

C_M = hydrodynamic force coefficient, the "inertia" or "mass" coefficient

The term f_i is of the form obtained from an analysis of force on a body in an accelerated flow of an ideal nonviscous fluid. The term f_D is the drag force exerted on a cylinder in a steady flow of a real viscous fluid (f_D is proportional to u^2 and acts in the direction of the velocity u ; for flows that change direction this is expressed by writing u^2 as $u|u|$). Although these remarks support the soundness of the formulation of the problem as given by equation (7-20), it should be realized that *expressing total force by the terms f_i and f_D is an assumption* justified only if it leads to sufficiently accurate predictions of wave force.

From the definitions of u and du/dt , given in equation (7-20) as the values of these quantities at the axis of the pile, it is seen that the influence of the pile on the flow field a short distance away from the pile has been neglected. Based on linear wave theory, MacCamy and Fuchs (1954) analyzed theoretically the problem of waves passing a circular cylinder. Their analysis assumes an ideal nonviscous fluid and leads, therefore, to a force having the form of f_i . Their result, however, is valid for all ratios of pile diameter to wavelength, D/L_A , and shows the force to be about proportional to the acceleration du/dt for small values of D/L_A (L_A is the Airy approximation of wavelength). Taking their result as indicative of how small the pile should be for equation (7-20) to apply, the restriction is obtained that

$$\frac{D}{L_A} < 0.05 \quad (7-21)$$

Figure 7-68 shows the relative wavelength L_A/L_0 and pressure factor K versus d/gT^2 for the Airy wave theory.

***** EXAMPLE PROBLEM 16 *****

GIVEN: A wave with a period of $T = 5$ s, and a pile with a diameter $D = 0.3$ m (1 ft) in 1.5 m (4.9 ft) of water.

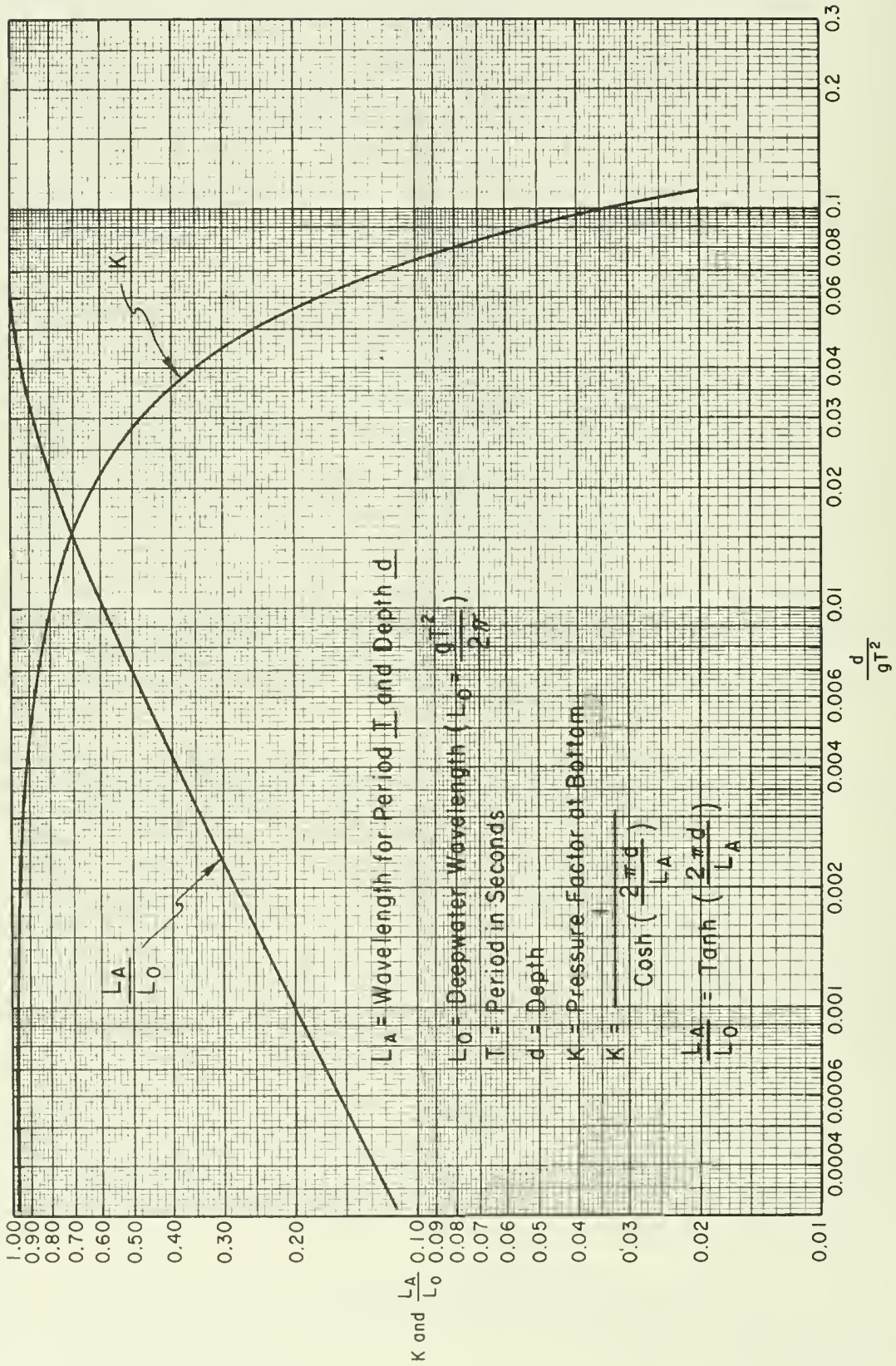

Figure 7-68. Relative wavelength and pressure factor versus d/gT^2 (Airy wave theory).

FIND: Can equation (7-20) be used to find the forces?

SOLUTION:

$$L_o = \frac{gT^2}{2\pi} = \frac{9.8(5)^2}{2\pi} = 39.0 \text{ m (128.0 ft)}$$

$$\frac{d}{gT^2} = \frac{1.5}{9.8(5)^2} = 0.0061$$

which, using Figure 7-68, gives

$$\frac{L_A}{L_o} = 0.47$$

$$L_A = 0.47 L_o = 0.47 (39.0) = 18.3 \text{ m (60.0 ft)}$$

$$\frac{D}{L_A} = \frac{0.3}{18.3} = 0.016 < 0.05$$

Since D/L_A satisfies equation (7-21), force calculations may be based on equation (7-20).

The result of the example problem indicates that the restriction expressed by equation (7-21) will seldom be violated for pile force calculations. However, this restriction is important when calculating forces on dolphins, caissons, and similar large structures that may be considered special cases of piles.

Two typical problems arise in the use of equation (7-20).

(1) Given the water depth d , the wave height H , and period T , which wave theory should be used to predict the flow field?

(2) For a particular wave condition, what are appropriate values of the coefficients C_D and C_M ?

c. Calculation of Forces and Moments. *It is assumed in this section that the coefficients C_D and C_M are known and are constants.* (For the selection of C_D and C_M see Chapter 7, Section III,1,e, Selection of Hydrodynamic Force Coefficients C_D and C_M .) To use equation (7-20), assume that the velocity and acceleration fields associated with the design wave can be described by Airy wave theory. With the pile at $x = 0$, as shown in Figure 7-67, the equations from Chapter 2 for surface elevation (eq. 2-10), horizontal velocity (eq. 2-13), and acceleration (eq. 2-15), are

$$\eta = \frac{H}{2} \cos \left(\frac{2\pi t}{T} \right) \quad (7-22)$$

$$u = \frac{H}{2} \frac{gT}{L} \frac{\cosh [2\pi (z + d)/L]}{\cosh [2\pi d/L]} \cos \left(\frac{2\pi t}{T} \right) \quad (7-23)$$

$$\frac{du}{dt} \approx \frac{\partial u}{\partial t} = \frac{g\pi H}{L} \frac{\cosh [2\pi (z + d)/L]}{\cosh [2\pi d/L]} \sin \left(-\frac{2\pi t}{T} \right) \quad (7-24)$$

Introducing these expressions into equation (7-20) gives

$$f_i = C_M \rho g \frac{\pi D^2}{4} H \left\{ \frac{\pi}{L} \frac{\cosh [2\pi (z + d)/L]}{\cosh [2\pi d/L]} \right\} \sin \left(-\frac{2\pi t}{T} \right) \quad (7-25)$$

$$f_D = C_D \frac{1}{2} \rho g D H^2 \left\{ \frac{gT^2}{4L^2} \left\{ \frac{\cosh [2\pi (z + d)/L]}{\cosh [2\pi d/L]} \right\}^2 \right\} \cos \left(\frac{2\pi t}{T} \right) \cos \left(\frac{2\pi t}{T} \right) \quad (7-26)$$

Equations (7-25) and (7-26) show that the two force components vary with elevation on the pile z and with time t . The inertia force f_i is maximum for $\sin (-2\pi t/T) = 1$, or for $t = -T/4$ for Airy wave theory. Since $t = 0$ corresponds to the wave crest passing the pile, the inertia force attains its maximum value $T/4$ sec *before* passage of the wave crest. The maximum value of the drag force component f_D coincides with passage of the wave crest when $t = 0$.

Variation in magnitude of the maximum inertia force per unit length of pile with elevation along the pile is, from equation (7-25), identical to the variation of particle acceleration with depth. The maximum value is largest at the surface $z = 0$ and decreases with depth. The same is true for the drag force component f_D ; however, the decrease with depth is more rapid since the attenuation factor, $\cosh [2\pi(z + d)/L]/\cosh[2\pi d/L]$, is squared. For a quick estimate of the variation of the two force components relative to their respective maxima, the curve labeled $K = 1/\cosh[2\pi d/L]$ in Figure 7-68 can be used. The ratio of the force at the bottom to the force at the surface is equal to K for the inertia forces, and to K^2 for the drag forces.

The design wave will usually be too high for Airy theory to provide an accurate description of the flow field. Nonlinear theories in Chapter 2 showed that wavelength and elevation of wave crest above stillwater level depend on wave steepness and the *wave height-water depth* ratio. The influence of steepness on crest elevation η_c and wavelength is presented graphically in Figures 7-69 and 7-70. The use of these figures is illustrated by the following examples.

***** EXAMPLE PROBLEM 17 *****

GIVEN: Depth $d = 4.5$ m (14.8 ft), wave height $H = 3.0$ m (9.8 ft), and wave period $T = 10$ s.

FIND: Crest elevation above stillwater level, wavelength, and relative variation of force components along the pile.

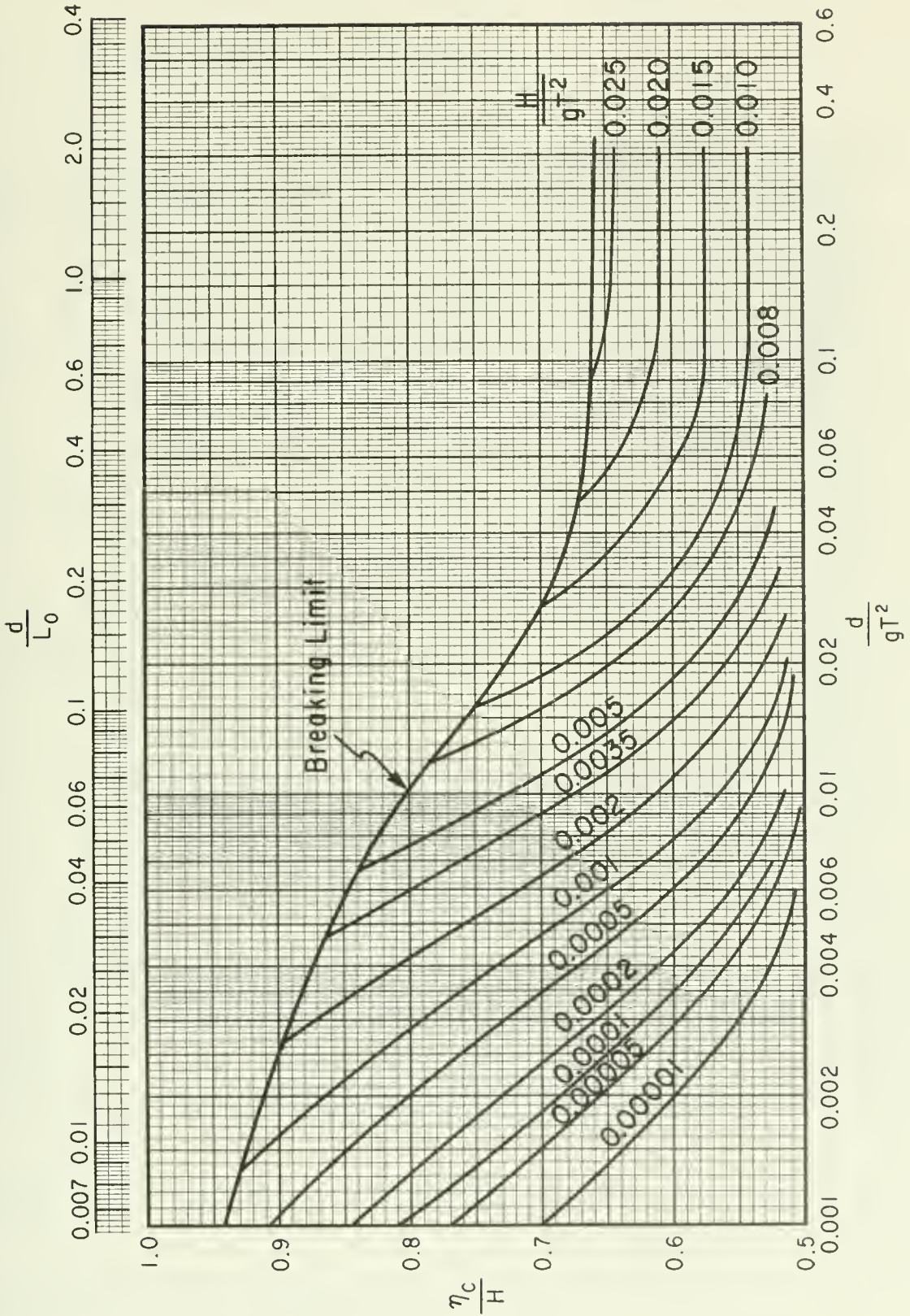
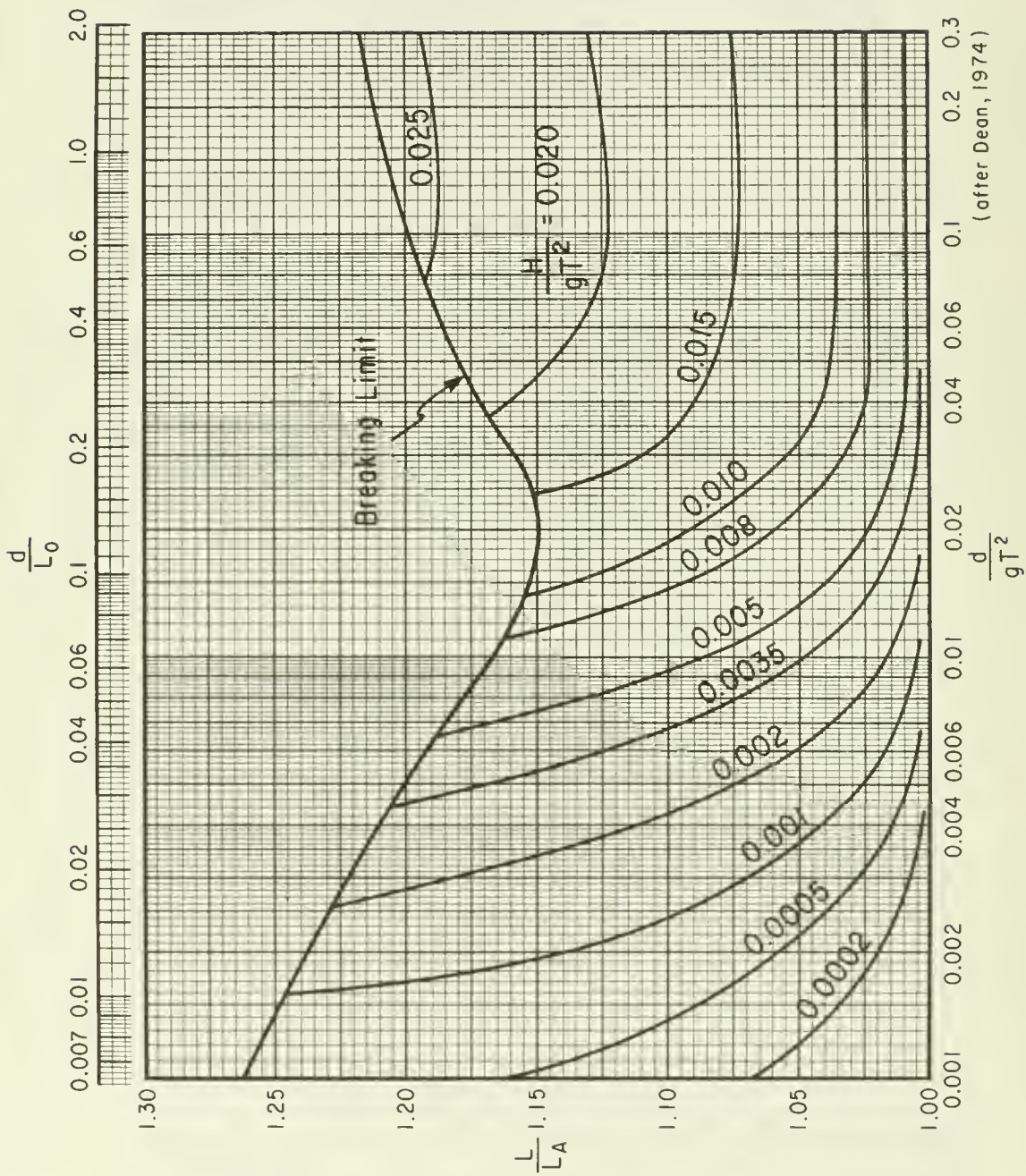

Figure 7-69. Ratio of crest elevation above still-water level to wave height.



(after Dean, 1974)

Figure 7-70. Wavelength correction factor for finite amplitude effects.

SOLUTION: Calculate,

$$\frac{d}{gT^2} = \frac{4.5}{9.8(10)^2} = 0.0046$$

$$\frac{H}{gT^2} = \frac{3.0}{9.8(10)^2} = 0.0031$$

From Figure 7-68,

$$L_A = 0.41 L_O = (0.41) \left(\frac{9.8}{2\pi} \right) T^2 = 63.9 \text{ m (209.7 ft)}$$

From Figure 7-69,

$$\eta_c = 0.85 H = 2.6 \text{ m (8.5 ft)}$$

From Figure 7-70,

$$L = 1.165 L_A = 1.165 (63.9) = 74.4 \text{ m (244.1 ft)}$$

and from Figure 7-68,

$$K = \frac{f_i(z = -d)}{f_i(z = 0)} = 0.9$$

$$K^2 = \frac{f_D(z = -d)}{f_D(z = 0)} = 0.81$$

Note the large increase in η_c above the Airy estimate of $H/2 = 1.5 \text{ m (4.9 ft)}$ and the relatively small change of drag and inertia forces along the pile. The wave condition approaches that of a long wave or shallow-water wave.

***** EXAMPLE PROBLEM 18 *****

GIVEN: Same wave conditions as preceding problem: $H = 3.0 \text{ m (9.8 ft)}$ and $T = 10 \text{ s}$; however, the depth $d = 30.0 \text{ m (98.4 ft)}$.

FIND: Crest elevation above stillwater level, wavelength, and the relative variation of force components along the pile.

SOLUTION: Calculate,

$$\frac{d}{gT^2} = \frac{30.0}{9.8 (10)^2} = 0.031$$

$$\frac{H}{gT^2} = \frac{3.0}{9.8 (10)^2} = 0.0031$$

From Figure 7-68,

$$L_A = 0.89 L_O = 0.89 \left(\frac{9.8}{2\pi} \right) T^2 = 138.8 \text{ m (455.4 ft)}$$

From Figure 7-69,

$$\eta_e = 0.52 H = 0.52(3.0) = 1.6 \text{ m (5.1 ft)}$$

From Figure 7-70,

$$L = 1.01 L_A = 1.01 (138.8) = 140.2 \text{ m (459.9 ft)}$$

and from Figure 7-68,

$$K = \frac{f_z(z = -d)}{f_z(z = 0)} = 0.46$$

$$K^2 = \frac{f_D(z = -d)}{f_D(z = 0)} = 0.21$$

Note the large decrease in forces with depth. The wave condition approaches that of a deepwater wave.

For force calculations, an appropriate wave theory should be used to calculate u and du/dt . Skjelbreia, et al. (1960) have prepared tables based on Stokes' fifth-order wave theory. For a wide variety of given wave conditions (i.e., water depth, wave period, and wave height) these tables may be used to obtain the variation of f_z and f_D with time (values are given for time intervals of $2\pi t/T = 20^\circ$) and position along the pile (values given at intervals of 0.1 d). Similar tables based on Dean's numerical stream-function theory (Dean, 1965b) are published in Dean (1974).

For structural design of a single vertical pile, it is often unnecessary to know in detail the distribution of forces along the pile. Total horizontal

force (F) acting on the pile and total moment of forces (M) about the mud line $z = -d$ are of primary interest. These may be obtained by integration of equation (7-20).

$$F = \int_{-d}^{\eta} f_i dz + \int_{-d}^{\eta} f_D dz = F_i + F_D \quad (7-27)$$

$$M = \int_{-d}^{\eta} (z+d) f_i dz + \int_{-d}^{\eta} (z+d) f_D dz = M_i + M_D \quad (7-28)$$

In general form these quantities may be written

$$F_i = C_M \rho g \frac{\pi D^2}{4} H K_i \quad (7-29)$$

$$F_D = C_D \frac{1}{2} \rho g D H^2 K_D \quad (7-30)$$

$$M_i = C_M \rho g \frac{\pi D^2}{4} H K_i d S_i = F_i d S_i \quad (7-31)$$

$$M_D = C_D \frac{1}{2} \rho g D H^2 K_D d S_D = F_D d S_D \quad (7-32)$$

in which C_D and C_M have been assumed constant and where K_i , K_D , S_i , and S_D are dimensionless. When using Airy theory (eqs. 7-25 and 7-26), the integration indicated in equations (7-27) and (7-28) may be performed if the upper limit of integration is zero instead of η . This leads to

$$K_i = \frac{1}{2} \tanh \left(\frac{2\pi d}{L} \right) \sin \left(-\frac{2\pi t}{T} \right) \quad (7-33)$$

$$K_D = \frac{1}{8} \left(1 + \frac{4\pi d/L}{\sinh [4\pi d/L]} \right) \left| \cos \left(\frac{2\pi t}{T} \right) \right| \cos \left(\frac{2\pi t}{T} \right) \quad (7-34)$$

$$= \frac{1}{4} n \left| \cos \left(\frac{2\pi t}{T} \right) \right| \cos \left(\frac{2\pi t}{T} \right)$$

$$S_i = 1 + \frac{1 - \cosh [2\pi d/L]}{(2\pi d/L) \sinh [2\pi d/L]} \quad (7-35)$$

$$S_D = \frac{1}{2} + \frac{1}{2n} \left(\frac{1}{2} + \frac{1 - \cosh [4\pi d/L]}{(4\pi d/L) \sinh [4\pi d/L]} \right) \quad (7-36)$$

where $n = C_g/C$ has been introduced to simplify the expressions. From equations (7-33) and (7-34), the maximum values of the various force and moment components can be written

$$F_{im} = C_M \rho g \frac{\pi D^2}{4} H K_{im} \quad (7-37)$$

$$F_{Dm} = C_D \frac{1}{2} \rho g D H^2 K_{Dm} \quad (7-38)$$

$$M_{im} = F_{im} d S_i \quad (7-39)$$

$$M_{Dm} = F_{Dm} d S_D \quad (7-40)$$

where K_{im} and K_{Dm} according to Airy theory are obtained from equations (7-33) and (7-34) taking $t = -T/4$ and $t = 0$, respectively and S_i and S_D are given by equations (7-35) and (7-36) respectively.

Equations (7-37) through (7-40) are general. Using Dean's stream-function theory (Dean, 1974), the graphs in Figures 7-71 through 7-74 have been prepared and may be used to obtain K_{im} , K_{Dm} , S_{im} , and S_{Dm} . S_i and S_D , as given in equations (7-35) and (7-36) for Airy theory, are independent of wave phase angle θ and thus are equal to the maximum values. For stream-function and other finite amplitude theories, S_i and S_D depend on phase angle; Figures 7-73 and 7-74 give maximum values, S_{im} and S_{Dm} . The degree of nonlinearity of a wave can be described by the ratio of wave height to the breaking height, which can be obtained from Figure 7-75 as illustrated by the following example.

***** EXAMPLE PROBLEM 19 *****

GIVEN: A design wave $H = 3.0$ m (9.8 ft) with a period $T = 8$ s in a depth $d = 12.0$ m (39.4 ft).

FIND: The ratio of wave height to breaking height.

SOLUTION: Calculate

$$\frac{d}{gT^2} = \frac{12.0}{(9.8)(8)^2} = 0.0191$$

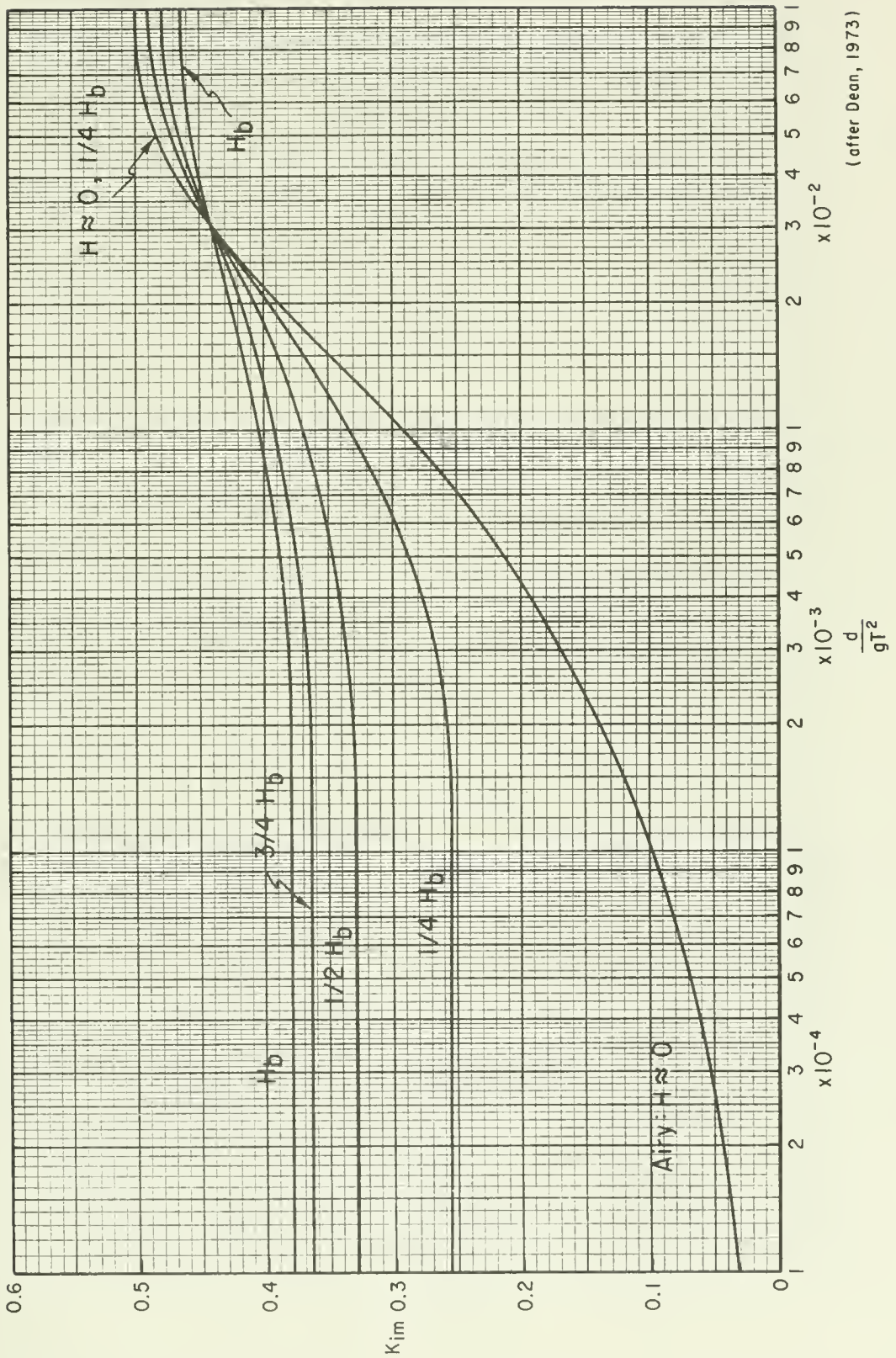

Figure 7-71. K_{im} versus relative depth, d/gT^2 .

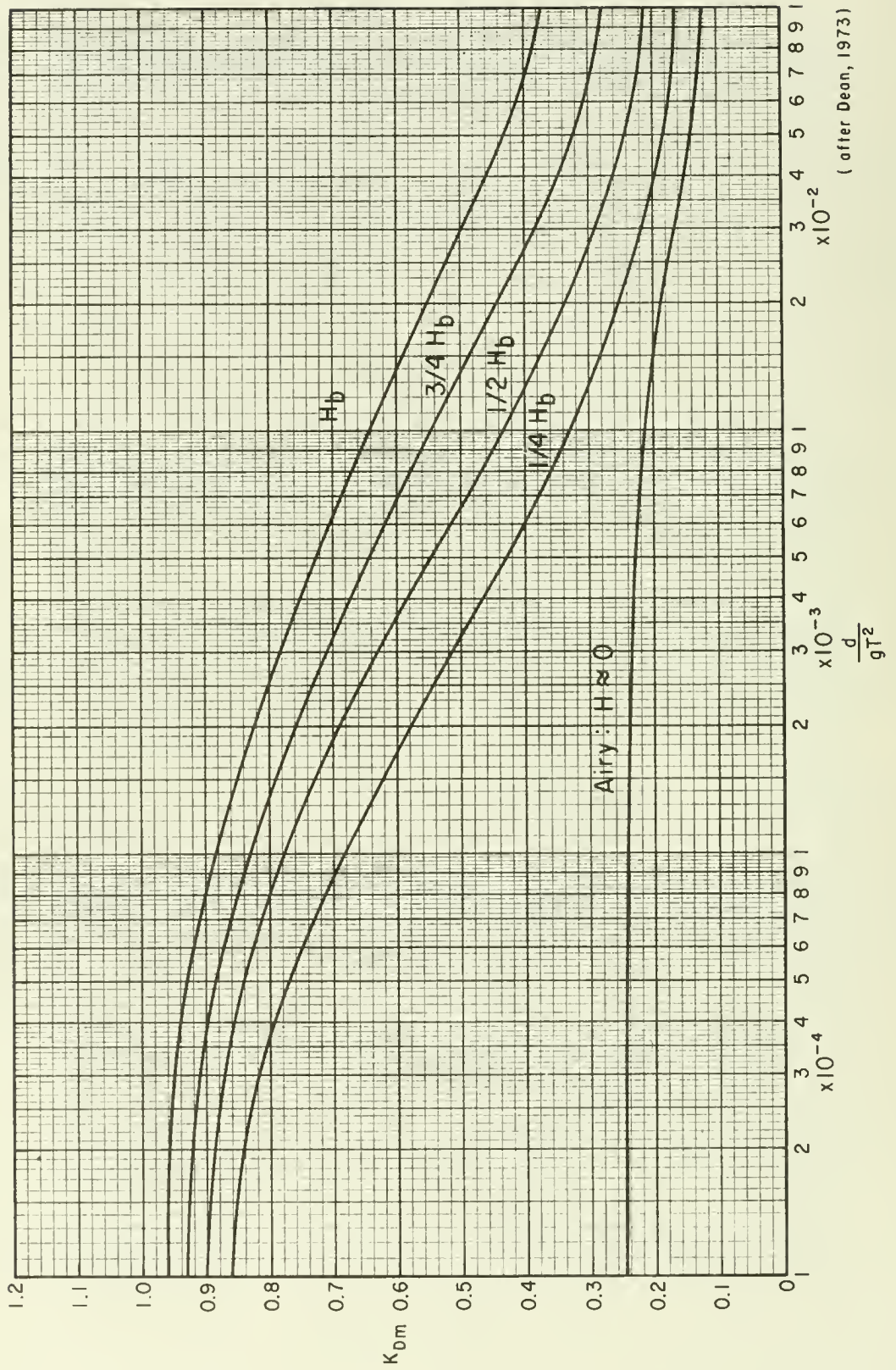

Figure 7-72. K_{Dm} versus relative depth, d/gT^2 .

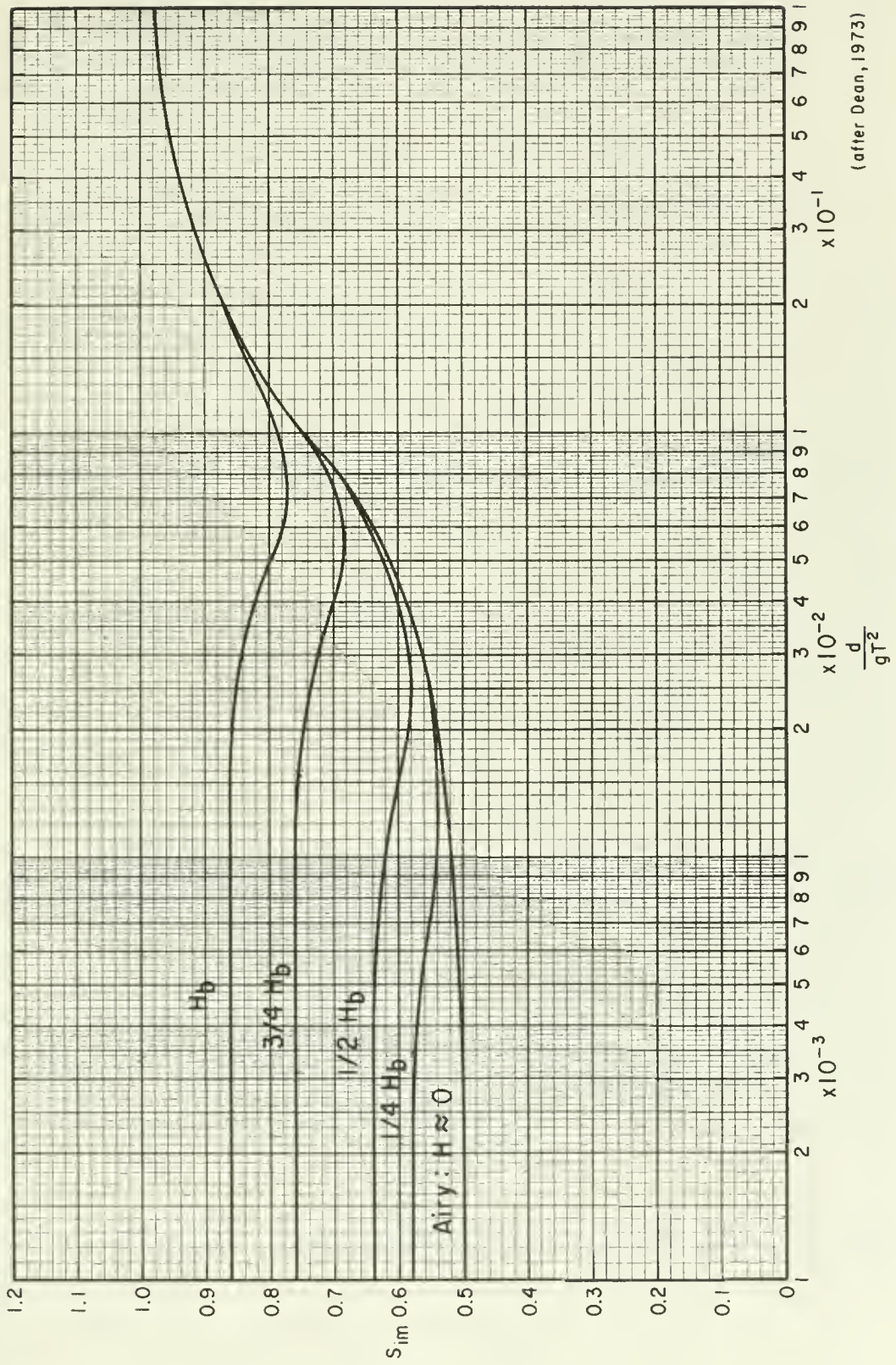

Figure 7-73. Inertia force moment arm, S_{im} , versus relative depth, d/gT^2 .

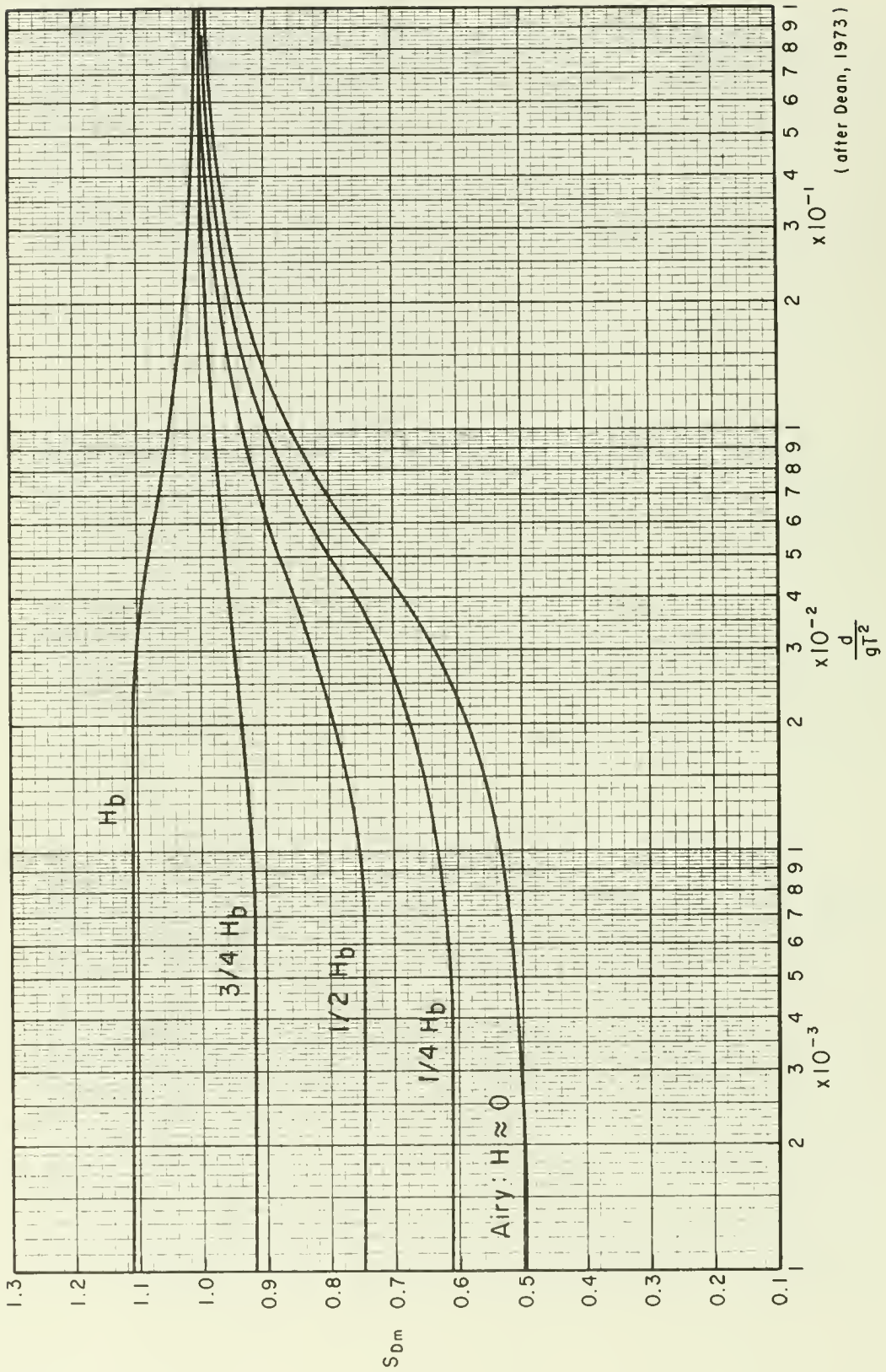

Figure 7-74. Drag force moment arm, S_{Dm} , versus relative depth, d/gT^2 .

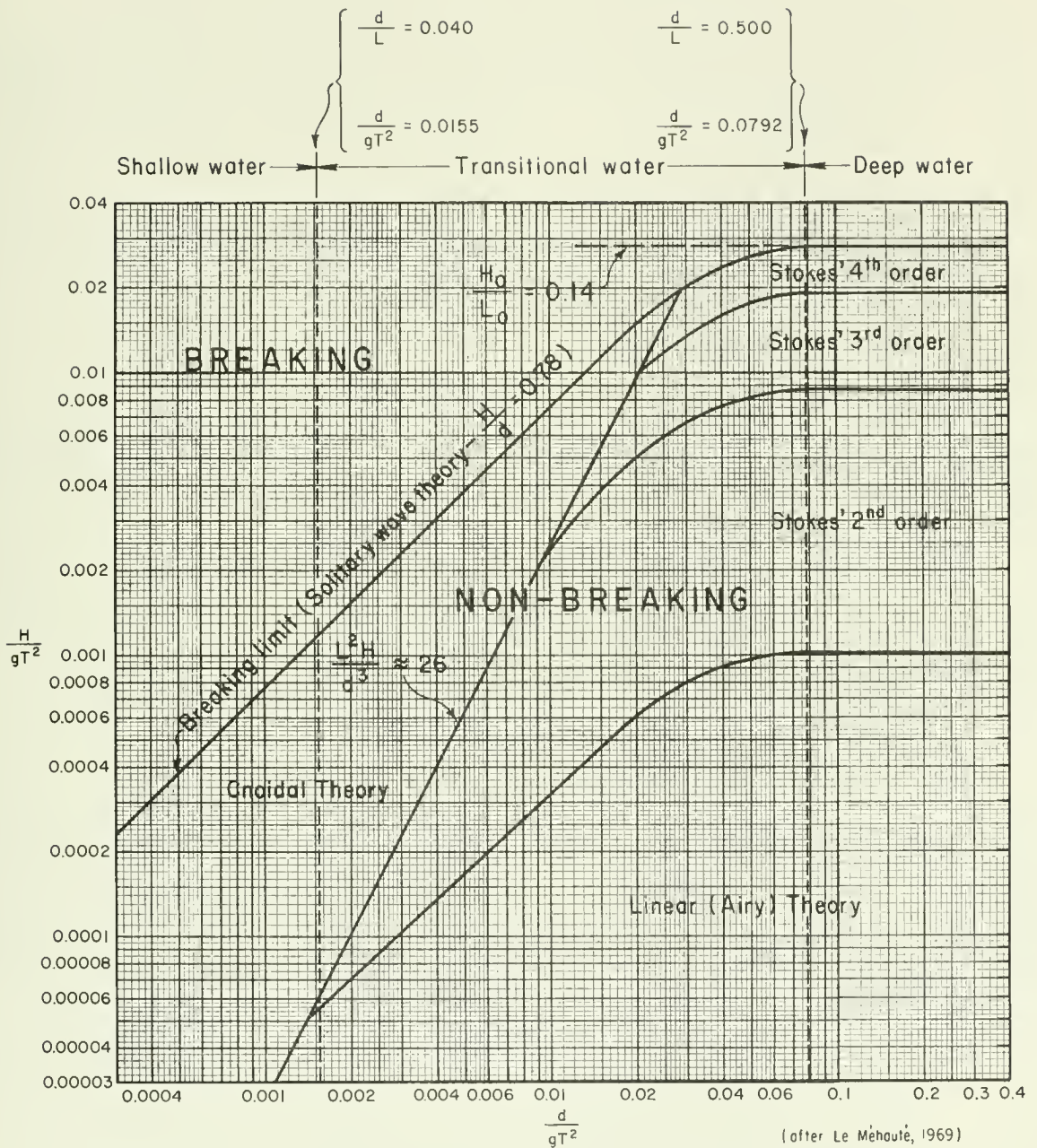

Figure 7-75. Breaking wave height and regions of validity of various wave theories.

Enter Figure 7-75 with $d/gT^2 = 0.0191$ to the curve marked Breaking limit and read,

$$\frac{H_b}{gT^2} = 0.014$$

Therefore,

$$H_b = 0.014 gT^2 = 0.014(9.8) (8)^2 = 8.8 \text{ m (28.9 ft)}$$

The ratio of the design wave height to the breaking height is

$$\frac{H}{H_b} = \frac{3.0}{8.8} = 0.34$$

By using equations (7-37) through (7-40) with Figures 7-71 through 7-74, the maximum values of the force and moment components can be found. To estimate the maximum total force F_m , Figures 7-76 through 7-79 by Dean (1965a) may be used. The figure to be used is determined by calculating

$$W = \frac{C_M D}{C_D H} \tag{7-41}$$

and the maximum force is calculated by

$$F_m = \phi_m w C_D H^2 D \tag{7-42}$$

where ϕ_m is the coefficient read from the figures. Similarly, the maximum moment M_m can be determined from Figure 7-80 through 7-83, which are also based on Dean's stream-function theory (Dean, 1965a). The figure to be used is again determined by calculating W using equation (7-41), and the maximum moment about the mud line ($z = -d$) is found from

$$M_m = \alpha_m w C_D H^2 D d \tag{7-43}$$

where α_m is the coefficient read from the figures.

Calculation of the maximum force and moment on a vertical cylindrical pile is illustrated by the following examples.

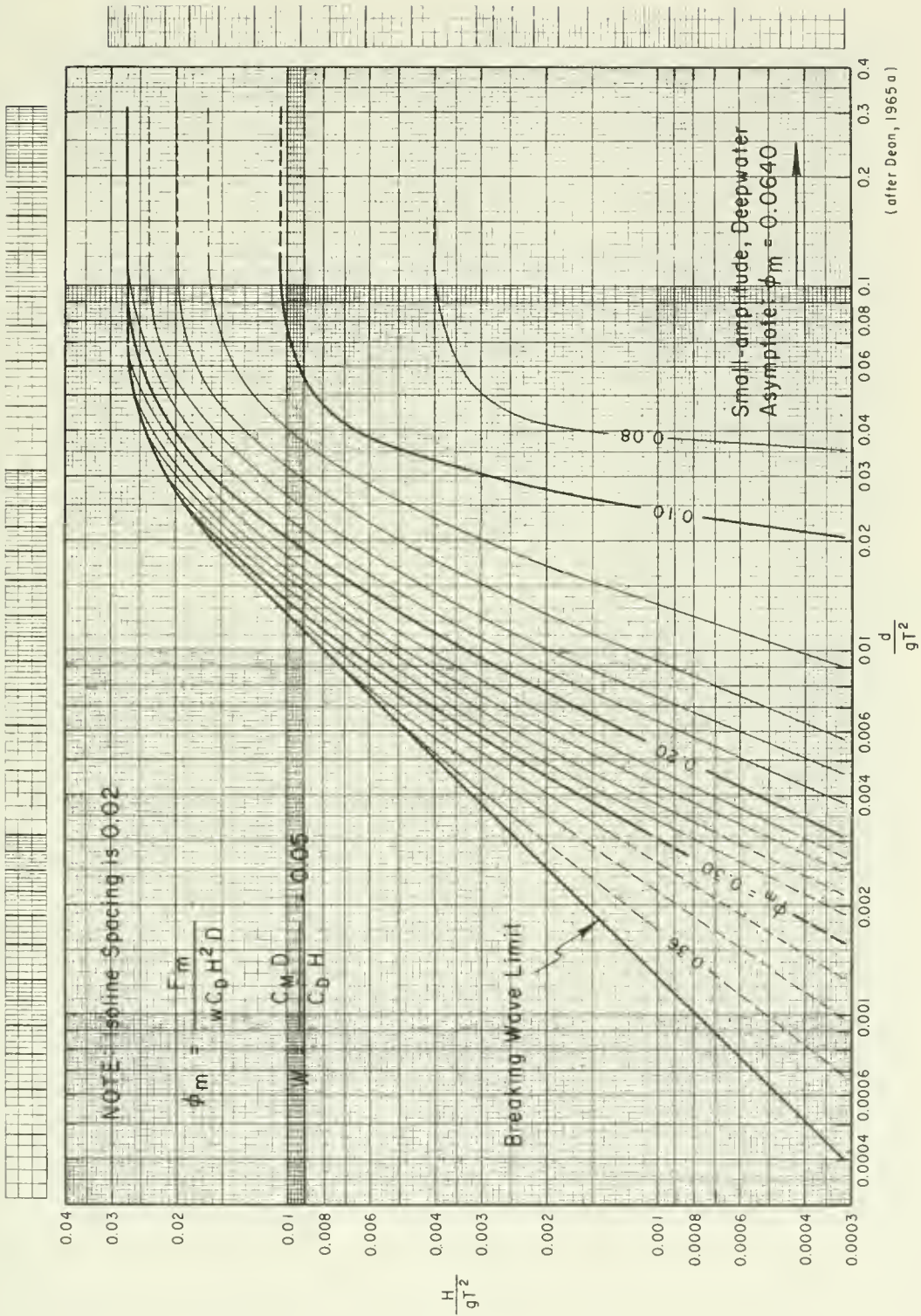

Figure 7-76. Isolines of ϕ_m versus H/gT^2 and d/gT^2 ... ($W = 0.05$) .

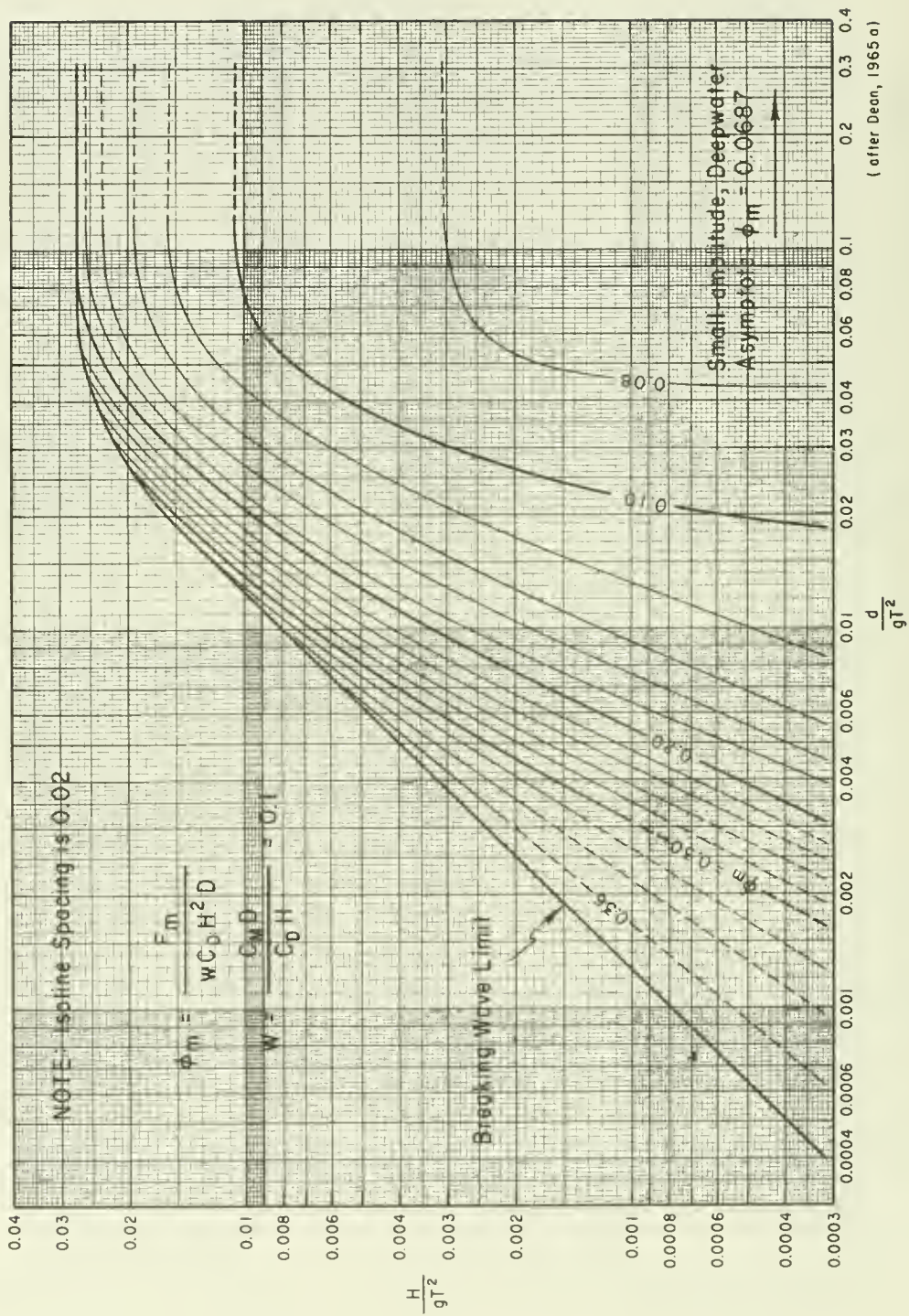

Figure 7-77. Isolines of ϕ_m versus H/gT^2 and d/gT^2 and d/gT^2 ... ($W = 0.1$) .

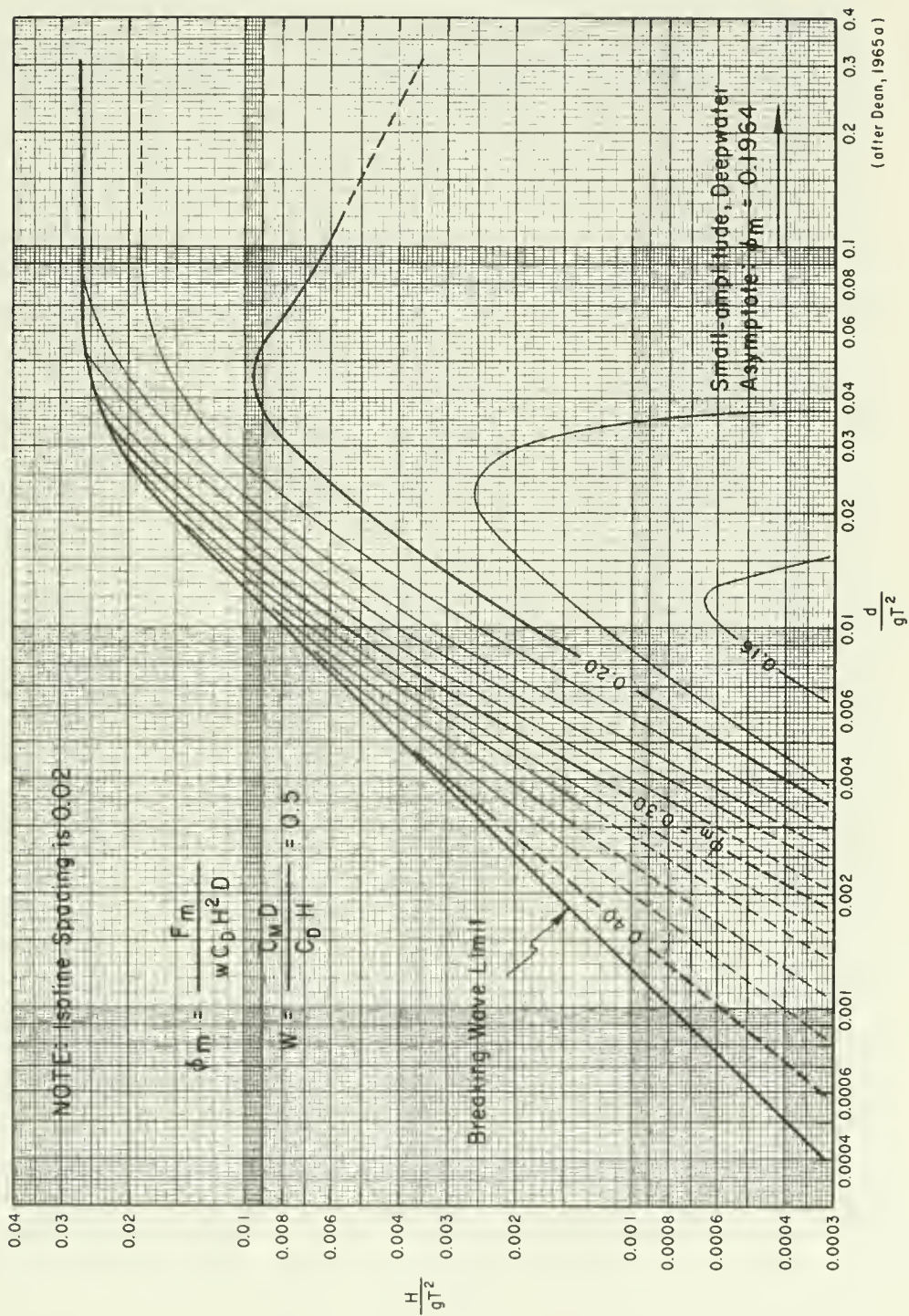

Figure 7-78. Isolines of ϕ_m versus H/gT^2 and d/gT^2 ... ($W = 0.5$) .

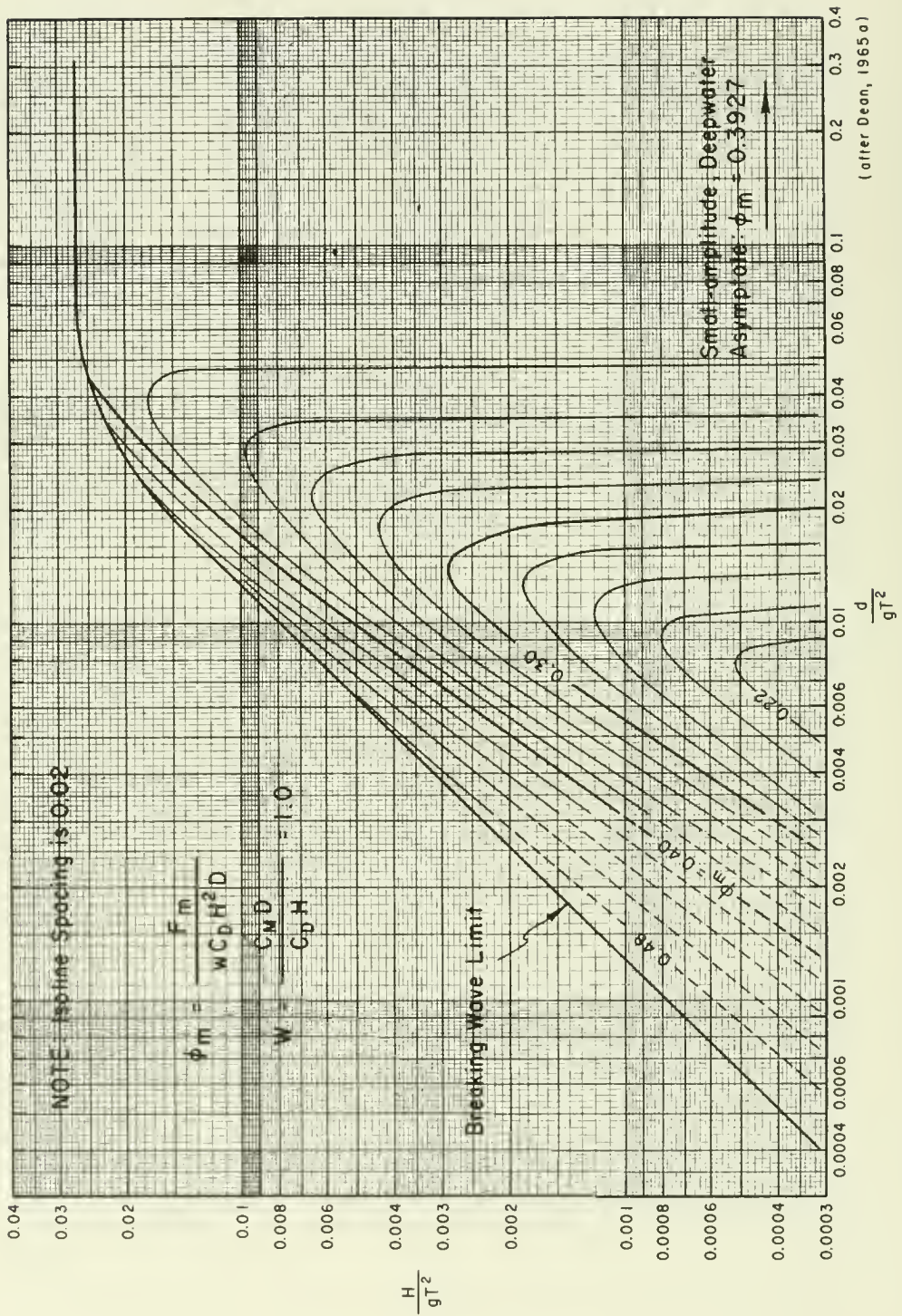

Figure 7-79. Isolines of ϕ_m versus H/gT^2 and d/gT^2 ... ($W = 1.0$) .

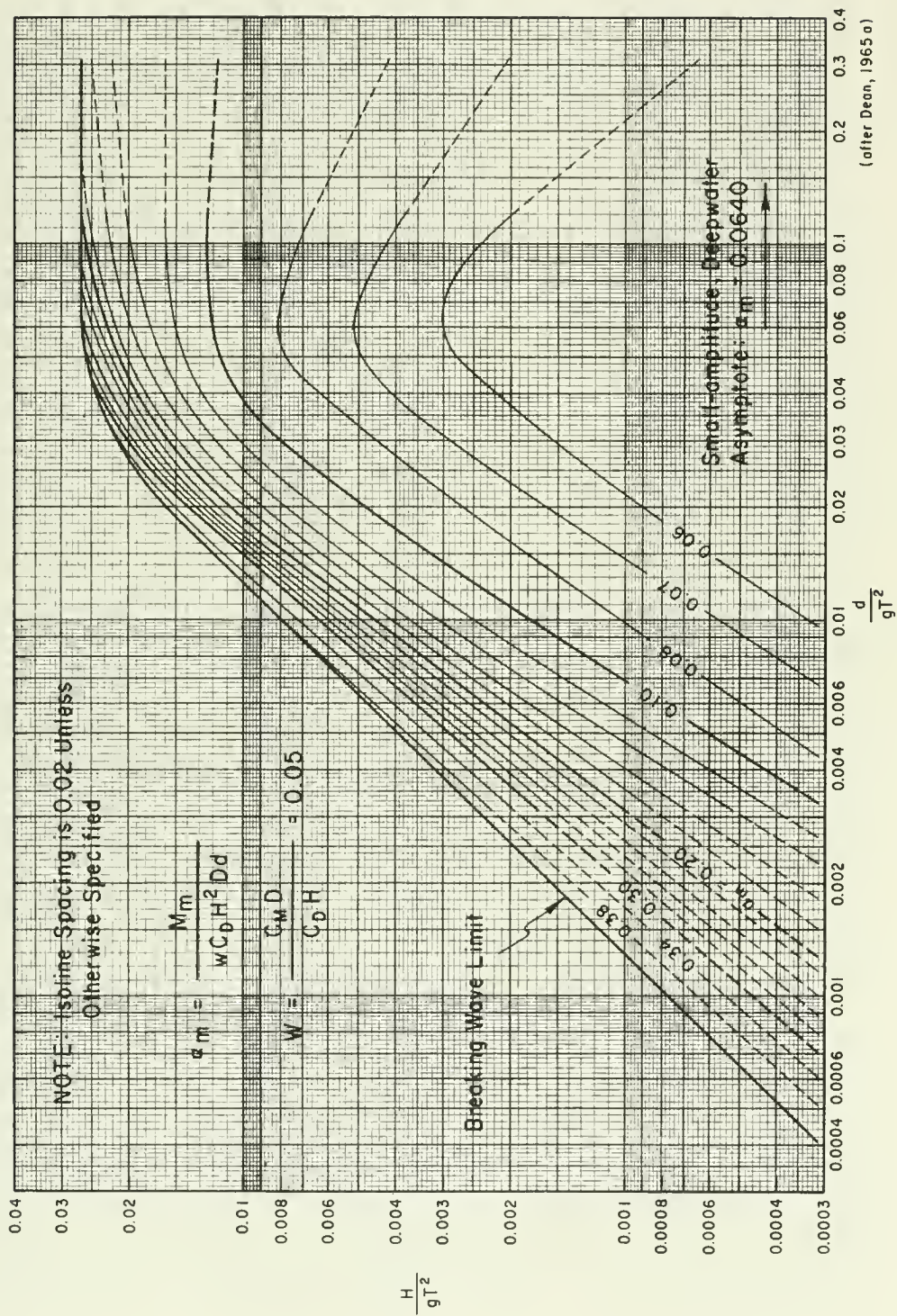

Figure 7-80. Isolines of α_m versus H/gT^2 and d/gT^2 ... ($W = 0.05$) .

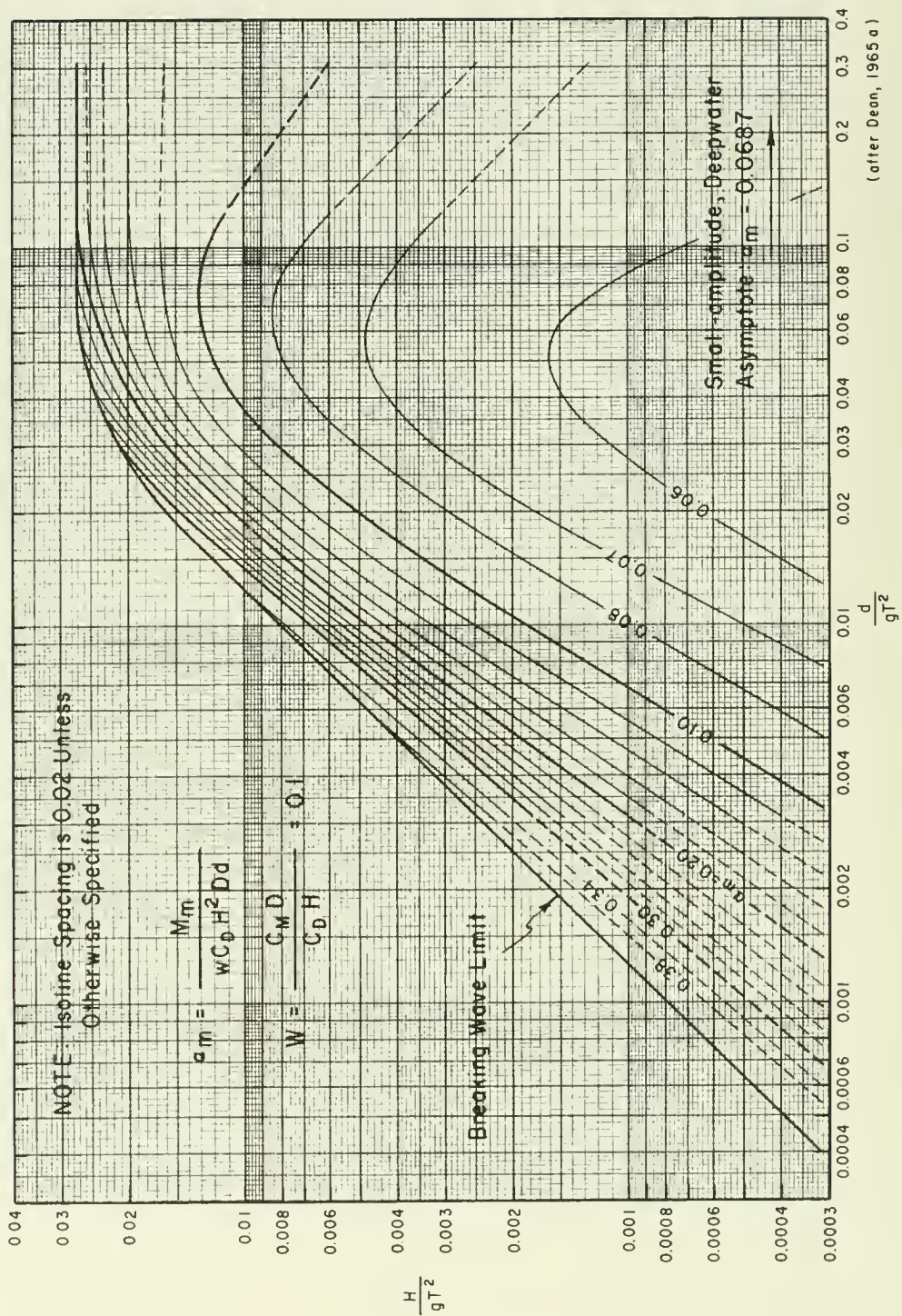

Figure 7-81. Isolines of α_m versus H/gT^2 and d/gT^2 ... ($W = 0.1$) .

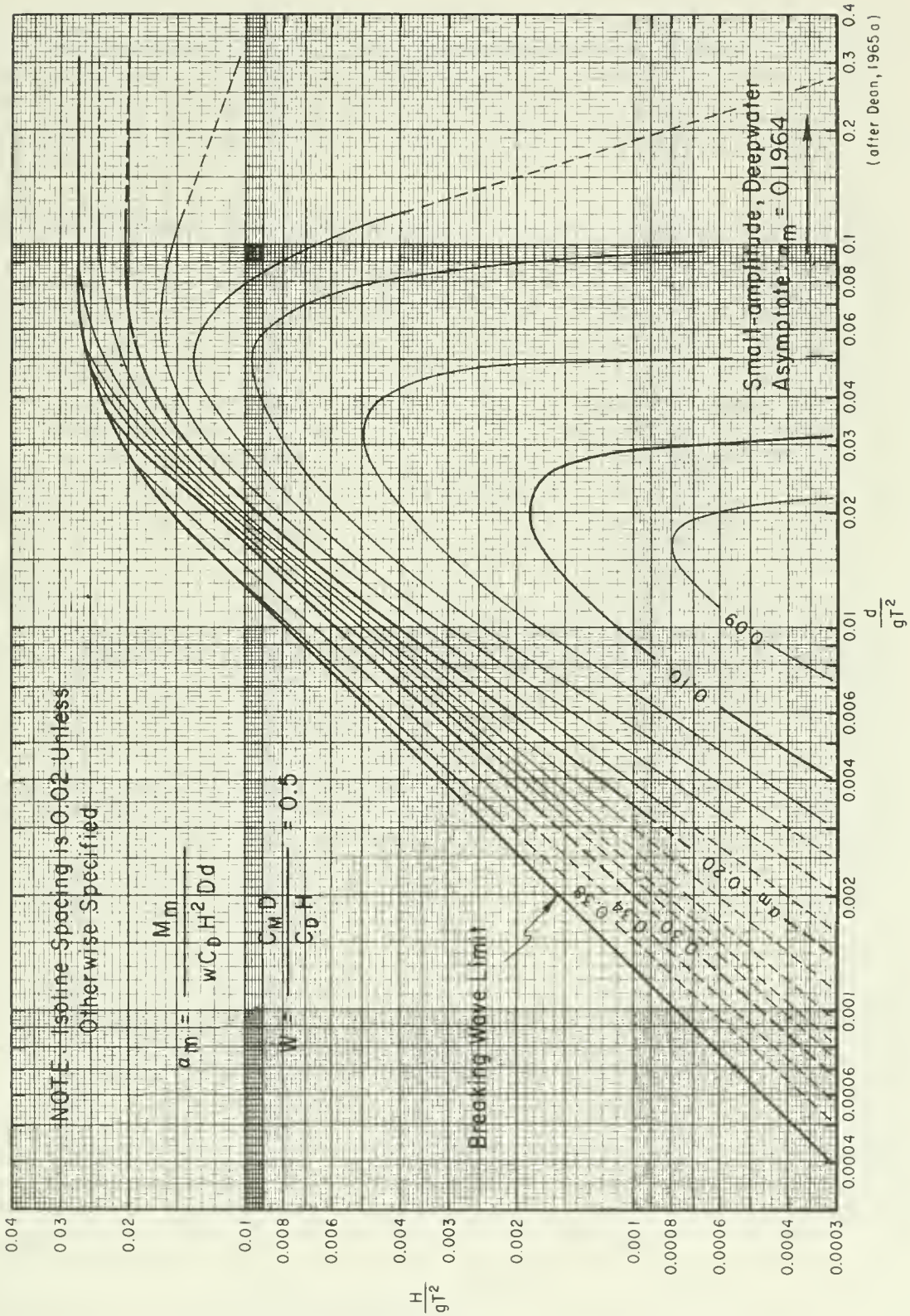

Figure 7-82. Isolines of α_m versus H/gT^2 and d/gT^2 ... ($W = 0.5$)

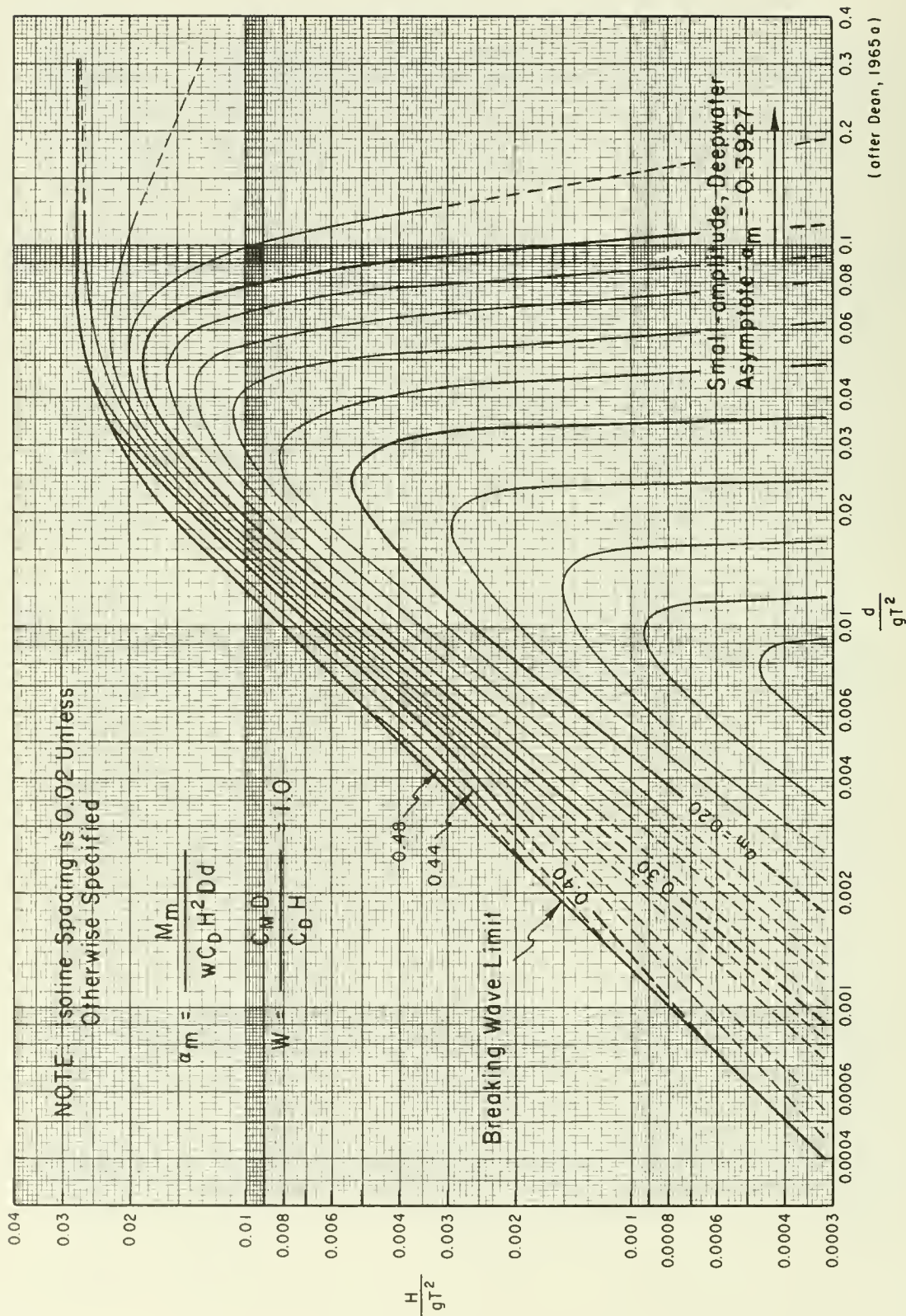

Figure 7-83. Isolines of α_m versus H/gT^2 and d/gT^2 and d/gT^2 ... ($W = 1.0$) .

***** EXAMPLE PROBLEM 20 *****

GIVEN: A design wave with height $H = 3.0$ m (9.8 ft) and period $T = 10$ s acts on a vertical circular pile with a diameter $D = 0.3$ m (1 ft) in depth $d = 4.5$ m (14.8 ft). Assume that $C_M = 2.0$, $C_D = 0.7$, and the density of seawater $\rho = 1025.2$ kg/m³ (1.99^M slugs/ft³). (Selection of C_M and C_D is discussed in Section III,1,e.)

FIND: The maximum total horizontal force and the maximum total moment around the mud line of the pile.

SOLUTION: Calculate

$$\frac{d}{gT^2} = \frac{4.5}{(9.8)(10)^2} = 0.0046$$

and enter Figure 7-75 to the breaking limit curve and read

$$\frac{H}{gT^2} = 0.0034$$

Therefore,

$$H_b = 0.0034 gT^2 = 0.00357(9.8)(10)^2 = 3.3 \text{ m (10.8 ft)}$$

and

$$\frac{H}{H_b} = \frac{3.0}{3.3} = 0.91$$

From Figures 7-71 and 7-72, using $d/gT^2 = 0.0046$ and $H = 0.91 H_b$, interpolating between curves $H = H_b$ and $H = 3/4 H_b$, find:

$$K_{im} = 0.38$$

$$K_{Dm} = 0.71$$

From equation 7-37:

$$F_{im} = C_M \rho g \frac{\pi D^2}{4} H K_{im}$$

$$F_{im} = (2)(1025.2)(9.8) \frac{\pi(0.3)^2}{4} (3.0)(0.38) = 1619 \text{ N (364 lb)}$$

and from equation (7-38):

$$F_{DM} = C_D \frac{1}{2} \rho g D H^2 K_{DM}$$

$$F_{DM} = (0.7) (0.5) (1025.2) (9.8) (0.3) (3)^2 (0.71) = 6,741 \text{ N (1,515 lb)}$$

From equation (7-41), compute

$$W = \frac{C_M^D}{C_D^H} = \frac{(2.0) (0.3)}{(0.7) (3)} = 0.29$$

Interpolation between Figures 7-77 and 7-78 for ϕ_m is required. Calculate

$$\frac{H}{gT^2} = \frac{3.0}{(9.8) (10)^2} = 0.0031$$

and recall that

$$\frac{d}{gT^2} = 0.0046$$

Find the points on Figures 7-77 and 7-78 corresponding to the computed values of H/gT^2 and d/gT^2 and determine ϕ_m ($w = 10,047 \text{ N/m}^3$ or 64 lb/ft^3).

Figure 7-77: $W = 0.1$; $\phi_m = 0.35$

Interpolated Value: $W = 0.29$; $\phi_m \approx 0.365$

Figure 7-78: $W = 0.5$; $\phi_m \approx 0.38$

From equation (7-42), the maximum force is

$$F_m = \phi_m w C_D H^2 D$$

$$F_m = 0.365 (10,047) (0.7) (3)^2 (0.3) = 6,931 \text{ N (1,558 lb)}$$

say

$$F_m = 7,000 \text{ N (1,574 lb)}$$

To calculate the inertia moment component, enter Figure 7-73 with

$$\frac{d}{gT^2} = 0.0046$$

and $H = 0.91 H_b$ (interpolate between $H = H_b$ and $H = 3/4 H_b$) to find

$$S_{im} = 0.82$$

Similarly, from Figure 7-74 for the drag moment component, determine

$$S_{Dm} = 1.01$$

Therefore from equation (7-39)

$$M_{im} = F_{im} d S_{im} = 1619 (4.5) (0.82) = 5,975 \text{ N-m (4,407 ft-lb)}$$

and from equation (7-40)

$$M_{Dm} = F_{Dm} d S_{Dm} = 6741 (4.5) (1.01) = 30.6 \text{ kN-m (22,600 ft-lb)}$$

The value of α_m is found by interpolation between Figures 7-81 and 7-82 using $W = 0.29^m$, $H/gT^2 = 0.0031$, and $d/gT^2 = 0.0046$.

Figure 7-81: $W = 0.1$; $\alpha_m = 0.33$

Interpolated Value $W = 0.29$; $\alpha_m \approx 0.34$

Figure 7-82: $W = 0.5$; $\alpha_m = 0.35$

The maximum total moment about the mud line is found from equation (7-43).

$$M_m = \alpha_m w C_D H^2 D d$$

$$M_m = 0.34 (10,047) (0.7) (3)^2 (0.3) (4.5) = 29.1 \text{ kN-m (21,500 ft-lb)}$$

The moment arm, measured from the bottom, is the maximum total moment M_m divided by the maximum total force F_m ; therefore,

$$\frac{M_m}{F_m} = \frac{29,100}{6,931} = 4.2 \text{ m (13.8 ft)}$$

If it is assumed that the upper 0.6 m (2 ft) of the bottom material lacks significant strength, or if it is assumed that scour of 0.6 m occurs, the maximum total horizontal force is unchanged, but the lever arm is increased by about 0.6 m. The increased moment can be calculated by increasing the moment arm by 0.6 m and multiplying by the maximum total force. Thus the maximum moment is estimated to be

$$\left(\frac{M_m}{F_m} \right) 0.6 \text{ m below mud line} = (4.2 + 0.6) F_m = 4.8 (6,931) = 33.3 \text{ kN-m (24,500 ft-lb)}$$

***** EXAMPLE PROBLEM 21 *****

GIVEN: A design wave with height $H = 3.0 \text{ m (9.8 ft)}$ and period $T = 10 \text{ s}$ acts on a vertical circular pile with a diameter $D = 0.3 \text{ m (1.0 ft)}$ in a depth $d = 30.0 \text{ m (98.4 ft)}$. Assume $C_M = 2.0$ and $C_D = 1.2$.

FIND: The maximum total horizontal force and the moment around the mud line of the pile.

SOLUTION: The procedure used is identical to that of the preceding problem.
Calculate

$$\frac{d}{gT^2} = \frac{30.0}{(9.8 (10))^2} = 0.031$$

enter Figure 7-75 to the breaking-limit curve and read

$$\frac{H_b}{gT^2} = 0.0205$$

Therefore

$$H_b = 0.0205 gT^2 = 0.0205 (9.8) (10)^2 = 20.1 \text{ m (65.9 ft)}$$

and

$$\frac{H}{H_b} = \frac{3.0}{20.1} = 0.15$$

From Figures 7-71 and 7-72, using $d/gT^2 = 0.031$ and interpolating between $H \approx 0$ and $H = 1/4 H_b$ for $H = 0.15 H_b$,

$$K_{im} = 0.44$$

$$K_{Dm} = 0.20$$

From equation (7-37),

$$F_{im} = C_M \rho g \frac{\pi D^2}{4} H K_{im}$$

$$F_{im} = 2.0 (1025.2) (9.8) \frac{\pi(0.3)^2}{4} (3) (0.44) = 1,875 \text{ N (422 lb)}$$

and from equation (7-38),

$$F_{Dm} = C_D \frac{1}{2} \rho g D H^2 K_{Dm}$$

$$F_{Dm} = 1.2 (0.5) (1025.2) (9.8) (0.3) (3)^2 (0.20) = 3,255 \text{ N (732 lb)}$$

Compute W from equation (7-41),

$$W = \frac{C_M D}{C_D H} = \frac{2.0(0.3)}{1.2 (3)} = 0.17$$

Interpolation between Figures 7-77 and 7-78 for ϕ_m , using $\frac{d}{gT^2} = 0.031$ and $\frac{H}{gT^2} = 0.0031$, gives

$$\phi_m = 0.11$$

From equation (7-42), the maximum total force is

$$F_m = \phi_m w C_D H^2 D$$

$$F_m = 0.11 (10,047) (1.2) (3)^2 (0.3) = 3,581 \text{ N (805 lb)}$$

say

$$F_m = 3600 \text{ N (809 lb)}$$

From Figures 7-73 and 7-74, for $H = 0.15 H_b$,

$$S_{im} = 0.57$$

and

$$S_{Dm} = 0.69$$

From equation (7-39),

$$M_{im} = F_{im} d S_{im} = 1,875 (30.0) (0.57) = 32.1 \text{ kN-m (23,700 ft-lb)}$$

and from equation (7-40),

$$M_{Dm} = F_{Dm} d S_{Dm} = 3,255 (30.0) (0.69) = 67.4 \text{ kN-m (49,700 ft-lb)}$$

Interpolation between Figures 7-81 and 7-82 with $W = 0.16$ gives

$$\alpha_m = 0.08$$

The maximum total moment about the mud line from equation (7-43) is,

$$M_m = \alpha_m w C_D H^2 D d$$

$$M_m = 0.08 (10,047) (1.2) (3)^2 (0.3) (30.0) = 78.1 \text{ kN-m (57,600 ft-lb)}$$

If calculations show the pile diameter to be too small, noting that F_{im} is proportional to D^2 and F_{Dm} is proportional to D will allow adjustment of the force for a change in pile diameter. For example, for the same wave conditions and a 0.6-m (2-ft) diameter pile the forces become

$$F_{im} (D = 0.6 \text{ m}) = F_{im} (D = 0.3 \text{ m}) \frac{(0.6)^2}{(0.3)^2} = 1,875 (4) = 7,500 \text{ N (1,686 lb)}$$

$$F_{DM} (D = 0.6 \text{ m}) = F_{DM} (D = 0.3 \text{ m}) \frac{0.6}{0.3} = 3,255 (2) = 6,510 \text{ N (1,464 lb)}$$

The new value of W from equation (7-41) is

$$W = \frac{C_M^D}{C_H^D} = \frac{2.0(0.6)}{1.2(3)} = 0.33$$

and the new values of ϕ_m and α_m are

$$\phi_m = 0.15$$

and

$$\alpha_m = 0.10$$

Therefore, from equation (7-42)

$$(F_m)_{0.6 \text{ -m diam.}} = \phi_m w C_H^2 D$$

$$(F_m)_{0.6 \text{ -m diam.}} = 0.15 (10,047) (1.2) (3)^2 (0.6) = 9,766 \text{ N (2,195 lb)}$$

and from equation (7-43)

$$(M_m)_{0.6 \text{ -m diam.}} = \alpha_m w C_H^2 D d$$

$$(M_m)_{0.6 \text{ -m diam.}} = 0.10 (10,047) (1.2) (3)^2 (0.6) (30.0) = 195.3 \text{ kN-m (144,100 ft-lb)}$$

d. Transverse Forces Due to Eddy Shedding (Lift Forces). In addition to drag and inertia forces that act in the direction of wave advance, transverse forces may arise. Because they are similar to aerodynamic lift force, transverse forces are often termed *lift forces*, although they do not act vertically but perpendicularly to both wave direction and the pile axis.

Transverse forces result from vortex or eddy shedding on the downstream side of a pile: eddies are shed alternately from one side of the pile and then the other, resulting in a laterally oscillating force.

Laird et al. (1960) and Laird (1962) studied transverse forces on rigid and flexible oscillating cylinders. In general, lift forces were found to depend on the dynamic response of the structure. For structures with a natural frequency of vibration about twice the wave frequency, a dynamic coupling between the structure motion and fluid motion occurs, resulting in

large lift forces. Transverse forces have been observed 4.5 times greater than the drag force.

For rigid structures, however, transverse forces equal to the drag force is a reasonable upper limit. *This upper limit pertains only to rigid structures*; larger lift forces can occur when there is dynamic interaction between waves and the structure (for a discussion see Laird (1962)). The design procedure and discussion that follow pertain only to rigid structures.

Chang (1964), in a laboratory investigation, found that eddies are shed at a frequency that is twice the wave frequency. Two eddies were shed after passage of the wave crest (one from each side of the cylinder), and two on the return flow after passage of the trough. The maximum lift force is proportional to the square of the horizontal wave-induced velocity in much the same way as the drag force. Consequently, for design estimates of the lift force, equation (7-44) may be used:

$$F_L = F_{Lm} \cos 2\theta = C_L \frac{\rho g}{2} DH^2 K_{Dm} \cos 2\theta \quad (7-44)$$

where F_L is the lift force, F_{Lm} is the maximum lift force, $\theta = (2\pi x/L - 2\pi t/T)$, and C_L is an empirical lift coefficient analogous to the drag coefficient in equation (7-38). Chang found that C_L depends on the Keulegan-Carpenter (1956) number $\bar{u}_{max} T/D$, where \bar{u}_{max} is the maximum horizontal velocity averaged over the depth. When this number is less than 3, no significant eddy shedding occurs and no lift forces arise. As $\bar{u}_{max} T/D$ increases, C_L increases until it is approximately equal to C_D (for rigid piles only). Bidde (1970, 1971) investigated the ratio of the maximum lift force to the maximum drag force F_{Lm}/F_{Dm} which is nearly equal to C_L/C_D if there is no phase difference between the lift and drag force (this is assumed by equation (7-44)). Figure 7-84 illustrates the dependence of C_L/C_D on $\bar{u}_{max} T/D$. Both Chang and Bidde found little dependence of C_L on Reynolds number $R_e = \bar{u}_{max} D/\nu$ for the ranges of R_e investigated. The range of R_e investigated is significantly lower than the range to be anticipated in the field, hence the data presented should be interpreted merely as a guide in estimating C_L and then F_L .

The use of equation (7-44) and Figure 7-84 to estimate lift forces is illustrated by the following example.

***** EXAMPLE PROBLEM 22 *****

GIVEN: A design wave with height $H = 3.0$ m (9.8 ft) and period $T = 10$

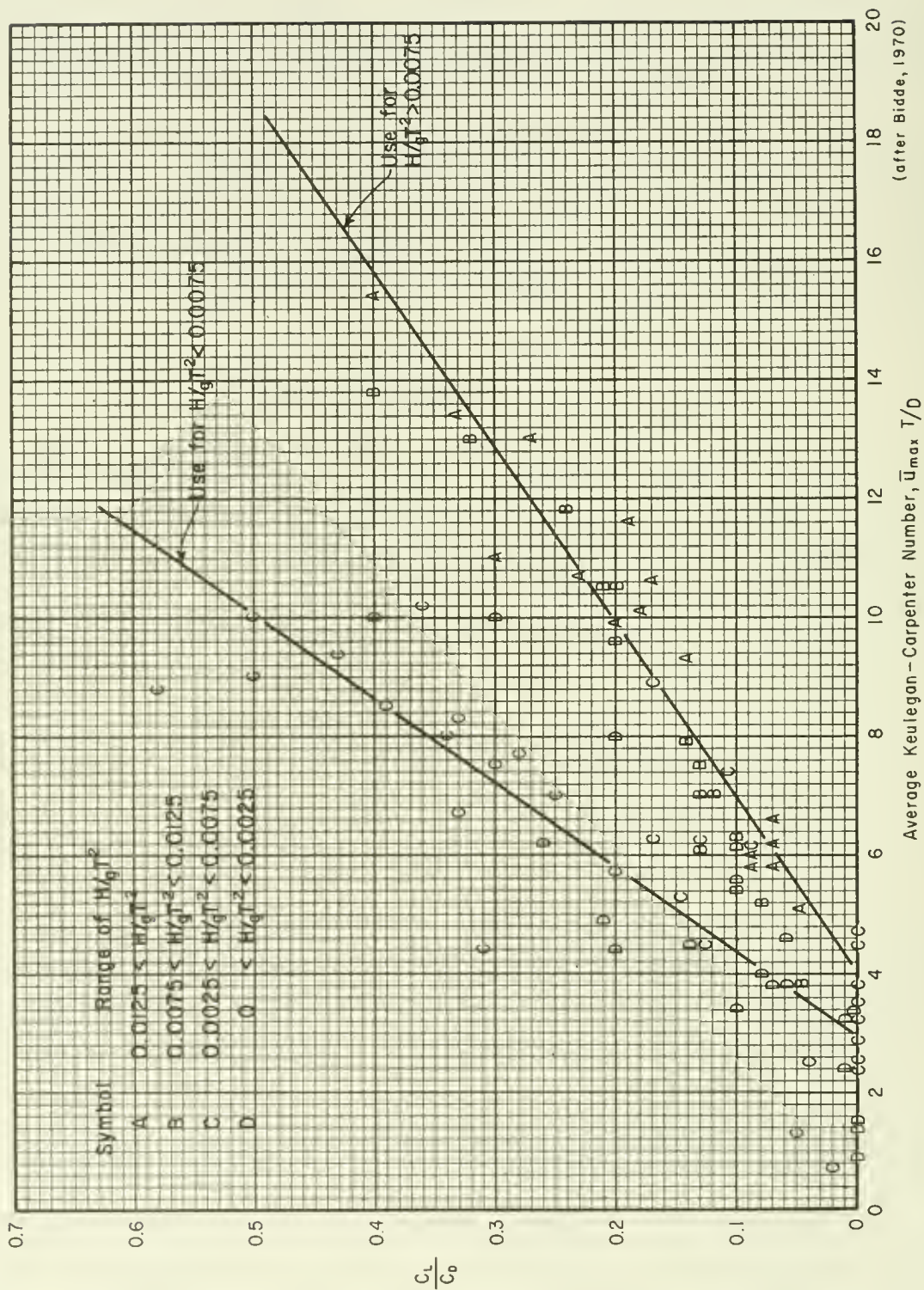

Figure 7-84. Variation of C_L/C_D with Keulegan-Carpenter number and H/gT^2 .

s acts on a vertical circular pile with a diameter $D = 0.3 \text{ m}$ (1 ft) in a depth $d = 4.5 \text{ m}$ (14.8 ft). Assume $C_M = 2.0$ and $C_D = 0.7$.

FIND: The maximum transverse (lift) force acting on the pile and the approximate time variation of the transverse force assuming that Airy theory adequately predicts the velocity field. Also estimate the maximum total force.

SOLUTION: Calculate,

$$\frac{H}{gT^2} = \frac{3.0}{(9.8)(10)^2} = 0.0031$$

$$\frac{d}{gT^2} = \frac{4.5}{(9.8)(10)^2} = 0.0046$$

and the average Keulegan-Carpenter number $\bar{u}_{max} T/D$, using the maximum horizontal velocity at the SWL and at the bottom to obtain \bar{u}_{max} . Therefore, from equation (7-23) with $z = -d$,

$$(u_{max})_{bottom} = \frac{H}{2} \frac{gT}{L_A} \frac{1}{\cosh\left(2\pi \frac{d}{L_A}\right)}$$

$$(u_{max})_{bottom} = \frac{3.0 (9.8) (10)}{2 (65.5)} (0.90) = 2.0 \text{ m/s (6.6 ft/s)}$$

where L_A is found from Figure 7-68 by entering with d/gT^2 and reading $L_A/L_0 = 2\pi L_A/gT^2 = 0.42$. Also, $1/\cosh [2\pi d/L_A]$ is the K value on Figure 7-68. Then, from equation (7-23) with $z = 0$,

$$(u_{max})_{SWL} = \frac{H}{2} \frac{gT}{L_A}$$

$$(u_{max})_{SWL} = \frac{3.0}{2} \frac{(9.8)(10)}{65.5} = 2.2 \text{ m/s (7.2 ft/s)}$$

The average velocity is therefore,

$$\bar{u}_{max} = \frac{(u_{max})_{bottom} + (u_{max})_{SWL}}{2}$$

$$\bar{u}_{max} = \frac{2.0 + 2.2}{2} = \frac{4.2}{2} = 2.1 \text{ m/s (6.9 ft/s)}$$

and the average Keulegan-Carpenter number is

$$\frac{\bar{u}_{max} T}{D} = \frac{2.1 (10)}{0.3} = 70.0$$

The computed value of $\bar{u}_{max} T/D$ is well beyond the range of Figure 7-84, and the lift coefficient should be taken to be equal to the drag coefficient (for a rigid structure). Therefore,

$$C_{Lmax} = C_D = 0.7$$

From equation (7-44),

$$F_L = C_L \frac{\rho g}{2} DH^2 K_{Dm} \cos 2\theta = F_{Lm} \cos 2\theta$$

The maximum transverse force F_{Lm} occurs when $\cos 2\theta = 1.0$. Therefore,

$$F_{Lm} = 0.7 \frac{(1025.2) (9.8)}{2} (0.3) (3)^2 (0.71) = 6,741 \text{ N (1,515 lb)}$$

where K_{Dm} is found as in the preceding examples. For the example problem the maximum transverse force is equal to the drag force.

Since the inertia component of force is small (preceding example), an estimate of the maximum force can be obtained by vectorially adding the drag and lift forces. Since the drag and lift forces are equal and perpendicular to each other, the maximum force in this case is simply

$$F_{max} \approx \frac{F_{Lm}}{\cos 45^\circ} = \frac{6,741}{0.707} = 9,535 \text{ N (2,144 lb)}$$

which occurs about when the crest passes the pile.

The time variation of lift force is given by

$$F_L = 6,741 \cos 2\theta$$

e. Selection of Hydrodynamic Force Coefficients C_D and C_M . Values of C_M , C_D and safety factors given in the sections that follow are suggested values only. Selection of C_M , C_D and safety factors for a given design must be dictated by the wave theory used and the purpose of the structure. Values given here are intended for use with the design curves and equations given in preceding sections for preliminary design and for checking design calculations. More accurate calculations require the use of appropriate wave tables such as those of Dean (1974) or Skjelbreia et al. (1960) along with the appropriate C_M and C_D .

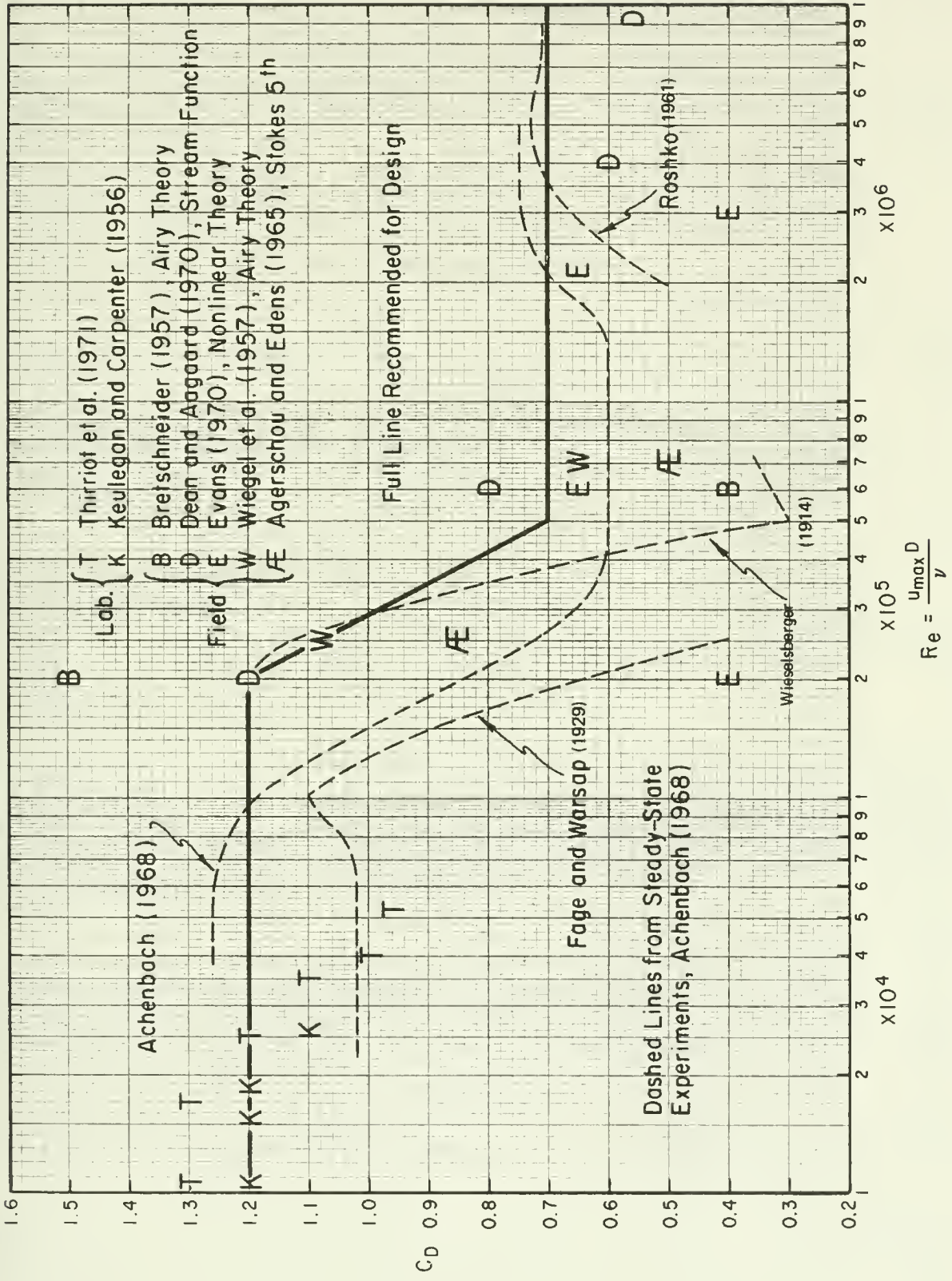

Figure 7-85. Variation of drag coefficient C_D with Reynolds number Re .

(1) Factors influencing C_D . The variation of drag coefficient C_D with Reynolds number R_e for steady flow conditions is shown in Figure 7-85. The Reynolds number is defined by

$$R_e = \frac{uD}{\nu} \quad (7-45)$$

where

u = velocity

D = pile diameter

ν = kinematic viscosity (approximately 1.0×10^{-5} ft²/sec for sea water)

Results of steady-state experiments are indicated by dashed lines (Achenbach, 1968). Taking these results, three ranges of R_e exist:

(1) Subcritical: $R_e < 1 \times 10^5$ where C_D is relatively constant (≈ 1.2).

(2) Transitional: $1 \times 10^5 < R_e < 4 \times 10^5$ where C_D varies.

(3) Supercritical: $R_e > 4 \times 10^5$ where C_D is relatively constant ($\approx 0.6 - 0.7$).

Thus, depending on the value of the Reynolds number, the results of steady-state experiments show that the value of C_D may change by about a factor of 2.

The steady-flow curves shown in Figure 7-85 show that the values of R_e defining the transitional region vary from investigator to investigator. Generally, the value of R_e at which the transition occurs depends on the roughness of the pile and the ambient level of turbulence in the fluid. A rougher pile will experience the transition at a smaller R_e . In the subcritical region, the degree of roughness has an insignificant influence on the value of C_D . However, in the supercritical region, the value of C_D increases with increasing surface roughness. The variation of C_D with surface roughness is given in Table 7-4.

The preceding discussion was based on experimental results obtained under steady, unidirectional flow conditions. To apply these results to the unsteady oscillatory flow conditions associated with waves, it is necessary to define a Reynolds number for the wave motion. As equation (7-23) shows, the fluid velocity varies with time and with position along the pile. In principle, an instantaneous value of the Reynolds number could be calculated, and the corresponding value of C_D used. However the accuracy with which C_D is determined hardly justifies such an elaborate procedure.

Keulegan and Carpenter (1956), in a laboratory study of forces on a cylindrical pile in oscillatory flow, found that over most of a wave cycle the value of the drag coefficient remained about constant. Since the maximum value of the drag force occurs when the velocity is a maximum, it seems

Table 7-4. Steady flow drag coefficients for supercritical Reynolds numbers.

Surface of 3-Foot-Diameter Cylinder	Average Drag Coefficient $R_e = 1 \times 10^6$ to 6×10^6
Smooth (polished)	0.592
Bitumastic, ¹ glass fiber, and felt wrap	0.61
Bitumastic, glass fiber, and felt wrap (damaged)	0.66
Number 16 grit sandpaper (approximately equivalent to a vinyl-mastic coating on a 1- to 2-foot-diameter cylinder)	0.76
Bitumastic, glass fiber, and burlap wrap (approximately equivalent to bitumastic, glass fiber, and felt wrap on a 1- to 2-foot-diameter cylinder)	0.78
Bitumastic and oyster shell coating (approximately equivalent to light fouling on a 1- to 2-foot-diameter cylinder)	0.88
Bitumastic and oyster shell with concrete fragments coating (approximately equivalent to medium barnacle fouling on a 1- to 2-foot-diameter cylinder)	1.02

Blumberg and Rigg, 1961

¹Bitumastic is a composition of asphalt and filler (as asbestos shorts) used chiefly as a protective coating on structural metals exposed to weathering or corrosion.

justified to use the maximum value of the velocity u_{max} when calculating a wave Reynolds number. Furthermore, since the flow near the still-water level contributes most to the moment around the mud line, the location at which u_{max} is determined is chosen to be $z = 0$. Thus, the wave Reynolds number is

$$R_e = \frac{u_{max} D}{\nu} \quad (7-46)$$

where ν = kinematic viscosity of the fluid ($\nu \approx 1.0 \times 10^{-5}$ ft²/s for salt water) and u_{max} = maximum horizontal velocity at $z = 0$, determined from Airy theory, is given by

$$u_{max} = \frac{\pi H}{T} \frac{L_o}{L_A} \quad (7-47)$$

The ratio L_A/L_o can be obtained from Figure 7-68.

An additional parameter, the importance of which was cited by Keulegan and Carpenter (1956), is the ratio of the amplitude of particle motion to pile diameter. Using Airy theory, this ratio A/D can be related to a period parameter equal to $(u_{max} T)/D$ (introduced by Keulegan and Carpenter) thus:

$$\frac{A}{D} = \frac{1}{2\pi} \frac{u_{max} T}{D} \quad (7-48)$$

When $z = 0$ equation (7-48) gives

$$A = \frac{H}{2} \frac{1}{\tanh \left[\frac{2\pi d}{L} \right]} = \frac{H}{2} \frac{L_o}{L_A} \quad (7-49)$$

The ratio L_A/L_o is from Figure 7-68.

In a recent laboratory study by Thirriot et al. (1971), it was found that for

$$\frac{A}{D} > 10, C_D \approx C_{D'} \text{ (steady flow)}$$

$$1 < \frac{A}{D} < 10, C_D > C_{D'} \text{ (steady flow)}$$

Combining this with equation (7-49), the steady-state value of C_D should apply to oscillatory motion, provided

$$\frac{A}{D} = \frac{H}{2D} \frac{L_o}{L_A} > 10 \quad (7-50)$$

or equivalently,

$$\frac{H}{D} > 20 \frac{L_A}{L_o} \quad (7-51)$$

***** EXAMPLE PROBLEM 23 *****

GIVEN: A design wave with height of $H = 3.0$ m (9.8 ft) and period $T = 10$ s in a depth $d = 4.5$ m (14.8 ft) acts on a pile of diameter $D = 0.3$ m (0.9 ft) .

FIND: Is the condition expressed by the inequality of equation (7-51) satisfied?

SOLUTION: Calculate,

$$\frac{d}{gT^2} = 0.0046$$

From Figure 7-68:

$$\frac{L}{L_o} A = 0.41$$

Then,

$$\frac{H}{D} = \frac{3.0}{0.3} = 10 > 20 \frac{L}{L_o} A = 8.2$$

Therefore, the inequality is satisfied and the steady-state C_D can be used.

Thirriot, et al. (1971) found that the satisfaction of equation (7-51) was necessary only when $Re < 4 \times 10^4$. For larger Reynolds numbers, they found C_D approximately equal to the steady flow C_D , regardless of the value of A/D . It is therefore unlikely that the condition imposed by equation (7-51) will be encountered in design. However, it is important to realize the significance of this parameter when interpreting data of small-scale experiments. The average value of all the C_D 's obtained by Keulegan and Carpenter (1956) is $(C_D)_{avg} = 1.52$. The results plotted in Figure 7-85 (Thirriot et al., 1971) that account for the influence of A/D show that $C_D \approx 1.2$ is a more representative value for the range of Reynolds numbers covered by the experiments.

To obtain experimental values for C_D for large Reynolds numbers, field experiments are necessary. Such experiments require simultaneous measurement of the surface profile at or near the test pile and the forces acting on the pile. Values of C_D (and C_M) obtained from prototype-scale experiments depend critically on the wave theory used to estimate fluid flow fields from measured surface profiles.

***** EXAMPLE PROBLEM 24 *****

GIVEN: When the crest of a wave, with $H = 3.0$ m (9.8 ft) and $T = 10$ s, passes a pile of $D = 0.3$ m (0.9 ft) in 4.5 m (14.8 ft) of water, a force $F = F_{Dm} = 7000$ N (1,573 lb) is measured.

FIND: The appropriate value of C_D .

SOLUTION: From Figure 7-72 as in the problem of the preceding section, $K_{Dm} = 0.71$ when $H = 0.87 H_b$. The measured force corresponds to F_{Dm} ; therefore, rearranging equation (7-38),

$$C_D = \frac{F_{Dm}}{(1/2)\rho g D H^2 K_{Dm}}$$

$$C_D = \frac{7,000}{(0.5)(1025.2)(9.8)(0.3)(3)^2 (0.71)} = 0.73$$

If Airy theory had been used ($H \approx 0$), Figure 7-72 with $d/gT^2 = 0.0046$ would give $K_{Dm} = 0.23$, and therefore

$$(C_D)_{\text{Airy}} = \left[(C_D)_{H = 0.87 H_b} \right] \frac{\left(\frac{K_{Dm}}{K_{Dm}} \right)_{H = 0.87 H_b}}{\left(\frac{K_{Dm}}{K_{Dm}} \right)_{\text{Airy } (H \approx 0)}} = 0.73 \frac{0.71}{0.235} = 2.25$$

***** EXAMPLE PROBLEM 25 *****

GIVEN: Same conditions as the preceding example, but with a wave height $H = 15.0$ m (49.2 ft), a depth $d = 30.0$ m (98.4 ft), and $F = F_{Dm} = 130,000$ N (29,225 lb).

FIND: The appropriate value of C_D .

SOLUTION: From Figure 7-75 $H_b = 20.6$ m (68 ft); then $H/H_b = 15.0/20.6 = 0.73$. Entering Figure 7-72 with $d/gT^2 = 0.031$, $K_{Dm} = 0.38$ is found. Therefore, from equation (7-33),

$$C_D = \frac{F_{Dm}}{1/2 \rho g D H^2 K_{Dm}}$$

$$C_D = \frac{130,000}{0.5(1025.2)(9.8)(0.3)(15.0)^2 (0.38)} = 1.01$$

If Airy theory had been used, $K_{Dm} = 0.17$ and

$$(C_D)_{\text{Airy}} = (C_D)_{H = 0.73 H_b} = \frac{\left(\frac{K_{Dm}}{K_{Dm}} \right)_{H = 0.73 H_b}}{\left(\frac{K_{Dm}}{K_{Dm}} \right)_{\text{Airy } (H \approx 0)}} = (1.01) \frac{(0.38)}{(0.17)} = 2.26$$

Some of the difference between the two values of C_D exists because the SWL (instead of the wave crest) was the upper limit of the integration performed to obtain K_{Dm} for Airy theory. The remaining difference occurs because Airy theory is unable to describe accurately the water-particle velocities of finite-amplitude waves.

The two examples show the influence of the wave theory used on the value of C_D determined from a field experiment. Since the determination of wave forces is the inverse problem (i.e., C_D and wave conditions known), *it is important in force calculations to use a wave theory that is equivalent to the wave theory used to obtain the value of C_D (and C_M)*. A wave theory that accurately describes the fluid motion should be used in the analysis of experimental data to obtain C_D (and C_M) and in design calculations.

Results obtained by several investigators for the variation of C_D with Reynolds number are indicated in Figure 7-85. The solid line is generally conservative and is recommended for design along with Figures 7-72 and 7-74 with the Reynolds number defined by equation (7-45).

***** EXAMPLE PROBLEM 26 *****

FIND: Were the values of C_D used in the preceding example problems reasonable?

SOLUTION: For the first example with $H = 3.0$ m (9.8 ft), $T = 10$ s, $d = 4.5$ m (14.8 ft), and $D = 0.3$ m (1 ft), from equation (7-47),

$$u_{max} = \frac{\pi H L_o}{T L_A}$$

$$u_{max} = \frac{\pi 3.0}{10} \frac{1}{0.41} = 2.3 \text{ m (7.5 ft/s)}$$

From equation (7-46)

$$R_e = \frac{u_{max} D}{\nu} \quad (\nu = 9.29 \times 10^{-7} \text{ m}^2/\text{s})$$

$$R_e = \frac{(2.3) (0.3)}{9.29 \times 10^{-7}} = 7.43 \times 10^5$$

From Figure 7-85, $C_D = 0.7$, which is the value used in the preceding example.

For the example with $H = 3.0$ m (9.8 ft), $T = 10$ s, $d = 30.0$ m (98.4 ft), and $D = 0.3$ m (1 ft), from equation (7-47),

$$u_{max} = \frac{\pi (3.0)}{(10)} \frac{(1)}{(0.89)} = 1.1 \text{ m/s (3.6 ft/s)}$$

From equation (7-46),

$$R_e = \frac{(1.1) (0.3)}{9.29 \times 10^{-7}} = 3.55 \times 10^5$$

From Figure 7-85, $C_D = 0.89$ which is less than the value of $C_D = 1.2$ used in the force calculation. Consequently, the force calculation gave a high force estimate.

Hallermeier (1976) found that when the parameter u^2/gD is approximately equal to 1.0, the coefficient of drag C_D may significantly increase because of surface effects. Where this is the case, a detailed analysis of forces should be performed, preferably including physical modeling.

(2). Factors Influencing C_M . MacCamy and Fuchs (1954) found by theory that for small ratios of pile diameter to wavelength,

$$C_M = 2.0 \tag{7-52}$$

This is identical to the result obtained for a cylinder in accelerated flow of an ideal or nonviscous fluid (Lamb, 1932). The theoretical prediction of C_M can only be considered an estimate of this coefficient. The effect of a real viscous fluid, which accounted for the term involving C_D in equation (7-48), will drastically alter the flow pattern around the cylinder and invalidate the analysis leading to $C_M = 2.0$. The factors influencing C_D also influence the value of C_M .

No quantitative dependence of C_M on Reynolds number has been established, although Bretschneider (1957) indicated a decrease in C_M with increasing R_e . However for the range of Reynolds numbers ($R_e < 3 \times 10^4$) covered by Keulegan and Carpenter (1956), the value of the parameter A/D plays an important role in determining C_M . For $A/D < 1$ they found $C_M \approx 2.0$. Since for small values of A/D the flow pattern probably deviates only slightly from the pattern assumed in the theoretical development, the result of $C_M = 2.0$ seems reasonable. A similar result was obtained by Jen (1968) who found $C_M \approx 2.0$ from experiments when $A/D < 0.4$. For larger A/D values that are closer to actual design conditions, Keulegan and Carpenter found (a) a minimum $C_M \approx 0.8$ for $A/D \approx 2.5$ and (b) that C_M increased from 1.5 to 2.5 for $6 < A/D < 20$.

Just as for C_D , Keulegan and Carpenter showed that C_M was nearly constant over a large part of the wave period, therefore supporting the initial assumption of constant C_M and C_D .

Table 7-5 presents values of C_M reported by various investigators. The importance of considering which wave theory was employed when determining C_D from field experiments is equally important when dealing with C_M .

Based on the information in Table 7-5, the following choice of C_M is recommended for use in conjunction with Figures 7-71 and 7-72:

$$\left. \begin{aligned} C_M &= 2.0 \text{ when } R_e < 2.5 \times 10^5 \\ C_M &= 2.5 - \frac{R_e}{5 \times 10^5} \text{ when } 2.5 \times 10^5 < R_e < 5 \times 10^5 \\ C_M &= 1.5 \text{ when } R_e > 5 \times 10^5 \end{aligned} \right\} \tag{7-53}$$

with R_e defined by equation (7-46).

Table 7-5. Experimentally determined values of C_M .

Investigator	Approximate R_e	C_M^*	Type of Experiment and Theory Used
Keulegan and Carpenter (1956)	$< 3 \times 10^4$	1.5 to 2.5	Oscillatory laboratory flow ($A/D > 6$)
Bretschneider (1957)	1.6×10^5 to 2.3×10^5	2.26 to 2.02	Field experiments
	3.8×10^5 to 6×10^5	1.74 to 1.23	Linear theory
Wilson (1965)	large ($> 5 \times 10^5$)	1.53	Field experiment, spectrum
Skjelbreia (1960)	large ($> 5 \times 10^5$)	1.02 ± 0.53	Field experiments, Stokes' fifth-order theory
Dean and Aagaard (1970)	2×10^5 to 2×10^6	1.2 to 1.7	Field experiments, Stream-function theory
Evans (1970)	large ($> 5 \times 10^5$)	1.76 ± 1.05	Field experiments, Numerical wave theory or Stokes' fifth-order theory
Wheeler (1970)	large ($> 5 \times 10^5$)	1.5	Field experiments, Modified spectrum analysis: using $C_D = 0.6$ and $C_M = 1.5$, the standard deviation of the calculated peak force was 33 percent

* Range or mean \pm standard deviation.

The values of C_M given in Table 7-5 show that Skjelbreia (1960), Dean and Aagaard (1970), and Evans (1970) used almost the same experimental data, and yet estimated different values of C_M . The same applies to their determination of C_D , but while the recommended choice of C_D from Figure 7-85 is generally conservative, from equation (7-53) the recommended choice of C_M for $R_e > 5 \times 10^5$ corresponds approximately to the average of the reported values. This possible lack of conservatism, however, is not significant since the inertia force component is generally smaller than the drag force component for design conditions. From equations (7-37) and (7-38) the ratio of maximum inertia force to maximum drag force becomes

$$\frac{F_{im}}{F_{Dm}} = \frac{\pi}{2} \frac{C_M}{C_D} \frac{D}{H} \frac{K_{im}}{K_{Dm}} \quad (7-54)$$

For example, if $C_M \approx 2 C_D$ and a design wave corresponding to $H/H_D = 0.75$ is assumed, the ratio F_{im}/F_{Dm} may be written (using Figures 7-71 and 7-72) as

$$\frac{F_{im}}{F_{Dm}} \approx \begin{cases} 1.25 \frac{D}{H} & \text{(shallow-water waves)} \\ 5.35 \frac{D}{H} & \text{(deepwater waves)} \end{cases} \quad (7-55)$$

Since D/H will generally be smaller than unity for a design wave, the inertia-force component will be much smaller than the drag-force component for shallow-water waves and the two force components will be of comparable magnitude only for deepwater waves.

f. Example Problem 27 and Discussion of Choice of a Safety Factor.

***** EXAMPLE PROBLEM 27 *****

GIVEN: A design wave, with height $H = 10.0$ m (32.8 ft) and period $T = 12$ s, acts on a pile with diameter $D = 1.25$ m (4.1 ft) in water of depth $d = 26$ m (85 ft).

FIND: The wave force on the pile.

SOLUTION: Compute

$$\frac{H}{gT^2} = \frac{10.0}{(9.8)(12)^2} = 0.0071$$

and

$$\frac{d}{gT^2} = \frac{26}{(9.8)(12)^2} = 0.0184$$

From Figure 7-68, for $d/gT^2 = 0.0184$,

$$\frac{L_A}{L_O} = 0.76$$

and

$$L_A = 0.76 L_O = 0.76 \frac{gT^2}{2\pi} = 0.76 \frac{(9.8)(12)^2}{2\pi} = 170.7 \text{ m (559.9 ft)}$$

From Figure 7-69 for $d/gT^2 = 0.0184$,

$$\frac{\eta_c}{H} = 0.68$$

and, therefore,

$$\eta_c = 0.68 H = 0.68 (10.0) = 6.8 \text{ m (22.3 ft)}$$

say

$$\eta_c = 7 \text{ m (23 ft)}$$

The structure supported by the pile must be 7 m (23 ft) above the still-water line to avoid uplift forces on the superstructure by the given wave.

Calculate, from equation (7-21),

$$\frac{D}{L_A} = \frac{1.25}{170.7} = 0.0073 < 0.05$$

Therefore equation (7-20) is valid.

From Figure 7-75,

$$\frac{H_b}{gT^2} = 0.014$$
$$\frac{H}{H_b} = \frac{\left(\frac{H}{gT^2}\right)}{\left(\frac{H_b}{gT^2}\right)} = \frac{0.0073}{0.014} = 0.52$$

From Figures 7-71 through 7-74,

$$K_{im} = 0.40$$

$$K_{Dm} = 0.35$$

$$S_{im} = 0.59$$

$$S_{Dm} = 0.79$$

From equations (7-46) and (7-47),

$$u_{max} = \frac{\pi H}{T} \left(\frac{L_o}{L_A}\right) = \frac{\pi(10.0)}{12} \frac{1}{0.76} = 3.4 \text{ m/s (11.1 ft/s)}$$

and

$$R_e = \frac{u_{max}^D}{\nu} = \frac{(3.4) (1.25)}{9.29 \times 10^{-7}} = 4.57 \times 10^6$$

From Figure 7-85,

$$C_D = 0.7$$

and from equation (7-53), with $Re > 5 \times 10^5$,

$$C_M = 1.5$$

Therefore,

$$F_{im} = C_M \rho g \frac{\pi D^2}{4} HK_{im}$$

$$F_{im} = (1.5) (1025.2) (9.8) \frac{\pi(1.25)^2}{4} (10.0) (0.40) = 74.0 \text{ kN (16,700 lb)}$$

$$F_{Dm} = C_D \frac{1}{2} \rho g D H^2 K_{Dm}$$

$$F_{Dm} = (0.7)(0.5)(1025.2)(9.8)(1.25)(10.0)^2 (0.35) = 153.8 \text{ kN (34,600 lb)}$$

$$M_{im} = F_{im} d S_{im} = (74,000)(26)(0.59) = 1,135 \text{ kN-m (0.837} \times 10^6 \text{ ft-lb)}$$

$$M_{Dm} = F_{Dm} d S_{Dm} = (153,800)(26)(0.79) = 3,160 \text{ kN-m (2.33} \times 10^6 \text{ ft-lb)}$$

From equation (7-41),

$$w = \frac{C_m^D}{C_D H} = \frac{(1.5) (1.25)}{(0.7) (10.0)} = 0.27$$

Interpolating between Figures 7-77 and 7-78 with $H/gT^2 = 0.0075$ and $d/gT^2 = 0.0183$,

$$\phi_m = 0.20$$

Therefore, from equation (7-42),

$$F_m = \phi_m w C_D H^2 D$$

$$F_m = (0.20) (10,047) (0.7) (10.0)^2 (1.25) = 175.8 \text{ kN (39,600 lb)}$$

Interpolating between Figures 7-81 and 7-82 gives

$$\alpha_m = 0.15$$

Therefore, from equation (7-43),

$$M_m = \alpha_m w C_D H^2 D d$$

$$M_m = (0.15)(10,407)(0.7)(10.0)^2(1.25)(26) = 3,429 \text{ kN-m } (2.529 \times 10^6 \text{ ft-lb})$$

Before the pile is designed or the foundation analysis is performed, a safety factor is usually applied to calculated forces. It seems pertinent to indicate (Bretschneider, 1965) that the design wave is often a large wave, with little probability of being exceeded during the life of the structure. Also, since the experimentally determined values of C_M and C_D show a large scatter, values of C_M and C_D could be chosen so that they would rarely be exceeded. Such an approach is quite conservative. For the recommended choice of C_M and C_D when used with the generalized graphs, the results of Dean and Aagaard (1970) show that predicted peak force deviated from measured force by at most ± 50 percent.

When the design wave is unlikely to occur, it is recommended that a safety factor of 1.5 be applied to calculated forces and moments and that this nominal force and moment be used as the basis for structural and foundation design for the pile.

Some design waves may occur frequently. For example, maximum wave height could be limited by the depth at the structure. *If the design wave is likely to occur, a larger safety factor, say greater than 2, may be applied to account for the uncertainty in C_M and C_D .*

In addition to the safety factor, changes occurring during the expected life of the pile should be considered in design. Such changes as scour at the base of the pile and added pile roughness due to marine growth may be important. For flow conditions corresponding to supercritical Reynolds numbers (Table 7-5), the drag coefficient C_D will increase with increasing roughness.

The design procedure presented above is a static procedure; forces are calculated and applied to the structure statically. The dynamic nature of forces from wave action must be considered in the design of some offshore structures. When a structure's natural frequency of oscillation is such that a significant amount of energy in the wave spectrum is available at that frequency, the dynamics of the structure must be considered. In addition, stress reversals in structural members subjected to wave forces may cause failure by fatigue. If fatigue problems are anticipated, the safety factor should be increased or allowable stresses should be decreased. Evaluation of these considerations is beyond the scope of this manual.

Corrosion and fouling of piles also require consideration in design. Corrosion decreases the strength of structural members. Consequently, corrosion rates over the useful life of an offshore structure must be estimated and the size of structural members increased accordingly. Watkins (1969) provides some guidance in the selection of corrosion rates of steel in seawater. Fouling of a structural member by marine growth increases (1) the roughness and effective diameter of the member and (2) forces on the member. Guidance on selecting a drag coefficient C_D can be obtained from Table 7-4. However, the increased diameter must be carried through the entire design procedure to determine forces on a fouled member.

g. Calculation of Forces and Moments on Groups of Vertical Cylindrical Piles. To find the maximum horizontal force and the moment around the mud line for a group of piles supporting a structure, the approach presented in Section III,1,b must be generalized. Figure 7-86 shows an example group of piles subjected to wave action. The design wave concept assumes a two-dimensional (long-crested) wave; hence the x-direction is chosen as the direction of wave propagation. If a reference pile located at $x = 0$ is chosen, the x-coordinate of each pile in the group may be determined from

$$x_n = \ell_n \cos \alpha_n \quad (7-56)$$

where the subscript n refers to a particular pile and ℓ_n and α_n are as defined in Figure 7-86. If the distance between any two adjacent piles is large enough, the forces on a single pile will be unaffected by the presence of the other piles. The problem is simply one of finding the maximum force on a series of piles.

In Section III,1,b, the force variation in a single vertical pile as a function of time was found. If the design wave is assumed to be a wave of permanent form (i.e., one that does not change form as it propagates), the variation of force at a particular point with time is the same as the variation of force with distance at an instant in time. By introducing the phase angle

$$\theta = \frac{2\pi x}{L} - \frac{2\pi t}{T} \quad (7-57)$$

where L is wavelength, the formulas given in Section III,1,c (eqs. (7-25) and (7-26)) for a pile located at $x = 0$ may be written in general form by introducing θ , defined by $2\pi x/L - 2\pi t/T$ in place of $-2\pi t/T$.

Using tables (Skjelbreia et al., 1960, and Dean, 1974), it is possible to calculate the total horizontal force $F(x)$ and moment around the mud line $M(x)$ as a function of distance from the wave crest x . By choosing the location of the reference pile at a certain position $x = x_r$ relative to the design wave crest the total force, or moment around the mud line, is obtained by summation

$$F_{Total} = \sum_{n=0}^{N-1} F(x_r + x_n) \quad (7-58)$$

$$M_{Total} = \sum_{n=0}^{N-1} M(x_r + x_n) \quad (7-59)$$

where

N = total number of piles in the group

x_n = from equation (7-56)

x_r = location of reference pile relative to wave crest

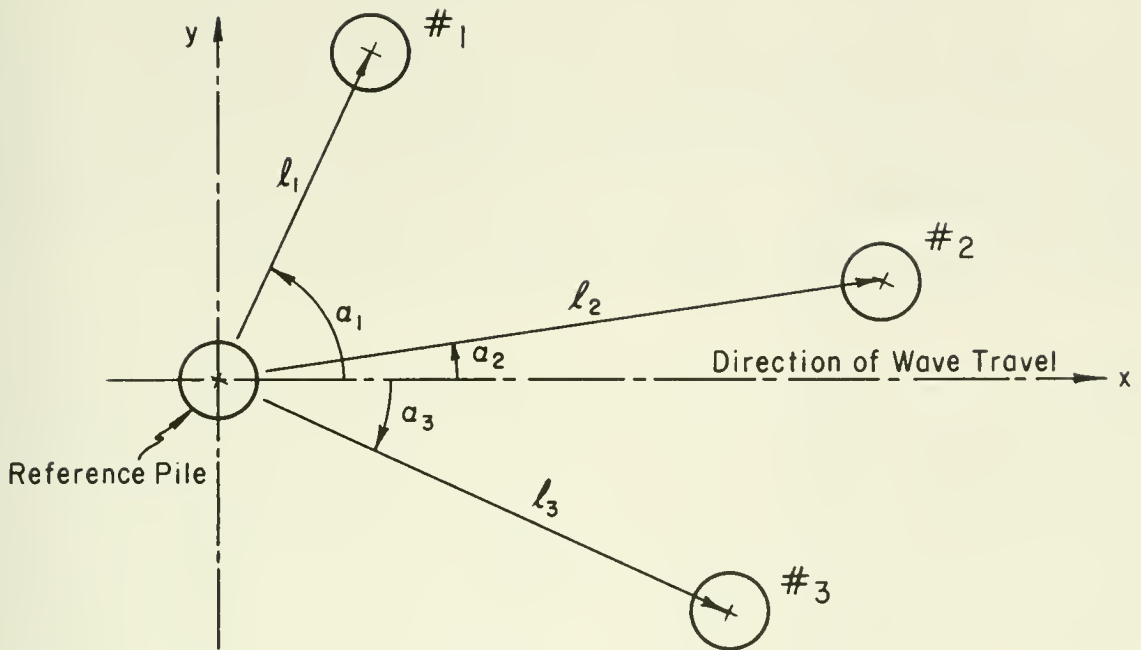

Figure 7-86. Definition sketch: calculation of wave forces on a group of piles that are structurally connected.

By repeating this procedure for various choices of x_r , it is possible to determine the maximum horizontal force and moment around the mud line for the pile group.

$F_D(\theta)$ is an even function, and $F_z(\theta)$ is an odd function; hence

$$F_D(\theta) = F_D(-\theta) \quad (7-60)$$

and

$$F_z(\theta) = -F_z(-\theta) \quad (7-61)$$

and calculations need only be done for $0 \leq \theta \leq \pi$ radians. Equations (7-60) and (7-61) are true for any wave that is symmetric about its crest, and are therefore applicable if the wave tables of Skjelbreia et al. (1960) and Dean (1974) are used. When these tables are used, the wavelength computed from the appropriate finite amplitude theory should be used to transform θ into distance from the wave crest, x .

The procedure is illustrated by the following examples. For simplicity, Airy theory is used and only maximum horizontal force is considered. The same computation procedure is used for calculating maximum moment.

GIVEN: A design wave with height $H = 10.0$ m (32.8 ft) and period $T = 12$ s in a depth $d = 26.0$ (85.3 ft) acts on a pile with a diameter $D = 1.25$ m (4.1 ft). (Assume Airy theory to be valid.)

FIND: The variation of the total force on the pile as a function of distance from the wave crest.

SOLUTION: From an analysis similar to that in Section III,1,e,

$$C_D = 0.7$$

and

$$C_m = 1.5$$

From Figures 7-71 and 7-72, using the curve for Airy theory with

$$\frac{d}{gT^2} = \frac{26.0}{9.8 (12)^2} = 0.0184$$

$$K_{im} = 0.38 ; K_{Dm} = 0.20$$

and from equations (7-37) and (7-38),

$$F_{im} = 1.5 (1025.2) (9.8) \frac{\pi(1.25)^2}{4} (10.0)(0.38) = 70.3 \text{ kN (15,800 lb)}$$

$$F_{Dm} = 0.7 (0.5)(1025.2)(9.8)(1.25)(10.0)^2 (0.20) = 87.9 \text{ kN (19,800 lb)}$$

Combining equations (7-29) and (7-33) gives

$$F_i = F_{im} \sin \theta$$

and combining equations (7-30) and (7-34) gives

$$F_D = F_{Dm} \cos \theta \quad | \cos \theta |$$

where

$$\theta = \frac{2\pi x}{L} - \frac{2\pi t}{T}$$

The wavelength can be found from Figure 7-68,

$$L \approx L_A = 171 \text{ m}$$

From Table 7-6, the maximum force on the example pile occurs when $(20^\circ < \theta < 40^\circ)$; $F_m \approx 102 \text{ kN (22,930 lb)}$.

Table 7-6. Example calculation of wave force variation with phase angle.

θ (deg)	x (m)	$F_i = F_{im} \sin \theta$ (kN)	$F_D = F_{Dm} \cos \theta \cos \theta$ (kN)	$F(\theta) = F_i + F_D$ (kN)	$F(-\theta) = F_D - F_i$ (kN)
0	0	0	87.9	87.9	87.9
20	9.5	24.1	77.6	101.7	53.5
40	19.0	45.2	51.6	96.8	6.4
60	28.5	60.9	22.0	82.9	-38.9
80	38.0	69.2	2.7	71.9	-66.5
100	47.5	69.2	-2.7	66.5	-71.9
120	57.0	60.9	-22.0	38.9	-82.9
140	66.5	45.2	-51.6	6.4	-96.8
160	76.0	24.1	-77.6	-53.5	-101.7
180	85.5	0	-87.9	-87.9	-87.9

Note: 1 Newton (N) = 0.225 pounds of force.

1 kN = 1000 N.

***** EXAMPLE PROBLEM 29 *****

GIVEN: Two piles each with a diameter $D = 1.25 \text{ m (4.1 ft)}$ spaced 30.0 m (98.4 ft) apart are acted on by a design wave having a height $H = 10.0 \text{ m (32.8 ft)}$ and a period $T = 12 \text{ s}$ in a depth $d = 26 \text{ m (85 ft)}$. The direction of wave approach makes an angle of 30° with a line joining the pile centers.

FIND: The maximum horizontal force experienced by the pile group and the location of the reference pile with respect to the wave crest (phase angle) when the maximum force occurs.

SOLUTION: The variation of total force on a single pile with phase angle θ was computed from Airy theory for the preceding problem and is given in Table 7-6. Values in Table 7-6 will be used to compute the maximum horizontal force on the two-pile group. Compute the phase difference between the two piles by equation (7-56)

$$x_n = l_n \cos \alpha_n = 30 (\cos 30^\circ)$$

$$x_n = 26.0 \text{ m (85.2 ft)}$$

From the previous example problem, $L \approx L_A = 171 \text{ m}$ for $d = 26 \text{ m}$ and $T = 12 \text{ s}$. Then, from the expression $\frac{x}{L} = \frac{\theta_n}{2\pi}$,

$$\theta_n = \frac{2\pi x}{L} = \frac{2\pi(26.0)}{171} = 0.96 \text{ rad}$$

or

$$\theta_n = \frac{360^\circ (26.0)}{171} = 54.7^\circ$$

Values in Table 7-6 can be shifted by 55 degrees and represent the variation of force on the second pile with the phase angle. The total horizontal force is the sum of the two individual pile forces. The same procedure can be applied for any number of piles. Table 7-6 can be used by offsetting the force values by an amount equal to 55 degrees (preferably by a graphical method). The procedure is also applicable to moment computations.

The maximum force is about 183.0 kN when the wave crest is about 8 degrees or $[(8^\circ / 360^\circ) 171] \approx 3.5 \text{ m}$ (11.5 ft) in front of the reference pile.

Because Airy theory does not accurately describe the flow field of finite-amplitude waves, a correction to the computed maximum force as determined above could be applied. This correction factor for structures of minor importance might be taken as the ratio of maximum total force on a single pile for an appropriate finite-amplitude theory to maximum total force on the same pile as computed by Airy theory. For example, the forces on a single pile are (from preceding example problems),

$$(F_m)_{\text{finite-amplitude}} = 175.9 \text{ kN (39,600 lb)}$$

$$(F_m)_{\text{Airy}} = 102 \text{ kN (22,930 lb)}$$

Therefore, the total force on the two-pile group, corrected for the finite-amplitude design wave, is given by,

$$\left[F_{\text{Total}} \right]_{2 \text{ piles}}^{\text{(corrected for finite-amplitude design wave)}} = \frac{(F_m)_{\text{finite-amplitude}}}{(F_m)_{\text{Airy}}} \left[F_{\text{Total}} \right]_{2 \text{ piles}}^{\text{(computed from Airy theory)}}$$

$$\left[F_{\text{Total}} \right]_{2 \text{ piles}} = \frac{175.9}{102.0} (183.0) = 315.6 \text{ kN (71,000 lb)}$$

This approach is an approximation and should be limited to rough calculations for checking purposes only. The use of tables of finite-amplitude wave properties (Skjelbreia et al., 1960 and Dean, 1974) is recommended for design calculations.

As the distance between piles becomes small relative to the wavelength, maximum forces and moments on pile groups may be conservatively estimated by adding the maximum forces or moments on each pile.

The assumption that piles are unaffected by neighboring piles is not valid when distance between piles is less than three times the pile diameter. A few investigations evaluating the effects of nearby piles are summarized by Dean and Harleman (1966).

h. Calculation of Forces on a Nonvertical Cylindrical Pile. A single, nonvertical pile subjected to the action of a two-dimensional design wave traveling in the +x direction is shown in Figure 7-67. Since forces are perpendicular to the pile axis, it is reasonable to calculate forces by equation (7-20) using components of velocity and acceleration perpendicular to the pile. Experiments (Bursnall and Loftin, 1951) indicate this approach may not be conservative, since the drag force component depends on resultant velocity rather than on the velocity component perpendicular to the pile axis. To consider these experimental observations, the following procedure is recommended for calculating forces on nonvertical piles.

For a given location on the pile (x_0, y_0, z_0 in Figure 7-87), the force per unit length of pile is taken as the horizontal force per unit length of a fictitious vertical pile at the same location.

***** EXAMPLE PROBLEM 30 *****

GIVEN: A pile with diameter $D = 1.25$ m (4.1 ft) at an angle of 45 degrees with the horizontal in the x-z plane is acted upon by a design wave with height $H = 10.0$ m (32.8 ft) and period $T = 12$ s in a depth $d = 26$ m (85 ft) .

FIND: The maximum force per unit length on the pile 9.0 m (29.5 ft) below the SWL ($z = -9.0$ m).

SOLUTION: For simplicity, Airy theory is used. From preceding examples, $C_M = 1.5$, $C_D = 0.7$, and $L = L_A = 171$ m.

From equation (7-25) with $\sin (-2\pi/T) = 1.0$,

$$f_{im} = C_M \rho g \frac{\pi D^2}{4} H \left\{ \frac{\pi \cosh [2\pi(d+z)/L]}{\cosh [2\pi d/L]} \right\}$$

$$f_{im} = 1.5 (1025.2) (9.8) \frac{\pi(1.25)^2}{4} (10.0) \frac{\pi}{171} (0.8) = 2,718 \text{ N/m (186 lb/ft)}$$

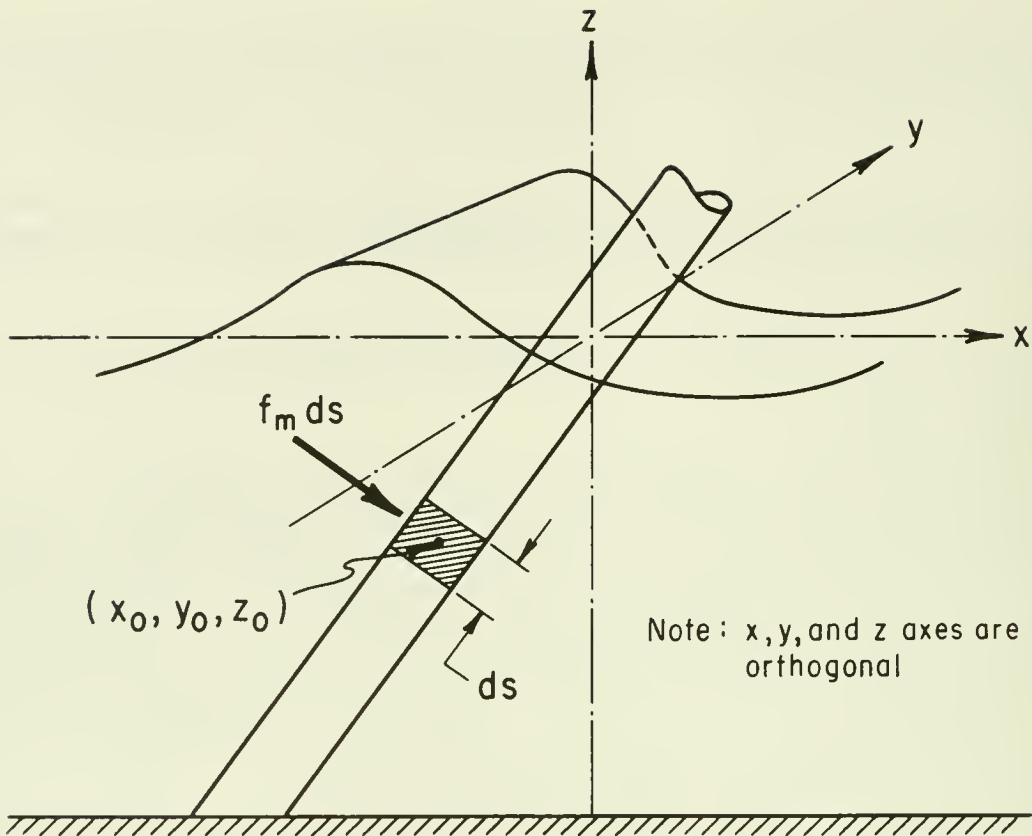

Figure 7-87. Definition sketch: calculation of wave forces on a nonvertical pile.

From equation (7-26) with $\cos(2\pi t/T) = 1.0$,

$$f_{Dm} = C_D \frac{\rho g}{2} D H^2 \frac{gT^2}{4L} \left\{ \frac{\cosh[2\pi(d+z)/L]}{\cosh[2\pi d/L]} \right\}^2$$

$$f_{Dm} = 0.7 \frac{(1025.2)(9.8)}{2} (1.25)(10.0)^2 \frac{(9.8)(12)^2}{4(171)^2} (0.8)^2 = 3,394 \text{ N/m} \quad (233 \text{ lb/ft})$$

The maximum force can be assumed to be given by

$$f_m = f_{Dm} \frac{F_m}{F_{Dm}}$$

where F_m and F_{Dm} are given by equations (7-42) and (7-38). Substituting these equations into the above gives

$$f_m = f_{Dm} \frac{\phi_m w C_D H^2 D}{C_D (\rho g / 2) H^2 D K_{Dm}} = f_{Dm} \frac{2\phi_m}{K_{Dm}}$$

From equation (7-41),

$$W = \frac{C_D}{C_H} = \frac{1.5(1.25)}{0.7(10.0)} = 0.27$$

Interpolating between Figures 7-77 and 7-78 with $H/gT^2 = 0.0075$ and $d/gT^2 = 0.0184$, it is found that $\phi_m = 0.20$.

From a preceding problem,

$$\frac{H}{H_b} = 0.52$$

Enter Figure 7-72 with $d/gT^2 = 0.0183$ and, using the curve labeled $1/2 H_b$, read

$$K_{Dm} = 0.35$$

Therefore,

$$f_m = f_{Dm} \frac{2\phi_m}{K_{Dm}}$$

$$f_m = 3,394.1 \frac{2(0.2)}{0.35} = 3,879 \text{ N/m (266 lb/ft)}$$

say

$$f_m = 3,900 \text{ N/m (267 lb/ft)}$$

The maximum horizontal force per unit length at $z = -9.0 \text{ m (-29.5 ft)}$ on the fictitious vertical pile is $f_m = 3,900 \text{ N/m}$. This is also taken as the maximum force per unit length perpendicular to the actual inclined pile.

i. Calculation of Forces and Moments on Cylindrical Piles Due to Breaking Waves. Forces and moments on vertical cylindrical piles due to breaking waves can, in principle, be calculated by a procedure similar to that outlined in Section III,1,b by using the generalized graphs with $H = H_b$. This approach is recommended for waves breaking in deep water (see Ch. 2, Sec. VI, BREAKING WAVES).

For waves in shallow water, the inertia force component is small compared to the drag force component. The force on a pile is therefore approximately

$$F_m \approx F_{Dm} = C_D \frac{1}{2} \rho g D H^2 K_{Dm} \tag{7-62}$$

Figure 7-72, for shallow-water waves with $H = H_b$, gives $K_{Dm} = 0.96 \approx 1.0$; consequently the total force may be written

$$F_m = C_D \frac{1}{2} \rho g D H_b^2 \quad (7-63)$$

From Figure 7-74, the corresponding lever arm is $d_b S_{Dm} \approx d_b (1.11)$ and the moment about the mud line becomes

$$M_m = F_m (1.11 d_b) \quad (7-64)$$

Small-scale experiments ($R_e \approx 5 \times 10^4$ by Hall, 1958) indicate that

$$F_m \approx 1.5 \rho g D H_b^2 \quad (7-65)$$

and

$$M_m \approx F_m H_b \quad (7-66)$$

Comparison of equation (7-63) with equation (7-65) shows that the two equations are identical if $C_D = 3.0$. This value of C_D is 2.5 times the value obtained from Figure 7-85 ($C_D = 1.2$ for $R_e \approx 5 \times 10^4$). From Chapter 2, Section VI, since H_b generally is smaller than $(1.11) d_b$, it is conservative to assume the breaker height approximately equal to the lever arm, $1.11 d_b$. Thus, the procedure outlined in Section III,1,b of this chapter may also be used for breaking waves in shallow water. However, C_D should be the value obtained from Figure 7-85 and multiplied by 2.5.

Since the Reynolds number generally will be in the supercritical region, where according to Figure 7-85, $C_D = 0.7$, it is recommended to calculate breaking wave forces using

$$(C_D)_{\text{breaking}} = 2.5 (0.7) = 1.75 \quad (7-67)$$

The above recommendation is based on limited information; however, large-scale experiments by Ross (1959) partially support its validity.

For shallow-water waves near breaking, the velocity near the crest approaches the celerity of wave propagation. Thus, as a first approximation the horizontal velocity near the breaker crest is

$$u_{\text{crest}} \approx \sqrt{gd_b} \approx \sqrt{gH_b} \quad (7-68)$$

where H_b is taken approximately equal to d_b , the depth at breaking. Using

equation (7-68) for the horizontal velocity, and taking $C_D = 1.75$, the force per unit length of pile near the breaker crest becomes

$$f_{Dm} \approx C_D \frac{1}{2} \rho D u_{crest}^2 \approx 0.88 \rho g D H_b \quad (7-69)$$

Table 7-7 is a comparison between the result calculated from equation (7-69) with measurements by Ross (1959) on a 1-foot-diameter pile ($R_e \approx 1.3 \times 10^6$).

Table 7-7. Comparison of measured and calculated breaker force.¹

Breaker Height m (ft)	f_{Dm}^2 N/m (lb/ft)	f_{Dm}^3 N/m (lb/ft)
1.1 (3.7)	3021 (207)	3211 (220)
1.16 (3.8)	3108 (213)	3648 (250)
1.2 (4.1)	3357 (230)	1824 (125)
1.3 (4.2)	3430 (235)	2481 (170)
1.3 (4.2)	3430 (235)	4086 (280)
1.5 (4.9)	4013 (275)	3648 (250)

- ¹ Values given are force per unit length of pile near breaker crest.
- ² Calculated from equation (7-69).
- ³ Measured by Ross, 1959.

Based on this comparison, the choice of $C_D = 1.75$ for $R_e > 5 \times 10^5$ appears justified for calculating forces and moments due to breaking waves in shallow water.

(a) Calculation of Forces on Noncircular Piles. The basic force equation (eq. 7-20) can be generalized for piles of other than those with a circular cross section, if the following substitutions are made:

$$\frac{\pi D^2}{4} = \text{volume per unit length of pile} \quad (7-70)$$

where

D = width perpendicular to flow direction per unit length of pile

Substituting the above quantities for a given noncircular pile cross section, equation (7-20) may be used. The coefficients K_{im} , etc., depend only on the flow field and are independent of pile cross-section geometry; therefore, the generalized graphs are still valid. However, the hydrodynamic coefficients C_D and C_M depend strongly on the cross-section shape of the pile. If values for C_D and C_M corresponding to the type of pile to be used are available, the procedure is identical to the one presented in previous sections.

Keulegan and Carpenter (1956) performed tests on flat plate in oscillating flows. Equation (7-20) in the form applicable for a circular cylinder, with D taken equal to the width of the plate, gave

$$\text{and } \left. \begin{array}{l} 3 < C_M < 4.5 \\ 1.8 < C_D < 2.7 \end{array} \right\} \text{ for } \frac{A}{D} > 10 \quad (7-71)$$

The fact that C_D approaches the value of 1.8 as A/D (eq. 7-50) increases is in good agreement with results obtained under steady flow conditions (Rouse, 1950).

The following procedure is proposed for estimating forces on piles having sharp-edged cross sections for which no empirical data are available for values of C_M and C_D .

(1) The width of the pile measured perpendicular to the flow direction is assumed to be the diameter of an equivalent circular cylindrical pile, D .

(2) The procedures outlined in the preceding sections are valid, and the formulas are used as if the pile were of circular cross section with diameter D .

(3) The hydrodynamic coefficients are chosen within the range given by equation (7-71); i.e., $C_M \approx 3.5$ and $C_D \approx 2.0$.

This approach is approximate and should be used with caution. More accurate analyses require empirical determination of C_M and C_D for the pile geometry under consideration.

Forces resulting from action of broken waves on piles are much smaller than forces due to breaking waves. When pile-supported structures are constructed in the surf zone, lateral forces from the largest wave breaking on the pile should be used for design (see Sec. I,2). While breaking-wave forces in the surf zone are great per unit length of pile, the pile length actually subjected to wave action is usually short, hence results in a small total force. Pile design in this region is usually governed primarily by vertical loads acting along the pile axis.

2. Nonbreaking Wave Forces on Walls.

a. General. In an analysis of wave forces on structures, a distinction is made between the action of *nonbreaking*, *breaking*, and *broken* waves (see Sec. I,2, Selection of Design Wave). Forces due to nonbreaking waves are primarily hydrostatic. Broken and breaking waves exert an additional force due to the dynamic effects of turbulent water and the compression of entrapped air pockets. Dynamic forces may be much greater than hydrostatic forces; therefore, structures located where waves break are designed for greater forces than those exposed only to nonbreaking waves.

b. Nonbreaking Waves. Typically, shore structures are located in depths where waves will break against them. However, in protected regions, or where the fetch is limited, and when depth at the structure is greater than about 1.5 times the maximum expected wave height, nonbreaking waves may occur.

Sainflou (1928) proposed a method for determining the pressure due to nonbreaking waves. The advantage of his method has been ease of application, since the resulting pressure distribution may be reasonably approximated by a straight line. Experimental observations by Rundgren (1958) have indicated Sainflou's method overestimates the nonbreaking wave force for steep waves. The higher order theory by Miche (1944), as modified by Rundgren (1958), to consider the wave reflection coefficient of the structure, appears to best fit experimentally measured forces on vertical walls for steep waves, while Sainflou's theory gives better results for long waves of low steepness. Design curves presented here have been developed from the Miche-Rundgren equations and the Sainflou equations.

c. Miche-Rundgren: Nonbreaking Wave Forces. Wave conditions at a structure and seaward of a structure (when no reflected waves are shown) are depicted in Figure 7-88. The wave height that would exist at the structure if the structure were not present is the incident wave height H_i . The wave height that actually exists at the structure is the sum of H_i and the height of the wave reflected by the structure H_r . The wave reflection coefficient χ equals H_r/H_i . Wave height at the wall H_w is given as

$$H_w = H_i + H_r = (1 + \chi) H_i \quad (7-72)$$

If reflection is complete and the reflected wave has the same amplitude as the incident wave, then $\chi = 1$ and the height of the *clapotis* or *standing wave* at the structure will be $2H_i$. (See Figure 7-88 for definition of terms associated with a clapotis at a vertical wall.) The height of the clapotis crest above the bottom is given by

$$y_c = d + h_o + \frac{1 + \chi}{2} H_i \quad (7-73)$$

where h_o is the height of the clapotis orbit center above SWL.

The height of the clapotis trough above the bottom is given by

$$y_t = d + h_o - \frac{1 + \chi}{2} H_i \quad (7-74)$$

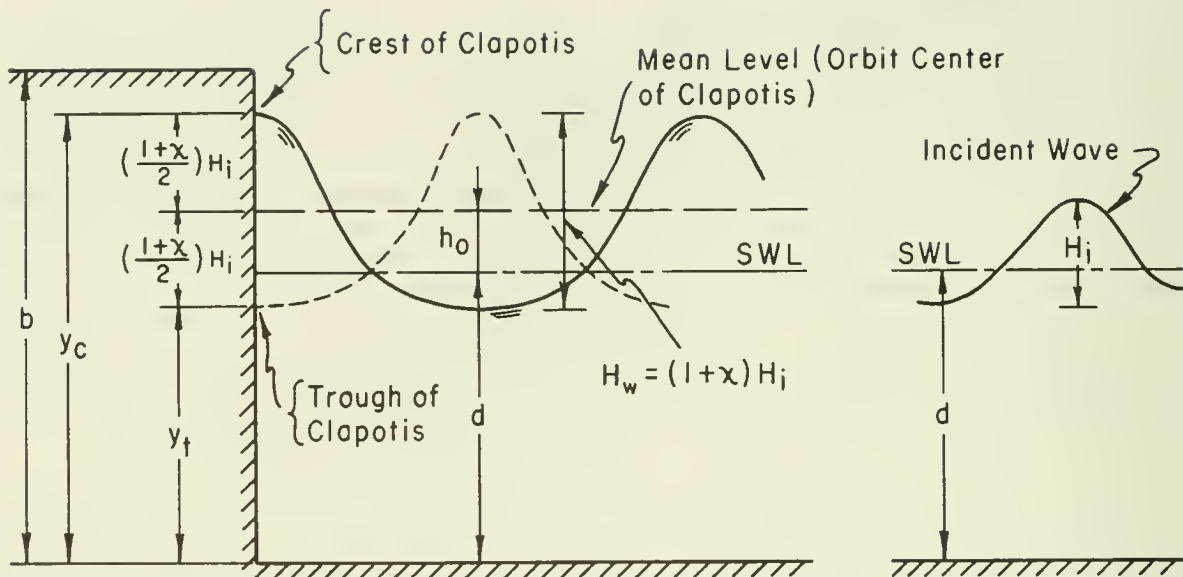

d = Depth from Stillwater Level

H_i = Height of Original Free Wave (In Water of Depth, d)

χ = Wave Reflection Coefficient

h_0 = Height of Clapotis Orbit Center (Mean Water Level at Wall) Above the Stillwater Level (See Figures 7-90 and 7-93)

y_c = Depth from Clapotis Crest = $d + h_0 + \left(\frac{1 + \chi}{2} \right) H_i$

y_t = Depth from Clapotis Trough = $d + h_0 - \left(\frac{1 + \chi}{2} \right) H_i$

b = Height of Wall

Figure 7-88. Definition of Terms: nonbreaking wave forces.

The reflection coefficient, and consequently clapotis height and wave force, depends on the geometry and roughness of the reflecting wall and possibly on wave steepness and the "wave height-to-water depth" ratio. Domzig (1955) and Greslou and Mahe (1954) have shown that the reflection coefficient decreases with both increasing wave steepness and "wave height-to-water depth" ratio. Goda and Abe (1968) indicate that for reflection from smooth vertical walls this effect may be due to measurement techniques and could be only an apparent effect. Until additional research is available, it should be assumed that smooth vertical walls completely reflect incident waves and $\chi = 1$. Where wales, tiebacks, or other structural elements increase the surface roughness of the wall by retarding vertical motion of the water, a lower value of χ may be used. A lower value of χ also may be assumed when the wall is built on a rubble base or when rubble has been placed seaward of the structure toe. *Any value of χ less than 0.9 should not be used for design purposes.*

Pressure distributions of the crest and trough of a clapotis at a vertical wall are shown in Figure 7-89. When the crest is at the wall, pressure

increases from zero at the free water surface to $wd + p_1$ at the bottom, where p_1 is approximated as

$$p_1 = \left(\frac{1 + \chi}{2} \right) \frac{w H_i}{\cosh (2\pi d/L)} \quad (7-75)$$

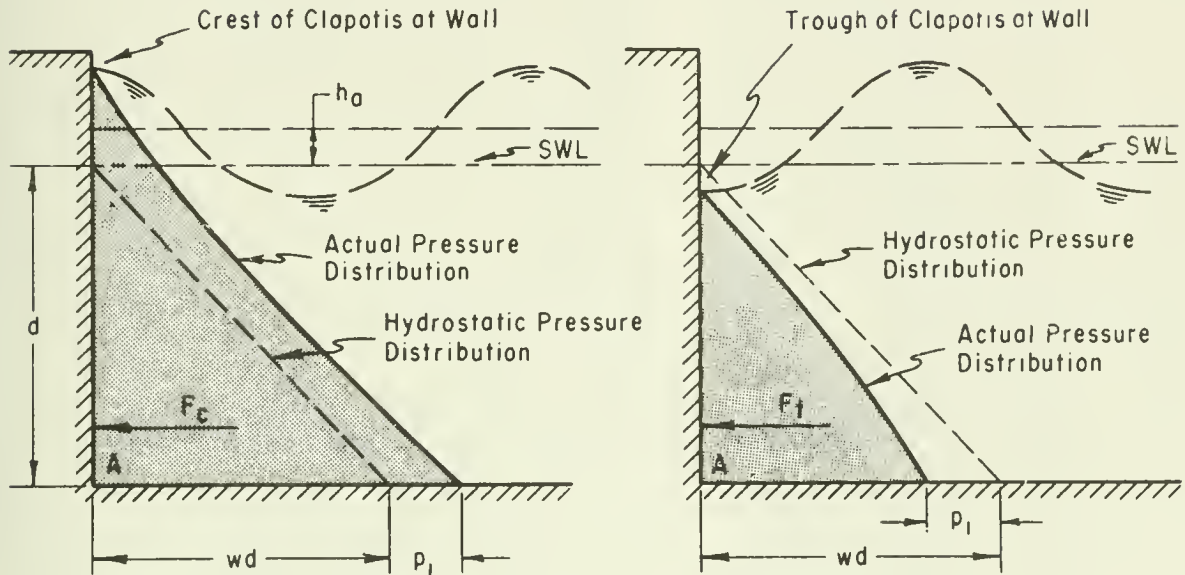

Figure 7-89. Pressure distributions for nonbreaking waves.

When the trough is at the wall, pressure increases from zero at the water surface to $wd - p_1$ at the bottom. The approximate magnitude of wave force may be found if the pressure is assumed to increase linearly from the free surface to the bottom when either the crest or trough is at the wall. However, this estimate will be conservative by as much as 50 percent for steep waves near the breaking limit.

Figures 7-90 through 7-95 permit a more accurate determination of forces and moments resulting from a nonbreaking wave at a wall. Figures 7-90 and 7-92 show the dimensionless height of the clapotis orbit center above still-water level, dimensionless horizontal force due to the wave, and dimensionless moment about the bottom of the wall (due to the wave) for a reflection coefficient $\chi = 1$. Figures 7-93 through 7-95 represent identical dimensionless parameters for $\chi = 0.9$.

The forces and moments found by using these curves *do not* include the force and moment due to the hydrostatic pressure at still-water level (see Figure 7-89).

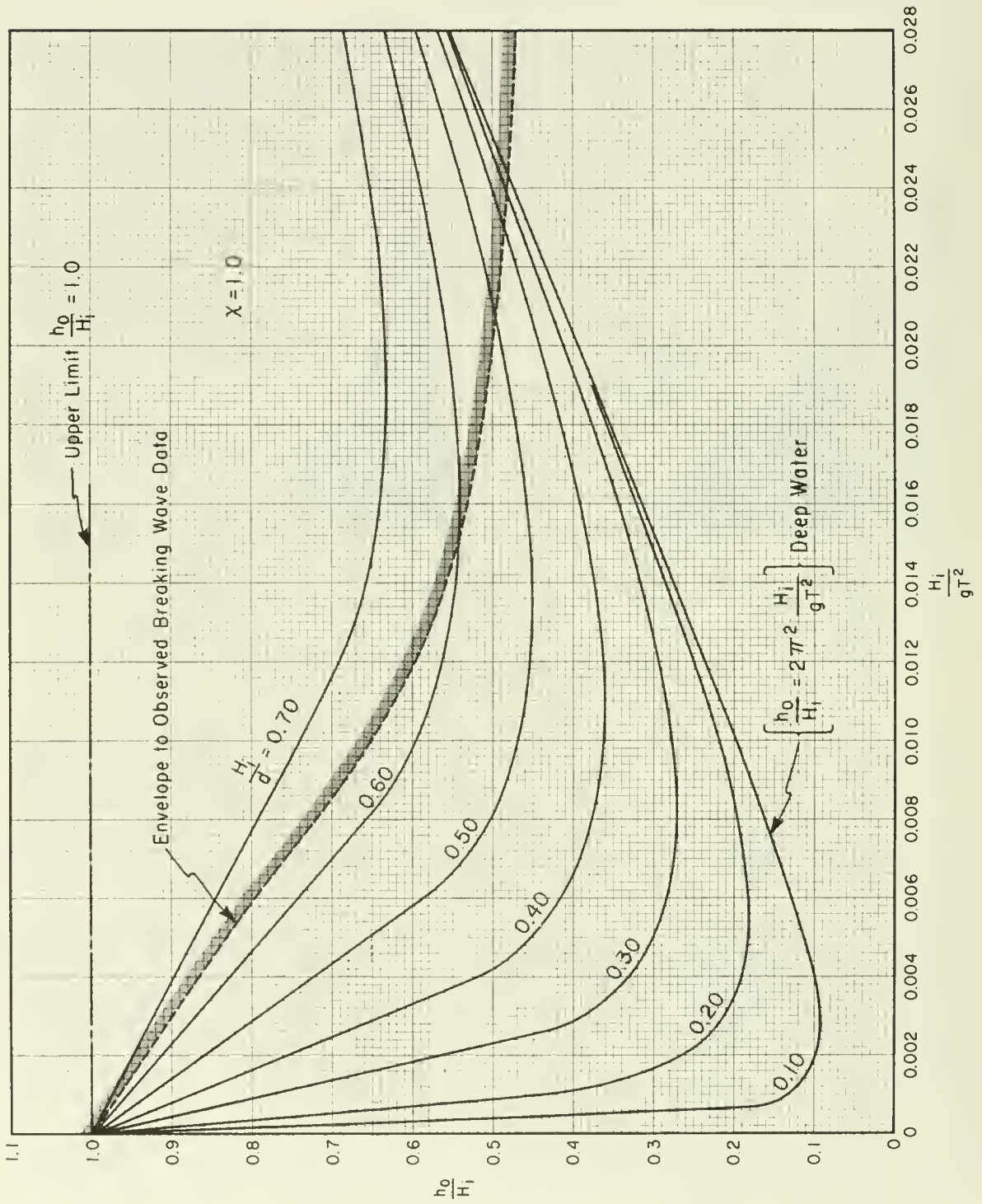

Figure 7-90. Nonbreaking waves; $X = 1.0$.

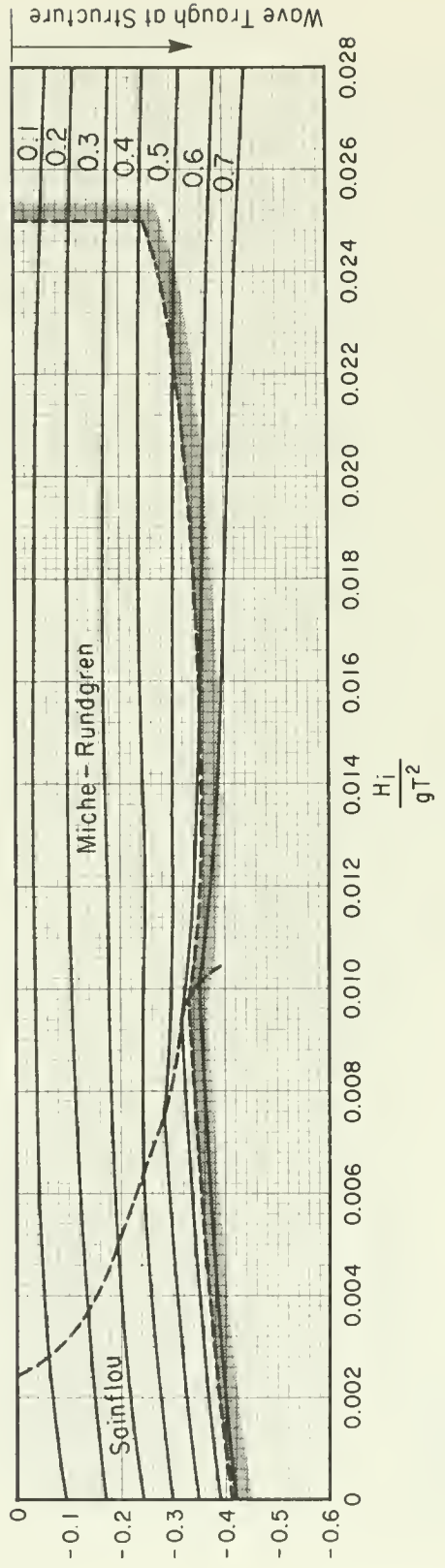
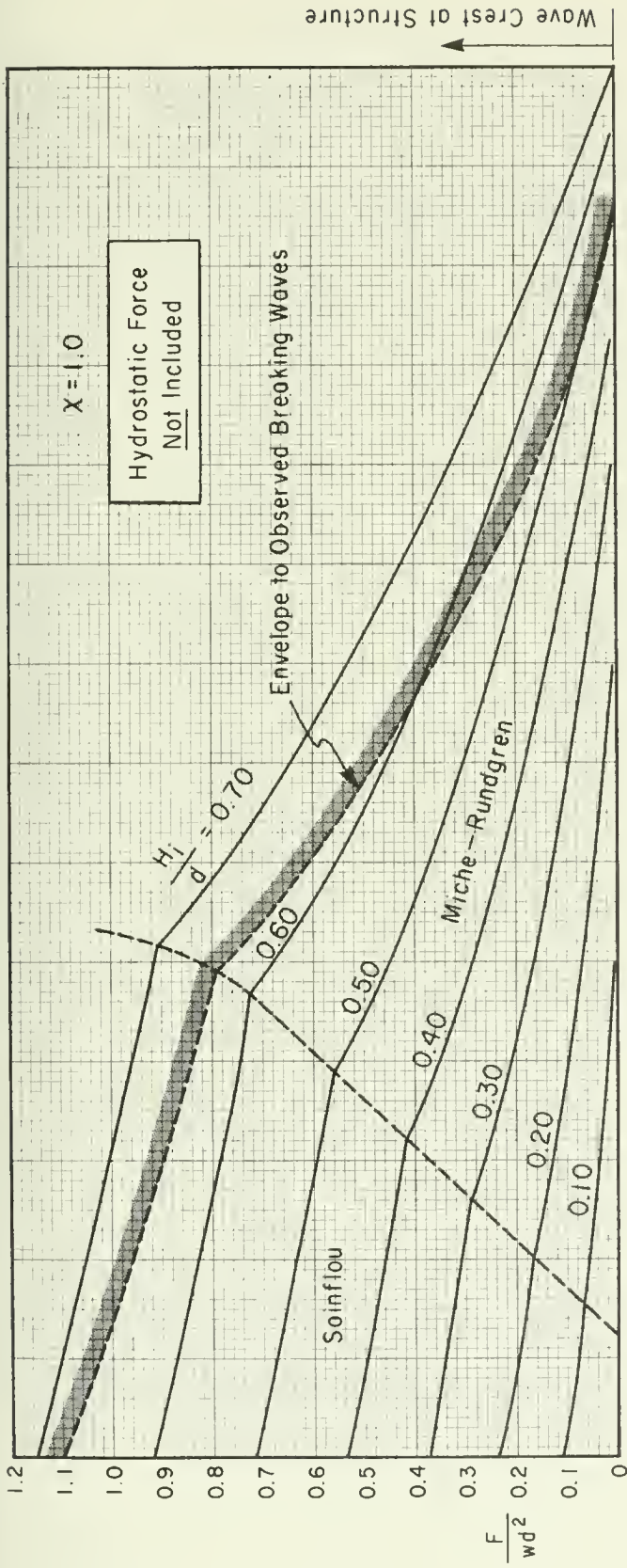

Figure 7-91. Nonbreaking wave forces; $X = 1.0$.

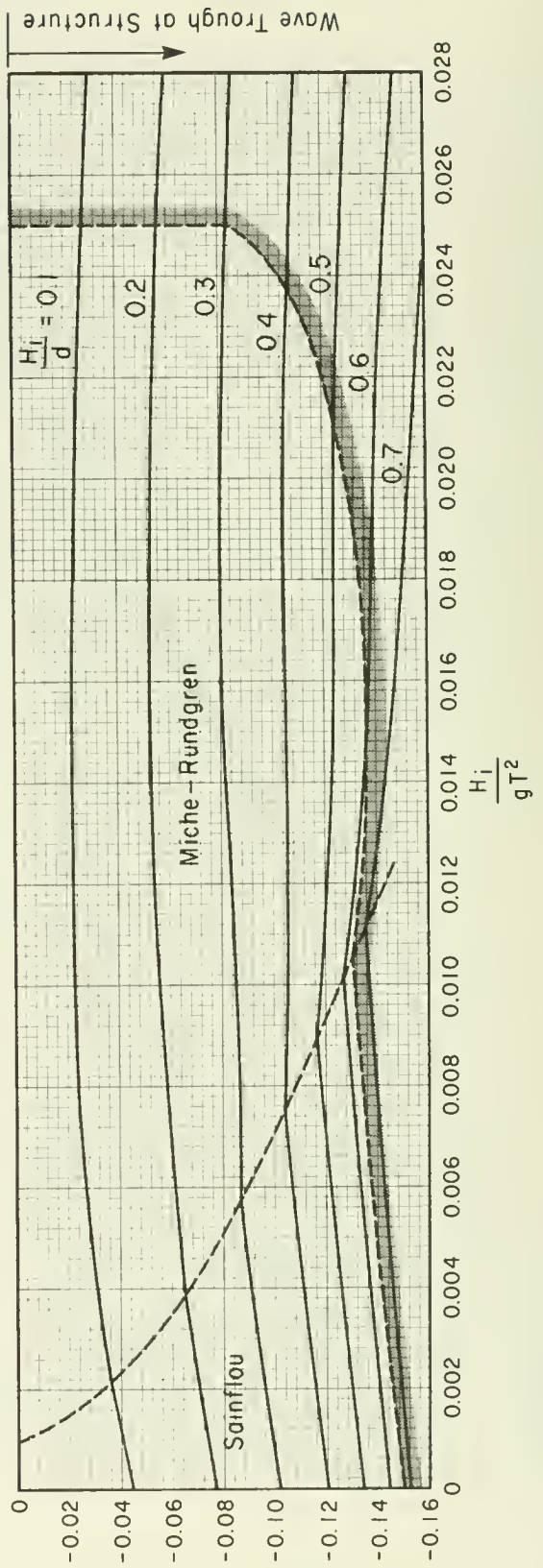
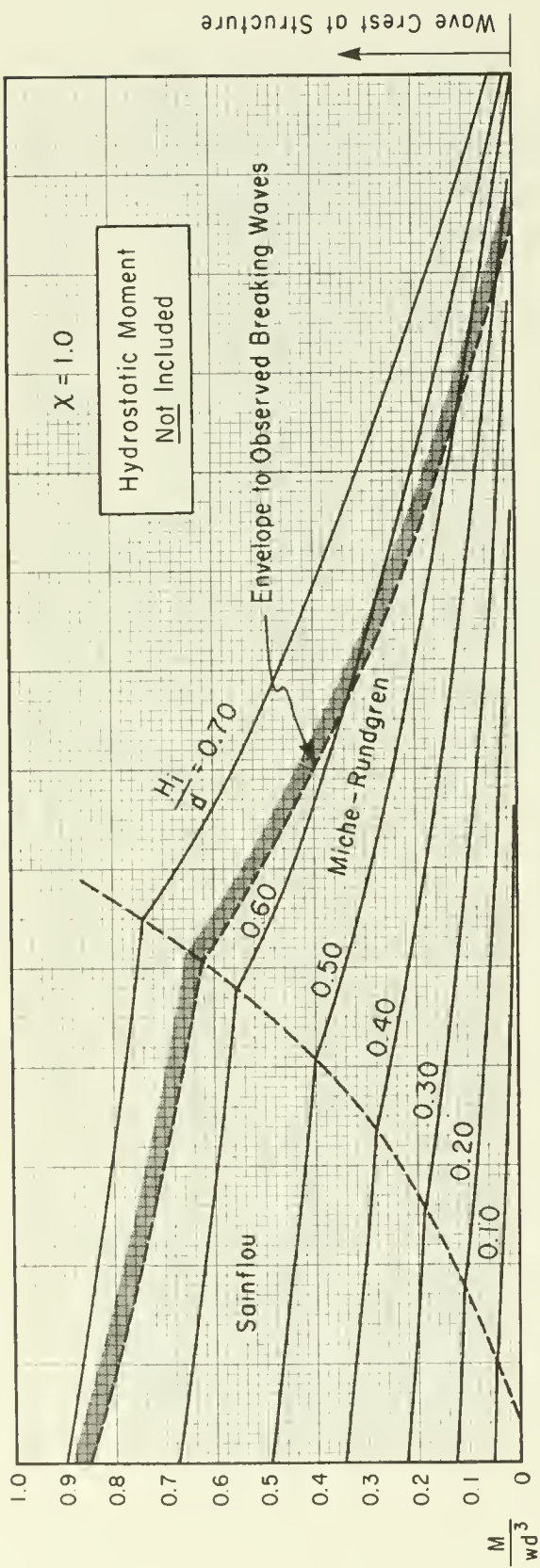

Figure 7-92. Nonbreaking wave moment; $\chi = 1.0$.

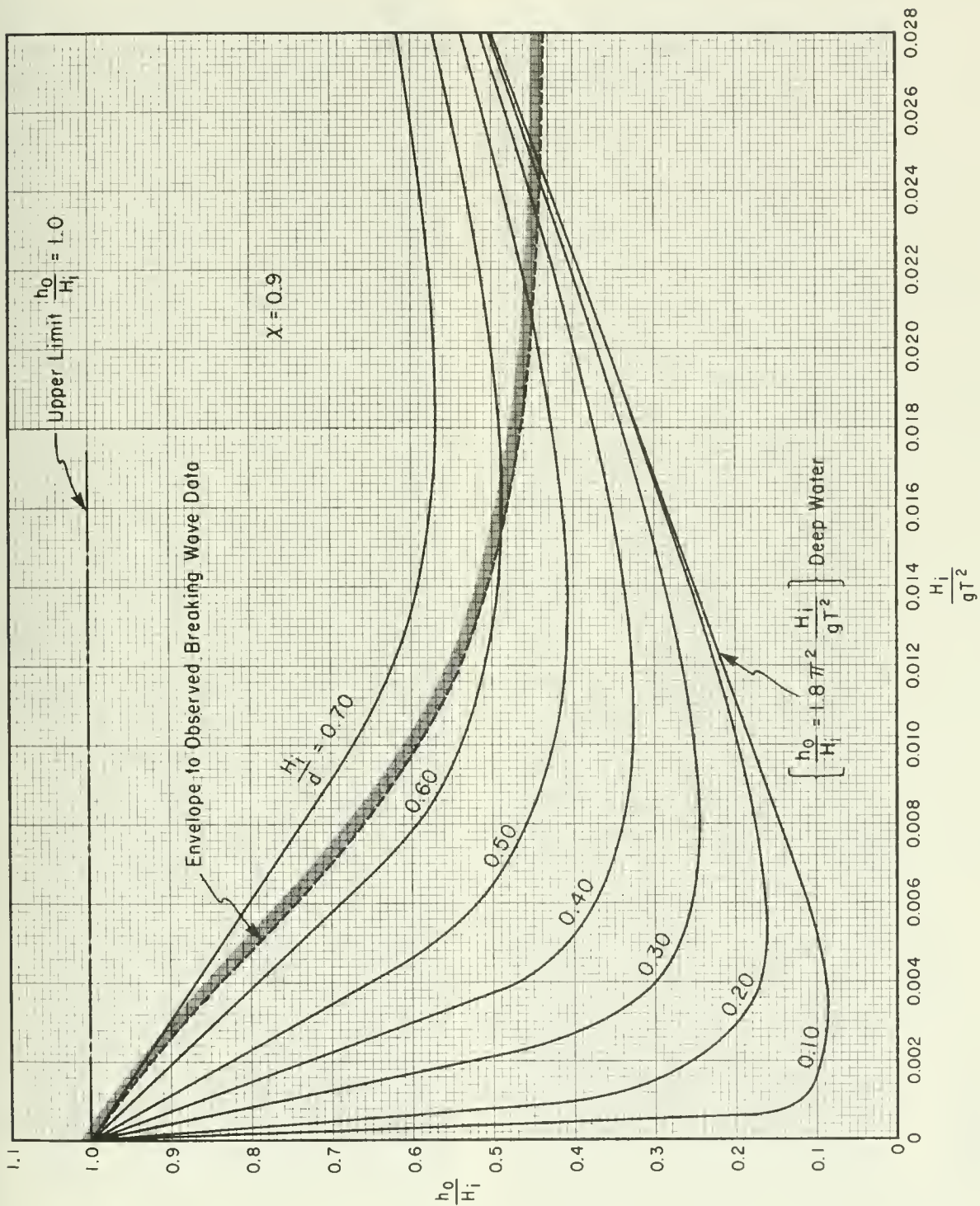

Figure 7-93. Nonbreaking waves; $X = 0.9$.

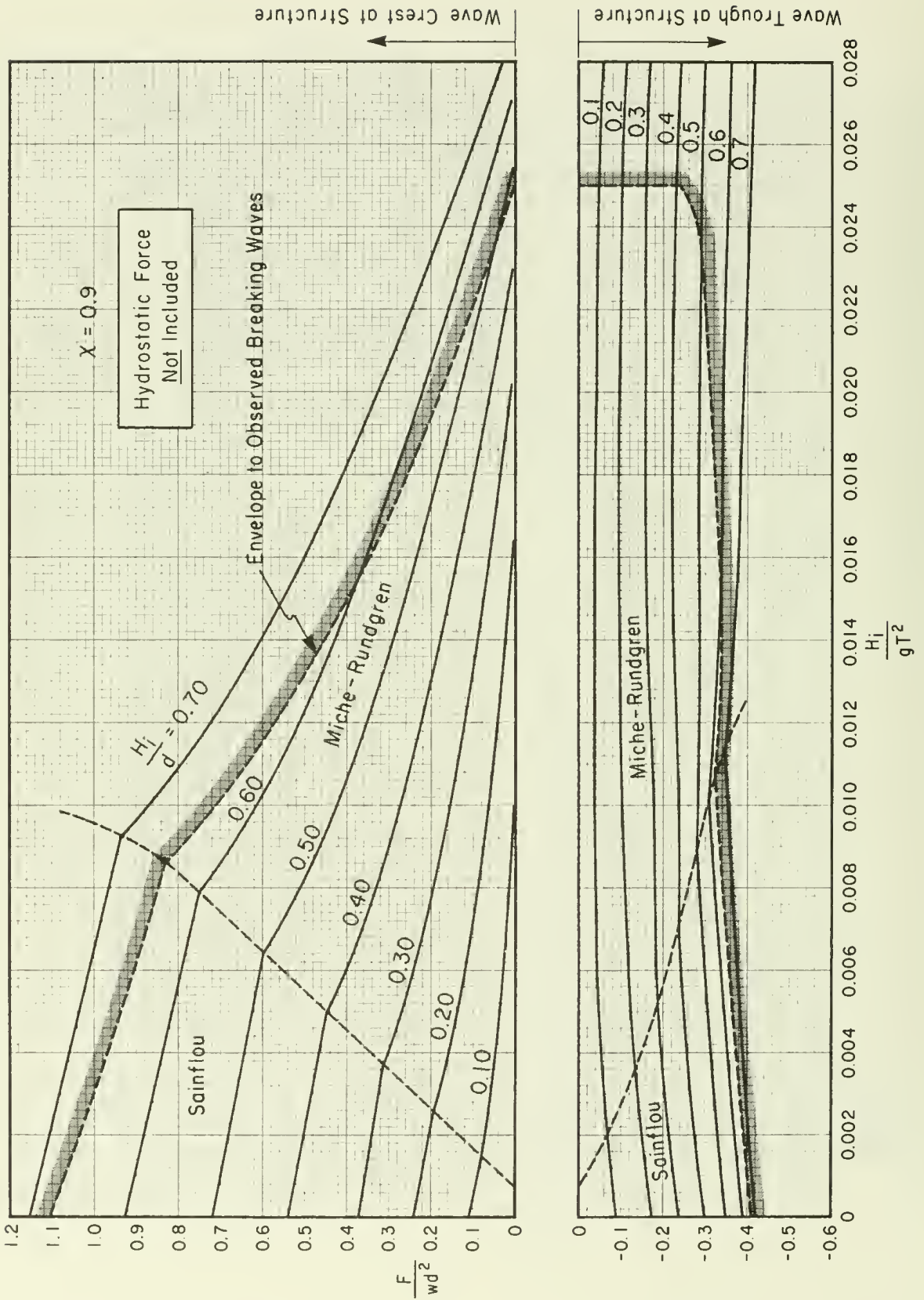

Figure 7-94. Nonbreaking wave forces; $X = 0.9$.

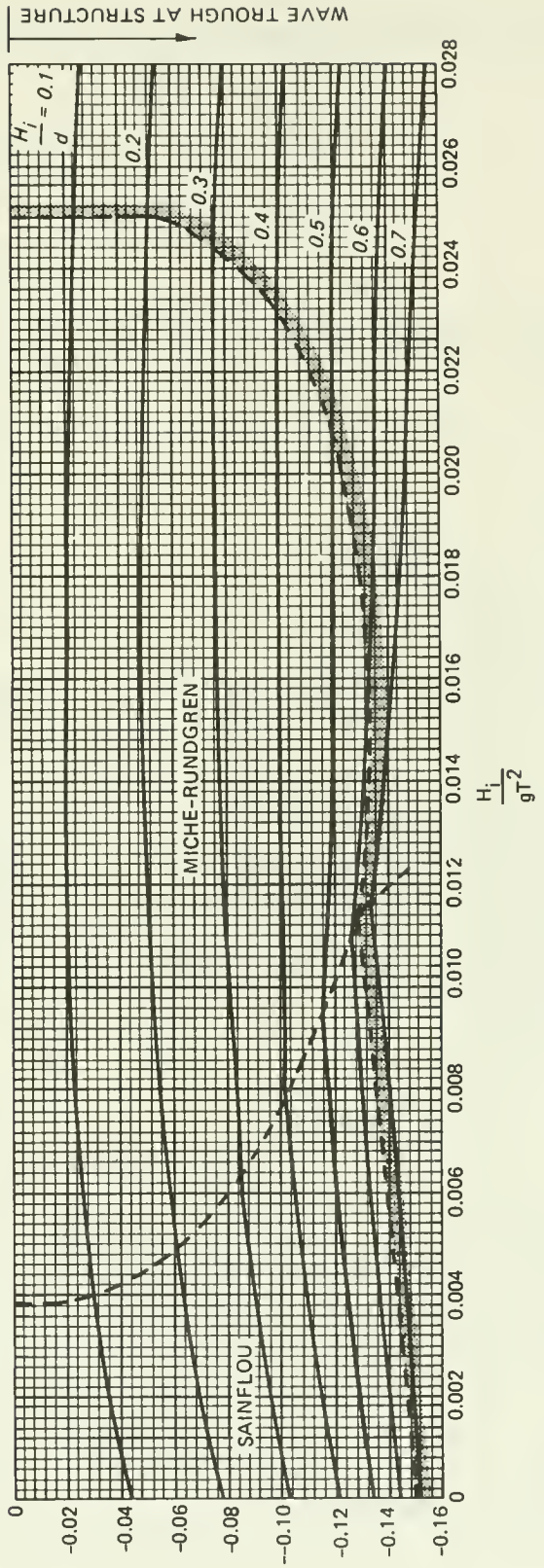
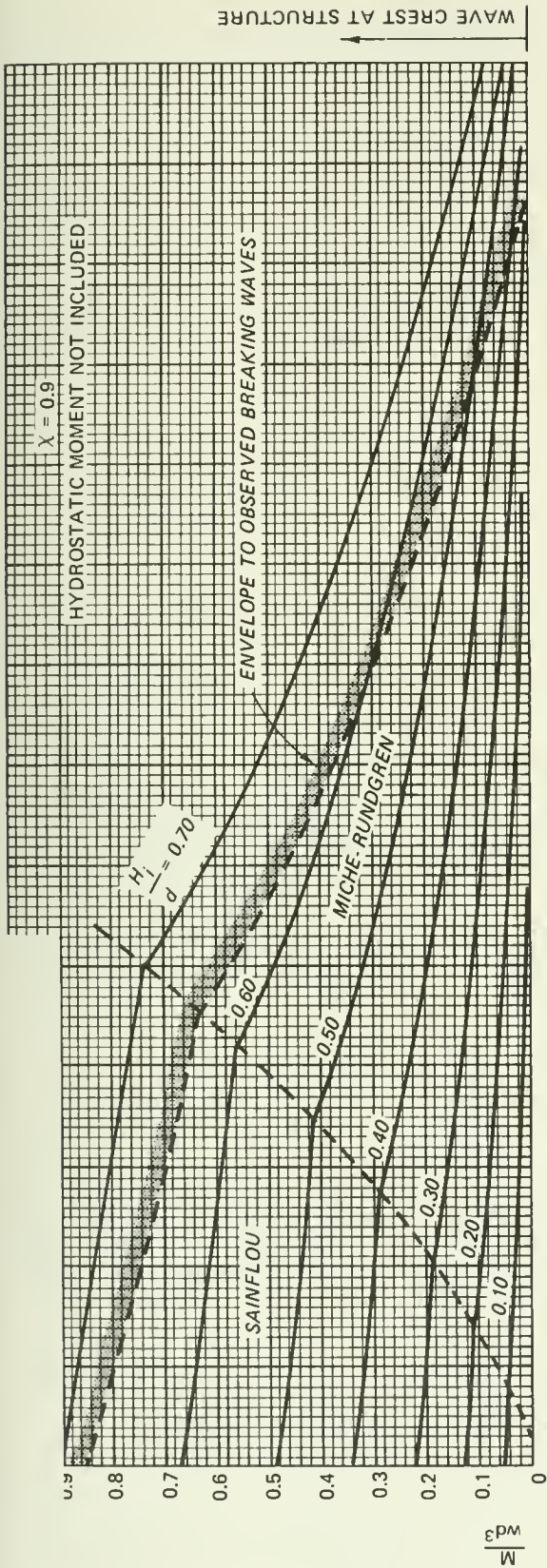

Figure 7-95. Nonbreaking wave moment; $\chi = 0.9$.

When it is necessary to include the hydrostatic effects (e.g., seawalls), the total force and moment are found by the expressions

$$F_{total} = \frac{wd^2}{2} + F_{wave} \quad (7-76)$$

$$M_{total} = \frac{wd^3}{6} + M_{wave} \quad (7-77)$$

where F_{wave} and M_{wave} are found from the design curves. The use of the figures to determine forces and moments is illustrated in the following example.

***** EXAMPLE PROBLEM 31 *****

GIVEN:

- (a) Smooth-faced vertical wall ($\chi = 1.0$).
- (b) Wave height at the structure if the structure were not there $H_i = 1.5$ m (5 ft).
- (c) Depth at structure $d = 3$ m (10 ft).
- (d) Range of wave periods to be considered in design $T = 6$ s (minimum) or $T = 10$ s (maximum).

FIND: The nonbreaking wave force and moments against a vertical wall resulting from the given wave conditions.

SOLUTION: Details of the computations are given for only the 6-second wave. From the given information, compute H_i/d and H_i/gT^2 for the design condition:

$$\frac{H_i}{d} = \frac{1.5}{3} = 0.5, \quad \frac{H_i}{gT^2} = \frac{1.5}{9.81(6)^2} = 0.0043 \quad (T = 6 \text{ s})$$

Enter Figure 7-90 (because the wall is smooth) with the computed value of H_i/gT^2 , and determine the value of H_o/H_i from the curve for $H_i/d = 0.5$. (If the wave characteristics fall outside of the dashed line, the structure will be subjected to breaking or broken waves and the method for calculating breaking wave forces should be used.)

For $\frac{H_i}{gT^2} = 0.0043$ $\frac{h_o}{H_i} = 0.66$ (T = 6 s)

Therefore,

$$h_o = 0.70 (H_i) = 0.66 (1.5) = 1.00 \text{ m (3.3 ft)} \quad (T = 6 \text{ s})$$

The height of the free surface above the bottom y , when the wave crest and trough are at the structure, may be determined from equations (7-73) and (7-74) as follows:

$$y_c = d + h_o + \left(\frac{1 + \chi}{2} \right) H_i$$

and

$$y_t = d + h_o - \left(\frac{1 + \chi}{2} \right) H_i$$

$$y_c = 3 + 1.00 + (1)(1.5) = 5.50 \text{ m (18.1 ft)}$$

$$y_t = 3 + 1.00 - (1)(1.5) = 2.50 \text{ m (8.2 ft) (T = 6 s)}$$

A similar analysis for the 10-second wave gives

$$y_c = 5.85 \text{ m (19.2 ft)}$$

$$y_t = 2.85 \text{ m (9.4 ft) (T = 6 s)}$$

The wall would have to be about 6 meters (20 feet) high if it were not to be overtopped by a 1.5-meter-(5-foot-) high wave having a period of 10 seconds.

The horizontal wave forces may be evaluated using Figure 7-91. Entering the figure with the computed value of H_i/gT^2 , the value of F/wd^2 can be determined from either of two curves of constant H_i/d . The upper family of curves (above $F/wd^2 = 0$) will give the dimensionless force when the crest is at the wall: F_c/wd^2 ; the lower family of curves (below $F/wd^2 = 0$) will give the dimensionless force when the trough is at the wall: F_t/wd^2 . For the example problem, with $H_i/gT^2 = 0.0043$ and $H_i/d = 0.50$,

$$\frac{F_c}{wd^2} = 0.63; \quad \frac{F_t}{wd^2} = -0.31 \quad (T = 6 \text{ s})$$

Therefore, assuming a weight per unit volume of 10 kN/m^3 (64.0 lb/ft^3) for sea water,

$$F_c = 0.63 (10) (3)^2 = 56.7 \text{ kN/m (3,890 lb/ft)} \quad (T = 6 \text{ s})$$

$$F_t = -0.31 (10) (3)^2 = -27.9 \text{ kN/m (-1,900 lb/ft)} \quad (T = 6 \text{ s})$$

The values found for F_c and F_t do not include the force due to the hydrostatic pressure distribution below the still-water level. For instance, if there is also a water depth of 3 meters (10 feet) on the leeward side of the structure in this example and there is no wave action on the leeward side, then the hydrostatic force on the leeward side exactly balances the hydrostatic force on the side exposed to wave action. Thus, in this case, the values found for F_c and F_t are actually the net forces acting on the structure.

If waves act on both sides of the structure, the maximum net horizontal force will occur when the clapotis crest acts against one side when the trough acts against the other. Hence the maximum horizontal force will be $F_c - F_t$, with F_c and F_t determined for the appropriate wave conditions. Assuming F_c for the example problem that the wave action is identical on both sides of the wall, then

$$F_{net} = 0.63 (10) (3)^2 - (-0.31)(10)(3)^2$$

$$F_{net} = (0.63 + 0.31) (10) (3)^2 = 84.6 \text{ kN/m (5,800 lb/ft)}$$

say

$$F_{net} = 85 \text{ kN/m} \quad (T = 6 \text{ s})$$

Some design problems require calculation of the total force including the hydrostatic contribution; e.g. seawalls. In these cases the total force is found by using equation (7-76). For this example,

$$F_{c \text{ total}} = 0.5 (10) (3)^2 + 56.7 = 101.7 \text{ kN/m (7,000 lb/ft)}$$

$$F_{t \text{ total}} = 0.5 (10) (3)^2 + (-27.9) = 17.1 \text{ kN/m (1,200 lb/ft)}$$

The total force acts against the seaward side of the structure, and the resulting net force will be determined by consideration of static loads (e.g., weight of structure), earth loads (e.g., soil pressure behind a seawall), and any other static or dynamic loading which may occur.

The moment about point A at the bottom of the wall (Fig. 7-89) may be determined from Figure 7-92. The procedures are identical to those given for the dimensionless forces, and again the moment caused by the hydrostatic pressure distribution is not included in the design curves. The upper family of curves (above $M/wd^3 = 0$) gives the dimensionless wave moment when the crest is at the wall, while the lower family of curves corresponds to the trough at the wall. Continuing the example problem, from Figure 7-92, with

$$\frac{M_c}{3wd} = 0.44; \quad \frac{M_t}{3wd} = -0.123 \quad (T = 6 \text{ s})$$

Therefore,

$$M_c = 0.44 (10) (3)^3 = 118.8 \frac{\text{kN-m}}{\text{m}} \left(26,700 \frac{\text{lb-ft}}{\text{ft}} \right) \quad (T = 6 \text{ s})$$

$$M_t = -0.123 (10) (3)^3 = -33.2 \frac{\text{kN-m}}{\text{m}} \left(-7,500 \frac{\text{lb-ft}}{\text{ft}} \right)$$

M_e and M_t , given above, are the total moments acting, when there is still water of depth 3 meters (10 feet) on the leeward side of the structure. The maximum moment at which there is wave action on the leeward side of the structure will be $M_e - M_t$, with M_e and M_t evaluated for the appropriate wave conditions prevail on both sides of the structure.

$$M_{net} = [0.44 - (-0.123)] (10)(3)^3 = 152.0 \frac{\text{kN-m}}{\text{m}} \left(34,200 \frac{\text{lb-ft}}{\text{ft}} \right) \quad (T = 6 \text{ s})$$

The combined moment due to both hydrostatic and wave loading is found using equation (7-77). For this example,

$$M_{e \text{ total}} = \frac{10(3)^3}{6} + 118.8 = 163.8 \frac{\text{kN-m}}{\text{m}} \left(36,800 \frac{\text{lb-ft}}{\text{ft}} \right) \quad (T = 6 \text{ s})$$

$$M_{t \text{ total}} = \frac{10(3)^3}{6} + (-33.2) = 11.8 \frac{\text{kN-m}}{\text{m}} \left(2,650 \frac{\text{lb-ft}}{\text{ft}} \right)$$

Figures 7-93, 7-94, and 7-95 are used in a similar manner to determine forces and moments on a structure which has a reflection coefficient of $\chi = 0.9$.

d. Wall of Low Height. It is often not economically feasible to design a structure to provide a non-overtopping condition by the design wave. Consequently, it is necessary to evaluate the force on a structure where the crest of the design clapotis is above the top of the wall, as shown in Figure 7-96. When the overtopping is not too severe, the majority of the incident wave will be reflected and the resulting pressure distribution is as shown in Figure 7-96, with the pressure on the wall being the same as in the non-overtopped case. This truncated distribution results in a force F' which is proportional to F , the total force that would act against the wall if it extended up to the crest of the clapotis (the force determined from Figures 7-91 or 7-94). The relationship between F' and F is given by

$$F' = r_f F \quad (7-78)$$

where r_f is a force reduction factor given by

$$\left. \begin{aligned} r_f &= \frac{b}{y} \left(2 - \frac{b}{y} \right) && \text{when} && 0.50 < \frac{b}{y} < 1.0 \\ \text{and} &&&&& \\ r_f &= 1.0 && \text{when} && \frac{b}{y} \geq 1.0 \end{aligned} \right\} \quad (7-79)$$

where b and y are defined in Figure 7-96. The relationship between r_f and b/y is shown in Figure 7-97.

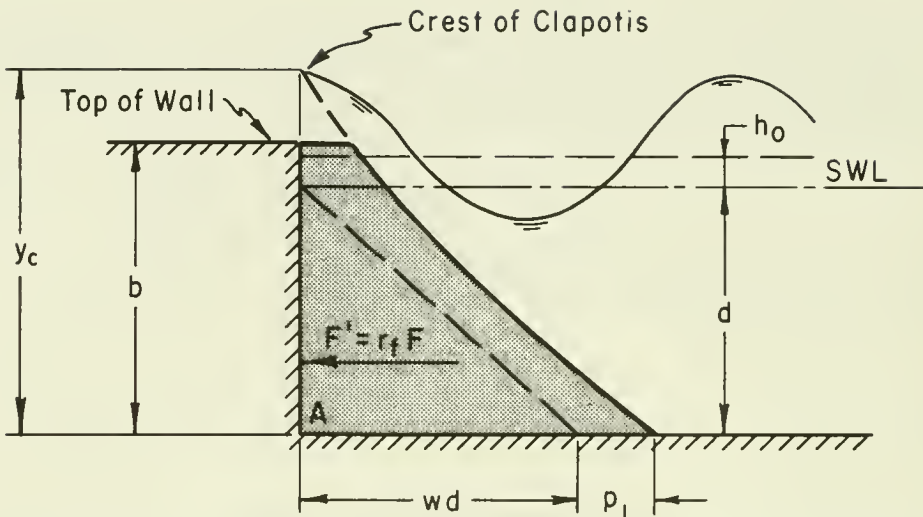

Figure 7-96. Pressure distribution on wall of low height.

Similarly, the reduced moment about point A is given by

$$M' = r_m M \tag{7-80}$$

where the moment reduction factor r_m is given by

$$r_m = \left(\frac{b}{y} \right)^2 \left(3 - 2 \frac{b}{y} \right) \quad \text{when} \quad 0.50 < \frac{b}{y} < 1.0$$

and

$$r_m = 1.0 \quad \text{when} \quad \frac{b}{y} \geq 1.0$$
} (7-81)

The relationship between r_m and b/y is also shown in Figure 7-97. Equations (7-78) through (7-81) are valid when either the wave crest or wave trough is at the structure, provided the correct value of y is used.

***** EXAMPLE PROBLEM 32 *****
GIVEN:

- (a) Wall height $b = 4.5 \text{ m (14.8 ft)}$.
- (b) Incident wave height $H_i = 1.5 \text{ m (4.9 ft)}$.
- (c) Depth at structure toe $d = 3 \text{ m (9.8 ft)}$.
- (d) Wave period $T = 6 \text{ s (minimum) or } 10 \text{ s (maximum)}$.

FIND: The reduced wave force and moment on the given vertical wall.

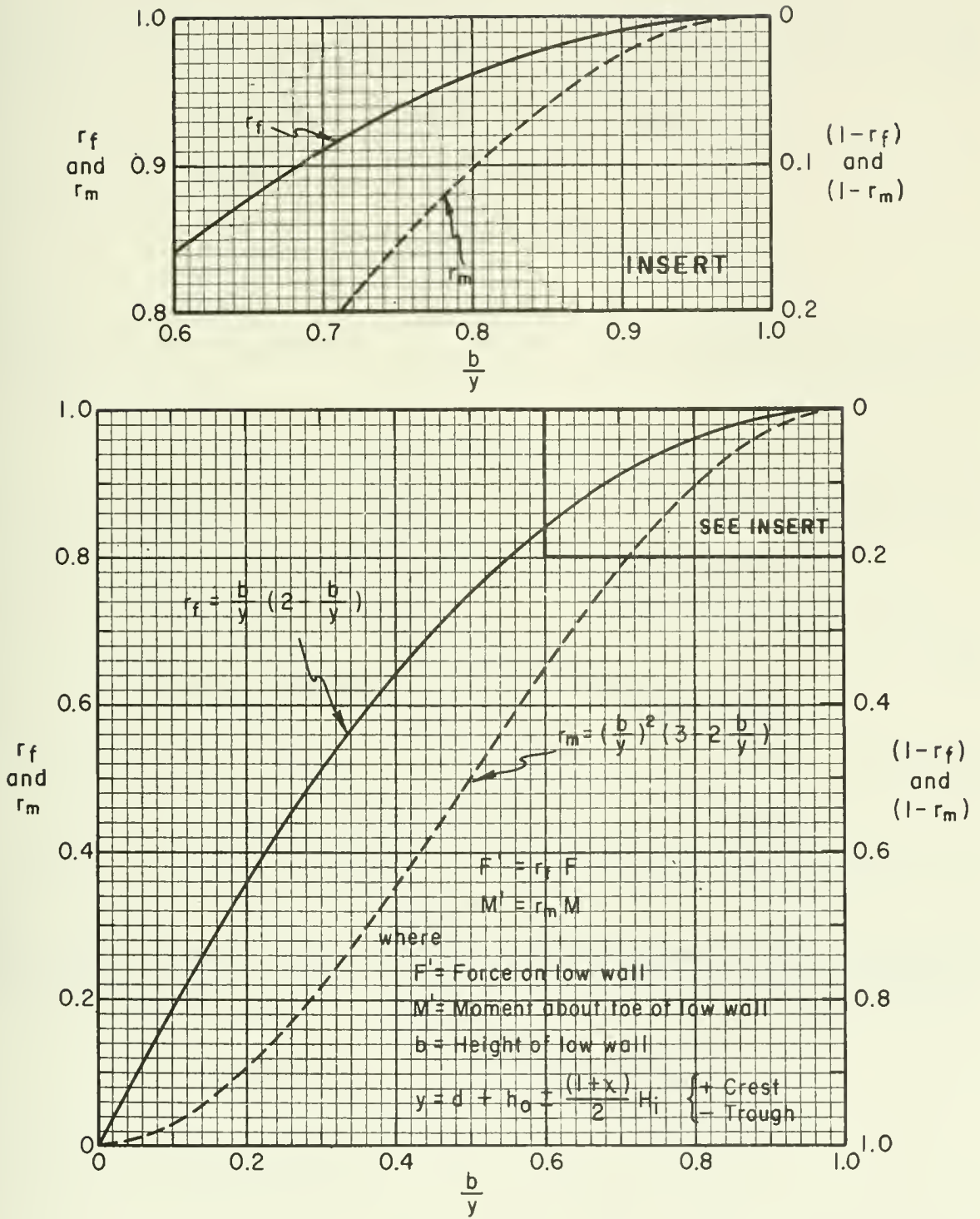

Figure 7-97. Force and moment reduction factors.

SOLUTION: From Example Problem 31,

$$y_c = 5.50 \text{ m (18.1 ft)} \quad (T = 6 \text{ s})$$

$$u_t = 2.50 \text{ m (8.2 ft)}$$

Compute b/y for each case

$$\frac{b}{y_c} = \frac{4.5}{5.5} = 0.818$$

(T = 6 s)

$$\frac{b}{y_t} = \frac{4.5}{2.5} = 1.80 > 1.0$$

Entering Figure 7-97 with the computed value of b/y , determine the values of r_f and r_m from the appropriate curve. For the wave with $T = 6 \text{ s}$,

$$\frac{b}{y_c} = 0.818$$

therefore,

$$r_f = 0.968$$

$$r_m = 0.912$$

and

$$\frac{b}{y_t} > 1.0$$

therefore,

$$r_f = 1.0$$

$$r_m = 1.0$$

Reduced forces and moments may be calculated from equations (7-78) and (7-80) using the values of F and M found in the example problem of the previous section; for $T = 6 \text{ s}$.

$$F'_c = 0.968 (101.7) = 98.5 \text{ kN/m (6,750 lb/ft)}$$

$$M'_c = 0.912 (163.8) = 149.4 \text{ kN-m (33,590 } \frac{\text{lb-ft}}{\text{ft}} \text{)}$$

$$F'_t = 1.0 (17.1) = 17.1 \text{ kN/m (1,200 lb/ft)}$$

$$M'_t = 1.0 (11.8) = 11.8 \text{ kN-m/m (2,650 } \frac{\text{lb-ft}}{\text{ft}} \text{)}$$

These values include the force and moment due to the hydrostatic component of the loading.

Again assuming that the wave action on both sides of the structure is identical, so that the maximum net horizontal force and maximum overturning moment occurs when a clapotis crest is on one side of the structure and a trough is on the other side

$$F'_{net} = F'_c - F'_t = 98.5 - 17.1 = 81.4 \text{ kN/m}$$

say (T = 6 s)

$$F'_{net} = 82 \text{ kN/m (5,620 lb/ft)}$$

and

$$M'_{net} = M'_c - M'_t = 149.4 - 11.8 = 137.6 \frac{\text{kN-m}}{\text{m}}$$

say (T = 6 s)

$$M'_{net} = 138 \frac{\text{kN-m}}{\text{m}} \left(31,000 \frac{\text{lb-ft}}{\text{ft}} \right)$$

A similar analysis for the 10-second wave gives,

$$F'_{net} = 85.2 \text{ kN/m (5,840 lb/ft)}$$

(T = 10 s)

$$M'_{net} = 139 \text{ kN/m (31,250 } \frac{\text{lb-ft}}{\text{ft}} \text{)}$$

e. Wall on Rubble Foundation. Forces acting on a vertical wall built on a rubble foundation are shown in Figure 7-98 and may be computed in a manner similar to computing the forces acting on a low wall if the complements of the force and moment reduction factors are used. As shown in Figure 7-98, the value of b which is used for computing b/y is the height of the rubble base and not the height of the wall above the foundation. The equation relating the reduced force F'' against the wall on a rubble foundation with the force F which would act against a wall extending the entire depth is

$$F'' = \left(1 - r_f \right) F \tag{7-82}$$

The equation relating the moments is,

$$\frac{M''}{A} = \left(1 - r_m \right) M \tag{7-83}$$

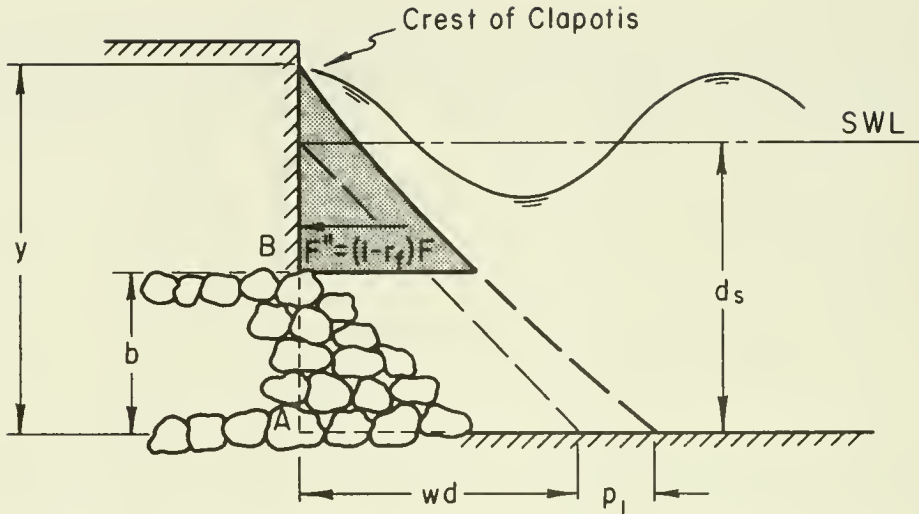

Figure 7-98. Pressure distribution on wall on rubble foundation.

where M''_A is the moment about the bottom (point A on Fig. 7-98). Usually, the moment desired is that about point B, which may be found from

$$M''_B = (1 - r_m) M - b (1 - r_f) F$$

(7-84)

or

$$M''_B = M''_A - bF''$$

The values of $(1 - r_m)$ and $(1 - r_f)$ may be obtained directly from Figure 7-97.

***** EXAMPLE PROBLEM 33 *****

GIVEN:

- (a) A smooth-faced vertical wall on a rubble base.
- (b) Height of rubble foundation, $b = 2.7$ m (9 ft).
- (c) Incident wave height $H_i = 1.5$ m (5 ft).
- (d) Design depth at the structure $d = 3$ m (10 ft).
- (e) Wave period $T = 6$ s (minimum) or 10 s (maximum).

FIND: The force and overturning moment on the given wall on a rubble foundation.

SOLUTION: For this example problem Figures 7-90 through 7-92 are used to

evaluate h_0 , F , and M , even though a rubble base will reduce the wave reflection coefficient of a structure by dissipating some incident wave energy. The values of h_0 , F , and M used in this example were determined in Example Problem 31.

$$y_c = 5.5 \text{ m} \quad (T = 6 \text{ s})$$

$$y_t = 2.5 \text{ m}$$

Compute b/y for each case, remembering that b now represents the height of the foundation.

$$\frac{b}{y_c} = \frac{2.7}{5.5} = 0.491 \quad (T = 6 \text{ s})$$

$$\frac{b}{y_t} = \frac{2.7}{2.5} = 1.08 > 1.0$$

Enter Figure 7-97 with the computed values of b/y , and determine corresponding values of $(1 - r_f)$ and $(1 - r_m)$. For the 6-second wave,

$$\frac{b}{y_c} = 0.491; (1 - r_f) = 0.26; (1 - r_m) = 0.52$$

and

$$\frac{b}{y_t} > 1.0; (1 - r_f) = 0.0; (1 - r_m) = 0.0$$

From equation (7-82),

$$F_c'' = 0.26 (101.7) = 26.5 \text{ kN/m (1,820 lb/ft)} \quad (T = 6 \text{ s})$$

$$F_t'' = 0.0 (17.1) = 0 \text{ kN/m}$$

For the 10-second wave, a similar analysis gives

$$F_c'' = 30.8 \text{ kN/m (2,100 lb/ft)} \quad (T = 10 \text{ s})$$

$$F_t'' \approx 0 \text{ kN/m}$$

The overturning moments about point A are, from equation (7-83)

$$(M_A'')_c = 0.52 (163.8) = 85.2 \text{ kN-m/m (19,200 } \frac{\text{lb-ft}}{\text{ft}}) \quad (T = 6 \text{ s})$$

$$(M_A'')_t = 0.0 (11.8) = 0 \frac{\text{kN-m}}{\text{m}}$$

and for the 10-second wave,

$$\begin{aligned} (M''_A)_c &= 95.9 \frac{\text{kN-m}}{\text{m}} \left(21,600 \frac{\text{lb-ft}}{\text{ft}} \right) \\ (M''_A)_t &\approx 0 \frac{\text{kN-m}}{\text{m}} \end{aligned} \quad (T = 10 \text{ s})$$

The overturning moments about point B are obtained from equation (7-84) thus

$$\begin{aligned} (M''_B)_c &= 85.2 - 2.7 (26.5) = 13.7 \frac{\text{kN-m}}{\text{m}} \left(3,080 \frac{\text{lb-ft}}{\text{ft}} \right) \\ (M''_B)_t &\approx 0 \frac{\text{kN-m}}{\text{m}} \end{aligned} \quad (T = 6 \text{ s})$$

and for the 10-second wave,

$$\begin{aligned} (M''_B)_c &= 12.7 \frac{\text{kN-m}}{\text{m}} \left(2,850 \frac{\text{lb-ft}}{\text{ft}} \right) \\ (M''_B)_t &\approx 0 \frac{\text{kN-m}}{\text{m}} \end{aligned} \quad (T = 10 \text{ s})$$

As in Examples Problems 31 and 32, various combinations of appropriate wave conditions for the two sides of the structure can be assumed and resulting moments and forces computed.

3. Breaking Wave Forces on Vertical Walls.

Waves breaking directly against vertical-face structures exert high, short duration, dynamic pressures that act near the region where the wave crests hit the structure. These impact or shock pressures have been studied in the laboratory by Bagnold (1939), Denny (1951), Ross (1955), Carr (1954), Leendertse (1961), Nagai (1961a), Kamel (1968), Weggel (1968), and Weggel and Maxwell (1970a and b). Some measurements on full-scale breakwaters have been made by deRouville et al., (1938) and by Muraki (1966). Additional references and discussion of breaking wave pressures are given by Silvester (1974). Wave tank experiments by Bagnold (1939) led to an explanation of the phenomenon. Bagnold found that impact pressures occur at the instant that the vertical front face of a breaking wave hits the wall and only when a plunging wave entraps a cushion of air against the wall. Because of this critical dependence on wave geometry, high impact pressures are infrequent against prototype structures; however, the possibility of high impact pressures must be recognized and considered in design. Since the high impact pressures are short (on the order of hundredths of a second), their importance in the design of breakwaters against sliding or overturning is questionable; however, lower dynamic forces which last longer are important.

a. Minikin Method: Breaking Wave Forces. Minikin (1955, 1963) developed a design procedure based on observations of full-scale breakwaters and the results of Bagnold's study. Minikin's method can give wave forces that are extremely high, as much as 15 to 18 times those calculated for nonbreaking waves. Therefore, the following procedures should be used with caution and only until a more accurate method of calculation is found.

The maximum pressure assumed to act at the SWL is given by

$$p_m = 101 w \frac{H_b}{L_D} \frac{d_s}{D} (D + d_s) \quad (7-85)$$

where p_m is the maximum dynamic pressure, H_b is the breaker height, d_s is the depth at the toe of the wall, D is the depth one wavelength in front of the wall, and L_D is the wavelength in water of depth D . The distribution of dynamic pressure is shown in Figure 7-99. The pressure decreases parabolically from p_m at the SWL to zero at a distance of $H_b/2$ above and below the SWL. The force represented by the area under the dynamic pressure distribution is

$$R_m = \frac{p_m H_b}{3} \quad (7-86)$$

i.e., the force resulting from dynamic component of pressure and the overturning moment about the toe is

$$M_m = R_m d_s = \frac{p_m H_b d_s}{3} \quad (7-87)$$

i.e., the moment resulting from the dynamic component of pressure. The hydrostatic contribution to the force and overturning moment must be added to the results obtained from equations (7-86) and (7-87) to determine total force and overturning moment.

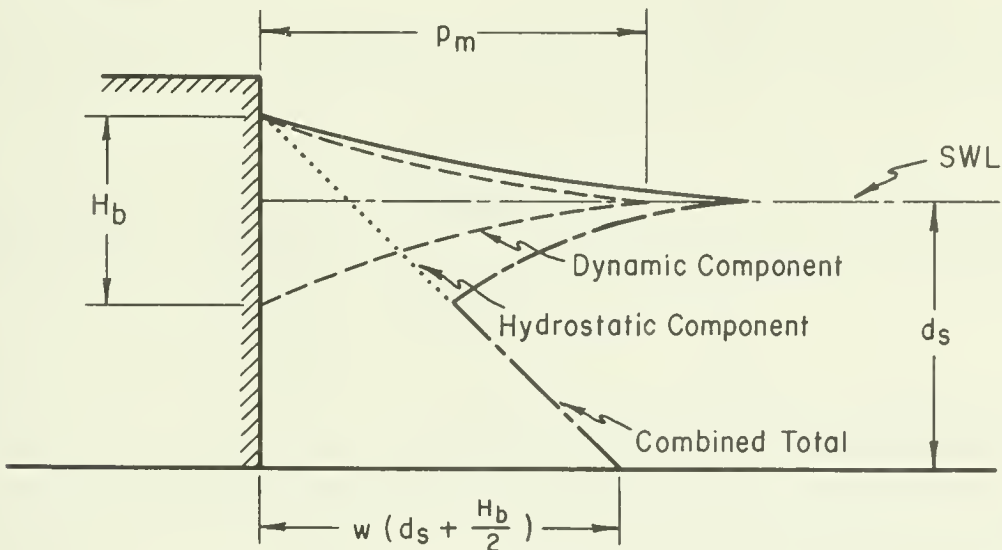

Figure 7-99. Minikin wave pressure diagram.

The Minikin formula was originally derived for composite breakwaters composed of a concrete superstructure founded on a rubble substructure; strictly, D and L_D in equation (7-85) are the depth and wavelength at the toe of the substructure, and d_s is the depth at the toe of the vertical wall (i.e., the distance from the SWL down to the crest of the rubble substructure). For caisson and other vertical structures where no substructure is present, the formula has been adapted by using the depth at the structure toe as d_s , while D and L_D are the depth and wavelength a distance one wavelength seaward of the structure. Consequently, the depth D can be found from

$$D = d_s + L_d m \quad (7-88)$$

where L_d is the wavelength in a depth equal to d_s , and m is the nearshore slope. The forces and moments resulting from the hydrostatic pressure must be added to the dynamic force and moment computed above. The triangular hydrostatic pressure distribution is shown in Figure 7-99; the pressure is zero at the breaker crest (taken at $H_b/2$ above the SWL), and increases linearly to $w(d_s + H_b/2)$ at the toe of the wall. The total breaking wave force on a wall per unit wall length is

$$R_t = R_m + \frac{w \left(d_s + \frac{H_b}{2} \right)^2}{2} = R_m + R_s \quad (7-89)$$

where R_s is the hydrostatic component of breaking wave on a wall, and the total moment about the toe is

$$M_t = M_m + \frac{w \left(d_s + \frac{H_b}{2} \right)^3}{6} = M_m + M_s \quad (7-90)$$

where M_s is the hydrostatic moment.

Calculations to determine the force and moment on a vertical wall are illustrated by the following example.

***** EXAMPLE PROBLEM 34 *****

GIVEN: A vertical wall, 4.3 m (14 ft) high is sited in sea water with $d_s = 2.5$ m (8.2 ft). The wall is built on a bottom slope of 1:20 ($m = 0.05$). Reasonable wave periods range from $T = 6$ s to $T = 10$ s.

FIND:

- (a) The maximum pressure, horizontal force, and overturning moment about the toe of the wall for the given slope.
- (b) The maximum pressure, horizontal force, and overturning moment for the 6-second wave if the slope was 1:100.

SOLUTION:

(a) From Example Problem 3, the maximum breaker heights for a design depth of 2.5 m (8.2 ft), a slope of 0.05, and wave periods of 6- and 10-seconds are

$$H_b = 2.8 \text{ m (9.2 ft)} \quad (T = 6 \text{ s})$$

$$H_b = 3.2 \text{ m (10.5 ft)} \quad (T = 10 \text{ s})$$

The wavelength at the wall in water 2.5 m (8.2 ft) deep can be found with the aid of Table C-1, Appendix C. First calculate the wavelength in deep water ($T = 6 \text{ s}$),

$$L_o = \frac{gT^2}{2\pi} = 1.56 (6)^2 = 56.2 \text{ m (184 ft)}$$

Then

$$\frac{d}{L_o} = \frac{2.5}{56.2} = 0.04448$$

and from Table C-1, Appendix C,

$$\frac{d}{L} = 0.08826$$

and

$$L_d = 28.3 \text{ m (92.8 ft)}$$

from equation (7-88)

$$D = d_s + L_d m = 2.5 + 28.3 (0.05) = 3.9 \text{ m (12.8 ft)}$$

and using Table C-1, as above,

$$\frac{D}{L_o} = 0.06940; \quad \frac{D}{L_D} = 0.1134$$

hence

$$L_D = \frac{D}{D/L_D} = \frac{3.9}{0.1134} = 34.4 \text{ m}$$

say

$$L_D = 35 \text{ m (115 ft)}$$

Equation (7-85) can now be used to find P_m .

$$P_m = 101 w \frac{H_b}{L_D} \frac{d_s}{D} (D + d_s)$$

$$P_m = 101 (10) \frac{2.8}{35} \frac{2.5}{3.9} (3.9 + 2.5)$$

$$= 331 \text{ kN/m}^2 (6,913 \text{ lb/ft}^2) \quad (T = 6 \text{ s})$$

A similar analysis for the 10-second wave gives,

$$P_m = 182 \text{ kN/m}^2 (3,801 \text{ lb/ft}^2) \quad (T = 10 \text{ s})$$

The above values can be obtained more rapidly by using Figure 7-100, a graphical representation of the above procedure. To use the figure, calculate for the 6-second wave,

$$\frac{d_s}{gT^2} = \frac{2.5}{9.81 (6)^2} = 0.0071$$

Enter Figure 7-100 with the calculated value of d_s/gT^2 , using the curve for $m = 0.05$, and read the value of P_m/wH_b .

$$\frac{P_m}{wH_b} = 12.0$$

Using the calculated values of H_b ,

$$P_m = 12.0wH_b = 12.0 (10) (2.8) = 336 \text{ kN/m}^2 (7,017 \text{ lb/ft}^2)$$

For the 10-second wave,

$$P_m = 5.5wH_b = 5.5 (10) (3.2) = 176 \text{ kN/m}^2 (3,676 \text{ lb/ft}^2) \quad (T = 10 \text{ s})$$

The force can be evaluated from equation (7-86) thusly:

$$R_m = \frac{P_m H_b}{3} = \frac{331 (2.8)}{3} = 309 \text{ kN/m} (21,164 \text{ lb/ft}) \quad (T = 6 \text{ s})$$

and

$$R_m = 194 \text{ kN/m} (13,287 \text{ lb/ft}) \quad (T = 10 \text{ s})$$

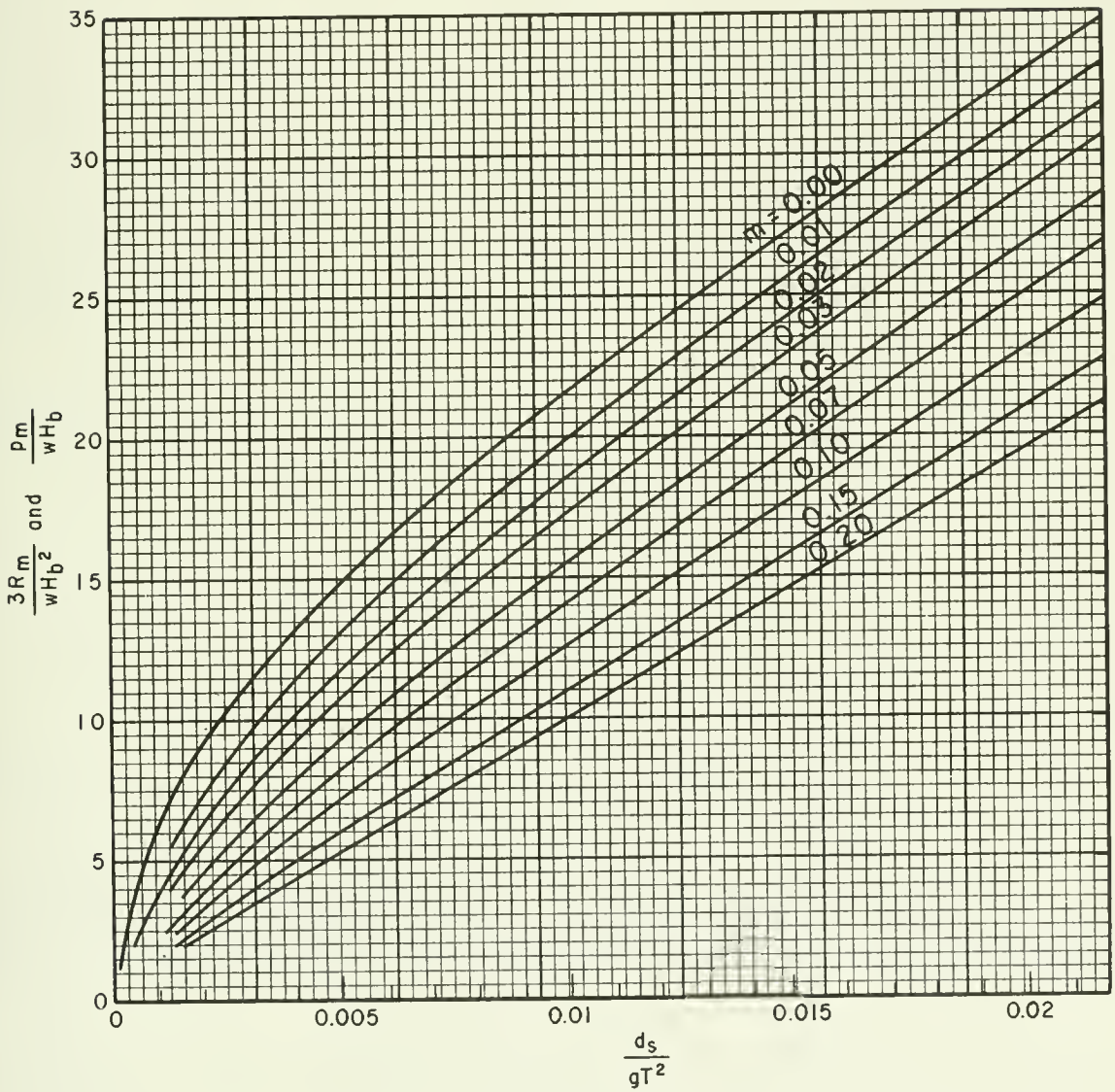
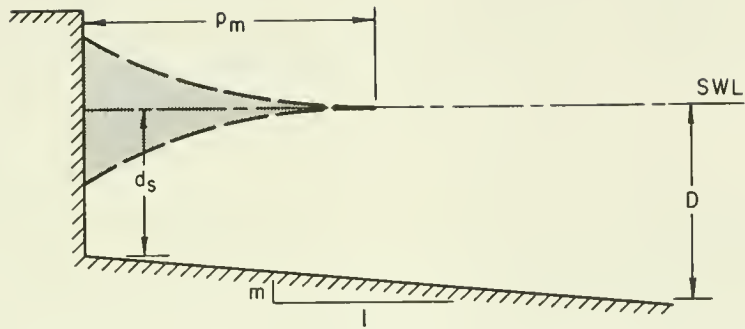

Figure 7-100. Dimensionless Minikin wave pressure and force.

The overturning moments are given by equation (7-87) as

$$M_m = R_m d_s = 309 (2.5) = 772 \frac{\text{kN-m}}{\text{m}} \left(173,561 \frac{\text{ft-lb}}{\text{ft}} \right) \quad (T = 6 \text{ s})$$

and

$$M_m = 485 \frac{\text{kN-m}}{\text{m}} \left(109,038 \frac{\text{ft-lb}}{\text{ft}} \right) \quad (T = 10 \text{ s})$$

For the example, the total forces, including the hydrostatic force from equations (7-89) and (7-90),

$$R_t = R_m + R_s$$

$$R_t = 309 + \frac{10 \left(2.5 + \frac{2.8}{2} \right)^2}{2} = 309 + 76 = 385 \text{ kN/m } (26,382 \text{ lb/ft}) \quad (T = 6 \text{ s})$$

$$R_t = 278 \text{ kN/m } (19,041 \text{ lb/ft}) \quad (T = 10 \text{ s})$$

Then

$$M_t = M_m + M_s$$

$$M_t = 772 + \frac{10 \left(2.5 + \frac{2.8}{2} \right)^3}{6} = 772 + 99$$

$$M_t = 871 \frac{\text{kN-m}}{\text{m}} \left(195,818 \frac{\text{ft-lb}}{\text{ft}} \right) \quad (T = 6 \text{ s})$$

and

$$M_t = 600 \frac{\text{kN-m}}{\text{m}} \left(134,892 \frac{\text{ft-lb}}{\text{ft}} \right) \quad (T = 10 \text{ s})$$

(b) If the nearshore slope is 1:100 ($m = 0.01$), the maximum breaker heights must be recomputed using the procedure given in Section I,2,b. For a 6-second wave on a 0.01 slope the results of an analysis similar to the preceding gives

$$H_b = 2.1 \text{ m } (d_b = 2.6 \text{ m } (7.9 \text{ ft}) > d_s)$$

$$p_m = 337 \text{ kN/m}^2 \left(7,035 \text{ lb/ft}^2 \right) \quad (T = 6 \text{ s})$$

and

$$R_m = 236 \text{ kN/m (16,164 lb/ft)}$$

The resulting maximum pressure is about the same as for the wall on a 1:20 sloping beach ($p_m = 336 \text{ kN/m}$); however, the dynamic force is less against the wall on a 1:100 slope than against the wall on a 1:20 slope, because the maximum possible breaker height reaching the wall is lower on a flatter slope.

b. Wall On a Rubble Foundation. The dynamic component of breaking wave force on a vertical wall built on a rubble substructure can be estimated with either equation (7-85) or Figure 7-101. The procedure for calculating forces and moments is similar to that outlined in the Example Problem 34, except that the ratio d_s/D is used instead of the nearshore slope when using Figure 7-101. Minikin's equation was originally derived for breakwaters of this type. For expensive structures, hydraulic models should be used to evaluate forces.

c. Wall of Low Height. When the top of a structure is lower than the crest of the design breaker, the dynamic and hydrostatic components of wave force and overturning moment can be corrected by using Figures 7-102 and 7-103. Figure 7-102 is a Minikin force reduction factor to be applied to the dynamic component of the breaking wave force equation

$$R'_m = r_m R_m \tag{7-91}$$

Figure 7-103 gives a moment reduction factor a for use in the equation

$$M'_m = d_s R'_m - (d_s + a) (1 - r'_m) R'_m \tag{7-92}$$

or

$$M'_m = R'_m [r'_m (d_s + a) - a] \tag{7-93}$$

***** EXAMPLE PROBLEM 35 *****

GIVEN:

- (a) A vertical wall 3 m (10 ft) high in a water depth of $d_s = 2.5 \text{ m (8.2 ft)}$ on a nearshore slope of 1:20 ($m = 0.05$);
- (b) Design wave periods of $T = 6 \text{ s}$ and $T = 10 \text{ s}$.

FIND: The reduced force and overturning moment because of the reduced wall height.

SOLUTION: Calculations of the breaker heights, unreduced forces, and moments are given in preceding example problems. From the preceding problems,

$$H_b = 2.8 \text{ m (9.2 ft)} \quad (d_b = 3.0 \text{ m} > d_s)$$

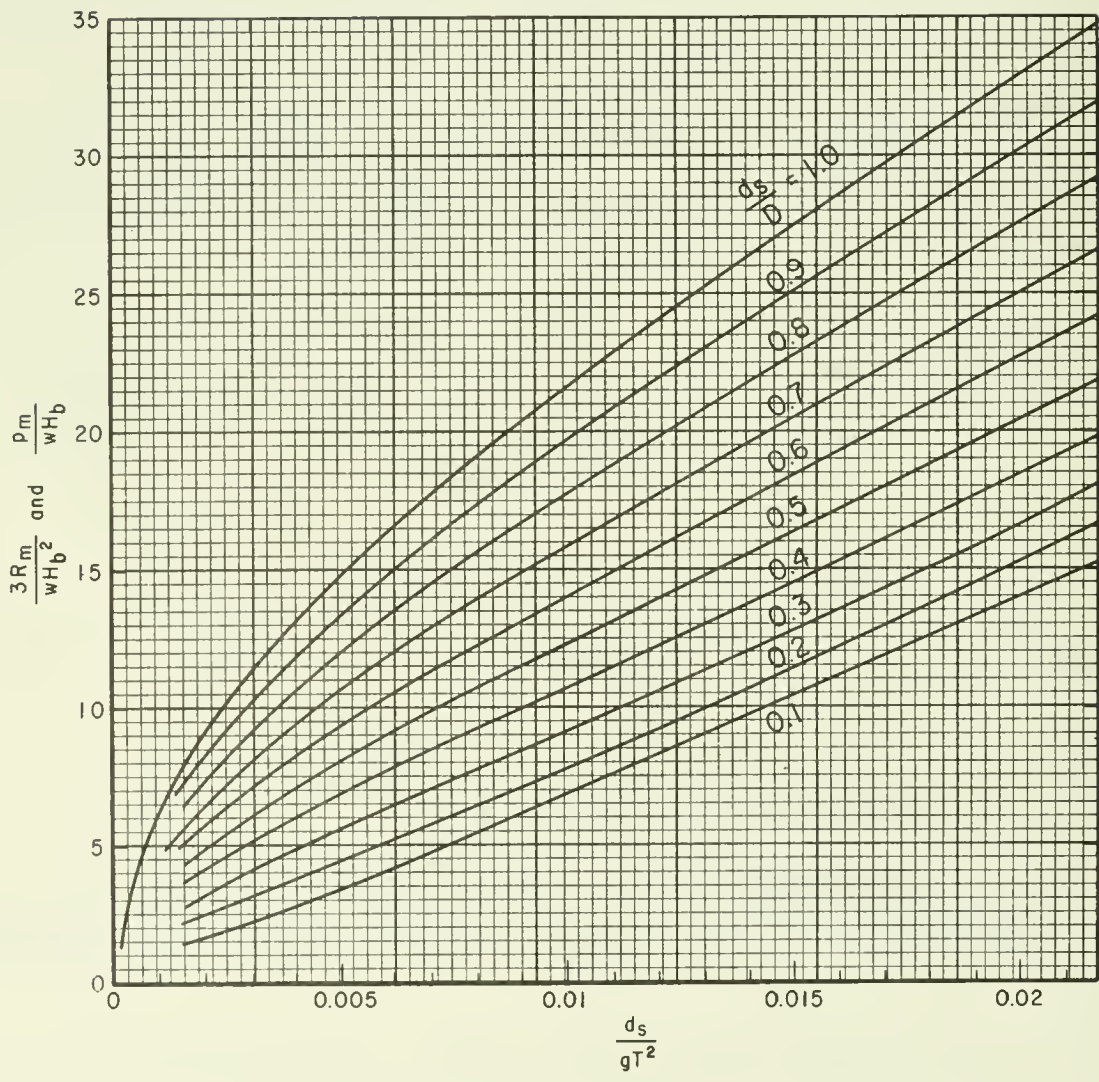
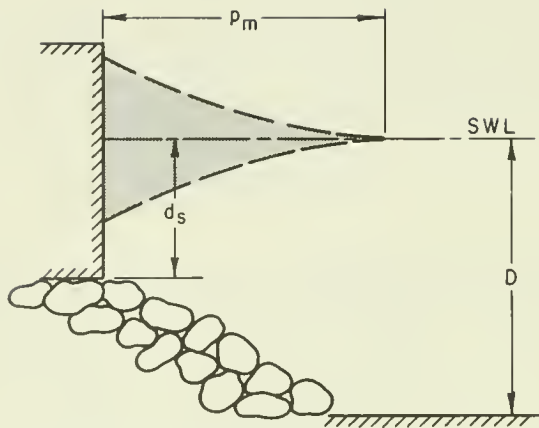

Figure 7-101. Dimensionless Minikin wave pressure and force.

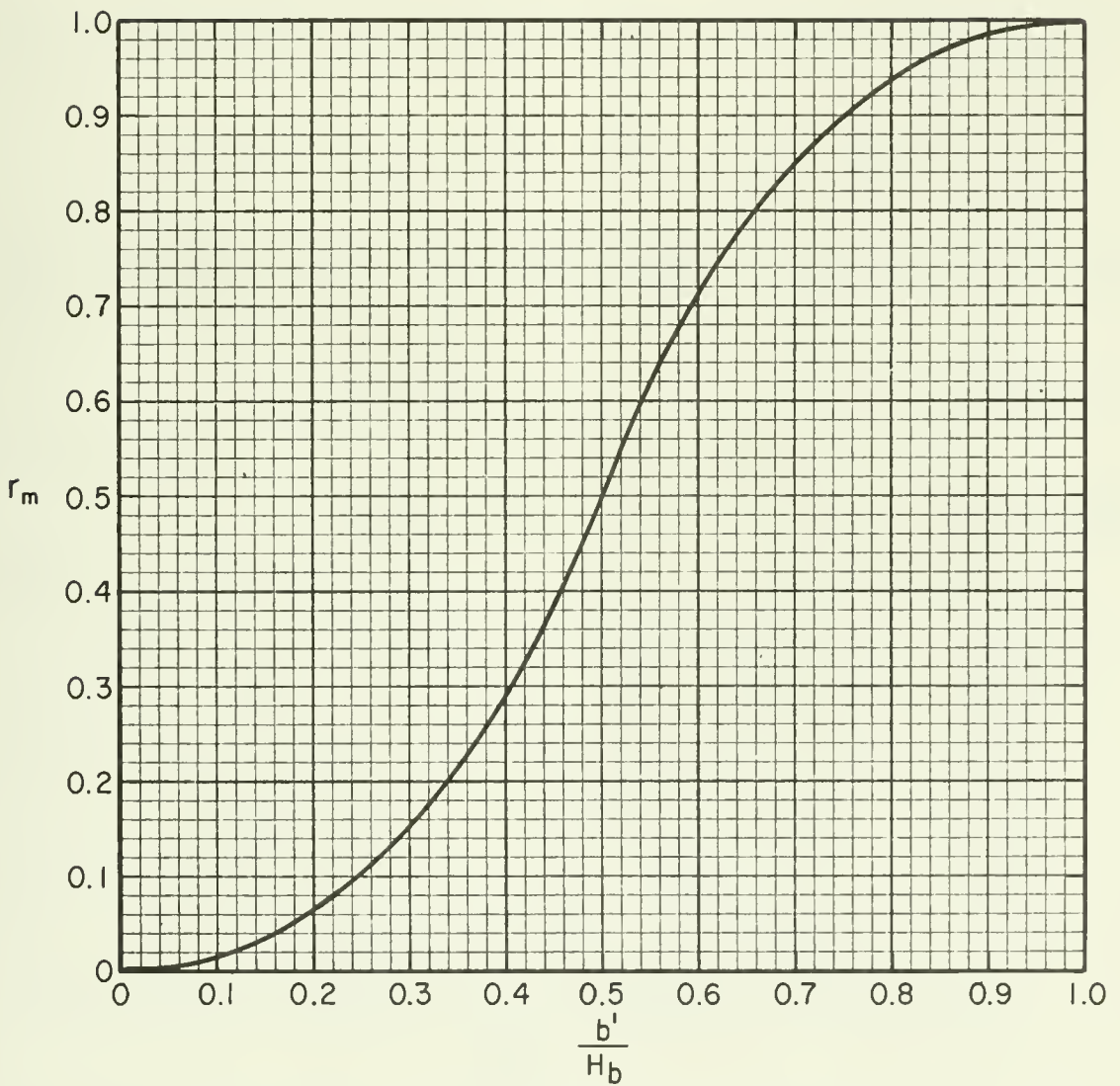
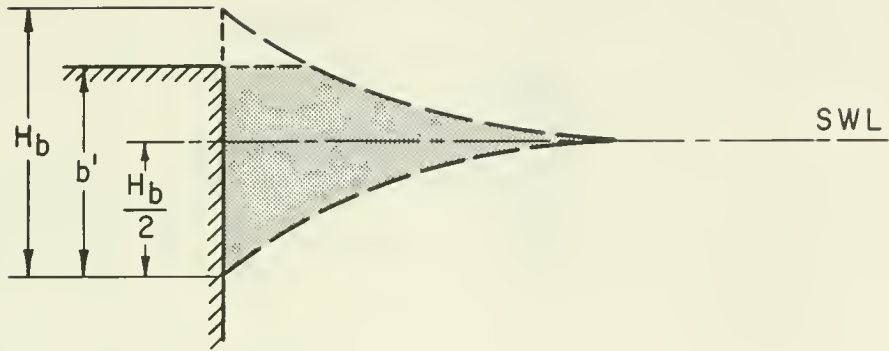

Figure 7-102. Minikin force reduction factor.

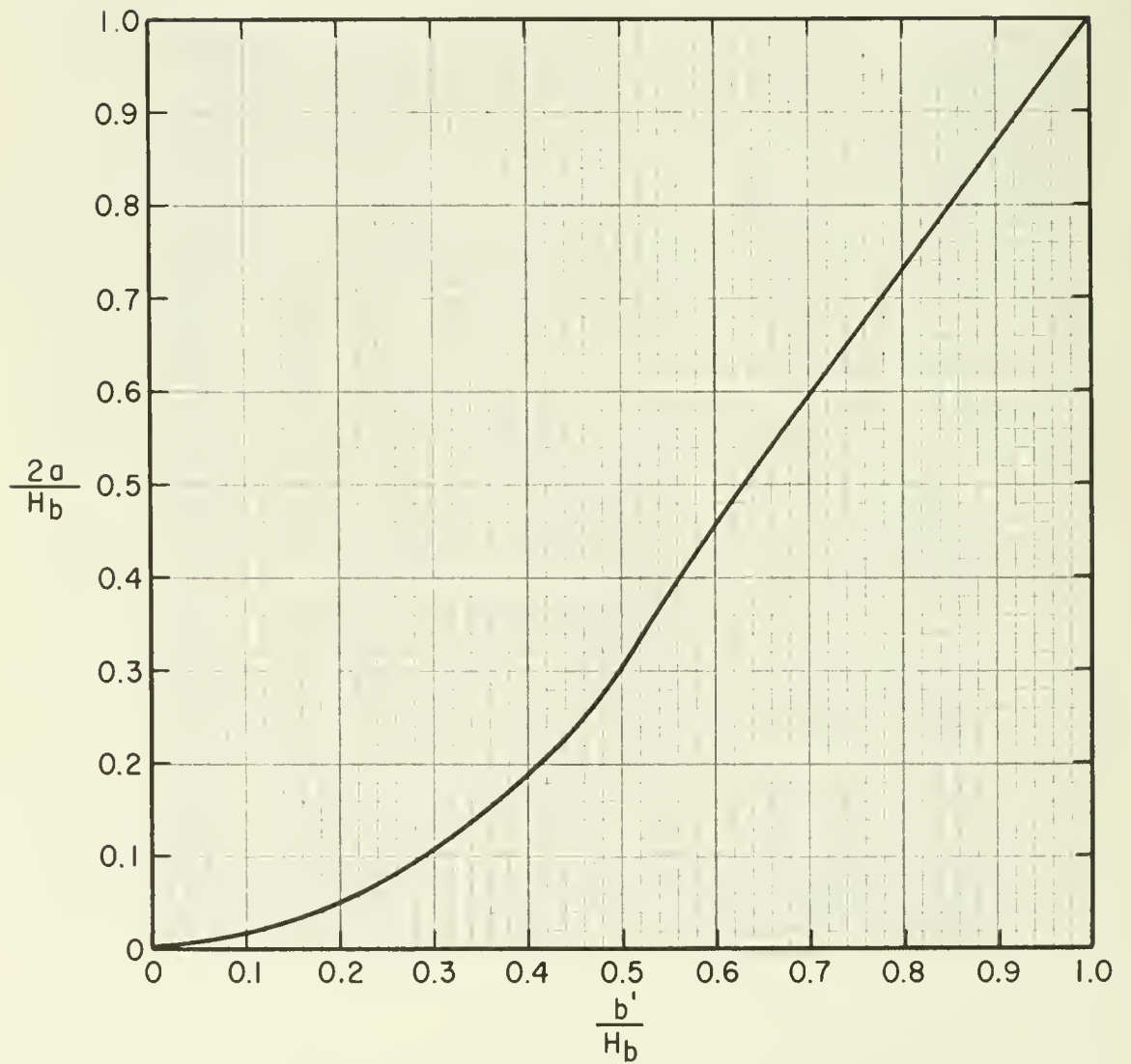
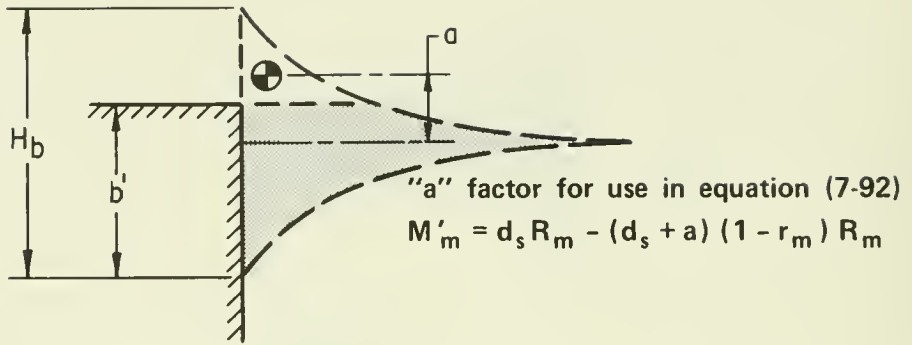

Figure 7-103. Minikin moment reduction for low wall.

$$R_m = 309 \text{ kN/m (21,164 lb/ft)}$$

$$M_m = 772 \frac{\text{kN}\cdot\text{m}}{\text{m}} \left(173,561 \frac{\text{ft}\cdot\text{lb}}{\text{ft}} \right) \quad (T = 6 \text{ s})$$

and

$$H_b = 3.2 \text{ m (10.5 ft)} \quad (d_b = 3.0 \text{ m} > d_s)$$

$$R_m = 194 \text{ kN/m (13,287 lb/ft)}$$

$$M_m = 485 \text{ kN}\cdot\text{m/m (109,038 ft}\cdot\text{lb/ft)} \quad (T = 10 \text{ s})$$

For the breaker with a period of 6 seconds, the height of the breaker crest above the bottom is

$$\left(d_s + \frac{H_b}{2} \right) = \left(2.5 + \frac{2.8}{2} \right) = 3.9 \text{ m (12.8 ft)}$$

The value of b' as defined in Figure 7-102 is 1.9 m (6.2 ft) (i.e., the breaker height H_b minus the height obtained by subtracting the wall crest elevation from the breaker crest elevation). Calculate

$$\frac{b'}{H_b} = \frac{1.9}{2.8} = 0.679 \quad (T = 6 \text{ s})$$

From Figure 7-102,

$$r_m = 0.83$$

therefore, from equation (7-91),

$$R'_m = r_m R_m = 0.83 (309) = 256 \text{ kN/m (17,540 lb/ft)} \quad (T = 6 \text{ s})$$

From Figure 7-103, entering with $b/H'_b = 0.679$,

$$\frac{2a}{H'_b} = 0.57$$

hence

$$a = \frac{0.57(2.8)}{2} = 0.80 \text{ m}$$

and from equation (7-93)

$$M'_m = R'_m \left[r_m (d_s + a) - a \right] = 309 [0.83 (2.5 + 0.80) - 0.80]$$

$$M'_m = 309 [1.94] = 600 \text{ kN-m/m (134,900 ft-lb/ft)} \quad (T = 6 \text{ s})$$

A similar analysis for the maximum breaker with a 10-second period gives

$$r'_m = 0.79$$

$$a = 0.86 \text{ m (2.82 ft)}$$

$$R'_m = 153 \text{ kN/m (10,484 lb/ft)}$$

$$M'_m = 348 \frac{\text{kN-m}}{\text{m}} \left(78,237 \frac{\text{lb-ft}}{\text{ft}} \right) \quad (T = 10 \text{ s})$$

The hydrostatic part of the force and moment can be computed from the hydrostatic pressure distribution shown in Figure 7-99 by assuming the hydrostatic pressure to be zero at $H_b/2$ above SWL and taking only that portion of the area under the pressure distribution which is below the crest of the wall.

* * * * *

4. Broken Waves.

Shore structures may be located so that even under severe storm and tide conditions waves will break before striking the structure. No studies have yet been made to relate forces of broken waves to various wave parameters, and it is necessary to make simplifying assumptions about the waves to estimate design forces. If more accurate force estimates are required, model tests are necessary.

It is assumed that, immediately after breaking, the water mass in a wave moves forward with the velocity of propagation attained before breaking; that is, upon breaking, the water particle motion changes from oscillatory to translatory motion. This turbulent mass of water then moves up to and over the stillwater line dividing the area shoreward of the breakers into two parts, seaward and landward of the stillwater line. For a conservative estimate of wave force, it is assumed that neither wave height nor wave velocity decreases from the breaking point to the stillwater line and that after passing the stillwater line the wave will run up roughly twice its height at breaking, with both velocity and height decreasing to zero at this point. Wave runup can be estimated more accurately from the procedure outlined in Section 1, Wave Runup.

Model tests have shown that, for waves breaking at a shore, approximately 78 percent of the breaking wave height H_b is above the stillwater level (Wiegel, 1964).

a. Wall Seaward of Stillwater Line. Walls located seaward of the stillwater line are subjected to wave pressures that are partly dynamic and partly hydrostatic (see Figure 7-104).

Using the approximate relationship $C = \sqrt{gd_b}$ for the velocity of wave propagation, C where g is the acceleration of gravity and d_b is the

breaking wave depth, wave pressures on a wall may be approximated in the following manner:

The dynamic part of the pressure will be

$$p_m = \frac{wC^2}{2g} = \frac{wd_b}{2} \quad (7-94)$$

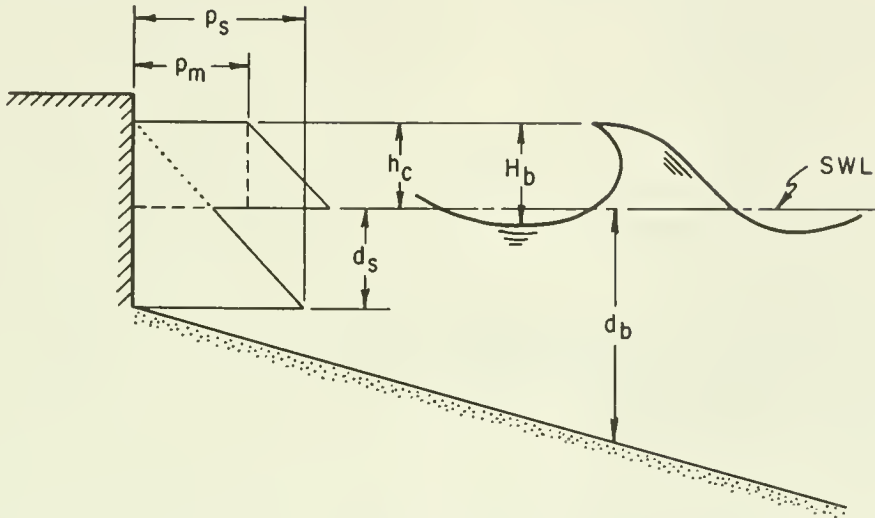

Figure 7-104. Wave pressures from broken waves: wall seaward of still-water line.

where w is the unit weight of water. If the dynamic pressure is uniformly distributed from the still-water level to a height h_c above SWL, where h_c is given as

$$h_c = 0.78H_b \quad (7-95)$$

then the dynamic component of the wave force is given as

$$R_m = p_m h_c = \frac{wd_b h_c}{2} \quad (7-96)$$

and the overturning moment caused by the dynamic force as

$$M_m = R_m \left(d_s + \frac{h_c}{2} \right) \quad (7-97)$$

where d_s is the depth at the structure.

The hydrostatic component will vary from zero at a height h_c above SWL to a maximum p_s at the wall base. This maximum will be given as,

$$p_s = w (d_s + h_c) \quad (7-98)$$

The hydrostatic force component will therefore be

$$R_s = \frac{w (d_s + h_c)^2}{2} \quad (7-99)$$

and the overturning moment will be,

$$M_s = R_s \frac{(d_s + h_c)}{3} = \frac{w (d_s + h_c)^3}{6} \quad (7-100)$$

The total force on the wall is the sum of the dynamic and hydrostatic components; therefore,

$$R_t = R_m + R_s \quad (7-101)$$

and

$$M_t = M_m + M_s \quad (7-102)$$

b. Wall Shoreward of Still-water Line. For walls landward of the still-water line as shown in Figure 7-105, the velocity v' of the water mass at the structure at any location between the SWL and the point of maximum wave runup may be approximated by,

$$v' = C \left(1 - \frac{x_1}{x_2} \right) = \sqrt{gd_b} \left(1 - \frac{x_1}{x_2} \right) \quad (7-103)$$

and the wave height h' above the ground surface by

$$h' = h_c \left(1 - \frac{x_1}{x_2} \right) \quad (7-104)$$

where

x_1 = distance from the still-water line to the structure

x_2 = distance from the still-water line to the limit of wave uprush; i.e., $x_2 = 2H_b \cot \beta = 2H_b/m$ (note: the actual wave runup as found from the method outlined in Section II,1 could be substituted for the value $2H_b$)

β = the angle of beach slope

$m = \tan \beta$

An analysis similar to that for structures located seaward of the still-water line gives for the dynamic pressure

$$p_m = \frac{wv'^2}{2g} = \frac{wd_b}{2} \left(1 - \frac{x_1}{x_2} \right)^2 \quad (7-105)$$

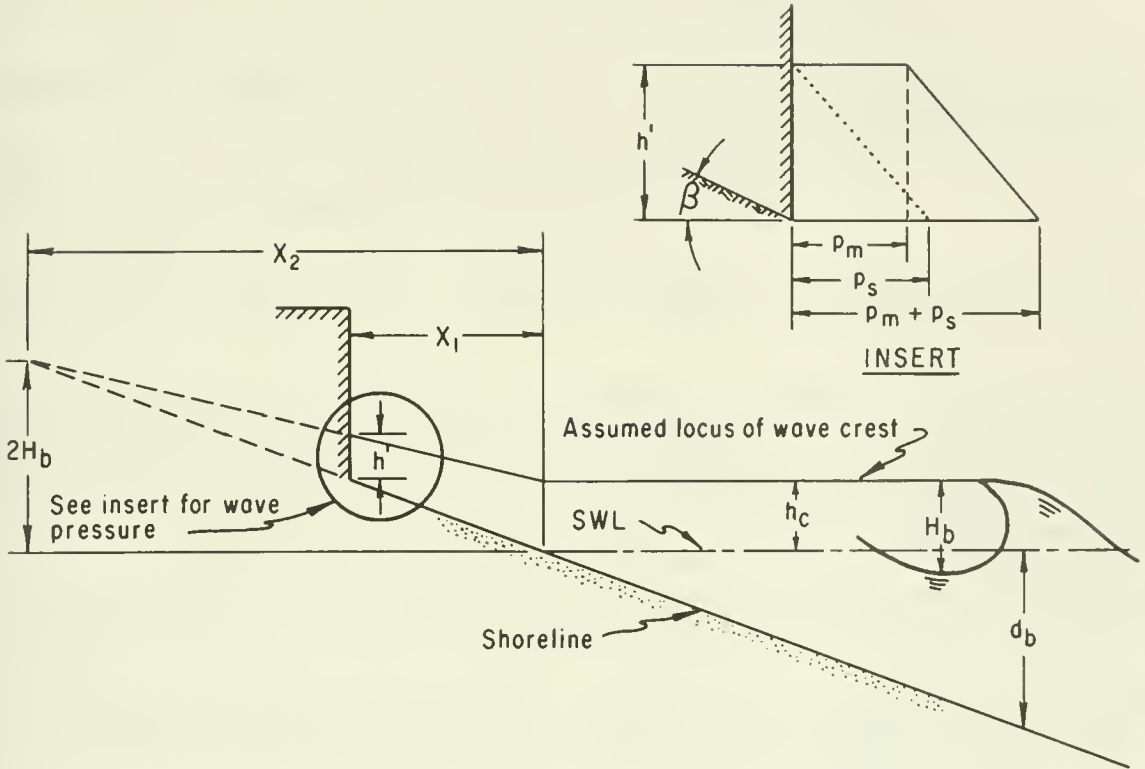

Figure 7-105. Wave pressures from broken waves: wall landward of still-water line.

The dynamic pressure is assumed to act uniformly over the broken wave height at the structure toe h' , hence the dynamic component of force is given by

$$R_m = p_m h' = \frac{wd_b h}{2} e \left(1 - \frac{x_1}{x_2} \right)^3 \quad (7-106)$$

and the overturning moment by

$$M_m = R_m \frac{h'}{2} = \frac{wd_b h^2}{4} e \left(1 - \frac{x_1}{x_2} \right)^4 \quad (7-107)$$

The hydrostatic force component is given by

$$R_s = \frac{wh^2}{2} = \frac{wh^2}{2} e \left(1 - \frac{x_1}{x_2} \right)^2 \quad (7-108)$$

and the moment resulting from the hydrostatic force by

$$M_s = R_s \frac{h'}{3} = \frac{wh^3}{6} \left(1 - \frac{x_1}{x_2} \right)^3 \quad (7-109)$$

The total forces and moments are the sums of the dynamic and hydrostatic components; therefore, as before,

$$R_t = R_m + R_s \quad (7-110)$$

and

$$M_t = M_m + M_s \quad (7-111)$$

The pressures, forces, and moments computed by the above procedure will be *approximations*, since the assumed wave behavior is simplified. Where structures are located landward of the still-water line the preceding equations will not be exact, since the runup criterion was assumed to be a fixed fraction of the breaker height. However, the assumptions should result in a high estimate of the forces and moments.

***** EXAMPLE PROBLEM 36 *****

GIVEN: The elevation at the toe of a vertical wall is 0.6 m (2 ft) above the mean lower low water (MLLW) datum. Mean higher high water (MHHW) is 1.3 m (4.3 ft) above MLLW, and the beach slope is 1:20. Breaker height is $H_b = 3.0$ m (9.8 ft), and wave period is $T = 6$ s .

FIND:

- (a) The total force and moment if the SWL is at MHHW; i.e., if the wall is seaward of still-water line.
- (b) The total force and moment if the SWL is at MLLW; i.e., if the wall is landward of still-water line.

SOLUTION:

- (a) The breaking depth d_b can be found from Figure 7-2. Calculate,

$$\frac{H_b}{gT^2} = \frac{3.0}{9.8 (6)^2} = 0.0085$$

and the beach slope,

$$m = \tan \beta = \frac{1}{20} = 0.05$$

Enter Figure 7-2 with $H_b/gT^2 = 0.0085$ and, using the curve for $m = 0.05$, read

$$\frac{d_b}{H_b} = 1.10$$

Therefore,

$$d_b = 1.10 H_b = 1.10 (3.0) = 3.3 \text{ m (10.8 ft)}$$

From equation (7-95)

$$h_c = 0.78 H_b = 0.78 (3.0) = 2.3 \text{ m (7.7 ft)}$$

The dynamic force component from equation (7-96) is

$$R_m = \frac{w d_b h_c}{2} = \frac{10,047 (3.3)(2.3)}{2} = 38.1 \text{ kN/m (2,610 lb/ft)}$$

and the moment from equation (7-97) is

$$M_m = R_m \left(d_s + \frac{h_c}{2} \right) = 38.1 \left(0.7 + \frac{2.3}{2} \right) = 70.5 \frac{\text{kN-m}}{\text{m}} \left(15,900 \frac{\text{ft-lb}}{\text{ft}} \right)$$

where $d_s = 0.7 \text{ m}$ is the depth at the toe of the wall when the SWL is at MHHW. The hydrostatic force and moment are given by equations (7-99) and (7-100):

$$R_s = \frac{w (d_s + h_c)^2}{2} = \frac{10,047 (0.7 + 2.3)^2}{2} = 45.2 \text{ kN/m (3,100 lb/ft)}$$

$$M_s = R_s \frac{(d_s + h_c)}{3} = 45,212 \frac{0.7 + 2.3}{3} = 45.2 \frac{\text{kN-m}}{\text{m}} \left(10,200 \frac{\text{ft-lb}}{\text{ft}} \right)$$

The total force and moment are therefore,

$$R_t = R_m + R_s = 38.1 + 45.2 = 83.3 \text{ kN/m (5,710 lb/ft)}$$

$$M_t = M_m + M_s = 70.5 + 45.2 = 115.7 \frac{\text{kN-m}}{\text{m}} \left(26,000 \frac{\text{ft-lb}}{\text{ft}} \right)$$

(b) When the SWL is at MLLW, the structure is landward of the still-water line. The distance from the still-water line to the structure x_1 is given by the difference in elevation between the SWL and the structure toe divided by the beach slope; hence

$$x_1 = \frac{0.6}{0.05} = 12 \text{ m (39.4 ft)}$$

The limit of wave runup is approximately

$$x_2 = \frac{2H_b}{m} = \frac{2 (3.0)}{0.05} = 120 \text{ m}$$

The dynamic component of force from equation (7-106) is,

$$R_m = \frac{wd_b h_c}{2} \left(1 - \frac{x_1}{x_2}\right)^3 = \frac{10,047 (3.3)(2.3)}{2} \left(1 - \frac{12}{120}\right)^3 = 27.8 \frac{\text{kN-m}}{\text{m}} \quad (1,905 \text{ lb/ft})$$

and the moment from equation (7-107) is

$$M_m = \frac{wd_b h_c^2}{4} \left(1 - \frac{x_1}{x_2}\right)^4 = \frac{10,047 (3.3)(2.3)^2}{4} \left(1 - \frac{12}{120}\right)^4 = 28.8 \frac{\text{kN-m}}{\text{m}} \quad (6,500 \frac{\text{ft-lb}}{\text{ft}})$$

The hydrostatic force and moment from equations (7-108) and (7-109) are,

$$R_s = \frac{wh_c^2}{2} \left(1 - \frac{x_1}{x_2}\right)^2 = \frac{10,047 (2.3)^2}{2} \left(1 - \frac{12}{120}\right)^2 = 21.5 \frac{\text{kN-m}}{\text{m}} \quad (1,475 \text{ lb/ft})$$

and

$$M_s = \frac{wh_c^3}{6} \left(1 - \frac{x_1}{x_2}\right)^3 = \frac{10,047 (2.3)^3}{6} \left(1 - \frac{12}{120}\right)^3 = 14.9 \frac{\text{kN-m}}{\text{m}} \quad (3,400 \frac{\text{ft-lb}}{\text{ft}})$$

Total force and moment are

$$R_t = R_m + R_s = 27.8 + 21.5 = 49.3 \frac{\text{kN-m}}{\text{m}} \quad (3,400 \text{ lb/ft})$$

$$M_t = M_m + M_s = 28.8 + 14.9 = 43.7 \frac{\text{kN-m}}{\text{m}} \quad (9,800 \frac{\text{ft-lb}}{\text{ft}})$$

5. Effect of Angle of Wave Approach.

When *breaking* or *broken waves* strike the vertical face of a structure such as a groin, bulkhead, seawall, or breakwater at an oblique angle, the *dynamic component of the pressure* or force will be less than for breaking or broken waves that strike perpendicular to the structure face. The force may be reduced by the equation,

$$R' = R \sin^2 \alpha \tag{7-112}$$

where α is the angle between the axis of the structure and the direction of wave advance, R' is the reduced dynamic component of force, and R is the dynamic force that would occur if the wave hit perpendicular to the structure. The development of equation (7-112) is given in Figure 7-106. *Force reduction by equation (7-112) should be applied only to the dynamic wave-force component of breaking or broken waves and should not be applied to the*

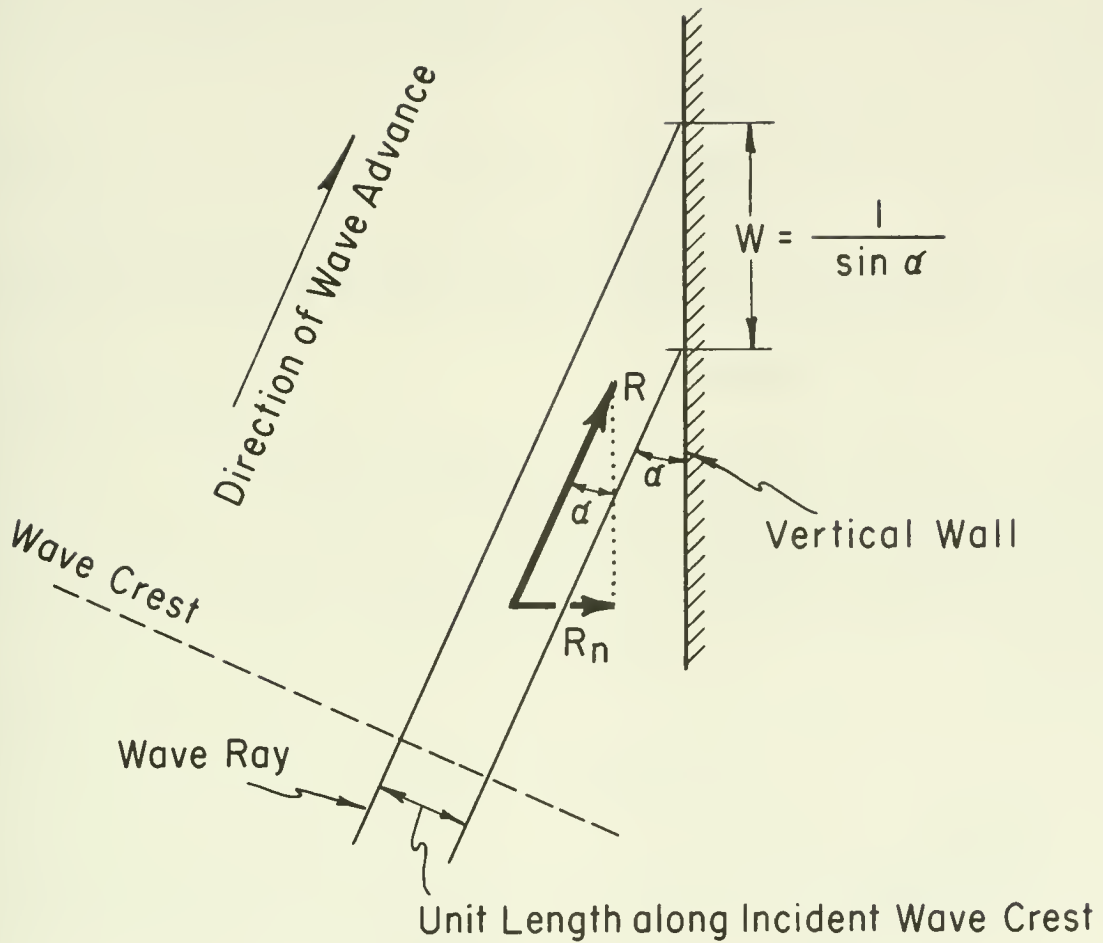

R = Dynamic Force Per Unit Length of Wall if Wall were Perpendicular to Direction of Wave Advance

R_n = Component of R Normal to Actual Wall. $R_n = R \sin \alpha$

W = Length Along Wall Affected by a Unit Length of Wave Crest. $W = l / \sin \alpha$

R' = Dynamic Force Per Unit Length of Wall

$$R' = \frac{R_n}{W} = \frac{R \sin \alpha}{l / \sin \alpha} = R \sin^2 \alpha$$

$$R' = R \sin^2 \alpha$$

Figure 7-106. Effect of angle of wave approach: plan view.

hydrostatic component. The reduction is not applicable to rubble structures. The maximum force does not act along the entire length of a wall simultaneously; consequently, the average force per unit length of wall will be lower.

6. Effect of a Nonvertical Wall.

Formulas previously presented for breaking and broken wave forces may be used for structures with nearly vertical faces.

If the face is sloped backward as in Figure 7-107a, the horizontal component of the dynamic force due to waves breaking either on or seaward of the wall should be reduced to

$$R'' = R' \sin^2 \theta \quad (7-113)$$

where θ is defined in Figure 7-107. The vertical component of the dynamic wave force may be neglected in stability computations. For design calculations, forces on stepped structures as in Figure 7-107b may be computed as if the face were vertical, since the dynamic pressure is about the same as computed for vertical walls. Curved nonreentrant face structures (Fig. 7-107c) and reentrant curved face walls (Fig. 7-107d) may also be considered as vertical.

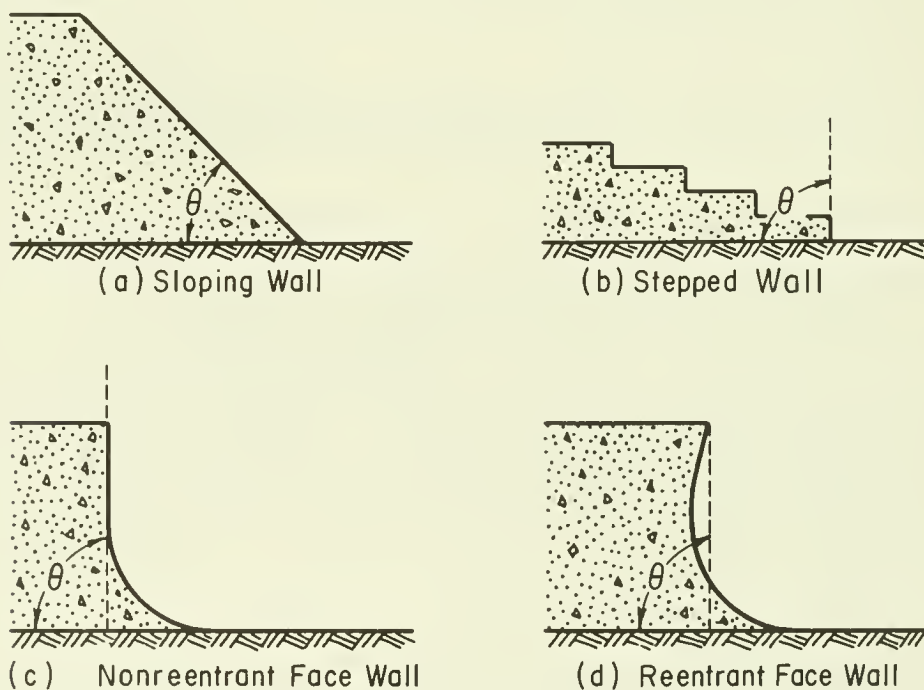

Figure 7-107. Wall shapes.

***** EXAMPLE PROBLEM 37 *****

GIVEN: A structure in water, $d_g = 2.3$ m (7.5 ft), on a 1:20 nearshore slope, is subjected to breaking waves, $H_b = 2.6$ m (8.4 ft) and period $T = 6$ s. The angle of wave approach is, $\alpha = 80^\circ$, and the wall has a shoreward sloping face of 10 (vertical) on 1 (horizontal).

FIND:

- (a) The reduced total horizontal wave force.
- (b) The reduced total overturning moment about the toe (Note: neglect the vertical component of the hydrostatic force).

SOLUTION: From the methods used in Example Problems 34 and 36 for the given wave conditions, compute

$$R_m = 250 \text{ kN/m (17,100 lb/ft)}$$

$$M_m = 575 \frac{\text{kN-m}}{\text{m}} \left(129,300 \frac{\text{ft-lb}}{\text{ft}} \right)$$

$$R_g = 65 \text{ kN/m (4,450 lb/ft)}$$

and

$$M_g = 78 \frac{\text{kN-m}}{\text{m}} \left(17,500 \frac{\text{ft-lb}}{\text{ft}} \right)$$

Applying the reduction of equation (7-112) for the angle of wave approach, with $R_m = R$

$$R' = R_m \sin^2 \alpha = 250 (\sin 80^\circ)^2$$

$$R' = 250 (0.985)^2 = 243 \text{ kN/m (16,700 lb/ft)}$$

Similarly,

$$M' = M_m \sin^2 \alpha = 575 (\sin 80^\circ)^2$$

$$M' = 575 (0.985)^2 = 558 \frac{\text{kN-m}}{\text{m}} \left(125,500 \frac{\text{ft-lb}}{\text{ft}} \right)$$

Applying the reduction for a nonvertical wall, the angle the face of the wall makes with the horizontal is

$$\theta = \arctan (10) \approx 84^\circ$$

Applying equation (7-113),

$$R'' = R' \sin^2 \theta = 243 (\sin 84^\circ)^2$$

$$R'' = 243 (0.995)^2 = 241 \text{ kN/m (16,500 lb/ft)}$$

Similarly, for the moment

$$M'' = M' \sin^2 \theta = 558 (\sin 84^\circ)^2$$

$$M'' = 558 (0.995)^2 = 553 \frac{\text{kN-m}}{\text{m}} (124,200 \frac{\text{ft-lb}}{\text{ft}})$$

The total force and overturning moment are given by the sums of the reduced dynamic components and the unreduced hydrostatic components. Therefore,

$$R_t = 241 + 65 = 306 \text{ kN/m (21,000 lb/ft)}$$

$$M_t = 553 + 78 = 631 \frac{\text{kN-m}}{\text{m}} (141,900 \frac{\text{ft-lb}}{\text{ft}})$$

7. Stability of Rubble Structures.

a. General. A rubble structure is composed of several layers of random-shaped and random-placed stones, protected with a cover layer of selected armor units of either quarystone or specially shaped concrete units. Armor units in the cover layer may be placed in an orderly manner to obtain good wedging or interlocking action between individual units, or they may be placed at random. Present technology does not provide guidance to determine the forces required to displace individual armor units from the cover layer. Armor units may be displaced either over a large area of the cover layer, sliding down the slope en masse, or individual armor units may be lifted and rolled either up or down the slope. Empirical methods have been developed that, if used with care, will give a satisfactory determination of the stability characteristics of these structures when under attack by storm waves.

A series of basic decisions must be made in designing a rubble structure. Those decisions are discussed in succeeding sections.

b. Design Factors. A primary factor influencing wave conditions at a structure site is the bathymetry in the general vicinity of the structure. Depths will partly determine whether a structure is subjected to breaking, nonbreaking, or broken waves for a particular design wave condition (see Section I, WAVE CHARACTERISTICS).

Variation in water depth along the structure axis must also be considered as it affects wave conditions, being more critical where breaking waves occur than where the depth may allow only nonbreaking waves or waves that overtop the structure.

When waves impinge on rubble structures, they do the following:

- (a) Break completely, projecting a jet of water roughly perpendicular to the slope.

(b) Partially break with a poorly defined jet.

(c) Establish an oscillatory motion of the water particles up or down the structure slope, similar to the motion of a clapotis at a vertical wall.

The design wave height for a flexible rubble structure should usually be the average of the highest 10 percent of all waves, H_{10} as discussed in Section I,2. Damage from waves higher than the design wave height is progressive, but the displacement of several individual armor units will not necessarily result in the complete loss of protection. A logic diagram for the evaluation of the marine environment presented in Figure 7-6 summarizes the factors involved in selecting the design water depth and wave conditions to be used in the analysis of a rubble structure. The most severe wave condition for design of any part of a rubble-mound structure is usually the combination of predicted water depth and extreme incident wave height and period that produces waves which would break directly on the part of interest.

If a structure with two opposing slopes, such as a breakwater or jetty, will not be overtopped, a different design wave condition may be required for each side. The wave action directly striking one side of a structure, such as the harbor side of a breakwater, may be much less severe than that striking the other side. If the structure is porous enough to allow waves to pass through it, more armor units may be dislodged from the sheltered side's armor layer by waves traveling through the structure than by waves striking the layer directly. In such a case, the design wave for the sheltered side might be the same as for the exposed side, but no dependable analytical method is known for choosing such a design wave condition or for calculating a stable armor weight for it. Leese side armor sizes have been investigated in model tests by Markle (1982).

If a breakwater is designed to be overtopped, or if the designer is not sure that it will not be overtopped the crest and perhaps, the leeward side must be designed for breaking wave impact. Lording and Scott (1971) tested an overtopped rubble-mound structure that was subjected to breaking waves in water levels up to the crest elevation. Maximum damage to the leese side armor units occurred with the still-water level slightly below the crest and with waves breaking as close as two breaker heights from the toe of the structure. This would imply that waves were breaking over the structure and directly on the lee slope rather than on the seaward slope.

The crest of a structure designed to be submerged, or that might be submerged by hurricane storm surge, will undergo the heaviest wave action when the crest is exposed in the trough of a wave. The highest wave which would expose the crest can be estimated by using Figure 7-69, with the range of depths at the structure d , the range of wave heights H , and period T , and the structure height h . Values of $\frac{\eta_c}{H}$, where η_c is the crest elevation above the still-water level, can be found by entering Figure 7-69 with $\frac{H}{gT^2}$ and $\frac{d}{gT^2}$. The largest breaking and nonbreaking wave heights for which

$$d \leq h + H - \eta_c \quad (7-114)$$

can then be used to estimate which wave height requires the heaviest armor. The final design breaking wave height can be determined by entering Figure 7-69 with values of $\frac{d}{gT^2}$, finding values of $\frac{\eta_c}{H}$ for breaking conditions, and selecting the highest breaking wave which satisfied the equation

$$d = h + H - \eta_c \quad (7-115)$$

A structure that is exposed to a variety of water depths, especially a structure perpendicular to the shore, such as a groin, should have wave conditions investigated for each range of water depths to determine the highest breaking wave to which any part of the structure will be exposed. The outer end of a groin might be exposed only to wave forces on its sides under normal depths, but it might be overtopped and eventually submerged as a storm surge approaches. The shoreward end might normally be exposed to lower breakers, or perhaps only to broken waves. In the case of a high rubble-mound groin (i.e., a varying crest elevation and a sloping beach), the maximum breaking wave height may occur inshore of the seaward end of the groin.

c. Hydraulics of Cover Layer Design. Until about 1930, design of rubble structures was based only on experience and general knowledge of site conditions. Empirical formulas that subsequently developed are generally expressed in terms of the stone weight required to withstand design wave conditions. These formulas have been partially substantiated in model studies. They are guides and must be used with experience and engineering judgment. Physical modeling is often a cost-effective measure to determine the final cross-section design for most costly rubble-mound structures.

Following work by Iribarren (1938) and Iribarren and Nogales Y Olano (1950), comprehensive investigations were made by Hudson (1953, 1959, 1961a, and 1961b) at the U.S. Army Engineer Waterways Experiment Station (WES), and a formula was developed to determine the stability of armor units on rubble structures. The stability formula, based on the results of extensive small-scale model testing and some preliminary verification by large-scale model testing, is

$$W = \frac{w_r H^3}{K_D (S_r - 1)^3 \cot \theta} \quad (7-116)$$

where

W = weight in newtons or pounds of an individual armor unit in the primary cover layer. (When the cover layer is two quarrestones in thickness, the stones comprising the primary cover layer can range from about 0.75 W to 1.25 W , with about 50 percent of the individual stones weighing more than W . The gradation should be uniform across the face of the structure, with no pockets of smaller stone. The maximum weight of individual stones depends on the size or shape of the unit. The unit should not be of such a size as to extend an appreciable distance above the average level of the slope)

w_r = unit weight (saturated surface dry) of armor unit in N/m^3 or lb/ft^3 .
 Note: Substitution of ρ_r , the mass density of the armor material in kg/m^3 or $slugs/ft^3$, will yield W in units of mass (kilograms or slugs)

H = design wave height at the structure site in meters or feet (see Sec. III,7,b)

S_r = specific gravity of armor unit, relative to the water at the structure
 ($S_r = w_r / w$)

w_w = unit weight of water: fresh water = $9,800 N/m^3$ ($62.4 lb/ft^3$)
 seawater = $10,047 N/m^3$ ($64.0 lb/ft^3$) Note: Substitution of
 $\left(\frac{P_r - P_w}{p_w} \right)^3$, where p_w is the mass density of water at the structure for $(S_r - 1)^3$, yields the same result

θ = angle of structure slope measured from horizontal in degrees

K_D = stability coefficient that varies primarily with the shape of the armor units, roughness of the armor unit surface, sharpness of edges, and degree of interlocking obtained in placement (see Table 7-8).

Equation 7-116 is intended for conditions when the crest of the structure is high enough to prevent major overtopping. Also the slope of the cover layer will be partly determined on the basis of stone sizes economically available. Cover layer slopes steeper than 1 on 1.5 are not recommended by the Corps of Engineers.

Equation 7-116 determines the weight of an armor unit of nearly uniform size. For a graded riprap armor stone, Hudson and Jackson (1962) have modified the equation to:

Table 7-8. Suggested K_D Values for use in determining armor unit weight¹.

No-Damage Criteria and Minor Overtopping							
Armor Units	n ³	Placement	Structure Trunk		Structure Head		Slope Cot θ
			K_D^2		K_D		
			Breaking Wave	Nonbreaking Wave	Breaking Wave	Nonbreaking Wave	
Quarrrystone	2	Random	1.2	2.4	1.1	1.9	1.5 to 3.0 ⁵
Smooth rounded	>3	Random ⁴	1.6 ⁴	3.2	1.4 ⁴	2.3	
Smooth rounded	1	Random		2.9		2.3	
Rough angular	2	Random	2.0	4.0	1.9 1.6 1.3	3.2 2.8 2.3	1.5 2.0 3.0
Rough angular	>3	Random ⁶	2.2	4.5	2.1	4.2	5 5
Rough angular	2	Special ¹	5.8	7.0	5.3	6.4	
Parallelepiped ⁷	2	Special	7.0 - 20.0	8.5 - 24.0	--	--	
Tetrapod and Quadripod	2	Random	7.0	8.0	5.0 4.5 3.5	6.0 5.5 4.0	1.5 2.0 3.0
Tribar	2	Random	9.0	10.0	8.3 7.8 6.0	9.0 8.5 6.5	1.5 2.0 3.0
Dolos	2	Random	15.8 ⁸	31.8 ⁸	8.0 7.0	16.0 14.0	2.0 ⁹ 3.0
Modified cube	2	Random	6.5	7.5	----	5.0	5
Hexapod	2	Random	8.0	9.5	5.0	7.0	5
Toskane	2	Random	11.0	22.0	--	--	5
Tribar	1	Uniform	12.0	15.0	7.5	9.5	5
Quarrrystone (K_{RR}) Graded angular	-	Random	2.2	2.5	--	--	

¹ CAUTION: Those K_D values shown in *italics* are unsupported by test results and are only provided for preliminary design purposes.

² Applicable to slopes ranging from 1 on 1.5 to 1 on 5.

³ n is the number of units comprising the thickness of the armor layer.

⁴ The use of single layer of quarrrystone armor units is not recommended for structures subject to breaking waves, and only under special conditions for structures subject to nonbreaking waves. When it is used, the stone should be carefully placed.

⁵ Until more information is available on the variation of K_D value with slope, the use of K_D should be limited to slopes ranging from 1 on 1.5 to 1 on 3. Some armor units tested on a structure head indicate a K_D -slope dependence.

⁶ Special placement with long axis of stone placed perpendicular to structure face.

⁷ Parallelepiped-shaped stone: long slab-like stone with the long dimension about 3 times the shortest dimension (Markle and Davidson, 1979).

⁸ Refers to no-damage criteria (<5 percent displacement, rocking, etc.); if no rocking (<2 percent) is desired, reduce K_D 50 percent (Zwamborn and Van Niekerk, 1982).

⁹ Stability of dolosse on slopes steeper than 1 on 2 should be substantiated by site-specific model tests.

$$W_{50} = \frac{w_r H^3}{K_{RR} (S_r - 1)^3 \cot \theta} \quad (7-117)$$

The symbols are the same as defined for equation (7-116). W_{50} is the weight of the 50 percent size in the gradation. The maximum weight of graded rock is 4.0 (W_{50}); the minimum is 0.125 (W_{50}). Additional information on riprap gradation for exposure to wave forces is given by Ahrens (1981b). K_{RR} is a stability coefficient for angular, graded riprap, similar to K_D . Values of K_{RR} are shown in Table 7-8. These values allow for 5 percent damage (Hudson and Jackson, 1962).

Use of graded riprap cover layers is generally more applicable to revetments than to breakwaters or jetties. A limitation for the use of graded riprap is that the design wave height should be less than about 1.5 m (5 ft). For waves higher than 1.5 m (5 ft), it is usually more economical to use uniform-size armor units as specified by equation (7-116).

Values of K_D and K_{RR} are obtained from laboratory tests by first determining values of the stability number N_s where

$$N_s = \frac{w_r^{1/3} H}{W^{1/3} (S_r - 1)} \quad \text{or} \quad \frac{w_r^{1/3} H}{W_{50}^{1/3} (S_r - 1)} \quad (7-118)$$

The stability number is plotted as a function of $\cot \theta$ on log-log paper, and a straight line is fitted as a bottom envelope to the data such that

$$N_s = (K_D \cot \theta)^{1/3} \quad \text{or} \quad (K_{RR} \cot \theta)^{1/3} \quad (7-119)$$

Powers of $\cot \theta$ other than 1/3 often give a better fit to the data. N_s can be used for armor design by replacing $K_D \cot \theta$ in equation (7-116) or $K_{RR} \cot \theta$ in equation (7-117) with N_s^3 , where N_s is a function of some power of $\cot \theta$.

d. Selection of Stability Coefficient. The dimensionless stability coefficient K_D in equation (7-116) accounts for all variables other than structure slope, wave height, and the specific gravity of water at the site (i.e., fresh or salt water). These variables include:

- (1) Shape of armor units
- (2) Number of units comprising the thickness of armor layer
- (3) Manner of placing armor units
- (4) Surface roughness and sharpness of edges of armor units (degree of interlocking of armor units)
- (5) Type of wave attacking structure (breaking or nonbreaking)

- (6) Part of structure (trunk or head)
- (7) Angle of incidence of wave attack
- (8) Model scale (Reynolds number)
- (9) Distance below still-water level that the armor units extend down the face slope
- (10) Size and porosity of underlayer material
- (11) Core height relative to still-water level
- (12) Crown type (concrete cap or armor units placed over the crown and extending down the back slope)
- (13) Crown elevation above still-water level relative to wave height
- (14) Crest width

Hudson (1959, 1961a, and 1961b), and Hudson and Jackson (1959), Jackson (1968a), Carver and Davidson (1977), Markle and Davidson (1979), Office, Chief of Engineers (1978), and Carver (1980) have conducted numerous laboratory tests with a view to establishing values of K_D for various conditions of some of the variables. They have found that, for a given geometry of rubble structure, the most important variables listed above with respect to the magnitude of K_D are those from (1) through (8). The data of Hudson and Jackson comprise the basis for selecting K_D , although a number of limitations in the application of laboratory results to prototype conditions must be recognized. These limitations are described in the following paragraphs.

(1) Laboratory waves were monochromatic and did not reproduce the variable conditions of nature. No simple method of comparing monochromatic and irregular waves is presently available. Laboratory studies by Oeullet (1972) and Rogan (1969) have shown that action of irregular waves on model rubble structures can be modeled by monochromatic waves if the monochromatic wave height corresponds to the significant wave height of the spectrum of the irregular wave train. Other laboratory studies (i.e., Carstens, Traetteberg, and Tørum (1966); Brorsen, Burcharth, and Larsen (1974); Feuillet and Sabaton (1980); and Tanimoto, Yagyu, and Goda (1982)) have shown, though, that the damage patterns on model rubble-mound structures with irregular wave action are comparable to model tests with monochromatic waves when the design wave height of the irregular wave train is higher than the significant wave height. As an extreme, the laboratory work of Feuillet and Sabaton (1980) and that of Tanimoto, Yagyu, and Goda (1982) suggest a design wave of H_5 when comparing monochromatic wave model tests to irregular wave model tests.

The validity of this comparison between monochromatic wave testing and irregular wave testing depends on the wave amplitude and phase spectra of the irregular wave train which, in turn, govern the "groupiness" of the wave train; i.e., the tendency of higher waves to occur together.

Groupiness in wave trains has been shown by Carstens, Traetteberg, and

Tørum (1966), Johnson, Mansard, and Ploeg (1978), and Burcharth (1979), to account for higher damage in rubble-mound or armor block structures. Burcharth (1979) found that grouped wave trains with maximum wave heights equivalent to monochromatic wave heights caused greater damage on dolosse- armored slopes than did monochromatic wave trains. Johnson, Mansard, and Ploeg (1978) found that grouped wave trains of energy density equivalent to that of monochromatic wave trains created greater damage on rubble-mound breakwaters.

Goda (1970b) and Andrew and Borgman (1981) have shown by simulation techniques that, for random-phased wave components in a wave spectrum, groupiness is dependent on the width of the spectral peak (the narrower the spectral width, the larger the groupiness in the wave train).

On a different tack, Johnson, Mansard, and Ploeg (1978) have shown that the same energy spectrum shape can produce considerably different damage patterns to a rubble-mound breakwater by controlling the phasing of the wave components in the energy spectrum. This approach to generating irregular waves for model testing is not presently attempted in most laboratories.

Typically, laboratory model tests assume random phasing of wave spectral components based on the assumption that waves in nature have random phasing. Tørum, Mathiesen, and Escutia (1979), Thompson (1981), Andrew and Borgman (1981), and Wilson and Baird (1972) have suggested that nonrandom phasing of waves appears to exist in nature, particularly in shallow water.

(2) Preliminary analysis of large-scale tests by Hudson (1975) has indicated that scale effects are relatively unimportant, and can be made negligible by the proper selection of linear scale to ensure that the Reynolds number is above 3×10^4 in the tests. The Reynolds number is defined in this case as

$$R = \frac{(gH)^{1/2} k_{\Delta}}{\nu} \left(\frac{W}{w^2} \right)^{1/3}$$

where ν is the kinematic viscosity of the water at the site and k_{Δ} is the layer coefficient (see Sec. III,7,g(2)).

(3) The degree of interlocking obtained in the special placement of armor units in the laboratory is unlikely to be duplicated in the prototype. Above the water surface in prototype construction it is possible to place armor units with a high degree of interlocking. Below the water surface the same quality of interlocking can rarely be attained. It is therefore advisable to use data obtained from random placement in the laboratory as a basis for K values.

(4) Numerous tests have been performed for nonbreaking waves, but only limited test results are available for plunging waves. Values for these conditions were estimated based on breaking wave tests of similar armor units. The ratio between the breaking and nonbreaking wave K 's for tetrapods and quadripods on structure trunks, for example, was used to estimate the breaking wave K 's for tribars, modified cubes, and hexapods

used on trunks. Similar comparisons of test results were used to estimate K_D values for armor units on structure heads.

(5) Under similar wave conditions, the head of a rubble structure normally sustains more extensive and frequent damage than the trunk of the structure. Under all wave conditions, a segment of the slope of the rounded head of the structure is usually subject to direct wave attack regardless of wave direction. A wave trough on the lee side coincident with maximum runup on the windward side will create a high static head for flow through the structure.

(6) Sufficient information is not available to provide firm guidance on the effect of angle of wave approach on stability of armor units. Quarry-stone armor units are expected to show greater stability when subject to wave attack at angles other than normal incidence. However, an analysis of limited test results by Whillock (1977) indicates that dolos units on a 1-on-2 slope become less stable as the angle of wave attack increases from normal incidence (0°) to approximately 45° . Stability increases rapidly again as the angle of wave attack increases beyond 45° . Whillock suggests that structures covered with dolosse should be designed only for the no-damage wave height at normal incidence if the structure is subject to angular wave attack. The stability of any rubble structures subjected to angular wave attack should be confirmed by hydraulic model tests.

Based on available data and the discussion above, Table 7-8 presents recommended values for K_D . Because of the limitations discussed, values in the table provide little or no safety factor. The values may allow some rocking of concrete armor units, presenting the risk of breakage. The K_D 's for dolosse may be reduced by 50 percent to protect against breakage, as noted in the footnote to Table 7-8. The experience of the field engineer may be utilized to adjust the K_D value indicated in Table 7-8, but deviation to less conservative values is not recommended without supporting model test results. A two-unit armor layer is recommended. If a one-unit armor layer is considered, the K_D values for a single layer should be obtained from Table 7-8. The indicated K_D values are less for a single-stone layer than for a two-stone layer and will require heavier armor stone to ensure stability. More care must be taken in the placement of a single armor layer to ensure that armor units provide an adequate cover for the underlayer and that there is a high degree of interlock with adjacent armor units.

These coefficients were derived from large- and small-scale tests that used many various shapes and sizes of both natural and artificial armor units. Values are reasonably definitive and are recommended for use in design of rubble-mound structures, supplemented by physical model test results when possible.

The values given in Table 7-8 are indicated as no-damage criteria, but actually consider up to 5 percent damage. Higher values of percent damage to a rubble breakwater have been determined as a function of wave height for several of the armor unit shapes by Jackson (1968b). These values, together with statistical data concerning the frequency of occurrence of waves of different heights, can be used to determine the annual cost of maintenance as a function of the acceptable percent damage without endangering the functional characteristics of the structure. Knowledge of maintenance costs can be used

to choose a design wave height yielding the optimum combination of first and maintenance costs. A structure designed to resist waves of a moderate storm, but which may suffer damage without complete destruction during a severe storm may have a lower annual cost than one designed to be completely stable for larger waves.

Table 7-9 shows the results of damage tests where $H/H_{D=0}$ is a function of the percent damage D for various armor units. H is the wave height corresponding to damage D . $H_{D=0}$ is the design wave height corresponding to 0- to 5-percent damage, generally referred to as no-damage condition.

Table 7-9. $H/H_{D=0}$ as a function of cover-layer damage and type of armor unit.¹

Unit		Damage (D) in Percent						
		0 to 5	5 to 10	10 to 15	15 to 20	20 to 30	30 to 40	40 to 50
Quarrrystone (smooth)	$H/H_{D=0}$	1.00	1.08	1.14	1.20	1.29	1.41	1.54
Quarrrystone (rough)	$H/H_{D=0}$	1.00	1.08	1.19	1.27	1.37	1.47	<i>1.56</i> ²
Tetrapods & Quadripods	$H/H_{D=0}$	1.00	1.09	1.17 ³	1.24 ³	1.32 ³	1.41 ³	1.50 ³
Tribar	$H/H_{D=0}$	1.00	1.11	1.25 ³	1.36 ³	1.50 ³	1.59 ³	1.64 ³
Dolos	$H/H_{D=0}$	1.00	1.10	1.14 ³	1.17 ³	1.20 ³	1.24 ³	1.27 ³

¹ Breakwater trunk, $n = 2$, random placed armor units, nonbreaking waves, and minor overtopping conditions.

² Values in *italics* are interpolated or extrapolated.

³ **CAUTION:** Tests did not include possible effects of unit breakage. Waves exceeding the design wave height conditions by more than 10 percent may result in considerably more damage than the values tabulated.

The percent damage is based on the volume of armor units displaced from the breakwater zone of active armor unit removal for a specific wave height. This zone, as defined by Jackson (1968a), extends from the middle of the breakwater crest down the seaward face to a depth equivalent to one zero-damage wave height $H_{D=0}$ below the still-water level. Once damage occurred, testing was continued for the specified wave condition until slope equilibrium was established or armor unit displacement ceased. Various recent laboratory tests on dolosse have indicated that once design wave conditions (i.e., zero-damage) are exceeded, damage progresses at a much greater rate than indicated

from tests of other concrete armor units. Note from the table that waves producing greater than 10 percent damage to a dolos structure will produce lesser damage levels to structures covered with other armor units. Concrete units in general will fail more rapidly and catastrophically than quarrystone armor.

Caution must be exercised in using the values in Table 7-9 for breaking wave conditions, structure heads, or structures other than breakwaters or jetties. The damage zone is more concentrated around the still-water level on the face of a revetment than on a breakwater (Ahrens, 1975), producing deeper damage to the armor layer for a given volume of armor removed. As a result, damage levels greater than 30 percent signify complete failure of a revetment's armor. Model studies to determine behavior are recommended whenever possible.

The following example illustrates the ways in which Table 7-9 may be used.

***** EXAMPLE PROBLEM 38 *****

GIVEN: A two-layer quarrystone breakwater designed for nonbreaking waves and minor overtopping from a no-damage design wave $H_{D=0} = 2.5$ m (8.2 ft) and $K_D = 4.0$.

FIND:

- (a) The wave heights which would cause 5 to 10 percent, 10 to 15 percent, 15 to 20 percent, and 20 to 30 percent damage. The return periods of these different levels of damage and consequent repair costs could also be estimated, given appropriate long-term wave statistics for the site.
- (b) The design wave height that should be used for calculating armor weight if the breakwater is a temporary or minor structure and 5 to 10 percent damage can be tolerated from 2.5-m waves striking it.
- (c) The damage to be expected if stone weighing 75 percent of the zero-damage weight is available at substantially less cost or must be used in an emergency for an expedient structure.

SOLUTION:

(a) From Table 7-9, for rough quarrystone:

Damage Level, %	0-5	5-10	10-15	15-20	20-30
$H/H_{D=0}$	1.00	1.08	1.19	1.27	1.37
H, m	2.5	2.7	3.0	3.2	3.4

Therefore, for instance, $H_D = 5-10 = (2.5) (1.08) = 2.7 \text{ m (88.8 ft)}$.

(b) From Table 7-9, for $D = 5$ to 10 percent

$$\frac{H}{H_{D=0}} = 1.08$$

$$H_{D=0} = \frac{H}{1.08}$$

Since the H causing 5 to 10 percent damage is 2.5 m ,

$$H_{D=0} = \frac{2.5}{1.08} = 2.3 \text{ m (7.5 ft)}$$

(c) To determine the damage level, a ratio of wave heights must be calculated. The higher wave height "H" will be the $H_{D=0}$ for the zero-damage weight $W_{D=0}$. The lower wave height " $H_{D=0}$ " will be the $H_{D=0}$ for the available stone weight W_{AV} .

Rearranging equation (7-116),

$$H = (S_r - 1) \left(\frac{W K_D \cot \theta}{w_r} \right)^{1/3}$$

from which

$$\frac{"H"}{H_{D=0}} = \left(\frac{W_{D=0}}{W_{AV}} \right)^{1/3}$$

Since $W_{AV} = 0.75 W_{D=0}$

$$\frac{"H"}{H_{D=0}} = \left(\frac{W_{D=0}}{0.75 W_{D=0}} \right)^{1/3}$$

$$\frac{"H"}{H_{D=0}} = \left(\frac{1}{0.75} \right)^{1/3} = 1.10$$

This corresponds to damage of about 5 to 10 percent if the available stone is used.

e. Importance of Unit Weight of Armor Units. The basic equation used for design of armor units for rubble structures indicates that the unit weight w_r of quarystone or concrete is important. Designers should carefully evaluate the advantages of increasing unit weight of concrete armor units to affect savings in the structure cost. Brandtzaeg (1966) cautioned that variations in unit weight should be limited within a range of, say, 18.9

kilonewtons per cubic meter (120 pounds per cubic foot) to 28.3 kilonewtons per cubic meter (180 pounds per cubic foot). Unit weight of quarrrystone available from a particular quarry will likely vary over a narrow range of values. The unit weight of concrete containing normal aggregates is usually between 22.0 kilonewtons per cubic meter (140 pounds per cubic foot) and 24.3 kilonewtons per cubic meter (155 pounds per cubic foot). It can be made higher or lower through use of special heavy or lightweight aggregates that are usually available but are more costly than normal aggregates. The unit weight obtainable from a given set of materials and mixture proportions can be computed from Method CRD-3 of the Handbook for Concrete and Cement published by the U.S. Army Engineer Waterways Experiment Station (1949).

The effect of varying the unit weight of concrete is illustrated by the following example problem.

***** EXAMPLE PROBLEM 39 *****

GIVEN: A 33.5-metric ton (36.8-short ton) concrete armor unit is required for the protection of a rubble-mound structure against a given wave height in salt water ($w_w = 10.0$ kilonewtons per cubic meter (64 pounds per cubic foot)). This weight was determined using a unit weight of concrete $w_r = 22.8$ kilonewtons per cubic meter (145 pounds per cubic foot).

FIND: Determine the required weight of armor unit for concrete with $w = 22.0$ kilonewtons per cubic meter (140 pounds per cubic foot) and $w_r = 26.7$ kilonewtons per cubic meter (170 pounds per cubic foot).

SOLUTION: Based on equation (7-116), the ratio between the unknown and known armor weight is

$$\frac{w_r / \left(\frac{w_r}{w} - 1 \right)^3}{22.8 / \left(\frac{22.8}{10.0} - 1 \right)^3}$$

Thus, for $w_r = 22.0$ kilonewtons per cubic meter

$$\frac{22.0 / \left(\frac{22.0}{10.0} - 1 \right)^3}{10.9} = 33.5 \times \frac{12.7}{10.9} = 39.0 \text{ mt (42.9 tons)}$$

For $w_r = 26.7 \text{ kN/m}^3$

$$\frac{26.7 / \left(\frac{26.7}{10.0} - 1 \right)^3}{10.9} = 33.5 \times \frac{5.7}{10.9} = 17.5 \text{ mt (19.2 tons)}$$

f. Concrete Armor Units. Many different concrete shapes have been developed as armor units for rubble structures. The major advantage of

concrete armor units is that they usually have a higher stability coefficient value and thus permit the use of steeper structure side slopes or a lighter weight of armor unit. This advantage has particular value when quarrystone of the required size is not available.

Table 7-10 lists the concrete armor units that have been cited in literature and shows where and when the unit was developed. One of the earlier nonblock concrete armor units was the *tetrapod*, developed and patented in 1950 by Neyrpic, Inc., of France. The tetrapod is an unreinforced concrete shape with four truncated conical legs projecting radially from a center point (see Fig. 7-108).

Figure 7-109 provides volume, weight, dimensions, number of units per 1000 square feet, and thickness of layers of the tetrapod unit. The *quadripod* (Fig. 7-108) was developed and tested by the United States in 1959; details are shown in Figure 7-110.

In 1958, R. Q. Palmer, United States, developed and patented the *tribar*. This concrete shape consists of three cylinders connected by three radial arms (see Fig. 7-108). Figure 7-111 provides details on the volume, dimensions, and thickness of layers of tribars.

The *dolos* armor unit, developed in 1963 by E. M. Merrifield, Republic of South Africa (Merrifield and Zwamborn, 1966), is illustrated in Figure 7-108. This concrete unit closely resembles a ship anchor or an "H" with one vertical perpendicular to the other. Detailed dimensions are shown in Figure 7-112.

The *toskane* is similar to the dolos, but the shapes at the ends of the central shank are triangular heads rather than straight flukes. The triangular heads are purported to be more resistant to breakage than the dolos flukes. A round hole may be placed through each head to increase porosity. Dimensions are shown in Figure 7-113.

As noted in Table 7-8, various other shapes have been tested by the Corps of Engineers. Details of the *modified cube* and *hexapod* are shown in Figures 7-114 and 7-115, respectively.

As noted, the tetrapod, quadripod, and tribar are patented, but the U.S. patents on these units have expired. Patents on these units may still be in force in other countries, however; payment of royalties to the holder of the patent for the use of such a unit is required. Since other units in Table 7-10 may be patented, in the U.S. or elsewhere, the status of patents should be reviewed before they are used.

Unlike quarrystone, concrete armor units have a history of breakage problems. If a unit breaks, its weight is reduced; if enough units break, the stability of an armor layer is reduced. For dolosse, for instance, model tests by Markel and Davidson (1984a) have demonstrated that random breakage of up to 15 percent or up to 5 broken units in a cluster will have little effect on stability. Breakage exceeding these limits may lead to catastrophic failure of the armor layer.

Table 7-10. Types of armor units¹.

Name of Unit	Development of Unit		Reference
	Country	Date	
Akmon	Netherlands	1962	Paape and Walther, 1963
Binnie block	England	-- ²	Hydraulics Research Station, 1980
Bipod	Netherlands	1962	Paape and Walther, 1963
Cob	England	1969	Anonymous, 1970; Wilkinson and Allsop, 1983
Cube ³	4	4	Hudson and Jackson, 1953
Cube (modified) ³	United States	1959	Jackson, 1968a
Dolos ³	South Africa	1963	Merrifield and Zwamborn, 1966
Dom	Mexico	1970	--
Gassho block	Japan	1967	Personal correspondence, 1971, Prof. S. Nagai, Dean of Faculty of Engineering, Osaka City University, Sugimoto-Cho, Sumiyoshi-Ku, Osaka, Japan
Grabbelar	South Africa	1957	Personal correspondence, 1971, Mr. P. Grobbelaar, Technical Manager, Fisheries Development Corp. of South Africa, Ltd., Cape Town, Republic of South Africa
Hexaleg block	Japan	--	Giken Kogyo Co., Ltd., undated
Hexapod ³	United States	1959	Jackson, 1968a
Hollow square	Japan	1960	Personal correspondence, 1971, Prof. S. Nagai (see above); Nagai, 1962.
Hollow Tetrahedron	Japan	1959	Personal correspondence, 1971, Prof. S. Nagai (see above); Nagai, 1961b; Tanaka et al., 1966
Interlocking H-block	United States	1958	U. S. Army Engineer District, Galveston, 1972
Mexapod	Mexico	1978	Porraz and Medina, 1978
N-shaped block	Japan	1960	Personal correspondence, 1971, Prof. S. Nagai (see above); Nagai, 1962
Pelican stool ³	United States	1960	Jackson, 1961
Quadripod	United States	1959	Jackson, 1968a
Rectangular block ³	4	4	Jackson, 1967
Rentrapod	England	--	Hydraulics Research Station, 1980
Seabee	Australia	1978	Brown, 1978
Shed	England	1982	Anonymous, 1982; Wilkinson and Allsop, 1983
Stabilopod	Romania	1965	Lates and Ulubeanu, 1966
Stabit	England	1961	Singh, 1968
Sta-Bar ³	United States	1966	Personal correspondence, 1971, Mr. R. J. O'Neill, Marine Modules, Inc. Yonkers, N.Y.
Sta-Pod ³	United States	1966	Personal correspondence, 1971, Mr. R. J. O'Neill (see above)
Stalk cube	Netherlands	1965	Hakkelling, 1971
Svee block	Norway	1961	Svee, Traettenberg, and Tørum, 1965
Tetrahedron (solid) ³	5	5	Jackson, 1968a
Tetrahedron (perforated) ³	United States	1959	Jackson, 1968a
Tetrapod	France	1950	Osnel, Chapus, and Dhsille, 1960; Jackson, 1968
Toskane ³	South Africa	1966	Personal correspondence, 1971, Mr. P. Grobbelaar (see above)
Tribar	United States	1958	Jackson, 1968a; Personal correspondence, Mr. Robert Q. Palmer, President, Tribars, Inc., Las Vegas, Nevada
Trigon	United States	1962	--
Tri-Long	United States	1968	Davidson, 1971
Tripod	Netherlands	1962	Paape and Walther, 1963
Tripod block	England	1974	British Transport Docks Board, 1979

¹ Modified from Hudson, 1974.

² Not available.

³ Units have been tested, some extensively, at the U. S. Army Engineer Waterways Experiment Station (WES); not all units were tested in two-layer armor layers.

⁴ Cubes and rectangular blocks are known to have been used in masonry-type breakwaters since early Roman times and in rubble-mound breakwaters during the last few centuries. The cube was tested at WES as a construction block for breakwaters as early as 1943.

⁵ Solid tetrahedrons are known to have been used in hydraulic works for many years. This unit was tested at WES in 1959.

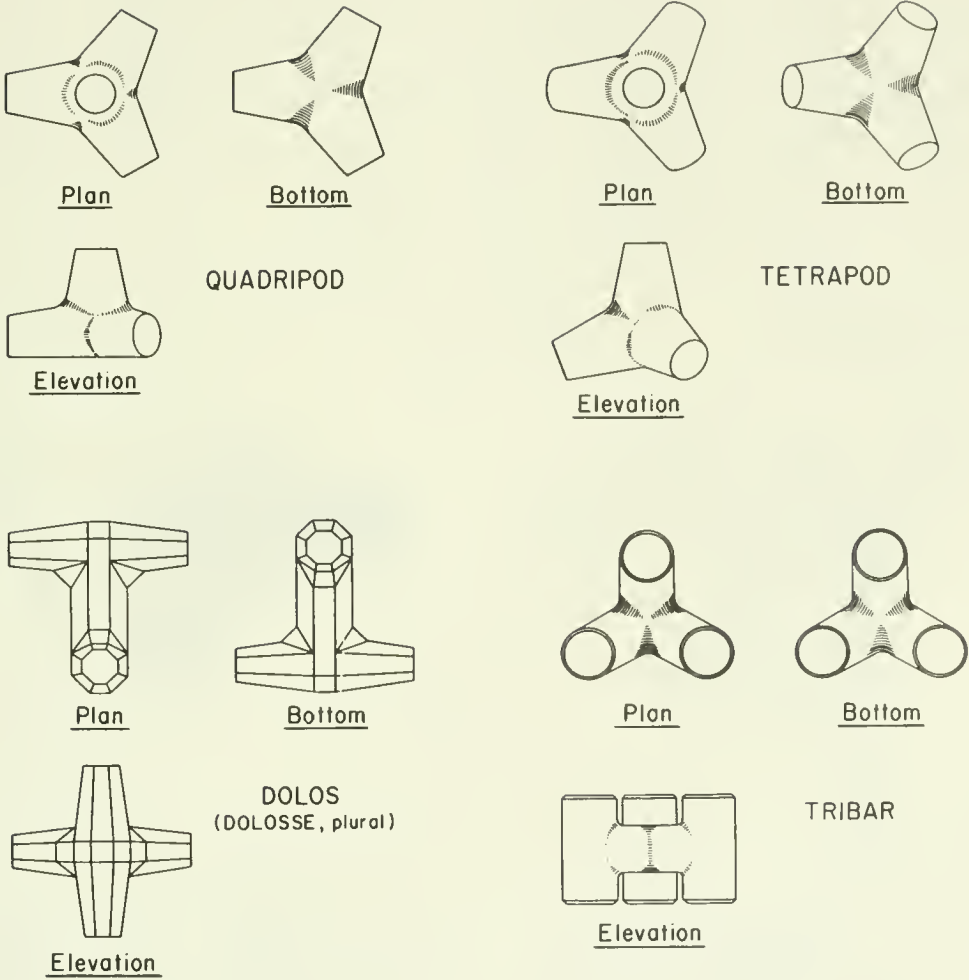
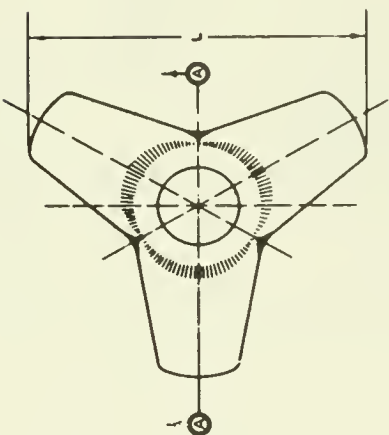
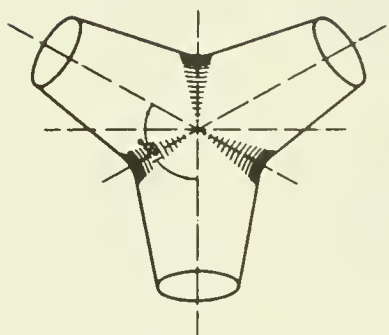

Figure 7-108. Views of the tetrapod, quadripod, tribar, and dolos armor units.



PLAN



BOTTOM

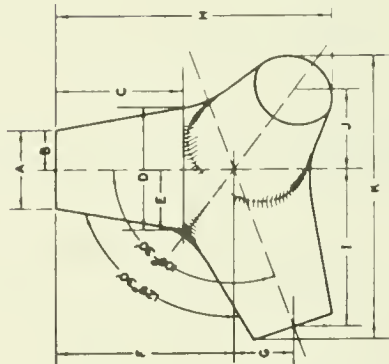

ELEVATION

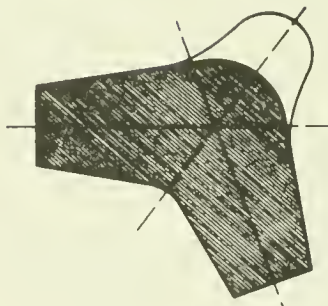

SECTION-AA

VOLUME OF INDIVIDUAL ARMOR UNITS (CU FT)									
7.16	14.29	29.57	59.15	118.30	236.61	473.21	946.42	1892.84	3785.68
UNIT WEIGHT LB/CU FT									
160.0	168.5	168.0	167.5	167.0	166.5	166.0	165.5	165.0	164.5
0.80	1.07	1.07	1.07	1.07	1.07	1.07	1.07	1.07	1.07
128.0	180.0	180.0	180.0	180.0	180.0	180.0	180.0	180.0	180.0
102.4	180.0	180.0	180.0	180.0	180.0	180.0	180.0	180.0	180.0
162.0	180.0	180.0	180.0	180.0	180.0	180.0	180.0	180.0	180.0

WEIGHT OF INDIVIDUAL ARMOR UNITS (TONS)									
0.80	1.07	1.07	1.07	1.07	1.07	1.07	1.07	1.07	1.07
128.0	180.0	180.0	180.0	180.0	180.0	180.0	180.0	180.0	180.0
102.4	180.0	180.0	180.0	180.0	180.0	180.0	180.0	180.0	180.0
162.0	180.0	180.0	180.0	180.0	180.0	180.0	180.0	180.0	180.0

AVERAGE MEASURED THICKNESS OF TWO LAYERS RANDOM PLACED (FT)									
6.01	6.34	6.63	6.87	7.08	7.26	7.41	7.54	7.64	7.71
NUMBER OF ARMOR UNITS PER 1000 SQ FT (TWO LAYERS RANDOM PLACED)									
290.16	176.46	111.16	60.42	37.84	23.02	14.02	8.61	5.16	3.16
DIMENSIONS OF ARMOR UNITS (FT)									
A	0.89	1.13	1.51	2.41	2.76	3.04	3.27	3.48	3.63
B	0.64	0.84	0.70	0.86	1.20	1.28	1.82	1.83	1.81
C	1.40	1.77	2.23	3.02	3.61	4.34	4.80	5.17	5.50
D	1.38	1.75	2.20	2.84	3.76	4.30	4.73	5.10	5.44
E	0.88	0.87	1.10	1.48	1.84	2.15	2.37	2.65	2.71
F	1.84	2.28	3.00	4.08	6.14	6.84	8.47	8.67	7.41
G	0.83	0.78	1.00	1.38	1.71	1.84	2.16	2.32	2.40
H	2.34	3.71	4.87	6.34	7.69	8.14	10.07	10.64	11.32
I	1.76	2.76	3.83	5.84	6.84	8.14	8.10	8.87	8.88
J	0.85	1.12	1.41	1.82	2.42	2.77	3.09	3.28	3.48
K	8.31	4.04	6.09	6.51	6.71	6.87	10.87	11.82	12.84
L	8.84	4.48	6.81	7.62	8.60	10.84	12.06	13.02	13.84

VOLUME OF INDIVIDUAL ARMOR UNIT (V) = 0.280H³
 where
 A = 0.307H
 B = 0.151H
 C = 0.471H
 D = 0.470H
 E = 0.275H
 F = 0.644H
 G = 0.215H
 H = overall dimension of unit
 I = 0.600H
 J = 0.300H
 K = 1.091H
 L = 1.701H

ARMOR LAYER THICKNESS (2 UNITS) = 1.361H
 NUMBER OF TETRAPODS (TWO LAYERS RANDOM PLACED) PER UNIT AREA (IN) = 100.2/V (see eq. (7-122))
 where
 V = 0.280H³
 P = 50

NOTE: DATA BASED ON TETRAPODS USED IN MODEL TESTS
 CONDUCTED AT THE WATERWAYS EXPERIMENT STATION

Figure 7-109. Tetrapod specifications.

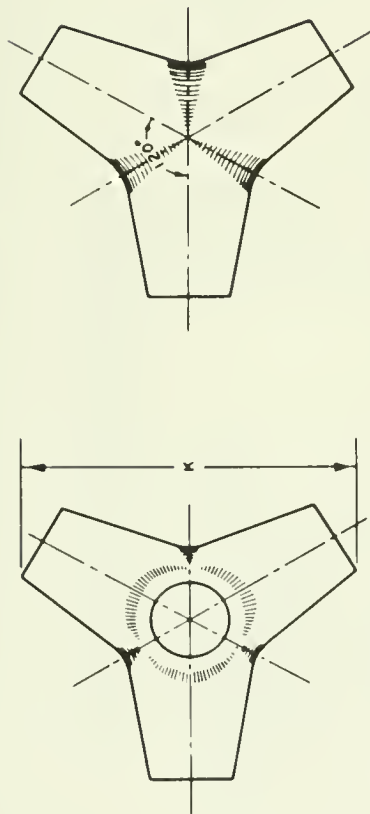

PLAN

BOTTOM

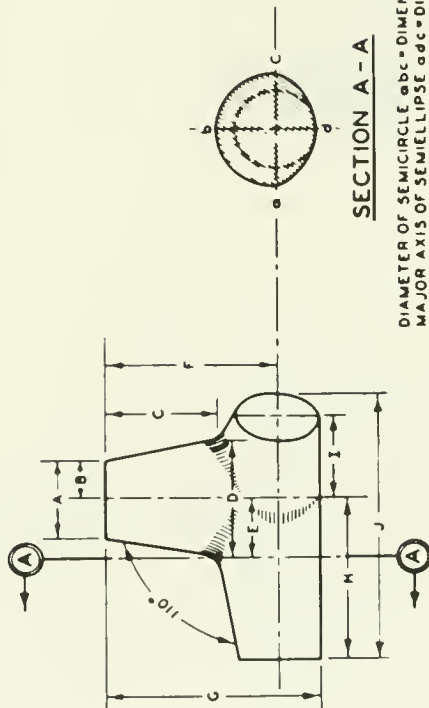

SECTION A-A

ELEVATION

DIAMETER OF SEMICIRCLE abc = DIMENSION D
 MAJOR AXIS OF SEMIELLIPSE abc = DIMENSION D
 MINOR AXIS OF SEMIELLIPSE abc = DIMENSION A

VOLUME OF INDIVIDUAL ARMOR UNITS (CU FT)

2.14	14.29	29.37	71.43	142.86	214.29	285.71	357.14	428.57	500.00	571.43
------	-------	-------	-------	--------	--------	--------	--------	--------	--------	--------

WEIGHT OF INDIVIDUAL ARMOR UNITS (TONS)

0.50	1.00	2.00	5.00	10.00	15.00	20.00	25.00	30.00	35.00	40.00
149.5	0.93	1.07	2.14	5.34	10.68	16.02	21.36	26.70	32.04	37.38
156.0	0.96	1.11	2.23	5.57	11.14	16.71	22.29	27.66	33.43	39.00
162.0	0.98	1.16	2.31	5.79	11.57	17.36	23.14	28.93	34.71	40.50

THICKNESS OF TWO LAYERS PLACED PELL-MELL (FT)

3.68	4.81	5.61	7.08	8.63	11.37	12.51	13.48	14.33	15.08	15.77
------	------	------	------	------	-------	-------	-------	-------	-------	-------

NUMBER OF ARMOR UNITS PER 1000 SQ FT (TWO LAYERS PLACED PELL-MELL)

261.05	164.44	103.95	56.30	35.37	27.04	22.38	19.28	17.15	15.41	14.19
--------	--------	--------	-------	-------	-------	-------	-------	-------	-------	-------

SYMBOL

A	0.83	1.17	1.48	2.00	2.32	2.86	3.17	3.42	3.63	3.82	4.01
B	0.46	0.96	0.74	1.00	1.26	1.44	1.95	1.71	1.82	1.92	2.00
C	1.28	1.61	2.03	2.76	3.48	3.98	4.38	4.72	5.02	5.32	5.52
D	0.98	1.74	2.18	2.97	3.74	4.28	4.71	5.08	5.40	5.66	5.94
E	1.87	2.46	3.13	4.25	5.35	6.12	6.74	7.28	7.72	8.12	8.48
F	2.43	3.07	3.86	5.24	6.61	7.57	8.33	8.93	10.03	10.49	10.88
G	1.87	2.46	3.13	4.25	5.35	6.12	6.74	7.28	7.72	8.12	8.48
H	0.99	1.24	1.56	2.12	2.67	3.06	3.37	3.63	3.86	4.06	4.25
I	3.36	4.23	5.33	7.23	8.12	10.43	11.49	12.37	13.15	13.83	14.47
J	3.08	4.08	6.15	8.35	10.92	12.03	13.26	14.28	15.18	15.88	16.70

DIMENSIONS OF ARMOR UNITS (FT)

VOLUME OF INDIVIDUAL ARMOR UNIT (V) = 0.495C³
 where
 A = 0.382G
 B = 0.191G
 C = 0.526G
 D = 0.566G
 E = 0.283G
 F = 0.809G
 G = overall height of unit
 H = 0.805G
 I = 0.405G
 J = 1.379G
 K = 1.594G

ARMOR LAYER THICKNESS (2 UNITS) = 1.602G
NUMBER OF QUADRIPODS (TWO LAYERS RANDOM PLACED) PER UNIT AREA (N₁) = 0.8V^{2/3} (see eq. (7.122))
 where
 K₀ = 0.95
 p = 49

NOTE DATA BASED ON QUADRIPODS USED IN MODEL TESTS CONDUCTED AT THE WATERWAYS EXPERIMENT STATION

Figure 7-110. Quadripod specifications.

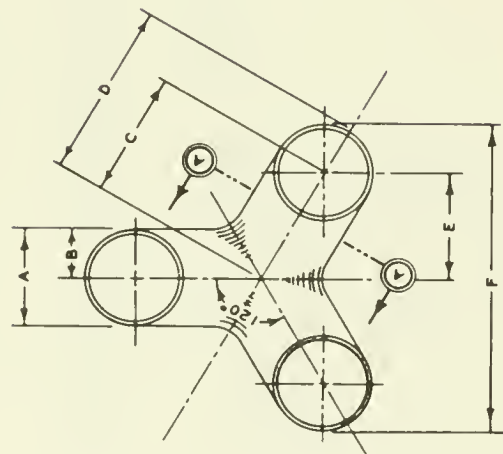

PLAN

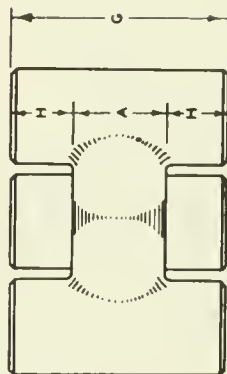

ELEVATION

NOTE SHAPE AND DIMENSIONS OF UNIT WERE BASED ON THOSE USED IN MODEL TESTS. AT PRESENT TIME INVENTOR RECOMMENDS C = 1.25A AND FILLETS AT INTERSECTION OF HORIZONTAL AND VERTICAL MEMBERS WITH A RADIUS EQUAL TO A/4. THE EQUATION FOR VOLUME IN CU YD IS THEN, APPROXIMATELY, $V = 0.74A^3$. DETAILS OF FORMS SHOULD BE OBTAINED FROM INVENTOR.

VOLUME OF INDIVIDUAL ARMOR UNITS (CU FT)

7.14	14.29	26.57	71.43	142.86	314.29	286.71	357.14	428.57	500.00	571.43
------	-------	-------	-------	--------	--------	--------	--------	--------	--------	--------

UNIT WEIGHT LB/CU FT

140.0	1.00	2.00	5.00	10.00	15.00	20.00	25.00	30.00	35.00	40.00
149.3	0.85	1.07	2.14	6.34	10.80	14.02	21.36	28.70	32.04	37.96
155.0	0.96	1.11	2.23	5.87	11.14	16.71	22.29	27.86	33.43	39.00
182.0	0.80	1.16	2.31	5.78	11.87	17.36	23.14	28.93	34.71	40.90

WEIGHT OF INDIVIDUAL ARMOR UNITS (TONS)

AVERAGE MEASURED THICKNESS OF ONE LAYER PLACED UNIFORMLY (FT)

2.10	2.74	3.45	4.89	5.81	6.76	7.44	8.02	8.52	8.97	9.38
------	------	------	------	------	------	------	------	------	------	------

AVERAGE MEASURED THICKNESS OF TWO LAYERS PLACED PELL-WELL (FT)

3.85	4.95	6.11	8.30	10.46	11.97	13.17	14.19	15.08	15.87	16.60
------	------	------	------	-------	-------	-------	-------	-------	-------	-------

NUMBER OF ARMOR UNITS PER 1000 SQ FT (ONE LAYER PLACED UNIFORMLY)

181.34	101.89	94.02	34.80	21.86	16.71	13.03	11.92	10.40	9.33	8.74
--------	--------	-------	-------	-------	-------	-------	-------	-------	------	------

NUMBER OF ARMOR UNITS PER 1000 SQ FT (TWO LAYERS PLACED PELL-WELL)

247.85	158.12	99.35	53.45	33.50	25.67	21.25	18.20	14.63	13.43
--------	--------	-------	-------	-------	-------	-------	-------	-------	-------

SYMBOL

DIMENSIONS OF ARMOR UNITS (FT)	
A	1.05 1.32 1.66 2.25 2.84 3.25 3.58 3.85 4.09 4.31 4.51
B	0.52 0.66 0.83 1.13 1.42 1.62 1.79 1.93 2.05 2.15 2.25
C	1.25 1.58 1.99 2.70 3.41 3.90 4.29 4.62 4.91 5.17 5.41
D	1.78 2.24 2.82 3.63 4.62 5.52 6.08 6.55 6.96 7.33 7.66
E	1.09 1.37 1.72 2.34 2.95 3.38 3.72 4.00 4.25 4.48 4.68
F	3.22 4.06 5.11 6.93 8.74 10.00 11.01 11.86 12.60 13.26 13.87
G	2.09 2.63 3.32 4.51 5.68 6.50 7.15 7.70 8.19 8.62 9.01
H	0.52 0.66 0.83 1.13 1.42 1.62 1.79 1.93 2.05 2.15 2.25

VOLUME OF INDIVIDUAL ARMOR UNIT (V) = 0.48A³

where

- A = diameter of leg
- E = 1.08A
- B = 0.5A
- F = 3.18A
- C = 1.25A
- G = 2A
- D = 1.75A
- H = B - 0.6A

ARMOR LAYER THICKNESS (2 UNITS, RANDOM) = 3.68A

NUMBER OF TRIBARS (TWO LAYERS UNIFORMLY PLACED) PER UNIT AREA (IN.) = 0.90V^{2/3} [see eq. (7.122)]

where

$$V_0 = 102$$

$$P = 66$$

NUMBER OF TRIBARS (TWO LAYERS RANDOM PLACED) PER UNIT AREA (IN.) = 0.90V^{2/3} [see eq. (7.122)]

where $V_0 = 1.13$

$$P = 47$$

Figure 7-111. Tribar specifications.

VOLUME OF INDIVIDUAL UNITS (CU FT)										
7.14	14.29	28.57	71.43	142.86	214.29	285.71	357.14	428.57	500.00	571.43

UNIT WEIGHT LB/CU FT	WEIGHT OF INDIVIDUAL ARMOR UNITS (TONS)										
140.0	0.50	1.00	2.00	5.00	10.00	15.00	20.00	25.00	30.00	35.00	40.00
149.5	0.53	1.07	2.14	5.34	10.68	16.02	21.36	26.70	32.04	37.38	42.71
156.0	0.56	1.11	2.23	5.57	11.14	16.71	22.29	27.86	32.43	39.00	44.57
162.0	0.58	1.16	2.31	5.79	11.57	17.36	23.14	28.93	34.71	40.50	46.29

NUMBER OF ARMOR UNITS PER 1,000 SQ FT (TWO LAYERS RANDOM PLACED)										
223.0	104.5	88.5	48.1	30.3	23.1	19.1	16.4	14.6	13.1	12.0

AVERAGE MEASURED THICKNESS OF TWO LAYERS RANDOM PLACED (FT)										
3.6	4.6	5.7	7.8	9.8	11.2	12.4	13.3	14.2	14.9	15.6

SYMBOL	DIMENSIONS OF ARMOR UNITS (FT)										
A	0.71	0.89	1.13	1.53	1.93	2.20	2.43	2.61	2.78	2.92	3.06
B	1.13	1.43	1.80	2.44	3.08	3.52	3.88	4.18	4.44	4.68	4.89
C	3.55	4.47	5.63	7.64	9.63	11.02	12.13	13.08	13.89	14.62	15.29
D	0.20	0.25	0.32	0.43	0.55	0.62	0.69	0.74	0.79	0.81	0.87

NOTE: SHAPE AND DIMENSIONS OF UNIT WERE BASED ON THOSE USED IN MODEL TESTS. AT PRESENT TIME INVENTOR RECOMMENDS $B = 0.32C$ TO $0.36C$ DEPENDING ON THE WEIGHT OF THE INDIVIDUAL UNIT.

$$\text{VOLUME OF INDIVIDUAL ARMOR UNIT (V)} = 0.16C^3$$

where: $A = 0.20C$ $C =$ overall dimension
 $B = 0.32C$ $D = 0.057C$

$$E = 0.364C$$

$$\text{ARMOR LAYER THICKNESS (2 UNITS)} = 1.020C$$

$$\text{NUMBER OF DOLOSSE (TWO LAYERS, RANDOM PLACED) PER UNIT AREA (N_1)} = 0.83V^{2/3} \text{ (see eq. (7.122))}$$

where: $k_{\Delta} = 0.94$ $P = 56$

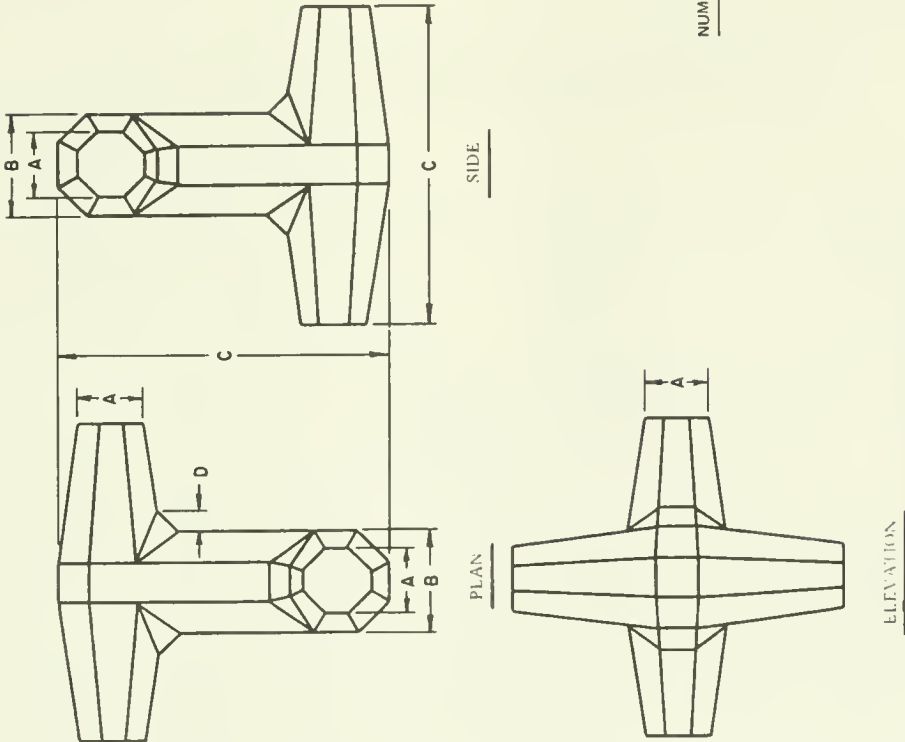

Figure 7-112. Dolos specifications.

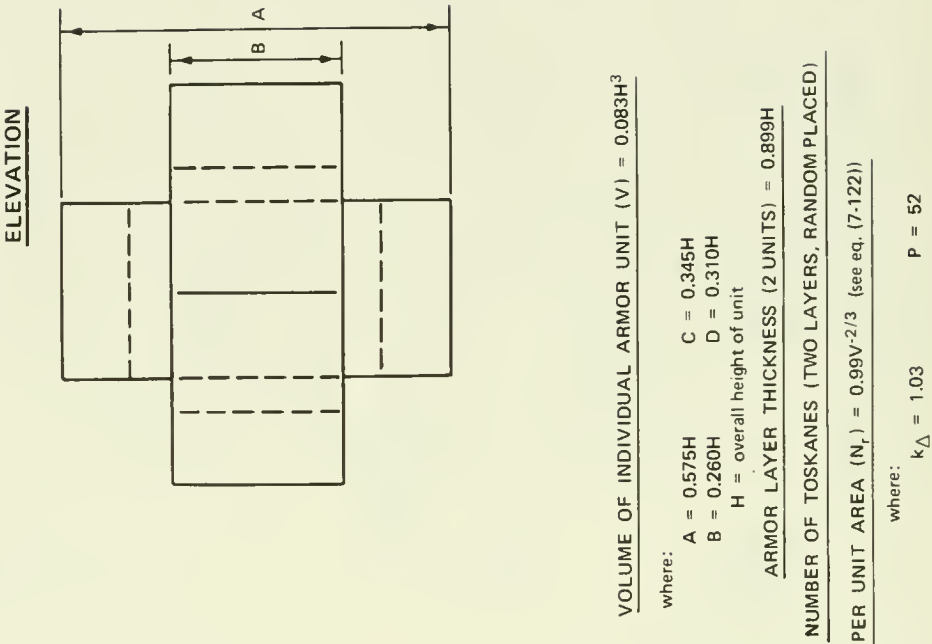
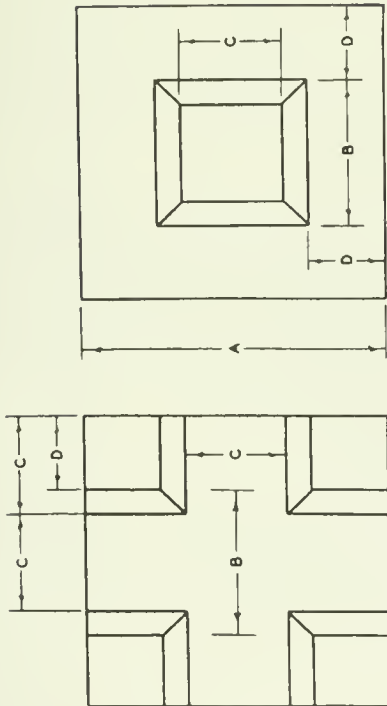

Figure 7-113. Toskane specifications.



VOLUME OF INDIVIDUAL ARMOR UNITS (CU FT)

7.14	14.29	26.57	71.43	142.86	214.29	285.71	357.14	428.57	500.00	571.43
------	-------	-------	-------	--------	--------	--------	--------	--------	--------	--------

UNIT WEIGHT LB/ CU FT

140.0	0.50	1.00	2.00	5.00	10.00	15.00	20.00	25.00	30.00	35.00	40.00
149.5	0.53	1.07	2.14	5.34	10.68	16.02	21.36	26.70	32.04	37.38	42.71
156.0	0.56	1.11	2.23	5.57	11.14	16.71	22.28	27.86	33.43	39.00	44.57
162.0	0.59	1.16	2.31	5.79	11.57	17.56	23.14	28.93	34.71	40.50	46.29

WEIGHT OF INDIVIDUAL ARMOR UNITS (TONS)

AVERAGE MEASURED THICKNESS OF ONE LAYER PLACED UNIFORMLY (FT)

2.16	2.72	3.42	4.65	5.86	6.70	7.36	7.93	8.44	8.69	9.29
------	------	------	------	------	------	------	------	------	------	------

AVERAGE MEASURED THICKNESS OF TWO LAYERS RANDOM PLACED (FT)

4.24	5.34	6.73	9.13	11.50	13.16	14.49	15.61	16.59	17.46	18.26
------	------	------	------	-------	-------	-------	-------	-------	-------	-------

NUMBER OF ARMOR UNITS PER 1000 SQ FT (ONE LAYER PLACED UNIFORMLY)

220.26	136.75	67.40	47.50	29.04	22.81	18.09	16.27	14.47	13.00	11.94
--------	--------	-------	-------	-------	-------	-------	-------	-------	-------	-------

NUMBER OF ARMOR UNITS PER 1000 SQ FT (TWO LAYERS RANDOM PLACED)

314.12	197.87	124.63	67.74	42.56	32.53	26.93	23.20	20.64	18.34	17.02
--------	--------	--------	-------	-------	-------	-------	-------	-------	-------	-------

SYMBOL

A	2.09	2.63	3.32	4.50	5.67	6.49	7.15	7.70	8.18	8.61	9.01
B	1.03	1.32	1.67	2.26	2.85	3.26	3.59	3.87	4.11	4.33	4.62
C	0.70	0.86	1.11	1.31	1.50	1.76	2.03	2.26	2.44	2.68	3.02
D	0.52	0.66	0.83	1.12	1.41	1.62	1.78	1.92	2.04	2.14	2.24

DIMENSIONS OF ARMOR UNITS (FT)

VOLUME OF INDIVIDUAL ARMOR UNIT (VI = 0.781A³)

where
 A = width of cube
 C = 0.335A
 D = 0.502A

ARMOR LAYER THICKNESS (2 UNITS RANDOM) = 1.03A

NUMBER OF MODIFIED CUBES (TWO LAYERS UNIFORMLY PLACED) PER UNIT AREA (N₁) = 0.85V₁^{2/3} [per eq (7.122)]
 where

$$N_1 = 1.12$$

$$P = 25$$

NUMBER OF MODIFIED CUBES (TWO LAYERS, RANDOM PLACED) PER UNIT AREA (N₂) = 1.17V₂^{2/3} [per eq (7.122)]

where

$$N_2 = 1.10$$

$$P = 47$$

NOTE: DATA BASED ON MODIFIED CUBES USED IN MDDEL TESTS CONDUCTED AT THE WATERWAYS EXPERIMENT STATION.

Figure 7-114. Modified cube specifications.

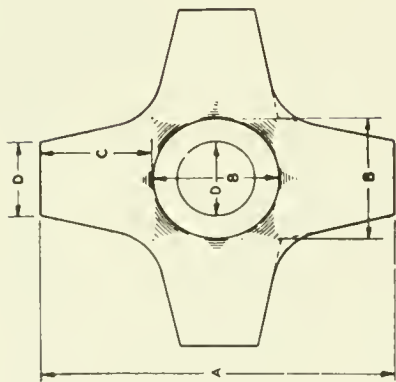

PLAN

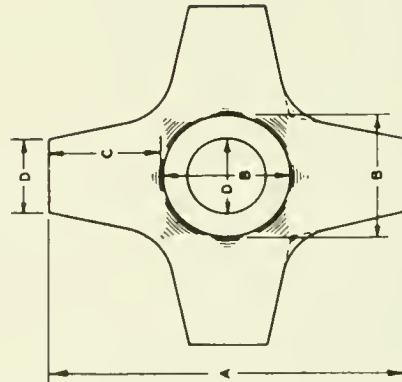

ELEVATION

VOLUME OF INDIVIDUAL ARMOR UNITS (CU FT)

7.14	14.28	28.57	71.43	142.86	214.29	285.71	357.14	428.57	500.00	571.43
------	-------	-------	-------	--------	--------	--------	--------	--------	--------	--------

UNIT
WEIGHT
LB./CU FT

WEIGHT OF INDIVIDUAL ARMOR UNITS (TONS)

0.50	1.00	2.00	5.00	10.00	15.00	20.00	25.00	30.00	35.00	40.00
0.53	1.07	2.14	5.34	10.68	16.02	21.36	26.70	32.04	37.38	42.71
0.56	1.11	2.23	5.57	11.14	16.71	22.29	27.86	33.43	39.00	44.57
0.58	1.16	2.31	5.79	11.57	17.36	23.14	28.93	34.71	40.50	46.29

AVERAGE MEASURED THICKNESS OF ONE LAYER PLACED UNIFORMLY (FT)

2.40	3.13	3.94	5.35	6.74	7.72	8.50	9.15	9.73	10.24	10.70
------	------	------	------	------	------	------	------	------	-------	-------

AVERAGE MEASURED THICKNESS OF TWO LAYERS RANDOM PLACED (FT)

4.43	5.56	7.03	9.54	12.02	13.76	15.15	16.32	17.34	18.28	19.09
------	------	------	------	-------	-------	-------	-------	-------	-------	-------

NUMBER OF ARMOR UNITS PER 1000 SQ FT ONE LAYER PLACED UNIFORMLY

198.09	124.78	78.60	42.72	26.04	20.51	18.99	14.83	13.01	11.69	10.74
--------	--------	-------	-------	-------	-------	-------	-------	-------	-------	-------

NUMBER OF ARMOR UNITS PER 1000 SQ FT (TWO LAYERS RANDOM PLACED)

328.40	206.86	130.31	70.62	44.49	34.01	29.18	24.26	21.56	19.36	17.80
--------	--------	--------	-------	-------	-------	-------	-------	-------	-------	-------

SYMBOL

A	3.44	4.33	5.46	7.41	9.34	10.69	11.78	12.87	13.47	14.16
B	1.23	1.35	1.95	2.63	3.34	3.62	4.21	4.53	4.82	5.30
C	1.11	1.40	1.76	2.39	3.01	3.43	3.80	4.09	4.35	4.76
D	0.74	0.93	1.17	1.59	2.01	2.30	2.53	2.73	2.90	3.19

VOLUME OF INDIVIDUAL ARMOR UNIT (V) = 0.176A³

where

A = overall dimension of unit C = 0.327A

B = 0.357A D = 0.215A

ARMOR LAYER THICKNESS (2 UNITS RANDOM) = 1.29A

NUMBER OF HEXAPODS (TWO LAYERS UNIFORMLY PLACED) PER UNIT AREA (IN.²) = 0.74V / (2A) (see eq. 17.122)

where

P = 43

NUMBER OF HEXAPODS (TWO LAYERS RANDOM PLACED) PER UNIT AREA (IN.²) = 1.22V / (2A) (see eq. 17.122)

NOTE DATA BASED ON HEXAPODS USED IN MODEL TESTS CONDUCTED AT THE WATERWAYS EXPERIMENT STATION.

Figure 7-115. Hexapod specifications.

Two approaches have been proposed to control breakage. Zwamborn and Van Niekerk, (1981, 1982) surveyed the performance of dolos-armor breakwaters worldwide and concluded that most structures that failed had been under-designed or had experienced construction difficulties. They formulated lower values for the stability coefficients to produce heavier armor units which would be stable against any crack-causing movement such as rocking in place under wave action. Their results are reflected in Table 7-8. Reinforcement of units with steel bar and fibers (Magoon and Shimizer, 1971) has been tried on several structures. Markle and Davidson (1984b) have surveyed the breakage of reinforced and unreinforced armor units on Corps structures and have found field tests to be inconclusive. No proven analytical method is known for predicting what wave conditions will cause breakage or what type or amount of reinforcement will prevent it.

Projects using tetrapods, tribars, quadripods, and dolosse in the United States are listed in Table 7-11.

g. Design of Structure Cross-Section. A rubble structure is normally composed of a bedding layer and a core of quarry-run stone covered by one or more layers of larger stone and an exterior layer(s) of large quarrystone or concrete armor units. Typical rubble-mound cross sections are shown in Figures 7-116 and 7-117. Figure 7-116 illustrates cross-section features typical of designs for breakwaters exposed to waves on one side (seaward) and intended to allow minimal wave transmission to the other (leeward) side. Breakwaters of this type are usually designed with crests elevated such that overtopping occurs only in very severe storms with long return periods. Figure 7-117 shows features common to designs where the breakwater may be exposed to substantial wave action from both sides, such as the outer portions of jetties, and where overtopping is allowed to be more frequent. Both figures show both a more complex "idealized" cross section and a "recommended" cross section. The idealized cross section provides more complete use of the range of materials typically available from a quarry, but is more difficult to construct. The recommended cross section takes into account some of the practical problems involved in constructing submerged features.

The right-hand column of the table in these figures gives the rock-size gradation of each layer as a percent of the average layer rock size given in the left-hand column. To prevent smaller rocks in an underlayer from being pulled through an overlayer by wave action, the following criterion for filter design (Sowers and Sowers, 1970) may be used to check the rock-size gradations given in Figures 7-116 and 7-117.

$$D_{15} \text{ (cover)} \leq 5 D_{85} \text{ (under)}$$

where D_{85} (under) is the diameter exceeded by the coarsest 15 percent of the underlayer and D_{15} (cover) is the diameter exceeded by the coarsest 85 percent of the layer immediately above the underlayer.

Table 7-11. Concrete armor projects in the United States.

Date	Location	Structure Type	Construction Type	Armor Type and Weight
1930 - 1958	Humboldt Bay, Calif. ¹	North and south jetties	Rehabilitation	100-ton concrete blocks and 12-ton tetrahedrons, unreinforced
1956	Kahului Harbor, Maui, Hawaii	Breakwater	Original	33-ton tetrapods, unreinforced
1957	Crescent City, Calif. ¹	Breakwater	Original	25-ton tetrapods, unreinforced
1957	Rincon Island, Calif. ⁵	Seawall	Original	31-ton tetrapods, unreinforced
1959	Nawiliwili, Kawai, Hawaii ¹	Breakwater	Rehabilitation	17.8-ton tribars, reinforced
1960 - 1963	Humboldt Bay, Calif. ¹	North and south jetties	Rehabilitation	20- to 100-ton concrete blocks, unreinforced
1963	Santa Cruz, Calif. ¹	West jetty	Original	28-ton quadripods, unreinforced
1963	Ventura Harbor, Calif. ¹	Jetty	Original	10.7-ton tribars, unreinforced
1966	Kahului Harbor, Maui, Hawaii ¹	Breakwater	Rehabilitation	35- to 50-ton tribars, reinforced
1969	Kahului Harbor, Maui, Hawaii ¹	Breakwater	Rehabilitation	19-ton tribars, reinforced
1971 - 1972	Humboldt Bay, Calif. ¹	North and south jetties	Rehabilitation	42- to 43-ton dolosse, reinforced
1972	Diablo Canyon, Calif. ²	Breakwater	Original	24.5- to 37.1-ton tribars, unreinforced
1973	Kahului Harbor, Maui, Hawaii ¹	Breakwater	Rehabilitation	19- to 35-ton tribars, reinforced
1974	Crescent City, Calif. ¹	Breakwater	Rehabilitation	40-ton dolosse, unreinforced
1975	Honolulu Airport, Oahu, Hawaii ³	Seawall	Original	4- to 6-ton dolosse, unreinforced
1977	Kahului Harbor, Maui, Hawaii ¹	East and west breakwater	Rehabilitation	20- to 30-ton dolosse, reinforced, and 6-ton dolosse, unreinforced.
1977	Nawiliwili Harbor, Kawai, Hawaii ¹	Breakwater	Rehabilitation	11-ton dolosse, unreinforced
1979	Poholki Bay, Hawaii, Hawaii ¹	Breakwater	Original	6-ton dolosse, unreinforced
1979	Wailanae Harbor, Oahu, Hawaii ¹	Breakwater	Original	2-ton dolosse, unreinforced
1980	Manasquan Inlet, N.J. ¹	Jetty	Rehabilitation	16-ton dolosse, reinforced
1980	Cleveland Harbor, Ohio ¹	Breakwater	Rehabilitation	2-ton dolosse, unreinforced
1982	Cleveland Harbor, Ohio ¹	Breakwater	Rehabilitation	2-ton dolosse, unreinforced
1983	International Airport, St. Thomas, Virgin Islands ⁴	Revetment	original	6- to 10-ton dolosse, unreinforced

¹ Markle and Davidson (1984b).

² Lillevang (1977).

³ Darling, (1976).

⁴ Czerniak, Lord, and Collins (1979) and personal communication with Earle Howard, U. S. Army Engineer District, Jacksonville, Fla., 1983.

⁵ Keith and Skjel (1974).

Seaward

Leeward

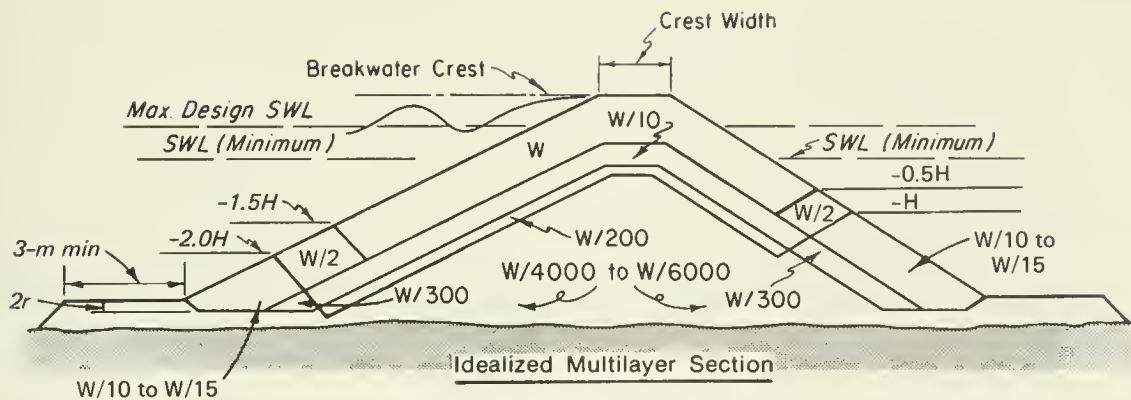

Rock Size	Layer	Rock Size Gradation (%)	
W	Primary Cover Layer ¹	125 to 75	H = Wave Height
W/2 and W/15	Secondary Cover Layer ²	125 to 75	W = Weight of Individual Armor Unit
W/10 and W/300	First Underlayer ³	130 to 70	r = Average Layer Thickness
W/200	Second Underlayer	150 to 50	
W/4000-W/6000	Core and Bedding Layer	170 to 30	

For concrete armor: ¹ Sections III, 7, g, (1), (2) and (6)

² Section III, 7, g, (7)

³ Section III, 7, g, (8)

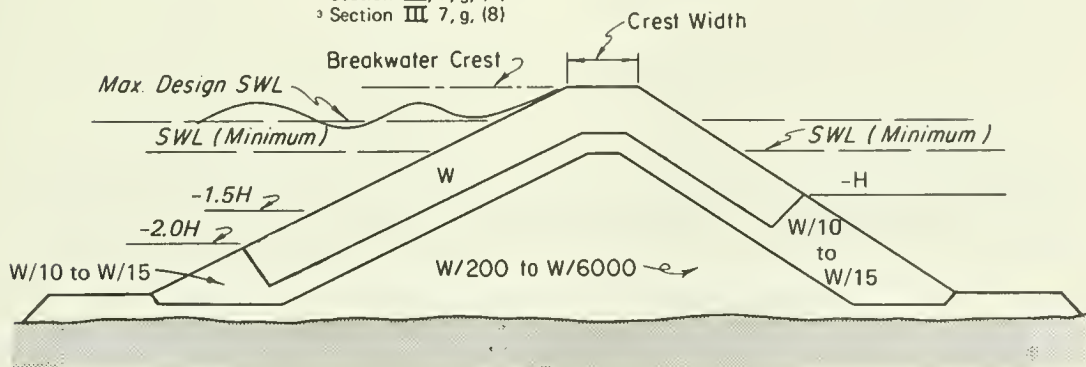

Recommended Three-layer Section

Figure 7-116. Rubble-mound section for seaward wave exposure with zero-to-moderate overtopping conditions.

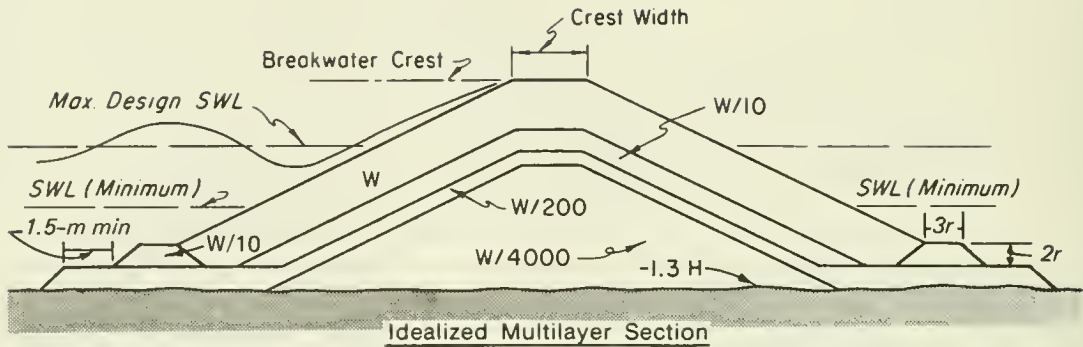

Rock Size	Layer	Rock Size Gradation (%)	
W	Primary Cover Layer ¹	125 to 75	H = Wave Height
W/10	Toe Berm and First Underlayer ²	130 to 70	W = Weight of Individual Armor Unit
W/200	Second Underlayer	150 to 50	r = Average Layer Thickness
W/4000	Core and Bedding Layer	170 to 30	

For concrete armor: ¹Sections III, 7, g, (1), (2) and (6)
²Sections III, 7, g, (5) and (8)

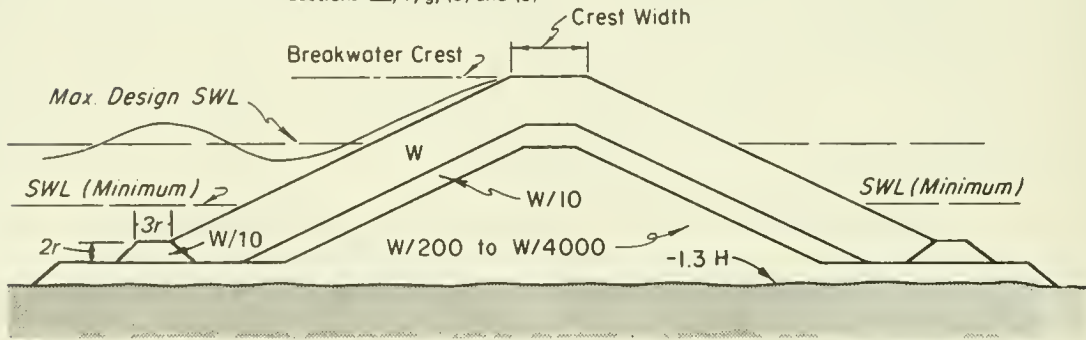

Recommended Three-layer Section

Figure 7-117. Rubble-mound section for wave exposure on both sides with moderate overtopping conditions.

Stone sizes are given by weight in Figures 7-116 and 7-117 since the armor in the cover layers is selected by weight at the quarry, but the smaller stone sizes are selected by dimension using a sieve or a grizzly. Thomsen, Wohlt, and Harrison (1972) found that the sieve size of stone corresponds approximately to $1.15 \frac{W}{w_p}^{1/3}$, where W is the stone weight and w_p is the stone unit weight, both in the same units of mass or force. As an aid to understanding the stone sizes referenced in Figures 7-116 and 7-117, Table 7-12 lists weights and approximate dimensions of stones of 25.9 kilonewtons per cubic meter (165 pounds per cubic foot) unit weight. The dimension given for stone weighing several tons is approximately the size the stone appears to visual inspection. Multiples of these dimensions should not be used to determine structure geometry since the stone intermeshes when placed.

A logic diagram for the preliminary design of a rubble structure is shown in Figure 7-118. The design can be considered in three phases: (1) structure geometry, (2) evaluation of construction technique, and (3) evaluation of design materials. A logic diagram for evaluation of the preliminary design is shown in Figure 7-119.

As part of the design analysis indicated in the logic diagram (Fig. 7-118), the following structure geometry should be investigated:

- (1) Crest elevation and width.
- (2) Concrete cap for rubble-mound structures.
- (3) Thickness of armor layer and underlayers and number of armor units.
- (4) Bottom elevation of primary cover layer.
- (5) Toe berm for cover layer stability.
- (6) Structure head and lee side cover layer.
- (7) Secondary cover layer.
- (8) Underlayers.
- (9) Bedding layer and filter blanket layer.
- (10) Scour protection at toe.
- (11) Toe berm for foundation stability.

(1) Crest Elevation and Width. Overtopping of a rubble structure such as a breakwater or jetty usually can be tolerated only if it does not cause damaging waves behind the structure. Whether overtopping will occur depends on the height of the wave runup R . Wave runup depends on wave characteristics, structure slope, porosity, and roughness of the cover layer. If the armor layer is chinked, or in other ways made smoother or less permeable--as a graded riprap slope--the limit of maximum riprap will be

Table 7-12. Weight and size selection dimensions of quarrystone¹.

Weight mt	Dimension m (ft)	Weight kg (lb)	Dimension m (ft)	Weight kg (lb)	Dimension cm (in.)	Weight kg (lb)	Dimension cm (in.)	Weight kg (lb)	Dimension cm (in.)
0.907 (1)	0.81 (2.64)	45.36 (100)	0.30 (0.97)	2.27 (5)	10.92 (4.30)	0.23 (0.5)	5.08 (2.00)	0.01 (0.025)	1.88 (0.74)
1.814 (2)	1.02 (3.33)	90.72 (200)	0.43 (1.40)	6.81 (15)	15.77 (6.21)	0.45 (1.0)	6.40 (2.52)	0.02 (0.050)	2.36 (0.93)
2.722 (3)	1.16 (3.81)	136.08 (300)	0.51 (1.66)	11.34 (25)	18.70 (7.36)	0.68 (1.5)	7.32 (2.88)	0.03 (0.75)	2.70 (1.06)
3.629 (4)	1.28 (4.19)	181.44 (400)	0.54 (1.77)	13.61 (30)	19.86 (7.82)	0.91 (2.0)	8.05 (3.17)	0.04 (0.100)	2.97 (1.17)
4.536 (5)	1.38 (4.52)	226.80 (500)	0.57 (1.86)	15.88 (35)	20.90 (8.23)	1.13 (2.5)	8.66 (3.41)	0.06 (0.125)	3.20 (1.26)
5.443 (6)	1.46 (4.80)	272.16 (600)	0.60 (1.95)	18.14 (40)	21.84 (8.60)	1.36 (3.0)	9.22 (3.63)	0.07 (0.150)	3.40 (1.34)
6.350 (7)	1.54 (5.05)	317.52 (700)	0.62 (2.02)	20.41 (45)	22.73 (8.95)	1.59 (3.5)	9.70 (3.82)	0.08 (0.175)	3.58 (1.41)
7.258 (8)	1.61 (5.28)	362.88 (800)	0.64 (2.10)	22.68 (50)	23.55 (9.27)	1.81 (4.0)	10.13 (3.99)	0.09 (0.200)	3.73 (1.47)
8.165 (9)	1.67 (5.49)	408.24 (900)	0.66 (2.16)	24.95 (55)	24.31 (9.57)	2.04 (4.5)	10.54 (4.15)	0.10 (0.225)	3.89 (1.53)
9.072 (10)	1.73 (5.69)	453.60 (1000)	0.68 (2.23)	27.22 (60)	25.02 (9.85)	2.27 (5.0)	10.92 (4.30)	0.11 (0.250)	4.04 (1.59)
9.979 (11)	1.79 (5.88)	498.96 (1100)	0.70 (2.27)	29.48 (65)	25.70 (10.12)				
10.866 (12)	1.84 (6.05)	544.32 (1200)	0.72 (2.35)	31.75 (70)	26.34 (10.37)				
11.793 (13)	1.89 (6.21)	589.68 (1300)	0.73 (2.40)	34.02 (75)	26.95 (10.61)				
12.700 (14)	1.94 (6.37)	635.04 (1400)	0.75 (2.45)	36.29 (80)	27.53 (10.84)				
13.608 (15)	1.98 (6.51)	680.40 (1500)	0.76 (2.50)	38.56 (85)	28.09 (11.06)				
14.515 (16)	2.03 (6.66)	725.76 (1600)	0.78 (2.55)	40.82 (90)	28.65 (11.28)				
15.422 (17)	2.07 (6.79)	771.12 (1700)	0.80 (2.60)	43.09 (95)	29.16 (11.48)				
16.330 (18)	2.11 (6.92)	816.48 (1800)	0.81 (2.64)	45.36 (100)	29.54 (11.63)				
17.237 (19)	2.15 (7.05)	861.84 (1900)							
18.144 (20)	2.19 (7.17)	907.20 (2000)							

¹ Dimensions correspond to size measured by sieve, grizzly, or visual inspection for stone of 25.9 kilonewtons per cubic meter unit weight. Do not use for determining structure crest width or layer thickness.

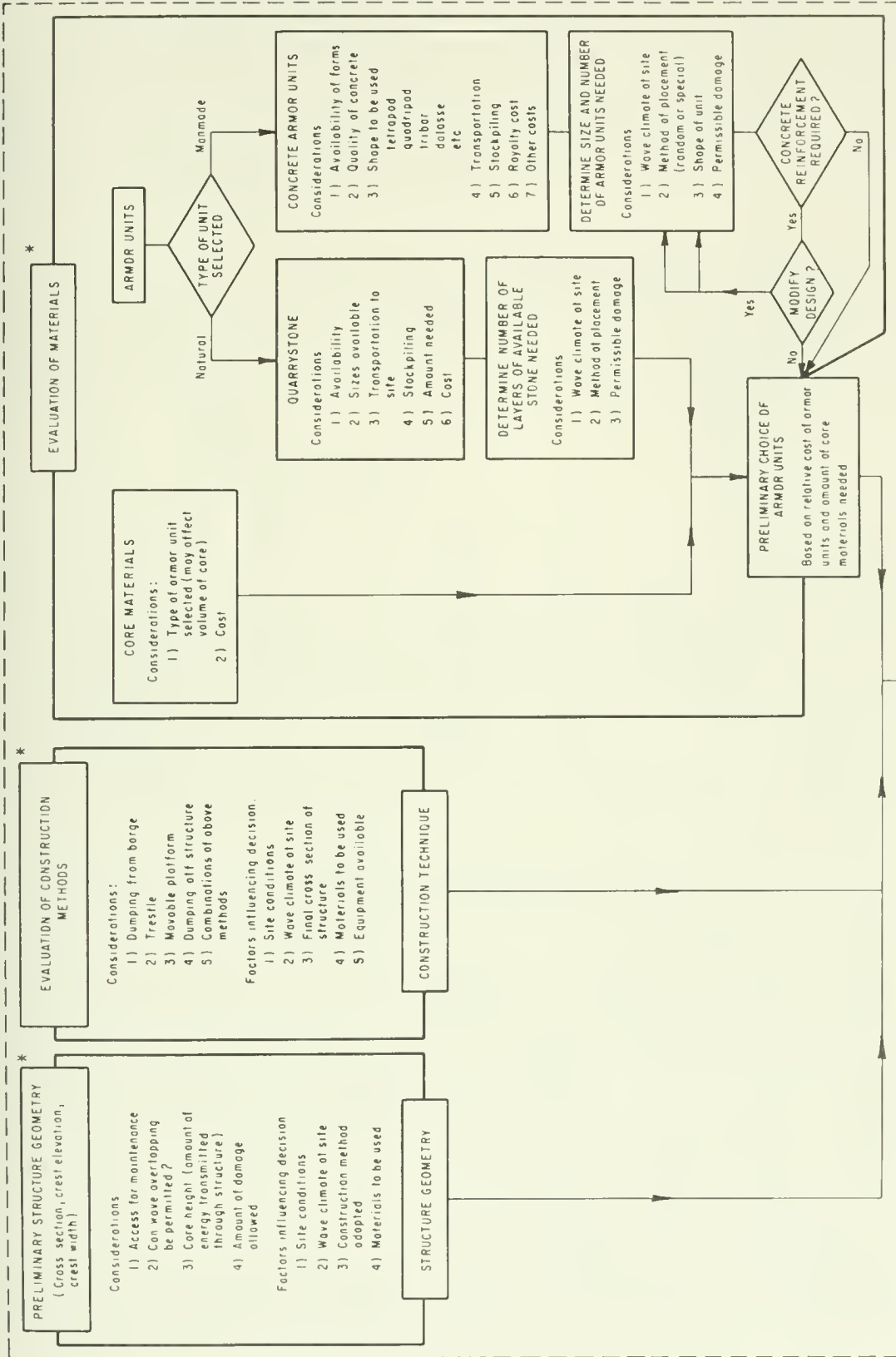

* NOTE Three phases of preliminary design are highly interrelated and generally must be performed concurrently

Figure 7-118. Logic diagram for preliminary design of rubble structure.

FIGURE 7-118

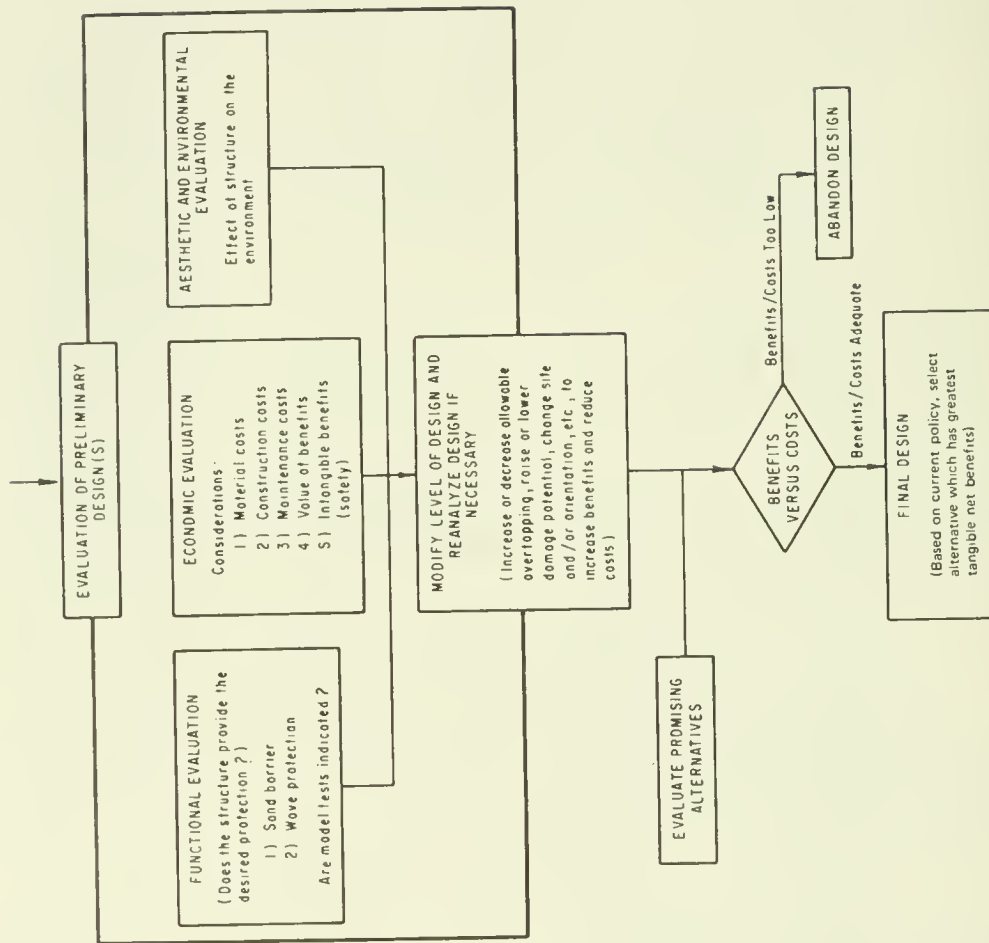

Figure 7-119. Logic diagram for evaluation of preliminary design.

higher than for rubble slopes (see Section II,1, and Figs. 7-19 and 7-20). The selected crest elevation should be the lowest that provides the protection required. Excessive overtopping of a breakwater or jetty can cause choppiness of the water surface behind the structure and can be detrimental to harbor operations, since operations such as mooring of small craft and most types of commercial cargo transfer require calm waters. Overtopping of a rubble seawall or revetment can cause serious erosion behind the structure and flooding of the backshore area. Overtopping of jetties can be tolerated if it does not adversely affect the channel.

The width of the crest depends greatly on the degree of allowable overtopping; where there will be no overtopping, crest width is not critical. Little study has been made of crest width of a rubble structure subject to overtopping. Consider as a general guide for overtopping conditions that the minimum crest width should equal the combined widths of three armor units ($n = 3$). Crest width may be obtained from the following equation.

$$B = nk_{\Delta} \left(\frac{W}{w_r} \right)^{1/3} \quad (7-120)$$

where

B = crest width, m (or ft)

n = number of stones ($n = 3$ is recommended minimum)

k_{Δ} = layer coefficient (Table 7-13)

W = mass of armor unit in primary cover layer, kg (or weight in lb)

w_r = mass density of armor unit, kg/m^3 (or unit weight in lb/ft^3)

The crest should be wide enough to accommodate any construction and maintenance equipment which may be operated from the structure.

Figures 7-116 and 7-117 show the armor units of the primary cover layer, sized using equation (7-116), extended over the crest. Armor units of this size are probably stable on the crest for the conditions of minor to no overtopping occurring in the model tests which established the values of K_D in Table 7-8. Such an armor unit size can be used for preliminary design of the cross section of an overtopped or submerged structure, but model tests are strongly recommended to establish the required stable armor weight for the crest of a structure exposed to more than minor overtopping. Concrete armor units placed on the crest of an overtopped structure may be much less stable than the equivalent quarrystone armor chosen using equation (7-116) on a structure with no overtopping. In the absence of an analytical method for calculating armor weight for severely overtopped or submerged structures, especially those armored with concrete units, hydraulic model tests are necessary. Markle and Carver (1977) have tested heavily overtopped and submerged quarrystone-armored structures.

Table 7-13. Layer coefficient and porosity for various armor units.

Armor Unit	n	Placement	Layer Coefficient k_{Δ}	Porosity (P) %
Quarrystone (smooth) ¹	2	Random	1.02	38
Quarrystone (rough) ²	2	Random	1.00	37
Quarrystone (rough) ²	>3	Random	1.00	40
Quarrystone (parallelepiped) ⁶	2	Special	--	27
Cube (modified) ¹	2	Random	1.10	47
Tetrapod ¹	2	Random	1.04	50
Quadripod ¹	2	Random	0.95	49
Hexipod ¹	2	Random	1.15	47
Tribar ¹	2	Random	1.02	54
Dolos ⁴	2	Random	0.94	56
Toskane ⁵	2	Random	1.03	52
Tribar ¹	1	Uniform	1.13	47
Quarrystone ⁷	Graded	Random	--	37

¹ Hudson (1974).

² Carver (1983).

³ Hudson, (1961a).

⁴ Carver and Davidson (1977).

⁵ Carver (1978).

⁶ Layer thickness is twice the average long dimension of the parallelepiped stones. Porosity is estimated from tests on one layer of uniformly placed modified cubes (Hudson, 1974).

⁷ The minimum layer thickness should be twice the cubic dimension of the W_{50} riprap. Check to determine that the graded layer thickness is ≥ 1.25 the cubic dimension of the W_{max} riprap (see eqs. 7-123 and 7-124 below).

(2) Concrete Cap for Rubble-Mound Structures. Placed concrete has been added to the cover layer of rubble-mound jetties and breakwaters. Such use ranges from filling the interstices of stones in the cover layer, on the crest, and as far down the slopes as wave action permits, to casting large monolithic blocks of several hundred kilograms. This concrete may serve any of four purposes: (a) to strengthen the crest, (b) to deflect overtopping waves away from impacting directly on the lee side slope, (c) to increase the crest height, and (d) to provide roadway access along the crest for construction or maintenance purposes.

Massive concrete caps have been used with cover layers of precast concrete armor units to replace armor units of questionable stability on an overtopped crest and to provide a rigid backup to the top rows of armor units on the slopes. To accomplish this dual purpose, the cap can be a slab with a solid or permeable parapet (Czerniak and Collins, 1977; Jensen, 1983; and Fig. 6-64, (see Ch. 6)), a slab over stone grouted to the bottom elevation of the armor layer (Figs. 6-60 and 6-63, or a solid or permeable block (Lillevang, 1977, Markle, 1982, and Fig. 6-65)).

Concrete caps with solid vertical or sloped walls reflect waves out through the upper rows of armor units, perhaps causing loss of those units. Solid slabs and blocks can trap air beneath them, creating uplift forces during heavy wave action that may crack or tip the cap (Magoon, Sloan, and Foote, 1974). A permeable cap decreases both of these problems. A parapet can be made permeable, and vertical vents can be placed through the slab or block itself (Mettam, 1976).

Lillevang (1977) designed a breakwater crest composed of a vented block cap placed on an unchinked, ungrouted extension of the seaward slope's underlayer, a permeable base reaching across the crest. Massive concrete caps must be placed after a structure has settled or must be sufficiently flexible to undergo settlement without breaking up (Magoon, Sloan, and Foote, 1974).

Ribbed caps are a compromise between the solid block and a covering of concrete armor units. The ribs are large, long, rectangular members of reinforced concrete placed perpendicular to the axis of a structure in a manner resembling railroad ties. The ribs are connected by reinforced concrete braces, giving the cap the appearance of a railroad track running along the structure crest. This cap serves to brace the upper units on the slopes, yet is permeable in both the horizontal and vertical directions. Ribbed caps have been used on Corps breakwaters at Maalea Harbor (Carver and Markle, 1981a), at Kahului (Markle, 1982), on Maui, and at Pohoiki Bay, all in the State of Hawaii.

Waves overtopping a concrete cap can damage the leeside armor layer (Magoon, Sloan, and Foote, 1974). The width of the cap and the shape of its lee side can be designed to deflect overtopping waves away from the structure's lee side (Czerniak and Collins, 1977; Lillevang, 1977; and Jensen, 1983). Ribbed caps help dissipate waves.

High parapet walls have been added to caps to deflect overtopping seaward and allow the lowering of the crest of the rubble mound itself. These walls present the same reflection problems described above and complicate the design

of a stable cap (Mettam, 1976; Jensen, 1983). Hydraulic model tests by Carver and Davidson (1976; 1983) have investigated the stability of caps with high parapet walls proposed for Corps structures.

To evaluate the need for a massive concrete cap to increase structural stability against overtopping, consideration should be given to the cost of including a cap versus the cost of increasing dimensions (a) to prevent overtopping and (b) for construction and maintenance purposes. A massive concrete cap is not necessary for the structural stability of a structure composed of concrete armor units when the difference in elevation between the crest and the limit of wave runup on the projected slope above the structure is less than 15 percent of the total wave runup. For this purpose, an all-rubble structure is preferable, and a concrete cap should be used only if substantial savings would result. Maintenance costs for an adequately designed rubble structure are likely to be lower than for any alternative composite-type structure.

The cost of a concrete cap should also be compared to the cost of covering the crest with flexible, permeable concrete armor units, perhaps larger than those used on the slopes, or large quarystone armor. Bottin, Chatham, and Carver (1976) conducted model tests on an overtopped breakwater with dolos armor on the seaward slope, but with large quarystone on the crest. The breakwater at Pria, Terceria, Azores, was repaired using large quarystone instead of a concrete cap on the crest to support the primary tetrapod armor units. Two rows of large armor stones were placed along the shoreward side of the crest to stabilize the top row of tetrapods. An inspection in March 1970 indicated that this placement has performed satisfactorily even though the structure has been subjected to wave overtopping.

Hydraulic model tests are recommended to determine the most stable and economical crest designs for major structures.

Experience indicates that concrete placed in the voids on the structure slopes has little structural value. By reducing slope roughness and surface porosity, the concrete increases wave runup. The effective life of the concrete is short, because the bond between concrete and stone is quickly broken by structure settlement. Such filling increases maintenance costs. For a roadway, a concrete cap can usually be justified if frequent maintenance of armored slopes is anticipated. A smooth surface is required for wheeled vehicles; tracked equipment can be used on ribbed caps.

(3) Thickness of Armor Layer and Underlayers and Number of Armor Units. The thickness of the cover and underlayers and the number of armor units required can be determined from the following formulas:

$$r = n k_{\Delta} \left(\frac{W}{w_r} \right)^{1/3} \quad (7-121)$$

where r is the average layer thickness in meters (or feet), n is the number of quarystone or concrete armor units in thickness comprising the cover layer, W is the mass of individual armor units in kilograms (or weight in pounds), and w_r is the mass density in kilograms per cubic meter (or unit weight in pounds per cubic foot). The placing density is given by

$$\frac{N_r}{A} = n k_{\Delta} \left(1 - \frac{P}{100}\right) \left(\frac{w_r}{W}\right)^{2/3} \quad (7-122)$$

where N_r is the required number of individual armor units for a given surface area, A is surface area, k_{Δ} is the layer coefficient, and P is the average porosity of the cover layer in percent. Values of k_{Δ} and P , determined experimentally, are presented in Table 7-13.

The thickness r of a layer of riprap is either 0.30 m, or one of the following:

$$r = 2.0 \left(\frac{W_{50}}{w_r}\right)^{1/3} \quad (7-123)$$

where W_{50} is the weight of the 50 percent size in the gradation, or

$$r = 1.25 \left(\frac{W_{max}}{w_r}\right)^{1/3} \quad (7-124)$$

where W_{max} is the heaviest stone in the gradation, whichever of the three is the greatest. The specified layer thickness should be increased by 50 percent for riprap placed underwater if conditions make placement to design dimensions difficult. The placing density of riprap is calculated as the weight of stone placed per unit area of structure slope, based on the measured weight per unit volume of riprap. The placing density may be estimated as the product of the layer thickness r , the unit weight of the rock w_r , and $\left(1 - \frac{P}{100}\right)$.

(4). Bottom Elevation of Primary Cover Layer. The armor units in the cover layer (the weights are obtained by eq. 7-116) should be extended downslope to an elevation below minimum SWL equal to the design wave height H when the structure is in a depth $>1.5H$, as shown in Figure 7-116. When the structure is in a depth $<1.5H$, armor units should be extended to the bottom, as shown in Figure 7-117.

On revetments located in shallow water, the primary cover layer should be extended seaward of the structure toe on the natural bottom slope as scour protection.

The larger values of K_D for special-placement parallelepiped stone in Table 7-8 can be obtained only if a toe mound is carefully placed to support the quarriestones with their long axes perpendicular to the structure slope (U.S. Army Corps of Engineers, 1979). For dolosse, it is recommended that the bottom rows of units in the primary cover layer be "special placed" on top of the secondary cover layer (Fig. 7-116), the toe berm (Fig. 7-117), or the bottom itself, whenever wave conditions and water clarity permit. Site-specific model studies have been performed with the bottom units placed with their vertical flukes away from the slope and the second row of dolosse placed on or overtopping the horizontal flukes of the lower units to assure that the units interlock with the random-placed units farther up the slope (Carver, 1976;

Bottin, Chatham, and Carver, 1976). The tests indicated that special placement of the bottom dolosse produces better toe stability than random placement. The seaward dolosse in the bottom row should be placed with the bottom of the vertical flukes one-half the length of the units (dimension C in Fig. 7-112) back from the design surface of the primary armor layer to produce the design layer thickness. Model tests to determine the bottom elevation of the primary cover layer and the type of armor placement should be made whenever economically feasible.

(5) Toe Berm for Cover Layer Stability. As illustrated in Figure 7-117, structures exposed to breaking waves should have their primary cover layers supported by a quarystone toe berm. For preliminary design purposes the quarystone in the toe berm should weigh $W/10$, where W is the weight of quarystone required for the primary cover layer as calculated by equation (7-116) for site conditions. The toe berm stone can be sized in relation to W even if concrete units are used as primary armor. The width of the top of the berm is calculated using equation (7-120), with $n = 3$. The minimum height of the berm is calculated using equation (7-121), with $n = 2$.

Model tests can establish whether the stone size or berm dimensions should be varied for the final design. Tests may show an advantage to adding a toe berm to a structure exposed to nonbreaking waves.

The toe berm may be placed before or after the adjacent cover layer. It must be placed first, as a base, when used with special-placement quarystone or uniform-placement tribars. When placed after the cover layer, the toe berm must be high enough to provide bracing up to at least half the height of the toe armor units. The dimensions recommended above will exceed this requirement.

(6) Structure Head and Lee Side Cover Layer. Armoring of the head of a breakwater or jetty should be the same on the lee side slope as on the seaside slope for a distance of about 15 to 45 meters from the structure end. This distance depends on such factors as structure length and crest elevation at the seaward end.

Design of the lee side cover layer is based on the extent of wave overtopping, waves and surges acting directly on the lee slope, porosity of the structure, and differential hydrostatic head resulting in uplift forces which tend to dislodge the back slope armor units.

If the crest elevation is established to prevent possible overtopping, the weight of armor units and the bottom elevation of the back slope cover layer should theoretically depend on the lesser wave action on the lee side and the porosity of the structure. When minor overtopping is anticipated, the armor weight calculated for the seaward side primary cover layer should be used on the lee side, at least down to the SWL or $-0.5 H$ for preliminary design; however, model testing may be required to establish an armor weight stable under overtopping wave impact. Primary armor on the lee side should be carried to the bottom for breakwaters with heavy overtopping in shallow water (breaking wave conditions), as shown in Figure 7-117. Equation 7-116 cannot be used with values of K_D listed in Table 7-8 calculate leeside armor weight under overtopping, since the K_D values were established for armor on

the seaward side and may be incorrect for leeside concrete or quarrystone units (Merrifield, 1977; Lillevang, 1977). The presence of a concrete cap will also affect overtopping forces on the lee side in ways that must be quantified by modeling. When both side slopes receive similar wave action (as with groins or jetties), both sides should be of similar design.

(7) Secondary Cover Layer. If the armor units in the primary and secondary cover layers are of the same material, the weight of armor units in the secondary cover layer, between $-1.5 H$ and $-2.0 H$, should be greater than about one-half the weight of armor units in the primary cover layer. Below $-2.0 H$, the weight requirements can be reduced to about $W/15$ for the same slope condition (see Fig. 7-116). If the primary cover layer is of quarrystone, the weights for the secondary quarrystone layers should be ratioed from the weight of quarrystone that would be required for the primary cover layer. The use of a single size of concrete armor for all cover layers--i.e., upgrading the secondary cover layer to the same size as the primary cover layer--may prove to be economically advantageous when the structure is located in shallow water (Fig. 7-117); in other words, with depth $d \leq 1.5 H$, armor units in the primary cover layer should be extended down the entire slope.

The secondary cover layer (Fig. 7-116) from $-1.5 H$ to the bottom should be as thick as or thicker than the primary cover layer. For cover layers of quarrystone, for example, and for the preceding ratios between the armor weight W in the primary cover layer and the quarrystone weight in the secondary cover layers, this means that if $n = 2$ for the primary cover layer (two quarrystones thick) then $n = 2.5$ for the secondary cover layer from $-H$ to $-2.0 H$ and $n = 5$ for that part of the secondary cover layer below $-2.0 H$.

The interfaces between the secondary cover layers and the primary cover layer are shown at the slope of 1-on-1.5 in Figure 7-116. Steeper slopes for the interfaces may contribute to the stability of the cover armor, but material characteristics and site wave conditions during construction may require using a flatter slope than that shown.

(8) Underlayers. The first underlayer directly beneath the primary armor units should have a minimum thickness of two quarrystones ($n = 2$) (see Figs. 7-116 and 7-117). For preliminary design these should weigh about one-tenth the weight of the overlying armor units ($W/10$) if (a) the cover layer and first underlayer are both quarrystone, or (b) the first underlayer is quarrystone and the cover layer is concrete armor units with a stability coefficient $K_D \leq 12$ (where K_D is for units on a trunk exposed to nonbreaking waves). When the cover layer is of armor units with $K_D > 12$, such as dolosse, toskanes, and tribars (placed uniformly in a single layer), the first underlayer quarrystone weight should be about $W/5$ or one-fifth the weight of the overlying armor units. The larger size is recommended to increase interlocking between the first underlayer and the armor units of high K_D . Carver and Davidson (1977) and Carver (1980) found, from hydraulic model tests of quarrystone armor units and dolosse placed on a breakwater trunk exposed to nonbreaking waves, that the underlayer stone size could range from $W/5$ to $W/20$, with little effect on stability, runup, or rundown. If the underlayer stone proposed for a given structure is available in weights from $W/5$ to $W/20$, the structure should be model tested with a first underlayer of the available stone before the design is made final. The tests

will determine whether this economical material will support a stable primary cover layer of the planned armor units when exposed to the site conditions.

The second underlayer beneath the primary cover layer and upper secondary cover layer (above $-2.0 H$) should have a minimum equivalent thickness of two quarrrstones; these should weight about one-twentieth the weight of the immediately overlying quarrrstones ($1/20 \times W/10 = W/200$ for quarrrstone and some concrete primary armor units).

The first underlayer beneath the lower secondary cover layer (below $-2.0 H$), should also have a minimum of two thicknesses of quarrrstone (see Fig. 7-116); these should weigh about one-twentieth of the immediately overlying armor unit weight ($1/20 \times W/15 = W/300$ for units of the same material). The second underlayer for the secondary armor below $-2.0 H$ can be as light as $W/6,000$, or equal to the core material size.

Note in the "recommended" section of Figure 7-116 that when the primary armor is quarrrstone and/or concrete units with $K_D \leq 12$, the first underlayer and second (below $-2.0 H$) quarrrstone sizes are $W/10$ to $W/15$. If the primary armor is concrete armor units with $K_D > 12$, the first underlayer and secondary (below $-2.0 H$) quarrrstone sizes are $W/5$ and $W/10$.

For a graded riprap cover layer, the minimum requirement for the underlayers, if one or more are necessary, is

$$D_{15} \text{ (cover)} \leq 5D_{85} \text{ (under)}$$

where $D_{15} \text{ (cover)}$ is the diameter exceeded by the coarsest 85 percent of the riprap or underlayer on top and $D_{85} \text{ (under)}$ is the diameter exceeded by the coarsest 15 percent of the underlayer or soil below (Ahrens, 1981). For a revetment, if the riprap and the underlying soil satisfy the size criterion, no underlayer is necessary; otherwise, one or more are required. The size criterion for riprap is more restrictive than the general filter criterion given at the beginning of Section III,7,g, above, and repeated below. The riprap criterion requires larger stone in the lower layer to prevent the material from washing through the voids in the upper layer as its stones shift under wave action. A more conservative underlayer than that required by the minimum criterion may be constructed of stone with a 50 percent size of about $W50/20$. This larger stone will produce a more permeable underlayer, perhaps reducing runup, and may increase the interlocking between the cover layer and underlayer; but its gradation must be checked against that of the underlying soil in accordance with the criterion given above.

The underlayers should be at least three 50 percent-size stones thick, but not less than 0.23 meter (Ahrens, 1981). The thickness can be calculated using equation (7-123) with a coefficient of 3 rather than 2. Note that, since a revetment is placed directly on the soil or fill of the bank it protects, a single underlayer also functions as a bedding layer or filter blanket.

(9) Filter Blanket or Bedding Layer. Foundation conditions for marine structures require thorough evaluation. Wave action against a rubble

structure, even at depths usually considered unaffected by such action, creates turbulence within both the structure and the underlying soil that may draw the soil into the structure, allowing the rubble itself to sink. Revetments and seawalls placed on sloping beaches and banks must withstand groundwater pressure tending to wash underlying soil through the structure. When large quarrystones are placed directly on a sand foundation at depths where waves and currents act on the bottom (as in the surf zone), the rubble will settle into the sand until it reaches the depth below which the sand will not be disturbed by the currents. Large amounts of rubble may be required to allow for the loss of rubble because of settlement. This settlement, in turn, can provide a stable foundation; but a rubble structure can be protected from excessive settlement resulting from leaching, undermining, or scour, by the use of either a filter blanket or bedding layer.

It is advisable to use a filter blanket or bedding layer to protect the foundations of rubble-mound structures from undermining except (a) where depths are greater than about three times the maximum wave height, (b) where the anticipated current velocities are too weak to move the average size of foundation material, or (c) where the foundation is a hard, durable material (such as bedrock).

When the rubble structure is founded on cohesionless soil, especially sand, a filter blanket should be provided to prevent differential wave pressures, currents, and groundwater flow from creating a quick condition in the foundation by removing sand through voids of the rubble and thus causing settlement. A filter blanket under a revetment may have to retain the foundation soil while passing large volumes of groundwater. Foundations of coarse gravel may be too heavy and permeable to produce a quick condition, while cohesive foundation material may be too impermeable.

A foundation that does not require a filter blanket may require a protective bedding layer. A bedding layer prevents erosion during and after construction by dissipating forces from horizontal wave, tide, and longshore currents. It also acts as a bearing layer that spreads the load of overlying stone (a) on the foundation soil to prevent excessive or differential settlement, and (b) on the filter material to prevent puncture. It interlocks with the overlying stone, increasing structure stability on slopes and near the toe. In many cases a filter blanket is required to hold foundation soil in place but a bedding layer is required to hold the filter in place. Gradation requirements of a filter layer depend principally on the size characteristics of the foundation material. If the criterion for filter design (Sowers and Sowers, 1970) is used, D_{15} (filter) is less than or equal to

D_{85} (foundation) (i.e., the diameter exceeded by the coarsest 85 percent of the filter material must be less than or equal to 5 times the diameter exceeded by the coarsest 15 percent of the foundation material) to ensure that the pores in the filter are too small to allow passage of the soil. Depending on the weight of the quarystone in the structure, a geotextile filter may be used (a) instead of a mineral blanket, or (b) with a thinner mineral blanket. Geotextiles are discussed in Chapter 6 and by Moffatt and Nichol, Engineers (1983) and Eckert and Callender (1984), who present detailed requirements for using geotextile filters beneath quarystone armor in coastal structures. A geotextile, coarse gravel, or crushed stone filter may be

placed directly over a sand, but silty and clayey soils and some fine sands must be covered by a coarser sand first. A bedding layer may consist of quarry spalls or other crushed stone, of gravel, or of stone-filled gabions. Quarry spalls, ranging in size from 0.45 to 23 kilograms, will generally suffice if placed over a geotextile or coarse gravel (or crushed stone) filter meeting the stated filter design criteria for the foundation soil. Bedding materials must be placed with care on geotextiles to prevent damage to the fabric from the bedding materials, as well as from heavier materials placed above.

Filter blanket or bedding layer thickness depends generally on the depth of water in which the material is to be placed and the size of quarystone used, but should not be less than 0.3 meter to ensure that bottom irregularities are completely covered. A filter blanket or bedding layer may be required only beneath the bottom edge of the cover and underlayers if the core material will not settle into or allow erosion of foundation material. Core material that is considerably coarser than the underlying foundation soil may need to be placed on a blanket or layer as protection against scour and settlement. It is also common practice to extend the bedding layer at least 1.5 meters beyond the toe of the cover stone. Details of typical rubble structures are shown in Chapter 6, STRUCTURAL FEATURES. In low rubble-mound structures composed entirely of cover and underlayers, leaving no room for a core, the bedding layer is extended across the full width of the structure. Examples are low and submerged breakwaters intended to control sand transport by dissipating waves (Markle and Carver, 1977) and small breakwaters for harbor protection (Carver and Markle, 1981b).

8. Stability of Rubble Foundations and Toe Protection.

Forces of waves on rubble structures have been studied by several investigators (see Section 7, above). Brebner and Donnelly (1962) studied stability criteria for random-placed rubble of uniform shape and size used as foundation and toe protection at vertical-faced, composite structures. In their experiments, the shape and size of the rubble units were uniform, that is, subrounded to subangular beach gravel of 2.65 specific gravity. In practice, the rubble foundation and toe protection would be constructed with a core of dumped quarry-run material. The superstructure might consist of concrete or timber cribs founded on the core material or a pair of parallel-tied walls of steel sheet piling driven into the rubble core. Finally, the apron and side slope of the core should be protected from erosion by a cover layer of armor units (see Sec. d and e below).

a. Design Wave Heights. For a composite breakwater with a superstructure resting directly on a rubble-mound foundation, structural integrity may depend on the ability of the foundation to resist the erosive scour by the highest waves. Therefore, it is suggested that the selected design wave height H for such structures be based on the following:

(1) For critical structures at open exposed sites where failure would be disastrous, and in the absence of reliable wave records, the design wave height H should be the average height of the highest 1 percent of all waves H_1 expected during an extreme event, based on the deepwater significant wave height H_0 corrected for refraction and shoaling. (Early

breaking might prevent the 1 percent wave from reaching the structure; if so, the maximum wave that could reach the structure should be taken for the design value of H .)

(2) For less critical structures, where some risk of exceeding design assumptions is allowable, wave heights between H_{10} and H_1 are acceptable.

The design wave for rubble toe protection is also between H_{10} and H_1 .

b. Stability Number. The stability number (N_s) is primarily affected by the depth of the rubble foundation and toe protection below the still-water level d_1 and by the water depth at the structure site, d_s . The relation between the depth ratio d_1/d_s and N_s^3 is indicated in Figure 7-120. The cube value of the stability number has been used in the figure to facilitate its substitution in equation (7-125).

c. Armor Stone. The equation used to determine the armor stone weight is a form of equation (7-116):

$$W = \frac{w_r H^3}{N_s^3 (S_r - 1)^3} \quad (7-125)$$

where

W = mean weight of individual armor unit, newtons or pounds.

w_r = unit weight of rock (saturated surface dry), newtons per cubic meter or pounds per cubic foot (Note: substitution of ρ_r , the mass density of the armor material in kilograms per cubic meter or slugs per cubic foot, will yield W in units of mass (kilograms or slugs))

H = design wave height (i.e., the incident wave height causing no damage to the structure)

S_r = specific gravity of rubble or armor stone relative to the water on which the structure is situated ($S_r = w_r/w_w$)

w_w = unit weight of water, fresh water = 9,800 newtons per cubic meter (62.4 pounds per cubic foot), seawater = 10,047 newtons per cubic meter (64.0 pounds per cubic foot). (Note: substitution of $\left(\frac{\rho_r - \rho_w}{\rho_w}\right)^3$, where ρ_w is the mass density of the water at the structure, for $(S_r - 1)^3$ yields the same result.)

N_s = design stability number for rubble foundations and toe protection (see Fig. 7-120).

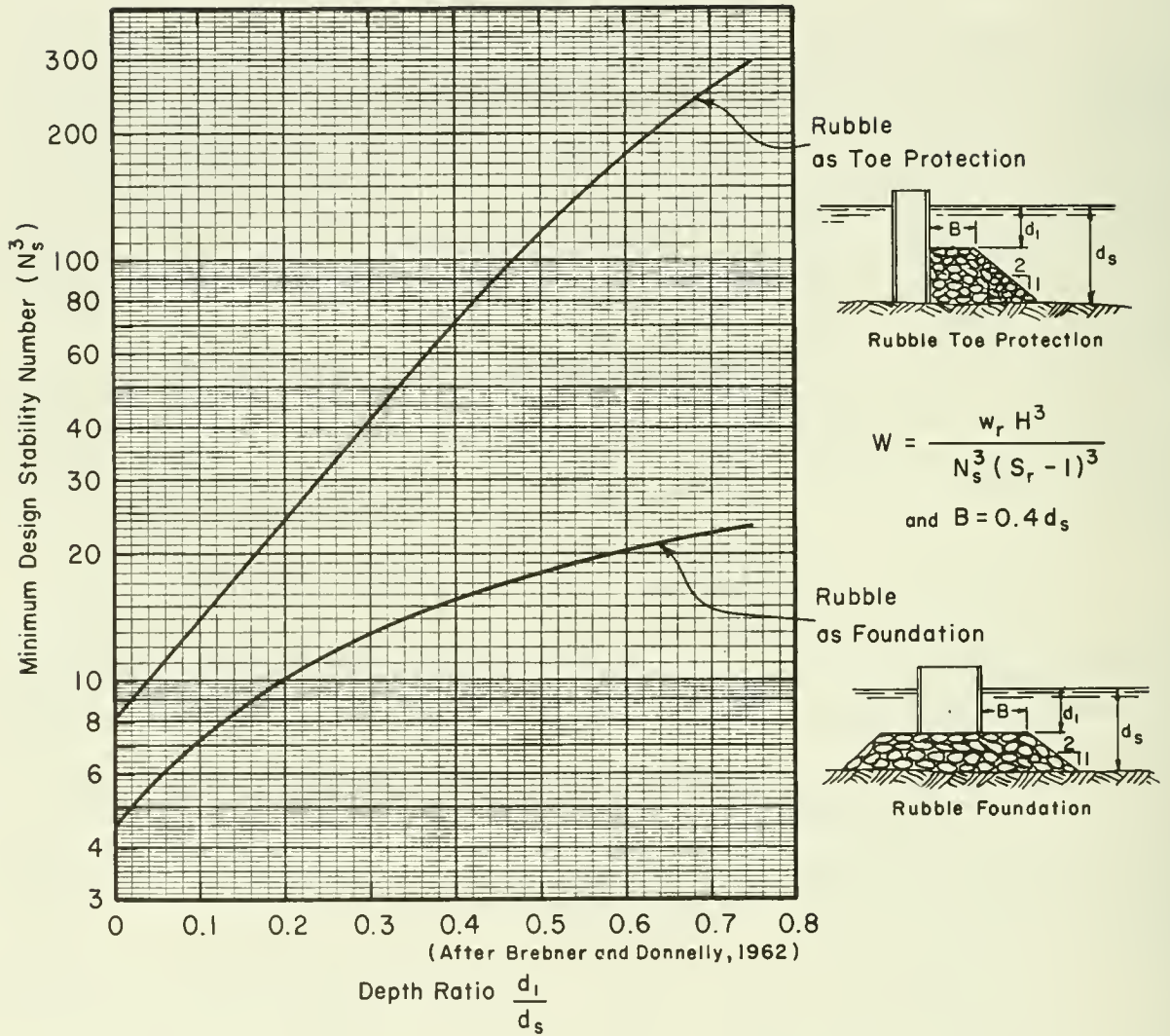

Figure 7-120. Stability number N_s for rubble foundation and toe protection.

d. Scour Protection. The forces causing loss of foundation soil from beneath a rubble-mound structure are accentuated at the structure toe. Wave pressure differentials and groundwater flow may produce a quick condition at the toe, then currents may carry the suspended soil away. A shallow scour hole may remove support for the cover layers, allowing them to slump down the face, while a deep hole may destabilize the slope of the structure, oversteepening it until bearing failure in the foundation soil allows the whole face to slip. Toe protection in the form of an apron must prevent such damage while remaining in place under wave and current forces and conforming to an uneven bottom that may be changing as erosion occurs.

Toe scour is a complex process. The toe apron width and stone size required to prevent it are related to the wave and current intensity; the bottom material; and the slope, roughness, and shape of the structure face. No definitive method for designing toe protection is known, but some general guidelines for planning toe protection are given below. The guidelines will provide only *approximate quantities* which may require doubling to be conservative, in some cases. A detailed study of scour in the natural bottom and near existing structures should be conducted at a planned site, and model studies should be considered before determining a final design.

(1) Minimum Design. Hales (1980) surveyed scour protection practices in the United States and found that the minimum toe apron was an extension of the bedding layer and any accompanying filter blanket measuring 0.6 to 1.0 meter thick and 1.5 meters wide. In the northwest United States, including Alaska, aprons are commonly 1.0 to 1.5 meters thick and 3.0 to 7.5 meters wide. Materials used, for example, were bedding of quarry-run stone up to 0.3 meter in dimension or of gabions 0.3 meter thick; core stone was used if larger than the bedding and required for stability against wave and current forces at the toe.

(2) Design for Maximum Scour Force. The maximum scour force occurs where wave downrush on the structure face extends to the toe. Based on Eckert (1983), the minimum toe apron will be inadequate protection against wave scour if the following two conditions hold. The first is the occurrence of water depth at the toe that is less than twice the height of the maximum expected unbroken wave that can exist in that water depth. The maximum unbroken wave is discussed in Chapter 5 and is calculated using the maximum significant wave height H_{sm} from Figure 3-21, and methods described in Section I of this chapter. Available wave data can be used to determine which calculated wave heights can actually be expected for different water levels at the site.

The second condition that precludes the use of a minimum toe apron is a structure wave reflection coefficient χ that equals or exceeds 0.25, which is generally true for slopes steeper than about 1 on 3. If the reflection coefficient is lower than the limit, much of the wave force will be dissipated on the structure face and the minimum apron width may be adequate. If the toe apron is exposed above the water, especially if waves break directly on it, the minimum quarrystone weight will be inadequate, whatever the slope.

(3) Tested Designs. Movable bed model tests of toe scour protection for a quarrystone-armored jetty with a slope of 1 on 1.25 were performed by Lee (1970; 1972). The tests demonstrated that a layer two stones thick of

stone weighing about one-thirtieth the weight of primary cover layer armor ($W/30$) was stable as cover for a core-stone apron in water depths of more than one but less than two wave heights. The width of the tested aprons was four to six of the aprons' cover layer stones, and so could be calculated using equation (7-120) with $n = 4$ to 6 and $W = \frac{w_p}{30}$.

Hales (1980) describes jetties, small breakwaters, and revetments with slopes of 1 on 3 or steeper and toes exposed to intense wave action in shallow water that have their aprons protected by a one-stone-thick layer of primary cover layer quarrrystone. The aprons were at least three to four cover stones wide; i.e., if equation (7-120) were used, $n = 3$ to 4 and $W = w_p$. In Hawaii, the sediment beneath the toes of such structures was excavated down to coral; or, if the sand was too deep, the toe apron was placed in a trench 0.6 to 2.0 meters deep.

(4) Materials. The quarrrystone of the structure underlayers, secondary cover layer, toe mound for cover layer stability, or the primary cover layer itself can be extended over a toe apron as protection, the size of which depends on the water depth, toe apron thickness, and wave height. Eckert (1983) recommended that, in the absence of better guidance, the weight of cover for a submerged toe exposed to waves in shallow water be chosen using the curve in Figure 7-120 for a rubble-mound foundation beneath a vertical structure and equation (7-125) as a guide. The design wave height H to be used in equation (7-125) is the maximum expected unbroken wave that occurs at the structure during an extreme event, and the design water depth is the minimum that occurs with the design wave height. Since scour aprons generally are placed on very flat slopes, quarrrystone of the size in an upper secondary cover layer $w_p/2$ probably will be the heaviest required unless the apron is exposed above the water surface during wave action. Quarrrystone of primary cover layer size may be extended over the toe apron if the stone will be exposed in the troughs of waves, especially breaking waves. The minimum thickness of cover over the toe apron should be two quarrrystones, unless primary cover layer stone is used.

(5) Shallow-Water Structures. The width of the apron for shallow-water structures with reflection coefficients equalling or greater than 0.25 can be planned from the structure slope and the expected scour depth. As discussed in Chapter 5, the maximum depth of a scour trough due to wave action below the natural bed is about equal to the maximum expected unbroken wave at the site. To protect the stability of the face, the toe soil must be kept in place beneath a surface defined by an extension of the face surface into the bottom to the maximum depth of scour. This can be accomplished by burying the toe, where construction conditions permit, thereby extending the face into an excavated trench the depth of the expected scour. Where an apron must be placed on the existing bottom or only can be partially buried, its width can be made equal to that of a buried toe; i.e., equal to the product of the expected scour depth and the cotangent of the face slope angle.

(6) Current Scour. Toe protection against currents may require smaller protective stone, but wider aprons. Stone size can be estimated from Section IV below. The current velocity used for selecting stone size, the scour depth to be expected, and the resulting toe apron width required can be

estimated from site hydrography, measured current velocities, and model studies (Hudson et al., 1979). Special attention must be given to sections of the structure where scour is intensified; i.e. to the head, areas of a section change in alignment, bar crossings, the channel sides of jetties, and the downdrift sides of groins. Where waves and currents occur together, Eckert (1983) recommends increasing the cover size by a factor of 1.5. The stone size required for a combination of wave and current scour can be used out to the width calculated for wave scour protection; smaller stone can be used beyond that point for current scour protection. Note that the conservatism of the apron width estimates depends on the accuracy of the methods used to predict the maximum depth of scour.

(7) Revetments. Revetments commonly are typically the smallest and most lightly armored of coastal protective structures, yet their failure leads directly to loss of property and can put protected structures in jeopardy. They commonly are constructed above the design water level or in very shallow water where their toes are likely to be exposed to intense wave and current forces during storms. For these reasons, their toes warrant special protection.

Based on guidance in EM 1110-2-1614 (U.S. Army Corps of Engineers, 1984), the cover for the toe apron of a revetment exposed to waves in shallow water should be an extension of the lowest cover layer on the revetment slope. Only the cover thickness is varied to increase stability. The toe apron should be buried wherever possible, with the revetment cover layer extended into the bottom for at least the distance of 1 meter or the maximum expected unbroken wave height, whichever is greater. If scour activity is light, the thickness of the cover on the buried toe can be a minimum of two armor stones or 50 percent size stones in a riprap gradation, the same as on the slope. For more intense scour, the cover thickness should be doubled and the extension depth increased by a factor of up to 1.5. For the most severe scour, the buried toe should be extended horizontally an additional distance equal to twice the toe's depth, that is, 2 to 3 times the design wave height (see Fig. 7-121).

If the apron is a berm placed on the existing bottom and the cover is quarystone armor, the cover thickness may be as little as one stone and the apron width may be three to four stones. A thickness of two stones and a width equal to that of a buried toe is more conservative and recommended for a berm covered by riprap. For the most severe wave scour the thickness should be doubled and a width equal to 3 to 4.5 design wave heights used, as illustrated in Figure 7-121. According to EM 1110-2-1601 (U.S. Army Corps of Engineers, 1970), the width of a toe apron exposed to severe current scour should be five times the thickness of the revetment cover layer, whether the toe is buried or a berm.

If a geotextile filter is used beneath the toe apron of a revetment or a structure that passes through the surf zone, such as a groin, the geotextile should not be extended to the outer edge of the apron. It should stop about a meter from the edge to protect it from being undermined. As an alternative, the geotextile may be extended beyond the edge of the apron, folded back over the bedding layer and some of the cover stone, and then buried in cover stone and sand to form a Dutch toe. This additionally stable form of toe is illustrated as an option in Figure 7-121.

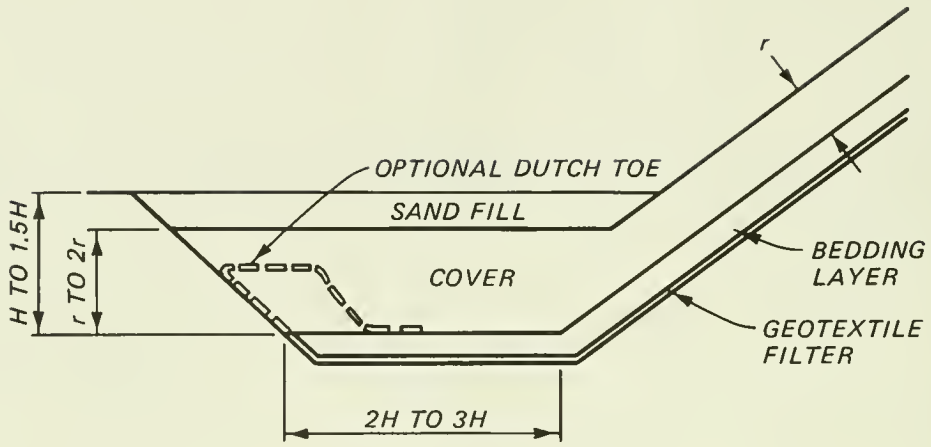

BURIED TOE APRON

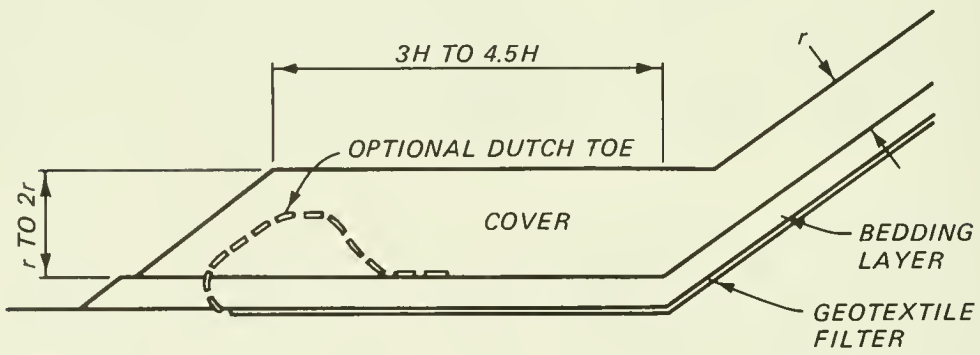

BERM TOE APRON

Figure 7-121. Revetment toe scour aprons for severe wave scour.

If a revetment is overtopped, even by minor splash, the stability can be affected. Overtopping can (a) erode the area above or behind the revetment, negating the structure's purpose; (b) remove soil supporting the top of the revetment, leading to the unraveling of the structure from the top down; and (c) increase the volume of water in the soil beneath the structure, contributing to drainage problems. The effects of overtopping can be limited by choosing a design height exceeding the expected runup height or by armoring the bank above or behind the revetment with a splash apron. The splash apron

can be a filter blanket covered by a bedding layer and, if necessary to prevent scour by splash, quarrystone armor or riprap; i.e., an apron similar in design to a toe apron. The apron can also be a pavement of concrete or asphalt which serves to divert overtopping water away from the revetment, decreasing the volume of groundwater beneath the structure.

e. Toe Berm for Foundation Stability. Once the geometry and material weights of a structure are known, the structure's bearing pressure on the underlying soil can be calculated. Structure settlement can be predicted using this information, and the structure's stability against a slip failure through the underlying soil can be analyzed (Eckert and Callender, 1984). If a bearing failure is considered possible, a quarrystone toe berm sufficiently heavy to prevent slippage can be built within the limit of the slip circle. This berm can be combined with the toe berm supporting the cover layer and the scour apron into one toe construction.

If the vertical structure being protected by a toe berm is a cantilevered or anchored sheet-pile bulkhead, the width of the berm B must be sufficient to cover the zone of passive earth support in front of the wall. Eckert and Callender (1984) describe methods of determining the width of this zone. As an approximation, B should be the greatest of (a) twice the depth of pile penetration, (b) twice the design wave height, or (c) $0.4 d_g$ (Eckert, 1983). If the vertical structure is a gravity retaining wall, the width of the zone to be protected can be estimated as the wall height, the design wave height, or $0.4 d_g$, whichever is greatest.

IV. VELOCITY FORCES--STABILITY OF CHANNEL REVETMENTS

In the design of channel revetments, the armor stone along the channel slope should be able to withstand anticipated current velocities without being displaced (Cox, 1958; Cambell, 1966).

The design armor weight is chosen by calculating the local boundary shear expected to act on a revetment and the shear that a design stone weight can withstand. Since the local boundary shear is a function of the revetment surface roughness, and the roughness is a function of the stone size, a range of stone sizes must be evaluated until a size is found which is stable under the shear it produces.

When velocities near the revetment boundaries are available from model tests, prototype measurements, or other means, the local boundary shear is

$$\tau_b = \frac{w_w}{g} \left(\frac{V}{5.75 \log_{10} \frac{30y}{d_g}} \right)^2 \quad (7-126)$$

where

τ_b = local boundary shear

V = the velocity at a distance y above the boundary

d_g = equivalent armor unit diameter; i.e.,

$$d_g = \left(\frac{6}{\pi}\right)^{1/3} \left(\frac{W}{w_r}\right)^{1/3} \quad (7-127)$$

w_r = armor unit weight for uniform stone

W = $W_{50 \text{ min}}$ for riprap

The maximum velocity of tidal currents in midchannel through a navigation opening as given by Sverdrup, Johnson, and Fleming (1942) can be approximated by

$$V = \frac{4\pi Ah}{3TS} \quad (7-128)$$

where

V = maximum velocity at center of opening

T = period of tide

A = surface area of harbor

S = cross section area of openings

h = tidal range

The current velocity at the sides of the channel is about two-thirds the velocity at midchannel; therefore, the velocity against the revetments at the sides can be approximated by

$$V = \frac{8}{9} \frac{\pi Ah}{3TS} \quad (7-129)$$

If no prototype or model current velocities are available, this velocity can be used as an approximation of V and to calculate the local boundary shear.

If the channel has a uniform cross section with identical bed and bank armor materials, on a constant bottom slope over a sufficient distance to produce uniform channel flow at normal depth and velocity, velocity can be calculated using the procedures described in Appendix IV of EM 1110-2-1601 (Office, Chief of Engineers, U.S. Army, 1970), or Hydraulic Design Charts available from the U.S. Army Engineer Waterways Experiment Station, Vicksburg, Miss.). In tidal channels, different water surface elevations at the ends of the channel are used to find the water surface elevation difference that gives the maximum flow volume and flow velocity. If the conditions described above hold, such that the flow is fully rough and the vertical velocity distribution is logarithmic, the local boundary shear τ_b is

$$\tau_b = \frac{w_w}{g} \left(\frac{\bar{V}}{5.75 \log_{10} \frac{12.1 d}{d_g}} \right)^2 \quad (7-130)$$

where

\bar{V} = average local velocity in the vertical

d = depth at site (\bar{V} is average over this depth)

If the channel is curved, the computed local boundary shear should be multiplied by a factor appropriate for that cross section (available in EM 1110-2-1601, Office, Chief of Engineers, 1970). If the conditions described above leading to a uniform channel flow at normal depth and velocity do not exist, as they will not for most tidal channels, the local boundary shear computed from the equation above should be increased by a factor of 1.5.

If the local boundary shear can be calculated by using the average velocity over depth, it should also be calculated using an estimated velocity at the revetment surface, as described in the two methods above. The calculated local boundary shears can be compared and the most conservative used.

Calculate the riprap design shear or armor stone design shear using

$$\tau = 0.040 (w_r - W_w) d_g \quad (7-131)$$

where τ = design shear for the channel bottom if essentially level, and

$$\tau' = \tau \left(1 - \frac{\sin^2 \theta}{\sin^2 \phi} \right)^{1/2} \quad (7-132)$$

where

τ' = design shear for channel side slopes

θ = angle of side slope with horizontal

ϕ = angle of repose of the riprap (normally about 40°)

For all graded stone armor (riprap), the gradation should have the following relations to the computed value for $W_{50 \min}$:

$$W_{100 \max} = 5 W_{50 \min} \quad (7-133)$$

$$W_{100 \min} = 2 W_{50 \min} \quad (7-134)$$

$$W_{50 \max} = 1.5 W_{50 \min} \quad (7-135)$$

$$W_{15 \max} = 0.5 W_{50 \max} \quad (7-136)$$

$$W_{15 \max} = 0.75 W_{50 \min} \quad (7-137)$$

$$W_{15 \min} = 0.31 W_{50 \min} \quad (7-138)$$

If stone is placed above water, the layer thickness is

$$r = 2.1 \left(\frac{W_{50 \min}}{w_r} \right)^{1/3}, \text{ or } 0.3 \text{ m (12 in.) minimum} \quad (7-139)$$

If stone is placed below water,

$$r = 3.2 \left(\frac{W_{50 \min}}{w_r} \right)^{1/3}, \text{ or } 0.5 \text{ m (18 in.) minimum} \quad (7-140)$$

to account for inaccuracy in placement.

Equations (7-133) through (7-138) are used by choosing a layer thickness for a type of placement, then calculating the d_g for $W_{50 \min}$ ($d_g \min$) and for $W_{50 \max}$ ($d_g \max$). The local boundary shear should be calculated using $d_g \max$; the design shear should be calculated using $d_g \min$. If the design shear matches or exceeds the local boundary shear, the layer thickness and stone sizes are correct.

For uniform stone, d_g is uniform so that the same value is used for calculating the local boundary and design shears. In the special case where the velocity is known within 3 meters of the surface of the revetment, the local boundary shear equation for velocities near the revetment surface can be used with y set equal to d_g . This gives

$$\tau_b = \frac{w_w}{g} \left(\frac{v}{5.75 \log_{10} 30} \right)^2$$

Setting this equal to the armor stone design shear, and solving the result for V gives

$$v = 5.75 (0.040)^{1/2} \log_{10} 30 g^{1/2} \left(\frac{w_r - w_w}{w_w} \right)^{1/2} \left(1 - \frac{\sin^2 \theta}{\sin^2 \phi} \right)^{1/4} d_g^{1/2}$$

or

$$v = 5.75 (0.020)^{1/2} \log_{10} 30 (2g)^{1/2} \left(\frac{w_r - w_w}{w_w} \right)^{1/2} \left(1 - \frac{\sin^2 \theta}{\sin^2 \phi} \right)^{1/4} d_g^{1/2}$$

$$v = 1.20 (2g)^{1/2} \left(\frac{w_r - w_w}{w} \right)^{1/2} \left(1 - \frac{\sin^2 \theta}{\sin^2 \phi} \right)^{1/4} d^{1/2} \quad (7-141)$$

This is Isbash's equation for stone embedded in the bottom of a sloped channel modified for stone embedded in a bank with angle θ to the horizontal (the coefficient 1.20 is Isbash's constant for embedded stone). From this, the armor stone weight required to withstand the velocity V is as follows:

$$W = \frac{\pi V^6}{6 (1.20)^6 (2g)^3} \frac{w_r - w_w}{w} \frac{3}{\left(\frac{w_r - w_w}{w} \right)^3 \left(1 - \frac{\sin^2 \theta}{\sin^2 \phi} \right)^{3/2}}$$

$$W = 0.0219 \frac{V^6 w_r}{g^3} \left(\frac{w_w}{w_r - w_w} \right)^3 \left(1 - \frac{\sin^2 \theta}{\sin^2 \phi} \right)^{-3/2} \quad (7-142)$$

V. IMPACT FORCES

Impact forces are an important design consideration for shore structures because of the increased use of thin flood walls and gated structures as part of hurricane protection barriers. High winds of a hurricane propelling small pleasure craft, barges, and floating debris can cause great impact forces on a structure. Large floating ice masses also cause large horizontal impact forces. If site and functional condition require the inclusion of impact forces in the design, other measures should be taken: either the depth of water against the face of the structure should be limited by providing a rubble-mound absorber against the face of the wall, or floating masses should be grounded by building a partially submerged structure seaward of the shore structure that will eliminate the potential hazard and need for impact design consideration.

In many areas impact hazards may not occur, but where the potential exists (as for harbor structures), impact forcer should be evaluated from impulse-momentum considerations.

VI. ICE FORCES

Ice forms are classified by terms that indicate manner of formation or effects produced. Usual classifications include sheet ice, shale, slush, frazil ice, anchor ice, and agglomerate ice (Striegl, 1952; Zumberg and Wilson, 1953; Peyton, 1968).

There are many ways ice can affect marine structures. In Alaska and along the Great Lakes, great care must be exercised in predicting the different ways in which ice can exert forces on structures and restrict operations. Most situations in which ice affects marine structures are outlined in Table 7-14.

The amount of expansion of fresh water in cooling from 12.6°C (39°F) to 0°C (32°F) is 0.0132 percent; in changing from water at 0°C (32°F) to ice at 0°C, the amount of expansion is approximately 9.05 percent, or 685 times as great. A change of ice structure to denser form takes place when with a temperature lower than -22°C (-8°F), it is subjected to pressures greater than about 200 kilonewtons per square meter (30,000 pounds per square inch). Excessive pressure, with temperatures above -22°C, causes the ice to melt. With the temperature below -22°C, the change to a denser form at high pressure results in shrinkage which relieves pressure. Thus, the probable maximum pressure that can be produced by water freezing in an enclosed space is approximately 200 kilonewtons per square meter (30,000 pounds per square inch).

Designs for dams include allowances for ice pressures of as much as 657,000 to 730,000 newtons per meter (45,000 to 50,000 pounds per linear foot). The crushing strength of ice is about 2,750 kilonewtons per square meter (400 pounds per square inch). Thrust per meter for various thicknesses of ice is about 43,000 kilograms for 0.5 meter, 86,000 kilograms for 1.0 meter, etc. Structures subject to blows from floating ice should be capable of resisting 97,650 to 120,000 kilograms per square meter (10 to 12 tons per square foot, or 139 to 167 pounds per square inch) on the area exposed to the greatest thickness of floating ice.

Ice also expands when warmed from temperatures below freezing to a temperature of 0°C without melting. Assuming a lake surface free of snow with an average coefficient of expansion of ice between -7°C (20°F) and 0°C equaling 0.0000512 m/m-°C, the total expansion of a sheet of ice a kilometer long for a rise in temperature of 10°C (50°F) would be 0.5 meter.

Normally, shore structures are subject to wave forces comparable in magnitude to the maximum probable pressure that might be developed by an ice sheet. As the maximum wave forces and ice thrust cannot occur at the same time, usually no special allowance is made for overturning stability to resist ice thrust. However, where heavy ice, either in the form of a solid ice sheet or floating ice fields may occur, adequate precautions must be taken to ensure that the structure is secure against sliding on its base. Ice breakers may be required in sheltered water where wave action does not require a heavy structure.

Floating ice fields when driven by a strong wind or current may exert great pressure on structures by piling up on them in large ice packs. This condition must be given special attention in the design of small isolated structures. However, because of the flexibility of an ice field, pressures probably are not as great as those of a solid ice sheet in a confined area.

Ice formations at times cause considerable damage on shores in local areas, but their net effects are largely beneficial. Spray from winds and waves freezes on the banks and structures along the shore, covering them with a protective layer of ice. Ice piled on shore by wind and wave action does not, in general, cause serious damage to beaches, bulkheads, or protective riprap, but provides additional protection against severe winter waves. Ice often affects impoundment of littoral drift. Updrift source material is less erodible when frozen, and windrowed ice is a barrier to shoreward-moving wave energy; therefore, the quantity of material reaching an impounding structure

is reduced. During the winters of 1951-52, it was estimated that ice caused a reduction in rate of impoundment of 40 to 50 percent at the Fort Sheridan, Illinois, groin system.

Table 7-14. Effects of ice on marine structures¹.

-
- A. Direct Results of Ice Forces on Structures.
1. Horizontal forces.
 - a. Crushing ice failure of laterally moving floating ice sheets.
 - b. Bending ice failure of laterally moving floating ice sheets.
 - c. Impact by large floating ice masses.
 - d. Plucking forces against riprap.
 2. Vertical forces.
 - a. Weight at low tide of ice frozen to structural elements.
 - b. Buoyant uplift at high tide of ice masses frozen to structural elements.
 - c. Vertical component of ice sheet bending failure introduced by ice breakers.
 - d. Diaphragm bending forces during water level change of ice sheets frozen to structural elements.
 - e. Forces created because of superstructure icing by ice spray.
 3. Second-order effects.
 - a. Motion during thaw of ice frozen to structural elements.
 - b. Expansion of entrapped water within structural elements.
 - c. Jamming of rubble between structural framing members.
- B. Indirect Results of Ice Forces on Structures.
1. Impingement of floating ice sheets on moored ships.
 2. Impact forces by ships during docking which are larger than might normally be expected.
 3. Abrasion and subsequent corrosion of structural elements.
- C. Low-Risk but Catastrophic Considerations.
1. Collision by a ship caught in fast-moving, ice-covered waters.
 2. Collision by extraordinarily large ice masses of very low probability of occurrence.
- D. Operational Considerations.
1. Problems of serving offshore facilities in ice-covered waters.
 2. Unusual crane loads.
 3. Difficulty in maneuvering work boats in ice-covered waters.
 4. Limits of ice cover severity during which ships can be moored to docks.
 5. Ship handling characteristics in turning basins and while docking and undocking.
 6. The extreme variability of ice conditions from year to year.
 7. The necessity of developing an ice operations manual to outline the operational limits for preventing the overstressing of structures.
-

¹ After Peyton (1968).

Some abrasion of timber or concrete structures may be caused, and individual members may be broken or bent by the weight of the ice mass. Piling has been slowly pulled by the repeated lifting effect of ice freezing to the piles, or to attached members such as wales, and then being forced upward by a rise in water stage or wave action.

VII. EARTH FORCES

Numerous texts on soil mechanics such as those by Anderson (1948), Hough (1957), and Terzaghi and Peck (1967) thoroughly discuss this subject. The forces exerted on a wall by soil backfill depend on the physical characteristics of the soil particles, the degree of soil compaction and saturation, the geometry of the soil mass, the movements of the wall caused by the action of the backfill, and the foundation deformation. In wall design, since pressures and pressure distributions are typically indeterminate because of the factors noted, approximations of their influence must be made. Guidance for problems of this nature should be sought from one of the many texts and manuals dedicated to the subject. The following material is presented as a brief introduction.

1. Active Forces.

When a mass of earth is held back by means of a retaining structure, a lateral force is exerted on the structure. If this is not effectively resisted, the earth mass will fail and a portion of it will move sideways and downward. The force exerted by the earth on the wall is called *active earth force*. Retaining walls are generally designed to allow minor rotation about the wall base to develop this active force, which is less than the at-rest force exerted if no rotation occurs. Coulomb developed the following active force equation:

$$P_a = \frac{wh^2}{2} \left[\frac{\csc \theta \sin (\theta - \phi)}{\sqrt{\sin (\theta + \delta) + \frac{\sin (\phi + \delta) \sin (\phi - i)}{\sin (\theta - i)}}} \right]^2 \quad (7-143)$$

where

P_a = active force per unit length, kilonewtons per meter (pounds per linear foot) of wall

w = unit weight of soil, kilonewtons per cubic meter (pounds per linear foot) of wall

h = height of wall or height of fill at wall if lower than wall, meters (feet)

θ = angle between horizontal and backslope of wall, degrees.

i = angle of backfill surface from horizontal, degrees

ϕ = internal angle of friction of the material, degrees

δ = wall friction angle, degrees

These symbols are further defined in Figure 7-122. Equation (7-143) may be reduced to that given by Rankine for the special Rankine conditions where δ is considered equal to i and θ equal to 90 degrees (vertical wall face). When, additionally, the backfill surface is level ($i = 0$ degrees), the reduced equation is

$$P_a = \frac{wh^2}{2} \tan^2 \left(45^\circ - \frac{\phi}{2} \right) \quad (7-144)$$

Figure 7-123 shows that P_a from equation (7-144) is applied horizontally.

Unit weights and internal friction angles for various soils are given in Table 7-15.

The resultant force for equation (7-143) is inclined from a line perpendicular to the back of the wall by the angle of wall friction δ (see Fig. 7-122). Values for δ can be obtained from Table 7-16, but should not exceed the internal friction angle of the backfill material ϕ and, for conservatism, should not exceed $(3/4)\phi$ (Office, Chief of Engineers, 1961).

2. Passive Forces.

If the wall resists forces that tend to compress the soil or fill behind it, the earth must have enough internal resistance to transmit these forces. Failure to do this will result in rupture; i.e., a part of the earth will move sideways and upward away from the wall. This resistance of the earth against outside forces is called *passive earth force*.

The general equation for the passive force P_p is

$$P_p = \frac{wh^2}{2} \left[\frac{\csc \theta \sin (\theta + \phi)}{\sqrt{\sin (\theta - \delta) - \frac{\sin (\phi - \delta) \sin (\phi + i)}{\sin (\theta - i)}}} \right]^2 \quad (7-145)$$

It should be noted that P_p is applied below the normal to the structure slope by an angle $-\delta$, whereas the active force is applied above the normal line by an angle $+\delta$ (see Fig. 7-122).

For the Rankine conditions given in Section 1 above, equation (7-145) reduces to

$$P_p = \frac{wh^2}{2} \tan^2 \left(45^\circ + \frac{\phi}{2} \right) \quad (7-146)$$

Equation (7-146) is satisfactory for use with a sheet-pile structure, assuming a substantially horizontal backfill.

Table 7-15. Unit weights and internal friction angles of soils¹.

Classification		Unit Weight, kg/m ³					
		Dry		Wet		Submerged	
		Min. (loose)	Max. (dense)	Min. (loose)	Max. (dense)	Min. (loose)	Max. (dense)
GRANDULAR MATERIALS							
1. Uniform Materials							
Standard Ottawa SAND							
Clean, uniform SAND (fine or medium)							
Uniform, inorganic SILT							
2. Well-graded Materials							
Silty SAND							
Clean, fine to coarse SAND							
Micaceous SAND							
Silty SAND and GRAVEL							
MIXED SOILS							
1. Sandy or silty CLAY							
2. Skip-graded silty CLAY with stones or rock fragments							
3. Well-graded GRAVEL, SAND, SILT and CLAY mixture							
CLAY SOILS							
1. CLAY (30 to 50 percent clay sizes)							
2. Colloidal CLAY (-0.002 mm 50 percent)							
ORGANIC SOILS							
1. Organic SILT							
2. Organic CLAY (30 to 50 percent clay size)							

Classification	Friction Angle ϕ (degrees)	Density or Consistency	Unit Weight, kg/m ³		
			Soil	Equivalent Fluid	
				Active Case	Passive Case
Coarse SAND or SAND and GRAVEL	45	compact	2,243 (140)	384 (24)	13,135 (820)
	38	firm	1,922 (120)	465 (29)	8,169 (510)
	32	loose	1,442 (90)	448 (28)	4,645 (290)
Medium SAND	40	compact	2,082 (130)	448 (28)	9,611 (600)
	34	firm	1,762 (110)	497 (31)	6,247 (390)
	30	loose	1,442 (90)	480 (30)	4,325 (270)
Fine SAND	34	compact	2,082 (130)	593 (37)	7,368 (460)
	30	firm	1,602 (100)	529 (33)	4,605 (300)
	28	loose	1,362 (85)	497 (31)	4,485 (280)
Fine, silty SAND or sandy SILT	32	compact	2,082 (130)	641 (40)	6,728 (420)
	30	firm	1,602 (100)	529 (33)	4,805 (300)
	28	loose	1,362 (85)	497 (31)	4,485 (280)
Fine, uniform SILT	30	compact	2,162 (135)	721 (45)	6,407 (400)
	28	firm	1,762 (110)	609 (38)	4,805 (300)
	26	loose	1,362 (85)	529 (33)	3,524 (220)
CLAY-SILT	20	medium	1,922 (120)	945 (59)	3,924 (245)
		soft	1,442 (90)	705 (44)	2,931 (183)
Silty CLAY	15	medium	1,922 (120)	1,137 (71)	3,268 (204)
		soft	1,442 (90)	849 (53)	2,451 (153)
CLAY	10	medium	1,922 (120)	1,345 (84)	2,723 (170)
		soft	1,442 (90)	849 (53)	2,451 (153)
CLAY	0	medium	1,922 (120)	1,922 (120)	1,922 (120)
		soft	1,442 (90)	1,442 (90)	1,442 (90)

¹ After Hough (1957).

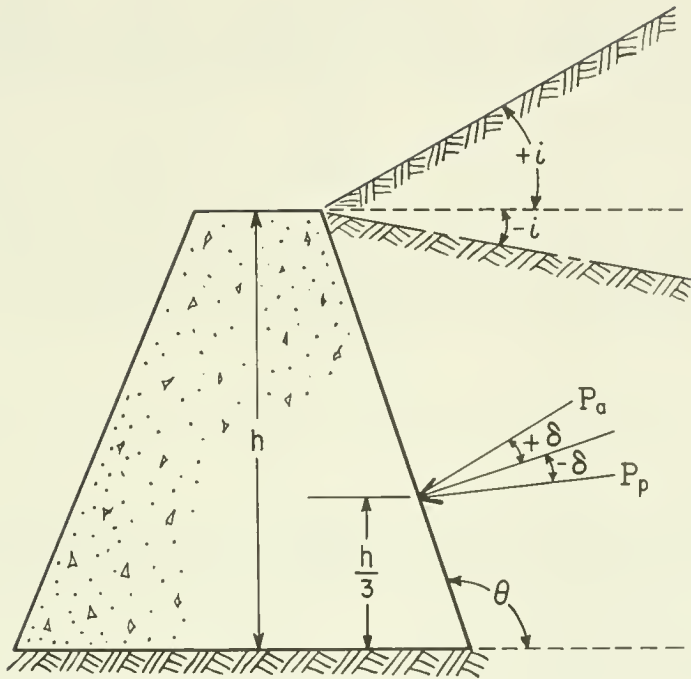

Figure 7-122. Definition sketch for Coulomb earth force equation.

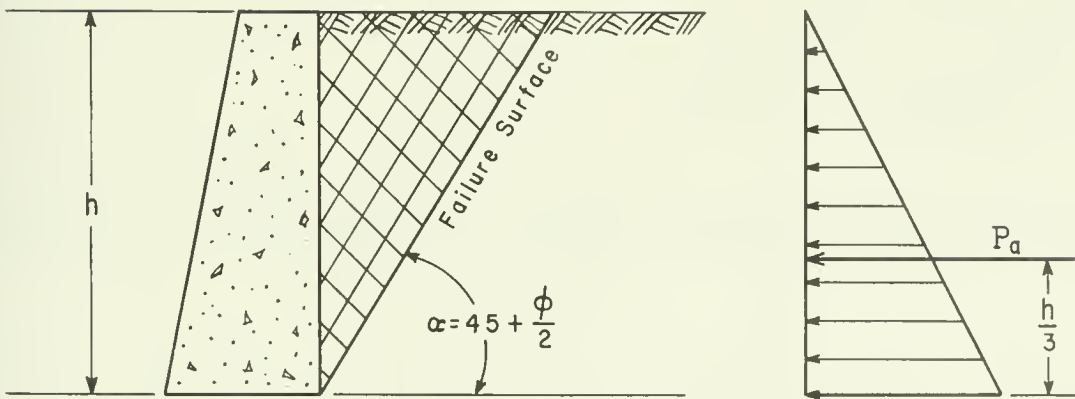

Figure 7-123. Active earth force for simple Rankine case.

Table 7-16. Coefficients and angles of friction.

Surface Stone - Brick - Concrete	Coefficient of Friction, μ	Angle of Wall Friction, δ
On Dry Clay	0.50	26° 40'
On Wet or Moist Clay	0.33	18° 20'
On Sand	0.40	21° 50'
On Gravel	0.60	31° 00'

NOTE: Angle of friction should be reduced by about 5 degrees if the wall fill will support train or truck traffic; the coefficient μ would then equal the tangent of the new angle δ .

3. Cohesive Soils.

Sections 1 and 2 above have briefly dealt with forces in cohesionless soil. A cohesive backfill which reduces the active force may be advantageous. However, unless the soil can move continuously to maintain the cohesive resistance, it may relax. Thus, walls should usually be designed for the active force in cohesionless soil.

4. Structures of Irregular Section.

Earth force against structures of irregular section such as stepped-stone blocks or those having two or more back batters may be estimated using equations (7-142) and (7-144) by substituting an approximate average wall batter or slope to determine the angle θ .

5. Submerged Material.

Forces due to submerged fills may be calculated by substituting the unit weight of the material reduced by buoyancy for the value of w in the preceding equations and then adding to the calculated forces the full hydrostatic force due to the water. Values of unit weight for dry, saturated, and submerged materials are indicated in Table 7-15.

6. Uplift Forces.

For design computations, uplift forces should be considered as full hydrostatic force for walls whose bases are below design water level or for walls with saturated backfill.

LITERATURE CITED

- ACHENBACH, E., "Distribution of Local Pressure and Skin Friction Around a Circular Cylinder in Cross-Flow Up to $Re = 5 \times 10^5$," *Journal of Fluid Mechanics*, Vol. 34, Part 4, 1968.
- AGERSCHOU, H.A., and EDENS, J.J., "Fifth and First Order Wave-Force Coefficients for Cylindrical Piles," *Coastal Engineering, Santa Barbara Specialty Conference*, ASCE, 1965.
- AHRENS, J., "Prediction of Irregular Wave Runup," CETA 77-2, Coastal Engineering Research Center, U.S. Army Engineer Waterways Experiment Station, Vicksburg, Miss., July 1977a.
- AHRENS, J., "Prediction of Irregular Wave Overtopping," Coastal Engineering Research Center, U.S. Army Engineer Waterways Experiment Station, Vicksburg, Miss., 1977b.
- AHRENS, J.P., "Large Wave Tank Tests of Riprap Stability," TM 51, Coastal Engineering Research Center, U.S. Army Engineer Waterways Experiment Station, Vicksburg, Miss., May 1975.
- AHRENS, J., "Irregular Wave Runup on Smooth Slopes," CETA 81-17, Coastal Engineering Research Center, U.S. Army Engineer Waterways Experiment Station, Vicksburg, Miss., 1981a.
- AHRENS, J.P., "Design of Riprap Revetments for Protection Against Wave Attack," TP 81-5, Coastal Engineering Research Center, U.S. Army Engineer Waterways Experiment Station, Vicksburg, Miss., December 1981b.
- AHRENS, J., and McCARTNEY, B.L., "Wave Period Effect on the Stability of Riprap," *Proceedings of Civil Engineering in the Oceans/III*, American Society of Civil Engineers, 1975, pp. 1019-1034 (also Reprint 76-2, Coastal Engineering Research Center, NTIS A029-726).
- ANDERSEN, P., *Substructure Analysis and Design*, Ronald Press, New York, 1948.
- ANDREWS, M.E., and BORGMAN, L.E., "Procedures for Studying Wave Grouping in Wave Records from the California Coastal Data Collection Program," Statistics Laboratory Report No. 141, University of Wyoming, Laramie, Wyoming, November 1981.
- ANONYMOUS, "Artificial Armouring for Marine Structures," *The Dock and Harbor Authority*, Vol. 51, No. 601, Nov. 1970, pp. 297-301.
- ANONYMOUS, "News Mix," *Concrete*, Vol. 16, No. 2, Feb. 1982, p. 10.
- BAGNOLD, R.A., "Interim Report on Wave Pressure Research," *Journal of the Institution of Civil Engineers*, Vol. 12, London, 1939.
- BATTJES, J.A., "Runup Distributions of Waves Breaking on Slopes," *Journal of the Waterways, Harbors and Coastal Engineering Division*, ASCE, Vol. 97, No. WW1, Proc. Paper 7923, 1971, pp. 91-114.

- BATTJES, J.A., "Wave Runup and Overtopping," Technical Advisory Committee on Protection Against Inundation, Rijkswaterstaat, The Hague, Netherlands, 1974.
- BIDDE, D.D., "Wave Forces on a Circular Pile Due to Eddy Shedding," HEL 9-16, Hydraulic Engineering Laboratory Research Report, University of California, Berkeley, Calif., 1970.
- BIDDE, D.D., "Laboratory Study of Lift Forces on Circular Piles," *Journal of the Waterways, Harbors and Coastal Engineering Division*, ASCE, WW 4, Paper No. 8495, Nov. 1971.
- BLUMBERG, R., and RIGG, A.M., "Hydrodynamic Drag at Super-Critical Reynolds Numbers," Paper Presented at *Petroleum Session, American Society of Mechanical Engineers*, Los Angeles, Calif., 1961.
- BOTTIN, R., CHATHAM, C., and CARVER, R., "Waianae Small-Boat Harbor, Oahu, Hawaii, Design for Wave Protection," TR H-76-8, U.S. Army Engineer Waterways Experiment Station, Vicksburg, Miss., May 1976.
- BRANDTZAEG, A., "The Effect of Unit Weights of Rock and Fluid on the Stability of Rubble-Mound Breakwaters," *Proceedings of the 10th Conference on Coastal Engineering*, ASCE, Vol. II, 1966.
- BREBNER, A., and DONNELLY, P., "Laboratory Study of Rubble Foundations for Vertical Breakwaters," Engineer Report No. 23, Queen's University at Kingston, Ontario, 1962.
- BRETSCHNEIDER, C.L., "Modification of Wave Height Due to Bottom Friction, Percolation and Refraction," TM-45, U.S. Army, Corps of Engineers, Beach Erosion Board, Washington, D.C., Sept. 1954a.
- BRETSCHNEIDER, C.L., "Field Investigations of Wave Energy Loss in Shallow Water Ocean Waves," TM-46, U.S. Army, Corps of Engineers, Beach Erosion Board, Washington, D.C., Sept. 1954b.
- BRETSCHNEIDER, C.L., "Evaluation of Drag and Inertial Coefficients from Maximum Range of Total Wave Force," Technical Report No. 55-5, Department of Oceanography, Texas A&M University, College Station, Texas, 1957.
- BRETSCHNEIDER, C.L., "Significant Waves and Wave Spectrum," *Ocean Industry*, Feb. 1968, pp. 40-46.
- BRITISH TRANSPORT DOCKS BOARD, "Port Talbot Breakwater," Southall, Middlesex, England, April 1979, pp. 7-8.
- BROWN, C.T., "Seabees, A Third-Generation Armour Unit," 7th International Harbor Congress, Antwerp, Royal Society for Flemish Engineers, May 1978.
- BROSEN, M., BURCHARTH, H.F.M and LARSEN, T., "Stability of Dolos Slopes," *Fourteenth Coastal Engineering Conference*, Copenhagen, Denmark, June 1974.

- BURCHARTH, H.F., "The Effect of Wave Grouping on On-Shore Structures," *Coastal Engineering*, 2, 1979, pp. 189-199.
- BURSNALL, W.J., and LOFTIN, L.K., "Experimental Investigation of the Pressure Distribution About a Yawed Cylinder in the Critical Reynolds Number Range, Technical Note 2463, National Advisory Committee for Aeronautics, 1951.
- CAMBELL, F.B., "Hydraulic Design of Rock Riprap," Miscellaneous Paper 2-777, U.S. Army Engineer Waterways Experiment Station, Vicksburg, Miss., 1966.
- CARR, J.H., "Breaking Wave Forces on Plane Barriers," Report No. E 11.3, Hydrodynamics Laboratory, California Institute of Technology, Pasadena, Calif., 1954.
- CARSTENS, T., TRATTEBERG, A., and TØRUM, A., "The Stability of Rubble-Mound Breakwaters Against Irregular Waves," *Proceedings of 10th Conference on Coastal Engineering*, Tokyo, Japan, 1965.
- CARVER, R.D., "Effects of First Underlayer Weight on the Stability of Stone-Armored, Rubble-Mound Breakwater Trunks Subjected to Nonbreaking Waves with No Overtopping," Technical Report HL-80-1, U.S. Army Engineer Waterways Experiment Station, Vicksburg, Miss., 1980.
- CARVER, R.D., "Stability of Stone- and Dolos-Armored, Rubble-Mound Breakwater Trunks Subjected to Breaking Waves with No Overtopping," Technical Report CERC-83-5, U.S. Army Engineer Waterways Experiment Station, Vicksburg, Miss., 1983.
- CARVER, R.D., and DAVIDSON, D.D., "Stability of Rubble-Mound Breakwater, Jubail Harbor, Saudi Arabia," Technical Report H-76-20, U.S. Army Engineer Waterways Experiment Station, Vicksburg, Miss., Dec. 1976.
- CARVER, R.D., and DAVIDSON, D.D., "Dolos Armor, Units Used on Rubble-Mound Breakwater Trunks Subjected to Nonbreaking Waves with No Overtopping," Technical Report H-77-19, U.S. Army Engineer Waterways Experiment Station, Vicksburg, Miss., 1977.
- CARVER, R.D., and DAVIDSON, D.D., "Jetty Stability Study, Oregon Inlet, North Carolina," Technical Report CERC-83-3, U.S. Army Engineer Waterways Experiment Station, Vicksburg, Miss., 1983.
- CARVER, R.D., and MARKLE, D.G., "Stability of Rubble-Mound Breakwater; Maalea Harbor, Maui, Hawaii," Miscellaneous Paper HL-81-1, U. S. Army Engineer Waterways Experiment Station, Vicksburg, Miss., January 1981a.
- CARVER, R.D., and MARKEL, D.G., "Rubble-Mound Breakwater Stability and Wave-Attenuation Tests, Port Ontario Harbor, New York," Technical Report HL-81-5, U.S. Army Engineer Waterways Experiment Station, Vicksburg, Miss., April 1981b.
- CHANG, K.S., "Transverse Forces on Cylinders Due to Vortex Shedding in Waves," M.A. Thesis, Department of Civil Engineering, Massachusetts Institute of Technology, Cambridge, Mass., 1964.

- CHESNUTT, C.B., "Scour of Simulated Gulf Coast Sand Beaches in Front of Seawalls and Dune Barriers," Report No. 139, Coastal and Ocean Engineering Division, Texas A&M University, College Station, Texas, 1971.
- COX, R.G., "Velocity Forces on Submerged Rocks," Miscellaneous Paper 2-265, U.S. Army Engineer Waterways Experiment Station, Vicksburg, Miss., April 1958.
- CROSS, R.H., and SOLLITT, C.K., "Wave Transmission by Overtopping," Technical Note 15, Department of Civil Engineering, Massachusetts Institute of Technology, Cambridge, Mass., 1971.
- CZERNIAK, M.T., and COLLINS, J.I., "Design Considerations for a Tetrapod Breakwater," *Proceedings of Ports '77*, ASCE, Long Beach, California, pp. 178-195, 1977.
- CZERNIAK, M.T., LORD, C.J., and COLLINS, J.I., "Dolosse Armoring Design for an Offshore Airport," *Coastal Structures '79*, ASCE, Alexandria, Va., pp. 547-561, March 1979.
- DAI, Y.B., and KAMEL, A.M., "Scale Effect Tests for Rubble-Mound Breakwaters," Research Report H-69-2, U. S. Army Engineer Waterways Experiment Station, Vicksburg, Miss., Dec. 1969.
- DANEL, P., CHAPUS, E., and DHAILLIE, R., "Tetrapods and Other Precast Blocks for Breakwaters," *Journal Waterways and Harbors Division*, American Society of Civil Engineers, Vol. 86, No. WW3, Part 1, Sept. 1960, pp. 1-14.
- DARLING, W.D., "Design and Construction of Protective Structure for New Reef Runway, Honolulu International Airport," *Proceedings of the Fifteenth Coastal Engineering Conference*, ASCE, Honolulu, Hawaii, pp. 2589-2603, July 1976.
- DAVIDSON, D.D., "Stability and Transmission Tests of Tribar Breakwater Section Proposed for Monterey Harbor, California," Miscellaneous Paper H-69-11, U. S. Army Engineer Waterways Experiment Station, Vicksburg, Miss., Sept. 1969.
- DEAN, R.G., "Stream Function Representation of Nonlinear Ocean Waves," *Journal of Geophysical Research*, Vol. 70, No. 18, 1965a.
- DEAN, R.G., "Stream Function Wave Theory; Validity and Application," *Coastal Engineering, Santa Barbara Specialty Conference*, ASCE, Ch. 12, 1965b.
- DEAN, R.G., "Evaluation and Development of Water Wave Theories for Engineering Application," SR-1, Vols I and II, U. S. Army Coastal Engineering Research Center, Stock Nos. 008-022-00083-6 and 008-022-00084-6, U. S. Government Printing Office, Washington, D.C., Nov. 1974.
- DEAN, R.G., and AAGAARD, P.M., "Wave Forces: Data Analysis and Engineering Calculation Method," *Journal of Petroleum Technology*, Vol. 22, No. 3, 1970.

- DEAN, R.G., and HARLEMAN, D.R.F., "Interaction of Structures and Waves," Ch. 8, *Estuary & Coastline Hydrodynamics*, A.T. Ippen, ed., McGraw-Hill, New York, 1966.
- DENNY D.F., "Further Experiments on Wave Pressures," *Journal of the Institution of Civil Engineers*, Vol. 35, London, 1951.
- de ROUVILLE, A., BESSON, P., and PETRY, P., "Etat Actuel des Etudes Internationales sur les Efforts dus aux Lames," *Annals des Ponts et Chausees*, Paris, Vol. 108, No. 2, 1938.
- DISKIN, M., VAJDA, M., and AMIR, I., "Piling-Up Behind Low and Submerged Permeable Breakwaters," *Journal of Waterways and Harbors Division*, ASCE, No. WW2, May 1970, pp. 359-372.
- DOMZIG, H., "Wellendruck und druckerzeugender Seegang," *Mitteilunge der Hannoverschen Versuchsanstalt für Grundbau und Wasserbau*, Hannover, West Germany, 1955.
- ECKERT, J.W., "Design of Toe Protection for Coastal Structures," *Proceedings of Coastal Structure '83*, ASCE, Alexandria, Va., pp. 331-341, March 1983.
- ECKERT, J.W., and CALLENDER, G., "Geotechnical Engineering in the Coastal Zone," Technical Report, Coastal Engineering Research Center, U.S. Army Engineer Waterways Experiment Station, Vicksburg, Miss., (in preparation, 1984).
- EVANS, D.J., "Analysis of Wave Force Data," *Journal of Petroleum Technology*, Vol. 22, No. 3, 1970.
- FAGE, A., and WARSAP, J.H., "Effects of Turbulences and Surface Roughness on the Drag of a Circular Cylinder," Aeronautical Research Committee (Air Ministry, Great Britain), RN 1283, October 1929.
- FEUILLET, J., and SABATON, M., "Stability of Rubble-Mound Breakwater," *Proceedings, Seventeenth Coastal Engineering Conference*, Sydney, Australia, March 1980.
- FREEMAN, J.C., and LeMEHAUTE, B., "Wave Breakers on a Beach and Surges on a Dry Bed," *Journal of the Hydraulics Division*, ASCE, Vol. 90, 1964, pp. 187-216.
- GALVIN, C.J., JR., "Horizontal Distance Traveled by a Breaking Wave," National Meeting on Transportation Engineering, ASCE, San Diego, Calif., Feb. 1968.
- GALVIN, C.J., JR., "Breaker Travel and Choice of Design Wave Height," *Journal of the Waterways and Harbors Division*, ASCE, WW2, Vol. 95, Paper 6569, 1969.
- GIKEN KOGYO CO., LTD., "Effective Coastal Protection and River Improvement with Hexaleg-Block Works," Tokyo, Japan, undated.

- GODA, Y., "Reanalysis of Laboratory Data on Wave Transmission over Breakwaters," *Report of the Port and Harbor Research Institute*, Vol. 18, No. 3. Sept. 1969.
- GODA, Y., "A Synthesis of Breaker Indices," *Transactions of the Japanese Society of Civil Engineers*, Vol. 2, Pt. 2, 1970a.
- GODA, Y., "Numerical Experiments on Wave Statistics with Spectral Simulation," *Report of the Port and Harbor Research Institute*, Vol. 9, No.3, Japan, 1970b.
- GODA, Y. "On Wave Groups," *Proceedings Boss '76*, Trondheim, Norway, Vol. I. pp. 115-128, 1976.
- GODA, Y., and ABE, T., "Apparent Coefficient of Partial Reflection of Finite Amplitude Waves," Port and Harbor Research Institute, Japan, 1968.
- GODA, Y., TAKAYAMA, T., and SUZUKI, Y., "Diffraction Diagrams for Directional Random Waves," *Proceedings of the 16th Conference on Coastal Engineering*, Hamburg, West Germany, 1978, pp. 628-650.
- GRESLOU, L., and MAHE, Y., "Etude du coefficient de reflexion d'une houle sur un obstacle constitue par un plan incline," *Proceedings of the Fifth Conference on Coastal Engineering*, ASCE, Grenoble, France, 1954.
- GUNBAK, A., "Rubble Mound Breakwaters," Report No. 1., Division of Port and Ocean Engineering, The University of Trondheim, Trondheim, Norway, 1979.
- HAKKELING B., "New Technique Used in Scheveningen Breakwater Construction," *The Dock and Harbor Authority*, Vol. 52, No. 609, July 1971.
- HALES, L.Z., "Erosion Control of Scour During Construction," HL-80-3, Report 1-3, U.S. Army Engineer Waterways Experiment Station, Vicksburg, Miss., 1980.
- HALL, J.V., and WATTS, G., "Laboratory Investigation of the Vertical Rise of Solitary Waves on Impermeable Slopes," TM-33, U. S. Army Corps of Engineers, Beach Erosion Board, Washington, D.C., Mar. 1953.
- HALL, M.A., "Laboratory Study of Breaking Wave Forces on Piles," TM-106, U. S. Army, Corps of Engineers, Beach Erosion Board, Washington, D. C., Aug. 1958.
- HALLERMEIER, ROBERT J., "Nonlinear Flow of Wave Crests Past a Thin Pile," *Journal of the Waterways, Harbors, and Coastal Engineering Division*, ASCE, Vol. 102, WW4, November 1976, pp. 365-377.
- HEDAR, PER ANDERS, "Rules for the Design of Rock-Fill Breakwaters and Revetment," *21st International Navigation Congress*, Stockholm, Section II, Subject 1, 1965.
- HO, D.V., and MEYER, R.E., "Climb of a Bore on a Beach-(1) Uniform Beach Slope," *Journal of Fluid Mechanics*, Vol. 14, 1962, pp. 305-318.

- HOUGH, B.K., *Basic Soils Engineering*, Ronald Press, New York, 1957.
- HUDSON, R.Y., "Wave Forces on Breakwaters," *Transactions of the American Society of Civil Engineers*, ASCE, Vol. 118, 1953, p. 653.
- HUDSON, R., "Design of Quarry-Stone Cover Layers for Rubble-Mound Breakwaters, Research Report No. 22, U.S. Army Engineer Waterways Experiment Station, Vicksburg, Miss., July 1958.
- HUDSON, R.Y., "Laboratory Investigations of Rubble-Mound Breakwaters," *Proceedings of the American Society of Civil Engineers*, ASCE, Waterways and Harbors Division, Vol. 85, No. WW3, Paper No. 2171, 1959.
- HUDSON, R.Y., "Waves Forces on Rubble-Mound Breakwaters and Jetties," Miscellaneous Paper 2-453, U.S. Army Engineer Waterways Experiment Station, Vicksburg, Miss., 1961a.
- HUDSON, R.Y., "Laboratory Investigation of Rubble-Mound Breakwaters," *Transactions of the American Society of Civil Engineers*, ASCE, Vol. 126, Pt IV, 1961b.
- HUDSON, R.Y., ed., "Concrete Armor Units for Protection Against Wave Attack, Report of Ad Hoc Committee on Artificial Armor Units for Coastal Structures," H-74-2, U.S. Army Engineer Waterways Experiment Station, Vicksburg, Miss., Jan., 1974.
- HUDSON, R.Y., "Reliability of Rubble-Mound Breakwater Stability Models," H-75-5, U.S. Army Engineer Waterways Experiment Station, Vicksburg, Miss., June 1975.
- HUDSON, R.Y., HERMANN, F.A., JR., SAGER, R.A., WHALIN, R.W., KEULEGAN, G.H., CHATHAM, C.E., JR., and HALES, L.Z., "Coastal Hydraulic Models," SR-5, U.S. Army Engineer Waterways Experiment Station, Vicksburg, Miss., May 1979.
- HUDSON, R.Y., and JACKSON, R.A., "Stability of Rubble-Mound Breakwaters," Technical Memorandum 2-365, U.S. Army Engineer Waterways Experiment Station, Vicksburg, Miss., 1953.
- HUDSON, R.Y., and JACKSON, R.A., "Design of Tribar and Tetrapod Cover Layers for Rubble-Mound Breakwaters," Miscellaneous Paper 2-296, U.S. Army Engineer Waterways Experiment Station, Vicksburg, Miss., Jan. 1959
- HUDSON, R.Y., and JACKSON, R.A., "Design of Riprap Cover Layers for Railroad Relocation Fills, Ice Harbor and John Day Lock and Dam Projects; Hydraulic Model Investigation," Miscellaneous Paper 2-465, U.S. Army Engineer Waterways Experiment Station, Vicksburg, Miss., 1962.
- HYDRAULICS RESEARCH STATION, "Breakwater Armour Blocks" (Chart), Wallingford, Oxfordshire, England, 1980.
- IRIBARREN CAVANILLES, R., "A Formula for the Calculation of Rock-Fill Dikes," *Revista de Obras Publicas*, 1938. (Translation in *The Bulletin of the Beach Erosion Board*, Vol. 3, No. 1, Jan. 1949.)

- IRIBARREN CAVANILLES, R., and NOGALES Y OLANO, C., "Generalization of the Formula for Calculation of Rock Fill Dikes and Verification of its Coefficients," *Revista de Obras Publicas*, 1950, (Translation in *The Bulletin of the Beach Erosion Board*, Vol. 5, No. 1, Jan. 1951.)
- IVERSEN, H.W., "Laboratory Study of Breakwaters," Circular No. 521, U.S. National Bureau of Standards, Washington, D.C., 1952a.
- IVERSEN, H.W., "Waves and Breakers in Shoaling Water," *Proceedings of the Third Conference on Coastal Engineering*, ASCE, Council on Wave Research, 1952b.
- JACKSON, R.A., "Designs for Rubble-Mound Breakwater Repair, Morro Bay Harbor, California," Technical Report 2-567, U.S. Army Engineer Waterways Experiment Station, Vicksburg, Miss., 1961.
- JACKSON, R.A., "Stability of Proposed Breakwater, Burns Waterway Harbor, Indiana," Technical Report 2-766, U.S. Army Engineer Waterways Experiment Station, Vicksburg, Miss., Mar. 1967.
- JACKSON, R.A., "Limiting Heights of Breaking and Nonbreaking Waves on Rubble-Mound Breakwaters," Technical Report H-68-3, U.S. Army Engineer Waterways Experiment Station, Vicksburg, Miss., 1968a.
- JACKSON, R.A., "Design of Cover Layers for Rubble-Mound Breakwaters Subjected to Nonbreaking Waves," Research Report No. 2-11, U.S. Army Engineer Waterways Experiment Station, Vicksburg, Miss., 1968b.
- JEN, Y., "Laboratory Study of Inertia Forces on a Pile," *Journal of the Waterways and Harbors Division*, ASCE, No. WW1, 1968.
- JENSEN, O.J., "Breakwater Superstructures," *Proceedings of Coastal Structures '83*, ASCE, Arlington, Va., pp. 272-285, March 1983.
- JOHNSON, R.R., MANSARD, E.P.D., and PLOEG, J., "Effects of Wave Grouping on Breakwater Stability," *Proceedings, 16th International Coastal Engineering Conference*, Paper No. 175, 1978.
- KADIB, A.L., "Beach Profile as Affected by Vertical Walls," Hydraulic Engineering Laboratory, University of California, Berkeley, Calif., 1962, (also in TM-134, U.S. Army, Corps of Engineers, Beach Erosion Board, Washington, D.C., June 1963).
- KAMEL, A.M., "Water Wave Pressures on Seawalls and Breakwaters," Research Report 2-10, U.S. Army Engineer Waterways Experiment Station, Vicksburg, Miss., 1968.
- KEITH, J.M., and SKJEI, R.E., "Engineering and Ecological Evaluation of Artificial-Island Design, Rincon Island, Punta Gorda, California," TM 43, Coastal Engineering Research Center, U.S. Army Engineer Waterways Experiment Station, Vicksburg, Miss., March 1974.

- KELLER, H.B., LEVINE, D.A., and WHITHAM, G.B., "Motion of a Bore Over a Sloping Beach," *Journal of Fluid Mechanics*, Vol. 7, 1960, pp. 302-315.
- KEULEGAN, G.H., and CARPENTER, L.H., "Forces on Cylinders and Plates in an Oscillating Fluid," NBS Report No. 4821, National Bureau of Standards, Washington, D.C., 1956.
- LAIRD, A.D.K., "Water Forces on Flexible, Oscillating Cylinders," *Journal of the Waterways and Harbor Division*, ASCE, Aug. 1962.
- LAIRD, A.D.K., JOHNSON, C.H., and WALKER, R.W., "Water Eddy Forces on Oscillating Cylinders," *Journal of the Hydraulics Division*, ASCE, Nov. 1960.
- LAMB, SIR HORACE, *Hydrodynamics*, Cambridge University Press, 6th ed., 1932.
- LATES, M., and ULUBEANU, M., "L'Emploi Des Blocs Artificiels en Benton du Type 'Stabilopode' aux Dignes de Protection du Port Constantza," *Proceedings, 10th Conference on Coastal Engineering*, Tokyo, Japan, 1966.
- LEE, T.T., "Estuary Inlet Channel Stabilization Study Using a Hydraulic Model," *Proceedings of the Twelfth Coastal Engineering Conference*, ASCE, Washington, D.C., pp. 1117-1136, Sept. 1970.
- LEE, T.T., "Design of Filter System for Rubble-Mound Structures," *Proceedings of the Thirteenth Coastal Engineering Conference*, ASCE, Vancouver, B.C., Canada, pp. 1917-1933, July 1972.
- LEENDERTSE, J.J., "Forces Induced by Breaking Water Waves on A Vertical Wall," Technical Report 092, U.S. Naval Civil Engineering Laboratory, 1961.
- LeMEHAUTE, B., "On Non-Saturated Breakers and the Wave Runup," *Proceedings of the Eighth Conference on Coastal Engineering*, ASCE, Mexico City, Council on Wave Research, 1963, pp. 77-92.
- LILLEVANG, O.V. "Breakwater Subject to Heavy Overtopping; Concept Design, Construction and Experience," *Proceedings of Ports '77*, ASCE, Long Beach, Calif. pp. 61-93, 1977.
- LORDING, P.T., and SCOTT, J.R., "Armor Stability of Overtopped Breakwater," *Journal of Waterways, Harbors and Coastal Engineering Division*, ASCE, Vol. 97, No. WW2, Proceedings Paper 8138, 1971, pp. 341-354.
- MacCAMY, R.C., and FUCHS, R.A., "Wave Forces on Piles: A Diffraction Theory," TM-69, U.S. Army, Corps of Engineers, Beach Erosion Board, Washington, D.C., Dec. 1954.
- MADSEN, O.S., and WHITE, S., "Reflection and Transmission Characteristics of Porous Rubble-Mound Breakwaters," MR 76-5, Coastal Engineering Research Center, U.S. Army Engineer Waterways Experiment Station, Vicksburg, Miss., May 1979.

- MAGOON, O.T., and SCHIMIZU, N., "Use of Dolos Armor Units in Rubble-Mound Structures, e.g., for Conditions in the Arctic," *Proceedings from the First International Conference on Port and Ocean Engineering Under Arctic Conditions*, Vol. II, Technical University of Norway, Trondheim, Norway, 1971, pp. 1089-1108 (also Reprint 1-73, Coastal Engineering Research Center, NTIS 757-973).
- MAGOON, O.T., SLOAN, R.L., and FOOTE, G.L., "Damages to Coastal Structures," *Proceedings of the Fourteenth Coastal Engineering Conference*, ASCE, Copenhagen, Denmark, pp. 1655-1676, June 1974.
- MARKLE, D.G., "Kahului Breakwater Stability Study, Kahului, Maui, Hawaii," Technical Report HL-82-14, U.S. Army Engineer Waterways Experiment Station, Vicksburg, Miss., 1982.
- MARKLE, D.G., and CARVER, R.D., "Breakwater Stability Study, Imperial Beach, California," Technical Report H-77-22, U.S. Army Engineer Waterways Experiment Station, Vicksburg, Miss., Dec. 1977.
- MARKLE, D.G., and DAVIDSON, D.D., "Placed-Stone Stability Tests, Tillamook, Oregon, Technical Report HL-79-16, U.S. Army Engineer Waterways Experiment Station, Vicksburg, Miss., April 1979.
- MARKLE, D.G., and DAVIDSON, D.D., "Effects of Dolos Breakage on the Stability of Rubble-Mound Breakwater Trunks Subjected to Breaking and Nonbreaking Waves with No Overtopping," Technical Report CERC-83-4, U.S. Army Engineer Waterways Experiment Station, Vicksburg, Miss., 1984a.
- MARKLE, D.G., and DAVIDSON, D.D., "Breakage of Concrete Armor Units; Survey of Existing Corps Structures," Miscellaneous Paper CERC-84-2, U.S. Army Engineer Waterways Experiment Station, Vicksburg, Miss., 1984b.
- MERRIFIELD, E.M., "Rubble-Mound Breakwaters--the State-of-the-Art," *The Dock & Harbor Authority*, Vol. LVIII, No. 682, Foxlow Publications Ltd., London, England, pp. 206-207, September 1977.
- MERRIFIELD, E.M., and ZWAMBORN, J.A., "The Economic Value of a New Breakwater Armor Unit, 'Dolos'," *Proceedings of the 10th Conference on Coastal Engineering*, ASCE, Tokyo, Japan, pp. 885-921, 1966.
- METTAM, J.D., "Design of Main Breakwater at Sines Harbor," *Proceedings of the Fifteenth Coastal Engineering Conference*, Honolulu, Hawaii, ASCE, pp. 2499-2518, July 1976.
- MICHE, R., "Mouvements ondulatoires de la mer in profondeur constante ou decroissante," *Annals des Ponts et Chaussées*, Paris, Vol. 114, 1944.
- MILLER, R.L., "Experimental Determination of Runup of Undular and Fully Developed Bores," *Journal of the Geophysical Research*, Vol. 73, 1968, pp. 4497-4510.
- MINIKIN, R.R., "Breaking Waves: A Comment on the Genoa Breakwater," *Dock and Harbour Authority*, London, 1955, pp. 164-165.

- MINIKIN, R.R., *Winds, Waves and Maritime Structures: Studies in Harbor Making and in the Protection of Coasts*, 2nd rev. ed., Griffin, London, 1963, 294 pp.
- MITSUYASU, H., "On the Growth of the Spectrum of Wind-Generated Waves (I)," Research Institute for Applied Mechanics, Kyushu University, Vol. XVI, No. 55, 1968, pp. 459-482.
- MOFFATT and NICHOL, ENGINEERS, "Construction Materials for Coastal Structures," Special Report 10, Coastal Engineering Research Center, U.S. Army Engineer Waterways Experiment Station, Vicksburg, Miss., Feb. 1983.
- MORRISON, J.R., et al., "The Force Exerted by Surface Waves on Piles," *Petroleum Transactions*, 189, TP 2846, 1950.
- MURAKI, Y., "Field Observations of Wave Pressure, Wave Run-up and Oscillation of Breakwater," *Proceedings 10th Conference on Coastal Engineering*, ASCE, Vol. I, 1966, pp. 302-321.
- NAGAI, S., "Shock Pressures Exerted by Breaking Waves on Breakwaters," *Transactions*, ASCE, Vol. 126, Part IV, No. 3261, 1961a.
- NAGAI, S., "Experimental Studies of Specially Shaped Concrete Blocks for Absorbing Wave Energy," *Proceedings 7th Conference on Coastal Engineering*, The Hague, Netherlands, Vol. II, 1961b, pp. 659-673.
- NAGAI, S., "Stable Concrete Blocks on Rubble-Mound Breakwaters," *Proceedings of the American Society of Civil Engineers*, ASCE, Vol. 88, WW3, 1962, pp. 85-113.
- OFFICE, CHIEF OF ENGINEERS, U.S. ARMY, "Retaining Walls," Engineering and Design, EM 1110-2-2502, May 1961. (rev. 1965.)
- OFFICE, CHIEF OF ENGINEERS, U.S. ARMY, "Hydraulic Design of Flood Control Channels," EM 1110-2-1601, Washington, D.C., July 1970.
- OFFICE, CHIEF OF ENGINEERS, U.S. ARMY, "Additional Guidance for Riprap Channel Protection," ETL 1110-2-120, Washington, D.C., May 1971.
- OFFICE, CHIEF OF ENGINEERS U.S. ARMY, "Hydraulic Model Tests of Toskane Armor Units," ETL 1110-2-233, Washington, D.C., 1978.
- OFFICE, CHIEF OF ENGINEERS, U.S. ARMY, "Summary of Placed-Stone Stability Tests: Tillamook, Oregon," ETL 1110-2-242, Washington, D.C., April 1979.
- OFFICE, CHIEF OF ENGINEERS, U.S. ARMY, "Design of Coastal Revetments, Seawalls and Bulkheads," EM 1110-2-1614, Washington, D.C., 1984.
- OUELLET, YVON, "Effect of Irregular Wave Trains on Rubble-Mound Breakwaters," *Journal of the Waterways, Harbors and Coastal Engineering Division*, ASCE, Vol. 98, No. WWI, Proc. Paper 8693, 1972, pp. 1-14.

- PAAPE, A., and WALTHER, A.W., "Akmon Armour Unit for Cover Layers of Rubble-Mound Breakwaters," *Proceedings of the Eighth Conference on Coastal Engineering*, ASCE, Council on Wave Research, 1963.
- PEYTON, H.R., "Ice and Marine Structure," *Ocean Industry Magazine*, Parts 1-3, Mar., Sept., and Dec., 1968.
- PORRAZ, MAURICIO I.L., and MEDINA, R.R., "Mexapod, A New Armor Unit for Breakwaters," Symposium on Technical, Environmental, Socioeconomic, and Regulatory Aspects of Coast Zone Planning and Management, American Society of Civil Engineers, San Francisco, California, March, 1978.
- ROGAN, A.J., "Destruction Criteria for Rubble-Mound Breakwaters," *Proceedings of the 11th Coastal Engineering Conference*, ASCE, London, 1969, pp. 761-778.
- ROSHKO, A., *Journal of Fluid Mechanics*, Vol. 10, 1961., p. 345.
- ROSS, C.W., "Laboratory Study of Shock Pressures of Breaking Waves," TM-59, U.S. Army, Corps of Engineers, Beach Erosion Board, Washington, D.C., Feb. 1955.
- ROSS, C.W., "Large-Scale Tests of Wave Forces on Piling," TM-111, U.S. Army, Corps of Engineers, Beach Erosion Board, Washington, D.C., May 1959.
- ROUSE, H., ED., *Engineering Hydraulics*, Wiley, New York, 1950.
- RUNDGREN, L., "Water Wave Forces," Bulletin No. 54, Royal Institute of Technology, Division of Hydraulics, Stockholm, Sweden, 1958,
- RUSSELL, R.C.H., and INGLIS, C., "The Influence of a Vertical Wall on a Beach in Front of It," *Proceedings of the Minnesota International Hydraulics Convention*, International Association of Hydraulic Research, Minneapolis, 1953.
- SAINFLOU, M., "Treatise on Vertical Breakwaters," *Annals des Ponts et Chaussées*, Paris, 1928. (Translated by W.J. Yardoff, U.S. Army Corps of Engineers.)
- SAVAGE, R.P., "Laboratory Study of Wave Energy Losses by Bottom Friction and Percolation," TM-31, U.S. Army, Corps of Engineers, Beach Erosion Board, Washington, D.C., 1953.
- SAVAGE, R.P., "Wave Runup on Roughened and Permeable Slopes," *Journals of the Waterways and Harbors Division*, ASCE, WW3, Paper No. 1640, 1958.
- SAVILLE, R., JR., "Laboratory Data on Wave Runup and Overtopping on Shore Structures," TM-64, U.S. Army, Corps of Engineers, Beach Erosion Board, Washington, D.C., Oct. 1955.
- SAVILLE, T., JR., "Wave Runup on Shore Structures," *Journal of the Waterways and Harbors Division*, WW2, Vol. 82, 1956.

- SAVILLE, T., JR., "Wave Runup on Composite Slopes," *Proceedings of the Sixth Conference on Coastal Engineering*, ASCE, Council on Wave Research, 1958a.
- SAVILLE, T., JR., "Large-Scale Model Tests of Wave Runup and Overtopping, Lake Okeechobee Levee Sections," Unpublished Manuscript, U.S. Army, Corps of Engineers, Beach Erosion Board, Washington, D.C., 1958b.
- SAVILLE, T., JR., "An Approximation of the Wave Runup Frequency Distribution," *Proceedings of the Eighth Conference on Coastal Engineering*, ASCE, Mexico City, Council on Wave Research, 1962, pp. 48-59.
- SAVILLE, T., JR., "Hydraulic Model Study of Transmission of Wave Energy by Low-Crested Breakwater," Unpublished Memo for Record, U.S. Army, Corps of Engineers, Beach Erosion Board, Washington, D.C., Aug. 1963.
- SAVILLE, T. JR., and CALDWELL, J.M., "Experimental Study of Wave Overtopping on Shore Structures," *Proceedings of the Minnesota International Hydraulics Convention*, Minneapolis, Minn., International Association of Hydraulic Research, 1953.
- SEELIG, W., "Estimation of Wave Transmission Coefficients for Permeable Breakwaters," CETA No. 79-6, Coastal Engineering Research Center, U.S. Army Engineer Waterways Experiment Station, Vicksburg, Miss., October 1979.
- SEELIG, W., "Two-Dimensional Tests of Wave Transmission and Reflection Characteristics of Laboratory Breakwaters," TR 80-1, Coastal Engineering Research Center, U.S. Army Engineer Waterways Experiment Station, Vicksburg, Miss., June 1980a.
- SEELIG, W., "Estimation of Wave Transmission Coefficients for Overtopping of Impermeable Breakwaters," CETA No. 80-7, Coastal Engineering Research Center, U.S. Army Engineer Waterways Experiment Station, Vicksburg, Miss., Dec. 1980b.
- SEELIG, W., and AHRENS, J., "Estimation of Wave Reflection and Energy Dissipation Coefficients for Beaches, Revetments, and Breakwaters," TP No. 81-1, Coastal Engineering Research Center, U.S. Army Engineer Waterways Experiment Station, Vicksburg, Miss., Feb. 1981.
- SEELIG, W., and WALTON, T., JR., "Estimation of Flow Through Offshore Breakwater Gaps Generated by Wave Overtopping," CETA No. 80-8, Coastal Engineering Research Center, U.S. Army Engineer Waterways Experiment Station, Vicksburg, Miss., Dec. 1980.
- SHEN, M.C., and MEYER, R.E., "Climb of a Bore on a Beach, (3) Runup," *Journal of Fluid Mechanics*, Vol. 16, 1963, pp. 113-125.
- SILVESTER, R., *Coastal Engineering*, Vol. I, Elsevier Scientific Publication Co., New York, 1974.
- SINGH, K.Y., "Stabit, A New Armour Block," *Proceedings of the 11th Conference on Coastal Engineering*, ASCE, Vol. II, 1968.

- SKJELBREIA, L., et al., "Loading on Cylindrical Pilings Due to the Action of Ocean Waves," Contract NBy-3196, 4 Volumes, U.S. Naval Civil Engineering Laboratory, 1960.
- SORENSEN, R., and SEELIG, W., "Laboratory Tests of Wave Transmission for a Smooth, Impermeable Breakwater," MFR, Memo for Record, Coastal Engineering Research Center, U.S. Waterways Experiment Station, Vicksburg, Miss., Nov. 1981.
- SOWERS, G.B., and SOWERS, G.F., *Introductory Soil Mechanics and Foundations*, 3d ed., MacMillan, New York, 1970.
- STOA, P.N., "Reanalysis of Wave Runup on Structures and Beaches," Technical Paper 78-2, Coastal Engineering Research Center, U.S. Army Engineer Waterways Experiment Station, Vicksburg, Miss., 1978.
- STRIEGL, A.R., "Ice on the Great Lakes and its Engineering Problems," *Presented at a Joint Conference of the American Meteorological Society and the American Geophysical Union*, 1952.
- SVEE, R.A., TRÆTTEBERG, A., and TØRUM, A., "The Stability Properties of the Svee-Block," *Proceedings of the 21st International Navigation Congress*, Sec. 11, Subject 1, Stockholm, 1965.
- SVERDRUP, H.U., JOHNSON, M.W., and FLEMING, R.H., *The Oceans; Their Physics, Chemistry, and General Biology*, Prentice-Hall, Englewood Cliffs, N.J., 1942.
- TANAKA, S., et al., "Experimental Report of Hollow Tetrahedron Blocks," Chisui Kogyo, Co., Ltd., Osaka, Japan, 1966.
- TANIMOTO, K., YAG YU, T., and GODA, Y., "Irregular Wave Tests for Composite Breakwater Foundations," *Proceedings, 18th International Conference on Coastal Engineering*, Capetown, South Africa, 14-19, Nov. 1982.
- TERZAGHI, K., and PECK, R.B., *Soil Mechanics in Engineering Practice*, Wiley, New York, 1967.
- THIRRIOT, C., LONGREE, W.D., AND BARTHET, H., "Sur la Perte de Charge due a un Obstacle en Mouvement Periodique," *Proceedings of the 14th Congress of the International Association of Hydraulic Research*, 1971.
- THOMSEN, A.L., WHOLT, P.E., and HARRISON, A.S., "Riprap Stability on Earth Embankments Tested in Large- and Small-Scale Wave Tanks," TM-37, U.S. Army, Corps of Engineers, Coastal Engineering Research Center, Washington, D.C., June 1972.
- THOMPSON, E.F., "Nonrandom Behavior in Field Wave Spectra and its Effect on Grouping of High Waves," Ph.D. Thesis, George Washington University, Washington, D.C., Feb. 1981.
- TØRUM, A., MATHIESEN, B., and ESCUTIA, R., "Reliability of Breakwater Model Tests," *Proceedings of Coastal Structures '79 Conference*, Alexandria, Va., March 1979.

- U.S. ARMY ENGINEER DISTRICT, GALVESTON, "Galveston Seawall, Galveston, Texas: Concrete Toe Protection," Letter, SWGED-DS, dated 14 Feb. 1972, to Office, Chief of Engineers, HQDA (DAEN-CWHE-H).
- U.S. ARMY ENGINEER WATERWAYS EXPERIMENT STATION, *Handbook for Concrete and Cement*, Vicksburg, Miss., 1949 (updated yearly).
- Van OORSCHOT, J.H., and d'ANGREMOND, K., "The Effect of Wave Energy Spectra on Wave Runup," *Proceedings of the 11th Conference on Coastal Engineering*, ASCE, 1968, pp. 888-900.
- Van WEELE, B., "Beach Scour Due to Wave Action on Seawalls," Report No. 45, Fritz Engineering Laboratory, Lehigh University, Bethlehem, Pa., 1965.
- WATKINS, L.L., "Corrosion and Protection of Steel Piling in Seawater," TM-27, U.S. Army, Corps of Engineers, Coastal Engineering Research Center, Washington, D.C., May 1969.
- WEGGEL, J.R., "Wave Overtopping Equation," *Proceedings of the the 15th Coastal Engineering Conference*, ASCE, Honolulu, Hawaii, 1976, pp. 2737-2755.
- WEGGEL, J.R., and MAXWELL, W.H.C., "Numerical Model for Wave Pressure Distributions," *Journal of the Waterways, Harbors and Coastal Engineering Division*, ASCE, Vol. 96, No. WW3, Paper No. 7467, 1970a, pp. 623-642.
- WEGGEL, J.R., and MAXWELL, W.H.C., "Experimental Study of Breaking Wave Pressures," *Preprint Volume of the Offshore Technology Conference*, Paper No. OTC 1244, 1970b.
- WHEELER, J.D., "Method for Calculating Forces Produced by Irregular Waves," *Journal of Petroleum Technology*, Vol. 22, No. 3, 1970.
- WIEGEL, R.L., *Oceanographical Engineering*, Prentice-Hall, Inc., Englewood Cliffs, New Jersey, 1964.
- WIEGEL, R.L., BEEBE, K.E., and MOON, J., "Ocean Wave Forces on Circular Cylindrical Piles," *Journal of the Hydraulics Division*, ASCE, Vol. 83, No. HY2, 1957.
- WIESELSBERGER, C., *Zeitschrift für Flugtechnik und Motorluftschiffahrt*, Vol. 5, p. 142, 1914.
- WHILLOCK, A.F., "Stability of Dolos Blocks Under Oblique Wave Attack," Report No. IT 159, Hydraulics Research Station, Wallingford, Oxon, England, Apr. 1977.
- WILKINSON, A.R., and ALLSOP, N.W.H., "Hollow Block Breakwater Armour Units," *Coastal Structures '83*, American Society of Civil Engineers, Arlington, Virginia, 1983, pp. 208-221.
- WILSON, B.W., "Analysis of Wave Forces on a 30-Inch-Diameter Pile Under Confused Sea Conditions," U.S. Army, Corps of Engineers, Coastal Engineering Research Center, Technical Memo No. 15, Washington, D.C., 1965.

- WILSON, J.R., and BAIRD, W.F., "A Discussion of Some Measured Wave Data," *Proceedings, 13th International Coastal Engineering Conference, 1972*, pp. 113-130.
- ZUMBERG, J.H., and WILSON, J.T., "Effects of Ice on Shore Development," *Proceedings of the Fourth Conference on Coastal Engineering, Chicago Illinois*, pp. 201-206, 1953.
- ZWAMBORN, J.A., and Van NIEKERK, M., "Survey of Dolos Structures," CSIR Research Report 385, Council for Scientific and Industrial Research, National Research Institute of Oceanology, Coastal Engineering and Hydraulics Division, Stellenbosch, South Africa, March 1981.
- ZWAMBORN, J.A., and Van NIEKERK, M., "Additional Model Tests--Dolos Packing Density and Effect of Relative Block Density," CSIR Research Report 554, Council for Scientific And Industrial Research, National Research Institute for Oceanology, Coastal Engineering and Hydraulics Division, Stellenbosch, South Africa, July 1982.

BIBLIOGRAPHY

- AHRENS, J., "Irregular Wave Runup," *Proceedings of the Coastal Structures '79 Conference*, American Society of Civil Engineers, 1979, pp. 998-1019.
- BATTJES, J.A., "Runup Distributions of Waves Breaking on Sloping Walls," Report, Department of Civil Engineering, Delft, The Netherlands, 1969.
- BRETSCHNEIDER, C.L., "On the Probability Distribution of Wave Force and an Introduction to the Correlation Drag Coefficient and the Correlation Inertial Coefficient," *Coastal Engineering, Santa Barbara Specialty Conference*, ASCE, 1965.
- BRODERICK L., "Riprap Stability, A Progress Report," *Coastal Structures '83*, ASCE, Arlington, Virginia, 1983.
- CARVER, R.D., "Stability of Rubble-Mound Breakwater, Lahaina Harbor, Hawaii," Miscellaneous Paper H-768, U.S. Army Engineer Waterways Experiment Station, Vicksburg, Miss., April 1976.
- DAI, Y.B., and JACKSON, R.A., "Designs for Rubble-Mound Breakwaters, Dana Point Harbor, California," Technical Report 2-725, U. S. Army Engineer Waterways Experiment Station, Vicksburg, Miss., June 1966.
- DANEL, P., and GRESLOU, L., "The Tetrapod," *Proceedings of the Eighth Conference on Coastal Engineering*, ASCE, Council on Wave Research, The Engineering Foundation, 1963.
- DAVIDSON, D., "Stability and Transmission Tests of Tribar Breakwater Section Proposed for Monterey Harbor, California," MP H-69-11, U.S. Army Engineer Waterways Experiment Station, Vicksburg, Miss., Sept. 1969.
- DAVIDSON, D.D., "Proposed Jetty-Head Repair Sections, Humboldt Bay, California," Technical Report H-71-8, U. S. Army Engineer Waterways Experiment Station, Vicksburg, Miss., 1971.
- de CASTRO, D.E., "Diques de escollera (Design of Rock-Fill Dikes)," *Revista de Obras Publicas*, Vol. 80, 1933.
- DICK, T.M., "On Solid and Permeable Submerged Breakwaters," C.E. Research Report No. 59, Department of Civil Engineering, Queen's University, Kingston, Ontario, 1968.
- ERGIN, A., and PORA, S., "Irregular Wave Action on Rubble-Mound Breakwaters," *Journal of the Waterways, Harbors and Coastal Engineering Division*, ASCE, Vol. 97, No. WW2, Proc. Paper 8114, 1971, pp. 279-293.
- FRANZIUS, L., "Wirkung und Wirtschaftlichkeit von Rauheckwereden im Hinblick auf den Wellenauflauf," *Mitteilungen des Franzius-Instituts für Grund- und Wasserbau der TH Hannover*, Heft 25, 1965, pp 149-268 (in German).
- FUNKE, E.R., and E.P.D. MANSARD, "On the Synthesis of Realistic Sea States," Hydraulics Laboratory Technical Report LTR-HY-66, National Research Council of Canada, 1979.

- GODA, Y., "Numerical Experiments on Wave Statistics with Spectral Simulation," *Report of the Port and Harbor Research Institute*, Vol. 9, No. 3, 1970.
- GODA, Y., "The Observed Joint Distribution of Periods and Heights of Sea Waves," *Proceedings of the 16th Conference on Coastal Engineering*, 1978.
- GODA, Y., and SUZUKI, Y., "Estimation of Incident and Reflected Waves in Random Wave Experiments," *Proceedings of the 15th Coastal Engineering Conference*, Vol. 1, Ch. 48, 1976, pp. 828-845.
- GODA, Y., TAKEDA, H., and MORIYA, Y., "Laboratory Investigation of Wave Transmission over Breakwaters," *Report of the Port and Harbor Research Institute*, No. 13, Apr. 1967.
- HALL, W.C., and HALL, J.V., "A Model Study of the Effect of Submerged Breakwaters on Wave Action," TM-1, U.S. Army, Corps of Engineers, Beach Erosion Board, Washington, D.C., May 1940.
- HENSEN, W., "Modellversuche über den Wellenaufwurf an Seedeichen im Wattengebiet," *Mitteilungen der Hannoverschen Versuchsanstalt für Grundbau und Wasserbau*, Franzius-Institut, Hannover, West Germany, 1954.
- HUDSON, E., et al., "Coastal Hydraulic Models," Coastal Engineering Research Center, SR 5, U.S. Army Engineer Waterways Experiment Station, Vicksburg, Miss., May 1979.
- HUDSON, R.Y., and JACKSON, R.A., "Design of Tetrapod Cover Layer for a Rubble-Mound Breakwater, Crescent City Harbor, Crescent City, Calif.," Technical Memorandum 2-413, U.S. Army Engineer Waterways Experiment Station, Vicksburg, Miss., 1955.
- HUDSON, R.Y., and JACKSON, R.A., "Stability Tests of Proposed Rubble-Mound Breakwaters, Nassau Harbor, Bahamas," Miscellaneous Paper No. 2-799, U.S. Army Engineer Waterways Experiment Station, Vicksburg, Miss., Mar. 1966.
- IPPEN, A.T., ed., *Estuary and Coastline Hydrodynamics*, McGraw-Hill, New York, 1966.
- IRIBARREN CANVANILLES, R., and NOGALES Y OLANO, C., "Report on Breakwaters," *18th International Navigation Congress*, Ocean Navigation Section, Question 1, Rome, 1953.
- JACKSON, R.A., "Design of Quadripod Cover Layers for Rubble-Mound Breakwaters," Miscellaneous Paper 2-372, U.S. Army Engineer Waterways Experiment Station, Vicksburg, Miss., 1960.
- JACKSON, R.A., "Design for Rubble-Mound Breakwater Construction, Tsoying Harbor, Taiwan," Technical Report 2-640, U.S. Army Engineer Waterways Experiment Station, Vicksburg, Miss., 1964a.
- JACKSON, R.A., "Designs for Rubble-Mound Breakwaters Repair, Kahului Harbor, Maui, Hawaii," Technical Report 2-644, U.S. Army Engineer Waterways Experiment Station, Vicksburg, Miss., 1964b.

- JACKSON, R.A., "Stability of Rubble-Mound Breakwaters, Nassau Harbor, Nassau, New Providence, Bahamas," Technical Report 2-697, U.S. Army Engineer Waterways Experiment Station, Vicksburg, Miss., 1965.
- JACKSON, R.A., "Designs for Rubble-Mound Breakwater, Noyo Harbor, California," Miscellaneous Paper 2-841, U.S. Army Engineer Waterways Experiment Station, Vicksburg, Miss., Aug. 1966.
- JACKSON, R.A., HUDSON, R.Y., and HOUSLEY, J.G., "Designs for Rubble-Mound Breakwater Repairs, Nawiliwili Harbor, Nawiliwili, Hawaii," Miscellaneous Paper No. 2-377, U.S. Army Engineer Waterways Experiment Station, Vicksburg, Miss., 1960.
- JEFFREYS, H., "Note on the Offshore Bar Problems and Reflection from a Bar," Wave Report No. 3, Great Britain Ministry of Supply, 1944.
- JOHNSON, J.W., FUCHS, R.A., and MORISON, J.R., "The Damping Action of Submerged Breakwaters," *Transactions of the American Geophysical Union*, Vol. 32, No. 5, 1951, pp. 704-718.
- KATO, J., and UEKITA, Y., "On the Wave Damping Effect of Block Mound Breakwater," *Transactions of the Japan Society of Civil Engineers*, Vol. 1, Part 1, 1969.
- KNAJES, R.Ya., "Protective Structures of Breakwater Type, and the Movement of Material on Sandy Shores," *Izn., Adkad Nauk, Latv. SSR*, 7(36).
- LAMARRE, P., "Water Wave Transmission by Overtopping of an Impermeable Breakwater," M.S. Thesis, Department of Civil Engineering, Massachusetts Institute of Technology, Cambridge, Mass., Sept. 1967.
- LAMBE, T.W., and WHITMAN, R.V., *Soil Mechanics*, Series in Soil Engineering, Wiley, New York, 1969.
- LEMEHAUTE, B., "Periodical Gravity Wave on a Discontinuity," *Journal of the Hydraulics Division*, ASCE, Vol. 86, No. HY 9, Part 1, 1960, pp. 11-41.
- LEMEHAUTE, B., "An Introduction to Hydrodynamics and Water Waves," Report No. ERL 118-POL3-1&2, U.S. Department of Commerce, Environmental Science Services Administration, Washington, D.C., July 1969.
- NAGAI, S., "Stable Concrete Blocks on Rubble-Mound Breakwaters," *Journal, Waterways and Harbors Division*, American Society of Civil Engineers, Vol. 88, No. WW3, Aug. 1962, pp. 85-115.
- NAKAMURA, M., SHIRAIISHI, H., and SASAKI, Y., "Wave Damping Effect of Submerged Dike," *Proceedings of the 10th Conference on Coastal Engineering*, ASCE, Tokyo, Vol. 1, Ch. 17, 1966, pp. 254-267.
- PALMER, R.Q., "Breakwaters in the Hawaiian Islands," *Proceedings of the American Society of Civil Engineers*, Waterways and Harbors Division, Vol. 86, No. WW2, Paper No. 2507, 1960.

- PECK, R.B., HANSON, W.E., and THORNBURN, T.H., *Foundation Engineering*, Wiley, New York, 1967.
- PRIEST, M.S. "Reduction of Wave Height by Submerged Offshore Structures," Bulletin No. 34, Alabama Polytechnic Institute, Engineering Experiment Station, Auburn, Alabama, 1958.
- REID, R.O., and BRETSCHEIDER, C.L., "The Design Wave in Deep or Shallow Water, Storm Tide, and Forces on Vertical Piling and Large Submerged Objects," Department of Oceanography, Texas A&M University, College Station, Texas, 1953.
- ROLLINGS, A.P. "Stability of Crescent City Harbor Breakwater, Crescent City, California," Miscellaneous Paper 2-171, U.S. Army Engineer Waterways Experiment Station, Vicksburg, Miss., 1956.
- RYE, H., "Ocean Wave Groups," Report URA-82-18, Marine Technology Center, Trondheim, Norway, Nov. 1981.
- SAVILLE, T., JR., "Discussion: Laboratory Investigation of Rubble-Mound Breakwaters by R.Y. Hudson," *Journal of the Waterways and Harbors Division*, WW3, Vol. 86, 1960, p. 151.
- SAVILLE, T., Jr., GARCIA, W.J., JR., and LEE, C.E., "Development of Breakwater Design," *Proceedings of the 21st International Navigation Congress*, Sec. 11, Subject 1, "Breakwaters with Vertical and Sloping Faces," Stockholm, 1965.
- SAVILLE, T., JR., McCLENDON, E.W., and COCHRAN, L.L., "Freeboard Allowances for Waves on Inland Reservoirs," *Journal of the Waterways and Harbors Division*, ASCE, Vol. 88, No. WW2, May 1962, pp. 93-124.
- SEELIG, W.N., "A Simplified Method for Determining Vertical Breakwater Crest Elevation Considering the Wave Height Transmitted by Overtopping," CDM No. 76-1, Coastal Engineering Research Center, U.S. Army Engineer Waterways Experiment Station, Vicksburg, Miss., May 1976.
- U.S. ARMY ENGINEER WATERWAYS EXPERIMENT STATION, "Stability of Rubble-Mound Breakwaters," Technical Memorandum No. 2-365, Vicksburg, Miss., 1953.
- WASSING, F., "Model Investigation on Wave Runup Carried Out in the Netherlands During the Past Twenty Years," *Proceedings of the Sixth Conference on Coastal Engineering*, ASCE, Council on Wave Research, 1957.
- WEGGEL, J.R., "The Impact Pressures of Breaking Water Waves," Ph.D. Thesis presented to the University of Illinois, Urbana, Illinois, (unpublished, available through University Microfilms, Ann Arbor, Michigan 1968).
- WEGGEL, J.R., "Maximum Breaker Height," *Journal of the Waterways, Harbors and Coastal Engineering Division*, ASCE, Vol. 98, No. WW4, Paper 9384, 1972.
- WEGGEL, J.R., "Maximum Breaker Height for Design," *Proceedings of the 13th Conference on Coastal Engineering*, Vancouver, B.C., 1973.

CHAPTER 8

Engineering Analysis: Case Study



Redondo-Malaga Cove, California, 23 January 1973

CHAPTER 8

ENGINEERING ANALYSIS: CASE STUDY

	Page
I INTRODUCTION	8-1
II STATEMENT OF PROBLEM.....	8-1
III PHYSICAL ENVIRONMENT.....	8-1
1. Site Description.....	8-1
2. Water Levels and Currents--Storm Surge and Astronomical Tides..	8-7
a. Design Hurricanes.....	8-7
b. Estimate of Storm Surge.....	8-9
c. Observed Water Level Data, Breakwater Harbor, Lewes, Delaware.....	8-10
d. Predicted Astronomical Tides.....	8-12
e. Design Water Level Summary.....	8-12
3. Wave Conditions.....	8-12
a. Wave Conditions on Bay Side of Island.....	8-12
b. Wave Conditions on Ocean Side of Island.....	8-26
IV PRELIMINARY DESIGN.....	8-46
1. Selection of Design Waves and Water Levels.....	8-46
a. Water Levels.....	8-46
b. Wave Conditions on Bay Side of Island.....	8-47
c. Wave Conditions on Ocean Side of Island.....	8-47
2. Revetment Design: Ocean Side of Island.....	8-47
a. Type of Wave Action.....	8-47
b. Selection Between Alternative Designs.....	8-47
3. Diffraction Analysis: Diffraction Around Breakwater.....	8-74
4. Preliminary Design of Quay Wall Caisson.....	8-75
a. Nonbreaking Wave Forces on Caisson.....	8-76
b. Stability Computations.....	8-81
c. Caisson Stability After Backfilling.....	8-84
d. Soil Bearing Pressure.....	8-85
e. Summary.....	8-85
V COMPUTATION OF POTENTIAL LONGSHORE TRANSPORT.....	8-85
1. Deepwater Wave Angle (α_o)	8-85
2. Calculation of Average F (α_o)	8-87
3. Potential Longshore Transport Computed by Energy Flux Method..	8-89

CONTENTS (Continued)

	Page
VI BEACHFILL REQUIREMENTS.....	8-90
1. Material Characteristics.....	8-91
a. Native Sand.....	8-91
b. Borrow--Source A.....	8-91
c. Borrow--Source B.....	8-91
2. Evaluation of Borrow Material.....	8-91
3. Required Volume of Fill.....	8-92
LITERATURE CITED.....	8-93

CHAPTER 8

ENGINEERING ANALYSIS: CASE STUDY

I. INTRODUCTION

This chapter presents as examples of the techniques presented in this manual a series of calculations for the preliminary design of a hypothetical offshore island in the vicinity of Delaware Bay. The problem serves to illustrate the interrelationships among many types of problems encountered in coastal engineering. The text progresses from development of the physical environment through a preliminary design of several elements of the proposed structure.

For brevity, the design calculations are incomplete; however, when necessary, the nature of additional work required to complete the design is indicated. It should be pointed out that a project of the scope illustrated here would require extensive model testing to verify and supplement the analysis. The design and analysis of such tests is beyond the scope of this manual. In addition, extensive field investigations at the island site would be required to establish the physical environment. These studies would include a determination of engineering and geological characteristics of local sediments, as well as measurement of waves and currents. The results of these studies would then have to be evaluated before beginning a final design.

While actual data for the Delaware Bay site were used when available, specific numbers used in the calculations should not be construed as directly applicable to other design problems in the Delaware Bay area.

II. STATEMENT OF PROBLEM

A 300-acre artificial offshore island is proposed in the Atlantic Ocean just outside the mouth of Delaware Bay. The following are required: (1) characterization of the physical environment at the proposed island site and (2) a preliminary design for the island. Reference is made throughout this chapter to appropriate sections of the Shore Protection Manual.

III. PHYSICAL ENVIRONMENT

1. Site Description.

Figures 8-1 through 8-5 present information on the general physical conditions at the proposed island site. Site plans showing the island location, surrounding shorelines, and bathymetry are given.

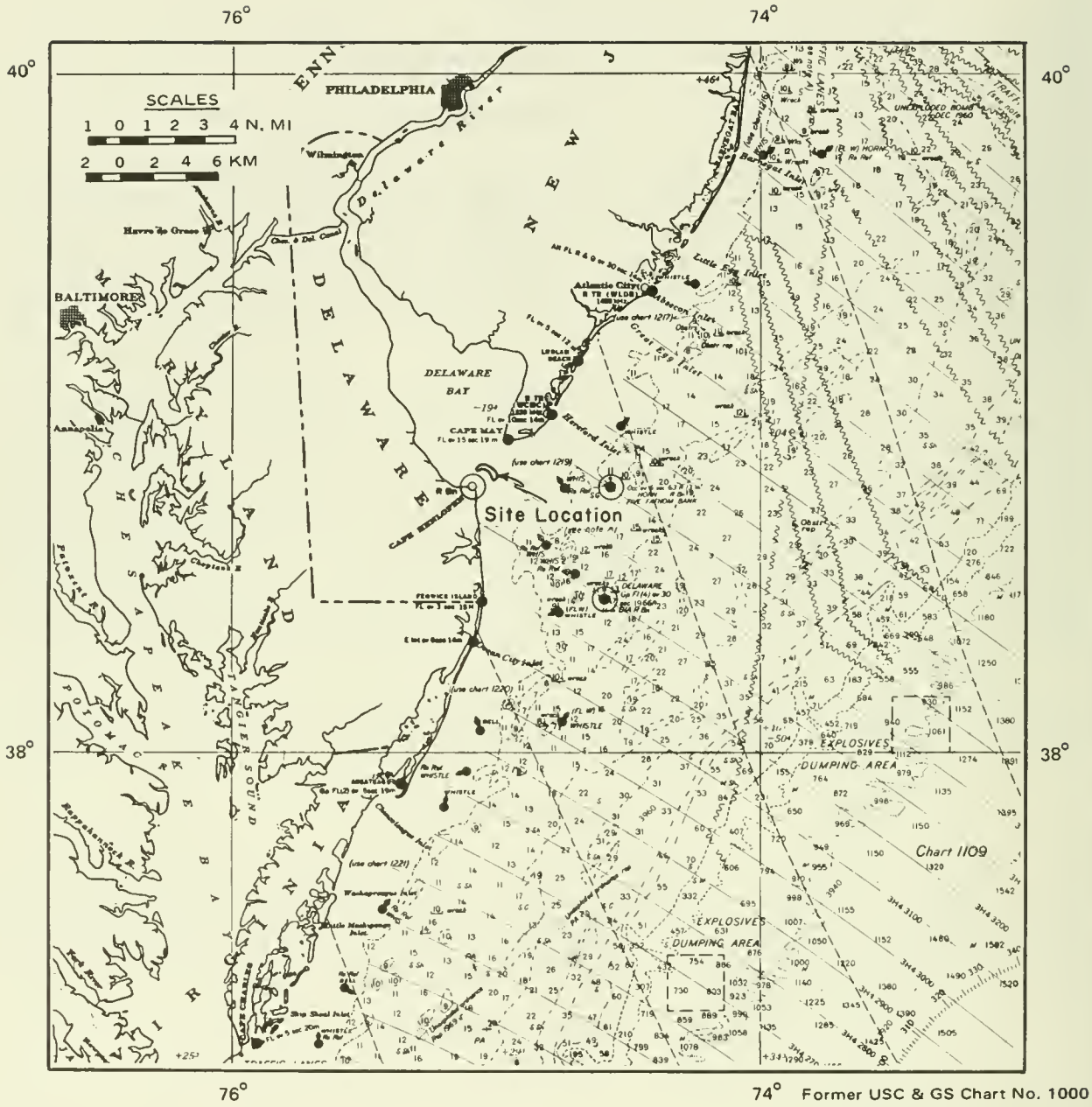

Figure 8-1. Location plan, offshore island.

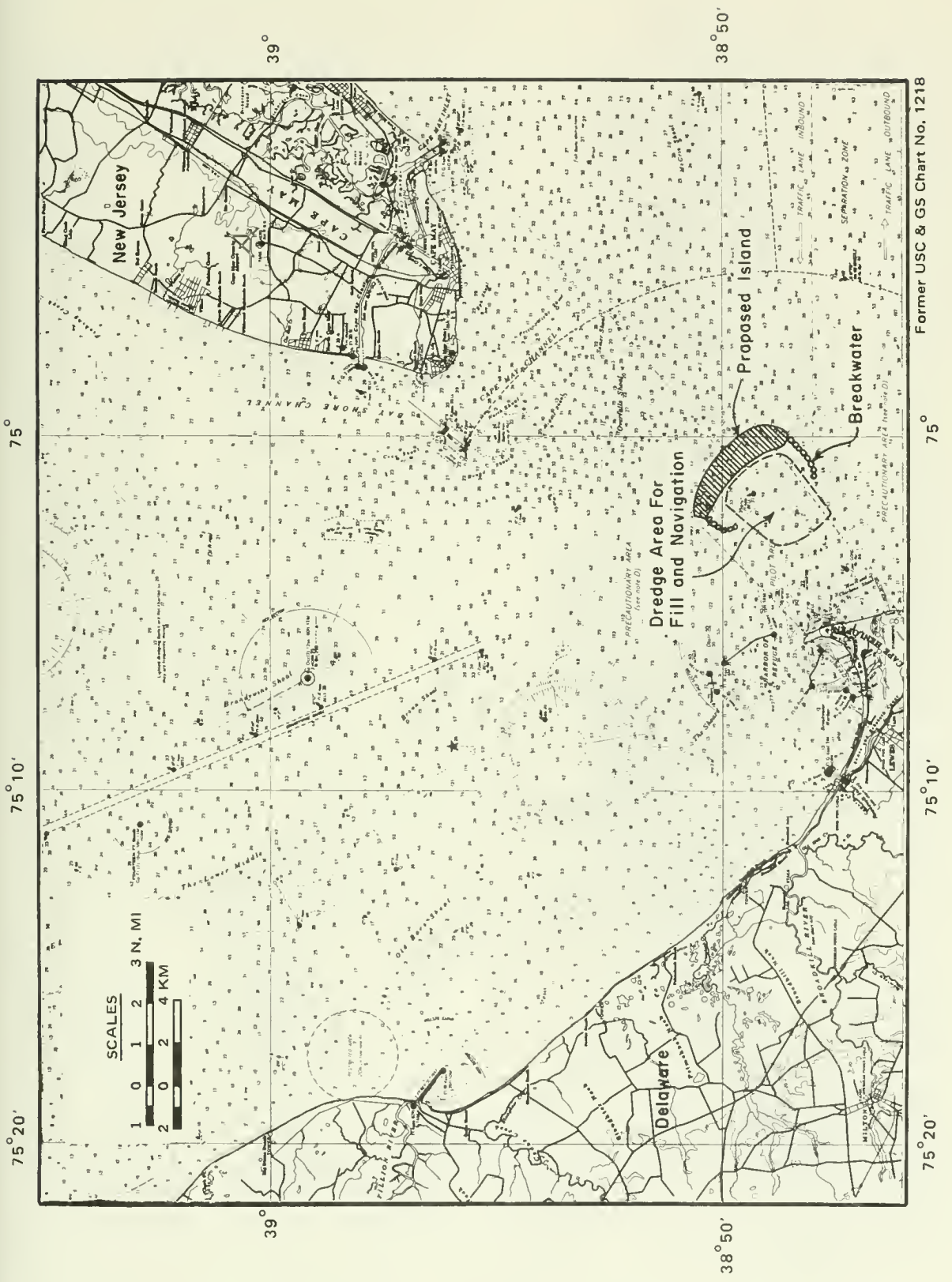
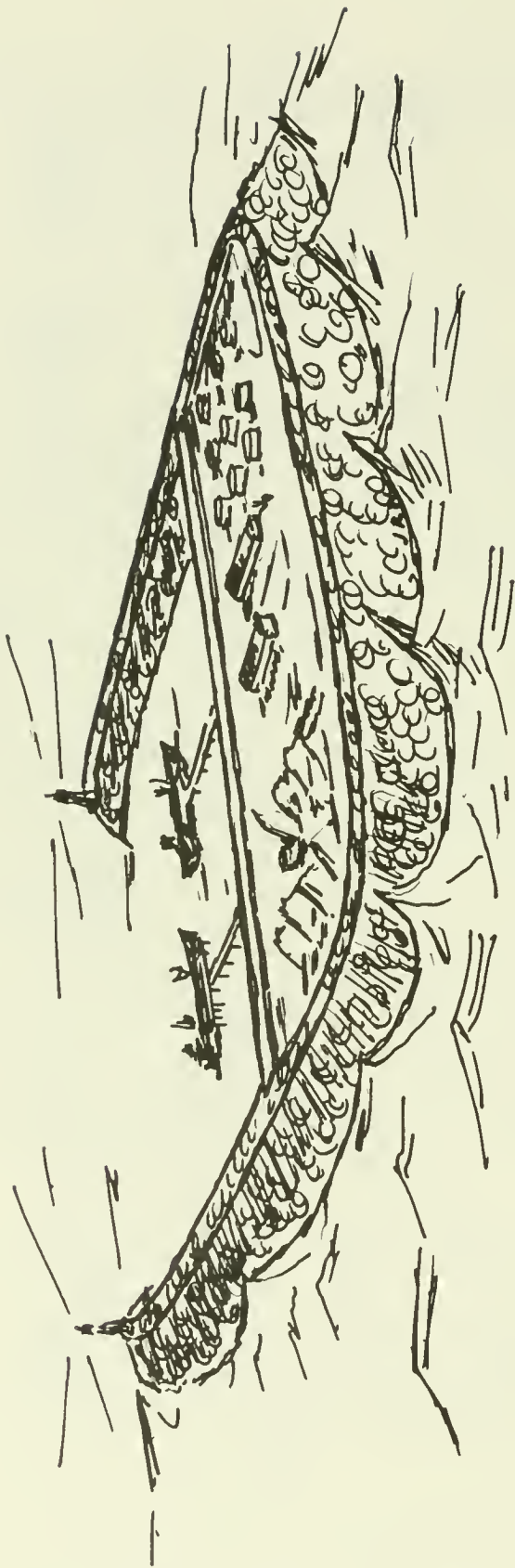
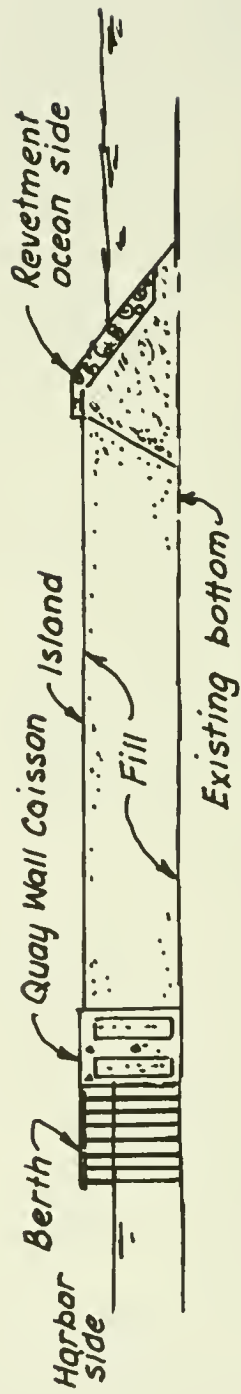

Figure 8-2. Site plan, offshore island.



View Looking Northwest



Section through Island

Figure 8-3. Perspective view and section through island.

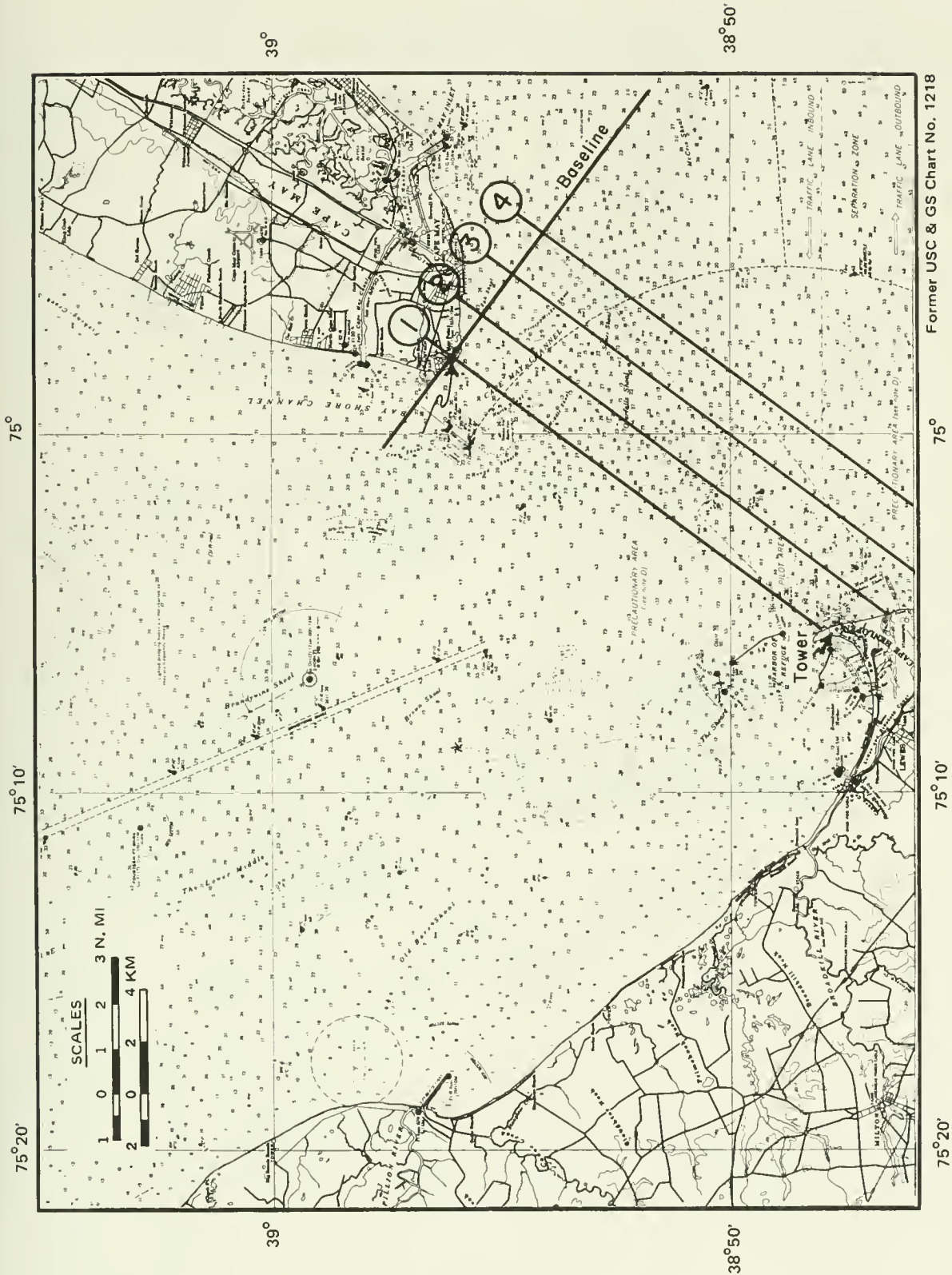

Former USC & GS Chart No. 1218

Figure 8-4. Location of bottom profiles.

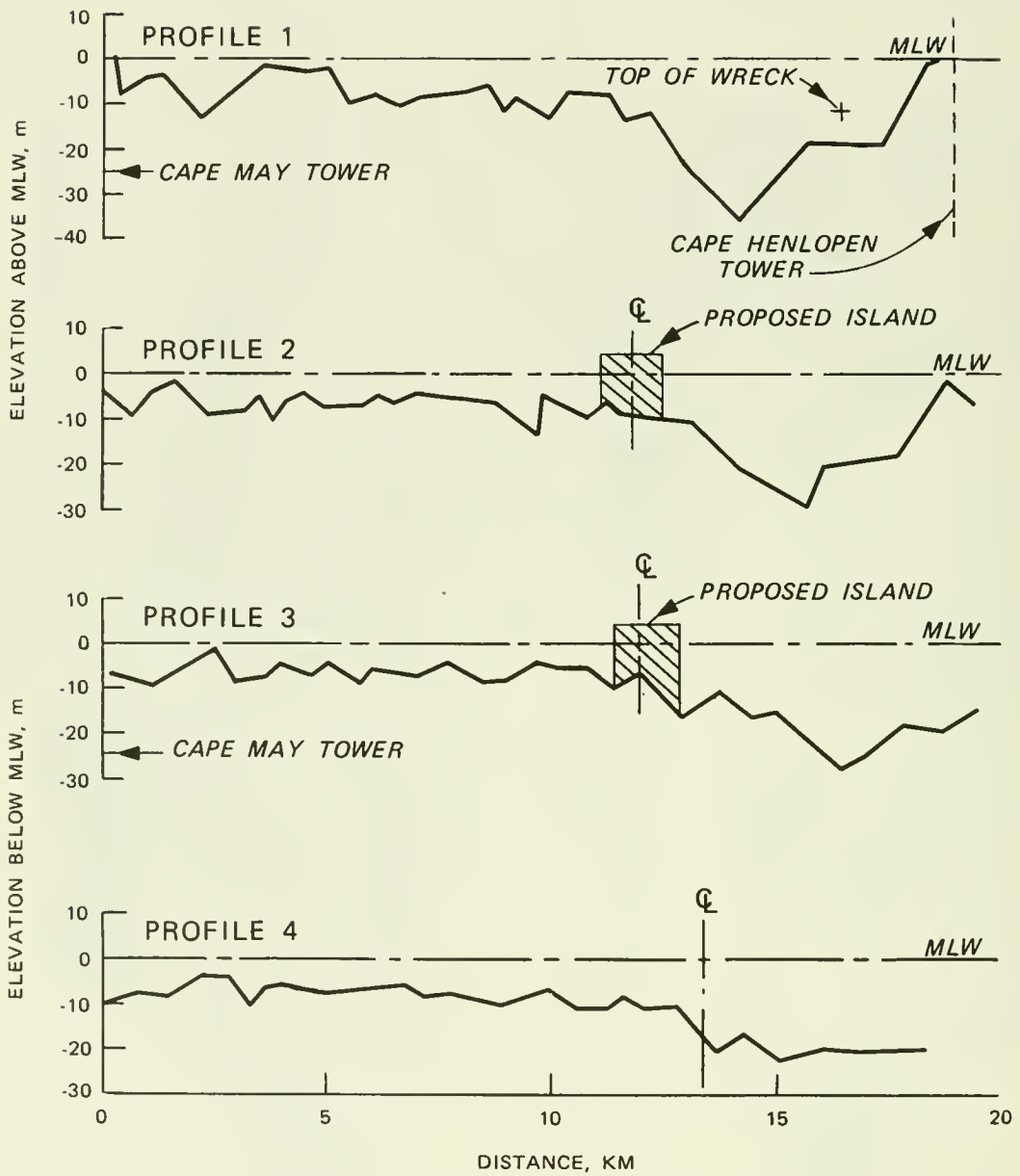

Figure 8-5. Bottom profiles through island site.

2. Water Levels and Currents--Storm Surge and Astronomical Tides.

The following calculations establish design water levels at the island site using the methods of Chapter 3 and supplemented by data for the Delaware Bay area given in Bretschneider (1959) and U.S. National Weather Service (formerly U.S. Weather Bureau) (1957) .

a. Design Hurricanes. For illustrative purposes use hurricanes "A" and "B" given by Bretschneider (1959).

Hurricane A

$$\text{Radius to maximum winds} = R = 62.04 \text{ km (33.5 nmi)}$$

$$\text{Central pressure} \quad \Delta P = 55.88 \text{ mm Hg (2.2 in. Hg)}$$

$$\text{Forward speed} \quad V_F = 27.78 \text{ to } 46.30 \text{ km/hr} \\ \text{(15 to 25 knots)}$$

$$\text{(use } V_F = 46.30 \text{ km/hr)}$$

Maximum gradient windspeed (eq. 3-63a)

$$U_{max} = 0.447 [14.5 (p_n - p_o)^{1/2} - R(0.31)f]$$

where for latitude 40 degrees N

$$f = 0.337$$

$$U_{max} = 0.447 [14.5 (55.88)^{1/2} - 62.04(0.31)(0.337)]$$

$$U_{max} = 45.55 \text{ m/s (163.98 km/hr)}$$

Maximum sustained windspeed (eq. 3-62) for $V_F = 46.3 \text{ km/hr}$

$$U_R = 0.865 U_{max} + 0.5 V_F$$

$$U_R = 0.865 (163.98) + 0.5 (46.3)$$

$$U_R = 165 \text{ km/hr}$$

Hurricane B

$$R = 62.04 \text{ km (33.5 nmi)}$$

$$V_F = 46.30 \text{ km/hr (25 knots)}$$

$$U_{max} = 8.05 \text{ km/hr greater than Hurricane A (8.05 km/hr = 2.23 m/s)}$$

Calculate ΔP for $U_{max} = (163.98 + 8.05) \text{ km/hr}$

$$U_{max} = 172.03 \text{ km/hr (47.79 m/s)}$$

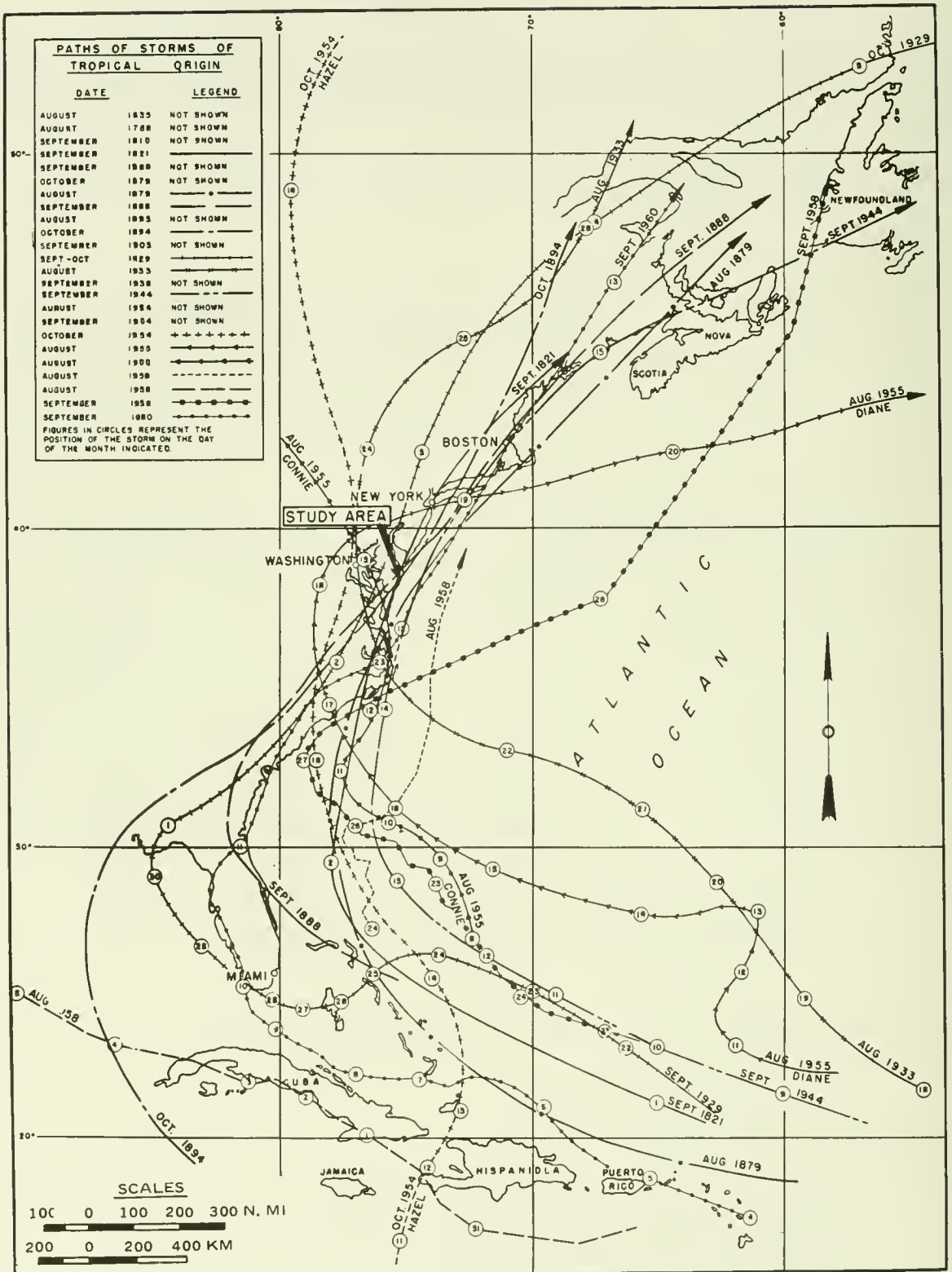

Figure 8-6. Hurricane storm tracks in the Delaware Bay area.

Rearranging equation (3-63a),

$$\Delta P = \left\{ \frac{1}{14.5} \left[\frac{U_{max}}{0.447} + R(0.31f) \right] \right\}^2$$

$$\Delta P = \left\{ \frac{1}{14.5} \left[\frac{47.79}{0.447} + (62.04)(0.31)(0.337) \right] \right\}^2$$

$$\Delta P = 61.16 \text{ mm Hg}$$

b. Estimate of Storm Surge. Bretschneider (1959) gives an empirical relationship between maximum sustained windspeed and surge height (both pressure- and wind-induced) at the Delaware Bay entrance (applicable only to Delaware Bay). Equation 11 from this reference is used for peak surge (S_o) computations:

$$S_o = 0.0001 U_R^2 \pm 10\% \text{ (} U_R \text{ in km/hr)}$$

Hurricane A (eq. 3-62)

$$U_R = 0.865 U_{max} + 0.5 V_F$$

$$U_R = 0.865 (163.98) + 0.5 (46.3)$$

$$U_R = 165 \text{ km/hr}$$

$$(S_o)_{max} = 0.0001 (U_R)^2 = 2.72 \text{ m}$$

$$\text{say } (S_o)_{max} = 2.75 \pm 0.25 \text{ m}$$

Hurricane B

$$(S_o)_{max} = 0.0001 (172)^2 = 2.96 \text{ m}$$

$$\text{say } (S_o)_{max} = 3.00 \text{ m} \pm 0.25 \text{ m}$$

Final results of storm surge estimates from the empirical equation of Bretschneider (1959):

$$\text{Hurricane A } (S_o)_{max} = 2.75 \pm 0.25 \text{ m}$$

$$\text{Hurricane B } (S_o)_{max} = 3.00 \pm 0.25 \text{ m}$$

c. Observed Water Level Data, Breakwater Harbor, Lewes, Delaware (National Ocean Service (NOS) Tide Tables) (see Ch. 3, Sec. VIII and Table 3-3).

(1) Length of record: 1936 to 1973

(2) Mean tidal range: 1.25 m

- (3) Spring range: 1.49 m
- (4) Highest observed water levels:
 - (a) Average yearly highest: 0.91 m above MHW
 - (b) Highest observed: 1.65 m above MHW (6 March 1962)
- (5) Lowest observed water levels:
 - (a) Average yearly lowest: 0.76 m below MLW
 - (b) Lowest observed: 0.91 m below MLW (28 March 1955)

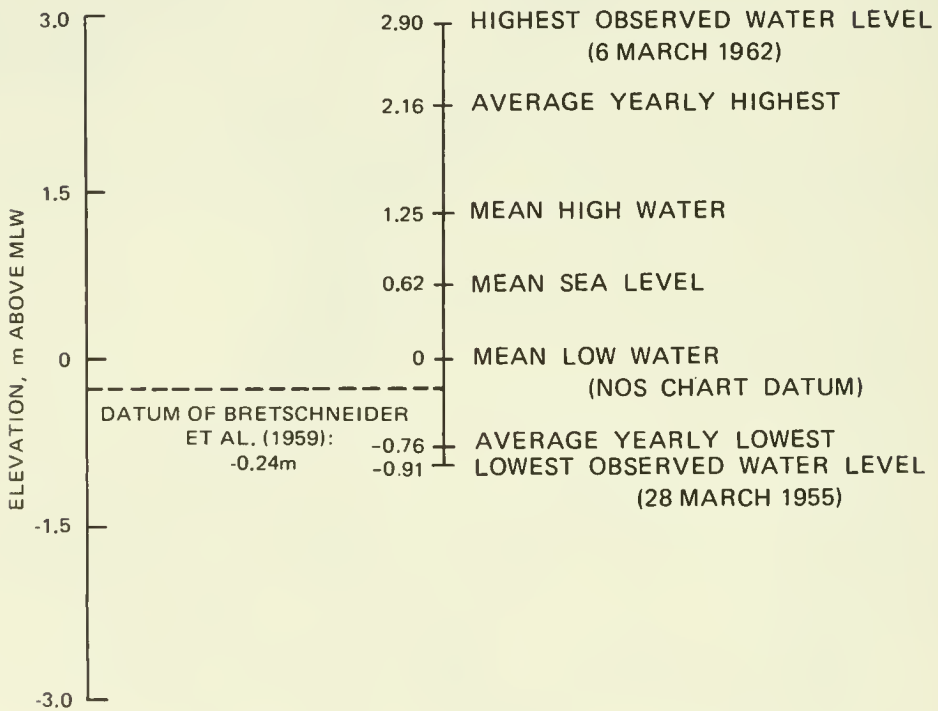

d. Predicted Astronomical Tides. The probabilities that the water will be above a given level at any time are tabulated for Lewes, Delaware, in Harris (1981), page 164.

The lower limit (LL) of the hour by values are normalized with respect to half the mean range (2.061 ft or 0.628 m). In order to tabulate the elevation above MLW with the corresponding probabilities (see Table 8-1), the following calculation must be done:

$$2.061 (1 + LL) = \text{MLW elevation (ft)}$$

$$0.628 (1 + LL) = \text{MLW elevation (m)}$$

Table 8-1. Astronomical tide-water level statistics at Lewes, Delaware.

Elevation above MLW, Z		Cumulative Frequency
(ft)	(m)	
5.785	1.763	0.0000
5.714	1.742	0.0000
5.643	1.717	0.0001
5.572	1.698	0.0005
5.501	1.677	0.0010
5.431	1.655	0.0018
5.359	1.634	0.0028
5.289	1.612	0.0040
5.218	1.590	0.0054
5.147	1.569	0.0072
5.076	1.547	0.0094
5.005	1.525	0.0118
4.934	1.504	0.0147
4.863	1.482	0.0181
4.792	1.461	0.0221
4.721	1.439	0.0269
4.650	1.417	0.0326
4.579	1.396	0.0392
4.508	1.374	0.0464
4.437	1.352	0.0540
4.366	1.331	0.0627
4.295	1.309	0.0717
4.224	1.288	0.0818
4.153	1.266	0.0926
4.082	1.244	0.1038
4.011	1.223	0.1162
3.869	1.179	0.1420
3.798	1.158	0.1556
3.728	1.136	0.1694
3.656	1.114	0.1840
3.586	1.093	0.1991
3.515	1.071	0.2146
3.444	1.050	0.2303
3.373	1.028	0.2462
3.302	1.006	0.2623
3.231	0.985	0.2783
3.160	0.963	0.2947
3.089	0.941	0.3103
3.018	0.920	0.3255
2.946	0.898	0.3407
2.876	0.877	0.3553
2.805	0.855	0.3693
2.734	0.833	0.3826
2.663	0.812	0.3959
2.592	0.790	0.4090
2.521	0.768	0.4215
2.450	0.747	0.4335
2.379	0.725	0.4457
2.308	0.704	0.4576
2.237	0.682	0.4697
2.166	0.660	0.4815
2.095	0.639	0.4935
2.024	0.617	0.5049

e. Design Water Level Summary. For purposes of the design problem the following water levels will be used. The criteria used here should not be assumed generally applicable since design water level criteria will vary with the scope and purpose of a particular project.

- (1) Astronomical tide: use + 1.5 m (MLW) (exceeded 1 percent of time)
- (2) Storm surge: use + 3.0 m
- (3) Wave setup: a function of wave conditions

Table 8-2. Tidal currents at Delaware Bay entrance (surface currents only), 1948 values.¹

Time	Velocity ² km/hr	Velocity ² m/s	Direction (degrees N)
Flood -2 hr	1.48	0.41	311
-1 hr	2.59	0.72	317
Flood	2.96	0.82	309
Flood +1 hr	2.41	0.67	301
+2 hr	1.11	0.31	293
+3 hr	0.56	0.16	40
Ebb -2 hr	2.41	0.67	135
-1 hr	3.89	1.08	140
Ebb	4.63	1.29	148
Ebb +1 hr	4.44	1.23	149
+2 hr	3.33	0.92	153
+3 hr	1.11	0.31	195

¹ From NOS Tidal Current Charts for Delaware Bay and River (1948 and 1960) and NOS Tide Tables.

² For spring tides.

Example charts from National Ocean Service (NOS) (1948 and 1960) and a summary of tidal current velocities are given in Figures 8-7 through 8-10 are given on the following pages.

3. Wave Conditions.

a. Wave Conditions on Bay Side of Island (see Ch. 3, Sec. V). Wave data on waves generated in Delaware Bay are not available for the island site. Consequently, wind data and longest fetch shallow-water wave forecasting techniques will be used to estimate wave conditions.

The longest fetch at the Delaware Bay entrance $F = 89.3$ km (see Figure 8-11).

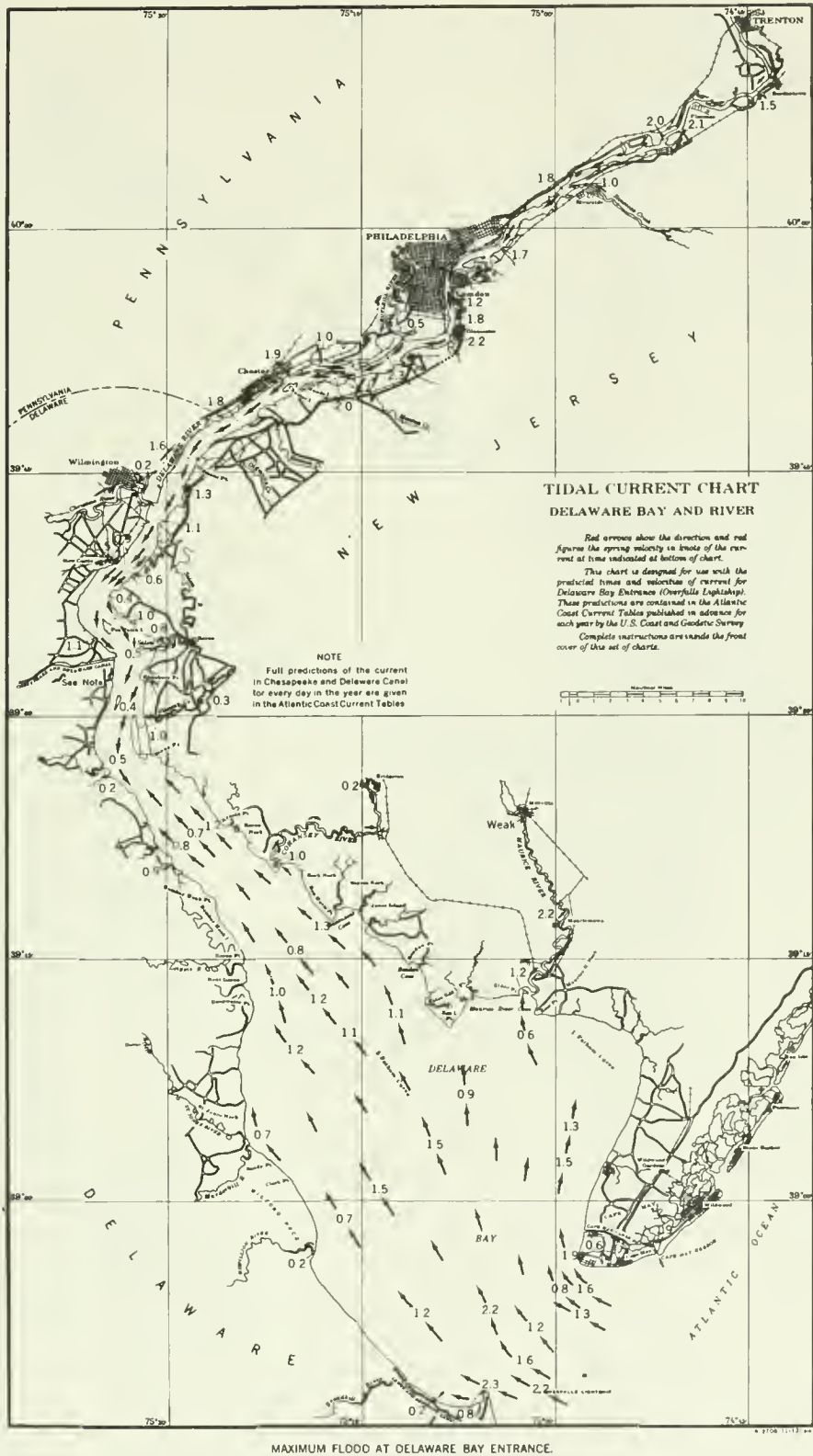

Figure 8-7. Tidal current chart—maximum flood at Delaware Bay Entrance.

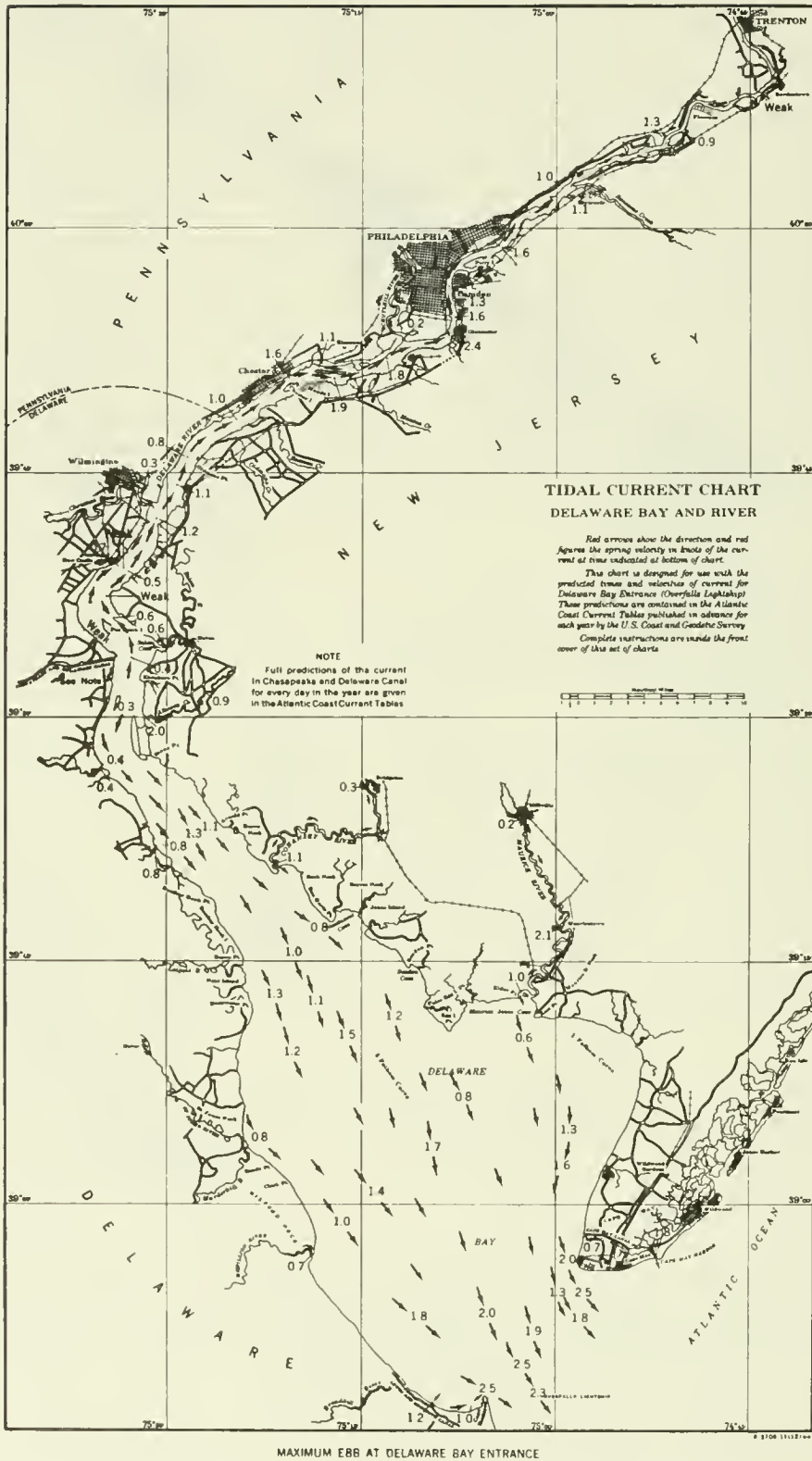

Figure 8-8. Tidal current chart-maximum ebb at Delaware Bay entrance.

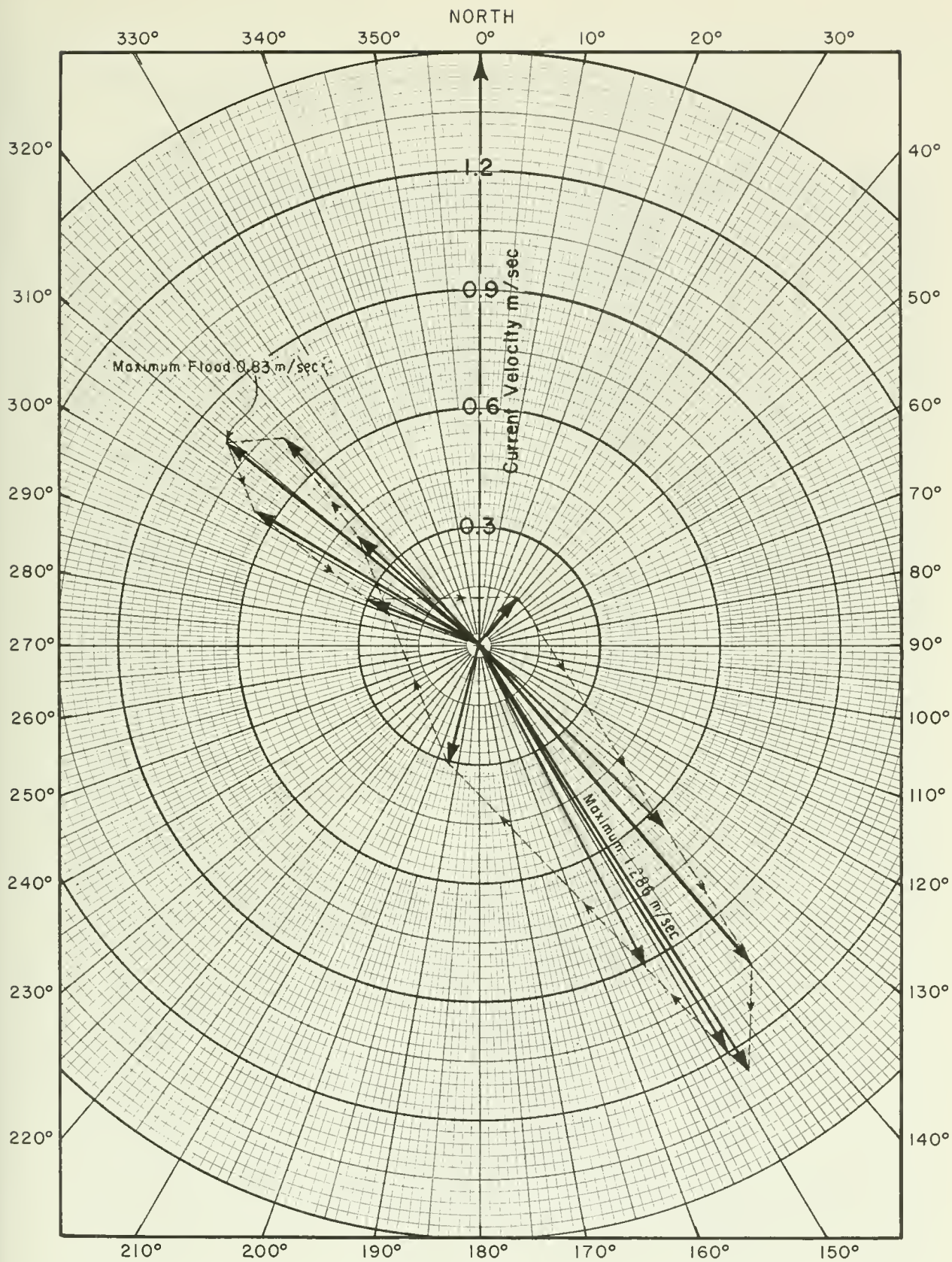

Figure 8-9. Polar diagram of tidal currents at island site.

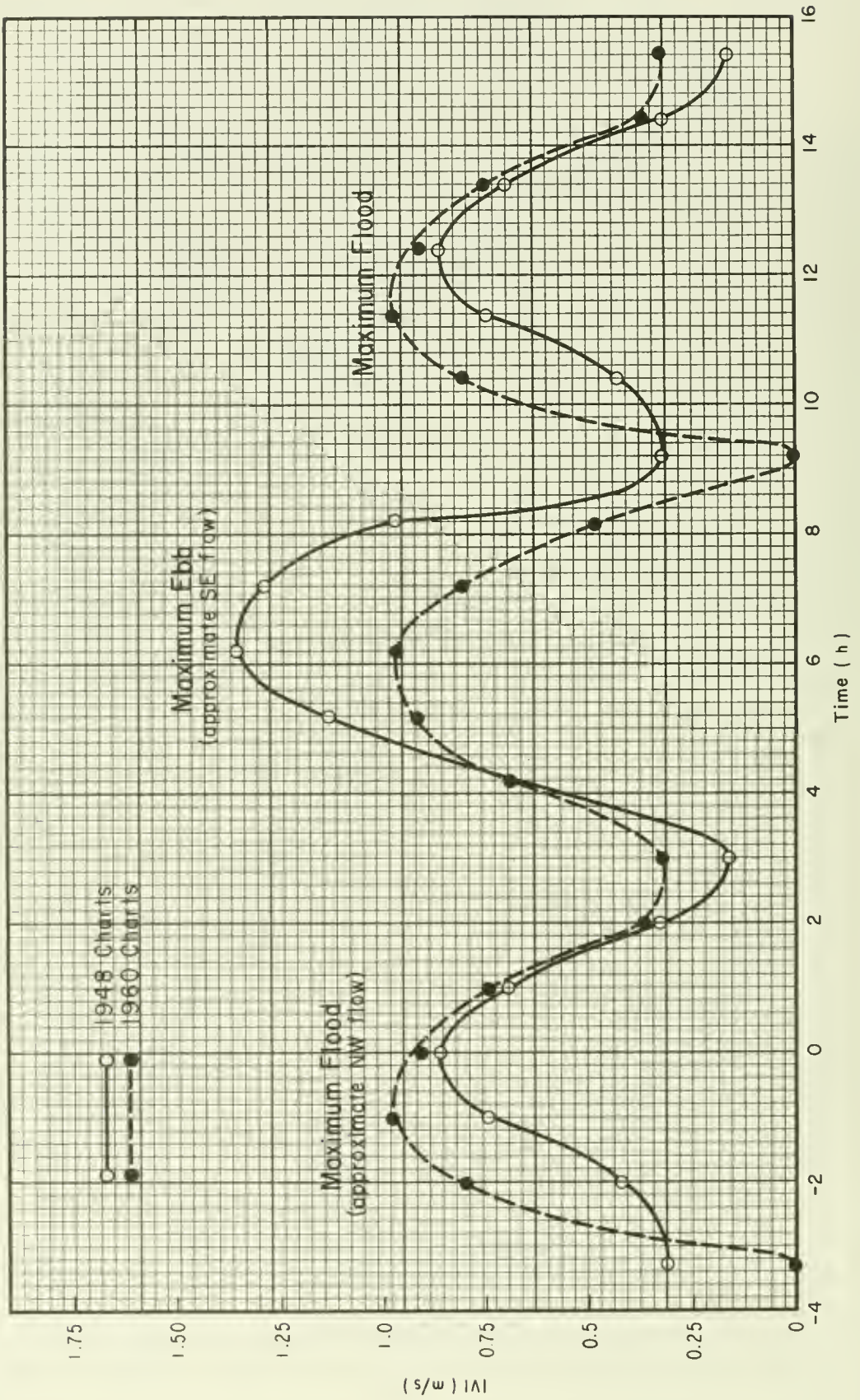

Figure 8-10. Time variation of tidal current speed at island site.

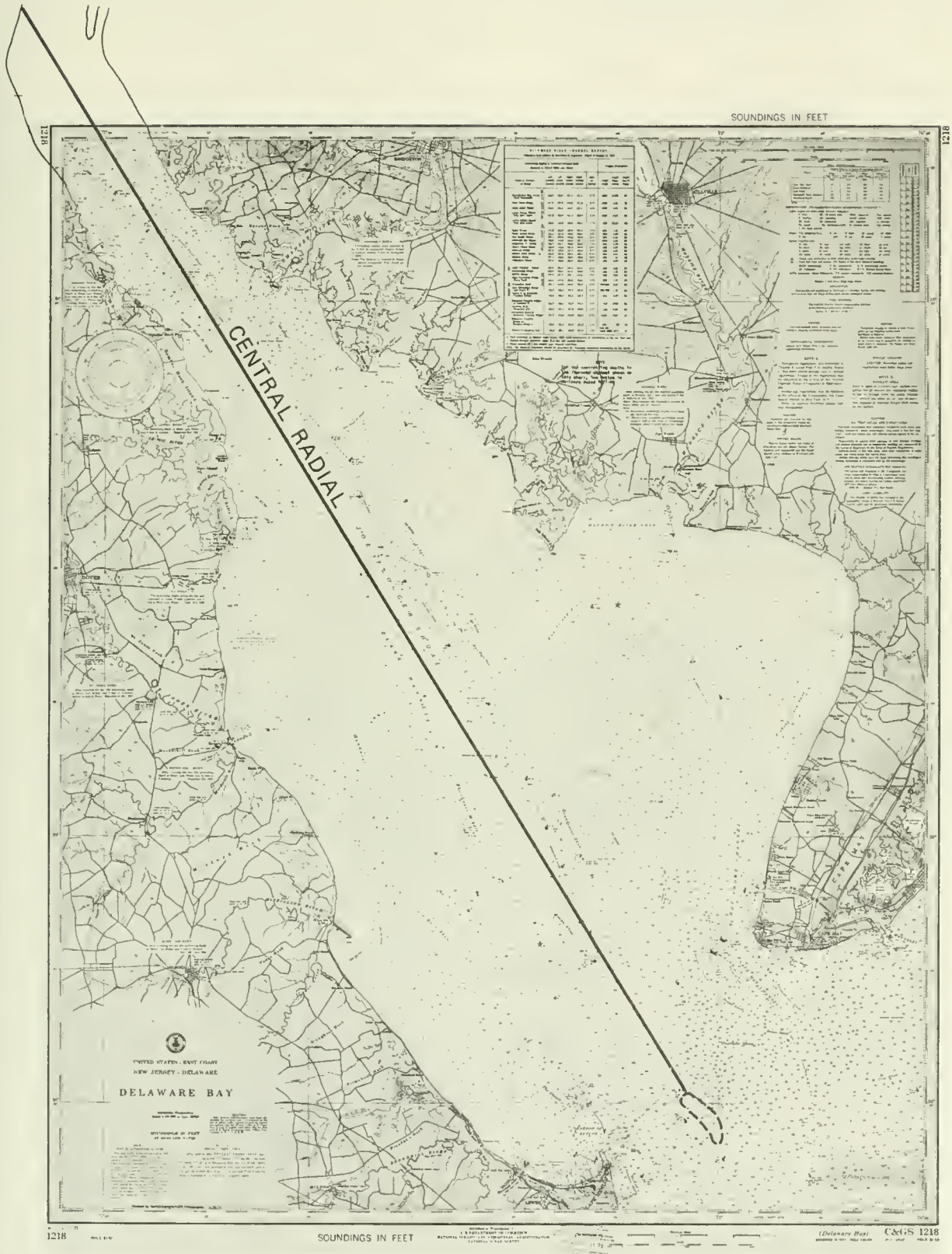
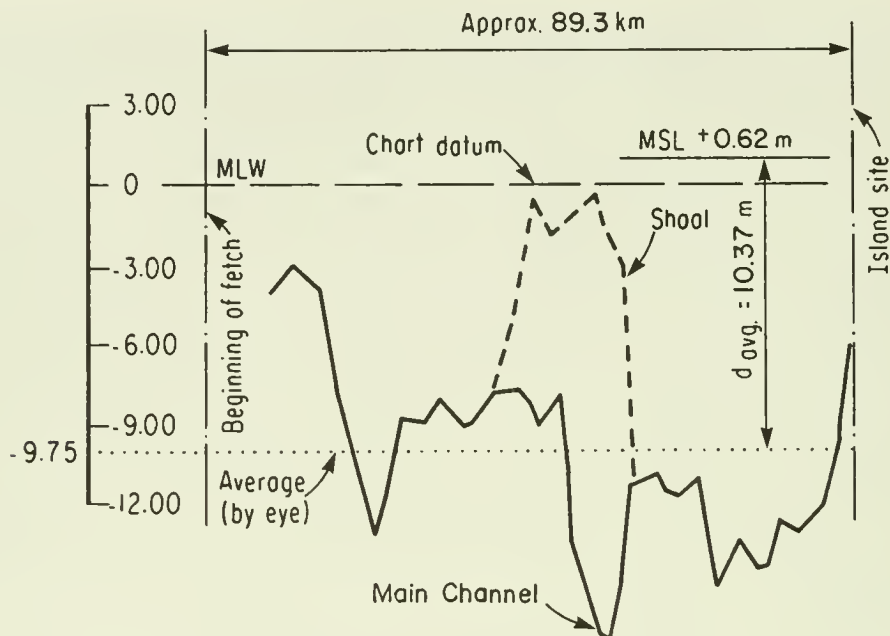

Figure 8-11. Determination of longest fetch: island site at Delaware Bay entrance.

(1) Significant Wave Height and Period (Wind From NNW Along Central Radial) (see Ch. 3, Sec. VI,1).

Average Depth Along Central Radial



Significant wave height (eq. 3-39):

$$H_s = \frac{0.283 U_A^2}{g} \tanh \left[0.530 \left(\frac{gd}{U_A^2} \right)^{3/4} \right] \tanh \left\{ \frac{0.00565 \left(\frac{gF}{U_A^2} \right)^{1/2}}{\tanh \left[0.530 \left(\frac{gd}{U_A^2} \right)^{3/4} \right]} \right\}$$

Significant wave period (eq. 3-40):

$$T_s = \frac{7.54 U_A}{g} \tanh \left[0.833 \left(\frac{gd}{U_A^2} \right)^{3/8} \right] \tanh \left\{ \frac{0.0379 \left(\frac{gF}{U_A^2} \right)^{1/3}}{\tanh \left[0.833 \left(\frac{gd}{U_A^2} \right)^{3/8} \right]} \right\}$$

where

$$U_A = \text{adjusted wind stress factor} = 0.71 U_s^{1.23} \quad (\text{eq. 3-28a})$$

$U_s =$ surface windspeed

(2) Example Calculation.

$$U = 80 \text{ km/hr} \quad (22.22 \text{ m/s})$$

$$F = 89.3 \text{ km} \quad (89,300 \text{ m})$$

$$D = 0.01 \text{ km} \quad (10.37 \text{ m})$$

$$U_A = 0.71 U^{1.23} = 0.71 (22.22)^{1.23} = 32.19 \text{ m/s}$$

$$\frac{gF}{U_A^2} = \frac{(9.806) (89,300)}{(32.19)^2} = 845.09$$

$$\frac{gd}{U_A^2} = \frac{(9.806) (10.37)}{(32.19)^2} = 0.0981$$

$$H_s = \frac{0.283(32.19)^2}{9.806} \tanh \left[0.530 (0.0981)^{3/4} \right]_x$$

(eq. 3-39)

$$\tanh \left\{ \frac{0.00565 (845.09)^{1/2}}{\tanh \left[(0.53) (0.0981)^{3/4} \right]} \right\}$$

$$H_s = 2.61 \text{ m}$$

$$T_s = \frac{7.54 (32.19)}{9.806} \tanh \left[0.833 (0.0981)^{3/8} \right]_x$$

(eq. 3-40)

$$\tanh \left\{ \frac{0.0379 (845.09)^{1/3}}{\tanh \left[(0.833)(0.0981)^{3/8} \right]} \right\}$$

$$T_s = 6.55 \text{ s}$$

See tabulation and graph on next page.

when $F = 89,300 \text{ m}$ and $d = 10.37 \text{ m}$,

U (km/hr)	U (m/s)	U_A (m/s)	H_S (m)	T_S (s)
80	22.2	32.19	2.61	6.55
90	25.0	37.22	2.85	6.86
100	27.7	42.36	3.07	7.14
110	30.5	47.63	3.29	7.40
120	33.3	53.02	3.49	7.65
130	36.1	58.50	3.68	7.89
140	38.8	64.08	3.86	8.11
150	41.6	69.76	4.04	8.32
160	44.4	75.52	4.22	8.52
170	47.2	81.37	4.38	8.71

(eqs. 3-39 and
3-40)

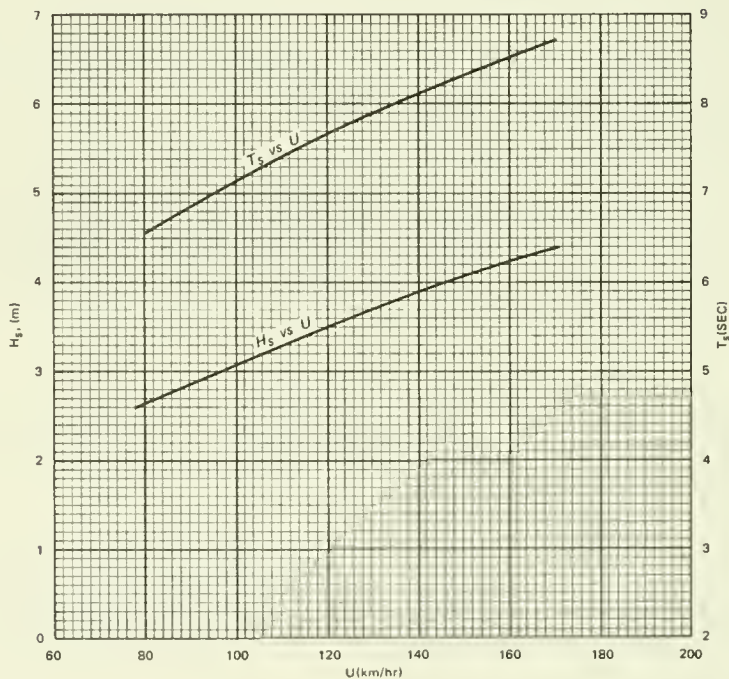

(2) Frequency Analysis.

(a) Wind Data. Wind roses for for the Delaware Bay area are given in Figure 8-12 (U.S. Army Engineer District, Philadelphia, 1970). Assume that sizeable waves occur primarily when wind is blowing along central radial from the NW. This is the predominant wind direction for the Delaware Bay area. Wind is from the NW approximately 16 percent of the time.

The maximum observed wind in 18 years of record was 113-km/hr (70-mph) gale from the NW (daily maximum 5-minute windspeed).

(b) Thom's Fastest-Mile Wind Frequency. In the absence of tabulated wind data (other than that given on the following page), the windspeed frequencies of Thom (1960), adjusted for wind direction, will be used. Thom's windspeed are multiplied by 0.16 to adjust for direction. This assumes that winds from the NW are distributed the same as are winds when all directions are considered.

Table 8-3. Thom's Windspeeds: Delaware Bay Area.

Quantile	Recurrence Interval (years)	Adjusted ¹ Recurrence Interval (years)	U ² mph	U ³ km/hr
0.5	2	12.5	55	88.5
0.02	50	312.5	90	144.8
0.01	100	625.0	100	160.9

¹ Adjusted for direction (column 2 divided by 0.16).

² Extreme fastest-mile windspeed.

³ Extreme fastest-km wind = 1.6093 x U fastest-mile windspeed.

WIND DATA
DELAWARE BREAKWATER, DEL.

NOTE:

DATA WERE OBTAINED FROM U.S. WEATHER BUREAU, PHILA., PA. FOR PERIOD 1924-1941.

THE INTENSITY DIAGRAMS REPRESENT WINDS OF GALE FORCE (10 MPH) OR GREATER, AND ARE BASED ON DAILY MAXIMUM 5 MINUTE VALUES. THE INTENSITY OF GALES IS INDICATED BY LENGTH OF LINE, AND WIDTH ALONG BASE SHOWS, TO THE SCALE INDICATED, THE NUMBER OF DAYS DURING THE 18 YEAR PERIOD HAVING WINDS OF A GIVEN INTENSITY RANGE.

THE WIND DURATION DIAGRAM INDICATES THE AVERAGE NUMBER OF DAYS PER YEAR FOR EACH DIRECTION, BASED ON HOURLY WIND RECORDS.

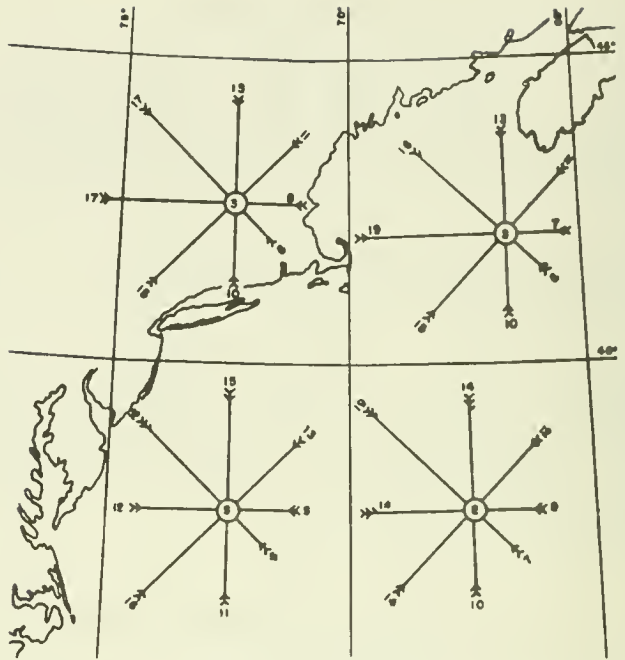
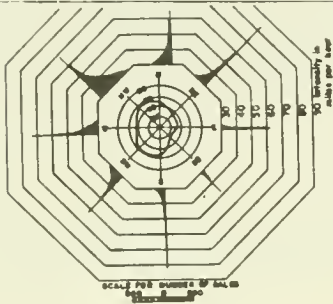

PREVAILING WINDS

WIND ROSES SHOW AVERAGE WINDS FOR 8° SQUARE OVER ENTIRE PERIOD OF RECORD. ARROWS PLY WITH THE WIND FIGURES AT END OF ARROWS INDICATE PERCENT OF OBSERVATIONS WIND HAS BLOWN FROM THAT DIRECTION. NUMBER OF FEATHERS REPRESENTS AVERAGE FORCE, BEAUFORT SCALE. FIGURE IN CIRCLE REPRESENTS PERCENTAGE OF CALMS, LIGHT AIRS AND VARIABLES.

BASED ON SHIP OBSERVATIONS AS COMPILED BY THE NAVY HYDROGRAPHIC OFFICE FOR 10 YEARS PERIOD, 1932-1942

WIND DATA

ATLANTIC CITY, N. J.
YEARLY AVERAGES

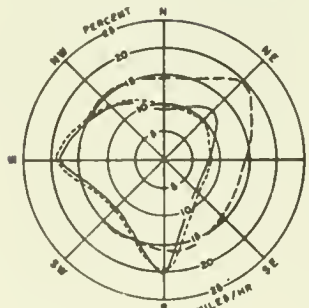

1923 - 1952

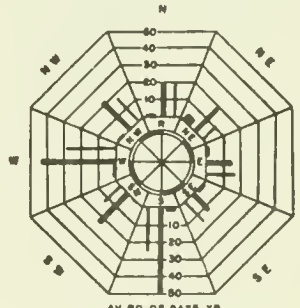

1936 - 1952

LEGEND

———— PERCENT OF TOTAL WIND MOVEMENT
 - - - - PERCENT OF TOTAL DURATION
 - - - - AVERAGE VELOCITY IN MILES PER HOUR

LEGEND

MILES PER HOUR
 0 TO 15
 14 TO 28
 29+

THE DATA SHOWN WERE DERIVED FROM HOURLY RECORDS OF WIND DIRECTION AND VELOCITY AS OBTAINED BY THE U. S. WEATHER BUREAU FROM AN ANEMOMETER ATOP THE ABSECON LIGHTHOUSE AT ATLANTIC CITY, N. J. AT AN ELEVATION OF 175 FEET M.S.L.

Figure 8-12. Wind data in the vicinity of Delaware Bay.

(c) Duration (t) of Fastest-Mile Wind.

$$t = \frac{1 \text{ km}}{U \text{ (km/hr)}} \times \frac{60 \text{ min}}{\text{hr}} \left(\frac{1 \text{ mile}}{U \text{ (mph)}} \times \frac{60 \text{ min}}{\text{hr}} \right)$$

t = duration of wind in minutes

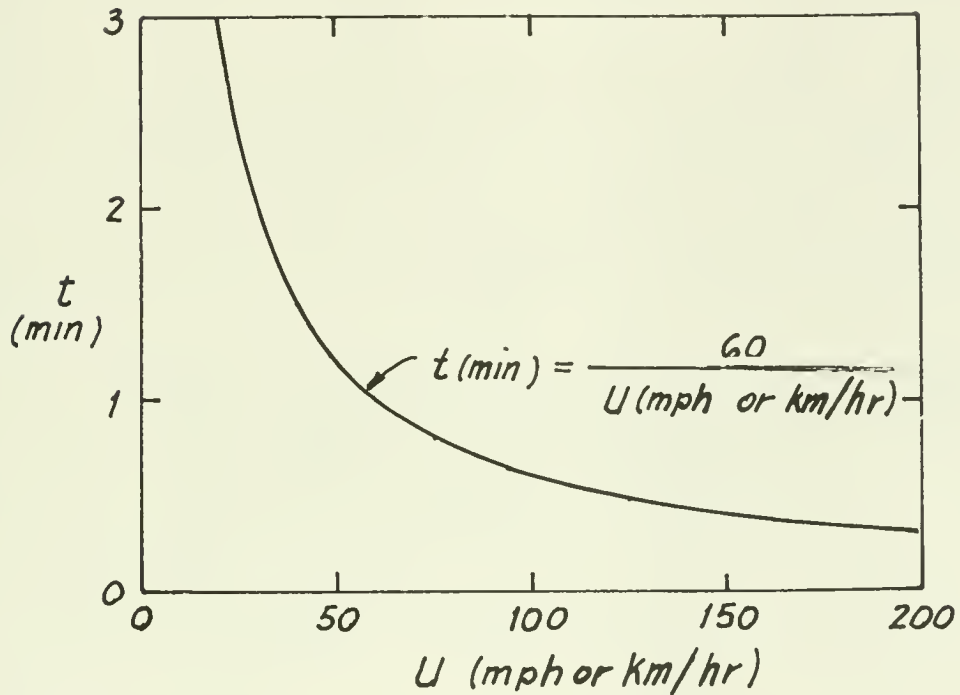

Since the durations under consideration here are not sufficiently long to generate maximum wave conditions, Thom's wind data will result in a high estimate of wave heights and periods. The dashed line on Figure 8-13 will be used to establish frequency of occurrence of given wave conditions; calculated wave height recurrence intervals will be conservative.

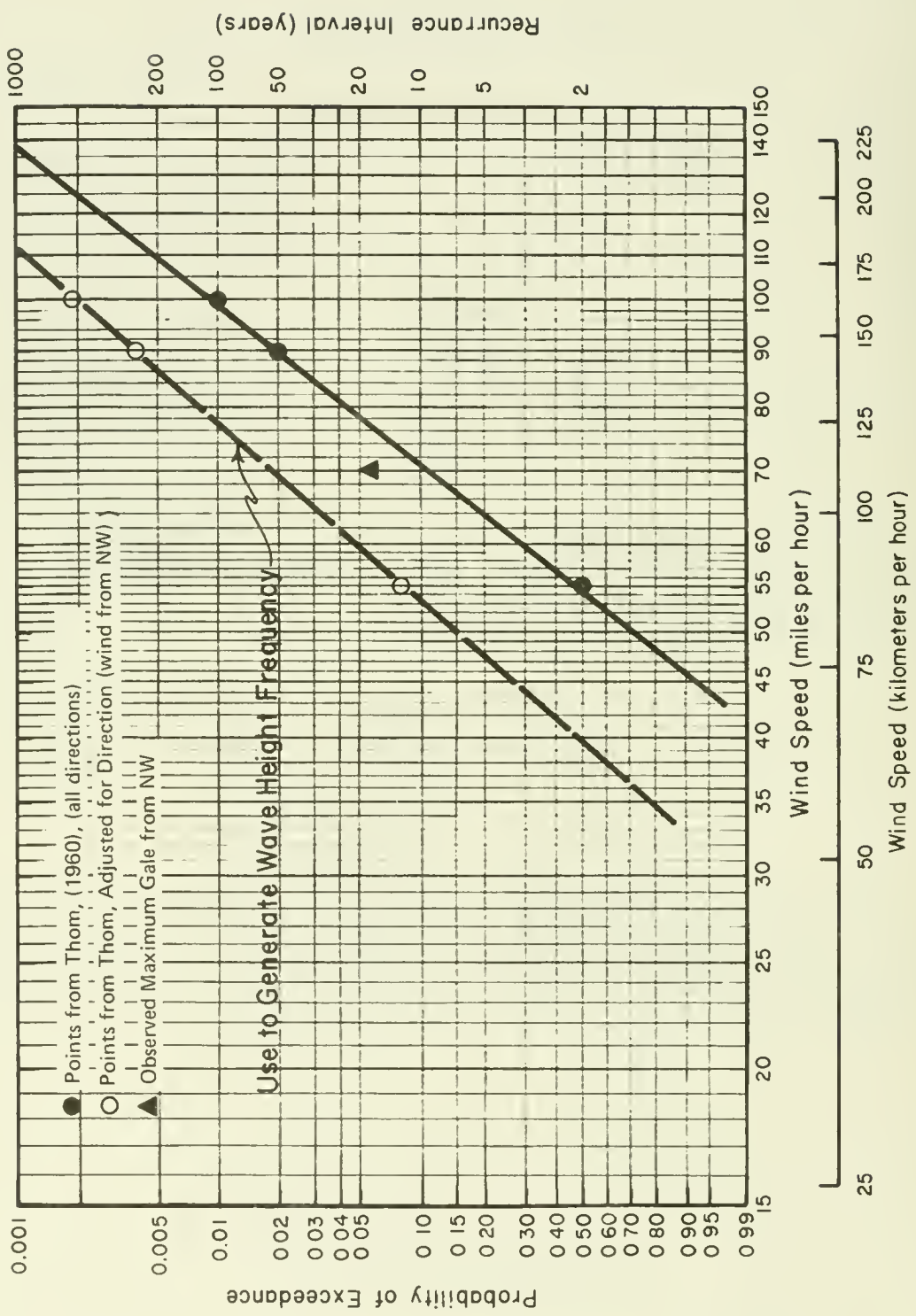

Figure 8-13. Probability distribution of maximum windspeed: Thom's fastest-mile wind.

From the dashed curve in Figure 8-13 and graph on page 8-20, for H_s and T_s as a function of U find the following:

Recurrence Interval (years)	Probability of Exceedance	U (km/hr)	H_s (m)	T_s (s)
2	0.5	64.4	2.21	6.00
5	0.2	77.2	2.55	6.46
10	0.1	86.9	2.78	6.76
20	0.05	96.6	3.00	7.05
50	0.02	111.0	3.31	7.43
100	0.01	125.5	3.59	7.78
200	0.005	138.4	3.83	8.07

The computed wave heights plot as a straight line on log-normal probability paper (see Fig. 8-14).

Economic considerations as well as the purpose of a given structure will determine the design wave conditions. The increased protection afforded by designing for a higher wave would have to be weighed against the increase in structure cost.

For the illustrative purposes of this problem, the significant wave height with a recurrence interval of 100 years will be used. Therefore, for design,

$$H_s = 1.09 \text{ m (3.59 ft)}$$

$$T_s = 7.78 \text{ s}$$

for waves generated in Delaware Bay.

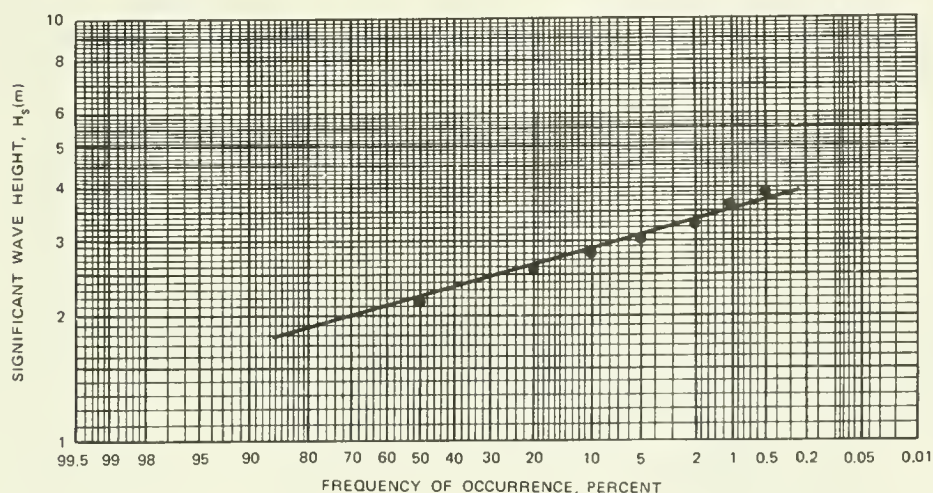

Figure 8-14. Frequency of occurrence of significant wave heights for waves generated in Delaware Bay.

b. Wave Conditions on Ocean Side of Island: Hindcast wave statistics are available for several U.S. east coast locations in Corson, et al. (1981), Corson et al. (1982), and Jensen (1983).¹ Data are available from the mouth of Delaware Bay; but deepwater wave data are chosen for statistical analysis to demonstrate the method of transforming data from deep water to another location in shallow water (i.e., the island site). (See Figure 8-15 for station 4 location and Table 8-4 for data.)

(1) Idealized Refraction Analysis (see Ch. 2, Sec. III). For purposes of this problem, refraction by straight parallel bottom contours will be assumed.

Azimuth of shoreline = 30° (see Fig. 8-17)

(2) Wave Directions.

Direction of Wave Approach	Angle Between Wave Direction and Shoreline (deg)	
NNE	-7.5	($\alpha_o > 90$, neglect)
NE	+15.0	$\alpha_o = 75^2$
ENE	+37.5	$\alpha_o = 52.5$
E	+60.0	$\alpha_o = 30.0$
ESE	+82.5	$\alpha_o = 7.5$
SE	+105.0	$\alpha_o = 15.0$
SSE	+127.5	$\alpha_o = 37.5$
S ³	+150.0	$\alpha_o = 60.0$
SSW	+172.5	$\alpha_o = 82.5$
SW	+195.0	$\alpha_o > 90$, neglect)

¹ The hindcast statistics are available for the Atlantic coast and the Great Lakes. They will be available for the Pacific and gulf coasts at a future date.

² α_o is the angle between the direction of wave approach and a normal to the shoreline.

³ Used for typical refraction calculations given on following pages.

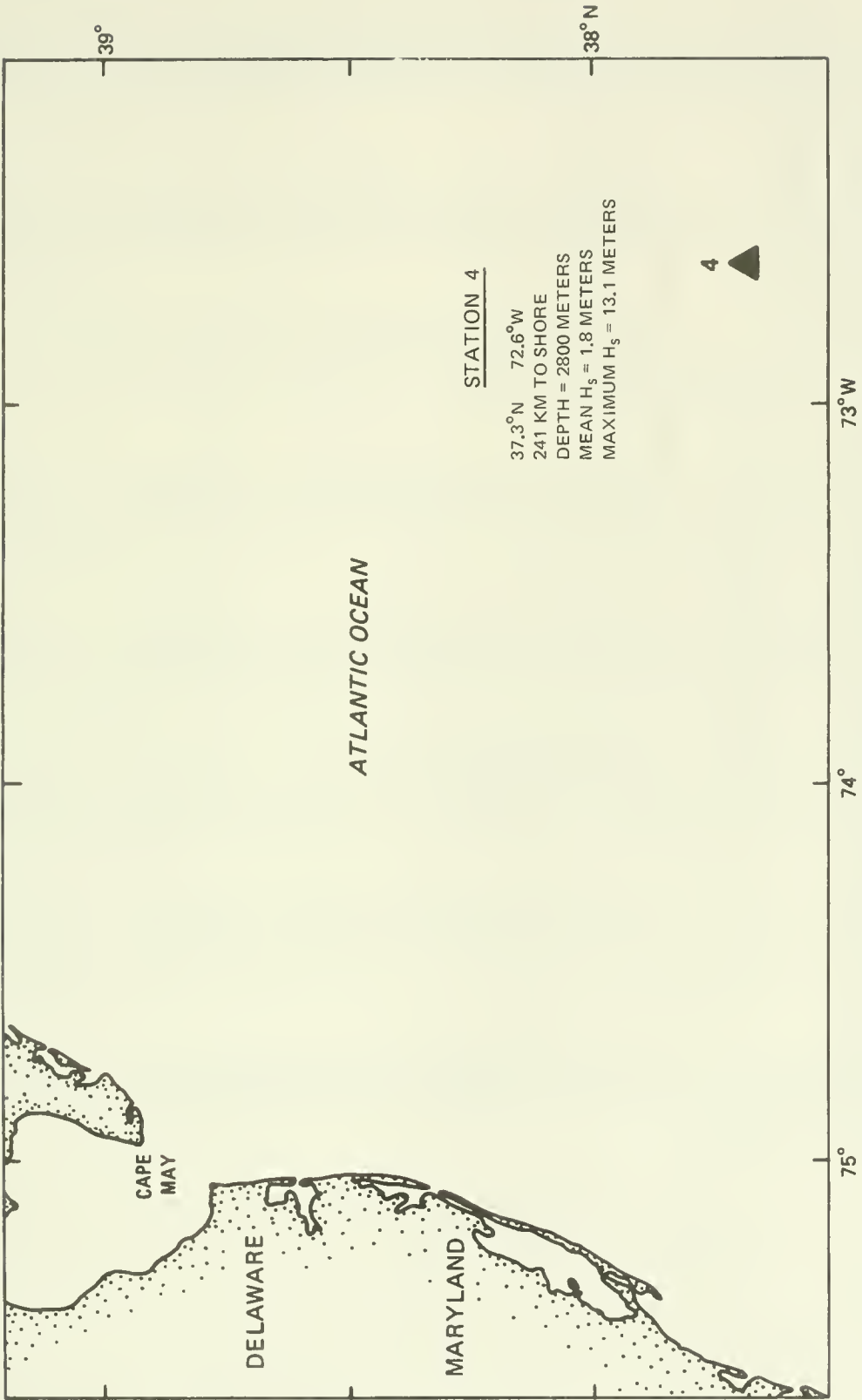

(CORSON ET AL., 1981)

Figure 8-15. Station 4 location.

Table 8-4. Hindcast wave statistics for station 4.¹

Direction (deg)	Duration (hr) for These Periods ²										Total Duration (hr)	Wave Height (m)
	3-4.9s	5-6.9s	7-8.9s	9-10.9s	11-12.9s	13-14.9s	15-16.9s	17-18.9s	19-20.9s	21-22.9s		
30-59.9	25		54	12							91	0 - 0.49
60-89.9	25		22	2							49	
90-119.9	28		20	2							50	
120-149.9	19		40	16	2						77	
150-179.9	30		57	27	2						116	
180-209.9	44		23	6	3						76	
	TOTAL FOR 0- TO 0.49-m WAVE HEIGHT:										459	
30-59.9	71	10	126	107	5						319	0.50-0.99
60-89.9	54	11	75	19							159	
90-119.9	50	5	59	13	1						128	
120-149.9	45	7	95	23	3						173	
150-179.9	79	12	84								175	
180-209.9												
	TOTAL FOR 0.50- TO 0.99-m WAVE HEIGHT:										954	
30-59.9	6	49	41	57	10						163	1.00-1.49
60-89.9	9	38	45	11							103	
90-119.9	11	26	47	11							95	
120-149.9	10	25	69	29	9						142	
150-179.9	8	45	76	53	26	2					210	
180-209.9	13	108	93	44	10	1					269	
	TOTAL FOR 1.00- TO 1.49-m WAVE HEIGHT:										982	
30-59.9	1	31	16	16	4						68	1.50-1.99
60-89.9		20	18	10	2						50	
90-119.9		15	27	9	1						52	
120-149.9		18	44	32	13	1					108	
150-179.9		32	56	42	23	4					157	
180-209.9	1	60	82	57	22	3	2				227	
	TOTAL FOR 1.50- TO 1.99-m WAVE HEIGHT:										662	
30-59.9		9	15	6							30	2.00-2.49
60-89.9		10	21	7							38	
90-119.9		6	20	6	1	1					34	
120-149.9		7	33	26	11	3					80	
150-179.9		10	38	24	15	6	1				94	
180-209.9		17	55	40	27	5	1				145	
	TOTAL FOR 2.00- TO 2.49-m WAVE HEIGHT:										421	
30-59.9		1	24	1	1						27	2.50-2.99
60-89.9		1	29	4	2						36	
90-119.9			26	6	2						34	
120-149.9		2	33	16	12	2					65	
150-179.9		1	37	19	14	6	1				78	
180-209.9		1	60	20	19	3	1				104	
	TOTAL FOR 2.50- TO 2.99-m WAVE HEIGHT:										344	
30-59.9			24	2	1						27	3.00-3.49
60-89.9			20	2	1						23	
90-119.9			13	5	1						19	
120-149.9			17	10	6	1					34	
150-179.9			22	5	10	4	1				42	
180-209.9			39	10	15	5	1				70	
	TOTAL FOR 3.00- TO 3.49-m WAVE HEIGHT:										215	

¹ From Corson et al. (1981).

² Only durations > 1 hr are shown.

Table 8-4. Hindcast wave statistics for station 4 (continued).

Direction (deg)	Duration (hr) for These Periods ²										Total Duration (hr)	Wave Height (m)
	3-4.9s	5-6.9s	7-8.9s	9-10.9s	11-12.9s	13-14.9s	15-16.9s	17-18.9s	19-20.9s	21-22.9s		
30-59.9			17	1							18	3.50-3.99
60-89.9			10	3	1						14	
90-119.9			4	3	1						8	
120-149.9			5	5	4	2					16	
150-179.9			9	3	4	5	2				23	
180-209.9			25	7	6	3					41	
						TOTAL FOR	3.50-	TO	3.99-m	WAVE HEIGHT:	120	
30-59.9			11	4							15	4.00-4.49
60-89.9			6	3							9	
90-119.9			2	2	1						5	
120-149.9			2	2	3	1					8	
150-179.9			3	3		2	2				10	
180-209.9			13	10	3	2	1				29	
						TOTAL FOR	4.00-	TO	4.49-m	WAVE HEIGHT:	76	
30-59.9			3	8							11	4.50-4.99
60-89.9			3	6							9	
90-119.9			1	1							2	
120-149.9				1	1	1					3	
150-179.9			1	2		1	3				7	
180-209.9			3	7	1	1	1				13	
						TOTAL FOR	4.50-	TO	4.99-m	WAVE HEIGHT:	45	
30-59.9			2	7							9	5.00-5.49
60-89.9			2	3							5	
90-119.9			1								1	
120-149.9				1		1					2	
150-179.9			1	1			1				3	
180-209.9			2	4	1	1	1				8	
						TOTAL FOR	5.00-	TO	5.49-m	WAVE HEIGHT:	28	
30-59.9			1	6							7	5.50-5.99
60-89.9			1	3							4	
90-119.9			1								1	
120-149.9						1					-	
150-179.9				1		1	1				3	
180-209.9			1	3							4	
						TOTAL FOR	5.50-	TO	5.99-m	WAVE HEIGHT:	19	
30-59.9			1	3	1						5	6.00-6.49
60-89.9				1							1	
90-119.9											-	
120-149.9											-	
150-179.9							1				1	
180-209.9				1							1	
						TOTAL FOR	6.00-	TO	6.49-m	WAVE HEIGHT:	8	
30-59.9			1	1	1						3	6.50-6.99
60-89.9											-	
90-119.9											-	
120-149.9											-	
150-179.9							1				1	
180-209.9					1						1	
						TOTAL FOR	6.50-	TO	6.99-m	WAVE HEIGHT:	5	

² Only durations > 1 hr are shown.

Table 8-4. Hindcast wave statistics for station 4 (concluded).

Direction (deg)	Duration (hr) for These Periods ²										Total Duration (hr)	Wave Height (m)		
	3-4.9s	5-6.9s	7-8.9s	9-10.9s	11-12.9s	13-14.9s	15-16.9s	17-18.9s	19-20.9s	21-22.9s				
30-59.9 60-89.9 90-119.9 120-149.9 150-179.9 180-209.9				2	2							4	7.00-7.49	
				1	1							2		
												-		
												-		
												-		
												-		
												6		
30-59.9 60-89.9 90-119.9 120-149.9 150-179.9 180-209.9				1	1							2	7.50-7.99	
					1							1		
												-		
												-		
												-		
												-		
												1		
30-59.9 60-89.9 90-119.9 120-149.9 150-179.9 180-209.9				1								1	8.00-8.49	
												-		
												-		
												-		
												-		
												-		
												1		
30-59.9 60-89.9 90-119.9 120-149.9 150-179.9 180-209.9				1								1	8.50-8.99	
												-		
												-		
												-		
												-		
												-		
												1		
30-59.9 60-89.9 90-119.9 120-149.9 150-179.9 180-209.9					1							1	9.00-9.49	
												-		
												-		
												-		
												-		
												-		
												1		
30-59.9 60-89.9 90-119.9 120-149.9 150-179.9 180-209.9					1							1	9.50-9.99	
												-		
												-		
												-		
												-		
												-		
												1		

² Only durations > 1 hr are shown.

STATION 4

JAN. - DEC.
59440 CASES

WAVE HEIGHT

OVER 4.99 M
4.50-4.99 M
4.00-4.49 M
3.50-3.99 M
3.00-3.49 M
2.50-2.99 M
2.00-2.49 M
1.50-1.99 M
1.00-1.49 M
0.50-0.99 M
0.00-0.49 M

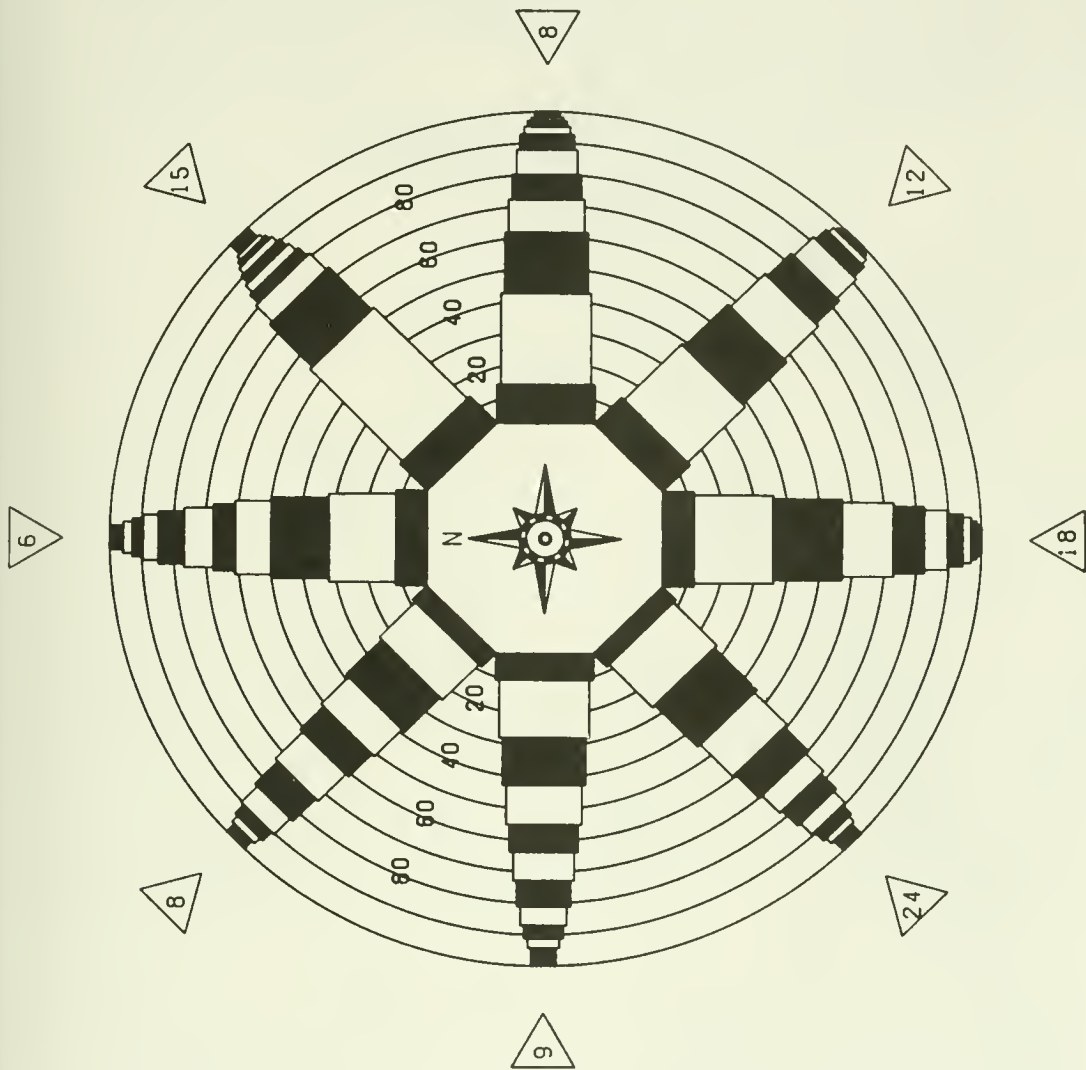

(CORSON ET AL., 1981)

Figure 8-16. Wave diagram for station 4 off the Delaware Bay entrance (numbers within concentric rings are percent of waves of different height occurring from each direction; numbers in triangles represent percent of time waves occur in each direction).

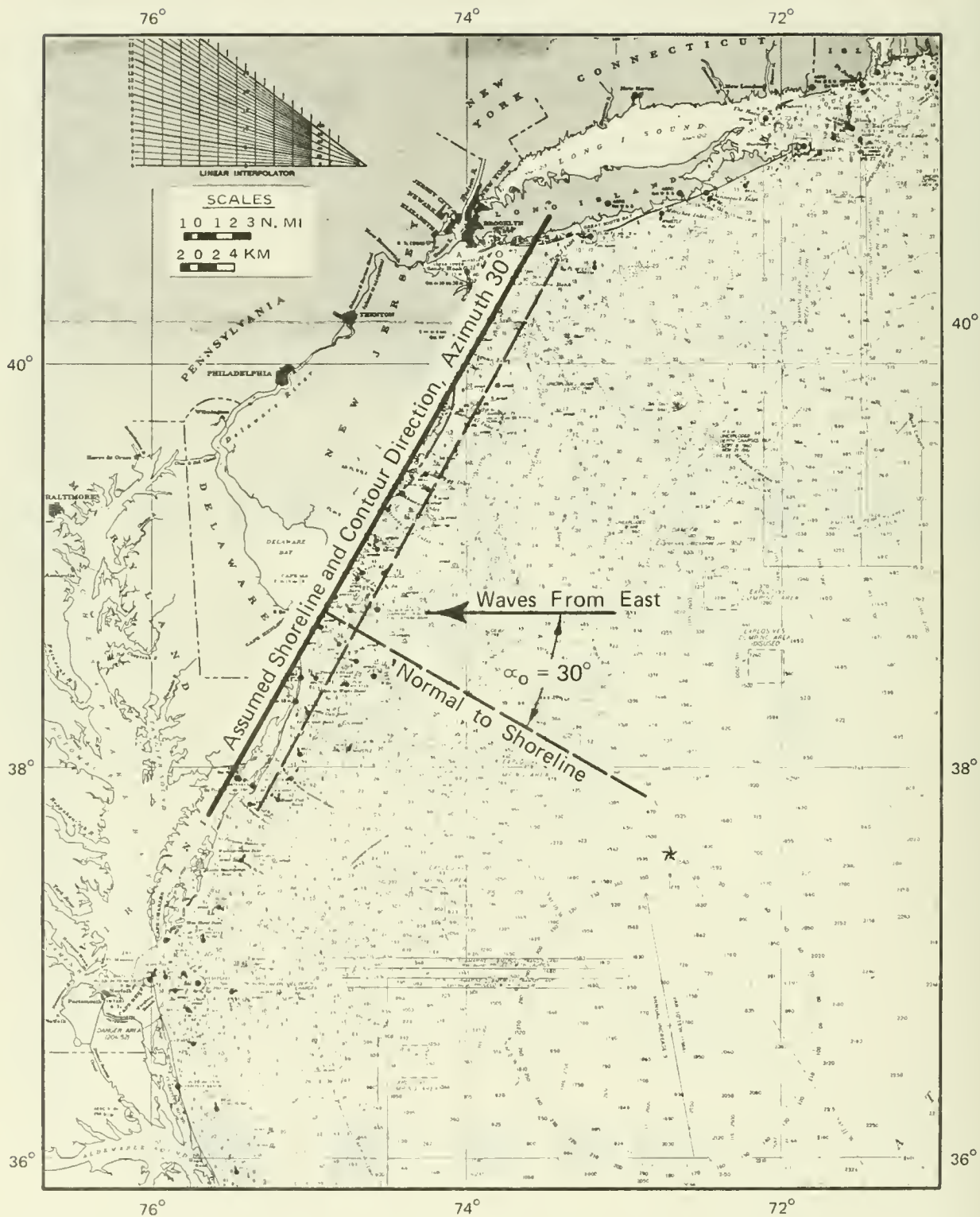

Figure 8-17. General shoreline alignment in vicinity of Delaware Bay for refraction analysis.

(3) Typical Refraction Calculations. Use $d = 12.0$ m at structure.

Shoaling Coefficient:

$$K_S = \frac{H}{H'_0} = \left[\frac{\coth \left(\frac{2\pi d}{L} \right)}{1 + \frac{4\pi d/L}{\sinh \left(4\pi d/L \right)}} \right]^{1/2} \quad (\text{eq. 2-44})$$

equivalently,

$$K_S = \left(\frac{C_0}{2nC} \right)^{1/2} = \left(\frac{gT^2}{4\pi nL} \right)^{1/2}$$

where

H = wave height

H'_0 = deepwater wave height equivalent to observed shallow-water wave if unaffected by refraction and friction

L = wavelength

C = wave velocity

C_0 = deepwater wave velocity

T = wave period

Refraction coefficient and angle:

$$\sin \alpha = \left(\frac{C}{C_0} \right) \sin \alpha_0 \quad (\text{eq.2-78b})$$

Note that equation (2-78b) is written between deep water and $d = 12.0$ m, since bottom contours and shoreline have been assumed straight and parallel. For straight parallel bottom contours, the expression for the refraction coefficient reduces to

$$K_R = \left(\frac{b_0}{b} \right)^{1/2} = \left(\frac{\cos \alpha_0}{\cos \alpha} \right)^{1/2}$$

where

b = spacing between wave orthogonals

b_0 = deepwater orthogonal spacing

Recall,

$$L_o = \frac{gT^2}{2\pi} = \text{deepwater wavelength in meters} \quad (\text{eq. 2-8a})$$

and

$$\frac{L}{L_o} = \frac{C}{C_o} = \tanh \left(\frac{2\pi d}{L} \right) \quad (\text{eq. 2-11})$$

Typical refraction-shoaling calculations are given in the tabulation below. Calculations for various directions and for a range of periods follow (see Tables 8-5 and 8-6).

The following tabulates the results of example calculations for waves between 150 and 179.9 degrees from North (angle between direction of wave approach and normal to the shoreline in deep water = $\alpha_o = 45$ degrees) ; $d = 12.0$ m .

(1) T (s)	(2) L_o (m)	(3) d/L_o	(4) H/H_o' K_s	(5) C/L_o	(6) α (deg)	(7) K_r	(8) $K_s K_r^1$
4	25.0	0.4806	0.98856	0.99536	44.7	0.9977	0.9863
6	56.2	0.2136	0.92142	0.90270	39.7	0.9584	0.8831
8	99.9	0.1201	0.92036	0.75913	32.5	0.9155	0.8426
10	156.1	0.0769	0.95926	0.63887	26.9	0.8903	0.8540
12	224.7	0.0534	1.01180	0.54670	22.7	0.8756	0.8860
14	305.9	0.0392	1.06800	0.47580	19.7	0.8670	0.9255
16	399.5	0.0300	1.12500	0.42050	17.3	0.8610	0.9682
18	505.7	0.0237	1.18130	0.37632	15.4	0.8565	1.0118

Column _____ Source of Information _____

- (2) From equation (2-8a).
- (3) 12.0 m divided by column (2).
- (4) Equation (2-44) or Table C-1, Appendix C.
- (5) Table C-1, Appendix C: $\frac{C}{C_o} = \tanh \left(\frac{2\pi d}{L} \right)$.
- (6) Equation (2-78b)
- (7) $K_r = \left(\frac{\cos \alpha_o}{\cos \alpha} \right)^{1/2}$.
- (8) Column (4) times column (7).

¹ $K_s K_r$ can also be obtained from Plate C-6, Appendix C.

Table 8-5. Breaker angles and refraction and shoaling coefficients in $d = 12 \text{ m}$.

		$\alpha_o = 15 \text{ deg}$							
T (s)		4	6	8	10	12	14	16	18
α (deg)		14.92	13.51	11.33	9.52	8.13	7.07	6.25	5.59
K_S		0.9886	0.9214	0.9204	0.9593	1.012	1.068	1.125	1.181
K_r		0.9998	0.9967	0.9925	0.9897	0.9878	0.9866	0.9857	0.9852
$K_S K_r$		0.9884	0.9184	0.9135	0.9493	0.9995	1.0537	1.1090	1.1638
		$\alpha_o = 45 \text{ deg}$							
T (s)		4	6	8	10	12	14	16	18
α (deg)		44.73	39.67	32.47	26.86	22.74	19.66	17.30	15.43
K_S		0.9886	0.9214	0.9204	0.9593	1.012	1.068	1.125	1.181
K_r		0.9977	0.9584	0.9155	0.8903	0.8756	0.8670	0.8610	0.8565
$K_S K_r$		0.9863	0.8831	0.8426	0.8540	0.8860	0.9255	0.9682	1.012
		$\alpha_o = 75 \text{ deg}$							
T (s)		4	6	8	10	12	14	16	18
α (deg)		74.03	60.67	47.16	38.11	31.88	27.36	23.96	21.31
K_S		0.9886	0.9214	0.9204	0.9593	1.012	1.068	1.125	1.181
K_r		0.9710	0.7271	0.6170	0.5735	0.5521	0.5398	0.5322	0.5271
$K_S K_r$		0.9590	0.6699	0.5678	0.5501	0.5586	0.5765	0.5987	0.6227

Table 8-6. Summary of refraction analyses in $d = 12$ m (numbers given in table are $K_S K_R$).

Direction from N (deg)	Range (deg)	α_0^1 (deg)	Wave Period (s)							
			4	6	8	10	12	14	16	18
45	30-59.9	75°	0.959	0.670	0.568	0.550	0.559	0.577	0.599	0.623
75	60-89.9	45°	0.986	0.883	0.843	0.854	0.886	0.926	0.968	1.012
105	90-119.9	15°	0.988	0.918	0.914	0.949	1.000	1.054	1.109	1.164
135	120-149.9	15°	0.988	0.918	0.914	0.949	1.000	1.054	1.109	1.164
165	150-179.9	45°	0.986	0.883	0.843	0.854	0.886	0.926	0.968	1.012
195	180-209.9	75°	0.959	0.670	0.568	0.550	0.559	0.577	0.599	0.623

¹ Angle between wave orthogonal and normal to the shoreline.

Refraction-shoaling coefficients are summarized graphically in Figure 8-18 on the next page.

(4) Transformation of Wave Statistics by Refraction and Shoaling. The refraction-shoaling coefficients calculated previously will be used to transform the deepwater wave statistics given in Table 8-4 (see Tables 8-7 and 8-8 and Figure 8-19). The resulting statistics will be only approximations since only the significant wave is considered in the analysis. The actual sea surface is made up of many wave periods or frequencies, each of which results in a different refraction-shoaling coefficient.

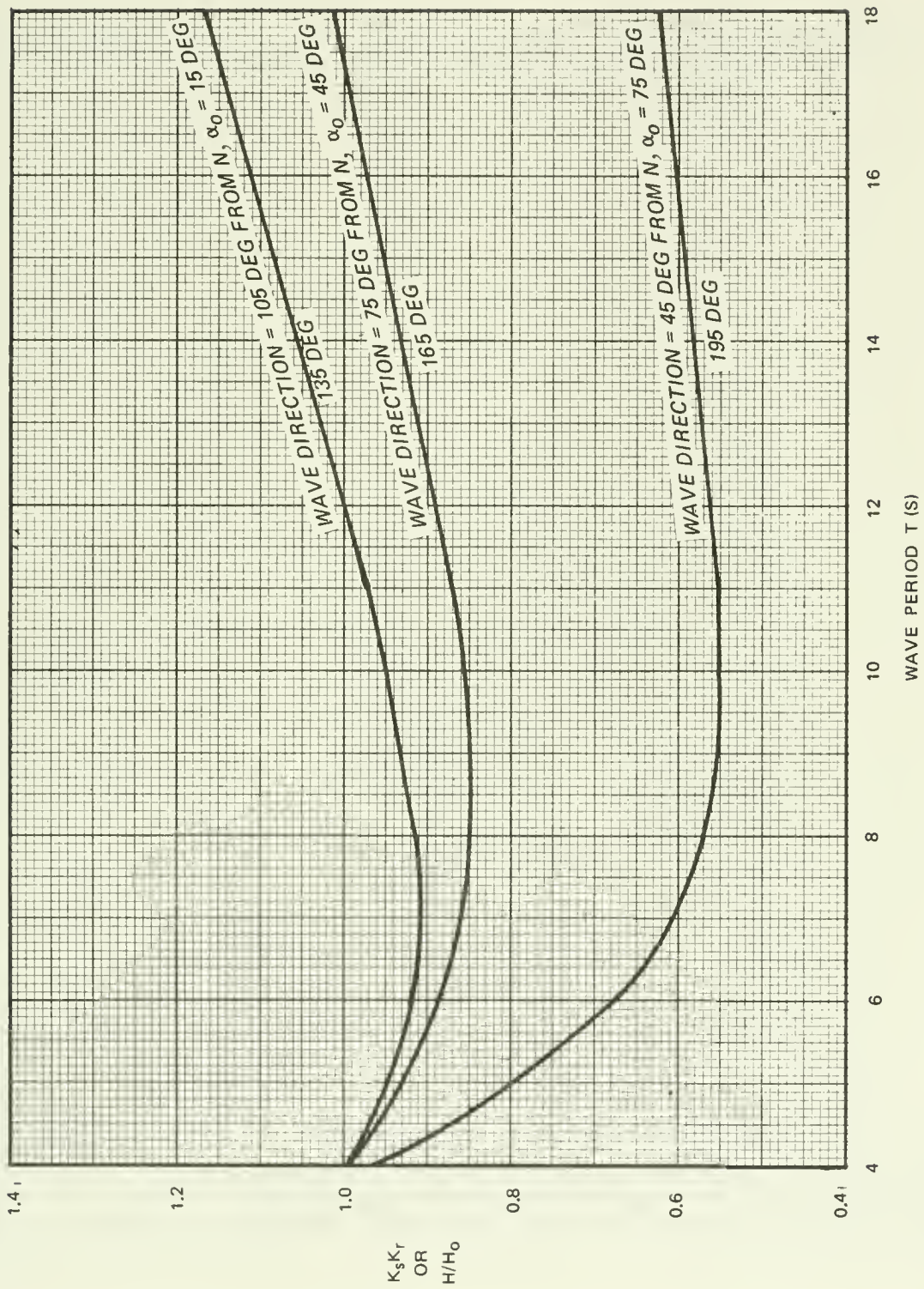

Figure 8-18. Refraction-shoaling coefficient as a function of wave direction and wave period.

Table 8-7. Transformed wave heights: significant heights and periods in
 $d = 12.0 \text{ m}$.

Deepwater Height (m)	α (deg)	Angle from North (deg)	Range (deg)	Wave Period (s)						
				6	8	10	12	14	16	18
<10	75	45 195	30-59.9 180-209.9	6.699 ¹	5.678	5.501	(1) ² 5.586	5.765	5.987	6.227
	45	75 165	60-89.9 150-179.9	8.831	8.476	8.540	8.860	9.255	9.682	10.120
	15	105 135	90-119.9 120-149.9	9.184	9.135	9.493	9.995	10.537	11.090	11.638
<9.5	75	45 195	30-59.9 180-209.9	6.364	5.394	5.226	(1) 5.307	5.477	5.688	5.916
	45	75 165	60-89.9 150-179.9	8.389	8.005	8.113	8.417	8.792	9.198	9.614
	15	105 135	90-119.9 120-149.9	8.725	8.678	9.018	9.495	10.010	10.536	11.056
<9.0	75	45 195	30-59.9 180-209.9	6.029	5.110	4.951	(1) 5.027	5.189	5.388	5.604
	45	75 165	60-89.9 150-179.9	7.948	7.583	7.687	7.974	8.330	8.714	9.108
	15	105 135	90-119.9 120-149.9	8.266	8.222	8.544	8.996	9.483	9.981	10.474
<8.5	75	45 195	30-59.9 180-209.9	5.694	4.826	(1) 4.676	4.748	4.900	5.089	5.293
	45	75 165	60-89.9 150-179.9	7.506	7.162	7.259	7.531	7.867	8.230	8.602
	15	105 135	90-119.9 120-149.9	7.806	7.765	8.069	8.496	8.956	9.427	9.892
<8.0	75	45 195	30-59.9 180-209.9	5.359	4.542	(1) 4.401	(1) 4.469	4.612	4.790	4.982
	45	75 165	60-89.9 150-179.9	7.065	6.741	6.832	(1) 7.088	7.404	7.746 (1)	8.096
	15	105 135	90-119.9 120-149.9	7.347	7.308	7.594	7.996	8.430	8.872	9.310

¹ Numbers represent transformed wave height. For example, a 10-meter-high deepwater wave with a period of 14 seconds approaching from N 75 deg E (in deep water) will be 9.255 meters high at the island site (i.e., in a depth of 12.0 meters).

² Numbers in parentheses represent the number of hours waves are below given height and above next lower height for given period and direction. For example, deepwater waves between 9.5 and 10 meters in height with a period of 12 seconds were experienced for 1 hour in the one year of hindcast data. Equivalently, the wave height at the structure site for the given deepwater wave statistics will be between 5.307 and 5.586 meters for 1 hour.

Table 8-7. Transformed wave heights: significant heights and periods in d = 12.0 m (continued).

Deepwater Height (m)	α_0 (deg)	Angle from North (deg)	Range (deg)	Wave Period (s)						
				6	8	10	12	14	16	18
<7.5	75	45 195	30-59.9 180-209.9	5.024 ¹	4.259	(2) ² 4.126	(2) 4.190	4.234	4.490	4.670
	45	75 165	60-89.9 150-179.9	6.623	6.320	(1) 6.405	(1) 6.645	6.941	7.262	7.590
	15	105 135	90-119.9 120-149.9	6.888	6.851	7.120	7.496	7.903	8.318	8.729
<7.0	75	45 195	30-59.9 180-209.9	4.689	(1) 3.975	(1) 3.851	(1) 3.910 (1)	4.036	4.191	4.359
	45	75 165	60-89.9 150-179.9	6.182	5.898	5.978	6.202	6.479	6.777 (1)	7.084
	15	105 135	90-119.9 120-149.9	6.429	6.395	6.645	6.997	7.376	7.763	8.147
<6.5	75	45 195	30-59.9 180-209.9	4.354	(1) 3.691	(3) 3.576 (1)	(1) 3.631	3.747	3.892	4.048
	45	75 165	60-89.9 150-179.9	5.740	5.477	(1) 5.551	5.759	6.016	6.293 (1)	6.578
	15	105 135	90-119.9 120-149.9	5.970	5.938	6.170	6.497	6.849	7.209	7.565
<6.0	75	45 195	30-59.9 180-209.9	4.019	(1) 3.407 (1)	(6) 3.301 (3)	3.352	3.459	3.592	3.736
	45	75 165	60-89.9 150-179.9	5.299	(1) 5.056	(3) 5.124 (1)	5.316	5.553 (1)	5.809 (1)	6.072
	15	105 135	90-119.9 120-149.9	5.510	(1) 5.481	5.696	5.997	6.322	6.654	6.983
<5.5	75	45 195	30-59.9 189-209.9	3.684	(2) 3.123 (2)	(7) 3.026 (4)	3.072 (1)	3.171 (1)	3.293	3.425
	45	75 165	60-89.9 150-179.9	4.857	(2) 4.634 (1)	(3) 4.697 (1)	4.873	5.090 (1)	5.325	5.566
	15	105 135	90-119.9 120-149.9	5.051	(1) 5.024	5.221 (1)	5.497	5.795 (1)	6.010	6.401

¹ Numbers represent transformed wave height. For example, a 10-meter-high deepwater wave with a period of 14 seconds approaching from N 75 deg E (in deep water) will be 9.255 meters high at the island site (i.e., in a depth of 12.0 meters).

² Numbers in parentheses represent the number of hours waves are below given height and above next lower height for given period and direction. For example, deepwater waves between 9.5 and 10 meters in height with a period of 12 seconds were experienced for 1 hour in the one year of hindcast data. Equivalently, the wave height at the structure site for the given deepwater wave statistics will be between 5.307 and 5.586 meters for 1 hour.

Table 8-7. Transformed wave heights: significant heights and periods in
 $d = 12.0$ m (continued).

Deepwater Height (m)	α (deg)	Angle from North (deg)	Range (deg)	Wave Period (s)						
				6	8	10	12	14	16	18
<5.0	75	45 195	30-59.9 180-209.9	3.350 ¹	(3) ² 2.839 (3)	(8) 2.751 (7)	2.793 (1)	2.883 (1)	2.994 (1)	3.114
	45	75 165	60-89.9 150-179.9	4.416	(3) 4.213 (1)	(6) 4.270 (2)	4.430	4.628 (1)	4.841 (3)	5.060
	15	105 135	90-119.9 120-149.9	4.592	(1) 4.568	(1) 4.747 (1)	4.998 (1)	5.269 (1)	5.545	5.819
<4.5	75	45 195	30-59.9 180-209.9	3.015	(11) 2.555 (13)	(4) 2.475 (10)	2.514 (3)	2.594 (2)	2.694 (1)	2.802
	45	75 165	60-89.9 150-179.9	3.974	(6) 3.792 (3)	(3) 3.843 (3)	3.987	4.165 (2)	4.357 (2)	4.554
	15	105 135	90-119.9 120-149.9	4.133	(2) 4.111 (2)	(2) 4.272 (2)	(1) 4.498 (3)	4.742 (1)	4.991 (1)	5.237
<4.0	75	45 195	30-59.9 180-209.9	2.680	(17) 2.271 (25)	(1) 2.200 (7)	2.234 (6)	2.306 (3)	2.395	2.491
	45	75 165	60-89.9 150-179.9	3.532	(10) 3.370 (9)	(3) 3.416 (3)	(1) 3.544 (4)	3.702 (5)	3.873 (2)	4.048
	15	105 135	90-119.9 120-149.9	3.674	(4) 3.654 (5)	(3) 3.797 (5)	(1) 3.998 (4)	4.215 (2)	4.436	4.655
<3.5	75	45 195	30-59.9 180-209.9	2.345	(24) 1.987 (39)	(2) 1.925 (10)	(1) 1.955 (15)	2.018 (5)	2.095 (1)	2.179
	45	75 165	60-89.9 150-179.9	3.091	(20) 2.949 (22)	(2) 2.989 (5)	(1) 3.101 (10)	3.239 (4)	3.389 (1)	3.542
	15	105 135	90-119.9 120-149.9	3.214	(13) 3.197 (17)	(5) 3.323 (10)	(1) 3.498 (6)	3.688 (1)	3.882	4.073
<3.0	75	45 195	30-59.9 180-209.9	(1) 2.010 (1)	(24) 1.703 (60)	(1) 1.650 (20)	(1) 1.676 (19)	1.730 (3)	1.796 (1)	1.868
	45	75 165	60-89.9 150-179.9	(1) 2.649 (1)	(29) 2.528 (37)	(4) 2.562 (19)	(2) 2.658 (14)	2.777 (6)	2.905 (1)	3.036
	15	105 135	90-119.9 120-149.9	2.755 (2)	(26) 2.741 (33)	(6) 2.848 (16)	(2) 2.999 (12)	3.161 (2)	3.327	3.491

¹ Numbers represent transformed wave height. For example, a 10-meter-high deepwater wave with a period of 14 seconds approaching from N 75 deg E (in deep water) will be 9.255 meters high at the island site (i.e., in a depth of 12.0 meters).

² Numbers in parentheses represent the number of hours waves are below given height and above next lower height for given period and direction. For example, deepwater waves between 9.5 and 10 meters in height with a period of 12 seconds were experienced for 1 hour in the one year of hindcast data. Equivalently, the wave height at the structure site for the given deepwater wave statistics will be between 5.307 and 5.586 meters for 1 hour.

Table 8-7. Transformed wave heights: significant heights and periods in d = 12.0 m (concluded).

Deepwater Height (m)	α (deg)	Angle from North (deg)	Range (deg)	Wave Period (s)							
				4	6	8	10	12	14	16	18
<2.5	75	45 195	30-59.9 180-209.9		(9) ² 1.675 ₁ (17)	(15) 1.420 (55)	(6) 1.375 (40)	1.397 (27)	1.441 (5)	1.497 (1)	1.557
	45	75 165	60-89.9 150-179.9		(10) 2.208 (10)	(21) 2.207 (38)	(7) 2.135 (24)	2.215 (15)	2.314 (6)	2.421 (1)	2.530
	15	105 135	90-119.9 120-149.9		(6) 2.296 (7)	(20) 2.284 (33)	(6) 2.373 (26)	(1) 2.499 (11)	(1) 2.634 (3)	2.773	2.910
<2.0	75	45 195	30-59.9 180-209.9	(1) 1.918 (1)	(31) 1.340 (60)	(16) 1.136 (82)	(16) 1.100 (57)	(4) 1.117 (22)	1.153 (3)	1.197 (2)	1.245
	45	75 165	60-89.9 150-179.9	1.973	(20) 1.766 (32)	(18) 1.685 (56)	(10) 1.708 (42)	(2) 1.772 (23)	1.851 (4)	1.936	2.024
	15	105 135	90-119.9 120-149.9	1.977	(15) 1.837 (18)	(27) 1.827 (44)	(9) 1.899 (32)	(1) 1.999 (13)	2.107 (1)	2.218	2.328
<1.5	75	45 195	30-59.9 180-209.9	(6) 1.439 (13)	(49) 1.005 (108)	(41) 0.852 (93)	(57) 0.825 (44)	(10) 0.838 (10)	0.865 (11)	0.898	0.934
	45	75 165	60-89.9 150-179.9	(9) 1.479 (8)	(38) 1.325 (45)	(45) 1.264 (76)	(11) 1.281 (53)	1.329 (26)	1.388 (2)	1.452	1.518
	15	105 135	90-119.9 120-149.9	(11) 1.483 (10)	(26) 1.378 (25)	(47) 1.370 (69)	(11) 1.424 (29)	1.499 (9)	1.581	1.664	1.746
<1.0	75	45 195	30-59.9 180-209.9	(71) 0.959	(10) 0.670	(126) 0.568	(107) 0.550	(5) 0.559	0.557	0.599	0.623
	45	75 165	60-89.9 150-179.9	(54) 0.986 (79)	(11) 0.883 (12)	(75) 0.843 (84)	(19) 0.854	0.886	0.926	0.968	1.012
	15	105 135	90-119.9 120-149.9	(50) 0.988 (45)	(5) 0.918 (7)	(59) 0.914 (95)	(13) 0.949 (23)	(1) 1.000 (3)	1.054	1.109	1.164
<0.5	75	45 195	30-59.9 180-209.9	(25) 0.480 (44)	0.335	(54) 0.284 (23)	(12) 0.275 (6)	0.279 (3)	0.2883	0.299	0.311
	45	75 165	60-89.9 150-179.9	(25) 0.493 (30)	0.442	(22) 0.421 (57)	(2) 0.427 (27)	0.443 (2)	0.463	0.484	0.506
	15	105 135	90-119.9 120-149.9	(28) 0.494 (19)	0.459	(20) 0.457 (40)	(2) 0.475 (16)	0.500 (2)	0.527	0.555	0.582

¹ Numbers represent transformed wave height. For example, a 10-meter-high deepwater wave with a period of 14 seconds approaching from N 75 deg E (in deep water) will be 9.255 meters high at the island site (i.e., in a depth of 12.0 meters).

² Numbers in parentheses represent the number of hours waves are below given height and above next lower height for given period and direction. For example, deepwater waves between 9.5 and 10 meters in height with a period of 12 seconds were experienced for 1 hour in the one year of hindcast data. Equivalently, the wave height at the structure site for the given deepwater wave statistics will be between 5.307 and 5.586 meters for 1 hour.

The following tabulations are to be used with Table 8-7. The first lists the number of hours waves of a particular height were present at the structure site. (For example, for waves 7 meters high, with a 12-second period from 75 degrees north (from Table 8-7), wave height at the structure was between 7.088 and 6.645 meters for 1 hour. Therefore, wave height was above 7 meters for $1 \times 0.088 / (7.088 - 6.645) = 0.199$ hour. Wave height between 6 and 7 meters was $1 - 0.199 = 0.801$ hour.) The second tabulation sums hours for a given wave height and associated frequency. Note that the total hours of waves less than 3 meters high is given, although the listing for these waves is either incomplete or not given; these totals were obtained by completing the calculations using the data in Table 8-7.

Computation of Number of Hours for Wave Groups of the Following Heights at the Structure					
$\geq 7m$	6 to 7m	5 to 6m	4 to 5m	3 to 4m	2 to 3m
0.199	0.801	1.000			
1.000		1.000			
		0.097	0.903		
	0.948	0.052	1.000		
	1.000		1.000		
	1.000		1.000		
	0.605	0.395	0.916	1.084	
			1.357	0.643	
		0.133	0.867		
		1.000		1.000	
		0.871	2.129	1.000	
		1.000		1.000	3.000
		1.000		1.000	3.000
		0.690	0.710	1.000	8.000
		1.000		3.000	7.000
			2.000	1.000	1.000
			1.000	1.000	1.000
			3.000	1.000	1.000
			1.000	6.000	
		0.671	0.329	1.000	
		0.053	0.947	3.000	
		0.466	0.534	0.866	1.134
		1.000		0.662	6.338
		0.133	0.867	0.866	1.134
				0.378	3.622
				0.258	0.742
			1.518	1.482	
			0.506	0.494	
				0.594	0.406
			3.794	2.206	11.000
			1.265	0.735	4.000
			1.000	6.000	13.000
			3.000	3.000	10.000
			1.000	3.000	3.000
			1.000	3.000	2.000
			1.000		1.000
			1.000		
		0.510	0.490		
			0.713	1.287	
			1.475	0.525	
			0.486	1.514	
			0.486	1.514	
			1.145	0.855	
			1.145	0.855	
			0.996	0.004	
			2.988	0.012	
			1.000		
				8.789	1.211
				7.910	1.090
				2.293	0.077
				2.293	0.077
				1.000	
				4.000	
				5.000	
				2.000	
				4.000	
				5.000	
				3.000	

Computation of Number of Hours for Wave Groups of the Following Heights at the Structure					
$\geq 7m$	6 to 7m	5 to 6m	4 to 5m	3 to 4m	2 to 3m
				5.000	
				1.000	
				4.000	
			0.816	1.184	
				0.228	0.772
				2.280	7.720
				2.069	1.931
				0.804	0.196
				5.616	7.384
				7.344	9.656
				3.400	1.600
				6.800	3.200
				0.998	0.002
				5.988	0.012
				1.000	
				0.611	1.389
1.199	4.354	11.071	46.382	146.441	Incomplete Listing

Total hours in record = 8766

Height (m)	Total Hours ¹	Frequency
$H \geq 7$	1.199	0.000137 ²
$H \geq 6$	5.553	0.000634
$H \geq 5$	16.091	0.001836
$H \geq 4$	60.606	0.006914
$H \geq 3$	208.307	0.023763
$H \geq 2$	769.689	0.087804
$H \geq 1$	2278.767	0.259955
$H \geq 0$	8766	1.0000

¹ Number of hours wave height equalled or exceeded given value.

² 1.99 hours/8766 hours = 0.000137.

Table 8-8. Deepwater wave statistics (without consideration of direction).¹

Significant Wave Height (m)	Cumulative Hours	Probability of Exceedance
< 10.0	1	0.00011
< 9.5	2	0.00023
< 9.0	3	0.00034
< 8.5	4	0.00046
< 8.0	8	0.00091
< 7.5	14	0.00160
< 7.0	19	0.00217
< 6.5	27	0.00308
< 6.0	46	0.00535
< 5.5	74	0.00844
< 5.0	119	0.01358
< 4.5	195	0.02225
< 4.0	315	0.03593
< 3.5	530	0.06046
< 3.0	874	0.09970
< 2.5	1295	0.14773
< 2.0	1957	0.22325
< 1.5	2939	0.33527
< 1.0	3893	0.44410
< 0.5	8766	1.00000

¹ Wave statistics are derived from data given in Corson et al. (1981).

Curves showing deepwater wave height statistics and transformed statistics are given in Figure 8-19.

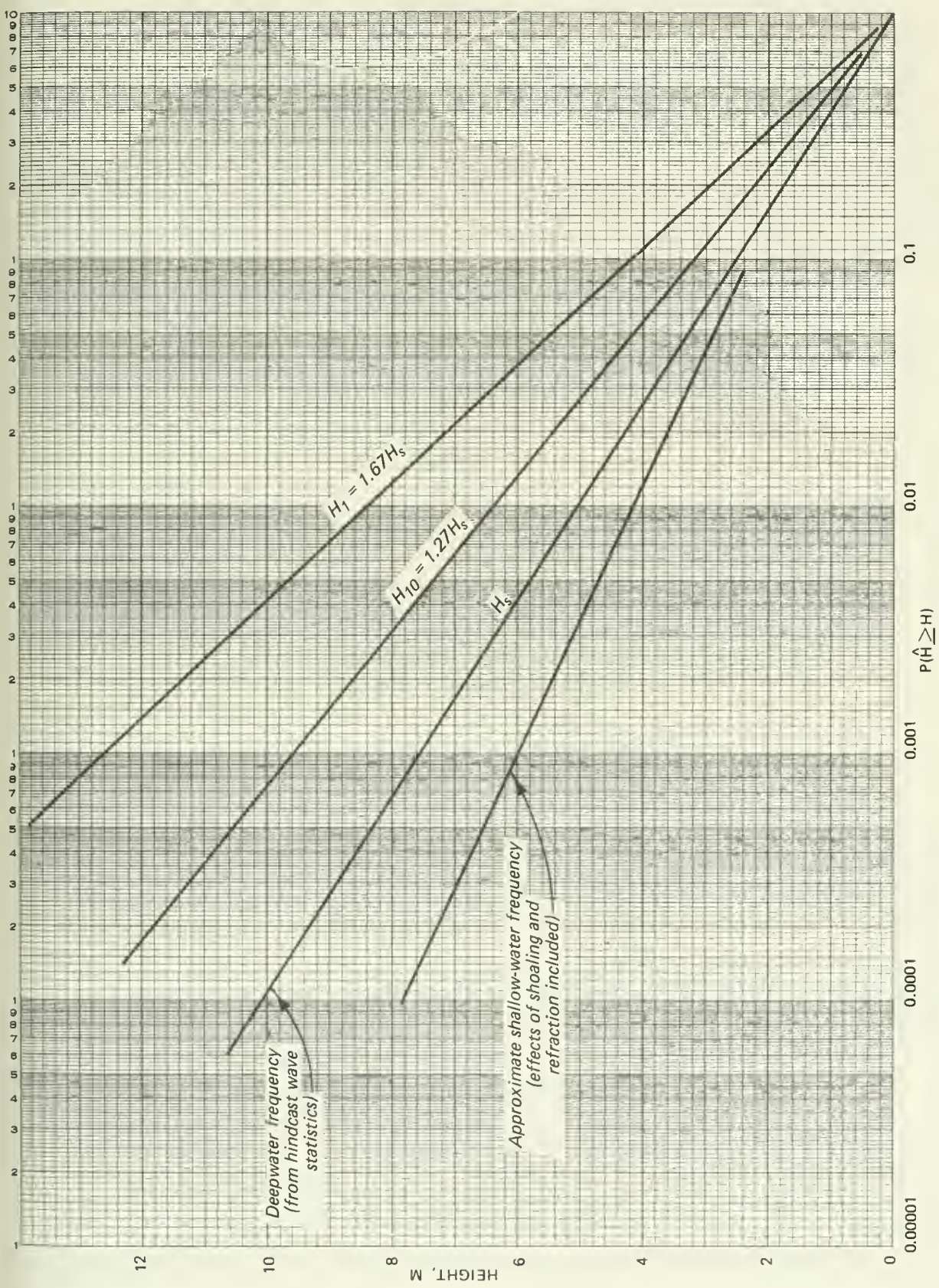
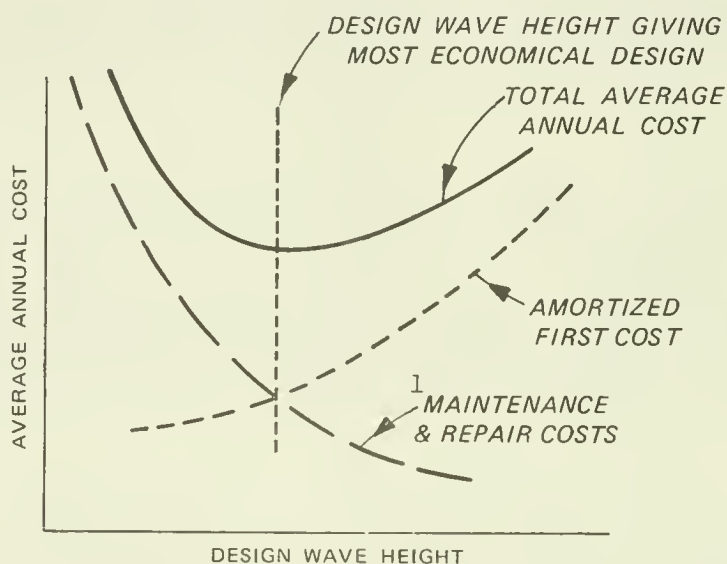

Figure 8-19. Frequency of occurrence of significant wave heights for waves generated in ocean transformation by refraction and shoaling.

IV. PRELIMINARY DESIGN

1. Selection of Design Waves and Water Levels.

The selection of design conditions is related to the economics of construction and annual maintenance costs to repair structure in the event of extreme wave action. These costs¹ are related to the probability of occurrence of extreme waves and high water levels. There will usually be some design wave height which will minimize the average annual cost (including amortization of first cost). This optimum design wave height will give the most economical design.



Intangible considerations such as the environmental consequences of structural failure or the possibility of loss of life in the event of failure must also enter into the decision of selecting design conditions. These factors are related to the specific purpose of each structure.

The following design conditions are assumed for the illustrative purposes of this problem.

a. Water Levels (MLW datum).

- (1) Storm surge (less astronomical tide): use 3.0 m .
- (2) Astronomical tide (use water level exceeded 1 percent of time): 1.5 m .
- (3) Wave setup (assumed negligible since structure is in relatively deep water and not at beach).

b. Wave Conditions on Bay Side of Island.

(1) Use conditions with 100-year recurrence interval:

$$H_s = 3.59 \text{ m}$$

$$T_s = 7.78 \text{ s}$$

c. Wave Conditions on Ocean Side of Island. From hindcast statistics (wave height exceeded 0.1 percent of the time in shallow water), use

$$H_s = 6.0 \text{ m}$$

Note that the reciprocal of an exceedance probability associated with a particular wave according to the present hindcast statistics is not the return period of this wave. For structural design purposes, a statistical analysis of extreme wave events is recommended.

2. Revetment Design: Ocean Side of Island.

The ocean side of the island will be protected by a revetment using concrete armor units.

a. Type of Wave Action. The depth at the site required to initiate breaking to the 6.0-meter design wave is as follows for a slope in front of the structure where $m = \text{zero}$ (see Ch. 7, Sec. 1):

$$\text{or} \quad H_b = 0.78 d_b$$

$$d_b = \frac{H_b}{0.78} = \frac{6.0}{0.78} = 7.7 \text{ m}$$

where H_b is the breaker height and d_b is the water depth at the breaking wave.

Since the depth at the structure ($d_s \approx 12.0 \text{ m}$) is greater than the computed breaking depth (7.7 m), the structure will be subjected to non-breaking waves.

b. Selection Between Alternative Designs. The choice of one cross section and/or armor unit type over another is primarily an economic design requiring evaluation of the costs of various alternatives. A comparison of several alternatives follows:

Type of Armor Unit: Tribars vs Tetrapods

Structure Slope: 1:1.5, 1:2, 1:2.5, and 1:3

Concrete Unit Weight: 23.56 kN/m^3 , 25.13 kN/m^3 , 26.70 kN/m^3

The use of concrete armor units will depend on the availability of suitable quarystone and on the economics of using concrete as opposed to stone.

(1) Preliminary Cross Section (modified from Figure 7-116).

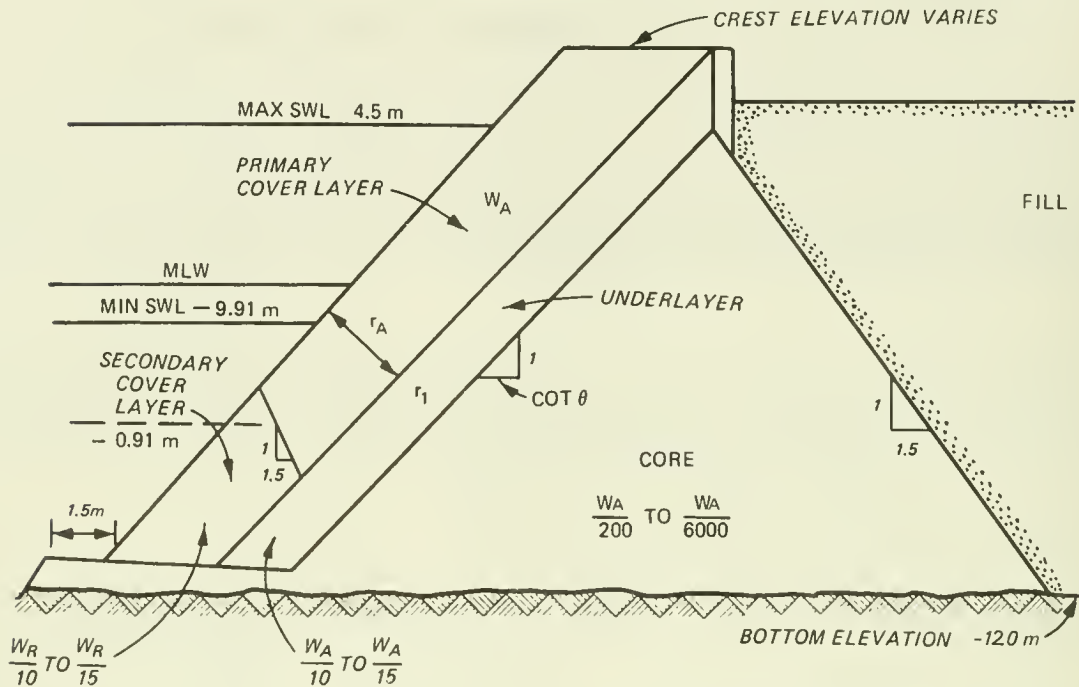

W_A = WEIGHT OF INDIVIDUAL ARMOR UNIT
 W_R = WEIGHT OF PRIMARY COVER LAYER IF MADE OF ROCK
 r_A = COVER LAYER THICKNESS
 r_1 = THICKNESS OF FIRST UNDERLAYER
 θ = ANGLE OF STRUCTURE FACE RELATIVE TO HORIZONTAL

(2) Crest Elevation. Established by maximum runup. Runup (R) estimate:

$$H_g = 6 \text{ m}$$

$$d = 16.5 \text{ m}$$

$T = ?$ (use point on runup curve giving maximum runup)

$$\frac{d}{H_g} = \frac{16.5}{6} = 2.75 \text{ (use Fig. 7-20)}$$

$\cot \theta$	$(R/H_o)_{max}$	R (m)	Crest Elevation ¹
1.5	1.05	6.3	use 10.8
2.0	1.10	6.6	use 11.1
2.5	1.05	6.3	use 10.8
3.0	1.00	6.0	use 10.5

¹ Waves over 6 m will result in some overtopping.

(3) Armor Unit Size.

(a) Primary Cover Layer (see Ch. 7, Sec. III,7,a).

$$W = \frac{w_r H^3}{gK_D (S_r - 1)^3 \cot \theta} \quad (\text{eq. 7-116})$$

where

W = mass of armor unit

H = design wave height = 6 m

w_r = unit weight of concrete

23.56 kN/m³ , 25.13 kN/m³ , and 26.70 kN/m³

$\cot \theta$ = structure slope 1.5, 2.0, 2.5, and 3.0

$S_r = \frac{w_r}{w_w}$ = ratio of concrete unit weight to unit weight of water

K_D = stability coefficient (depends on type of unit, type of wave action, and structure slope)

The calculations that follow (Tables 8-9 and 8-10 and Figs. 8-20 through 8-25) are for the structure trunk subjected to nonbreaking wave action. Stability coefficients are obtained from Table 7-8.

Table 8-9. Required armor unit weights: structure trunk.

Type of Armor Unit	w_p (kN/m ³)	Slope (cot θ)	Armor Unit Stability Coefficient, K_D	W_A^1 (metric tons)	Percent ² Damage for 1% Wave
Tribar	23.56	1.5	10.0	14.259	> 50% $H_1^3 = 10m$
		2.0		10.694	
		2.5		8.555	
		3.0		7.129	
	25.13	1.5	10.0	10.934	> 50% $H_1 = 10m$
		2.0		8.201	
		2.5		6.560	
		3.0		5.467	
	26.70	1.5	10.0	8.629	> 50% $H_1 = 10m$
		2.0		6.473	
		2.5		5.178	
		3.0		4.315	
Tetrapod	23.56	1.5	8.0	17.824	> 50% $H_1 = 10m$
		2.0		13.368	
		2.5		10.694	
		3.0		8.912	
	25.13	1.5	8.0	13.668	> 50% $H_1 = 10m$
		2.0		10.251	
		2.5		8.201	
		3.0		6.834	
	26.70	1.5	8.0	10.787	> 50% $H_1 = 10m$
		2.0		8.091	
		2.5		6.473	
		3.0		5.394	

¹ 1 metric ton = 1000 kg.

² Represents damage under sustained wave action of waves as high as the 1 percent wave, not the damage resulting from a few waves in the spectrum having a height $H_1 = 1.67 H_S$.

³ $H_1 =$ average height of highest 1 percent of waves for given time period = $1.67 H_S$

$$H_1 = 1.67 (6)$$

$$H_1 = 10m$$

Table 8-10. Volume of concrete: primary cover layer of structure trunk.

Type of Armor Unit	w_p (kN/m^3)	Slope $\cot \theta$	Armor Layer Area per 100 m of structure (m) ¹	W_A (metric tons)	Required Number of Armor ² Units, N_r	Volume of Concrete per 100 m of structure (m^3)
Tribar	23.56	1.5	3733.5	14.259	1069	6344
		2.0	4698.0	10.694	1630	7255
		2.5	5576.3	8.555	2245	7994
		3.0	6454.2	7.129	2934	8706
Tribar	25.13	1.5	3733.5	10.934	1332	5683
		2.0	4698.0	8.201	2031	6499
		2.5	5576.3	6.560	2797	7160
		3.0	6454.2	5.467	3655	7797
Tribar	26.70	1.5	3733.5	8.629	1624	5147
		2.0	4698.0	6.473	2475	5884
		2.5	5576.3	5.178	3409	6483
		3.0	6454.2	4.315	4456	7062
Tetrapod	23.56	1.5	3733.5	17.824	1021	7574
		2.0	4698.0	13.368	1556	8657
		2.5	5576.3	10.694	2144	9543
		3.0	6454.2	8.912	2802	10393
Tetrapod	25.13	1.5	3733.5	13.668	1272	6784
		2.0	4698.0	10.251	1939	7756
		2.5	5576.3	8.201	2671	8548
		3.0	6454.2	6.834	3491	9309
Tetrapod	26.70	1.5	3733.5	10.787	1551	6145
		2.0	4698.0	8.091	2364	7025
		2.5	5576.3	6.473	3256	7741
		3.0	6454.2	5.394	4256	8431

$$^1 \text{ Area} = \frac{(9.91 + \text{crest elev}) (100)}{\sin \theta} .$$

² Numbers of units and concrete volumes determined from Figures 8-20 and 8-21, which were derived, in turn, from Figures 7-109 and 7-111.

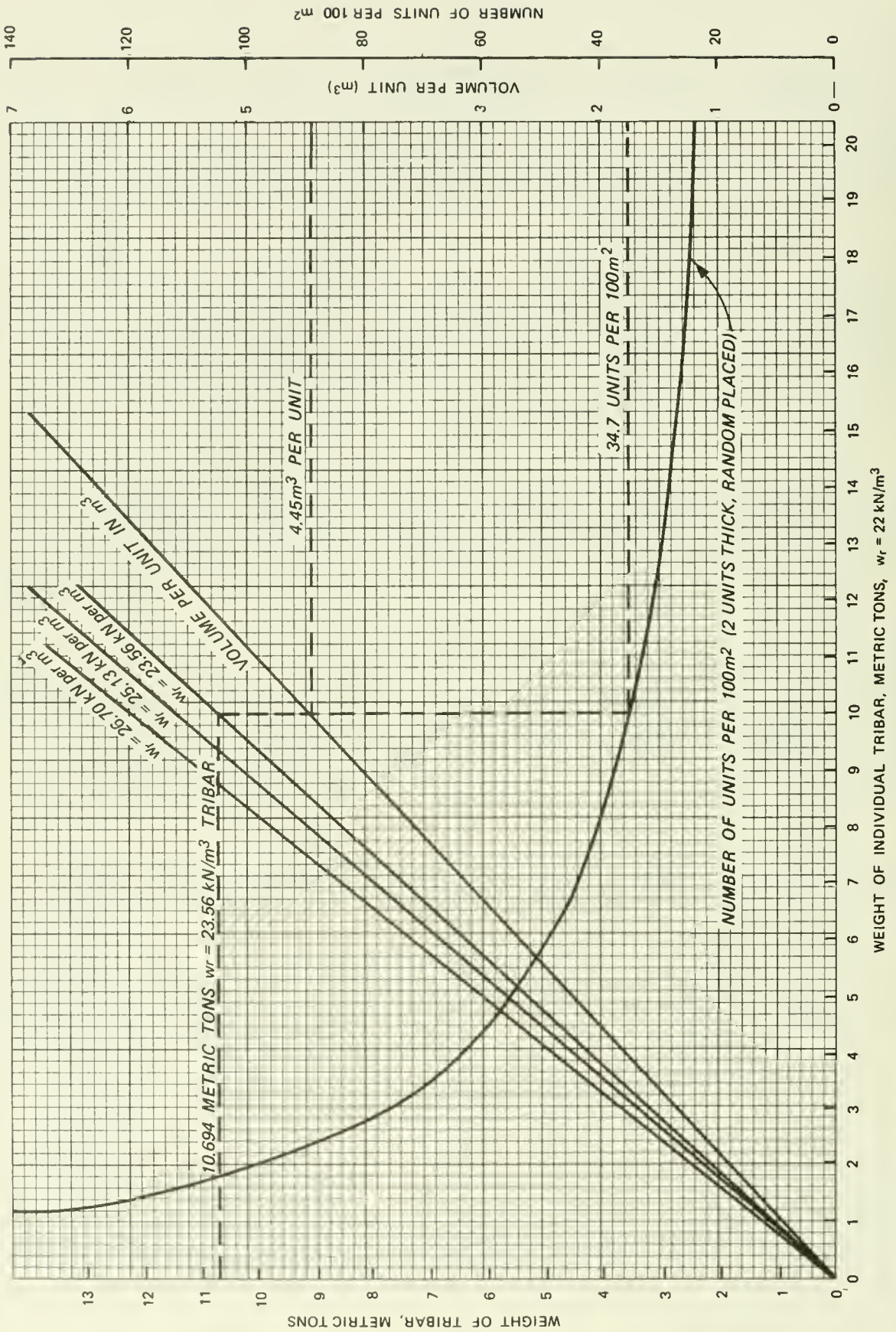
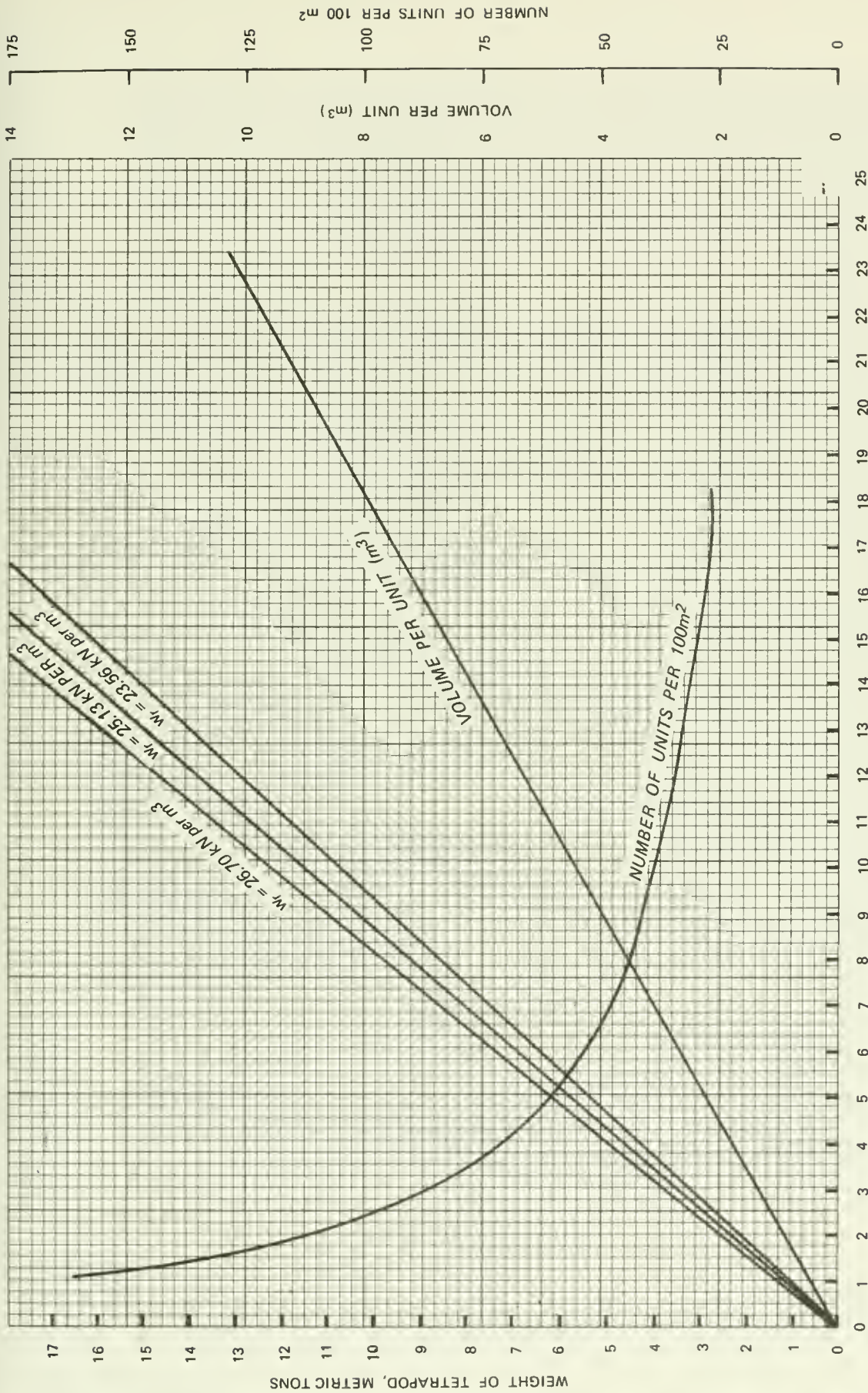

Figure 8-20. Engineering data: tribars.



WEIGHT OF INDIVIDUAL TETRAPOD, METRIC TONS, $w_r = 22 \text{ kN/m}^3$

Figure 8-21. Engineering data: tetrapods.

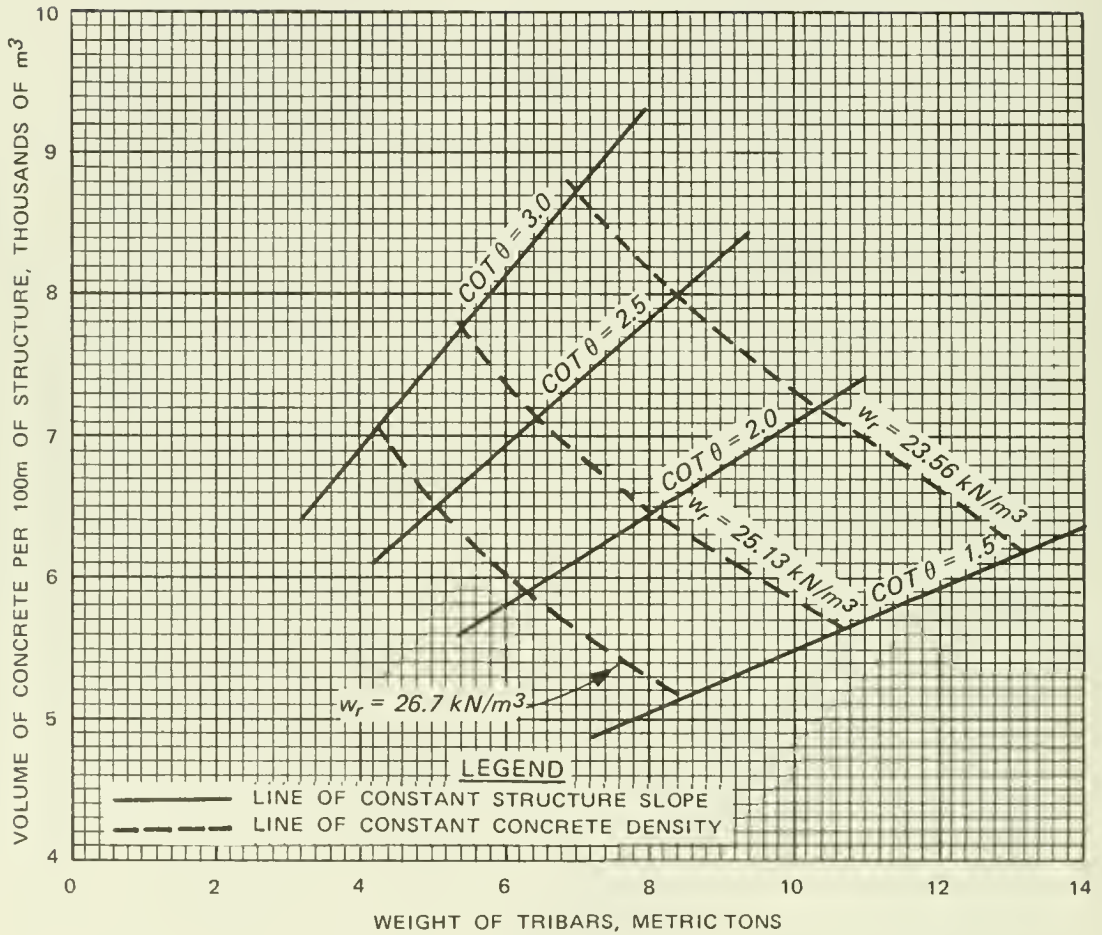

Figure 8-22. Volume of concrete required per 100 meters of structure as a function of tribar weight, concrete unit weight, and structure slope.

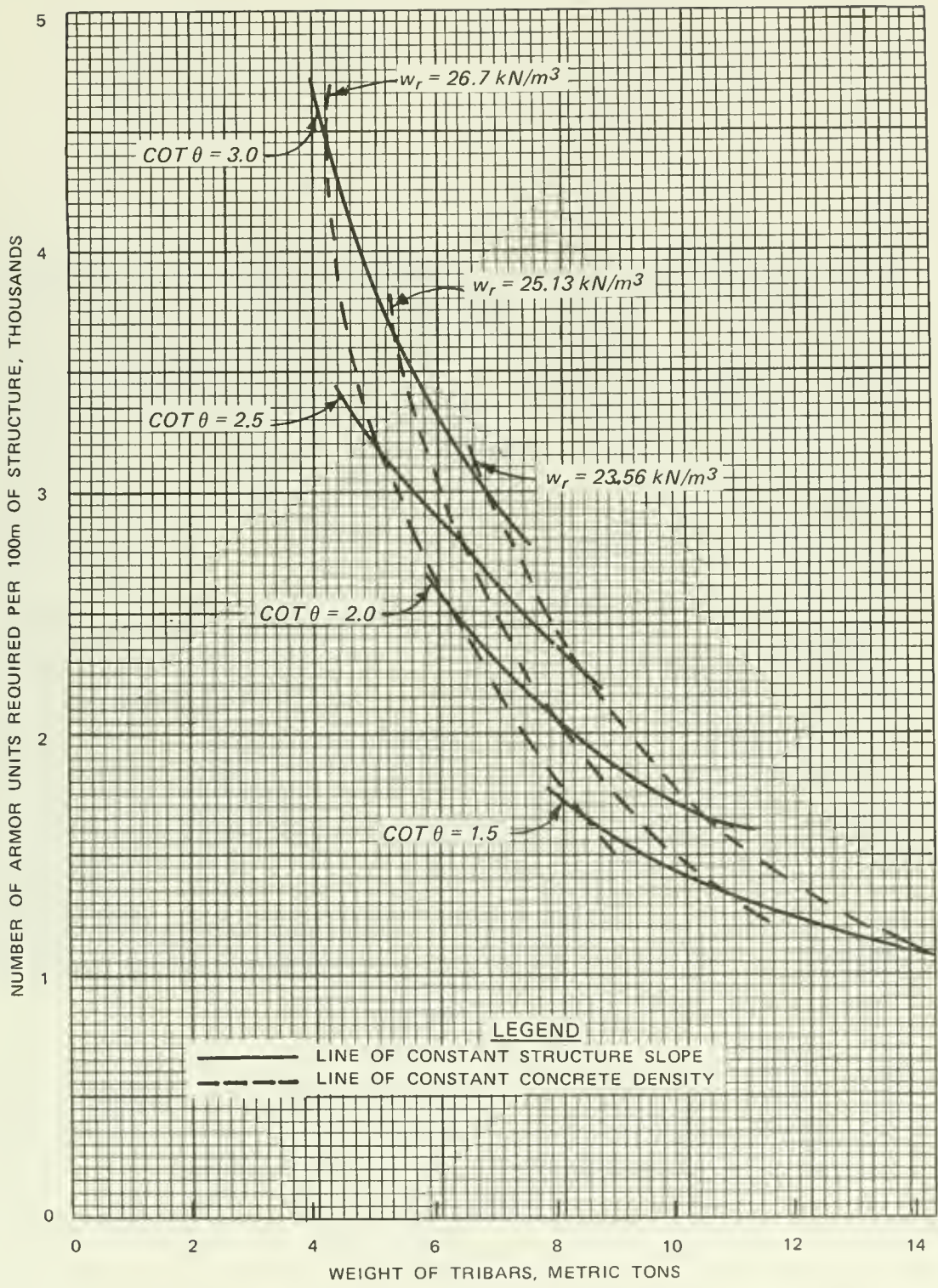

Figure 8-23. Number of tribars required per 100 meters of structure as a function of tribar weight, concrete unit weight, and structure slope.

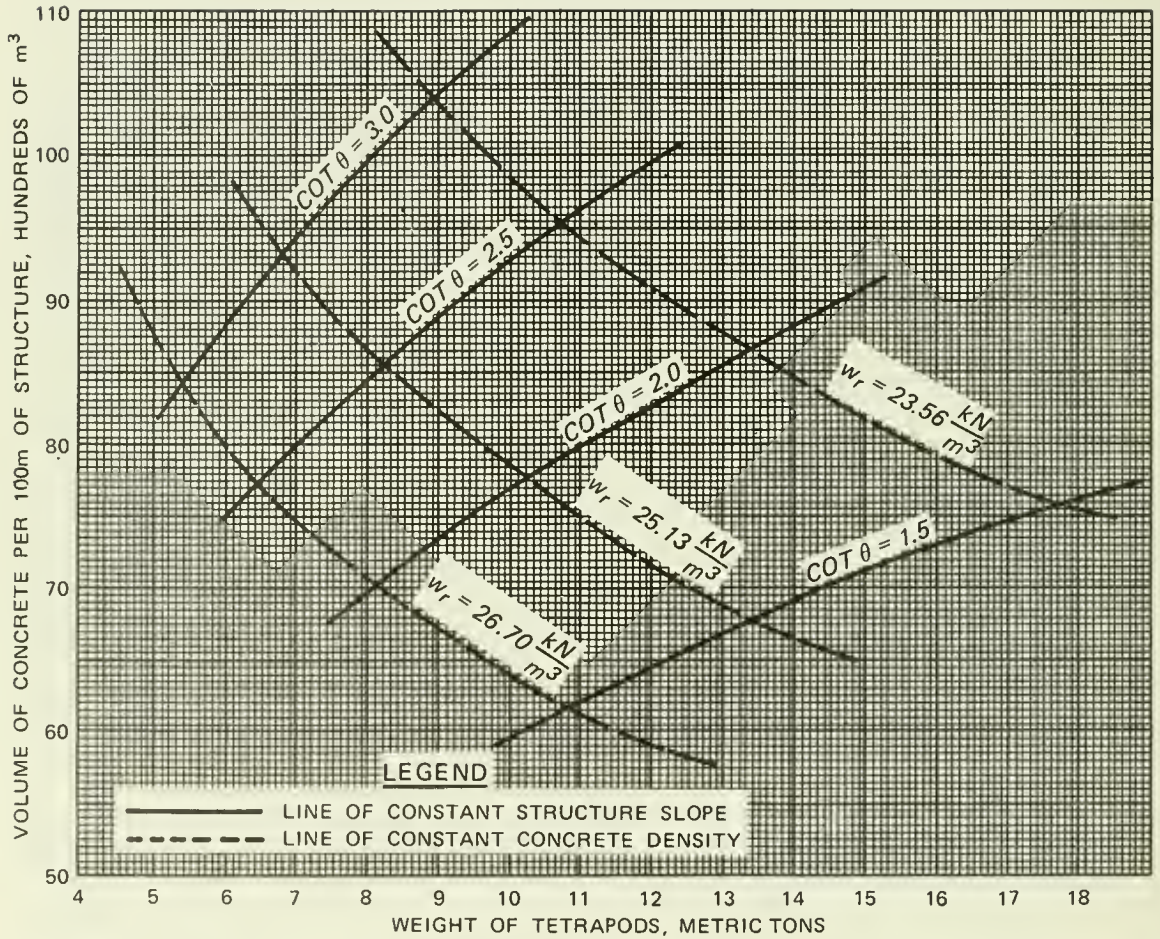

Figure 8-24. Volume of concrete required per 100 meters of structure as a function of tetrapod weight, concrete unit weight, and structure slope.

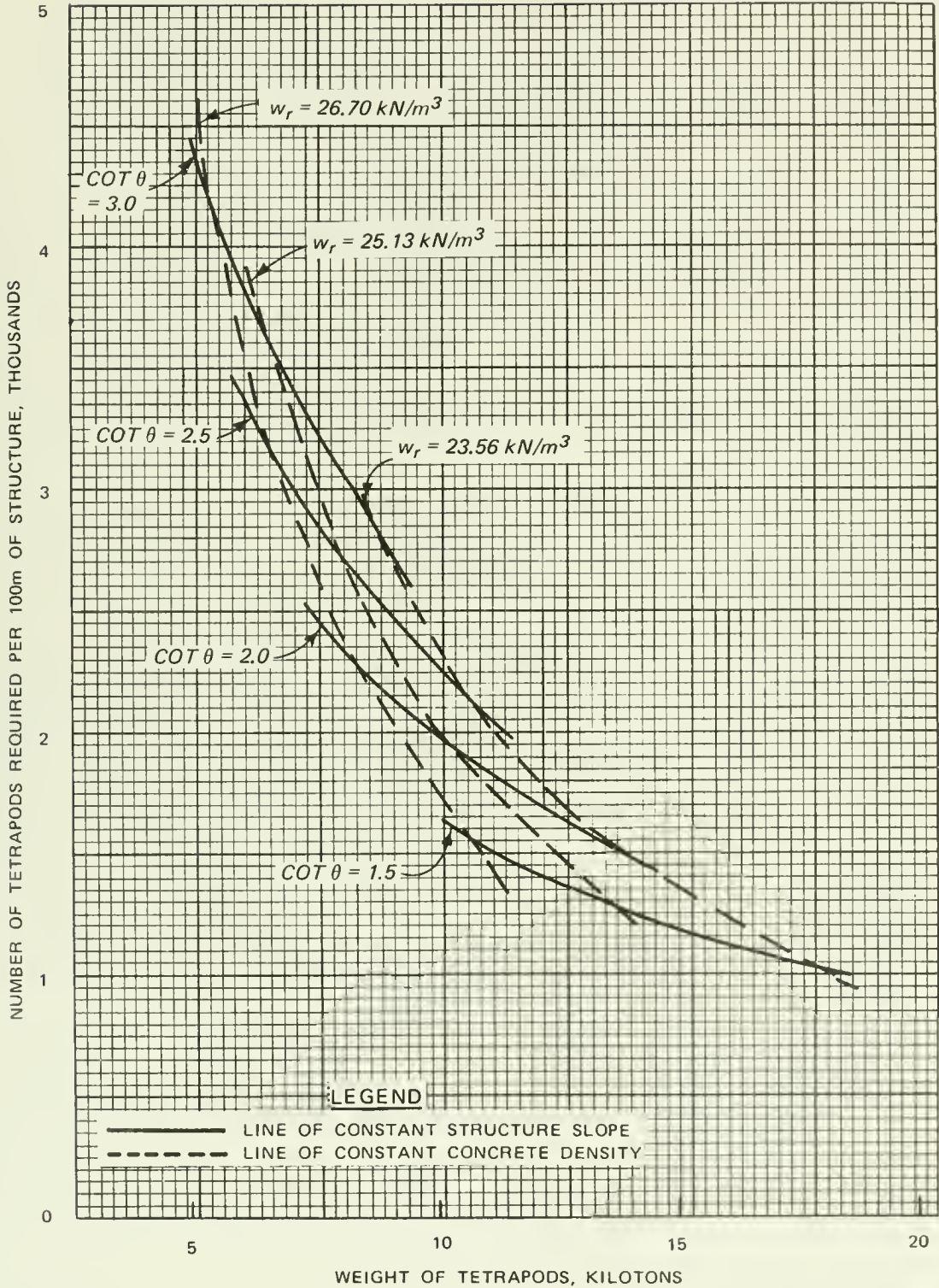
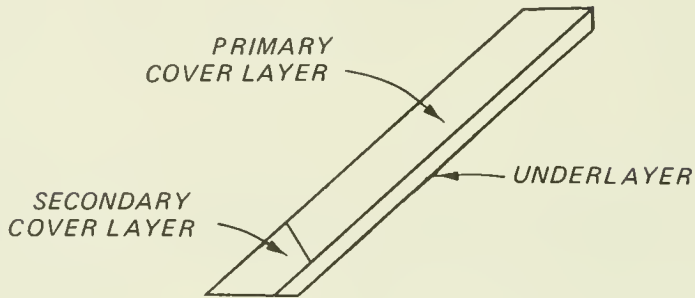

Figure 8-25. Number of tetrapods required per 100 meters of structure as a function of tetrapod weight, concrete unit weight, and structure slope.

(b) Secondary Cover Layer. The weight of the secondary cover layer $\frac{W_R}{10}$ is based on the weight of a primary cover layer made of rock W_R .



W_R = weight of primary cover layer if it were made of rock

$\frac{W_R}{10}$ = weight of secondary cover layer

w_r = unit weight of rock = 25.92 kN/m³

K_D = 4.0 for stone under nonbreaking wave conditions

$$W_R \text{ metric tons} = \frac{w_r H^3}{gK_D (S_R - 1)^3 \cot \theta}$$

$\cot \theta$	W_R (metric tons)	$\frac{W_R}{10}$ (metric tons)
1.5	24.21	2.42
2.0	18.16	1.82
2.5	14.53	1.45
3.0	12.11	1.21

(c) Thickness of Cover Layer. Primary and secondary layers have the same thickness.

$$r_A = n k_{\Delta} \left(\frac{g W_A}{w_r} \right)^{1/3} \quad (\text{eq. 7-121})$$

where

r_A = thickness of cover layer (m)

n = number of armor units comprising the layer

W_A = weight of individual armor unit (metric tons)

w_r = unit weight of stone material (concrete or quarrystone)

k_Δ = layer coefficient of rubble structure

(d) Number of Stones Required.

where

$$N_R = A n k_\Delta \left(1 - \frac{P}{100}\right) \left(\frac{w_r}{g W_A}\right)^{2/3} \quad (\text{eq. 7-122})$$

N_R = number of armor units or stones in cover layer

A = area (m^2)

P = porosity (%)

Type of Armor Unit	Weight of Individual Stones, W_A (metric tons)	Armor Layer Thickness (m) When $n = 2$ for the Stone Unit Weights Below		
		$w_r = 23.56$ kN/m^3	$w_r = 25.13$ kN/m^3	$w_r = 26.70$ kN/m^3
$k_\Delta = 1.02$ $P = 54\%$	16	3.84	3.76	3.68
	14	3.67	3.59	3.52
	12	3.49	3.41	3.34
	10	3.28	3.21	3.15
	8	3.05	2.98	2.92
	6	2.77	2.71	2.65
	4	2.42	2.37	2.32
Tetrapod $k_\Delta = 1.04$ $P = 50\%$	18	4.07	3.98	3.90
	16	3.91	3.83	3.75
	14	3.74	3.66	3.59
	12	3.56	3.48	3.41
	10	3.35	3.27	3.21
	8	3.11	3.04	2.98
	6	2.82	2.76	2.71
4	2.47	2.41	2.36	

¹ k_Δ and P from Table 7-13.

(e) Volume and Weight of Stones in Secondary Cover Layer.

$$A = \frac{(12.0 - 9.91)(100)}{\sin \theta} = \frac{209}{\sin \theta} = \text{area per 100 m of structure}$$

Number of stones in secondary cover layer:

$$r_A = n k_{\Delta} \left(\frac{g W_R}{10 w_r} \right)^{1/3} \quad (W_R \text{ in metric tons and } w_r = \text{unit weight of rock} = 25.92 \text{ kN/m}^3)$$

$$n = \frac{r_A}{k_{\Delta}} \left(\frac{10 w_r}{g W_R} \right)^{1/3} = \text{number of layers}$$

$$N_R = A n k_{\Delta} \left(1 - \frac{P}{100} \right) \left(\frac{10 w_r}{g W_R} \right)^{2/3}$$

$$N_R = A \left[\frac{r_A}{k_{\Delta}} \left(\frac{10 w_r}{g W_R} \right)^{1/3} \right] k_{\Delta} \left(1 - \frac{37}{100} \right) \left(\frac{10 w_r}{g W_R} \right)^{2/3}$$

$$N_R = \frac{6.3 A r_A w_r}{g W_R}$$

Volume of secondary cover layer:

$$V = r_A A$$

Volume of rock in secondary cover layer:

$$V_R = 0.63V$$

Weight of Rock:

$$W = \frac{g W_R}{10} N_R \quad \text{or} \quad W = 0.63 V w_r$$

Table 8-11. Summary of secondary cover layer characteristics for tribars and tetrapods.

Type of Unit	w_p (kN/m ³)	$\cot \theta$	w_A (metric tons)	$\frac{w_R}{10}$ (metric tons)	r_A (m)	A per 100 m of structure (m ²)	N_R per 100 m	Volume of Secondary Cover Layer per 100 m ³	Weight of Rock per 100 m (metric tons)
Tribar	23.56	1.5	14.259	2.421	3.69	376.8	957	1390	2317
		2.0	10.694	1.816	3.36	467.3	1440	1570	2615
		2.5	8.555	1.453	3.11	562.7	2006	1750	2915
		3.0	7.129	1.211	2.93	660.9	2663	1936	3225
	25.13	1.5	10.934	2.421	3.31	376.8	858	1247	2077
		2.0	8.201	1.816	3.01	467.3	1290	1407	2343
		2.5	6.560	1.453	2.79	562.7	1800	1570	2615
		3.0	5.467	1.211	2.63	660.9	2391	1738	2896
	26.70	1.5	8.629	2.421	3.00	376.8	778	1130	1884
		2.0	6.473	1.816	2.72	467.3	1166	1271	2117
		2.5	5.178	1.453	2.53	562.7	1632	1424	2371
		3.0	4.315	1.211	2.38	660.9	2163	1573	2619
Tetrapod	23.56	1.5	17.824	2.421	4.06	376.8	1053	1530	2549
		2.0	13.368	1.816	3.69	467.3	1582	1724	2873
		2.5	10.694	1.453	3.42	562.7	2206	1924	3205
		3.0	8.912	1.211	3.22	660.9	2927	2128	3545
	25.13	1.5	13.668	2.421	3.63	376.8	941	1368	2278
		2.0	10.251	1.816	3.30	467.3	1415	1542	2570
		2.5	8.201	1.453	3.07	562.7	1980	1727	2877
		3.0	6.834	1.211	2.88	660.9	2618	1903	3170
	26.70	1.5	10.787	2.421	3.29	376.8	853	1240	2065
		2.0	8.091	1.816	2.99	467.3	1282	1397	2328
		2.5	6.471	1.453	2.78	562.7	1793	1564	2605
		3.0	5.394	1.211	2.61	660.9	2373	1725	2874

(4) Thickness of Underlayer.

Quarystone

$$k_{\Delta} = 1.00$$

$$P = 37\%$$

$$w_p = 25.92 \text{ kN/m}^3$$

$$n = 2$$

Weight of Armor Unit, W_A (metric tons)	Weight of an Underlayer Stone, $\frac{W_A}{10}$ (metric tons)	Thickness of Underlayer, r_1 (m)	Number of Stones per 100 m ² of Underlayer, N_r	Weight of Rock per 100 m of Underlayer (metric tons)
18	1.8	1.76	163	293.4
16	1.6	1.69	177	283.2
14	1.4	1.62	193	270.2
12	1.2	1.54	214	256.8
10	1.0	1.45	241	241.0
8	0.8	1.34	280	224.0
6	0.6	1.22	339	203.4
4	0.4	1.07	444	177.6

$$r_1 = n k_{\Delta} \left(\frac{W_g}{w_r} \right)^{1/3} = 2 (1.00) \left(\frac{W_A}{10} \times \frac{9.806}{25.92} \right)^{1/3} = 2 \left(0.038 W_A \right)^{1/3}$$

$$N_r = A n k_{\Delta} \left(1 - \frac{P}{100} \right) \left(\frac{w_r}{W_g} \right)^{2/3} = (100)(2)(1.00) \left(1 - \frac{37}{100} \right) \left(\frac{25.92(10)}{W_A g} \right)^{2/3}$$

$$N_r = 126 \left(\frac{26.43}{W_A} \right)^{2/3}$$

$$\frac{\text{Weight}}{100 \text{ m}^2} = \left(\frac{W_A}{10} \right) N_r$$

The equation for the volume of the first underlayer is as follows:

$$V_1 = \left(\frac{E + 12.0}{2 \sin \theta} + \frac{E + 12.0 - \frac{r_1}{\cos \theta}}{2 \sin \theta} \right) r_1 \times 100 \text{ m}$$

(equation derived from preliminary geometry of cross section on page 8-48)

where

E = crest elevation (m above MLW)

r_A = thickness of cover layer (m)

r_1 = thickness of first underlayer (m)

V_1 = volume of first underlayer per 100 m of structure (m³)

The equation for the volume of the core per 100 m of structure is as follows:

$$V_c = \frac{1}{2} \left(12.0 + E - \frac{r_1}{\cos \theta} \right)^2 (1.5 + \cot \theta) (100)$$

(equation derived from preliminary geometry of cross section on page 8-48)

(5) Volume of First Underlayer. The volume per 100 m of structure (in thousands of m³) is shown in the tabulation below.

Armor Unit ¹ size (metric (tons)	cot θ			
	1.5	2.0	2.5	3.0
18	6.899	8.704	10.356	12.006
16	6.637	8.372	9.961	11.549
14	6.374	8.040	9.565	11.089
12	6.073	7.658	9.110	10.562
10	5.732	7.227	8.597	9.967
8	5.313	6.697	7.966	9.235
6	4.853	6.116	7.274	8.432
4	4.274	5.384	6.403	7.422

¹ Valid for tribars and tetrapods because V_1 depends only on θ and r_1 (r_1 is dependent on the armor unit size, but not the type).

See Figure 8-26 for a graphic comparison of costs.

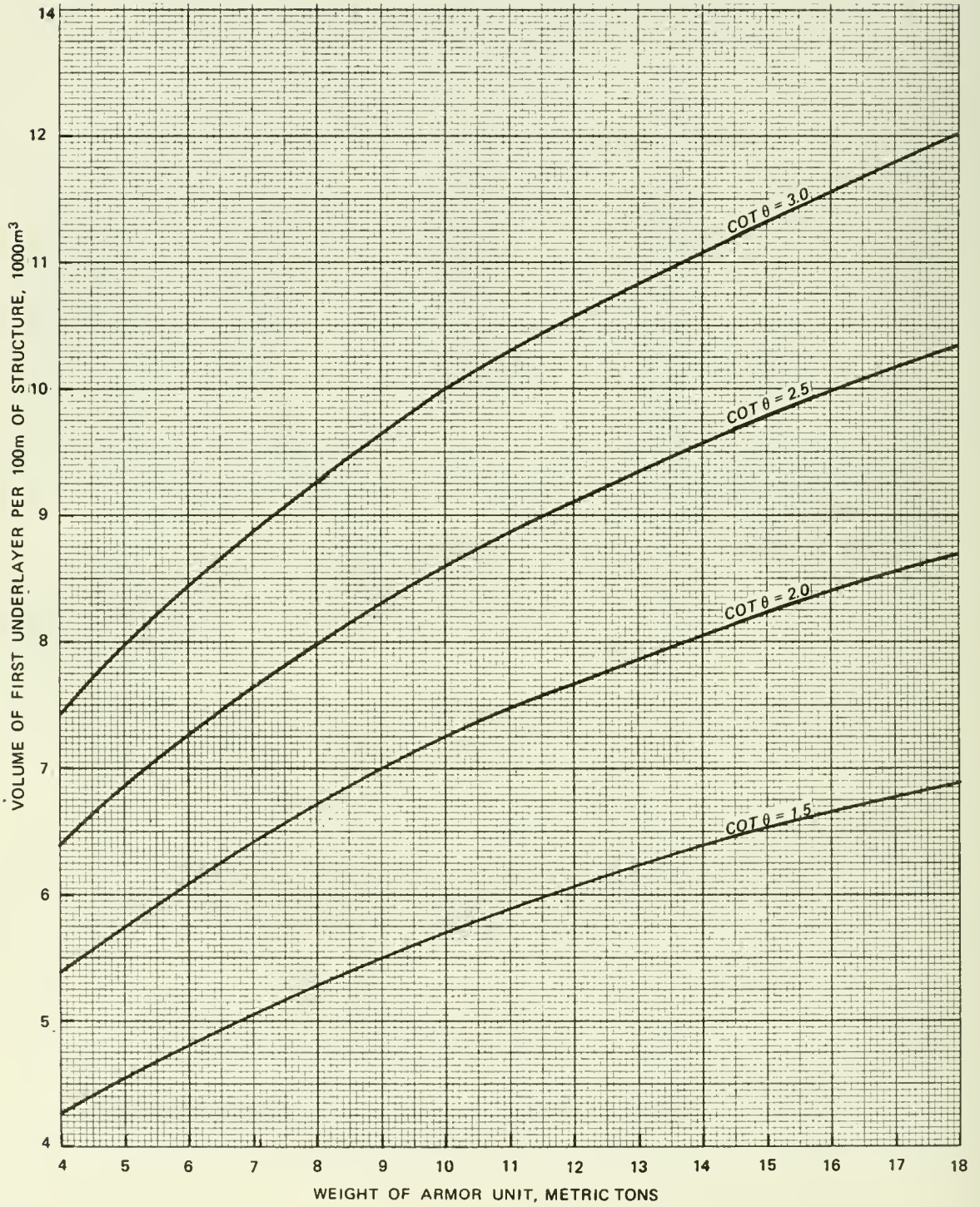

Figure 8-26. Volume of first underlayer per 100 meters of structure as a function of armor unit weight and structure slope.

(6) Volume of Core: Tribars and Tetrapods. Volume per 100 m of structure (1000 m³) is shown in the following tabulation:

Weight of Tribar or Tetrapod (metric tons)	cot θ			
	1.5	2.0	2.5	3.0
18	64.179	78.150	87.399	95.896
16	64.702	78.730	88.031	96.583
14	65.227	79.312	88.664	97.273
12	65.830	79.980	89.391	98.063
10	66.512	80.735	90.213	98.956
8	67.349	81.662	91.222	100.054
6	68.269	82.679	92.330	101.258
4	69.428	83.960	93.723	102.773

See Figure 8-27 for a graphic comparison of costs.

(7) Cost Analysis: The following cost analysis will be assumed for the illustrative purposes of this problem. Actual costs for particular project would have to be based on the prevailing costs in the project area. Costs will vary with location, time, and the availability of suitable materials. Unit costs of concrete are shown in the tabulation below.

w_r (lb/ft ³)	w_r (kN/m ³)	Cost (\$ per yd ³)	Cost (\$ per m ³)
150	23.56	60.00	78.40
160	25.13	63.00	82.40
170	26.70	82.50	107.90

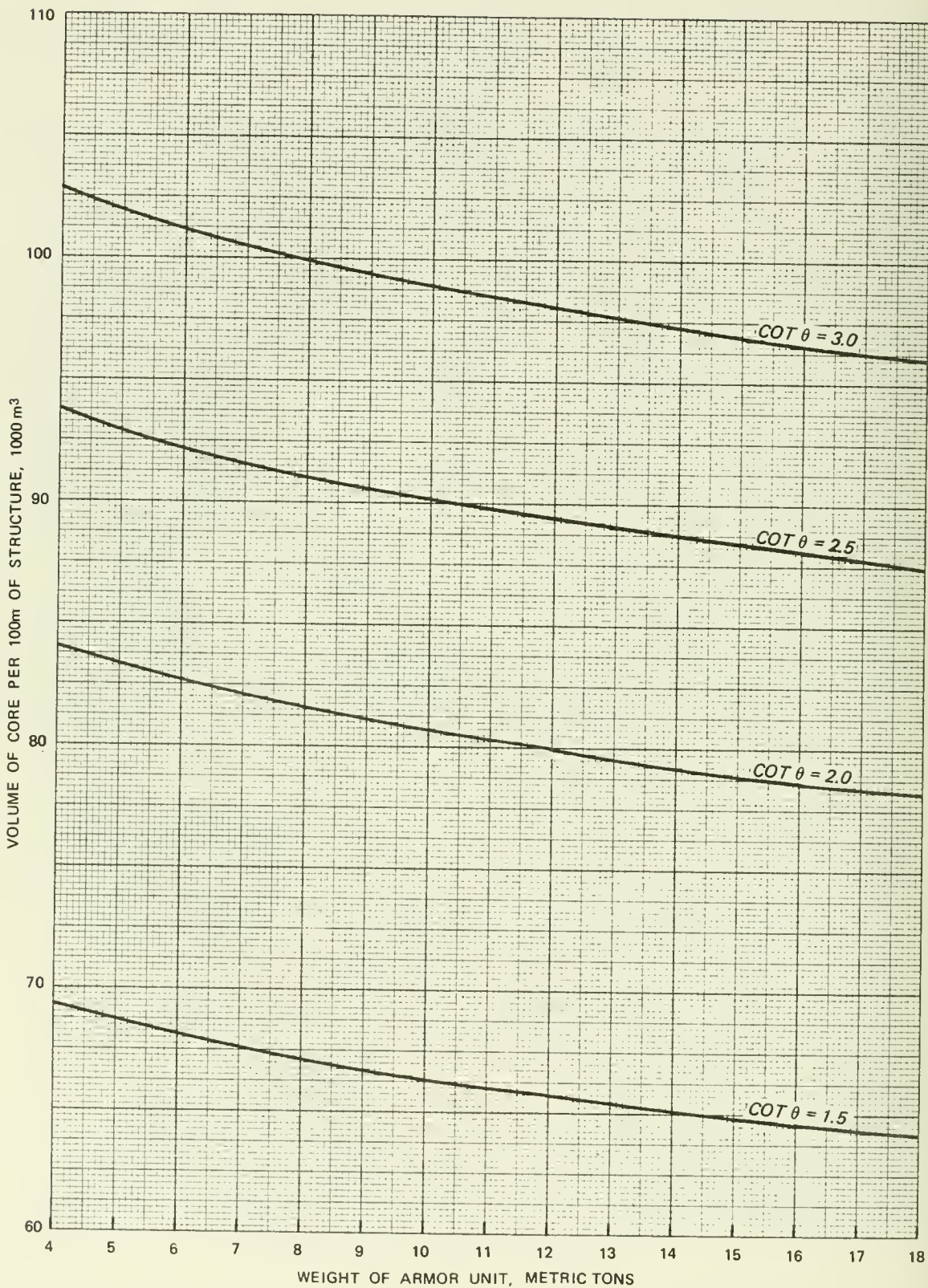

Figure 8-27. Volume of core per 100 meters of structure as a function of armor unit weight and structure slope.

(a) Cost of Casting, Handling, and Placing Tribars and Tetrapods. Cost per unit is as follows:

Weight of Armor Unit (tons)	Weight of Armor Unit (metric tons)	cot = 1.5 and 2.0		cot = 2.5 and 3.0			
		Cost per Ton (\$)	Cost per Metric Ton (\$)	Cost per Unit (\$)	Cost per Ton (\$)	Cost per Metric Ton (\$)	Cost per Unit (\$)
16	14.515	33.91	37.38	542.50	38.28	42.20	612.50
14	12.701	35.88	39.54	502.25	40.63	44.78	568.75
12	10.887	38.65	42.60	463.75	43.17	47.58	518.00
10	9.072	40.25	44.37	402.50	45.50	50.15	455.00
8	7.258	40.47	44.61	323.75	47.03	51.84	376.25
6	5.443	39.38	43.40	236.25	46.67	51.44	280.00
4	3.629	43.75	48.22	175.00	48.13	53.04	192.50
2	1.814	68.25	75.25	136.50	74.38	82.00	148.75

The tabulated costs are graphically presented in Figure 8-28.

(b) Rock costs. In place, when $w_r = 25.92 \text{ kN/m}^3$,

Weight (tons)	Weight (metric tons)	Cost per Ton (\$)	Cost per Metric Ton (\$)
1.5 to 2.0	1.36 to 1.81	25.00	27.56
1.0 to 1.5	0.91 to 1.36	20.00	22.04
0.5 to 1.0	0.45 to 0.91	20.00	22.04
up to 0.5	up to 0.45	17.50	19.29
Quarry run	Quarry run	15.00	16.53

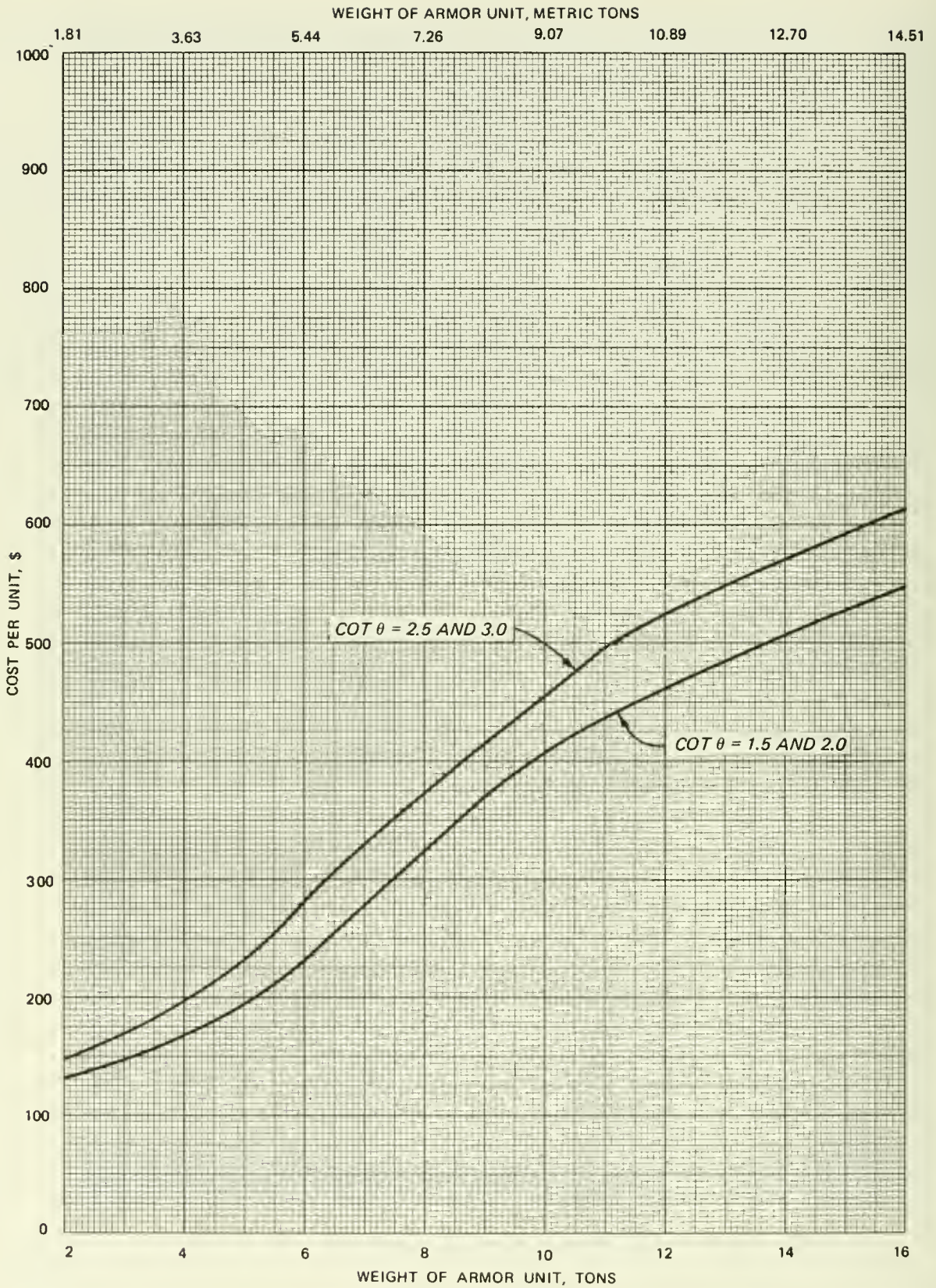

Figure 8-28. Costs of casting, handling, and placing concrete armor units as a function of unit weight and structure slope.

(c) Total Cost per 100 Meters of Structure. The following tabulation sums revetment cost by weight of tribar unit:

Weight of Armor Unit (metric tons)	w_p (kN/m^3)	$\cot \theta$	Concrete Cost per 100 m of Structure ¹	Handling Costs per 100 m of Structure ¹	First Underlayer Cost ¹	Secondary Cover Layer Cost ¹	Core Cost ¹	Total Cost ¹
14.259	23.56	1.5	497.88	573.86	294.10	63.79	1793.62	3223.25
10.694		2.0	569.37	745.30	270.74	72.05	2215.17	3872.63
8.555		2.5	627.37	971.09	298.80	80.32	2503.35	4480.93
7.129		3.0	683.25	1083.85	326.11	71.06	2768.60	4950.87
10.934	25.13	1.5	468.28	619.04	216.22	57.23	1822.10	3182.87
8.201		2.0	535.52	740.68	247.75	64.57	2245.33	3833.85
6.560		2.5	589.98	948.84	274.09	72.05	2533.01	4417.97
5.467		3.0	642.47	1028.05	299.60	63.79	2798.43	4832.34
8.629	26.70	1.5	555.36	622.43	199.84	51.86	1846.66	3276.15
6.473		2.0	634.88	707.62	229.52	58.33	2269.27	3899.62
5.178		2.5	699.52	910.94	253.83	65.35	2557.31	4486.95
4.315		3.0	761.99	1005.23	243.53	57.73	2822.45	4890.93

¹All costs are in thousands of dollars per 100 m of structure; all the intermediate steps of cost calculation are not included.

For a graphic cost comparison, see Figure 8-29.

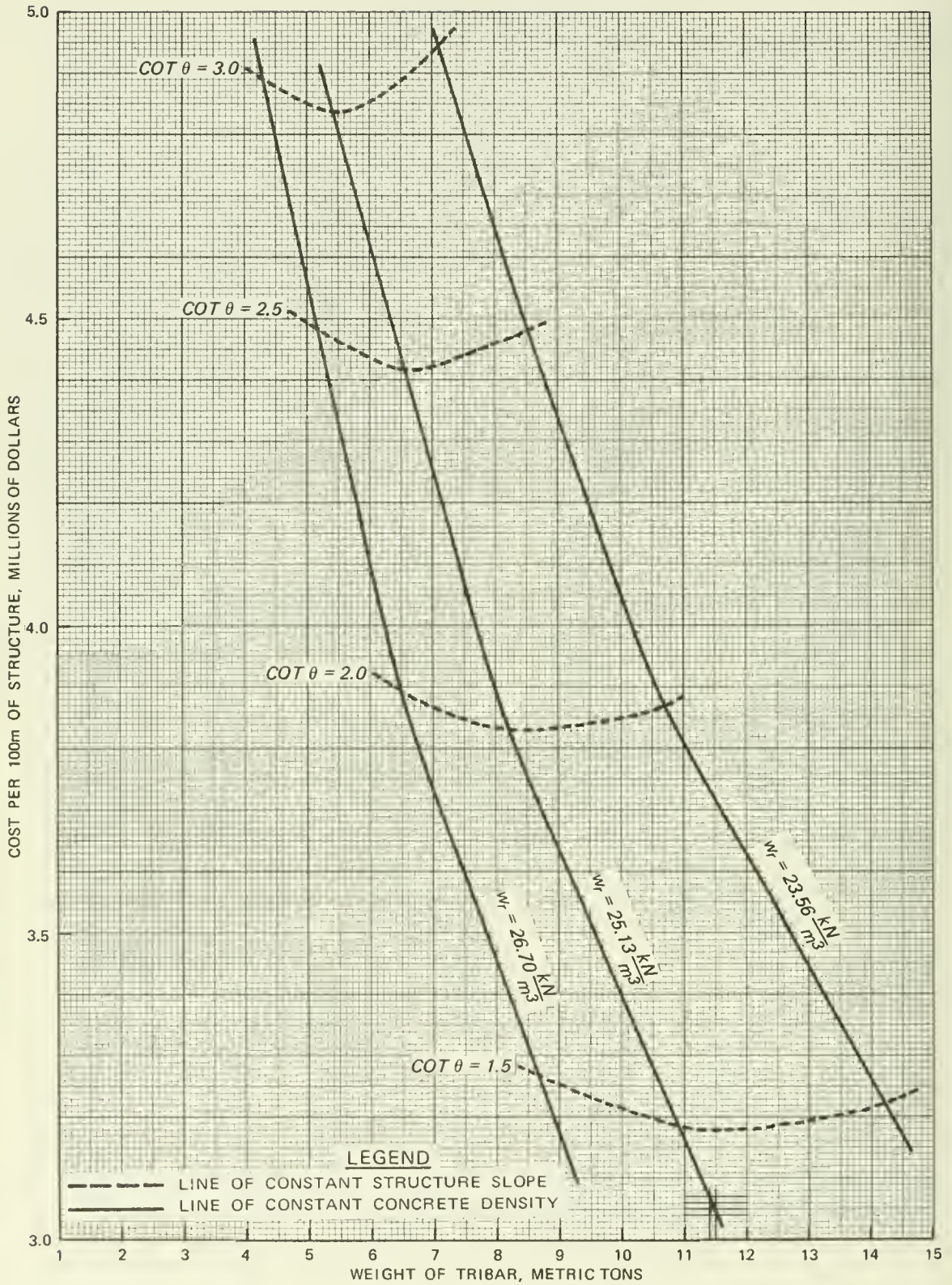

Figure 8-29. Total cost of 100 meters of structure as a function of tribar weight, concrete unit weight, and structure slope.

The tabulation below sums cost of revetment by tetrapod unit:

Weight of Armor Unit (metric tons)	w_p (kN/m^3)	cot θ	Concrete Cost per 100 m ¹ of Structure	Handling Costs per 100 m ¹ of Structure	First Underlayer Cost ¹	Secondary Cover Layer Cost ¹	Core ¹ Cost ¹	Total ¹ Cost ¹
17.824	23.56	1.5	594.41	592.18	315.57	70.22	1767.91	3340.29
13.368		2.0	679.40	804.53	290.66	79.12	2189.02	4042.73
10.694		2.5	748.93	1096.23	322.06	88.30	2475.43	4730.95
8.912		3.0	815.64	1255.45	351.20	78.10	2740.39	5240.78
13.668	25.13	1.5	559.00	666.15	290.24	62.78	1798.25	3376.42
10.251		2.0	639.09	857.59	267.23	70.77	2219.77	4054.45
8.201		2.5	704.36	1114.31	294.70	79.26	2508.26	4700.89
6.834		3.0	767.06	1234.99	321.77	69.84	2773.49	5167.15
10.787	26.70	1.5	663.05	714.04	215.30	56.91	1823.48	3472.78
8.091		2.0	758.00	850.83	246.68	64.11	2246.74	4166.36
6.473		2.5	835.25	1089.53	272.98	71.78	2534.34	4803.88
5.394		3.0	909.70	1181.62	298.24	63.31	2799.95	5252.82

¹All costs are in thousands of dollars per 100 m of structure.

Note that total cost given here does not include royalty costs for using tetrapods. For a graphic cost comparison, see Figure 8-30.

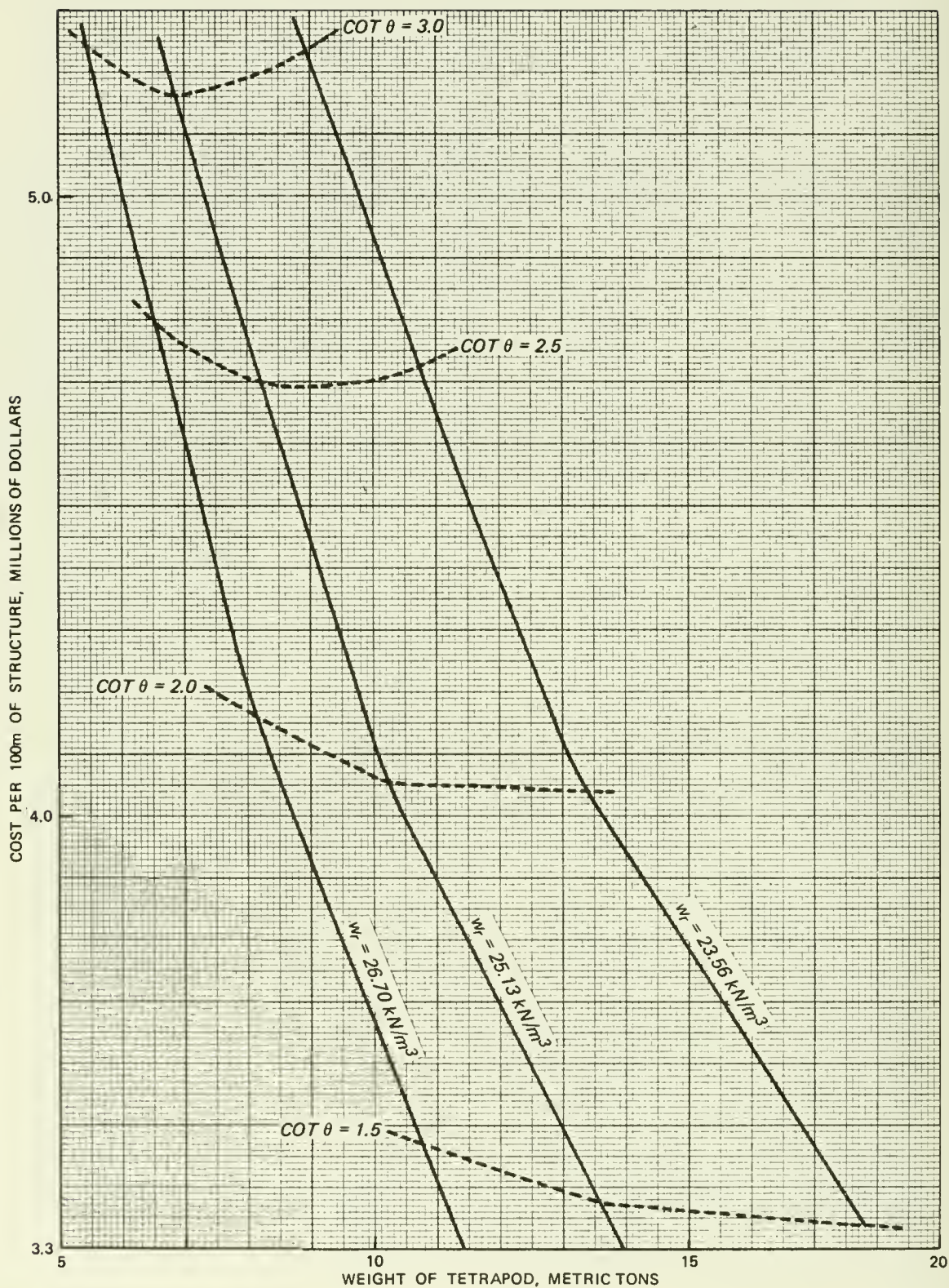

Figure 8-30. Total cost of 100 meters of structure as a function of tetrapod weight, concrete unit weight, and structure slope.

(d) Selection of Armor Unit, Concrete Density, and Structure Slope Based on First Cost (Construction Cost). The preceding analysis is considered the first cost of the structure. To complete the analysis, average annual maintenance and repair costs should be established for each alternative and for a range of design wave heights. Maintenance and repair costs may modify the conditions established here as the most economical based on first cost.

1. Type of unit: tribar
2. Weight of unit: 11.5 metric tons
3. Structure slope: $\cot \theta = 1.5$
4. Unit weight of concrete: 24.87 kN/m^3
5. Cost per 100 meter of structure: \$3,180,000

Stability Check

$$W = \frac{w_p H^3}{K_D (S_p - 1)^3 \cot \theta g}$$

$$K_D = 10.0$$

$$w_p = 24.87 \text{ kN/m}^3$$

$$\cot \theta = 1.5$$

$$S_p = \frac{w_p}{10.05} = 2.47$$

$$H = 6 \text{ m}$$

$$W = \frac{(24.87) (6)^3}{10.0 (2.47 - 1)^3 (1.5) (9.806)}$$

$$W = 11.5 \text{ metric tons}$$

6. Volume of concrete per 100 m: 5794 m^3
7. Number of armor units per 100 m: 1288
8. Thickness of armor layer: 3.37 m
9. Volume of first underlayer per 100 m: 5988 m^3
10. Thickness of first underlayer: 1.52 m
11. Weight of underlayer stone: 1.15 metric tons

12. Volume of core per 100 m: 66,000 m³
13. Weight of core stone: 0.00192 - 0.0575 metric tons
(1.92 to 57.5 kg)
14. Volume of secondary cover layer per 100 m: 1271 m³
15. Thickness of secondary cover layer: 3.37 m
16. Weight of secondary cover layer stone: 2.421 metric tons

3. Diffraction Analysis: Diffraction Around Breakwater.

For the purposes of this problem, establish the required breakwater length so that the maximum wave height in the harbor is 1 meter when the incident wave height is 6 meters (1 percent wave for $H_s = 3.59$ m) and the period $T = 7.78$ s. Assume waves generated in Delaware Bay.

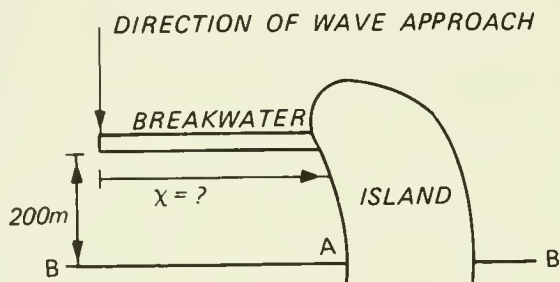

$$L_o = \frac{gT^2}{2\pi} = 1.56 T^2 = 1.56 (7.78)^2 = 94.42 \text{ m}$$

$$\text{Depth at breakwater } d = 16.50 \text{ m}$$

$$\text{Depth in basin } d = 31.74 \text{ m}$$

$$\frac{d}{L_o} = \frac{31.74}{94.42} = 0.33817$$

From Appendix C, Table C-1,

$$\frac{d}{L} = 0.34506$$

Therefore,

$$L = 91.98 \text{ m} , \text{ say } L = 92 \text{ m}$$

The 200-m distance, therefore, translates to

$$\frac{y}{L} = \frac{200}{92} = 2.17$$

At 200 meters, the wave height should be 1 meter.

$$H_1 = K_s(6)$$

$$1 = K_s(6)$$

$$K_s = 0.167$$

From Figure 7-61

$$\frac{x}{L} \approx 8$$

$$x = (8)(92)$$

$$x = 736 \text{ m} \quad \text{say } 750 \text{ m}$$

required breakwater length = 750 m .

4. Preliminary Design of Quay Wall Caisson.

Since the quay will be protected by breakwaters after construction is complete, the caisson will experience extreme wave action only during construction. For illustrative purposes the following conditions will be used to evaluate the stability of the caisson against wave action. It should be noted that these conditions have a low probability of occurrence during construction.

$$H_s = 3.59 \text{ m}$$

$$H_1 = 6.0 \text{ m}$$

$$T_s = 7.78 \text{ s}$$

$$d = 12.0 + 1.5^1$$

$$d = 13.5 \text{ m}$$

Note that the bearing area for the quay wall acting on the foundation soil may be reduced by toe scour under the edge or by local bearing capacity failures near the toe when the foundation pressure there exceeds the soil's bearing capacity.

Further information on this problem may be found in Eckert and Callender, 1984 (in press) or in most geotechnical textbooks.

¹Probability of extreme surge during construction is assumed negligible.

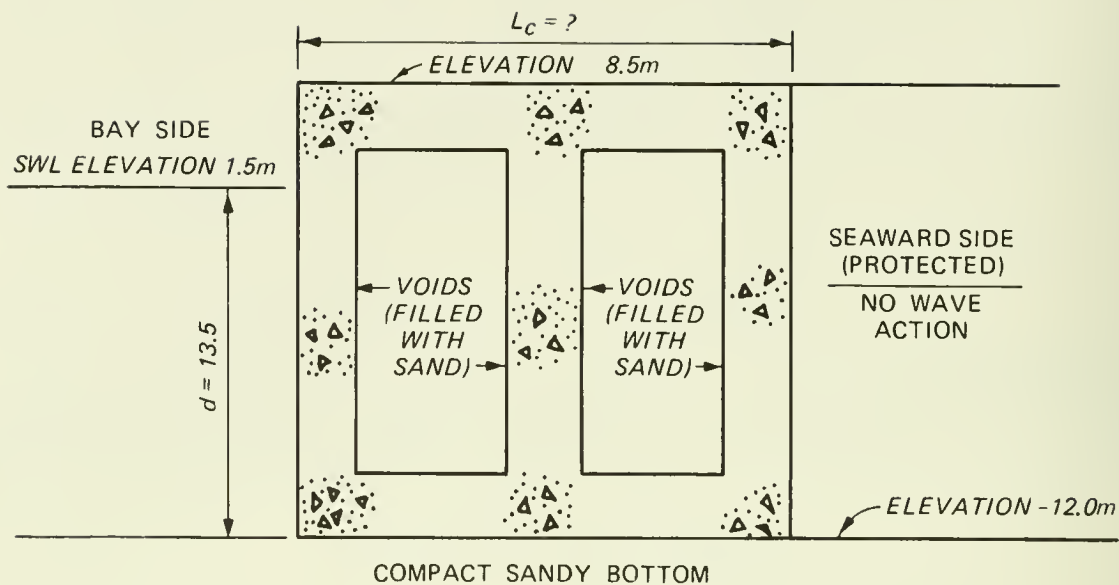

For preliminary design, assume 75 percent voids filled with seawater and unit weight of water $w_w = 10.05 \text{ kN/m}^3$.

a. Nonbreaking Wave Forces on Caisson (see Ch. 7, Sec. III,2).

- (1) Incident Wave Height: $H_i = 6 \text{ m}$.
- (2) Wave Period: $T_g = 7.78 \text{ s}$.
- (3) Structure Reflection Coefficient: $\chi = 1.0$.
- (4) Depth: $d_s = 13.5 \text{ m}$.

$$\frac{H_i}{gT^2} = \frac{6}{(9.806)(7.78)^2} = 0.0101$$

$$\frac{H_i}{d_s} = \frac{6}{13.5} = 0.444$$

(5) Height of Orbit Center Above SWL (see Fig. 7-90).

$$\frac{h_o}{H_i} = 0.37$$

$$h_o = 0.40 (H_i) = 0.37(6) = 2.22 \text{ m}$$

(6) Height of Wave Crest Above Bottom (see Fig. 7-88).

$$y_c = d_s + h_o + \frac{1 + \chi}{2} H_i$$

$$y_c = 13.5 + 2.22 + \left(\frac{1 + 1}{2}\right) (6) \quad (6)$$

$$y_c = 21.72 \text{ m}$$

Wave will overtop caisson by 1.2 meters; therefore assume structure is not 100 percent reflective. Use 0.9 and recalculate h_o .

$$\frac{h_o}{H_i} = 0.36 \quad (\text{see Fig. 7-93})$$

$$h_o = 0.36 H_i = 0.36 (6) = 2.16 \text{ m}$$

$$y_c = 13.5 + 2.16 + \left(\frac{1 + 0.9}{2}\right) (6) = 21.36 \text{ m}$$

(7) Dimensionless Force (Wave Crest at Structure) (see Fig.

7-94). For

$$\frac{H_i}{gT^2} = \frac{6}{(9.806)(7.78)^2} = 0.0101, \quad \frac{H_i}{d_s} = \frac{6}{13.5} = 0.444, \quad \text{and} \quad \chi = 0.9$$

$$\frac{F_c}{w d_s^2} = 0.33, \quad F_c = 0.33 (10.05) (13.5)^2 = 604.48 \frac{\text{kN}}{\text{m}} \quad (\text{force due to wave})$$

Hydrostatic force is not included.

(8) Hydrostatic Force.

$$F = \frac{wd^2}{2} = \frac{(10.05) (13.5)^2}{2} = 915.81 \frac{\text{kN}}{\text{m}}$$

(9) Total Force.

$$F_t = 604.43 + 915.81 = 1520.24 \frac{\text{kN}}{\text{m}}$$

(10) Force Reduction Due to Low Height.

$$b = 12.0 + 8.5 = 20.50 \text{ m}$$

$$y_c = 21.36 \text{ m}$$

$$\frac{b}{y_c} = \frac{20.50}{21.36} = 0.9597$$

From Figure 7-97, $r_f = 0.998$

$$F_t = 0.998 (1520.24) = 1517.20 \frac{\text{kN}}{\text{m}}$$

(11) Net Horizontal Force (Due to Presence of Waves).

$$F_{net} = 1517.20 - 915.81 = 601.39 \frac{\text{kN}}{\text{m}}$$

(12) Dimensionless Moment (Wave Crest at Structure) (see Figure

7-95. For

$$\frac{H_i}{gT^2} = 0.0101, \quad \frac{H_i}{d_s} = 0.444, \quad \text{and } \chi = 0.9$$

$$\frac{M_c}{wd^3} = 0.24$$

$$M_c = 0.24 w d_s^3 = 0.24 (10.05) (13.5)^3$$

$$M_c = 5934.4 \frac{\text{KN} - \text{m}}{\text{m}}$$

(13) Hydrostatic Moment.

$$M = \frac{wd^3}{6} = \frac{10.05 (13.5)^3}{6} = 4121.1 \frac{\text{kN} - \text{m}}{\text{m}}$$

(14) Total Moment.

$$M_t = 4121.1 + 5934.4 = 10,055.5 \frac{\text{kN} - \text{m}}{\text{m}}$$

(15) Moment Reduction for Low Height.

From Figure 7-97 with $\frac{b}{y_c} = 0.9597$

$$r_m = 0.996$$

$$M = 0.996 (10,005.5) = 10,015.3 \frac{\text{kN} - \text{m}}{\text{m}}$$

(16) Net Overturning Moment About Bottom (Due to Presence of Waves).

$$M_{net} = 10,015.3 - 4121.1 = 5894.2 \frac{\text{kN} - \text{m}}{\text{m}}$$

b. Stability Computations.

(1) Overturning.

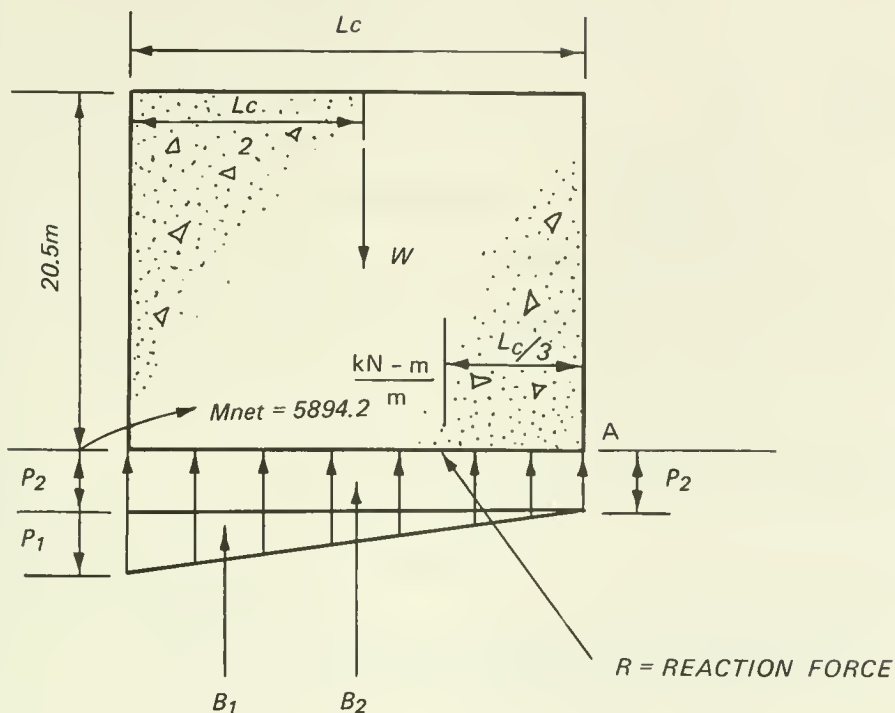

(a) Weight per Unit Length of Structure.

Concrete, $w_p = 23.56 \text{ kN/m}^3$ (25 percent of area)

Water in voids, $w_w = 10.05 \text{ kN/m}^3$ (75 percent of area)

Height = 20.5 m

Equation for weight/unit length:

$$W = 20.5 L_c \{ (0.25)(23.56) + (0.75)(10.05) \}$$

$$W = 275.26 L_c$$

(b) Uplift per Unit Length of Structure (see Equation 7-75

and Figure 7-89).

$$P_1 = \frac{1 + \chi}{2} \frac{w_w H_c}{\cosh\left(\frac{2\pi d}{L}\right)}$$

$$L_o = 1.5606 (7.78)^2 = 94.470 \text{ m}$$

$$\frac{d}{L_o} = \frac{13.5}{94.47} = 0.1429$$

$$\frac{d}{L} = 0.1773 \rightarrow L = 76.14 \text{ m (see Table C-1)}$$

$$\cosh \frac{2\pi d}{L} = 1.687$$

$$p_1 = \frac{1 + 0.9}{2} \frac{(10.05)(6)}{1.687} = 33.957 \text{ kN/m}^2$$

$$p_2 = w_w d \text{ (hydrostatic pressure)}$$

$$p_2 = (10.05)(13.5) = 135.68 \text{ kN/m}^2$$

Equations for uplift forces/unit length:

$$B_1 = \frac{p_1 L_c}{2} = \frac{(33.957)(L_c)}{2} = 16.979 L_c$$

$$B_2 = p_2 L_c = 135.68 L_c$$

(2) Summation of Vertical Forces.

$$B_1 + B_2 - W + R_v^1 = 0$$

$$16.979 L_c + 135.68 L_c - 275.26 L_c + R_v = 0$$

$$R_v = 122.601 L_c \text{ kN/m}$$

(3) Summation of Moments About A .

$$B_1 \left(\frac{2}{3}\right) L_c + B_2 \left(\frac{1}{2}\right) L_c - W \left(\frac{1}{2}\right) L_c + R_v \left(\frac{1}{3}\right) L_c + M_{net} = 0$$

$$16.979 \left(\frac{2}{3}\right) L_c^2 + 135.68 \left(\frac{1}{2}\right) L_c^2 - 275.26 \left(\frac{1}{2}\right) L_c^2 + 122.601 \left(\frac{1}{3}\right) L_c^2 + 5894.2 = 0$$

$$L_c^2 = \frac{5894.2}{17.604}$$

$$L_c = 18.298 \text{ m}$$

This is the width required to prevent negative soil bearing pressure under caisson (reaction within middle third). Assume $L_c = 18.5 \text{ m}$.

¹ R_v = vertical component of reaction R .

(4) Sliding.

Coefficient of friction (see Table 7-16) for concrete on sand

$$\mu_s = 0.40$$

Vertical Forces for $L_c = 18.5$ m

$$W = 275.26 L_c = 5092.31 \text{ kN/m}$$

$$B_1 = -16.979 L_c = -314.11 \text{ kN/m}$$

$$B_2 = -135.68 L_c = -2510.08 \text{ kN/m}$$

$$\sum F_v = 5092.31 - 314.11 - 2510.08 = 2268.12 \text{ kN/m}$$

(5) Horizontal Force to Initiate Sliding.

$$F_H = \mu_s F_v = 0.40 (2268.12) = 907.25 \text{ kN/m}$$

Since the actual net horizontal force is only 601.39 kN/m, the caisson will not slide.

c. Caisson Stability after Backfilling.

(1) Assumptions:

- (a) No wave action (protected by breakwater).
- (b) Voids filled with dry sand.
- (c) Minimum water level at -0.91 MLW.
- (d) Surcharge of 0.6 meter on fill (dry sand).

OVERTURNING SEAWARD

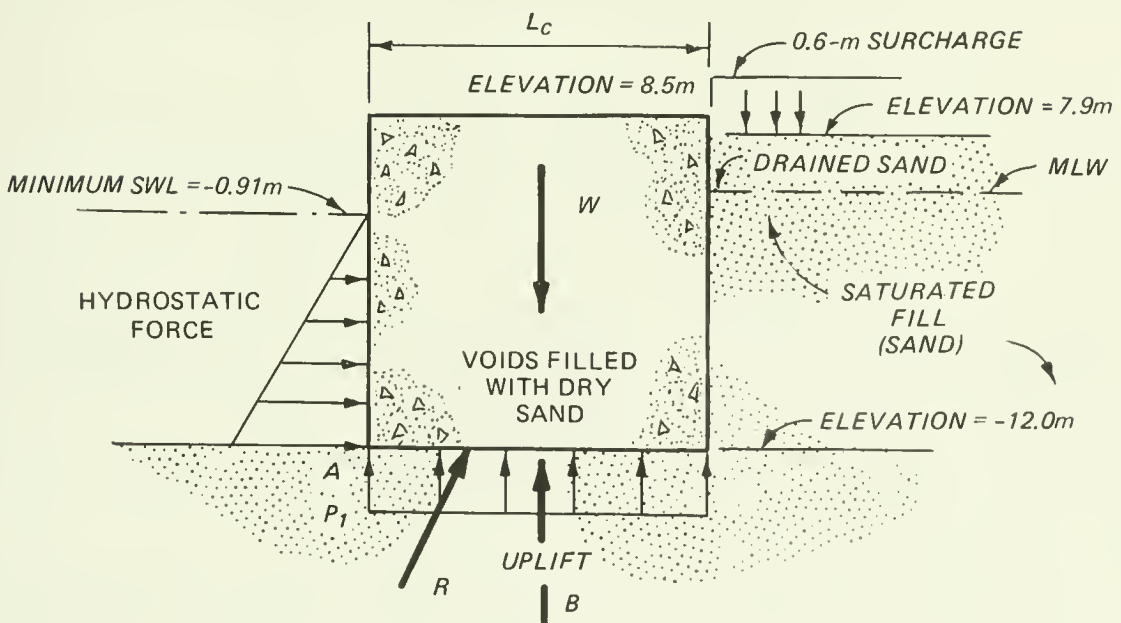

(2) Earth Pressure Diagrams.

(2) EARTH PRESSURE DIAGRAMS

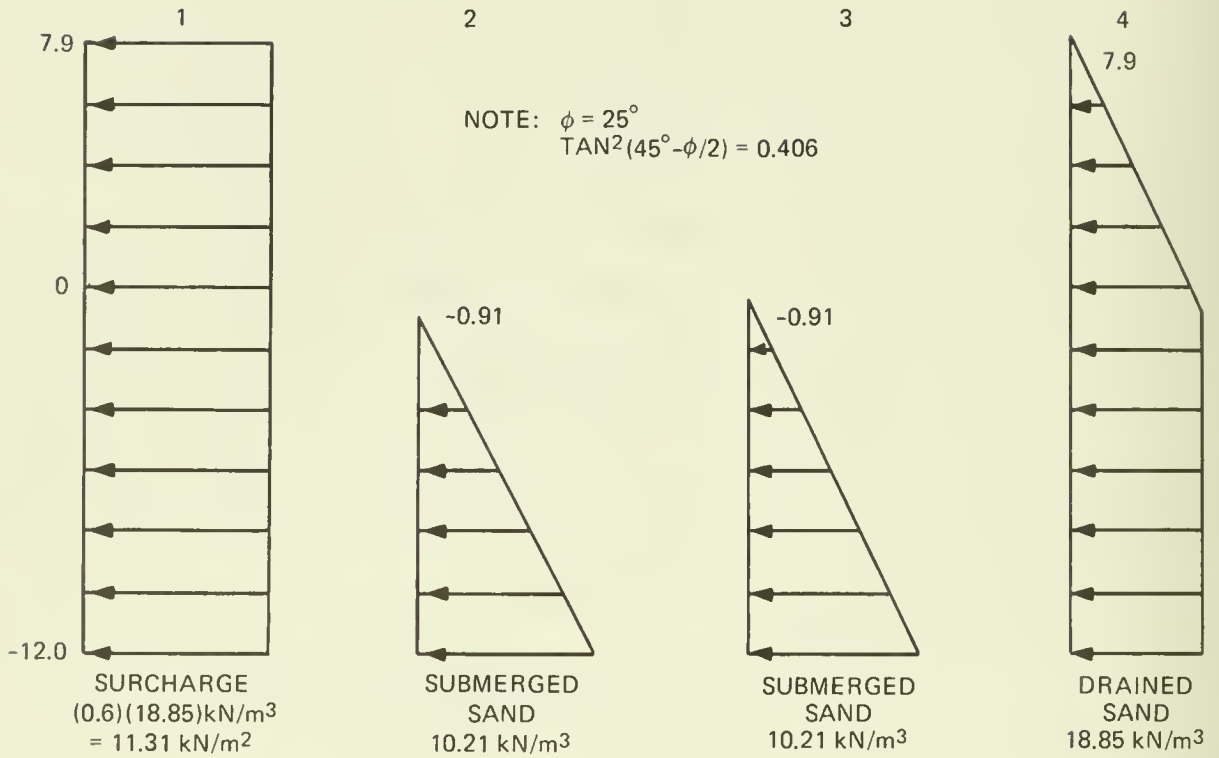

Diagram Number	Force (kN/m)	Moment Arm (m)	Moment (kN - m/m)
1	$(0.406)(0.6)(18.85)(19.9) = 91.378$	$\frac{19.9}{2} = 9.95$	909.21
2	$\frac{(0.406)(10.21)(11.09)^2}{2} = 254.909$	$\frac{11.09}{3} = 3.70$	943.16
3	$\frac{10.05 (11.09)^2}{2} = 618.015$	$\frac{11.09}{3} = 3.7$	2286.66
4	$0.406 \left[\frac{(18.85)(8.81)^2}{2} + 8.81(18.85)(11.09) \right] = 1044.732$	7.96	8316.07

(3) Total Horizontal Earth Force.

$$F_E = 2009.034 \text{ kN/m}$$

(4) Total Overturning Moment.

$$M_E = 12455.10 \text{ kN - m/m}$$

(5) Moment Arm.

$$r = \frac{M_E}{F_E} = \frac{12455.10}{2009.034} = 6.20 \text{ m}$$

(6) Weight/Unit Length.

Voids filled with dry sand:

$$W = L_c (12 + 7.9 + 0.6) \{ (23.56)(0.25) + (18.85)(0.75) \} = 410.56 L_c \frac{\text{kN}}{\text{m}}$$

(7) Uplift Force.

$$p_1 = wd = 10.05 (11.09) = 111.45 \text{ kN/m}^2$$

$$B = 111.45 L_c \text{ kN/m}$$

(8) Hydrostatic Force (Seaward Side).

$$F_h = \frac{wd^2}{2} = \frac{10.05 (11.09)^2}{2} = 618.02 \frac{\text{kN}}{\text{m}}$$

$$\text{(moment arm} = \frac{11.09}{3} = 3.70 \text{ m above bottom)}$$

(9) Summation of Vertical Forces.

$$B + R_v^1 - W = 0$$

$$111.45 L_c + R_v - 410.56 L_c = 0 \quad R_v = 299.11 L_c$$

(10) Summation of Moments About A .

$$\frac{W L_c}{2} + F_h (3.70) - B \frac{L_c}{2} - M_E - R_v \frac{L_c}{3} = 0$$

$$\frac{410.561}{2} L_c^2 + 618.02 (3.70) - \frac{111.45}{2} L_c^2 - 12455.10 - \frac{299.11}{3} L_c^2 = 0$$

$$49.85 L_c^2 = 10168.426$$

¹ R_v = vertical component of reaction R .

$$L_c^2 = 203.98$$

$$L_c = 14.28 \text{ m}$$

$$R_v = 299.11 (14.28) = 4271.3 \text{ kN}$$

Required width of caisson = $L_c = 14.28$ meters.

d. Soil Bearing Pressure.

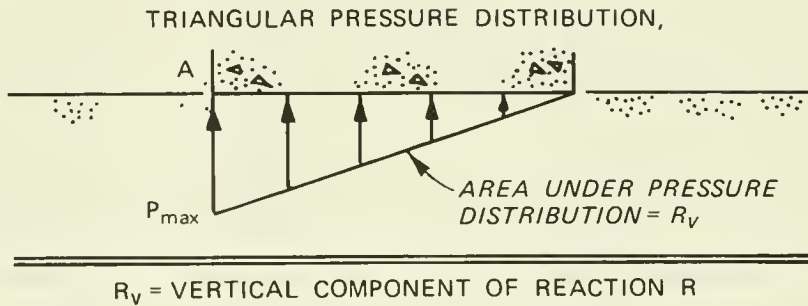

$$R_v = \frac{P_{max} L_c}{2}$$

$$P_{max} = \frac{2 R_v}{L_c} = \frac{2 (4271.3)}{14.28} = 598.22 \text{ kN/m}^2$$

(1) Sliding.

Summation of horizontal forces:

$$F_E - F_h - R_H^1 = 0$$

$$R_H = 2009.034 - 618.02$$

$$R_H = 1391.014 \text{ kN/m}$$

Vertical forces:

$$R_v = 4271.3 \text{ kN/m}$$

¹ R_H = horizontal component of reaction R.

²Factor of safety against sliding should be 2: hence $F_H \geq 2 R_H$ for safe design. Caisson should be widened.

Coefficient of friction:

$$\mu = 0.40$$

(2) Horizontal Force to Initiate Sliding.

$$F_H = \mu R_v$$

$$F_H = 0.40 (4271.3) = 1708.52 \text{ kN/m}$$

$$F_H > R_H^2$$

Caisson will not slide.

e. Summary. The preceding calculations illustrate the types of calculations required to determine the stability of the proposed quay wall. Many additional loading conditions also require investigation, as do the foundation and soil conditions. Field investigations to determine soil conditions are required, in addition to hydraulic model studies to determine wave effects on the proposed island.

V. COMPUTATION OF POTENTIAL LONGSHORE TRANSPORT
(see Ch. 4, Sec. V)

Using the hindcast deepwater wave data from Table 8-4, the net and gross potential sand transport rates will be estimated for the beaches south of Ocean City, Maryland (see Fig. 8-31). Assume refraction is by straight, parallel bottom contours.

Azimuth of shoreline = 20 degrees

1. Deepwater Wave Angle (α_o). The angle the wave crest makes with the shoreline (equal to the angle the wave ray makes with normal to shoreline) is shown in the following tabulation:

Direction of Approach from North (degrees)	Deepwater Angle α_o (degrees)
45	65
75	35
105	5
135	25
165	55
195	85

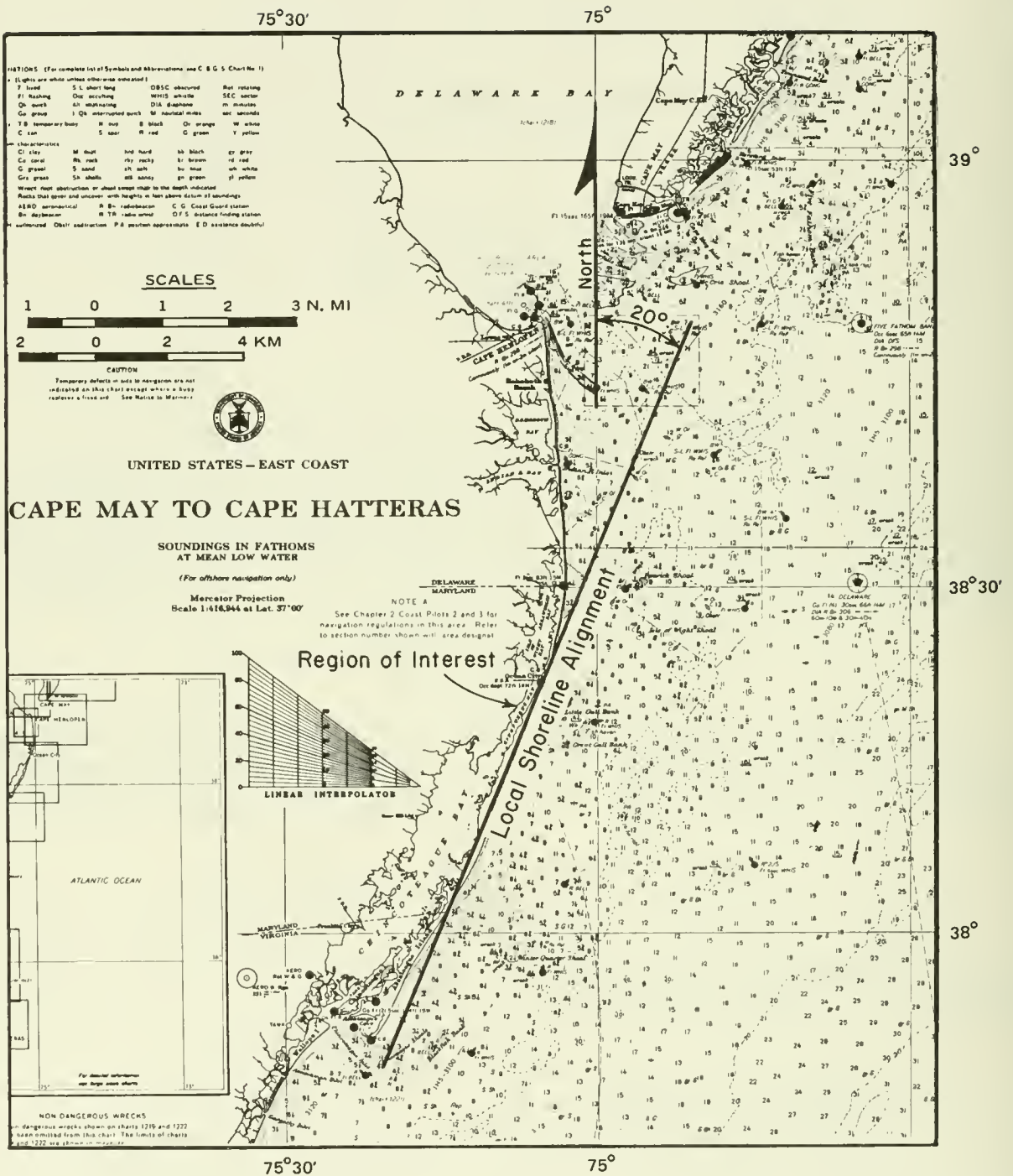

Figure 8-31. Local shoreline alignment in vicinity of Ocean City, Maryland.

Table 8-12. Deepwater Wave Statistics (summary of data in Table 8-4).

H _s (m)	Duration for These Deepwater Wave Angles (Azimuth of Shoreline = 20°)						Total (hour/year)
	α ₀ = 65°	α ₀ = 35°	α ₀ = 5°	α ₀ = 25°	α ₀ = 55°	α ₀ = 85°	
0.25	91	49	50	77	116	76	459
0.75	319	159	128	173	175	-	954
1.25	163	103	95	142	210	269	982
1.75	68	50	52	108	157	227	662
2.25	30	38	34	80	94	145	421
2.75	27	36	34	65	78	104	344
3.25	27	23	19	34	42	70	215
3.75	18	14	8	16	23	41	120
4.25	15	9	5	8	10	29	76
4.75	11	9	2	3	7	13	45
5.25	9	5	1	2	3	8	28
5.75	7	4	1	-	3	4	19
6.25	5	1	-	-	1	1	18
6.75	3	-	-	-	1	1	5
7.25	4	2	-	-	-	-	6
7.75	2	1	-	-	1	-	4
8.25	1	-	-	-	-	-	1
8.75	1	-	-	-	-	-	1
9.25	1	-	-	-	-	-	1
9.75	1	-	-	-	-	-	1

2. Calculation of Average F (α₀).

Equations (4-54) and (4-55) will be used to calculate the potential longshore sand transport rates. Since the wave angle α₀ in both equations represents a 30-degree sector of wave directions, equation (4-55) is averaged over the 30-degree range for more accurate representation; i.e.,

$$\begin{aligned} \bar{F}(\alpha_0) &= \frac{1}{\Delta\alpha} \int_{\alpha_1}^{\alpha_2} (\cos \alpha)^{1/4} \sin 2\alpha \, d\alpha \\ &= \pm \frac{8}{9(\Delta\alpha)} \left[(\cos \alpha_2)^{9/4} - \cos(\alpha_1)^{9/4} \right] \end{aligned}$$

where Δα = α₂ - α₁ = π/6 and the + or - sign is determined by the direction of transport. Special care should be exercised when 0° < α₀ < 15° and 75° < α < 90°. Further discussion on the method of averaging is given in Chapter 4, Section V,3,d. The results of calculation are shown in the following tabulation and also in Figure 8-32.

α ₀ , deg.	$\bar{F}(\alpha_0)$
65	0.595
35	0.848
5	0.222 or - 0.058
25	0.708
55	0.780
85	0.152

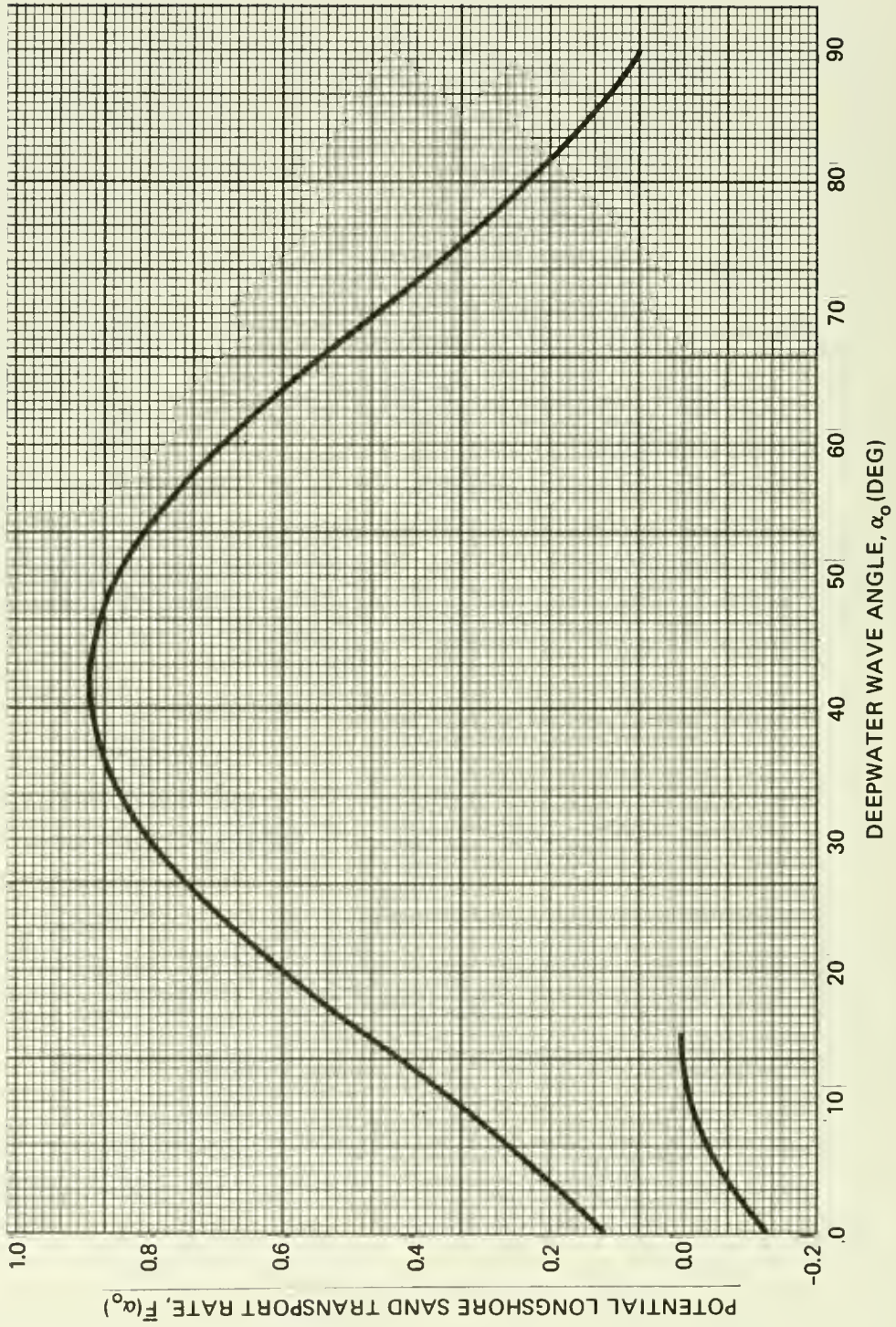

Figure 8-32. Average $F(\alpha_0)$ for 30-degree sector.

3. Potential Longshore Transport Computed by Energy Flux Method.

H_g (m)	Q_{α_0}, H_o ($10^3 \text{ m}^3/\text{year}$) for These Deepwater Wave Angles ¹					
	65°	35°	5°	25°	55°	85°
0.25	0.392	0.301	0.808 -0.021 ²	-0.395	-0.655	-0.084
0.75	21.412	15.210	3.206 -0.838	-13.817	15.399	-
1.25	39.235	35.335	8.532 -2.229	-40.672	-66.265	-16.541
1.75	37.959	39.779	10.830 -2.829	-71.738	-114.890	-32.371
2.25	31.390	56.667	13.273 -3.468	-99.603	-128.936	-38.758
2.75	46.656	88.659	21.921 -5.727	-133.651	-176.691	-45.910
3.25	70.841	86.006	18.600 -4.859	-106.149	-144.460	-46.919
3.75	67.540	74.868	11.200 -2.926	-71.437	-113.135	-39.301
4.25	76.962	65.812	9.572 -2.501	-48.842	-67.261	-38.010
4.75	74.531	86.909	5.056 -1.321	-24.187	-62.176	-22.501
5.25	78.316	62.010	3.247 -0.848	-20.709	-34.222	-17.784
5.75	76.468	62.276	4.076 -1.065	-	-42.962	-11.164
6.25	67.279	19.177	-	-	-17.640	-3.437
6.75	48.932	-	-	-	-21.382	-4.167
7.25	78.004	55.586	-	-	-	-
7.75	46.078	32.836	-	-	-30.203	-
8.25	26.937	-	-	-	-	-
8.75	31.206	-	-	-	-	-
9.25	35.856	-	-	-	-	-
9.75	40.900	-	-	-	-	-
Total	996.894	781.431	109.593 -28.632	-631.200	-1,036.277	-316.947

¹ $Q_{\alpha_0}, H_o = 2.03 \times 10^6 \times f \times H_g^{5/2} \times \bar{F}(\alpha_0)$ in m^3/year where f = numbers of hours of a specific wave (Table 8-12) divided by 8,766.

² Negative values represent northward transport.

With a shoreline azimuth of 20 degrees,

$$(Q_{\ell})_{\text{south}} = (996.9 + 781.4 + 109.6) \times 10^3 = 1.89 \times 10^6 \text{ m}^3/\text{year}$$

$$(Q_{\ell})_{\text{north}} = (28.6 + 631.2 + 1036.3 + 316.9) \times 10^3 = 2.01 \times 10^6 \text{ m}^3/\text{year}$$

$$(Q_{\ell})_{\text{net}} = (Q_{\ell})_{\text{north}} - (Q_{\ell})_{\text{south}} = 0.12 \times 10^6 \text{ m}^3/\text{year} \text{ (north)}$$

$$(Q_{\ell})_{\text{gross}} = (Q_{\ell})_{\text{north}} + (Q_{\ell})_{\text{south}} = 3.90 \times 10^6 \text{ m}^3/\text{year}$$

Note that the computed values are suspect since the net longshore transport is northward which is contrary to the field observations at the adjacent areas (Table 4-6). Except for the net transport rate, the computed values appear larger than those measured at various east coast locations. One of the possible factors that contribute to this discrepancy is the wave data used in the analysis. It is noted that hindcast wave data is for deep water at a location approximately 240 kilometers east of the shoreline of interest. Furthermore, energy dissipation due to bottom and/or internal friction is not considered in the analysis. Consequently, higher energy flux is implied in the sand transport computation.

Since the hindcast wave statistics are available at an offshore location¹ approximately 10 kilometers off the shoreline of interest, analysis of longshore sand transport should be based on this new data rather than on the deepwater data listed in Table 8-4. By using the procedure shown in the preceding calculations, the potential sand transport rates below are obtained.

$$(Q_{\ell})_{\text{south}} = 1.17 \times 10^6 \text{ m}^3/\text{year}$$

$$(Q_{\ell})_{\text{north}} = 0.66 \times 10^6 \text{ m}^3/\text{year}$$

$$(Q_{\ell})_{\text{net}} = 510,000 \text{ m}^3/\text{year} \text{ (south)}$$

$$(Q_{\ell})_{\text{gross}} = 1.83 \times 10^6 \text{ m}^3/\text{year}$$

VI. BEACH FILL REQUIREMENTS

(See Ch. 5, Sec. III,3)

A beach fill is proposed for the beach south of Ocean City, Maryland. Determine the volume of borrow material required to widen the beach 20 meters over a distance of 1.0 kilometers. Borrow material is available from two sources.

¹ Station No. 32 (Corson et al., 1982).

1. Material Characteristics.

a. Native Sand.

$$\phi_{84} = 2.51 \phi (0.1756 \text{ mm}) \quad (\text{see Table C-5}).$$

$$\phi_{16} = 1.37 \phi (0.3869 \text{ mm})$$

Mean diameter (see eq. 5-2):

$$M_{\phi n} = \frac{\phi_{84} + \phi_{16}}{2}$$

$$M_{\phi n} = \frac{2.51 + 1.37}{2} = 1.94 \phi (0.2606 \text{ mm})$$

Standard deviation (see eq. 5-1):

$$\sigma_{\phi n} = \frac{\phi_{84} - \phi_{16}}{2}$$

$$\sigma_{\phi n} = \frac{2.51 - 1.37}{2} = 0.570 \phi (0.6736 \text{ mm})$$

b. Borrow--Source A.

$$\phi_{84} = 2.61 \phi (0.1638 \text{ mm})$$

$$\phi_{16} = 1.00 \phi (0.500 \text{ mm})$$

Mean diameter (see eq. 5-2):

$$M_{\phi A} = \frac{2.61 + 1.00}{2} = 1.81 \phi (0.285 \text{ mm})$$

$$\sigma_{\phi A} = \frac{2.61 - 1.00}{2} = 0.805 \phi (0.572 \text{ mm})$$

c. Borrow--Source B.

$$\phi_{84} = 3.47 \phi (0.0902 \text{ mm})$$

$$\phi_{16} = 0.90 \phi (0.5359 \text{ mm})$$

Mean diameter (see eq. 5-1):

$$M_{\phi B} = \frac{3.47 + 0.90}{2} = 2.19 \phi (0.219 \text{ mm})$$

$$\sigma_{\phi B} = \frac{3.47 - 0.90}{2} = 1.29 \phi (0.4090 \text{ mm})$$

2. Evaluation of Borrow Materials (see Fig. 5-3).

$$\frac{M_{\phi A} - M_{\phi n}}{\sigma_{\phi n}} = \frac{1.81 - 1.94}{0.57} = -0.228$$

$$\frac{\sigma_{\phi A}}{\sigma_{\phi n}} = \frac{0.805}{0.57} = 1.412$$

From Figure 5-3, quadrant 2,

$$\text{(Source A) } R_A \text{ (overflow ratio) } = 1.10$$

$$\frac{M_{\phi B} - M_{\phi n}}{\sigma_{\phi n}} = \frac{2.19 - 1.94}{0.57} = 0.439$$

$$\frac{\sigma_{\phi B}}{\sigma_{\phi n}} = \frac{1.29}{0.57} = 2.26$$

From Figure 5-3, quadrant 1,

$$\text{(Source B) } R_A \text{ (overflow ratio) } = 1.55$$

Conclusion: use material from Source A.

3. Required Volume of Fill.

Rule of thumb: 2.5 cubic meters of native material per meter (1 cubic yard per foot) of beach width or 8.23 cubic meters per square meter of beach.

$$\text{Volume of native sand} = 20.00 \text{ m} \left(\frac{8.23 \text{ m}^3}{\text{m}^2} \right) (1.00 \text{ km}) \times \frac{1000 \text{ m}}{\text{km}}$$

$$\text{Volume of native sand} = 1.65 \times 10^5 \text{ m}^3$$

$$\text{Volume from Source A} = 1.10 (1.65 \times 10^5) = 1.81 \times 10^5 \text{ m}^3$$

LITERATURE CITED

- BRETSCHNEIDER, C.L., "Hurricane Surge Predictions for Delaware Bay and River," Beach Erosion Board, Miscellaneous Paper No. 4-59, 1959.
- CALDWELL, J.M., "Coastal Processes and Beach Erosion," Coastal Engineering Research Center, RI-67, 1967.
- CORSON, W.D., et al., "Atlantic Coast Hindcast, Deepwater, Significant Wave Information," WIS Report 2, U.S. Army Engineer Waterways Experiment Station, Vicksburg, Miss., Jan. 1981.
- CORSON, W.D. et al., "Atlantic Coast Hindcast Phase II, Significant Wave Information," WIS Report 6, U.S. Army Engineer Waterways Experiment Station, Vicksburg, Miss., Mar. 1982.
- ECKERT, J., and CALLENDER, G.W., "Geotechnical Engineering in the Coastal Zone," Instruction Report in preparation, U.S. Army Engineer Waterways Experiment Station, Vicksburg, Miss., 1984 (in press).
- HARRIS, D.L., "Tides and Tidal Datums in the United States," SR 7, Coastal Engineering Research Center, U.S. Army Engineer Waterways Experiment Station, Vicksburg, Miss., Feb. 1981.
- JENSEN, R.E., "Atlantic Coast Hindcast, Shallow-Water Significant Wave Information," WIS Report 9, U.S. Army Engineer Waterways Experiment Station, Vicksburg, Miss., Jan. 1983.
- KOMAR, P.D., "The Longshore Transport of Sand on Beaches," Unpublished Ph.D. Thesis, University of California, San Diego, 1969.
- NATIONAL OCEAN SERVICE (USC&GS), "Tide Tables" (available each year).
- NATIONAL OCEAN SERVICE (USC&GS), "Tidal Current Tables" (available for each year).
- NATIONAL OCEAN SERVICE (USC&GS), "Tidal Current Charts--Delaware Bay and River," 1948 and 1960.
- NATIONAL WEATHER SERVICE (U.S. Weather Bureau), "Winds Over Chesapeake Bay for Hurricane of September 14, 1944, Transposed and Adjusted for Filling," Weather Bureau Memorandum HUR 7-26, 1957.
- SAVILLE, T., Jr., "North Atlantic Coast Wave Statistics Hindcast by Bretschneider Revised Sverdrup-Munk Method," Beach Erosion Board, TM 55, 1954.
- THOM, H.C.S., "Distributions of Extreme Winds in the United States," *Proceedings of the Structural Division*, ASCE, ST 4, No. 2433, 1960.
- U.S. ARMY ENGINEER DISTRICT, BALTIMORE, "Atlantic Coast of Maryland and Assateague Island, Virginia--Draft Survey Report on Beach Erosion Control and Hurricane Protection," 1970.

U.S. ARMY ENGINEER DISTRICT, PHILADELPHIA, "Beach Erosion Control Report on Cooperative Study of Delaware Coast, Kitts Hummock to Fenwick Island," 1956.

U.S. ARMY ENGINEER DISTRICT, PHILADELPHIA, "Beach Erosion Control and Hurricane Protection Along the Delaware Coast," 1966.

U.S. ARMY ENGINEER DISTRICT, PHILADELPHIA, "Detailed Project Report, Small Beach Erosion Control Project, Lewes, Delaware," 1970.

APPENDIX A

Glossary of Terms



Newport Cove, Maine, 12 September 1958

The glossary that follows was compiled and reviewed by the staff of the Coastal Engineering Research Center. Although the terms came from many sources, the following publications were of particular value:

American Geological Institute (1957) *Glossary of Geology and Related Sciences with Supplement*, 2d Edition

American Geological Institute (1960) *Dictionary of Geological Terms*, 2nd Edition

American Meteorological Society (1959) *Glossary of Meteorology*

Johnson, D.W. (1919) *Shore Process and Shoreline Development*, John Wiley and Sons, Inc., New York

U.S. Army Coastal Engineering Research Center (1966) *Shore Protection, Planning and Design*, Technical Report No. 4, 3d Edition

U.S. Coast and Geodetic Survey (1949) *Tide and Current Glossary*, Special Publication No. 228, Revised (1949) Edition

U.S. Navy Oceanographic Office (1966) *Glossary of Oceanographic Terms*, Special Publication (SP-35), 2d Edition

Wiegel, R.L. (1953) *Waves, Tides, Currents and Beaches: Glossary of Terms and List of Standard Symbols*. Council on Wave Research, The Engineering Foundation, University of California

GLOSSARY OF TERMS

ACCRETION. May be either NATURAL or ARTIFICIAL. Natural accretion is the buildup of land, solely by the action of the forces of nature, on a BEACH by deposition of water- or airborne material. Artificial accretion is a similar buildup of land by reason of an act of man, such as the accretion formed by a groin, breakwater, or beach fill deposited by mechanical means. Also AGGRADATION.

ADVANCE (of a beach). (1) A continuing seaward movement of the shoreline. (2) A net seaward movement of the shoreline over a specified time. Also PROGRESSION.

AGE, WAVE. The ratio of wave velocity to wind velocity (in wave forecasting theory).

AGGRADATION. See ACCRETION.

ALLUVIUM. Soil (sand, mud, or similar detrital material) deposited by streams, or the deposits formed.

ALONGSHORE. Parallel to and near the shoreline; LONGSHORE.

AMPLITUDE, WAVE. (1) The magnitude of the displacement of a wave from a mean value. An ocean wave has an amplitude equal to the vertical distance from still-water level to wave crest. For a sinusoidal wave, the amplitude is one-half the wave height. (2) The semirange of a constituent tide.

ANTIDUNES. BED FORMS that occur in trains and are in phase with, and strongly interact with, gravity water-surface waves.

ANTINODE. See LOOP.

ARMOR UNIT. A relatively large quarystone or concrete shape that is selected to fit specified geometric characteristics and density. It is usually of nearly uniform size and usually large enough to require individual placement. In normal cases it is used as primary wave protection and is placed in thicknesses of at least two units.

ARTIFICIAL NOURISHMENT. The process of replenishing a beach with material (usually sand) obtained from another location.

ATOLL. A ring-shaped coral reef, often carrying low sand islands, enclosing a lagoon.

ATTENUATION. (1) A lessening of the amplitude of a wave with distance from the origin. (2) The decrease of water-particle motion with increasing depth. Particle motion resulting from surface oscillatory waves attenuates rapidly with depth, and practically disappears at a depth equal to a surface wavelength.

AWASH. Situated so that the top is intermittently washed by waves or tidal action. Condition of being exposed or just bare at any stage of the tide between high water and chart datum.

BACKBEACH. See BACKSHORE.

BACKRUSH. The seaward return of the water following the uprush of the waves. For any given tide stage the point of farthest return seaward of the backrush is known as the LIMIT of BACKRUSH or LIMIT BACKWASH. (See Figure A-2.)

BACKSHORE. That zone of the shore or beach lying between the foreshore and the coastline comprising the BERM or BERMS and acted upon by waves only during severe storms, especially when combined with exceptionally high water. Also BACKBEACH. (See Figure A-1.)

BACKWASH. (1) See BACKRUSH. (2) Water or waves thrown back by an obstruction such as a ship, breakwater, or cliff.

BANK. (1) The rising ground bordering a lake, river, or sea; or of a river or channel, for which it is designated as right or left as the observer is facing downstream. (2) An elevation of the sea floor or large area, located on a continental (or island) shelf and over which the depth is relatively shallow but sufficient for safe surface navigation; a group of shoals. (3) In its secondary sense, used only with a qualifying word such as "sandbank" or "gravelbank," a shallow area consisting of shifting forms of silt, sand, mud, and gravel.

BAR. A submerged or emerged embankment of sand, gravel, or other unconsolidated material built on the sea floor in shallow water by waves and currents. (See Figures A-2 and A-9.) See BAYMOUTH BAR, CUSPATE BAR.

BARRIER BEACH. A bar essentially parallel to the shore, the crest of which is above normal high water level. (See Figure A-9.) Also called OFFSHORE BARRIER and BARRIER ISLAND.

BARRIER LAGOON. A bay roughly parallel to the coast and separated from the open ocean by barrier islands. Also, the body of water encircled by coral islands and reefs, in which case it may be called an atoll lagoon.

BARRIER REEF. A coral reef parallel to and separated from the coast by a lagoon that is too deep for coral growth. Generally, barrier reefs follow the coasts for long distances and are cut through at irregular intervals by channels or passes.

BASIN, BOAT. A naturally or artificially enclosed or nearly enclosed harbor area for small craft.

BATHYMETRY. The measurement of depths of water in oceans, seas, and lakes; also information derived from such measurements.

BAY. A recess in the shore or an inlet of a sea between two capes or headlands, not so large as a gulf but larger than a cove. (See Figure A-9.) See also BIGHT, EMBAYMENT.

BAYMOUTH BAR. A bar extending partly or entirely across the mouth of a bay (see Figure A-9).

BAYOU. A minor sluggish waterway or estuarial creek, tributary to, or connecting, other streams or bodies of water, whose course is usually through lowlands or swamps. Sometimes called SLOUGH.

BEACH. The zone of unconsolidated material that extends landward from the low water line to the place where there is marked change in material or physiographic form, or to the line of permanent vegetation (usually the effective limit of storm waves). The seaward limit of a beach--unless otherwise specified--is the mean low water line. A beach includes FORESHORE and BACKSHORE. See also SHORE. (See Figure A-1.)

BEACH ACCRETION. See ACCRETION.

BEACH BERM. A nearly horizontal part of the beach or backshore formed by the deposit of material by wave action. Some beaches have no berms, others have one or several. (See Figure A-1.)

BEACH CUSP. See CUSP.

BEACH EROSION. The carrying away of beach materials by wave action, tidal currents, littoral currents, or wind.

BEACH FACE. The section of the beach normally exposed to the action of the wave uprush. The FORESHORE of a BEACH. (Not synonymous with SHORE-FACE.) (See Figure A-2.)

BEACH FILL. Material placed on a beach to renourish eroding shores.

BEACH RIDGE. See RIDGE, BEACH.

BEACH SCARP. See SCARP, BEACH.

BEACH WIDTH. The horizontal dimension of the beach measured normal to the shoreline.

BED FORMS. Any deviation from a flat bed that is readily detectable by eye and higher than the largest sediment size present in the parent bed material; generated on the bed of an alluvial channel by the flow.

BEDLOAD. See LOAD.

BENCH. (1) A level or gently sloping erosion plane inclined seaward. (2) A nearly horizontal area at about the level of maximum high water on the sea side of a dike.

BENCH MARK. A permanently fixed point of known elevation. A primary bench mark is one close to a tide station to which the tide staff and tidal datum originally are referenced.

BERM, BEACH. See BEACH BERM.

BERM CREST. The seaward limit of a berm. Also called BERM EDGE. (See Figure A-1.)

BIGHT. A bend in a coastline forming an open bay. A bay formed by such a bend. (See Figure A-8.)

BLOWN SANDS. See EOLIAN SANDS.

BLUFF. A high, steep bank or cliff.

BOLD COAST. A prominent landmass that rises steeply from the sea.

BORE. A very rapid rise of the tide in which the advancing water presents an abrupt front of considerable height. In shallow estuaries where the range of tide is large, the high water is propagated inward faster than the low water because of the greater depth at high water. If the high water overtakes the low water, an abrupt front is presented, with the high-water crest finally falling forward as the tide continues to advance. Also EAGER.

BOTTOM. The ground or bed under any body of water; the bottom of the sea. (See Figure A-1.)

BOTTOM (nature of). The composition or character of the bed of an ocean or other body of water (e.g., clay, coral, gravel, mud, ooze, pebbles, rock, shell, shingle, hard, or soft).

BOULDER. A rounded rock more than 10 inches in diameter; larger than a cobblestone. See SOIL CLASSIFICATION.

BREAKER. A wave breaking on a shore, over a reef, etc. Breakers may be classified into four types (see Figure A-4):

SPILLING--bubbles and turbulent water spill down front face of wave. The upper 25 percent of the front face may become vertical before breaking. Breaking generally occurs over quite a distance.

PLUNGING--crest curls over air pocket; breaking is usually with a crash. Smooth splash-up usually follows.

COLLAPSING--breaking occurs over lower half of wave, with minimal air pocket and usually no splash-up. Bubbles and foam present. (See Figure 2-77).

SURGING--wave peaks up, but bottom rushes forward from under wave, and wave slides up beach face with little or no bubble production. Water surface remains almost plane except where ripples may be produced on the beachface during runback.

BREAKER DEPTH. The still-water depth at the point where a wave breaks. Also called **BREAKING DEPTH.** (See Figure A-2).

BREAKWATER. A structure protecting a shore area, harbor, anchorage, or basin from waves.

BULKHEAD. A structure or partition to retain or prevent sliding of the land. A secondary purpose is to protect the upland against damage from wave action.

BUOY. A float; especially a floating object moored to the bottom to mark a channel, anchor, shoal, rock, etc.

BUOYANCY. The resultant of upward forces, exerted by the water on a submerged or floating body, equal to the weight of the water displaced by this body.

BYPASSING, SAND. Hydraulic or mechanical movement of sand from the accreting updrift side to the eroding downdrift side of an inlet or harbor entrance. The hydraulic movement may include natural movement as well as movement caused by man.

CANAL. An artificial watercourse cut through a land area for such uses as navigation and irrigation.

CANYON. A relatively narrow, deep depression with steep slopes, the bottom of which grades continuously downward. May be underwater (submarine) or on land (subaerial).

CAPE. A relatively extensive land area jutting seaward from a continent or large island which prominently marks a change in, or interrupts notably, the coastal trend; a prominent feature.

CAPILLARY WAVE. A wave whose velocity of propagation is controlled primarily by the surface tension of the liquid in which the wave is traveling. Water waves of length less than about 1 inch are considered capillary waves. Waves longer than 1 inch and shorter than 2 inches are in an indeterminate zone between CAPILLARY and GRAVITY WAVES. See RIPPLE.

CAUSEWAY. A raised road across wet or marshy ground, or across water.

CAUSTIC. In refraction of waves, the name given to the curve to which adjacent orthogonals of waves refracted by a bottom whose contour lines are curved, are tangents. The occurrence of a caustic always marks a region of crossed orthogonals and high wave convergence.

CAY. See KEY.

CELERITY. Wave speed.

CENTRAL PRESSURE INDEX (CPI). The estimated minimum barometric pressure in the eye (approximate center) of a particular hurricane. The CPI is considered the most stable index to intensity of hurricane wind velocities in the periphery of the storm; the highest wind speeds are associated with storms having the lowest CPI.

CHANNEL. (1) A natural or artificial waterway of perceptible extent which either periodically or continuously contains moving water, or which forms a connecting link between two bodies of water. (2) The part of a body of water deep enough to be used for navigation through an area otherwise too shallow for navigation. (3) A large strait, as the English Channel. (4) The deepest part of a stream, bay, or strait through which the main volume or current of water flows.

CHARACTERISTIC WAVE HEIGHT. See SIGNIFICANT WAVE HEIGHT.

CHART DATUM. The plane or level to which soundings (or elevations) or tide heights are referenced (usually LOW WATER DATUM). The surface is called a tidal datum when referred to a certain phase of tide. To provide a safety factor for navigation, some level lower than MEAN SEA LEVEL is generally selected for hydrographic charts, such as MEAN LOW WATER or MEAN LOWER LOW WATER. See DATUM PLANE.

CHOP. The short-crested waves that may spring up quickly in a moderate breeze, and which break easily at the crest. Also WIND CHOP.

CLAPOTIS. The French equivalent for a type of STANDING WAVE. In American usage it is usually associated with the standing wave phenomenon caused by the reflection of a nonbreaking wave train from a structure with a face that is vertical or nearly vertical. Full clapotis is one with 100 percent reflection of the incident wave; partial clapotis is one with less than 100 percent reflection.

CLAY. See SOIL CLASSIFICATION.

CLIFF. A high, steep face of rock; a precipice. See also SEA CLIFF.

CNOIDAL WAVE. A type of wave in shallow water (i.e., where the depth of water is less than $1/8$ to $1/10$ the wavelength). The surface profile is expressed in terms of the Jacobian elliptic function $cn u$; hence the term cnoidal.

COAST. A strip of land of indefinite width (may be several kilometers) that extends from the shoreline inland to the first major change in terrain features. (See Figure A-1.)

COASTAL AREA. The land and sea area bordering the shoreline. (See Figure A-1.)

COASTAL PLAIN. The plain composed of horizontal or gently sloping strata of clastic materials fronting the coast, and generally representing a strip of sea bottom that has emerged from the sea in recent geologic time.

COASTLINE. (1) Technically, the line that forms the boundary between the COAST and the SHORE. (2) Commonly, the line that forms the boundary between the land and the water.

COBBLE (COBBLESTONE). See SOIL CLASSIFICATION.

COMBER. (1) A deepwater wave whose crest is pushed forward by a strong wind; much larger than a whitecap. (2) A long-period breaker.

CONTINENTAL SHELF. The zone bordering a continent and extending from the low water line to the depth (usually about 180 meters) where there is a marked or rather steep descent toward a greater depth.

CONTOUR. A line on a map or chart representing points of equal elevation with relation to a DATUM. It is called an ISOBATH when connecting points of equal depth below a datum. Also called DEPTH CONTOUR.

CONTROLLING DEPTH. The least depth in the navigable parts of a waterway, governing the maximum draft of vessels that can enter.

CONVERGENCE. (1) In refraction phenomena, the decreasing of the distance between orthogonals in the direction of wave travel. Denotes an area of increasing wave height and energy concentration. (2) In wind-setup phenomena, the increase in setup observed over that which would occur in an equivalent rectangular basin of uniform depth, caused by changes in planform or depth; also the decrease in basin width or depth causing such increase in setup.

CORAL. (1) (Biology) Marine coelenterates (Madreporaria), solitary or colonial, which form a hard external covering of calcium compounds or other materials. The corals which form large reefs are limited to warm, shallow waters, while those forming solitary, minute growths may be found in colder waters to great depths. (2) (Geology) The concretion of coral polyps, composed almost wholly of calcium carbonate, forming reefs and tree-like and globular masses. May also include calcareous algae and other organisms producing calcareous secretions, such as bryozoans and hydrozoans.

CORE. A vertical cylindrical sample of the bottom sediments from which the nature and stratification of the bottom may be determined.

COVE. A small, sheltered recess in a coast, often inside a larger embayment. (See Figure A-8.)

CREST LENGTH, WAVE. The length of a wave *along* its crest. Sometimes called CREST WIDTH.

CREST OF BERM. The seaward limit of a berm. Also called BERM EDGE. (See Figure A-1.)

CREST OF WAVE. (1) the highest part of a wave. (2) That part of the wave above still-water level. (See Figure A-3.)

CREST WIDTH, WAVE. See CREST LENGTH, WAVE.

CURRENT. A flow of water.

CURRENT, COASTAL. One of the offshore currents flowing generally parallel to the shoreline in the deeper water beyond and near the surf zone; these are not related genetically to waves and resulting surf, but may be related to tides, winds, or distribution of mass.

CURRENT, DRIFT. A broad, shallow, slow-moving ocean or lake current. Opposite of CURRENT, STREAM.

CURRENT, EBB. The tidal current away from shore or down a tidal stream. Usually associated with the decrease in the height of the tide.

CURRENT, EDDY. See EDDY.

CURRENT, FEEDER. Any of the parts of the NEARSHORE CURRENT SYSTEM that flow parallel to shore before converging and forming the neck of the RIP CURRENT.

CURRENT, FLOOD. The tidal current toward shore or up a tidal stream. Usually associated with the increase in the height of the tide.

CURRENT, INSHORE. See INSHORE CURRENT.

CURRENT, LITTORAL. Any current in the littoral zone caused primarily by wave action; e.g., LONGSHORE CURRENT, RIP CURRENT. See also CURRENT, NEARSHORE.

CURRENT, LONGSHORE. The littoral current in the breaker zone moving essentially parallel to the shore, usually generated by waves breaking at an angle to the shoreline.

CURRENT, NEARSHORE. A current in the NEARSHORE ZONE. (See Figure A-1.)

CURRENT, OFFSHORE. See OFFSHORE CURRENT.

CURRENT, PERIODIC. See CURRENT, TIDAL.

CURRENT, PERMANENT. See PERMANENT CURRENT.

CURRENT, RIP. See RIP CURRENT.

CURRENT, STREAM. A narrow, deep, and swift ocean current, as the Gulf Stream. CURRENT, DRIFT.

CURRENT SYSTEM, NEARSHORE. See NEARSHORE CURRENT SYSTEM.

CURRENT, TIDAL. The alternating horizontal movement of water associated with the rise and fall of the tide caused by the astronomical tide-producing forces. Also CURRENT, PERIODIC. See also CURRENT, FLOOD and CURRENT, EBB.

CUSP. One of a series of low mounds of beach material separated by crescent-shaped troughs spaced at more or less regular intervals along the beach face. Also BEACH CUSP. (See Figure A-7.)

CUSPATE BAR. A crescent-shaped bar uniting with the shore at each end. It may be formed by a single spit growing from shore and then turning back to again meet the shore, or by two spits growing from the shore and uniting to form a bar of sharply cusped form. (See Figure A-9.)

CUSPATE SPIT. The spit that forms in the lee of a shoal or offshore feature (breakwater, island, rock outcrop) by waves that are refracted and/or diffracted around the offshore feature. It may be eventually grown into a TOMBOLO linking the feature to the mainland. See TOMBOLO.

CYCLOIDAL WAVE. A steep, symmetrical wave whose crest forms an angle of 120 degrees and whose form is that of a cycloid. A trochoidal wave of maximum steepness. See also TROCHOIDAL WAVE.

DATUM, CHART. See CHART DATUM.

DATUM, PLANE. The horizontal plane to which soundings, ground elevations, or water surface elevations are referred. Also REFERENCE PLANE. The plane is called a TIDAL DATUM when defined by a certain phase of the tide. The following datums are ordinarily used on hydrographic charts:

MEAN LOW WATER--Atlantic coast (U. S.), Argentina, Sweden, and Norway.
MEAN LOWER LOW WATER--Pacific coast (U. S.).
MEAN LOW WATER SPRINGS--United Kingdom, Germany, Italy, Brazil, and Chile.
LOW WATER DATUM--Great Lakes (U. S. and Canada).
LOWEST LOW WATER SPRINGS--Portugal.
LOW WATER INDIAN SPRINGS--India and Japan (See INDIAN TIDE PLANE).
LOWEST LOW WATER--France, Spain, and Greece.

A common datum used on topographic maps is based on MEAN SEA LEVEL. See also BENCH MARK.

DEBRIS LINE. A line near the limit of storm wave uprush marking the landward limit of debris deposits.

DECAY DISTANCE. The distance waves travel after leaving the generating area (FETCH).

DECAY OF WAVES. The change waves undergo after they leave a generating area (FETCH) and pass through a calm, or region of lighter winds. In the process of decay, the significant wave height decreases and the significant wavelength increases.

DEEP WATER. Water so deep that surface waves are little affected by the ocean bottom. Generally, water deeper than one-half the surface wavelength is considered deep water. Compare SHALLOW WATER.

DEFLATION. The removal of loose material from a beach or other land surface by wind action.

DELTA. An alluvial deposit, roughly triangular or digitate in shape, formed at a river mouth.

DEPTH. The vertical distance from a specified tidal datum to the sea floor.

DEPTH OF BREAKING. The still-water depth at the point where the wave breaks. Also BREAKER DEPTH. (See Figure A-2.)

DEPTH CONTOUR. See CONTOUR.

DEPTH, CONTROLLING. See CONTROLLING DEPTH.

DEPTH FACTOR. See SHOALING COEFFICIENT.

DERRICK STONE. See STONE, DERRICK.

DESIGN HURRICANE. See HYPOTHETICAL HURRICANE.

DIFFRACTION (of water waves). The phenomenon by which energy is transmitted laterally along a wave crest. When a part of a train of waves is interrupted by a barrier, such as a breakwater, the effect of diffraction is manifested by propagation of waves into the sheltered region within the barrier's geometric shadow.

DIKE (DYKE). A wall or mound built around a low-lying area to prevent flooding.

DIURNAL. Having a period or cycle of approximately one TIDAL DAY.

DIURNAL TIDE. A tide with one high water and one low water in a tidal day. (See Figure A-10.)

DIVERGENCE. (1) In refraction phenomena, the increasing of distance between orthogonals in the direction of wave travel. Denotes an area of decreasing wave height and energy concentration. (2) In wind-setup phenomena, the decrease in setup observed under that which would occur in an equivalent rectangular basin of uniform depth, caused by changes in planform or depth. Also the increase in basin width or depth causing such decrease in setup.

DOLPHIN. A cluster of piles.

DOWNCOAST. In United States usage, the coastal direction generally trending toward the south.

DOWNDRIFT. The direction of predominant movement of littoral materials.

DRIFT (noun). (1) Sometimes used as a short form for LITTORAL DRIFT. (2) The speed at which a current runs. (3) Floating material deposited on a beach (driftwood). (4) A deposit of a continental ice sheet; e.g., a drumlin.

DRIFT CURRENT. A broad, shallow, slow-moving ocean or lake current.

DUNES. (1) Ridges or mounds of loose, wind-blown material, usually sand. (See Figure A-7.) (2) BED FORMS smaller than bars but larger than ripples that are out of phase with any water-surface gravity waves associated with them.

DURATION. In wave forecasting, the length of time the wind blows in nearly the same direction over the FETCH (generating area).

DURATION, MINIMUM. The time necessary for steady-state wave conditions to develop for a given wind velocity over a given fetch length.

EAGER. See BORE.

EBB CURRENT. The tidal current away from shore or down a tidal stream; usually associated with the decrease in height of the tide.

EBB TIDE. The period of tide between high water and the succeeding low water; a falling tide. (See Figure A-10.)

ECHO SOUNDER. An electronic instrument used to determine the depth of water by measuring the time interval between the emission of a sonic or ultrasonic signal and the return of its echo from the bottom.

EDDY. A circular movement of water formed on the side of a main current. Eddies may be created at points where the main stream passes projecting obstructions or where two adjacent currents flow counter to each other. Also EDDY CURRENT.

EDDY CURRENT. See EDDY.

EDGE WAVE. An ocean wave parallel to a coast, with crests normal to the shoreline. An edge wave may be STANDING or PROGRESSIVE. Its height diminishes rapidly seaward and is negligible at a distance of one wavelength offshore.

EMBANKMENT. An artificial bank such as a mound or dike, generally built to hold back water or to carry a roadway.

EMBAYED. Formed into a bay or bays, as an embayed shore.

EMBAYMENT. An indentation in the shoreline forming an open bay.

ENERGY COEFFICIENT. The ratio of the energy in a wave per unit crest length transmitted forward with the wave at a point in shallow water to the energy in a wave per unit crest length transmitted forward with the wave in deep water. On refraction diagrams this is equal to the ratio of the distance between a pair of orthogonals at a selected shallow-water point to the distance between the same pair of orthogonals in deep water. Also the square of the REFRACTION COEFFICIENT.

ENTRANCE. The avenue of access or opening to a navigable channel.

EOLIAN SANDS. Sediments of sand size or smaller which have been transported by winds. They may be recognized in marine deposits off desert coasts by the greater angularity of the grains compared with waterborne particles.

EROSION. The wearing away of land by the action of natural forces. On a beach, the carrying away of beach material by wave action, tidal currents, littoral currents, or by deflation.

ESCARPMENT. A more or less continuous line of cliffs or steep slopes facing in one general direction which are caused by erosion or faulting. Also SCARP. (See Figure A-1.)

ESTUARY. (1) The part of a river that is affected by tides. (2) The region near a river mouth in which the fresh water of the river mixes with the salt water of the sea.

EYE. In meteorology, usually the "eye of the storm" (hurricane); the roughly circular area of comparatively light winds and fair weather found at the center of a severe tropical cyclone.

FAIRWAY. The parts of a waterway that are open and unobstructed for navigation. The main traveled part of a waterway; a marine thoroughfare.

FATHOM. A unit of measurement used for soundings equal to 1.83 meters (6 feet).

FATHOMETER. The copyrighted trademark for a type of echo sounder.

FEEDER BEACH. An artificially widened beach serving to nourish downdrift beaches by natural littoral currents or forces.

FEEDER CURRENT. See CURRENT, FEEDER.

FEELING BOTTOM. The initial action of a deepwater wave, in response to the bottom, upon running into shoal water.

FETCH. The area in which SEAS are generated by a wind having a fairly constant direction and speed. Sometimes used synonymously with FETCH LENGTH. Also GENERATING AREA.

FETCH LENGTH. The horizontal distance (in the direction of the wind) over which a wind generates SEAS or creates a WIND SETUP.

FIRTH. A narrow arm of the sea; also, the opening of a river into the sea.

FIORD (FJORD). A narrow, deep, steep-walled inlet of the sea, usually formed by entrance of the sea into a deep glacial trough.

FLOOD CURRENT. The tidal current toward shore or up a tidal stream, usually associated with the increase in the height of the tide.

FLOOD TIDE. The period of tide between low water and the succeeding high water; a rising tide. (See Figure A-10.)

FOAM LINE. The front of a wave as it advances shoreward, after it has broken. (See Figure A-4.)

FOLLOWING WIND. Generally, the same as a tailwind; in wave forecasting, wind blowing in the direction of ocean-wave advance.

FOREDUNE. The front dune immediately behind the backshore.

FORERUNNER. Low, long-period ocean SWELL which commonly precedes the main swell from a distant storm, especially a tropical cyclone.

FORESHORE. The part of the shore, lying between the crest of the seaward berm (or upper limit of wave wash at high tide) and the ordinary low-water mark, that is ordinarily traversed by the uprush and backrush of the waves as the tides rise and fall. See BEACH FACE. (See Figure A-1.)

FORWARD SPEED (hurricane). Rate of movement (propagation) of the hurricane eye in meters per second, knots, or miles per hour.

FREEBOARD. The additional height of a structure above design high water level to prevent overflow. Also, at a given time, the vertical distance between the water level and the top of the structure. On a ship, the distance from the waterline to main deck or gunwale.

FRINGING REEF. A coral reef attached directly to an insular or continental shore.

FRONT OF THE FETCH. In wave forecasting, the end of the generating area toward which the wind is blowing.

FROUDE NUMBER. The dimensionless ratio of the inertial force to the force of gravity for a given fluid flow. It may be given as $Fr = V / Lg$ where V is a characteristic velocity, L is a characteristic length, and g the acceleration of gravity--or as the square root of this number.

FULL. See RIDGE, BEACH.

GENERATING AREA. In wave forecasting, the continuous area of water surface over which the wind blows in nearly a constant direction. Sometimes used synonymously with FETCH LENGTH. Also FETCH.

GENERATION OF WAVES. (1) The creation of waves by natural or mechanical means. (2) The creation and growth of waves caused by a wind blowing over a water surface for a certain period of time. The area involved is called the GENERATING AREA or FETCH.

GEOMETRIC MEAN DIAMETER. The diameter equivalent of the arithmetic mean of the logarithmic frequency distribution. In the analysis of beach sands, it is taken as that grain diameter determined graphically by the intersection of a straight line through selected boundary sizes, (generally points on the distribution curve where 16 and 84 percent of the sample is coarser by weight) and a vertical line through the median diameter of the sample.

GEOMETRIC SHADOW. In wave diffraction theory, the area outlined by drawing straight lines paralleling the direction of wave approach through the extremities of a protective structure. It differs from the actual protected area to the extent that the diffraction and refraction effects modify the wave pattern.

GEOMORPHOLOGY. That branch of both physiography and geology which deals with the form of the Earth, the general configuration of its surface, and the changes that take place in the evolution of landform.

GRADIENT (GRADE). See SLOPE. With reference to winds or currents, the rate of increase or decrease in speed, usually in the vertical; or the curve that represents this rate.

GRAVEL. See SOIL CLASSIFICATION.

GRAVITY WAVE. A wave whose velocity of propagation is controlled primarily by gravity. Water waves more than 2 inches long are considered gravity waves. Waves longer than 1 inch and shorter than 2 inches are in an indeterminate zone between CAPILLARY and GRAVITY WAVES. See RIPPLE.

GROIN (British, GROUYNE). A shore protection structure built (usually perpendicular to the shoreline) to trap littoral drift or retard erosion of the shore.

GROIN SYSTEM. A series of groins acting together to protect a section of beach. Commonly called a groin field.

GROUND SWELL. A long high ocean swell; also, this swell as it rises to prominent height in shallow water.

GROUND WATER. Subsurface water occupying the zone of saturation. In a strict sense, the term is applied only to water below the WATER TABLE.

GROUP VELOCITY. The velocity of a wave group. In deep water, it is equal to one-half the velocity of the individual waves within the group.

GULF. A large embayment in a coast; the entrance is generally wider than the length.

GUT. (1) A narrow passage such as a strait or inlet. (2) A channel in otherwise shallower water, generally formed by water in motion.

HALF-TIDE LEVEL. MEAN TIDE LEVEL.

HARBOR (British, HARBOUR). Any protected water area affording a place of safety for vessels. See also PORT.

HARBOR OSCILLATION (HARBOR SURGING). The nontidal vertical water movement in a harbor or bay. Usually the vertical motions are low; but when oscillations are excited by a tsunami or storm surge, they may be quite large. Variable winds, air oscillations, or surf beat also may cause oscillations. See SEICHE.

HEADLAND (HEAD). A high, steep-faced promontory extending into the sea.

HEAD OF RIP. The part of a rip current that has widened out seaward of the breakers. See also CURRENT, RIP; CURRENT, FEEDER; and NECK (RIP).

HEIGHT OF WAVE. See WAVE HEIGHT.

HIGH TIDE, HIGH WATER (HW). The maximum elevation reached by each rising tide. See TIDE. (See Figure A-10.)

HIGH WATER. See HIGH TIDE.

HIGH WATER LINE. In strictness, the intersection of the plane of mean high water with the shore. The shoreline delineated on the nautical charts of the National Ocean Service is an approximation of the high water line. For specific occurrences, the highest elevation on the shore reached during a storm or rising tide, including meteorological effects.

HIGH WATER OF ORDINARY SPRING TIDES (HWOST). A tidal datum appearing in some British publications, based on high water of ordinary spring tides.

HIGHER HIGH WATER (HHW). The higher of the two high waters of any tidal day. The single high water occurring daily during periods when the tide is diurnal is considered to be a higher high water. (See Figure A-10.)

HIGHER LOW WATER (HLW). The higher of two low waters of any tidal day. (See Figure A-10.)

HINDCASTING, WAVE. The use of historic synoptic wind charts to calculate characteristics of waves that probably occurred at some past time.

HOOK. A spit or narrow cape of sand or gravel which turns landward at the outer end.

HURRICANE. An intense tropical cyclone in which winds tend to spiral inward toward a core of low pressure, with maximum surface wind velocities that equal or exceed 33.5 meters per second (75 mph or 65 knots) for several minutes or longer at some points. TROPICAL STORM is the term applied if maximum winds are less than 33.5 meters per second.

HURRICANE PATH or TRACK. Line of movement (propagation) of the eye through an area.

HURRICANE STAGE HYDROGRAPH. A continuous graph representing water level stages that would be recorded in a gage well located at a specified point of interest during the passage of a particular hurricane, assuming that effects of relatively short-period waves are eliminated from the record by damping features of the gage well. Unless specifically excluded and separately accounted for, hurricane surge hydrographs are assumed to include effects of astronomical tides, barometric pressure differences, and all other factors that influence water level stages within a properly designed gage well located at a specified point.

HURRICANE SURGE HYDROGRAPH. A continuous graph representing the difference between the hurricane stage hydrograph and the water stage hydrograph that would have prevailed at the same point and time if the hurricane had not occurred.

HURRICANE WIND PATTERN or ISOVEL PATTERN. An actual or graphical representation of near-surface wind velocities covering the entire area of a hurricane at a particular instant. Isovels are lines connecting points of simultaneous equal wind velocities, usually referenced 9 meters (30 feet) above the surface, in meters per second, knots, or meters per hour; wind directions at various points are indicated by arrows or deflection angles on the isovel charts. Isovel charts are usually prepared at each hour during a hurricane, but for each half hour during critical periods.

HYDRAULICALLY EQUIVALENT GRAINS. Sedimentary particles that settle at the same rate under the same conditions.

HYDROGRAPHY. (1) A configuration of an underwater surface including its relief, bottom materials, coastal structures, etc. (2) The description and study of seas, lakes, rivers, and other waters.

HYPOTHETICAL HURRICANE ("HYPOHURRICANE"). A representation of a hurricane, with specified characteristics, that is assumed to occur in a particular study area, following a specified path and timing sequence.

TRANPOSED--A hypohurricane based on the storm transposition principle, assumed to have wind patterns and other characteristics basically comparable to a specified hurricane of record, but *transposed* to follow a new path to serve as a basis for computing a hurricane surge hydrograph that would be expected at a selected point. Moderate adjustments in timing or rate of forward movement may also be made, if these are compatible with meteorological considerations and study objectives.

HYPOHURRICANE BASED ON GENERALIZED PARAMETERS--Hypohurricane estimates based on various logical combinations of hurricane characteristics used in estimating hurricane surge magnitudes corresponding to a range of probabilities and potentialities. The STANDARD PROJECT HURRICANE is most commonly used for this purpose, but estimates corresponding to more severe or less severe assumptions are important in some project investigations.

STANDARD PROJECT HURRICANE (SPH)--A hypothetical hurricane intended to represent the most severe combination of hurricane parameters that is *reasonably characteristic* of a specified region, excluding extremely rare combinations. It is further assumed that the SPH would approach a given project site from such direction, and at such rate of movement, to produce the highest HURRICANE SURGE HYDROGRAPH, considering pertinent hydraulic characteristics of the area. Based on this concept, and on extensive meteorological studies and probability analyses, a tabulation of "Standard Project Hurricane Index Characteristics" mutually agreed upon by representatives of the U. S. Weather Service and the Corps of Engineers, is available.

PROBABLE MAXIMUM HURRICANE--A hypohurricane that might result from the most severe combination of hurricane parameters that is considered reasonably possible in the region involved, if the hurricane should approach the point under study along a critical path and at optimum rate of movement. This estimate is substantially more severe than the SPH criteria.

DESIGN HURRICANE--A representation of a hurricane with specified characteristics that would produce HURRICANE SURGE HYDROGRAPHS and coincident wave effects at various key locations along a proposed project alignment. It governs the project design after economics and other factors have been duly considered. The design hurricane may be more or less severe than the SPH, depending on economics, risk, and local considerations.

IMPERMEABLE GROIN. A groin through which sand cannot pass.

INDIAN SPRING LOW WATER. The approximate level of the mean of lower low waters at spring tides, used principally in the Indian Ocean and along the east coast of Asia. Also INDIAN TIDE PLANE.

INDIAN TIDE PLANE. The datum of INDIAN SPRING LOW WATER.

INLET. (1) A short, narrow waterway connecting a bay, lagoon, or similar body of water with a large parent body of water. (2) An arm of the sea (or other body of water) that is long compared to its width and may extend a considerable distance inland. See also TIDAL INLET.

INLET GORGE. Generally, the deepest region of an inlet channel.

INSHORE (ZONE). In beach terminology, the zone of variable width extending from the low water line through the breaker zone. Also SHOREFACE. (See Figure A-1.)

INSHORE CURRENT. Any current in or landward of the breaker zone.

INSULAR SHELF. The zone surrounding an island extending from the low water line to the depth (usually about 183 meters (100 fathoms)) where there is a marked or rather steep descent toward the great depths.

INTERNAL WAVES. Waves that occur within a fluid whose density changes with depth, either abruptly at a sharp surface of discontinuity (an interface), or gradually. Their amplitude is greatest at the density discontinuity or, in the case of a gradual density change, somewhere in the interior of the fluid and not at the free upper surface where the surface waves have their maximum amplitude.

IRROTATIONAL WAVE. A wave with fluid particles that do not revolve around an axis through their centers, although the particles themselves may travel in circular or nearly circular orbits. Irrotational waves may be PROGRESSIVE, STANDING, OSCILLATORY, or TRANSLATORY. For example, the Airy, Stokes, cnoidal, and solitary wave theories describe irrotational waves. Compare TROCHOIDAL WAVE.

ISOBATH. A contour line connecting points of equal water depths on a chart.

ISOVEL PATTERN. See HURRICANE WIND PATTERN.

ISTHMUS. A narrow strip of land, bordered on both sides by water, that connects two larger bodies of land.

JET. To place (a pile, slab, or pipe) in the ground by means of a jet of water acting at the lower end.

JETTY. (1) (United States usage) On open seacoasts, a structure extending into a body of water, which is designed to prevent shoaling of a channel by littoral materials and to direct and confine the stream or tidal flow. Jetties are built at the mouths of rivers or tidal inlets to help deepen and stabilize a channel. (2) (British usage) WHARF or PIER. See TRAINING WALL.

KEY. A low, insular bank of sand, coral, etc., as one of the islets off the southern coast of Florida. Also CAY.

KINETIC ENERGY (OF WAVES). In a progressive oscillatory wave, a summation of the energy of motion of the particles within the wave.

KNOLL. A submerged elevation of rounded shape rising less than 1000 meters from the ocean floor and of limited extent across the summit. Compare SEAMOUNT.

KNOT. The unit of speed used in navigation equal to 1 nautical mile (6,076.115 feet or 1,852 meters) per hour.

LAGGING. See TIDES, DAILY RETARDATION OF.

LAGOON. A shallow body of water, like a pond or lake, usually connected to the sea. (See Figures A-8 and A-9.)

LAND BREEZE. A light wind blowing from the land to the sea, caused by unequal cooling of land and water masses.

LAND-SEA BREEZE. The combination of a land breeze and a sea breeze as a diurnal phenomenon.

LANDLOCKED. Enclosed, or nearly enclosed, by land--thus protected from the sea, as a bay or a harbor.

LANDMARK. A conspicuous object, natural or artificial, located near or on land, which aids in fixing the position of an observer.

LEAD LINE. A line, wire, or cord used in sounding. It is weighted at one end with a plummet (sounding lead). Also SOUNDING LINE.

LEE. (1) Shelter, or the part or side sheltered or turned away from the wind or waves. (2) (Chiefly nautical) The quarter or region toward which the wind blows.

LEEWARD. The direction *toward* which the wind is blowing; the direction toward which waves are traveling.

LENGTH OF WAVE. The horizontal distance between similar points on two successive waves measured perpendicularly to the crest. (See Figure A-3.)

LEVEE. A dike or embankment to protect land from inundation.

LIMIT OF BACKRUSH (LIMIT OF BACKWASH). See BACKRUSH, BACKWASH.

LITTORAL. Of or pertaining to a shore, especially of the sea.

LITTORAL CURRENT. See CURRENT, LITTORAL.

LITTORAL DEPOSITS. Deposits of littoral drift.

LITTORAL DRIFT. The sedimentary *material* moved in the littoral zone under the influence of waves and currents.

LITTORAL TRANSPORT. The *movement* of littoral drift in the littoral zone by waves and currents. Includes movement parallel (longshore transport) and perpendicular (on-offshore transport) to the shore.

LITTORAL TRANSPORT RATE. Rate of transport of sedimentary material parallel or perpendicular to the shore in the littoral zone. Usually expressed in cubic meters (cubic yards) per year. Commonly synonymous with LONGSHORE TRANSPORT RATE.

LITTORAL ZONE. In beach terminology, an indefinite zone extending seaward from the shoreline to just beyond the breaker zone.

LOAD. The quantity of sediment transported by a current. It includes the suspended load of small particles and the bedload of large particles that move along the bottom.

LONGSHORE. Parallel to and near the shoreline; ALONGSHORE.

LONGSHORE BAR. A bar running roughly parallel to the shoreline.

LONGSHORE CURRENT. See CURRENT, LONGSHORE.

LONGSHORE TRANSPORT RATE. Rate of transport of sedimentary material parallel to the shore. Usually expressed in cubic meters (cubic yards) per year. Commonly synonymous with LITTORAL TRANSPORT RATE.

LOOP. That part of a STANDING WAVE where the vertical motion is greatest and the horizontal velocities are least. Loops (sometimes called ANTINODES) are associated with CLAPOTIS and with SEICHE action resulting from wave reflections. Compare NODE.

LOW TIDE (LOW WATER, LW). The minimum elevation reached by each falling tide. See TIDE. (See Figure A-10.)

LOW WATER DATUM. An approximation to the plane of mean low water that has been adopted as a standard reference plane. See also DATUM, PLANE and CHART DATUM.

LOW WATER LINE. The intersection of any standard low tide datum plane with the shore.

LOW WATER OF ORDINARY SPRING TIDES (LWOST). A tidal datum appearing in some British publications, based on low water of ordinary spring tides.

LOWER HIGH WATER (LHW). The lower of the two high waters of any tidal day. (See Figure A-10.)

LOWER LOW WATER (LLW). The lower of the two low waters of any tidal day. The single low water occurring daily during periods when the tide is diurnal is considered to be a lower low water. (See Figure A-10.)

MANGROVE. A tropical tree with interlacing prop roots, confined to low-lying brackish areas.

MARIGRAM. A graphic record of the rise and fall of the tide.

MARSH. An area of soft, wet, or periodically inundated land, generally treeless and usually characterized by grasses and other low growth.

MARSH, SALT. A marsh periodically flooded by salt water.

MASS TRANSPORT. The net transfer of water by wave action in the direction of wave travel. See also ORBIT.

MEAN DIAMETER, GEOMETRIC. See GEOMETRIC MEAN DIAMETER.

MEAN HIGH WATER (MHW). The average height of the high waters over a 19-year period. For shorter periods of observations, corrections are applied to eliminate known variations and reduce the results to the equivalent of a mean 19-year value. All high water heights are included in the average where the type of tide is either semidiurnal or mixed. Only the higher high water heights are included in the average where the type of tide is diurnal. So determined, mean high water in the latter case is the same as mean higher high water.

MEAN HIGH WATER SPRINGS. The average height of the high waters occurring at the time of spring tide. Frequently abbreviated to HIGH WATER SPRINGS.

MEAN HIGHER HIGH WATER (MHHW). The average height of the higher high waters over a 19-year period. For shorter periods of observation, corrections are applied to eliminate known variations and reduce the result to the equivalent of a mean 19-year value.

MEAN LOW WATER (MLW). The average height of the low waters over a 19-year period. For shorter periods of observations, corrections are applied to eliminate known variations and reduce the results to the equivalent of a mean 19-year value. All low water heights are included in the average where the type of tide is either semidiurnal or mixed. Only lower low water heights are included in the average where the type of tide is diurnal. So determined, mean low water in the latter case is the same as mean lower low water.

MEAN LOW WATER SPRINGS. The average height of low waters occurring at the time of the spring tides. It is usually derived by taking a plane depressed below the half-tide level by an amount equal to one-half the spring range of tide, necessary corrections being applied to reduce the result to a mean value. This plane is used to a considerable extent for hydrographic work outside of the United States and is the plane of reference for the Pacific approaches to the Panama Canal. Frequently abbreviated to LOW WATER SPRINGS.

MEAN LOWER LOW WATER (MLLW). The average height of the lower low waters over a 19-year period. For shorter periods of observations, corrections are applied to eliminate known variations and reduce the results to the equivalent of a mean 19-year value. Frequently abbreviated to LOWER LOW WATER.

MEAN SEA LEVEL. The average height of the surface of the sea for all stages of the tide over a 19-year period, usually determined from hourly height readings. Not necessarily equal to MEAN TIDE LEVEL.

MEAN TIDE LEVEL. A plane midway between MEAN HIGH WATER and MEAN LOW WATER. Not necessarily equal to MEAN SEA LEVEL. Also HALF-TIDE LEVEL.

MEDIAN DIAMETER. The diameter which marks the division of a given sand sample into two equal parts by weight, one part containing all grains larger than that diameter and the other part containing all grains smaller.

MEGARIPPLE. See SAND WAVE.

MIDDLE-GROUND SHOAL. A shoal formed by ebb and flood tides in the middle of the channel of the lagoon or estuary end of an inlet.

MINIMUM DURATION. See DURATION, MINIMUM.

MINIMUM FETCH. The least distance in which steady-state wave conditions will develop for a wind of given speed blowing a given duration of time.

MIXED TIDE. A type of tide in which the presence of a diurnal wave is conspicuous by a large inequality in either the high or low water heights, with two high waters and two low waters usually occurring each tidal day. In strictness, all tides are mixed, but the name is usually applied without definite limits to the tide intermediate to those predominantly semidiurnal and those predominantly diurnal. (See Figure A-10.)

MOLE. In coastal terminology, a massive land-connected, solid-fill structure of earth (generally revetted), masonry, or large stone, which may serve as a breakwater or pier.

MONOCHROMATIC WAVES. A series of waves generated in a laboratory; each wave has the same length and period.

MONOLITHIC. Like a single stone or block. In coastal structures, the type of construction in which the structure's component parts are bound together to act as one.

MUD. A fluid-to-plastic mixture of finely divided particles of solid material and water.

NAUTICAL MILE. The length of a minute of arc, $1/21,600$ of an average great circle of the Earth. Generally one minute of latitude is considered equal to one nautical mile. The accepted United States value as of 1 July 1959 is 1,852 meters (6,076.115 feet), approximately 1.15 times as long as the U.S. statute mile of 5,280 feet. Also geographical mile.

NEAP TIDE. A tide occurring near the time of quadrature of the moon with the sun. The neap tidal range is usually 10 to 30 percent less than the mean tidal range.

NEARSHORE (zone). In beach terminology an indefinite zone extending seaward from the shoreline well beyond the breaker zone. It defines the area of NEARSHORE CURRENTS. (See Figure A-1.)

NEARSHORE CIRCULATION. The ocean circulation pattern composed of the CURRENTS, NEARSHORE and CURRENTS, COASTAL. See CURRENT.

NEARSHORE CURRENT SYSTEM. The current system caused primarily by wave action in and near the breaker zone, and which consists of four parts: the shoreward mass transport of water; longshore currents; seaward return flow, including rip currents; and the longshore movement of the expanding heads of rip currents. (See Figure A-7.) See also NEARSHORE CIRCULATION.

NECK. (1) The narrow band of water flowing seaward through the surf. Also RIP. (2) The narrow strip of land connecting a peninsula with the mainland.

NIP. The cut made by waves in a shoreline of emergence.

NODAL ZONE. An area in which the predominant direction of the LONGSHORE TRANSPORT changes.

NODE. That part of a STANDING WAVE where the vertical motion is least and the horizontal velocities are greatest. Nodes are associated with CLAPOTIS and with SEICHE action resulting from wave reflections. Compare LOOP.

NOURISHMENT. The process of replenishing a beach. It may be brought about naturally by longshore transport, or artificially by the deposition of dredged materials.

OCEANOGRAPHY. The study of the sea, embracing and indicating all knowledge pertaining to the sea's physical boundaries, the chemistry and physics of seawater, and marine biology.

OFFSHORE. (1) In beach terminology, the comparatively flat zone of variable width, extending from the breaker zone to the seaward edge of the Continental Shelf. (2) A direction seaward from the shore. (See Figure A-1.)

OFFSHORE BARRIER. See BARRIER BEACH.

OFFSHORE CURRENT. (1) Any current in the offshore zone. (2) Any current flowing away from shore.

OFFSHORE WIND. A wind blowing seaward from the land in the coastal area.

ONSHORE. A direction landward from the sea.

ONSHORE WIND. A wind blowing landward from the sea in the coastal area.

OPPOSING WIND. In wave forecasting, a wind blowing in a direction opposite to the ocean-wave advance; generally, a headwind.

ORBIT. In water waves, the path of a water particle affected by the wave motion. In deepwater waves the orbit is nearly circular, and in shallow-water waves the orbit is nearly elliptical. In general, the orbits are slightly open in the direction of wave motion, giving rise to MASS TRANSPORT. (See Figure A-3.)

ORBITAL CURRENT. The flow of water accompanying the orbital movement of the water particles in a wave. Not to be confused with wave-generated LITTORAL CURRENTS. (See Figure A-3.)

ORTHOGONAL. On a wave-refraction diagram, a line drawn perpendicularly to the wave crests. WAVE RAY. (See Figure A-6.)

OSCILLATION. (1) A periodic motion backward and forward. (2) Vibration or variance above and below a mean value.

OSCILLATORY WAVE. A wave in which each individual particle oscillates about a point with little or no permanent change in mean position. The term is commonly applied to progressive oscillatory waves in which only the form advances, the individual particles moving in closed or nearly closed orbits. Compare WAVE OF TRANSLATION. See also ORBIT.

OUTFALL. A structure extending into a body of water for the purpose of discharging sewage, storm runoff, or cooling water.

OVERTOPPING. Passing of water over the top of a structure as a result of wave runup or surge action.

OVERWASH. That portion of the uprush that carries over the crest of a berm or of a structure.

PARAPET. A low wall built along the edge of a structure such as a seawall or quay.

PARTICLE VELOCITY. The velocity induced by wave motion with which a specific water particle moves within a wave.

PASS. In hydrographic usage, a navigable channel through a bar, reef, or shoal, or between closely adjacent islands.

PEBBLES. See SOIL CLASSIFICATION.

PENINSULA. An elongated body of land nearly surrounded by water and connected to a larger body of land.

PERCHED BEACH. A beach or fillet of sand retained above the otherwise normal profile level by a submerged dike.

PERCOLATION. The process by which water flows through the interstices of a sediment. Specifically, in wave phenomena, the process by which wave action forces water through the interstices of the bottom sediment and which tends to reduce wave heights.

PERIODIC CURRENT. A current caused by the tide-producing forces of the moon and the sun; a part of the same general movement of the sea that is manifested in the vertical rise and fall of the tides. See also CURRENT, FLOOD and CURRENT, EBB.

PERMANENT CURRENT. A current that runs continuously, independent of the tides and temporary causes. Permanent currents include the freshwater discharge of a river and the currents that form the general circulatory systems of the oceans.

PERMEABLE GROIN. A groin with openings large enough to permit passage of appreciable quantities of LITTORAL DRIFT.

PETROGRAPHY. The systematic description and classification of rocks.

PHASE. In surface wave motion, a point in the period to which the wave motion has advanced with respect to a given initial reference point.

PHASE INEQUALITY. Variations in the tides or tidal currents associated with changes in the phase of the Moon in relation to the Sun.

PHASE VELOCITY. Propagation velocity of an individual wave as opposed to the velocity of a wave group.

PHI GRADE SCALE. A logarithmic transformation of the Wentworth grade scale for size classifications of sediment grains based on the negative logarithm to the base 2 of the particle diameter: $\phi = -\log_2 d$. See SOIL CLASSIFICATION.

PIER. A structure, usually of open construction, extending out into the water from the shore, to serve as a landing place, recreational facility, etc., rather than to afford coastal protection. In the Great Lakes, a term sometimes improperly applied to jetties.

PILE. A long, heavy timber or section of concrete or metal to be driven or jettied into the earth or seabed to serve as a support or protection.

PILE, SHEET. A pile with a generally slender flat cross section to be driven into the ground or seabed and meshed or interlocked with like members to form a diaphragm, wall, or bulkhead.

PILING. A group of piles.

PLAIN, COASTAL. See COASTAL PLAIN.

PLANFORM. The outline or shape of a body of water as determined by the still-water line.

PLATEAU. A land area (usually extensive) having a relatively level surface raised sharply above adjacent land on at least one side; table land. A similar undersea feature.

PLUNGE POINT. (1) For a plunging wave, the point at which the wave curls over and falls. (2) The final breaking point of the waves just before they rush up on the beach. (See Figure A-1.)

PLUNGING BREAKER. See BREAKER.

POCKET BEACH. A beach, usually small, in a coastal reentrant or between two littoral barriers.

POINT. The extreme end of a cape; the outer end of any land area protruding into the water, usually less prominent than a cape.

PORT. A place where vessels may discharge or receive cargo; it may be the entire harbor including its approaches and anchorages, or only the commercial part of a harbor where the quays, wharves, facilities for transfer of cargo, docks, and repair shops are situated.

POTENTIAL ENERGY OF WAVES. In a progressive oscillatory wave, the energy resulting from the elevation or depression of the water surface from the undisturbed level.

PRISM. See TIDAL PRISM.

PROBABLE MAXIMUM WATER LEVEL. A hypothetical water level (exclusive of wave runup from normal wind-generated waves) that might result from the most severe combination of hydrometeorological, geoseismic, and other geophysical factors and that is considered reasonably possible in the region involved, with each of these factors considered as affecting the locality in a maximum manner.

This level represents the physical response of a body of water to maximum applied phenomena such as hurricanes, moving squall lines, other cyclonic meteorological events, tsunamis, and astronomical tide combined with maximum probable ambient hydrological conditions such as wave setup, rainfall, runoff, and river flow. It is a water level with virtually no risk of being exceeded.

PROFILE, BEACH. The intersection of the ground surface with a vertical plane; may extend from the top of the dune line to the seaward limit of sand movement. (See Figure A-1.)

PROGRESSION (of a beach). See ADVANCE.

PROGRESSIVE WAVE. A wave that moves relative to a fixed coordinate system in a fluid. The direction in which it moves is termed the direction of wave propagation.

PROMONTORY. A high point of land projecting into a body of water; a HEADLAND.

PROPAGATION OF WAVES. The transmission of waves through water.

PROTOTYPE. In laboratory usage, the full-scale structure, concept, or phenomenon used as a basis for constructing a scale model or copy.

QUARRYSTONE. Any stone processed from a quarry.

QUAY (Pronounced KEY). A stretch of paved bank, or a solid artificial landing place parallel to the navigable waterway, for use in loading and unloading vessels.

QUICKSAND. Loose, yielding, wet sand which offers no support to heavy objects. The upward flow of the water has a velocity that eliminates contact pressures between the sand grains and causes the sand-water mass to behave like a fluid.

RADIUS OF MAXIMUM WINDS. Distance from the eye of a hurricane, where surface and wind velocities are zero, to the place where surface windspeeds are maximum.

RAY, WAVE. See ORTHOGONAL.

RECESSION (of a beach). (1) A continuing landward movement of the shoreline. (2) A net landward movement of the shoreline over a specified time. Also RETROGRESSION.

REEF. An offshore consolidated rock hazard to navigation, with a least depth of about 20 meters (10 fathoms) or less.

REEF, ATOLL. See ATOLL.

REEF, BARRIER. See BARRIER REEF.

REEF, FRINGING. See FRINGING REEF.

REEF, SAND. BAR.

REFERENCE PLANE. See DATUM PLANE.

REFERENCE STATION. A place for which tidal constants have previously been determined and which is used as a standard for the comparison of simultaneous observations at a second station. Also, a station for which independent daily predictions are given in the tide or current tables from which corresponding predictions are obtained for other stations by means of differences or factors.

REFLECTED WAVE. That part of an incident wave that is returned seaward when a wave impinges on a steep beach, barrier, or other reflecting surface.

REFRACTION (of water waves). (1) The process by which the direction of a wave moving in shallow water at an angle to the contours is changed: the part of the wave advancing in shallower water moves more slowly than that part still advancing in deeper water, causing the wave crest to bend toward alignment with the underwater contours. (2) The bending of wave crests by currents. (See Figure A-5.)

REFRACTION COEFFICIENT. The square root of the ratio of the distance between adjacent orthogonals in deep water to their distance apart in shallow water at a selected point. When multiplied by the SHOALING FACTOR and a factor for friction and percolation, this becomes the WAVE HEIGHT COEFFICIENT or the ratio of the refracted wave height at any point to the deepwater wave height. Also, the square root of the ENERGY COEFFICIENT.

REFRACTION DIAGRAM. A drawing showing positions of wave crests and/or orthogonals in a given area for a specific deepwater wave period and direction. (See Figure A-6.)

RESONANCE. The phenomenon of amplification of a free wave or oscillation of a system by a forced wave or oscillation of exactly equal period. The forced wave may arise from an impressed force upon the system or from a boundary condition.

RETARDATION. The amount of time by which corresponding tidal phases grow later day by day (about 50 minutes).

RETROGRESSION (of a beach). (1) A continuing landward movement of the shoreline. (2) A net landward movement of the shoreline over a specified time. Also RECESSION.

REVTMENT. A facing of stone, concrete, etc., built to protect a scarp, embankment, or shore structure against erosion by wave action or currents.

REYNOLDS NUMBER. The dimensionless ratio of the inertial force to the viscous force in fluid motion,

$$Re = \frac{LV}{\nu}$$

where L is a characteristic length, ν the kinematic viscosity, and V a characteristic velocity. The Reynolds number is of importance in the theory of hydrodynamic stability and the origin of turbulence.

RIA. A long, narrow inlet, with depth gradually diminishing inward.

RIDGE, BEACH. A nearly continuous mound of beach material that has been shaped by wave or other action. Ridges may occur singly or as a series of approximately parallel deposits. British usage, FULL. (See Figure A-7.)

RILL MARKS. Tiny drainage channels in a beach caused by the flow seaward of water left in the sands of the upper part of the beach after the retreat of the tide or after the dying down of storm waves.

RIP. A body of water made rough by waves meeting an opposing current, particularly a tidal current; often found where tidal currents are converging and sinking.

RIP CURRENT. A strong surface current flowing seaward from the shore. It usually appears as a visible band of agitated water and is the return movement of water piled up on the shore by incoming waves and wind. With the seaward movement concentrated in a limited band its velocity is somewhat accentuated. A rip consists of three parts: the FEEDER CURRENTS flowing parallel to the shore inside the breakers; the NECK, where the feeder currents converge and flow through the breakers in a narrow band or "rip"; and the HEAD, where the current widens and slackens outside the breaker line. A rip current is often miscalled a rip tide. Also RIP SURF. See NEARSHORE CURRENT SYSTEM. (See Figure A-7.)

RIP SURF. See RIP CURRENT.

RIPARIAN. Pertaining to the banks of a body of water.

RIPARIAN RIGHTS. The rights of a person owning land containing or bordering on a watercourse or other body of water in or to its banks, bed, or waters.

RIPPLE. (1) The ruffling of the surface of water; hence, a little curling wave or undulation. (2) A wave less than 0.05 meter (2 inches) long controlled to a significant degree by both surface tension and gravity. See CAPILLARY WAVE and GRAVITY WAVE.

RIPPLES (bed forms). Small bed forms with wavelengths less than 0.3 meter (1 foot) and heights less than 0.03 meter (0.1 foot).

RIPRAP. A protective layer or facing of quarystone, usually well graded within wide size limit, randomly placed to prevent erosion, scour, or sloughing of an embankment of bluff; also the stone so used. The quarystone is placed in a layer at least twice the thickness of the 50 percent size, or 1.25 times the thickness of the largest size stone in the gradation.

ROLLER. An indefinite term, sometimes considered to denote one of a series of long-crested, large waves which roll in on a shore, as after a storm.

RUBBLE. (1) Loose angular waterworn stones along a beach. (2) Rough, irregular fragments of broken rock.

RUBBLE-MOUND STRUCTURE. A mound of random-shaped and random-placed stones protected with a cover layer of selected stones or specially shaped concrete armor units. (Armor units in a primary cover layer may be placed in an orderly manner or dumped at random.)

RUNNEL. A corrugation or trough formed in the foreshore or in the bottom just offshore by waves or tidal currents.

RUNUP. The rush of water up a structure or beach on the breaking of a wave. Also UPRUSH, SWASH. The amount of runup is the vertical height above still-water level to which the rush of water reaches.

SALTATION. That method of sand movement in a fluid in which individual particles leave the bed by bounding nearly vertically and, because the motion of the fluid is not strong or turbulent enough to retain them in suspension, return to the bed at some distance downstream. The travel path of the particles is a series of hops and bounds.

SALT MARSH. A marsh periodically flooded by salt water.

SAND. See SOIL CLASSIFICATION.

SANDBAR. (1) See BAR. (2) In a river, a ridge of sand built up to or near the surface by river currents.

SAND BYPASSING. See BYPASSING, SAND.

SAND REEF. BAR.

SAND WAVE. A large wavelike sediment feature composed of sand in very shallow water. Wavelength may reach 100 meters; amplitude is about 0.5 meter. Also MEGARIPPLE.

SCARP. See ESCARPMENT.

SCARP, BEACH. An almost vertical slope along the beach caused by erosion by wave action. It may vary in height from a few centimeters to a meter or so, depending on wave action and the nature and composition of the beach. (See Figure A-1.)

SCOUR. Removal of underwater material by waves and currents, especially at the base or toe of a shore structure.

SEA BREEZE. A light wind blowing from the sea toward the land caused by unequal heating of land and water masses.

SEA CHANGE. (1) A change wrought by the sea. (2) A marked transformation.

SEA CLIFF. A cliff situated at the seaward edge of the coast.

SEA LEVEL. See MEAN SEA LEVEL.

SEAMOUNT. An elevation rising more than 1000 meters above the ocean floor, and of limited extent across the summit. Compare KNOLL.

SEA PUSS. A dangerous longshore current; a rip current caused by return flow; loosely, the submerged channel or inlet through a bar caused by those currents.

SEAS. Waves caused by wind at the place and time of observation.

SEASHORE. The SHORE of a sea or ocean.

SEA STATE. Description of the sea surface with regard to wave action. Also called state of sea.

SEAWALL. A structure separating land and water areas, primarily designed to prevent erosion and other damage due to wave action. See also BULKHEAD.

SEICHE. (1) A standing wave oscillation of an enclosed waterbody that continues, pendulum fashion, after the cessation of the originating force, which may have been either seismic or atmospheric. (2) An oscillation of a fluid body in response to a disturbing force having the same frequency as the natural frequency of the fluid system. Tides are now considered to be seiches induced primarily by the periodic forces caused by the Sun and Moon. (3) In the Great Lakes area, any sudden rise in the water of a harbor or a lake whether or not it is oscillatory (although inaccurate in a strict sense, this usage is well established in the Great Lakes area).

SEISMIC SEA WAVE. See TSUNAMI.

SEMIDIURNAL TIDE. A tide with two high and two low waters in a tidal day with comparatively little diurnal inequality. (See Figure A-10.)

SET OF CURRENT. The direction toward which a current flows.

SETUP, WAVE. Superelevation of the water surface over normal surge elevation due to onshore mass transport of the water by wave action alone.

SETUP, WIND. See WIND SETUP.

SHALLOW WATER. (1) Commonly, water of such a depth that surface waves are noticeably affected by bottom topography. It is customary to consider water of depths less than one-half the surface wavelength as shallow water. See TRANSITIONAL ZONE and DEEP WATER. (2) More strictly, in hydrodynamics with regard to progressive gravity waves, water in which the depth is less than $1/25$ the wavelength; also called VERY SHALLOW WATER.

SHEET PILE. See PILE, SHEET.

SHELF, CONTINENTAL. See CONTINENTAL SHELF.

SHELF, INSULAR. See INSULAR SHELF.

SHINGLE. (1) Loosely and commonly, any beach material coarser than ordinary gravel, especially any having flat or flattish pebbles. (2) Strictly and accurately, beach material of smooth, well-rounded pebbles that are roughly the same size. The spaces between pebbles are not filled with finer materials. Shingle often gives out a musical sound when stepped on.

SHOAL (noun). A detached elevation of the sea bottom, comprised of any material except rock or coral, which may endanger surface navigation.

SHOAL (verb). (1) To *become* shallow gradually. (2) To *cause* to become shallow. (3) To *proceed* from a greater to a lesser depth of water.

SHOALING COEFFICIENT. The ratio of the height of a wave in water of any depth to its height in deep water with the effects of refraction, friction, and percolation eliminated. Sometimes SHOALING FACTOR or DEPTH FACTOR. See also ENERGY COEFFICIENT and REFRACTION COEFFICIENT.

SHOALING FACTOR. See SHOALING COEFFICIENT.

SHORE. The narrow strip of land in immediate contact with the sea, including the zone between high and low water lines. A shore of unconsolidated material is usually called a BEACH. (See Figure A-1.)

SHOREFACE. The narrow zone seaward from the low tide SHORELINE, covered by water, over which the beach sands and gravels actively oscillate with changing wave conditions. See INSHORE (ZONE). See Figure A-1.

SHORELINE. The intersection of a specified plane of water with the shore or beach (e.g., the high water shoreline would be the intersection of the plane of mean high water with the shore or beach). The line delineating the shoreline on National Ocean Service nautical charts and surveys approximates the mean high water line.

SIGNIFICANT WAVE. A statistical term relating to the one-third highest waves of a given wave group and defined by the average of their heights and periods. The composition of the higher waves depends upon the extent to which the lower waves are considered. Experience indicates that a careful observer who attempts to establish the character of the higher waves will record values which approximately fit the definition of the significant wave.

SIGNIFICANT WAVE HEIGHT. The average height of the one-third highest waves of a given wave group. Note that the composition of the highest waves depends upon the extent to which the lower waves are considered. In wave record analysis, the average height of the highest one-third of a selected number of waves, this number being determined by dividing the time of record by the significant period. Also **CHARACTERISTIC WAVE HEIGHT.**

SIGNIFICANT WAVE PERIOD. An arbitrary period generally taken as the period of the one-third highest waves within a given group. Note that the composition of the highest waves depends upon the extent to which the lower waves are considered. In wave record analysis, this is determined as the average period of the most frequently recurring of the larger well-defined waves in the record under study.

SILT. See **SOIL CLASSIFICATION.**

SINUSOIDAL WAVE. An oscillatory wave having the form of a sinusoid.

SLACK TIDE (SLACK WATER). The state of a tidal current when its velocity is near zero, especially the moment when a reversing current changes direction and its velocity is zero. Sometimes considered the intermediate period between ebb and flood currents during which the velocity of the currents is less than 0.05 meter per second (0.1 knot). See **STAND OF TIDE.**

SLIP. A berthing space between two piers.

SLOPE. The degree of inclination to the horizontal. Usually expressed as a ratio, such as 1:25 or 1 on 25, indicating 1 unit vertical rise in 25 units of horizontal distance; or in a decimal fraction (0.04); degrees ($2^{\circ} 18'$); or percent (4 percent).

SLOUGH. See **BAYOU.**

SOIL CLASSIFICATION (size). An arbitrary division of a continuous scale of grain sizes such that each scale unit or grade may serve as a convenient class interval for conducting the analysis or for expressing the results of an analysis. There are many classifications used; the two most often used are shown graphically in Table A-1.

SOLITARY WAVE. A wave consisting of a single elevation (above the original water surface), whose height is not necessarily small compared to the depth, and neither followed nor preceded by another elevation or depression of the water surfaces.

SORTING COEFFICIENT. A coefficient used in describing the distribution of grain sizes in a sample of unconsolidated material. It is defined as $S_o = Q_1/Q_3$, where Q_1 is the diameter (in millimeters) which has 75 percent of the cumulative size-frequency (by weight) distribution smaller than itself and 25 percent larger than itself, and Q_3 is that diameter having 25 percent smaller and 75 percent larger than itself.

SOUND (noun). (1) A wide waterway between the mainland and an island, or a wide waterway connecting two sea areas. See also STRAIT. (2) A relatively long arm of the sea or ocean forming a channel between an island and a mainland or connecting two larger bodies, as a sea and the ocean, or two parts of the same body; usually wider and more extensive than a strait.

SOUND (verb). To measure the depth of the water.

SOUNDING. A measured depth of water. On hydrographic charts the soundings are adjusted to a specific plane of reference (SOUNDING DATUM).

SOUNDING DATUM. The plane to which soundings are referred. See also CHART DATUM.

SOUNDING LINE. A line, wire, or cord used in sounding, which is weighted at one end with a plummet (sounding lead). Also LEAD LINE.

SPILLING BREAKER. See BREAKER.

SPIT. A small point of land or a narrow shoal projecting into a body of water from the shore. (See Figure A-9.)

SPIT, CUSPATE. See CUSPATE SPIT.

SPRING TIDE. A tide that occurs at or near the time of new or full moon (SYZYGY) and which rises highest and falls lowest from the mean sea level.

STAND OF TIDE. A interval at high or low water when there is no sensible change in the height of the tide. The water level is stationary at high and low water for only an instant, but the change in level near these times is so slow that it is not usually perceptible. See SLACK TIDE.

STANDARD PROJECT HURRICANE. See HYPOTHETICAL HURRICANE.

STANDING WAVE. A type of wave in which the surface of the water oscillates vertically between fixed points, called nodes, without progression. The points of maximum vertical rise and fall are called antinodes or loops. At the nodes, the underlying water particles exhibit no vertical motion, but maximum horizontal motion. At the antinodes, the underlying water particles have no horizontal motion, but maximum vertical motion. They may be the result of two equal progressive wave trains traveling through each other in opposite directions. Sometimes called CLAPOTIS or STATIONARY WAVE.

STATIONARY WAVE. A wave of essentially stable form which does not move with respect to a selected reference point; a fixed swelling. Sometimes called STANDING WAVE.

STILL-WATER LEVEL. The elevation that the surface of the water would assume if all wave action were absent.

STOCKPILE. Sand piled on a beach foreshore to nourish downdrift beaches by natural littoral currents or forces. See FEEDER BEACH.

STONE, DERRICK. Stone heavy enough to require handling individual pieces by mechanical means, generally weighing 900 kilograms (1 ton) and up.

STORM SURGE. A rise above normal water level on the open coast due to the action of wind stress on the water surface. Storm surge resulting from a hurricane also includes that rise in level due to atmospheric pressure reduction as well as that due to wind stress. See WIND SETUP.

STORM TIDE. See STORM SURGE.

STRAIT. A relatively narrow waterway between two larger bodies of water. See also SOUND.

STREAM. (1) A course of water flowing along a bed in the Earth. (2) A current in the sea formed by wind action, water density differences, etc.; e.g. the Gulf Stream. See also CURRENT, STREAM.

SURF. The wave activity in the area between the shoreline and the outermost limit of breakers.

SURF BEAT. Irregular oscillations of the nearshore water level with periods on the order of several minutes.

SURF ZONE. The area between the outermost breaker and the limit of wave uprush. (See Figures A-2 and A-5.)

SURGE. (1) The name applied to wave motion with a period intermediate between that of the ordinary wind wave and that of the tide, say from 1/2 to 60 minutes. It is low height; usually less than 0.9 meter (0.3 foot). See also SEICHE. (2) In fluid flow, long interval variations in velocity and pressure, not necessarily periodic, perhaps even transient in nature. (3) see STORM SURGE.

SURGING BREAKER. See BREAKER.

SUSPENDED LOAD. (1) The material moving in suspension in a fluid, kept up by the upward components of the turbulent currents or by colloidal suspension. (2) The material collected in or computed from samples collected with a SUSPENDED LOAD SAMPLER. Where it is necessary to distinguish between the two meanings given above, the first one may be called the "true suspended load."

SUSPENDED LOAD SAMPLER. A sampler which attempts to secure a sample of the water with its sediment load without separating the sediment from the water.

SWALE. The depression between two beach ridges.

SWASH. The rush of water up onto the beach face following the breaking of a wave. Also UPRUSH, RUNUP. (See Figure A-2.)

SWASH CHANNEL. (1) On the open shore, a channel cut by flowing water in its return to the present body (e.g., a rip channel). (2) A secondary channel passing through or shoreward of an inlet or river bar. (See Figure A-9.)

SWASH MARK. The thin wavy line of fine sand, mica scales, bits of seaweed, etc., left by the uprush when it recedes from its upward limit of movement on the beach face.

SWELL. Wind-generated waves that have traveled out of their generating area. Swell characteristically exhibits a more regular and longer period and has flatter crests than waves within their fetch (SEAS).

SYNOPTIC CHART. A chart showing the distribution of meteorological conditions over a given area at a given time. Popularly called a weather map.

SYZYGY. The two points in the Moon's orbit when the Moon is in conjunction or opposition to the Sun relative to the Earth; time of new or full Moon in the cycle of phases.

TERRACE. A horizontal or nearly horizontal natural or artificial topographic feature interrupting a steeper slope, sometimes occurring in a series.

THALWEG. In hydraulics, the line joining the deepest points of an inlet or stream channel.

TIDAL CURRENT. See CURRENT, TIDAL.

TIDAL DATUM. See CHART DATUM and DATUM PLANE.

TIDAL DAY. The time of the rotation of the Earth with respect to the Moon, or the interval between two successive upper transits of the Moon over the meridian of a place, approximately 24.84 solar hours (24 hours and 50 minutes) or 1.035 times the mean solar day. (See Figure A-10.) Also called lunar day.

TIDAL FLATS. Marshy or muddy land areas which are covered and uncovered by the rise and fall of the tide.

TIDAL INLET. (1) A natural inlet maintained by tidal flow. (2) Loosely, any inlet in which the tide ebbs and flows. Also TIDAL OUTLET.

TIDAL PERIOD. The interval of time between two consecutive, like phases of the tide. (See Figure A-10.)

TIDAL POOL. A pool of water remaining on a beach or reef after recession of the tide.

TIDAL PRISM. The total amount of water that flows into a harbor or estuary or out again with movement of the tide, excluding any freshwater flow.

TIDAL RANGE. The difference in height between consecutive high and low (or higher high and lower low) waters. (See Figure A-10.)

TIDAL RISE. The height of tide as referred to the datum of a chart. (See Figure A-10.)

TIDAL WAVE. (1) The wave motion of the tides. (2) In popular usage, any unusually high and destructive water level along a shore. It usually refers to STORM SURGE or TSUNAMI.

TIDE. The periodic rising and falling of the water that results from gravitational attraction of the Moon and Sun and other astronomical bodies acting upon the rotating Earth. Although the accompanying horizontal movement of the water resulting from the same cause is also sometimes called the tide, it is preferable to designate the latter as TIDAL CURRENT, reserving the name TIDE for the vertical movement.

TIDE, DAILY RETARDATION OF. The amount of time by which corresponding tides grow later day by day (about 50 minutes). Also LAGGING.

TIDE, DIURNAL. A tide with one high water and one low water in a day. (See Figure A-10.)

TIDE, EBB. See EBB TIDE.

TIDE, FLOOD. See FLOOD TIDE.

TIDE, MIXED. See MIXED TIDE.

TIDE, NEAP. See NEAP TIDE.

TIDE, SEMIDIURNAL. See SEMIDIURNAL TIDE.

TIDE, SLACK. See SLACK TIDE.

TIDE, SPRING. See SPRING TIDE.

TIDE STATION. A place at which tide observations are being taken. It is called a *primary* tide station when continuous observations are to be taken over a number of years to obtain basic tidal data for the locality. A *secondary* tide station is one operated over a short period of time to obtain data for a specific purpose.

TIDE, STORM. See STORM SURGE.

TOMBOLO. A bar or spit that connects or "ties" an island to the mainland or to another island. See CUSPATE SPIT. (See Figure A-9.)

TOPOGRAPHY. The configuration of a surface, including its relief and the positions of its streams, roads, building, etc.

TRAINING WALL. A wall or jetty to direct current flow.

TRANSITIONAL ZONE (TRANSITIONAL WATER). In regard to progressive gravity waves, water whose depth is less than $1/2$ but more than $1/25$ the wavelength. Often called SHALLOW WATER.

TRANSLATORY WAVE. See WAVE OF TRANSLATION.

TRANSPOSED HURRICANE. See HYPOTHETICAL HURRICANE.

TROCHOIDAL WAVE. A theoretical, progressive oscillatory wave first proposed by Gerstner in 1802 to describe the surface profile and particle orbits of finite amplitude, nonsinusoidal waves. The wave form is that of a prolate cycloid or trochoid, and the fluid particle motion is rotational as opposed to the usual irrotational particle motion for waves generated by normal forces. Compare IRROTATIONAL WAVE

TROPICAL CYCLONE. See HURRICANE

TROPICAL STORM. A tropical cyclone with maximum winds less than 34 meters per second (75 mile per hour). Compare HURRICANE.

TROUGH OF WAVE. The lowest part of a waveform between successive crests. Also, that part of a wave below still-water level. (See Figure A-3.)

Tsunami. A long-period wave caused by an underwater disturbance such as a volcanic eruption or earthquake. Also SEISMIC SEA WAVE. Commonly miscalled "tidal wave."

TYPHOON. See HURRICANE.

UNDERTOW. A seaward current near the bottom on a sloping inshore zone. It is caused by the return, under the action of gravity, of the water carried up on the shore by waves. Often a misnomer for RIP CURRENT.

UNDERWATER GRADIENT. The slope of the sea bottom. See also SLOPE.

UNDULATION. A continuously propagated motion to and fro, in any fluid or elastic medium, with no permanent translation of the particles themselves.

UPCOAST. In United States usage, the coastal direction generally trending toward the north.

UPDRIFT. The direction opposite that of the predominant movement of littoral materials.

UPLIFT. The upward water pressure on the base of a structure or pavement.

UPRUSH. The rush of water up onto the beach following the breaking of a wave. Also SWASH, RUNUP. (See Figure A-2.)

VALLEY, SEA. A submarine depression of broad valley form without the steep side slopes which characterize a canyon.

VALLEY, SUBMARINE. A prolongation of a land valley into or across a continental or insular shelf, which generally gives evidence of having been formed by stream erosion.

VARIABILITY OF WAVES. (1) The variation of heights and periods between individual waves within a WAVE TRAIN. (Wave trains are not composed of waves of equal height and period, but rather of heights and periods which vary in a statistical manner.) (2) The variation in direction of propagation of waves leaving the generating area. (3) The variation in height along the crest, usually called "variation along the wave."

VERY SHALLOW WATER. See SHALLOW WATER.

VELOCITY OF WAVES. The speed at which an individual wave advances. See WAVE CELERITY.

VISCOSITY (or internal friction). That molecular property of a fluid that enables it to support tangential stresses for a finite time and thus to resist deformation.

WATERLINE. A juncture of land and sea. This line migrates, changing with the tide or other fluctuation in the water level. Where waves are present on the beach, this line is also known as the limit of backrush. (Approximately, the intersection of the land with the still-water level.)

WAVE. A ridge, deformation, or undulation of the surface of a liquid.

WAVE AGE. The ratio of wave speed to wind speed.

WAVE, CAPILLARY. See CAPILLARY WAVE.

WAVE CELERITY. Wave speed.

WAVE CREST. See CREST OF WAVE.

WAVE CREST LENGTH. See CREST LENGTH, WAVE.

WAVE, CYCLOIDAL. See CYCLOIDAL WAVE.

WAVE DECAY. See DECAY OF WAVES.

WAVE DIRECTION. The direction from which a wave approaches.

WAVE FORECASTING. The theoretical determination of future wave characteristics, usually from observed or predicted meteorological phenomena.

WAVE GENERATION. See GENERATION OF WAVES.

WAVE, GRAVITY. See GRAVITY WAVE.

WAVE GROUP. A series of waves in which the wave direction, wavelength, and wave height vary only slightly. See also GROUP VELOCITY.

WAVE HEIGHT. The vertical distance between a crest and the preceding trough. See also SIGNIFICANT WAVE HEIGHT. (See Figure A-3.)

WAVE HEIGHT COEFFICIENT. The ratio of the wave height at a selected point to the deepwater wave height. The REFRACTOPM COEFFICIENT multiplied by the shoaling factor.

WAVE HINDCASTING. See HINDCASTING, WAVE.

WAVE, IRROTATIONAL. See IRROTATIONAL WAVE.

WAVE, MONOCHROMATIC. See MONOCHROMATIC WAVES.

WAVE, OSCILLATORY. See OSCILLATORY WAVE.

WAVE PERIOD. The time for a wave crest to traverse a distance equal to one wavelength. The time for two successive wave crests to pass a fixed point. See also SIGNIFICANT WAVE PERIOD.

WAVE, PROGRESSIVE. See PROGRESSIVE WAVE.

WAVE PROPAGATION. The transmission of waves through water.

WAVE RAY. See ORTHOGONAL.

WAVE, REFLECTED. That part of an incident wave that is returned seaward when a wave impinges on a steep beach, barrier, or other reflecting surface.

WAVE REFRACTION. See REFRACTION (of water waves).

WAVE SETUP. See SETUP, WAVE.

WAVE, SINUSOIDAL. An oscillatory wave having the form of a sinusoid.

WAVE, SOLITARY. See SOLITARY WAVE.

WAVE SPECTRUM. In ocean wave studies, a graph, table, or mathematical equation showing the distribution of wave energy as a function of wave frequency. The spectrum may be based on observations or theoretical considerations. Several forms of graphical display are widely used.

WAVE, STANDING. See STANDING WAVE.

WAVE STEEPNESS. The ratio of the wave height to the wavelength.

WAVE TRAIN. A series of waves from the same direction.

WAVE OF TRANSLATION. A wave in which the water particles are permanently displaced to a significant degree in the direction of wave travel. Distinguished from an OSCILLATORY WAVE.

WAVE, TROCHOIDAL. See TROCHOIDAL WAVE.

WAVE TROUGH. The lowest part of a wave form between successive crests. Also that part of a wave below still-water level.

WAVE VARIABILITY. See VARIABILITY OF WAVES.

WAVE VELOCITY. The speed at which an individual wave advances.

WAVE, WIND. See WIND WAVES.

WAVELENGTH. The horizontal distance between similar points on two successive waves measured perpendicular to the crest. (See Figure A-3.)

WAVES, INTERNAL. See INTERNAL WAVES.

WEIR JETTY. An updrift jetty with a low section or weir over which littoral drift moves into a predredged deposition basin which is dredged periodically.

WHARF. A structure built on the shore of a harbor, river, or canal, so that vessels may lie alongside to receive and discharge cargo and passengers.

WHITECAP. On the crest of a wave, the white froth caused by wind.

WIND CHOP. See CHOP.

WIND, FOLLOWING. See FOLLOWING WIND.

WIND, OFFSHORE. A wind blowing seaward from the land in a coastal area.

WIND, ONSHORE. A wind blowing landward from the sea in a coastal area.

WIND, OPPOSING. See OPPOSING WIND.

WIND SETUP. On reservoirs and smaller bodies of water (1) the vertical rise in the still-water level on the leeward side of a body of water caused by wind stresses on the surface of the water; (2) the difference in still-water levels on the windward and the leeward sides of a body of water caused by wind stresses on the surface of the water. STORM SURGE (usually reserved for use on the ocean and large bodies of water). (See Figure A-11.)

WIND TIDE. See WIND SETUP, STORM SURGE.

WIND WAVES. (1) Waves being formed and built up by the wind. (2) Loosely, any wave generated by wind.

WINDWARD. The direction from which the wind is blowing.

Table A-1. Grain size scales (soil classification).

Unified Soils Classification		ASTM Mesh	mm Size	Phi Value	Wentworth Classification			
COBBLE			256.0	-8.0	BOULDER			
			76.0	-6.25	COBBLE			
COARSE GRAVEL			64.0	-6.0	PEBBLE			
			19.0	-4.25	PEBBLE			
FINE GRAVEL		4	4.76	-2.25	PEBBLE			
SAND	coarse		5	4.0	-2.0	GRAVEL		
			10	2.0	-1.0	very coarse	SAND	
	medium		18	1.0	0.0	coarse		
			25	0.5	1.0	medium		
			40	0.42	1.25	medium		
	fine		60	0.25	2.0	fine		
			120	0.125	3.0	fine		
			200	0.074	3.75	very fine		
	SILT		230	0.062	4.0	SILT		
				0.0039	8.0	CLAY		
CLAY			0.0024	12.0	COLLOID			

¹Phi value (ϕ) = \log_2 x diameter (mm).

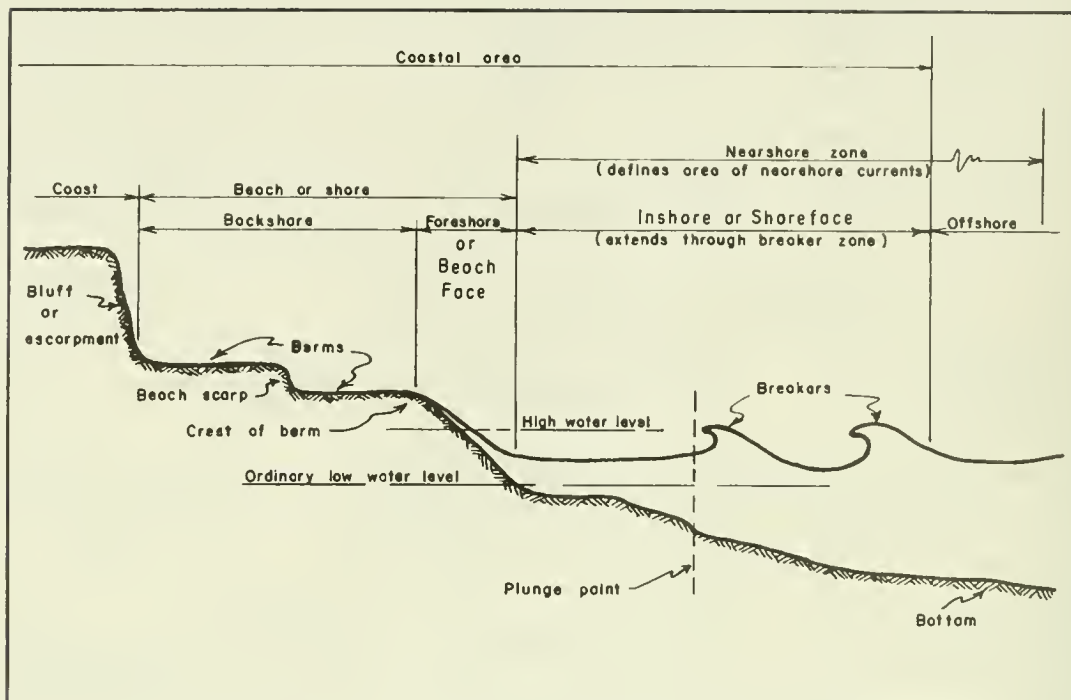

Figure A-1. Beach profile-related terms.

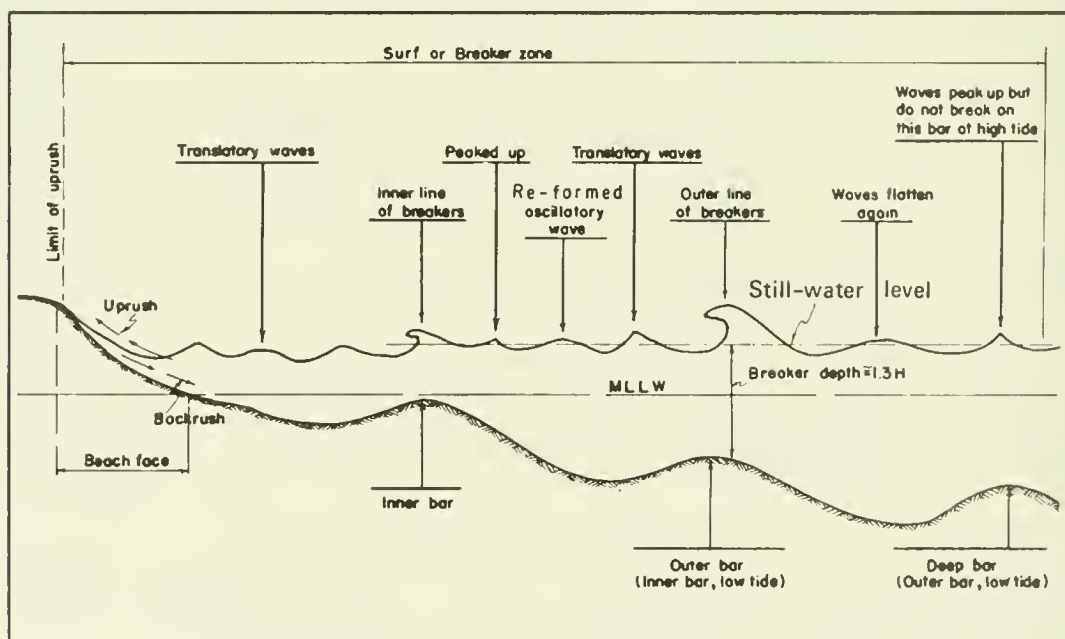
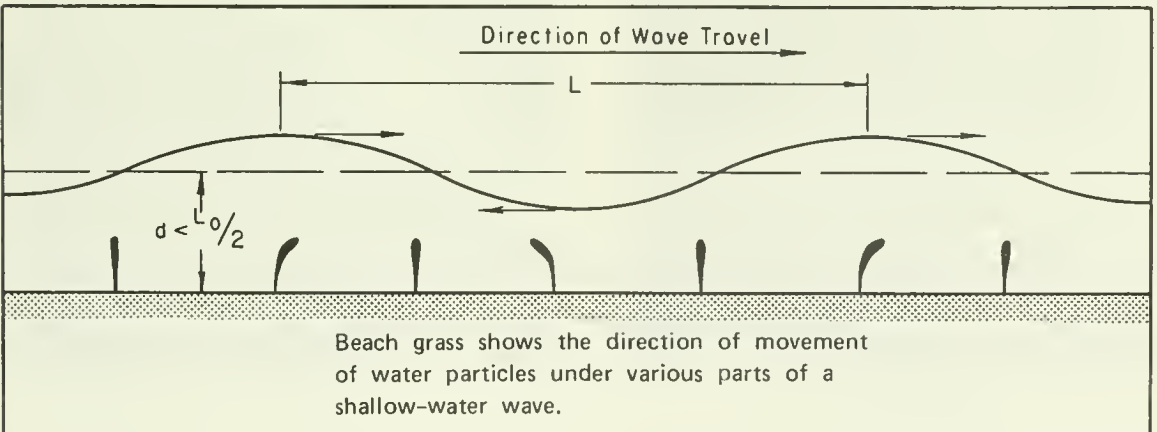
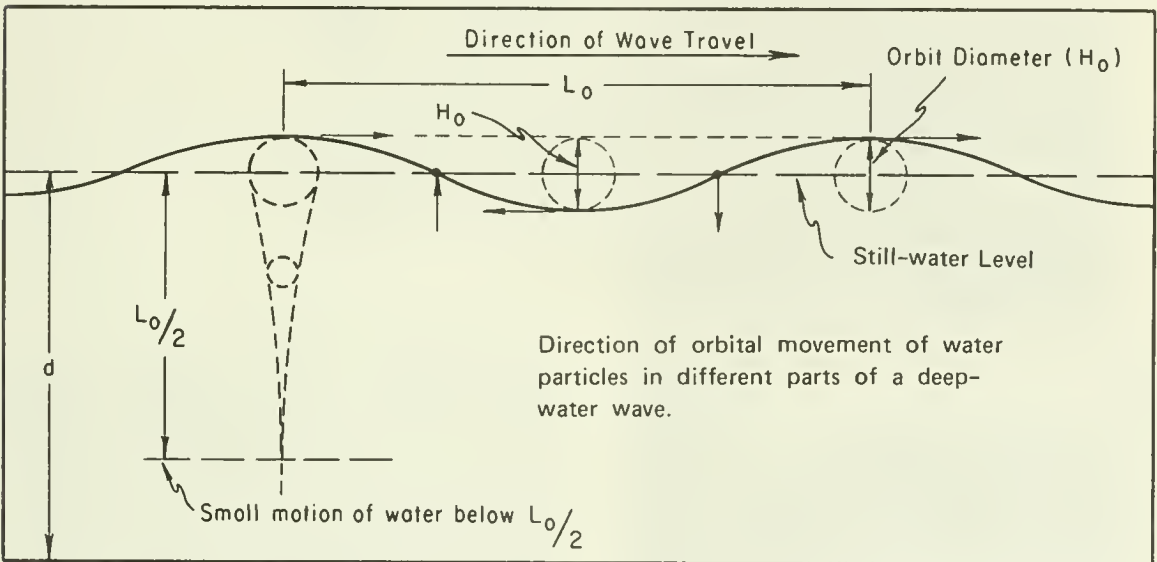
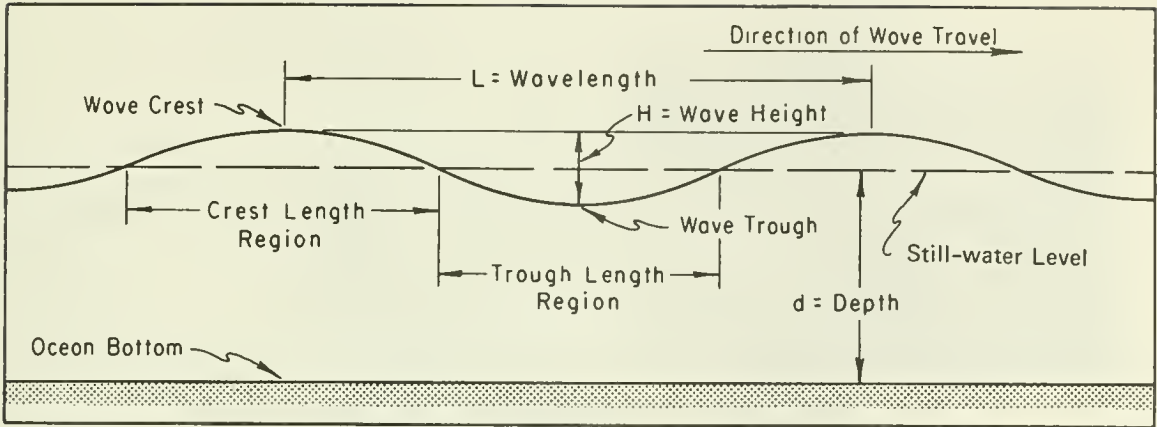

Figure A-2. Schematic diagram of waves in the breaker zone.



(Wiegel, 1953)

Figure A-3. Wave characteristics and direction of water particle movement.



SPILLING BREAKER

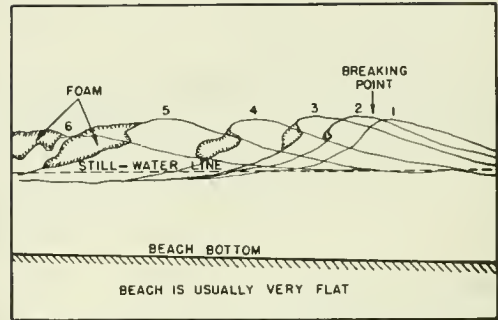

SKETCH SHOWING THE GENERAL CHARACTER OF SPILLING BREAKERS



PLUNGING BREAKER

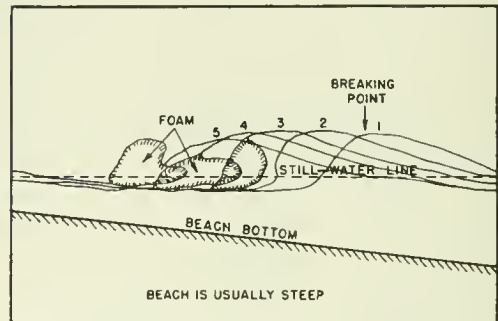

SKETCH SHOWING THE GENERAL CHARACTER OF PLUNGING BREAKERS



SURGING BREAKER

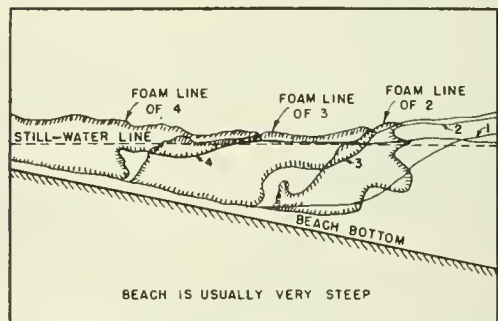

SKETCH SHOWING THE GENERAL CHARACTER OF SURGING BREAKERS

Both photographs and diagrams of the three types of breakers are presented above. The sketches consist of a series of profiles of the wave form as it appears before breaking, during breaking and after breaking. The numbers opposite the profile lines indicate the relative times of occurrences.

(Wiegel, 1953)

Figure A-4. Breaker types.

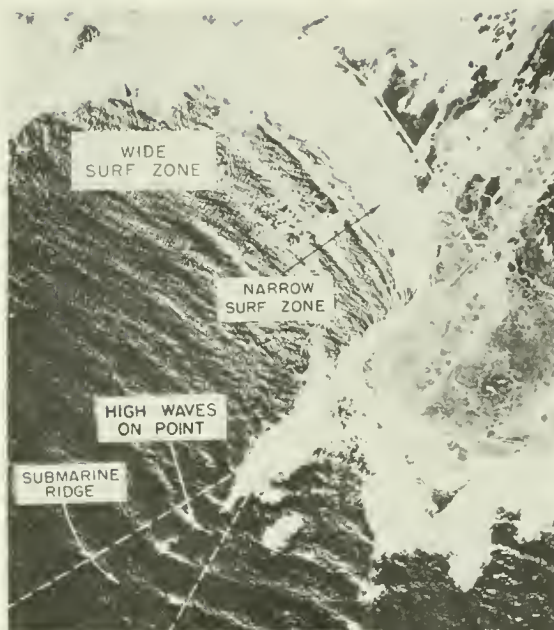

Pt Pinos, California

Waves moving over a submarine ridge concentrate to give large wave heights on a point



Halfmoon Bay, California

Note the increasing width of the surf zone with increasing degree of exposure to the south

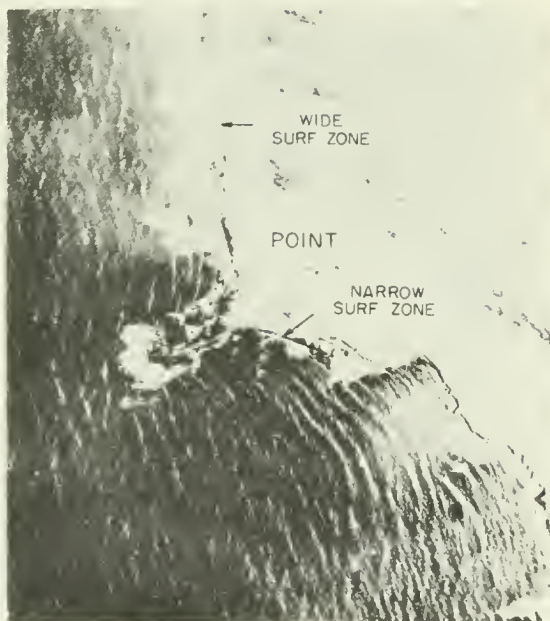

Purisima Pt, California

Refraction of waves around a headland produces low waves and a narrow surf zone where bending is greatest

(Wiegel, 1953)

Figure A-5. Refraction of waves.

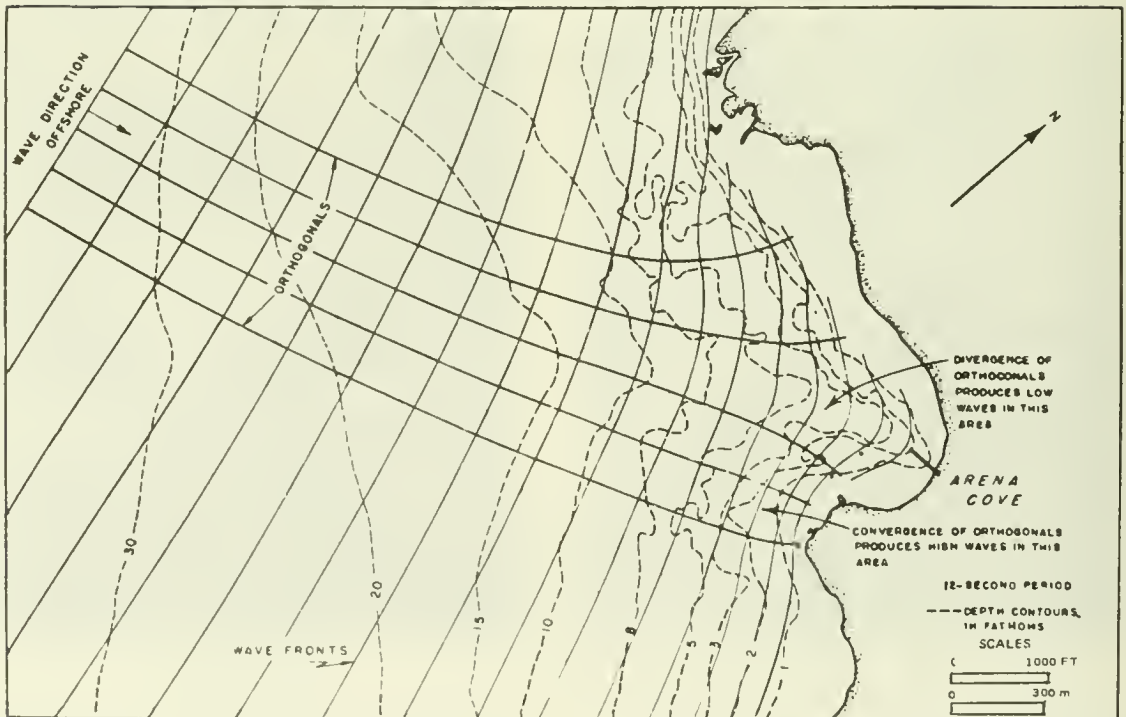
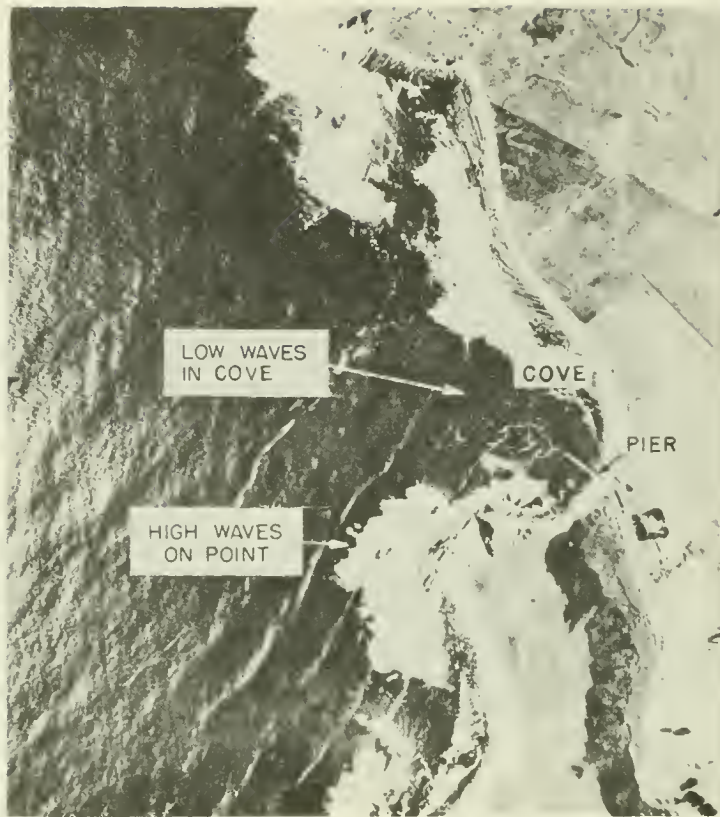

(Wiegel, 1953)

Figure A-6. Refraction diagram.

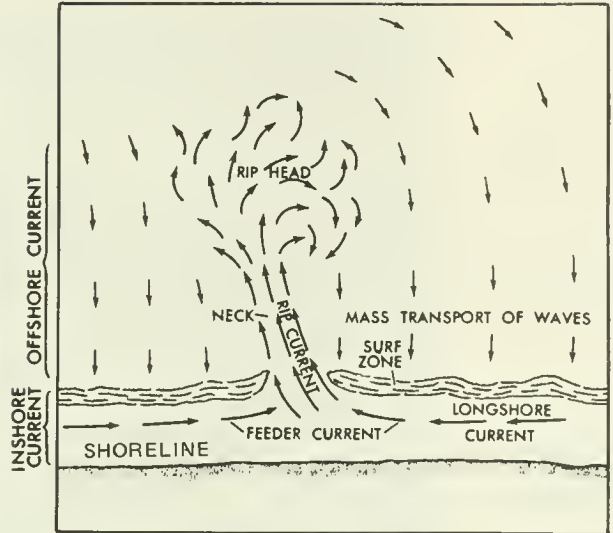

Nearshore Current System

(after Wiegel 1953)

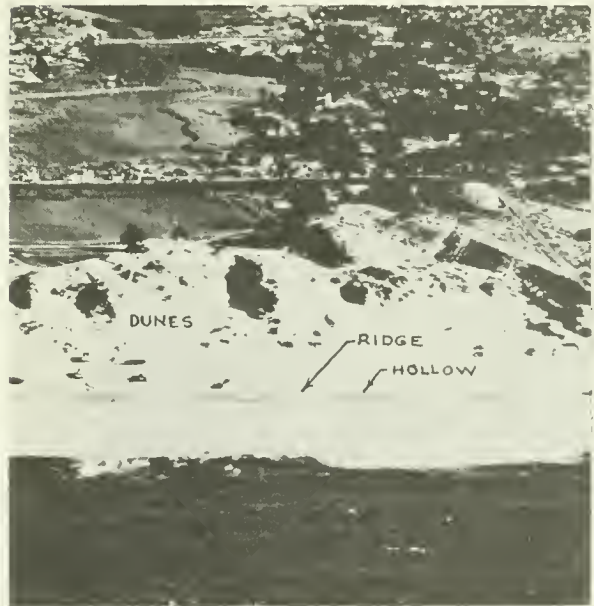
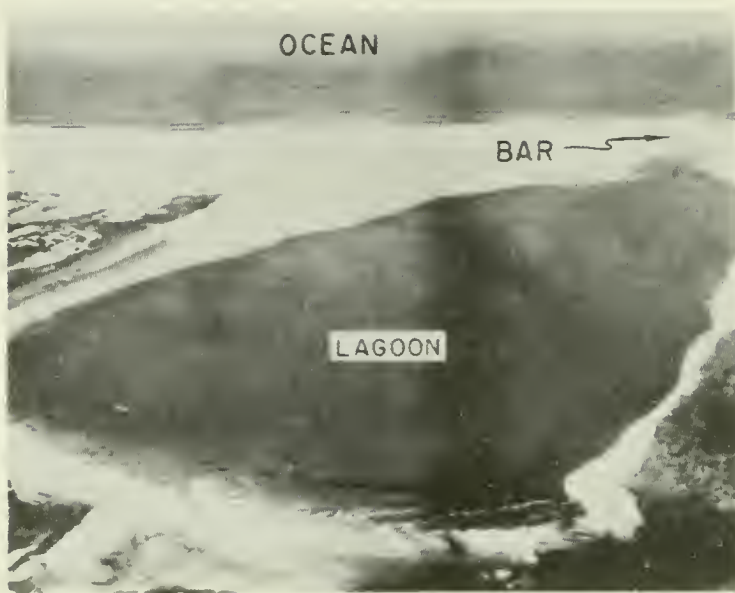

Figure A-7. Beach features.



(Wiegell, 1953)

Figure A-8. Shoreline features.

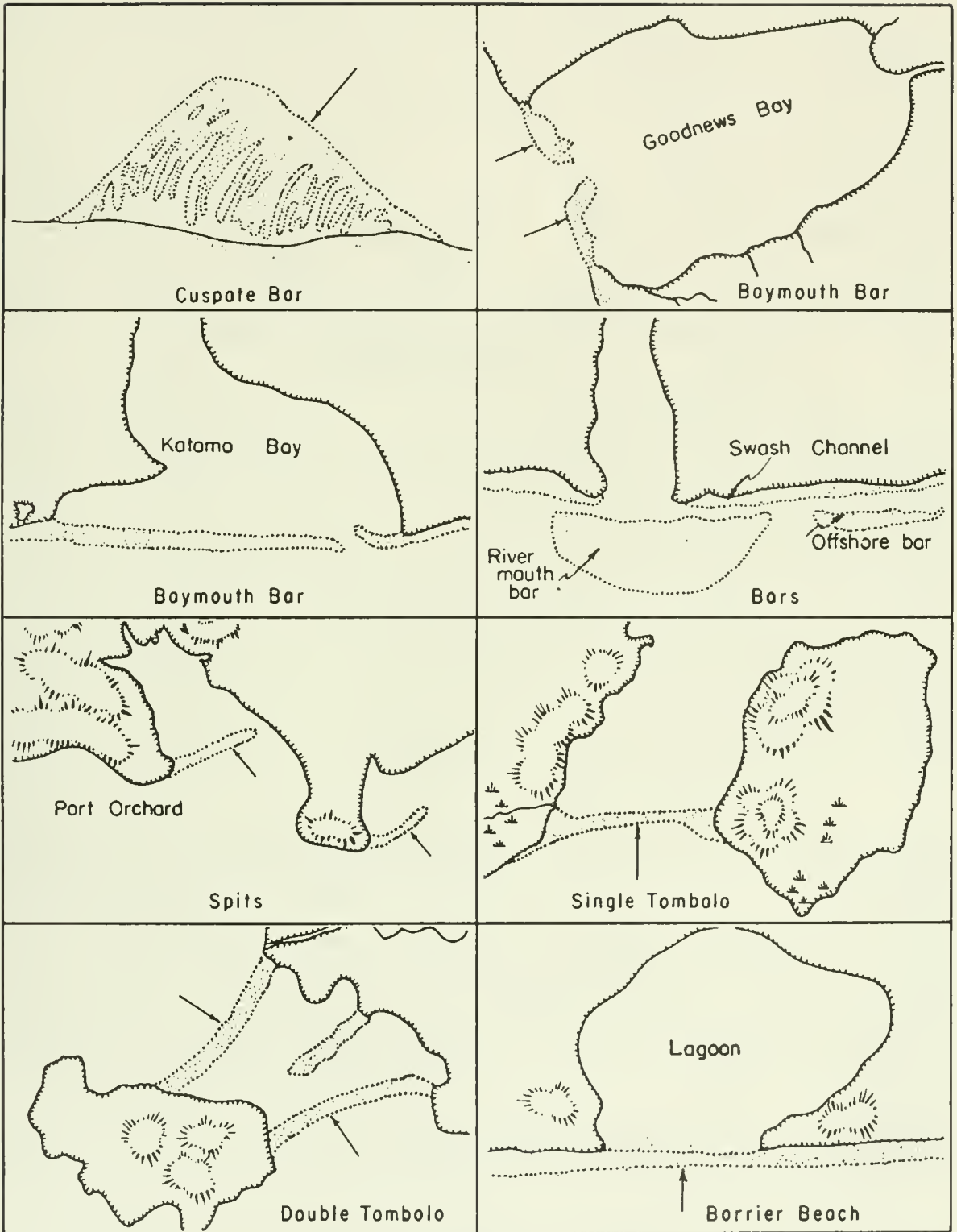

Figure A-9. Bar and beach forms. (Johnson 1919).

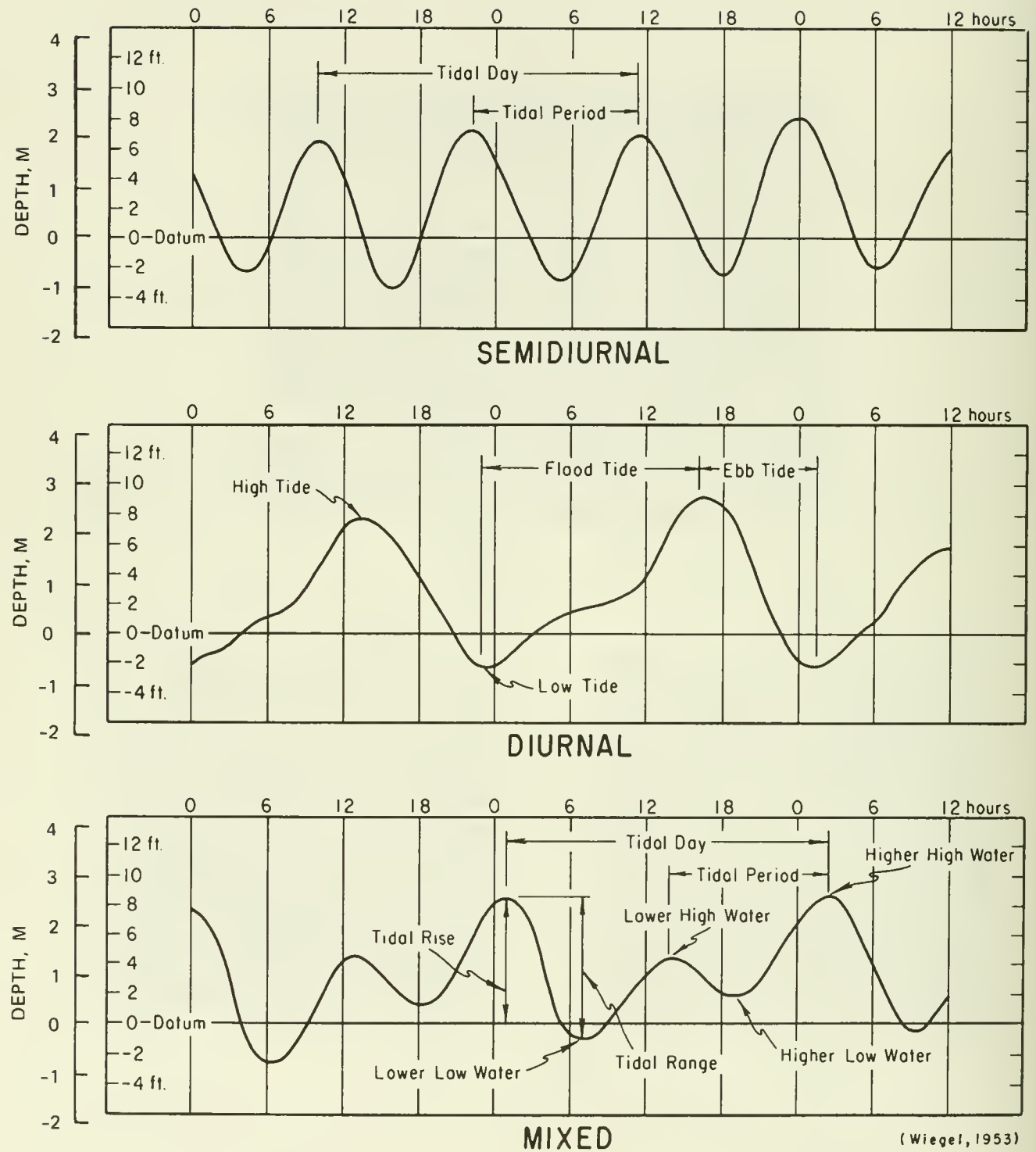

Figure A-10. Types of tides.

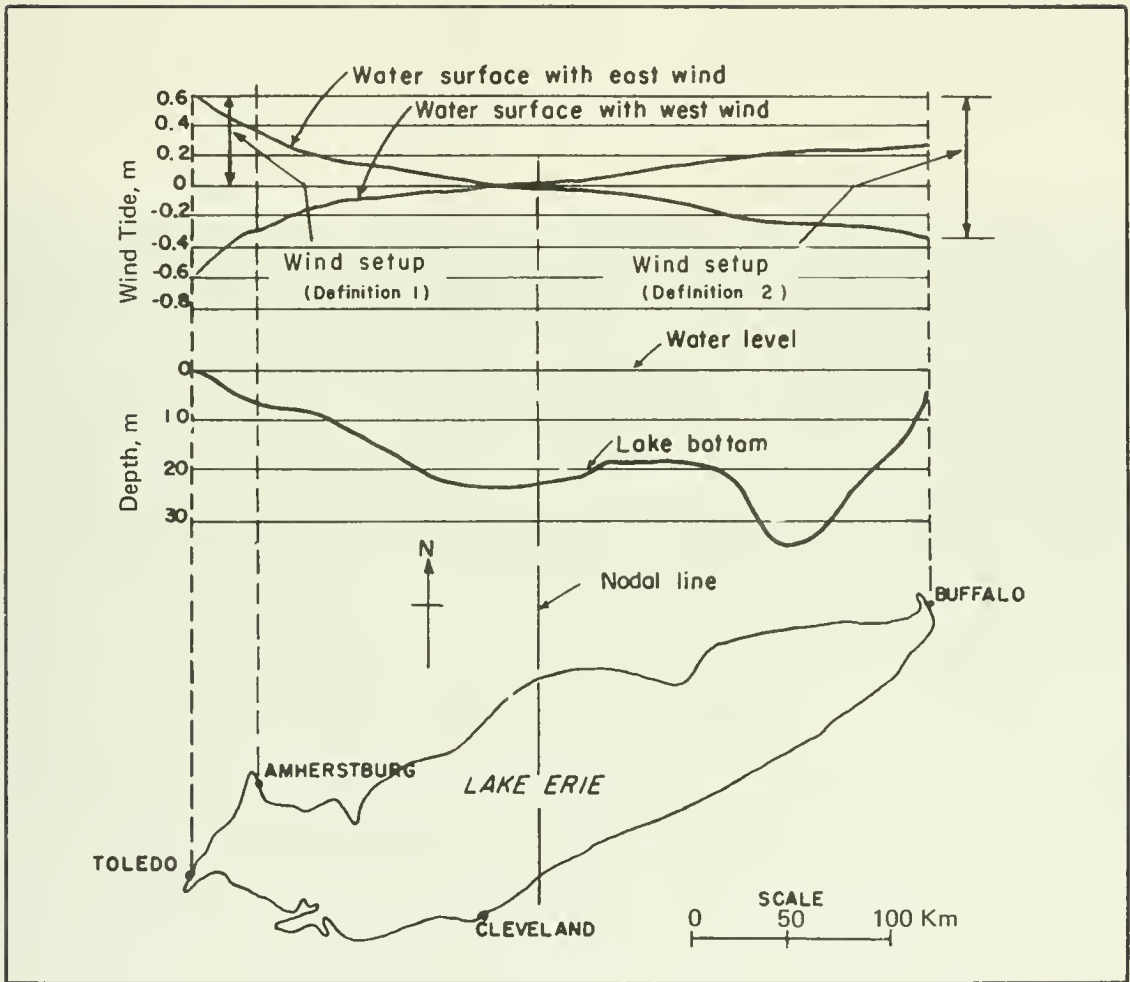

Figure A-11. Wind setup.

APPENDIX B

List of Symbols



Dam Neck, Virginia, 20 August 1970

Symbol	Definition	Dimension	Example Units	
			Metric	English
A	Area	L^2	m^2 , ha	ft^2 , mi^2
	● Constant = 7500	L^3/F	$m^3-s/N-yr$	$yd^3-s/lb-yr$
	● Major ellipse semiaxis of wave particle motion (eq. 2-22)	L	m	ft
	● Amplitude of particle motion	L	m	ft
A_b	Surface area of bay (eq. 4-65)	L^2	m^2	ft^2
A_c	Cross-sectional area of inlet channel (eq. 4-64)	L^2	m^2	ft^2
A_{c*}	Individual cross-sectional areas of n sections of an inlet channel (eq. 4-69)	L^2	m^2	ft^2
a	Waveform amplitude	L	m	ft
	● Breaking wave dynamic moment reduction factor for low wall	--	--	--
	● Breaker height parameter (eq. 2-93)	--	--	--
a'	Volume of solids divided by total volume	L^3	m^3	ft^3
a_b	Wave amplitude of bay response to ocean tide (eq. 4-64)	L	m	ft
a_j	Amplitude of j^{th} wave in series	L	m	ft
a_o	Tidal amplitude (eq. 4-70)	L	m	ft
a_s	Wave amplitude of ocean tide (eq. 4-64)	L	m	ft
B	Breakwater gap width	L	m	ft
	● Minor ellipse semiaxis of wave particle movement (eq. 2-23)	L	m	ft
	● Rubble structure crest width	L	m	ft
	● Rubble crest width in front of wall	L	m	ft
	● Buoyancy index	--	--	--
	● Inlet channel width	L	m	ft, mi
● Berm width	L	m	ft	
B_1, B_2	Hydrostatic uplift forces	F	kN	lb
B'	Effective breakwater gap width	L	m	ft
b	Spacing between wave orthogonals	L	m	ft
	● Breaker height parameter (eq. 2-94)	--	--	--
	● Structure crest width (Fig. 7-47)	L	m	ft
	● Height of overtopped wall, sea floor to wall crest (eq. 7-79; Fig. 7-96)	L	m	ft
	● Height of rubble base alone (Fig. 7-98)	L	m	ft
	● Amplitude of offshore bar	L	m	ft
b'	Overtopped wall height above wave trough (Fig. 7-102)	L	m	ft
b_i	Length of shoreline considered as line source for littoral zone sediment (eq. 4-58)	L	m	ft
b_o	Orthogonal spacing, deep water	L	m	ft

(Continued)

Symbol	Definition	Dimension	Example Units	
			Metric	English
C	Wave celerity; phase velocity	L/T	m/s	ft/s
	● Volumetric particle concentration (eq. 4-10)	--	--	--
	● Empirical overtopping coefficient (eq. 7-18)	--	--	--
C_b	Wave speed at breaking	L/T	m/s	ft/s
C_f	Friction factor (eq. 4-51)	--	--	--
C_D	Drag coefficient	--	--	--
C_g	Group velocity	L/T	m/s	ft/s
C_L	Lift coefficient	--	--	--
C_M	Mass or inertia coefficient	--	--	--
C_o	Deepwater wave velocity	L/T	m/s	ft/s
cn	Jacobian elliptical cosine function	--	--	--
D	Total water depth, including surge	L	m	ft
	● Depth one wavelength in front of wall (eq. 7-85)	L	m	ft
	● Duration of an observation	T	s, hr	s, hr
	● Decay distance	L	m	nmi
	● Pile diameter	L	m	ft
	● Percent damage to rubble structure (Table 7-9)	--	--	--
	● Area perpendicular to flow direction per unit length of pile	L ²	m ²	ft ²
● Quarystone diameter	L	m	ft	
d	Water depth (bed to SWL)	L	m	ft
	● Grain diameter	L	mm	--
	● Undisturbed water depth	L	m	ft
d_b	Depth of water at breaking wave	L	m	ft
d_e	Water depth at seaward limit to extreme surf-related effects	L	m	ft
d_g	Equivalent stone diameter	L	m	ft
d_i	Water depth at seaward limit to sand agitation by the median annual wave condition (eq. 4-28)	L	m	ft
	● Water depth at seaward edge of structure	L	m	ft
d_s	Water depth at toe of structure	L	m	ft
	● Sphere diameter (eq. 4-6)	L	Units consistent with units of gravitational acceleration and viscosity in equation (4-6)	
d_l	Depth below SWL of rubble foundation crest (Fig. 7-120)	L	m	ft
d_{50}	Size of 50 th percentile of sediment sample ($d_{50} = M_d$)	L	mm	--
E	Total energy in one wavelength per unit crest width	LF/L	N-m/m crest width	ft-lb/ft crest width
	● Crest elevation of structure above MLW or other datum plane	L	m	ft

(Continued)

Symbol	Definition	Dimension	Example Units	
			Metric	English
\bar{E}	Total average wave energy per unit surface area; specific energy; energy density	LF/L^2	$N\text{-m}/m^2$	$\text{ft}\text{-lb}/\text{ft}^2$
$(\bar{E})_A$	Average wave energy per unit water surface area for several waves	LF/L^2	$N\text{-m}/m^2$	$\text{ft}\text{-lb}/\text{ft}^2$
\bar{E}_o	Total average wave energy per unit surface area in deep water	LF/L^2	$N\text{-m}/m^2$	$\text{ft}\text{-lb}/\text{ft}^2$
E_k	Kinetic energy in one wavelength per unit crest width	LF/L	$N\text{-m}/m$ of crest width	$\text{ft}\text{-lb}/\text{ft}$ of crest width
$E(k)$	Complete elliptic integral of second kind	--	--	--
E_o	Deepwater wave energy	LF/L	$N\text{-m}/m$ of crest width	$\text{ft}\text{-lb}/\text{ft}$ of crest width
E_p	Potential energy in one wavelength per unit crest width	LF/L	$N\text{-m}/m$ of crest width	$\text{ft}\text{-lb}/\text{ft}$ of crest width
$E(w)$	Continuous energy spectrum (eq. 3-17)	L^2	m^2	ft^2
$E(w_j)$	Energy density in the j^{th} component of the energy spectrum (eq. 3-18)	LF/L^2	$N\text{-m}/m^2$	$\text{ft}\text{-lb}/\text{ft}^2$
F	Fetch length	L	m	ft
	● Total horizontal force acting about mud line on pile at a given instant	F	N	lb
	● Nonbreaking, nonovertopping wave force on wall extending the full water depth	F/L	N/m of wall	lb/ft of wall
	● Freeboard	L	m	ft
F'	(Reduced) force on overtopped wall which extends full water depth (eq. 7-78)	F/L	N/m of wall	lb/ft of wall
F''	(Reduced) force on wall resting on rubble foundation (eq. 7-82)	F/L	N/m of wall	lb/ft of wall
F_a	Adjusted fetch length	L	m	ft
F_c	Total horizontal force per unit length of wall from nonbreaking wave crest	F/L	N/m of wall	lb/ft of wall
F_D	Total horizontal drag force on a pile at a given instant	F	N	lb
F_{Dm}	Maximum value of F_D for a given wave	F	N	lb
F_E	Effective fetch length due to limited width	L	m	ft
	● Total horizontal earth force	F	N	lb
F_e	Effective fetch length on an unrestricted body of water	L	m	ft
F_H	Horizontal forces on quay wall caisson to initiate sliding	F	N	lb

(Continued)

Symbol	Definition	Dimension	Example Units	
			Metric	English
F_h	Hydrostatic force on seaward side of quay wall caisson after backfilling	F/L	kN/m	lb/ft
F_i	Total horizontal inertial force on a pile at a given instant	F	N	lb
F_{im}	Maximum value of F_i for given wave	F	N	lb
F_L	Lift force (lateral force on pile from flow velocity)	F	N	lb
F_{Lm}	Maximum lift force for given wave	F	N	lb
F_m	Minimum fetch length	L	m	ft
F_o	Dimensionless fall time parameter (eq. 4-29)	--	--	--
F_t	Total horizontal force per unit length of wall subjected to nonbreaking wave length	F/L	N/m of wall	lb/ft of wall
F_{Total}	Total force on pile group	F	N	lb
F_v	Vertical forces on quay wall caisson to initiate sliding	F	N	lb
$F(\alpha_o)$	Direction term (eq. 4-55)	--	--	--
f	Coriolis parameter <ul style="list-style-type: none"> ● Wave frequency ● Horizontal force per unit length of pile ● Decimal frequency (eq. 4-53) ● Darcy-Weisbach resistance coefficient (eq. 4-67) 	T^{-1} T^{-1}	s^{-1} , hr^{-1} s^{-1} , hr^{-1}	s^{-1} , br^{-1} s^{-1} , br^{-1}
f_D	Horizontal drag force per unit length of vertical pile	F/L	N/m	lb/ft
f_f	Bottom friction factor	--	--	--
f_{fi}	Bottom friction factor at seaward edge of segment	--	--	--
f_i	Horizontal inertial force per unit length of vertical pile	F/L	N/m	lb/ft
f_m	Maximum force per unit length of pile <ul style="list-style-type: none"> ● Frequency of wind sea spectral peak (eq. 3-32) 	F/L T^{-1}	N/m s^{-1}	lb/ft s^{-1}
G_i	Fractional growth factor of equivalent initial wave	--	--	--
G_o	Dimensionless parameter for determining beach accretion or erosion	--	--	--
g	Gravitational acceleration	L/T^2	m/s^2	ft/s^2
-g	Subscript for: <ul style="list-style-type: none"> ● Group ● Gage ● Gross 	--	--	--

(Continued)

Symbol	Definition	Dimension	Example Units	
			Metric	English
H	Wave height	L	m	ft
	● Design wave height--wave height for which structure is designed; maximum wave height causing no damage or damage within specified limits	L	m	ft
	● High-pressure area on weather maps	F/L ²	mmHg, N/m ²	in. of mercury, mbar
\bar{H}	Average wave height; $\bar{H} = 0.886 H_{rms}$	L	m	ft
\hat{H}	Arbitrary wave height for probability distributions	L	m	ft
H_b	Wave height at breaking (breaker height)	L	m	ft
H_D	Significant wave height, end of decay distance	L	m	ft
$H_{D=0}$	Zero-damage wave height	L	m	ft
H_e	Equivalent wave height at end of fetch	L	m	ft
H_f	Wave height at end of fetch	L	m	ft
H_g	Gage wave height	L	m	ft
H_i	Incident wave height	L	m	ft
	● Initial wave height	L	m	ft
H_{ie}	Equivalent initial wave height	L	m	ft
H_j	Height of j th wave in a series	L	m	ft
H_m	Maximum stable wave height	L	m	ft
H_{max}	Maximum wave height for specified period of time	L	m	ft
H_{m_0}	Significant wave height (energy based); 4 times the standard deviation of the sea surface elevation	L	m	ft
H_n	Most probable n th highest wave	L	m	ft
H_o	Deepwater significant wave height	L	m	ft
H'_o	Deepwater wave height equivalent to observed shallow-water wave if unaffected by refraction and friction	L	m	ft
H_r	Reflected wave height	L	m	ft
H_{rms}	Root-mean-square wave height	L	m	ft
\hat{H}_s	Significant wave height (statistically based); $H_{1/3}$; average height of highest one-third of waves for a specified time period	L	m	ft
H_{sm}	Maximum significant wave height	L	m	ft
\bar{H}_s	Mean significant wave height (eq. 4-13)	L	m	ft

(Continued)

Symbol	Definition	Dimension	Example Units	
			Metric	English
H_s	Arbitrary significant wave height for probability distributions (eq. 4-12)	L	m	ft
$H_{s \min}$	Approximate minimum significant wave height from a distribution of significant heights (eq. 4-12)	L	m	ft
H_{s5}	Average height of highest 5 percent of all waves for a given time	L	m	ft
H_{s50}	Median annual significant wave height (eq. 4-26)	L	m	ft
H_{sb}	Significant wave height, breaker value	L	m	ft
H_{so}	Significant wave height, deep-water value	L	m	ft
h	Range of tide	L	m	ft
	● Height of retaining wall	L	m	ft
	● Height of backfill at wall if lower than wall	L	m	ft
	● Structure height, toe to crest	L	m	ft
	● Vertical distance from dune base or berm crest to depth of seaward limit of significant longshore transport (Fig. 4-44)	L	m	ft
	● Mean channel water depth (eq. 4-70)	L	m	ft
h'	Broken wave height above ground surface at structure toe landward of SWL	L	m	ft
h_c	Height of broken wave above SWL	L	m	ft
h_o	Height of clapotis orbit center above SWL	L	m	ft
I_{ℓ}	Submerged weight of longshore transport	F/T	N/yr	lb/yr
i	Angle of backfill surface from horizontal (eq. 7-143)	--		deg
-i	Subscript dummy variable	--	--	--
K	Pressure response factor at bottom (eq. 2-31)	--	--	--
	● Constant for Rankin vortex model of hurricane wind field (eq. 3-55)	T^{-1}	s^{-1}	s^{-1}
	● Dimensionless coefficient proportional to immersed weight transport rate I_{ℓ} and longshore energy flux factor $P_{\ell S}$	--	--	--
K'	Diffraction coefficient	--	--	--
K_D	Armor unit stability coefficient (eq. 7-116)	--	--	--
	● Dimensionless factor for calculation of total drag force on pile at a given phase (eq. 7-30)	--	--	--

(Continued)

Symbol	Definition	Dimension	Example Units	
			Metric	English
K_{Dm}	Maximum value of K_D for given wave	--	--	--
K_f	Wave height reduction factor from friction; friction factor (Fig. 3-38)	--	--	--
$K_{f.01}$	Wave height reduction factor where $K_f = 0.01$	--	--	--
K_{fa}	Wave height reduction factor where $K_f \neq 0.01$	--	--	--
K_i	Dimensionless factor for calculation of total inertial force on pile at a given phase (eq. 7-29)	--	--	--
K_{im}	Maximum value of K_i for a given wave	--	--	--
$K(k)$	Complete elliptic integral of the first kind	--	--	--
K_R	Refraction coefficient	--	--	--
K_{RR}	Stability coefficient for smooth, relatively rounded, graded riprap armor units (eq. 7-117)	--	--	--
K_s	Shoaling coefficient (eq. 2-44)	--	--	--
K_T	Wave transmission coefficient (eq. 7-15)	--	--	--
K_{TO}	Wave transmission-by-overtopping coefficient (eq. 7-17)	--	--	--
K_{Tt}	Wave transmission-through-the-breakwater coefficient (eq. 7-19)	--	--	--
K_z	Pressure response factor at any depth z (eq. 2-29)	--	--	--
K_1	Friction coefficient for tributary inflow (eq. 4-65)	--	--	--
K_2	Frequency coefficient for tributary inflow (eq. 4-66)	--	--	--
k	Wave number ($2\pi/L$) <ul style="list-style-type: none"> ● Modulus of elliptic integrals ● Kip: a unit of force; 1 kip = 4448.222 N (1000 lb) ● Runup correction factor (Fig. 7-13) 	L^{-1} -- F --	m^{-1} -- N --	ft^{-1} -- lb --
k_{en}	Entrance loss coefficient for inlet channel (eq. 4-67)	--	--	--
k_{ex}	Exit loss coefficient for inlet channel (eq. 4-67)	--	--	--
k'	Wind correction factor for overtopping rates (eq. 7-12)	--	--	--
k_i	Source (or sink) fraction of gross longshore transport rate (eq. 4-59)	--	--	--

(Continued)

Symbol	Definition	Dimension	Example Units	
			Metric	English
k_{Δ}	Layer coefficient of rubble structure	--	--	--
L	Wavelength ● Low pressure on weather map	L F/L ²	m mmHg, N/m ²	ft in. of mercury, mbar
	● Length of inlet channel (eq. 4-66)	L	m	ft
L_A	Wavelength in given depth according to linear (Airy) theory; L_A may differ from L (eq. 7-21)	L	m	ft
L_b	Wavelength at breaking	L	m	ft
	● Length to farthest point of channel (eq. 4-68)	L	m	ft
L_c	Width of caisson	L	m	ft
L_D	Wavelength in water depth D (eq. 7-85)	L	m	ft
L_d	Wavelength in water depth d_s (eq. 7-88)	L	m	ft
L_o	Deepwater wavelength	L	m	ft
L_x	Effective inlet channel length (eq. 4-69)	L	m	ft
ℓ	Structure slope length	L	m	ft
	● Length of an offshore bar or other underwater feature	L	m	ft
ℓ_B	Enclosed basin length (eqs. 2-81 and 3-68)	L	m	ft
$\ell_{B'}$	Length of rectangular basin open at one end (eqs. 2-85 and 3-70)	L	m	ft
ℓ_n	Distance from reference pile to n th pile of pile group (eq. 7-56; Fig. 7-86)	L	m	ft
$-\ell_t$	Subscript for longshore transport to left as viewed from beach	--	--	--
M	Total wave moment about mud line on pile (eq. 7-28)	LF	N-m	ft-lb
	● Nonbreaking wave moment about toe of wall extending full depth of water	LF/L	N-m/m of wall	ft-lb/ft of wall
	● Variable of solitary wave theory, function of H/d (eq. 2-67)	--	--	--
	● Mean diameter of sediment sample	L	mm	--
M'	Moment about toe of wall overtopped by nonbreaking wave	LF/L	N-m/m of wall	ft-lb/ft of wall
M''_A	Moment about bottom (mud line) for wall on a rubble foundation (eq. 7-83)	LF/L	N-m/m of wall	ft-lb/ft of wall
M''_B	Moment about base of wall on rubble foundation (eq. 7-84)	LF/L	N-m/m of wall	ft-lb/ft of wall
M_c	Total moment about toe of wall per unit length from nonbreaking wave crest	LF/L	N-m/m of wall	ft-lb/ft of wall

(Continued)

Symbol	Definition	Dimension	Example Units	
			Metric	English
M_D	Total drag moment acting on pile about mud line (eq. 7-32)	LF	N-m	ft-lb
M_{Dm}	Maximum value of M_D (eq. 7-40)	LF	N-m	ft-lb
M_d	Median diameter of sediment sample	L	mm	--
$M_{d\phi}$	Median diameter of sediment sample in phi units	L		phi
M_E	Total overturning moment	LF/L	kN-m/m	ft-lb/ft
M_i	Total inertial moment acting on pile about mud line (eq. 7-31)	LF	N-m	ft-lb
M_{im}	Maximum value of M_i for a given wave (eq. 7-39)	LF	N-m	ft-lb
M_m	Maximum total moment on pile about mud line (eq. 7-43) ● Maximum overturning moment about toe of wall from dynamic component of wave pressure (breaking or broken waves) (eq. 7-87)	LF	N-m	ft-lb
M'	Reduced moment about toe for low wall (eq. 7-80)	LF/L	kN-m/m of wall	ft-lb/ft of wall
M'_m	Reduced maximum moment against wall from breaking wave of height greater than wall (eq. 7-93)	LF/L	N-m/m of wall	ft-lb/ft of wall
M_s	Hydrostatic moment against wall from breaking or broken waves	LF/L	N-m/m of wall	ft-lb/ft of wall
M_t	Total moment about toe of wall per unit length from nonbreaking wave trough (Ch. 7) ● Total moment about toe of wall per unit length from breaking or broken wave crest	LF/L	N-m/m of wall	ft-lb/ft of wall
M_{Total}	Total moment on pile group about mud line	LF	N-m	ft-lb
M_{xx}	Momentum transport quantity per unit width (eq. 3-77)	L^2/T^2	m^2/s^2	ft^2/s^2
M_{yy}	Momentum transport quantity per unit width (eq. 3-77)	L^2/T^2	m^2/s^2	ft^2/s^2
M_ϕ	Mean diameter of sediment sample in phi units	L		phi
M_{net}	Net overturning moment about wall bottom due to presence of waves	LF/L	kN-m/m	ft-lb/ft
$M_{\phi b}$	Mean diameter (phi units) of borrow material (eq. 5-3)	L		phi
$M_{\phi n}$	Mean diameter (phi units) of native (beach) material (eq. 5-3)	L		phi
M_l	Coefficient determined by equation (4-20)	--	--	--
m	Beach slope	L/L	m(rise)/m(run)	ft(rise)/ft(run)

(Continued)

Symbol	Definition	Dimension	Example Units	
			Metric	English
N	Correction factor in determination of η (eta) from subsurface pressure (eq. 2-32)	--	--	--
	● Variable in solitary wave theory (eq. 2-67)	--	--	--
	● Total number of items	--	--	--
N_R	Number of armor units or stones in cover layer	--	--	--
N_r	Required number of individual armor units (eq. 7-122)	--	--	--
N_s	Design stability number for rubble foundations and toe protection (eq. 7-118)	--	--	--
n	Number of layers of armor units in rubble structure protective cover	--	--	--
	● Number of armor units across rubble structure crest	--	--	--
	● Ratio of group velocity to individual wave velocity	--	--	--
	● Number of seiche nodes along closed rectangular basin axis	--	--	--
	● Degrees latitude (isobar spacing--not location)	--	--	deg
	● A number	--	--	--
	● Manning resistance coefficient	--	--	--
n'	Number of seiche nodes along rectangular basin open at one end, excluding node at opening	--	--	--
$-n$	Subscript referencing a particular pile in a pile group	--	--	--
	● Subscript for net longshore transport rate	--	--	--
n_o	Deepwater ratio of group velocity to individual wave velocity	--	--	--
$-o$	Subscript for deepwater condition	--	--	--
P	Average porosity of rubble structure cover layer (eq. 7-122)	--	--	percent
	● Probability	$\frac{--}{L^3}$	$\frac{--}{m^3}$	$\frac{--}{ft^3}$
	● Tidal prism; $2A_b a_b$ ● Precipitation rate	L/T	mm/hr	in./hr
ΔP	Central hurricane pressure	F/L ²	mmHg, N/m ²	in. of mercury, mbar
\bar{P}	Wave power; average energy flux transmitted across a plane perpendicular to wave advance	LF/TL	N-m/s-m	ft-lb/s-ft
P_a	Active earth force (eq. 7-143)	F/L	N/m of wall	lb/ft of wall
P_ℓ	Longshore component of wave energy flux (eq. 4-36)	LF/TL	N-m/s-m	ft-lb/s-ft
$P_{\ell b}$	Breaker line approximation of P_ℓ (eq. 4-37)	LF/TL	N-m/s-m	ft-lb/s-ft

(Continued)

Symbol	Definition	Dimension	Example Units	
			Metric	English
$P_{\ell s}$	Surf zone approximation of P_{ℓ} (eq. 4-39)	LF/TL	N-m/s-m	ft-lb/s-ft
\bar{P}_o	Deepwater \bar{P}	LF/TL	N-m/s-m	ft-lb/s-ft
P_p	Passive earth force (eq. 7-145)	F/L	N/m of wall	lb/ft of wall
p	Gage pressure; pressure at any distance below fluid surface relative to surface ● Atmospheric pressure at point located distance r from hurricane storm center ● Precipitation rate ● Percentage of exceedance (Fig. 7-41)	F/L ² F/L ² L/T --	N/m ² mmHg, N/m ² mm/hr	lb/ft ² in. of mercury, mbar in/hr percent
p'	Total or absolute subsurface pressure--includes dynamic, static, and atmospheric pressures (eq. 2-26)	F/L ²	N/m ²	lb/ft ²
p_a	Atmospheric pressure (eq. 2-26)	F/L ²	N/m ²	lb/ft ²
p_m	Maximum dynamic pressure by breaking and broken waves on vertical wall (eq. 7-85)	F/L ²	N/m ²	lb/ft ²
p_{max}	Maximum soil bearing pressure beneath quay wall caisson after backfilling	F/L ²	kN/m ²	lb/ft ²
p_n	Pressure at outskirts or periphery of storm	F/L ²	N/m ²	lb/ft ²
p_o	Central pressure of storm; CPI	F/L ²	mmHg, N/m ²	in. of mercury, mbar
p_s	Maximum broken wave hydrostatic pressure against wall (eq. 7-98)	F/L ²	N/m ²	lb/ft ²
p_1	Nonbreaking wave pressure difference from still-water hydrostatic pressure as clapotis crest or trough passes (eq. 7-75)	F/L ²	N/m ²	lb/ft ²
p_2	Hydrostatic pressure	F/L ²	kN/m ²	lb/ft ²
Q	Overtopping rate	L ³ /TL	m ³ /s-m	ft ³ /s-ft
\bar{Q}	Average overtopping rate for irregular waves (spectra)	L ³ /TL	m ³ /s-m	ft ³ /s-ft
Q_g	Gross longshore transport rate	L ³ /T	m ³ /yr	yd ³ /yr
Q_i^+	Point source for littoral zone sediment budget	L ³ /T	m ³ /yr	yd ³ /yr
Q_i^-	Point sink for littoral zone sediment budget	L ³ /T	m ³ /yr	yd ³ /yr
Q_i^{**+}	Line source total contribution to littoral zone sediment budget	L ³ /T	m ³ /yr	yd ³ /yr
Q_i^{*-}	Line sink total deduction from littoral zone sediment budget	L ³ /T	m ³ /yr	yd ³ /yr

(Continued)

Symbol	Definition	Dimension	Example Units	
			Metric	English
Q_o^*	Empirically determined coefficient depending on incident wave characteristics and structure geometry used for figuring overtopping rate (eq. 7-10)	--	--	--
Q_l	Longshore transport rate ($Q_l = Q$)	L^3/T	m^3/yr	yd^3/yr
Q_{pt}	Amounts of littoral drift transported to the left (eq. 4-31)	L^3/T	m^3/yr	yd^3/yr
Q_n	Net longshore transport rate	L^3/T	m^3/yr	yd^3/yr
Q_o^*	Empirically determined overtopping coefficient (eq. 7-10)	--	--	--
Q_p	Overtopping rate associated with R_p , wave runup with a particular probability of exceedance (eq. 7-14)	L^3/TL	$m^3/s-m$	$ft^3/s-ft$
$Q_{\theta r}$	Amounts of littoral drift transported to the right (eq. 4-31)	L^3/T	m^3/yr	yd^3/yr
Q_{a_o, H_o}	Longshore transport rate computed from deepwater data (eq. 4-53)	L^3/T	m^3/yr	yd^3/yr
q_i^+	Line source per unit length in littoral zone sediment budget	L^3/TL	$m^3/yr-m$	$yd^3/yr-ft$
q_i^-	Line sink per unit in littoral zone sediment budget	L^3/TL	$m^3/yr-m$	$yd^3/yr-ft$
R	Wave runup	L	m	ft
	● Dynamic component of breaking or broken wave force per unit length of wall if wall is perpendicular to direction of wave advance (eq. 7-112)	F/L	N/m of wall	lb/ft of wall
	● Radial distance from storm (hurricane) center to region of maximum winds (or to region of maximum waves) (eq. 3-55)	L	km	nmi
	● Distance along bottom contours, as used in refraction problems (R/J method)	L	m	ft
	● Hydraulic radius (eq. 4-67)	L	m	ft
	● Reaction force	F	kN	lb
R'	Reduced dynamic component of force per unit wall length from a breaking or broken wave striking a structure at an oblique angle (eq. 7-112)	F/L	N/m of wall	lb/ft of wall
R''	Reduced horizontal dynamic component of force per unit wall length from a breaking or broken wave striking a nonvertical structure face (eq. 7-113)	F/L	N/m of wall	lb/ft of wall
R_A	Ratio of artificial beach nourishment: ratio of volume required for placement to volume retained on beach after equilibrium (Fig. 5-3)	--	--	--
R_E	Reynolds number	--	--	--
R_G	Ratio of artificial beach nourishment (eq. 5-4)	--	--	--

(Continued)

Symbol	Definition	Dimension	Example Units	
			Metric	English
R_g	Ratio of windspeed to wind stress factor (Fig. 3-19)	--	--	--
R_H	Horizontal component of reaction force	F/L	kN/m	lb/ft
R_i	Fractional reduction at the seaward edge of the fetch segment (eq. 3-51)	--	--	--
R_j	Periodic beach nourishment-to-erosion ratio (eq. 5-3)	--	--	--
R_L	Ratio of overwater to overland windspeed as a function of overland windspeed (Fig. 3-15)	--	--	--
R_m	Maximum dynamic component of breaking or broken wave on wall (eq. 7-86)	F/L	N/m of wall	lb/ft of wall
R'_m	Reduced maximum dynamic component on wall of height lower than wave crest (eq. 7-91)	F/L	N/m of wall	lb/ft of wall
R_n	Component of R normal to actual wall (Fig. 7-106)	F/L	N/m of wall	lb/ft of wall
R_s	Hydrostatic component of breaking or broken wave on wall (eq. 7-89) ● Wave runup of significant wave	F/L L	N/m of wall m	lb/ft of wall ft
R_T	Amplification ratio (eq. 3-27)	--	--	--
R_t	Total breaking or broken wave force on wall per unit wall length (includes dynamic and hydrostatic components) (eq. 7-89)	F/L	N/m of wall	lb/ft of wall
R_v	Vertical component of reaction force	F/L	kN/m	lb/ft
R_x	Individual hydraulic radii of n sections of an inlet channel (eq. 4-69)	L	m	ft
r	Total rubble layer thickness	L	m	ft
	● Radial distance from storm (hurricane) center to any specified point in storm system	L	m	nmi
	● Roughness and porosity correction factor (eq. 7-7)	--	--	--
	● Average armor layer thickness (eq. 7-121)	L	m	ft
	● Moment arm	L	m	ft
r_A	Armor layer thickness (rubble structure)	L	m	ft
r_f	Reduction factor for force on wall of height lower than clapotis crest (eq. 7-78)	--	--	--
r_m	Reduction factor for moment on wall of height lower than clapotic crest (eq. 7-80) ● Reduction factor for maximum dynamic component of force when breaking wave height is higher than wall height (eq. 7-81)	--	--	--

(Continued)

Symbol	Definition	Dimension	Example Units	
			Metric	English
-rt	Subscript for longshore transport to right as viewed from beach	--	--	--
r_1	Thickness of first underlayer of rubble structure	L	m	ft
S	Channel opening cross-sectional area (eq. 7-128) ● Surge; height resulting from storm surge of free surface above or below the undisturbed water level datum (eq. 3-77); also called wind setup	L^2	m^2	ft^2
ΔS	Wave setup between breaker zone and shore (eq. 3-73)	L	m	ft
S_A	Astronomical tide component of total storm surge	L	m	ft
S_b	Setdown at breaking zone (eq. 3-72)	L	m	ft
S_D	Dimensionless moment arm of total drag force on pile at a given phase angle (eq. 7-32)	--	--	--
S_{Dm}	Maximum value of S_D	--	--	--
S_i	Dimensionless moment arm of total inertial force on pile at a given wave phase angle	--	--	--
S_{im}	Maximum value of S_i	--	--	--
S_{max}	Maximum directional concentration parameter for a wave spectrum	--	--	--
S_r	Specific gravity of armor unit (w_r/w_w)	--	--	--
S_w	Net wave setup at shore (eq. 3-73)	L	m	ft
-s	Subscript for significant wave	--	--	--
T	Wave period ● Astronomic tidal period ● Temperature	T T --	s hr °C	s hr °F
T_j	Fundamental period of wave oscillation (eq. 2-83)	T	s	s
T_m	Period of the peak wave spectrum	T	s	s
T_n	Natural, free-oscillating period of seiche in closed basin with n nodes (excluding node at opening)	T	hr	hr
T'_n	Free oscillation period in basin open at one end with n' nodes (excluding node at opening) (eq. 3-70)	T	hr	hr
T_p	Peak spectral period; inverse of the dominant frequency of a wave energy spectrum	T	s	s
T_s	Significant wave period	T	s	s
\bar{T}_s	Annual average significant wave period (eq. 4-28)	T	s	s

(Continued)

Symbol	Definition	Dimension	Example Units	
			Metric	English
T'_0	Period of fundamental mode of seiche in rectangular basin open at one end	T	hr	hr
T_1	Fundamental and maximum period of seiches in closed basin	T	hr	hr
t	Time	T	s, min, hr	s, min, hr
t_*	Time a tidal wave will take to propagate to a given point	T	hr	hr
U	Windspeed ● x component (perpendicular to shore) of volume transport per unit width	L/T L ³ /TL	m/s km ³ /hr-km	knots, mi/hr mi ³ /hr-mi
U_A	Wind-stress factor (eq. 3-28)	L/T	m/s	mi/hr
U_f	Fastest-mile windspeed	L/T	m/s	mi/hr
U_g	Geostrophic windspeed (eq. 3-30)	L/T	m/s	knots, mi/hr
U_{gr}	Gradient windspeed (eq. 3-57)	L/T	m/s	knots, mi/hr
U_L	Windspeed over land	L/T	m/s	mi/hr
U_{max}	Maximum gradient windspeed (eq. 3-61)	L/T	m/s	knots, mi/hr
U_R	Maximum sustained gradient windspeed (eq. 3-60) ● Ursell parameter (eq. 2-45)	L/T --	m/s --	knots, mi/hr --
$U_{SM}(r)$	Convection term to be added vectorially to wind velocity at each location r to correct for storm motion (eq. 3-58)	--	--	--
U_s	Surface windspeed	L/T	m/s	mi/hr
U_t	Duration-averaged windspeed	L/T	m/s	mi/hr
U_w	Windspeed over water	L/T	m/s	knots, mi/hr
U_*	Friction velocity (eq. 3-25)	L/T	m/s	knots, mi/hr
$\bar{U}(z)$	Mass transport velocity at depth z for a water particle subject to wave motion mean drift velocity (eq. 2-55)	L/T	m/s	ft/s
u	Horizontal (x) normal-to-the-shoreline component of local fluid velocity (water particle velocity); current velocity (eq. 2-13) ● Maximum water velocity at entrance to inlet channel (eq. 4-70)	L/T L/T	m/s m/s	ft/s ft/s
u_b	Particle velocity under a breaking wave	L/T	m/s	ft/s
u_{crest}	Horizontal velocity near the breaker crest	L/T	m/s	ft/s
u_{max}	Maximum horizontal water particle velocity	L/T	m/s	ft/s
\bar{u}_{max}	Maximum horizontal water particle velocity averaged over depth	L/T	m/s	ft/s

(Continued)

Symbol	Definition	Dimension	Example Units	
			Metric	English
$u_{\max(-d)}$	Maximum bottom velocity (eq. 4-18)	L/T	m/s	ft/s
V	Velocity	L/T	m/s, km/hr	knots, mi/hr, ft/s
	● Maximum velocity of tidal currents in midchannel (eq. 7-128)	L/T	m/s	ft/s
	● Volume transport parallel to shore (y component) (eq. 3-77)	L^3/TL	$m^3/s-m$	$mi^3/hr-mi$
	● A volume (eq. 2-65)	L^3/L	m^3/m of crest width	ft^3/ft of crest width
	● Instantaneous average velocity of tidal current in inlet (Fig. 4-74)	L/T	m/s	ft/s
	● Volume of secondary cover layer of revetment	L^3	m^3	ft^3
\bar{V}	Average local channel velocity in the vertical	L/T	m/s	ft/s
V	Volume of sand stored in ebb-tidal delta (eq. 4-71)	L^3/L	m^3/m	$ft^3/in.$
V_c	Volume of core in a rubble structure	L^3	m^3	ft^3
V_F	Storm center velocity	L/T	m/s	knots, mi/hr
V_f	Fall velocity of particles in water column	L/T	m/s	ft/s
V_{fs}	Fall velocity of a sphere	L/T	m/s	ft/s
V_{fsc}	Fall velocity of a concentrated suspension of spheres	L/T	m/s	ft/s
V_{LEO}	Average longshore current due to breaking waves (eq. 4-51)	L/T	m/s	ft/s
V_m	Maximum velocity during a tidal cycle (eq. 4-64)	L/T	m/s	ft/s
V'_m	Dimensionless maximum channel velocity during tidal cycle (eq. 4-64)	--	--	--
V_R	Volume of rock in secondary cover layer of revetment	L^3	m^3	ft^3
v	Horizontal (y) component of local fluid velocity (water particle velocity) (eq. 3-79)	L/T	m/s	ft/s
		L/T	m/s	ft/s
		L^2/T	m^2/s	ft^2/s
v'	Velocity of broken wave water mass at structure located landward of SWL (eq. 7-103)	L/T	m/s	ft/s

(Continued)

Symbol	Definition	Dimension	Example Units	
			Metric	English
W	Weight (or mass) of individual armor units in primary cover layer; weight (or mass) of individual units, any layer	F [†]	N	lb
	● Fetch width of channel or other restricted body of water (Ch. 3)	L	km	nmi, mi
	● Windspeed	L/T	m/s	knots, mi/hr
	● Maximum sustained windspeed (Ch. 3)	L/T	m/s	knots, mi/hr
	● Parameter used in pile force and moment calculations (eq. 7-41)	--	--	--
	● Length of vertical wall affected by unit width of wave crest ($W = 1/\sin \alpha$)	L	m	ft
	● Width of surf zone (eq. 4-51)	L	m	ft
W _A	Weight of individual armor unit	F [†]	N	lb
W _{AV}	Weight of available quarrystone	F [†]	N	lb
W _{D=0}	Zero-damage quarrystone weight	F [†]	N	lb
W _f	Windspeed coefficient (eq. 7-12)	--	--	--
W _{max}	Heaviest stone in the gradation of a layer of riprap (eq. 7-124)	F [†]	N	lb
W _R	Weight of primary cover layer made of rock	F [†]	N	lb
W _x	x component of windspeed (eq. 3-77)	L/T	m/s	knots, mi/hr
W _y	y component of windspeed (eq. 3-78)	L/T	m/s	knots, mi/hr
W ₅₀	Weight of 50 percent size of armor riprap gradation (eq. 7-117)	F [†]	N	lb
w	Unit weight (or mass density) [†]	F/L ³ (or M/L ³)	N/m ³ (or kg/m ³)	lb/ft ³
	● Vertical (z) component of local fluid velocity or current velocity	L/T	m/s	knots, mi/hr
w _r	Unit weight (or mass density) [†] of armor (rock or concrete) unit (saturated surface dry) (eq. 7-116)	F/L ³ (or M/L ³)	N/m ³ (or kg/m ³)	lb/ft ³
w _w	Unit weight (or mass density) [†] of water	F/L ³ (or M/L ³)	N/m ³ (or kg/m ³)	lb/ft ³
x	Coordinate axis in direction of wave propagation relative to wave crest	--	--	--
	● Coordinate axis along basin major axis	--	--	--
	● Coordinate axis perpendicular to and positive toward shore	--	--	--
	● A distance	L	m	ft
-x	Subscript for x-coordinate	--	--	--

(Continued)

[†]Note: the SI unit of weight (meaning force, or mass accelerated at the standard free-fall rate of 9.80665 m/s²) is the newton, which is equal to 1 kg-m/s². When computing armor unit weights for practical purposes, newtons can be converted to kilograms (mass) by multiplying by 9.80665.

Symbol	Definition	Dimension	Example Units	
			Metric	English
α_r	Factor for increasing fetch length (eq. 3-47)	--	--	--
α_x	Local fluid particle acceleration in x-direction (eq. 2-15)	L/T ²	m/s ²	ft/s ²
α_z	Local fluid particle acceleration in z-direction (eq. 2-16)	L/T ²	m/s ²	ft/s ²
α_ϕ	Skewness of sediment sample using phi size measures (eq. 4-5)	--	--	--
β (Beta)	Lower limit of observed d_b/H_b <ul style="list-style-type: none"> ● Empirically determined overtopping coefficient ● Depth-to-height ratio of breaking waves in shallow water (eq. 4-21) ● Constant for wave spectrum predictions 	--	--	--
Γ (Gamma)	Horizontal mixing coefficient in surf zone (eq. 4-21) perpendicular to the shoreline	--	--	--
γ	Specific gravity of a fluid (eq. 4-6) <ul style="list-style-type: none"> ● Ratio between left and right longshore transport rates (eq. 4-31) 	--	--	--
γ_s	Specific gravity of a solid (eq. 4-6)	--	--	--
Δ (Delta)	Change; algebraic difference	--	--	--
δ	Wall friction angle (eq. 7-143)	--		deg
ε (Epsilon)	Characteristic length describing pile roughness elements (Ch. 7) <ul style="list-style-type: none"> ● Phase lag for bay high water with respect to sea high water 	L	m	in., ft
ζ (Zeta)	Vertical particle displacement caused by wave passage (eq. 2-18) <ul style="list-style-type: none"> ● Astronomical tide potential in head of water (eq. 3-77) 	L	m	ft
η (Eta)	Displacement of water surface relative to SWL by passage of wave (eq. 2-10)	L	m	ft
η (envelope)	Envelope waveform of two or more superimposed wave trains (eq. 2-34)	L	m	ft
η_i	Water surface displacement by incident wave (Ch. 2)	L	m	ft
η_c	Wave crest elevation above SWL (Ch. 7)	L	m	ft
η_r	Water surface displacement by reflected wave (Ch. 2)	L	m	ft
$\eta(t)$	Departure of water surface from its average position as a function of time (eq. 3-11)	L	m	ft

(Continued)

Symbol	Definition	Dimension	Example Units	
			Metric	English
θ (Theta)	Wave phase angle (Ch. 2)	--		rad
	● Angle of wind measured counter-clockwise from x axis at shore	--		deg
	● Angle of structure face relative to horizontal (eq. 7-113; Fig. 7-107)	--		deg
	● Angle of backslope of retaining wall (eq. 7-142)	--		deg
	● Angle of side slope with the horizontal in direction of flow	--		deg
μ (Mu)	Coefficient of friction (soil)	--	--	--
(Nu)	Kinematic viscosity (Ch. 7)	L^2/T	m^2/s	ft^2/s
ξ (Xi)	Atmospheric pressure deficit in head of water (eq. 3-77)	L	m	ft
	● Horizontal particle displacement from wave passage (eq. 2-17)	L	m	ft
	● Surf similarity parameter (eq. 2-86)	--	--	--
π (Pi)	Constant = 3.14159	--	--	--
ρ (Rho)	Mass density = w/g^\dagger	FT^2/L^4	$N-s^2/m^4$ (or $kg-s^2/m^4$)	$lb-s^2/ft^4$
	● Mass density of water [†] (eq. 4-35)	FT^2/L^4	$N-s^2/m^4$ (or $kg-s^2/m^4$)	$lb-s^2/m^4$
ρ_a	Mass density of air [†]	FT^2/L^4	$N-s^2/m^4$ (or $kg-s^2/m^4$)	$lb-s^2/ft^4$
ρ_{fw}	Mass density of fresh water (1000 kg/m^3) [†]	FT^2/L^4	$N-s^2/m^4$ (or $kg-s^2/m^4$)	$lb-s^2/ft^4$
ρ_r	Mass density of armor material [†]	FT^2/L^4	$N-s^2/m^4$ (or $kg-s^2/m^4$)	$lb-s^2/ft^4$
ρ_s	Mass density of sediment [†]	FT^2/L^4	$N-s^2/m^4$ (or $kg-s^2/m^4$)	$lb-s^2/ft^4$
ρ_w	Mass density of water (salt water = $10.31 \times 10^3 \text{ kg/m}^3$; fresh water = 1000 kg/m^3) [†]	FT^2/L^4	$N-s^2/m^4$ (or $kg-s^2/m^4$)	$lb-s^2/ft^4$
σ (Sigma)	Standard deviation	T^{-1}	s^{-1}	s^{-1}
	● Wave frequency, $2\pi/T$			
σ_H	Annual standard deviation of significant wave height (eq. 4-26)	--	--	--
σ_ϕ	Sediment-size standard deviation in phi units	L		phi

(Continued)

[†]Note: the SI unit of weight (meaning force, or mass accelerated at the standard free-fall rate of 9.80665 m/s^2) is the newton, which is equal to 1 kg-m/s^2 . When computing armor unit weights for practical purposes, newtons can be converted to kilograms (mass) by multiplying by 9.80665.

Symbol	Definition	Dimension	Example Units	
			Metric	English
$\sigma_{\phi A}, \sigma_{\phi B}, \sigma_{\phi b}$	Standard deviation of artificial beach nourishment borrow material in phi units	L		phi
$\sigma_{\phi n}$	Standard deviation of native beach material in phi units	L		phi
τ (Tau)	Bottom shear for an approximately level bottom (eq. 7-131)	F/L ²	N/m ²	lb/ft ²
τ'	Design shear for channel side slope (eq. 7-132)	F/L ²	N/m ²	lb/ft ²
τ_b	Local boundary shear (eq. 7-126)	F/L ²	N/m ²	lb/ft ²
τ_{bx}, τ_{by}	x and y components of surface wind stress	F/L ²	N/m ²	lb/ft ²
τ_{sx}, τ_{sy}	x and y components of surface wind stress	F/L ²	N/m ²	lb/ft ²
ϕ (Phi)	Velocity potential <ul style="list-style-type: none"> ● Angle between wave direction and plane across which energy is being transmitted (Ch. 2) ● Angle of incident wave to gap in breakwater ● Latitude of location ● Grain size units ($\phi = -\log_2 d$ (mm)) ● Internal angle of friction of earthfill or other material ● Angle of riprap repose (eq. 7-132) 	L ² /T	m ² /s	ft ² /s
ϕ_j	Phase of the j th wave at time t = 0 (eq. 3-11)	--		deg
ϕ_m	Coefficient for calculation of maximum total force on piles (eq. 7-42)	--	--	--
ϕ_x	Particle size in phi units of the x th percentile in sediment sample	L		phi
χ (Chi)	Wave reflection coefficient (eqs. 2-27, 7-72)	--	--	--
ψ (Psi)	Effects of stability of air column on wind velocity (eq. 3-25)	--	--	--
ω (Omega)	Wave angular frequency <ul style="list-style-type: none"> ● Earth angular frequency 	T ⁻¹ T ⁻¹		rad/s rad/s, rad/hr
ω_j	Frequency of the j th wave at time t = 0 (eq. 3-11)	T ⁻¹		rad/s

APPENDIX C

Miscellaneous Tables and Plates



Cape Florida State Park, Florida, 28 July 1970

MISCELLANEOUS TABLES AND PLATES

LIST OF PLATES

Plate		Page
C-1	Illustration of various functions of d/L_0	C-2
C-2	Relationship between wave period, length, and depth.....	C-31
C-3	Relationship between wave period, length, and depth for waves of shorter period and wavelength.....	C-32
C-4	Relationship between wave period, velocity, and depth.....	C-33
C-5	Relationship between wave energy, wavelength, and wave height.....	C-34
C-6	Change in wave direction and height due to refraction on slopes with straight, parallel depth contours including shoaling.....	C-35

LISTS OF TABLES

Table		
C-1	Functions of d/L for even increments of d/L_0	C-5
C-2	Functions of d/L for even increments of d/L	C-17
C-3	Deepwater wavelength (L_0) and velocity (C_0) as a function of wave period.....	C-30
C-4	Conversion factors: English to metric (SI) units of measurement...	C-36
C-5	Phi-millimeter conversion table.....	C-40
C-6	Values of slope angle θ and $\cot \theta$ for various slopes.....	C-45

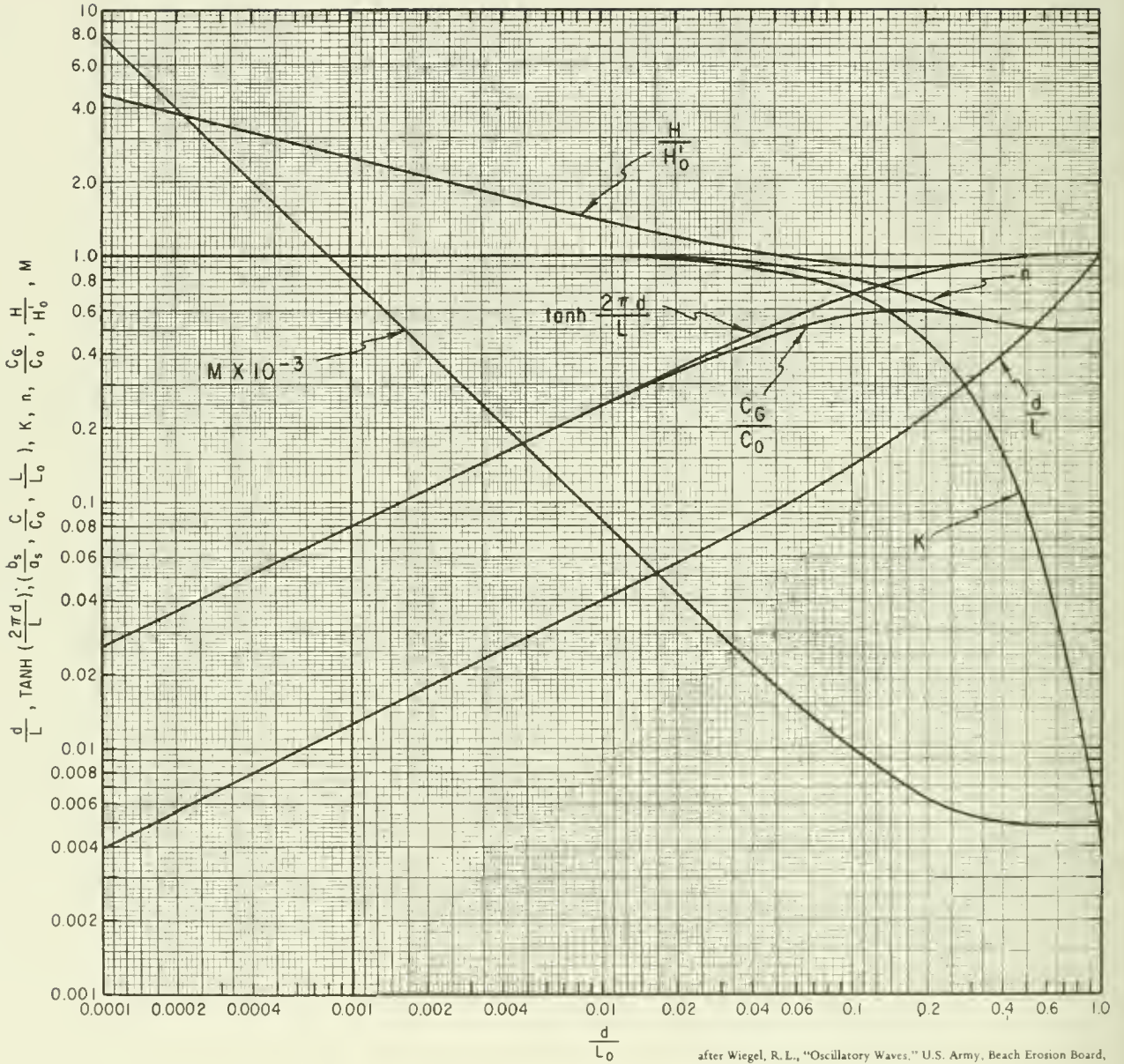

Plate C-1. Illustration of various functions of $\frac{d}{L_0}$

GUIDE FOR USE OF TABLES C-1 AND C-2

$\frac{d}{L_0}$ = ratio of the depth of water at any specific location to the wavelength in deep water

$\frac{d}{L}$ = ratio of the depth of water at any specific location to the wavelength at that same location

$\frac{H}{H_0}$ = ratio of the wave height in shallow water to what its wave height would have been in deep water if unaffected by refraction

$$= \sqrt{\frac{1}{2}} \times \frac{1}{n} \times \frac{1}{C/C_0} = K_s \text{ (shoaling coefficient)}$$

K = a pressure response factor used in connection with underwater pressure instruments, where

$$= \frac{H'}{H} = \frac{P}{P_0} = \frac{\cosh \left[\frac{2\pi d}{L} (1 + z/d) \right]}{\cosh \left(\frac{2\pi d}{L} \right)} \text{ or } \frac{\cosh \left[\frac{2\pi (d+z)}{L} \right]}{\cosh \left(\frac{2\pi d}{L} \right)}$$

where P is the pressure fluctuation at a depth z measured negatively below still water, P₀ is the surface pressure fluctuation, d is the depth of water from still-water level to the ocean bottom, L is the wavelength in any particular depth of water, and H is the corresponding variation of head at a depth z. The values of K shown in the tables are for the instrument placed on the bottom using the equation when z = - d

$$= \frac{1}{\cosh \left(\frac{2\pi d}{L} \right)} \text{ values tabulated in column 8}$$

n = the fraction of wave energy that travels forward with the waveform: i.e., with the wave velocity C rather than the group velocity C_G

$$= \left[\frac{1}{2} \left(1 + \frac{4\pi d/L}{\sinh \left(\frac{4\pi d}{L} \right)} \right) \right] = \frac{C_G}{C}$$

n is also the ratio of group velocity C_G to wave velocity C

$\frac{C_G}{C_0}$ = ratio of group velocity to deepwater wave velocity where

$$\frac{C_G}{C_O} = \frac{C_G}{C} \times \frac{C}{C_O} = n \tanh \left(\frac{2\pi d}{L} \right)$$

M = an energy coefficient defined as

$$\frac{\pi^2}{2 \tanh^2 \left(\frac{2\pi d}{L} \right)}$$

Table C-1. Functions of d/L for even increments of d/L₀ (from 0.0001 to 1.000).

d/L ₀	d/L	2π d/L	TANH 2π d/L	SINH 2π d/L	COSH 2π d/L	H/H ₀	K	4π d/L	SINH 4π d/L	COSH 4π d/L	n	C _G /C ₀	M
0	0	0	0	0	1	∞	1	0	0	1	1	0	∞
.000100	.003990	.02507	.02506	.02507	1.0003	4.467	.9997	.05014	.05016	1.001	.9998	.02506	7,855
.000200	.005643	.03546	.03546	.03547	1.0006	3.757	.9994	.07091	.07097	1.003	.9996	.03543	3,928
.000300	.006912	.04343	.04340	.04344	1.0009	3.395	.9991	.08686	.08697	1.004	.9994	.04336	2,620
.000400	.007982	.05015	.05011	.05018	1.0013	3.160	.9987	.1003	.1005	1.005	.9992	.05007	1,965
.000500	.008925	.05608	.05602	.05611	1.0016	2.989	.9984	.1122	.1124	1.006	.9990	.05596	1,572
.000600	.009778	.06144	.06136	.06148	1.0019	2.856	.9981	.1229	.1232	1.008	.9988	.06128	1,311
.000700	.01056	.06637	.06627	.06642	1.0022	2.749	.9978	.1327	.1331	1.009	.9985	.06617	1,124
.000800	.01129	.07096	.07084	.07102	1.0025	2.659	.9975	.1419	.1424	1.010	.9983	.07072	983.5
.000900	.01198	.07527	.07513	.07534	1.0028	2.582	.9972	.1505	.1511	1.011	.9981	.07499	874.3
.001000	.01263	.07935	.07918	.07943	1.0032	2.515	.9969	.1587	.1594	1.013	.9979	.07902	787.0
.001100	.01325	.08323	.08304	.08333	1.0035	2.456	.9966	.1665	.1672	1.014	.9977	.08285	715.6
.001200	.01384	.08694	.08672	.08705	1.0038	2.404	.9962	.1739	.1748	1.015	.9975	.08651	656.1
.001300	.01440	.09050	.09026	.09063	1.0041	2.357	.9959	.1810	.1820	1.016	.9973	.09001	605.8
.001400	.01495	.09393	.09365	.09407	1.0044	2.314	.9956	.1879	.1890	1.018	.9971	.09338	562.6
.001500	.01548	.09723	.09693	.09739	1.0047	2.275	.9953	.1945	.1957	1.019	.9969	.09663	525
.001600	.01598	.1004	.1001	.1006	1.0051	2.239	.9949	.2009	.2022	1.020	.9967	.09977	493
.001700	.01648	.1035	.1032	.1037	1.0054	2.205	.9946	.2071	.2086	1.022	.9965	.1028	463
.001800	.01696	.1066	.1062	.1068	1.0057	2.174	.9943	.2131	.2147	1.023	.9962	.1058	438
.001900	.01743	.1095	.1091	.1097	1.0060	2.145	.9940	.2190	.2207	1.024	.9960	.1087	415
.002000	.01788	.1123	.1119	.1125	1.0063	2.119	.9937	.2247	.2266	1.025	.9958	.1114	394
.002100	.01832	.1151	.1146	.1154	1.0066	2.094	.9934	.2303	.2323	1.027	.9956	.1141	376
.002200	.01876	.1178	.1173	.1181	1.0069	2.070	.9931	.2357	.2379	1.028	.9954	.1161	359
.002300	.01918	.1205	.1199	.1208	1.0073	2.047	.9928	.2410	.2433	1.029	.9952	.1193	343
.002400	.01959	.1231	.1225	.1234	1.0076	2.025	.9925	.2462	.2487	1.031	.9950	.1219	329
.002500	.02000	.1257	.1250	.1260	1.0079	2.005	.9922	.2513	.2540	1.032	.9948	.1243	316
.002600	.02040	.1282	.1275	.1285	1.0082	1.986	.9919	.2563	.2592	1.033	.9946	.1268	304
.002700	.02079	.1306	.1299	.1310	1.0085	1.967	.9916	.2612	.2642	1.034	.9944	.1292	292
.002800	.02117	.1330	.1323	.1334	1.0089	1.950	.9912	.2661	.2692	1.036	.9942	.1315	282
.002900	.02155	.1354	.1346	.1358	1.0092	1.933	.9909	.2708	.2741	1.037	.9939	.1338	272
.003000	.02192	.1377	.1369	.1382	1.0095	1.917	.9906	.2755	.2790	1.038	.9937	.1360	263
.003100	.02228	.1400	.1391	.1405	1.0098	1.902	.9903	.2800	.2837	1.040	.9935	.1382	255
.003200	.02264	.1423	.1413	.1427	1.0101	1.887	.9900	.2845	.2884	1.041	.9933	.1404	247
.003300	.02300	.1445	.1435	.1449	1.0104	1.873	.9897	.2890	.2930	1.042	.9931	.1425	240
.003400	.02335	.1467	.1456	.1472	1.0108	1.860	.9893	.2934	.2976	1.043	.9929	.1446	233
.003500	.02369	.1488	.1477	.1494	1.0111	1.847	.9890	.2977	.3021	1.045	.9927	.1466	226
.003600	.02403	.1510	.1498	.1515	1.0114	1.834	.9887	.3020	.3065	1.046	.9925	.1487	220
.003700	.02436	.1531	.1519	.1537	1.0117	1.822	.9884	.3061	.3109	1.047	.9923	.1507	214
.003800	.02469	.1551	.1539	.1558	1.0121	1.810	.9881	.3103	.3153	1.049	.9921	.1527	208
.003900	.02502	.1572	.1559	.1579	1.0124	1.799	.9878	.3144	.3196	1.050	.9919	.1546	203
.004000	.02534	.1592	.1579	.1599	1.0127	1.788	.9875	.3184	.3238	1.051	.9917	.1565	198
.004100	.02566	.1612	.1598	.1619	1.0130	1.777	.9872	.3224	.3280	1.052	.9915	.1584	193
.004200	.02597	.1632	.1617	.1639	1.0133	1.767	.9869	.3263	.3322	1.054	.9912	.1602	189
.004300	.02628	.1651	.1636	.1659	1.0137	1.756	.9865	.3302	.3362	1.055	.9910	.1621	184
.004400	.02659	.1671	.1655	.1678	1.0140	1.746	.9862	.3341	.3403	1.056	.9908	.1640	180
.004500	.02689	.1690	.1674	.1698	1.0143	1.737	.9859	.3380	.3444	1.058	.9906	.1658	176
.004600	.02719	.1708	.1692	.1717	1.0146	1.727	.9856	.3417	.3483	1.059	.9904	.1676	172
.004700	.02749	.1727	.1710	.1736	1.0149	1.718	.9853	.3454	.3523	1.060	.9902	.1693	169
.004800	.02778	.1745	.1728	.1754	1.0153	1.709	.9849	.3491	.3562	1.062	.9900	.1711	165
.004900	.02807	.1764	.1746	.1773	1.0156	1.701	.9846	.3527	.3601	1.063	.9898	.1728	162
.005000	.02836	.1782	.1764	.1791	1.0159	1.692	.9843	.3564	.3640	1.064	.9896	.1746	159
.005100	.02864	.1800	.1781	.1809	1.0162	1.684	.9840	.3599	.3678	1.066	.9894	.1762	156
.005200	.02893	.1818	.1798	.1827	1.0166	1.676	.9837	.3635	.3715	1.067	.9892	.1779	153
.005300	.02921	.1835	.1815	.1845	1.0169	1.669	.9834	.3670	.3753	1.068	.9889	.1795	150
.005400	.02948	.1852	.1832	.1863	1.0172	1.662	.9831	.3705	.3790	1.069	.9887	.1811	147
.005500	.02976	.1870	.1848	.1880	1.0175	1.654	.9828	.3739	.3827	1.071	.9885	.1827	145
.005600	.03003	.1887	.1865	.1898	1.0178	1.647	.9825	.3774	.3864	1.072	.9883	.1843	142
.005700	.03030	.1904	.1881	.1915	1.0182	1.640	.9822	.3808	.3900	1.073	.9881	.1859	140
.005800	.03057	.1921	.1897	.1932	1.0185	1.633	.9818	.3841	.3937	1.075	.9879	.1874	137
.005900	.03083	.1937	.1913	.1949	1.0188	1.626	.9815	.3875	.3972	1.076	.9877	.1890	135

*Also: b_s/a_s, C/C₀, L/L_c

Table C-1. Continued.

d/L_0	d/L	$2\pi d/L$	TANH $2\pi d/L$	SINH $2\pi d/L$	COSH $2\pi d/L$	H/H ₀	K	$4\pi d/L$	SINH $4\pi d/L$	COSH $4\pi d/L$	n	C _G /C ₀	M
.006000	.03110	.1954	.1929	.1967	1.0192	1.620	.9812	.3908	.4008	1.077	.9875	.1905	133
.006100	.03136	.1970	.1945	.1983	1.0195	1.614	.9809	.3941	.4044	1.079	.9873	.1920	130
.006200	.03162	.1987	.1961	.2000	1.0198	1.607	.9806	.3973	.4079	1.080	.9871	.1935	128
.006300	.03188	.2003	.1976	.2016	1.0201	1.601	.9803	.4006	.4114	1.081	.9869	.1950	126
.006400	.03213	.2019	.1992	.2033	1.0205	1.595	.9799	.4038	.4148	1.083	.9867	.1965	124
.006500	.03238	.2035	.2007	.2049	1.0208	1.589	.9796	.4070	.4183	1.084	.9865	.1980	123
.006600	.03264	.2051	.2022	.2065	1.0211	1.583	.9793	.4101	.4217	1.085	.9863	.1994	121
.006700	.03289	.2066	.2037	.2081	1.0214	1.578	.9790	.4133	.4251	1.087	.9860	.2009	119
.006800	.03313	.2082	.2052	.2097	1.0217	1.572	.9787	.4164	.4285	1.088	.9858	.2023	117
.006900	.03338	.2097	.2067	.2113	1.0221	1.567	.9784	.4195	.4319	1.089	.9856	.2037	116
.007000	.03362	.2113	.2082	.2128	1.0224	1.561	.9781	.4225	.4352	1.091	.9854	.2051	114
.007100	.03387	.2128	.2096	.2144	1.0227	1.556	.9778	.4256	.4386	1.092	.9852	.2065	112
.007200	.03411	.2143	.2111	.2160	1.0231	1.551	.9774	.4286	.4419	1.093	.9850	.2079	111
.007300	.03435	.2158	.2125	.2175	1.0234	1.546	.9771	.4316	.4452	1.095	.9848	.2093	109
.007400	.03459	.2173	.2139	.2190	1.0237	1.541	.9768	.4346	.4484	1.096	.9846	.2106	108
.007500	.03482	.2188	.2154	.2205	1.0240	1.536	.9765	.4376	.4517	1.097	.9844	.2120	106
.007600	.03506	.2203	.2168	.2221	1.0244	1.531	.9762	.4406	.4549	1.099	.9842	.2134	105
.007700	.03529	.2218	.2182	.2236	1.0247	1.526	.9759	.4435	.4582	1.100	.9840	.2147	104
.007800	.03552	.2232	.2196	.2251	1.0250	1.521	.9756	.4464	.4614	1.101	.9838	.2160	102
.007900	.03576	.2247	.2209	.2265	1.0253	1.517	.9753	.4493	.4646	1.103	.9836	.2173	101
.008000	.03598	.2261	.2223	.2280	1.0257	1.512	.9750	.4522	.4678	1.104	.9834	.2186	100
.008100	.03621	.2275	.2237	.2295	1.0260	1.508	.9747	.4551	.4709	1.105	.9832	.2199	98.6
.008200	.03644	.2290	.2250	.2310	1.0263	1.503	.9744	.4579	.4741	1.107	.9830	.2212	97.5
.008300	.03666	.2304	.2264	.2324	1.0266	1.499	.9741	.4607	.4772	1.108	.9827	.2225	96.3
.008400	.03689	.2318	.2277	.2338	1.0270	1.495	.9737	.4636	.4803	1.109	.9825	.2237	95.2
.008500	.03711	.2332	.2290	.2353	1.0273	1.491	.9734	.4664	.4834	1.111	.9823	.2250	94.1
.008600	.03733	.2346	.2303	.2367	1.0276	1.487	.9731	.4691	.4865	1.112	.9821	.2262	93.0
.008700	.03755	.2360	.2317	.2381	1.0280	1.482	.9728	.4719	.4896	1.113	.9819	.2275	91.9
.008800	.03777	.2373	.2330	.2396	1.0283	1.478	.9725	.4747	.4927	1.115	.9817	.2287	90.9
.008900	.03799	.2387	.2343	.2410	1.0286	1.474	.9722	.4774	.4957	1.116	.9815	.2300	89.9
.009000	.03821	.2401	.2356	.2424	1.0290	1.471	.9718	.4801	.4988	1.118	.9813	.2312	88.9
.009100	.03842	.2414	.2368	.2438	1.0293	1.467	.9715	.4828	.5018	1.119	.9811	.2324	88.0
.009200	.03864	.2428	.2381	.2452	1.0296	1.463	.9712	.4855	.5049	1.120	.9809	.2336	87.1
.009300	.03885	.2441	.2394	.2465	1.0299	1.459	.9709	.4882	.5079	1.122	.9807	.2348	86.1
.009400	.03906	.2455	.2407	.2479	1.0303	1.456	.9706	.4909	.5109	1.123	.9805	.2360	85.2
.009500	.03928	.2468	.2419	.2493	1.0306	1.452	.9703	.4936	.5138	1.124	.9803	.2371	84.3
.009600	.03949	.2481	.2431	.2507	1.0309	1.448	.9700	.4962	.5168	1.126	.9801	.2383	83.5
.009700	.03970	.2494	.2443	.2520	1.0313	1.445	.9697	.4988	.5198	1.127	.9799	.2394	82.7
.009800	.03990	.2507	.2456	.2534	1.0316	1.442	.9694	.5014	.5227	1.128	.9797	.2406	81.8
.009900	.04011	.2520	.2468	.2547	1.0319	1.438	.9691	.5040	.5257	1.130	.9794	.2417	81.0
.01000	.04032	.2533	.2480	.2560	1.0322	1.435	.9688	.5066	.5286	1.131	.9792	.2429	80.2
.01100	.04233	.2660	.2598	.2691	1.0356	1.403	.9656	.5319	.5574	1.145	.9772	.2539	73.1
.01200	.04426	.2781	.2711	.2817	1.0389	1.375	.9625	.5562	.5853	1.159	.9751	.2643	67.1
.01300	.04612	.2898	.2820	.2938	1.0423	1.350	.9594	.5795	.6125	1.173	.9731	.2743	62.1
.01400	.04791	.3010	.2924	.3056	1.0456	1.327	.9564	.6020	.6391	1.187	.9710	.2838	57.8
.01500	.04964	.3119	.3022	.3170	1.0490	1.307	.9533	.6238	.6651	1.201	.9690	.2928	54.0
.01600	.05132	.3225	.3117	.3281	1.0524	1.288	.9502	.6450	.6906	1.215	.9670	.3011	50.8
.01700	.05296	.3328	.3209	.3389	1.0559	1.271	.9471	.6655	.7158	1.230	.9649	.3096	47.9
.01800	.05455	.3428	.3298	.3495	1.0593	1.255	.9440	.6856	.7405	1.244	.9629	.3176	45.3
.01900	.05611	.3525	.3386	.3599	1.0628	1.240	.9409	.7051	.7650	1.259	.9609	.3253	43.0
.02000	.05763	.3621	.3470	.3701	1.0663	1.226	.9378	.7242	.7891	1.274	.9588	.3327	41.0
.02100	.05912	.3714	.3552	.3800	1.0698	1.213	.9348	.7429	.8131	1.289	.9568	.3399	39.1
.02200	.06057	.3806	.3632	.3898	1.0733	1.201	.9317	.7612	.8368	1.304	.9548	.3468	37.4
.02300	.06200	.3896	.3710	.3995	1.0768	1.189	.9287	.7791	.8603	1.319	.9528	.3535	35.9
.02400	.06340	.3984	.3786	.4090	1.0804	1.178	.9256	.7967	.8837	1.335	.9508	.3600	34.4
.02500	.06478	.4070	.3860	.4184	1.0840	1.168	.9225	.8140	.9069	1.350	.9488	.3662	33.1
.02600	.06613	.4155	.3932	.4276	1.0876	1.159	.9195	.8310	.9310	1.366	.9468	.3722	31.9
.02700	.06747	.4239	.4002	.4367	1.0912	1.150	.9164	.8478	.9530	1.381	.9448	.3781	30.8
.02800	.06878	.4322	.4071	.4457	1.0949	1.141	.9133	.8643	.9760	1.397	.9428	.3838	29.8
.02900	.07007	.4403	.4138	.4546	1.0985	1.133	.9103	.8805	.9988	1.413	.9408	.3893	28.8

Table C-1. Continued.

d/L ₀	d/L	2π d/L	TANH 2π d/L	SINH 2π d/L	COSH 2π d/L	H/H' ₀	K	4π d/L	SINH 4π d/L	COSH 4π d/L	n	C _G /C ₀	M
.03000	.07135	.4483	.4205	.4634	1.1021	1.125	.9073	.8966	1.022	1.430	.9388	.3947	27.4
.03100	.07260	.4562	.4269	.4721	1.1059	1.118	.9042	.9124	1.044	1.446	.9369	.4000	27.1
.03200	.07385	.4640	.4333	.4808	1.1096	1.111	.9012	.9280	1.067	1.462	.9349	.4051	26.3
.03300	.07507	.4717	.4395	.4894	1.1133	1.104	.8982	.9434	1.090	1.479	.9329	.4100	25.6
.03400	.07630	.4794	.4457	.4980	1.1171	1.098	.8952	.9588	1.113	1.496	.9309	.4149	24.8
.03500	.07748	.4868	.4517	.5064	1.1209	1.092	.8921	.9737	1.135	1.513	.9289	.4196	24.19
.03600	.07867	.4943	.4577	.5147	1.1247	1.086	.8891	.9886	1.158	1.530	.9270	.4242	23.56
.03700	.07984	.5017	.4635	.5230	1.1285	1.080	.8861	1.003	1.180	1.547	.9250	.4287	22.97
.03800	.08100	.5090	.4691	.5312	1.1324	1.075	.8831	1.018	1.203	1.564	.9230	.4330	22.42
.03900	.08215	.5162	.4747	.5394	1.1362	1.069	.8801	1.032	1.226	1.582	.9211	.4372	21.90
.04000	.08329	.5233	.4802	.5475	1.1401	1.064	.8771	1.047	1.248	1.600	.9192	.4414	21.40
.04100	.08442	.5304	.4857	.5556	1.1440	1.059	.8741	1.061	1.271	1.617	.9172	.4455	20.92
.04200	.08553	.5374	.4911	.5637	1.1479	1.055	.8711	1.075	1.294	1.636	.9153	.4495	20.46
.04300	.08664	.5444	.4964	.5717	1.1518	1.050	.8688	1.089	1.317	1.654	.9133	.4534	20.03
.04400	.08774	.5513	.5015	.5796	1.1558	1.046	.8652	1.103	1.340	1.672	.9114	.4571	19.62
.04500	.08883	.5581	.5066	.5876	1.1599	1.042	.8621	1.116	1.363	1.691	.9095	.4607	19.23
.04600	.08991	.5649	.5116	.5954	1.1639	1.038	.8592	1.130	1.386	1.709	.9076	.4643	18.85
.04700	.09098	.5717	.5166	.6033	1.1679	1.034	.8562	1.143	1.409	1.728	.9057	.4679	18.49
.04800	.09205	.5784	.5215	.6111	1.1720	1.030	.8532	1.157	1.433	1.747	.9037	.4713	18.15
.04900	.09311	.5850	.5263	.6189	1.1760	1.026	.8503	1.170	1.456	1.766	.9018	.4746	17.82
.05000	.09416	.5916	.5310	.6267	1.1802	1.023	.8473	1.183	1.479	1.786	.8999	.4779	17.50
.05100	.09520	.5981	.5357	.6344	1.1843	1.019	.8444	1.196	1.503	1.805	.8980	.4811	17.19
.05200	.09623	.6046	.5403	.6421	1.1884	1.016	.8415	1.209	1.526	1.825	.8961	.4842	16.90
.05300	.09726	.6111	.5449	.6499	1.1926	1.013	.8385	1.222	1.550	1.845	.8943	.4873	16.62
.05400	.09829	.6176	.5494	.6575	1.1968	1.010	.8356	1.235	1.574	1.865	.8924	.4903	16.35
.05500	.09930	.6239	.5538	.6652	1.2011	1.007	.8326	1.248	1.598	1.885	.8905	.4932	16.09
.05600	.1003	.6303	.5582	.6729	1.2053	1.004	.8297	1.261	1.622	1.906	.8886	.4960	15.84
.05700	.1013	.6366	.5626	.6805	1.2096	1.001	.8267	1.273	1.646	1.926	.8867	.4988	15.60
.05800	.1023	.6428	.5668	.6880	1.2138	.9985	.8239	1.286	1.670	1.947	.8849	.5015	15.36
.05900	.1033	.6491	.5711	.6956	1.2181	.9958	.8209	1.298	1.695	1.968	.8830	.5042	15.13
.06000	.1043	.6553	.5753	.7033	1.2225	.9932	.8180	1.311	1.719	1.989	.8811	.5068	14.91
.06100	.1053	.6616	.5794	.7110	1.2270	.9907	.8150	1.323	1.744	2.011	.8792	.5094	14.70
.06200	.1063	.6678	.5834	.7187	1.2315	.9883	.8121	1.336	1.770	2.033	.8773	.5119	14.50
.06300	.1073	.6739	.5874	.7265	1.2355	.9860	.8093	1.348	1.795	2.055	.8755	.5143	14.30
.06400	.1082	.6799	.5914	.7335	1.2402	.9837	.8063	1.360	1.819	2.076	.8737	.5167	14.11
.06500	.1092	.6860	.5954	.7411	1.2447	.9815	.8035	1.372	1.845	2.098	.8719	.5191	13.92
.06600	.1101	.6920	.5993	.7486	1.2492	.9793	.8005	1.384	1.870	2.121	.8700	.5214	13.74
.06700	.1111	.6981	.6031	.7561	1.2537	.9772	.7977	1.396	1.896	2.144	.8682	.5236	13.57
.06800	.1120	.7037	.6069	.7633	1.2580	.9752	.7948	1.408	1.921	2.166	.8664	.5258	13.40
.06900	.1130	.7099	.6106	.7711	1.2628	.9732	.7919	1.420	1.948	2.189	.8646	.5279	13.24
.07000	.1139	.7157	.6144	.7783	1.2672	.9713	.7890	1.432	1.974	2.213	.8627	.5300	13.08
.07100	.1149	.7219	.6181	.7863	1.2721	.9694	.7861	1.444	2.000	2.236	.8609	.5321	12.92
.07200	.1158	.7277	.6217	.7937	1.2767	.9676	.7833	1.455	2.026	2.260	.8591	.5341	12.77
.07300	.1168	.7336	.6252	.8011	1.2813	.9658	.7804	1.467	2.053	2.284	.8572	.5360	12.62
.07400	.1177	.7395	.6289	.8088	1.2861	.9641	.7775	1.479	2.080	2.308	.8554	.5380	12.48
.07500	.1186	.7453	.6324	.8162	1.2908	.9624	.7747	1.490	2.107	2.332	.8537	.5399	12.34
.07600	.1195	.7511	.6359	.8237	1.2956	.9607	.7719	1.502	2.135	2.357	.8519	.5417	12.21
.07700	.1205	.7569	.6392	.8312	1.3004	.9591	.7690	1.514	2.162	2.382	.8501	.5435	12.08
.07800	.1214	.7625	.6427	.8386	1.3051	.9576	.7662	1.525	2.189	2.407	.8483	.5452	11.95
.07900	.1223	.7683	.6460	.8462	1.3100	.9562	.7634	1.537	2.217	2.432	.8465	.5469	11.83
.08000	.1232	.7741	.6493	.8538	1.3149	.9548	.7605	1.548	2.245	2.458	.8448	.5485	11.71
.08100	.1241	.7799	.6526	.8614	1.3198	.9534	.7577	1.560	2.274	2.484	.8430	.5501	11.59
.08200	.1251	.7854	.6558	.8687	1.3246	.9520	.7549	1.571	2.303	2.511	.8413	.5517	11.47
.08300	.1259	.7911	.6590	.8762	1.3295	.9506	.7522	1.583	2.331	2.537	.8395	.5533	11.36
.08400	.1268	.7967	.6622	.8837	1.3345	.9493	.7494	1.594	2.360	2.563	.8378	.5548	11.25
.08500	.1277	.8026	.6655	.8915	1.3397	.9481	.7464	1.605	2.389	2.590	.8360	.5563	11.14
.08600	.1286	.8080	.6685	.8989	1.3446	.9469	.7437	1.616	2.418	2.617	.8342	.5577	11.04
.08700	.1295	.8137	.6716	.9064	1.3497	.9457	.7409	1.628	2.448	2.644	.8325	.5591	10.94
.08800	.1304	.8193	.6747	.9141	1.3548	.9445	.7381	1.639	2.478	2.672	.8308	.5605	10.84
.08900	.1313	.8250	.6778	.9218	1.3600	.9433	.7353	1.650	2.508	2.700	.8290	.5619	10.74

Table C-1. Continued.

d/L _o	d/L	2πd/L	TANH 2πd/L	SINH 2πd/L	COSH 2πd/L	H/H _o	K	4πd/L	SINH 4πd/L	COSH 4πd/L	n	C _G /C _o	M
.09000	.1322	.8306	.6808	.9295	1.3653	.9422	.7324	1.661	2.538	2.728	.8273	.5632	10.65
.09100	.1331	.8363	.6838	.9372	1.3706	.9411	.7296	1.672	2.568	2.756	.8255	.5645	10.55
.09200	.1340	.8420	.6868	.9450	1.3759	.9401	.7268	1.684	2.599	2.785	.8238	.5658	10.46
.09300	.1349	.8474	.6897	.9525	1.3810	.9391	.7241	1.695	2.630	2.814	.8221	.5670	10.37
.09400	.1357	.8528	.6925	.9600	1.3862	.9381	.7214	1.706	2.662	2.843	.8204	.5682	10.29
.09500	.1366	.8583	.6953	.9677	1.3917	.9371	.7186	1.717	2.693	2.873	.8187	.5693	10.21
.09600	.1375	.8639	.6982	.9755	1.3970	.9362	.7158	1.728	2.726	2.903	.8170	.5704	10.12
.09700	.1384	.8694	.7011	.9832	1.4023	.9353	.7131	1.739	2.757	2.933	.8153	.5716	10.04
.09800	.1392	.8749	.7039	.9908	1.4077	.9344	.7104	1.750	2.790	2.963	.8136	.5727	9.962
.09900	.1401	.8803	.7066	.9985	1.4131	.9335	.7076	1.761	2.822	2.994	.8120	.5737	9.884
.1000	.1410	.8858	.7093	1.006	1.4187	.9327	.7049	1.772	2.855	3.025	.8103	.5747	9.808
.1010	.1419	.8913	.7120	1.014	1.4242	.9319	.7022	1.783	2.888	3.057	.8086	.5757	9.734
.1020	.1427	.8967	.7147	1.022	1.4297	.9311	.6994	1.793	2.922	3.088	.8069	.5766	9.661
.1030	.1436	.9023	.7173	1.030	1.4354	.9304	.6967	1.805	2.956	3.121	.8052	.5776	9.590
.1040	.1445	.9076	.7200	1.037	1.4410	.9297	.6940	1.815	2.990	3.153	.8036	.5785	9.519
.1050	.1453	.9130	.7226	1.045	1.4465	.9290	.6913	1.826	3.024	3.185	.8019	.5794	9.451
.1060	.1462	.9184	.7252	1.053	1.4523	.9282	.6886	1.837	3.059	3.218	.8003	.5803	9.384
.1070	.1470	.9239	.7277	1.061	1.4580	.9276	.6859	1.848	3.094	3.251	.7986	.5812	9.318
.1080	.1479	.9293	.7303	1.069	1.4638	.9269	.6833	1.858	3.128	3.284	.7970	.5820	9.254
.1090	.1488	.9343	.7327	1.076	1.4692	.9263	.6806	1.869	3.164	3.319	.7954	.5828	9.191
.1100	.1496	.9400	.7352	1.085	1.4752	.9257	.6779	1.880	3.201	3.353	.7937	.5836	9.129
.1110	.1505	.9456	.7377	1.093	1.4814	.9251	.6752	1.891	3.237	3.388	.7920	.5843	9.068
.1120	.1513	.9508	.7402	1.101	1.4871	.9245	.6725	1.902	3.274	3.423	.7904	.5850	9.009
.1130	.1522	.9563	.7426	1.109	1.4932	.9239	.6697	1.913	3.312	3.459	.7888	.5857	8.950
.1140	.1530	.9616	.7450	1.117	1.4990	.9234	.6671	1.923	3.348	3.494	.7872	.5864	8.891
.1150	.1539	.9670	.7474	1.125	1.5051	.9228	.6645	1.934	3.385	3.530	.7856	.5871	8.835
.1160	.1547	.9720	.7497	1.133	1.5108	.9223	.6619	1.944	3.423	3.566	.7840	.5878	8.780
.1170	.1556	.9775	.7520	1.141	1.5171	.9218	.6592	1.955	3.462	3.603	.7824	.5884	8.726
.1180	.1564	.9827	.7543	1.149	1.5230	.9214	.6566	1.966	3.501	3.641	.7808	.5890	8.673
.1190	.1573	.9882	.7566	1.157	1.5293	.9209	.6539	1.977	3.540	3.678	.7792	.5896	8.621
.1200	.1581	.9936	.7589	1.165	1.5356	.9204	.6512	1.987	3.579	3.716	.7776	.5902	8.569
.1210	.1590	.9989	.7612	1.174	1.5418	.9200	.6486	1.998	3.620	3.755	.7760	.5907	8.518
.1220	.1598	1.004	.7634	1.182	1.5479	.9196	.6460	2.008	3.659	3.793	.7745	.5913	8.468
.1230	.1607	1.010	.7656	1.190	1.5546	.9192	.6433	2.019	3.699	3.832	.7729	.5918	8.419
.1240	.1615	1.015	.7678	1.198	1.5605	.9189	.6407	2.030	3.740	3.871	.7713	.5922	8.371
.1250	.1624	1.020	.7700	1.207	1.5674	.9186	.6381	2.041	3.782	3.912	.7698	.5926	8.324
.1260	.1632	1.025	.7721	1.215	1.5734	.9182	.6356	2.051	3.824	3.952	.7682	.5931	8.278
.1270	.1640	1.030	.7742	1.223	1.5795	.9178	.6331	2.061	3.865	3.992	.7667	.5936	8.233
.1280	.1649	1.036	.7763	1.231	1.5862	.9175	.6305	2.072	3.907	4.033	.7652	.5940	8.189
.1290	.1657	1.041	.7783	1.240	1.5927	.9172	.6279	2.082	3.950	4.074	.7637	.5944	8.146
.1300	.1665	1.046	.7804	1.248	1.5990	.9169	.6254	2.093	3.992	4.115	.7621	.5948	8.103
.1310	.1674	1.052	.7824	1.257	1.6060	.9166	.6228	2.104	4.036	4.158	.7606	.5951	8.061
.1320	.1682	1.057	.7844	1.265	1.6124	.9164	.6202	2.114	4.080	4.201	.7591	.5954	8.020
.1330	.1691	1.062	.7865	1.273	1.6191	.9161	.6176	2.125	4.125	4.245	.7575	.5958	7.978
.1340	.1699	1.068	.7885	1.282	1.6260	.9158	.6150	2.135	4.169	4.288	.7560	.5961	7.937
.1350	.1708	1.073	.7905	1.291	1.633	.9156	.6123	2.146	4.217	4.334	.7545	.5964	7.897
.1360	.1716	1.078	.7925	1.300	1.640	.9154	.6098	2.156	4.262	4.378	.7530	.5967	7.857
.1370	.1724	1.084	.7945	1.308	1.647	.9152	.6073	2.167	4.309	4.423	.7515	.5969	7.819
.1380	.1733	1.089	.7964	1.317	1.654	.9150	.6047	2.177	4.355	4.468	.7500	.5972	7.781
.1390	.1741	1.094	.7983	1.326	1.660	.9148	.6022	2.188	4.402	4.514	.7485	.5975	7.744
.1400	.1749	1.099	.8002	1.334	1.667	.9146	.5998	2.198	4.450	4.561	.7471	.5978	7.707
.1410	.1758	1.105	.8021	1.343	1.675	.9144	.5972	2.209	4.498	4.607	.7456	.5980	7.671
.1420	.1766	1.110	.8039	1.352	1.681	.9142	.5947	2.219	4.546	4.654	.7441	.5982	7.636
.1430	.1774	1.115	.8057	1.360	1.688	.9141	.5923	2.230	4.595	4.663	.7426	.5984	7.602
.1440	.1783	1.120	.8076	1.369	1.696	.9140	.5898	2.240	4.644	4.751	.7412	.5986	7.567
.1450	.1791	1.125	.8094	1.378	1.703	.9139	.5873	2.251	4.695	4.800	.7397	.5987	7.533
.1460	.1800	1.131	.8112	1.388	1.710	.9137	.5847	2.261	4.746	4.850	.7382	.5989	7.499
.1470	.1808	1.136	.8131	1.397	1.718	.9136	.5822	2.272	4.798	4.901	.7368	.5990	7.465
.1480	.1816	1.141	.8149	1.405	1.725	.9135	.5798	2.282	4.847	4.951	.7354	.5992	7.432
.1490	.1825	1.146	.8166	1.415	1.732	.9134	.5773	2.293	4.901	5.001	.7339	.5993	7.400

Table C-1. Continued.

d/L_0	d/L	$2\pi d/L$	TANH $2\pi d/L$	SINH $2\pi d/L$	COSH $2\pi d/L$	H/H_0	K	$4\pi d/L$	SINH $4\pi d/L$	COSH $4\pi d/L$	n	C_G/C_0	M
.1500	.1833	1.152	.8183	1.424	1.740	.9133	.5748	2.303	4.954	5.054	.7325	.5994	7.369
.1510	.1841	1.157	.8200	1.433	1.747	.9133	.5723	2.314	5.007	5.106	.7311	.5994	7.339
.1520	.1850	1.162	.8217	1.442	1.755	.9132	.5699	2.324	5.061	5.159	.7296	.5995	7.309
.1530	.1858	1.167	.8234	1.451	1.762	.9132	.5675	2.335	5.115	5.212	.7282	.5996	7.279
.1540	.1866	1.173	.8250	1.460	1.770	.9132	.5651	2.345	5.169	5.265	.7268	.5996	7.250
.1550	.1875	1.178	.8267	1.469	1.777	.9131	.5627	2.356	5.225	5.320	.7254	.5997	7.221
.1560	.1883	1.183	.8284	1.479	1.785	.9130	.5602	2.366	5.283	5.376	.7240	.5998	7.191
.1570	.1891	1.188	.8301	1.488	1.793	.9129	.5577	2.377	5.339	5.432	.7226	.5999	7.162
.1580	.1900	1.194	.8317	1.498	1.801	.9130	.5552	2.387	5.398	5.490	.7212	.5998	7.134
.1590	.1908	1.199	.8333	1.507	1.809	.9130	.5528	2.398	5.454	5.544	.7198	.5998	7.107
.1600	.1917	1.204	.8349	1.517	1.817	.9130	.5504	2.408	5.513	5.603	.7184	.5998	7.079
.1610	.1925	1.209	.8365	1.527	1.825	.9130	.5480	2.419	5.571	5.660	.7171	.5998	7.052
.1620	.1933	1.215	.8381	1.536	1.833	.9130	.5456	2.429	5.630	5.718	.7157	.5998	7.026
.1630	.1941	1.220	.8396	1.546	1.841	.9130	.5432	2.440	5.690	5.777	.7144	.5998	7.000
.1640	.1950	1.225	.8411	1.555	1.849	.9130	.5409	2.450	5.751	5.837	.7130	.5998	6.975
.1650	.1958	1.230	.8427	1.565	1.857	.9131	.5385	2.461	5.813	5.898	.7117	.5997	6.949
.1660	.1966	1.235	.8442	1.574	1.865	.9132	.5362	2.471	5.874	5.959	.7103	.5996	6.924
.1670	.1975	1.240	.8457	1.584	1.873	.9132	.5339	2.482	5.938	6.021	.7090	.5996	6.900
.1680	.1983	1.246	.8472	1.594	1.882	.9133	.5315	2.492	6.003	6.085	.7076	.5995	6.876
.1690	.1992	1.251	.8486	1.604	1.890	.9133	.5291	2.503	6.066	6.148	.7063	.5994	6.853
.1700	.2000	1.257	.8501	1.614	1.899	.9134	.5267	2.513	6.130	6.212	.7050	.5993	6.830
.1710	.2008	1.262	.8515	1.624	1.907	.9135	.5243	2.523	6.197	6.275	.7036	.5992	6.807
.1720	.2017	1.267	.8529	1.634	1.915	.9136	.5220	2.534	6.262	6.342	.7023	.5991	6.784
.1730	.2025	1.272	.8544	1.644	1.924	.9137	.5197	2.544	6.329	6.407	.7010	.5989	6.761
.1740	.2033	1.277	.8558	1.654	1.933	.9138	.5174	2.555	6.395	6.473	.6997	.5988	6.738
.1750	.2042	1.282	.8572	1.664	1.941	.9139	.5151	2.565	6.465	6.541	.6984	.5987	6.716
.1760	.2050	1.288	.8586	1.675	1.951	.9140	.5127	2.576	6.534	6.610	.6971	.5985	6.694
.1770	.2058	1.293	.8600	1.685	1.959	.9141	.5104	2.586	6.603	6.679	.6958	.5984	6.672
.1780	.2066	1.298	.8614	1.695	1.968	.9142	.5081	2.597	6.672	6.747	.6946	.5982	6.651
.1790	.2075	1.304	.8627	1.706	1.977	.9144	.5058	2.607	6.744	6.818	.6933	.5980	6.631
.1800	.2083	1.309	.8640	1.716	1.986	.9145	.5036	2.618	6.818	6.891	.6920	.5979	6.611
.1810	.2092	1.314	.8653	1.727	1.995	.9146	.5013	2.629	6.890	6.963	.6907	.5977	6.591
.1820	.2100	1.320	.8666	1.737	2.004	.9148	.4990	2.639	6.963	7.035	.6895	.5975	6.571
.1830	.2108	1.325	.8680	1.748	2.013	.9149	.4967	2.650	7.038	7.109	.6882	.5974	6.550
.1840	.2117	1.330	.8693	1.758	2.022	.9150	.4945	2.660	7.113	7.183	.6870	.5972	6.530
.1850	.2125	1.335	.8706	1.769	2.032	.9152	.4922	2.671	7.191	7.260	.6857	.5969	6.511
.1860	.2134	1.341	.8718	1.780	2.041	.9154	.4899	2.681	7.267	7.336	.6845	.5967	6.492
.1870	.2142	1.346	.8731	1.791	2.051	.9155	.4876	2.692	7.345	7.412	.6832	.5965	6.474
.1880	.2150	1.351	.8743	1.801	2.060	.9157	.4854	2.702	7.421	7.488	.6820	.5963	6.456
.1890	.2159	1.356	.8755	1.812	2.070	.9159	.4832	2.712	7.500	7.566	.6808	.5961	6.438
.1900	.2167	1.362	.8767	1.823	2.079	.9161	.4809	2.723	7.581	7.647	.6796	.5958	6.421
.1910	.2176	1.367	.8779	1.834	2.089	.9163	.4787	2.734	7.663	7.728	.6784	.5955	6.403
.1920	.2184	1.372	.8791	1.845	2.099	.9165	.4765	2.744	7.746	7.810	.6772	.5952	6.385
.1930	.2192	1.377	.8803	1.856	2.108	.9167	.4743	2.755	7.827	7.891	.6760	.5950	6.368
.1940	.2201	1.383	.8815	1.867	2.118	.9169	.4721	2.765	7.911	7.974	.6748	.5948	6.351
.1950	.2209	1.388	.8827	1.879	2.128	.9170	.4699	2.776	7.996	8.059	.6736	.5946	6.334
.1960	.2218	1.393	.8839	1.890	2.138	.9172	.4677	2.787	8.083	8.145	.6724	.5944	6.317
.1970	.2226	1.399	.8850	1.901	2.148	.9174	.4655	2.797	8.167	8.228	.6712	.5941	6.300
.1980	.2234	1.404	.8862	1.913	2.158	.9176	.4633	2.808	8.256	8.316	.6700	.5938	6.284
.1990	.2243	1.409	.8873	1.924	2.169	.9179	.4611	2.819	8.346	8.406	.6689	.5935	6.268
.2000	.2251	1.414	.8884	1.935	2.178	.9181	.4590	2.829	8.436	8.495	.6677	.5932	6.253
.2010	.2260	1.420	.8895	1.947	2.189	.9183	.4569	2.840	8.524	8.583	.6666	.5929	6.237
.2020	.2268	1.425	.8906	1.959	2.199	.9186	.4547	2.850	8.616	8.674	.6654	.5926	6.222
.2030	.2277	1.430	.8917	1.970	2.210	.9188	.4526	2.861	8.708	8.766	.6642	.5923	6.206
.2040	.2285	1.436	.8928	1.982	2.220	.9190	.4504	2.872	8.803	8.860	.6631	.5920	6.191
.2050	.2293	1.441	.8939	1.994	2.231	.9193	.4483	2.882	8.897	8.953	.6620	.5917	6.176
.2060	.2302	1.446	.8950	2.006	2.242	.9195	.4462	2.893	8.994	9.050	.6608	.5914	6.161
.2070	.2310	1.451	.8960	2.017	2.252	.9197	.4441	2.903	9.090	9.144	.6597	.5911	6.147
.2080	.2319	1.457	.8971	2.030	2.263	.9200	.4419	2.914	9.187	9.240	.6586	.5908	6.133
.2090	.2328	1.462	.8981	2.042	2.274	.9202	.4398	2.925	9.288	9.342	.6574	.5905	6.119

Table C-1. Continued

d/L_0	d/L	$2\pi d/L$	TANH $2\pi d/L$	SINH $2\pi d/L$	COSH $2\pi d/L$	H/H' °	K	$4\pi d/L$	SINH $4\pi d/L$	COSH $4\pi d/L$	n	C_G/C_0	M
.2100	.2336	1.468	.8991	2.055	2.285	.9205	.4377	2.936	9.389	9.442	.6563	.5901	6.105
.2110	.2344	1.473	.9001	2.066	2.295	.9207	.4357	2.946	9.490	9.542	.6552	.5898	6.091
.2120	.2353	1.479	.9011	2.079	2.307	.9210	.4336	2.957	9.590	9.642	.6541	.5894	6.077
.2130	.2361	1.484	.9021	2.091	2.318	.9213	.4315	2.967	9.693	9.744	.6531	.5891	6.064
.2140	.2370	1.489	.9031	2.103	2.329	.9215	.4294	2.978	9.796	9.847	.6520	.5888	6.051
.2150	.2378	1.494	.9041	2.115	2.340	.9218	.4274	2.989	9.902	9.952	.6509	.5884	6.037
.2160	.2387	1.500	.9051	2.128	2.351	.9221	.4253	2.999	10.01	10.06	.6498	.5881	6.024
.2170	.2395	1.506	.9061	2.142	2.364	.9223	.4232	3.010	10.12	10.17	.6488	.5878	6.011
.2180	.2404	1.511	.9070	2.154	2.375	.9226	.4211	3.021	10.23	10.28	.6477	.5874	5.999
.2190	.2412	1.516	.9079	2.166	2.386	.9228	.4191	3.031	10.34	10.38	.6467	.5871	5.987
.2200	.2421	1.521	.9088	2.178	2.397	.9231	.4171	3.042	10.45	10.50	.6456	.5868	5.975
.2210	.2429	1.526	.9097	2.192	2.409	.9234	.4151	3.052	10.56	10.61	.6446	.5864	5.963
.2220	.2438	1.532	.9107	2.204	2.421	.9236	.4131	3.063	10.68	10.72	.6436	.5861	5.951
.2230	.2446	1.537	.9116	2.218	2.433	.9239	.4111	3.074	10.79	10.84	.6425	.5857	5.939
.2240	.2455	1.542	.9125	2.230	2.444	.9242	.4091	3.085	10.91	10.95	.6414	.5854	5.927
.2250	.2463	1.548	.9134	2.244	2.457	.9245	.4071	3.095	11.02	11.07	.6404	.5850	5.915
.2260	.2472	1.553	.9143	2.257	2.469	.9248	.4051	3.106	11.15	11.19	.6394	.5846	5.903
.2270	.2481	1.559	.9152	2.271	2.481	.9251	.4031	3.117	11.27	11.31	.6383	.5842	5.891
.2280	.2489	1.564	.9161	2.284	2.493	.9254	.4011	3.128	11.39	11.44	.6373	.5838	5.880
.2290	.2498	1.569	.9170	2.297	2.506	.9258	.3991	3.138	11.51	11.56	.6363	.5834	5.869
.2300	.2506	1.575	.9178	2.311	2.518	.9261	.3971	3.149	11.64	11.68	.6353	.5830	5.858
.2310	.2515	1.580	.9186	2.325	2.531	.9264	.3952	3.160	11.77	11.81	.6343	.5826	5.848
.2320	.2523	1.585	.9194	2.338	2.543	.9267	.3932	3.171	11.90	11.93	.6333	.5823	5.838
.2330	.2532	1.591	.9203	2.352	2.556	.9270	.3912	3.182	12.03	12.07	.6323	.5819	5.827
.2340	.2540	1.596	.9211	2.366	2.569	.9273	.3893	3.192	12.15	12.19	.6313	.5815	5.816
.2350	.2549	1.602	.9219	2.380	2.581	.9276	.3874	3.203	12.29	12.33	.6304	.5811	5.806
.2360	.2558	1.607	.9227	2.393	2.594	.9279	.3855	3.214	12.43	12.47	.6294	.5807	5.796
.2370	.2566	1.612	.9235	2.408	2.607	.9282	.3836	3.225	12.55	12.59	.6284	.5804	5.786
.2380	.2575	1.618	.9243	2.422	2.620	.9285	.3816	3.236	12.69	12.73	.6275	.5800	5.776
.2390	.2584	1.623	.9251	2.436	2.634	.9288	.3797	3.247	12.83	12.87	.6265	.5796	5.766
.2400	.2592	1.629	.9259	2.450	2.647	.9291	.3779	3.257	12.97	13.01	.6256	.5792	5.756
.2410	.2601	1.634	.9267	2.464	2.660	.9294	.3760	3.268	13.11	13.15	.6246	.5788	5.746
.2420	.2610	1.640	.9275	2.480	2.674	.9298	.3741	3.279	13.26	13.30	.6237	.5784	5.736
.2430	.2618	1.645	.9282	2.494	2.687	.9301	.3722	3.290	13.40	13.44	.6228	.5780	5.727
.2440	.2627	1.650	.9289	2.508	2.700	.9304	.3704	3.301	13.55	13.59	.6218	.5776	5.718
.2450	.2635	1.656	.9296	2.523	2.714	.9307	.3685	3.312	13.70	13.73	.6209	.5772	5.710
.2460	.2644	1.661	.9304	2.538	2.728	.9310	.3666	3.323	13.85	13.88	.6200	.5768	5.701
.2470	.2653	1.667	.9311	2.553	2.742	.9314	.3648	3.334	14.00	14.04	.6191	.5764	5.692
.2480	.2661	1.672	.9318	2.568	2.755	.9317	.3629	3.344	14.15	14.19	.6182	.5760	5.684
.2490	.2670	1.678	.9325	2.583	2.770	.9320	.3610	3.355	14.31	14.35	.6173	.5756	5.675
.2500	.2679	1.683	.9332	2.599	2.784	.9323	.3592	3.367	14.47	14.51	.6164	.5752	5.667
.2510	.2687	1.689	.9339	2.614	2.798	.9327	.3574	3.377	14.62	14.66	.6155	.5748	5.658
.2520	.2696	1.694	.9346	2.629	2.813	.9330	.3556	3.388	14.79	14.82	.6146	.5744	5.650
.2530	.2705	1.700	.9353	2.645	2.828	.9333	.3537	3.399	14.95	14.99	.6137	.5740	5.641
.2540	.2714	1.705	.9360	2.660	2.842	.9336	.3519	3.410	15.12	15.15	.6128	.5736	5.633
.2550	.2722	1.711	.9367	2.676	2.856	.9340	.3501	3.421	15.29	15.32	.6120	.5732	5.624
.2560	.2731	1.716	.9374	2.691	2.871	.9343	.3483	3.432	15.45	15.49	.6111	.5728	5.616
.2570	.2740	1.722	.9381	2.707	2.886	.9346	.3465	3.443	15.63	15.66	.6102	.5724	5.608
.2580	.2749	1.727	.9388	2.723	2.901	.9349	.3447	3.454	15.80	15.83	.6093	.5720	5.600
.2590	.2757	1.732	.9394	2.739	2.916	.9353	.3430	3.465	15.97	16.00	.6085	.5716	5.592
.2600	.2766	1.738	.9400	2.755	2.931	.9356	.3412	3.476	16.15	16.18	.6076	.5712	5.585
.2610	.2775	1.744	.9406	2.772	2.946	.9360	.3394	3.487	16.33	16.36	.6068	.5707	5.578
.2620	.2784	1.749	.9412	2.788	2.962	.9363	.3376	3.498	16.51	16.54	.6060	.5703	5.571
.2630	.2792	1.755	.9418	2.804	2.977	.9367	.3359	3.509	16.69	16.73	.6052	.5699	5.563
.2640	.2801	1.760	.9425	2.820	2.992	.9370	.3342	3.520	16.88	16.91	.6043	.5695	5.556
.2650	.2810	1.766	.9431	2.837	3.008	.9373	.3325	3.531	17.07	17.10	.6035	.5691	5.548
.2660	.2819	1.771	.9437	2.853	3.023	.9377	.3308	3.542	17.26	17.28	.6027	.5687	5.541
.2670	.2827	1.776	.9443	2.870	3.039	.9380	.3291	3.553	17.45	17.45	.6018	.5683	5.534
.2680	.2836	1.782	.9449	2.886	3.055	.9383	.3274	3.564	17.64	17.67	.6010	.5679	5.527
.2690	.2845	1.788	.9455	2.904	3.071	.9386	.3256	3.575	17.84	17.87	.6002	.5675	5.520

Table C-1. Continued

d/L ₀	d/L	2π d/L	TANH 2π d/L	SINH 2π d/L	COSH 2π d/L	H/H ₀	K	4π d/L	SINH 4π d/L	COSH 4π d/L	n	C ₀ /C ₀	M
.2700	.2854	1.793	.9461	2.921	3.088	.9390	.3239	3.587	18.04	18.07	.5994	.5671	5.513
.2710	.2863	1.799	.9467	2.938	3.104	.9393	.3222	3.598	18.24	18.27	.5986	.5667	5.506
.2720	.2872	1.804	.9473	2.956	3.120	.9396	.3205	3.610	18.46	18.49	.5978	.5663	5.499
.2730	.2880	1.810	.9478	2.973	3.136	.9400	.3189	3.620	18.65	18.67	.5971	.5659	5.493
.2740	.2889	1.815	.9484	2.990	3.153	.9403	.3172	3.631	18.86	18.89	.5963	.5655	5.486
.2750	.2898	1.821	.9490	3.008	3.170	.9406	.3155	3.642	19.07	19.10	.5955	.5651	5.480
.2760	.2907	1.826	.9495	3.025	3.186	.9410	.3139	3.653	19.28	19.30	.5947	.5647	5.474
.2770	.2916	1.832	.9500	3.043	3.203	.9413	.3122	3.664	19.49	19.51	.5940	.5643	5.468
.2780	.2924	1.837	.9505	3.061	3.220	.9416	.3106	3.675	19.71	19.74	.5932	.5639	5.462
.2790	.2933	1.843	.9511	3.079	3.237	.9420	.3089	3.686	19.93	19.96	.5925	.5635	5.456
.2800	.2942	1.849	.9516	3.097	3.254	.9423	.3073	3.697	20.16	20.18	.5917	.5631	5.450
.2810	.2951	1.854	.9521	3.115	3.272	.9426	.3057	3.709	20.39	20.41	.5910	.5627	5.444
.2820	.2960	1.860	.9526	3.133	3.289	.9430	.3040	3.720	20.62	20.64	.5902	.5623	5.438
.2830	.2969	1.866	.9532	3.152	3.307	.9433	.3024	3.731	20.85	20.87	.5895	.5619	5.432
.2840	.2978	1.871	.9537	3.171	3.325	.9436	.3008	3.742	21.09	21.11	.5887	.5615	5.426
.2850	.2987	1.877	.9542	3.190	3.343	.9440	.2992	3.754	21.33	21.35	.5880	.5611	5.420
.2860	.2996	1.882	.9547	3.209	3.361	.9443	.2976	3.765	21.57	21.59	.5873	.5607	5.414
.2870	.3005	1.888	.9552	3.228	3.379	.9446	.2959	3.776	21.82	21.84	.5866	.5603	5.409
.2880	.3014	1.893	.9557	3.246	3.396	.9449	.2944	3.787	22.05	22.07	.5859	.5600	5.403
.2890	.3022	1.899	.9562	3.264	3.414	.9452	.2929	3.798	22.30	22.32	.5852	.5596	5.397
.2900	.3031	1.905	.9567	3.284	3.433	.9456	.2913	3.809	22.54	22.57	.5845	.5592	5.392
.2910	.3040	1.910	.9572	3.303	3.451	.9459	.2898	3.821	22.81	22.83	.5838	.5588	5.386
.2920	.3049	1.916	.9577	3.323	3.471	.9463	.2882	3.832	23.07	23.09	.5831	.5584	5.380
.2930	.3058	1.922	.9581	3.343	3.490	.9466	.2866	3.843	23.33	23.35	.5824	.5580	5.375
.2940	.3067	1.927	.9585	3.362	3.508	.9469	.2851	3.855	23.60	23.62	.5817	.5576	5.371
.2950	.3076	1.933	.9590	3.382	3.527	.9473	.2835	3.866	23.86	23.88	.5810	.5572	5.366
.2960	.3085	1.938	.9594	3.402	3.546	.9476	.2820	3.877	24.12	24.15	.5804	.5568	5.361
.2970	.3094	1.944	.9599	3.422	3.565	.9480	.2805	3.888	24.40	24.42	.5797	.5564	5.356
.2980	.3103	1.950	.9603	3.442	3.585	.9483	.2790	3.900	24.68	24.70	.5790	.5560	5.351
.2990	.3112	1.955	.9607	3.462	3.604	.9486	.2775	3.911	24.96	24.98	.5784	.5556	5.347
.3000	.3121	1.961	.9611	3.483	3.624	.9490	.2760	3.922	25.24	25.26	.5777	.5552	5.342
.3010	.3130	1.967	.9616	3.503	3.643	.9493	.2745	3.933	25.53	25.55	.5771	.5549	5.337
.3020	.3139	1.972	.9620	3.524	3.663	.9496	.2730	3.945	25.82	25.83	.5764	.5545	5.332
.3030	.3148	1.978	.9624	3.545	3.683	.9499	.2715	3.956	26.12	26.14	.5758	.5541	5.328
.3040	.3157	1.984	.9629	3.566	3.703	.9502	.2700	3.968	26.42	26.44	.5751	.5538	5.323
.3050	.3166	1.989	.9633	3.587	3.724	.9505	.2685	3.979	26.72	26.74	.5745	.5534	5.318
.3060	.3175	1.995	.9637	3.609	3.745	.9509	.2670	3.990	27.02	27.04	.5739	.5530	5.314
.3070	.3184	2.001	.9641	3.630	3.765	.9512	.2656	4.002	27.33	27.35	.5732	.5527	5.309
.3080	.3193	2.007	.9645	3.651	3.786	.9515	.2641	4.013	27.65	27.66	.5726	.5523	5.305
.3090	.3202	2.012	.9649	3.673	3.806	.9518	.2627	4.024	27.96	27.98	.5720	.5519	5.300
.3100	.3211	2.018	.9653	3.694	3.827	.9522	.2613	4.036	28.28	28.30	.5714	.5515	5.296
.3110	.3220	2.023	.9656	3.716	3.848	.9525	.2599	4.047	28.60	28.62	.5708	.5511	5.292
.3120	.3230	2.029	.9660	3.738	3.870	.9528	.2584	4.058	28.93	28.95	.5701	.5507	5.288
.3130	.3239	2.035	.9664	3.760	3.891	.9531	.2570	4.070	29.27	29.28	.5695	.5504	5.284
.3140	.3248	2.041	.9668	3.782	3.912	.9535	.2556	4.081	29.60	29.62	.5689	.5500	5.280
.3150	.3257	2.046	.9672	3.805	3.934	.9538	.2542	4.093	29.94	29.96	.5683	.5497	5.276
.3160	.3266	2.052	.9676	3.828	3.956	.9541	.2528	4.104	30.29	30.31	.5678	.5494	5.272
.3170	.3275	2.058	.9679	3.851	3.978	.9544	.2514	4.116	30.64	30.65	.5672	.5490	5.268
.3180	.3284	2.063	.9682	3.873	4.000	.9547	.2500	4.127	30.99	31.00	.5666	.5486	5.264
.3190	.3294	2.069	.9686	3.896	4.022	.9550	.2486	4.139	31.35	31.37	.5660	.5483	5.260
.3200	.3302	2.075	.9690	3.919	4.045	.9553	.2472	4.150	31.71	31.72	.5655	.5479	5.256
.3210	.3311	2.081	.9693	3.943	4.068	.9556	.2459	4.161	32.07	32.08	.5649	.5476	5.252
.3220	.3321	2.086	.9696	3.966	4.090	.9559	.2445	4.173	32.44	32.46	.5643	.5472	5.249
.3230	.3330	2.092	.9700	3.990	4.114	.9562	.2431	4.185	32.83	32.84	.5637	.5468	5.245
.3240	.3339	2.098	.9703	4.014	4.136	.9565	.2418	4.196	33.20	33.22	.5632	.5465	5.241
.3250	.3349	2.104	.9707	4.038	4.160	.9568	.2404	4.208	33.60	33.61	.5627	.5462	5.237
.3260	.3357	2.110	.9710	4.061	4.183	.9571	.2391	4.219	33.97	33.99	.5621	.5458	5.234
.3270	.3367	2.115	.9713	4.085	4.206	.9574	.2378	4.231	34.37	34.38	.5616	.5455	5.231
.3280	.3376	2.121	.9717	4.110	4.230	.9577	.2364	4.242	34.77	34.79	.5610	.5451	5.227
.3290	.3385	2.127	.9720	4.135	4.254	.9580	.2351	4.254	35.18	35.19	.5605	.5448	5.223

Table C-1. Continued.

d/L _o	d/L	2π d/L	TANH 2π d/L	SINH 2π d/L	COSH 2π d/L	H/H _o	K	4π d/L	SINH 4π d/L	COSH 4π d/L	n	C _o /C _o	M
.3300	.3394	2.133	.9723	4.159	4.277	.9583	.2338	4.265	35.58	35.59	.5599	.5444	5.220
.3310	.3403	2.138	.9726	4.181	4.301	.9586	.2325	4.277	35.99	36.00	.5594	.5441	5.217
.3320	.3413	2.144	.9729	4.209	4.326	.9589	.2312	4.288	36.42	36.43	.5589	.5438	5.214
.3330	.3422	2.150	.9732	4.234	4.350	.9592	.2299	4.300	36.84	36.85	.5584	.5434	5.210
.3340	.3431	2.156	.9735	4.259	4.375	.9595	.2286	4.311	37.25	37.27	.5578	.5431	5.207
.3350	.3440	2.161	.9738	4.284	4.399	.9598	.2273	4.323	37.70	37.72	.5573	.5427	5.204
.3360	.3449	2.167	.9741	4.310	4.424	.9601	.2260	4.335	38.14	38.15	.5568	.5424	5.201
.3370	.3459	2.173	.9744	4.336	4.450	.9604	.2247	4.346	38.59	38.60	.5563	.5421	5.198
.3380	.3468	2.179	.9747	4.361	4.474	.9607	.2235	4.358	39.02	39.04	.5558	.5417	5.194
.3390	.3477	2.185	.9750	4.388	4.500	.9610	.2222	4.369	39.48	39.49	.5553	.5414	5.191
.3400	.3468	2.190	.9753	4.413	4.525	.9613	.2210	4.381	39.95	39.96	.5548	.5411	5.188
.3410	.3495	2.196	.9756	4.439	4.550	.9615	.2198	4.392	40.40	40.41	.5544	.5408	5.185
.3420	.3504	2.202	.9758	4.466	4.576	.9618	.2185	4.404	40.87	40.89	.5539	.5405	5.182
.3430	.3514	2.208	.9761	4.492	4.602	.9621	.2173	4.416	41.36	41.37	.5534	.5402	5.179
.3440	.3523	2.214	.9764	4.521	4.630	.9623	.2160	4.427	41.85	41.84	.5529	.5399	5.176
.3450	.3532	2.220	.9767	4.547	4.656	.9626	.2148	4.439	42.33	42.34	.5524	.5396	5.173
.3460	.3542	2.225	.9769	4.575	4.682	.9629	.2136	4.451	42.83	42.84	.5519	.5392	5.171
.3470	.3551	2.231	.9772	4.602	4.709	.9632	.2124	4.462	43.34	43.35	.5515	.5389	5.168
.3480	.3560	2.237	.9775	4.629	4.736	.9635	.2111	4.474	43.85	43.86	.5510	.5386	5.165
.3490	.3570	2.243	.9777	4.657	4.763	.9638	.2099	4.486	44.37	44.40	.5505	.5383	5.162
.3500	.3579	2.249	.9780	4.685	4.791	.9640	.2087	4.498	44.89	44.80	.5501	.5380	5.159
.3510	.3588	2.255	.9782	4.713	4.818	.9643	.2076	4.509	45.42	45.43	.5496	.5377	5.157
.3520	.3598	2.260	.9785	4.741	4.845	.9646	.2064	4.521	45.95	45.96	.5492	.5374	5.154
.3530	.3607	2.266	.9787	4.770	4.873	.9648	.2052	4.533	46.50	46.51	.5487	.5371	5.152
.3540	.3616	2.272	.9790	4.798	4.901	.9651	.2040	4.544	47.03	47.04	.5483	.5368	5.149
.3550	.3625	2.278	.9792	4.827	4.929	.9654	.2029	4.556	47.59	47.60	.5479	.5365	5.147
.3560	.3635	2.284	.9795	4.856	4.957	.9657	.2017	4.568	48.15	48.16	.5474	.5362	5.144
.3570	.3644	2.290	.9797	4.885	4.987	.9659	.2005	4.579	48.72	48.73	.5470	.5359	5.141
.3580	.3653	2.296	.9799	4.914	5.015	.9662	.1994	4.591	49.29	49.30	.5466	.5356	5.139
.3590	.3663	2.301	.9801	4.944	5.044	.9665	.1983	4.603	49.88	49.89	.5461	.5353	5.137
.3600	.3672	2.307	.9804	4.974	5.072	.9667	.1972	4.615	50.47	50.48	.5457	.5350	5.134
.3610	.3682	2.313	.9806	5.004	5.103	.9670	.1960	4.627	51.07	51.09	.5453	.5347	5.132
.3620	.3691	2.319	.9808	5.034	5.132	.9673	.1949	4.638	51.67	51.67	.5449	.5344	5.130
.3630	.3700	2.325	.9811	5.063	5.161	.9675	.1938	4.650	52.27	52.28	.5445	.5342	5.127
.3640	.3709	2.331	.9813	5.094	5.191	.9677	.1926	4.661	52.89	52.90	.5441	.5339	5.125
.3650	.3719	2.337	.9815	5.124	5.221	.9680	.1915	4.673	53.52	53.53	.5437	.5336	5.123
.3660	.3728	2.342	.9817	5.155	5.251	.9683	.1904	4.685	54.15	54.16	.5433	.5333	5.121
.3670	.3737	2.348	.9819	5.186	5.281	.9686	.1894	4.697	54.78	54.79	.5429	.5330	5.118
.3680	.3747	2.354	.9821	5.217	5.312	.9688	.1883	4.708	55.42	55.43	.5425	.5327	5.116
.3690	.3756	2.360	.9823	5.248	5.343	.9690	.1872	4.720	56.09	56.10	.5421	.5325	5.114
.3700	.3766	2.366	.9825	5.280	5.374	.9693	.1861	4.732	56.76	56.77	.5417	.5322	5.112
.3710	.3775	2.372	.9827	5.312	5.406	.9696	.1850	4.744	57.43	57.44	.5413	.5319	5.110
.3720	.3785	2.378	.9830	5.345	5.438	.9698	.1839	4.756	58.13	58.14	.5409	.5317	5.107
.3730	.3794	2.384	.9832	5.377	5.469	.9700	.1828	4.768	58.82	58.83	.5405	.5314	5.105
.3740	.3804	2.390	.9834	5.410	5.502	.9702	.1818	4.780	59.52	59.53	.5402	.5312	5.103
.3750	.3813	2.396	.9835	5.443	5.534	.9705	.1807	4.792	60.24	60.25	.5398	.5309	5.101
.3760	.3822	2.402	.9837	5.475	5.566	.9707	.1797	4.803	60.95	60.95	.5394	.5306	5.099
.3770	.3832	2.408	.9839	5.508	5.598	.9709	.1786	4.815	61.68	61.68	.5390	.5304	5.097
.3780	.3841	2.413	.9841	5.541	5.631	.9712	.1776	4.827	62.42	62.42	.5387	.5301	5.095
.3790	.3850	2.419	.9843	5.572	5.661	.9714	.1766	4.838	63.13	63.14	.5383	.5299	5.093
.3800	.3860	2.425	.9845	5.609	5.697	.9717	.1756	4.851	63.91	63.91	.5380	.5296	5.091
.3810	.3869	2.431	.9847	5.643	5.731	.9719	.1745	4.862	64.67	64.67	.5376	.5294	5.090
.3820	.3879	2.437	.9848	5.677	5.765	.9721	.1735	4.875	65.45	65.46	.5372	.5291	5.088
.3830	.3888	2.443	.9850	5.712	5.798	.9724	.1725	4.885	66.16	66.17	.5369	.5288	5.086
.3840	.3898	2.449	.9852	5.746	5.833	.9726	.1715	4.898	67.02	67.03	.5365	.5286	5.084
.3850	.3907	2.455	.9854	5.780	5.866	.9728	.1705	4.910	67.80	67.81	.5362	.5284	5.082
.3860	.3917	2.461	.9855	5.814	5.900	.9730	.1695	4.922	68.61	68.62	.5359	.5281	5.081
.3870	.3926	2.467	.9857	5.850	5.935	.9732	.1685	4.934	69.45	69.46	.5355	.5279	5.079
.3880	.3936	2.473	.9859	5.886	5.970	.9735	.1675	4.946	70.28	70.29	.5352	.5276	5.077
.3890	.3945	2.479	.9860	5.921	6.005	.9737	.1665	4.958	71.12	71.13	.5349	.5274	5.076

Table C-1. Continued.

d/L_0	d/L	$2\pi d/L$	TANH $2\pi d/L$	SINH $2\pi d/L$	COSH $2\pi d/L$	H/H_0	K	$4\pi d/L$	SINH $4\pi d/L$	COSH $4\pi d/L$	n	C_G/C_0	M
.3900	.3955	2.485	.9862	5.957	6.040	.9739	.1656	4.970	71.97	71.98	.5345	.5271	5.074
.3910	.3964	2.491	.9864	5.993	6.076	.9741	.1646	4.982	72.85	72.86	.5342	.5269	5.072
.3920	.3974	2.497	.9865	6.029	6.112	.9743	.1636	4.993	73.72	73.72	.5339	.5267	5.071
.3930	.3983	2.503	.9867	6.066	6.148	.9745	.1627	5.005	74.58	74.59	.5336	.5265	5.069
.3940	.3993	2.509	.9869	6.103	6.185	.9748	.1617	5.017	75.48	75.49	.5332	.5262	5.067
.3950	.4002	2.515	.9870	6.140	6.221	.9750	.1608	5.029	76.40	76.40	.5329	.5260	5.066
.3960	.4012	2.521	.9872	6.177	6.258	.9752	.1598	5.041	77.31	77.32	.5326	.5258	5.064
.3970	.4021	2.527	.9873	6.215	6.295	.9754	.1589	5.053	78.24	78.24	.5323	.5255	5.063
.3980	.4031	2.532	.9874	6.252	6.332	.9756	.1579	5.065	79.19	79.19	.5320	.5253	5.062
.3990	.4040	2.538	.9876	6.290	6.369	.9758	.1570	5.077	80.13	80.13	.5317	.5251	5.060
.4000	.4050	2.544	.9877	6.329	6.407	.9761	.1561	5.089	81.12	81.12	.5314	.5248	5.058
.4010	.4059	2.550	.9879	6.367	6.445	.9763	.1552	5.101	82.07	82.08	.5311	.5246	5.056
.4020	.4069	2.556	.9880	6.406	6.483	.9765	.1542	5.113	83.06	83.06	.5308	.5244	5.055
.4030	.4078	2.562	.9882	6.444	6.521	.9766	.1533	5.125	84.07	84.07	.5305	.5242	5.053
.4040	.4088	2.568	.9883	6.484	6.561	.9768	.1524	5.137	85.11	85.12	.5302	.5240	5.052
.4050	.4098	2.575	.9885	6.525	6.601	.9770	.1515	5.149	86.14	86.14	.5299	.5238	5.050
.4060	.4107	2.581	.9886	6.564	6.640	.9772	.1506	5.161	87.17	87.17	.5296	.5236	5.049
.4070	.4116	2.586	.9887	6.603	6.679	.9774	.1497	5.173	88.19	88.20	.5293	.5234	5.048
.4080	.4126	2.592	.9889	6.644	6.718	.9776	.1488	5.185	89.28	89.28	.5290	.5232	5.046
.4090	.4136	2.598	.9890	6.684	6.758	.9778	.1480	5.197	90.38	90.39	.5287	.5229	5.045
.4100	.4145	2.604	.9891	6.725	6.799	.9780	.1471	5.209	91.44	91.44	.5285	.5227	5.044
.4110	.4155	2.610	.9892	6.766	6.839	.9782	.1462	5.221	92.54	92.55	.5282	.5225	5.043
.4120	.4164	2.616	.9894	6.806	6.879	.9784	.1454	5.233	93.67	93.67	.5279	.5223	5.041
.4130	.4174	2.622	.9895	6.849	6.921	.9786	.1445	5.245	94.83	94.83	.5277	.5221	5.040
.4140	.4183	2.629	.9896	6.890	6.963	.9788	.1436	5.257	95.95	95.96	.5274	.5219	5.039
.4150	.4193	2.635	.9898	6.932	7.004	.9790	.1428	5.269	97.13	97.13	.5271	.5217	5.037
.4160	.4203	2.641	.9899	6.974	7.046	.9792	.1419	5.281	98.29	98.30	.5269	.5215	5.036
.4170	.4212	2.647	.9900	7.018	7.088	.9794	.1411	5.294	99.52	99.52	.5266	.5213	5.035
.4180	.4222	2.653	.9901	7.060	7.130	.9795	.1403	5.305	100.7	100.7	.5263	.5211	5.034
.4190	.4231	2.659	.9902	7.102	7.173	.9797	.1394	5.317	101.9	101.9	.5261	.5209	5.033
.4200	.4241	2.665	.9904	7.146	7.215	.9798	.1386	5.329	103.1	103.1	.5258	.5208	5.031
.4210	.4251	2.671	.9905	7.190	7.259	.9800	.1378	5.341	104.4	104.4	.5256	.5206	5.030
.4220	.4260	2.677	.9906	7.234	7.303	.9802	.1369	5.353	105.7	105.7	.5253	.5204	5.029
.4230	.4270	2.683	.9907	7.279	7.349	.9804	.1361	5.366	107.0	107.0	.5251	.5202	5.028
.4240	.4280	2.689	.9908	7.325	7.392	.9806	.1353	5.378	108.3	108.3	.5248	.5200	5.027
.4250	.4289	2.695	.9909	7.371	7.438	.9808	.1345	5.390	109.7	109.7	.5246	.5198	5.026
.4260	.4298	2.701	.9910	7.412	7.479	.9810	.1337	5.402	110.9	110.9	.5244	.5196	5.025
.4270	.4308	2.707	.9911	7.457	7.524	.9811	.1329	5.414	112.2	112.2	.5241	.5195	5.024
.4280	.4318	2.713	.9912	7.503	7.570	.9812	.1321	5.426	113.6	113.6	.5239	.5193	5.023
.4290	.4328	2.719	.9913	7.550	7.616	.9814	.1313	5.438	115.0	115.0	.5237	.5191	5.022
.4300	.4337	2.725	.9914	7.595	7.661	.9816	.1305	5.450	116.4	116.4	.5234	.5189	5.021
.4310	.4347	2.731	.9915	7.642	7.707	.9818	.1298	5.462	117.8	117.8	.5232	.5187	5.020
.4320	.4356	2.737	.9916	7.688	7.753	.9819	.1290	5.474	119.2	119.3	.5230	.5186	5.019
.4330	.4366	2.743	.9917	7.735	7.800	.9821	.1282	5.486	120.7	120.7	.5227	.5184	5.018
.4340	.4376	2.749	.9918	7.783	7.847	.9823	.1274	5.499	122.2	122.2	.5225	.5182	5.017
.4350	.4385	2.755	.9919	7.831	7.895	.9824	.1267	5.511	123.7	123.7	.5223	.5181	5.016
.4360	.4395	2.762	.9920	7.880	7.943	.9826	.1259	5.523	125.2	125.2	.5221	.5179	5.015
.4370	.4405	2.768	.9921	7.922	7.991	.9828	.1251	5.535	126.7	126.7	.5218	.5177	5.014
.4380	.4414	2.774	.9922	7.975	8.035	.9829	.1244	5.547	128.3	128.3	.5216	.5176	5.013
.4390	.4424	2.780	.9923	8.026	8.088	.9830	.1236	5.560	129.9	129.9	.5214	.5174	5.012
.4400	.4434	2.786	.9924	8.075	8.136	.9832	.1229	5.572	131.4	131.4	.5212	.5172	5.011
.4410	.4443	2.792	.9925	8.124	8.185	.9833	.1222	5.584	133.0	133.0	.5210	.5171	5.010
.4420	.4453	2.798	.9926	8.175	8.236	.9835	.1214	5.596	134.7	134.7	.5208	.5169	5.009
.4430	.4463	2.804	.9927	8.228	8.285	.9836	.1207	5.608	136.3	136.3	.5206	.5168	5.008
.4440	.4472	2.810	.9928	8.274	8.334	.9838	.1200	5.620	137.9	137.9	.5204	.5166	5.007
.4450	.4482	2.816	.9929	8.326	8.387	.9839	.1192	5.632	139.6	139.7	.5202	.5165	5.006
.4460	.4492	2.822	.9930	8.379	8.438	.9841	.1185	5.644	141.4	141.4	.5200	.5163	5.005
.4470	.4501	2.828	.9930	8.427	8.486	.9843	.1178	5.657	143.1	143.1	.5198	.5161	5.005
.4480	.4511	2.834	.9931	8.481	8.540	.9844	.1171	5.669	144.8	144.8	.5196	.5160	5.004
.4490	.4521	2.840	.9932	8.532	8.590	.9846	.1164	5.681	146.6	146.6	.5194	.5158	5.003

Table C-1. Continued.

d/L _o	d/L	2π d/L	TANH 2π d/L	SINH 2π d/L	COSH 2 d/L	H/H _o	K	4π d/L	SINH 4π d/L	COSH 4π d/L	n	C _g /C _o	M
.4500	.4531	2.847	.9933	8.585	8.643	.9847	.1157	5.693	148.4	148.4	.5192	.5157	5.002
.4510	.4540	2.853	.9934	8.638	8.695	.9848	.1150	5.705	150.2	150.2	.5190	.5156	5.001
.4520	.4550	2.859	.9935	8.693	8.750	.9849	.1143	5.717	152.1	152.1	.5188	.5154	5.000
.4530	.4560	2.865	.9935	8.747	8.804	.9851	.1136	5.730	154.0	154.0	.5186	.5152	5.000
.4540	.4569	2.871	.9936	8.797	8.854	.9852	.1129	5.742	155.9	155.9	.5184	.5151	4.999
.4550	.4579	2.877	.9937	8.853	8.910	.9853	.1122	5.754	157.7	157.7	.5182	.5150	4.998
.4560	.4589	2.883	.9938	8.910	8.965	.9855	.1115	5.766	159.7	159.7	.5181	.5148	4.997
.4570	.4599	2.890	.9938	8.965	9.021	.9857	.1109	5.779	161.7	161.7	.5179	.5146	4.997
.4580	.4608	2.896	.9939	9.016	9.072	.9858	.1102	5.791	163.6	163.6	.5177	.5145	4.996
.4590	.4618	2.902	.9940	9.074	9.129	.9859	.1095	5.803	165.6	165.6	.5175	.5144	4.995
.4600	.4628	2.908	.9941	9.132	9.186	.9860	.1089	5.815	167.7	167.7	.5173	.5143	4.994
.4610	.4637	2.914	.9941	9.183	9.238	.9862	.1083	5.827	169.7	169.7	.5172	.5141	4.994
.4620	.4647	2.920	.9942	9.242	9.296	.9863	.1076	5.840	171.8	171.8	.5170	.5140	4.993
.4630	.4657	2.926	.9943	9.301	9.354	.9864	.1069	5.852	173.9	173.9	.5168	.5139	4.992
.4640	.4666	2.932	.9944	9.353	9.406	.9865	.1063	5.864	176.0	176.0	.5167	.5138	4.991
.4650	.4676	2.938	.9944	9.413	9.466	.9867	.1056	5.876	178.2	178.2	.5165	.5136	4.991
.4660	.4686	2.944	.9945	9.472	9.525	.9868	.1050	5.888	180.4	180.4	.5163	.5135	4.990
.4670	.4695	2.951	.9946	9.533	9.585	.9869	.1043	5.900	182.6	182.6	.5162	.5134	4.989
.4680	.4705	2.957	.9946	9.586	9.638	.9871	.1037	5.912	184.8	184.8	.5160	.5132	4.989
.4690	.4715	2.963	.9947	9.647	9.699	.9872	.1031	5.925	187.2	187.2	.5158	.5131	4.988
.4700	.4725	2.969	.9947	9.709	9.760	.9873	.1025	5.937	189.5	189.5	.5157	.5129	4.988
.4710	.4735	2.975	.9948	9.770	9.821	.9874	.1018	5.949	191.8	191.8	.5155	.5128	4.987
.4720	.4744	2.981	.9949	9.826	9.877	.9875	.1012	5.962	194.2	194.2	.5154	.5127	4.986
.4730	.4754	2.987	.9949	9.888	9.938	.9876	.1006	5.974	196.5	196.5	.5152	.5126	4.986
.4740	.4764	2.993	.9950	9.951	10.00	.9877	.1000	5.986	199.0	199.0	.5150	.5125	4.985
.4750	.4774	2.999	.9951	10.01	10.07	.9878	.09942	5.999	201.4	201.4	.5149	.5124	4.984
.4760	.4783	3.005	.9951	10.07	10.12	.9880	.09882	6.011	203.9	203.9	.5147	.5122	4.984
.4770	.4793	3.012	.9952	10.13	10.18	.9881	.09820	6.023	206.5	206.5	.5146	.5121	4.983
.4780	.4803	3.018	.9952	10.20	10.25	.9882	.09759	6.036	209.0	209.0	.5144	.5120	4.983
.4790	.4813	3.024	.9953	10.26	10.31	.9883	.09698	6.048	211.7	211.7	.5143	.5119	4.982
.4800	.4822	3.030	.9953	10.32	10.37	.9885	.09641	6.060	214.2	214.2	.5142	.5117	4.982
.4810	.4832	3.036	.9954	10.39	10.43	.9886	.09583	6.072	216.8	216.8	.5140	.5116	4.981
.4820	.4842	3.042	.9955	10.45	10.50	.9887	.09523	6.085	219.5	219.5	.5139	.5115	4.980
.4830	.4852	3.049	.9955	10.52	10.57	.9888	.09464	6.097	222.2	222.2	.5137	.5114	4.980
.4840	.4862	3.055	.9956	10.59	10.63	.9889	.09405	6.109	225.0	225.0	.5136	.5113	4.979
.4850	.4871	3.061	.9956	10.65	10.69	.9890	.09352	6.121	228.3	228.3	.5134	.5112	4.979
.4860	.4881	3.067	.9957	10.71	10.76	.9891	.09294	6.134	230.6	230.6	.5133	.5111	4.978
.4870	.4891	3.073	.9957	10.78	10.83	.9892	.09236	6.146	233.5	233.5	.5132	.5110	4.978
.4880	.4901	3.079	.9958	10.85	10.90	.9893	.09178	6.159	236.4	236.4	.5130	.5109	4.977
.4890	.4911	3.086	.9958	10.92	10.96	.9895	.09121	6.171	239.6	239.6	.5129	.5107	4.977
.4900	.4920	3.092	.9959	10.99	11.03	.9896	.09064	6.183	242.3	242.3	.5128	.5106	4.976
.4910	.4930	3.098	.9959	11.05	11.09	.9897	.09010	6.195	245.2	245.2	.5126	.5105	4.976
.4920	.4940	3.104	.9960	11.12	11.16	.9898	.08956	6.208	248.3	248.3	.5125	.5104	4.975
.4930	.4950	3.110	.9960	11.19	11.24	.9899	.08901	6.220	251.3	251.3	.5124	.5103	4.975
.4940	.4960	3.117	.9961	11.26	11.31	.9899	.08845	6.232	254.5	254.5	.5122	.5102	4.974
.4950	.4969	3.122	.9961	11.32	11.37	.9900	.08793	6.245	257.6	257.6	.5121	.5101	4.974
.4960	.4979	3.128	.9962	11.40	11.44	.9901	.08741	6.257	260.8	260.8	.5120	.5100	4.973
.4970	.4989	3.135	.9962	11.47	11.51	.9902	.08691	6.269	264.0	264.0	.5119	.5099	4.973
.4980	.4999	3.141	.9963	11.54	11.59	.9903	.08637	6.282	267.3	267.3	.5118	.5098	4.972
.4990	.5009	3.147	.9963	11.61	11.65	.9904	.08584	6.294	270.6	270.6	.5116	.5097	4.972
.5000	.5018	3.153	.9964	11.68	11.72	.9905	.08530	6.306	274.0	274.0	.5115	.5096	4.971
.5010	.5028	3.159	.9964	11.75	11.80	.9906	.08477	6.319	277.5	277.5	.5114	.5095	4.971
.5020	.5038	3.166	.9964	11.83	11.87	.9907	.08424	6.331	280.8	280.8	.5113	.5094	4.971
.5030	.5048	3.172	.9965	11.91	11.95	.9908	.08371	6.343	284.3	284.3	.5112	.5093	4.970
.5040	.5058	3.178	.9965	11.98	12.02	.9909	.08320	6.356	287.9	287.9	.5110	.5092	4.970
.5050	.5067	3.184	.9966	12.05	12.09	.9909	.08270	6.368	291.4	291.4	.5109	.5092	4.969
.5060	.5077	3.190	.9966	12.12	12.16	.9910	.08220	6.380	295.0	295.0	.5108	.5091	4.969
.5070	.5087	3.196	.9967	12.20	12.24	.9911	.08169	6.393	298.7	298.7	.5107	.5090	4.968
.5080	.5097	3.203	.9967	12.28	12.32	.9912	.08119	6.405	302.4	302.4	.5106	.5089	4.968
.5090	.5107	3.209	.9968	12.35	12.39	.9913	.08068	6.417	306.2	306.2	.5105	.5088	4.967

Table C-1. Continued.

d/L ₀	d/L	2π d/L	TANH 2π d/L	SINH 2π d/L	COSH 2π d/L	H/H' ₀	K	4π d/L	SINH 4π d/L	COSH 4π d/L	n	C _G /C ₀	M
.5100	.5117	3.215	.9968	12.43	12.47	.9914	.08022	6.430	310.0	310.0	.5104	.5087	4.967
.5110	.5126	3.221	.9968	12.50	12.54	.9915	.07972	6.442	313.8	313.8	.5103	.5086	4.967
.5120	.5136	3.227	.9969	12.58	12.62	.9915	.07922	6.454	317.7	317.7	.5102	.5086	4.966
.5130	.5146	3.233	.9969	12.66	12.70	.9916	.07873	6.467	321.7	321.7	.5101	.5085	4.966
.5140	.5156	3.240	.9970	12.74	12.78	.9917	.07824	6.479	325.7	325.7	.5100	.5084	4.965
.5150	.5166	3.246	.9970	12.82	12.86	.9918	.07776	6.491	329.7	329.7	.5098	.5083	4.965
.5160	.5176	3.252	.9970	12.90	12.94	.9919	.07729	6.504	333.8	333.8	.5097	.5082	4.965
.5170	.5185	3.258	.9971	12.98	13.02	.9919	.07682	6.516	337.9	337.9	.5096	.5082	4.964
.5180	.5195	3.264	.9971	13.06	13.10	.9920	.07634	6.529	342.2	342.2	.5095	.5081	4.964
.5190	.5205	3.270	.9971	13.14	13.18	.9921	.07587	6.541	346.4	346.4	.5094	.5080	4.964
.5200	.5215	3.277	.9972	13.22	13.26	.9922	.07540	6.553	350.7	350.7	.5093	.5079	4.963
.5210	.5225	3.283	.9972	13.31	13.35	.9923	.07494	6.566	355.1	355.1	.5092	.5078	4.963
.5220	.5235	3.289	.9972	13.39	13.43	.9924	.07449	6.578	359.6	359.6	.5092	.5077	4.963
.5230	.5244	3.295	.9973	13.47	13.51	.9924	.07404	6.590	364.0	364.0	.5091	.5077	4.962
.5240	.5254	3.301	.9973	13.55	13.59	.9925	.07358	6.603	368.5	368.5	.5090	.5076	4.962
.5250	.5264	3.308	.9973	13.64	13.68	.9926	.07312	6.615	373.1	373.1	.5089	.5075	4.962
.5260	.5274	3.314	.9974	13.73	13.76	.9927	.07266	6.628	377.8	377.8	.5088	.5074	4.961
.5270	.5284	3.320	.9974	13.81	13.85	.9927	.07221	6.640	382.5	382.5	.5087	.5074	4.961
.5280	.5294	3.326	.9974	13.90	13.94	.9928	.07177	6.652	387.3	387.3	.5086	.5073	4.961
.5290	.5304	3.333	.9975	13.99	14.02	.9929	.07134	6.665	392.2	392.2	.5085	.5072	4.960
.5300	.5314	3.339	.9975	14.07	14.10	.9930	.07091	6.677	397.0	397.0	.5084	.5071	4.960
.5310	.5323	3.345	.9975	14.16	14.19	.9931	.07047	6.690	402.0	402.0	.5083	.5070	4.960
.5320	.5333	3.351	.9976	14.25	14.28	.9931	.07003	6.702	406.9	406.9	.5082	.5070	4.959
.5330	.5343	3.357	.9976	14.34	14.37	.9932	.06959	6.714	412.0	412.0	.5082	.5069	4.959
.5340	.5353	3.363	.9976	14.43	14.46	.9933	.06915	6.727	417.2	417.2	.5081	.5068	4.959
.5350	.5363	3.370	.9976	14.52	14.55	.9933	.06872	6.739	422.4	422.4	.5080	.5068	4.959
.5360	.5373	3.376	.9977	14.61	14.64	.9934	.06829	6.752	427.7	427.7	.5079	.5067	4.958
.5370	.5383	3.382	.9977	14.70	14.73	.9935	.06787	6.764	433.1	433.1	.5078	.5066	4.958
.5380	.5393	3.388	.9977	14.79	14.82	.9935	.06746	6.776	438.5	438.5	.5077	.5066	4.958
.5390	.5402	3.394	.9977	14.88	14.91	.9936	.06705	6.789	444.0	444.0	.5077	.5065	4.958
.5400	.5412	3.401	.9978	14.97	15.01	.9936	.06664	6.801	449.5	449.5	.5076	.5065	4.957
.5410	.5422	3.407	.9978	15.07	15.10	.9937	.06623	6.814	455.1	455.1	.5075	.5064	4.957
.5420	.5432	3.413	.9978	15.16	15.19	.9938	.06582	6.826	460.7	460.7	.5074	.5063	4.957
.5430	.5442	3.419	.9979	15.25	15.29	.9938	.06542	6.838	466.4	466.4	.5073	.5063	4.956
.5440	.5452	3.426	.9979	15.35	15.38	.9939	.06501	6.851	472.2	472.2	.5073	.5062	4.956
.5450	.5461	3.432	.9979	15.45	15.48	.9940	.06461	6.863	478.1	478.1	.5072	.5061	4.956
.5460	.5471	3.438	.9979	15.54	15.58	.9941	.06420	6.876	484.3	484.3	.5071	.5060	4.956
.5470	.5481	3.444	.9980	15.64	15.67	.9941	.06380	6.888	490.3	490.3	.5070	.5060	4.955
.5480	.5491	3.450	.9980	15.74	15.77	.9942	.06341	6.901	496.4	496.4	.5070	.5059	4.955
.5490	.5501	3.456	.9980	15.84	15.87	.9942	.06302	6.913	502.5	502.5	.5069	.5059	4.955
.5500	.5511	3.463	.9980	15.94	15.97	.9942	.06263	6.925	508.7	508.7	.5068	.5058	4.955
.5510	.5521	3.469	.9981	16.04	16.07	.9942	.06224	6.937	515.0	515.0	.5067	.5058	4.954
.5520	.5531	3.475	.9981	16.14	16.17	.9943	.06186	6.950	521.6	521.6	.5067	.5057	4.954
.5530	.5541	3.481	.9981	16.24	16.27	.9944	.06148	6.962	528.1	528.1	.5066	.5056	4.954
.5540	.5551	3.488	.9981	16.34	16.37	.9944	.06110	6.975	534.8	534.8	.5065	.5056	4.954
.5550	.5560	3.494	.9982	16.44	16.47	.9945	.06073	6.987	541.4	541.4	.5065	.5056	4.953
.5560	.5570	3.500	.9982	16.54	16.57	.9945	.06035	7.000	548.1	548.1	.5064	.5055	4.953
.5570	.5580	3.506	.9982	16.65	16.68	.9946	.05997	7.012	554.9	554.9	.5063	.5054	4.953
.5580	.5590	3.512	.9982	16.75	16.78	.9947	.05960	7.025	562.0	562.0	.5063	.5053	4.953
.5590	.5600	3.519	.9982	16.85	16.88	.9947	.05923	7.037	569.1	569.1	.5062	.5053	4.953
.5600	.5610	3.525	.9983	16.96	16.99	.9947	.05887	7.050	576.1	576.1	.5061	.5053	4.952
.5610	.5620	3.531	.9983	17.06	17.09	.9948	.05850	7.062	583.3	583.3	.5061	.5052	4.952
.5620	.5630	3.537	.9983	17.17	17.20	.9949	.05814	7.074	590.7	590.7	.5060	.5051	4.952
.5630	.5640	3.543	.9983	17.28	17.31	.9949	.05778	7.087	598.0	598.0	.5059	.5051	4.952
.5640	.5649	3.550	.9984	17.38	17.41	.9950	.05743	7.099	605.0	605.0	.5059	.5050	4.951
.5650	.5659	3.556	.9984	17.49	17.52	.9950	.05707	7.112	613.2	613.2	.5058	.5050	4.951
.5660	.5669	3.562	.9984	17.60	17.63	.9951	.05672	7.124	620.8	620.8	.5057	.5049	4.951
.5670	.5679	3.568	.9984	17.71	17.74	.9951	.05637	7.136	628.5	628.5	.5057	.5049	4.951
.5680	.5689	3.575	.9984	17.82	17.85	.9952	.05602	7.149	636.4	636.4	.5056	.5048	4.951
.5690	.5699	3.581	.9985	17.94	17.97	.9952	.05567	7.161	644.3	644.3	.5056	.5048	4.950

Table C-1. Continued.

d/L _o	d/L	2πd/L	TANH 2πd/L	SINH 2πd/L	COSH 2πd/L	H/H' °	K	4πd/L	SINH 4πd/L	COSH 4πd/L	n	c _G /c _o	M
.5700	.5709	3.587	.9985	18.05	18.08	.9953	.05532	7.174	652.4	652.4	.5055	.5047	4.950
.5710	.5719	3.593	.9985	18.16	18.19	.9953	.05497	7.186	660.5	660.5	.5054	.5047	4.950
.5720	.5729	3.600	.9985	18.28	18.31	.9954	.05463	7.199	668.8	668.8	.5054	.5046	4.950
.5730	.5738	3.606	.9985	18.39	18.42	.9954	.05430	7.211	677.2	677.2	.5053	.5046	4.950
.5740	.5748	3.612	.9985	18.50	18.53	.9955	.05396	7.224	685.6	685.6	.5053	.5045	4.950
.5750	.5758	3.618	.9986	18.62	18.64	.9955	.05363	7.236	694.3	694.3	.5052	.5045	4.949
.5760	.5768	3.624	.9986	18.73	18.76	.9956	.05330	7.249	703.2	703.2	.5052	.5044	4.949
.5770	.5778	3.630	.9986	18.85	18.88	.9956	.05297	7.261	711.5	711.5	.5051	.5044	4.949
.5780	.5788	3.637	.9986	18.97	19.00	.9957	.05264	7.274	720.8	720.8	.5051	.5043	4.949
.5790	.5798	3.643	.9986	19.09	19.12	.9957	.05231	7.286	729.9	729.9	.5050	.5043	4.949
.5800	.5808	3.649	.9987	19.21	19.24	.9957	.05198	7.298	739.0	739.0	.5049	.5043	4.948
.5810	.5818	3.656	.9987	19.33	19.36	.9958	.05166	7.311	748.1	748.1	.5049	.5042	4.948
.5820	.5828	3.662	.9987	19.45	19.48	.9958	.05134	7.323	757.5	757.5	.5048	.5042	4.948
.5830	.5838	3.668	.9987	19.58	19.60	.9959	.05102	7.336	767.0	767.0	.5048	.5041	4.948
.5840	.5848	3.674	.9987	19.70	19.73	.9959	.05070	7.348	776.7	776.7	.5047	.5041	4.948
.5850	.5858	3.680	.9987	19.81	19.84	.9960	.05040	7.361	786.5	786.5	.5047	.5040	4.948
.5860	.5867	3.686	.9987	19.94	19.96	.9960	.05009	7.373	796.4	796.4	.5046	.5040	4.948
.5870	.5877	3.693	.9988	20.06	20.09	.9960	.04978	7.386	806.5	806.5	.5046	.5040	4.947
.5880	.5887	3.699	.9988	20.19	20.21	.9961	.04947	7.398	816.5	816.5	.5045	.5039	4.947
.5890	.5897	3.705	.9988	20.32	20.34	.9961	.04916	7.411	826.7	826.7	.5045	.5039	4.947
.5900	.5907	3.712	.9988	20.45	20.47	.9962	.04885	7.423	837.1	837.1	.5044	.5038	4.947
.5910	.5917	3.718	.9988	20.57	20.60	.9962	.04855	7.436	847.6	847.6	.5044	.5038	4.947
.5920	.5927	3.724	.9988	20.70	20.73	.9963	.04824	7.448	858.2	858.2	.5043	.5037	4.947
.5930	.5937	3.730	.9989	20.83	20.86	.9963	.04794	7.460	868.9	868.9	.5043	.5037	4.946
.5940	.5947	3.737	.9989	20.97	20.99	.9963	.04764	7.473	879.8	879.8	.5043	.5037	4.946
.5950	.5957	3.743	.9989	21.10	21.12	.9964	.04735	7.485	890.8	890.8	.5042	.5036	4.946
.5960	.5967	3.749	.9989	21.23	21.25	.9964	.04706	7.498	901.9	901.9	.5042	.5036	4.946
.5970	.5977	3.755	.9989	21.35	21.37	.9964	.04677	7.510	913.4	913.4	.5041	.5036	4.946
.5980	.5987	3.761	.9989	21.49	21.51	.9965	.04648	7.523	925.0	925.0	.5041	.5035	4.946
.5990	.5996	3.767	.9989	21.62	21.64	.9965	.04619	7.535	936.5	936.5	.5040	.5035	4.946
.6000	.6006	3.774	.9990	21.76	21.78	.9965	.04591	7.548	948.1	948.1	.5040	.5035	4.945
.6100	.6106	3.836	.9991	23.17	23.19	.9969	.04313	7.673	1,074	1,074	.5036	.5031	4.944
.6200	.6205	3.899	.9992	24.66	24.68	.9972	.04052	7.798	1,217	1,217	.5032	.5028	4.943
.6300	.6305	3.961	.9993	26.25	26.27	.9975	.03806	7.923	1,379	1,379	.5029	.5025	4.942
.6400	.6404	4.024	.9994	27.95	27.97	.9977	.03576	8.048	1,527	1,527	.5026	.5023	4.941
.6500	.6504	4.086	.9994	29.75	29.77	.9980	.03359	8.173	1,771	1,771	.5023	.5020	4.940
.6600	.6603	4.149	.9995	31.68	31.69	.9982	.03155	8.298	2,008	2,008	.5021	.5018	4.940
.6700	.6703	4.212	.9996	33.73	33.74	.9983	.02964	8.423	2,275	2,275	.5019	.5017	4.939
.6800	.6803	4.274	.9996	35.90	35.92	.9985	.02784	8.548	2,579	2,579	.5017	.5015	4.939
.6900	.6902	4.337	.9997	38.23	38.24	.9987	.02615	8.674	2,923	2,923	.5015	.5013	4.938
.7000	.7002	4.400	.9997	40.71	40.72	.9988	.02456	8.799	3,314	3,314	.5013	.5012	4.938
.7100	.7102	4.462	.9997	43.34	43.35	.9989	.02307	8.925	3,757	3,757	.5012	.5011	4.937
.7200	.7202	4.525	.9998	46.14	46.15	.9990	.02167	9.050	4,258	4,258	.5011	.5010	4.937
.7300	.7302	4.588	.9998	49.13	49.14	.9991	.02035	9.175	4,828	4,828	.5010	.5009	4.937
.7400	.7401	4.650	.9998	52.31	52.32	.9992	.01911	9.301	5,473	5,473	.5009	.5008	4.937
.7500	.7501	4.713	.9998	55.70	55.71	.9993	.01795	9.426	6,204	6,204	.5008	.5007	4.936
.7600	.7601	4.776	.9999	59.31	59.31	.9994	.01686	9.552	7,034	7,034	.5007	.5006	4.936
.7700	.7701	4.839	.9999	63.15	63.16	.9995	.01583	9.677	7,976	7,976	.5006	.5005	4.936
.7800	.7801	4.902	.9999	67.24	67.25	.9996	.01487	9.803	9,042	9,042	.5005	.5004	4.936
.7900	.7901	4.964	.9999	71.60	71.60	.9996	.01397	9.929	10,250	10,250	.5005	.5004	4.936
.8000	.8001	5.027	.9999	76.24	76.24	.9996	.01312	10.05	11,620	11,620	.5004	.5004	4.936
.8100	.8101	5.090	.9999	81.18	81.19	.9996	.01232	10.18	13,180	13,180	.5004	.5004	4.936
.8200	.8201	5.153	.9999	86.44	86.44	.9997	.01157	10.31	14,940	14,940	.5003	.5003	4.935
.8300	.8301	5.215	.9999	92.04	92.05	.9997	.01086	10.43	17,340	17,340	.5003	.5003	4.935
.8400	.8400	5.278	1.000	98.00	98.01	.9997	.01020	10.56	19,210	19,210	.5003	.5003	4.935
.8500	.8500	5.341	1.000	104.4	104.4	.9998	.009582	10.68	21,780	21,780	.5002	.5002	4.935
.8600	.8600	5.404	1.000	111.1	111.1	.9998	.009000	10.81	24,690	24,690	.5002	.5002	4.935
.8700	.8700	5.467	1.000	118.3	118.3	.9998	.008451	10.93	28,000	28,000	.5002	.5002	4.935
.8800	.8800	5.529	1.000	126.0	126.0	.9998	.007934	11.06	31,750	31,750	.5002	.5002	4.935
.8900	.8900	5.592	1.000	134.2	134.2	.9998	.007454	11.18	36,000	36,000	.5002	.5002	4.935

Table C-1. Concluded.

d/L_o	d/L	$2\pi d/L$	TANH $2\pi d/L$	SINH $2\pi d/L$	COSH $2\pi d/L$	H/H_o'	K	$4\pi d/L$	SINH $4\pi d/L$	COSH $4\pi d/L$	n	C_G/C_o	M
.9000	.9000	5.655	1.000	142.9	142.9	.9999	.007000	11.31	40,810	40,810	.5001	.5001	4.935
.9100	.9100	5.718	1.000	152.1	152.1	.9999	.006574	11.44	46,280	46,280	.5001	.5001	4.935
.9200	.9200	5.781	1.000	162.0	162.0	.9999	.006173	11.56	52,470	52,470	.5001	.5001	4.935
.9300	.9300	5.844	1.000	172.5	172.5	.9999	.005797	11.69	59,500	59,500	.5001	.5001	4.935
.9400	.9400	5.906	1.000	183.7	183.7	.9999	.005445	11.81	67,470	67,470	.5001	.5001	4.935
.9500	.9500	5.969	1.000	195.6	195.6	.9999	.005114	11.94	76,490	76,490	.5001	.5001	4.935
.9600	.9600	6.032	1.000	208.2	208.2	.9999	.004802	12.06	86,740	86,740	.5001	.5001	4.935
.9700	.9700	6.095	1.000	221.7	221.7	.9999	.004510	12.19	98,340	98,340	.5001	.5001	4.935
.9800	.9800	6.158	1.000	236.1	236.1	.9999	.004235	12.32	111,500	111,500	.5001	.5001	4.935
.9900	.9900	6.220	1.000	251.4	251.4	1.000	.003977	12.44	126,500	126,500	.5000	.5000	4.935
1.000	1.000	6.283	1.000	267.7	267.7	1.000	.003735	12.57	143,400	143,400	.5000	.5000	4.935

after Wiegel, R. L., "Oscillatory Waves," U.S. Army, Beach Erosion Board, Bulletin, Special Issue No. 1, July 1948.

Table C-2. Functions of d/L for even increments of d/L (from 0.0001 to 1.000).

d/L	d/L_o	$2\pi d/L$	TANH $2\pi d/L$	SINH $2\pi d/L$	COSH $2\pi d/L$	H/H_o'	K	$4\pi d/L$	SINH $4\pi d/L$	COSH $4\pi d/L$	n	C_G/C_o	M
0	0	0	0	0	1.0000	∞	1.000	0	0	1.000	1.000	0	∞
.000100	6.283×10^{-8}	.0006283	.0006283	.0006283	1.0000	28.21	1.000	.001257	.001257	1.000	1.000	.0006283	12,500,000
.000200	2.514×10^{-7}	.001257	.001257	.001257	1.0000	19.95	1.000	.002513	.002513	1.000	1.000	.001257	3,125,000
.000300	5.655×10^{-7}	.001885	.001885	.001885	1.0000	16.29	1.000	.003770	.003770	1.000	1.000	.001885	1,389,000
.000400	1.005×10^{-6}	.002513	.002513	.002513	1.0000	14.10	1.000	.005027	.005027	1.000	1.000	.002513	781,300
.000500	1.571×10^{-6}	.003142	.003142	.003142	1.0000	12.62	1.000	.006283	.006283	1.000	1.000	.003142	500,000
.000600	2.226×10^{-6}	.003770	.003770	.003770	1.0000	11.52	1.000	.007540	.007540	1.000	1.000	.003770	347,200
.000700	3.079×10^{-6}	.004398	.004398	.004398	1.0000	10.66	1.000	.008796	.008797	1.000	1.000	.004398	255,100
.000800	4.022×10^{-6}	.005027	.005027	.005027	1.0000	9.974	1.000	.01005	.01005	1.000	1.000	.005026	195,300
.000900	5.090×10^{-6}	.005655	.005655	.005655	1.0000	9.403	1.000	.01131	.01131	1.000	1.000	.005655	154,300
.001000	6.283×10^{-6}	.006283	.006283	.006283	1.0000	8.921	1.000	.01257	.01257	1.000	1.000	.006283	125,000
.001100	7.603×10^{-6}	.006912	.006912	.006912	1.0000	8.506	1.000	.01382	.01382	1.000	1.000	.006912	103,300
.001200	9.048×10^{-6}	.007540	.007540	.007540	1.0000	8.144	1.000	.01508	.01508	1.000	1.000	.007540	86,810
.001300	.00001062	.008168	.008168	.008168	1.0000	7.824	1.000	.01634	.01634	1.000	1.000	.008168	73,970
.001400	.00001231	.008796	.008796	.008797	1.0000	7.539	1.000	.01759	.01759	1.000	1.000	.008796	63,780
.001500	.00001414	.009425	.009425	.009425	1.0000	7.284	1.000	.01885	.01885	1.000	1.000	.009424	55,560
.001600	.00001608	.01005	.01005	.01005	1.0001	7.052	.9999	.02011	.02011	1.000	1.000	.01005	48,830
.001700	.00001816	.01068	.01068	.01068	1.0001	6.842	.9999	.02136	.02136	1.000	1.000	.01068	43,260
.001800	.00002036	.01131	.01131	.01131	1.0001	6.649	.9999	.02262	.02262	1.000	1.000	.01131	38,580
.001900	.00002269	.01194	.01194	.01194	1.0001	6.472	.9999	.02388	.02388	1.000	1.000	.01194	34,630

Table C-2. Continued.

d/L	d/L _o	2π d/L	TANH 2π d/L	SINH 2π d/L	COSH 2π d/L	H/H _o	K	hπ d/L	SINH hπ d/L	COSH hπ d/L	n	c _o /c _o	M
.002000	.00002514	.01257	.01257	.01257	1.0001	6.308	.9999	.02513	.02513	1.000	.9999	.01257	31,250
.002100	.00002772	.01319	.01319	.01320	1.0001	6.156	.9999	.02639	.02639	1.000	.9999	.01319	28,350
.002200	.00003040	.01382	.01382	.01382	1.0001	6.015	.9999	.02765	.02765	1.000	.9999	.01382	25,830
.002300	.00003324	.01445	.01445	.01445	1.0001	5.882	.9999	.02890	.02891	1.000	.9999	.01445	23,630
.002400	.00003619	.01508	.01508	.01508	1.0001	5.759	.9999	.03016	.03016	1.000	.9999	.01508	21,700
.002500	.00003928	.01571	.01571	.01571	1.0001	5.642	.9999	.03142	.03142	1.000	.9999	.01571	20,000
.002600	.00004248	.01634	.01634	.01634	1.0001	5.533	.9999	.03267	.03268	1.001	.9999	.01633	18,190
.002700	.00004579	.01696	.01696	.01697	1.0001	5.429	.9999	.03393	.03394	1.001	.9999	.01696	17,150
.002800	.00004925	.01759	.01759	.01759	1.0002	5.332	.9998	.03519	.03519	1.001	.9999	.01759	15,950
.002900	.00005284	.01822	.01822	.01822	1.0002	5.239	.9998	.03644	.03645	1.001	.9999	.01822	14,870
.003000	.00005652	.01885	.01885	.01885	1.0002	5.151	.9998	.03770	.03771	1.001	.9999	.01885	13,890
.003100	.00006039	.01948	.01948	.01948	1.0002	5.067	.9998	.03896	.03897	1.001	.9999	.01947	13,010
.003200	.00006435	.02011	.02010	.02011	1.0002	4.987	.9998	.04021	.04022	1.001	.9999	.02010	12,210
.003300	.00006841	.02073	.02073	.02073	1.0002	4.911	.9998	.04147	.04148	1.001	.9999	.02073	11,480
.003400	.00007262	.02136	.02136	.02136	1.0002	4.838	.9998	.04273	.04274	1.001	.9998	.02136	10,820
.003500	.00007697	.02199	.02199	.02199	1.0002	4.769	.9998	.04398	.04399	1.001	.9998	.02199	10,210
.003600	.00008140	.02262	.02262	.02262	1.0003	4.702	.9997	.04524	.04525	1.001	.9998	.02261	9,648
.003700	.00008599	.02325	.02324	.02325	1.0003	4.638	.9997	.04650	.04652	1.001	.9998	.02324	9,134
.003800	.00009071	.02388	.02387	.02388	1.0003	4.577	.9997	.04775	.04777	1.001	.9998	.02387	8,660
.003900	.00009551	.02450	.02450	.02451	1.0003	4.518	.9997	.04901	.04903	1.001	.9998	.02449	8,221
.004000	.0001005	.02513	.02513	.02513	1.0003	4.462	.9997	.05027	.05029	1.001	.9998	.02511	7,815
.004100	.0001056	.02576	.02576	.02576	1.0003	4.407	.9997	.05152	.05154	1.001	.9998	.02574	7,439
.004200	.0001108	.02639	.02639	.02639	1.0003	4.354	.9997	.05278	.05280	1.001	.9998	.02637	7,090
.004300	.0001161	.02702	.02701	.02702	1.0004	4.303	.9996	.05404	.05406	1.001	.9998	.02700	6,764
.004400	.0001216	.02765	.02764	.02765	1.0004	4.254	.9996	.05529	.05531	1.002	.9997	.02763	6,460
.004500	.0001272	.02827	.02827	.02828	1.0004	4.207	.9996	.05655	.05658	1.002	.9997	.02825	6,176
.004600	.0001329	.02890	.02889	.02890	1.0004	4.161	.9996	.05781	.05784	1.002	.9997	.02888	5,911
.004700	.0001387	.02953	.02952	.02953	1.0004	4.116	.9996	.05906	.05909	1.002	.9997	.02951	5,662
.004800	.0001447	.03016	.03015	.03016	1.0005	4.073	.9995	.06032	.06035	1.002	.9997	.03014	5,429
.004900	.0001508	.03079	.03078	.03079	1.0005	4.032	.9995	.06158	.06161	1.002	.9997	.03076	5,209
.005000	.0001570	.03142	.03141	.03143	1.0005	3.991	.9995	.06283	.06287	1.002	.9997	.03139	5,003
.005100	.0001634	.03204	.03203	.03205	1.0005	3.951	.9995	.06409	.06413	1.002	.9997	.03202	4,809
.005200	.0001698	.03267	.03266	.03268	1.0005	3.913	.9995	.06535	.06539	1.002	.9996	.03265	4,626
.005300	.0001764	.03330	.03329	.03331	1.0005	3.876	.9995	.06660	.06665	1.002	.9996	.03328	4,453
.005400	.0001832	.03393	.03392	.03394	1.0006	3.840	.9994	.06786	.06791	1.002	.9996	.03391	4,290
.005500	.0001900	.03456	.03455	.03457	1.0006	3.805	.9994	.06911	.06916	1.002	.9996	.03454	4,135
.005600	.0001970	.03519	.03517	.03520	1.0006	3.771	.9994	.07037	.07042	1.002	.9996	.03515	3,989
.005700	.0002041	.03584	.03580	.03582	1.0006	3.738	.9994	.07163	.07169	1.003	.9996	.03579	3,851
.005800	.0002112	.03644	.03642	.03645	1.0007	3.706	.9993	.07288	.07294	1.003	.9996	.03644	3,719
.005900	.0002186	.03707	.03705	.03708	1.0007	3.675	.9993	.07414	.07420	1.003	.9995	.03703	3,594
.006000	.0002261	.03770	.03768	.03771	1.0007	3.644	.9993	.07540	.07547	1.003	.9995	.03766	3,475
.006100	.0002337	.03833	.03831	.03834	1.0007	3.614	.9993	.07665	.07672	1.003	.9995	.03829	3,363
.006200	.0002414	.03896	.03894	.03897	1.0008	3.584	.9992	.07791	.07798	1.003	.9995	.03892	3,255
.006300	.0002492	.03958	.03956	.03959	1.0008	3.556	.9992	.07917	.07925	1.003	.9995	.03954	3,153
.006400	.0002570	.04021	.04019	.04022	1.0008	3.528	.9992	.08042	.08050	1.003	.9995	.04017	3,055
.006500	.0002653	.04084	.04082	.04085	1.0008	3.501	.9992	.08168	.08177	1.003	.9994	.04080	2,962
.006600	.0002735	.04147	.04144	.04148	1.0009	3.475	.9991	.08294	.08303	1.003	.9994	.04142	2,873
.006700	.0002819	.04210	.04207	.04211	1.0009	3.449	.9991	.08419	.08428	1.004	.9994	.04204	2,788
.006800	.0002904	.04273	.04270	.04274	1.0009	3.423	.9991	.08545	.08555	1.004	.9994	.04267	2,707
.006900	.0002990	.04335	.04333	.04336	1.0009	3.398	.9991	.08671	.08681	1.004	.9994	.04330	2,629
.007000	.0003077	.04398	.04395	.04399	1.0010	3.374	.9990	.08796	.08807	1.004	.9994	.04392	2,554
.007100	.0003165	.04461	.04458	.04462	1.0010	3.350	.9990	.08922	.08933	1.004	.9993	.04455	2,483
.007200	.0003254	.04524	.04521	.04525	1.0010	3.327	.9989	.09048	.09060	1.004	.9993	.04518	2,415
.007300	.0003346	.04587	.04584	.04589	1.0011	3.304	.9989	.09173	.09185	1.004	.9993	.04581	2,349
.007400	.0003439	.04650	.04646	.04652	1.0011	3.281	.9989	.09299	.09312	1.004	.9993	.04644	2,286
.007500	.0003532	.04712	.04709	.04714	1.0011	3.260	.9989	.09425	.09438	1.004	.9993	.04706	2,226
.007600	.0003627	.04775	.04772	.04777	1.0011	3.238	.9988	.09550	.09565	1.005	.9992	.04780	2,167
.007700	.0003722	.04838	.04834	.04840	1.0012	3.217	.9988	.09676	.09681	1.005	.9992	.04830	2,112
.007800	.0003820	.04901	.04897	.04903	1.0012	3.197	.9988	.09802	.09817	1.005	.9992	.04893	2,058
.007900	.0003918	.04964	.04960	.04966	1.0012	3.176	.9988	.09927	.09943	1.005	.9992	.04956	2,006

Table C-2. Continued.

d/L	d/L ₀	2π d/L	TANH 2π d/L	SINH 2π d/L	COSH 2π d/L	H/H' ₀	K	4π d/L	SINH 4π d/L	COSH 4π d/L	n	C ₀ /C ₀	M
.008000	.0004018	.05027	.05022	.05029	1.0013	3.157	.9987	.1005	.1007	1.005	.9992	.05018	1,956
.008100	.0004118	.05089	.05085	.05091	1.0013	3.137	.9987	.1018	.1020	1.005	.9991	.05080	1,909
.008200	.0004221	.05152	.05147	.05154	1.0013	3.118	.9987	.1030	.1032	1.005	.9991	.05142	1,862
.008300	.0004324	.05215	.05210	.05217	1.0014	3.099	.9986	.1043	.1045	1.005	.9991	.05205	1,818
.008400	.0004429	.05278	.05273	.05280	1.0014	3.081	.9986	.1056	.1058	1.006	.9991	.05268	1,775
.008500	.0004536	.05341	.05336	.05343	1.0014	3.062	.9986	.1068	.1070	1.006	.9991	.05331	1,733
.008600	.0004644	.05404	.05398	.05406	1.0015	3.044	.9985	.1081	.1083	1.006	.9990	.05394	1,693
.008700	.0004751	.05466	.05461	.05469	1.0015	3.027	.9985	.1093	.1095	1.006	.9990	.05456	1,655
.008800	.0004860	.05529	.05524	.05533	1.0015	3.010	.9985	.1106	.1108	1.006	.9990	.05518	1,617
.008900	.0004972	.05592	.05586	.05595	1.0016	2.993	.9984	.1118	.1121	1.006	.9990	.05580	1,581
.009000	.0005084	.05655	.05649	.05658	1.0016	2.977	.9984	.1131	.1133	1.006	.9989	.05643	1,546
.009100	.0005198	.05718	.05712	.05721	1.0016	2.960	.9984	.1144	.1146	1.006	.9989	.05706	1,513
.009200	.0005312	.05781	.05774	.05784	1.0017	2.944	.9983	.1156	.1158	1.007	.9989	.05768	1,480
.009300	.0005427	.05843	.05836	.05846	1.0017	2.929	.9983	.1169	.1171	1.007	.9989	.05830	1,449
.009400	.0005545	.05906	.05899	.05909	1.0017	2.913	.9983	.1181	.1184	1.007	.9988	.05892	1,418
.009500	.0005664	.05969	.05962	.05973	1.0018	2.898	.9982	.1194	.1196	1.007	.9988	.05955	1,388
.009600	.0005784	.06032	.06025	.06036	1.0018	2.882	.9982	.1206	.1209	1.007	.9988	.06018	1,360
.009700	.0005905	.06095	.06087	.06099	1.0019	2.867	.9981	.1219	.1222	1.007	.9988	.06080	1,332
.009800	.0006027	.06158	.06150	.06162	1.0019	2.853	.9981	.1232	.1235	1.008	.9987	.06142	1,305
.009900	.0006150	.06220	.06212	.06224	1.0019	2.839	.9981	.1244	.1247	1.008	.9987	.06204	1,279
.01000	.0006275	.06283	.06275	.06287	1.0020	2.825	.9980	.1257	.1260	1.0079	.9987	.06267	1,253
.01100	.0007591	.06912	.06901	.06917	1.0024	2.694	.9976	.1382	.1387	1.0096	.9984	.06890	1,036
.01200	.0009031	.07540	.07526	.07547	1.0028	2.580	.9972	.1508	.1513	1.0114	.9981	.07511	871.0
.01300	.001060	.08168	.08150	.08177	1.0033	2.480	.9967	.1634	.1641	1.0134	.9978	.08131	742.9
.01400	.001228	.08795	.08774	.08808	1.0039	2.389	.9961	.1759	.1768	1.0155	.9974	.08751	642.1
.01500	.001410	.09425	.09397	.09439	1.0044	2.310	.9956	.1885	.1896	1.0178	.9970	.09369	558.9
.01600	.001603	.1005	.1002	.1007	1.0051	2.238	.9949	.2011	.2024	1.0203	.9966	.09986	491.6
.01700	.001809	.1068	.1064	.1070	1.0057	2.172	.9943	.2136	.2153	1.0229	.9962	.1060	435.8
.01800	.002027	.1131	.1126	.1133	1.0064	2.112	.9936	.2262	.2281	1.0257	.9958	.1121	389.1
.01900	.002258	.1194	.1188	.1197	1.0071	2.056	.9929	.2388	.2410	1.0286	.9953	.1183	349.5
.02000	.002500	.1257	.1250	.1260	1.008	2.005	.9922	.2513	.2540	1.032	.9947	.1244	315.8
.02100	.002755	.1320	.1312	.1323	1.009	1.958	.9914	.2639	.2669	1.035	.9942	.1305	286.8
.02200	.003022	.1382	.1374	.1387	1.010	1.915	.9905	.2765	.2800	1.038	.9937	.1365	261.5
.02300	.003301	.1445	.1435	.1450	1.011	1.873	.9896	.2890	.2931	1.042	.9931	.1425	239.6
.02400	.003592	.1508	.1497	.1514	1.011	1.834	.9887	.3016	.3062	1.046	.9925	.1485	220.3
.02500	.003895	.1571	.1558	.1577	1.012	1.799	.9878	.3142	.3194	1.050	.9919	.1545	203.3
.02600	.004210	.1634	.1619	.1641	1.013	1.765	.9868	.3267	.3326	1.054	.9912	.1605	188.2
.02700	.004537	.1697	.1680	.1705	1.014	1.733	.9858	.3393	.3458	1.058	.9905	.1665	174.8
.02800	.004876	.1759	.1741	.1768	1.016	1.703	.9847	.3519	.3592	1.063	.9898	.1724	162.7
.02900	.005226	.1822	.1802	.1832	1.017	1.675	.9836	.3644	.3725	1.067	.9891	.1783	151.9
.03000	.005589	.1885	.1863	.1896	1.018	1.648	.9825	.3770	.3860	1.072	.9884	.1841	142.2
.03100	.005963	.1948	.1924	.1960	1.019	1.622	.9813	.3896	.3995	1.077	.9876	.1900	133.4
.03200	.006347	.2011	.1984	.2024	1.020	1.598	.9801	.4021	.4131	1.082	.9868	.1958	125.4
.03300	.006746	.2073	.2044	.2088	1.022	1.575	.9789	.4147	.4267	1.087	.9860	.2016	118.1
.03400	.007155	.2136	.2104	.2153	1.023	1.553	.9776	.4273	.4404	1.093	.9851	.2073	111.4
.03500	.007575	.2199	.2164	.2217	1.024	1.532	.9763	.4398	.4541	1.098	.9843	.2130	105.3
.03600	.008007	.2262	.2224	.2281	1.026	1.512	.9749	.4524	.4680	1.104	.9834	.2187	99.75
.03700	.008450	.2325	.2284	.2346	1.027	1.493	.9736	.4650	.4819	1.110	.9824	.2244	94.61
.03800	.008905	.2388	.2343	.2410	1.029	1.475	.9722	.4775	.4959	1.116	.9815	.2300	89.88
.03900	.009370	.2450	.2403	.2472	1.030	1.457	.9708	.4901	.5099	1.123	.9805	.2356	85.50
.04000	.009847	.2513	.2462	.2540	1.032	1.440	.9693	.5027	.5241	1.129	.9795	.2411	81.43
.04100	.01033	.2576	.2521	.2605	1.033	1.424	.9677	.5152	.5383	1.136	.9785	.2467	77.67
.04200	.01083	.2639	.2579	.2670	1.035	1.408	.9662	.5278	.5526	1.143	.9775	.2521	74.17
.04300	.01134	.2702	.2638	.2735	1.037	1.393	.9646	.5404	.5670	1.150	.9765	.2576	70.91
.04400	.01186	.2765	.2696	.2800	1.039	1.379	.9630	.5529	.5815	1.157	.9754	.2630	67.88
.04500	.01239	.2827	.2754	.2865	1.040	1.365	.9613	.5655	.5961	1.164	.9743	.2684	65.05
.04600	.01294	.2890	.2812	.2931	1.042	1.352	.9596	.5781	.6108	1.172	.9732	.2737	62.39
.04700	.01349	.2953	.2870	.2996	1.044	1.339	.9579	.5906	.6256	1.180	.9721	.2790	59.91
.04800	.01405	.3016	.2928	.3062	1.046	1.326	.9562	.6032	.6404	1.188	.9709	.2843	57.57
.04900	.01463	.3079	.2985	.3128	1.048	1.314	.9544	.6158	.6554	1.196	.9697	.2895	55.38

Table C-2. Continued.

d/L	c/L ₀	2πd/L	TANH 2πd/L	SINH 2πd/L	COSH 2πd/L	H/H ₀	κ	4πd/L	SINH 4πd/L	COSH 4πd/L	n	C ₀ /C ₀	M
.05000	.01521	.3142	.3042	.3194	1.050	1.303	.9526	.6783	.6705	1.204	.9685	.2947	53.32
.05100	.01580	.3204	.3099	.3260	1.052	1.291	.9508	.6409	.6857	1.213	.9673	.2998	51.38
.05200	.01644	.3267	.3156	.3326	1.054	1.281	.9489	.6535	.7010	1.221	.9661	.3049	49.55
.05300	.01702	.3330	.3212	.3392	1.056	1.270	.9470	.6660	.7164	1.230	.9649	.3099	47.82
.05400	.01765	.3393	.3269	.3458	1.058	1.260	.9451	.6786	.7319	1.239	.9636	.3149	46.19
.05500	.01829	.3456	.3325	.3525	1.060	1.250	.9431	.6912	.7475	1.249	.9623	.3199	44.65
.05600	.01893	.3519	.3380	.3592	1.063	1.241	.9411	.7037	.7633	1.258	.9610	.3248	43.19
.05700	.01958	.3581	.3436	.3658	1.065	1.231	.9391	.7163	.7791	1.268	.9597	.3297	41.80
.05800	.02025	.3644	.3491	.3726	1.067	1.222	.9371	.7289	.7951	1.278	.9583	.3346	40.49
.05900	.02092	.3707	.3546	.3793	1.070	1.214	.9350	.7414	.8112	1.288	.9570	.3394	39.24
.06000	.02161	.3770	.3601	.3860	1.072	1.205	.9329	.7540	.8275	1.298	.9556	.3441	38.06
.06100	.02230	.3833	.3656	.3927	1.074	1.197	.9308	.7666	.8439	1.308	.9542	.3488	36.93
.06200	.02300	.3896	.3710	.3995	1.077	1.189	.9286	.7791	.8604	1.319	.9528	.3534	35.86
.06300	.02371	.3958	.3764	.4062	1.079	1.182	.9265	.7917	.8770	1.330	.9514	.3581	34.83
.06400	.02444	.4021	.3818	.4130	1.082	1.174	.9243	.8043	.8938	1.341	.9499	.3626	33.86
.06500	.02516	.4084	.3871	.4199	1.085	1.167	.9220	.8168	.9107	1.353	.9484	.3672	32.93
.06600	.02590	.4147	.3925	.4267	1.087	1.160	.9198	.8294	.9278	1.364	.9470	.3716	32.04
.06700	.02665	.4210	.3978	.4335	1.090	1.153	.9175	.8419	.9450	1.376	.9455	.3761	31.19
.06800	.02739	.4273	.4030	.4404	1.093	1.147	.9152	.8545	.9624	1.388	.9440	.3804	30.38
.06900	.02817	.4335	.4083	.4473	1.095	1.140	.9128	.8671	.9799	1.400	.9424	.3848	29.61
.07000	.02895	.4398	.4135	.4541	1.098	1.134	.9105	.8796	.9976	1.412	.9409	.3891	28.86
.07100	.02973	.4461	.4187	.4611	1.101	1.128	.9081	.8922	1.015	1.425	.9393	.3933	28.15
.07200	.03052	.4524	.4239	.4680	1.104	1.122	.9057	.9048	1.033	1.438	.9378	.3975	27.47
.07300	.03132	.4587	.4290	.4749	1.107	1.116	.9033	.9173	1.052	1.451	.9362	.4016	26.81
.07400	.03213	.4650	.4341	.4819	1.110	1.110	.9008	.9299	1.070	1.464	.9346	.4057	26.18
.07500	.03294	.4712	.4392	.4889	1.113	1.105	.8984	.9425	1.088	1.478	.9330	.4098	25.58
.07600	.03377	.4775	.4443	.4958	1.116	1.099	.8959	.9551	1.107	1.492	.9314	.4138	25.00
.07700	.03460	.4838	.4493	.5029	1.119	1.094	.8934	.9676	1.126	1.506	.9298	.4177	24.45
.07800	.03543	.4901	.4542	.5100	1.123	1.089	.8909	.9802	1.145	1.520	.9281	.4216	23.92
.07900	.03628	.4964	.4593	.5170	1.126	1.084	.8883	.9927	1.164	1.534	.9264	.4255	23.40
.08000	.03714	.5027	.4642	.5241	1.129	1.079	.8857	1.005	1.183	1.549	.9248	.4293	22.90
.08100	.03799	.5089	.4691	.5312	1.132	1.075	.8831	1.018	1.203	1.564	.9231	.4330	22.42
.08200	.03887	.5152	.4740	.5383	1.136	1.070	.8805	1.030	1.223	1.580	.9214	.4367	21.96
.08300	.03975	.5215	.4789	.5455	1.139	1.066	.8779	1.043	1.243	1.595	.9197	.4404	21.52
.08400	.04063	.5278	.4837	.5526	1.143	1.061	.8752	1.056	1.263	1.611	.9179	.4440	21.09
.08500	.04152	.5341	.4885	.5598	1.146	1.057	.8726	1.068	1.283	1.627	.9162	.4476	20.68
.08600	.04242	.5404	.4933	.5670	1.150	1.053	.8699	1.081	1.304	1.643	.9145	.4511	20.28
.08700	.04333	.5466	.4980	.5743	1.153	1.049	.8672	1.093	1.324	1.660	.9127	.4545	19.90
.08800	.04424	.5529	.5027	.5815	1.157	1.045	.8645	1.106	1.346	1.676	.9109	.4579	19.53
.08900	.04516	.5592	.5074	.5888	1.160	1.041	.8617	1.118	1.367	1.693	.9092	.4613	19.17
.09000	.04608	.5655	.5120	.5961	1.164	1.037	.8590	1.131	1.388	1.711	.9074	.4646	18.82
.09100	.04702	.5718	.5167	.6034	1.168	1.034	.8562	1.144	1.410	1.728	.9056	.4679	18.49
.09200	.04796	.5781	.5213	.6108	1.172	1.030	.8534	1.156	1.431	1.746	.9038	.4711	18.16
.09300	.04890	.5843	.5258	.6182	1.176	1.027	.8506	1.169	1.453	1.764	.9020	.4743	17.85
.09400	.04985	.5906	.5303	.6256	1.180	1.023	.8478	1.181	1.476	1.783	.9002	.4774	17.55
.09500	.05081	.5969	.5348	.6330	1.184	1.020	.8450	1.194	1.498	1.801	.8984	.4805	17.26
.09600	.05177	.6032	.5393	.6404	1.188	1.017	.8421	1.206	1.521	1.820	.8966	.4835	16.97
.09700	.05275	.6095	.5438	.6479	1.192	1.014	.8392	1.219	1.544	1.840	.8947	.4865	16.69
.09800	.05372	.6158	.5482	.6554	1.196	1.011	.8364	1.232	1.567	1.859	.8929	.4894	16.42
.09900	.05470	.6220	.5526	.6629	1.200	1.008	.8335	1.244	1.591	1.879	.8910	.4923	16.16
.1000	.05569	.6283	.5569	.6705	1.204	1.005	.8306	1.257	1.615	1.899	.8892	.4952	15.91
.1010	.05668	.6346	.5612	.6781	1.208	1.002	.8277	1.269	1.638	1.920	.8873	.4980	15.67
.1020	.05768	.6409	.5655	.6857	1.213	.9993	.8247	1.282	1.663	1.940	.8854	.5007	15.43
.1030	.05869	.6472	.5698	.6933	1.217	.9966	.8218	1.294	1.687	1.961	.8836	.5034	15.20
.1040	.05970	.6535	.5740	.7010	1.221	.9940	.8189	1.307	1.712	1.983	.8817	.5061	14.98
.1050	.06071	.6597	.5782	.7087	1.226	.9914	.8159	1.319	1.737	2.004	.8798	.5087	14.76
.1060	.06173	.6660	.5824	.7164	1.230	.9891	.8129	1.332	1.762	2.026	.8779	.5113	14.55
.1070	.06276	.6723	.5865	.7241	1.235	.9865	.8100	1.345	1.788	2.049	.8760	.5138	14.35
.1080	.06378	.6786	.5906	.7319	1.239	.9841	.8070	1.357	1.811	2.071	.8741	.5163	14.15
.1090	.06482	.6849	.5947	.7397	1.244	.9818	.8040	1.370	1.840	2.094	.8722	.5187	13.95

Table C-2. Continued.

d/L	d/L ₀	2π d/L	TANH 2π d/L	SINH 2π d/L	COSH 2π d/L	H/H ₀	K	4π d/L	SINH 4π d/L	COSH 4π d/L	n	C ₀ /C ₀	M
.1100	.06586	.6912	.5987	.7475	1.249	.9197	.8010	1.382	1.867	2.118	.8703	.5211	13.77
.1110	.06690	.6974	.6027	.7554	1.253	.9775	.7980	1.395	1.893	2.141	.8684	.5234	13.58
.1120	.06795	.7037	.6067	.7633	1.258	.9753	.7949	1.407	1.920	2.165	.8665	.5257	13.41
.1130	.06901	.7100	.6107	.7712	1.263	.9731	.7919	1.420	1.948	2.189	.8645	.5279	13.23
.1140	.07006	.7163	.6146	.7791	1.268	.9711	.7888	1.433	1.975	2.214	.8626	.5301	13.06
.1150	.07113	.7226	.6185	.7871	1.273	.9691	.7858	1.445	2.003	2.239	.8607	.5323	12.90
.1160	.07220	.7289	.6224	.7951	1.278	.9672	.7827	1.458	2.032	2.264	.8587	.5344	12.74
.1170	.07327	.7351	.6262	.8032	1.283	.9654	.7797	1.470	2.060	2.290	.8568	.5365	12.59
.1180	.07434	.7414	.6300	.8112	1.288	.9635	.7766	1.483	2.089	2.316	.8549	.5386	12.43
.1190	.07542	.7477	.6338	.8193	1.293	.9617	.7735	1.495	2.118	2.343	.8529	.5406	12.29
.1200	.07650	.7540	.6375	.8275	1.298	.9600	.7704	1.508	2.148	2.369	.8510	.5425	12.14
.1210	.07759	.7603	.6412	.8357	1.303	.9583	.7673	1.521	2.178	2.397	.8491	.5444	12.00
.1220	.07868	.7666	.6449	.8439	1.309	.9567	.7642	1.533	2.208	2.424	.8471	.5463	11.87
.1230	.07978	.7728	.6486	.8521	1.314	.9551	.7612	1.546	2.239	2.452	.8452	.5482	11.73
.1240	.08085	.7791	.6520	.8604	1.319	.9535	.7581	1.558	2.270	2.480	.8432	.5500	11.61
.1250	.08198	.7854	.6558	.8687	1.325	.9520	.7549	1.571	2.301	2.509	.8413	.5517	11.48
.1260	.08308	.7917	.6594	.8770	1.330	.9505	.7518	1.583	2.333	2.538	.8393	.5534	11.35
.1270	.08419	.7980	.6629	.8854	1.336	.9490	.7487	1.596	2.365	2.568	.8374	.5551	11.23
.1280	.08530	.8043	.6664	.8938	1.341	.9476	.7456	1.609	2.398	2.598	.8354	.5568	11.11
.1290	.08642	.8105	.6699	.9022	1.347	.9463	.7424	1.621	2.430	2.628	.8335	.5584	11.00
.1300	.08753	.8168	.6733	.9107	1.353	.9450	.7393	1.634	2.464	2.659	.8316	.5599	10.89
.1310	.08866	.8231	.6768	.9192	1.358	.9437	.7362	1.646	2.497	2.690	.8296	.5614	10.78
.1320	.08978	.8294	.6801	.9278	1.364	.9424	.7331	1.659	2.531	2.722	.8277	.5629	10.67
.1330	.09091	.8357	.6835	.9364	1.370	.9412	.7299	1.671	2.566	2.754	.8257	.5644	10.56
.1340	.09204	.8420	.6868	.9450	1.376	.9401	.7268	1.684	2.600	2.786	.8238	.5658	10.46
.1350	.09317	.8482	.6902	.9537	1.382	.9389	.7237	1.696	2.636	2.819	.8218	.5672	10.36
.1360	.09431	.8545	.6934	.9624	1.388	.9378	.7205	1.709	2.671	2.852	.8199	.5685	10.26
.1370	.09544	.8608	.6967	.9711	1.394	.9367	.7174	1.722	2.707	2.886	.8179	.5698	10.17
.1380	.09659	.8671	.6999	.9799	1.400	.9357	.7142	1.734	2.744	2.920	.8160	.5711	10.07
.1390	.09773	.8734	.7031	.9887	1.406	.9347	.7111	1.747	2.781	2.955	.8141	.5724	9.983
.1400	.09888	.8797	.7063	.9976	1.412	.9337	.7080	1.759	2.818	2.990	.8121	.5736	9.894
.1410	.1000	.8859	.7094	1.006	1.419	.9327	.7048	1.772	2.856	3.026	.8102	.5748	9.806
.1420	.1012	.8922	.7125	1.015	1.425	.9318	.7017	1.784	2.894	3.062	.8083	.5759	9.721
.1430	.1023	.8985	.7156	1.024	1.432	.9309	.6985	1.797	2.933	3.099	.8064	.5770	9.638
.1440	.1035	.9048	.7186	1.033	1.438	.9300	.6954	1.810	2.972	3.136	.8044	.5781	9.556
.1450	.1046	.9111	.7216	1.042	1.445	.9292	.6923	1.822	3.012	3.173	.8025	.5791	9.476
.1460	.1058	.9174	.7247	1.052	1.451	.9284	.6891	1.835	3.052	3.211	.8006	.5801	9.398
.1470	.1070	.9236	.7276	1.061	1.458	.9276	.6860	1.847	3.092	3.250	.7987	.5811	9.321
.1480	.1081	.9299	.7306	1.070	1.464	.9268	.6829	1.860	3.133	3.289	.7968	.5821	9.246
.1490	.1093	.9362	.7335	1.079	1.471	.9261	.6797	1.872	3.175	3.329	.7949	.5830	9.173
.1500	.1105	.9425	.7364	1.088	1.478	.9254	.6766	1.885	3.217	3.369	.7930	.5839	9.101
.1510	.1116	.9488	.7392	1.098	1.485	.9247	.6734	1.898	3.260	3.410	.7911	.5848	9.031
.1520	.1128	.9551	.7421	1.107	1.492	.9240	.6703	1.910	3.303	3.451	.7892	.5856	8.962
.1530	.1140	.9613	.7449	1.116	1.499	.9234	.6672	1.923	3.346	3.493	.7873	.5864	8.894
.1540	.1151	.9676	.7477	1.126	1.506	.9228	.6641	1.935	3.391	3.535	.7854	.5872	8.828
.1550	.1163	.9739	.7504	1.135	1.513	.9222	.6610	1.948	3.435	3.578	.7835	.5880	8.763
.1560	.1175	.9802	.7531	1.145	1.520	.9216	.6579	1.960	3.481	3.621	.7816	.5887	8.700
.1570	.1187	.9865	.7558	1.154	1.527	.9211	.6547	1.973	3.526	3.665	.7797	.5893	8.638
.1580	.1199	.9928	.7585	1.164	1.535	.9205	.6516	1.985	3.573	3.710	.7779	.5900	8.577
.1590	.1210	.9990	.7612	1.174	1.542	.9200	.6485	1.998	3.620	3.755	.7760	.5907	8.517
.1600	.1222	1.005	.7638	1.183	1.549	.9196	.6454	2.011	3.667	3.801	.7741	.5913	8.459
.1610	.1234	1.012	.7664	1.193	1.557	.9191	.6423	2.023	3.715	3.847	.7723	.5919	8.401
.1620	.1246	1.018	.7690	1.203	1.564	.9186	.6392	2.036	3.764	3.894	.7704	.5925	8.345
.1630	.1258	1.024	.7716	1.213	1.572	.9182	.6361	2.048	3.813	3.942	.7686	.5930	8.290
.1640	.1270	1.030	.7741	1.223	1.580	.9179	.6331	2.061	3.863	3.990	.7667	.5935	8.236
.1650	.1281	1.037	.7766	1.233	1.587	.9175	.6300	2.073	3.913	4.039	.7649	.5940	8.183
.1660	.1293	1.043	.7791	1.243	1.595	.9171	.6269	2.086	3.964	4.088	.7631	.5945	8.131
.1670	.1305	1.049	.7815	1.253	1.603	.9167	.6239	2.099	4.016	4.138	.7613	.5950	8.079
.1680	.1317	1.056	.7840	1.263	1.611	.9164	.6208	2.111	4.068	4.189	.7595	.5954	8.029
.1690	.1329	1.062	.7864	1.273	1.619	.9161	.6177	2.124	4.121	4.241	.7576	.5958	7.980

Table C-2. Continued.

d/L	d/L ₀	2π d/L	TANH 2π d/L	SINH 2π d/L	COSH 2π d/L	H/H ₀	K	4π d/L	SINH 4π d/L	COSH 4π d/L	n	C ₀ /C ₀	M
.1700	.1341	1.068	.7887	1.283	1.627	.9158	.6147	2.136	4.175	4.293	.7558	.5962	7.932
.1710	.1353	1.074	.7911	1.293	1.635	.9155	.6117	2.149	4.229	4.346	.7540	.5965	7.885
.1720	.1365	1.081	.7935	1.304	1.643	.9153	.6086	2.161	4.284	4.399	.7523	.5969	7.838
.1730	.1377	1.087	.7958	1.314	1.651	.9150	.6056	2.174	4.340	4.454	.7505	.5972	7.793
.1740	.1389	1.093	.7981	1.325	1.660	.9148	.6026	2.187	4.396	4.508	.7487	.5975	7.748
.1750	.1401	1.100	.8004	1.335	1.668	.9146	.5995	2.199	4.453	4.564	.7469	.5978	7.704
.1760	.1413	1.106	.8026	1.345	1.676	.9144	.5965	2.212	4.511	4.620	.7451	.5980	7.661
.1770	.1425	1.112	.8048	1.356	1.685	.9142	.5935	2.224	4.569	4.677	.7434	.5983	7.619
.1780	.1437	1.118	.8070	1.367	1.693	.9140	.5905	2.237	4.628	4.735	.7416	.5985	7.577
.1790	.1449	1.125	.8092	1.377	1.702	.9138	.5875	2.249	4.688	4.793	.7399	.5987	7.536
.1800	.1460	1.131	.8114	1.388	1.711	.9137	.5845	2.262	4.749	4.853	.7382	.5989	7.496
.1810	.1472	1.137	.8135	1.399	1.720	.9136	.5816	2.275	4.810	4.918	.7364	.5991	7.457
.1820	.1484	1.144	.8156	1.410	1.728	.9135	.5786	2.287	4.872	4.974	.7347	.5992	7.419
.1830	.1496	1.150	.8177	1.420	1.737	.9134	.5757	2.300	4.935	5.035	.7330	.5993	7.381
.1840	.1508	1.156	.8198	1.431	1.746	.9133	.5727	2.312	4.999	5.098	.7313	.5995	7.343
.1850	.1520	1.162	.8218	1.442	1.755	.9132	.5697	2.325	5.063	5.161	.7296	.5996	7.307
.1860	.1532	1.169	.8239	1.454	1.764	.9131	.5668	2.337	5.129	5.225	.7279	.5997	7.271
.1870	.1544	1.175	.8259	1.465	1.773	.9131	.5639	2.350	5.195	5.290	.7262	.5997	7.235
.1880	.1556	1.181	.8278	1.476	1.783	.9131	.5610	2.362	5.262	5.356	.7245	.5998	7.201
.1890	.1568	1.188	.8298	1.487	1.792	.9130	.5581	2.375	5.329	5.422	.7228	.5998	7.167
.1900	.1580	1.194	.8318	1.498	1.801	.9130	.5551	2.388	5.398	5.490	.7212	.5998	7.133
.1910	.1592	1.200	.8337	1.510	1.811	.9130	.5522	2.400	5.467	5.558	.7195	.5998	7.100
.1920	.1604	1.206	.8356	1.521	1.820	.9130	.5493	2.413	5.538	5.625	.7179	.5998	7.068
.1930	.1616	1.213	.8375	1.533	1.830	.9130	.5465	2.425	5.609	5.697	.7162	.5998	7.036
.1940	.1628	1.219	.8393	1.544	1.840	.9131	.5436	2.438	5.681	5.768	.7146	.5998	7.005
.1950	.1640	1.225	.8412	1.556	1.849	.9131	.5408	2.450	5.754	5.840	.7129	.5997	6.974
.1960	.1652	1.232	.8430	1.567	1.859	.9131	.5379	2.463	5.827	5.913	.7113	.5997	6.944
.1970	.1664	1.238	.8448	1.579	1.869	.9132	.5350	2.476	5.902	5.988	.7097	.5996	6.914
.1980	.1676	1.244	.8466	1.591	1.879	.9133	.5322	2.488	5.978	6.061	.7081	.5995	6.885
.1990	.1688	1.250	.8484	1.603	1.889	.9133	.5294	2.501	6.055	6.137	.7065	.5994	6.856
.2000	.1700	1.257	.8501	1.614	1.899	.9134	.5266	2.513	6.132	6.213	.7049	.5993	6.828
.2010	.1712	1.263	.8519	1.626	1.909	.9135	.5238	2.526	6.211	6.291	.7033	.5992	6.801
.2020	.1724	1.269	.8535	1.638	1.920	.9137	.5210	2.538	6.290	6.369	.7018	.5990	6.774
.2030	.1736	1.276	.8552	1.651	1.930	.9138	.5182	2.551	6.371	6.449	.7002	.5988	6.747
.2040	.1748	1.282	.8570	1.663	1.940	.9139	.5154	2.564	6.452	6.529	.6987	.5987	6.720
.2050	.1760	1.288	.8586	1.675	1.951	.9140	.5127	2.576	6.535	6.611	.6971	.5986	6.694
.2060	.1772	1.294	.8602	1.687	1.961	.9141	.5099	2.589	6.619	6.694	.6956	.5984	6.669
.2070	.1784	1.301	.8619	1.700	1.972	.9142	.5071	2.601	6.703	6.777	.6941	.5982	6.644
.2080	.1796	1.307	.8635	1.712	1.983	.9144	.5044	2.614	6.789	6.862	.6925	.5980	6.619
.2090	.1808	1.313	.8651	1.725	1.994	.9146	.5016	2.626	6.876	6.948	.6910	.5978	6.594
.2100	.1820	1.320	.8667	1.737	2.004	.9147	.4989	2.639	6.963	7.035	.6895	.5976	6.570
.2110	.1832	1.326	.8682	1.750	2.015	.9149	.4962	2.652	7.052	7.123	.6880	.5973	6.547
.2120	.1844	1.332	.8697	1.762	2.026	.9151	.4935	2.664	7.143	7.219	.6865	.5971	6.524
.2130	.1856	1.338	.8713	1.775	2.037	.9153	.4908	2.677	7.234	7.302	.6850	.5969	6.501
.2140	.1868	1.345	.8728	1.788	2.049	.9155	.4881	2.689	7.326	7.394	.6835	.5966	6.479
.2150	.1880	1.351	.8743	1.801	2.060	.9157	.4854	2.702	7.420	7.487	.6821	.5963	6.457
.2160	.1892	1.357	.8757	1.814	2.071	.9159	.4828	2.714	7.514	7.580	.6806	.5960	6.435
.2170	.1904	1.364	.8772	1.827	2.083	.9161	.4801	2.727	7.610	7.675	.6792	.5958	6.413
.2180	.1915	1.370	.8786	1.840	2.094	.9164	.4775	2.739	7.707	7.772	.6777	.5955	6.393
.2190	.1927	1.376	.8801	1.853	2.106	.9166	.4749	2.752	7.805	7.869	.6763	.5952	6.372
.2200	.1939	1.382	.8815	1.867	2.118	.9168	.4722	2.765	7.905	7.968	.6749	.5949	6.351
.2210	.1951	1.389	.8829	1.880	2.129	.9170	.4696	2.777	8.006	8.068	.6735	.5946	6.331
.2220	.1963	1.395	.8842	1.893	2.141	.9173	.4670	2.790	8.108	8.169	.6720	.5943	6.312
.2230	.1975	1.401	.8856	1.907	2.153	.9175	.4644	2.802	8.211	8.272	.6706	.5939	6.292
.2240	.1987	1.407	.8869	1.920	2.165	.9178	.4619	2.815	8.316	8.375	.6692	.5936	6.273
.2250	.1999	1.414	.8883	1.934	2.177	.9181	.4593	2.827	8.422	8.481	.6679	.5933	6.254
.2260	.2011	1.420	.8896	1.948	2.189	.9183	.4567	2.840	8.529	8.587	.6665	.5929	6.236
.2270	.2022	1.426	.8909	1.962	2.202	.9186	.4542	2.853	8.637	8.695	.6651	.5925	6.218
.2280	.2034	1.433	.8922	1.975	2.214	.9189	.4516	2.865	8.756	8.800	.6637	.5921	6.200
.2290	.2046	1.439	.8935	1.989	2.227	.9191	.4491	2.878	8.859	8.915	.6624	.5918	6.182

Table C-2. Continued.

d/L	c/L _c	2π d/L	TANH 2π d/L	SINH 2π d/L	COSH 2π d/L	H/H ₀	K	4π d/L	SINH 4π d/L	COSH 4π d/L	n	C _G /C ₀	M
.2300	.2058	1.445	.8947	2.003	2.239	.9194	.4466	2.890	8.971	9.027	.6611	.5915	6.165
.2310	.2070	1.451	.8960	2.017	2.252	.9197	.4441	2.903	9.085	9.110	.6597	.5911	6.148
.2320	.2082	1.458	.8972	2.032	2.264	.9200	.4416	2.915	9.201	9.255	.6584	.5907	6.131
.2330	.2093	1.464	.8984	2.046	2.277	.9203	.4391	2.928	9.318	9.372	.6571	.5904	6.114
.2340	.2105	1.470	.8996	2.060	2.290	.9206	.4366	2.941	9.437	9.489	.6558	.5900	6.097
.2350	.2117	1.477	.9008	2.075	2.303	.9209	.4342	2.953	9.557	9.609	.6545	.5896	6.081
.2360	.2129	1.483	.9020	2.089	2.316	.9212	.4318	2.966	9.678	9.730	.6532	.5892	6.066
.2370	.2141	1.489	.9032	2.104	2.329	.9215	.4293	2.978	9.801	9.852	.6519	.5888	6.050
.2380	.2152	1.495	.9043	2.118	2.343	.9218	.4269	2.991	9.926	9.976	.6507	.5884	6.034
.2390	.2164	1.502	.9055	2.133	2.356	.9221	.4244	3.003	10.05	10.10	.6494	.5880	6.019
.2400	.2176	1.508	.9066	2.148	2.370	.9225	.4220	3.016	10.18	10.23	.6481	.5876	6.004
.2410	.2188	1.514	.9077	2.163	2.383	.9228	.4196	3.029	10.31	10.36	.6469	.5872	5.990
.2420	.2199	1.521	.9088	2.178	2.397	.9231	.4172	3.041	10.44	10.49	.6456	.5868	5.976
.2430	.2211	1.527	.9099	2.193	2.410	.9234	.4149	3.054	10.57	10.62	.6444	.5863	5.961
.2440	.2223	1.533	.9110	2.208	2.424	.9238	.4125	3.066	10.71	10.75	.6432	.5859	5.947
.2450	.2234	1.539	.9120	2.224	2.438	.9241	.4101	3.079	10.84	10.89	.6420	.5855	5.933
.2460	.2246	1.546	.9131	2.239	2.452	.9244	.4078	3.091	10.98	11.03	.6408	.5851	5.919
.2470	.2258	1.552	.9141	2.255	2.466	.9248	.4055	3.104	11.12	11.17	.6396	.5846	5.906
.2480	.2270	1.558	.9151	2.270	2.480	.9251	.4032	3.116	11.26	11.31	.6384	.5842	5.893
.2490	.2281	1.565	.9162	2.286	2.495	.9255	.4008	3.129	11.40	11.45	.6372	.5838	5.880
.2500	.2293	1.571	.9172	2.301	2.509	.9258	.3985	3.142	11.55	11.59	.6360	.5833	5.867
.2510	.2305	1.577	.9182	2.317	2.524	.9262	.3962	3.154	11.70	11.74	.6348	.5829	5.854
.2520	.2316	1.583	.9191	2.333	2.538	.9265	.3940	3.167	11.84	11.89	.6337	.5824	5.841
.2530	.2328	1.590	.9201	2.349	2.553	.9269	.3917	3.179	11.99	12.04	.6325	.5820	5.829
.2540	.2339	1.596	.9210	2.365	2.568	.9273	.3894	3.192	12.15	12.19	.6314	.5815	5.817
.2550	.2351	1.602	.9220	2.381	2.583	.9276	.3872	3.204	12.30	12.34	.6303	.5811	5.805
.2560	.2363	1.609	.9229	2.398	2.598	.9280	.3849	3.217	12.46	12.50	.6291	.5807	5.793
.2570	.2374	1.615	.9239	2.414	2.613	.9283	.3827	3.230	12.61	12.65	.6280	.5802	5.782
.2580	.2386	1.621	.9248	2.430	2.628	.9287	.3805	3.242	12.77	12.81	.6269	.5797	5.770
.2590	.2398	1.627	.9257	2.447	2.643	.9291	.3783	3.255	12.94	12.98	.6258	.5793	5.759
.2600	.2409	1.634	.9266	2.464	2.659	.9294	.3761	3.267	13.10	13.14	.6247	.5788	5.748
.2610	.2421	1.640	.9275	2.480	2.674	.9298	.3739	3.280	13.27	13.31	.6236	.5784	5.737
.2620	.2432	1.646	.9283	2.497	2.690	.9301	.3717	3.292	13.44	13.47	.6225	.5779	5.726
.2630	.2444	1.653	.9292	2.514	2.706	.9305	.3696	3.305	13.61	13.64	.6215	.5775	5.716
.2640	.2455	1.659	.9301	2.531	2.722	.9309	.3674	3.318	13.78	13.81	.6204	.5770	5.705
.2650	.2467	1.665	.9309	2.548	2.737	.9313	.3653	3.330	13.95	13.99	.6193	.5765	5.695
.2660	.2478	1.671	.9317	2.566	2.754	.9316	.3632	3.343	14.13	14.17	.6183	.5761	5.685
.2670	.2490	1.678	.9326	2.583	2.770	.9320	.3610	3.355	14.31	14.34	.6172	.5756	5.675
.2680	.2501	1.684	.9334	2.600	2.786	.9324	.3589	3.368	14.49	14.53	.6162	.5752	5.665
.2690	.2513	1.690	.9342	2.618	2.803	.9328	.3568	3.380	14.67	14.71	.6152	.5747	5.655
.2700	.2524	1.697	.9350	2.636	2.819	.9331	.3547	3.393	14.86	14.89	.6142	.5742	5.645
.2710	.2536	1.703	.9357	2.653	2.835	.9335	.3527	3.405	15.05	15.08	.6132	.5737	5.636
.2720	.2547	1.709	.9365	2.671	2.852	.9339	.3506	3.418	15.24	15.27	.6122	.5733	5.627
.2730	.2559	1.715	.9373	2.689	2.869	.9343	.3485	3.431	15.43	15.46	.6112	.5728	5.617
.2740	.2570	1.722	.9381	2.707	2.886	.9346	.3465	3.443	15.63	15.66	.6102	.5724	5.608
.2750	.2582	1.728	.9388	2.726	2.903	.9350	.3444	3.456	15.83	15.86	.6092	.5719	5.599
.2760	.2593	1.734	.9396	2.744	2.920	.9354	.3424	3.468	16.03	16.06	.6082	.5714	5.590
.2770	.2605	1.740	.9403	2.762	2.938	.9358	.3404	3.481	16.23	16.26	.6072	.5710	5.582
.2780	.2616	1.747	.9410	2.781	2.955	.9362	.3384	3.493	16.43	16.47	.6063	.5705	5.573
.2790	.2627	1.753	.9417	2.799	2.973	.9366	.3364	3.506	16.64	16.67	.6053	.5701	5.565
.2800	.2639	1.759	.9424	2.818	2.990	.9369	.3344	3.519	16.85	16.88	.6044	.5696	5.556
.2810	.2650	1.766	.9431	2.837	3.008	.9373	.3324	3.531	17.07	17.10	.6035	.5691	5.548
.2820	.2662	1.772	.9438	2.856	3.026	.9377	.3304	3.544	17.28	17.31	.6025	.5687	5.540
.2830	.2673	1.778	.9445	2.875	3.044	.9381	.3285	3.556	17.50	17.53	.6016	.5682	5.532
.2840	.2684	1.784	.9452	2.894	3.062	.9384	.3266	3.569	17.72	17.75	.6007	.5677	5.524
.2850	.2696	1.791	.9458	2.913	3.080	.9388	.3247	3.581	17.95	17.98	.5998	.5673	5.516
.2860	.2707	1.797	.9465	2.933	3.099	.9392	.3227	3.594	18.18	18.20	.5989	.5668	5.509
.2870	.2718	1.803	.9472	2.952	3.117	.9396	.3208	3.607	18.40	18.43	.5980	.5664	5.501
.2880	.2730	1.810	.9478	2.972	3.136	.9400	.3189	3.619	18.64	18.67	.5971	.5659	5.493
.2890	.2741	1.816	.9484	2.992	3.154	.9404	.3170	3.632	18.88	18.90	.5962	.5654	5.486

Table C-2. Continued.

d/L	d/L _o	$\frac{2nd}{L}$	$\frac{\tanh \frac{2nd}{L}}{L}$	$\frac{\sinh \frac{2nd}{L}}{L}$	$\frac{\cosh \frac{2nd}{L}}{L}$	H/H _o	K	$\frac{4nd}{L}$	$\frac{\sinh \frac{4nd}{L}}{L}$	$\frac{\cosh \frac{4nd}{L}}{L}$	n	C _G /C _o	M
.2900	.2752	1.822	.9491	3.012	3.173	.9407	.3151	3.644	19.11	19.14	.5953	.5650	5.479
.2910	.2764	1.828	.9497	3.032	3.192	.9411	.3133	3.657	19.36	19.38	.5945	.5645	5.472
.2920	.2775	1.835	.9503	3.052	3.211	.9415	.3114	3.669	19.60	19.63	.5936	.5641	5.465
.2930	.2786	1.841	.9509	3.072	3.231	.9419	.3095	3.682	19.85	19.87	.5927	.5636	5.458
.2940	.2797	1.847	.9515	3.093	3.250	.9422	.3077	3.695	20.10	20.13	.5919	.5632	5.451
.2950	.2809	1.854	.9521	3.113	3.269	.9426	.3059	3.707	20.36	20.38	.5911	.5627	5.444
.2960	.2820	1.860	.9527	3.133	3.289	.9430	.3040	3.720	20.61	20.64	.5902	.5622	5.437
.2970	.2831	1.866	.9532	3.154	3.309	.9434	.3022	3.732	20.87	20.90	.5894	.5618	5.431
.2980	.2842	1.872	.9538	3.175	3.329	.9437	.3004	3.745	21.14	21.16	.5886	.5614	5.424
.2990	.2854	1.879	.9544	3.196	3.349	.9441	.2986	3.757	21.41	21.43	.5878	.5610	5.418
.3000	.2865	1.885	.9549	3.217	3.369	.9445	.2968	3.770	21.68	21.70	.5870	.5605	5.412
.3010	.2876	1.891	.9555	3.238	3.389	.9449	.2951	3.782	21.95	21.97	.5862	.5601	5.405
.3020	.2887	1.898	.9560	3.260	3.410	.9452	.2933	3.795	22.23	22.25	.5854	.5596	5.399
.3030	.2898	1.904	.9566	3.281	3.430	.9456	.2915	3.808	22.51	22.53	.5846	.5592	5.393
.3040	.2910	1.910	.9571	3.303	3.451	.9459	.2898	3.820	22.80	22.82	.5838	.5587	5.387
.3050	.2921	1.916	.9576	3.325	3.472	.9463	.2880	3.833	23.08	23.11	.5830	.5583	5.381
.3060	.2932	1.923	.9581	3.347	3.493	.9467	.2863	3.845	23.38	23.40	.5823	.5579	5.376
.3070	.2943	1.929	.9586	3.368	3.514	.9471	.2846	3.858	23.67	23.69	.5815	.5574	5.370
.3080	.2954	1.935	.9592	3.391	3.535	.9474	.2829	3.870	23.97	23.99	.5807	.5570	5.364
.3090	.2965	1.942	.9597	3.413	3.556	.9478	.2812	3.883	24.28	24.30	.5800	.5566	5.359
.3100	.2977	1.948	.9602	3.435	3.578	.9482	.2795	3.896	24.58	24.60	.5792	.5562	5.353
.3110	.2988	1.954	.9606	3.458	3.600	.9485	.2778	3.908	24.89	24.91	.5785	.5557	5.348
.3120	.2999	1.960	.9611	3.481	3.621	.9489	.2761	3.921	25.21	25.23	.5778	.5553	5.342
.3130	.3010	1.967	.9616	3.503	3.643	.9493	.2745	3.933	25.53	25.55	.5770	.5549	5.337
.3140	.3021	1.973	.9621	3.526	3.665	.9496	.2728	3.946	25.85	25.87	.5763	.5545	5.332
.3150	.3032	1.979	.9625	3.549	3.688	.9500	.2712	3.958	26.18	26.20	.5756	.5540	5.327
.3160	.3043	1.986	.9630	3.573	3.710	.9504	.2695	3.971	26.51	26.53	.5749	.5536	5.321
.3170	.3054	1.992	.9634	3.596	3.733	.9508	.2679	3.984	26.84	26.86	.5742	.5532	5.316
.3180	.3065	1.998	.9639	3.620	3.755	.9511	.2663	3.996	27.18	27.20	.5735	.5528	5.311
.3190	.3076	2.004	.9643	3.643	3.778	.9514	.2647	4.009	27.53	27.55	.5728	.5524	5.307
.3200	.3087	2.011	.9648	3.667	3.801	.9518	.2631	4.021	27.88	27.89	.5721	.5520	5.302
.3210	.3098	2.017	.9652	3.691	3.824	.9521	.2615	4.034	28.23	28.25	.5714	.5516	5.297
.3220	.3109	2.023	.9656	3.715	3.847	.9525	.2599	4.046	28.59	28.60	.5708	.5512	5.292
.3230	.3120	2.030	.9661	3.739	3.871	.9528	.2583	4.059	28.95	28.97	.5701	.5508	5.288
.3240	.3131	2.036	.9665	3.764	3.894	.9532	.2568	4.072	29.31	29.33	.5694	.5504	5.283
.3250	.3142	2.042	.9669	3.788	3.918	.9535	.2552	4.084	29.69	29.70	.5688	.5500	5.279
.3260	.3153	2.048	.9673	3.813	3.942	.9539	.2537	4.097	30.06	30.08	.5681	.5496	5.274
.3270	.3164	2.055	.9677	3.838	3.966	.9542	.2521	4.109	30.44	30.46	.5675	.5492	5.270
.3280	.3175	2.061	.9681	3.863	3.990	.9545	.2506	4.122	30.83	30.84	.5669	.5488	5.266
.3290	.3186	2.067	.9685	3.888	4.015	.9549	.2491	4.134	31.22	31.23	.5662	.5484	5.261
.3300	.3197	2.074	.9689	3.913	4.039	.9552	.2476	4.147	31.61	31.63	.5656	.5480	5.257
.3310	.3208	2.080	.9692	3.939	4.064	.9555	.2461	4.159	32.01	32.03	.5650	.5476	5.253
.3320	.3219	2.086	.9696	3.964	4.088	.9559	.2446	4.172	32.42	32.43	.5644	.5472	5.249
.3330	.3230	2.092	.9700	3.990	4.114	.9562	.2431	4.185	32.83	32.84	.5637	.5468	5.245
.3340	.3241	2.099	.9704	4.016	4.139	.9566	.2416	4.197	33.24	33.26	.5631	.5464	5.241
.3350	.3252	2.105	.9707	4.042	4.164	.9569	.2402	4.210	33.66	33.68	.5625	.5461	5.237
.3360	.3263	2.111	.9711	4.069	4.189	.9572	.2387	4.222	34.09	34.10	.5619	.5457	5.233
.3370	.3274	2.117	.9715	4.095	4.215	.9576	.2373	4.235	34.52	34.53	.5613	.5453	5.229
.3380	.3285	2.124	.9718	4.121	4.241	.9579	.2358	4.247	34.96	34.97	.5608	.5449	5.225
.3390	.3296	2.130	.9722	4.148	4.267	.9582	.2344	4.260	35.40	35.41	.5602	.5446	5.222
.3400	.3307	2.136	.9725	4.175	4.293	.9585	.2329	4.273	35.85	35.86	.5596	.5442	5.218
.3410	.3317	2.143	.9728	4.202	4.319	.9589	.2315	4.285	36.30	36.31	.5590	.5438	5.214
.3420	.3328	2.149	.9732	4.229	4.346	.9592	.2301	4.298	36.76	36.77	.5585	.5435	5.211
.3430	.3339	2.155	.9735	4.256	4.372	.9595	.2287	4.310	37.22	37.24	.5579	.5431	5.207
.3440	.3350	2.161	.9738	4.284	4.399	.9598	.2273	4.323	37.70	37.71	.5573	.5427	5.204
.3450	.3361	2.168	.9742	4.312	4.426	.9601	.2259	4.335	38.17	38.19	.5568	.5424	5.200
.3460	.3372	2.174	.9745	4.340	4.454	.9604	.2245	4.348	38.65	38.67	.5562	.5420	5.197
.3470	.3383	2.180	.9748	4.368	4.481	.9608	.2232	4.361	39.14	39.16	.5557	.5417	5.193
.3480	.3393	2.187	.9751	4.396	4.509	.9611	.2218	4.373	39.64	39.65	.5552	.5413	5.190
.3490	.3404	2.193	.9754	4.424	4.536	.9614	.2205	4.386	40.14	40.15	.5546	.5410	5.187

Table C-2. Continued.

d/L	d/L ₀	$\frac{2nd}{L}$	$\frac{\tanh 2nd}{L}$	$\frac{\sinh 2nd}{L}$	$\frac{\cosh 2nd}{L}$	H/H ₀ [*]	K	$\frac{4nd}{L}$	$\frac{\sinh 4nd}{L}$	$\frac{\cosh 4nd}{L}$	n	C _G /C ₀	M
.3500	.3415	2.199	.9757	4.453	4.564	.9617	.2191	4.398	40.65	40.66	.5541	.5406	5.184
.3510	.3426	2.205	.9760	4.482	4.592	.9620	.2178	4.411	41.16	41.17	.5536	.5403	5.181
.3520	.3437	2.212	.9763	4.511	4.620	.9623	.2164	4.423	41.68	41.70	.5531	.5400	5.177
.3530	.3447	2.218	.9766	4.540	4.649	.9626	.2151	4.436	42.21	42.22	.5525	.5396	5.174
.3540	.3458	2.224	.9769	4.569	4.678	.9629	.2138	4.449	42.74	42.76	.5520	.5393	5.171
.3550	.3469	2.231	.9772	4.600	4.706	.9632	.2125	4.461	43.28	43.30	.5515	.5389	5.168
.3560	.3480	2.237	.9774	4.628	4.735	.9635	.2112	4.474	43.83	43.84	.5510	.5386	5.165
.3570	.3491	2.243	.9777	4.658	4.764	.9638	.2099	4.486	44.39	44.40	.5505	.5383	5.162
.3580	.3501	2.249	.9780	4.688	4.794	.9641	.2086	4.499	44.95	44.96	.5500	.5379	5.159
.3590	.3512	2.256	.9783	4.719	4.823	.9644	.2073	4.511	45.52	45.53	.5496	.5376	5.156
.3600	.3523	2.262	.9785	4.749	4.853	.9647	.2060	4.524	46.09	46.10	.5491	.5373	5.154
.3610	.3534	2.268	.9788	4.779	4.883	.9650	.2048	4.536	46.68	46.69	.5486	.5370	5.151
.3620	.3544	2.275	.9791	4.810	4.913	.9652	.2035	4.549	47.27	47.28	.5481	.5367	5.148
.3630	.3555	2.281	.9793	4.840	4.943	.9655	.2023	4.562	47.86	47.87	.5477	.5363	5.145
.3640	.3566	2.287	.9796	4.872	4.974	.9658	.2010	4.574	48.47	48.48	.5472	.5360	5.143
.3650	.3576	2.293	.9798	4.904	5.005	.9661	.1998	4.587	49.08	49.09	.5467	.5357	5.140
.3660	.3587	2.300	.9801	4.935	5.035	.9664	.1986	4.599	49.70	49.71	.5463	.5354	5.137
.3670	.3598	2.306	.9803	4.967	5.067	.9667	.1974	4.612	50.33	50.34	.5458	.5351	5.135
.3680	.3609	2.312	.9806	4.999	5.098	.9670	.1962	4.624	50.97	50.98	.5454	.5348	5.132
.3690	.3619	2.319	.9808	5.031	5.129	.9672	.1950	4.637	51.61	51.62	.5449	.5345	5.130
.3700	.3630	2.325	.9811	5.063	5.161	.9675	.1938	4.650	52.27	52.28	.5445	.5342	5.127
.3710	.3641	2.331	.9813	5.096	5.193	.9678	.1926	4.662	52.93	52.94	.5440	.5339	5.125
.3720	.3651	2.337	.9815	5.129	5.225	.9680	.1914	4.675	53.60	53.61	.5436	.5336	5.122
.3730	.3662	2.346	.9817	5.161	5.257	.9683	.1902	4.687	54.27	54.28	.5432	.5333	5.120
.3740	.3673	2.350	.9820	5.195	5.290	.9686	.1890	4.700	54.99	54.97	.5427	.5330	5.118
.3750	.3683	2.356	.9822	5.228	5.322	.9688	.1879	4.712	55.66	55.66	.5423	.5327	5.115
.3760	.3694	2.363	.9824	5.262	5.356	.9691	.1867	4.725	56.36	56.37	.5419	.5324	5.113
.3770	.3705	2.369	.9826	5.295	5.389	.9694	.1856	4.738	57.07	57.08	.5415	.5321	5.111
.3780	.3715	2.375	.9829	5.329	5.422	.9696	.1844	4.750	57.79	57.80	.5411	.5318	5.109
.3790	.3726	2.381	.9831	5.363	5.456	.9699	.1833	4.763	58.53	58.53	.5407	.5315	5.106
.3800	.3736	2.388	.9833	5.398	5.490	.9702	.1822	4.775	59.27	59.27	.5403	.5313	5.104
.3810	.3747	2.394	.9835	5.432	5.524	.9704	.1810	4.788	60.01	60.02	.5399	.5310	5.102
.3820	.3758	2.400	.9837	5.467	5.558	.9707	.1799	4.800	60.77	60.78	.5395	.5307	5.100
.3830	.3768	2.407	.9839	5.502	5.593	.9709	.1788	4.813	61.54	61.55	.5391	.5304	5.098
.3840	.3779	2.413	.9841	5.537	5.627	.9712	.1777	4.826	62.32	62.33	.5387	.5301	5.096
.3850	.3790	2.419	.9843	5.573	5.662	.9714	.1766	4.838	63.11	63.12	.5383	.5299	5.094
.3860	.3800	2.425	.9845	5.609	5.697	.9717	.1755	4.851	63.91	63.91	.5380	.5296	5.092
.3870	.3811	2.432	.9847	5.645	5.732	.9719	.1744	4.863	64.72	64.72	.5376	.5293	5.090
.3880	.3821	2.438	.9849	5.681	5.768	.9721	.1734	4.876	65.53	65.54	.5372	.5291	5.088
.3890	.3832	2.444	.9850	5.717	5.804	.9724	.1723	4.889	66.40	66.40	.5368	.5288	5.086
.3900	.3842	2.450	.9852	5.753	5.840	.9726	.1712	4.901	67.20	67.21	.5365	.5285	5.084
.3910	.3853	2.457	.9854	5.790	5.876	.9729	.1702	4.913	68.05	68.06	.5361	.5283	5.082
.3920	.3864	2.463	.9856	5.827	5.913	.9731	.1691	4.926	68.91	68.92	.5357	.5280	5.080
.3930	.3874	2.469	.9858	5.865	5.949	.9733	.1681	4.939	69.78	69.79	.5354	.5278	5.078
.3940	.3885	2.476	.9860	5.902	5.988	.9736	.1670	4.951	70.67	70.67	.5350	.5275	5.077
.3950	.3895	2.482	.9861	5.940	6.024	.9738	.1660	4.964	71.56	71.57	.5347	.5273	5.075
.3960	.3906	2.488	.9863	5.978	6.061	.9740	.1650	4.976	72.47	72.47	.5343	.5270	5.073
.3970	.3916	2.494	.9865	6.016	6.099	.9743	.1640	4.989	73.38	73.39	.5340	.5268	5.071
.3980	.3927	2.501	.9866	6.054	6.137	.9745	.1630	5.001	74.31	74.32	.5337	.5265	5.070
.3990	.3937	2.507	.9868	6.093	6.175	.9747	.1619	5.014	75.25	75.26	.5333	.5263	5.068
.4000	.3948	2.513	.9870	6.132	6.213	.9749	.1609	5.027	76.20	76.21	.5330	.5260	5.066
.4010	.3958	2.520	.9871	6.172	6.252	.9752	.1600	5.039	77.16	77.17	.5327	.5258	5.064
.4020	.3969	2.526	.9873	6.210	6.290	.9754	.1590	5.052	78.14	78.15	.5323	.5256	5.063
.4030	.3979	2.532	.9874	6.250	6.330	.9756	.1580	5.064	79.13	79.14	.5320	.5253	5.061
.4040	.3990	2.538	.9876	6.290	6.369	.9758	.1570	5.077	80.13	80.14	.5317	.5251	5.060
.4050	.4000	2.545	.9878	6.330	6.409	.9760	.1560	5.089	81.14	81.15	.5314	.5249	5.058
.4060	.4011	2.551	.9879	6.371	6.449	.9763	.1551	5.102	82.17	82.18	.5310	.5246	5.056
.4070	.4021	2.557	.9881	6.412	6.489	.9765	.1541	5.115	83.21	83.21	.5307	.5244	5.055
.4080	.4032	2.564	.9882	6.452	6.529	.9767	.1532	5.127	84.25	84.26	.5304	.5242	5.053
.4090	.4042	2.570	.9883	6.493	6.571	.9769	.1522	5.140	85.33	85.33	.5301	.5239	5.052

Table C-2. Continued.

d/L	d/L ₀	$\frac{2nd}{L}$	$\frac{\tanh 2nd}{L}$	$\frac{\sinh 2nd}{L}$	$\frac{\cosh 2nd}{L}$	H/H ₀ ^o	κ	$\frac{4nd}{L}$	$\frac{\sinh 4nd}{L}$	$\frac{\cosh 4nd}{L}$	n	C _G /C ₀	M
.4100	.4053	2.576	.9885	6.535	6.611	.9771	.1513	5.152	86.41	86.41	.5298	.5237	5.050
.4110	.4063	2.582	.9886	6.577	6.653	.9773	.1503	5.165	87.50	87.50	.5295	.5235	5.049
.4120	.4074	2.589	.9888	6.619	6.694	.9775	.1494	5.177	88.61	88.61	.5292	.5233	5.048
.4130	.4084	2.595	.9889	6.661	6.736	.9777	.1485	5.190	89.73	89.73	.5289	.5231	5.046
.4140	.4095	2.601	.9891	6.703	6.777	.9779	.1476	5.202	90.87	90.87	.5286	.5228	5.045
.4150	.4105	2.608	.9892	6.746	6.819	.9781	.1466	5.215	92.02	92.02	.5283	.5226	5.043
.4160	.4116	2.614	.9893	6.789	6.862	.9783	.1457	5.228	93.18	93.18	.5281	.5224	5.042
.4170	.4126	2.620	.9895	6.832	6.905	.9785	.1448	5.240	94.36	94.36	.5278	.5222	5.041
.4180	.4136	2.626	.9896	6.876	6.948	.9787	.1439	5.253	95.55	95.55	.5275	.5220	5.039
.4190	.4147	2.633	.9897	6.920	6.992	.9789	.1430	5.265	96.76	96.76	.5272	.5218	5.038
.4200	.4157	2.639	.9899	6.963	7.035	.9791	.1422	5.278	97.98	97.98	.5269	.5216	5.037
.4210	.4168	2.645	.9900	7.008	7.079	.9793	.1413	5.290	99.22	99.22	.5267	.5214	5.035
.4220	.4178	2.652	.9901	7.052	7.123	.9795	.1404	5.303	100.5	100.5	.5264	.5212	5.034
.4230	.4189	2.658	.9902	7.097	7.167	.9797	.1395	5.316	101.7	101.7	.5261	.5210	5.033
.4240	.4199	2.664	.9903	7.143	7.212	.9799	.1387	5.328	103.0	103.0	.5259	.5208	5.032
.4250	.4210	2.670	.9905	7.188	7.257	.9801	.1378	5.341	104.3	104.3	.5256	.5206	5.030
.4260	.4220	2.677	.9906	7.233	7.302	.9803	.1370	5.353	105.7	105.7	.5253	.5204	5.029
.4270	.4230	2.683	.9907	7.280	7.348	.9804	.1361	5.366	107.0	107.0	.5251	.5202	5.028
.4280	.4241	2.689	.9908	7.326	7.394	.9806	.1352	5.378	108.3	108.3	.5248	.5200	5.027
.4290	.4251	2.696	.9909	7.373	7.440	.9808	.1344	5.391	109.7	109.7	.5246	.5198	5.026
.4300	.4262	2.702	.9910	7.420	7.487	.9810	.1336	5.404	111.1	111.1	.5243	.5196	5.025
.4310	.4272	2.708	.9912	7.467	7.534	.9811	.1327	5.416	112.5	112.5	.5241	.5194	5.023
.4320	.4282	2.714	.9913	7.514	7.580	.9813	.1319	5.429	113.9	113.9	.5238	.5193	5.022
.4330	.4293	2.721	.9914	7.562	7.628	.9815	.1311	5.441	115.4	115.4	.5236	.5191	5.021
.4340	.4303	2.727	.9915	7.610	7.673	.9817	.1303	5.454	116.8	116.8	.5233	.5189	5.020
.4350	.4313	2.733	.9916	7.659	7.723	.9818	.1295	5.466	118.3	118.3	.5231	.5187	5.019
.4360	.4324	2.740	.9917	7.707	7.772	.9820	.1287	5.479	119.8	119.8	.5229	.5185	5.018
.4370	.4334	2.746	.9918	7.756	7.821	.9822	.1279	5.492	121.3	121.3	.5226	.5183	5.017
.4380	.4345	2.752	.9919	7.805	7.869	.9823	.1271	5.504	122.8	122.8	.5224	.5182	5.016
.4390	.4355	2.758	.9920	7.855	7.918	.9825	.1263	5.517	124.4	124.4	.5222	.5180	5.015
.4400	.4365	2.765	.9921	7.905	7.968	.9827	.1255	5.529	126.0	126.0	.5219	.5178	5.014
.4410	.4376	2.771	.9922	7.955	8.018	.9828	.1247	5.542	127.6	127.6	.5217	.5177	5.013
.4420	.4386	2.777	.9923	8.006	8.068	.9830	.1239	5.554	129.2	129.2	.5215	.5175	5.012
.4430	.4396	2.784	.9924	8.057	8.119	.9831	.1232	5.567	130.8	130.8	.5213	.5173	5.011
.4440	.4407	2.790	.9925	8.107	8.169	.9833	.1224	5.579	132.6	132.6	.5210	.5171	5.010
.4450	.4417	2.796	.9926	8.159	8.220	.9835	.1217	5.592	134.1	134.1	.5208	.5170	5.009
.4460	.4427	2.802	.9927	8.211	8.272	.9836	.1209	5.605	135.8	135.8	.5206	.5168	5.008
.4470	.4438	2.809	.9928	8.263	8.322	.9838	.1202	5.617	137.6	137.6	.5204	.5166	5.007
.4480	.4448	2.815	.9929	8.316	8.376	.9839	.1194	5.630	139.3	139.3	.5202	.5165	5.006
.4490	.4458	2.821	.9929	8.369	8.428	.9841	.1186	5.642	141.1	141.1	.5200	.5163	5.005
.4500	.4469	2.827	.9930	8.421	8.480	.9842	.1179	5.655	142.8	142.8	.5198	.5162	5.004
.4510	.4479	2.834	.9931	8.475	8.534	.9844	.1172	5.667	144.7	144.7	.5196	.5160	5.003
.4520	.4489	2.840	.9932	8.529	8.587	.9845	.1165	5.680	146.5	146.5	.5194	.5159	5.003
.4530	.4500	2.846	.9933	8.583	8.641	.9847	.1157	5.693	148.3	148.3	.5192	.5157	5.002
.4540	.4510	2.853	.9934	8.638	8.695	.9848	.1150	5.705	150.2	150.2	.5190	.5156	5.001
.4550	.4520	2.859	.9935	8.692	8.750	.9850	.1143	5.718	152.1	152.1	.5188	.5154	5.000
.4560	.4531	2.865	.9935	8.747	8.804	.9851	.1136	5.730	154.0	154.0	.5186	.5153	4.999
.4570	.4541	2.871	.9936	8.803	8.859	.9852	.1129	5.743	156.0	156.0	.5184	.5151	4.999
.4580	.4551	2.878	.9937	8.859	8.915	.9854	.1122	5.755	158.0	158.0	.5182	.5150	4.998
.4590	.4561	2.884	.9938	8.915	8.971	.9855	.1115	5.768	159.9	159.9	.5180	.5148	4.997
.4600	.4572	2.890	.9938	8.972	9.022	.9857	.1108	5.781	162.0	162.0	.5178	.5147	4.996
.4610	.4582	2.897	.9939	9.029	9.084	.9858	.1101	5.793	164.0	164.0	.5177	.5145	4.995
.4620	.4592	2.903	.9940	9.085	9.140	.9859	.1094	5.806	166.1	166.1	.5175	.5144	4.995
.4630	.4603	2.909	.9941	9.143	9.197	.9861	.1087	5.818	168.2	168.2	.5173	.5142	4.994
.4640	.4613	2.915	.9941	9.201	9.255	.9862	.1080	5.831	170.3	170.3	.5171	.5141	4.993
.4650	.4623	2.922	.9942	9.260	9.313	.9863	.1074	5.843	172.5	172.5	.5169	.5140	4.992
.4660	.4633	2.928	.9943	9.318	9.372	.9865	.1067	5.856	174.7	174.7	.5168	.5138	4.992
.4670	.4644	2.934	.9944	9.378	9.431	.9866	.1060	5.869	176.9	176.9	.5166	.5137	4.991
.4680	.4654	2.941	.9944	9.436	9.489	.9867	.1054	5.881	179.1	179.1	.5164	.5136	4.990
.4690	.4664	2.947	.9945	9.496	9.549	.9868	.1047	5.894	181.4	181.4	.5162	.5134	4.990

Table C-2. Continued.

d/L	d/L ₀	$\frac{2\pi d}{L}$	$\frac{\tanh \frac{2\pi d}{L}}{\frac{2\pi d}{L}}$	$\frac{\sinh \frac{2\pi d}{L}}{\frac{2\pi d}{L}}$	$\frac{\cosh \frac{2\pi d}{L}}{\frac{2\pi d}{L}}$	H/H ₀ ¹	K	$\frac{4\pi d}{L}$	$\frac{\sinh \frac{4\pi d}{L}}{\frac{4\pi d}{L}}$	$\frac{\cosh \frac{4\pi d}{L}}{\frac{4\pi d}{L}}$	n	C _G /C ₀	M
.4700	.4675	2.953	.9946	9.557	9.609	.9870	.1041	5.906	183.7	183.7	.5161	.5133	4.989
.4710	.4685	2.959	.9946	9.617	9.669	.9871	.1034	5.919	186.0	186.0	.5159	.5131	4.988
.4720	.4695	2.966	.9947	9.678	9.730	.9872	.1028	5.931	188.3	188.3	.5157	.5130	4.987
.4730	.4705	2.972	.9948	9.740	9.791	.9873	.1021	5.944	190.7	190.7	.5156	.5129	4.987
.4740	.4716	2.978	.9948	9.801	9.852	.9875	.1015	5.956	193.1	193.1	.5154	.5128	4.986
.4750	.4726	2.985	.9949	9.863	9.914	.9876	.1009	5.969	195.6	195.6	.5153	.5126	4.986
.4760	.4736	2.991	.9950	9.926	9.976	.9877	.1002	5.982	198.0	198.0	.5151	.5125	4.985
.4770	.4746	2.997	.9950	9.989	10.04	.9878	.09961	5.994	200.5	200.5	.5149	.5124	4.984
.4780	.4757	3.003	.9951	10.05	10.10	.9880	.09899	6.007	203.1	203.1	.5148	.5123	4.984
.4790	.4767	3.010	.9952	10.12	10.17	.9881	.09838	6.019	205.6	205.6	.5146	.5121	4.983
.4800	.4777	3.016	.9952	10.18	10.23	.9882	.09776	6.032	208.2	208.2	.5145	.5120	4.983
.4810	.4787	3.022	.9953	10.24	10.29	.9883	.09715	6.044	210.9	210.9	.5143	.5119	4.982
.4820	.4798	3.029	.9953	10.31	10.36	.9884	.09655	6.057	213.5	213.5	.5142	.5118	4.981
.4830	.4808	3.035	.9954	10.37	10.42	.9885	.09595	6.070	216.2	216.2	.5140	.5117	4.981
.4840	.4818	3.041	.9954	10.44	10.49	.9887	.09535	6.082	219.0	219.0	.5139	.5115	4.980
.4850	.4828	3.047	.9955	10.51	10.55	.9888	.09475	6.095	221.7	221.7	.5137	.5114	4.980
.4860	.4838	3.054	.9956	10.57	10.62	.9889	.09416	6.107	224.5	224.5	.5136	.5113	4.979
.4870	.4849	3.060	.9956	10.64	10.69	.9890	.09358	6.120	227.4	227.4	.5135	.5112	4.978
.4880	.4859	3.066	.9957	10.71	10.75	.9891	.09300	6.132	230.3	230.3	.5133	.5111	4.978
.4890	.4869	3.073	.9957	10.77	10.82	.9892	.09241	6.145	233.2	233.2	.5132	.5110	4.977
.4900	.4879	3.079	.9958	10.84	10.89	.9893	.09183	6.158	236.1	236.1	.5130	.5109	4.977
.4910	.4890	3.085	.9958	10.91	10.96	.9894	.09126	6.170	239.1	239.1	.5129	.5108	4.976
.4920	.4900	3.091	.9959	10.98	11.03	.9895	.09069	6.183	242.1	242.1	.5128	.5107	4.976
.4930	.4910	3.098	.9959	11.05	11.10	.9896	.09013	6.195	245.2	245.2	.5126	.5106	4.975
.4940	.4920	3.104	.9960	11.12	11.17	.9897	.08957	6.208	248.3	248.3	.5125	.5104	4.975
.4950	.4930	3.110	.9960	11.19	11.24	.9898	.08901	6.220	251.4	251.4	.5124	.5103	4.974
.4960	.4941	3.117	.9961	11.26	11.31	.9899	.08845	6.233	254.6	254.6	.5122	.5102	4.974
.4970	.4951	3.123	.9961	11.33	11.38	.9900	.08790	6.246	257.8	257.8	.5121	.5101	4.973
.4980	.4961	3.129	.9962	11.40	11.45	.9901	.08736	6.258	261.1	261.1	.5120	.5100	4.973
.4990	.4971	3.135	.9962	11.48	11.52	.9902	.08681	6.271	264.4	264.4	.5119	.5099	4.972
.5000	.4981	3.142	.9963	11.55	11.59	.9903	.08627	6.283	267.7	267.7	.5117	.5098	4.972
.5010	.4992	3.148	.9963	11.62	11.67	.9904	.08573	6.296	271.1	271.1	.5116	.5097	4.971
.5020	.5002	3.154	.9964	11.70	11.74	.9905	.08519	6.308	274.5	274.5	.5115	.5096	4.971
.5030	.5012	3.160	.9964	11.77	11.81	.9906	.08466	6.321	278.0	278.0	.5114	.5095	4.971
.5040	.5022	3.167	.9965	11.84	11.89	.9907	.08413	6.333	281.5	281.5	.5112	.5094	4.970
.5050	.5032	3.173	.9965	11.92	11.96	.9908	.08361	6.346	285.1	285.1	.5111	.5093	4.970
.5060	.5043	3.179	.9965	11.99	12.03	.9909	.08309	6.359	288.7	288.7	.5110	.5092	4.969
.5070	.5053	3.186	.9966	12.07	12.11	.9910	.08257	6.371	292.4	292.4	.5109	.5092	4.969
.5080	.5063	3.192	.9966	12.15	12.19	.9911	.08205	6.384	296.1	296.1	.5108	.5091	4.968
.5090	.5073	3.198	.9967	12.22	12.26	.9911	.08154	6.396	299.8	299.8	.5107	.5090	4.968
.5100	.5083	3.204	.9967	12.30	12.34	.9912	.08103	6.409	303.6	303.6	.5106	.5089	4.967
.5110	.5093	3.211	.9968	12.38	12.42	.9913	.08053	6.421	307.4	307.4	.5104	.5088	4.967
.5120	.5104	3.217	.9968	12.46	12.50	.9914	.08002	6.434	311.3	311.3	.5103	.5087	4.967
.5130	.5114	3.223	.9968	12.53	12.57	.9915	.07952	6.447	315.4	315.4	.5102	.5086	4.966
.5140	.5124	3.230	.9969	12.62	12.65	.9916	.07903	6.459	319.2	319.2	.5101	.5085	4.966
.5150	.5134	3.236	.9969	12.70	12.74	.9917	.07853	6.472	323.3	323.3	.5100	.5084	4.965
.5160	.5144	3.242	.9970	12.77	12.81	.9917	.07804	6.484	327.4	327.4	.5099	.5084	4.965
.5170	.5154	3.248	.9970	12.86	12.89	.9918	.07756	6.497	331.5	331.5	.5098	.5083	4.965
.5180	.5165	3.255	.9970	12.94	12.98	.9919	.07707	6.509	335.7	335.7	.5097	.5082	4.964
.5190	.5175	3.261	.9971	13.02	13.06	.9920	.07659	6.522	339.9	339.9	.5096	.5081	4.964
.5200	.5185	3.267	.9971	13.10	13.14	.9921	.07611	6.535	344.2	344.2	.5095	.5080	4.964
.5210	.5195	3.274	.9971	13.18	13.22	.9921	.07564	6.547	348.2	348.2	.5094	.5079	4.963
.5220	.5205	3.280	.9972	13.27	13.30	.9922	.07517	6.560	353.0	353.0	.5093	.5079	4.963
.5230	.5215	3.286	.9972	13.35	13.38	.9923	.07469	6.572	357.5	357.5	.5092	.5078	4.963
.5240	.5226	3.292	.9972	13.44	13.47	.9924	.07422	6.585	362.0	362.0	.5091	.5077	4.962
.5250	.5236	3.299	.9973	13.52	13.56	.9925	.07376	6.597	366.6	366.6	.5090	.5076	4.962
.5260	.5246	3.305	.9973	13.61	13.64	.9925	.07330	6.610	371.2	371.2	.5089	.5076	4.962
.5270	.5256	3.311	.9974	13.69	13.72	.9926	.07284	6.622	375.9	375.9	.5088	.5075	4.961
.5280	.5266	3.318	.9974	13.78	13.81	.9927	.07239	6.635	380.3	380.3	.5087	.5074	4.961
.5290	.5276	3.324	.9974	13.86	13.89	.9928	.07194	6.648	385.5	385.5	.5086	.5073	4.961

Table C-2. Continued.

d/L	d/L ₀	$\frac{2nd}{L}$	$\frac{\tanh \frac{2nd}{L}}$	$\frac{\sinh \frac{2nd}{L}}$	$\frac{\cosh \frac{2nd}{L}}$	H/H ₀ [*]	K	$\frac{4nd}{L}$	$\frac{\sinh \frac{4nd}{L}}$	$\frac{\cosh \frac{4nd}{L}}$	n	C _G /C ₀	M
.5300	.5286	3.330	.9974	13.95	13.99	.9929	.07149	6.600	390.3	390.3	.5085	.5072	4.960
.5310	.5297	3.336	.9975	14.04	14.08	.9929	.07104	6.673	395.3	395.3	.5084	.5072	4.960
.5320	.5307	3.343	.9975	14.13	14.17	.9930	.07059	6.685	400.3	400.3	.5084	.5071	4.960
.5330	.5317	3.349	.9975	14.22	14.25	.9931	.07016	6.698	405.3	405.3	.5083	.5070	4.959
.5340	.5327	3.355	.9976	14.31	14.34	.9931	.06972	6.710	410.5	410.5	.5082	.5069	4.959
.5350	.5337	3.362	.9976	14.40	14.43	.9932	.06928	6.723	415.6	415.6	.5081	.5069	4.959
.5360	.5347	3.368	.9976	14.49	14.52	.9933	.06885	6.736	420.9	420.9	.5080	.5068	4.958
.5370	.5357	3.374	.9977	14.58	14.62	.9933	.06842	6.748	426.2	426.2	.5079	.5067	4.958
.5380	.5368	3.380	.9977	14.67	14.71	.9934	.06799	6.761	431.6	431.6	.5078	.5067	4.958
.5390	.5378	3.387	.9977	14.77	14.80	.9935	.06757	6.773	437.1	437.1	.5077	.5066	4.958
.5400	.5388	3.393	.9977	14.86	14.89	.9935	.06715	6.786	442.6	442.6	.5077	.5065	4.957
.5410	.5398	3.399	.9978	14.95	14.99	.9936	.06673	6.798	448.2	448.2	.5076	.5065	4.957
.5420	.5408	3.405	.9978	15.05	15.08	.9937	.06631	6.811	453.9	453.9	.5075	.5064	4.957
.5430	.5418	3.412	.9978	15.14	15.18	.9937	.06589	6.824	459.6	459.6	.5074	.5063	4.956
.5440	.5428	3.418	.9979	15.25	15.27	.9938	.06548	6.836	465.4	465.4	.5073	.5063	4.956
.5450	.5438	3.424	.9979	15.34	15.37	.9939	.06507	6.849	471.2	471.2	.5073	.5062	4.956
.5460	.5449	3.431	.9979	15.43	15.46	.9939	.06467	6.861	477.2	477.2	.5072	.5061	4.956
.5470	.5459	3.437	.9979	15.53	15.56	.9940	.06426	6.874	483.3	483.3	.5071	.5061	4.955
.5480	.5469	3.443	.9980	15.63	15.66	.9941	.06386	6.886	489.4	489.4	.5070	.5060	4.955
.5490	.5479	3.449	.9980	15.73	15.76	.9941	.06346	6.899	495.6	495.6	.5070	.5059	4.955
.5500	.5489	3.456	.9980	15.83	15.86	.9942	.06306	6.912	501.9	501.9	.5069	.5059	4.955
.5510	.5499	3.462	.9980	15.93	15.96	.9942	.06267	6.924	508.2	508.2	.5068	.5058	4.954
.5520	.5509	3.468	.9981	16.03	16.06	.9943	.06228	6.937	514.6	514.6	.5067	.5058	4.954
.5530	.5519	3.475	.9981	16.13	16.16	.9944	.06189	6.949	521.1	521.1	.5067	.5057	4.954
.5540	.5530	3.481	.9981	16.23	16.26	.9944	.06150	6.962	527.7	527.7	.5066	.5056	4.954
.5550	.5540	3.487	.9981	16.33	16.36	.9945	.06112	6.974	534.4	534.4	.5065	.5056	4.953
.5560	.5550	3.493	.9982	16.44	16.47	.9945	.06074	6.987	541.2	541.2	.5065	.5055	4.953
.5570	.5560	3.500	.9982	16.54	16.57	.9946	.06036	6.999	548.0	548.0	.5064	.5055	4.953
.5580	.5570	3.506	.9982	16.64	16.67	.9946	.05998	7.012	554.9	554.9	.5063	.5054	4.953
.5590	.5580	3.512	.9982	16.75	16.78	.9947	.05960	7.025	561.9	561.9	.5063	.5054	4.953
.5600	.5590	3.519	.9982	16.85	16.88	.9948	.05923	7.037	569.1	569.1	.5062	.5053	4.952
.5610	.5600	3.525	.9983	16.96	16.99	.9948	.05886	7.050	576.3	576.3	.5061	.5052	4.952
.5620	.5610	3.531	.9983	17.07	17.10	.9949	.05849	7.062	583.5	583.5	.5061	.5052	4.952
.5630	.5621	3.537	.9983	17.17	17.20	.9949	.05813	7.075	590.9	590.9	.5060	.5051	4.952
.5640	.5631	3.544	.9983	17.28	17.31	.9950	.05776	7.087	598.4	598.4	.5059	.5051	4.951
.5650	.5641	3.550	.9984	17.39	17.42	.9950	.05740	7.100	606.0	606.0	.5059	.5050	4.951
.5660	.5651	3.556	.9984	17.50	17.53	.9951	.05704	7.113	613.6	613.6	.5058	.5050	4.951
.5670	.5661	3.563	.9984	17.61	17.64	.9951	.05669	7.125	621.4	621.4	.5057	.5049	4.951
.5680	.5671	3.569	.9984	17.72	17.75	.9952	.05633	7.138	629.2	629.2	.5057	.5049	4.951
.5690	.5681	3.575	.9984	17.84	17.86	.9952	.05598	7.150	637.3	637.3	.5056	.5048	4.950
.5700	.5691	3.581	.9985	17.95	17.98	.9953	.05563	7.163	645.2	645.2	.5056	.5048	4.950
.5710	.5701	3.588	.9985	18.06	18.09	.9953	.05528	7.175	653.4	653.4	.5055	.5047	4.950
.5720	.5711	3.594	.9985	18.18	18.20	.9954	.05494	7.188	661.7	661.7	.5054	.5047	4.950
.5730	.5722	3.600	.9985	18.29	18.32	.9954	.05459	7.201	670.0	670.0	.5054	.5046	4.950
.5740	.5732	3.607	.9985	18.41	18.43	.9955	.05425	7.213	678.5	678.5	.5053	.5046	4.949
.5750	.5742	3.613	.9986	18.52	18.55	.9955	.05391	7.226	687.1	687.1	.5053	.5045	4.949
.5760	.5752	3.619	.9986	18.64	18.67	.9956	.05358	7.238	695.8	695.8	.5052	.5045	4.949
.5770	.5762	3.625	.9986	18.76	18.78	.9956	.05324	7.251	704.6	704.6	.5051	.5044	4.949
.5780	.5772	3.632	.9986	18.88	18.90	.9957	.05291	7.263	713.5	713.5	.5051	.5044	4.949
.5790	.5782	3.638	.9986	18.99	19.02	.9957	.05258	7.276	722.5	722.5	.5050	.5043	4.949
.5800	.5792	3.644	.9986	19.11	19.14	.9957	.05225	7.289	731.6	731.6	.5050	.5043	4.948
.5810	.5802	3.651	.9987	19.23	19.26	.9958	.05192	7.301	740.9	740.9	.5049	.5043	4.948
.5820	.5812	3.657	.9987	19.36	19.38	.9958	.05160	7.314	750.3	750.3	.5049	.5042	4.948
.5830	.5822	3.663	.9987	19.48	19.50	.9959	.05127	7.326	759.8	759.8	.5048	.5042	4.948
.5840	.5832	3.669	.9987	19.60	19.63	.9959	.05095	7.339	769.4	769.4	.5048	.5041	4.948
.5850	.5843	3.676	.9987	19.73	19.75	.9960	.05063	7.351	779.1	779.1	.5047	.5041	4.948
.5860	.5853	3.682	.9987	19.85	19.87	.9960	.05032	7.364	788.9	788.9	.5047	.5040	4.947
.5870	.5863	3.688	.9988	19.97	20.00	.9960	.05000	7.376	798.9	798.9	.5046	.5040	4.947
.5880	.5873	3.695	.9988	20.10	20.13	.9961	.04969	7.389	809.0	809.0	.5046	.5039	4.947
.5890	.5883	3.701	.9988	20.23	20.25	.9961	.04938	7.402	819.3	819.3	.5045	.5039	4.947

Table C-2. Concluded.

d/L	d/L ₀	$\frac{2nd}{L}$	$\frac{\tanh 2nd}{L}$	$\frac{\sinh 2nd}{L}$	$\frac{\cosh 2nd}{L}$	H/H ₀ ¹	K	$\frac{4nd}{L}$	$\frac{\sinh 4nd}{L}$	$\frac{\cosh 4nd}{L}$	n	C _G /C ₀	M
.5900	.5893	3.707	.9988	20.36	20.38	.9962	.04907	7.414	829.6	829.6	.5045	.5039	4.947
.5910	.5903	3.713	.9988	20.48	20.51	.9962	.04876	7.427	840.1	840.1	.5044	.5038	4.947
.5920	.5913	3.720	.9988	20.61	20.64	.9962	.04846	7.439	850.7	850.7	.5044	.5038	4.946
.5930	.5923	3.726	.9988	20.74	20.77	.9963	.04815	7.452	861.5	861.5	.5043	.5037	4.946
.5940	.5933	3.732	.9989	20.87	20.90	.9963	.04785	7.464	872.4	872.4	.5043	.5037	4.946
.5950	.5943	3.739	.9989	21.01	21.03	.9964	.04755	7.477	883.4	883.4	.5042	.5037	4.946
.5960	.5953	3.745	.9989	21.14	21.16	.9964	.04725	7.490	894.6	894.6	.5042	.5036	4.946
.5970	.5963	3.751	.9989	21.27	21.30	.9964	.04696	7.502	905.9	905.9	.5041	.5036	4.946
.5980	.5974	3.757	.9989	21.41	21.43	.9965	.04667	7.515	917.3	917.3	.5041	.5036	4.946
.5990	.5984	3.764	.9989	21.54	21.55	.9965	.04639	7.527	929.0	929.0	.5041	.5035	4.945
.6000	.5994	3.770	.9989	21.68	21.70	.9966	.04609	7.540	940.7	940.7	.5040	.5035	4.945
.6100	.6094	3.833	.9991	23.08	23.11	.9970	.04328	7.666	1067.	1067.	.5036	.5031	4.944
.6200	.6195	3.896	.9992	24.58	24.60	.9972	.04065	7.791	1210.	1210.	.5032	.5028	4.943
.6300	.6295	3.958	.9993	26.18	26.20	.9975	.03817	7.917	1371.	1371.	.5029	.5025	4.942
.6400	.6396	4.021	.9994	27.88	27.89	.9978	.03585	8.043	1555.	1555.	.5026	.5023	4.941
.6500	.6496	4.084	.9994	29.69	29.70	.9980	.03367	8.163	1754.	1754.	.5023	.5020	4.941
.6600	.6597	4.147	.9995	31.61	31.63	.9982	.03162	8.294	1999.	1999.	.5021	.5018	4.940
.6700	.6697	4.210	.9996	33.66	33.68	.9984	.02969	8.419	2267.	2267.	.5019	.5016	4.939
.6800	.6797	4.273	.9996	35.85	35.86	.9985	.02789	8.545	2571.	2571.	.5017	.5015	4.939
.6900	.6898	4.335	.9997	38.17	38.18	.9987	.02619	8.671	2915.	2915.	.5015	.5013	4.938
.7000	.6998	4.398	.9997	40.65	40.66	.9988	.02459	8.796	3305.	3305.	.5013	.5012	4.938
.7100	.7098	4.461	.9997	43.29	43.30	.9989	.02310	8.922	3748.	3748.	.5012	.5011	4.938
.7200	.7198	4.524	.9998	46.09	46.10	.9990	.02169	9.048	4250.	4250.	.5011	.5010	4.937
.7300	.7299	4.587	.9998	49.08	49.09	.9991	.02037	9.173	4819.	4819.	.5010	.5009	4.937
.7400	.7399	4.650	.9998	52.27	52.28	.9992	.01913	9.299	5464.	5464.	.5009	.5008	4.937
.7500	.7499	4.712	.9998	55.66	55.66	.9993	.01796	9.425	6195.	6195.	.5008	.5007	4.936
.7600	.7599	4.775	.9999	59.26	59.27	.9994	.01687	9.550	7025.	7025.	.5007	.5006	4.936
.7700	.7699	4.838	.9999	63.11	63.12	.9995	.01584	9.676	7966.	7966.	.5006	.5005	4.936
.7800	.7799	4.901	.9999	67.20	67.21	.9995	.01488	9.802	9032.	9032.	.5005	.5005	4.936
.7900	.7899	4.964	.9999	71.56	71.56	.9996	.01397	9.927	10240.	10240.	.5005	.5004	4.936
.8000	.7999	5.027	.9999	76.21	76.21	.9996	.01312	10.05	11610.	11610.	.5004	.5004	4.936
.8100	.8099	5.089	.9999	81.14	81.14	.9997	.01232	10.18	13170.	13170.	.5004	.5004	4.936
.8200	.8199	5.152	.9999	86.40	86.40	.9997	.01157	10.30	14930.	14930.	.5003	.5003	4.936
.8300	.8300	5.215	.9999	92.01	92.01	.9997	.01087	10.43	16930.	16930.	.5003	.5003	4.935
.8400	.8400	5.278	1.000	97.98	97.98	.9998	.01021	10.56	19200.	19200.	.5003	.5003	4.935
.8500	.8500	5.341	1.000	104.3	104.3	.9998	.009585	10.68	21770.	21770.	.5002	.5002	4.935
.8600	.8600	5.404	1.000	111.1	111.1	.9998	.009000	10.81	24680.	24680.	.5002	.5002	4.935
.8700	.8700	5.466	1.000	118.3	118.3	.9998	.008453	10.93	27990.	27990.	.5002	.5002	4.935
.8800	.8800	5.529	1.000	126.0	126.0	.9998	.007939	11.06	31730.	31730.	.5002	.5002	4.935
.8900	.8900	5.592	1.000	134.1	134.1	.9999	.007455	11.18	35980.	35980.	.5002	.5002	4.935
.9000	.9000	5.655	1.000	142.8	142.8	.9999	.007001	11.31	40800.	40800.	.5001	.5001	4.935
.9100	.9100	5.718	1.000	152.1	152.1	.9999	.006575	11.44	46260.	46260.	.5001	.5001	4.935
.9200	.9200	5.781	1.000	162.0	162.0	.9999	.006174	11.56	52460.	52460.	.5001	.5001	4.935
.9300	.9300	5.843	1.000	172.5	172.5	.9999	.005798	11.69	59480.	59480.	.5001	.5001	4.935
.9400	.9400	5.906	1.000	183.7	183.7	.9999	.005445	11.81	67450.	67450.	.5001	.5001	4.935
.9500	.9500	5.969	1.000	195.6	195.6	.9999	.005114	11.94	76480.	76480.	.5001	.5001	4.935
.9600	.9600	6.032	1.000	208.2	208.2	.9999	.004802	12.06	86720.	86720.	.5001	.5001	4.935
.9700	.9700	6.095	1.000	221.7	221.7	.9999	.004510	12.19	98340.	98340.	.5001	.5001	4.935
.9800	.9800	6.158	1.000	236.1	236.1	.9999	.004235	12.32	111500.	111500.	.5001	.5001	4.935
.9900	.9900	6.220	1.000	251.4	251.4	1.0000	.003977	12.44	126400.	126400.	.5000	.5000	4.935
1.000	1.000	6.283	1.000	267.7	267.7	1.0000	.003735	12.57	143400.	143400.	.5000	.5000	4.935

after Wiegel, R.L., "Oscillatory Waves," U.S. Army, Beach Erosion Board, Bulletin, Special Issue No. 1, July 1948.

Table C-3. Deepwater wavelength (L_0) and velocity (C_0) as a function of wave period

T (s)	L_0^1 (m)	C_0^2 (m/s)	L_0 (ft)	C_0 (ft/s)	T (s)	L_0 (m)	C_0 (m/s)	L_0 (ft)	C_0 ft/s
3.0	14.1	4.7	46.1	15.4	12.2	232.4	19.0	762.1	62.5
3.2	16.0	5.0	52.4	16.4	12.4	240.1	19.4	787.3	63.5
3.4	18.0	5.3	59.2	17.4	12.6	247.9	19.7	812.9	64.5
3.6	20.2	5.6	66.4	18.4	12.8	255.8	20.0	838.9	65.5
3.8	22.5	5.9	73.9	19.5	13.0	263.9	20.3	865.3	66.6
4.0	25.0	6.2	81.9	20.5	13.2	272.0	20.6	892.1	67.6
4.2	27.5	6.6	90.3	21.5	13.4	280.3	20.9	919.3	68.6
4.4	30.2	6.9	99.1	22.5	13.6	288.8	21.2	947.0	69.6
4.6	33.0	7.2	108.3	23.6	13.8	297.3	21.5	975.1	70.7
4.8	36.0	7.5	118.0	24.6	14.0	306.0	21.9	1003.5	71.7
5.0	39.0	7.8	128.0	25.6	14.2	314.8	22.2	1032.4	72.7
5.2	42.2	8.1	138.4	26.6	14.4	323.8	22.5	1061.7	73.7
5.4	45.5	8.4	149.3	27.6	14.6	332.8	22.8	1091.4	74.8
5.6	49.0	8.7	160.6	28.7	14.8	342.0	23.1	1121.5	75.8
5.8	52.5	9.1	172.2	29.7	15.0	351.3	23.4	1152.0	76.8
6.0	56.2	9.4	184.3	30.7	15.2	360.7	23.7	1182.9	77.8
6.2	60.0	9.7	196.8	31.7	15.4	370.3	24.0	1214.3	78.8
6.4	64.0	10.0	209.7	32.8	15.6	380.0	24.4	1246.0	79.9
6.6	68.0	10.3	223.0	33.8	15.8	389.8	24.7	1278.2	80.9
6.8	72.2	10.6	236.7	34.8	16.0	399.7	25.0	1310.7	81.9
7.0	76.5	10.9	250.9	35.8	16.2	409.7	25.3	1343.7	82.9
7.2	80.9	11.2	265.4	36.9	16.4	419.9	25.6	1377.1	84.0
7.4	85.5	11.6	280.4	37.9	16.6	430.2	25.9	1410.9	85.0
7.6	90.2	11.9	295.7	38.9	16.8	440.7	26.2	1445.1	86.0
7.8	95.0	12.2	311.5	39.9	17.0	451.2	26.5	1479.7	87.0
8.0	99.9	12.5	327.7	41.0	17.2	461.9	26.9	1514.7	88.1
8.2	105.0	12.8	344.3	42.0	17.4	472.7	27.2	1550.1	89.1
8.4	110.2	13.1	361.3	43.0	17.6	483.6	27.5	1586.0	90.1
8.6	115.5	13.4	378.7	44.0	17.8	494.7	27.8	1622.2	91.1
8.8	120.9	13.7	396.5	45.1	18.0	505.9	28.1	1658.9	92.2
9.0	126.5	14.1	414.7	46.1	18.2	517.2	28.4	1695.9	93.2
9.2	132.1	14.4	433.4	47.1	18.4	528.6	28.7	1733.4	94.2
9.4	138.0	14.7	452.4	48.1	18.6	540.1	29.0	1771.3	95.2
9.6	143.9	15.0	471.9	49.2	18.8	551.8	29.4	1809.6	96.3
9.8	149.9	15.3	491.7	50.2	19.0	563.6	29.7	1848.3	97.3
10.0	156.1	15.6	512.0	51.2	19.2	575.6	30.0	1887.4	98.3
10.2	162.4	15.9	532.7	52.2	19.4	587.6	30.3	1927.0	99.3
10.4	168.9	16.2	553.8	53.2	19.6	599.8	30.6	1966.9	100.4
10.6	175.4	16.5	575.3	54.3	19.8	612.1	30.9	2007.2	101.4
10.8	182.1	16.9	597.2	55.3	20.0	624.5	31.2	2048.0	102.4
11.0	188.9	17.2	619.5	56.3	21.0	688.5	32.8	2257.9	107.5
11.2	195.8	17.5	642.3	57.3	22.0	755.7	34.3	2478.1	112.6
11.4	202.9	17.8	665.4	58.4	23.0	825.9	35.9	2708.5	117.8
11.6	210.1	18.1	688.9	59.4	24.0	899.3	37.5	2949.1	122.9
11.8	217.4	18.4	712.9	60.4	25.0	975.8	39.0	3200.0	128.0
12.0	224.8	18.7	737.3	61.4	26.0	1055.4	40.6	3461.1	133.1

$$^1L_0 = \frac{gT^2}{2\pi}$$

$$^2C_0 = \frac{gT}{2\pi}$$

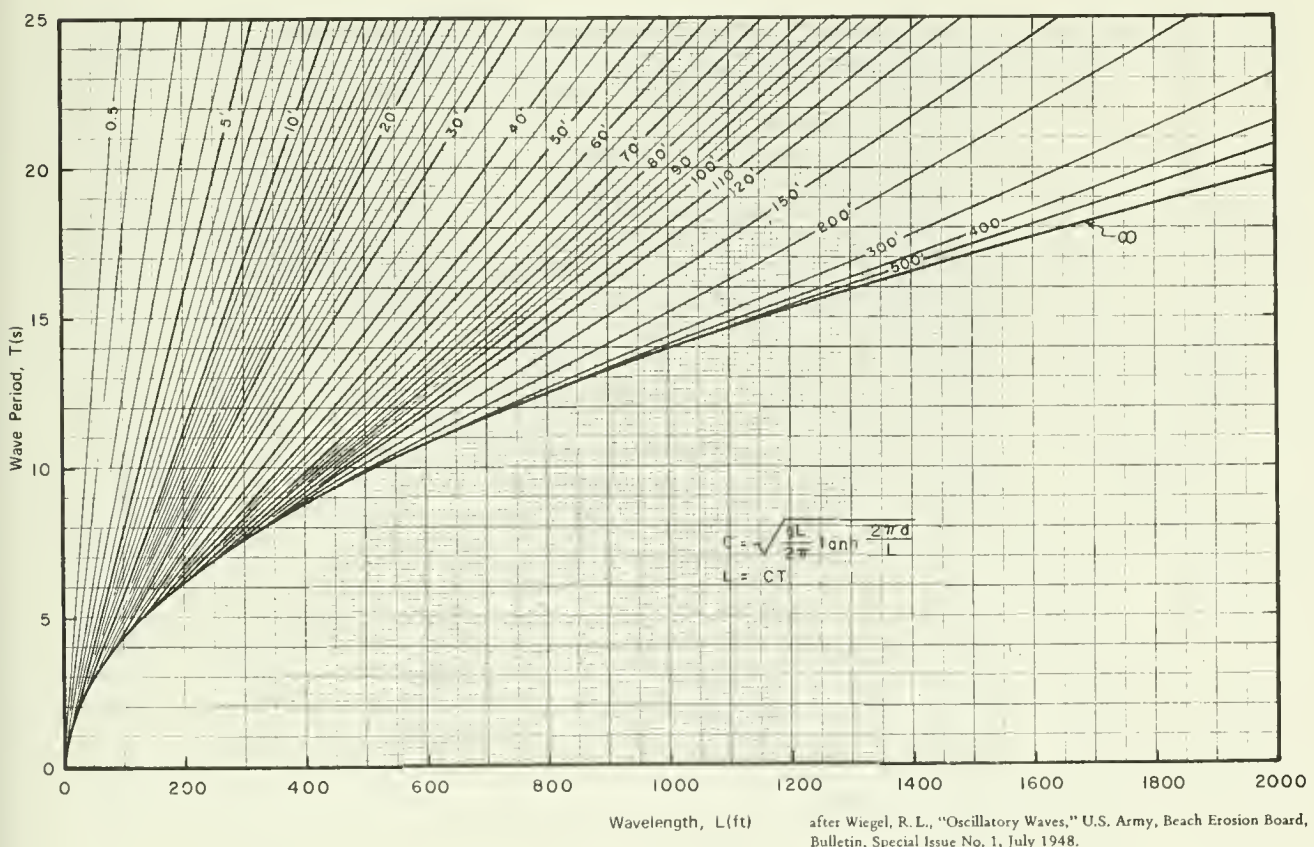
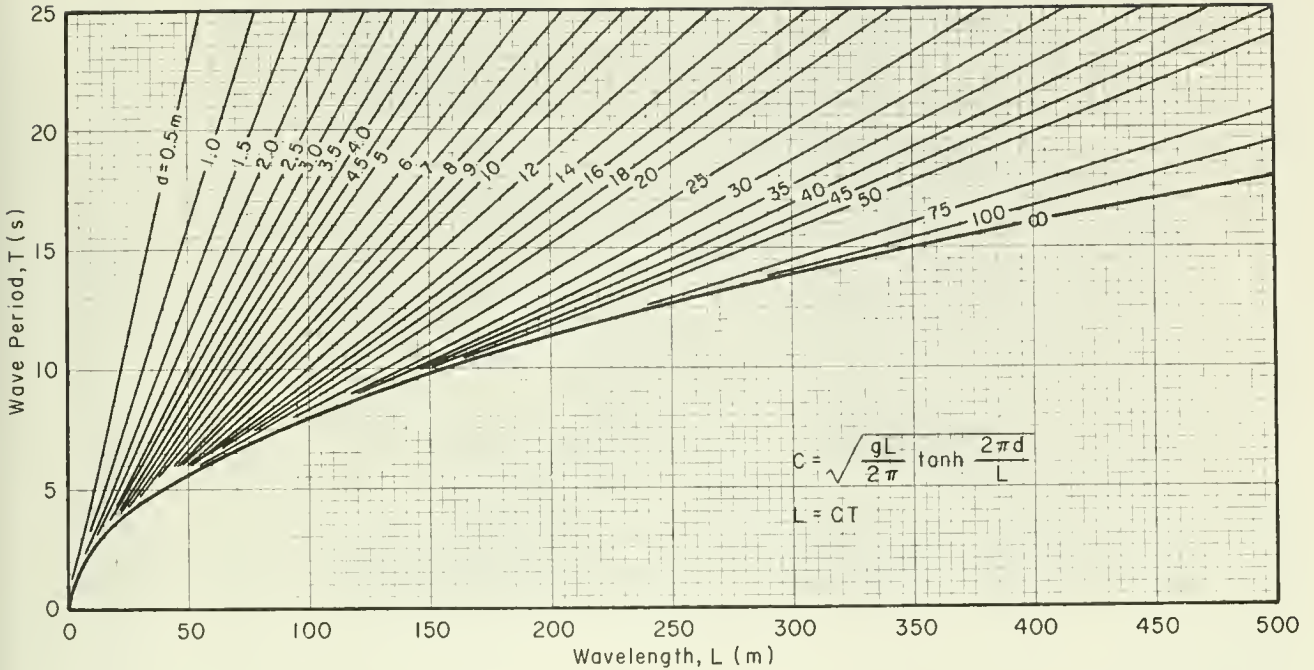

after Wiegel, R. L., "Oscillatory Waves," U.S. Army, Beach Erosion Board, Bulletin, Special Issue No. 1, July 1948.

Plate C-2. Relationship between wave period, length, and depth (upper graph shows metric, lower graph English units).

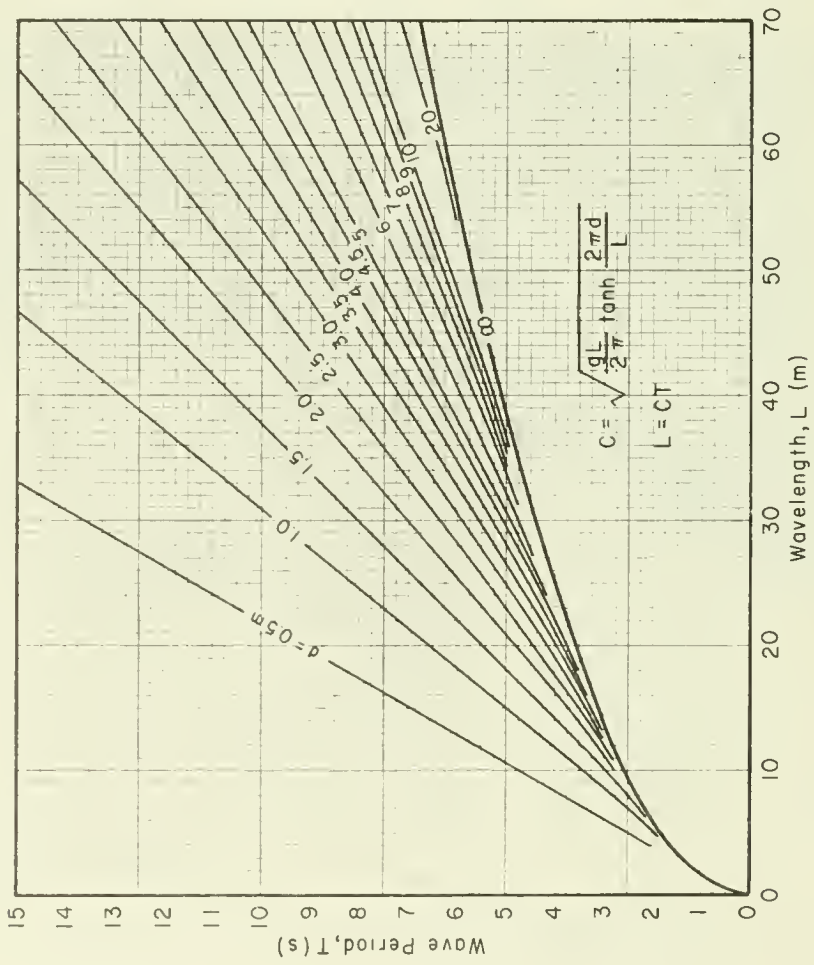
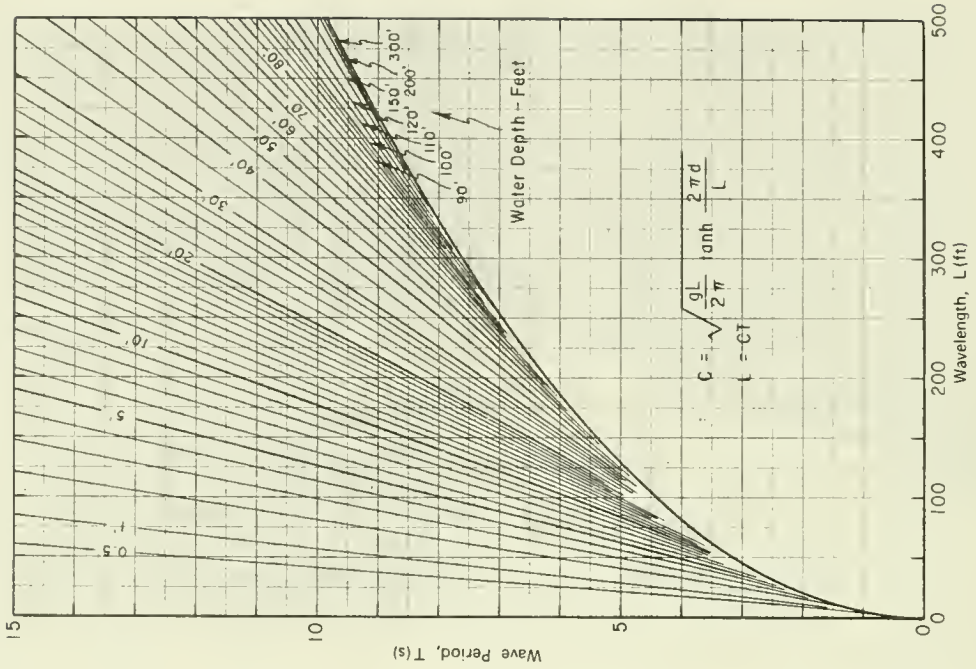
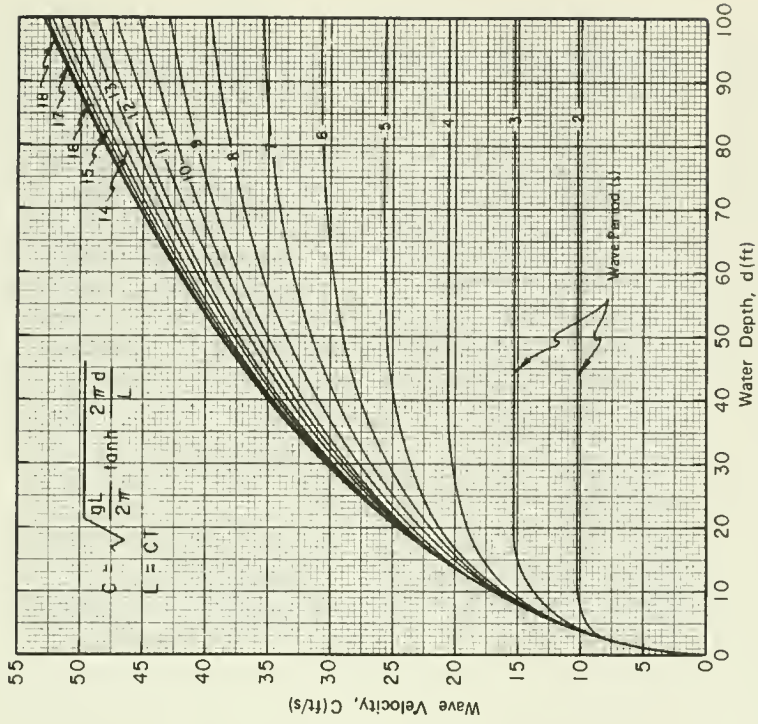
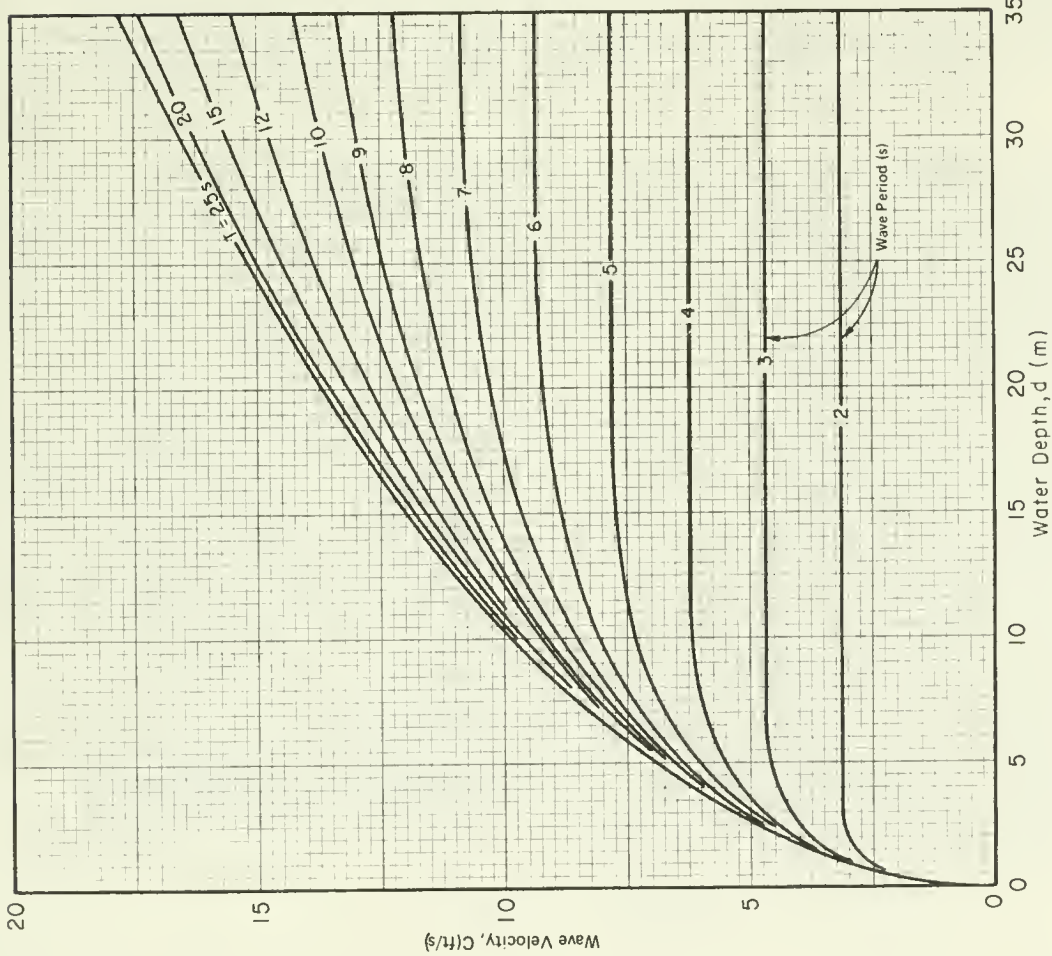

Plate C-3. Relationship between wave period, length, and depth for waves of shorter period and wavelength (graph to the left shows metric, to the right English units).



after Wiegel, R. L., "Oscillatory Waves," U.S. Army, Beach Erosion Board, Bulletin, Special Issue No. 1, July 1948.

Plate C-4. Relationship between wave period, velocity, and depth (graph to the left shows metric, to the right English units).

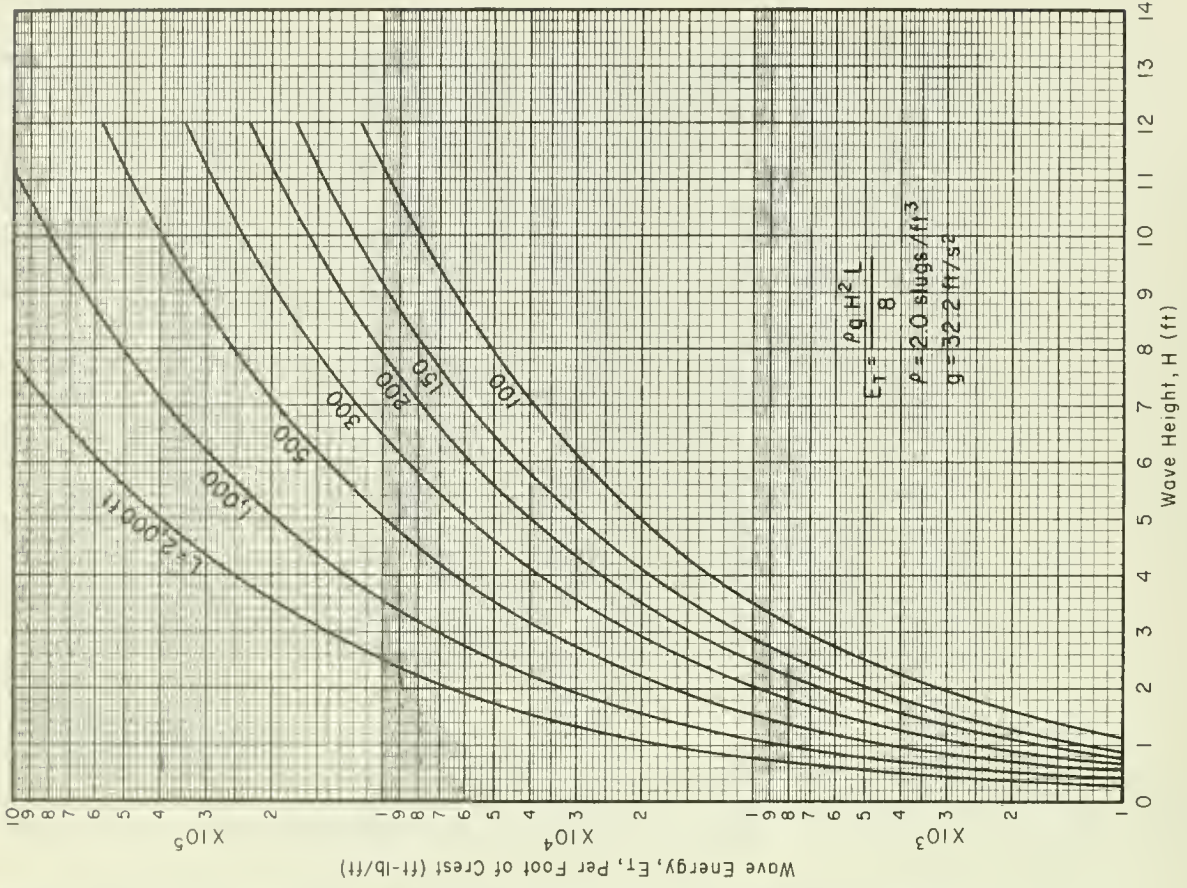
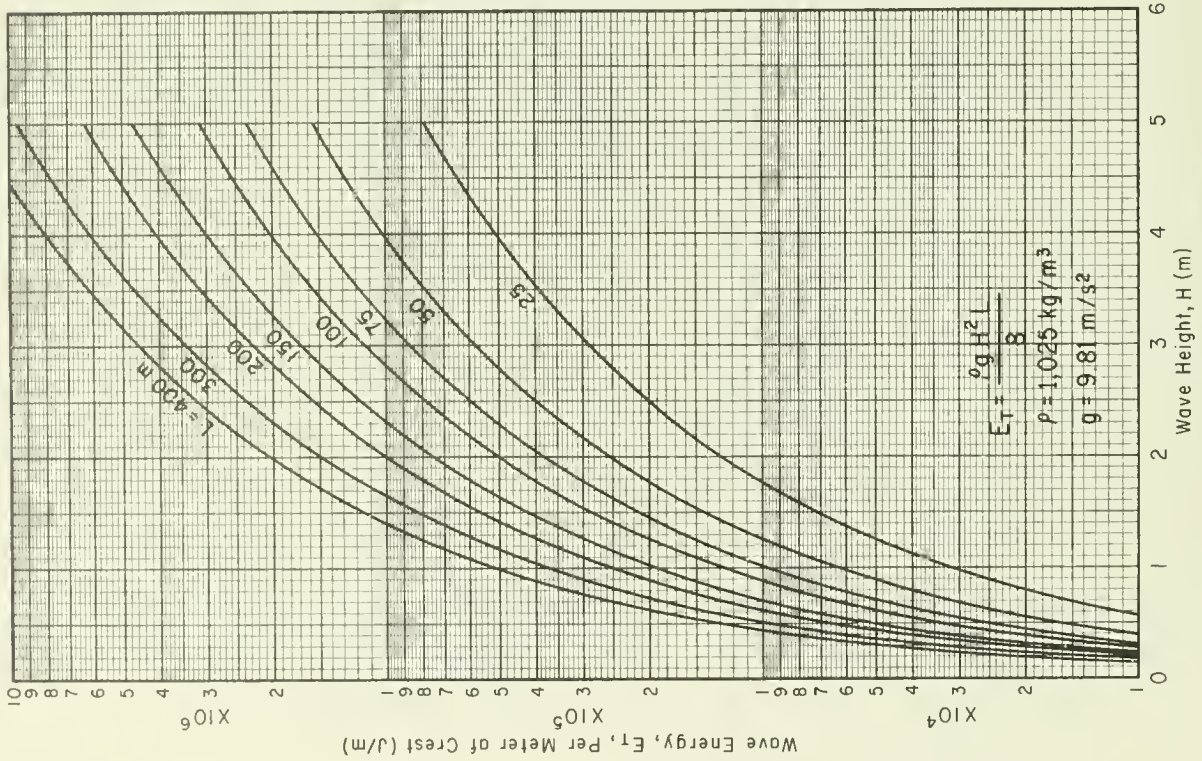

Plate C-5. Relationship between wave energy, wavelength, and wave height (graph to the left shows metric, to the right English units).

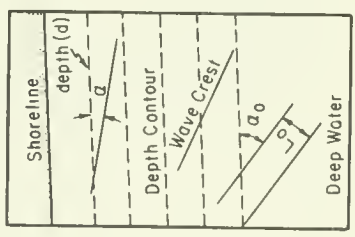
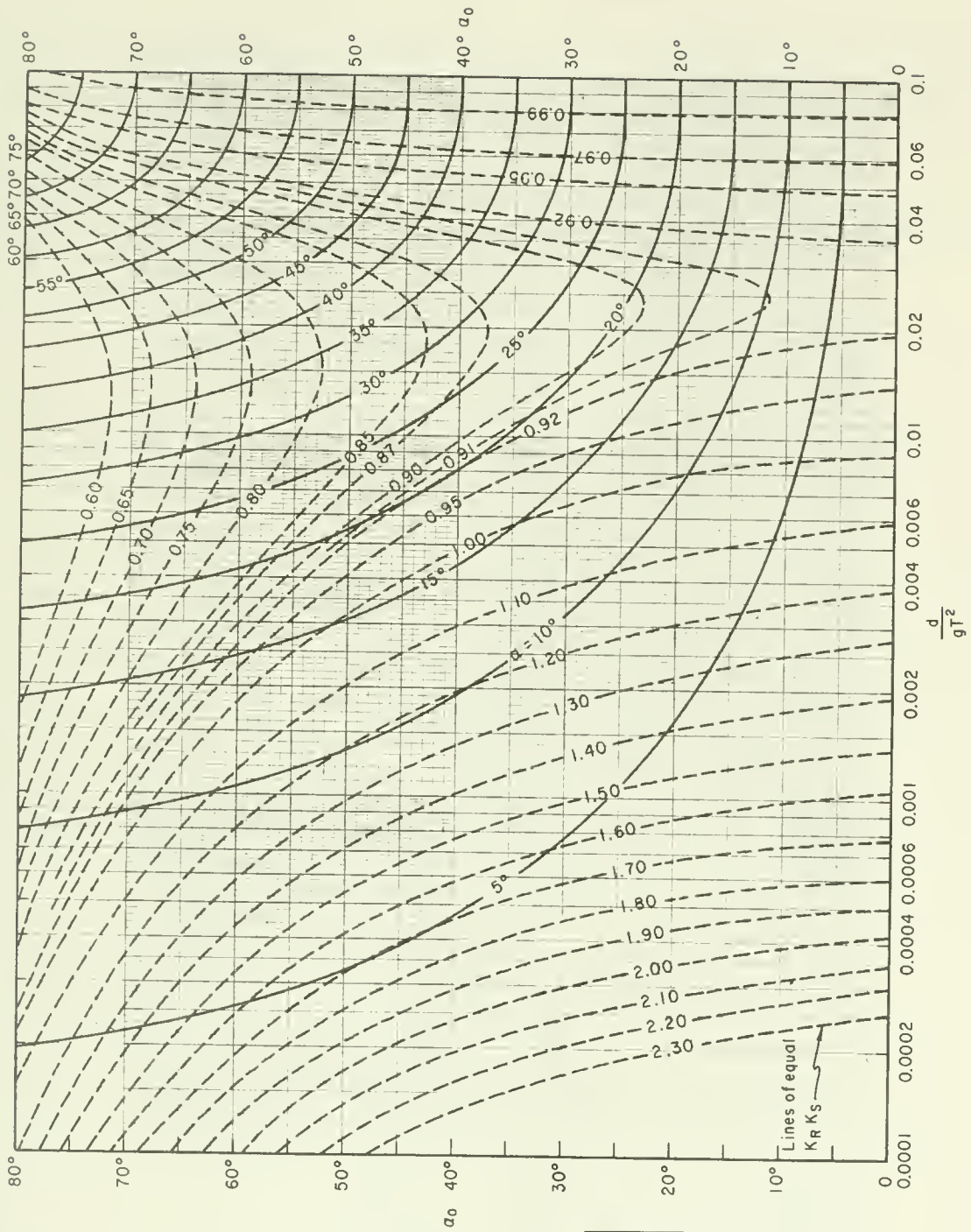

Plate C-6. Change in wave direction and height due to refraction on slopes with straight, parallel depth contours including shoaling.

Table C-4. Conversion factors: English to metric (SI) units of measurement

The following conversion factors adopted by the U.S. Department of Defense are those published by the American Society for Testing and Materials (ASTM) (Standard for Metric Practice, December 1979), except that additional derived conversion factors have been added. The metric units and conversion factors adopted by ASTM are based on the "International System of Units" (designated SI) which has been fixed by the International Committee for Weights and Measures.

For most scientific and technical work it is generally accepted that the metric SI system of units is superior to all other systems of units. The SI is the most widely accepted and used language for scientific and technical data and specifications.

In the SI system the unit of mass is the kilogram (kg) and the unit of force is the newton (N). N is defined as the force which, when applied to a mass of 1 kg, gives the mass an acceleration of 1 m/s^2 .

Former metric systems used kilogram-force as the force unit, and this has resulted in the conversion of pound-force to kilogram-force in many present-day situations, particularly in expressing the weight of a body. In the SI system the weight of a body is correctly expressed in newtons. When the value for weight is encountered expressed in kilograms, it is best to first convert it into newtons by multiplying kilograms by 9.80665. This provides consistent usage of the SI system, and will help to eliminate errors in derived units.

Multiply	By	To Obtain
Length		
inches	2.54	centimeters
feet	0.304 8 ¹	meters
yards	0.914 4 ¹	meters
fathoms	1.828 8	meters
statute miles (U.S.)	1 609.4	meters
.	1.609 34	kilometers
nautical miles	1 852.0 ¹	meters
.	1.852 ¹	kilometers
Area		
square inches	6.451 6 ¹	square centimeters
square feet	0.092 903 0	square meters
square yards	0.836 127	square meters
acres	0.404 687	hectares
.	4 046.87	square meters
square miles (U.S. statute)	2.589 99	square kilometers
Volume		
cubic inches	16.387 1	cubic centimeters
cubic feet	0.028 316 8	cubic meters
cubic yards	0.764 555	cubic meters
cubic yards per foot	2.508 38	cubic meters per meter
Liquid Capacity		
fluid ounces (U.S.)	29.573 5	cubic centimeters
.	29.573 5	milliliters
liquid pints (U.S.)	0.473 176	liters
quarts (U.S.)	0.946 353	liters
gallons (U.S.)	3.785 41	liters
cubic feet	28.316 8	liters
acre-feet	1 233.48	cubic meters
Mass		
ounces (avoirdupois)	28.349 5	grams
pounds (avoirdupois)	0.453 592 37 ¹	kilograms
slugs	14.593 902 9 ¹	kilograms
Mass Per Unit Time (Mass Flow)		
pounds per second	0.453 592	kilograms per second
Mass Per Unit Volume (Density)		
ounces per cubic inch	1 729.99	kilograms per cubic meter
pounds per cubic foot	16.0185	kilograms per cubic meter
slugs per cubic foot	515.379	kilograms per cubic meter
Force (Weight)		
pounds-force	4.448 22	newtons
kips (1000 lbf)	4.448 22	kilonewtons
kilograms-force ²	9.806 65	newtons
short tons (2000 lbf)	8.896 44	kilonewtons
long tons (2240 lbf)	9.964 02	kilonewtons

¹Exact conversion value.

²Technically, mass-to-force conversion.

Table C-4. Concluded.

Multiply	By	To Obtain
Force per Unit Length		
pounds-force per foot	14.593 9	newtons per meter
kips per foot	14.593 9	kilonewtons per meter
Force per Unit Area (Pressure or Stress)		
millibar	100.0 ¹	newtons per square meter ²
pounds-force per square inch	6.894 76	kilonewtons per square meter ²
pounds-force per square foot	47.880 3	newtons per square meter ²
short tons per square foot ³	95.760 5	kilonewtons per square meter ²
kilograms per square meter ³	9.806 65 ¹	newtons per square meter ²
Force per Unit Volume (Unit Weight = Specific Weight)		
pounds-force per cubic inch	271.447	kilonewtons per cubic meter
pounds-force per cubic foot	157.087	newtons per cubic meter
kilograms per cubic meter ⁴	9.806 65	newtons per cubic meter
Bending Moment or Torque		
inch-pounds-force	0.112 985	newton-meters ⁵
foot-pounds-force	1.355 82	newton-meters ⁵
Velocity		
feet per second	0.304 8 ¹	meters per second
miles per hour (International)	0.447 04 ¹	meters per second
.	1.609 344 ¹	kilometers per hour
knots (international)	0.514 444	meters per second
.	1.852	kilometers per hour
Velocity		
feet per second	0.3048 ¹	meters per second
Volume per Unit Time (Discharge)		
cubic feet per second	0.028 317	cubic meters per second
cubic yards per year	0.764 555	cubic meters per year
Energy or Work		
foot-pounds-force	1.355 82	newton-meters ⁵
kilowatt hours	3.60 ¹	meganeutron-meters ⁵
British thermal units (Btu)	1 055.06	newton-meters ⁵
Power		
horsepower (550 foot-pounds-force per second)	745.700	newton-meters per second ⁶
Btu's per hour	0.293 071	newton-meters per second ⁶
foot-pounds-force per second	1.355 82	newton-meters per second ⁶

¹Exact conversion value.

²The SI unit for a newton per square meter is a pascal.

³Technically, mass/area-to-force/area conversion.

⁴Technically, density-to unit weight conversion.

⁵The SI unit for a newton-meter is a joule.

⁶The SI unit for a newton-meter per second is a watt.

Table C-5. Phi-millimeter conversion table

Table C-5 is reproduced from the *Journal of Sedimentary Petrology*, with the permission of the author and publisher. It was taken from the Harry G. Page, "Phi-Millimeter Conversion Table," published in Volume 25, pp. 285-292, 1955, and includes that part of the table from -5.99 (about 63 mm) to +5.99 (about 0.016 mm) which provides a sufficient range for beach sediments. The complete table extends from about -6.65 (about 100 mm) to +10.00 (about 0.001 mm).

The first column of the table shows the absolute value of phi. If it is positive, the corresponding diameter value is shown in the second column. If phi is negative, the corresponding diameter is shown in the third column of the table. In converting diameter values in millimeters to their phi equivalents, the closest phi value to the given diameter may be selected. It is seldom necessary to express phi to more than two decimal places.

The conversion table is technically a table of negative logarithms to the base 2, from the defining equation of phi: $\phi = \log_2 d$, where d is the diameter in millimeters

Values of phi can also be determined with an electronic calculator having scientific notation by use of the following relationship:

$$\phi = -\log_2 d = -\frac{\log_{10} d}{\log_{10} 2}$$

The table begins on the following page.

Table C-5. Phi-millimeter conversion table

ϕ	(+ ϕ) mm	(- ϕ) mm	ϕ	(+ ϕ) mm	(- ϕ) mm	ϕ	(+ ϕ) mm	(- ϕ) mm
0.00	1.0000	1.0000	0.50	0.7071	1.4142	1.00	0.5000	2.0000
01	0.9931	0070	51	7022	4241	01	4965	0139
02	9862	0140	52	6974	4340	02	4931	0279
03	9794	0210	53	6926	4439	03	4897	0420
04	9718	0285	54	6877	4540	04	4863	0562
05	9659	0355	55	6830	4641	05	4841	0705
06	9593	0425	56	6783	4743	06	4796	0849
07	9526	0498	57	6736	4845	07	4763	0994
08	9461	0570	58	6690	4948	08	4730	1140
09	9395	0644	59	6643	5052	09	4697	1287
0.10	9330	0718	0.60	6598	5157	1.10	4665	1435
11	9266	0792	61	6552	5263	11	4633	1585
12	9202	0867	62	6507	5369	12	4601	1735
13	9138	0943	63	6462	5476	13	4569	1886
14	9075	1019	64	6417	5583	14	4538	2038
15	9013	1096	65	6373	5692	15	4506	2191
16	8950	1173	66	6329	5801	16	4475	2346
17	8890	1251	67	6285	5911	17	4444	2501
18	8827	1329	68	6242	6021	18	4414	2658
19	8766	1408	69	6199	6133	19	4383	2815
0.20	8705	1487	0.70	6156	6245	1.20	4353	2974
21	8645	1567	71	6113	6358	21	4323	3134
22	8586	1647	72	6071	6472	22	4293	3295
23	8526	1728	73	6029	6586	23	4263	3457
24	8468	1810	74	5987	6702	24	4234	3620
25	8409	1892	75	5946	6818	25	4204	3784
26	8351	1975	76	5905	6935	26	4175	3950
27	8293	2058	77	5864	7053	27	4147	4116
28	8236	2142	78	5824	7171	28	4118	4284
29	8179	2226	79	5783	7291	29	4090	4453
0.30	8123	2311	0.80	5743	7411	1.30	4061	4623
31	8066	2397	81	5704	7532	31	4033	4794
32	8011	2483	82	5664	7654	32	4005	4967
33	7955	2570	83	5625	7777	33	3978	5140
34	7900	2658	84	5586	7901	34	3950	5315
35	7846	2746	85	5548	8025	35	3923	5491
36	7792	2834	86	5510	8150	36	3896	5669
37	7738	2924	87	5471	8276	37	3869	5847
38	7684	3014	88	5434	8404	38	3842	6027
39	7631	3104	89	5396	8532	39	3816	6208
0.40	7579	3195	0.90	5359	8661	1.40	3789	6390
41	7526	3287	91	5322	8790	41	3763	6574
42	7474	3379	92	5285	8921	42	3729	6759
43	7423	3472	93	5249	9053	43	3711	6945
44	7371	3566	94	5212	9185	44	3686	7132
45	7321	3660	95	5176	9319	45	3660	7321
46	7270	3755	96	5141	9453	46	3635	7511
47	7220	3851	97	5105	9588	47	3610	7702
48	7170	3948	98	5070	9725	48	3585	7895
49	7120	4044	99	5035	9862	49	3560	8089

Table C-5. Continued.

ϕ	(+ ϕ) mm	(- ϕ) mm	ϕ	(+ ϕ) mm	(- ϕ) mm	ϕ	(+ ϕ) mm	(- ϕ) mm
1.50	0.3536	2.8284	2.00	0.2500	4.0000	2.50	0.1768	5.6569
51	3511	8481	01	2483	0278	51	1756	6962
52	3487	8679	02	2466	0558	52	1743	7358
53	3463	8879	03	2449	0840	53	1731	7757
54	3439	9079	04	2432	1125	54	1719	8159
55	3415	9282	05	2415	1411	55	1708	8563
56	3392	9485	06	2398	1699	56	1696	8971
57	3368	9690	07	2382	1989	57	1684	9381
58	3345	9897	08	2365	2281	58	1672	9794
59	3322	3.0105	09	2349	2575	59	1661	6.0210
1.60	3299	0314	2.10	2333	2871	2.60	1649	0629
61	3276	0525	11	2316	3169	61	1638	1050
62	3253	0737	12	2300	3469	62	1627	1475
63	3231	0951	13	2285	3772	63	1615	1903
64	3209	1166	14	2269	4076	64	1604	2333
65	3186	1383	15	2253	4383	65	1593	2767
66	3164	1602	16	2238	4691	66	1582	3203
67	3143	1821	17	2222	5002	67	1571	3643
68	3121	2043	18	2207	5315	68	1560	4086
69	3099	2266	19	2192	5631	69	1550	4532
1.70	3078	2490	2.20	2176	5948	2.70	1539	4980
71	3057	2716	21	2161	6268	71	1528	5432
72	3035	2944	22	2146	6589	72	1518	5887
73	3015	3173	23	2132	6913	73	1507	6346
74	2994	3404	24	2117	7240	74	1497	6807
75	2973	3636	25	2102	7568	75	1487	7272
76	2952	3870	26	2088	7899	76	1476	7740
77	2932	4105	27	2073	8232	77	1466	8211
78	2912	4343	28	2059	8568	78	1456	8685
79	2892	4581	29	2045	8906	79	1446	9163
1.80	2872	4822	2.30	2031	9246	2.80	1436	9644
81	2852	5064	31	2017	9588	81	1426	7.0128
82	2832	5308	32	2003	9933	82	1416	0616
83	2813	5554	33	1989	5.0281	83	1406	1107
84	2793	5801	34	1975	0631	84	1397	1602
85	2774	6050	35	1961	0983	85	1387	2100
86	2755	6301	36	1948	1337	86	1377	2602
87	2736	6553	37	1934	1694	87	1368	3107
88	2717	6808	38	1921	2054	88	1358	3615
89	2698	7064	39	1908	2416	89	1350	4110
1.90	2679	7321	2.40	1895	2780	2.90	1340	4643
91	2661	7581	41	1882	3147	91	1330	5162
92	2643	7842	42	1869	3517	92	1321	5685
93	2624	8106	43	1856	3889	93	1312	6211
94	2606	8371	44	1843	4264	94	1303	6741
95	2588	8637	45	1830	4642	95	1294	7275
96	2570	8906	46	1817	5022	96	1285	7812
97	2553	9177	47	1805	5404	97	1276	8354
98	2535	9449	48	1792	5790	98	1267	8899
99	2517	9724	49	1780	6178	99	1259	9447

Table C-5. Continued.

ϕ	(+ ϕ) mm	(- ϕ) mm	ϕ	(+ ϕ) mm	(- ϕ) mm	ϕ	(+ ϕ) mm	(- ϕ) mm
3.00	0.1250	8.0000	3.50	0.0884	11.314	4.00	0.0625	16.000
01	1241	0556	51	0878	392	01	0621	111
02	1233	1117	52	0872	472	02	0616	223
03	1224	1681	53	0866	551	03	0612	336
04	1216	2249	54	0860	632	04	0608	450
05	1207	2821	55	0854	713	05	0604	564
06	1199	3397	56	0848	794	06	0600	679
07	1191	3977	57	0842	876	07	0595	795
08	1183	4561	58	0836	959	08	0591	912
09	1174	5150	59	0830	12.042	09	0587	17.030
3.10	1166	5742	3.60	0825	126	4.10	0583	148
11	1158	6338	61	0819	210	11	0579	268
12	1150	6939	62	0813	295	12	0575	388
13	1142	7544	63	0808	381	13	0571	509
14	1134	8152	64	0802	467	14	0567	630
15	1127	8766	65	0797	553	15	0563	753
16	1119	9383	66	0791	641	16	0559	877
17	1111	9.0055	67	0786	729	17	0556	18.001
18	1103	0631	68	0780	817	18	0552	126
19	1096	1261	69	0775	906	19	0548	252
3.20	1088	1896	3.70	0769	996	4.20	0544	379
21	1081	2535	71	0764	13.086	21	0540	507
22	1073	3179	72	0759	178	22	0537	635
23	1066	3827	73	0754	269	23	0533	765
24	1058	4479	74	0748	361	24	0529	896
25	1051	5137	75	0743	454	25	0526	19.027
26	1044	5798	76	0738	548	26	0522	160
27	1037	6465	77	0733	642	27	0518	293
28	1029	7136	78	0728	737	28	0515	427
29	1022	7811	79	0723	833	29	0511	562
3.30	1015	8492	3.80	0718	929	4.30	0508	698
31	1008	9177	81	0713	14.026	31	0504	835
32	1001	9866	82	0708	123	32	0501	973
33	0994	10.0561	83	0703	221	33	0497	20.112
34	0988	1261	84	0698	320	34	0494	252
35	0981	1965	85	0693	420	35	0490	393
36	0974	2674	86	0689	520	36	0487	535
37	0967	3388	87	0684	621	37	0484	678
38	0960	4107	88	0679	723	38	0480	821
39	0954	4831	89	0675	825	39	0477	966
3.40	0947	5561	3.90	0670	929	4.40	0474	21.112
41	0941	6295	91	0665	15.032	41	0470	259
42	0934	7034	92	0661	137	42	0467	407
43	0928	7779	93	0656	242	43	0464	556
44	0921	8528	94	0652	348	44	0461	706
45	0915	9283	95	0647	455	45	0458	857
46	0909	11.0043	96	0643	562	46	0454	22.009
47	0902	0809	97	0638	671	47	0451	162
48	0896	1579	98	0634	780	48	0448	316
49	0890	2356	99	0629	889	49	0445	471

Table C-5. Concluded.

ϕ	(+ ϕ) mm	(- ϕ) mm	ϕ	(+ ϕ) mm	(- ϕ) mm	ϕ	(+ ϕ) mm	(- ϕ) mm
4.50	0.0442	22.627	5.00	0.0313	32.000	5.50	0.0221	45.255
51	0439	785	01	0310	223	51	0219	570
52	0436	943	02	0308	447	52	0218	886
53	0433	23.103	03	0306	672	53	0216	46.206
54	0430	264	04	0304	900	54	0215	527
55	0427	425	05	0302	33.128	55	0213	851
56	0424	588	06	0300	359	56	0212	47.177
57	0421	752	07	0298	591	57	0211	505
58	0418	918	08	0296	825	58	0209	835
59	0415	24.084	09	0294	34.060	59	0208	48.168
4.60	0412	251	5.10	0292	297	5.60	0206	503
61	0409	420	11	0290	535	61	0205	840
62	0407	590	12	0288	776	62	0203	49.180
63	0404	761	13	0286	35.017	63	0202	522
64	0401	933	14	0284	261	64	0201	867
65	0398	25.107	15	0282	506	65	0199	50.213
66	0396	281	16	0280	753	66	0198	563
67	0393	457	17	0278	36.002	67	0196	914
68	0390	634	18	0276	252	68	0195	51.268
69	0387	813	19	0274	504	69	0194	625
4.70	0385	992	5.20	0272	758	5.70	0192	984
71	0382	26.173	21	0270	37.014	71	0191	52.346
72	0379	355	22	0268	271	72	0190	710
73	0377	538	23	0266	531	73	0188	53.076
74	0374	723	24	0265	792	74	0187	446
75	0372	909	25	0263	38.055	75	0186	817
76	0369	27.096	26	0261	319	76	0185	54.192
77	0367	284	27	0259	586	77	0183	569
78	0364	474	28	0257	854	78	0182	948
79	0361	665	29	0256	39.124	79	0181	55.330
4.80	0359	858	5.30	0254	397	5.80	0179	715
81	0356	28.051	31	0252	671	81	0178	56.103
82	0354	246	32	0250	947	82	0177	493
83	0352	443	33	0249	40.224	83	0176	886
84	0349	641	34	0247	504	84	0175	57.282
85	0347	840	35	0245	786	85	0173	680
86	0344	29.041	36	0243	41.070	86	0172	58.081
87	0342	243	37	0242	355	87	0171	485
88	0340	446	38	0240	643	88	0170	892
89	0337	651	39	0238	933	89	0169	59.302
4.90	0335	857	5.40	0237	42.224	5.90	0167	714
91	0333	30.065	41	0235	518	91	0166	60.129
92	0330	274	42	0234	814	92	0165	548
93	0328	484	43	0232	43.111	93	0164	969
94	0326	696	44	0230	411	94	0163	61.393
95	0324	910	45	0229	713	95	0162	820
96	0321	31.125	46	0227	44.017	96	0161	62.250
97	0319	341	47	0226	426	97	0160	683
98	0317	559	48	0224	632	98	0158	63.119
99	0315	779	49	0223	942	99	0157	558

Table C-6. Values of slope angle ϕ and cot ϕ for various slopes.

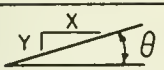

Slope Angle θ	Cot θ (X/Y)	%	Slope (Y on X)
45° 00'	1.0	100	1 on 1.0
42° 16'	1.1		1 on 1.1
39° 48'	1.2		1 on 1.2
38° 40'	1.25		1 on 1.25
37° 34'	1.3		1 on 1.3
35° 32'	1.4		1 on 1.4
33° 41'	1.5		1 on 1.5
32° 00'	1.6		1 on 1.6
29° 45'	1.75		1 on 1.75
26° 34'	2.0	50	1 on 2.0
23° 58'	2.25		1 on 2.25
21° 48'	2.5		1 on 2.5
19° 59'	2.75		1 on 2.75
18° 26'	3.0	33.3	1 on 3.0
17° 06'	3.25		1 on 3.25
15° 57'	3.5		1 on 3.5
14° 56'	3.75		1 on 3.75
14° 02'	4.0	25	1 on 4.0
13° 14'	4.25		1 on 4.25
12° 32'	4.5		1 on 4.5
11° 53'	4.75		1 on 4.75
11° 19'	5.0	20	1 on 5.0
10° 18'	5.5		1 on 5.5
9° 28'	6.0	16.7	1 on 6.0
8° 49'	6.5		1 on 6.5
8° 08'	7.0	14.3	1 on 7.0
7° 36'	7.5		1 on 7.5
7° 08'	8.0	12.5	1 on 8.0
6° 43'	8.5		1 on 8.5
6° 20'	9.0	11.1	1 on 9.0
6° 01'	9.5		1 on 9.5
5° 43'	10.0	10.0	1 on 10.0
4° 46'	12	8.3	1 on 12
4° 05'	14	7.1	1 on 14
3° 35'	16	6.25	1 on 16
3° 11'	18	5.6	1 on 18
2° 52'	20	5.0	1 on 20
1° 55'	30	3.3	1 on 30
1° 26'	40	2.5	1 on 40
1° 09'	50	2.0	1 on 50
0° 57'	60	1.7	1 on 60
0° 49'	70	1.4	1 on 70
0° 43'	80	1.25	1 on 80
0° 38'	90	1.1	1 on 90
0° 34'	100	1.0	1 on 100

APPENDIX D

Subject Index



Mustang Island, Texas, 16 November 1972

SUBJECT INDEX

- - A - -

Absecon Inlet, New Jersey, 4-91, 4-157
 Active earth force, 7-256, 7-257, 7-259, 7-260
 Adak Island, Alaska, 3-118
 Adjustable groin, 1-24, 5-53
 Adjusted shoreline (see Beach alinement)
 Airy, 2-2
 Wave Theory, 2-2, 2-4, 2-25, 2-31 thru 2-33, 2-44, 2-46, 2-54, 7-103 thru 7-106, 7-111 thru 7-117, 7-135, 7-137, 7-139, 7-140, 7-142, 7-151 thru 7-155
 Akmon, 7-216
 Algae, coralline (see Coralline algae)
 Alongshore transport (see Longshore transport)
 American beach grass, 6-44 thru 6-50, 6-52, 6-53
 Amsterdam, The Netherlands, 6-92
 Anaheim Bay, California, 4-91, 5-9
 Analysis, sediment (see Sediment analysis)
 Anchorage, Alaska, 1-6, 3-91
 Anemometer, 3-30, 3-33, 3-52
 Angle of
 internal friction (see Internal friction angle)
 wall friction, 7-257, 7-260
 wave approach, 2-90, 2-91, 2-99, 2-116, 5-35, 7-198, 7-199, 7-201, 7-210
 Angular frequency (see Wave angular frequency)
 Annapolis, Maryland, 3-116, 3-124
 Antinode, 2-113, 2-114, 3-98, 3-99
 Apalachicola, Florida, 3-92
 Aransas Pass, Texas, 4-167
 Armor
 stone, 1-23, 2-119, 6-83, 7-210, 7-236, 7-243, 7-247, 7-249, 7-251 thru 7-253
 units (see also Articulated armor unit revetment; Concrete armor units; Precast concrete armor units; Quarystone armor units; Rubble-mound structure; Stone armor units; Stability coefficient), 2-119, 2-121, 2-122, 6-88, 7-3, 7-4, 7-202 thru 7-225, 7-229, 7-231, 7-233 thru 7-240, 7-242, 7-243, 7-249, 8-50, 8-51, 8-59, 8-60, 8-73
 akmon (see Akmon)
 cube, modified (see Modified cube)
 dolos (see Dolos)
 hexapod (see Hexapod)
 hollow
 square (see Hollow square)
 tetrahedron (see Hollow tetrahedron)
 interlocking blocks (see Interlocking concrete block)
 porosity (see Porosity)
 quadripod (see Quadripod)
 stabit (see Stabit)
 svee block (see Svee block)
 tetrapod (see Tetrapod)
 toskane (see Toskane)
 tribar (see Tribar)
 types, 7-216
 weight, 7-206, 7-240, 7-249, 7-250, 8-48, 8-50, 8-62, 8-67 thru 8-69, 8-71
 Articulated armor unit revetment, 6-6
 Artificial
 beach nourishment (see also Protective beach), 1-19, 4-76, 5-6, 5-7, 5-24, 5-28, 5-34, 5-55, 5-56, 6-16
 tracers (see also Fluorescent tracers; Radioactive tracers), 4-145
 Asbury Park, New Jersey, 4-91, 6-83
 Asphalt, 6-76, 6-83, 6-84, 7-139, 7-249
 groin, 6-83
 Assateague, Virginia, 1-17, 4-37
 Astoria, Oregon, 3-118

Astronomical tides, 3-88, 3-89, 3-92, 3-104, 3-111, 3-119, 3-121, 3-123, 7-2, 7-81, 8-7, 8-10 thru 8-12, 8-46
 Atchafalaya Bay, Louisiana, 3-92
 Atlantic
 Beach, North Carolina, 4-91
 City, New Jersey, 1-3, 1-9, 3-116, 3-124, 3-125, 4-11, 4-16, 4-31 thru 4-33, 4-37, 4-41, 4-77 thru 4-79, 4-180, 6-25
 Intercoastal Waterway, 6-28
 Atmospheric pressure (see also Central pressure index), 1-7, 2-21, 3-34, 3-35, 3-89, 3-96, 3-107, 3-110, 3-111, 3-121
 Attu Island, Alaska, 3-118
 Avalon, New Jersey, 6-9

- - B - -

Backfill, 7-256, 7-257, 7-260, 8-81
 Backshore, 1-2, 1-13, 1-17, 1-20, 1-23, 3-105, 3-109, 4-62, 4-76, 4-83, 4-108, 4-115, 4-120, 4-127, 4-128, 5-20, 6-31, 6-37, 7-233
 protection, 3-105, 5-19
 Bakers Haulover Inlet, Florida, 6-32
 Bal Harbor, Florida, 6-32
 Baltimore, Maryland, 3-116, 3-124, 3-125
 Bar (see also Inner bar; Longshore bar; Offshore bar; Outer bar; Spits; Swash bar), 1-8, 1-13 thru 1-15, 1-17, 2-124, 2-125, 4-80, 4-82, 4-83, 4-149 thru 4-151, 5-6, 6-75, 7-14, A-49
 Harbor, Maine, 3-116, 3-124, 3-125
 Barnegat
 Inlet, New Jersey, 4-91, 4-170, 6-25
 Light, New Jersey, 4-77, 4-79
 Barrier (see also Littoral barrier), 1-6, 1-22, 2-75, 2-109, 2-112 thru 2-114, 3-122, 4-57, 4-136, 4-147, 4-154, 5-28, 5-31, 6-1, 6-72, 7-44, 7-232, 7-254
 beach, 1-8, 3-110, 4-24, 4-165, 5-56, 6-36
 inlet effect on (see Inlet effect on barrier beaches)
 island, 1-8, 1-9, 1-13, 1-16, 1-17, 3-123, 4-1, 4-3, 4-5, 4-6, 4-22, 4-24, 4-45, 4-108 thru 4-110, 4-112, 4-113, 4-115, 4-119, 4-120, 4-133, 4-140 thru 4-142, 4-167, 4-177, 6-32
 deflation plain (see Deflation plain)
 Barrow, Alaska, 4-45
 Bathymetry (see also Nearshore bathymetry; Offshore bathymetry; Shelf bathymetry), 2-60, 2-62, 2-122, 3-24, 3-123, 4-75, 4-147, 4-151, 4-174, 5-1, 7-13, 7-14, 7-17, 7-202, 8-1
 Battery, New York, 3-116, 3-124, 3-125, 4-77
 Bay County, Florida, 4-77, 4-79
 Bayou Rigaud, 3-117
 Beach (see also Backshore; Berm; Deflation plain; Dune; Feeder beach; Pocket beach; Protective beach), 1-2 thru 1-4, 1-7, 1-9, 1-10, 1-12, 1-13, 1-19, 2-1, 2-112, 2-118, 3-100, 3-101, 4-108, 5-6, 5-30, 5-55, 5-56, 6-37, A-47, A-49
 alinement, 1-14, 1-17, 5-1, 5-40 thru 5-46, 5-48 thru 5-50, 5-52, 5-54, 5-73, 8-32, 8-86
 changes, 4-6, 4-23, 4-30, 4-45, 4-46, 4-77, 4-78, 4-108, 4-110, 4-126, 4-143, 6-26, 6-27
 long-term, 4-6, 5-5
 short-term, 4-6, 5-4
 characteristics, 1-7, 4-79
 composition, 2-1
 erosion, 1-10, 1-13, 1-16, 1-23, 3-110, 4-76, 4-80, 4-83, 4-85, 4-89, 4-110, 4-114, 4-117, 4-129, 4-134, 4-148, 5-6, 6-16, 6-54, 6-61, 6-72
 rate, 4-110, 4-130

SUBJECT INDEX

Beach (Cont)

face (see also Shoreface), 1-17, 4-1, 4-6, 4-27, 4-50, 4-59, 4-76, 4-83, 4-108, 5-9
 fill (see also Artificial beach nourishment), 1-19, 4-12, 4-15, 4-58, 4-60, 4-80, 4-119, 4-121, 4-143, 5-4, 5-5, 5-8 thru 5-10, 5-13, 5-15, 5-19 thru 5-23, 5-71, 6-15, 6-16, 6-26, 6-28, 6-31, 6-32, 6-35, 6-36, 6-95, 8-90
 erosion, 6-26
 slopes, 5-21, 5-22
 grasses (see also American beach grass; European beach grass; Panic grasses; Sea oats), 4-5, 4-108, 6-38, 6-44, 6-46 thru 6-48, 6-52, 6-53
 planting summary, 6-47
 seeding, 6-47
 transplanting, 6-46
 Haven, New Jersey, 4-9
 nourishment (see also Artificial beach nourishment), 1-16, 1-19, 4-71, 4-173, 4-180, 5-22, 5-24, 5-34, 5-39, 5-73, 5-74, 6-14, 6-26, 6-32, 6-75
 offshore bar (see Offshore bar)
 profile (see also Profile accuracy), 1-2, 1-9, 1-10, 1-16, 1-17, 4-1, 4-2, 4-5, 4-6, 4-27, 4-43, 4-45, 4-58, 4-60 thru 4-64, 4-76, 4-80, 4-86, 4-89, 4-117, 4-143, 4-147, 5-3, 5-4, 5-6, 5-8, 5-19, 5-20, 5-31, 5-35, 5-40, 5-43, 5-48 thru 5-51, 5-67, 6-26
 terms, A-42
 protection (see also Artificial beach nourishment; Beach grasses; Beach nourishment; Beach restoration; Shore protection), 1-8, 1-10, 4-23, 4-119, 6-75
 vegetation (see Beach grasses; Vegetation)
 recovery, 1-13, 4-76, 4-78, 4-80, 4-83
 replenishment, 4-119, 4-127 thru 4-129, 4-134, 5-6, 5-21, 6-30
 response, 1-9 thru 1-11, 1-15
 restoration (see also Artificial beach nourishment; Beach nourishment; Dune), 1-19, 1-22, 5-6, 5-7, 5-20, 5-23, 6-15, 6-16, 6-25, 6-28, 6-34
 rock, 4-23, 4-24
 sediment, 1-7, 1-13, 1-16, 2-60, 4-12, 4-15, 4-23, 4-27, 4-85, 5-12, 5-13, 5-21, C-38
 slopes, 1-7 thru 1-9, 1-14, 2-129, 2-130, 2-135, 3-102, 3-105, 3-107, 4-44, 4-49, 4-54, 4-83, 4-87, 4-88, 5-20, 5-35, 5-49, 5-50, 5-64, 5-67, 5-71, 7-8, 7-194, 7-196, 7-197
 stability, 1-15, 5-56, 6-54
 storm effects (see Storm attack on beaches)
 surveys, 4-143
 Beacon Inn, California, 4-10
 Beaumont, Texas, 3-112, 3-113
 Bedding layer, 7-227, 7-228, 7-240 thru 7-242, 7-245, 7-247 thru 7-249
 Bedload (see also Suspended load), 4-58, 4-59, 4-65, 4-66, 4-147
 Belfast, Maine, 3-92
 Berm (see also Storm berm; Toe berm), 1-2, 1-3, 1-10, 1-12, 1-17, 3-100, 4-1, 4-10, 4-21, 4-62, 4-67, 4-80, 4-83, 4-108, 4-117, 4-120, 4-148, 5-5, 5-6, 5-20 thru 5-22, 5-24 thru 5-26, 5-28, 5-40, 5-41, 5-43 thru 5-46, 5-49 thru 5-53, 5-60, 6-26, 6-32, 6-39, 6-46, 6-84, 7-35 thru 7-40, 7-247
 elevation, 1-7, 1-10, 4-76, 4-79, 4-86, 5-8, 5-20, 5-45, 5-50, 7-37
 width, 1-7, 1-10, 5-20 thru 5-22, 5-45, 7-238
 Biloxi, Mississippi, 4-35
 Biscayne Bay, Florida, 6-36
 Boca
 Grande Inlet, Florida, 4-149
 Raton, Florida, 4-37
 Inlet, 6-61
 Bodie Island, North Carolina, 4-77, 4-79
 Borrow
 areas, 4-119, 4-173, 5-10, 5-12, 5-19, 6-14 thru 6-16, 6-28, 6-36, 6-75

Borrow (Cont)

material, 5-6, 5-8 thru 5-13, 5-16, 5-17, 5-19, 5-21, 6-16, 6-26, 8-90, 8-91
 selection, 5-8, 5-9
 Boston, Massachusetts, 3-90, 3-116, 3-124, 3-125, 4-35, 4-77
 Harbor, 4-119
 Bottom
 friction, 2-2, 2-63, 3-55, 3-66 thru 3-68, 3-70, 3-75, 4-29, 4-30, 4-36, 4-124, 7-13, 7-14, 8-90
 factor, 3-24, 3-67, 3-68
 profile, 7-2, 8-5, 8-6
 slopes, 2-6, 2-109, 2-126, 4-85, 7-16, 7-182, 7-237, 7-250
 topography, 2-60, 2-62, 2-66, 2-74, 4-29, 4-31, 7-14
 velocity, 1-10, 4-47, 4-49, 4-67 thru 4-69, 4-73, 5-37
 Breaker (see Breaking wave)
 Breaking wave (see also Design breaking wave), 1-1, 1-2, 1-9, 1-14, 2-37, 2-73, 2-129, 2-130, 2-133, 2-134, 3-12, 3-15, 3-99, 3-105, 4-4, 4-49, 4-50, 4-53, 4-55, 4-57 thru 4-60, 4-67, 4-100, 4-107, 4-142, 4-143, 4-147, 5-3, 5-5, 5-63, 5-65, 6-88, 7-2 thru 7-4, 7-8, 7-11, 7-14, 7-17, 7-18, 7-38, 7-40, 7-45 thru 7-53, 7-100, 7-117, 7-119 thru 7-126, 7-157 thru 7-161, 7-164 thru 7-170, 7-180, 7-182, 7-191, 7-192, 7-198, 7-201 thru 7-204, 7-206, 7-207, 7-209, 7-212, 7-238, 7-246, 8-35
 depth, 2-59, 2-130, 5-39, 7-37, 7-193, 7-196
 forces (see also Minikin), 7-158 thru 7-160, 7-170, 7-181, 7-200
 on piles, 7-100, 7-157
 on walls, 7-100, 7-180, 7-182, 7-187
 geometry, 7-5
 height (see also Design breaking wave height), 2-37, 2-119, 2-121, 2-130, 2-135, 2-136, 3-15, 3-102, 3-104, 4-4, 4-22, 4-51, 4-54, 4-92, 4-98, 4-100, 4-104 thru 4-106, 7-4, 7-5, 7-8, 7-9, 7-11, 7-13, 7-112, 7-117, 7-118, 7-159, 7-181, 7-183, 7-186, 7-187, 7-192, 7-193, 7-204
 index, 2-130, 2-131, 4-104, 7-7, 7-12
 types, 1-9, 2-130, 2-133 thru 2-135, 4-49, A-44
 Breakwater (see also Cellular-steel sheet-pile breakwater; Composite breakwater; Concrete caisson breakwater; Floating breakwater; Impermeable breakwater; Offshore breakwater; Permeable breakwater; Rubble-mound breakwater; Shore-connected breakwater; Steel sheet-pile breakwater; Stone-asphalt breakwater; Subaerial breakwater; Submerged breakwater), 1-5, 1-19, 1-22, 1-23, 2-75, 2-76, 2-90 thru 2-100, 2-109, 2-110, 2-115, 2-116, 2-119, 3-110, 5-28, 5-59, 5-64 thru 5-72, 6-1, 6-54, 6-59, 6-73, 7-1, 7-3, 7-61, 7-62, 7-64, 7-66, 7-67, 7-73 thru 7-75, 7-81 thru 7-85, 7-89, 7-92 thru 7-94, 7-100, 7-180, 7-181, 7-187, 7-198, 7-203, 7-207, 7-211, 7-225, 7-226, 7-229, 7-233, 7-236, 7-238, 7-239, 7-242, 7-246, 8-74, 8-75, 8-81
 gaps, 2-92, 2-93, 2-99 thru 2-103, 2-107, 2-108, 5-64, 5-65, 5-67, 5-72, 5-73, 6-95, 7-89, 7-94 thru 7-98
 Harbor, Delaware, 3-116, 3-124, 3-125
 Brigantine, New Jersey, 4-37
 Broken wave, 1-3, 1-9, 4-59, 7-2, 7-3, 7-16, 7-17, 7-100, 7-160, 7-161, 7-170, 7-192, 7-193, 7-195, 7-198, 7-200, 7-202, 7-204
 Broward County, Florida, 6-74
 Brown Cedar Cut, Texas, 4-167, 4-171
 Brownsville, Texas, 3-114
 Brunswick County, North Carolina, 5-15
 Buffalo Harbor, Lake Michigan, 4-136
 Bulkhead (see also Cellular-steel sheet-pile bulkhead; Concrete bulkhead; Sheet-pile bulkhead; Steel sheet-pile bulkhead; Timber sheet-pile bulkhead), 1-19 thru 1-21, 2-112, 2-126, 5-2 thru 5-4, 6-1, 6-6, 6-7, 6-14, 6-56, 6-73, 7-100, 7-198, 7-249, 7-254

SUBJECT INDEX

- Burrwood, Louisiana, 3-81
 Bypassing sand (see Sand bypassing)
- - C - -
- Caisson (see also Cellular-steel caisson; Concrete caisson; Nonbreaking wave forces on caissons), 5-56, 6-93, 7-105, 7-182, 8-75, 8-77, 8-81, 8-84 stability, 8-75, 8-81
 Calcais, Maine, 3-92
 Camp Pendleton, California, 4-91
 Cantilever steel sheet-pile groin, 6-79, 6-83
 Canyon (see also Submarine canyon), 4-124
 Cape
 Canaveral, Florida, 6-15, 6-25
 Cod, Massachusetts, 1-11, 3-110, 3-126, 4-24, 4-37, 4-44, 4-77, 4-79, 4-80, 4-110, 4-112, 6-38, 6-52
 Fear
 North Carolina, 6-15, 6-16
 River, 5-19, 6-22, 6-28
 Hatteras, North Carolina, 4-35, 4-112, 4-120, 4-153, 8-86
 Henlopen, Delaware, 4-124
 Henry, Virginia, 3-92
 Lookout, North Carolina, 4-120
 National Seashores, 4-112
 May, New Jersey, 3-92, 4-80, 5-54, 6-15, 8-28, 8-86
 Mendocino, California, 3-92
 Sable, Florida, 4-24
 Romano, Florida, 4-24
 Capillary wave, 2-5, 2-24
 Carbonate
 loss, 4-124, 4-127, 4-128
 production, 4-119, 4-127 thru 4-129
 Carmel Beach, California, 4-10
 Carolina
 Beach, North Carolina, 5-21, 5-22, 6-16, 6-21, 6-22, 6-25 thru 6-28
 Inlet, 6-16, 6-28
 Carteret, New Jersey, 3-123, 3-124
 Casagrande size classification, 4-12
 Cathodic protection, 6-88
 Caustic, 2-74
 Caven Point, New York, 3-124, 3-125
 Cedar Key, Florida, 3-117
 Cedarhurst, Maryland, 6-13
 Celerity (see Wave celerity)
 Cellular-steel
 caisson, 6-88
 sheet-pile
 breakwater, 5-61, 6-91 thru 6-93
 bulkhead, 6-6
 groin, 6-80, 6-83, 6-84
 jetty, 6-87
 structures, 6-88, 6-92
 Central pressure index, 3-110, 3-126
 Channel (see also Navigation channel), 1-24, 3-122, 4-154 thru 4-157, 4-161, 4-162, 4-164, 4-165, 4-177, 5-2, 5-26, 5-28, 5-56 thru 5-58, 6-56, 6-58 thru 6-60, 6-73, 6-74, 7-233, 7-250, 7-251, 7-253
 Islands Harbor, California (Port Hueneme), 1-23, 2-77, 4-37, 4-90, 5-61, 5-62, 6-61, 6-64, 6-72
 revetment stability, 7-249
 shoaling, 1-24, 4-177, 4-180, 5-56, 5-58
 Charleston, South Carolina, 3-92, 3-117, 3-124, 3-125, 4-35
 Chatham, Massachusetts, 3-92, 4-169
 Chesapeake Bay
 Bridge Tunnel, Virginia, 3-3
 Maryland, 4-22, 4-141, 6-11, 6-15
 Clapotis (see also Seiche; Standing wave), 2-3, 2-113, 2-114, 7-161 thru 7-163, 7-172 thru 7-174, 7-177, 7-178, 7-203
 Clatsop
 Plains, Oregon, 6-52
 Spit, Oregon, 4-110, 6-52
 Clay, 1-7, 4-12, 4-13, 4-17, 4-18, 4-21, 4-22, 4-24, 4-115, 7-258, 7-260
 Cleveland Harbor, Ohio, 7-226
 Cliff erosion, 1-17, 4-45, 4-114, 4-115, 4-117, 4-127 thru 4-129
 Cnoidal wave, 2-44 thru 2-48, 2-54, 2-57, 2-58, 7-117
 theory, 2-2, 2-3, 2-31, 2-33, 2-44, 2-46, 2-54, 7-54, 7-55
 Coast, 1-2
 Coastal
 engineering (see also Planning analysis), 1-1, 1-2, 1-4, 4-64, 5-1
 erosion (see Shoreline erosion)
 profile, 4-60
 structures, 1-2, 1-17, 2-1, 3-126, 4-58, 4-74, 7-1, 7-58, 7-100, 7-241, 7-247
 Cobble, 1-7, 4-12, 4-13
 Coefficient (see Drag coefficient; Diffraction coefficient; Energy coefficient; Expansion of ice coefficient; Friction coefficient; Hydrodynamic force coefficient; Inertia coefficient; Isbash coefficient; Layer coefficient; Lift coefficient; Mass coefficient; Overtopping coefficient; Reflection coefficient; Refraction coefficient; Refraction-diffraction coefficient; Shoaling coefficient; Stability coefficient; Steady flow drag coefficient; Transmission coefficient)
 Cohesionless soil, 7-241
 Cohesive material (see also Clay; Peat; Silt), 4-21
 Cohesive soil, 7-260
 Cold Spring Inlet, New Jersey, 4-90, 4-91
 Columbia River, Washington, 3-92
 Complex wave, 2-2 thru 2-4
 Composite
 breakwater, 7-182, 7-242
 slopes, 7-35 thru 7-37, 7-40
 Computer programs, 2-71, 3-89, 5-44, 7-82, 7-88
 Concrete (see also Interlocking concrete block; Unit weight--concrete), 1-23, 1-24, 5-2, 5-56, 6-1 thru 6-4, 6-6, 6-7, 6-10, 6-14, 6-76, 6-81, 6-83, 6-84, 6-95, 6-96, 6-98, 7-213, 7-214, 7-235, 7-236, 7-242, 7-249, 7-260, 8-47, 8-51, 8-54, 8-65, 8-69, 8-71, 8-73, 8-79
 armor unit, 5-61, 6-88, 7-32, 7-202, 7-210, 7-212 thru 7-215, 7-225 thru 7-227, 7-231, 7-233, 7-235, 7-236, 7-239, 7-240, 8-47, 8-68
 bulkhead, 6-6, 6-7
 caisson, 5-59, 5-61, 6-88, 6-93
 breakwater, 6-93
 cap, 5-59, 6-12, 6-82, 6-89, 7-208, 7-229, 7-235, 7-236, 7-239
 groin, 6-83, 6-84
 pile, 1-20, 6-88
 revetment, 6-6, 6-10
 sheet-pile, 6-74, 6-75, 6-84, 6-88
 groin, 6-81, 6-84
 Consolidated material (see also Beach rock; Coral; Rock), 4-23
 Construction, 6-95, 6-97
 design practices, 6-95, 6-97
 materials, 6-95
 Continental shelf (see also Shelf bathymetry; Shelf profile), 3-122, 3-123, 4-17, 4-61, 4-65, 4-70, 4-71, 4-93, 4-117, 4-147, 6-15, 7-14
 Convergence, 2-74
 Conversion factors: English to metric, C-36
 Coos Bay, Oregon, 4-37
 Coquille River, Oregon, 4-37
 Coquina, 4-24

SUBJECT INDEX

- Coral, 4-17, 4-22, 4-23, 7-246
 Coralline algae, 4-23
 Core Banks, North Carolina, 4-108, 6-38, 6-49, 6-50, 6-53
 Coriolis, 3-24, 3-119
 effects, 2-6, 3-115
 force, 2-5, 3-24
 parameter, 3-34, 3-38, 3-82, 3-84, 3-121
 Corpus Christi, Texas, 3-112 thru 3-114, 4-37, 6-16 thru 6-18, 6-25
 Corrosion, 6-88, 6-92, 6-96, 7-139, 7-149, 7-255
 Coulomb equation, 7-259
 Cover layer, 7-202, 7-205, 7-207, 7-211, 7-227 thru 7-229, 7-233, 7-235 thru 7-240, 7-242, 7-245 thru 7-249, 8-48, 8-49, 8-51, 8-58 thru 8-61, 8-69, 8-71
 design, 7-204
 stability, 7-238, 7-246
 thickness, 8-48, 8-58, 8-59, 8-62, 8-74
 Crane Beach, Massachusetts, 4-82, 4-83
 Crescent City, California, 3-118, 6-89, 6-92, 7-226
 Crest, wave (see Wave crest)
 Crib, 5-56, 5-59, 5-61, 5-62, 6-6, 6-14, 6-59, 7-242
 Cube, modified (see Modified cube)
 Current (see also Density currents; Inlet currents; Littoral currents; Longshore current; Nearshore currents; Onshore-offshore currents; Rip currents; Salinity currents; Tidal currents), 1-3, 1-4, 1-6, 1-7, 1-13, 2-60, 2-62, 4-1, 4-4, 4-5, 4-12, 4-23, 4-48, 4-49, 4-55, 4-57, 4-58, 4-89, 4-105, 4-126, 4-147, 4-150, 4-157, 4-159, 4-177, 5-1, 5-2, 5-9, 5-21, 5-22, 5-35, 5-56, 5-57, 5-65, 5-73, 6-1, 6-56, 6-73, 7-241, 7-245 thru 7-247, 7-254, 8-1, 8-7
 velocity (see also Longshore current velocity), 3-119, 3-121, 7-241, 7-246, 7-247, 7-249, 7-250, 8-12
 Cuspate spit, 5-61, 5-63 thru 5-67, 5-69, 5-71
 Cuttyhank, Massachusetts, 3-92
 Cylinders, 7-102, 7-132
 Cylindrical pile, 7-138, 7-157
- - D - -
- d/L--Tables of Functions, 2-64, C-5, C-17
 Dade County, Florida, 1-19, 1-22, 5-20, 6-16, 6-25, 6-32 thru 6-34, 6-36
 Dams, 1-17, 7-254
 Datum plane, 3-92
 Daytona Beach, Florida, 1-8, 4-35, 4-37, 6-71
 Decay, wave (see Wave decay)
 Deep water, 1-3, 1-5, 2-9, 2-15, 2-18, 2-20, 2-24 thru 2-28, 2-30 thru 2-32, 2-35, 2-37, 2-60, 2-62 thru 2-64, 2-66, 2-68, 2-70, 2-71, 2-74, 2-129, 3-11, 3-15, 3-18, 3-24, 3-39, 3-55, 3-77, 3-101, 4-29, 4-30, 4-95, 4-105, 4-107, 4-123, 4-124, 4-129, 6-92, 7-1, 7-2, 7-13, 7-15, 7-33, 7-63, 7-117, 7-119 thru 7-126, 7-157, 7-164, 7-167, 7-183, 8-26, 8-33, 8-34, C-3, C-35
 significant wave height, 3-49, 3-50, 3-83 thru 3-86, 3-101, 3-105, 3-107, 4-85, 4-93, 4-99, 7-1, 7-15, 7-59, 7-242
 wave, 2-10, 2-11, 2-17, 2-66, 3-2, 3-21, 3-24, 3-45, 3-46, 3-55 thru 3-66, 4-36, 4-46, 4-85, 4-94, 7-3, 7-7, 7-11, 7-14, 7-89, 7-110, 7-146, 8-26, 8-33, 8-36, 8-44, 8-85, 8-87 thru 8-89
 forecasting equation, 3-48
 height, 2-20, 2-64, 2-130, 2-135, 3-104, 3-107, 4-102, 7-5, 7-11, 7-13, 7-14, 7-16, 7-33, 7-35, 7-44, 7-54, 8-33
 length, 2-130, 7-4, 7-93, 7-94, 8-34, C-3, C-30
 prediction, 3-44, 3-49, 3-50, 3-66
 Deflation, 1-16, 4-5, 4-124, 4-127, 4-128, 5-9
 plain, 4-108, 4-109, 4-112
- Del Mar, California, 4-10, 4-142
 Delaware Bay, 4-140, 8-1, 8-7 thru 8-9, 8-12 thru 8-14, 8-17, 8-21, 8-22, 8-25, 8-26, 8-31, 8-32, 8-74
 Delray Beach, Florida, 6-25
 Density (see also Energy density; Mass density), 2-6, 3-6, 3-33, 3-121, 4-18, 4-50, 7-127, 7-236, 7-237
 currents, 4-49, 4-164
 Design, 7-149, 7-232, 8-1
 analysis, 5-73, 5-74, 7-3
 breaking wave, 7-11, 7-13, 7-187
 height, 7-4, 7-8 thru 7-10, 7-13, 7-14, 7-204
 hurricane, 8-7
 practices (see Construction design practices)
 profile, 6-26
 storm, 3-115, 3-126, 3-127
 water level, 3-123, 3-126, 7-2, 7-3, 7-15, 7-16, 7-247, 7-260, 8-12
 wave, 3-104, 5-5, 5-58, 6-83, 7-3, 7-4, 7-9, 7-14, 7-15, 7-17, 7-33, 7-35, 7-37, 7-105, 7-106, 7-112, 7-127, 7-129, 7-133, 7-140, 7-146, 7-149, 7-150, 7-152 thru 7-155, 7-173, 7-203, 7-208, 7-212, 7-243, 8-46, 8-47
 conditions, 7-3, 7-16, 7-202 thru 7-204, 7-211, 8-25
 height, 7-3, 7-4, 7-15, 7-118, 7-127, 7-133, 7-146, 7-203, 7-205, 7-207, 7-208, 7-211, 7-212, 7-237, 7-242, 7-243, 7-246, 7-247, 7-249, 8-46, 8-49
 period, 5-5, 7-3, 7-127, 7-133, 7-146
 Destin, Florida, 4-37
 Diablo Canyon, California, 7-226
 Diffraction coefficient (see also Wave diffraction), 2-77, 2-92 thru 2-98, 2-105 thru 2-107, 2-110, 7-89, 7-93, 7-94, 7-99
 Dispersive medium, 2-25
 wave, 2-25, 2-56
 Diurnal tide, 3-89, 3-92
 Divergence, 2-74
 Doheny
 Beach State Park, California, 6-79, 6-81
 Street Beach, California, 6-25
 Dolos, 6-86, 6-88, 7-75, 7-206, 7-209 thru 7-212, 7-215 thru 7-217, 7-221, 7-225, 7-226, 7-231, 7-234, 7-236 thru 7-239
 Drag
 coefficient (see also Steady flow drag coefficient), 3-30, 7-101, 7-103, 7-133, 7-136 thru 7-139, 7-144, 7-149
 forces, 7-106, 7-109, 7-116, 7-132, 7-133, 7-136, 7-138, 7-145, 7-146, 7-155, 7-157
 Drakes Bay, California, 4-145
 Dredges (see also Floating dredges; Hopper dredges; Pipeline dredges; Split-hull dredges), 5-32, 5-33, 6-14, 6-31, 6-36
 Dredging (see also Land-based vehicles; Side-cast dredging), 1-17, 1-24, 1-26, 4-105, 4-117, 4-119, 4-124, 4-127 thru 4-129, 4-134, 4-176, 4-177, 4-179, 4-180, 5-28, 5-30, 5-31, 5-58, 5-73, 5-74, 6-30, 6-35, 6-36, 6-54, 6-72 thru 6-75
 plant (see also Land-based dredging plant), 5-19, 5-30
 discharge line, 5-31, 5-33
 Drift, littoral (see Littoral drift)
 Orum Inlet, North Carolina, 4-120, 4-121, 4-143, 4-153, 4-177
 Duck, North Carolina, 4-77, 4-80, 4-81
 Dune (see also Foredune), 1-8 thru 1-13, 1-16, 1-17, 1-19, 1-21, 1-25, 1-26, 3-71, 3-105, 3-106, 4-1, 4-5, 4-27, 4-44, 4-46, 4-76, 4-78, 4-83, 4-108, 4-110, 4-117, 4-118, 4-120, 4-127, 4-128, 5-24 thru 5-27, 6-1, 6-26, 6-37 thru 6-43, 6-48 thru 6-53
 construction, 5-26, 6-43, 6-53
 using
 sand fencing, 4-110, 6-38, 6-39
 vegetation, 4-110, 6-43
 formation, 4-5, 6-38, 6-48

SUBJECT INDEX

- Dune (Cont)
 migration, 4-124, 4-125, 5-24, 5-25
 profile, 6-48, 6-51
 stabilization, 5-24, 5-25, 6-38, 6-43, 6-44
 trapping capacity, 6-41, 6-43, 6-51, 6-53
 Duration, wind (see Wind duration)
 Durban, Natal, South Africa, 6-54
 Dutch
 Harbor, Unalaska Island, Alaska, 3-91, 3-118
 toe, 7-247, 7-248
 Duval County, Florida, 6-25
 Dynamic
 forces, 7-161, 7-180, 7-182, 7-187, 7-193, 7-197,
 7-200
 pressure, 7-193 thru 7-195, 7-200
- - E - -
- Earth
 forces (see also Active earth force; Hydrostatic
 forces; Passive earth force), 6-76, 7-256, 7-259,
 7-260, 8-83
 pressure, 8-82
 Earthquakes, 1-7, 2-56, 3-89, 3-92, 3-93, 7-1
 East Pass, Florida, 4-179, 4-180, 6-61, 6-70
 Eastport, Maine, 1-6, 3-116, 3-124, 3-125, 4-35
 Ebb-tidal delta, 4-148 thru 4-152, 4-154, 4-155, 4-157,
 4-160, 4-167, 4-173, 4-174, 4-177, 4-180
 Echo sounder, 4-62
 Ecological considerations, 5-73
 Eddy shedding (see also Lift forces), 7-132
 Ediz Hook, Port Angeles, Washington, 6-25
 El Segundo, California, 4-91
 Energy (see also Kinetic energy; Longshore energy;
 Potential energy; Wave energy; Wind energy), 2-5,
 3-5, 3-11, 3-12, 3-14, 3-15, 3-20, 3-21, 3-79, 5-3,
 5-65, 5-67, 5-69, 5-71, 7-2, 7-209
 coefficient, C-4
 density, 2-26, 3-11, 3-12, 3-14, 4-95, 7-67, 7-89,
 7-93, 7-94, 7-99, 7-209
 flux (see also Longshore energy flux factor), 2-26
 thru 2-28, 2-109, 4-54, 4-92, 4-93, 4-96, 4-101,
 4-147, 5-69, 8-89, 8-90
 Engineering, coastal (see Coastal engineering)
 Englishman Bay, Maine, 3-92
 Environmental considerations, 5-19, 5-74
 Equilibrium geometry, 4-157
 Erosion (see also Beach erosion; Beach fill erosion;
 Cliff erosion; Longshore transport; Shoreline ero-
 sion), 1-1, 1-3, 1-7, 1-12 thru 1-17, 1-19 thru
 1-21, 1-24 thru 1-26, 2-60, 2-126, 4-1, 4-10, 4-44,
 4-57, 4-60, 4-65, 4-77, 4-78, 4-80, 4-83, 4-85,
 4-91, 4-113, 4-116 thru 4-118, 4-124, 4-131, 4-172,
 4-173, 5-2, 5-4 thru 5-7, 5-24, 5-26, 5-28, 5-35,
 5-43, 5-52, 5-53, 5-55, 5-56, 5-58, 5-60, 5-64, 6-1,
 6-26, 6-27, 6-32, 6-46, 6-53, 6-54, 6-73, 6-95, 7-233,
 7-241, 7-242, 7-245
 rate (see also Beach erosion rate), 1-17, 4-6,
 4-129, 4-133, 4-147, 5-22, 5-23, 6-51
 Estuary, 1-2, 1-3, 1-7, 1-13, 1-26, 3-1, 3-107,
 3-109, 3-115, 3-123, 4-5, 4-49, 4-117, 4-148, 4-166,
 5-57
 Eugene Island, Louisiana, 3-117
 European beach grass, 4-110, 6-44, 6-45, 6-47, 6-52, 6-53
 Evanston, Illinois, 4-91
 Expansion of ice coefficient, 7-254
 Extratropical storm, 3-11, 3-110, 3-119, 3-123, 3-126
 Extreme events (see also Hurricane; Storm; Tsunami),
 4-43, 4-44, 4-76, 7-2, 7-3, 7-242, 7-246
- Fall velocity, 4-18 thru 4-21, 4-28, 4-85
 Fan diagrams (see Wave refraction analysis--fan diagrams)
 Father Point, Quebec, 3-95, 3-96
 Feeder beach, 5-8, 5-23, 5-24, 6-72, 6-73
 Feldspar, 4-21, 4-22
 Fernandina, Florida, 3-117
 Beach, 6-5, 6-82
 Fetch, 1-6, 1-7, 1-13, 3-24, 3-33, 3-35, 3-36, 3-39,
 3-41 thru 3-44, 3-47, 3-48, 3-51 thru 3-65, 3-67,
 3-70 thru 3-72, 3-74, 3-76, 3-127, 4-29, 7-17,
 7-161, 8-12, 8-17
 delineation, 3-39
 length, 3-42, 3-49 thru 3-51, 3-66 thru 3-68,
 3-70, 3-71, 3-84, 7-1
 width, 3-41
 Filter blanket (see also Bedding layer), 7-229, 7-240
 thru 7-242, 7-245, 7-249
 Finite
 amplitude wave, 7-142, 7-154, 7-155
 theory (see also Trochoidal Wave Theory; Stokes
 Theory), 2-2, 2-4, 2-6, 2-7, 2-34, 2-35, 7-108,
 7-112, 7-137, 7-154
 element models, 2-109
 Fire Island Inlet, New York, 4-37, 4-142, 6-25,
 6-61, 6-66
 First-Order Wave Theory (see Airy Wave Theory)
 Fixed
 bypassing plant, 5-31, 6-53, 6-56 thru 6-58, 6-60
 Lake Worth Inlet, Florida, 6-54, 6-56, 6-58
 Rundee Inlet, Virginia Beach, Virginia, 6-54,
 6-56, 6-60
 South Lake Worth Inlet, Florida, 6-54, 6-57
 groin, 1-24, 5-53
 Flexible
 revetment (see Articulated armor unit revetment)
 structures, 6-6, 6-14, 7-3
 Floating
 breakwater, 5-59, 6-93
 bypassing plant, 5-28, 5-30, 6-54, 6-59
 Channel Islands Harbor, California, 6-61, 6-64,
 6-72
 Hillsboro Inlet, Florida, 6-61, 6-67, 6-74
 Jupiter Inlet, Florida, 6-59, 6-62, 6-72
 Masonboro Inlet, North Carolina, 6-61, 6-68, 6-74
 Perdido Pass, Alabama, 6-61, 6-69, 6-75
 Ponce de Leon Inlet, Florida, 6-61, 6-71
 Port Hueneme, California, 6-59, 6-61, 6-72
 Santa Barbara, California, 6-61, 6-65, 6-73
 Sebastian Inlet, Florida, 6-63, 6-73
 dredges, 1-23, 5-30, 5-32, 5-33, 6-14, 6-59, 6-61,
 6-72, 6-73, 6-93
 Flood-tidal delta, 4-152, 4-174, 4-177
 Fluorescent tracers, 4-144, 4-146
 Fluid
 motion, 2-2, 2-3, 2-15, 4-19, 4-49, 4-58, 7-132, 7-143
 velocity, 2-12 thru 2-14, 2-45, 2-58, 4-18, 4-67,
 7-101, 7-138
 Force (see also Active earth force; Drag forces; Dynamic
 forces; Earth forces; Eddy shedding; Horizontal
 forces; Hydrostatic forces; Ice forces; Impact forces;
 Inertia forces; Lift forces; Passive earth force;
 Transverse forces; Uplift forces; Velocity forces;
 Wave forces), 1-4, 1-6, 1-7, 1-19, 1-21, 2-1, 2-60,
 3-88, 3-89, 3-98, 7-1, 7-3, 7-101, 7-102, 7-105,
 7-110 thru 7-112, 7-118, 7-128, 7-129, 7-131, 7-138,
 7-144, 7-149, 7-150, 7-152 thru 7-161, 7-163, 7-170,
 7-172, 7-173, 7-175 thru 7-178, 7-180 thru 7-182,
 7-184, 7-186, 7-192, 7-194 thru 7-198, 7-200, 7-202,
 7-245, 7-253, 7-255 thru 7-257, 7-260, 8-77, 8-80,
 8-81, 8-83, 8-84
 calculations, 7-143, 7-144

SUBJECT INDEX

Forecasting (see also Deep water wave prediction; Hurricane wave prediction; Shallow water wave prediction; Wave hindcasting; Wave prediction), 3-1, 3-34, 3-55
 curves, 3-45, 3-46, 3-55 thru 3-66
 Foredune, 1-12, 4-5, 4-62, 4-108 thru 4-110, 4-112, 5-24, 5-26, 5-27, 6-37 thru 6-39, 6-45, 6-51
 destruction, 6-38
 Forerunner (water level), 3-111
 Foreshore, 1-2, 1-3, 1-8, 1-10, 1-21, 4-62, 4-72, 4-76, 4-83, 4-86, 5-31, 5-35, 5-37, 5-40, 6-75, 6-76
 slopes, 4-86 thru 4-88, 4-148, 5-8, 5-21, 6-16, 6-27
 Fort
 Hamilton, New York, 3-124, 3-125
 Macon State Park, North Carolina, 6-25
 Myers, Florida, 4-35
 Pierce, Florida, 6-15, 6-25
 Point, Texas, 3-112
 Pulaski, Georgia, 3-117
 Sheridan, Illinois, 7-255
 Foundation (see also Pile foundation; Rubble foundation; Rubble-mound foundation), 1-23, 6-6, 6-84, 6-88, 6-92, 6-93, 7-177, 7-179, 7-241, 7-242, 7-244, 7-256
 conditions, 6-13, 6-14, 6-93, 7-240, 8-85
 design, 5-73, 7-149
 materials, 6-14, 6-84, 6-93, 7-241, 7-242
 soil, 7-241, 7-242, 7-245, 8-75
 stability, 7-229, 7-249
 Freeport, Texas, 3-112
 Frequency, wave (see Wave frequency)
 Friction (see also Angle of wall friction; Bottom friction; Internal friction angle), 3-20, 3-34, 3-74, 3-75, 3-98, 4-30, 8-33
 coefficient, 4-55, 4-162, 7-260, 8-84
 factor, 3-68, 3-72, 4-100, 4-164
 loss, 3-55, 3-69
 velocity, 3-25, 3-26
 Friday Harbor, Washington, 3-118
 Fully arisen sea, 3-24, 3-42, 3-49, 3-50, 3-53, 3-77

- - G - -

Gabions, 1-20, 7-242, 7-245
 Galveston, Texas, 3-90, 3-111, 3-112, 3-114, 3-117, 4-35, 4-37, 4-41, 6-2, 6-15
 Harbor, 4-144
 Gay Head, Martha's Vineyard, Massachusetts, 4-23
 Geostrophic wind, 3-25, 3-34, 3-35, 3-38, 3-40
 Geotextile, 6-97, 7-241, 7-242, 7-247
 filter, 6-1, 6-6, 6-13, 6-14, 7-241, 7-242, 7-247, 7-248
 Gerstner, 2-2
 Glossary of terms, A-1 thru A-40
 Goleta Beach, California, 4-10
 Government Cut, Florida, 6-32, 6-35
 Gradient wind, 3-34
 Grain size (see also Median grain size), 1-16, 4-12 thru 4-14, 4-18, 4-26, 4-66, 4-67, 4-71, 4-83, 4-85 thru 4-88, 4-145, 4-148, 4-180, 5-9 thru 5-12, 5-15, 5-19, 5-64, 5-67, 6-16, 6-26, 6-36, 6-39, A-41
 Grand
 Isle, Louisiana, 3-117
 Marais, Michigan, 6-87
 Graphic measures, 4-15
 Grasses, beach (see Beach grasses)
 Gravel, 4-12, 4-13, 4-21, 4-124, 6-6, 7-241, 7-242, 7-258, 7-260
 Gravity wave, 2-4, 2-5, 2-9, 2-25, 2-31, 2-37, 3-88, 3-92, 3-107

Great Lakes, 1-13, 1-14, 3-19, 3-21, 3-23, 3-30, 3-32, 3-96, 3-99, 3-127, 4-78, 4-91, 5-21, 5-39, 5-56, 5-59, 6-83, 6-92, 6-93, 7-253, 8-26
 Greyhound Rock, California, 4-136, 4-138
 Groin (see also Adjustable groin; Asphalt groin; Cantilever sheet-pile groin; Cellular-steel sheet-pile groin; Concrete groin; Concrete sheet-pile groin; Fixed groin; High groin; Impermeable groin; Low groin; Permeable groin; Rubble-mound groin; Sheet-pile groin; Steel groin; Steel sheet-pile groin; Terminal groin; Timber groin; Timber sheet-pile groin; Timber-steel sheet-pile groin; Transitional groin; Weir groin), 1-17, 1-19, 1-23, 1-24, 2-109, 3-110, 4-6, 4-58, 4-60, 4-76, 4-136, 4-139, 5-7, 5-22, 5-24, 5-32, 5-35 thru 5-56, 5-62, 6-1, 6-27, 6-56, 6-65, 6-76, 6-83, 6-84, 7-1 thru 7-3, 7-100, 7-198, 7-204, 7-239, 7-247
 alinement (see also Beach alinement), 5-53
 artificial filling, 5-7, 5-52, 5-54
 construction, 4-6, 5-7, 5-39, 5-41, 5-52, 5-54 thru 5-56, 6-83
 definition, 1-23, 5-35
 design, 4-143, 5-35, 5-37, 5-40, 5-45, 6-84
 dimension, 5-44
 economic justification, 5-40
 field (see Groin system)
 functional design, 5-39, 5-56
 legal aspects, 5-56
 operation, 5-35
 system, 1-23, 5-7, 5-35, 5-39 thru 5-41, 5-43 thru 5-47, 5-52, 5-54 thru 5-56, 6-54, 7-255
 types, 6-76, 6-84
 Groundwater, 1-16, 7-241, 7-245, 7-249
 Group velocity, 2-23 thru 2-25, 2-29, 2-31, 2-32, 3-43, 4-94, 4-95, C-3

- - H - -

Haleiwa Beach, Hawaii, 5-62
 Halfmoon Bay, 4-86
 Hamlin Beach, New York, 2-111
 Hammonasset Beach, Madison, Connecticut, 6-25
 Hampton
 Beach, New Hampshire, 6-25
 Harbor, New Hampshire, 4-169
 Roads, Virginia, 3-90, 3-124, 3-125
 Harbor
 protection, 1-22, 1-23, 5-1, 6-88, 6-93, 7-242
 resonance, 2-75, 2-112
 Harrison County, Mississippi, 5-20, 6-4, 6-25
 Harvey Cedars, Long Beach Island, New Jersey, 6-83
 Haulover Beach Park, Florida, 6-32, 6-35
 Heavy minerals, 4-17, 4-18, 4-21, 4-22, 4-145
 Height, wave (see Wave height)
 Hexapod, 7-206, 7-209, 7-215, 7-216, 7-224, 7-234
 High groin, 1-23, 1-24, 5-37, 5-39, 5-40, 6-76
 Hillsboro Inlet, Florida, 4-91, 5-30, 6-61, 6-67, 6-74
 Hilo, Hawaii, 3-93
 Hindcasting (see Wave hindcasting; Wave prediction)
 Holden Beach, North Carolina, 4-37
 Holland, Michigan, 4-84
 Hollow
 square, 7-216
 tetrahedron, 7-216
 Honolulu, Hawaii, 1-3, 3-94, 7-226
 Hopper dredges, 1-26, 4-180, 5-32, 5-33, 6-14, 6-15, 6-32, 6-36, 6-71, 6-73, 6-75, 6-76
 Horizontal forces, 7-127, 7-129, 7-150, 7-151, 7-153 thru 7-155, 7-157, 7-163, 7-177, 7-182, 7-255, 8-78, 8-81, 8-84
 Houston, Texas, 3-114

SUBJECT INDEX

- Humboldt Bay, California, 6-86, 6-88, 7-226
Hunting Island Beach, North Carolina, 6-25
Huntington Beach, California, 3-3, 4-37, 4-41
Hurricane (see also Design hurricane; Hypothetical hurricane; Probable maximum hurricane; Standard Project Hurricane), 1-10, 3-1, 3-11, 3-77, 3-81 thru 3-87, 3-89, 3-101, 3-105, 3-110 thru 3-113, 3-123 thru 3-126, 3-128, 4-5, 4-31, 4-34, 4-35, 4-42 thru 4-45, 6-16, 6-27, 7-4, 7-16, 7-253, 8-7 thru 8-9
Agnes, 3-77
Allen, 6-53
Audrey, 3-81, 4-45
Beulah, 6-53
Camille, 3-77, 3-115, 4-43, 4-45, 6-4
Carla, 3-111 thru 3-115, 4-45
Carol, 3-123, 3-124
Cindy, 4-45
Connie, 3-80
David, 3-79, 6-35, 6-37
defined, 3-110
Diane, 3-80
Donna, 3-77, 3-115, 4-45
Ella, 3-81
Eloise, 4-77, 4-78
Fern, 4-110
Fredric, 1-8, 6-75
protection barriers, 7-253
storm tracks (see Storm tracks)
surge (see Storm surge)
wave, 3-77, 3-78
 prediction, 3-83
 wind field, 3-81
Hydraulic pipeline dredges (see Pipeline dredges)
Hydrodynamic
 equations, 2-31, 2-59, 2-62, 3-119
 force coefficient, 7-101 thru 7-103, 7-105, 7-136, 7-160
Hydrograph, 3-95
Hydrographic surveys, 4-62, 7-17
Hydrostatic
 forces (see also Uplift forces), 6-1, 6-6, 7-161, 7-163, 7-171, 7-186, 7-194, 7-195, 7-197, 7-198, 7-201, 7-260, 8-77, 8-81, 8-83
 pressure, 7-171, 7-172, 7-182, 7-192, 8-80
Hypothetical
 hurricane, 3-126
 slopes, 7-35, 7-38, 7-39
- - I - -
- Ice (see also Expansion of ice coefficient), 7-253 thru 7-256
 forces, 7-253, 7-255
Ijmuiden, The Netherlands, 6-92
Immersed weight, 4-96
Impact forces, 7-253
Imperial Beach, California, 1-3, 4-37, 5-9
Impermeable
 breakwater, 2-78 thru 2-89, 7-61, 7-64, 7-67, 7-71, 7-73, 7-77, 7-90
 groin, 1-24, 5-52, 6-76, 6-83
 slopes (see also Wave runup--impermeable slopes), 7-11, 7-16, 7-18 thru 7-23, 7-34, 7-49
 structures, 7-16, 7-18, 7-33, 7-41, 7-54, 7-59, 7-73
Indian
 River Inlet, Delaware, 5-59
 Rocks Beach, Florida, 6-25
Inertia coefficient, 7-101, 7-103
Inertial forces, 7-103, 7-106, 7-109, 7-115, 7-132, 7-136, 7-145, 7-146, 7-157
Initial water level, 3-111
Inlet (see also Tidal inlets), 1-3, 1-6, 1-8, 1-13, 1-14, 1-17, 1-24, 1-26, 2-60, 3-110, 4-1, 4-21, 4-44, 4-45, 4-58, 4-63, 4-78, 4-89, 4-90, 4-114, 4-120, 4-127 thru 4-133, 4-140, 4-142, 4-148 thru 4-150, 4-152, 4-153, 4-157 thru 4-159, 4-161, 4-162, 4-164 thru 4-167, 4-169, 4-173 thru 4-178, 5-24, 5-26, 5-28, 5-30, 5-32, 5-34, 5-35, 5-54, 5-56, 5-57, 6-72 thru 6-76
 barrier beach (see Barrier beach)
 currents, 4-148, 4-161, 4-166, 5-24, 6-73
 effect on barrier beaches, 1-14
 inner bar (see Inner bar)
 middleground shoal (see Middleground shoal)
 outer bar (see Outer bar)
 stabilization (see also Jetty stabilization), 4-167, 5-56
Inner bar, 1-14, 5-28
Inshore (see Shoreface)
Interlocking concrete block, 6-6, 6-12, 6-13
 revetment, 6-6, 6-12, 6-13
Internal friction angle, 7-256 thru 7-258
Irregular wave, 2-108, 3-15, 3-19, 7-39, 7-41, 7-58, 7-59, 7-62, 7-67, 7-69 thru 7-72, 7-80, 7-81, 7-88 thru 7-90, 7-208, 7-209
Irbash coefficient, 7-253
Island (see also Barrier island; Offshore island), 1-8, 2-75, 2-109, 4-108, 4-110, 4-112
 profile, 4-112
Isobar, 3-34, 3-35, 3-38, 3-39, 3-81
Isolines, 3-69, 3-85, 5-11, 5-14, 7-119 thru 7-126
- - J - -
- Jetty (see also Cellular-steel sheet-pile jetty; Rubblemound jetty; Sheet-pile jetty; Weir jetty), 1-3, 1-19, 1-24, 2-109, 3-110, 3-112, 3-113, 4-58, 4-76, 4-89, 4-136, 4-144, 4-151, 4-152, 4-158, 4-164, 4-167, 4-173, 5-22, 5-24, 5-28 thru 5-30, 5-32, 5-34, 5-56 thru 5-60, 6-1, 6-32, 6-54 thru 6-56, 6-58, 6-61, 6-64, 6-66, 6-67, 6-69 thru 6-72, 6-74, 6-84, 6-86, 6-88, 7-2, 7-3, 7-100, 7-203, 7-207, 7-212, 7-225, 7-226, 7-229, 7-233, 7-238, 7-239, 7-245, 7-247
 construction, 4-6, 4-147, 6-53, 6-59, 6-61, 6-73, 6-84, 6-88
 definition, 5-56
 effect on shoreline, 5-58
 siting, 5-57
 stabilization, 5-28, 5-56, 6-56, 6-74
 types, 5-56, 6-84
Johnston Island, Hawaii, 3-94
Joint North Sea Wave Project, 3-44
Jones
 Beach, New York, 4-11, 4-57, 4-77, 4-79, 4-110
 Inlet, New York, 6-25
Juneau, Alaska, 3-118
Jupiter
 Inlet, Florida, 6-59, 6-62, 6-72
 Island, Florida, 6-12, 6-25
- - K - -
- Kahului, Hawaii, 6-90, 6-92, 7-226, 7-235
Kakuda-Hama, Japan, 5-70
Kenosha, Wisconsin, 4-91
Ketchikan, Alaska, 3-91, 3-118
Keulegan-Carpenter number, 7-134 thru 7-137, 7-145

SUBJECT INDEX

- Key
 Biscayne, Florida, 6-25
 West Florida, 3-90, 3-92, 3-117
 Kill Devil Hills, North Carolina, 4-37
 Kinematic viscosity, 7-101, 7-138, 7-139, 7-209
 Kinetic energy, 2-25, 2-26, 2-29, 2-58, 3-20, 3-99
 Kodiak Island, Alaska, 1-6, 3-118
 Kure Beach, North Carolina, 6-22
- - L - -
- Lagoon, 1-2, 1-6 thru 1-8, 1-13, 1-14, 1-26, 4-4, 4-22, 4-57, 4-108, 4-110, 4-120, 4-127 thru 4-129, 4-133, 4-174, 4-177, 4-178, 5-19, 6-15
 Laguna Point, California, 4-124, 4-125
 La Jolla, California, 3-118, 4-51, 4-124
- Lake
 Charles, Louisiana, 4-35
 Erie, 2-116, 3-23, 3-95 thru 3-97, 3-99, 3-122, 6-15, 6-95
 Huron, 3-95 thru 3-97
 levels, 3-93, 3-97, 4-84, 6-95
 Great Lakes, 3-93, 3-95 thru 3-97, 3-127
 Michigan, 3-95 thru 3-97, 3-122, 4-83, 4-84, 4-110, 6-15
 Okeechobee, Florida, 3-82, 3-110, 3-127, 3-128, 7-43
 Ontario, 3-95 thru 3-97
 St. Clair, 3-95, 3-96
 Superior, 3-95 thru 3-97
 Worth, Florida, 4-37, 4-41, 6-55
 Inlet (see also South Lake Worth Inlet, Florida), 6-54, 6-56, 6-58
- Lakeview Park, Ohio, 5-62, 5-72, 6-94, 6-95
- Land
 based
 dredging plant (see also Landlocked plant), 5-28, 5-30, 5-31, 5-33
 vehicles (see also Split-hull barge), 5-28, 5-30, 5-33, 6-54, 6-75
 subsidence, 1-16
 Landlocked plant, 5-31
 Lawrence Point, New York, 3-124, 3-125
 Layer coefficient, 7-209, 7-233, 7-234, 7-237, 8-59
 Length (see Fetch length; Wave length)
 Lewes, Delaware, 3-116, 8-9 thru 8-11
- Lift
 coefficient, 7-136
 forces, 7-132, 7-133, 7-135, 7-136
- Lincoln Park, Illinois, 5-62
- Line
 sinks, 4-113, 4-114
 sources, 4-113, 4-114
- Linear Wave Theory, 2-4, 2-11, 2-18, 2-22 thru 2-24, 2-31, 2-34, 2-46, 2-75, 2-112, 2-122, 2-124, 5-66, 7-55, 7-103, 7-117, 7-145
- Little
 Creek, Virginia, 3-124, 3-125
 Egg Harbor, New Jersey, 4-7 thru 4-9
- Littoral
 barrier (see also Sand impoundment), 1-18, 4-134, 4-147, 5-8, 5-28, 5-29, 5-31 thru 5-33, 5-58, 5-60, 5-61, 5-64, 6-54, 6-55, 6-59, 6-61, 6-72, 6-75, 6-93
 types, 5-28, 6-54, 6-55
 currents, 1-24, 4-150, 5-28, 6-76
 drift, 1-13, 1-19, 4-44, 4-89, 4-123, 4-129, 4-132, 4-142, 5-28, 5-30, 5-31, 5-35, 5-39, 5-43, 5-45, 5-52, 5-56 thru 5-58, 5-63, 5-64, 6-54, 6-56, 6-59, 6-61, 6-72, 6-73, 6-74, 7-254
- Littoral (Cont)
 material (see also Cohesive material; Consolidated material; Sand; Sediment; Specific gravity--littoral material; Unit weight--littoral material), 1-1, 1-15, 1-17, 4-12, 4-14, 4-15, 4-17, 4-18, 4-21 thru 4-24, 4-26, 4-115, 4-119, 4-126, 4-173, 5-1, 5-2, 5-7, 5-24, 5-31, 5-40, 5-44, 5-56, 5-60, 6-56, 6-93
 classification (see Soil classification)
 composition, 4-17, 4-26
 immersed weight (see Immersed weight)
 occurrence, 4-24, 4-26
 properties, 4-17
 sampling, 4-26
 sinks, 4-120, 4-123, 4-124, 4-126
 size (see also Grain size; Mean diameter; Median diameter; Median grain size), 4-12, 4-15
 distribution, 4-14, 4-15, 4-24, 4-26
 sources (see also Sediment sources), 4-115, 4-126
 transport (see also Bedload; Longshore transport; Onshore-offshore transport; Sediment transport; Suspended load), 1-1, 1-13, 1-17, 4-5, 4-30, 4-36, 4-43, 4-46, 4-55, 4-57, 4-58, 4-101, 4-112, 4-146, 4-150, 5-22, 5-23, 5-28, 5-34
 rate, 5-55
 sediment budget (see Sediment budget)
 seaward limit, 4-70, 4-71, 4-76, 4-147
 tracers (see Tracers)
 trap (see Sand impoundment)
 wave climate, 4-29
 zone, 1-15 thru 1-17, 4-1, 4-4, 4-6, 4-12, 4-21, 4-22, 4-27, 4-29, 4-36, 4-40, 4-43, 4-46, 4-49, 4-50, 4-55, 4-57, 4-63, 4-71, 4-75, 4-89, 4-90, 4-114, 4-117 thru 4-120, 4-124, 4-127, 4-128, 4-134, 4-145 thru 4-148, 5-9, 5-58, 5-64
 long-term changes, 4-6
 short-term changes, 4-6
- Load (see Bedload; Suspended load)
- Long
 Beach
 California, 6-95
 New Jersey, 4-110, 4-180
 Island, 4-11, 4-77, 4-79
 Island, New York, 4-24, 4-25, 4-45, 4-63, 4-64, 4-120, 4-140, 4-144
 Shores, 6-15
 Sound, 4-22, 6-15
- Longshore
 bar, 4-6, 4-49, 4-60, 4-62, 4-66
 current, 1-7, 1-14, 1-16, 3-104, 4-4, 4-42, 4-44, 4-50, 4-53 thru 4-55, 4-59, 4-65, 4-100, 4-127, 5-21, 5-37, 5-38, 5-61, 5-65, 7-241
 velocity, 4-50, 4-53 thru 4-56, 4-100
 drift (see Littoral drift)
 energy, 4-92, 4-94, 4-96, 4-101, 4-107
 flux factor, 4-93, 4-94, 4-96, 4-97, 4-100, 4-101
 transport (see also Littoral transport), 1-7, 1-13, 1-14, 1-16, 1-17, 1-19, 1-23, 1-24, 1-26, 4-4, 4-6, 4-12, 4-29, 4-44, 4-45, 4-53, 4-57, 4-58, 4-60, 4-65, 4-89 thru 4-91, 4-102, 4-105, 4-113 thru 4-116, 4-123, 4-126, 4-128, 4-133, 4-134, 4-136, 4-140, 4-142, 4-145, 5-9, 5-22, 5-24, 5-28, 5-31, 5-32, 5-35, 5-37, 5-39, 5-41, 5-43, 5-45, 5-52, 5-54, 5-60, 5-63, 5-71, 6-27, 6-53, 6-75
 direction, 1-14, 4-4, 4-134, 5-8, 5-29, 5-35, 5-36, 5-41, 5-43, 5-44, 5-60, 6-16, 6-57
 reversals, 1-14, 5-44, 5-45
 energy (see Longshore energy)
 nodal zones, 4-136, 4-139, 4-140
 rate, 1-14, 4-6, 4-53, 4-60, 4-89 thru 4-93, 4-96 thru 4-99, 4-101, 4-104, 4-106, 4-134, 4-141, 4-146, 4-147, 5-8, 5-23, 5-31, 5-35, 5-39, 5-52, 5-58, 5-63, 5-64, 5-71

SUBJECT INDEX

- Longshore (Cont)
 transport (Cont)
 rate (Cont)
 gross, 1-14, 4-89, 4-92, 4-104, 4-105, 4-107, 4-114, 4-120, 4-126, 4-147, 5-1, 5-58
 net, 1-14, 4-12, 4-89, 4-92, 4-120, 4-130, 4-167, 5-1, 5-8, 5-58, 5-60, 6-57, 8-90
 potential, 4-104, 8-85, 8-87, 8-88 thru 8-90
 tracers (see Tracers)
 wave energy (see Longshore energy)
 Los Angeles, California, 3-118, 6-95
 Low groin (see also Weir groin), 1-24, 1-25, 5-39, 5-40, 6-76
 Ludlam
 Beach, New Jersey, 4-77, 4-79
 Island, New Jersey, 4-11, 4-37, 4-52
- - M - -
- Maalea Harbor, 7-235
 Malaga Cove (Redondo Beach), California (see also Redondo Beach (Malaga Cove), California), 5-33
 Manahawkin Bay, New Jersey, 4-7
 Manasquan, New Jersey, 4-91, 7-226
 Mandalay, California, 4-37
 Marine
 environment, 7-14, 7-17
 Street, California, 4-10
 structures, 2-57, 7-253, 7-255
 Martha's Vineyard, Massachusetts, 4-24
 Masonboro
 Beach, North Carolina, 6-22, 6-68, 6-74
 Inlet, North Carolina, 6-16, 6-22, 6-61, 6-68, 6-74, 6-83
 Mass
 coefficient, 7-101, 7-103
 density (see also Specific gravity; Unit weight), 7-205, 7-233, 7-236, 7-243
 sand, 4-90
 water, 2-21, 3-121, 4-90, 7-205
 transport, 2-4, 2-15, 2-18, 2-31, 2-36, 4-4, 4-48, 4-49, 4-59, 4-147
 Massachusetts Bay, Massachusetts, 6-15
 Matagorda, Texas, 3-112, 3-113
 Materials, construction (see Construction materials)
 Mathematical models, 3-1, 3-19, 3-42, 3-77, 3-81, 3-83, 3-105, 3-115, 3-122, 3-126, 5-44, 5-45
 Maximum
 probable wave (see Probable maximum wave)
 surge, 3-123
 water level, 3-104, 3-123, 4-166
 Mayport, Florida, 3-92, 3-117
 Mean
 diameter, 4-15, 5-11, 8-91
 water level, 2-6, 3-2, 3-95, 3-96, 3-99, 3-100, 3-105, 3-106, 3-108, 3-126, 7-162
 wave height, 4-36, 4-37
 Median
 diameter, 4-14, 4-15, 4-24, 4-25, 4-69, 4-181, 6-30
 grain size, 4-12, 4-17, 4-86 thru 4-88
 Merian's equation, 2-115, 3-98
 Merrimack River
 Estuary, Massachusetts, 4-151, 4-160
 Inlet, Massachusetts, 4-150, 4-151, 4-160
 Miami, Florida, 4-35
 Beach, 1-3, 1-19, 3-117, 6-15, 6-32, 6-36
 Miche-Rundgren Theory, 7-161, 7-165, 7-166, 7-168, 7-169
 Michell (wave steepness), 2-37, 2-129
 Middleground shoal, 1-14, 4-120, 4-152, 5-15, 5-19, 5-26, 5-28, 6-56, 6-57
 Miles-Phillips-Hasselmann Theory, 3-19, 3-21, 3-43
 Millibar, 3-34, 3-35, 3-37
 Milwaukee County, Wisconsin, 4-91
 Minerals (see also Heavy minerals), 1-17, 4-21, 4-22, 4-144, 6-30
 Minikin, 7-181, 7-182, 7-185, 7-187 thru 7-189
 Mining, 4-114, 4-124, 4-127 thru 4-129
 Misquamicut, Rhode Island, 4-37, 4-77, 4-79
 Beach, 4-11
 Mississippi River, 4-24, 4-115
 Mobile, Alabama, 1-6
 Modified cube, 7-206, 7-209, 7-215, 7-216, 7-223, 7-234
 Mokuoloe Island, Hawaii, 3-94
 Moments (see also Skewness; Standard deviation), 7-105, 7-111, 7-112, 7-118, 7-127, 7-129, 7-131, 7-149 thru 7-151, 7-155, 7-157 thru 7-159, 7-163, 7-166, 7-169, 7-170, 7-172 thru 7-181, 7-187, 7-193 thru 7-198, 7-202, 8-78, 8-80, 8-83
 Monochromatic wave, 2-62, 2-74, 2-108, 2-112, 3-1, 3-15, 3-18, 3-101, 3-106, 7-16, 7-43, 7-58, 7-62, 7-65, 7-67, 7-68, 7-74, 7-76, 7-78 thru 7-81, 7-83 thru 7-90, 7-94, 7-101, 7-102, 7-208, 7-209
 Monomoy-Nauset Inlet, Massachusetts, 4-169
 Montauk, New York, 3-116, 3-124, 3-125
 Point, 3-92
 Monterey, California, 3-42
 Morehead City, North Carolina, 3-117, 3-124, 3-125
 Moriches Inlet, 4-45
 Hugu Canyon, California, 4-123
 Murrells Inlet, South Carolina, 1-24, 1-25, 4-37, 6-61
 Mustang Island, Texas, 4-110, 4-112
 Myrtle
 Beach, Connecticut, 4-11
 Sound, North Carolina, 6-16
- - N - -
- Nags Head, North Carolina, 3-13, 4-37, 4-41, 6-48, 6-83
 Nantucket Island, Massachusetts, 4-24, 6-8
 Naples, Florida, 4-37, 4-41
 National Shoreline Study, 1-2, 4-24, 4-135
 Natural
 Bridges, California, 4-37
 tracers, 4-21, 4-144
 Nauset
 Beach, Massachusetts, 4-108, 6-52
 Spit, Cape Cod, Massachusetts, 1-11, 4-169
 Navigation channel, 1-1, 1-23, 1-24, 1-26, 3-110, 4-58, 4-180, 5-28 thru 5-30, 5-57, 6-56, 6-73 thru 6-75
 Nawiliwili, Kawai, Hawaii, 7-226
 Neah Bay, Washington, 3-118
 Nearshore
 bathymetry, 2-60
 currents (see also Littoral currents; Littoral transport), 1-1, 1-2, 4-46, 4-49, 4-50, 4-51, 4-134
 profile, 4-59 thru 4-64, 4-66, 4-75, 4-147, 6-32
 slopes, 1-7, 1-9, 2-59, 2-136, 4-76, 4-143, 5-6, 5-9, 5-20, 6-16, 6-27, 7-4 thru 7-6, 7-9 thru 7-11, 7-45 thru 7-53, 7-182, 7-183, 7-186, 7-187, 7-201
 wave climate, 4-31, 4-42, 4-89
 zone, 1-2, 1-4, 1-6, 1-7, 1-13, 4-49, 4-50, 4-62, 4-65, 4-115, 4-119, 4-147
 New
 London, Connecticut, 3-116, 3-124, 3-125
 River Inlet, North Carolina, 6-75
 York, New York, 3-90, 4-35
 Bight, 4-57, 6-15
 Harbor, 3-124, 4-136, 4-140, 4-180

SUBJECT INDEX

- Newark, New Jersey, 3-124, 3-125
- Newport
 Beach, California, 6-25, 6-79
 Rhode Island, 3-116, 3-124, 3-125, 4-23, 4-77
- Nodal zones (see Longshore transport nodal zones)
- Node, 2-113, 3-97 thru 3-99
- Nonbreaking wave (see also Miche-Rundgren Theory), 3-18,
 7-2, 7-3, 7-14, 7-17, 7-45 thru 7-53, 7-100 thru
 7-102, 7-117, 7-161, 7-163, 7-164, 7-166, 7-167,
 7-169, 7-181, 7-202, 7-206, 7-207, 7-209, 7-211,
 7-212, 7-238, 7-239, 8-47, 8-49, 8-58
 forces (see also Sainflou Method), 7-161, 7-162,
 7-165, 7-168, 7-170
 on caissons, 8-76
 on piles, 7-100
 on walls, 7-161
 height, 7-204
- Noncircular pile, 7-102, 7-159, 7-160
- Nonlinear
 deformation, 4-29, 4-30
 Wave Theory (see Finite Amplitude Wave Theory)
- Nonvertical walls, 7-200, 7-201
- Norfolk, Virginia, 3-117
- Northeaster (see also Standard Project Northeaster),
 3-110, 4-31, 4-44, 4-78, 4-157, 6-28
- Nourishment, beach (see Artificial beach nourishment;
 Beach nourishment)
- Numerical models (see Mathematical models)
- - 0 - -
- Oak Island, North Carolina, 5-19
- Ocean
 City
 Maryland, 4-91, 6-83, 8-85, 8-86, 8-90
 Inlet, 1-18
 New Jersey, 4-91
 Beach, 6-25
 wave, 1-4, 2-4, 2-74, 3-1, 3-2, 3-15, 6-32, 6-93
- Oceanside, California, 4-10, 6-25
 Harbor, 6-61
- Ocracoke Island, North Carolina, 4-110, 6-49, 6-52
- Offshore, 1-2, 1-3, 3-107, 4-72, 4-80, 4-147, 5-3, 5-9,
 5-19, 5-21, 5-22, 5-55, 5-62, 5-64, 5-67, 5-69,
 5-71, 5-73, 7-14, 7-17
 bar, 1-3, 1-10, 1-13, 2-122, 4-78, 6-16
 bathymetry, 1-7, 2-124, 3-123, 4-78
 breakwater, 1-23, 2-105 thru 2-108, 4-167, 5-29,
 5-30, 5-34, 5-61 thru 5-67, 5-69, 5-71, 5-73,
 6-55, 6-61, 6-72, 6-93 thru 6-95
 types, 5-59, 6-93
 island, 4-30, 4-114, 4-117, 8-1 thru 8-3
 slopes, 4-117, 4-120, 4-121, 4-127, 4-128, 5-5,
 5-21, 5-22, 7-41
 structures, 1-22, 2-108, 7-149
 wave climate, 4-29, 4-42
 zone, 4-55, 4-58, 4-60, 4-73, 4-121, 4-126,
 4-129, 6-56
- Old Point Comfort, Virginia, 3-124, 3-125
- Onshore-offshore
 currents (see also Littoral currents; Nearshore
 currents), 4-49
 profiles, 4-75
 transport, 1-13, 4-57, 4-58, 4-65, 4-66, 4-71, 4-73,
 4-74, 4-76, 4-83, 4-117, 4-133, 4-147, 5-35, 5-63
- Orange, Texas, 3-112, 3-113
- Organic reefs, 4-23
- Orthogonal, 2-61 thru 2-66, 2-68 thru 2-75, 2-109,
 2-110, 7-15, 7-156, 8-33
- Oscillatory wave (see also Airy Wave Theory; Linear
 Wave Theory), 1-5, 2-4, 2-6, 2-9, 2-27, 2-55 thru
 2-57, 2-59
- Outer
 Banks, North Carolina, 6-41, 6-42, 6-48
 bar, 1-14, 1-24, 4-152, 4-157, 4-173, 4-175,
 4-177, 5-26, 5-28
- Overtopping, 1-13, 2-119, 3-122, 4-44, 4-108, 4-110,
 4-112, 5-3, 5-4, 5-20, 5-26, 5-58, 5-69, 5-73, 6-1,
 6-48, 6-93, 7-16, 7-18, 7-33, 7-43 thru 7-54, 7-56,
 7-58, 7-59, 7-61 thru 7-63, 7-67 thru 7-69, 7-73,
 7-74, 7-80 thru 7-83, 7-89, 7-173, 7-205, 7-211,
 7-212, 7-225, 7-227 thru 7-229, 7-231, 7-233, 7-235,
 7-236, 7-238, 7-239, 7-248, 7-249, 8-48
 coefficient, 7-67, 7-71, 7-72
- Overwash, 1-13, 1-16, 1-17, 4-43, 4-80, 4-108, 4-110
 thru 4-112, 4-114, 4-120, 4-122, 4-127, 4-128, 6-73
 fans, 1-13, 1-16
- Oxnard Plain Shore, California, 4-91
- - P - -
- Padre Island, Texas, 1-11, 4-108 thru 4-111, 4-124,
 4-136, 6-37, 6-38, 6-40, 6-42, 6-43, 6-49, 6-51
 thru 6-53
- Palm Beach, Florida, 4-37, 4-91, 5-9, 6-15
 County, 6-72
- Panic grasses, 6-44, 6-48, 6-53
- Pass Christian, Mississippi, 3-115
- Passive earth force, 7-257
- Peahala, New Jersey, 4-8
- Peak surge, 3-123, 8-9
- Peat, 4-17, 4-22, 4-27
- Pelican Island, Texas, 3-112, 3-113
- Pensacola, Florida, 3-90, 3-117, 4-35
 Inlet, 4-179, 4-180
- Percolation, 2-2, 2-63, 3-55, 4-29, 4-36, 4-124
- Perdido Pass, Alabama, 4-91, 6-61, 6-69, 6-75
- Period, wave (see Design wave period; Significant wave
 period; Tidal period; Wave period)
- Periodic wave, 2-3, 4-58, 4-94, 7-11, 7-16
- Permeable
 breakwater, 7-61, 7-64, 7-73, 7-80 thru 7-82
 groin, 1-24, 5-52, 5-53, 6-76
- Perth Amboy, New Jersey, 3-124, 3-125
- Phase velocity (see also Wave celerity), 2-7, 2-23
 thru 2-25, 2-31
- Phi
 millimeter conversion table, C-38
 units, 4-14, 4-15, 4-17, 4-25, 5-11
- Philadelphia, Pennsylvania, 3-116, 3-124, 3-125
- Pierson-Neuman-James wave prediction model, 3-43
- Pile (see also Breaking wave forces on piles; Concrete
 pile; Concrete sheet-pile; Cylindrical pile; Non-
 breaking wave forces on piles; Noncircular pile;
 Sheet-pile; Steel sheet-pile; Timber pile; Vertical
 pile; Wave forces on piles), 5-53, 6-1, 6-76, 6-83,
 6-84, 6-93, 7-101, 7-103, 7-106, 7-109 thru 7-111,
 7-127, 7-129, 7-132, 7-138, 7-141, 7-147, 7-149
 thru 7-155, 7-157, 7-159, 7-160, 7-256
 diameter, 7-103, 7-131, 7-138, 7-140, 7-144, 7-146,
 7-155
 foundation, 4-27
 group, 7-153 thru 7-155
- Pinellas County, Florida, 4-91
- Pioneer Point, Cambridge, Maryland, 6-10
- Pipeline dredges, 5-32, 5-33, 5-54, 5-60, 6-14, 6-16,
 6-30 thru 6-32, 6-56, 6-59, 6-61, 6-73, 6-76
- Pismo Beach, California, 4-124
- Planning analysis, 1-1, 5-1, 5-2, 6-14

SUBJECT INDEX

- Plum Island, 4-151, 4-160
 Pocket beach, 4-1, 4-3, 4-138
 Pohoiki Bay, Hawaii, Hawaii, 7-226, 7-235
 Point
 Arguello, California, 3-36, 4-124
 Barrow, Alaska, 4-45
 Conception, California, 4-145
 Loma, California, 3-92
 Mugu, California, 4-10, 4-37, 4-71, 4-74, 4-136, 4-137
 Reyes, California, 4-10
 sinks, 4-113, 4-114
 sources, 4-113, 4-114, 4-117, 4-119
 Sur, California, 4-10
 Pompano Beach, Florida, 6-15, 6-25
 Ponce de Leon Inlet, Florida, 6-61, 6-71
 Ponding, 7-89, 7-90
 Poorly-
 graded sediment, 4-14
 sorted sediment, 4-14
 Porosity, 4-66, 7-3, 7-18, 7-208, 7-215, 7-229, 7-234, 7-236 thru 7-238
 Port
 Aransas, Texas, 3-112, 3-113
 Arthur, Texas, 3-112 thru 3-114
 Hueneme, California, 1-23, 4-91, 5-28, 6-59, 6-61, 6-72
 Isabel, Texas, 3-92, 3-112, 3-113, 3-117, 4-35
 Lavaca, Texas, 3-114
 O'Conner, Texas, 3-112, 3-113
 Orford, Oregon, 4-37
 Sanilac, Michigan, 6-91, 6-92
 Townsend, Washington, 3-92
 Portland, Maine, 3-116, 3-124, 3-125
 Portsmouth
 Island, North Carolina, 4-122
 New Hampshire, 3-116, 3-124, 3-125
 Virginia, 3-116, 3-124, 3-125
 Potential energy, 2-25, 2-26, 2-29, 2-58, 3-15, 3-99, 3-107
 Potham Beach, Maine, 1-21
 Power, wave (see Wave power)
 Precast concrete armor units, 1-21
 Prediction, wave (see Wave prediction)
 Presque Isle, Pennsylvania, 5-62, 5-63, 6-80
 Pressure (see also Atmospheric pressure; Central pressure index; Dynamic pressure; Earth pressure; Hydrostatic pressure; Soil bearing pressure; Sub-surface pressure), 2-6, 2-43, 2-58, 3-34, 3-52, 3-81, 3-82, 3-84, 3-110, 4-28, 6-6, 7-161 thru 7-163, 7-173, 7-180, 7-181, 7-187, 7-193, 7-196, 7-198, 7-254, 7-256, C-3
 distribution, 2-46, 7-161 thru 7-163, 7-173, 7-174, 7-178, 7-181, 7-182, 7-192, 7-256
 gradient, 2-36, 3-24, 3-30, 3-33, 3-34, 4-50
 profile, 3-82
 pulse, 3-20
 response factor, 2-22, 7-104, C-3
 Pria, Terceira, Azores, 7-236
 Probable maximum
 hurricane, 3-126
 wave, 3-87
 Profile (see also Beach profile; Bottom profile; Coastal profile; Design profile; Dune profile; Island profile; Nearshore profile; Onshore-offshore profile; Pressure profile; Shelf profile; Temperature profile; Wave profile; Wind profile), 2-39, 2-114, 3-20, 3-24, 3-97, 3-120, 4-6, 4-60, 4-61, 4-64, 4-65, 4-73 thru 4-78, 4-80, 4-83, 4-85, 4-117, 4-118, 4-143, 4-161, 5-5, 5-6, 5-9, 5-21, 5-22, 5-31, 5-35, 5-43, 5-45, 5-48, 5-49, 5-67, 6-26, 6-27, 6-80
 Profile (Cont)
 accuracy, 4-62
 closure error, 4-62, 4-63
 sounding error, 4-62
 spacing error, 4-62, 4-63
 temporal fluctuations, 4-62
 zonation, 4-73, 4-76
 Progressive wave, 2-3, 2-6 thru 2-8, 2-10, 2-37
 theory, 2-6
 Prospect Beach, West Haven, Connecticut, 6-25
 Protective beach (see also Artificial beach nourishment; Beach nourishment; Beach protection; Berm; Dune; Feeder beach; Groin), 5-2, 5-6, 5-7, 5-33, 5-35, 5-63, 6-1, 6-14 thru 6-24, 6-29, 6-30, 6-33
 erosion (see Beach erosion)
 Providence, Rhode Island, 3-116
 Provincetown, Massachusetts, 3-92
 Puget Sound, Washington, 3-92
 -- Q --
 Quadrupod, 6-85, 6-88, 7-206, 7-209, 7-211, 7-215 thru 7-217, 7-219, 7-225, 7-226, 7-231, 7-234
 Quarystone, 1-21, 1-23, 1-24, 5-58, 5-61, 6-5, 6-6, 6-11, 6-97, 7-16, 7-26, 7-32, 7-202, 7-205, 7-206, 7-211, 7-212, 7-214, 7-215, 7-225, 7-230, 7-231, 7-233, 7-234, 7-236 thru 7-242, 7-245, 7-246, 8-47, 8-61
 armor units, 1-24, 6-88, 6-97, 7-210, 7-212, 7-236, 7-241, 7-245, 7-247, 7-249
 revetment, 1-21, 6-6, 6-11
 slopes, 7-16, 7-26
 weight and size, 7-230
 Quartz, 4-18, 4-21, 4-22, 4-69, 4-73, 4-74, 4-124, 6-36
 Quay, 8-75, 8-85
 Quincy Shore Beach, Quincy, Massachusetts, 6-25
 -- R --
 Racine County, Wisconsin, 4-91
 Radioactive tracers 4-144, 4-145
 Radioisotopic sand tracing (RIST), 4-145
 Rainfall, 3-111, 3-115
 Random wave, 3-106 thru 3-109, 7-62, 7-67, 7-74, 7-92, 7-95 thru 7-98
 Rankine, 7-257, 7-259
 Rayleigh distribution, 3-2, 3-5 thru 3-8, 3-10 thru 3-12, 3-81, 4-40, 4-93, 7-2, 7-39, 7-58, 7-67
 Redfish Pass, Florida, 4-167, 4-168, 4-173
 Redondo Beach (Malaga Cove), California (see also Malaga Cove (Redondo Beach), California), 4-91, 5-20, 6-14, 6-16, 6-25, 6-28 thru 6-32
 Reefs, organic (see Organic reefs)
 Reflection coefficient (see also Wave reflection), 2-112, 2-116 thru 2-119, 2-121 thru 2-125, 7-73, 7-77, 7-82, 7-84, 7-85, 7-161 thru 7-163, 7-173, 7-179, 7-245, 7-246
 Refraction
 analysis (see Wave refraction analysis)
 coefficient (see also Wave refraction), 2-64, 2-67, 2-71, 2-72, 2-110, 2-135, 2-136, 3-104, 4-94, 4-95, 7-14, 7-15, 7-33, 8-33, 8-35 thru 8-37, 8-76
 diagrams (see Wave refraction analysis--diagrams)
 diffraction coefficient, 2-109, 2-110
 template, 2-65, 2-66, 2-69
 Rehoboth Beach, Delaware, 1-20

SUBJECT INDEX

- - 5 - -

- Relative depth, 2-9, 2-10, 2-32, 2-112, 2-129, 3-118, 7-10, 7-62, 7-113 thru 7-116
- Resonant wave, 2-113
- Revetment (see also Articulated armor unit revetment; Channel revetment stability; Concrete revetment; Interlocking concrete block revetment; Quarystone revetment; Riprap revetment), 1-19 thru 1-21, 2-112, 2-116, 2-119, 2-121, 4-76, 5-2 thru 5-4, 6-1, 6-6, 6-14, 6-92, 7-100, 7-207, 7-212, 7-233, 7-237, 7-240, 7-241, 7-246 thru 7-252, 8-47, 8-69, 8-71
- Reynolds number, 4-14, 7-101, 7-137 thru 7-139, 7-141, 7-143, 7-144, 7-149, 7-158, 7-208, 7-209
- Ridge-and-runnel, 4-82, 4-84, 4-148
- Rigid structures, 7-3, 7-133, 7-136
revetment (see Concrete revetment)
- Rincon Beach, California, 4-10
Island, California, 7-226
- Rip currents, 1-7, 4-4, 4-49, 4-50, 4-52, 4-66, 5-37, 5-38, 5-54
- Ripple, 1-4, 3-93, 4-48, 4-49, 4-58 thru 4-60, 4-62, 4-66, 4-72, 4-147
- Riprap, 7-26, 7-30, 7-33, 7-34, 7-49, 7-73, 7-75, 7-205, 7-207, 7-229, 7-234, 7-237, 7-240, 7-247, 7-249 thru 7-251, 7-254, 7-255
revetment, 6-6, 6-14
slopes, 7-35, 7-229
- RIST (see Radioisotopic sand tracing)
- Rivers (see also specific rivers), 1-3, 1-6, 1-7, 1-15, 1-17, 1-25, 3-41, 3-115, 3-122, 4-22, 4-114, 4-115, 4-117, 4-127, 4-128, 4-148, 4-166, 5-56, 6-30
- Rock (see also Beach rock; Unit weight--rock), 4-23, 4-24, 4-136, 4-144, 5-59, 6-1, 6-35, 6-73, 7-207, 7-225, 7-227, 7-228, 7-258, 8-58, 8-61, 8-62, 8-67
- Rockaway Beach, New York, 5-20, 5-22, 6-16, 6-23 thru 6-25
- Rogue River, Oregon, 4-37
- Rubble, 6-88, 7-63, 7-100, 7-241 thru 7-244, 7-255
foundation, 7-177, 7-178, 7-187, 7-242 thru 7-244
stability, 7-242 thru 7-244
slope, 5-3, 5-4, 7-31, 7-233
seawall, 5-4
structures (see Rubble-mound structure)
toe protection, 2-112, 7-242 thru 7-244
- Rubble-mound, 7-225, 7-227, 7-228
breakwater, 2-112, 2-117 thru 2-119, 5-59, 5-62, 6-72, 6-89, 6-90, 6-92 thru 6-95, 7-16, 7-61, 7-73, 7-75, 7-78, 7-79, 7-82, 7-86 thru 7-88, 7-90, 7-209, 7-210, 7-216, 7-235
construction, 1-24, 5-56, 5-59, 5-61, 5-93
foundation, 7-242, 7-246
groin, 5-40, 6-82 thru 6-84, 7-204
jetty, 6-84 thru 6-86, 6-88, 7-235
seawall, 6-5, 6-6, 6-28
structure (see also Wave runoff--rubble-mound structure), 1-20, 6-84, 6-93, 7-3, 7-4, 7-18, 7-100, 7-200, 7-202 thru 7-204, 7-208 thru 7-210, 7-213, 7-214, 7-225, 7-229, 7-231, 7-233, 7-235, 7-236, 7-240 thru 7-242, 7-245, 8-59
cross-section example, 6-89, 6-90, 7-227, 7-228, 8-48
design (see also Armor units weight; Bedding layer; Concrete cap; Cover layer; Filter blanket; Layer coefficient; Underlayer), 7-202, 7-203, 7-225, 7-229, 7-231, 7-232
core volume, 8-65, 8-74
economic evaluation, 8-46, 8-65, 8-67 thru 8-73
layer volumes, 8-60 thru 8-66, 8-73, 8-74
number of armor units, 7-236, 7-237, 8-59, 8-73
stability, 7-202
- Rudee Inlet, Virginia Beach, Virginia, 5-31, 6-54, 6-56, 6-59, 6-60
- Runup, wave (see Wave runoff)
- Sabellariid worms, 4-23
- Safety factor, 7-136, 7-146, 7-149, 7-210, 8-84
- Sainflou Method, 7-161
- St.
Augustine Beach, Florida, 6-75
Lucie Inlet, Florida, 4-176
Marks, Florida, 4-35
Mary's River, Florida, 4-167, 4-172, 4-173
Petersburg, Florida, 3-117
Thomas, Virgin Islands, 7-226
- Salina Cruz, Mexico, 6-54
- Salinity currents, 4-166, 5-57
- Saltation, 6-38
- Sampling sediment (see Sediment sampling)
- San Buenaventure State Beach, California, 6-25
Clemente, California, 4-37
Diego, California, 1-3, 3-118
Francisco, California, 3-91, 3-118, 6-3
Onofre, California, 4-10
Simeon, California, 4-37
- Sand (see also Borrow areas; Littoral material; Specific gravity--sand), 1-7, 1-8, 1-10, 1-13 thru 1-16, 1-19, 1-23 thru 1-26, 4-5, 4-6, 4-12, 4-13, 4-17, 4-18, 4-21, 4-22, 4-24, 4-26 thru 4-29, 4-43 thru 4-45, 4-55, 4-57, 4-59, 4-60, 4-65, 4-66, 4-70 thru 4-74, 4-76, 4-80, 4-82, 4-83, 4-90, 4-108, 4-110, 4-113, 4-115, 4-117 thru 4-121, 4-124, 4-128 thru 4-130, 4-134, 4-136, 4-137, 4-139, 4-144, 4-147, 4-148, 4-173 thru 4-177, 4-180, 4-181, 5-6 thru 5-9, 5-11 thru 5-13, 5-15, 5-19, 5-24, 5-28 thru 5-31, 5-33, 5-35, 5-37, 5-40, 5-41, 5-43, 5-52, 5-53, 5-55, 5-64, 6-16, 6-26, 6-28, 6-30, 6-31, 6-37 thru 6-44, 6-51 thru 6-55, 6-61, 6-64, 6-73, 6-74, 6-83, 6-93, 7-1, 7-241, 7-247, 7-258, 7-260, 8-76, 8-81 thru 8-83, 8-91, 8-92
budget (see also Sediment budget), 1-1, 4-6, 4-114, 4-126, 4-128, 4-130 thru 4-133
bypassing, 1-17, 1-24, 4-134, 4-167, 5-24, 5-26, 5-28, 5-30, 5-31, 5-34, 5-37, 5-53, 5-58, 5-60, 6-1, 6-53, 6-54, 6-56, 6-59, 6-61 thru 6-75
plants (see Fixed bypassing plant; Floating bypassing plant)
land-based vehicles (see Land-based vehicles)
legal aspects, 5-33, 5-34
mechanical, 1-26, 5-28, 5-30, 6-54
methods, 6-54
composition, 1-7, 4-21
conservation, 1-25, 1-26
dune (see Dune)
fence (see also Dune construction using sand fencing), 5-26, 6-38, 6-42 thru 6-44, 6-49, 6-50
heavy minerals (see Heavy minerals)
Hill Cove Beach, Narragansett, Rhode Island, 6-25
impoundment, 1-23, 1-24, 4-5, 4-6, 4-174, 5-26 thru 5-29, 6-40, 6-43, 6-47 thru 6-49, 6-51, 6-53, 6-55, 6-59, 6-62, 6-63, 6-72, 6-73
motion (see Sediment motion)
movement (see also Littoral transport; Longshore transport; Sediment transport), 1-14 thru 1-16, 1-23, 1-24, 1-26, 4-5, 4-23, 4-45, 4-66, 4-70, 4-104, 4-108, 4-114, 4-119, 4-120, 4-124, 4-126, 4-128, 4-144, 4-149, 4-150, 4-172, 4-180, 5-8, 5-26, 5-30, 5-35, 5-37, 5-61, 5-63, 6-37, 6-51, 7-242, 8-90
deflation (see Deflation)
saltation (see Saltation)
surface creep, 6-38
suspension, 6-38

SUBJECT INDEX

Sand (Cont)

origin, 1-7
size (see also Grain size; Mean diameter; Median diameter; Median grain size), 4-12, 4-14, 4-16, 4-17, 4-25, 4-79, 4-86, 4-97, 4-112, 7-180, 5-9, 5-35, 6-36
classification (see Soil classification)
spillway, 6-74
tracers (see Tracers)
transport (see Sand movement)
trap (see Sand impoundment)
Sandy Hook, New Jersey, 3-92, 3-116, 3-124, 3-125, 4-57, 4-77, 4-79, 4-90, 4-91, 4-121, 4-123, 4-134, 4-135, 4-147, 5-54
Santa
Barbara, California, 1-23, 4-91, 4-180, 5-60, 5-62, 6-61, 6-65, 6-73
Cruz, California, 4-62, 6-85, 6-88, 7-226
Monica, California, 3-118, 4-91, 5-62
Mountains, 4-10
Sapelo Island, Georgia, 4-71, 4-74
Savannah
Coast Guard Light Tower, 3-13
Georgia, 3-92, 3-124, 3-125
River, 3-90
Saybrook, Connecticut, 3-92
Scale effects (see Wave runup scale effects)
Scour (see also Toe scour), 1-21, 3-110, 4-49, 4-172, 5-3 thru 5-5, 5-54, 5-73, 6-1, 6-5, 6-6, 6-14, 6-75, 6-93, 7-14, 7-129, 7-149, 7-237, 7-241, 7-242, 7-245 thru 7-249
Scripps
Beach, California, 4-10
Canyon, California, 4-51
Pier, California, 4-10
Sea, 1-4, 1-7 thru 1-10, 3-1, 3-21, 3-51, 3-77, 3-106 thru 3-109, 3-120
Girt, New Jersey, 6-15, 6-32
Isle City, New Jersey, 5-54
level changes, 1-15, 1-16, 1-19, 4-5, 4-126
oats, 6-44, 6-45, 6-47 thru 6-53
Seacrest, North Carolina, 4-37
Seas (see also Fully arisen sea), 1-6, 2-4
Seaside Park, Bridgeport, Connecticut, 6-25
Seattle, Washington, 3-91, 3-118
Seawall (see also Rubble-mound seawall; Rubble slope seawall), 1-19 thru 1-22, 2-112, 4-80, 5-2 thru 5-4, 5-24, 5-62, 5-71, 6-1 thru 6-5, 6-14, 6-28, 6-32, 6-54, 7-16, 7-28, 7-29, 7-100, 7-170, 7-172, 7-198, 7-226, 7-233, 7-241
face, 1-21, 6-1 thru 6-4
functional planning, 5-3, 6-1
purpose, 5-2, 5-4, 6-1
types, 6-1
Sebastian Inlet, Florida, 6-59, 6-63, 6-73
Sediment (see also Beach sediment; Poorly-graded sediment; Poorly-sorted sediment; Well-graded sediment; Well-sorted sediment), 1-7, 1-10, 1-13 thru 1-17, 1-19, 1-26, 2-18, 4-1, 4-28, 4-48, 4-50, 4-59, 4-60, 4-66, 4-67, 4-71, 4-72, 4-74 thru 4-76, 4-83, 4-85, 4-89, 4-117, 4-120, 4-121, 4-123, 4-134, 4-144, 4-145, 4-149, 4-174, 5-8, 5-9, 5-12, 5-13, 5-15, 5-17, 5-19, 5-21, 5-22, 5-28, 5-35, 5-37, 5-40, 5-43, 5-64 thru 5-65, 5-67, 5-71, 6-15, 6-76, 6-83, 7-246, 8-1
analysis, 4-28
budget (see also Sand budget), 4-58, 4-63, 4-113 thru 4-117, 4-119, 4-123, 4-124, 4-126, 4-129, 4-143, 4-146, 4-148
sinks (see Line sinks; Littoral material sinks; Point sinks)
sources (see Line sources; Littoral material sources; Point sources; Sediment sources)
classification (see Soil classification)

Sediment (Cont)

load (see Bedload; Suspended load)
motion, 4-4, 4-17, 4-66 thru 4-70
properties, 4-66
sampling, 4-21, 4-142, 4-143
sinks (see Line sinks; Littoral material sinks; Point sinks)
size (see also Grain size; Mean diameter; Median diameter; Median grain size), 1-7, 1-14, 4-12, 4-14, 4-28, 4-44, 4-66, 4-71, 4-112, 4-117, 4-147, 5-12, 5-67
sorting, 4-66
loss, 4-121
sources (see also Line sources; Point sources), 4-117, 4-119
tracers (see Tracers)
transport (see also Littoral transport; Longshore transport; Sand movement), 1-16, 1-17, 4-4 thru 4-6, 4-17, 4-18, 4-29, 4-46, 4-48, 4-49, 4-55, 4-58, 4-65, 4-66, 4-71, 4-75, 4-76, 4-83, 4-114, 4-119, 4-136, 4-144, 4-146, 4-147, 5-21, 5-26, 5-61, 6-95
rate, 4-101, 4-126, 5-67
Seiche (see also Clapotis; Standing wave), 2-115, 3-88, 3-89, 3-93, 3-96, 3-98, 3-99
antinode (see Antinode)
forced, 3-98
free, 3-98
node (see Node)
Semirigid structures, 7-3
Setdown (see Wave setdown)
Settling tube, 4-21, 4-28, 4-29
analysis, 4-27, 4-28, 5-10
Setup (see Surge; Wave setup; Wind setup)
Seward, Alaska, 3-118
Shallow water, 2-2, 2-3, 2-6, 2-9, 2-10, 2-25, 2-26, 2-30, 2-32, 2-33, 2-44, 2-46, 2-57, 2-63, 2-64, 2-66, 2-68, 2-70, 3-2, 3-6, 3-11, 3-12, 3-15, 3-18, 3-24, 3-39, 3-44, 3-55, 3-66, 3-67, 3-89, 3-110, 3-122, 4-30, 4-46, 4-47, 4-49, 4-58, 4-93, 5-3, 5-33, 5-65, 7-3, 7-15, 7-63, 7-82, 7-85, 7-91, 7-117, 7-158, 7-159, 7-209, 7-237 thru 7-239, 7-246, 7-247, 8-26, C-3
structures, 7-246
wave, 2-17, 2-31, 2-126, 3-45, 3-46, 3-56 thru 3-65, 3-93, 4-29, 4-30, 4-47, 4-162, 7-3, 7-4, 7-14, 7-33, 7-109, 7-146, 7-157, 7-158, 8-33
prediction, 3-55, 8-12
Shark River Inlet, New Jersey, 4-91, 6-75
Sheet-pile, 5-3, 5-59, 6-1, 6-76, 6-83, 6-88
bulkhead, 6-6, 7-249
groin, 6-84
jetty, 4-165, 6-88
Shelf
bathymetry, 4-31
profile, 4-60, 4-61, 4-64
Sherwood Island State Park, Westport, Connecticut, 6-25
Shesholik Spit, Alaska, 4-90
Shingle, 1-16, 4-21
Shinnecock Inlet, Long Island, New York, 4-45, 4-120, 4-140
Shipbottom, New Jersey, 4-7
Shoal (see also Middleground shoal), 1-14, 1-15, 1-17, 2-109, 2-122, 4-30, 4-65, 4-117, 4-119, 4-149, 4-152, 4-157, 4-173 thru 4-175, 4-177, 5-30, 5-60, 6-56, 6-72 thru 6-74
Shoaling (see also Channel shoaling), 1-24, 2-27, 2-60, 2-74, 2-109, 3-93, 3-99, 3-110, 4-29, 4-30, 4-36, 4-49, 4-89, 4-92, 4-146, 4-157, 4-174, 4-176, 4-179, 4-180, 5-30, 5-56, 5-65, 6-16, 6-72, 7-1, 7-242, 8-45, C-35
coefficient, 2-28, 2-64, 2-67, 4-95, 4-97, 4-104, 4-105, 4-107, 7-13 thru 7-15, 8-33, 8-35 thru 8-37, C-3
water, 2-37, 2-46, 2-57, 2-58, 2-129

SUBJECT INDEX

- Shore, 1-2 thru 1-4, 1-6, 1-7, 1-9, 1-13 thru 1-15, 1-19, 1-23 thru 1-25, 3-1, 3-4, 3-30, 3-51, 3-81, 3-99, 3-101, 3-102, 4-66, 4-89, 4-117, 4-147, 4-181, 5-2, 5-3, 5-6 thru 5-8, 5-10, 5-23, 5-28, 5-32, 5-39, 5-40, 5-44, 5-45, 5-52, 5-55, 5-56, 5-58, 5-60 thru 5-62, 5-64, 5-66, 5-67, 5-71, 5-74
 alinement (see Beach alinement)
 connected breakwater, 1-23, 5-29, 5-30, 5-58 thru 5-60, 6-55, 6-61, 6-88
 types, 5-59, 6-88
 protection (see also Beach protection), 1-1, 1-3, 1-15, 1-22, 2-1, 2-2, 5-2, 5-6, 5-7, 5-62, 5-64, 5-74, 6-6, 6-93, 7-16
- Shoreface (see also Beach face), 1-2, 2-1, 4-67, 4-71 thru 4-73, 4-75, 5-9, 6-84
- Shoreline, 1-2 thru 1-4, 1-7, 1-13, 1-15, 2-27, 2-71, 2-73, 2-126, 2-127, 2-136, 3-42, 3-99, 3-106, 3-119, 3-120, 3-123, 4-1, 4-3, 4-8, 4-23, 4-50, 4-53, 4-54, 4-57, 4-65, 4-75, 4-80, 4-82, 4-85, 4-89, 4-92, 4-94, 4-95, 4-113, 4-114, 4-134, 4-140, 4-142, 4-147, 4-148, 4-152, 4-154, 4-157, 4-167, 4-168, 4-170, 4-171, 4-173, 4-175, 4-180, 5-2 thru 5-4, 5-7, 5-22 thru 5-24, 5-26, 5-34 thru 5-44, 5-46, 5-53, 5-58 thru 5-63, 5-65 thru 5-67, 5-69, 5-71, 5-73, 6-27, 6-80, 6-93, 6-95, 7-2, 7-89, 7-195, 8-1, 8-26, 8-33, 8-34, 8-85, 8-90, A-48, C-35
 erosion, 1-10, 1-13, 1-15 thru 1-17, 4-5 thru 4-7, 4-9, 4-114, 4-117, 4-173
- Side-cast dredging, 6-76
- Sieve analysis, 4-17, 4-27, 4-28, 5-10
- Significant wave, 3-2, 3-11, 3-71, 3-87, 3-104, 4-69, 7-14, 7-41, 7-59, 7-61, 8-36
 height (see also Deep water significant wave height), 3-2, 3-6, 3-10, 3-21, 3-22, 3-39, 3-43, 3-52, 3-70, 3-71, 3-75, 3-77, 3-85, 3-87, 3-102, 3-104, 4-31, 4-37, 4-40, 4-41, 4-73, 4-74, 4-93, 4-94, 7-2, 7-3, 7-14, 7-41, 7-59, 7-67, 7-69, 7-72, 7-80, 7-93, 7-94, 7-99, 7-208, 7-245, 8-18, 8-25, 8-38 thru 8-41, 8-44, 8-45
 period, 3-2, 3-6, 3-52, 3-77, 3-81, 3-84, 3-87, 7-1, 7-2, 7-67, 7-93, 7-94, 8-18, 8-38 thru 8-41
- Silt, 1-7, 4-12, 4-13, 4-17, 4-21, 4-22, 4-71, 4-115, 7-258
- Simple
 harmonic wave (see Sinusoidal wave)
 wave, 2-2, 2-3
- Sinks (see also Line sinks; Littoral material sinks; Point sinks), 4-60, 4-114, 4-126, 4-129, 4-131, 4-132
- Sinusoidal wave, 2-3, 2-6, 2-8, 2-10, 2-24, 3-5, 3-11, 3-18
- Sitka, Alaska, 3-118
- Siuslaw River, Oregon, 3-92
- Size
 analysis, 4-27, 4-28
 classification, sediment (see Soil classification)
- Skagway, Alaska, 3-118
- Skewness (see also Moments), 4-15, 4-17, 5-12
- Sliding, 7-254, 8-81, 8-84
- Slopes (see also Beach fill slopes; Beach slopes; Bottom slopes; Composite slopes; Foreshore slopes; Hypothetical slopes; Impermeable slopes; Nearshore slopes; Offshore slopes; Quarystone slopes; Riprap slopes; Rubble slope; Structure slope), 2-59, 2-67, 2-74, 2-116 thru 2-118, 3-99, 3-102, 3-107 thru 3-109, 3-119, 4-44, 4-65, 4-85 thru 4-88, 5-6, 5-9, 5-21, 5-22, 5-37, 5-40, 5-45, 5-49, 5-50, 5-67, 6-32, 6-46, 6-88, 7-4, 7-6, 7-8, 7-9, 7-18 thru 7-21, 7-24 thru 7-38, 7-40, 7-43, 7-44, 7-54, 7-56, 7-59, 7-63, 7-72, 7-82, 7-84, 7-183, 7-187, 7-202 thru 7-206, 7-210, 7-211, 7-235 thru 7-239, 7-241, 7-245 thru 7-247, 7-251, 7-257, 7-260, C-35, C-43
- Small Amplitude Wave Theory, 2-2, 2-4, 2-6, 2-7, 4-46, 4-48, 4-65, 4-67, 4-68, 4-73, 4-92, 4-94, 4-105
- Soil (see also Cohesionless soil; Cohesive soil; Foundation soil; Unit weight--soil), 5-6, 6-97, 7-240, 7-241, 7-245, 7-248, 7-249, 7-256 thru 7-258, 7-260, 8-85
 bearing pressure, 8-75, 8-81, 8-84, 8-85
 classification (see also Casagrande size classification; Unified soil classification; Wentworth size classification), 4-13, A-41
 mechanics, 4-18, 6-84, 7-256
- Solitary wave, 2-4, 2-45, 2-49, 2-56 thru 2-59, 7-16
 theory, 2-2, 2-3, 2-33, 2-44, 2-49, 2-55, 2-58, 2-130, 3-101, 4-94, 4-95, 7-117
- Solomons Island, Maryland, 3-116, 3-124, 3-125
- South Lake Worth Inlet, Florida, 4-144, 6-54, 6-57
- Southampton, New York, 4-37
- Southport, North Carolina, 3-117, 3-124, 3-125
- Specific
 energy (see Energy density)
 gravity (see also Mass density; Unit weight), 4-18, 4-21, 4-22, 4-86, 6-97, 7-205, 7-207, 7-242, 7-243
 littoral material, 4-17, 4-18
 sand, 4-18
- Speed, wind (see Wind speed)
- Spillway, sand (see Sand spillway)
- Spits (see also Cuspate spit), 1-8, 4-57, 4-90, 4-112, 4-121, 4-123, 4-129, 4-130, 4-132, 4-147, 6-74
- Split-hull
 barge, 6-75, 6-76
 dredges, 1-26
- Spring tides, 4-45, 4-80, 4-152, 8-12
- Spuyten Duyvil, New York, 3-124, 3-125
- Stability (see also Beach stability; Caisson stability; Channel revetment stability; Cover layer stability; Dune stabilization; Foundation stability; Inlet stabilization; Jetty stabilization; Rubble foundation stability; Rubble-mound structure stability; Structural stability; Toe stability), 3-25, 3-26, 3-30, 3-32, 3-33, 3-35, 3-52, 4-6, 4-112, 4-133, 5-6, 5-8, 5-10, 6-1, 6-13, 6-31, 6-83, 6-88, 6-92, 6-93, 7-200, 7-204, 7-206, 7-210, 7-215, 7-235, 7-236, 7-239, 7-242, 7-245, 7-247 thru 7-249, 7-254, 8-79
 coefficient, 7-205, 7-207, 7-215, 7-225, 7-239, 8-49, 8-50
 number, 7-207, 7-243, 7-244
- Stabit, 7-216
- Standard
 deviation (see also Moments), 3-11, 3-14, 3-15, 3-17, 4-14, 4-15, 4-17, 4-40, 4-77, 5-10, 6-26, 7-2, 7-145, 8-91
- Project
 Hurricane, 3-126, 4-42
 Northeaster, 3-126
- Standing wave (see also Clapotis; Seiche), 2-3, 2-75, 2-113, 2-114, 3-89, 3-96 thru 3-98, 7-161
 antinode (see Antinode)
 node (see Node)
- Staten Island, New York, 4-136, 4-139
- Steady flow drag coefficient, 7-139
- Steel, 1-20, 1-23, 1-24, 5-56, 5-59, 6-1, 6-84, 6-88, 6-96, 6-98, 7-149
 groin, 6-76 thru 6-80, 6-84
 sheet-pile, 5-56, 5-59, 5-62, 6-76, 6-80, 6-84, 6-88, 6-92, 7-242
 breakwater (see also Cellular-steel sheet-pile breakwater), 6-91, 6-92
 bulkhead, 6-6, 6-8
 groin, 6-76, 6-84
- Steepness, wave (see Wave steepness)
- Stevensville, Michigan, 4-110

SUBJECT INDEX

- Stillwater
 level, 1-5, 2-7, 2-55, 2-57, 3-1, 3-88, 3-99 thru 3-101, 3-104, 3-106 thru 3-108, 7-16, 7-33, 7-41, 7-106, 7-107, 7-109, 7-139, 7-162, 7-163, 7-171, 7-192, 7-193, 7-203, 7-204, 7-208, 7-211, 7-212, 7-243, C-3
 line, 7-147, 7-192 thru 7-197
 Stockpile (see Artificial beach nourishment; Beach replenishment; Feeder beach)
 Stokes, 2-2, 2-3, 2-37
 Wave Theory, 2-31, 2-34, 2-44, 2-59, 7-110, 7-137, 7-145
 Stone (see also Armor stone), 5-2 thru 5-5, 5-40, 6-5, 6-14, 6-36, 6-76, 6-83, 6-84, 6-88, 6-93, 6-97, 7-202, 7-205, 7-206, 7-212, 7-213, 7-225, 7-229 thru 7-231, 7-233 thru 7-237, 7-239 thru 7-242, 7-245 thru 7-247, 7-249, 7-250, 7-252, 7-253, 7-258, 7-260, 8-47, 8-59
 armor units, 3-109, 3-110
 asphalt breakwater, 6-92
 Storm (see also Oesign storm; Extratropical storm; Hurricane; Northeaster; Thunderstorms; Tropical storm), 1-3, 1-4, 1-6 thru 1-10, 1-13, 1-15, 1-17, 1-19, 1-20, 3-1, 3-21, 3-26, 3-53, 3-77, 3-80 thru 3-83, 3-104, 3-107, 3-110, 3-111, 3-123, 3-126 thru 3-128, 4-6, 4-30 thru 4-35, 4-42 thru 4-46, 4-76 thru 4-78, 4-80 thru 4-83, 4-110, 4-134, 4-143, 4-147, 4-148, 4-169, 5-4, 5-6, 5-9, 5-20, 5-24, 5-26, 5-39, 5-40, 5-54, 5-63, 5-71, 6-38, 6-48, 6-95, 7-2, 7-4, 7-14, 7-16, 7-192, 7-211, 7-225, 7-247
 attack on beaches (see also Wave attack), 1-10, 1-12, 1-13, 1-19, 4-76, 4-110, 5-24, 5-27
 berm, 5-20, 5-26
 surge, 1-1, 1-4, 1-6, 1-7, 1-10, 1-12, 1-13, 1-16, 1-19, 3-1, 3-74, 3-88, 3-89, 3-105, 3-107, 3-110 thru 3-112, 3-115, 3-119, 3-121 thru 3-124, 3-126, 3-127, 4-4, 4-5, 4-30, 4-44, 4-76, 4-78, 4-79, 4-147, 5-1, 5-4, 5-6, 5-24, 5-26, 5-57, 6-32, 6-34, 6-53, 7-16, 7-17, 7-204, 8-7, 8-9, 8-12, 8-46
 prediction, 3-115, 3-123, 3-126
 tide (see Storm surge)
 tracks, 3-77, 3-82, 3-83, 3-111, 3-123, 4-30, 4-31, 8-8
 wave, 1-3, 1-10, 1-12 thru 1-17, 1-19, 1-21, 1-24, 3-106, 4-29, 4-31, 4-43, 4-44, 4-46, 4-62, 4-76, 5-6, 5-27, 5-54, 6-92, 7-59, 7-81, 7-202
 Stream Function Wave Theory, 2-31, 2-33, 2-59, 3-15, 3-17, 7-110, 7-112, 7-118, 7-137, 7-145
 Stress, wind (see Wind stress)
 Structural stability, 5-58, 6-83, 7-1, 7-3, 7-89, 7-236, 7-241
 Structure (see also Cellular-steel sheet-pile structures; Coastal structures; Flexible structures; Impermeable structures; Marine structures; Off-shore structures; Rigid structures; Rubble-mound structure; Semirigid structures; Shallow water structures; and specific types of structures), 1-19, 1-21, 1-25, 2-60, 2-124, 5-2, 5-4, 5-22, 5-60, 5-69, 5-74, 7-1 thru 7-4, 7-8, 7-10, 7-11, 7-14, 7-16 thru 7-21, 7-41, 7-44, 7-132, 7-136, 7-147, 7-161, 7-170 thru 7-174, 7-177 thru 7-180, 7-193, 7-194, 7-200, 7-202 thru 7-205, 7-211, 7-212, 7-249, 7-253 thru 7-256, 7-260, 8-79
 damage, 5-58
 design, 3-110, 7-82, 7-110, 7-149, 8-47
 face (see also Seawall face), 5-4, 7-198, 7-206, 7-245, 8-48
 head, 7-206, 7-212, 7-229, 7-238
 scour (see Scour)
 Structure (Cont)
 slope, 2-116, 2-119, 2-121, 2-129, 5-69, 7-16, 7-18, 7-32, 7-35, 7-39, 7-41, 7-43, 7-44, 7-46, 7-50, 7-54, 7-61, 7-203, 7-205, 7-207, 7-215, 7-229, 7-236, 7-237, 7-246, 7-257, 8-47, 8-49, 8-54 thru 8-57, 8-64, 8-66, 8-68, 8-70, 8-72, 8-73
 toe, 2-90, 2-119, 2-120, 2-126, 5-4, 5-5, 7-4, 7-8, 7-9, 7-16, 7-33, 7-35, 7-38, 7-41, 7-43, 7-44, 7-54, 7-162, 7-174, 7-182, 7-195, 7-197, 7-204, 7-237, 7-245
 Subaerial breakwater, 7-64, 7-73, 7-76
 Submarine canyon, 1-26, 2-73, 4-114, 4-123, 4-127 thru 4-129, 6-61
 Submerged breakwater, 7-62, 7-64, 7-65, 7-73, 7-242
 Subsurface pressure, 2-21, 2-32, 2-36, 3-33
 Suffolk County, New York, 4-91
 Summary of Synoptic Meteorological Observations, 4-42, 4-101, 4-104
 Sunset Beach, California, 5-9, 5-22, 6-25
 Surf zone, 1-2, 1-3, 1-10, 1-16, 1-24, 3-15, 3-89, 4-4, 4-5, 4-29, 4-30, 4-36, 4-46, 4-48 thru 4-50, 4-53, 4-54, 4-55, 4-58, 4-59, 4-60, 4-65, 4-66, 4-82, 4-92, 4-94, 4-96, 4-100, 4-104, 4-110, 4-112, 4-120, 5-67, 5-71, 6-75, 7-100, 7-160, 7-241, 7-247
 Surfside, California, 5-9, 5-22, 6-25
 Surge (see also Maximum surge; Peak surge; Storm surge), 1-6, 1-7, 1-16, 3-109, 3-110, 3-122, 3-123, 4-4, 4-5, 4-78, 5-59, 7-2, 7-238, 8-75
 Surveys (see also Beach surveys; Hydrographic surveys; Profile accuracy), 4-63, 4-64, 4-77, 4-78, 4-80, 4-85, 4-90, 4-119, 4-180, 4-181, 5-8, 5-34, 6-27
 Suspended load (see also Bedload), 4-58, 4-59, 4-65, 4-66, 4-91, 4-147
 Svec block, 7-216
 Sverdrup-Munk-Bretschneider wave prediction method, 3-44
 Swash bar, 4-149 thru 151
 Swell, 1-6, 1-13, 1-15, 2-4, 3-4, 3-24, 3-43, 3-77, 3-106, 5-26, 5-35, 7-89
 Symbols (list of), 8-1 thru 8-22
 Synoptic surface weather chart, 3-33 thru 3-36, 7-15 thru 7-17

- - T - -

- Tarpon Springs, Florida, 4-24
 Temperature profile, 3-20
 Template, refraction (see Refraction template)
 Ten Mile River Beach, California, 4-124
 Terminal groin, 4-167, 5-40, 5-56, 5-62
 Tetrapod, 5-59, 6-89, 6-92, 7-206, 7-209, 7-215 thru 7-218, 7-225, 7-226, 7-231, 7-234, 7-236, 8-47, 8-50, 8-51, 8-53, 8-56, 8-57, 8-59 thru 8-61, 8-63, 8-65 thru 8-67, 8-72, 8-73
 Texas City, Texas, 3-112, 3-113
 Theories, wave (see Wave theories)
 Thunderstorms, 3-26, 3-30, 3-33, 3-41
 Tidal
 currents, 1-6, 1-8, 1-10, 3-88, 4-5, 4-49, 4-58, 4-127, 4-128, 4-147, 4-152, 5-24, 5-28, 5-32, 5-57, 6-74, 7-250, 8-12 thru 8-16
 delta (see also Ebb-tidal delta; Flood-tidal delta), 4-153
 inlets, 1-13, 1-14, 4-113, 4-148, 4-152, 4-157, 4-167, 4-177, 4-180, 6-53
 period, 4-161, 4-162
 prisms, 4-140, 4-152, 4-157, 4-158, 4-161, 4-165, 4-166, 4-174, 4-177, 5-57, 5-58, 6-73

SUBJECT INDEX

- Tidal (Cont)
 range, 1-6, 1-17, 3-92, 4-4, 4-83, 4-86, 4-128, 4-164
 thru 4-166, 5-65, 5-66 thru 5-68, 5-73, 5-74, 6-74,
 6-75, 6-96, 7-2, 7-17, 7-250, 8-9
 wave (see also Tide; Tsunami), 3-92, 4-148, 4-166
 Tide (see also Astronomical tides; Diurnal tide; Spring
 tide), 1-1, 1-4, 1-6, 1-7, 1-10, 3-1, 3-88, 3-89,
 3-92, 3-93, 3-117 thru 3-114, 3-125, 4-1, 4-4, 4-5,
 4-44, 4-76, 4-83, 4-152, 4-161, 4-162, 4-165, 5-1,
 5-9, 5-20, 5-39, 5-40, 5-57, 5-66 thru 5-69, 7-192,
 7-241, 7-250, 7-255, A-50
 curves, 3-89 thru 3-91
 gage record, 3-11, 3-93, 3-94
 prediction, 3-88, 3-89
 Tillamook Bay, Oregon, 4-37
 Timber, 1-20, 1-23, 1-24, 5-56, 5-59, 5-61, 6-1, 6-76,
 6-83, 6-93, 6-96
 groin, 6-76 thru 6-78, 6-84
 pile, 5-56, 5-59, 6-76, 6-88, 6-96, 6-97
 sheet-pile, 6-84, 6-88
 bulkhead, 6-6, 6-9
 groin, 6-77, 6-84
 steel sheet-pile groin, 6-76, 6-78
 Toe (see also Dutch toe; Structure toe), 1-21, 2-92,
 3-105, 5-21, 5-22, 5-26, 6-1, 7-175, 7-181, 7-182,
 7-196, 7-197, 7-201, 7-237, 7-241, 7-242, 7-245
 thru 7-248, 8-75
 apron, 7-245 thru 7-249
 berm, 7-228, 7-229, 7-237, 7-238, 7-249
 protection, 5-5, 7-229, 7-245, 7-246
 scour, 7-245, 7-248, 8-75
 stability 7-238
 Toledo, Ohio, 3-97
 Tombofo, 1-23, 4-136, 4-138, 5-62 thru 5-67, 5-69,
 5-71, 5-73, 6-95
 Torrey Pines, California, 4-37
 Toskane, 7-206, 7-215, 7-216, 7-222, 7-234, 7-239
 Tracers (see also Artificial tracers; Fluorescent
 tracers; Natural tracers; Radioactive tracers),
 4-133 thru 4-145
 Transition zone, 4-72, 4-73, 5-22, 5-23
 Transitional
 depths, 2-10
 groins, 5-45 thru 5-47
 water, 2-9, 2-15, 2-24, 2-25, 2-31 thru 2-33, 2-37,
 2-62, 2-64, 3-24, 3-55, 7-63, 7-117
 Translatory wave, 2-4, 2-56
 Transmission
 coefficient, 2-112, 7-62, 7-66, 7-67, 7-73, 7-80
 thru 7-82, 7-88
 wave (see Wave transmission)
 Transport (see Littoral transport; Longshore transport;
 Mass transport; Sand movement; Sediment transport)
 Transverse forces, 7-132, 7-133, 7-135
 Treasure Island, Florida, 6-25
 Tribar, 5-59, 6-90, 6-92, 7-81, 7-83, 7-206, 7-209,
 7-211, 7-215 thru 7-217, 7-220, 7-225, 7-226, 7-231,
 7-234, 7-239, 8-47, 8-50 thru 8-52, 8-54, 8-55, 8-59
 thru 8-61, 8-63 thru 8-65, 8-67, 8-69, 8-70, 8-73
 Trochoidal Wave Theory, 2-2
 Tropical storm, 3-110, 3-119, 3-123, 3-126, 4-31, 4-34,
 4-35
 Tsunami, 1-1, 1-4, 1-7, 2-5, 2-56, 3-88, 3-89, 3-92
 thru 3-94, 3-96, 4-46, 7-1
 Tybee Island, Georgia, 6-25
- - U - -
- Umpqua River, Oregon, 4-37
 Unalaska Island, Alaska, 3-118
- Underlayer, 7-210, 7-227 thru 7-229, 7-236, 7-239, 7-240,
 7-242, 7-246, 8-48, 8-63, 8-64, 8-66, 8-69, 8-71
 thickness, 8-62, 8-63, 8-73
 Unified soil classification, 4-12, 4-13
 Unit weight (see also Mass density; Specific gravity),
 4-18, 7-213, 7-214, 7-229, 7-233, 7-236, 7-257,
 7-258, 7-260
 concrete, 8-47, 8-49, 8-54 thru 8-57, 8-70, 8-72,
 8-73
 littoral material (see also Immersed weight), 4-18
 rock, 7-237, 7-243, 8-58, 8-60
 soil, 7-256
 stone material, 8-59, 8-60
 water, 7-205, 7-243, 8-49, 8-76
 Uplift forces, 6-6, 6-97, 7-147, 7-235, 7-238, 7-260,
 8-80
- - V - -
- Variability, wave (see Wave height variability)
 Vegetation (see also American beach grass; Beach grasses;
 Dune construction using vegetation; European beach
 grass; Panic grasses; Sea oats), 1-13, 1-17, 3-66,
 3-72, 3-75, 4-5, 4-6, 4-76, 5-24, 5-26, 6-37 thru 6-39,
 6-43, 6-44, 6-48, 6-51
 Velocity (see also Bottom velocity; Current velocity;
 Fall velocity; Fluid velocity; Friction velocity;
 Group velocity; Longshore current velocity; Phase
 velocity; Water particle velocity; Wave celerity;
 Wind speed), 2-113, 3-12, 3-25, 3-35, 3-83, 3-84,
 4-47, 4-48, 4-54, 4-55, 4-70, 4-146, 4-161 thru
 4-163, 5-28, 7-102, 7-135, 7-138, 7-139, 7-249
 thru 7-253
 forces, 7-249
 Venice, California, 4-37, 5-62
 Ventura, California, 4-145, 7-226
 Marina, 6-61
 Vertical
 piles, 7-102, 7-110, 7-118, 7-127, 7-129, 7-135,
 7-150, 7-157
 walls, 1-17, 2-112, 2-113, 6-6, 7-45, 7-161, 7-162,
 7-170, 7-174, 7-177, 7-178, 7-182, 7-187, 7-196,
 7-199, 7-200, 7-203
 Virginia
 Beach, Virginia, 4-37, 4-41, 6-7, 6-25, 6-54
 Key, Florida, 6-25
 Viscosity, water (see Kinematic viscosity)
- - W - -
- Wachapreague Inlet, 4-159
 Waianae Harbor, Oahu, Hawaii, 7-226
 Waikiki Beach, Hawaii, 4-91, 5-62
 Wallops Island, Virginia, 6-77
 Walls (see also Angle of wall friction; Breaking wave
 forces on walls; Nonbreaking wave forces on walls;
 Nonvertical walls; Seawalls; Vertical walls; Wave
 forces on walls), 1-20, 2-126, 5-2 thru 5-6, 6-6,
 6-14, 6-88, 7-3, 7-25, 7-45, 7-51 thru 7-53, 7-162,
 7-163, 7-172 thru 7-174, 7-177, 7-178, 7-180 thru
 7-183, 7-187, 7-190, 7-192 thru 7-197, 7-199 thru
 7-201, 7-235, 7-242, 7-249, 7-256, 7-257, 7-260
 Walton County, Florida, 4-77, 4-79
 Washington, D.C., 3-116
 Water
 depth (see also Deep water; Relative depth; Shallow
 water; Shoaling water; Transitional water), 2-2, 2-9,

SURJECT INDEX

Water (Cont)

depth (Cont)

2-10, 2-13, 2-46, 2-60, 2-62, 2-64, 2-90, 2-122, 2-124, 2-126, 2-128, 3-2, 3-17, 3-45, 3-46, 3-55 thru 3-67, 3-70 thru 3-72, 3-74, 3-76, 3-107, 3-119, 3-122, 4-53, 4-66 thru 4-71, 4-73 thru 4-75, 4-94, 4-166, 4-180, 5-5, 5-6, 5-34, 5-65, 5-73, 6-6, 6-88, 6-93, 6-95, 7-3 thru 7-5, 7-16, 7-35, 7-41, 7-43, 7-61, 7-62, 7-81, 7-94, 7-101, 7-105, 7-106, 7-110, 7-162, 7-202 thru 7-204, 7-243, 7-245, 7-246, C-3, C-31 thru C-33

level (see also Design water level; Initial water level; Maximum water level; Mean water level; Stillwater level), 1-6, 1-10, 1-15, 3-1, 3-88, 3-89, 3-93, 3-95, 3-96, 3-99, 3-101, 3-102, 3-104, 3-105, 3-107, 3-109, 3-110, 3-111, 3-115 thru 3-119, 3-122, 3-123, 3-126, 3-127, 4-5, 4-36, 4-43, 4-44, 4-49, 4-62, 4-108, 4-110 thru 4-112, 4-134, 4-161, 4-162, 5-3, 5-6, 5-20, 5-37, 5-39, 6-80, 7-1 thru 7-3, 7-14, 7-16, 7-62, 7-82, 7-163, 7-203, 7-245, 7-255, 8-7, 8-9 thru 8-12, 8-46, 8-81

fluctuations (see also Sea level changes), 1-1, 1-16, 1-17, 3-88, 3-89, 3-96, 4-62, 5-20

particle, 1-5, 1-6, 2-1, 2-2, 2-4, 2-15, 2-18, 2-20, 2-43, 2-55, 2-113, 2-114, 4-46, 4-47, 4-50, 7-203, A-43

displacement, 2-15 thru 2-18, 2-20, 2-32, 2-35 velocity, 2-7, 2-25, 2-32, 2-35, 2-36, 2-57, 2-59, 2-129, 7-101, 7-103, 7-142

Waukegan, Illinois, 4-91

Wave (see also Breaking wave; Broken wave; Capillary wave; Clapotis; Cnoidal wave; Complex wave; Deep water wave; Design breaking wave; Design wave; Dispersive wave; Finite-amplitude wave; Gravity wave; Hurricane wave; Monochromatic wave; Nonbreaking wave; Ocean wave; Oscillatory wave; Periodic wave; Probable maximum wave; Progressive wave; Random wave; Resonant wave; Seiche; Shallow water wave; Significant wave; Simple wave; Sinusoidal wave; Solitary wave; Standing wave; Storm wave; Translatory wave; Tsunami; Wind wave), 1-1, 1-4 thru 1-7, 1-16, 2-1 thru 2-6, 2-11, 2-56, 2-77, 2-90, 2-92, 2-99, 3-1, 3-20, 3-25, 3-42 thru 3-44, 4-1, 4-12, 4-57, 4-58, 4-76, 4-147, 4-148, 5-1, 5-2, 5-9, 5-20, 5-21, 5-35, 5-36, 5-57, 5-72, 7-5, 7-11, 7-13, 7-54, 7-55, 7-103, 7-138, 7-180, 7-202, 7-247, C-32

action, 1-1, 1-3, 1-8, 1-12, 1-13, 1-16, 1-23, 2-18, 2-71, 3-89, 3-99, 3-109, 4-1, 4-22, 4-43, 4-44, 4-66, 4-89, 4-110, 4-120, 4-148, 4-149, 4-150, 4-174, 5-2, 5-20, 5-21, 5-28, 5-30, 5-33, 5-55, 5-56, 5-59, 5-61, 6-1, 6-5, 6-6, 6-13, 6-14, 6-26, 6-32, 6-59, 6-72, 6-75, 6-83, 6-88, 6-93, 7-1 thru 7-4, 7-16, 7-100, 7-101, 7-149, 7-150, 7-160, 7-171 thru 7-173, 7-177, 7-203, 7-204, 7-208, 7-225, 7-235, 7-238 thru 7-240, 7-246, 7-254, 7-256, 8-47, 8-49, 8-50, 8-75

angular frequency, 2-7

approach (see also Angle of wave approach), 1-7, 2-66, 2-71, 2-78 thru 2-89, 2-92, 2-106, 5-35, 5-37, 5-40, 8-26, 8-34, 8-74

attack (see also Storm attack on beaches), 1-3, 1-6 thru 1-8, 1-10, 1-13, 1-20, 3-109, 4-23, 4-43, 4-76, 4-116, 5-3, 5-4, 5-24, 5-26, 5-27, 5-54, 5-63, 5-64, 6-39, 6-83, 6-92, 7-208, 7-210

celerity, 2-7, 2-10, 2-11, 2-14, 2-23, 2-25, 2-27, 2-32, 2-34, 2-37, 2-44, 2-46, 2-54, 2-55, 2-57, 2-59, 2-60, 2-62, 2-63, 2-129, 3-20, 4-47, 4-48, 4-70, 4-93, 5-65, 7-133, 7-192, 8-33, C-33

characteristics, 1-5, 2-9, 2-32, 2-34, 2-44, 2-112, 3-15, 3-24, 3-43, 4-4, 4-71, 5-55, 7-1, 7-3, 7-8, 7-14, 7-16, 7-44, 7-61, 7-170, 7-229, 8-43

Wave (Cont)

climate (see also Littoral wave climate; Nearshore wave climate; Offshore wave climate; Wave conditions), 3-42, 4-4, 4-22, 4-23, 4-29, 4-30, 4-36, 4-40, 4-42, 4-44, 4-45, 4-63, 4-71, 4-73, 4-75, 4-115, 4-134, 4-140, 5-20, 5-21, 5-35, 5-37, 5-41, 5-65, 6-1, 6-16, 6-26, 6-59, 6-76, 7-14, 7-17, 7-231

conditions (see also Design wave conditions; Wave climate), 2-2, 2-54, 2-122, 3-1, 3-39, 3-44, 3-47, 3-51, 3-83, 3-87, 3-107, 4-1, 4-4, 4-6, 4-29, 4-36, 4-43, 4-46, 4-50, 4-68, 4-70, 4-73, 4-76, 4-78, 4-83, 4-86, 4-90, 4-92, 4-93, 4-108, 5-30, 5-64, 5-67, 5-71, 6-36, 6-73, 6-76, 7-1 thru 7-4, 7-8, 7-13, 7-14, 7-16, 7-58, 7-61, 7-81, 7-82, 7-93, 7-105, 7-109, 7-110, 7-131, 7-143, 7-161, 7-170, 7-172, 7-173, 7-180, 7-201 thru 7-204, 7-210, 7-211, 7-225, 7-237, 7-239, 8-12, 8-23, 8-26, 8-47

crest, 1-5, 2-7, 2-8, 2-25, 2-27, 2-28, 2-37, 2-38, 2-46, 2-55 thru 2-57, 2-59, 2-60, 2-62 thru 2-64, 2-67, 2-71, 2-73, 2-75, 2-76, 2-78 thru 2-89, 2-91, 2-92, 2-99, 2-100, 2-105, 2-106, 2-108 thru 2-110, 2-129, 3-104, 4-4, 4-30, 4-46, 4-53, 4-59, 4-92, 4-94, 4-160, 5-41, 5-63 thru 5-67, 5-71, 7-4, 7-106, 7-133, 7-141, 7-142, 7-150 thru 7-154, 7-171, 7-174, 7-180, 7-195, 7-199, 8-77, 8-78, 8-85, C-35

data, 4-32, 4-33, 4-42, 4-76, 4-78, 4-93, 4-134, 4-142, 4-147, 5-20, 5-32, 7-2, 7-3, 7-14, 7-15, 7-245, 8-12, 8-90

decay (see also Wave field decay), 1-6, 3-14, 3-21, 3-24, 3-66 thru 3-68, 3-70, 3-71, 3-75, 3-76, 4-29 distance, 1-6, 7-89

diffraction (see also Diffraction coefficient), 1-1, 2-75, 2-76, 2-90 thru 2-92, 2-99, 2-101 thru 2-103, 2-105, 2-106, 2-108, 2-109, 5-32, 5-65, 5-71, 7-89 analysis, 5-60, 7-16, 7-17, 8-74 calculations, 2-75, 2-77

diagram, 2-77 thru 2-90, 2-93, 2-99, 2-104, 2-105, 2-107, 2-109, 7-89, 7-92, 7-94 thru 7-98

direction, 2-60, 2-66, 2-67, 2-100, 2-109, 2-124, 3-14, 3-19, 3-39, 3-67, 3-71, 3-74, 3-80, 3-85, 3-87, 3-104, 4-29, 4-31, 4-36, 4-40, 4-65, 4-92, 4-103, 4-134, 4-143, 4-147, 4-148, 4-150, 5-55, 5-57, 5-64, 5-65, 5-67, 5-71, 7-2, 7-3, 7-12, 7-91, 7-92, 7-95 thru 7-98, 7-132, 7-151, 7-199, 7-210, 8-26, 8-37, 8-87, A-43, C-35

effects (see also Storm attack on beaches; Wave attack), 2-1, 2-124, 4-71, 4-73 thru 4-75

energy (see also Kinetic energy; Longshore energy; Potential energy; Wave power; Wave spectra), 1-9, 1-10, 1-14, 1-16, 1-17, 1-22, 1-24, 2-1, 2-2, 2-4, 2-5, 2-25 thru 2-31, 2-38, 2-44, 2-58, 2-60, 2-62, 2-71, 7-74, 2-75, 2-109, 2-112, 2-116, 2-119, 2-122, 2-124, 2-126, 3-5, 3-11 thru 3-13, 3-18 thru 3-21, 3-24, 3-39, 3-42, 3-43, 3-55, 3-78, 3-107, 4-6, 4-30, 4-43, 4-66, 4-71, 4-86, 4-90, 4-92, 4-149, 4-173, 5-3, 5-6, 5-7, 5-24, 5-61, 5-63, 5-64, 5-69, 5-71, 6-16, 6-88, 6-95, 7-2, 7-13, 7-61, 7-62, 7-64, 7-91, 7-179, 7-254, C-3, C-34

transmission, 2-26, 2-63 field, 2-90, 2-105, 2-108, 3-11, 3-12, 3-14, 3-19 thru 3-21, 3-24, 3-42, 3-77, 3-99, 4-69 decay, 3-21

forces (see also Breaking wave forces; Nonbreaking wave forces), 1-3, 1-20, 1-24, 2-12, 2-57, 7-100 thru 7-103, 7-143, 7-149, 7-151, 7-153, 7-162, 7-163, 7-174, 7-181, 7-187, 7-192, 7-193, 7-198, 7-200, 7-201, 7-204, 7-207, 7-245, 7-247, 7-254 on piles, 7-100, 7-101, 7-146, 7-156 on structures, 7-1, 7-3, 7-161 on walls, 7-100

SUBJECT INDEX

Wave (Cont)

forecasting (see Wave hindcasting; Wave prediction)
 frequency (see also Wave angular frequency), 2-4, 2-108, 3-19, 3-42, 4-102, 7-2, 7-132, 7-133
 fully arisen sea (see Fully arisen sea)
 generation, 2-1, 3-1, 3-19 thru 3-21, 3-24, 3-26, 3-55, 3-77, 4-29
 group velocity (see Group velocity)
 growth, 3-14, 3-20, 3-21, 3-24, 3-26, 3-27, 3-30, 3-41, 3-43, 3-44, 3-47, 3-51, 3-53, 3-55, 3-66, 3-70
 height (see also Breaking wave height; Deep water significant wave height; Design breaking wave height; Design wave height; Mean wave height; Nonbreaking wave height; Significant wave height), 1-5, 2-3, 2-20, 2-27, 2-30, 2-31, 2-58, 2-67, 2-91, 2-105, 2-117, 2-119, 2-122, 3-39, 3-44, 3-45, 3-47, 3-55, 3-66, 3-74 thru 3-77, 3-80, 4-44, 5-65, 7-2, 7-33, 7-34, 7-39, 7-41, C-34, C-35
 average, 3-2, 3-6
 distribution, 2-75, 3-7 thru 3-11, 3-81, 4-43, 4-142, 4-143, 7-2, 7-39
 Rayleigh distribution (see Rayleigh distribution)
 root-mean-square, 3-5, 4-93
 statistics, 3-81, 4-40, 4-43, 4-105
 variability, 3-2, 3-81
 hindcasting (see also Wave prediction), 2-66, 3-1, 3-18, 3-21, 3-24, 4-42, 4-77, 4-78, 7-17, 8-26, 8-28 thru 8-30, 8-85, 8-90
 length (see also Deep water wave length), 1-5, 1-6, 2-2, 2-7, 2-9, 2-18, 2-24, 2-25, 2-29, 2-32, 2-34, 2-37, 2-44 thru 2-46, 2-60, 2-62, 2-64, 2-66, 2-77 thru 2-99, 2-101 thru 2-105, 2-107, 2-108, 2-113, 2-115, 2-116, 2-119, 2-121, 2-124, 2-126, 3-2, 3-93, 3-98, 4-47, 4-85, 5-64, 5-65, 5-71, 5-72, 7-4, 7-35, 7-93, 7-94, 7-99, 7-101, 7-103, 7-104, 7-106, 7-108, 7-109, 7-144, 7-150 thru 7-152, 7-155, 7-181 thru 7-183, 8-33, C-3, C-31, C-32, C-34
 mass transport (see Mass transport)
 mechanics, 2-1
 motion, 1-1, 1-6, 1-9, 2-1, 2-59, 2-112, 2-115, 4-4, 4-46, 4-48, 7-138
 nonlinear deformation (see Nonlinear deformation)
 number, 2-7, 2-30, 2-112
 overtopping (see Overtopping)
 period (see also Design wave period; Significant wave period), 1-5, 1-6, 2-4, 2-7, 2-9, 2-24, 2-25, 2-31, 2-36, 2-42 thru 2-45, 2-54, 2-60, 2-66, 2-112, 2-122, 3-2, 3-13, 3-14, 3-39, 3-46, 3-51, 3-55 thru 3-65, 3-70, 3-71, 3-74, 3-77, 3-80, 3-81, 3-85 thru 3-87, 3-101, 3-105, 4-29 thru 4-31, 4-38, 4-44, 4-51, 4-68, 4-69, 4-74, 4-85, 4-94, 4-104, 5-69, 7-2, 7-9, 7-14, 7-15, 7-43, 7-54, 7-61, 7-62, 7-89, 7-92, 7-95 thru 7-99, 7-101, 7-105, 7-110, 7-144, 7-170, 7-174, 7-178, 7-182, 7-183, 7-187, 7-203, 7-204, 8-23, 8-33, 8-37, 8-74, 8-76, C-30 thru C-33
 potential energy (see Potential energy)
 power (see also Wave energy), 2-25, 2-26, 2-44, 2-63, 3-5
 prediction (see also Deep water wave prediction; Hurricane wave prediction; Shallow water wave prediction; Wave hindcasting), 1-1, 3-1, 3-19, 3-21, 3-24, 3-27, 3-32, 3-39, 3-41 thru 3-44, 3-47, 3-49, 3-50, 3-53, 3-67, 3-88
 fetch (see Fetch)
 method (see Sverdrup-Munk-Bretschneider wave prediction method)
 models (see also Pierson-Neuman-James wave prediction model), 3-14, 3-26, 3-42
 wind duration (see Wind duration)
 pressure (see also Pressure pulse; Subsurface pressure), 7-192, 7-193, 7-195, 7-241
 profile, 2-2, 2-8, 2-10, 2-32, 2-37, 2-44 thru 2-46, 2-55, 3-15, 4-29, 7-5
 propagation (see Wave transmission)

Wave (Cont)

reflection (see also Reflection coefficient), 1-1, 2-109, 2-111 thru 2-114, 2-116 thru 2-118, 2-122, 2-124, 3-98, 7-8, 7-62, 7-89
 refraction (see also Refraction coefficient; Refraction template), 2-60 thru 2-62, 2-64, 2-67, 2-71 thru 2-74, 2-126, 4-29, 4-30, 5-24, 5-32, 8-33, 8-35, 8-36, A-45
 analysis, 2-62, 2-63, 2-68, 2-71, 2-135, 3-24, 5-60, 7-1, 7-11, 7-13, 7-16, 7-17, 8-26, 8-32, 8-36
 computer methods, 2-71
 diagrams, 2-64, 2-66, 2-70 thru 2-72, 2-74, 2-109, 7-14, A-46
 fan diagrams, 2-70, 2-72, 7-14
 orthogonal method, 2-66
 R/J method, 2-70
 wave-front method, 2-71
 runup, 3-99, 3-101, 3-104 thru 3-106, 4-66, 4-76, 4-108, 4-110, 5-3, 5-4, 5-20, 5-58, 7-16, 7-18, 7-25, 7-28 thru 7-35, 7-37 thru 7-44, 7-55, 7-58, 7-59, 7-62, 7-67, 7-72, 7-73, 7-75, 7-192, 7-194, 7-196, 7-197, 7-210, 7-229, 7-239, 7-240, 8-48
 composite slopes, 7-35, 7-36, 7-40
 impermeable slopes, 7-16, 7-18 thru 7-23, 7-26, 7-27, 7-34
 rubble-mound structure, 7-18
 scale effects, 7-16, 7-18, 7-24, 7-34, 7-37, 7-55
 setback, 3-99, 3-101, 3-107, 3-109, 3-111
 setup, 3-88, 3-89, 3-99 thru 3-102, 3-104 thru 3-109, 3-111, 3-115, 4-49, 4-50, 5-20, 5-37, 7-35, 8-12, 8-46
 spectra (see also Wave energy), 2-108, 3-11 thru 3-14, 3-77, 3-78, 7-43, 7-89, 7-93, 7-94, 7-149, 7-209
 steepness, 1-9, 1-10, 1-13 thru 1-15, 2-37, 2-60, 2-112, 2-116, 2-117, 2-119, 2-129 thru 2-131, 3-12, 3-15, 3-86, 3-107, 4-43, 4-44, 4-49, 4-85, 7-5, 7-7, 7-9, 7-16, 7-44, 7-64, 7-73, 7-101, 7-106, 7-162
 swell (see Swell)
 theories (see also Airy Wave Theory; Cnoidal Wave Theory; Finite Amplitude Wave Theory; Linear Wave Theory; Progressive Wave Theory; Small Amplitude Wave Theory; Solitary Wave Theory; Stokes Wave Theory; Stream Function Wave Theory; Trochoidal Wave Theory), 1-1, 2-1 thru 2-4, 2-31, 2-33, 7-102, 7-105, 7-110, 7-117, 7-136, 7-141, 7-143, 7-144
 regions of validity, 2-31, 2-33
 train, 2-23 thru 2-25, 3-4, 3-11, 3-12, 3-14, 3-18, 3-21, 3-43, 3-77, 4-30, 4-31, 4-36, 4-39, 4-93, 7-3, 7-108, 7-209
 translation (see Translatory wave)
 transmission (see also Transmission coefficient), 2-1, 2-3, 2-8, 2-14, 2-15, 2-26, 2-36, 2-38, 2-109, 2-119, 3-14, 3-20, 3-21, 3-122, 7-1, 7-16, 7-61 thru 7-65, 7-67 thru 7-69, 7-73, 7-74, 7-76 thru 7-87, 7-89, 7-150, 7-158, 7-192, 7-225
 variability (see Wave height variability)
 velocity (see Wave celerity)
 Weir, 1-24, 5-34, 6-59, 6-61, 6-74, 6-75
 groin, 5-40
 jetty, 1-24, 1-25, 4-89, 5-30, 5-31, 5-34, 5-40, 6-59, 6-74, 6-75
 Well-
 graded sediment, 4-14
 sorted sediment, 4-14
 Wentworth size classification, 4-12, 4-13
 West
 Quoddy Head, Maine, 3-92
 Palm Beach, Florida, 3-79
 Westhampton, New York, 4-61, 4-77, 4-79
 Beach, 2-61, 4-1, 4-2, 4-11, 5-54, 6-82
 Willets Point, New York, 3-116, 3-124, 3-125
 Wilmington, North Carolina, 3-117, 3-124, 3-125
 Beach, 6-22

SUBJECT INDEX

Wind (see also Geostrophic wind; Gradient wind), 1-4,
 1-6, 1-7, 1-10, 1-13, 2-62, 3-1, 3-20, 3-21, 3-24,
 3-26, 3-27, 3-30, 3-32 thru 3-35, 3-37, 3-39, 3-42
 thru 3-44, 3-51, 3-52, 3-55, 3-81 thru 3-85, 3-87,
 3-96, 3-107, 3-110, 3-111, 3-119, 3-123, 3-126,
 3-127, 4-1, 4-4, 4-5, 4-12, 4-29, 4-30, 4-42 thru
 4-44, 4-48, 4-76, 4-101, 4-112, 4-119, 4-120,
 4-127, 4-128, 5-1, 5-3, 5-4, 5-57, 6-37, 6-39,
 6-40, 6-47, 6-49, 6-76, 7-44, 7-54, 7-61, 7-253,
 7-254, 8-21, 8-22
 action, 1-13, 1-16
 data, 3-26, 3-30, 3-32, 3-33, 7-3, 7-17, 8-12, 8-21
 thru 8-23
 direction, 3-19, 3-21, 3-25, 3-43, 6-39, 7-43, 7-44,
 8-21
 duration, 1-6, 3-26 thru 3-29, 3-32, 3-33, 3-35,
 3-41 thru 3-44, 3-47, 3-49 thru 3-53, 3-66, 3-77,
 4-29, 7-1, 8-21
 energy, 3-21, 3-54
 estimation, 3-24, 3-26, 3-32 thru 3-35, 3-39, 3-41,
 field (see also Hurricane wind field), 3-21, 3-24,
 3-25, 3-33, 3-39, 3-53, 3-81, 3-83, 3-126, 3-127
 frequency, 8-21
 frictional effects, 3-24
 generated wave (see Wind wave)
 profile, 3-16, 3-20, 3-82
 roses, 8-21, 8-22
 sand transport (see Sand movement)
 setup (see also Surge), 1-7, 3-93, 3-96, 3-104,
 3-107, 3-127, 4-110, 5-1, 5-57, A-51
 speed, 1-6, 1-7, 3-20, 3-24 thru 3-27, 3-30 thru
 3-36, 3-38 thru 3-44, 3-47, 3-49 thru 3-53,
 3-66, 3-67, 3-70, 3-71, 3-74, 3-76, 3-77, 3-81
 thru 3-84, 3-96, 3-110, 3-119, 3-121, 3-126
 thru 3-128, 4-5, 4-29, 4-44, 4-48, 6-38 thru
 6-40, 7-1, 7-43, 7-44, 7-57, 8-9, 8-21, 8-24
 adjusted, 3-30, 3-66
 duration (see Wind duration)
 stress, 1-6, 3-32, 3-42, 3-66, 3-70, 3-74, 3-89,
 3-96, 3-119, 3-121, 3-127
 factor, 3-30, 3-32, 3-33, 3-35, 3-44, 3-47, 3-49
 thru 3-51, 3-53, 3-56 thru 3-66
 velocity (see Wind speed)
 wave, 1-4 thru 1-6, 2-1, 3-4, 3-19, 3-24, 3-66, 4-77,
 7-1, 7-39, 7-58, 7-81, 7-89
 Winthrop Beach, Massachusetts, 5-62, 5-68
 Woods Hole, Massachusetts, 3-116, 3-124, 3-125
 Wrightsville Beach, North Carolina, 4-37, 5-21, 5-22,
 6-16, 6-19, 6-20, 6-25, 6-68, 6-74, 6-83

- - Y - -

Yakutat, Alaska, 3-118
 Yaquina Bay, Oregon, 4-37

- - Z - -

Zero Up Crossing Method, 3-2



Point Reyes National Seashore, California, 8 April 1969

